



U.S. Department  
of Transportation

**Federal Highway  
Administration**

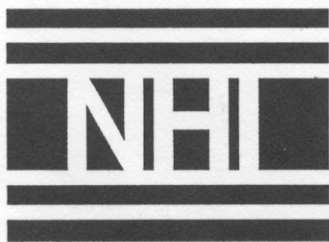
Publication No. FHWA-HI-92-001

Prepared in 1991

NHI Course No. 13211

---

# Rock Blasting and Overbreak Control



*National Highway Institute*

1. Report No.		2. Government Accession No.		3. Recipient's Catalog No.	
4. Title and Subtitle  Rock Blasting and Overbreak Control				5. Report Date December 1991	
				6. Performing Organization Code	
				8. Performing Organization Report No.	
7. Author(s) Calvin J. Konya, Ph.D., and Edward J. Walter, Ph.D.				10. Work Unit No. (TRAIS)	
9. Performing Organization Name and Address Precision Blasting Services PO Box 189 Montville, OH 44064				11. Contract or Grant No. DTFH 61-90-R-00058	
				13. Type of Report and Period Covered	
12. Sponsoring Agency Name and Address U.S. Department of Transportation Federal Highway Administration Office of Implementation 6300 Georgetown Pike, McLean, Virginia 22101				14. Sponsoring Agency Code	
15. Supplementary Notes FHWA Contracting Officer's Technical Representative: Chien-Tan Chang (HRT-10) Technical Review by: Ronald G. Chassie, P.E. (FHWA Portland, Oregon).					
16. Abstract  This handbook is specifically designed as a guide to highway engineers and blasting practitioners working with highway applications. It was used as a handbook for the FHWA courses of the above title. The handbook is a basic review of explosives and their characteristics, along with explosive selection criteria. Initiations and timing effects as well as patterns are also discussed.  A simple step by step procedure is outlined to help the engineer review blasting submittals in a systematic fashion.  Airblast and ground vibration are discussed along with methods for evaluation and control.  Several solved examples are presented in a manner to simplify the necessary calculations with step by step procedures given where appropriate.					
17. Key Words Explosives, Blasting, Initiators, Blasting caps, Vibration airblast, seismographs			18. Distribution Statement No restrictions. This document is available to the public through the National Technical Information Service Springfield, Virginia 22161		
19. Security Classif. (of this report) Unclassified		20. Security Classif. (of this page) Unclassified		21. No. of Pages 430	22. Price



# TABLE OF CONTENTS

CHAPTER 1 - EXPLOSIVES ENGINEERING.....	2
1.1 INTRODUCTION.....	2
1.1.1 SOURCES OF EXPLOSIVE'S ENERGY .....	3
1.1.2 SHOCK ENERGY .....	4
1.1.3 GAS ENERGY .....	6
1.1.4 CHEMICAL EXPLOSIVES .....	6
1.2 IDENTIFICATION OF PROBLEM MIXTURES .....	12
1.3 CHAPTER 1 SUMMARY .....	13
CHAPTER 2 - MECHANICS OF ROCK BREAKAGE .....	15
2.1 SHOCK ENERGY IN ROCK BREAKAGE .....	15
2.2 CONFINED CHARGES IN BOREHOLES.....	16
2.3 BENCH STIFFNESS .....	18
2.4 EFFECTS OF BLASTHOLE LENGTH.....	20
2.5 BLASTING PARAMETERS .....	21
2.6 STIFFNESS ANALYSIS.....	21
2.7 GEOLOGICAL EFFECTS ON DISPLACEMENT.....	24
2.8 FIELD CONSIDERATIONS .....	27
2.9 CHAPTER 2 SUMMARY .....	28
CHAPTER 3 - EXPLOSIVE PRODUCTS .....	30
3.1 ENVIRONMENTAL CHARACTERISTICS OF EXPLOSIVES.....	30
3.1.1 SENSITIVENESS.....	30
3.1.2 WATER RESISTANCE .....	31
3.1.3 FUMES.....	32
3.1.4 FLAMMABILITY .....	33
3.1.5 TEMPERATURE RESISTANCE .....	34
3.1.5.1 THE CYCLING OF AMMONIUM NITRATE .....	34
3.1.5.2 COLD RESISTANCE.....	36
3.2 PERFORMANCE CHARACTERISTICS OF EXPLOSIVES .....	37

3.2.1 SENSITIVITY.....	37
3.2.2 VELOCITY .....	38
3.2.3 DETONATION PRESSURE.....	39
3.2.4 DENSITY .....	39
3.2.5 STRENGTH .....	41
3.2.6 COHESIVENESS .....	41
3.3 COMMERCIAL EXPLOSIVES .....	41
3.3.1 DYNAMITE.....	43
3.3.1.1 GRANULAR DYNAMITE .....	43
3.3.1.2 STRAIGHT DYNAMITE .....	44
3.3.1.3 HIGH DENSITY EXTRA DYNAMITE.....	44
3.3.1.4 LOW DENSITY EXTRA DYNAMITE.....	44
3.3.2 GELATIN DYNAMITE .....	44
3.3.2.1 STRAIGHT GELATIN DYNAMITE. ....	44
3.3.2.2 AMMONIA GELATIN DYNAMITE.....	45
3.3.2.3 SEMIGELATIN DYNAMITE.....	45
3.3.3 SLURRY EXPLOSIVES .....	45
3.3.3.1 CARTRIDGED SLURRIES.....	47
3.3.3.2 BULK SLURRIES.....	47
3.4 DRY BLASTING AGENTS .....	48
3.4.1 CARTRIDGED BLASTING AGENTS .....	49
3.4.2 BULK ANFO.....	49
3.4.3 WATER RESISTANCE OF AMMONIUM NITRATE .....	49
3.4.4 ENERGY OUTPUT OF ANFO.....	50
3.4.5 PROPERTIES OF BLASTING PRILLS .....	51
3.4.6 HEAVY ANFO .....	52
3.5 TWO COMPONENT EXPLOSIVES .....	53
3.6 CHAPTER 3 SUMMARY .....	53
CHAPTER 4 - INITIATORS AND BLASTHOLE DELAY DEVICES.....	55
4.1 INTRODUCTION.....	55
4.2 ELECTRIC BLASTING CAPS .....	55
4.2.1 INSTANTANEOUS EB CAPS .....	56
4.2.2 LONG PERIOD DELAY ELECTRIC CAPS .....	57
4.2.3 MILLISECOND DELAY ELECTRIC BLASTING CAPS (HIGH PRECISION).....	57
4.3 ELECTRONIC DELAY BLASTING CAPS.....	59
4.4 MAGNADET .....	59

4.4.1	MAGNADET ELECTRIC DETONATOR & MAGNA PRIMER WORKING PRINCIPLE .....	59
4.4.2	INITIATION SOURCE .....	60
4.4.3	DETONATOR DESCRIPTION .....	60
4.4.4	MAGNADET SLIDING PRIMERS .....	60
4.4.5	SAFETY FEATURES CLAIMED .....	62
4.4.6	OPERATIONAL ADVANTAGES CLAIMED .....	62
4.5	SEQUENTIAL BLASTING MACHINE .....	62
4.6	NON-ELECTRIC INITIATION SYSTEMS .....	63
4.6.1	DETALENE INITIATION SYSTEM .....	64
4.6.2	DETALENE CORD .....	64
4.6.3	DETALENE MS SURFACE DELAYS .....	65
4.6.4	DETALENE MS IN-HOLE DELAYS .....	65
4.7	DETONATING CORD AND COMPATIBLE DELAY SYSTEMS .....	66
4.8	DELAYED PRIMERS .....	66
4.9	HERCUDET SYSTEM .....	67
4.9.1	TUBING DELAY .....	69
4.9.2	HERCUDET CAP DELAYS .....	69
4.10	SHOCK TUBE INITIATION SYSTEMS .....	69
4.10.1	LP SERIES SHOCK TUBE INITIATORS .....	70
4.10.2	S.L. SERIES NONEL PRIMADETS .....	71
4.10.3	L.L.H.D. SERIES SHOCK TUBE INITIATORS .....	72
4.10.4	SHOCK TUBE TRUNKLINE DELAYS .....	72
4.10.5	EZ DET .....	74
4.10.6	NONEL LEAD-IN .....	75
4.11	CHAPTER 4 SUMMARY .....	75
	PROBLEMS - CHAPTER 4 .....	78
	CHAPTER 5 - PRIMER AND BOOSTER SELECTION .....	81
5.1	PRIMER TYPES .....	81
5.1.1	DETERMINATION OF NUMBERS NEEDED .....	82
5.1.2	SELECTION CRITERIA FOR PRIMER .....	83
5.1.3	PRIMER SELECTION GUIDELINES .....	84
5.2	BOOSTER .....	85
5.3	EFFECTS OF DETONATING CORD ON ENERGY RELEASE .....	86
5.4	CHAPTER 5 SUMMARY .....	87

CHAPTER 6 - BLAST DESIGN.....	89
6.1 BURDEN .....	89
6.1.1 ADJUSTMENTS FOR ROCK & EXPLOSIVE TYPE.....	91
6.1.2 CORRECTIONS FOR NUMBERS OF ROWS.....	93
6.1.3 GEOLOGIC CORRECTION FACTORS .....	94
6.2 STEMMING DISTANCE.....	96
6.3 SUBDRILLING.....	98
6.4 SELECTION OF BLASTHOLE SIZE.....	100
6.4.1 BLASTING CONSIDERATIONS.....	100
6.4.2 INITIATION TIMING AND CAP SCATTER .....	103
6.5 TIMING EFFECTS ON FRAGMENTATION.....	104
6.5.1 HOLE-TO-HOLE DELAYS .....	104
6.5.2 ROW-TO-ROW DELAYS .....	105
6.6 BOREHOLE TIMING EFFECTS .....	106
6.6.1 FRAGMENTATION SIZE.....	106
6.6.2 PILING OR CASTING MATERIAL.....	107
6.6.3 AIR BLAST AND FLYROCK .....	107
6.6.4 MAXIMUM VIBRATION .....	108
6.6.5 FIRING TIME OVERLAP.....	108
6.6.6 EFFECTS OF TIME AND DIRECTION.....	109
6.6.7 CAP SCATTER.....	111
6.6.8 OVERBREAK, BACKBREAK AND ENDBREAK.....	113
6.6.8 SELECTION OF THE PROPER TIMING.....	113
6.6.10 IMPLEMENTATION PROBLEMS.....	113
6.7 TIMING CALCULATIONS.....	114
6.8 CHAPTER 6 SUMMARY .....	134
PROBLEMS - CHAPTER 6 .....	135
CHAPTER 7 - PATTERN DESIGN .....	138
7.1 PRINCIPLES OF PRODUCTION BLASTING PATTERNS.....	138
7.1.1 INSTANTANEOUS INITIATION LOW BENCHES.....	139
7.1.2 INSTANTANEOUS INITIATION HIGH BENCHES.....	140
7.1.3 DELAYED INITIATION LOW BENCHES .....	141
7.1.4 DELAYED INITIATION HIGH BENCHES.....	142
7.2 MAXIMUM FRAGMENTATION.....	143
7.3 ROCK FRAGMENTATION AND WALL CONTROL .....	145

7.3.1	FRAGMENTATION .....	145
7.3.2	KUZNETSOV EQUATION.....	146
7.3.3	SIZE DISTRIBUTION.....	146
7.3.4	FIELD RESULTS .....	147
7.3.5	LIMITATIONS ON THE KUZ-RAM MODEL .....	148
	7.3.5.1 EFFECTS OF BLASTING PARAMETERS ON "n" .....	149
	7.3.5.2 THE EFFECTS OF STRONGER EXPLOSIVES .....	149
7.3.6	FRAGMENTATION EFFECTS ON WALL CONTROL.....	149
7.4	RIP-RAP PRODUCTION.....	164
7.5	ROCK PILING CONSIDERATIONS.....	164
7.6	SINKING CUTS.....	166
7.7	HILLSIDE OR SLIVER CUTS .....	168
7.8	UTILITY TRENCH DESIGN.....	169
7.9	SECONDARY BLASTING.....	171
	7.9.1 MUD CAPPING (BOULDER BUSTING) .....	171
	7.9.2 BLOCKHOLING (BOULDER BUSTING).....	172
	7.9.3 AIR CUSHION BLASTING .....	172
7.10	CHAPTER 7 SUMMARY .....	173
	PROBLEMS CHAPTER 7 .....	174
	CHAPTER 8 - OVERBREAK CONTROL.....	176
8.1	CONTROLLED BLASTING.....	176
	8.1.1 PRINCIPLES OF OPERATION .....	177
	8.1.2 EFFECTS OF LOCAL GEOLOGIC CONDITIONS .....	182
	8.1.3 PRESPLITTING .....	183
	8.1.4 TRIM (CUSHION) BLASTING.....	185
	8.1.5 TRIM BLASTING WITH DETONATING CORD .....	187
	8.1.6 LINE DRILLING.....	187
	8.1.7 ASSESSMENT OF RESULTS .....	188
	8.1.7.1 CAUSES OF OVERBREAK.....	190
	8.1.7.2 BACKBREAK.....	190
	8.1.7.3 ENDBREAK.....	192
	8.1.7.4 FLYROCK CONTROL.....	192
8.2	CHAPTER 8 SUMMARY .....	193
	PROBLEMS CHAPTER 8 .....	194



CHAPTER 9 - SITE CONDITIONS AND FIELD PROCEDURE.....	196
9.1 SITE CONDITIONS .....	196
9.1.1 WET BLASTHOLES.....	196
9.1.2 GEOLOGIC CONDITIONS .....	197
9.1.3 REGIONAL JOINTING PATTERNS .....	197
9.1.3.1 DOMINANT JOINTS PARALLEL THE FACE.....	198
9.1.3.2 JOINTS PERPENDICULAR TO FACE.....	198
9.1.3.3 JOINTS AT AN ANGLE WITH FACE .....	198
9.1.3.4 JOINTS AT LESS THAN 30 DEGREE ANGLE TO FACE.....	199
9.1.3.5 BLASTING WITH THE DIP .....	199
9.1.3.6 MUD OR SOFT SEAMS.....	200
9.1.3.7 BLASTING IN BEDDED ROCK .....	200
9.2 SELECTION OF DRILLING EQUIPMENT .....	201
9.2.1 DRIFTER DRILLING .....	201
9.2.2 ROTARY DRILLING.....	202
9.2.3 DOWN HOLE DRILLING.....	202
9.2.4 BITS.....	203
9.2.5 DRILLING ACCURACY .....	207
9.2.5.1 OPERATOR INFLUENCE .....	207
9.2.5.2 HOLE DIAMETER .....	208
9.2.5.3 DEPTH LIMITATIONS.....	208
9.2.5.4 ALIGNMENT DEVICES .....	208
9.2.5.5 LOCAL GEOLOGY.....	208
9.2.6 ANGLE DRILLING.....	209
9.3 BLASTING SAFETY.....	211
9.3.1 STORAGE OF EXPLOSIVES.....	211
9.3.2 TRANSPORTATION OF EXPLOSIVES.....	211
9.3.3 HANDLING OF EXPLOSIVES .....	212
9.3.3.1 ELECTRICAL HAZARDS .....	212
9.3.3.2 BLAST AREA SECURITY .....	214
9.3.3.3 FLYROCK.....	214
9.3.3.4 DISPOSAL.....	214
9.4 POST SHOT PROCEDURES .....	214
9.4.1 POST SHOT INSPECTION.....	215
9.4.2 POST WALL SCALING.....	215
9.4.3 MISFIRES.....	216
9.4.4 RECORDKEEPING .....	216

9.5	COST ESTIMATION.....	217
9.5.1	DETERMINATION OF DRILLING COSTS .....	218
9.5.2	BLASTING COST ANALYSIS.....	222
9.6	CHAPTER 9 SUMMARY .....	225
CHAPTER 10 - VIBRATION AND SEISMIC WAVES.....		229
10.1	SEISMIC WAVES.....	229
10.1.1	BODY WAVES .....	229
10.1.2	SURFACE WAVES.....	230
10.1.3	CAUSES OF SEISMIC WAVES.....	230
10.1.4	WAVE PARAMETERS .....	231
10.2	UNDERSTANDING VIBRATION INSTRUMENTATION .....	232
10.2.1	SEISMIC SENSOR.....	232
10.2.2	SEISMOGRAPH SYSTEMS.....	234
10.2.3	VIBRATION PARAMETERS.....	235
10.3	VIBRATION RECORDS AND INTERPRETATION .....	236
10.3.1	SEISMOGRAPH RECORD CONTENT.....	236
10.3.2	RECORD READING AND INTERPRETATION .....	238
10.3.3	FIELD PROCEDURE AND OPERATIONAL GUIDES .....	240
10.3.4	PRACTICAL INTERPRETATIONS .....	241
10.4	FACTORS AFFECTING VIBRATION.....	242
10.4.1	PRINCIPAL FACTORS.....	242
10.4.2	CHARGE - DISTANCE RELATIONSHIP .....	242
10.4.3	ESTIMATING PARTICLE VELOCITY .....	244
10.4.4	CHARGE WEIGHT, DISTANCE EFFECTS .....	244
10.4.5	VIBRATION CONTROL .....	248
10.4.5.1	DELAY BLASTING .....	248
10.4.5.2	PROPAGATION VELOCITY VS. PARTICLE VELOCITY .....	249
10.4.5.3	SCALED DISTANCE.....	250
10.4.5.4	ADJUSTED SCALED DISTANCE.....	252
10.4.5.4.1	AVERAGING METHOD .....	252
10.4.5.4.2	PARTICLE VELOCITY - SCALED DISTANCE GRAPH.....	252
10.4.5.5	SCALED DISTANCE CHARTS .....	254
10.4.5.6	GROUND CALIBRATION .....	255
10.4.5.7	VARIABILITY OF VIBRATION.....	256
10.4.5.8	FACTORS EFFECTING VIBRATION.....	257

10.5	VIBRATION STANDARDS.....	258
10.5.1	RECENT DAMAGE CRITERIA .....	260
10.5.2	ALTERNATIVE BLASTING CRITERIA.....	261
10.5.3	THE OFFICE OF SURFACE MINING REGULATIONS .....	262
10.5.4	CHARACTERISTIC VIBRATION FREQUENCIES.....	263
10.5.5	SPECTRAL ANALYSIS .....	264
10.5.6.	RESPONSE SPECTRA.....	265
10.5.7	LONG TERM VIBRATION AND FATIGUE.....	266
10.5.8	VIBRATION EFFECTS.....	267
10.5.8.1	DIRECTIONAL VIBRATIONAL EFFECTS .....	268
10.5.8.2	FREQUENCY WAVE LENGTH EFFECTS.....	268
10.5.8.3	NON-DAMAGE EFFECTS.....	271
10.5.8.4	CAUSES FOR CRACKS OTHER THAN BLASTING.....	271
10.5.9	BLAST DESIGN ADJUSTMENT TO REDUCE VIBRATION LEVELS.....	272
10.5.9.1	CHARGE REDUCTION.....	272
10.5.9.2	BLAST DESIGN .....	272
10.5.9.3	BLASTING STANDARD FOR NON RESIDENTIAL STRUCTURES.....	273
10.5.9.4	BLASTING NEAR CONCRETE STRUCTURES.....	273
10.5.9.5	GREEN CONCRETE .....	273
10.5.9.6	BLASTING NEAR GREEN CONCRETE.....	273
10.5.9.7	BRIDGES.....	274
10.5.9.8	BURIED PIPELINES .....	274
10.5.9.9	COMPUTERS AND HOSPITALS.....	274
10.5.9.10	COMPUTER SPECIFICATIONS .....	274
10.6	SENSITIVITY TO VIBRATION.....	275
10.7	AIR BLAST MONITORING AND CONTROL.....	277
10.7.1	AIR BLAST .....	277
10.7.2	OVERPRESSURE AND DECIBELS .....	277
10.7.3	GLASS BREAKAGE.....	278
10.7.4	SCALED DISTANCE FOR AIR BLAST .....	279
10.7.5	REGIONS OF POTENTIAL DAMAGE FOR AIR BLAST.....	280
10.7.5.1	NEAR FIELD .....	280
10.7.5.2	FAR FIELD AND AIR BLAST FOCUSING .....	280
10.7.5.3	ATMOSPHERIC INVERSION.....	280
10.7.5.4	WIND EFFECT.....	282
10.7.5.5	PROCEDURES TO AVOID AIR BLAST FOCUSING.....	283
10.8	PREBLAST SURVEYS.....	283
10.8.1	PREBLAST INSPECTIONS.....	283
10.8.2	PURPOSE.....	283
10.8.3	INSPECTION PROCEDURE .....	284
10.8.3.1	ATTIC INSPECTION.....	285
10.8.3.2	BASEMENT INSPECTION .....	285
10.8.3.3	STAIRWAY INSPECTION.....	285

10.8.4	EXTERIOR INSPECTION .....	286
10.8.4.1	GARAGE.....	286
10.8.4.2	WALKS AND DRIVEWAYS .....	286
10.8.5	UNUSUAL CONDITIONS .....	286
10.8.6	PREBLAST SURVEY REPORTS .....	287
10.9	EFFECTS OF BLASTING ON WATER WELLS AND AQUIFERS .....	287
10.9.1	AQUIFERS.....	287
10.9.2	VIBRATION EFFECTS.....	288
10.9.3	OPEN CUT.....	288
10.10	ASSESSMENT OF RIPPABILITY VS. BLASTING .....	289
10.10.1	DEFINITION.....	289
10.10.2	RIPPABILITY AND SEISMIC VELOCITY .....	289
10.10.3	RIPPABILITY CHARTS .....	289
10.11	CHAPTER 10 SUMMARY .....	291
	PROBLEMS CHAPTER 10.....	294
	CHAPTER 11 - APPLICATIONS .....	301
11.1	STEPS IN PRODUCTION BLAST DESIGN .....	301
11.2	EVALUATION OF A PROPOSED BLAST DESIGN .....	302
11.2.1	BLASTING SUBMITTAL EXAMPLE .....	302
11.2.2	BLASTING PLAN EVALUATION.....	302
11.3	TEST BLASTS .....	307
11.4	SOFTWARE FOR DESIGN EVALUATION.....	309
11.4.1	BLAST DESIGN.....	310
11.4.2	BLASTHOLE TIMING SELECTION .....	310
11.4.3	VIBRATION AND AIR BLAST CONTROL.....	310
11.4.4	DRILLING COST ANALYSIS.....	311
11.4.5	BLASTING COST ANALYSIS .....	311
11.4.6	BULK EXPLOSIVE PERFORMANCE .....	311
11.4.7	FIRING TIME, TIMING, OVERLAPS, PATTERN DESIGN.....	311
11.4.8	FRAGMENTATION SIZE PREDICTION.....	312
11.4.9	CONTROLLED BLAST DESIGN.....	312
11.4.10	STRUCTURAL BLAST DESIGNER.....	312
11.4.11	PATTERN DESIGN TRAINING PROGRAMS.....	312
11.5	CHAPTER 11 SUMMARY .....	313

CHAPTER 12 - INSPECTOR'S GUIDE .....	315
12.1 INTRODUCTION .....	315
12.2 QUICK REFERENCE CHARTS.....	315
12.2.1 BURDEN ESTIMATE CHART.....	315
12.2.2 STEMMING AND SUBDRILLING ESTIMATE CHART.....	315
12.2.3 HOLE SPACING ESTIMATE CHART .....	316
12.2.4 LOADING DENSITY CHART .....	316
12.3 RECORDKEEPING FORMS.....	316
12.3.1 BLASTING PLAN FORM.....	316
12.3.2 DRILL LOG FORM .....	316
12.3.3 BLAST REPORT FORM.....	317
12.3.4 PREBLAST INSPECTION FORM .....	317
12.3.5 SEISMIC MONITORING FORM .....	317
12.3.6 DRILL PATTERN INSPECTION FORM .....	317
12.3.7 PRESPLIT DRILLHOLE EVALUATION FORM .....	317
12.4 CHAPTER 12 SUMMARY .....	318
APPENDICES	
APPENDIX I GLOSSARY OF BLASTING TERMS .....	335
APPENDIX II BLASTING EQUATIONS .....	347
APPENDIX III BLASTING EQUATION REVIEW .....	350
APPENDIX IV BLASTING SPECIFICATIONS .....	367
APPENDIX V PROBLEM SOLUTIONS .....	387
APPENDIX VI BIBLIOGRAPHY .....	403
APPENDIX VII CONVERSION TABLES .....	414

## LIST OF FIGURES

Figure 1.1	Pressure Profiles for Low and High Explosives .....	4
Figure 1.2	Mud Cap Blasting.....	5
Figure 1.3	Nomograph of Detonation and Explosion Pressure.....	7
Figure 1.4	Carbon-Oxygen Ideal Reaction .....	9
Figure 1.5	Hydrogen-Oxygen Ideal Reaction .....	9
Figure 1.6	Nitrogen-Nitrogen Ideal Reaction .....	10
Figure 1.7	Non-Ideal Carbon-Oxygen Reaction .....	11
Figure 1.8	Non-Ideal Nitrogen-Oxygen Reaction .....	11
Figure 1.9	Identification of Problem Mixtures .....	12
Figure 1.10	Energy Loss in ANFO .....	13
Figure 2.1	Reflected and Waste Energy in Mud Cap Blasting .....	15
Figure 2.2	Fracture of Frozen Water Pipes .....	16
Figure 2.3	Radial Cracking in Plexiglass.....	17
Figure 2.4	Influence of Distance to Face on Radial Crack System .....	17
Figure 2.5	Axisymmetric Bending Diagram .....	18
Figure 2.6	Cantilever Bending Diagram.....	19
Figure 2.7	Finite Element Model Configuration .....	20
Figure 2.8	Free Body Diagram for Simulated Condition of Bench Blasting .....	21
Figure 2.9	XZ-View of the Deformed Geometry Configuration as L/B Ratio Changes from 1.2 to 4.0 .....	22
Figure 2.10	Actual Displacements for XZ View as L/B Changes from 1.2 to 4.0 .....	22
Figure 2.11	Comparison Between Calculated Finite Element Displacements and Rectangular Cross Section Deflections .....	23
Figure 2.12	Geologic Structure of Models .....	24
Figure 2.13	Deformed Geometry After Blasting .....	25
Figure 2.14	Breakage Without and With Mud Seams .....	27
Figure 3.1	Cycled Prill .....	36
Figure 3.2	Slurry Warm Up Chart.....	37
Figure 3.3	Types of Explosives .....	42
Figure 3.4	Characteristics of Dynamite .....	43
Figure 3.5	Slurry Formulations .....	45
Figure 3.6	Emulsion Explosives .....	46
Figure 3.7	Slurry Bulk Loading Truck.....	46
Figure 3.8	Pumping Blastholes.....	47
Figure 3.9	Sleeves with ANFO .....	48
Figure 3.10	Blasting Agent Formulations .....	48
Figure 3.11	Cartridged ANFO.....	49
Figure 3.12	Effects of Water in ANFO.....	50
Figure 3.13	Effects of Fuel Oil Content on ANFO.....	51
Figure 3.14	ANFO Prills .....	51
Figure 3.15	Heavy ANFO Bulk Loading Truck.....	53
Figure 4.1	Instantaneous Electric Blasting Cap.....	56
Figure 4.2	Delay Electric Blasting Caps.....	56
Figure 4.3	Schematic of Magnadet Assembly.....	59
Figure 4.4	Plastic Covered Ferrite Ring .....	60
Figure 4.5	Magna Primer .....	61
Figure 4.6	Magna Sliding Primer.....	61
Figure 4.7	Sequential Timer .....	63

Figure 4.8	Detaline.....	64
Figure 4.9	Nonel MS Connector.....	66
Figure 4.10	Austin Delay Primer (APD).....	67
Figure 4.11	Hercudet Series.....	68
Figure 4.12	Open End Series.....	68
Figure 4.13	Hercudet Blasting Machine.....	69
Figure 4.14	Nonel Surface Delay.....	72
Figure 4.15	EZ Det Unit.....	74
Figure 5.1	Primer and Booster in Borehole.....	81
Figure 5.2	Detaprime and Other Primers.....	83
Figure 5.3	Explosive Composition and Primer Performance (after Junk).....	84
Figure 5.4	Primer Diameter and Primer Performance (after Junk).....	84
Figure 5.5	Energy Loss Caused by Detonating Cord.....	87
Figure 6.1	Symbols for Blast Design.....	90
Figure 6.2	Stemming Zone Performance.....	97
Figure 6.3	Stemming Material Compaction Immediately Above Charge. Compact Material Results from Crushed Stone (on the left).....	98
Figure 6.4	Backfill Borehole to Soft Seam.....	99
Figure 6.5	Problems of Soft Seam Off Bottom.....	99
Figure 6.6	Subdrilling and Maximum Tensile Stress Levels.....	100
Figure 6.7	Rule of Five.....	102
Figure 6.8	Effects of Cap Scatter Time.....	103
Figure 6.9	Piling and Uplift Resulting from Timing.....	106
Figure 6.10	Two Separate Waves.....	109
Figure 6.11	Overlapping Waves.....	109
Figure 6.12	Vibration Directionality, General Case, Covers All Possible Azimuths.....	110
Figure 6.13	Vibration Directionality Perpendicular to the Shot Line.....	110
Figure 6.14	Vibration Directionality Along the Shot Line.....	111
Figure 6.15	Vibration Wave Passes Second Hole Before It Fires With No Directional Effects.....	111
Figure 7.1	Shattered Zone from Close Spacing.....	138
Figure 7.2	Rough Walls from Excessive Spacing.....	139
Figure 7.3	Typical Crater Forms (Plan View).....	144
Figure 7.4	Predicted and Actual Fragmentation Distribution.....	148
Figure 7.5	Data for Pattern Number 1.....	151
Figure 7.6	Data for Pattern Number 2.....	152
Figure 7.7A	Summary of Fragmentation Data.....	153
Figure 7.7B	Summary of Fragmentation Data.....	154
Figure 7.8A	Comparison of Sizes From Both Blasts.....	155
Figure 7.8B	Cumulative Distribution of Fragmentation Data.....	155
Figure 7.9	Single Row Progressive Delays, $S = B$ .....	156
Figure 7.10	Single Row Progressive Delays, $S = 1.4 B$ .....	156
Figure 7.11	Single Row Alternating Delays, $S = 1.4 B$ .....	157
Figure 7.12	Single Row Instantaneous, $S = 1.4 B$ .....	157
Figure 7.13	Progressive Delays, $S = 2 B$ .....	158
Figure 7.14	Single Row Instantaneous, $S = 2 B$ .....	158
Figure 7.15	V-Cut (Square Corner), Progressive Delays, $S = 1.4 B$ .....	159
Figure 7.16	V-Cut (Angle Corner), Progressive Delays, $S = 1.4 B$ .....	159
Figure 7.17	Box Cut, Progressive Delays, $S = 1.4 B$ .....	160
Figure 7.18	Box Cut, Alternating Delays, $S = 1.4 B$ .....	160
Figure 7.19	Square Corner, Cut Fired on Echelon, $S = 1.4 B$ .....	161
Figure 7.20	Angle Corner, Fired on Echelon, $S = 1.4 B$ .....	161
Figure 7.21	Angle Corner, Instantaneous Rows, $S = 2 B$ .....	162

Figure 7.22	Angle Corner, Progressive Delays, $S = 1.4B$ .....	162
Figure 7.23	Angle Corner, Progressive Delays (Low Bench) $S = 1.15B$ .....	163
Figure 7.24	Angle Corner, Fired on Echelon (Low Bench) $S = 1.15B$ .....	163
Figure 7.25	Production of Large Rip-Rap, $S = B$ .....	164
Figure 7.26	Sinking Cuts, Square Pattern, $S = B$ .....	167
Figure 7.27	Hillside Sliver Cuts, $S = 1.4 B$ .....	169
Figure 7.28	Two Row Trench Design.....	171
Figure 7.29	Three Row Trench Design.....	171
Figure 7.30	Air Cushion Blasting.....	172
Figure 8.1	Stress Levels from Decoupled Shots.....	177
Figure 8.2	Old Concepts of Stress Wave Breakage (after DuPont).....	178
Figure 8.3A	Presplit Fracture Formation in Plexiglass Models.....	178
Figure 8.3B	Presplit Fracture Formation in Plexiglass Models.....	179
Figure 8.3C	Presplit Fracture Formation in Plexiglass Models.....	179
Figure 8.4	3-Hole Presplit.....	180
Figure 8.5	Presplit at Niagara Power Project.....	181
Figure 8.6	Close Presplit Spacing.....	188
Figure 8.7	Extended Presplit Spacing.....	188
Figure 8.8	Presplit with Joints at 90°.....	189
Figure 8.9	Presplit with Joints at Acute Angle.....	189
Figure 8.10	Presplit in Plexiglass with Joints at Angle with Face (after Worsey).....	189
Figure 8.11	Breakage Diagram for Presplit in Jointed Rock (after Worsey).....	190
Figure 8.12	Backbreak Due to Excessive Burden.....	190
Figure 8.13	Backbreak Due to Excessive Stiffness.....	191
Figure 8.14	Satellite Charges in Collar.....	191
Figure 8.15	Charge Extended into Stemming.....	192
Figure 8.16	Endbreak (Plan View).....	192
Figure 8.17	Blasting Mats.....	193
Figure 9.1	Regional Joining Pattern.....	197
Figure 9.2	Dominant Joints Parallel to the Face.....	198
Figure 9.3	Dominant Joints Perpendicular to the Face.....	198
Figure 9.4	Dominant Joints at Angle.....	199
Figure 9.5	Dominant Joints at Acute Angles.....	199
Figure 9.6	Consideration for Dipping Beds.....	199
Figure 9.7	Blasting in Bedded Rock.....	200
Figure 9.8A	Percussive Rock Bits.....	204
Figure 9.8B	Percussive Rock Bits.....	204
Figure 9.8C	Percussive Rock Bits.....	205
Figure 9.9	Drag Bits for Soft to Medium Formations.....	205
Figure 9.10	Rotary Bits for Soft Formations.....	205
Figure 9.11	Rotary Bits for Medium Formations.....	206
Figure 9.12	Rotary Bits For Medium Hard Formulations.....	206
Figure 9.13	Rotary Bits for Hard Formulations.....	206
Figure 9.14	Rotary Bits for Very Hard Formations.....	207
Figure 9.15	Rotary Bits for Extremely Hard Formations.....	207
Figure 9.16	Vertical vs. Angle Drilling.....	209
Figure 9.17	Drilling Error Which Results from Drill Deviation.....	210
Figure 10.1	Compressional Wave.....	230
Figure 10.2	Shear Wave.....	230
Figure 10.4	Deformation of Shear.....	231
Figure 10.3	Deformation by Compression.....	231
Figure 10.5	Wave Motion And Parameters.....	232



Figure 10.6	Seismograph Sensor.....	233
Figure 10.7	Sensor Mechanism .....	233
Figure 10.8	Vibration Record.....	236
Figure 10.9	Vibration Components .....	237
Figure 10.10	Measure Of Vibration Amplitude And Period .....	237
Figure 10.11	Half Period Measurement .....	239
Figure 10.12	Relative Particle Velocity Vs. Charge Weight.....	244
Figure 10.13	Particle Velocity vs. Distance Relationship .....	245
Figure 10.14	Seismic Waves from Delay Blasting.....	249
Figure 10.15	Particle Velocity vs. Scaled Distance .....	253
Figure 10.16	Scaled Distance Chart.....	255
Figure 10.17	Normal Distribution of Data.....	256
Figure 10.18	Safe Vibration Levels (RI 8507) .....	260
Figure 10.19	Alternative Blasting Level Criteria Source: RI 8507, U.S. Bureau of Mines .....	261
Figure 10.20	OSM Alternative Blasting Level Criteria (Modified from Figure B 1, RI 8507, U.S. Bureau of Mines) .....	263
Figure 10.21	Frequencies From Coal Mine, Quarry And Construction Blasting (RI 8507) .....	264
Figure 10.22	Spectral Analysis (RI 8169) .....	265
Figure 10.23	Vibration X - Crack Pattern .....	267
Figure 10.24	Converging Equal Wavelets .....	268
Figure 10.25	Composite Wave Motion at Maximum Coincidence.....	268
Figure 10.26	Converging and Diverging Wave Interaction .....	269
Figure 10.27	Composite Motion .....	270
Figure 10.28	Human Response To Vibration (RI 8507).....	276
Figure 10.29	Typical Sound Levels.....	278
Figure 10.30	Normal Atmospheric Conditions.....	281
Figure 10.31	Atmospheric Inversion.....	281
Figure 10.32	Sound Focusing-Inversion Effect .....	281
Figure 10.33	Wind Effect .....	282
Figure 10.34	Air Blast Focusing Plus Wind Effect.....	282
Figure 10.35	Air Blast Focusing .....	283
Figure 10.36	Sketch Of Typical Wall Crack Pattern .....	287
Figure 10.37	D9N Ripper Performance .....	290
Figure 10.38	D10N Ripper Performance.....	291
Figure 10.39	D11N Ripper Performance.....	292
Figure 10.40	Measurement of Vibration Amplitude and Period.....	295
Figure 10.41	Half Period Measurement .....	297
Figure 11.1A	Drawings With Example Blasting Submittal .....	303
Figure 11.1B	Drawings With Example Blasting Submittal.....	304
Figure 11.2	Test Blast Both With And Without Presplitting. (Basalt, Idaho) .....	307
Figure 11.3	Test Blast Both With And Without Presplitting. (Granite, Canada) .....	308
Figure 11.4A	Blast Without Presplit (Siltstone, Alaska) .....	308
Figure 11.4B	Blast With Presplitting. (Siltstone, Alaska).....	309

## LIST OF TABLES

TABLE 1.1	EXPLOSIVE INGREDIENTS .....	7
TABLE 1.2	HEATS OF FORMATION FOR SELECTED CHEMICAL COMPOUNDS.....	8
TABLE 3.1	SENSITIVENESS (CRITICAL DIAMETER).....	31
TABLE 3.2	WATER RESISTANCE .....	32
TABLE 3.3	FUME QUALITY .....	33
TABLE 3.4	TEMPERATURE RESISTANCE .....	34
TABLE 3.5	SENSITIVITY .....	38
TABLE 3.6	DETONATION VELOCITY (FT/S) .....	38
TABLE 3.7	DETONATION PRESSURE.....	39
TABLE 3.8	DENSITY .....	40
TABLE 3.9	PROPERTIES OF FERTILIZER AND BLASTING PRILLS.....	52
TABLE 4.1	LP SERIES OF ELECTRIC BLASTING CAPS.....	57
TABLE 4.2	MS SERIES OF ELECTRIC BLASTING CAPS .....	58
TABLE 4.3	DETALINE SURFACE DELAYS .....	65
TABLE 4.4	HERCUDET CAP DELAYS .....	70
TABLE 4.5	LP SHOCK TUBE DELAY DETONATORS .....	71
TABLE 4.6	NONEL S. L. SERIES PRIMADETS.....	72
TABLE 4.7	LONG LEAD HEAVY DUTY MS SHOCK TUBE DELAY DETONATORS.....	73
TABLE 4.8	NON-ELECTRICAL SHOCK TUBE TRUNKLINE DELAYS.....	74
TABLE 5.1	MAXIMUM CORD LOAD .....	86
TABLE 6.1	ROCK DENSITY .....	92
TABLE 6.2	CORRECTIONS FOR NUMBER OF ROWS.....	94
TABLE 6.3	CORRECTIONS FOR ROCK DEPOSITION.....	94
TABLE 6.4	CORRECTIONS FOR GEOLOGIC STRUCTURE.....	95
TABLE 6.5	POTENTIAL PROBLEMS AS RELATED TO STIFFNESS RATIO (L/B) .....	101
TABLE 6.6	TIME DELAY BETWEEN BLASTHOLES (FOR 2 FREE FACES).....	104
TABLE 6.7	TIME DELAY BETWEEN ROWS .....	105
TABLE 6.8	TIMING CONTROL FUNCTIONS .....	115
TABLE 6.9	SELECTION OF TIME WINDOWS .....	116
TABLE 9.1	DOWNHOLE DRILL VS. DRIFTER DRILL.....	202
TABLE 9.2	DOWNHOLE DRILL VS. ROTARY DRILL .....	203
TABLE 10.1	VIBRATION DATA.....	250
TABLE 10.2	CHARGE - DISTANCE DATA .....	254
TABLE 10.3	VIBRATION DATA.....	253
TABLE 10.4	CHARGE - DISTANCE DATA .....	254
TABLE 10.5	SAFE PEAK PARTICLE VELOCITY FOR RESIDENTIAL .....	260
TABLE 10.6	OFFICE OF SURFACE MINING, REQUIRED GROUND.....	262
TABLE 10.7	FAILURE IN CONCRETE DUE TO VIBRATION .....	273
TABLE 10.8	VIBRATION LEVELS FOR GREEN CONCRETE.....	274
TABLE 10.9	FLOOR VIBRATION .....	275
TABLE 10.10	HUMAN RESPONSE .....	275
TABLE 10.11	SOUND LEVEL LIMITS .....	279
TABLE 11.1	HOLE SPACING VERSUS BENCH HEIGHT .....	305



## CHAPTER 1 OBJECTIVES

To examine the sources of explosive energy. To delineate the types of energy and their relationship to producing useful work in rock blasting while minimizing unwanted waste energy. To examine the factors affecting the different types of energy.

## CHAPTER 1 SUMMARY

The two types of energy produced from explosive reactions are shock and gas energy. Shock energy is used when charges are unconfined while gas energy is used to produce the majority of the useful work when charges are confined. The gas energy is responsible for most of the rock fragmentation during surface blasting operations.

Factors which produce different effects on either shock or gas energy are charge geometry, direction of initiation, detonation velocity and charge chemical composition.

# CHAPTER 1

## EXPLOSIVES ENGINEERING

### 1.1 INTRODUCTION

Most raw materials, from which our modern society is built, are produced by the use of explosives in mines throughout the world. The construction of highways, canals and buildings are aided by the use of explosives. The plentiful food, which is available in this country, would not exist without explosives to produce the fertilizers and the metallic ores, which ultimately become tractors and other equipment.

The use of explosives in mining and construction applications dates back to 1627. From 1627 through 1865, the explosive used was black powder. Black powder was a different type of explosive than the explosives used today. In 1865, Nobel invented nitroglycerin dynamite in Sweden. He invented gelatin dynamites in 1866. These new products were more energetic than black powder and performed differently since confinement of the explosive was not necessary to produce good results, as was the case with black powder. From 1867 through the mid-1950's, dynamite was the workhorse of the explosive industry.

In the mid-1950's, a new product appeared which was called ANFO, ammonium nitrate and fuel oil. This explosive was more economical to use than dynamite. During the decades of the 1970's and the 1980's, ANFO has become the workhorse of the industry and approximately 80% of all explosives used in the United States was ammonium nitrate and fuel oil.

Other new explosive products appeared on the scene in the 1960's and 1970's. Explosives, which were called slurries or water gels, have replaced dynamite in many applications. In the late 1970's, a modification of the water gels called emulsions appeared on the scene. The emulsions were simple to manufacture and could be used in similar applications as dynamites and water gels. Commercial explosives fall into three major generic categories, dynamites, blasting agents and slurries (commonly called water gels or emulsions).

Blasting problems generally result from poor blast design, poor execution in drilling and loading the proposed design and because the rock mass was improperly evaluated.

Blast design parameters such as burden, stemming, subdrilling, spacing and initiation timing must be carefully determined in order to have a blast function efficiently, safely and within reasonable vibration and air blast levels.

Controlled blasting along highways must be done to reduce maintenance costs and produce stable safe contours. Those responsible for the execution and evaluation of controlled blasting must be aware of the procedures used to produce acceptable results and must understand how geologic factors can change the appearance of the final contour.

Rock strengths change over both small and large scale. Geologic structures such as joints, bedding planes, faults and mud seams cause problems. These variations in structure require the blaster to change his patterns and methods to obtain reasonable results. Therefore, one must assume, from surface indicators, what the rock mass will be at depth. The drilling of blastholes provides information as to what type of structure intersects those holes. To enable the blaster to make enlightened judgments, when adjusting his blasting pattern to compensate for rock structure, he must have a thorough understanding of exactly how the explosive functions during blasting. Without that understanding, blasting is just a random trial-and-error process.

This manual was designed to provide a systematic approach to surface blast design. The information is presented in a practical manner. The book provides the reader with information to promote an understanding of the phenomenon and the anticipated results. The formulas presented are empirical and should provide reasonable values for general job conditions. However, unusual geologic conditions can require adjustments to calculated values.

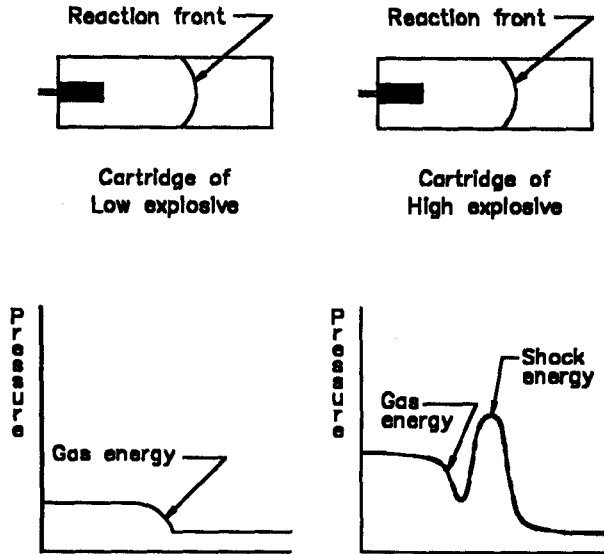
This manual is written for use by FHWA and State Highway agency personnel in the evaluation and execution of blasting for highway construction purposes.

### **1.1.1 SOURCES OF EXPLOSIVE'S ENERGY**

Two basic forms of energy are released when high explosives react. The first type of energy will be called shock energy. The second type will be called gas energy. Although both types of energy are released during the detonation process, the blaster can select explosives with different proportions of shock or gas energy to suit a particular application. If explosives are used in an unconfined manner, such as mud capping boulders (commonly called plaster shooting) or for shearing structural members in demolition, the selection of an explosive with a high shock energy would be advantageous. On the other hand, if explosives are being used in boreholes and are confined with stemming materials, an explosive with a high gas energy output would be beneficial.

To help form a mental picture of the difference between the two types of energy, compare the difference in reaction of a low and high explosives. Low explosives are those which deflagrate or burn very rapidly. These explosives may have reaction velocities of two to five thousand feet per second and produce no shock energy. They produce work only from gas expansion. A very typical example of a low explosive would be black powder. High explosives detonate and produce not only gas pressure, but also another energy or pressure which is called shock pressure. Figure 1.1 shows a diagram of a reacting cartridge of low explosive. If the reaction is stopped when the cartridge has been partially consumed and the

pressure profile is examined, one can see a steady rise in pressure at the reaction until the maximum pressure is reached. Low explosives only produce gas pressure during the combustion process. A high explosive detonates and exhibits a totally different pressure profile (Figure 1.1).



**Figure 1.1** Pressure Profiles for Low and High Explosives

During a detonation in high explosives, the shock pressure at the reaction front travels through the explosive before the gas energy is released. This shock energy, normally is of higher pressure than the gas pressure. After the shock energy passes, gas energy is released. The gas energy in detonating explosives is much greater than the gas energy released in low explosives. In a high explosive, there are two distinct and separate pressures. The shock pressure is a transient pressure that travels at the explosives rate of detonation. This pressure is estimated to account for only 10% to 15% of the total available useful work energy in the explosion. The gas pressure accounts for 85% to 90% of the useful work energy and follows thereafter. However, the gas energy produces a force that is constantly maintained until the confining vessel, the borehole, ruptures.

### 1.1.2 SHOCK ENERGY

In high explosives, a shock pressure spike at the reaction front travels through the explosive before the gas energy is released. There are, therefore, two distinct separate pressures resulting from a high explosive and only one from a low explosive. The shock pressure is a transient pressure that travels at the explosives rate of detonation. The gas pressure follows thereafter.

The shock energy is commonly believed to result from the detonation pressure of the explosion. The detonation pressure is a function of the explosive density times the explosion detonation velocity squared and is a form of kinetic energy. Determination of the detonation pressure is very complex. There are a number of different computer codes written to approximate this pressure. Unfortunately, the computer codes come up with widely varying answers. Until recently, no method existed to measure the detonation pressure. Now that methods exist to produce accurate measurements, one would hope that the computer codes would be corrected. Until that time occurs, one could use one of a number of approximations to achieve a number that may approximate the detonation pressure. As an example, one could use:

$$P = \frac{4.18 \times 10^{-7} SG_e V_e^2}{1 + 0.8 SG_e} \quad (1.1)$$

where:

- P = Detonation pressure (Kbar, 1 Kilobar  $\cong$  14,504 psi)
- SG<sub>e</sub> = Specific gravity of the explosive
- V<sub>e</sub> = Detonation velocity (ft/s)

The detonation pressure or shock energy can be considered similar to kinetic energy and is maximum in the direction of travel, which would mean that the detonation pressure would be maximum in the explosive cartridge at the end opposite that where initiation occurred. It is generally believed that the detonation pressure on the sides of the cartridge are virtually zero, since the detonation wave does not extend to the edges of the cartridge. To get maximum detonation pressure effects from an explosive, it is necessary to place the explosives on the material to be broken and initiate it from the end opposite that in contact with the material. Laying the cartridge over on its side and firing in a manner where detonation is parallel to the surface of the material to be broken reduces the effects of the detonation pressure. Instead, the material is subjected to the pressure caused by the radial expansion of the gases after the detonation wave has passed. Detonation pressure can be effectively used in blasting when shooting with external charges or charges which are not in boreholes. This application can be seen in mud capping or plaster shooting of boulders or in the placement of external charges on structural members during demolition (Figure 1.2).

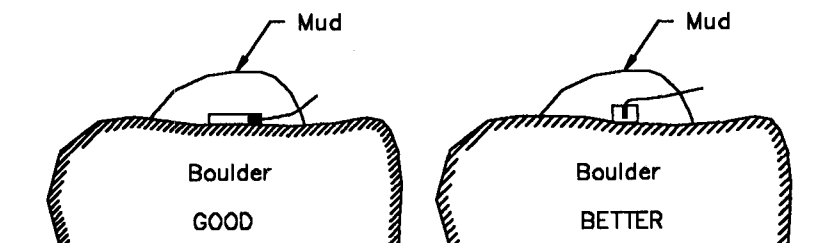


Figure 1.2 Mud Cap Blasting



To maximize the use of detonation pressure one would want the maximum contact area between the explosive and the structure. The explosive should be initiated on the end opposite that in contact with the structure. An explosive should be selected which has a high detonation velocity and a high density. A combination of high density and high detonation velocity results in a high detonation pressure.

### **1.1.3 GAS ENERGY**

The gas energy released during the detonation process causes the majority of rock breakage in rock blasting with charges confined in boreholes. The gas pressure, often called explosion pressure, is the pressure that is exerted on the borehole walls by the expanding gases after the chemical reaction has been completed. Explosion pressure results from the amount of gases liberated per unit weight of explosive and the amount of heat liberated during the reaction. The higher the temperature produced, the higher the gas pressure. If more gas volume is liberated at the same temperature, the pressure will also increase. For a quick approximation, it is often assumed that explosion pressure is approximately one-half of the detonation pressure (Figure 1.3).

It should be pointed out that this is only an approximation and conditions can exist where the explosion pressure exceeds the detonation pressure. This explains the success of ANFO which yields a relatively low detonation pressure, but relatively high explosion pressure. Explosion pressures are calculated from computer codes or measured using underwater tests. Explosion pressures can also be measured directly in boreholes, however, few of the explosive manufacturers use the new technique in rating their explosives. A review of some very basic explosives chemistry helps one to understand how powdered metals and other substances effect explosion pressures.

### **1.1.4 CHEMICAL EXPLOSIVES**

Chemical explosives are materials which undergo rapid chemical reactions to release gaseous products and energy. These gases under high pressure exert forces against borehole walls which causes rock to fracture.

The elements, which comprise explosives, are generally considered either fuel elements or oxidizer elements (Table 1.1). Explosives use oxygen as the oxidizer element. Nitrogen is also a common element in explosives and is in either a liquid or solid state, but once it reacts it forms gaseous nitrogen. Explosives sometimes contain ingredients other than fuels and oxidizers. Powdered metals such as powdered aluminum are used in explosives. The reason for the use of the powder metals is that, upon reaction, powdered metals give off heat. The heat formed heats up the gases, which result from the other ingredients, causing a higher explosion pressure.

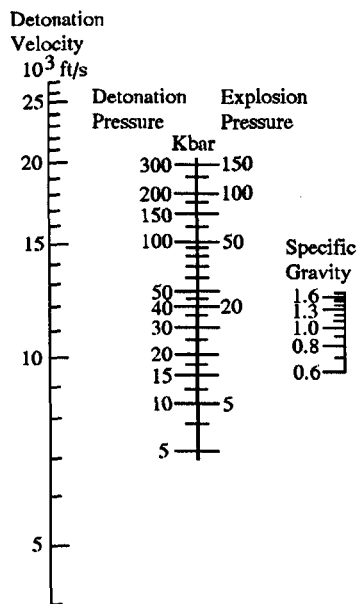


Figure 1.3 Nomograph of Detonation and Explosion Pressure

TABLE 1.1 EXPLOSIVE INGREDIENTS

INGREDIENT	CHEMICAL FORMULA	FUNCTION
Nitroglycerin	$C_3H_5O_9N_3$	Explosive Base
Nitrocellulose	$C_6H_7O_{11}N_3$	Explosive Base
Trinitrotoluene (TNT)	$C_7H_5O_6N_3$	Explosive Base
Ammonium Nitrate	$H_4O_3N_2$	Oxygen Carrier
Sodium Nitrate	$NaNO_3$	Oxygen Carrier
Fuel Oil	$CH_2$	Fuel
Wood Pulp	$C_6H_{10}O_5$	Fuel
Carbon	C	Fuel
Powdered Aluminum	Al	Sensitizer-Fuel
Chalk	$CaCO_3$	Antacid
Zinc Oxide	ZnO	Antacid
Sodium Chloride	NaCl	Flame Depressant

Explosives may contain other elements and ingredients which really add nothing to the explosives energy. These other ingredients are put into explosives to decrease sensitivity or increase surface area. Certain ingredients such as chalk or zinc oxide serve as an antacid to increase the storage life of the explosive. Common table salt actually makes an explosive less efficient because it functions as a flame depressant and cools the reaction. On the other hand,

the addition of table salt allows the explosive to be used in explosive methane atmospheres because the cooler flame and shorter flame duration makes it less likely that a gas explosion would occur. This is the reason that permissible explosives are used in coal mines or in tunnelling operations in sedimentary rock where methane is encountered.

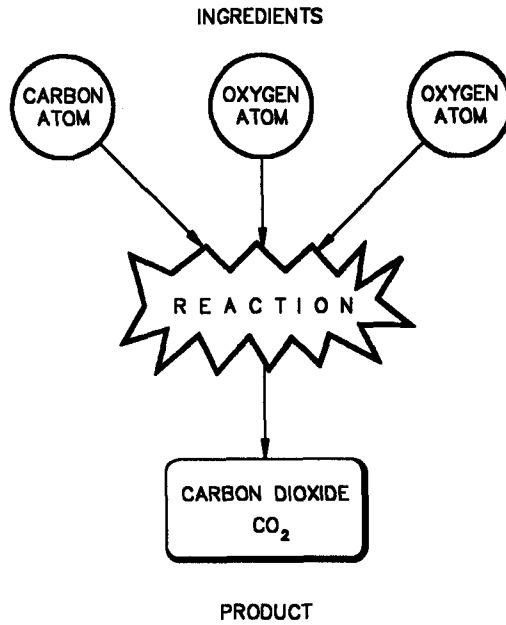
The basic elements or ingredients which directly produce work in blasting are those elements which form gases when they react, such as carbon, hydrogen, oxygen, and nitrogen.

When carbon reacts with oxygen, it can either form carbon monoxide or carbon dioxide. In order to extract the maximum heat from the reaction, we want all elements to be completely oxidized or in other words for carbon dioxide to form rather than carbon monoxide. Table 1.2 shows the difference in heat released when one carbon atom forms carbon monoxide versus the case where one carbon atom forms carbon dioxide. In order to release the maximum energy from the explosive reaction, the elements should react and form the following products:

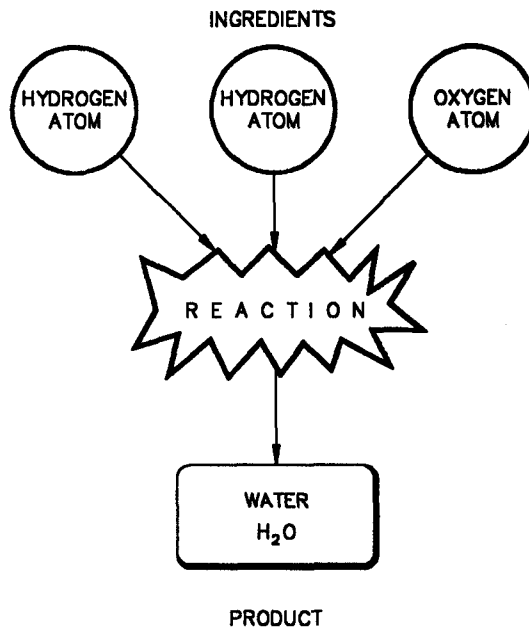
1. Carbon reacts to form carbon dioxide. (Figure 1.4)
2. Hydrogen reacts to form water. (Figure 1.5)
3. Liquid or solid nitrogen reacts to form gaseous nitrogen. (Figure 1.6)

**TABLE 1.2 HEATS OF FORMATION FOR SELECTED CHEMICAL COMPOUNDS**

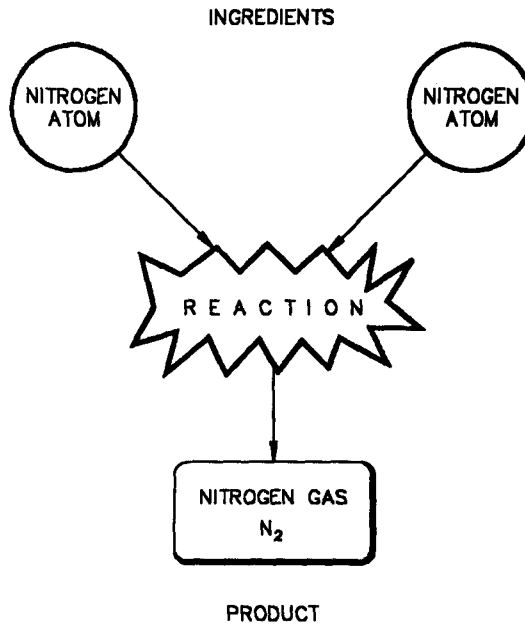
COMPOUND	FORMULA	MOL. WEIGHT	$Q_p$ or $Q_r$ (Kcal/Mole)
Corundum	$Al_2O_3$	102.0	-399.1
Fuel Oil	$CH_2$	14.0	- 7.0
Nitromethane	$CH_3O_2N$	61.0	- 21.3
Nitroglycerin	$C_3H_5O_9N_3$	227.1	- 82.7
PETN	$C_5H_8O_{12}N_4$	316.1	-123.0
TNT	$C_7H_5O_6N_3$	227.1	- 13.0
Carbon monoxide	CO	28.0	- 26.4
Carbon dioxide	$CO_2$	44.0	- 94.1
Water	$H_2O$	18.0	- 57.8
Ammonium nitrate	$N_2H_4O_3$	80.1	- 87.3
Aluminum	Al	27.0	0.0
Carbon	C	12.0	0.0
Nitrogen	N	14.0	0.0
Nitrogen oxide	NO	30.0	+ 21.6
Nitrogen dioxide	$NO_2$	46.0	+ 8.1



**Figure 1.4** Carbon-Oxygen Ideal Reaction



**Figure 1.5** Hydrogen-Oxygen Ideal Reaction



**Figure 1.6** Nitrogen-Nitrogen Ideal Reaction

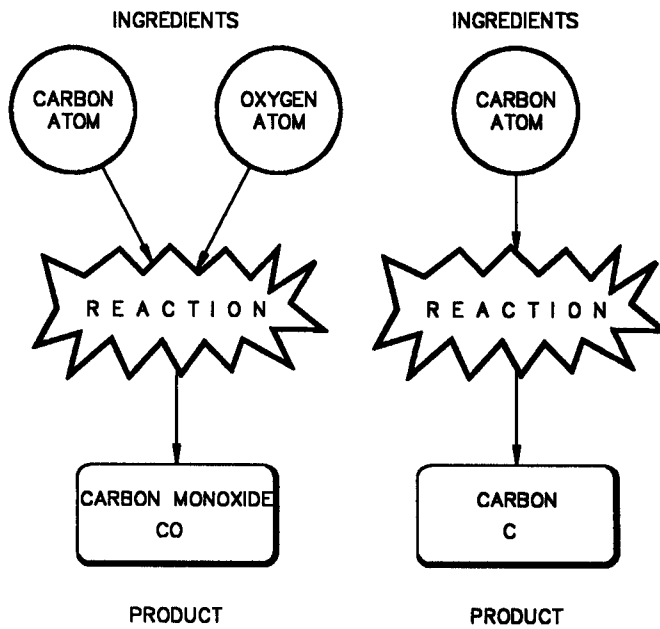
If only the ideal reactions occur from the carbon, hydrogen, oxygen, and nitrogen, there is no oxygen left over or any additional oxygen needed. The explosive is oxygen balanced and produces the maximum amount of energy.

If two ingredients are mixed together, such as ammonium nitrate and fuel oil, and an excess amount of fuel oil is put into the mixture, the explosive reaction is said to be oxygen negative. This means that there is not enough oxygen to fully combine with the carbon and hydrogen to form the desired end products. Instead, what occurs is that free carbon (soot) and carbon monoxide will be liberated (Figure 1.7).

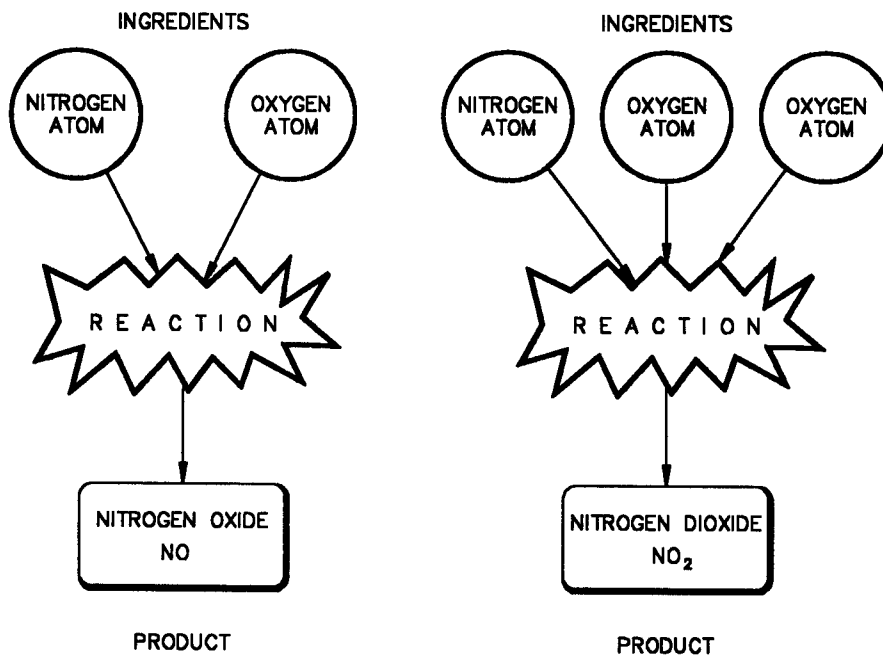
If too little fuel is added to a mixture of ammonium nitrate and fuel oil, then the mixture has excess oxygen which cannot react with carbon or hydrogen. This is called an oxygen positive reaction. What occurs is that the nitrogen which is normally an inert gas will be changed from nitrogen gas to an oxide of nitrogen (Figure 1.8). If oxides of nitrogen are formed, they will form rust colored fumes and reduce the energy of the reaction.

The energy is reduced because other ideal gases liberate heat when they form, nitrogen oxides absorb heat in order for them to form. This can be seen in Table 1.2. Water and carbon dioxide have a negative sign which means they give off heat when they form. The nitrogen oxides near the bottom of Table 1.2 have a plus sign meaning that they take in heat when they form.

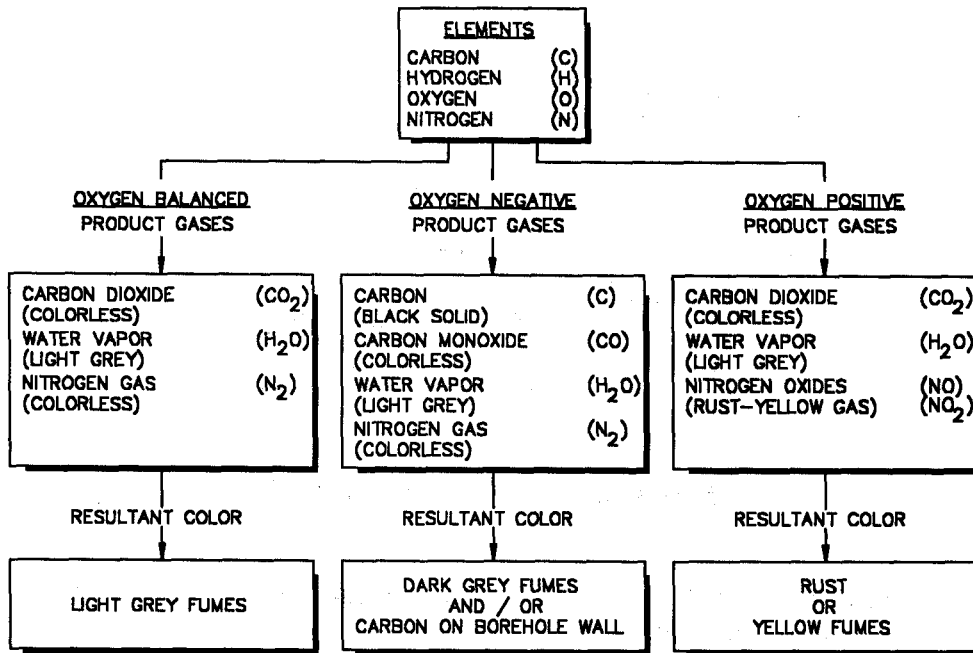
The net result is that the reaction will occur at a lower temperature. The gas pressure is lowered if the reaction temperature is lowered. Figure 1.9 shows the reaction products which form if the reaction is oxygen positive.



**Figure 1.7** Non-Ideal Carbon-Oxygen Reaction



**Figure 1.8** Non-Ideal Nitrogen-Oxygen Reaction



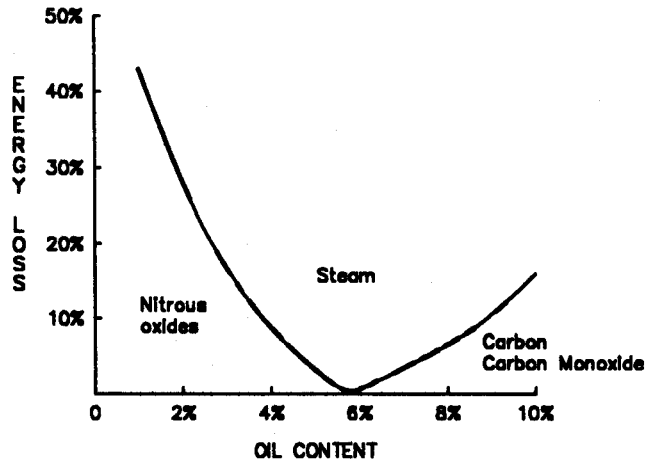
**Figure 1.9 Identification of Problem Mixtures**

## **1.2 IDENTIFICATION OF PROBLEM MIXTURES**

There are visual signs of proper and improper energy release. Gas colors are indicators of reaction efficiency and associated energy release. When light gray colored steam is present, oxygen balance is near ideal and maximum energy is released. When gases are either yellow or rust colored, they indicate an inefficient reaction that may be due to an oxygen positive mixture. Oxygen negative mixtures produce dark gray gases and can leave carbon on borehole walls (Figure 1.9).

In order to demonstrate the importance of oxygen balance to energy release, one can explore the example of ammonium nitrate and fuel oil which is a very common explosive. If either too little or too much fuel oil is added to ammonium nitrate, non-ideal chemical reactions occur which cause an energy loss.

Figure 1.10 shows energy loss versus the percent of fuel oil in the mixture. It can be seen that the ideal amount of fuel oil is near 6%. When insufficient oil is added and too much oxygen remains in the mixture, oxides of nitrogen are produced and large energy losses occur. At 1% fuel oil the energy loss is approximately 42%. If too much fuel is added, the energy losses are not as severe as in the case where too little fuel is added. When fuel oil is greater than 6%, free carbon and carbon monoxide will form.



**Figure 1.10** Energy Loss in ANFO

These visual signs can give the operator an indication as to whether or not the explosives are functioning properly.

### **1.3 CHAPTER 1 SUMMARY**

The two types of energy produced from explosive reactions are shock and gas energy. Shock energy is used when charges are unconfined while gas energy is used to produce the majority of the useful work when charges are confined. The gas energy is responsible for most of the rock fragmentation during surface blasting operations.

Factors which produce different effects on either shock or gas energy are charge geometry, direction of initiation, detonation velocity and charge chemical composition.



## CHAPTER 2 OBJECTIVES

To understand how explosives break rock. To define a way to control explosive energy and to understand the rock breakage process for both shock and gas energy.

## CHAPTER 2 SUMMARY

Unconfined charges are inefficient since only a small percentage of their energy can be used to break rock. The rock fractures as a result of the reflected shock wave.

Confined charges are more efficient and less disturbing than unconfined charges. They produce breakage by three mechanisms, shock wave reflection, radial cracking and flexural failure.

## CHAPTER 2

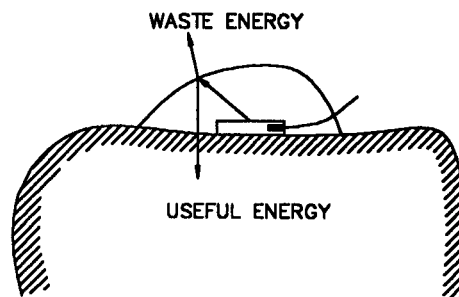
### MECHANICS OF ROCK BREAKAGE

#### 2.1 SHOCK ENERGY IN ROCK BREAKAGE

Unconfined charges placed on boulders and subsequently detonated produce shock energy which will be transmitted into the boulder at the point of contact between the charge and the boulder. Since most of the charge is not in contact with the boulder, the majority of the useful explosive energy travels out into space and is wasted. This wasted energy manifests itself in excessive air blast. Gas pressure can never build since the charge is totally unconfined, therefore, gas energy does little work. Only a small amount of the useful energy is utilized when high explosive charges are placed unconfined on boulders.

If one compared two examples, one in which the explosive charge is placed in a drill hole, in a boulder and the hole stemmed to the collar and in the second case the charge is placed unconfined on top of the boulder, one would find that it requires many times the amount of explosive on top of the boulder to obtain the same fragmentation as the confined charge within the borehole.

Years ago it was found that a thin layer of mud placed on the boulder with the explosive cartridges pressed into this mud and subsequently covered by mud causes the explosive charge to exert more downward force into the boulder than if the mud was not used. One could conclude that the gas confinement offered by a few handfuls of mud helped in the breakage process. Common sense would indicate that this would not be logical since a few handfuls of mud could not significantly resist pressures near one million psi. What may happen is that the mud forms a wave trap, whereby some of the wasted shock energy, which would normally go off into space, is reflected back into the boulder (Figure 2.1).

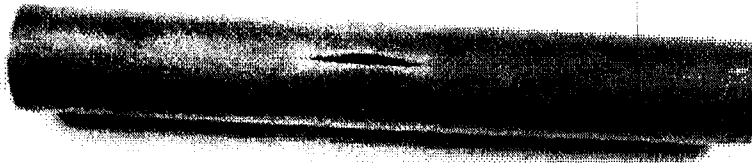


**Figure 2.1** Reflected and Waste Energy in Mud Cap Blasting

## **2.2 CONFINED CHARGES IN BOREHOLES**

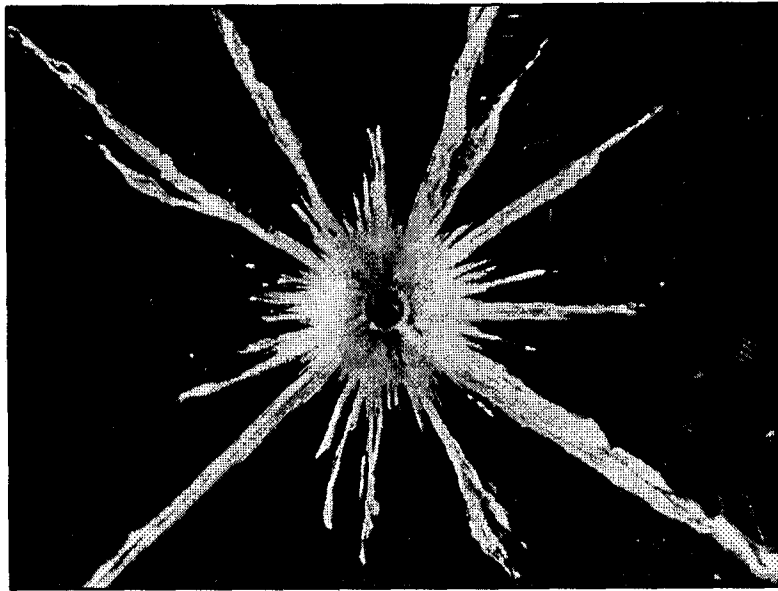
Three basic mechanisms contribute to rock breakage with charges confined in boreholes. The first and least significant mechanism of breakage is caused by the shock wave. At most, the shock wave causes microfractures to form on the borehole walls and initiates microfractures at discontinuities in the burden. This transient pressure pulse quickly diminishes with distance from the borehole and since the propagation velocity of the pulse is approximately 2.5 to 5 times the maximum crack propagation velocity, the pulse quickly outruns the fracture propagation.

The two major mechanisms of rock breakage results from the sustained gas pressure in the borehole. When the solid explosive is transformed into a gas during the detonation process, the borehole acts similar to a cylindrical pressure vessel. Failures in pressure vessels, such as water pipes or hydraulic lines, offer an analogy to this mechanism of rock breakage. When the pressure vessel is overpressurized, the pressure exerted perpendicular to the confining vessel's walls will cause a fracture to occur at the weakest point in the pressure vessel. In the case of frozen water pipes, a longitudinal split occurs parallel to the axis of the pipe (Figure 2.2).



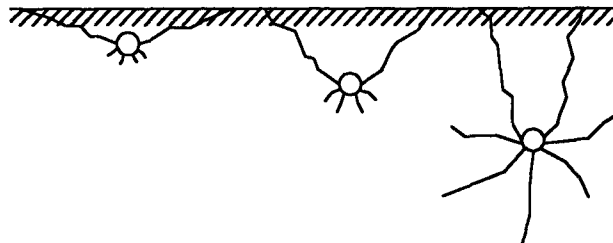
**Figure 2.2** Fracture of Frozen Water Pipes

The same phenomenon occurs in other cylindrical pressure vessels due to the generation of hoop stresses. If a borehole is considered a pressure vessel, one would expect fractures to orient themselves parallel to the axis of the borehole. The major difference between pressurizing a borehole and pressurizing a water pipe is rate of loading. A borehole is overpressurized almost instantaneously and therefore does not fail at one weakest point along the borehole wall. Instead, it will simultaneously fail in many locations. Each resulting fracture will be oriented parallel to the axis of the borehole. Failure by this mechanism has been recognized for many years and is commonly called radial cracking (Figure 2.3).



**Figure 2.3** Radial Cracking in Plexiglass

Direction and extent of the radial crack system can be controlled by the selection of the proper distance from the borehole to the face (burden) (Figure 2.4).



**Figure 2.4** Influence of Distance to Face on Radial Crack System

The second major breakage mechanism occurs after the radial cracking has been completed. There is a time lag before the second breakage mechanism goes into play. The second mechanism influences the breakage perpendicular to the axis of the charge.

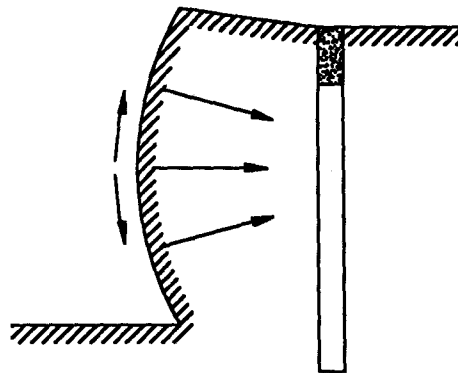
Before the second breakage mechanism is discussed, form a mental picture of what has happened during the radial cracking process. Stress wave energy (shock) has caused minor cracking or microfracturing on the borehole walls and at discontinuities throughout the burden. The sustained gas pressure, which follows the shock pressure, puts the borehole walls into tension due to the hoop stresses generated and causes the existing microfractures to grow. The high pressure gases extend fractures throughout the burden. The burden in massive rock is

transformed from a solid rock mass into one that is broken by the radial cracks in many wedge-shaped or pie-shaped pieces. These wedges function as columns, supporting the burden weight. Columns become weaker if their length to diameter ratio or slenderness ratio increases. Therefore, once the massive burden is transformed into pie-shaped pieces with a fixed bench height, it has been severely weakened due to the fact that its slenderness ratio has increased.

The work process has not yet been completed since the expanding borehole still contains very high pressure gases. These gases subject the wedges to forces acting perpendicular to the axis of the hole. One can say they are pushing towards relief or towards the line of least resistance. This concept of relief perpendicular to the axis of the hole has been known for well over a hundred years. Relief must be available perpendicular to the axis of the hole for borehole charges to function properly. If relief is not available, only radial cracks will form and boreholes will crater or the stemming will be blown out. In either case, the fragmentation suffers and environmental problems result.

### 2.3 BENCH STIFFNESS

In most blasting operations, the first visible movement occurs when the face bows outward near the center. In other words, the center portion of the face is moving faster than the top or bottom of the burden (Figure 2.5).



**Figure 2.5** Axisymmetric Bending Diagram

This type of bowing or bending action does not always occur. One can find cases where instead of the center bowing outward, the top or bottom portion of the burden is cantilevering outward (Figure 2.6).

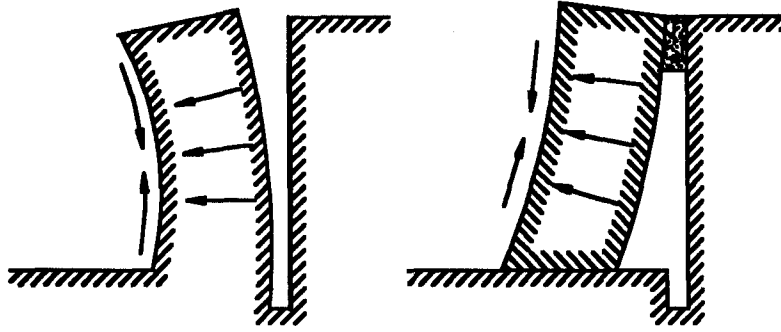


Figure 2.6 Cantilever Bending Diagram

In either of these cases, the differential movement causes the burden to break in the third dimension. This breakage mechanism has been called flexural rupture or flexural failure. To properly discuss flexural failure, one must realize that these individual pie-shaped columns of rock caused by the radial cracking will also be influenced by a force perpendicular to the length of the column. This would be similar to beam loading conditions. When one discusses beam loading, the stiffness ratio is significant. The stiffness ratio relates the thickness of the beam to its length. The effect of the stiffness can be explained by using, as an example, a full-length pencil. It is quite easy to break a pencil with the force exerted with one's fingers. However, if the same force is exerted on a two-inch long pencil, it becomes more difficult to break. The pencil's diameter has not changed, the only thing that has changed is its length. A similar stiffness phenomenon also occurs in blasting. The burden rock is more difficult to break by flexural failure when bench heights approach the burden dimension in length. When bench heights are many times the burden in length, the burden rock is more easily broken.

Two general modes of flexural failure of the burden exist. In one case, the burden bends outward or bulges in the center more quickly than it does on the top or bottom. In the second case, the top or the bottom of the burden moves at a higher rate than the center. When the burden rock bulges at its center, tensile stresses result at the face and compression results near the charge. Under this type of bending condition, the rock will break from the face back toward the hole (Figure 2.5). This mode of failure generally leads to desirable breakage.

In the second case, the rock is cantilevered outward (Figure 2.6) and the face is put into compression and the borehole walls are in tension.

This second case is undesirable. This mechanism occurs when cracks between blastholes link before the burden is broken and is normally caused by insufficient blasthole spacings. When the cracks between holes reach the surface, gases can be prematurely vented before they have accomplished all potential work. Air blast and flyrock can result along with potential bottom problems.

The bending mechanism or flexural failure is controlled by selecting the proper blasthole spacing and initiation time of adjacent holes. When blasthole timing results in charges being delayed from one another along a row of holes, the spacing must be less than that required if all the holes in a row were fired simultaneously. The selection of the proper spacing is further complicated by the stiffness ratio. As bench heights are reduced compared to the burden, one must also reduce the spacing between holes to overcome the problems of stiffness.

## 2.4 EFFECTS OF BLASTHOLE LENGTH

The rock breakage process occurs in four distinctive steps. As the explosives detonates, a stress wave moves through the rock uniformly in all directions around the charge. Radial cracks then propagate predominantly toward the free face. After the radial cracking process is finished, high pressure gases penetrate into the cracks approximately 2/3 of the distance from the hole to the face throughout the radial crack system. Only after the gas has time to penetrate into the crack system are the stresses on the face of sufficient magnitude, to cause the face to move outward. Before the face begins to move and bend outward, fractures are created in the third dimension as a result of the flexural failure or bending.

In order to better understand the rock breakage process, a finite element model was created to closely resemble the radial crack network before burden movement occurs. The model was unique in that it allowed the study of radial cracks which were partially pressurized. An interim technique was used to recalculate and update the borehole pressures as borehole volume increased. The model was designed to study two important aspects of bench blasting. The first was to determine the effect of the bench height on the bending and flexural failure, and the second was to determine the effect of changing geologic conditions on the movement of the burden itself (Figure 2.7).

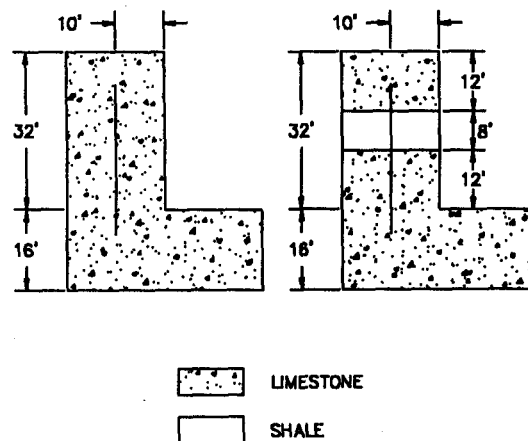
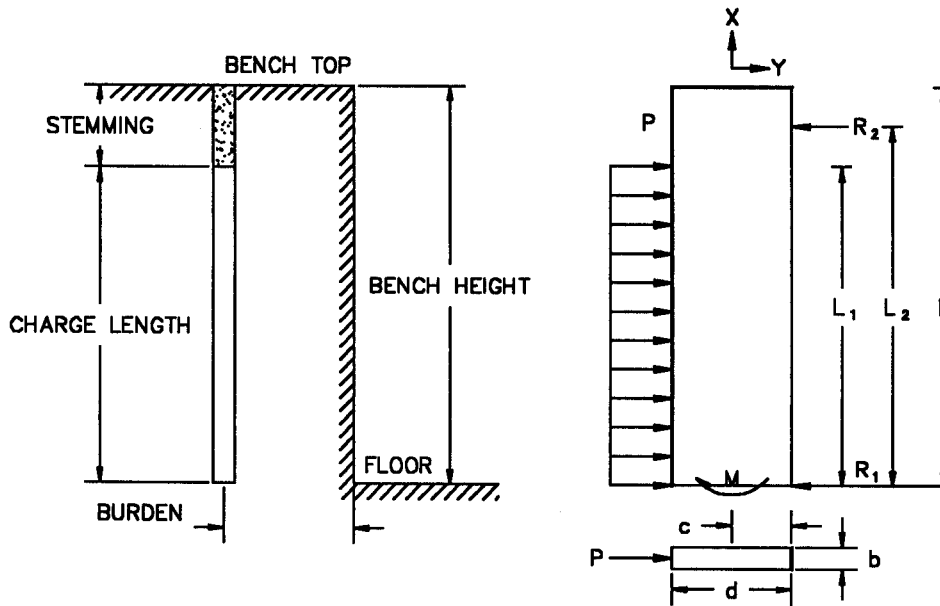


Figure 2.7 Finite Element Model Configuration

## 2.5 BLASTING PARAMETERS

In order to compare the model's behavior with that of actual field results, parameters were chosen so that actual burden movement could be predicted. The model consisted of a single hole, four inches in diameter (Figure 2.8). The burden was fixed at ten feet, stemming and subdrilling were eight feet and four feet respectively and the bench height was varied from twelve to one hundred feet. Therefore, the stiffness ratio (bench height divided by burden) changed from 1.2 to 10. The explosive parameters used in the model were those of ammonium nitrate and fuel oil. The borehole was initially pressurized with explosive gases to 425,000 psi.



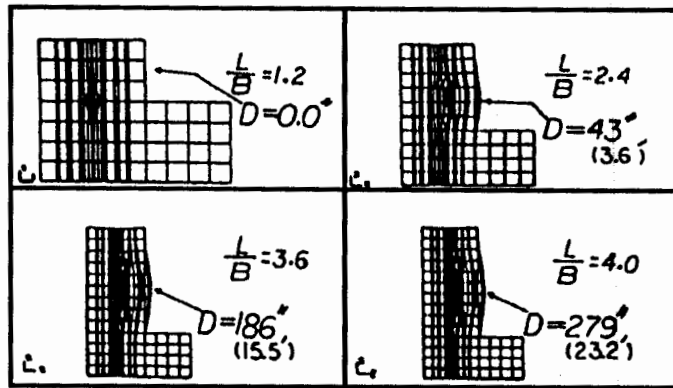
**Figure 2.8** Free Body Diagram for Simulated Condition of Bench Blasting

## 2.6 STIFFNESS ANALYSIS

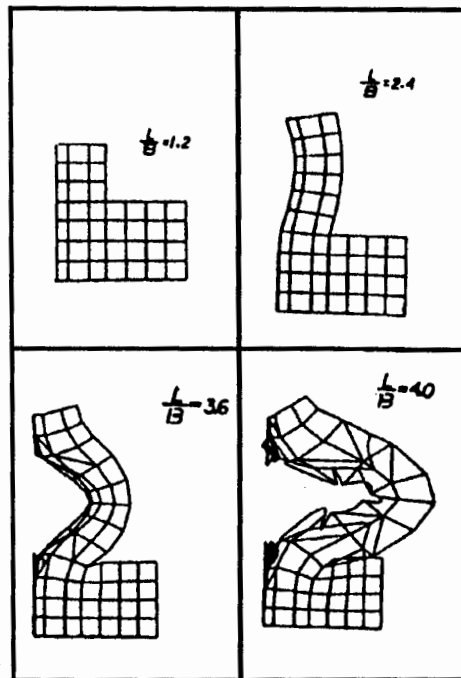
The burden was held constant at 10 feet throughout the analysis, therefore, changes in the stiffness ( $L/B$ ) ratio resulted from varying the bench height. As the  $L/B$  ratio increased from 1.2 to 10, the bench height increased from 12 to 100 feet. Fourteen different models were used for the displacement analysis. Displacements and outer fiber stresses were calculated for nodes, which were located on the face, in the middle of the bench and in the direction of the burden face.



For discussion purposes, four different L/B ratios, 1.2, 2.4, 3.6, and 4.0 will be considered. With an L/B ratio of 1.2, there was no displacement on the face of the shot, instead local crushing occurred around the hole. As the bench height increased and the L/B ratio became 2.4, less local crushing occurred and the model indicated a maximum displacement on the face of the 43 inches. For an L/B ratio of 3.6, the model indicated a displacement of 186 inches and at an L/B ratio of 4.0 and the displacement was 279 inches or 23.2 feet. Figure 2.9 shows the deformed geometry configuration of this model and Figure 2.10 shows scaled displacements.

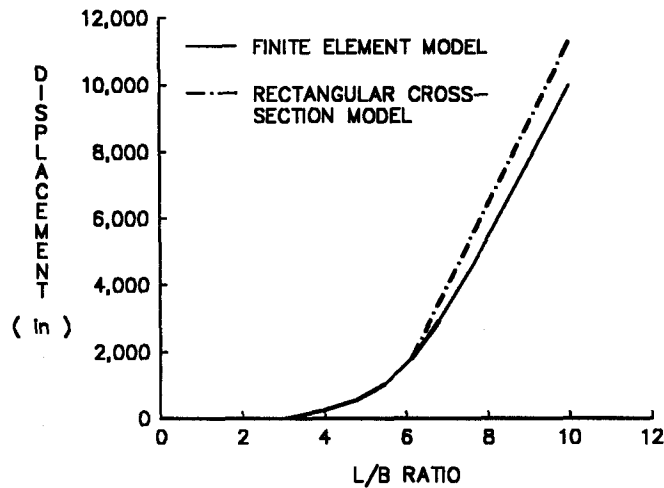


**Figure 2.9** XZ-View of the Deformed Geometry Configuration as L/B Ratio Changes from 1.2 to 4.0



**Figure 2.10** Actual Displacements for XZ View as L/B Changes from 1.2 to 4.0

Further analysis was conducted applying beam bending theory in an effort to quantitatively explain the behavior of burden rock subjected to explosive gas pressure loads. A rectangular cross section was selected having a depth of 120 inches and a width of 1 inch. The beam length would be equivalent to the bench height. The deflection at the middle of the beams were calculated and compared to the results of the finite element model. A close correlation between the finite element model and the rectangular cross section was observed as shown in Figure 2.11.



**Figure 2.11** Comparison Between Calculated Finite Element Displacements and Rectangular Cross-Section Deflections

The graph of L/B ratio vs displacement for both the finite element model and the rectangular cross sectional model produce a better understanding of why this ratio is so important in bench blasting. The graph shows that the displacement increased at a slower rate when L/B ratios varied between 1 and 3.5. At 3.5, there was a distinct change in slope of the curve, which indicated that for the same gas pressure there was additional displacement. When the L/B ratio was greater than 6, there were significant increases in displacement with small changes in the L/B ratio.

Research conducted by Konya in 1967 and empirical data from the field indicate that a practical upper limit for L/B ratio is approximately 4. Above 4, the effects of stiffness are minimal and are no longer considered in field work. In this finite element analysis, the curve made two slope changes, one at approximately 3.5 and the other at 6. In both of these transitional zones, there was a significant increase in displacement for small changes in the L/B ratio.

## 2.7 GEOLOGICAL EFFECTS ON DISPLACEMENT

In order to analyze the significance of beds of different materials on bench blasting, five different models were analyzed using the same finite element model (Figure 2.12). The massive rock was considered to be a sandstone, which was homogeneous isotropic and elastic with a modulus of elasticity of 2.5 x million psi and a Poisson's ratio of 0.27. In addition to this sandstone, two other materials were considered, a limestone rock with a modulus of elasticity of 5.0 million psi and a Poisson's ratio of 0.21. A third material was considered which was a weak shale having a modulus of elasticity of one half million psi and a Poisson's ratio of 0.20. A similar analysis was conducted as previously described using the same burden, stemming, subdrilling and explosive. The difference in this model was that L/B was held at 3.2 which meant that the bench height was 32 feet. All parameters were constant except the composition of the bench itself. Five cases were studied. In Figure 2.13 - Case 1, the shale layer is located between two layers of limestone, representing a condition in which the soft layer is present in the harder rock bench column. The analysis indicated that the middle of the soft layer, at the free face, could be displaced significantly as much as 45 feet.

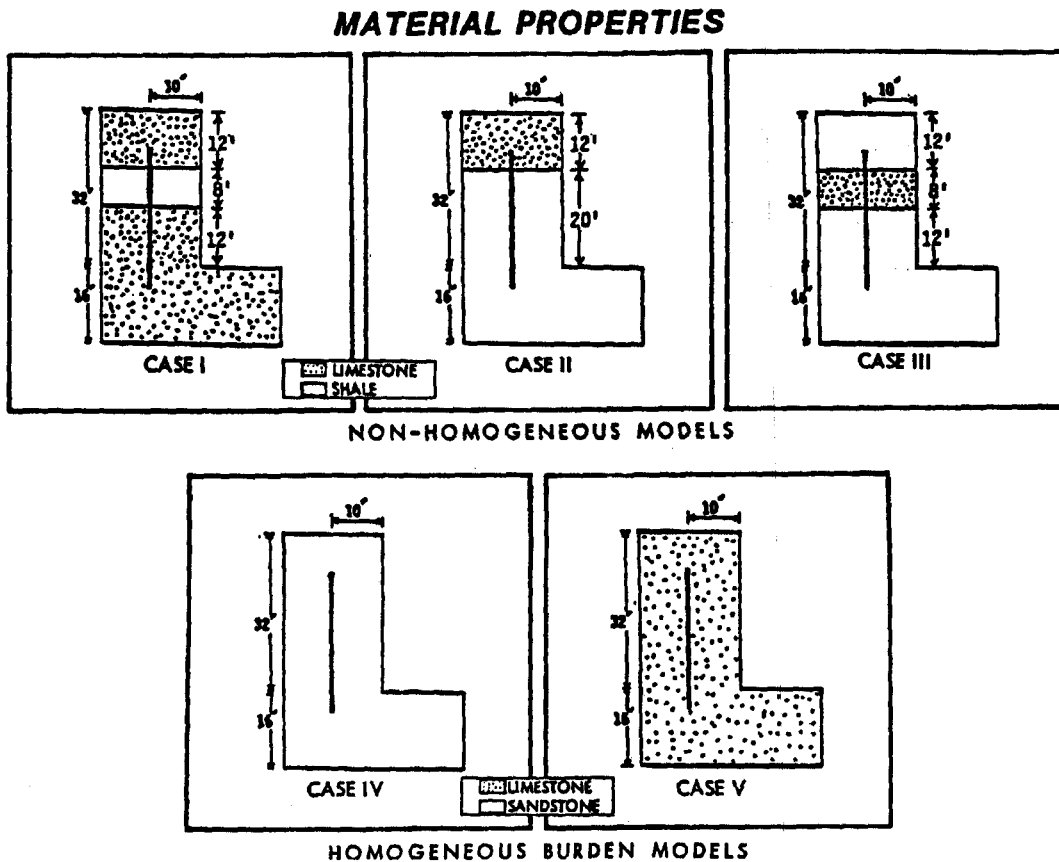
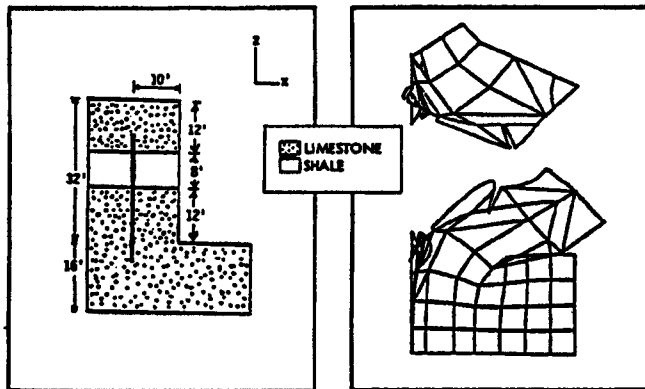


Figure 2.12 Geologic Structure of Models

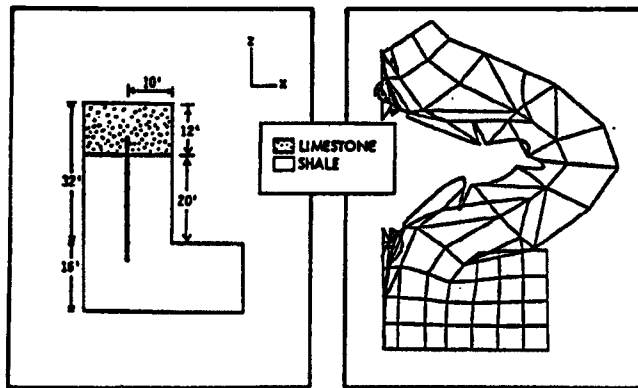
Case 1

**NON-HOMOGENEOUS MODEL**  
**DEFORMED GEOMETRY CONFIGURATION**



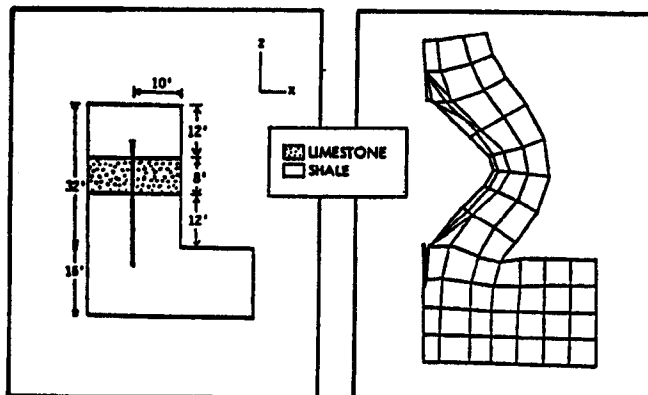
MAXIMUM DISPLACEMENT = 45.4'

Case 2



MAXIMUM DISPLACEMENT = 30.2'

Case 3



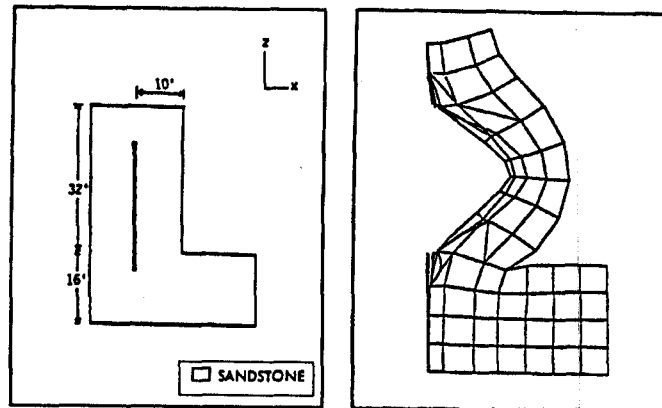
MAXIMUM DISPLACEMENT = 9.2'

Figure 2.13 Deformed Geometry After Blasting

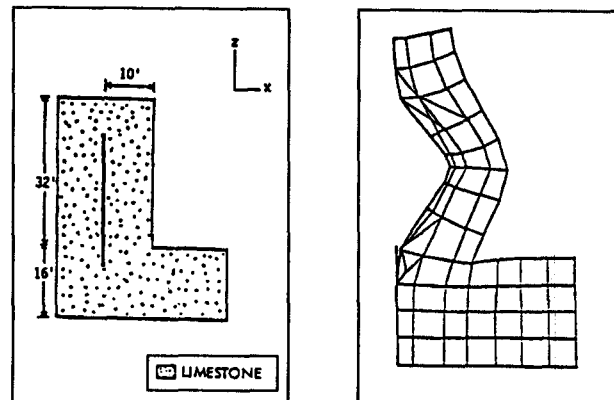
Case 4

**HOMOGENEOUS BURDEN MODEL**

**DEFORMED GEOMETRY CONFIGURATION**



MAXIMUM DISPLACEMENT = 10.1'



MAXIMUM DISPLACEMENT = 6.7'

**Figure 2.13 Continued**

In Case 2, a limestone cap rock was in the collar region of a shale formation. This condition resulted in significantly less burden displacement, only about 30 feet.

Case 3, was a hard limestone layer located in the shale bed, the model showed that the middle of the bench was displaced only 9.2 feet, as shown in Figure 2.13. In other words, the hard rock layer restrained the motion of the center of the bench.

Case 4 consisted of homogeneous materials, solid sandstone and limestone. The limestone model, which had a modulus of elasticity greater than the sandstone, showed less displacement. The results of these analysis further confirm the hypothesis that rock breaks as a result of the gas pressure moving into the radial fractures and causing a burden displacement, and breakage as a result of flexural failure.

## 2.8 FIELD CONSIDERATIONS

For unconfined charges, the shock pressure produces the majority of the breakage. When blasting with boreholes, there are two mechanisms of rock breakage, the radial fracturing and the breakage perpendicular to the axis of the charge by flexural failure. Both are caused by the gas pressure. One practical example follows to illustrate the role of both the shock and gas pressure in rock fragmentation.

If the rock bench, to be blasted, contains a large mud seam which intersects both the face and the borehole, totally different fragmentation would result than if the rock contained no mud seam (Figure 2.14).

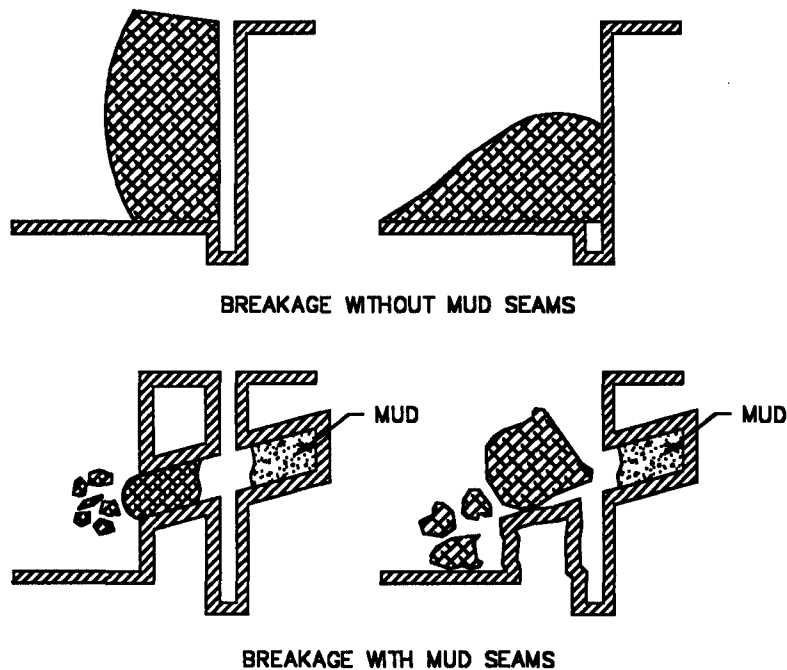


Figure 2.14 Breakage Without and With Mud Seams

When a large mud seam exists and no stemming is used across the seam to confine the gases, little rock fragmentation results. The mud seam would not significantly affect the minor breakage which results from the shock energy. It would, however, allow premature venting of the gases and drastically reduce the gas energy necessary for both radial cracking and flexural failure.

## **2.9 CHAPTER 2 SUMMARY**

Unconfined charges are inefficient since only a small percentage of their energy can be used to break rock. The rock fractures as a result of reflected shock wave.

Confined charges are more efficient and less disturbing than unconfined charges. They produce breakage by three mechanisms, stress wave reflection, radial cracking and flexural failure.

## CHAPTER 3 OBJECTIVES

To examine the characteristics of explosive and understand the factors which effect performance and site specific explosive selection.

To review the generic family of explosives along with their general composition and ingredients.

## CHAPTER 3 SUMMARY

The environmental characteristics, sensitiveness, water resistance, fumes, flammability and temperature resistance and the performance characteristics, sensitivity, velocity, detonation pressure, density, strength and cohesiveness must be considered when selecting commercial explosives for specific applications.

The term commercial explosive covers the generic family of dynamites, blasting agents, slurries and two component explosives.



## CHAPTER 3

### EXPLOSIVE PRODUCTS

#### 3.1 ENVIRONMENTAL CHARACTERISTICS OF EXPLOSIVES

The selection of the type of explosive to be used for a particular task is based on two primary criteria. The explosive must be able to function safely and reliably under the environmental conditions of the proposed use, and the explosive must be the most economical to use to produce the desired end result. Before any blaster selects an explosive to be used for a particular task, one must determine which explosives would best suit the particular environment and the performance characteristics which will suit the economy of the job. Five characteristics are considered in the selection of explosives which concern environmental factors, sensitiveness, water resistance, fumes, flammability and temperature resistance.

##### 3.1.1 SENSITIVENESS

Sensitiveness is the characteristic of an explosive which defines its ability to propagate through the entire length of the column charge and controls the minimum diameter for practical use.

Sensitiveness is measured by determining the explosive's critical diameter. The term critical diameter is commonly used in the industry to define the minimum diameter in which a particular explosive compound will detonate reliably. All explosive compounds have a critical diameter. For some explosive compounds, the critical diameter may be as little as a thousandth of an inch. On the other hand, other compounds may have critical diameters measured in inches. The diameter of the proposed borehole on a particular job will determine the maximum diameter of explosive column. This explosive diameter must be greater than the critical diameter of the explosive to be used in that borehole. Therefore, by preselecting certain borehole sizes, one may eliminate certain explosive products from use on that particular job (Table 3.1).

Sensitiveness is also a measure of the explosive's ability to propagate from cartridge-to-cartridge, assuming the diameter is above critical. It can be expressed as the maximum separation distance (in inches) between a primed donor cartridge and an unprimed receptor cartridge, where detonation transfer will occur.

**TABLE 3.1 SENSITIVENESS (CRITICAL DIAMETER)**

TYPE	CRITICAL DIAMETER		
	< 1 in	1 - 2 in	> 2 in
Granular Dynamite	X	-	-
Gelatine Dynamite	X	-	-
Cartridged Slurry	X	X	X
Bulk Slurry	-	X	X
Air Emplaced ANFO	X	-	-
Poured ANFO	-	X	-
Packaged ANFO	-	X	X
Heavy ANFO	-	-	X

**3.1.2 WATER RESISTANCE**

Water resistance is the ability of an explosive to withstand exposure to water without it suffering detrimental effects in performance. Explosive products have two types of water resistance, internal and external. Internal water resistance is defined as water resistance provided by the explosive composition itself. As an example, some emulsions and water gels can be pumped directly into boreholes filled with water. These explosives displace the water upward, but are not penetrated by the water and show no detrimental effects if fired within a reasonable period of time. External water resistance is provided not by the explosive materials itself, but by the packaging or cartridging into which the material is placed. As an example, ANFO has no internal water resistance yet, if it is placed in a sleeve or in a cartridge within a borehole, it can be kept dry and will perform satisfactorily. The sleeve on a cartridge provides the external water resistance for this particular product.

The effect which water has on explosives is that it can dissolve or leach some of the ingredients, or cool the reaction to such a degree that the ideal products of detonation will not form even though the product is oxygen-balanced. The emission of reddish-brown or yellow fumes from a blast often indicates inefficient detonation reactions frequently caused by water deterioration of the explosive. This condition can be remedied if a more water resistant explosive or better external packaging is used.

Manufacturers can describe the water resistance of a product in two different ways. One way would be using terms such as excellent, good, fair, or poor (Table 3.2). When water is encountered in blasting operations, the explosive with at least a fair water resistance rating should be selected and this explosive should be detonated as soon as possible after loading. If the explosive is to be in water for an appreciable amount of time, it is advisable to select an explosive with at least a good water resistance rating. If water conditions are severe and the exposure time is significant, the prudent blaster may select an explosive with an excellent water resistance rating. Explosives with a poor water resistance rating should not be used in wet blastholes.

**TABLE 3.2 WATER RESISTANCE**

<b>TYPE</b>	<b>RESISTANCE</b>
Granular Dynamite	Poor to good
Gelatin Dynamite	Good to excellent
Cartridged Slurry	Very good
Bulk Slurry	Very good
Air Emplaced ANFO	Poor
Poured ANFO	Poor
Packaged ANFO	Very good *
Heavy ANFO	Poor to very good

\* Becomes poor if package is broken

Water resistance ratings have also been given numbers, such as a Class 1 water resistance would indicate 72 hours of exposure to water with no detrimental effects; Class 2 - 48 hours, Class 3 - 24 hours, and Class 4 - 12 hours. The descriptive method of rating water resistance is the one commonly seen on explosive data sheets. In general, product price is related to water resistance. The more water resistant the product, the higher the cost.

The ability to remain unaffected by high static pressures is defined as water pressure tolerance. Some explosive compounds are densified and desensitized by hydrostatic pressures which result in deep boreholes. Combinations of factors such as cold weather and small primers will contribute to failure. Under these conditions, energy release may be minimal. Problems with water pressure tolerance most often occur with slurry and heavy ANFO.

### **3.1.3 FUMES**

The fume class of an explosive is the measure of the amount of toxic gases produced in the detonation process. Carbon monoxide and oxides of nitrogen are the primary gases that are considered in the fume class ratings. Although most commercial blasting agents are near oxygen-balanced to minimize fumes and optimize energy release, fumes will occur and the blaster should be aware of their production. In underground mining or construction applications, the problems which can result from producing fumes with inadequate ventilation is obvious. It should be pointed out that in surface operations, especially in deep cuts or trenches, fume production and retention can be hazardous to the personnel on the job. Certain blasting conditions may produce toxic fumes even when the explosive is oxygen balanced. Some conditions which can cause toxic fume production are insufficient charge diameter, inadequate water resistance, inadequate priming and premature loss of confinement.

The Institute of Makers of Explosives have adopted a method of rating fumes. The test is conducted by the Bichel Gauge method. The number of cubic feet of poisonous gases released per 200 grams of explosives is measured. If less than 0.16 cubic feet of toxic fumes are produced per 200 grams of explosives, the fume class rating would be 1. If 0.16 to 0.33 cubic feet of poisonous gases are produced, the fume class rating is 2, and if 0.33 to 0.67 cubic feet of poisonous gases are produced, the fume class rating is 3. Typical products are qualitatively rated in Table 3.3.

**TABLE 3.3 FUME QUALITY**

TYPE	RESISTANCE
Granular Dynamite	Poor to good
Gelatin Dynamite	Fair to very good
Cartridged Slurry	Good to very good
Bulk Slurry	Fair to very good
Air Emplaced ANFO	Good *
Poured ANFO	Good *
Packaged ANFO	Good to very good
Heavy ANFO	Good*

\* Can be poor under adverse conditions

Strictly speaking, carbon dioxide is not a fume since it is not a toxic gas in its own right, however, many deaths have occurred over the years due to the generation of large amounts of carbon dioxide during blasting in confined areas. Although carbon dioxide is not poisonous, it is produced in large quantities in most blasts and it has the effect of causing the involuntary muscles of the body to stop working. In other words, the heart and lungs would stop working if one was placed in high concentrations of carbon dioxide. If concentrations are 18% or higher in volume, death can occur by suffocation. An additional problem with carbon dioxide is that it has a density of 1.53 as compared to air and it would tend to pocket in low places in the excavation or where there is little movement. A simple solution to the problem is to use compressed air to dilute any possible high concentrations in depressions of trenches.

### **3.1.4 FLAMMABILITY**

The flammability of an explosive is defined as the characteristic which deals with the ease of initiation from spark, fire or flame. Some explosive compounds will explode from just a spark while others can be burned and will not detonate. Flammability is important for the storage, transportation and use standpoint. Some explosives, although very economical, have lost their marketability due to flammability. A good example is LOX, liquid oxygen and carbon, which was used in the 1950's as a blasting agent. Its flammability and inherent safety problems caused its demise. Most explosive compounds used today are not anywhere near as flammable as LOX, however, accidents still occur due to flammability.

Over the past two decades, explosive products, in general, have become less flammable. Some manufacturers indicate that certain products can be burned without detonation in quantities as large as 40,000 lbs. The problem results because many blasters are given a false sense of security. Some believe that all products today are relatively inflammable. This false sense of security has led to the death of people who have been careless with explosives and have assumed that flammability is not a problem. All explosive compounds should be treated as highly flammable. There should not be smoking during the loading process, and if the explosives are to be destroyed by burning, the guidelines produced by the IME should be followed regardless of the type of explosive involved.

### 3.1.5 TEMPERATURE RESISTANCE

Explosive compounds can suffer in performance if stored under extremely hot or cold conditions (Table 3.4). Under hot storage conditions, above 90 degrees Fahrenheit, many compounds will slowly decompose or change properties and shelf life will be decreased. Storage of ammonium nitrate blasting agents in temperatures above 90 degrees Fahrenheit can result in cycling, which will effect the performance and safety of the product.

**TABLE 3.4 TEMPERATURE RESISTANCE**

TYPE	BETWEEN 0°F - 100°F
Granular Dynamite	Good
Gelatin Dynamite	Good
Cartridged Slurry	Poor below 40°F
Bulk Slurry	Poor below 40°F
Air Emplaced ANFO	Poor above 90°F
Poured ANFO	Poor above 90°F
Packaged ANFO	Poor above 90°F
Heavy ANFO	Poor below 40°F

#### 3.1.5.1 THE CYCLING OF AMMONIUM NITRATE

The chemical formula for ammonium nitrate is  $\text{NH}_4\text{NO}_3$  or more simply written  $\text{N}_2\text{H}_4\text{O}_3$ . For its weight, it supplies more gas volume upon detonation than any other explosive. In pure form, ammonium nitrate (AN) is almost inert and is composed of 60% oxygen by weight, 33% nitrogen, and 7% hydrogen. With the addition of fuel oil, the ideal oxygen balanced reactions for  $\text{NH}_4\text{NO}_3$  is:



Two characteristics make this compound both unpredictable and dangerous. Ammonium nitrate is water soluble and if uncoated can attract water from the atmosphere and slowly dissolve itself. For this reason, the spherical particles, prills, have a protective coating of silica flour ( $\text{SiO}_2$ ), which offers some amount of water resistance. The second and most important characteristic is a phenomena called cycling. Cycling is the ability of a material to change its crystal form with temperature. Ammonium nitrate will have one of the five crystal forms depending on temperature.

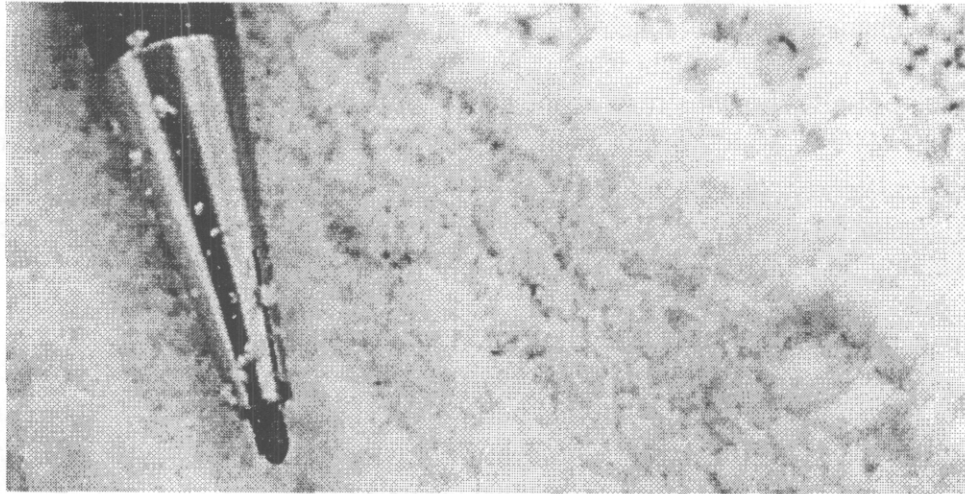
1. Above  $257^\circ\text{F}$  cubic crystals exist.
2. Above  $184^\circ\text{F}$  and below  $257^\circ\text{F}$  tetragonal crystals exist.
3. Above  $90^\circ\text{F}$  and below  $184^\circ\text{F}$  orthorhombic crystals exist.
4. Above  $0^\circ\text{F}$  and below  $90^\circ\text{F}$  pseudotetragonal crystals exist.
5. Below  $0^\circ\text{F}$  tetragonal crystals exist.

The cycling phenomena can seriously effect both the storage and performance of any explosive which contains ammonium nitrate. Most dynamites, both regular NG or permissibles, contain some percentages of AN while blasting agents are composed almost totally of this compound. The two temperatures at which cycling will occur under normal conditions are  $0^\circ\text{F}$  and  $90^\circ\text{F}$ . This is to say that products which are stored over the winter or for a period of time during the summer most likely will undergo some amount of cycling. During the summer in a poorly ventilated powder magazine or storage bin located in the sun, the cycling temperature may be reached daily. The effect of cycling on AN when isolated from the humidity in the air is that the prills break down into finer and finer particles.

The prills are made up of pseudotetragonal crystals. When the temperature exceeds  $90^\circ\text{F}$ , each crystal breaks into smaller crystals of orthorhombic structure. When the temperature again falls below  $90^\circ\text{F}$ , the small crystals break into even finer crystals of the pseudotetragonal form. This process can continue until the density is no longer near  $0.8 \text{ g/cm}^3$ , but can reach a density near  $1.2 \text{ g/cm}^3$ . The density increase can make the product more sensitive and contain more energy per unit volume.

To further complicate the situation, some cartridge blasting agents or those stored in bins may not efficiently exclude humidity. After the AN has undergone cycling, the water-resistant coating is broken and the water vapor in the air condenses on the particles. As cycling continues water collects on the particles and the mass starts to dissolve (Figure 3.1). Recrystalizing into large crystals can occur with a reduction of temperature.

Therefore, it is evident that a volume of AN after cycling may have very dense areas and areas of large crystals. The performance of this product may range from that of a very powerful explosive to one that deflagrates or one that will not shoot at all.



**Figure 3.1** Cycled Prill

#### **3.1.5.2 COLD RESISTANCE**

Extreme cold conditions can also effect the performance of products. Most dynamites and blasting agents will not freeze under ordinary exposure under the lowest temperature encountered in the country. This is because the manufacturers have added ingredients to these products which allow them to perform properly, in spite of the cold weather. Some products may tend to stiffen and become firm after prolonged exposure to low temperatures and may become more difficult to use in the field.

Slurry explosives, which include water gel and emulsions, can have serious detonation problems if stored in cold temperatures and not allowed to warm up before they are detonated. Slurries are quite different from the other products previously mentioned, such as dynamite and blasting agents. The problem comes about because in the past the blaster has been accustomed to using blasting agents from any manufacturer without having any problems due to cold weather. The blaster also has become accustomed to using dynamites from any manufacturer with good results. Today the slurry explosives do not all perform identically. Some can be used immediately if stored at temperatures below zero where others will not detonate if stored at temperatures below 40°F. The sensitivity of the product can become affected. The priming procedure, which was employed when the produce was stored at 70°F, may cause a misfire if the product is stored at 42°F. It is a good practice to consult the manufacturer's data sheet whenever any new product is introduced on the job, but it is absolutely essential to consult that data sheet if any new slurry explosives are introduced, since their properties and performance with temperatures can vary greatly (Figure 3.2).

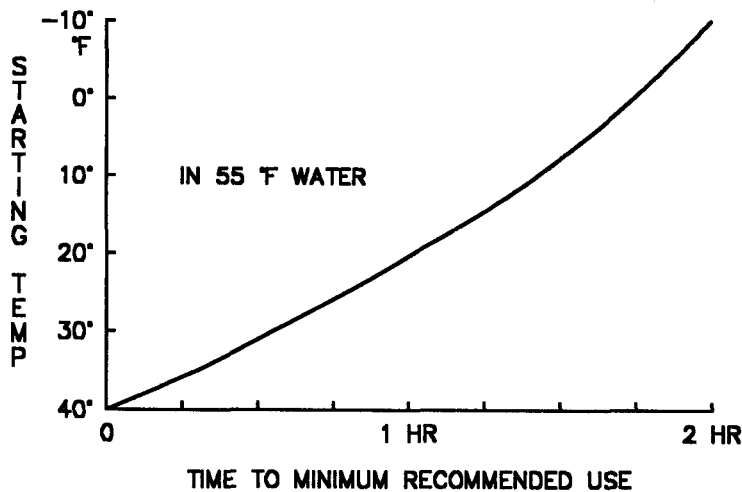


Figure 3.2 Slurry Warm Up Chart

## 3.2 PERFORMANCE CHARACTERISTICS OF EXPLOSIVES

In the explosive selection process, the environmental conditions can eliminate certain types of explosives from consideration on a particular project. After the environmental conditions have been considered, one must consider the performance characteristics of explosives. Characteristics of main concern are sensitivity, velocity, density, strength and cohesiveness.

### 3.2.1 SENSITIVITY

The sensitivity of an explosive product is defined by the amount of input energy necessary to cause the product to detonate reliably. This is sometimes called the minimum booster rating or minimum priming requirements. Some explosives require little energy to detonate reliably. The standard number 8 blasting cap will detonate in dynamite and some of the cap sensitive slurry explosives. On the other hand, a blasting cap alone will not initiate bulk loaded ANFO and slurry. For reliable detonation, one would have to use a booster or primer in conjunction with the blasting cap.

Many factors can influence the sensitivity of a product. As an example, the sensitivity can be reduced by the effect of water in the blasthole, inadequate charge diameter and temperature extremes. Sensitivity of a product defines its priming requirements, the primer size and energy output. If reliable detonation of the main charge does not occur, fumes can increase, ground vibration levels can rise, blastholes can geyser and flyrock can be thrown. Hazard sensitivity defines an explosive's response to the accidental addition of energy, such as bullet impact (Table 3.5).



**TABLE 3.5 SENSITIVITY**

TYPE	HAZARD SENSITIVITY	PERFORMANCE SENSITIVITY
Granular Dynamite	Moderate to high	Excellent
Gelatin Dynamite	Moderate	Excellent
Cartridged Slurry	Low	Good to very good
Bulk Slurry	Low	Good to very good
Air Emplaced ANFO	Low	Poor to good *
Poured ANFO	Low	Poor to good *
Packaged ANFO	Low	Good to very good
Heavy ANFO	Low	Poor to good*

\* Heavily dependent on field condition

**3.2.2 VELOCITY**

The detonation velocity is the speed at which the reaction moves through the column of explosive. It ranges from 5,000 to 25,000 ft/s for commercially used products. Detonation velocity is an important consideration for applications outside a borehole, such as plaster shooting, mud capping or shearing structural members. Detonation velocity has significantly less importance if the explosives are used in the borehole.

Detonation velocity can be used as a tool to determine the efficiency of the explosive reaction in field use. If a question arises as to performance of an explosive compound during actual field use, velocity probes can be inserted in the product. When the product is detonated, the reaction rate of the product can be measured and its performance judged by the recorded velocity. If the product is shooting at a velocity significantly lower than its rated velocity, it is an indication that its performance is not up to standard expectations. Typical explosive detonation velocities are given in Table 3.6.

**TABLE 3.6 DETONATION VELOCITY (ft/s)**

TYPE	DIAMETER		
	1.25 in	3 in	9 in
Granular Dynamite	7000 - 19000		
Gelatin Dynamite	12000 - 25000		
Cartridge Slurry	13000 - 15000	14000 - 16000	
Bulk Slurry		14000 - 16000	12000 - 19000
Air Emplaced ANFO	7000 - 10000	12000 - 13000	14000 - 15000
Poured ANFO	6000 - 7000	10000 - 11000	14000 - 15000
Packaged ANFO		10000 - 12000	14000 - 15000
Heavy ANFO			11000 - 19000

### 3.2.3 DETONATION PRESSURE

The detonation pressure is the near instantaneous pressure derived from the shock wave moving through the explosive compound (Table 3.7). When initiating one explosive with another, the shock pressure from the primary explosive is used to cause initiation in the secondary explosive. Detonation pressure can be related to borehole pressure but it is not necessarily a linear relationship. Two explosives with similar detonation pressures will not necessarily have equal borehole pressure or gas pressure. Detonation pressure is calculated mathematically.

TABLE 3.7 DETONATION PRESSURE

TYPE	DETONATION PRESSURE (kbar)
Granular Dynamite	20 - 70
Gelatin Dynamite	70 - 140
Cartridged Slurry	20 - 100
Bulk Slurry	20 - 100
Poured ANFO	7 - 45
Packaged ANFO	20 - 60
Heavy ANFO	20 - 90

The detonation pressure is related to the density of the explosive and the reaction velocity. When selecting explosives for primers, detonation pressure is an important consideration. Methods to approximate detonation pressure and their relationship to priming will be discussed in Chapter 5, Primer and Booster Selection.

### 3.2.4 DENSITY

The density of an explosive is important because explosives are purchased, stored and used on a weight basis. Density is normally expressed in terms of specific gravity, which is the ratio of explosive density to water density. The density of an explosive determines the weight of explosive that can be loaded into a specific borehole diameter. On a weight basis, there is not a great deal of difference in energy between various explosives. The difference in energy on a unit weight basis is nowhere near as great as the difference in energy on a volume basis. When hard rock is encountered and drilling is expensive, a denser product of higher cost is often justified. Typical specific gravity values for explosive products are given in Table 3.8.

TABLE 3.8 DENSITY

TYPE	SPECIFIC GRAVITY (g/cm <sup>3</sup> )
Granular Dynamite	0.8 - 1.4
Gelatin Dynamite	1.0 - 1.7
Cartridged Slurry	1.1 - 1.3
Bulk Slurry	1.1 - 1.6
Air Emplaced ANFO	0.8 - 1.0
Poured ANFO	0.8 - 0.9
Packaged ANFO	1.1 - 1.2
Heavy ANFO	1.1 - 1.4

The specific gravity of the explosive is commonly used as a tool to approximate strength and design parameters between explosives of different manufacturers and different generic families. In general terms, the higher the explosive density, the more energetic the product. A useful expression of density is what is commonly called loading density or the weight of explosive per foot of charge at specified diameter. Loading density is used to determine the total pounds of explosive which will be used per borehole and per blast. The specific gravity of commercial products range from about 0.8 to 1.6

An easy method to calculate loading density is:

$$d_e = 0.34 \times SG_e \times D_e^2 \quad (3.1)$$

where:

- $d_e$  = Loading density (lbs/ft)
- $SG_e$  = Specific gravity of the explosive (g/cm<sup>3</sup>)
- $D_e$  = Diameter of explosive (in)

Determine the loading density of an explosive which has a charge diameter of 3 inches and a specific gravity of 1.2.

$$d_e = 0.34 \times SG_e \times D_e^2$$

$$d_e = 0.34 \times 1.2 \times 32$$

$$d_e = 3.67 \text{ lbs/ft}$$

### **3.2.5 STRENGTH**

Strength refers to the energy content of an explosive which in turn is the measure of the force it can develop and its ability to do work. Strength has been rated by various manufacturers, both on an equal weight and an equal volume basis, and are commonly called weight strength and cartridge or bulk strength. There is no standard strength measurement method universally used by the explosives manufacturers. Instead many different strength measurement methods exist such as the ballistic mortar test, seismic execution values, strain pulse measurement, cratering, calculation of detonation pressures, calculation of borehole pressures, and determination of heat release. However, none of these methods can be used satisfactorily for blast design purposes. Strength ratings are misleading and do not accurately compare rock fragmentation effectiveness with explosive type. In general, one can say that strength ratings are only a tool used to identify the end results and associate them with a specific product.

One type of strength rating, the underwater shock and bubble energy test used to determine the shock energy and the expanding gas energy, is used by some for design purposes. As an example, the bubble energy test used does produce reliable results which can be used for approximating blast design dimensions.

### **3.2.6 COHESIVENESS**

Cohesiveness is defined as the ability of the explosive to maintain its original shape. There are times when explosive must maintain its original shape and others when it should flow freely. For example, when blasting in cracked or broken ground, one definitely wants to use an explosive which will not flow into the cracked area causing holes to be overloaded. Conversely, in other applications such as in bulk loading, explosives should flow freely and not bridge the borehole nor form gaps in the explosive column.

## **3.3 COMMERCIAL EXPLOSIVES**

The products used as the main borehole charge can be broken into three generic categories, dynamite, slurries, and blasting agents (Figure 3.3). A fourth, very minor, category will be added to the discussion which is the binary or two component explosives. Although the volume of binary explosives sold annually is insignificant when compared to the other major generic categories, its unique properties warrants its mention.

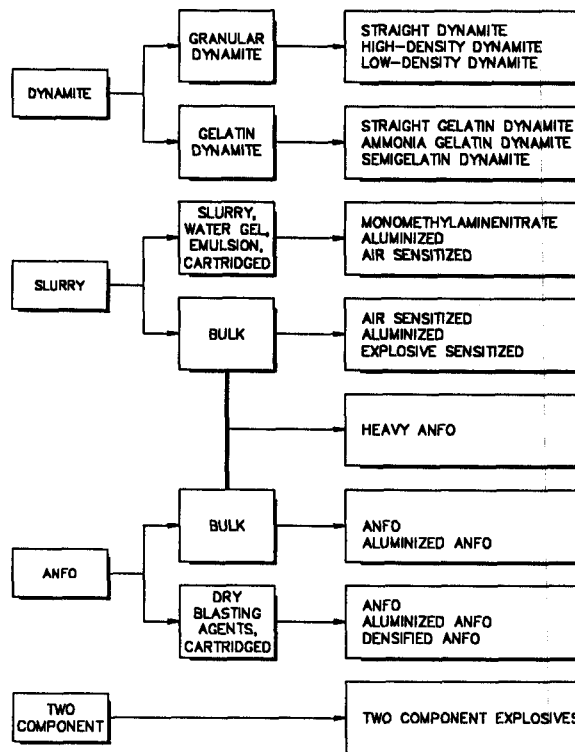


Figure 3.3 Types of Explosives

All the generic categories discussed in this section are high explosives from the standpoint that they will all detonate. On the other hand, one commonly hears some of these high explosives called by other terms such as blasting agents. The term blasting agent does not detract from an explosive's ability to detonate or function as a high explosive. The term blasting agent is a classification considered from the standpoint of storage and transportation. Explosives which are blasting agents are less sensitive to initiation and therefore can be stored and transported under different regulations than what would normally be used for more sensitive high explosives. The term high explosive refers to any product used in blasting that is cap sensitive and that reacts at a speed faster than the speed of sound in the explosive media. The reaction must be accompanied by a shock wave for it to be considered a high explosive.

Blasting agents, a subclass of high explosives, is a material or mixture which consists of a fuel and an oxidizer. The finished product, as mixed and package for shipping, cannot be detonated by a number 8 blasting cap in a specific test described by the Bureau of Mines. Normally, blasting agents do not contain ingredients which in themselves are high explosives. Some slurries containing TNT, smokeless powder or other high explosive ingredients can be classed as a blasting agent if they are insensitive to initiation by a number 8 blasting cap (Figure 3.3).

### 3.3.1 DYNAMITE

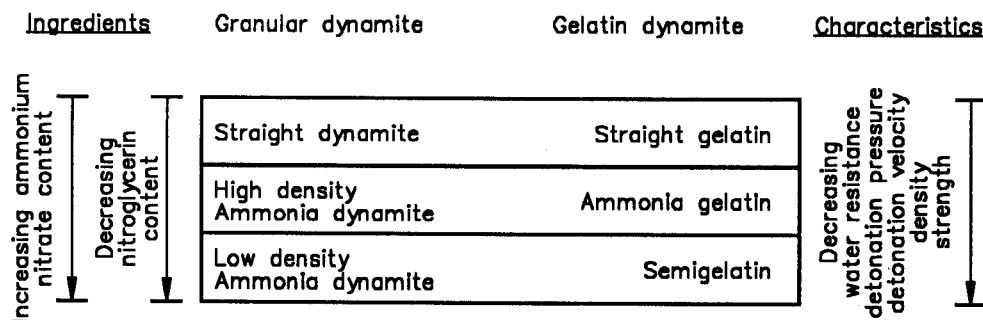
Most dynamites are nitroglycerin based products. A few manufacturers of dynamite have products in which they substituted non-headache producing high explosives such as nitrostarch for the nitroglycerin. Dynamites are the most sensitive of all the generic classes of explosives used today. Because of the sensitivity, they offer an extra margin of dependability in the blasthole since gaps in loading within the explosive column and many other environmental factors which cause other explosives to malfunction would not affect dynamite. Of course, it is true that dynamite is somewhat more susceptible to accidental initiation because of the sensitivity. Operators must decide which of these properties is most important to them when making their explosive selections.

Nitroglycerin was the first high explosive used in commercial blasting. It has a specific gravity of 1.6 and detonation velocity of approximately 25,000 ft/s. Nitroglycerin is extremely sensitive to shock, friction and heat, which makes its use in liquid form extremely hazardous. In Sweden in 1865, Nobel found that if this hazardous liquid was absorbed into an inert material, the resulting product would be safe to handle and would be much less sensitive to shock, friction and heat. This product was called dynamite.

Within the dynamite family, there are two major subclassifications, granular dynamite and gelatin dynamite. Granular dynamite is a compound which uses nitroglycerin as the explosive base. Gelatin dynamite is a mixture of nitroglycerin and nitrocellulose which produces a rubbery waterproof compound.

#### 3.3.1.1 GRANULAR DYNAMITE

Under the granular dynamites, there are three subclassifications which are straight dynamite, high density extra dynamite and low density extra dynamite (Figure 3.4).



**Figure 3.4** Characteristics of Dynamite

### **3.3.1.2 STRAIGHT DYNAMITE**

Straight dynamite consists of nitroglycerin, sodium nitrate, carbonaceous fuels, sulfur and antacids. The term straight means that a dynamite contains no ammonium nitrate. Straight dynamite is the most sensitive commercial high explosive in use today. It should not be used for construction applications since its sensitivity to shock could result in sympathetic detonation from adjacent holes, firing on an earlier delay. On the other hand, straight dynamite is an extremely valuable product for dirt ditching. The sympathetic detonation previously discussed is an attribute in ditching because it eliminates the need for a detonator in each and every hole. In ditching applications, normally one detonator is used in the first hole and all other holes fired by sympathetic detonation. Although ditching dynamite is more costly than other types of dynamite, for ditching applications it can save a considerable amount of money and time since the charges need no initiator and no hookup of initiation system is required.

### **3.3.1.3 HIGH DENSITY EXTRA DYNAMITE**

This product is the most widely used dynamite. It is similar to straight dynamite except that some of the nitroglycerin and sodium nitrate is replaced with ammonium nitrate. The ammonia or extra dynamite is less sensitive to shock and friction than the straight dynamite. It has found broad use in all applications, quarries, underground mines and construction.

### **3.3.1.4 LOW DENSITY EXTRA DYNAMITE**

Low density extra dynamites are similar in composition to the high density products except that more nitroglycerin and sodium nitrate is replaced with ammonium nitrate. Since the cartridge contains a large proportion of ammonium nitrate, its bulk or volume strength is relatively low. This product is useful in soft rock or where a deliberate attempt is made to limit the energy placed into the blasthole.

## **3.3.2 GELATIN DYNAMITE**

Gelatin dynamite, used in commercial applications, can be broken into three subclasses, straight gelatin, ammonia gelatin and semigelatin dynamites.

### **3.3.2.1 STRAIGHT GELATIN DYNAMITE**

Straight gelatins are basically blasting gels with additional sodium nitrate, carbonaceous fuel and sometimes sulfur added. In strength, it is the gelatinous equivalent of straight dynamite. A straight blasting gelatin is the most powerful nitroglycerin-based explosive. A straight gel, because of its composition, would also be the most waterproof dynamite.

### 3.3.2.2 AMMONIA GELATIN DYNAMITE

Ammonia gelatin is sometimes called special or extra gelatin. It is a mixture of straight gelatin with additional ammonium nitrate added to replace some of the nitroglycerin and sodium nitrate. Ammonia gels are suitable for wet conditions and are primarily used as bottom loads in small diameter blastholes. Ammonia gelatins do not have the water resistance of a straight gel. Ammonia gels are often used as primers for blasting agents.

### 3.3.2.3 SEMIGELATIN DYNAMITE

Semigelatin dynamites are similar in some respects to ammonia gels except that more of the nitroglycerin, nitrocellulose mixture and sodium nitrate is replaced by ammonium nitrate. Semigelatin dynamites are less water resistant than the ammonium gels and more economical because of their lower costs. Because of their gelatinous nature, they do have more water resistance than many of the granular dynamites and are often used under wet conditions and sometimes used as primers for blasting agents.

### 3.3.3 SLURRY EXPLOSIVES

A slurry explosive is a mixture of ammonium nitrate or other nitrates and a fuel sensitizer which can either be a hydrocarbon or hydrocarbons and aluminum. In some cases explosive sensitizers, such as TNT or nitrocellulose, along with varying amounts of water are used (Figure 3.5). An emulsion is somewhat different from a water gel or slurry in characteristics, but the composition contains similar ingredients and functions similarly in the blasthole (Figure 3.6). In general, emulsions have a somewhat higher detonation velocity and in some cases, may tend to be wet or adhere to the blasthole causing difficulties in bulk loading. For discussion purposes, emulsions and water gels will be treated under the generic family of slurries.

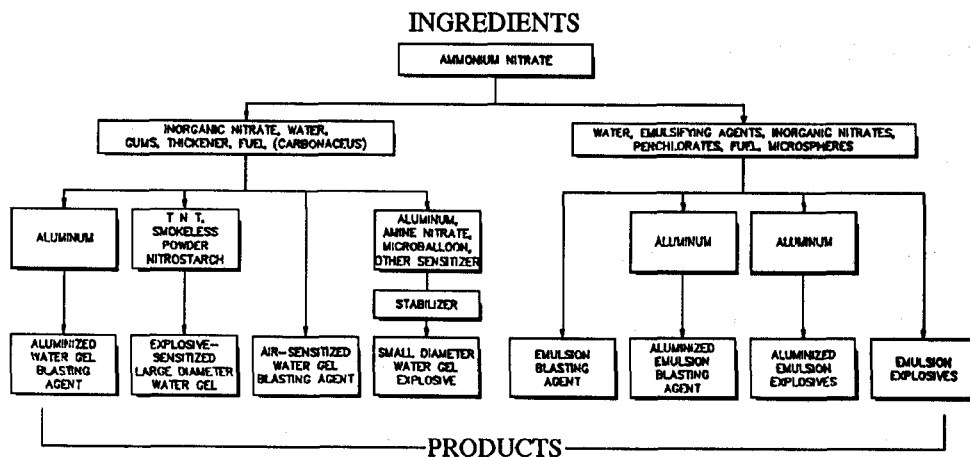
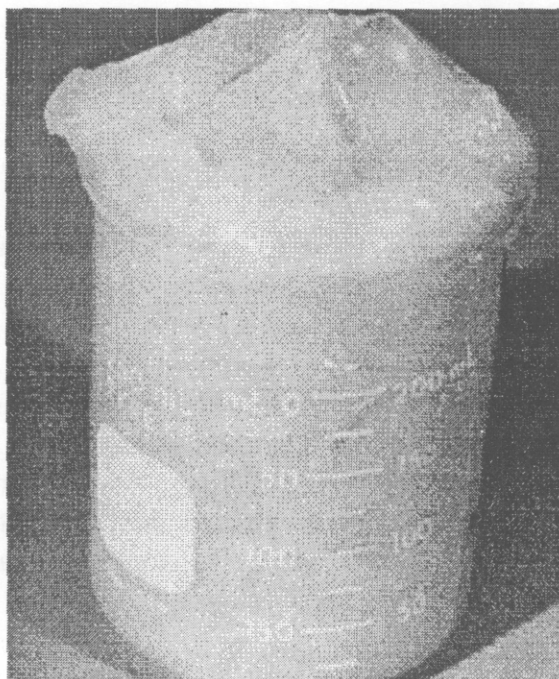


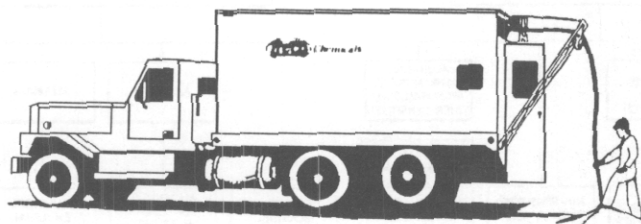
Figure 3.5 Slurry Formulations





**Figure 3.6** Emulsion Explosives

Slurries, in general, contain larger amounts of ammonium nitrate and are made water-resistant through the use of gum, waxes, cross linking agents or emulsifiers. A number of varieties of slurries exist, and it must be remembered that different slurries will exhibit different characteristics in the field. Some slurries may be classified as high explosives while others are classified as blasting agents since they are not sensitive to a number 8 blasting cap. This difference in classification is important from the standpoint of magazine storage. An added advantage to slurries over dynamites is that they can be delivered as separate ingredients for on-site mixing. The separate ingredients brought to the job site in large tank trucks is non-explosive until mixed at the blasthole. The bulk loading of slurries can greatly reduce the time and cost of loading large quantities of explosives (Figure 3.7). Slurries can be broken down into two general classifications, cartridge and bulk.



**Figure 3.7** Slurry Bulk Loading Truck

### 3.3.3.1 CARTRIDGED SLURRIES

Cartridge slurries come in both large and small diameter cartridges. In general, cartridges less than two inches in diameter are normally made cap-sensitive so that they can be substituted for dynamite. The temperature sensitivity of slurries and their lower sensitivity can cause problems when substituted for some dynamite applications. The blaster must be aware of some of the limitations before he tries a one-for-one substitution. The larger diameter cartridge slurries may not be cap-sensitive and must be primed with cap-sensitive explosives. In general, large diameter slurries are the least sensitive. Cartridge slurries are normally sensitized with monometholamine nitrate or aluminum, and air sensitized in the case of emulsions. Air sensitizing is accomplished by the addition of microspheres or entrapping air during the mixing process itself.

### 3.3.3.2 BULK SLURRIES

Bulk slurries are sensitized by one of three methods. Air sensitizing can be accomplished by the addition of gassing agents which after being pumped into the blasthole produce small gas bubbles throughout the mixture. The addition of powdered or scrap grade aluminum to the mixture also increases sensitivity. The addition of nitrocellulose or TNT to the mixture will sensitize it to initiation. Slurries containing neither aluminum nor explosive sensitizers are the cheapest. They are often the least dense and the least powerful. In wet conditions where dewatering is not practiced, low cost slurries offer competition to ANFO. It should be pointed out that these low cost slurries have less energy than ANFO. Aluminized slurries and those containing significant amounts of other high explosive sensitizers produce significantly more energy and are used for blasting harder dense rock. The alternative to using high energy slurries is pumping blastholes, where possible, with submersible blasthole pumps (Figure 3.8) and using polyethylene blasthole liners within the hole with ammonium nitrate as the explosive (Figure 3.9). In most applications, the use of pumping with sleeves and ammonium nitrate will produce blasting costs which are significantly less than would result from using the higher priced slurries. These supplies are available from many explosive distributors.



**Figure 3.8** Pumping Blastholes

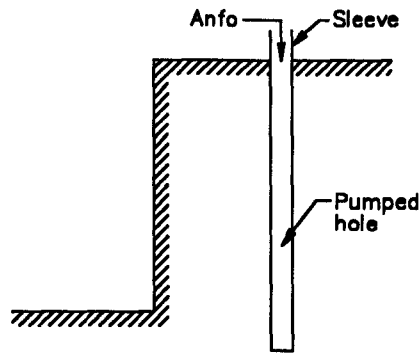


Figure 3.9 Sleeves with ANFO

### 3.4 DRY BLASTING AGENTS

Dry blasting agents are the most common of all explosives used today. Approximately 80% of the explosives used in this country are dry blasting agents. The term dry blasting agent describes any material in which no water is used in the formulation. Early dry blasting agents employed fuels of solid carbon or coal combined with ammonium nitrate in various forms. Through experimentation, it was found that solid fuels tend to segregate in transportation and provide less than optimum blasting results. It was found that diesel oil mixed with porous ammonium nitrate prills gave the best overall blasting results. The term ANFO (ammonium nitrate and fuel oil) has become synonymous with dry blasting agents. An oxygen balanced mixture of ANFO is the cheapest source of explosive energy available today (Figure 3.10). Adding finely divided aluminum to dry blasting agents increases the energy output and also increases cost. Dry blasting agents can be broken down into two categories, cartridge and bulk.

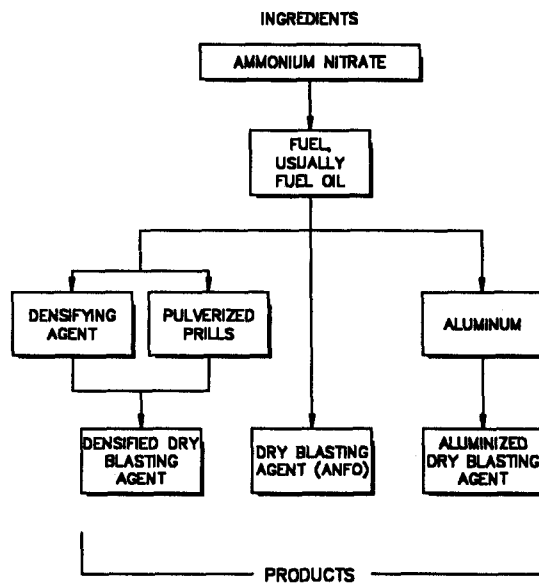


Figure 3.10 Blasting Agent Formulations

### 3.4.1 CARTRIDGED BLASTING AGENTS

For wet hole use, where blastholes are not pumped, an aluminized or densified ANFO cartridge can be used (Figure 3.11). Densified ANFO is made by either crushing approximately 20% of the prills and adding them back into the normal prill mixture or by adding iron compounds to increase the density of the cartridge. In both cases, the object is to produce an explosive with a density greater than one so that it will sink in water. Another type of ANFO cartridge is made from the normal bulk ANFO with a density of 0.8. This cartridge will not sink in water, however, it is advantageous to use this type of cartridged ANFO when placing them in wet holes that were recently pumped and contain only small amounts of water.



Figure 3.11 Cartridged ANFO

### 3.4.2 BULK ANFO

Bulk ANFO is prilled ammonium nitrate and fuel oil. It is often either blown or augured into the blasthole from a bulk truck. The mixed ANFO can be placed in the truck for borehole loading or in some trucks the dry ammonium nitrate and diesel oil can be mixed in the field as the material is being placed in the borehole. The blasting industry has a great dependence on dry blasting agents because of the large volume used. Dry blasting agents will not function properly if placed in wet holes for extended periods of time. For this reason, the blaster should know the limitations of his product.

### 3.4.3 WATER RESISTANCE OF AMMONIUM NITRATE

Ammonium nitrate, which is bulk loaded into a blasthole, has no water resistance. If the product is placed in water and shot within a very short period of time, marginal detonation can occur with the production of rust colored fumes of nitrous oxide. The liberation of nitrous oxide is commonly seen on blasts involving bulk ammonium nitrate when operators have not taken the care to load the product in a proper manner which ensures that it will stay dry. Although a marginal detonation occurs, the energy produced is significantly less than the product would be capable of producing under normal conditions. For this reason, blastholes

geyser, flyrock is thrown, and other problems arise from using ammonium nitrate fuel oil mixtures in wet blastholes. If ammonium nitrate is placed in wet blastholes, it will absorb water. When the water content reaches approximately 9%, it is questionable whether the ammonium nitrate will detonate regardless of the size primer used. Figure 3.12 indicated the effect of water content on the performance of ammonium nitrate. It indicates that as water content increases, minimum booster values also increase and detonation velocity decreases significantly.

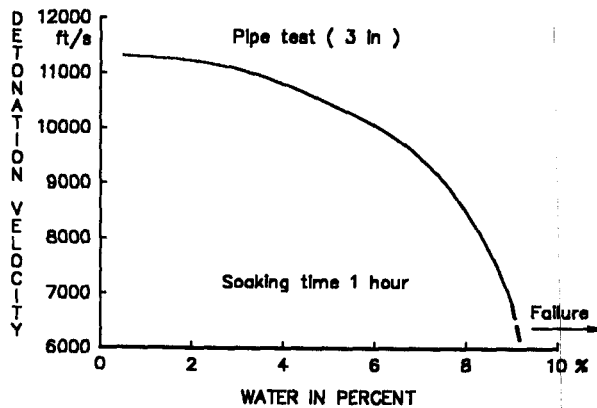


Figure 3.12 Effects of Water in ANFO

#### 3.4.4 ENERGY OUTPUT OF ANFO

When ammonium nitrate fuel oil mixtures are made in the field, variations in oil content can easily occur. Bagged mixtures received from some distributors have similar problems. The amount of fuel oil placed on the ammonium nitrate is extremely critical from the standpoint of efficient detonation (Figure 3.13). To get the optimum energy release, one would want about a 94.5% ammonium nitrate with a 5.5% diesel oil mixture. This would be approximately 3-1/2 quarts of fuel oil per 100 lbs. of mixture. If for some reason, rather than the required 5.5% oil on the prills, they contain only 2-4% oil, a significant amount of the energy is wasted and the explosive will not perform properly. Having too little fuel will promote the formation of rust colored nitrous oxide fumes in dry holes. On the other hand, having an excess of fuel oil is detrimental to the maximum energy output in ammonium nitrate fuel oil mixtures. It is less detrimental than to have too little fuel. Figure 3.13 indicates the effect on theoretical energy of having different fuel oil percentages. The graph indicates that the minimum booster required is less when ANFO is under-fueled. ANFO is more sensitive to initiation when under-fueled than when properly fueled. Once initiation is taken place, it will not produce anywhere near the optimum amount of energy.

### 3.4.5 PROPERTIES OF BLASTING PRILLS

Ammonium nitrate used for bulk loading comes in the form of prills. The prills are spherical particles of ammonium nitrate manufactured in a prilling tower with a similar process to that used in making bird shot for shot shells (Figure 3.14). Ammonium nitrate prills are also used in the fertilizer industry. During times of explosive shortages, the blaster has often gone to feed mills and purchased fertilizer grade ammonium nitrate prills. There are differences between the fertilizer grade and the blasting grade prills. The blasting prill is considered a porous prill, which better distributes the fuel oil and results in much better performance on the blasting job. Table 3.9 indicates the difference in properties of fertilizer and blasting prills.

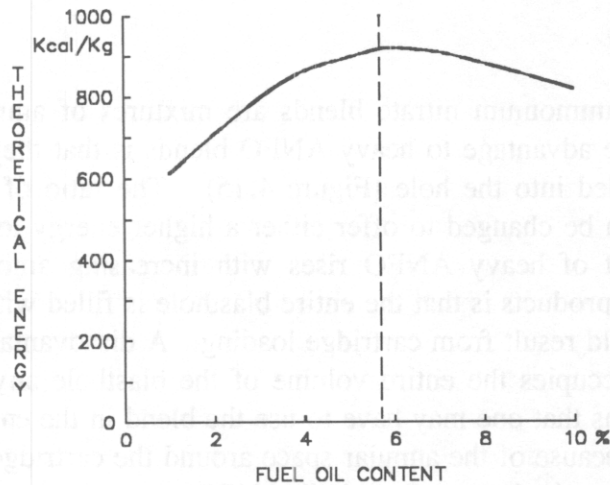


Figure 3.13 Effects of Fuel Oil Content on ANFO

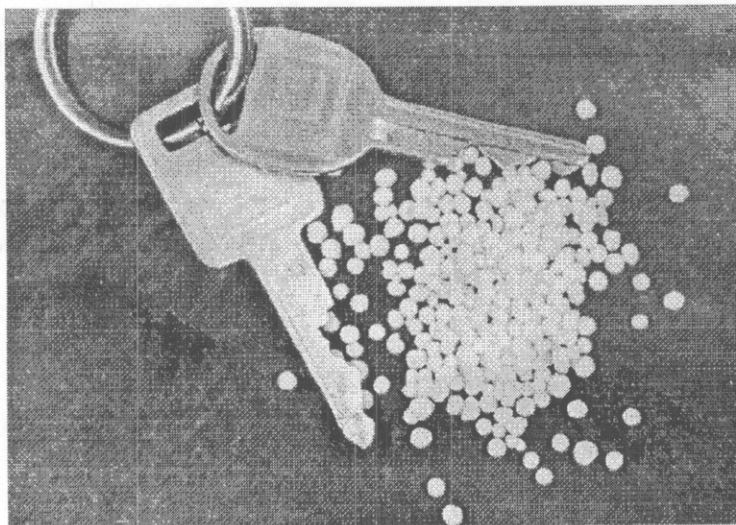


Figure 3.14 ANFO Prills

**TABLE 3.9 PROPERTIES OF FERTILIZER AND BLASTING PRILLS**

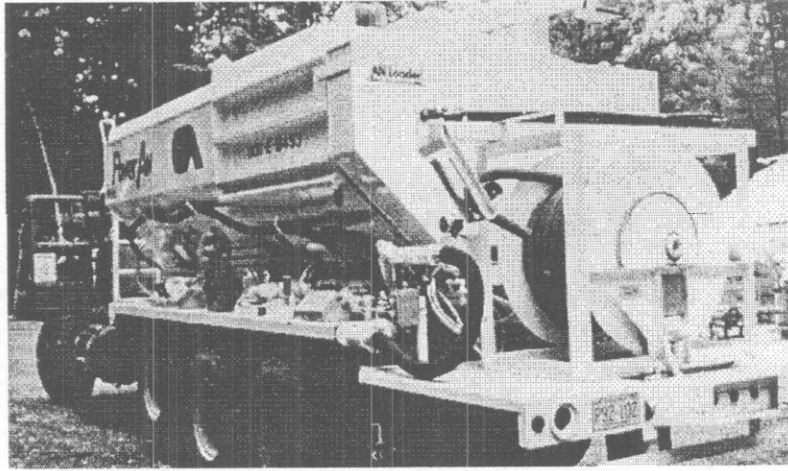
	<b>FERTILIZER PRILL</b>	<b>BLASTING PRILL</b>
Insert Coating	3% - 5%	0.5% - 1%
Hardness	Very hard	Soft
Physical Form	Solid Crystal	Porous
Fuel Oil Distribution	Surface only	Throughout Prill
Minimum Diameter for Unconfined Detonation	9 in	2.5 in
4 in Confined Velocity	6,000 ft/s	11,000 ft/s

### **3.4.6 HEAVY ANFO**

Heavy ANFO or ammonium nitrate blends are mixtures of ammonium nitrate prills, fuel oil, and slurries. The advantage to heavy ANFO blends is that they can be mixed at the blasthole and quickly loaded into the hole (Figure 4.15). The ratio of the amount of slurry mixed with the ANFO can be changed to offer either a higher energy load or a load which is water resistant. The cost of heavy ANFO rises with increasing amounts of slurry. The advantage over cartridge products is that the entire blasthole is filled with energy and have no wasted volume which would result from cartridge loading. A disadvantage using the blends is that since the explosive occupies the entire volume of the blasthole any water in the hole is forced upward. This means that one may have to use the blend in the entire hole. Conversely with cartridge products, because of the annular space around the cartridge, one can build up to get out of water and then use the lower priced bulk ANFO.

Cartridge loading of explosives is more tedious and requires more personnel since the cartridges have to be physically taken to the blast site and stacked by each hole. The cartridges are then dropped into the borehole during the loading process. Heavy ANFO requires less personnel since explosive is pumped directly into the blasthole from the bulk truck.

Some operators try to use heavy ANFO in wet holes, however, they do not use mixtures which contain sufficient slurry. To provide the necessary water resistance, it is recommended that at least 50% slurry be used in heavy ANFO which is to be used under wet borehole conditions.



**Figure 3.15** Heavy ANFO Bulk Loading Truck

### **3.5 TWO COMPONENT EXPLOSIVES**

Two component explosives are often called binary explosives since they are made of two separate ingredients. Neither ingredient is explosive until mixed. Binary explosives are normally not classified as explosives. They can be shipped and stored as non-explosive materials. Commercially available two component explosives are a mixture of pulverized ammonium nitrate and nitromethane, which has been dyed either red or green. These components are brought to the job site and only the amount needed will be mixed. Upon mixing the material it becomes cap sensitive and is ready to use. These binary explosives can be used in applications where dynamite or cap sensitive slurries would be used. Binary explosives can also be used as primers for blasting agents and bulk slurries. In most states, binary explosives are not considered explosive until mixed. They, therefore, offer the small operator a greater degree of flexibility on the job. Their unit price is considerably higher than that of dynamite. However, the money saved in transportation and magazine costs outweighs the difference in unit price. If large quantities of explosives are needed on a particular job, the higher cost per pound and the inconvenience of on-site mixing negates any savings that would be realized from less stringent storage and transportation requirements.

### **3.6 CHAPTER 3 SUMMARY**

The environmental characteristics, sensitiveness, water resistant, fumes, flammability and temperature resistances and the performance characteristics, sensitivity, velocity, detonation pressure, density strength and cohesiveness must be considered when selecting commercial explosives for specific applications.

The term commercial explosive covers the generic family of dynamites, blasting agents, slurries and two component explosives.



## CHAPTER 4 OBJECTIVES

To promote an understanding of initiator and blasthole delay devices which are necessary for the selection of the initiation system best suited for a specific application. To delineate the principles by which the different systems function.

## CHAPTER 4 SUMMARY

Electric and non-electric initiation systems were reviewed. The delay periods for electric caps from all major manufacturers were discussed.

Non-electric systems, detonating cord, Detaline, Hercudet and Nonel as well as new technologies in electric initiators were reviewed. The delay periods available for these systems were discussed.

## CHAPTER 4

### INITIATORS AND BLASTHOLE DELAY DEVICES

#### 4.1 INTRODUCTION

The initiation system transfers the detonation signal from hole-to-hole at a precise time. The selection of an initiation system is critical for the success of a blast. The initiation system not only controls the sequencing of blastholes, but also effects the amount of vibration generated from a blast, the amount of fragmentation produced, and the backbreak and violence which will occur. Although the cost of the systems is an important consideration in the selection process, it should be a secondary consideration, especially if the most economical initiation system causes problems with backbreak, ground vibration, or fragmentation. It would be foolish to select a system based strictly on cost.

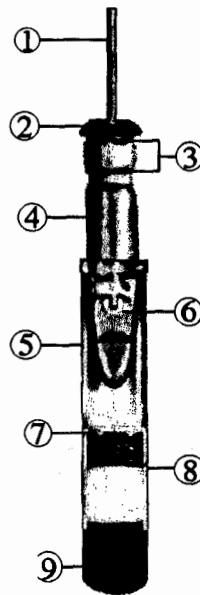
The selection of the initiation system is one of the most important consideration in blast design. It is the intent of this section to review the currently available hardware used in the United States to obtain precise delay times in initiation both hole-to-hole and row-to-row.

Initiators can be broken down into two broad classifications, electric and non-electric. The following brief review of initiators available on the market will follow that sequence. The discussion will first be centered around electric methods of initiation.

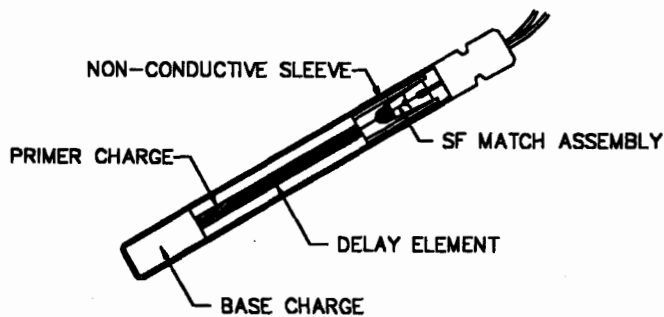
#### 4.2 ELECTRIC BLASTING CAPS

The electric blasting cap (E.B. Cap) consists of a cylindrical aluminum or copper shell containing a series of powder charges (Figure 4.1). Electric current is supplied to the cap by means of two leg wires that are internally connected by a small length of high-resistance wire known as the bridge wire. The bridge wire serves a function similar to the filament in an electric light bulb. When a current of sufficient intensity is passed through the bridge wire, the wire heats to incandescence and ignites a heat-sensitive flash compound. Once ignition occurs, it sets off a primer charge and base charge in the cap either near instantaneously or after traveling through a delay element which acts as an internal fuse. This delay element provides a time delay before the base charge fires (Figure 4.2). The leg wires on E.B. caps are made of either iron or copper. Each leg wire on an E.B. cap is a different color and all caps in a series have the same two colors of leg wires which serve as an aid in hooking up.

1. Plastic Insulated Legwires
2. Rubber Sealing Plug
3. Double Crimp
4. Metal Shell
5. Plastic Insulating Tube
6. "SF" Electric Match
7. Inner Capsule
8. Primary Charge
9. Base Charge



**Figure 4.1** Instantaneous Electric Blasting Cap



**Figure 4.2** Delay Electric Blasting Caps

The leg wires enter the E.B. cap through the open end of the cap. To avoid contamination by foreign material or water, a rubber plug seals the opening so that only the leg wires pass through the plug.

There are four different electric cap manufacturers in the United States, Atlas, Austin, ETI and Ireco.

#### **4.2.1 INSTANTANEOUS EB CAPS**

Instantaneous E.B. caps are made to fire within a few milliseconds after current is applied. Instantaneous caps contain no delay tube or delay element.

#### **4.2.2 LONG PERIOD DELAY ELECTRIC CAPS**

Long period delays have intervals ranging from a hundred millisecond to over a half second delay. They provide time for rock movement under tight shooting conditions. They are generally used in tunnel driving, shaft sinking and underground mining. Table 4.1 gives the periods and delay times for the different manufacturers of long period caps.

**TABLE 4.1 LP SERIES OF ELECTRIC BLASTING CAPS**

<b>PERIOD</b>	<b>ATLAS (ms)</b>	<b>AUSTIN (ms)</b>	<b>E.T.I. (ms)</b>	<b>IRECO (ms)</b>
0	8	-	-	-
1/2	25	-	-	-
1	50	-	25	25
1-1/2	75	-	100	100
2	1000	-	200	200
2-1/2	-	-	300	300
3	1500	-	400	400
4	2000	-	600	600
5	2500	-	800	800
6	3000	-	1000	1000
7	3500	-	1200	1200
8	4000	-	1400	1400
9	4500	-	1600	1600
10	5000	-	1900	1900
11	5500	-	2200	2200
12	6000	-	2500	2500
13	6500	-	2900	2900
14	7000	-	3300	3300
15	7500	-	3800	3800
16	-	-	4400	4400
17	-	-	5100	5100

#### **4.2.3 MILLISECOND DELAY ELECTRIC BLASTING CAPS (HIGH PRECISION)**

Millisecond delay electric blasting caps are commonly used for surface blasting applications. These delays vary between periods depending on the manufacturer, however, the common increments are 25 and 50 milliseconds. Table 4.2 gives the different manufacturer's delays and periods.

**TABLE 4.2 MS SERIES OF ELECTRIC BLASTING CAPS**

<b>PERIOD</b>	<b>ATLAS (ms)</b>	<b>AUSTIN (ms)</b>	<b>E.T.I. (ms)</b>	<b>IRECO (ms)</b>
0	Instant	Instant	5	5
1	25	25	25	25
2	50	50	50	50
3	75	75	75	75
4	100	100	100	100
5	125	125	125	125
6	150	150	150	150
7	175	175	175	175
8	200	200	200	200
9	225	225	225	225
10	250	250	250	250
11	275	275	275	275
12	300	300	300	300
13	325	325	325	325
14	350	350	350	350
15	375	375	375	375
16	400	400	400	400
17	425	425	425	425
18	450	450	450	450
19	475	475	475	475
20	500	500	500	500
21	550	550	550	550
22	600	600	600	600
23	650	650	650	650
24	700	700	700	700
25	750	750	750	750
26	800	800	-	-
27	850	850	-	-
28	900	900	-	-
29	950	950	-	-
30	1000	1000	-	-

### 4.3 ELECTRONIC DELAY BLASTING CAPS

Over the years, a definite need has surfaced for super-accurate delays. Electronic technology has advanced to the point that technology exists to create electronic delays at a reasonable cost. In some countries, electronic delays are already being used. In the United States, there is reluctance on the part of manufacturers to put these on the market. However, as soon as one U.S. cap manufacturer starts producing electronic delays, others will rapidly follow. An electronic detonator with super-accurate firing times and the ability to have infinite delay periods at any interval of time will revolutionize the blasting industry. This initiation system would virtually eliminate the problems of cap scatter times, inaccurate firing and out-of-sequence shooting. Control of ground vibration, flyrock, air blast, and fragmentation will result. Because of the sophistication available in electronic components, caps could be given a specific code whereby accidental firing by stray current would not be a hazard.

### 4.4 MAGNADET

Because of the recognized importance of having an accurate safe initiation system, many companies are in the process of research and development on new systems. One system which will be briefly mentioned is the Magnadet system of initiation which was invented by ICI in Scotland and is presently being used in a number of different countries throughout the world including the U.S.A.

The Magnadet system offers the advantage over conventional electrical systems of ease of hookup and reduction of many common electrical blasting hazards.

#### 4.4.1 MAGNADET ELECTRIC DETONATOR & MAGNA PRIMER WORKING PRINCIPLE

The transfer of electrical energy in the Magnadet system is not by direct wiring connections. The system functions by electromagnetic induction between the primary and secondary coil of a transformer (Figure 4.3).

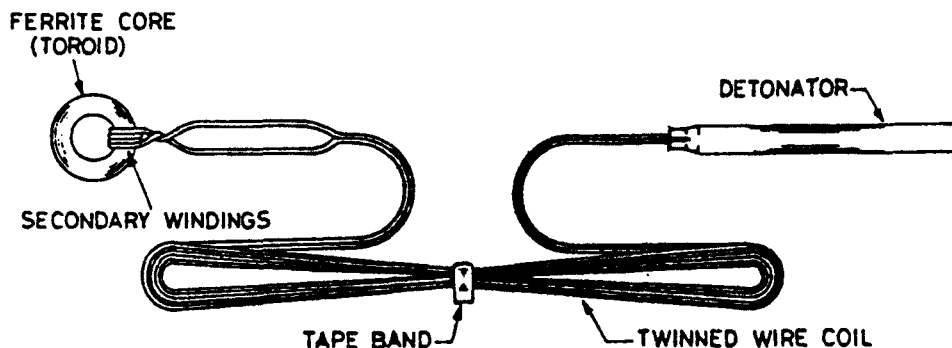


Figure 4.3 Schematic of Magnadet Assembly

#### 4.4.2 INITIATION SOURCE

An AC power source operating at a frequency of 15,000 Hz or above is provided by a special blasting machine.

#### 4.4.3 DETONATOR DESCRIPTION

Magnadet consists of a separate transformer external to each detonator. The transformer device is 20 mm outside diameter, 10 mm inside diameter x 10 mm wide ferrite ring. Lead wires from each detonator attached to its own ferrite ring and form the secondary windings of the transformer. A plastic covered connecting wire passing through the center of each ferrite ring forms the primary winding of the transformer (Figure 4.4). The detonator portion of the assembly is of conventional construction. The ferrite ring with the secondary windings leading to the detonator wire is encapsulated within a brightly colored plastic sheath for protection against mechanical damage. Each plastic protector is stamped with a number corresponding to the delay number of the detonator to which it is attached.

The delay blasting cap itself is of conventional construction.

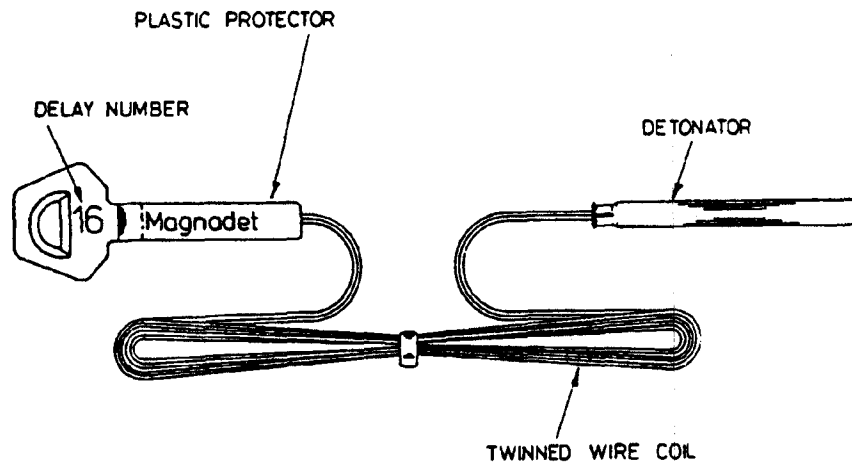
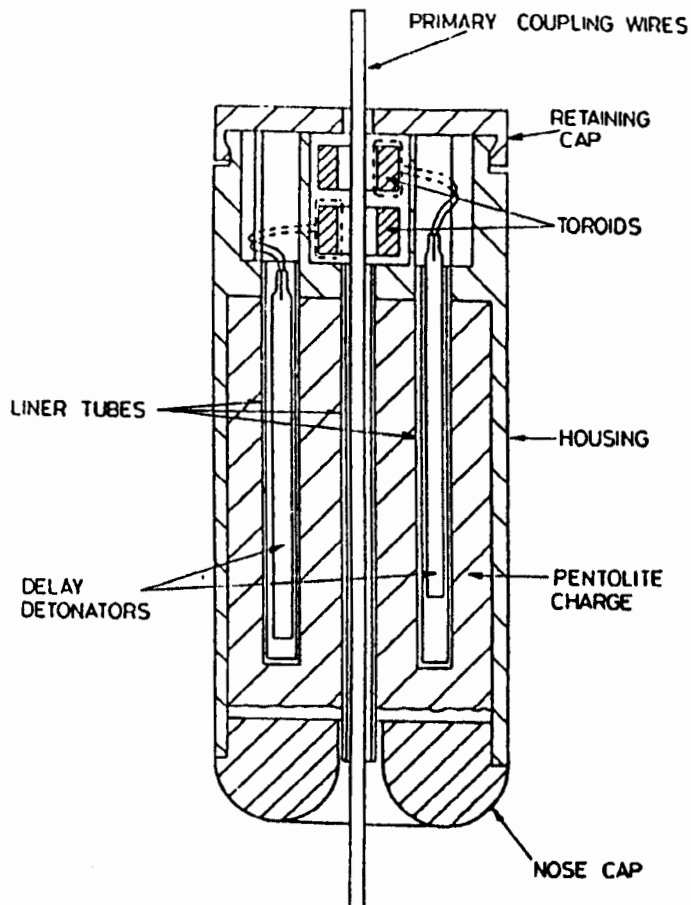


Figure 4.4 Plastic Covered Ferrite Ring

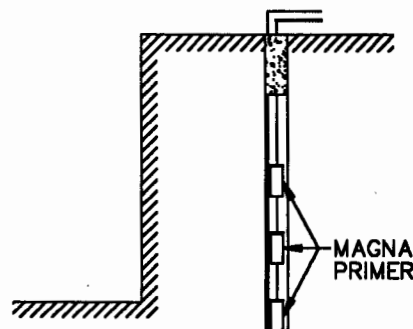
#### 4.4.4 MAGNADET SLIDING PRIMERS

The Magnadet Sliding Primer is a booster which can accommodate Magnadet electric caps with 50 mm leads. The central hole allows a length of electrical cable to be threaded through the primer and through the ferrite rings of the Magnadet electric detonators thus providing the primary circuit and an inductive coupling is formed as previously explained (Figure 4.5).



**Figure 4.5 Magna Primer**

If more than one Magnadet Primer is required per hole, such as when firing decked charges, then subsequent Magnadet Primer units can be slid down on the same primary circuit cable to the desired location within the hole (Figure 4.6).



**Figure 4.6 Magna Sliding Primer**



#### **4.4.5 SAFETY FEATURES CLAIMED**

1. Protection against stray currents from DC power services - the transformer device will not respond to DC energy.
2. Protection against stray currents from AC power sources - the standard 50 or 60 Hz main supply frequency is too low compared to 15,000 Hz required for reliable firing.
3. Protection against electrostatic energy - the assembly is designed to withstand potential hazards associated with pneumatically loaded ANFO over the leading wires of electric detonators.
4. Protection against radio frequency energy.
5. Protection against current leakage - the effective voltage across each unit is low, typically 1 to 2 volts. There is insufficient driving force for current leakage to occur.

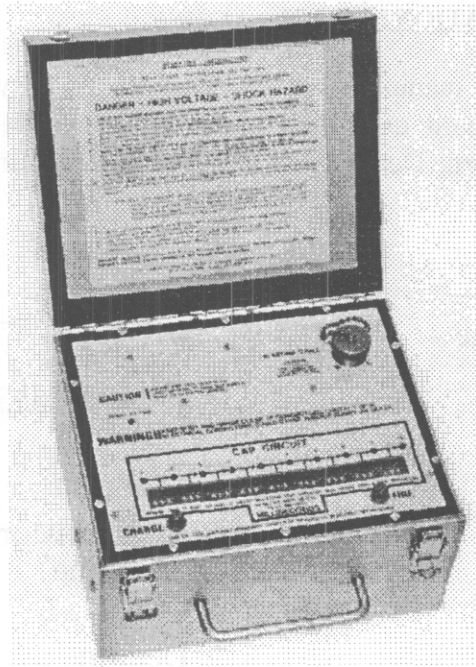
#### **4.4.6 OPERATIONAL ADVANTAGES CLAIMED**

1. Simplicity and convenience of the connecting-up procedure, all that is required is to thread a wire continuously through the holes in the plastic protector attached to the cap leg wires protruding from each hole.
2. The system can result in appreciable time-saving in the loading/connecting up procedure.
3. The initiation system with Magnadet Sliding Primers offer a sliding primer system with a simple and safe in-hole delay technique and allows firing decked charges with each deck fired on a separate delay.
4. Offers all the advantages of electrical initiation without the safety hazards.

### **4.5 SEQUENTIAL BLASTING MACHINE**

The sequential blasting machine was first developed by Research Energy of Ohio, Inc. It is solid state condenser-discharge blasting machine with a sequential timer that permits the detonation of many electric caps. The machine is capable of firing 175 ohms per circuit, at different, precisely timed intervals. The machine consists of 10 different firing circuits that are programmed to fire one after another at selected intervals. The combination of 10 different circuits, or intervals, in conjunction with delay blasting caps can yield many independent blasts.

Sequential timers are used in construction as well as mining applications. The timers allow the use of many delays within a blast. The pounds of explosives fired per delay period can be significantly reduced to control noise and vibration effects since there are many delays available. The sequential blasting machine can be set to fire from 5 to 199 ms in increments of 1 ms (Figure 4.7).



**Figure 4.7** Sequential Timer

The programmable sequential timer allows the machine to be set with nine different delay increments. The machine also allows for the use of four slave units with the master unit. Using slaves and the master unit, one can get 50 different delays which are fully adjustable.

Sequential timers are available for regular electric caps as well as for the Magnadet System.

#### **4.6 NON-ELECTRIC INITIATION SYSTEMS**

Non-electric initiation systems have been used in the explosive industry for many years. Cap and fuse, the first method of non-electric initiation, provided a low cost, but hazardless system. The cap and fuse system has declined in use with the introduction of more sophisticated, less dangerous methods. Accurate timing with cap and fuse is impossible. The system has no place in a modern construction industry.

Four non-electric initiation systems are currently available. All may find use in the construction industry. To increase the number of delays available, individuals often combine the use of more than one non-electric system on a blast. Often electric and non-electric system components are combined to give a larger selection of delays and specific delay times.

#### 4.6.1 DETALINE INITIATION SYSTEM

The Detaline system manufactured by DuPont is a two-path non-electric system compatible with detonating cord downlines and non-electric in-hole delays. The Detaline system consists of Detaline cord, Detaline starter, Detaline ms surface delays, and Detaline ms in-hole delays (Figure 4.8).

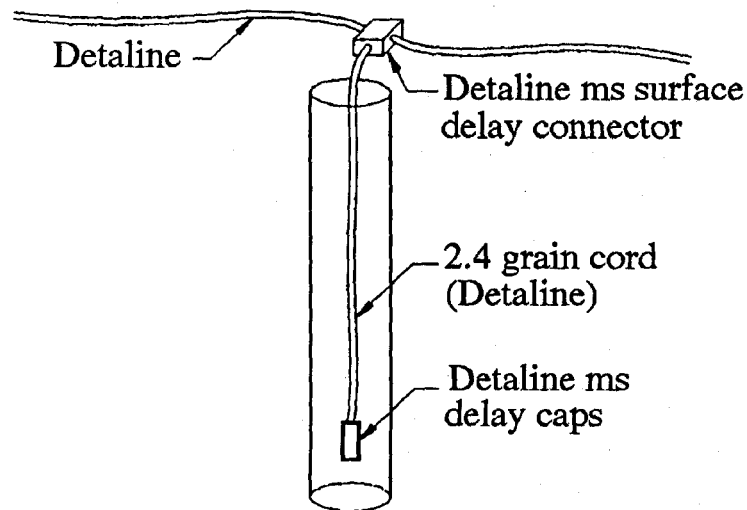


Figure 4.8 Detaline

#### 4.6.2 DETALINE CORD

Detaline cord is a low energy detonating cord having a pentaerythritetranitrate (PETN) explosive charge of 2.4 grains per foot. The explosive core is within textile fibers and covered by a seamless outer plastic jacket. Detaline cord will not propagate through a knotted splice. To splice the cord, a Detaline starter is needed. A starter is also needed to initiate the Detaline trunkline.

#### **4.6.3 DETALINE MS SURFACE DELAYS**

Detaline MS surface delays are shaped like the Detaline starter and contain a slower burning explosive to provide a time delay between activation and initiation of the detonating cord downline locked in the pointed arrow end. Detaline ms surface delays are as listed in Table 4.3 with their identifying color:

**TABLE 4.3 DETALINE SURFACE DELAYS**

<b>PERIOD</b>	<b>COLOR</b>	<b>PERIOD</b>	<b>COLOR</b>
MS- 9	Blue	MS- 42	Purple
MS-17	Yellow	MS- 60	Orange
MS-30	Red	MS-100	Pink

#### **4.6.4 DETALINE MS IN-HOLE DELAYS**

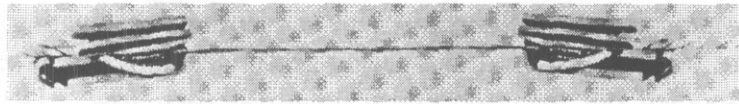
Detaline ms in-hole delays resemble an ordinary blasting cap except for a special top closure that is designed for insertion at a Detaline cord. Nineteen delay periods are available from 25 ms through 1,000 ms. A delay tag is affixed to the shell of each cap for delay period identification.

Detaline systems are connected similar to conventional detonating cord systems except that connections are made easier and no right angle connections are necessary. The Detaline cord trunkline is spooled out over the entire length at each row. Detaline starters or ms surface delays are then placed at the collar of each hole. The detonating cord downline is bent into a U shape and the loop is inserted into the arrow end and locked in place with the sawtooth pin. Finally, the tail end of each Detaline starter or ms surface delay is connected in the same manner to the continuous Detaline cord trunkline running along each row. The two open sides are closed in by running Detaline cord cross ties along each end and attaching properly oriented starters at the ends of each row. The system is connected as to create a redundant, two-path system. A cap and fuse or an electric blasting cap is inserted into a starter to initiate the Detaline trunkline.

## **4.7 DETONATING CORD AND COMPATIBLE DELAY SYSTEMS**

Detonating cord is a round, flexible cord containing a center core of high explosive, usually PETN, within a reinforced waterproofing covering. Detonating cord is relatively insensitive and requires a proper detonator, such as No. 6 strength cap, for initiation. It has a very high velocity of detonation approximately equal to 21,000 ft/s. The cord's detonation pressure fires cap-sensitive high explosives with which it comes into contact. Detonating cord is insensitive to ordinary shock and friction. Surface as well as inhole delays can be achieved by proper delay devices attached to detonating cord. A major disadvantage in the use of detonating cord on the surface is the loud crack as the cord detonates and grass and brush fires have been started in dry areas.

Ensign Bickford Company and ETI produces ms connectors that consist of two molded plastic units and contain an aluminum tube delay elements in the center portion. The two delay elements connected with an 18 inch length of shock tube. Each end of the unit is made so that the detonating cord can be looped and locked in the connectors (Figure 4.9). MS connector from Ensign Bickford are available in five delay intervals: 9, 17, 25, 35, and 65 milliseconds. They are installed by cutting the detonating cord and attaching the ms connector units to the cut ends.



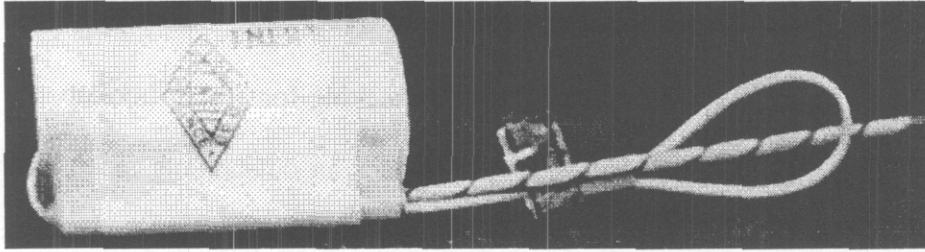
**Figure 4.9 Nonel MS Connector**

## **4.8 DELAYED PRIMERS**

Delay primers are units that contain a cap-sensitive high explosive primer with individual non-electric delay caps held in a detonation relationship with a down line of detonating cord. The delay primer is used for detonating ANFO, blasting agents, or any non-cap-sensitive explosives. The delay primers are ideal for bottom or top initiation. They can be used for either full column or deck loaded holes.

A tube runs alongside the primer cap in which a single downline is threaded. This eliminates the need of separate downline within each individual deck. Any number of primers can be threaded on this single downline.

Delay primers were first available from Austin Powder Company. The 1 pound unit is used for bulk loaded or packaged blasting agents and slurries in holes of four or more inches (Figure 4.10).



**Figure 4.10** Austin Delay Primer (APD)

Austin recommends using a 25 grain detonating cord downline that has a tensile strength in excess of 200 pounds.

#### **4.9 HERCUDET SYSTEM**

Hercudet is a noiseless, non-electric initiation system in which the ignition charge in each individual cap is activated by a gas detonation traveling through plastic tubing from cap to cap at a speed of 8,000 ft/s.

The Hercudet cap has an empty air space above the ignition charge instead of the usual bridge wire associated with an electric cap. Other than that, the cap has components similar to electric blasting caps such as the delay element, primary charge and main base.

In order to ready this cap for use, it must be connected in such a way that there is an open path from one end of the series of caps to the other (Figure 4.11). A number of series may then be connected in parallel with one another so that a gas, introduced to a common trunkline inlet tube, will travel from that tube into each series of caps and out the open end of each of the series (Figure 4.12). This path is first used for testing the circuit with air or nitrogen. After testing, when the area is readied for blasting, an explosive mixture of gaseous oxygen and fuel is introduced and initiated by the Hercudet blasting machine (Figure 4.13). The gas detonation starts the ignition charge in each cap. The unique aspects of the Hercudet system are:

1. The reaction through the tubing is virtually noiseless.
2. Propagation speed of gas detonation in the tube provides tubing delay, thus different delay action is achieved through the combining of tubing delay and cap delay.

3. One can use cap-sensitive powder in the hole without fear of its initiation by the downline or dead-pressing of insensitive powders or slurries, or of disturbing stemming.
4. The circuit test capability allows positive checking for proper hookup.
5. The inert until charged characteristic provides an outstanding safety advantage and eliminates all electrical hazards.

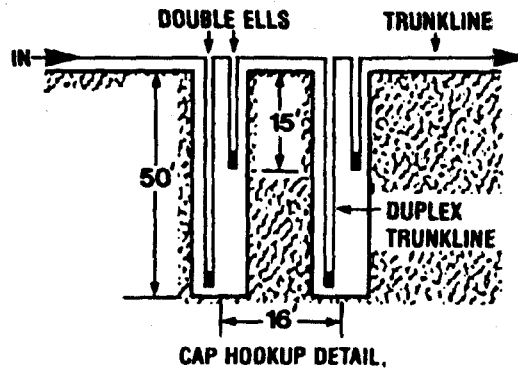


Figure 4.11 Hercudet Series

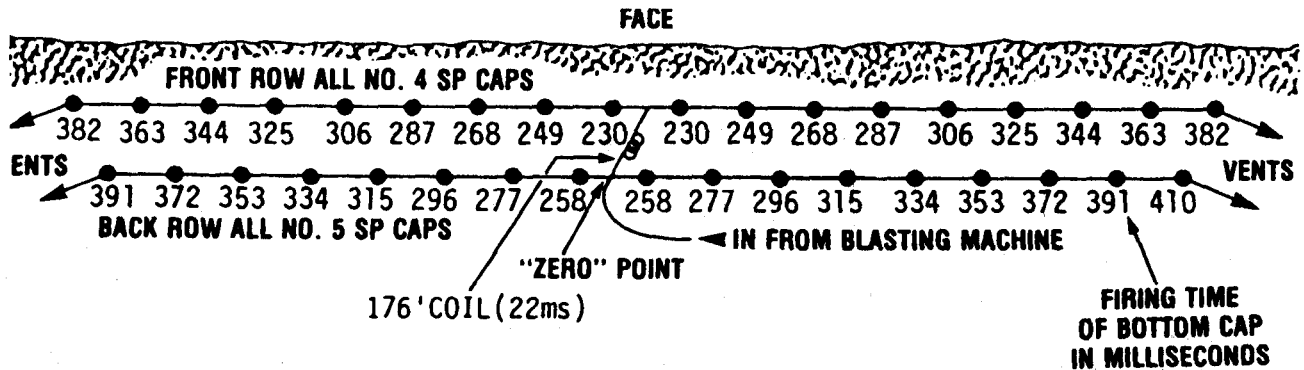
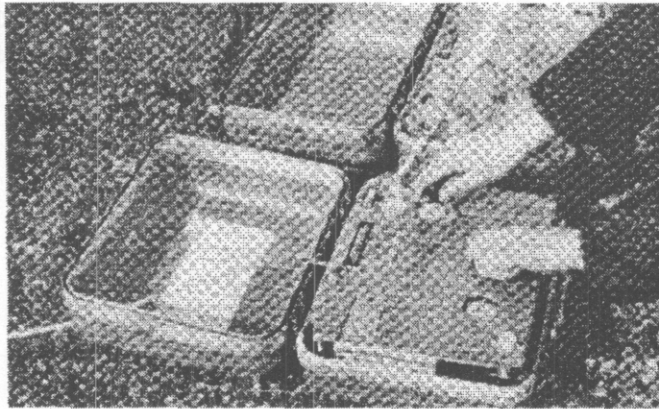


Figure 4.12 Open End Series



**Figure 4.13** Hercudet Blasting Machine

#### **4.9.1 TUBING DELAY**

The detonation rate of the mixed gas is 8,000 ft/s. At 8,000 ft/s, it takes 10 ms to travel 80 feet of tubing. This tubing delay can often be used to supplement the built-in delay element in the cap.

#### **4.9.2 HERCUDET CAP DELAYS**

The delays available with Hercudet cap are given in Table 4.4.

### **4.10 SHOCK TUBE INITIATION SYSTEMS**

The shock tube is a non-electric, instantaneous, non-disruptive signal transmission system. The system detonates in a plastic tube that has a thin coating of reactive material on the inside. This reactive material has a powder weight of about 0.1 grains per foot (1/70,000 pounds) and propagates a noiseless shock wave signal at a speed of approximately 6,000 ft/s. The system eliminates all electrical hazards except possible initiation by direct lightning strike.

Shock tube systems take a precise energy input to initiate the reaction inside the tube. It may be initiated by detonating cord, electric blasting cap, cap and fuse or a starter consisting of a shotgun primer in a firing device. The unique aspects of shock tube systems are:

1. They are completely safe from most electrical and radio frequency hazards.
2. They are noiseless on the surface.
3. They will not initiate cap sensitive explosives in the blastholes.
4. They will propagate a reaction through and around tight kinks and knots.



A number of different companies manufacture shock tube systems. The original company that manufactured them in the United States was Ensign Bickford. Today, Atlas, Austin, ETI and Ireco manufacture shock tube systems.

**TABLE 4.4 HERCUDET CAP DELAYS**

DELAY PERIOD	SHORT PERIOD (ms)	LONG PERIOD (s)
1/10	-	0.05
1/4	-	0.25
1/2	-	0.50
3/4	-	0.73
1	50	0.35
	2	100
	3	150
	4	200
	5	250
	6	300
	7	350
	8	400
	9	450
	10	500
	11	550
	12	610
	13	670
	14	730
	15	790
	16	850
		2.05
		2.73
		3.45
		4.5
		5.5
		6.6
		7.6
		8.6
		9.6
		10.6
		11.6
		12.8
		-
		-
		-

**4.10.1 LP SERIES SHOCK TUBE INITIATORS**

Shock Tube System LP Series provide precise non-electric delay in underground mining, shaft sinking and special construction needs. The caps are available in different lengths of the shock tube. The LP series caps are shown in

Shock tube detonators are suited for use with commercially available dry sensitive water gels or emulsion type high explosives because the tube will disrupt these explosives. Shock tube initiators can be used for initiation of non-blasting agents with a suitable primer.

**4.10.2 S.L. SERIES NONEL PRIMADETS**

A rugged model of the millisecond series, called the S.L. Series Primadet, is designed for open pit, strip mines, quarries and construction. S.L. Nonel Primadets consist of a length of Nonel (15 inches) tube which is heat sealed on one end and has a millisecond delay blasting cap crimped to the open end. This unit is field assembled to the proper lead length desired by tying to a specially designed 7.5 grain Primaline (detonating cord). This small explosive charge allows Primaline to function with minimum disruption of ANFO, slurry or other non cap-sensitive explosives. At the surface, the Primaline is attached to the Primacord trunkline by a double wrap clove hitch knot. The S.L. Primadet periods are given in Table 4.6.

**TABLE 4.5 LP SHOCK TUBE DELAY DETONATORS**

<b>PERIOD</b>	<b>ATLAS (ms)</b>	<b>AUSTIN (ms)</b>	<b>E.T.I. (ms)</b>	<b>IRECO (ms)</b>	<b>ENSIGN BICKFORD (ms)</b>
0	Instant	-	3	3	-
1/2	100	-	-	-	100
1	200	-	500	500	200
1-1/2	300	-	-	-	300
2	400	-	800	800	400
2-1/2	500	-	-	-	500
3	600	-	1100	1100	600
4	800	-	1400	1400	1000
5	1000	-	1700	1700	1400
6	1250	-	2000	2000	1800
7	1500	-	2300	2300	2400
8	2000	-	2700	2700	3000
9	2500	-	3100	3100	3800
10	3000	-	3500	3500	4600
11	3500	-	3900	3900	5500
12	4000	-	4400	4400	6400
13	4500	-	4900	4900	7400
14	5000	-	5400	5400	8500
15	5500	-	5900	5900	9600
16	6000	-	6500	6500	-
17	6500	-	7200	7200	-
18	7000	-	8000	8000	-
19	7500	-	-	-	-
20	8000	-	-	-	-

**TABLE 4.6 NONEL S. L. SERIES PRIMADETS**

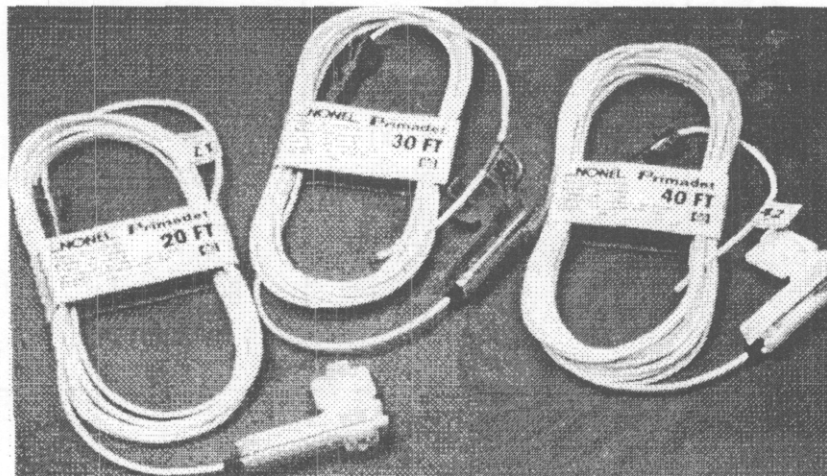
PERIOD	DELAY (ms)	PERIOD	DELAY (ms)
0	Instant	9	250
1	25	10	300
2	50	11	350
3	75	12	400
5	125	14	500
6	150	15	600
7	175		
8	200		

**4.10.3 L.L.H.D. SERIES SHOCK TUBE INITIATORS**

Long length, heavy duty (L.L.H.D.) MS initiators are similar to the L.P initiators except that delays are of shorter intervals. The L.L.H.D. unit has a long length tube which extends to the collar of the blasthole. The long length tube eliminates the need for any detonating cord in the blasthole which allows the use of cap-sensitive explosives in the hole. L.L.H.D. primadets are available in the periods as shown in Table 4.7.

**4.10.4 SHOCK TUBE TRUNKLINE DELAYS**

Trunkline delays are used in place of detonating cord trunklines. All units contain built-in delays to replace conventional MS connectors used with detonating cord. Trunkline delays are factory assembled units with five main components, the shock tube, the blasting cap, the connector, the delay tag, and the plastic sleeve (Figure 4.14). Trunkline delays available are shown in Table 4.8.



**Figure 4.14 Nonel Surface Delay**

**TABLE 4.7 LONG LEAD HEAVY DUTY MS SHOCK TUBE DELAY DETONATORS**

<b>PERIOD</b>	<b>ATLAS (ms)</b>	<b>AUSTIN (ms)</b>	<b>E.T.I. (ms)</b>	<b>IRECO (ms)</b>	<b>ENSIGN BICKFORD (ms)</b>
1	25	25	25	25	25
2	50	50	50	50	50
3	75	75	75	75	75
4	100	100	100	100	100
5	125	125	125	125	125
6	150	150	150	150	150
7	175	175	175	175	175
8	200	200	200	200	200
9	225	225	225	225	250
10	250	250	250	250	300
11	275	275	275	275	350
12	300	300	300	300	400
13	325	325	325	325	450
14	350	350	350	350	500
15	375	375	375	375	600
16	400	400	400	400	-
17	425	425	425	425	-
18	450	450	450	450	-
19	475	475	475	475	-
20	500	500	500	500	-
21	550	550	550	550	-
22	600	600	600	600	-
23	650	650	650	650	-
24	700	700	700	700	-
25	750	750	750	750	-
26	800	800	-	-	-
27	850	850	-	-	-
28	900	900	-	-	-
29	950	950	-	-	-
30	1000	1000	-	-	-

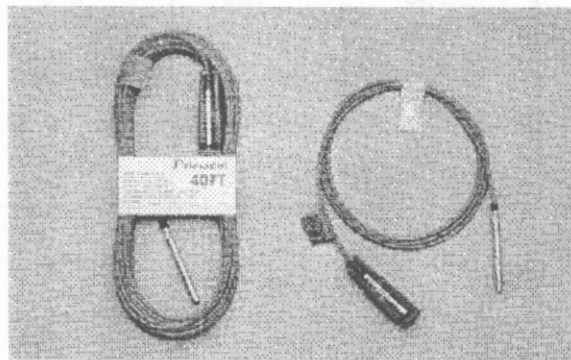
**TABLE 4.8 NON-ELECTRICAL SHOCK TUBE TRUNKLINE DELAYS**

ATLAS (ms)	AUSTIN (ms)	E.T.I. (ms)	IRECO (ms)	ENSIGN BICKFORD (ms)
5	-	5	5	5
9	9	9	9	9
17	17	17	17	17
25	25	25	25	25
-	-	35	35	-
42	42	42	42	42
-	-	50	50	-
65	-	65	65	-
100	100	100	100	100
-	-	-	-	150
200	200	200	200	200

**4.10.5 EZ DET**

The EZ Det is a shock tube system component manufactured by Ensign Bickford which eliminates the need of a surface trunkline delay. The EZ Det unit is composed of a shock tube with a delay blasting cap fixed to one end of the tube and another delay unit fixed to the opposite end of the tube. This second delay unit clips to the shock tube in the adjacent blasthole.

The EZ Det unit is quick and easy to use in construction blasting applications (Figure 4.15).



**Figure 4.15 EZ Det Unit**

#### **4.10.6 NONEL LEAD-IN**

Noiseless Nonel lead-in line is used as the non-electric primary initiator for the blast. Nonel lead-in consists of a continuous length of Nonel tube, heat sealed on one end with an instantaneous blasting cap on the opposite end. The Nonel lead-in cap end is attached to the downline of the first hole to fire in the blast. Noiseless lead-in lines may be initiated by electric blasting caps, cap and fuse or a Nonel starter. Nonel lead-in lines are available on spools in continuous lengths of 200, 500, 1,000 and 2,500 feet with a plastic connector block at the end.

#### **4.11 CHAPTER 4 SUMMARY**

Electric and non-electric initiation systems were reviewed. The delay periods for electric caps from all major manufacturers were discussed.

Non-electric systems, Detonating Cord, Detaline, Hercudet and Nonel as well as new technologies in electric initiators were reviewed. The delay periods available for these systems were discussed.

## Example Sequential Timer and Electric Blasting Caps

**TIME SCHEDULE\***  
MS Time Overlap Zone

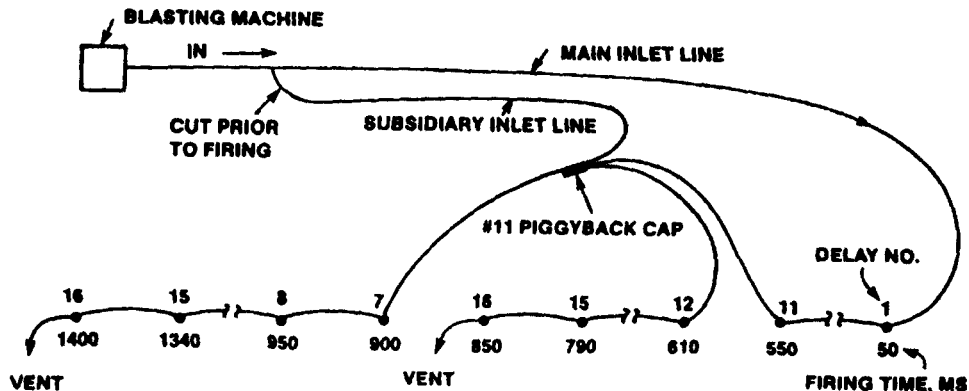
MASTER Cable Position & CIRCUIT NO. CIRCUIT TIME	1 0	2 60	3 120	4 180	5 240	6 300	7 360	8 420	9 480	10 540											
CAP MS: DET. TIME:	500 500	550 550	500 560	550 610	500 620	550 670	500 680	550 730	500 740	550 790	500 800	550 850	500 880	550 910	500 920	550 970	500 980	550 1030	500 1040	550 1090	Row 5
CAP MS: DET. TIME:	400 400	450 450	400 480	450 510	400 520	450 570	400 580	450 630	400 640	450 690	400 700	450 750	400 780	450 810	400 820	450 870	400 880	450 930	400 940	450 990	Row 4
CAP MS: DET. TIME:	300 300	350 350	300 360	350 410	300 420	350 470	300 480	350 530	300 540	350 590	300 600	350 650	300 660	350 710	300 720	350 770	300 780	350 830	300 840	350 890	Row 3
CAP MS: DET. TIME:	200 200	250 250	200 260	250 310	200 320	250 370	200 380	250 430	200 440	250 490	200 500	250 550	200 560	250 610	200 620	250 670	200 680	250 730	200 740	250 790	Row 2
CAP MS: DET. TIME:	100 100	150 150	100 160	150 210	100 220	150 270	100 280	150 330	100 340	150 390	100 400	150 450	100 480	150 510	100 520	150 570	100 580	150 630	100 640	150 690	Row 1

1st Cap on Hole #1      . . . . . OPEN FACE . . . . .

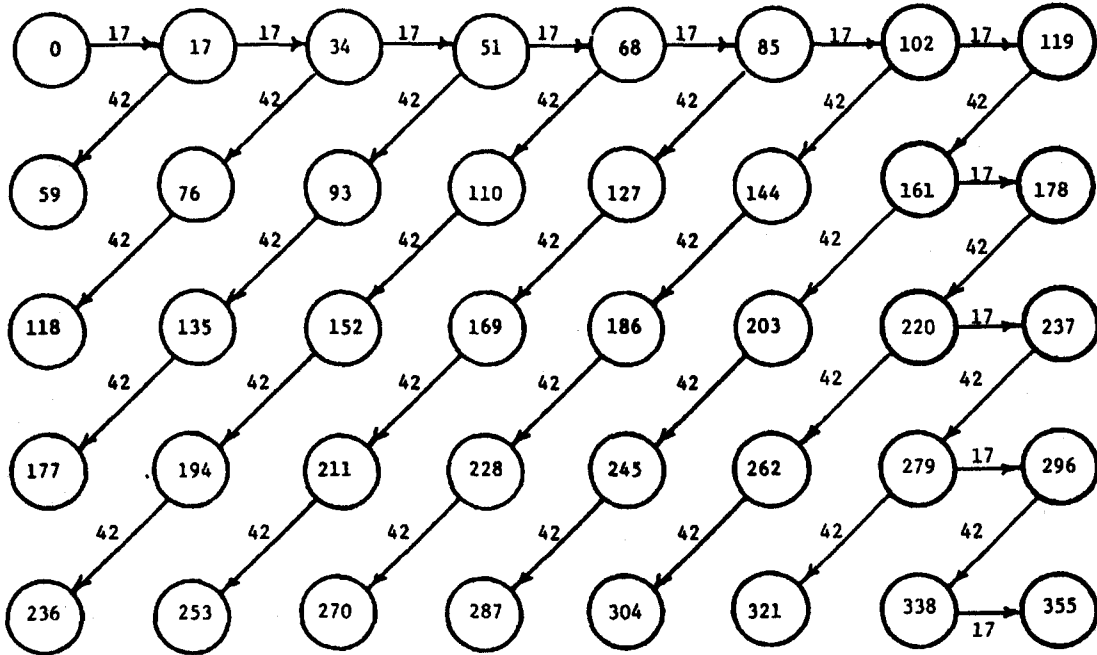
CAP MS Actual time tag on cap.  
 DET. TIME Detonation time as sequenced by the BM-125-10. Total time on this plan 1090 MS, less starting time of 100 MS.  
 1000 MS 1second.  
 MODE OF OPERATION Circuit No. 1 0 MS · cap time · · Circuit No. 2 60 MS · cap time, etc.  
 \*Please note on this typical layout that the timing doubles up starting with the sixth circuit as the 400 MS in the first row matches the 400 MS in the fourth row. This blast pattern, timing and other data are for illustration purposes only. Success and accuracy of the blast and timing are not intended. MS cap error and other factors must be calculated prior to all blasting operations.

## Example Hercudet Piggyback System

### HERCUDET PIGGYBACK DITCH HOOKUP



Example Nonel Initiation System delays 17 & 42



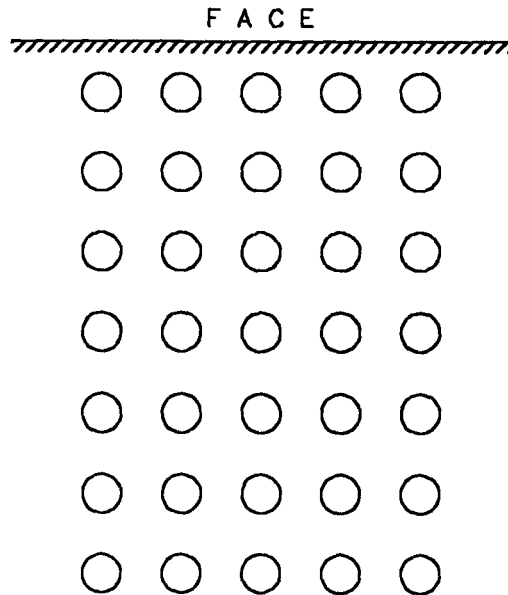
Note: Third row overlaps beginning 8th hole in first row and thereafter. Additional rows will also overlap. (Less than 8 MS delay considered to overlap)



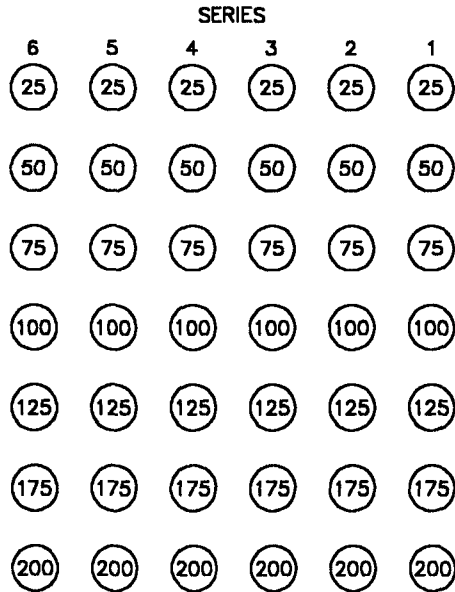
## PROBLEMS - CHAPTER 4

1) A contractor is using Nonel to initiate his blast. The holes all contain number 8 period L.L.H.D.'s. The blast is a box cut with one free face. The blast contains 7 rows with 5 holes per row. Trunk line delays available are 17, 25, and 42 ms delays. Because of a vibration problem no two holes can fire together. The minimum delay allowable is 8 ms.

- a. Design the pattern as a v cut with the center hole in the first row firing first.
- b. Show your series, firing times and hook up on the design below.
- c. Will this pattern function if there are 6 holes per row?



2) A contractor is using a sequential timer and electric blasting caps for the blast given on the diagram below. Houses are close and each hole must fire independently. Would you approve this design?



## CHAPTER 5 OBJECTIVES

To understand primer and booster selection criteria. To examine problems associated with improper primer and booster selection. To delineate reasons for selection criteria.

## CHAPTER 5 SUMMARY

Adequate priming can only be obtained if the size and composition of the primer meet certain minimum criteria. The criteria for primer selection, such as composition, size, length and number needed, were reviewed. Conditions under which boosters are needed were discussed.

## CHAPTER 5

### PRIMER AND BOOSTER SELECTION

The difference between a primer and booster is in its use, rather than in its physical composition or makeup. A primer is defined as an explosive unit which contains an initiator. As an example, if a blasting cap is placed into a cartridge of dynamite, that cartridge with initiator becomes the primer. A booster, on the other hand, is an explosive unit of different composition than the borehole charge and does not contain a firing device. The booster is initiated by the column charge adjacent to it. A booster is used to put additional energy into a hard or tough rock layer (Figure 5.1).

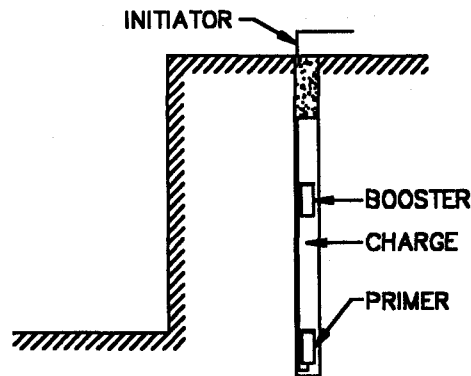


Figure 5.1 Primer and Booster in Borehole

#### 5.1 PRIMER TYPES

Primers can be found in many sizes and in many varying compositions. Primers may be as small as a Detaprime, which fits over the end of a blasting cap and weighs a few ounces, or may consist of a 50 pound cartridge of explosive (Figure 5.2). Diameters can vary from a fraction of an inch to over a foot. Primers come in many different compositions. Various grades of dynamite are used as primers as well as water gels, emulsions and densified ammonium nitrate compounds. Various types of cast explosives of high density, high velocity and high costs are also used for priming. Because of the vast number of sizes and compositions of primers, it is confusing for the operator. Improper selections are often made which can cause less than optimum results.

Inadequate priming can be costly to the operator. If the main charge in a borehole is not being properly initiated, patterns by necessity may be much smaller than would normally be needed. Fragmentation size may also get larger. Poor priming procedures are not only costly, but totally inadequate priming can cause excessive ground vibration, air blast, flyrock and considerably more damage behind the last row of holes than would occur if good priming procedures were used.

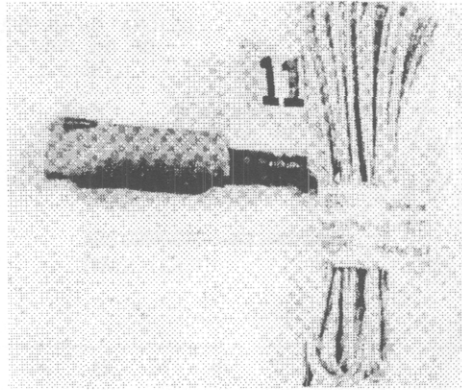
### 5.1.1 DETERMINATION OF NUMBERS NEEDED

The number of primers which are placed in a blasthole is dependent on a number of different factors. There is no one method of priming which would define a universally accepted procedure.

It is common practice for some operators to routinely put two primers into a blasthole regardless of the borehole length. They are concerned about the possibility of getting a poor blasting cap, which may not fire, or they may have a concern for cutoffs of the hole due to shifting rock caused by a previous delay firing. In either case, their rationale is that using a second primer is insurance against problems. If a rock mass contains considerable numbers of mud seams, whereby confinement on the main charge could be lost during the detonation process, it is common to find operators placing additional primers in the blasthole to cause the explosive charge to fire more rapidly, thereby reducing possible problems due to loss of confinement. If the blaster is working in competent rock, the use of blastholes whose length is greater than twice the burden may require a second primer to get efficient detonation throughout the total length of the charge. Conversely, in most cases from a purely technical standpoint, only one primer is needed for a single column charge of explosive if the bench

height is less than twice the burden. In those cases where more than one primer is used, it is assumed that both primers would be firing near instantaneously.

Two or more primers are being placed in a blasthole, normally the second primer is placed on a later delay period since the first primer location may be critical for the form properly. The second delayed primer would act only as a back-up unit should the first fail to initiate at the proper time.



(A) Detaprime



(B) Primers

**Figure 5.2** Detaprime and Other Primers

### 5.1.2 SELECTION CRITERIA FOR PRIMER

The two most critical criteria in primer selection are primer composition and primer size. The primer composition determines the detonation pressure which is directly responsible for the initiation of the main charge. Research conducted by Norm Junk at the Atlas Powder Company had demonstrated that primer composition significantly affected the performance of ANFO charges. Figure 5.3 is a graph illustrating the effect of detonation pressure for a 3-inch diameter ANFO charge and the response of the ANFO at various distance from the primer. It will be noted that thermal primers of low detonation pressure actually caused a burning reaction to start rather than a detonation. All primers producing detonation velocities above steady state would be acceptable.

Primer size is also important to obtain a proper reaction. Very small diameter primers are not as efficient as large diameter units. Figure 5.4 demonstrates the effect of primer diameter on ANFO response in 3-inch diameter charges at various distances from the primers. This research conducted by Norm Junk from Atlas Powder Company, indicated that small diameter primers become inefficient regardless of the composition of the material used.

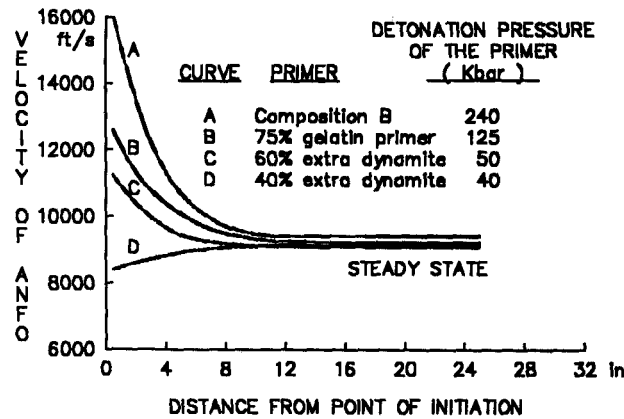


Figure 5.3 Explosive Composition and Primer Performance (after Junk)

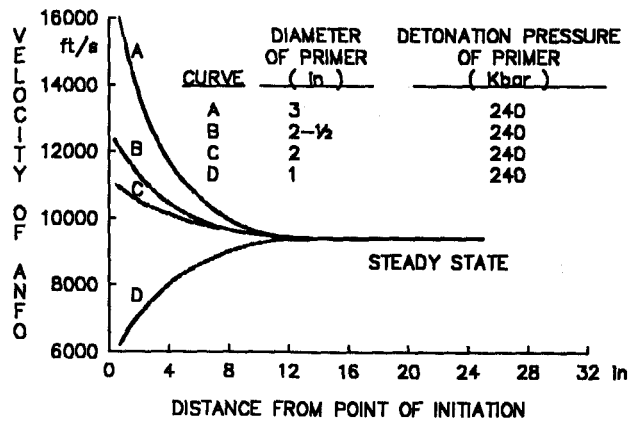


Figure 5.4 Primer Diameter and Primer Performance (after Junk)

### 5.1.3 PRIMER SELECTION GUIDELINES

The following are some general guidelines for priming:

1. The detonation pressure of a primer must be above the level necessary to cause the main charge to detonate at or above its normal velocity. The specific gravity and confined detonation velocity can be used as indicators of detonation pressure if detonation pressure values are not available. A primer that has a specific gravity of approximately 1.2 with a confined detonation velocity greater than 15,000 feet would normally be adequate when priming non-cap sensitive explosives, materials such as ANFOs, blasting agents and most water gels. This combination of density and velocity produces a detonation pressure of about 60 kilobars. For explosives such as emulsions, which would detonate at higher velocities, more energetic primers would produce better results. A specific gravity of primer of 1.3

with a confined detonation velocity greater than 17,000 ft/s would be adequate to more quickly achieve the explosive's normal velocity. This combination of density and velocity produces a detonation pressure of about 80 kilobars.

2. The diameter of the primer should be larger than the critical diameter of the explosive used for the main column charge.

3. The primer must be sensitive to the initiator. A wide variety of the products are used as primers. These primers have different sensitivities. Some may be initiated by low energy detonating cord, while others may be insensitive to these initiators. It is important that the operator understand the sensitivity of the primer to ensure that detonation in the main column charge will properly occur.

4. The explosive in the primer must reach its rated velocity of detonation within the length of the cartridge. If this is achieved, then additional cartridges of primer explosive serve no useful purpose.

5. For most blasting applications, no more than two primers per blasthole are needed. The second primer, although technically not needed, is commonly used as a backup system should the first primer fail or fail to shoot the entire charge.

## **5.2 BOOSTER**

Boosters are used to intensify the explosive reaction at a particular location within the explosive column. Boosters are sometimes used between each cartridge of detonating explosive to ensure a detonation transfer across the ties of the cartridge. This normally is a poor excuse for the use of boosters, since booster cost can be considerable. The selection of an explosive in a cartridge which would not require a booster between each cartridge may be a more economical solution.

In general, boosters are used to put more energy into a hard layer within the rock column. They are sometimes also used to intensify the reaction around the primer which will put more energy at the primer location. This is commonly used when primers are near the bottom of the hole, since the bottom of the hole is the hardest place to break. Using a booster at hole bottom normally allows the increase in the burden dimension and better breakage at the toe of the shot. Boosters can be made of similar explosive materials as primers. Their sole function is to place more energy at point locations within the explosive column.



### 5.3 EFFECTS OF DETONATING CORD ON ENERGY RELEASE

Cap sensitive explosives, such as dynamite, are initiated by detonating cord. Non-cap-sensitive explosives such as ammonium nitrate, emulsions, and water gels can be effected in many ways by detonating cord passing through the explosive column. If the detonating cord has sufficient energy explosives may detonate or burn. A burning reaction, rather than a detonation, releases only a fraction of the explosives available energy. The blast is underloaded because of a low energy release. Ground vibration levels increase while blast holes may vent and produce flyrock.

To prevent the main explosive charge from burning or deflagrating, one must be sure that the detonating cord is not too large for the borehole diameter. Cord grain loads that should not cause deflagration are in Table 5.1.

TABLE 5.1 MAXIMUM CORD LOAD

BOREHOLE DIAMETER (in)	MAXIMUM CORD LOAD (grain/ft)
2 - 5	10
5 - 8	25
8 - 15	50

If the detonating cord is not of sufficient size to cause a reaction in the explosive, it can cause the explosive to be damaged. The location of the cord can be in the center, or side of the hole and its location will control the severity of affects. The damage that results is called dead pressing or pre-compression. Dead pressing increases the explosive density and it will not detonate. This occurs when the detonating cord is of sufficient energy to crush out the air spaces within the explosive or to break the air filled microspheres placed in some products. Air pockets provide locations to form hot spots for detonation. The adiabatic compression of air is necessary for detonation to proceed throughout the explosive.

When the explosive is partially compressed or damaged by precompression, it may detonate or burn releasing only a fraction of the available energy. This effect can be confusing since the explosive may be totally consumed yet little rock breakage results. Commonly, the blaster who suffers this type of problem believes that the problem is because of hard, tough rock. To obtain a better understanding of this problem, look at the energy loss that results from passing a detonating cord though an explosive column. Figure 5.5 shows the energy loss for ANFO, which is damaged by detonating cord. Slurry can also suffer similar damage. Even a four-grain detonating cord can cause a significant energy loss in ANFO. Approximately 38% of the useful energy is lost with as little as a four-grain cord in a two-inch diameter blasthole.

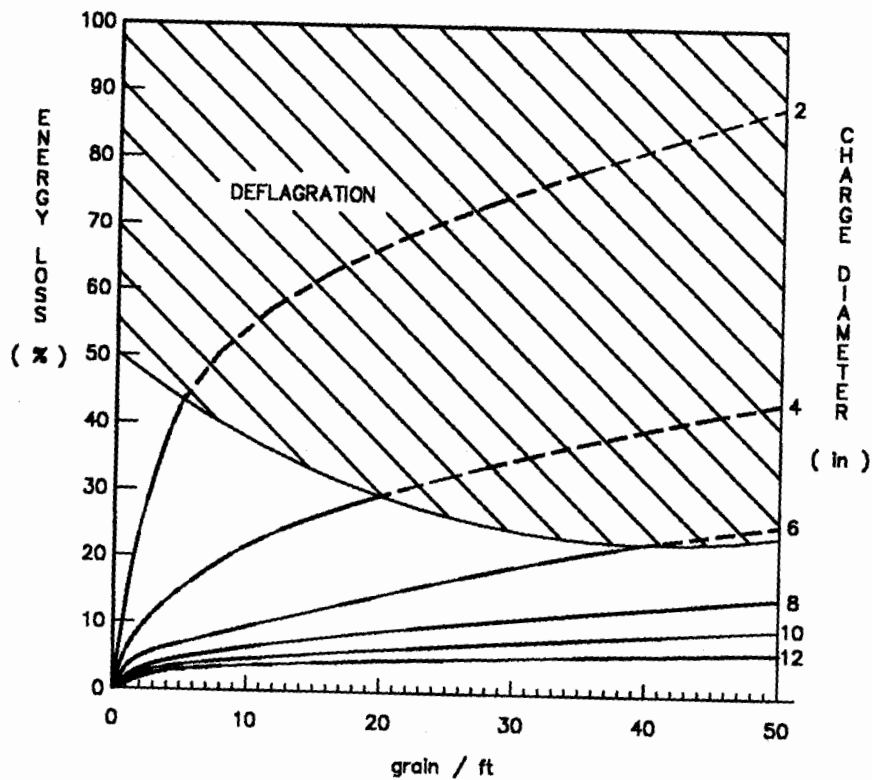


Figure 5.5 Energy Loss Caused by Detonating Cord

The general recommendation is not to use any detonating cord in small diameter holes loaded with non-cap sensitive explosives.

#### 5.4 CHAPTER 5 SUMMARY

Adequate priming can only be obtained if the size and composition of the primer meet certain minimum criteria. The criteria for primer selection, such as composition, size, length and number needed, were reviewed. Conditions under which boosters are needed were discussed.

## CHAPTER 6 OBJECTIVES

To propose methods to approximate the dimensions and design of a single hole in a blast. To understand calculations to determine the values of the design dimensions.

## CHAPTER 6 SUMMARY

The design calculations for the burden, stemming, subdrilling, powder load and initiation timing must be compensated for rock type and explosives characteristics. Each design variable is interdependent with the others. The design of these variables requires the understanding of a simple step-by-step design method.

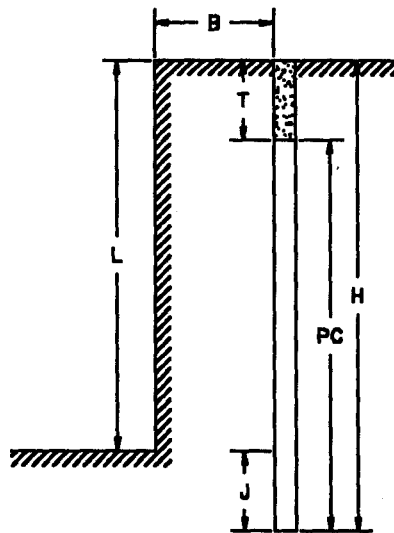
## CHAPTER 6

### BLAST DESIGN

The design of blasts must encompass the fundamental concepts of ideal blast design, which are then modified when necessary to account for local geologic conditions. In order to evaluate a blasting plan, the plan must be taken apart and each variable or dimension must be evaluated. A plan must be designed and checked one step at a time. This chapter will lay out a step-by-step procedure for the analysis of a blasting plan. Methods to determine whether design variables are in normally acceptable ranges will be examined.

#### **6.1 BURDEN**

Burden distance is defined as the shortest distance to relief at the time the hole detonates (Figure 6.1). Relief is normally considered to be either a ledge face or the internal face created by a row of holes that have previously shot on an earlier delay. The selection of the proper burden is one of the most important decisions made in any blast design. Of all the design dimensions in blasting, it is the most critical. If burdens are too small, rock is thrown a considerable distance from the face. Air blast levels are high and the fragmentation may be excessively fine. If burdens are too large, severe backbreak and back shattering results on the back wall. Excessive burdens may also cause blastholes to geyser throwing flyrock considerable distances, vertical cratering and high levels of air blast will occur when blastholes relieve by blowing out. Excessive burdens cause overconfinement of the blastholes, which result in significantly higher levels of ground vibration per pound of explosive used. Rock breakage can be extremely coarse and bottom or toe problems often result. Of all the design variables, there is the least allowable error in the burden dimension. Other variables are more flexible and will not produce the drastic differences in results as would the same proportion of error in the burden dimension.



**Figure 6.1** Symbols for Blast Design

where:

- B = Burden
- T = Stemming
- J = Subdrilling
- L = Bench height
- H = Blasthole depth
- PC = Powder column length

If the operator has selected a burden and used it successfully for a drill hole of another size and wants to determine a burden for a drill hole that is either larger or smaller, one can do so quite easily if the only thing that he is changing is the size of the hole and the rock type and explosives are staying the same. To do this, one can use the following simple ratio:

$$B_2 = B_1 \frac{De_2}{De_1} \quad (6.1)$$

where:

- $B_1$  = Burden successfully used on previous blasts
- $De_1$  = Diameter of explosive for  $B_1$
- $B_2$  = New burden
- $De_2$  = New diameter of explosive for  $B_2$

---

### Example 6.1

A contractor was blasting on a highway cut. Six-inch blastholes in sandstone rock were loaded with ammonium nitrate. The operator decided to reduce his blasthole size to four-inch while still using ammonium nitrate as the explosive. By substituting the numbers into Equation 6.1, the new burden needed on the four-inch charge size can be determined. Given information:

$$\begin{aligned} B_1 &= 15 \text{ ft} \\ D_{e1} &= 6 \text{ in} \\ D_{e2} &= 4 \text{ in} \end{aligned}$$

What is  $B_2$ ?

$$B_2 = B_1 \frac{D_{e2}}{D_{e1}} = 15 \frac{4}{6} = 10 \text{ ft}$$

Equation 6.1 has severe limitations since it can be used only if the explosives and rock characteristics remain unchanged.

---

#### 6.1.1 ADJUSTMENTS FOR ROCK & EXPLOSIVE TYPE

When an operator is moving into a new area where he has no previous experience, he would have only general rock and explosive characteristics to work with. When moving into a new area, especially one where there are residents nearby, it is essential that the first shot not be a disaster. To approximate burden under these situations, the following empirical formula is helpful.

$$B = \left[ \frac{2 SG_e}{SG_r} + 1.5 \right] D_e \quad (6.2)$$

where:

$$\begin{aligned} B &= \text{Burden (ft)} \\ SG_e &= \text{Specific gravity of explosive} \\ SG_r &= \text{Specific gravity of rock} \\ D_e &= \text{Diameter of explosive (in)} \end{aligned}$$

---

### Example 6.2

An operator has designed a blasting pattern in a limestone formation using 3 inch blastholes. The 3 inch blastholes will be loaded with a semigelatin dynamite. The semigelatin has a specific gravity of 1.3. Limestone has a specific gravity of 2.6, while the diameter of cartridge in a 3 inch hole is 2-1/2 inches. Equation 6.2 can be used to determine the burden (Rock density given in Table 6.1).

$$B = \left[ \frac{2 SG_e}{SG_r} + 1.5 \right] D_e = \left[ \frac{2 \times 1.3}{2.6} + 1.5 \right] \times 2.5 = 6.25 \text{ ft}$$

---

TABLE 6.1 ROCK DENSITY

ROCK TYPE	SPECIFIC GRAVITY	ton/yd <sup>3</sup>
Basalt	2.8 - 3.0	2.57
Diabase	2.6 - 3.0	2.36
Diorite	2.8 - 3.0	2.50
Dolomite	2.8 - 2.9	2.43
Gneiss	2.6 - 2.9	2.43
Granite	2.6 - 2.9	2.30
Hematite	4.5 - 5.3	4.12
Limestone	2.4 - 2.9	2.23
Marble	2.1 - 2.9	2.09
Micaschist	2.5 - 2.9	2.30
Quartzite	2.0 - 2.8	2.16
Sandstone	2.0 - 2.8	2.03
Shale	2.4 - 2.8	2.16
Slate	2.5 - 2.8	2.23
Trap Rock	2.6 - 3.0	2.36

In the general case, burdens, which are used on the job, will be reasonable if they are within plus or minus 10% of the value obtained from Equation 6.2. Rock density is used in Equation 6.2 as an indication of matrix strength. There is a relationship between rock density and rock strength. The denser the rock, the more energy needed to overcome its tensile strength and to cause breakage to occur. There is also a relationship between the amount of energy needed to move rock. The denser the rock the more energy needed to move it.

Explosive strength characteristics can be approximated using specific gravity because the stronger the explosive, the denser the explosive. If the strength of explosives were the same on a unit weight basis, then strength would be proportional to the density. However, there are differences also in explosive energy on a unit weight basis. Those differences as compared to the differences in density are normally quite small, which allow the use of Equation 6.2 as a first approximation.

The previous equations proposed for burden selection used the specific gravity of the explosives as an indicator of energy. The new generation of slurry explosives called emulsions have somewhat different energies but near constant specific gravity. The burden equations thus far proposed will define a reasonable burden but will not differentiate between the energy levels of some explosives such as emulsions. In order to more closely approximate the burden for a test blast, one can use an equation that uses relative bulk strength rather than explosive specific gravity. Relative bulk strength is the energy level at constant volume as compared to a standard explosive. The standard explosive is defined as ammonium nitrate and fuel oil which is defined to have an energy level of 100. To use the energy equation, one would consider the relative bulk strength (relative volume strength) of the explosive. It has been found that the relative bulk strength values which result from data obtained from bubble energy tests, normally produce reasonable results. Working with relative energies can be somewhat misleading since relative energies may be calculated rather than obtained from bubble energy test data. The explosive in the borehole environment may not be as efficient as would have been expected from the underwater test data. The equation that uses relative energy is:

$$B = 0.67 De \sqrt[3]{\frac{St_v}{SG_r}} \quad (6.3)$$

where:

- B = Burden (ft)
- De = Diameter of explosive (in)
- St<sub>v</sub> = Relative bulk strength (ANFO = 100)
- SG<sub>r</sub> = Specific gravity of the rock

### 6.1.2 CORRECTIONS FOR NUMBERS OF ROWS

Many blasting operations are conducted using one or two rows of blastholes. In this case, the burden between the first and second row would be equal. On some blasts, however, three or more rows of blastholes are used. When blasthole timing is not correct, it is more difficult to break the last rows of holes in multiple row blasts because the previous rows are adding additional resistance and added confinement on the later rows. This also commonly occurs in buffer blasting. Buffer blasting is blasting to a face where the previously shot rock has not been removed. To adjust the burdens in the third, fourth, and subsequent rows one can use the correction factor, Kr, as shown in Table 6.2. The burden for the test shot would be the originally calculated burden multiplied times Kr.



**TABLE 6.2 CORRECTIONS FOR NUMBER OF ROWS**

<b>ROWS</b>	<b>Kr</b>
One or two holes	1.0
Third and subsequent rows or buffer blasts	0.9

**6.1.3 GEOLOGIC CORRECTION FACTORS**

No one number will suffice as the exact burden in a particular rock type because of the variable nature of geology. Even when strength characteristics are unchanged the manner of rock deposition and geologic structure must also be considered in the blast design. The manner in which the beds are dipping, influences the design of the burden in the pattern.

There are two rock strengths that the explosive energy must overcome. There is a tensile strength of the rock matrix and the tensile strength of the rock mass. The tensile strength of the matrix is that strength which one can measure using the Brazilian or modulus or rupture test conducted on a uniaxial testing machine. Mechanical testing procedures would dictate that a massive undamaged sample of material be used for testing. A test may have biased results because one uses intact samples rather than those that are already broken. By doing so, only the matrix strength is being measured and not the strength of the rock mass. The mass strength can be very weak while the matrix strength can be strong. For example, one can have a very strong rock that is highly fractured, broken, foliated and laminated. The rock mass, however, could be on the verge of collapse simply due to the rock structure.

To estimate the deviation from the normal burden formula for unusual rock structure, two constants are incorporated into the formula. Kd is a correction for the rock deposition and Ks is a correction for the geologic structure. Kd values range from 1.0 to 1.18 and describe the dipping of the beds (Table 6.3). The classification method is broken into three general cases of deposition, beds steeply dipping into the cut, beds steeply dipping into the face or into the massive rock, and other cases of deposition.

**TABLE 6.3 CORRECTIONS FOR ROCK DEPOSITION**

<b>BEDDING ORIENTATION</b>	<b>Kd</b>
Bedding steeply dipping into cut	1.18
Bedding steeply dipping into face	0.95
Other cases of deposition	1.00

The correction for the geologic structure takes into account the fractured nature of the rock in place, the joint strength and frequency as well as cementation between layers of rock. The correction factors for rock structure ranges from 0.95 to 1.30 (Table 6.4). Massive intact rock would have a Ks value of 0.95 while heavily broken fractured rock could have a Ks value of about 1.3.

**TABLE 6.4 CORRECTIONS FOR GEOLOGIC STRUCTURE**

GEOLOGIC STRUCTURE	Ks
Heavily cracked, frequent weak joints weakly cemented layers	1.30
Thin well-cemented layers with tight joints	1.10
Massive intact rock	0.95

Example 6.3 will help demonstrate the use of the correction factors.

### Example 6.3

The rock formation is a horizontally bedded limestone (specific gravity = 2.6) with many sets of weak joints. It is highly laminated with many weakly cemented beds. The explosive will be a cartridge slurry (relative bulk strength of 140) with a specific gravity of 1.2. The five inch diameter cartridges will be loaded into 6.5 inch diameter wet blastholes.

$$B = 0.67 D e^3 \sqrt{\frac{St_v}{SG_r}} = 0.67 \times 5 \times \sqrt[3]{\frac{140}{2.6}} = 12.6 \text{ ft}$$

Correction for Geologic Conditions

$$B = K_d \times K_s \times B = 1 \times 1.3 \times 12.6 = 16.4 \text{ ft}$$

First calculate the average burden using either Eq. 6.2 or Eq. 6.3. With five inch diameter cartridge, the average burden is 12.6 feet. When the geologic correction factors are applied, a burden would be 16 feet.

## 6.2 STEMMING DISTANCE

Stemming distance refers to the top portion of the blasthole normally filled with inert material to confine the explosive gases. In order that a high explosive charge functions properly and releases the maximum energy, the charge must be confined in the borehole. Adequate confinement is also necessary to control air blast and flyrock. The common relationship for stemming determination is:

$$T = 0.7 \times B \quad (6.4)$$

where:

$$\begin{aligned} T &= \text{Stemming (ft)} \\ B &= \text{Burden (ft)} \end{aligned}$$

In most cases, a stemming distance of 0.7 times burden is adequate to keep material from ejecting prematurely from the hole. It must be remembered that stemming distance is proportional to the burden, therefore, charge diameter, specific gravity of explosive and specific gravity of rock were all needed to determine the burden, and stemming distance is also a function of these variables. If the blast is poorly designed, a stemming distance equal  $0.7 \times B$  may not be adequate to keep the stemming from blowing out. In fact, under conditions of poor design doubling, tripling and quadrupling the stemming distance may not ensure the holes will function properly, therefore, the average stemming distance previously discussed is only valid if the shot is functioning properly.

---

### Example 6.4

In example 6.2, a 3 inch diameter blasthole was used in limestone. It was determined that a 6.25 feet burden would be a good first approximation. To determine the stemming distance needed in that blast:

$$T = 0.7 \times B \text{ (For crushed stone or drilling chips)}$$

$$T = 0.7 \times 6.25 = 4.38 \text{ ft}$$

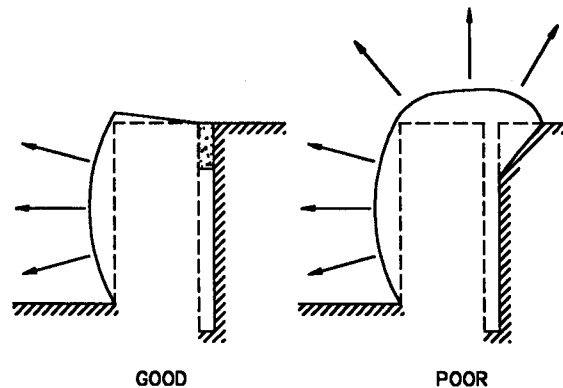
where:

$$\begin{aligned} T &= \text{Stemming (ft)} \\ B &= \text{Burden (ft)} \end{aligned}$$

---

The common material used for stemming is drill cuttings, since they are conveniently located at the collar of the blasthole. However, very fine cuttings commonly called drilling dust make poor stemming material. If one uses drill cuttings heavy with drilling dust, approximately 30% or  $0.3 \times B$  more stemming would have to be used than if the crushed stone were used for the stemming material. In instances where solid rock is located near the surface of the bench (cap rock), operators often bring the main explosive column as high as possible to break this massive zone. However, they do not want to risk the possibility of blow-out, flyrock and air blast. In cases such as this, it is common to bring crushed stone to the job site to use as stemming material. In example 6.4, where the stemming distance was calculated, if drilling dust were used instead of crushed stone or drilling chips, it may be necessary to increase the stemming depth to equal burden distance. Drilling dust makes poor stemming material since it will not lock into borehole walls and is easily ejected.

If stemming distances are excessive, poor top breakage will result and the amount of backbreak will increase. When a blast functions properly, the stemming zone will gently lift and slowly drop onto the broken rock pile after the burden has moved out. This action is illustrated in Figure 6.2.



**Figure 6.2** Stemming Zone Performance

Selection of the proper size of stemming material is important if one wants to minimize the stemming depth in order to break cap rock. Very fine drilling dust will not hold into the blasthole. Very coarse materials have the tendency to bridge the hole when loading and may be ejected like golf balls. The optimum size of stemming material would be material that has an average diameter of approximately 0.05 times the diameter of the blasthole. Material must be angular to function properly. The best size would be determined as follows:

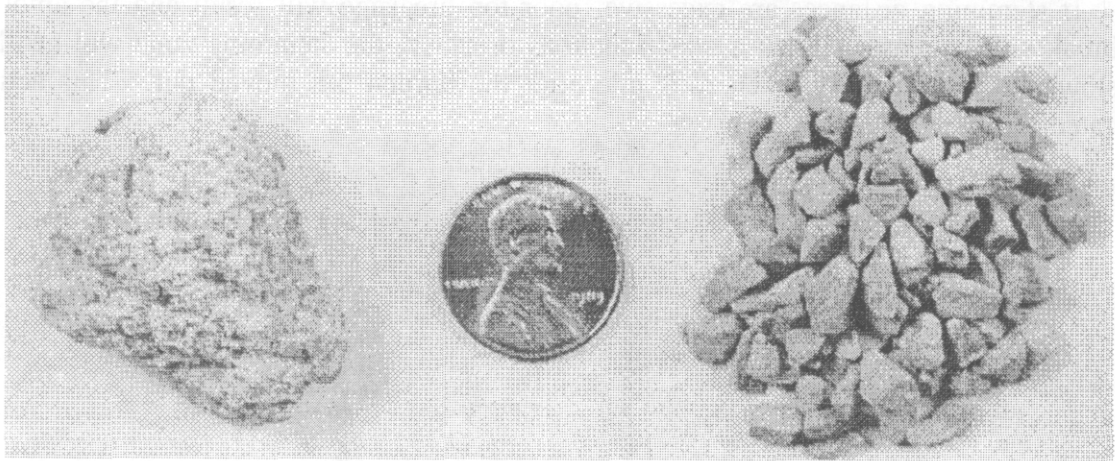
$$S_z = \frac{D_h}{20} \quad (6.5)$$

where:

$S_z$  = Particle size (in)

$D_h$  = Blasthole diameter (in)

River gravel of this size, which has become rounded, will not function as well as crushed stone. Upon detonation of the explosive in the blasthole, stemming particles will be compressed to mortar consistency for a short distance above the charge (Figure 6.3).



**Figure 6.3** Stemming Material Compaction Immediately Above Charge. Compact Material Results from Crushed Stone (on the left)

### **6.3 SUBDRILLING**

Subdrilling is a common term to denote the depth which a blasthole will be drilled below the proposed grade to ensure that breakage will occur to the grade line. Blastholes normally do not break to full depth. On most construction projects, subdrilling is used unless, by coincidence, there is either a soft seam or a bedding plane located at the grade line. If this occurs, no subdrilling would be used. In fact, blastholes may be back filled a distance of 6 to 12 charge diameters to confine the gasses and keep them away from a soft seam (Figure 6.4). On the other hand, if there is a soft seam located a short distance above the grade line and below there exists massive material, it is not uncommon to have to subdrill considerably deeper in order to break the material below the soft seam. As an example, Figure 6.5 indicates a soft seam one foot above the grade. In this case, a subdrilling approximately equal to the burden distance was required below the grade to ensure breakage to grade. In most instances, subdrilling is approximated as follows:

$$J = 0.3 \times B \quad (6.6)$$

where:

- J = Subdrilling (ft)  
 B = Burden (ft)

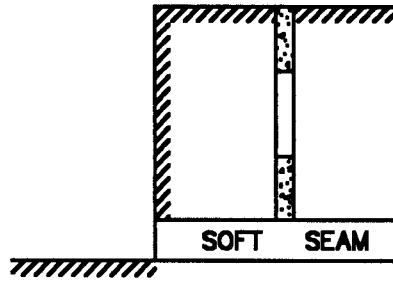


Figure 6.4 Backfill Borehole to Soft Seam

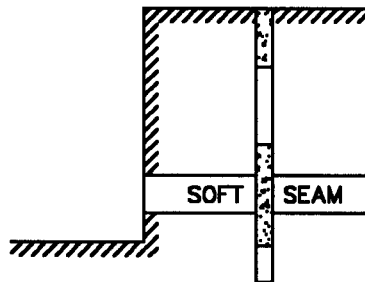


Figure 6.5 Problems of Soft Seam Off Bottom

The subdrilling must not contain drill cuttings, mud or any rock materials. If borehole walls naturally slough and fill in, drilling must be deeper than the subdrilling previously discussed so that at the time of loading the calculated amount of subdrilling is open and will contain explosives.

In order to get a flat bottom in an excavation, it makes good economic sense to drill to a depth below grade, which ensures, in spite of random drilling depth errors and sloughing holes, that all hole bottoms will be down to the proper depth at the time of loading. If drilling is done slightly deeper than required and some holes are too deep at the time of loading, the blaster can always place drill cuttings in the bottom of those holes to bring them up to the desired height. The blaster, however, does not have the ability, at the time of loading, to remove excessive cuttings or material which has fallen into the hole.

The function of subdrilling is illustrated in Figure 6.6. The lines on the figure represent stress contours or zones where the stresses in the rock are equal. The zone which is cross-hatched indicated the zone of maximum tension in the rock. In Figure 6.6, where subdrilling was used, there is a larger zone of maximum tension and it occurs closer to floor level or the area which must be sheared.

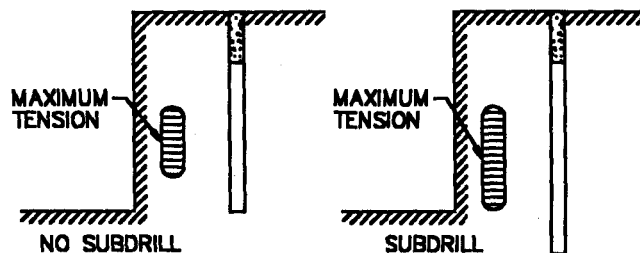


Figure 6.6 Subdrilling and Maximum Tensile Stress Levels

### Example 6.5

A 3 inch blasthole was used in Figure 6.2 in limestone rock. The burden was determined to be 6.25 feet. The amount of additional drilling or subdrilling which would be needed below grade to ensure breakage to grade is determined by using equation 6.6.

Solution:

$$J = 0.3 \times B = 0.3 \times 6.25 = 1.88 \text{ ft}$$

## 6.4 SELECTION OF BLASTHOLE SIZE

The selection of the proper size blasthole for any job requires a two-part evaluation. The first part would consider the effect of the drillhole size on fragmentation, air blast, flyrock and ground vibration. The second would consider drilling economics.

### 6.4.1 BLASTING CONSIDERATIONS

The blasting consideration of fragmentation, air blast, flyrock and ground vibration would have to be assessed. In general, the larger the hole size, the more problems are possible with air blast, flyrock, ground vibration and fragmentation. To gain insight into the potential problems which can result requires the consideration of the stiffness ratio, which is the bench height divided by the burden distance, or L/B. Table 6.5 is a summary of general potential problems as related to the stiffness ratio.

With the help of Table 6.5, the operator can determine his potential for the unwanted effects which were previously discussed, and determined how much of a tradeoff he wants to make with the drilling and loading economics and these factors. The more massive the rock in a production blast, the more probable the outcome listed in Table 6.5.

**TABLE 6.5 POTENTIAL PROBLEMS AS RELATED TO STIFFNESS RATIO (L/B)**

Stiffness Ratio	1	2	3	4
Fragmentation	Poor	Fair	Good	Excellent
Air blast	Severe	Fair	Good	Excellent
Flyrock	Severe	Fair	Good	Excellent
Ground Vibration	Severe	Fair	Good	Excellent
Comments	Severe backbreak & toe problems. Do not shoot. REDESIGN!	Redesign if possible.	Good control and fragmentation.	No increased benefit by increasing stiffness ratio above 4.

### Example 6.6

The Ajax Construction Company is removing a cut for a highway project. The maximum bench height is 20 feet deep. Because of the small loading equipment fragmentation must be good. The operator has track drills capable of drilling up to 5-inch diameters and a down-the-hole hammer capable of going up to 7-7/8 diameter in his equipment inventory. What hole size should be selected base on the local conditions?

Solution: Questions which must be answered:

- a) Are the blastholes wet? Should cartridged or bulk powder be used? (Assume dry holes: ANFO used as explosive.)
- b) What amount of explosive can be loaded per blasthole or per deck without having vibration problems?
- c) Must air blast and flyrock be totally avoided and should blasting mats be used?

Since fragmentation must be good, select an L/B ratio of 3. The explosive selected based on the answer to question "a" has a density of 0.8 and the rock density is 2.6.

Equation 6.2 can be used and solved for charge diameter (De).

$$\text{If } L / B = 3 \text{ and } L = 20 \text{ feet then } B = \frac{L}{3} = \frac{20}{3} = 6.67 \text{ ft}$$



Using equation 6.2:

$$B = \left[ \frac{2 SG_e}{SG_r} + 1.5 \right] D_e$$

Substituting 6.67 for B and rearranging the equation:

$$D_e = \frac{B}{\left[ \frac{2 SG_e}{SG_r} + 1.5 \right]} = \frac{6.67}{\left[ \frac{2 \times 0.8}{2.6} + 1.5 \right]} = 3.15 \text{ in}$$

The number found with these calculations would not necessarily be the optimum hole size. It would be the maximum hole size one would want to use to minimize the conditions previously discussed. The vibration limitations, if any, from question "b" would now be acceptable. On the other hand, any size larger than 3 inches would increase the probability of coarse fragmentation, air blast, flyrock and ground vibration per pound of explosive used.

---

A simple method used to approximate a blasthole length where the stiffness ratio is above 2, is given in Figure 6.7 and is often called the "Rule of Five".

$$L_H = 5 \times D_e \tag{6.7}$$

where:

$L_H$  = Minimum bench height (ft)

$D_e$  = Diameter of explosive (in)

The minimum length of blasthole in feet is approximated by multiplying the hole diameter in inches by 5.

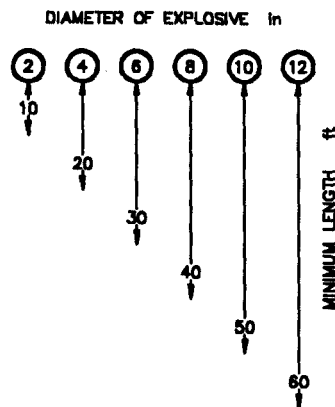


Figure 6.7 Rule of Five

## 6.4.2 INITIATION TIMING AND CAP SCATTER

All initiation systems used today have scatter times of initiation, which means that the blasting cap will not fire exactly on the rated delay. In general, unless told otherwise by the manufacturer, one could assume that the rated cap delay period has a maximum scatter time of approximately plus or minus 10%. This is to say, for example, that either an electric or non-electric blasting cap that is rated as a 200 millisecond delay will fire between 180 and 220 ms. In Figure 6.8A, if the subsequent hole is due to fire at 210 milliseconds, the probability of having a true 10 millisecond delay time between the two holes is relatively small. If each hole contains a 200 millisecond cap. Each has a potential scatter time of 200 plus or minus 20 ms. In one case, the delays in the cap could fire 40 milliseconds apart plus an additional 10 milliseconds between holes from the sequential timer or a total of 50 milliseconds apart. In another instance (Figure 6.8B), if hole No. 1 fired late, 220 ms, and if hole No. 2 fired 20 milliseconds early at 180 ms, in spite of the 10 ms delay between hole, reverse firing would occur.

If good wall control and low vibration and violence is to be achieved, sequential movement of rows is necessary. Serious consideration of the effect of scatter time especially on row-to-row delays must be made when designing the blast.

Although not a common occurrence, cap scatter time has been responsible for backbreak, flyrock, air blast and excessive ground vibration.

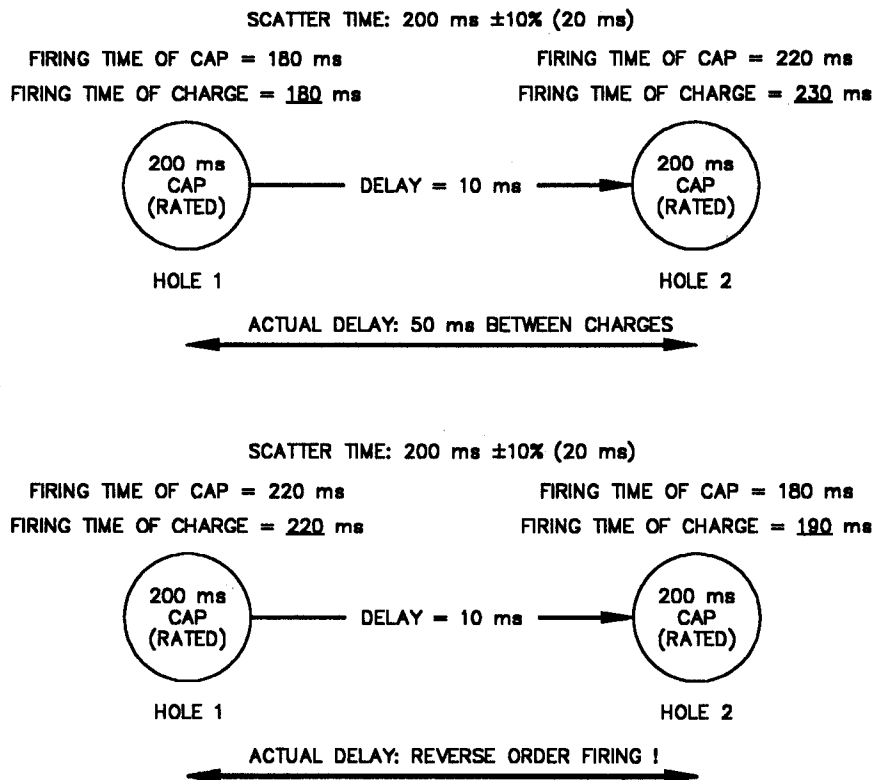


Figure 6.8 Effects of Cap Scatter Time

## **6.5 TIMING EFFECTS ON FRAGMENTATION**

Selection of the proper initiation timing is every bit as important as the selection of the proper physical dimension, such as burden and spacing. Two general conditions of initiation timing will be discussed. The first is where holes within a row are fired instantaneously or simultaneously. Simultaneous initiation along a row does mandate a larger spacing and therefore, since holes are spaced further apart, the cost per yard or per ton of the broken material is reduced. The drawbacks of having simultaneous initiation along a row, of course, are problems which would arise due to ground vibration or having many holes firing at the same time. Although more yardage is produced by instantaneous initiation, the fragments would be coarser than that produced by proper delay initiation timing with shorter spacings. Delay initiation timing along a row does reduce ground vibration and produce finer fragmentation at elevated cost. Some relatively simple rules on delay initiation timing hole-to-hole are as follows. Table 6.6 supplies time constants for various rock types. The information in this table can be used along with the equation 6.8.

**TABLE 6.6 TIME DELAY BETWEEN BLASTHOLES (FOR 2 FREE FACES)**

<b>ROCK TYPE</b>	<b>T<sub>H</sub> CONSTANT (ms/ft)</b>
Sands, loams, marls, coals	1.8 - 2.1
Some Limestone, rock sale, some shales	1.5 - 1.8
Compact limestones an marbles, some granites and basalts, quartzite rocks, some gneisses and gabbroe	1.2 - 1.5
Biabase, diabase porphyrites, Compact gneisses and micashists, magnetites	0.9 - 1.2

### **6.5.1 HOLE-TO-HOLE DELAYS**

$$t_H = T_H \times S \quad (6.8)$$

where:

- t<sub>H</sub> = Hole-to-hole delay (ms)
- T<sub>H</sub> = Delay constant hole-to-hole from Table 6.2
- S = Spacing (ft)

### 6.5.2 ROW-TO-ROW DELAYS

Guidelines for row-to-row initiation are as follows:

- a) Short delay times cause higher rock piles closer to the face.
- b) Short delay times cause more endbreak.
- c) Short delay times cause more violence, air blast and ground vibration.
- d) Short delay times have more potential for flyrock.
- e) Long delay times decrease levels of ground vibration.
- f) Long delay times decrease the amount of backbreak.

To determine the delay time to be used between rows in production blasts, the general guidelines are given in Table 6.7.

**TABLE 6.7 TIME DELAY BETWEEN ROWS**

<b>T<sub>R</sub> CONSTANT (ms/ft)</b>	<b>RESULT</b>
2	Violent excessive air blast, backbreak, etc.
2-3	High pile close to face, moderate air blast, backbreak
3-4	Average pile height, average air blast and backbreak
4-6	Scattered pile with minimum backbreak

Delayed times should not be less than two milliseconds per foot of burden between rows. Delay times should normally be no greater than 6 milliseconds per foot of burden between rows. When wall control is critical in multi-row shots (6 or more rows), row-to-row delays may be expanded to as much as 10-20 ms/ft. of burden to obtain low muck piles. An equation for delay time between rows is as follows:

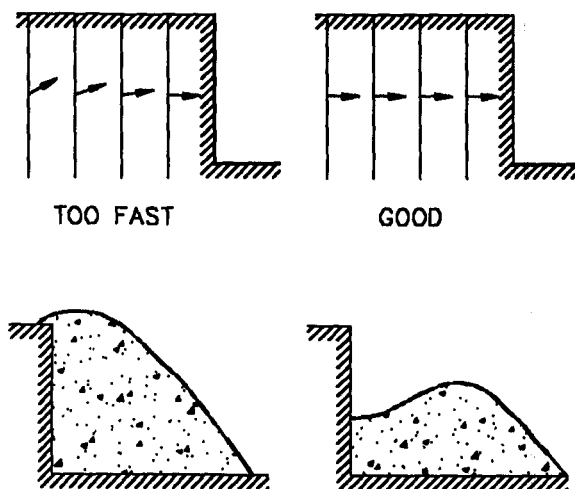
$$t_R = T_R \times B \quad (6.9)$$

where:

- t<sub>R</sub> = Time delay between rows (ms)
- T<sub>R</sub> = Time factor between rows
- B = Burden (ft)

The selection of an approximate time in milliseconds is found by determining a time factor using tables 6.6 and 6.7 and making one multiplication. The values obtained may be difficult if not impossible to implement in the field because of the limitations in hardware available from the manufacturers. Obtaining accurate time is critical. The following section will illustrate methods of determining the time and using different initiation systems available to meet those times as closely as possible.

A significant portion of the problems, which result from blasting and cause air blast, flyrock, excessive vibration and poor fragmentation, are directly related to the initiation timing (Figure 6.9). Table 6.6 and Table 6.7 produce initiation timing values, which could be used to determine performance characteristics of timing. However, timing must also be considered for its potential to cause ground vibration.



**Figure 6.9** Piling and Uplift Resulting from Timing

It is generally proposed by various regulatory agencies that charges be fired on an 8 millisecond or more delay if they are to be considered independent events from the standpoint of ground vibration. Both the vibration character and the blasting performance time previously discussed must be looked at from a realistic standpoint.

## **6.6 BOREHOLE TIMING EFFECTS**

Blasters have recognized the need for sequencing blast holes. The need for proper sequencing is even more pronounced in underground work. If holes do not sequence properly boot legs result and rounds do not pull to full depth. Sequencing holes has been used for many years, unfortunately, there is a lot more to timing than just sequencing holes. If a pattern is properly drilled and loaded, the initiation timing controls the fragmentation size, piling of the broken material, maximum vibration level, amount of air blast created, amount of flyrock produced, backbreak, endbreak and general overbreak. Timing is one of the most important blast design variables and, unfortunately, it is most often neglected. Poor timing in combination with other design inadequacies are responsible for most blasting problems.

### **6.6.1 FRAGMENTATION SIZE**

The size to which the rock is broken, from the blast, is dependent on the way the energy works both between the holes and between rows. The spacing of the holes is also dependent on the timing. Breakage will suffer if the spacing and timing are wrong. In the past 30 years, a great deal of research has been done in many different countries investigating the effects of hole to hole timing on breakage and there are many different recommendations in literature as to what the optimal timing should be. It is a recognized fact, that initiation within a certain timing window will produce better results, with no additional explosives used.

### **6.6.2 PILING OR CASTING MATERIAL**

The timing between rows in a blasts controls the piling or casting of the broken material. If delays are too short row to row, the rock will be thrown vertically into the air and may even create backspill on the bench. If longer times are used, the material can peel away, row by row, allowing forward motion of the broken rock. Operators, using explosive casting in coal mining operations, know that timing controls the amount of materials which can be put into the spoil pile.

### **6.6.3 AIR BLAST AND FLYROCK**

Air blast and flyrock are also influenced by the timing. A good shot can go bad with a change of nothing more than the cap periods in the hole. In general, too fast a timing, row to row, will increase the air blast and flyrock problems. As an example, if the row to row timing is too fast and the previous row has not had a chance to move, there is added resistance on that second row. The hole, in fact, senses a much larger burden and cannot relieve itself laterally and tends to blow out vertically. This blowout can be very difficult to control. At one coal mining operation in Appalachian, more than three times the normal stemming was used to try to control blowout and the results were still marginal. The problem wasn't with the amount of stemming used, the problem was with the timing system. A change in initiation timing increased fragmentation and allowed a 60% reduction in the amount of stemming needed to control blowout. Top breakage improved significantly.

Another source of air blast is the concussion, sub-audible sound produced by the falling wall. If the initiation rate along a face equals the velocity of sound in air, airwaves can be superimposed causing increased air blast, which under some circumstances can have directional effects.

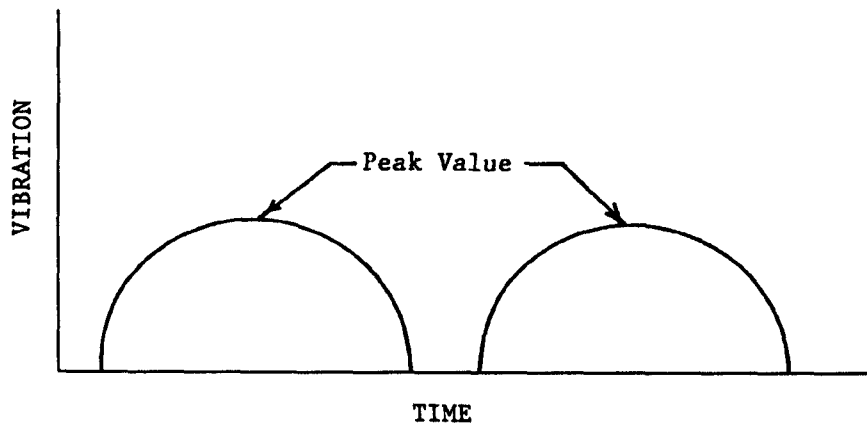
#### **6.6.4 MAXIMUM VIBRATION**

Ground vibration is also controlled by the timing. The timing effects the ground vibration in two separate ways. As an example, if the row to row timing is too fast, there is added resistance on the blastholes and less breakage occurs and more of the total energy becomes seismic energy causing problems with ground vibration. Heavy confinement is known to raise vibration levels by as much as 500%. Hole to hole timing can effect ground vibration also, since increased relief on a blasthole, at the time it fire, increases breakage and decreases seismic effects. An even more critical effect of the timing on vibration, both hole to hole and row to row, can be seen in the following discussion.

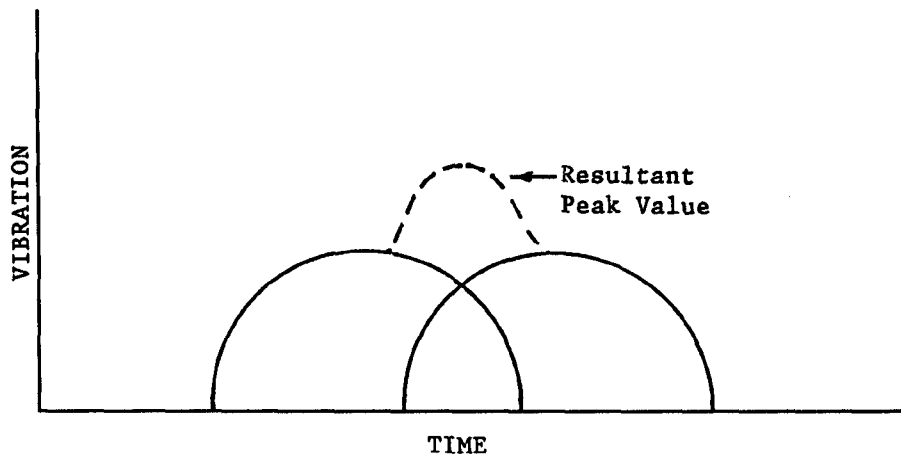
#### **6.6.5 FIRING TIME OVERLAP**

When two blastholes fire at times approaching one another, one can get ground vibration from two holes adding together creating a much higher level then would result from each hole independently. The ground vibration standards, which are used in this country, are based on peak particle velocity. It is the maximum vibration level reached at any instant of time during the blast. From an operational standpoint that means that regardless of the number of holes in the blast, whether is be 5 or 500, any two holes overlapping can create the peak value, which can exceed the standards and specifications. If one is either sloppy in our drilling, blast design, or execution, vibration levels will be much more variable on that operation then in one which maintains close accurate execution of design on each and every hole in the shot. In the typical operation some holes in the blast are 30% to 50% off of their desired location. Since the possibility of overlap of only two charges in the entire blast is being examined, timing effects provide a greater degree of variability in vibrations than the ground itself.

When a charge goes off, a wave moves out in a somewhat circular fashion. It is not truly a circle because there are differences in the transmission rates depending on ground conditions. For the purpose of this discussion, assume that it moves out in circular fashion. The wave has a peak value, but is not an instantaneous event. As an analogy, look at a water wave and see that after its peak there is some additional displacement behind the wave for a short period of time. Very similarly in ground vibration, there is peak and vibrations of lesser magnitude on either side of the peak. These waves are drawn in idealized form in Figure 6.10. In Figure 6.11, notice the two waves are not separated by enough time they will overlap and the dotted line indicates the resultant peak particle velocity that occurs due to the overlap of the two individual waves. The peak on the resultant is much higher than that of the two individual waves. Remember that if two charges go off at a time, it allows the vibrational waves to overlap, higher vibration levels would occur from either charge firing individually. In this idealized case, the overlap of only two vibration waves resulting from two charges are being considered. (It is not impossible to have overlaps of many holes in an actual blast.)



**Figure 6.10** Two Separate Waves

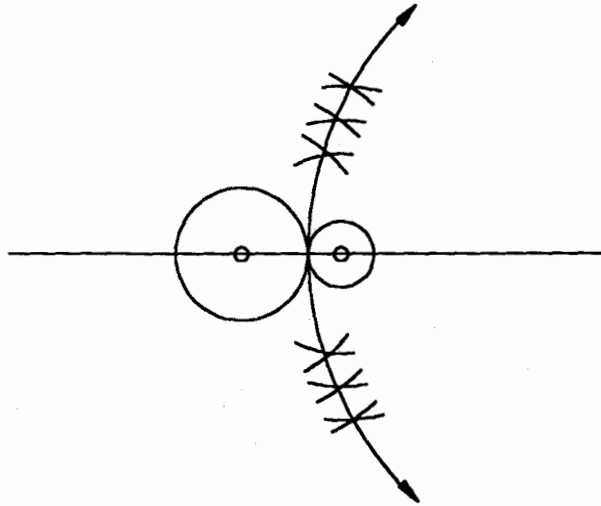


**Figure 6.11** Overlapping Waves

#### **6.6.6 EFFECTS OF TIME AND DIRECTION**

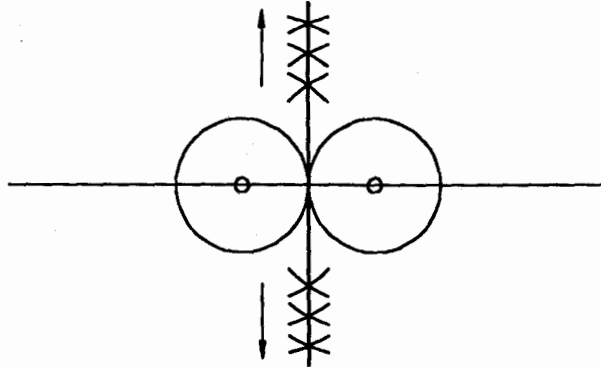
To further complicate matters, one must realize that this overlap can occur in one direction on a blast and not in others, therefore, the overlap can cause a directional effect. How much protection is the seismograph then offering if one is measuring the vibration in one direction, however, in another direction from the shot, the level is significantly higher? To understand the directional effect of vibration, look at four general cases which result as two charges fire within a blast. In the first case, the wave has nearly, but not yet reached the second hole at the time the second hole detonates (Figure 6.12). The waves will collide between holes, but because the circles are of different diameters, the resultant will form a curve of hot spots as indicated by the path of the arrows on either side of the blast Figure 6.12. In other directions, other than on this line of hot spots, vibration levels would be significantly less.





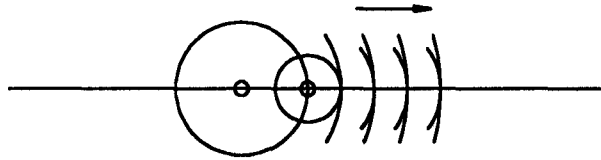
**Figure 6.12** Vibration Directionality, General Case, Covers All Possible Azimuths

In case two, we notice a line of hot spots which result moving perpendicular to the line of holes. This case would only result if both blastholes fire at exactly the same time and the resulting waves collided midway between the holes. In directions other than those shown by the arrows, the vibration levels would be significantly less (Figure 6.13).



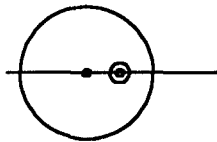
**Figure 6.13** Vibration Directionality Perpendicular to the Shot Line

In case three, the vibrational wave from hole one has just reached hole two at the time hole two fires. When this results the vibrational wave from hole two and the energy from hole one will superimpose to form a vibration level that is the resultant of both the vibrational energy in hole one and hole two, but only in the direction of the arrow, which is also in line with the holes (Figure 6.14). In other directions, two separate vibrational events separated by sufficient time would exist where levels would not be as high as they would be in the direction of the arrow.



**Figure 6.14** Vibration Directionality Along the Shot Line

Case four represents the ideal effect of using delays. It shows the vibrational wave from hole one has passed hole two with sufficient time before hole two fires, such that, the wave train from hole one and hole two are not added together (Figure 6.15). Therefore, in every direction around the blast, similar vibrations with no build-up in any one direction would occur.



**Figure 6.15** Vibration Wave Passes Second Hole Before It Fires With No Directional Effects

The four conditions which can occur are a result of the timing between two charges firing. Is there then one best time that can be used to ensure that the proper condition as in case four results? The collision of these waves is dependent upon time, but it is also dependent upon distance between charges and the ground transmission rate. For the same ground conditions the larger the distance between holes, the more time will be needed so that these overlap conditions do not occur. Therefore, with large blastholes and large spacings, to get the proper timing effects, one must have longer time intervals than with the same rock type doing construction blasting with small diameter holes. There is no one proper time delay period to use in any rock type or for any one hole size. One must know the approximate ground transmission rate and also the distance between holes. Since there is no one time which cures all situations, the effect of overlap in one set of blasting circumstances can be devastating, where in another case because of different distances and different transmission times, the overlap situation may be nowhere near as severe and may not produce problems.

### **6.6.7 CAP SCATTER**

Let us examine a typical problem. The blast has gone off, the superintendent has returned to his office and was waiting to get the seismograph report from the field personnel. The telephone rang and he received a call giving him air blast and ground vibration readings. To his dismay, the readings were three times higher than anticipated. Shortly after receiving the seismic readings, he began receiving call from dozens of irate neighbors. This scenario is a frequent occurrence for blasting operations whether they be for construction or for mining operations.

What went wrong? The blast was carefully designed, the drilling was controlled and proper. They had been using that same pattern for days with low vibration levels and yet the vibration level tripled on the last blast. When blasts like this occur, the operator will often believe that the only uncontrolled variable was the ground conditions and he assumes that he is helpless to reduce these random occurrences.

Was the operator right in his assumption that he was helpless against these types of variabilities in his vibration readings, and were they caused exclusively by ground conditions, over which he has no control? The answer to both questions is absolutely not. The operator was not right, since normally high vibration and air blast levels are caused by either poor blast design, poor execution of the design, or as a result of cap scatter.

The term cap scatter may be new to many. Cap scatter is the deviation in the blasting cap firing time, from the rated firing time. Many, in the past, have assumed that blasting caps will fire precisely at the rated firing time, in fact, regulations normally state that as long as there is a difference of at least 8 milliseconds between cap periods, that is between the rated firing times, the caps are considered to be firing delayed from one another. One must realize that these caps, whether electric or non-electric, will not fire precisely on the rated firing time. In general, one can assume that they will fire in a normal distribution, whose mean should be somewhere near the rated firing time. The normal distribution is the bell shaped curve that is frequently used to define deviation around an average value. What is then the effect of cap scatter of the actual firing time of blasting caps? Blasting caps should have under good conditions, a deviation that ranges between 1 and 15 percent of the cap period, depending on which cap period is being considered. Since different caps have different pyrotechnic delays, the deviation of between 1 and 15 percent of period is measured on new caps when they leave the factory. What happens to older caps, which were produced one, two or three years before they were actually used? Extreme age on blasting caps has been known to change the delay period and in fact, most people have probably witnessed caps firing out of sequence. Cap scatter can cause serve problems in blasting. Both regular and high precision millisecond caps, electric and non-electric can cause problems.

Deviations from rated times can cause problems and overlaps in timing that are both unexpected and undetected. The overlaps can cause high vibration levels, however, not necessarily equal in all directions. From the diagrams Figure 6.14, one can see that if rows of holes were fired with these time delays one could have a tremendous build-up of energy in one direction and the waves not overlapping in another. This technique is sometimes used in reverse to try to reduce the energy, which reaches the nearest structure surrounding an operation. The technique can be effective if there is only one nearby structure, but it may be devastating if there is another structure a little farther away, in a different direction. The overlap of ground waves, in one particular direction can, as indicated before, cause hot spots of much higher vibration levels in one direction around the shot. This same phenomena can also occur with airborne waves if the holes are timed in such a manner that the sound wave from one is just reaching the other at the time it releases its energy into the atmosphere.

### **6.6.8 OVERBREAK, BACKBREAK AND ENDBREAK**

Breakage beyond the excavation limits is common in many types of blasting. The increased backbreak and endbreak, in general, can be controlled by the selection of the proper timing. It is common, on operations, to often give the last row and sometimes the end rows more time before they fire to allow earlier firing rows to move out of the way. This reduces the resistance on those holes and reduces the pressure on the back walls, whereby, cleaner breaks with less endbreak and backbreak will occur.

### **6.6.9 SELECTION OF THE PROPER TIMING**

In the previous sections, some of the physical effects of timing on the blast were discussed. To control different effects, one must fire holes within certain timing windows. Unfortunately, these windows are not the same for all effects, and a window must be found, if possible, that will control all of the effects that have been discussed. Timing becomes even more complicated since the amount of time to control these different effects, is dependent on two major factors. The first being the rock type, but more importantly, the physical dimensions of the shot, the burden and spacing. It should be quite obvious, to retain the same effects, if one doubles the burden, one must also double the timing. The reason for this is that cracks travel at a certain maximum speed in the rock mass, which cannot be changed by increasing or decreasing the amount of explosive.

The manufacturers provide certain fixed periods of caps. Often these same periods are used regardless of the size of the blasthole. If in one case there are three inch holes with six foot burdens, while in another case there are 15 inch holes with 30 foot burdens, the effect on the breakage can be completely different. The fixed times that were used in those holes will perform better for one situation than the other.

It is a common practice on larger strip mine blasts to increase hole to hole timing to larger values than one would have on small hole blasts. Experience has shown that this does produce better results.

With the supplies available from the manufacturer, one may not be able to select the absolute best time for every situation, even if those best times were known. At best, one could get "close".

### **6.6.10 IMPLEMENTATION PROBLEMS**

One of the major problems in the implementation of proper timing, is that timing is often looked at in a simplistic fashion. One makes assumptions that detonators will fire at their rated firing times and lays out patterns based on the rated firing times. Often, first rows of patterns function properly, but as later rows fire, they do not function as anticipated, firing either too soon or too late. Fragmentation can be more coarse and wall problems vary from place to place within the shot. The signs are all there, but these signs are not interpreted properly. Most often problems that result in blasting are blamed on ground conditions.

Although ground conditions do effect the blast, normally they are the scape goat for problems which occur from poor drilling which changes the timing effects between holes and also problems which occur with the timing itself. One must design patterns realizing that blasting caps do not normally fire on the rated firing time, they may either fire sooner or later. Cap scatter must be considered in design. Cap scatter can change the actual number of milliseconds both hole to hole and row to row on any hole in the shot. In general, the larger the delays, the larger the number of milliseconds of cap scatter.

## **6.7 TIMING CALCULATIONS**

In order to approach the problems of timing in a systematic manner, the expected outcomes must be evaluated in a a step-by-step fashion before the timing system can be determined. Questions must be asked and the answers prioritized based on the desired final outcome. Such questions are as follows:

1. Is muck pile height a consideration? If so, is the goal to pile the material, scatter the material or deliberately cast the material?
2. Is wall control a factor? If so, is it more or less important than the piling and casting considerations?
3. Is the sizing of the rock important, is uniformity important, or only mean size? Is producing rip-rap in the blast desired?
4. Is air blast a concern? If so, is blowout from back rows causing enhanced concussion, as a result of a wall falling within a certain time period.
5. Is flyrock traveling a considerable distance a concern, especially from the back rows in the blast?
6. Is the maximum vibration level a problem or is the distance great enough from residents that one does not have to worry about effects of vibration? If vibration is a problem, what standards are being used to measure vibration? Is the 8 millisecond legal limit between holes being used to calculate pounds per delay? Are maximum vibration levels a concern which should be measured by a seismograph? Is the formation of hot spots, where average vibration limits will be low but some areas will receive considerably higher levels, a concern, ?

These general types of questions will have to have specific answers before one can proceed with the best timing layout. One may want to address these concerns with a simple check list given in Table 6.8.

**TABLE 6.8 TIMING CONTROL FUNCTIONS**

1. Rock Placement Considerations
A. High Pile Close to Face
B. Average Pile
C. Scattered Pile
D. Rock Casting
2. Wall Control is Important
3. Fragmentation Sizing Desired
A. Average
B. Best Possible
4. Air Blast
A. Back Holes Venting Important
B. Wall Collapse Concussion Important
5. Flyrock Control Important
6. Blast Vibration Important
A. 8 ms Legal Limit
B. Few Nearby Homes
C. Homes Surrounding Blast Site

The timing control functions from, Table 6.8, are identified for the specific site and blast. The functions are prioritized. Table 6.9 is a listing of time windows to coincide with timing control functions of Table 6.8. Time lines can then be established and "Best" time windows identified. Example 6.7 illustrates the step-by-step process in detail.

The "Pattern Designer" software package will be used to solve examples 6.8 - 6.9. The input and output of the program will be used to graphically explain the effects of initiation timing and cap scatter. Example 6.10 show use of some of the equation in chapter 6 for solving blasting problems.

Example 6.8 compares effects of "Legal definitions" and actual cap scatter on overlaps in initiation timing.

Example 6.9 illustrates a method to determine the best timing for maximum breakage.

\*\* "Pattern Designer" is a copyrighted software package produced by "Precision Blasting Services", P.O. Box 189, Montville, Ohio 44064

**NOTE:** Row to row time should be at least twice as great as hole to hole so that proper relief will be available for subsequent rows.

**TABLE 6.9 SELECTION OF TIME WINDOWS**

<b>FUNCTIONS</b>	<b>TIME WINDOWS</b>
1A	2 - 3 ms/ft of burden
1B	3 - 4 ms/ft of burden
1C	4 - 6 ms/ft of burden
1D	7 - 14 ms/ft of burden
2	3 - 14 ms/ft of burden
3A	0 - 5 ms/ft of spacing (or more)
3B	1 - 2 ms/ft of spacing for massive, depending on rock type, 3 - 4 ms/ft of spacing for highly fissured
4A	2 or more ms/ft of burden between rows
4B	Direction of initiation along row, adjacent holes $0.8 \text{ ms} > t > 1 \text{ ms/ft of spacing}$
5	2 or more ms/ft of burden between rows less than 25 ms/ft of spacing
6A	8 ms nominal times between delays
6B	Tune blast to minimize vibration in one direction danger between 0.1 ms - 1 ms/ft of burden or spacing, whichever significant. (Include cap scatter considerations)
6C	Time (including scatter) greater than 1 ms/ft to hole on next delay

**Example 6.7**

**Pattern Information:**

A massive limestone formation is blasted with 6 rows of holes with 10 holes per row. The drill pattern is accurately drilled with 4 inch holes on a 10 by 12 feet pattern, the shot cannot have more than one hole firing at a time since homes surround the operation. The pattern will open at only one location and it will be a row by row pattern. Assume a 10% of period cap scatter.

Air blast, flyrock and blowout must be kept to a minimum. Wall control is an important consideration, vibration levels are also of concern.

**SOLUTION**

1. Select and prioritize function.
2. Order of priority are 2, 4A, 5, 6C, 3A, 1B.
3. Establish prioritize listing with Time Windows

**Function : Time Windows**

- 2 3 -14 ms/ft of Burden between rows
- 4A 2 or more/ft of Burden between rows
- 5 2 or more ms./ft of Burden between rows less than 25 ms/ft of Spacing along row
- 6C Time (includes scatter) greater than 1 ms/ft to next delay
- 3A 0 - 5 ms/ft of Spacing along row
- 1B 2 - 4 ms/ft of Burden
- 4 Multiply Time Windows by Actual Pattern Dimension and Fill in Time lines below
- 5 Evaluation of Time Diagrams

The row to row window is most critical giving a 30 - 40 ms row to row time as best to meet all criteria.

The time window along the row could be between 12 - 60 ms, however, if this is a row by row pattern and relief is desired at time the second row shoots, time should be no greater than 1/2 the time selected row to row. Therefore, if for example 40 ms was selected between rows than time along row would be minimum 12 ms. and maximum 20 ms.

These times should be available after considering the cap scatter of the specific initiators.



-----  
**EXAMPLE 6.7**

**PRIORITY FUNCTION CODES:**

- |                                   |                               |
|-----------------------------------|-------------------------------|
| 1 = Rock placement considerations | 4 = Air blast                 |
| 2 = Wall control is important     | 5 = Flyrock control important |
| 3 = Fragmentation sizing desired  | 6 = Blast vibration important |
- 

**ENTRY 1**

- |                                  |                               |
|----------------------------------|-------------------------------|
| 3 = Fragmentation sizing desired | 6 = Blast vibration important |
|----------------------------------|-------------------------------|

Number of holes in a row      10  
 Number of rows                      6

Burden                              10.00 ft  
 Spacing                             12.00 ft  
 Bench height                       40.00 ft  
 Stemming                            7.00 ft  
 Subdrill                            3.00 ft  
 Powder column                     36.00 ft  
 Hole length                        43.00 ft

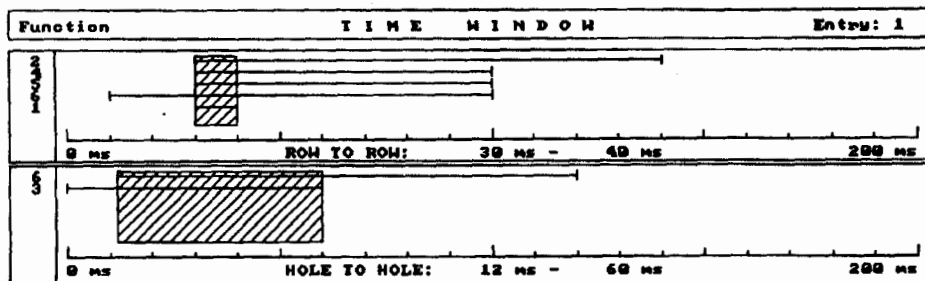
Explosive type                      ANFO  
 Explosive spec. gravity            0.85

Rock type                            LIMESTONE  
 Rock specific gravity              2.60

----- Selected priorities -----

- |                                 |                                 |
|---------------------------------|---------------------------------|
| 2 Wall control is important     |                                 |
| 4 Air blast                     | Back holes venting is important |
| 5 Flyrock control important     |                                 |
| 6 Blast vibration important     |                                 |
| 3 Fragmentation sizing desired  | Average                         |
| 1 Rock placement considerations | Average pile                    |
- 

Row to row time:                    30 ms -                    40 ms  
 Hole to hole time:                 12 ms -                    60 ms



---

### Example 6.8

#### Pattern Information:

Use a single row of 20 holes employing delays between 0-1000 ms. Assume no cap scatter and a legal limit of 8 ms between delays.

#### Determine:

1. Do any holes overlap in time using the legal limit?
2. Do any holes overlap if the 8 ms legal limit is changed to 0 and a cap scatter of 3% of period occurs? If so, which hole overlap?
3. Which holes will overlap if a cap scatter of 6% of period occurs.

F H W A                      P A T T E R N     D E S I G N E R                      V2.05 Page:     1  
                                    F O R   E L E C T R I C A L   I N I T I A T I O N                      D a t e :   0 6 - 1 8 - 1 9 9 1

-----

#### NOTE: EXAMPLE 6.8A

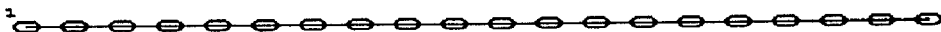
Maximum number of holes per row : 20  
Maximum number of rows : 1  
Maximum number of decks : 1  
Minimum delay time allowed [ms] : 8  
Overlap criteria [charges/delay] : 8

#### --- IN-HOLE TIMING DELAYS ---

ROW 1										
HOLE	1	2	3	4	5	6	7	8	9	10
DECK 1	25	50	75	100	125	150	175	200	225	250
ROW 1										
HOLE	11	12	13	14	15	16	17	18	19	20
DECK 1	275	300	325	350	375	400	425	450	475	500

#### FIRING TIMES INCLUDING DELAY CRITERIA \* LESS THAN MINIMUM INTERVAL DELAY TIME (8 ms)

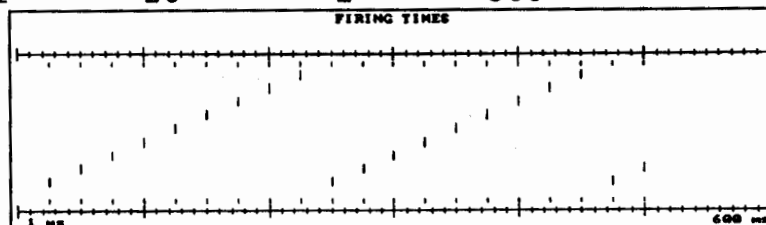
ROW 1										
HOLE	1	2	3	4	5	6	7	8	9	10
DECK 1	25	50	75	100	125	150	175	200	225	250
ROW 1										
HOLE	11	12	13	14	15	16	17	18	19	20
DECK 1	275	300	325	350	375	400	425	450	475	500



NOTE: **EXAMPLE 6.8A**

CHARGE TIMING DATA BY FIRING SEQUENCE (Minimum delay allowed:8ms)

Fir. Seq.	Row	Hole	Deck	Firing time [ms]	Interval time [ms]
1)	1	1	1	25	25
2)	1	2	1	50	25
3)	1	3	1	75	25
4)	1	4	1	100	25
5)	1	5	1	125	25
6)	1	6	1	150	25
7)	1	7	1	175	25
8)	1	8	1	200	25
9)	1	9	1	225	25
10)	1	10	1	250	25
11)	1	11	1	275	25
12)	1	12	1	300	25
13)	1	13	1	325	25
14)	1	14	1	350	25
15)	1	15	1	375	25
16)	1	16	1	400	25
17)	1	17	1	425	25
18)	1	18	1	450	25
19)	1	19	1	475	25
20)	1	20	1	500	25



NOTE: **EXAMPLE 6.8B**

Maximum number of holes per row : 20  
 Maximum number of rows : 1  
 Maximum number of decks : 1  
 Component scatter time [ % ] : 3.00  
 Standard deviation : 2  
 Overlap criteria [charges/delay] : 1

--- IN-HOLE TIMING DELAYS ---

ROW 1  
 HOLE 1 2 3 4 5 6 7 8 9 10

DECK 1 25 50 75 100 125 150 175 200 225 250

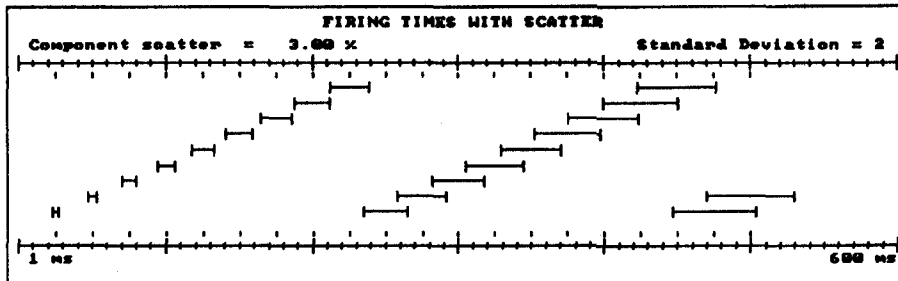
ROW 1  
 HOLE 11 12 13 14 15 16 17 18 19 20

DECK 1 275 300 325 350 375 400 425 450 475 500

FIRING TIMES INCLUDING CAP SCATTER (scatter: 3.00% std.dev: 2)

\* CHARGES WITH PROBABLE OVERLAP

ROW 1										
HOLE	1	2	3	4	5	6	7	8	9	10
DECK 1	24	47	71	94	118	141	165	188	212	235
	25	50	75	100	125	150	175	200*	225*	250*
	27	53	80	106	133	159	186	212	239	265
ROW 1										
HOLE	11	12	13	14	15	16	17	18	19	20
DECK 1	259	282	306	329	353	376	400	423	447	470
	275*	300*	325*	350*	375*	400*	425*	450*	475*	500*
	292	318	345	371	398	424	451	477	504	530



-----  
NOTE: EXAMPLE 6.8B

CHARGE TIMING DATA BY FIRING SEQUENCE (scatter:3.00% std.dev:2)

Fir. Seq.	Row	Hole	Deck	Firing time [ms]	Interval time [ms]	+/- [ms]	Min. [ms]	Max. [ms]	Overlap Prob.
1)	1	1	1	25	25	0.75	24	27	
2)	1	2	1	50	25	1.50	47	53	
3)	1	3	1		25	2.25	71	80	
4)	1	4	1	10	25	3.00	94	106	
5)	1	5	1	125	25	3.75	118	133	
6)	1	6	1	150	25	4.50	141	159	
7)	1	7	1	175	25	5.25	165	186	
8)	1	8	1	200	25	6.00	188	212	
9)	1	9	1	225	25 *	6.75	212	239	8.34%
10)	1	10	1	250	25 *	7.50	235	265	10.79%
11)	1	11	1	275	25 *	8.25	259	292	13.14%
12)	1	12	1	300	25 *	9.00	282	318	15.32%
13)	1	13	1	325	25 *	9.75	306	345	17.34%
14)	1	14	1	350	25 *	10.50	329	371	19.19%
15)	1	15	1	375	25 *	11.25	353	398	20.86%
16)	1	16	1	400	25 *	12.00	376	424	22.40%
17)	1	17	1	425	25 *	12.75	400	451	23.80%
18)	1	18	1	450	25 *	13.50	423	477	25.09%
19)	1	19	1	475	25 *	14.25	447	504	26.26%
20)	1	20	1	500	25 *	15.00	470	530	27.33%

-----  
NOTE: **EXAMPLE 6.8B**

## CHARGES EXCEEDING OVERLAP CRITERIA ( 1 )

Row	Hole	Deck	Firing time [ms]	Row	Hole	Deck	Firing time [ms]	Interval time [ms]	Probability of overlap [%]
1	8	1	200	1	9	1	225	25	8.34
1	9	1	225	1	10	1	250	25	10.79
1	10	1	250	1	11	1	275	25	13.14
1	11	1	275	1	12	1	300	25	15.32
1	12	1	300	1	13	1	325	25	17.34
1	13	1	325	1	14	1	350	25	19.19
1	14	1	350	1	15	1	375	25	20.86
1	15	1	375	1	16	1	400	25	22.40
1	16	1	400	1	17	1	425	25	23.80
1	17	1	425	1	18	1	450	25	25.09
1	18	1	450	1	19	1	475	25	26.26
1	19	1	475	1	20	1	500	25	27.33

NOTE: **EXAMPLE 6.8C**

Maximum number of holes per row : 20  
 Maximum number of rows : 1  
 Maximum number of decks : 1  
 Component scatter time [ % ] : 6.00  
 Standard deviation : 2  
 Overlap criteria [charges/delay] : 1

--- IN-HOLE TIMING DELAYS ---

ROW 1  
 HOLE 1 2 3 4 5 6 7 8 9 10

DECK 1 25 50 75 100 125 150 175 200 225 250

ROW 1  
 HOLE 11 12 13 14 15 16 17 18 19 20

DECK 1 275 300 325 350 375 400 425 450 475 500

FIRING TIMES INCLUDING CAP SCATTER (scatter: 6.00% std.dev: 2)

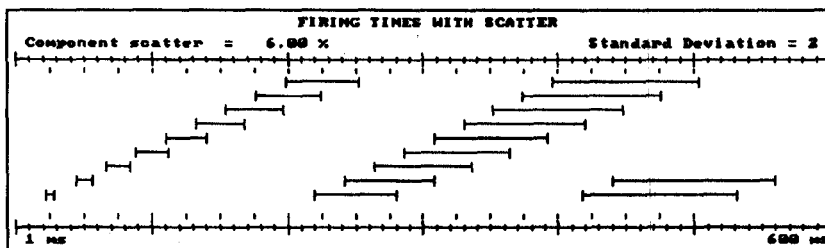
\* CHARGES WITH PROBABLE OVERLAP

ROW 1  
 HOLE 1 2 3 4 5 6 7 8 9 10

DECK 1 22 44 66 88 110 132 154 176 198 220  
 25 50 75 100\* 125\* 150\* 175\* 200\* 225\* 250\*  
 8 56 84 112 140 168 196 224 252 280

ROW 1  
 HOLE 11 12 13 14 15 16 17 18 19 20

DECK 1 242 264 286 308 330 352 374 396 418 440  
 275\* 300\* 325\* 350\* 375\* 400\* 425\* 450\* 475\* 500\*  
 308 336 364 392 420 448 476 504 532 560



-----  
NOTE: EXAMPLE 6.8C

CHARGE TIMING DATA BY FIRING SEQUENCE (scatter: 6.00% std.dev: 2)

Fir. Seq.	Row	Hole	Deck	Firing time [ms]	Interval time [ms]	+/- [ms]	Min. [ms]	Max. [ms]	Overlap Probability
1)	1	1	1	25	25	1.50	22	28	
2)	1	2	1	50	25	3.00	44	56	
3)	1	3	1	75	25	4.50	66	84	
4)	1	4	1	100	25 *	6.00	88	112	9.61%
5)	1	5	1	125	25 *	7.50	110	140	14.26%
6)	1	6	1	150	25 *	9.00	132	168	18.27%
7)	1	7	1	175	25 *	10.50	154	196	21.63%
8)	1	8	1	200	25 *	12.00	176	224	24.43%
9)	1	9	1	225	25 *	13.50	198	252	26.76%
10)	1	10	1	250	25 *	15.00	220	280	28.74%
11)	1	11	1	275	25 *	16.50	242	308	30.42%
12)	1	12	1	300	25 *	18.00	264	336	31.87%
13)	1	13	1	325	25 *	19.50	286	364	33.10%
14)	1	14	1	350	25 *	21.00	308	392	34.19%
15)	1	15	1	375	25 *	22.50	330	420	35.16%
16)	1	16	1	400	25 *	24.00	352	448	36.01%
17)	1	17	1	425	25 *	25.50	374	476	36.78%
18)	1	18	1	450	25 *	27.00	396	504	37.46%
19)	1	19	1	475	25 *	28.50	418	532	38.08%
20)	1	20	1	500		30.00	440	560	



-----  
NOTE: **EXAMPLE 6.8C**

## CHARGES EXCEEDING OVERLAP CRITERIA ( 1 )

Row	Hole	Deck	Firing time [ms]	Row	Hole	Deck	Firing time [ms]	Interval time [ms]	Probability of overlap [%]
1	4	1	100	1	5	1	125	25	9.61
1	5	1	125	1	6	1	150	25	14.26
1	6	1	150	1	7	1	175	25	18.27
1	7	1	175	1	8	1	200	25	21.63
1	8	1	200	1	9	1	225	25	24.43
1	9	1	225	1	10	1	250	25	26.76
1	10	1	250	1	11	1	275	25	28.74
1	11	1	275	1	12	1	300	25	30.42
1	12	1	300	1	13	1	325	25	31.87
1	13	1	325	1	14	1	350	25	33.10
1	14	1	350	1	15	1	375	25	34.19
1	15	1	375	1	16	1	400	25	35.16
1	16	1	400	1	17	1	425	25	36.01
1	17	1	425	1	18	1	450	25	36.78
1	18	1	450	1	19	1	475	25	37.46
1	19	1	475	1	20	1	500	25	38.08

**Example 6.9**

## Given Information:

Limestone rock formation. Pattern is ten holes 12 foot burden single row, delay initiation sequence. Use electric caps. Assume a 3% cap scatter.

## Determine:

Which timing is best for breakage along a row?

1. 100 ms cap in each hole with 25 ms sequential timer setting
2. 100 ms cap in each hole with 10 ms between holes as a sequential timer setting.
3. Use a 500 ms cap in each hole with 10 ms between holes as a sequential timer setting.

NOTE: EXAMPLE 6.9A

Maximum number of holes per row : 10  
 Maximum number of rows : 1  
 Maximum number of decks : 1  
 Component scatter time [ % ] : 3.00  
 Standard deviation : 2  
 Overlap criteria [charges/delay] : 1

Timer delays:

Between circuit --> circuit	Setting
1 --> 2	25 ms
2 --> 3	25 ms
3 --> 4	25 ms
4 --> 5	25 ms
5 --> 6	25 ms
6 --> 7	25 ms
7 --> 8	25 ms
8 --> 9	25 ms
9 --> 10	25 ms

--- IN-HOLE TIMING DELAYS ---

ROW 1										
HOLE	1	2	3	4	5	6	7	8	9	10
DECK 1	100	100	100	100	100	100	100	100	100	100

FIRING TIMES INCLUDING CAP SCATTER (scatter: 3.00% std.dev: 2)

\* CHARGES WITH PROBABLE OVERLAP

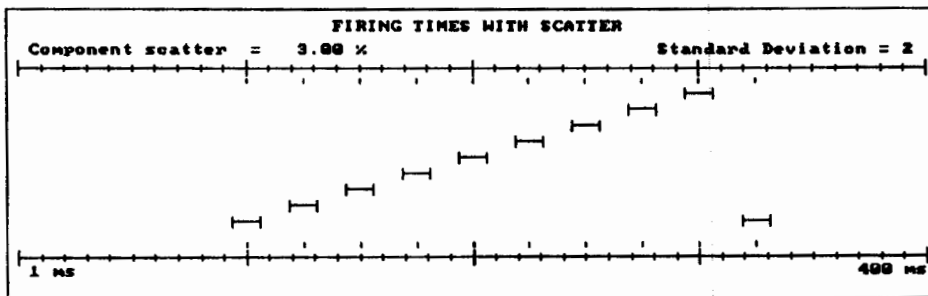
ROW 1										
HOLE	1	2	3	4	5	6	7	8	9	10
	94	119	144	169	194	219	244	269	294	319
DECK 1	100	125	150	175	200	225	250	275	300	325
	106	131	156	181	206	231	256	281	306	331



NOTE: EXAMPLE 6.9A

CHARGE TIMING DATA BY FIRING SEQUENCE (scatter: 3.00% std.dev: 2)

Fir. Seq.	Row	Hole	Deck	Firing time [ms]	Interval time [ms]	+/- [ms]	Min. [ms]	Max. [ms]	Overlap Probability
1)	1	1	1	100		3.00	94	106	
					25				
2)	1	2	1	125		3.00	119	131	
					25				
3)	1	3	1	150		3.00	144	156	
					25				
4)	1	4	1	175		3.00	169	181	
					25				
5)	1	5	1	200		3.00	194	206	
					25				
6)	1	6	1	225		3.00	219	231	
					25				
7)	1	7	1	250		3.00	244	256	
					25				
8)	1	8	1	275		3.00	269	281	
					25				
9)	1	9	1	300		3.00	294	306	
					25				
10)	1	10	1	325		3.00	319	331	



-----  
NOTE: EXAMPLE 6.9B

Maximum number of holes per row : 10  
 Maximum number of rows : 1  
 Maximum number of decks : 1  
 Component scatter time [ % ] : 3.00  
 Standard deviation : 2  
 Overlap criteria [charges/delay] : 1

## Timer delays:

Between circuit	--> circuit	Setting
1	--> 2	10 ms
2	--> 3	10 ms
3	--> 4	10 ms
4	--> 5	10 ms
5	--> 6	10 ms
6	--> 7	10 ms
7	--> 8	10 ms
8	--> 9	10 ms
9	--> 10	10 ms

## --- IN-HOLE TIMING DELAYS ---

ROW 1										
HOLE	1	2	3	4	5	6	7	8	9	10
DECK 1	100	100	100	100	100	100	100	100	100	100

FIRING TIMES INCLUDING CAP SCATTER (scatter: 3.00% std.dev: 2)

\* CHARGES WITH PROBABLE OVERLAP

ROW 1										
HOLE	1	2	3	4	5	6	7	8	9	10
	94	104	114	124	134	144	154	164	174	184
DECK 1	100*	110*	120*	130*	140*	150*	160*	170*	180*	190*
	106	116	126	136	146	156	166	176	186	196

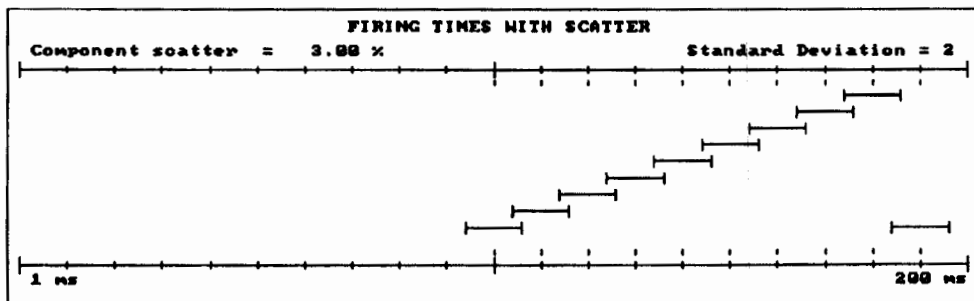
NOTE: **EXAMPLE 6.9B**

CHARGE TIMING DATA BY FIRING SEQUENCE (scatter: 3.00% std.dev: 2)

Fir. Seq.	Row	Hole	Deck	Firing time [ms]	Interval time [ms]	+/- [ms]	Min. [ms]	Max. [ms]	Overlap Probability
1)	1	1	1	100		3.00	94	106	
					10 *				12.07%
2)	1	2	1	110		3.00	104	116	
					10 *				12.07%
3)	1	3	1	120		3.00	114	126	
					10 *				12.07%
4)	1	4	1	130		3.00	124	136	
					10 *				12.07%
5)	1	5	1	140		3.00	134	146	
					10 *				12.07%
6)	1	6	1	150		3.00	144	156	
					10 *				12.07%
7)	1	7	1	160		3.00	154	166	
					10 *				12.07%
8)	1	8	1	170		3.00	164	176	
					10 *				12.07%
9)	1	9	1	180		3.00	174	186	
					10 *				12.07%
10)	1	10	1	190		3.00	184	196	

CHARGES EXCEEDING OVERLAP CRITERIA ( 1 )

Row	Hole	Deck	Firing time [ms]	Row	Hole	Deck	Firing time [ms]	Interval time [ms]	Probability of overlap [%]
1	1	1	100	1	2	1	110	10	12.07
1	2	1	110	1	3	1	120	10	12.07
1	3	1	120	1	4	1	130	10	12.07
1	4	1	130	1	5	1	140	10	12.07
1	5	1	140	1	6	1	150	10	12.07
1	6	1	150	1	7	1	160	10	12.07
1	7	1	160	1	8	1	170	10	12.07
1	8	1	170	1	9	1	180	10	12.07
1	9	1	180	1	10	1	190	10	12.07



-----  
NOTE: **EXAMPLE 6.9C**

Maximum number of holes per row : 10  
 Maximum number of rows : 1  
 Maximum number of decks : 1  
 Component scatter time [ % ] : 3.00  
 Standard deviation : 2  
 Overlap criteria [charges/delay] : 1  
 Timer delays:

Between circuit	--> circuit	Setting
1	--> 2	10 ms
2	--> 3	10 ms
3	--> 4	10 ms
4	--> 5	10 ms
5	--> 6	10 ms
6	--> 7	10 ms
7	--> 8	10 ms
8	--> 9	10 ms
9	--> 10	10 ms

## --- IN-HOLE TIMING DELAYS ---

ROW 1										
HOLE	1	2	3	4	5	6	7	8	9	10
DECK 1	500	500	500	500	500	500	500	500	500	500

FIRING TIMES INCLUDING CAP SCATTER (scatter: 3.00% std.dev: 2)

\* CHARGES WITH PROBABLE OVERLAP

ROW 1										
HOLE	1	2	3	4	5	6	7	8	9	10
DECK 1	470	480	490	500	510	520	530	540	550	560
	500*	510*	520*	530*	540*	550*	560*	570*	580*	590*
	530	540	550	560	570	580	590	600	610	620

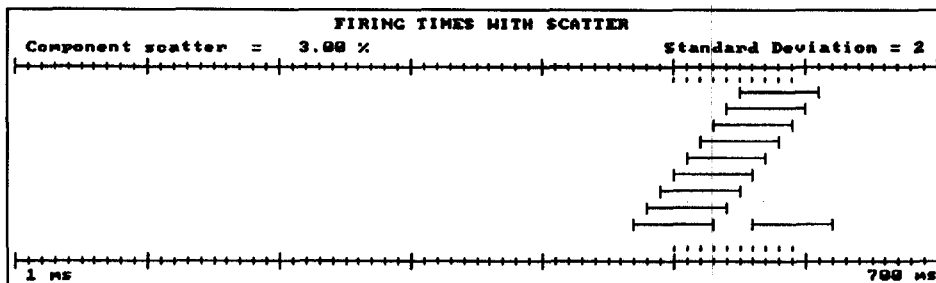
NOTE: **EXAMPLE 6.9C**

CHARGE TIMING DATA BY FIRING SEQUENCE(scatter: 3.00% std.dev: 2)

Fir. Seq.	Row	Hole	Deck	Firing time [ms]	Interval time [ms]	+/- [ms]	Min. [ms]	Max. [ms]	Overlap Probability
1)	1	1	1	500		15.00	470	530	
					10 *				40.65%
2)	1	2	1	510		15.00	480	540	
					10 *				40.65%
3)	1	3	1	520		15.00	490	550	
					10 *				40.65%
4)	1	4	1	530		15.00	500	560	
					10 *				40.65%
5)	1	5	1	540		15.00	510	570	
					10 *				40.65%
6)	1	6	1	550		15.00	520	580	
					10 *				40.65%
7)	1	7	1	560		15.00	530	590	
					10 *				40.65%
8)	1	8	1	570		15.00	540	600	
					10 *				40.65%
9)	1	9	1	580		15.00	550	610	
					10 *				40.65%
10)	1	10	1	590		15.00	560	620	

CHARGES EXCEEDING OVERLAP CRITERIA ( 1 )

Row	Hole	Deck	Firing time [ms]	Row	Hole	Deck	Firing time [ms]	Interval time [ms]	Probability of overlap [%]
1	1	1	500	1	2	1	510	10	40.65
1	2	1	510	1	3	1	520	10	40.65
1	3	1	520	1	4	1	530	10	40.65
1	4	1	530	1	5	1	540	10	40.65
1	5	1	540	1	6	1	550	10	40.65
1	6	1	550	1	7	1	560	10	40.65
1	7	1	560	1	8	1	570	10	40.65
1	8	1	570	1	9	1	580	10	40.65
1	9	1	580	1	10	1	590	10	40.65



---

### Example 6.10

A blasting plan was submitted for evaluation. The plan was as follows:

Given information:

Rock type = granite (massive)

Explosive = semigelatin dynamite, size 2 in

Blasthole size = 2.5 in

Proposed:

Burden = 8 ft

Stemming = 4 ft (drill cuttings)

Subdrilling = 2 ft

Check:

Burden check (Eq. 6.2)

$$B = \left[ \frac{2 SG_e}{SG_r} + 1.5 \right] D_e$$

Where:

$SG_e = 1.3$  (Manufacturers' information)

$SG_r = 2.75$  (average from Table 6.1)

$$B = \left[ \frac{2 SG_e}{SG_r} + 1.5 \right] D_e = \left[ \frac{2 \times 1.3}{2.75} + 1.5 \right] \times 2 = 4.89 \text{ ft} \cong 5 \text{ ft}$$

Therefore, design burden of 8 feet too large.

Range 4 to 6 feet

Stemming check (Eq. 6.3)

$$T = 0.7 \times B = 0.7 \times 5 = 3.5 \text{ ft}$$

Therefore, 4 feet proposed stemming is acceptable with drilling chips, dangerous with drilling dust.

Subdrill check:

$$J = 0.3 \times B = 0.3 \times 5 = 1.5 \text{ ft}$$

Therefore, 2 feet proposed subdrill is acceptable.

---



## **6.8 CHAPTER 6 SUMMARY**

The design calculations for the burden, stemming, subdrilling, powder load and initiation timing must be compensated for rock type and explosives characteristics. Each design variable is interdependent with the others. The design of these variables requires the understanding of a simple step-by-step design method.

## PROBLEMS - CHAPTER 6

1) To determine the economics of a blast, it is necessary to evaluate drilling equipment which can produce holes with diameters from 1 to 5 inches. The rock has a specific gravity of 2.6 and a free-flow or bulk-loaded ANFO with a specific gravity of 0.9 is to be used. Calculate the approximate burden, in feet, for the 1, 3 and 5 inch diameter holes.

2) The bench in the above problem is 16 feet high. For the 1, 3, and 5 inch diameter blastholes, determine for each the approximate amounts of :

- (a) Stemming to be used.
- (b) The total depth of a blasthole (H).
- (c) ANFO that would be required to load one hole.

3) Assume the 5 inch blasthole is the most economic choice for problem 1, as far as drilling and explosive costs are concerned. What would be the expected results based on considerations of stiffness for:

- (a) Rock breakage.
- (b) Collar overbreak (Backbreak).
- (c) Air blast.
- (d) Leaving a toe.

4) Six inch blastholes which are normally dry and loaded with bulk ANFO have been found to contain considerable water. Therefore, they will be loaded with 5 inch diameter water gel cartridges. The burden for the six inch holes drilled in shale ( $SG_r = 2.4$ ) is 13 feet.

Determine the specific gravity of the water gel which would be necessary to result in breakage equivalent to dry holes loaded with ANFO.

5) The Ajax Construction Company is blasting in shale. They are using a 2 inch diameter hole on a 6 foot by 8 foot pattern. The blast contains 3 rows of holes. Each hole is on an independent delay.

(a) What would be the delay time hole to hole within a row?

(b) What would be the delay time row to row?

## CHAPTER 7 OBJECTIVES

To delineate a method of blast pattern design taking into consideration the effects obtained by many individual blastholes working together. To understand how to compensate for burden stiffness in pattern design. To examine adjustments to pattern design for initiation timing.

## CHAPTER 7 SUMMARY

The interrelationships between initiation timing, burden, stiffness and physical dimensions must be considered in the design of any blast. Some basic equations help one understand the relationships and allow pattern designs with a step by step design method. Specific applications include production patterns for sinking cuts, hillside cuts, utility trenches, rip-rap production and secondary blasting applications.

# CHAPTER 7

## PATTERN DESIGN

### 7.1 PRINCIPLES OF PRODUCTION BLASTING PATTERNS

A blasting pattern consists of placing properly designed single blastholes into a geometrical relationship with one another and with the open face. The spacing between blastholes in a single row is dependent upon two variables, the initiation timing of the adjacent holes and the stiffness ratio,  $L/B$ .

If holes are initiated simultaneously, spacings must be spread further apart than if holes are timed on a delay. If holes are spaced too close together and fired instantaneously, a number of undesirable effects will occur. Cracks from the closely spaced blastholes will link prematurely causing a shattered zone in the wall between holes (Figure 7.1). The premature linking will form a plane whereby gasses will be vented prematurely to the atmosphere causing air blasts and flyrock. The venting procedure will reduce the available amount of energy and in effect the holes will become overconfined. The overconfinement condition will cause the amount of ground vibration to increase. In spite of the close spacing and the large amount of energy per unit volume of rock, fragmentation of the burden rock usually will be poor. Conversely, it is obvious that if blastholes are spaced too far apart for either delay or instantaneous initiation, fragmentation will become coarse and rough walls will result (Figure 7.2).

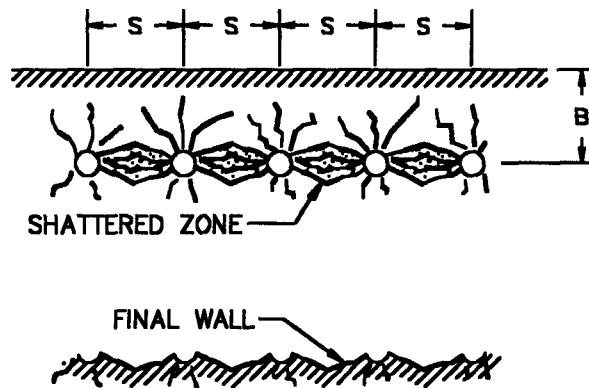
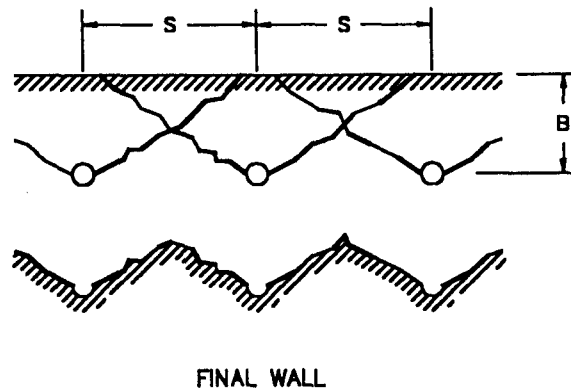


Figure 7.1 Shattered Zone from Close Spacing



**Figure 7.2** Rough Walls from Excessive Spacing

Blasthole spacing must be normalized to overcome problems with stiffness. Therefore, when benches are low when compared to the burden, stiffness is a factor that must be considered. When benches are high, stiffness is no longer a consideration.

Therefore, there are two factors that must be considered. The first is to determine if blastholes function either instantaneously or delayed. The second is whether benches are classified as low or high as compared to the burden. The first decision as to whether holes function simultaneously or delayed is obvious. The second as to whether benches are classified as low or high must be tied to physical dimensions such as the burden and the bench height. The stiffness ratio or  $L/B$  is used to make this determination. If  $L/B$  is less than four and greater than one, benches are considered low and stiffness must be considered. On the other hand, if  $L/B$  is greater than four, stiffness is no longer a concern. There are, therefore, four separate conditions which must be discussed, instantaneous initiation low benches, instantaneous initiation high benches, delayed initiation low benches and delayed initiation high benches.

### 7.1.1 INSTANTANEOUS INITIATION LOW BENCHES

In order to check the blasting plan and determine if spacing is within normal limits, the following equation can be used:

$$S = \frac{L + 2B}{3} \quad (7.1)$$

where:

- S = Spacing (ft)
- L = Bench height (ft)
- B = Burden (ft)

If the conditions from the particular blast are placed in this equation and if the actual spacing is within plus or minus 15% of the calculated spacing, then the spacing is considered within reasonable limits. In no case should the spacing be less than the burden.

---

### Example 7.1

Four-inch diameter blastholes, bulk loaded with ANFO, are to be fired row-by-row with instantaneous initiation along a row. The proposed pattern is drilled with an 8-foot burden and 14-foot spacing. The bench height on one portion of the excavation is 15 feet. Is the proposed spacing correct?

Check L/B for high or low bench

$$L/B = 15 / 8 = 1.88 \text{ (low bench)}$$

Check instantaneous or delay timing

Answer: instantaneous

Therefore:

$$S = \frac{L + 2B}{3} = \frac{15 + 2 \times 8}{3} = 10.33 \text{ ft}$$

The proposed spacing of 14 feet is greater than  $10.33 \pm 15\%$  (range 8.78 - 11.88). The spacing is too large.

---

#### 7.1.2 INSTANTANEOUS INITIATION HIGH BENCHES

To function as a high bench, the bench height to burden ratio must be four or more. With instantaneous initiation between holes, the following relationship can be used to check whether spacing is within reasonable limits.

$$S = 2 B \tag{7.2}$$

If the calculated spacing from equation 7.2 is within 15% of the actual spacing, it is within reasonable limits.

---

**Example 7.2**

The 8 x 14 feet pattern in Example 7.1 is considered for a portion of the excavation where the bench height is planned to be 33 feet deep. Is the proposed spacing acceptable?

Check L/B for high or low bench

$$L/B = 33 / 8 = 4.12 \text{ (high bench)}$$

Check instantaneous or delay timing

Answer: instantaneous

Therefore:

$$S = 2 B = 2 \times 8 = 16 \text{ ft}$$

The proposed spacing of 16 feet is within  $16 \pm 15\%$ . The spacing is acceptable.

---

**7.1.3 DELAYED INITIATION LOW BENCHES**

When the stiffness ratio is between one and four with delayed initiation between holes, the following relationship is used to check spacing:

$$S = \frac{L + 7B}{8} \quad (7.3)$$

where:

- S = Spacing (ft)
- L = Bench height (ft)
- B = Burden (ft)

When using this equation, the calculated spacing is normally within plus or minus 15% of the actual spacing and is within reasonable limits.



---

### Example 7.3

Four inch diameter blastholes are bulk loaded with ANFO. The operator proposed to use an 8 x 8 foot drill pattern (8 foot burden and 8 foot spacing). Assuming the burden is correct, would the spacing be reasonable if the bench height is 12 feet and each hole is fired on a separate delay?

Check L/B for high or low bench

$$L/B = 12 / 8 = 1.5 \text{ (low bench)}$$

Check instantaneous or delay timing

Answer: delay

Therefore:

$$S = \frac{L + 7B}{8} = \frac{12 + 7 \times 8}{8} = 8.5 \text{ ft}$$

The proposed spacing of 8 feet is within 8.5 feet plus or minus 15%. The proposed spacing is acceptable.

---

#### 7.1.4 DELAYED INITIATION HIGH BENCHES

When the L/B stiffness ratio is four or more and holes in a row are delayed, the following equation is used to check the spacing:

$$S = 1.4 B \tag{7.4}$$

where:

S = Spacing (ft)

B = Burden (ft)

If the calculated spacing value is within plus or minus 15% of the actual spacing, the spacing is within reasonable limits.

---

### Example 7.4

The 8 x 8 foot pattern described in Example 7.3 is proposed for a section in the excavation where the bench height is 35 feet. Is the proposed spacing acceptable?

Check L/B for high or low bench

$$L/B = 35 / 8 = 4.38$$

Check instantaneous or delay timing

Answer: delay

Therefore:

$$S = 1.4 B = 1.4 \times 8 = 11.2 \text{ ft}$$

The proposed spacing of 8 feet is too close, since it is outside the range of  $11.2 \pm 15\%$  (range 9.52 - 12.88).

---

## 7.2 MAXIMUM FRAGMENTATION

In order to maximize fragmentation and minimize unwanted side effects from blasting, the design variables of burdens, stemming, subdrilling, spacing and timing must be selected such that all variables are working together. To better understand the relationship between the variables, figures will be used to illustrate the effects of having properly matched variables and improperly matched variables. Unless otherwise specified, it will be assumed that there are no geologic complications and all bench heights are at least four times the burden.

When a blasting pattern is constructed, each and every hole must be analyzed to determine if it will respond properly. Analyzing spacings or drill burdens without consideration for initiation timing does not produce a true picture of what will occur when the hole is fired. If a pattern is properly designed, one will notice a repetitive sequence in the crater forms broken per hole. As an example, depending upon the relationship between the blasthole and the free face, different crater shapes will be created from independent holes firing. This can be seen in Figure 7.3. To make analysis easy, one can assume that the breakage angle between the burden line and the edge of the crater is approximately  $45^\circ$ . If a blasthole has more than one burden direction at the time of its detonation, the distance to the free face along both burden directions should be equal. Figure 7.3A illustrates the breakage angle formed when one vertical free face is present. For the purposes of this analysis, the horizontal free face or the bench top will not be considered since from the previous discussion

it was evident that explosives preferentially function radially away from the blastholes. In Figure 7.3B two free faces are present and form a  $90^\circ$  angle, breakage patterns would be different than in Figure 7.3A. In Figure 7.3F a corner cut illustrates a different area of breakage because of the orientation of the face. If the blasthole is on a corner with two free faces, the breakage area is equivalent to two craters of area shown in Figure 7.3A. In Figure 7.3E, the crater will be considerably larger than in Figures 7.3A thru 7.3D.

It is apparent that for the same amount of explosive used in each blasthole in the above examples, different volumes of rock are broken depending upon the orientation to the free face. This simple example shows that powder factor or the amount of explosive used per cubic yard is not a constant number within a shot, even if the rock type and explosive type are identical.

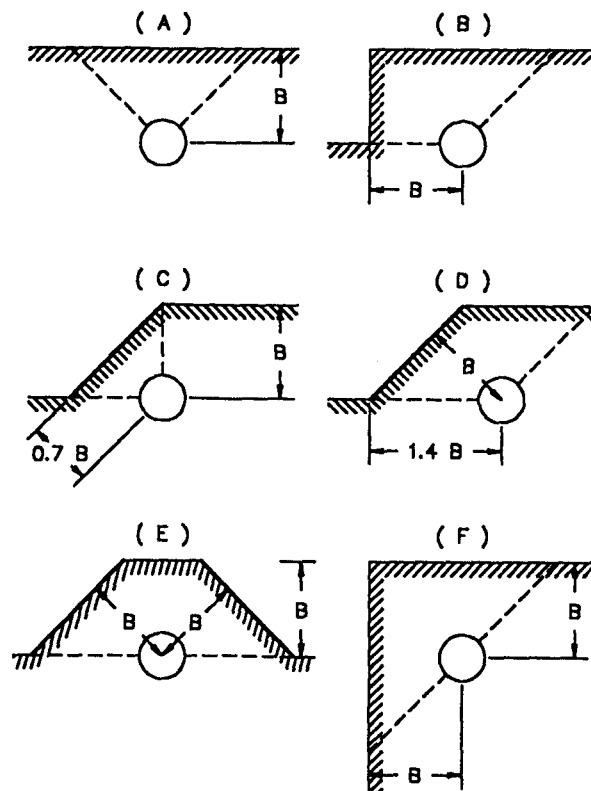


Figure 7.3 Typical Crater Forms (Plan View)

## **7.3 ROCK FRAGMENTATION AND WALL CONTROL**

In order to control fragmentation, two important principles must be correctly applied. The proper amount of energy must be applied at strategic locations within the rock mass. The energy must also be released at a precise time to allow the proper interactions to occur.

The energy distribution within the rock mass is further broken down into two distinct areas. First one must have sufficient energy, by using the proper amount of explosives. To break the rock mass, the explosive must also be placed in a geometric configuration where the energy is maximized for fragmentation. This geometric configuration is commonly called the blasting pattern.

The release of the energy at the wrong time can change the end result, even though the proper amount of energy is strategically placed throughout the rock mass in the proper pattern. If the initiation timing is not correct, differences in breakage, vibration, air blast, flyrock and backbreak can occur. This discussion does not consider the effects of the timing of the release of the energy, the strategic placement of the proper amount of energy in a correct blasting pattern will only be considered in this section.

The study of the concerns of fragmentation go back to the early days of blasting. Blasters had realized that on some blasts, the energy was very efficiently used in the breakage process. On others, very little energy was used in an efficient manner and instead a great deal of noise, ground vibration, air blast, and flyrock resulted with little breakage. There have been many empirical methods that have surfaced over the decades, suggesting methods of design which would more efficiently utilize this energy. These design methods would also give the blaster a way of producing consistency in his results, by applying similar techniques under different circumstances and in different rock masses.

### **7.3.1 FRAGMENTATION**

Kuznetsov did research on fragmentation and published his results in 1973. Kuznetsov's work relates a mean fragmentation size to the powder factor of TNT and to the geologic structure. Kuznetsov's work was very important, since it showed that there was a relationship between average fragmentation size and the amount of explosive used in a particular rock type. His work, however, fell short, in that, although the mean fragmentation size could be predicted, it told nothing about the amount of fines produced or the amount of boulders. That is to say, that the same mean size could result from four foot diameter boulders and dust, or from every bit of the breakage of exactly a two foot size. What was then needed was a way of determining the actual size distribution, not just the mean size. The actual size distribution is a function of the pattern, the manner in which the explosive is geometrically applied to the rock mass.

### 7.3.2 KUZNETSOV EQUATION

The original Kuznetsov equation is given as:

$$\bar{x} = A \left[ \frac{V_0}{Q} \right]^{0.8} Q^{0.167} \quad (7.5)$$

where:

- $\bar{x}$  = Mean fragment size (cm)
- A = Rock factor (7 for medium rocks 10 for hard, highly fissured rocks 13 for hard, weakly fissured rocks)
- V = Rock volume (cubic meters, m<sup>3</sup>) broken per blasthole, taken as burden x spacing x bench height
- Q = Mass (Kg) of TNT which is equivalent in energy to that of the explosive charge in each blasthole

Normally the explosive in the sub-drill section is excluded, as this seldom contributes significantly to fragmentation in the column area.

With the use of the original Kuznetsov equation and the modifications supplied by Cunningham, one can determine the mean fragmentation size with any explosive and the index of uniformity. With this information, a Rosin Rammler projection of size distribution can be made.

### 7.3.3 SIZE DISTRIBUTION

Cunningham, in South Africa, realized that the Rosin Rammler Curve had been generally recognized as a reasonable description of fragmentation for both crushed or blasted rock. One point on that curve, the mean size, could be determined by using the Kuznetsov equation. To properly define the Rosin Rammler Curve, what was needed was the exponent "n" in the following equation:

$$R = e^{-\left[ \frac{x}{x_c} \right]^n} \quad (7.6)$$

where:

- R = Proportion of material retained on screen
- x = Screen size
- x<sub>c</sub> = Empirical constant
- n = Index of uniformity

To obtain this value, Cunningham used field data and regression analysis of the field parameters that were previously studied and obtained "n" in terms of:

Drilling Accuracy  
 Ratio of Burden to Blasthole Diameter  
 Staggered or Square Drilling Pattern  
 Spacing/Burden Ratio  
 Ratio of Charge Length to Bench Height

The combination of the algorithms thus developed along with the Kuznetsov equation, became known as the "Kuz-Ram Model". The present form of the algorithm used is:

$$n = \left[ 2.2 - 1.4 \frac{B}{d} \right] \left[ 1 - \frac{W}{B} \right] \left[ 1 + \frac{A-1}{2} \right] \frac{L}{H} \quad (7.7)$$

where:

n = Index of Uniformity  
 B = Burden (m)  
 d = Hole diameter (mm)  
 W = Standard deviation of drilling accuracy (m)  
 A = Spacing/burden ratio  
 L = Charge length above grade level (m)  
 H = Bench height (m)

A further development which enable the use of different explosives other than TNT, was incorporated into the Kuznetsov equation by Cunningham. The final equation to determine average fragmentation size is shown below:

$$\bar{x} = A \left[ \frac{V_0}{Q} \right]^{0.8} Q^{0.17} \left[ \frac{E}{115} \right]^{-0.63} \quad (7.8)$$

The "E" is a relative weight strength term of the actual explosive (where ANFO = 100) while the relative weight strength of TNT is 115. The strength values are available from the explosives manufacturers, they are commonly provided on the product data sheet.

#### **7.3.4 FIELD RESULTS**

Kuznetsov's initial studies were done in models of different materials, and later applied to surface mining operations. There was some difference between the fragmentation measured and the predictions, as was expected, considering the nature of mining and variability of rock. One would expect correlation to be best in the model work, where the materials properties can be tightly controlled. The larger the scale of the operation and the bigger the holes and more

varied the rock, the greater would be the expected deviation between the predicted results and the measured results in fragmentation. The actual measurement of fragmentation from large scale blasts is extremely difficult. As a result, there are only a few such measurements in existence, some are suspect in accuracy since they were done with photographic techniques. The biggest problem with the assessment would probably be in the fines content.

The same problems that plagued Kuznetsov in deriving his empirical equation, also apply to the application of such an equation as a predicative tool.

Verification of the equations were done both in small and large scale blasts. The United States Bureau of Mines (USBM) in 1973 conducted tests on small scale blasts in limestone. Fragments from the blast were collected and sized. This data was put into the model for evaluation. It is interesting to note that the data produced by the USBM fit the predictions quite reasonably with less than a 10% variation from the measured range over the greatest part of the curve. A typical result from both the predicted and the measured data is shown in Figure 7.4. The Kuz-Ram method was used to evaluate some of the fragmentation from overburden blasts at some Australian coal mines. The model gave extremely good correlation in the coarse region of the curve, but indicated more fines than are given by the photographic analysis, which was used.

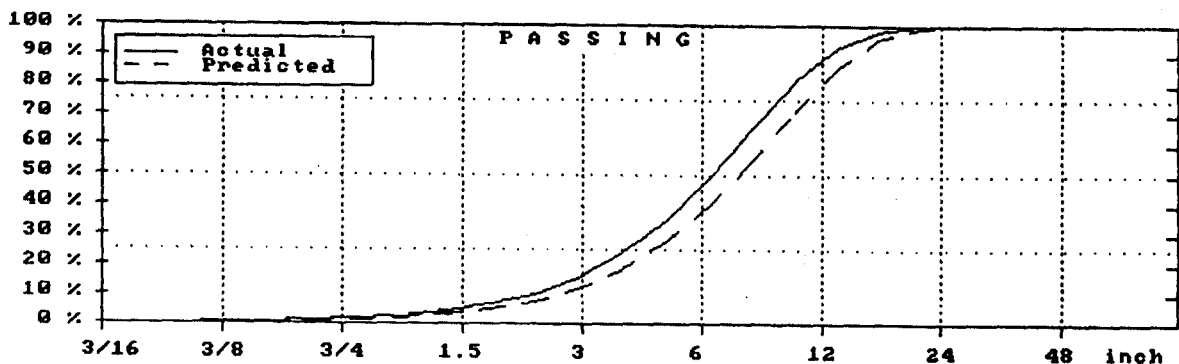


Figure 7.4 Predicted and Actual Fragmentation Distribution

### 7.3.5 LIMITATIONS ON THE KUZ-RAM MODEL

A simple model as this, requires caution in its use and the following factors should be understood:

- a. The S/B ratio applies only to the drilling function, not the timing. Therefore, spacing is always considered along the row where burden is considered the distance between rows, which parallel the face. The layout on this blast can never be such that the spacing to burden ratio is greater than two.

b. It is assumed that reasonable timing sequences are used which will enhance or maintain fragmentation.

c. The explosive should actually yield energy close to its Relative Weight Strength for the diameters that are being used on the job.

d. Jointing and bedding, especially in the case of loose jointing which is more closely spaced than the drill pattern, can effect the size distributions. Maximum sizes could be controlled by geologic features rather than the explosives energy released from the blasting process.

#### **7.3.5.1 EFFECTS OF BLASTING PARAMETERS ON "n"**

It would normally be desired to have uniform fragmentation in a blast, avoiding both excessive fines and boulders. If this is to be obtained, high values of "n" are preferred. The blasting pattern parameters used to determine "n" change as follows:

1. The value for "n" increases as the burden/hole diameter decreases.
2. The value for "n" increases as the drilling accuracy increases.
3. The value for "n" increases as the charge length/bench height increases.
4. The value for "n" increases as the spacing/burden increases.
5. The value for "n" increases with the use of a staggered pattern rather than a square pattern.

#### **7.3.5.2 THE EFFECTS OF STRONGER EXPLOSIVES**

In many operations, a standard drilling pattern is used. The drill pattern is based on nontechnical considerations such as drilling capacity or the policy of drilling well ahead of the blasting operation. Where patterns are fixed, improvements can be implemented by increasing the explosive strength.

Explosive strength is determined by density as well as strength. By increasing the density, one increases the total pounds of explosives put into the blast. Also higher strength explosives produce a reduction in oversized material, on a standard drilling pattern.

#### **7.3.6 FRAGMENTATION EFFECTS ON WALL CONTROL**

In general, it can be said that the better the breakage obtained and the better the displacement on a row by row shot, the better the wall control. If insufficient energy is available to break rock properly in the burden, the added burden resistance placed against the borehole causes increased confinement and will cause more fracturing (back shatter) behind the



blast. If large boulders are produced from the stemming area, rather than from the burden, increase backbreak, especially at the top of the bench, will result, thereby causing problems with subsequent drilling of patterns and the final wall will be less stable. In general, one can conclude that higher the "n" value, the better the potential wall control. One could also conclude that the lower the mean size on a specific design, the smaller the chance of causing back shatter and excessive overbreak beyond the excavation limits. Values of "n" below 1.0 should be avoided. Values of "n" between 1.0 and 1.3 indicate potential wall damage.

The fragmentation model can, therefore, be used for two purposes, to determine the sizing, which results from the blast, and the effect of one pattern versus another on potential problems with wall control.

To illustrate the effects on fragmentation and wall control, "Breaker" will be used. "Breaker" is a commercial software package available to perform the calculations. The commercial software package used a modified Kuz-Ram method, however, the results are similar to the method previously described.

Examples in Figures 7.5 - 7.8 illustrate the effect of changing bench height from 60 feet to 10 feet. The input data on the two patterns are given in Figure 7.5 and 7.6, Figures 7.7 and 7.8 show the resulting changes in fragmentation size. The 10 foot bench height results in a larger average size.

The fragmentation index also drops below 1 for the 10 foot bench height, thereby, producing an unacceptable value and a condition that is likely to cause severe wall damage.

\*\* "Breaker" is a copyrighted software package produced by Precision Blasting Services, P.O. Box 189, Montville, Ohio 44064.

Figures 7.9 through 7.14 illustrates the effect of timing and spacing in pattern design.

File: FHWA75 (ENTRY 1) FHWA 60 feet bench  
 ENTRY 1 Calculation based on Volume Strength, Square pattern

Number of rows ..... 5  
 Total number of holes ..... 50  
 Burden ..... 9.00 ft  
 Spacing ..... 9.00 ft  
 Stemming ..... 6.00 ft  
 Hole depth ..... 63.00 ft  
 Bench height ..... 60.00 ft  
 Diameter of blasthole ..... 4.00 in

Type of rock ..... LIMESTONE  
 Specific gravity of rock ..... 2.60  
 Rock strength (weak=1, strong=10) ... 6.34

Type (brand) of explosive ..... ANFO  
 Specific gravity of explosive ..... 0.85  
 Explosive strength (ANFO=100) ..... 100.00  
 Diameter of explosive ..... 4.00 in  
 Total weight per hole ..... 263.00 lb  
 Length of column charge ..... 56.80 ft

SCREEN SIZE	Entry	PASSING			FRACTION		
inch		yd <sup>3</sup>	ton	%	yd <sup>3</sup>	ton	%
3/16	1	5	11	0.06			
					18	39	0.20
3/8	1	18	39	0.20			
					45	99	0.50
3/4	1	63	138	0.70			
					158	345	1.75
1.5	1	221	438	2.45			
					535	1,171	5.94
3	1	755	1,655	8.39			
					1,640	3,594	18.23
6	1	2,395	5,249	26.62			
					3,587	7,860	39.86
12	1	5,982	13,109	66.47			
					2,828	6,196	31.42
24	1	8,810	19,305	97.89			
					190	416	2.11
48	1	9,000	19,721	100.00			

1 Average size = 9.34 in Fragmentation index = 1.820

Figure 7.5 Data for Pattern Number 1.

File: FHWA76 (ENTRY 2) FHWA 10 feet bench  
 ENTRY 2 Calculation based on Volume Strength, Square pattern

```

Number of rows ..... 5
Total number of holes ..... 50
Burden ..... 9.00 ft
Spacing ..... 9.00 ft
Stemming ..... 6.00 ft
Hole depth ..... 13.00 ft
Bench height ..... 10.00 ft
Diameter of blasthole ..... 4.00 in

Type of rock ..... LIMESTONE
Specific gravity of rock ..... 2.60
Rock strength (weak=1, strong=10) ... 6.34

Type (brand) of explosive ..... ANFO
Specific gravity of explosive ..... 0.85
Explosive strength (ANFO=100) ..... 100.00
Diameter of explosive ..... 4.00 in
Total weight per hole ..... 32.00 lb
Length of column charge ..... 6.91 ft
    
```

SCREEN SIZE inch	Entry	P A S S I N G			F R A C T I O N		
		yd <sup>3</sup>	ton	%	yd <sup>3</sup>	ton	%
3/16	2	47	103	3.13			
					81	178	5.42
3/8	2	81	178	5.42	58	128	3.88
3/4	2	139	306	9.30	96	211	6.42
1.5	2	236	517	15.72	153	334	10.17
3	2	388	851	25.89	224	491	14.95
6	2	613	1,342	40.84	289	634	19.29
12	2	902	1,976	60.13	299	654	19.90
24	2	1,200	2,630	80.03	210	461	14.02
48	2	1,411	3,091	94.05			
2		Average size = 8.46 in		Fragmentation index = 0.809			

Figure 7.6 Data for Pattern Number 2.

	ENTRY 1 -----	ENTRY 2 -----
Number of rows .....	5	5
Total number of holes .....	50	50
Burden .....	9.00 ft	9.00 ft
Spacing .....	9.00 ft	9.00 ft
Stemming .....	6.00 ft	6.00 ft
Hole depth .....	63.00 ft	13.00 ft
Bench height .....	60.00 ft	10.00 ft
Diameter of blasthole .....	4.00 in	4.00 in
Type of rock .....	LIMESTONE	LIMESTONE
Specific gravity of rock .....	2.60	2.60
Rock strength (weak=1, strong=10)	6.00	6.00
Type (brand) of explosive .....	ANFO	ANFO
Specific gravity of explosive ...	0.85	0.85
Explosive strength (ANFO=100) ...	100.00	100.00
Diameter of explosive .....	4.00 in	4.00 in
Total weight per hole .....	263.00 lb	32.00 lb
Length of column charge .....	56.80 ft	6.91 ft

Figure 7.7A Summary of Fragmentation Data

SCREEN SIZE inch	Entry	P A S S I N G			F R A C T I O N		
		yd <sup>3</sup>	ton	%	yd <sup>3</sup>	ton	%
3/16	1	5	11	0.06			
	2	47	103	3.13			
3/8	1	18	39	0.20	18	39	0.20
	2	81	178	5.42	81	178	5.42
3/4	1	63	138	0.70	45	99	0.50
	2	139	306	9.30	58	128	3.88
1.5	1	221	483	2.45	158	345	1.75
	2	236	517	15.72	96	211	6.42
3	1	755	1,655	8.39	535	1,171	5.94
	2	388	851	25.89	153	334	10.17
6	1	2,395	5,249	26.62	1,640	3,594	18.23
	2	613	1,342	40.84	224	491	14.95
12	1	5,982	13,109	66.47	3,587	7,860	39.86
	2	902	1,976	60.13	289	634	19.29
24	1	8,810	19,305	97.89	2,828	6,196	31.42
	2	1,200	2,630	80.03	299	654	19.90
48	1	9,000	19,721	100.00	190	416	2.11
	2	1,411	3,091	94.05	210	461	14.02
1	Average size = 9.34 in Fragmentation index = 1.820						
2	Average size = 8.46 in Fragmentation index = 0.809						

Figure 7.7B Summary of Fragmentation Data

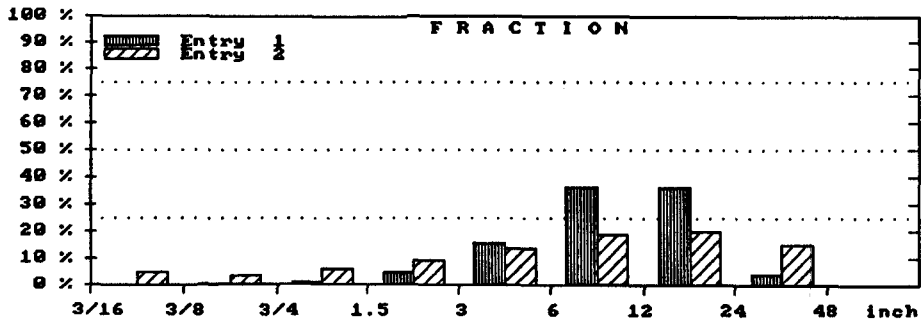


Figure 7.8A Comparison of Sizes From Both Blasts

File: FHWA75 (ENTRY 1) FHWA 60 ft bench  
 File: FHWA76 (ENTRY 2) FHWA 10 ft bench

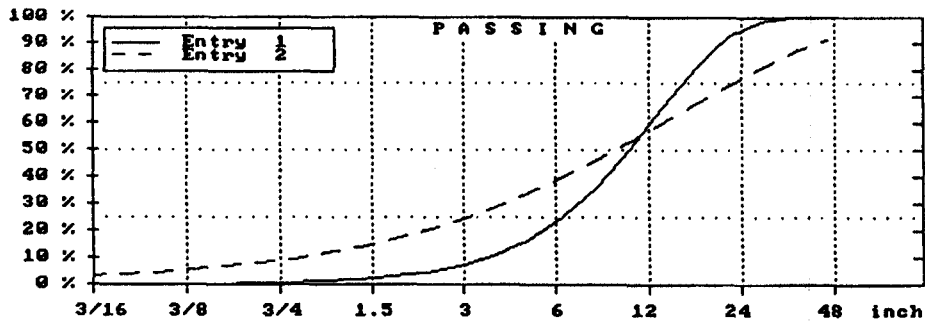
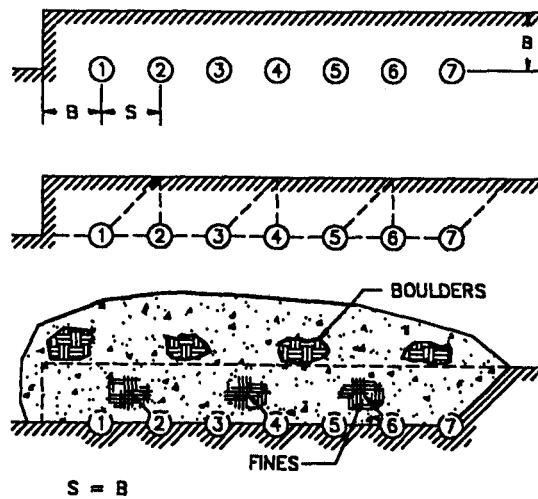


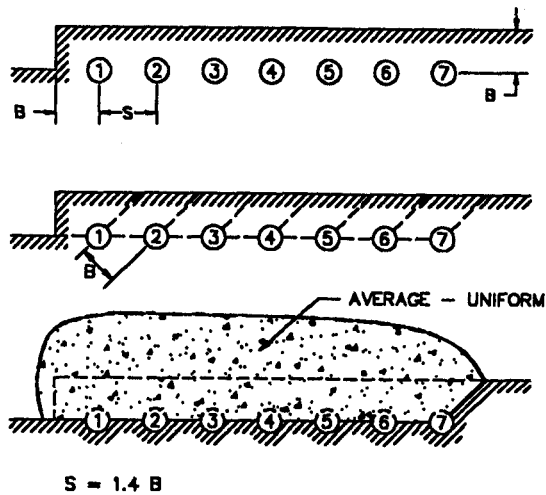
Figure 7.8B Cumulative Distribution of Fragmentation Data



**Conditions:**

- Drill Pattern: All holes spaced at burden distance
- Initiation Timing: Progressive MS Delays
- Vibration Level: Low, each hole on separate delay
- Fragmentation: Two separate distributions. Fines and some boulders.
- High Bench:  $L/B > 4$

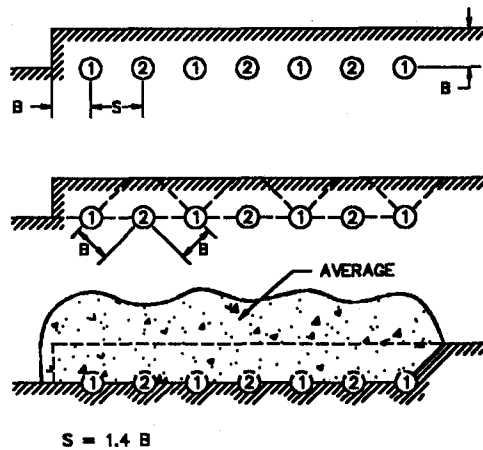
**Figure 7.9** Single Row Progressive Delays,  $S = B$



**Conditions:**

- Drill Pattern: First hole burden distance from face. Spacing is  $1.4B$  for  $L/B \geq 4$
- Initiation Timing: Progressive MS Delays
- Vibration Level: Low, each hole on separate delay
- Fragmentation: Uniform, one tight distribution
- High Bench:  $L/B > 4$

**Figure 7.10** Single Row Progressive Delays,  $S = 1.4 B$



**Conditions:**

Drill Pattern: First hole burden distance from face. Spacing is  $1.4B$  for  $L/B \geq 4$

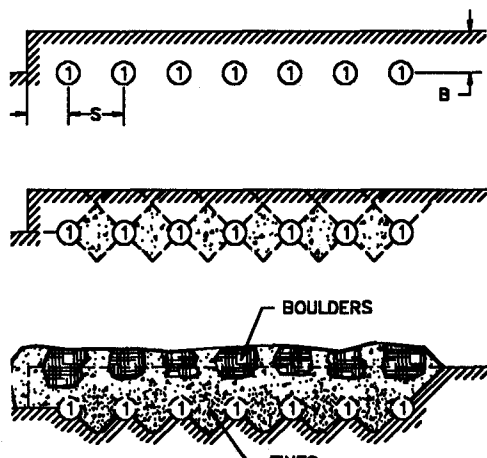
Initiation Timing: Alternating MS Delays

Vibration Level: High since one-half of total holes firing on one delay

Fragmentation: Majority of rock in two different size distribution.

High Bench:  $L/B > 4$

**Figure 7.11** Single Row Alternating Delays,  $S = 1.4 B$



**Conditions:**

Drill Pattern: First hole burden distance from face. Spacing is  $1.4B$  for  $L/B$

Initiation Timing: Instantaneous

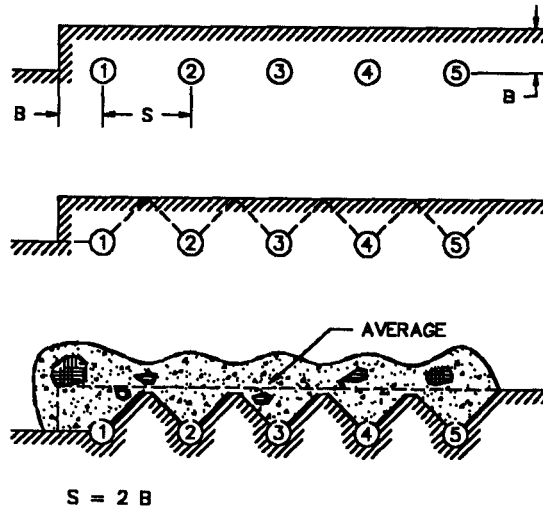
Vibration Level: High since all holes firing together

Fragmentation: Majority of rock in two different size distributions (fines and boulders)

High Bench:  $L/B > 4$

**Figure 7.12** Single Row Instantaneous,  $S = 1.4 B$

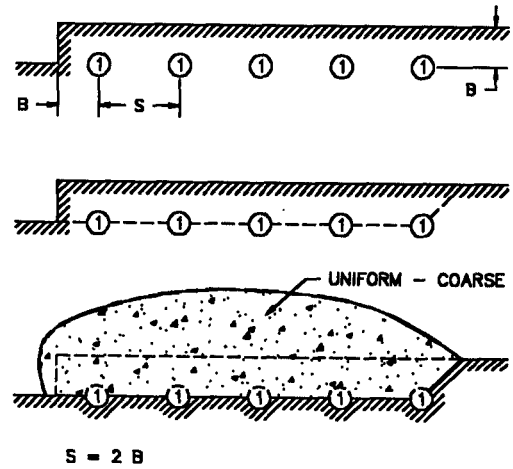




**Conditions:**

- Drill Pattern: First hole burden distance from face. Spacing is 2B.
- Initiation Timing: Progressive Delays
- Vibration Level: Low, each hole on separate delays
- Fragmentation: Average, some boulders, rough face
- High Bench:  $L/B > 4$

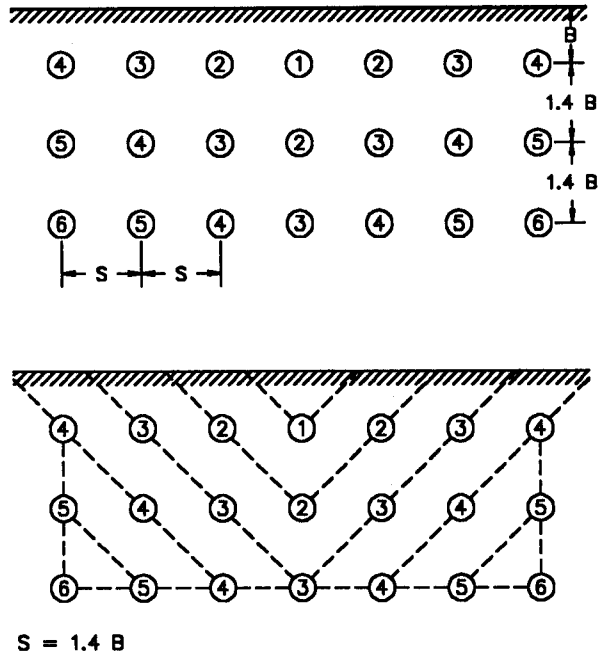
**Figure 7.13** Progressive Delays,  $S = 2B$



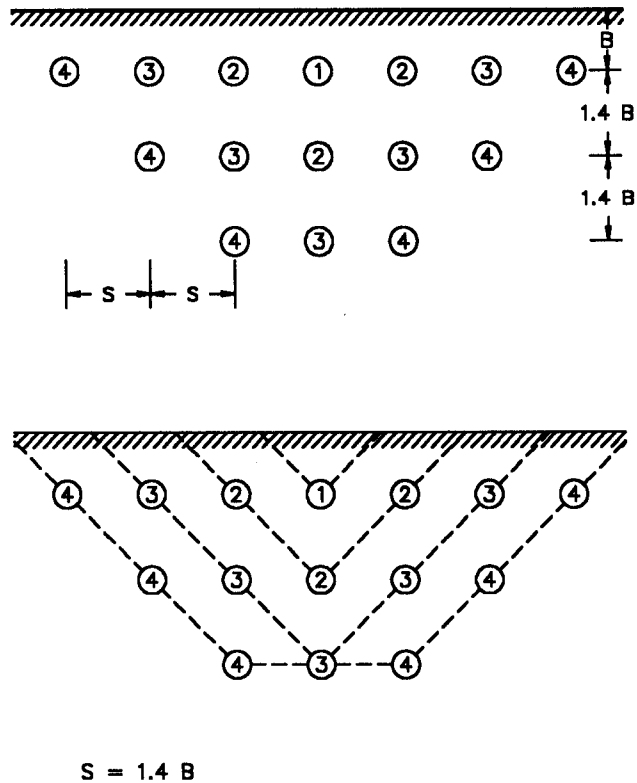
**Conditions:**

- Drill Pattern: First hole burden distance from face. Spacing is 2B for  $L/B \geq 4$
- Initiation Timing: Instantaneous row
- Vibration Level: High
- Fragmentation: Uniform coarse
- High Bench:  $L/B > 4$

**Figure 7.14** Single Row Instantaneous,  $S = 2B$



**Figure 7.15** V-Cut (Square Corner), Progressive Delays,  $S = 1.4 B$



**Figure 7.16** V-Cut (Angle Corner), Progressive Delays,  $S = 1.4 B$

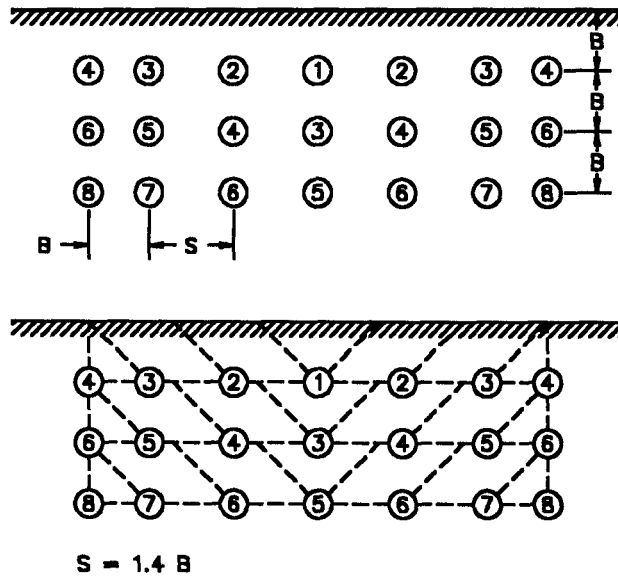


Figure 7.17 Box Cut, Progressive Delays,  $S = 1.4 B$

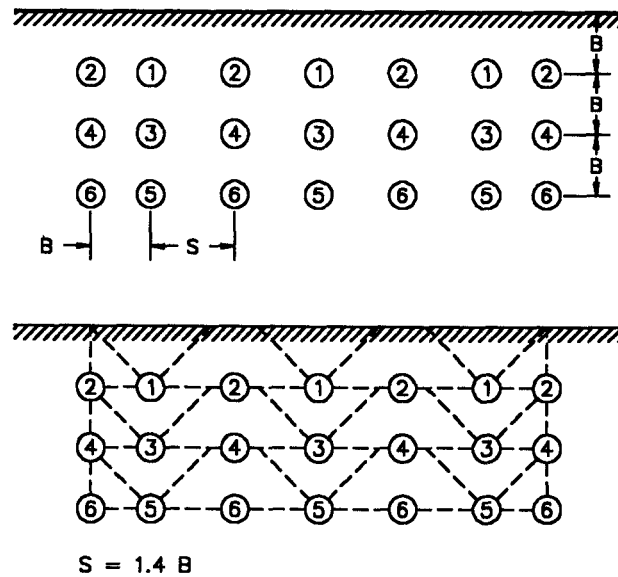
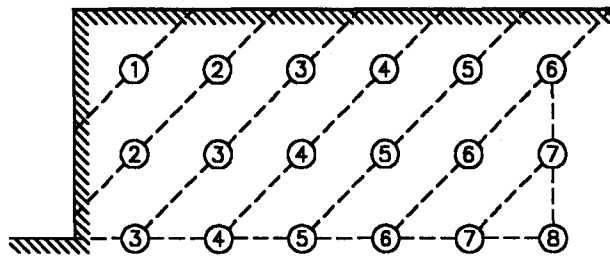
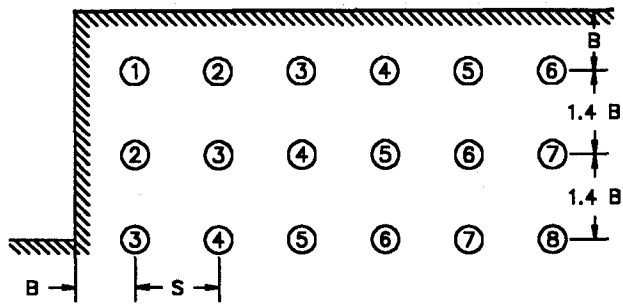
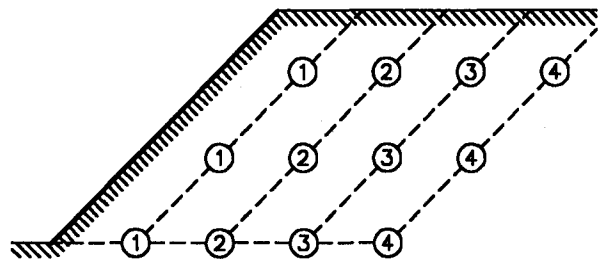
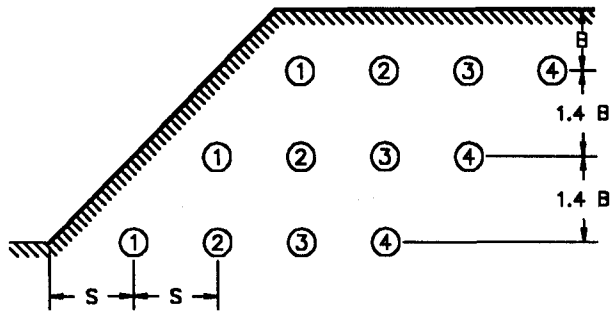


Figure 7.18 Box Cut, Alternating Delays,  $S = 1.4 B$



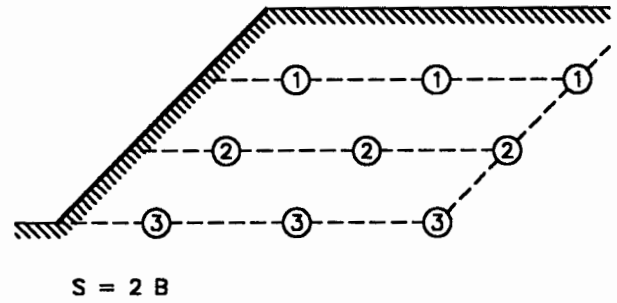
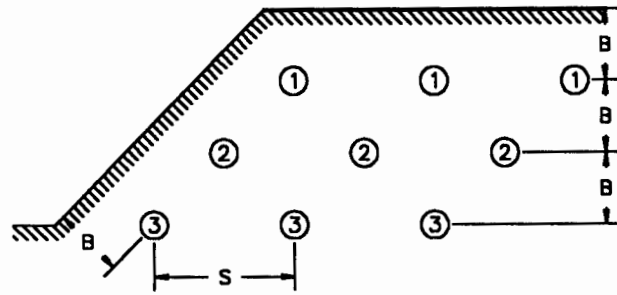
$$S = 1.4 B$$

Figure 7.19 Square Corner, Cut Fired on Echelon,  $S = 1.4 B$

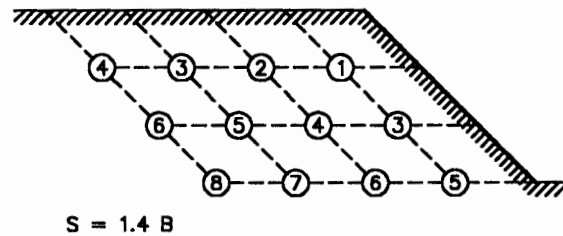
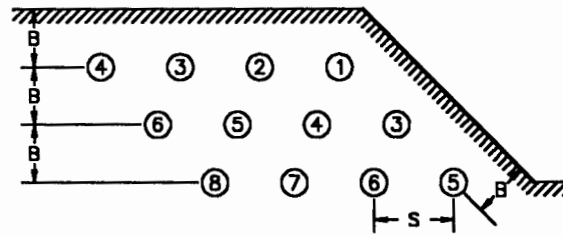


$$S = 1.4 B$$

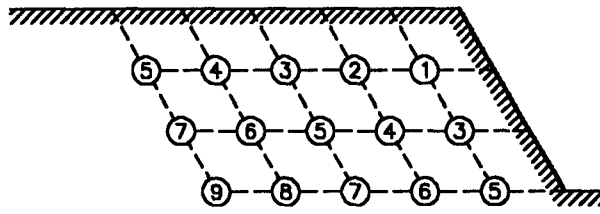
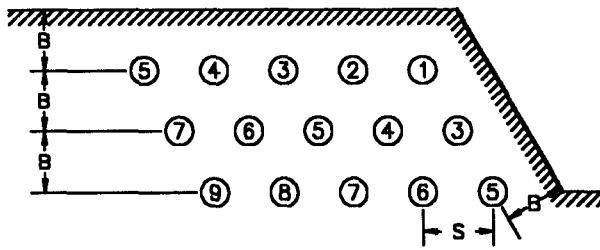
Figure 7.20 Angle Corner, Fired on Echelon,  $S = 1.4 B$



**Figure 7.21** Angle Corner, Instantaneous Rows,  $S = 2B$

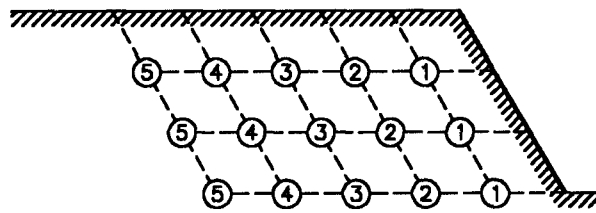
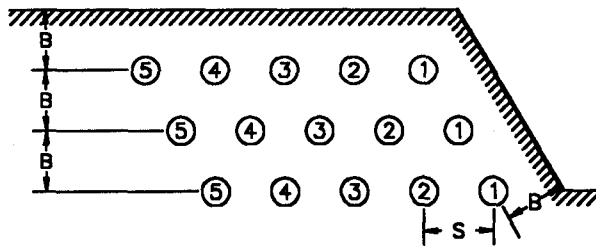


**Figure 7.22** Angle Corner, Progressive Delays,  $S = 1.4B$



$$S = 1.15 B$$

**Figure 7.23** Angle Corner, Progressive Delays  
(Low Bench)  $S = 1.15 B$



$$S = 1.15 B$$

**Figure 7.24** Angle Corner, Fired on Echelon  
(Low Bench)  $S = 1.15 B$

## 7.4 RIP-RAP PRODUCTION

Rip-rap is larger size rock normally used to protect banks or slopes from the effect of water and erosion. Rip-rap can weigh a few pounds or a few tons each depending upon the end use of the product. Small size rip-rap can be produced in production blasts by increasing the burden distance and reducing the spacing distance. Large size rip-rap, on the other hand, weighing thousands of pounds must be produced using a different technique. Large stone for breakwater walls must be undamaged so that the action of waves and freezing action will not deteriorate the rock prematurely. Extreme care must be taken to produce unfractured rock. This can be accomplished by using principles of controlled blasting along with the production blast. As an example, blastholes can be drilled with excessive burdens and minimum spacing. Blastholes are loaded lightly to prevent major damage from occurring around the borehole. When the blast is fired, large pieces of unfractured rock are produced (Figure 7.25). Not every rock can be used for rip-rap production. Geologically speaking, the rock must be either massive or inner bedded with considerable cohesion across the bedding planes.

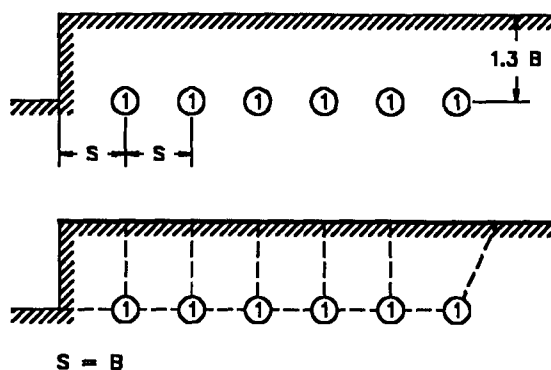


Figure 7.25 Production of Large Rip-Rap,  $S = B$

## 7.5 ROCK PILING CONSIDERATIONS

The function of the blasting pattern is not only to fracture the rock to the desired size distribution, but also to pile or place the rock in a manner which is most economic to handle in the next step of the operation. The type of equipment which will be used for digging the blasted material is an important consideration when the blast is designed. If the benches are relatively low and a shovel is used for loading, one may want to stack the rock to ensure a high bucket-fill factor. On the other hand, if benches are high and an end loader is to be used for digging, intentional scattering of the broken rock is needed. To ensure the proper piling of material, the following principles should be considered in the design process.

1. Rock movement will be parallel to the burden dimension.
2. Instantaneous initiation along a row causes more displacement than delayed initiation.
3. Shots delayed row-by-row scatter the rock more than shots arranged in a v-cut.
4. Shots designed in a v-cut give maximum piling close to the face.

Figures 7.9 through 7.14 show the type of piling and fragmentation anticipated from different patterns. Examples of multi-row patterns are given in Figures 7.15 through 7.24.

Whenever a new bench is started a box cut is needed to open the bench. Box cuts begin with only one vertical face for relief. For that reason they are often more prone to result in violence, especially from the corner holes marked number 6 in Figure 7.15. One often hears rules of thumb in the field indicating that blow out of corner holes can be controlled by skipping a delay or doubling the delay in the corner holes. This may or may not be effective depending on which delay period (in milliseconds) is actually used in the corner holes. A more effective solution to the problem is to design the blast as indicated in Figure 7.16 where the corner holes were totally eliminated.

In both Figures 7.15 and 7.16, the rock is piled in the center and rock movement is perpendicular to the break lines shown in the diagrams.

A major disadvantage of this type of pattern is that many holes fire on the same period, thereby creating higher vibration levels. The major advantage of the pattern is a reduced drilling and explosive cost since blastholes are drilled on a spacing equal to twice the burden.

In situations where lower vibration levels are required or where it is desired to break the rock somewhat finer, the pattern in Figure 7.17 could be used. The cost per cubic yard would increase with the use of this pattern. This is a delayed pattern where no blasthole is reinforcing a neighboring blasthole. Delay periods could be considered different than those indicated in Figure 7.17. If vibration is a concern, each blasthole within the pattern could be fired independently. An example of a different timing sequence, which would result in a change in size distribution, is given in Figure 7.18.

If the box cut shown in Figure 7.15 is used to open a bench, the corner cut shown in Figure 7.19 could be used to continue production along this bench. If the box cut as shown in Figure 7.16 was used, it could be followed by the corner cut shown in Figure 7.20.

If the operator desires to change the direction of rock movement in Figure 7.19 (movement perpendicular to break line), the pattern could be designed as indicated in Figure 7.21.

When box cuts similar to those discussed in Figure 7.17 are used, corner cuts as indicated by Figure 7.21 would follow. As in the box cut, each hole could be fired on a separate delay to reduce vibration.



On low benches where L/B ratios are near one, equilateral triangle patterns, as indicated in Figure 7.23 and 7.24, are commonly used. The true spacing on blastholes within these patterns is 1.15 B. The close spacing helps compensate for the added burden stiffness resulting from these low benches. Regardless of the pattern chosen, fragmentation from low bench blasts in massive rock is normally less than optimum and the chance of violence is great.

If the operator desires to produce rip-rap, a pattern such as that shown in Figure 7.25 could be employed. A pattern such as this will increase the chance of violence and increase the vibration level per pound of explosive used.

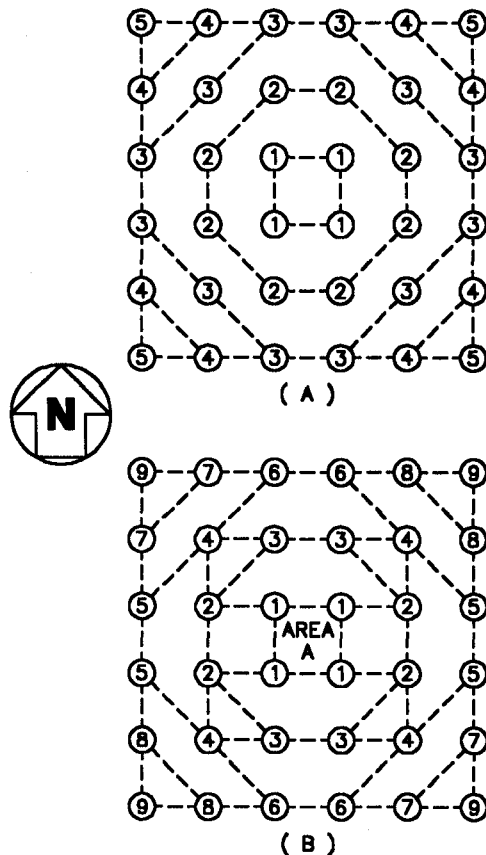
The methods of pattern construction previously discussed have indicated general timing sequence or the sequencing of blastholes. The actual time in milliseconds to be used in these patterns will also control scatter or piling along with air blast, flyrock and ground vibration. The general guidelines for producing proper timing were given in Chapter 6. These must be considered in the selection of the actual timing in milliseconds both hole-to-hole or row-to-row in the shots described in the previous section. The combination of blasting pattern sequencing, along with actual timing, further controls scatter or heaping of the pile.

## **7.6 SINKING CUTS**

When starting off from a flat rock surface and dropping down to a lower level, such as in highway construction, foundation placement, or blasting for a bridge pier, a blasting pattern commonly called a sinking cut, drop shot or drop cut will be used. This shot is different than production blasting patterns previously discussed in that there is only one free face, the horizontal top surface of the rock, at the time the shot is initiated.

The first holes to fire in this type of shot function totally different than those previously discussed. These opening holes must create the second free face toward which the rock can push, bend or move. Timing of these holes are critical in that if the time is too short between the initiation of the first or center holes and the subsequent holes, poor breakage results along with extreme violence. Figure 7.26A shows sequencing from row-to-row with only one cap period between each hole. The pattern in Figure 7.26B shows a totally different firing sequence, which allows additional movement before each subsequent delay fires. Pattern 7.26A also has many holes firing on the same delay period, which will increase the vibration level. Vibration from this type of shot will be higher than from other production round because the first holes to fire are heavily confined at the time they detonate.

To better understand the functioning of a sinking cut, pattern 7.26B will be discussed in detail. In the analysis of pattern 7.26B, it is evident that there are only four holes firing per delay period. This is important, especially near the center of the shot, since if too much rock moves into the center of the shot at one time, the center of the pattern may stick and not move. If this occurs, the remainder of the holes in the pattern will rifle causing poor breakage and excessive flyrock and air blast problems.



**Figure 7.26** Sinking Cuts, Square Pattern,  $S = B$

The first holes to fire in the pattern are functioning differently than the rest of the holes in the pattern. As an example, the number one holes are functioning on area A, as indicated in the diagram, with a tremendous concentration of energy within the zone. Number two holes and others, thereafter, use half the number of holes and approximately half the explosive to break a similar volume of rock. Holes marked number one radially crack the rock, but cannot bend or displace it since there is no place for this type of motion to occur. Instead, the radial cracks are pressurized by the gasses and begin to lift as in a cratering shot. Number two holes function differently. Number one holes are lifting and number two holes function toward a free face outlined by the break line of number one holes. They, therefore, radially crack and displace into the crater produced by number one holes. Subsequent holes in the shot all have a vertical free face to work toward as did holes number two holes. Pattern 7.26B is somewhat different than other patterns previously discussed because the physical direction of the burden changes with each hole firing. If the pattern is laid out in a north and south direction as indicated, holes number two sense a burden in an east-west direction where number three holes sense a burden in a north-south direction. The burden is the most important dimension in a blast. To ensure that all holes have the same maximum distance as the burden, the pattern will be drilled square with a burden and spacing equal.

The number one holes must break to grade to ensure that the subsequent holes can break to grade. If number one hole breaks only partially to the grade line, the entire bottom of the shot will be high and above grade level. To ensure that number one holes break properly, they should be drilled deeper than those in the remainder of the shot. The number one holes should be subdrilled approximately twice as deep as others in the blast or to a depth of 0.5 times the burden.

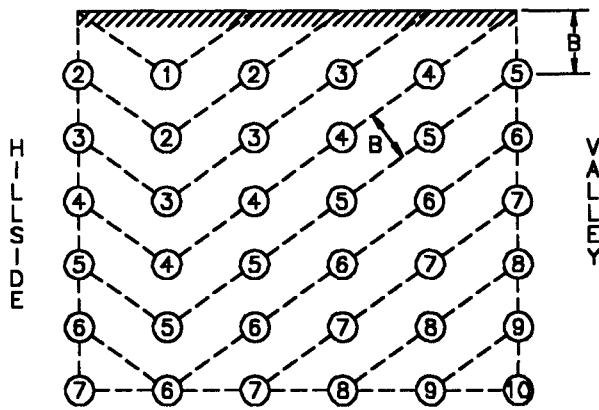
Number one holes function differently than the remainder of the holes in the shot and are designed to crater. To control flyrock from the shot, the number one holes should be stemmed equal to the burden distance. The remainder of the holes will be stemmed to a depth of approximately 0.7 burden.

The final dimension in a sinking cut, which needs to be considered, is the depth of the shot. It is obvious that unlimited depth is not a realistic assumption. Gravity effects cause problems with rock motion necessary to produce the desired results.

There are two rules of thumb which are considered when designing sinking cuts. The first states that the depth of holes should not be greater than half the dimension of the pattern. This is to say that the cut depth will be one-half the distance obtained if spacing between blastholes in a row are added together. As an example, if the pattern width was 60 feet, the depth of the cut should be no more than half that, or 30 feet. A second rule of thumb states that the maximum L/B or bench height to burden ratio for a sinking cut to function properly should not be greater than 4. For example, if the burden between holes in a pattern would be 5 feet, a practical sinking cut depth of 20 feet would be realistic. On the other hand, if 6-1/2 inch holes were being used for sinking cuts with burdens of 15 feet, than practical depth of the cut might be as great as 60 feet. It must be remembered that the greater the depth in a sinking cut, the greater the probability that the cut will not function properly and will not break totally to grade. Laminated rock with closely spaced bedding planes is more forgiving to errors in judgment than massive rock. In the situation of massive rock, these ratios should be clearly followed, while in laminated rock additional depth is often obtained.

## **7.7 HILLSIDE OR SLIVER CUTS**

Hillside or sliver cuts can be difficult to control, since in most instances the rock cannot be thrown from the hillside. If the purpose of the blasting was to scatter the rock down the hillside, there would be no problem in designing the blast. When it is the intent of the operator to keep as much rock as possible in the cut itself, procedures can be used which are either similar to a modified sinking cut or similar to a modified v-cut. The method of timing of the blastholes will ensure rock movement in a manner to keep the rock pushing toward the bank rather than pushing toward the slope. An example of this type of cut is given in Figure 7.27.



**Figure 7.27 Hillside Sliver Cuts,  $S = 1.4 B$**

On steeply sloping hillsides, the outer row of holes has very little depth. To produce the proper fragmentation, displacement and piling, especially in massive rock, the operator must consider the general principles of rock breakage as described in Chapter 2. The  $L/B$  ratio must never be less than 1. If large diameter holes are used where considerable depth is available, blasthole size and related burdens and spacings must be reduced on the outer edges of the slope. Air track drilling with smaller drills may be necessary to produce the proper results.

## **7.8 UTILITY TRENCH DESIGN**

There are many considerations when designing a utility trench. The size of pipe or utility which will go into the trench, of course, is one of the prime considerations. One does not want to blast a six-foot wide trench if only an 8-inch line is going into the ground. On the other hand, the size of the excavation equipment bucket is also an important consideration, since it will be used to remove the material from the shot. In no instance can one design a shot, regardless of the size of the utility line, which has a width less than the excavator bucket.

In trench blasting, the local geology is extremely important. Trenches are at the surface of the earth, where one can encounter the most weathered, unstable type of rock. Often there has been significant decomposition of the rock resulting in clay or mud pockets and seams within the rock mass. The overburden, whether it be weathered rock or soil, may not be flat-lying and this is an important consideration when the holes are loaded. One does not place explosive in the overburden above the solid rock. It is, therefore, imperative that the blaster knows the actual depth to rock within each hole. To blast efficiently, explosives would be loaded in the hole and stemming must be placed within the rock itself, not only in the overburden.

In utility trench blasting, techniques which are used in bedded weak rock may not function in solid massive material. Bedding planes will allow gas migration into the rock mass allowing more cratering action. On the other hand, similar techniques used in massive rock may not cause cratering. Instead, blastholes may rifle with little, if any, resulting breakage.

In the following discussion, the difference in blasting techniques between massive, hard materials and interbedded, weaker rock will be reviewed. If a narrow trench is needed in an innerbedded rock mass, one can often use a single row of holes down the center of the trench line. The burden distance or spacing between these single row holes would be similar to that indicated in equation 6.2. A minimum L/B ratio of one must be used in all types of blasting.

If the trench is to be shallow, smaller diameter holes will be needed than if the trench is to be deep. The timing should be such that holes will sequence down the row. If blastholes are all fired instantaneously, considerable rock will be scattered in the nearby area. As bench heights are reduced, the probability of scatter will increase and blasting mats may be necessary. The single row technique is not applicable in massive hard rock. Normally blastholes will rifle with little, if any, breakage between holes. In massive material, a double row trench is normally used.

The double row trench is designed as indicated in Figure 7.28. In massive materials, the blasthole should be placed at the excavation limit. In highly bedded weaker materials, on the other hand, it is often recommended that the blastholes be placed about a foot within the excavation limit since considerable overbreak usually results. Placing the blastholes within a foot of the excavation limit, in massive materials, will produce poor results. To determine if a utility trench pattern is within reasonable limits, the following guideline are used.

1. The burden distance should be as approximated by equation 6.2 and that burden is placed at the location indicated in Figure 7.28. Note that this is not the true burden or the perpendicular distance from the hole to the face at the time the hole detonates is less.

2. The width of the trench must be between  $0.75B$  and  $1.25B$ . If trench widths must be less than  $.75B$ , then smaller holes and smaller powder charges should be used with burdens which are appropriate for these smaller charges. On the other hand, if trench widths must be greater than  $1.25B$ , either a larger borehole would be needed with its appropriate burden, or a three-row trench as indicated in Figure 7.29 could be used.

3. The L/B ratio must be greater than 1.

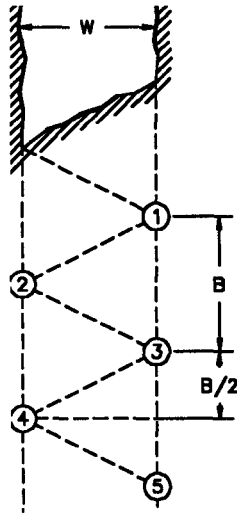


Figure 7.28 Two Row Trench Design

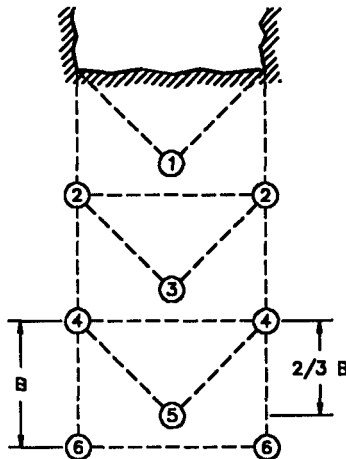


Figure 7.29 Three Row Trench Design

## 7.9 SECONDARY BLASTING

Secondary blasting is used when boulders too large to handle are provided from the primary blast. There are three common secondary blasting techniques used; mud capping, blockholing and air cushion blasting.

### 7.9.1 MUD CAPPING (BOULDER BUSTING)

Mud capping or plaster shooting was previously discussed under the section on shock energy in Chapter 2. Mud capping utilizes an external charge placed on top of the boulder with a cap of mud placed on top of the charge. When mud capping is used, charges of between 0.5 to 1 pound of explosive per cubic yard of boulder are normally sufficient.

### 7.9.2 BLOCKHOLING (BOULDER BUSTING)

Blockholing simple means placing a hole or holes into the boulder and lightly loading these holes with explosives. The load is approximately 2 ounces per cubic yard for the test shot, and thereafter, either increased or decreased depending on the type of rock being blasted. If the boulder is not spherical in shape and instead is rectangular, many small holes may have to be drilled and the powder load distributed between those smaller holes. Blockholing techniques utilize much less explosive than mud capping; however, the degree of fragmentation and the direction which the fragments fly is not controllable by the blaster, since the charges are functioning as cratering charges and breaking randomly in the direction of least resistance.

### 7.9.3 AIR CUSHION BLASTING

A technique similar to blockholing called air cushion blasting provides some control over the number of fragments and the direction in which the fragments fly. Air cushion blasting works as indicated in Figure 7.30. A blasthole is drilled between  $2/3$  and  $3/4$  of the distance through the boulder. A charge which equals approximately 2 ounces per cubic yard is used for the test shot. Blastholes are stemmed to a minimum of  $1/3$  the depth of the hole. Common stemming materials are clay rather than crushed stone. The reason clay is used rather than crushed stone is that crushed stone must have distance to move up the hole and lock into place to function properly. In general, in air cushion blasting the length of the stemming zone is not sufficient to allow material to lock into place, therefore, clay is used, which will not lock into the hole but will provide a time lag between the time the hole is pressurized and the clay is ejected. The minimum depth of stemming with this type of blasting should be approximately 12 inches. If stemming depths are less, holes may rifle with little breakage resulting.

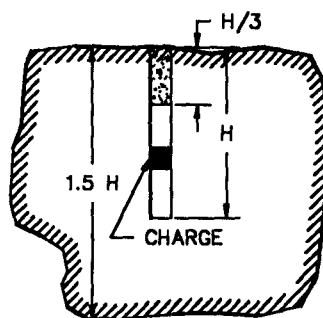


Figure 7.30 Air Cushion Blasting

If the minimum amount of stemming is used, the maximum air cushion occurs. The rock will break into the minimum number of pieces. Often, in massive materials an operator can predict with fair accuracy whether the rock will break into two or three pieces, or three or four pieces. When air cushion techniques are used, the minimum amount of flyrock will occur with the rock normally popping open and laying in its original location with little, if any, throw. If more fragments are desired, the air cushion can be reduced by increasing the amount of stemming in the hole. The more stemming placed into the blasthole, the more fragments will result and more violence will occur.

## **7.10 CHAPTER 7 SUMMARY**

The interrelationship between initiation timing burden, stiffness, and physical dimensions must be considered in the design of any blast. Some basic equations help one understand the relationships and allow pattern designs with a step-by-step method. Specific applications include production patterns for sinking cuts, hillside cuts, utility trenches, rip-rap production and secondary blasting applications.



## PROBLEMS CHAPTER 7

- 1) A blasting contractor will bulk load ANFO into 4 inch diameter holes in granite for blasts on a highway cut. The hillside cuts will have bench heights which vary from 16 to 32 feet.
  - (a) Determine the spacing with instantaneous initiation along a row and a bench height of 16 feet.
  - (b) Determine the spacing with instantaneous initiation along a row and a bench height of 32 feet.
  - (c) Determine the spacing for section 1a if delays are used along the row.
  - (d) Determine the spacing for section 1b if delays are used along the row.
  
- 2) You have been asked to design a sinking cut in limestone rock. A 2.5 inch blasthole will be used. Since the blastholes are wet, a semigelatin dynamite will be used ( $SG_e = 1.3$ ). The depth of cut will be 18 feet. Sixty-four blastholes will be used in the pattern. Design the shot, determine stemming distance, burden, spacing, subdrilling and timing sequence.
  
- 3) The 30 inch sewer lines must have 4 feet of cover. The rock is wet, hard, massive sandstone. Houses are within several hundred feet. We will drill 2 1/2" holes. Determine drill pattern and explosive load.
  
- 4) A thinly laminated dolomite will be blasted on a construction job. The cut will be 20 feet deep. There are no vibration problems since the nearest house is 7000 feet away. The contractor has a 3 inch track drill. ANFO will be used since holes are dry.
  - (a) Design the drill pattern and explosive load.
  - (b) The contractor is considering change from the 3 inch track drill to a 6.75 inch rotary. What would be the design for the 6.75 inch drill?
  - (c) Assume the 3 inch drill holes cost \$1.00 per foot and the 6.75 inch cost \$2.00 per foot. Which drill would be the most economical choice?

## CHAPTER 8 OBJECTIVES

To understand the principles of controlled blasting and the differences between various controlled blasting techniques. To examine geologic factors which effect the results of controlled blasting.

## CHAPTER 8 SUMMARY

The basic principles of controlled blasting techniques are different than those which were commonly accepted a decade ago. Stress waves are not responsible for the fracture and therefore, blast design consideration must reflect these differences to produce good perimeters with little disturbance.

Presplitting, cushion blasting and line drilling are discussed with formulas for the determination of the appropriate design dimensions.

The effects of local geology has considerable effects on the results of controlled blasting.

## CHAPTER 8

### OVERBREAK CONTROL

#### 8.1 CONTROLLED BLASTING

Blasting techniques have been developed to control overbreak at excavation limits. The operator must decide the ultimate purpose of the control technique, before selection of the technique can be made. Some techniques are used to produce a cosmetically appealing wall with little or no concern for stability within the rock mass. Other techniques are used to provide stability by forming a fracture plane before any production blasting is conducted. This second technique may or may not be as cosmetically appealing, but from a stability standpoint, performs its function. Overbreak control methods can be broken down into three types: presplitting, trim (cushion) blasting and line drilling.

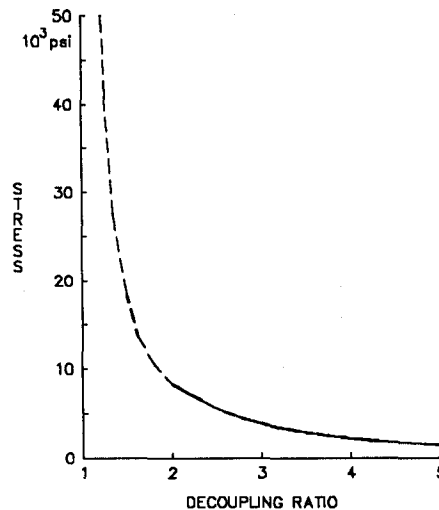
Presplitting utilizes lightly loaded, closely spaced drill holes, fired before the production blast. The purpose of presplitting is to form a fracture plane across which the radial cracks from the production blast cannot travel. The fracture plane formed may be cosmetically appealing and allow the use of steeper slopes with less maintenance. Presplitting should be thought of as a protective measure to keep the final wall from being damaged by the production blasting.

Trim blasting is a control technique which is used to clean up a final wall after production blasting has taken place. The production blasting may have taken place many years earlier or could have taken place on an earlier delay within the same blast. Since the trim row of holes along a perimeter is the last to fire in a production blast, it does nothing to protect the stability of the final wall. Radial fractures from production blasting can go back into the final wall. Mud seams or other discontinuities can channel gasses from the production blast areas into the final wall. The sole purpose of a trim blast is to create a cosmetically appealing, stable perimeter. It offers no protection to the wall from the production blast.

Line drilling is an expensive technique, that under the proper geologic conditions, can be used to produce a cosmetically appealing final wall. It may, under proper circumstances, help protect the final contour from radial fractures by acting as stress concentrators causing the fracture to form between line drill holes during the production blasting cycle. If, on the other hand, the wall contour was extremely important, one could not depend on line drilling to necessarily protect the final wall. Line drilling is more commonly used in conjunction with either presplitting or trim blasting rather than being used alone. Although the use of control blasting is more common for surface excavations, it has been successfully used underground, residual stress conditions permitting.

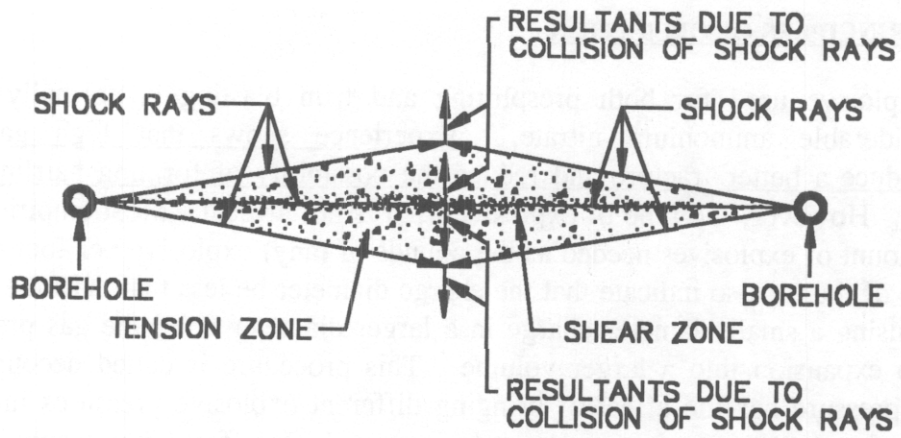
### 8.1.1 PRINCIPLES OF OPERATION

The explosive used for both presplitting and trim blasting is normally one which contains considerable ammonium nitrate. Experience shows that high gas-producing explosives produce a better fracture and reduce the possibility of forming hairline cracks on borehole walls. However, the type of explosive used is not critical. Most empirical formulas express the amount of explosives needed as the pounds of (any) explosive per foot of borehole. Common rules of thumb also indicate that the charge diameter be less than half the diameter of the hole. By using a small diameter charge in a larger diameter hole, the gas pressures drop quickly due to expansion into a larger volume. This procedure is called decoupling. This rapid drop in pressure has the effect of bringing different explosive pressures into a narrow range of values for most types of common explosives used. In effect what occurs is that under the proper decoupling, different explosives produce stresses in the rock which are approximately within 10% of one another in a presplitting or trim blasting application. An example of the stresses produced 12 inches from the blasthole is given in Figure 8.1. The decoupling ratio is defined as the diameter of borehole divided by the diameter of charge.

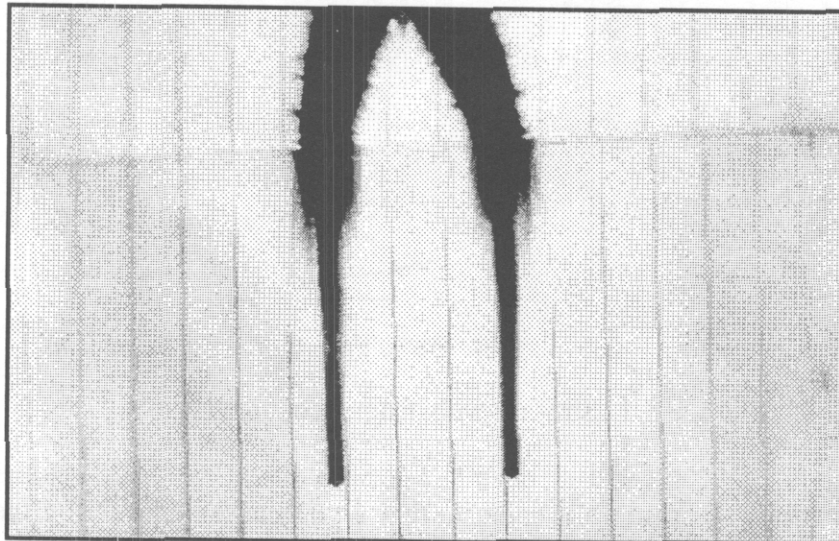


**Figure 8.1** Stress Levels from Decoupled Shots

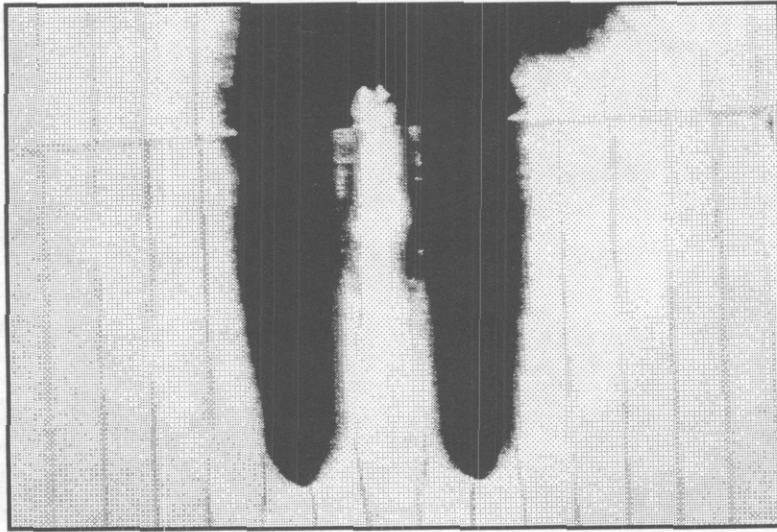
Past explanations of presplitting indicate that it was caused entirely by the reflection of stress waves as shown in Figure 8.2. Later research proved that the magnitude of the resultant stress wave is insufficient to cause the splitting action to occur in real blasting situations. If one had to rely only on the stress waves to cause presplitting, spacings would have to be reduced to 1/5 of those which are commonly used in the field. According to Figure 8.2, if blastholes within a presplit row were not fired truly instantaneously, the splitting action could not possibly result since stress wave collision would not occur between holes. This is contrary to fact, since blasters commonly delay each hole in a presplit shot and still produce good wall conditions. Figure 8.3 shows a presplit forming from radial crack growth, not stress wave collision.



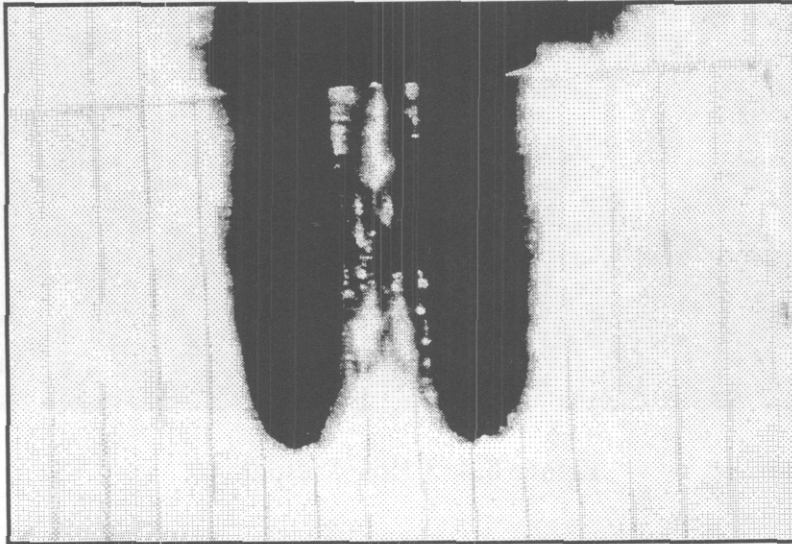
**Figure 8.2** Old Concepts of Stress Wave Breakage (after DuPont)



**Figure 8.3A** Presplit Fracture Formation in Plexiglass Models

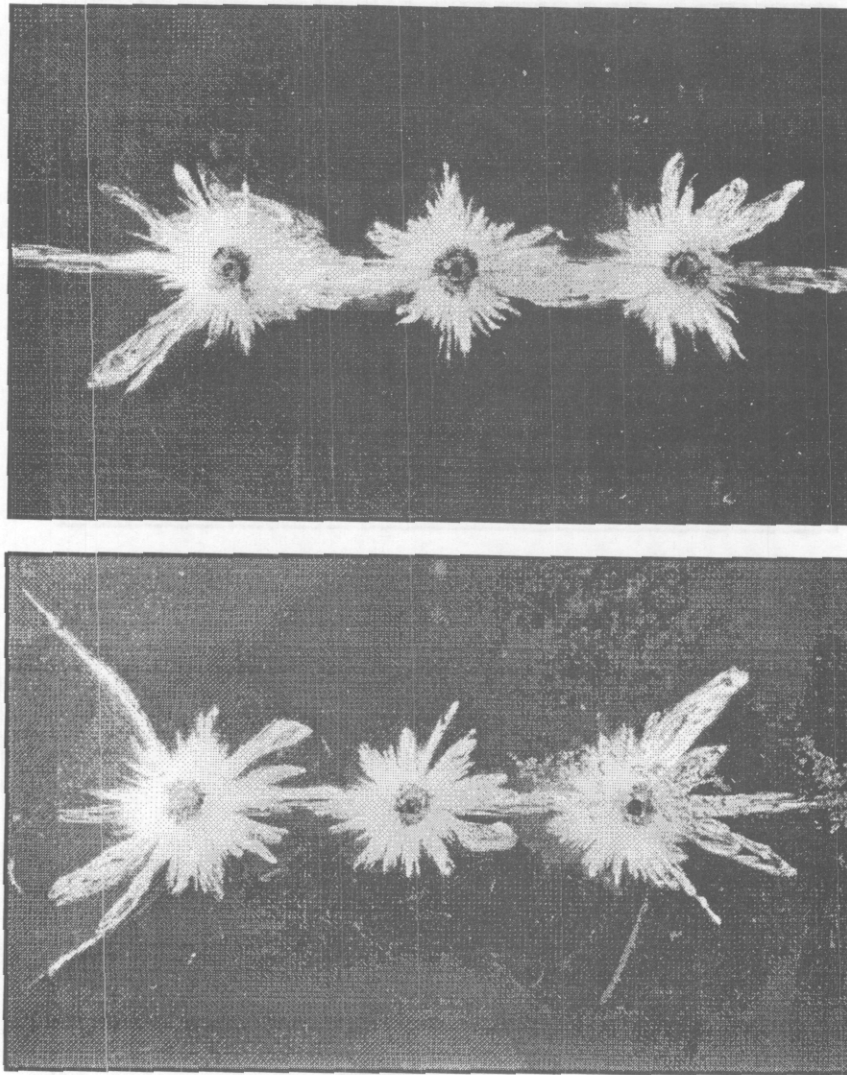


**Figure 8.3B** Presplit Fracture Formation in Plexiglass Models



**Figure 8.3C** Presplit Fracture Formation in Plexiglass Models

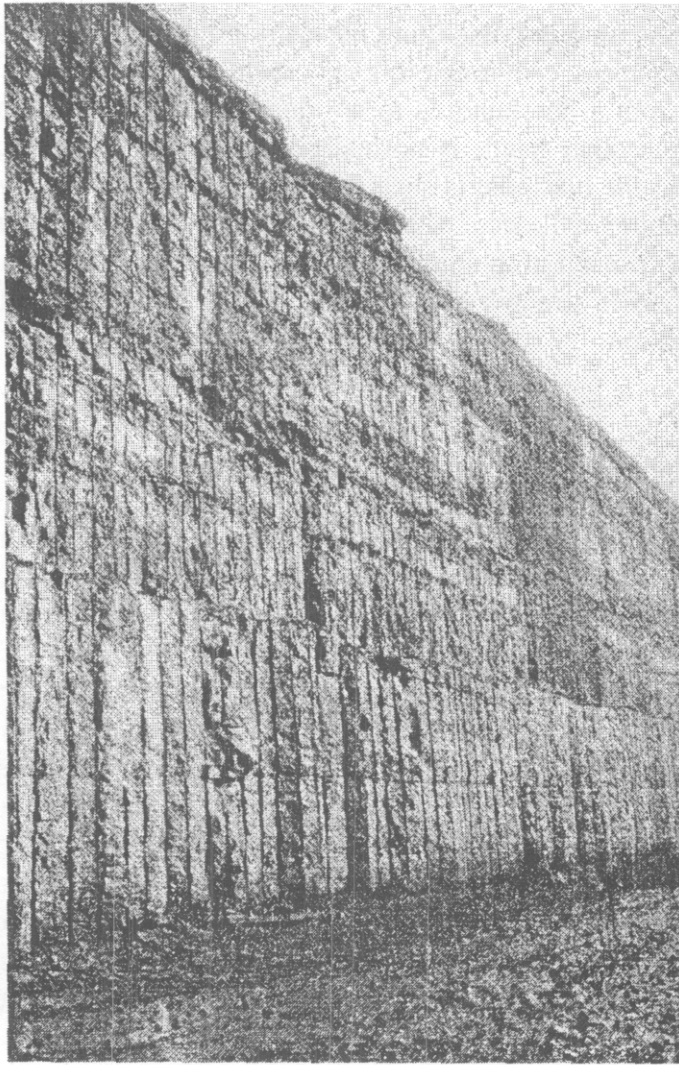
Figure 8.4A is a photograph of a Plexiglass model in which three blastholes were fired instantaneously. Figure 8.4B is a photograph of a model where blastholes were fired on what would be equivalent to a 25 millisecond delay in full scale work. One can notice that there is no significant difference in breakage between holes, further showing that stress wave interactions are not responsible for blasting in full scale.



**Figure 8.4** 3-Hole Presplit

This point is significant because if one would believe in the stress wave breakage concept as being the prime mechanism for presplit formation, then all presplit holes would need to be fired instantaneously. Since the presplit blastholes are normally the closest to residences and also the most heavily confined holes in the entire blast, higher vibration levels would be produced per pound used. Levels could be as much as five times higher than those in production blasting. In most cases, many holes fired instantaneously would cause excessively high ground vibrations. The realization that holes can be delayed is important because it allows the contractor flexibility to fire each hole on a separate delay if necessary.

Presplitting is nothing new. It became a recognized technique for wall control when it was used in the mid-1950's on the Niagara Power Project (Figure 8.5). Its use was reported as early as the 1940's on a sporadic basis.



**Figure 8.5** Presplit at Niagara Power Project

Presplitting was used as a rock fracturing technique before explosives were used for blasting. The pyramids of ancient Egypt were built by craftsmen that used presplitting. The technique was employed by pounding wooden wedges into natural cracks or holes drilled into the rock. The wooden wedges were soaked with water and the wood expansion caused fractures to occur between wedges. The blocks could then be removed.

In northern climates, man found that he could use ice to cause rock to fracture by drilling holes in a rock mass, filling them with water and letting the water freeze during the winter. Rock would then crack between holes freeing the blocks. Both the wooden wedges and the freezing water exerted static pressure on the rock mass similar to what occurs from the explosive gas pressure.



Empirical formulas used in presplitting normally do not take into consideration strength characteristics of the rock mass. Although this may seem unusual, it must be remembered that tensile strength ranges from a few hundred to no more than a few thousand psi in most rock. Crushing strength, on the other hand, is normally rated in tens of thousands of psi. If the explosive pressure within the blasthole is such that it is below the crushing strength and above the tensile strength, fractures will occur without damaging the rock mass around the borehole. In most presplitting and trim blasting applications, pressures approximate 8,000 to 15,000 psi and vastly exceed the tensile strength of any rock. Therefore, these strength characteristics would not be a consideration.

### **8.1.2 EFFECTS OF LOCAL GEOLOGIC CONDITIONS**

Control techniques such as presplitting, trim blasting and line drilling work best in massive rock. In massive rock, one can see the half casts or half of each borehole on the final wall. In massive rock, 100% of the holes produce half cast. Some operators try to assess the success or failure of presplit or cushion blasts by what is called a half cast factor. Half cast factors are the percentage of the total half casts which are visible after the rock has been excavated. If only 40% of the drill holes remain visible on the final wall as half casts, then the half cast factor would be 40%. This technique could have some merit when blasting in solid homogeneous massive material. However, half casts may totally disappear in geologically complicated rock. One cannot assume that the lack of half casts indicate a poor blasting job. In geologically complicated material a simple crack does not form. There is a broken shatter zone formed along the perimeter, and that zone serves as protection for the final wall from the effects of radial cracks emanating from the production blast. Half cast factors only have validity if the rock type in which the half casts are being counted are considered in the evaluation.

When rock has numerous joints between blastholes and those joints intersect the face at less than a 15° angle, it will be impossible to form a good smooth face with control blasting techniques. In fact, for the wall to be halfway cosmetically pleasing, the joints must intersect the face at greater than a 30° angle. Anything less will cause fractures to intersect the jointing planes having large pieces of material fall out from the face during the excavation process.

In a weak material, the skill of the excavator operator is extremely critical. Some machines can exert considerable thrust, whereby they can dig into an unblasted wall severely damaging the final contour. Other geologic factors which effect the outcome of control blasting techniques are soft seams or mud seams. If the bench is intersected by numerous mud seams it is difficult to produce good results.

### 8.1.3 PRESPLITTING

In order to evaluate presplit blasting plan, one could use the equations shown below.

To determine the approximate powder load per foot which will not damage the wall but will produce sufficient pressure to cause the splitting action to occur, the powder load can be approximated by:

$$d_{ec} = \frac{D_h^2}{28} \quad (8.1)$$

where:

$$\begin{aligned} d_{ec} &= \text{Explosive load (lbs/ft)} \\ D_h &= \text{Diameter of empty holes (in)} \end{aligned}$$

If this approximate powder load is used, the spacing between holes in a presplit blast can be determined by:

$$S = 10 D_h \quad (8.2)$$

where:

$$\begin{aligned} S &= \text{Spacing (in)} \\ D_h &= \text{Diameter of the empty hole (in)} \end{aligned}$$

The constant 10 in the above formula is somewhat conservative. It is meant to make sure that the presplit distance is not excessive and that the presplit will occur. Field experience indicates that often this value can be increased to 12 and sometimes 14.

In most presplitting applications there is no drilling below grade. However, a concentrated charge, which is equivalent to approximately 2 or 3 times  $d_{ec}$ , is placed in the bottom of the blasthole. The blasthole should be fired either instantaneously or on a short delay between each hole. Although some contractors have reported satisfactory results, it is not recommended to delay greater than 50 milliseconds between holes.

A presplit shot is meant to cause a fracture to occur and travel to the surface of the ground. If this occurs, no amount of stemming placed in the hole will hold and it will be ejected. Therefore, drill cuttings can be used safely as stemming since its function is to momentarily confine the gasses and to cut down on some of the noise. Normally, holes are stemmed in the top two to five feet depending on their diameter. The larger the hole diameter, in general, the more stemming is used.

The question as to whether to stem between charges in the hole is one where there are differing opinions. The author recommends the following, if the rock mass to be blasted is seamy in nature and has many partings of low cohesion and mud seams, it might be wise to stem between charges. On the other hand, if the rock mass is competent, although it may be bedded, stemming between charges is not necessary, especially in materials that have a very low crushing strength such as weak shales. Leaving an air gap around charges is beneficial. By not stemming around charges, a greater empty volume is available for the explosive gas expansion, thereby dropping the gas pressure more quickly. The pressure per square inch is lower yet, more square inches of the hole are being stressed and therefore good fracture results. In weak rock, if stemming is used between charges, the walls can be pock-marked at the charge locations.

Explosives for presplitting come in many types. There are polyethylene coils which are snaked down the hole in diameters less than an inch. These polyethylene tubes contain slurry explosives. Other types of charges are slender dynamite cartridges which couple together as they are put down the hole to form a continuous charge. Other methods of placing charges consist of taping either full or fractions of dynamite cartridges to detonating cord and lowering that assembly into the blasthole. The choice of which charges to use depends on the operator and what is available in his area. What is important is that the charges be less than half the diameter of the blasthole and preferably not touching the blasthole walls. An example of the use of these formulas for determining the adequacy of design for a presplit shot is given in example 8.1.

---

### Example 8.1

A presplit blasting plan is submitted for approval. The plan shows 3 inch blastholes spaced at 48 inches. The explosive load is 0.2 lbs/ft. The bottom load is one pound of dynamite. Holes will be fired with detonating cord. Is the plan reasonable?

Check powder load:

$$d_{ec} = \frac{D_h^2}{28} = \frac{3^2}{28} = 0.32 \text{ lbs/ft}$$

Check spacing:

$$S = 10 \times D_h = 10 \times 3 = 30 \text{ in}$$

$$\text{Bottom load: } d_{eb} = 3 \times d_{ec} \quad (8.3)$$

$$d_{eb} = 3 \times d_{ec} = 3 \times 0.32 = 0.96 \text{ lbs}$$

The proposed plan has too large a spacing and too light a column load. The bottom load is acceptable.

---

Some operators prefer to load the production holes nearest the presplit line lighter than they would load the remainder of the production holes. The first row of buffer holes, as they are commonly called, are often closer spaced with smaller burdens and lighter loads so that less pressure will be placed on the final wall.

#### **8.1.4 TRIM (CUSHION) BLASTING**

Trim blasts are fired after the production round has been fired. They are designed in a similar manner to presplit blasts. The powder load per foot of hole is determined by equation 8.1 as used in presplitting. The spacing is normally larger than one would expect in a presplit. The following equation could be used to determine the approximate spacing for a trim blast.

$$S = 16xD_h \quad (8.4)$$

where:

S = Spacing (in)

D<sub>h</sub> = Diameter of the empty hole (in)

With trim blasting, confinement conditions are different than when presplitting. During presplitting, the production round has not yet fired, and for all practical purposes, the burden is infinite. In trim blasting, burdens exist since the production round has been fired. The burden must be considered in the design of a trim blast. To be sure that the fractures link properly between holes rather than prematurely going toward the burden, one would design the blast so that the burden is greater than the spacing. The following equation is commonly used:

$$B > = 1.3xS \quad (8.5)$$

where:

B = Burden (in)

S = Spacing (in)

Stemming considerations both at the collar of the blasthole and also around the charges for trim blasting would be the same as those for presplitting. In the trim blast application, subdrilling is not normally necessary. However, concentrated bottom loads to cause the cracks to go to the grade line are normally used. These bottom loads can be determined in the same fashion as was described under presplitting. Example 8.2 shows how a trim blast design can be evaluated.

---

### Example 8.2

A contractor proposed the following plan for a trim blast.

Blasthole size	=	2.5	in
Blasthole spacing	=	25	in
Powder load	=	0.25	lbs/ft
Bottom load	=	0.75	lbs
Minimum burden	=	30	in

Check powder load (Eq. 8.1):

$$d_{ec} = \frac{D_h^2}{28} = \frac{2.5^2}{28} = 0.22 \text{ lb/ft}$$

Check spacing (Eq. 8.4):

$$S = 16 \times D_h = 16 \times 2.5 = 40 \text{ in}$$

Check bottom load:

$$d_{eb} = 3 \times d_{ec} = 3 \times 0.22 = 0.66 \text{ lbs}$$

Check minimum burden (Eq. 8.5)

$$B = 1.3 \times S = 1.3 \times 40 = 52 \text{ in}$$

---

### **8.1.5 TRIM BLASTING WITH DETONATING CORD**

In some applications where trim holes must be drilled at very close spacings, normal charges are too large and cause overbreak around the holes. The use of closely spaced holes, on 12 to 24 inch centers, may be necessary in some geologic formations and for concrete removal in some structures. In some cases, it is necessary to drill larger holes than normally would be used, however, the spacings are small. Additional airspace around the charges is not normally detrimental to the formation of the split. If one uses the equations based on the hole diameter to calculate the loads, the charges would be too large for the spacings. On these close spacings, use formula 8.6 to determine the amount of explosive which would be necessary for a fixed close spacing. It is often convenient to use detonating cord to provide this small distributed load.

$$d_{ec} = 7000 \left[ \frac{S}{85} \right]^2 \quad (8.6)$$

where:

$d_{ec}$  = Loading density (grain/ft)

$S$  = Spacing (in)

---

#### **Example 8.3**

Two inch diameter blastholes will be drilled on 18 inch centers and 20 feet deep. Determine the grain load of detonating cord needed to shear the rock web on the trim blast.

$$d_{ec} = 7000 \left[ \frac{S}{85} \right]^2 = 7000 \left[ \frac{18}{85} \right]^2 = 314 \text{ grain/ft}$$

---

### **8.1.6 LINE DRILLING**

Line drilling is a technique where blastholes are normally drilled within two to four diameters of one another. These unloaded, closely spaced drill holes under proper geologic conditions can act as stress concentrators or guides to cause cracks to form between them. Unloaded line drill holes are sometimes used in tight corners to guide cracks into a specific angle. Line drilling is also employed between presplit or trim blastholes to help guide the cracks. In geologically complicated material line drilling may not function as desired since fractures tend to concentrate at naturally occurring weakness planes rather than at the man-made weakness plane created by the line drilled holes. It is the author's opinion that although there has been research in the exclusive use of line drilling for perimeter control purposes, applications of line drilling in conjunction with either presplitting or trim blasting techniques is the proven, safe method.

### 8.1.7 ASSESSMENT OF RESULTS

The above formulas are guidelines which are used both in this country and overseas to approximate the powder loads and spacing for controlled blasting techniques. After test shots are conducted, the operator can evaluate the results and determine whether changes are needed in the blasting plan.

If the rock is massive with few geologic discontinuities, too great or too little spacing can be assessed by looking at the fracture plane formed. Figure 8.6 indicates the results which would be obtained if blastholes are spaced too closely for the powder load used. Numerous fractures link in the plane between holes and when the blast is excavated the material between holes will fall out leaving half casts protruding from the final wall. If spacings are too far, a face that is generally rough in appearance will result (Figure 8.7). If the powder load is too great and holes are overloaded, crushing of the borehole wall will result.

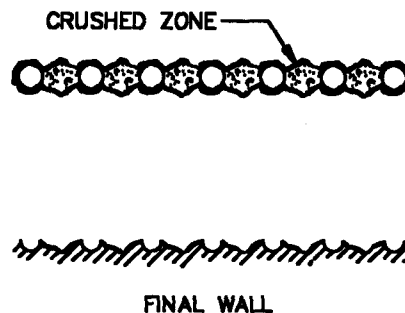


Figure 8.6 Close Presplit Spacing

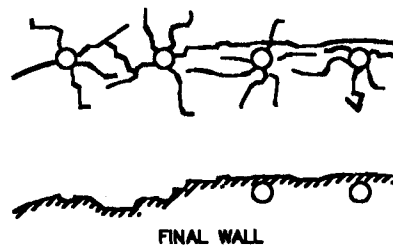


Figure 8.7 Extended Presplit Spacing

If rock is not massive but contains numerous near vertical joints intersecting the face, the results will be different. If the joints intersect a line between holes at a 90° angle, the break line should be relatively straight between the face (Figure 8.8). If the joints intersect the face at an acute angle, breakage as indicated in Figures 8.9 and 8.10 will occur. This type of breakage, which leaves the half cast protruding from the final face, would seem to indicate that boreholes are spaced too close. In fact, boreholes may be spaced properly, but the acute angles of rock joints cause the rough face, not overloaded holes (Figure 8.11).

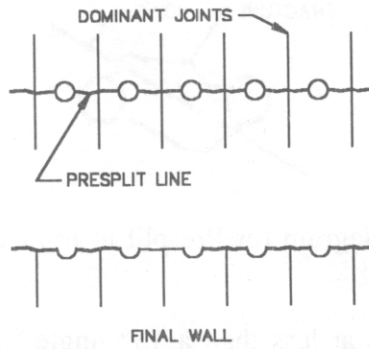


Figure 8.8 Presplit with Joints at 90°

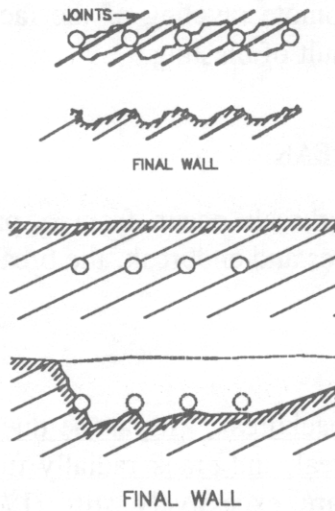


Figure 8.9 Presplit with Joints at Acute Angle

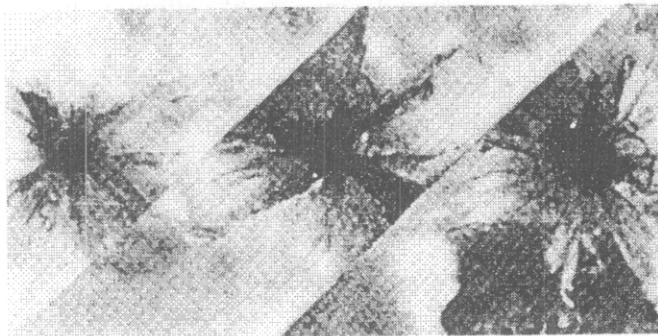
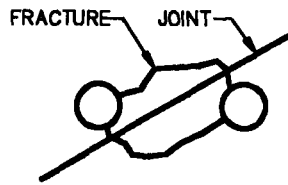


Figure 8.10 Presplit in Plexiglass with Joints at Angle with Face (after Worsey)





**Figure 8.11** Breakage Diagram for Presplit in Jointed Rock (after Worsey)

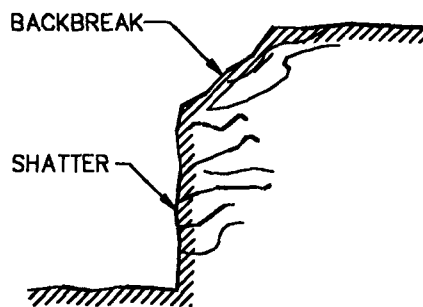
If joints approach the face at less than a  $15^\circ$  angle, the face produced by the control technique may show no half casts whatsoever and may appear to be rough and torn. Little can be done in this situation. Although not cosmetically pleasing, the face should be stable. This type of geologic structure may promote raveling of the face, yet the mass movement due to instability should not occur as a result of blasting.

#### **8.1.7.1 CAUSES OF OVERBREAK**

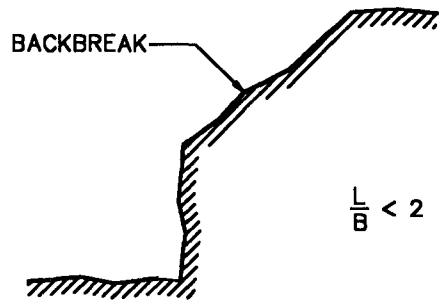
Two general types of overbreak occur from a production blast. Backbreak, the breakage behind the last row of holes and endbreak, the breakage off the end of the shot.

#### **8.1.7.2 BACKBREAK**

There are many causes of backbreak. It can be due to excessive burden on the holes thereby causing the explosive to break and crack radially further behind the last row of holes (Figure 8.12). Benches which are excessively stiff ( $L/B < 2$ ) cause more uplift and backbreak near the collar of the hole (Figure 8.13). Long stemming depths on stiff benches also promotes backbreak. Improper delay timing from row-to-row can cause backbreak if the timing is too short, thereby resulting in excessive confinement on the last rows in the shot. The timing problem will not be discussed since it has already been referred to in another chapter. If blastholes are short, with low  $L/B$  ratios due to excessive burden, the obvious solution to the problem would be to change to smaller holes thereby reducing the burden and increasing the stiffness ratio. This procedure cannot be followed in all operations. Therefore, other techniques must be used to cleanly shear holes at their collars.

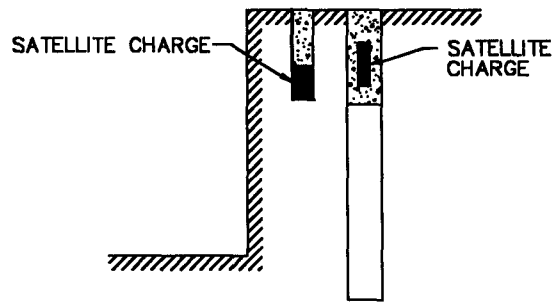


**Figure 8.12** Backbreak Due to Excessive Burden



**Figure 8.13** Backbreak Due to Excessive Stiffness

Satellite holes can be used between the production holes whereby the cap rock in the area of the stemming zone can be lightly loaded and fired on a later delay. Operators often drill satellite holes (Figure 8.14). This helps reduce problems with cap rock and reduce overbreak. If satellite charges are used within the stemming zone as indicated in Figure 8.14, those charges should be fired on a shot delay after the main charge shoots. One would not want to prematurely unconfine the main charge in the blasthole by having the satellite charge fire first and blow out the stemming.



**Figure 8.14** Satellite Charges in Collar

Another technique similar to using satellite charges is to continue the main charge into the stemming zone. However, the main charge is significantly reduced in diameter. This small diameter charge in a much larger hole produces sufficient pressure to cause some cracking similar to presplitting in the collar area (Figure 8.15).

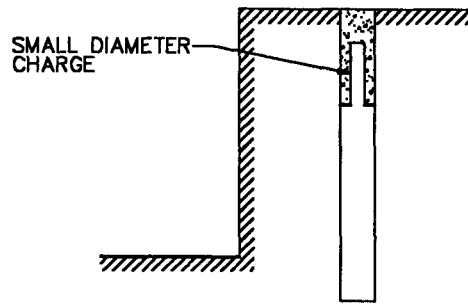


Figure 8.15 Charge Extended into Stemming

### 8.1.7.3 ENDBREAK

Endbreak off the end of a shot usually results from one of two reasons (Figure 8.16). The local geologic structure can promote extension of cracks off the end of the shot. This can be corrected by shortening the spacing distance on the end to the nearest production holes thereby causing the hole to function and respond in a different fashion.

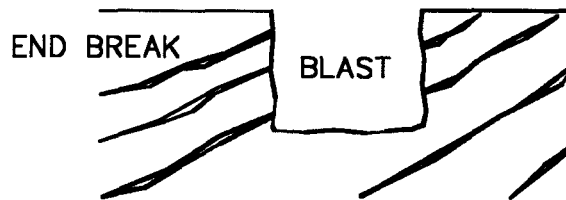


Figure 8.16 Endbreak (Plan View)

Endbreak can also be caused by having improper timing on the perimeter holes. If the timing is too fast, blastholes will tend to sense a much larger than normal burden thereby either rifling and causing uplift, or by cracking back into the formation. The problem of timing can be corrected in the same manner as that described for backbreak. Longer delay times, such as those which were previously discussed in Chapter 6, can be used on the end holes, allowing time for the center portion of the blast to move out. This produces additional relief before the end holes fire.

### 8.1.7.4 FLYROCK CONTROL

In general, flyrock results from one of two places in the shot. It either comes from the face or it comes from the top. If flyrock is originating from the face and flying considerable distances, it could be an indication that too little burden is used or that mud seams or other geologic discontinuities are prevalent. Most flyrock, however, is not produced from the face. It is produced from the top of the shot. It results from geysering or vertical cratering of holes. Geysering of blastholes normally results from overconfinement of holes at the time they fire, due to poor initiation timing. Although vertical cratering can result for similar reasons, it can

also occur due to careless loading where explosive columns are either brought up too high in the hole or powder cartridge during loading becomes lodged in the stemming zone and insufficient stemming is used. Care in loading would solve both problems before they occur. The timing problem is similar to what has been discussed for backbreak and endbreak. Increasing the time between rows of holes within the blast should solve the problem.

There are times when to produce proper breakage, one must deliberately load higher and heavier in the hole than would normally be required. These situations result when very low L/B ratios occur in massive rock. In these cases, when blastholes are deliberately slightly overloaded to promote top breakage, one can use 3 - 4 feet of deep soil over the shot to act as a blasting mat to restrain potential flyrock. Blasting mats made of woven wire or wire and rubber tires can also be placed on top of the shot both with and without earth mats to contain the flyrock (Figure 8.17).



**Figure 8.17** Blasting Mats

## **8.2 CHAPTER 8 SUMMARY**

The basic principles of controlled blasting techniques are different than those which were commonly accepted a decade ago. Stress waves are not responsible for the fracture and therefore blast design considerations must reflect these differences to produce good perimeters with little disturbance.

Presplitting, cushion blasting and line drilling are discussed with formulas for the determination of the appropriate design dimensions.

The effects of local geology has considerable effects on the results of controlled blasting.

## PROBLEMS - CHAPTER 8

1). The perimeter along a highway must be presplit for stability. The depth of the cut will be 40 feet. A track drill with 3.5 inch bit will be used to drill the blastholes.

- (a) Determine the loading density of the explosive.
- (b) Determine the total explosive load per hole.
- (c) Determine the spacing.

2). You are responsible to trim blast a 30 foot granite face. The specific gravity of the granite is 2.65. The drilling holes will be 2.75 inches in diameter.

- (a) Determine the loading density.
- (b) Determine the spacing of blastholes.
- (c) Determine the necessary burden.

## CHAPTER 9 OBJECTIVES

To investigate the influence of site conditions on the results of blasting. To investigate the influence of field procedure on the execution of blasting plans. To examine common field blasting problems and techniques to overcome some of these problems.

## CHAPTER 9 SUMMARY

Site conditions for consideration include the effects for wet blastholes and local geology on the blast design. Geologic structure often causes the blaster to change patterns to achieve the desired end result.

Drilling capabilities include drilling deviation and accuracy. Blasting cannot be successful with poor drilling.

Blasting safety is an important part of field procedure. Safety procedures in use, transportation, and storage must be followed to avoid problems.

Post shot responsibilities of the blaster were delineated for protection of the workers and the public.

## CHAPTER 9

### SITE CONDITIONS AND FIELD PROCEDURE

#### 9.1 SITE CONDITIONS

Local site conditions have a significant influence on the performance of any blast. Blasting plans can be made in advance, however, as more history is developed on the site conditions during the drilling process, blasting plans are often radically changed. The two most common problems associated with site conditions are wet blastholes and local geology.

##### 9.1.1 WET BLASTHOLES

Water conditions in blastholes can range from totally dry holes to those which not only have water clear to the collar, but actually have water under pressure which causes an artesian flow from the collar of the hole. Water conditions will influence the type of explosive used and the cost of the project. In general, one could say that the worse the water conditions, the higher the cost of the project. Hence, more water resistant explosives will be needed. Many different kinds of problems can be encountered due to water conditions. The most serious problem results when powder becomes wet and will not function properly. A few examples of water problems which result in low explosive energy yield are given below.

1. The blaster did not take into account when loading the hole that the water level would rise because the explosive displaced water in the hole. Therefore, he used cartridge powder in the lower portion of holes but did not totally load out of the rising water. When bulk powders were subsequently used, water invaded the powder causing it to react at less than optimum energy yield.

2. This situation ended in similar results, but occurred because the time factor was not considered during the loading process. Water may slowly seep into a hole. At the time of loading, cartridge powder may occupy the portion of the hole under water and dry bulk ANFO may be placed in the portion of the hole which is dry. A blast may take many hours to load, water can continually rise into the bulk powder.

3. A similar end result can occur because of geologic conditions within the rock mass itself. In many patterns, some holes are wet to the collar and others are totally dry. What often happens is that the blaster does not realize that by placing cartridge explosives in holes that contain some water, the water level will rise. If there is communication between that hole at a higher lever and an adjacent dry hole, water from the wet hole can be forced up and through the fracture system into what was previously loaded as a totally dry hole, thereby causing problems.

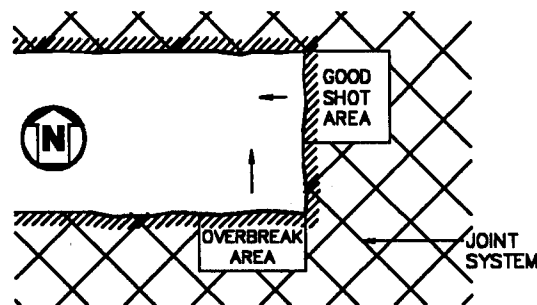
Water flowing through blastholes can cause serious problems. Some operators consider bulk loaded water gel and emulsion explosives to be waterproof. They are only waterproof and water resistant in stagnant water. Flowing water will cut through any bulk emulsion of water gel rendering that portion of the column useless and unable to transfer detonation from one section of the column to another. If flowing water is encountered, cartridge explosives must be used or blastholes sleeved to ensure that the explosive column will not be cut by flowing water dissolving the explosive.

### 9.1.2 GEOLOGIC CONDITIONS

Local geologic conditions have a significant impact on the success of a blasting operation. Local geologic conditions are often very difficult to assess. No one has x-ray vision to look into the rock mass and assess geologic conditions. Even if this were possible, their affect on the blast performance cannot always be predicted accurately. There are times when geologic structure has a serious influence on breakage and other times when the same structure seems to have little if any influence. The single most important geologic consideration is geologic structure. The jointing systems, dip and strike of bedding planes, and mud or soft seams can have a serious influence on the blasting process both from a performance and safety standpoint.

### 9.1.3 REGIONAL JOINTING PATTERNS

The regional jointing pattern can influence both the breakage and overbreak in a blast. Figure 9.1 shows the directions of best and worst blasting along with the overbreak areas for a typical rock mass.



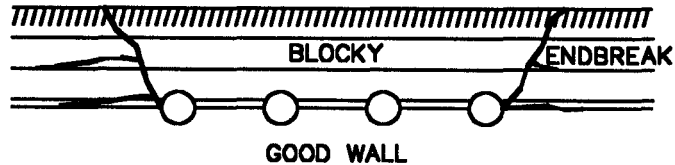
**Figure 9.1** Regional Jointing Pattern

Regardless of the number of joint sets in a rock mass, one set of joints will be weakest or dominant. The dominant joint direction will in general cause the following to occur.



### 9.1.3.1 DOMINANT JOINTS PARALLEL THE FACE

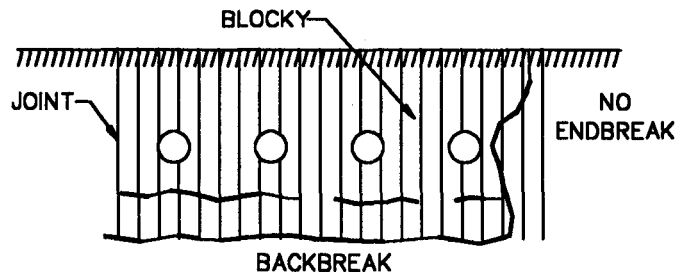
If the dominant joints parallel the face (Figure 9.2) fractures between, boreholes will prematurely link. The premature linking will cause coarse or blocky burden fragmentation. Endbreak will be severe. Borehole spacing can be increased and fragmentation size will then decrease. If the intent of the blast is to produce rip rap, a reduction of explosive load with close borehole spacing will accomplish the task.



**Figure 9.2** Dominant Joints Parallel to the Face

### 9.1.3.2 JOINTS PERPENDICULAR TO FACE

When the dominant jointing direction is perpendicular to the face as in Figure 9.3, no endbreak will occur. However, backbreak will be significant. If large blastholes are used and significant numbers of joints occur between holes along a row, blocky breakage will occur between holes. The block breakage can be corrected by reducing spacing, but the backbreak may get worse as spacing is reduced. The use of smaller blastholes with a better distribution of powder in the rock mass may be the best solution.



**Figure 9.3** Dominant Joints Perpendicular to the Face

### 9.1.3.3 JOINTS AT AN ANGLE WITH FACE

When dominant joints are at an angle with the face, fragmentation is good and both endbreak and backbreak are normally within acceptable limits. (Figure 9.4).

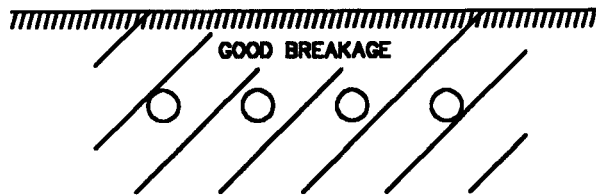


Figure 9.4 Dominant Joints at Angle

**9.1.3.4 JOINTS AT LESS THAN 30 DEGREE ANGLE TO FACE**

Joints which form an acute angle with the face cause both breakage and wall stability problems. Figure 9.5 illustrates the results of the type of jointing. Burden breakage will be blocky and the back wall will be shattered, rough and broken.

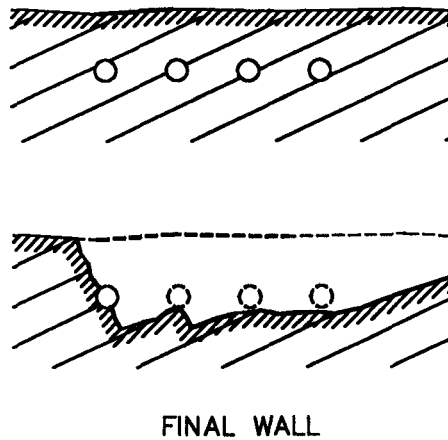


Figure 9.5 Dominant Joints at Acute Angles

**9.1.3.5 BLASTING WITH THE DIP**

Figure 9.6 illustrates a through cut. On one side of the cut, the blast will be with the dip, while on the other side the blast will be against the dip.

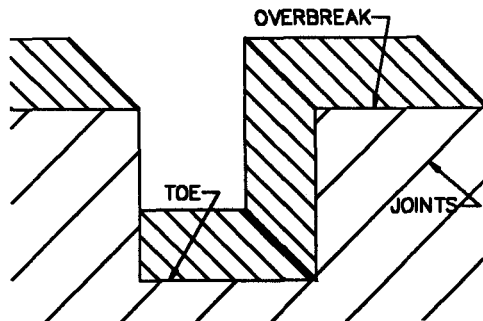


Figure 9.6 Consideration for Dipping Beds

When shooting with the dip, there will be more chance of backbreak. A smoother pit floor should result with less toe problems. The blasted rock should encounter less resistance and move further from the face. Burden distance can often be increased when shooting with the dip.

When shooting against the dip, less backbreak will occur and the potential for rock overhanging the face will increase. The toe of the shot will be more difficult to remove and the floor can get rough. The muck pile will increase in height. The burden may need to be reduced to produce the desired floor and fragmentation conditions.

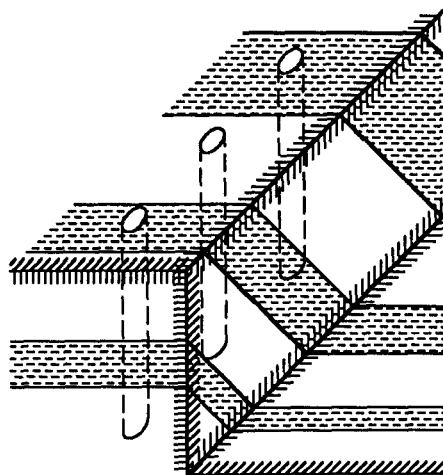
#### **9.1.3.6 MUD OR SOFT SEAMS**

Mud or soft seams cause more problems to blasters than any other geologic problem. They can occur in all types of rock. They are often unseen, yet near a blasthole can cause severe violence and poor fragmentation.

Mud seams allow an almost instantaneous release of the explosive energy since they often move as a hydraulic fluid. Mud can be thrown great distances with flyrock travelling with the mud. Stemming across mud or soft seams is essential to obtain good blasting results.

#### **9.1.3.7 BLASTING IN BEDDED ROCK**

Blasting parallel with the strike (Figure 9.7) can produce results which are difficult to predict since many different rock layers can be intersected by a single pattern. Since burdens and spacings are uniform in the pattern, layers will respond differently. Fragmentation will be different in each rock layer. Floor conditions and backbreak will differ in various section of the blast.



**Figure 9.7** Blasting in Bedded Rock

## **9.2 SELECTION OF DRILLING EQUIPMENT**

The discussion on drilling for the purposes of this section will be limited to concerns of blasting personnel and not necessarily concerns of optimizing drilling costs. There are three methods of rock drilling, drifter drilling (air or hydraulic,) rotary drilling, and downhole hammer drilling.

These three types of drilling use two basic mechanisms to mechanically attack the rock, percussion and rotation. For percussion drilling, a chisel-shaped or button-studded tool impacts the rock with hammer-like blows. The machine is self-indexing causing rotation of the bit which changes the location of the impact on the rock. The rotational torque caused by indexing is not responsible for any penetration in the rock. The impact is in an axial direction and is responsible for the stress effective in breaking the rock.

Rotation for cutting is used in drag bits and rotary drilling. The shaving action of a drag bit is performed by a variety of tools including drag bits and diamond bits. The cutting action is supplied by two forces on the bit, the thrust or static load acting axially upon the steel and the torque or the force component of the rotation moment acting tangentially on the bit.

Roller bit rotary drilling is a hybrid action of both rotation and percussion. The geometry of the roller bit is such that as the bit turns, its cutting teeth or buttons alternately engage the rock both impacting and shaving it.

### **9.2.1 DRIFTER DRILLING**

A drifter drill, commonly called an air track drill, is used on many small construction projects. Bit size at maximum would be approximately 5 inches in diameter. By utilizing special couplings and jack hammer steel, a minimum hole size of 1-5/8 inch diameter can be drilled. Drifter drills function strictly with principles of percussion. Drifters in general are used with blastholes less than 40 feet in depth. In some unique instances they have been used on faces well over 100 feet high. Drilling accuracy is questionable and loss of power and drilling speed does not make them a good choice for high benches. In general, drifter drills tend to wander more than other types of drills. Minor geologic discontinuities can cause holes to deviate considerably. For applications such as presplitting, small diameter holes 2-1/2 to 3-1/2 inches in diameter are used. Drilling depth greater than 20 feet can have problems with deviation, especially with careless driller. A comparison of drifter drills versus down hole drills from a performance standpoint is given in Table 9.1 A major advantage in the use of drifter drilling is that the drilling unit has the capability of drilling inclined blastholes. In general, neither the rotary drilling or down the hole hammer units can be inclined as much as the drifter drills.

**TABLE 9.1 DOWNHOLE DRILL VS. DRIFTER DRILL**

<b>DOWNHOLE</b>	<b>DRIFTER</b>
Hard rock drilling of relatively deep holes. Straighter holes. Larger holes with same rig.	Rock drilling of relatively shallow holes.
Maintains a virtually constant penetration rate at all depths. For deep holes, average drilling speed is higher.	Higher initial penetration rates, but drilling speed falls off with each steel added.
Uses less air because drill exhaust helps clean hole. Can use high pressure air for increased drilling speeds.	Uses more total air because all hole cleaning air is in addition to drilling air. Drifter and high steel life considerations preclude use of high pressure.
Comparatively low-impact and exhaust noise muffled in the hole.	Requires drill exhaust muffler if noise is critical. Impact noise difficult to control.
No shank pieces or coupling required. Uses standard API rod threads.	Shank piece and coupling threads subject to higher wear rates and more frequent replacement.
Fewer moving parts. Almost all energy goes into rock instead of into mounting - hence less wear and tear on rig.	Rig must withstand much of the drilling impact and vibration.

### **9.2.2 ROTARY DRILLING**

Rotary drills are usually used on large construction projects, hole sizes are normally in excess of 6 inches in diameter. Rotary drills deviate less than drifter units. In general, rotary drills have little, if any, ability to be inclined. A major advantage to rotary drilling is that they have the ability to drill holes to great depths which is a not the case with drifter drilling. Rotary drills have an advantage over drifter drilling in that bit change is not serious consideration. As an example, rotary drills used for oil well drilling can often drill a well thousands of feet deep without pulling the drill string to change bits. Rotary drilling is more quiet than drifter drilling and less disturbing to the neighboring residents.

### **9.2.3 DOWN HOLE DRILLING**

The downhole hammer bridges the gap in drilling technology between the conventional rotary drill and the drifter. The downhole hammer is an air operated pneumatic tool that supplies a percussive action at a constant distance from the rock. The rotating action and down pressure are changed to one of percussion without losses of energy through the drill

string. The downhole hammer has advantages over both the drifter drills and the rotary drills under certain conditions. The hammering action takes place in the hole and not above the ground on the drilling machine. Therefore, the drilling action is considerably more quiet with down the hole hammer drills. Depending on the conditions, the down hole tool itself acts like a stabilizer and tends to keep the hole in better alignment than with either rotary or drifter drilling. Downhole hammers come in a diameters of approximately three inches and up to nine inches or more. However, in normal construction practices, drills above seven inches in diameter would not be used. A major advantage in the use of a down hole hammer is that it maintains a constant penetration rate in homogeneous rock regardless of the depth. There is no loss of drilling performance due to energy losses through a long drill string as would occur in drifter drilling. A comparison of performance characteristics of down hole versus rotary drilling is given in Table 9.2.

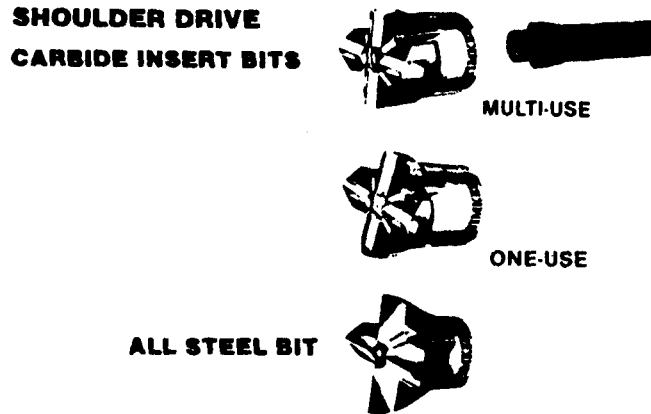
Angle hole drilling with down hole drills is more restricted than with drifter drills.

**TABLE 9.2 DOWNHOLE DRILL VS. ROTARY DRILL**

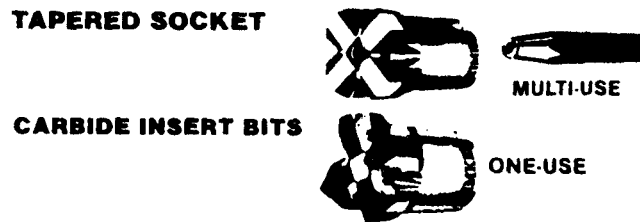
<b>DOWNHOLE</b>	<b>ROTARY</b>
Excellent penetration rates with less downfeed pressure. Lighter rig can drill bigger holes.	Requires heavier downfeed to approach or equal DHD penetration.
Drill exhaust supplies hole cleaning air. Total air requires are about the same as for rotary air drilling.	Requires large volumes of air or mud for hole cleaning and bringing cuttings to surface, depending on bit and rod size.
Comparatively low-exhaust noise muffled in the hole.	Very low-engine noise is a major source.
Rod costs low due to lower feed pressure and torque.	Heavier feeds and higher rotation torque contribute to shorter rod life.
Longer maintenance intervals because of lower feed pressures and minimal vibration on machine.	Higher vibration levels from heavier feed pressures may require more frequent maintenance intervals.

#### **9.2.4 BITS**

Various types of bits are used depending on ground conditions. Figures 9.8 through 9.15 give a descriptive overview of the different types of bits available for both rotary and percussive drilling under different ground conditions.



**Figure 9.8A Percussive Rock Bits**

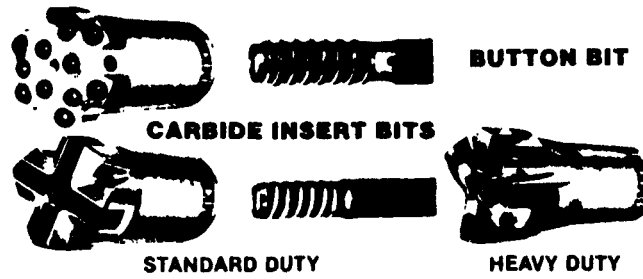


**Tapered Socket** drive rock bits are generally used in shaft sinking, tunnel driving and mining. The objective of using tapered drill steel and tapered socket bits is to achieve full utilization of the drill steel. With integral steel if the chisel insert breaks the entire steel is scrapped.

The "**tapered socket**" allows bit replacement and the rod can be easily "**retapered**" if required. Tapered Socket Bits are generally used with  $\frac{7}{8}$ " & 1" drill steel but are offered up through 1  $\frac{1}{4}$ " for certain applications.

**BOTTOM DRIVE**

**Figure 9.8B Percussive Rock Bits**



Bottom Drive rock bits are used to deliver the **MOST** powerful drilling blows and are offered in both "**CARBIDE BUTTON**" and "**CARBIDE INSERT**" design. They generally are offered in all the popular threads Hi Lead; rope; trapezoidal and double entry in steel sizes from 1" to 2½".

Figure 9.8C Percussive Rock Bits

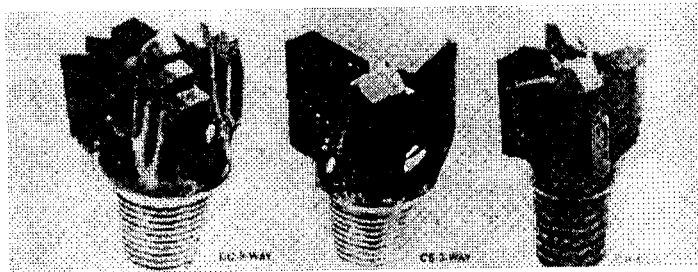


Figure 9.9 Drag Bits for Soft to Medium Formations

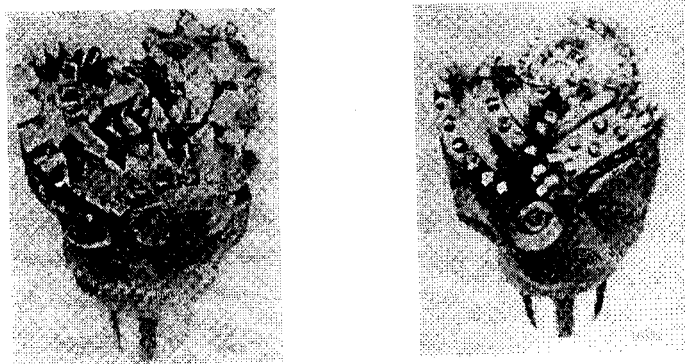
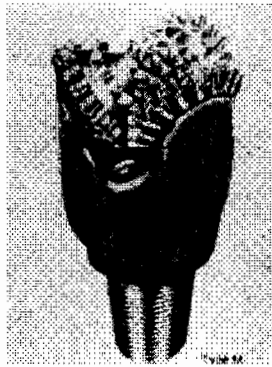
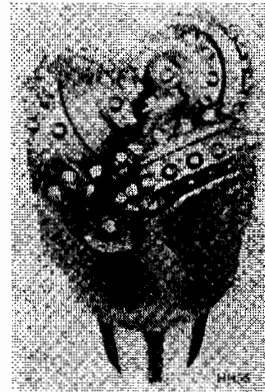


Figure 9.10 Rotary Bits for Soft Formations

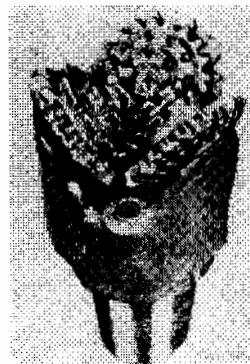




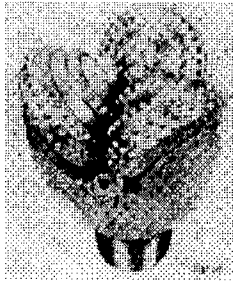
**Figure 9.11 Rotary Bits for Medium Formations**



**Figure 9.12 Rotary Bits For Medium Hard Formulations**



**Figure 9.13 Rotary Bits for Hard Formulations**



**Figure 9.14 Rotary Bits for Very Hard Formations**



**Figure 9.15 Rotary Bits for Extremely Hard Formations**

### **9.2.5 DRILLING ACCURACY**

There are a number of factors which influence the accuracy of drilling such as operator influence, hole diameter, hole depth, alignment devices, and local geology.

#### **9.2.5.1 OPERATOR INFLUENCE**

The operator has the major influence on the alignment of any blasthole. If the operator does not use or does not properly use alignment devices that may be on the drill, holes will deviate greatly from their preferred alignment. Eyeballing in drill rigs especially on drifter units is very common. Alignment devices which may have existed on the drill at purchase are often broken and not functional. The operator's influence, especially on drifter units, can create problems if he is not attentive to the drilling action. When drifter drills are crossing seams, the operator should recollar the hole on the other side of the seam. If he does not do so, drills tend to wander significantly in seamy rock.

#### **9.2.5.2 HOLE DIAMETER**

The hole diameter needed for a particular project does influence the type of unit which will be used. Rotary drills are not readily available in small diameters and down the hole hammers are not used in less than three inch size. Therefore, the hole diameter can influence the type of drill selected for a particular project. The type of unit also influences its ability to be aligned. Smaller size drilling units tend to wander more due to local geologic conditions than rotary or down the hole hammers of larger size.

#### **9.2.5.3 DEPTH LIMITATIONS**

A different type of drill may be selected as depth of blastholes increase. An air track drill may be sufficient for drilling holes up to 40 feet in length whereas if blastholes must be 100 feet deep, one may decide to use a down the hole hammer or a rotary unit both from a standpoint of better alignment and better drilling economics. The depth and rock characteristics would determine whether or not a rotary or down the hole hammer would be the proper selection in deep hole drilling.

#### **9.2.5.4 ALIGNMENT DEVICES**

In general, the smaller the drilling unit, the worse the alignment devices available for it. Air track drilling units are normally sighted into position and only rarely have mechanical devices to show whether or not the mast is perpendicular. When air track drills are used to drill angle hole, the leveling or alignment is even less accurate. Down the hole hammer units and rotary drills tend to have better alignment devices, however, their ability to be angled is limited.

#### **9.2.5.5 LOCAL GEOLOGY**

The local geology has a considerable influence on the deviation drilling. Down the hole hammers and rotary drills have less problems with local geology than drifter units. Drifter units can wander considerably due to such things as change in rock hardness, joints, vugs, mud seams, and improper operator control at geologic discontinuities. In general, the larger the hole, the more control over geologic problems. Down the hole hammers of large size can drill holes accurately down to 60 to 70 foot depths. Some drifter units may have problems with accuracy at depths over 20 feet.

### 9.2.6 ANGLE DRILLING

Different types of drills have different angling capabilities. In general, in the United States, production holes are vertically drilled and angle drilling normally is only used for controlled blasting applications such as presplitting or trim blasting. In many foreign countries, however, angle drilling is used on production holes as well as controlled blasting applications. To better understand the rationale for angle versus vertical drilling, one would have to compare the advantages and disadvantages of both methods and look at them from a site specific application (Figure 9.16).

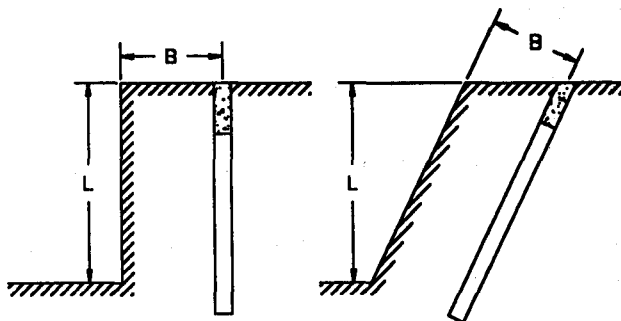


Figure 9.16 Vertical vs. Angle Drilling

#### Advantages of Angle Drilling

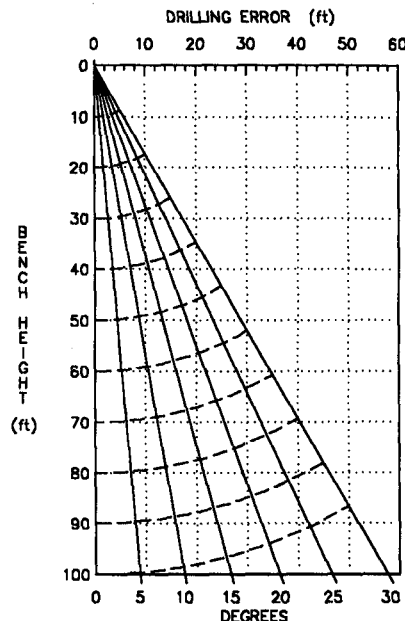
1. Less backbreak
2. Less problems at grade
3. More throw, especially on low benches
4. Better fragmentation on low benches
5. Loose rock better held on face by gravity

#### Disadvantages of Angle Drilling

1. Harder to collar holes
2. Difficult to maintain accurate angle
3. More problems with geologic discontinuities
4. Easier to hang steel in holes
5. More difficult to load explosives
6. Often not possible with drilling machines being used.

The many factors previously discussed all influence the possibility of non-alignment of the blasthole. In construction blasting, the perimeter holes which are often angle drilled holes are of greatest concern. There is no easy method to ensure proper alignment. The purchase of the most capable piece of equipment does not ensure proper alignment if operator error is great. Maintaining alignment cannot be done by sight alignment of a drilling rig. The drilling rigs must have the proper alignment devices affixed to the units and those devices must both be in working condition and must be used by the operator.

It is quite easy to check the alignment on perimeter holes after the blast. One readily sees whether the holes were in proper alignment and the amount of deviation which occurred. Operators can be positively influenced to do the maximum to control alignment, both with machinery and by the selection of competent operators if non-alignment causes serious cost consequences. When alignment is extremely important, the operator should only be allowed to drill lifts to depths which meet his alignment requirements. That is to say this if after a test blast his boreholes deviate more than what is considered to be acceptable, the future lift depths would be limited to only depths at which alignment requirements were met. For example, at a 10 foot depth alignment is out of control, the operator should be constrained to drill no deeper than a 10 foot lift. On the other hand, another operator that can maintain alignment with the same drilling unit down to 35 foot depth should be given the ability to use a 35 foot lift. Limiting the lift depth at which the operator maintains control on alignment will do more to get proper alignment of holes than any other control method. Drilling and blasting economics are seriously affected by depths. It will cost the operator more to take out three 10 foot lifts than one 30 foot lift. A wise operator, knowing this, will do everything in his power including purchasing alignment devices, getting better operators, or even changing the type of drill unit to allow him to take the deeper lift (Figure 9.17).



**Figure 9.17** Drilling Error Which Results from Drill Deviation

### **9.3 BLASTING SAFETY**

Safety in blasting is extremely important because of the inherent danger in explosive use. The Institute of Makers of Explosives has established various recommended safe practices for blasting. These practices should be studied and followed. The Institute has many different pamphlets dealing with storage requirements, hazards from radio frequency energy, do's and don'ts in explosives use, the American Table of Distances as well as numerous other publications. These publications are made available to the blaster to ensure that blasting is accomplished in a safe, efficient manner. It is not the intent of this section to recite safety rules or review material which the Institute of Makers of Explosives has published. It is the intent of this section to discuss commonly violated guidelines and the causes of accidents in transportation, storage, and use of explosives.

#### **9.3.1 STORAGE OF EXPLOSIVES**

Explosives should be stored in accordance with federal, state and local regulations. When explosives are stored in a magazine, the magazine should be clean, dry, cool, well-ventilated, and properly located as in accordance with the American Table of Distance. The magazine should be constructed so that it is bullet-proof, fire-resistant, and meeting all federal or state codes. Magazines should be locked with shielded locks to discourage theft.

Initiators such as electric blasting caps, Nonel, Hercudet, or any other type of blasting cap should not be stored in the same magazine with high explosives. Blasting agents require less stringent storage requirements than high explosives. However, if they are placed in a high explosive magazine, their weight would count toward the total weight allowable in that magazine. Explosives in magazines should be thoroughly marked as to the date of purchase and the oldest products should be used first. Hazardous conditions sometimes arise when explosives, especially those containing nitroglycerin, begin to deteriorate due to age and leak onto the floor of the magazine.

No source of fire flame should be brought near an explosive magazine, and the magazine should be located so that there is no grass, brush, or debris nearby. When explosives are brought to the job, they must be stored in day boxes that meet federal or state codes. They should be placed in an area that is not in any danger from falling objects, fire or heavy equipment.

#### **9.3.2 TRANSPORTATION OF EXPLOSIVES**

When explosives are transported on the highway, they should be transported in vehicles in proper working condition and equipped with federal, state or locally approved containers for safe transport. If the load is in an open body truck, it should be covered with a waterproof, fire-resistant tarpaulin. Unless the explosives are in the proper approved containers, caps and explosives should not be carried on the same vehicle. Smoking should not be permitted while loading and unloading the vehicle containing explosives. Trucks and vehicles containing

explosives should bypass cities, towns or villages, if possible. The explosive cargo should be gently unloaded and cases should not be thrown onto the ground. Accidents have occurred when truck fires have occurred during explosive transit. Personnel, including firemen, should be evacuated when the explosive begins to burn. When the fire has reached the cargo, many types of explosives will detonate.

### **9.3.3 HANDLING OF EXPLOSIVES**

Most accidents with explosives are caused during or subsequent to the handling of explosives. Accidents have occurred when drill operator have drilled into explosive in bootlegs. In many instances, this is not accidental because it is easier to collar holes in bootlegs. Operators sometimes take shortcuts assuming that no explosive is in the bottom of the hole. Some operators have used air track drills to force explosives beyond obstructions in blastholes. This is a dangerous practice and has cost the lives of people on blasting jobs.

#### **9.3.3.1 ELECTRICAL HAZARDS**

Premature initiation of electric cap circuits have occurred. The hazards associated with electric blasting should be recognized and known by the blaster and all in charge on the job. Electrical hazards can be broken down into six categories, current leakage, lightning, static electricity, stray currents, galvanic action, and radio frequency energy.

Current leakage into the ground is a hazard, but not because it results in premature initiation. It can, however, cause a round to misfire or partially fire since a large portion of the current may flow into the ground and not through the cap circuit. Conductive material such as wet shale, clay, magnetite, galena, and ammonium nitrate are more prone to current leakage problems. The reduced current which reaches the cap may be insufficient to fire the entire round. If such environmental conditions occur, the cap series should be set up such that the ground resistance is at least 10 times that of the series resistance. A blasting multi-meter can be used to make the proper tests.

Lightning is a hazard to both surface and underground blasting. Should a lightning bolt strike the blasting circuit, a detonation would most probably result with both electric or non-electric initiators. The probability that a direct hit would occur is remote, but a lightning bolt striking a far away object could induce enough current into an electric circuit to cause a detonation. The danger from lightning is increased if a fence, stream, or power transmission line exists between the blasting site and the storm. Underground blasting is not safe from lightning hazards since induced currents large enough to cause detonations can and have been transmitted through the ground. All blasting operations should cease and the area should be guarded when a storm is approaching. Commercially available lightning detectors can be purchase in areas where electrical storms are common.

Static electricity, both that occurring in nature and man-made, is a hazard to blasting. Electrical storms are not only dangerous because of lightning, but also because of the build up of a static electric front at some distance from the storm's center. The static charge can be stored on any ungrounded object. The insulations on the cap wires will not prevent the cap, whether shunted or unshunted, from detonating from static electrical discharge. The movement of particles under dry conditions can generate static charges. Particles of dust or snow driven by high winds, escaping steam under pressure, or motor driven belts can accumulate a static charge. To throw the leg wires of a blasting cap into the air to straighten them in a snow or sandstorm can be dangerous. To minimize the hazards of static electric buildup from man-made sources, the equipment near the loading site should have all moving parts grounded. All metallic parts of any machinery should be kept away from the blasting circuit. Moving equipment should be shut down in the immediate area when the blasting circuit is being connected. Pneumatic loading of explosives constitutes a possible hazard. Some materials act as capacitors and become charged from small static charges and can cause a premature detonation.

Stray currents can result from any power source. Electric current originating from a battery, transformer, or generator will always return to the source by any available path. Normally, it is expected that the current will return along insulated transmission lines or by a ground, which is the earth itself. If the return path is interrupted by a broken line or a blown fuse, high ground currents can result in an earth-grounded system. Under normal operating conditions, the return is continuous, the resistance of the earth is usually sufficiently high and the potential difference between two points close together on the ground is usually low. Exceptions can occur when two highly conducted beds are separated by a narrow bed of low conductivity material.

Dangerous currents in excess of 0.05 amps can be produced when leg wires contact rails, pipes, or ventilation ducts in underground operations. The maximum current which can be tolerated is 0.05 amps or 1/5th of the minimum firing current for one EBC which is 0.25 amps.

Power transmission lines are another source of current which can be hazardous. The cap wires or lead wires can be thrown by the blast. If this occurs and the wires touch the power transmission line, electrocution of the blaster can result. The blast should not be located closer to a power line than the combined distance of the leading wire plus both cap leg wires since cap leg wires can separate making one long conductor. Ground currents can also exist near high power transmission lines, therefore, ground currents should be checked.

Galvanic action occurs when two dissimilar metals are in the presence of a conducting fluid. Premature explosions have occurred in the case where aluminum tamping poles were used in steel casing in the presence of an alkaline mud. The above situation can be compared to a crude battery.



Radio frequency (RF) transmitters which include television, radar, and A.M. and F.M. radio create powerful electromagnetic fields which decrease in intensity at distance from the transmission point. Tests have demonstrated that under certain conditions, electrical blasting wires may receive enough electrical energy to cause them to detonate. To date, few if any cases of premature detonation have been authenticated. Although the possibility of premature detonation due to radio waves exists, the chance that they will occur is remote.

Commercial A.M. broadcast transmitters 0.555 to 1.605 MHz are potentially the most hazardous. They combine high power and low frequency resulting in small loss of radio frequency energy in the lead line. Mobile radio transmitters are a potential hazard because they can be brought directly into the blasting areas. The leg wires of blasting caps whether shunted or unshunted can act as a radio receiving antenna. The most hazardous condition exists when the circuit wires or leg wires are elevated a few feet above the ground, when the length of the wire is 1/2 or 1/4 the wave length or some multiple, thereof, or when the EBC is located at the point of maximum RF current.

#### **9.3.3.2 BLAST AREA SECURITY**

Blasting accidents have occurred due to the failure of the operator to clear the blasting area. Failure to clear the blasting area can be broken down into other functions such as failure to follow instructions, inadequate guarding, having personnel under insufficient cover, or at an unsafe location. The end result can be injuries or fatalities from flyrock in the blasting area.

#### **9.3.3.3 FLYROCK**

An additional cause of fatalities, injuries, and property damage outside of the blasting area is flyrock. Occasionally flyrock can travel thousands of feet from a poorly designed blast. Even with the best care and competent personnel, flyrock may not be totally avoided. The majority of flyrock problems which exist today are due to carelessness in the loading, execution, and design of blasts.

#### **9.3.3.4 DISPOSAL**

Accidents occur during the routine disposal of explosives. Safety rules are violated and workmen are often too close to the fires at the time of burning. When a detonation occurs, workmen can be injured.

### **9.4 POST SHOT PROCEDURES**

After the blast has been initiated, the blaster in charge has a series of responsibilities to protect his workmen, public and company.

#### **9.4.1 POST SHOT INSPECTION**

The blaster should be the first to return to the blasting area and check if all holes have been fired. If electrical initiation is used, one should check cap wires in areas where the ground did not break properly to be sure that caps have initiated. If non-electric systems are used, a blaster should check plastic tubes for signs of undetonated material or should look for live detonating cord going down into the blasthole. If it is suspected that one or more holes have not fired, a process for misfire handling should be initiated. If a misfire has resulted, no workman should be allowed to re-enter the area until the dangers from the misfire are eliminated. If all holes have fired properly and the blaster has no reason to suspect misfires, the workmen can be called back into the area.

#### **9.4.2 POST WALL SCALING**

In operations where high walls or multiple lifts will result, it is extremely important to scale the wall and remove all loose material during the excavation process immediately after the blast. Scaling can most easily and economically be done with less danger to all involved if it is conducted on a blast-by-blast basis rather than waiting until the entire excavation is finished. Loose rock falling from improperly scaled high walls can cause danger to workmen during the excavation process and can be a continual hazard to future users of the excavations. As an example, on a multi-bench slope on a highway cut, falling rock has caused injuries and fatalities to occupants of vehicles driving through the cut. Good scaling procedures may not eliminate all falling rock, but certainly will be helpful. Scaling can be conducted by a number of different methods depending on the depth of the cut and the equipment available for excavation.

Hand scaling is the oldest method. It is extremely important that the man start from the top side of the wall and do a thorough job working downward as he goes.

Mechanical scaling is often used on excavations and mining projects. Mechanical scaling is conducted by using a crane with a drop ball or dozer track which is run up and down the face to remove loose rock. If shovels or draglines are used for the excavation process, their bucket can be run up and down the walls to remove loose rock. It is the blaster's responsibility after the shot to go back into the area where high walls exist and look for potential dangers from loose rock before allowing equipment and men to move back into the area. If these dangers are evident, the wall should be scaled and the hazardous pieces removed before workmen return.

### **9.4.3 MISFIRES**

The most hazardous part of blasting is the handling of misfired explosives. The instances of misfire can be all but eliminated if well-trained, careful blasting crews are employed. In most instances, misfires are not a result of poor product. Instead, they occur because of the abuse, negligent use, or ignorance in the proper use of the product. The best way to handle misfires is to not let them occur at all. With proper careful blasting procedures, the instances of misfire are rare.

When a misfire does occur, the degree of hazard depends on the type of explosive used in the blasthole. In the general case, if the blastholes are relatively intact, the explosive should be shot in place. Shooting in place is the least hazardous method of handling the misfire. In cases where the rock is cracked near the blasthole, it may be necessary to pile dirt or soil on top and around the hole to ensure that flyrock may be reduced or eliminated. If the initiator has fired or has been torn away from the hole, the next option would be to remove the stemming and reprime the hole. The stemming could be removed pneumatically with compressed air or possibly with water pressure and a new primer placed on top of the main explosive column. Water would not be used with blasting agents which have no water resistance unless desensitization of the product would be the intent. If a primer is placed on top of the column charge, it can be stemmed and fired.

If the blastholes are broken away or there are no continuous column of explosive or the flyrock hazard would be too great, different steps could be used to handle the misfire. If the blasthole was filled with an explosive product that had no water resistance such as ANFO, it may be possible to wash the product out of the hole and desensitize it. If the product is washed from the hole, the live primer is still a hazard during the excavation process. If the blasthole contains cap-sensitive or cartridge explosives, the manufacturer of the explosive should be contacted to recommend the method of disposal which is the least hazardous with the particular explosive involved. In no case should an inexperienced person try to retrieve undetonated explosive without contacting the manufacturer.

### **9.4.4 RECORDKEEPING**

The keeping of accurate blasting records is absolutely essential. Blasting records and blasting logs are often considered a necessary evil on the part of the operator and only minimal records are kept as defined by regulations or specifications on the project.

Good blasting records offer the operator important information which he has no way of obtaining from any other source. The effects of local geology, water in blastholes, wall control methods, flyrock, air blast, and ground vibration control methods can all be obtained from the information in a blasting log. This engineering information not only sheds light on the control methods previously discussed, but can also be used to produce the best production results at the lowest possible cost. If records are not used for this purpose, they are being misused.

There are many types of records which should be kept of the blasting operation. Blasting logs are extremely valuable. A blasting log is shown in Chapter 12 which contains the Inspectors Manual. Other types of logs and reports are commonly used. For example, seismic monitoring reports which indicate the locations of the seismographs as well as the readings obtained. An example of a seismic monitoring report is shown in Chapter 12.

When blasting in a geologically complicated area, it is necessary for the driller to keep a drilling log indicating the seams, open joints, mud pocket, etc which are necessary for the blaster to know in order for him to properly load the blastholes. Examples of these types of logs are also shown in Chapter 12.

Blasting records not only provide engineering information, but a method of insurance against invalid blasting damage claims or lawsuits. Careful recordkeeping can, when combined with vibration information, show that alleged damage due to vibrations or air blast could not truly occur. On the other hand, the lack of good records can give the impression to regulatory agencies or the courts that the company is negligent, incompetent, and can raise doubt of the operator's innocence. Damage suits can be costly, and court injunctions can unnecessarily stop or slow down the completion of a project.

A thorough blasting log contains sufficient information to allow a blaster of reasonable skill in the art who is not associated nor has ever seen the job site, to set up the identical blast working from only the blasting log. All physical dimensions such as burden, spacing, subdrilling, stemming, decking, powder loads, and timing should be recorded in the log. The log should also have an accompanying drawing or sketch indicating the direction of the face or faces and the physical shot layout. The blast should be referenced to some benchmark on the property. The elevation of the cut in which the shot occurred should also be given. It should be remembered that years in the future when a suit for damages may be in the courts and the entire excavation is completed, not knowing the exact distances to the nearest structures from the shot location can cause damage claims to be upheld.

## **9.5 COST ESTIMATION**

To properly estimate costs on a blasting project would require the operator to plan his blasting procedure as if he was going to do the job in the very near future. Shot designs, layout, hole size, drilling equipment, and wall control methods with actual predicted dimensions should be used to determine costs.

The information provided in Chapter 1 through 8 of this manual can be helpful in determining the physical dimensions on the blasting operation. The operator's equipment and explosive costs could then be used to determine a cost per yard on the project. Unfortunately, many operators do not bid jobs or determine cost based on the methods discussed. Instead, they assume a number for a power factor which relates the amount of explosive used per cubic yard for that particular rock.

Powder factor is an artificial number which is influenced significantly by job conditions. There is no one powder factor that can be used successfully for a particular type of rock. Bidding in this manner will normally result in underestimation of the actual cost of the blasting operation. If the job is underestimated, the operator will be continually trying to cut costs to fall within his budgeted limits. This, of course, will lead to poor shooting, higher vibration levels, higher air blast, coarser fragmentation, and poor wall control. If an operator uses a very conservative estimate of powder factor to bid all blasting jobs, most likely he will not get most jobs. That is the reason for the previous statement that normally when powder factor is used, blasting jobs are underbid.

Our system of competitive bidding unfortunately often results in the most unorganized operators, those that have not done a realistic cost projection to get the work. If detailed blasting plans are requested at the time of the bid to backup bid costs, the operator will be forced to realistically bid a project rather than using a powder factor value.

### **9.5.1 DETERMINATION OF DRILLING COSTS**

There are a number of ways of obtaining drilling cost for job estimation purposes. One of the easiest and quickest methods is to contact local contract drillers and determine what their rate is for particular blasthole size. Another method is to do a detailed analysis of all the components that go into the drilling cost and obtain the true cost of drilling for particular types of drilling equipment. The method used will depend upon how accurate a drilling cost estimate is needed for job estimation purposes, using the rate quoted by local drillers may be sufficient. The problem with this method, however, is that true drilling costs are equipment dependent and the drilling cost for one contractor can be considerably different than the drilling cost for another depending upon the age and type of equipment used. When equipment is to be purchased for a particular project or if true cost control is desired by an operation than the true drilling cost should be calculated in a detailed manner.

In order to determine an accurate cost of drilling, one must determine the fixed and operating costs. For a fixed cost determination, the factory cost of the unit as well as the compressor if an air drifter is used will be needed. The freight cost is also needed as well as the projected economic life from the manufacturer.

In order to determine compressor costs, the fuel consumption, engine filter cost and oil costs will be needed. The compressor filter costs, oil costs, and air intake filter costs are also necessary. The bit, steel, coupling and striker bar costs are also needed for an air track drill. Along with the four mentioned costs, the type of rock, penetration rates, and life of the various expendable equipment such as bits, steel, couplings, and striker bar need to be known. If rotary drills are used, similar information will be needed. With this information one can determine for a particular job both the fixed and operating costs and determine a cost per foot of drilling as well as a cost per cubic yard. Input data and results of the drill cost calculations are given in Example 9.1.

EXAMPLE 9.1

FHWA

DRILLING COST  
ANALYST

V3.05 Page: 1  
Date: 06-18-1991

NOTE: UNIT 1 AIR DRIFTER

INPUT DATA OF ENTRY # 1 AIR DRIFTER

Type of rock .....	GRANITE
Factory cost of the drill.....	100,000.00 \$
Freight cost .....	1,000.00 \$
Economic life (hours) .....	10,000.00 h
Factory cost of the comp.....	100,000.00 \$
Freight cost .....	1,000.00 \$
Economic life (hours) .....	10,000.00 h

Fix. cost/hour .....	20.20 \$/h
Hole length .....	40.00 ft
Burden .....	12.00 ft
Spacing .....	12.00 ft
Subdrill .....	6.00 ft
Bench height .....	34.00 ft
Specific gravity of rock .....	2.60
Diameter of blasthole .....	4.00 in
Penetration rate .....	140.00 ft/h
Air compressor capacity .....	1,200.00 CFM
Operating pressure .....	125.00 psi
Driller labor cost .....	15.00 \$/h
Helper labor cost .....	0.00 \$/h
Other labor cost .....	0.00 \$/h

Total labor cost / hour ..... 15.00 \$/h

Engine shaft power .....	313.00 hp
Engine fuel consumption .....	25.04 gal/h
Engine fuel cost .....	1.00 \$/gal
Total fuel cost / hour .....	25.04 \$/h
Engine filter cost .....	6.10 \$
Engine oil capacity .....	8.00 gal
Engine oil cost .....	3.10 \$/gal
Eng. oil change interval .....	100.00 h
Other costs .....	0.00 \$/h

Total engine oil / filter..... 25.35 \$/h

Cost of compr. filters .....	50.00 \$
Compressor oil capacity .....	100.00 gal
Compressor oil cost .....	4.78 \$/gal
Comp. oil change interval.....	500.00 h
Air intake filter cost .....	300.00 \$
Filter change interval .....	500.00 h
Other costs .....	0.00 \$/h

Total compr. oil / filter..... 1.66 \$/h

Example 9.1 Continued

FHWA

DRILLING COST  
ANALYST

V3.05 Page: 2  
Date: 06-18-1991

-----  
NOTE: UNIT 1 AIR DRIFTER

INPUT DATA OF ENTRY # 1 AIR DRIFTER

Lubrication oil used/hour.....		0.50 gal/h
Lubrication oil cost .....		4.00 \$/gal
Other costs .....		0.00 \$/h
-----		
Total lubrication oil .....		2.00 \$/h
Bit cost / unit .....		220.00 \$
Bit life .....	1,000.00	ft
Bit reconditioning cost .....		60.00 \$
Operating bit cost / len .....		0.28 \$/ft
Operating bit cost / h .....		39.20 \$/h
Steel cost / unit .....		575.00 \$
Steel life .....	4,000.00	ft
Operating steel cost/len .....		0.14 \$/ft
Operating steel cost/h .....		20.13 \$/h
Coupling cost / unit .....		97.00 \$
Coupling life .....	2,000.00	ft
Operating coupling cost .....		0.05 \$/ft
Operating coupl. cost/h .....		6.79 \$/h
Striker bar cost / unit .....		195.00 \$
Striker bar life .....	4,000.00	ft
Operating striker bar/len.....		0.05 \$/ft
Operating striker bar/h .....		6.83 \$/h
-----		
Total accessory cost/len .....		0.52 \$/ft
Total accessory cost/hour.....		72.94 \$/h

### Example 9.1 Continued

FHWA

DRILLING COST  
ANALYST

V3.05 Page: 3  
Date: 06-18-1991

NOTE: UNIT 1 AIR DRIFTER

RESULTS OF ENTRY # 1	AIR DRIFTER	
Diameter of blasthole	.....	4.00 in
Penetration rate	.....	140.00 ft/h
Air compressor capacity	.....	1,200.00 CFM
Operating pressure	.....	125.00 psi
Fix. cost/length	.....	0.14 \$/ft
Fix. cost/hour	.....	20.20 \$/h
Fix. cost/weight	.....	0.01 \$/ton
Fix. cost/volume	.....	0.03 \$/yd <sup>3</sup>
Oper. cost/length	.....	0.84 \$/ft
Oper. cost/hour	.....	116.95 \$/h
Oper. cost/weight	.....	0.07 \$/ton
Oper. cost/volume	.....	0.16 \$/yd <sup>3</sup>
Total cost/length	.....	0.98 \$/ft
Total cost/hour	.....	137.15 \$/h
Total cost/weight	.....	0.08 \$/ton
Total cost/volume	.....	0.18 \$/yd <sup>3</sup>
Net volume / length	.....	5.33 yd <sup>3</sup> /ft
Net volume / hour	.....	746.67 yd <sup>3</sup> /h



### Example 9.1 Continued

F H W A

### DRILLING COST ANALYST

V3.05 Page: 4  
Date: 06-18-1991

ENTRY #	1	2	3	4	unit
Drill type:	AIR DRIFTER	HYDRAULIC	DOWN HOLE	DOWN HOLE	
Diameter of blast h	4.00	4.00	4.00	4.00	in
Air compressor capa	1,200.00	250.00	375.00	375.00	CFM
Operating pressure	125.00	100.00	200.00	200.00	psi
Fix. cost/length	0.14	0.11	0.25	0.15	\$/ft
Fix. cost/hour	20.20	20.20	22.70	13.10	\$/h
Fix. cost/weight	0.01	0.01	0.02	0.01	\$/ton
Fix. cost/volume	0.03	0.02	0.05	0.03	\$/yd <sup>3</sup>
Oper. cost/length	0.84	0.44	0.54	0.49	\$/ft
Oper. cost/hour	116.95	84.29	48.41	44.39	\$/h
Oper. cost/weight	0.07	0.04	0.05	0.04	\$/ton
Oper. cost/volume	0.16	0.08	0.10	0.09	\$/yd <sup>3</sup>
Total cost/length	0.98	0.55	0.79	0.64	\$/ft
Total cost/hour	137.15	104.49	71.11	57.49	\$/h
Total cost/weight	0.08	0.05	0.07	0.05	\$/ton
Total cost/volume	0.18	0.10	0.15	0.12	\$/yd <sup>3</sup>

### 9.5.2 BLASTING COST ANALYSIS

There are many different ways to design a blast for a particular application. Different hole sizes can be used as well as different bench heights. With different hole sizes, burdens and spacings change, drilling costs change, as well as the type of explosive that might be used. For a mass rock excavation project, we may want to compare different alternatives and determine which ones are the most cost effective. When estimating costs for a particular job, the volume of material to be removed is known and one would like to determine a reasonable cost per cubic yard for the entire job. One of these types of calculations can be done simply and easily by using existing computer software which is sold by a number of companies in the mining and construction industry. Some of the items to be considered when determining costs of blasting operations are shown in Example 9.2.

## Example 9.2

FHWA

### BLASTING COST ANALYST

V3.05 Page: 1  
Date: 06-18-1991

NOTE: EXAMPLE 1

ENTRY # 1            Column loaded borehole with one explosive

Type (brand) of explosive .....	ANFO	
Diameter of blasthole            in		6.00
Total number of holes .....		15
Burden            ft .....		12.00
Spacing            ft .....		16.00
Stemming            ft .....		8.00
Subdrill            ft .....		4.00
Bench height    ft .....		40.00
Specific gravity of rock .....		2.60
Primers per hole .....		2
Initiators per hole .....		2
Cost of explosive            \$/lbs .....		0.10
Specific gravity of explosive .....		0.85
Diameter of explosive    in .....		6.00
Energy per pound .....		10.00
Cost of primers            \$/unit		2.00
Cost of initiators            \$/unit		1.60
Total cost of delay between holes		7.00
Total cost of sleeves		20.00
Total cost of pumping		50.00
Total shot service cost		150.00
Total seismic monitoring cost		10.00
Total explosive delivery cost		200.00
Total blast protection cost		300.00
Drilling cost per length            \$/ft		2.00

### R E S U L T S

Blasted yd <sup>3</sup> .....	4,266.67
Blasted ton .....	9,345.02
Energy / yd <sup>3</sup> .....	13.17
Energy / ton .....	6.01
Cost / yd <sup>3</sup> .....	0.64
Cost / ton .....	0.29
Total cost .....	2,726.82

One may want to compare different alternative for the same job. Similar calculations can be done to determine the difference in cost per cubic yard with one alternative versus another, Example 9.3.

### Example 9.3

FHWA	BLASTING COST ANALYST				V3.05 Page: 2
					Date: 06-18-1991
ENTRY #	1	2	3	4	
Explosive used:					
A	ANFO	ANFO	ANFO	ANFO	
B		ANFO2	ANFO2	ANFO2	
C		DYNAMITE	DYNAMITE	SLURRY A	
Hole diameter [in]	6.00	6.00	6.00	6.00	
Tot. number of hole	15.00	15.00	15.00	15.00	
Burden ft	12.00	12.00	12.00	12.00	
Spacing ft	16.00	16.00	16.00	16.00	
Stemming ft	8.00	8.00	8.00	8.00	
Subdrill ft	4.00	4.00	4.00	4.00	
Bench height ft	40.00	40.00	40.00	40.00	
Specific gravity of	2.60	2.60	2.60	2.60	
Primers per hole	2.00	2.00	2.00	2.00	
Initiators per hole	2.00	2.00	2.00	2.00	
Blasted yd <sup>3</sup>	4,266.67	4,266.67	4,266.67	4,266.67	
Blasted ton	9,345.02	9,345.02	9,345.02	9,345.02	
Energy / yd <sup>3</sup>	13.17	1.05	1.44	1.30	
Energy / ton	6.01	0.48	0.66	0.59	
Cost / yd <sup>3</sup>	0.64	0.89	1.09	0.84	
Cost / ton	0.29	0.41	0.50	0.39	
Total cost	2,726.82	3,815.00	4,671.14	3,602.44	

Special provisions and specifications can greatly effect the cost of a blasting operation. For example, if extremely low vibration levels are placed on a job they can increase the cost drastically. Why would someone place extremely low vibration levels on a project? Extremely low levels are those which are below levels known to cause even the most superficial damage in structures. These low levels are placed on some projects to keep local residence from calling the project engineering with complaints that they feel the vibration. The problem with this approach to setting specifications is that the body makes an extremely good seismograph and some people will feel vibration from blasting even at the lowest levels. There is no vibration level which will guarantee that local residence will not feel the blasting. Writing blasting specifications based on annoyance is not sound judgement and increases the cost of the project.

Other factors which can increase costs are design factors such as extremely shallow benches or limitations on blasthole diameter. Limitations which are arbitrary and not based on sound engineering, are counterproductive and increase costs.

Limiting the total amount of explosive in any particular shot can also drastically increase costs because it increase the number of blasts necessary to remove a certain volume of material. If blasting is conducted properly, it is not the total pounds of explosive in the blast that is important to control vibration, only the number of pounds per delay. Whether 1,000 pounds or 10,000 pounds are shot in a blast, they should produce similar vibration readings if they are delayed properly.

Before any blasting specifications and special provisions are placed on a particular project, the effect on costs should be evaluated. Specifications should be based on sound engineering judgement and not arbitrary. Examples of FHWA Guide Specifications are presented later in this manual.

## **9.6 CHAPTER 9 SUMMARY**

Site conditions for consideration include the effects of wet blastholes and local geology on the blast design. Geologic structure often causes the blaster to change patterns to achieve the desired end result.

Drilling capabilities include drilling deviation and accuracy. Blasting cannot be successful with poor drilling.

Blasting safety is an important part of field procedure. Safety procedures in use, transportation, and storage must be followed to avoid problems.

Post shot responsibilities of the blaster were delineated for protection of the worker and the public.

## CHAPTER 10 OBJECTIVES

To examine vibration as a seismic wave. To consider the various wave types and wave parameters. To describe a seismograph and how it works and define the vibration parameters . To examine a vibration record and explain how to interpret it.

To state the factors which determine vibration level. To state the Propagation Law in its fundamental and simplified forms and illustrate its use.

To examine delay blasting, how it reduces vibration and why it works. To define and illustrate scaled distance. To examine the variable nature of blasting vibration and the attendant problems.

To examine vibration standards and recently proposed damage criteria. To describe vibration cracks and other non-damage effects. To examine special cases such as computers, hospitals, etc. To examine human response.

To examine air blast in the near field and air blast focusing in the far field. To examine preblast surveys. To examine water well and aquifer effects. To examine rippability.

## CHAPTER 10 SUMMARY

Vibration is simply seismic waves generated by the detonation of an explosive charge. These waves are classified as body waves which travel through the rock and surface waves that travel over the surface but do not penetrate into the rock mass.

Wave parameters are the properties used to describe the wave motion such as amplitude, period, crest, trough and frequency.

Instrumentation used to measure vibration is a seismograph which consists of two parts, a sensor and a recorder. The sensor converts the ground motion energy into electrical energy. The recorder then makes a record that is a reproduction of the ground motion. This record is calibrated to insure that the seismograph is functioning properly.

Vibration parameters are the physical quantities used to describe vibration. These are displacement, velocity, acceleration and frequency. A seismograph system measures three mutually perpendicular components of ground motion designated vertical, longitudinal and transverse.

A seismograph record has three lines or vibration traces, one for each component vertical, longitudinal and transverse. There may be a fourth trace for recording sound level. The maximum amplitude on each trace is measured to determine the maximum vibration level. The frequency of vibration in cycles per second can also be measured from the record.

The principal factors that determine vibration level are distance and charge weight. Formulas have been developed to show the relationship between vibration level, distance and weight of the explosive charge. This is called the propagation law.

The scaled distance concept was developed from the propagation law and is an effective means for controlling vibration.

When starting operations in a new area, the ground or area can be calibrated by plotting scaled distance vs. particle velocity.

Vibration behaves as a statistical variable and care must be taken so that the variation in vibration level does not result in exceeding prescribed vibration limits.

The first vibration standards were developed in the 1930's. Since that time, research and investigation have refined these limits to be safer and safer. Bulletin 656 of the US Bureau of Mines recommended a particle velocity of 2 in/s as a safe limit for structures which has been widely used. Recent investigation by the Bureau of Mines has suggested lowering this value. Thus, the question of a safe vibration limit is in a state of flux.

Vibration frequency varies with the kind of blasting so that construction blasting tends to generate high frequency while strip mine blasting tends to generate low frequency vibration. Low frequency tends to be more dangerous for structures which tend to vibrate in the low frequency range also.

New techniques such as spectral analysis and response spectra are used to get a better understanding of the problem. Fatigue and long term vibration do not seem to be major problems.

Typical cracks have an X shape due to tensional failure as the structure is deformed. They are most likely to be associated with large blasts if they occur at all.

People are very sensitive to vibration and can feel vibration far below the level necessary to cause damage. This produces much anxiety, concern, and complaints of damage.

Controlled tests by many investigators have documented the sensitive response of people to vibration. Rather than simplify the problem this has clearly indicated the annoyance factor which has resulted in a lowering of permissible vibration levels.

Vibration has been described as cultural and acultural. Vibration from blasting is acultural which causes complaints and strained relations.

Blasting generates an atmospheric pressure wave called air blast. At close distances where direct propagation occurs, air blast is safe for structures (mainly glass breakage) if the vibration level is maintained below 2 in/s.

At large distance (5-20 miles) air blast focusing due to an atmospheric inversion can occur. The sound energy may concentrate in a narrow region and has the potential to be one hundred times greater than normal, which may cause damage. Evaluation of this problem is difficult.

The sound levels are measured either in pressure, psi, or in decibels dB. A large part of the blast sound is concussion which is low frequency energy that is not audible. Sound measuring equipment must have a low frequency capability to measure this.

Preblast inspections are a useful tool in documenting blasting damage. Many regulatory agencies, insurance companies and concerned operators are advocating this.

If inspections are made, they must be done thoroughly and competently, with reports that are intelligible to others who must read and evaluate them.

The effect of blasting vibration on water wells and aquifers has been debated for some time. Recent investigations sponsored by the U.S. Bureau of Mines indicate the vibration levels below 2 in/s are safe for wells.

A drop in the water level of a well after blasting has been interpreted to be due to an increase in water storage capacity of the aquifer. Recovery occurred soon resulting in an increase in well performance.

The rippability of a rock depends on the rock type, its strength and jointing. Rock type can be determined by test drilling. Rock strength is a function of its elasticity which determines the seismic wave velocity. Combining rock type and seismic wave velocity, the Caterpillar Tractor Company has developed rippability tables for various rock types.

## CHAPTER 10

### VIBRATION AND SEISMIC WAVES

#### 10.1 SEISMIC WAVES

Seismic waves are waves that travel through the earth. These waves represent the transmission of energy through the solid earth. Other types of wave transmission of energy are sound waves, light waves, and radio waves. Earthquakes generate seismic waves. The science that studies earthquakes is Seismology, the name being derived from the Greek word *seismos* meaning to shake. In addition to the naturally generated seismic waves, there are many man made sources of seismic waves. When these man made seismic waves are sensible, that is when they can be felt, they are referred to as "vibration".

For some time now there has been a "Vibration Problem." What this means is that some of man's activities such as blasting, pile driving, etc., produce seismic waves which people can feel. They are disturbed, concerned, perhaps fearful, and begin inquiring about what is happening. Thus begins a confrontation know as the "Vibration Problem."

The vibration problem has been thoroughly investigated in the past and continues to be the subject of ongoing research. Since the subject starts with seismic energy and seismic waves, a brief discussion of these waves is in order.

Seismic waves are divided into two large classes, body waves and surface waves.

##### 10.1.1 BODY WAVES

Body waves travel through the mass of the rock, penetrating down into the interior of the rock mass. There are two kinds of body waves: compressional waves and shear waves. The compressional wave is a push-pull type wave that produces alternating compression and dilatation in the direction of wave travel, such as occurs in a stretched spring. The shear wave is a transverse wave that vibrates at right angles to the direction of wave travel. The motion of a shear wave can be seen in a rope which is strongly flexed at one end. The rope moves up and down, but the wave travels outward toward the other end. Liquids do not transmit shear waves.



### 10.1.2 SURFACE WAVES

Surface waves travel over the surface of rock mass but do not travel through it. The depth to which the rock mass is affected by the wave motion is approximately one wave length. Surface waves are generated by body waves which are restrained by physical and geometrical conditions from traveling into the interior of the rock mass. Surface waves produce the largest ground motions and are the large energy carriers.

A schematic representation of the motion for compressional waves and shear waves is shown in Figures 10.1 and 10.2.

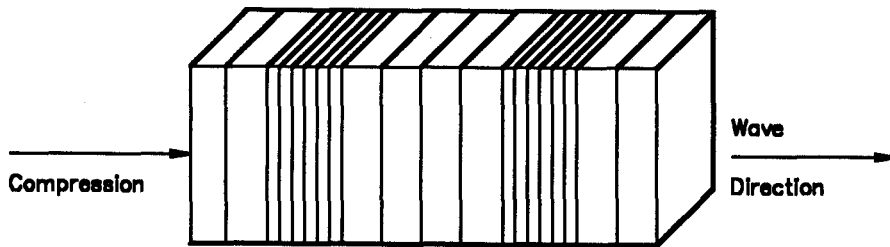


Figure 10.1 Compressional Wave

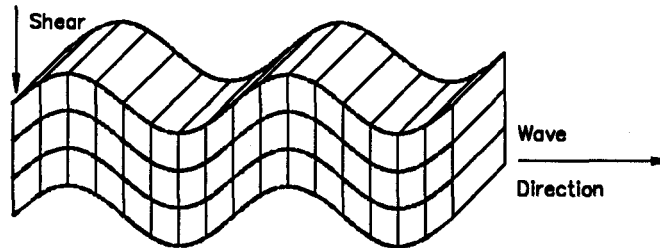


Figure 10.2 Shear Wave

### 10.1.3 CAUSES OF SEISMIC WAVES

Seismic waves are elastic waves. Elasticity is a property of matter which causes a material to regain its original shape or size if it is deformed. A very familiar example of elastic behavior is that of a stretched rubber band which springs back to its original length when released. Rock materials are highly elastic and thus produce strong elastic or seismic waves when deformed. Deformation occurs in two ways, a change in volume which is a compression or in shape which is a shear.

Materials resist deformation and this resistance is called an elastic modulus. If the deformation is a compression, the resistance is measured by modulus of incompressibility or the bulk modulus. If the deformation is a shear, the resistance is measured by the modulus of rigidity or the shear modulus. Thus, there are the two types of seismic waves, compressional and shear.

Operations such as blasting will always produce vibration or seismic waves. The reason for this is quite simple. The purpose of blasting and other such operations is to fracture rock. This requires an amount of energy sufficient to exceed the strength of the rock or exceed the elastic limit. When this occurs, the rock fractures. As fracturing continues, the energy is used up and eventually falls to a level less than the strength of the rock and fracturing stops. The remaining energy will pass through the rock, deforming it but not fracturing it because it is within the elastic limit. This will result in the generation of seismic waves. A simple schematic representation of compression and shear is shown in Figures 10.3 and 10.4.

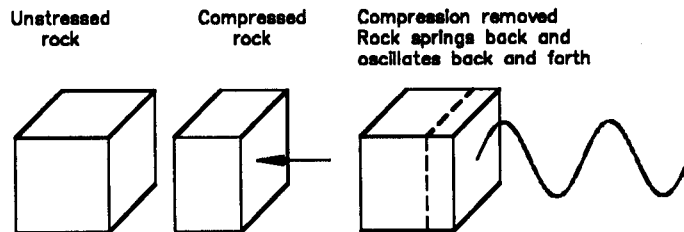


Figure 10.3 Deformation by Compression

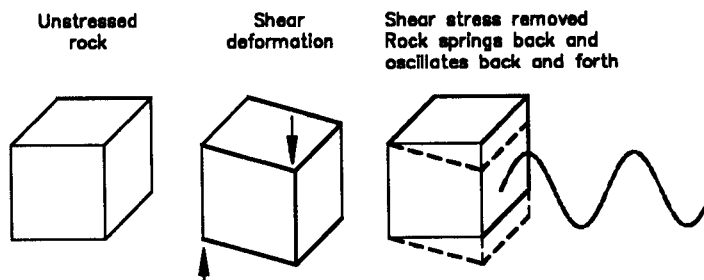


Figure 10.4 Deformation of Shear

#### 10.1.4 WAVE PARAMETERS

The fundamental properties that describe wave motion are called wave parameters. These are measured and quantified when discussing wave motion or vibration. Consider the simple harmonic wave motion illustrated in Figure 10.5 and represented by the equation:

$$y = A \sin(\omega t)$$

where:

- y = Displacement at any time t, measured from the zero line or time axis
- t = Time
- A = Amplitude or maximum value of y
- $\omega = 2 \pi f$
- T = Period or time for one complete oscillation or cycle
- f = Frequency, the number of vibrations or oscillations occurring in one second, designated Hertz, Hz

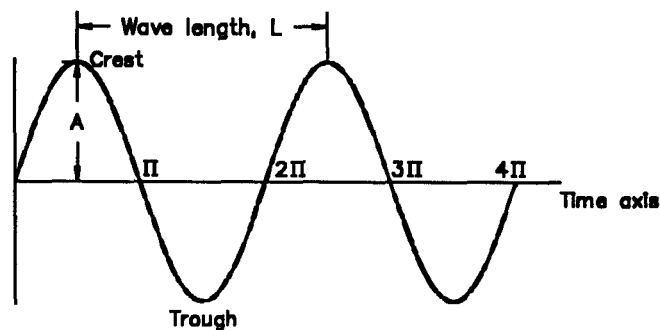


Figure 10.5 Wave Motion And Parameters

Period and frequency are reciprocals so that:

$$f = \frac{1}{T} \quad \text{or} \quad T = \frac{1}{f} \quad (10.1)$$

Wave length L is the distance from crest to crest or trough to trough measured in feet and is equal to the wave period multiplied by the propagation velocity V.

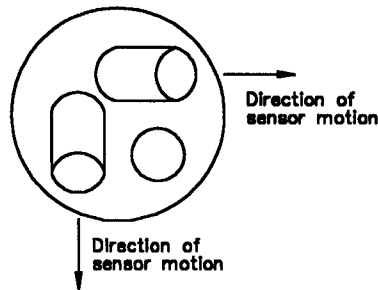
$$L = V T \quad (10.2)$$

## **10.2 UNDERSTANDING VIBRATION INSTRUMENTATION**

### **10.2.1 SEISMIC SENSOR**

The function of vibration instrumentation is to measure and record the motion of the vibrating earth. In basic scientific terms, this is a seismograph comprised of a sensor and recorder.

The sensor is in fact three independent sensor units placed at right angles to each other. One unit is set in the vertical plane, while the remaining two units lie in the horizontal plane at right angles to each other. Each sensor will respond to motion along its axis. Three are necessary to completely determine the ground motion. The three units are enclosed in a case as shown in Figure 10.6.

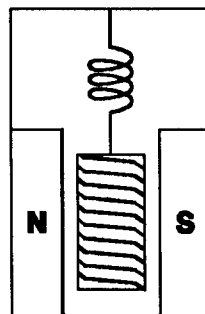


**Figure 10.6** Seismograph Sensor

The configuration of the sensor case varies with the manufacturer, and may be round, square, rectangular, or triangular.

The sensor is usually an electromagnetic transducer which converts ground motion into electrical voltage. Inside the sensor is a coil of wire suspended in a permanent magnet field. The magnet is attached to the sensor case and cannot move, but the coil suspended in the magnetic field by springs or hinges is free to move. Any movement of the coil relative to the magnetic field will generate an electrical voltage proportional to the speed of the coil movement. If the coil moves slowly, a small voltage is generated. If the coil moves fast, a large voltage is generated. When the ground vibrates, the sensor will vibrate, but the suspended coil inside will tend to remain motionless due to its inertia, thus producing relative motion between the coil and the magnetic field, resulting in the generation of an electrical voltage.

A schematic diagram of the sensor transducer is shown in Figure 10.7.



**Figure 10.7** Sensor Mechanism

The recorder takes the voltage output of the sensor, converts it back into motion, and produces a visual record of the ground motion. Since the sensor consists of three mutually perpendicular independent units, there will be three traces on the record, one for each sensor unit. This record is then ready for analysis and interpretation.

The recorder changes the output voltage of the sensor into motion by use of a galvanometer. When a voltage is generated at the sensor, a current will flow through the circuit causing the galvanometer coil to move. Thus the electrical energy has been changed back into motion and may be amplified in the process. The recorder also puts timing lines and calibration signals on the record. Finally, the recording of the motion may be done photographically or by heat stylus.

The ground motion may also be recorded on magnetic tape. To obtain a record from magnetic tape, it is necessary to have a playback system and a chart recorder. This system is somewhat more involved, but adds increased flexibility. The tape can be played back at different amplifications or for varied analysis techniques. In addition, many events (i.e., blasts) can be recorded on a single magnetic tape. Tape cassettes are inexpensive and easily available.

### **10.2.2 SEISMOGRAPH SYSTEMS**

There are many seismograph systems, or simply seismographs, available today, each of which performs the basic function of measuring ground motion. The many variations are a response to needs, constraints, and advancing technology. A brief description of the main types of seismographs will be helpful.

Analog seismograph - a three component system that produces a record of the ground motion. It is called analog because the record is an exact reproduction of the ground motion only changed in size, amplified, or de-amplified.

Tape seismograph - the same as the analog seismograph, except that it records on a magnetic tape cassette instead of producing a graphic record. A record of the ground motion is obtained by use of a playback systems and a chart recorder.

Vector sum seismograph - the standard seismograph system consists of three mutually perpendicular components. The resultant ground motion can be determined by combining the components using the relationship:

$$R = \sqrt{V^2 + L^2 + T^2} \quad (10.3)$$

where:

- R = Resultant motion
- V = Vertical component of motion
- L = Longitudinal component of motion
- T = Transverse component of motion

The vector sum seismograph performs this mathematical calculation electronically; that is, it squares the value of each of the components for each instant of time, adds them, and takes the square root of the sum. It then produces a record of the vector sum.

Bar graph seismograph - a three component system that differs in its recording system. Instead of recording the wave form of the ground motion at each instant of time, only the maximum ground motion of three components is recorded as a single deflection or bar whose magnitude can be read from the record graph. This is a very slow speed recording system which can be put in place and left to record for periods up to thirty or sixty days.

Triggered seismograph - an analog or tape seismograph which automatically starts to record when the ground vibration level reaches a predetermined set value, which triggers the system.

Most seismographs are equipped with meters that register and hold the maximum value of the vibration components and the sound level. Other seismographs are equipped to produce a printout which gives a variety of information such as maximum values for each vibration component, frequency of vibration for the maximum value, vector sum, and sound level. Blast information such as date, blast number, time, location, job designation, and other pertinent information can also be added to the printout.

### **10.2.3 VIBRATION PARAMETERS**

Wave parameters were discussed earlier. Vibration parameters are the fundamental properties of motion used to describe the character of the ground motion. These are displacement, velocity, acceleration and frequency. As a seismic wave passes through rock, the rock particles vibrate, or are moved from the rest position. This is displacement. When the particle is displaced and moves, it then has velocity and can exert force that is proportional to the particle's acceleration. These fundamental vibration parameters are defined here:

Displacement - The distance that a rock particle moves from its rest position. It is measured in fractions of an inch, usually thousandths.

Velocity - The speed at which the rock particle moves when it leaves its rest position. It starts at zero, rises to a maximum, and returns to zero. Particle velocity is measured in inches per second.

Acceleration - The rate at which particle velocity changes. Force exerted by the vibrating particle is proportional to the particle acceleration. Acceleration is measured in fractions of "g", the acceleration of gravity.

Frequency - The number of vibrations or oscillations occurring in one second, designated Hertz (Hz).

Vibration seismographs normally measure particle velocity since the standards of damage are based on particle velocity. There are, however, displacement seismographs and acceleration seismographs. Also, velocity seismographs can be equipped to electronically integrate or differentiate the velocity signals to produce a displacement or acceleration record.

### **10.3 VIBRATION RECORDS AND INTERPRETATION**

#### **10.3.1 SEISMOGRAPH RECORD CONTENT**

Normally a seismograph record will show the following:

Four lines or traces running parallel to the length of the record. Three traces are the vibration traces, while the fourth trace is the acoustic or sound trace. (There may not be an acoustic trace.)

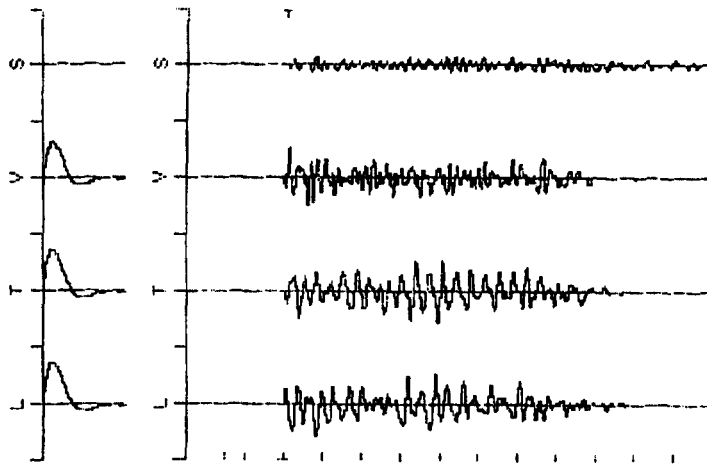
Each of the four traces will have a calibration signal to show that the instrument is functioning properly.

Timing lines will appear as vertical lines crossing the entire record or at the top only, the bottom, or both top and bottom.

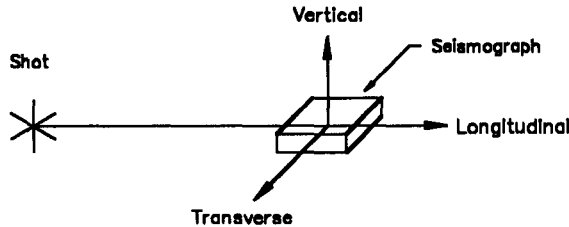
An example of a typical seismogram, or vibration record, is shown in Figure 10.8.

One vibration trace or component is vertical, the other two horizontal. The components are usually specified as follows in Figure 10.9.

- |                        |  |
|------------------------|--|
| Vertical               | - motion up and down, designated V.  |
| Longitudinal or Radial | - motion along a line joining the source and the recording point, designated L or R.         |
| Transverse             | - motion at right angles to a line joining the source and the recording point, designated T. |



**Figure 10.8** Vibration Record



**Figure 10.9** Vibration Components

The sensor normally has an arrow inscribed on the top. By pointing the arrow toward the vibration source, the vibration traces will always occur in the same sequence, with the arrow indicating the L component also the direction of motion will be consistent from shot to shot. The instrument manufacturer will indicate the proper sequences.

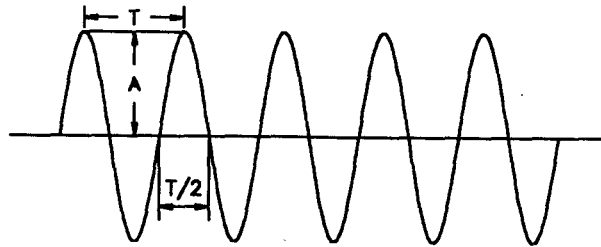
Each trace represents how the ground is vibrating in that component. If the seismograph is measuring velocity, then each trace shows how the particle velocity is changing from instant to instant in that component.

Similarly, if the seismograph is a displacement system or an acceleration system, the traces will show the instant to instant change in these parameters. The acoustic trace shows how the sound level changes with time.



### 10.3.2 RECORD READING AND INTERPRETATION

The maximum vibration level is found by measuring the largest amplitude, either up or down from the zero line on any given trace. This value, in inches (usually fractions of an inch, e.g., 0.54), is then divided by the instrument gain setting. The result is the maximum ground motion. Figure 10.10 illustrates the operation.



**Figure 10.10** Measure Of Vibration Amplitude And Period

Trace amplitude A = 0.54  
Seismograph gain = 5

$$V = \frac{A}{G} \quad (10.4)$$

where:

V = Ground vibration  
A = Trace amplitude  
G = Seismograph gain

$$V = \frac{A}{G} = \frac{0.54}{5} = 0.108$$

Assuming the seismograph is a velocity seismograph, the result is 0.108 in/s. If it is a displacement seismograph, then the result is 0.108 inches. If it is an acceleration seismograph, then the result is 0.108 g's.

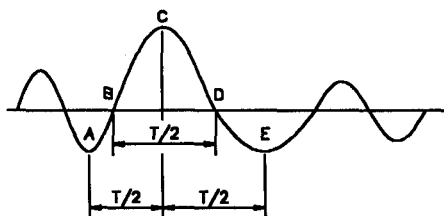
To measure the frequency of vibration, it is necessary to examine the wave motion on the record. A sinusoidal wave would have equal amplitudes for the crests and trough, and the distance between successive crests or troughs measures the period of the wave or the time for one complete oscillation. This is an ideal condition that does not normally occur on vibration records. That is, successive equal crests or trough do not usually occur. Hence, it will be necessary to modify the procedure. The procedure will be illustrated for both the ideal case and for the normal occurring case.

Figure 10.10 shows several approximately equal successive crests. The distance between these successive peaks is measured by counting the number of timing lines from the first to the second peak. There are three, and since each timing space has a value of 0.02 seconds, then:

$$T = 3 \times 0.02 = 0.06 \text{ seconds}$$

$$f = \frac{1}{T} = \frac{1}{0.06} = 16.67 \text{ Hz}$$

Now assume that the vibration record looks as following Figure 10.11.



**Figure 10.11** Half Period Measurement

Since there are not successive peaks or troughs of full equal amplitude measurement will be made from the trough to the crest, this is a half period. There are 2.7 timing spaces from the trough to the crest in the first  $T/2$  space going left to right. It is a trough to crest value since each timing line represents 0.02 seconds.

$$T = 2.7 \times 0.02 = 0.108 \text{ seconds}$$

$$f = \frac{1}{T} = \frac{1}{0.108} = 9.26 \text{ Hz}$$

Use  $f = 9 \text{ Hz}$

Notice the difference in  $T/2$  spacing values. The second  $T/2$  spacing represents the zero crossing value. The third  $T/2$  spacing is a crest to trough value. Each of these spacing values will yield a different frequency. When records are read manually, this is a judgement call by the analyst and depends on this experience and expertise. The time values were read as multiples of the timing spaces. In practice it may be necessary to measure fractions of a timing space.

Frequency determined by reading from the record is highly susceptible to error. Frequency values read electronically by the seismograph system are much more precise and reliable. Early investigations and research show a wide scatter in data, and much of it no doubt is due to the difficulties associated with reading frequency off a record.

Acoustic levels are read in much the same way, except that there is usually a base level below which the instrument does not respond. (What is the point in recording sound levels in the normal environmental range?) This base level value is then added to the computed value to give the true sound level reading. The following example illustrates the procedure.

$$SL = \frac{A}{AG} + AB \quad (10.5)$$

where:

SL = Sound level  
 A = Trace amplitude  
 AG = Acoustic gain  
 AB = Acoustic base level

Acoustic trace amplitude = 0.22 in  
 Acoustic gain = 0.005  
 Acoustic base level = 80 dB

$$\text{Sound level} = \frac{0.22}{0.005} + 80 = 44 + 80 = 124 \text{ dB}$$

Sound level changes less than 3 dB are normally not noticeable to the human ear.

### **10.3.3 FIELD PROCEDURE AND OPERATIONAL GUIDES**

Site selection is the first item of procedure. This is usually determined by a complaint or sensitive area which needs to be checked. If there is no such problem, than place the seismograph at the nearest structure that is not owned by or connected with the operation. The seismograph distance should always be less than or at most equal to the distance to the structure.

When dealing with residents or persons in the vibration affected area be factual and direct. Emphasize that the purpose of the seismograph measurement is to protect them and their property from vibration damage, and that standards have been developed by the Federal Government to do this.

Place the sensor on solid ground. Do not place it on:

- Grass
- Isolated slab on stone or concrete
- Loose earth
- Any soft material
- Inside a structure except on a basement floor
- Concrete or driveway connected to a blast area

Failure to observe these precautions will result in distorted readings that are not representative of the true ground vibration.

Level the sensor, some sensors have bulls eye level on top for this purpose. Others can be leveled by eye.

Make sure the sensor is solidly planted. In cases of large ground motion it may be necessary to cover the sensor with a sand bag, spike it down or dig a hole and cover it with earth otherwise the sensor may be decoupled from the earth and the vibration record will not represent the true ground motion. Remember that the ground displacement is usually only a few thousandths of an inch so do not expect to see the decoupling of the sensor.

Most sound measurement is made with a hand held microphone. Hold the mike at arm's length away from you to avoid reflection of the sound wave from your body.

Regardless if the microphone is used set up on a stand or hand held, do not set it up in front of a wall. This will prevent sound reflection from the wall.

#### **10.3.4 PRACTICAL INTERPRETATIONS**

The seismograph record can be used for much more than obtaining the peak particle velocity. It can be helpful in engineering the blast and provide information to the operator as to how to achieve the best vibration control as well as optimizing the use of the explosives energy to break rock. Assume one has a seismograph record that exhibits one large peak in the center of the wave trace. That large peak has a particle velocity of 2 in/s. Also assume that no other peak on the record is larger than 1.0 in/s. That one large peak is at 2 ms controlling how we design and execute all our blast in the future. In blasting, it is not the average vibration value that counts, it is the maximum. Therefore, common sense would dictate that if one could reduce that 2 in/s peak to 1.0 in/s, it would not only be better for the residence in the area but would be more economical for the operator because he would not have to go to extreme measures to try to reduce this one peak value.

What does this large peak mean from a practical standpoint? It was indicated that if it occurred in the center of the record, it is indicating that something occurred that was of unusual nature approximately half way through the blast. If one assumes that these peaks and the vibration record indicate energy release over time, then the record tells one that for some reason significantly more seismic energy was obtained approximately halfway through the blast. If all blastholes were loaded the same, this indicates there is inefficiency in the blasting process approximately half way through the blast. Now go back to the blasting pattern and determine approximately where the problem resulted. One might be able to then correct the problem so that one does not have to go to unusual measures to reduce vibration. A common problem which occurs is that if blastholes are wet, one commonly does not place as much

energy in the wet portion of the hole as in a totally dry hole. This is because cartridge product is used instead of, for example, bulk ANFO. The smaller diameter cartridge product may not have as much energy as ANFO and therefore, the vibration level would increase. How one handles wet hole situations can greatly effect the vibration generated from the blast.

Another common problem is drilling inaccuracy. If a blasthole within the pattern has an excessive burden at the time it shoots, vibration levels go up.

The seismograph record, therefore, can be used as a diagnostic tool to determine where within the blast the problem occurred which resulted in the higher vibration level.

Ideally, if one looks at vibration records and assumes that the peaks indicate energy release over time. Common sense would dictate that one would like to see all peaks near equal throughout the entire record. If this would occur, the explosives energy is being used efficiently and is reducing vibration to a minimum.

In the past, to expect a vibration record to have near identical peaks would have been considered an academic solution which was not practical in the field, however, today with advanced technology this type of vibration record can be achieved on blasts that are well engineered.

## **10.4 FACTORS AFFECTING VIBRATION**

### **10.4.1 PRINCIPAL FACTORS**

There are two principal factors that affect the vibration level that results from detonation of an explosive charge. These are distance and charge size. Common sense indicates that it is safer to be far away from a blast than to be near it. Common sense further indicates that a large explosive charge will be more hazardous than a small charge.

### **10.4.2 CHARGE - DISTANCE RELATIONSHIP**

Extensive research has been conducted to determine the mathematical relationship between vibration level, charge size, and distance. The U.S. Bureau of Mines Bulletin 656 (Nichols, Johnson and Duvall, 1971) states such a relationship. The relationship is:

$$V = H \left[ \frac{D}{W^\alpha} \right]^\beta \quad (10.6)$$

where:

- V = Predicted particle velocity (in/s)
- W = Maximum explosive charge weight per delay (lbs)
- D = Distance from shot to sensor measured in 100's of feet (e.g., for distance of 500 feet., D=5)
- H = Particle velocity intercept
- $\alpha$  = Charge weight exponent
- $\beta$  = Slope factor exponent

This is known as the Propagation Law because it shows how the particle velocity changes with distance and explosive charge weight. The numerical values for H  $\alpha$  and  $\beta$  are slightly different for each component. For the longitudinal or radial component, the law is numerically expressed as:

$$V_r = 0.052 \left[ \frac{D}{W^{0.512}} \right]^{-1.63} \quad (10.7)$$

Introducing the following approximations:

$$\begin{aligned} \alpha &= 0.512 \cong 0.5 \\ \beta &= -1.63 \cong -1.6 \end{aligned}$$

Expressing D in feet instead of hundreds of feet produces a simplified approximation for this relationship:

$$V = 100 \left[ \frac{d}{\sqrt{W}} \right]^{-1.6} \quad (10.8)$$

where:

- d = Distance from shot to sensor (ft)
- W = Maximum explosive charge weight per delay (lbs)

The Dupont Blaster's Handbook (E.I. Dupont de Nemours & Co., 1977) gives the following relationship:

$$V = 160 \left[ \frac{d}{\sqrt{W}} \right]^{-1.6} \quad (10.9)$$

### 10.4.3 ESTIMATING PARTICLE VELOCITY

The formulas enable one to estimate the particle velocity likely to result from the detonation of a given charge weight of explosive at a given distance. Obviously the Dupont formula will give a higher value for the expected particle velocity. From this, it can be seen that these formulas serve merely as guides, and only give ballpark figures.

The values of  $\alpha$ ,  $\beta$  and  $H$  are determined by conditions in the area, rock type, local geology, thickness of overburden and other factors. The values of  $\alpha = 0.5$  and  $\beta = 1.6$  are fairly well fixed. The value of  $H$  is highly variable and is influenced by many factors.

### 10.4.4 CHARGE WEIGHT, DISTANCE EFFECTS

To illustrate the effect of charge weight and distance, two graphs are presented, one for charge weight vs. particle velocity, the second for distance vs. particle velocity, consider:

$$V = 100 \left[ \frac{d}{\sqrt{W}} \right]^{-1.6} = 100 \frac{W^{0.8}}{d^{1.6}}$$

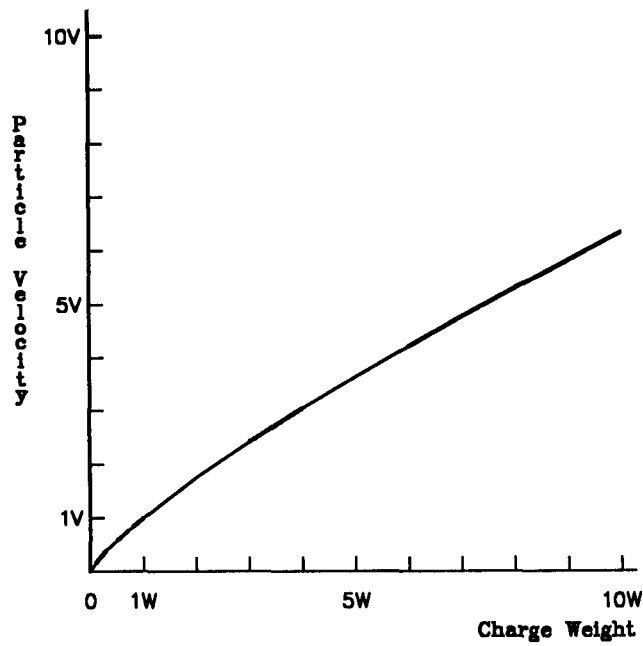
Equation 10.8 is useful in determining vibration levels which would occur at different distances and charge weights from the blast. This equation can be written in a different manner which will help predict the charge weight based on a certain vibration level which we would like to maintain as a maximum value. The equation would be written as follows:

$$W = d^2 \left[ \frac{V}{H} \right]^{1.25} \quad (10.10)$$

where:

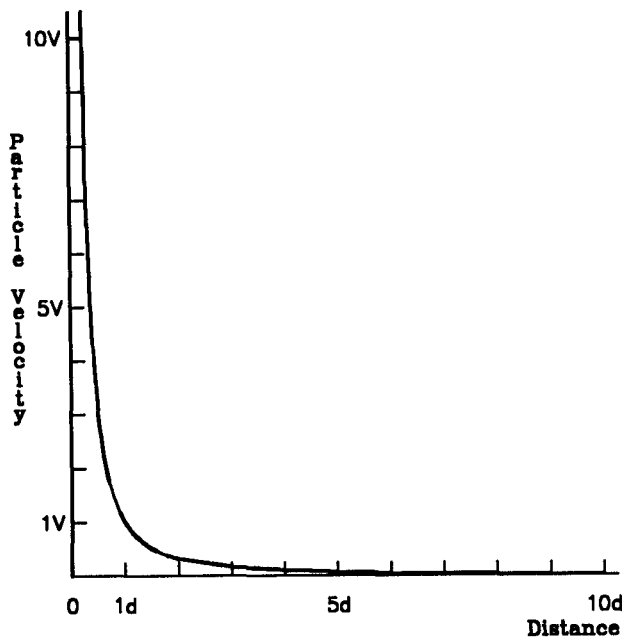
- W = Charge weight per delay (lbs/delay)
- H = 100
- d = Distance (ft)
- V = Vibration level

Assuming a charge  $W$  produces a particle velocity  $V$  at a distance,  $d$ , in equation 10.8. Then by letting  $W$  vary in multiples,  $2W$ ,  $3W$ , etc., for the fixed value of  $d$ , the relative values of  $V$  are plotted against charge weight in Figure 10.12.



**Figure 10.12** Relative Particle Velocity vs. Charge Weight

Similarly, assuming a charge  $W$  produces a particle velocity  $V$  at a distance  $d$  then by letting the distance increase in multiples  $2d$ ,  $3d$ , etc., for a fixed value of  $W$ , the relative values of  $V$  can be computed. The relative values of  $V$  are plotted against distance in Figure 10.13.



**Figure 10.13** Particle Velocity vs. Distance Relationship



These graphs illustrate the effects produced, but a numerical example will be helpful. Consider the following questions:

Question: If the charge weight is doubled, how much will the particle velocity increase?

Using:  $V_1 = 100 \left[ \frac{d}{\sqrt{W}} \right]^{-1.6}$

Calculate:  $V_2 = 100 \left[ \frac{d}{\sqrt{2W}} \right]^{-1.6}$

$$V_2 = 100 \left[ \frac{d}{1.41\sqrt{W}} \right]^{-1.6}$$

$$V_2 = 1.41^{1.6} 100 \left[ \frac{d}{\sqrt{W}} \right]^{-1.6}$$

$$V_2 = 1.41^{1.6} V_1 = 1.74 V_1$$

Answer: Doubling the charge weight increases the particle velocity 1.74 times. (Note: It is not double!)

Question: If the charge weight is cut in half, how much will the particle velocity decrease?

Using:  $V_1 = 100 \left[ \frac{d}{\sqrt{W}} \right]^{-1.6}$

Calculate:  $V_2 = 100 \left[ \frac{d}{\sqrt{\frac{W}{2}}} \right]^{-1.6}$

$$V_2 = 100 \left[ \frac{d}{\frac{1}{1.41}\sqrt{W}} \right]^{-1.6}$$

$$V_2 = \frac{1}{1.41^{-1.6}} 100 \left[ \frac{d}{\sqrt{W}} \right]^{-1.6}$$

$$V_2 = \frac{1}{1.74} = 0.57 V_1 \cong 0.6 V_1$$

**Answer:** Cutting the charge weight in half will decrease the particle velocity to six tenths its original value. (Note: It is not cut in half!)

**Question:** If the distance is doubled, how much will the particle velocity decrease?

**Using:** 
$$V_1 = 100 \left[ \frac{d}{\sqrt{W}} \right]^{-1.6}$$

**Calculate:** 
$$V_2 = 100 \left[ \frac{2d}{\sqrt{W}} \right]^{-1.6}$$

$$V_2 = 2^{-1.6} 100 \left[ \frac{d}{\sqrt{W}} \right]^{-1.6}$$

$$V_2 = \frac{1}{2^{1.6}} V_1 = 0.33 V_1$$

**Answer:** If the distance is doubled, the particle velocity is reduced to one third of its original value. (Note: It is not cut in half!)

**Question:** If the distance is cut in half, how much will the particle velocity increase?

**Using:** 
$$V_1 = 100 \left[ \frac{d}{\sqrt{W}} \right]^{-1.6}$$

**Calculate:** 
$$V_2 = 100 \left[ \frac{\frac{d}{2}}{\sqrt{W}} \right]^{-1.6}$$

$$V_2 = 2^{1.6} 100 \left[ \frac{d}{\sqrt{W}} \right]^{-1.6}$$

$$V_2 = 2^{1.6} V_1 = 3.03 V_1 \cong 3 V_1$$

Answer: If the distance is cut in half, the particle velocity will be tripled. (Note: It is not doubled!)

### 10.4.5 VIBRATION CONTROL

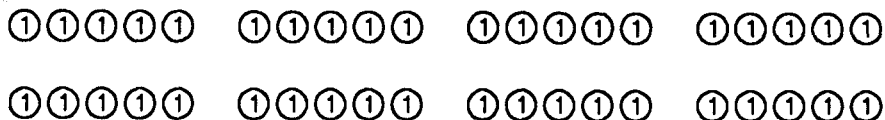
The operator would like to have a convenient, effective means of vibration control. The formulas just discussed are a means to such control, and have led to the development of other techniques.

#### 10.4.5.1 DELAY BLASTING

Before discussing these techniques, delay blasting should be considered. With the development of the delay cap, particularly millisecond delays, a method came into play by which a large explosive charge could be detonated as a series of small charges, rather than one large charge. Obviously, the reduction in charge size can be made by the use of multiple delays. For example, the use of ten delays would reduce the effective vibration generating charge to one tenth the original charge.

Consider the following example:

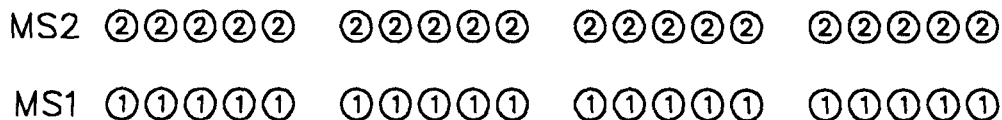
A shot consists of 40 holes, 250 lbs. of explosive per hole with a total charge of 10,000 lbs. and is fired instantaneously. The probable vibration level can be calculated at a distance of 1,000 feet.



40 Holes Fired Instantaneously

$$V = 100 \left[ \frac{1000}{\sqrt{10000}} \right]^{-1.6} = 2.51 \text{ in/s}$$

This is a dangerously high particle velocity, two delays were introduced to reduce the vibration level. This divided the shot into two series or parts of 20 holes each, with 5,000 lbs. per delay.



20 Holes Fired Per Delay

$$V = 100 \left( \frac{1000}{\sqrt{5000}} \right)^{-1.6} = 1.44 \text{ in/s}$$

If two more delays MS3 and MS4 were introduced, reducing the number of holes per delay to 10 and the charge per delay to 2,500 lbs., the probable particle velocity can be calculated.

MS3 (3)(3)(3)(3)(3) (3)(3)(3)(3)(3) (4)(4)(4)(4)(4) (4)(4)(4)(4)(4) MS4

MS1 (1)(1)(1)(1)(1) (1)(1)(1)(1)(1) (2)(2)(2)(2)(2) (2)(2)(2)(2)(2) MS2

10 Holes Fired Per Delay

$$V = 100 \left( \frac{1000}{\sqrt{2500}} \right)^{-1.6} = 0.83 \text{ in/s}$$

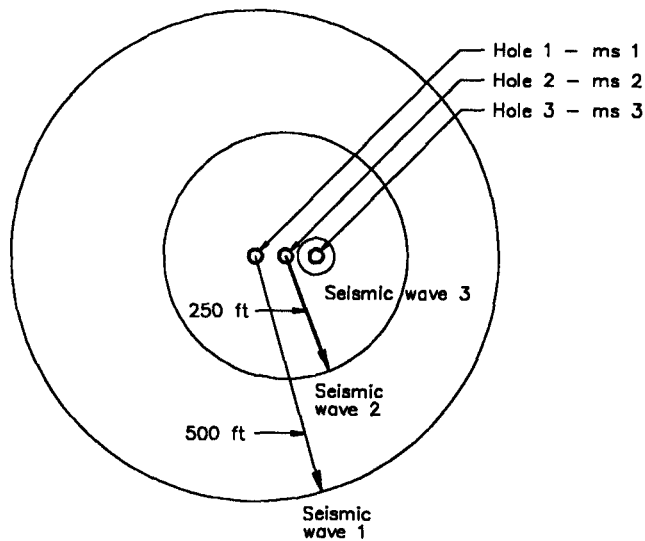
Thus a significant reduction in vibration level can be achieved by the use of delays. Why does delay blasting reduce vibration? The answer is fairly simple, but to understand it one must understand the difference between particle velocity and propagation velocity.

#### 10.4.5.2 PROPAGATION VELOCITY VS. PARTICLE VELOCITY

Propagation velocity is more familiar. It is the speed at which a seismic wave travels through the earth from shot to sensor and beyond. The general range of values is from 1,000 to 20,000 ft/s. For a given area, the value is approximately constant.

Particle velocity is quite different. A rock particle vibrates in an elliptical orbit around a rest position. A simple example of particle motion and velocity is the motion of a fisherman in a boat. A passing speed boat generates a wave which passes under the fisherman, causing his boat to oscillate up and down. This is a particle motion. The speed at which it oscillates is particle velocity. Particle velocity is measured in inches per second (in/s) and is the parameter measured by the seismograph.

Delay blasting works or reduces the ground vibration because the seismic wave generated by one delay has traveled a considerable distance due to its propagation velocity before the next delay has fired. The second seismic wave travels at the same propagation velocity as the first and can never catch up to the first. So the seismic waves or vibrations are separated. The following Figure 10.14 illustrates the process.



**Figure 10.14** Seismic Waves from Delay Blasting

**10.4.5.3 SCALED DISTANCE**

Scaled distance is a further development of the Propagation Law of the U. S. Bureau of Mines and is a practical and effective way to control vibration. Scaled distance is defined by the relation:

$$D_s = \frac{d}{\sqrt{W}} \tag{10.11}$$

where:

- Ds = Scaled distance
- d = Distance from shot to structure (ft)
- W = Maximum charge weight per delay (lbs)

Scaled distance is similar to ordinary distance in that the greater the value, the safer it is. Large values ( $D_s > 50$ ) indicates safe vibration conditions with low probability of damage while small values ( $D_s < 25$ ) indicates greater hazard with a higher probability of damage. The U.S. Bureau of Mines proposed a scaled distance of 50 as a safe blasting limit for vibration. This is a conservative limit, but many regulatory agencies are using a scaled distance of 60 for greater safety.

Using the modified propagation law, the probable particle velocities can be calculated for these scaled distance values.

Using:  $V_1 = 100 \left[ \frac{d}{\sqrt{W}} \right]^{-1.6}$

Ds = 50  $V_2 = 100 ( 50 )^{-1.6} = 0.19 \text{ in/s}$

Ds = 60  $V_2 = 100 ( 60 )^{-1.6} = 0.14 \text{ in/s}$

Scaled distance is easily calculated from the distance and charge weight. The operator can then compare the calculated Ds with the regulatory value, and make a judgment as to the relative safety of the vibration. Examples of this are given in Table 10.1.

**TABLE 10.1 VIBRATION DATA**

SHOT	DISTANCE	MAX. CHARGE WEIGHT PER DELAY	SCALED DISTANCE $Ds = \frac{d}{\sqrt{W}}$	JUDGEMENT
1	180	25	$\frac{180}{\sqrt{25}} = 36$	Caution
2	563	110	$\frac{563}{\sqrt{110}} = 53.68$	Safe
3	1440	238	$\frac{1440}{\sqrt{238}} = 93.34$	Safe

The scaled distance formula can be used to calculate safe distances for a given charge, or the safe charge for a given distance, using the specified regulatory value. Example of these calculations follow.

Assume a regulatory statute  $\frac{d}{\sqrt{W}} = 60$

A quarry normally uses a charge of 450 lbs. per delay. A new housing development is starting at a distance of 1200 feet. Is the quarry in compliance?

$$Ds = \frac{d}{\sqrt{W}} = \frac{1200}{\sqrt{450}} = 56.57 \text{ Non-compliance}$$

What charge weight will bring the quarry into compliance?

$$W = \left[ \frac{d}{Ds} \right]^2 = \left[ \frac{1200}{60} \right]^2 = 400 \text{ lbs/delay}$$

Any charge weight per delay of 400 lbs. or less will be in compliance.

The quarry is considering asking for a variance on the regulation since it cannot shoot effectively with less than 450 lbs. per delay. What is the distance that would be in compliance?

$$d = D_s\sqrt{W} = 60\sqrt{450} = 1272.79 \cong 1273 \text{ ft.}$$

The quarry then is asking for 73 feet setback of buildings in the housing development.

#### 10.4.5.4 ADJUSTED SCALED DISTANCE

A scaled distance regulation may represent conditions under which a blasting project cannot operate. If so, there are several methods for adjusting scaled distance levels to be safe. This must be verified by seismic measurement.

##### 10.4.5.4.1 AVERAGING METHOD

Compute the scaled distance value for a series of blasts. Each of these blasts have been recorded by seismograph and are within regulatory limits. Calculate the average scaled distance for these blasts. This average scaled distance, when approved by the regulatory agency, becomes the working scaled distance for computing charges or distances. Examples of these calculations are in Table 10.2.

**TABLE 10.2 VIBRATION DATA**

SHOT	DISTANCE (d)	CHARGE WEIGHT (W)	$\sqrt{W}$	SCALED DISTANCE (Ds)
1	1120	1390	37.28	30.04
2	1250	1476	38.42	32.54
3	1320	1610	40.12	32.90
4	1110	1420	37.68	29.46
5	1280	1621	40.26	31.79
6	1090	1350	36.74	29.67
S =				<b>186.39</b>

$$\text{Average } D_s = 31.06 \cong 31$$

##### 10.4.5.4.2 PARTICLE VELOCITY - SCALED DISTANCE GRAPH

This method involves seismic measurement in addition to calculating the scaled distance values from the blast data.

Data is then plotted on log-log graph paper with particle velocity on the vertical axis and scaled distance on the horizontal axis. To be effective, there must be a spread of data from low to high values. This can be accomplished fairly simple by placing the seismograph at increasingly greater distances on successive shots.

Plot the data on the graph, one point for each particle velocity-scaled distance pair. When all the points are plotted, a straight line or envelope should be drawn on the graph so that all the points are below the line. A reasonably accurate eye-ball fit is sufficient (Figure 10.15).

After the data is plotted and the envelope line drawn in, a working value of scaled distance can be read off the graph using this procedure. Start on the particle velocity scale at the specified regulatory particle velocity, e.g., 1.0 in/s. Draw a line horizontally across the graph until it intersects the envelope line. At the point of intersection, drop a vertical line down to the scaled distance axis. The point at which it touches the scaled distance axis is the working value for scaled distance. This value will insure that particle velocities generated by blasting will be less than 1.0 in/s.

If the regulatory value for particle velocity is different from 1.0 in/s, like 2.0 in/s or 0.5 in/s, then start at the proper value and proceed in the same way in Figure 10.15.

**TABLE 10.3 VIBRATION DATA**

SHOT	DISTANCE (d)	CHARGE WEIGHT (W)	$\sqrt{W}$	SCALED DISTANCE (Ds)	PARTICLE VELOCITY
1	275	406	20.15	13.65	1.74
2	385	348	18.65	20.64	0.72
3	590	291	17.06	34.59	0.34
4	790	286	16.91	46.71	0.21
5	1060	362	19.03	55.71	0.17

The working value for scaled distance read from the graph is  $D_s = 19$ . This value can now be used to calculate charge weights and distances that will produce vibration levels less than 1.0 in/s.

For either the average method or the particle velocity-scaled distance method, an on-going addition of data as it occurs should be made. The square dot represents a shot that produced an undesirably high particle velocity due to propagation, cap scatter, bad drilling control, overloading the hole or whatever the cause. The high vibration shows up above the envelope line. Thus, the operator can take immediate steps to control the vibration. Also, a safety factor should be added to the adjusted  $D_s$  value. If the adjusted value is 19, then use a value of 23 or 25 as a safety factor.



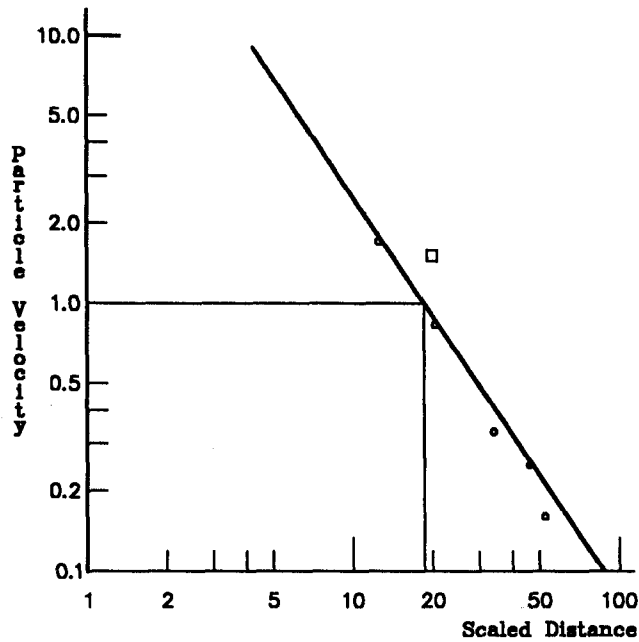


Figure 10.15 Particle Velocity vs. Scaled Distance

#### 10.4.5.5 SCALED DISTANCE CHARTS

Scaled distance charts can be made up on log-log graph paper by calculation for given values of the scaled distance. Choosing a scaled distance of 50, one can compute the explosive charge values for various distances. Since the log-log graph is linear, a straight line, it is only necessary to choose two distance values and compute the corresponding charges. The following illustrates the calculation in Table 10.4.

$$D_s = \frac{d}{\sqrt{W}} = 50$$

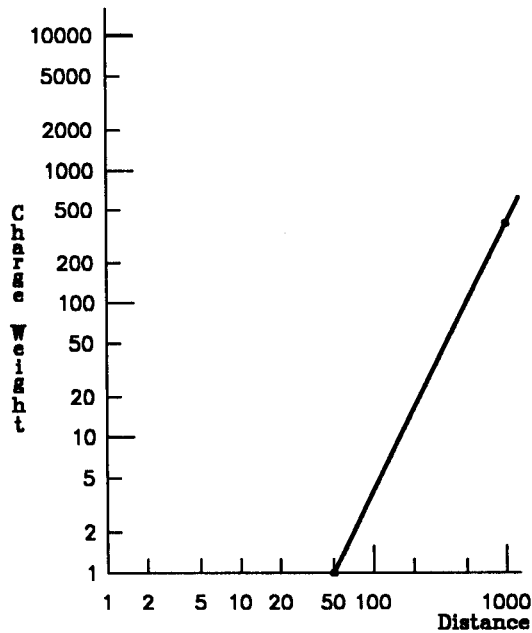
$$W = \left( \frac{d}{50} \right)^2$$

TABLE 10.4 CHARGE - DISTANCE DATA

DISTANCE (d) (selected) ft	CHARGE WEIGHT (W) (calculated) lbs
50	1
1,000	400

By plotting these pairs of points (50, 1) and (1000, 400) on the log-log graph paper, and connecting them by a straight line, the result is the scaled distance curve for  $D_s = 50$ . Additional lines for scaled distance values of 10, 20, 100, or any desired value, can be computed and plotted.

These scale distance curves enable one to graphically determine the permissible explosive charge at any distance for a specified scaled distance value. Figure 10.16 is an example of a scaled distance chart. The chart can be used in the following way. Assume that a scaled distance of 50 is the operational level. What charge is permissible at a distance of 500 feet? Draw a vertical line upward from the distance value 500 until it intersects the  $D_s = 50$  line. Then at the point of intersection on the scaled distance line, draw a horizontal line to the charge weight axis. This point is a value of charge weight, 100 lbs. for the case in question.



**Figure 10.16** Scaled Distance Chart

#### **10.4.5.6 GROUND CALIBRATION**

Ground calibration should be done when entering a new area or starting a new project. The two principal factors that affect vibration level are charge weight and distance. In addition, rock type, rock density, presence or absence of rock layering, slope of layers, nature of the terrain, blasthole conditions, presence or absence of water, all combine to influence the transmission of vibration. The simplest way to evaluate these factors is by observation of the vibration levels generated. This is called ground or area calibration.

Ground or area calibration can be accomplished by a scaled distance-particle velocity plot on log-log graph paper using data from a series of blasts as discussed previously. A minimum number of five shots will serve as a starter with more data added as additional shots are fired and recorded. The method synthesizes the many factors affecting vibration transmission and enables the operator to determine a safe working value for the scaled distance. Once the scaled distance is adequately determined, all shots should generate vibration levels less than the corresponding particle velocity.

#### 10.4.5.7 VARIABILITY OF VIBRATION

A very important fact of life in dealing with vibration resulting from blasting that cannot be stressed too much is that it is highly variable. It seems logical to assume that if two blasts were identical with respect to charge, distance, rock formation, etc., that the resulting vibration levels would also be the same. In general, they will not be the same, they will be different.

The reason for the above difference is that vibration is a statistical variable. If a large number of identical blasts were detonated and recorded at the same distance by seismographs, the resulting vibration levels will differ from shot to shot and will be distributed over a fairly wide range on both sides of an average value.

This distribution of data approximates the form of a statistically normal distribution with a mean value and a standard deviation. Data of this kind are usually grouped in intervals and have the form shown in Figure 10.17. Sigma ( $\sigma$ ) is the standard deviation.

The importance of this lies in the fact that higher vibration levels than expected will occur regularly. Lower vibration levels will also occur, but these are of no concern, the lower the better. Ninety-five percent of the data will lie within  $\pm 2\sigma$  of the mean, with half the data, or 47.7%, above the mean value and half below the mean value.

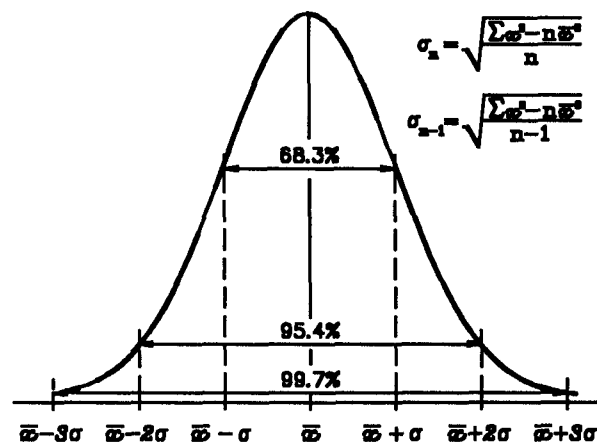


Figure 10.17 Normal Distribution of Data

The variation in vibration level may be as large as sixty percent (60%). For example, if the average vibration reading is 1.00 in/s, readings could range from 0.40 to 1.60 in/s. The variation on the high side may result in exceeding a regulatory specification, or even damage to adjacent structures. If the operator is aware of this potential, he will be prepared to prevent its occurrence.

#### **10.4.5.8 FACTORS EFFECTING VIBRATION**

If blasting operations were conducted with a 100% efficiency, one would expect that if the same type of blast was done many times, the same particle velocity would result. It is obvious from the previous sections that there is a great deal of variability in vibration levels even if the same thing is done each time. It is not uncommon for two blasts which are designed theoretically identically to perform quite differently in the field. This is especially confusing when two blasts are side by side in what appears to be uniform rock material and the vibrations are measured at a particular home thousands of feet from the blast. It would seem that the vibration should be very similar since the energy is following almost the identical path through the ground from the blast area to the home. Then why then is there such a great difference in our blasting vibration. How do frequencies change from blast to blast? There are many factors which effect vibration transmission. A listing of these factors are given below:

#### **FACTORS EFFECTING VIBRATION**

- |                              |                              |
|------------------------------|------------------------------|
| 1. Burden                    | 14. Number of primers        |
| 2. Spacing                   | 15. Primer Composition       |
| 3. Subdrilling               | 16. Boosters                 |
| 4. Stemming depth            | 17. Geologic factors         |
| 5. Type of stemming          | 18. Number of holes in a row |
| 6. Bench height              | 19. Number of rows           |
| 7. Number of decks           | 20. Type of initiator        |
| 8. Charge geometry           | 21. Row to row delays        |
| 9. Powder column length      | 22. Inhole delays            |
| 10. Rock type                | 23. Initiator accuracy       |
| 11. Rock physical properties | 24. Distance to structure    |
| 12. Explosive energy         | 25. Face angle to structure  |
| 13. Actual delivered energy  |                              |

The above listing indicates the importance of the execution of the blast design in the field. Changes in burden, spacing, stemming, powder column length, number of rows, number of holes, types of delays can change the vibration generated. Precise execution of the blast design with limitations of the tolerances and deviations from the design hole to hole will drastically reduce vibration. Vibration records will begin to resemble one another if the variability in the design parameter is controlled.

## 10.5 VIBRATION STANDARDS

The present vibration standards are the result of more than a half century of research and investigation by concerned scientists. The first significant investigation was initiated by the U.S. Bureau of Mines in 1930, and culminated in 1942 with publication of Bulletin 442, Seismic Effects of Quarry Blasting. This and other programs will be briefly described.

Thoenen and Windes. Seismic Effects of Quarry Blasting U.S. Bureau of Mines, Bulletin 442, 1942.

### Acceleration Index

Safe zone	-	less than 0.1 g
Caution zone	-	between 0.1 and 1.0 g
Damage zone	-	greater than 1.0 g

Crandell, F. J. Ground Vibration Due to Blasting and Its Effect Upon Structures. Journal of the Boston Society of Civil Engineers, 1949.

$$\text{Energy Ratio Index} \quad ER = \left[ \frac{a}{f} \right]^2 \quad (10.12)$$

where:

$$\begin{aligned} a &= \text{Acceleration (ft/s}^2\text{)} \\ f &= \text{Frequency (Hz)} \end{aligned}$$

Safe zone	=	ER less than 3
Caution zone	=	ER between 3 and 6
Damage zone	=	ER greater than 6

Energy Ratio has the dimension of velocity and an  $ER = 1$  is equivalent to a particle velocity = 1.9 in/s

Langefors, Westerberg and Kihlstrom. Ground Vibration in Blasting, Parts I-III, Water Power, 1958.

### Velocity Index

No damage	-	less than 2.8 in/s
Fine cracks	-	4.3 in/s
Cracking	-	6.3 in/s
Serious cracking	-	9.1 in/s

Edwards and Northwood. Experimental Blasting Studies on Structures. National Research Council. Ottawa: Canada, 1959.

Velocity Index

Safe zone	-	Less than 2.0 in/s
Damage	-	4.0 to 5.0 in/s

Nichols, Johnson and Duvall, Blasting Vibration and Their Effects on Structures. U. S. Bureau of Mines, Bulletin, 656, 1971.

Velocity Index

Safe zone	-	less than 2.0 in/s
Damage zone	-	greater than 2.0 in/s

In addition to the Bureau's own work, Bulletin 656 is also a syntheses of the work of the number of other investigators. Particle velocity is considered to be the best measure of damage potential. The safe vibration criterion was specified in Bulletin 656 as follows:

The safe vibration criterion is based on the measurement of individual components, and if the particle velocity of any component exceeds 2 in/s damage is likely to occur.

Damage means the development of fine cracks in plaster. Very quickly the particle velocity, 2 in/s, became known as the Safe Limit. Many regulations were and continue to be still based on this value. Additional levels of vibration based on the results of other investigations used in Bulletin 656 are the following:

Threshold of damage (4 in/s)

- opening of old cracks
- formation of new cracks
- dislodging of loose objects

Minor damage (5.4 in/s)

- fallen plaster
- broken windows
- fine cracks in masonry
- no weakening structure

Major damage (7.6 in/s)

- large cracks in masonry
- shifting of foundation-bearing walls
- serious weakening of structure

The major damage zone correlates reasonably well with the beginning damage level for natural earthquakes.

### **10.5.1 RECENT DAMAGE CRITERIA**

In 1980, the U.S. Bureau of Mines reported on its most recent investigation of surface mine blasting in R.I. 8507 (Siskind, et al). Structural resonance responding to low frequency ground vibration, resulting in increased displacement and strain, was found to be a serious problem.

This reintroduced the dependence of damage on frequency. Prior to this, the safe limit particle velocity was independent of frequency. Also, measurements were made inside structures rather than just by ground measurements. Inside measurement seems quite reasonable and logical, but data from previous investigations of structural vibration yielded very poor results, hence, the emphasis on ground measurement.

The threshold of damage used in RI 8507 was specified as cosmetic damage of the most superficial type, of interior cracking that develops in all homes, independent of blasting.

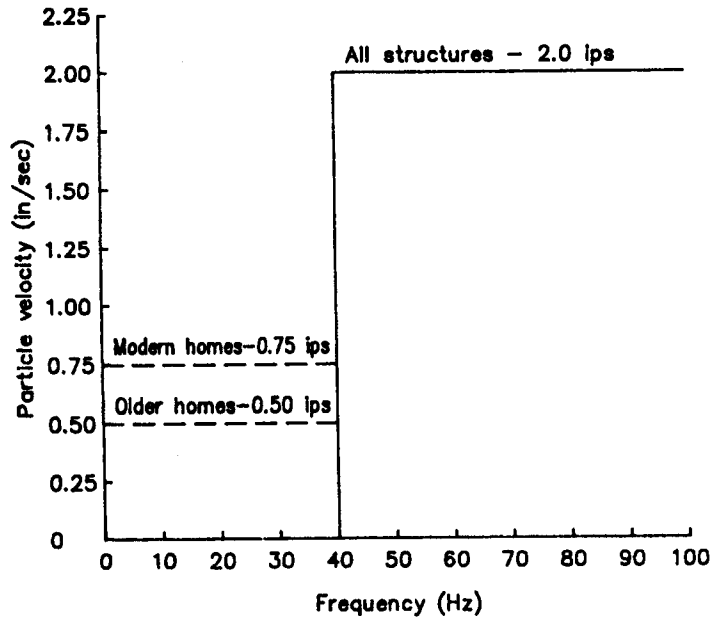
The safe vibration level was defined as levels unlikely to produce interior cracking or other damages in residences.

Safe vibration levels as specified in RI 8507 are given in Table 10.5. These criteria are based on a 5% probability of damage.

**TABLE 10.5 SAFE PEAK PARTICLE VELOCITY FOR  
RESIDENTIAL STRUCTURES (RI 8507)**

<b>TYPE OF STRUCTURE</b>	<b>f &lt; 40 Hz</b>	<b>f &gt; 40 Hz</b>
Modern homes - drywall interiors	0.75 in/s	2 in/s
Older homes - plaster on wood lath for interior walls	0.50 in/s	2 in/s

These safe vibration levels represent a conservative approach to damage and have been the subject of intense criticism by the blasting industry.



**Figure 10.18** Safe Vibration Levels (RI 8507)

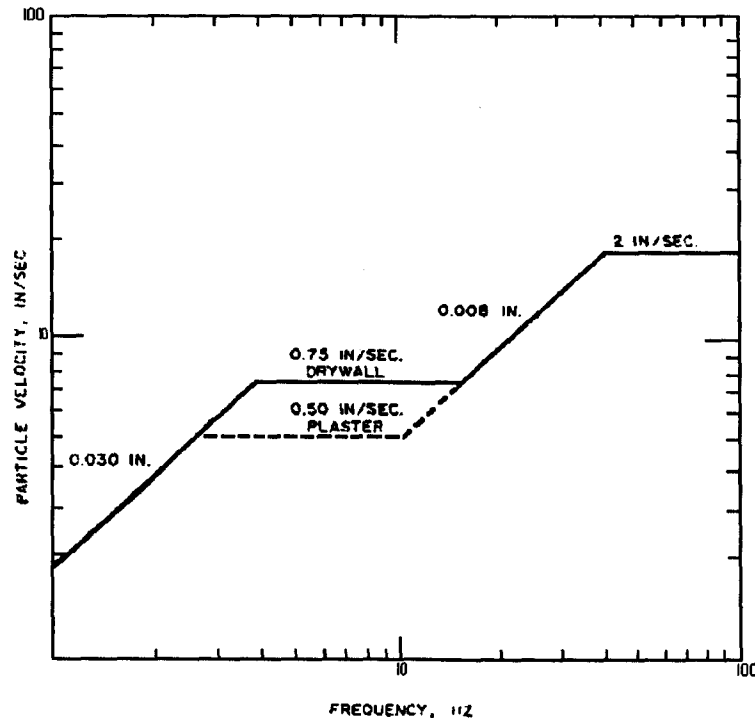
### **10.5.2 ALTERNATIVE BLASTING CRITERIA**

RI 8507 also proposed alternative blasting criteria using a combination of displacement and velocity criteria applied over several frequency ranges. These alternative criteria are shown in Figure 10.19.

These criteria using both displacement and velocity over respective frequency ranges have not been accepted by all concerned. Instrumentation will need frequency reading capability in addition to the capability of reading both displacement and velocity in order to cover all ranges. This indicates the state of flux in which the question of safe vibration standards existed, which still exists today.

The problem is associated with the concept of what really constitutes vibration damage. The most superficial type of cracking advocated in RI 8507, while not to be condoned, is scarcely a realistic guide for control. Limiting vibration to a level with a low probability of producing the most superficial type of cracking will cost industry untold millions of dollars. What is the alternative? Damage of this description, if it occurs could be handled through insurance adjustment.





**Figure 10.19** Alternative Blasting Level Criteria Source: RI 8507, U.S. Bureau of Mines

An important consideration to be noted is that there probably is no lower limit beyond which damage will not occur, since there will always be structures at the point of failure due to normal environmental stresses. It is not unusual to read of a structure collapsing for no apparent reason.

In RI 8896, (1984), "Effects of Repeated Blasting on a Wood-Frame House" U.S. Bureau of Mines, it indicates that cosmetic cracks occurred during construction of a test house and also during periods when no blasts were detonated. It was further noticed that human activity, temperature, and humidity changes caused strains equivalent to ground particle velocity of 1.2 in/s to 3.0 in/sec.

### **10.5.3 THE OFFICE OF SURFACE MINING REGULATIONS**

The Office of Surface Mining, in preparing its regulations, modified the Bureau of Mines proposed criteria based on counter proposals that it received and came up with a less stringent standard similar to the Bureau of Mines alternative safe blasting criteria. Recognizing a frequency dependence for vibration associated with distance, the Office of Surface Mining Presented its regulation as follows:

**TABLE 10.6 OFFICE OF SURFACE MINING, REQUIRED GROUND VIBRATION LIMITS**

<b>DISTANCE FROM THE BLASTING SITE (ft)</b>	<b>MAXIMUM ALLOWABLE PEAK PARTICLE VELOCITY (in/s)</b>	<b>SCALED DISTANCE FACTOR TO BE APPLIED WITHOUT SEISMIC MONITORING</b>
0 to 300	1.25	50
301 to 5000	1.00	55
5001 and beyond	0.75	65

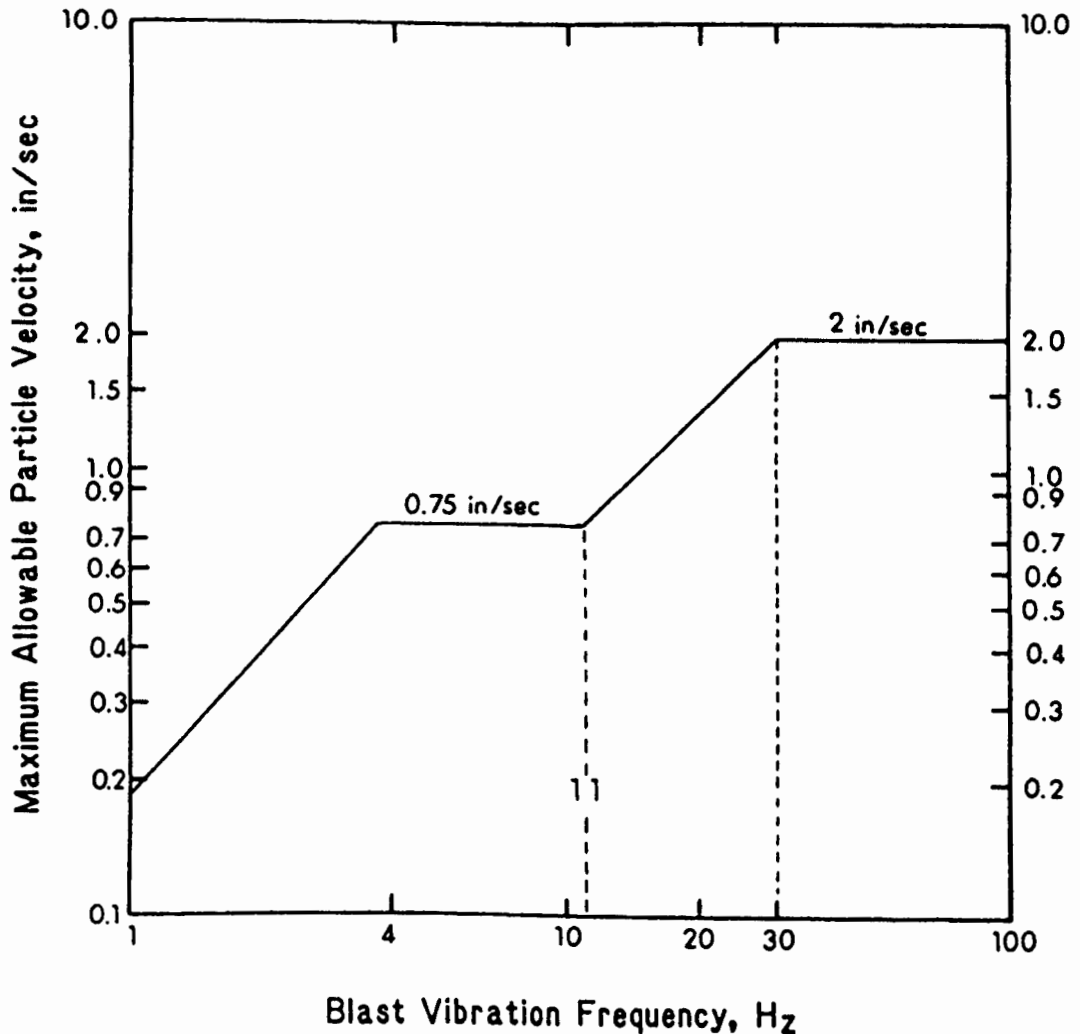
This table combines the effects of distance and frequency. At short distances, high frequency vibration predominates. At larger distances, the high frequency vibration has attenuated or died out and low frequency vibration predominates. Buildings have low frequency response characteristics and will resonate and may sustain damage. Therefore, at large distances a lower peak particle velocity, 0.75 in/s, and a larger scaled distance,  $D_s = 65$ , are mandated. At the shorter distances, a higher peak particle velocity, 1.25 in/s, and a smaller scaled distance,  $D_s = 50$ , are permitted.

The displacement and velocity values and the frequency ranges over which each applies as specified by the Office of Surface Mining are shown in Figure 10.20.

**10.5.4 CHARACTERISTIC VIBRATION FREQUENCIES**

The Bureau of Mines in RI 8507 distinguished frequencies associated with coal mine blasting, quarry blasting and construction blasting. Coal mine blasting produced the lowest frequencies, quarry blasting was next followed by construction blasting which produced the highest frequencies. This is shown graphically in Figure 10.21.

Although these frequencies are labeled as coal mine, quarry and construction the differences are due to shot size, distance, and rock properties which are characteristic of the operation. Distance is probably the most important factor since low frequency vibration will appear on any blast record if the distance is large enough. High frequency vibration attenuates rapidly because it requires much more energy than low frequency, the energy required varying as the square of the frequency. Thus, low frequency energy propagates to large distances.



**Figure 10.20** OSM Alternative Blasting Level Criteria (Modified from Figure B 1, RI 8507 U.S. Bureau of Mines)

### 10.5.5 SPECTRAL ANALYSIS

Spectral analysis is a method for analyzing the frequency content of a vibration record. The record of the ground motion is referred to as a time-domain record. This time-domain record is digitized, usually at one millisecond intervals, after which the digitized data are subjected to a computer performed Fourier Analysis of the blast. The data is now said to be in the frequency domain. It shows the vibration levels associated with each frequency.

Figure 10.22 shows a vibration record in the time-domain and the resulting frequency domain plot after Fourier analysis. This is taken from RI 8168, Siskind, et al, 1976.

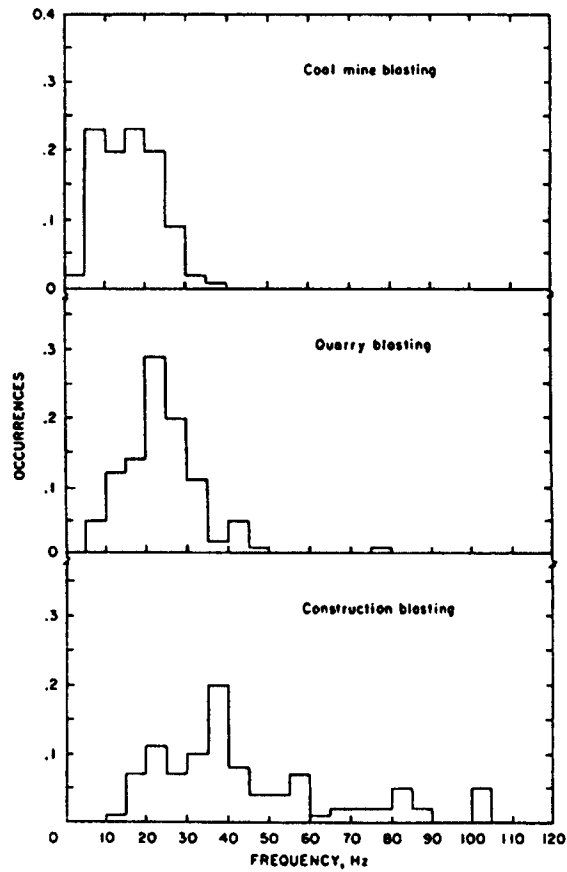


Figure 10.21 Frequencies From Coal Mine, Quarry And Construction Blasting (RI 8507)

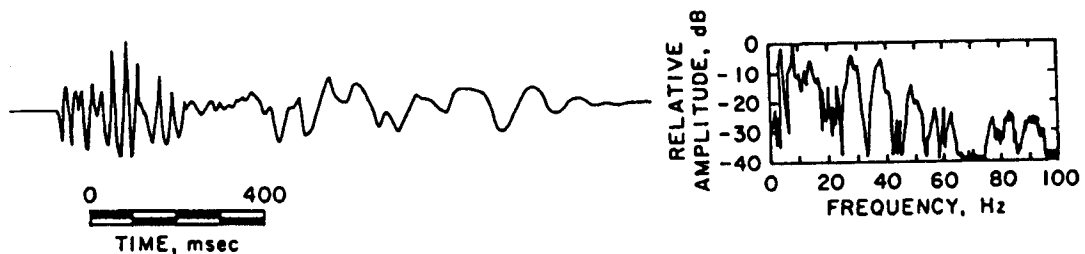


Figure 10.22 Spectral Analysis (RI 8169)

### 10.5.6 RESPONSE SPECTRA

Response spectra is a methodology in which the response of the structure to a given vibration can be estimated mathematically. Different kinds of blasting generate different frequency spectra. For example, quarry and construction blasting generate higher frequencies than mining blasts. A given structure will respond differently to each of these different frequency generating blasts. Structures also differ, so that two structures may respond differently to the same blast.

A structure is considered as a damped oscillator, with a specific frequency of vibration. The equation of motion of this damped oscillator is programmed into a computer. The digitized data from a blast record is then fed into the computer (impressed on the structure) which calculates the structural response or displacement for each piece of digitized data. The maximum displacement that occurs and the assumed frequency constitute one point (frequency, displacement) of the response-spectra curve.

The process is repeated for additional frequencies and each frequency with its maximum displacement is an additional point for the response spectra curve. When all the frequencies and their maximum displacements have been plotted and the points joined together, the result is the response-spectra curve. This response-spectra curve is a relative displacement curve. It can be converted to a relative velocity response spectra by multiplying by  $2 \pi f$ .

Response spectrum analysis is important because one can estimate the response of a structure to various impressed frequencies, thus anticipating, and hopefully eliminating problems before they arise.

#### **10.5.7 LONG TERM VIBRATION AND FATIGUE**

Blasting vibration is a short term phenomenon. The question of repeated blasting effects arises regularly as a point of concern. These could be included with the effects from pile driving and recurring industrial operations. Generally, the effects are relatively low level vibrations, which individually fall below recommended levels of safe vibration and are not considered as potentially damaging.

There is not much information available on this topic, which is generally not regarded as an important problem. Obviously, if it were a significant problem, there would be many damage claims and a general awareness.

One investigation by Walter, 1967, used impact vibration continuously generated in a structure for approximately thirteen months, twenty-four hours a day. The structure was an ordinary room approximately 8 x 8 x 8 feet of dry wall construction. The vibrator was mounted on the ceiling, generating motion that was transmitted throughout the structure and surrounding area.

The natural frequency of the wall panels was 12.5 Hz and the ceiling panel was 60 Hz. Vibration frequencies measured in the wall panels ranged from 10 to 18 Hz. with particle velocity ranging from 0.05 to 0.16 in/s.

The total time of vibration was of the order of thirty million seconds. No noticeable effects resulted from this extended vibration. It was concluded that low level vibration even in the natural frequency response range of the structure has practically zero potential for causing damage.

The U. S. Army Corp. of Engineers, Civil Engineering Research Laboratory, CERL, conducted a fatigue test for the U.S. Bureau of Mines using a biaxial shake table on which was mounted a typical residential room, 8 x 8 x 8 feet. The shake table was programmed with one horizontal component and the vertical component of a quarry blast from Bulletin 656 whose predominant frequencies were 26 and 30 Hz respectively.

Vibration test levels were 0.1, 0.5, 1.0, 2.0, 4.0, 8.0, and 16.0 in/s. Each was run a series of times starting with 1 run, then 5 runs, then 10, 50, 100, and 500 runs with inspection after each series. No damage occurred until the sixth run at 4.0 in/s. This sixth run was preceded by 2669 prior runs with no damage. In fact, there were 666 runs at 2.0 in/s and 5 at 4.0 in/s. with no damage. It is significant to note that when damage occurred it occurred at a particle velocity in excess of 2.0 in/s.

Koerner tested 1/10 scale block masonry walls at resonant frequencies. Failure was observed after approximately 10,000 cycles at particle velocities of 1.2 to 2.0 in/s. Later tests on 1/4 scale block walls showed cracking after 60,000 to 400,000 cycles at particle velocities 1.69 to 1.95 in/s.

These studies show that fatigue effects such as cracking may occur at vibration levels that are relatively high.

#### 10.5.8 VIBRATION EFFECTS

Cracks produced in structures by natural earthquakes, which are low intensity effects, have a characteristic pattern called the X - crack or vibration crack. These cracks result from the fact that the top of a structure, due to its inertia, lags behind. The structure is deformed from a regular rectangular shape into a parallelogram, with one of its diagonals elongated and the other compressed. If the elongation exceeds the strength of the material, it will fail producing a tension crack. As the earth vibration reverses, the same thing will occur in reverse, with the opposite diagonals being elongated and compressed with the possible formation of another tension crack. When both cracks occur they form an X - crack pattern. Figure 10.23 illustrates the process. If it occurs, the X - crack pattern is most likely to be associated with large blasts.

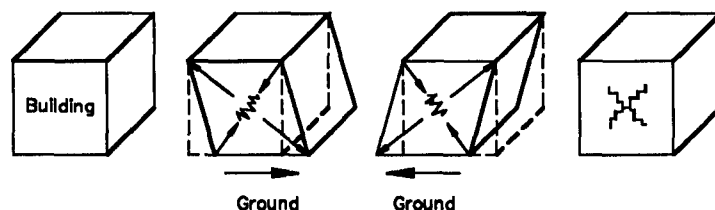


Figure 10.23 Vibration X - Crack Pattern

### **10.5.8.1 DIRECTIONAL VIBRATIONAL EFFECTS**

The energy which moves out from the source of the blast, measured in terms of ground vibration and peak particle velocity, moves out in all directions from the source. If the ground would transmit vibration in the same manner in all directions and if all other factors remain constant, then theoretically at the same distance in any direction from a blast, the vibration levels would be equal. Unfortunately, on true job conditions, vibration transmission is not ideal and because of changes in the earth structure, vibration is transferred differently in different directions. The geologic structure, joints and faults, will change vibration levels and frequency in different directions of the source. Other factors dealing with blasting pattern design can also contribute to these directional vibration effects.

In the past, it was common practice to monitor behind the blast at the nearest structure since it was assumed that in this direction vibration levels would be greatest. Recommendations for monitoring practice have changed and research has shown that the highest vibration levels are commonly, not behind the shot, but to the sides of the blast. In particular, vibration levels are commonly highest in the direction towards which the delays are progressing. For example, if a blast is fired with the first hole on the left hand side of the pattern and the delays are progressing toward the right hand side of the pattern, then in the direction toward the right hand side of the pattern one would commonly find the highest vibration levels.

In order to calibrate the ground and determine site specific transmission characteristics, it is recommended that at least two seismographs be used when blasting in close proximity to structures. One seismograph placed on the end of the shot and one at 90 degrees. For example, behind the blast. After test shooting is completed and the transmission characteristics are known, the second seismograph may be unnecessary since the ground has already been calibrated and vibration levels in one direction can be related to vibration levels in the other direction.

### **10.5.8.2 FREQUENCY WAVE LENGTH EFFECTS**

When a line of increased motion occurs, what are its dimensions and how large an area is affected? It will cover a space of the order of one to two wave lengths. Wave length is defined as propagation velocity multiplied by the wave period (Eq. 10.2).

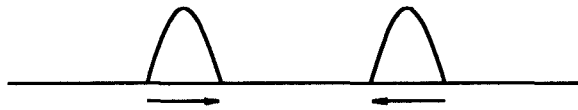
$$L = V T$$

where:

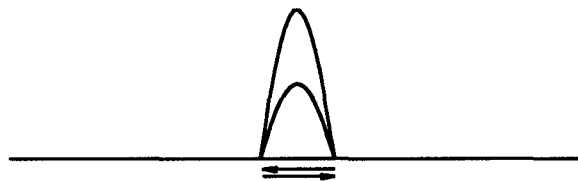
$$\begin{aligned} L &= \text{Wave length (ft)} \\ V &= \text{Propagation velocity (ft/s)} \\ T &= \text{Wave period (s)} \end{aligned}$$

For a wave of period 1/10 sec and propagation velocity 2,000 ft/s, the wave length is 200 feet.

Assuming the waves are approximately the same (Fig. 10.24), at maximum coincidence the motion would be doubled but the wave length will be that of either wave since they are the same (Figure 10.25).



**Figure 10.24** Converging Equal Wavelets



**Figure 10.25** Composite Wave Motion at Maximum Coincidence

This form will be repeated after the maximum has occurred when the waves pass complete coincidence and begin to separate each into its own distinct form. Thus, there is a periodicity whose wave length approaches the sum of the two wave lengths. Also, the wave length of the composite motion varies from a single wave length to approximately double the single wave length. The converging and diverging wavelets are shown in Figure 10.26 and the resulting composite motion is shown in Figure 10.27.

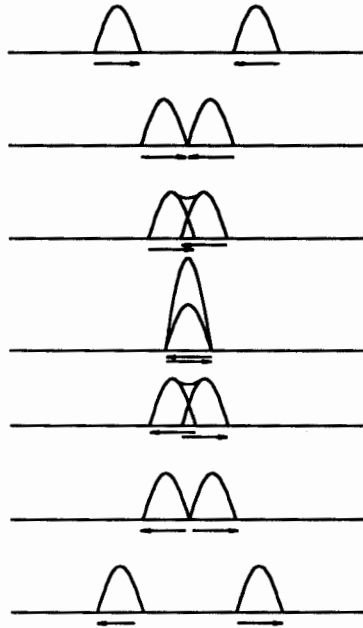
The wave period and the frequency are both effected. At the point of maximum coincidence the period and frequency are those of the single wave. Since the period may approach double that of a single wave, the frequency will be cut approximately in half.

The significant points here are that they can exist.

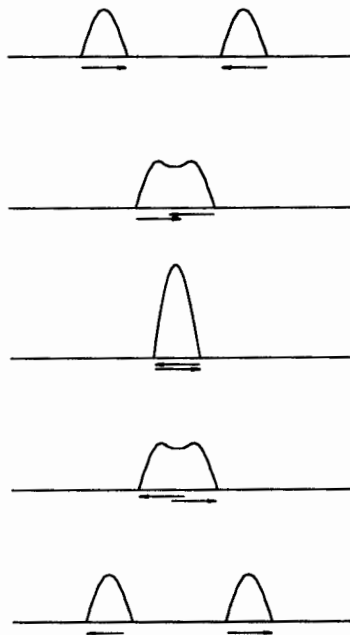
1. A region of increased seismic motion and hence increased peak particle velocity with maximum at the center, minimum at the edges of the resultant combined waves.
2. The region in which this occurs, the order of two wave lengths wide approximately 400 to 800 feet depending on propagation velocity and wave period.



3. Wave periods will be increased to approximately double with a corresponding lowering of the frequency to half.
4. A region of high-seismic risk because of the increased motion and reduced frequency of vibration.



**Figure 10.26** Converging and Diverging Wave Interaction



**Figure 10.27** Composite Motion

### **10.5.8.3 NON-DAMAGE EFFECTS**

Damage producing vibration seldom occurs, but many other effects occur that are disconcerting and alarming to persons who feel and hear the vibration. Some of these effects are:

- Walls and floors vibrate and make noise.
- Pipes and duct work may rattle.
- Loose objects, plates, etc., may rattle.
- Objects may slide over a table or shelf, and may fall off.
- Chandeliers and hanging objects may swing.
- Water may ripple and oscillate.
- Noise inside a structure is greatly amplified over noise outside.
- Vibration is very disturbing to occupants.

### **10.5.8.4 CAUSES FOR CRACKS OTHER THAN BLASTING**

Cracking is a normal occurrence in the walls and ceilings of structures, and the causes are multiple, ranging from poor construction to normal environmental stress, such as thermal stresses, wind, etc. The Small Home, published by the Architects Small House Service Bureau of the United States, Inc. 1925, gave a list of reasons for the development of cracks, which included the following:

- Building a house on a hill.
- Failure to make the footings wide enough.
- Failure to carry the footings below the frost line.
- Width of footings not made proportional to the loads they carry.
- The posts in the basement not provided with separate footings.
- Failure to provide a base raised above the basement floor line for the setting of wooden posts.
- Not enough cement used in the concrete.
- Dirty sand or gravel used in the concrete.
- Failure to protect beams and sills from rotting through dampness.
- Setting floor joists one end on masonry and the other end on wood.
- Wooden beams used to support masonry over openings.
- Mortar, plaster, or concrete work allowed to freeze before setting.
- Braces omitted in wooden walls.
- Sheathing omitted in wooden walls (excepting in "back-plastered" construction).
- Drainage water from roof not carried away from foundations.
- Floor joists not bridged.
- Supporting posts too small.
- Cross beams too light.
- Sub-flooring omitted.
- Wooden walls not framed so as to equalize shrinkage.

- Poor materials used in plaster.
- Plaster applied too thin.
- Lath placed to close together.
- Lath run behind studs at corners.
- Metal reinforcement omitted in plaster at corners.
- Metal lath omitted where wooden walls join masonry.
- Metal lath omitted on wide expanses of ceiling.
- Plaster applied directly on masonry at chimney stack.
- Plaster applied on lath that are too dry.
- Too much cement in the stucco.
- Stucco not kept wet until set.
- Subsoil drainage not carried away from walls.
- First coat of plaster not properly keyed to backing.
- Floor joists placed too far apart.
- Wood beams spanned too long between posts.
- Failure to use double joists under unsupported partitions.
- Too few nails used.
- Rafters too light or too far apart.
- Failure to erect trusses over wide wooden openings.

\* Published in Monthly Service Bulletin 44 of the Architects' Small House Service Bureau of the United States, Inc.

#### **10.5.9 BLAST DESIGN ADJUSTMENT TO REDUCE VIBRATION LEVELS**

When vibration levels are too high and it becomes desirable and even necessary to reduce them, there are a number of options.

##### **10.5.9.1 CHARGE REDUCTION**

The maximum charge per delay may be reduced by decreasing the number of holes per delay. If the number of holes per delay cannot be reduced then it may be possible to deck load and fire each hole with two or more delays.

##### **10.5.9.2 BLAST DESIGN**

The vibration level can be reduced by redesigning the blast so that less energy per hole is necessary to fragment the rock. This may require changing the hole spacing, the burden and even the hole size. A change in explosive may be helpful also. This requires going back to square one and starting over. This is an extreme circumstance and not likely to be necessary.

### **10.5.9.3 BLASTING STANDARD FOR NON RESIDENTIAL STRUCTURES**

Vibration standards can be divided into two other groups in addition to the normal building standards, high level vibration structures and low level vibration sensitive components.

### **10.5.9.4 BLASTING NEAR CONCRETE STRUCTURES**

On many demolition projects, old concrete is near the blasting operation. In fact, it is not uncommon to blast away part of a structure, leaving the other structure intact. This is a common procedure when locks along rivers need to be refurbished. When locks become eroded due to the water and the environmental conditions, approximately two feet of old concrete is blasted away and new concrete is poured in its place. It is obvious that the concrete which remains from the original structure has been subjected to very high peak particle velocity. Oriard measured values of strain and peak particle velocity which produced various types of failure in concrete. His results are given in Table 10.7.

**TABLE 10.7 FAILURE IN CONCRETE DUE TO VIBRATION**

<b>TYPE</b>	<b>STRAIN (<math>\mu\text{in/in}</math>)</b>	<b>PPV (in/s)</b>
Static	140	20
Grout Spall	700	100
Skin Spall	1300	200
Cracking	2400	375

### **10.5.9.5 GREEN CONCRETE**

Concrete and bridges fall into the high level vibration structures. Green concrete, however, is not in this group. Different types of concrete exist. Therefore, general conservative guidelines for concrete may be given. Since concrete acquires about one third its strength in 72 hours, after this time a peak particle velocity of 1.0 in/s is a reasonable maximum until the concrete reaches full strength at 28 days. Before 72 hours it is not advisable to blast.

### **10.5.9.6 BLASTING NEAR GREEN CONCRETE**

It is not uncommon to have blasting operations in one section of a project and the pouring of concrete in another. Contractors do have concern as to what effect the blasting vibration have on the integrity of the new structure being poured. Some guidelines for peak particle velocities related to time after pouring are given in Table 10.8.

**TABLE 10.8 VIBRATION LEVELS FOR GREEN CONCRETE**

<b>TIME AFTER POUR (HOURS)</b>	<b>PPV (in/s)</b>
0 - 4 Hours	2.00
4 - 24 Hours	0.25
1 - 3 Days	1.00
3 - 7 Days	2.00
7 - 10 Days	5.00'
> 10 Days	10.00

**10.5.9.7 BRIDGES**

Bridges present a variety of sizes, types, construction, age, etc. A steel structure and reinforced concrete structure would minimally be covered by 2.0 in/s and might go to 5.0 in/s.

**10.5.9.8 BURIED PIPELINES**

Buried pipelines such as gas and oil transmission lines are normally fabricated of steel which has a much greater strength than the rock or soil in which it is buried. The primary consideration is that the pipe should be in the elastic zone and never in the fracture zone. This can be accomplished by employing a stand off distance from the blasthole equal to 3 to 5 times the hole spacing. If the hole spacing is 6 foot then the stand off distance is 18 to 30 feet.

**10.5.9.9 COMPUTERS AND HOSPITALS**

Computers and hospitals fall into the low level sensitive category. It is usually not the hospital structure that is of concern but instrumentation employed therein. It is usually not possible to get vibration specifications for the delicate instrumentation used in the hospital. A practical procedure is to measure the ambient background vibration in the sensitive areas of the hospital and compare this with a test shot.

**10.5.9.10 COMPUTER SPECIFICATIONS**

Computer specifications are usually frequency dependent changing with the frequency range. One computer manufacturer has the following specifications.

**TABLE 10.9 FLOOR VIBRATION**

<b>FREQUENCY Hz</b>	<b>DOUBLE AMPLITUDE</b>	<b>ACCELERATION</b>
5-25	0.001 in / 0.0254 mm	
25-100	0.0005 in / 0.0127 mm	
100-300		0.25 g / 2.45 m/s <sup>2</sup>

## **10.6 SENSITIVITY TO VIBRATION**

Human beings are remarkably sensitive to vibration. If this were not so, the vibration problem would scarcely exist. The explosives technology of today insures that most operations are conducted in a safe manner. In relatively few cases is there a significant probability of damage.

Since vibration is felt in practically all cases, the reaction to this sensation is one of curiosity, concern, and even fear. Hence, it is important to understand something about human response to vibration which depends on vibration levels, frequency and duration. In addition to these physical factors, it is important to keep in mind that human response is a highly subjective phenomenon.

Human response has been investigated by many researchers. One of the early investigations was by Reiher and Meister, Berlin, 1931. Other investigations were made by Goldman, 1948, and Wiss and Parmelee, 1974. A composite of these investigators' results was presented graphically in the U. S. Bureau of Mines RI 8507, Siskind, et al, 1980. This composite is represented here in Figure 10.28.

The human response curves are all similar and highly subjective in that the response is a mixture of physiological and psychological factors individual to each person. Based on these curves, a very simple and practical set of human responses can be designated as follows:

**TABLE 10.10 HUMAN RESPONSE**

<b>RESPONSE</b>	<b>PARTICLE VELOCITY</b>	<b>DISPLACEMENT AT 10 Hz</b>	<b>DISPLACEMENT AT 40 Hz</b>
Noticeable	0.02 in/s	0.00032 in	0.00008 in
Troublesome	0.2 in/s	0.0032 in	0.0008 in
Severe	0.7 in/s	0.011 in	0.0028 in

Vibration is a fact of daily life which one regularly experiences but is seldom aware of. This type of vibration has been designated cultural vibration. Generally, it elicits no reaction from the person affected.

Other vibration that contrasts sharply, because it is not part of the daily experience but is unusual, has been designated acultural. It surprises a person, is disturbing, and causes an acute awareness.

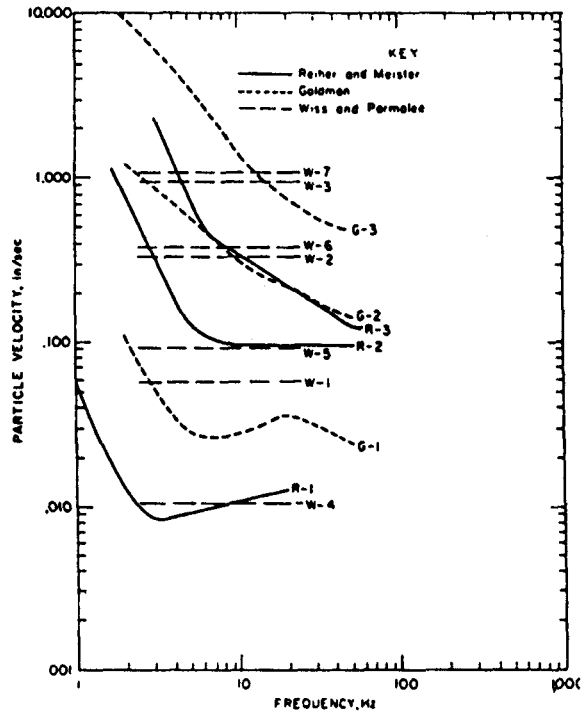


Figure 10.28 Human Response To Vibration (RI 8507)

Some example of cultural and acultural vibration are listed in the following:

**CULTURAL VIBRATION**

- Automobile
- Commuter Train
- Household
- Industrial Plant or Office
- Airplane

Common Denominator:  
No reaction

**ACULTURAL VIBRATION**

- Blasting
- Pile Driving
- Impact Machinery
- Jack Hammer
- Forging Hammers

Common Denominator:  
Persons react because these vibrations  
are unfamiliar, disturbing

Blasting is definitely acultural for the average person. The annoyance and fear associated with it begin at levels much lower than the damage level for structures.

## 10.7 AIR BLAST MONITORING AND CONTROL

### 10.7.1 AIR BLAST

Air blast is an atmospheric pressure wave transmitted from the blast outward into the surrounding area. This pressure wave consists of audible sound that can be heard, and concussion or subaudible sound which cannot be heard. If the pressure of this wave, termed overpressure, is sufficient it can cause damage. Generally air blast is an annoyance problem which does not cause damage but causes unpleasantness between the operator and those affected.

Air blast is generated by the explosive gases being vented to the atmosphere as the rock ruptures, by stemming blow out, by displacement of the rock face, by displacement around the borehole and by ground vibration. Various combinations of these may exist for any given blast.

### 10.7.2 OVERPRESSURE AND DECIBELS

Air blast overpressure is most commonly measured in decibel (dB). It is also measured in pounds per square inch (psi) The decibel is defined in terms of the overpressure by the equation:

$$dB = 20 \log \frac{P}{P_0} \quad (10.13)$$

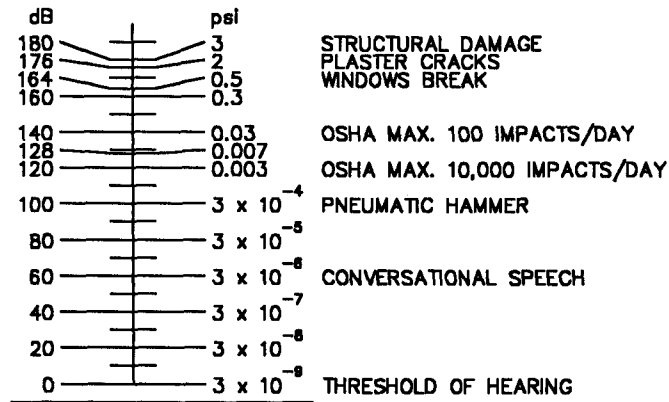
where:

- dB = Sound levels in decibels (dB)
- P = Overpressure in psi (lbs/in<sup>2</sup>)
- P<sub>0</sub> = Overpressure of the lowest sound that can be heard
- P<sub>0</sub> =  $2.9 \times 10^{-9} = 3 \times 10^{-9}$  psi (lbs/in<sup>2</sup>)

Some typical sound levels with values in both dB and psi are shown in Figure 10.29.

Sound levels are measured on different weighting networks designated A, B, C, and Linear. These differ essentially in the ability to measure low frequency sound. The A-network corresponds most closely to the human ear and discriminates severely against the low frequencies. The B-network discriminates moderately and the C-network only slightly while the Linear network measures all frequencies.





**Figure 10.29** Typical Sound Levels

Sound levels are measured on different weighting networks designated A, B, C, and Linear. These differ essentially in the ability to measure low frequency sound. The A-network corresponds most closely to the human ear and discriminates severely against the low frequencies. The B-network discriminates moderately and the C-network only slightly while the Linear network measures all frequencies.

Sound produced by a blast is primarily low frequency energy and sound measuring devices should have a low frequency response capability to accurately represent the sound levels. A C-weighted network, or preferably a linear-peak, should be used.

Spectral analysis of blast sounds was done by Siskind and Summers, 1974, which clearly showed the very low subaudible frequencies.

### 10.7.3 GLASS BREAKAGE

Extensive tests were conducted by the U. S. Bureau of Mines and reported in Bulletin 656 to determine the sound levels likely to cause glass breakage, and the scaling law that would apply. Glass breakage occurs at much lower levels of overpressure that structural damage, such as cracking plaster. The absence of glass breakage precludes structural damage. Air blast regulation is keyed to glass breakage.

Bulletin 656 proposed an overpressure of 0.5 psi (164 dB) as a safe level for prevention of glass breakage and indicated that blasting which generated ground vibration below 2 in/s automatically limited air overpressures to safe levels, that is, less than 0.5 psi (164 dB).

Siskind and Summers, Bureau of Mines TPS 78 (1974), proposed safe levels for preventing glass breakage. These levels also helped reduce annoyance. These values are shown in the following table.

**TABLE 10.11 SOUND LEVEL LIMITS**

	LINEAR PEAK		C-PEAK OR C-FAST	A-PEAK OR A-FAST
	dB	psi	dB	dB
Safe	128	0.007	120	95
Caution	128	0.007	120	95
	to 136	to 0.018	to 130	to 115
Limit	136	0.018	130	115
	<u>Recommended</u>		<u>Not Recommended</u>	

**10.7.4 SCALED DISTANCE FOR AIR BLAST**

Air blast is scaled according to the cube root of the charge weight, that is:

$$K = \frac{d}{\sqrt[3]{W}} \tag{10.14}$$

where:

- d = Distance (ft)
- W = Maximum charge weight per delay (lbs)
- K = Scaled distance value for air overpressure

Recall that vibration is scaled according to the square root of the charge.

$$D_s = \frac{d}{\sqrt{W}}$$

Taking the safe overpressure of 0.007 psi, suggested by Siskind and Summers, and interpolating the air blast scaled distance diagram of Bulletin 656 for this value gives an approximate value for K = 180, or:

$$180 = \frac{d}{\sqrt[3]{W}} \tag{10.15}$$

This is quite conservative, since it is based on the conservative safe limit value, 0.007 psi. It is derived from quarry blast data and may not apply to other kinds of operations.

## **10.7.5 REGIONS OF POTENTIAL DAMAGE FOR AIR BLAST**

There are two distinct regions of potential air blast damage which are quite different. They are referred to as Near Field and Far Field.

### **10.7.5.1 NEAR FIELD**

This is the region surrounding the blast site to which there is direct transmission of the pressure pulse. The potential for damage in the near field is small and readily minimized by proper planning. This requires attention to the details of spacing, burden, stemming, explosive charge, delays, covering of detonating cord trunklines and use of cord with minimal core load. Proper execution of these tasks insures a very low probability of glass breakage.

### **10.7.5.2 FAR FIELD AND AIR BLAST FOCUSING**

This represents the region far from the blast site (i.e., 4 to 20 miles) where direct transmission cannot account for the effects produced. It represents a focusing or concentration of sound waves in a narrow region. These waves have traveled up into the atmosphere and have been refracted back to the earth, producing an intense overpressure in a narrow focal region.

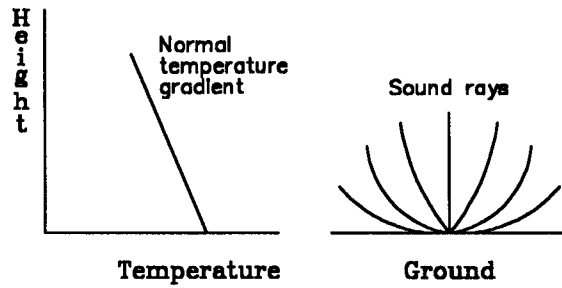
The cause of air blast focusing is the presence of an atmospheric inversion. The more severe the inversion, the more intense the focusing may be. Wind can also be a significant factor adding to the inversion effect.

### **10.7.5.3 ATMOSPHERIC INVERSION**

An atmospheric inversion is an abnormal, but not uncommon phenomenon. Normally temperature decreases with height in the atmosphere, cooling at the normal lapse rate of 3.5 °F for each 1,000 feet of height. For example, assume a surface air temperature of 70°F, then under normal lapse rate conditions, the air temperature at 4,000 feet would be:

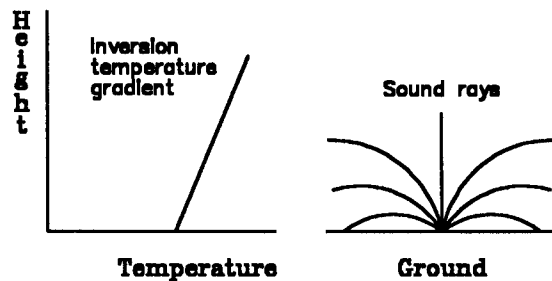
$$70 - 4(3.5) = 56$$

The velocity of sound in air is temperature dependent, increasing as temperature rises and gets warmer or decreasing as temperature falls and gets colder. The change is approximately 1 ft/sec for a temperature change of 1°F. Under normal atmospheric conditions, the air temperature decreases with height so the velocity of sound decreases, causing the sound waves to curve upward away from the ground. The sound is absorbed in the atmosphere. This effect is illustrated in Figure 10.30.



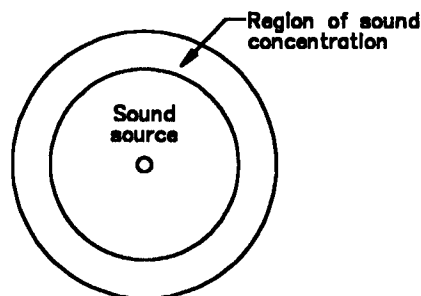
**Figure 10.30** Normal Atmospheric Conditions

In an atmospheric inversion, the air temperature increases with height, so the velocity of sound increased, causing the sound waves to curve downward toward the ground. Thus, the sound may return to the earth, but at some distance from its point or origin. Figure 10.31 illustrates the inversion condition and the curving downward of the sound rays in the atmosphere.



**Figure 10.31** Atmospheric Inversion

When the sound returns to the earth as just described, it may under appropriate conditions concentrate or focus in a narrow region and produce much higher sound levels than in adjacent regions on either side. This effect is shown in Figure 10.32.



**Figure 10.32** Sound Focusing-Inversion Effect

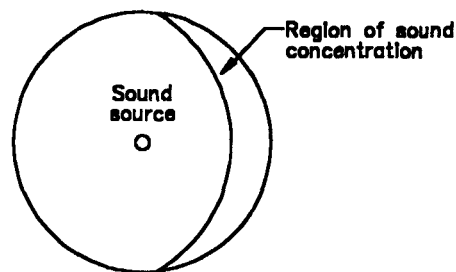
#### **10.7.5.4 WIND EFFECT**

Wind may contribute significantly to causing air blast focusing. On the downwind side, the wind will add to the velocity effect produced by the inversion and increase the sound velocity. On the upwind side, the wind will oppose the velocity effect and decrease the sound velocity. If the wind is strong enough, the sound may be completely blown away from the upwind side. Figure 10.33 shows the wind effect.



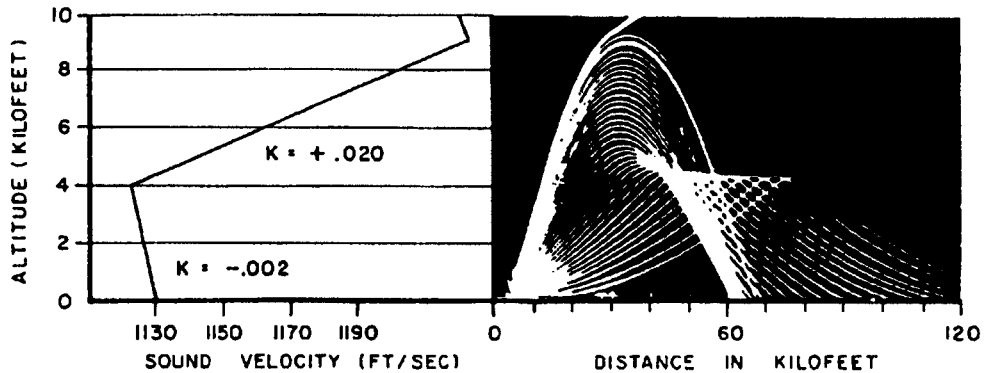
**Figure 10.33** Wind Effect

The focal region previously shown as a circular region with sound source at the center may be reduced to a crescent shape by the wind effect, resulting in a higher sound intensity in the focal region. This is shown in Figure 10.34.



**Figure 10.34** Air Blast Focusing Plus Wind Effect

Air blast focusing is produced by the combination of an atmospheric temperature inversion and wind. The effect varies with height and must be evaluated at successive elevation (approximately every 1,000 feet). This requires meteorological data and a sophisticated computer program to process it. This is not feasible for normal day to day operations. A diagram of intense air blast focusing is shown in Figure 10.35.



**Figure 10.35** Air Blast Focusing

#### **10.7.5.5 PROCEDURES TO AVOID AIR BLAST FOCUSING**

1. Do not shoot if there is an atmospheric inversion.
2. Contact the local weather bureau to find out if there is an inversion.
3. Radiation inversions commonly exist in the mornings, but normally disappear by noon. Hold the shot until the inversion has been dissipated. Frontal and air mass inversions tend to persist and do not go away.
4. Obtain wind information from the Weather Bureau. If the downwind direction is a populated sensitive area, avoid shooting, if it is unpopulated or industrial shooting may be feasible.

### **10.8 PREBLAST SURVEYS**

#### **10.8.1 PREBLAST INSPECTIONS**

Preblast inspections are being mandated more and more by various regulatory agencies, insurance companies and concerned operators.

#### **10.8.2 PURPOSE**

The purpose of a preblast inspection is to document the condition of a structure prior to its exposure to vibration from blasting. Most structures have cracks in various areas which for the most part are not known or only sparsely known to the structures occupants.

The documentation is useful in a number of ways. First the occupant becomes educated to the fact that there are cracks, the usual reaction is one of surprise. Secondly, the documentation can be used to verify or refute claims of damage resulting from vibration. Since this is so, the preblast inspection must be done carefully and thoroughly.

Cracks in a structure are not static but are dynamic in nature changing from season to season and are affected by a series of factors such as temperature, humidity, wind, soil conditions and overall structural integrity. Assuming reasonably stable soil conditions and structural integrity the diurnal temperature changes produce thermal stresses that may cause cracks to grow in length and width. Similarly the larger seasonal temperature changes, from summer to winter and back, produce significant thermal stresses. In addition, the winter heating season normally causes a drying out of the structure resulting in shrinkage. The process is reversed with spring and summer, when the humidity rises and the structure absorbs moisture and expands.

In general, environmental stresses cause cracks to occur in practically all structures. When blasting vibration occurs, the affected persons examine the premises for possible damage and find the prior existing environmentally produced cracks. The conclusion is automatic, the blasting cause the cracks, when in fact it did not.

### **10.8.3 INSPECTION PROCEDURE**

The inspection procedure should begin with the name of the project, the principal involved, address, date and time. This should be followed by a description of the structure, 1 floor, 2 floors, frames, painted or masonry construction, porches, foundations. Gutters and downspouts and drainage should be noted. Any low unusual ground and soil conditions should be noted (i.e. lot has a 1 in 3 slope, slope failure, retaining wall inclined due to soil pressure, drainage problems, pooling of water.)

The interior inspection should be a room by room process with each room designated and described (i.e. living room with plaster walls that are covered with wall paper, plastered and painted ceiling with plastered cove and wood molding juncture of cove and wall paper).

Walls should be numbered in a clockwise fashion 1,2,3,4 (there may be more than 4 walls, if so state it and continue numbering) beginning with the wall to the left of the door by which you entered. Each wall is then inspected, noting the number of windows, doors, wall corners and ceiling corners. Separation of dry wall joints or crazed plaster are to be noted. Window, floor and ceiling moldings should be checked for openings in mitered joints, straight joints and for separations from wall, floor or ceiling. Glass panes should be examined for cracks. A closet in a wall should be inspected after the wall inspection. Diagrams and sketches are helpful.

Floors should be examined for openings between boards, loose, or squeaky boards, discoloration and general wear of wood. If the floor is covered with tile examine tile for joint separations, cracked tile, holes, and general wear. If carpeted state so and indicate that the floor is not visible for inspection.

Ceilings should be examined for cracked, loose or hanging plaster, water discoloration and holes. Ceiling and floor are inspected with inspector's back to wall 1. This insures uniformly.

If a wall has no cracks, simply state wall 1 - clear.

A fireplace in a wall should be examined for separation from the wall and for cracks in the masonry and plaster.

#### **10.8.3.1 ATTIC INSPECTION**

The attic is inspected as a room or series of rooms if so divided and finished. If unfinished, attention should be given to the roof rafters and keel board for separation. Also note cross bracing and knee walls and any open spaces where day light from the outside can be seen.

#### **10.8.3.2 BASEMENT INSPECTION**

When entering the basement by stairway from the first floor, the wall opposite the stairway is wall 1. Proceed with the inspection in clockwise fashion. Examine walls for cracks in mortar joints, cracks across block or stone, holes at pipe entry, cracks at juncture with next wall. Also note any evidence of settling. Note the plates on top of the wall, are they uniformly level, etc. Note water stains and seepage.

In the floor inspection note location of floor drain, any cracked, broken areas or holes in the floor, evidence of water seepage. Also note if floor consists of sections.

Check ceiling for cross bracing between floor joists, cracked or broken joist, or rotted areas.

Check waterpipes, heat pipes, and electrical conduit for any unusual circumstances.

#### **10.8.3.3 STAIRWAY INSPECTION**

Stairway is considered as a unit going up. Describe right wall, left wall, and ceiling. Stairs consist of tread and riser which are described for cracks, marred finish, etc.



#### **10.8.4 EXTERIOR INSPECTION**

Inspection usually begins at front of house and proceeds in a clockwise direction inspecting each side in turn. State condition of masonry with regard to cracks, holes, poor mortar, shrinkage cracks, etc. If of frame construction describe condition of siding, presence of cracks, openings at juncture of siding boards, warping, paint condition, new, old, flaking, etc.

State number of windows and doors and examine frames and casing for cracks, warping, and openings.

Fireplace, furnace, or chimney, should be checked for separation from wall, cracks in masonry and joints, etc.

Porches should be checked for level and settling. Check for separation at juncture with wall. Check for cracked, separated and rotting boards.

Foundation - check for cracks, holes, settling, condition of mortar.

Gutter and downspouts - check for general condition and drainage. Does water drain onto roof, porch or side of house.

##### **10.8.4.1 GARAGE**

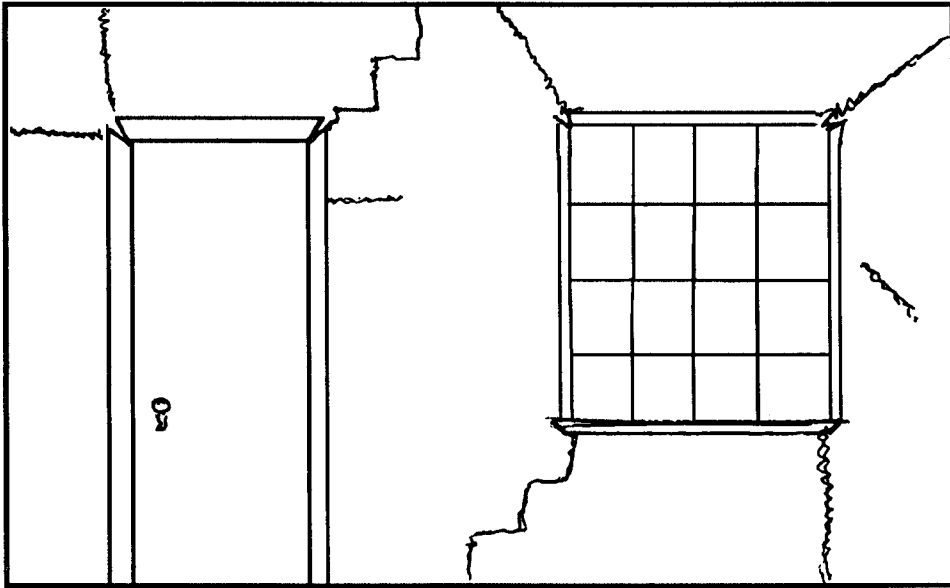
Garage should be inspected as a room.

##### **10.8.4.2 WALKS AND DRIVEWAYS**

All concrete walks, driveways, etc. should be inspected for cracks, level conditions, holes, etc.

#### **10.8.5 UNUSUAL CONDITIONS**

Photographs should be made of any unusual conditions that are more severe than ordinary. For example, suppose a fireplace chimney settled because of an inadequate foundation and caused cracks in the basement masonry, the living room wall plaster, or both.



**Figure 10.36** Sketch Of Typical Wall Crack Pattern.

#### **10.8.6 PREBLAST SURVEY REPORTS**

Thoroughness and care are important in a building inspection. Common sense based on knowledge of what to look for and where to look for it will insure an adequate inspection. The preblast survey report should be an adequate and complete description of what the inspection was able to document. It should be clearly written so that the independent examiner can readily understand what is being reported. An example form is given in Chapter 12.

### **10.9 EFFECTS OF BLASTING ON WATER WELLS AND AQUIFERS**

#### **10.9.1 AQUIFERS**

Not uncommonly when blasting occurs in a region and either waterwells or the aquifer appear to undergo a change, the blasting is cited as the cause. Under normal blasting circumstances this is only remotely possible.

An aquifer is a rock formation with sufficient porosity and permeability to allow for the storage of water and the flow of water through the system. Charging of the aquifer results from rainfall percolating into the porous rock beneath the surface. Hence, the aquifer is intimately affected by the amount of rainfall and the seasonal conditions. The top of the water surface is known as the water table.

A well is a man made opening or hole drilled from the surface down into the aquifer to some depth below the water table. The level of the water in the well is the same as the level of the water table. During dry spells the water table is lowered and wells with only a shallow penetration into aquifer may go dry. When the aquifer is recharged the well will return.

### **10.9.2 VIBRATION EFFECTS**

Although vibration has frequently been blamed for problems that occur in wells, recent investigations by the U.S. Bureau of Mines (P.R. Berger and Associates, 1982) indicate that blasting has little or no effect and that vibration below 2.0 in/s will not cause damage to a well.

Fracturing around a blasthole is limited to a radius of 20- 40 blasthole diameters. For a six inch hole this is 10-20 feet and for a large blasthole 18 inches in diameter this is 30-60 feet.

In the Bureau of Mines investigations (P.R. Berger and Associates, 1982), twenty-five wells were drilled at four sites and tested before blasting occurred and after blasting. When the blasting approached within 300 feet of a well at three of the sites the static water level (water level) dropped abruptly but was followed shortly by a significant improvement in well performance. At the fourth site, no change occurred. The time when the water level dropped indicated that it was not a direct result of the blasting.

Particle velocities in the series of tests ranged from 5.4 in/s to 0.84 in/s resultant particle velocity.

The interpretation of these effects is that the storage capacity of the aquifer may have been increased thus enabling the aquifer to hold a larger volume of water. This resulted in a drop in the water level which soon recovered and increased the well performance.

The principal effect of blasting on water wells, that are close, is that temporary turbidity may occur in the well. This turbidity condition passes quickly and is a temporary annoyance rather than a problem. Vibration levels below 2.0 in/s are not sufficient to cause damage to water wells.

### **10.9.3 OPEN CUT**

If the purpose of the blasting is to excavate an open cut then nearby wells might be affected. Several factors that would have to be considered are the depth of the open cut and the direction of the underground flow from the aquifer into the well relative to the open cut.

Under the right conditions the open cut may have an undesirable effect on wells that are close by ranging from reduced capacity to total loss of the well.

## **10.10 ASSESSMENT OF RIPPABILITY VS. BLASTING**

### **10.10.1 DEFINITION**

Rippability refers to the ability of a bulldozer with a ripper hook to rip or tear out the rock. If the rock is relatively thin layered so that the ripper can cut into the bedding planes there is a good chance that it can be ripped. Massive rock that is thick layered is difficult to rip. Strength of the rock is an important factor also.

### **10.10.2 RIPPABILITY AND SEISMIC VELOCITY**

Caterpillar Tractor has published tables of rippability based on seismic velocity and rock type. Seismic velocity or propagation velocity is the speed at which seismic waves travel through the rock. It varies from 1,000 to 20,000 ft/s and there is a lot of overlap for various rock types. For example, there are shales, sandstones, and limestones which have velocities of 9,200 ft/s. At this velocity the sandstone and the shale are marginally rippable with a D9L ripper but the limestone is non-rippable. It is necessary to know the rock type and the seismic velocity.

The rock type can be determined by test drilling the area. The seismic velocities can be determined by a shallow refraction seismic survey.

### **10.10.3 RIPPABILITY CHARTS**

Rippability charts have been prepared by Caterpillar Tractor for various size bulldozers. These charts for D-9, D-10, and D-11 bulldozers are shown in Figures 10.37, 10.38 and 10.39.

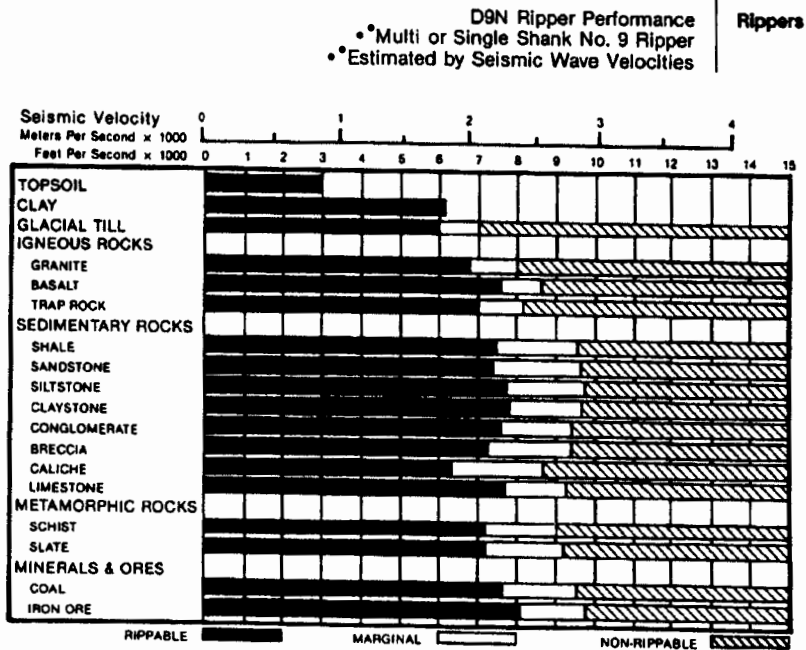


Figure 10.37 D9N Ripper Performance

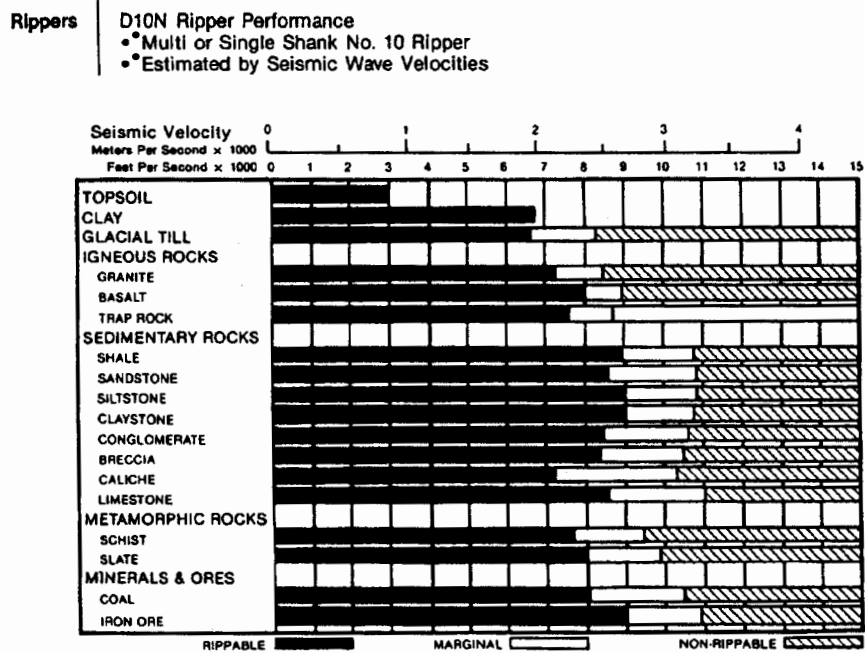


Figure 10.38 D10N Ripper Performance

**Rippers** | **D11N Ripper Performance**

- Multi or Single Shank No. 11 Ripper
- Estimated by Seismic Wave Velocities

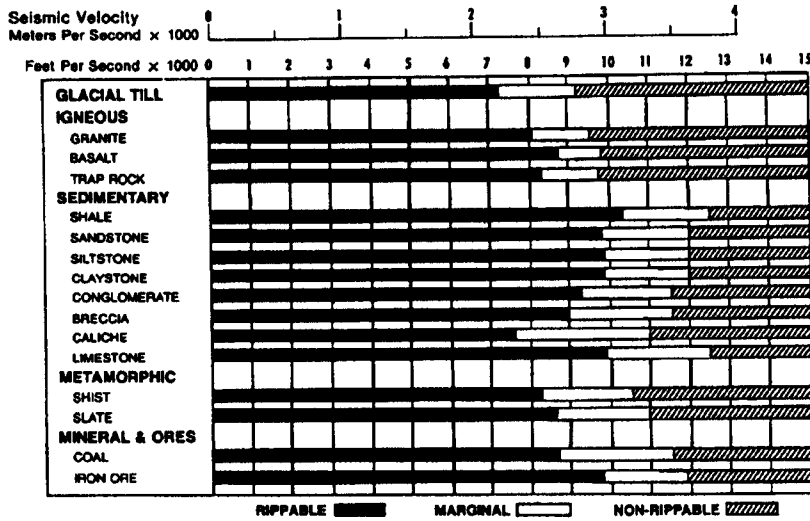


Figure 10.39 D11N Ripper Performance

**10.11 CHAPTER 10 SUMMARY**

Vibration is simply seismic waves generated by the detonation of an explosive charge. These waves are classified as body waves which travel through the rock and surface waves that travel over the surface but do not penetrate into the rock mass.

Wave parameters are the properties used to describe the wave motion such as amplitude, period, crest, trough and frequency.

Instrumentation used to measure vibration is a seismograph which consists of two parts, a sensor and a recorder. The sensor converts the ground motion energy into electrical energy.

The recorder then makes a record that is a reproduction of the ground motion. This record is used to verify that the seismograph is functioning properly.

Wave parameters are the physical quantities used to describe vibration. These are velocity, acceleration and frequency. A seismograph system measures three particular components of ground motion designated vertical, longitudinal and

calibrated

Vertical displacement mutually perpendicular transverse

A seismograph record has three lines or vibration traces, one for each component vertical, longitudinal and transverse. There may be a fourth trace for recording sound level. The maximum amplitude on each trace is measured to determine the maximum vibration level. The frequency of vibration in cycles per second can also be measured from the record.

The principal factors that determine vibration level are distance and charge weight. Formulas have been developed to show the relationship between vibration level, distance and weight of the explosive charge. This is called the propagation law.

The scaled distance concept was developed from the propagation law and is an effective means for controlling vibration.

When starting operations in a new area, the ground or area can be calibrated by plotting scaled distance vs. particle velocity.

Vibration behaves as a statistical variable and care must be taken so that the variation in vibration level does not result in exceeding prescribed vibration limits.

The first vibration standards were developed in the 1930's. Since that time, research and investigation have refined these limits to be safer and safer. Bulletin 656 of the US Bureau of Mines recommended a particle velocity of 2 in/s as a safe limit for structures which has been widely used. Recent investigation by the Bureau of Mines has suggested lowering this value. Thus, the question of a safe vibration limit is in a state of flux.

Vibration frequency varies with the kind of blasting so that construction blasting tends to generate high frequency while strip mine blasting tends to generate low frequency vibration. Low frequency tends to be more dangerous for structures which tend to vibrate in the low frequency range also.

New techniques such as spectral analysis and response spectra are used to get a better understanding of the problem. Fatigue and long term vibration do not seem to be major problems.

Typical cracks have an X shape due to tensional failure as the structure is deformed. They are most likely to be associated with large blasts if they occur at all.

People are very sensitive to vibration and can feel vibration far below the level necessary to cause damage. This produces much anxiety, concern, and complaints of damage.

Controlled tests by many investigators have documented the sensitive response of people to vibration. Rather than simplify the problem this has clearly indicated the annoyance factor which has resulted in a lowering of permissible vibration levels.

Vibration has been described as cultural and acultural. Vibration from blasting is acultural which causes complaints and strained relations.

Blasting generates an atmospheric pressure wave called air blast. At close distances where direct propagation occurs, air blast is safe for structures (mainly glass breakage) if the vibration level is maintained below 2 in/s.

At large distance (5-20 miles) air blast focusing due to an atmospheric inversion can occur. The sound energy may concentrate in a narrow region and has the potential to be one hundred times greater than normal, which may cause damage. Evaluation of this problem is difficult.

The sound levels are measured either in pressure, psi, or in decibels dB. A large part of the blast sound is concussion which is low frequency energy that is not audible. Sound measuring equipment must have a low frequency capability to measure this.

Preblast inspections are a useful tool in documenting blasting damage. Many regulatory agencies, insurance companies and concerned operators are advocating this.

If inspections are made, they must be done thoroughly and competently, with reports that are intelligible to others who must read and evaluate them.

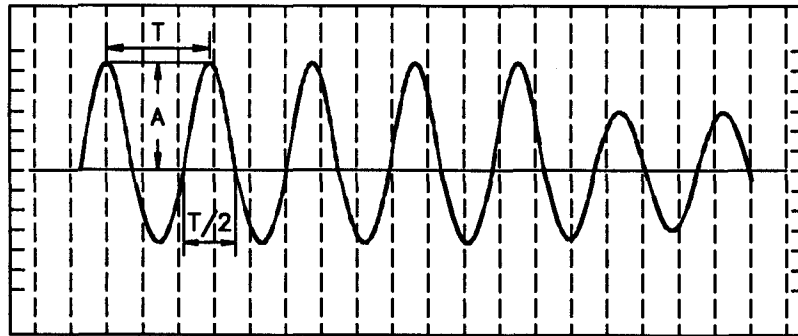
The effect of blasting vibration on water wells and aquifers has been debated for some time. Recent investigations sponsored by the U.S. Bureau of Mines indicate the vibration levels below 2 in/s are safe for wells.

A drop in the water level of a well after blasting has been interpreted to be due to an increase in water storage capacity of the aquifer. Recovery occurred soon resulting in an increase in well performance.

The rippability of a rock depends on the rock type, its strength and jointing. Rock type can be determined by test drilling. Rock strength is a function of its elasticity which determines the seismic wave velocity. Combining rock type and seismic wave velocity, the Caterpillar Tractor Company has developed rippability tables for various rock types.



## Problems - Chapter 10



**Figure 10.40** Measurement of Vibration Amplitude and Period

- 1a) In Figure 10.40, measure the amplitude of the first peak and calculate the particle velocity of the ground using the equation:

$$\text{Particle velocity} = \frac{\text{Trace amplitude}}{\text{Seismograph gain}}$$

for:

GAIN	PARTICLE VELOCITY (in/s)
1.0	
2.0	
20.0	
0.5	

- 1b) Measure the amplitude of the first trough and calculate the particle velocity for:

GAIN	PARTICLE VELOCITY (in/s)
1.0	
2.0	
20.0	
0.5	

- 2a) Measure the time between the first two peaks in Figure 10.40, end of problem set, and calculate the period of the wave and the frequency of vibration. Each timing space has a value 0.02 seconds and

$$\text{Period}(T) = \text{Number of timing spaces} \times 0.02$$

$$T =$$

$$\text{Frequency}(f) = \frac{1}{\text{Period}}$$

$$f =$$

- 2b) Measure the time from the first peak to the fifth peak. This is the time for four complete oscillations or vibrations. Find the average time or period for one oscillation using:

$$\text{Average Period} = \frac{\text{Time for N oscillation}}{N}$$

Compare this average T with the value measured for T in problem 2a.

AVERAGE T	T FROM 2a

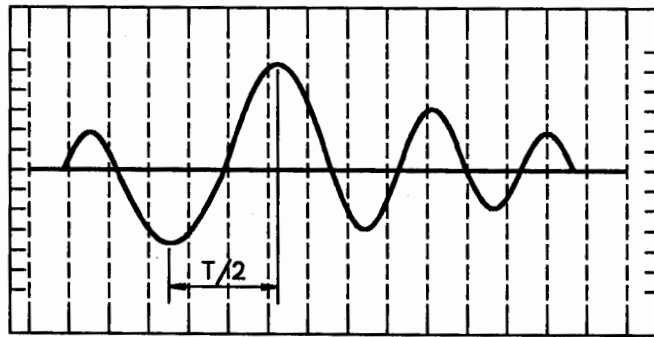
- 2c) Repeat the measurement of problem 2b and calculate the average period using the first 2 peaks, then 3 peaks, then 4 peaks.

	AVERAGE T	FREQUENCY $f=1/T$ (Hz)
2 peaks		
3 peaks		
4 peaks		

- 2d) Calculate the wave length of the seismic wave or vibration assuming a wave or propagation velocity of 2,000 ft/s using the equation:

$$\text{Wave length (L)} = \text{Period} \times \text{Wave length}$$

$$L = T \times 2,000$$



**Figure 10.41** Half Period Measurement

- 3a) In Figure 10.41, end of problem set, measure the maximum amplitude (peak or trough) and calculate the particle velocity of the ground using a gain of 8.0.

PV =

- 3b) Determine the period and frequency of vibration by measuring the half period as indicated in Figure 10.41

$$T/2 = \text{Number of timing spaces} \times 0.02$$

$$T/2 =$$

$$T =$$

$$\text{Frequency} = \frac{1}{\text{Period}}$$

$$f =$$

- 3c) Calculate the wave length of the vibration assuming a wave velocity of 2,000 ft/s.

- 4a) In general, particle velocity is measured by the seismograph but it may be desired to know the ground displacement or the ground acceleration. Assuming simple harmonic motion these quantities can be calculated from the particle velocity and the frequency.

$$\text{Displacement} = \frac{\text{Particle velocity}}{2\pi \times \text{Frequency}}$$

$$D = \frac{V}{6.28 f} = 0.16 \frac{V}{f} \text{ [in]}$$

$$\text{Acceleration} = 2\pi \times \text{Frequency} \times \text{Particle velocity}$$

$$A = 0.016 f V \text{ [g]}$$

Assume a particle velocity 0.108 in/s and a frequency of 16.7 Hz (cycles per second) and calculate the ground displacement D and the ground acceleration A:

$$D = \frac{0.16 V}{f}$$

$$D = \quad \text{in}$$

$$A = 0.016 f V$$

$$A = \quad \text{g}$$

- 4b) Using the particle velocity and frequency that was measured from Figure 10.41 calculate the displacement D and the acceleration A:

$$D = \frac{0.016 V}{f} \text{ in}$$

$$A = 0.016 f V$$

Handbook formula:

$$V = 160 \left( \frac{d}{\sqrt{W}} \right)^{-1.6}$$

V =

- 6) Using  $V = 100 \left( \frac{d}{\sqrt{W}} \right)^{-1.6}$  calculate the probable particle velocity for a distance of  $d = 1,140$  feet and charge weight of  $W = 852$  lbs.

V =

- 7) A shot is designed to fire with only 1 hole per delay. Three holes however, fired at the same time. What is the probable increase in particle velocity as a result of the 3 holes firing together?

Use  $V = 100 \left( \frac{d}{\sqrt{W}} \right)^{-1.6}$  replace W with 3W and calculate new V:

V =

- 8) Given the following distance and charge weights calculate the scaled distance for each shot:

SHOT	DISTANCE (ft)	CHARGE WEIGHT (lbs)	SCALED DISTANCE Ds
1	172	29	
2	486	86	
3	973	254	
4	1,481	482	

Calculate:

- a) The permissible charge for a distance of 89 feet.
- b) The permissible charge for a distance of 1,450 feet.
- c) The safe conforming distance for a charge weight of 4 lbs.
- d) The safe conforming distance for a charge weight of 860 lbs.

10a) Calculate the expected velocity for a scaled distance value of  $D_s = 50$  by using the equations:

$$V = 100 \left( \frac{d}{\sqrt{W}} \right)^{-1.6}$$

$$\text{since } D_s = \frac{d}{\sqrt{W}}$$

$$V =$$

10b) Calculate  $V$  for a scaled distance of  $D_s = 60$ .

$$V =$$

11) Given the following data for scaled distance and particle velocity:

SHOT	$D_s$	PV (in/s)
1	12.5	1.82
2	22.1	0.76
3	36.5	0.39
4	44.3	0.30
5	59.8	0.23

- a) Plot this data on log-log graph paper.
- b) Draw in an envelope line for the data.
- c) Determine the scaled distance value  $D_s$  for a particle velocity of:

PARTICLE VELOCITY (in/s)	SCALED DISTANCE $D_s$
2.0	
1.0	
0.5	

## CHAPTER 11 OBJECTIVES

To apply the procedures discussed in this manual to a typical proposed blasting plan.  
To evaluate the plan with a simple step by step procedure.

## CHAPTER 11 SUMMARY

A simplified step by step procedure was used to evaluate a typical blasting plan submittal. The procedure was presented as a check list which can be adapted for future use by the seminar participants. Examples of blasts with and without perimeter control techniques are shown. Computer software to check pattern designs and controlled blasting effects were discussed.

Controlled blasting will minimize damage to the rock back slope and help insure long term stability. This results in decreased maintenance cost and improved safety.

## CHAPTER 11

### APPLICATIONS

This chapter is devoted to the applications of the blast design evaluation methods proposed in the previous chapters.

The proposed blasting plan must be evaluated in a step by step method to determine whether or not the proposed design dimensions will result in a reasonable blast.

#### 11.1 STEPS IN PRODUCTION BLAST DESIGN

The following list provides a guide to the steps followed in the evaluation of a production blast.

1. Determine drilling equipment capabilities.
2. Check explosive selection for specific site conditions.
3. Determine specific gravity of rock and explosives.
4. Check burden dimension.
5. Check stiffness ratio.
6. Check stemming depth.
7. Check subdrilling depth.
8. Determine loading density.
9. Determine powder column length.
10. Determine total weight of explosive per borehole.
11. Check scaled distance formula.
12. Check timing sequence.
13. Check spacing.
14. Determine potential of violence to determine if mats are needed.

If specific wall control techniques are to be employed the following additional steps would be added.

15. Determine proposed drillhole size.
16. Check loading density.
17. Check drillhole spacing.
18. Check burden (Applicable to trim blasting only).



## **11.2 EVALUATION OF A PROPOSED BLAST DESIGN**

The following example of a typical proposed blasting plan for a hillside cut will be evaluated by the steps given in section 11.1.

### **11.2.1 BLASTING SUBMITTAL EXAMPLE**

A. Drill Patterns - Blasthole pattern will consist of 3 inch diameter holes drilled in a pattern on 7 foot centers. The first row of holes will be 5 feet from the face. Stemming depth will be 5 feet (Figure 11.1A).

B. Hole Depth - Holes will be drilled the depth of the lift (20 feet) plus the necessary subdrilling to achieve the specified excavated lift. Initially the subdrilling will be 2 feet (Figure 11.1B).

C. Explosive Used - The explosives used will be a Hercules Unigel, cartridges are 2 inches in a diameter and 16 inches in length. Specific gravity is 1.3. Rock is granite. Many wet holes.

D. Loading - Pattern to be loaded with delays. Maximum pounds per delay will initially be controlled by using a scaled distance of 60. The nearest homes are 1000 feet from the blast area.

E. Initiation System - DuPont millisecond series electric blasting caps will be used.

F. Presplit pattern - Will be initially drilled on 48 inch centers and loaded with 0.25 pounds/foot of explosive (Figure 11.1B).

G. Presplit holes - Will be drilled to a depth of 20 feet.

H. Explosive - Explosives used for the presplitting will be Dupont presplit cartridges, 7/8 inch diameter by 24 inches long. Specific gravity is 0.95.

J. Ten presplit holes will be fired per delay.

### **11.2.2 BLASTING PLAN EVALUATION**

**STEP 1.** Determine drilling equipment capabilities.

Air track drill available, hole sizes 1.6 inches to 4.0 inches. Contractor selected 3.0 inch diameter.

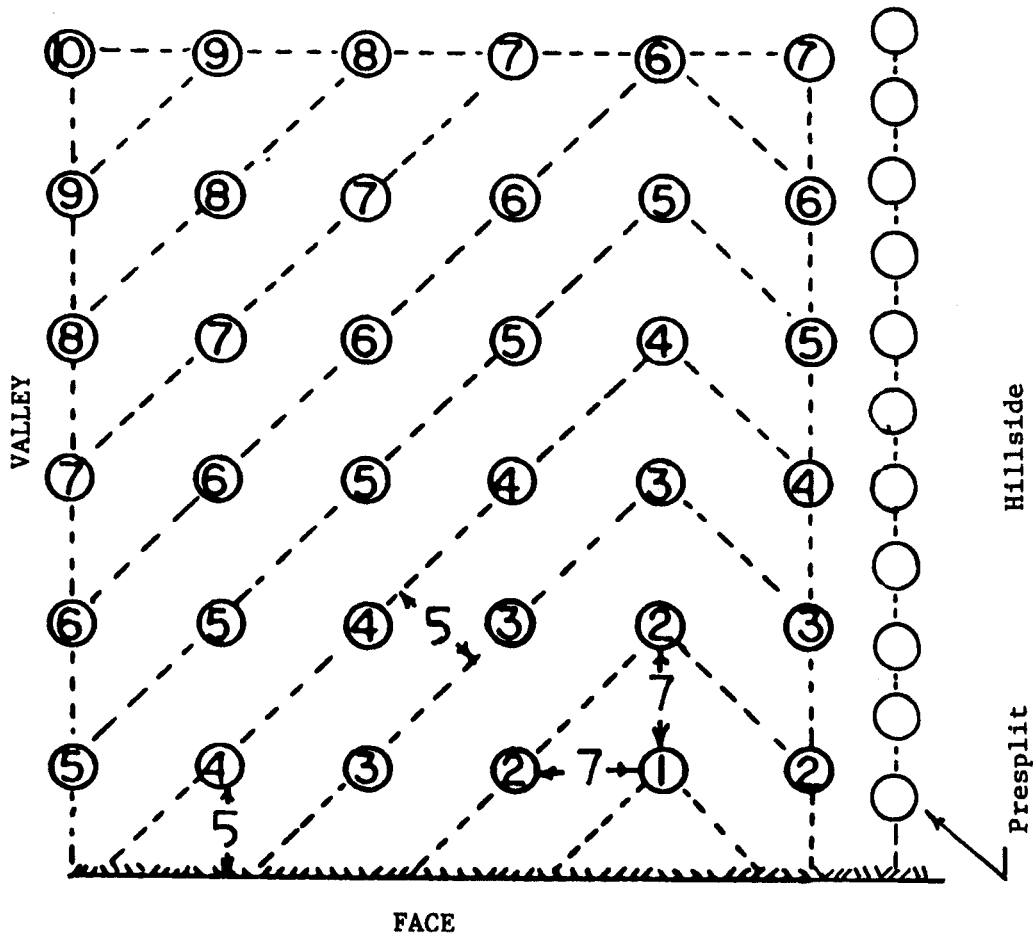
**STEP 2.** Check explosives selection for specific site conditions.

A semigelatin dynamite of specific gravity of 1.3. A reasonable selection for wet holes in granite. Two inch diameter charge is reasonable.

**STEP 3.** Determine specific gravity of rock and explosives.

Specific gravity of explosive 1.3, specific gravity of rock 2.6 - 2.9 (average 2.75).

**STEP 4.** Check burden dimension.



**Figure 11.1A** Drawings With Example Blasting Submittal

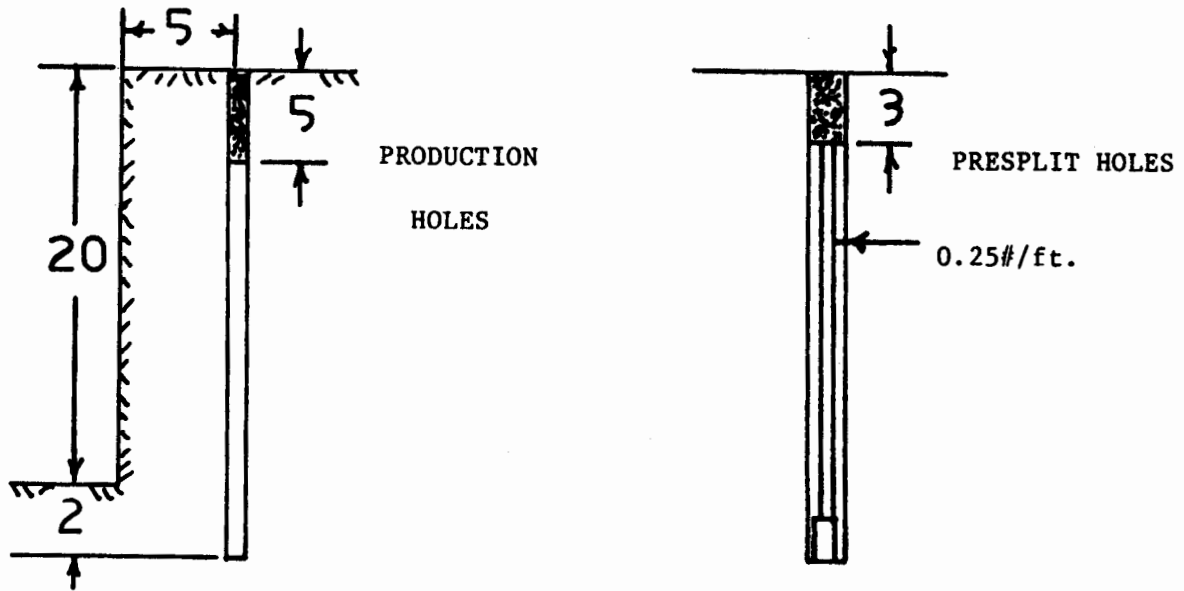


Figure 11.1B Drawings With Example Blasting Submittal.

$$B = (2 \text{ SGc/SGr} + 1.5) D_e$$

$$B = ((2 \times 1.3/2.75) + 1.5) 2$$

$$B = 4.89 \text{ feet (5 feet proposed)}$$

Burden proposed within 10% of calculated. Value is reasonable.

**STEP 5.** Check stiffness ratio.

$$L/B = 20/5 = 4 \text{ (Reasonable Value)}$$

**STEP 6.** Check stemming depth.

$$T = 0.7 \times B$$

$$T = 0.7 \times 5 = 3.5 \text{ feet}$$

Stemming depth proposed was 5 feet. Value is reasonable regardless of material used for stemming.

**STEP 7.** Check subdrilling depth.

$$J = 0.3 \times B$$

$$J = 0.3 \times 5 = 1.5 \text{ feet}$$

Subdrilling proposed was 2 feet. Value is reasonable.

**STEP 8.** Determine loading density.

Check loading density table, value, is 1.77 lbs/ft.

**STEP 9.** Determine powder column length.

Powder column equals hole depth minus stemming or  $22 - 5 = 17$  feet.

**STEP 10.** Determine total weight of explosive per borehole.

Powder column length times loading density equals total explosive load or  $17 \text{ feet} \times 1.77 \text{ lbs/ft} = 30$  pounds.

**STEP 11.** Check scaled distance formula. (Vibration control)

$$W = (D/60)^2$$

$$W = (1000/60)^2 = 278 \text{ pounds}$$

From pattern maximum 6 holes per delay or  $6 \times 30 = 180$  lbs/delay. Proposed lbs/delay is reasonable.

**STEP 12.** Check timing sequence.

Row to row true distance is 5 feet. Minimum time in pattern row to row is 25 ms with DuPont electric caps. Therefore, the time constant (Tr) row to row is  $25/5 = 5$ . Timing is not too small. Holes firing instantaneous along a row.

**STEP 13.** Check spacing.

The following chart will be helpful to determine correct spacing formula.

**TABLE 11.1 HOLE SPACING VERSUS BENCH HEIGHT**

INITIATION	L/B < 4	L/B ≥ 4
Instantaneous	$S = (L+2B) / 3$	$S = 2 B$
Delay	$S = (L+7B) / 8$	$S = 1.4 B$

True hole spacings along in blasting submittal is 10 feet. Using Table 11.1, the correct spacing formula to use is  $S = 2B$  or  $S = 2 \times 5 = 10$ . The proposed spacing is reasonable.

**STEP 14.** Determine potential of violence to determine if mats are needed.

L/B = 4 Therefore violence is minimum.

**STEP 15.** Determine proposed drillhole size for presplit.

Proposed size is 3 inch diameter.

**STEP 16.** Check loading density and charge diameter for presplit.

$$\text{dec} = \text{Dh}^2 / 28$$

$$\text{dec} = 3^2 / 28 = 0.32 \text{ lbs/ft.}$$

Proposed loading density is 0.25 lbs/ft calculated loading density is 0.32 lbs/ft. Must check spacing before any conclusions can be reached.

**STEP 17.** Check blasthole spacing (presplit).

$$S = 10 \text{ Dh}$$

$$S = 10 \times 3 = 30 \text{ inches}$$

Proposed spacing was 48 inch center. The contractor proposes a lighter load and almost 60% greater spacing than one would calculate. The presplit may not function properly. The plan should not be approved until the reason for deviation from the norm is known and approved. Amount of explosive per delay is no problem.

**STEP 18.** Check burden. (Applicable to trim blasting only)

Not Applicable

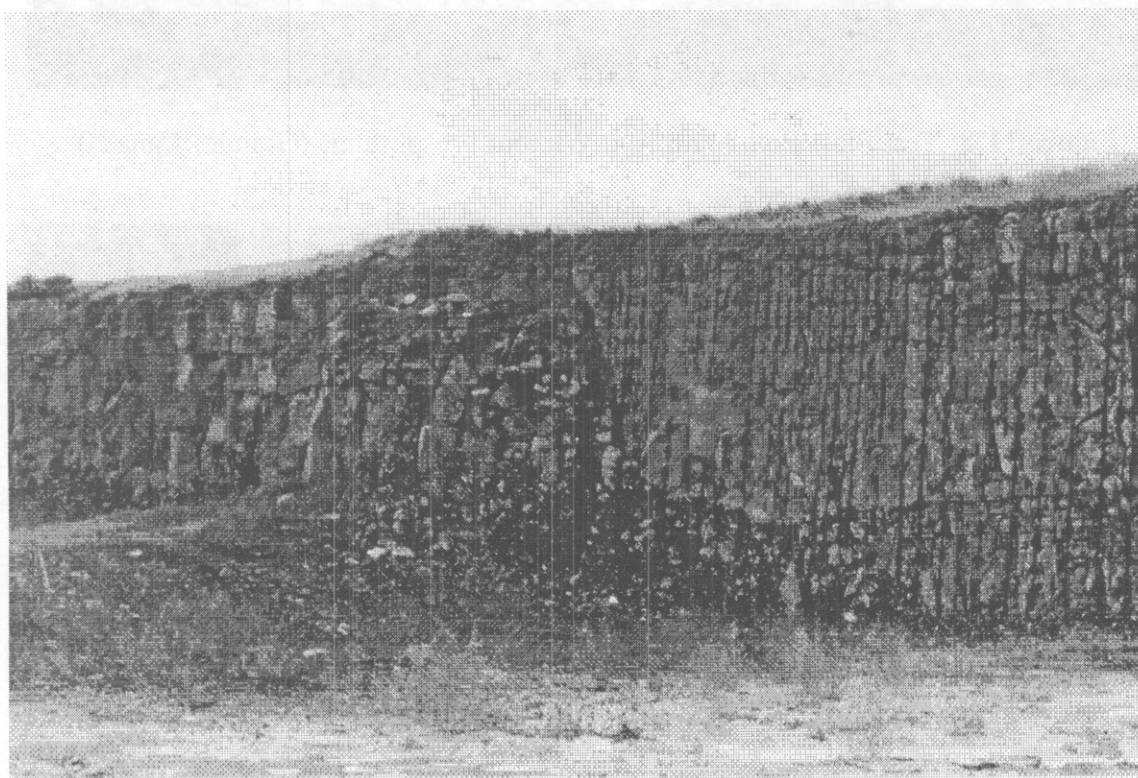
The previous example provides an overview of the methods used to evaluate a blasting plan. There are many other minor factors which could be added to the check list based on the material discussed in this manual. Each individual should add to this check list those items which are of importance to the particular job function.

### 11.3 TEST BLASTS

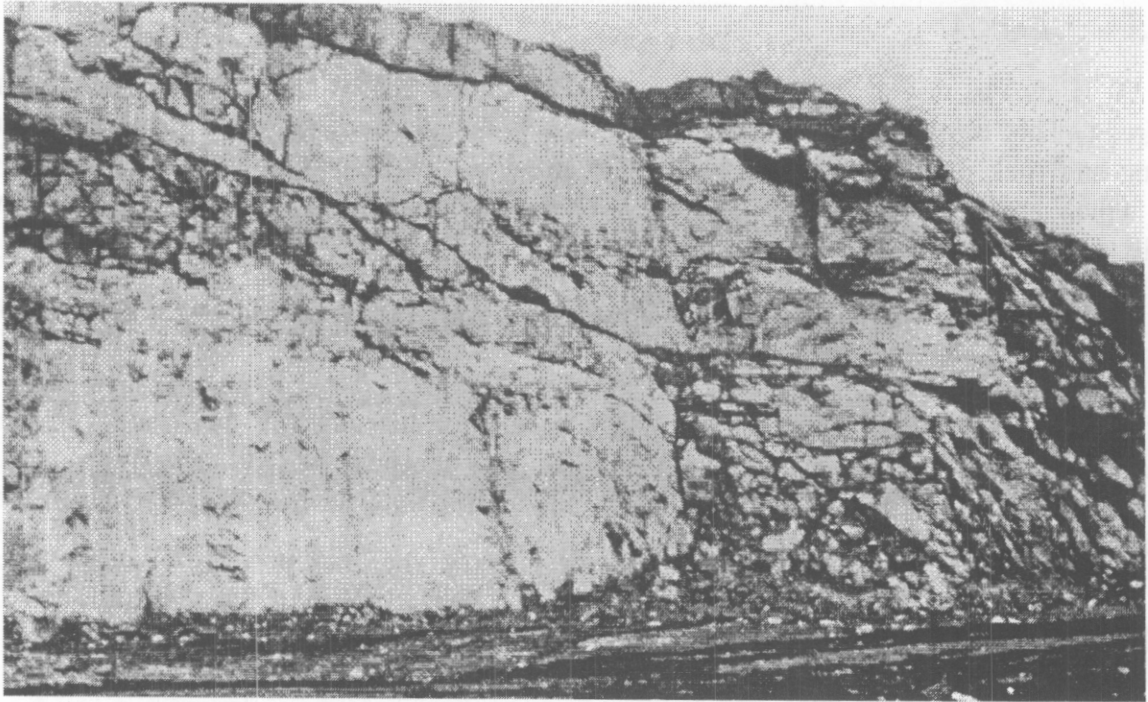
It is always wise to try test blasting a few blastholes before full scale blasting patterns are fired. This is particularly important in areas where there is no recent experience with blasting and rock response is unknown. When possible these blasts should be conducted in areas which are not near final perimeters. The engineer then has the ability to approve techniques before any permanent wall damage results.

The importance of proper wall control and the effects of blasting with and without presplitting are shown in Figure 11.2 through 11.4.

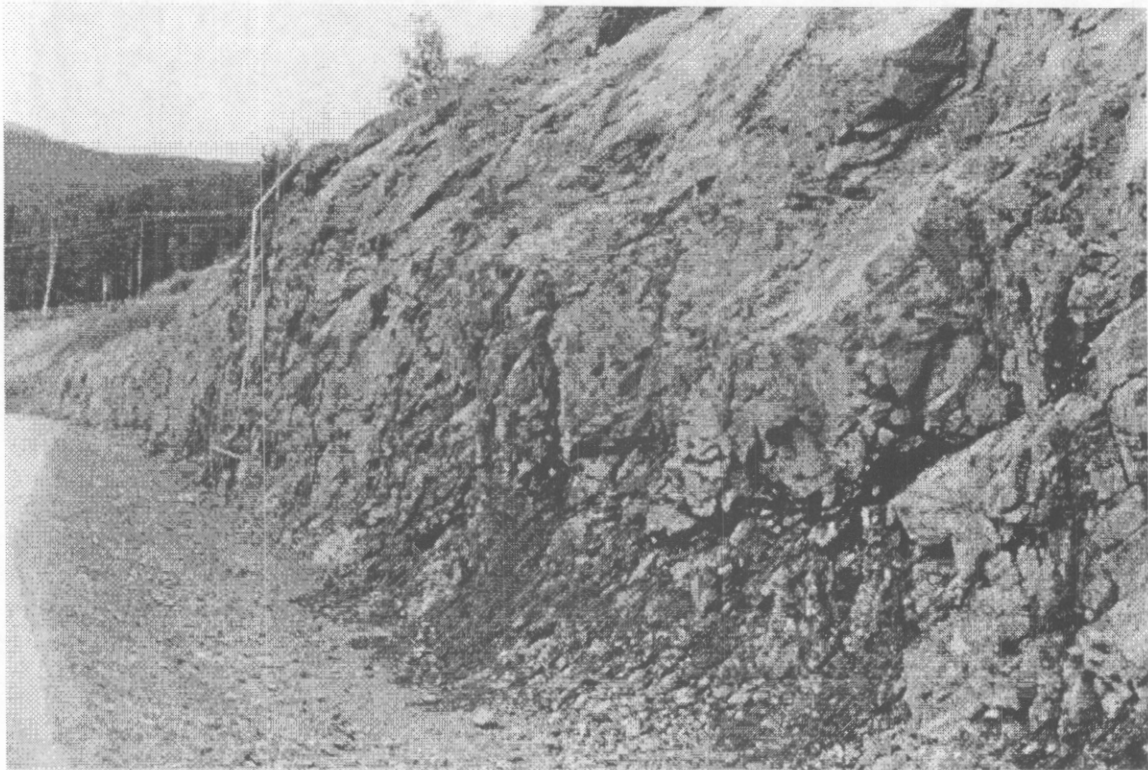
Notice that portions of the slopes where production blasting was used have extensive fracturing of the rock due to blast damage and the cut face is extremely ragged with overhangs. This will result in long term rock fall, high maintenance cost, and safety hazard compared to the presplit portions of the slopes.



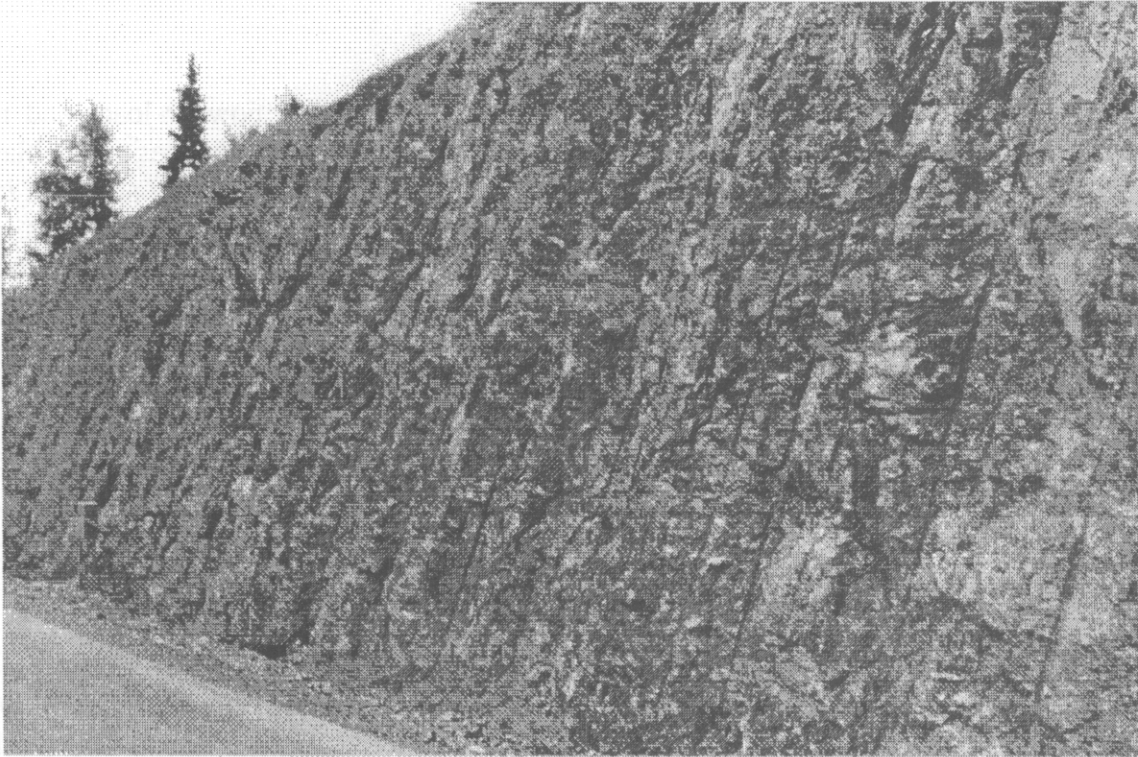
**Figure 11.2** Test Blast Both With And Without Presplitting. (Basalt, Idaho)



**Figure 11.3** Test Blast Both With And Without Presplitting. (Granite, Canada)



**Figure 11.4A** Blast Without Presplit (Siltstone, Alaska)



**Figure 11.4B** Blast With Presplitting. (Siltstone, Alaska)

#### **11.4 SOFTWARE FOR DESIGN EVALUATION**

The blasting industry has used computer software for many years to design or evaluate blast designs. Explosive manufacturers and consultants have designed software packages for their own use for both design and controlling blast effects. During the past 5 years commercial software packages have been made available to the blasting industry from private consulting companies and vibration monitoring companies. This software is being used by contractors, mining operations as well as state and federal agencies to both design and evaluate blasts.

Blast design software can be a valuable tool to aid those evaluating blast designs. It must be remembered, however, that specific site conditions may require different values than those obtained from the software. Blasting software can work with general conditions, however, it is very difficult to put descriptive numbers onto geology. For this reason, if actual blast designs are different than what would be obtained from the software, these may be attributed to geologic effects. The following is a summary of some of the types of blast design software available in the blasting industry.



#### **11.4.1 BLAST DESIGN**

One can determine burdens, spacing, stemming, subdrilling, powder loads and many other important design variables for estimating blasting jobs and for the design of blasting patterns. Programs allow the user to consider many factors including geologic structure in the blast design. One can calculate powder loads using both one or two types of explosives in the blasthole. The blastholes can be either angled or vertical. Powder factors, total drill footage and other important information which may take hours to calculate by hand are available in a matter of seconds. The program allows for the comparison of different methods of design, on the screen, so that the operator can make comparisons without needing a printer in the field. Full reports of each different design as well as the comparisons can be printed out at a later time. On-screen helps make the program user friendly even to those who are just beginning to use the computer for blast design.

#### **11.4.2 BLASTHOLE TIMING SELECTION**

The program enables the operator to select the proper millisecond delay time to accomplish specific effects in blasting. Delay times are dependent on many factors which include rock type, rock structure, burden, spacing as well as the overall effects one wants to achieve. The delay times are calculated both from hole to hole along a row and between rows. By selecting the proper delay time, one can enhance wall control, reduce flyrock, increase fragmentation and decrease vibration. Many other parameters can also be controlled by proper timing.

#### **11.4.3 VIBRATION AND AIR BLAST CONTROL**

The vibration analysis programs perform linear regression analysis of blast vibration data and predict peak particle velocity at any distance from the blast. The software produces a table showing the maximum charge-per-delay for various distances, the goodness of fit of the collected data, graphical output, both on the screen or on hard copy. One has a choice of printing graphs of peak particle velocity versus scaled distance, peak particle velocity versus frequency and charge weight per delay versus distance. The program also performs a linear regression analysis of air overpressure and plots air overpressure versus scaled distance. The program will predict overpressure values at any distance from the blast. This program does most of the functions for which you would hire a vibration consultant.

#### **11.4.4 DRILLING COST ANALYSIS**

The user can compare fixed and/or the actual direct operating costs of all types of blasthole drills. The program considers labor, daily maintenance, bit, steel, pipe, patterns and power costs. The costs are identified per hour, per foot or cubic yard.

#### **11.4.5 BLASTING COST ANALYSIS**

One can compare costs resulting from as many as four different blasting patterns and also calculate the cost per cubic yard and the cost per ton for each design. One can change burden, spacing, hole depth, stemming, subdrilling, hole diameter, priming, initiators and determine the effects on the cost. One can also consider the effects of up to 3 different explosives in each hole, initiators, primers booster, drilling cost, liners, pumping, shot services and seismic monitoring on the total cost picture. The cost per energy unit can be compared to select the most efficient cost effective explosives for the particular job.

#### **11.4.6 BULK EXPLOSIVE PERFORMANCE**

Readings from a bulk explosive truck or chemical analysis of oil content in ANFO along with the software can give an accurate estimate of energy efficiency as a result of improper mixtures quickly without an explosive chemist to do the calculations. Energy efficiency will calculate both the theoretical and measured energy to help understand why blasts may not have behaved as expected.

#### **11.4.7 FIRING TIME, TIMING, OVERLAPS, PATTERN DESIGN**

This software will quickly calculate firing times and check blasting pattern timing overlaps for both surface and underground rounds and for both square or staggered patterns. Versions are available for electric initiation or non-electric initiation and the universal program which handles both electric and non-electric. This software allows one to quickly load pattern libraries or to build a pattern. The programs work with up to 40 holes per row 12 rows and 10 decks per hole. Patterns can be irregularly shaped, with lost holes anywhere in patterns. The software will allow the user to find timing overlaps of any number of holes and indicate the probability of such overlaps. For example, one may allow 5 holes to overlap, what is the probability of 6 holes overlapping and where are they located. The program also shows animated firing of the patterns and decks. A pattern design report can be produced on the printer. One can design an infinite number of patterns quickly and easily. The patterns can be saved for future convenience. Pattern libraries are available for fast and easy pattern design and analysis.

#### **11.4.8 FRAGMENTATION SIZE PREDICTION**

The comparison of breakage from one blasting pattern to another has always been difficult to assess. A program is now available which can predict and compare relative difference in fragmentation from one blast to another. The program can compare the changes in fragmentation as affected by many of the normal blasting variables such as burden, spacing, bench height and type of explosive used. The program will also work with two different explosives in the borehole. A scientific method to determine the effects of rock strength and geologic structure is also provided. The program will print the percentage, tons and cubic yardage of material produced in various size ranges and display graphic interpretations in the form of line and bar graphs.

#### **11.4.9 CONTROLLED BLAST DESIGN**

The Controlled Blasting program considers presplitting trim (cushion) blasting and line drilling methods for wall control. The program uses basic information and state of the art design formulas to determine powder loads, bottom loads, stemming distances, and spacings for different methods of controlled blasting.

#### **11.4.10 STRUCTURAL BLAST DESIGNER**

Structural Blast Designer is a unique IBM program which was developed in Europe by individuals with decades of experience in building and structural demolition. The program designs blasting patterns and powder loads for 45 different structural elements of brick, concrete, and reinforced concrete and provides designs for demolition of columns, piers, slabs, arches, chimneys and various other structural members. This unique program was proprietary and was recently released to the general public. The program designs powder loads, number of decks, burden spacing and hole layout for each structural element.

#### **11.4.11 PATTERN DESIGN TRAINING PROGRAMS**

This program is a design simulator that quickly calculates firing times, identifies and graphically explains overlaps and out-of-sequence shooting which promotes excessive vibration, air blast, ground vibration and fragmentation problems causing added cost to any operation. The software and accompanying manual also instructs in selection of proper timing windows, hole to hole and row to row. The student will learn to assess the effects of cap scatter and will learn to produce good patterns even with cap scatter considerations. Even the most experienced blaster or engineer will benefit and gain new insight for efficient pattern design. The program contains blasting patterns for electric and non-electric initiation systems.

## **11.5 CHAPTER 11 SUMMARY**

A simplified step by step procedure was used to evaluate a typical blasting plan submittal. The procedure was presented as a check list which can be adapted for future use by the seminar participants. Examples of blasts with and without perimeter control techniques are shown. Computer software to check pattern designs and controlled blasting effects were discussed.

Controlled blasting will minimize damage to the rock back slope and help insure long term stability. This results in decreased maintenance cost and improved safety.

## CHAPTER 12 OBJECTIVES

To provide the inspector with charts and tables to easily determine approximate design dimension in the field. To provide forms for proper recordkeeping of blasting operations.

## CHAPTER 12 SUMMARY

A simplified method a blast evaluation was used to estimate blast design dimensions. Forms for recordkeeping and inspection were shown.

## CHAPTER 12

### INSPECTOR'S GUIDE

#### 12.1 INTRODUCTION

This brief Inspector's Guide will provide methods to estimate burden, spacing, stemming and subdrilling as well as explosive loads. The first section of the manual will provide a series of tables which, with little effort, can be used to determine average blast design dimensions.

Additional forms are also given for blasting plans, seismic monitoring reports and blasting logs.

This chapter will enable the inspector to estimate dimensions in the field as well as provide the necessary forms for control of blasting operations. An example of the use of the charts follows.

#### 12.2 QUICK REFERENCE CHARTS

##### 12.2.1 BURDEN ESTIMATE CHART

Assume that the blaster is using a two inch diameter cartridge of dynamite with a specific gravity of 1.3 and blasting in a limestone that has a specific gravity of 2.6. If one takes the ratio of the two densities, 1.3 divided by 2.6, it is equal to 0.5.

Go to the "Burden Estimate" chart and find the approximate burden by using the density ratio and charge diameter. For example, the burden would be 5.0 feet.

##### 12.2.2 STEMMING AND SUBDRILLING ESTIMATE CHART

Once the burden is known, go to the second chart, entitled "Stemming and Subdrill Estimate" to determine the approximate stemming and subdrilling needed. At a burden of 5 feet, the stemming distance would be 5 feet if drill cuttings are used. If drilling chips or crushed stone is used, the stemming depth would be 3.5 feet. Subdrilling would be approximately 1.6 feet.

### **12.2.3 HOLE SPACING ESTIMATE CHART**

To determine the hole spacing along the row, one would have to know whether the holes are firing on the same delay period or whether they are truly delayed one from another. One would also have to know the hole depth ratio. To determine hole depth ratio, one would need the depth of the hole and the burden. Assume that the depth of the hole is 15 feet. To determine the spacing distance, take the 15 feet and divide it by the 5 foot burden which gives a hole depth ratio of 3.

The "Hole Spacing Estimate" chart shows that for a ratio of 3, one would have a multiplier of 1.67 times the burden if using the same delay time. Since the burden is 5 feet in the example, multiply 1.67 times 5 and obtain a spacing of approximately 8.35 feet. If the blastholes were delayed one from another, the multiplier is 1.25 times the burden or 6.25 feet.

### **12.2.4 LOADING DENSITY CHART**

To determine the weight of explosive per foot of loaded hole, use the "Loading Density" chart. Find the specific gravity of the explosive along the top of the chart. Values range from 0.8 to 1.6. Find the charge diameter along the left hand column.

Find the intersection of the proper specific gravity column and the horizontal line of the charge diameter. The answer is the loading density in pounds of explosive per foot of borehole.

## **12.3 RECORDKEEPING FORMS**

### **12.3.1 BLASTING PLAN FORM**

In addition to the tables, the Inspector's Guide contains forms which may be needed for reporting purposes by the blasting contractor. In specifications, one commonly requests a blasting plan. The contractor may want to use the standardized "Blasting Plan" form as shown in the next section.

### **12.3.2 DRILL LOG FORM**

When blasting in locations where one has many mud seams and mud pockets, one may request the contractor to keep a blasthole drill log. A copy of a "Blasthole Drill Log" is also included in this package of forms.

### **12.3.3 BLAST REPORT FORM**

Commonly, in specifications, one requires the blaster to submit blast reports for each and every blast on the project. Standardized "Blast Report" forms are also included. Along with the blast report forms, there is an additional sheet called "Blasthole Loading Information". This is used when holes are loaded with different explosives at different depths. It is not uncommon to find blastholes loaded with two or more types of explosive. This form can be used to record the hole number and the depth to which different explosives are loaded from the collar of the hole.

### **12.3.4 PREBLAST INSPECTION FORM**

Before blasting commences on an operation, it is common to require a preblast survey to be conducted at the nearest homes. The Inspector's Guide includes "Preblast Survey" forms for both interior and exterior inspections.

### **12.3.5 SEISMIC MONITORING FORM**

As blasting commences on the operation, one may want the contractor to report the results of his seismograph readings. Standardized "Vibration Report" forms are also included.

### **12.3.6 DRILL PATTERN INSPECTION FORM**

In projects which are critical and where blasting improperly can cause severe problems, the inspector may want to inspect both production blasting patterns and the presplit drillholes to determine the accuracy of drilling. The "Drill Pattern Inspection" form shows hole number and row number, and the inspector can measure the burden, spacing and depth for each hole.

### **12.3.7 PRESPLIT DRILLHOLE EVALUATION FORM**

Commonly, in specifications, a tolerance is given for the drilling of presplit blastholes. If blastholes are not in the proper locations, one cannot expect good results. Two types of tolerances are commonly discussed. Tolerances at the collar of the holes and tolerances on the slope itself. For example, a special provision may indicate the blastholes must be drilled within 2 borehole diameters of their intended center. The inspector can measure the spacing of the holes and indicate, by just checking yes or no, whether or not the spacing was within the tolerance.

In some specifications, it is required that 95% of the holes be within a tolerance distance from one another and also in and out of the slope. This tolerance distance is commonly given as 6 inches. These same specifications may state that if more than 5% of the holes are outside of the given tolerance, blastholes will be shortened to the depth at which the drilling tolerance is met. The "Presplit Drillhole Evaluation" form can be used after a blast to determine how many holes meet the desired tolerance and at what depth.



The blasting forms included in this Inspector's Guide can be photo copied for field use. For this reason, no figure numbers are placed on these forms. These forms are also available to the contractor through commercial vendors.

#### **12.4 CHAPTER 12 SUMMARY**

A simplified method a blast evaluation was used to estimate blast design dimensions. Forms for recordkeeping and inspection were shown.

## BURDEN ESTIMATE

CHARGE DIAMETER	DENSITY RATIO (DR) DENSITY OF EXPLOSIVE / DENSITY OF ROCK						
	0.20	0.30	0.40	0.50	0.60	0.70	0.80
1.25	2.3	2.6	2.9	3.1	3.3	3.5	3.7
1.50	2.8	3.2	3.5	3.8	4.0	4.2	4.4
1.75	3.2	3.7	4.1	4.4	4.7	4.9	5.1
2.00	3.7	4.2	4.6	5.0	5.3	5.6	5.8
2.50	4.6	5.3	5.8	6.3	6.6	7.0	7.3
3.00	5.5	6.3	7.0	7.5	8.0	8.4	8.8
3.50	6.5	7.4	8.1	8.8	9.3	9.8	10.2
4.00	7.4	8.4	9.3	10.0	10.6	11.2	11.7
4.50	8.3	9.5	10.4	11.3	12.0	12.6	13.2
5.00	9.2	10.5	11.6	12.5	13.3	14.0	14.6
5.50	10.1	11.6	12.8	13.8	14.6	15.4	16.1
6.00	11.1	12.7	13.9	15.0	15.9	16.8	17.5
6.50	12.0	13.7	15.1	16.3	17.3	18.2	19.0
7.00	12.9	14.8	16.3	17.5	18.6	19.6	20.5

PBS967

### INSTRUCTIONS FOR USE OF TABLE:

1. DIVIDE DENSITY OF EXPLOSIVE BY DENSITY OF ROCK TO DETERMINE DENSITY RATIO (DR)
2. FIND DENSITY RATIO IN TABLE, FIND CHARGE DIAMETER IN COLUMN 1
3. FIND WHERE BOTH VERTICAL COLUMN AND HORIZONTAL ROW INTERSECT AND READ BURDEN IN FEET

# STEMMING AND SUBDRILLING ESTIMATE

BURDEN	STEMMING (CUTTINGS)	STEMMING (CHIPS)	SUBDRILLING
3	3	2.1	0.9
4	4	2.8	1.2
5	5	3.5	1.5
6	6	4.2	1.8
7	7	4.9	2.1
8	8	5.6	2.4
9	9	6.3	2.7
10	10	7.0	3.0
11	11	7.7	3.3
12	12	8.4	3.6
13	13	9.1	3.9
14	14	9.8	4.2
15	15	10.5	4.5
16	16	11.2	4.8
17	17	11.9	5.1
18	18	12.6	5.4

PBS323

## INSTRUCTIONS FOR USE OF TABLE:

1. FIND BURDEN, IN FEET, IN COLUMN 1
2. DETERMINE IF STEMMING IS DRILL CUTTINGS OR ROCK CHIPS
3. READ ACROSS THE ROW TO DETERMINE APPROPRIATE STEMMING AND SUBDRILLING, IN FEET

# HOLE SPACING ESTIMATE

<b>RATIO (H/B)</b>	<b>SAME PERIOD (F)</b>	<b>DELAY PERIOD (F)</b>
1.00	1.00	1.00
1.25	1.08	1.03
1.50	1.17	1.06
1.75	1.25	1.09
2.00	1.33	1.13
2.25	1.42	1.16
2.75	1.58	1.22
3.00	1.67	1.25
3.25	1.75	1.28
3.50	1.83	1.31
3.75	1.92	1.35
4.00	2.00	1.40
> 4.00	2.00	1.40

pbe231

## **INSTRUCTIONS FOR USE OF TABLE:**

1. Divide burden (B) into hole depth (H) -  $H/B = \text{Ratio}$
2. Find ratio in column 1 of table
3. Determine if adjacent hole in row is firing on the same delay period or if it is delayed
4. Go to appropriate column in table and obtain factor number (F)
5. Multiply factor number times burden (B) -  $F \times B = \text{Spacing in feet}$

**IN POUNDS PER FOOT  
OF BOREHOLE**

<b>CHARGE DIAMETER</b>	<b>SPECIFIC GRAVITY</b>												
	0.80	0.90	1.00	1.10	1.15	1.20	1.25	1.30	1.35	1.40	1.45	1.50	1.60
1.00	0.27	0.31	0.34	0.37	0.39	0.41	0.43	0.44	0.46	0.48	0.49	0.51	0.54
1.25	0.43	0.48	0.53	0.59	0.61	0.64	0.67	0.69	0.72	0.74	0.77	0.80	0.85
1.50	0.61	0.69	0.77	0.84	0.88	0.92	0.96	1.00	1.03	1.07	1.11	1.15	1.23
1.75	0.83	0.94	1.04	1.15	1.20	1.25	1.30	1.36	1.41	1.46	1.51	1.56	1.67
2.00	1.09	1.23	1.36	1.50	1.57	1.63	1.70	1.77	1.84	1.91	1.97	2.04	2.18
2.50	1.70	1.92	2.13	2.34	2.45	2.55	2.66	2.77	2.87	2.98	3.09	3.19	3.41
3.00	2.45	2.76	3.06	3.37	3.52	3.68	3.83	3.98	4.14	4.29	4.44	4.60	4.90
3.50	3.34	3.75	4.17	4.59	4.80	5.01	5.21	5.42	5.63	5.84	6.05	6.26	6.67
4.00	4.36	4.90	5.45	5.99	6.27	6.54	6.81	7.08	7.35	7.63	7.90	8.17	8.72
4.50	5.52	6.21	6.90	7.58	7.93	8.27	8.62	8.96	9.31	9.65	10.00	10.34	11.03
5.00	6.81	7.66	8.51	9.36	9.79	10.22	10.64	11.07	11.49	11.92	12.34	12.77	13.62
5.50	8.24	9.27	10.30	11.33	11.85	12.36	12.88	13.39	13.91	14.42	14.94	15.45	16.48
6.00	9.81	11.03	12.26	13.48	14.10	14.71	15.32	15.94	16.55	17.16	17.77	18.39	19.61
6.50	11.51	12.95	14.39	15.82	16.54	17.26	17.98	18.70	19.42	20.14	20.86	21.58	23.02
7.00	13.35	15.02	16.68	18.35	19.19	20.02	20.86	21.69	22.52	23.36	24.19	25.03	26.70
7.50	15.32	17.24	19.15	21.07	22.03	22.98	23.94	24.90	25.86	26.81	27.77	28.73	30.65
8.00	17.43	19.61	21.79	23.97	25.06	26.15	27.24	28.33	29.42	30.51	31.60	32.69	34.87
8.50	19.68	22.14	24.60	27.06	28.29	29.52	30.75	31.98	33.21	34.44	35.67	36.90	39.36
9.00	22.06	24.82	27.58	30.34	31.72	33.10	34.48	35.85	37.23	38.61	39.99	41.37	44.13
9.50	24.58	27.66	30.73	33.80	35.34	36.88	38.41	39.95	41.49	43.02	44.56	46.10	49.17
10.00	27.24	30.65	34.05	37.46	39.16	40.86	42.56	44.27	45.97	47.67	49.37	51.08	54.48
10.50	30.03	33.79	37.54	41.29	43.17	45.05	46.93	48.80	50.68	52.56	54.43	56.31	60.06
11.00	32.96	37.08	41.20	45.32	47.38	49.44	51.50	53.56	55.62	57.68	59.74	61.80	65.92
11.50	36.02	40.53	45.03	49.53	51.79	54.04	56.29	58.54	60.79	63.04	65.30	67.55	72.05
12.00	39.23	44.13	49.03	53.94	56.39	58.84	61.29	63.74	66.19	68.64	71.10	73.55	78.45

pbs989

**INSTRUCTIONS:**

1. Select proper specific gravity of explosive (range 0.8-1.6)
2. Select explosive diameter
3. Find intersection of specific gravity column and charge diameter row and read loading density in pounds/foot

# BLASTING PLAN

LOCATION \_\_\_\_\_ JOB \_\_\_\_\_ DATE \_\_\_\_\_  
 TYPE OF SHOT \_\_\_\_\_ STATION \_\_\_\_\_  
 TYPE OF MATERIAL \_\_\_\_\_  
 DISTANCE TO NEAREST STRUCTURE \_\_\_\_\_ FEET

## PRODUCTION BLAST

NUMBER OF HOLES _____	HOLE DIAMETER _____	DRILL ANGLE _____	
BURDEN _____	FT SPACING _____	FT DEPTH _____	FT
STEMMING _____	FT	STEMMING MATERIAL _____	
SUBDRILLING _____		LIFT HEIGHT _____	

METHOD OF FIRING (CHECK ONE)	ELECTRIC _____	NON-ELECTRIC _____
SEQUENTIAL TIMER (CHECK ONE)	YES ___ NO ___	TIMER SETTING(S) _____
SURFACE DELAY PERIODS _____		
DOWN HOLE DELAY PERIODS _____		

TYPES OF EXPLOSIVES _____	
SIZE OF PRIMERS _____	
PRIMER LOCATIONS _____	

TRADE NAMES OF EXPLOSIVES _____	AMOUNT _____	
_____	AMOUNT _____	
_____	AMOUNT _____	
_____	AMOUNT _____	
TRADE NAMES OF PRIMERS _____	AMOUNT _____	
_____	AMOUNT _____	
_____	AMOUNT _____	
TRADE NAMES OF INITIATORS _____	AMOUNT _____	
_____	AMOUNT _____	
_____	AMOUNT _____	

MAXIMUM LBS./DELAY _____	
ANTICIPATED VIBRATION LEVEL _____	
SCALED DISTANCE _____	

pbe167

**NOTE:**

1. Provide drawing of pattern, initiator hookup, hole firing times and row section of blasthole showing explosive loads and primer locations, depth, subdrill, stemming, etc.
2. Include manufactures data sheets for all products.

# BLASTING PLAN (continued)

## CONTROLLED BLAST

CHECK ONE: PRESPLIT _____	CUSHION BLAST _____	LINE DRILL _____
DIAMETER OF DRILLHOLE _____	HOLE DEPTH _____	
DRILLHOLE ANGLE _____		

METHOD OF INITIATION _____	
DELAYS USED _____	HOLES/DELAY _____

DESCRIBE METHODS USED TO MAINTAIN HOLE ALIGNMENT:

DISTANCE FROM PRODUCTION HOLES _____	
OR	
DISTANCE FROM BUFFER ROW _____	

BUFFER ROW	HOLE DIAMETER _____	CHARGE DIAMETER _____	
	TOTAL CHARGE _____	BURDEN _____	
	SPACING _____	DEPTH _____	

TRADE NAMES OF EXPLOSIVES _____	AMOUNT _____	
_____	AMOUNT _____	
_____	AMOUNT _____	
_____	AMOUNT _____	
TRADE NAMES OF PRIMERS _____	AMOUNT _____	
_____	AMOUNT _____	
_____	AMOUNT _____	
TRADE NAMES OF INITIATORS _____	AMOUNT _____	
_____	AMOUNT _____	
_____	AMOUNT _____	

pbs167a

**NOTE:**

1. Provide drawing of pattern, initiator hookup, firing times and cross section of blasthole showing explosive loads and primer locations, depth, stemming.
2. Include manufactures data sheets for all products.











# BLASTHOLE LOADING INFORMATION

EXPLOSIVE					EXPLOSIVE				
LOADING DENSITY					LOADING DENSITY				
HOLE/CHARGE NUMBER	TO:	TO:	TO:	TO:	HOLE/CHARGE NUMBER	TO:	TO:	TO:	TO:
1					31				
2					32				
3					33				
4					34				
5					35				
6					36				
7					37				
8					38				
9					39				
10					40				
11					41				
12					42				
13					43				
14					44				
15					45				
16					46				
17					47				
18					48				
19					49				
20					50				
21					51				
22					52				
23					53				
24					54				
25					55				
26					56				
27					57				
28					58				
29					59				
30					60				

# PREBLAST SURVEY

## EXTERIOR REPORT

Property Owner \_\_\_\_\_

Page \_\_\_\_ of \_\_\_\_ Pages

Outside Photos Taken: Yes \_\_\_\_ No \_\_\_\_ B&W \_\_\_\_ Color \_\_\_\_

Description of Lot: Level \_\_\_\_ Sloping to front \_\_\_\_ Sloping to rear \_\_\_\_ Or to side

Standing Water or Pooling Area: Front \_\_\_\_ Back \_\_\_\_ Left \_\_\_\_ Back \_\_\_\_

Condition Codes: (E) - Excellant (G) - Good, not New (F) - Fair

Remarks:

Roofs \_\_\_\_ Type of Material \_\_\_\_\_

Siding \_\_\_\_ Type of Material \_\_\_\_\_

Gutters/Dnspouts \_\_\_\_ Type of Material \_\_\_\_\_

Driveway \_\_\_\_ Type of Material \_\_\_\_\_

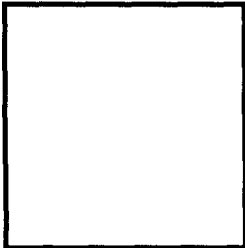
Foundation \_\_\_\_ Type of Material \_\_\_\_\_

Walkway(s) \_\_\_\_ Type of Material \_\_\_\_\_

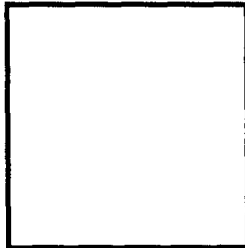
Porch(es) \_\_\_\_ Patio(s) \_\_\_\_\_ Windows \_\_\_\_\_

Chimney(s) Brick \_\_\_\_ Stone \_\_\_\_ C-Block \_\_\_\_ Metal \_\_\_\_

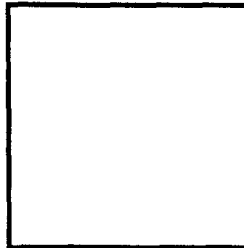
Front (facing foundations)



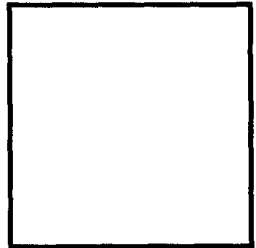
Right



Left



Rear



Detached Buildings:

Number:

Condition:

Garage(s) \_\_\_\_\_

Barn(s) \_\_\_\_\_

Shed(s) \_\_\_\_\_

Utility Building(s) \_\_\_\_\_

Other \_\_\_\_\_

# PREBLAST SURVEY

## INTERIOR REPORT

Property Owner \_\_\_\_\_ Page \_\_\_\_ of \_\_\_\_ Pages

ROOM \_\_\_\_\_ ENTERED FROM \_\_\_\_\_

Walls Plaster \_\_\_\_ Dry Wall \_\_\_\_ Panel \_\_\_\_ Paper \_\_\_\_ C.Block \_\_\_\_ Other \_\_\_\_

Ceiling Plaster \_\_\_\_ Dry Wall \_\_\_\_ Ac. Tile/Panel \_\_\_\_ Paper \_\_\_\_ Open C. \_\_\_\_ Other \_\_\_\_

Floor Carpet \_\_\_\_ Linoleum \_\_\_\_ Square Tile \_\_\_\_ Wood \_\_\_\_ Concrete \_\_\_\_ Other \_\_\_\_

Wall \_\_\_\_\_ Ceiling/Floor \_\_\_\_\_

--	--	--	--

REMARKS:

ROOM \_\_\_\_\_ ENTERED FROM \_\_\_\_\_

Walls Plaster \_\_\_\_ Dry Wall \_\_\_\_ Panel \_\_\_\_ Paper \_\_\_\_ C.Block \_\_\_\_ Other \_\_\_\_

Ceiling Plaster \_\_\_\_ Dry Wall \_\_\_\_ Ac. Tile/Panel \_\_\_\_ Paper \_\_\_\_ Open C. \_\_\_\_ Other \_\_\_\_

Floor Carpet \_\_\_\_ Linoleum \_\_\_\_ Square Tile \_\_\_\_ Wood \_\_\_\_ Concrete \_\_\_\_ Other \_\_\_\_

Wall \_\_\_\_\_ Ceiling/Floor \_\_\_\_\_

--	--	--	--

REMARKS:

# VIBRATION REPORT

EVENT: _____	SHOT: _____	SEISMOGRAPH UNIT: _____
LOCATION: _____	DATE: _____	TIME: _____

STATION: _____	
SHOT POSITION: COORDINATES: EAST: _____ ft	NORTH: _____ ft

STATION: _____	
MONITOR POSITION: COORDINATES: EAST: _____ ft	NORTH: _____ ft

DISTANCE FROM THE SHOT: _____	ft
MAXIMUM CHARGE WEIGHT PER DELAY: _____	lb
AIR OVERPRESSURE: _____	dB

	RADIAL	TRANSVERSE	VERTICAL	VECTOR SUM	MAXIMUM
P.P.V.					
FREQUENCY					

PBS444

JOB \_\_\_\_\_ INSPECTOR/BLASTER \_\_\_\_\_







## APPENDIX I

### GLOSSARY OF BLASTING TERMS

**A-Scale** A sound level measurement scale. It discriminates against low frequencies. It approximates the human ear.

**Acceleration** A measure of force ( $F = ma$ ). It is the time rate of change of velocity. It is measured in g's the acceleration of gravity.

**Accessories** General term applied to small equipment and tools used in conjunction with explosives, i.e., blasting machine, punches, wire, fuses, Galvanometer, etc.

**Acoustic Trace** The line on the vibration record that records the sound level.

**Acoustical Impedance** The mathematical expression for characterizing a material as to its energy transfer properties (the product of its unit density and its sound velocity ( $pV$ )).

**Acultural Vibration** Vibration that is strange and unfamiliar to the observer.

**Adit** A nearly horizontal passage from the surface by which an underground mine is entered, as opposed to a tunnel.

**Air Blast** A sound pressure wave from a blast traveling through the atmosphere.

**Air Blast Focusing** The concentration of sound energy in a small region at ground level due to refraction of the sound waves back to the earth from the atmosphere.

**Air Cushion** A blasting technique wherein a charge is suspended in a borehole, and the hole tightly stemmed so as to allow a time lapse between detonation and ultimate failure of the rock. (No coupling realized).

**American Table of Distances** Table showing distances that explosives must be stored from other explosives, inhabited buildings, railroads, highways, and magazines, according to amount of explosives stored. Usually called only Table of Distances.

**Amplitude** The height of a vibration or wave above the zero line on a vibration record. It usually refers to the maximum value.

**ANFO** Ammonium Nitrate-Fuel Oil Mixture. Used as a blasting agent.

**AN Prills** Small spheres or pellets of ammonium nitrate, as opposed to flaked, granular, or powdered ammonium nitrate.

**Back** The roof or top of an underground opening. Also, used to specify the ore between a level and the surface, or that between two levels.

**Back Break** Rock broken beyond the limits of the last row of holes.

**Bedding Planes** Rock formation formed by layering of rock as it was deposited, as in igneous flows or in separated sedimentary deposits.

**Bench** The horizontal ledge in a quarry face along which holes are drilled vertically. Benching is the process of excavating whereby terraces or ledges are worked in a stepped shape.

**Blast** The operation of breaking rock by means of explosives. Shot is also used to mean blast.

**Blasting Agent** Any material or mixture, consisting of a fuel and oxidizer intended for blasting, not otherwise classified as an explosive and in which none of the ingredients are classified as an explosive, provided that the finished product, as mixed and packaged for use or shipment, cannot be detonated by means of a No. 8 test blasting cap when unconfined.

**Blasthole** (Borehole) A hole drilled in rock or other material for the placement of explosives.

**Blockhole** A hole drilled into a boulder to allow the placement of a small charge to break the boulder.

**Body Waves** Seismic wave that travels through the mass or body of a rock material.

**Booster** A chemical compound used for intensifying an explosive reaction. A booster does not contain an initiating device.

**Boot-Leg** A situation in which the blast fails to cause total failure of the rock because of insufficient explosives for the amount of burden, or caused by incomplete detonation of the explosives. That portion of a borehole that remains relatively intact after having been charged with explosive and fired.

**Bridging** Where the continuity of a column of explosives in a borehole is broken, either by improper placement, as in the case of slurries or poured blasting agents, or where some foreign matter has plugged the hole.

**Buffer** Previously shot material, not removed, lying against a face to be shot.

**Bulk Strength** Refers to the strength of a cartridge of dynamite in relation to the same sized cartridge of straight Nitroglycerine dynamite.

**Burden** Generally considered the distance from an explosive charge to the nearest free or open face at the time the hole detonates. Technically, there may be an apparent burden and a true burden, the latter being measured always in the direction in which the displacement of broken rock will occur following firing of an explosive charge.

**C-Scale** A sound level measurement scale that has only slight discrimination at low frequencies.

**Centers** The distance measured between two or more adjacent blastholes without reference to hole locations as to row. The term has no association with the blasthole burdens.

**Charge Weight** The amount of explosive charge in pounds.

**Chambering** More commonly termed springing. The process of enlarging a portion of a blasthole (usually the bottom) by firing a series of small explosive charges.

**Collar** The mouth or opening of a borehole, drill steel, or shaft. Also, to collar in drilling means the act of starting a borehole.

**Compressional Wave** A seismic wave whose motion is compression-dilatation or push-pull, generated by rock's resistance to compression.

**Condensor-Discharge** A blasting machine which uses batteries to energize a series of condensers, whose stored energy is released into a blasting circuit.

**Connecting Wire** Any wire used in a blasting circuit to extend the length of a leg wire or leading wire.

**Connector** Refers to a device used to initiate a delay in a Primacord circuit, connecting one hole in a circuit with another, or one row of holes to other rows of holes.

**Coupling** The act of connecting or joining two or more distinct parts. In blasting, the reference concerns the transfer of energy from an explosive reaction into the surrounding rock and is considered perfect when there are no losses due to absorption or cushioning.

**Coyote Blasting** The practice of drilling blastholes (tunnels) horizontally into a rock face at the foot of the shot. Used where it is impractical to drill vertically.

**Crest** The top of the face created by a previous shot. The maximum amplitude of a wave in the upward direction above the zero line.

**Cultural Vibration** Vibration that is commonplace and familiar to the observer.

**Cushion Blasting** The technique of firing of a single row of holes along a neat excavation line to shear the web between the closely drilled holes. Fired after production shooting has been accomplished.

**Cut** More strictly it is that portion of an excavation with more or less specific depth and width, and continued in similar manner along or through the extreme limits of the excavation. A series of cuts are taken before complete removal of the excavated material is accomplished. The specific dimensions of any cut is closely related to the material's properties and required production levels.

**Cut Off** Where a portion of a column of explosives has failed to detonate because of bridging, or to a shifting of the rock formation due to an improper delay system.

**Decibel** (dB) The unit of sound level measurement.

**Deck** In blasting a smaller charge or portion of a blasthole loaded with explosives that is separated from the main charge by stemming or air cushion.

**Deflagration** An explosive reaction that consists of a burning action at a high rate of speed along which occur gaseous formation and pressure expansions.

**Delay** The term used to describe a blasting cap which does not fire instantaneously but has a predetermined built-in lag or delay.

**Delay Blasting** Blasting that uses delays or delay caps.

**Delay Element** That portion of a blasting cap which causes a delay between the instant of impressment of electrical energy on the cap and the time of detonation of the base charge of the cap.

**Density** The mass of an explosive per unit volume. Expressed in GM/cc. Water has a density of 1.0 gram per cubic centimeter.

**Detonating Cord** A plastic covered core of high velocity explosives used to detonate charges of explosives in boreholes and under water, e.g., Primacord.

**Detonation** An explosive reaction that consists of the propagation of a shock wave through the explosive accompanied by a chemical reaction that furnishes energy to sustain the shock-wave propagation in a stable manner, with gaseous formation and pressure expansion following shortly thereafter.

**Dip** The angle at which strata, beds, or veins are inclined from the horizontal.

**Displacement** The amount of motion associated with vibration of waves, measured in inches.

**Double Priming** A blasthole containing two priming units, usually on the same time delay. They are usually placed one near the top and one near the bottom of the blasthole.

**Downlines** Primacord lines running from the top of the holes. The primer is attached to the bottom end and additional primers may be slid down the cord in the case of decking and/or multiple priming.

**Drop Ball** Known also as a Headache Ball. An iron or steel weight held on a wire rope that is dropped from a height onto large boulders for the purpose of breaking them into smaller fragments.

**EBC (Electric Blasting Cap)** May be instantaneous or delayed. Used to initiate primers or detonating cord.

**Elastic Limit** The limit of elasticity or strength of a rock. Stress below the elastic limit generates elastic waves (seismic waves) while stress above the elastic limit produces rock breakage.

**Elasticity** The property of material that enables it to regain its original size and shape after it has been deformed.

**Energy Ratio** A standard for damage caused by vibration from blasting. Also written as ER and defined as (acceleration in feet/seconc/frequency).

**Explosion** A thermochemical process whereby mixtures of gases, solids, or liquids react with the almost instantaneous formation of gaseous pressures and near sudden heat release. There must always be a source of ignition and the proper temperature limit reached to initiate the reaction. Technically, a boiler can rupture but cannot explode.

**Explosive** Any chemical mixture that reacts at high speed to liberate gas and heat and thus cause tremendous pressures. The distinctions between High and Low Explosives are twofold; the former are designed to detonate and contain at least one high explosive ingredient; the latter always deflagrate and contains no ingredients which by themselves can explode. Both High and Low Explosives can be initiated by a single No. 8 blasting cap as opposed to Blasting Agents which cannot be so initiated.

**Explosive Charge** The quantity of explosive that is to be detonated.

**Explosive Decks** Explosives placed in certain areas of the hole separated by drill cuttings.

**Face** The end of an excavation toward which work is progressing or that which was last done. It is also any rock surface exposed to air.

**Far Field** The region sufficiently far from a sound source in which direct transmission of sound waves is negligible.

**Fatigue** The weakening or failure of a material because of repeated vibration or strain.

**Fire** In blasting, it is the act of initiating an explosive reaction.

**Floor** The bottom horizontal, or nearly so, part of an excavation upon which haulage or walking is done.

**Flyrock** Rock that is propelled into the air by the force of the explosion. Usually comes from prebroken material on the surface or upper open face. Flyrock is an indicator of wasted energy.

**Fracture** Literally, the breaking of rock without movement of the broken pieces.

**Fragmentation** The extent to which rock is broken into small pieces by primary blasting.

**Frequency** The number of vibrations or complete oscillations occurring in one second designated Hertz, (Hz) or cycles per second (Cps).

**Fuel** In explosive calculations it is the chemical compound used for purposes of combining with oxygen to form gaseous products and cause a release of heat.

**Galvanic Action** Currents caused when dissimilar metals contact each other or through a conductive medium. This action may create sufficient voltage to cause premature firing of an electric blasting circuit, particularly in the presence of salt water.

**Galvanometer** A device containing a silver chloride cell which is used to measure resistance in an electric blasting circuit.

**Grade** In excavation, it specifies the elevation of a roadbed, rail, foundation, and so on. When given a value such as percent or degree grade it is in the amount of fall or inclination compared to a unit horizontal distance for a ditch, road, etc. To Grade means to level ground irregularities to a prescribed level.

**Gram Atom** The unit used in chemistry to express the atomic weight of an element in terms of grams (weight).

**Ground Calibration** Determination of the vibration transmission characteristics of a region.

**Hardpan** Boulder clay, or layers of gravel found usually a few feet below the surface and so cemented together that it must be blasted or ripped in order to excavate.

**Hertz** The frequency of vibration written Hz or cycles per second (Cps).

**Highwall** The bench, bluff or ledge on the edge of a surface excavation and most usually used only in coal strip mining.

**Human Response** The reaction of a person to different vibration levels.

**Initiation** The act of detonating a high explosive by means of a mechanical device or other means.

**Initiator** A device or product used to transmit and/or supply heat and/or shock to start an explosion.

**Inversion** An abnormal atmospheric condition such that the air temperature increases with height instead of decreasing.

**Joints** Planes within rock masses along which there is no resistance to separation and along which there has been no relative movement of the material on each side of the break. They occur in sets, the planes of which are generally mutually perpendicular. Joints, like stratification, are often called partings.

**Jumbo** A machine designed to contain two or more mounted drilling units which may or may not be operated independently.

**Kelly Bar** A two-piece drill steel. The inner steel may be withdrawn, allowing the loading of a cardboard casing and/or explosives, while the outer steel prevents rocks or cuttings bridging the blasthole. Used mainly in Florida.

**Lead Wire** The wires connecting the electrodes of an electric blasting machine with the final leg wires of a blasting circuit.

**LEDC Low Energy Detonating Cord** Used to initiate nonelectric caps at the bottom of boreholes.

**Linear Scale** A sound level measurement scale that is nonweighted so that there is little or no discrimination at low frequencies.

**Longitudinal Component** That component of vibration which produces motion in the direction of a line joining the vibration source and the seismograph.

**Longitudinal Trace** The line on the vibration record that records the longitudinal component of motion.

**Low Order** Used to describe a condition of detonation that is not as rapid or complete as it should be.

**Mat** Used to cover a shot to hold down flying material; usually made of woven wire cable or rope.



**Millisecond Delay Caps** Delay electric caps which have a built-in delay element, usually 25/1000th of a second apart, consecutively. This timing may vary from manufacturer to manufacturer.

**Misfire** A charge, or part of a charge, which for any reason has failed to fire as planned. All misfires are to be considered extremely dangerous until the cause of the misfire has been determined.

**Mole** A unit in chemical technology equal to the molecular weight of a substance expressed in grams (weight).

**Muck Pile** The pile of broken material or dirt in excavating that is to be loaded for removal.

**Mud Cap** Referred to also as Adobe or Plaster Shot. A charge of explosive fired in contact with the surface of a rock after being covered with a quantity of mud, wet earth, or similar substance, no borehole being used.

**MS Connector** A nonelectric millisecond delay device used with detonating cord for delaying shots from the surface.

**Near Field** The region near the sound source in which there is direct transmission of sound.

**Normal Distribution** The bell shaped symmetrical curve used in statistical analysis to generalize the relative frequency of occurrence of events.

**Normal Lapse Rate** Rate of decrease of temperature upward through the atmosphere. The average value is 3.5°F/1000 feet.

**Open Pit** A surface operation for the mining of metallic ores, coal, clay, and so on.

**Overbreak** Excessive breakage of rock beyond the desired excavation limit.

**Overburden** The material lying on top of the rock to be shot; usually refers to dirt and gravel, but can mean another type of rock; e.g. shale over limestone.

**Overpressure** The pressure generated by a sound wave which produces vibration in the atmospheric pressure. Overpressure is measured in psi or decibels.

**Over Shot** Condition resulting from more than the necessary amount of explosives. Usually characterized by excesses of fragmentation, flyrock, and noise.

**Oxidizer** A supplier of oxygen.

**Particle Velocity** The velocity at which the earth vibrates, measured in inches per second.

**Peak Particle Velocity** The maximum particle velocity.

**Period** The time for one complete vibration or oscillation of a wave measured in seconds.

**Permissible** Explosives having been approved by the U.S. Bureau of Mines for nontoxic fumes, and allowed in underground work.

**Powder** Any of various solid explosives.

**Premature** A charge which detonates before it is intended to.

**Presplitting** Stress relief involving a single row of holes, drilled along a neat excavation line, where detonation of explosives in the hole causes shearing of the web of rock between the holes. Presplit holes are fired in advance of the production holes.

**Primary Blast** The main blast executed to sustain production.

**Primer** An explosive unit containing a suitable firing device that is used for the initiation of an entire explosive charge.

**Propagation** The movement of a detonation wave, either in a column or from hole to hole.

**Propagation Velocity** The velocity at which a vibration or seismic wave travels outward from the source. It is measured in thousands of feet per second.

**Quarry** An open or surface mine used for the extraction of rock such as limestone, slate, building stone and so on.

**Response-Spectra** A methodology in which the response of a structure to different frequencies can be estimated mathematically.

**Rip Rap** Coarse sized rocks used for river bank, dam and so forth, stabilization to reduce erosion by water flow.

**Round** A group or set of blastholes constituting a complete cut in underground headings, tunnels, etc.

**Safe Limit** The amount of vibration that a structure can safely withstand. Vibration below this limit has a very low probability of causing damage. Vibration above this limit has a reasonable probability of causing damage.

**Scaled Distance** Factor of distance and quantity of explosive which relates to seismic disturbance.

**Seam** A stratum or bed of mineral. Also, a stratification plane in a sedimentary rock deposit.

**Secondary Blasting** Using explosives to break up larger masses of rock resulting from the primary blasts, the rocks of which are generally too large for easy handling.

**Seismic Velocity** The same as propagation velocity. The velocity at which a seismic wave travels outward from its source.

**Seismic Waves** Waves that travel through the earth.

**Seismograph** An instrument that measures and supplies a permanent record of earthborn vibrations induced by earthquakes, blasting, and so forth.

**Seismograph Trace** A line on a seismograph record showing the vibration of the seismic wave.

**Sensitizer** The ingredient used in explosive compounds to promote greater ease in initiation or propagation of the reactions.

**Sensor** A device that senses or measures the vibration of the ground.

**Shear Wave** A seismic wave whose motion is at right angles to the direction of travel. It is generated by the rock's resistance to shear or change in shape.

**Shot Firer** Also referred to as the Shooter or Blaster. The person who actually fires a blast. A Powderman, on the other hand, may charge or load blastholes with explosives but may not fire the blast.

**Shunt** A piece of metal connecting two ends of leg wires to prevent stray currents from causing accidental detonation of the cap. The act of deliberately shorting any portion of an electrical blasting circuit.

**Sinking-Cut** A round drilled, loaded, and timed to be lifted vertically, due to the fact that no open face is available.

**Slope** Used to define the ratio of the vertical rise or height to horizontal distances in describing the angle a bank or bench face makes with the horizontal. For example, a 1 1/2 to 1 slope means there would be a 1 1/2 foot rise to each 1 foot or horizontal distance.

**Snakehole** A hole drilled or bored under a rock or tree stump for the placement of explosives.

**Sound Level** The value of the sound level pressure in psi or in decibels.

Spacing In blasting, the distance between holes or charges in a row.

Spectral Analysis A method of analyzing the vibration frequencies present in a vibration record. It is basically a Fourier analysis.

Steady State Velocity The chemically compounded rate of detonation of an explosive. Governed by diameter, degree of confinement, temperature, and so forth.

Stemming The inert material such as drill cuttings, used in the collar portion (or elsewhere) of a blasthole so as to confine the gaseous products formed on explosion. Also, the length of blasthole left uncharged.

Strength Refers to the energy content of an explosive in relation to an equal amount of ANFO.

Stratification Planes within sedimentary rock deposits formed by interruptions in the deposition of sediments.

Strike The course or bearing of the outcrop of an inclined bed or geologic structure on a level surface.

Subdrill To drill blastholes beyond the planned grade lines or below floor level.

Surface Waves Seismic waves that travel over the surface of the earth or rock rather than traveling into the rock mass.

Swell Factor The ratio of the volume of material in its solid state to that when broken.

Tamping The process of compressing the stemming or explosive in a blasthole.

Throw and Heave This has to do with the displacement of rock as a result of a detonation and the resulting expansion of gases.

Toe The burden or distance between the bottom of a borehole to the vertical free face of a bench in an excavation.

Trace A line on a vibration record.

Trace Amplitude The amplitude of a seismic wave on any of the traces of the vibration record.

Transducer A device which can change energy from one form to another, i.e., mechanical energy into electrical energy.

Transverse A direction of motion at right angles to another direction of motion.

**Transverse Trace** The trace on a vibration record that records motion at right angles to the line joining the vibration source and the seismograph.

**Transverse Wave** A seismic wave that vibrates at right angles to the line joining the vibration source and the seismograph.

**Trough** The maximum amplitude of a wave in the downward direction below the zero line.

**Trunk--Trunkline** Detonation cord line on the surface, to which the downline or Primadet line is tied prior to firing.

**Under Shot** A condition resulting from not enough explosive or a pattern size too large for the amount of explosive used. Usually characterized by poor fragmentation and lack of movement.

**Velocity** The rate of change of distance with time. The rate of detonation.

**Vertical** The direction perpendicular to the earth's gravity field. In this case, the up and down motion of the earth's vibration.

**Vertical Trace** A line on the vibration record that shows the up and down motion of the earth's vibration.

**Vibration Crack** A tension crack characteristic of material failure because of vibration. It has X-shape.

**Vibration Parameters** Those physical quantities that are used to describe the vibration. These parameters are displacement, velocity acceleration, and frequency.

**Vibration Problem** The human problem that arises when vibration is large enough to be felt.

**Wave length** The distance between two successive crests or troughs of a wave.

**Wave Parameters** Those mathematical quantities that are used to describe wave motion. These parameters are amplitude, period, frequency, wave length and so on.

**X-Crack** A tension crack characteristic of material failure due to vibration.

**APPENDIX II**  
**BLASTING EQUATIONS**

**CHAPTER 6**

$$B_2 = B_1 \frac{D_{e2}}{D_{e1}} \quad \text{ft} \quad (6.1)$$

$$B = \left[ \frac{2 SG_e}{SG_r} + 1.5 \right] D_e \quad \text{ft} \quad (6.2)$$

$$B = 0.67 D_e \sqrt[3]{\frac{ST_v}{SG_r}} \quad \text{ft} \quad (6.3)$$

$$T = 0.7 B \quad \text{ft} \quad (6.4)$$

$$S_z = \frac{D_h}{20} \quad \text{in} \quad (6.5)$$

$$J = 0.3 B \quad \text{ft} \quad (6.6)$$

$$L_{\min} = 5 D_e \quad \text{ft} \quad (6.7)$$

$$t_H = T_H \times S \quad \text{ms} \quad (6.8)$$

$$t_R = T_R \times B \quad \text{ms} \quad (6.9)$$

**CHAPTER 7**

$$S = \frac{L + 2 B}{3} \quad \text{ft} \quad (7.1)$$

$$S = 2 B \quad \text{ft} \quad (7.2)$$

$$S = \frac{L + 7 B}{8} \quad \text{ft} \quad (7.3)$$

$$S = 1.4 B \quad \text{ft} \quad (7.4)$$

$$\bar{x} = A \left[ \frac{V_0}{Q} \right]^{0.8} Q^{0.167} \quad \text{ft} \quad (7.5)$$

$$R = e^{-\left[ \frac{x}{x_c} \right]^n} \quad \text{ft} \quad (7.6)$$

$$n = \left[ 2.2 - 1.4 \frac{B}{d} \right] \left[ 1 - \frac{W}{B} \right] \left[ 1 + \frac{A-1}{2} \right] \frac{L}{H} \quad \text{ft} \quad (7.7)$$

$$\bar{x} = A \left[ \frac{V_0}{Q} \right]^{0.8} Q^{0.167} \left[ \frac{E}{115} \right]^{-0.63} \quad \text{ft} \quad (7.8)$$

## CHAPTER 8

$$\text{dec} = \frac{D_h^2}{28} \quad \text{lb / ft} \quad (8.1)$$

$$S = 10 \times D_h \quad \text{in} \quad (8.2)$$

$$d_{eb} = 2 \times d_{ec} \quad \text{lb} \quad (8.3)$$

$$S = 16 \times D_h \quad \text{in} \quad (8.4)$$

$$B = 1.3 \times S \quad \text{in} \quad (8.5)$$

$$d_{ec} = 7,000 \left[ \frac{S}{85} \right]^2 \quad \text{grain / ft} \quad (8.6)$$

## CHAPTER 10

$$f = \frac{1}{T} \quad \text{Hz (cycles/second)} \quad (10.1)$$

$$L = V T \quad \text{ft} \quad (10.2)$$

$$R = \sqrt{V^2 + L^2 + T^2} \quad \text{in / s} \quad (10.3)$$

$$V = \frac{A}{G} \quad \text{in / s} \quad (10.4)$$

$$SL = \frac{A}{AG} + AB \quad \text{dB} \quad (10.5)$$

$$V = H \left[ \frac{D}{W^\alpha} \right]^\beta \quad \text{in / s} \quad (10.6)$$

$$V_r = 0.052 \left[ \frac{D}{W^{0.512}} \right]^{-1.63} \quad \text{in / s} \quad (10.7)$$

$$V = 100 \left[ \frac{d}{\sqrt{W}} \right]^{-1.6} \quad \text{in / s} \quad (10.8)$$

$$V = 160 \left[ \frac{d}{\sqrt{W}} \right]^{-1.6} \quad \text{in / s} \quad (10.9)$$

$$W = d^2 \left[ \frac{V}{H} \right]^{1.25} \quad \text{lb} \quad (10.10)$$

$$D_s = \frac{d}{\sqrt{W}} \quad \frac{\text{ft}}{\sqrt{\text{lb}}} \quad (10.11)$$

$$ER = \left[ \frac{a}{f} \right]^2 \quad \frac{\text{ft}^2}{\text{s}^2} \quad (10.12)$$

$$\text{dB} = 20 \log \frac{P}{P_0} \quad \text{dB} \quad (10.13)$$

$$K = \frac{d}{\sqrt[3]{W}} \quad \frac{\text{ft}}{\sqrt[3]{\text{lb}}} \quad (10.14)$$



## APPENDIX III

### BLASTING EQUATION REVIEW

---

#### EQUATION 6.1

$$B_2 = B_1 \frac{De_2}{De_1}$$

where:

- $B_2$  = New burden (ft)
- $De_2$  = New explosive diameter (in)
- $B_1$  = Burden successfully used on previous blasts (ft)
- $De_1$  = Diameter of explosive for  $B_1$  (in)

#### BACKGROUND

This equation is used to approximate a new burden from known information at a particular blasting site.

Local geology causes changes in fragmentation as burdens increased or decreased. As an example; joint sets, which occur between blastholes or between the burden and the face, can influence the fragmentation distribution. The larger the burdens and spacings, the larger the probability that additional joint sets will be encountered between holes. The definition of burden, however, is not dependent upon fragmentation alone. The definition of burden considers two separate criteria. The burden is generally measured at the grade level, since this is the most difficult place to cause breakage to occur. If the proper burden is selected, the rock will shear to grade level. If the burden is too large, a hump or toe will occur at the grade line, which will require secondary blasting. An additional criterion for burden selection is the production of reasonably sized material from the blast. Different types of operations, such as mining, quarrying and construction may require slightly different sizes of materials and may, therefore, adjust the burden accordingly to produce the size desired. Normally, both criteria must be satisfactory to the operator before one can conclude that the proper burden has been chosen. This equation could be used in either metric or English united in its present form, since either ratio of the charge diameters has no units.

## LIMITATIONS

1. The equation is only valid if the rock type does not change.
  2. The equation is only valid if the explosive type does not change.
  3. Use of this equation does not mean that fragmentation results will be identical as hole sizes increase or decrease. There are other blasting parameters which if held constant with changing burdens, would cause fragmentation size to change.
- 

## EQUATION 6.2

$$B = \left[ \frac{2 SG_e}{SG_r} + 1.5 \right] D_e$$

where:

- B = Burden (ft)  
SG<sub>e</sub> = Specific gravity of explosive  
SG<sub>r</sub> = Specific gravity of rock  
D<sub>e</sub> = Diameter of explosive (in)

## BACKGROUND

It has always been an important need in the blasting industry to be able to approximate burden at a new site, where there has been no previous blasting experience. There have been many equations that have evolved over the years to predict the burden, based on the characteristics of both the explosives to be used and the rock mass to be shot. In the 1950's, Alsmann & Speath proposed an equation based on the following parameters:

$$B = K \frac{D_e}{12} \sqrt{\frac{P_e}{S_t}}$$

where:

- B = Burden (ft)  
K = Constant (0.8 for most rock)  
D<sub>e</sub> = Diameter of explosive charge (in)  
P<sub>e</sub> = Explosion pressure (psi)  
S<sub>t</sub> = Rock tensile strength (psi)

The difficulty in using this equation was that the borehole pressure and the tensile strength of the rock mass were not readily available. It is significant to note that the equation also indicated that burden was linear with charge diameter.

In 1964, Dr. Richard Ash from the University of Missouri at Rolla, published a Burden Equation in a series of articles in "Pit and Quarry" magazine.

$$B = K_b \frac{D_e}{12}$$

where:

- B = Burden (ft)
- $K_b$  = Burden constant
- $D_e$  = Diameter of explosive (in)

The equation was simple to use and it related burden to some constant number times the charged diameter. The article defined ranges of constants to be used based on explosive and rock types. The difference between the Ash approach and the Alsman & Speath approach was that Ash integrated the borehole pressure with the tensile strength relationship into the first constant which Alsman used as a separate function. In this manner, the blaster did not have to predetermine these difficult to obtain values, in fact, they could be estimated.

In 1968, in an article published by Dr. Ash in a book entitled "Surface Mining", he proposed a method to adjust the constant in the burden calculation by using the velocity of the explosive squared times the density of the explosive. This method of adjustment seemed to work reasonably well in mid-range, however; at both ends of the velocity range, the compensations in burden were extreme.

In 1972, Dr. Konya proposed a burden equation similar to the Ash equation.

$$B = 3.15 D_e \sqrt[3]{\frac{SG_e}{SG_r}}$$

where:

- B = Burden (ft)
- $D_e$  = Diameter of explosive (in)
- $SG_e$  = Specific gravity of explosive
- $SG_r$  = Specific gravity of rock

In this equation the constant was defined as 3.15 and the constant could be adjusted by using a ratio of a specific gravity of the explosive to the specific gravity of the rock, both raised to the one third power. This approach gave identical values in the mid-range and both ends of the range were more accurately defined.

The adjustments to the constants made by Konya function well for both explosives and rock types worldwide, however; field personnel found it difficult to work with a relationship which contained a quantity raised to the 0.333 power.

In 1983, Konya discovered another function (Equation 6.2), which would give similar results to those using the earlier burden equation. This new equation was simple to use, required no power functions and was ideally suited for field use.

### LIMITATIONS

There are no known limitations to this equation. There should be, however, less accuracy with the emulsion explosives, since many with different strengths have similar specific gravities. Dr. Konya has already developed another more accurate equation to be used with the emulsion explosives, however: it is not as yet ready for distribution.

---

### EQUATION 6.3

$$B = 0.67 D_e \sqrt[3]{\frac{ST_v}{SG_r}}$$

where:

B	=	Burden (ft)
De	=	Diameter of explosive (in)
ST <sub>v</sub>	=	Relative bulk strength when ANFO = 100
SG <sub>r</sub>	=	Specific gravity of rock

### BACKGROUND

Some of the new emulsion slurries have similar densities with different strength values. In order to produce a better first estimation of burden using emulsion slurries or other explosives, one can use Equation 6.3 proposed by Dr. Konya in 1981.

### LIMITATIONS

There are no known limitations to this equation.

---

## **EQUATION 6.4**

$$T = 0.7 B$$

where:

$$\begin{aligned} T &= \text{Stemming (ft)} \\ B &= \text{Burden (ft)} \end{aligned}$$

## **BACKGROUND**

The function of the stemming material is to provide a delayed action for gas ejection from the blast hole. During time delay, after detonation and before the rock movement occurs, the hoop stresses set up by the gas pressure have a chance to rupture the burden and produce radial cracks and the subsequent flexural failure. The amount of stemming needed in a blasthole is generally recommended between 0.5 and 1.0 times the burden. An average number of approximately 2/3 or 70 percent of the burden has evolved as a standard number in the blasting industry. In an attempt to trace back the history of the equation, it was found that even during the days of shooting black powder, in 1903, it was recommended that a stemming distance of about 2/3 of the burden be used.

## **LIMITATIONS**

Although it is sometimes possible to use stemming lengths as small as 0.5 burden, in the majority of the cases this minimum amount of stemming would eject. The reason for the ejection is that the stemming distance is a complex variable, which is a function of many of the other blasting variables, such as burden, spacing, hole depth, timing, etc. In general, if drilling chips are used along with an accurately drilled and timed pattern, a stemming distance of 0.7 burden would be sufficient. However, if drilling dust is used for stemming, the stemming distance may be equal to the burden.

---

## **EQUATION 6.5**

$$S_z = \frac{D_h}{20}$$

where:

$$\begin{aligned} S_z &= \text{Particle size (in)} \\ D_h &= \text{Blasthole diameter (in)} \end{aligned}$$

## **BACKGROUND**

Equation 6.5 deals with the approximation of the proper stemming particle size for maximum confinement.

This relationship was determined as a result of a Federal Research Contract from the Office of Surface Mining by Dr. Konya at Ohio State University. The specific size of the material is not absolutely critical, therefore, whether the size would be the diameter of the hole divided by 18, 20 or 25 it would not be a critical factor. The factors that were critical were the materials used for stemming and are as follows:

1. Material angular rather than round in nature (preferably crushed stone).
2. River gravel and dust will not function as well as crushed stone.
3. The mechanism of the particles locking into the borehole walls and bridging over is similar to that which could result in bin flow.
4. The rock particles should have minimum strength characteristics somewhere near that of the parent rock.
5. In situations where the stemming is totally saturated, it is extremely important to have the angular material within the size range prescribed so that it can resist the effects of the hydraulic action generated when the explosive detonates under saturated conditions.

## **LIMITATIONS**

This equation assumes an accurately drilled and timed blasting pattern.

---

## **EQUATION 6.6**

$$J = 0.3B$$

where:

$$\begin{aligned} J &= \text{Subdrilling (ft)} \\ B &= \text{Burden (ft)} \end{aligned}$$

## **BACKGROUND**

The amount of subdrilling is related as approximately 1/3 burden.

When calculating the proper burden one must take into account the powder diameter, the powder types and the rock type. These same factors are important in the determination of the subdrilling. However, by taking it as a function of the burden, we can more easily calculate the proper subdrilling, since the same factors that influence burden also influence subdrilling. Subdrilling alone is not a guarantee that one will pull to the bottom of the grade, it also depends upon the spacing, timing and length of blastholes.

## **LIMITATIONS**

If the spacing, timing and length are within normal ranges, the stemming is a function of the burden. If, however, the additional pattern variables are far from being correct, no amount of subdrilling can guarantee that the floor will be broken to grade. If planes of weakness occur at grade level subdrilling may be unnecessary.

---

## **EQUATION 6.7**

$$L = 5D_e$$

where:

L = Minimum bench height (ft)  
D<sub>e</sub> = Diameter of explosive (in)

## **BACKGROUND**

This equation should only be used as an approximation for the condition when L/B = 2. The reason it can be used is that the average burden in feet is approximately 2.5 times the charge diameter in inches. Therefore, 5 times the diameter in inches would be equivalent to 2 burdens, in feet, or be equivalent to L.

## **LIMITATIONS**

This equation is used as a quick field approximation and could deviate in either a positive or negative direction depending on how far the explosive or rock deviate from what we consider an average condition.

---

## **EQUATION 6.8**

$$t_H = T_H \times S$$

where:

$$\begin{aligned} t_H &= \text{Hole-to-hole delay (ms)} \\ T_H &= \text{Delay constant hole to hole} \\ S &= \text{Spacing (ft)} \end{aligned}$$

## **BACKGROUND**

This equation determines the hole to hole time for optimum breakage. The "T<sub>H</sub>" value is an empirical constant for the spacing in feet. The original equations developed in the 1950's had used a value of burden rather than a value of spacing, as the multiple for the time constant. It was recognized, that the values were normally the same, therefore, the equation was changed to use spacing. It should be pointed out that timing alone does not control fragmentation, it is tied together with the actual physical feet of spacing. If the spacing is too great on a particular shot, then regardless of the timing, the rock may become more coarse. If the spacing is too small, similar phenomena can occur. This method of timing is commonly used in European countries, however, it is expressed in metric units, we have made the conversion to feet. Recent research in the USA has confirmed the validity of some of the values.

---

## **EQUATION 6.9**

$$t_R = T_R \times B$$

where:

$$\begin{aligned} t_R &= \text{Row-to-row delay (ms)} \\ T_R &= \text{Time factor between row} \\ B &= \text{Burden (ft)} \end{aligned}$$

## **BACKGROUND**

This equation refers to the timing between adjacent rows of boreholes in a blast. The timing row to row does not consider the rock types or explosive load. Those two factors were considered to determine "B", the burden. Dr. Konya has assembled the Tr values from accepted industry standards. Some of these standards are accepted not only in the United States but also worldwide.



## LIMITATIONS

The limitations are that the initiators must actually fire at the rated time, should cap scatter be large or if caps are firing far from their nominal time, then the equation breaks down. The second limitation is that the burden is actually drilled at the exact distance. Some patterns have as much as 50% drilling deviation in the field.

---

## EQUATION 7.1

$$S = \frac{L + 2B}{3}$$

where:

S = Spacing (ft)  
L = Bench height (ft)  
B = Burden (ft)

## BACKGROUND

The proper spacing of blastholes has always been a concern. Intuitively blasters knew that the shorter the bench the smaller the spacing which has to be used. This has been documented as early as 1916. The problem, however, was that the magnitude of adjustment was unknown.

In 1967, Konya did a model study to determine the spacing for simultaneous initiation on different bench heights. The equation was as follows:

$$S = 0.45 \times \text{Log}_e (AL + B) + C$$

where:

S = Spacing (ft)  
L = Bench Height (ft)  
A, B, C = Material constants

Field equation evolved from this work. The equation was  $S = (BH)^{0.5}$ , where "B" is for burden and "H" is for hole depth and the product is taken to the 0.5 power. In 1974, Konya further modified the relationship to produce Equation 7.1.

## **LIMITATIONS**

Geologic features may require the adjustment of spacing values. Holes must fire near instantaneously. The effects of cap scatter can cause problems especially in high delay period caps. This equation is only valid between stiffness ratios of above one and below four.

---

## **EQUATION 7.2**

$$S = 2B$$

where:

$$\begin{aligned} S &= \text{Spacing (ft)} \\ B &= \text{Burden (ft)} \end{aligned}$$

## **BACKGROUND**

This spacing equation is intended for use when the maximum spacing and uniform, but coarse fragmentation is acceptable. Experience in the field has proven that spacings along a row, equal to twice the burden, are commonly used and function properly when blastholes fire near instantaneously along a row. Under conditions of adverse geology, or large blastholes, this value may have to be reduced even with instantaneous initiation. Under some conditions of extremely unique rock structure, there are recorded cases where spacings as much as three times the burden were achieved. The use of broad spacings with instantaneous initiation was first documented in the year 1725.

## **LIMITATIONS**

1. The equation only functions with instantaneous initiation along the row.
  2. Bench height must have a stiffness ratio greater than four.
  3. Average geologic conditions must exist.
  4. Cap scatter on long delay periods may require spacings to be reduced.
-

### **EQUATION 7.3**

$$S = \frac{L + 7B}{8}$$

where:

S = Spacing (ft)  
L = Bench height (ft)  
B = Burden (ft)

### **BACKGROUND**

Continuation of the Dr. Konya's work on blasthole spacing and the effects of initiation timing, which began in 1966, resulted in the development of an empirical equation to overcome the effects of stiffness for delay blasting. The details of development of the spacing equation for low benches was previously discussed in Equation 7.1. The spacing for delayed initiation of blastholes has been used as somewhere between 1 and 1.5 times the burden for many decades. Equation 7.3 would account for the low end of that scale, which is due to low stiffness ratios.

### **LIMITATIONS**

1. This equation is valid between the ranges of stiffness of one to four.
  2. This equation is only valid with delayed initiation between blastholes.
  3. It is assumed that blastholes are drilled within one charge diameter of their desired location.
  4. It is assumed that the effect of cap scatter, which could produce overlap in neighboring holes, is not significant.
- 

### **EQUATION 7.4**

$$S = 1.4 B$$

where:

S = Spacing (ft)  
B = Burden (ft)

## **BACKGROUND**

This equation is used for holes delayed one from another. When stiffness ratios are four or more, the spacing remains relatively constant at the ratio of approximately 1.4 times the burden.

## **LIMITATIONS**

1. 1.4 is a conservative number, but in some cases the author has used spacing as much as 1.6 times the burden with satisfactory results.
2. The equation is only valid for stiffness ratios of four or more.
3. The equation is only valid for holes which have delayed initiation one from another.
4. It is assumed that blastholes will be firing at a delayed time, in spite of the effects of cap scatter.

---

## **EQUATION 8.1**

$$d_{ec} = \frac{D_h^2}{28}$$

where:

$d_{ec}$  = Explosive load (lbs/ft)

$D_h$  = Diameter of borehole (in)

## **BACKGROUND**

This equation was developed by Dr. Konya in 1973. It predicts the loading density in decoupled holes, which will be used for either pre-splitting or cushion (trim) blasting. The use of this equation should provide sufficient energy to cause the splitting action between normally spaced presplit or trim blastholes, without significant damage to the borehole walls. The loading density obtained by this equation should not damage the walls, yet should permit blasthole spacing to be extended. If for geologic reasons, it is desired to bring blastholes closer together than that proposed in equations 8.2 and 8.4 then the explosive load would have to be reduced. This equation gives a conservative starting point, which can be fine tuned or adjusted to meet local conditions.

## LIMITATIONS

1. It is assumed that the hole spacing will be as given in equation 8.2 and 8.4.
  2. Powder loads tend to be conservative with a small excess of energy.
  3. It is not uncommon, if spacings are reduced significantly, to reduce the loading density while maintaining a constant borehole size.
- 

## EQUATION 8.2

$$S = 10D_h$$

where:

$$\begin{aligned} S &= \text{Spacing (in)} \\ D_h &= \text{Diameter of borehole (in)} \end{aligned}$$

## BACKGROUND

This equation deals with the spacing in inches of blastholes which are to be used for presplitting. The values obtained by this equation are intended to be conservative, to ensure that a split does result. Spacings may be able to be spread to 12 times the diameter or more under favorable geologic conditions. The range of spacing, therefore, can be 10 to 14 times the hole diameter. This general equation was developed from empirical data by Dr. Konya in 1973.

## LIMITATIONS

1. Must be used with charge loads given in equation 8.1. The use of other charge sizes, either larger or smaller, would necessitate the change of spacing.
- 

## EQUATION 8.3

$$d_{eb} = 3 \times d_{ec}$$

where:

$$\begin{aligned} d_{eb} &= \text{Bottom load (lbs)} \\ d_{ec} &= \text{Column load (lbs)} \end{aligned}$$

## **BACKGROUND**

Equation 8.3 refers to the amount of bottom load needed to be placed in a presplit to cause the hole to break to its entire depth. The bottom portion of the hole is the toughest place to break, therefore, additional energy is needed to ensure that fractures will break to the bottom. The general practice is to use 2 to 3 times the per foot load in the bottom of the hole. The use of a bottom charge of this type has been used by industry since the advent of presplit or cushion blasting. Although it may not be necessary in all cases, it is added insurance that the entire face, including the bottom, will be split..

## **LIMITATIONS**

1. Charges in excess of this should not be necessary to split the bottom if proper spacings are used.
  2. It is not always essential that a bottom load be used.
- 

## **EQUATION 8.4**

$$S = 16D_h$$

where:

$$\begin{aligned} S &= \text{Spacing (in)} \\ D_h &= \text{Diameter of empty holes (in)} \end{aligned}$$

## **BACKGROUND**

This equation produces a spacing, in inches, between cushion or trim blastholes. The equation is dependent on the use of equation 8.1 to produce the proper loading density and energy in the hole. Larger spacings could possibly be used under favorable geologic conditions. If smaller spacings are used, powder loads should be decreased accordingly. In cushion blasting it is essential that a burden on any hole be greater than the spacing between holes, to get the proper splitting action. If burdens are smaller than the spacing, the spacing will have to be reduced along with the powder load. This equation was prepared from empirical data by Dr. Konya in 1973.

## **LIMITATIONS**

1. This equation is meant to be used with a powder charge as given in equation 8.1.
  2. The spacings are also designed to be used with equation 8.5
  3. Should geologic conditions or small burdens require a change in spacing, then smaller spacings can be used, however; powder loads must be reduced.
- 

## **EQUATION 8.5**

$$B = 1.3 S$$

where:

$$\begin{aligned} B &= \text{Burden (in)} \\ S &= \text{Spacing (in)} \end{aligned}$$

## **BACKGROUND**

This equation defines the minimum burden on any hole in a trim blast shot. It is necessary to keep a larger burden than spacing to ensure that a crack will form between holes before the burden is removed. This equation was proposed by Dr. Konya in 1973, as a result of analysis of empirical data.

## **LIMITATIONS**

1. This equation is used only with cushion (trim) blasting.
  2. This equation is meant to be used with equation 8.4 only.
  3. Larger burdens can be used if necessary without any detrimental effects to wall control.
-

## **EQUATION 8.6**

$$d_{ec} = 7000 \left[ \frac{S}{85} \right]^2$$

where:

$d_{ec}$  = Explosive load (lbs/ft)  
 $S$  = Spacing (in)

## **BACKGROUND**

This equation defines the core load (grains/ft) of detonating cord which could be used in trim blasting. It is used in situations where the blastholes are closely spaced and normal presplit explosives, supplied by manufacturers, produce excessive energy. This equation was developed by Dr. Konya in 1975.

## **LIMITATIONS**

1. In general this equation is used when blastholes are spaced at less than 24 inches.
- 

## **EQUATION 10.6**

$$V = H \left[ \frac{D}{W^\alpha} \right]^\beta$$

where:

$V$  = Predicted particle velocity (in/s)  
 $W$  = Maximum explosive charge weight per delay (lbs)  
 $D$  = Distance from shot to sensor measured in 100's of feet (e.g.,  
for distance of 500 ft,  $D = 5$ )  
 $H$  = Particle velocity intercept  
 $\alpha$  = Charge weight exponent  
 $\beta$  = Slope factor exponent



## **BACKGROUND**

This equation was published by the United States Bureau of Mines in Bulletin 656, as a method of Vibration Prediction. The equation has been used by the Bureau of Mines for decades. It was determined as a result of research into blast vibrations that the effects of distance and charge weight on vibration levels was reasonably predictable. The equation was derived theoretically, however; the exponents and the constant "H" were determined from field data. The equation is commonly called the "Propagation Equation". It was found that the exponent on "W" varied from site to site, however; the variation was small and "W" could be scaled as a square root. The factor "beta" also varied slightly from site to site, but its average value is approximately -1.6. The constant "H" is commonly called the "Ground Correlation Coefficient" because it can vary significantly from site to site, depending on both blast design parameters and ground conditions. It is the most variable of all the empirical constants. The Bureau of Mines recommended an "H" value of approximately 100. The DuPont Blaster's Handbook, which was published in 1977, recommended a more conservative constant of about 160. These two constants are used in the industry to project average anticipated vibration levels. The scale distance law, which is commonly used in vibration calculation, resulted from an abbreviated form of equation 10.6

## **LIMITATIONS**

1. Value of " $\beta$ " commonly used is -1.6.
  2. The value of " $\alpha$ " commonly used is 0.5.
  3. "H" in the average case, is assumed to be between 100 and 160. An actual value can be determined from test blasts at the site and can vary considerably.
-

**APPENDIX IV**  
**BLASTING SPECIFICATIONS**  
**TABLE OF CONTENTS**

1.0	DESCRIPTION .....	368
2.0	GENERAL REQUIREMENTS .....	369
2.1	Use of Explosives.....	369
2.2	Product Specifications.....	369
2.3	Scaling and Stabilization .....	370
3.0	PRODUCTION BLASTING OPERATIONS .....	371
3.1	Blasting Plan Submittal .....	371
3.2	Production Holes.....	372
3.3	Blasting Test Section(s).....	373
4.0	SAFETY PROCEDURES .....	374
4.1	Warnings and Signals .....	374
4.2	Lightning Protection.....	374
4.3	Check for Misfires.....	375
4.4	Misfire Handling Procedures .....	375
5.0	CONTROLLED BLASTING METHODS.....	376
5.1	Presplitting.....	376
5.2	Cushion (Trim) Blasting .....	379
5.3	Sliver Cuts .....	379
6.0	SPECIAL REQUIREMENTS .....	380
6.1	Blasting Consultant .....	380
6.2	Pre-Blast Condition Survey .....	380
6.3	Vibration Control and Monitoring .....	380
6.4	Air Blast and Noise Control.....	382
6.5	Flyrock Control .....	383
6.6	Public Meetings.....	383
7.0	RECORDKEEPING.....	383
7.1	Daily Explosive Material Consumption .....	383
7.2	Report of Loss.....	383
7.3	Daily Blasting Logs .....	384
7.4	Video Recording of Blasts.....	385
8.0	METHOD OF MEASUREMENT .....	385
9.0	BASIS OF PAYMENT .....	386

## FHWA

### GUIDE BLASTING SPECIFICATION

#### 1.0 DESCRIPTION

Controlled blasting techniques, as covered herein, shall be used for forming highway rock cut slopes at the locations shown on the plans or called for in the special provisions.

Controlled blasting refers to the controlled use of explosives and blasting accessories in carefully spaced and aligned drillholes to produce a free surface or shear plane in the rock along the specified excavation backslope. Controlled blasting techniques covered by this specification include presplitting and cushion (trim) blasting.

When presplitting, the detonation of the presplit line shall be before the detonation of any production holes.

Cushion blasting is similar to presplitting, except that the detonation along the cut face shall be performed after the detonation of the production holes.

Production blasting, as covered herein, refers to the rock fragmentation blasts resulting from more widely spaced production holes drilled throughout the main excavation area adjacent to the controlled blast line. Production holes shall be detonated in a controlled delay sequence.

The purpose of controlled blasting is to minimize damage to the rock backslope and to help insure long-term stability. The Engineer may require the Contractor to use controlled blasting to form the faces of slopes, even if the main excavation can be ripped.

#### REMARKS

Some agencies specify slope dimension criteria to establish when controlled blasting will be used, such as "when blasting to excavation slopes 3/4:1 or steeper and more than 10 feet high." Other agencies have successfully used controlled blasting techniques on 1:1 slopes and slopes less than 10 feet high. Therefore, inclusion of specific slope and depth criteria in the specification, if desired, is left to the individual highway agency.

## **2.0 GENERAL REQUIREMENTS**

**2.1 Use of Explosives** All blasting operations, including the storage and handling of explosives and blasting agents, shall be performed in accordance with the applicable provisions of the Standard Specifications and all other pertinent Federal, State, and local regulations.

Whenever explosives are used, they shall be of such character and in such amount as is permitted by the State and local laws and ordinances and all respective agencies having jurisdiction over them.

### **REMARKS**

Project specific constraints on time of blasting or other restrictions, such as road closure times, should be covered in the project special provisions.

When it is required to store explosives, blasting agents or detonators, on state or federal property, the Contractor will conform to all applicable state and federal laws governing explosives storage. The Contractor will submit his storage plans along with the type of magazine or explosive storage facility to be used on the job site. The Contractor will append to the plan the state or federal regulations governing explosives storage. The Contractor is required to conform to all requirements of state and federal agencies applicable to explosive storage and will conform to the record keeping, placarding, safe distances and all other requirements concerning storage. Applicable magazine permits will be obtained and displayed as required by state or federal regulations.

**2.2 Product Specifications** The delay elements in blasting caps are known to deteriorate with age. For this reason, it is required that all blasting caps used on the project be one year or less of age.

### **REMARKS**

Date codes on the boxes allow the Engineer easy access to this information.

To ensure the accuracy of firing times of blasting caps, it is required that each cap period come from one lot number. Mixing of lot numbers for any one cap period is prohibited.

Explosives are also known to age and deliver much less than the rated energy. For this reason, it is required that all explosives used on the project be 1 year or less of age.

## REMARKS

Date codes on these cartridges can be used to determine the age of the product.

Bulk explosives, such as ammonium nitrate and fuel oil, may not contain the proper amount of diesel oil, due to evaporation or improper mixing. Low diesel oil drastically reduces the energy content of the explosive and commonly produces reddish brown or yellow fumes upon detonation even in dry blastholes. Product that does not meet manufacturers specifications will not be used on the project.

When, in the opinion of the Engineer, any blasting product is either of excessive age or in what appears to be a deteriorated condition, all work will cease until the products age or quality can be determined.

No blasting product will be brought to the job site if the date codes are missing. At the option of the Engineer, he can require product to be tested by an independent organization to determine its performance as compared to the manufacturers data sheet. If product performance or composition deviates by more than 10% in any manner from the manufacturers data sheet, that lot number will be rejected.

**2.3 Scaling and Stabilization** All rock on the cut face that is loose, hanging, or which creates a potentially dangerous situation shall be removed or stabilized, to the Engineer's satisfaction, during or upon completion of the excavation in each lift. Drilling of the next lift will not be allowed until this work has been completed.

The slopes shall be scaled throughout the span of the contract and at such frequency as required to remove all hazardous loose rock or overhangs. The slopes shall be hand scaled using a suitable standard steel mine scaling rod. Subject to the Engineer's approval, other methods such as machine scaling, hydraulic splitters or light blasting may be used in lieu of or to supplement hand scaling. Payment for scaling shall be incidental to the contract unit price for roadway excavation.

If in-place stabilization is required, as determined by the Engineer, rock bolting or other Engineer approved stabilization techniques will be used. Stabilization necessitated, in the opinion of the Engineer, by the rock geology, will be paid for at the appropriate unit price or force account. Stabilization necessitated, in the opinion of the Engineer, by the Contractor's blasting operations, shall be performed at the Contractor's expense.

### **3.0 PRODUCTION BLASTING OPERATIONS**

**3.1 Blasting Plan Submittal** Not less than two weeks prior to commencing drilling and blasting operations, or at any time the Contractor proposes to change the drilling and blasting methods, the Contractor shall submit a "Blasting Plan" to the Engineer for review. The blasting plan shall contain the full details of the drilling and blasting patterns and controls the Contractor proposes to use for both the controlled and production blasting. The blasting plan shall contain the following minimum information:

- 1) Station limits of proposed shot.
- 2) Plan and section views of proposed drill pattern including free face, burden, blasthole spacing, blasthole diameters, blasthole angles, lift height, and subdrill depth.
- 3) Loading diagram showing type and amount of explosives, primers, initiators and location and depth of stemming.
- 4) Initiators sequence of blastholes including delay times and delay system.
- 5) Manufactures data sheets for all explosives, primers, and initiators to be employed.

The blasting plan submittal is for quality control and recordkeeping purposes. Review of the blasting plan by the Engineer shall not relieve the Contractor of his responsibility for the accuracy and adequacy of the plan when implemented in the field.

When the contract requires the Contractor to retain a blasting consultant to assist with the blast design, all blasting plan submittals must be approved by the blasting consultant.

### **REMARKS**

A sample blasting plan form is provided in this manual to aid the Contractor in the proper submittal of blasting information to the Engineer. The Contractor should be required to submit the form with information about the proposed shot, prior to drilling for each blast. Additional information on actual explosive loading and shot evaluation is added after the blast to provide a complete shot record. Adoption of some type of similar simplified form for the blasting plan submittal is strongly encouraged. Use of such a standard format will insure that the pertinent data is obtained, will improve communication and will make the job much easier for the Project Engineer and/or highway agency person in charge of reviewing and evaluating the blasting operations.

**3.2 Production Holes** All production blasting, including that carried out in conjunction with the blasting test section requirements of Section 3.2, shall be performed in accordance with the following general requirements.

### **REMARKS**

Production blast operations adjacent to the excavation perimeter can have a serious influence on the success of controlled blasting. Backbreak and endbreak cracks are known to travel hundreds of feet and can influence the final contour and wall stability. Presplitting or controlled blasting alone cannot guarantee undamaged perimeters unless the production blasting is also done in a controlled manner.

Production blastholes shall be drilled on the patterns submitted by the Contractor and approved by the Engineer. The production blastholes shall be drilled within two (2) blasthole diameters of the staked collar location. If more than 5% of the holes are drilled outside of this tolerance, at the option of the Engineer, the Contractor may be required to refill these holes with crushed stone and redrill them at the proper location.

If the blastholes are plugged or unable to be fully loaded, at the option of the Engineer, the Contractor may be required to deepen or clean-out these holes. The blastholes should all be checked and measured before any explosives are loaded into any of the holes to eliminate any safety hazard resulting from drilling near loaded holes.

All blastholes should reach their desired depth. If more than 5% of the holes are short before loading, the Contractor may be required by the Engineer to redrill the short holes to proper grade at the Contractor's expense.

In order to control blasting effects, the Contractor must maintain a burden distance which is not more than one half the bench height.

Blastholes will be covered to keep overburden from falling into the holes after drilling.

The row of production blastholes immediately adjacent to the controlled blast line shall be drilled on a plane approximately parallel to the controlled blast line. Production blastholes shall not be drilled closer than 6 feet to the controlled blast line, unless approved by the Engineer. The bottom of the production holes shall not be lower than the bottom of the controlled blastholes. By approval of the Engineer, the bottom of the production hole may be lower than the controlled blastholes by the amount of subdrilling used on the production holes. Production holes shall not exceed 6 inches in diameter, unless approved by the Engineer. Detonation of production holes shall be on a delay sequence toward a free face. Stemming material used in production holes shall be sand or other dry angular granular material, all of which passes a 3/8 inch sieve.

It is the Contractor's responsibility to take all necessary precautions in the production blasting so as to minimize blast damage to the rock backslope.

Payment for production blasting shall be incidental to the contract unit price for roadway excavation.

### **REMARKS**

A few highway agencies specify that the first row of production holes adjacent to the presplit line shall be a "buffer" row. If desired, the following wording can be included in the specification to cover use of a buffer row:

"If presplit results are not satisfactory and production holes are damaging the presplit then, at the option of the Engineer, a line of buffer holes shall be drilled on a parallel plane adjacent to the presplit holes. Buffer hole diameters shall be between 2.5 and 3 inches. The line of buffer holes shall be drilled approximately 3 feet out from the presplit line and spaced 3 to 5 feet center to center. The explosive loads in these holes shall not exceed 50 percent of the full explosive load that could be placed in a 3 inch production hole. Detonation of the buffer holes shall be on a delay sequence toward a free face."

**3.3 Blasting Test Section(s)** Prior to commencing full-scale blasting operations, the Contractor shall demonstrate the adequacy of the proposed blast plan by drilling, blasting and excavating short test sections, up to 100 feet in length, to determine which combination of method, hole spacing and charge works best. When field conditions warrant, as determined by the Engineer, the Contractor may be ordered to use test section lengths less than 100 feet.

Unless otherwise allowed by the Engineer, the Contractor shall begin the controlled blasting tests with the controlled blastholes spaced 30 inches apart, then adjust if needed until the Engineer approves the spacing to be used for full-scale blasting operations.

Requirements for controlled and production blasting operations covered elsewhere in this specification shall also apply to the blasting carried out in conjunction with the test shots.

The Contractor will not be allowed to drill ahead of the test shot area until the test section has been excavated and the results evaluated by the Engineer. If the results of the test shot(s), in the opinion of the Engineer, are unsatisfactory, then, notwithstanding the Engineer's prior review of such methods, the Contractor shall adopt such revised methods as are necessary to achieve the required results. Unsatisfactory test shot results include an excessive amount of fragmentation beyond the indicated lines and grade, excessive flyrock, or violation of other requirements within these specifications. All costs incurred by the Contractor in adopting revised blasting methods necessary to produce an acceptable test shot shall be considered incidental to the contract unit prices for roadway excavation and controlled blasting.



If at any time during the progress of the work, the methods of drilling and blasting do not produce the desired result of a uniform slope and shear face, within the tolerances specified, the Contractor will be required to drill, blast, and excavate in short sections, not exceeding 100 feet in length, until a technique is arrived at that will produce the desired results. Extra cost resulting from this requirement shall be borne by the Contractor.

### **REMARKS**

Individual State highway agencies are encouraged to designate a qualified technical person(s) to provide blasting technical assistance to Project Engineers. It is impractical to expect every Project Engineer to be able to achieve or maintain the level of technical expertise necessary to adequately review and evaluate a Contractor's detailed blasting operations. Highway agencies who presently have and use such in-house blasting expertise typically achieve superior quality final slopes versus those that do not.

## **4.0 SAFETY PROCEDURES**

**4.1 Warnings and Signals** The Contractor will establish a method of warning all employees on the job site of an impending blast. The signal should consist of a five minute warning signal to notify all in the area that a blast will be fired within a five minute period. A second warning signal will be sounded 1 minute before the blast. After the blast is over, there will be an all clear signal sounded so all in the area understand that all blasting operations are finished.

Five minutes prior to the blast, five long signals on a air horn or siren will be sounded. One minute prior to the blast, five short signals on an air horn or siren will be sounded. The all clear will be 1 long signal of at least 30 seconds in duration to indicate that all blasting has ceased.

**4.2 Lightning Protection** The Contractor shall furnish, maintain and operate lightning detection equipment during the entire period of blasting operations and/or during the periods that explosives are used at the site. Equipment shall be similar or equal to the Thomas Instruments SD250 Storm Alert as manufactured by DL Thomas Equipment, Keene, New Hampshire. The equipment shall be installed when approved by the Engineer. When the lightning detection device indicates a blasting hazard potential, personnel shall be evacuated from all areas where explosives are present. When a lightning detector indicates a blasting hazard, the following shall be performed.

1. Clear the blasting area of all personnel.
2. Notify the project Engineer of the potential hazards and precautions to be taken.
3. Terminate the loading of holes and return the unused explosives to the day storage area.
4. If blastholes are loaded and would pose a hazard to traffic if detonated, roads will be closed until the lightning hazard has passed.
5. When the hazard dissipates, inform the project Engineer that production blasting will continue.

**4.3 Check for Misfires** The Contractor shall observe the entire blast area for a minimum of 5 minutes following a blast to guard against rock fall before commencing work in the cut. The five minute delay between blasting and allowing anyone but the blaster to enter the area is needed to make sure that no misfires have occurred.

During the five minute delay, it is the blaster's responsibility to go into the shot area and check all holes to make sure that they have detonated. If any holes have not fired, these misfires will be handled by the blaster before others enter the work area.

The Engineer shall, at all times, have the authority to prohibit or halt the Contractor's blasting operations if it is apparent that, through the methods being employed, the required slopes are not being obtained in a stable condition or the safety and convenience of the traveling public is being jeopardized.

**4.4 Misfire Handling Procedures** Should a visual inspection indicate that complete detonation of all charges did not take place, the following procedures will be followed:

1. If the system was energized and no charges fired for electric systems, the lead wire will be tested for continuity prior to inspection of the remainder of the blast. For nonelectric systems, the lead in or tube will be checked to make sure that detonation has entered the blast area.
2. Should an inspection of the electrical trunkline or lead in tubing-line indicate that there is a break in the line or if the tubing did not fire, then the system will be repaired and the blast refired. If the inspection indicates that the trunkline has fired and misfired charges remain, the blaster will do the following:

- a. The blaster will exclude all employees except those necessary to rectify the problem.
- b. Traffic will be closed if a premature explosion could be a hazard to traffic on nearby roads.
- c. The blaster will correct the misfire in a safe manner. If the misfire poses problems that cannot be safely corrected by the blaster, a consultant or an explosive company representative skilled in the art of correcting misfires, will be called to rectify the problem.

## **5.0 CONTROLLED BLASTING METHODS**

**5.1 Presplitting** All presplitting, including that carried out in conjunction with the blasting test section requirements of Section 3.3, shall be performed in accordance with the following requirements.

Unless otherwise permitted by the Engineer, the Contractor shall completely remove all overburden soil and loose or decomposed rock along the top of the excavation for a distance of at least 30 feet beyond the end of the production hole drilling limits, or to the end of the cut, before drilling the presplitting holes.

Potentially dangerous boulders or other material located beyond the excavation limits shall also be removed as ordered by the Engineer. Payment for removal of the material located beyond the excavation limits shall be by force account.

The presplit drillholes shall not be less than 2.5 inches and not more than 3 inches in diameter.

The Contractor shall control his drilling operations by the use of proper equipment and technique to insure that no hole shall deviate from the plane of the planned slope by more than 9 inches either parallel or normal to the slope. Presplit holes exceeding these limits shall not be paid for unless, in the Engineer's opinion, satisfactory slopes are being obtained.

## **REMARKS**

Good drillhole alignment is probably the most critical factor in obtaining good presplit or cushion blast results. Hole tolerances given in most blasting specifications typically vary from 6 to 12 inches. Nine inches is presented in this guide specification as a practical average value which can be achieved through reasonable workmanship and yet still provide good results. Selection of a tolerance value other than 9 inches is left to the preference of individual highway agencies.

Presplit holes shall be drilled within 3 inches of the staked collar location. If more than 5% of the presplit holes are outside of the 3 inch tolerance, they will be filled with crushed stone, stemmed and redrilled.

All drilling equipment used to drill the presplit holes shall have electro-mechanical or electronic devices affixed to that equipment to accurately determine the angle at which the drill steel enters the rock. Presplit hole drilling will not be permitted if these devices are either missing or inoperative.

Presplit holes shall extend a minimum of 30 feet beyond the limits of the production holes to be detonated or to the end of the cut as applicable.

The length of presplit holes for any individual lift shall not exceed 30 feet unless the Contractor can demonstrate to the a Engineer that he can stay within the above tolerances and produce a uniform slope. Upon satisfactory demonstration, the length of holes may be increased to a maximum of 60 feet upon written approval of the Engineer. If greater than 5 percent of the presplit holes are misaligned in any one lift, the Contractor shall reduce the height of the lifts until the 9 inch alignment tolerance is met.

When the cut height will require more than one lift, a maximum 2 foot offset between lifts shall be permitted to allow for drill equipment clearances. The Contractor shall begin the control blasthole drilling at a point which will allow for necessary offsets and shall adjust, at the start of lower lifts, to compensate for any drift which may have occurred in the upper lifts. Payment for the additional excavation volume, resulting from the allowed 2 foot offsets, shall be at the contract unit price for roadway excavation.

## **REMARKS**

Some agencies design their rock cuts with a 2 foot offset included for each 30 to 40 foot lift. The additional excavation volume due to the offsets is then already included in the excavation bid quantity.

Drilling 2 feet below ditch bottom will be allowed to facilitate removal of the toe berm.

Before placing charges, the Contractor shall determine that the hole is free of obstructions for its entire depth. All necessary precautions shall be exercised so that the placing of the charges will not cause caving of material from the walls of the holes.

Drillhole conditions may vary from dry to filled with water. The Contractor will be required to use whatever type(s) of explosives and/or blasting accessories necessary to accomplish the specified results.

The diameter of explosives used in presplit holes shall not be greater than 1/2 the diameter of the presplit hole.

Bulk ammonium nitrate and fuel oil (ANFO) shall not be allowed in the presplit holes.

Only standard explosives manufactured especially for presplitting shall be used in presplit holes, unless otherwise approved by the Engineer.

If fractional portions of standard explosive cartridges are used, they shall be firmly affixed to the detonating cord in such a manner that the cartridges will not slip down the detonating cord nor bridge across the hole. Spacing of fractional cartridges along the length of the detonating cord shall not exceed 30 inches center to center and shall be adjusted to give the desired results.

Continuous column cartridge type of explosives used with detonating cord shall be assembled and affixed to the detonating cord in accordance with the explosive manufacturer's instructions, a copy of which shall be furnished to the Engineer.

The bottom charge of a presplit hole may be larger than the line charges but shall not be large enough to cause overbreak. The top charge of the presplitting hole shall be placed far enough below the collar, and reduced sufficiently, to avoid overbreaking and heaving.

The upper portion of all presplit holes, from the top charge to the hole collar, shall be stemmed. Stemming materials must be sand or other dry angular granular material and must pass through a 3/8 inch sieve.

As long as equally satisfactory presplit slopes are obtained, the Contractor, at his option, may either presplit the slope face before drilling for production blasting or may presplit the slope face and production blast at the same time, provided that the presplitting drillholes are fired first. If required to reduce ground vibrations or noise, presplit holes may be delayed, providing the hole to hole delay is no more than 25 milliseconds.

The presplit slope face shall not deviate more than one foot from a plane passing through adjacent drillholes, except where the character of the rock is such that, as determined by the Engineer, irregularities are unavoidable. The one foot tolerance shall be measured perpendicular to the plane of the slope. In no case shall any portion of the slope encroach on the roadbed.

### **REMARKS**

A few highway agencies include wording in their controlled blasting specifications covering the use of "Guide" holes (also referred to as auxiliary or relief holes). These are holes which are drilled between the presplit holes and which remain unloaded and unstemmed. Their function is primarily to minimize severe backbreak problems or to help guide the shear plane to form a neat excavation corner. Since the use of guide holes is not common among the majority of highway agencies, inclusion of wording covering their use is left to the preference of individual agencies. If desired, the following wording can be included in the specification to cover use of guide holes:

"Unloaded and unstemmed guide holes, when used between presplit holes, shall be of the same diameter and drilled in the same plane and to the same tolerance as the presplit holes. Payment for guide holes meeting the drilling tolerance shall be at 50 percent of the contract unit price for presplitting holes."

Alternate pay methods being used for guide holes are force account or separate pay item.

**5.2 Cushion (Trim) Blasting** Where the horizontal distance from the cut face to the existing rock face is less than 15 feet, the Contractor may cushion blast in lieu of presplitting. Cushion blasting is similar to presplitting except that the detonation along the cut face shall be performed after the detonation of all production holes. Differences in delay times between the trim line and the nearest production row shall not be greater than 75 milliseconds nor less than 25 milliseconds. With the exception of the above criteria, requirements previously given for presplitting shall also apply to cushion blasting.

**5.3 Sliver Cuts** For sliver cuts, pioneering the top of cuts and preparing a working platform to begin the controlled blasting drilling operations may require unusual working methods and use of equipment. The Contractor may use angle drilled holes or fan drilled holes during the initial pioneering operations to obtain the desired rock face. The hole diameter requirements for controlled blasting are applicable for pioneering work. Hole spacing shall not exceed 30 inches.

## **6.0 SPECIAL REQUIREMENTS**

**6.1 Blasting Consultant** When called for in the contract special provisions, the Contractor shall retain a recognized blasting consultant to assist in the blast design. The blast design shall include both the controlled and production blasting. The consultant shall be an expert in the field of drilling and blasting who derives his primary source of income from providing specialized blasting and/or blasting consulting services. The consultant shall not be an employee of the Contractor, explosives manufacturer, or explosives distributor.

Not later than the preconstruction conference, the Contractor shall submit a resume of the credentials of the proposed blasting consultant. The resume shall include a list of at least 5 highway rock excavation projects on which the blasting consultant has worked. The list shall contain a description of the projects, details of the blast plans, and modifications made during the project. The list shall also contain the names and telephone numbers of project owners with sufficient knowledge of the projects to verify the submitted information. The blasting consultant must be approved by the Engineer prior to the beginning of any drilling and blasting work.

### **REMARKS**

Sections 6.2 to 6.5, which follow, will generally only apply to "close in" work where blasting will be carried out near existing buildings, structures, or utilities.

**6.2 Pre-Blast Condition Survey** When called for in the contract special provisions, the Contractor shall arrange for a pre-blast survey of any nearby buildings, structures, or utilities which may potentially be at risk from blasting damage. The survey method used shall be acceptable to the Contractor's insurance company. The Contractor shall be responsible for any damage resulting from blasting. The pre-blast survey records shall be made available to the Engineer for review. Occupants of local buildings shall be notified by the Contractor prior to the commencement of blasting.

**6.3 Vibration Control and Monitoring** When blasting near buildings, structures, or utilities which may be subject to damage from blast induced ground vibrations, the ground vibrations shall be controlled by the use of properly designed delay sequences and allowable charge weights per delay. Allowable charge weights per delay shall be based on vibration levels which will not cause damage. The allowable charge weights per delay shall be established by carrying out trial blasts and measuring vibration levels. The trial blasts shall be carried out in conformance with the blasting test section requirements of Section 3.3, modified as required to limit ground vibrations to a level which will not cause damage.

Whenever vibration damage to adjacent structures is possible, the Contractor shall monitor each blast with an approved seismograph located, as approved, between the blast area and the closest structure subject to blast damage. The seismograph used shall be capable of recording particle velocity for three mutually perpendicular components of vibration in the range generally found with controlled blasting.

Peak particle velocity of each component shall not be allowed to exceed the safe limits of the nearest structure subject to vibration damage. The Contractor shall employ a qualified vibration specialist to establish the safe vibration limits. The vibration specialist shall also interpret the seismograph records to insure that the seismograph data shall be effectively utilized in the control of the blasting operations with respect to the existing structures. The vibration specialist used shall be subject to the Engineer's approval.

Data recorded for each shot shall be furnished to the Engineer prior to the next blast and shall include the following:

- (1) Identification of instrument used.
- (2) Name of qualified observer and interpreter.
- (3) Distance and direction of recording station from blast area.
- (4) Type of ground at recording station and material on which the instrument is sitting.
- (5) Maximum particle velocity in each component.
- (6) A dated and signed copy of seismograph readings record.

### **REMARKS**

For those agencies with little experience in setting limits for maximum peak particle velocity, Table 1 below gives suggested conservative limits:



**TABLE 1**

<b><u>STRUCTURE TYPE</u></b>	<b><u>MAXIMUM PPV (INCHES PER SECOND)</u></b>
Standard Construction Timber Frame, Brick, and Concrete Buildings	2.0
Reinforced Concrete Structures	4.0
Steel Structures	4.0
Buried Utilities	2.0
Wells and Aquifers	2.0
Green Concrete (Less Than 7 Days)	1.0

Older deteriorated structures or utilities and structures housing computers or other sensitive equipment may require lower peak particle velocity limits than given in Table 1. Also, buried pipelines owned by private utility companies or bridge structures owned by other agencies are sometimes subject to lower limiting values imposed by the owner. On critical projects where vibration control is important, the safe limits should be established by a vibration specialist experienced in this type of work.

**6.4 Air Blast and Noise Control** When called for in the contract special provisions, an air blast monitoring system shall be installed between the main blasting area and the nearest structure subject to blast damage or annoyance. The equipment used to make the air blast measurements shall be the type specifically manufactured for that purpose. Peak overpressure shall be held below 0.05 psi at the nearest structure or other designated location. Appropriate blasthole patterns, detonation systems, and stemming shall be used to prevent venting of blasts and to minimize air blast and noise levels produced by the blasting operations. The overpressure limit shall be lowered if it proves too high based on damage or complaints. A permanent, signed and dated record of the peak overpressure measurements shall be furnished to the Engineer immediately after each shot.

**REMARKS**

A few highway agencies are equipped and have trained personnel to do vibration and air blast monitoring. When the highway agency will perform the monitoring, the following alternate wording may be substituted in the specifications for that previously given in the vibration and air blast sections relating to Contractor monitoring:

"If the above stated vibration and air blast provisions are imposed, all blasting shall be monitored by the Engineer using State furnished monitoring devices. State personnel will be responsible for the location and placement of these monitoring devices. The Contractor will be responsible for the protection of these devices from his equipment and operations."

**6.5 Flyrock Control** Before the firing of any blast in areas where flying rock may result in personal injury or unacceptable damage to property or the work, the rock to be blasted shall be covered with approved blasting mats, soil, or other equally serviceable material, to prevent flyrock.

If flyrock leaves the construction site and lands on private property all blasting operations will cease until a qualified blasting consultant, hired by the Contractor, reviews the site and determines the cause and solution to the flyrock problem. Before blasting proceeds, a written report will be submitted to the Engineer for his approval.

**6.6 Public Meetings** The Contractor shall make his qualified vibration and air blast specialist and blasting consultant available for one day if requested by the contracting officer to prepare for and participate in a public meeting conducted by the contracting officer to better inform the public about anticipated drilling and blasting operations. The specialists shall be prepared to answer any questions dealing with the magnitude of seismic motion, air blast overpressure and flyrock expected to impact on the public.

## **7.0 RECORDKEEPING**

**7.1 Daily Explosive Material Consumption** The Contractor shall keep a daily record of transactions to be maintained at each storage magazine. Inventory records shall be updated at the close of every business day. The records shall show the class and quantities received and issued and total remaining on hand at the end of each day. Remaining explosive inventory shall be checked each day and any discrepancies that would indicate a theft or loss of explosive material would be immediately reported.

**7.2 Report of Loss** Should a loss or theft of explosives occur, all circumstances and details of the loss or theft will be immediately reported to the nearest office of Alcohol, Tobacco & Firearms as well as to the local law enforcement authorities and Contractors offices representative.

**7.3 Daily Blasting Logs** The Contractor shall provide the contracting officer, on a weekly basis, a daily log of blasting operations. The log shall be updated at the close of each business day. The log shall include the number of blasts, times, and dates of blasts. The blasting locations and patterns and all information shown below:

- 1) Station limits of the shot.
- 2) Plan and section views of drill pattern including free face, burden, blasthole spacing, blasthole diameters, blasthole angles, lift height, and subdrill depth.
- 3) Loading diagram showing type and amount of explosive, primers, initiators and location and depth of stemming.
- 4) Initiators sequence of blastholes including delay times and delay system in each blasthole.
- 5) Trade names and sizes of all explosives, primers, and initiators to be employed.
- 6) Signature of the blaster in charge.

The blasting logs are for quality control and recordkeeping purposes. Review of the blast log by the Engineer shall not relieve the Contractor of his responsibility for the accuracy and adequacy of the blasting log.

### **REMARKS**

The blasting log form is provided in this manual to aid the Contractor in the proper submittal of blasting information to the Engineer. The Contractor is required to submit the form with information about the shot. The blasting plan is a generalized report indicating how the Contractor plans to conduct the project. In actual blasts, the number of holes and the number of rows may differ from that in the blasting plan submittal. In addition, explosive supplies may not be available at all times and substitutions may be made with slightly different products. For this reason, it is necessary to keep a blasting log which shows what actually occurred on each and every shot. Adoption of some type of simplified form for the blasting log submittal is strongly encouraged. Use of such a standard format will insure that the pertinent data is obtained, will improve communication, and will make the job easier for the Project Engineer and/or highway agency person charged with review and evaluation of the blasting operations.

**7.4 Video Recording of Blasts** Video tape recordings will be taken of each blast. The tapes or sections of tapes will be indexed in a manner to properly identify each blast. At the option of the Engineer, copies of video tapes of blasts will be furnished on a weekly basis.

### **REMARKS**

Video recordings of blasts can be extremely useful. For example, if most blasts are well controlled and due to geologic conditions, one blast throws flyrock, the Contractor has the backup evidence to show that his blasting was good and that this was a unique circumstance. When blasts are not behaving as expected, fragmentation may be large and presplits are not functioning as intended, valuable information on how to change the blast design to accomplish the desired goals may be found from the video tape.

In many locations in the country, distributors of explosives take it upon themselves to video tape each and every blast. This provides not only a paper record, but a video record of what occurred on each blast. It is strongly urged that on every blasting project, the Engineer require the Contractor or the explosive distributor to take a video tape of each and every blast.

### **8.0 METHOD OF MEASUREMENT**

When controlled blasting is specified as a pay item in the bid schedule, measurement shall be per linear foot of controlled blasthole. The lineal feet of controlled blastholes to be paid for shall be the plan length computed from hole collar elevations to a depth of 2 feet below finished ditch grade. Holes whose misalignment is in excess of 9 inches shall not be measured for payment.

### **REMARKS**

Some highway agencies prefer to use square yards of control blasted surface as the method of measurement rather than lineal feet of blasthole. When the square yard measurement is used, a percentage adjustment in contract price should be allowed commensurate with the increase or decrease in hole spacing from the hole spacing upon which the contract price is based.

## **9.0 BASIS OF PAYMENT**

The unit contract price per lineal foot of drillhole for controlled blasting shall be full pay for all materials, explosives, labor, tools, and equipment needed. Quantities shown in the plans are based on 30 inch hole spacing. Actual quantities will depend on field conditions and results from test sections.

Payment for controlled blastholes will be made under:

<b><u>Pay Item</u></b>	<b><u>Pay Unit</u></b>
<b>Controlled Blastholes</b>	<b>Linear Foot</b>

### **REMARKS**

A few highway agencies do not provide a separate pay item for controlled blasting. The cost of controlled blasting is made incidental to the rock excavation. This method has a major disadvantage in that it does not provide any equitable adjustment to either the Contractor or the highway agency when the controlled blasthole spacing has to be decreased or increased from the initial spacing given in the specifications. Controlled blasting should always be a separate pay item.

Payment for blasting consultant services, vibration and air blast monitoring, and pre-blast surveys, if part of the contract, can be a separate contingency item or made incidental to the excavation bid price.

Payment for scaling may also be by force account or separate bid item for scaling man hours, in lieu of being incidental to the excavation bid price. A separate bid item is recommended.

# APPENDIX V

## PROBLEM SOLUTIONS

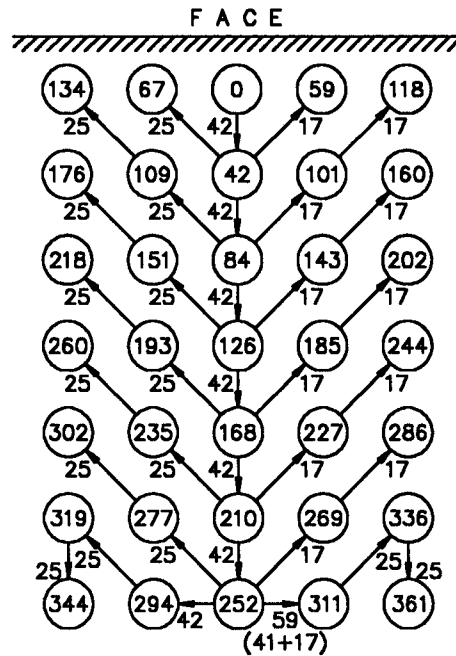
### CHAPTER 4 ANSWERS

1) A contractor is using Nonel to initiate his blast. The holes all contain number 8 period LLHD's. The blast is a box cut with one free face. The blast contains 7 rows with 5 holes per row. Trunk line delays available are 17, 25, and 42 ms delays. Because of a vibration problem no two holes can fire together. The minimum delay allowable is 8 ms.

(a) Design the pattern as a V-cut with the center hole in the first row firing first.

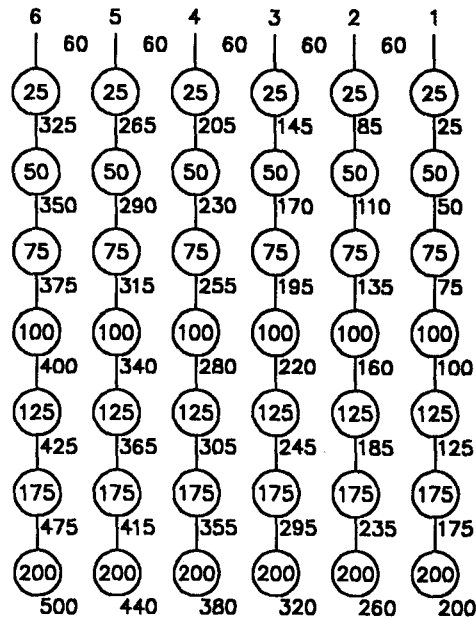
(b) Show your series, firing times and hook up on the design below.

(c) Will this pattern function if there are 6 holes per row?



c. No overlaps occur.

- 2) A contractor is using a sequential timer and electric blasting caps for the blast given on the diagram below. Houses are close by and each hole must fire independently. Would you approve this design?



No! Timing within 5 ms without scatter.

### CHAPTER 6 ANSWERS

- 1) Burden for one inch hole:

$$B = \left[ \frac{2 SG_e}{SG_r} + 1.5 \right] D_e$$

$$B = \left[ \frac{2 \times 0.9}{2.6} + 1.5 \right] 1 = 2.19 \text{ ft}$$

For three inch holes:  $B = 6.58 \text{ ft}$

For five inch holes:  $B = 10.96 \text{ ft}$

- 2a) Stemming for one inch hole:  $T = 0.7 B = 0.7 \times 2.2 = 1.54 \text{ ft}$

For three inch hole:  $T = 4.62 \text{ ft}$

For five inch hole:  $T = 7.7 \text{ ft}$

2b) Hole depth for one inch hole:

$$\text{Subdrilling:} \quad J = 0.3 B = 0.3 \times 2.2 = 0.66 \text{ ft}$$

$$\text{Hole depth:} \quad H = L + J = 16 + 0.66 = 16.66 \text{ ft}$$

$$\text{Hole depth for three inch hole:} \quad J = 2 \text{ ft} \quad H = 17.98 \text{ ft}$$

$$\text{Hole depth for five inch hole:} \quad J = 3.3 \text{ ft} \quad H = 19.3 \text{ ft}$$

2c) For one inch hole:

$$\text{Loading density (from chart):} \quad d_e = 0.31 \text{ lb / ft}$$

$$\text{Powder column length:} \quad PC = H - T = 16.66 - 1.5 = 15.16 \text{ ft}$$

$$\text{ANFO load per hole:} \quad E = PC \times d_e = 15.16 \times 0.31 = 4.7 \text{ lb}$$

$$\text{For three inch hole:} \quad d_e = 2.75 \quad PC = 13.4 \text{ ft} \quad E = 36.9 \text{ lb}$$

$$\text{For five inch hole:} \quad d_e = 7.65 \quad PC = 11.6 \quad E = 88.7 \text{ lb}$$

3)  $L / B = 16 / 11 = 1.45$ : 3a. poor 3b. poor 3c. severe 3d. toe occurs

4)

$$B = \left[ \frac{2 SG_e}{SG_r} + 1.5 \right] D_e \quad SG_e = \frac{SG_r \left[ \frac{B}{D_e} - 1.5 \right]}{2}$$

$$SG_e = \frac{2.4 \left[ \frac{13}{5} - 1.5 \right]}{2} = 1.32$$



$$5a) \quad t_H = T_H \times S \quad (T_H \text{ from table 6.3})$$

$$T_H = 1.5 - 1.8$$

$$t_H = 1.5 \times 8 = 12 \text{ ms}$$

$$t_H = 1.8 \times 8 = 14 \text{ ms}$$

$$5b) \quad t_R = T_R \times B \quad (T_R \text{ from table 6.4})$$

$$T_R = 3 - 4$$

$$t_R = 3 \times 6 = 18 \text{ ms}$$

$$t_R = 4 \times 6 = 24 \text{ ms}$$

## CHAPTER 7 ANSWERS

1a)

$$B = \left[ \frac{2 SG_e}{SG_r} + 1.5 \right] D_e$$

$$B = \left[ \frac{2 \times 0.8}{2.75} + 1.5 \right] 4 = 8.33 = 8 \text{ ft}$$

$$L / B = 16 / 8 = 2$$

$$S = \frac{L + 2B}{3} = \frac{16 + 2 \times 8}{3} = 10.67 = 11 \text{ ft}$$

1b)  $L / B = 32 / 8 = 4$

$$S = 2B = 2 \times 8 = 16 \text{ ft}$$

1c)  $L / B = 16 / 8 = 2$

$$S = \frac{L + 7B}{8} = \frac{16 + 7 \times 8}{8} = 9 \text{ ft}$$

$$1d) \quad L / B = 32 / 8 = 4$$

$$S = 1.4 B = 1.4 \times 8 = 11 \text{ ft}$$

2)

$$B = \left[ \frac{2 SG_e}{SG_r} + 1.5 \right] D_e$$

$$B = \left[ \frac{2 \times 1.3}{2.6} + 1.5 \right] 2 = 5 \text{ ft}$$

$$S = B = 5 \text{ ft}$$

Pattern dimensions 5 x 5 ft (See figure 7.26B)

For #1 opening holes:  $T = B = 5 \text{ ft}$

$$J = 0.5 B = 0.5 \times 5 = 2.5 \text{ ft}$$

For all but #1 holes:  $T = 0.7 B = 0.7 \times 5 = 3.5 \text{ ft}$

$$J = 0.3 B = 0.3 \times 5 = 1.5 \text{ ft}$$

Timing sequence as in Figure 7.26B.

$$3) \quad B = \left[ \frac{2 SG_e}{SG_r} + 1.5 \right] D_e$$

$$B = \left[ \frac{2 \times 1.3}{2.4} + 1.5 \right] 2 = 5.17 \approx 5 \text{ ft}$$

$$T = 0.7 B = 0.7 \times 5 = 3.5 \text{ ft}$$

$$J = 0.3 B = 0.3 \times 5 = 1.5 \text{ ft}$$

Contractor desire 4.5 ft width

Check  $L / B = 7 / 5 = 1.4$  Burden of 5 ft is acceptable.

Check  $1.25 B > W > 0.75 B$

$$1.25 B = 6.25 \text{ ft}$$

$$0.75 B = 3.75 \text{ ft}$$

4.5 ft width is acceptable

Powder column  $PC = H - T = 8.5 - 3.5 = 5 \text{ ft}$

$$de = 1.77 \text{ lb / ft}$$

$$E = 5 \times 1.77 = 8.9 \text{ lb / hole}$$

Drill pattern same as Figure 7.28

4a)

$$B = \left[ \frac{2 SG_e}{SG_r} + 1.5 \right] D_e$$

$$B = \left[ \frac{2 \times 0.8}{2.85} + 1.5 \right] 3 = 6.18 \approx 6 \text{ ft}$$

$$T = 0.7 B = 0.7 \times 6.18 = 4.33 \approx 4 \text{ ft.}$$

$$J = 0.3 B = 0.3 \times 6.18 = 1.85 \approx 2 \text{ ft.}$$

$$L / B = 20 / 6 = 3.33$$

Instantaneous initiation:  $S = \frac{L + 2 B}{3} = \frac{20 + 2 \times 6}{3} = 10.67 \approx 11 \text{ ft}$

Delay initiation:  $S = \frac{L + 7 B}{3} = \frac{20 + 7 \times 6}{3} = 7.75 \approx 8 \text{ ft}$

4b)  $B = 14 \text{ ft}, T = 10 \text{ ft}, J = 5 \text{ ft}$   $L/B = 1.4, S(\text{ins.}) = 16 \text{ ft}, S(\text{delay}) = 15 \text{ ft}$

- 4c) Cost per drill hole: 3 in. diameter = 22 x \$ 1.00 = \$ 22.00  
 6.75 in. diameter = 25 x \$ 2.00 = \$ 50.00

Cubic yards per drill hole:

$$3 \text{ in. diameter} = (6 \times 11 \times 20)/27 = 48.49 \text{ yd}^3$$

$$6.75 \text{ diameter} = (14 \times 16 \times 20)/27 = 165.93 \text{ yd}^3$$

$$3 \text{ in. cost/yd}^3 = 22 / 49 = \$ 0.45 / \text{yd}^3$$

$$6.75 \text{ in. cost/yd}^3 = 50 / 165 = \$ 0.30 / \text{yd}^3$$

### CHAPTER 8 ANSWERS

1a)

$$\text{dec} = \frac{D_h^2}{28} = \frac{3.5^2}{28} = 0.44 \text{ lb / ft}$$

1b) Loaded hole length: 40 - 3 = 37 ft.

$$\text{Load / Hole} = \text{Load / Foot} + \text{Bottom load}$$

$$37 \times 0.44 + 2 \times 0.44 = 17.16 \text{ lb}$$

1c)  $S = 10 D = 10 \times 3.5 = 35 \text{ in}$

2a)

$$\text{dec} = \frac{D_h^2}{28} = \frac{2.75^2}{28} = 0.27 \text{ lb / ft}$$

2b)  $S = 16 D_h = 16 \times 2.75 = 44 \text{ in}$

2c)  $B = 1.3 \times S = 1.3 \times 44 = 57.2 \text{ in}$

## CHAPTER 10 ANSWERS

1a) Amplitude of first peak = 0.54 in

GAIN	PARTICLE VELOCITY (in/s)
1.0	$0.54 / 1.0 = 0.54 \text{ in/s}$
2.0	$0.54 / 5.0 = 0.108 \text{ in/s}$
20.0	$0.54 / 20 = 0.027 \text{ in/s}$
0.5	$0.54 / 0.5 = 1.08 \text{ in/s}$

1b) Amplitude of first trough = 0.37 in

GAIN	PARTICLE VELOCITY (in/s)
1.0	$0.37 / 1.0 = 0.37 \text{ in/s}$
2.0	$0.37 / 5.0 = 0.074 \text{ in/s}$
20.0	$0.37 / 20.0 = 0.0185 \text{ in/s}$
0.5	$0.37 / 0.5 = 0.74 \text{ in/s}$

2a) Number of timing spaces between the first 2 peaks = 3

Period = number of timing spaces x 0.02 seconds per timing space.

$$T = 3 \times 0.02 = 0.06 \text{ seconds}$$

$$\text{Frequency} = \frac{1}{\text{period}}$$

$$f = \frac{1}{0.06} = 16.67 \text{ Hz}$$

2b) Number of timing spaces from first to fifth peak = 11.4.

Total time from first to fifth peak =  $11.4 \times 0.02 = 0.228$  seconds

$$\text{Average period} = \frac{\text{Total time for N oscillations}}{N}$$

$$\text{Av. } T = \frac{0.228}{4} = 0.057$$

<b>AVERAGE T</b>	<b>T FROM 2a</b>
0.057	0.06

2c)

<b>NO. PEAKS</b>	<b>NO. OF TIME SPACES</b>	<b>TOTAL TIME</b>	<b>AVERAGE T</b>	<b>FREQUENCY <math>f = \frac{1}{T}</math> (Hz)</b>
2 peaks	3.0	0.060	$\frac{0.060}{1} = 0.060$	$\frac{1}{0.060} = 16.67$
3 peaks	5.8	0.116	$\frac{0.116}{2} = 0.058$	$\frac{1}{0.058} = 17.24$
4 peaks	8.5	0.170	$\frac{0.170}{3} = 0.057$	$\frac{1}{0.057} = 17.65$

2d) Wave length = period x propagation velocity

<b>PERIOD</b>	<b>WAVE LENGTH L IN FEET</b>
0.060	$L = 0.060 \times 2000 = 120$ ft
0.058	$L = 0.058 \times 2000 = 116$ ft
0.057	$L = 0.057 \times 2000 = 114$ ft

3a) Maximum amplitude = 0.53 inches ( 2Nd peak)

Particle velocity =  $\frac{\text{amplitude in inches}}{\text{gain}}$

$$pv = \frac{0.53}{8} = 0.066 \text{ in/s}$$

3b) Number of timing spaces for the half period  $T / 2 = 2.7$

$$T / 2 = \text{number of timing spaces} \times 0.02$$

$$T / 2 = 2.7 \times 0.02 = 0.054$$

$$T = 0.108 \text{ second}$$

$$f = \frac{1}{\text{period}} = \frac{1}{0.108} = 9.3 \text{ Hz}$$

3c) Wave length = period  $\times$  wave velocity

$$L = 0.108 \times 2000 = 216 \text{ ft}$$

4a)

$$\text{Displacement} = \frac{\text{particle velocity}}{2 \pi f}$$

$$D = \frac{V}{2 \pi f} = \frac{V}{6.28 f} = \frac{0.16 V}{f} = \frac{0.16 \times 0.108}{16.7} = 0.00103 \text{ in}$$

$$\text{Acceleration} = 2 \pi f V \text{ (in / s}^2\text{)}$$

$$g = 32.2 \text{ ft / s}^2$$

$$A = \frac{2 \pi f V}{12 g} = \frac{6.28 f V}{386.4} = 0.016 f V = 0.016 \times 16.7 \times 0.108 = 0.029 \text{ g}$$

Alternate Solution:

$$\text{Acceleration} = 2 \pi f V \text{ (in / s}^2\text{)}$$

$$A = 2 \pi f V = 2 \times 3.14 \times 16.7 \times 0.108 = 11.332 \text{ in / s}^2$$

$$A = 11.332 / 12 = 0.944 \text{ ft / s}^2$$

$$g = 32.2 \text{ ft / s}^2$$

$$A = 0.944 / 32.2 = 0.029 \text{ g}$$

4b)

$$\text{Displacement} = \frac{V}{2 \pi f} = \frac{0.16 V}{f}$$

$$\text{Velocity from 3a} = 0.066 \text{ in/s}$$

$$\text{Frequency from 3b} = 9.3 \text{ Hz}$$

$$\text{Displacement} = \frac{0.16 \times 0.066}{9.3} = 0.0011 \text{ in}$$

$$\text{Acceleration} = 0.016 f V = 0.016 \times 9.3 \times 0.066 = 0.0098 = 0.01 \text{ g}$$

5a)

$$V = 100 \left[ \frac{d}{\sqrt{W}} \right]^{-1.6}$$

$$V = 100 \left[ \frac{736}{\sqrt{256}} \right]^{-1.6}$$

$$V = 100 \left[ \frac{736}{16} \right]^{-1.6}$$

$$V = 100 (46)^{-1.6}$$

$$V = 100 \left[ \frac{1}{46} \right]^{1.6}$$

Change sign of exponent by reciprocal

$$V = 100 (0.022)^{1.6}$$

Use pocket calculator  $y^x$

$$V = 100 \times 0.0022 = 0.22 \text{ in/s}$$

5b)

$$V = 160 \left[ \frac{d}{\sqrt{W}} \right]^{-1.6} = 160 \left[ \frac{736}{\sqrt{256}} \right]^{-1.6} = 160 \times 0.0022 = 0.35 \text{ in/s}$$



6)

$$V = 100 \left[ \frac{d}{\sqrt{W}} \right]^{-1.6}$$

$$V = 100 \left[ \frac{1140}{\sqrt{852}} \right]^{-1.6}$$

$$V = 100 \left[ \frac{1140}{29.19} \right]^{-1.6}$$

$$V = 100 (39.06)^{-1.6}$$

$$V = 100 \left[ \frac{1}{39.06} \right]^{1.6}$$

Change sign of exponent by reciprocal

$$V = 100 (0.0256)^{1.6}$$

Use pocket calculator  $y^x$ 

$$V = 100 \times 0.00284 = 0.284 \text{ in/s}$$

7)

$$V = 100 \left[ \frac{d}{\sqrt{W}} \right]^{-1.6}$$

$$V_1 = 100 \left[ \frac{d}{\sqrt{W}} \right]^{-1.6}$$

$$V_2 = 100 \left[ \frac{d}{\sqrt{3W}} \right]^{-1.6}$$

$$V_2 = 100 \left[ \frac{d}{1.73\sqrt{W}} \right]^{-1.6}$$

$$V_2 = (1.73)^{1.6} 100 \left[ \frac{d}{\sqrt{W}} \right]^{-1.6}$$

$$V_2 = (1.73)^{1.6} V_1$$

$$V_2 = 2.41 V_1$$

8)

SHOT	DISTANCE (ft)	CHARGE WEIGHT (lb)	SCALED DISTANCE $\frac{d}{\sqrt{W}}$
1	172	29	$\frac{172}{\sqrt{29}} = 31.94$
2	486	80	$\frac{486}{\sqrt{80}} = 54.34$
3	973	254	$\frac{973}{\sqrt{254}} = 61.05$
4	1481	482	$\frac{1481}{\sqrt{482}} = 67.46$

9a)

$$\text{Given } \frac{d}{\sqrt{W}} = 60$$

$$\sqrt{W} = \frac{d}{60}$$

$$\sqrt{W} = \frac{89}{60}$$

$$\sqrt{W} = 1.48$$

$$W = 2.2 \text{ lb}$$

9b)

$$\sqrt{W} = \frac{1450}{60}$$

$$\sqrt{W} = 24.17$$

$$W = 584 \text{ lb}$$

9c)

$$\text{Given } d = 60 \sqrt{W}$$

$$d = 60 \sqrt{4}$$

$$d = 60 \times 2$$

$$d = 120 \text{ ft}$$

9d)

$$d = 60 \sqrt{860}$$

$$d = 60 \times 29.33$$

$$d = 1,759.55 \text{ ft}$$

10a)

$$V = 100 \left[ \frac{d}{\sqrt{W}} \right]^{-1.6}$$

$$V = 100 (50)^{-1.6}$$

$$V = 100 \left[ \frac{1}{50} \right]^{1.6}$$

$$V = 100 (0.02)^{1.6}$$

$$V = 100 \times 0.00191$$

$$V = 0.191 \text{ in / s}$$

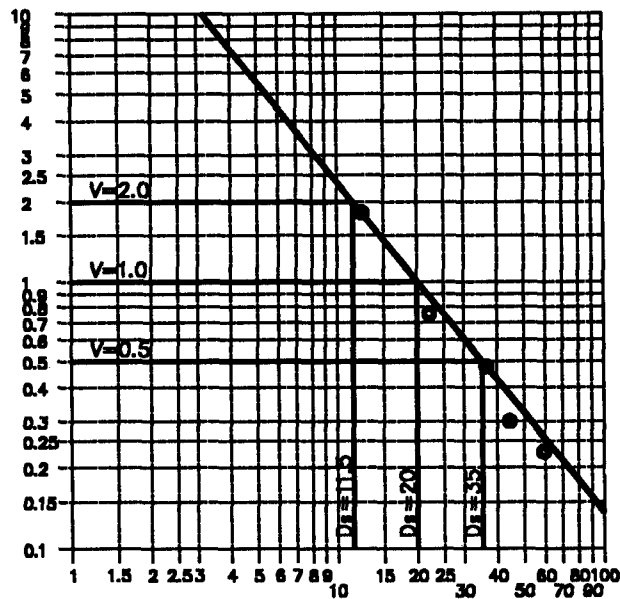
10b)

$$V = 100 (60)^{-1.6}$$

$$V = 100 \left[ \frac{1}{60} \right]^{1.6}$$

$$V = 100 (0.0167)^{1.6}$$

$$V = 100 \times 0.00143 = 0.143 \text{ in / s}$$



11a) See Graph. Graph paper is 2 x 2 cycle log paper.

The horizontal scale represents scaled distance. Let the first cycle have Ds values 1 to 10 and the second cycle have Ds values from 10 to 100.

The vertical scale represents particle velocity. Let the first cycle have PV values 0.1 to 1.0 and the second cycle have PV values 1.0 to 10. Now plot the Ds, PV values for each shot.

Example shot 1:

On the horizontal scale go to a Ds value of 12.5. At a Ds value of 12.5 go up vertically to a PV value of 1.82. At this precise point place a dot. This is the point representing the pair of values. Ds and PV, for shot 1. Continue in the same way on the other shots.

11b) After all points are plotted, draw a straight line from left to right so that all points are beneath the line. This is called the envelope line.

11c) Proceed as follows:

On the vertical scale at the particle velocity of 2.0 in/s draw a horizontal line until it intersects the envelope. At this point of intersection, draw a vertical line to the scaled distance axis. The value of the scaled distance at this point is the value corresponding to a particle velocity of 2.0 in/s.

Make similar constructions for 1.0 in/s and 0.5 in/s.

The values determined by doing this are:

P.V.	Ds
2.0	11.5
1.0	20.0
0.5	35.0

## APPENDIX VI

### BIBLIOGRAPHY

#### Chapter 1

Ash, R.L., "The Mechanics of Rock Breakage", Parts I, II, III, and IV. Pit and Quarry, v. 56, No. 2 Aug. 1963, pp. 98-112; No. 3, Sept. 1963, pp. 118-123; No. 4, Oct. 1963, pp. 126-131; No. 5, Nov. 1963, pp. 109-111, 114-118.

Cook, M.A., "Explosive - A Survey of Technical Advances", Ind. and Eng. Chem., v. 60, No. 7 July 1968, pp. 45-55.

Cook, M.A., "The Science of Industrial Explosives", Ireco Chemicals, Salt Lake City, UT, 1974, pp. 449.

Hodgman, C. D. (Ed), The Handbook of Chemistry and Physics, Forty-Third Edition, Chemical Rubber Publishing Co., Cleveland, 1962.

Leet, L.D., "Earth Waves", Howard University, 7th Edition, 1973, Cambridge, MA, 1950.

Macelwane, J.B., S.J., "Theoretical Seismology", John Wiley & Sons, New York, 1936.

Richter, C.F., "Elementary Seismology", San Francisco, CA: W.H. Freeman and Co., 1958.

#### Chapter 2

Ash, R.L., and Konya, C.J., "Flexural Rupture: A New Theory on Rock Breakage by Blasting." In Proceedings of the International Conference on Explosives and Blasting Technique, pp. 13-19, Linz, Austria: WIFI, 1975.

Haghighi, R.G. and Konya, C.J., "Effects of Geology on Burden Displacement", Proceedings of the Twelfth Conference on Explosives and Blasting Techniques, Society of Explosives Engineers, Montville, Ohio, 1986.

Konya, C.J., "Spacing of Explosives Charges", M.S. thesis, University of Missouri, Rolla, 1968.

Konya, C.J., "The Mechanics of Rock Breakage Around a Confined and Air Gapped Charge", Proceedings of the International-Blasting Section of the Scientific Society of Buildings, 1973.

Otuonye, F.O. Skidmore, D.R., and Konya, C.J., "Measurements and Predictions of Borehole Pressure Variation in Model Blasting Systems", Conference Proceedings of the First International Symposium on Rock Fragmentation by Blasting, Lulea, Sweden, August 22-25, 1983.

### Chapter 3

"Blast Regression Analysis", Computer Software, Precision Blasting Systems, Montville, OH, 1987.

Bollinger, G.A., "Blast Vibration Analysis", Carbondale, IL: Southern Illinois University Press, 1971.

Bruel, Kraer, "Acoustic Noise Measurements", 1979.

Dupont, E.I. de Nemours and Co. Blasters Handbook 1977, Blasters Handbook (175th Anniversary Ed.), Wilmington, DE: Author.

Duvall, W.I., "Design Criteria for Portable Seismographs", RI 5708, U.S. Bureau of Mines, 1961.

General Radio "Handbook of Noise Measurement", 7th Edition, 1973.

Konya, C.J., and Walter, E.J., "Blasthole Timing Controls Vibration, Airblast and Flyrock", Coal Mining, January 1988.

Konya, C.J., and Walter, E.J., "Timing Controls Blasting Effects", Rock Products, June 1988.

Leet, L.D., "Earth Waves", Howard University, 7th Edition, 1973, Cambridge, MA, 1950.

Nicholls, H.R., Johnson, C.F., and Duvall, W.I., "Blasting Vibrations and Their Effects on Structures", Bulletin No. 656, Washington, DC: U.S. Bureau of Mines, 1971.

## Chapter 4

Brown, F.W., "Determination of Basic Performance Properties of Blasting Explosives". Quarterly (Colorado School of Mines) 51(3):160-188.

Damon, G.H. Mason, C.M., Hanna, N.E., and Forshey, D.R. "Safety Recommendations for Ammonium Nitrate-Based Blasting Agents." Bureau of Mines IC 8746, 1977.

Dick, R.A., "The Impact of Blasting Agents and Slurries on Explosives Technology". Bureau of Mines IC 8560, 1972, pp.44.

Dick, R.A., Fletcher, L.R., D'Andrea, D.V., "Explosives and Blasting Procedures Manual," U.S. Bureau of Mines, IC 8925, 1983.

Drury, F. and Westmaas, D.J., "Considerations Affecting the Selection and Use of Modern Chemical Explosives". Proceedings of the 4th Conference on Explosives and Blasting Technique, New Orleans, LA, Feb. 1-3, 1979. Society of Explosives Engineers, Montville, OH., pp. 128-153.

Grant, C.H., "Metallized Slurry Boosting: What it is and How it Works". Coal Age v.71, No. 4, April 1966, pp. 90-91.

Johansson, C.H., and Langefors, U., "Methods of Physical Characterization of Explosives." Proceedings 36th International Cong. of Ind. Chem., Brussels, v. 3, 1966, p. 610; available for consultation at Bureau of Mines Twin Cities Research, Minneapolis, MN.

Monsanto Co.(St. Louis, MO), Monsanto Blasting Products AN-FO Manual "Its Explosive Properties and Field Performance Characteristics." Sept. 1972, pp.37.

Morhard, R.C., (ed) , "Explosive and Rock Blasting," Atlas Powder Company, Dallas, 1987, pp. 13-78.

Robinson, R.V., "Water Gel Explosives--Three Generations". Canadian Min. and Met. Bull., v. 62, No. 692, Dec. 1969, pp. 1317-1325.

## Chapter 5

Blasters Handbook, E.I. du Pont, de Nemours & Co., Wilmington, 1977.

Dick, R.A., Fletcher, L.R., D'Andrea, D.V., "Explosives and Blasting Procedures Manual," U.S. Bureau of Mines, IC 8925, 1983.



Handbook of Electric Blasting, Atlas Powder Co., Dallas, 1985.

"Internationally Accepted Standards and Sequential Blasting Control Systems and Accessories", Research Energy of Ohio, Huron, 1988.

Morhard, R.C., (ed) , "Explosive and Rock Blasting," Atlas Powder Company, Dallas, 1987, pp. 79-156.

Shotfires Guide, Hercules, Inc., Wilmington, 1978.

"Technical Bulletins for Nonel Primadets, Primacord and Related Products," Ensign-Bickford Co., Simsbury, 1985.

## Chapter 6

Bhushan, V., Konya, C.J., and Lukovic, S., "Effects of Detonating Cord Downline on Explosive Energy Release". Proceedings of the Second Mini-Symposium on Explosives and Blasting Research, Society of Explosive Engineers, Montville, 1986, pp.41-55.

Condon, J.L., and Snodgrass, J.J., "Effects of Primer Type and Borehole Diameter on An-Fo Detonation Velocities". Min. Cong. J., v. 60, No. 6, June 1974, pp. 46-47, 50-52.

Dick, R. A., "Puzzled About Primers for Large Diameter An-Fo Charges? Here's Some Help to End the Mystery", Coal Age, V. 81, No. 8, Aug., 1976, pp. 102-107.

Hagan, T.N., "Optimum Priming for Ammonium Nitrate Fuel-Oil Type Explosives", Proc. Southern and Central Queensland Conf. of the Australasian Inst. of Min. and Met., Parkville, Australia, July 1974, pp. 283-297, available for consultation at Bureau of Mines Twin Cities Research Center, Minneapolis, MN.

Konya, C.J., "Directional Effects of Small Diameter Primers", Proceedings of Sixth Conference on Explosive and Blasting Technique, Tampa, 1980.

Konya, C.J., "Priming and Boostering Practices", Proceedings of Explosives and Blasting Conference, Lexington, 1974.

Konya, C.J. and Foldesi, J., "As Inicialasi Pontok Szamanak Meghatározása Andoval Toltott Robbantolyukak Esetén", Epitoanyag, Budapest, Hungary, Dec., 1975.

Konya, C.J. and Foldesi, J., "Priming Techniques Employed at the Tallya Quarry", Proceedings of the Second Conference of Explosives and Blasting Technique, Louisville, Feb., 1976.

Junk, N.M., "Research on Primers for Blasting Agents", Min. Cong. J., v. 50, No. 4, April 1964, pp.98-101.

Junk, N.M., "The Principles of Priming and Boosting An-Fo with Slurry Explosives", Preprint No 68-F-7, Annual Meeting AIME, 1968.

## Chapter 7

Allsman, P.L., "Analysis of Explosives Action in Breaking Rock", Transactions of AIME, 217:468-478, 1960.

Ash, R.L., "The Design of Blasting Rounds", In Surface Mining, Ed. E.P. Pfeider, pp. 373-397, New York: American Institute of Mining Engr., 1968.

Ash, R.L., "The Influence of Geologic Discontinuities on Rock Blasting", Ph.D., dissertation, University of Minnesota.

Ash, R.L., "The Mechanics of Rock Breakage", Parts I, II, III, and IV. Pit and Quarry, v. 56, No. 2 Aug. 1963, pp. 98-112; No. 3, Sept. 1963, pp. 118-123; No. 4, Oct. 1963, pp. 126-131; No. 5, Nov. 1963, pp. 109-111, 114-118.

"Rock Fragmentation Prediction (Breaker)", Computer Software Package, Precision Blasting Services, Montville, OH, 1989.

Cunningham, C., "The Kuz-Ram Model for Prediction of Fragmentation from Blasting", Preprint First International Symposium on Rock Fragmentation by Blasting, Lulea, 1983, pp. 439-453.

Dick, R.A., "Explosives and Borehole Loading", Subsection 11.7, SME Mining Engineering Handbook, ed. by A.B. Cummins and I.A. Given, Society of Mining Engineers of the American Institute of Mining, Metallurgical, and Petroleum Engineers, Inc., New York, v. 1, 1973, pp. 11-78-11-99.

Dick, R.A., Fletcher, L.R., and D'Andrea, D.V., "A Study of Fragmentation from Bench Blasting in Limestone at a Reduced Scale", R.I. 7704 U.S. Bureau of Mines, (1973), 24 p.

Hemphill, G.B., "Blasting Operations", McGraw-Hill, New York, 1981, pp. 258.

Konya, C.J., "Current Blasting Practice Seminar", Precision Blasting Services, Morgantown, WV, 1972.

Konya, C.J., "Proper Blasting Planning and Techniques", Constructor Magazine, March, 1976.

Konya, C.J., and Davis, J., "The Effects of Stemming Consist on Retention in Blastholes", In Proceedings of the 4th. Conference on Explosives and Blasting Technique, pp. 102-112, Morgantown, WV: Society of Explosives Engineers.

Konya, C.J., Skidmore, D.R., "Blasthole Depth and Stemming Height Measuring Systems", Final Report USBM Contract J0208022, 1981.

Konya, C.J., Walter, E.J., "Rock Blasting Manual", FHWA, Contract DTFH 61-83-C-00110, 1983, pp. 95-98.

Konya, C.J., Skidmore, D.R., And Otuonye, F.O., "Control of Airblast and Excessive Ground Vibration From Blasting by Use of Efficient Stemming", Washington, DC: U.S. Department of the Interior, Office of Surface Mining, 1981.

Kuznetsov, V.M., Soviet Mining Science Vol. 9, No. 2, 1973, pp. 144-148.

Otuonye, F.O., Konya, C.J., and Skidmore, D.R., "Effects of Stemming Size Distribution on Explosive Charge Confinement: A Laboratory Study", Transactions of the Society of Mining Engineers of AIME, 1983.

Porter, D.D., "Use of Fragmentation to Evaluate Explosives for Blasting", Min. Cong. J., V. 60, No. 1, Jan. 1974, pp.41-43.

Phuphaibul, S., "A Fragmentation Study with Explosive Column Charges", MS Thesis, West Virginia University, Morgantown, 1975.

Speath, G.L., "Formula for Proper Blasthole Spacing", Engineering News Record, 218(3):53, 1960.

## Chapter 8

Bajpayee, T.S., Mainiero, R.J., Hay, J.E., "Overlap Probability for Short-Period-Delay Detonators used in Underground Coal Mining", US Bureau of Mines, RI 8888, 1985.

Konya, C.J., "Addendum - Rock Blasting Manual", FHWA Contract DTFH-61-83-c-00110, Washington, 1986.

"Pre-Seis Computer Analysis", Precision Blasting Systems, Montville, OH, 1988.

"Time Delay Analyzer (Quartz Series)", Computer Software, Precision Blasting Systems, Montville, Ohio, 1987.

Winzer, S.R., "The Firing Times of MS Delay Blasting Caps and Their Effect on Blasting Performance", Prepared for National Science Foundation (NSF APR.77-05171), Martin Marietta Laboratories (Baltimore, MD), June 1978, pp. 36; available for consultation at Bureau of Mines Twin Cities Research Center, Minneapolis, MN.

## Chapter 9

Andrews, A.B., "Design of Blasts, Emphasis on Blasting", Ensign Bickford Co., (Simsburg, CT), Spring 1980, pp. 1, 4.

Ash, R.L., Konya, C.J., "Spacing: The Most Important Problem in Blasting", Proceedings of Fifth Conference on Explosive and Blasting Technique, Feb. 1979.

Ash, R.L., Konya, C.J., and Rollins, R.R., "Enhancement Effects from Simultaneously Fired Explosive Charges", Transactions, SME/AIME, 224:427-435, 1969.

"Rock Fragmentation Prediction (Breaker)", Computer Software Package, Precision Blasting Services, Montville, OH, 1989.

Chiappetta, R.F., Borg, D.G., "Increased Productivity through Field Control and High-Speed Photography", First International Symposium on Rock Fragmentation by Blasting, Lulea, 1983.

Drinker, H.S., "Tunneling, Explosive Compounds, and Rock Drills", New York: John Wiley and Sons, 1882.

Gillette, H.P., "Handbook of Rock Excavation Methods and Cost", New York: McGraw-Hill Book Co., 1916.

Gustaffson, R., "Swedish Blasting Technique", SPI, Gothenburg, Sweden, 1973, pp. 323, available for consultation at Bureau of Mines Twin Cities Research Center, Minneapolis, MN.

Konya, C.J., "Blasting Procedures at Woodville Lime and Chemical Company", Proceedings of the Third Conference on Explosives and Blasting Technique, Pittsburgh, Feb., 1977.

Konya, C.J., "The Effects of Joints and Bedding Planes on Rock Blasting", Proceedings of the Second Conference on Drilling and Blasting, International Society of Explosive Specialists, Phoenix, Feb. 1973.

Konya, C.J., "Problems with Malfunctioning Blastholes", Proceedings of the Fourteenth Conference on Explosives and Blasting Techniques, Society of Explosives Engineers, Montville, OH, Feb. 1988.

Konya, C.J., "Spacing of Explosives Charges", M.S. thesis, University of Missouri, Rolla, 1968.

Konya, C.J., and Foldesi, J., "A banyafal also reszenek jovesztesi problemai, nagy atmeroju nyujtott toltetek robbantasakor", *Banyaszati es Kohaszati Lapok--Banyaszat* 109(11):728-732.

Konya, C.J., and Foldesi, J., "Kobanyaszati robbantasok tervezese nagyatmeroju nyujtott toltetekkel", *Epitoanyag*, Budapest, Hungary, Jan., 1977.

Konya, C.J., and Walter, E.J., Chap.6, Blast Monitoring, Surface Mining Environmental Monitoring and Reclamation Handbook, Sendlein, L.V.A., et, al, Ed. New York, Elsevier Scientific Publishing Co., 1983, (in Press).

Langfores, U. and Kihlstrom, B.A., "A Modern Technique of Rock Blasting", John Wiley and Sons, Inc., New York, 1963, pp. 405.

Lundborg, N., Persson, P.A., Ladegaard-Pederson, A., and Holmberg, R., "Keeping the Lid on Flyrock from Open Pit Blasting", Eng. and Min. J., v. 176, No., 5, May 1975, pp. 95-100.

Pearse, G.E., "Rock Blasting - Some Aspects on the Theory and Practice", Mine and Quarry Engineering, 21(1):25-30, 1955.

Pugliese, J.M., "Designing Blast Patterns Using Empirica Formulas", BuMines IC 8550, 1972, pp. 33.

Schaffer, A., "A gyakorlati robbanto technika kezikonyve", Budapest: Pallas Reszveny-Tarsasag Nyomdaja, 1903.

Speath, G.L., "Formula for Proper Blasthole Spacing", Engineering News Record, 218(3):53, 1960.

Vsetin, Z., "Blasters Handbook", Prague, Czechoslovakia: Omnipol Prague, 1969.

## Chapter 10

E.I. duPont de Nemours & Co., Inc. (Wilmington, DE), "Blaster's Handbook", 16th Ed., 1978, pp. 494.

E.I. dePont de Nemours & Co., Inc. (Wilmington, DE), "Four Major Methods of Controlled Blasting", 1964,, pp. 16.

Konya, C.J., "High Speed Photographic analysis of the Mechanics of Pre-Split Blasting", Proceedings of Sprengtechnik International, Linz, Austria (in German), 1973.

Konya, C.J., "Presplit Blasting: Theory and Practice", Preprint, AIME, Las Vegas, 1980.

Konya, C.J., Barrett, D., and Smith, Jr., Ed., "Presplitting Granite Using Pyrodex, A Propellant", Proceedings of the Twelfth Conference on Explosives and Blasting Techniques, Society of Explosives Engineers, Montville, OH, 1986.

Worsey, P.N., "The Effects of Discontinuity Orientation on the Success of Pre-Split Blasting", Proceedings of the Tenth Conference on Explosives and Blasting Technique, pp. 197-217, 1984.

## Chapter 11

Ballistic Research Laboratories, "Forecasting the Focus of Airblasts Due to Meteorological Conditions in the Lower Atmosphere", Report 1118, 1960.

Ballistic Research Laboratories, "Handbook for Predictions of Airblast Focusing", Report 1240, 1964.

Berger, P.R. and Associates, "Survey of Blasting Effects on Ground Water Supplies in Appalachia", vol. 1 & 2, Washington, DC, U.S. Bureau of Mines, 1982.

Crandell, F.J., "Ground Vibration Due to Blasting and Its Effect Upon Structures", Journal of the Boston Society of Civil Engineers, 49 (2):152-168, 1949.

Edwards, A.T. and Northwood, T.D., "Experimental Blasting Studies on Structures", Ottawa, Canada, National Research Council, 1959.

Goldman, D.E., "A Review of Subjective Responses to Vibrating Motion of the Human Body in the Frequency Range, 1 to 70 cycles per second", Naval Medical Research Institute Report No. 1, Project NM 004001, Mar. 19, 1948.

Handbook of Ripping, Caterpillar Tractor, Co., Peoria, IL.

Koerner, R.M. Deisler, J.N. and Scheller, R.P., "Laboratory Study of Cracking in Model Block Masonry Walls", Proceedings of the 3rd Conference on Explosives and Blasting Technique, Pittsburgh, PA: Society of Explosives Engineers, pp. 227-237, Feb. 23, 1977.

Langfors, U., Westerberg, H., and Hihlstrom, B., "Ground Vibrations in Blasting", Parts I-III, Water Power, Sept. 1958, 335-338; Oct. 1958, 390-395; Nov. 1958, 421-424.

Leet, L.D., "Effects Produced by Blasting Rock", Wilmington, DE: Hercules Powder Co., 1971.

Medearis, K., "Dynamic Characteristics of Ground Motion Due to Blasting", Bulletin of the Seismological Society of America, 63(2):627-639, 1979.

Nicholls, H.R., Johnson, C.F., and Duvall, W.I., "Blasting Vibrations and Their Effects on Structures", Bulletin No. 656, Washington, DC: U.S. Bureau of Mines, 1971.

Oriard, L.L., "Observations on the Performance of Concrete at High Level Stresses from Blasting", Proceedings of the Sixth Conference on Explosives and Blasting Technique, 1980.

Perkins, B., Jr. and Jackson, W.F., "Handbook for Predictions of Airblast Focusing", (Report No. 1240), Ballistic Research Labs, 1964.

Perkins, B.J., Jr., Lorrain, P.H., and Townsend, W.H., "Forecasting the Focus of Airblasts Due to Meteorological Conditions in the Lower Atmosphere", (Report No. 1118), Ballistic Research Labs, Oct. 1960.

Reiher, H. and Meister, F.J., "Die Empfindlichkeit des Menschen gegen Erschuelterungen", (Sensitivity of Human Beings to Vibration) Forschung auf dem Gebert des Ingenieurwesens, Berlin: 2:381-386, Feb. 1931.

Siskind, D.E., and Summers, C.R., "Blast Noise Standards and Instrumentation", (Report No. TPR 78), Washington, DC: U.S. Bureau of Mines, 1974.

Siskind, D.E., Stagg, M.S., Kopp, J.W. and Dowding, C.H., "Structure Response and Damage Produced by Ground Vibration from Surface Mine Blasting", (Report No. RI 8507), Washington, DC: U.S. Bureau of Mines, 1980.

Sperry Univac, "Vibration Specifications for Computers", Minneapolis, MN, 1982.

The Small Home, "Forty Reasons Why Walls and Ceilings Crack", (Architects Small House Service Bureau of the United States, Inc., Minneapolis, MN.) 4(8), 1925.

Thoenen, J.R. and Windes, S.L., "Seismic Effects on Quarry Blasting", Bulletin No. 442, Washington, DC: U.S. Bureau of Mines, 1942.

Walter, E.J., "Lithologic Variations and Vibration Effects", Proceedings of the Seventh Conference on Explosives and Blasting Technique, pp. 52-61, 1981.

Walter, E.J., "Natural Variation of Vibration Level Associated with Blasting", Proceedings of the Sixth Conference on Explosives and Blasting Technique, pp. 331-340, 1980.

Wiss, J.F. and Parmelee, R.A., "Human Perception of Transient Vibrations", Journal of the Structural Division, ASCE, 100(ST4):773-787, 1974.



## APPENDIX VII

### CONVERSION TABLES

#### Length

1 mile	=	1.6093	Km	1 Km	=	0.6214	mile
1 yd	=	0.9144	m	1 m	=	1.0936	yd
1 ft	=	0.3048	m	1 m	=	3.2808	ft
1 in	=	2.54	cm	1 cm	=	0.3937	in

#### Area

1 mi <sup>2</sup>	=	2.59	Km <sup>2</sup>	1 Km <sup>2</sup>	=	0.3861	mi <sup>2</sup>
1 yd <sup>2</sup>	=	0.8361	m <sup>2</sup>	1 m <sup>2</sup>	=	1.196	yd <sup>2</sup>
1 ft <sup>2</sup>	=	0.0929	m <sup>2</sup>	1 m <sup>2</sup>	=	10.7639	ft <sup>2</sup>
1 in <sup>2</sup>	=	6.4516	cm <sup>2</sup>	1 cm <sup>2</sup>	=	0.155	in <sup>2</sup>
1 acre	=	0.4047	ha	1 ha	=	2.471	acre

#### Volume

1 yd <sup>3</sup>	=	0.7646	m <sup>3</sup>	1 m <sup>3</sup>	=	1.308	yd <sup>3</sup>
1 ft <sup>3</sup>	=	0.0283	m <sup>3</sup>	1 m <sup>3</sup>	=	35.3147	ft <sup>3</sup>
1 in <sup>3</sup>	=	16.3871	cm <sup>3</sup>	1 cm <sup>3</sup>	=	0.061	in <sup>3</sup>

### Weight

1 ton	=	0.9072	t	1 t	=	1.1023	ton
1 lb	=	0.4536	Kg	1 Kg	=	2.2046	lb
1 oz	=	28.3495	g	1 g	=	0.0353	oz
1 grain	=	0.0648	g	1 g	=	15.4324	grain

### Pressure

$$1 \text{ psi} = 6894.76 \text{ Pa} \qquad 1 \text{ Pa} = 145.04 \times 10^{-6} \text{ psi}$$

$$\text{dB} = 20 \log \left[ \frac{\text{psi}}{2.9 \times 10^{-9}} \right] \qquad \text{psi} = 2.9 \times 10^{-9} \text{ alog} \left[ \frac{\text{dB}}{20} \right]$$

### Temperature

$$F^{\circ} = 1.8 \times C^{\circ} + 32$$

$$C^{\circ} = \frac{(F^{\circ} - 32)}{1.8}$$