



U.S. Department  
of Transportation  
**National Highway  
Traffic Safety  
Administration**



---

DOT HS 811 033

September 2007

# Investigation of Safety-Based Advanced Forward-Lighting Concepts to Reduce Glare

**This publication is distributed by the U.S. Department of Transportation, National Highway Traffic Safety Administration, in the interest of information exchange. The opinions, findings and conclusions expressed in this publication are those of the author(s) and not necessarily those of the Department of Transportation or the National Highway Traffic Safety Administration. The United States Government assumes no liability for its content or use thereof. If trade or manufacturers' names or products are mentioned, it is because they are considered essential to the object of the publication and should not be construed as an endorsement. The United States Government does not endorse products or manufacturers.**

**Technical Report Documentation Page**

1. Report No. DOT HS 811 033	2. Government Accession No.	3. Recipient's Catalog No.	
4. Title and Subtitle Investigation of Safety-Based Advanced Forward-Lighting Concepts to Reduce Glare		5. Report Date September 2008	
		6. Performing Organization Code	
7. Author(s) John D. Bullough, Nicholas P. Skinner, Yukio Akashi, and John Van Derlofske		8. Performing Organization Report No.	
9. Performing Organization Name and Address Lighting Research Center, Rensselaer Polytechnic Institute 21 Union Street Troy, NY 12180		10. Work Unit No. (TRAIS)	
		11. Contract or Grant No.	
12. Sponsoring Agency Name and Address National Highway Traffic Safety Administration NHTSA, NRD-13 1200 New Jersey Avenue SE. Washington, DC 20590		13. Type of Report and Period Covered Final Report (2004-2008)	
		14. Sponsoring Agency Code	
15. Supplementary Notes Michael Perel and Stephanie Binder were the NHTSA COTRs for this project.			
16. Abstract This two-part report addresses the feasibility of two approaches for using adaptive forward-lighting systems (AFS) to reduce headlamp glare under different conditions. AFS approaches involve dynamically changing headlamp beam patterns that respond in real time to different surrounding conditions such as roadway geometry, ambient lighting, or the presence of other drivers. In the first part, four field studies are described that investigated interactions between roadway lighting and vehicle headlamps, to determine whether dimming headlamps can be a suitable AFS strategy when roadway lighting is present. The studies found that glare impairs drivers' forward visibility and produces feelings of discomfort, even when street lighting is present, and that in lighted areas, it is possible to dim headlamps (potentially via AFS), reducing glare to oncoming and preceding drivers, without significantly impairing drivers' performance with respect to detection distance. In the second part, another AFS approach was investigated. This approach involved use of a "prime beam" optimized for forward visibility as the main beam pattern, subtracting portions of light when needed to reduce glare to oncoming or preceding drivers. A prototype system using a prime beam was developed, evaluated for visibility and glare in field tests in comparison with conventional low and high beam patterns, and demonstrated on a moving vehicle. The prime beam approach appears to be a promising one to ensure adequate forward visibility under a wide range of conditions while controlling glare to other drivers, and for studying characteristics of lighting as they pertain to visual performance and safety.			
17. Key Words: headlamp, headlight, discomfort glare, visibility, town beam, detection distance, glare evaluation, field study, advanced forward-lighting system (AFS), low beam, high beam		18. Distribution Statement	
19. Security Classif. (of this report) Unclassified	20. Security Classif. (of this page) Unclassified	21. No. of Pages 70	22. Price



# TABLE OF CONTENTS

LIST OF TABLES AND FIGURES.....	iv
ABSTRACT.....	vii
PART I	
Summary: Part I.....	2
I-1. Introduction.....	4
I-2. Literature Survey.....	5
I-3. Objectives.....	8
I-4. Pilot Study.....	9
I-5. Detection Study.....	16
I-6. Oncoming Glare Study.....	22
I-7. Discomfort Glare Evaluation.....	27
I-8. Discussion.....	34
PART II	
Summary: Part II.....	38
II-1. Introduction.....	39
II-2. Characterizing Prime Beam Requirements.....	41
II-3. Development of the SAFS Prototype.....	45
II-4. Acceptability Evaluation.....	48
II-5. Forward Visibility Evaluation.....	51
II-6. Glare Evaluation.....	54
II-7. Moving Vehicle Demonstration.....	58
II-8. Discussion.....	62
REFERENCES.....	64
ACKNOWLEDGMENTS.....	68
APPENDIX: RESULTS OF ANOVA.....	69

## LIST OF TABLES

**Table I-1.** Just acceptable vertical illuminance at eyes for side mirror glare (in lx).

**Table I-2.** Measured mirror illuminance.

**Table I-3.** Experimental conditions.

**Table I-4.** Experimental conditions for oncoming headlamp glare study.

**Table I-5.** Results (P-values) of paired T-tests in the oncoming glare study.

**Table I-6.** Comparison of contrast threshold between measurements and estimations for 100-percent roadway illuminance in the detection study.

**Table I-7.** Experimental conditions (32 conditions in total).

**Table I-8.** Measurements of illuminance at a driver's eye (lx).

**Table II-1.** Illuminances (in lx) required to achieve a reaction time of 600 ms or shorter to a 0.4-reflectance, 20-cm square target located 60 m ahead at various locations and while exposed to different glare illuminances.

**Table II-2.** Illuminances (in lx) required to achieve a missed target percentage of 30 percent or less to a 0.4-reflectance, 20-cm square target located 60 m ahead at various locations and while exposed to different glare illuminances.

**Table A-1.** Results of repeated-measures ANOVA in the pilot study.

**Table A-2.** Results of repeated-measures ANOVA in the detection study.

**Table A-3.** Results of repeated-measures ANOVA in the oncoming glare study.

**Table A-4.** Results of repeated-measures ANOVA in the mounting height study.

## LIST OF FIGURES

**Figure I-1.** Reaction time under two spectral power distributions and two forward headlamp conditions (After Akashi and Rea, 2001 and 2002).

**Figure I-2.** Beam patterns of an adaptive forward headlamp system (After Kalze, 2001).

**Figure I-3.** Experimental setup.

**Figure I-4.** Pneumatically telescoping pole completely contracted.

**Figure I-5.** Luminous intensity distribution of right headlamp.

**Figure I-6.** Illuminance distributions (lx).

**Figure I-7.** Pilot experiment results: mean detection distances.

**Figure I-8.** Detection distance for three roadway illuminance levels.

**Figure I-9.** Detection distance for three headlamp intensity levels.

**Figure I-10.** View of modified target presentation system.

**Figure I-11.** View of setup layout.

**Figure I-12.** Detection study results of mean detection distance.

**Figure I-13.** Mean detection distances for three roadway illuminances in the detection study.

**Figure I-14.** Mean detection distances for three headlamp intensity levels in the detection study.

**Figure I-15.** Mean detection distances for oncoming glare study.

**Figure I-16.** Mean detection distances comparing glare and no-glare conditions.

**Figure I-17.** Layout of experimental setup and three poles.

**Figure I-18.** Results of oncoming and following glare for all 20 subjects.

**Figure I-19.** Comparison of oncoming glare evaluations between 11 young subjects and 9 older subjects.

**Figure I-20.** Comparison of following glare evaluations between for 11 younger subjects and 9 older subjects.

**Figure I-21.** Results of oncoming and following glare for all 20 subjects.

**Figure II-1.** Vertical illuminances at 60 m ahead from the projector modules used in the AFS prototype system.

**Figure II-2.** Experimental headlamp assembly.

**Figure II-3.** Illustration of the shielded portion of the experimental headlamp beam pattern.

**Figure II-4.** Subjects' satisfaction with various beam shielding conditions (error bars indicate standard error of the mean).

**Figure II-5.** Experimental layout for forward visibility study.

**Figure II-6.** Vertical illuminances measured on targets.

**Figure II-7.** Mean reaction times to each target location under each lighting condition.

**Figure II-8.** Discomfort ratings (using the De Boer scale) elicited by low and high (no shielding) beams, and from baffled conditions varying in angular width, plotted as a function of illuminance at subjects' eyes.

**Figure II-9.** Illuminances on targets during the glare evaluation experiment.

**Figure II-10.** Mean reaction times to each target for each oncoming lighting condition (1=high beam, 2=low beam, 3=prime beam with 3° shielding, 6=prime beam with 6° shielding).

**Figure II-11.** Mean discomfort ratings (and standard errors of the mean) for the oncoming lighting conditions in the glare evaluation experiment.

**Figure II-12.** Prototype AFS modules mounted on the test vehicle.

**Figure II-13.** View from the test vehicle toward an oncoming vehicle with the shielded prime beam installed.

**Figure II-14.** Observers' mean discomfort ratings while viewing an approaching vehicle containing the prime beam prototype system.

**Figure II-15.** Observers' mean satisfaction and comfort ratings while driving the prime beam system prototype.



## ABSTRACT

This two-part report addresses the feasibility of two approaches for using adaptive forward-lighting systems (AFS) to reduce headlamp glare under different conditions. AFS approaches involve dynamically changing headlamp beam patterns that respond in real time to different surrounding conditions such as roadway geometry, ambient lighting, or the presence of other drivers. In the first part, four field studies are described that investigated interactions between roadway lighting and vehicle headlamps, to determine whether dimming headlamps can be a suitable AFS strategy when roadway lighting is present. The studies found that glare impairs drivers' forward visibility and produces feelings of discomfort, even when street lighting is present, and that in lighted areas, it is possible to dim headlamps (potentially via AFS), reducing glare to oncoming and preceding drivers, without significantly impairing drivers' performance with respect to detection distance. In the second part, another AFS approach was investigated. This approach involved use of a "prime beam" optimized for forward visibility as the main beam pattern, subtracting portions of light when needed to reduce glare to oncoming or preceding drivers. A prototype system using a prime beam was developed, evaluated for visibility and glare in field tests in comparison with conventional low- and high-beam patterns, and demonstrated on a moving vehicle. The prime beam approach appears to be a promising one to ensure adequate forward visibility under a wide range of conditions while controlling glare to other drivers, and for studying characteristics of lighting as they pertain to visual performance and safety.



**PART I:**

**THE FEASIBILITY OF HEADLAMP GLARE REDUCTION IN LIGHTED ENVIRONMENTS THROUGH ADVANCED FORWARD LIGHTING**

## SUMMARY: PART I

This study addressed questions of how fixed roadway lighting, vehicle forward lighting, and oncoming glare interact with each other and affect visual performance. The goal of this project was to determine the feasibility of using advanced forward lighting systems (AFS) to reduce headlamp glare under high ambient lighting conditions.

In order to achieve this goal the LRC conducted a literature survey and four field studies: two target detection studies without glare, a target detection study with glare, and a glare evaluation study. The target detection studies (without glare) examined if headlamps can be dimmed while maintaining drivers' visual performance when fixed roadway lighting exists. The target detection study with glare explored whether and how headlamp glare impaired drivers' target detections under a lit ambient condition and whether forward headlamps help drivers mitigate the effects of glare. The objective of the glare evaluation study was to explore if dimming headlamp intensity can reduce feelings of discomfort to oncoming and preceding drivers in a lighted area and, if so, how much headlamp intensity should be reduced to ease discomfort. The glare evaluation study also explored if and how headlamp mounting height influences discomfort glare.

The results of the detection study suggest that, except for a small effect at large peripheral angles, automotive forward headlamps improved target detection little when roadway lighting was present. Fixed street lighting helps drivers detect targets significantly more than do headlamps.

The results of the detection study with glare clearly indicate that oncoming glare, even in conditions of high ambient light levels, negatively impacts target detection. Additionally, the presence of vehicle forward lighting did not meaningfully mitigate these glare effects. This implies that, in order to prevent oncoming glare from reducing drivers' visual performance, it may be important to dim forward headlamp intensity.

The results of the glare evaluation study suggest that discomfort from both oncoming and following glare was significant, even under high ambient light levels. Feelings of discomfort increased as the luminous intensity and mounting height increased, but became acceptable when the headlamps were dimmed to less than 50 percent of the initial intensity for most mounting heights.

This project led to the following overall conclusions:

- Glare impairs drivers' target detection and produces feelings of discomfort, even under high ambient light level environments (roadways lit by street lighting).
- Target detection distances can be increased and feelings of discomfort can be reduced by lowering headlamp glare light levels.
- Under the conditions tested here, it is possible to dim headlamps without meaningfully impairing drivers' target detection performance in lit areas.

- To reduce glare without significantly impairing forward visibility, dimming forward lighting to 50 percent of the initial intensity may be most appropriate for most mounting heights and angular directions within the beam.
- Headlamps with a high mounting height (1200 mm) must be dimmed further to reduce discomfort. Removing glare in these cases may be difficult without impairing drivers' forward visibility. A sophisticated AFS may resolve this difficulty by appropriately controlling headlamp beams in the near future.

## I-1. INTRODUCTION

Automotive forward lighting has to meet two seemingly antithetical requirements: increasing forward visibility and decreasing glare. Therefore, forward lighting requires restrictive optical control. However, under certain conditions (e.g., at high ambient illuminances), vehicle forward lighting may not be as needed for visibility. The forward lighting, if it is dimmable according to traffic density and ambient lighting conditions, may be able to more efficiently control glare to oncoming and preceding drivers.

A study in 1975 proposed a “city beam,” having lower luminous intensity (e.g., 20-100 cd) than conventional low-beam headlamps (Schreuder, 1975), and proved that in well-lit areas headlamps can be dimmed to reduce glare while maintaining drivers’ visual performance. Although it might have been difficult to apply the “city beam” concept to automotive practice in the 1970s for technical reasons, recent advanced forward-lighting technology could spur putting this concept into good practice.

Before implementing the concept of dimmable forward lighting, however, it is important to determine if forward lighting can be dimmed without compromising visual performance. The Lighting Research Center (LRC), with the sponsorship of the U.S. National Highway Traffic Safety Administration (NHTSA), has examined the interactions among fixed roadway lighting, vehicle forward lighting, and oncoming glare on visual performance. To examine this issue further, the LRC performed a set of activities. The relevant literature was reviewed and a series of field experiments were performed – a target detection study, a target detection study with glare, and a discomfort glare evaluation study. This report summarizes the results of the above-described literature survey and the field experiments.

Roadway lighting (ANSI/IESNA, 2000) serves several purposes to the driver, among which are increased detection distances for objects outside the range of vehicle headlamps, reduced disability and discomfort glare, and increased adaptation levels within the mesopic luminance range (Bullough and Rea, 2004). Issues associated with adaptation and glare reduction from roadway lighting are outside the scope of the present study; consult ANSI/IESNA (2000) or Rea (2000) for more information about these topics.

The reader is also referred to a recent literature review of adaptive forward-lighting systems (AFS) (Akashi et al., 2005), which discusses several applications for AFS including the reduction of headlamp intensity for glare reduction. That report discusses the technological as well as human factors issues associated with implementing such solutions on vehicles.

## I-2. LITERATURE SURVEY

The literature survey investigated (1) ambient illuminance under which headlamp beam intensity could be reduced, (2) the feasibility of adaptive forward headlamp system to reduce glare, and (3) how headlamp light reflected off of rearview mirror causes glare.

### Ambient Illuminance Under Which Headlamp Beam Intensity Could Be Reduced

A study by Schreuder (1975) suggested that when road lighting was present (even very poor road lighting), low-beam headlamps could make only a small, and mostly negligible, contribution to illumination and thus to the visibility of objects. Additionally, a recent field study proved that headlamps minimally impacted driver performance of off-axis target detection when fixed street-lighting exists (Akashi and Rea, 2001, 2002). The subjects of this field study were asked to drive along a closed track at a speed of 20 mph, fixate on the central task, and detect an off-axis target at an eccentricity angle of 15° or 23° from the central fixation point under a mesopic light level. The field study employed two kinds of lamp spectral power distributions (metal halide and high-pressure sodium lamps) and two forward-headlamp conditions (ON and OFF). Figure I-1 shows the results of the study.

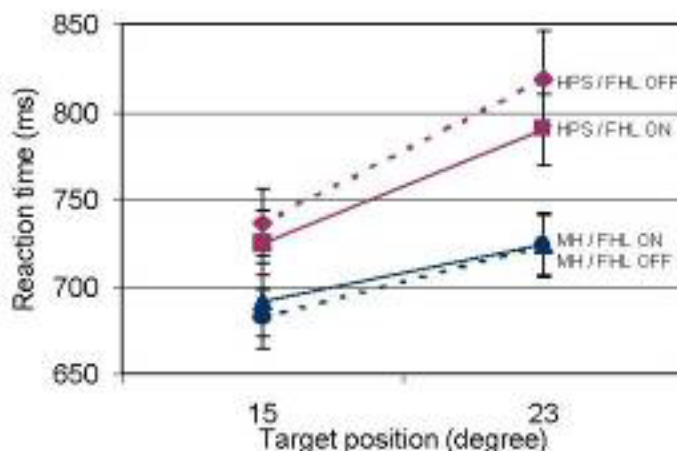

**Figure I-1.** Reaction time under two spectral power distributions and two forward headlamp conditions (After Akashi and Rea, 2001 and 2002).

Figure I-1 shows that the difference in reaction time between the headlamp on and off conditions was statistically negligible. This suggests that forward headlamps had little impact on drivers when detecting off-axis targets while spectral power distribution had greater impact on drivers' performance for off-axis target detection. These implications suggest that headlamps can be dimmed to reduce glare without impairing drivers' visual performance in lit areas. However, what the minimum ambient illuminance level is under which headlamps can be dimmed, or how much the headlamp beam intensity can be reduced, have not been investigated. Schreuder (1975) reviewed relevant studies from the 1950s to the 1970s and concluded that appropriate luminous intensity for headlamps could be up to 100 cd to reduce glare towards oncoming drivers with maintaining the conspicuity of the headlamps.

However, it is necessary to verify whether the luminous intensity of 100 cd is enough to maintain visual performance through field studies. It is also important to investigate how such a headlamp control method contributes to glare reduction.

### Feasibility of Glare Reduction Through Advanced Forward Lighting

Schreuder's 1975 study proposed concepts for "city beam" of which intensity is lower than regular forward headlamps but higher than side lights. His "city beam" was intended to reduce glare to oncoming drivers but signal the existence of the car. Although it was not easy in the 1970s to equip headlamps with dimming function or add additional lamps to a car, the recent Advanced or Adaptive Frontlighting System (AFS) technology may bring to realization the concept of "city beams."

Recently, many studies on AFS have proposed similar ideas to "city beams." Birch (2001) suggested that in lit areas where vehicle speed is relatively low, the high-intensity spots of headlamps are unnecessary and therefore can be turned off (Birch, 2001). Kalze (2001) proposed that a symmetrical cutoff geometry with low intensity could be better for forward headlamps to reduce glare to oncoming drivers in lit areas. Figure I-2 compares two forward-headlamp patterns for town light and country light in such AFSs. These adaptive headlamps are achievable by a dimming control system or swivel mechanism in conjunction with a photo-sensor system. Although the concept is already well-established (Worner, 1999, Kobayashi and Hayami, 1999), few field studies investigated how the adaptable forward headlamp system functions in practice or how the system influences driver performance.

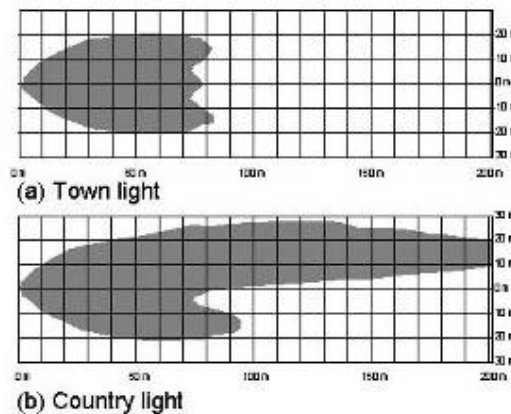

*Figure I-2 Beam patterns of an adaptive forward headlamp system (After Kalze, 2001).*

### Glare Reflected on Rearview Mirrors

There are several studies discussing glare from following headlamps reflected on rearview mirrors and side mirrors. For instance, Miller et al. (1974) suggested that acceptable near-foveal (from sources close to the line of sight) illuminance is 0.43 to 1.72 lx at eye position. Olson and Sivak (1984) also found that side mirror illuminance causing just below "admissible" glare was from 2.37 to 8.61 lx at eye position for long exposure durations and short exposure durations, respectively. SAE's Mounting Height Task Force (MHTF) reviewed these existing studies on



side mirror glare, including Miller et al. (1974), Olson and Sivak (1984), Sivak et al. (1997), and Schmidt-Clausen and Bindels (1974), and concluded the “just acceptable” limit of eye illuminance for side mirror glare (Table I-1). The MHTF suggested that side mirror illuminance should be lower than 10-20 lx (SAE-Headlamp Mounting Height Task Force, 2000).

**Table I-1. Just acceptable vertical illuminance at eyes for side mirror glare (in lx).**

Authors	Sivak et al. (1997)			Olson and Sivak (1984)	
	3 sec	10-20 sec	3 min	10 sec	3 min
Foveal glare	3.0	1.5	1.0	-	-
Peripheral glare (35-45 degree) *	10.1-11.3	4.3-4.9	3.2-3.1	8.6	2.4
Side mirror illuminance**	21	9.2	6.6	17.2	4.7

\*Peripheral glare was obtained by adjusting the results of foveal glare to peripheral glare by using Schmidt-Clausen and Bindels algorithm.

\*\*Assuming total transmittance (mirror reflectance × window) equals 50 percent, the eye illuminance was multiplied by two.

The MHTF also conducted a field measurement. A vehicle having a photocell at the lower edge of a side mirror centered at a height of 900 mm was driven along interstate highways and recorded side mirror illuminance data (Table I-2). Table I-2 shows that the measured side mirror illuminance often exceeded the side mirror illuminance limit of 10 lx. These data suggest that dimming headlamp intensity in lit areas may function well to prevent headlamps from causing glare to preceding drivers. These data are also convertible to rearview mirror glare and very useful for the LRC experiments.

**Table I-2. Measured mirror illuminance.**

Conditions	Mirror illuminance (lx)
Heavy trucks following in the right lane	5 to 15
Heavy trucks passing on the left lane	5 to 60
Passenger vehicles following in the right lane	3 to 15
SUV following in the right lane	5 to 15

Based on the results of the literature survey, several studies were performed: two target detection studies without glare, a target detection study with glare, and a discomfort glare evaluation study which also examined headlamp mounting height. The first target detection study was a pilot study to examine the sensitivity of the experimental design and method and to test the reliability of the experimental system for use in subsequent studies described in the present report. Based on the results of the pilot study the final experimental system was developed and the experimental procedure was improved. The detection studies examined if headlamps can be dimmed when fixed roadway lighting exists and maintains drivers’ visual performance. The oncoming glare study explored whether and how oncoming headlamp glare impaired drivers’ target detections under a lit ambient condition and whether forward headlamps help drivers detect targets with oncoming glare. The subjective glare evaluation study was performed to confirm if dimmed headlamps can reduce glare to drivers under a lit ambient. While types of mirrors (e.g., convex, planar) would affect discomfort in situations of following glare, this factor was not within the scope of the current study.

### **I-3. FIELD STUDY OBJECTIVES**

Based on the results of the literature survey, four studies—the pilot detection study, the detection study without glare, the target detection study with glare, and the subjective glare evaluation study were conducted. The purpose of the pilot study was to examine the sensitivity of the experimental design and method and to test the reliability of the experimental system. Based on the results of the pilot study the final experimental system was developed and the experimental procedure was improved. The detection study (without glare) examined if headlamps can be dimmed when fixed roadway lighting exists and maintains drivers' visual performance. The oncoming glare study explored whether and how oncoming headlamp glare impaired drivers' target detections under a lit ambient condition and whether forward headlamps help drivers detect targets with oncoming glare. The glare evaluation study explored if dimming headlamp intensity can reduce glare to oncoming and preceding drivers in a lit area and how much headlamp intensity should be reduced to ease glare. This glare evaluation study also addressed a question of whether and how headlamp mounting height influences glare.

## I-4. PILOT STUDY

To examine the sensitivity of the experimental design and test the reliability of the experimental system, the pilot study was conducted.

### Location and Apparatus

The pilot study took place on an unused runway at Schenectady County Airport in Scotia, New York. Three temporary roadway lighting poles, spaced at a distance of 30 m in a staggered arrangement, demarcated a two-lane roadway approximately 100 m in length and 7 m in width (Figure I-3). Each pole contained two full cutoff luminaire heads (G13-4XL-150HPS-277V-NP, Gardco Emco McPhilben) on the top (Figure I-4). Only one of the two heads was equipped with a 150 W high-pressure sodium lamp (LU150/55/MED67508-1, OSRAM SYLVANIA Inc.). This head functioned as an illuminator and the other head was used to balance the weight. The pole could be contracted and telescoped from 2 m to 6 m in height by a pneumatic (CO<sub>2</sub>) pump. This allowed the experimenter to reach the luminaire head to alter the intensity by using different transmittance mesh filters when the pole was at the lowest level. At one end of the roadway, a passenger car was parked. In front of the car, a rack with a headlamp system corresponding to Federal Motor Vehicle Safety Standard (FMVSS) 108 requirements, and containing 51W tungsten halogen headlamps was set. Figure I-5 shows the luminous intensity distribution of the right headlamp (the distribution of the left is similar). The mounting height of the forward headlamps was 0.65 m, a typical mounting height for a passenger car. Neutral density filters dimmed the intensity of the forward headlamps. The headlamp rack was not visible to subjects in the driver seat of the car.

On the centerline of the roadway and adjacent to the driver seat of the car, a target presentation system was located. The system was composed of five pulleys and two motors. All five pulleys have a single vertical axel in common. Each of the five pulleys pulled a target and a string suspended between itself and a fixed pulley at a distance of approximately 100 m from the car. Five targets moved along lines (strings) radiated from the target presentation system in five directions, -15°, -5°, 0°, 5°, and 15° (Figure I-3). Each target was an 18 cm × 18 cm square wooden board with a reflectance of 20 percent and was vertically attached to a four-wheel chassis, so all targets faced the driver. The target had the same size as used for small target visibility (STV) evaluation (ANSI/IESNA, 2000). The speed of targets was approximately 5 km/hour and this speed was slightly faster than the speed of average pedestrians. A computer with LabView 6.0 software controlled the target presentation. The computer operated only one of the five targets at a time. A manual switch, also connected to the computer, was used by subjects to signal target detection. A numerical signboard composed of seven LED segments was placed near the other end of the straight track at a distance of 90 m from the car. The signboard displayed 30 cm × 20 cm numerical characters from 0 to 9 in a random order for one second each. The subjects fixated on the signboard and were assigned to keep reading the number when the number was changed.

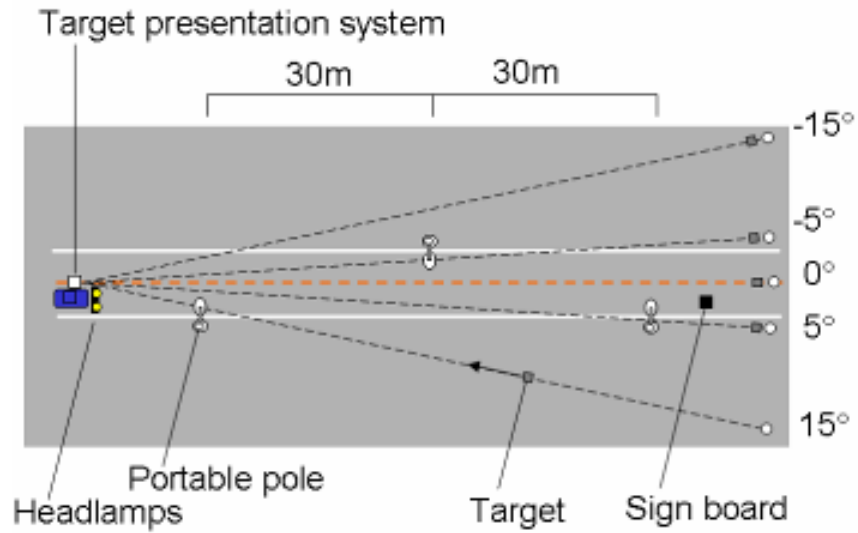

Figure I-3. Experimental setup.



Figure I-4. Pneumatically-telescoping pole completely contracted.

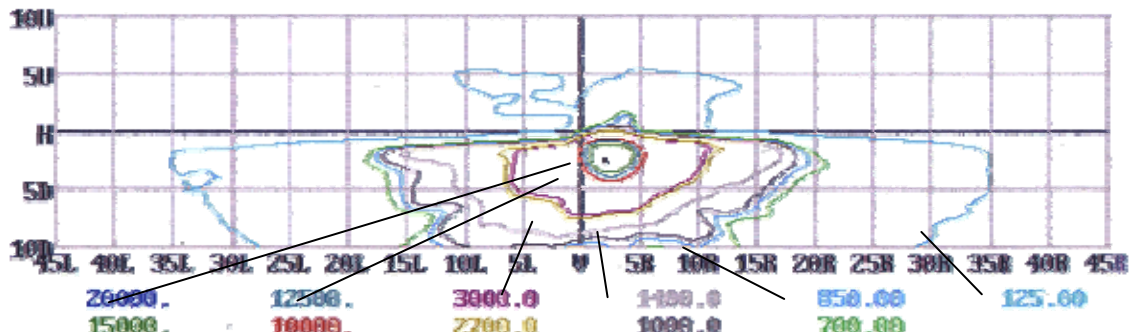

Figure I-5. Luminous intensity distribution of right headlamp.

## Experimental Conditions

Ambient roadway illuminance (3 conditions) and headlamp luminous intensity (3 conditions) were changed as independent variables. The intensity of the luminaires, and therefore the ambient illuminance, was altered by using different transmittance mesh filters. The headlamp intensity was changed by using different transmittance neutral density filters. Table I-3 summarizes experimental conditions employed in this study. Figure I-6 illustrates the measured illuminance distribution of the roadway pavement. The iso-lux contours were created from illuminance measurements at 25 (5×5) points between the first pole and the second pole. The measurements were conducted every 4.57 m (15 feet) crosswise and 7.62 m (25 feet) lengthwise along the 7 m wide roadway, covering an area of 18.2 m (60 feet) wide and 30.5 m (100 feet) long. The average illuminance on the roadway was 7.4 lx while the minimum illuminance was 1.2 lx. Therefore, the uniformity of the ambient illuminance ( $E_{ave}/E_{min}$ ) was 6.1:1. These illuminance measurements corresponded to ANSI/IESNA’s illuminance recommendation for roadways in local intermediate areas (ANSI/IESNA RP-8-00).

**Table I-3. Experimental conditions.**

Independent variables	Range
Ambient illuminance levels	100, 30, 10%
Headlamp intensity	100, 30, 10%
Target position*	-15°, -5°, 0°, 5°, 15°

\*Target position: Negative (-15 and -5) and positive (5 and 15) values mean left and right to the center of the visual field, respectively.

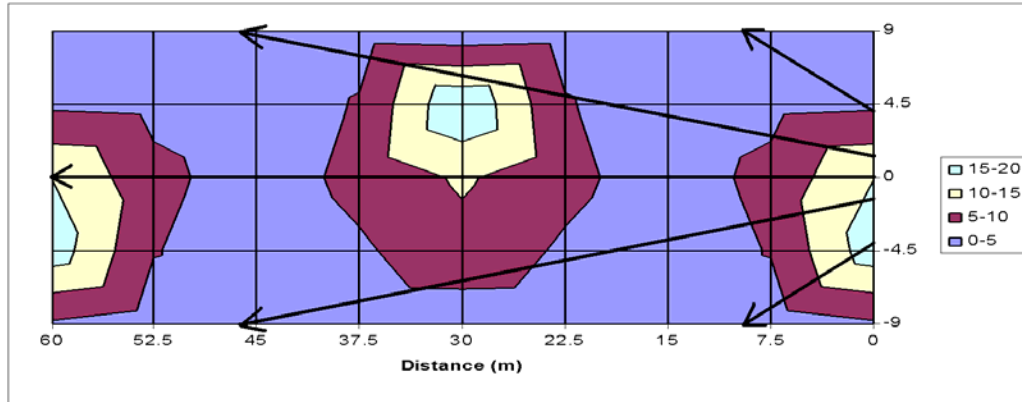

**Figure I-6. Illuminance distributions (lx).** The layout orientation is the same as Figure I-3. Arrows indicate the initial locations of each target.

## Procedure

Eight male subjects, ranging from 24 to 33 years in age, with normal or corrected-to-normal visual acuity and normal color vision participated in the field study. All subjects had driver’s licenses in the United States. After receiving instructions from an experimenter, a subject sat in the driver seat of the parked car under one of the three ambient illuminance levels. An experimenter sat in the passenger seat to observe the behavior of the subject and help the subject smoothly respond to the target presentation. Another experimenter outside of the car prepared one of the three headlamp intensity conditions by attaching a neutral density filter to the forward

headlamps. The experimenter in the car asked the subject to fixate on the numerical signboard and read aloud the numbers shown on the signboard. While the subject read the numbers, one of the five detection targets moved along the straight lines from the far end of the string towards the subject in the parked car. The subject signaled the detection by pressing the manual switch as soon as the target was detected. Then, the signal was sent to the computer, and the computer stopped the target. The computer automatically recorded the distance the target stopped from the subject and sent the target to the initial position at the far end of the string. After the target returned to the initial position, the computer moved the second target towards the subject. The order of the five target presentations was randomized. After the five target presentations, the headlamp intensity was changed and the next five-target presentation started. After all 15 (five targets  $\times$  three headlamp intensities) target presentations, the ambient roadway illuminance level was changed. To change the roadway illuminance, experimenters lowered the pneumatic poles and altered the mesh filters of the three luminaires. Changing roadway illuminance took the experimenters about 15 minutes while the subject took a rest. The order of the ambient illuminance levels and headlamp intensity levels was counterbalanced across subjects. The experiment took each subject about 2.5 to 3 hours.

## **Results**

Means and medians of all eight subject detection distances for the 45 (three ambient illuminances  $\times$  three headlamp intensities  $\times$  five target positions) conditions were calculated. Figure I-7 shows the means for the 45 experimental conditions. The results of medians were similar to those of means. Figure I-7 suggests: (1) detection distance appears to increase as ambient roadway illuminance (RI) increases, (2) detection distances are the shortest for the most peripheral angles ( $\pm 15^\circ$ ), and (3) the impact of headlamp intensity (HL) on detection distance is smaller than that of ambient roadway illuminance.

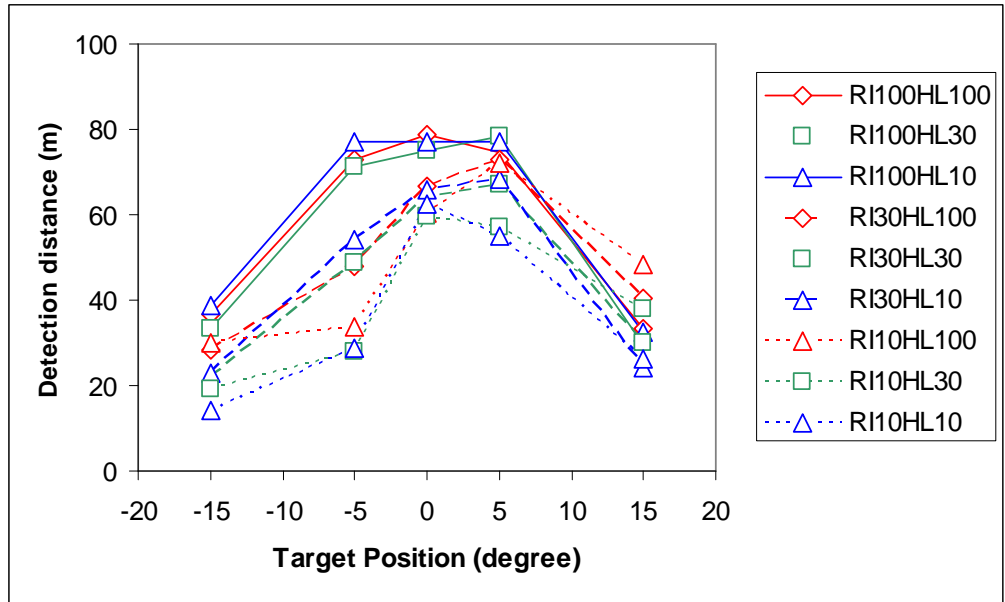

**Figure I-7.** Pilot experiment results: mean detection distances.

*RI:* ambient roadway illuminance, ranged from 10 percent to 30 percent and 100 percent.

*HL:* headlamp intensity, ranged from 10 percent to 30 percent and 100 percent.

To statistically analyze these tendencies, a repeated-measures analysis of variance (ANOVA) was conducted using all detection distances for each target presentation (three roadway lighting conditions  $\times$  three headlamp intensities  $\times$  five target positions) using Minitab Release 12.21, a statistical analysis program. The results of the ANOVA revealed that all main effects of roadway illuminance ( $p < 0.001$ ), headlamp intensity ( $p < 0.01$ ), target position ( $p < 0.001$ ), and all interactions ( $p < 0.05$ ) are statistically significant (Table A-1, Appendix).

Figures I-8 and I-9 illustrate average detection distances and standard deviations of all subjects for three ambient illuminances on the roadway pavement and three headlamp luminous intensities, respectively. Figure I-8 clearly indicates that as ambient roadway illuminance increases, detection distance is increased. This illustrates the interaction between ambient illuminance and target position as the ANOVA suggested. The effect of roadway illuminance on detection distance becomes smaller as the target eccentricity angle increases. There appears to be no contribution of ambient illuminance to target detection distance at the eccentricity angle of  $15^\circ$  to the right. In Figure I-9, the contribution of headlamp intensity to target detection distance is less apparent than the contribution of ambient illuminance. The three lines for different headlamp intensity conditions cluster at most eccentricity angles in the graph. Interestingly, at the eccentricity angles of  $15^\circ$ , the contribution of headlamps appears stronger. What Figures I-8 and I-9 suggest was consistent with the results of the ANOVA.

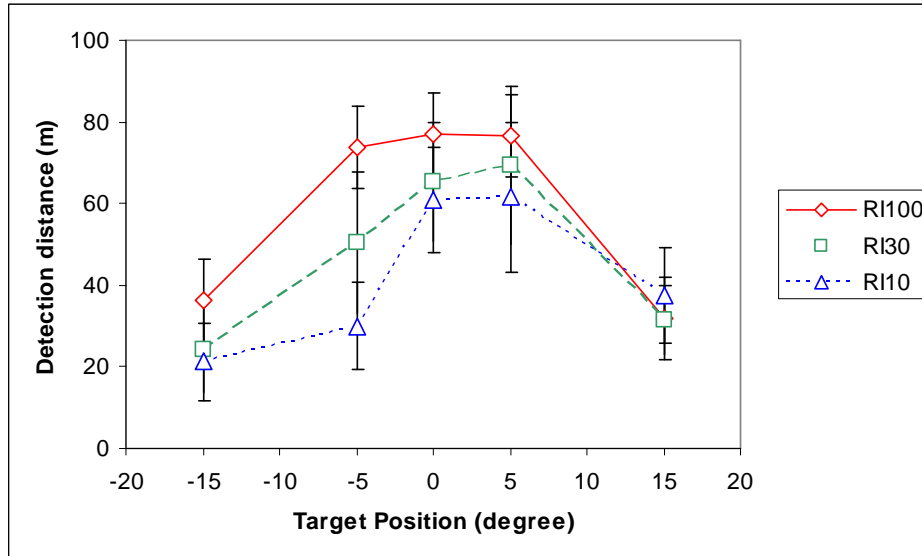

*Figure I-8. Detection distance for three roadway illuminance levels.*

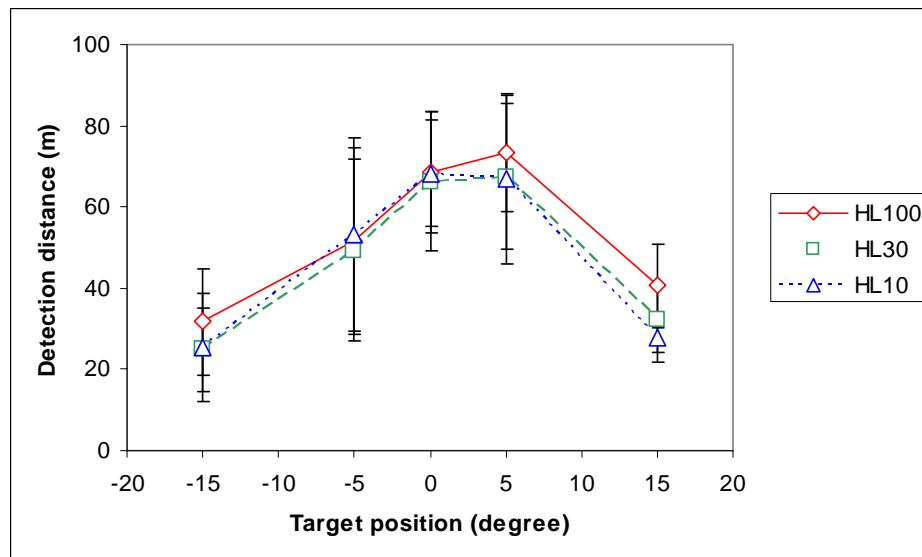

*Figure I-9. Detection distance for three headlamp intensity levels.*

## Conclusions

The results of the study clearly indicated that target visibility is improved as ambient illuminance on the roadway pavement is increased. Automotive forward headlamps did little to improve target visibility when roadway lighting was present, except for a small effect at the eccentricity angle of 15°, where roadway illumination was relatively low for the experimental layout used. Therefore, the results of the pilot study showed that the sensitivity of the experimental design was high enough to find the effects of headlamp reduction on detection distance and examine the interaction between fixed roadway lighting and vehicle forward lighting.

However, the pilot study identified several issues with the target presentation system:



- (1) The target presentation system required frequent maintenance during the experiment.
- (2) Since the target presentation system was too tall to be located in front of the car, the system was located adjacent to a driver. Therefore, the discrepancy in angle between each target's eccentricity angle and the predetermined one (e.g.,  $-15^\circ$ ,  $-5^\circ$ ,  $0^\circ$ ,  $5^\circ$ , or  $15^\circ$ ) was increased as the target moves closer to the driver.
- (3) Since the single motor of the target presentation system can operate only a single pulley and a target at a time, it took each subject approximately 3 hours to complete the experiment. This might cause subjects' fatigue influencing their ability to maintain attention to the targets during the experiment.

Due to these issues, the target presentation system was improved for the main target detection study without glare as described in the next session.

## I-5. DETECTION STUDY

After modifying the target presentation system, the detection study was conducted. The purpose of the detection study was to investigate whether headlamps can be dimmed when fixed roadway lighting exists while maintaining drivers' visual performance.

### Location and Apparatus

The detection study used the same location as the pilot study. However, the target presentation system used in the detection study was modified to address the issues described in the pilot study session. Figure I-10 shows a view of the improved system. This improved system used five motors, one motor for each of the five targets. This modification simplified the mechanism, reducing the frequency of maintenance, enabling the system to operate two pulleys at a time, and therefore reducing time required by the experiment. This improvement also resulted in the lower physical height of the system, enabling it to be located in front of the car and reducing the discrepancy of targets in eccentricity angle from the predetermined target angles even if the targets were close to the car.



**Figure I-10.** View of modified target presentation system.

*The target presentation system in front of the car was composed of five motors. Each motor rotates a pulley pulling a target.*

Due to the modification of target presentation system and the change of its location, the layout of the experimental setup was slightly changed. As shown in the Figure I-11, the 15° target moved behind the first pole while moving in front of the pole in the pilot study.

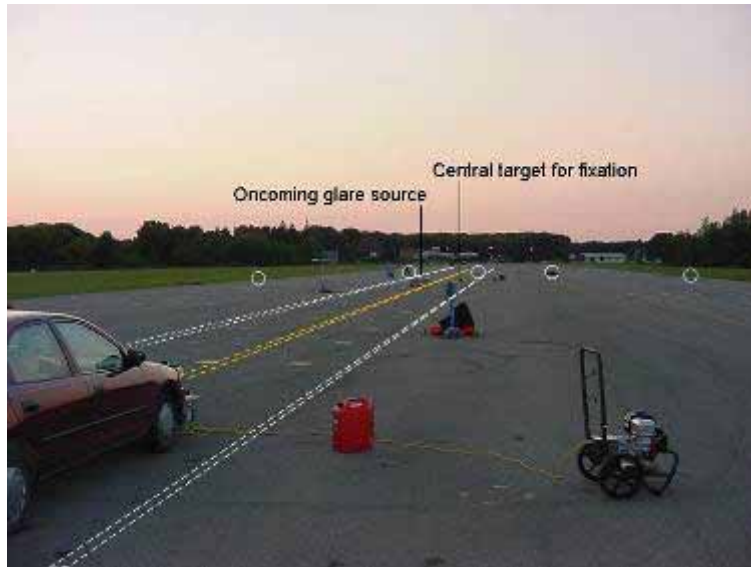

**Figure I-11.** View of setup layout.

*White circles indicate five target locations. Telescoping pneumatic poles for fixed roadway lighting are still contracted at the lowest height. Although an oncoming glare source (headlamp system) is located in the center of the picture, the oncoming glare source was not used in the detection study but was used in the oncoming glare study. A power generator was used for forward headlamps through a converter and for the computer.*

## Experimental Conditions

The main detection study used the same experimental conditions as the pilot study (Table I-3). Therefore, 45 (three ambient illuminances  $\times$  three headlamp intensities  $\times$  five target positions) experimental conditions in total were prepared.

## Experimental Procedure

The detection study employed 12 male subjects, ranging from 24 to 40 in age, with normal or corrected-to-normal visual acuity and normal color vision participated. The detection study used the same experimental procedure as the pilot study. The improvement of the target presentation shortened the time required by the experiment from nearly three hours to less than two hours.

## Results

Means and medians of all 12 subject detection distances for the 45 (three ambient illuminances  $\times$  three headlamp intensities  $\times$  five target positions) experimental conditions were calculated. Figure I-12 shows average detection distances for all subjects under each lighting condition (three ambient illuminances  $\times$  three headlamp intensities). Again, the results of medians were similar to those of means, shown in Figure I-12. Figure I-12 shows the same tendencies to those of the pilot study, suggesting (1) detection distance appears to increase as ambient roadway illuminance (RI) increases, (2) detection distances are the shortest for the most peripheral angles ( $\pm 15^\circ$ ), and (3) the impact of headlamp intensity (HL) on detection distance is smaller than that of ambient roadway illuminance except the  $15^\circ$  off-axis target. When the roadway illuminance was low (RI30 and RI10), the detection distance for the  $5^\circ$  off-axis target was the longest. This

tendency corresponds to the headlamp beam distribution that has the highest luminous intensity at a few degrees off-axis. At the target eccentricity angle of 15°, interestingly, the headlamp intensity drove detection distance. The detection distance was increased as the headlamp intensity increases.

To statistically analyze the effects of roadway lighting and forward lighting on target detection and verify the validity of the tendencies described above, a repeated-measures ANOVA was applied to all subject detection distances under the 45 experimental conditions. The results of the ANOVA suggest that there were significant differences in detection distance between roadway illuminances, headlamp intensities, target positions, and subjects (Table A-2, Appendix).

The interactions between roadway illuminance and headlamp intensity, between roadway illuminance and target position, and between headlamp intensity and target position were also significant. The significant interaction between roadway illuminance and headlamp intensity indicates that detection distance for each of the three headlamp intensities, while roadway illuminance is 10 percent or 30 percent of the initial roadway illuminance, differs from the others. This indicates that forward headlamps improve target detection under low illuminance conditions. However, for the 100 percent roadway illuminance, there is little difference in detection distance as the three lines cluster into a group; forward headlamps contribute little to target detection. The other significant interaction between roadway illuminance and target position suggests that the roadway illuminance slightly affects detection distance only for the 15° off-axis target. At the eccentricity angle of 15°, the headlamp intensity is the main driver for detection distance. This is also the reason of the other interaction between headlamp intensity and target position. Headlamp intensity seems influential to detection distance only when roadway illuminance values are relatively low.

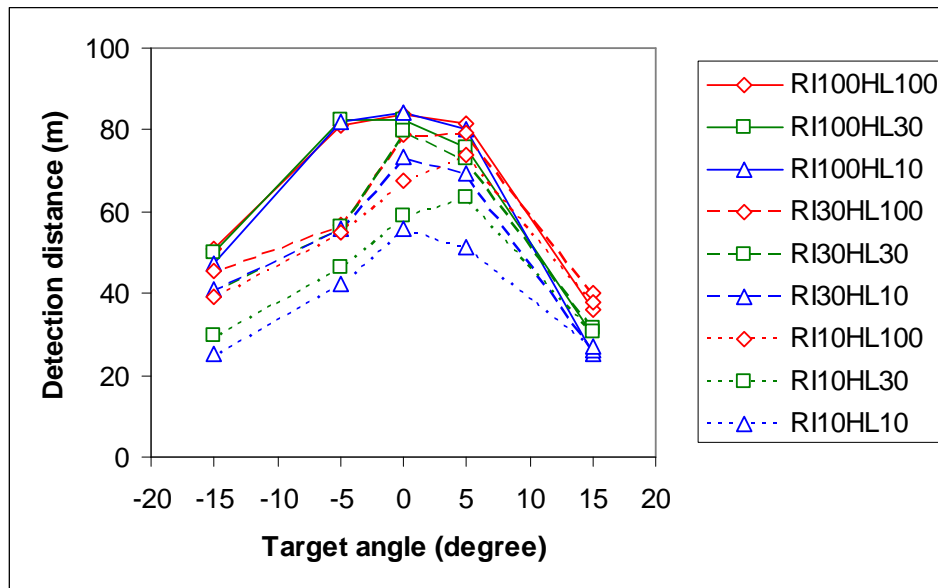
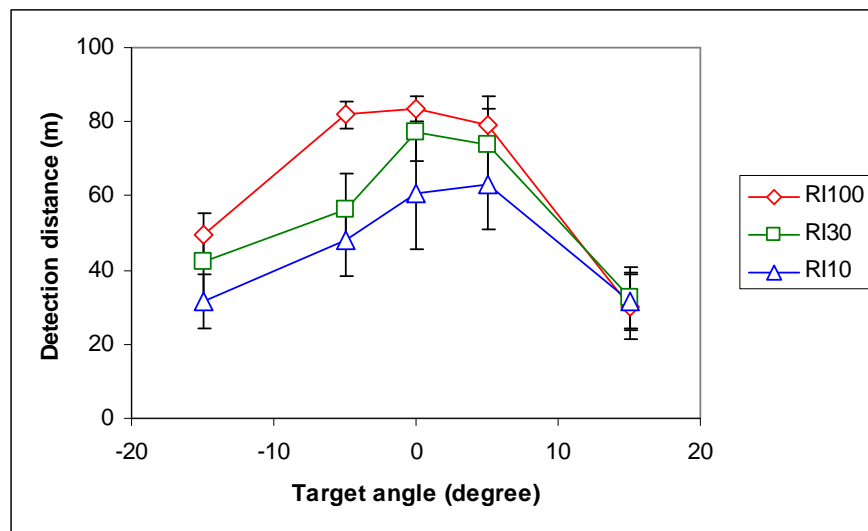

**Figure I-12.** Detection study results of mean detection distance.

*RI: Roadway illuminance; HL: Headlamp intensity; 100, 30, and 10 represent 100 percent, 30 percent, and 10 percent of the initial roadway illuminance or headlamp intensity respectively.*

To clearly illustrate the results of the ANOVA, average detection distances and standard deviations of all 12 subjects for three ambient roadway illuminances and three headlamp luminous intensities, respectively, were calculated as shown in Figures I-13 and I-14. Figure I-13 indicates that ambient illuminance can improve target visibility. In other words, as ambient roadway illuminance is decreased, detection distance is also reduced. For instance, at the eccentricity angle of  $-5^\circ$ , illuminance reduction from 100 percent to 30 percent or 10 percent decreases detection distance by 25 m or 15 m respectively. Figure I-13 also confirms that the interaction between ambient illuminance and target position as the ANOVA suggested. The effect of roadway illuminance on detection distance was the largest at the target eccentricity angle of  $5^\circ$  and there appears to have little contribution of roadway illuminance to detection distance at the eccentricity angle of  $15^\circ$ .

As Figure I-14 shows, the contribution of headlamp intensity to detection distance is less apparent than the effect of ambient illuminance. The three lines for different headlamp intensity conditions cluster at most eccentricity angles in the graph. The difference in detection distance between 100 percent and 10 percent headlamp intensities was less than 12 m. Interestingly, at the eccentricity angles of  $15^\circ$ , the contribution of headlamp intensity to target detection distance appears largest, approximately 12 m. These ANOVA results are consistent with those of the pilot study.



**Figure I-13.** Mean detection distances for three roadway illuminances in the detection study. Each error bar represents standard deviation of all detection distances within each condition.

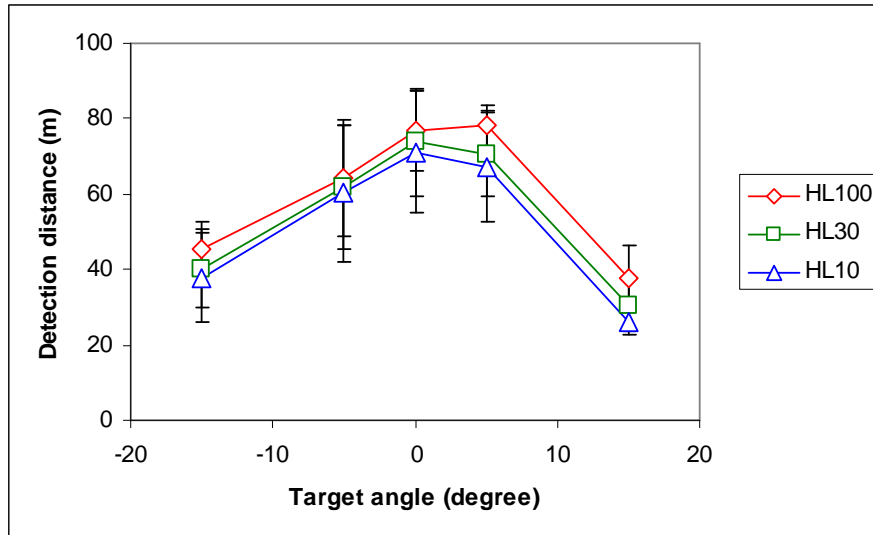

**Figure I-14.** Mean detection distances for three headlamp intensity levels in the detection study. Each error bar represents standard deviation of all detection distances within each condition.

## Discussion

The results of this study showed that the magnitude of the effect of headlamps on detection distance was smaller than the magnitude of the effect of ambient illuminance. Assuming the luminous intensity of headlamps toward oncoming drivers to be 1000 cd (based on the median value reported by Sivak et al. [2001] for low-beam luminous intensity toward an oncoming driver at a distance of 50 m), the lowest headlamp luminous intensity used in the present study, 10 percent of the full output, would produce a luminous intensity of 100 cd toward oncoming drivers; this is identical to the recommended intensity of the “city beam” of 100 cd (Schreuder, 1975). This study therefore supports the validity of the finding nearly 30 years ago that lowering headlamp luminous intensity to 100 cd in the direction of oncoming drivers only slightly impairs visual performance in lit areas.

However, the ambient roadway illuminance distribution employed in this study might influence the results of the experiment, especially with regard to the angular effects of ambient illuminance and headlamp intensity. Figures I-13 and I-14 show that, at the eccentricity angle of 15°, ambient illuminance has no contribution to detection distance, but headlamp intensity has some influence on detection distance. This opposes the general tendency found in this study, but this might be caused by the specific layout of poles. The nearest lighting pole provided a high illuminance between subjects and the target at the eccentricity angle of 15°. The high contrast between this location and the target might locally reduce the visibility of the target until the target reached the high illuminance spot (Nakamura and Akashi, 2002).

The results of this study showed that at the eccentricity angle of 15°, headlamps contributed to target detection (Figure I-9). This implies that when headlamps are dimmed in a lit area, the luminous intensity distribution of the headlamps should be wide enough to make peripheral targets visible. This finding may support recent “town light” beams that have wider luminous intensity distribution than the normal distribution (e.g., Hella, 2000).

## **Conclusions from the Detection Study**

As the results of the pilot study suggested, the results of the detection study indicated that target visibility was decreased as ambient illuminance on the roadway pavement was reduced. Automotive forward headlamps little improved target visibility when roadway lighting was present for the  $-15^\circ$ ,  $-5^\circ$ ,  $0^\circ$  and  $5^\circ$  targets, but headlamps did improve visibility for the  $15^\circ$  target. For the former targets, roadway lighting influenced visibility, but roadway lighting did not seem to affect the visibility of the latter target. These results imply that, within the range of lighting conditions used in this study, to reduce the impact of headlamp glare to oncoming drivers, headlamps can be dimmed while maintaining drivers' visual performance for target detection in lit areas.

## I-6. ONCOMING GLARE STUDY

To investigate interactions between ambient roadway lighting, forward headlamps, and oncoming glare, an oncoming glare study was conducted. This study explored whether and how oncoming headlamp glare impaired drivers' target detections under a lit ambient condition and whether forward headlamps help drivers detect targets while oncoming glare exists.

### Location and Apparatus

The location and experimental apparatus used in the oncoming glare study was the same as the detection study except using an additional headlamp system as an oncoming glare source (Figure I-11). The oncoming glare headlamp system was located 50 m away from the driver on the center of the opponent lane. Therefore, the center of the headlamp system was located at an eccentricity angle of approximately 4° from the center of the visual field. Figure I-11 includes the oncoming glare headlamp system.

### Experimental Conditions

To investigate whether and how oncoming headlamp glare affects driver performance for various forward-headlamp intensity conditions, this oncoming glare study used three forward-headlamp intensities identical to those of the detection study. For an ambient roadway illuminance, 30 percent of the maximum ambient illuminance level was chosen among the three (100%, 30% and 10%) roadway illuminances in the detection study. As shown in Figure I-8, it is obvious that the headlamps used little helped target visibility at 100 percent of the headlamp intensity, but at 30 percent of the maximum roadway illuminance the effect of forward-headlamp intensity appeared to begin becoming more important. At 10 percent of the maximum illuminance, the headlamp intensity clearly affected the detection distance of the target. Table I-4 summarizes the experimental conditions for the oncoming headlamp glare study. To minimize the time required by the experiment, this experiment used only four of six possible combinations (three headlamp intensities × two oncoming glare conditions) for lighting conditions. In this experiment, only three headlamp intensities (100%, 30%, and 10%) with oncoming glare and 100 percent headlamp intensity without oncoming glare were chosen. To maintain the contribution of the glare source to illuminance at a subject's eyes constant, illuminance at the left eye of the standard driver (at a height of 1.3 m from the pavement) was measured and adjusted to 1 lx before presenting each experimental condition.

**Table I-4. Experimental conditions for oncoming headlamp glare study.**

<b>Independent variables</b>	<b>Range</b>
Forward headlamp intensity (%)	100, 30, 10
Oncoming headlamp glare	On, off
Target position*	-15°, -5°, 0°, 5°, 15°

\*Target position: Negative (-15 and -5) and positive (5 and 15) values mean left and right to the center of the visual field, respectively.



## Procedure

Eleven subjects (three females and eight males, ranging from 20 to 40 in age), having driver licenses in the United States, participated in the study. All subjects had normal or corrected-to-normal visual acuity and normal color vision. After receiving instructions from an experimenter, a subject sat in the driver seat of the parked car. Then, this study followed the same procedure as the detection study except the oncoming glare condition. The order of the four experimental conditions was counterbalanced across subjects. The whole procedure in this experiment took a subject about one hour.

## Results

Means and medians of all 11 subject detection distances for the 20 (four lighting conditions × five target positions) experimental conditions were calculated for the oncoming glare study. Figure I-15 shows the means and standard deviations of detection distances of all 11 subjects for all 20 experimental conditions. The results of medians, since they were similar to those of means in Figure I-15, are not shown in this report. Figure I-15 suggests that the detection distance is reduced as the eccentricity angle of targets increases. From a comparison between the with-glare and without-glare conditions for 100 percent headlamp intensity, it is obvious that detection distances for the with-glare conditions are always shorter than those for the without-glare condition. Especially at the eccentricity angles of 0°, -5°, and -15°, oncoming glare decreased detection distance by up to 30 m. To identify the effect of oncoming glare on detection distance, the detection distances for all three (100%, 30%, and 10%) headlamp intensity conditions were averaged as shown in Figure I-16. Figure I-16 confirms that the detection distance is approximately 15 m to 25 m greater without glare than with glare. This indicates that oncoming glare did impair drivers detecting peripheral targets.

For most targets, forward-headlamp intensity does little to affect detection distance when oncoming glare exists. This emphasizes the importance of reducing oncoming glare to improve forward visibility. However, exceptions include targets that are located angularly far from the glare source (targets 5° and 15°) and/or in the high intensity regions of the headlamp beam (target 5°). For these targets, detection distance decreases as the forward headlamp intensity decreases. This implies that, if the targets are close to the oncoming glare source, the impact of oncoming glare is too strong for forward headlamps to improve target visibility. However, headlamps may still help drivers detect targets which are located away from a glare source and/or in the intense areas of the headlamp beam where the forward headlamps are strong enough to overcome the negative impact of oncoming glare and improve target visibility. Therefore, an attempt to specify dimming levels in the high-intensity regions of headlamp beams would be needed.

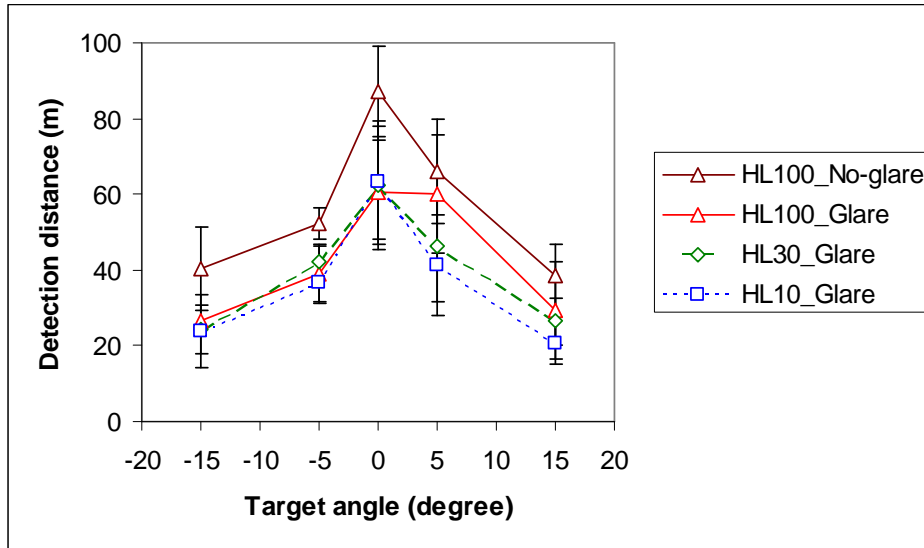

**Figure I-15.** Mean detection distances for oncoming glare study.

Each error bar represents standard deviation for all eleven subjects' detection distances within each condition.

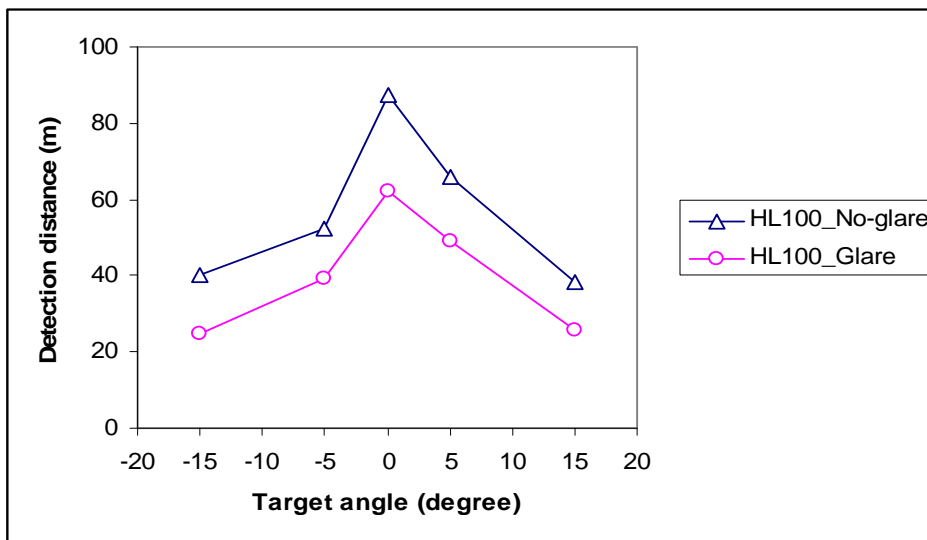

**Figure I-16.** Mean detection distances comparing glare and no-glare conditions.

To statistically analyze the effects of forward-headlamp intensity on detection distance, a repeated-measures ANOVA was applied to all subjects' detection distances for the with-glare conditions. The results of the ANOVA indicated that there were significant impacts of forward headlamp intensity, target positions, and the interaction between headlamp intensity and target positions (Table A-3, Appendix). Then, paired T-tests were applied to all six combinations of the four curves using the all subjects' data. Table I-5 shows the results of the paired T-tests. The results indicate significant differences between the no-glare condition and each of the other three glare conditions ( $p < 0.05$ ) and therefore the strong impact of oncoming glare on target detection.

**Table I-5. Results (P-values) of paired T-tests in the oncoming glare study.**

	HL10 Glare	HL30 Glare	HL100 Glare
HL30_Glare	0.035*		
HL100_Glare	0.010*	0.209	
HL100_No-glare	<0.001**	<0.001**	<0.001**

\*\* : p<0.01 (p<0.05 using Bonferroni correction), \* : p<0.05 (p>0.05 using Bonferroni correction)

## Discussion

The effects of disability glare on foveal visual performance are well-known, and a validated model was already established. However, for the effects of disability glare on peripheral visual performance, a few studies have been done. A recent study suggested that oncoming glare impaired off-axis visual performance (Akashi and Rea, 2001). In this study, subjects sitting in a stationary car fixated on a foveal task. The subjects detected peripheral targets located 15° and 23° from the central fixation point under a mesopic light level while oncoming headlamps on the opponent lane provided glare sources to the subjects. There was significant difference in reaction time between with- and without-oncoming-glare sources. Another recent study used two different reflectances for five targets located -2.5°, 2.5°, 7.5°, 12.5°, and 17.5° from the center. As soon as subjects detect a target activated, they pressed a manual switch to signal the detection to experimenters. The results suggested that glare sources significantly increased reaction time for the peripheral targets (Bullough et al., 2003). Those existing studies support the results of this oncoming study.

## Conclusions From Oncoming Glare Study

The results of the oncoming-glare study suggested that detection distance can be reduced by up to 30 m with oncoming glare. Oncoming glare can impair drivers detecting peripheral targets even when street lighting is present. In most cases, forward headlamps cannot help drivers improve peripheral target visibility. This suggested the importance of reducing oncoming headlamp intensity to ease glare and therefore improve the forward visibility. However, the experimental results also suggested that forward headlamps may have a small effect in helping drivers detect targets located in the most intense parts of the beam distribution and/or located away from the glare source. This implies that some care is required for those areas when controlling headlamp distribution through AFS.

## Discussion

The experimental results in the detection study were compared with contrast threshold derived by a Blackwell's experiment (1946). First, target luminance ( $L_T$ ) and background luminance ( $L_B$ ) at a position where each target was detected by the average subject were obtained through illuminance measurement by using an illuminance meter (X9<sub>1</sub> Photometer, Gigahertz-Optik). For the background of the target, luminance on the pavement adjacent to the center of the bottom of the target was measured by a luminance meter (LS-100 with one-degree measurement angle, Minolta). Second, contrast threshold measured ( $C_M$ ) was obtained by calculating  $(L_T - L_B) / L_B$ . Third, an estimation of contrast threshold was done by using Blackwell's contrast threshold data for targets brighter than the background, Table II in his paper (1946). From the target size (in

minute of arc) and background luminance (in  $\text{cd/m}^2$ ) for each target, a contrast threshold was interpolated by using linear interpolation algorithm (MATLAB Version 6.1.0.450 Release 12.1, MathWorks, Inc.) Finally, the measured contrast thresholds were compared with the estimated contrast thresholds. Table I-6 summarizes the results of the comparison under the 100 percent ambient roadway illuminance conditions as an example. Table I-6 suggests that the actual measurements of contrast threshold were 3.75-18.28 times higher than the estimations of contrast threshold. There appear to be a tendency that the larger the target eccentricity angle the larger the discrepancy in contrast between the estimation and the measurement. Another study, measuring contrast threshold for peripheral targets for a single background luminance of  $257 \text{ cd/m}^2$  (Blackwell and Moldauer, 1958), implied that contrast threshold for a 3.6 min-target at an eccentricity angle of 12.5 degrees could be 10 times higher than contrast threshold for the central target. However, the  $C_M/C_E$  ratios in Table I-6 are higher than the 10 times. And, even for the central targets, the  $C_M$  is about 5 times higher than the  $C_E$ . This is because, in the field study, there are many factors, such as fatigue due to the long experimental period of time and the high luminance of the central fixation target, which might distract the attention and sensitivity of subjects. And, non-uniform luminance distribution may impair the ability to detect adjacent targets. A high-illuminance patch provided by a nearby pole might increase the luminance contrast between this location and the target and locally reduce the visibility of the target until the target reached the high-illuminance spot (Nakamura and Akashi, 2002), although the present data cannot be used to determine whether this possible interpretation might be correct. This might be the reason why the experimental results showed higher threshold contrasts than would be expect by applying theoretical results.

**Table I-6.** Comparison of contrast threshold between measurements and estimations for 100 percent roadway illuminance in the detection study. Contrast threshold estimated was interpolated from Table II of Blackwell's paper (1946).

HL (%)	Off-axis Angle (degree)	Detection Distance (m)	Target size (min)	Lt ( $\text{cd/m}^2$ )	Lb ( $\text{cd/m}^2$ )	Contrast threshold measured $C_M$	Contrast threshold estimated $C_E$	Ratio ( $C_M/C_E$ )
100	15	36.1	17.1	0.16	0.06	1.65	0.10	16.84
100	5	81.7	7.6	0.41	0.13	2.26	0.25	8.99
100	0	83.8	7.4	0.34	0.16	1.15	0.23	4.99
100	-5	81.0	7.6	0.49	0.22	1.23	0.18	6.81
100	-15	50.7	12.2	0.14	0.07	1.00	0.15	6.58
30	15	29.6	20.9	0.08	0.03	1.55	0.11	13.60
30	5	75.9	8.2	0.68	0.48	0.42	0.11	3.94
30	0	82.6	7.5	0.36	0.18	1.02	0.21	4.85
30	-5	82.6	7.5	0.40	0.20	1.01	0.20	5.09
30	-15	50.1	12.3	0.15	0.10	0.46	0.12	3.78
10	15	25.3	24.4	0.13	0.06	1.43	0.08	18.28
10	5	80.4	7.7	0.27	0.15	0.82	0.22	3.75
10	0	84.1	7.4	0.28	0.11	1.55	0.29	5.42
10	-5	82.1	7.5	0.42	0.21	1.00	0.19	5.27
10	-15	47.5	13.0	0.18	0.13	0.42	0.10	4.27

## I-7. DISCOMFORT GLARE EVALUATION

### Objective

The objective of this study was to explore if dimming headlamp intensity can reduce discomfort glare to oncoming and preceding drivers in a lit area and, if so, to what levels headlamp intensity should be reduced to ease glare. This study also addressed the question of whether and how headlamp mounting height influences glare.

### Location and Setup

This experiment took place on an unused runway at Schenectady County Airport in Scotia, New York. On the runway, a two-lane roadway approximately 100 m in length and 7 m in width was placed along existing markings on the runway pavement. Along the roadway, three temporary roadway lighting poles were located, spaced at a distance of 30 m in a staggered arrangement. Each pole contained two full cutoff luminaire heads (G13-4XL-150HPS-277V-NP, Gardco Emco McPhilben) on the top. Only one of the two heads was equipped with a 150 W high-pressure sodium lamp (LU150/55/MED67508-1, OSRAM SYLVANIA Inc.) This head functioned as an illuminator and the other head was used to balance the weight. These three poles with mesh filters provided an average ambient illuminance of 2.2 lx over the two lanes with a minimum illuminance of 0.4 lx. This is the same as the 30 percent ambient illuminance condition in the detection study and was selected so the results of the two experiments could be compared in a similar context. Figure I-17 shows the layout of the experimental setup and the view of the three poles.

At one end of the roadway, a compact passenger car was parked for subjects to be seated. In front of the car, a rack having a projector headlamp system, conforming to FMVSS 108 requirements, containing 51 W tungsten halogen headlamps, was located. This headlamp system was to provide forward lighting for the subjects in the driver seat of the car. The mounting height of the forward headlamps was 0.65 m, a typical mounting height for a passenger car. The headlamp rack was not visible to subjects in the driver seat of the car.

A reflector headlamp system, conforming to FMVSS 108 requirements, was located 50 m away in front of the car to provide oncoming glare or 15 m away behind the car for following glare. The headlamp height was adjusted to the test mounting heights by a hydraulic jack and a mechanic jack. By covering the headlamp lenses with neutral density filters the luminous intensity of the headlamps was varied.

As a fixation point, a numeric signboard composed of seven LED segments was placed facing subjects at a distance of 60 m from the car. The signboard displayed 30 cm × 20 cm numeric characters from 0 to 9 in a random order for one second each. The subjects fixated on the signboard and were assigned to read the number when the number was changed.

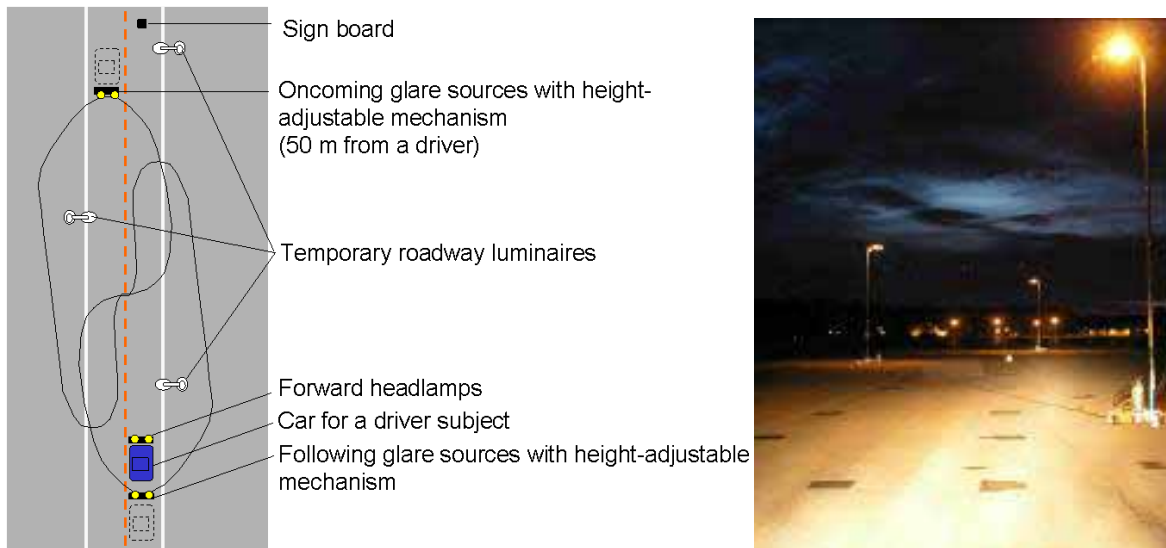

*Figure I-17. Layout of experimental setup and three poles.*

## Experimental Conditions

Table I-7 summarizes the experimental conditions. As independent variables, the glare source position, mounting height, and intensity of the glare sources (headlamps) were changed. There were two reference points to measure headlamp mounting heights, one at the center of the lamp and the other at the top edge of the lamp. Measurement at the top edge followed ECE regulation R48 rev. 2 on the Installation of Lamps.<sup>1</sup> The heights of 850 mm and 950 mm correlated to mounting heights for SUVs. The criterion 950 mm to the upper edge was from the ECE standard and the other criterion, 850 mm at the center of lamp, was a potential criterion for the SAE standard. Both mounting heights were used in this experiment in order to determine if discomfort from headlamps at both mounting heights were significantly different. In the case of the Ford Focus headlamp system used in this experiment as a glare source, the criterion of 950 mm to the upper edge was approximately 20 mm higher than the other criterion of 850 mm at the center of lamp.

As a dependent variable, this study used the de Boer rating scale, a nine-point scale - 1: unbearable, 3: disturbing, 5: just acceptable, 7: satisfactory, and 9: just noticeable (de Boer, 1977).

---

<sup>1</sup> In the section 2.9.2. "Illuminating surface of a light-signalling device other than a retro-reflector" (paragraphs 2.7.11. to 2.7.15., 2.7.17., 2.7.19. and 2.7.21. to 2.7.24.) means the orthogonal projection of the lamp in a plane perpendicular to its axis of reference and in contact with the exterior light-emitting surface of the lamp, this projection being bounded by the edges of screens situated in this plane, each allowing only 98 percent of the total luminous intensity of the light to persist in the direction of the axis of reference. To determine the lower, upper and lateral limits of the illuminating surface, only screens with horizontal or vertical edges shall be used.

*Table I-7. Experimental conditions (32 conditions in total).*

<b>Independent variables</b>	<b>Range</b>	<b>Conditions</b>
Glare source position	50 m away in front of the car 15 m away behind the car	2
Mounting height (mm)	660 mm to the center of lamp (475 mm lower from the average eye height) 850 mm to the center of lamp (285 mm lower from the average eye height) 950 mm to the upper edge* (265 mm lower from the average eye height) 1200 mm to the upper edge** (15 mm lower from the average eye height)	4
Headlamp intensity (%)	10, 30, 50, 100	4

\* “950 mm to the upper edge” is equivalent to “870 mm to the center.”

\*\* “1200 mm to the upper edge” is equivalent to “1120 mm to the center.”

## **Procedure**

The experiment employed 11 young (<34 in age) and 9 older (>56 in age) subjects, 20 in total. The experiments were conducted from approximately 9 p.m. to midnight for eight nights between May 19, 2004, and July 28, 2004. On each night, two to five subjects participated in the glare evaluations for either oncoming or following glare position. Each subject attended the experiments on two nights to complete both glare source positions. All glare presentations were divided into four mounting height sessions - 660 mm, 850 mm, 950 mm, and 1200 mm. Between the sessions, the headlamp height was adjusted to each target mounting height. After each mounting height adjustment, the headlamps were re-aimed.

Prior to the experiment, an experimenter gave instructions about the procedure of the experiment to all subjects. Then, subjects read and signed informed consent forms. However, one subject took part in the evaluation at a time while other subjects stayed at a rest area. The first subject was escorted and seated in the driver’s seat of the parked passenger car. An experimenter sat with the subject to help him/her with glare evaluations. First, the experimenter asked the subject to adjust the driver seat, the rearview mirror, and the side mirrors to the subject’s normal positions and orientation. Second, the experimenter explained details of how a subject could evaluate glare. The experimenter in the car communicated with other experimenters, who presented and changed experimental conditions in the field, by using a pair of walkie-talkies. While the experimenter explained the procedure to the first subject in the car, the field experimenters set the first mounting height condition.

Then, the glare headlamps, set to the first intensity condition, were presented to the subject for four seconds. After the four-second exposure to the glare source the subject evaluated the degree of glare by choosing a number between 1 and 9 in the de Boer rating scale. The experimenter in the car recorded the subject response and let the field experimenter know of the completion of the first evaluation so that the field experimenters could change the headlamp luminous intensity. This procedure was repeated for four headlamp luminous intensities. After the four evaluations, the subject got out of the car and took a rest while other subjects participated in the glare evaluation. The next subject was escorted to the car and seated in the driver seat. The subject evaluated the four headlamp luminous intensities in the same manner. The order of the headlamp intensity presentations was randomized and the order of the mounting height was

counterbalanced across subjects. On another day, all the subjects participated in the other half of the experiment for the other glare position. The order of the glare positions was also counterbalanced across subjects.

## Measurements

To understand how much light reaches a driver’s eyes from headlamps of varying mounting height, illuminance was measured in the subject car at a height of 1.15 m from the pavement with 100% of the headlamp intensity, i.e., without any filters. The receptor of the illuminance meter faced front during the measurements. The measurement height was regarded as a typical driver’s eye height. This measurement was repeated three times for each condition. Table I-8 shows the means of the three sets of measurements for the eight experimental conditions.

*Table I-8. Measurements of illuminance at a driver’s eye (lx). Shown in brackets are the corresponding estimated single-headlamp luminous intensity values (cd; the total luminous intensity from the two headlamps would be approximately twice these values). Shown in parentheses is the estimated angular location from the headlamps toward the subjects (or subjects’ rear-view mirror, for following glare).*

Glare position	Mounting height (mm)			
	660	850	950	1200
Oncoming	0.73 [912] (4°L, 0.59°U)	0.91 [1138] (4°L, 0.33°U)	1.17 [1462] (4°L, 0.30°U)	3.16 [3950] (4°L, 0.02°U)
Following	0.07 [8] (0°, 1.81°U)	0.36 [41] (0°, 1.09°U)	0.41 [46] (0°, 1.01°U)	1.41 [159] (0°, 0.06°U)

## Results

The de Boer ratings of all 20 subjects were averaged for each condition. Figures I-18 (a) and (b) show the glare evaluation results for the following and oncoming glare conditions. The glare evaluation data were also compared between two age groups. Figures I-19 and I-20 show the results of the age-group comparisons for the oncoming and following glare source positions respectively. Figure I-21 show the same data in three dimensional diagrams. This analysis used, as a glare threshold, the forth point “4” that is rated between “3: disturbing” and “5: just acceptable” in the nine-point scale of the de Boer rating. Therefore, a headlamp system is not assumed to cause glare unless the glare rating of the system falls below “4.”

Figures I-18 (a) and (b) suggest:

### For oncoming glare:

- Glare was increased (the de Boer rating was decreased) as the luminous intensity and mounting height of headlamps increased.
- Glare became acceptable, if the headlamps were dimmed to less than 50 percent of the initial intensity for all four mounting heights.
- Glare for the mounting height of 850 mm was more acceptable than glare from headlamps at 950 mm.



For following glare:

- Glare was increased (the de Boer rating was decreased) as luminous intensity and mounting height of headlamps increases. At the mounting height of 1200 mm, headlamps caused glare was much higher than the other three mounting heights.
- For the mounting heights of 950 mm, 850 mm, and 660 mm, if the luminous intensity is reduced to or below the 50 percent of initial intensity, the glare became acceptable.
- However, for the mounting height of 1200 mm, glare is unacceptable until the luminous intensity becomes lower than 10 percent of the initial intensity.
- There was little difference in glare among the 660 mm, 850 mm, and 950 mm mounting heights.

Comparison between both glare positions:

- Difference in glare among the four mounting heights was smaller for the oncoming headlamp position than the following headlamp position. Especially, for following glare, headlamps at the mounting height of 1200 mm appeared to create more discomfort than those at the other three mounting heights.

Figures I-19 and I-20 suggest:

Comparison between young and older subject groups:

- Younger subjects and older subjects showed similar tendency to the above-described overall results.
- However, young subjects were more sensitive to glare than older ones. Difference in glare evaluations between the young and older subject groups was approximately half of a unit.

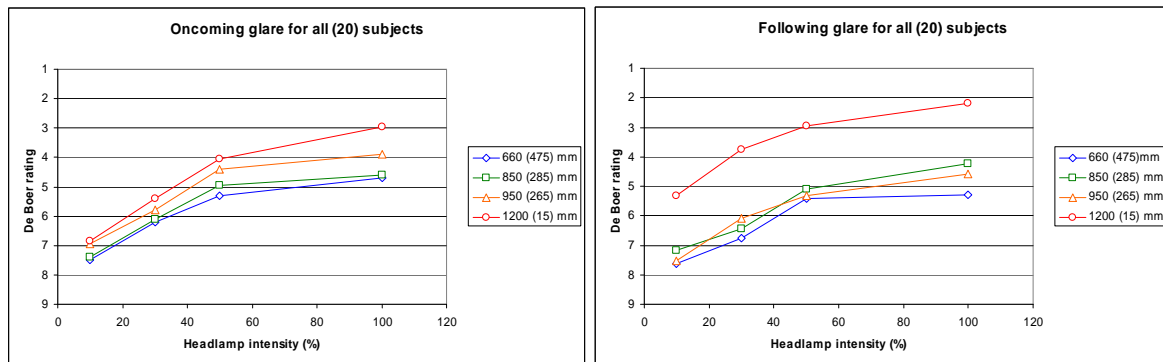

(a) Oncoming glare

(b) Following glare

**Figure I-18.** Results of oncoming and following glare for all 20 subjects (See Table I-7 for details of mounting height and the distance from the lamp center to the average eye).

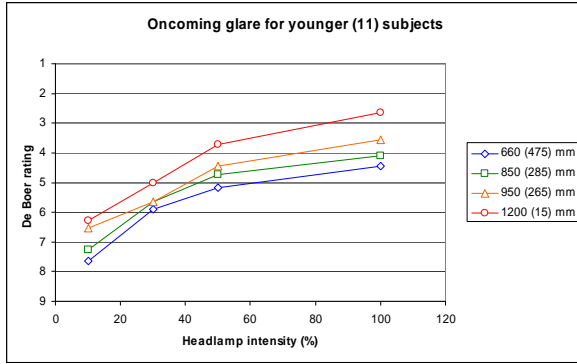

(a) Young subjects

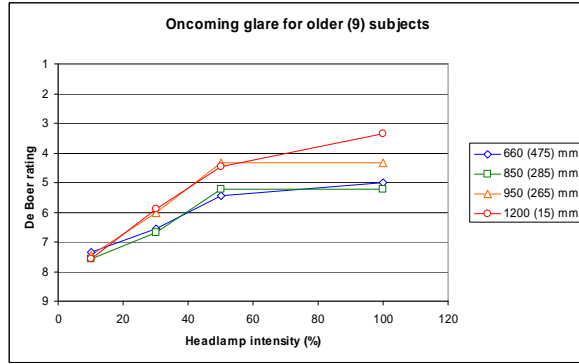

(b) Older subjects

**Figure I-19.** Comparison of oncoming glare evaluations between younger and older subjects (See Table I-7 for details of mounting height and the distance from the lamp center to the average eye).

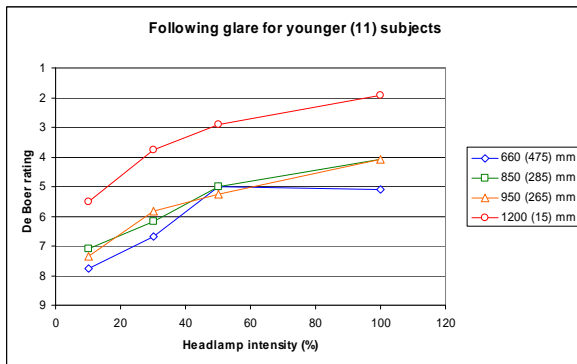

(a) Young subjects

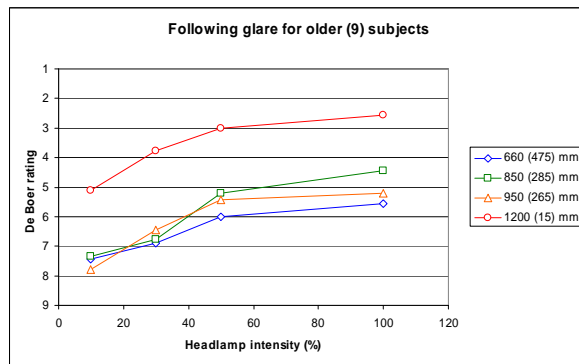

(b) Older subjects

**Figure I-20.** Comparison of following glare evaluations between younger and older subjects (See Table I-7 for details of mounting height and the distance from the lamp center to the average eye).

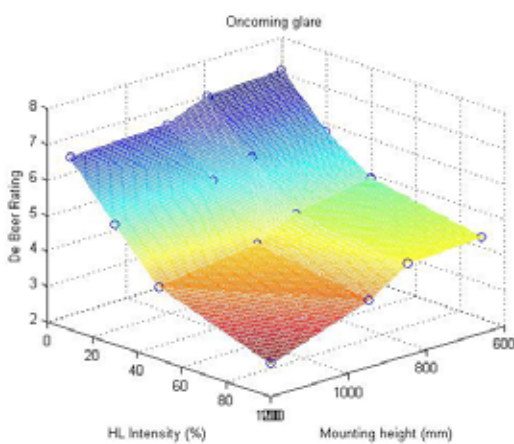

(a) Oncoming glare

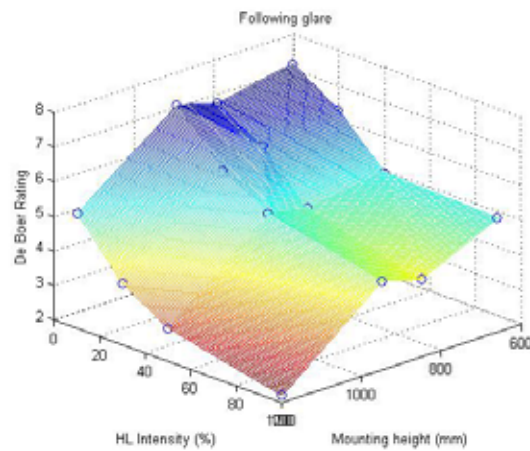

(b) Following glare

**Figure I-21.** Results of oncoming and following glare for all 20 subjects (All mounting heights were measured to the lamp center. See Table I-7 for details).

To confirm the above-described tendencies, a repeated-measures analysis of variance (ANOVA) was conducted. The results of the ANOVA suggest that there are main effects of the mounting height and headlamp intensity on glare evaluation (Table A-4, Appendix). There are significant interactions for the headlamp position and mounting height. This interaction implies that, only at the highest mounting height (1200 mm), headlamps at the following position cause much more serious glare than those at the oncoming glare. Those results of the ANOVA support all of the above described findings. To statistically confirm the difference between the two age groups (since this factor was not part of the repeated-measures ANOVA), a t-test was applied. The results of the t-test showed that there was a significant difference between the two groups ( $p < 0.05$ ). This suggests that, in this experiment, the younger subjects were more sensitive to glare than the older subjects.

## **Conclusions**

The results of this glare evaluation study suggested that both oncoming and following glare was decreased as the luminous intensity and mounting height of headlamps decreased and became acceptable when the headlamps were dimmed. For oncoming glare, glare became acceptable, if the headlamps were dimmed to less than 50 percent of the initial intensity for all four mounting heights (1200 mm, 950 mm, 850 mm, and 660 mm). Following glare, if the luminous intensity is reduced to or below 50 percent of the initial intensity, glare became acceptable for the mounting heights of 950 mm, 850 mm, and 660 mm. However, for the mounting height of 1200 mm, glare was unacceptable until the intensity became lower than 10 percent of the initial intensity.

## I-8. DISCUSSION

The results of the target detection study with glare clearly indicated that the presence of oncoming glare could reduce detection distances by up to 30 m. Therefore, it is important to prevent oncoming glare from reducing drivers' visual performance. One way to accomplish this may be by dimming forward lighting.

The results of the target detection study (without glare) suggested that fixed street lighting has a much larger influence on target detection than do headlamps; target visibility improved as ambient illuminance on the roadway pavement increased. This implies that it is possible to dim vehicle forward lighting without significantly impairing drivers' performance. The question then becomes to what value should headlamp intensity be reduced? The results of the glare evaluation study suggested that, when the headlamps were dimmed to 50 percent of the initial intensity, most headlamps became acceptable regardless of the mounting heights and angular directions. Such reduction in headlamp intensity to 50 percent does not significantly influence visibility in lit areas according to the results of the target detection study (without glare). Therefore, this glare reduction strategy may be applied to most vehicles.

One exception to this 50 percent value is evident from the results. Headlamps with very high mounting heights (i.e., 1200 mm) are likely to cause glare to preceding drivers unless the intensity is dimmed to or below 10 percent of full output.

In the near future, however, an AFS that senses traffic flow and controls the headlamp beam patterns depending on the traffic flow may be able to address these issues. An ideal AFS may work in such a way that, once a vehicle enters a lit area, the headlamps could be dimmed to 50 percent of the full output – then, the headlamps may not cause glare to oncoming drivers. When the vehicle closely follows a passenger car (particularly those vehicles with high headlamp-mounting heights), the high-intensity regions of the headlamps could be dimmed to 10 percent. Such dimming control would mitigate glare to the preceding driver without impairing peripheral visibility.

Since the oncoming glare study did not alter ambient roadway illuminance or oncoming glare intensity, the study could not conclude how fixed roadway lighting helped drivers detect peripheral targets while oncoming glare impaired the visibility of targets, or how dimming headlamps could improve the visual performance of oncoming drivers. Nor was the issue of inclement weather studied, all experiments being conducted in clear conditions. These questions still remain to be investigated by additional experiments before implementing the concept of dimmable forward lighting.

Another important function of headlamps is to maintain conspicuity of vehicles at night. Dimming headlamps may lose such function. Schreuder (1975) suggested that a luminous intensity of 100 cd is appropriate for "city beam" to maintain the conspicuity of vehicles. Assuming a luminous intensity of headlamps toward oncoming drivers of about 1000 cd (Sivak et al., 2001), the lowest headlamp luminous intensity used in this study, 10 percent of the full output is identical to the intensity of Schreuder's "city beam." This means that reduction in headlamp intensity to 10 percent may not reduce the conspicuity of vehicles. However, it is

important to confirm if such headlamp intensity reduction can maintain vehicle conspicuity under more practical conditions.

In general, this study concluded that it may be possible to dim headlamps (potentially via AFS) without significantly impairing drivers' performance, with respect to detection distance, in lit areas.



**PART II:**

**DEVELOPMENT AND EVALUATION OF A SAFETY-BASED ADVANCED  
FORWARD-LIGHTING SYSTEM PROTOTYPE**

## **SUMMARY: PART II**

In current form, standards and regulations for headlamps assume one of two beam patterns, a high beam for driving at relatively high speeds and in conditions of little adjacent traffic, and a low beam for driving at lower speeds and when there are many other vehicles in proximity. The high-beam pattern is designed with forward visibility in mind and has little glare control, whereas the design of the low-beam pattern balances forward visibility against excessive glare to oncoming and preceding drivers. Advanced forward-lighting systems (AFS), which can produce modified beam patterns to improve forward visibility in specific situations while still working to control glare, are being introduced to vehicles. Examples include bending lights, city beams with wide distributions, and adverse weather beam patterns, which supplement or replace low beam functionality. Another AFS approach, investigated in the present study, involves using a "prime beam" optimized for forward visibility as the main beam pattern, subtracting portions of light when needed to reduce glare to oncoming or preceding drivers. A prototype system using a prime beam was developed, evaluated for visibility and glare in field tests in comparison with conventional low- and high-beam patterns, and demonstrated on a moving vehicle. The prime beam approach appears to be a promising one for ensuring adequate forward visibility under a wide range of conditions while controlling glare to other drivers, and for studying characteristics of lighting as they pertain to visual performance and safety.



## II-1. INTRODUCTION

In current form, standards and regulations (Federal Motor Vehicle Safety Standard [FMVSS] 108) for vehicular headlamps assume one of two beam patterns: a high beam for driving at relatively high speeds and in conditions of little adjacent traffic, and a low beam for driving at lower speeds and when there are many other vehicles in proximity. The high-beam pattern is designed largely with forward visibility in mind and has little glare control, whereas the design of the low beam pattern balances forward visibility against excessive glare to oncoming and preceding drivers. To some extent there is an inherent tradeoff between visibility and glare using existing headlamp low-beam patterns, which are the predominantly used beam patterns by drivers in the United States (Sullivan et al., 2003). It is claimed that when driving with low-beam headlamps that many potentially hazardous objects cannot be detected in time to respond by braking or steering at driving speeds in excess of 30 to 35 mph (Leibowitz et al., 1998; Olson and Farber, 2003). There is evidence that if all drivers used high-beam headlamps at all times, forward visibility would be improved, even in oncoming headlamp situations (Bergstrom, 1963; Helmers and Rumar, 1975; Flannagan et al., 2000). However, subjective impressions of discomfort when approaching a vehicle with high-beam headlamps, even when high-beam headlamps are used on one's own vehicle, are so great that few would tolerate such conditions.

Advanced forward-lighting systems (AFS) for vehicles have been proposed as a solution to this dilemma (Kobayashi and Hayakawa, 1991; Damasky and Huhn, 1997; Hogrefe, 2000). Akashi et al. (2005) reviewed AFS related literature and technologies. Most approaches to AFS involved categories of supplemental or alternative beam patterns to account for specific roadway conditions (e.g., bending or swiveling headlamp beam patterns when driving around curves, wider beam patterns when driving in urban areas with large pedestrian populations, high-intensity beam patterns when driving along freeways). These approaches have focused on improving driver visibility. A different approach that has been suggested in more recent literature (Decker and Schmidt, 2006; Bishop, 2007; Decker et al., 2007; Richardson, 2007; Shadeed and Wallaschek, 2007; Shadeed et al., 2007; Sprute and Khanh, 2007; Gunther, 2008; Neumann, 2008) is the use of a high-beam pattern in conjunction with an "adaptive cutoff" that can adjust the position of the horizontal cutoff line (so that the headlamps can provide significant forward illumination when no oncoming or preceding vehicles are present), or with shielding to selectively reduce illumination from the high-beam pattern in order to reduce glare to other drivers. A benefit of such an approach is that the "default" condition for the system is biased toward visibility (Bergstrom, 1963; Helmers and Rumar, 1975; Flannagan et al., 2000) rather than the former approach involving supplementing the low beam pattern, but glare control is an obviously important component of such a system in order for it to be successful.

Identifying means for drivers to take advantage of the high-beam pattern produced by vehicular headlamps while mitigating glare is not new. In the technical literature, Onksen (1953) described an automatic headlamp dimming system that used a photomultiplier tube as a detector; when sufficient levels were measured, the system would switch from the high- to the low-beam pattern, and back to high beams when the detected light levels were low. Such systems were used on mid- to high-end passenger cars through the 1980s. Stam (2001) describes a more recent and more complex automatic beam control system that uses a digital camera to record the

forward scene and perform image processing calculations to determine whether a vehicle is likely to be present in the scene.

In Part I of the present report, an AFS function for driving in urban areas was tested in which the low-beam pattern was reduced in intensity to reduce glare while taking advantage of ambient light in such locations that supports forward visibility. The objective of the present study was to develop a safety-based AFS (SAFS) prototype utilizing the latter approach described above, to begin to determine if, and how, a high-beam-like headlamp pattern might be modified for optimizing forward visibility and the obvious need for glare control. The prototype was developed and evaluated through several investigations to address the following questions:

- What are the characteristics of an appropriate beam pattern for the SAFS prototype?
- What is the angular size of a reduction in intensity that can be tolerated by drivers?
- What is the effect of reducing intensity on forward visibility (for a driver with such a system)?
- What is the effect of reducing intensity on forward visibility and visual comfort (for a driver facing such a system)?
- Is the prototype of such size and weight to be able to be implemented practically on a passenger vehicle?

As described in the following sections of Part II of the present report, preliminary guidelines for the performance characteristics of a "prime beam" were developed. The prime beam is similar in functionality to the high beam, except that it is envisioned as the main beam pattern (with localized reductions in luminous intensity for glare control). In the present study, the SAFS prototype was developed and evaluated for visibility and glare in field tests in comparison with conventional low- and high-beam patterns, and finally was demonstrated on a moving vehicle. The prime-beam approach may be a promising one for ensuring adequate forward visibility under a wide range of conditions while controlling glare to other drivers.

In each evaluation study, the prime beam SAFS prototype was compared against a conventional low-beam and a conventional high-beam pattern. Ultimately, the objective of a prime-beam SAFS would not only be to provide forward visibility comparable to (or ideally, better than) that from conventional high-beam headlamps, but to create glare to oncoming or preceding drivers comparable to (and ideally, better than) that from conventional low beam headlamps. Because low and high beams have been studied extensively in published research whereas the prime-beam SAFS concept is novel, the prototype was compared to both of the conventional types of beam patterns as often as practically possible, so that its performance (in terms of acceptability, visibility, and glare) can be compared to these better-known types of forward lighting.

## II-2. CHARACTERIZING PRIME-BEAM REQUIREMENTS

From a practical point of view, the conventional high-beam pattern found on existing passenger vehicles would appear to be a reasonable starting point for a beam pattern optimized for forward visibility. Bullough and Van Derlofske (2004) developed a model of forward visibility under headlamp illumination (defined as the vertical illuminance  $E$ , in lx, on the target) that predicts reaction times (RT, in ms) and missed target probabilities (MT, defined as not detecting a target within 1 s) to small (20 cm square) targets varying in reflectance ( $\rho$ ) located 60 m ahead in the field of view at various angles ( $\theta$ ) from the line of sight. Predictions of RT and MT can be made without oncoming headlamp glare or with headlamp glare located  $5^\circ$  to the left of the line of sight (corresponding to the angular location of oncoming traffic 50 m ahead along a two-lane highway). When no glare is present, RT (in ms) is calculated using a power function of the form:

$$RT = aE^{-0.33} + 400 \quad (1)$$

Where  $a$  is defined in terms of several other parameters ( $b$ ,  $c$  and  $d$ ) as described by the following equations:

$$a = b|\theta|^c + d \quad (2)$$

$$b = 0.0065\rho^{-2.64} \quad (3)$$

$$c = 3.52\rho^{0.35} \quad (4)$$

$$d = 143\rho^{-0.28} \quad (5)$$

The value of MT (from 0 to 1) is defined in terms of a power function:

$$MT = fE^g \text{ (or 1 when } fE^g > 1) \quad (6)$$

Where  $g = -0.49$  and  $f$  is defined by additional parameters ( $h$ ,  $j$  and  $k$ ) as follows:

$$f = h|\theta|^j + k \quad (7)$$

$$h = 0.000064\rho^{-3.11} \quad (8)$$

$$j = 3.98\rho^{0.63} \quad (9)$$

$$k = 0.0099\rho^{-2.2} \quad (10)$$

To account for glare, the RT and MT data from Bullough et al. (2003) were used to estimate the increment in RT and MT caused by different glare illuminances (defined as the vertical illuminance  $E_{gl}$ , in lx, at a driver's eyes) from oncoming headlamps located 50 m ahead in a two-lane highway. The RT increment ( $RT_{inc}$ , in ms) is defined empirically as:

$$RT_{inc} = 2[e^{m + n/(\theta + 20) + p \ln(\theta + 20)}] E_{gl}^{0.49} \quad (11)$$

In Equation 11, the parameters m, n and p are defined as follows:

$$m = -345(0.6 - \rho) \quad (12)$$

$$n = 2095(0.6 - \rho) \quad (13)$$

$$p = 82.3(0.6 - \rho) \quad (14)$$

The MT increment ( $MT_{inc}$ ) is defined as:

$$MT_{inc} = a\theta^3 + b\theta^2 + c\theta + d \quad (15)$$

Where the parameters a, b, c and d are defined as:

$$a = -\rho E_{gl}/10000 - 0.0012\rho^{0.42} \quad (16)$$

$$b = (0.007\rho - 0.002)E_{gl} + 0.028\rho^{0.28} \quad (17)$$

$$c = (-0.078\rho + 0.029)E_{gl} - 0.19\rho^{0.17} \quad (18)$$

$$d = (-0.3\rho + 0.105)E_{gl} + 0.67\rho^{0.56} \quad (19)$$

Using this model, Table II-1 shows, for several target locations ( $0^\circ$ ,  $5^\circ$  and  $10^\circ$  to the right of the line of sight) and for several glare illuminances (0, 1, 2 and 4 lx), the target illuminances (to the nearest lx) required to achieve an RT of 600 ms or shorter to a target having a reflectance of 0.4. Table II-2 shows the target illuminances for the same conditions required to achieve an MT of 0.3 (meaning 30% of the targets under such conditions would not be detected within 1 s). These values of RT and MT correspond approximately to the performance provided by low-beam headlamps for targets located  $10^\circ$  off-axis without any glare present (Van Derlofske et al., 2001).

Target location ( $\theta$ )	Glare illuminance ( $E_{gl}$ )			
	0 lx	1 lx	2 lx	4 lx
$0^\circ$	1	2	2	2
$5^\circ$	1	1	2	2
$10^\circ$	2	2	2	2

*Table II-1. Illuminances (in lx) required to achieve a reaction time of 600 ms or shorter to a 0.4-reflectance, 20-cm square target located 60 m ahead at various locations and while exposed to different glare illuminances.*

Target location	Glare illuminance ( $E_{gl}$ )			
	0 lx	1 lx	2 lx	4 lx

( $\theta$ )				
$0^\circ$	1	-	-	-
$5^\circ$	1	1	1	1
$10^\circ$	1	3	3	4

**Table II-2.** Illuminances (in lx) required to achieve a missed target percentage of 30 percent or less to a 0.4-reflectance, 20-cm square target located 60 m ahead at various locations and while exposed to different glare illuminances.

From Tables 1 and 2, it can be seen that when glare is present, the RT and MT values for the target location are worse at  $0^\circ$  than at  $5^\circ$ , which seems counterintuitive since the former location is on-axis while the latter is off-axis. However, Bullough et al. (2003) found that responses to targets located closest to a glare source (which was located at  $5^\circ$  to the left of the line of sight) are most impacted by glare.

Based on Tables 1 and 2, target illuminances of at least 4 lx on targets located 60 m ahead would provide RT values of 600 ms or shorter and MT values of less than 0.3 (or 30%) even in the presence of headlamp glare producing 4 lx at drivers' eyes, for targets located at  $0^\circ$ ,  $5^\circ$ , or  $10^\circ$  from the line of sight. An illuminance of 4 lx from oncoming headlamps is relatively uncommon, based on data from a naturalistic driving study in which driver-eye illuminances from oncoming vehicles were measured (Bullough et al., 2005), and so this criterion appears to be relatively conservative in providing visibility, even when substantial glare is present, equivalent to (or better than) that provided by typical low beam headlamps when no glare is present.

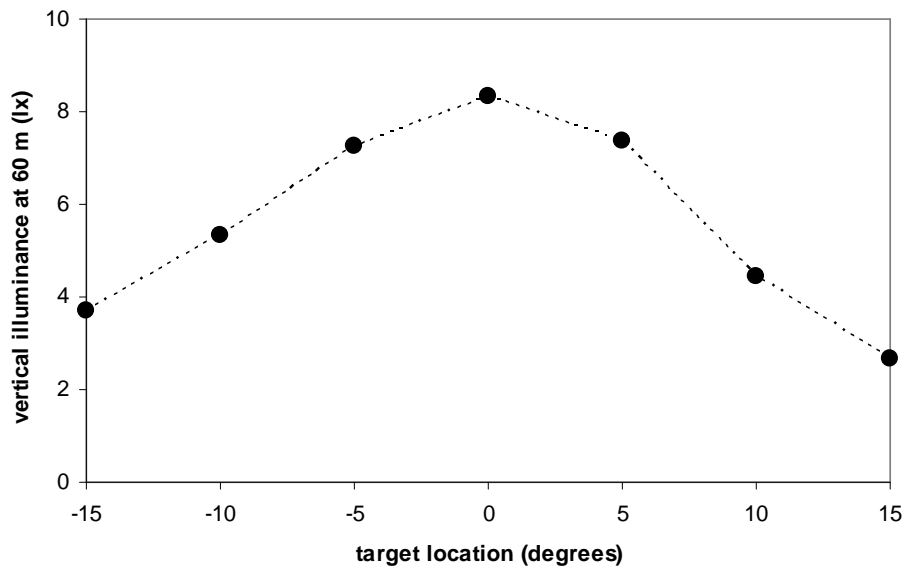

**Figure II-1.** Vertical illuminances at 60 m ahead from the projector modules used in the AFS prototype system.

As described in subsequent sections of the present report, the SAFS prototype used bi-function projector headlamp modules as the light source. Such modules are equipped with a retractable baffle that can be positioned to provide a low-beam cutoff pattern, or that can be retracted to

provide a high-beam pattern. Figure II-1 shows the vertical illuminance distribution produced by a pair of these modules at a distance of 60 m; it can be seen from this figure that they produce an illuminance of at least 4 lx at an angle of  $10^{\circ}$  off-axis. Based on this result, the high-beam function of the projector modules were used as the basis for the prime beam in the SAFS prototype.

### **II-3. DEVELOPMENT OF THE SAFS PROTOTYPE**

As discussed earlier, it has been demonstrated that driving with high beam headlamps on is superior for a driver's visibility when compared to low-beam headlamps, even in the face of oncoming high beam headlamps (Helmert and Rumar, 1975; Mefford et al., 2006). On that basis and using the analysis in the preceding chapter, it was decided to investigate the concept of using a beam distribution resembling that of a high beam (Figure II-1), with angular regions of light removed when necessary (i.e., the regions of light that correspond to the position of an oncoming or preceding car).

Ultimately, such a system is envisioned as being dynamically adjusted to changing environmental requirements by a computerized control system. The control system would utilize devices such as sensors, a machine vision system, and the vehicle's onboard data bus to modify the beam pattern. As described earlier, implementations of the so-called "glare-free high-beam" pattern or adaptive cutoff are in research and development stages by several headlamp manufacturers (Decker and Schmidt, 2006; Bishop, 2007; Decker et al., 2007; Richardson, 2007; Shadeed and Wallaschek, 2007; Shaheed et al., 2007; Sprute and Khanh, 2007; Gunther, 2008; Neumann, 2008).

#### **Implementation**

Because a set of production vehicle headlamp modules meeting the performance criteria for a prime beam was available, it was modified as the basis of the SAFS prototype. The headlamp modules chosen for modification were combined low/high (bi-function) beam projector units outfitted with high-intensity discharge (HID) lamps. Figure II-2 shows the experimental headlamp assembly.

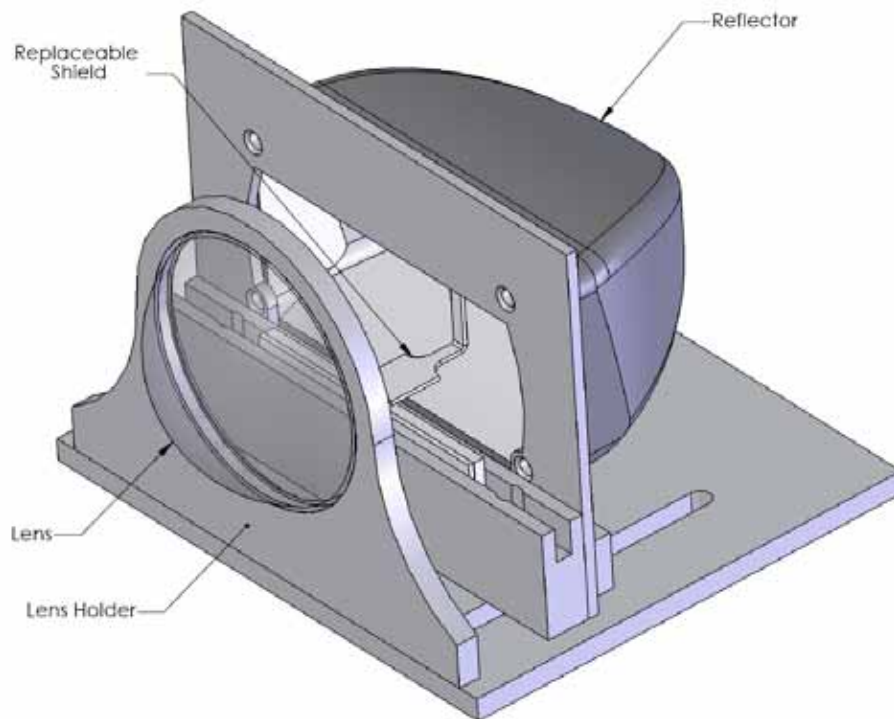

**Figure II-2.** *Experimental headlamp assembly.*

The reflector and lens were taken from the production headlamps. The remainder of the parts were custom machined to preserve the geometry of the parts in their original housing. The reflector was mounted to a plate, which in turn was mounted to blocks that were designed to slide forward and back in the slots milled into the base.

A set of stainless steel shields was designed to create shadowed portions of the beam pattern of varying angular width (i.e., 1°, 2°, 3°, 4°, 5°, 6°) in the headlamp's illumination pattern. Stainless steel was chosen so that the shields would be able to endure the high temperatures present at the focal point of the optical system without deforming. A slotted rail for holding the shields was machined so that it could move forward and back, and the shields could move side to side. Doing so allowed the shields to be focused and positioned appropriately.

### **Optical Alignment**

As described above, the machined parts were designed in such a manner that lens and reflector were vertically and horizontally aligned as they were in the original headlamp assembly. The distance from the lens to the reflector was set by adjusting the position of the reflector using a digital caliper. Once this distance was set, it was locked into place with screws.

Focusing of the shields was accomplished by shining the beam pattern on a flat, vertical surface at a distance of approximately 8 m (25 ft) and moving the shields along the longitudinal axis until their image was judged to be the "sharpest." Once this position was identified, the screws holding the track were tightened to lock it into place.





## II-4. ACCEPTABILITY EVALUATION

The objective of this evaluation was to determine the angular size of the reduced-intensity region that would be seen as acceptable by drivers using the SAFS prototype as their forward lighting system.

### Method

The first portion of the evaluation was performed in order to identify how much of a high-beam headlamp distribution can be "removed" using the replaceable shields in Figure II-2, while still maintaining driver satisfaction and comfort with the beam pattern. Standard high- and low-beam distributions were used as reference conditions, and were included among the experimental beam distributions that were evaluated. A total of seven subjects (ages 24 to 61) participated in the experiment.

A previously constructed headlamp mounting rack was positioned directly in front of the subject vehicle (1999 Ford Contour). Several children's toys (e.g., a tricycle, wagon, scooter, toy lawnmower, and toy trucks) were located on the paved surface ahead of the vehicle at random locations to provide relevant visual targets. The experimental conditions (listed below) were randomized in terms of order to minimize learning or expectation effects. The first condition was set up (including adjustment of aim) and the subjects were instructed to sit in the driver's seat, one at a time, and rate their satisfaction and comfort with that condition. The rating scale for satisfaction was numeric with a range of -2 ("Very dissatisfied") to +2 ("Very satisfied"). Likewise, the comfort scale ranged from -2 ("Very uncomfortable") to +2 ("Very comfortable"). Once all subjects had seen the first condition, the second condition was deployed by the researchers. All subjects then rated this condition in the same manner as the first. This process was followed for all of the experimental conditions.

The conditions evaluated were as follows:

- Low beam
- High beam
- Prime beam: Unshielded
- Prime beam: 1° Shield
- Prime beam: 3° Shield
- Prime beam: 6° Shield

Figure II-3, below, shows the different shielding conditions used. The leftmost boundary was defined to be located at -6° along the horizontal axis. The left edge of the shielded region was always located at this angle. (This location results in an oncoming driver's eyes on a two-lane highway being located within the shadowed area of the beam pattern.) The black angular region in Figure II-3 only corresponds to 1° of shielding. The combined black and dark grey areas correspond to the 3° shielding condition. The combined black, medium grey, and light grey areas correspond to the 6° shielding condition. This approach was chosen because it presumed that eliminating peripheral illumination would be less detrimental to visibility than center illumination, and because oncoming vehicle traffic on a two-lane highway at a distance of 50 m

corresponds to a location 5° to the left of the center of the field of view so that reducing an angular portion of the beam pattern starting at 6° to the left of center was judged to be a reasonable scenario.

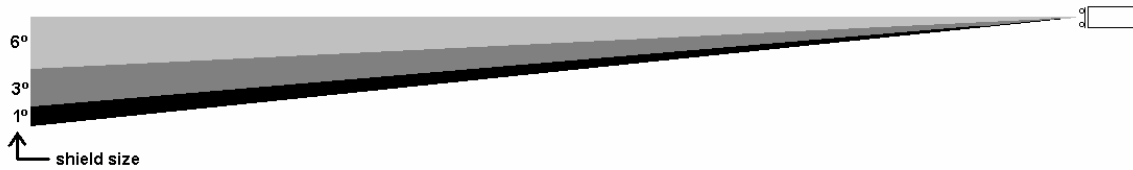

*Figure II-3. Illustration of the shielded portion of the experimental headlamp beam pattern.*

## Results

A within-subjects analysis of variance (ANOVA) showed that shielding type had a statistically significant effect ( $p < 0.05$ ) on satisfaction ratings. Bonferroni pairwise comparisons of the shielding conditions showed a reliable difference in satisfaction between the unshielded and 6° conditions, and between the low beam and 6° conditions. A criterion of  $p < 0.05$ , then adjusted to account for multiple comparisons (McGuigan, 1990), was used to determine if the pairwise comparisons were statistically significant. Figure II-4 shows the subjects' satisfaction with each type of headlamp beam (both modified and stock headlamp units). A positive rating corresponds to feelings of satisfaction and comfort, a rating of zero represents indifference, and negative ratings represent feelings of dissatisfaction and discomfort. Generally speaking, the more of the beam that is shielded, the lower average rating assigned, although the overall ratings were positive except for the 6° shielding condition.

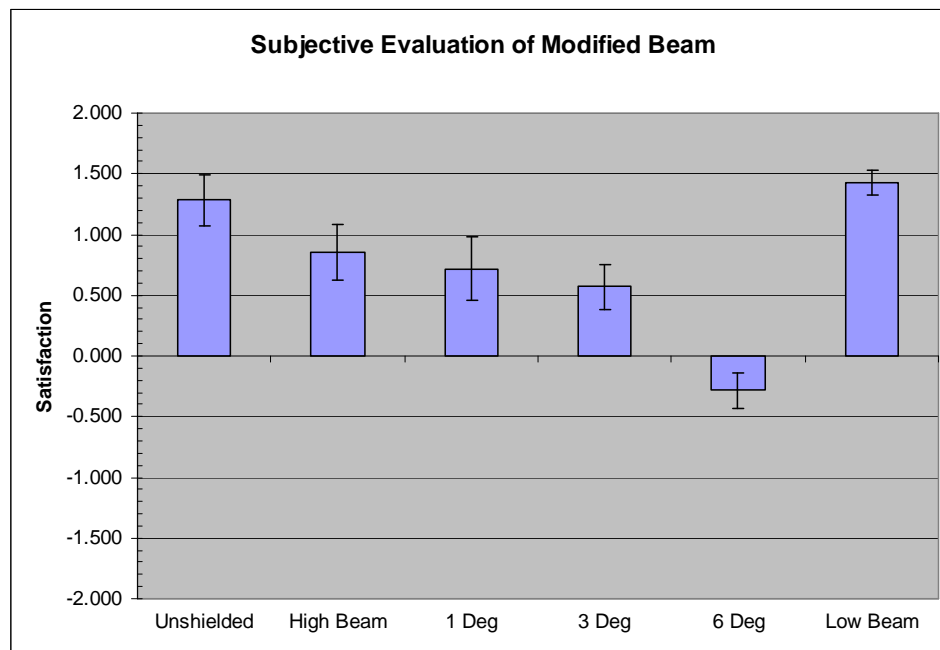

*Figure II-4. Subjects' satisfaction with various beam shielding conditions (error bars indicate standard error of the mean).*

An ANOVA showed that neither shielding nor subject had a statistically significant effect on comfort ratings (at  $p < 0.05$ ).

## II-5. FORWARD-VISIBILITY EVALUATION

The purpose of the forward-visibility evaluation was to determine the extent to which reducing the intensity (in regions of varying angular width) of the prime beam in the SAFS prototype would reduce visibility.

### Method

A subsequent study measured the forward visibility with the SAFS prototype (using the 3° and 6° angular width shields) compared with conventional low- and high-beam headlamps. Small flip-dot targets were located 30 m ahead at 5° intervals to the left and right of a numerical display located in the center of the field of view (Figure II-5). The flip-dot targets were constructed from swiveling, 1-cm disks painted black on one side and white on the other. Using a relay switch, the array of disks could be "flipped" from black to white or vice versa with a total flip time of 20 ms. The disks were seen against a black background; the average reflectance of the square array formed by the disks was 0.4, appearing light grey from more than 10 m away.

The numerical display served as a visual fixation point. Under each lighting condition (illuminances on targets are shown in Figure II-6), subjects responded to the onset of targets (presented at random intervals between 2 and 4 s) in random locations by releasing a switch to measure reaction times. This experimental procedure is very similar to that used by Bullough et al. (2003) in an earlier investigation of headlamp glare and forward visibility.

For the conditions in which the prime beam was modified to create regions of reduced intensity, the shadowed regions (such as those illustrated in Figure II-3) were positioned to be coincident with the target located 5° to the left of the fixation point.

Ten subjects (ages 24 to 61) participated in the forward-visibility evaluation.

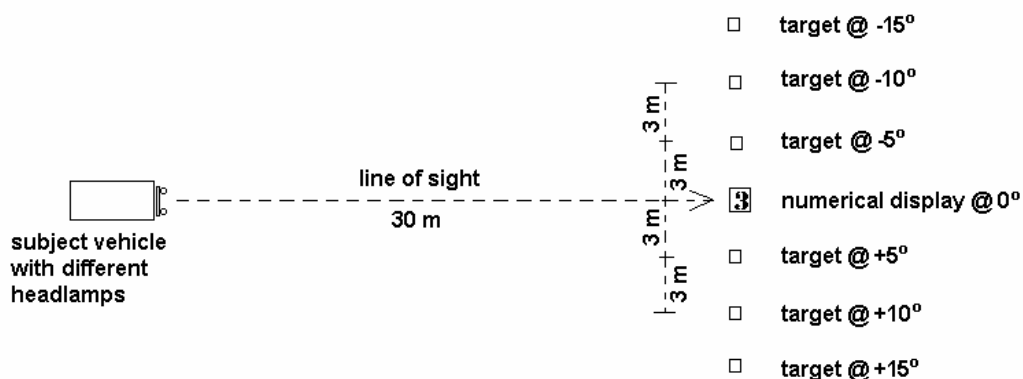

*Figure II-5. Experimental layout for forward visibility study.*

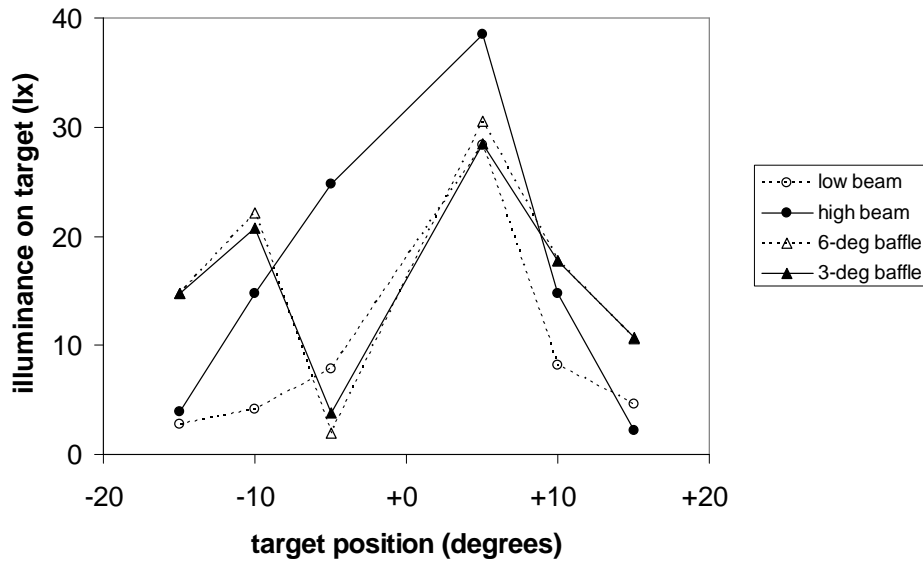

*Figure II-6. Vertical illuminances measured on targets.*

## Results

Figure II-7 shows the mean reaction times measured at each target and under each condition. A within-subjects analysis of variance (ANOVA) revealed reliable ( $p < 0.05$ ) effects of lighting condition on reaction times that were consistent with the illuminances on the targets; the higher the target illuminances, the shorter the reaction times. The results of a Student's t-test comparing the reaction times to the 5° target under the 3° shield and under the low-beam illumination revealed that the shielding did not significantly ( $p > 0.05$ ) worsen the visibility for this particular target relative to the low beam, even though the shielding reduced the illuminance on this target (Figure II-6).

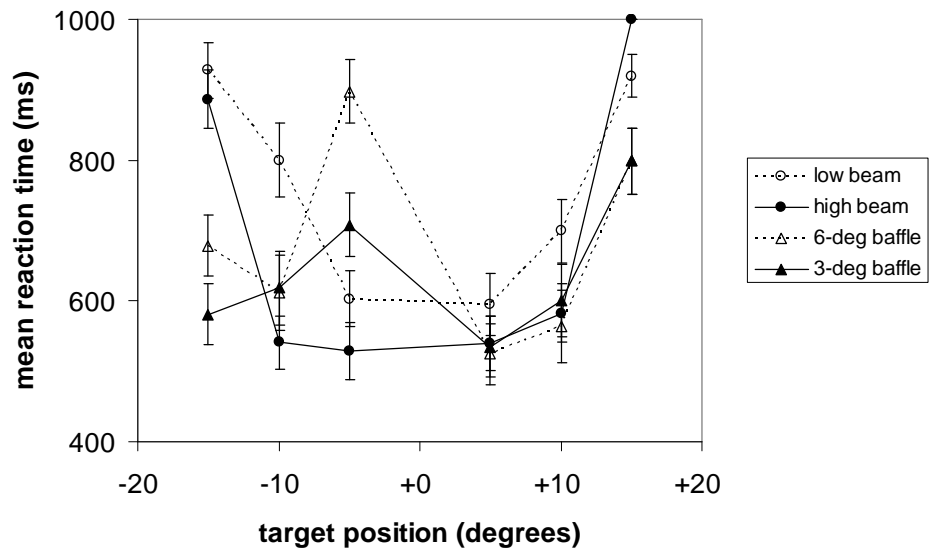

*Figure II-7. Mean reaction times to each target location under each lighting condition.*

## II-6. GLARE EVALUATION

The objective of the glare evaluation is to determine the effect of reducing the intensity of the SAFS prototype on disability and discomfort glare for drivers facing the prototype system in an oncoming vehicle scenario. Assessment of glare was conducted through a laboratory pilot study and through a static field study.

### Laboratory Pilot Study: Methods

A laboratory pilot study involved assessing discomfort glare (using the De Boer [1967] rating scale) with the prototype using baffles having angular sizes of  $1.67^\circ$ ,  $3.33^\circ$  and  $6.67^\circ$ , in comparison to low and high beams. Subjects viewed a single SAFS prototype module from a viewing distance of 15 m in a black-painted laboratory at the Lighting Research Center.

### Laboratory Pilot Study: Results

The laboratory study involved assessing discomfort glare using baffles with angular sizes of  $1.67^\circ$ ,  $3.33^\circ$  and  $6.67^\circ$ , in comparison to low and high beams (the light source used for all of these comparisons was an HID lamp). The results showed that in general, rated discomfort was largely correlated with the illuminance measured at subjects' eyes. The resulting data from this laboratory evaluation showed that the  $3.33^\circ$  baffle reduced discomfort glare to about the same level as a low-beam headlamp (Figure II-8).

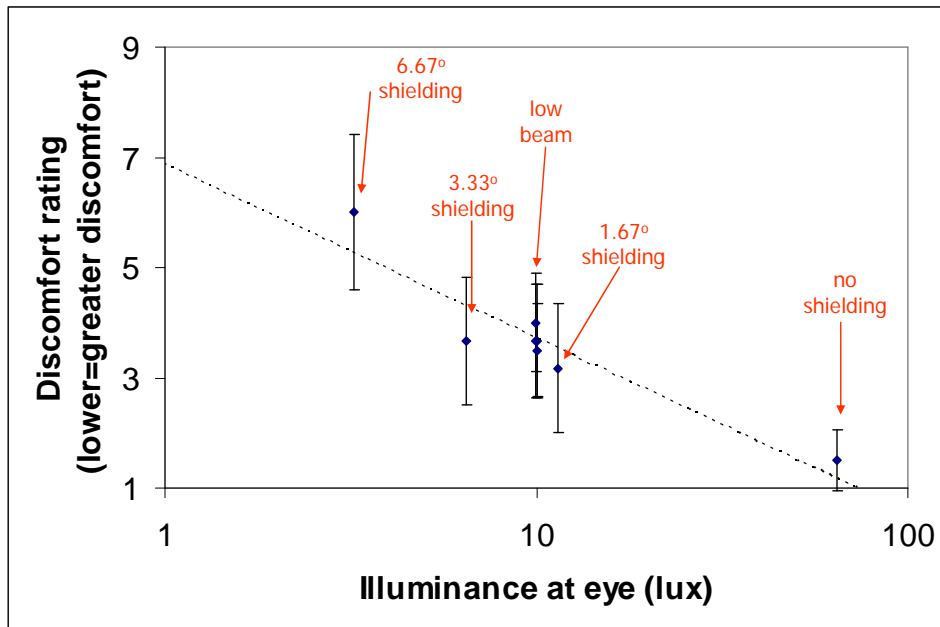

*Figure II-8. Discomfort ratings (using the De Boer scale) elicited by low and high (no shielding) beams, and from baffled conditions varying in angular width, plotted as a function of illuminance at subjects' eyes.*



## Field Study: Methods

In order to assess both disability glare and discomfort glare from the prototype, a field experiment similar in experimental layout to the forward-visibility field experiment was conducted. In this experiment, a set of halogen low-beam headlamps was placed in front of the test subjects' vehicle (1999 Ford Contour) and aimed properly. The same flip-dot targets used in the visibility evaluation were positioned 30 m ahead of the test vehicle at angular locations of  $-15^\circ$ ,  $-10^\circ$ ,  $+5^\circ$ ,  $+10^\circ$  and  $+15^\circ$ .

The vertical illuminances on the targets during the experiment are plotted in Figure II-9.

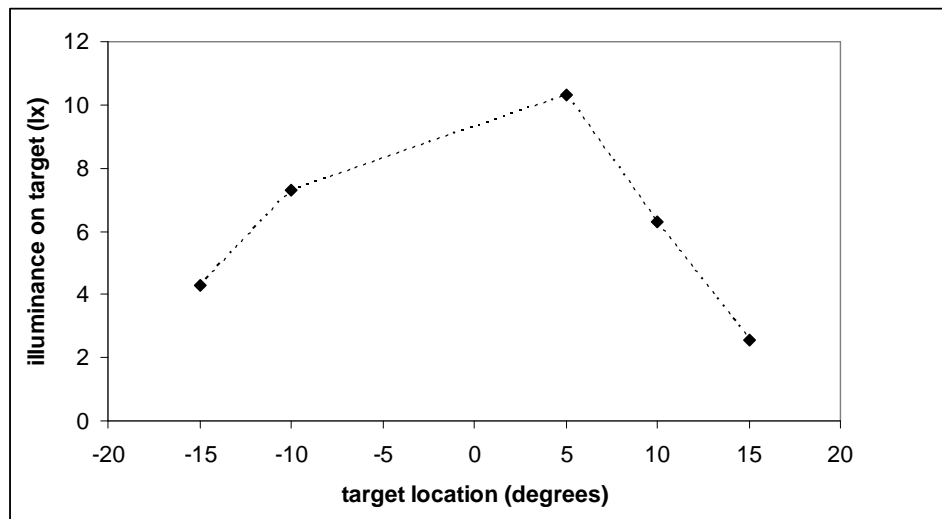

*Figure II-9. Illuminances on targets during the glare evaluation experiment.*

A numerical display that sequenced random digits was positioned at the  $0^\circ$  location. At the  $-5^\circ$  location, in randomized order for each group of subjects, one of four headlamp conditions were positioned:

- Halogen low-beam pattern
- Halogen high-beam pattern
- Prime beam with  $3^\circ$  shielding
- Prime beam with  $6^\circ$  shielding

For the prime-beam/shielded conditions, the angular shadowed region was centered on the subjects' seating position in the driver seat of the test vehicle in order to reduce the driver's eye illuminance to a value as close to that produced by low beam headlamps as possible. The vertical illuminance was measured near driver eye position, by placing an illuminance meter at the bottom center of the driver side sun visor when the visor was opened to a vertical position. The vertical illuminances from the low beam, high beam,  $6^\circ$  shielded, and  $3^\circ$  shielded conditions were 0.6, 2.8, 1.3 and 1.9 lx, respectively.

For each oncoming headlamp condition, subjects responded to the onset of the flip-dot targets, presented in random order and at random intervals from 2 to 4 s, by releasing a switch on a hand-held box. Each target was presented twice and after each set of reaction time trials, subjects were asked to provide a subjective rating of visual discomfort using the De Boer (1967) scale.

Eleven subjects ranging in age from 24 to 61 years participated in this experiment during one of two nighttime sessions.

### Field Study: Results

In the field study, a within-subjects ANOVA on the reaction time data (Figure II-10), with "missed" targets assigned a reaction time of 1,000 ms, revealed statistically significant ( $p < 0.01$ ) effects of target location and of the oncoming headlamp condition. In addition, there was a statistically significant interaction between target location and oncoming lighting condition. Response times to the  $+5^\circ$  target, closest to the line of sight, were relatively resistant to the negative effects of glare.

Not surprisingly, the overall reaction times were correlated with the illuminances produced by each lighting configuration near subjects' eyes. The low-beam condition, which produced 0.6 lx at subjects' eyes, had the shortest overall response times while the high beam, which produced 2.8 lx, had the longest response times.

Interestingly, although the illuminance from the (halogen) high beam, 2.8 lx, was greater than from either of the shielded conditions (1.3 lx for  $3^\circ$  and 1.9 lx for  $6^\circ$ , from an HID lamp), the mean discomfort rating from the high-beam condition was between those of the shielded prime beam conditions (Figure II-11), consistent with previous research showing that the spectral distribution of HID headlamps contributes to visual discomfort even though it does not affect disability glare, as measured in terms of response times.

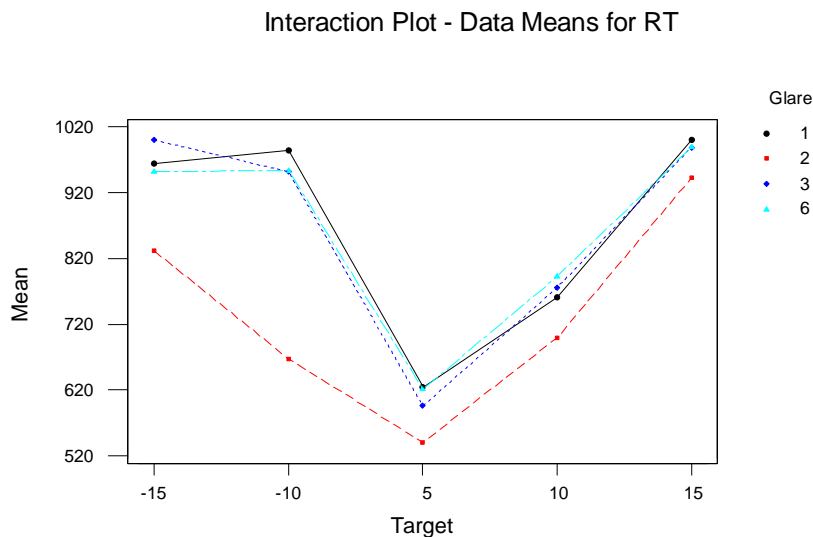

**Figure II-10.** Mean reaction times to each target for each oncoming lighting condition (1=high beam, 2=low beam, 3=prime beam with  $3^\circ$  shielding, 6=prime beam with  $6^\circ$  shielding).

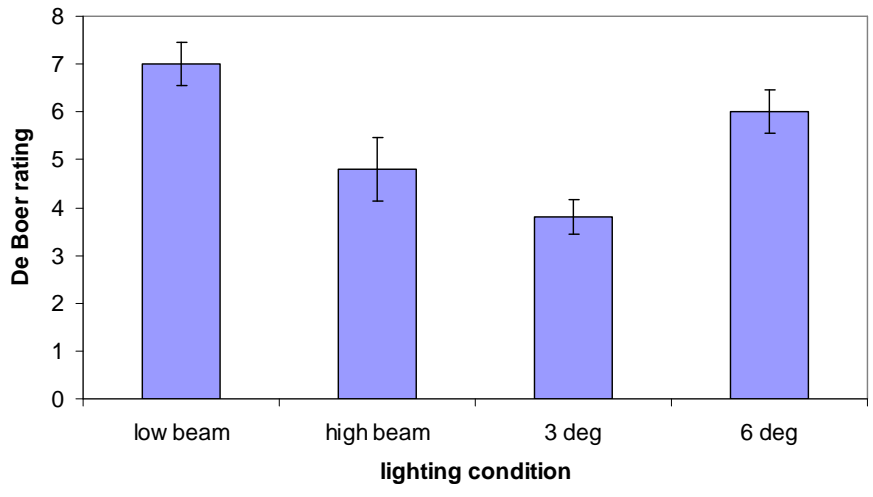

*Figure II-11. Mean discomfort ratings (and standard errors of the mean) for the oncoming lighting conditions in the glare evaluation experiment.*

## II-7. MOVING VEHICLE DEMONSTRATION

It was deemed important that the prototype system developed in the present study could be mounted onto a vehicle and driven. A prototype that resulted in an excessive size would not be practical for vehicular forward lighting because of styling and aerodynamic concerns. The purpose of the moving vehicle demonstration was to show that the SAFS prototype could be mounted onto and driven with a passenger vehicle.

### Methods

Since the prototype utilized the optical system from a commercially available existing headlamp assembly, it was about as large as the original headlamp. An angle-iron rack was affixed onto the front of the demonstration vehicle (1999 Ford Contour) and positioned such that the prototype modules, mounted to plywood bases, could be screwed to the rack directly in front of the vehicle's original headlamps (Figure II-12).

A demonstration of the SAFS prototype mounted as described above on the test vehicle was conducted at the Schenectady County Airport along an unused paved taxiway containing very little ambient illumination. Four observers sat in a stationary passenger vehicle while the vehicle containing the prototype approached it from the location of an oncoming vehicle, between 100 m and 50 m away. Three conditions were viewed in random order by each observer: the prime beam with no shielding, the prime beam with a 4° shield and the prime beam with a 6° shield. The 4° shield was used during the demonstration rather than the 3° shield used in earlier evaluations because it was unclear whether small changes in vehicle yaw would result in the angular shaded region (illustrated in Figure II-3) of 3° being too small to be easily maintained over an oncoming drivers' eyes. Observers provided subjective discomfort ratings of the dynamic approach for each condition.

Following the completion of each oncoming scenario, the same observers (all licensed drivers between the ages of 24 and 61) drove the vehicle 100 m down the taxiway, turned around near the location of an experimenter serving as a confederate pedestrian, and drove back, under each of the same conditions evaluated as oncoming situations. Observers provided subjective ratings of satisfaction and comfort using the same scales as in the acceptability evaluation, to rate their driving experience under each condition. Figure II-13 shows a view from the test vehicle with the 4° shield in place.



*Figure II-12. Prototype AFS modules mounted on the test vehicle.*

Evident from Figure II-13 is the shadowed region on the pavement corresponding to the shield location. In the oncoming driving scenario, this shadowed area could be positioned to be coincident with oncoming drivers' eyes.



*Figure II-13. View from the test vehicle toward an oncoming vehicle with the shielded prime beam installed.*

## Results

Although the demonstration was not designed to be a formal experiment with a sample of participants large enough to expect statistical significance, the visual discomfort and acceptability ratings from the observers were nonetheless analyzed using within-subjects ANOVAs. There were statistically significant ( $p < 0.05$ ) effects of lighting condition on all of the ratings provided by the observers.

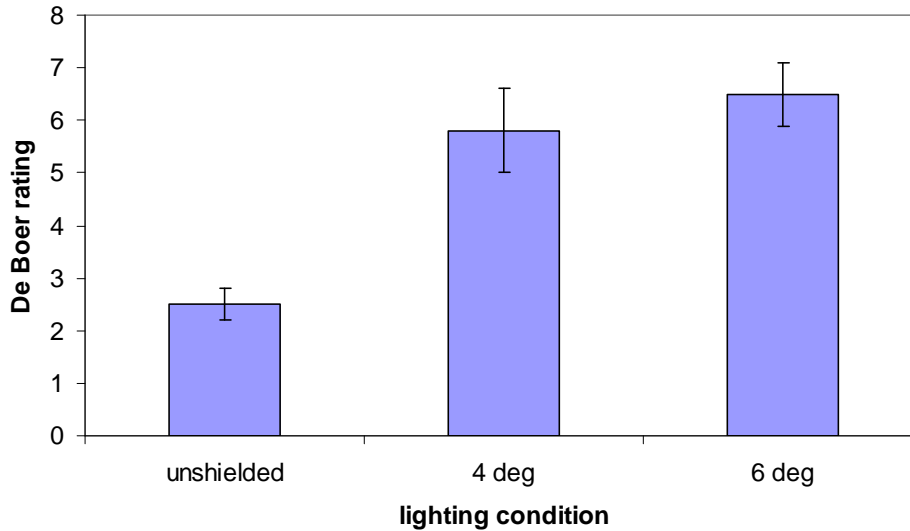

*Figure II-14. Observers' mean discomfort ratings while viewing an approaching vehicle containing the prime beam prototype system.*

As expected, the unshielded prime beam condition was rated as producing more discomfort glare (i.e., a lower De Boer rating) than the shielded conditions (Figure II-14). Similarly, when observers rated their satisfaction and comfort while driving, they found the shielded prime-beam conditions to provide less satisfaction and comfort (Figure II-15). This could be in part because the shadowed region illustrated in Figure II-13 produces relatively dark shadows in the visual foreground. The height of the shields as presently implemented in the SAFS prototype could perhaps be reduced, which would have the effect of increasing the distance at which the bottoms of the shadowed regions appear, and presumably would increase driver satisfaction.

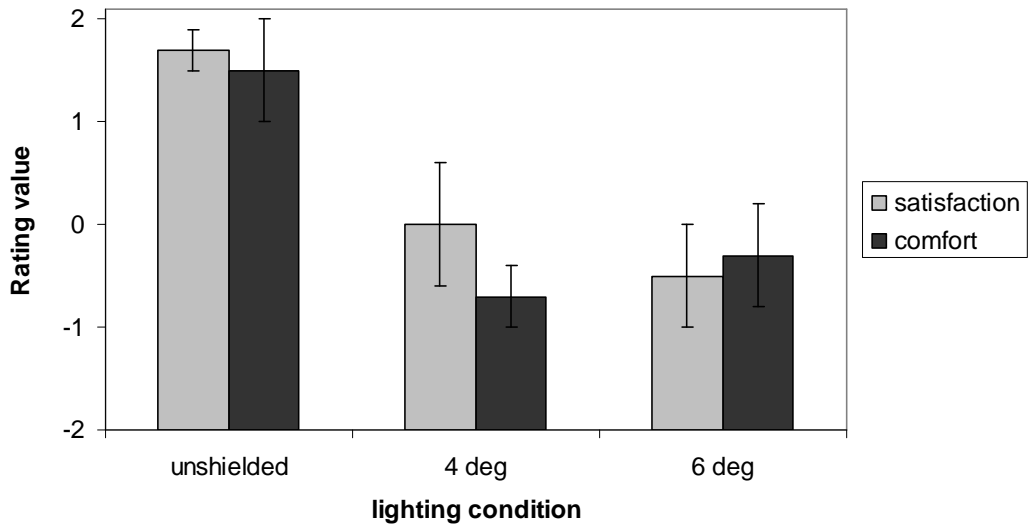

*Figure II-15. Observers' mean satisfaction and comfort ratings while driving the prime-beam system prototype.*

## II-8. DISCUSSION

The purpose of the research and development activities undertaken and documented in the present report was to provide answers to the following questions:

- What are the characteristics of an appropriate beam pattern for the SAFS prototype?
- What is the angular size of a reduction in intensity that can be tolerated by drivers?
- What is the effect of reducing intensity on forward visibility (for a driver with such a system)?
- What is the effect of reducing intensity on forward visibility and visual comfort (for a driver facing such a system)?
- Is the prototype of such size and weight to be able to be implemented practically on a passenger vehicle?

Regarding the first question, the analysis presented in an earlier chapter supports the use of a prime beam that produces a vertical illuminance of at least 4 lx at 10° off-axis at a distance of 60 m to ensure acceptable visibility in the presence of oncoming headlamp glare.

Regarding the second, third, and fourth questions, a reduction of forward intensity having an angular width of 3° appeared to be acceptable to drivers. Further, such a reduction did not impair forward visibility in a manner that could be reliably differentiated from the visibility with typical low-beam patterns, and resulted in significantly less discomfort glare than would be produced by high-beam patterns.

Regarding the final question, the SAFS prototype is no larger than a conventional headlamp system utilizing projector optics. It can readily be mounted on a vehicle for dynamic evaluation. The use of shields to modify the beam pattern is practical and relatively inexpensive. Manufacturers are presently developing "glare-free high-beam" and adaptive cutoff systems using similar concepts and the technical feasibility of the prime beam SAFS approach seems high.

Taken together, the data converge in identifying that utilizing a prime beam, producing a pattern of illumination similar to that from a high-beam headlamp, in conjunction with reducing the luminous intensity of a headlamp within a 3° angular width to mitigate glare can result in performance (defined in terms of driver acceptability, visibility, and discomfort and disability glare to oncoming drivers) that is not reliably worse than from a conventional low-beam pattern while providing forward visibility comparable to that of a conventional high-beam headlamp pattern.

Reducing intensity within a larger angular width will compromise visibility and satisfaction, while using a narrower width will result in increased glare compared to a conventional low-beam pattern.

The approach utilized in the present study of modifying projector headlamp modules results in a prototype that can be readily mounted to a vehicle for dynamic driving investigations, and which can be used to provide straightforward modification of a beam pattern using shielding (as in the



present study), liquid crystal display (LCD) elements or other components in the focal plane of the projector source. While the present investigations focused on glare for an oncoming driver, the shield position in the SAFS prototype can be moved to nearly any angular position, to be able to account for reduction of intensity toward preceding vehicles' mirrors, or toward the location of vehicles in other situations aside from the two-lane straight roadways investigated in the present study. It could also be possible for more than one shield to be deployed in order to reduce intensity toward an oncoming driver and toward a preceding driver at the same time. A segmented shield approach that has been described by some authors as a means for controlling headlamp intensity (Shadeed et al., 2007) would be relatively straightforward to implement. Such approaches differ from those described by the SAE (2002); it its recommended practice for adaptive forward-lighting systems.

Abundant evidence exists to support the claim that driving with low-beam headlamps can result in insufficient visibility for a number of driving situations (e.g., Helmers and Rumar, 1975; Liebowitz et al., 1998; Olson and Farber, 2003). Similarly abundant evidence suggests that most drivers use low beams primarily, if not exclusively (Sullivan et al., 2003; Mefford et al., 2006). A beam pattern that emphasizes forward visibility is likely to reduce possible safety-related issues resulting from such evidence.

One reason that high beam patterns are under-used is to avoid creating glare to other drivers. The present evaluation demonstrates the feasibility of reducing illumination in specific angular regions to reduce glare. At the same time, the SAFS prime beam used in the present study has been demonstrated to maintain a relatively higher level of visibility in the rest of the visual scene without impairing visibility in the reduced region significantly below that obtained with low-beam headlamps.

As described above, the evaluation methods used in the present study were relatively simple and straightforward, whereas nighttime driving can result in many situations not considered in the present set of studies. The SAFS prototype system provides a means by which NHTSA can investigate different driving scenarios and modify the lighting conditions in a relatively straightforward manner to achieve a wide variety of beam patterns. While the results from the present investigations demonstrate that the SAFS prototype has promise as a platform for future study, they are also intended to demonstrate the utility of providing forward illumination optimized for forward visibility while controlling glare in a practical manner.

## REFERENCES

- Akashi, Y., Van Derlofske, J., and Bullough, J. (2005b). Recommendations for dimming headlamps through AFS. *Proceedings of the International Symposium on Automotive Lighting*. Munich, Germany: Herbert Utz Verlag.
- Akashi, Y., Van Derlofske, J., Watkinson, J., and Fay, C. (2005a). Assessment of Headlamp Glare and Potential Countermeasures: Survey of Advanced Front Lighting Systems (AFS) (DOT HS 809 973). Washington, DC: National Highway Traffic Safety Administration.
- Akashi, Y., and Rea, M. (2001). The effect of oncoming headlight glare on peripheral detection under a mesopic light level. *Proceedings of the 2001 Symposium on Progress in Automobile Lighting, Darmstadt, Germany, 9-22*.
- Akashi, Y., and Rea, M. (2002). Peripheral detection while driving under a mesopic light level. *Journal of the Illuminating Engineering Society, 31(1)*, 85-94.
- ANSI / IESNA. (2000). American National Standard Practice for Roadway Lighting (RP-8-00).
- Bergstrom, S. S. (1963). Visible distances during night driving. In *Lighting Problems in Highway Traffic*. New York, NY: Macmillan.
- Birch, B. (2001). Adaptive front lighting. *Automotive Engineering International, 12*, 39-42.
- Bishop, R. (2007). Camera-controlled LED arrays pinpoint danger. *European Automotive Design* (1 May 2007).
- Blackwell, H. R. (1946). Contrast threshold of the human eye. *Journal of the Optical Society of America, 36*, 11.
- Blackwell, H. R., and Moldauer, A.B. (1958). Detection thresholds for point sources in the near periphery (ERI Project 2455). Ann Arbor: Engineering Research Institute, the University of Michigan (DTIC No. AD759739).
- Bullough, J. D., and Rea, M. S. (2004). Visual performance under mesopic conditions: Consequences for roadway lighting. *Transportation Research Record, 1862*, 89-94.
- Bullough, J. D., Van Derlofske, J., Dee, P., Chen, J., and Akashi, Y. (2003). An Investigation of Headlamp Glare: Intensity, Spectrum, and Size (DOT 809 672). Washington, DC: National Highway Traffic Safety Administration.
- Bullough, J. D., Van Derlofske, J., and Zhang, C. (2005). Characterizing oncoming headlamp illumination. *Proceedings of the International Symposium on Automotive Lighting*. München, Germany: Herbert Utz Verlag.

Bullough, J. D., and Van Derlofske, J. (2004). Headlamp illumination and glare: an approach to predicting peripheral visibility (SAE paper 2004-01-1094). In *Lighting*, SP-1875. Warrendale, PA: Society of Automotive Engineers.

Damasky, J., and Huhn, W. (2003). Variable headlamp beam pattern: lighting requirements for different driving situations (SAE paper 970647). In D. J. Holt (Ed.), *Advances in Lighting Technology*. Warrendale, PA: Society of Automotive Engineers.

De Boer, J. B. (1967). Visual perception in road traffic and the field of vision of the motorist. In *Public Lighting*. Eindhoven, Netherlands: Philips Technical Library.

Decker, D., Himmler, A., and Amsel, C. (2007). The road to active light: headlamp concepts with enhanced adaptive functionalities (SAE paper 2007-01-0601). In *Automotive Lighting Technology and Human Factors in Driver Vision and Lighting*, SP-2106. Warrendale, PA: Society of Automotive Engineers.

Decker, D., and Schmidt, C. (2006). Adaptive systems for motor vehicle lighting: first steps and future (SAE paper 2006-01-1013). In *Lighting Technology and Human Factors*, SP-1932. Warrendale, PA: Society of Automotive Engineers.

Flannagan, M. J., Sivak, M., Traube, E. C., and Kojima, S. (2000). Effects of overall low-beam intensity on seeing distance in the presence of glare. *Transportation Human Factors*, 2(4), 313-330.

Gunther, A. (2008). Optical concept for an active headlamp with a DMD array. *Proceedings of SPIE Vol. 7003*. Bellingham, WA: Society of Photo-Optical Instrumentation Engineers.

Hella. (2000). Research & Development Review 2000. Lippstadt, Germany: Hella KG Hueck & Co.

Helmers, G., and Rumar, K. (1975). High beam intensity and obstacle visibility. *Lighting Research and Technology*, 7(1), 35-42.

Hogrefe, H. (2003). Adaptive front lighting systems for optimum illumination of curved roads, highway lanes, and other driving situations (SAE paper 2000-01-0431). In D. J. Holt (Ed.), *Advances in Lighting Technology*. Warrendale, PA: Society of Automotive Engineers.

Kalze, F.-J. (1999). Static bending light – a new light function for modern headlamp systems. SAE 1999, 131-134.

Kobayashi, S., Hayakawa, M. (2003). Beam controllable headlighting system (SAE paper 910829). In D. J. Holt (Ed.), *Advances in Lighting Technology*. Warrendale, PA: Society of Automotive Engineers.

- Kobayashi, S., and Hayami, T. (1999). Development of the Phase-1 AFS Front Lighting System. *Proceedings of the 1999 Symposium on Progress in Automobile Lighting, Darmstadt, Germany*, 449-464.
- Leibowitz, H. W., Owens, D. A., and Tyrrell, R. A. (1998). The assured clear distance ahead rule: implications for nighttime traffic safety and the law. *Accident Analysis and Prevention*, 30(1), 93-99.
- McGuigan, F. J. (1990). *Experimental Psychology: Methods of Research*. Englewood Cliffs, NJ: Prentice-Hall.
- Mefford, M. L., Flannagan, M. J., and Bogard, S. E. (2006). Real-World Use of High-Beam Headlamps (report number UMTRI-2006-11). Ann Arbor, MI: University of Michigan.
- Miller, N. D., Baumgardner, D., and Mortimer, R. G. (1974). An evaluation of glare in nighttime driving caused by headlights reflected from rearview mirrors (SAE 740962).
- Nakamura, Y., and Akashi, Y. (2003). The effect of immediate background size on target detection. *Journal of the Illuminating Engineering Society*, 32(2), 74-87.
- Neumann, R. (2008). Glare free headlamp: first approach and system definition (SAE paper 2008-01-0668). In *Automotive Lighting Technology*, SP-2149. Warrendale, PA: Society of Automotive Engineers.
- Olson, P. L., and Farber, E. (2003). *Forensic Aspects of Driver Perception and Response*. Tucson, AZ: Lawyers and Judges.
- Olson, P. L., and Sivak, M. (1984). Discomfort glare from automobile headlights. *Journal of the Illuminating Engineering Society*, 13(3), 296-303.
- Onksen, G. W. (1953). Development of the Guide 'Autronic Eye'. *Highway Research Board Bulletin*, 68, 31-39.
- Rea, M. S. (Ed.). (2000). *IESNA Lighting Handbook: Reference and Application* (9th ed.). New York, NY: Illuminating Engineering Society of North America.
- Richardson, M. (2007). Lights, camera, action! *New Electronics* (11 September 2007): 19-20.
- Schmidt-Clausen, H. J., and Bindels, J. T. H. (1974). Assessment of discomfort glare in motor vehicle lighting. *Lighting Research and Technology*, 6(2), 79-88.
- Schreuder, D. A. (1975). *Vehicle lighting within built-up areas*. Voorburg, Netherlands: Institute for Roadway Safety Research.

Shadeed, H., Wallaschek, J., and Mojrzisch, S. (2007). On intelligent adaptive vehicle front-lighting assistance systems. *Proceedings of the IEEE International Conference on Intelligent Transportation Systems*. New York, NY: Institute of Electrical and Electronics Engineers.

Shadeed, H., and Wallaschek, J. (2007). Concept of intelligent adaptive vehicle front-lighting assistance system. *Proceedings of the IEEE International Vehicle Symposium*. New York, NY: Institute of Electrical and Electronics Engineers.

Sivak, M., Flannagan, M., Schoettle, B., and Nakata, Y. (2001). Quantitative comparison of the benefits of applying adaptive headlighting to the current U.S. and European low-beam patterns. *Proceedings of the 2001 Symposium on Progress in Automobile Lighting, Darmstadt, Germany*, 942-957.

Sivak, M., Flannagan, M., Traube, E., and Kojima, S. (1997). The influence of stimulus duration on discomfort glare for persons with and without visual correction (UMTRI-97-23). Ann Arbor, MI: University of Michigan.

Society of Automotive Engineers. (2002). Adaptive Forward Lighting Systems, J2591. Warrendale, PA: Society of Automotive Engineers.

Sprute, J. H., Khanh, T. Q. (2007). Approval requirements for a front-lighting system with variable cut-off line in Europe. *Proceedings of the International Symposium on Automotive Lighting*. Munich, Germany: Herbert Utz Verlag.

Stam, J. S. (2001). Automatic vehicle high-beam headlamp control system (SAE paper 2001-01-0318). In *Lighting Technology Developments for Automobiles*, SP-1595. Warrendale, PA: Society of Automotive Engineers.

Sullivan, J. M., Adachi, G., Mefford, M. L., and Flannagan, M. J. (2003). High-Beam Headlamp Usage on Unlighted Rural Roadways, UMTRI-2003-2. Ann Arbor, MI: University of Michigan.

Van Derlofske, J., Bullough, J. D., and Hunter, C. M. (2001). Evaluation of high-intensity discharge automotive forward lighting (SAE paper 2001-01-0298). In *Lighting Technology Developments for Automobiles*, SP-1595. Warrendale, PA: Society of Automotive Engineers.

Worner, B. (2001). Adaptive front-lighting—experimental system. *Proceedings of the 1999 Symposium on Progress in Automobile Lighting, Darmstadt, Germany*, 844 - 845.

## **ACKNOWLEDGMENTS**

The authors gratefully acknowledge support of this study from the National Highway Traffic Safety Administration under the supervision of Michael Perel and Stephanie Binder, through a subcontract to Westat, Inc. managed by Neil Lerner. The technical contributions of Andrew Bierman, Peping Dee, Jean Paul Freyssinier, Daniel Miller, Nadarajah Narendran, Terrie Ondek, Martin Overington, Richard Pysar, Mark Rea, and Xin Zhang from the Lighting Research Center at Rensselaer are also acknowledged. The authors would also like to acknowledge Stephen Israel of the Schenectady County Airport for permitting us to conduct field studies at the runway.

## APPENDIX: RESULTS OF ANOVA

*Table A-1. Results of repeated-measures ANOVA in the pilot study.*

Source	df	SS	MS	F	p-value
RI	2	189474	94737	33.04	<0.001 **
HL	2	21793	10897	10.68	0.002 **
Target	4	1139788	284947	92.31	<0.001 **
Subject	7	258049	36864	78.35	<0.001 **
RI*HL	4	17938	4485	5	0.004 **
RI*Target	8	162582	20323	14.27	<0.001 **
RI*Subject	14	40145	2867	6.09	<0.001 **
HL*Target	8	17904	2238	4.26	<0.001 **
HL*Subject	14	14286	1020	2.17	0.013 *
Target*Subject	28	86432	3087	6.56	<0.001 **
RI*HL*Target	16	14115	882	1.88	0.03 *
RI*HL*Subject	28	25117	897	1.91	0.01 *
RI*Target*Subject	56	79749	1424	3.03	<0.001 **
HL*Target*Subject	56	29407	525	1.12	0.308
Error	112	52696	471		
Total	359	2149474			

RI: Roadway ambient Illuminance, HL: Headlamp intensity; \*\*: p<0.01, \*: p<0.05

*Table A-2. Results of repeated-measures ANOVA in the detection study.*

Source	df	SS	MS	F	p-value
RL	2	28817.5	14408.8	124.94	<0.001 **
HL	2	5881.8	2940.9	60.58	<0.001 **
Target	4	154882.5	38720.6	485.91	<0.001 **
Subject	11	3974.3	361.3	7.64	<0.001 **
RL*HL	4	2097.7	524.4	10.25	<0.001 **
RL*Target	8	14459	1807.4	23.92	<0.001 **
RL*Subject	22	2537.1	115.3	2.44	0.001 **
HL*Target	8	881.8	110.2	3.38	0.002 **
HL*Subject	22	1067.9	48.5	1.03	0.434
Target*Subject	44	3506.2	79.7	1.69	0.010 *
RL*HL*Target	16	1291.4	80.7	1.71	0.049 *
RL*HL*Subject	44	2251.5	51.2	1.08	0.352
RL*Target*Subject	88	6648.3	75.5	1.6	0.005 **
HL*Target*Subjec					
t	88	2872.6	32.6	0.69	0.974
Error	176	8321.7	47.3		
Total	539	239491.3			

RI: Roadway ambient Illuminance, HL: Headlamp intensity; \*\*: p<0.01, \*: p<0.05

**Table A-3. Results of repeated-measures ANOVA in the oncoming glare study.**

Source	df	SS	MS	F	p-value
HL	2	979.33	489.66	2.13	0.145
Position	4	33369.13	8342.28	73.88	0.001 **
Subject	10	3706.31	370.63	5.48	0.001 **
HL*Position	8	1747.54	218.44	3.23	0.003 **
HL*Subject	20	4599.86	229.99	3.4	0.001 **
Position*Subject	40	4516.92	112.92	1.67	0.026 *
Error	80	5407.85	67.6		
Total	164	54326.93			

HL: Forward headlamp intensity; \*\*: p<0.01, \*p<0.05

**Table A-4. Results of repeated-measures ANOVA in the mounting height study.**

Source	df	SS	MS	F	p-value
Position	1	0.756	0.756	0.07	0.799
MH	3	343.488	114.496	46.36	0.000**
HL	3	809.437	269.812	241.01	0.000**
Subject	19	139.375	7.336	11.65	0.000**
Position*MH	3	87.756	29.252	10.61	0.000**
Position*HL	3	3.606	1.202	1.15	0.338
Position*Subject	19	215.119	11.322	17.98	0.000**
MH*HL	9	9.75	1.083	1.9	0.056
MH*Subject	57	140.762	2.47	3.92	0.000**
HL*Subject	57	63.812	1.12	1.78	0.003**
Position*MH*HL	9	10.181	1.131	1.8	0.072
Position*MH*Subject	57	157.119	2.756	4.38	0.000**
Position*HL*Subject	57	59.769	1.049	1.66	0.007**
MH*HL*Subject	171	97.75	0.572	0.91	0.736
Error	171	107.694	0.63		
Total	639	2246.375			

HL: Forward headlamp intensity, MH: Mounting height; \*\*: p<0.01, \*p<0.05





DOT HS 811 033  
September 2008



U.S. Department  
of Transportation  
**National Highway  
Traffic Safety  
Administration**

