

LARGE SCALE ANALYSIS OF GENE EXPRESSION

Evolution and Revolution

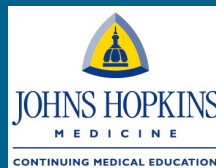

Current Topics in Genome Analysis 2012

Paul Meltzer

*No Relevant Financial Relationships with
Commercial Interests*

**AFTER THE SEQUENCE:
WHOLE GENOME APPROACHES TO
BIOLOGICAL QUESTIONS**

**GENE EXPRESSION
GENE VARIATION
GENE FUNCTION**

**MICROARRAYS PROVIDE A TOOL
FOR WHOLE GENOME ANALYSIS**

**PRIMARY IMPACT:
ACCELERATED DISCOVERY AND
HYPOTHESIS GENERATION**

PUBMED CITATIONS FOR DNA MICROARRAYS

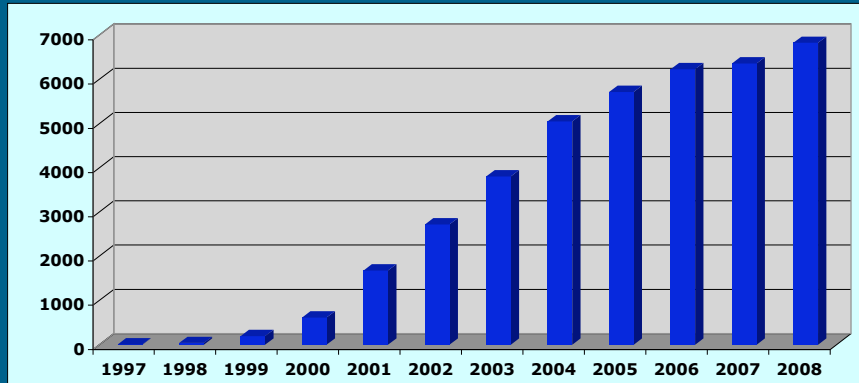

PUBMED CITATIONS FOR DNA MICROARRAYS

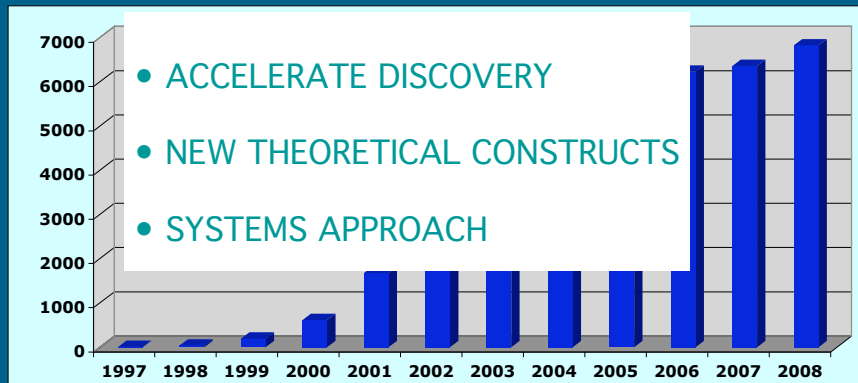

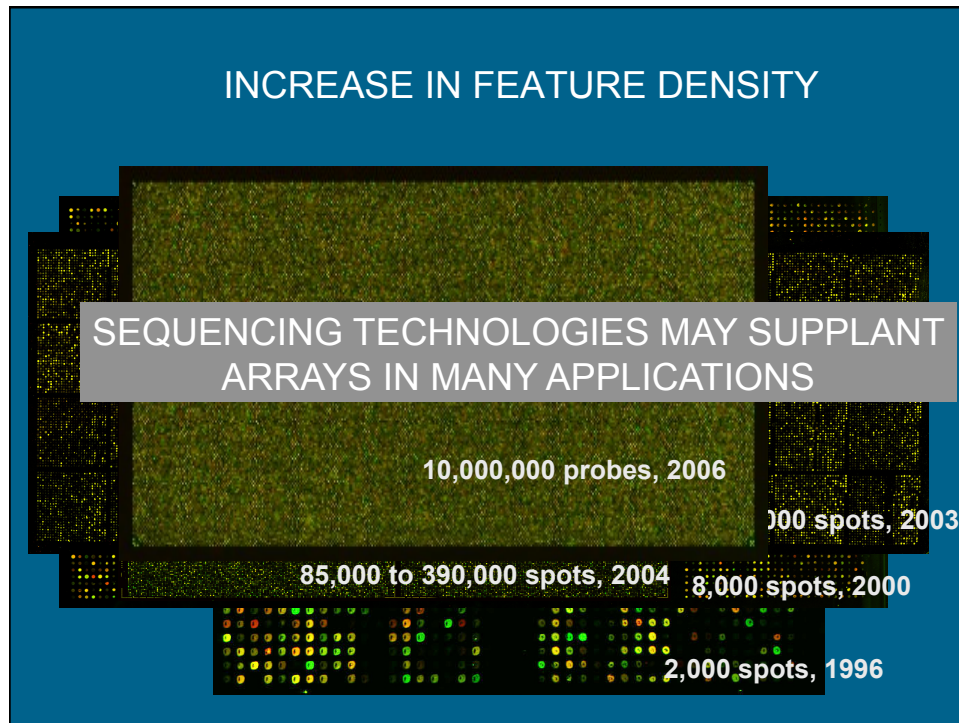

MICROARRAY TERMINOLOGY

- Feature--an array element
- Probe--a feature corresponding to a defined sequence
- Target--a pool of nucleic acids of unknown sequence

POSSIBLE ARRAY FEATURES

- **Synthetic Oligonucleotides**
- **PCR products from**
 - Cloned DNAs
 - Genomic DNA
- **Cloned DNA**

OLIGONUCLEOTIDE ARRAY DESIGN

- **Extremely flexible**
 - **3' bias**
 - **full length**
 - **exon specific**
 - **candidate transcripts**
 - **miRNAs**
- **Very high density possible**
- **Requires sequence data**

Microarray Manufacture

- Printing

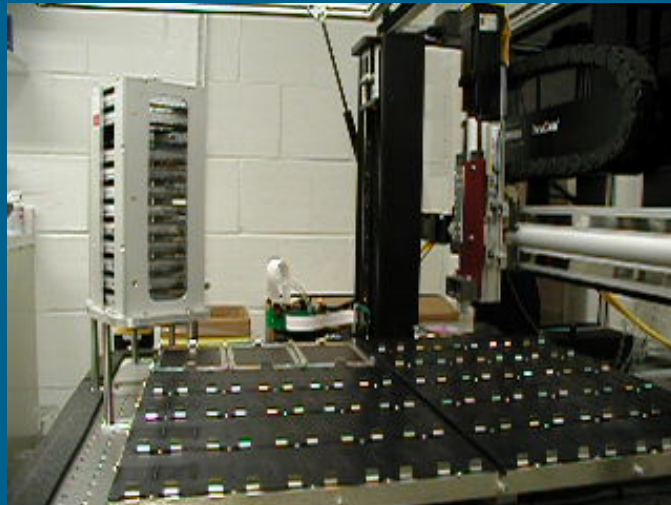

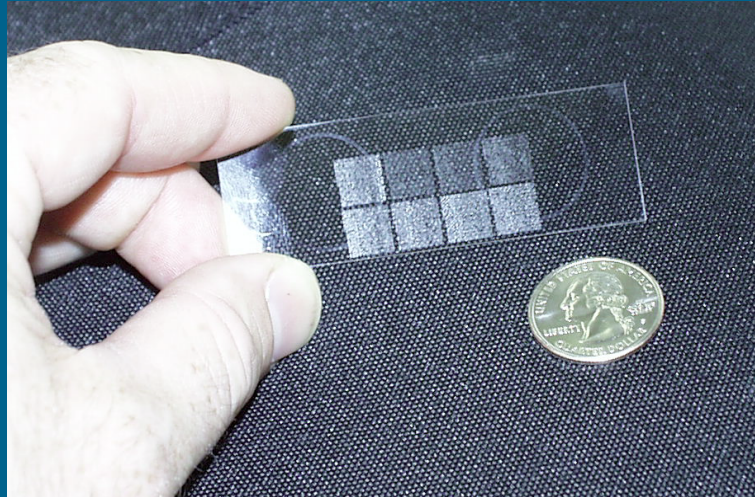

Microarray Manufacture

- **Printing**
- **Synthesis *in situ***
 - light directed
 - mechanically directed

LIGHT DIRECTED OLIGONUCLEOTIDE SYNTHESIS

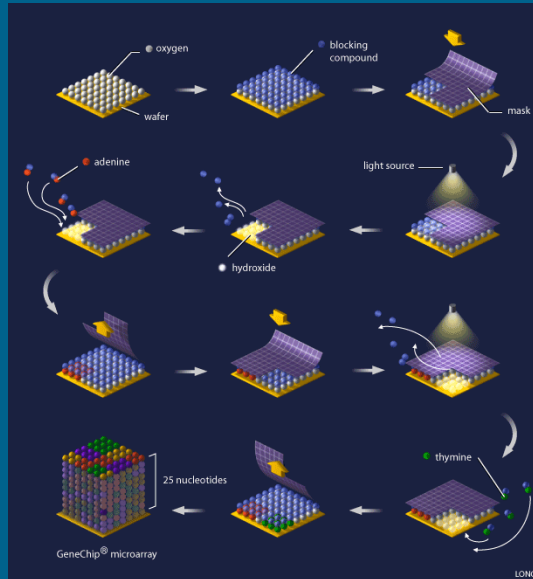

LIGHT DIRECTED OLIGONUCLEOTIDE SYNTHESIS

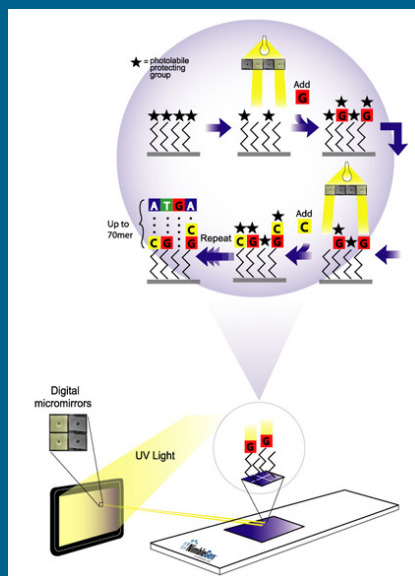

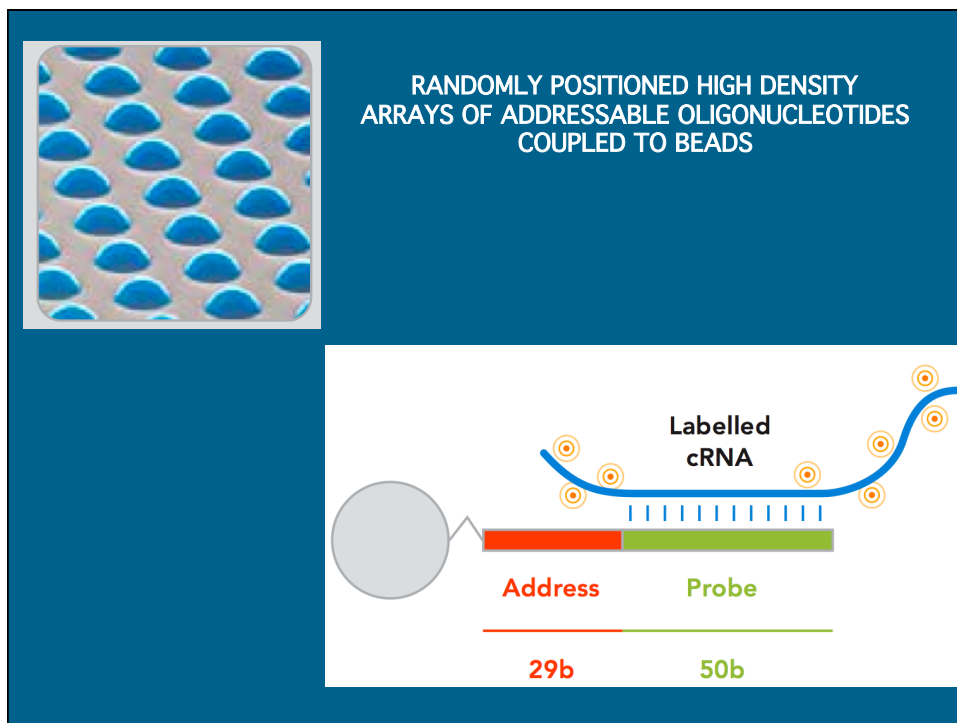
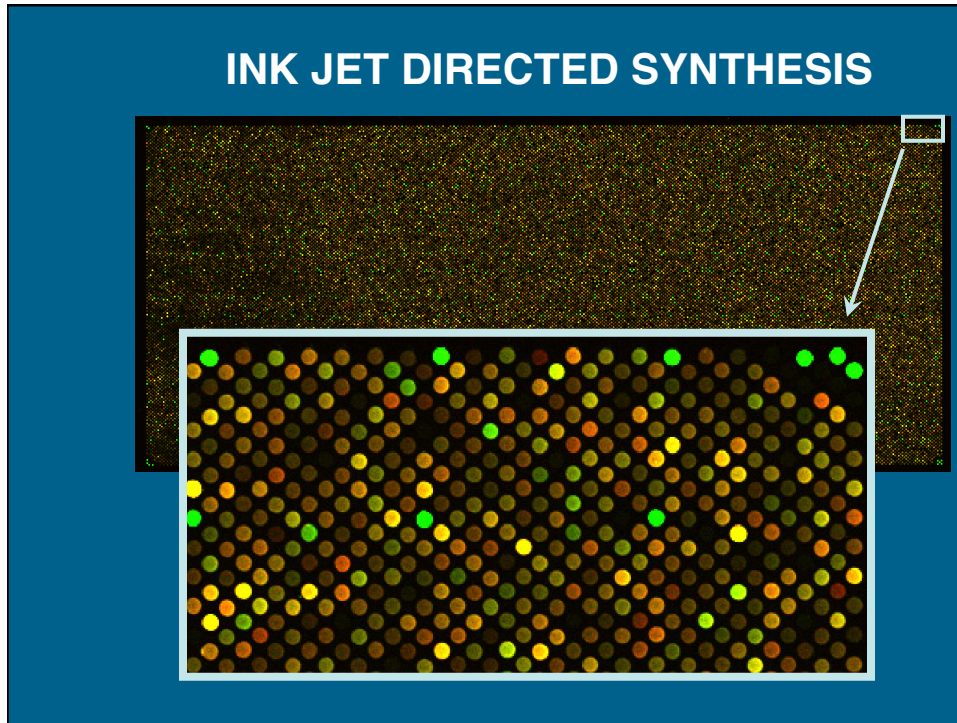

MICROARRAY READOUT

- **Determine quantity of target bound to each probe in a complex hybridization**
- **Must have high sensitivity, low background**
- **High spatial resolution essential**
- **Dual channel capability useful**
- **Fluorescent tags meet these demands**

Building Microarrays

- **Methods are applicable to any organism**
- **Sequenced organisms: oligonucleotides**
- **Unsequenced organisms: cloned DNAs**

Building Microarrays

- Density depends on specific technology
- Pin printing based methods limited to 40-50K
- In situ synthesis/bead arrays: millions
- Array design is linked to purpose.

Laboratory Essentials

- Arrays
 - Hybridization and Wash Equipment
 - Scanner
- Software for processing array image
- Software for data analysis and display
 - Bioinformatics collaborator

DNA Microarray Applications

- Gene Expression
- Comparative Genomic Hybridization
- Resequencing (SNPs)
- Transcription factor localization
- Chromatin/DNA modification



Reports on Microarray Data Quality

Nature Biotechnology

September 2006

Accessing Expression Data

- Individual Lab and Journal Sites; public databases

GEO

Currently contains
 expression data on
 592,204 sample sets.

<http://www.ncbi.nlm.nih.gov/geo/>

Accessing Expression Data

<http://www.ebi.ac.uk/microarray-as/ae/>

Publishing Expression Data

- MIAME standard

Minimum Information about a Microarray Experiment

- Format required by many journals
- Essential for database submissions

<http://www.mged.org/Workgroups/MIAME/miame.html>

STRATEGIES FOR SIGNAL GENERATION FROM mRNA

- Fluorochrome conjugated cDNA
- Ligand substituted nucleotides with secondary detection (e.g. biotin-streptavidin)
- Radioactivity
- RNA amplification

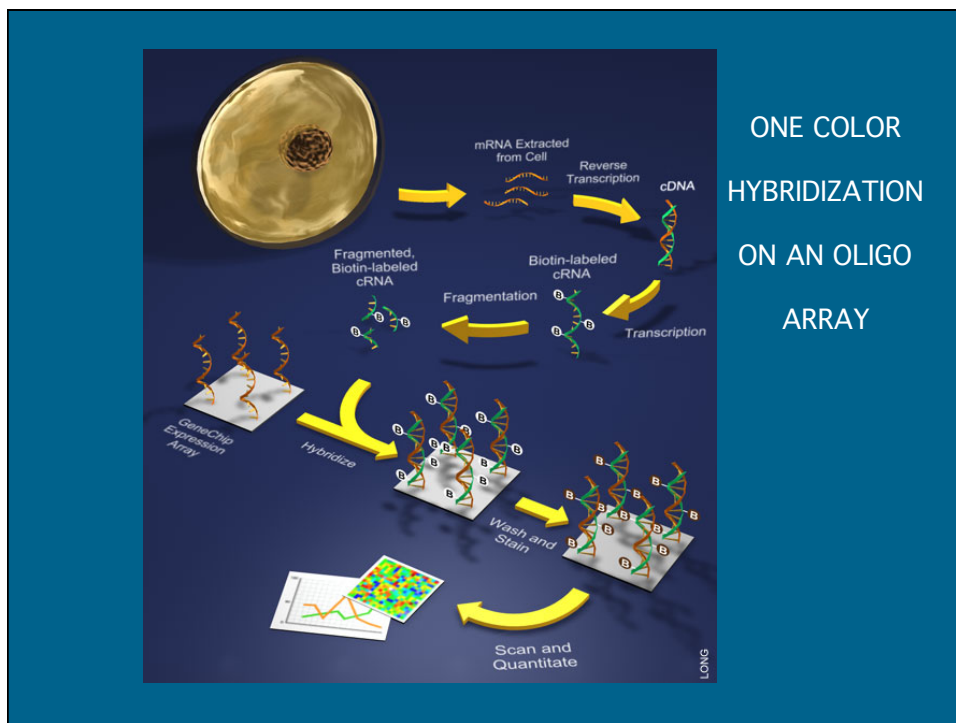
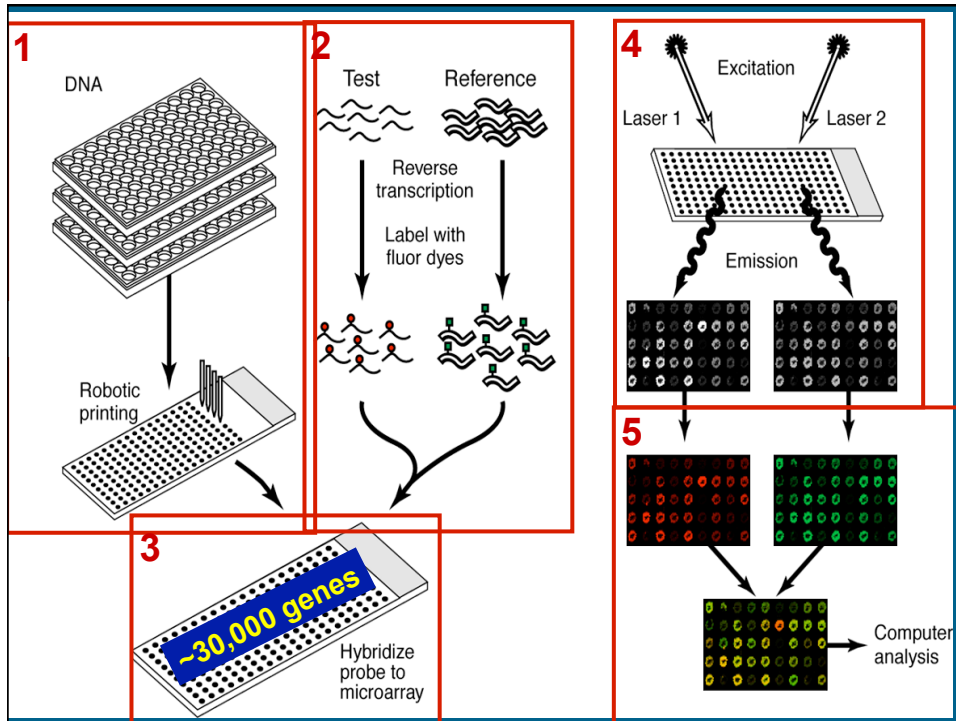

Output of Microarray Analysis:

expression ratio
(2 color hybridization)

or

relative expression level
(1 color hybridization)

**Both types of data can be analyzed with
essentially the same tools.**

APPLICATIONS OF EXPRESSION ARRAYS

•Expression profiling

Power arises from increasing sample number

•Direct comparisons (Induction)

Biological system critical

•Genome Annotation

A RECURRING PROBLEM

Disease Genes

Transcription factors

Hormones/growth factors

Drugs

Toxins

Infectious agents

Physical agents

siRNA's



?????

Downstream Genes

•Direct targets

•Indirect targets

EXPRESSION DATA ANALYSIS

•Large amount of data

Examples: 200 samples x 25000 probes= 5,000,000 data points

•Requires analysis and visualization tools

Overview of microarray bioinformatics:
Simon R, Curr Opin Biotechnol. 2008 Feb;19(1):26-9.

EXPRESSION DATA ANALYSIS

- Check quality of individual experiments

- Preprocessing

- Normalization

- Remove genes which are not accurately measured

- Remove genes which are similarly expressed in all samples

- Unsupervised Clustering

- Supervised Clustering

MICROARRAY SCATTER PLOT

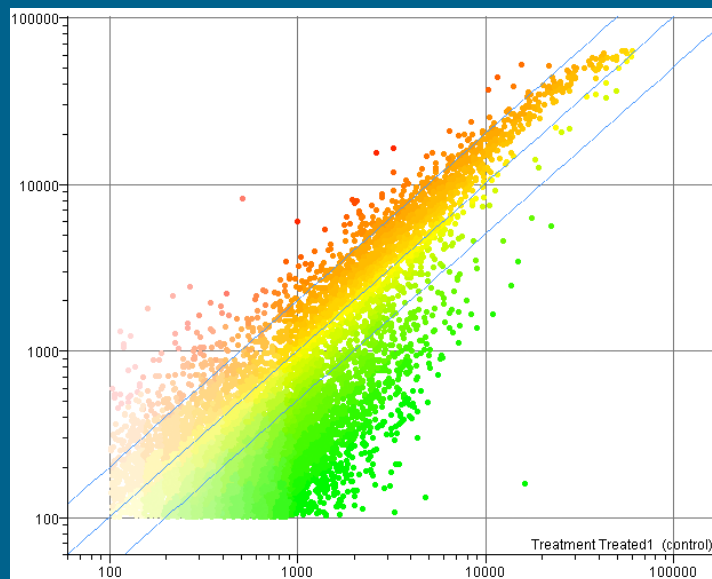

Unsupervised Clustering

How do genes and samples organize into groups?

Powerful method of data display.

Does not prove the validity of groups.

- Clustered Samples Are Biologically Similar
 - Clusters of Co-expressed genes
 - May be functionally related
 - May be enriched for pathways

UNSUPERVISED CLUSTERING IS BASED ON A GLOBAL SIMILARITY METRIC

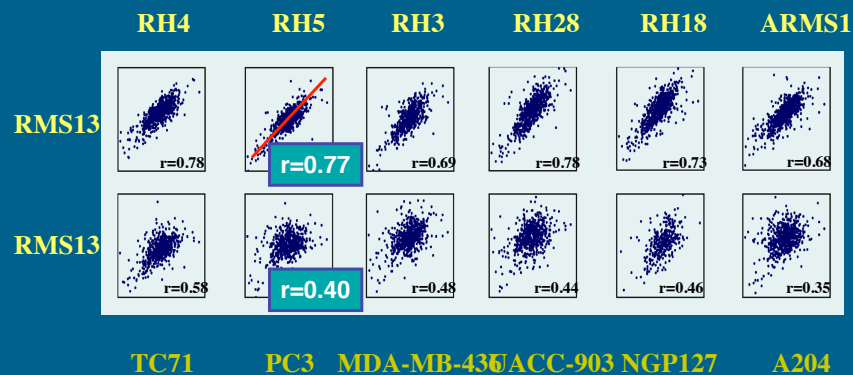

Khan et al. Can Res 58:5009

Matrix of Pearson Correlation Coefficients Distance Map

	RH3	RH4	RH5	RMS13	RH18	RH28	A204	NGP127	TC71	UACC-903	MDA-MB-436	PC3	
ARMS1	0.547	0.606	0.726	0.683	0.634	0.615	0.307	0.39	0.498	0.426	0.417	0.314	
RH3		0.759	0.736	0.69	0.606	0.807	0.444	0.565	0.566	0.391	0.452	0.403	
RH4			0.771	0.778	0.672	0.74	0.441	0.486	0.558	0.488	0.555	0.476	
RH5				0.769	0.667	0.751	0.37	0.486	0.607	0.43	0.532	0.447	
RMS13					0.731	0.746	0.35	0.463	0.582	0.446	0.475	0.404	
RH18						0.703	0.274	0.281	0.549	0.389	0.405	0.36	
RH28							0.417	0.493	0.644	0.479	0.478	0.42	
A204								0.426	0.361	0.398	0.368	0.377	
NGP127									0.352	0.241	0.371	0.368	
TC71										0.46	0.456	0.472	
UACC-903											0.507	0.538	
MDA-MB-436												0.662	
PC3													0.662

Hierarchical Clustering Dendrogram

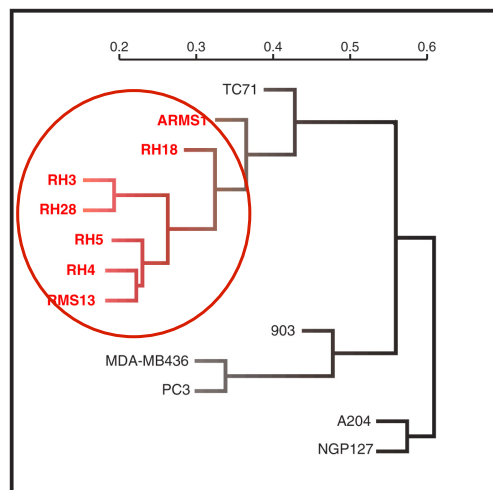

DATA DISPLAY BY MULTIDIMENSIONAL SCALING

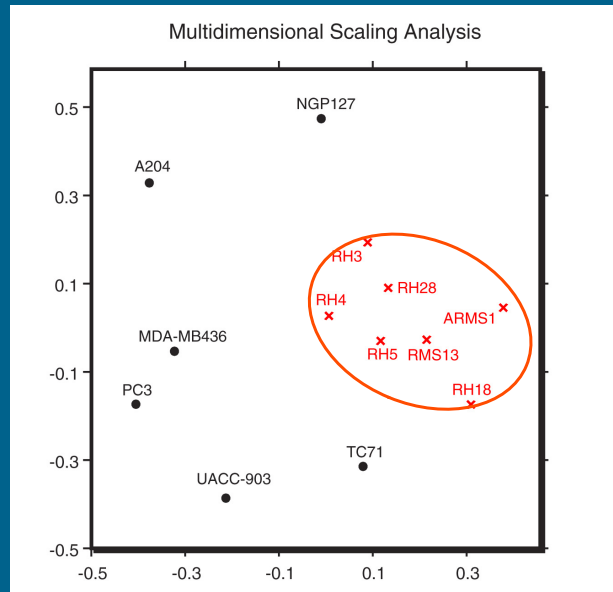

MDS PLOT

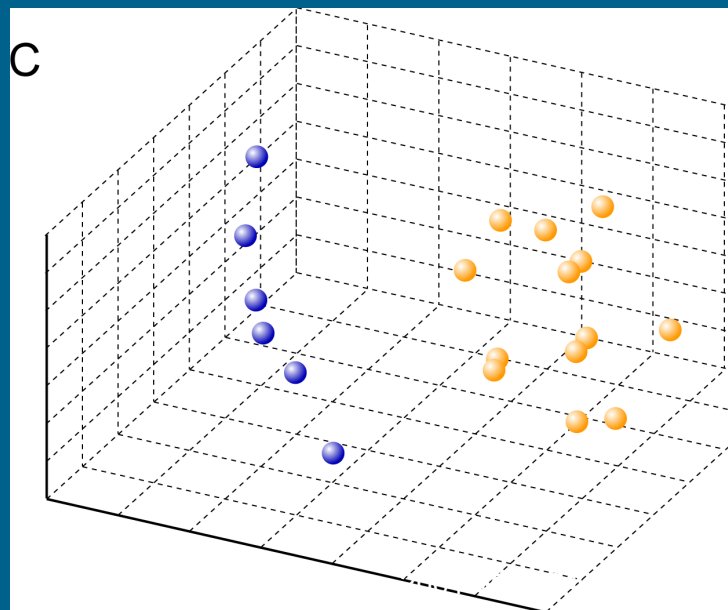

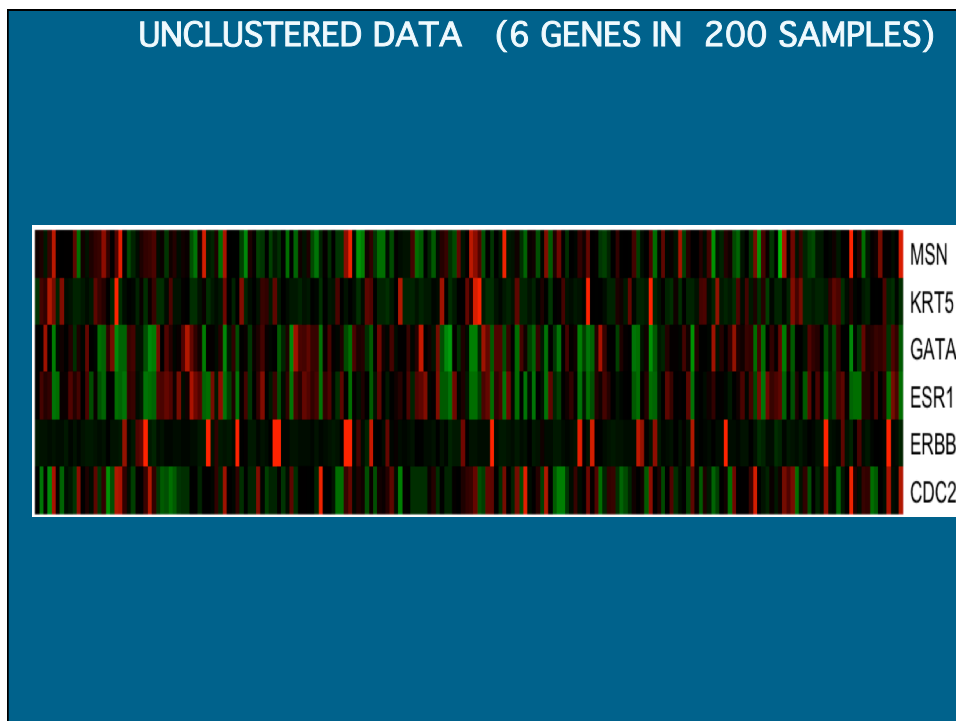
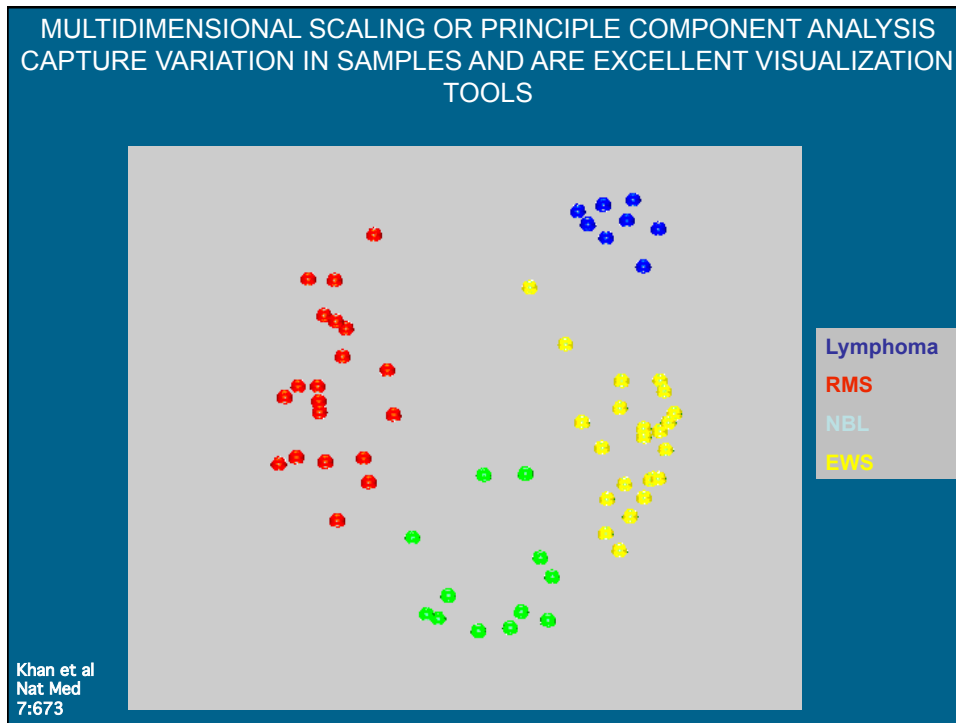



CLUSTERING GENES AND SAMPLES

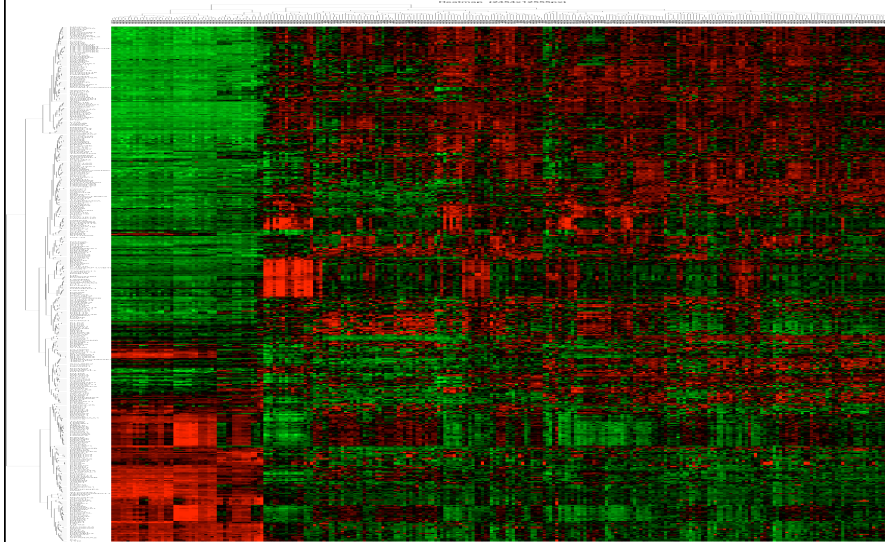

DATA FROM GEO

Supervised Clustering

What genes distinguish samples in selected groups from each other?

- Choice of groups can be based on any known property of the samples.
- Many possible underlying methods: t-test or F-statistic frequently used.
- Output includes ranked gene list.
- Leads to the development of classifiers which can be applied to unknown samples.
- Must address the problem of false discovery due to multiple comparisons and discrepancy between sample/gene numbers.

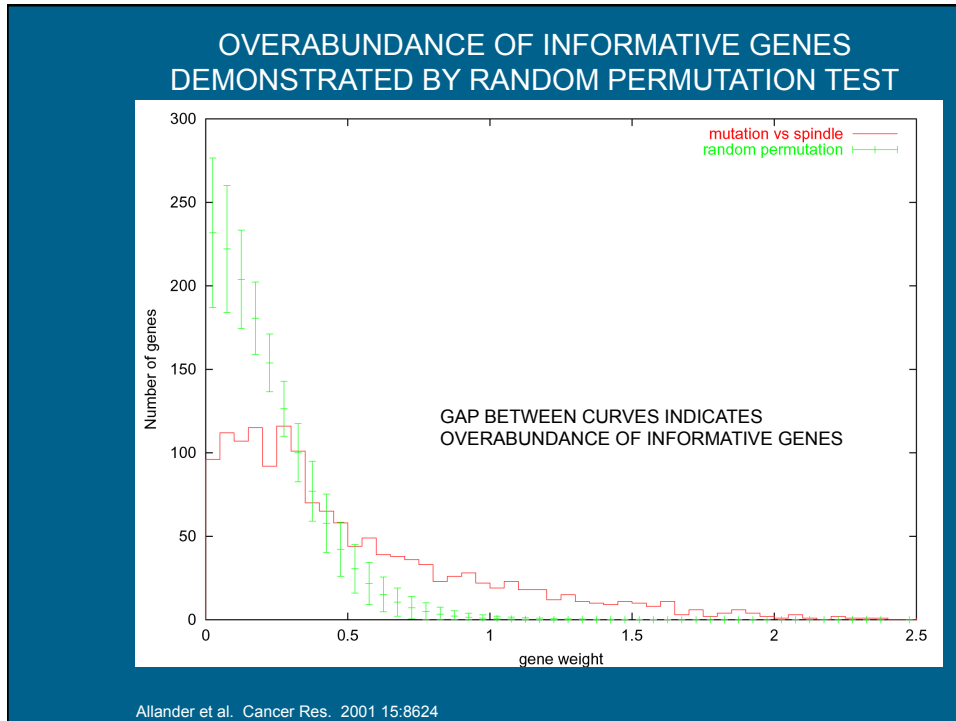

SUPERVISED METHODS GENERATE RANKED GENE LISTS

TOP DISCRIMINATORS FOR GIST

<u>Rank</u>	<u>Weight</u>	<u>Gene Description</u>
1	7.55575	<u>v-kit sarcoma oncogene</u>
2	6.48306	G coupled receptor 20
3	4.60057	G coupled receptor 20
4	4.51681	annexin A3
5	3.33057	KIAA0353 protein
6	3.31734	phosphofructokinase
7	2.95095	DKFZP434N161 n
8	2.83435	protein kinase C, theta
9	2.79721	butyrylcholinesterase
10	2.72752	annexin A3

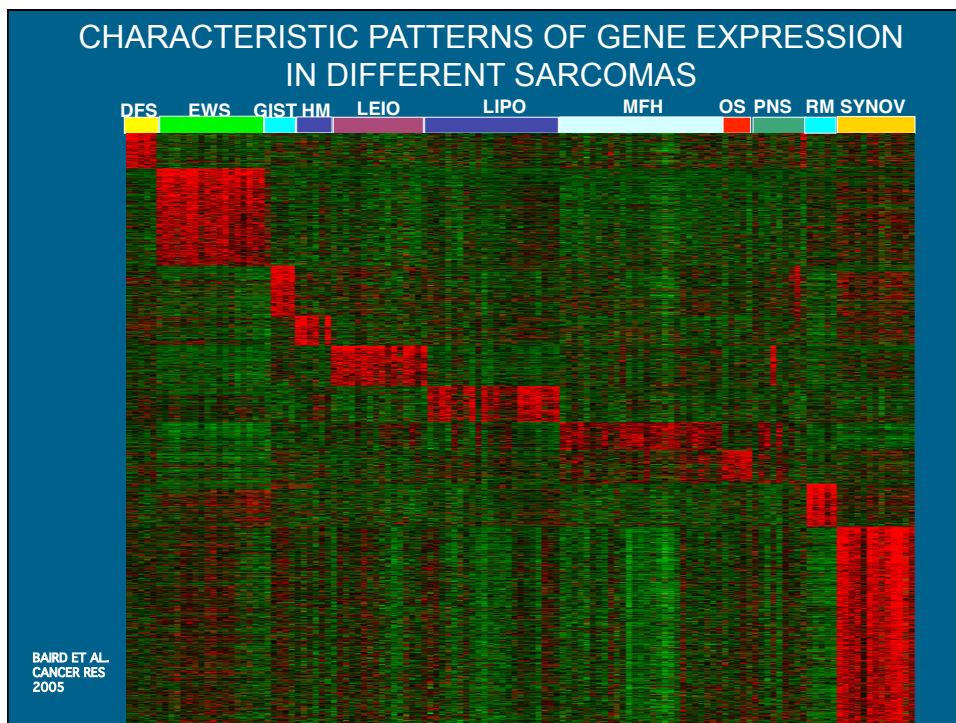
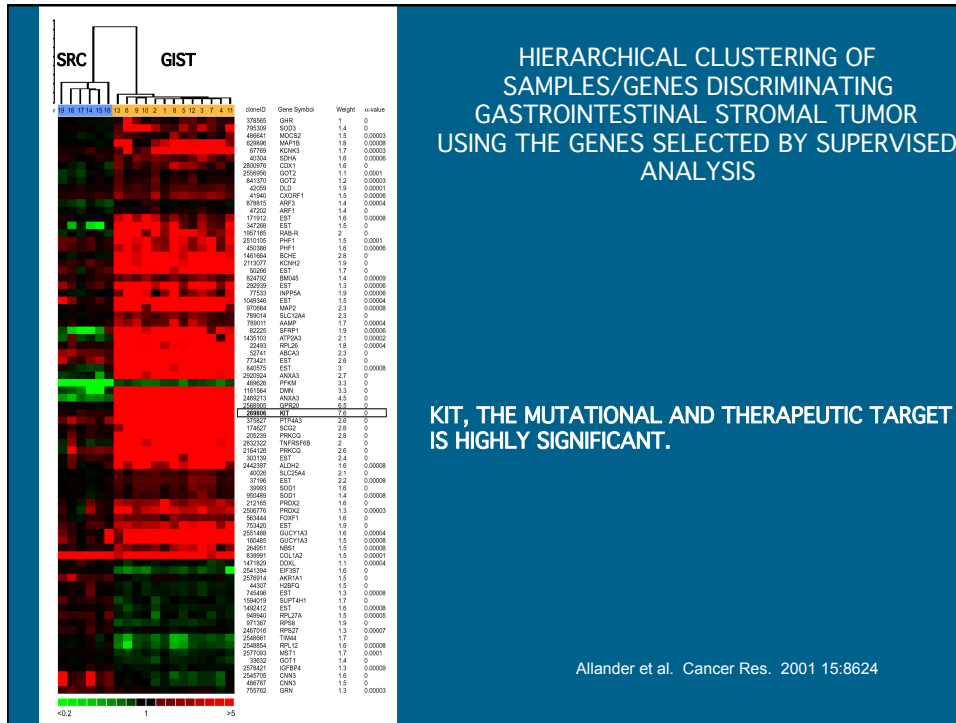

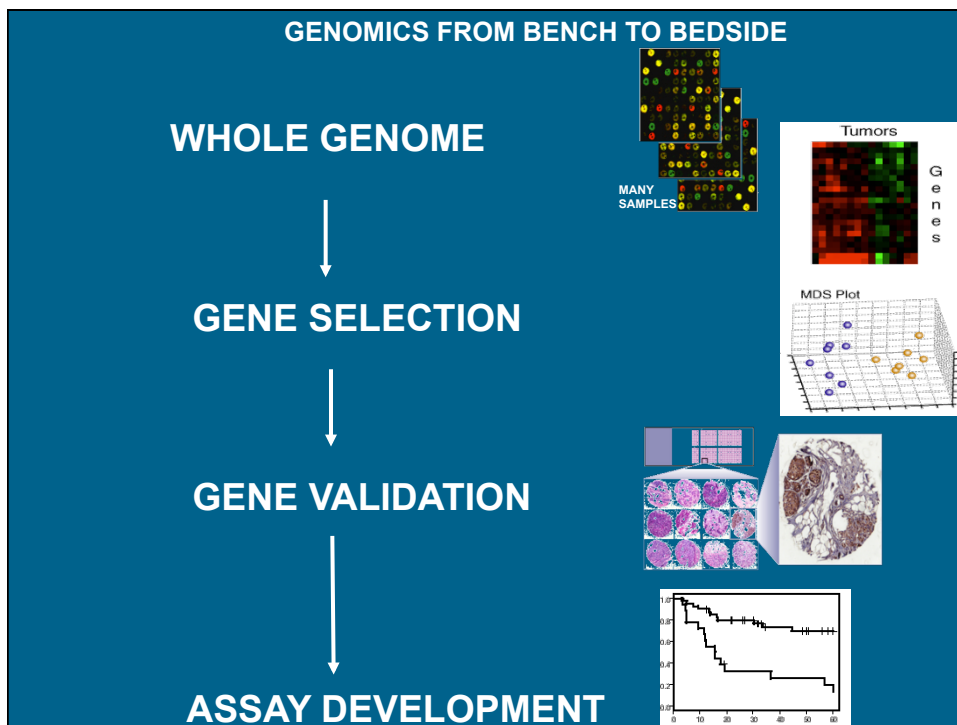

**SIGNAL STRENGTH VARIES IN
TISSUE PROFILING EXPERIMENTS**

**THE MOST INTERESTING QUESTIONS
TEND TO BE ASSOCIATED WITH
WEAKER SIGNAL.**

CONSIDER A SAMPLE SET

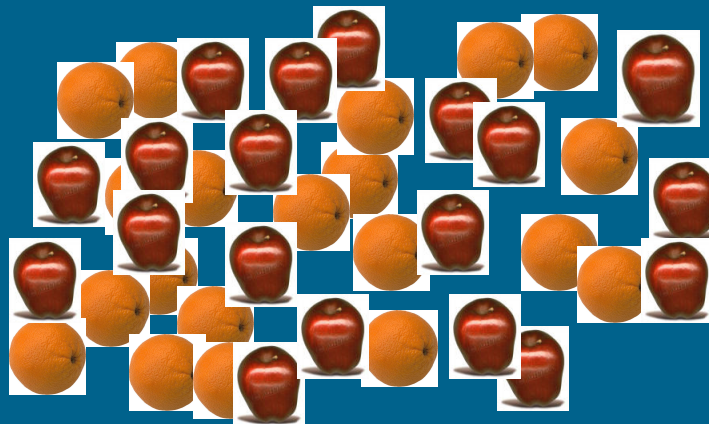

CONSIDER A SAMPLE SET

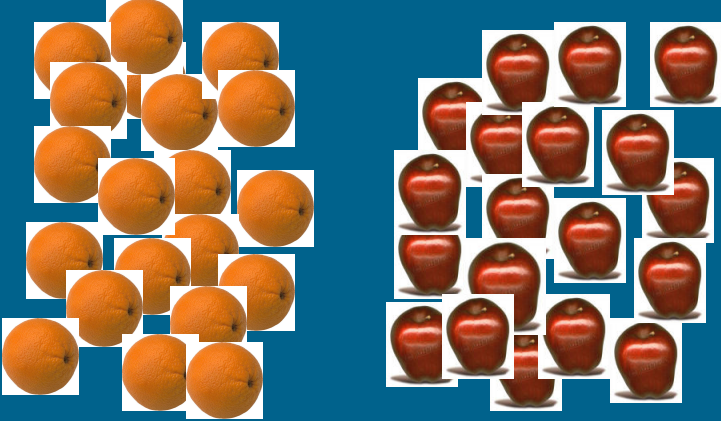

THESE ARE EASY TO DISTINGUISH BY ONE MEASUREMENT PER INDIVIDUAL.

CONSIDER A SAMPLE SET

TUMORS

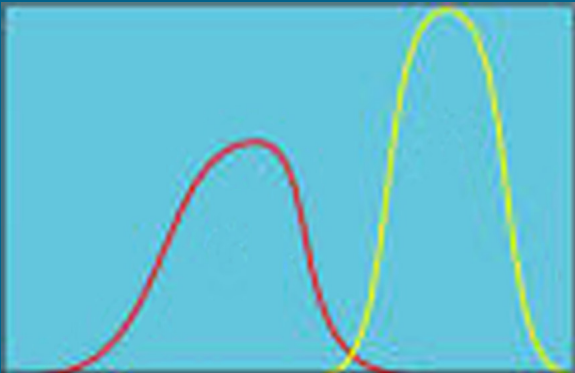

EXPRESSION LEVEL
(HIGHLY INFORMATIVE GENE)

THESE ARE EASY TO DISTINGUISH BY ONE MEASUREMENT PER INDIVIDUAL.

CONSIDER A SAMPLE SET



THESE ARE HARDER TO DISTINGUISH. REQUIRE MORE THAN ONE MEASUREMENT PER INDIVIDUAL.

CONSIDER A SAMPLE SET

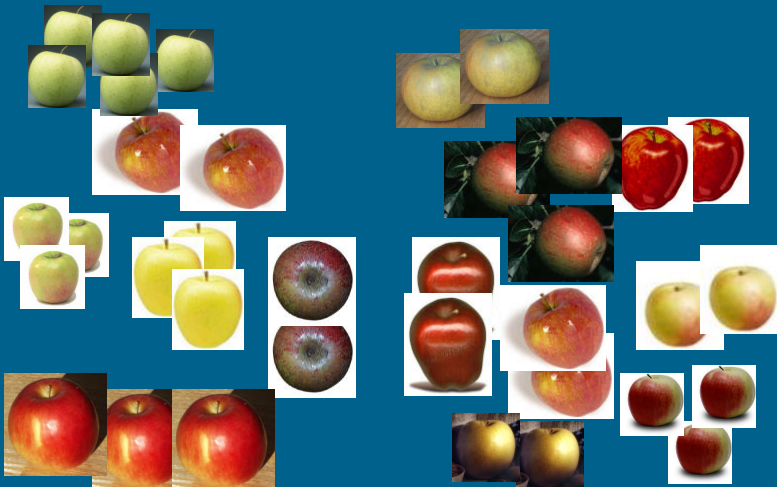

THESE ARE HARDER TO DISTINGUISH. REQUIRE MORE THAN ONE MEASUREMENT PER INDIVIDUAL.

CONSIDER A SAMPLE SET

TUMORS

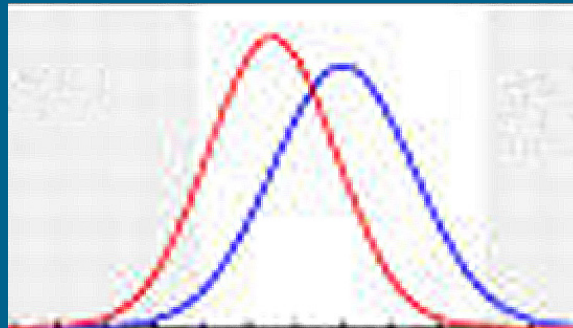

EXPRESSION LEVEL
(POORLY INFORMATIVE GENE)

THESE ARE HARDER TO DISTINGUISH. REQUIRE
MORE THAN ONE MEASUREMENT PER INDIVIDUAL.

WE CAN TELL APPLES
FROM ORANGES.

CAN WE DISTINGUISH
DIFFERENT KINDS OF APPLES?

A CONTINUUM OF POSSIBLE OUTCOMES FROM MICROARRAY RESEARCH

- SOME FEATURES WILL SEPARATE TUMORS EASILY INTO CLASSES, AND MIGHT BE REDUCED TO SINGLE GENE TESTS, IMPLEMENTED IN A CONVENTIONAL FASHION.
- OTHERS WILL BE MORE DIFFICULT, AND REQUIRE MULTIPLE GENE MEASUREMENTS.
- MANY CLINICALLY RELEVANT FEATURES APPEAR TO FALL WITHIN THIS DIFFICULT GROUP.

A CONTINUUM OF POSSIBLE OUTCOMES FROM MICROARRAY RESEARCH

- SOME GENES WILL SHOW DIFFERENCES BETWEEN GROUPS OF SAMPLES BY CHANCE ALONE.
- THERE MAY BE NO ONE GENE WHICH SEPARATES GROUPS RELIABLY.
- FIND THE MOST INFORMATIVE GENES AND USE THEM IN COMBINATION .

RISK OF OVERFITTING IN CLINICAL STUDIES WITH SMALL SAMPLE SETS

NEED INDEPENDENT VALIDATION SETS.

J Natl Cancer Inst. 2007 Jan 17;99(2):147-57.

**Critical review of published microarray studies for cancer
outcome and guidelines on statistical analysis and reporting.
Dupuy A, Simon RM.**

BACKGROUND: Both the validity and the reproducibility of microarray-based clinical research have been challenged. There is a need for critical review of the statistical analysis and reporting in published microarray studies that focus on cancer-related clinical outcomes. **METHODS:** Studies published through 2004 in which microarray-based gene expression profiles were analyzed for their relation to a clinical cancer outcome were identified through a Medline search followed by hand screening of abstracts and full text articles. Studies that were eligible for our analysis addressed one or more outcomes that were either an event occurring during follow-up, such as death or relapse, or a therapeutic response. We recorded descriptive characteristics for all the selected studies. A critical review of outcome-related statistical analyses was undertaken for the articles published in 2004. **RESULTS:** Ninety studies were identified, and their descriptive characteristics are presented. Sixty-eight (76%) were published in journals of impact factor greater than 6. A detailed account of the 42 studies (47%) published in 2004 is reported. **Twenty-one (50%) of them contained at least one of the following three basic flaws:** 1) in outcome-related gene finding, an unstated, unclear, or inadequate control for multiple testing; 2) in class discovery, a spurious claim of correlation between clusters and clinical outcome, made after clustering samples using a selection of outcome-related differentially expressed genes; or 3) in supervised prediction, a biased estimation of the prediction accuracy through an incorrect cross-validation procedure. **CONCLUSIONS:** The most common and serious mistakes and misunderstandings recorded in published studies are described and illustrated. Based on this analysis, a proposal of guidelines for statistical analysis and reporting for clinical microarray studies, presented as a checklist of "Do's and Don'ts," is provided.

MICROARRAY STUDIES GENERATE ORGANIZED LIST OF GENES

- Often cryptic and hard to interpret.
- Hypothesis generating, but this is often rather subjective.
- Seldom provide strong evidence for a specific mechanism.
- Expression data is intrinsically limited.

GETTING BEYOND GENE LISTS

- Optimal use of gene annotations.
 - Gene Ontology
(<http://david.abcc.ncifcrf.gov/>)
- Optimizing use of public data.
 - GEO, ARRAY EXPRESS, ACADEMIC DATA
 - GENE SIGNATURE BASED METHODS (Gene Set Enrichment Analysis).

GSEA
 Gene Set Enrichment Analysis

GSEA Home Downloads Molecular Signatures Database Documentation Contact

MSigDB Home
 About Collections
 Browse Gene Sets
 Search Gene Sets
 Investigate Gene Sets
 View Gene Families
 Help

MSigDB
 Molecular Signatures Database

Molecular Signatures Database v3.0

Overview
 The Molecular Signatures Database (MSigDB) is a collection of annotated gene sets for use with GSEA software. From this web site, you can

- Search for gene sets by keyword.
- Browse gene sets by name or collection.
- Examine a gene set and its annotations. See, for example, the *ANGIOGENESIS* gene set page.
- Download gene sets.
- Investigate gene sets:
 - Compute overlaps between your gene set and gene sets in MSigDB.
 - Categorize members of a gene set by gene families.
 - View the expression profile of a gene set in any of the three provided public expression compendia.

Registration
 Please register to download the GSEA software and view the MSigDB gene sets. After registering, you can log in at any time using your email address. Registration is free. Its only purpose is to help us track usage for reports to our funding agencies.

Current Version
 MSigDB database v3.0 updated Sep 9, 2010. Release notes. GSEA/MSigDB web site v3.02 released Oct 7, 2011

Contributors
 The MSigDB is maintained by the GSEA team with the support of our MSigDB Scientific Advisory Board. We also welcome and appreciate contributions to this shared resource and encourage users to submit their gene sets to genesets@broadinstitute.org. Our thanks to our many contributors.

Funded by: National Cancer Institute, National Institutes of Health, National Institute of General Medical Sciences.

Collections
 The MSigDB gene sets are divided into five major collections:

- C1 positional gene sets** for each human chromosome and each cytogenetic band.
- C2 curated gene sets** from online pathway databases, publications in PubMed, and knowledge of domain experts.
- C3 motif gene sets** based on conserved cis-regulatory motifs from a comparative analysis of the human, mouse, rat and dog genomes.
- C4 computational gene sets** defined by expression neighborhoods centered on 380 cancer-associated genes.
- C5 GO gene sets** consist of genes annotated by the same GO terms.

Citing the MSigDB
 To cite your use of the Molecular Signatures Database (MSigDB), please reference Subramanian, Tamayo, et al. (2005), PNAS 102, 15545-15550) and also the source for the gene set as listed on the gene set page.

Contact Us
 If you have comments or questions, please contact us: gsea@broadinstitute.org.

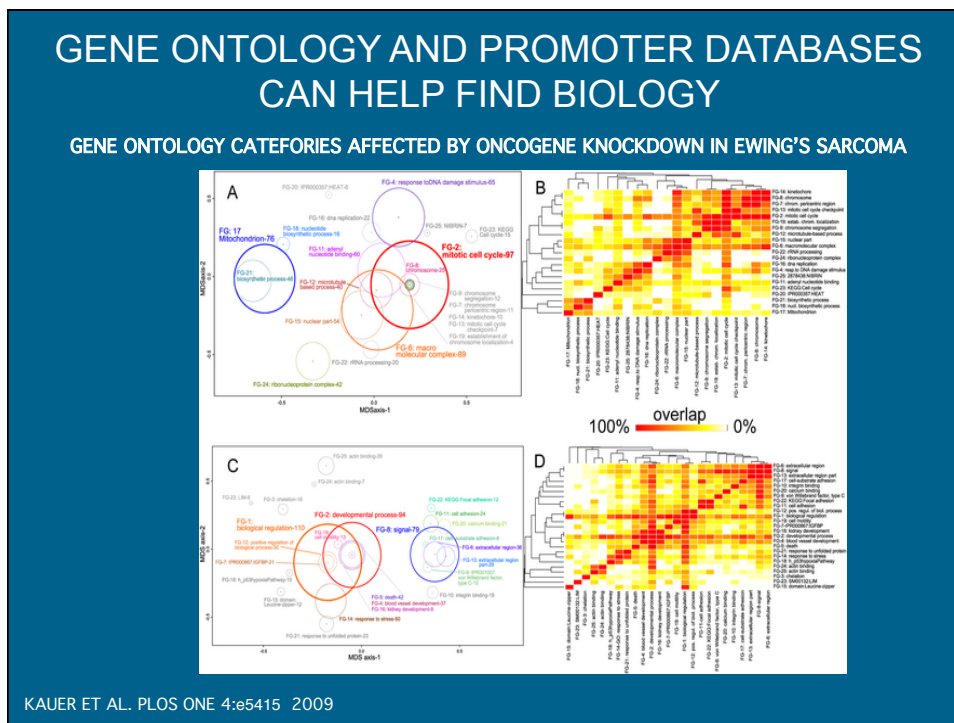

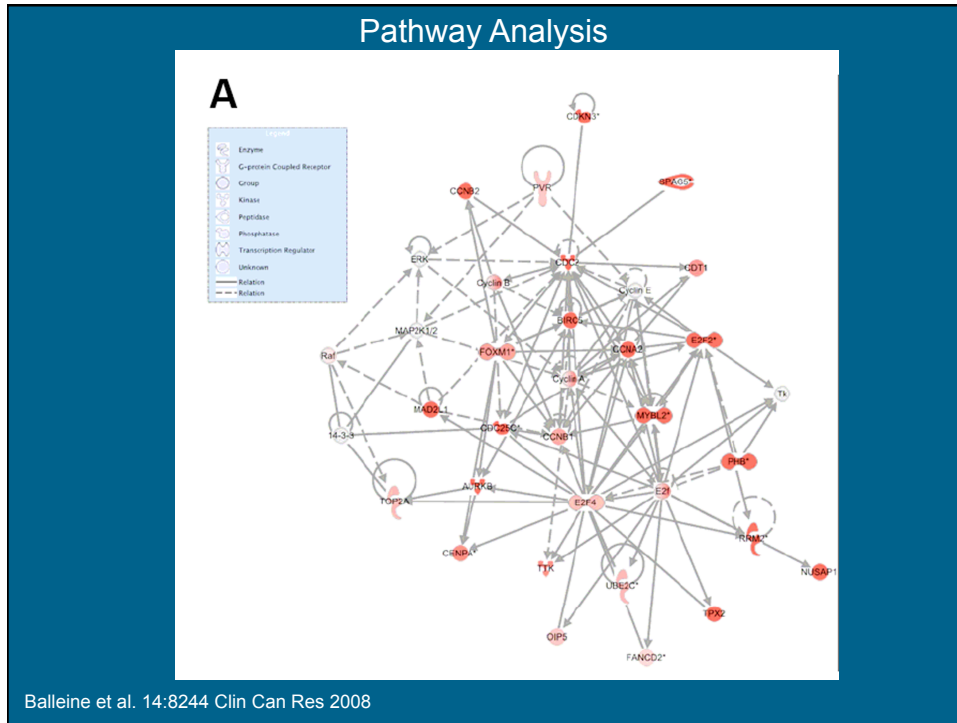

WHAT TO LOOK FOR IN CLINICAL
CORRELATIVE STUDIES
USING MICROARRAYS

- WELL DEFINED QUESTION AND PATIENT SAMPLE.
- HIGH QUALITY ARRAY MEASUREMENTS
(HARD TO ASSESS WITHOUT REFERENCE TO
PRIMARY DATA---SHOULD BE MADE PUBLIC).
- APPROPRIATE AND RIGOROUS STATISTICAL
ANALYSIS OF ARRAY DATA.
- FORMAL CLASSIFIER THAT CAN BE APPLIED TO
NEW SAMPLES.
- VALIDATION SAMPLE SET.

WHAT TO LOOK FOR IN CLINICAL
CORRELATIVE STUDIES
USING MICROARRAYS

- **GOAL SHOULD BE TO SEEK AND
VALIDATE CLINICALLY RELEVANT
SIGNATURES WITHIN DEFINED
PATIENT GROUPS FOR WHICH NO
CURRENT FEATURES ADEQUATELY
ANSWER THE CLINICAL QUESTION
POSED.**

EXPRESSION PROFILING IN THE CLINIC?

PROBLEMS:

- SPECIALIZED TECHNOLOGY
- RNA IS UNSTABLE
- FROZEN TISSUE NOT PART OF USUAL OR SAMPLE FLOW

EXPRESSION PROFILING IN THE CLINIC?

OPTIONS:

- REFERENCE LABORATORIES
 - RNA PRESERVATIVES
 - USE OF PARAFFIN EMBEDDED MATERIALS.
- USE ARRAYS FOR DISCOVERY TO EXTRACT SIGNATURES WHICH CAN BE ASSAYED WITH ALTERNATIVE TECHNOLOGIES.

FDA APPROVED TESTS FOR BREAST CANCER BASED ON EXPRESSION STUDIES

70 GENE MICROARRAY SIGNATURE

Van de Vijver et al
 NEJM 347:1999 .

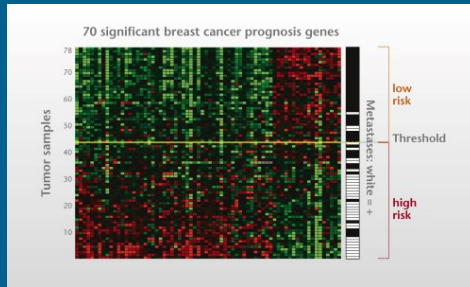

Multigene RT-PCR Signature

Paik et al NEJM 351:2817

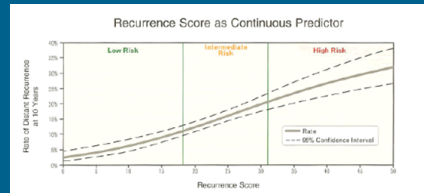

THEY'RE EVERYWHERE!



<http://pathogenomics.bham.ac.uk/hts/>

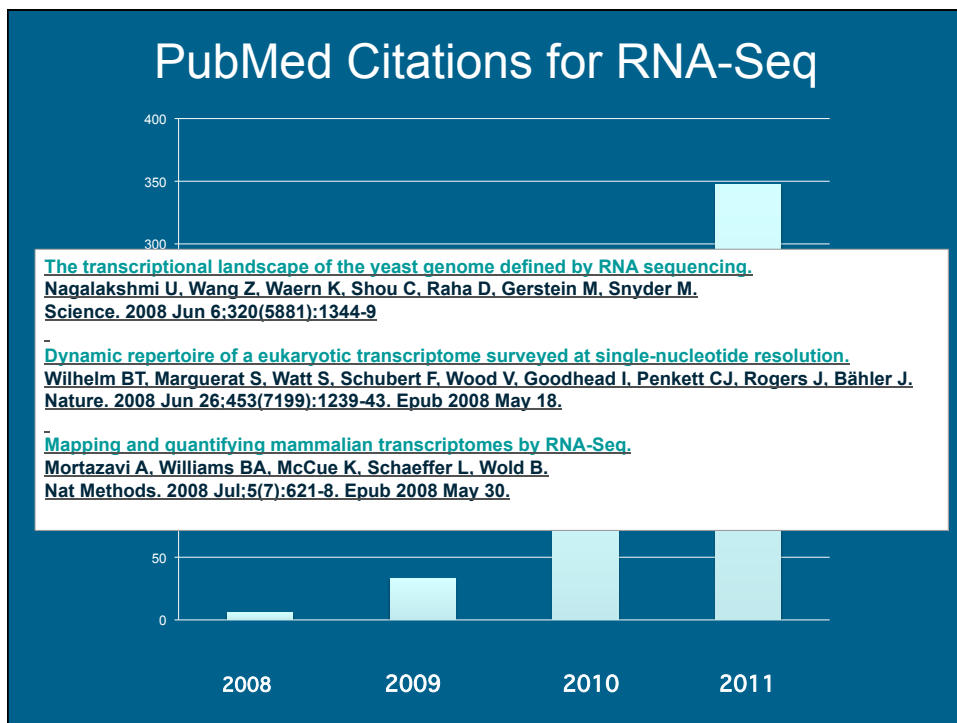
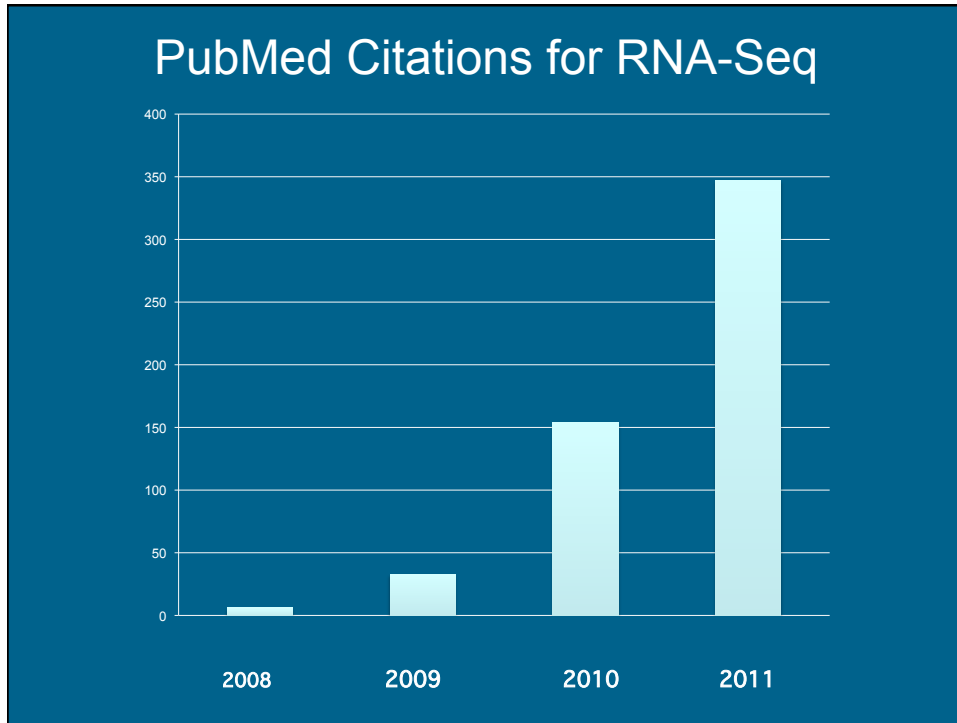

ARRAYS VS. NEXT GENERATION SEQUENCING

- ARRAY TECHNOLOGIES MEASURE THE RELATIVE ABUNDANCE OF NUCLEIC ACIDS OF DEFINED SEQUENCE IN A COMPLEX MIXTURE.
- SEQUENCING CAN ACCOMPLISH THE SAME THING.

ARRAYS VS. NEXT GENERATION SEQUENCING

MICROARRAYS

- READILY AVAILABLE MATURE TECHNOLOGY
- RELATIVELY INEXPENSIVE
- EFFECTIVE WITH VERY COMPLEX SAMPLES
- HUNDREDS OF SAMPLES PRACTICAL
- CAN TARGET SUBSET OF GENOME

SEQUENCING

- WHOLE GENOME DATA
- RELATIVELY UNIFORM ANALYTICAL PIPELINE
- FREE OF HYBRIDIZATION ARTIFACTS
- POSSIBILITY OF ONE PLATFORM FOR ALL APPLICATIONS

PROS

CONS

- REQUIRE PLATFORM AND APPLICATION SPECIFIC DATA PROCESSING
- PRONE TO PLATFORM SPECIFIC ARTIFACTS
- MANY SOURCES OF NOISE
- WHOLE GENOME STUDIES GENERALLY REQUIRE MANY ARRAYS, INCREASING SAMPLE REQUIREMENTS AND COMPLICATING ANALYSIS

- IMMATURE TECHNOLOGY
- TECHNOLOGY SPECIFIC ARTIFACTS
- RESOURCE INTENSIVE
- COMPUTATIONALLY INTENSIVE
- NO STANDARD ANALYSIS YET
- LOWER SAMPLE THROUGHPUT

MICROARRAYS

SEQUENCING

MEASURING GENE EXPRESSION BY RNA SEQUENCING

ADVANTAGES

- RNA SEQUENCE VARIATIONS DETECTED AT SINGLE NUCLEOTIDE RESOLUTION
 - ALLELE SPECIFIC EXPRESSION
 - MUTATIONS
 - RNA EDITING
- RNA STRUCTURE: SPLICING, START SITES, TERMINATION SITES; REARRANGEMENTS
- DETECTED SIGNALS ARE RELATIVELY UNAMBIGUOUS; POTENTIAL TO OUTPERFORM MICROARRAY
- DE NOVO ASSEMBLY IS POSSIBLE

MEASURING GENE EXPRESSION BY RNA SEQUENCING

- FULL LENGTH mRNA----RNA-Seq
- TAG SEQUENCING (SAGE-LIKE)
- PolyA vs. Total (ribosomal depleted)
- Strand specific vs. non-strand specific
- miRNA sequencing
- lincRNA sequencing

MEASURING GENE EXPRESSION BY RNA SEQUENCING: PROS AND CONS

LIMITATIONS

- LOWER LIMIT OF DETECTION IS CONSTRAINED BY THE mRNA ABUNDANCE DISTRIBUTION AND THE NUMBER OF ALIGNED READS PER SAMPLE.
- LARGE SAMPLE NUMBERS DIFFICULT TO ACHIEVE, EXCEPT IN TAG MODE.
- SOFTWARE IS STILL DEVELOPMENTAL: REQUIRES SOPHISTICATED BIOINFORMATICS COLLABORATION. [For review see Pepke et al. Nat Methods 6:S22 (2009)]
- COMPUTATIONAL HARDWARE REQUIREMENTS ARE SUBSTANTIAL
- LIBRARY PREP METHODS EVOLVING
- DATA MAY NOT MERGE WELL IF NOT GENERATED WITH THE SAME METHOD

MEASURING GENE EXPRESSION BY RNA SEQUENCING

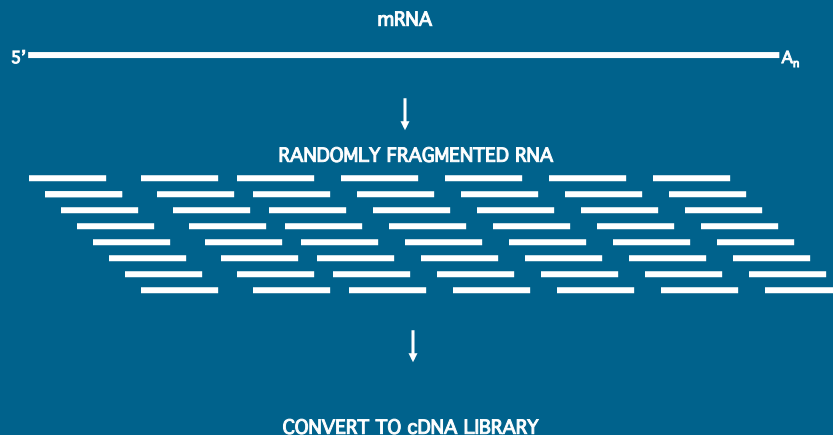

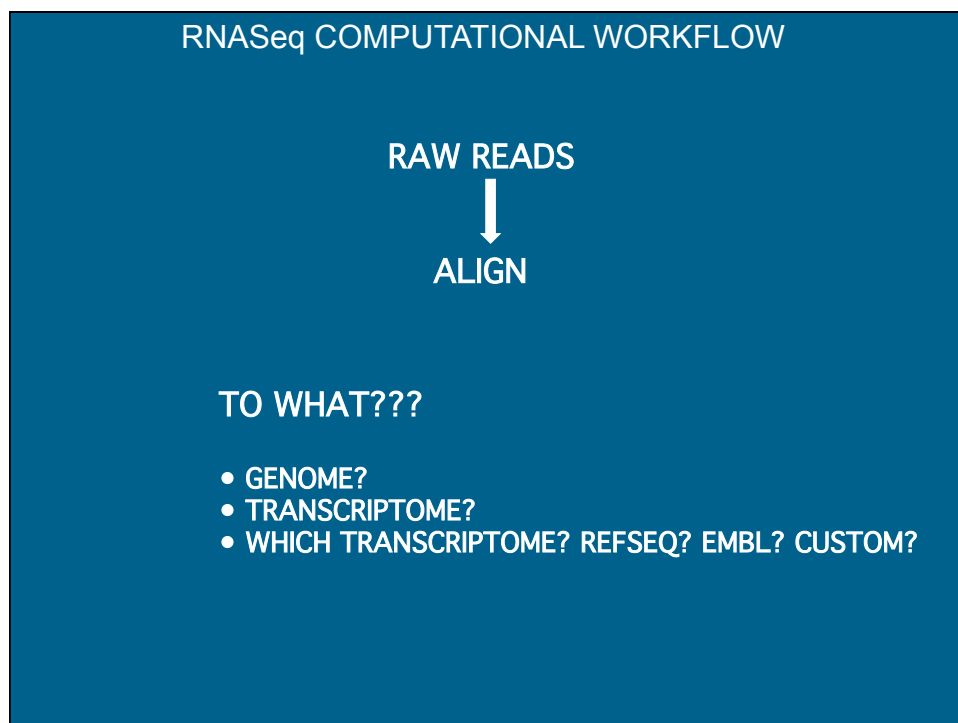
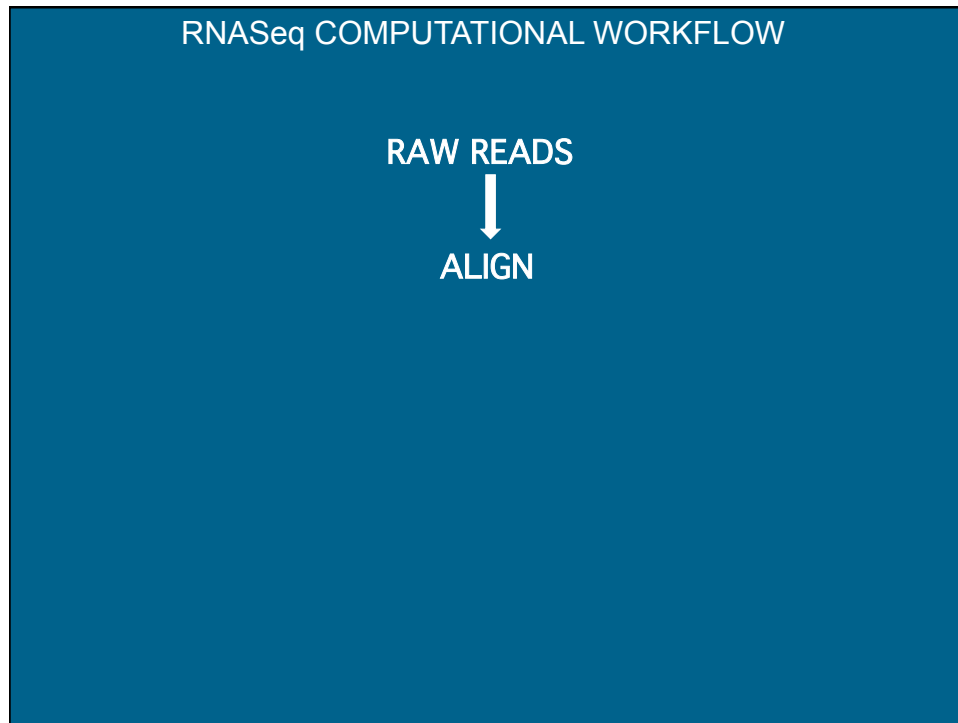

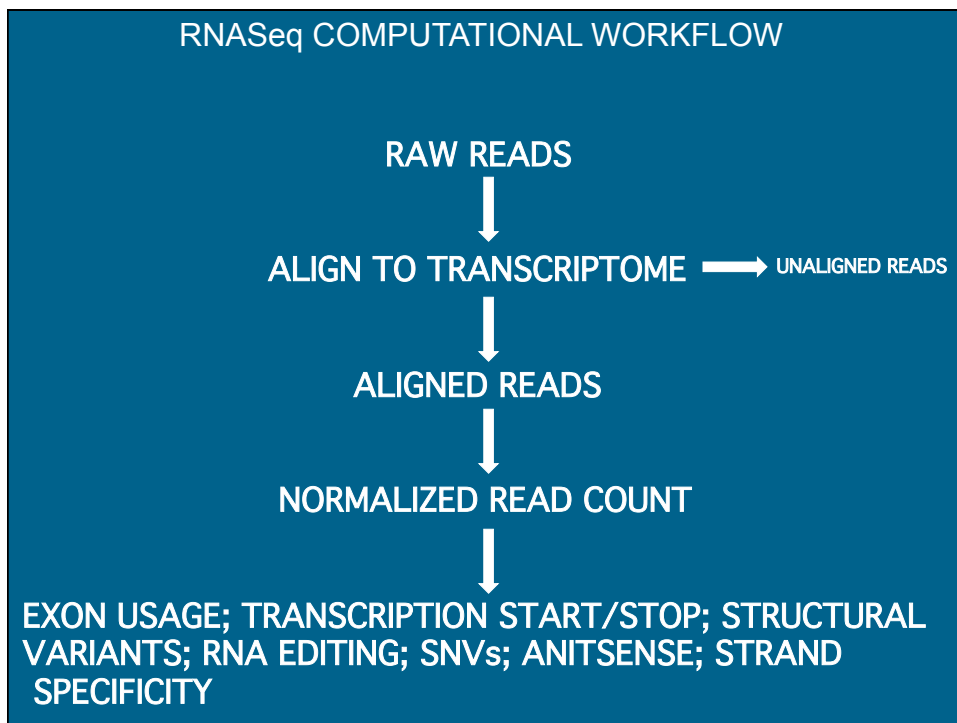
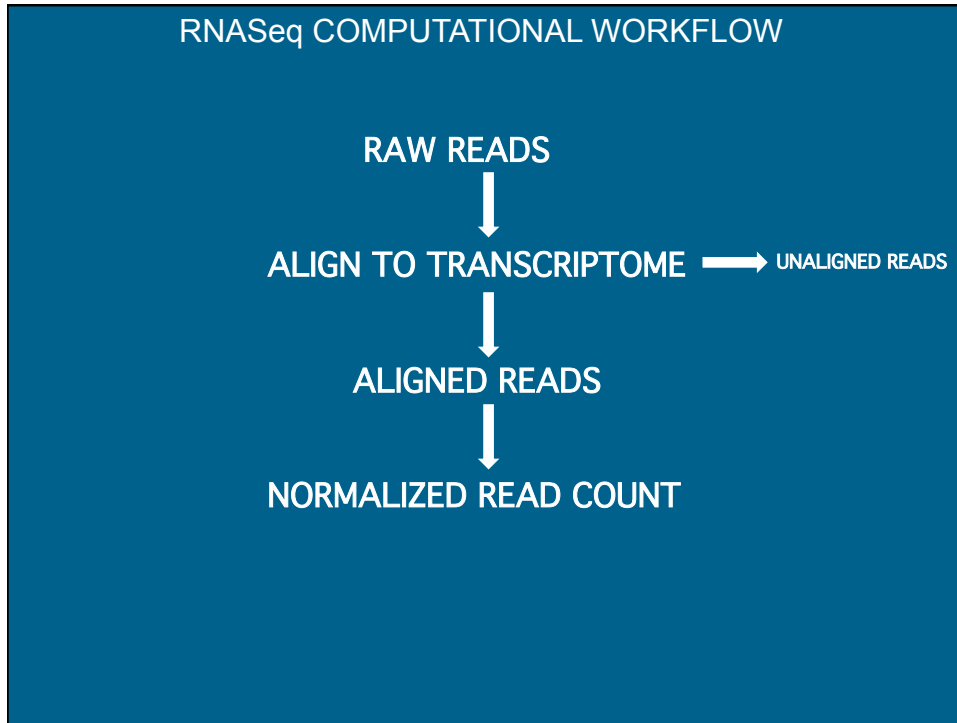

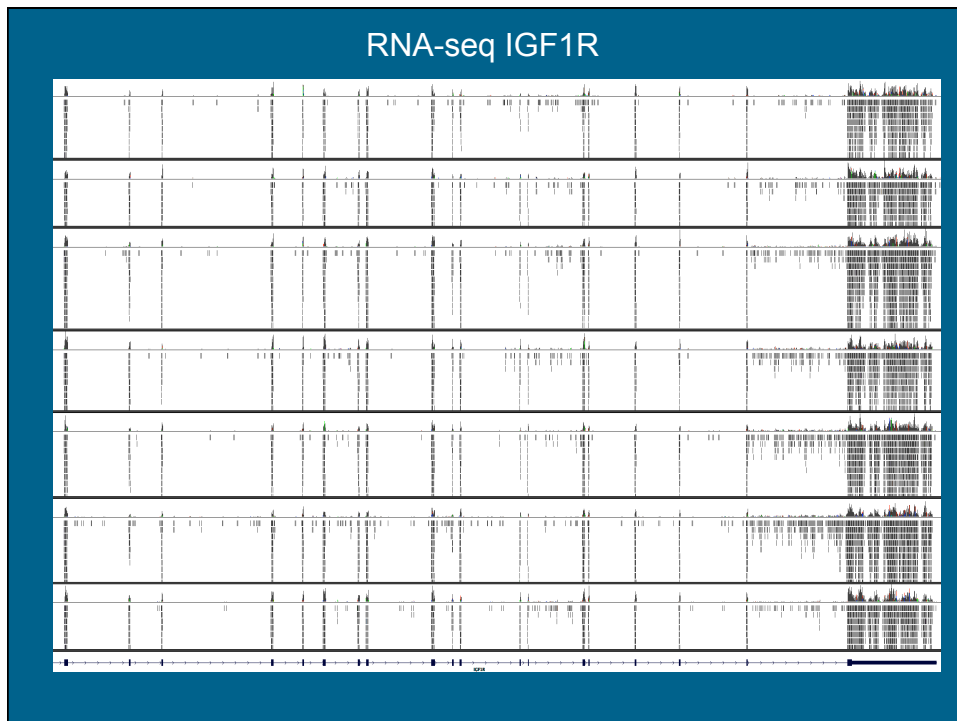
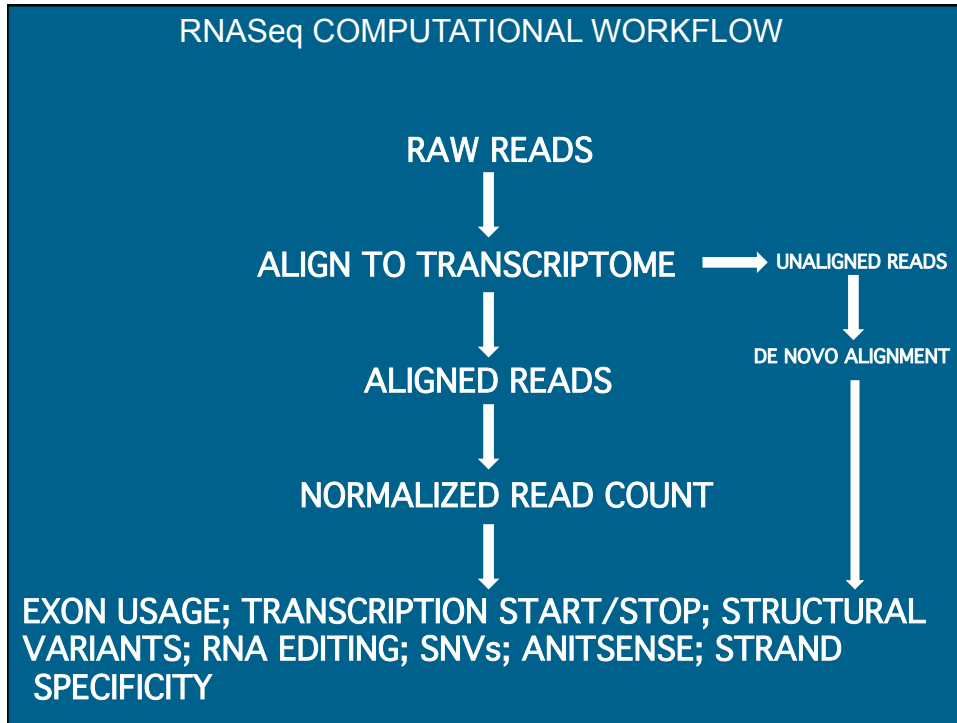

MEASURING GENE EXPRESSION BY RNA SEQUENCING

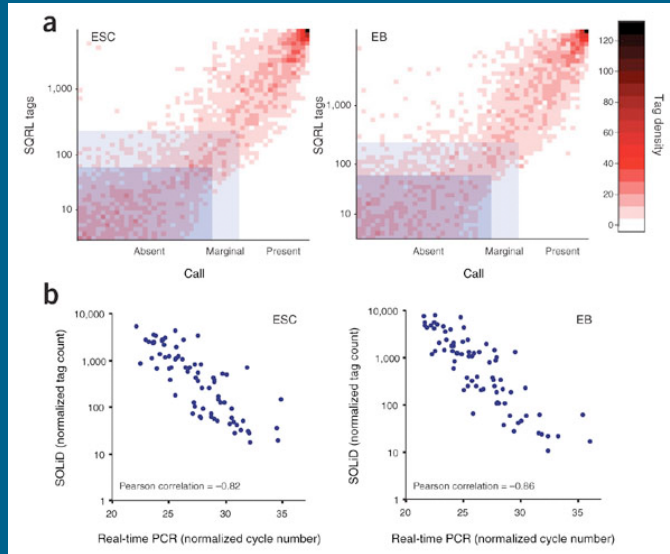

Cloonan et al.

Nature Methods - 5, 613 - 619 (2008)

mRNA ABUNDANCE VARIES OVER A LARGE DYNAMIC RANGE

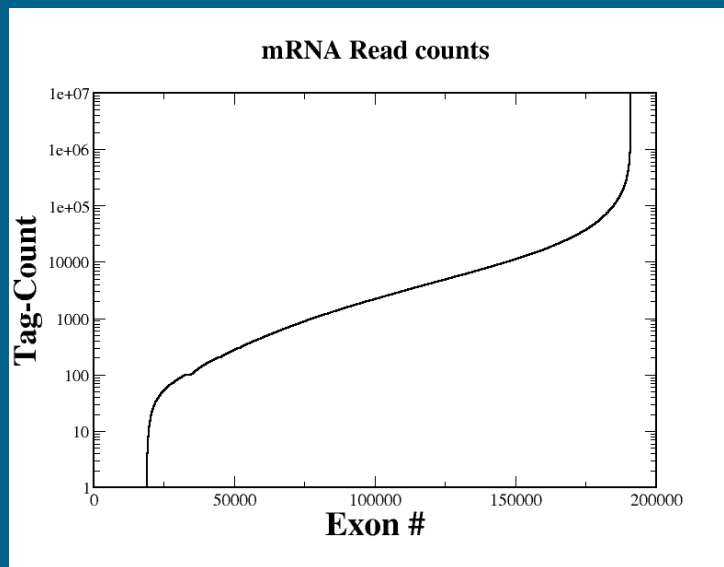

Sven Bilke

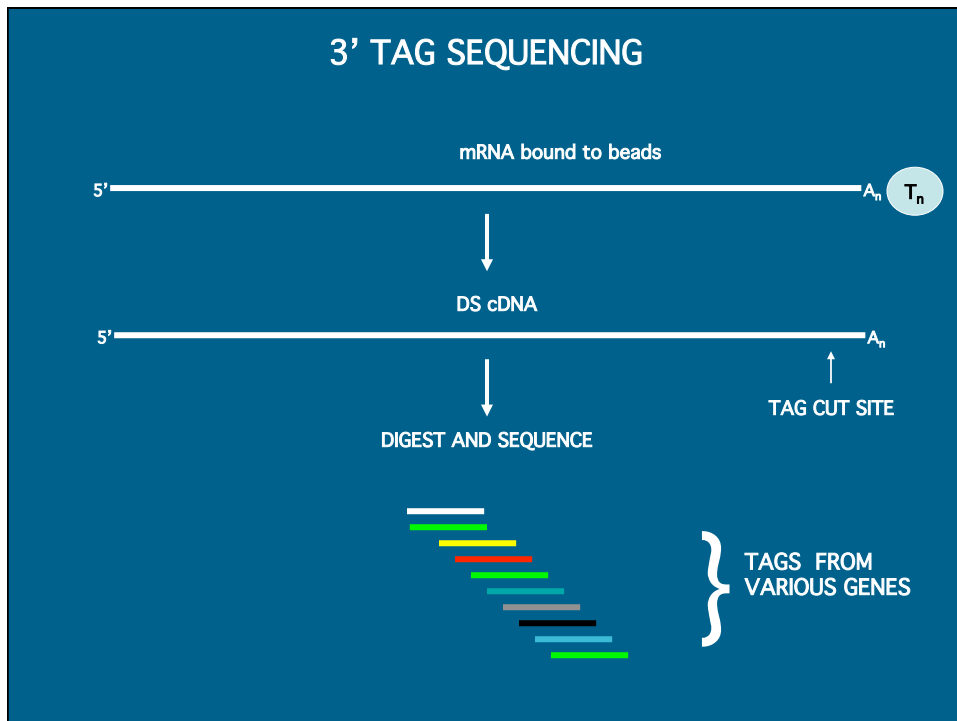
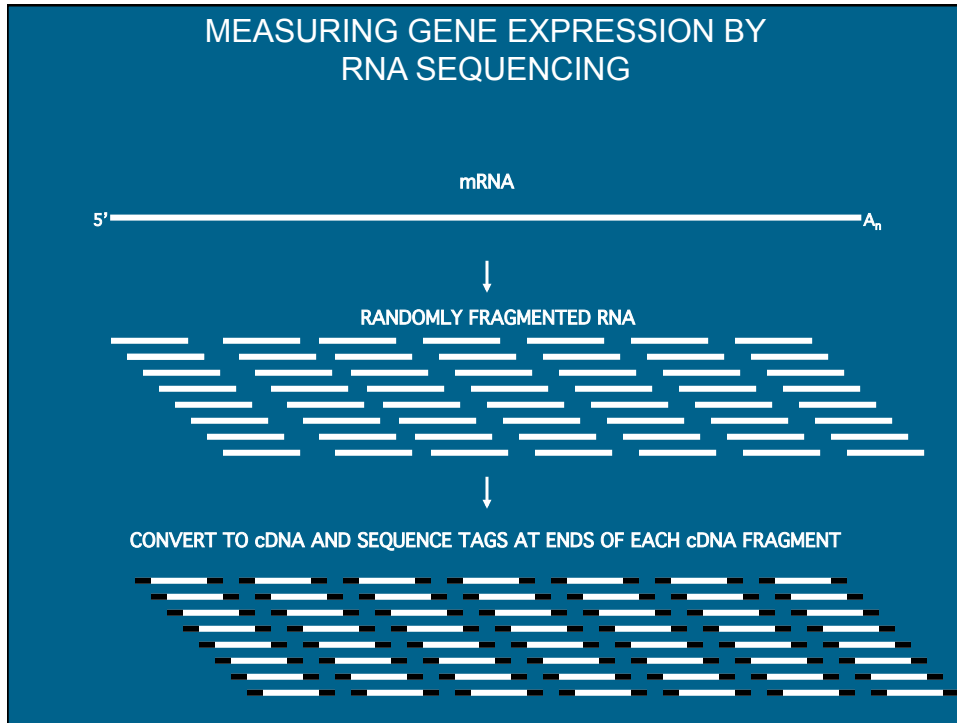

3' TAG SEQUENCING

- SEQUENCES ALIGNED AND COUNTED
- LIBRARIES OF TAGS FROM MANY SAMPLES CAN BE IDENTIFIED BY ADDING A “BARCODE” AND POOLED BEFORE SEQUENCING
- POTENTIAL TO ANALYZE LARGE NUMBERS OF SAMPLES IN PARALLEL

THE FUTURE?

AS SEQUENCE THROUGHPUT INCREASES AND COSTS PER READ DECLINE, SEQUENCING IS LIKELY TO BECOME AN ATTRACTIVE ALTERNATIVE TO MICROARRAYS IN MORE AND MORE APPLICATIONS.

USEFUL WEB SITES

MGEGD The Microarray Gene Expression Data Society:

<http://www.mged.org/>

NCBI Gene Expression Omnibus:

<http://ncbi.nih.gov/geo/>

NCBI Sequence Read Archive (SRA):

<http://www.ncbi.nlm.nih.gov/sra>

EBI Microarray informatics:

<http://www.ebi.ac.uk/microarray/index.html>

Stanford Microarray Database:

<http://smd.stanford.edu/>

UCSF DeRisi lab:

<http://derisilab.ucsf.edu/data/microarray/index.html>

Broad Institute:

Gene Set Enrichment Analysis (GSEA)

<http://www.broadinstitute.org/gsea/>

Connectivity Map:

<http://www.broadinstitute.org/cmap/>