

Temperature-Dependent Battery Models for High-Power Lithium-Ion Batteries

Valerie H. Johnson
Ahmad A. Pesaran
National Renewable Energy Laboratory
1617 Cole Boulevard
Golden, Colorado 80401
E-mail: valerie_johnson@nrel.gov

Thomas Sack
Saft America
107 Beaver Court
Cockeysville, MD 21030

Presented at the
17th Electric Vehicle Symposium
Montreal, CANADA
October 16-18, 2000

Abstract

In this study, two battery models for a high-power lithium ion (Li-Ion) cell were compared for their use in hybrid electric vehicle simulations in support of the U.S. Department of Energy's Hybrid Electric Vehicle Program. Saft America developed the high-power Li-Ion cells as part of the U.S. Advanced Battery Consortium/U.S. Partnership for a New Generation of Vehicles programs. Based on test data, the National Renewable Energy Laboratory (NREL) developed a resistive equivalent circuit battery model for comparison with a 2-capacitance battery model from Saft. The ADvanced VehIcle SimulatOR (ADVISOR) was used to compare the predictions of the two models over two different power cycles. The two models were also compared to and validated with experimental data for a US06 driving cycle. The experimental voltages on the US06 power cycle fell between the NREL resistive model and Saft capacitance model predictions. Generally, the predictions of the two models were reasonably close to the experimental results; the capacitance model showed slightly better performance. Both battery models of high-power Li-Ion cells could be used in ADVISOR with confidence as accurate battery behavior is maintained during vehicle simulations.

Introduction

Solid battery pack performance in hybrid electric vehicles (HEVs) is critical to the vehicle's performance and energy management strategies. Accurate battery models are needed for control strategy development and general HEV simulations. At the National Renewable Energy Laboratory (NREL), as part of the U.S. Department of Energy's (DOE) HEV Program, we have developed and validated battery models for our ADvanced VehIcle SimulatOR (ADVISOR) (1-3). Models for various battery chemistries used in ADVISOR are based on a resistive equivalent circuit model.

Saft America developed high-power 6 Ah and 12 Ah lithium ion (Li-Ion) cells for HEVs under the sponsorship of the U.S. Partnership for a New Generation of Vehicles (PNGV) and the U.S. Advanced Battery Consortium (USABC) (4). The cells have high power characteristics of 1350–1500 W/kg and relatively good specific energy of 64–70 Wh/kg (5,6). As part of our collaborations with Saft under the cost-shared DOE HEV program, we tested 6 Ah Li-Ion cells and developed a temperature-dependent equivalent circuit battery model. The internal resistances were not dependent on the magnitude of the current draw from the battery. We then compared this model with Saft’s 2-capacitance model with rate-dependent impedance.

The purpose of this paper is to present a brief description of the two Li-Ion battery models, contrast them with each other, and validate them with experimental data.

Lithium Ion Battery Models in ADVISOR

In 1994, the Center for Transportation Technologies and Systems at NREL developed a vehicle simulation tool called ADVISOR, which runs in the Matlab/Simulink software platform. Since 1996, NREL has tested batteries and developed temperature dependent models to expand the battery library of ADVISOR. DOE continues to refine and support this tool.

NREL Resistive Model

In ADVISOR, the battery is modeled as an equivalent circuit with no rate-dependent resistance, as shown in Figure 1.

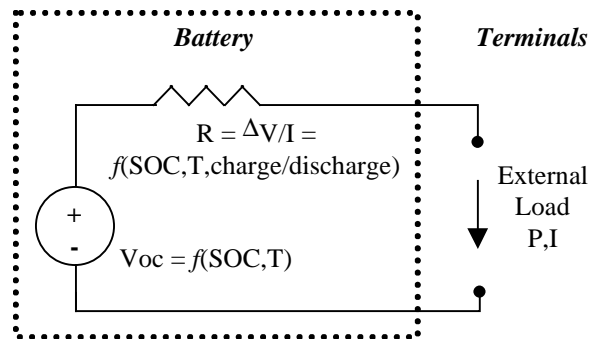

Figure 1
ADVISOR Resistive Battery Model

ADVISOR’s internal resistance (R_{int}) is intended to account for the full voltage drop experienced by a battery from its equilibrium open circuit voltage (OCV) to the terminal voltage that is seen under load. R_{int} is assumed to be dependent on state of charge (SOC), temperature, and the direction of current flow. To determine the R_{ints} , a series of pulses of constant current for 18 seconds was applied to the battery and the voltage response was monitored. An example of the voltage response to a current pulse is shown in Figure 2. V_1 , V_2 , and V_3 in Figure 2 are easily measured. Both the OCV and the resistance are assumed to be constant over the pulse period such that the ΔV at the beginning of the pulse is the same at the end of the pulse. The 18 second pulse length was based on two factors: 1) the PNGV Battery Test Manual suggests an 18 second pulse for resistance characterization, and 2) 18 seconds was enough time for most of the transient behavior of the cells to die away.

The starting equilibrium voltage of the battery is correlated to SOC, and the effective resistance of the battery is determined according to the following equation:

$$R = \frac{V_{oc} - V_{terminal}}{I} = \frac{V_3 - V_2}{I} \quad (1)$$

where V_2 and V_3 are shown in Figure 2, and I is the current. NREL tested the 6 Ah Saft cells at three different temperatures to measure capacity, OCV, and R_{ints} to develop the model.

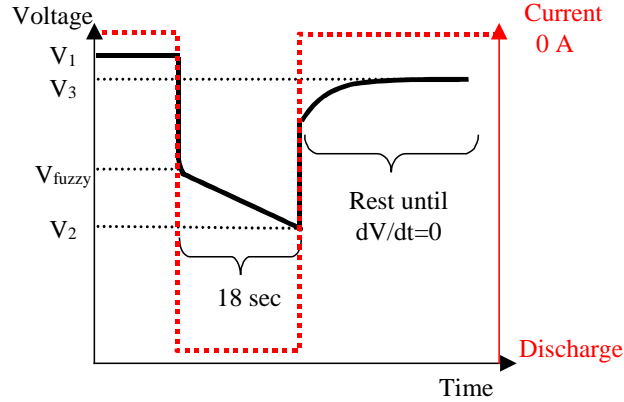

Figure 2
Schematic of Battery Voltage Response under a Current Pulse

Saft Capacitance Model

Saft supplied NREL with their 2-capacitance model of their 12 Ah high power Li-Ion cells, which, except for their length, are similar in construction to 6 Ah cells. Both had a nominal voltage of 3.6 V. Saft also supplied test data including OCV versus SOC, bulk impedance as a function of SOC and temperature, and bulk capacitance as a function of temperature.

The Saft capacitance model was originally developed in the P-Spice software platform and was not compatible with ADVISOR's Matlab platform. Therefore, the Saft P-Spice model was converted into the Matlab environment with accuracy maintained. The state space equations describing the model are presented in Equation 2 and the revised Saft capacitance model in Matlab is shown in Figure 3. This model is referred to as the RC model.

$$\begin{bmatrix} \dot{V}_{Cb} \\ \dot{V}_{Cc} \end{bmatrix} = \begin{bmatrix} -\frac{1}{C_b(R_e + R_c)} & \frac{1}{C_b(R_e + R_c)} \\ \frac{1}{C_c(R_e + R_c)} & -\frac{1}{C_c(R_e + R_c)} \end{bmatrix} \begin{bmatrix} V_{Cb} \\ V_{Cc} \end{bmatrix} + \begin{bmatrix} -\frac{R_c}{C_b(R_e + R_c)} \\ -\frac{1}{C_c} + \frac{R_c}{C_c(R_e + R_c)} \end{bmatrix} [I_s] \quad (2)$$

$$[V_o] = \begin{bmatrix} \frac{R_c}{(R_e + R_c)} & \frac{R_e}{(R_e + R_c)} \end{bmatrix} \begin{bmatrix} V_{Cb} \\ V_{Cc} \end{bmatrix} + \begin{bmatrix} R_t - \frac{R_c R_e}{(R_e + R_c)} \end{bmatrix} [I_s]$$

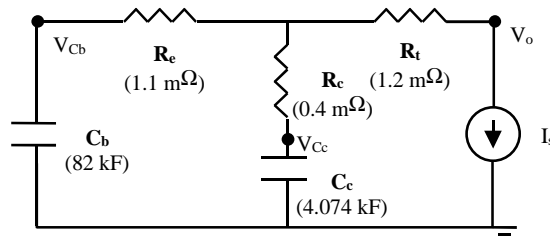

Figure 3
Revised Saft 2-Capacitance Model in Matlab Platform

The equations were solved using Simulink’s state space block, with initial voltages of the two capacitors set to V_s (V_s is a source voltage from the P-Spice model representing the initial voltage, $=f(\text{SOC})$). As a check on this circuit in Matlab, model predictions were compared to model results from Saft’s P-Spice model. The output voltage of the Matlab RC model for a single 18 second 200 A discharge plotted in Figure 4 exactly replicates the results of the RC model in P-Spice—in both models the voltage begins at 3.86 V, drops to 3.561 V at 0 seconds, further drops to 3.386 V after 18 seconds, and recovers to a steady state of 3.818 V after 100 seconds.

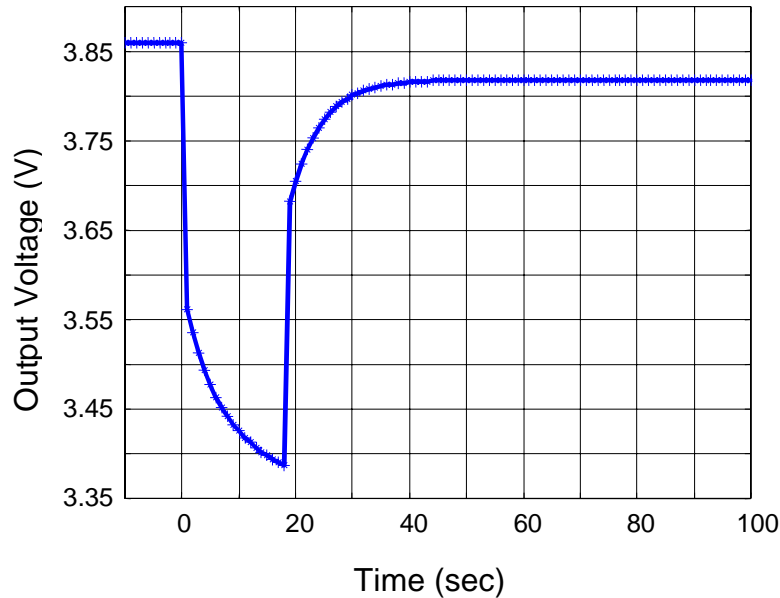

Figure 4

Verification of the Matlab Translation of Saft’s RC Model (18 second 200 A discharge)

Comparison of NREL and Saft Battery Models

To elicit the basic model parameters of the Saft Li-Ion battery, three main tests were run: capacity, open circuit voltage (OCV), and internal resistance (R_{int}). Data supplied by Saft on a 12 Ah cell was used for a comparison to the NREL test data. Some variation between the models is expected because of the difference in capacity of the batteries (6 Ah versus 12 Ah).

Basic Parameters between Saft and NREL Tests

The bulk capacitance provided by Saft varies with temperature much like the maximum Ah capacity (at the C/5 rate) from NREL test data. The capacity increases at higher temperatures and drops at lower temperatures. At 40°C, the capacity increased 6% from ambient (7 Ah) to reach a maximum near 7.4 Ah, and at 0°C, the capacity decreased 15% from ambient with a maximum capacity of 6 Ah (see Figure 5).

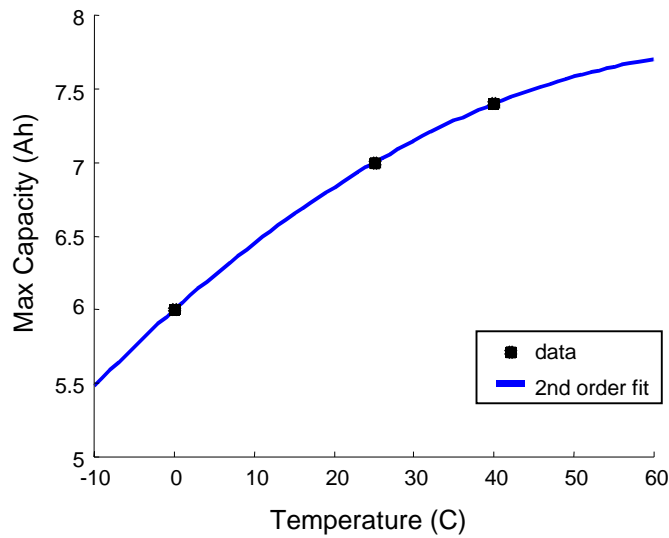

Figure 5
NREL Test Capacity versus Temperature for 6 Ah Battery

The OCV tests entailed successive discharges of the battery at various SOC increments and then rest periods of 1 hour to determine the OCV as a function of SOC. These tests covered multiple rates (C/5 to 15C) and multiple temperatures (0°C, 25°C, and 40°C). The OCV did not vary greatly with temperature. At 40°C, the OCV is nearly the same as the ambient values. At 0°C, the OCV diverges from the ambient levels due to the decreased capacity at the lower temperature. Figure 6 shows that the OCV results from NREL tests and data provided from Saft have excellent agreement.

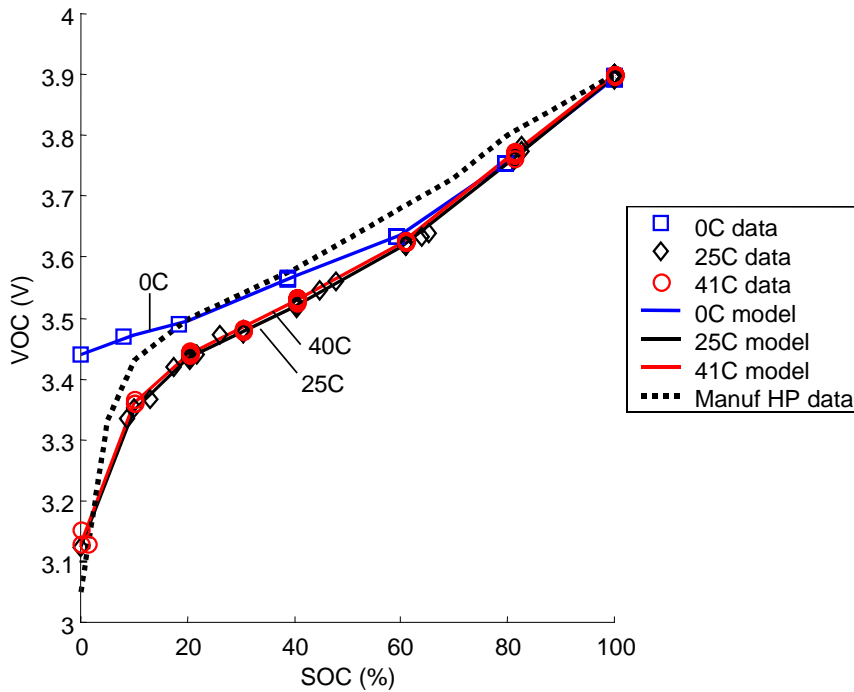

Figure 6
Open Circuit Voltage versus SOC for Saft Li-Ion 6 Ah cell, 0°C, 25°C, 40°C

The temperature variation of the R_{int} with temperatures from 25-40°C is small. The R_{int} increases by approximately 3 times the ambient levels as the temperature drops to 0°C. Agreement between R_{int} s NREL test data versus Saft available data is again strong, as shown in Figure 7. For ambient temperatures, R_{int} values lie near 5 mΩ, and rise sharply as SOC approaches zero (or as VOC approaches 3.4 V). Differences between the NREL and Saft data include:

- NREL 6 Ah tests show slightly lower R_{int} s than Saft 12 Ah data at 25°C and 40°C, slightly higher at 0°C.
- At 25°C, NREL tests show a higher R_{int} at low SOC (extrapolated to ~70 mΩ vs. 50 mΩ Saft)

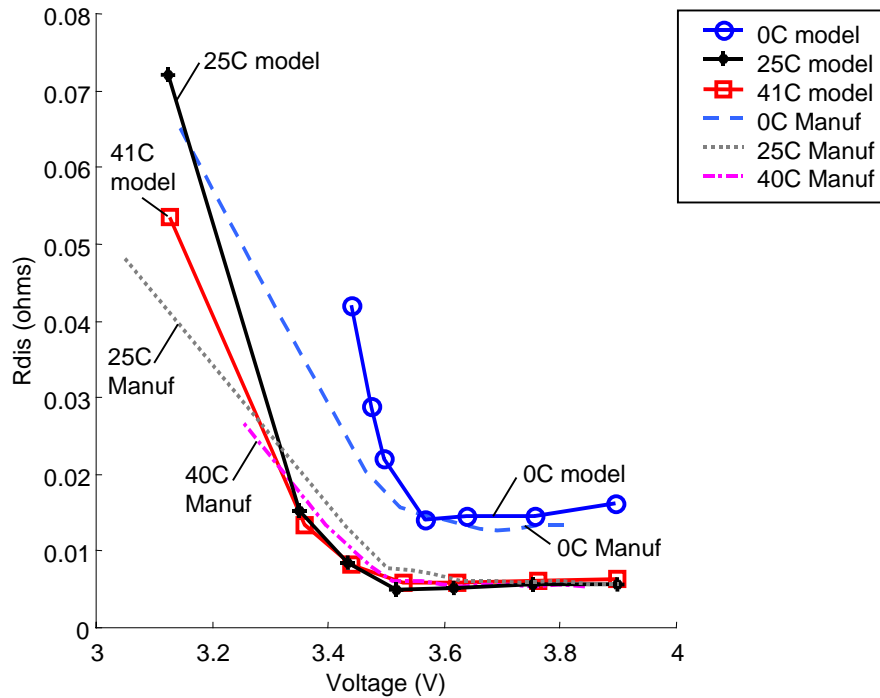

Figure 7
NREL Discharge Resistance for 6 Ah cell versus Saft 12 Ah cell Bulk Resistance, 0°C, 25°C, 40°C

Comparison of Saft’s RC Circuit Model to NREL’s R-Voc Model in ADVISOR

Once Saft’s 2-capacitor model (here referred to as the RC model) was successfully brought over to the Matlab environment, the RC model could be compared to ADVISOR’s R_{int} -VOC model (here referred to as the ADV model). However, the general ADVISOR battery model needed several details that were missing in the RC model, including:

1. The RC model used current as input and an ADVISOR battery model used power as input.
2. The RC model did not have an SOC predictor, which ADVISOR needed.

Additions were made to the base Saft RC model to address these differences. Power was used as the base request, and iteration using the output voltage determined the requested current. The SOC was predicted using the voltage of the larger capacitor, V_{cb} , and the

OCV-SOC correlation given by test data (see Figure 6). The voltage on the capacitor C_c is not the main contributor to the SOC, but it is also a possible indicator of SOC (see capacitance values in Figure 3). Therefore, the associated SOC based on V_{cc} is also plotted in the SOC graphs for a comparison.

Another difference between the RC and ADV models arose in running the simulations. The RC simulation could not run with the default ADVISOR parameter settings because of an algebraic loop in the RC model (iteration was required to convert a power request into a current request). Therefore, the RC model ran with different parameters (variable time step solver with the maximum step size of 0.1 second) and the ADVISOR model ran with default parameters (fixed time step of 0.1 second).

Model Comparisons for a Demanding Power Request

The following analysis compares the performance of a module consisting of three cells for the 6 Ah NREL models and the 12 Ah Saft model. A battery's instantaneous power delivery capability is related to its voltage and internal resistance ($P_{inst,max} = V_{oc}^2/4R_{int}$), given that its lower voltage limits are not exceeded. Because there is little difference in the instantaneous power delivery available from a 6 Ah and a hypothetical 12 Ah cell with the same R_{int} characteristics, these results compare the actual 6 Ah NREL model with the Saft 12 Ah model.

Figure 8 shows a 100-second, challenging power profile and the model comparisons. The request profile was chosen to be very demanding to illustrate the differences between the RC and ADV models. Power *request* of a single module reached 5 kW on discharge and -4 kW on charge.

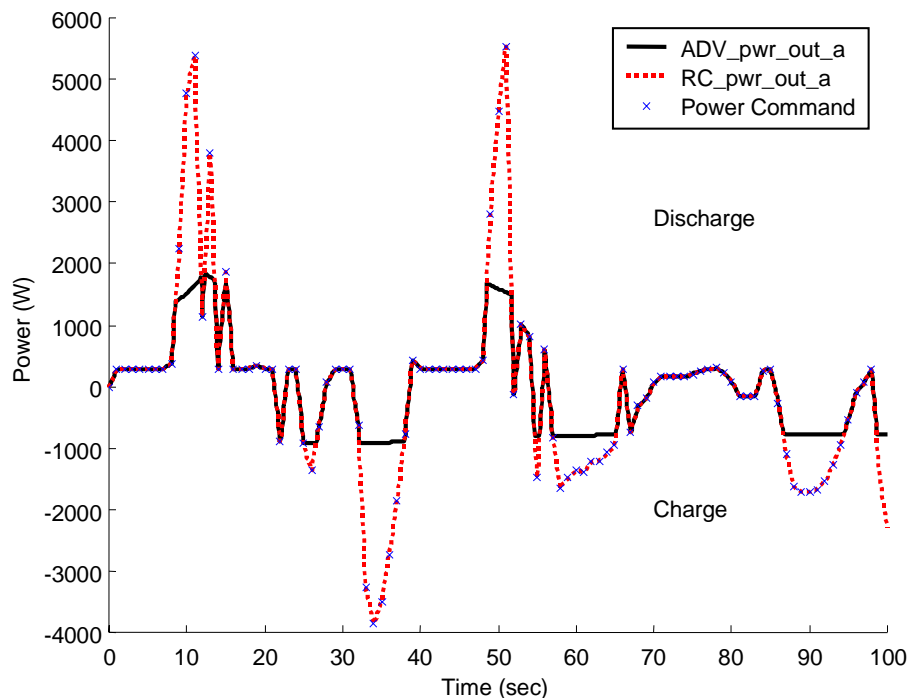

Figure 8
ADV Model versus RC Model Power Comparison, Demanding Power Request

Except in the limiting cases, the general behavior of the two models' power predictions is similar. The RC model meets the high discharge and charge power requests of 5 kW and -4 kW; the ADV model is seen to limit the available peak power to under 2 kW discharge and -1kW charge. In the limiting cases, the current from the ADV model is lower than the RC model. The general behavior of the two models on current performance, other than the limiting cases, is again very similar.

Figure 9 shows the voltage comparison for the module level comparison of the two models. The RC voltage has the expected damping characteristics of including a capacitor in the model. The RC voltage reacts more slowly and does not reach as many extremes as the ADV model. The ADV model reaches limiting behavior when its voltage limits are exceeded. For charge, this means the voltage hits a maximum of 3.9 V/cell, or 11.7 V/module. For discharge, this means the voltage hits a lower limit of 2 V/cell, or 6 V/module. During limiting behavior, Figure 9 shows two scenarios:

1. The RC voltage stays within the allowable voltage range (e.g. discharge at 10 seconds and charge 90 seconds).
2. The RC voltage exceeds the allowable safe voltage range (e.g. discharge at 51 seconds and charge at 35 seconds).

The second scenario, where the voltage limits were exceeded, would need to be addressed in a more robust RC model for vehicle simulation. The power request of the battery would need to be limited so that these voltage limits were not exceeded.

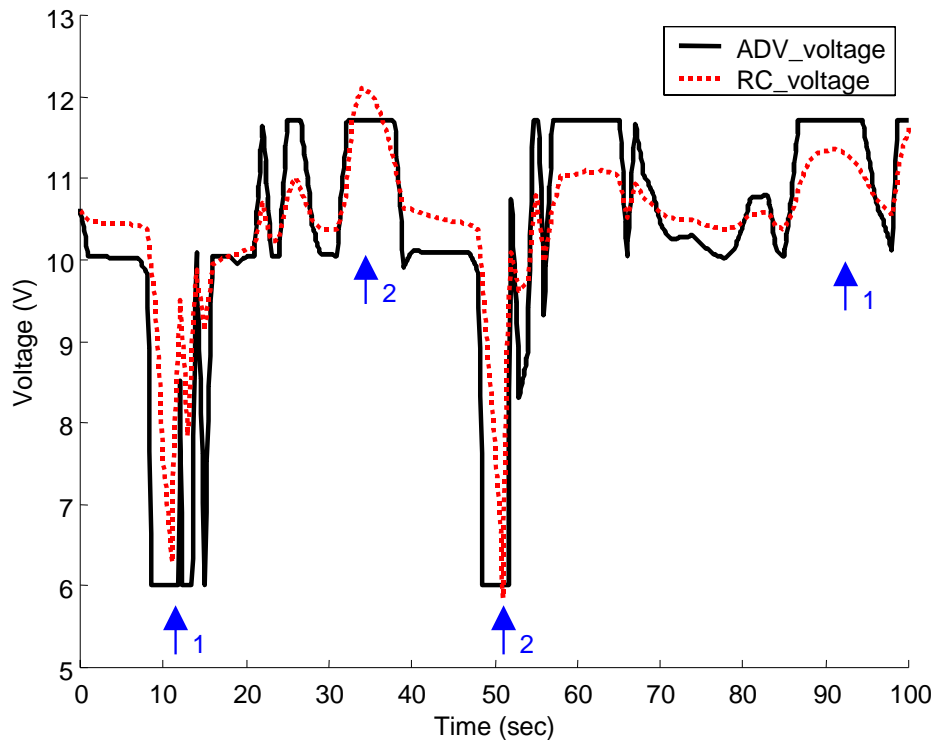

Figure 9
ADV versus RC Voltage Comparison, Demanding Power Request

Validation of RC Model and ADV Model over a US06 Profile

The most significant comparison of the two Li-Ion battery models lies in their validation over a power profile by comparison to experimental data. At NREL, a power profile of an US06-derived hybrid vehicle cycle (lasting 600 seconds) was applied to the actual battery consisting of three 6 Ah cells, with a beginning SOC of 0.43. Figure 10 shows that the power profile requested of a module varied from 1200 W discharge to -750 W charge. Figure 10 also shows that both the ADV model and the RC model were able to exactly meet the power request.

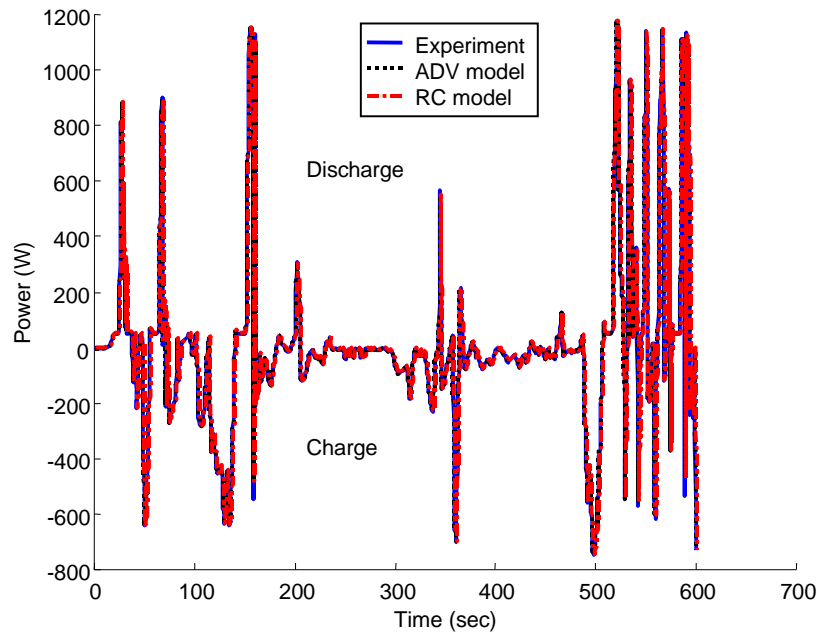

Figure 10

Module Validation: 2 Models versus Test Data, US06 Power Request, 600 sec

A close-up look at the first 100 seconds of the test in Figure 11 shows that the currents are similar. The large range of currents (-60A to 100A) obscures small differences between models and the experiment. Over the 600 seconds, on average the ADV model was within 1.1 A (standard deviation of 2.3A), and a maximum error of 17.5 A. The RC model was within an average of 1.3 A (standard deviation of 2.5A), and a maximum error of 14 A.

Figure 12 shows the voltage comparison for the first 100 seconds. Several points are illustrated:

- The experimental values lie between the ADV model and the RC model.
- Neither discharge (6 V) nor charge (11.7 V) voltage limits are exceeded.
- The ADV model substantially overshoots the experimental voltage on both discharge and charge.
- During rests (e.g. 56-64 seconds), the RC voltage slowly drops, as does the experimental voltage, while the ADV model is constant as it has no time dependent behavior.
- During rests, the ADV voltage is slightly lower than experimental values.

Over the 600 seconds, on average the ADV model was within 0.2 V (standard deviation of 0.2 V), and a maximum error of 1.5 V. The RC model was within an average of 0.1 V (standard deviation of 0.1 V), and a maximum error of 0.5 V.

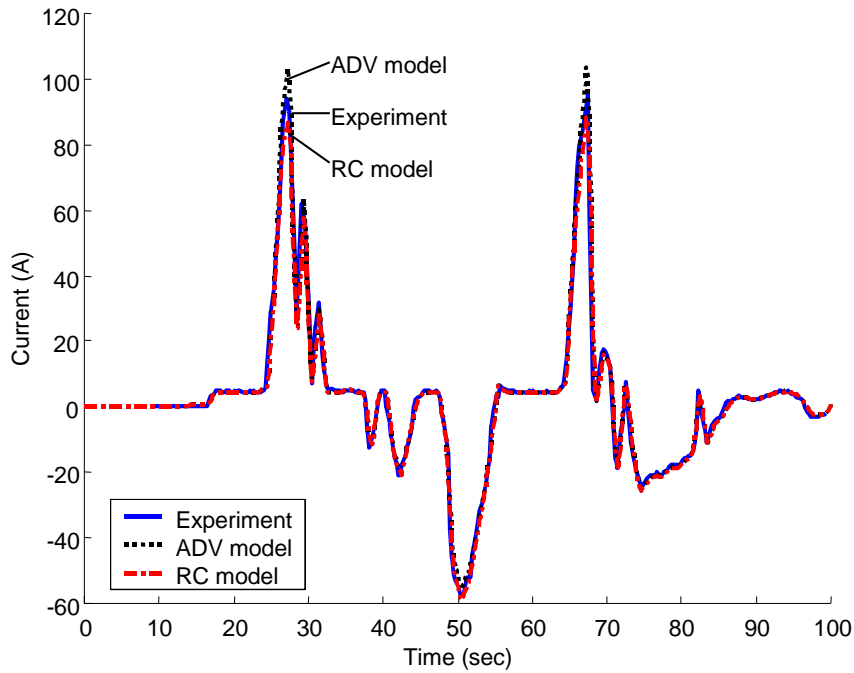

Figure 11
Module Current—2 Models versus Test Data, 100 sec

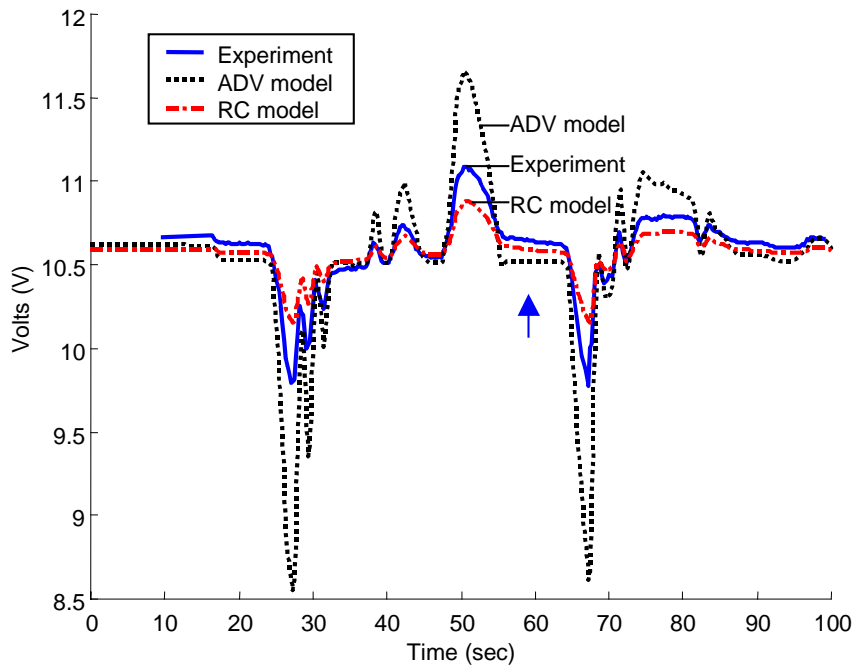

Figure 12
Module Voltage—2 Models versus Test Data, 100 sec

One of the metrics chosen to quantitatively assess the accuracy of the models was the voltage percentage error, defined as:

$$\% \text{ Error} = 100 * \left| \frac{V_{\text{actual}} - V_{\text{model}}}{V_{\text{actual}}} \right| \text{ (1 second average)} \quad (3)$$

Over the 600 seconds, on average the ADV model was within 1.4% (standard deviation of 2%), and a maximum error of 15%. The RC model was within an average of 1.2% (standard deviation of 0.7%), and a maximum error of 5%.

Figure 13 shows the comparison between the experimental and model predicted SOC for the first 100 seconds. The “experiment SOC” cannot be measured, but was calculated based on the experimental data similarly to ADVISOR’s calculation (based on Amp-hours used), so it is expected to have a similar behavior pattern as the ADV model. In particular,

$$\text{SOC} = \frac{\text{Ah}_{\text{max}} - \text{Ah}_{\text{used}}(\eta_{\text{coulomb}})}{\text{Ah}_{\text{max}}} \quad (4)$$

$$\text{where } \text{Ah}_{\text{used}} = \begin{cases} \int_0^t A dt & \text{for } A > 0 \text{ discharge} \\ \int_0^t \eta_{\text{coulomb}} A dt & \text{for } A < 0 \text{ charge} \end{cases}$$

where SOC is state of charge, A is current in amps, η_{coulomb} is the coulombic efficiency when charging, and dt is time in hours. For experimental calculations, the maximum Ah capacity was taken to be 7 Ah, and the coulombic efficiency to be 0.98 (based on NREL test data). NREL tests measured the capacity to be 5.94, 7.03, and 7.4 Ah, and the coulombic efficiency to be 96.8%, 99%, and 99.2% for 0°C, 25°C, and 40°C, respectively. The ADV model used these temperature-dependent parameters in its SOC calculation.

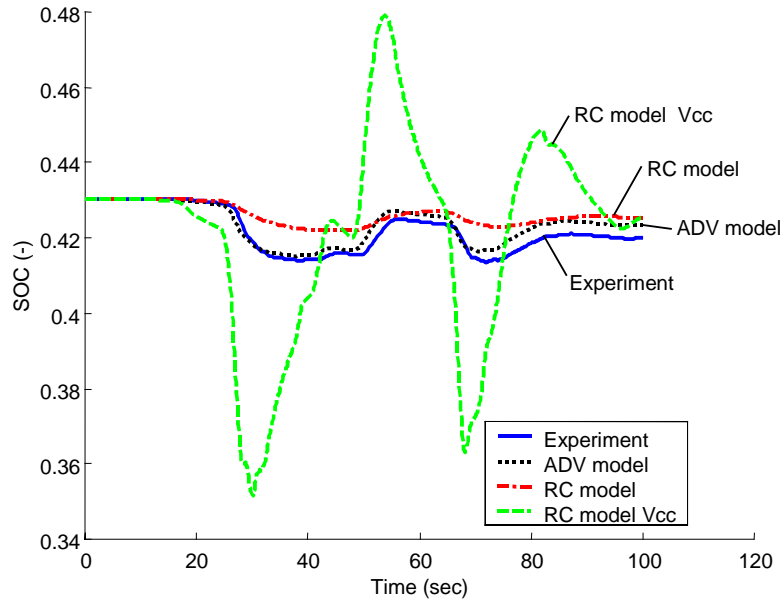

Figure 13
Module SOC— ADV and RC Models versus Test Data, 100 sec

Instantaneous SOC is difficult to measure, but using an open circuit voltage from a rested battery to determine the SOC is relatively accurate. Once the battery was cycled on the 600 second profile, it was allowed to rest for 1200 seconds. The resulting open circuit resting voltage was 10.672 (3.557 V/cell), which corresponds to a SOC of 0.4803 (see Figure 14). This value of ending SOC (or true SOC) is higher than the “experiment” ending value of 0.43 by 5%. After 600 seconds, the final SOC predicted by the two models were 0.45 for the ADV model (3% lower than true SOC) and 0.443 for the RC model (3.7% lower than true SOC).

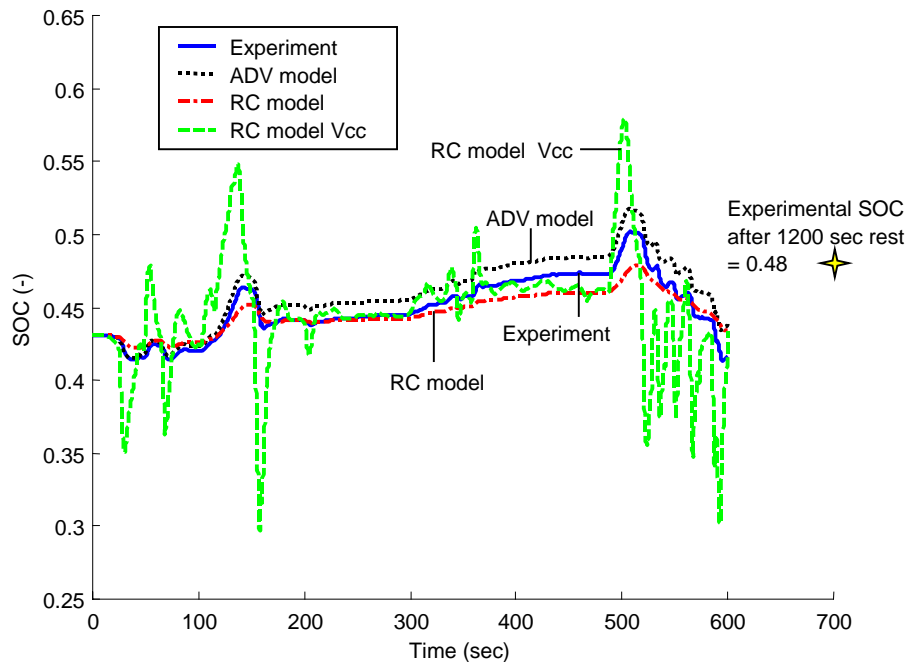

Figure 14
Module SOC—ADV and RC Models versus Test Data, 600 sec

Advantages and Limitation of the Models

The ADVISOR resistive model had the following advantages:

- Instantaneous SOC was more accurately predicted, and the final ADV SOC was closer to the true SOC than the RC model. Temperature effects of battery performance were included.
- Safe operational limits were not exceeded.

The Saft RC model limitations were:

- SOC needed to be estimated from capacitor voltage.
- ADVISOR works on a power request basis, not a current request.
- Operational limits need to be added (minimum and maximum voltages)
- Static Rints do not change with SOC, thus diminishing the model’s predictive capabilities as the SOC drops.
- The RC model cannot solve an algebraic loop when running a fixed time step (ADVISOR’s default simulation parameters). A variable time step solver was required for the RC model.

Advantages of RC model were:

- Smooth SOC, voltage, and current behavior.
- Fluctuations in voltage behavior were limited by capacitance damping. The ADVISOR Rint model jumps quickly and reaches voltage limits more quickly.
- Lower average and maximum errors over a cycle.

Summary and Conclusions

Saft’s 2-capacitor (RC) model was successfully brought into the Matlab environment and compared with the ADVISOR resistive equivalent circuit (ADV) model, which was generated by tests performed at NREL. The basic parameters of the battery (capacity trends with temperature, OCV versus SOC, and Rint) compared well between models. Other than expected capacity differences (6 Ah vs. 12 Ah), there was a minimal difference between the 12 Ah cell and the 6 Ah cell performance metrics.

A demanding power request on a 3-cell module showed that the ADV model was more volatile, reaching voltage limits more quickly than the RC model, but that the RC model exceeded safe operating voltages of the battery. Validation of the models over a US06 derived power profile showed that the power request was met, current was tracked closely, the experiment’s voltage fell between the ADV model and RC model predictions, and SOC predictions were reasonable. Table 1 details the accuracy and behavior of the models against experimental data.

Table 1
Summary of Accuracy and Behavior of Models versus Experiment

Cycle Validation	ADV model	RC model
<i>Overall US06 cycle (600 seconds) Voltage Error</i>	Avg: 1.4% + Std dev 2%, Max: 15%, over-predict voltage swings	Avg: 1.2% + Std dev 0.7%, Max: 5%, under-predict voltage swings
<i>Instantaneous SOC</i>	Close tracking, slightly over-predict SOC	Slower tracking, similar behavior patterns
<i>Final SOC (after resting)</i>	3% below	3.7 % below

NREL plans to develop an ADVISOR battery model that will incorporate capacitance and capitalize on the RC model advantages while eliminating the RC model limitations. The future ADVISOR RC model will:

- Allow resistances and capacitances to vary with temperature.
- Allow resistances to vary with SOC.
- Investigate SOC estimator as a function of both capacitor voltages.

Based on the analysis and comparisons presented in this paper, we believe that the NREL equivalent circuit model of the Saft high-power Li-Ion battery in ADVISOR is sufficiently close to both the Saft 2-capacitance model and experimental results. The minor differences between the models will not affect the overall vehicle level simulation results such as acceleration times, fuel economy, and emissions. The Li-Ion battery model is currently available in the public release of ADVISOR.

Acknowledgments

This work was supported by the DOE's Office of Advanced Transportation Technologies as part of Hybrid Propulsion Vehicle Systems Program. We wish to thank Robert Kost and Ray Sutula (DOE Program Managers) and Terry Penney (NREL HEV Technology Manager) for their support of this project. We wish to recognize Matthew Keyser for his work and guidance on battery testing. We are also grateful for support and technical advice we received from Guy Chagnon and Salah Oweis of Saft America.

Definitions, Acronyms

Ah	capacity in Amp-hours
ADV	abbreviation for ADVISOR's battery model, based on internal resistance and open circuit voltages, with a state of charge predictor
ADVISOR	NREL's vehicle simulator. Stands for ADvanced VehIcle SimulatOR
DOE	U.S. Department of Energy
HEV	hybrid electric vehicle
HP	high power
ηCoulomb	coulombic efficiency
Manuf	Manufacturer of the batteries, refers to Saft America
NREL	National Renewable Energy Laboratory
OCV, VOC	open circuit voltage
Preq	power request
R, Rint	internal resistance
RC	Resistance-Capacitance Model in Matlab, derived from Saft's 2-cap model
SOC	state of charge
V	voltage

References

1. Wipke, K., Cuddy, M., Burch, S., "ADVISOR 2.1: A User-Friendly Advanced Powertrain Simulation Using a Combined Backward/Forward Approach," IEEE Transactions on Vehicular Technology, Special Issue on Hybrid and Electric vehicles, Columbus, OH, August 1999.
2. Wipke et al., ADVISOR 2.2 Documentation, NREL, September 1999, see www.ctts.nrel.gov/analysis/advisor_doc
3. See www.ctts.nrel.gov/analysis/reading_room
4. Chagnon, G., Oweis, S., and Sack, T., "High Power Lithium-Ion Batteries," in *Proceedings of the 15th International Electric Vehicle Symposium*, Brussels, Belgium, October 1–October 3, 1998, U.S.
5. Saft brochure, 6 and 12 Ah High Power Lithium-Ion Cells, Document number 09 98-51019-2, 1998.
6. Keyser, M., Pesaran, A., Oweis, S. Chagnon, G., Ashtiani, C. "Thermal Evaluation and Performance of High-Power Lithium-Ion Cells," in *Proceedings of the 16th International Electric Vehicle Symposium*, Beijing, China, October 1–3, 1999.