



Energy Storage R&D

# Battery Thermal Modeling and Testing

**PI: Matt Keyser and Kandler Smith**

**Presenter: Kandler Smith**

**Energy Storage Task Lead: Ahmad Pesaran**

**Other Contributors: John Ireland, Gi-Heon Kim, Kyu-Jin Lee**

**Dirk Long, Jeremy Neubauer**

---

Presented at the 2011 U.S. DOE Hydrogen  
Program and Vehicle Technologies Program  
Annual Merit Review & Peer Evaluation Meeting  
held 9-13 May 2011 in Arlington, Virginia

**Project ID: ES110**

**NREL/PR-5400-50916**

**This presentation does not contain any proprietary, confidential or otherwise restricted information.**

# NREL Energy Storage Program

*Our projects support the major elements of DOE's integrated Energy Storage Program to develop advanced energy storage systems for vehicle applications.*

## Battery Development, Testing, Analysis

- **Thermal characterization and analysis**
- **Energy storage simulation and analysis**
- **Battery life trade-off studies**
- Safety modeling & internal short circuit test method

Discussed in this poster presentation

Poster presentation by Gi-Heon Kim

## Computer-Aided Engineering of Batteries (CAEBAT)

- Development and linkage of multi-physics battery design models

Poster presentation by Ahmad Pesaran

## Exploratory Battery Research

- Development of ALD-coated silicon anodes

New BATT project (PI: Anne Dillon)

# Overview

## Timeline

Project start date: Oct 2004

Project end date: Sep 2015

Percent complete: ongoing

## Partners

- USABC
- A123 Systems
- CEA/INES-France
- Colorado School of Mines
- CPI/LG Chem
- Dow-Kokam
- EnerDel
- Johnson Controls-Saft (JSC)
- NASA-Jet Propulsion Lab (JPL)
- Southern California Edison (SCE)
- Zero Emissions Mobility

## Barriers

- Decreased energy storage life at high temperatures (15-year target)
- High energy storage cost due to cell and system integration costs
- Cost, size, complexity & energy consumption of thermal management systems

## Budget

Funding received in

- FY10: \$800k
- FY11: \$150k (under continuing resolution)

# Relevance of Battery Thermal Testing & Modeling

*Life, cost, performance and safety of energy storage systems are strongly impacted by **temperature***

*as supported by testimonials from leading automotive battery engineers, scientists and executives.*

## Objectives of NREL's work

- To thermally characterize cell and battery hardware and provide technical assistance and modeling support to DOE/FreedomCAR, USABC and developers for improved designs
- To enhance and validate physics-based models to support the design of long-life, low-cost energy storage systems
- To quantify the impact of temperature and duty-cycle on energy storage system life and cost

# Milestones

Month-Year	Milestone	Status
April 2011	<b>Thermal Analysis and Characterization of Advanced Batteries</b> <ul style="list-style-type: none"><li>• Battery testing and characterization</li><li>• Battery thermal modeling and simulation</li><li>• Support of integrated thermal management for electric drive vehicles</li></ul>	On track (as of March 21, 2011)
April 2011	<b>Battery Trade-Off Studies &amp; Life Modeling</b> <ul style="list-style-type: none"><li>• Duty-cycle and thermal environment scenario analysis</li></ul>	On track (as of March 21, 2011)

# Outline\*

1. Thermal testing
2. Thermal/physics modeling
3. Life/temperature trade-off analysis

\* Approach and accomplishments will be covered under each subtopic.

# Outline



## 1. Thermal testing

- Approach
- Accomplishments
  - Cell level
  - Module level
  - Pack level

## 2. Thermal/physics modeling

## 3. Life/temperature trade-off analysis

# 1. Thermal Testing – Approach

## *Cells, Modules and Packs*

### Tools

- Calorimeters
- Thermal imaging
- Electrical cyclers
- Environmental chambers
- Dynamometer
- Vehicle simulation
- Thermal analysis tools

### Test Profiles

- Normal operation
- Aggressive operation
- Driving cycles
  - US06
  - UDDS
  - HWY
- Discharge/charge rates
  - Constant current
  - Geometric charge/discharge
  - FreedomCAR profiles

### Measurements

- Heat capacity
- Heat generation
- Efficiency
- Thermal performance
  - Spatial temperature distribution
  - Cell-to-cell temp. imbalance
  - Cooling system effectiveness

Results reported to DOE, USABC, and developers





# 1. Thermal Testing – Accomplishments

## Cell-level testing

### Thermal Imaging

- **Temperature variation** across cell
- Profiles: US06 cycles, CC discharge

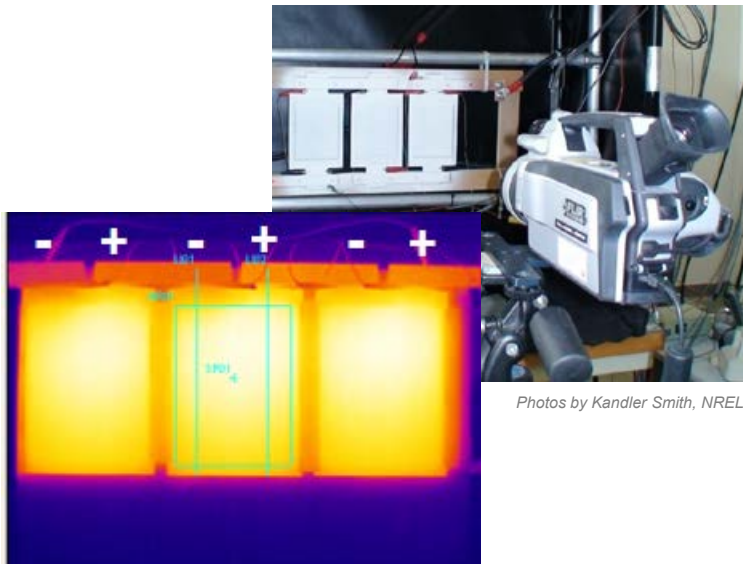

- FY10-11 cell-level test articles included hybrid-electric, plug-in hybrid-electric and pure-electric vehicle (HEV, PHEV, EV) cell designs from A123, CPI, Dow-Kokam, EnerDel, JCS, JSR Micro, K2
- Results reported to DOE, USABC and developers

### Large-Cell Calorimetry

- Heat capacity, **heat generation** & efficiency
- Temperatures: -30 to +45°C
- Profiles: USABC & US06 cycles, const. current

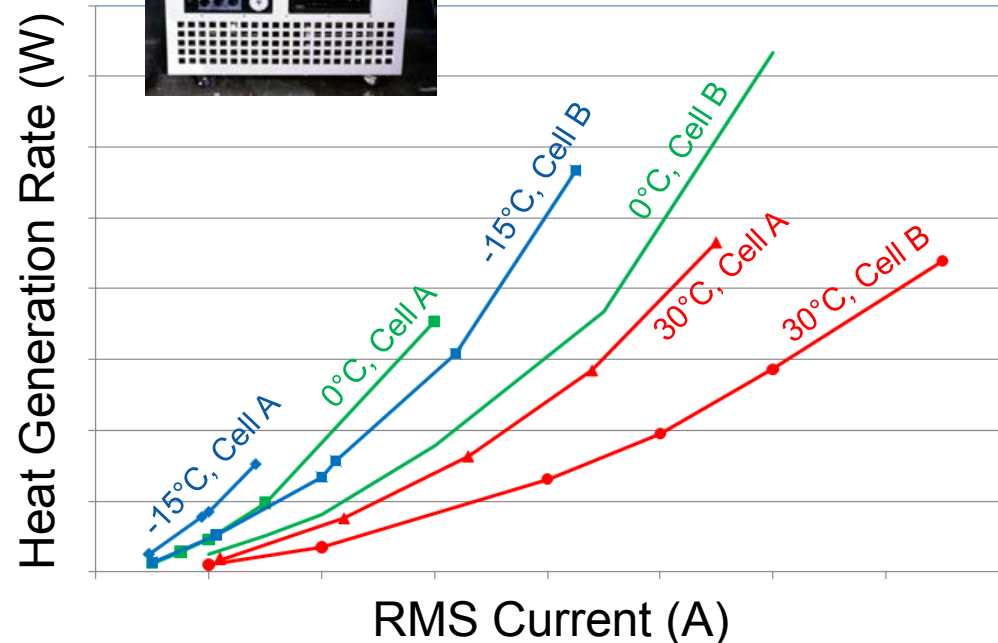
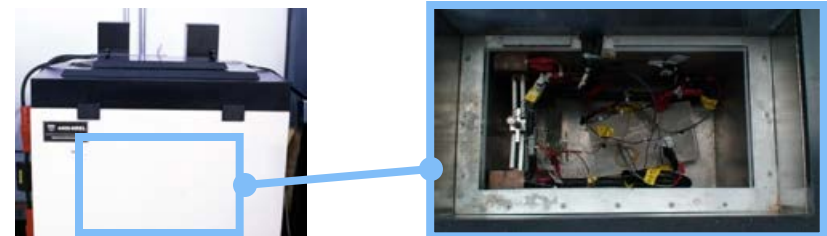

# 1. Thermal Testing – Accomplishments

## Cell-level testing

### Example Large-Cell Calorimeter Results

- Non-intuitive results often difficult to isolate with other test methods

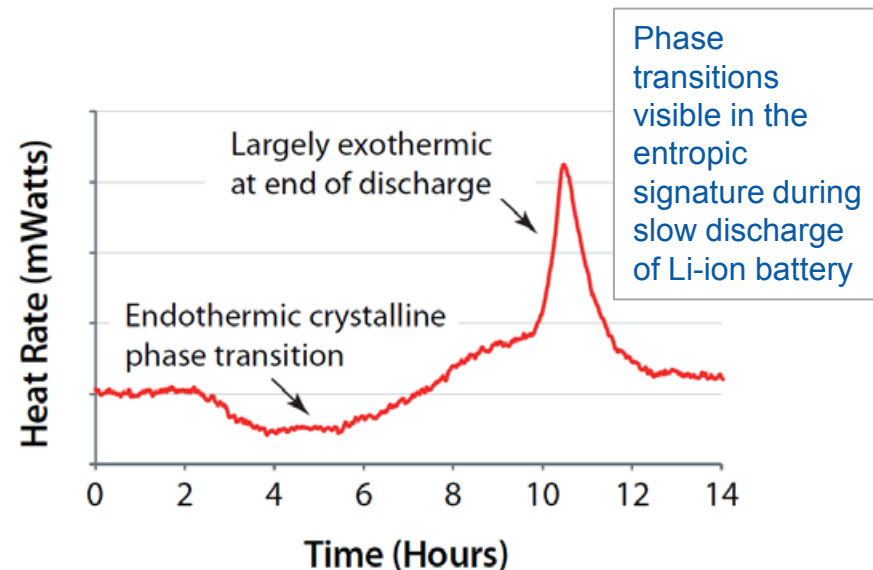
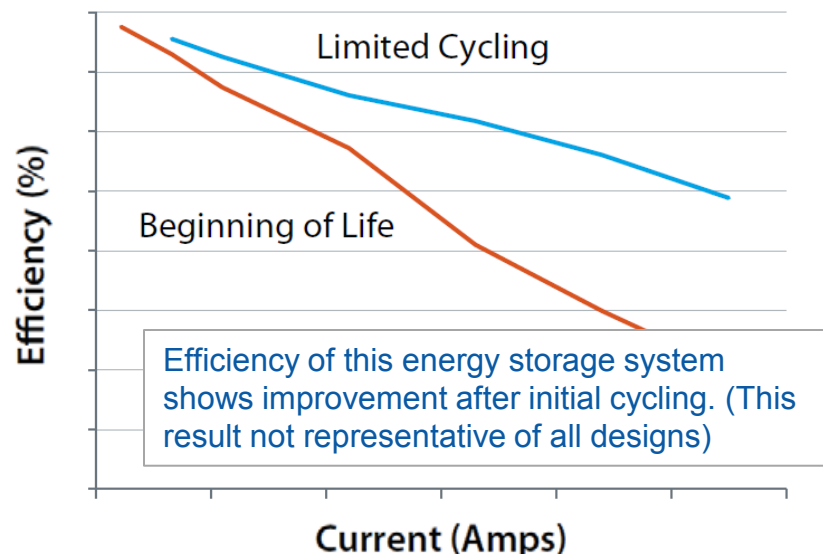
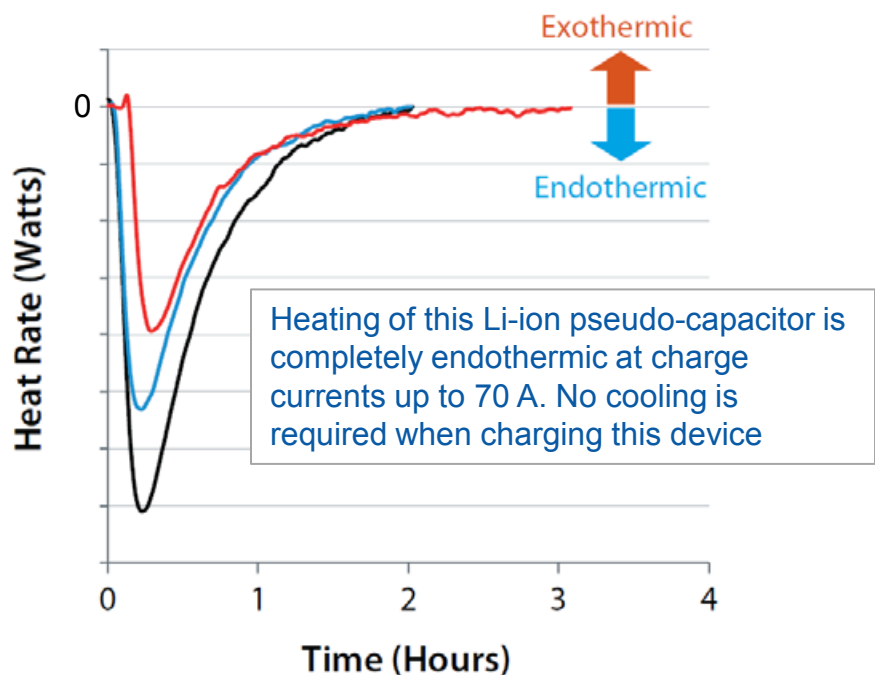

# 1. Thermal Testing – Accomplishments

## Module-level testing

### NREL custom calorimeter calibrated and commissioned for module and pack testing

- Test articles up to 60x 40x40 cm,
  - 4kW thermal load,
  - -40°C to 100°C range,
  - Two electrical ports (max 530 A, 440 V)
  - Inlet & outlet liquid cooling ports
- Enables validation of module and small-pack thermal performance, including functioning thermal management systems
  - Unique capability available for industry use

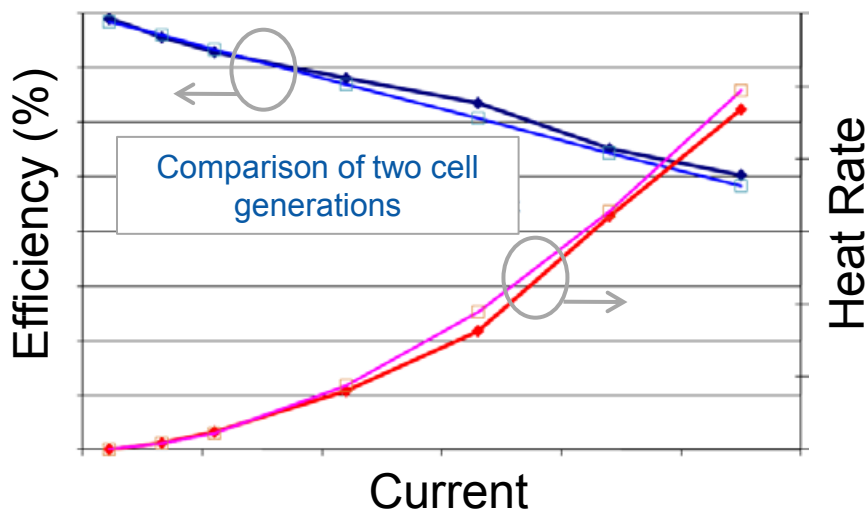

Calorimeter test chamber in isothermal fluid tank



Top view of calorimeter test chamber



Photos by Dennis Schroeder, NREL

Test results reported to DOE, USABC and developers

# 1. Thermal Testing – Accomplishments

## Module-level testing

The NREL custom calorimeter was calibrated from  $-30^{\circ}\text{C}$  to  $60^{\circ}\text{C}$ , with measurement error less than 2%. The minimum detectable heat, 15 Joules, is roughly equivalent to the nutritional energy content of 1/1000<sup>th</sup> of a piece of M&M candy.

Error associated with calibrated electrical pulses at  $30^{\circ}\text{C}$

Pulse	Actual Energy Input (Joules)	Measured Energy (Joules)	Error (%)
0.5 watt – 1 kilojoule	1025	1017	-0.8
1.0 watt – 1 kilojoule	1024	1025	0.05
2.0 watt – 2 kilojoules	2046	2053	0.3

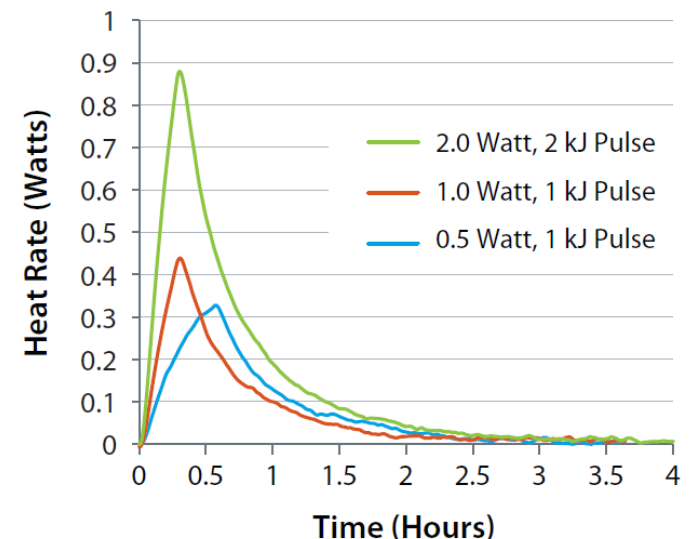
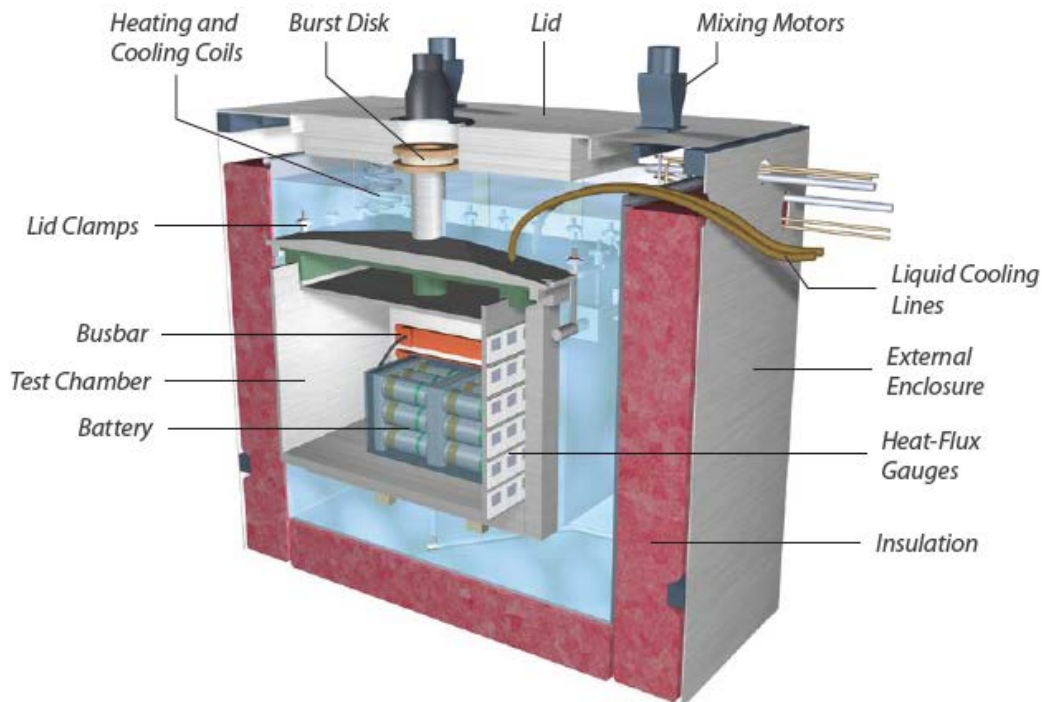

# 1. Thermal Testing – Accomplishments

## *Pack-level testing*

- Tested CPI pack utilizing refrigeration system with unique capability to cool below ambient temperature and thereby extend calendar life

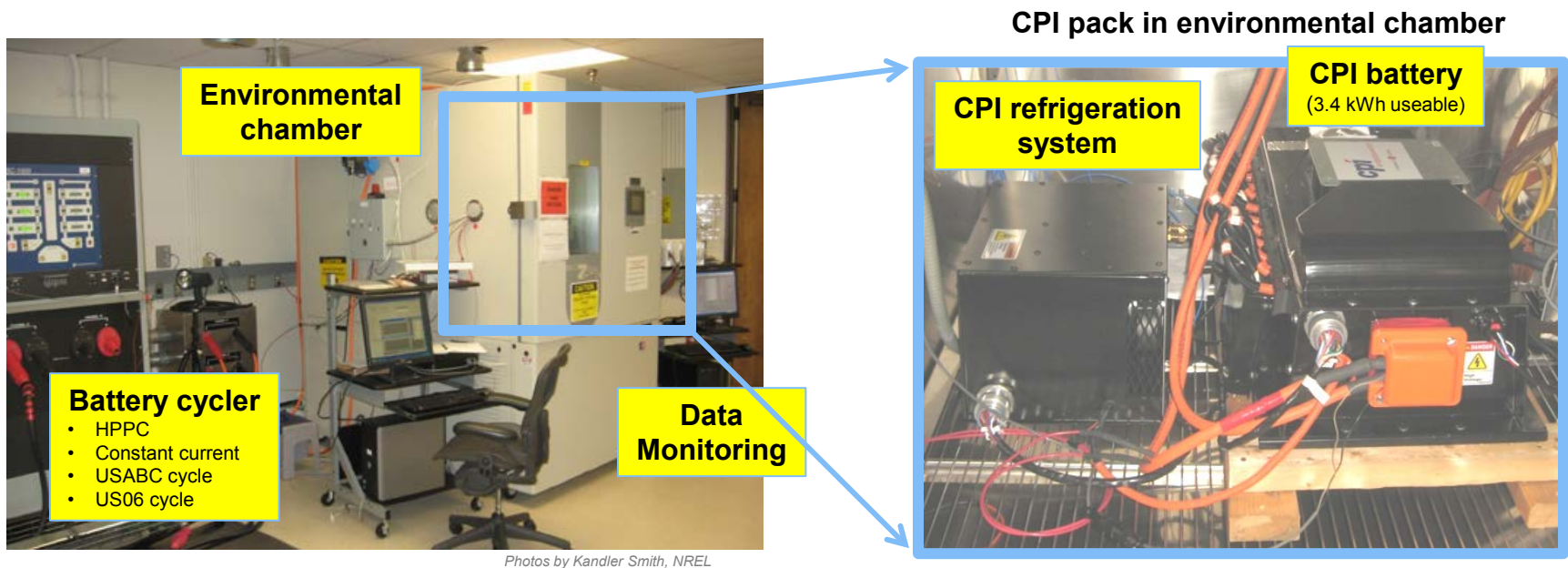

- Measured temperature rise, temperature uniformity and parasitic losses versus temperature and duty-cycle. Extrapolating calendar life for different scenarios with and without refrigeration system
- Results reported to DOE, USABC and developers

# Outline

## 1. Thermal testing

## 2. Thermal/physics modeling

- Approach
- Accomplishments
  - Empirical heat generation model
  - 3D thermal/electrochemical model – overview
  - 3D spiral-wound geometry model
  - Model validation study

## 3. Life/temperature trade-off analysis

## 2. Thermal / Physics Modeling – Approach

*Various length-scale physics dictate battery thermal / electrical behavior.*

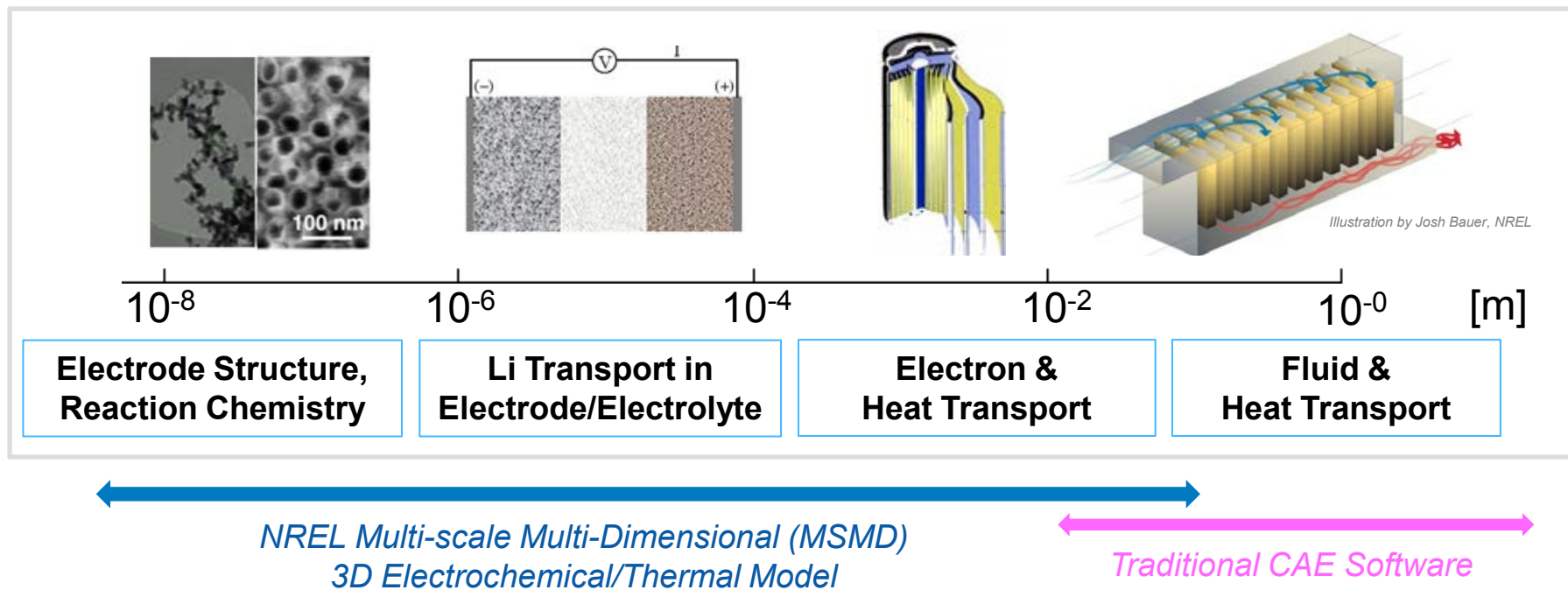

NREL develops empirical- and physics-based models for automotive Li-ion battery design and evaluation using the following approach:

- Separate computational domains/sub-models solve for desired length-scale physics, resulting in fast-running models suitable for computer-aided design
- Through the DOE CAEBAT program, NREL is working with industry and other labs to integrate battery models into commercial software packages for use by automotive industry

# 2. Thermal Modeling – Accomplishments

## Empirical heat generation model

**Motivation:** Can HPPC current/voltage data be used to predict heat generation rate?

**Approach:** Circuit model was fit to HPPC cycling data. Graph below shows comparison between

- Calorimeter-measured heat generation and
- Model-predicted heat generation

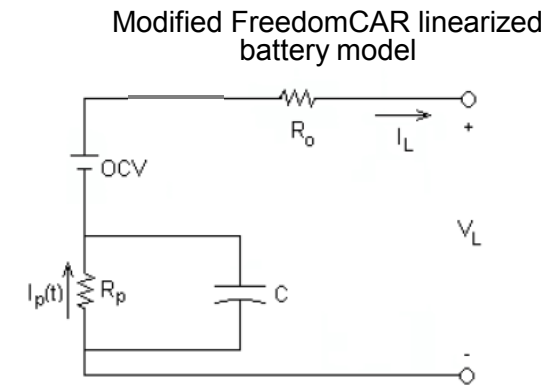
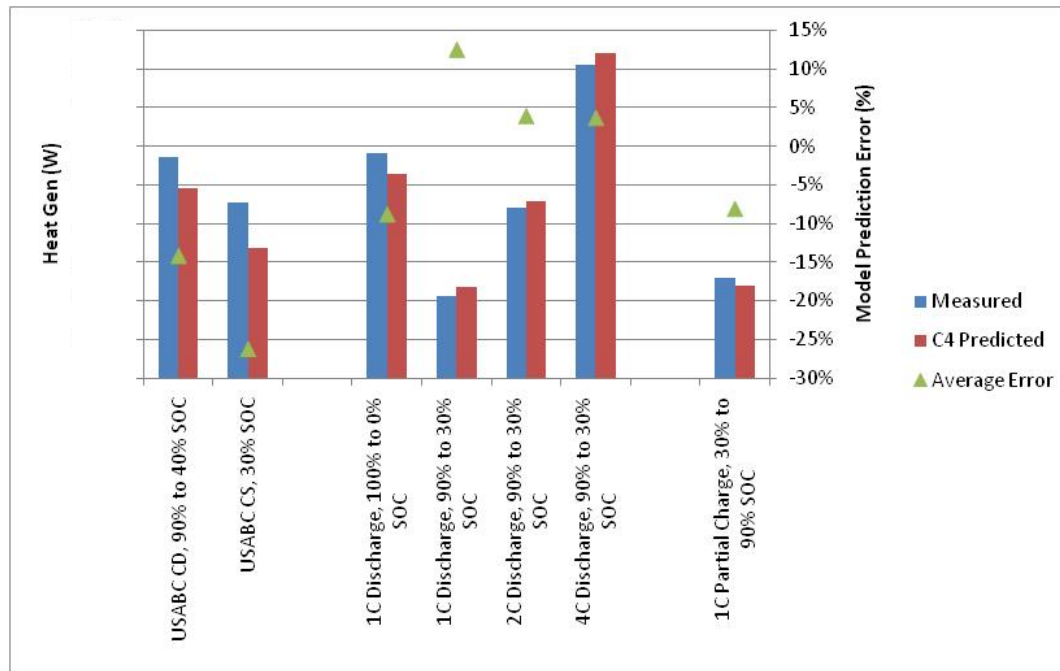

## Findings:

- Circuit model predicts heat generation with  **$\pm 20\%$  error**
  - **Circuit model** suitable for rough thermal management system sizing when using existing cell designs
  - **Physics models** expected to increase accuracy (at expense of complexity) and provide **guidance for future cell designs**



# 2. Thermal Modeling – Accomplishments

## 3-D thermal / electrochemical model – Overview

### MSMD model for large Li-ion cells

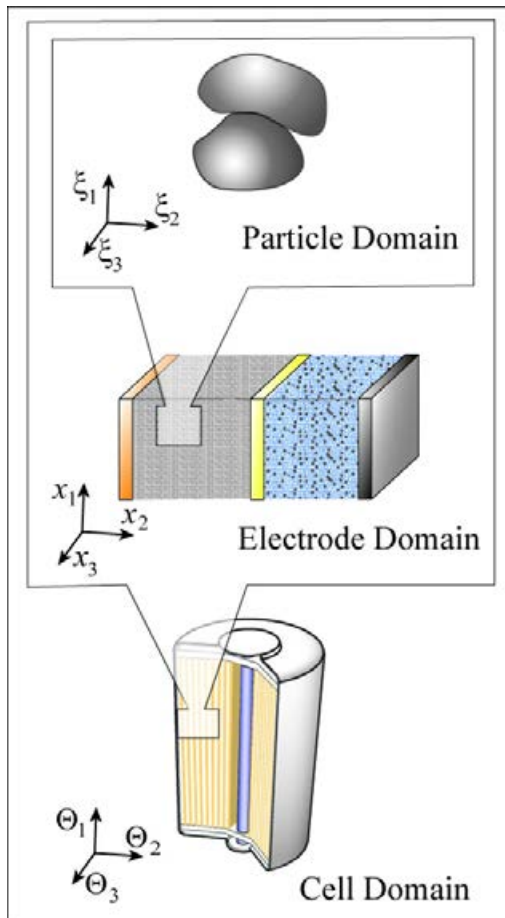

Illustration by Kyu-Jin Lee, NREL

- Submitted **technical paper on NREL multi-scale multi-dimensional (MSMD) model for large cell design and performance prediction**
  - Mathematical formulation for computational efficiency
  - Design study compares performance of four pouch cell designs
- Developed extensions to MSMD model
  - Linear **superposition method (LSM)** to **speed up cell and pack simulation**
  - Interfaced model with process **design optimization toolset**
  - **Spiral-wound cylindrical cell model\***
- Initiated **model validation study with commercial cells\***

\* Described on next slides

# 2. Thermal Modeling – Accomplishments

## 3-D thermal / electrochemical model for spiral-wound cells

Illustrations by Kyu-Jin Lee, NREL

- MSMD model extended to spiral-cell geometry formed when dual-sided electrode pairs are wound together
- Captures complex current distributions that arise from location and number of current-collector tabs placed along spiral winding
- Suitable for design and duty-cycle optimization

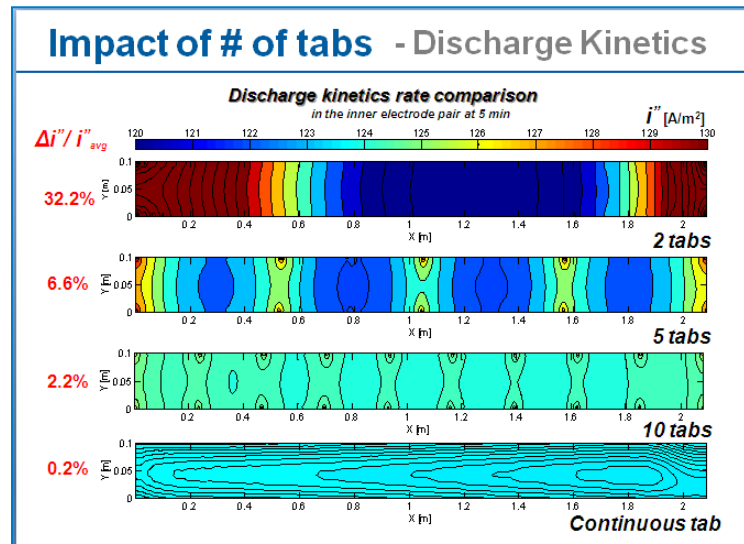
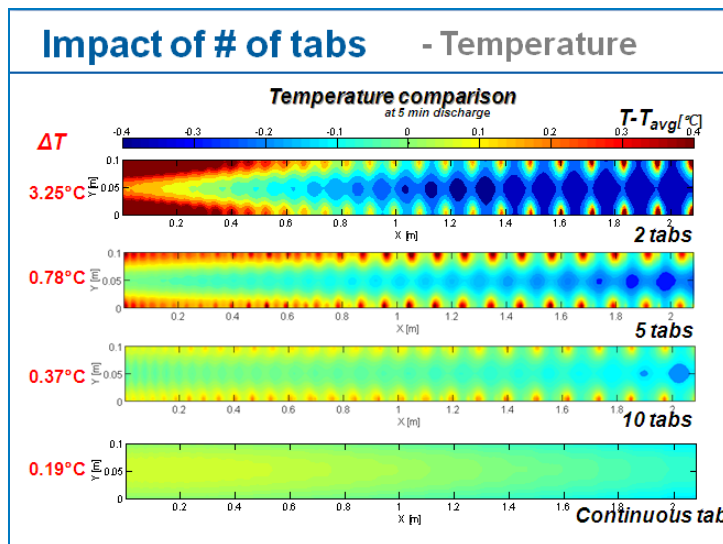
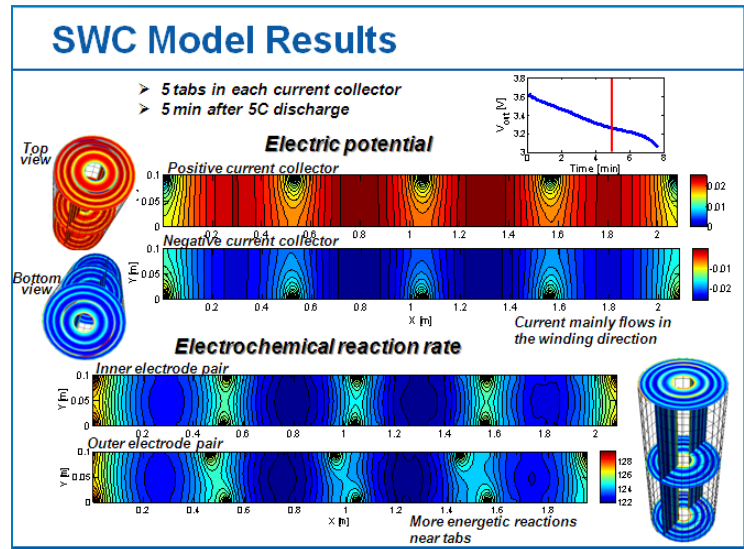

# 2. Thermal Modeling – Validation Accomplishments

## Initiated model validation study

NREL purchased Dow-Kokam cells ranging from 25 mAh to 8 Ah with various tab configurations. NREL also constructed several special test cells.

- 3-electrode cells used to obtain electrochemistry model parameters
- 25-mAh and coin cells used to validate electrochemistry and heat-generation models
- 8-Ah cell test results used to validate 3-D thermal / electrochemical MSMD model

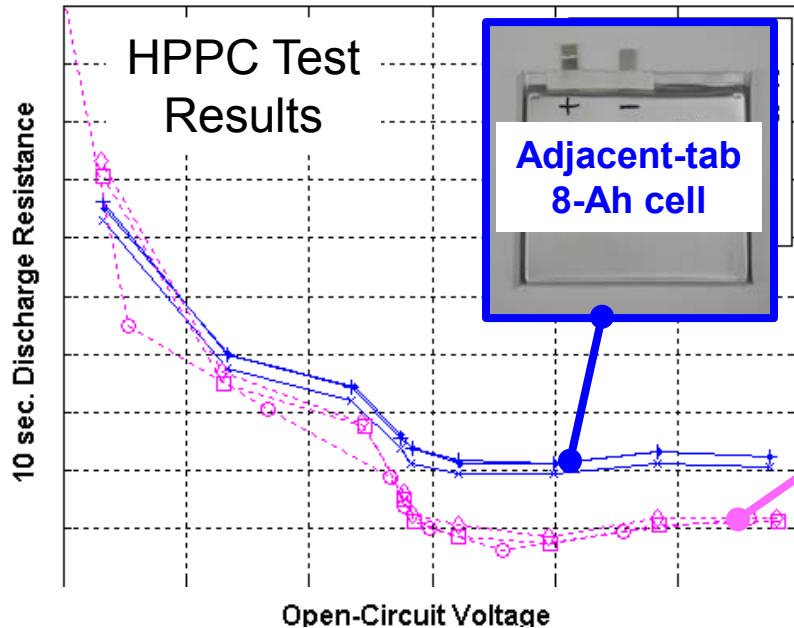

Adjacent-tab  
8-Ah cell

Counter-tab  
8-Ah cell

*Counter-tab design has lower resistance. Previous NREL modeling showed counter-tab designs have more uniform internal current distribution & fewer losses.*

### Status

- Testing 50% complete
- Model parameter extraction underway

# Outline

1. Thermal testing
2. Thermal & physics-based modeling

## 3. Life/temperature trade-off analysis

- Approach
- Accomplishments
  - Life expectations in various thermal environments
  - Thermal preconditioning of electric vehicle batteries

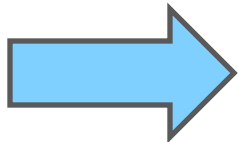

# 3. Life / Temperature Trade-offs – Approach

Explore systems & strategies to reduce battery cost & extend life

- Develop life models that predict battery degradation under real-world temperature & duty-cycle scenarios
- Integrate life models with vehicle-system and thermal models to quantify life/cost benefits

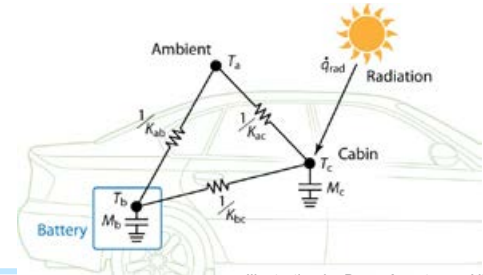
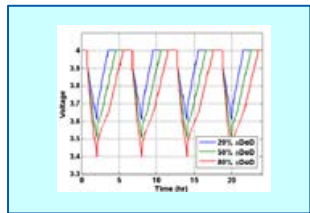

Illustration by Dean Armstrong, NREL

Leverage **existing battery aging datasets** from DOE and other labs



Lab data

Use **physical degradation mechanisms** to interpolate test results to **variable temperatures and duty-cycles**

Real-world **geography & duty-cycle**



Simulation inputs

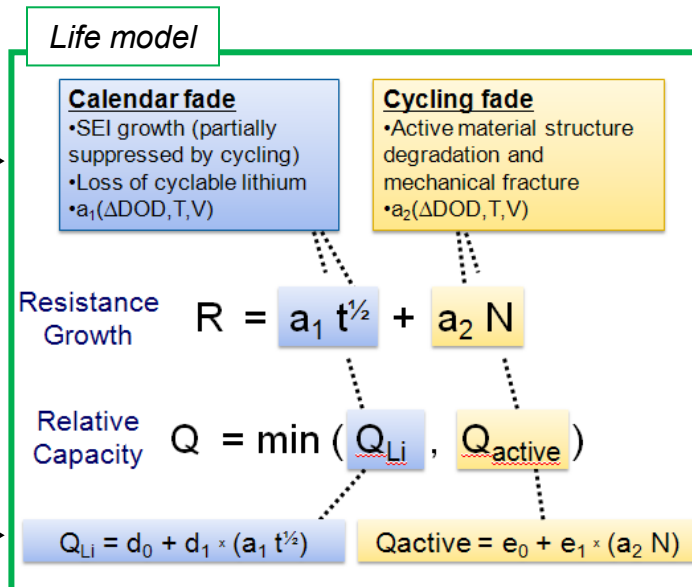

Life prediction

Life/cost/  
performance  
**trade-off**  
analyses

# 3. Life Trade-offs – Accomplishments

## Life expectation in various thermal environments

### Geographic Impact on Battery Life

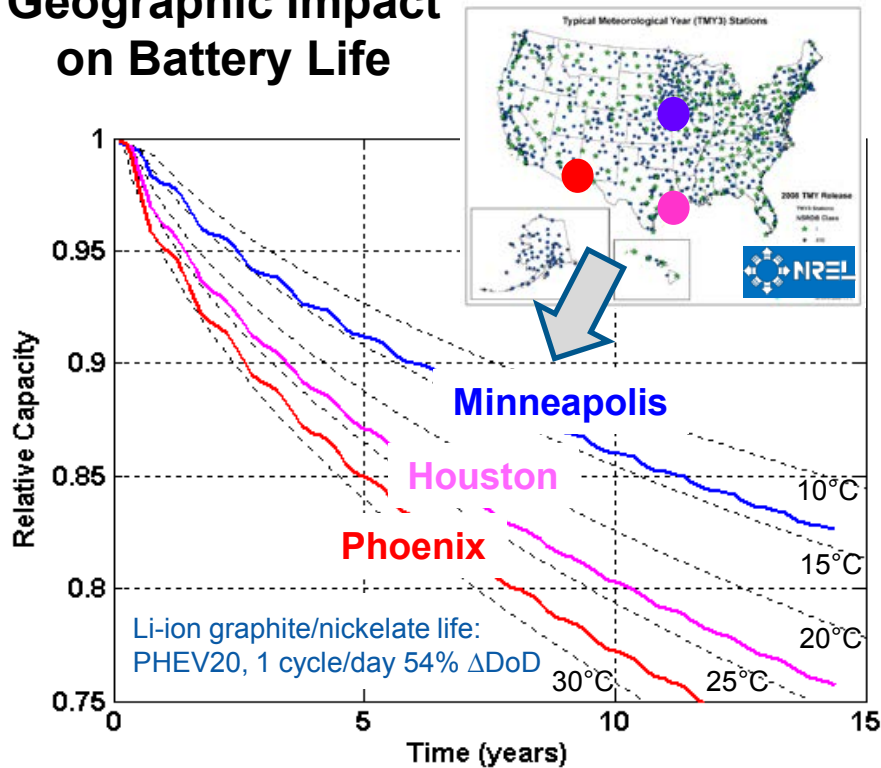

### Thermal Management Impact on Battery Life

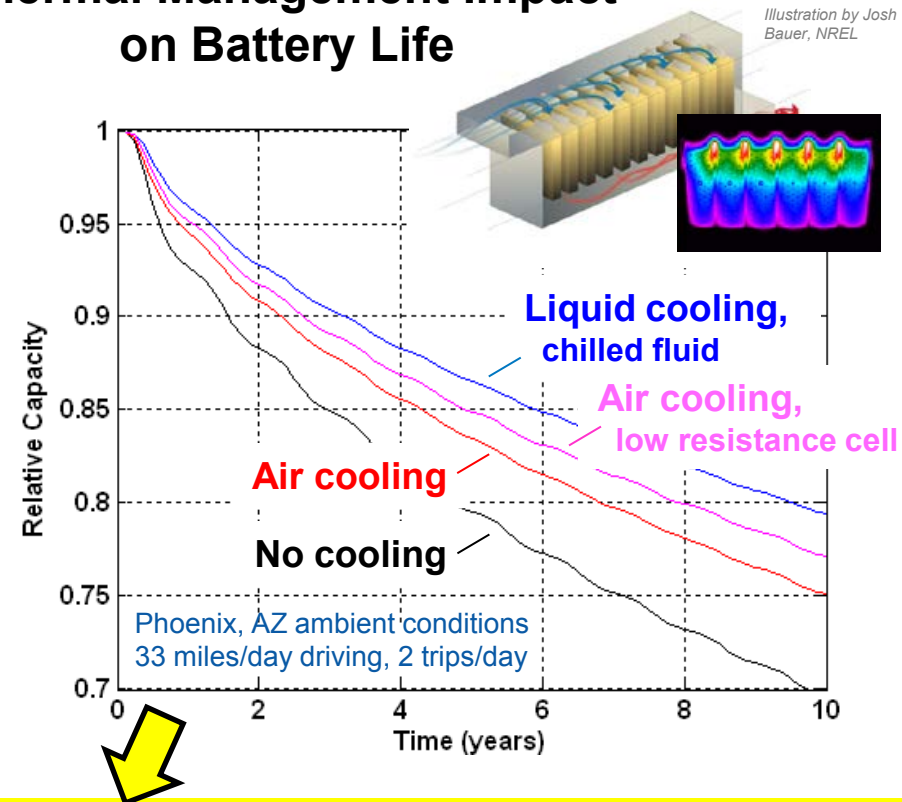

Compared with no cooling, the liquid-cooled battery can use 12% fewer cells and still achieve a 10-year life in Phoenix. Air cooling using low-resistance cells also seems appealing from a thermal / life perspective; however, this battery has the highest cell costs of the four options shown due to the cost of its high excess power.

# 3. Life Trade-offs – Accomplishments

## *Thermal preconditioning of electric-vehicle batteries*

*Cost-shared with DOE-OVT Vehicle Systems (Program Managers: Slezak and Anderson)*

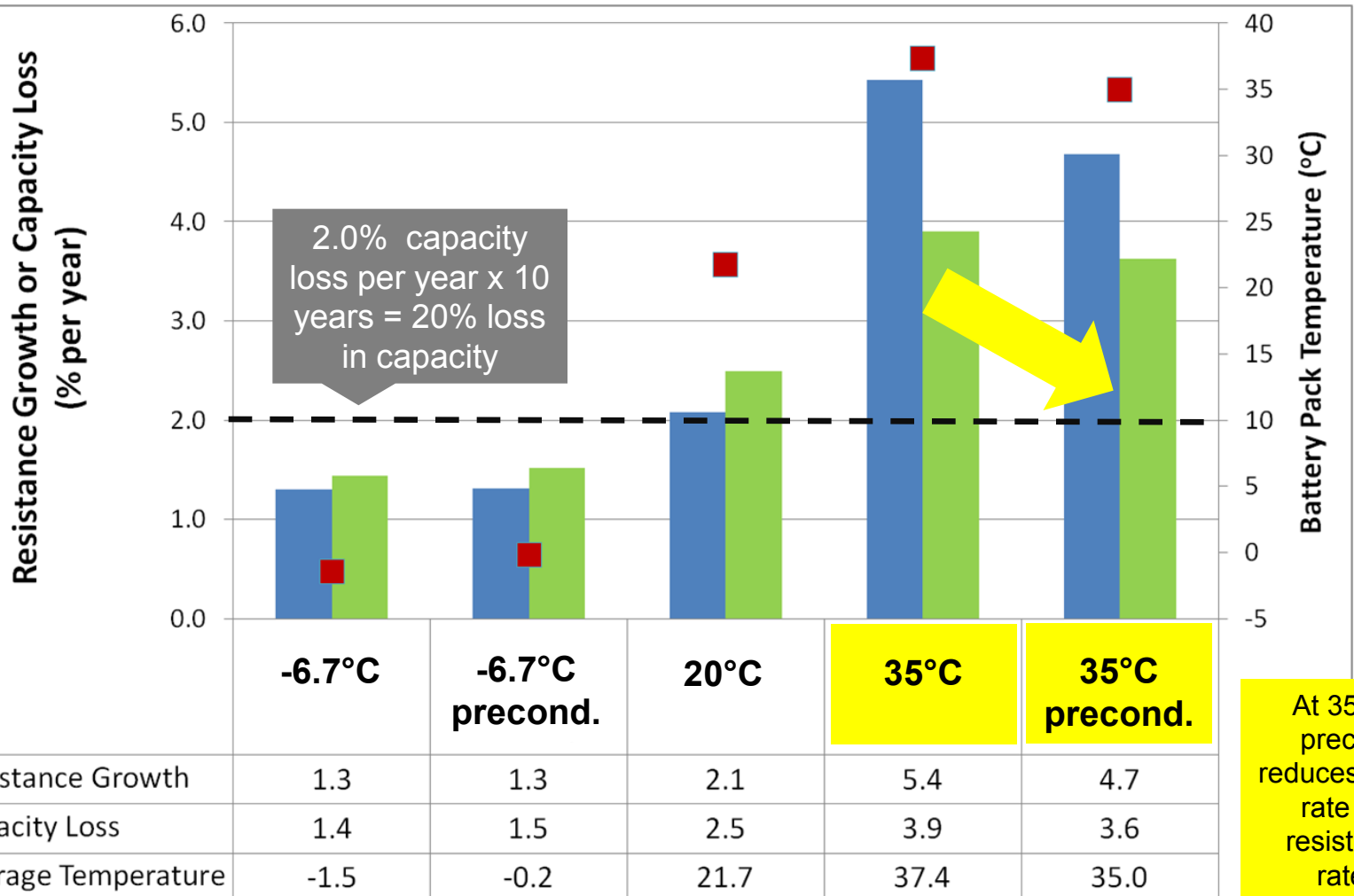

# Collaborators

---

- USABC partners Chrysler, GM, and Ford
- USABC contractors A123, CPI, EnerDel, and JCS
- Dow-Kokam – model validation studies
- Battery aging data
  - Idaho & Argonne National Laboratories
  - NASA-Jet Propulsion Laboratory
  - Southern California Edison
  - CEA-INES (France)
  - Aerospace industry collaborators
- Zero Emissions Mobility – fleet battery life analysis tools
- Colorado School of Mines – elementary chemical reaction models



# Future Work

- Continue **thermal characterization** for DOE, USABC and partners
  - Large calorimeter available for industry validation of full energy storage systems
- Enhance **physics-based battery models** in conjunction with DOE CAEBAT program
- Complete **validation study** for 3-D electrochemical / thermal model
  - First: Predict **performance** of large-format cells with varying geometry
  - Next: Predict **life** and **safety** of large-format cells with varying geometry
- Extend **life model** to additional Li-ion **chemistries** and **validate** life predictions using real-world automotive data
- Integrate life model into **techno-economic studies** in support of DOE **Energy Storage and Vehicle Systems** programs
  - Unified vehicle thermal management system design
  - Grid-integration of electric-drive vehicle batteries
  - Alternative business models and battery 2<sup>nd</sup> use

# Summary

- **Temperature** presents a significant challenge to vehicle energy storage **life, safety and performance**, which ultimately impacts **cost** and consumer acceptance
- **NREL laboratory tests** provide data to address **thermal barriers** of energy storage cells, modules and packs. Results are reported to DOE, USABC and industry partners
- **Physics-based battery models** provide understanding of battery-internal behavior not possible through experiment alone. Model validation study will assess suitability of models to replace physical prototypes in future **computer-aided design optimization** processes
- **Life-predictive models** clarify the role of advanced thermal management and other strategies to meet 10- to 15-year battery life at lowest possible system cost. Cell count may be reduced by 6% to 12% using thermal preconditioning and/or chilled-liquid cooling strategies for some vehicles
- Modeling methodology is being **transferred to industry** through **DOE CAEBAT program** and licensing

# Publications and Presentations

1. G.-H. Kim, K. Smith, K.-J. Lee, S. Santhanagopalan, A. Pesaran, “Multi-Domain Modeling of Lithium-ion Batteries Encompassing Multi-Physics in Varied Length Scales,” submitted for journal publication.
2. G.-H. Kim, K. Smith, K.-J. Lee, S. Santhanagopalan, A. Pesaran, “Integrated Lithium-Ion Battery Model Encompassing Physics in Varied Length Scales,” International Battery Modeling Workshop at 11<sup>th</sup> AABC, Pasadena, California, Jan. 2011.
3. R. Barnitt, A. Brooker, L. Ramroth, J. Rugh, K. Smith, “Analysis of Off-Board Powered Thermal Preconditioning in Electric Drive Vehicles,” 25<sup>th</sup> World Battery, Hybrid and Fuel Cell Electric Vehicle Symposium & Exhibition, Shenzhen, China, Nov. 2010.
4. K.-J. Lee, G.-H. Kim, K. Smith, “3D Thermal and Electrochemical Model for Spirally Wound Large Format Lithium-ion Batteries,” 217<sup>th</sup> Electrochemical Society Meeting, Las Vegas, Nevada, Oct. 2010.
5. K. Smith, A. Pesaran, “Opportunities for Improving the Thermal Design of Electric-Vehicle Batteries,” EV Battery Tech Conference, Troy, Michigan, Sept. 2010.
6. K. Smith, T. Markel, Gi-Heon Kim, A. Pesaran, “Design of Electric-Drive Vehicle Batteries for Long Life and Low Cost,” IEEE Workshop on Accelerated Stress Testing & Reliability, Denver, Colorado, Oct. 2010.
7. K. Smith, A. Vlahinos, G.-H. Kim, A. Pesaran, “Computer-Aided Optimization of Macroscopic Design Factors for Lithium-Ion Cell Performance and Life,” 217<sup>th</sup> Electrochemical Society Meeting,” Vancouver, Canada, April 2010.