



Lithium-Ion Battery Safety Study Using Multi-Physics *Internal Short-Circuit* Model

The 5th Intl. Symposium on
Large Lithium-Ion Battery Technology and Application
in Conjunction with AABC09

June 9-10, 2009, Long Beach, CA

Gi-Heon Kim, Kandler Smith, Ahmad Pesaran
National Renewable Energy Laboratory
Golden, Colorado

gi-heon.kim@nrel.gov

This research activity is funded by US DOE's ABRT program (Dave Howell)

NREL/PR-540-45856



Background

- NREL's Li-ion thermal abuse modeling study was started under the Advanced Technology Development (ATD) program; it is currently funded by Advanced Battery Research for Transportation (ABRT) program.
- NREL's [previous model study](#)
 - ✓ focused on understanding the [interaction between heat transfer](#) and [exothermic abuse reaction propagation](#) for a particular cell/module design, and
 - ✓ provided insight on how thermal characteristics and conditions can impact safety events of lithium-ion batteries.

Total Volumetric Heat Release from Component Reactions

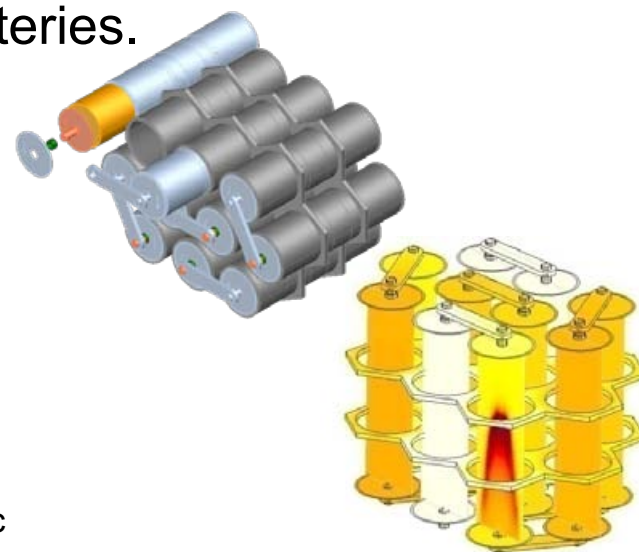
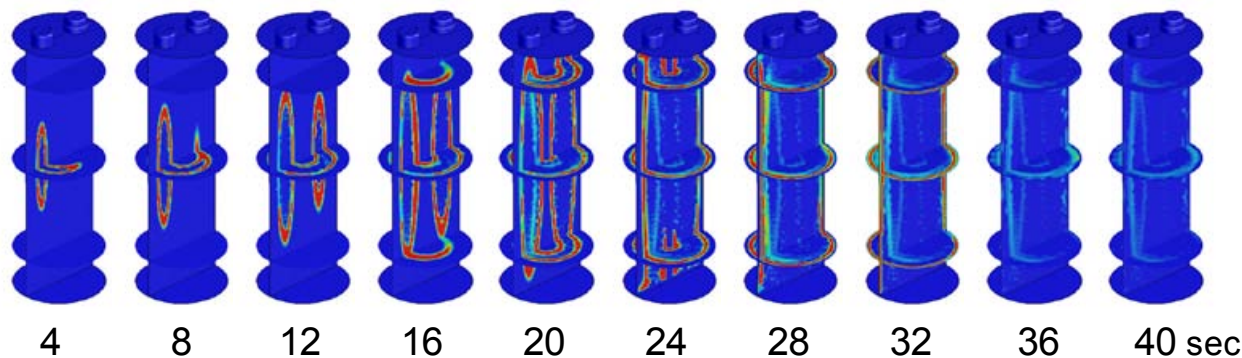

Focus Here: Internal Short-Circuit

- Li-Ion thermal runaway due to **internal short-circuit** is a major safety concern.
 - Other safety concerns may be controlled by electrical and mechanical methods.
- Initial **latent defects** leading to later internal shorts may not be easily controlled, and **evolve into a hard short** through various mechanisms:
 - separator wear-out,
 - metal dissolution and deposition on electrode surface, or
 - extraneous metal debris penetration, etc.
- **Thermal behavior** of a lithium-ion battery system for an internal short-circuit **depends on various factors** such as nature of the short, cell capacity, electrochemical characteristics of a cell, electrical and thermal designs, system load, etc.
- Internal short-circuit is a **multi-physics, 3-dimensional problem** related to the electrochemical, electro-thermal, and thermal abuse reaction kinetics response of a cell.

Approach:

Understanding of Internal Short Circuit Through Modeling

- Perform 3D multi-physics internal short simulation study to characterize an internal short and its evolution over time
- Expand understanding of internal shorts by linking and integrating NREL's electrochemical cell, electro-thermal, and abuse reaction kinetics models

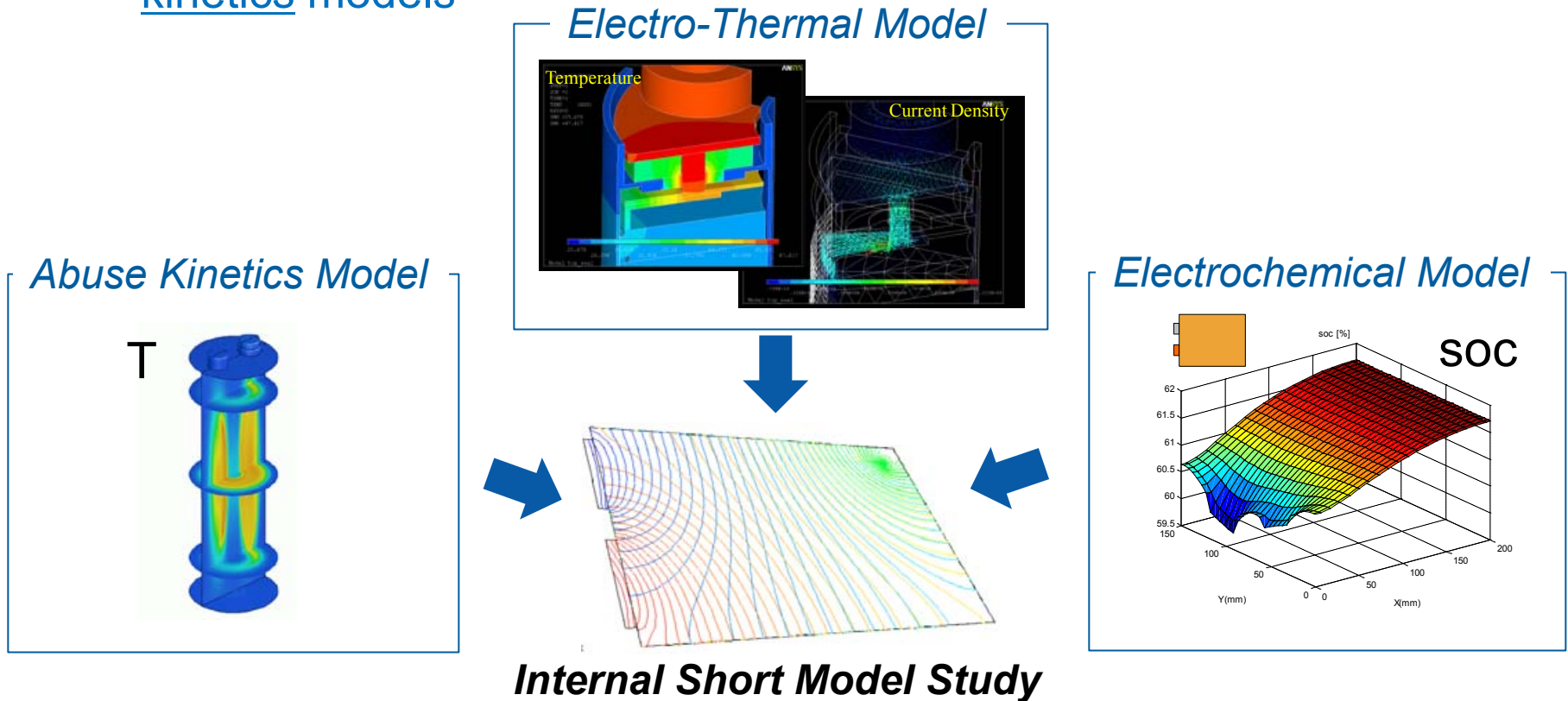

Research Focus Is on ...

- Understanding **electrochemical response** for short
- Understanding **heat release** for short event
- Understanding **exothermic reaction** propagations
- Understanding **function and response of mitigation technology** designs and strategies

Heating Pattern Change

- A multi-physics model simulation demonstrates that heating patterns at short events depend on the nature of the short, cell characteristics such as capacity and rate capability.

Example of Synergetic Model Combination for Study on Heat Release for Short

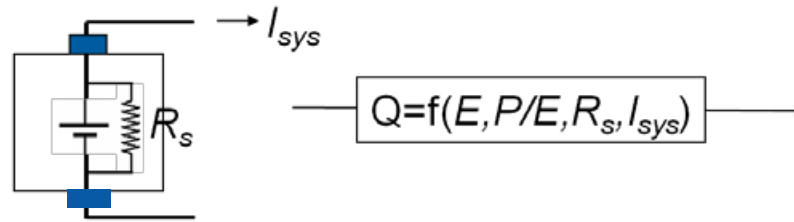

Electrical(Electrochemical) Short Cell Model

3D Abuse Reaction Model

Heating Pattern at Different Resistance-Shorts

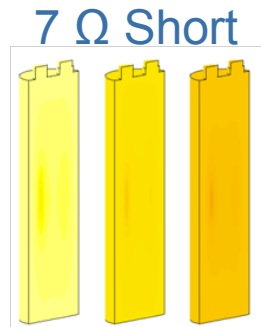

3 min 6min 9 min

Affected by external thermal conditions

Can slow down the evolution?

Can suppress?

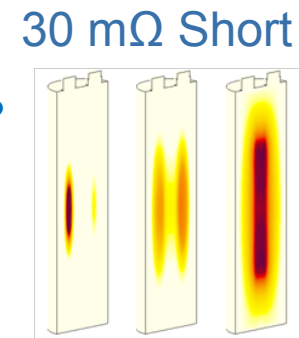

4s 8s 12s

Undetectable from external probes



Understanding Heating Response Differences

Heating from Short Circuit = Heat from Cell Discharge + Joule Heat at Short

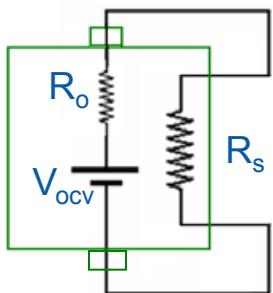

Short Heating =

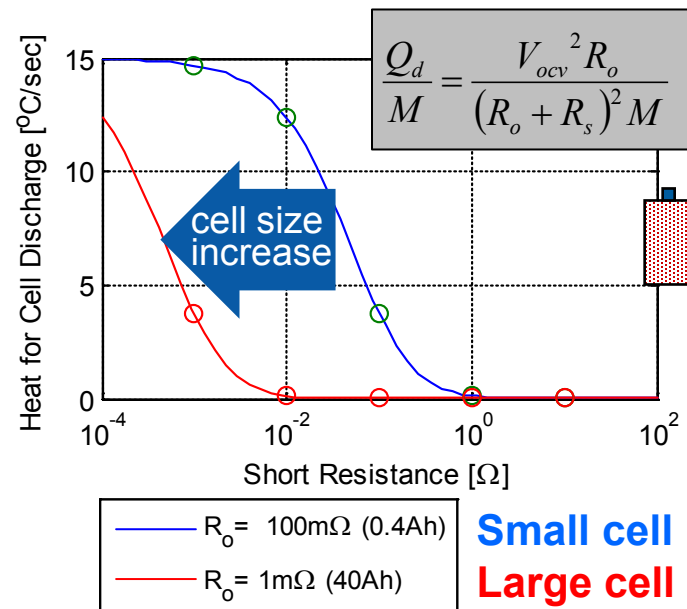
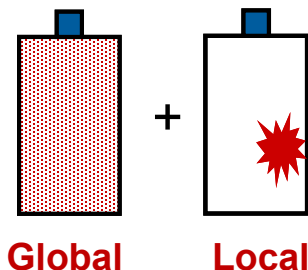

Understanding Heating Response Differences

Heating from Short Circuit = Heat from Cell Discharge + Joule Heat at Short

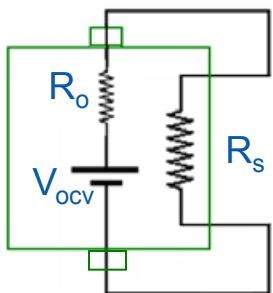

Short Heating =

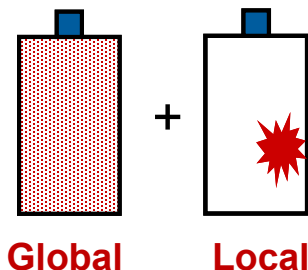

Qualitative Representation for Heating Pattern

10 mΩ Short

10 Ω Short

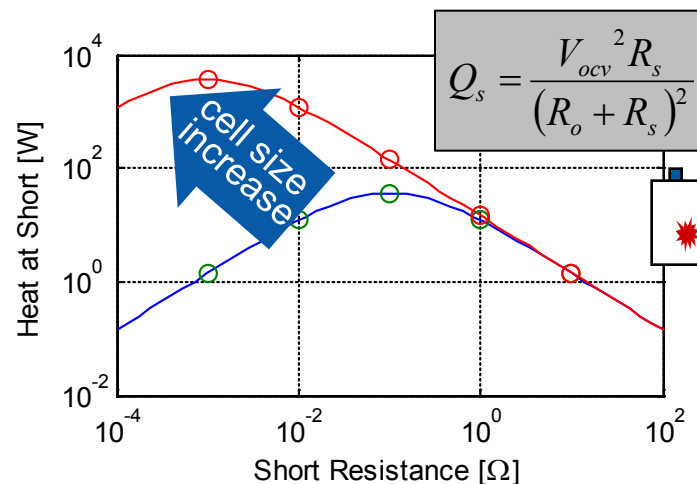
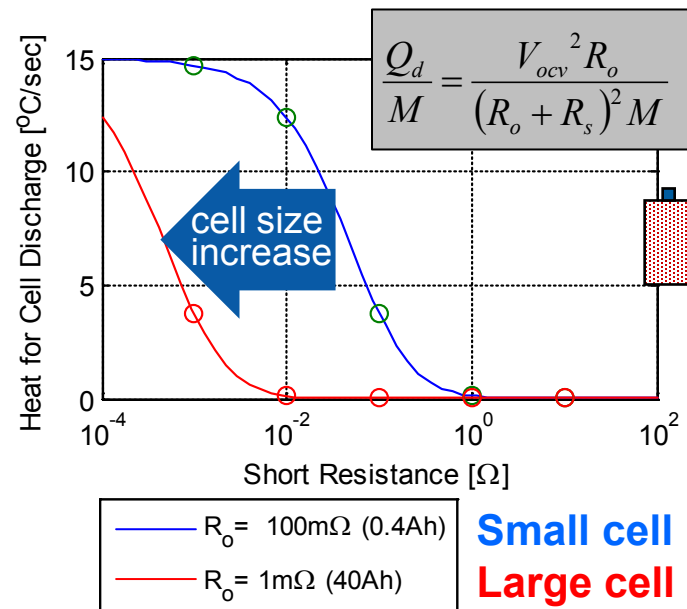

Understanding Heating Response Differences

Heating from Short Circuit = Heat from Cell Discharge + Joule Heat at Short

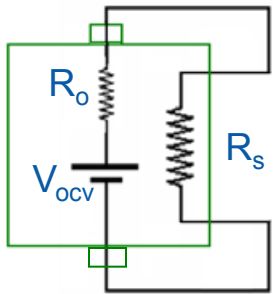

Short Heating =

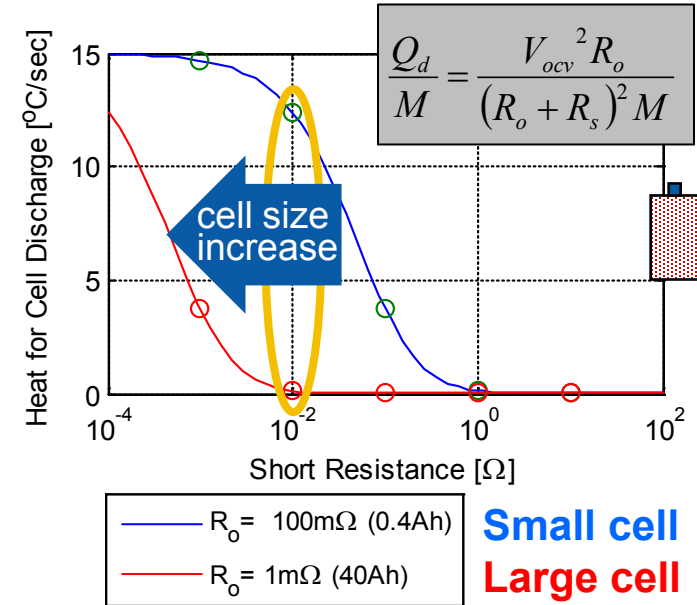
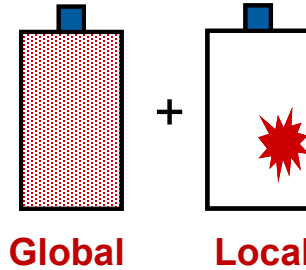

Qualitative Representation for Heating Pattern

10 mΩ Short

10 Ω Short

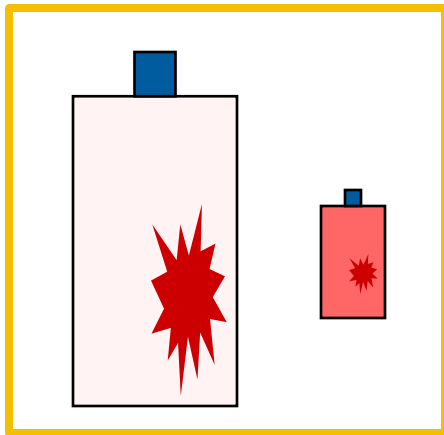

Large cell: localized heating
Small cell: global heating

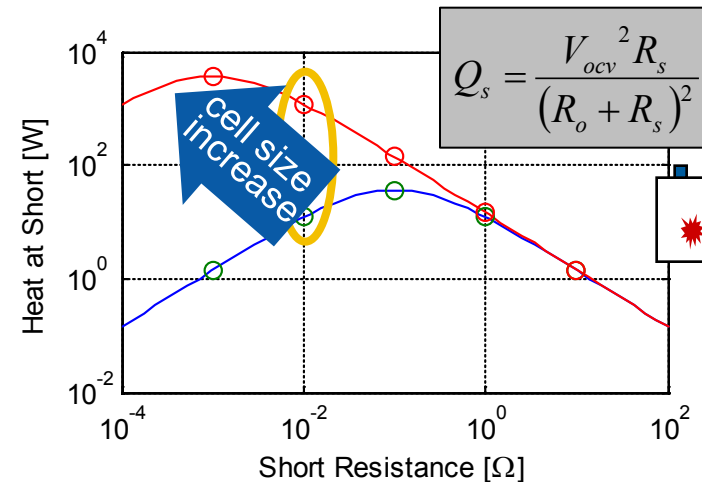

Understanding Heating Response Differences

Heating from Short Circuit = Heat from Cell Discharge + Joule Heat at Short

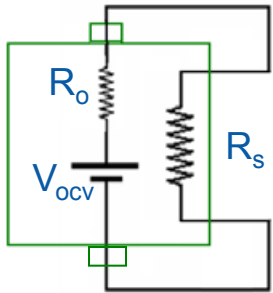

Short Heating =

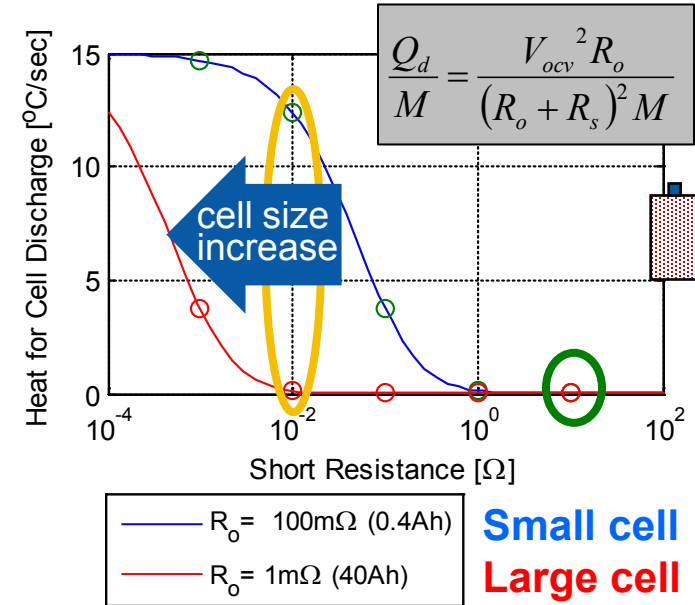
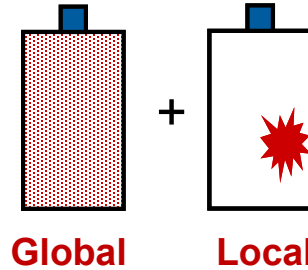

Qualitative Representation for Heating Pattern

10 mΩ Short

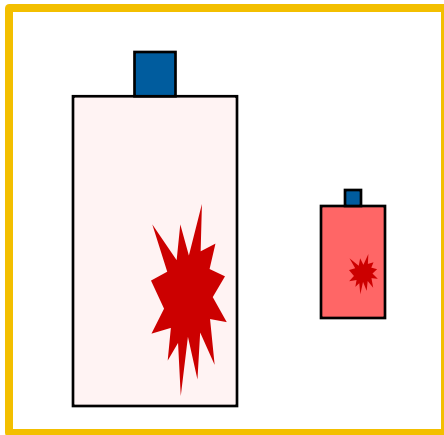

Large cell: localized heating
Small cell: global heating

10 Ω Short

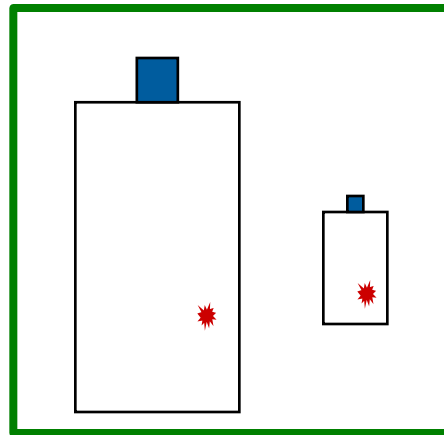

Same local heating, and
Negligible global heating for both

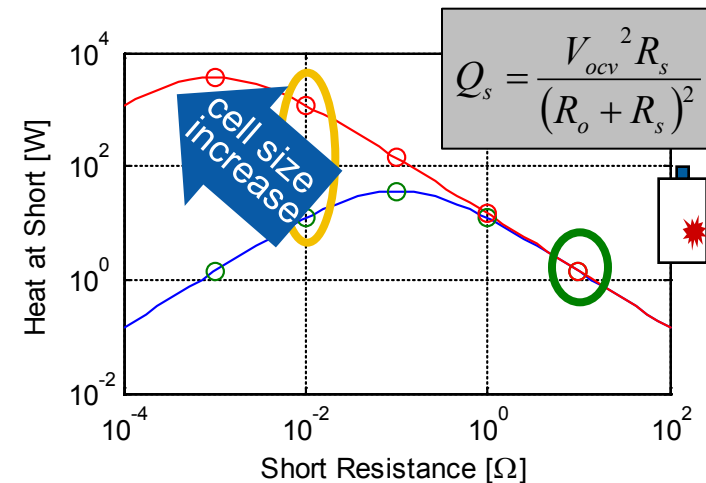

Observations from Literature:

Various Short Resistances

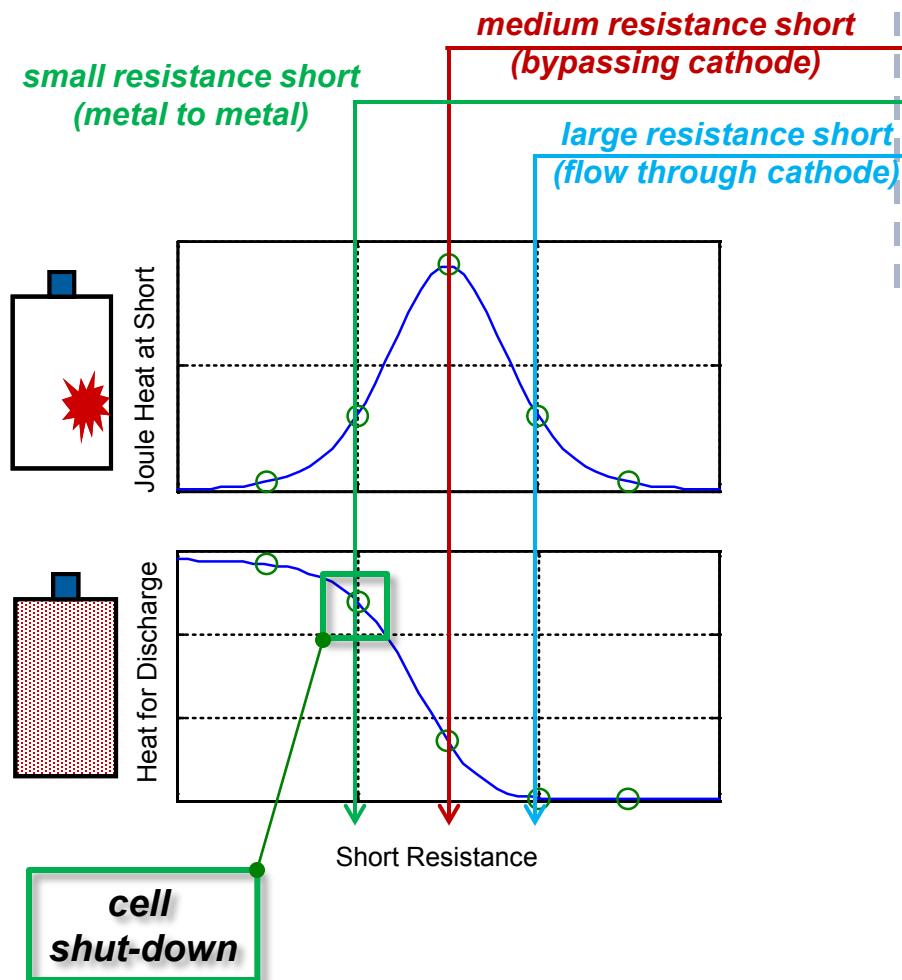

John Zhang, Celgard, AABC08

No Particle

1. $Al \rightarrow LiC_6$
2. $Al \rightarrow C_6$
3. $Al \rightarrow Cu$
4. $LCO \rightarrow LiC_6$
5. $Cu \rightarrow LCO$

A **POLYPOR** Company

Easier Explore and Fire

Very Difficult to Explore and Fire

Celgard LLC

*Small Cell with Shut-Down Separator

Observations from Literature:

Various Short Resistances

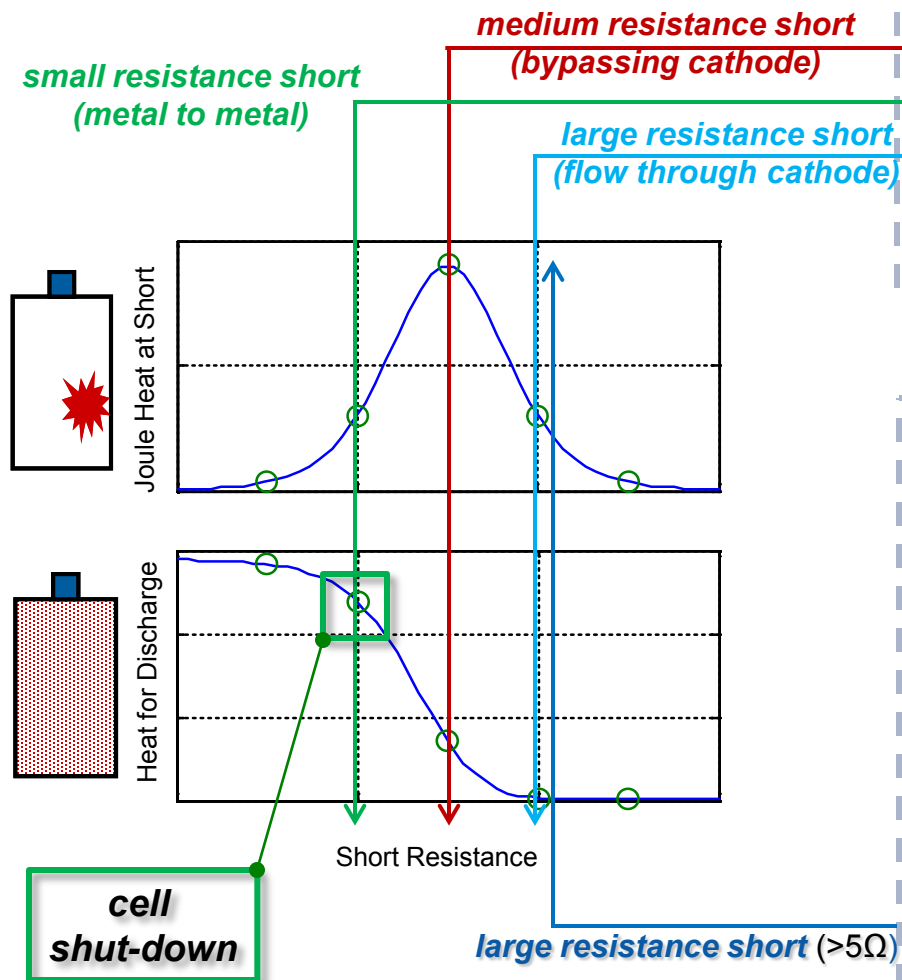

John Zhang, Celgard, AABC08

No Particle

1. $Al \rightarrow LiC_6$
2. $Al \rightarrow C_6$
3. $Al \rightarrow Cu$
4. $LCO \rightarrow LiC_6$
5. $Cu \rightarrow LCO$

Easier Explore and Fire

Very Difficult to Explore and Fire

A **POLYPOR** Company

Celgard LLC

*Small Cell with Shut-Down Separator

Peter Roth, SNL, ATD presentation

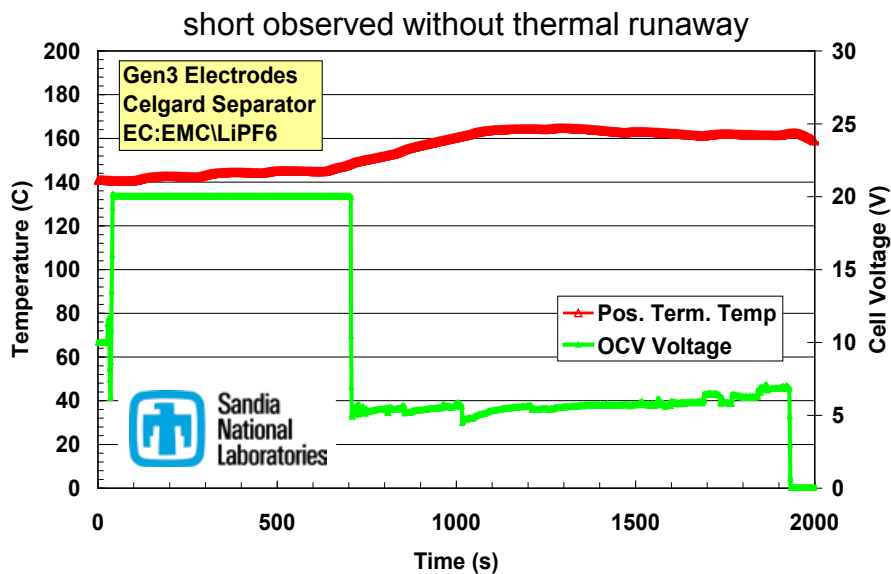

➤ Literature cases with wide range of internal short resistances are observed

Prismatic Stack Cell Short Simulation

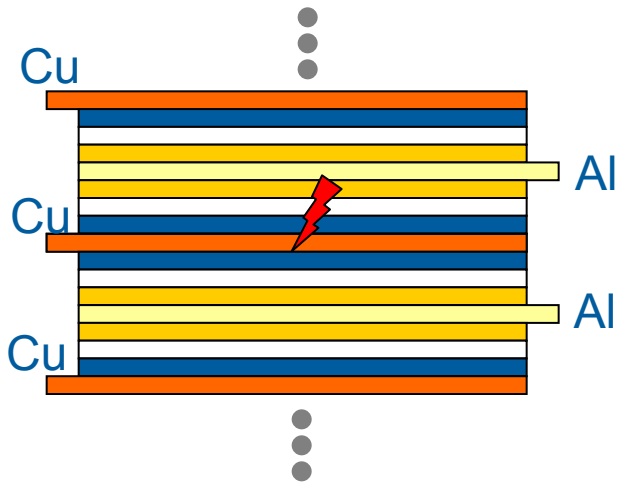

- 20 Ah
- P/E $\sim 10 \text{ h}^{-1}$
- Stacked prismatic
- Form factor: 140 mm x 200 mm x 7.5 mm
- Layer thickness: (Al-Cathode-Separator-Anode-Cu)
15 μm -120 μm -20 μm -135 μm -10 μm
- Multi-physics model parameters
 - ✓ Electrochemistry model: a set evaluated at NREL
 - ✓ Exothermic kinetics: Hatchard and Dahn (1999)
 - ✓ Electronic conductivity: Srinivasan and Wang (2003)

Modeling Objectives

- Characterize short natures
- Predict cell responses
- Predict onset of thermal runaway

Assumptions

- Short remains same
- Structurally intact
- No venting and no combustion

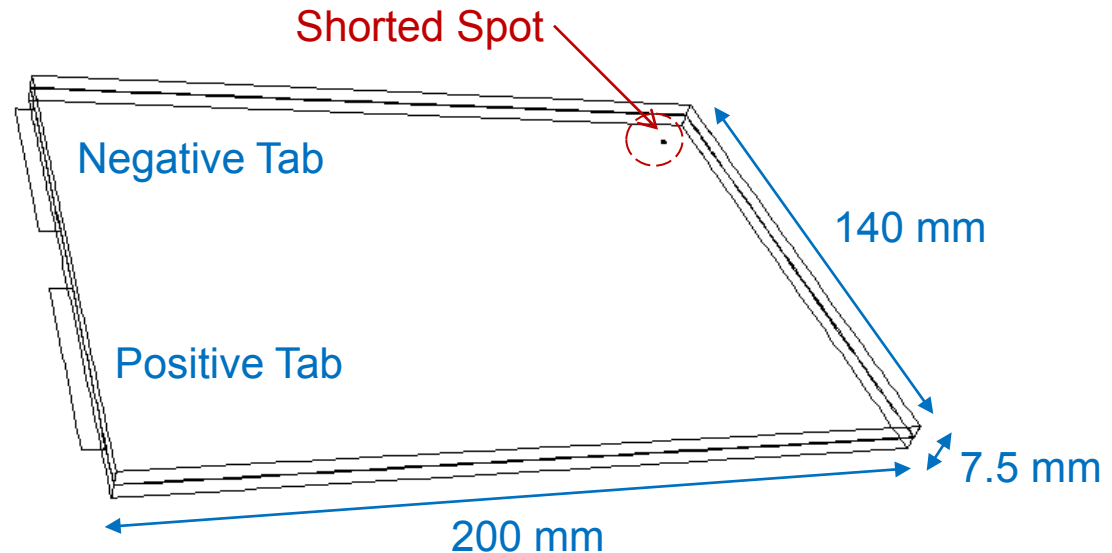

Short Between Al & Cu Current Collector Foils

- Shorted area: 1 mm x 1 mm
- e.g.,
 - ✓ metal debris penetration through electrode & separator layers
 - ✓ contact between outermost bare Al foil and negative-bias can



$$R_{\text{short}} \sim 10 \text{ m}\Omega$$
$$I_{\text{short}} \sim 300 \text{ A (15 C-rate)}$$

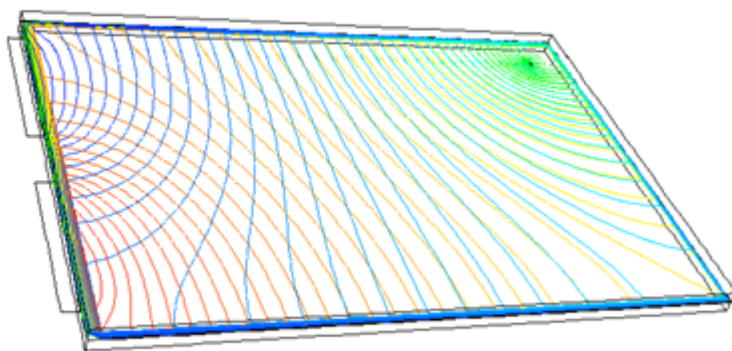
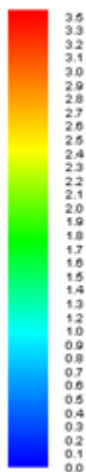

electric potential distribution at shorted metal foil layers

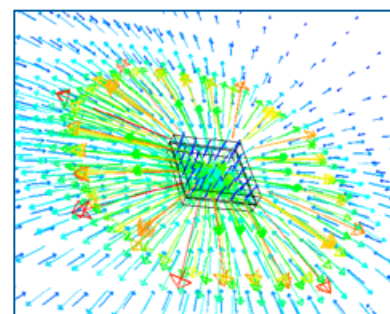

current density field near short

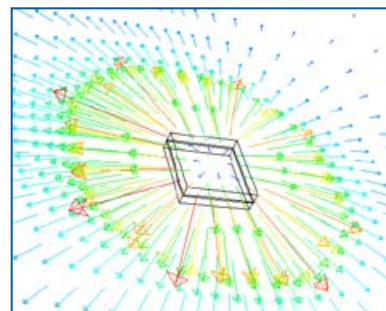

diverging current at Cu foil

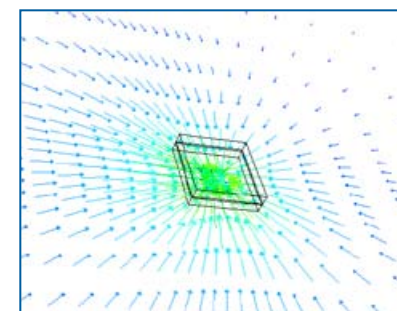

converging current at Al foil

Short Between Al & Cu Current Collector Foils

Joule Heat for Short

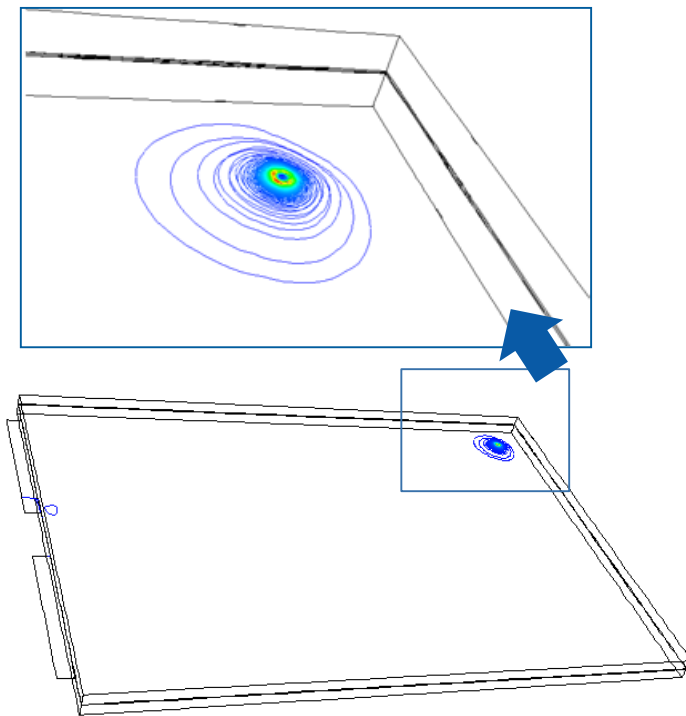

Temperature @10 sec after short

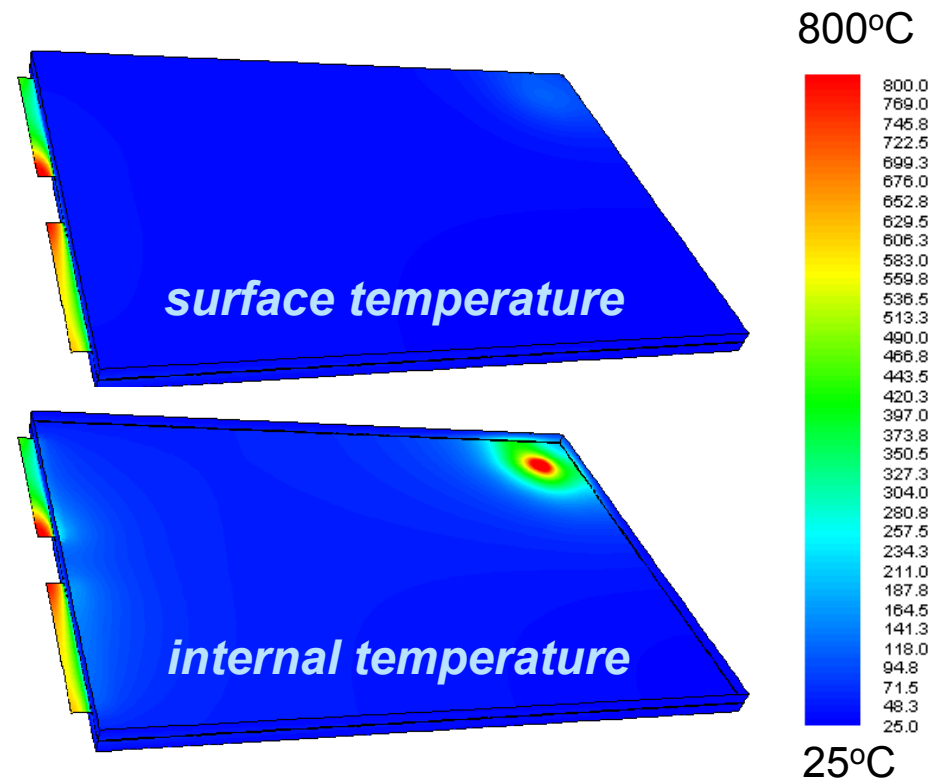

- Joule heat release is localized for converging current near short
- Localized temperature rise is observed.
- Temperature of Al tab appears to reach its melting temperatures (~600°C)

Short Between Al & Cu Foils: Reaction Propagation

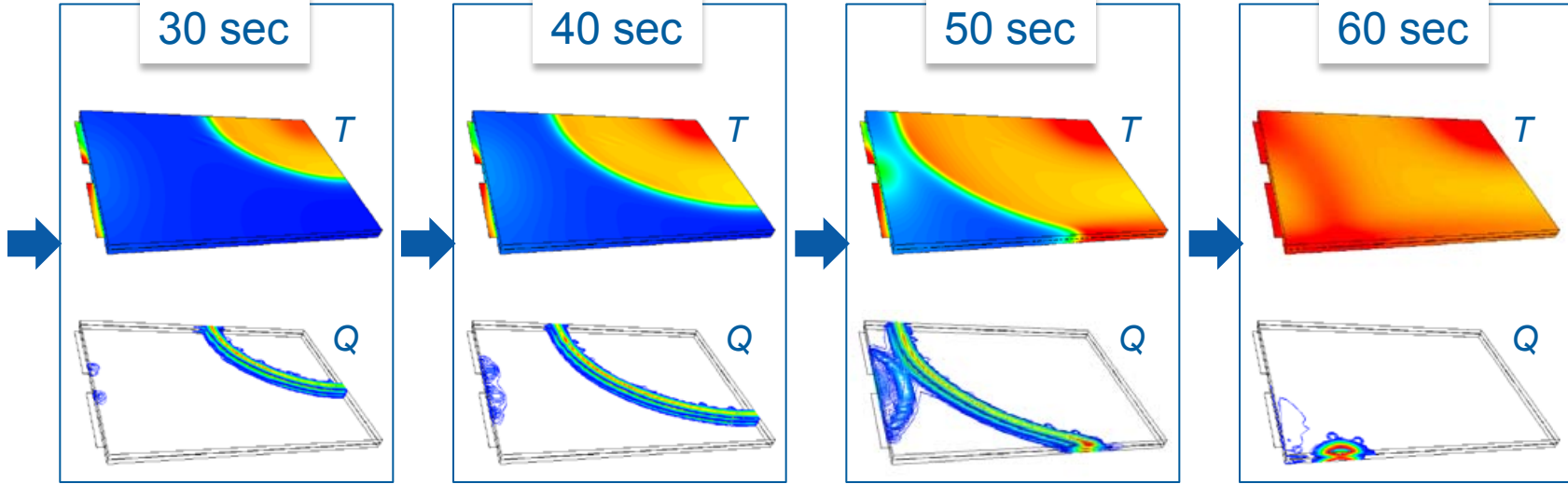
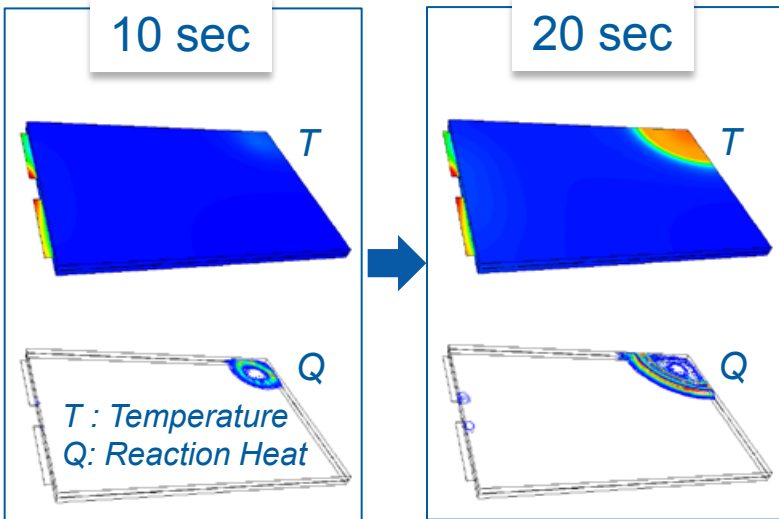
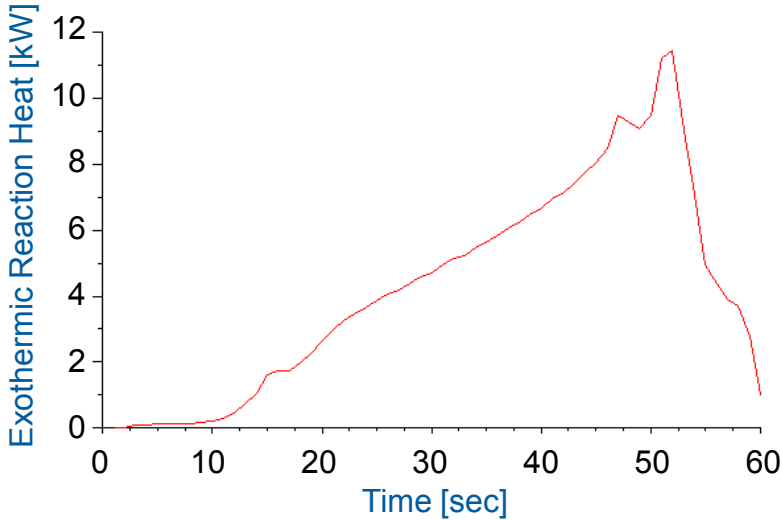

Short Between Cathode and Anode Electrodes

- Shorted area: 1 mm x 1 mm
- e.g.,
 - ✓ separator puncture
 - ✓ separator wearout under electrochemical environment



$$R_{\text{short}} \sim 20 \Omega$$

$$I_{\text{short}} \sim 0.16 \text{ A } (< 0.01 \text{ C-rate})$$

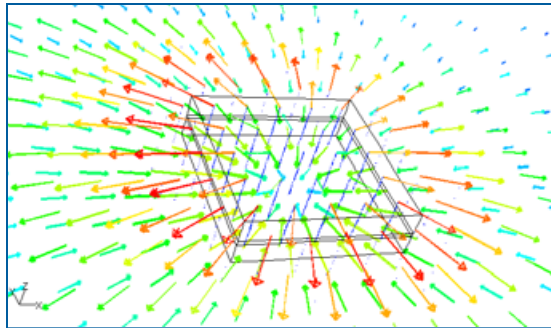

current density field near short

potential near short

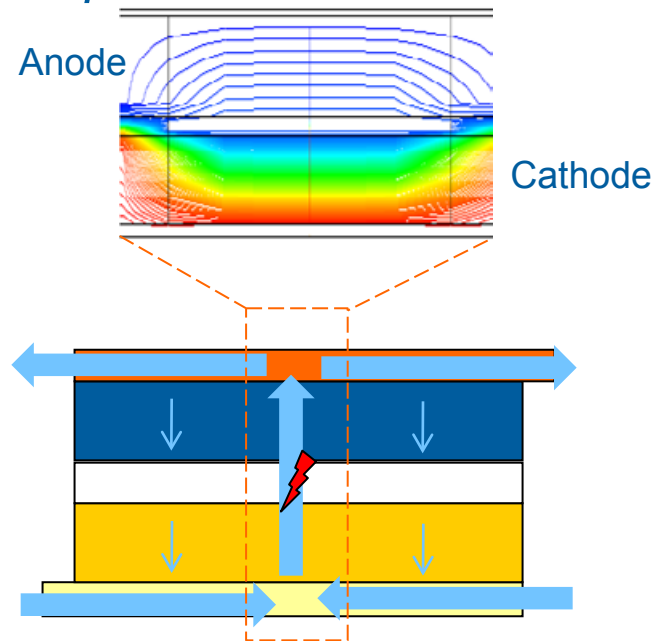

- Electron current is still carried mostly by metal current collectors
- Short current should get through the resistive electrode layers
- Potential drop occurs mostly across positive electrode

Short Between Electrodes: Temperature

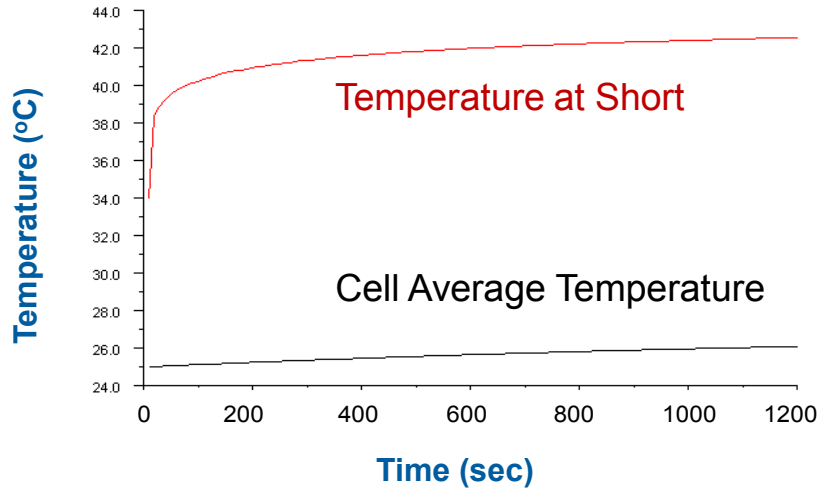

Temperatures at 20 min after Short

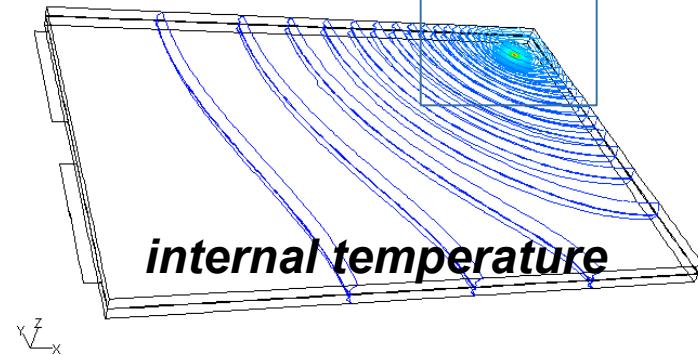
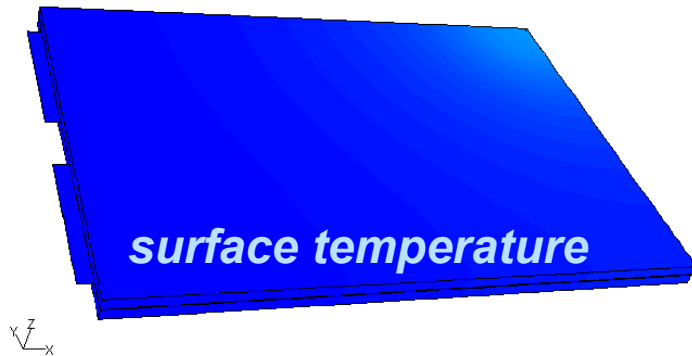
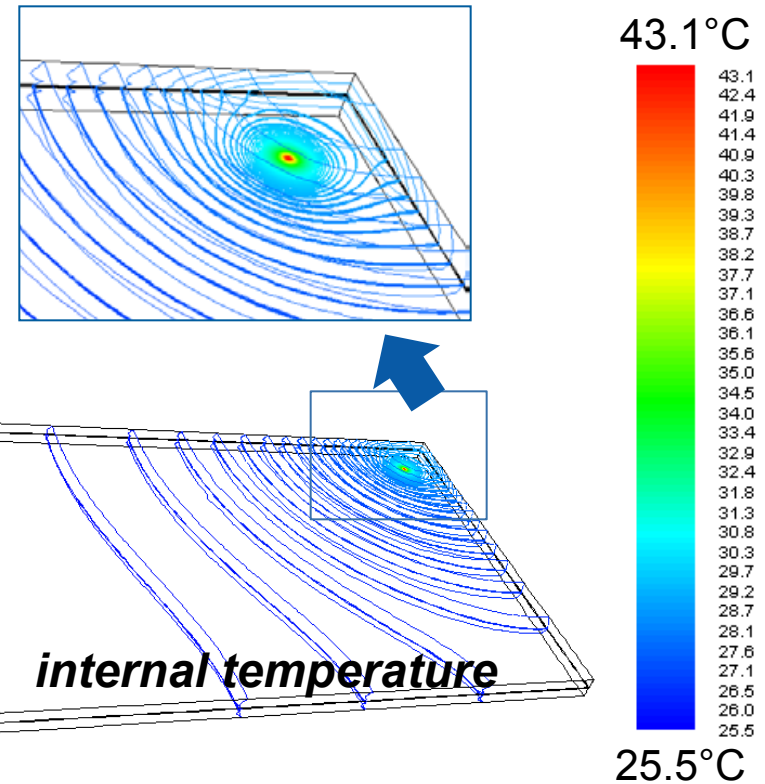

- Thermal signature of the short is hard to detect from the surface
- The short for simple separator puncture is not likely to lead to an immediate thermal runaway

Observations: Simple Separator Puncture

Celina Mikolajczak, Exponent, NASA Aerospace Battery Workshop 2008

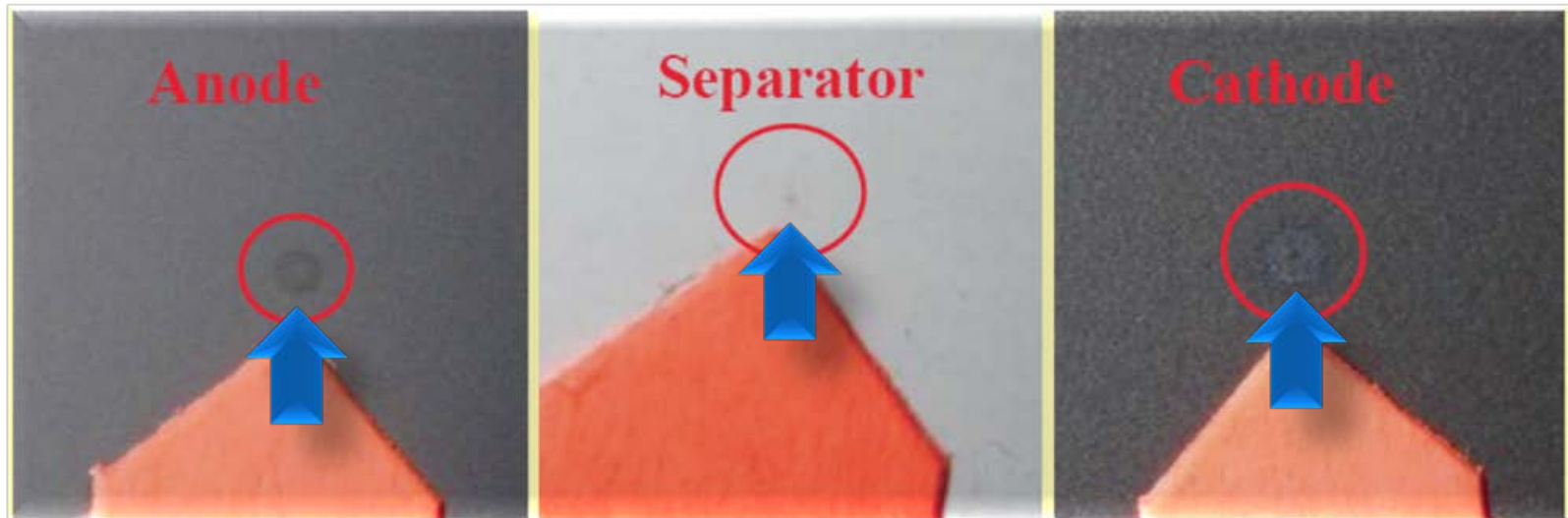

- Wear and puncture or degradation of separator
- Local degradation of electrode materials

Exponent

 **Issue on Structural Integrity of Separator**

Short Between Electrodes: Impact of Short Area

Impact of Separator Structural Integrity

Separator Hole Propagation

1 mm x 1 mm → 3 cm x 3 cm

$$R_{short} \sim 20 \Omega$$

$$I_{short} \sim 0.16 \text{ A } (< 0.01 \text{ C-rate})$$



$$R_{short} \sim 30 \text{ m}\Omega$$

$$I_{short} \sim 100 \text{ A } (5 \text{ C})$$

3cm x 3cm Separator Hole

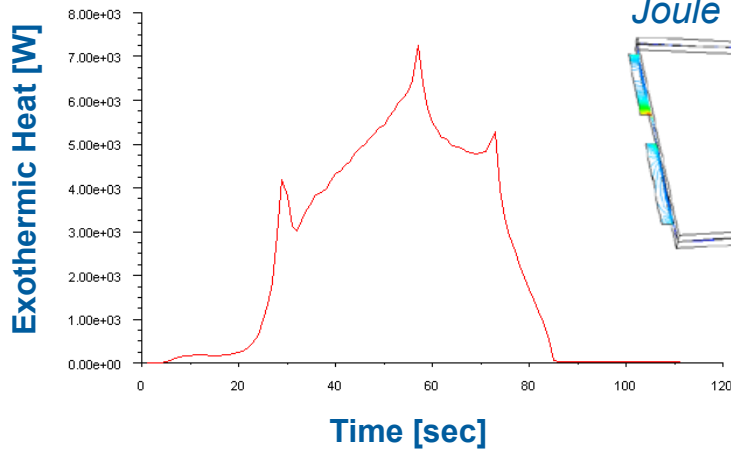

Joule Heat @ cathode layer

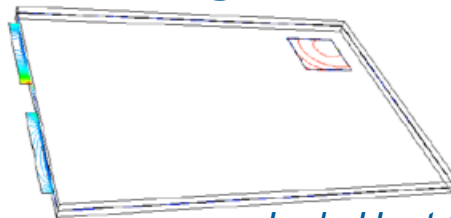

Joule Heat @ foils

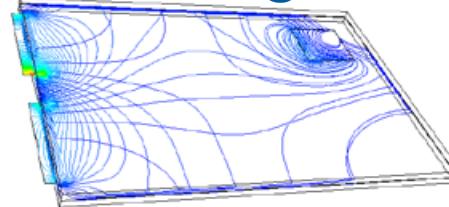

Myung Hwan Kim, LG Chem, AABC08

Hole Propagation Test for Simulating Internal Short

Hot Tip at 450 °C for 10 sec

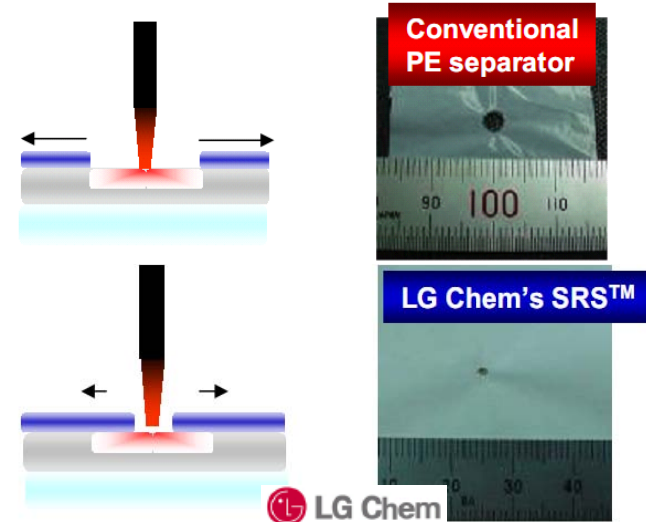

Temperature at 1min after short

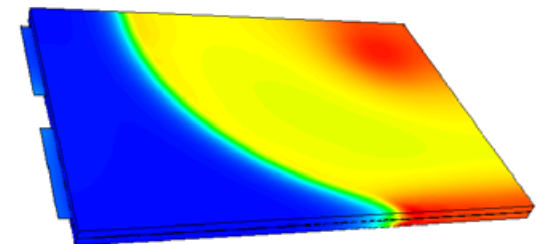

Observations: Structurally Reinforced Separator

Y. Baba, Sanyo Electric, PRIME 2008 (214th ECS)

- Ceramic coated (one-side) functional separator was tested.
- Improvements in safety were **NOT** observed clearly **against typical abuse tests**.
- Slight performance improvements were reported.

SANYO

VS

Myung Hwan Kim, LG Chem, AABC08

- Mn-spinel based cathode, **ceramic coated separator**, and laminated packaging provide good abuse-tolerance **against typical abuse tests**.

Nail Penetration Test

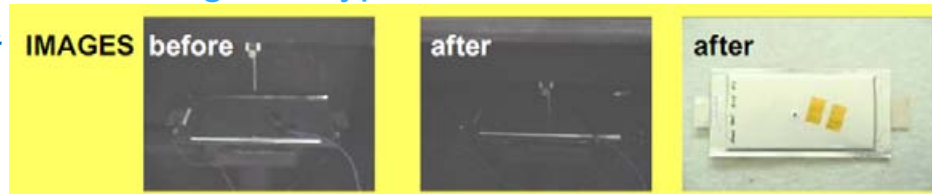

LG Chem

NOTE:

An abuse test such as nail-penetration is not likely to represent the process of formation and evolution of internal short-circuits.

Rationale: metal plating – lowering R_s

Celina Mikolajczak,
Exponent, NASA Aerospace
Battery Workshop 2008

Li plating on Anode Surface

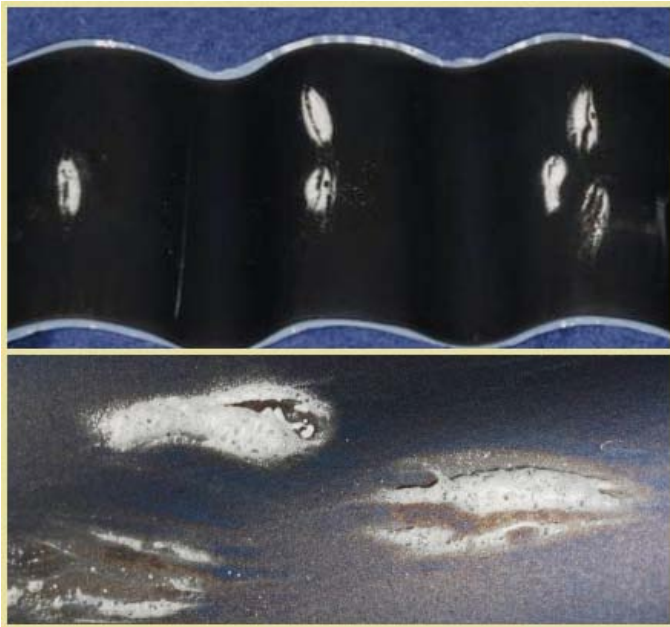

Exponent

Short Resistance (R_s) Decrease
With increase in plating area and depth

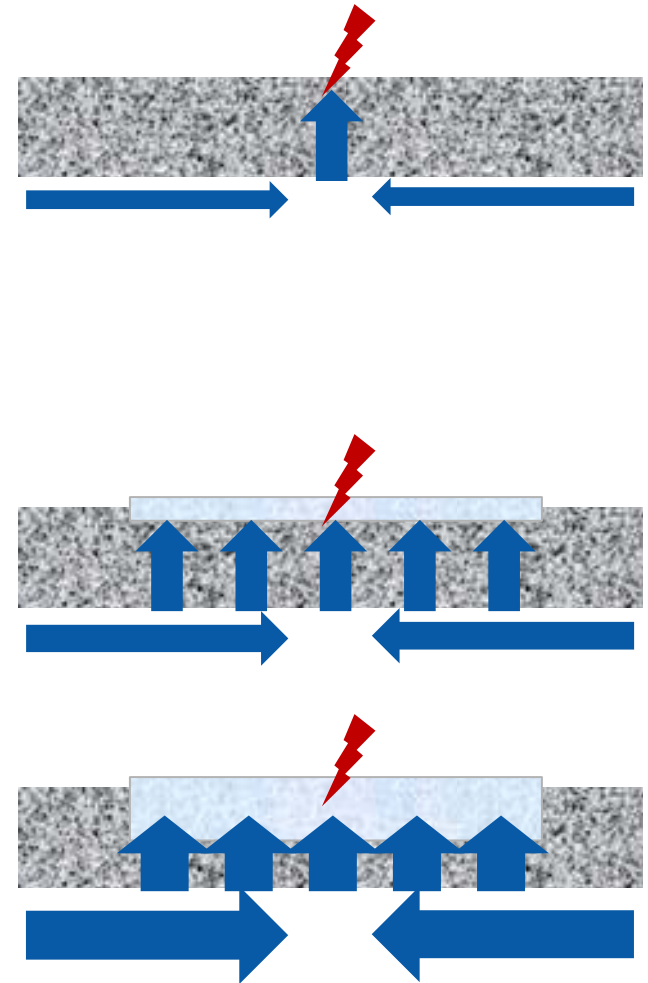

Metal plating provides a potential site for low resistance short formation.

Short Between Anode and Al Foil

- Shorted area: 1 mm x 1 mm
- e.g.,
 - ✓ metal particle inclusion in cathode slurry
 - ✓ deep copper deposition on cathode during overdischarge

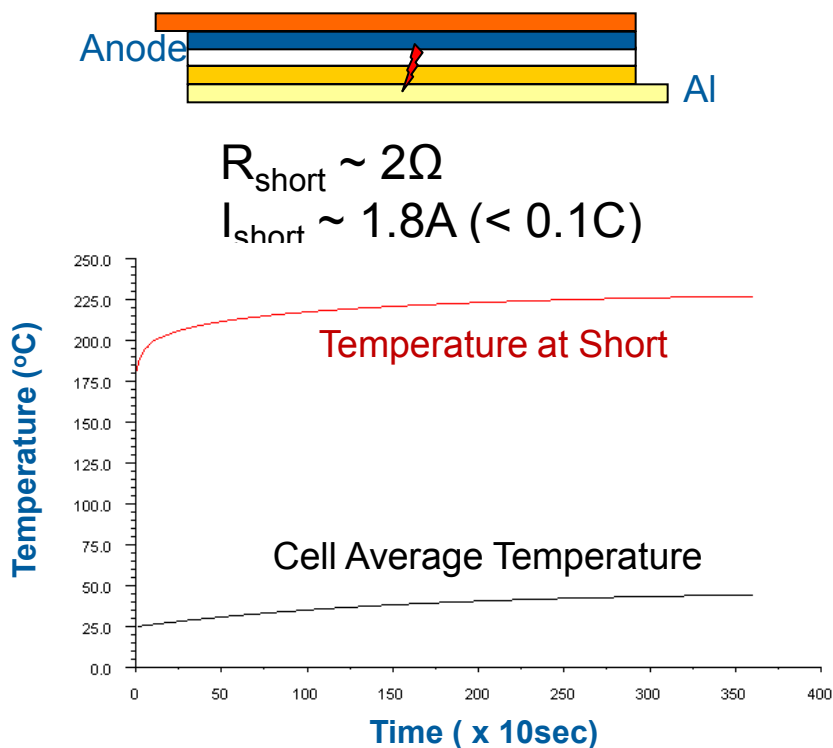

Temperatures at 1 hr after short

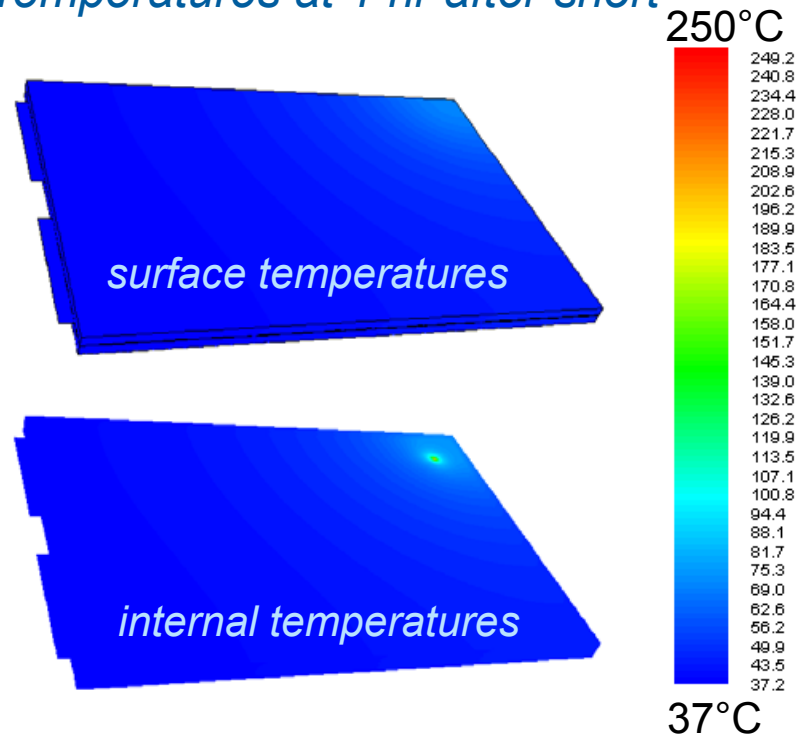

- Temperature at short quickly reaches over **200°C**.
- This type of short is likely to evolve into a hard short in relatively short time.

Observations: Cathode Layer Bypassing

Takefumi Inoue, GS YUASA, NASA Aerospace Battery Workshop 2008

Explanation published by **SONY** and presented by **GS YUASA**

The mechanism of the fire accident on the DELL PC / SONY Lithium-Ion battery published by SONY in "Nikkei Electronics, Nov. 6, 2006".

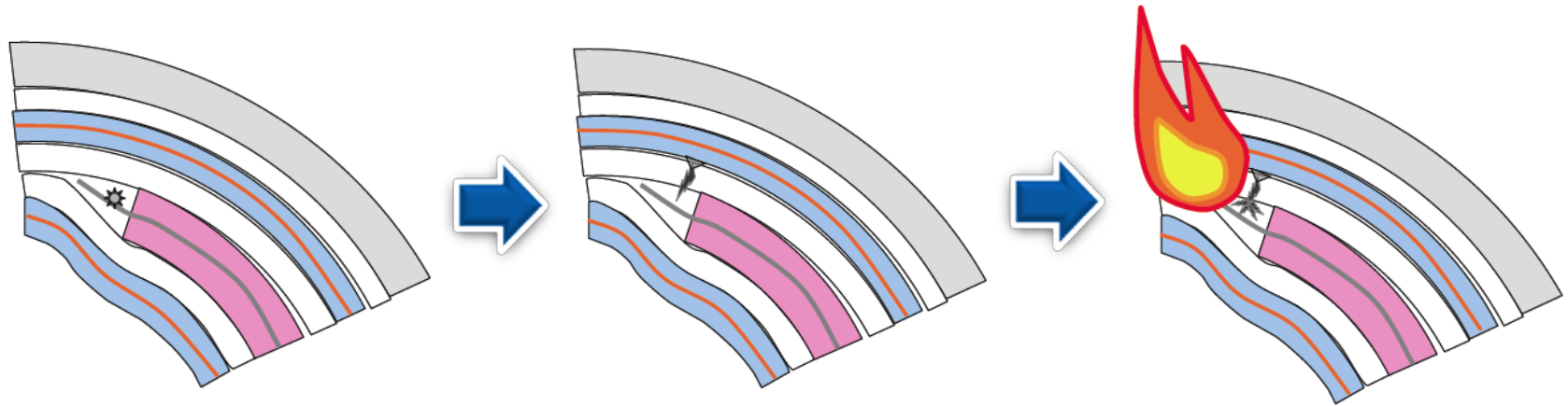

Metal particle enters into the triangle zone at the edge of positive electrode where bare Al foil is exposed.

Metal particle dissolves and deposits on anode surfaces. Lithium dendrite grows back on the deposited nickel.

Low resistance short forms.

NOTE:

A short formed through or bypassing a resistive cathode layer would result in relatively low resistance short and, highly likely, evolve quickly into a more severe short leading to a safety incident.

Small Cell (0.4 Ah) Short: metal to metal

- 0.4 Ah cell
- Shorted area: 1 mm x 1 mm



$R_{short} \sim 7 \text{ m}\Omega$
 $I_{short} \sim 34 \text{ A (85 C-rate)}$



Large cell (20Ah)
 $R_{short} \sim 10 \text{ m}\Omega$
 $I_{short} \sim 300 \text{ A (15 C-rate)}$

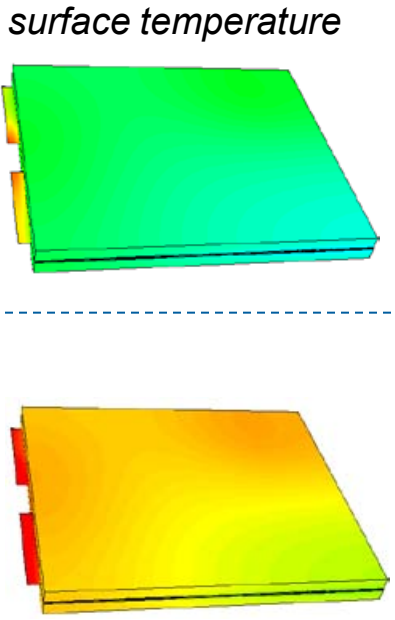
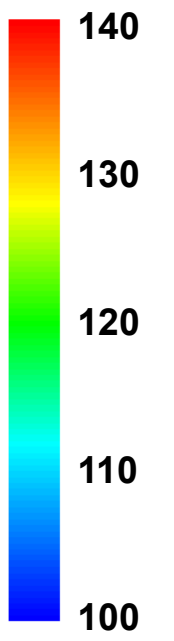
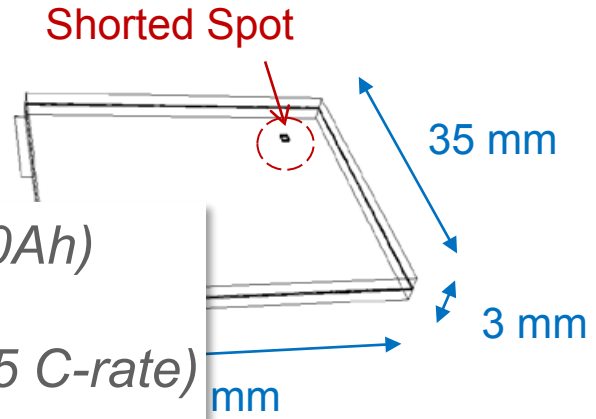

7 sec
 8 sec

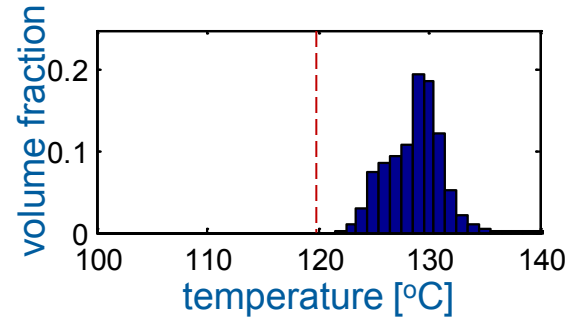
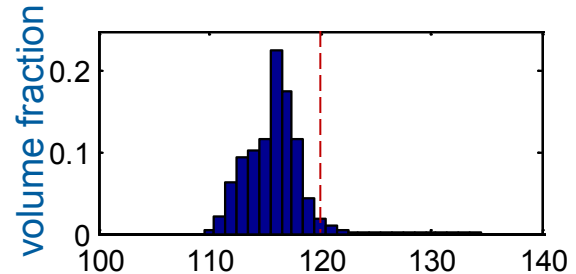

Shut-Down Separator

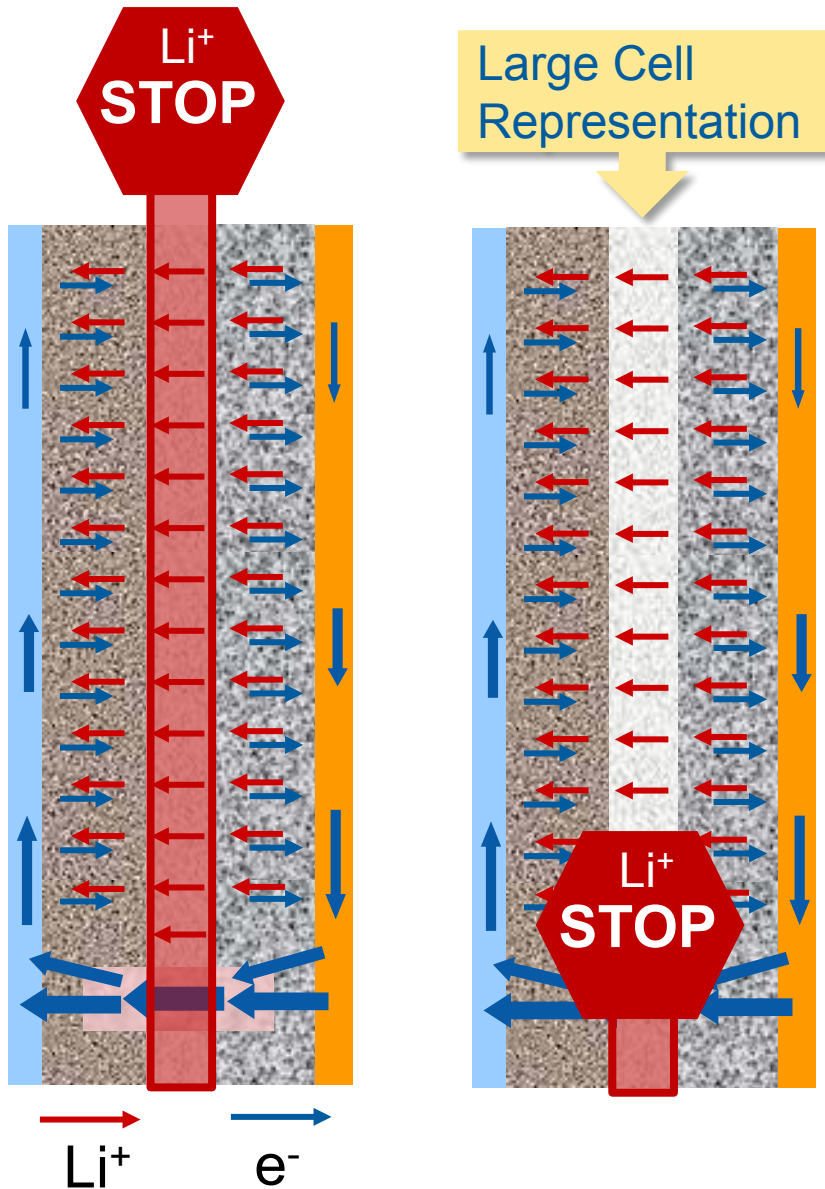

- Thermally triggered
- Block the ion current in circuit

Difficult to apply in

- Large capacity system
- High voltage system

Thermal Behavior of a Small Cell

Even with a small cell, in some conditions, shutdown separator may not function

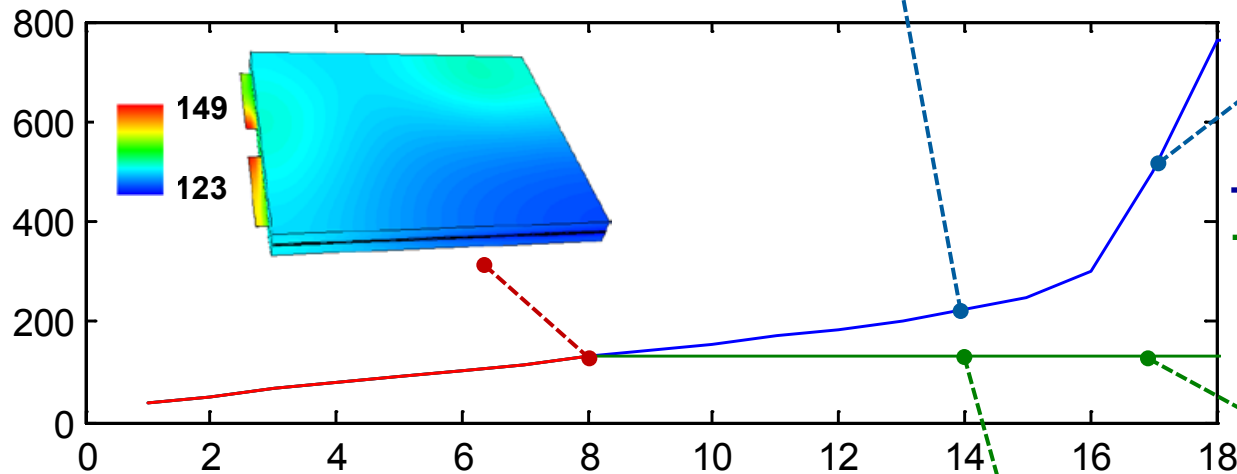
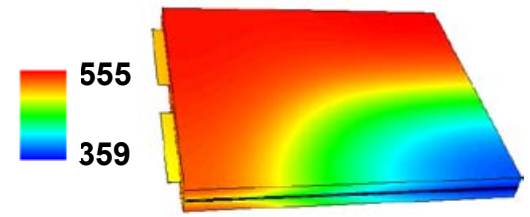
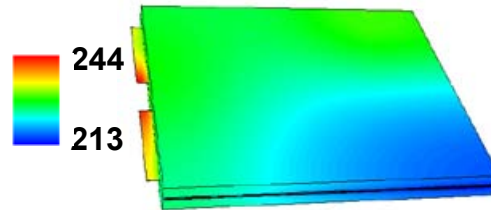

In some conditions, shutdown separator will function

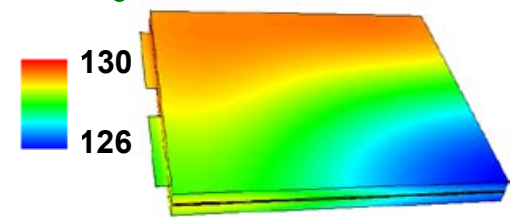
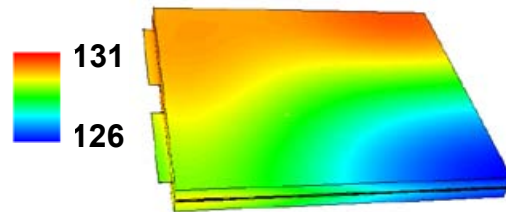

Summary

- NREL performed an internal short model simulation study to characterize an internal short and its evolution over time by linking and integrating NREL's electrochemical cell, electro-thermal, and abuse reaction kinetics models.
- Initial heating pattern at short events depends on various physical parameters such as nature of short, cell size, rate capability.
- Temperature rise for short is localized in large-format cells.
- Electron short current is carried mostly by metal collectors.
- A simple puncture in the separator is not likely to lead to an immediate thermal runaway of a cell.
- Maintaining the integrity of the separator seems critical to delay short evolution.
- Electrical, thermal, and electrochemical responses of a shorted cell change significantly for different types of internal shorts.

Future Work

- Perform in depth analysis for evaluating recommended safety designs such as **structurally intact separators** and **shutdown featured device/strategy** in relation to cell design parameters (materials, electrode thickness, cell capacity, etc.)
- **Design experimental apparatus** for model validation through the collaboration with other national labs (Sandia National Laboratory)
- Partner with cell manufacturers and auto industries to help them design safer lithium-ion battery system that appears critical to realize technologies for green mobility

Acknowledgments

Vehicle Technology Program at DOE

Advanced Battery Research for Transportation program

- Dave Howell
- Gary Henriksen

