



# Retrofit Best Practices Guide:

## *How to Save Energy When You Fix Up the Outside of Your Not-So-New House*

### The Challenge and the Opportunity 1

#### Step 1: Your House Today 1

*How does a house “work”?* 1

*Inspecting your house* 2

Moisture 4

Walls 4

Windows 4

#### Step 2: Your Options 5

*Replacement Windows* 5

*Storm Windows* 7

*Walls* 7

*How Much Can You Save?* 10

#### Step 3: Choosing Your Contractor 11

#### Other Energy Saving Opportunities in Your Home 12

*Attics* 13

*Basements and Crawlspace* 14

#### Where To Find Out More 15

*For the Homeowner* 15

*For the Builder/Contractor* 15

#### Acknowledgements 16

#### House Inspection Checklist 17

#### Window Replacement Checklist 18

#### Appendix A: Savings Estimates for Ten Cities 19

## The Challenge and the Opportunity

Few people add siding or change their windows just to reduce their energy bills. But whatever your reasons for retrofitting your home, this will be an important opportunity to improve your home's energy efficiency. Not only will this reduce your utility bills, it will also improve your comfort level and improve our environment.

Retrofitting your house is a big deal, and you shouldn't underestimate the effort that will be required to plan the job properly. The energy conservation rewards can be great, but there are also pitfalls that you'll want to avoid. That's what this Best Practices Guide is all about. We can't cover all the issues in these few pages, but we'll tell you some things you need to know if you're changing your siding or windows, and tell you where to learn more about other changes you may want to make to your house.

What exactly is a 'best practice'? To put this guide together, we've tested products, talked to contractors and manufacturers, and reviewed the results from a large number of house retrofits. Of course, 'best' will vary according to the situation. That's why you must start with a careful examination of your house and its existing condition.

### Step 1: Your House Today

#### *How does a house “work”?*

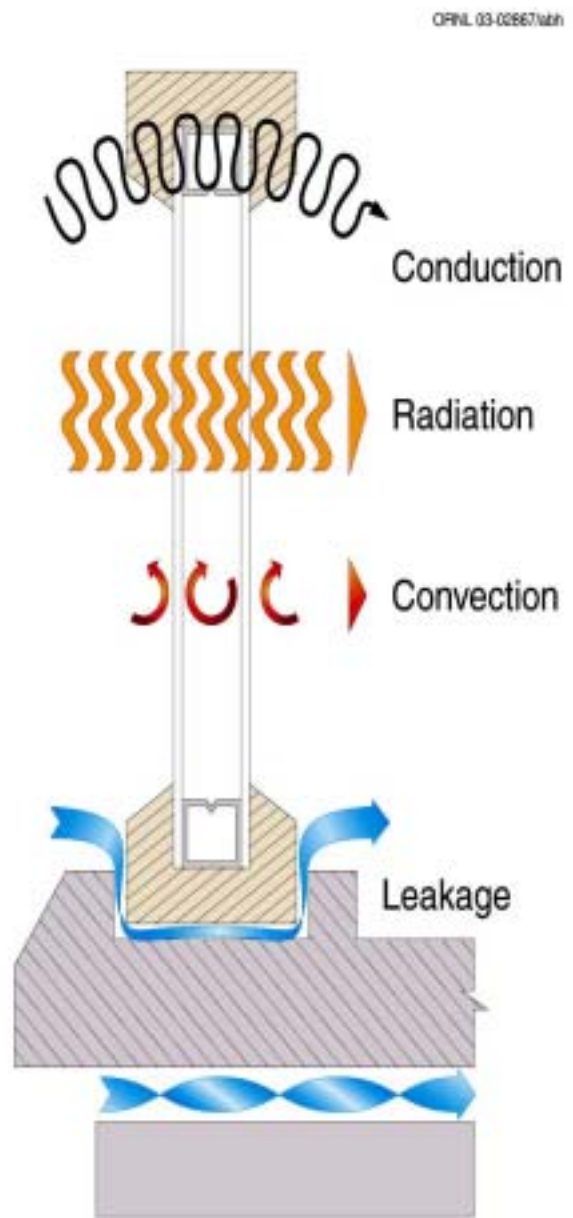
Step back and take a good look at your house. Think of your house as a machine. It may not seem like something so complicated, but it's made up of a

large number of small parts and connections between these parts. If any of these parts or connections are damaged, they will cause problems in other parts of the structure. When a new part is added onto the house, or an existing part is replaced, it has to be done carefully. Just as you wouldn't want to leave a wrench in the gears of a machine, you don't want to change your house in a way that interferes with any of the existing working parts.

This can be tricky because it involves appreciating what is working well, which can be much more difficult than spotting problems. Most often, these nearly invisible 'gears' are related to moisture management – both keeping moisture out of your house and making sure that any moisture that does get into your house has an escape path. The **rain plane** (see "Rain Plane" box) on the exterior walls is one such working system.

Your house is also built with back up systems that you probably take for granted. For example, your bathrooms *should* be vented to the outside so that moisture doesn't enter the rest of your house or attic. But the fans may be too small, or may not run long enough (especially if you turn them off because they're noisy). In this case, the back-up system is the ventilation within the house and attic spaces. If you change that back-up system, the bathroom moisture could become a problem, even though you haven't changed the bathroom itself.

The windows are another complicated system. They serve multiple functions, letting in light and sometimes air, but keeping out rain and bad weather. Windows are especially important from an energy conservation standpoint. As Fig. 1 shows, energy travels many paths through a window unit. A variety of window designs have evolved to reduce the energy traveling through each of



**Figure 1. Energy paths through a window**

these paths, while still providing the open views and light you want in your home.

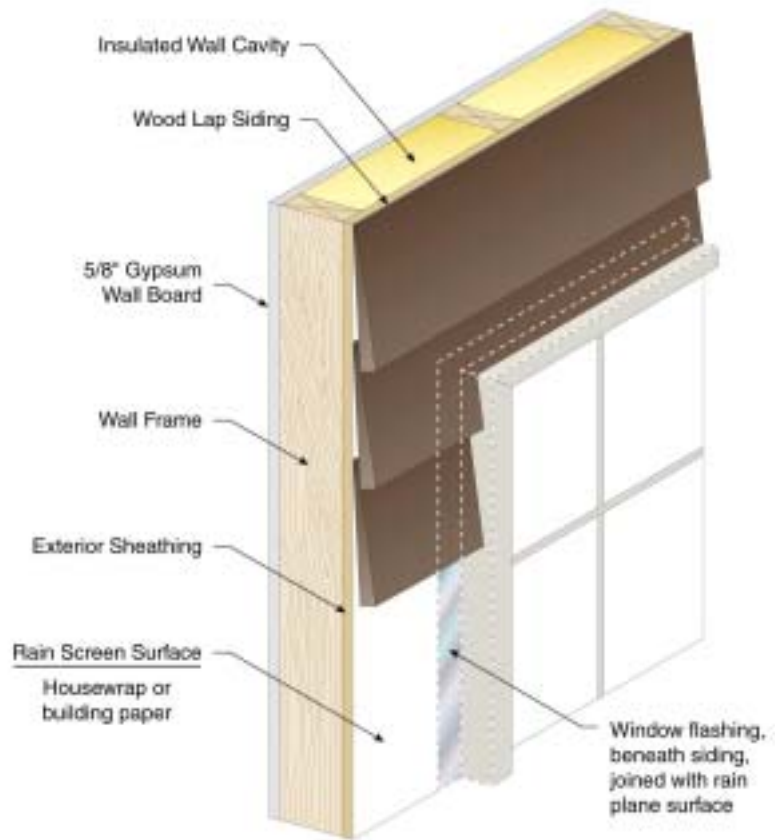
### ***Inspecting your house***

A checklist is available at the back of this guide to help you organize your home retrofit inspection. Another extensive checklist, designed for new homes but useful for retrofit as well, is available as a

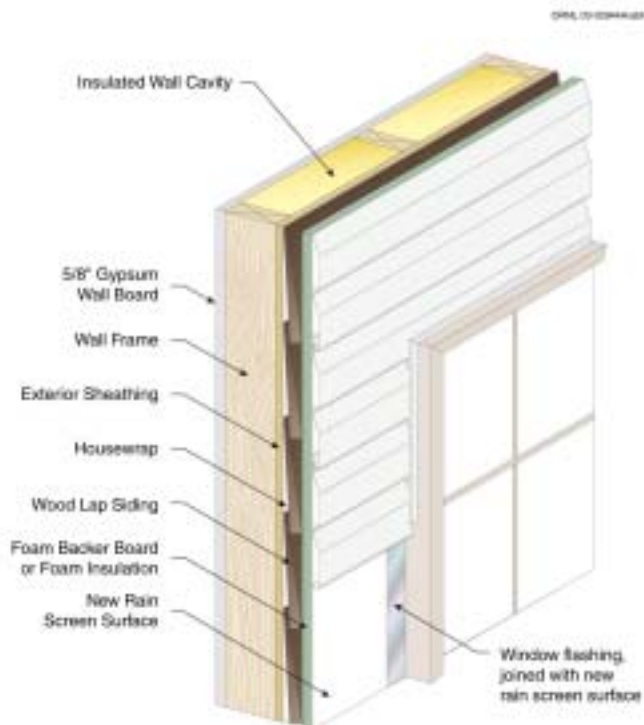
The **RAIN PLANE** is the true boundary between the inner and outer portions of your wall. The location of the rain plane is especially important when you replace your windows or add siding, because the window flashing for every window must be properly integrated with this rain plane surface, which is not necessarily the exterior siding surface. If you seal the frames improperly, or to the wrong surface, you will likely allow water to get inside the wall cavities beneath the window frames, where it will eventually damage the insulation and wood framing.

Many people think that all the rain is stopped on the outside of their siding. But many siding systems are actually designed to breath so that the wall system can dry out after the rain stops. In a home with wood, aluminum, or vinyl siding, there is a small air space between the siding and the exterior building sheathing. This sheathing is usually covered with housewrap or with asphalt felt building paper, see Fig. 2.

**Fig 2. Existing Wall**



**Fig. 3. Retrofit Wall**



This surface is the true rain plane, because this is the barrier that keeps rain out of the interior of the wall. (Usually there are openings at the bottom of the wall to allow most of the trapped water to drain, while air circulation through the weep holes in the siding is used to dry out the rest.)

So when you add new siding on top of old (see Fig. 3), you often move the rain plane to a new location, usually to the exterior surface of the new siding's underlayment!

technology fact sheet on [DOE's Building Technology](#) publications web site.

## Moisture

Whole books have been written about moisture management in buildings. These books are filled with horror stories about buildings that have failed due to moisture. Many of these reference sources are listed in the back of this guide, and a bit of homework on your part now could save you time, trouble, and money. We can't duplicate all that information here, but will cover a few key concepts that are directly associated with common building retrofits. In general, there are two goals in moisture management: (1) keep water out and (2) provide escape paths for any moisture that does get into your house. These escape paths are especially important because few houses are built perfectly enough to keep out all water and because moisture also enters your house in other ways. For example, when you breathe you are putting moisture into your home.

If you find blistered paint, peeling or bubbled wallpaper, rotten windowsills, stained paint, mildew, or mold, you have a moisture problem. You need to investigate until you find the root of the problem. Don't just fix the visible symptoms. For example, blistered paint is usually caused by moisture trapped between the surface and the paint. If you just scrape and re-paint the wall without fixing the moisture source, the new paint will probably blister too. Similarly, cleaning up a moldy surface isn't a permanent fix if moisture is still available to support the growth of new mold colonies.

Besides looking for moisture problems, you also need to figure out how moisture is managed successfully within any building component that you'll be changing. For example, if you are going to replace siding that shows no signs of

moisture damage, look to see how that siding was installed. Very often you'll find a ventilation space behind the siding, and you'll want to include this design element in your retrofit siding job.

## Walls

This is the time to find out whether or not your walls are properly insulated. You need to look for both cavity insulation and insulating sheathing. You may be able to see into the wall cavity by removing a switch cover or an electrical outlet cover (after turning off the breaker or removing the fuse for the outlet), or by looking in your attic if any of the exterior rooms have a dropped ceiling. Go to [DOE's Energy Savers](#) web site for more details on how to safely perform this inspection.

If you are going to install new siding on your house, you will need to remove a small piece of your existing siding to find out how the wall was constructed. You'll be able to see whether insulating sheathing is already in place, and whether the housewrap or building paper is in good condition. You'll also be able to identify the location of the current rain plane (see "*Rain Plane*" box).

## Windows

Your house may have more than one type of window, and the outdoor exposure and installation quality could vary, so check each and every window. You will find a checklist for this purpose at the back of this guide. Identify the types of windows in place: the number of panes, the framing material(s), and any labels that indicate special coatings or safety glass. Look at the window sills and the walls beneath the windows for signs of moisture or rotting wood. Look at the condition of the caulking and weather stripping. Check the operability of each window — does it open and close properly? Consider the orientation and shading of each window. They could influence your choice of special coatings

for replacement or storm windows. Think back to some cold days last winter — do you remember any particular drafty locations near your windows? Look at the trim fit and caulking between the wall and the window on both the inside and outside of your house.

## **Step 2: Your Options**

If you are both residing your walls and replacing windows, it's best to do it all together as a single job with a qualified contractor who can take that opportunity to carefully incorporate the window flashing into the wall's rain plane (see *Rain Plane* box). This is also the best approach if the new siding will make your wall thicker, because the new window jambs can be sized to fit the new wall thickness.

If you have to do window and wall retrofits separately, either for budget or convenience reasons, **DO THE WINDOWS FIRST**. Also, remember to plan for the new wall thickness when you order the jambs for your new windows.

Keep installation details in mind too. We all know that increasing the R-values of walls or windows will save energy, but controlling air and moisture leaks can be just as important.

### ***Replacement Windows***

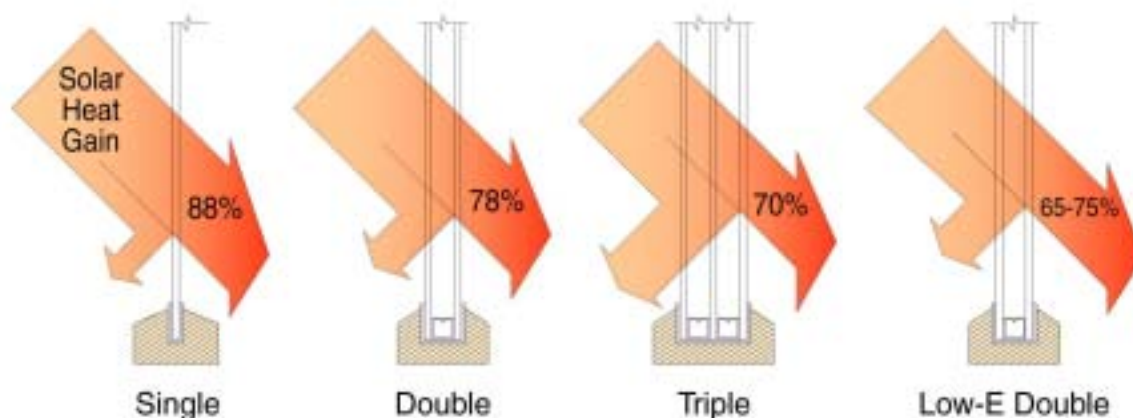
When you choose new windows, you'll be balancing performance and price. Think about the long-term consequences when you make that decision. Better quality windows will save significant amounts of energy by reducing window heat losses and air leaks. Better windows will also reduce condensation which will in turn reduce window sill moisture problems. There are a number of features to consider when comparing windows: window type, number of panes, frame materials, special coatings, and gas

fillers. The [Efficient Windows Collaborative](#) can help you select an energy-efficient window.

The window type is often selected to match the original windows, but you may want to consider other types as well. From an energy conservation standpoint, windows that compress a gasket, rather than a sliding seal, will typically allow less air to leak in and out of your house. So you should consider casement or awning windows even if your existing windows are double or single-hung sliding windows.

Most consumers understand that single-pane windows lose more energy than double-pane or triple-pane windows because of the insulating air space between the layers. But the multiple panes of glass will also reduce the solar heat gain entering your house (see Fig. 4). Sometimes special inert gases are used to fill the space between panes and reduce the heat losses still further. Coatings may also be placed on the glass to reduce the radiation energy loss (or gain, during the summer) while still permitting visible light to pass through the window. The window label (see "*Window Labels*" box) will help you consider all these energy performance factors.

The frame also influences the energy performance of the window. Frames can be made from a variety of materials. Aluminum is light, strong, and durable but has a high thermal conductance. Wood offers good insulating value but must be protected from the weather. Vinyl is a very versatile plastic with good insulating value that can be reinforced to increase its strength. Fiberglass has good structural strength and durability and requires minimal maintenance. Hollow sections of a fiberglass frame can be insulated to further decrease heat loss.



**Figure 4. Solar heat transmission and reflection**

There are other important factors to consider in selecting your replacement windows. One expert offers the following advice,

*“The first step in installing a window correctly is to install the*

*correct window. Use safety glass if required, get the proper grade, don’t violate egress requirements, and make sure the window fits in the rough opening with the clearance recommended by the manufacturer.”*

***WINDOW LABELS***

It can be difficult to compare windows. Fortunately the National Fenestration Rating Council (NFRC) has devised a label to summarize the energy performance characteristics of windows. This label may look complicated at first glance, but the [NFRC web site](#) gives a complete explanation. If you don’t have time to learn all the terminology, use this abbreviated key to compare window labels:

<u>U-factor</u>	Lower is better Range: 0.2 to 1.2	Non-solar heat flow through both glass and frame
<u>Solar Heat Gain Coefficient</u>	Lower is better, especially in the South Range: 0 to 1	Fraction of the sun’s energy that hits the window that will enter your home
<u>Visible Transmittance</u>	Higher is better Range: 0 to 1	Fraction of visible light that gets through the window
<u>Air Leakage</u>	Lower is better Range: 0 to 1	Measure of the air that can leak through cracks in the window assembly
<u>Condensation Resistance</u>	Higher is better Range: 0 to 100	Measure of water condensing out of air on window surface

Many window manufacturers participate in the Energy Star labeling program as well. Windows bearing the Energy Star label are likely to conserve more energy than those that don’t. You can find out about this labeling system, and get additional information at the [Energy Star](#) window web site.

Building codes change over time, and safety glass may be required even if the old window was standard glass. Egress requirements are especially important because they ensure that occupants can escape, and fire fighters can enter, if the need arises.

It's impossible to overstress the importance of getting all the details correct when you install new windows. Installation mistakes can lead to windows that don't operate properly or can cause serious moisture problems due to water intrusion into the wall structure. If you plan to do the job yourself, be sure and seek out the detailed instructions found for replacement windows in the "*Where To Find Out More*" section of this guide.

One of these details is the gap between the rough opening in your wall and the window frame. This can be an unseen Achilles heel for both air and water to get into your house. After the window installation is complete, this gap may be hidden by interior and exterior trim, so it's important to seal this gap before the trim is installed. The best method is to fill the space with a low-pressure polyurethane aerosol foam sealant. You should select a product marketed specifically for door and window installation and proven not to exert excessive pressure build during cure. This foam usually does the best job of stopping both air and moisture, but be careful to follow the directions so that you don't cause your window frame to bow (which can make it difficult or impossible to open and close the window!) Two alternative methods are to use a specialty tape product sold for this specific purpose, or to use backer rod and caulk. One traditional method used to seal this gap is to loosely stuff it full of fiberglass before applying and caulking the trim. This traditional method does a moderate job of stopping airflow through the gap, but can still allow moisture diffusion through the space. So if you use

fiberglass, you should apply caulk in the gap as well. Whichever method you use to seal this gap, keep in mind that perfection is hard to achieve, and harder still to maintain. So you should be sure that the interior and exterior trims are properly installed and caulked as an additional line of defense against air and moisture.

## **Storm Windows**

Storm windows often represent an economic compromise, because their cost is usually much less than replacement windows, and they have the potential to save nearly as much energy. This is especially true for some of the new storm window products that are available with a low-e coating. As with replacement windows, it is important to pay careful attention to sealing all air leakage pathways when mounting the storm windows.

## **Walls**

If you're going to put new siding on your house, you have two big opportunities to save energy (see Fig. 5). The greatest saving potential is for those houses that were built with little or no wall insulation in the wall cavity (the space between the studs). The second best place to save energy is with foam sheathing placed beneath the new siding. The thicker foam sheathing products will save more energy, but you may be limited by the thickness of your window and door jambs.

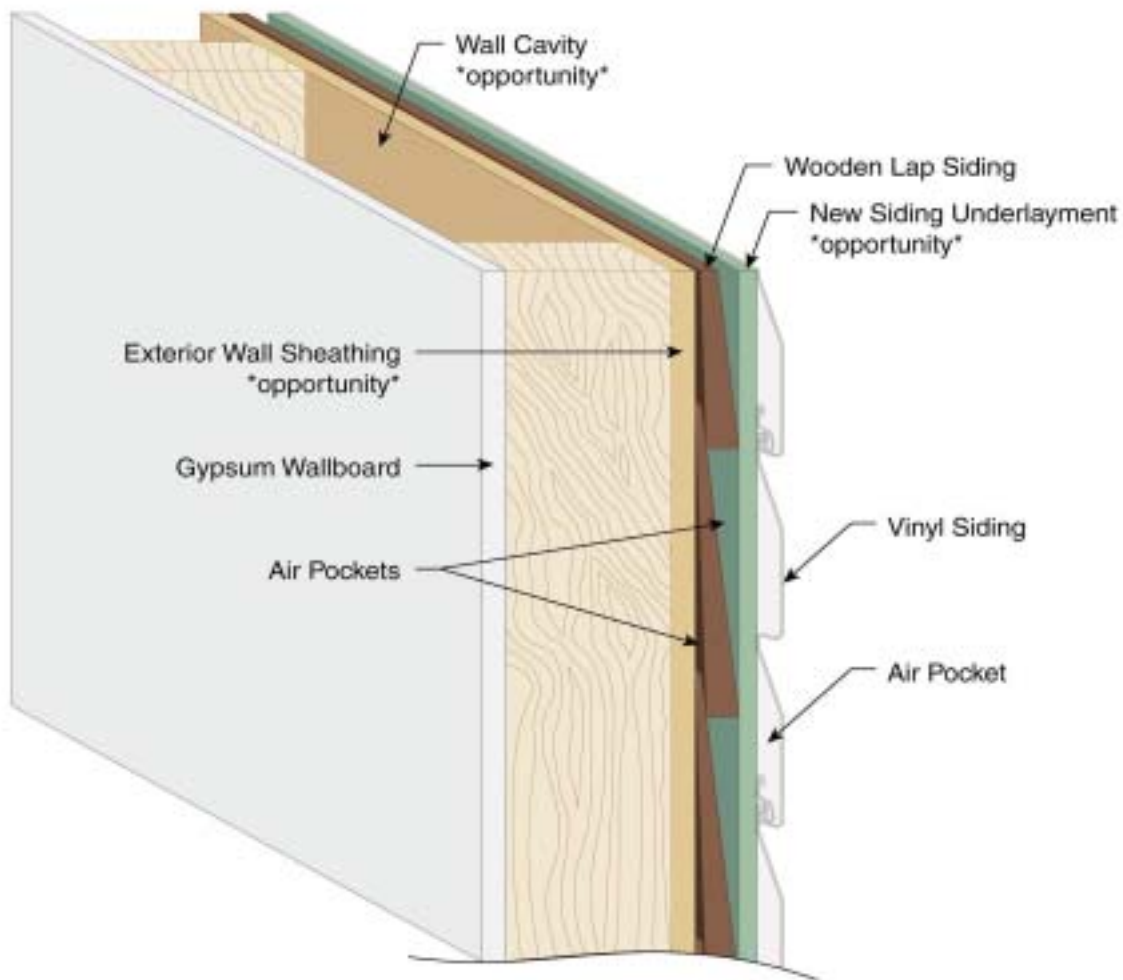
1. If you've learned during your house inspection that your wall cavities are poorly insulated, or uninsulated, this is a great opportunity to blow insulation into this empty space. People are often reluctant to tackle this job because it involves cutting small holes into their home's exterior walls, and the patched holes are sometimes noticeable. But if you're putting up new siding, the patches

will be hidden anyway! This step will save you more energy, and more heating and cooling dollars, than anything else you can do to your walls. You'll need to hire a contractor to do this job and you can choose either loose-fill cellulose or fiberglass. (See the [DOE Insulation Fact Sheet](#) for more information about different forms of insulation.) In either case, be sure to talk about the finished R-value of the fill material—you want at least R-11—and you want to talk about their method for ensuring that the entire cavity is filled and remains filled. One such method is called the 'dense-pack'

method. This method not only prevents settling within the cavity and reduces air leakage through the wall, but also offers a higher R-value than insulation blown in at lower densities.

2. If you're removing your old siding, you will have easy access to your original sheathing layer. It will usually be possible to place a foam sheathing layer on top of the original sheathing before adding the new siding. The thicker this foam is, the more energy you will save. Foil-faced products can also increase your savings (be sure the reflective side faces the open

ORNL 03-02504/abh



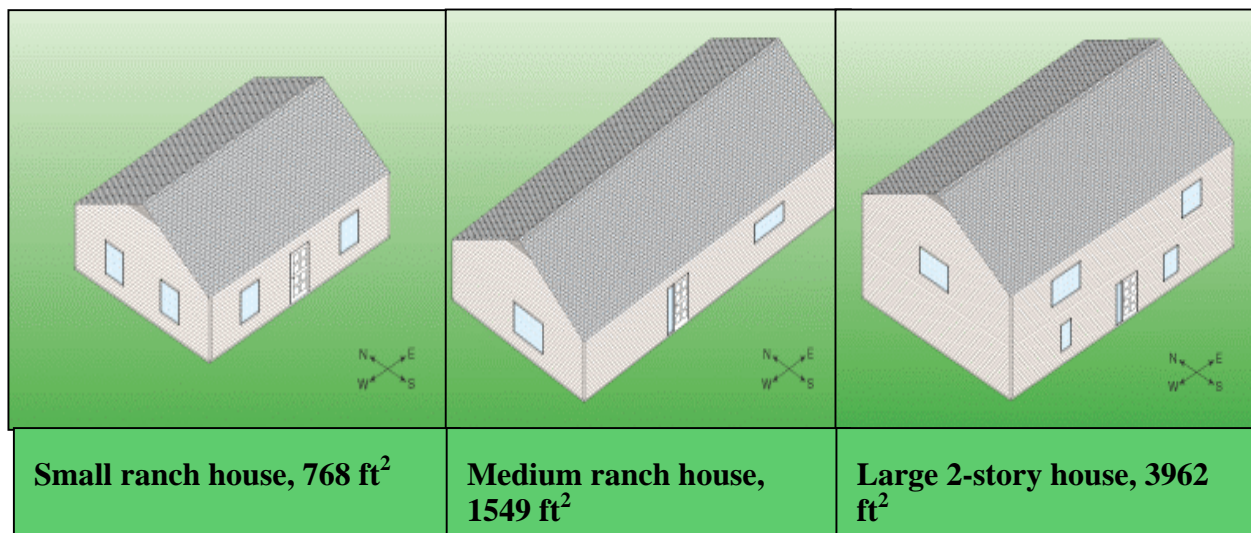
**Figure 5. "Opportunity" locations to consider when you add new siding to your home.**



air spaces behind the new siding, not the solid surface of the old sheathing). Foam sheathing boards act as a vapor retarder, so be sure your windows and doors are properly integrated with the outside of this new layer to avoid moisture intrusion between the original sheathing and the new foam sheathing (or underlayment). See the previous “Rain Plane” box.

3. If you’re placing new siding on top of the old siding, you’ll have to provide a flat

supportive surface for the new siding. Often, 1/4” or 3/8” foam is used to provide that flat surface. But you can increase your energy savings by choosing a foil-faced foam and/or a thicker foam underlayment. The trick here is figuring out the thickest foam you can use without having to extend all the window and door jambs, because that can be a costly procedure. (If you’re replacing most or all of your windows at the same time, the extra cost for extended jambs may be



**Figure 6. Locations and house designs used for savings estimates**

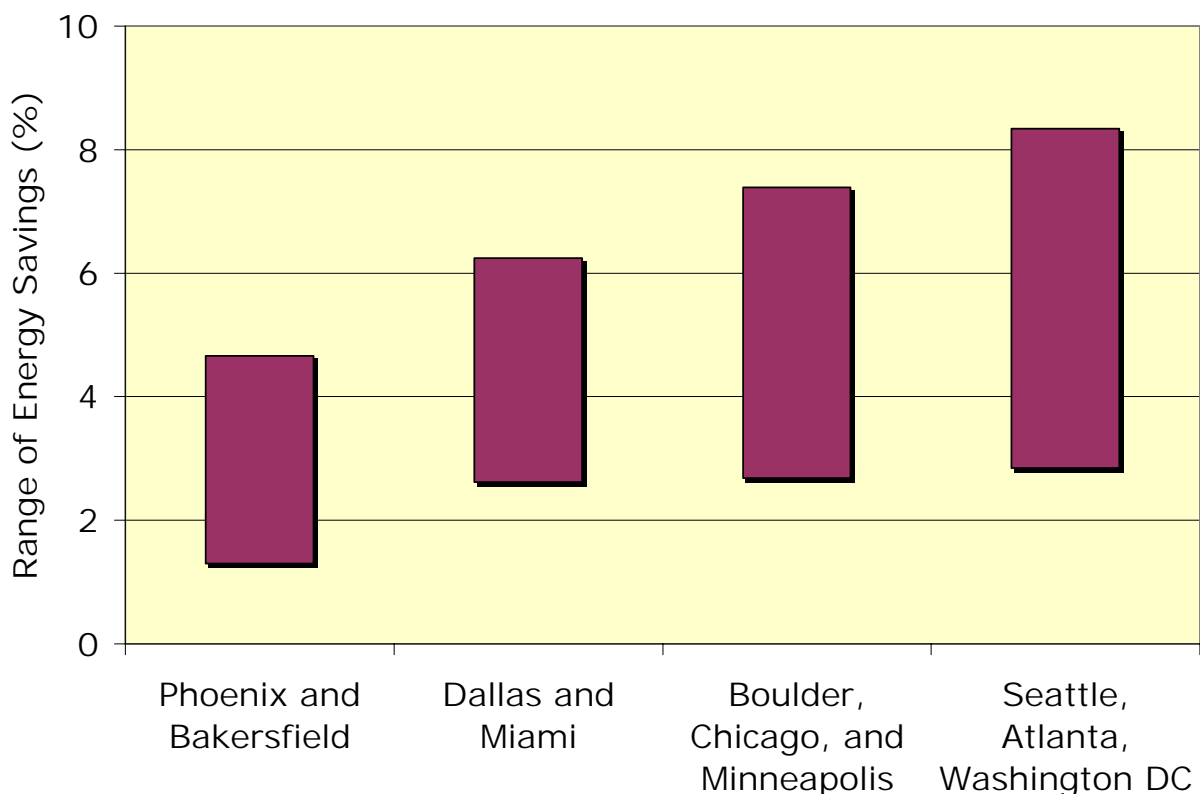
reasonable.) If you choose a foil-faced product, be sure the reflective side faces the largest open air spaces, which could be facing either the new or the old siding (see the “air pocket” locations in Fig. 5).

### **How Much Can You Save?**

Every house is different, and your savings will depend just as much on the condition of your home before you retrofit your walls and windows as it does on the retrofit you choose. That said, it helps to have some idea of the savings you could expect. We've used a combination of experimental measurements and home energy modeling to estimate the savings for three different houses in ten different cities, shown in Fig. 6. To get an idea of the savings you can expect, choose the city which best represents your climate from Fig. 6. Then go to the corresponding Fig. 7 in Appendix A. This figure shows the estimated annual

heating and cooling energy cost for the three ‘typical’ houses used in these calculations. You can pull out your own past utility bills to see whether your energy costs are similar. (You can usually tell how much of your bill is due to heating and cooling by comparing your winter and summer bills to those for the spring and fall months when you don't use very much heating or air conditioning. Be sure to keep any recent fuel or electricity price changes in mind when you make this comparison.)

So how much can you save by adding insulation to your exterior walls? The Fig. 8 for your selected city from Appendix A shows the range of savings calculated for these three modeled houses, as a percent of annual heating and cooling costs. Remember that these savings depend upon the condition of your home before you make any changes. If your house inspection revealed empty wall



**Figure 9. Range of annual energy savings you can achieve by properly sealing all gaps between your window frames and walls.**

cavities, Fig. 8 shows that filling those cavities with blown-in insulation and adding a 3/8" insulating board beneath new vinyl siding will save about 20% of your heating and cooling costs.

The energy lost to infiltration varies widely from one house to another. Air infiltrates your house in numerous locations, wherever two exterior walls meet, or where the walls meet the ceiling, as well as the locations you typically think about, around your windows and doors. To get a feel for the energy saving potential of sealing these leaks, we looked at the savings for sealing only those cracks between the windows and the walls. These savings also depend on the initial condition of these window/wall joints. The window/wall sealing savings estimates shown in Fig. 9 assume that the gap between the windows and the rough wall framing was poorly sealed to start. If you think the pre-existing condition was reasonably good, your savings will of course be less. The range of savings shown in Fig. 9, for example from 3 to 8% for Seattle, reflects only the window arrangements in our three house models. If you have many windows, your savings could be near the top of the range. If you have few or smaller windows, your savings could be closer to the bottom of the range.

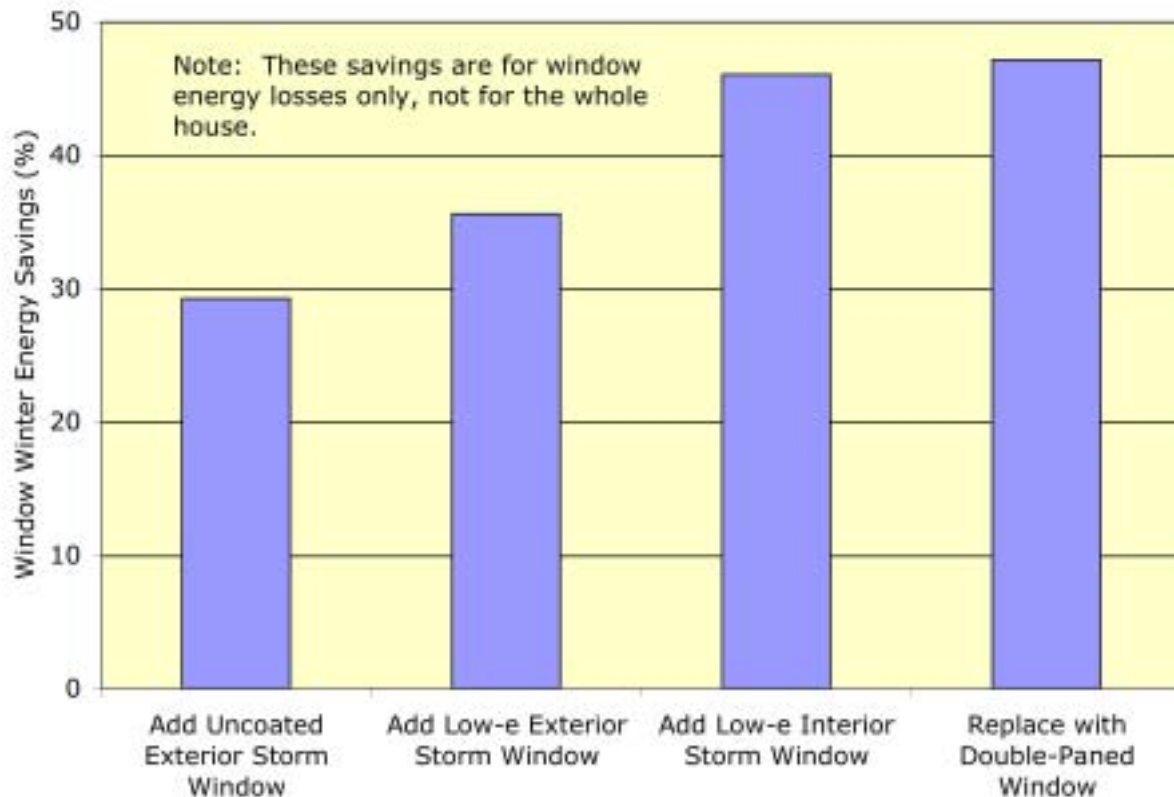
The above discussion and Fig. 9 address savings for improving the seal between your windows and the wall framing. Estimating savings for replacing the entire window units is even more complex, because the energy lost through your windows depends not only on the temperature difference, but also on the energy that radiates through the glass. This radiation heat transfer includes solar gains that increase your air conditioning costs. Windows also radiate warmth from your house into the cold outside

environment during the winter and increase your heating costs. So your savings will depend on the condition of your original windows, the windows' orientation, your climate, and even the location of your trees.

A series of long-term tests were made to compare a modern vinyl replacement double-paned window and the addition of several different types of storm windows to a single-paned wood-framed window. (These windows were allowed to be as 'leaky' as average windows during the tests.) Looking at Fig. 10, you can see that the replacement window saved almost half of the energy lost through the single pane wooden-framed window. But the storm windows also saved significant energy, especially the low-e coated storm windows. So if replacement windows are too expensive for your budget, try to find some of the new low-e coated storm windows, because they can save almost as much energy.

### **Step 3: Choosing Your Contractor**

It is impossible to overstress the importance of this step – don't skimp on time or effort here. Your contractor will become your 'expert', and will ultimately control the quality of the job, so find out as much as possible about all the candidates. Costs can vary widely, but also consider the quality of the proposed work and materials. Low cost bids may reflect not only the use of lesser products, but also the use of untrained or inexperienced workers. Proper training is crucial when it comes to installing windows and siding. So ask your contractor about the training and experience of the people who will perform the actual installation.



**Figure 10. Winter window energy savings compared to a single-paned wood-framed window, not counting solar energy gains through the window.**

Ask for local references and names of previous customers who will allow you to inspect their homes. If possible, check into jobs that have been complete for at least a year, because some problems don't appear until long after a job is done. Ask about the contractor's experience with homes similar to yours in style and materials, and with retrofit projects similar to yours. Call your local Better Business Bureau. Many people neglect this step until after they have problems, and then find that other customers have had similar problems with the same contractor. Of course, make sure the contractor is properly licensed, bonded, and insured and that all local building permit regulations are followed.

Inspect the job in progress – often! Don't be afraid to ask questions or to stop the work to confer with your contractor. Getting it done right the first time is your goal.

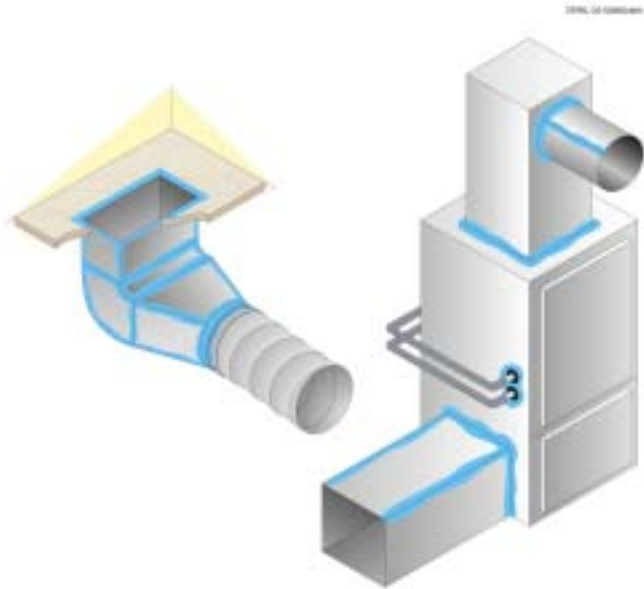
## Other Energy Saving Opportunities in Your Home

While improving the outside of your house, you may also want to consider other energy improvements to your attic or foundation. The amount of insulation recommended for attics, basements, and crawlspaces for your region can be found by using the [ZipCode calculator](#). This tool can also tell you whether or not you need to add insulation, depending on how much you already have in place.

If you want to consider a broad variety of energy conservation measures for your house, including appliances and lighting, the Department of Energy has provided two web-based tools, the [Home Energy Saver](#) and the [Home Energy Advisor](#), for your use. These tools will ask you a few simple questions about your house and suggest different things you can do to

## **DUCTS** Play an Important Role in Energy Conservation

If you are looking around in your attic, basement, or crawlspace, you may find ductwork that carries conditioned air from your furnace and air conditioner to the rest of your home. These ducts probably aren't your primary focus, but one of the most important retrofits you can make is to seal all the leaks in that ductwork. You could be losing 20% or more of your heating and cooling energy to air leaking in and out of your ducts. Some utilities offer duct testing programs, so you may want to give them a call. Otherwise, Fig. 11 shows the joints that you should check. One common leakage area that is always



**Figure 11. Duct leak locations**

accessible is the joint between your ductwork and the registers on the floor or wall. Please don't use standard duct tape for any duct repair; it won't stay in place more than a year or two. Special fiberglass tape, heat-sealed aluminum tape, or mastic should be used for the job. These sealants should be labeled "UL 181A" for rigid ducts and "UL181B" for flexible ducts. You can find more complete guidance in both sealing and insulating your ducts in another DOE factsheet at [DOE's Building Technology](#) publications web site and in the DOE HVAC Best Practices Guide. Because many duct leaks are in inaccessible locations, researchers at LBNL have developed and licensed an effective [aerosol duct sealing technology](#).

save energy. The Home Energy Advisor also provides estimated savings.

### **Attics**

There are four key things to look for in your attic. (1) Are there ducts running through the attic? (2) How is the attic ventilated? (3) How much insulation is already in the attic? (4) Is the attic properly sealed to keep air and moisture from the house out of the attic?

If you find ductwork in your attic, examine it closely to look for leaky joints or loose insulation (see box). Check your attic ventilation to be sure that it hasn't been blocked by insulation. This can happen to soffit vents if baffles (often made from

foam or cardboard) haven't been placed to hold back loose-fill insulation. You should check the thickness and type of insulation on the attic floor. The [Insulation Fact Sheet](#) can help you translate this information into the R-value for your existing insulation level.

Before adding any insulation to the floor of your attic, it is important to check for duct problems (see "Ducts" box) and to seal all air passageways between the attic and the rest of your house. It's very important to keep air and moisture from your house out of the attic because it's not only a significant energy loss, but could also lead to moisture problems in the attic. These air passageways will

include light fixtures, kitchen soffits, vent pipes, duct chases, open partition walls, etc. Look for ventilation fans, especially over your kitchen and bathrooms. The ventilation fans should never vent into the attic directly. They must be routed into vents that exhaust outside the house. The Department of Energy has published a detailed fact sheet with complete instructions on how to find and seal these leaks. See [DOE's Building Technology publications web site](#). (*Safety first: some recessed light fixtures require ventilation to remove heat. Be sure not to cover these recessed fixtures with insulation unless they are specially-rated IC fixtures. Also, don't get insulation too close to hot flues or other sources of heat.*)

In general, it's seldom economical to add more insulation if you already have R-30 or more. But if you have less than 10 inches of insulation in your attic, you may need more depending upon your heating fuel and climate. Before adding insulation, be sure you've corrected any ventilation or moisture problems that you identified during your inspection. Another DOE fact sheet gives detailed guidance for installing attic insulation, see [DOE's Building Technology publications web site](#).

In summary, the best attic advice we can give you here is to seal and insulate the ductwork, seal air leaks between the house and the attic, then add insulation to the attic floor if necessary to bring it up to the level recommended for your area.

### ***Basements and Crawlspace***

When you inspect your basement or crawl space, look for whether or not 1) plumbing pipes and/or ducts run through the space, 2) the crawl space is ventilated, 3) there is plastic sheeting on the crawl space ground, 4) moisture/water is present, 5) the floor above the space is insulated, and 6) the walls are insulated. If you do find pipes or ducts, check their

insulation and look for leaks in the duct joints (see "[Ducts](#)" box).

*If you find moisture or water under your house, it is critical that you fix this problem before you do anything else.* For more information about how to keep the space under your house dry, go to the [moisture page](#) from the Insulation Fact Sheet or the [Moisture Control Handbook](#).

Crawl spaces can be treated either by insulating the floor above and ventilating the crawl space, or by insulating the walls of the crawl space and not ventilating the space. Your choice will depend on your local building code (some codes still require ventilated crawl spaces), whether you have ducts and pipes in the space, and whether you already have floor insulation. From an energy performance point of view, an unventilated crawl space with wall insulation is the best choice. But if you already have floor insulation above your crawlspace, it's probably not economical to insulate the crawl space walls as well. Whether or not your crawlspace is ventilated, you should have the ground covered with a thick plastic sheet to keep the ground moisture away from your house. See the [Builder's Foundation Handbook](#) and a DOE technical fact sheet at [DOE's Building Technology publications web site](#) for more detailed instructions.

If you choose a ventilated crawl space arrangement and the floor above the crawlspace is not insulated, you could save energy by insulating that surface. If however, pipes in the crawlspace have been heated by energy leaking through your floor, you will need to make other arrangements to prevent the pipes from freezing during cold weather. These arrangements can include pipe insulation and adding a thermostatically-controlled heat-tape product available at most hardware stores.

If you have ductwork in your crawlspace, the most important retrofit you can make is to seal and insulate that ductwork (see “Ducts” box).

If you have an unheated basement, you can choose to insulate the floor above the basement, but you must pay attention to any piping or ductwork that runs through the basement. Many basements fall into a “semi-conditioned” category – these basements are not deliberately supplied with heating, but ductwork running through the basement provides adequate heat so that the space can be used for laundry or workshop purposes. These basements can be made more comfortable by adding wall insulation (without a moisture retarder), which will also provide modest energy savings.

If your basement is conditioned and the walls are not insulated, you can save energy by adding wall insulation. These energy savings will be even more pronounced if you’ve already improved the energy performance of the rest of your house. Your best bet is to use insulation without a moisture retarder because that could lead to moisture problems on your basement walls.

## Where To Find Out More

### *For the Homeowner*

[Home Energy](#), the online site for “the magazine of home performance” contains a wealth of helpful information.

[“No-Regrets Remodeling”](#) a book available from Home Energy Magazine. 1997.

Consumer guides on how windows work and other helpful ideas

[www.uoxray.uoregon.edu/phys161/consumer\\_guide.pdf](http://www.uoxray.uoregon.edu/phys161/consumer_guide.pdf)

<http://www.eere.energy.gov/buildings/homes/buyingwindows.cfm>

How to select an energy efficient window; [www.efficientwindows.org](http://www.efficientwindows.org)

A large number of useful technology fact sheets are available from DOE. These were developed for new home construction, but also contain a wealth of information helpful to people retrofitting existing homes, especially if your retrofit project includes adding on to your home. Go to the [DOE Building Technology publications web site](#). Among other topics, these fact sheets include detailed information about insulating floors, basements, and crawlspaces; air-sealing, especially between the ceiling and attic; and choosing and installing a weather resistant barrier on the exterior wall beneath the new siding.

The [Canada Mortgage and Housing Corporation](#) has prepared a helpful package of advice for renovation projects.

You can learn more about the relative merits of different wall construction methods by visiting the [Whole Wall Calculator](#).

### *For the Builder/Contractor*

If you are a builder or contractor, here are some additional resources:

[ASTM E2112](#) Standard Practice for Installation of Exterior Windows, Doors and Skylights

[Vinyl Siding Institute](#)

Vinyl Siding Installation from [Fine Home Building](#)

[Home Energy's](#) Guide to Training Programs.

[American Architectural Manufacturers Association](#), certified window installation training: [Installation Masters](#)

*Builder's Guide - Mixed Climate;*  
*Builder's Guide - Cold Climate;*  
*Builder's Guide - Hot-Dry & Mixed Dry*  
*Climates.* By Joseph Lstiburek.  
[Energy Efficient Building Association](#)  
1998.

LBNL HVAC Best Practices Guide.

## **Acknowledgements**

This guide was sponsored by the Building America Existing Buildings Program within the Office of Energy Efficiency and Renewable Energy of the U. S. Department of Energy. The direction and participation of the project manager, Terry Logee, was much appreciated.

A workshop was held to gather input for this guide from manufacturers, contractors, and researchers. Participants in this workshop were instrumental in the final content of the document, and included: Robert Braun from Dow Consumer and Building Products, Todd Bushburger of Protecto Wrap Company, Claude Browne from Crane Performance Siding, George Chrenka of the NuWool Company, Steve Duren of Illbruck Sealant Systems, Inc., Brian Keith Hearon of the Denver L. Hunt Company, Terry Logee from the Department of Energy, and John William Lubker of Pactiv Building Products. Oak Ridge National Laboratory researchers participating included Jerry Atchley, Phillip Childs, Andre Desjarlais, Jan Kosny, Thomas Petrie, Therese Stovall, Mark Ternes, and Bob Wendt.

Thanks are due to Pactiv Building Products for contributing fan-fold extruded polystyrene siding underlayment products and to Certainteed Corporation for contributing the vinyl siding that was used during the experimental portion of this effort.

A team of researchers, including Joe Klems and Guy Kelly at LBNL, tested window performance at the MoWitt facility and shared the windows with us for our window/wall performance testing. See Symposium paper KC-03-12-1, ASHRAE Transactions, Vol. 109 Part 2 , June 28 - July 2, 2003

Extensive experimental work at ORNL was performed to increase our understanding of the thermal and infiltration performance of wall retrofit combinations. These efforts were directed by Jan Kosny, Thomas Petrie, Phillip Childs, and Jerry Atchley.

Figures 1 and 4 taken from the *Consumer's Guide to Buying Energy-Efficient Windows and Doors*, used by permission from Natural Resources Canada, Office of Energy Efficiency



# House Inspection Checklist

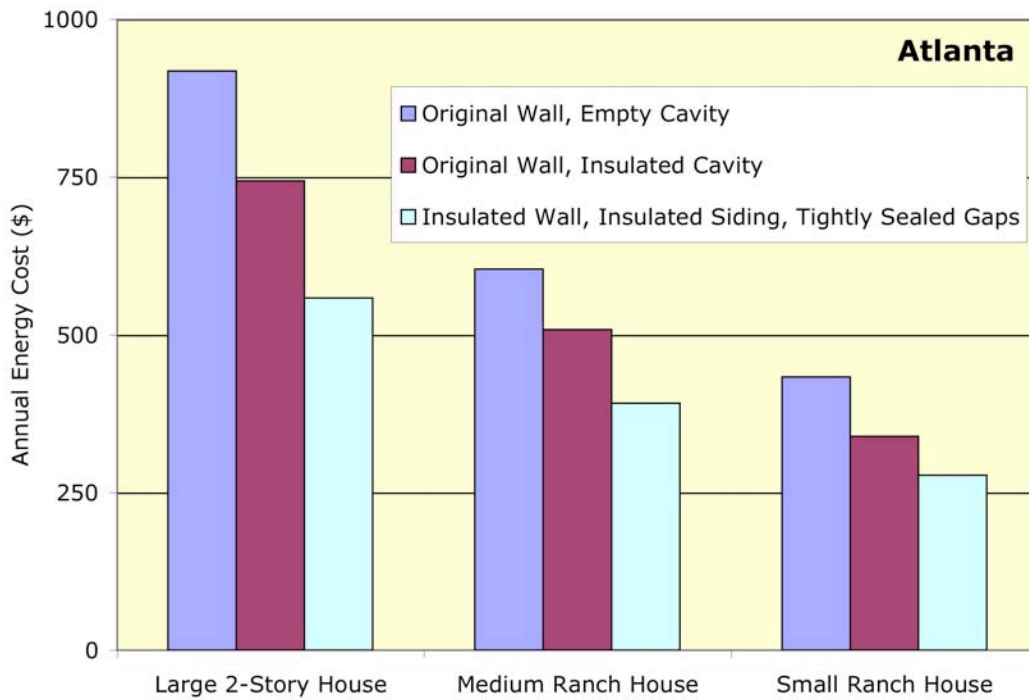
Use this checklist as a handy reminder. More details can be found in the Best Practice Guide.

<b>Moisture problems</b>		<b>OK</b>	<b>Not OK</b>	<b>Notes</b>
<input type="checkbox"/>	Exterior painted surfaces			
<input type="checkbox"/>	Interior painted surfaces			
<input type="checkbox"/>	Window sills			
<input type="checkbox"/>	Wallpaper			
<input type="checkbox"/>	Bathroom surfaces			
<input type="checkbox"/>	Basement			
<input type="checkbox"/>	Crawlspace			
<input type="checkbox"/>	Roof			
<input type="checkbox"/>	Siding			
<b>Attic</b>				
<input type="checkbox"/>	Ductwork leak(s) visible			
<input type="checkbox"/>	Ductwork insulation (missing or torn?)			
<input type="checkbox"/>	Stained wood (indicating moisture/leaks)			
<input type="checkbox"/>	Attic ventilation path obstructed			
<input type="checkbox"/>	Ceiling penetrations that should be sealed			
<input type="checkbox"/>	Lights (except recessed fixtures)			
<input type="checkbox"/>	Vents (bathrooms and kitchens)			
<input type="checkbox"/>	Duct chases			
<input type="checkbox"/>	Soffits and dropped ceilings			
<input type="checkbox"/>	Open partition walls			
<input type="checkbox"/>	Knee walls should be insulated			
<input type="checkbox"/>	Insulation type			
<input type="checkbox"/>	Insulation amount/level			
<b>Windows and Doors</b>				
<input type="checkbox"/>	Weather stripping			
<input type="checkbox"/>	Caulking			
<input type="checkbox"/>	Fogging (condensation or mold between panes of glass)			
<b>Walls</b>				
<input type="checkbox"/>	Cavity insulation			
<input type="checkbox"/>	Insulating sheathing			
<input type="checkbox"/>	Building paper or housewrap			
<input type="checkbox"/>	Siding			
<b>Basement</b> ( <i>heated and/or cooled ?</i> )				
<input type="checkbox"/>	Ductwork leak(s) visible			
<input type="checkbox"/>	Ductwork insulation (missing or torn?)			
<input type="checkbox"/>	Pipe insulation			
<input type="checkbox"/>	Basement wall insulation			
<input type="checkbox"/>	Insulation on floor above			
<b>Crawlspace</b>				
<input type="checkbox"/>	Floor covered with plastic sheeting			
<input type="checkbox"/>	Ductwork leak(s) visible			
<input type="checkbox"/>	Ductwork insulation (missing or torn?)			
<input type="checkbox"/>	Pipe insulation			
<input type="checkbox"/>	If ventilated: insulation on floor above			
<input type="checkbox"/>	If not ventilated: wall insulation			

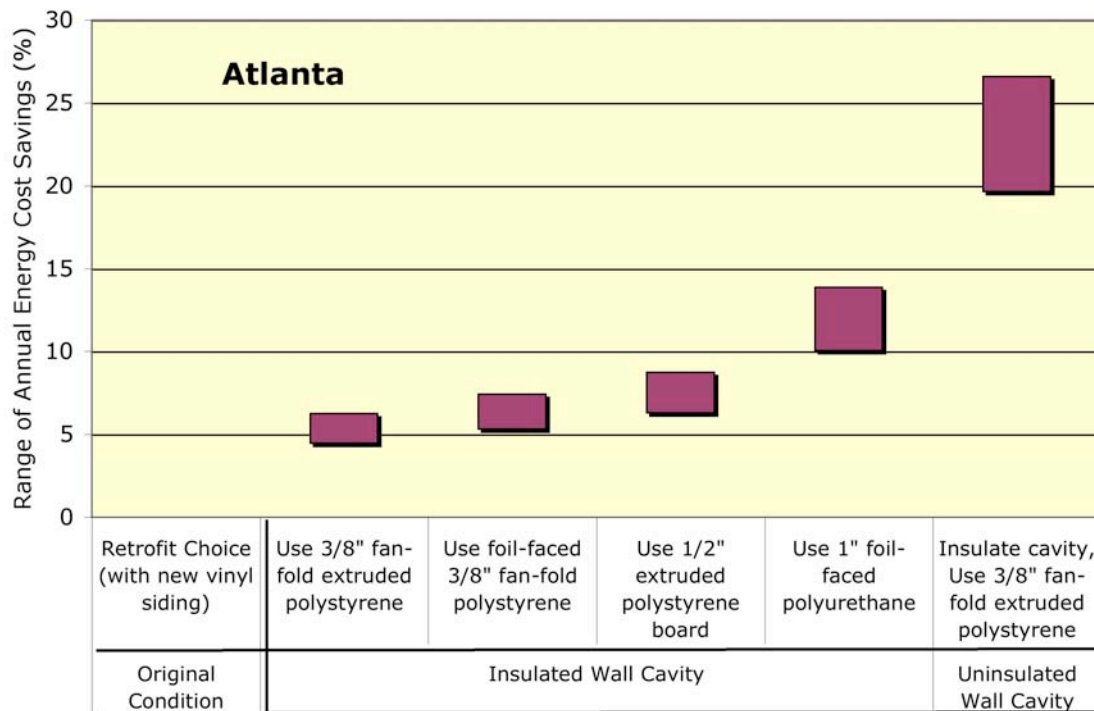
## Window Replacement Checklist

Number	Size	Glazing (single, double, or triple pane)	Frame (wood, vinyl, or aluminum)	Type (sliding or hinged)	Notes (Besides general condition, include label information: safety glass, low-e coating, gas fillers,etc.)
<b>Facing South and West (consider shading to reduce solar heat gain during the summer)</b>					
<b>Facing North and East</b>					

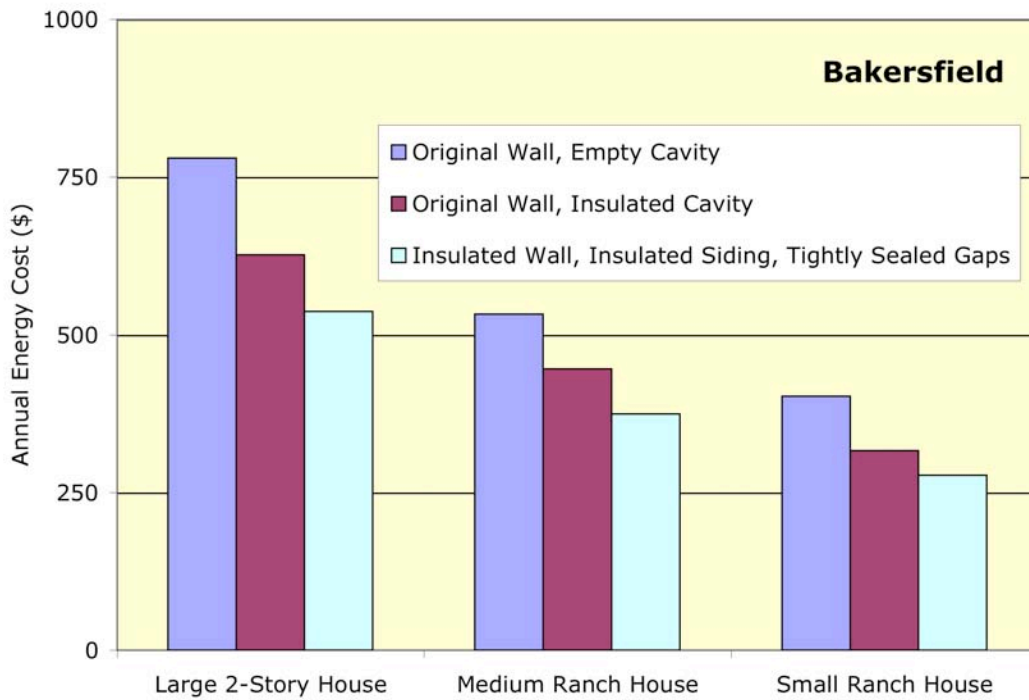
# Appendix A: Savings Estimates for Ten Cities



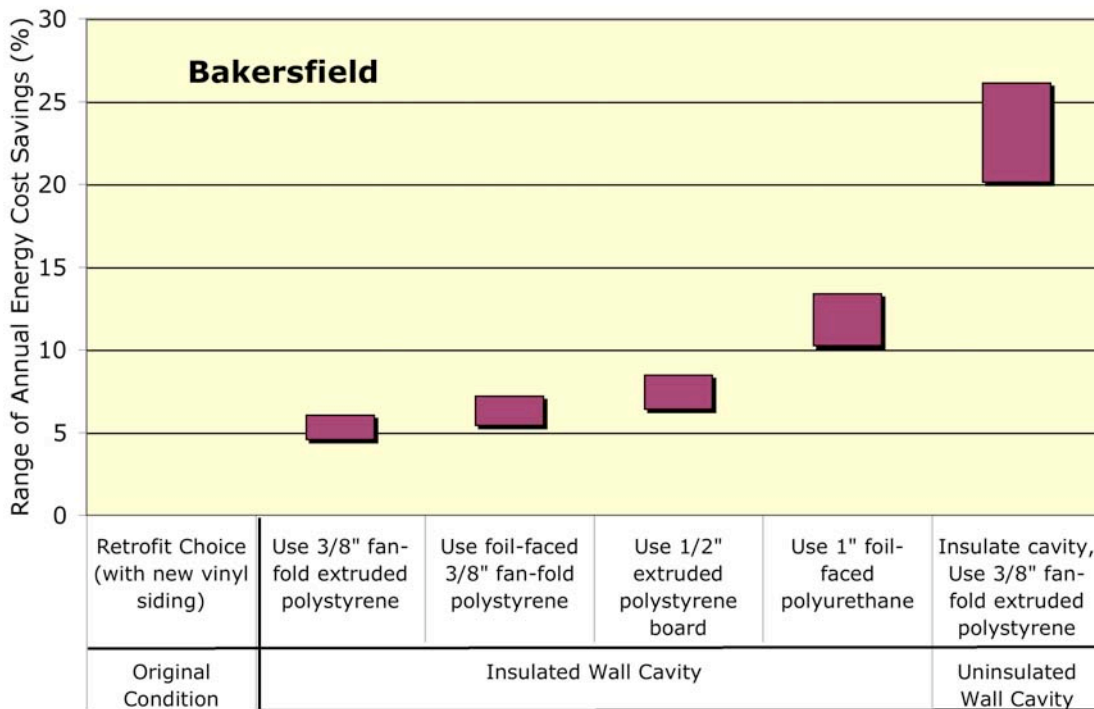
**Figure 7. Annual Energy Costs**



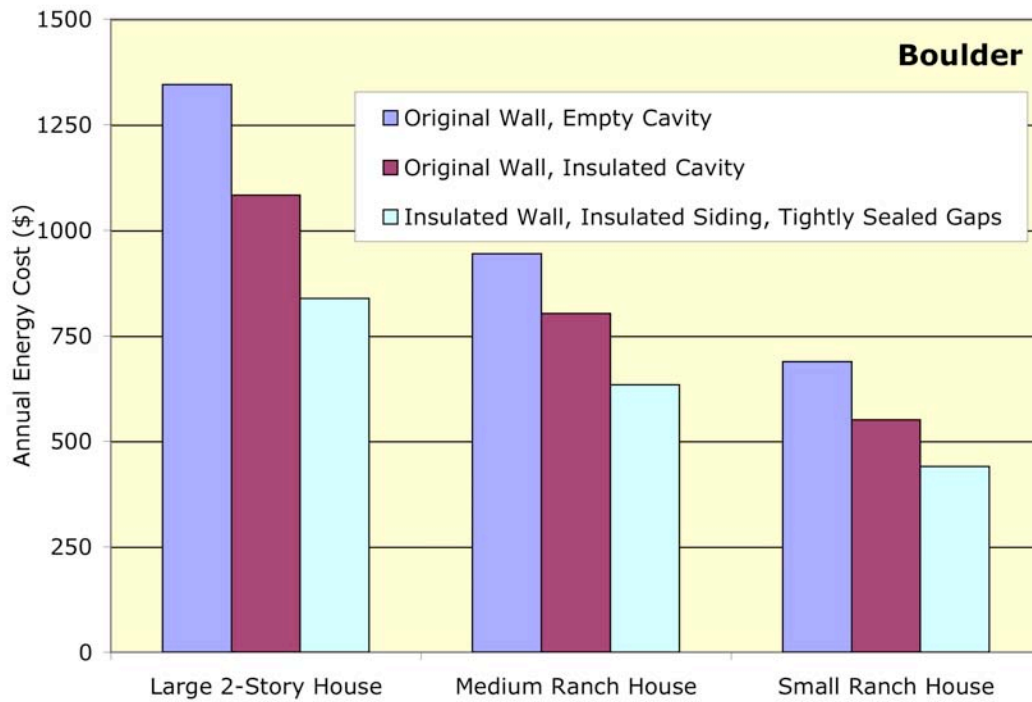
**Figure 8. Potential Annual Heating and Cooling Energy Savings for Different Wall Retrofit Options**



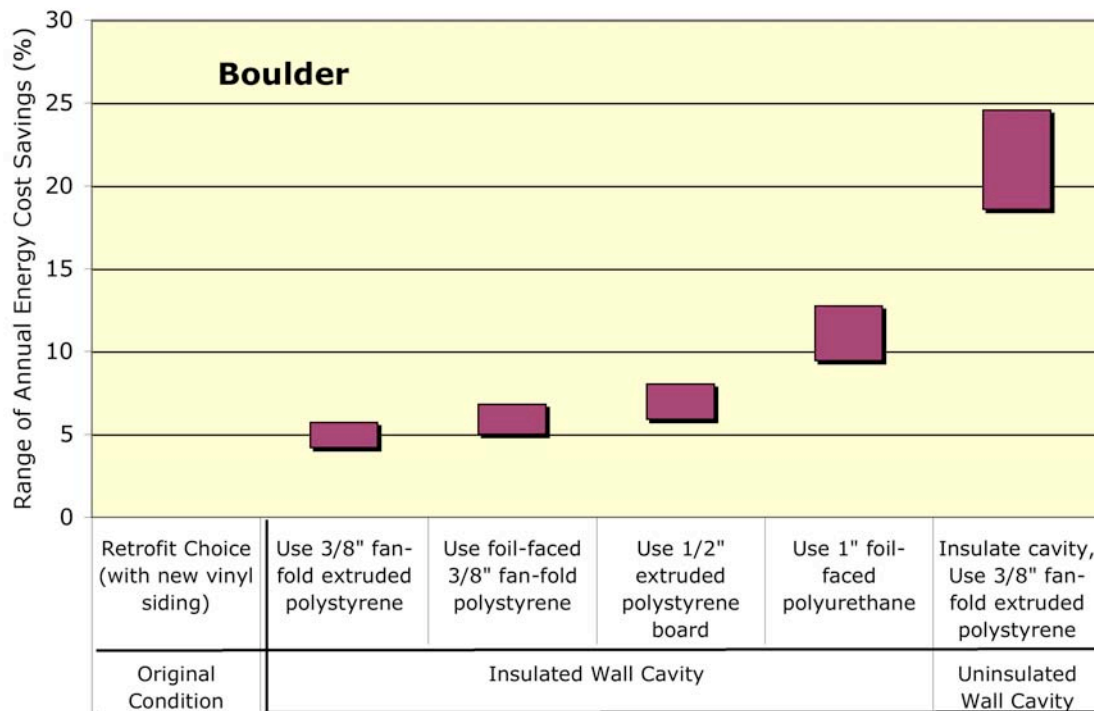
**Figure 7. Annual Energy Costs**



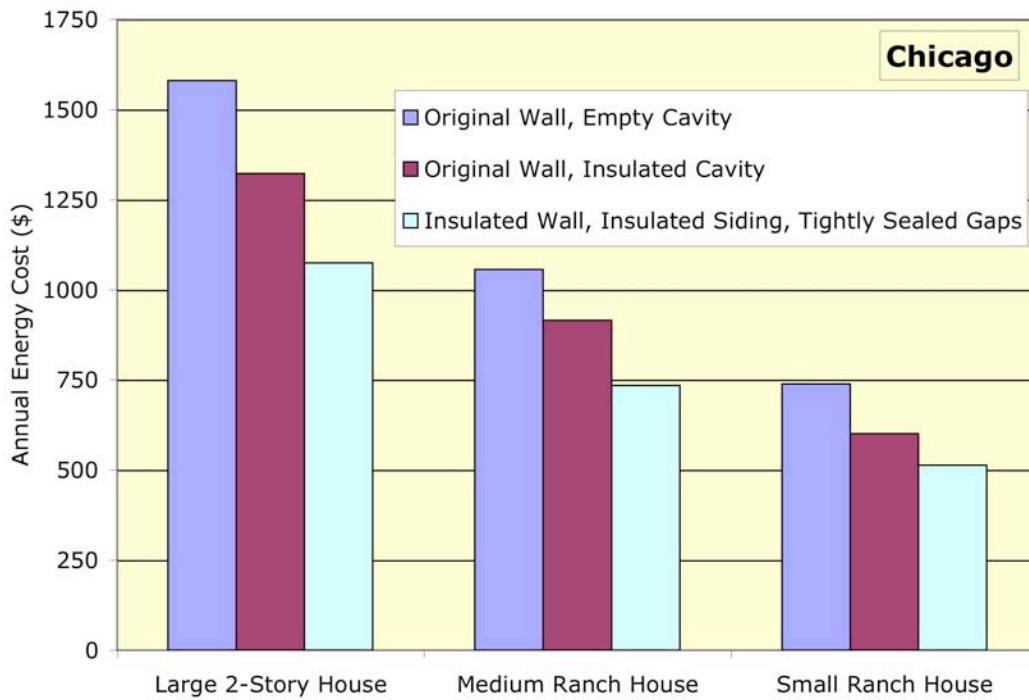
**Figure 8. Potential Annual Heating and Cooling Energy Savings for Different Wall Retrofit Options**



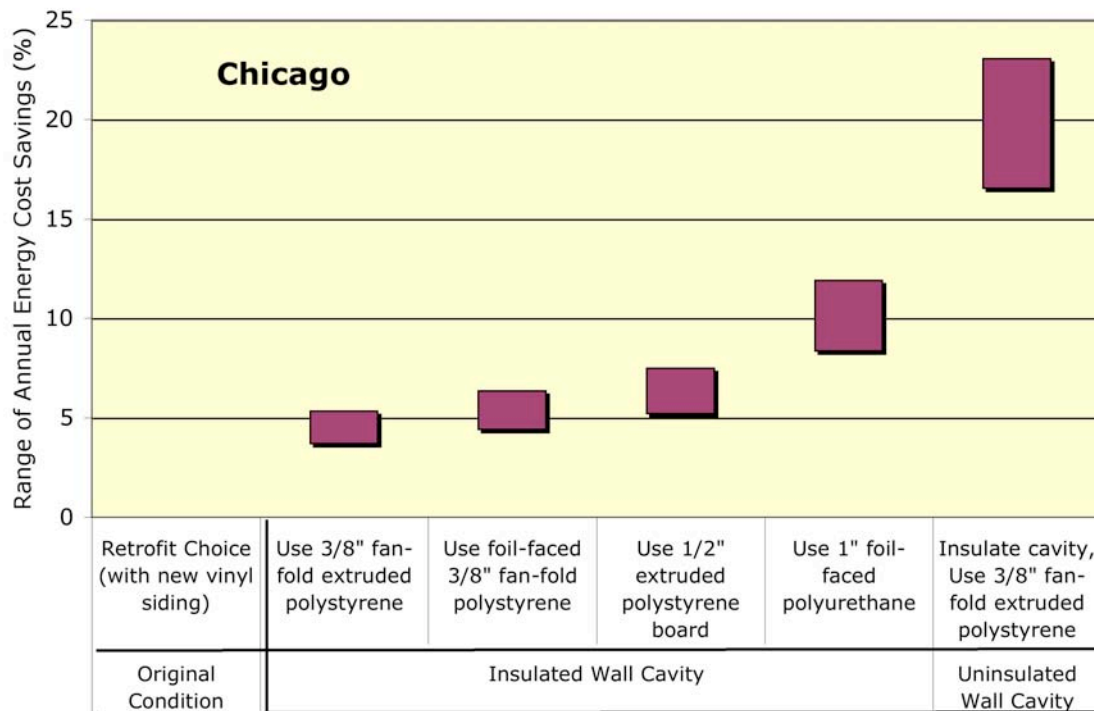
**Figure 7. Annual Energy Costs**



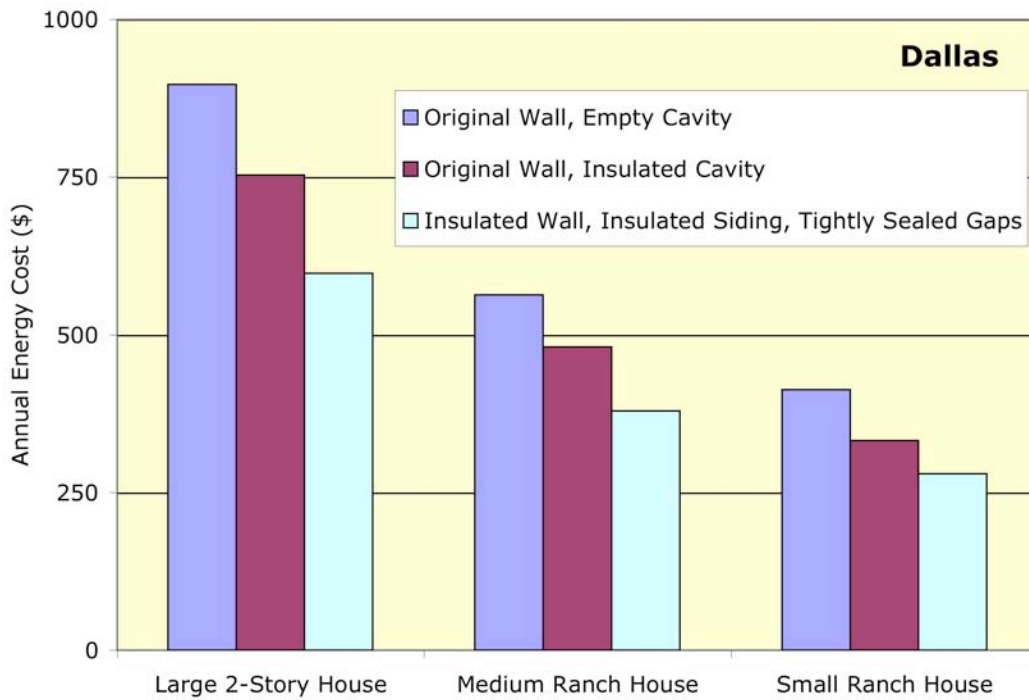
**Figure 8. Potential Annual Heating and Cooling Energy Savings for Different Wall Retrofit Options**



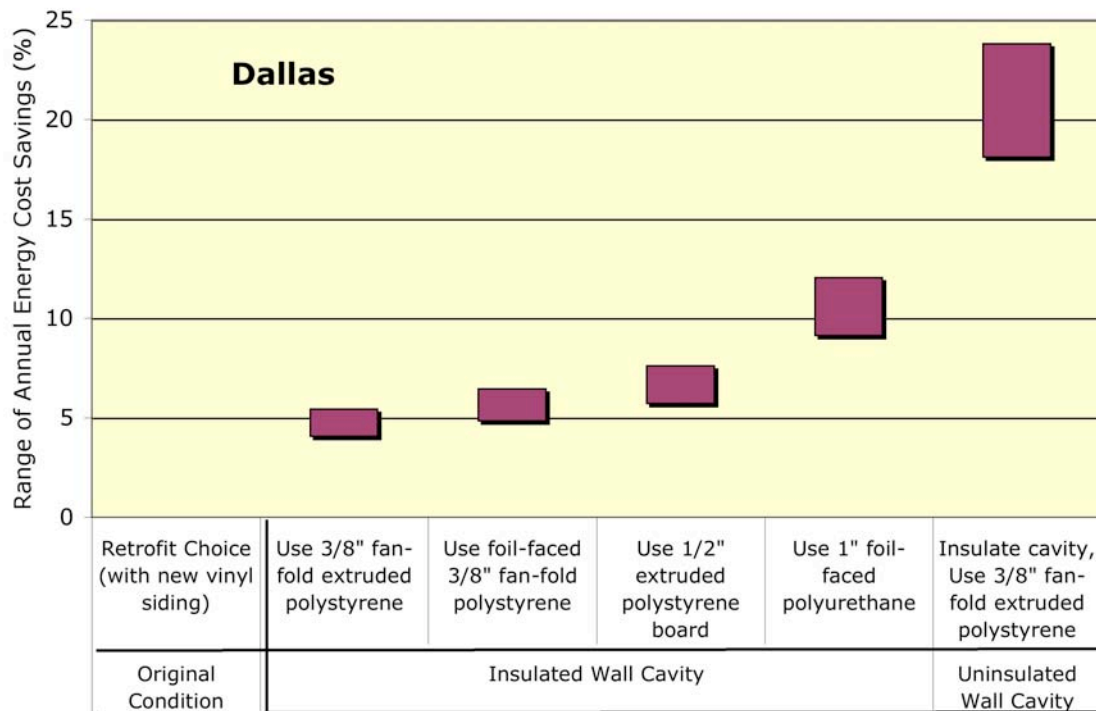
**Figure 7. Annual Energy Costs**



**Figure 8. Potential Annual Heating and Cooling Energy Savings for Different Wall Retrofit Options**

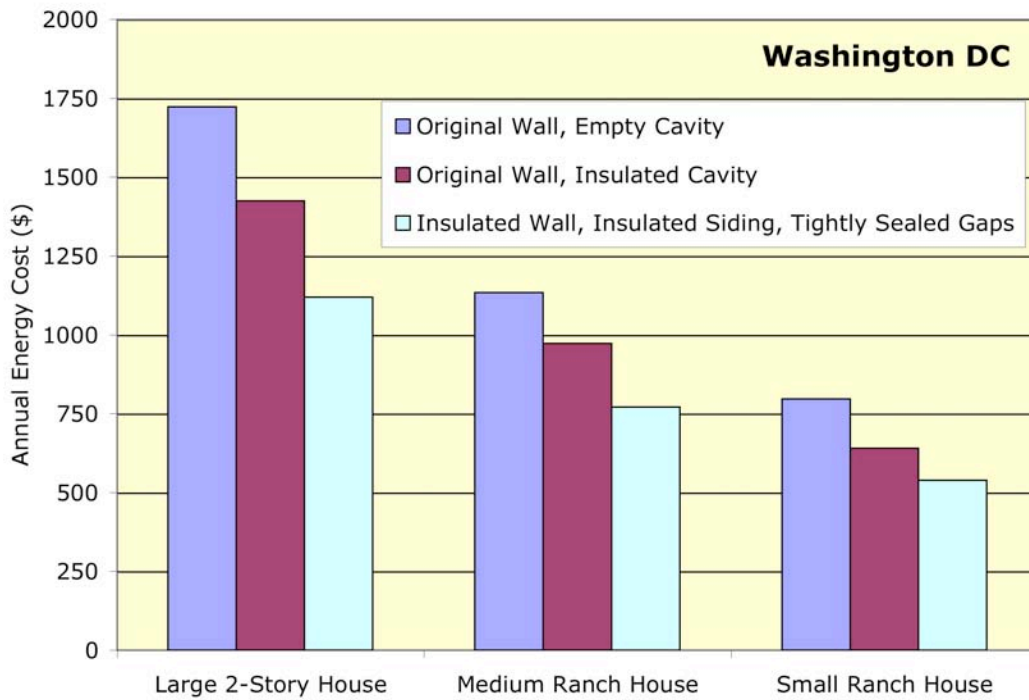


**Figure 7. Annual Energy Costs**

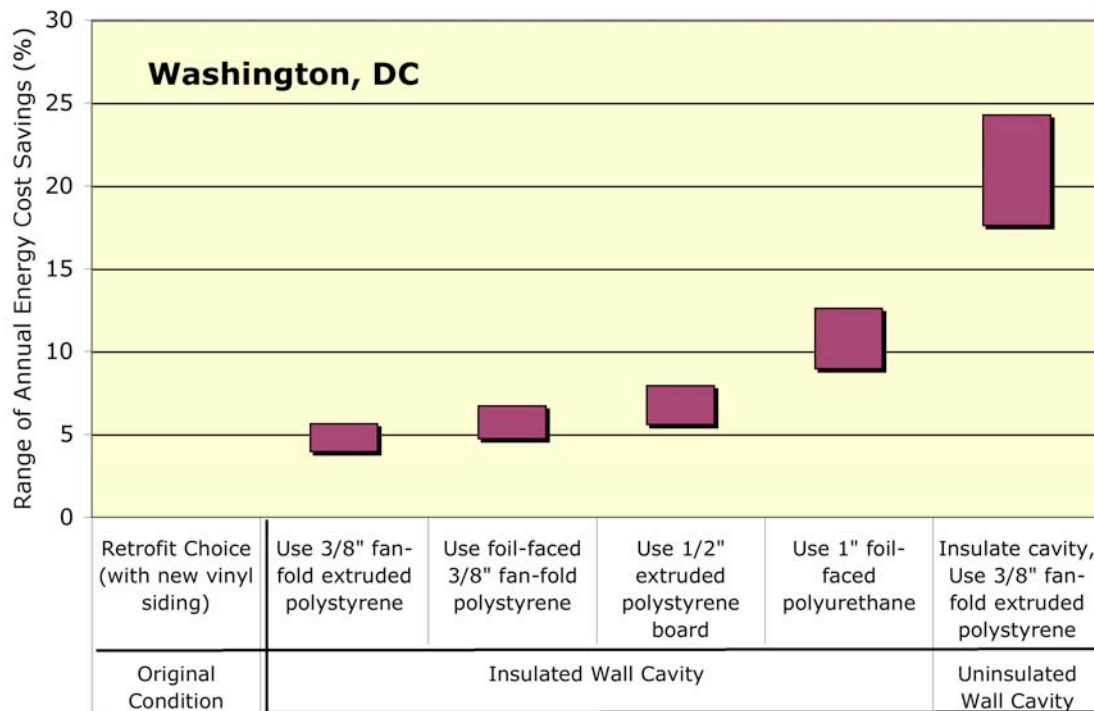


**Figure 8. Potential Annual Heating and Cooling Energy Savings for Different Wall Retrofit Options**

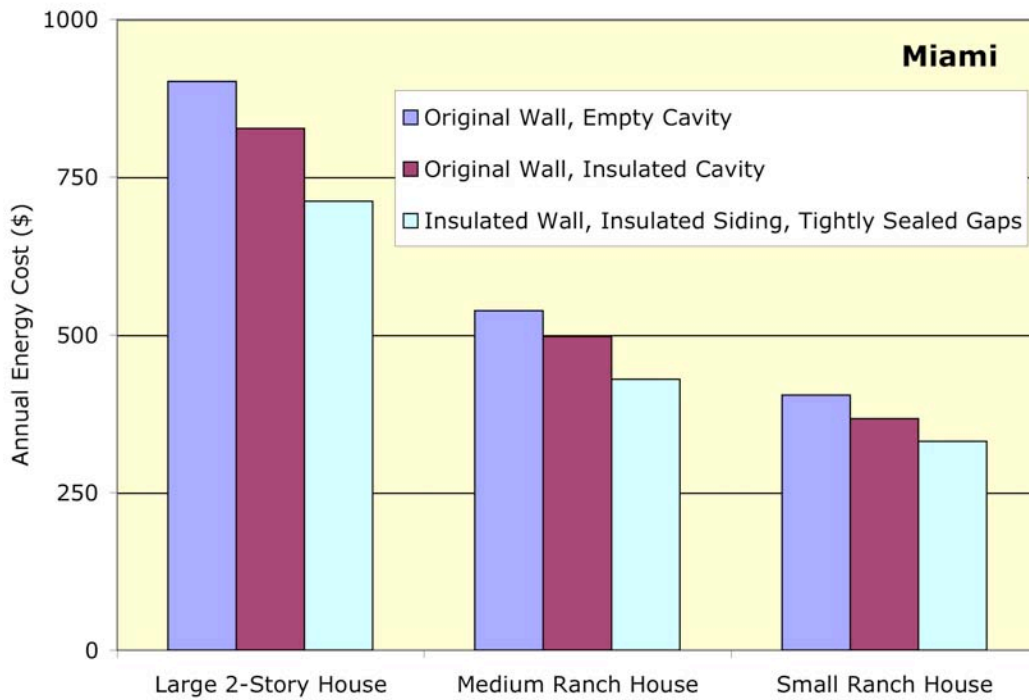




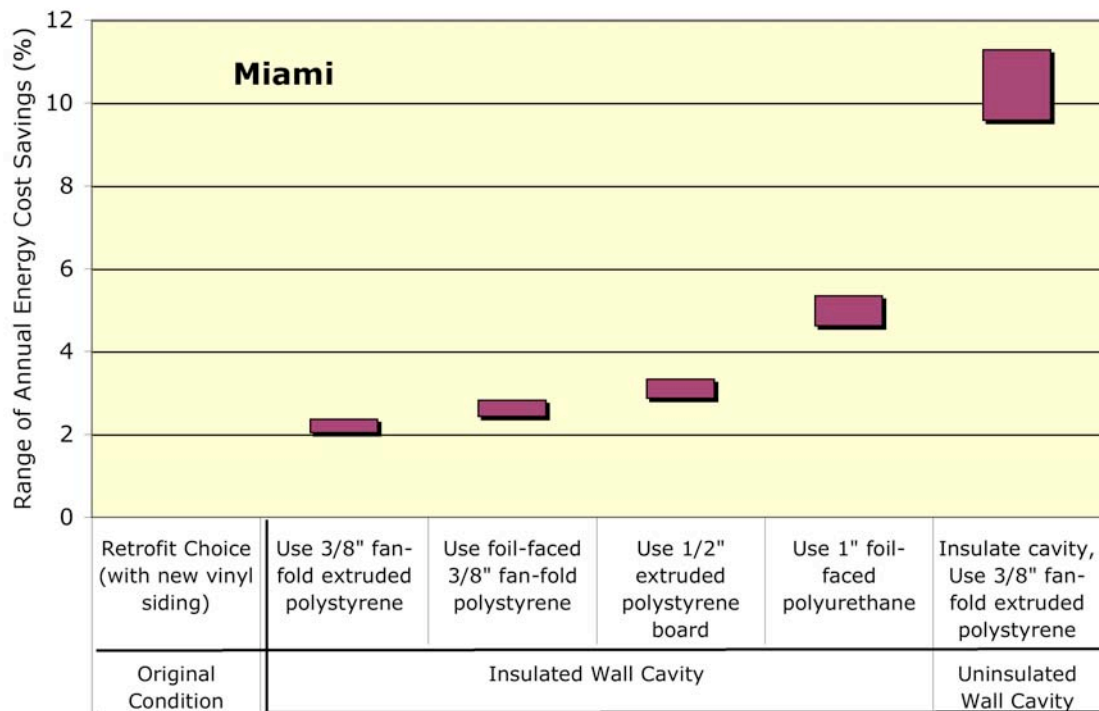
**Figure 7. Annual Energy Costs**



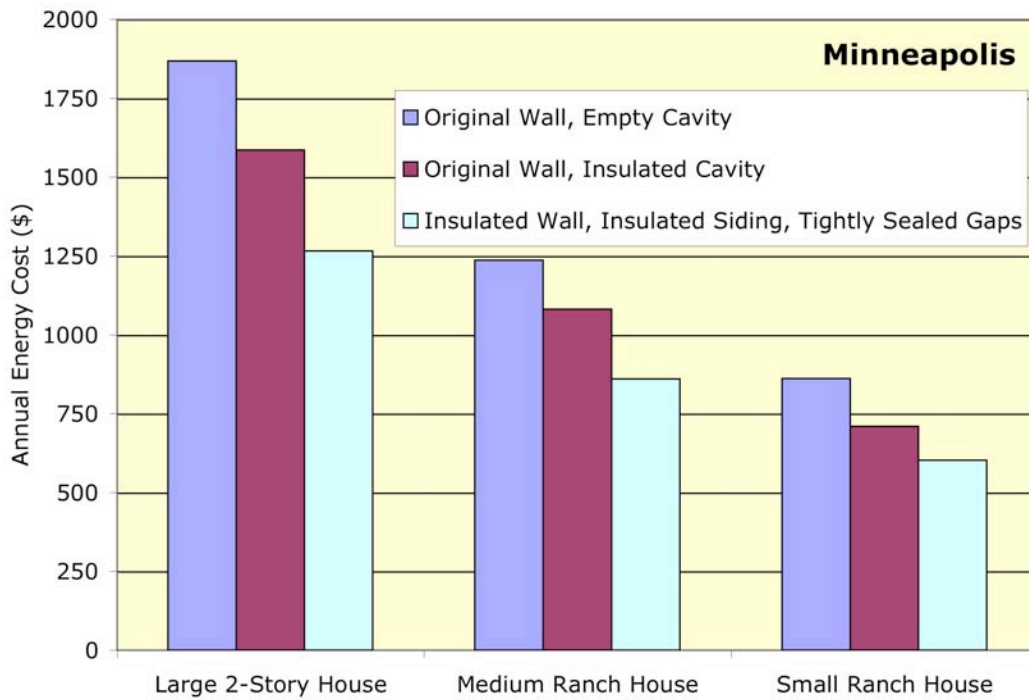
**Figure 8. Potential Annual Heating and Cooling Energy Savings for Different Wall Retrofit Options**



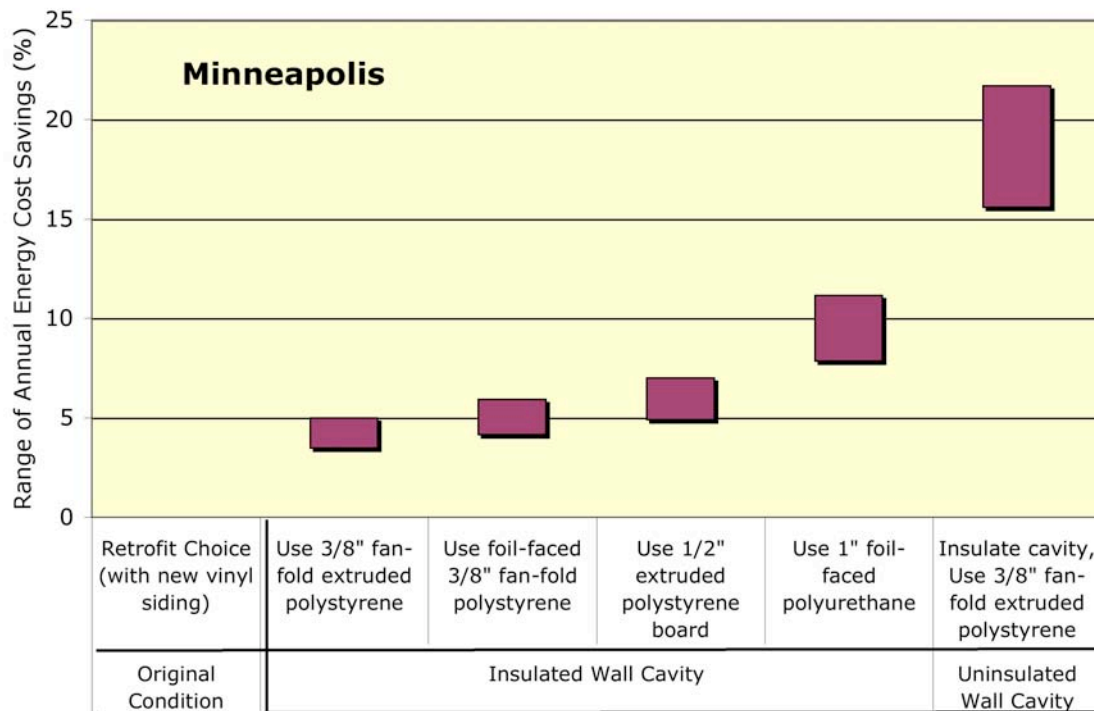
**Figure 7. Annual Energy Costs**



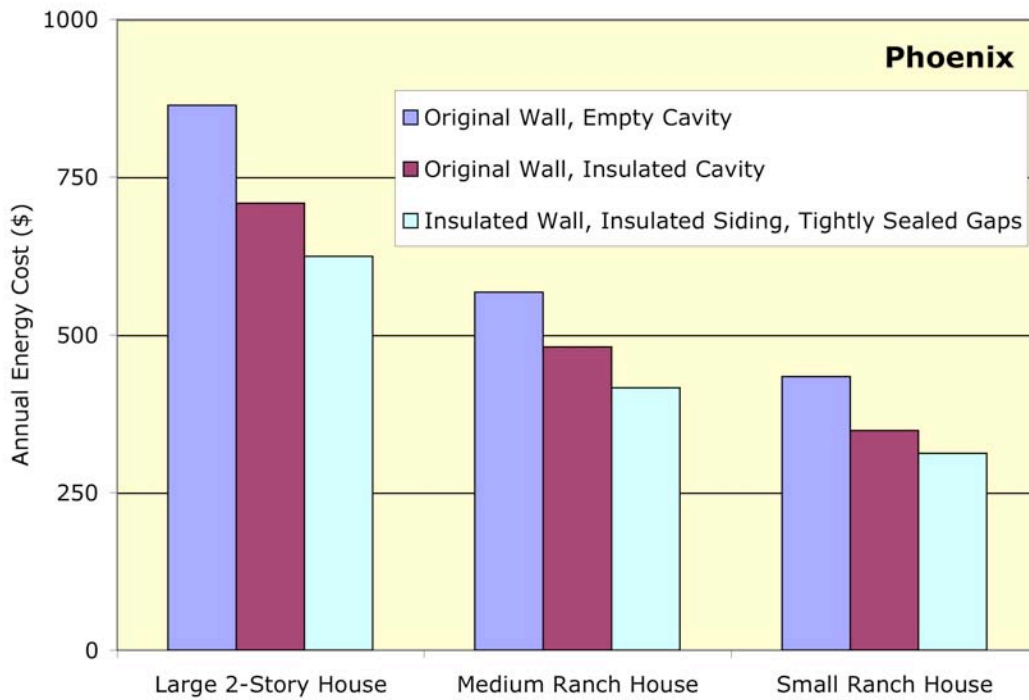
**Figure 8. Potential Annual Heating and Cooling Energy Savings for Different Wall Retrofit Options**



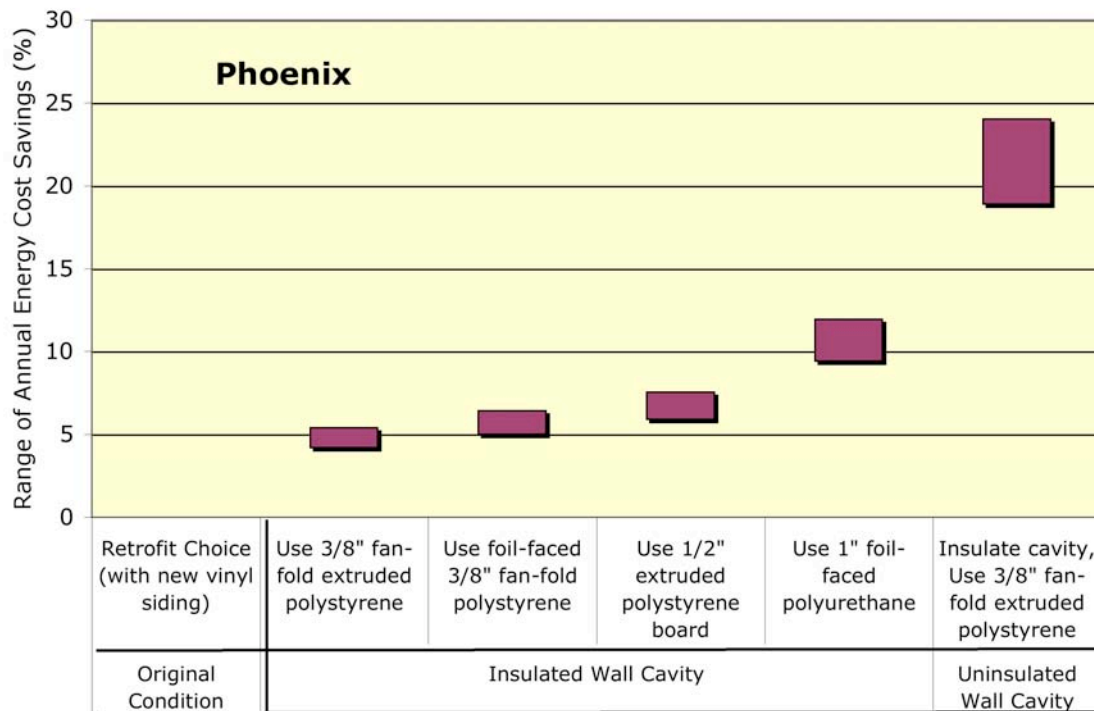
**Figure 7. Annual Energy Costs**



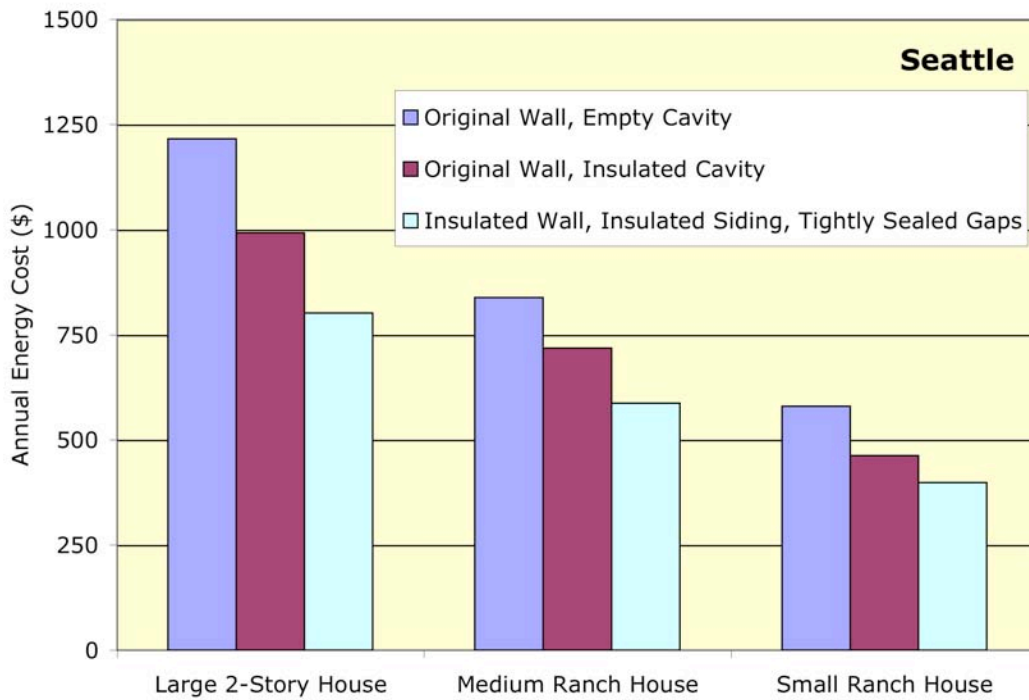
**Figure 8. Potential Annual Heating and Cooling Energy Savings for Different Wall Retrofit Options**



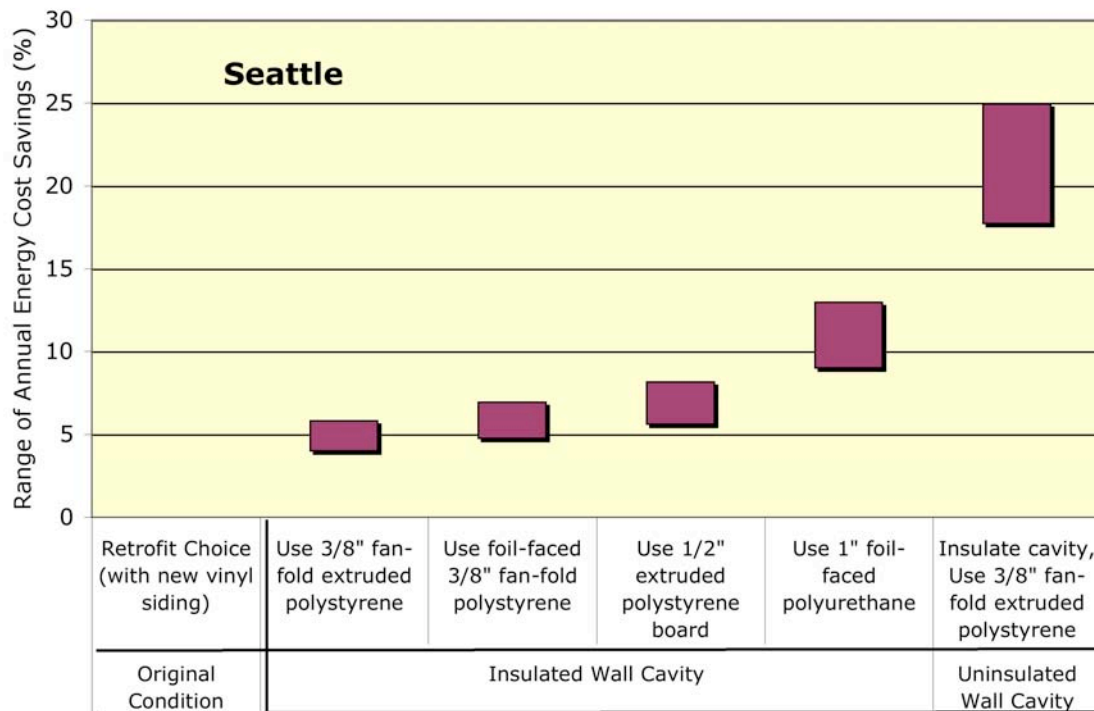
**Figure 7. Annual Energy Costs**



**Figure 8. Potential Annual Heating and Cooling Energy Savings for Different Wall Retrofit Options**



**Figure 7. Annual Energy Costs**



**Figure 8. Potential Annual Heating and Cooling Energy Savings for Different Wall Retrofit Options**