

**BASRAH CHILDREN'S HOSPITAL
BASRAH, IRAQ**



**SIGIR PA-08-160
JULY 28, 2009**



Basrah Children's Hospital

Summary of Report: PA-08-160

Why SIGIR Did This Study

SIGIR is charged to conduct assessments of Iraq reconstruction projects funded with amounts appropriated or made available by the U.S. Congress. SIGIR assessed this project to provide real-time information on relief and reconstruction to interested parties to enable appropriate action, when warranted.

This public-private multi-funded project which began in July 2004, is still ongoing, has more than tripled in cost, and may not be completed until 2011.

The objective of this project assessment was to determine if:

- project components were adequately designed
- construction complied with design standards
- adequate quality management programs were used
- project sustainability was addressed
- project results were consistent with original objectives

What SIGIR Recommends

This report does not contain any negative findings or recommendations for corrective action with respect to contracts funded by the U.S. government; therefore, management comments are not required.

Contracts and grants funded by non-U.S. Government entities are outside SIGIR's jurisdiction; therefore, recommendations were not made on them.

SIGIR received comments on the draft of this report from the Multi-National Corps-Iraq and the Gulf Region Division of the U.S. Army Corps of Engineers. Multi-National Corps-Iraq advised that it had no issues with the report. The Gulf Region Division indicated that it generally agreed with the facts presented in the report.

What SIGIR Found

On 6 January 2009, SIGIR performed an on-site assessment of the Basrah Children's Hospital in Basrah, Iraq. The objective of the project was to construct a "state of the art" two-story, 160,000 square foot, 94-bed acute and referral care center, pediatric specialist hospital. Because of security concerns, SIGIR performed only an expedited one-hour assessment; therefore, a complete review of all work completed was not possible.

The project was significantly behind schedule and in June 2006 a "stop work" order was issued to the contractor—Bechtel. On 30 September 2006, a new contract was awarded to MID Contracting, with a new finish date of 21 July 2008.

SIGIR determined that the design was sufficient to construct the hospital. However, the sewer system, although adequate, depends on maintaining 16 pumps to cover 85,000 square meters; the failure of one lift station pump will shut down the entire system until it is repaired or replaced. The ongoing construction appeared to meet requirements. The contractor's quality control plan was sufficient and the government quality assurance program was effective. To date, the project results are partially consistent with the project objective; however, the project results are not consistent with a "state of the art" hospital with respect to medical equipment and its operation.

Several factors have contributed to the escalation of the project's costs and the drastic schedule slippage: unrealistic timeframes for design and construction; poor soil conditions; drastically changing security situation at the project site, including the murder of 24 workers; multiple partners and funding sources; and the Government of Iraq not following through on its obligations.

Several key lessons for other contingency reconstruction operations should be applied for future reconstruction projects: ensure that key utilities are available; have realistic requirements for the contractor; ensure effective management and oversight; note that multiple funding sources can lead to delays; and understand local government budget processes.

As of May 2009, the U.S. government, Project HOPE, and the Government of Spain have contributed \$156.9 million of the \$165.7 million for the Basrah Children's Hospital. Even though Iraq's portion is considerably smaller (\$9.8 million) than the other partners, not carrying out its essential obligations will have a significant negative impact on this project.





SPECIAL INSPECTOR GENERAL FOR IRAQ RECONSTRUCTION

July 28, 2009

MEMORANDUM FOR COMMANDING GENERAL, MULTI-NATIONAL FORCE-IRAQ
COMMANDING GENERAL, MULTI-NATIONAL CORPS-IRAQ
COMMANDING GENERAL, JOINT CONTRACTING COMMAND-
IRAQ/AFGHANISTAN
COMMANDING GENERAL, GULF REGION DIVISION, U.S.
ARMY CORPS OF ENGINEERS
DIRECTOR, IRAQ TRANSITION ASSISTANCE OFFICE

SUBJECT: Report on the Basrah Children's Hospital, Basrah, Iraq (SIGIR Project Number PA-08-160)

We are providing this project assessment report for your information and use. We assessed the design and construction work being performed at the Basrah Children's Hospital in Basrah, Iraq, to determine its status and whether the intended objectives will be achieved. This assessment was made to provide you and other interested parties with real-time information on a relief and reconstruction project underway and in order to enable appropriate action to be taken, if warranted.

This report does not contain any negative findings or recommendations for corrective action with respect to contracts funded by the U.S. government; therefore, management comments were not required. However, comments on the draft of this report were received from Multi-National Corps-Iraq and the Gulf Region Division of the U.S. Army Corps of Engineers. Multi-National Corps-Iraq advised that it had no issues with the report. The Gulf Region Division indicated that it generally agreed with the facts presented in the report and provided technical comments for clarification. SIGIR reviewed the comments provided by the U.S. Army Corps of Engineers and revised the final report to address them. No additional comments are required.

We appreciate the courtesies extended to our staff by representatives of the Gulf Region Division and the Gulf Region District South of the U.S. Army Corps of Engineers. If you have any questions, please contact Mr. Brian Flynn at brian.flynn@iraq.centcom.mil or at 240-553-0581, extension 2485. For public queries concerning this report, please contact SIGIR Public Affairs at publicaffairs@sigir.mil or at 703-428-1100.

Stuart W. Bowen, Jr.
Inspector General

Special Inspector General for Iraq Reconstruction

SIGIR PA-08-160

July 28, 2009

Basrah Children's Hospital Basrah, Iraq

Synopsis

Introduction. The Special Inspector General for Iraq Reconstruction is assessing projects funded primarily by the Iraq Relief and Reconstruction Fund, Commander's Emergency Response Program, and Child Survivor and Health Programs Fund to provide real-time information on relief and reconstruction to interested parties to enable appropriate action, when warranted.

Background. Large oil reserves and abundant natural and human resources enabled Iraq to attain the status of a middle-income country in the 1970s while enjoying perhaps the best health care system in the Middle East. However, over the past 35 years, Iraq's health care system deteriorated to that of a third world developing country, primarily because of a lack of investment in health care for children and in modern training for health care providers. In addition, three wars and international economic sanctions have stifled economic growth and development, which has debilitated basic infrastructure and social services.

In a 27 June 2006 report by the Louis Berger Group, Inc. on the Basrah Children's Hospital, the background of the decline in healthcare in Iraq was explained. Mortality rates for children and maternity mortality rates have doubled; moreover, adult mortality has grown exponentially. In Iraq, childhood cancers are 8-10 times more common than in the western world; the incidence rate in Iraq is 8%, compared to 0.5-1% in developed countries. The most common childhood cancers are leukemia, lymphomas, brain tumors, and other nervous system tumors. Since 1993, the Iraqi cancer registry has reported an increase in the number and proportion of cases of leukemia in the southern provinces. For example, in 1989, Basrah accounted for 5.5% of Iraq's leukemia cases. In 1993, that number grew to 8.5%; in 1995, 9.1%; in 1997, 8.4%; and in 1998, 9.2%. Children under the age of five account for approximately 56% of the registered cancer cases.

Of the five common forms of cancer that account for more than 50% of all cases, a large proportion of cancers are preventable, and half can be diagnosed early. If diagnosed in time, four are curable by standard therapies, where available. However, because of the lack of adequate health care services in Iraq, most cancer cases are detected in advanced stages; therefore, they are incurable even if the best therapies are accessible.

The report by the Louis Berger Group, Inc. notes that presently, 8% of Iraqi children with leukemia survive compared to 80% in the United States. Late diagnosis and a lack of standard curative therapy are the main causes of death. Without palliative care, most of today's cancer patients in Iraq die with avoidable pain and suffering.

In 2003, the First Lady of The United States became increasingly concerned about the deteriorating Iraqi health care system, especially for the children suffering from cancer.

Project HOPE (Health Opportunities for People Everywhere)¹ was asked to make a fact-finding mission to Iraq to identify the most appropriate opportunity to fund a children's hospital. Project HOPE found "deplorable health care conditions plaguing Iraqi society." Specifically, Project HOPE identified a very high child mortality rate in southern Iraq, where 150 out of 1,000 children were dying before reaching the age of five; most died before their first birthday. In addition, cancer is almost five times higher in southern Iraq than the national average.

While the U.S. government contracted to construct new primary health care centers and rehabilitate existing Iraqi hospitals and clinics, this project in particular was envisioned as a signature project to meet the urgent medical needs of the Iraqis, specifically the needs of critically ill children. The project eventually became known as the Basrah Children's Hospital (BCH), also referred to as the Laura Bush Children's Hospital.

Project Assessment Objective. The objective of this project assessment was to provide real-time relief and reconstruction project information to interested parties to enable appropriate action, when warranted. Specifically, the Special Inspector General for Iraq Reconstruction (SIGIR) determined whether

1. Project components were adequately designed prior to construction or installation;
2. Construction or rehabilitation is in compliance with the standards of the design;
3. Adequate quality management programs were being utilized;
4. Sustainability was addressed in the contract or task order for the project; and
5. Project results were or will be consistent with their original objectives.

SIGIR conducted this limited scope assessment in accordance with the Quality Standards for Inspections issued by the Council of the Inspectors General on Integrity and Efficiency. The assessment team comprised two engineers/inspectors and two auditors/inspectors.

Project Objective. To combat the alarming rate of child mortality in southern Iraq, the U.S. Agency for International Development (USAID) and Project HOPE formed a public-private partnership to establish a "state of the art" pediatric specialist hospital in the southern city of Basrah, Iraq. Specifically, USAID was responsible for the construction of a two-story, 160,000 square foot, 94-bed acute and referral care center; Project HOPE was responsible for providing the medical equipment and training Iraqi doctors and nurses. The focus of the BCH would be pediatric oncology: early projections called for annual pediatric admissions of 360 cancer patients, 468 intensive care patients, 354 neonatal intensive care patients, and 2,230 acute care patients. In addition, this hospital is intended to lead the southern provinces in meeting the goal of the Ministry of Health (MOH) to reduce child mortality by 50% over the next five years, affecting more than one million children living in the region.

Actions Taken. On 5 January 2004, USAID awarded an indefinite delivery/indefinite quantity, cost-plus-fixed-fee contract to Bechtel National, Inc. (Bechtel), for the "design, rehabilitation, reconstruction, and construction of infrastructure projects in support of U.S. assistance to Iraq in electric, water and sanitation services, telecommunications, and selected public buildings." Job Order Number 04-511 of the Bechtel contract required the design and construction of a pediatric teaching hospital in Basrah, focusing on acute care and oncology services for children. The projected start date was 1 July 2004; the completion date was December 2005. By June 2006, the project had experienced

¹ Project HOPE is an international non-profit health, education, and humanitarian assistance organization.

significant cost growth and repeated schedule delays primarily because of poor subcontractor performance and limited oversight by the prime contractor. USAID issued a “stop work” notice to Bechtel on the project, and on 27 June 2006, the U.S. Embassy Iraq issued a directive outlining the program transfer from USAID to the U.S. Army Corps of Engineers Gulf Region Division (GRD).² SIGIR completed its audit of the BCH in July 2006 detailing these events. At the time of the transfer, the project was approximately 30% complete.

Since then, the U.S. government and the United Nations Development Program (UNDP) have awarded 24 separate contracts to complete the BCH facility and ancillary buildings. This project was originally projected to be completed by December 2005 with construction costs amounting to \$50 million. The SIGIR audit on 31 July 2006 forecast that increased construction as well as medical equipment, training, and consumables would result in estimated costs of \$149.5 million to 169.5 million (including non-U.S. government funding). At the time of the SIGIR site visit in January 2009, construction of the facility was still ongoing, and the total cost of the project had reached \$165.7 million (including construction, medical equipment, training, and consumables). This project has already entered its fifth year of construction and the date of full operation of the facility is still unknown.

The BCH project cost more than \$100 million in U.S. funding alone. Including the main hospital building and associated supporting facilities, BCH is one of the largest projects undertaken by the U.S. government in Iraq. The U.S. government and Government of Iraq (GOI) have identified it as a priority project because it intends to reduce the child mortality rate in Iraq (specifically in the southern area). The BCH also will serve as an educational facility for improving and expanding the training of health professionals throughout Iraq.

Issues affecting costs and scheduling delays. Several factors have contributed to the escalation of the project’s costs and drastically slipping schedule, including:

- unrealistic timeframes for designing and constructing a new hospital, including determining the scope/size of the facility, while integrating more than 8,000 pieces of equipment, furniture, and computers.
- poor soil conditions of the project site
- drastically changing security situation in and around the project site, including the murder of 24 workers in the course of construction so far.
- multiple BCH partners and funding sources
- the GOI’s difficulty supporting the assigned tasks of construction and operation of the hospital

Because contracts funded by the UNDP and GOI are outside SIGIR’s jurisdiction, this assessment is primarily focused on the MID Contracting (MIDCON) contract for the main hospital building. However, because the BCH will not be fully operational until all construction and services contracts are completely finished, medical equipment is delivered and installed, and training is received, this assessment will also discuss the status of the contracts funded by non-U.S. government sources and their implications on the opening and operation of the hospital.

² The U.S. Army Corps of Engineers (USACE) Gulf Region Division (GRD) and its three districts provide construction management services and assist the capacity of the GOI to maintain its own construction, operation, and maintenance program of essential services and national infrastructure.

Conclusions. The assessment determined that:

1. The contractor's design was sufficient to construct the two-story hospital facility and site utilities, which will comprise the BCH campus. The design submittals included architectural, electrical, mechanical, and plumbing drawings. With the exception of the seismic design for mechanical hangers and block walls, the overall design drawings and specifications appeared to be complete and consistent with the requirements of the contract.

The contractor's seismic design for the mechanical hangers and block walls did not meet the International Building Code (IBC) standards required by the contract. Specifically, the contractor installed all hanging equipment with vertical supports, but no diagonal braces. During an earthquake, diagonal braces transfer the lateral load into the slab above. The Basrah Area Office (BAO) of Gulf Region South (GRS)³ determined that the IBC standards required diagonal bracings. In addition, BAO also determined that the interior masonry block walls cannot withstand the design earthquake force. Even though the block walls are non-load bearing, the IBC required that the walls must be able to maintain their structural integrity during an earthquake. BAO determined that under the design earthquake lateral loading, the walls would collapse. In February 2009, the contractor submitted design drawings to rectify Bechtel's previously deficient seismic design for the mechanical hangers and interior block walls, which BAO approved as sufficient to satisfy the requirements of the IBC.

The contractor designed the sewer system as a gravity conveyance system, with eight lift stations discharging at a single point to the municipal sewer system. The project incorporates 8 duplex lift stations using 16 electric pumps into the collection system design. According to BAO representatives, the water table in the area is very high, which limited the length of run of gravity flow pipe; consequently, the sewer system had to be designed with a large number of lift stations. Although not a design deficiency, SIGIR is concerned about the significant amount of operation and maintenance costs associated with the operation of eight duplex lift stations. The facilities engineer will be responsible for maintaining the 16 pumps, which are spread out over the 85,000 square meter (m²) medical campus. The failure of a single lift station will shut down the entire sewer system until it is repaired or replaced.

Overall, the contractor's designs provided enough information and detail to adequately construct the BCH campus.

2. At the time of the site visit, construction work on the hospital facility was still ongoing. In general, the construction appeared to meet the standards of the Statement of Work. SIGIR did not observe significant deficiencies or any noticeable defects associated with the quality of workmanship. At the time of the site visit, no furniture or equipment had been installed in the rooms; therefore, SIGIR could not test the wiring, bed-heads, and medical equipment. The observed construction work associated with the BCH facility appeared to meet the standards of the contract.

The project file documentation identified one instance in which construction did not meet the standard of the design, but it was not visible to SIGIR during the site

³ GRS is one of three districts under the USACE Gulf Region Division (GRD).

visit. In southern Iraq, subterranean termite infestation is widely acknowledged to be chronic, regardless of building type; termite damage to concrete buildings has even been reported. To combat the termite problem, Bechtel planned to apply Chlorofet 48% TC⁴ on all soils below the slabs, pile caps, and footings. Yet, in September 2005, the USAID instructed Bechtel to immediately stop using the termite treatment on the hospital site. According to project file documentation, USAID does not allow the use of pesticides on any of its projects. By the time USAID instructed Bechtel to stop using the termite treatment, Bechtel had already applied Chlorofet 48% TC to approximately 2,000m² of the site (out of a total building footprint of approximately 15,000m²). Bechtel provided an extensive justification for the use of termiticide; USAID eventually approved the application of termiticide. However, by the time USAID approved the application of termiticide, the building slabs and foundations had been poured. Bechtel concluded that the BCH facility is not adequately protected against termite infestation.

Because USAID directed Bechtel to stop using the previously planned termite treatment, SIGIR does not consider the fact that the entire site was not treated as a deficiency by Bechtel. Rather, SIGIR is documenting this example of construction that did not meet the standards of the design.

3. The contractor's quality control (QC) plan was sufficiently detailed to effectively guide the contractor's quality management program. The contractor submitted a QC plan, which based on SIGIR's review, met the standards addressed in Engineering Regulation 1180-1-6 (*Construction Quality Management*). The QC representatives monitored field activities and completed daily reports, which were reviewed by the BAO project engineer. The QC daily reports presented a brief background on the work activities performed and major equipment on site. The QC representatives supplemented the daily QC reports with detailed photographs that reinforce the information provided in the reports. In addition, the QC representatives kept a comprehensive deficiency log of identified deficiencies either by type (electrical, mechanical, and civil) or by location (zones 1-5).

The government quality assurance (QA) program was effective in monitoring the contractor's QC program. BAO had dedicated personnel on site. Local national QA representatives monitored field activities and completed daily QA reports, which were reviewed by the BAO project engineer; the daily reports documented the work performed for the day. In addition, the QA representatives supplemented the daily QA reports with detailed photographs that reinforced the information provided in the reports. SIGIR reviewed the daily QA reports and found that the QA representatives did an effective job in identifying and correcting construction deficiencies at the project site. Further, the QA representatives used a deficiency spreadsheet to document each identified construction deficiency, the date it was identified, the corrective action taken, the date the corrective action was taken, and the current status.

In addition, GRS assumed all jobsite activities for the UNDP contracts, which included design review and construction monitoring. Therefore, in addition to

⁴ Chlorofet 48% TC, manufactured by Vapco, is a Chlorpyrifos-based termiticide. First introduced in the mid-1960s, Chlorpyrifos is widely used as an insecticide in agricultural and non-agricultural settings. It is used in many different indoor areas, such as homes, offices, schools, hotels, hospitals, and restaurants. This specific product, Vapco Chlorofet 48% TC, is a special formulation to control all species of subterranean termites.

providing construction management, technical support, and QA reporting for the four contracts funded by the U.S. government (including the key contract to complete the main hospital building), BAO also provides QA reporting on all UNDP-awarded contracts. BAO's QA representatives became responsible for overseeing multiple projects simultaneously throughout the entire complex. In addition, BAO staff became responsible for daily oversight of the activities of approximately 1,000 contractor personnel on site. Currently, BAO employs seven local national QA representatives working full time on site. GRS personnel generally visit the site weekly to determine contractor progress and monitor construction quality.

However, due to a partnership agreement between UNDP and the Department of State, GRS's standard Supervisory and Administration fees for project management and QA responsibilities were eliminated; consequently, from December 2007 to May 2009, the UNDP did not reimburse GRS for performing project management and QA for its contracts. In May 2009, GRS terminated QA support for UNDP projects. In order to allow for a smooth transition, GRS will continue to provide a project manager responsible for coordinating and reporting on the activities of Project HOPE, UNDP, MOH, and U.S. government activities related to the BCH until 31 July 2009.

BAO's vigorous QA program is ensuring the successful completion of the hospital facility and ancillary buildings on the BCH campus.

4. Sustainability was addressed in the contract requirements. The Statement of Work included sustainability elements to assist the MOH, which is ultimately responsible for operating the BCH after turnover. The contract specifications require that the contractor provide a 12-month contractor-certified construction warranty for all building equipment, construction, and components. In addition, the contractor must provide and certify warranties in the name of the MOH. Further, the contractor must provide all operation and maintenance (O&M) manuals for all facility equipment, and is responsible for testing/commissioning all mechanical and electrical systems. The contract also required catalog cuts and a spare parts list for the facility noting the required materials or equipment, cost, and the years of maintenance that are projected to be required. This list includes all requirements for the years of operation, ranging from the second year to the fifth. Finally, a MIDCON electrical engineer familiar with the installed electrical and mechanical equipment and systems will stay in Basrah for one year, beginning 27 June 2009. The engineer will provide full-time technical support to the BCH engineering staff to ensure that the engineering staff understands and can maintain the equipment and electrical systems.
5. To date, the BCH project results are partially consistent with the project objective to establish a "state of the art" pediatric specialist hospital in the southern city of Basrah. Specifically, the project results are consistent with respect to the design and construction of a pediatric specialist hospital. The newly constructed hospital facility will provide cancer-stricken children and their families a safe and peaceful environment to undergo advanced medical treatment.

However, the project results are not consistent with a "state of the art" pediatric specialist hospital with respect to medical equipment and its operation. For a hospital, "state of the art" refers to the latest and most sophisticated or advanced stage of a technology. When USAID and Project HOPE formed the public-private partnership in 2004 to establish the new hospital center, Project HOPE

was responsible for providing \$20 million in specialty equipment, including 12 pieces of high-end (“state of the art”) medical equipment. With construction originally scheduled for completion by December 2005, Project HOPE planned to deliver and install 2005 model high-end medical equipment. However, when construction is complete and the equipment is installed, it will be years old. In the January 2009 BCH Steering Group Meeting, the BCH Hospital Director brought to the group’s attention that this hospital should no longer be considered or described as a state-of-the-art facility; instead recommending it be referred to as a “modern” hospital. The Steering Group unanimously agreed, and in February 2009, representatives of the U.S. government, GOI, UNDP, and Project HOPE signed a Memorandum of Understanding that described the BCH as a “modern pediatric hospital in Basrah.”

The GOI’s challenges in supporting the BCH project. Throughout the course of this project, the U.S. government and Project HOPE have continually provided the MOH with the status of the project in terms of construction and equipping/training. In addition, they outlined the MOH’s responsibilities for the success of this project:

- identifying and providing qualified candidates for training
- allocating an annual operating budget
- service contracts in place (housekeeping, laundry, food service, cleaning)
- maintenance contracts for high-end medical equipment in place
- consumables
- site security

In addition, in May 2008, GRD advised the MOH, in writing, that this project required additional features to complete for which no U.S. government funding was available. As a result, these additional construction and operations requirements would fall to the MOH. Specifically, the MOH needed to provide the project with a packaged wastewater treatment plant (WWTP), medical fluid waste treatment (bio-waste water treatment plant), and dedicated electrical power.

As of June 2009, the GOI has had difficulty supporting the assigned tasks of construction and operation of the hospital. For example, the GOI has not:

- provided qualified candidates for critical training courses, such as radiation therapy
- allocated funding for an annual operating budget
- allocated funding, advertised, or awarded service contracts
- allocated funding, advertised, or awarded maintenance contracts for the high-end medical equipment
- advertised or awarded the WWTP contract
- developed, advertised, or awarded a contract for medical fluid waste treatment
- provided dedicated electrical power

The GOI faces many challenges in opening and operating the Basrah Children’s Hospital. These challenges directly affect the work being completed by the U.S. government, Project HOPE, and UNDP. For example, until the MOH provides qualified candidates for radiation therapy training Project HOPE will not allow the U.S. government’s contractor to install six pieces of high-end medical equipment, because of the danger of operating such equipment without proper training.

Lessons Learned. This reconstruction project yields several key lessons learned for other contingency reconstruction operations, which should be applied in the decision-making process for future reconstruction projects:

- Prior to construction, the availability of key utilities, such as water and power, should be assured. The lack of essential utilities can negatively affect both the ability of the contractor to construct the project and the ability of the ministry to properly operate the project after construction is completed.
- Realistic expectations should be established for the contractor in terms of costs and schedules.
- Effective program management and oversight are needed to avoid significantly increased costs and considerable schedule delays.
- Large reconstruction projects require detailed cost analysis to determine a realistic cost projection.
- Funding individual reconstruction projects through multiple sources can lead to delays; specifically, the inaction of one project partner can directly affect the ability of the other partners to complete their work.
- The budget execution processes of other countries may differ significantly from that of the U.S. government. Other countries may not have the funding in place to immediately open and operate a project upon its completion.

Recommendations. Contracts and grants funded by Project HOPE, the UNDP, and the GOI are outside SIGIR's jurisdiction. This report does not contain any negative findings or recommendations for corrective action with respect to contracts funded by the U.S. government; therefore, management comments are not required.

Management Comments. SIGIR received comments on the draft of this report from the Multi-National Corps-Iraq and the Gulf Region Division of the U.S. Army Corps of Engineers. Multi-National Corps-Iraq advised that it had no issues with the report. The Gulf Region Division indicated that it generally agreed with the facts presented in the report and provided technical comments for clarification. SIGIR reviewed the comments provided by the U.S. Army Corps of Engineers and revised the final report to address them.

Evaluation of Management Comments. SIGIR appreciates the concurrences with regards to the draft report by the Multi-National Corps-Iraq and the U.S. Army Corps of Engineers. No additional comments are required.

Table of Contents

Synopsis	i
Introduction	
Background	1
Objective of the Project Assessment	4
Pre-Site Assessment Background	4
Contract, Costs and Payments	4
Multiple Partners and Funding Sources	6
Current Cost of the BCH Project	8
Project Objective	9
Pre-Construction Description	9
Statement of Work	10
Project Design and Specifications	10
Important Project Significantly Behind Schedule	15
Unrealistic Timeframes	16
Poor Soil Condition at the Project Site	17
Security Issues	17
Site Assessment	18
Project Quality Management	30
Project Sustainability	33
Status of BCH Partners' Efforts	34
GOI Challenges Supporting the BCH Project	38
Stalemate between Project HOPE and MOH	44
Phased Opening of the BCH	45
A Modern Pediatric Hospital	48
Shifting Priorities of the GOI	48
Conclusions	49
Lessons Learned	53
Recommendations	53
Management Comments	53
Evaluation of Management Comments	53
Appendices	
A. Scope and Methodology	54
B. Acronyms	55
C. Contract Breakdown	56
D. MNC-I Comments on the Draft Report	57
E. GRD Comments on the Draft Report	58
F. Report Distribution	61
G. Project Assessment Team Members	63

Introduction

Background

The province of Basrah is known as the “crucible where Muslim civilization took shape,” born amidst the earliest Mesopotamian and “People of The Book” civilizations, is an ancient maritime city built on a network of canals and known as the port where Sinbad the Sailor set sail. It is a major oil-rich city in southeast Iraq bordering the Persian Gulf. Overwhelmingly populated by Muslim Shia, Saddam Hussein brutalized its citizens for over three decades. Broad healthcare system abuse and withholding medical care was one form of Saddam’s punishment for the Shia of Basrah.

Quality of health care in Iraq prior to 2003

Large oil reserves and abundant natural and human resources enabled Iraq to attain the status of a middle income country in the 1970s while enjoying perhaps the best health care system in the Middle East. There was an extensive network of well-equipped and well-staffed health care facilities. The Government of Iraq (GOI) estimated that 97% of urban and 79% of rural populations had access to health care, which included public health programs for malaria and tuberculosis control, and an expanded immunization program.

However, three wars and international economic sanctions have stifled economic growth and development and debilitated basic infrastructure and social services. The combination of wars, sanctions, and neglect has left many Iraqi sectors dysfunctional. Although the needs are dire and extend to cover all sectors, the extremely deteriorated health sector situation, medical facilities status, and capacity, coupled with the ongoing violence, has resulted in bringing the attention of all involved to the urgent needs of the sector.

In a 27 June 2006 report by the Louis Berger Group, Inc. on the Basrah Children’s Hospital, it was reported that Iraq’s population has more than doubled over the last 25 years, with the population in 2003 standing at approximately 27.1 million and is growing at a rate of approximately 3% per year. Since 1990, mortality rates for children and maternal mortality rates are doubling and adult mortality has grown exponentially. For example, in 1997, general malnutrition occurred in approximately 25% of children under the age of 15 in the southern and central governorates of Iraq.

Several studies and reports attributed this situation to many factors, such as lack of tangible sector investments and deficient operations and maintenance (O&M) practices. Specifically:

- Throughout the 1990s, the established infrastructure to distribute medicines progressively deteriorated.
- Problems maintaining essential medical equipment negatively affected health facilities, specifically an acute shortage of anesthetics, surgical equipment, and supplies.
- Laboratory services lacked essential equipment, such as catheters, chemicals and reagents, which limited the ability to perform basic pathological investigations.
- Loss of qualified and experienced health workers, which led to gaps in coverage and quality of health care services.

As a result, by the late 1990s, the number of major surgical interventions had been reduced by 35%, only one-quarter of the medical equipment available in health care

facilities was operational, the level of laboratory services had declined by 40%, and health care professionals who did stay in Iraq had been isolated from up-to-date medical practices for over 25 years. According to the Iraqi Ministry of Health (MOH), inadequate nutrition, low incomes, shortages of drugs and medical equipment, intellectual isolation, and emigration of experienced health care professionals have seriously affected the prognosis of people with chronic illnesses since the 1970s.

The severity of the decline in Iraq's health care sector is emphasized by the contrasting improvement of children's health in many other countries. Its health care, once the envy of the Middle East, now is rated by the World Health Organization (WHO), as a country with high adult and child mortality alongside much poorer countries, such as the Sudan, Yemen, and Djibouti.

Cancer in Iraq

The Iraqi cancer registry was established in 1976. A total of 25,000 malignant cases were registered between 1995-1997, with an annual number of cases between 8,000 and 9,000. This figure increased to 10,888 in 2000 but cancer registration is still incomplete.⁵ In Iraq, childhood cancers are 8-10 times more common than in the Western World with about an 8% incidence rate in Iraq as compared to 0.5-1% in developed countries. The most common childhood cancers are leukemia, followed by lymphomas, brain tumors, and other nervous system tumors.

Since 1993, the cancer registry has reported an increase in the number and proportion of cases of leukemia in the southern governorates. For example, 8.5%, 9.1%, 8.4%, and 9.2% of leukemia cases were concentrated in Basrah in 1993, 1995, 1997, and 1998, respectively, compared to 5.5% in 1989. Children under the age of five account for approximately 56% of the registered cancer cases, which is a disturbing rate in view of the 11-fold increase in cancer cases over the past 15 years.

Out of five common cancers that constitute over 50% of all cancers, a large proportion of cancers are preventable and half are eligible for early diagnosis. If diagnosed in time, four are curable by standard therapies where available. However, due to the lack of adequate health care services, the majority of cancer cases are detected in advanced stages and therefore incurable even if the best therapies are accessible. It is essential to link therapies with early detection initiatives by adopting health education approaches both for the public and for health care professionals.

The report by the Louis Berger Group, Inc. on the Basrah Children's Hospital notes that many surgeons deal with cancer treatment but no full-time surgical oncologists work in Iraq. There are no functioning linear accelerators⁶ in Iraq and radiotherapy facilities, which exist only in two northern Iraqi cities, are outdated and inadequate. There is a pressing need to train full-time oncology specialists, needle cytologists, oncologist nurses, palliative nurses, radiotherapy assistants, radiation physicists, dosimetrists, and engineers for future linear accelerator services. At present, a mere 8% of Iraqi children with leukemia survive compared to 80% in the U.S.

It is estimated that up to 50% of cancer patients could have been cured if diagnosed in the early stages. Late diagnosis and a lack of standard curative therapy stand at the forefront

⁵ Strengthening the cancer registry in the southern governorates is a priority of the MOH.

⁶ A linear accelerator is a device commonly used for external beam radiation treatments for patients with cancer. It delivers a uniform dose of high-energy x-ray to the region of the patient's tumor. These x-rays can destroy the cancer cells while sparing the surrounding normal tissue.

of cases for their death. With the lack of palliative care, most of today's cancer patients die with avoidable pain and suffering.

Status of Iraqi health care system in 2003

According to project file documentation, surveys taken in 2003 of the Iraqi health care system found the following:

- A severe shortage of nurses, particularly female, across the country. National estimates stated there is one nursing staff per physician compared to 3-6 nurses per physician for other countries in the region. According to Iraqi MOH reports, less than one-third of nursing professionals received education past high school.
- Too many, but poorly trained, administrative staff. For example, for the Basrah province, a health administrative staff of 350 was needed; yet there were approximately 1,700 on staff.
- Childhood cancer rates in Iraq are 8-10 times more common than in the developed world. According to the Iraq Cancer Registry, the most common childhood cancer is leukemia, followed by lymphomas and brain and other nervous system tumors. Due to the rise in pediatric leukemia cases particularly in the southern regions, the MOH has specifically identified strengthening the cancer registry in the south as a high priority. The MOH also estimates that "if early and adequate therapy could be offered to the exceptionally large number of children with tumors, up to two-thirds may be cured."
- Radiotherapy facilities are outdated and grossly inadequate. There are no radiotherapy facilities in all of southern Iraq. There are currently no functioning linear accelerators in the entire country.
- A critical need for trained radiotherapy oncologists and related professions. There were 17 radiotherapy oncologists serving in all of Iraq. There were no full-time surgical oncologists nationwide. The Iraqi MOH also cited a need for specialists trained in needle cytology, oncology nursing, palliative care nursing, and radiotherapy assistance as well as radiation physicists and engineers for future linear accelerator services.

Origin of the Basrah Children's Hospital

In 2003, the First Lady of The United States became increasingly concerned over the deteriorating Iraqi health care system, especially for the children suffering from cancer. For children suffering from cancer, the current options for treatment are limited. Patients with the financial means can go to the King Hussein Medical Center in Amman, Jordan; while those families without the necessary financial resources must rely on the limited hospital facilities available within Iraq. The existing hospitals are often overcrowded and outdated. For example, the children's ward for the existing hospital in Basrah was constructed in 1938. While the U.S. government contracted to construct new primary healthcare centers and rehabilitate existing Iraqi hospitals and clinics, this project was envisioned as a signature project to meet more urgent medical needs, specifically the needs of critically ill children. This project eventually became known as the Basrah Children's Hospital (BCH) (also referred to as the "Laura Bush Children's Hospital").

Project HOPE and the decision to locate the hospital in Basrah

According to project file documentation, in July 2003, the Project HOPE (Health Opportunities for People Everywhere)⁷ was asked to make a fact-finding mission to Iraq

⁷ Project HOPE is an international non-profit health, education, and humanitarian assistance organization.

to identify the most appropriate opportunity to donate a children's hospital. Project HOPE's visit to Baghdad and Basrah was conducted in coordination with the then-Acting Iraqi Minister of Health and the Coalition Provisional Authority Senior Health Advisor. While visiting six existing health care facilities, Project HOPE representatives described witnessing "deplorable health care conditions plaguing Iraqi society." Of note was the very high child mortality rate in southern Iraq, where 150 out of 1,000 children were dying before reaching the age of five; most dying before their first birthday. In addition, according to project file documentation, cancer rates are almost five times higher in southern Iraq than the national average.

In an effort to combat the alarming rate of child mortality in southern Iraq, Iraqi MOH and U.S. government representatives agreed the most appropriate site for the hospital was in the Basrah province. The MOH provided a 13-acre parcel of land located in the southern perimeter of Basrah, which the MOH characterized as capable of supporting a three-story hospital building.

Objective of the Project Assessment

The objective of this project assessment was to provide real-time relief and reconstruction project information to interested parties to enable appropriate action, when warranted. Specifically, the Special Inspector General for Iraq Reconstruction (SIGIR) determined whether:

1. Project components were adequately designed prior to construction or installation;
2. Construction or rehabilitation is in compliance with the standards of the design;
3. Adequate quality management programs are being utilized;
4. Sustainability was addressed in the contract or task order for the project; and
5. Project results were or will be consistent with their original objectives.

Pre-Site Assessment Background

Contract, Costs and Payments

The original concept required the U.S. government to fund the construction of the hospital and Project HOPE to provide the medical equipment and training for Iraqi doctors and nurses. In January 2004, Project HOPE signed a Memorandum of Understanding (MOU) with the U.S. Agency for International Development (USAID) on a public-private initiative, under White House sponsorship, to construct the first new hospital in Iraq since 1980, which would serve as a center of excellence in technology, practice, and administration.

In addition to constructing the 94 bed "state of the art" children's hospital, the U.S. government also decided to provide approximately 8,000 pieces of medical equipment, furniture, and computers in support of the BCH project. The contracting strategy consisted of a single construction contract and an equipment integration contract (referred to as "Turn Key" logistics contract). In 2004, the U.S. Congress approved \$50 million in Iraq Relief and Reconstruction Fund (IRRF) funds to construct the hospital, which USAID used to award the original construction contract to Bechtel. Project HOPE donated \$30 million of private funding to procure medical equipment and provide necessary training.

On 5 January 2004, USAID awarded Contract SPU-C-00-04-00001-00, an indefinite delivery/indefinite quantity, cost-plus-fixed-fee contract to Bechtel National, Inc. (Bechtel) in the amount of \$1.8 billion. This indefinite delivery/indefinite quantity contract made Bechtel responsible for the “design, rehabilitation, reconstruction, and construction of infrastructure projects in support of U.S. assistance to Iraq in electric, water and sanitation services, telecommunications, and selected public buildings.” Job Order (JO) Number 04-511 and its two modifications required the design and construction of a pediatric teaching hospital in Basrah focusing on acute care and oncology services for children.

In June 2006, the U.S. government conducted an assessment to determine construction progress and cost to complete. By the time of this assessment, the project had experienced significant cost growth and repeated schedule delays due primarily to poor subcontractor performance and limited oversight by the prime contractor. Consequently, in June 2006, the USAID issued a “stop work” notice to Bechtel on the project JO, and on 27 June 2006, the U.S. Embassy Iraq issued a directive outlining the program transfer of this project from USAID to the U.S. Army Corps of Engineers Gulf Region Division (GRD). SIGIR completed its audit of the BCH in July 2006 detailing these events. At the time of the transfer, the project was approximately 30% complete.

On 30 September 2006, the Joint Contracting Command – Iraq/Afghanistan awarded Contract W91GXZ-06-C-0023, a firm-fixed-price contract in the amount of \$32,300,000, to MID Contracting (MIDCON) (Bechtel’s primary subcontractor for the project). This contract required MIDCON to finish constructing the main hospital building, mechanical and electrical plant buildings, utility trench work, guard houses, site work, and site security. The contract’s period of performance was 660 days, which required the construction to be completed by 21 July 2008. There have been eight subsequent modifications to the contract, which increased the total contract cost to \$37,682,168.60 and extended the construction completion date to 5 February 2009.

In addition, on 14 November 2006, the U.S. government awarded Contract W915WE663154471, a firm-fixed-price contract, in the amount of \$9,607,301.81, to Universal Hospital Services (UHS). UHS was responsible for the medical equipment design coordination, integration (including equipment storage, installation, commissioning and training), quality assurance, and procurement (including freight, insurance, and transportation) for the completion of the BCH project.

In addition to the MIDCON and UHS contracts, there have been at least 22 additional contracts awarded by the U.S. government and United Nations Development Program (UNDP) for supporting work, such as an 11-kilovolt electrical feeder, closed circuit television, and other equipment. In addition, the Government of Iraq (GOI) is responsible for awarding construction contracts for domestic water connection, wastewater treatment plant (WWTP), mobile substation, and overhead electrical lines; as well as awarding service contracts for facility management and biomedical equipment maintenance.

Multiple Partners and Funding Sources

By June 2006, when USAID issued Bechtel the “stop work” order, the \$50 million funding was nearly exhausted with the main hospital portion of the project reported to be approximately 30% complete⁸. Simultaneously, the U.S. government performed a thorough assessment to evaluate project progress and conducted a detailed cost to complete. The assessment concluded that poor contractor performance and inadequate management oversight were key reasons for project cost overruns and for being over 9 months behind schedule. The comprehensive cost to complete analysis determined a total project cost of \$117.4 million, which required an additional \$67.4 million in funding beyond the initial \$50 million.

On 26 July 2006, the Department of State (DoS) and USAID each submitted Congressional Notifications to document the plan to fund the remaining portion of the BCH project. The DoS notification advised Congress of its intent to reallocate \$34.4 million within IRRF; while USAID intended to obligate approximately \$11 million in Fiscal Year 2006 Child Survivor and Health⁹ funds. The two Congressional Notifications combined for a total of \$45.4 million of the \$67.4 million determined necessary to complete the project. DoS also advised Congress that the Government of Spain (GOS) would donate the remaining \$22 million.

In August 2006, GRD discovered there was an “equipment design gap” in the “Turn Key” logistics contract for items such as additional equipment, consumable lists, operations and maintenance, training, and sustainability requirements that were never fully defined and priced. GRD determined this “gap” was approximately \$15 million.

The U.S. government earmarked the \$22 million Government of Spain (GOS) donation for construction, construction contingencies, medical equipment, capacity development, and non-construction contingencies. Specifically, the GOS donation would fund the following:

- MIDCON’s \$5.4 million bid option
- complete the construction of the 38-bed residence facility
- connect the site utilities to the public utility system (water, electric, and sanitary)
- construct the medical logistics warehouses
- landscaping
- install kitchen and laundry equipment
- medical equipment (medical waste autoclave, oxygen generation system, compressors, dental accessories, therapy ultrasound units, and x-ray accessories)
- laboratory and workshop equipment (water purification systems, cryostat microtomes, transport ventilators)
- hospital furniture
- training for hospital administrators, facility engineers, and biomedical engineers

⁸ GRD would later dispute the 30% completion estimate as far too high.

⁹ USAID is committed to improving the health and well-being of children and families, promoting reproductive health, and helping to safeguard the world against infectious diseases. Since 1985, when the U.S. Congress created the Child Survival Initiative, USAID has obligated more than \$5 billion in support of initiatives in child survival, reproductive health, HIV/AIDS, and other infectious diseases.

However, the GOS donation encountered several problems. Instead of providing the donated funds directly to the U.S. government to contract for the above-referenced construction, equipment, and training, the GOS channeled its funds through the United Nations Development Programme (UNDP)¹⁰. The UNDP formed a partnership with the WHO to bring more international political credibility to the BCH project. As fund custodian, UNDP is limited, by strict rules and regulations, in its ability to allocate the funds for BCH construction. Therefore, the UNDP could not “pass through” the funds to the U.S. government; rather the UNDP executed all contracts and control of the GOS donation. While the objective of the UNDP was to ensure coordinated, flexible, and swift donor response for reconstruction activities in Iraq, the UNDP project funding approval process is very complex and time-consuming, requiring extensive coordination between United Nations agencies and Iraqi ministries. In addition, the UNDP overhead fees¹¹ combined with the loss due to converting the donation from Euros to US dollars¹² resulted in less than \$20 million of the original \$22 million donation.

On 26 November 2007, the UNDP signed an MOU with the DoS outlining the roles and responsibilities of each entity. The UNDP agreed to execute 18 individual contracts in support of the BCH project; however, UNDP restrictions have caused the slow execution of the donated funds. By June 2009, the UNDP had awarded all 18 contracts; however, it took UNDP almost 18 months to award three of the contracts. The delays in awarding these three contracts have pushed the completion dates of the UNDP contracts to at least 30 November 2009.

One of the contracts just awarded in June 2009 is the re-awarding of the accommodation building (38-bed residence facility for doctors and nurses). Poor contractor construction performance resulted in the contractor’s termination; while a lack of UNDP oversight allowed this project to flounder indefinitely prior to contractor termination. According to GRS documentation, the UNDP allowed the contractor to progress only 3% over the nine months prior to terminating the contractor. UNDP’s original schedule reflected a completion date of 24 April 2008. In January 2009, GRS representatives stated that the construction of the accommodations building¹³ would be completed by 30 April 2009. However, the contract was awarded on 1 June 2009 with an estimated completion date of 30 November 2009. The MOH’s plan is for the doctors and nurses to live in one of the BCH’s wards until such time as the completion of the accommodation building. This unnecessary delay will force the MOH to relocate its staff into one hospital ward for a significant amount of time. In addition, doctors and nurses living in one hospital ward may delay the installation of medical equipment into that ward and could possibly affect the warranty status of many items within the rooms.

The accommodation building’s current status will be addressed in the Site Assessment section of this report.

¹⁰ The GOS donation was provided to the United Nations International Reconstruction Fund Facility for Iraq, which in turn provided the funds to the UNDP who is responsible for the execution of the project.

¹¹ UNDP overhead fees were approximately \$1.5 million.

¹² The original GOS commitment was 17 million Euros, which at the time was approximately \$22 million US dollars; however, due to currency fluctuations, by the time the GOS donated the funds to the UNDP, the donation was worth approximately \$500,000 less.

¹³ The accommodation building is also referred to as the residence building.

Even with the GOS donation, completing the BCH project required additional funding. The U.S. government used Commander's Emergency Response Program (CERP) funding in the amount of \$0.6 million to contract the external electrical line routing. In addition, the MOH agreed to contribute approximately \$10 million for the following start up costs:

- hospital consumables
- medicines/instruments
- services
- security

In September 2008, the U.S. government funded two additional contracts in further support of the BCH project. The first contract, in the amount of \$1 million, provides specialized oncology training to health practitioners in Iraq in coordination with the MOH; while the second contract, in the amount of \$411,000, supports the hospital integrator for the BCH.

Current Cost of the BCH Project

The original estimated cost and funded amount for the BCH project was \$50 million. Project HOPE then contributed \$30 million in medical equipment and training of Iraqi doctors and nurses. In June 2006, a comprehensive cost to complete analysis raised the total project cost to \$117.4 million. As of May 2009, the total project cost is \$165.7 million, more than three times the original estimated costs as detailed below.

U.S. Government Funds

• IRRF Funded Construction	\$81.3M ¹⁴
• USAID IRRF Transfer	\$3.1M
• USAID Child Survivor and Health (\$11+\$2.4)	\$13.4M
• IRRF Re-obligation	\$3.6M
• CERP Funded Construction	\$0.6M
• Expired IRRF Transfer	<u>\$1.9M</u>

Total U.S. Government Funds ***\$103.9M***

Non U.S. Government Funds:

• UNDP Trust Fund (GOS donation)	\$22.0M
• Iraqi MOH (consumables, service contracts)	\$9.8M
• Project HOPE (training, equipment)	<u>\$30.0M</u>

Total Non-U.S. Government Funds ***\$61.8M***

Total Funding ***\$165.7M***

Since contracts funded by the UNDP and GOI are outside of SIGIR's jurisdiction, this assessment is primarily focused on the \$37,682,168.60 MIDCON contract for the main hospital building. However, since the BCH will not be fully operational until all construction and services contracts are completely finished, medical equipment delivered and installed, and training received, this assessment will also discuss the status of the non-U.S. government funded contracts and their implications on the opening and operation of the hospital.

¹⁴ This amount includes \$46.9 million in USAID completed construction under the original Bechtel contract.

Project Objective

In an effort to combat the alarming rate of child mortality in southern Iraq, the MOH established a priority goal of reducing child mortality by 50% over the next five years. The U.S. government agreed to fund a “state of the art” pediatric specialist hospital in the southern city of Basrah, the first new hospital constructed in Iraq since 1980. Specifically, a 160,000 square foot, 94-bed acute and referral care center with a focus on pediatric oncology. The Basrah Children’s Hospital will utilize modern hospital management and treatment techniques to address the needs of the most seriously ill children in Iraq. Early projections called for annual pediatric admissions of 360 cancer patients, 468 intensive care, 354 neonatal intensive care, and 2,230 acute care patients.

The Iraqi Minister of Health wants the BCH to become a training facility capable of improving and expanding the training of health professionals throughout Iraq to serve as a model for “best practice,” a platform for health sector development, future hospital renovations, and new health facility construction across Iraq. The BCH is intended to serve as a model of excellence for improving pediatric healthcare and treatment for critically ill infants and children in Iraq.

Pre-Construction Description

The MOH provided a 13-acre parcel of land located in the southern perimeter of Basrah, which the MOH characterized as capable of supporting a three-story hospital building. The donated parcel of land is in the southwest of the city near an extension of Baghdad University and an old transmitter compound (Figure 1).

There is a primary road running north to south along the west side of the site, which is a main arterial route into and out of the city, particularly for industrial vehicles coming from Umm Qasr. To the north and east of the project site are routes that allow access into Hayy-Al-Beladiyat and Hayy-Al-Qaad neighborhoods. Directly to the west of the site is an area of particular concern – Al Hyyaniyah and to the south Al Qibla; both densely populated neighborhoods have been characterized by political unrest, poverty, and violence. Immediately south of the site is open waste ground, which is water logged and stretches for over two kilometers.

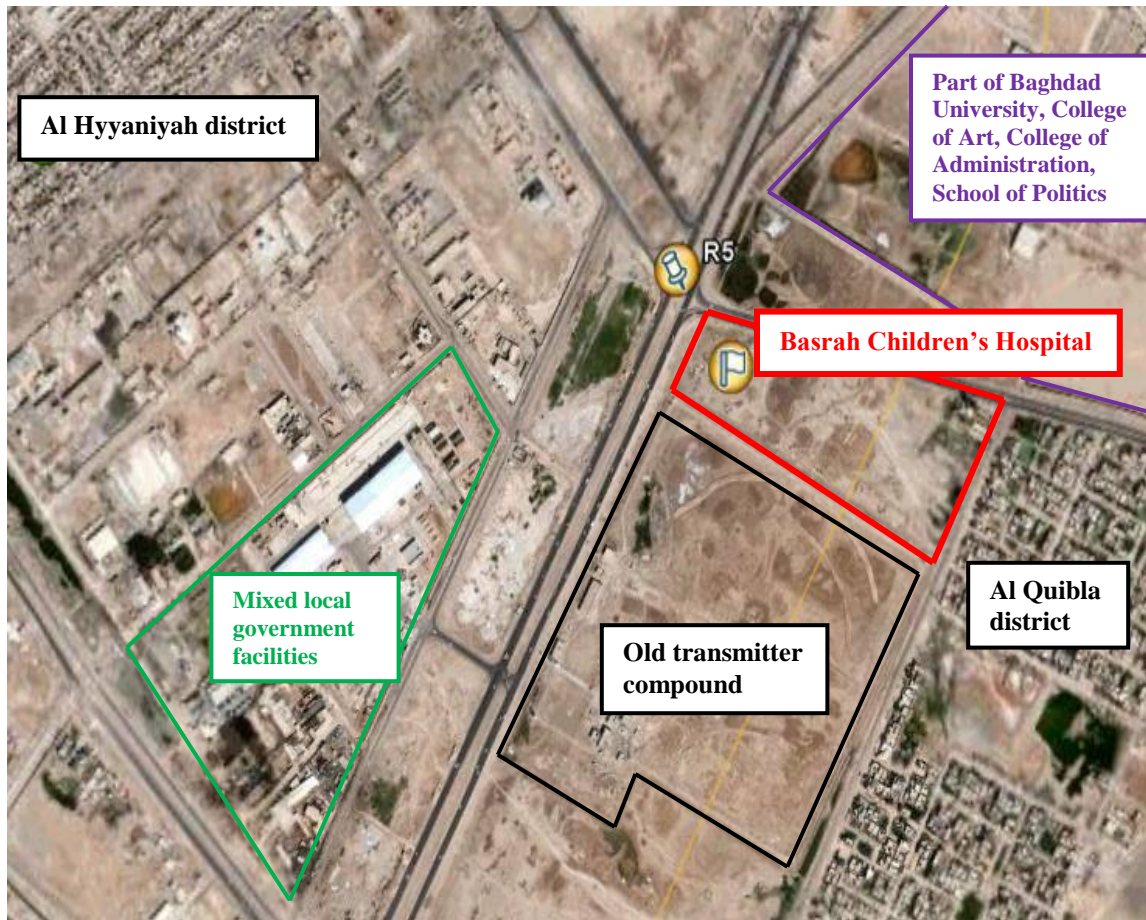

Figure 1. Site of the Basrah Children's Hospital (Courtesy of GRD)

Statement of Work

Bechtel's Statement of Work

The original JO Statement of Work (SOW) required Bechtel to “construct a pediatric teaching hospital in Basrah,” which will be designed to focus on providing health care facilities for inpatient and outpatient specialized pediatric care. In addition, the JO required a conceptual plan for future expansion up to a 200-bed facility.

Project Design and Specifications

The SOW required preliminary planning, design, and construction efforts.

The planning work consisted of the following:

- Documenting project site conditions, including topography, locations and sizing of utilities, width of adjacent streets, location of existing landscape materials, and other obstructions in sufficient detail to ensure the facility site is acceptable and costs are adequate for the requirements.
- Estimate utility capacity and building load. Accumulate data such as maps of existing utility and transportation systems with capacities indicated; prepare an estimate of the anticipated utility and transportation loading which the new

facility will place on the existing systems. Install utility runs (i.e. water, sewer, electrical) and connect to off-site city utility services.

- Prepare the site; including clearing the site and placing and compacting fill material to an appropriate depth as determined by the results of the geotechnical investigation.

The design work required Bechtel to prepare and submit the following:

- site development plan
- schematic floor plans
- furniture and equipment layout
- building area tabulations
- exterior elevations
- building sections
- outline methods and concerns regarding any operating and maintenance issues
- disability access to all public areas, services, and emergency egresses

The SOW required Bechtel to “construct hospital and support structures” to include the following:

- outpatient area for primary, specialty, and emergency treatment
- operating rooms and supporting facilities
- 94-bed inpatient area for providing medical, surgical, and critical treatment
- training facilities for doctors and nurses and other care providers

In addition, the SOW required the construction of supporting facilities to include the following:

- cafeteria and associated facilities (i.e. kitchen, refrigeration)
- laboratory facilities
- housing for nurses, doctors, and other personnel who are students in the teaching program
- conference rooms, classrooms, workspace and offices to support training
- power plant and uninterrupted power supply
- on-site supply water treatment plant
- laundry facilities
- high temperature medical waste incinerator
- water storage tank sized to supply hospital fire suppression system
- all fixed communication connections including telephone, intercom, and computer network wiring

GRS provided SIGIR with the project designs for the BCH facility, including site utilities. The general site design indicated the general layout of the site, including the location of the buildings and parking areas, security fence, site utilities, site lighting, and landscaping. The architectural plans identified the location, dimensions, and proposed uses of various spaces within the facility. The architectural plans appeared complete with detailed information for the rooms and corridors. In addition, the architectural plans included information on various building systems, including electricity, plumbing, and mechanical. The plans appeared to contain adequate detail to construct the various systems in the facility.

The foundation drawings called for the facility to be constructed on a “pile and grade beams” foundation system. This type of foundation system is usually specified where subsurface investigation detects soils with low allowable bearing pressures.

The foundation system is designed to use pile caps and grade beams to transmit loads from the structure to the piles (Figure 2). Groups of piles are connected together with a pile cap for a load bearing column to sit on. In areas where the walls are intended to carry lateral load (sheer walls) or to support structural members, the walls are supported directly on an elongated pile group and cap. Grade beams are shown between the pile caps to support the exterior walls. These beams are constructed below grade and support the weight of the building elements and transfer this load to the pile groups.

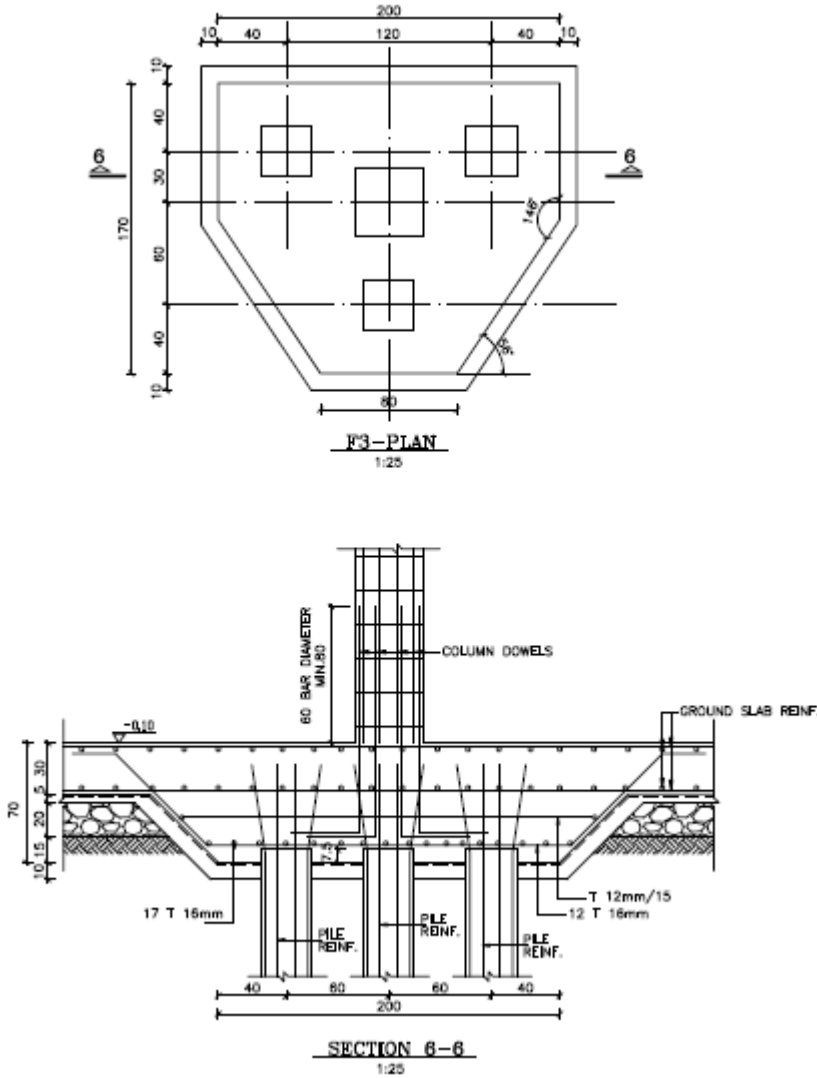

Figure 2. Pile cap plan and section

The structural drawings included information regarding the size, location, and configuration of the primary structural system and secondary components and cladding (the bonding together of dissimilar metals). The design drawings indicate the proposed facility is to be constructed of cast-in-place reinforced concrete. The framing method for the facility is reinforced concrete beams, columns, and floor slabs with concrete masonry unit infill and reinforced concrete shear walls.

Seismic Design

The contract for the construction of the BCH facility required the design to meet the 2003 International Building Code (IBC). The contractor's seismic design for the mechanical hangers and block walls did not meet the 2003 IBC standards for seismic design parameters. Specifically, the contractor installed all hanging equipment with vertical supports, but no diagonal braces, which transfer lateral load experienced from an earthquake into the slab above. GRS determined that the 2003 IBC required diagonal bracings. In addition, GRS also determined that the interior masonry block walls cannot withstand the design earthquake force. Even though the block walls are non-load bearing, the 2003 IBC required that they be able to maintain their structural integrity during an earthquake. GRS determined that under the design earthquake lateral loading, the walls would collapse.

In February 2009, the contractor submitted design drawings to rectify Bechtel's previously deficient seismic design for the mechanical hangers and interior block walls. GRS approved the contractor's design.

Water Supply

According to project file documentation, the BCH will require 40 cubic meters (10,570 gallons) per day of potable water to operate at full capacity. Bechtel previously hydrostatically tested the existing Basrah municipal water line to determine the amount of water it could provide. Bechtel's testing found that the Basrah municipal line had only 1 bar of pressure, which is not sufficient to supply the quantity of water needed by the BCH. (One bar of pressure is 14.5 pounds per square inch. Typical pressure for commercial buildings is 80 to 100 pounds per square inch.) Bechtel designed the water system to treat the municipal water as non-potable and featured a full reverse osmosis and filtration system. However, for design purposes, Bechtel assumed that an adequate amount of water would be available from the Basrah municipal system.

In the event the municipal system could not support the demand of the hospital, Bechtel provided an inlet to the domestic water supply tank to allow potable or non-potable water to be delivered to the site by tanker truck. There is not enough static pressure to bring the municipal water in the quantity needed to meet daily demand to the elevation of the holding tank's inlet; consequently, a booster pump would be required. The connection of the inlet to the municipal system and the booster pump were not included in the MIDCON contract; therefore, it falls to the MOH to contract for the booster pump. SIGIR is concerned that a simple booster pump attached to the municipal system may not provide sufficient water to operate the facility at full capacity.

Sewer System

According to the design plans, the sewer system consists of a gravity conveyance system with multiple lift stations discharging at a single point to the municipal sewer system. The project incorporates eight duplex lift stations that utilize 16 electric pumps. According to GRS representatives, the water table in the area is very high, which limits the length of run of gravity flow pipe. Consequently, the sewer system had to be designed with a large number of lift stations.

SIGIR is concerned about the significant amount of O&M costs associated with the operation of eight duplex lift stations. The facilities engineer will be responsible for maintaining the 16 pumps, which are spread out over the 85,000 square meter (m²)

medical campus. The failure of a single lift station will shut down the entire sewer system until it is repaired or replaced.

Termite Treatment

Project file documentation indicated that southern Iraq is widely acknowledged as being prone to termite infestation. After extensive consultation with engineers and construction professionals from the region, it was concluded that subterranean termite infestation is chronic regardless of building type; damage to concrete buildings had even been reported. Termites can pass easily through small cracks, as small as 1/32 inch, which may occur in slab foundations (Photo 1).



Photo 1. Termite tubes in a concrete structure in Basrah, Iraq (Courtesy of GRS)

Bechtel's drawings and specifications for the BCH facility called for the application of termiticide to all soils below the slabs, pile caps, and footings. The project specifications for termite control called for the following:

- termiticide applicators conform to the U.S. Environmental Protection Agency pesticide applicator category, which includes structural pest control
- termiticide will not be allowed to enter water system, aquifers, or endanger humans or animals

Bechtel regarded the use of Chlorofet 48% TC¹⁵ as prudent and appropriate. The use of sub-soil termite control for hospitals and other institutional or public buildings is standard design practice.

¹⁵ Chlorofet 48% TC, manufactured by Vapco, is a Chlorpyrifos based termiticide. First introduced in the mid-1960s, Chlorpyrifos is widely used as an insecticide in agricultural and non-agricultural settings. It is used in many different indoor areas such as homes, offices, schools, hotels, hospitals, and restaurants. This specific product, Vapco Chlorofet 48% TC, is a special formulation to control all species of subterranean termites.

In addition to the requirement for contractor-provided technical specifications, the follow-on contract references several international codes and standards to govern the design and construction, such as the following:

- 2003 IBC
- 2002 National Fire Protection Association 99 Healthcare Facilities
- 2003 National Fire Protection Association 101 Life Safety Code
- 2001 Guidelines for Design and Construction of Hospital and Healthcare Facilities
- 2002 Recommended Standards for Newborn Intensive Care Unit (ICU) Design (Consensus Committee to Establish Recommended Standards for Newborn ICU Design. 5th Conference)
- 2005 National Fire Protection Association 70 National Electric Code

If during construction, situations arise that are not adequately covered under the above codes, the contract provides that, “All works are to be carried out to British/American Standards where/as applicable.”

Important Project Significantly Behind Schedule

Costing more than \$100 million in U.S. funding alone, the BCH project, including the main hospital building and associated supporting facilities, is one of the largest projects undertaken by the U.S. government in Iraq. It has been identified as a priority project for the U.S. government and GOI since its intention is to reduce the staggering child mortality rate in Iraq (specifically in the southern area); while also serving as a educational facility for improving and expanding the training of health professionals throughout Iraq.

This project was originally projected to be completed by December 2005 with construction costs amounting to \$50 million. The SIGIR audit in July of 2006 forecast that increased construction as well as medical equipment, training, and consumables would result in estimated costs of \$149.5 million to 169.5 million (including non-U.S. government funding). At the time of the SIGIR site visit in January 2009, construction of the facility was still ongoing, and the total cost of the project had reached \$165.7 million (including construction, medical equipment, training, and consumables).

However, this project has already entered its fifth year of construction and the date of full operation of the facility is still unknown. This assessment will identify the significant factors contributing to the project’s drastic slip behind schedule and escalating costs; while also determining the quality of the contractor’s construction of the BCH, and also comment on the status of the remaining items necessary to open, operate, and sustain the facility.

In a July 2006 SIGIR Audit report¹⁶, SIGIR identified a lack of effective program management and oversight by USAID which hampered this project from the beginning. In addition, cost escalations caused by spiraling labor/local material costs, increased site/personal security, truck escorts, and backup power costs.

During this inspection, SIGIR determined that several other factors further contributed to the project’s drastic slip behind schedule and cost escalation:

¹⁶ SIGIR Audit report 06-026, “Review of the U.S. Agency for International Development’s Management of the Basrah Children’s Hospital Project,” 31 July 2006.

- unrealistic timeframes for designing and constructing a new hospital, including determining the scope/size of the facility, while integrating over 8,000 pieces of equipment, furniture, and computers
- poor soil conditions of the project site
- a drastically changing security situation in and around the project site, including the murder of 24 workers in the course of construction so far.

The quality of construction for the main hospital building will be discussed in the Site Assessment section of this report.

Unrealistic Timeframes

According to project file documentation, in February 2004, USAID requested a “fast cost estimate” for a new 200-bed pediatric hospital. Planning and designing a hospital can take years as the needs and suggestions of many interested groups are addressed. In the case of the BCH, there were three primary parties/stakeholders involved with the project — USAID, the Senior Health Advisor of the Coalition Provisional Authority, and the Iraqi MOH. In many cases, the entities had a different vision for the BCH. For example, originally USAID and Coalition Provisional Authority wanted to use the available funding to rehabilitate an existing Iraqi hospital; however, the Minister of Health stated that given the poor state of infrastructure throughout the country, rehabilitation of an existing structure would only present the MOH with additional problems in the future. According to the Minister, the infrastructure in Iraq had been run down for decades and even the top Iraqi hospitals have problems with infrastructure. Consequently, the idea of rehabilitating an existing structure that would not last more than a few years was not favored by the MOH. The Health Minister declared he would reject U.S. government offers to rehabilitate an existing facility. Instead, the Minister expressed his preference for a new, 30-50-bed pediatric specialty facility stating that a new, smaller facility would be easier for the MOH to manage over time.

Over the course of more than a year of negotiations from February 2004 to July 2005, the project repeatedly underwent fundamental changes based on discussions between USAID and the MOH. Among the changes:

- an original estimate of \$250 million to support a 200-bed pediatric hospital¹⁷
- reduced to a \$50 million, 35-50-bed pediatric and teaching hospital
- enlarged to a 100+ bed facility focusing on oncology
- reduced to a 94-bed facility supporting oncology and pediatrics

On 7 June 2004, the U.S. government issued Bechtel the JO to design and construct the BCH with a completion date of 31 December 2005. However, USAID and MOH did not settle on the 94-bed design of the facility until after Bechtel presented an in-depth cost analysis in February 2005. And, the design of the facility required a hospital that could be expanded to the original vision of 200 beds. Bechtel requested a JO Amendment to incorporate the changes in scope, cost, and schedule. USAID approved the request on 7 July 2005, which marked the official scope definition of the project. At the time USAID approved the JO Amendment, the original JO was 13 months old and had less than six months to complete the facility within the original timeframe. The battle over project scope pushed the contract completion date back from December 2005 to well into 2006.

¹⁷ The \$250 million included medical equipment, certification, and other costs. Estimate for the design and construction of the facility was \$93.8 million.

Poor Soil Condition at the Project Site

The MOH provided a 13-acre parcel of land in southern Basrah as the site for the future hospital, which the MOH characterized as capable of supporting a three-story hospital building without the need for a pile-supported foundation. As this property was prone to flooding during the rainy season, significant excavation, backfill, grade elevation, and compaction were required to properly prepare the site. In addition, bore samples raised questions about the load-bearing capacity of the site. An independent Saudi Arabian laboratory confirmed that the soil would not support the weight of the BCH building. In order to compensate for this, Bechtel decided to use as many as 1300 piles for the foundation, which added approximately 90 days to the schedule and \$2.5 million to the cost.



Site Photo 1. Site provided by the GoI for the Basrah Children's Hospital (Courtesy of USACE).

Security Issues

When the project was originally conceived, Basrah was one of the most peaceful areas in Iraq. However, as the BCH project began, the security situation drastically changed throughout Iraq, especially in and around the project site. Kidnappings and beheadings of Iraqis and foreign expatriates became frequent occurrences. Highly sophisticated roadside bombs appeared throughout the area, including all routes approaching the BCH. In addition, criminal gangs became bolder. Crime surged and a wave of smuggling by organized criminal networks began to impact the local economy. A subcontractor stated that in order to get to the project site, a person must be connected with one of the groups or militia controlled gangs.

The human cost of the Basrah Children's Hospital

By August 2005, the already tenuous security situation in and around the BCH project site had completely unraveled, leaving the subcontractor's on-site workers vulnerable to extortion, intimidation, and execution. 24 on-site workers for the BCH project were murdered including:

- the site security manager
- 12 employees of the subcontractor's mechanical-electrical-plumbing sub tier contractor
- 11 employees of the subcontractor's concrete supplier

In addition, the senior Bechtel Iraqi engineer resigned due to the kidnapping of his daughter. Numerous threats and intimidation led to the resignation of other workers, including the site manager.

Aside from the tragic loss of life, the murders had a direct impact upon the overall project's schedule, triggering a chilling effect upon the remaining subcontractor personnel and causing many to boycott the project site due to the lack of security.

Site Assessment

On 6 January 2009, SIGIR performed an on-site assessment of the BCH project. During the site visit, USACE GRS Basrah Area Office (BAO) representatives accompanied SIGIR. Due to security concerns, the total time available on site was approximately 60 minutes. Consequently, SIGIR performed an expedited assessment of the areas available; therefore a complete review of all work completed was not possible.

The time limitations on site allowed SIGIR to only inspect the following areas of the BCH project:

- parking and sidewalk area (grading only)
- main hospital building interior rooms
- accommodation building
- mechanical plant
- electrical plant
- perimeter security wall

The remaining areas of the project, such as the autoclave, fire tanks, warehouse, irrigation tanks, and water and wastewater facilities could not be inspected; therefore, some requirements of the project could not be verified.

Access to the Facility

The BCH is a 13-acre complex, which includes numerous accessory buildings that surround and support the main two-story hospital building. The complex is an irregular shaped piece of property that is enclosed by a 1,100-meter (m) security wall. The main hospital entrance is provided for the general public and a separate entrance for emergency use and staff is located a sufficient distance away to allow emergency vehicles to enter quickly and avoid potential traffic backups at the main entrance (Figure 3). An entrance for service vehicles is provided off a side street, which will lessen the amount of vehicle traffic entering via the main hospital and emergency entrances.

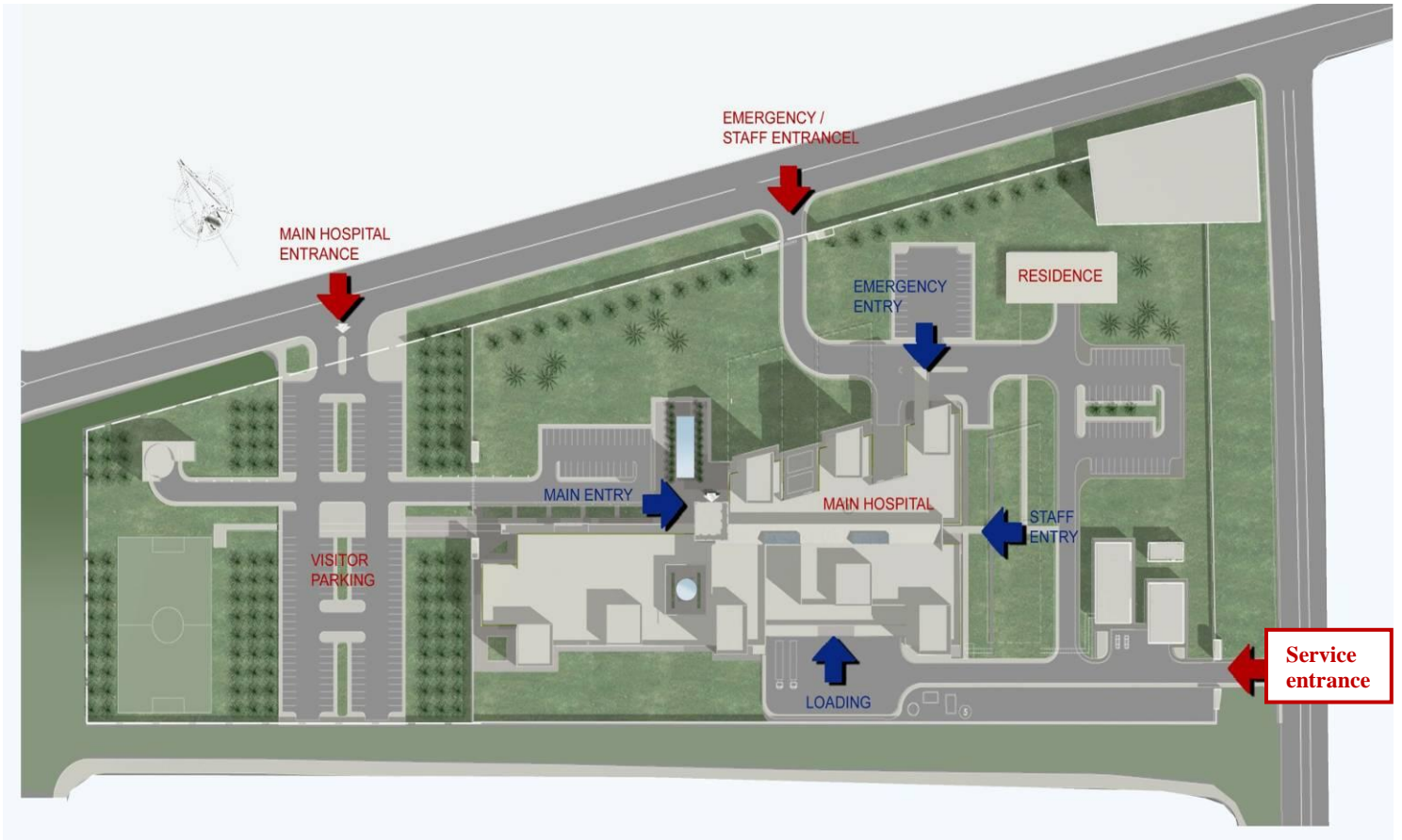

Figure 3. Layout of the BCH (Courtesy of GRD)

Parking and Sidewalk Area (Grading Only)

The 13-acre parcel of land provided by the MOH was prone to flooding during the rainy season and required 103,000 cubic meters of structural fill to raise the site. SIGIR observed the fill material in the staff parking lot and determined that the compaction and fill materials appeared appropriate.

At the time of SIGIR’s site visit, only minimal grading had been performed for the asphalt parking lots and concrete sidewalks. SIGIR observed curbstones at the site, which appeared to be ready for installation along the perimeter of the parking areas (Site Photo 2). Excavation for the curbstones was also in progress at the time of the site visit.

Due to time limitations, SIGIR did not inspect the drainage structures.



Site Photo 2. Curb stones and grading for the staff parking lot

Main Hospital Building

The main hospital building is a two-story reinforced concrete structure with masonry block walls. As mentioned in the Project Design section of this report, due to poor soil conditions, the design called for constructing pile caps to support the building columns. The contractor used 1,300 piles, 24m long, to support the 241 building columns.

The exterior and interior in-fill includes 26,000m² of masonry block walls. The typical interior wall is covered with a slurry (a thick suspension of liquids in a solid) coat of mortar and then plastered before final painting. At the time of SIGIR’s site visit, the exterior walls were beginning to receive an outer layer of white colored stone cladding (Site Photo 3). The stone was being affixed to the block wall by wire mesh, hangers, and mortar (Site Photo 4).



Site Photo 3. Masonry block wall & concrete column--typical construction



Site Photo 4. Exterior stone cladding installation

The BCH was designed to be a two-story, 94-bed, clinical and training pediatric oncology facility. The architectural floor plans divided the ground floor of the facility into the following areas (Figure 4):

- administration and admitting
- physical/respiratory therapy
- kitchen and dining
- laundry
- minor emergency
- imaging
- pharmacy
- laboratory
- morgue
- education and conference
- oncology (radio therapy, chemotherapy, and endoscopy)
- outpatient clinics (primary care clinics and specialty clinics)

Due to time constraints, SIGIR could not verify the construction of all the rooms within the hospital. However, GRS representatives provided SIGIR a tour of several rooms in each of the different areas of the hospital as a representative sample in order to gauge the current status of construction.

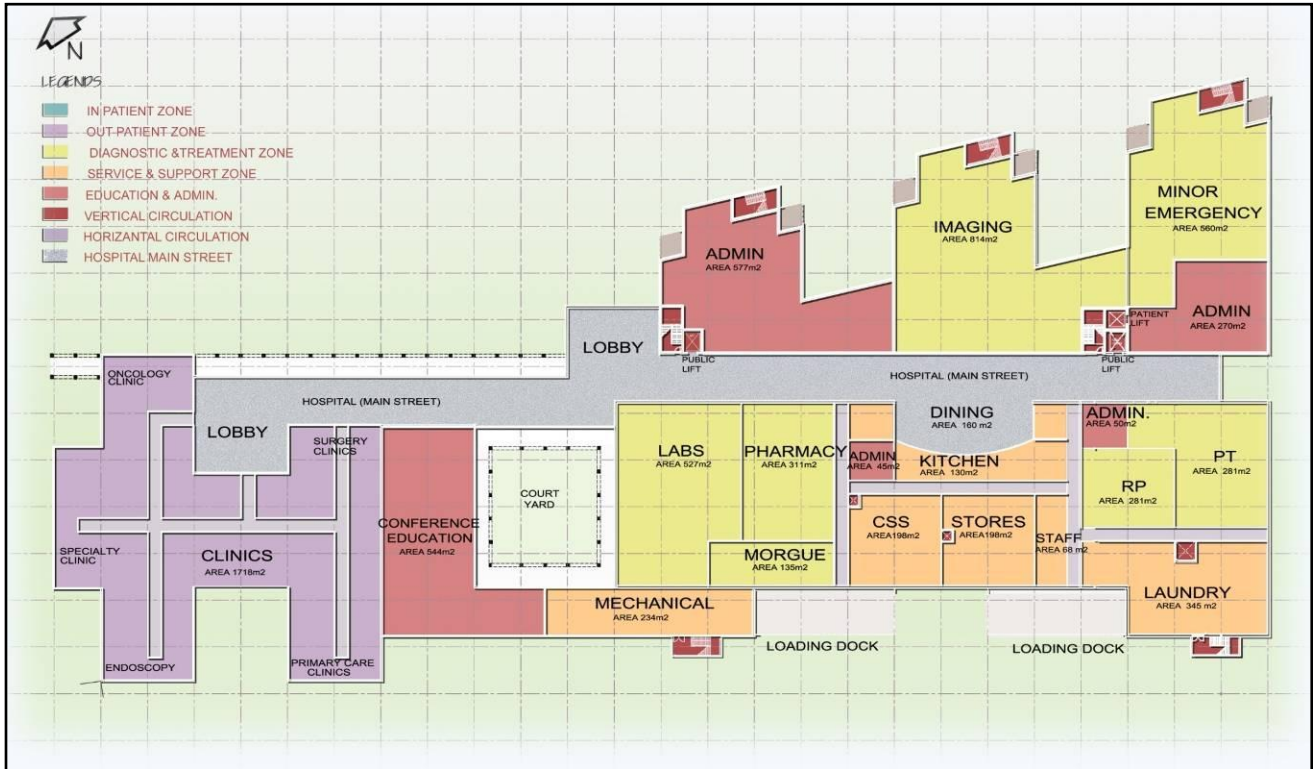

Figure 4. Architectural floor plan for the ground floor (Courtesy of GRD)

The ground floor consisted of a total area of 10,250m². A main corridor connected the different departments to the main lobby. The corridor was sufficiently large and provided an open-air feeling. Each of the four wards had its own exit for emergency purposes. Two public elevator/lifts to the first floor were centrally located by the administration and laboratory departments and kitchen and imaging departments. One patient elevator/lift was located near the minor emergency and administration departments. Two sets of staircases to provide access from the main lobby to the first floor were located next to the public elevators/lifts.

SIGIR observed signage present throughout the corridor areas of the building and found the corridors, in general, to be aesthetically pleasing (Site Photos 5-7).



Site Photos 5 and 6. Hospital signage for the ground (Level 1) and first (Level 2) floors



Site Photo 7. Hospital corridor

SIGIR inspected randomly selected rooms throughout the ground floor and found them either nearing completion or completed. No furnishings were present and the medical equipment was not installed. Preparations and hook-ups for the future medical equipment and furnishings were present throughout (Site Photos 8 and 9). Due to time limitations and ongoing construction, SIGIR could not test the adequacy of the electrical, water, sewer, internet, gas, phones, and closed circuit TV connections.

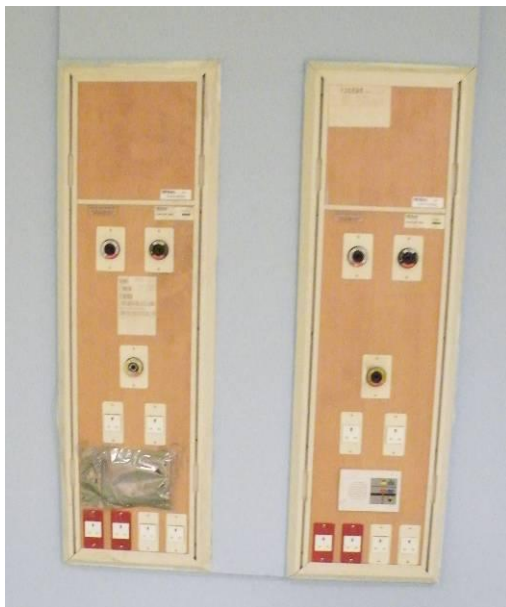

Site Photos 8 and 9. Hook-ups for medical equipment

SIGIR tested the individual room and public restrooms fixtures by turning the faucets on and off (Site Photos 10 and 11). SIGIR determined that the contractor installed quality fixtures in all bathrooms. The fixtures were sturdy and did not rotate or disengage from the sink when turned on and off; a common problem SIGIR has identified at many other construction sites.



Site Photos 10 and 11. Examples of quality bathroom fixtures

The kitchen and laundry facilities included good, durable, industrial quality equipment, which, if properly operated and maintained, should have long life spans (Site Photos 12 and 13).



Site Photos 12 and 13. Good quality kitchen and laundry equipment

The hospital's first floor (Figure 5) was divided into the following areas:

- patient wards A,B,C, and D
- ICU ward
- surgery ward

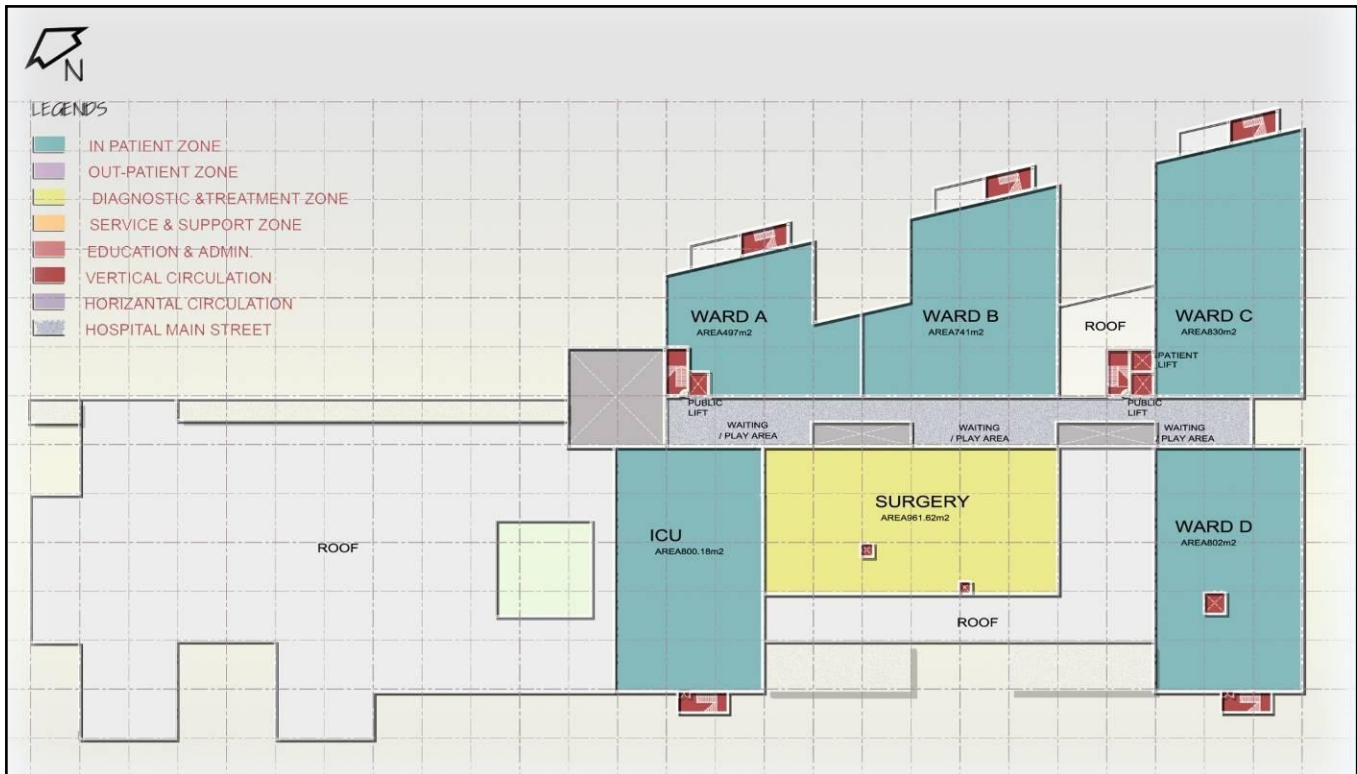

Figure 5. Layout of first floor of BCH (Courtesy of GRD)

The first floor consisted of a total area of 6,100m². The first floor design had similarities and differences from the ground floor. As with the ground floor, the first floor had a large main corridor, which provided an open air feeling, connecting the six different wards. Each of the six wards had its own stairwell for emergency exit purposes. Separate elevators/lifts were located by wards A and C, respectively. The west end of the corridor is open to the main lobby below, with stairs providing access from the lobby to the first floor corridor.

SIGIR observed signage present throughout the corridor areas of the building and found the corridors, in general, to be aesthetically pleasing (Site Photos 14 and 15).



Site Photos 14 and 15. Hospital signage and view to main lobby below.

Although many of the rooms were nearing completion, SIGIR staff noticed several items that had already been identified on the QA/QC ongoing punch list. The punch list items included poor vinyl flooring construction, touch-up painting, still-required caulking, and poorly constructed control joints (Site Photos 16-18). None of the deficiencies identified were of a serious nature and are typical items that contractors normally repair near the end of a construction project.

At the time of the site visit, no furniture or equipment had been installed in the rooms; therefore, SIGIR could not test the wiring, bed-heads, and medical equipment.



Site Photos 16 and 17. Poor installation of vinyl flooring as noted on punch list



Site Photo 18. Poorly constructed control joints

Mechanical Plant

Due to time limitations, SIGIR only briefly toured a portion of the mechanical plant. Specifically, SIGIR inspected the water storage tanks and water pumps, but not the offices and workshops. The water pumps appeared to be a package unit of three pressure booster pumps, which are widely used throughout the world and should provide the BCH with good performance (Site Photo 19). The storage tanks were simple steel rectangular tanks (Site Photo 20) and the water system appeared to be adequately constructed.



Site Photos 19 and 20. Water booster pumps and storage tanks

Electrical Plant

Due to time limitations, SIGIR only briefly toured a portion of the electrical plant. SIGIR viewed the generators and fuel storage tanks; however, time did not permit a full

inspection. Four new electrical generators (Site Photo 21) and a concrete pad for a fifth generator were in place and two large diesel fuel storage tanks (Site Photo 22) were installed, including a concrete spill containment structure. The electrical plant construction appeared to be adequate.



Site Photos 21 and 22. Electrical generators and diesel fuel storage tanks

Perimeter Security Wall

Time limitations and security concerns restricted SIGIR's ability to inspect the entire perimeter security wall. Consequently, SIGIR briefly viewed one small section of the perimeter security wall, which was still under construction at the time of the site visit (Site Photo 23). The contractor constructed the wall with a concrete foundation, concrete block, and formed and poured concrete columns, and then a slurry coat of mortar applied. The quality of the perimeter security wall appeared adequate.



Site Photo 23. Perimeter security wall construction

Termite Treatment

As mentioned in the Project Design and Specifications section, the chronic subterranean termite infestation is widely acknowledged in southern Iraq. Bechtel planned to use the

application of Chlorofet 48% TC on all soils below the slabs, pile caps, and footings. However, in September 2005, USAID instructed Bechtel to immediately stop using the termite treatment on the hospital site. According to project file documentation, USAID does not allow the use of any pesticides on any of its projects.

By the time of USAID's instruction to stop using the termite treatment, Bechtel had already applied Chlorofet 48% TC to approximately 2,000m² of the site (out of a total building footprint of approximately 15,000m²). Bechtel provided an extensive justification for the use of termiticide and USAID eventually approved its application. However, by the time USAID approved the application of termiticide, the building slabs and foundations had been poured. Bechtel concluded that the BCH facility is not adequately protected against termite infestation.

UNDP Funded Project - Accommodation Building

While the accommodation building is a UNDP funded project and outside of SIGIR's jurisdiction, SIGIR inspected this partially constructed building to determine its current status, because until this building is completed, the doctors and nurses will instead have to live in one of the BCH's wards. As mentioned earlier in this report, doctors and nurses living in the BCH ward potentially affects the installation of medical equipment and the warranty status of many items delivered. In addition, this will also limit the number of rooms available for patients.

The accommodation building's purpose is to provide BCH doctors and nurses comfortable living quarters within the complex. This building will eliminate the potential problem of getting doctors and nurses into/out of the BCH complex if the security situation warrants. In addition, this building will house doctors and nurses visiting from other parts of the country.

The design called for a two-story building consisting of 18 double occupancy bedrooms, a separate bathroom with eastern and western toilets and showers, a kitchen, a dining room, a lounge, a library, and a computer room.

At the time of the site visit, SIGIR determined that the partially constructed building was approximately 30% complete. Structural concrete columns and beams had been formed and poured. When UNDP terminated the previous contractor, the concrete block in-fill was nearing completion and the plumbing was being installed (Site Photo 24).



Site Photo 24. Poor structural concrete work

The block in-fill had areas that had not been mortared, which allowed gaps between the columns and blocks (Site Photo 25). Although SIGIR does not consider any of the deficiencies severe, they will reduce the building's ability to withstand seismic loading. Also, they highlight the previous contractor's poor workmanship.



Site Photo 25. Poor block in-fill work

Project Quality Management

Contractor's Quality Control Program

Department of the Army Engineering Regulation (ER) 1180-1-6, dated 30 September 1995, provides general policy and guidance for establishing quality management procedures in the execution of construction contracts. According to ER 1180-1-6, "...obtaining quality construction is a combined responsibility of the construction contractor and the government."

The SOW required the contractor to submit an overall quality control (QC) plan, to include implementing a three-phase QC control system (preparatory, initial, and follow-up phases) necessary to ensure the construction complies with the requirements of the contract. The QC representatives are responsible for preparing daily reports, identifying and tracking deficiencies, documenting progress of work, and supporting other contractor QC requirements. In addition, the SOW required the contractor to develop and maintain a complete list of QC testing and transferred and installed property.

The contractor submitted a QC plan on 28 December 2006, which the GRS BAO accepted as meeting the standards addressed in ER 1180-1-6.

The QC representatives monitored field activities and completed daily QC reports, which presented a brief background on the number of workers on site, the work activities and testing performed, documented deficiencies identified, and were signed off by the QA representative. In addition, the QC representatives supplemented the daily QC reports with photographs reinforcing the information provided in the daily reports. Further, the QC representatives were also present for all significant pours and testing and follow-up on the test results. The QC representatives kept a comprehensive deficiency log of identified deficiencies either by type (i.e. electrical, mechanical, and civil) or by location (i.e. zones 1-5).

Government Quality Assurance

The USACE ER 1110-1-12 and GRD policy “Quality Assurance through Visits at Construction Worksites” specify requirements for a government quality assurance (QA) program. Similar to the QC program, a crucial oversight technique is presence at the construction site.

GRS BAO, which is responsible for the construction of the BCH project, employs local-national Iraqi engineers to serve as QA representatives responsible for visiting the project site daily and writing daily QA reports. In addition, GRS BAO representatives visited project sites weekly to verify the contractor’s work and perform mentoring activities for the local-national QA representatives. However, the length of the site visits was often shortened due to the volatile security situation around the project site.

Local-national QA representatives monitored field activities and completed daily QA reports, which were reviewed by the GRS BAO project engineer. The reports document the number of workers on site and the work performed for the day. Also, the QA representatives supplement the daily QA reports with detailed photographs that reinforced the information provided in the reports.

SIGIR reviewed the daily QA reports and found that the QA representatives did an effective job in identifying and correcting construction deficiencies at the project site. Further, the QA representatives utilized a deficiency spreadsheet to document each identified construction deficiency, the date it was identified, the corrective action taken, the date the corrective action was taken, and the current status.

Quality Assurance for Multiple Contracts

The UNDP and DoS signed a MOU in November 2007 identifying the roles and responsibilities of each entity with regards to the completion of the BCH project. From the beginning, UNDP wanted to manage its projects remotely from Jordan;

however, construction projects need on-site visibility to ensure quality and progress. Therefore, the UNDP and DoS established a partnership whereby the UNDP was responsible for the procurement of construction and equipment; while DoS assumed the role and responsibilities of UNDP's "Owner's Engineer" with respect to all jobsite activities related to UNDP's contribution to the BCH construction and equipping project. Since GRS acted as the DoS's construction agent for the BCH, GRS assumed all jobsite activities for the UNDP contracts, which included design review and construction monitoring. Therefore, in addition to providing construction management, technical support, and QA reporting for the four U.S. government-funded contracts (including the key contract to complete the main hospital building), the GRS BAO also provides QA reporting on all UNDP awarded contracts.

The added responsibility of providing construction oversight and QA for 15 UNDP contracts, in addition to overseeing the four U.S. government funded projects, stretched the GRS BAO staff. GRS BAO QA representatives became responsible for overseeing multiple projects being done simultaneously throughout the entire complex. Figure 6 identifies the name and location of UNDP's construction contracts, for which GRS BAO representatives had oversight responsibility. In addition, GRS BAO staff became responsible for overseeing the activities of approximately 1,000 on-site contractor personnel daily. Currently, GRS employs seven local-national QA representatives working full time on site. GRS personnel generally visit the site weekly to determine contractor progress and monitor construction quality.

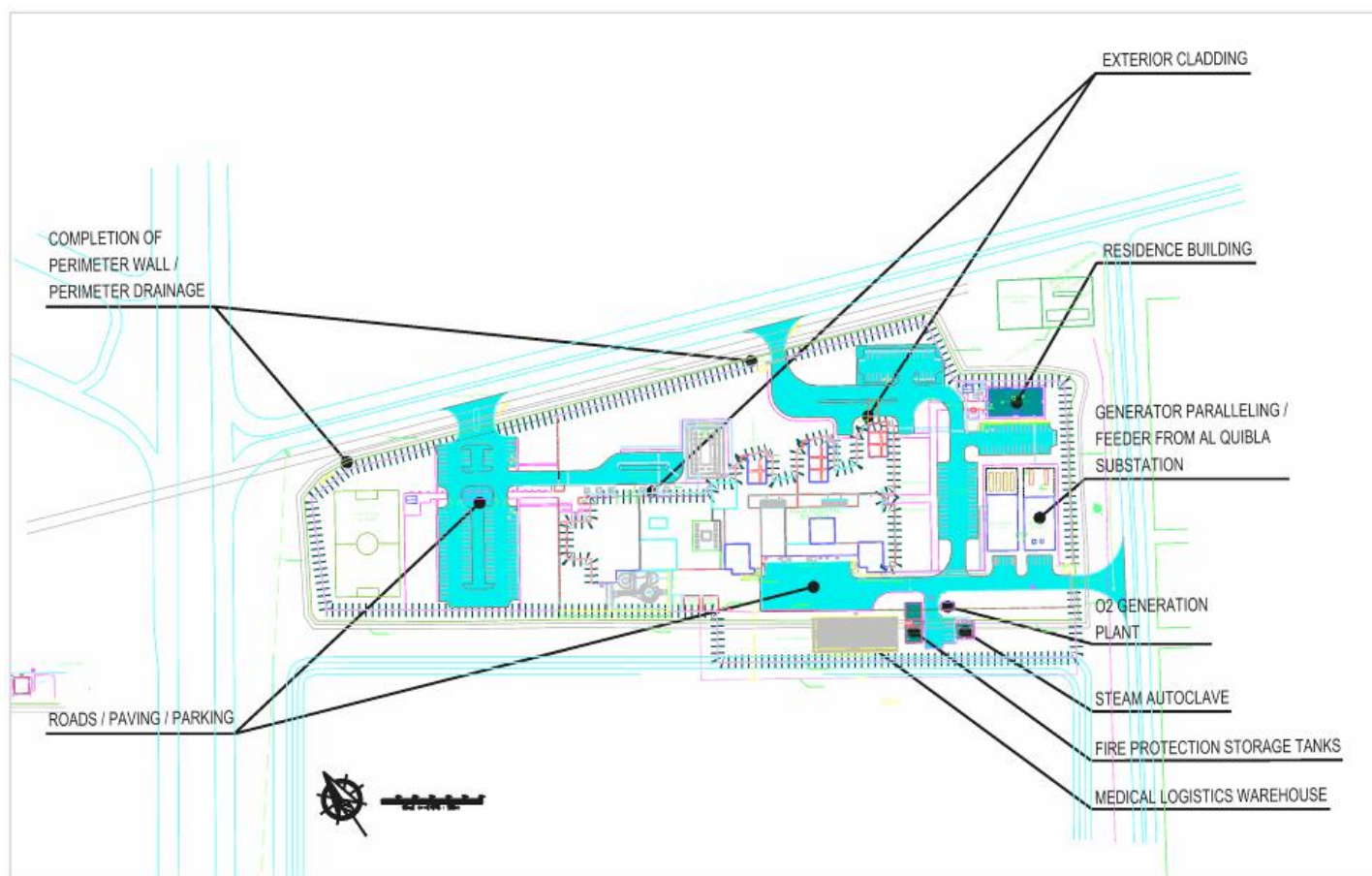

Figure 6. Identification of the name and location of UNDP's construction contracts (Courtesy of GRD)

To perform project management and QA responsibilities, GRS is paid between 4.0% and 6.5% of the contract's value by the contracting entity. However, the partnership agreement between UNDP and DoS eliminated these fees (known as Supervisory and Administration [S&A]) for all UNDP-awarded contracts. Therefore, from December 2007 to May 2009, the UNDP did not reimburse GRS for performing project management and QA for its contracts. However, in May 2009, citing S&A shortfalls in three funding programs (one being IRRF, which is the major funding source for the BCH) and the need to reduce S&A expenditures, GRS terminated QA support for UNDP projects. In order to allow for a smooth transition, GRS will continue to provide a project manager position responsible for coordinating and reporting on the activities of Project HOPE, UNDP, MOH, and U.S. government activities related to the BCH until 31 July 2009.

Considering the limited staff GRS BAO had available and the fact that at any point in time there were close to one thousand contractor and subcontractor workers on site, the GRS BAO staff did an effective job providing construction oversight.

Project Sustainability

The SOW included sustainability elements to assist the MOH, which is ultimately responsible for operating the BCH after turnover. The contract specifications require that the contractor provide a twelve month contractor-certified construction warranty for all building equipment, construction, and components. In addition, the contractor must provide and certify warranties in the name of the MOH. Further, the contractor must provide all O&M manuals for all facility equipment, and is responsible for testing and commissioning of all mechanical and electrical systems. Specific contract requirements include:

Submittals

The contract required the contractor to provide submittals, which includes the contractor or manufacturer's drawings, catalog cuts, diagrams, operating charts, test reports, test cylinders, samples, certifications, and warranties.

Spare Parts

The contract required the contractor to provide one-year spare parts for the maintenance and operation of the substation. In addition, the contractor must provide a spare parts list in accordance with manufacturer's recommendations. Further, the contractor must provide a recommended list of spares for the facility noting required materials or equipment, cost, and the year of maintenance the material or equipment is projected to be required. The list includes all requirements for the years of operation ranging from the second to the fifth year.

As-built Drawings

Upon completion of the project, the contractor must provide one original and two copies of as-built drawings, legibly marked in red pencil, to indicate all changes, additions, deletions, etc., from the contract drawings. Final as-built drawings will be prepared after the completion of each definable feature of work (i.e. foundations, utilities, structural steel, etc.).

Warranty Management Plan

The contract required the contractor to develop a warranty management plan, which will contain information relevant to the clause *Warranty of Construction in Specifications*. The plan must include all required actions and documents to assure that the “Government receives all warranties to which it is entitled.” The plan must be in narrative form and contain sufficient detail to render it suitable for use by future maintenance and repair personnel, whether tradesmen, or of engineering background, and not necessarily familiar with this contract. The construction warranty period begins on the date of project acceptance and continues for the full product warranty period.

Warranty of Construction Work

The contract states the warranty for construction work continues for a “period of 1 year from the date of final acceptance of the work. If the Government takes possession of any part of the work before final acceptance, this warranty shall continue for a period of 1 year from the date the Government takes possession.”

In addition, a MIDCON electrical engineer familiar with the installed electrical and mechanical equipment and systems will stay in Basrah for a period of one year beginning 27 June 2009 to provide full-time technical support to the BCH engineering staff to assure the engineering staff understands and can maintain the equipment and electrical systems.

Status of BCH Partners’ Efforts

As the construction of the main hospital facility nears completion, the status of the medical equipment, training, and ancillary support facilities, funded by other BCH partners, becomes crucial to the opening, operating, and maintaining the BCH.

The full opening of the BCH requires a completed main hospital facility, residence facility, medical equipment, training, consumables, a WWTP, and a dedicated budget by the GOI. However, each BCH element is interlocking; consequently, if the medical equipment or the training or the consumables are not provided, the BCH will not be fully functional. Instead, the BCH will, at best, open in a limited capacity. Since the original goal of the BCH project was to reduce the growing number of children’s cancer patients, a limited opening of the hospital would not meet the intended goal.

Project HOPE

Project HOPE has been involved with this project since the beginning. Responding to a request from the White House, Project HOPE and USAID established a public-private initiative. Project HOPE’s main focus was twofold – provide the medical equipment and train the health care professionals. Specifically, Project HOPE’s commitment was to provide \$20 million in privately funded medical equipment donations along with \$10 million long-term training engagement for human, organizational, and institutional capacity development.

Medical Equipment

Project HOPE is responsible for acquiring the hospital equipment needed to place the BCH into operation. Project HOPE will integrate/synchronize the transportation, installation, inspection, commissioning, and operation of the equipment in close

coordination with the equipment donors. The types of medical equipment required include:

- imaging technology (computed tomography, magnetic resonance imaging)
- radiation therapy (linear accelerator)
- diagnostic equipment
- operating room systems
- laboratory equipment
- beds/stretchers
- physiologic monitoring equipment
- exam room equipment
- ward equipment
- pediatric/neonatal ICU equipment
- hospital information systems

Project HOPE committed to purchasing all new equipment with donor funding only from Tier 1 vendors¹⁸.

Status of Medical Equipment

Project HOPE agreed to purchase 221 line items of equipment from 71 Tier 1 vendors. According to project file documentation, as of May 2009, Project HOPE has purchased 199 line items (90%) of the equipment, of which 62% has either been delivered or is in-transit. However, equipment was put on hold if the individual rooms within the hospital were not ready. Specifically, Project HOPE had the following requirements for installation:

- security (must have a securable ward or location to store equipment)
- facility deep cleaned (donor requirement)
- uninterrupted power source installed for required equipment
- main power and utilities installed and functioning
- adequate staffing and training to operate/maintain equipment
- controlled environment in rooms (working heating, ventilation, and air conditioning system)
- housekeeping contract in place (no gaps in cleanliness)
- maintenance contracts in place to maintain facilities/systems
- certified operators

In addition, one condition of the equipment donors was that the MOH have an operating budget in place prior to the installation of the high-end medical equipment. Project HOPE has long been concerned about the ability of the MOH to operate and maintain the high-end medical equipment and bio-medical equipment. The GOI promised almost two years ago to have O&M service contracts in place to maintain this equipment. In April 2009, Project HOPE reiterated that equipment will be delivered in accordance with being able to place it in an appropriate location and having equipment service contracts in place.

Training

Project HOPE is responsible for training key members of the BCH hospital staff, ensuring that they are prepared for the short, mid, and long-term to place the hospital into operation, sustain modern health care administration and clinical systems over time with the goal that BCH becomes a pediatric referral hospital and training center-of-excellence

¹⁸ A Tier 1 vendor is one of the largest and most well known in its field – often enjoying national or international recognition and acceptance.

for the southern Iraqi governorates. Specifically, Project HOPE will plan, coordinate, and implement tailored, multi-tiered training for the pediatric hospital staff using international board-certified experts in specific specialties and a consultative team of physicians, nurses, and administrators to steer and evaluate the training program.

Educational programs include fellowships, certificate-awarding courses, short courses, workshops, and visiting scholars programs. Training includes classroom, laboratory, and clinical observation training in recognized training centers with a focus on “training the trainer.”

Medical training priorities include the following:

- *Nursing* – Project HOPE plans to train approximately 250 nurses in a multi-echelon fashion, addressing the short, mid, and long-term goal of training the 6+ levels of nurses existing in Iraq (less than one third of nurses in Iraq have received any training past the 9th grade). Training focuses on professionalizing pediatric nursing care, team collaboration, enhancing the nursing scope of practice, and capacity building. Specialized pediatric nursing training focuses on operating room procedures, pediatric intensive care, neonatal intensive care, emergency room procedures, oncology, infection control, endoscopy, quality assurance, and medical/surgical ward nursing specialties.
- *Pediatrics, Oncology, and Radiotherapy* – Since BCH will be a pediatric referral hospital, Project HOPE focuses its clinical effort on training specialists in the latest skills in the diagnosis, treatment, and long-term management of pediatric cancer. Instruction in the latest techniques of radiotherapy planning and management coincides with the installation of a linear accelerator (the first functioning device of this type in Iraq).
- *Hospital Management* – At the request of the MOH, selected senior staff and managers of the BCH will be trained and updated on modern hospital organization, staffing, equipping, training, policy, budgeting, information management, administration, and hospital management. The University of North Carolina, Chapel Hill, one of the nation’s top ranked graduate institutes, will lead the training workshops. The MOH goal is to produce a revolution in modern health care management evidenced by the successful operation of the BCH and its surrounding cooperating hospital health systems.
- *Biomedical Engineering* – Training in biomedical engineering will comprehensively address all associated systems of equipment corresponding to the BCH equipment acquisition process and be synchronized with the major equipment manufacturers and donors.

Hospital Clinical Integrator

The Hospital Clinical Integrator (HCI) works to assist the U.S. Embassy Health Attaché’s office, which is responsible for the construction and turnover of the BCH. This contract required the HCI, International Medical Corps (IMC), to manage health equipment installation, ensure initiation of health service activities, including plans and operations, human resource management, logistics management, patient administration, budgetary and fiscal management, medical manpower, medical facility management, biometrics, and medical recruiting.

Specifically, IMC has focused its efforts on radiation oncology training and emphasizing the increased responsibility to MOH for ongoing projects, such as installation of a booster pump, provision to provide, reliable electrical power, and an on-site WWTP.

Status of Project HOPE and IMC Training

According to Project HOPE, as of May 2009, training is significantly behind schedule due to the inability of the MOH to allocate staff to be trained and funding limitations. In many cases, the BCH has nominated candidates for training to the MOH for approval; yet the MOH has not approved the candidates. Until the MOH provides the candidates for training, the full utilization of the BCH will not be met. Key medical personnel needed to open the BCH will not have sufficient training, which will result in limited services being provided.

In addition, equipment operators and facilities maintenance personnel responsible for maintaining and protecting the BCH will not be adequately trained which will result in potential misuse and/or damage to equipment.

Since this project's inception in early 2004, the U.S. government and Project HOPE notified the MOH that training would be provided to Iraqi doctors and nurses to staff the BCH. From the start, Project HOPE committed to developing and providing the necessary training; while the MOH's responsibility was solely to approve the candidates for the training. Five years later, the MOH has yet to provide the necessary candidates for the training classes developed by Project HOPE.

IMC has expressed frustrations about the status of the radiation oncology training. Specifically, IMC prepared the radiation oncology training for qualified Iraqi medical physicists; however, each candidate had to be nominated by the BCH and approved by the MOH prior to beginning training. In April 2009, IMC stated that it was still waiting on the MOH to approve the medical physicist candidates for training; while radiation therapy candidates still needed to be identified and submitted to the MOH for approval. In May 2009, IMC stated there "has been no activity over the past month. Candidates have been identified by BCH and are awaiting approval of MOH-Central to start training."

In addition, IMC had doubts that the physicists nominated by the BCH had the anatomical knowledge necessary to be trained as radiation therapists.

UNDP Projects

A GOS donation of \$22 million channeled through the UNDP was allocated for construction, construction contingencies, medical equipment, capacity development, and non-construction contingencies in support of the BCH project. The UNDP was responsible for the completion of 18 individual contracts utilizing the GOS funds in support of the BCH.

Status of UNDP Projects

As of June 2009, the UNDP has awarded 18 individual contracts; one contract has been completed, while the other contracts range from 0% complete (two contracts awarded in June 2009) to 95%. Appendix C provides a list of all 18 awarded UNDP contracts and the status as of 20 June 2009.

According to project file documentation, the UNDP planned on re-awarding the accommodations building contract by the end of May 2009, with an estimated completion date of 30 October 2009. However, the last BCH Steering Group meeting stated the

contract was awarded 1 June 2009, with an estimated completion date of 30 November 2009.

According to UNDP documentation, the original completion date for the accommodations building was April 2008; however, due to poor contractor performance, the accommodations building was only partially constructed when UNDP terminated the contractor. It took the UNDP six months to re-award a contract to complete the accommodations building. As a result, the MOH staff will initially have to move into one hospital ward for lodging. This will affect the availability of beds for patients and also result in uncertainties regarding any warranties associated with that specific ward's rooms.

GOI Challenges Supporting the BCH Project

In July 2003, representatives from Project HOPE visited Basrah and conducted meetings with the then-Acting Minister of Health to discuss the project. The original MOU between USAID and Project HOPE identified the parties as being responsible for constructing the facility (USAID) and equipping and training (Project HOPE). In July 2004, USAID signed an MOU with the MOH indicating that the MOH would be responsible to provide the land parcel for the project and operate and maintain the facility and equipment after construction was completed.

Throughout the course of this project, the U.S. government and Project HOPE have continually provided the MOH with the status of the project in terms of construction, equipment, and training. In addition, they outlined the MOH's actions for the success of this project:

- identifying and providing qualified candidates for training
- allocating an annual operating budget
- service contracts in place (housekeeping, laundry, food service, cleaning)
- maintenance contracts for high-end medical equipment in place
- consumables
- site security

After construction management responsibilities were transferred from USAID to GRD, all interested parties agreed to have monthly status meetings. In addition to providing updates, the monthly BCH Steering Group meetings identified the mid and long-term responsibilities of each party in order to successfully open, operate, and maintain the BCH.

Identifying and Approving Candidates for Training

The process for recommending a candidate for Project HOPE or IMC's training courses requires the BCH to identify and nominate a candidate and then final approval provided by the MOH. According to Project HOPE and IMC, the MOH has not provided an adequate number of candidates for training. In some cases, the BCH has identified and nominated potential candidates to the MOH; yet the MOH has not approved the candidates for training. In other cases, the BCH has not identified candidates for training to the MOH.

The BCH Steering Group has identified concerns in the area of training deficiencies. In the September 2008 Steering Group meeting, one of the concerns was that the MOH "cannot provide trained staff to ensure safe patient care and treatment (some staff still in training; significant staff shortfalls of 300 pax)." Eight months later, the May 2009

Steering Group meeting continued to report significant training shortfalls due to a lack of candidates.

Operating Budget

In January 2005, the MOH originally budgeted \$9.8 million annually for consumables, supplies, and long term maintenance for equipment (not including salaries). However, as the first new hospital in 30 years, and one with technologically advanced equipment, the MOH lacked experience in estimating an annual operating budget for the BCH. Project HOPE provided the MOH with a \$29 million proposed annual hospital budget based upon cost estimates derived from three 100-bed pediatric hospitals in Oman. In addition, Project HOPE provided specific information about each piece of equipment and estimated annual maintenance budgets. Utilizing this input the MOH was responsible for determining an updated annual operating budget by October 2007. By April 2008, the MOH had yet to determine the annual operating budget for the BCH. Project HOPE proposed a first year operating budget of approximately \$29.64 million, which included \$15.35 million in start-up and one-time costs (excluding salaries and allowances). Project HOPE further projected that the recurring annual BCH budget would be approximately \$19.29 million (excluding salaries and allowances).

MOH representatives felt these budget estimates were too high and believed that the BCH could be operated for significantly less. However, as of May 2009, the MOH has not provided a comprehensive operating budget, which is needed by Project HOPE to determine if it will be adequate to safeguard the donated equipment.

In addition, Iraq's budget execution process for allocating and funding an operating budget is significantly different from that of the U.S. In the U.S., an operating budget would be allocated and funded prior to construction completion, which allows for the opening of the facility immediately following construction completion. Iraq's budget execution process will only allocate and fund an operating budget for an open and operating hospital; therefore, since the BCH is still considered in the "construction phase," the MOH will not allocate and fund its operating budget.

Maintenance Contracts

Prior to the installation of the specific pieces of high-end medical equipment, Project HOPE required the MOH to have maintenance contracts in place. Specifically, the donors requested an individual multi-year maintenance contract for bio-medical equipment and high-end medical equipment. Project HOPE and its donors are concerned that without an individual contract in place at the time of installation, there is an increased potential for equipment damage and/or failure.

The bio-medical equipment maintenance contract covers day to day activities, such as cleaning microscopes and calibrating equipment; while the high-end medical equipment maintenance contract covers regularly scheduled maintenance of the equipment as called for in the O&M manuals. Maintaining appropriate equipment calibration is critical for enhancing the life span of the equipment and for the accuracy of the equipment.

Project HOPE, through direct interaction with the MOH and via the Steering Group meetings, has consistently alerted the MOH regarding the requirement for maintenance contracts. For example, in a September 2007 Steering Group meeting, Project HOPE identified the maintenance contracts as an area of concern. The meeting advised the MOH that the opening of the hospital was anticipated in approximately 14 months and multi-year maintenance contracts needed to be in place.

In addition, Project HOPE warned the MOH about the direct long term costs involved with not properly maintaining the equipment. Project HOPE determined that this equipment, if properly maintained, should last 6 years before needing replacement; however, if this equipment is not adequately maintained, it will need to be replaced every 2 years. Project HOPE provided the MOH with a 10-year cost-benefit analysis of the maintenance contract (Figure 7). Project HOPE projected that funding a 10-year maintenance contract and replacing the equipment according to the manufacturers' recommendation will cost a total of approximately \$23 million; while not funding a maintenance contract and having to replace the equipment every two years will result in a 10-year cost of approximately \$64 million. The 10-year maintenance-only contract cost of approximately \$10 million will result in a cost savings of more than \$40 million over 10 years.

ITEM #	ITEM DESCRIPTION	QUANTITY	2005 UNIT PRICE	TOTAL COST	MAINT COST / YEAR (10%/YR)	10 YEAR COSTS WITH CONTRACTS (REPLACE EQUIPMENT EVERY 6 YEARS)	10 YEAR COSTS WITHOUT CONTRACT (REPLACE EQUIPMENT EVERY 2 YEARS)
ME15976	SCANNERS, ULTRASONIC, GENERAL PURPOSE	1	\$472,121	\$472,121	\$47,212	\$1,125,536	\$3,115,999
ME17204	CARDIAC, DATA ANALYSIS SYSTEM, ULTRASOUND	1	\$0	\$0	\$0	\$0	\$0
ME17422	SCANNERS, ULTRASOUND, CARDIAC	1	\$0	\$0	\$0	\$0	\$0
RT12364	LINEAR ACCELERATORS, HIGH ENERGY	1	\$3,000,000	\$3,000,000	\$300,000	\$7,152,000	\$19,800,000
RT13280	RADIOTHERAPY, SIMULATION SYSTEMS	1	\$750,000	\$750,000	\$75,000	\$1,788,000	\$4,950,000
RT13281	COMPUTER TREATMENT PLANNING SYS., RADIO.	1	\$0	\$0	\$0	\$0	\$0
XR11758	RADIOGRAPHIC/FLUOROS UNITS, MOBILE	1	\$133,752	\$133,752	\$13,375	\$318,865	\$882,763
XR13272	RADIOGRAPHIC UNITS, MOBILE	3	\$250,000	\$750,000	\$75,000	\$1,788,000	\$4,950,000
XR15952C	RADIOGRAPHIC/FLUOROS DIGITAL UNITS	1	\$213,138	\$213,138	\$21,314	\$508,121	\$1,406,711
XR15956C	SCANNERS, COMPUTED TOMOGRAPHY, MULTI SLICE	1	\$1,463,462	\$1,463,462	\$146,346	\$3,488,893	\$9,658,849
XR16260	MAGNETIC RESONANCE IMAGING, 1.5 T	1	\$2,000,000	\$2,000,000	\$200,000	\$4,768,000	\$13,200,000
XR17174B	RADIOGRAPHIC UNIT, G.PURPOSE, FLAT PANEL	2	\$428,864	\$857,728	\$85,773	\$2,044,824	\$5,661,005
RADIOLOGY EQUIPMENT TOTAL				\$9,640,201	\$964,020	\$22,982,239	\$63,625,327

Figure 7. Ten year cost benefit analysis of the maintenance contract (Courtesy of Project HOPE)

Services Contracts

The MOH also had responsibility to award two additional contracts – facilities maintenance and housekeeping/food service/laundry. The facilities maintenance contract covers day to day physical operation of the facility, such as maintaining the generators and changing out light bulbs. The housekeeping/food service/laundry contract covers regular cleaning of the hospital (general cleaning such as sweeping floors and emptying trash, not the elimination of germs) and accommodations building, providing food for the hospital patients and staff, and providing laundry services (cleaning of sheets and linens).

In the September 2007 Steering Group meeting, Project HOPE identified that the service contract was significant for the eventual opening of the hospital.

Status of the Maintenance and Service Contracts

In hospitals throughout the world, maintenance and service contracts are commonplace in order to safeguard the expensive, technical equipment and provide a warm and comfortable environment for patients, staff, and visitors.

The BCH Steering Group meeting in September 2007 brought to the MOH's attention the need to have maintenance and service contracts in place prior to the opening of the

hospital. The U.S. government reiterated this point in May 2008 when it officially notified the GOI, in writing, of its obligation to fund and award maintenance contracts to support the BCH. However, by September 2008, the MOH had not prepared a tender for any of the required contracts. In September 2008, representatives from the U.S. funded Procurement Assistance Center (PAC) began assisting the MOH in preparing tenders for the maintenance and service contracts.

In February 2009, the PAC completed the tenders for three contracts (facilities maintenance, cleaning/food service/laundry, and bio-medical maintenance) and passed them onto the MOH to review and advertise. However, as of June 2009, the MOH had not advertised any of the contracts. Iraqi procurement law forbids the advertising or awarding of a contract without a specific budget previously allocated for the contract. The MOH has already received its FY 2009 budget but has not allocated a portion of the overall budget to cover these contracts. Until the MOH allocates a budget for these contracts, the Iraqi Central Department of Planning will not allow them to be advertised. The PAC estimates that, in a best case scenario the contracts could be in place within two months of the date of advertisement.

The PAC stated that the tender for the high-end medical equipment is incomplete due to a lack of responsiveness by the MOH. In February 2009, the PAC requested additional direction/information from the MOH to confirm how they would like to proceed with the service contract, such as whether the MOH wanted to award this as an annual contract with options for additional years or as a multi-year contract, the address to send the bids to, and where the pre-bid conference will be held. As of June 2009, the MOH has not responded.

Contracting-out the Operation of the BCH

Given the MOH's difficulties with staffing, training, and awarding of service and maintenance contracts, the PAC suggested awarding a contract to an international company to operate the BCH for the initial year. According to U.S. government representatives, there are several regional companies capable of opening, operating, and maintaining the BCH. These companies have operated hospitals of similar size and complexity in the region and could bring that experience and knowledge to the BCH. These companies, while operating the BCH, would also mentor future BCH staff on everything from O&M to establishing standardized policies and procedures. In addition, another benefit to the MOH would be a single contract would cover all areas of operating and maintaining the BCH instead of having to award several individual contracts for the same services.

The MOH declined this approach citing it was more than capable of operating and maintaining the facility on its own. In addition, the MOH stated that it did not want a foreign company operating an Iraqi hospital.

Additional GOI Contracts to be Awarded

On 1 May 2008, GRD advised the MOH, in writing, that this project required additional features to complete for which no U.S. government funding was available. As a result, these additional construction and operating requirements would fall to the MOH. Specifically, the MOH needed to provide the BCH with a packaged WWTP, medical fluid waste treatment (bio-WWTP), and dedicated uninterrupted electrical power.

GRD further told the MOH that the BCH would not be fully operational until the WWTP has been installed¹⁹. Specifically, until the WWTP is constructed and operational, the BCH will only be able to offer outpatient services.

The U.S. government has continually stressed the importance of these features to the opening and operating of the BCH; however, as of June 2009, none of the projects have been completed.

Wastewater Treatment Plant

The waste water design called for the effluent from the hospital to be connected to the Basrah city municipal sewer system. However, in October 2007, the Iraqi Minister of Sewers stated that the hospital's effluent did not meet the existing Basrah waste water criteria; consequently, the Minister of Sewers stated that the BCH cannot tie into the sewer line unless the waste water is first treated by a WWTP. On 4 October 2007, the U.S. government asked the MOH to provide effluent test results from existing Basrah area hospitals to help determine whether the effluent from the BCH needed additional processing beyond what was originally designed. The project file lacked documentation to support the MOH ever provided the effluent test results of the existing Basrah area hospitals. Yet, in January 2008, without providing GRS the effluent criteria, the MOH wanted the WWTP constructed with U.S. government funding. U.S. government representatives advised the MOH that either U.S. or UNDP funding was unlikely. However, the MOH decided not to attempt funding the project itself; instead it waited to see if either U.S. or UNDP funding became available.

As of June 2009, more than 13 months after being notified of the need to construct the WWTP, the MOH has not advertised the WWTP contract. According to U.S. government representatives, similar to the maintenance and services contracts, the Ministry of Planning will not allow the MOH to advertise this contract.

In the June 2009 BCH Steering Group meeting, the BCH Director stated that the Basrah MOH Director General (DG) approved the WWTP for 12 Basrah hospitals, including the BCH. Funding has been approved but not yet provided. According to project file documentation, construction of the WWTP will take at least five months. Yet, according to the BCH Director, the "status of the WWTP does not impact the opening of the hospital to patients." However, until the WWTP is installed, the BCH will not be able to offer any chemotherapy or radiation oncology services, reducing the BCH to an outpatient clinic.

Medical Fluid Waste Treatment

A 94-bed oncology hospital will produce a considerable amount of medical fluid waste, such as blood, medical test samples, tissues, and organs. For example, hospital surgical procedures often produce a mixture of irrigation solution, blood, and other body fluids, which can be quite infectious. Untreated medical fluid waste is not appropriate for disposal through the Basrah municipal sewer line.

On 1 May 2008, the U.S. government advised the MOH that the BCH required specialized treatment of medical fluid waste. Until the MOH contracts for the required infrastructure to treat the medical fluid waste, the BCH will not be fully operational. Specifically, until the MOH installs the required medical fluid waste treatment infrastructure, the BCH will only be able to offer outpatient services.

¹⁹ At best the BCH would be able to open as an Outpatient Specialty Clinic, but will not be authorized to begin chemotherapy or radiation oncology until the WWTP is installed.

As of June 2009, more than 13 months after being notified of the need to treat the medical fluid waste, the MOH has not taken any action. According to U.S. government representatives, the MOH believes that the medical fluid waste will be “treated” by the WWTP. It appears the MOH does not appreciate that medical fluid waste requires a significantly different treatment than waste water. The WWTP will not properly treat the medical fluid waste prior to disposal into the Basrah municipal sewer line; consequently, potentially harmful elements will enter the sewer line, endangering the local population.

Electrical Power

The estimated electrical demand load for the BCH was determined to be 6 megavolt amperes (MVA). Four 1.5-MVA generators are on site; however, the generators were intended only for emergency backup, not as a source of primary power for the BCH. In December 2007, the decision was made to have two independent (from the national grid) sources of electricity power the BCH. Specifically, two 11-kilovolt (kV) feeders, one from an existing electrical substation and one new electrical substation located at the BCH site, would each support at least 5 MVA.

On 1 May 2008, the U.S. government advised the MOH that it needed to award a contract for the construction of a mobile substation at the BCH site. On 28 October 2008, the MOH awarded a contract for the construction of the mobile substation; the substation is scheduled to arrive on site on 11 September 2009. Current estimates call for installation of the substation to take approximately two weeks, with an additional 2-3 weeks for testing and commissioning. The substation will initially be powered by a 33-kV line run underground by the Ministry of Electricity (MOE) from the Al Kibler substation, which is approximately 8 kilometers from the BCH site. The Al Kibler substation will power the BCH substation until MOE completes construction of the 33-kV overhead lines from the Shark Al Basrah substation to the site, a distance of approximately 12 kilometers, and ties the overhead lines into the BCH substation. The hope is that the Al Kibler and Shark Al Basrah substations will provide the hospital with continuous power for 24 hours per day. The estimated completion date for the substations is mid-October 2009. Construction of the overhead line is expected to take an additional eight months.

However, Basrah continues to suffer from power grid interruptions. In June 2009, power interruptions were reported to occur approximately 14 times per day with an average duration of 25 minutes (approximately 6 hours per day of down time). U.S. government representatives believe that the number and duration of the interruptions will increase as we get further into the summer months. The number of interruptions per day will have a decided negative impact on machinery and equipment at the BCH.

In lieu of uninterrupted electrical power, the BCH will have the ability to operate with generator power. The BCH monthly fuel allotment is reported to be 5,500 liters. However, given the current power interruptions and durations, U.S. government representatives estimate that the generators will consume 180,000 liters of fuel per month if continuous power is to be supplied to the hospital.

The BCH Director stated that he has discussed the issues of phasing, power interruption, and voltage levels with the MOH DG. The MOH DG, Basrah governor, and MOE DG met to discuss and resolve electricity issues; however, to date, no actions have been identified.

Additional Responsibility of the GOI – Municipal Water Supply

The original Bechtel water supply design was predicated on the availability of an adequate amount of water from the existing municipal water system. Bechtel's initial hydrostatic tests found the municipal line had only 1 bar of pressure, which was not sufficient to supply the quantity of water needed by the BCH. (One bar of pressure is 14.5 pounds per square inch. Typical pressure for commercial buildings is 80 to 100 pounds per square inch.) Currently, there is insufficient static head pressure in the service line to the hospital to bring the water level high enough to empty into the BCH booster station's holding tank in sufficient volume to operate a hospital.

According to the June 2009 BCH Steering Group meeting, the BCH Director is conferring with the municipal water ministry to either provide a booster pump station at the tie-in point to the water main or a suction pump at the booster station. The BCH Director has sent an official letter to the Department of Water and Sewer regarding this issue and anticipates an official response as to how the department expects to assure adequate water flow to the hospital. In addition, the BCH Director stated that water in the existing municipal line is available only six hours per day.

In the interim, the BCH Director stated the MOH will truck in 16 tons (approximately 16 cubic meters) of water three days per week, which would amount to 48 cubic meters of water per week. Unfortunately, according to project file documentation, the BCH will require 40 cubic meters (10,570 gallons) per day of potable water to operate at full capacity.

Stalemate between Project HOPE and MOH

From the inception of the BCH project, Project HOPE repeatedly provided the MOH specific requirements necessary to ensure the successful opening, short and long term operation and sustainment of a children's oncology hospital. The key requirements were the following:

- providing qualified candidates to be trained to ensure safely operating the technically sophisticated equipment
- developing and funding an operating budget
- awarding service and maintenance contracts
- providing dedicated electrical power
- providing adequate staff (non-technical positions)
- providing a WWTP

As of June 2009, approximately 3,100 of the 8,000 pieces of equipment (medical equipment, furniture, and computers) have been installed in the BCH. However, Project HOPE will not deliver the 6 pieces²⁰ of high-end medical equipment²¹ until specific requirements by the MOH are met (i.e. service and maintenance contracts in place and dedicated uninterrupted power supply) in order to safeguard the expensive equipment. Improper treatment of the equipment (including operators mishandling the equipment and/or not performing the required routine maintenance) will lead to a significantly reduced lifespan for each piece of equipment. In addition, Project HOPE is concerned

²⁰ In the May 2009 BCH Steering Group meeting, Project HOPE refused to deliver 12 pieces of high-end medical equipment; however, by the June 2009 BCH Steering Group meeting, Project HOPE reduced the number to six.

²¹ The six pieces of high-end medical equipment are the following: Tomography scanner, MRI, LINAC, radiotherapy simulation system, computer treatment planning equipment, and water phantom.

about the manufacturer's warranties. Once the equipment arrives and is installed, the warranty period, which has a financial value (approximately \$300,000 for the linear accelerator), starts; therefore, if the equipment is delivered prior to training being completed, the donors and the MOH are losing the value of those warranties.

Further, Project HOPE will not deliver the equipment until training has been completed in order to ensure safe patient care and treatment. The operation of specific high-end medical equipment, particularly the linear accelerator, by untrained operators used in a non-coordinated environment could ultimately result in hospital patient deaths.

As mentioned earlier in this report, as of June 2009, significant MOH requirements for the installation of the high-end medical equipment have not been completed, and in some cases, even attempted. For example, the 18-month radiation therapy training has not been started due to the lack of MOH approved candidates. Even if the MOH approved candidates and training began immediately (i.e. July 2009), the candidates would not become qualified to operate the equipment until approximately January 2011.

Phased Opening of the BCH

It is commonplace for hospitals to open in phases rather than all at once. Slowly opening a hospital in phases allows the administration to identify any shortfalls in staffing, equipment, or consumables with a limited number of patients. In addition, the administration will be better able to gauge the magnitude of operating the facility at full capacity.

The BCH Steering Group decided on a five phased turnover/acceptance and opening of the BCH. The five phases consisted of the following:

- ▶ **Phase 0 – Planning and Training** (Planning/training prior to move in)
 - ◆ Turnover Ceremony
- ▶ **Phase 1 – Staff Move-in/Setup** (Rehearsals/no patient care)

• Staff move-in	- Admin Areas	- Conference
• Education	- Stores	- Medical Warehouse
• Staff areas	- Kitchen	- Laundry
- ▶ **Phase 2 – Soft Opening** (Easy-to-access outpatient areas)

• Primary Care Clinic	- Mobile x-ray	- Gen Rad if staff avail
• Satellite Pharmacy	- Satellite Lab	- Dental
- ▶ **Phase 3 – Full Opening** (Based on staff training/availability)

• All Outpatient	- Endoscopy	- Acute care
• Chemo/Rad Tx (later)	- MRI, CT, Fluoroscopy	- Surgery
• 3 Wards (B,C & D)	- PICU (2-bassinets)	- CSSD
- ▶ **Phase 4 – Full Opening (TBD)** (Based on staff training/availability)

• Bone Marrow Transplant	- Ward A (Gen Peds)	- NICU (7-bassinets)
--------------------------	---------------------	----------------------

The phased opening approach is based on the achievement of specific goals and criteria. For example, Phase 0 consists of the construction of the BCH and ancillary facilities; while staff planning for the opening and training of the doctors and nurses is ongoing simultaneously. For this phase, staff on hand is essential for planning, training,

organizing, and synchronizing the move in. When the BCH facility is turned over to the MOH, Phase 1 ensues with the administrative staff moving into the facility. No patients will be seen during this phase as the administrators perform rehearsals. Phase 2's "Soft Opening" follows with easy access outpatient care. During this phase the BCH will act as a primary health care clinic. Phase 3's "Full Opening" consists of non-invasive patient care areas; radiotherapy, imaging, respiratory therapy, and oncology. During Phase 4's "Full Opening" the BCH will perform invasive patient care services, such as surgeries and bone marrow transplants.

All phases of this plan are based on turnover and acceptance of the facility, completed staffing and training, an operating budget, adequate security, and having maintenance contracts in place.

Standardized Policies and Processes to Support Patients

Prior to opening a hospital in any capacity, there must be written standardized policies and processes in place to support patients. Specifically, there must be an operations document that spells out in critical detail the operations of the hospital, staff, and departments, such as departmental practices and infection control policies.

According to U.S. government representatives, the MOH does not have any standardized policies and processes in place to support the patients of the BCH. In addition to the lack of an operations document, the MOH has not addressed cleaning policies. Considering the type of services planned for the BCH (i.e. surgeries, radiation therapy, bone marrow transplants), the hospital, specifically the operating rooms and intensive care units, must remain germ free. Detailed cleaning policies must be decided upon and written so that all hospital personnel are familiar with the requirements. Realizing the lack of policies and processes, IMC became engaged with the MOH on the concept of operations and departmental policies. According to U.S. government representatives, IMC has helped the MOH develop some draft policies; however, to date, there are no formally established policies and processes for the BCH.

In addition, the MOH has not addressed the whole support network either. For example, once a CAT scan is taken, where will the image be stored and are the administrative staff capable of retrieving it? Some U.S. government representatives believe a slower paced phased opening would be beneficial. Opening the BCH for outpatient services only one or two hours a day at the beginning will allow the administrative staff to create/modify the necessary standardized policies and procedures.

A key component of Phase 1 should consist of the review, implementation, and rehearsal of the hospital's standardized policies and processes. There are a considerable number of logistical and practical issues the MOH must address prior to seeing its first patient.

Dates Continue to Slip

Project HOPE identified the phase opening goals/criteria in January 2008. Phase 1 required staff move-in between the months of November 2008 and January 2009; Phase 2 Soft Opening between the months of January 2009 and June 2009; Phase 3 Full Opening of non-invasive care between the months of July 2009 and December 2009; and Phase 4 Full Opening at a to be determined date.

Over the past 18 months, the phased opening dates have continued to slip for a variety of reasons. For example, construction of the BCH is still ongoing, which has denied the opportunity for turnover and acceptance. In addition, the Phase 1 staff was originally to move into the accommodations building; however, this facility is only partially

completed and will not be completed until at least 30 November 2009. In an attempt to accelerate the start of Phase 1, the MOH agreed to move the staff into one ward of the BCH. However, the staff move-in has been delayed several times from the originally scheduled date of January 2009. In April 2009, the BCH director stated that the start of Phase 1 would occur on 1 June 2009; however, in June 2009, the move-in date was pushed back to July 2009.

The opening of Phases 2-4 are directly affected by the delays of Phase 1. The originally scheduled Phase 2 “Soft Opening” of January 2009 to June 2009 will not be met. In April 2009, the MOH stated Phase 2 opening would occur on 1 August 2009; however, considering that as of June 2009 the administrative staff has not moved into the facility, the August 2009 deadline will not be met. A more realistic date for the opening of Phase 2 would be at least several months after the move-in of the staff. It must be mentioned that the Phase 2 opening is also dependent upon the MOH allocating and funding an operating budget for the BCH. The MOH has assured U.S. government representatives that it will approve an operating budget; however, as of June 2009, a MOH operating budget has not been approved.

In April 2009, the MOH divided Phase 3 into Phases 3a and 3b because surgical services could not be initiated and the pediatric ICU could not be opened due to the duration of training required. While the MOH predicted a start date of 1 October 2009 for Phase 3a, the start of this phase cannot be predicted at this time because the MOH must first fulfill responsibilities it has not addressed for several years. For example, Inpatient Oncology Services (Phase 3a) will produce medical fluid waste, which must be treated prior to entering the Basrah municipal sewer system. According to U.S. government representatives, the MOH does not have an adequate plan to address the issue of medical fluid waste treatment. In addition, a WWTP must be awarded and constructed, service and maintenance contracts must be in place, dedicated on-site electrical power must be provided, and medical equipment must be installed and tested and the staff trained to operate it.

Phase 3b and 4 are also directly affected by the MOH’s inability to address the significant issues continually raised by the U.S. government.

Turnover and Acceptance of the BCH

Currently, the U.S. government anticipates MIDCON will complete the BCH facility in July 2009. The U.S. government is responsible for performing a final inspection of the facility to determine if the contractor’s work meets the requirements of the SOW. Once satisfied with the contractor’s work, the U.S. government will formally accept, in writing, the BCH facility from the contractor.

After accepting the BCH facility from the contractor, the U.S. government plans to turn over the facility to the MOH. However, at the May 2009 BCH Steering Group meeting, the BCH director stated that the MOH would only partially accept the hospital once it is “totally complete” – i.e. the facility is finished, equipment is installed, and training of staff has been completed. As mentioned earlier in this report, Project HOPE is not willing to provide six pieces of high-end medical equipment for UHS to install until a five year maintenance contract is in place and training has been completed. Project HOPE is concerned about potential damage to the expensive equipment and potential harm to patients. As of June 2009, the MOH has not provided candidates for the Radiation Therapy training or awarded the maintenance contract; therefore, Project HOPE will not provide the high-end medical equipment. Consequently, the MOH will not accept the BCH facility from the U.S. government. Since the Radiation Therapy

training is 18 months long, the earliest the candidates could complete the training is January 2011 (if the MOH approves the candidates by July 2009).

A Modern Pediatric Hospital

The original objective of the U.S. government and Project HOPE was to provide a “state of the art”²² pediatric specialist hospital in the southern city of Basrah. Project HOPE promised the donation of \$20 million in specialty equipment, including 12 pieces of high-end medical equipment. With construction originally scheduled for completion by December 2005, Project HOPE planned on the delivery and installation of 2005 model high-end medical equipment. However, as construction is currently scheduled to continue through at least July 2009, and the use of specific pieces of high-end medical equipment is not practical until at least 2011, the 2005 model medical equipment is no longer the most up-to-date equipment available.

In the January 2009 BCH Steering Group meeting, the BCH Director brought to the group’s attention that this hospital should no longer be considered or described as a “state of the art” facility; instead recommending it be referred to as a “modern” hospital. The Steering Group unanimously agreed, and in February 2009, a Memorandum of Understanding signed by representatives of the U.S. government, GOI, UNDP, and Project HOPE described the BCH as a “modern pediatric hospital in Basrah.”

Shifting Priorities of the GOI

In 2008, the MOH performed a country wide assessment of its existing health care infrastructure to determine if it had the capability to adequately provide medical services to a growing Iraqi population. The MOH assessment concluded that the “health indicators fell to levels comparable to some of the least developed countries” due to neglect over the past two decades. The overall health infrastructure was determined to be in “poor condition.” The MOH concluded that, over the next five years, 63,900 new hospital beds will need to be created.

In pursuit of this goal, the MOH decided to allocate, fund, and award a \$1.5 billion contract for the construction of 10 new 400-bed “advanced” general hospitals throughout Iraq. The hospital locations will be in the following governorates: Baghdad, Basrah, Thi Qar, Missan, Karbala, Babylon, Diwaniyah, Diyala, Najaf, and Ninawa.

While the desire of the MOH/GOI is to provide improved medical care to the Iraqi people, it also indicates a shifting of priorities from the importance of the BCH to overall health care for the entire country. This is evidenced by the fact that the MOH, which is currently experiencing problems allocating and funding service and maintenance contracts worth several million dollars, allocated, funded, and awarded a \$1.5 billion contract for the construction of 10 new hospitals.

In addition, the MOH plans to allow international maintenance and service companies to operate the 10 new hospitals; an idea that was previously suggested by the PAC for the BCH, but rejected by the MOH.

²² “State of the Art” refers to the highest level of development, as of a device, technique, or scientific field, achieved at a particular time.

Conclusions

The assessment determined that:

1. The contractor's design was sufficient to construct the two-story hospital facility and site utilities, which will comprise the BCH campus. The design submittals included architectural, electrical, mechanical, and plumbing drawings. With the exception of the seismic design for mechanical hangers and block walls, the overall design drawings and specifications appeared to be complete and consistent with the requirements of the contract.

The contractor's seismic design for the mechanical hangers and block walls did not meet the International Building Code (IBC) standards required by the contract. Specifically, the contractor installed all hanging equipment with vertical supports, but no diagonal braces. During an earthquake, diagonal braces transfer the lateral load into the slab above. The Basrah Area Office (BAO) of Gulf Region South (GRS)²³ determined that the IBC standards required diagonal bracings. In addition, BAO also determined that the interior masonry block walls cannot withstand the design earthquake force. Even though the block walls are non-load bearing, the IBC required that the walls must be able to maintain their structural integrity during an earthquake. BAO determined that under the design earthquake lateral loading, the walls would collapse. In February 2009, the contractor submitted design drawings to rectify Bechtel's previously deficient seismic design for the mechanical hangers and interior block walls, which BAO approved as sufficient to satisfy the requirements of the IBC.

The contractor designed the sewer system as a gravity conveyance system, with eight lift stations discharging at a single point to the municipal sewer system. The project incorporates 8 duplex lift stations using 16 electric pumps into the collection system design. According to BAO representatives, the water table in the area is very high, which limited the length of run of gravity flow pipe; consequently, the sewer system had to be designed with a large number of lift stations. Although not a design deficiency, SIGIR is concerned about the significant amount of operation and maintenance costs associated with the operation of eight duplex lift stations. The facilities engineer will be responsible for maintaining the 16 pumps, which are spread out over the 85,000 square meter (m²) medical campus. The failure of a single lift station will shut down the entire sewer system until it is repaired or replaced.

Overall, the contractor's designs provided enough information and detail to adequately construct the BCH campus.

2. At the time of the site visit, construction work on the hospital facility was still ongoing. In general, the construction appeared to meet the standards of the Statement of Work. SIGIR did not observe significant deficiencies or any noticeable defects associated with the quality of workmanship. At the time of the site visit, no furniture or equipment had been installed in the rooms; therefore, SIGIR could not test the wiring, bed-heads, and medical equipment. The observed construction work associated with the BCH facility appeared to meet the standards of the contract.

²³ GRS is one of three districts under the USACE Gulf Region Division (GRD).

The project file documentation identified one instance in which construction did not meet the standard of the design, but it was not visible to SIGIR during the site visit. In southern Iraq, subterranean termite infestation is widely acknowledged to be chronic, regardless of building type; termite damage to concrete buildings has even been reported. To combat the termite problem, Bechtel planned to apply Chlorofet 48% TC²⁴ on all soils below the slabs, pile caps, and footings. Yet, in September 2005, the USAID instructed Bechtel to immediately stop using the termite treatment on the hospital site. According to project file documentation, USAID does not allow the use of pesticides on any of its projects. By the time USAID instructed Bechtel to stop using the termite treatment, Bechtel had already applied Chlorofet 48% TC to approximately 2,000m² of the site (out of a total building footprint of approximately 15,000m²). Bechtel provided an extensive justification for the use of termiticide; USAID eventually approved the application of termiticide. However, by the time USAID approved the application of termiticide, the building slabs and foundations had been poured. Bechtel concluded that the BCH facility is not adequately protected against termite infestation.

Because USAID directed Bechtel to stop using the previously planned termite treatment, SIGIR does not consider the fact that the entire site was not treated as a deficiency by Bechtel. Rather, SIGIR is documenting this example of construction that did not meet the standards of the design.

3. The contractor's quality control (QC) plan was sufficiently detailed to effectively guide the contractor's quality management program. The contractor submitted a QC plan, which based on SIGIR's review, met the standards addressed in Engineering Regulation 1180-1-6 (*Construction Quality Management*). The QC representatives monitored field activities and completed daily reports, which were reviewed by the BAO project engineer. The QC daily reports presented a brief background on the work activities performed and major equipment on site. The QC representatives supplemented the daily QC reports with detailed photographs that reinforce the information provided in the reports. In addition, the QC representatives kept a comprehensive deficiency log of identified deficiencies either by type (electrical, mechanical, and civil) or by location (zones 1-5).

The government quality assurance (QA) program was effective in monitoring the contractor's QC program. BAO had dedicated personnel on site. Local national QA representatives monitored field activities and completed daily QA reports, which were reviewed by the BAO project engineer; the daily reports documented the work performed for the day. In addition, the QA representatives supplemented the daily QA reports with detailed photographs that reinforced the information provided in the reports. SIGIR reviewed the daily QA reports and found that the QA representatives did an effective job in identifying and correcting construction deficiencies at the project site. Further, the QA representatives used a deficiency spreadsheet to document each identified construction deficiency, the date it was identified, the corrective action taken, the date the corrective action was taken, and the current status.

²⁴ Chlorofet 48% TC, manufactured by Vapco, is a Chlorpyrifos-based termiticide. First introduced in the mid-1960s, Chlorpyrifos is widely used as an insecticide in agricultural and non-agricultural settings. It is used in many different indoor areas, such as homes, offices, schools, hotels, hospitals, and restaurants. This specific product, Vapco Chlorofet 48% TC, is a special formulation to control all species of subterranean termites.

In addition, GRS assumed all jobsite activities for the UNDP contracts, which included design review and construction monitoring. Therefore, in addition to providing construction management, technical support, and QA reporting for the four contracts funded by the U.S. government (including the key contract to complete the main hospital building), BAO also provides QA reporting on all UNDP-awarded contracts. BAO's QA representatives became responsible for overseeing multiple projects simultaneously throughout the entire complex. In addition, BAO staff became responsible for daily oversight of the activities of approximately 1,000 contractor personnel on site. Currently, BAO employs seven local national QA representatives working full time on site. GRS personnel generally visit the site weekly to determine contractor progress and monitor construction quality.

However, due to a partnership agreement between UNDP and DoS, GRS's standard Supervisory and Administration fees for project management and QA responsibilities were eliminated; consequently, from December 2007 to May 2009, the UNDP did not reimburse GRS for performing project management and QA for its contracts. In May 2009, GRS terminated QA support for UNDP projects. In order to allow for a smooth transition, GRS will continue to provide a project manager responsible for coordinating and reporting on the activities of Project HOPE, UNDP, MOH, and U.S. government activities related to the BCH until 31 July 2009.

BAO's vigorous QA program is ensuring the successful completion of the hospital facility and ancillary buildings on the BCH campus.

4. Sustainability was addressed in the contract requirements. The Statement of Work included sustainability elements to assist the MOH, which is ultimately responsible for operating the BCH after turnover. The contract specifications require that the contractor provide a 12-month contractor-certified construction warranty for all building equipment, construction, and components. In addition, the contractor must provide and certify warranties in the name of the MOH. Further, the contractor must provide all operation and maintenance (O&M) manuals for all facility equipment, and is responsible for testing/commissioning all mechanical and electrical systems. The contract also required catalog cuts and a spare parts list for the facility noting the required materials or equipment, cost, and the years of maintenance that are projected to be required. This list includes all requirements for the years of operation, ranging from the second year to the fifth. Finally, a MIDCON electrical engineer familiar with the installed electrical and mechanical equipment and systems will stay in Basrah for one year, beginning 27 June 2009. The engineer will provide full-time technical support to the BCH engineering staff to ensure that the engineering staff understands and can maintain the equipment and electrical systems.
5. To date, the BCH project results are partially consistent with the project objective to establish a "state of the art" pediatric specialist hospital in the southern city of Basrah. Specifically, the project results are consistent with respect to the design and construction of a pediatric specialist hospital. The newly constructed hospital facility will provide cancer-stricken children and their families a safe and peaceful environment to undergo advanced medical treatment.

However, the project results are not consistent with a "state of the art" pediatric specialist hospital with respect to medical equipment and its operation. For a

hospital, “state of the art” refers to the latest and most sophisticated or advanced stage of a technology. When USAID and Project HOPE formed the public-private partnership in 2004 to establish the new hospital center, Project HOPE was responsible for providing \$20 million in specialty equipment, including 12 pieces of high-end (“state of the art”) medical equipment. With construction originally scheduled for completion by December 2005, Project HOPE planned to deliver and install 2005 model high-end medical equipment. However, when construction is complete and the equipment is installed, it will be years old. In the January 2009 BCH Steering Group Meeting, the BCH Hospital Director brought to the group’s attention that this hospital should no longer be considered or described as a state-of-the-art facility; instead recommending it be referred to as a “modern” hospital. The Steering Group unanimously agreed, and in February 2009, representatives of the U.S. government, GOI, UNDP, and Project HOPE signed a Memorandum of Understanding that described the BCH as a “modern pediatric hospital in Basrah.”

The GOI’s challenges in supporting the BCH project

Throughout the course of this project, the U.S. government and Project HOPE have continually provided the MOH with the status of the project in terms of construction and equipping/training. In addition, they outlined the MOH’s responsibilities for the success of this project:

- identifying and providing qualified candidates for training
- allocating an annual operating budget
- service contracts in place (housekeeping, laundry, food service, cleaning)
- maintenance contracts for high-end medical equipment in place
- consumables
- site security

In addition, in May 2008, GRD advised the MOH, in writing, that this project required additional features to complete for which no U.S. government funding was available. As a result, these additional construction and operations requirements would fall to the MOH. Specifically, the MOH needed to provide the project with a packaged wastewater treatment plant (WWTP), medical fluid waste treatment (bio-waste water treatment plant), and dedicated electrical power.

As of June 2009, the GOI’s has had difficulty supporting the assigned tasks of construction and operation of the hospital. For example, the GOI has not:

- provided qualified candidates for critical training courses, such as radiation therapy
- allocated funding for an annual operating budget
- allocated funding, advertised, or awarded service contracts
- allocated funding, advertised, or awarded maintenance contracts for the high-end medical equipment
- advertised or awarded the WWTP contract
- developed, advertised, or awarded a contract for medical fluid waste treatment
- provided dedicated electrical power

GOI faces many challenges in opening and operating the Basrah Children’s Hospital. These challenges directly affect the work being completed by the U.S. government, Project HOPE, and UNDP. For example, until the MOH provides qualified candidates for radiation therapy training Project HOPE will not allow the U.S. government’s

contractor to install six pieces of high-end medical equipment, because of the danger of operating such equipment without proper training.

Lessons Learned

This reconstruction project yields several key lessons learned for other contingency reconstruction operations, which should be applied in the decision-making process for future reconstruction projects:

- Prior to construction, the availability of key utilities, such as water and power, should be assured. The lack of essential utilities can negatively affect both the ability of the contractor to construct the project and the ability of the ministry to properly operate the project after construction is completed.
- Realistic expectations should be established for the contractor in terms of costs and schedules.
- Effective program management and oversight are needed to avoid significantly increased costs and considerable schedule delays.
- Large reconstruction projects require detailed cost analysis to determine a realistic cost projection.
- Funding individual reconstruction projects through multiple sources can lead to delays; specifically, the inaction of one project partner can directly affect the ability of the other partners to complete their work.
- The budget execution processes of other countries may differ significantly from that of the U.S. government. Other countries may not have the funding in place to immediately open and operate a project upon its completion.

Recommendations

Contracts and grants funded by Project HOPE, the UNDP, and the GOI are outside SIGIR's jurisdiction. This report does not contain any negative findings or recommendations for corrective action with respect to contracts funded by the U.S. government; therefore, management comments are not required.

Management Comments

SIGIR received comments on the draft of this report from the Multi-National Corps - Iraq and the Gulf Region Division of the U.S. Army Corps of Engineers. Multi-National Corps – Iraq advised that it had no issues with the report. The Gulf Region Division indicated that it generally agreed with the facts presented in the report and provided technical comments for clarification. SIGIR reviewed the comments provided by the U.S. Army Corps of Engineers and revised the final report to address them.

Evaluation of Management Comments

SIGIR appreciates the concurrences with regards to the draft report by the Multi-National Corps - Iraq and the U.S. Army Corps of Engineers. No additional comments are required.

Appendix A. Scope and Methodology

SIGIR performed this project assessment from December 2008 through July 2009 in accordance with the Quality Standards for Inspections issued by the Council of Inspectors General on Integrity and Efficiency. The assessment team included two engineers/inspectors and two auditors/inspectors.

In performing this Project Assessment SIGIR:

- Reviewed documentation to include the following: contracts, contract modifications, bill of quantities, notice to proceed, Statement of Work, and quality assurance/quality control reports;
- Reviewed the design package (plans) and photographs documenting construction progress;
- Interviewed the U.S. Army Corps of Engineers Gulf Region South personnel, Health Attaché personnel, and Iraq Transition Assistance Office personnel; and
- Conducted an on-site assessment and documented results at the Basrah Children's Hospital project in Basrah, Iraq.

Scope Limitation. Due to security concerns, an expedited assessment was performed. The time allotted for the Basrah Children's Hospital project was approximately one hour; therefore, a complete review of all work completed was not possible.

Appendix B. Acronyms

BAO	Basrah Area Office
BCH	Basrah Children's Hospital
CERP	Commander's Emergency Response Program
DG	Director General
DoS	Department of State
GOI	Government of Iraq
GOS	Government of Spain
GRD	Gulf Region Division
GRS	Gulf Region South
HCI	Hospital Clinical Integrator
HOPE	Health Opportunities for People Everywhere
IBC	International Building Code
ICU	Intensive Care Unit
IMC	International Medical Corps
IRRF	Iraq Relief and Reconstruction Fund
JO	Job Order
kV	Kilovolt
m	Meter
m ²	Square Meter
MIDCON	MID Contracting (Bechtel's primary subcontractor for the project)
MOE	Ministry of Electricity
MOH	Ministry of Health
MOU	Memorandum of Understanding
MVA	Megavolt Amperes
O&M	Operations and Maintenance
PAC	Procurement Assistance Center
QA	Quality Assurance
QC	Quality Control
SIGIR	Special Inspector General for Iraq Reconstruction
SOW	Statement of Work
UHS	Universal Hospital Services
UNDP	United Nations Development Program
USACE	U.S. Army Corps of Engineers
USAID	U.S. Agency for International Development
WHO	World Health Organization
WWTP	Wastewater Treatment Plant

Appendix C. Contract Breakdown

Contract	Award Date	Estimated Completion Date	% complete
CCTV	4-Dec-07	15-Jul-09	95
Roads & Parking	9-Dec-07	30-Aug-09	52
Warehouse	5-Oct-08	1-Jul-09	39
Stone Cladding	8-Oct-08	1-Oct-09	77
Electrical Works	10-Dec-07	15-Jul-09	90
Three Bldgs & Wall	1-Dec-07	15-Aug-09	93
Irrigation/Landscaping	11-Dec-07	30-Aug-09	58
Gap Package	27-Aug-08	30-Aug-09	75
Oxygen Equipment	10-Aug-08	20-Aug-09	90
Autoclave Equipment	22-Aug-08	15-Sep-09	50
Furniture General	26-Nov-08	5-Sep-09	45
Furniture Domestic	26-Nov-08	5-Sep-09	45
Off Site Internet	11-Nov-08	TBD	90
IT Equipment	1-Dec-08	15-Apr-09	100
Warehouse Shelving	5-May-09	1-Aug-09	0
Accommodation Bldg	1-Jun-09	30-Nov-09	0
Off Site Telephone	26-May-09	1-Sep-09	0
Asset Management	1-Jun-09	TBD	0

Appendix D. MNC-I Comments on Draft Report

**SIGIR DRAFT REPORT – DATED 2 JULY 2009
SIGIR 08-160**

“Basrah Children's Hospital Basrah, Iraq”

GENERAL COMMENTS ON THE REPORT

1. (U) This was a GRD project which used \$600K in CERP funds to contract the external electrical lines routing for the Hospital. This report was reviewed by C8. This report has no recommendations made by SIGIR with this report. MNC-I C8 had no issues with this report.

APPROVED BY:
Peter C. Bayer
BG, USA
Chief of Staff, MNC-I

PREPARED BY:
Bryan Novak
SGM, USA
MNC-I IG, 241-8833

2. (U) GRD's comments are attached in TAB B.

APPROVED BY:
Michael R. Eyre
MG, USA
Commanding General, USACE

PREPARED BY:
Robert Donner
Civilian, US Army
USACE, (540) 665-5022

Appendix E. GRD Comments on Draft Report



REPLY TO
ATTENTION OF

DEPARTMENT OF THE ARMY
U.S. ARMY CORPS OF ENGINEERS
GULF REGION DIVISION
BAGHDAD, IRAQ
APO AE 09346

CEGRD-CG

16 July 2009

MEMORANDUM FOR Special Inspector General for Iraq Reconstruction, US Embassy Annex II, Room 1013, APO AE 09316

SUBJECT: SIGIR Draft Project Assessment Report – Basrah Children’s Hospital, Basrah, Iraq (PA-08-160)

1. The Gulf Region Division reviewed the subject draft report and generally agrees with the facts and figures as presented in the report. GRD provides additional comments for clarity in the enclosure.
2. Thank you for the opportunity to review the draft report and provide our written comments for incorporation in the final report.
3. If you have any questions, please contact Mr. Robert Donner at (540) 665-5022 or via email Robert.L.Donner@usace.army.mil.

Encl
as

Michael R. Eyre
MICHAEL R. EYRE
Major General, USA
Commanding

Appendix E. GRD Comments on Draft Report

**GULF REGION DIVISION
COMMAND REPLY**

to

**SIGIR Draft Project Assessment Report – Basrah Children’s Hospital
Basrah, Iraq
SIGIR Report Number 08-160
(Project Numbers PA-08- 160)**

The Gulf Region Division (GRD) reviewed the draft report and generally agrees with the facts and figures presented in the report. GRD provides the following additional comments for clarity and accuracy.

1. Draft Report, page iii, second paragraph and page 15, third paragraph. This project was originally projected to be completed by December 2005 for \$50 million; however, at the time of the SIGIR assessment, construction of the facility was still ongoing, and the total cost of the project had reached \$165.7 million (including construction, medical equipment, training, and consumables).

GRD Comment. The original \$50 million estimate is for construction and does not include medical equipment, training and consumables.

2. Draft Report, page vii an viii, Lessons Learned section. This reconstruction project yields several key lessons learned for other contingency reconstruction operations, which should be applied in the decision-making process for future reconstruction projects:

- Prior to construction, the U.S. government and contractors need to identify whether key utilities, such as water and power, are available. The lack of essential utilities can negatively affect both the ability of the contractor to construct the project and the ability of the ministry to properly operate the project after construction is completed.
- The U.S. government imposed unrealistic expectations on the contractor in terms of costs and schedules, which are not achieved.
- Ineffective program management and oversight can hamper a reconstruction project, leading to significantly increased costs and considerable schedule delays.
- Large reconstruction projects require detailed cost analysis to determine a realistic cost projection.

Enclosure

Appendix E. GRD Comments on Draft Report

- Funding individual reconstruction projects through multiple sources can lead to delays; specifically, the inaction of one project partner can directly affect the ability of the other partners to complete their work.
- The U.S. government should not assume that other countries will budget funding for projects in the same way the U.S. government does. The budget execution processes of other countries may differ significantly from that of the U.S. government; therefore, other countries may not have the funding in place to immediately open and operate a project.

GRD Comment. The listed lessons learned imply negative performance on the part of the U.S. Government; however, the report does not contain any negative findings or recommendations for corrective action with respect to contracts funded by the U.S. government.

3. Draft Report, page 15, third paragraph. This project was originally projected to be completed by December 2005 for \$50 million; yet currently, construction of the facility is still ongoing and the total cost of the project is \$165.7 million (including non-U.S. government funding).

GRD Comment. The original \$50 million estimate is for construction and does not include medical equipment, training and consumables.

Appendix F. Report Distribution

Department of State

Secretary of State

Senior Advisor to the Secretary and Coordinator for Iraq

Director of U.S. Foreign Assistance/Administrator, U.S. Agency for
International Development

Director, Office of Iraq Reconstruction

Assistant Secretary for Resource Management/Chief Financial Officer,
Bureau of Resource Management

U.S. Ambassador to Iraq

Director, Iraq Transition Assistance Office

Mission Director-Iraq, U.S. Agency for International Development

Inspector General, Department of State

Department of Defense

Secretary of Defense

Deputy Secretary of Defense

Under Secretary of Defense (Comptroller)/Chief Financial Officer

Deputy Chief Financial Officer

Deputy Comptroller (Program/Budget)

Deputy Assistant Secretary of Defense-Middle East, Office of Policy/International
Security Affairs

Inspector General, Department of Defense

Director, Defense Contract Audit Agency

Director, Defense Finance and Accounting Service

Director, Defense Contract Management Agency

Department of the Army

Assistant Secretary of the Army for Acquisition, Logistics, and Technology

Principal Deputy to the Assistant Secretary of the Army for Acquisition,
Logistics, and Technology

Deputy Assistant Secretary of the Army (Policy and Procurement)

Commanding General, Joint Contracting Command-Iraq/Afghanistan

Assistant Secretary of the Army for Financial Management and Comptroller

Chief of Engineers and Commander, U.S. Army Corps of Engineers

Commanding General, Gulf Region Division

Chief Financial Officer, U.S. Army Corps of Engineers

Auditor General of the Army

U.S. Central Command

Commanding General, Multi-National Force-Iraq

Commanding General, Multi-National Corps-Iraq

Commanding General, Multi-National Security Transition Command-Iraq

Commander, Joint Area Support Group-Central

Other Federal Government Organizations

Director, Office of Management and Budget
Comptroller General of the United States
Inspector General, Department of the Treasury
Inspector General, Department of Commerce
Inspector General, Department of Health and Human Services
Inspector General, U.S. Agency for International Development
President, Overseas Private Investment Corporation
President, U.S. Institute for Peace

Congressional Committees

U.S. Senate

Senate Committee on Appropriations
Senate Committee on Armed Services
Senate Committee on Foreign Relations
Senate Committee on Homeland Security and Governmental Affairs

U.S. House of Representatives

House Committee on Appropriations
House Committee on Armed Services
House Committee on Oversight and Government Reform
House Committee on Foreign Affairs

Appendix G. Project Assessment Team Members

The Office of the Assistant Inspector General for Inspections, Office of the Special Inspector General for Iraq Reconstruction, prepared this report. The principal staff members who contributed to the report were:

Kevin O'Connor

Angelina Johnston

Shawn Sassaman, P.E.

Todd Criswell, P.E.