

Final Rulemaking to Establish Greenhouse Gas Emissions Standards and Fuel Efficiency Standards for Medium- and Heavy-Duty Engines and Vehicles

Regulatory Impact Analysis

Final Rulemaking to Establish Greenhouse Gas Emissions Standards and Fuel Efficiency Standards for Medium- and Heavy-Duty Engines and Vehicles

Regulatory Impact Analysis

Office of Transportation and Air Quality
U.S. Environmental Protection Agency

and

National Highway Traffic Safety Administration
U.S. Department of Transportation

Heavy-Duty GHG and Fuel Efficiency Standards FRM: Table of Contents, Acronym List, and Executive Summary

TABLE OF CONTENTS

EXECUTIVE SUMMARY	ES-1
CHAPTER 1: INDUSTRY CHARACTERIZATION	
1.1 Introduction	1-1
1.2 Heavy-Duty Truck Categories	1-6
1.3 Heavy-Duty Truck Segments	1-9
1.4 Operations	1-12
1.5 Tire Manufacturers	1-24
1.6 Current U.S. and International GHG Voluntary Actions and Regulations	1-28
CHAPTER 2: TECHNOLOGIES, COST, AND EFFECTIVENESS	
2.1 Overview of Technologies	2-1
2.2 Overview of Technology Cost Methodology	2-3
2.3 Heavy-Duty Pickup Truck and Van (Class 2b and 3) Technologies and Costs	2-11
2.4 Heavy-Duty Engines	2-27
2.5 Class 7 and 8 Day Cabs and Sleeper Cabs	2-43
2.6 Class 2b-8 Vocational Vehicles	2-81
2.7 Air Conditioning	2-94
2.8 Other Fuel Consumption and GHG Reducing Strategies	2-97
2.9 Summary of Technology Costs Used in this Analysis	2-106
CHAPTER 3: TEST PROCEDURES	
3.1 Heavy-Duty Engine Test Procedure	3-1
3.2 Aerodynamic Assessment	3-4
3.3 Tire Rolling Resistance	3-36
3.4 Drive Cycle	3-37
3.5 Tare Weights and Payload	3-43
3.6 Heavy-Duty Chassis Test Procedure	3-46
3.7 Hybrid Powertrain Test Procedures	3-48
3.8 HD Pickup Truck and Van Chassis Test Procedure	3-59
3.8.2 LHD UDDS and HWFE Hybrid Testing	3-60
CHAPTER 4: VEHICLE SIMULATION MODEL	
4.1 Purpose and Scope	4-1
4.2 Model Code Description	4-2
4.3 Feasibility of Using a Model to Simulate Testing	4-5
4.4 EPA and NHTSA Vehicle Compliance Model	4-10
4.5 Application of Model for Certification	4-23

Regulatory Impact Analysis

CHAPTER: 5 EMISSIONS IMPACTS

5.1	Executive Summary	5-1
5.2	Introduction	5-2
5.3	Program Analysis and Modeling Methods	5-4
5.4	Greenhouse Gas Emission Impacts	5-13
5.5	Non-Greenhouse Gas Emission Impacts	5-13
5.6	Inventories Used for Air Quality Analyses	5-15

CHAPTER 6: RESULTS OF FINAL AND ALTERNATIVE STANDARDS

6.1	What Are the Alternatives that the Agencies Considered?	6-1
6.2	How Do These Alternatives Compare in Overall GHG Emissions Reductions and Fuel Efficiency and Cost?	6-14

CHAPTER 7: TRUCK COSTS AND COSTS PER TON OF GHG EMISSIONS REDUCED

7.1	Costs Associated with the Program	7-1
7.2	Cost per Ton of GHG Emissions Reduced	7-4
7.3	Impacts of Reduction in Fuel Consumption	7-6
7.4	Key Parameters Used in the Estimation of Costs and Fuel Savings	7-7

CHAPTER 8: HEALTH AND ENVIRONMENTAL IMPACTS

8.1	Health and Environmental Effects of Non-GHG Pollutants	8-1
8.2	Air Quality Impacts of Non-GHG Pollutants	8-33
8.3	Quantified and Monetized Non-GHG Health and Environmental Impacts	8-76
8.4	Changes in Atmospheric CO ₂ Concentrations, Global Mean Temperature, Sea Level Rise, and Ocean pH Associated with the Program's GHG Emissions Reductions	8-105

CHAPTER 9: ECONOMIC AND OTHER IMPACTS

9.1	Framework for Benefits and Costs	9-1
9.2	Conceptual Framework for Evaluating Impacts	9-1
9.3	Rebound Effect	9-9
9.4	Monetized CO ₂ Impacts	9-19
9.5	Additional Impacts	9-27
9.6	The Effect of Safety Standards and Voluntary Safety Improvements on Vehicle Weight	9-32
9.7	Petroleum, Energy and National Security impact	9-35
9.8	Summary of Benefits and Costs	9-44
9.9	Employment Impacts	9-54

CHAPTER 10.	SMALL BUSINESS FLEXIBILITY ANALYSIS	10-1
-------------	-------------------------------------	------

**Heavy-Duty GHG and Fuel Efficiency Standards FRM: Table of Contents, Acronym List,
and Executive Summary**

CHAPTER 11:	TRAILERS	
11.1	Overview	11-2
11.2	Why are the agencies considering the regulation of trailers?	11-6
11.3	What does the trailer industry look like?	11-6
11.4	What technologies are available to reduce fuel consumption and GHG emissions from trailers?	11-8
11.5	What approaches could the agencies consider for evaluating fuel efficiency and GHG emissions contributions from trailers?	11-11
11.6	Potential Approaches to Evaluate GHG Emissions and Fuel Consumption Reducing Technologies	11-12
11.7	What actions are already being taken to improve the efficiency of trailers?	11-13

List of Acronyms

µg	Microgram
µm	Micrometers
2002\$	U.S. Dollars in calendar year 2002
2009\$	U.S. Dollars in calendar year 2009
A/C	Air Conditioning
ABS	Antilock Brake Systems
AC	Alternating Current
ACES	Advanced Collaborative Emission Study
AEO	Annual Energy Outlook
ANL	Argonne National Laboratory
APU	Auxiliary Power Unit
AQ	Air Quality
AQCD	Air Quality Criteria Document
AR4	Fourth Assessment Report
ARB	California Air Resources Board
ASL	Aggressive Shift Logic
ASPEN	Assessment System for Population Exposure Nationwide
ATA	American Trucking Association
ATRI	Alliance for Transportation Research Institute
Avg	Average
BAC	Battery Air Conditioning
BenMAP	Benefits Mapping and Analysis Program
bhp	Brake Horsepower
bhp-hrs	Brake Horsepower Hours
BSFC	Brake Specific Fuel Consumption
BTS	Bureau of Transportation
BTU	British Thermal Unit
CAA	Clean Air Act
CAE	Computer Aided Engineering
CAFE	Corporate Average Fuel Economy
CARB	California Air Resources Board
CCP	Coupled Cam Phasing
Cd	Coefficient of Drag
CDC	Centers for Disease Control
CFD	Computational Fluid Dynamics
CFR	Code of Federal Regulations
CH ₄	Methane
CILCC	Combined International Local and Commuter Cycle
CITT	Chemical Industry Institute of Toxicology
CMAQ	Community Multiscale Air Quality
CO	Carbon Monoxide

Heavy-Duty GHG and Fuel Efficiency Standards FRM: Table of Contents, Acronym List, and Executive Summary

CO ₂	Carbon Dioxide
CO ₂ eq	CO ₂ Equivalent
COFC	Container-on-Flatcar
COI	Cost of Illness
COPD	Chronic Obstructive Pulmonary Disease
CoV	Coefficient of Variation
CRC	Coordinating Research Council
CRGNSA	Columbia River Gorge National Scenic Area
CRR	Rolling Resistance Coefficient
CSI	Cambridge Systematics Inc.
CSV	Comma-separated Values
CVD	Cardiovascular Disease
CVT	Continuously-Variable Transmission
D/UAUF	Downward and Upward Adjustment Factor
DCP	Dual Cam Phasing
DE	Diesel Exhaust
DEAC	Cylinder Deactivation
DEER	Diesel Engine-Efficiency and Emissions Research
DEF	Diesel Exhaust Fluid
DHHS	U.S. Department of Health and Human Services
DOC	Diesel Oxidation Catalyst
DOD	Department of Defense
DOE	Department of Energy
DOHC	Dual Overhead Camshaft Engines
DOT	Department of Transportation
DPF	Diesel Particulate Filter
DPM	Diesel Particulate Matter
DR	Discount Rate
DRIA	Draft Regulatory Impact Analysis
EC	European Commission
EC	Elemental Carbon
ECU	Electronic Control Unit
ED	Emergency Department
EGR	Exhaust Gas Recirculation
EHPS	Electrohydraulic Power Steering
EIA	Energy Information Administration (part of the U.S. Department of Energy)
EISA	Energy Independence and Security Act
EMS-HAP	Emissions Modeling System for Hazardous Air Pollution
EO	Executive Order
EPA	Environmental Protection Agency
EPS	Electric Power Steering
ERG	Eastern Research Group

Regulatory Impact Analysis

ESC	Electronic Stability Control
EV	Electric Vehicle
F	Frequency
FEL	Family Emission Limit
FET	Federal Excise Tax
FHWA	Federal Highway Administration
FIA	Forest Inventory and Analysis
FMCSA	Federal Motor Carrier Safety Administration
FOH	Fuel Operated Heater
FR	Federal Register
FTP	Federal Test Procedure
g	Gram
g/s	Gram-per-second
g/ton-mile	Grams emitted to move one ton (2000 pounds) of freight over one mile
gal	Gallon
gal/1000 ton-mile	Gallons of fuel used to move one ton of payload (2,000 pounds) over 1000 miles
GDP	Gross Domestic Product
GEM	Greenhouse gas Emissions Model
GEOS	Goddard Earth Observing System
GHG	Greenhouse Gases
GIFT	Geospatial Intermodal Freight Transportation
GREET	Greenhouse Gases, Regulated Emissions, and Energy Use in Transportation
GUI	Graphical User Interface
GVWR	Gross Vehicle Weight Rating
GWP	Global Warming Potential
HAD	Diesel Health Assessment Document
HC	Hydrocarbon
HD	Heavy-Duty
HDUDDS	Heavy Duty Urban Dynamometer Driving Cycle
HEI	Health Effects Institute
HES	Health Effects Subcommittee
HEV	Hybrid Electric Vehicle
HFC	Hydrofluorocarbon
HFET	Highway Fuel Economy Dynamometer Procedure
HHD	Heavy Heavy-Duty
hp	Horsepower
hrs	Hours
HSC	High Speed Cruise Duty Cycle
HTUF	Hybrid Truck User Forum
hz	Hertz
IARC	International Agency for Research on Cancer
IATC	Improved Automatic Transmission Control

Heavy-Duty GHG and Fuel Efficiency Standards FRM: Table of Contents, Acronym List, and Executive Summary

ICCT	International Council on Clean Transport
ICD	International Classification of Diseases
ICF	ICF International
ICM	Indirect Cost Multiplier
ICP	Intake Cam Phasing
IMPROVE	Interagency Monitoring of Protected Visual Environments
IPCC	Intergovernmental Panel on Climate Change
IRIS	Integrated Risk Information System
ISA	Integrated Science Assessment
JAMA	Journal of the American Medical Association
k	Thousand
kg	Kilogram
km	Kilometer
km/h	Kilometers per Hour
kW	Kilowatt
L	Liter
lb	Pound
LD	Light-Duty
LHD	Light Heavy-Duty
LSC	Low Speed Cruise Duty Cycle
LT	Light Trucks
LTCCS	Large Truck Crash Causation Study
m ²	Square Meters
m ³	Cubic Meters
MD	Medium-Duty
MDPV	Medium-Duty Passenger Vehicles
mg	Milligram
MHD	Medium Heavy-Duty
mi	mile
min	Minute
MM	Million
MMBD	Million Barrels per Day
MMT	Million Metric Tons
MOVES	Motor Vehicle Emissions Simulator
mpg	Miles per Gallon
mph	Miles per Hour
MSAT	Mobile Source Air Toxic
MY	Model Year
N ₂ O	Nitrous Oxide
NA	Not Applicable
NAAQS	National Ambient Air Quality Standards
NAICS	North American Industry Classification System

Regulatory Impact Analysis

NAS	National Academy of Sciences
NATA	National Air Toxic Assessment
NCAR	National Center for Atmospheric Research
NCI	National Cancer Institute
NCLAN	National Crop Loss Assessment Network
NEC	Net Energy Change Tolerance
NEI	National Emissions Inventory
NEMS	National Energy Modeling System
NEPA	National Environmental Policy Act
NESCCAF	Northeast States Center for a Clean Air Future
NESHAP	National Emissions Standards for Hazardous Air Pollutants
NHS	National Highway System
NHTSA	National Highway Traffic Safety Administration
NiMH	Nickel Metal-Hydride
NIOSH	National Institute of Occupational Safety and Health
Nm	Newton-meters
NMHC	Nonmethane Hydrocarbons
NMMAPS	National Morbidity, Mortality, and Air Pollution Study
NO	Nitrogen Oxide
NO ₂	Nitrogen Dioxide
NOAA	National Oceanic and Atmospheric Administration
NO _x	Oxides of Nitrogen
NPRM	Notice of Proposed Rulemaking
NPV	Net Present Value
NRC	National Research Council
NREL	National Renewable Energy Laboratory
NVH	Noise Vibration and Harshness
O&M	Operating and maintenance
O ₃	Ozone
OAQPS	Office of Air Quality Planning and Standards
OC	Organic Carbon
OE	Original Equipment
OEHHA	Office of Environmental Health Hazard Assessment
OEM	Original Equipment Manufacturer
OHV	Overhead Valve
OMB	Office of Management and Budget
OPEC	Organization of Petroleum Exporting Countries
ORD	EPA's Office of Research and Development
ORNL	Oak Ridge National Laboratory
OTAQ	Office of Transportation and Air Quality
Pa	Pascal
PAH	Polycyclic Aromatic Hydrocarbons

Heavy-Duty GHG and Fuel Efficiency Standards FRM: Table of Contents, Acronym List, and Executive Summary

PEMS	Portable Emissions Monitoring System
PGM	Platinum Group Metal
PHEV	Plug-in Hybrid Electric Vehicles
PM	Particulate Matter
PM ₁₀	Coarse Particulate Matter (diameter of 10 µm or less)
PM _{2.5}	Fine Particulate Matter (diameter of 2.5 µm or less)
POM	Polycyclic Organic Matter
Ppb	Parts per Billion
Ppm	Parts per Million
Psi	Pounds per Square Inch
PTO	Power Take Off
R&D	Research and Development
RBM	Resisting Bending Moment
RESS	Rechargeable Energy Storage System
RfC	Reference Concentration
RFS2	Renewable Fuel Standard 2
RIA	Regulatory Impact Analysis
RPE	Retail Price Equivalent
Rpm	Revolutions per Minute
S	Second
SAB	Science Advisory Board
SAB-HES	Science Advisory Board - Health Effects Subcommittee
SAE	Society of Automotive Engineers
SAR	Second Assessment Report
SBA	Small Business Administration
SBAR	Small Business Advocacy Review
SBREFA	Small Business Regulatory Enforcement Fairness Act
SCC	Social Cost of Carbon
SCR	Selective Catalyst Reduction
SER	Small Entity Representation
SGDI	Stoichiometric Gasoline Direct Injection
SI	Spark-Ignition
SIDI	Spark Ignition Direct Injection
SO ₂	Sulfur Dioxide
SOA	Secondary Organic Aerosol
SOC	State of Charge
SOHC	Single Overhead Cam
SO _x	Oxides of Sulfur
SPR	Strategic Petroleum Reserve
STB	Surface Transportation Board
Std.	Standard
SUV	Sport Utility Vehicle

Regulatory Impact Analysis

SVOC	Semi-Volatile Organic Compound
SwRI	Southwest Research Institute
TAR	Technical Assessment Report
THC	Total Hydrocarbon
TIAX	TIAX LLC
TOFC	Trailer-on-Flatcar
Ton-mile	One ton (2000 pounds) of payload over one mile
TRU	Trailer Refrigeration Unit
TSD	Technical Support Document
TSS	Thermal Storage
U/DAF	Upward and Downward Adjustment Factor
UCT	Urban Creep and Transient Duty Cycle
UFP	Ultra Fine Particles
USDA	United States Department of Agriculture
UV	Ultraviolet
UV-b	Ultraviolet-b
VHHD	Vocational Heavy Heavy-Duty
VIUS	Vehicle Inventory Use Survey
VLHD	Vocational Light Heavy-Duty
VMHD	Vocational Medium Heavy-Duty
VMT	Vehicle Miles Traveled
VOC	Volatile Organic Compound
VSL	Vehicle Speed Limiter
VVT	Variable Valve Timing
WTP	Willingness-to-Pay
WTVC	World Wide Transient Vehicle Cycle
WVU	West Virginia University

Executive Summary

The Environmental Protection Agency (EPA) and the National Highway Traffic Safety Administration (NHTSA), on behalf of the Department of Transportation, are each adopting rules to establish a comprehensive Heavy-Duty National Program that would reduce greenhouse gas emissions and increase fuel efficiency for on-road heavy-duty vehicles, responding to the President’s directive on May 21, 2010, to take coordinated steps to produce a new generation of clean vehicles. NHTSA’s fuel consumption standards and EPA’s carbon dioxide (CO₂) emissions standards would be tailored to each of three regulatory categories of heavy-duty vehicles: (1) Combination Tractors; (2) Heavy-duty Pickup Trucks and Vans; and (3) Vocational Vehicles, as well as gasoline and diesel heavy-duty engines. EPA’s hydrofluorocarbon emissions standards will apply to air conditioning systems in tractors, pickup trucks, and vans, and EPA’s nitrous oxide (N₂O) and methane (CH₄) emissions standards will apply to all heavy-duty engines, pickup trucks, and vans.

Table 1 presents the rule-related fuel savings, costs, benefits and net benefits in both present value terms and in annualized terms. In both cases, the discounted values are based on an underlying time varying stream of values that extend into the future (2012 through 2050). The distribution of each monetized economic impact over time can be viewed in the RIA Chapters that follow this summary.

Present values represent the *total* amount that a stream of monetized fuel savings/costs/benefits/net benefits that occur over time are worth now (in year 2009 dollar terms for this analysis), accounting for the time value of money by discounting future values using either a 3 or 7 percent discount rate, per OMB Circular A-4 guidance. An annualized value takes the present value and converts it into a *constant stream of annual values* through a given time period (2012 through 2050 in this analysis) and thus averages (in present value terms) the annual values. The present value of the constant stream of annualized values equals the present value of the underlying time varying stream of values. Comparing annualized costs to annualized benefits is equivalent to comparing the present values of costs and benefits, except that annualized values are on a per-year basis.

It is important to note that annualized values cannot simply be summed over time to reflect total fuel savings/costs/benefits/net benefits; they must be discounted and summed. Additionally, the annualized value can vary substantially from the time varying stream of fuel savings/cost/benefit/net benefit values that occur in any given year.

Table 1 Estimated Lifetime Discounted Fuel Savings, Costs, Benefits, and Net Benefits for 2014-2018 Model Year HD Vehicles assuming the Model Average, 3% Discount Rate SCC Value^{ab} (billions, 2009 dollars)

Lifetime Present Value ^c – 3% Discount Rate	
Program Costs	\$8.1
Fuel Savings	\$50
Benefits	\$7.3

Regulatory Impact Analysis

Net Benefits	\$49
Annualized Value ^d – 3% Discount Rate	
Annualized costs	\$0.4
Annualized fuel savings	\$2.2
Annualized benefits	\$0.4
Net benefits	\$2.2
Lifetime Present Value ^c - 7% Discount Rate	
Program Costs	\$8.1
Fuel Savings	\$34
Benefits	\$6.7
Net Benefits	\$33
Annualized Value ^d – 7% Discount Rate	
Annualized costs	\$0.6
Annualized fuel savings	\$2.6
Annualized benefits	\$0.5
Net benefits	\$2.5

Notes:

^a The agencies estimated the benefits associated with four different values of a one ton CO₂ reduction (model average at 2.5% discount rate, 3%, and 5%; 95th percentile at 3%), which each increase over time. For the purposes of this overview presentation of estimated costs and benefits, however, we are showing the benefits associated with the marginal value deemed to be central by the interagency working group on this topic: the model average at 3% discount rate, in 2009 dollars. Chapter 9.3 provides a complete list of values for the 4 estimates.

^b Note that net present value of reduced GHG emissions is calculated differently than other benefits. The same discount rate used to discount the value of damages from future emissions (SCC at 5, 3, and 2.5 percent) is used to calculate net present value of SCC for internal consistency. Refer to Section Chapter 9.3 for more detail.

^c Present value is the total, aggregated amount that a series of monetized costs or benefits that occur over time is worth now (in year 2009 dollar terms), discounting future values to the present.

^dThe annualized value is the constant annual value through a given time period (2012 through 2050 in this analysis) whose summed present value equals the present value from which it was derived.

This Regulatory Impact Analysis (RIA) provides detailed supporting documentation to the EPA and NHTSA joint program under each of their respective statutory authorities. Because there are slightly different requirements and flexibilities in the two authorizing statutes, this RIA provides documentation for the primary joint provisions as well as for provisions specific to each agency.

This RIA is generally organized to provide overall background information, methodologies, and data inputs, followed by results of the various technical and economic analyses. A summary of each chapter of the RIA follows.

Chapter 1: Industry Characterization. In order to assess the impacts of greenhouse gas (GHG) and fuel efficiency regulations upon the affected industries, it is important to understand the nature of the industries impacted by the regulations. The heavy-duty vehicle industries include the manufacturers of Class 2b through Class 8 trucks, engines, and some equipment.

Heavy-Duty GHG and Fuel Efficiency Standards FRM: Table of Contents, Acronym List, and Executive Summary

This chapter provides market information for each of these affected industries, as well as the variety of ownership patterns, for background purposes. Vehicles in these classes range from over 8,500 pounds (lbs) gross vehicle weight rating (GVWR) to upwards of 80,000 lbs and can be used in applications ranging from ambulances to vehicles that transport the fuel that powers them. The heavy-duty segment is very diverse both in terms of its type of vehicles and vehicle usage patterns. Unlike the light-duty segment whose primary mission tends to be transporting passengers for personal travel, the heavy duty segment has many different missions. Some heavy-duty pickup trucks may be used for personal transportation to and from work with an average annual mileage of 15,000 miles, while Class 7 and 8 combination tractors are primarily used for freight transportation, can carry up to 50,000 pounds of payload, and can travel more than 150,000 miles per year.

Chapter 2: Technology Packages, Cost and Effectiveness. This chapter presents details of the vehicle and engine technology packages for reducing greenhouse gas emissions and fuel consumption. These packages represent potential ways that the industry could meet the CO₂ and fuel consumption stringency levels, and they provide the basis for the technology costs and effectiveness analyses.

Chapter 3: Test Procedures. Laboratory procedures to physically test engines, vehicles, and components are a crucial aspect of the heavy-duty vehicle GHG and fuel consumption program. The rulemaking will establish several new test procedures for both engine and vehicle compliance. This chapter describes the development process for the test procedures being adopted, including methodologies for assessing engine emission performance, the effects of aerodynamics and tire rolling resistance, as well as procedures for chassis dynamometer testing and their associated drive cycles.

Chapter 4: Vehicle Simulation Model. An important aspect of a regulatory program is its ability to accurately estimate the potential environmental benefits of heavy-duty truck technologies through testing and analysis. Most large truck manufacturers employ various computer simulation methods to estimate truck efficiency for purposes of developing and refining their products. Each method has advantages and disadvantages. This section will focus on the use of a type truck simulation modeling that the agencies have developed specifically for assessing tailpipe GHG emissions and fuel consumption for purposes of this rulemaking. The agencies are adopting this newly-developed simulation model -- the "Greenhouse gas Emissions Model (GEM)" -- as the primary tool to certify vocational and combination tractor heavy-duty vehicles (Class 2b through Class 8 heavy-duty vehicles that are not heavy-duty pickups or vans) and discuss the model in this chapter.

Chapter 5: Emissions Impacts. This program estimates anticipated impacts from the CO₂ emission and fuel efficiency standards. The agencies quantify emissions from the GHGs carbon dioxide (CO₂), methane (CH₄), nitrous oxide (N₂O) and hydrofluorocarbons (HFCs). In addition to reducing the emissions of greenhouse gases and fuel consumption, this program would also influence the emissions of "criteria" air pollutants, including carbon monoxide (CO), fine particulate matter (PM_{2.5}) and sulfur dioxide (SO_x) and the ozone precursors hydrocarbons (VOC) and oxides of nitrogen (NO_x); and several air toxics (including benzene, 1,3-butadiene, formaldehyde, acetaldehyde, and acrolein), as described further in Chapter 5.

Regulatory Impact Analysis

The agencies used EPA's Motor Vehicle Emission Simulator (MOVES2010a) to estimate downstream (tailpipe) emission impacts, and a spreadsheet model based on emission factors the "GREET" model to estimate upstream (fuel production and distribution) emission changes resulting from the decreased fuel. Based on these analyses, the agencies estimate that this program would lead to 77 million metric tons (MMT) of CO₂ equivalent (CO₂EQ) of annual GHG reduction and 6.0 billion gallons of fuel savings in the year 2030, as discussed in more detail in Chapter 5.

Chapter 6: Results of Preferred and Alternative Standards. The heavy-duty truck segment is very complex. The sector consists of a diverse group of impacted parties, including engine manufacturers, chassis manufacturers, truck manufacturers, trailer manufacturers, truck fleet owners and the public. The agencies have largely designed this program to maximize the environmental and fuel savings benefits, taking into account the unique and varied nature of the regulated industries. In developing this program, we considered a number of alternatives that could have resulted in fewer or potentially greater GHG and fuel consumption reductions than the program we are adopting. Chapter 6 section summarizes the alternatives we considered.

Chapter 7: Truck Costs and Costs per Ton of GHG. In this chapter, the agencies present our estimate of the costs associated with the final program. The presentation summarizes the costs associated with new technology expected to be added to meet the GHG and fuel consumption standards, including hardware costs to comply with the air conditioning (A/C) leakage program. The analysis discussed in Chapter 7 provides our best estimates of incremental costs on a per truck basis and on an annual total basis.

Chapter 8: Environmental and Health Impacts. This chapter discusses the health effects associated with non-GHG pollutants, specifically: particulate matter, ozone, nitrogen oxides (NO_x), sulfur oxides (SO_x), carbon monoxide and air toxics. These pollutants will not be directly regulated by the standards, but the standards will affect emissions of these pollutants and precursors. Reductions in these pollutants are the co-benefits of the final rulemaking (that is, benefits in addition to the benefits of reduced GHGs). This chapter also discusses GHG-related impacts, such as changes in atmospheric CO₂ concentrations, global mean temperature, sea level rise, and ocean pH associated with the program's GHG emissions reductions.

Chapter 9: Economic and Social Impacts. This chapter provides a description of the net benefits of the HD National Program. To reach these conclusions, the chapter discusses each of the following aspects of the analyses of benefits:

Rebound Effect: The VMT rebound effect refers to the fraction of fuel savings expected to result from an increase in fuel efficiency that is offset by additional vehicle use.

Energy Security Impacts: A reduction of U.S. petroleum imports reduces both financial and strategic risks associated with a potential disruption in supply or a spike in cost of a particular energy source. This reduction in risk is a measure of improved U.S. energy security.

Monetized CO₂ Impacts: The agencies estimate the monetized benefits of GHG reductions by assigning a dollar value to reductions in CO₂ emissions using recent estimates of

Heavy-Duty GHG and Fuel Efficiency Standards FRM: Table of Contents, Acronym List, and Executive Summary

the social cost of carbon (SCC). The SCC is an estimate of the monetized damages associated with an incremental increase in carbon emissions in a given year.

Other Impacts: There are other impacts associated with the GHG emissions and fuel efficiency standards. Lower fuel consumption would, presumably, result in fewer trips to the filling station to refuel and, thus, time saved. The increase in vehicle-miles driven due to a positive rebound effect may also increase the societal costs associated with traffic congestion, motor vehicle crashes, and noise. The agencies also discuss the impacts of safety standards and voluntary safety improvements on vehicle weight.

Chapter 9 also presents a summary of the total costs, total benefits, and net benefits expected under the program.

Chapter 10: Small Business Flexibility Analysis. This chapter describes the agencies' analysis of the small business impacts due to the joint program.

Chapter 11: Trailers. This chapter describes the agencies' evaluation of trailers.

Chapter 1: Industry Characterization

1.1 Introduction

1.1.1 Overview

In order to assess the impacts of greenhouse gases (GHG) and fuel efficiency regulations upon the affected industries, it is important to understand the nature of the industries impacted by the regulations. These industries include the manufacturers of Class 2b through Class 8 trucks, engines, and some equipment. This chapter provides market information for each of these affected industries for background purposes. Vehicles in these classes range from over 8,500 pounds (lb) gross vehicle weight rating (GVWR) to upwards of 80,000 lb and can be used in applications ranging from ambulances to vehicles that transport the fuel that powers them. Figure 1-1 shows the difference in vehicle classes in terms of GVWR and the different applications found in these classes.

Figure 1-1 Description and Weight Ratings of Vehicle Classes

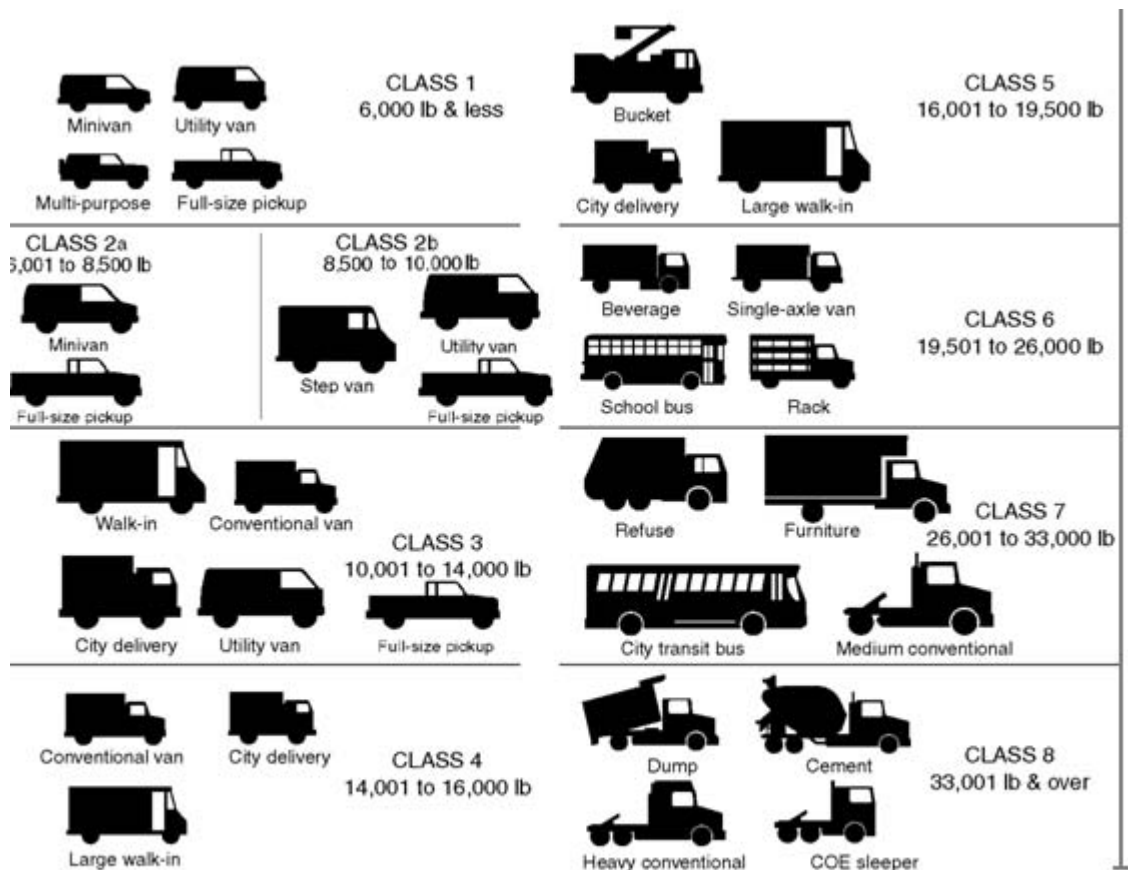

Source: Commercial Carrier Journal <http://www.ccmagazine.com>

Regulatory Impact Analysis

“Heavy-duty trucks” in this rulemaking are generally defined as on-highway vehicles with a GVWR greater than 8,500 lb and which are not Medium-Duty Passenger Vehicles (MDPV). MDPV are vehicles with a GVWR less than 10,000 lb which meet the criteria outlined in 40 C.F.R. §86.1803-01. This grouping typically includes large sport utility vehicles, small pickup trucks, and mini-vans, and these vehicles are regulated under the light-duty vehicle standards for GHG emissions and fuel economy established by EPA and NHTSA for model years 2012-2016 (75 Fed. Reg. 25323, May 7, 2010).

The heavy-duty segment is very diverse both in terms of types of vehicles and vehicle usage patterns. Unlike the light-duty segment whose primary mission tends to focus on transporting passengers for personal travel, the heavy duty segment has many different missions. Some heavy-duty pickup trucks may be primarily used for personal transportation to and from work with an average annual accumulated mileage of 15,000 miles. Class 7 and 8 combination tractors are primarily used for freight transportation, can carry up to 50,000 lb of payload, and can travel more than 150,000 miles per year. For the purposes of this chapter which describes the industry characterization, the agencies have separated the heavy-duty segment as follows: Class 2b and 3 pickup trucks and vans (also referred to as HD pickup trucks and vans), Class 2b through 8 vocational vehicles, and Class 7 and 8 combination tractors. The actual standards established by the agencies do not include transit buses as a separate regulatory category, but instead group them with the Class 2b-8 vocational vehicles.

1.1.2 Freight Moved by Heavy-Duty Trucks

In 2007, heavy-duty trucks carried 71 percent of all freight moved in the U.S. by tonnage and 87 percent by value in the U.S., and are expected to move freight at an even greater rate in the future.¹ According to the Federal Highway Administration (FHWA) of the U.S. Department of Transportation (DOT), the U.S. transportation system moved, on average, an estimated 59 million tons of goods worth an estimated \$55 billion (in U.S. \$2008) per day in 2008, or over 21 billion tons of freight worth more than \$20 trillion in the year 2008.² Of this, heavy-duty trucks moved over 13 billion tons of freight worth an estimated \$13 trillion in 2008, or an average of nearly 36 million tons of freight worth \$37 billion a day. The FHWA’s 2009 Freight Analysis Framework estimates that this tonnage will increase nearly 73 percent by 2035, and that the value of the freight moved is increasing faster than the tons transported. Figure 1-2 shows the total tons of freight moved by each mode of freight transportation in 2002, 2008 and projections for 2035.³

Figure 1-2 Total Weight of Shipments by Transportation Mode

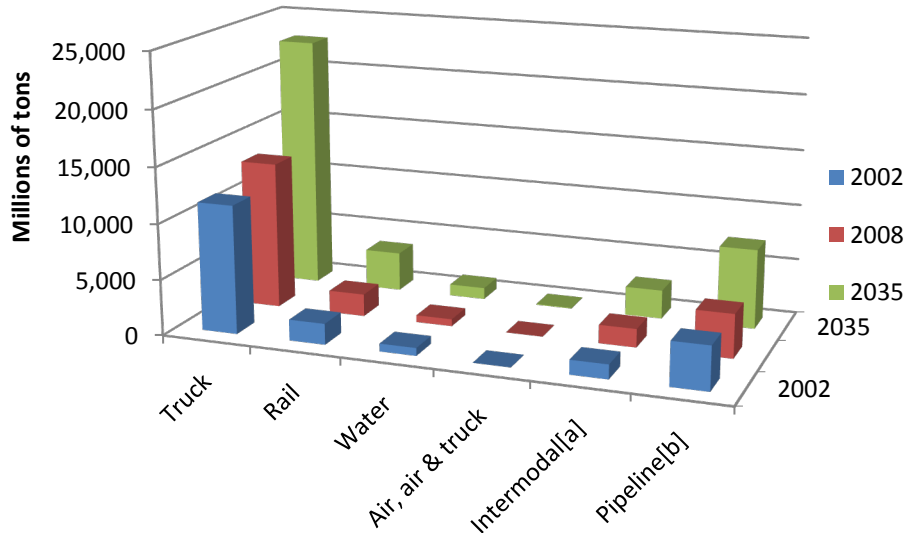

Source: U.S. DOT, Federal Highway Administration, "Freight Facts and Figures 2009."

Notes:

[a] Intermodal includes U.S. Postal Service and courier shipments and all intermodal combinations, except air and truck. Intermodal also includes oceangoing exports and imports that move between ports and interior domestic locations by modes other than water.

[b] Pipeline also includes unknown shipments as data on region-to-region flows by pipeline are statistically uncertain.

1.1.3 Greenhouse Gas Emissions from Heavy-Duty Vehicles

The importance of this rulemaking is highlighted by the fact that heavy-duty trucks are the largest source of GHG emissions in the transportation sector after light-duty vehicles. This sector represents approximately 22 percent of all transportation related GHG emissions as shown in Figure 1-3.⁴ Heavy-duty trucks are also a fast-growing source of GHG emissions; total GHG emissions from this sector increased over 72 percent from 1990-2008 while GHG emissions from passenger cars grew approximately 20 percent over the same period.⁴

Figure 1-3 Transportation Related Greenhouse Gas Emissions (Tg CO₂eq) in 2008

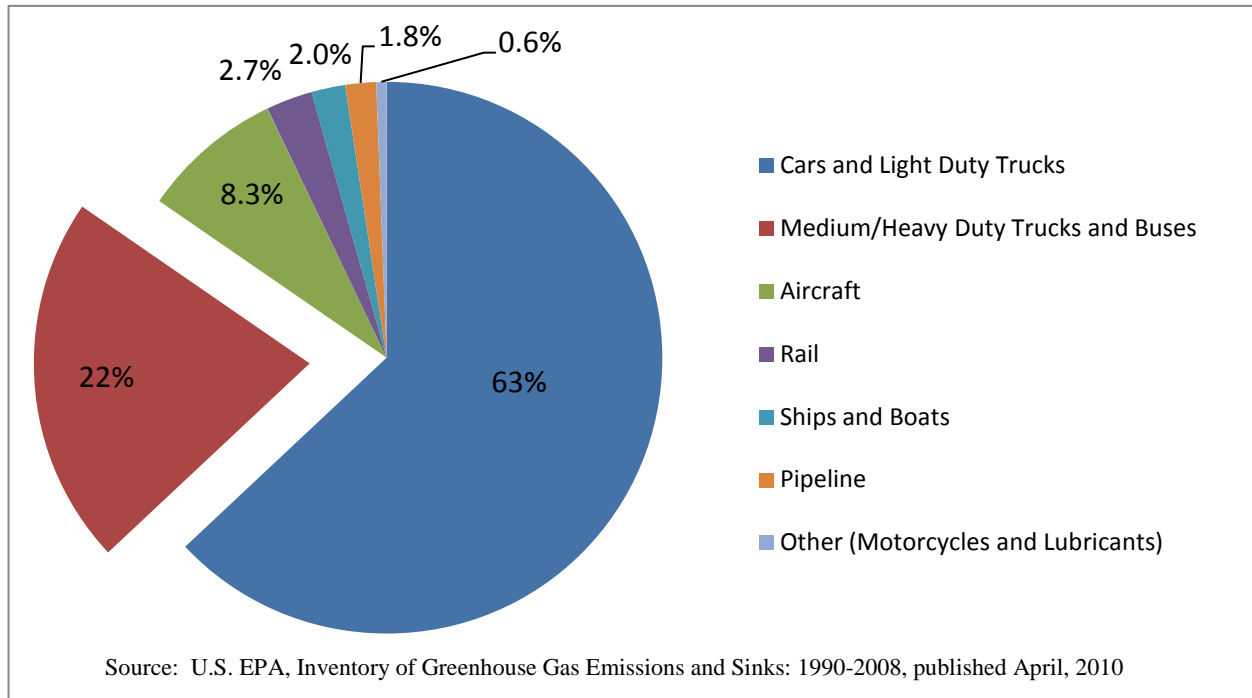

1.1.4 Fuel Efficiency of Heavy-Duty Vehicles

While there is a corporate average fuel economy (CAFE) program for light-duty trucks and vehicles, the nature of the commercial truck market can present complications to such a corporate average structure, in particular due to the production process, diversity of products, and usage patterns.⁵ For example, in the light-duty market manufacturers build complete vehicles, and are therefore easily made responsible for compliance with applicable fuel economy standards, because that manufacturer has control over every part of the vehicle as it is being produced. In the heavy-duty truck market, there may be separate chassis, engine, body and equipment manufacturers that contribute to the build process of a single truck, making it much harder to identify a similarly responsible party as in the light-duty world. In addition, there are no companies that produce both trucks and trailers, and a given tractor may pull hundreds of different trailer types over the course of its life, so it is difficult to determine whether or how to hold a truck manufacturer (if one can be identified) responsible for the truck's lifetime fuel efficiency which depends so heavily on what trailers it pulls. Further, fuel efficiency is highly dependent on the configuration of the truck itself, depending, for example, on the type of body or box, the engine, the axle/gear ratios, the cab, any other equipment installed on the vehicle; and on whether a truck carries cargo or has a specialized function (e.g. a bucket truck). Due to the varying needs of the industry, many of these trucks are largely or even entirely custom-built, resulting in literally thousands of different truck configurations. And finally, usage patterns and duty cycles also greatly affect

Heavy-Duty GHG and Fuel Efficiency Standards FRM: Industry Characterization

fuel efficiency, such as how trucks are loaded (“cubed out”^A or “weighed out”^B) and how they are driven (delivery trucks travel at lower speeds and make more frequent stops compared to a line-haul combination tractor). The potential to reduce fuel consumption, therefore, is also highly dependent on the truck configuration and usage.

The agencies recognize that while historic fuel efficiency and GHG emissions on a mile per gallon basis from heavy-duty trucks has been largely flat for more than 30 years, we cannot conclude with certainty that future improvements absent regulation would not occur.^C Programs like EPA’s SmartWay program are not only helping the industry improve logistics and operations, but are also helping to encourage greater use of truck efficiency technologies. Looking at the total fuel consumed, total miles traveled, and total tons shipped in the U.S. or the average payload specific fuel consumption for the entire heavy-duty fleet from 1975 through 2005, the amount of fuel required to move a given amount of freight a given distance has been reduced by more than half as a result of improvements in technology, as shown in Figure 1-4.5:

Figure 1-4 U.S. Average Payload-Specific Fuel Consumption of the Heavy-Duty Fleet

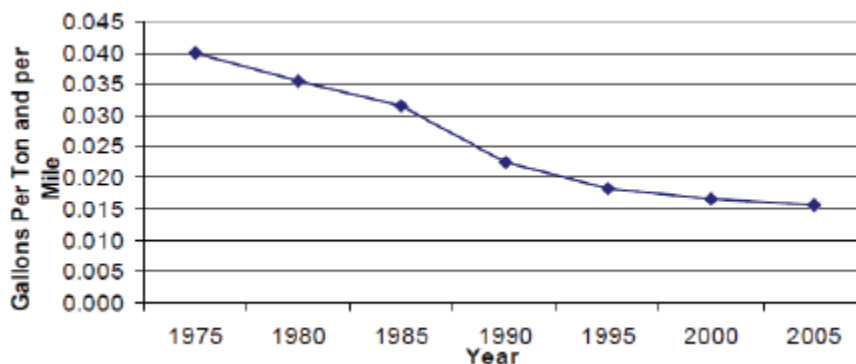

Source: NAS, Technologies and Approaches to Reducing Fuel Consumption of Medium- and Heavy-Duty Vehicles available here: http://www.nap.edu/openbook.php?record_id=12845&page=R1

Currently, manufacturers of vehicles with a GVWR of over 8,500 lb are not required to test and report fuel economy values because they have not been regulated under the CAFE program for light-duty vehicles, however, fuel economy ranges as of 2007 by vehicle class are presented in a study completed by the NAS Committee.^{5,D} The data reported in this study by vehicle class is presented below in Table 1-1, along with an example vehicle in production for that class. As one would expect, the larger the size of the vehicles in the truck class, the lower

^A A “cubed out” vehicle is filled to its volume capacity before it reaches its weight limit.

^B A “weighed out” vehicle reaches its weight capacity before the volume of the vehicle is filled.

^C Over the last 30 years the average annual improvement in fuel economy has been 0.09%. See U. S. Department of Transportation, Federal Highway Administration, Highway Statistics 2008, Washington, DC, 2009, Table VM1 averaging annual performance for the years from 1979-2008.

^D As noted above, MDPVs will be regulated under the light-duty CAFE standards beginning with MY 2011, which will necessarily entail testing and reporting of their fuel economy for compliance purposes.

Regulatory Impact Analysis

the fuel economy they achieve. For example, as shown in Table 1-1, a typical mile per gallon (mpg) estimate for a Class 2b vehicle is 10-15 mpg, while a typical Class 8 combination tractor is estimated to get 4-7.5 mpg.

Table 1-1 Estimated Fuel Economy by Truck Class

CLASS	EXAMPLE PRODUCTION VEHICLE	GVWR	TYPICAL MPG RANGE IN 2007	TYPICAL TON-MPG	ANNUAL FUEL CONSUMPTION RANGE (THOUSANDS OF GALLONS)
2b	Dodge Ram 2500 Pickup Truck	8,501-10,000	10-15	26	1.5-2.7
3	Chevrolet Silverado 3500 Pickup Truck	10,001-14,000	8-13	30	2.5-3.8
4	Ford F-450	14,001-16,000	7-12	42	2.9-5.0
5	Kenworth T170	16,001-19,500	6-12	39	3.3-5.0
6	Peterbilt Model 330	19,501-26,000	5-12	49	5.0-7.0
7	Kenworth T370	26,001-33,000	4-8	55	6.0-8.0
8 Combination Tractors	International Lone Star	33,001-80,000	4-7.5	155	19 - 27
8 Other	Mack Granite GU814	33,001-80,000	2.5-6	115	10 - 13

1.2 Heavy-Duty Truck Categories

This program addresses heavy-duty vehicles that fall into the following three regulatory categories established by the agencies: HD pickups and vans (typically Class 2b and 3), Vocational vehicles (typically Class 2b-8), and line-haul tractors (typically Class 7 and 8), and also addresses heavy-duty engines.^E Class 2b and 3 pickups and vans include heavy-duty work truck-type pickups and related van-type vehicles, and may be used for a variety of commercial purposes, including as ambulances, shuttle buses, etc. The U.S. Energy Information Administration (EIA) estimates that Class 2b vehicles achieved approximately 14.5 – 15.6 mpg in 2010.⁶ Class 2b-8 vocational vehicles encompass a wide range of heavy-duty vehicles such as delivery trucks, school buses, etc. Achieved fuel economy estimates for Class 3-6 vehicles were 7.9 mpg gasoline equivalent in 2010.⁸ Class 8 combinations tractors operate as either short-haul or long-haul trucks. Combination tractors are designed either with sleeping quarters (sleeper cab) or no sleeping quarters (day cab). Generally, day cab tractors are used to haul trailers over shorter distances, typically into metropolitan areas. Sleeper cab tractors generally haul trailers longer distances between cities and states with trips well over 1,000 miles in length. The EIA estimates that in 2010, Class 8 freight hauling trucks achieved approximately 6.1 mpg.⁶

^E For purposes of this document, the term “heavy-duty” or “HD” is used to apply to all highway vehicles and engines that are not within the range of light-duty vehicles, light-duty trucks, and medium-duty passenger vehicles (MDPV) covered by the GHG and Corporate Average Fuel Economy (CAFE) standards issued for model years (MY) 2012-2016. Unless specified otherwise, the heavy-duty category incorporates all vehicles rated at a gross vehicle weight of 8,500 pounds, and the engines that power them, except for MDPVs.

Heavy-Duty GHG and Fuel Efficiency Standards FRM: Industry Characterization

Figure 1-5 below shows the relative contributions of GHG emissions from the different vehicle categories in 2005. Sleeper cab tractors contributed the most GHG emissions of these categories at about 39 percent of the total heavy-duty CO₂ emissions, as shown.

Figure 1-5 CO₂ Emissions from Heavy-Duty Truck Category in 2005⁷

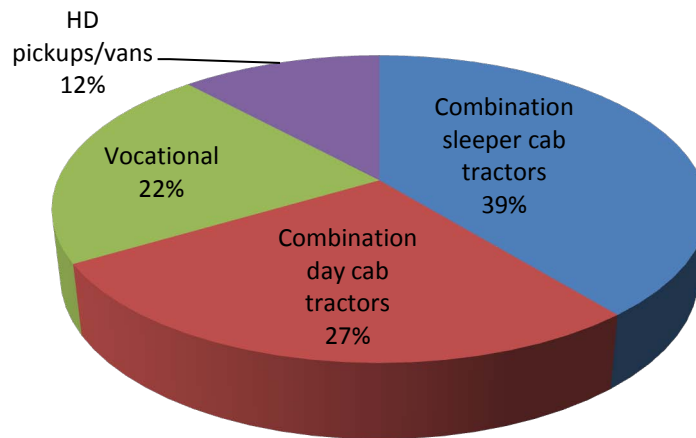

1.2.1 Heavy-Duty Vehicle Sales

Although not first in terms of GHG emissions, Class 2b and 3 pickup trucks and vans are first in terms of sales volumes, with sales of over 1.3 million units in 2005, or nearly 66 percent of the heavy-duty market. Sales of Class 2b-8 vocational vehicles are the second most numerous, selling over one-half million units in 2005, or nearly 25 percent of the heavy-duty market. Since 2005, sales of all heavy-duty trucks have decreased as the economy contracted, and EPA's MOVES model, using sales growth from the 2011 Annual Energy Outlook for combination tractors and vocational vehicles along with CSM Worldwide forecasts for HD pickup trucks and vans, reflects a slow recovery in sales. Figure 1-6 and Figure 1-7 show the sales volumes used in MOVES for 2005 and projected sales for 2014 respectively, reflecting the market slowdown and recovery, while Table 1-2 shows sales projections by market segment for 2014-2018.⁶

Table 1-2 Sales Projection by Market Segment 2014-2018

SALES ESTIMATES	2B/3 PICKUPS/VANS	VOCATIONAL VEHICLES	COMBINATION TRACTORS	TOTAL
2014	784,780	563,004	179,087	1,526,871
2015	729,845	529,533	157,103	1,416,481
2016	712,328	508,856	144,533	1,365,717
2017	708,054	511,068	148,286	1,367,408
2018	716,549	531,001	160,979	1,408,529

Figure 1-6 2005 Heavy-Duty Truck Sales by Category

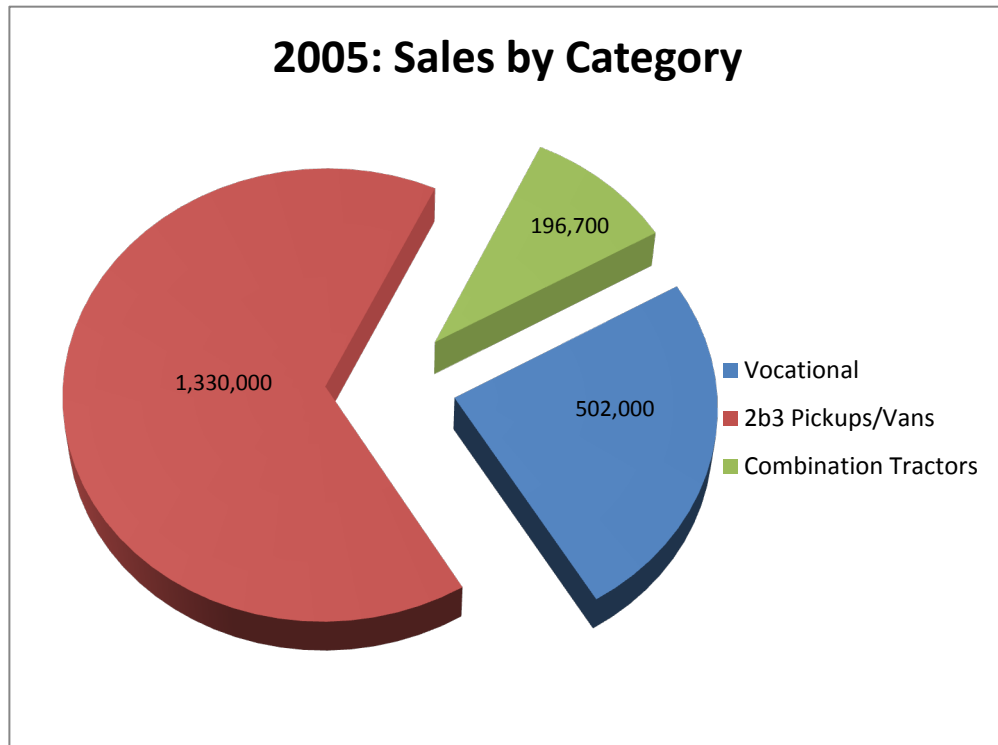
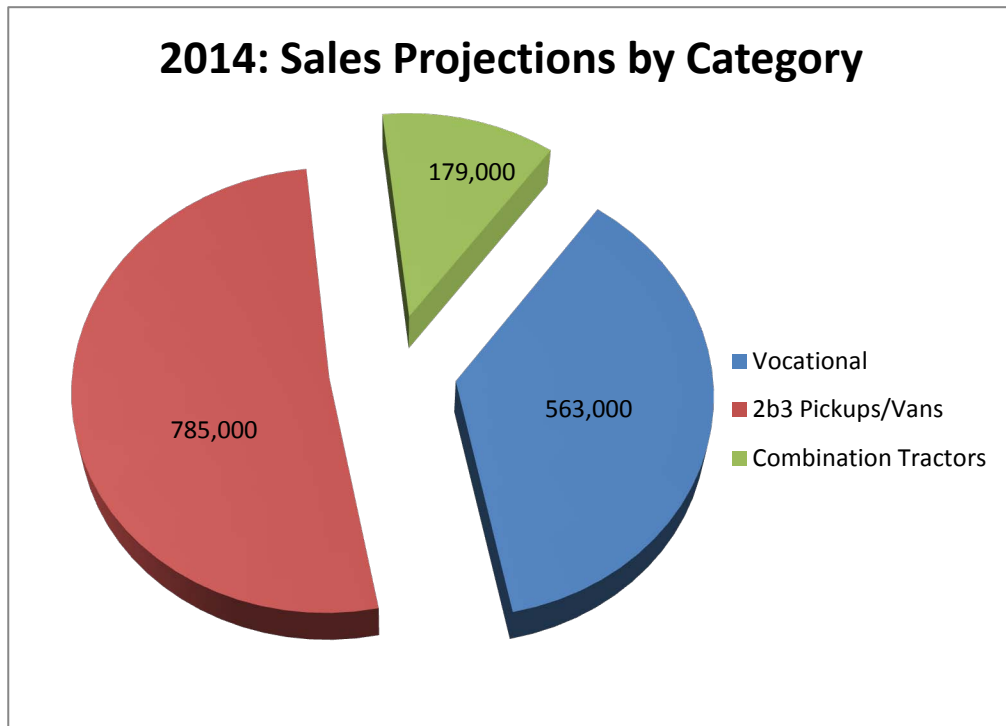

Figure 1-7 Projected Truck Sales for 2014 by Category



1.3 Heavy-Duty Truck Segments

1.3.1 Heavy-Duty Pickup Trucks and Vans

Class 2b and 3 pickup trucks and vans rank highest in terms of sales volumes, but together make up the third largest sector contributing to the heavy-duty truck GHG emissions (including Class 2b through Class 8). There are number of reasons to explain this difference, but mainly it is due to vehicle usage patterns and engine size. Class 2b and 3 consists of pickup trucks and vans with a GVWR between 8,500 and 14,000 pounds. The largest Class 2b and 3 truck manufacturers are GM, Ford, and Chrysler, with Isuzu, Daimler, and Mitsubishi FUSO; Nissan also offers vehicles in this market segment. Figure 1-8 shows two examples of this category, a GM Chevrolet Express G3500 and a Dodge Ram 3500HD.

Figure 1-8 Examples of Class 2b and 3 Pickup Trucks and Vans



Source: <http://www.truckpaper.com>



Source: <http://www.autofans.us/images/>

Class 2b and 3 vehicles are sold either as complete or incomplete vehicles. A ‘complete vehicle’ can be a chassis-cab (engine, chassis, wheels, and cab) or a rolling-chassis (engine, chassis and wheels), while an ‘incomplete-chassis’ could be sold as an engine and chassis only, without wheels. The technologies that can be used to reduce fuel consumption and GHG emissions from this segment are very similar to the ones used for lighter pickup trucks and vans (Class 2a), which are subject to the GHG and fuel economy standards for light-duty vehicles. These technologies include, but are not limited to, engine improvements such as friction reduction, cylinder deactivation, cam phasing, and gasoline direct injection; aerodynamic improvements; low rolling resistance tires; and transmission improvements. The Class 2b and 3 gasoline pickup trucks and vans are currently certified with chassis dynamometer testing. Class 2b and 3 diesel pickup trucks and vans have an option to certify using the chassis dynamometer test procedure. As an alternative, some engines used in 2b and 3 diesel trucks are certified as engines on an engine dynamometer. The reason for this is that some manufacturers of complete vehicles and incomplete vehicles also sell the engines used in the vehicles. These engines are certified on an engine dynamometer. Given the structure of this market, the agencies have tried to provide manufacturers with some flexibility in how they choose to certify.

Regulatory Impact Analysis

1.3.2 Vocational Vehicles

This market segment includes a wide range of Class 2b-8 heavy-duty vehicles ranging from 8,501 lb to greater than 33,000 lb GVWR. In 2005, sales of these vehicles were the second most numerous in the heavy-duty truck market, with over 500,000 units sold, making up nearly one-quarter of all heavy-duty truck sales. A majority of these vehicles are powered by diesel engines; examples of this truck type include delivery trucks, dump trucks, cement trucks, buses, cranes, etc. Figure 1-9 shows two examples of this vehicle category including a United Parcel Service (UPS) delivery truck, and a Ford F750 Bucket Truck.

Figure 1-9 Examples of Class 3-8 Vocation Truck Applications



www.versalifeast.com/Rent-Bucket-Trucks.htm



www.seedmagazine.com/images/uploads/upstr

Class 2b-8 vocational vehicles are typically sold as an incomplete chassis with multiple “outfitters” who complete the vehicle for sale: for example, an engine manufacturer, a body manufacturer, and an equipment manufacturer (*e.g.* a crane manufacturer) may all be involved in the production of the final vehicle product. Manufacturers of vehicles within this segment vary widely and shift with class, as Figure 1-10 highlights.⁸ Vocational vehicle manufacturers include GM, Ford, Chrysler, Isuzu, Mitsubishi, Volvo, Daimler, International, and PACCAR, while engine manufacturers include Cummins, GM, Navistar, Hino, Isuzu, Volvo, Detroit Diesel, and PACCAR. Examples of Class 3 vocational vehicles are the Isuzu NPR Eco-max, the Mitsubishi Fuso FE 125, and the Nissan UD 1200; an example of a Class 4 vocational vehicle is the Hino 145. Manufacturers of vocational vehicle bodies are numerous: according to the 2008 Statistics of U.S. Business annual data, there were 746 companies classified under the North American Industry Classification System (NAICS) 336211, “Motor Vehicle Body Manufacturers.”⁹ Examples of these companies include Utilimaster and Heller Truck Body Corp.

Opportunities for GHG and fuel consumption reductions can include both engine and vehicle improvements. There are a limited number of currently available Class 2b-8 vocational vehicles produced in a hybrid configuration. International (owned by Navistar) makes the DuraStar™ Hybrid and claims that this option offers a 30 to 40 percent fuel

Heavy-Duty GHG and Fuel Efficiency Standards FRM: Industry Characterization

economy benefit over standard in-city pickup and delivery applications, and offers more than a 60 percent increase in fuel economy in utility-type applications where the vehicle can be shut off while electric power still operates the vehicle.¹⁰

Figure 1-10 Class 3-8 Vocational Vehicle Manufacturer Shift with Class

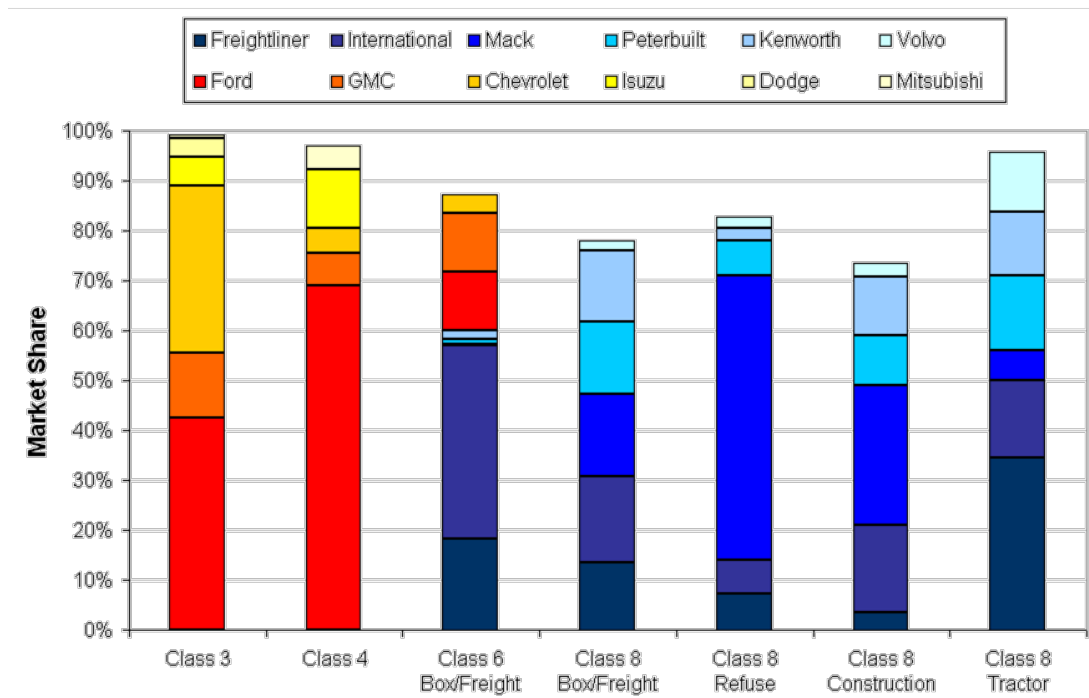

Source: ICCT¹¹

1.3.3 Combination Tractors

Class 7 and 8 combination tractors are the largest and most powerful trucks of the heavy duty vehicle fleet. These trucks use almost two-thirds of all the fuel used in the trucking industry, and are typically categorized into two segments – regional-haul and long-haul.¹¹ Truck tractors operating as regional-haul trucks are tractor trailer combination vehicles used for routes less than 500 miles, and tend to travel at lower average speeds than long-haul trucks. Regional-haul combination tractors, therefore, generally do not include sleeping accommodations for the driver.

Long-haul combination tractors typically travel at least 1,000 miles along a trip route. Long-haul operation occurs primarily on highways and accounts for 60 to 70 percent of the fuel used by Class 7 and 8 combination tractors. The remaining 30 to 40 percent of fuel is used by other regional-haul applications.¹² The most common trailer hauled by both regional- and long-haul combination tractors is a 53-foot dry box van trailer, which accounts for approximately 60 percent of heavy-duty Class 8 on-road mileage.¹³ Leading U.S. manufacturers of Class 8 trucks include companies such as International, Freightliner, Peterbilt, PACCAR, Kenworth, Mack, Volvo, and Western Star; while common engine manufacturers include companies such as Cummins, Navistar, and Detroit Diesel. Figure

Regulatory Impact Analysis

1-11 shows example Class 8 day cab and sleeper cab combination tractors. The price of a new Class 8 vehicle can range from \$90,000 to well over \$110,000 for fully equipped models.¹⁴

Figure 1-11 Example Day Cab and Sleeper Cab Tractors



Source: www.internationaltrucks.com/Trucks/Trucks/Series/L-oneStar



Source: www.freightlinertrucks.com/media/pdf/coronado_brochure.pdf

1.4 Operations

1.4.1 Trucking as a Mode of Freight Transportation

Trucks travel over a considerably larger domain than trains do, for example, in 2008 there were over 4 million miles of public roads compared to 160,000 miles of railroad track operated over by Class I railroads.^{15,16} According to the 2009 Highway Statistics published by the U.S. FHWA, in 2008 there were just over 2.2 million combination tractors (*e.g.* Class 7 and 8) registered in the U.S. out of a total of over 108 million trucks of all types (private and commercial) registered in the U.S., and over 5.6 million trailers (including all commercial type vehicles and semitrailers that are in private or for hire use).¹⁷ Table 1-3 presents the number of trucks compared to the number of vessels and other modes of transportation that move freight.

Heavy-Duty GHG and Fuel Efficiency Standards FRM: Industry Characterization

Table 1-3 Number of U.S. Vehicles, Vessels, and Other Conveyances: 1980-2007

	1980	1990	2000	2008
Highway	161,490,159	193,057,376	225,821,241	255,917,664
Truck, single-unit 2-axle 6-tire or more	4,373,784	4,486,981	5,926,030	6,790,882
Truck, combination	1,416,869	1,708,895	2,096,619	2,215,856
Truck, total	5,790,653	6,195,876	8,022,649	9,006,738
Trucks as percent of all highway vehicles	3.6	3.2	3.6	3.5
Rail				
Class I, locomotive	28,094	18,835	20,028	24,003
Class I, freight cars ¹	1,168,114	658,902	560,154	450,297
Nonclass I, freight cars ¹	102,161	103,527	132,448	109,487
Car companies and shippers freight cars ¹	440,552	449,832	688,194	833,188
Water	38,788	39,445	41,354	40,301
Nonself-propelled vessels ²	31,662	31,209	33,152	31,238
Self-propelled vessels ³	7,126	8,236	8,202	9,063
Oceangoing steam and motor ships ⁴	864	636	454	272
US Flag fleet as percent of world fleet ⁴	3.5	2.7	1.6	0.8
¹ Beginning with 2001 data, Canadian-owned U.S. railroads are excluded. Canadian-owned U.S. railroads accounted for over 46,000 freight cars in 2000.				
² Nonself-propelled vessels include dry-cargo barges, tank barges, and railroad-car floats.				
³ Self-propelled vessels include dry cargo, passenger, off-shore support, tankers, and towboats.				
⁴ 1,000 gross tons and over.				

Source: The Federal Highway Administration “Freight Facts and Figures 2010 Table 3-2 “Number of U.S. Vehicles, Vessels, and Other Conveyances: 1980-2008.” Available here:
http://www.ops.fhwa.dot.gov/freight/freight_analysis/nat_freight_stats/docs/10factsfigures/table3_2.htm

According to the FHWA “Freight Facts and Figures 2010,” trucks^F move more than one-half of all hazardous materials shipped within the U.S.; however, truck ton-miles of hazardous shipments account for only about one-third of all transportation ton-miles due to the relatively short distances these materials are typically carried by trucks.¹⁸ Trucks move this freight an average of 96 miles per shipment whereas rail shipments travel an average of 578 miles per trip. In terms of growing international trade, trucks are the most common mode used to move imports and exports between both borders and inland locations, Table 1-5 shows the tons and value moved by truck compared to other transportation methods.¹⁹

^F The U.S. Federal Highway Administration: Freight Management Operations “Freight Facts and Figures 2010,” does not specify which category of truck (*i.e.* Class 7 or Class 8) is included in their definition of “truck” as a category for which they provide data. Therefore, this chapter assumes that all classes of commercial trucks are included unless the term “combination truck” is used, in which case we assume this means only Class 7 and 8 combination tractors.

Regulatory Impact Analysis

Table 1-4 Domestic Mode of Exports and Imports by Tonnage and Value in 2002 and Projections for 2035

	MILLIONS OF TONS		BILLIONS OF DOLLARS (U.S. \$2002)	
	2002	2035	2002	2035
Truck ^a	797	2116	1198	6193
Rail	200	397	114	275
Water	106	168	26	49
Air, air and truck ^b	9	54	614	5242
Intermodal ^c	22	50	52	281
Pipeline and unknown ^d	524	760	141	238

Source: U.S. FHWA, "2009 Facts and Figures," Table 2-6, available here:

http://www.ops.fhwa.dot.gov/freight/freight_analysis/nat_freight_stats/docs/09factsfigures/pdfs/fff2009_ch2.pdf

Notes: ^a Excludes truck moves to and from airports.

^b Includes truck moves to and from airports.

^c Intermodal includes U.S. Postal Service and courier shipments and all intermodal combinations, except air and truck. In this table, oceangoing exports and imports that move between ports and domestic locations by single modes are classified by the domestic mode rather than the intermodal.

^d Pipeline and unknown shipments are combined because data on region-to-region flows by pipeline are statistically

Conversely, transportation of foreign trade is dominated by movement via water with trucks hauling approximately 16 percent of imported freight followed by rail and pipeline.²⁰ As of 2009, Canada was the top trading partner with the United States in terms of the value of the merchandise traded (\$430 billion in U.S. \$2009), second was China (\$366 billion in U.S. \$2009), and third was Mexico (\$305 billion in U.S. \$2008).²¹ Truck traffic dominates transportation modes from the two North American trade partners. As of 2009, over 58 percent of total imported and exported freight moved between the U.S. and Canada was hauled by truck, while over 68 percent of total imported and exported freight moved between the U.S. and Mexico was hauled by truck, as shown in Figure 1-12.²²

Figure 1-12 North American Transborder Freight²³

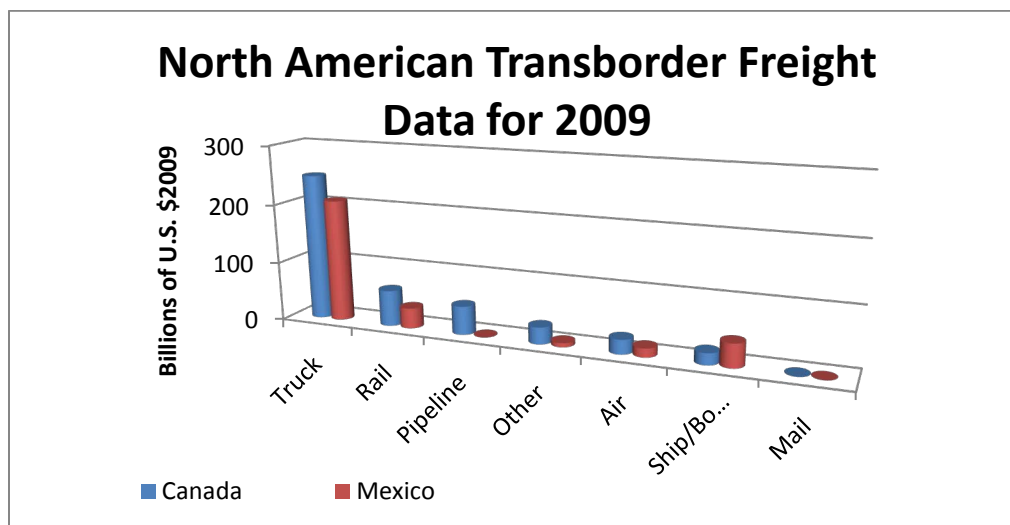

Source: Bureau of Transportation Statistics: North American Transborder Freight Data

1.4.2 Operators

There are nearly nine million people in all types of trucking related jobs, with 15 percent involved in manufacturing of the vehicles and trailers, and the majority at over three million working as truck drivers. Many drivers are not part of large fleets, but are independent owner-operators where the driver independently owns his or her vehicle, leaving 87 percent of trucking fleets operating less than 6 percent of all trucks.

The U.S. Department of Transportation’s Federal Motor Carrier Safety Administration has developed Hours-of-Service regulations that limit when and how long commercial motor vehicle drivers may drive (Table 1-5 summarizes these rules). In general, drivers must take a ten consecutive hour rest / break per 24 hour day, and they may not drive for more than a week without taking a 34 consecutive hour break. These regulations have increased on-road safety significantly, but they have also increased the importance of idle reduction technologies, as drivers can have a significant amount of downtime during a trip in order to comply with these mandates. During their required off-duty hours, drivers face additional regulations they must abide by if they rest in their truck and idle the main engine to provide cab comfort. Currently, regulations that prohibit trucks from idling can differ from state to state, county to county, and city to city. The American Transportation Research Institute has compiled a list of nearly 45 different regulations that exist in different locals with fines for non-compliance ranging from \$50 to \$25,000 and can include up to two years in prison.

The need for auxiliary cab heating, cooling, and sources of electricity such as those provided by idle reduction devices such as auxiliary power units is highlighted by the fact that driver comfort is not typically included as an exemption to allow idling, nor are, in some cases, the idling of trailer refrigeration units that require power to keep freight at a controlled temperature.

Table 1-5 Summary of Hours of Service Rules

PROPERTY-CARRYING CMV DRIVERS	PASSENGER-CARRYING CMV DRIVERS
11-Hour Driving Limit	10-Hour Driving Limit
May drive a maximum of 11 hours after 10 consecutive hours off duty.	May drive a maximum of 10 hours after 8 consecutive hours off duty.
14-Hour Limit	15-Hour On-Duty Limit
May not drive beyond the 14th consecutive hour after coming on duty, following 10 consecutive hours off duty. Off-duty time does not extend the 14-hour period.	May not drive after having been on duty for 15 hours, following 8 consecutive hours off duty. Off-duty time is not included in the 15-hour period.
60/70-Hour On-Duty Limit	60/70-Hour On-Duty Limit
May not drive after 60/70 hours on duty in 7/8 consecutive days. A driver may restart a 7/8 consecutive day period after taking 34 or more consecutive hours off duty.	May not drive after 60/70 hours on duty in 7/8 consecutive days.
Sleeper Berth Provision	Sleeper Berth Provision
Drivers using the sleeper berth provision must take at least 8 consecutive hours in the sleeper berth, plus a separate 2 consecutive hours either in the sleeper berth, off duty, or any combination of the two.	Drivers using a sleeper berth must take at least 8 hours in the sleeper berth, and may split the sleeper-berth time into two periods provided neither is less than 2 hours.

Source: Federal Motor Carrier Safety Administration

Regulatory Impact Analysis

1.4.3 Heavy-Duty Truck Operating Speeds

In addition to the federal operating regulations, drivers must be aware of the variety of speed limits along their route, as these can vary both interstate and intrastate.^{24,25} Currently, eight states have different speed limits for cars than they do for trucks, one state has different truck speed limits for night and day, and one state has a different speed limit for hazmat haulers than other trucks. In all, there are thirteen different car and truck speed combinations in the U.S. today: Table 1-6 shows the different combination of vehicle and truck speed limits, as well as the different speed limits by location.

Table 1-6 U.S. Truck and Vehicle Speed Limits

SPEED LIMIT	STATES WITH THE SAME SPEED LIMIT
Trucks 75 / Autos 75	Arizona, Colorado, Nebraska, Nevada, New Mexico, North Dakota, Oklahoma, South Dakota, Utah ^c , Wyoming
Trucks 70 / Autos 70	Alabama, Florida, Georgia, Iowa, Kansas, Louisiana, Minnesota, Mississippi, Missouri, North Carolina, South Carolina, Tennessee, West Virginia,
Trucks 65 / Autos 65	Alaska, Connecticut, Delaware, Illinois, Kentucky ^a , Maine, Maryland, Massachusetts, New Hampshire, New Jersey, New York, Ohio, Pennsylvania, Rhode Island, Vermont, Virginia ^d , Wisconsin
Trucks 60 / Autos 60	Hawaii
Trucks 55 / Autos 55	District of Columbia
Trucks 65 / Autos 75	Montana, Idaho
Trucks 65 / Autos 70	Arkansas, Indiana
Trucks 60 / Autos 70	Washington, Michigan
Trucks 55 / Autos 70	California
Trucks 55 / Autos 65	Oregon
Trucks 65 (on the Turnpike Only)	Ohio
Trucks and Autos 70 (65 at night)	Texas ^b
Hazmat Trucks 55mph	Alabama

Notes: [a] Effective as of July 10, 2007, the posted speed limit is 70 mph in designated areas on I-75 and I-71.

[b] In sections of I-10 and I-20 in rural West Texas, the speed limit for passenger cars and light trucks is 80 mph. For large trucks, the speed limit is 70 mph in the daytime and 65 mph at night. For cars, it is also 65 mph at night.

[c] Based on 2008 Utah House Bill 406, which became effective on May 5, 2008, portions of I-15 have a posted limit of 80 mph.

[d] Effective July 1, 2006, the posted speed limit on I-85 may be as high as 70 mph.

1.4.4 Trucking Roadways

The main function of the National Network is to support interstate commerce by regulating the size of trucks. Its authority stems from the Surface Transportation Assistance Act of 1982 (P.L. 97-424) which authorized the National Network to allow conventional combinations on “the Interstate System and those portions of the Federal-aid Primary System ... serving to link principal cities and densely developed portions of the States ... [on] high volume route[s] utilized extensively by large vehicles for interstate commerce ... [which do] not have any unusual characteristics causing current or anticipated safety problems.”²⁶ The National Network has not changed significantly since its inception and is only modified if

Heavy-Duty GHG and Fuel Efficiency Standards FRM: Industry Characterization

states petition to have segments outside of the current network added or deleted. Figure 1-13 shows the National Network of the U.S.^G

Additionally, there is the National Highway System (NHS), which was created by the National Highway System Designation Act of 1995 (P.L. 104-59). The main focus of the NHS is to support interstate commerce by focusing on federal investments. Currently, there is a portion of the NHS that is over 4,000 miles long which supports a minimum of 10,000 trucks per day and can have sections where at least every fourth vehicle is a truck.²⁷ Both the National Network and the NHS include approximately the same total length of road, roughly 200,000 miles, but the National Network includes approximately 65,000 miles of highways in addition to the NHS, and the NHS includes about 50,000 miles of highways that are not in the National Network.

Figure 1-13 The National Network for Conventional Combination Tractors

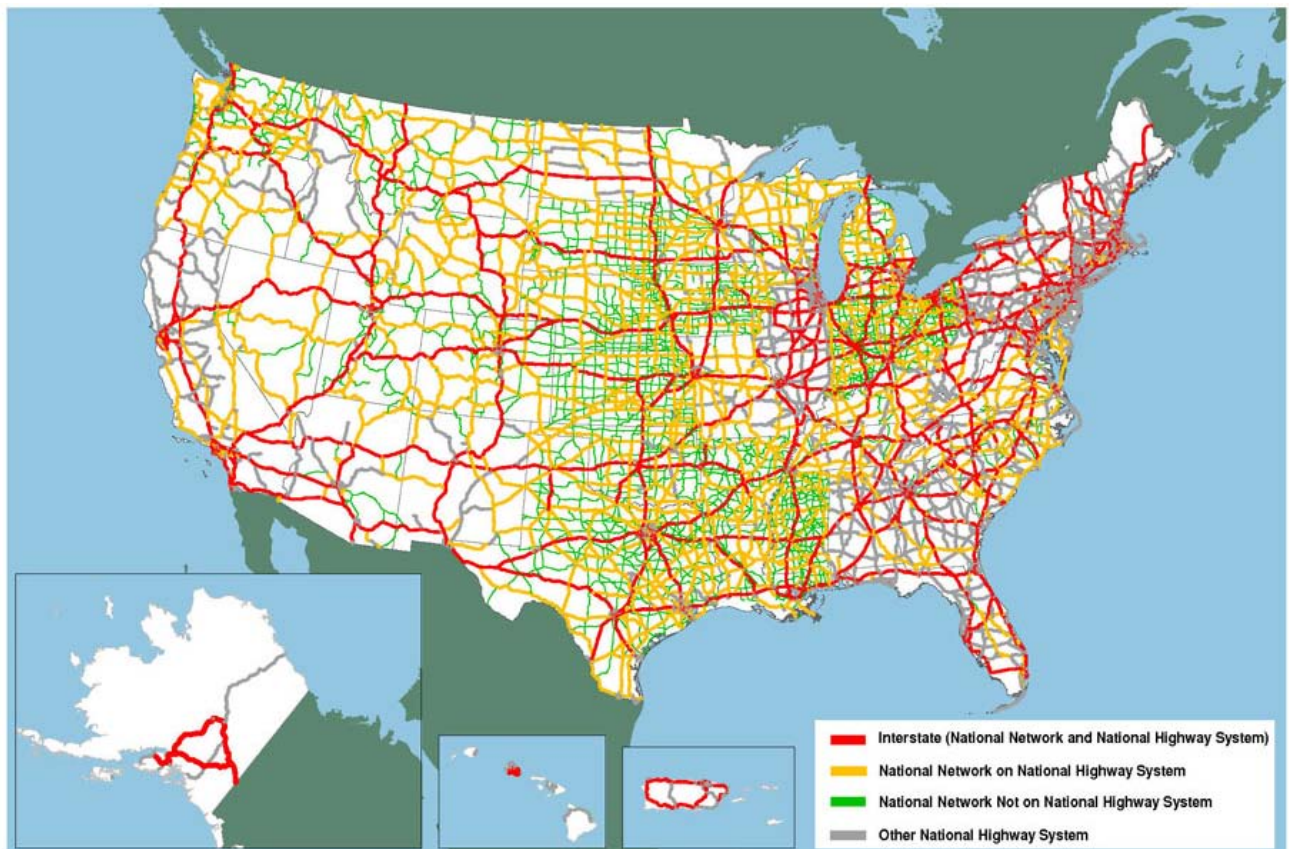

Note: This shall not be interpreted as the official National Network nor shall it be used for truck size and weight enforcement purposes.

Source: U.S. Department of Transportation, Federal Highway Administration, Office of Freight Management and Operations, Freight Analysis Framework, version 2.2, 2007.

^G Tractors with one semitrailer up to 48 feet in length, or with one 28-foot semitrailer and one 28-foot trailer, can be up to 102 inches wide. Single 53-foot trailers are allowed in 25 states without special permits and in an additional 3 states subject to limits on distance of kingpin to rearmost axle.

1.4.5 Weigh Stations

Individual overweight trucks can damage roads and bridges; therefore, both federal and state governments are concerned about trucks that exceed the maximum weight limits operating without permits on U.S. roadways. In order to ensure that the trucks are operating within the correct weight boundaries, weigh stations are distributed throughout the U.S. roadways to ensure individual trucks are in compliance. In 2008, there were approximately 200 million truck weight measurements taken, with less than one percent of those found to have a violation.²⁷

There are two types of weigh stations, dynamic or ‘weigh-in-motion’ where the operator drives across the scales at normal speed, and static scales where the operator must stop the vehicle on the scale to obtain the weight. As of 2008, 60 percent of the scales in the U.S. were dynamic and 40 percent were static. The main advantage of the dynamic weigh-in-motion scales are that they allow weight measurements to be taken while trucks are operating at highway speeds, reducing the time it takes for them to be weighed individually, as well as reducing idle time and emissions.^{28,29} Officers at weigh stations are primarily interested in ensuring the truck is compliant with weight regulations; however, they can also inspect equipment for defects or safety violations, and review log books to ensure drivers have not violated their limited hours of service.

1.4.6 Types of Freight Carried

Prior to 2002, the U.S. Census Bureau completed a “Vehicle Inventory and Use Survey” (VIUS), which has since been discontinued. It provided data on the physical and operational characteristics of the nation’s private and commercial truck fleet, and had a primary goal of producing national and state-level estimates of the total number of trucks. The VIUS also tallied the amount and type of freight that was hauled by heavy-duty trucks. The most prevalent type of freight hauled in 2002, according to the survey, was mixed freight, followed by nonpowered tools. Three fourths of the miles traveled by trucks larger than panel trucks, pickups, minivans, other light vans, and government-owned vehicles were for the movement of products from electronics to sand and gravel. Most of the remaining mileage is for empty backhauls and empty shipping containers. Table 1-7 shows the twenty most commonly hauled types of freight in terms of miles moved.²⁷

Heavy-Duty GHG and Fuel Efficiency Standards FRM: Industry Characterization

Table 1-7 Top Twenty Types of Freight Hauled in 2002 in Terms of Mileage

TYPE OF PRODUCT CARRIER	MILLIONS OF MILES
Mixed freight	14,659
Tools, nonpowered	7,759
All other prepared foodstuffs	7,428
Tools, powered	6,478
Products not specified	6,358
Mail and courier parcels	4,760
Miscellaneous manufactured products	4,008
Vehicles, including parts	3,844
Wood products	3,561
Bakery and milled grain products	3,553
Articles of base metal	3,294
Machinery	3,225
Paper or paperboard articles	3,140
Meat, seafood, and their preparations	3,056
Non-metallic mineral products	3,049
Electronic and other electrical equipment	3,024
Base metal in primary or semi-finished forms	2,881
Gravel or crushed stone	2,790
All other agricultural products	2,661
All other waste and scrape (non-EPA manifest)	2,647

Source: The U.S. Census Bureau "Vehicle Inventory and Use Survey" 2002

1.4.7 Heavy-Duty Trucking Traffic Patterns

One of the advantages inherent in the trucking industry is that trucks can not only carry freight over long distances, but due to their relatively smaller size and increased maneuverability they are able to deliver freight to more destinations than other modes such as rail. However, this also means they are in direct competition with light-duty vehicles for road space, and that they are more prone to experiencing traffic congestion delays than other modes of freight transportation. Figure 1-16 shows the different modes of freight transportation and the average length of their routes.

Regulatory Impact Analysis

Figure 1-14 Lengths of Routes by Type of Freight Transportation Mode

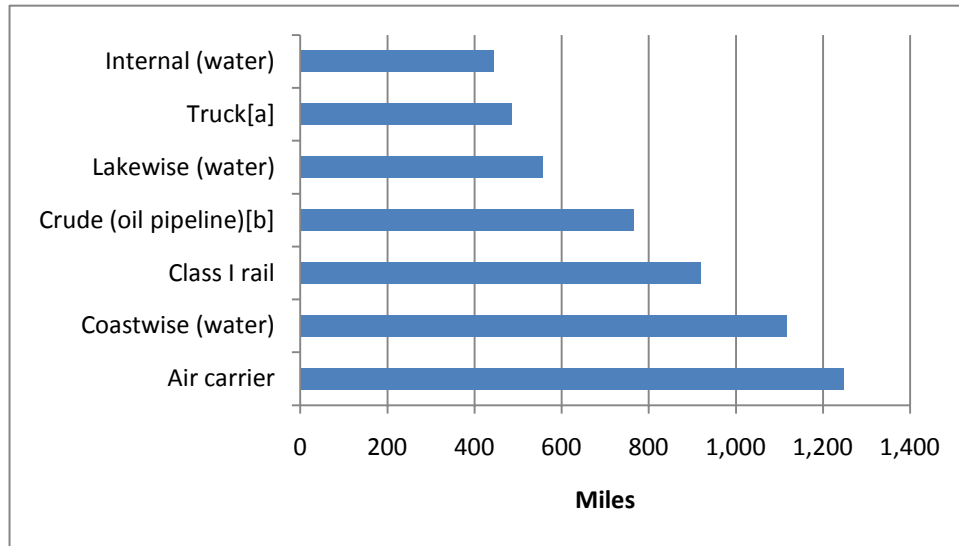

Source: http://www.bts.gov/publications/national_transportation_statistics/html/table_01_38.html

The Federal Highway Administration (FHWA) projects that long-haul trucking between places which are at least 50 miles apart will increase substantially on Interstate highways and other roads throughout the U.S., forecast data indicates that this traffic may reach up to 600 million miles per day.²⁷ In addition, the FHWA projects that segments of the NHS supporting more than 10,000 trucks per day will exceed 14,000 miles, an increase of almost 230 percent over 2002 levels. Furthermore, if no changes are made to alleviate current congestion levels, the FHWA predicts that these increases in truck traffic combined with increases in passenger vehicle traffic could slow traffic overall on nearly 20,000 miles of the NHS and create stop-and-go conditions on an additional 45,000 miles. Figure 1-17 shows the projected impacts of traffic congestion. These predicted congestion areas would also have an increase in localized engine emissions. It is possible that eventual advances in hybrid truck technology could provide large benefits and help combat the increased emissions that occur with traffic congestion.

Figure 1-15 Federal Highway Administration's Projected Average Daily Long-Haul Truck Traffic on the National Highway System in 2035

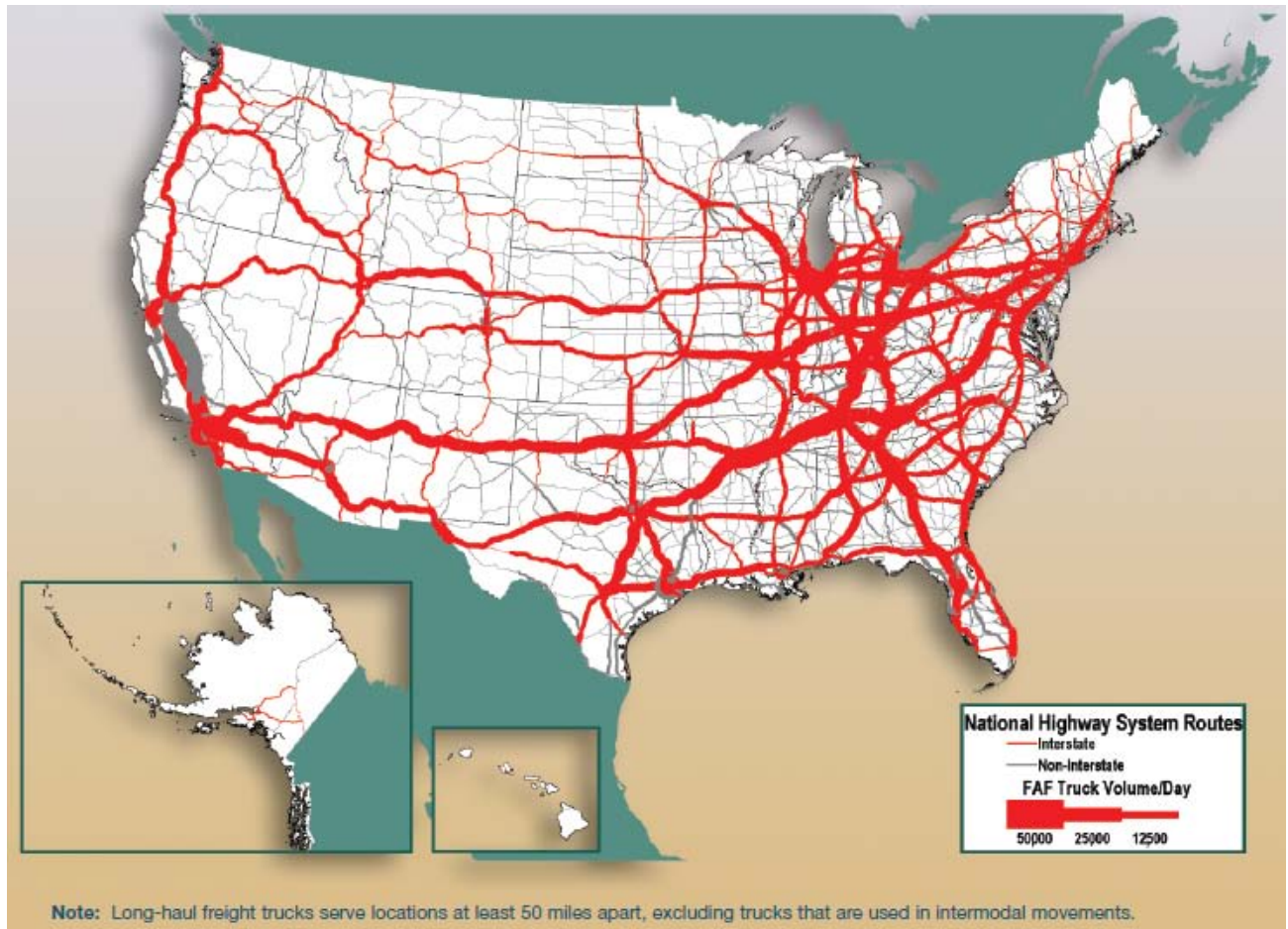

Source: The Federal Highway Administration: 2009 Facts and Figures

1.4.8 Intermodal Freight Movement

Since trucks are more maneuverable than other common modes of freight shipment, trucks are often used in conjunction with these modes to transport goods across the country, known as intermodal shipping. Intermodal traffic typically begins with containers carried on ships, and then they are loaded onto railcars, and finally transported to their end destination via truck. There are two primary types of rail intermodal transportation which are trailer-on-flatcar (TOFC) and container-on-flatcar (COFC); both are used throughout the U.S. with the largest usage found on routes between West Coast ports and Chicago, and between Chicago and New York. The use of TOFCs (see Figure 1-16) allows for faster transition from rail to truck, but is more difficult to stack on a vessel; therefore the use of COFCs (see Figure 1-17) has been increasing steadily.

Figure 1-16 Trailer-on-Flatcar (TOFC)



Figure 1-17 Container-on-Flatcar (COFC)



1.4.9 Purchase and Operational Related Taxes

Currently, there is a Federal retail tax of 12 percent of the sales price (at the first retail sale) on heavy trucks, trailers, and tractors. This tax does not apply to truck chassis and bodies suitable for use with a vehicle that has a gross vehicle weight of 33,000 pounds or less. It also does not apply to truck trailer and semitrailer chassis or bodies suitable for use with a trailer or semitrailer that has a gross vehicle weight of 26,000 pounds or less. Tractors that have a gross vehicle weight of 19,500 pounds or less and a gross combined weight of 33,000 pounds or less are excluded from the 12 percent retail tax.³⁰ This tax is applied to the vehicles as well as any parts or accessories sold on or in connection with the sale of the truck. However, idle reduction devices affixed to the tractor and approved by the Administrator of the EPA, in consultation of the Secretary of Energy and Secretary of Transportation, are generally exempt from this tax. There are other exemptions for certain truck body types, such as refuse packer truck bodies with load capacities of 20 cubic yards or less, other specific installed equipment, and sales to certain entities such as state or local governments for their exclusive use.

There is also a tire tax for tires used on some heavy-duty trucks. This tax is based on the pounds of maximum rated load capacity over 3,500 pounds rather than on the actual weight of the tire, as was done in the past.³¹ A new method of calculating the federal excise tax (FET) on tires was included in the American Jobs Creation Act that changed the method

Heavy-Duty GHG and Fuel Efficiency Standards FRM: Industry Characterization

for calculating the FET on truck tires. Previously, the tax was based on the actual weight of the tire, where before for a tire weighing more than 90 pounds there was a 50¢ tax for every 10 pounds of weight above 90 pounds plus a flat fee of \$10.50. Since truck and trailer tires can weigh on average 120 pounds, this would carry a tax penalty of approximately \$25 per tire; this method gave singlewide tires a tax advantage as they weigh less in part because they have two fewer sidewalls. The new FET is based on the load-carrying capacity of the tire. For every 10-pound increment in load-carrying capacity above 3,500 pounds, a tax of 9.45¢ cents is levied. A typical heavy-duty tire has a load carrying capacity of over approximately 6,000 pounds and would therefore carry a similar tax burden as before.³² The change, however, is that the tax rate for bias ply and single wide tires is half that of a standard tire.

Finally, there is a usage tax for heavy duty vehicles driven over 5,000 miles per year (or over 7,500 miles for agricultural vehicles). This tax is based on the gross weight of the truck, and includes a rate discounted 25 percent for logging trucks.³³ For trucks with a GVWR of 55,000 – 75,000 pounds the tax rate is \$100 plus \$22 for each additional 1,000 pounds in excess of 55,000 pounds; trucks with a GVWR over 75,000 pay a flat \$550.

1.4.10 Heavy-Duty Vehicle Age Trends

Class 8 long-haul combination tractors are typically sold after the first three to five years of ownership and operation by large fleets, however, smaller fleets and owner-operators will continue to use these trucks for many years thereafter.³⁴ As of 2009, the average age of the U.S. Class 8 fleet was 7.87 years.³⁵ These newest trucks travel between 150,000 – 200,000 miles per year, and 50 percent of the trucks in this Class 8 segment use 80 percent of the fuel.³⁶ Although the overall fleet average age is less than ten years old, Figure 1-18 shows that nearly half of all of Class 4-8 trucks live well past 20 years of age, and that smaller Class 4-6 trucks typically remain in the U.S. fleet longer than other classes.

Figure 1-18 Survival Probability of Class 4-8 Trucks

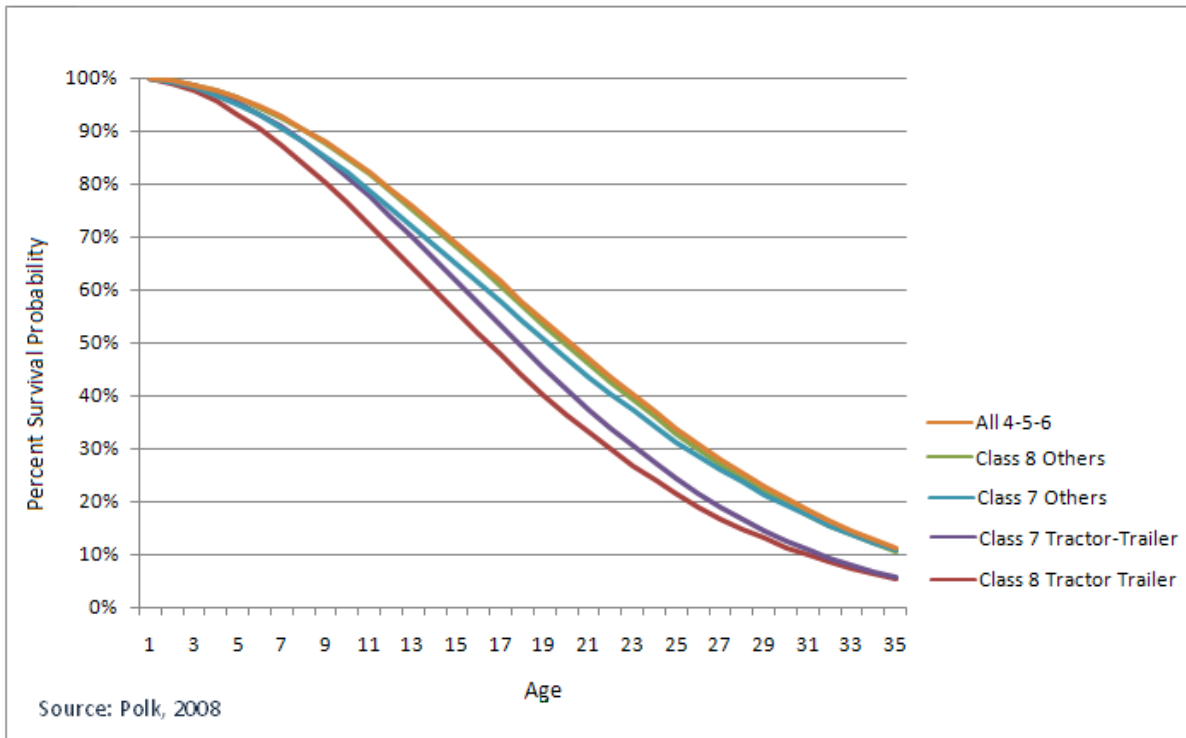

1.5 Tire Manufacturers

The three largest suppliers to the U.S. commercial new truck tire market (heavy-duty truck tires) are Bridgestone Americas Tire Operations LLC, Goodyear Tire and Rubber Company, and Michelin North America, Incorporated. Collectively, these companies account for over two-thirds of the new commercial truck tire market. Continental Tire of the Americas LLC, Yokohama Tire Company, Toyo Tires U.S.A. Corporation, Hankook Tire America Corporation, and others also supply this market. New commercial tire shipments totaled 12.5 million tires in 2009. This number was down nearly 20 percent from the previous year, due to the economic downturn, which hit the trucking industry especially hard.³⁷

1.5.1 Single Wide Tires

A typical configuration for a combination tractor-trailer is five axles and 18 wheels and tires, hence the name “18-wheeler.” There are two wheel/tire sets on the steer axle, one at each axle end, and four wheel/tire sets on each of the two drive and two trailer axles, with two at each axle end (dual tires), Figure 1-19 shows the position and name of each axle.

Figure 1-19 Class 8 Standard "18 Wheeler" Axle Identification



Steer tires, dual drive, and trailer tires vary in size. A typical tire size for a tractor-trailer highway truck is 295/75R22.5. This refers to a tire that is 295 millimeters (or 11.6") wide with an aspect ratio (the sidewall height to tire section width, expressed as a percent) of 75, for use on a rim with a 22.5 inch diameter. The higher the aspect ratio, the taller the tire's sidewall is relative to its section width. Conversely, the lower the aspect ratio, the shorter the tire's sidewall is relative to its section width. Truck tires with a sidewall height between 70 percent and 80 percent of the tire section width use this metric sizing; other common highway truck tire sizes are 275/80R22.5, 285/75R24.5, and 275/80R24.5. Tire size can also be expressed in inches. 11R22.5 and 11R24.5 refer to tires that are 11 inches wide for use on a rim with a 22.5- and 24.5 inch diameter, respectively. Tires expressed in this non-metric nomenclature typically have an aspect ratio of 90, meaning the sidewall height is 90 percent of the tire section width.

Single wide tires have a much wider "base" or section width than tires used in dual configurations and have a very low aspect ratio. A typical size for a single wide tire used on a highway tractor trailer is 455/50R22.5. This refers to a tire that is 455 millimeters wide with a sidewall height that is 50 percent of its section width, for use on a rim with a 22.5 inch diameter. As implied by its name, a single wide tire is not installed in a dual configuration. Only one tire is needed at each wheel end of the two drive and two trailer axles, effectively converting an "18-wheeler" heavy-duty truck into a 10-wheeler, including the two steer tires. Except for certain applications like refuse trucks, in which the additional weight capacity over the steer axle could be beneficial, single wide tires are not used on the steer axle.

Proponents of single wide tires cite a number of advantages relative to conventional dual tires. These include lower weight, less maintenance, and cost savings from replacing 16 dual tire/wheel sets with 8 single wide tire/wheel sets; improved truck handling and braking, especially for applications like bulk haulers that benefit from the lower center of gravity; reduced noise; fewer scrapped tires to recycle or add to the waste stream; and better fuel economy. A recent in-use study conducted by the Department of Energy's Oak Ridge National Laboratory found fuel efficiency improvement for single wide tires compared to dual tires of at least 6 percent up to 10 percent. These findings are consistent with assessments by EPA using vehicle simulation modeling and in controlled track testing conducted by EPA's SmartWay program.³⁸

Sales of single wide tires have grown steadily since today's single wide tires entered the U.S. market in 2000. However, overall market share of single wide tires is still low

Regulatory Impact Analysis

relative to dual tires. There are several reasons why trucking fleets or drivers might be slow to adopt single wide tires. Fleets might be concerned that in the event of a tire failure with a single wide tire, the driver would need to immediately pull to the side of the road rather than “limping along” to an exit. “Limping along” on one dual tire after the other dual tire fails places the entire weight of the axle end on the one remaining good tire. In most cases, this is a dangerous practice that should be avoided regardless of tire type; however, some truck operators still use “limp along” capability. Fleets might also be concerned that replacement single wide tires are not widely available, if replacement service is needed on the road. As single wide tires continue to gain broader acceptance, tire availability will increase for road service calls. Trucking fleets also might not want to change tire usage practices. For example, some fleets like to switch tires between the steer and trailer axles or retreaded steer tires for use on trailers. Since single wide tires are not used on the steer position of tractor-trailers, using single wide tires on the trailer constrains steer-trailer tire and retreaded tire interchangeability, this practice also decreases the number of rims a fleet or tire service company needs to have in stock.

New trucks and trailers can be ordered with single wide tires, and existing vehicles can be retrofit to accommodate single wide tires. If a truck or trailer is retrofit with single wide tires, the dual wheels will need to be replaced with wider single wheels. Also, if a trailer is retrofit or newly purchased with single wide tires, it may be preferable to use the heavier, non-tapered “P” type trailer axles rather than the narrow, lighter, tapered “N” spindle axles, because of changes in load stress at the axle end. Single wide tires are typically offset by 2 inches due to the wider track width, and offset wheels may require a slight de-rating of the hub load. Industry is developing advanced hub and bearing components optimized for use with single wide wheels and tires, which could make hub load de-rating unnecessary. As new tractors are built with disc-brakes to meet new stopping requirements, the clearance between the disc brake components and the rims may complicate existing wheel offsets. Whatever type of wheels and tires are used, it is important that trucking fleets follow the guidance and recommended practices issued by equipment manufacturers, the Tire and Rim Association, and the American Trucking Association’s Technology and Maintenance Council, regarding inflation pressure, speed and load ratings.

When today’s single wide tires were first introduced in 2000, there were questions about adverse pavement impacts. This is because in the early 1980s, a number of “super single” tires were marketed which studies subsequently showed to be more detrimental to pavement than dual tires. These circa-1980s wide tires were fundamentally different than today’s single wide tires. They were much narrower (16 percent to 18 percent) and taller, with aspect ratios in the range of 70 percent, rather than the 45 – 55 percent of today’s single wide tires. The early wide tires were constructed differently as well, lacking the engineering sophistication of today’s single wide tires. The steel belts were oriented in a way that concentrated contact stresses in the crown, leading to increased pavement damage. The tires also flexed more, which increased rolling resistance and thus decreased fuel efficiency.

In contrast, today’s single wide tires are designed to provide more uniform tire-pavement contact stress, with a tire architecture that allows wider widths at low aspect ratios and reduces the amount of interaction between the crown and sides of the tire, to reduce

flexing and improve rolling resistance. Research on pavement response using instrumented roads and finite element modeling shows that depending upon pavement structure, single wide tires with a 55 percent aspect ratio produce similar bottom-up cracking and rutting damage as dual tires, and improve top-down cracking. Single wide tires with a 45 percent aspect ratio showed slightly more pavement damage. The new studies found that earlier research failed to take into account differences in tire pressure between two tires in a dual configuration, a situation that is common in the real world. Uneven inflation pressure with dual tire configurations can be very detrimental to pavement. The research also found that conventional steer tires damage pavement more than other tires, including single wide tires.³⁹ Research is ongoing to provide pavement engineers the data they need to optimize road and pavement characteristics to fit current and emerging tire technologies.

1.5.2 Retreaded Tires

Although retreading tires is no longer a common practice for passenger vehicles, it is very common in commercial trucking. Even the federal government is directed by Executive Order to use retreaded tires in its fleets whenever feasible.⁴⁰ Retreading a tire greatly increases its mileage and lifetime, saving both money and resources. It costs about one-third to one-half of the cost of a new truck tire to retread it, and uses a lot less rubber. On average, it takes about 325 pounds of rubber to produce a new medium- or heavy-duty truck tire, but only about 24 pounds of rubber to retread the same tire.⁴¹ A 2008 report published by NHTSA noted that there are no documented safety concerns with commercial medium retreaded tires, in this tire debris study, it was determined that retread tires are not overrepresented in the population of tire debris found on the roadway.⁴² In addition, detailed analysis on the debris collected showed that even on retreaded tires, underinflation not poor retreading was the primary cause of failure.

The Department of Transportation Federal Motor Carrier Safety Administration (FMCSA) issues federal regulations that govern the minimum amount of tread depth allowable before a commercial truck tire must be retreaded or replaced. These regulations prohibit “Any tire on any steering axle of a power unit with less than 4/32 inch tread when measured at any point on a major tread groove. ...All tires other than those found on the steering axle of a power unit with less than 2/32 inch tread when measured at any point on a major tread groove.”⁴³ Trucking fleets often retread tires before tire treads reach this minimum depth in order to preserve the integrity of the tire casing for retreading. If the casing remains in good condition, a truck tire can be safely retreaded multiple times. Heavy truck tires in line haul operation can be retread 2 to 3 times and medium-duty truck tires in urban use can be retread 5 or more times.⁴⁴ To accommodate this practice, many commercial truck tire manufacturers warranty their casings for up to five years, excluding damage from road hazards or improper maintenance.

In 2009, the number of retreaded tires sold to the commercial trucking industry outsold the number of new replacement tire shipments by half a million units – 13 million retreaded tires were sold, versus 12.5 million replacement tires.⁴⁵ Retreaded tire sales (without casings) totaled \$1.64 billion in 2009.⁴⁶ All of the top commercial truck tire manufacturers are involved in tire retread manufacturing. Bridgestone Bandag Tire Solutions accounts for 42 percent of the domestic retreaded truck tire market with its Bandag retread

Regulatory Impact Analysis

products; Goodyear Tire and Rubber Company accounts for 28 percent, mostly through its Wingfoot Commercial Tire Systems; Michelin Retread Technologies Incorporated, with Megamile, Oliver, and Michelin retread products, accounts for 23 percent. Other tire companies like Continental and independent retread suppliers like Marangoni Tread North America (which also produces the Continental “ContiTread” retread product) make up the remaining 7 percent.⁴⁷

Although the “big 3” tire companies produce the majority of retread products through their retread operations, the retreading industry itself consists of hundreds of retreaders who sell and service retreaded tires, often (but not always) using machinery and practices identified with one of the “big 3” retread producers. There are about 800 retread plants in North America.⁴⁸ The top 100 retreaders in the U.S. retread 47,473 truck tires per day. They also retread 2,625 light truck tires and 625 off road tires daily. Tire retreaders are industry-ranked by the amount of rubber they use annually in their businesses. In 2009, the top 12 retreaders in the US accounted for nearly 150 million pounds of rubber used to retread tires.⁴⁹

1.6 Current U.S. and International GHG and Fuel Efficiency Voluntary Actions and Regulations

Heavy-duty trucks in the U.S. today are not required to meet national GHG or fuel efficiency standards or regulations. The only current national requirement for heavy-duty trucks is the set of engine standards for Non-Methane Hydrocarbons (NMHC), nitrous oxides (NOx), particulate matter (PM), and carbon monoxide (CO). U.S. efforts to reduce GHG emissions and fuel consumption from the heavy-duty truck sector to date have been limited to voluntary measures and actions by the States. Congress has mandated the U.S. Department of Transportation to take action to set fuel efficiency standards for heavy-duty trucks through the Energy Independence and Security Act (EISA) of 2007. International fuel consumption regulations have been implemented in Japan and are under consideration in other countries.

Additionally, there are existing heavy-duty engine certification and useful life requirements, as shown for example in Figure 1-20. Heavy-Duty Engines have a single full life standard. Manufacturers certify results are cleaner than their test results to account for production and testing variability. Manufacturers also develop a deterioration factor which is used to demonstrate compliance at end of life.

Figure 1-20 Current Heavy-Duty Useful Life Years and Miles

ENGINE TYPE	YEARS	MILES
Spark Ignited (SI) Engines	10	110,000
Light Heavy-Duty Diesel Engines	10	110,000
Medium Heavy-Duty Diesel Engines	10	185,000
Heavy Heavy-Duty Diesel Engines	10	435,000

1.6.1 U.S. EPA SmartWay™ Transport Partnership

The U.S. EPA SmartWay™ Transport Partnership is a highly recognized voluntary program established in the U.S., and is a collaborative program between EPA and the freight industry that will increase the energy efficiency of heavy-duty trucks while significantly reducing air pollution and GHG emissions. While SmartWay has always been open to any type of freight carrier, the program initially focused much of its testing and verification efforts on combination tractors, since these trucks account for a large percent of the fuel consumed by commercial trucks and are commonly used by SmartWay truck fleet partners. As the program continues to grow, both its partner base and technical focus are becoming more diverse. The Partnership provides strong market-based incentives to companies shipping products and the truck companies delivering these products, to improve the environmental performance of freight operations. SmartWay Transport partners improve their energy efficiency, save money, reduce greenhouse gas emissions and improve air quality.

SmartWay is a collaborative effort between the government and business, to improve the efficiency of goods movement from global supply chains while reducing fuel consumption and emissions. SmartWay was launched by the Environmental Protection Agency in 2004 with full support of the trucking industry and their freight shipping customers. SmartWay started with fifty initial partners including 15 Charter Partners. Since that time, the number of Partners has grown to over 2,700 members including most of the largest trucking fleets in the United States, and many of the largest multi-national shippers. SmartWay trucking fleet partners operate over 650,000 trucks, which represent 10 percent of all heavy-duty trucks. The SmartWay program promotes the benefits of key truck technologies including idle reduction, aerodynamics, efficient tires, and operational strategies that include enhanced logistics management, reduced packaging, driver training, equipment maintenance, and intermodal options. SmartWay partners employ these strategies and technologies on new and existing equipment to reduce emissions and save fuel, contributing to environmental, energy security, and economic goals. SmartWay partners have helped to reduce CO₂ emissions from trucks by nearly 15 million metric tons, NO_x by 215,000 tons, and PM by 8,000 tons, and have saved 1.5 billion gallons of diesel fuel as well as \$3.6 billion in fuel costs. Other countries have expressed significant interest in SmartWay, and EPA has participated in workshops and pilot projects to demonstrate SmartWay tools and approaches internationally. Beginning in 2007, working with truck, trailer and engine manufacturers as well as states and public interest groups, SmartWay developed specifications to designate the cleanest and most efficient Class 8 tractor-trailers. SmartWay-certified trucks now represent more than 5 percent of new Class 8 sleeper truck sales, and every major truck maker offers at least one EPA SmartWay Certified Tractor.

1.6.2 The 21st Century Truck Partnership

Additionally, the DOE, EPA, DOT, Department of Defense (DOD), and national laboratories together with members of the heavy-duty truck industry work toward making freight and passenger transportation more efficient, cleaner, and safer under the 21st Century Truck Partnership.⁵⁰ The Partnership has several activities related to reducing greenhouse gas emissions, including:

Regulatory Impact Analysis

- Integrated vehicle systems research and development to validate and deploy advanced technologies.
- Research for engine, combustion, exhaust aftertreatment, fuels, and advanced materials to achieve both higher efficiency and lower emissions.
- Research on advanced heavy-duty hybrid propulsion systems, reduced parasitic losses, and reduced idling emissions.

The Partnership provides a forum for parties to exchange information on the heavy-duty sector across government and industry. The Partnership has developed, among many other aspects, the widely referenced vehicle energy balance for heavy trucks and specific research goals for improvement efficiency.

1.6.3 California Assembly Bill 32

The state of California passed the Global Warming Solutions Act of 2006 (Assembly Bill 32), enacting the state's 2020 greenhouse gas emissions reduction goal into law. Pursuant to this Act, the California Air Resource Board (CARB) was required to begin developing early actions to reduce GHG emissions. Accordingly, the California Air Resource Board issued the Regulation to Reduce Greenhouse Gas Emissions from Heavy-Duty Vehicles in December 2008.⁵¹

This regulation reduces GHG emissions by requiring improvement in the efficiency of heavy-duty tractors and 53 foot or longer dry and refrigerated box trailers which operate in California. The program begins in 2010, although small fleets are allowed special compliance opportunities to phase in the retrofits of their existing trailer fleets through 2017. The regulation requires that new tractors and trailers subject to the rule be certified by SmartWay and existing tractors and trailers are retrofit with SmartWay verified technologies. The efficiency improvements are achieved through the use of aerodynamic equipment and low rolling resistance tires on both the tractor and trailer.

1.6.4 U.S. Energy Independence and Security Act

The U.S. Energy Independence and Security Act of 2007 was enacted by Congress in December of 2007.⁵² EISA requires the DOT, in consultation with DOE and EPA, to study the fuel efficiency of heavy-duty trucks and determine: the appropriate test procedures and metric for measuring and expressing fuel efficiency of MD/HD vehicles; the range of factors that affect fuel efficiency of such vehicles; and factors that could have an impact on a program to improve these vehicles' fuel efficiency. In addition, EISA directed the DOT, in consultation with DOE and the EPA, to implement, via rulemaking and regulations, "a commercial heavy-duty on-highway vehicle and work truck fuel efficiency improvement program" and to "adopt and implement appropriate test methods, measurement metrics, fuel economy standards, and compliance and enforcement protocols that are appropriate, cost-effective, and technologically feasible for commercial heavy-duty on-highway vehicles and work trucks." This authority permits DOT to set "separate standards for different classes of

vehicles.” The standards must provide at least four full model years of regulatory lead time and three full model years of regulatory stability.

Section 108 of the Act directed the Secretary of Transportation to execute an agreement with the National Academy of Sciences (NAS) to develop a report evaluating heavy-duty truck fuel economy standards. The study includes an assessment of technologies and costs to evaluate MD/HD vehicle fuel economy; analysis of existing and potential technologies to improve such vehicles’ fuel economy; analysis of how the technologies may be integrated into the manufacturing process; assessment of how the technologies may be used to meet fuel economy standards; and associated costs and other impacts on operation. The NAS panel published this study, titled “Technologies and Approaches to Reducing the Fuel Consumption of Medium- and Heavy-duty Vehicles” March 31, 2010.”⁵

1.6.5 International GHG Emissions and Fuel Consumption Activities

The international regulatory actions to reduce GHG emissions and fuel consumption from heavy-duty trucks have been limited in scope. Japan has been at the forefront of heavy-duty truck fuel consumption regulations while other nations, such as China and the European Union, are still in the development stage of potential regulatory programs for this sector.

Japan introduced legislation which set the minimum fuel economy standards for new heavy-duty vehicles with a GVWR of greater than 7,700 pounds beginning in 2015 model year.

References

- ¹ 2010 Bureau of Transportation Statistics, Table 1-50: U.S. Ton-Miles of Freight (BTS Special Tabulation). Available here:
http://www.bts.gov/publications/national_transportation_statistics/html/table_01_50.html
- ² U.S. Department of Transportation, Federal Highway Administration, Table 2-1 of Freight Facts and Figures 2009 available here:
http://www.ops.fhwa.dot.gov/freight/freight_analysis/nat_freight_stats/docs/09factsfigures/pdfs/fff2009_ch2.pdf
- ³ Federal Highway Administration, Freight Facts and Figures 2009, Table 2-1 “Weight of Shipments by Mode; 2002, 2008, and 2035.” Available here:
http://www.ops.fhwa.dot.gov/freight/freight_analysis/nat_freight_stats/docs/09factsfigures/pdfs/fff2009_ch2.pdf
- ⁴ U.S. EPA, Inventory of Greenhouse Gas Emissions and Sinks: 1990-2008, published April 15, 2010. Available: http://www.epa.gov/climatechange/emissions/downloads10/US-GHG-Inventory-2010_Report.pdf
- ⁵ Committee to Assess Fuel Economy Technologies for Medium- and Heavy-Duty Vehicles, Board on Energy and Environmental Systems, Division of Engineering and Physical Sciences, and the Transportation Research Board, “Technologies and Approaches to Reducing the Fuel Consumption of Medium- and Heavy-Duty Vehicles,” published by the National Research Council of the National Academies in 2010, available here: http://www.nap.edu/catalog.php?record_id=12845
- ⁶ Energy Information Administration, Annual Energy Outlook 2010 with Projections to 2035. Available at: http://www.eia.doe.gov/oiaf/aeo/natgas_fuel.html
- ⁷ CO₂ emissions by regulatory category in calendar year 2005, taken from MOVES runs and analysis described in Chapter 5: Emissions Inventory.
- ⁸ The International Council on Clean Transportation (ICCT). Heavy-Duty Vehicle Market Analysis. May 2009.
- ⁹ U.S. Census Bureau, Statistics of U.S. Businesses, 2008 SUBS Annual Data, U.S. and States: “U.S., all industries table,” available here: <http://www.census.gov/econ/susb/>
- ¹⁰ International@ Truck/DuraStar Hybrid website, available at:
<http://www.internationaltrucks.com/portal/site/Trucks/menuitem.a1d4a3932b46e05831f8e968121010a0/?vgnnextoid=945d07aafbfe6110VgnVCM10000085d0eb0aRCRD>, Accessed 07/22/2010.
- ¹¹ Northeast States Center for a Clean Air Future (NESCCAF), International Council on Clean Transportation (ICCT), Southwest Research Institute, “Reducing Heavy-Duty Long Haul Combination Truck Fuel Consumption and CO₂ Emissions”, Final Report, October, 2009
- ¹² TIAX, LLC. “Assessment of Fuel Economy Technologies for Medium- and Heavy-Duty Vehicles,” Final Report to the National Academy of Sciences, November 19, 2009.
- ¹³ Union of Concerned Scientists, “California Diesel Truck Rules New Opportunities to Improve Public Health, Reduce Global Warming Pollution,” available here:
http://www.ucsusa.org/assets/documents/clean_vehicles/california-diesel-truck-rules.pdf

Heavy-Duty GHG and Fuel Efficiency Standards FRM: Industry Characterization

- ¹⁴ ICF International. Investigation of Costs for Strategies to Reduce Greenhouse Gas Emissions for Heavy-Duty On-Road Vehicles. July 2010. Pages 4-16. Docket Identification Number EPA-HQ-OAR-2010-0162-0044.
- ¹⁵ U.S. DOT, FHWA Highway Statistics 2009, Public Road Length Chart VMT-421. Available here: <http://www.fhwa.dot.gov/policyinformation/statistics/2009/vmt421.cfm>
- ¹⁶ Association of American Railroads, Class I Railroad Statistics, October 29, 2010, “Miles of Track Operated Less Trackage Rights.” Available here: <http://www.aar.org/~media/aar/Industry%20Info/AAR%20Stats%202010%201123.ashx>
- ¹⁷ U.S. DOT, FHWA Highway Statistics 2009, Truck-and Truck-Tractor Registrations – 2008. Available at: <http://www.fhwa.dot.gov/policyinformation/statistics/2009/mv11.cfm>
- ¹⁸ U.S. DOT, Federal Highway Administration: Freight Management and Operations, “Freight Facts and Figures 2010,” Tables 2-4 and 2-4M, available here: http://www.ops.fhwa.dot.gov/freight/freight_analysis/nat_freight_stats/docs/10factsfigures/table2_4.htm
- ¹⁹ U.S. DOT, Federal Highway Administration, “2009 Fact and Figures – Chapter 2.” Available here: http://www.ops.fhwa.dot.gov/freight/freight_analysis/nat_freight_stats/docs/09factsfigures/pdfs/fff2009_ch2.pdf
- ²⁰ From the 2009 FHWA report which used the following Sources: Total, water and air data: U.S. Department of Commerce, U.S. Census Bureau, Foreign Trade Division, U.S., Imports of Merchandise and U.S Exports of Merchandise DVD's, December 2008. Truck, rail, and pipeline data: U.S. Department of Transportation, Research and Innovative Technology Administration, Bureau of Transportation Statistics, Transborder Freight Data, available at www.bts.gov/transborder as of August 20, 2009. Other, unknown and miscellaneous data: special tabulation, August 2009.
- ²¹ U.S. Department of Commerce, International Trade Administration, Top Trade Partners statistics. Available at: http://www.trade.gov/mas/ian/build/groups/public/@tg_ian/documents/webcontent/tg_ian_003020.pdf
- ²² Bureau of Transportation Statistics, North American Transborder Freight Data. Available here: http://www.bts.gov/programs/international/transborder/TBDR_QuickSearch.html
- ²³ Bureau of Transportation Statistics, North American Transborder Freight Data. Available here: http://www.bts.gov/programs/international/transborder/TBDR_QAPC07.html
- ²⁴ Trucker Country, “U.S. Truck and Auto Speed Limits,” available here: <http://www.truckercountry.com/speed-limits.html>, Accessed 07/20/2010.
- ²⁵ Abels & Annes, P.C., “Illinois increases truck speed limit to 65 mph,” August 24m 2009. Available here: http://www.chicagocaraccidentlawyersblog.com/2009/08/illinois_increases_truck_speed.html
- ²⁶ U.S. DOT and The Federal Highway Administration, Freight Management and Operations, available here: http://ops.fhwa.dot.gov/freight/infrastructure/national_network.htm
- ²⁷ U.S. DOT, Federal Highway Administration, “2009 Fact and Figures – Chapter 3.” Available here: http://www.ops.fhwa.dot.gov/freight/freight_analysis/nat_freight_stats/docs/09factsfigures/pdfs/fff2009_ch3.pdf
- ²⁸ University of Washington, Pavement Tools Consortium, Pavement Guide Interactive, available here: http://training.ce.washington.edu/wsdot/Modules/04_design_parameters/wim.htm

Regulatory Impact Analysis

²⁹ Oregon Department of Transportation, Green Light Weight Station Preclearance, available here: <http://www.oregon.gov/ODOT/MCT/GREEN.shtml>

³⁰ U.S. IRS, “Retail Tax on Heavy Trucks, Trailers, and Tractors,” available here: <http://www.irs.gov/publications/p510/ch06.html>

³¹ U.S. IRS, “Instructions for Quarterly Federal Excise Tax Returns,” available here: <http://www.irs.gov/pub/irs-pdf/i720.pdf>

³² TireBusiness.com, “With trucking continuing to roll on expect strong commercial tire year”, available here: http://www.tirebusiness.com/subscriber/comm_tire2.html?cat=12&id=1104858239&subtitle=

³³ U.S. IRS “Heavy Highway Vehicle Use Tax Return Form 2290,” available here: <http://www.irs.gov/pub/irs-pdf/f2290.pdf>

³⁴ FleetOwner, “Rethinking resale.” Available here: http://fleetowner.com/equipment/usedtruckblue/rethinking_class8_truck_resales_1208/ Accessed: 08/03/2010

³⁵ Mele, Jim, “Plotting the Recovery” January 1, 2010. Available at: http://fleetowner.com/management/feature/fleet_plotting_recovery/

³⁶ U.S. DOE, Research and Development Opportunities for Heavy Trucks, June, 2009. Available at: http://www1.eere.energy.gov/vehiclesandfuels/pdfs/truck_efficiency_paper_v2.pdf

³⁷ Modern Tire Dealer, Top Retreaders (April, 2010), accessed August 2, 2010, at <http://www.moderntiredealer.com/Stats/Viewer.aspx?file=http%3a%2f%2fwww.moderntiredealer.com%2ffiles%2fstats%2fMTD06marketshare.pdf>

³⁸ US Department of Transportation, *Effect of Tires on Class 8 Heavy Truck Fuel Efficiency*, Franzese, Oscar, Knee, Helmut (Bill), Slezak, Lee (July, 2009), accessed August 2, 2010, at <http://info.ornl.gov/sites/publications/files/Pub20686.pdf>

³⁹ Al-Qadi, Imad, and Wang, Hao, *Evaluation of Pavement Damage Due to New Tire Design*, Illinois Center for Transportation, FHWA-ICT-09-048 (May, 2009).

Greene, James, *Impact of Wide-Base Tires on Pavement Damage* (April, 2010), accessed August 2, 2010, at <http://www.dot.state.fl.us/statematerialsoffice/administration/resources/library/publications/articles/tirestudy.pdf> Al-Qadi, Imad, *Impact of Wide-Base Tires on Pavement and Trucking Operation*, Illinois Center for Transportation, presentation at the International Workshop on the Use of Wide-Base Tires, Federal Highway Administration, Turner-Fairbank Highway Research Center (October, 2007), accessed August 2, 2010, at

http://www.arc.unr.edu/Workshops/Wide-Base_Tires/International_Workshop_on_the_Use_of_Widebase_Tires-Minutes-Final.pdf

⁴⁰ White House, Executive Order 13149 of April 21, 2000, *Greening the Government Through Federal Fleet and Transportation Efficiency*

⁴¹ Modern Tire Dealer, Top Retreaders (April, 2010), accessed August 2, 2010, at <http://www.moderntiredealer.com/Stats/Viewer.aspx?file=http%3a%2f%2fwww.moderntiredealer.com%2ffiles%2fstats%2fMTD-32-40-1.pdf>

Heavy-Duty GHG and Fuel Efficiency Standards FRM: Industry Characterization

⁴² Woodrooffe, J.F., Page, O., Blower, D., and Green, P.E. “Commercial Medium Tire Debris Study”, published by the U.S. Department of Transportation, NHTSA, DOT HS 8211 060. Available here: <http://www.nhtsa.gov/DOT/NHTSA/NRD/Multimedia/PDFs/Crash%20Avoidance/2008/811060.pdf>

⁴³ Appendix G to Subchapter B—Minimum periodic inspection standards: 49 CFR Subtitle B Chapter III Subchapter B Appendix G

⁴⁴ Todaystrucking.com, *Retread Tires FAQ* (07/17/2006), accessed August 2, 2010.

⁴⁵ Modern Tire Dealer, *Top Retreaders* (April, 2010), accessed at <http://www.moderntiredealer.com/Stats/Viewer.aspx?file=http%3a%2f%2fwww.moderntiredealer.com%2ffiles%2fstats%2fMTD-32-40-1.pdf>

⁴⁶ Manges, Mike, *Retreaders Look for a Better Year*, Commercial Tire Dealer (February 19, 2010), accessed August 2, 2010, at <http://www.moderntiredealer.com/Article/Story/2010/02/Retreaders-look-for-better-year.aspx>

⁴⁷ Modern Tire Dealer, *Top Retreaders*, *ibid.*

⁴⁸ Tire Industry Association and the Tire Retread and Repair Information Bureau, *Understanding Retreading*, accessed August 2, 2010, at http://www.retread.org/pdf/UR/UnderstandingRetreading_web.pdf

⁴⁹ Ulrich, Bob, *Breaking Down the Top Retreaders*, Modern Tire Dealer (June 7, 2009), accessed August 2, 2010, at <http://www.moderntiredealer.com/Article/Print/Story/2009/06/Breaking-down-the-top-100-retreaders.aspx>

⁵⁰ U.S. Department of Energy, Energy Efficiency & Renewable Energy – Vehicle Technologies Program. 21st Century Truck Partnership. Viewed 12/8/2009 at <http://www1.eere.energy.gov/vehiclesandfuels/about/partnerships/21centurytruck/>

⁵¹ California Air Resource Board, Heavy-Duty Vehicle Greenhouse Gas Measure. Viewed 12/8/2009 at <http://www.arb.ca.gov/cc/hdghg/hdghg.htm>

⁵² One Hundred Tenth Congress of the United States of America. Energy Independence and Security Act of 2007. January 2007. Viewed 12/8/2009 at http://frwebgate.access.gpo.gov/cgi-bin/getdoc.cgi?dbname=110_cong_bills&docid=f:h6enr.txt.pdf

Chapter 2: Technologies, Cost, and Effectiveness

2.1 Overview of Technologies

In discussing the potential for CO₂ emission and fuel consumption reductions, it can be helpful to think of the work flow through the system. The initial work input is fuel. Each gallon of fuel has the potential to produce some amount of work and will produce a set amount of CO₂ (about 22 pounds (10 kg) of CO₂ per gallon of diesel fuel). The engine converts the chemical energy in the fuel to useable work to move the truck. Any reductions in work demanded of the engine by the vehicle or improvements in engine fuel conversion efficiency will lead directly to CO₂ emission and fuel consumption reductions.

Current diesel engines are 35-38 percent efficient over a range of operating conditions with peak efficiency levels between 40 and 45 percent depending on engine sizes and applications, while gasoline engines are approximately 30 percent efficient overall. This means that approximately one-third of the fuel's chemical energy is converted to useful work and two-thirds is lost to friction, gas exchange, and waste heat in the coolant and exhaust. In turn, the truck uses this work delivered by the engine to overcome overall vehicle-related losses such as aerodynamic drag, tire rolling resistance, friction in the vehicle driveline, and to provide auxiliary power for components such as air conditioning and lights. Lastly, the vehicle's operation, such as vehicle speed and idle time, affects the amount of total energy required to complete its activity. While it may be intuitive to look first to the engine for CO₂ reductions given that only about one-third of the fuel is converted to useable work, it is important to realize that any improvement in vehicle efficiency reduces both the work demanded and also the waste energy in proportion.

Technology is one pathway to improve heavy-duty truck GHG emissions and fuel consumption. Near-term solutions exist, such as those being deployed by SmartWay partners in heavy-duty truck long haul applications. Other solutions are currently underway in the Light-Duty vehicle segment, especially in the Large Pickup sector where many of the technologies can apply to the heavy-duty pickup trucks covered under this rulemaking. Long-term solutions are currently under development to improve efficiencies and cost-effectiveness. While there is not a "silver bullet" that will significantly eliminate GHG emissions from heavy-duty trucks like the catalytic converter has for criteria pollutant emissions, significant GHG and fuel consumption reductions can be achieved through a combination of engine, vehicle system, and operational technologies. |

The following sections will discuss technologies in relation to each of the regulatory categories – Heavy-Duty Pickup Trucks and Vans, Heavy-Duty Engines, Class 7 and 8 Combination Tractors, and Class 2b-8 Vocational Vehicles. In each of these sections information on technological approaches, costs, and percent improvements is provided. Not all of the technologies discussed in these sections are assumed to be used for compliance with the engine and vehicle standards, for reasons that are also discussed in each section. A summary of technologies, costs, fuel consumption and GHG emissions improvement

Regulatory Impact Analysis

percentages is provided in Table 2-39 at the end of this chapter for each of the engine/vehicle types listed above.

EPA and NHTSA collected information on the cost and effectiveness of fuel consumption and CO₂ emission reducing technologies from several sources. The primary sources of information were the 2010 National Academy of Sciences report on Technologies and Approaches to Reducing the Fuel Consumption of Medium- and Heavy-Duty Vehicles (NAS)¹, TIAX's assessment of technologies to support the NAS panel report (TIAX)², EPA's Heavy-Duty Lumped Parameter Model³, the analysis conducted by NESCCAF, ICCT, Southwest Research Institute and TIAX for reducing fuel consumption of heavy-duty long haul combination tractors (NESCCAF/ICCT)⁴, and the technology cost analysis conducted by ICF for EPA (ICF).⁵ In addition, the agencies used the vehicle simulation model (the Greenhouse gas Emissions Model or (GEM) to quantify the effectiveness of various technologies on CO₂ emission and fuel consumption reductions in terms of vehicle performance as they are evaluated in determining compliance with the HD program. The simulation tool is described in RIA Chapter 4 in more detail.

2.1.1 Baseline Engine and Vehicle Configuration

The agencies have derived the baseline engine and vehicle configuration for each regulatory category by examining engines and vehicles in the existing fleet to represent the typical 2010 model year vehicle and engine, as described later in this RIA chapter, and as shown in Table 2-1. The technology paths that the agencies considered available for each category for purposes of determining what regulatory standards would be cost-effective, and technologically feasible and otherwise appropriate in the lead time afforded by the rulemaking are, in turn, built from the baseline.

Table 2-1: Baseline Engine and Vehicle Configurations

REGULATORY CATEGORY	BASELINE CONFIGURATION
Heavy-Duty Gasoline Pickup Truck and Van	<ul style="list-style-type: none"> • V8 engine • Electronic control • Naturally aspirated • Coupled cam phasing • 6 speed automatic transmission
Heavy-Duty Diesel Pickup Truck and Van	<ul style="list-style-type: none"> • 2010 emission compliant diesel engine • Electronic control • 6 speed automatic transmission
Heavy-Duty Gasoline Engine	<ul style="list-style-type: none"> • V8 engine • Electronic control • Naturally aspirated • Fixed valve timing

Heavy-Duty GHG and Fuel Efficiency Standards FRM: Technologies, Cost, and Effectiveness

REGULATORY CATEGORY	BASELINE CONFIGURATION
Heavy-Duty Diesel Engine	<ul style="list-style-type: none"> • Electronic control • SCR/EGR/DPF exhaust aftertreatment system which achieves 2010MY criteria emissions standards • Turbocharged with variable geometry turbocharger • 2200 bar injection pressure • Single fixed overhead valve • Belt driven accessories
Combination Tractor	<ul style="list-style-type: none"> • Aerodynamics: tractor fleet consists of 25% Bin I, 70% Bin II, and 5% Bin III • Tires: Dual tires with steel wheels, CRR=7.8 (steer) and 8.2 (drive) • Body and Chassis: steel components • Idle Reduction: Currently 30% of sleeper cabs contain an idle reduction technology, but not necessarily an automatic engine shutoff • Vehicle Speed Limiter: 0% of tractors contain a non-override VSL set at below 65 mph
Vocational Vehicle	<ul style="list-style-type: none"> • Tires: average tire with a CRR=9.0

2.2 Overview of Technology Cost Methodology

Section 2.2.1 presents the methods used to address indirect costs in this analysis. Section 2.2.2 presents the learning effects applied throughout this analysis. Section 2.9 presents a summary in tabular form of all the technology costs expected to be implemented in response to the standards.

2.2.1 Markups to Address Indirect Costs

To produce a unit of output, engine and truck manufacturers incur direct and indirect costs. Direct costs include cost of materials and labor costs. Indirect costs are all the costs associated with producing the unit of output that are not direct costs – for example, they may be related to production (such as research and development [R&D]), corporate operations (such as salaries, pensions, and health care costs for corporate staff), or selling (such as transportation, dealer support, and marketing). Indirect costs are generally recovered by allocating a share of the costs to each unit of good sold. Although it is possible to account for direct costs allocated to each unit of good sold, it is more challenging to account for indirect costs allocated to a unit of goods sold. To make a cost analysis process more feasible, markup factors, which relate total indirect costs to total direct costs, have been developed. These factors are often referred to as retail price equivalent (RPE) multipliers.

Cost analysts and regulatory agencies (including both EPA and NHTSA) have frequently used these multipliers to predict the resultant impact on costs associated with manufacturers' responses to regulatory requirements. The best approach, if it were possible, to determining the impact of changes in direct manufacturing costs on a manufacturer's

Regulatory Impact Analysis

indirect costs would be to actually estimate the cost impact on each indirect cost element. However, doing this within the constraints of an agency's time or budget is not always feasible, or the technical, financial, and accounting information to carry out such an analysis may simply be unavailable.

RPE multipliers provide, at an aggregate level, the relative shares of revenues (Revenue = Direct Costs + Indirect Costs + Net Income) to direct manufacturing costs. Using RPE multipliers implicitly assumes that incremental changes in direct manufacturing costs produce common incremental changes in all indirect cost contributors as well as net income. However, a concern in using the RPE multiplier in cost analysis for new technologies added in response to regulatory requirements is that the indirect costs of vehicle modifications are not likely to be the same for different technologies. For example, less complex technologies could require fewer R&D efforts or less warranty coverage than more complex technologies. In addition, some simple technological adjustments may, for example, have no effect on the number of corporate personnel and the indirect costs attributable to those personnel. The use of RPEs, with their assumption that all technologies have the same proportion of indirect costs, is likely to overestimate the costs of less complex technologies and underestimate the costs of more complex technologies.

To address this concern, modified multipliers have been developed by EPA, working with a contractor, for use in rulemakings. These multipliers are referred to as indirect cost multipliers (or ICMs). In contrast to RPE multipliers, ICMs assign unique incremental changes to each indirect cost contributor as well as net income.

$$\text{ICM} = (\text{direct cost} + \text{adjusted indirect cost}) / (\text{direct cost})$$

Developing the ICMs from the RPE multipliers requires developing adjustment factors based on the complexity of the technology and the time frame under consideration: the less complex a technology, the lower its ICM, and the longer the time frame for applying the technology, the lower the ICM. This methodology was used in the cost estimation for the recent light-duty 2012-2016 MY vehicle rulemaking. The ICMs for the light-duty context were developed in a peer-reviewed report from RTI International and were subsequently discussed in a peer-reviewed journal article.⁶

For the heavy-duty pickup truck and van cost projections in the proposal, the agencies used ICM adjustment factors developed for light-duty vehicles, inclusive of a return on capital, primarily because the manufacturers involved in this segment of the heavy-duty market are the same manufacturers which build light-duty trucks. The cost of capital (reflected in profit) is included because of the assumption implicit in ICMs (and RPEs) that capital costs are proportional to direct costs, and businesses need to be able to earn returns on their investments. The capital costs are those associated with the incremental costs of the new technologies.

For the combination tractors, vocational vehicles, and heavy-duty engine cost projections in the proposal, EPA contracted with RTI International to update EPA's methodology for accounting for indirect costs associated with changes in direct manufacturing

Heavy-Duty GHG and Fuel Efficiency Standards FRM: Technologies, Cost, and Effectiveness

costs for heavy-duty engine and truck manufacturers.⁷ In addition to the indirect cost contributors varying by complexity and time frame, there is no reason to expect that the contributors would be the same for engine manufacturers as for truck manufacturers. The resulting report from RTI provides a description of the methodology, as well as calculations of the indirect cost multipliers used in the proposal. These indirect cost multipliers were used, along with calculations of direct manufacturing costs, to provide estimates of the full additional costs associated with new technologies.

For the analysis supporting this final rulemaking, the agencies have made some changes to both the ICMs factors and to the method of applying those factors to arrive at a final cost estimate. The first of these changes was done in response to continued thinking among the EPA-NHTSA team about how past ICMs have been developed and what are the most appropriate data sources to rely upon in determining the appropriate ICMs. The second change has been done in response to both staff concerns and public feedback suggesting that the agencies were inappropriately applying learning effects to indirect costs via the multiplicative approach to applying the ICMs.

Regarding the first change – to the ICM factors themselves – a little background must first be provided. In the original work done under contract to EPA by RTI International,⁸ EPA experts had undergone a consensus approach to determining the impact of specific technology changes on the indirect costs of a company. Subsequent to that effort, EPA experts underwent a blind survey to make this determination on a different set of technology changes. This subsequent effort, referred to by EPA as a modified-Delphi approach, resulted in different ICM determinations. This effort is detailed in a memorandum contained in the docket for this rulemaking.⁹ Upon completing this effort, EPA determined that the original RTI values should be averaged with the modified-Delphi values to arrive at the final ICMs for low and medium complexity technologies and that the original RTI values would be used for high complexity level 1 while the modified-Delphi values would be used for high complexity level 2. These final ICMs were used in the 2012-2016 light-duty GHG/CAFE rulemaking. Subsequent to that, EPA contracted RTI to update their light-duty report with an eye to the heavy-duty industry. In that effort, RTI determined the RPE of both the heavy-duty engine and heavy truck industries, then applied the light-duty indirect cost factors—those resulting from the averaging of the values from their original report with the modified-Delphi values—to the heavy-duty RPEs to arrive at heavy-duty specific ICMs. That effort is described in their final heavy-duty ICM report mentioned above.¹⁰

More recently, the EPA and NHTSA team has decided that the original light-duty RTI values, given the technologies considered for low and medium complexity, should no longer be used and that we should rely solely on the modified-Delphi values for these complexity levels. The original light-duty RTI study used low rolling resistance tires as a low complexity technology example and a dual clutch transmission as a medium complexity technology. Upon further thought, the technologies considered for the modified Delphi values (passive aerodynamic improvements for low complexity and turbocharging with downsizing for medium complexity were considered to better represent the example technologies). As a result, the modified-Delphi values were to become the working ICMs for low and medium complexity rather than averaging those values with the original RTI report values. NHTSA

Regulatory Impact Analysis

and EPA staff also re-examined the technology complexity categories that were assigned to each light-duty technology and modified these assignments to better reflect the technologies that are now used as proxies for each category. This decision impacts the low and medium complexity heavy-duty ICMs too because the modified-Delphi values alone were now to be applied to the heavy-duty RPEs to arrive at heavy-duty ICMs rather than using the averaged values developed for the 2012-2016 rulemaking.

A secondary-level change was also made as part of this ICM recalculation to the light-duty ICMs and, therefore, to the ICMs used in this analysis for HD pickups and vans. That change was to revise upward the RPE level reported in the original RTI report from an original value of 1.46 to 1.5 to reflect the long term average RPE. The original RTI study was based on 2008 data. However, an analysis of historical RPE data indicates that, although there is year to year variation, the average RPE has remained roughly 1.5. ICMs will be applied to future year's data and therefore NHTSA and EPA staff believe that it would be appropriate to base ICMs on the historical average rather than a single year's result. Therefore, ICMs were adjusted to reflect this average level. As a result, the High 1 and High 2 ICMs used for HD pickups and vans have also changed.

Table 2-2 shows both the ICM values used in the proposal and the new ICM values used for the analysis supporting this final rulemaking. Near term values (2014 through 2021 in this analysis) account for differences in the levels of R&D, tooling, and other indirect costs that will be incurred. Once the program has been fully implemented, some of the indirect costs will no longer be attributable to the standards and, as such, a lower ICM factor is applied to direct costs in 2022 and later.

Table 2-2 Indirect Cost Multipliers Used in this Analysis^a

CLASS	COMPLEXITY	PROPOSAL		FINAL	
		NEAR TERM	LONG TERM	NEAR TERM	LONG TERM
HD Pickup Trucks and Vans	Low	1.17	1.13	1.24	1.19
	Medium	1.31	1.19	1.39	1.29
	High1	1.51	1.32	1.56	1.35
	High2	1.70	1.45	1.77	1.50
Loose diesel engines	Low	1.11	1.09	1.15	1.12
	Medium	1.18	1.13	1.24	1.18
	High1	1.28	1.19	1.28	1.19
	High2	1.43	1.29	1.43	1.29
Loose gasoline engines	Low	1.17	1.13	1.24	1.19
	Medium	1.31	1.19	1.39	1.29
	High1	1.51	1.32	1.56	1.35
	High2	1.70	1.45	1.77	1.50
Vocational Vehicles and Combination Tractors	Low	1.14	1.10	1.18	1.14
	Medium	1.26	1.16	1.30	1.23
	High1	1.42	1.27	1.42	1.27
	High2	1.57	1.36	1.57	1.36

Note:^a Rogozhin, A., et. al., "Using indirect cost multipliers to estimate the total cost of adding new technology in the automobile industry," International Journal of Production Economics (2009); "Documentation of the Development of Indirect Cost Multipliers for Three Automotive Technologies," Helfand, G., and Sherwood, T., Memorandum dated August 2009;

Heavy-Duty GHG and Fuel Efficiency Standards FRM: Technologies, Cost, and Effectiveness

“Heavy Duty Truck Retail Price Equivalent and Indirect Cost Multipliers,” Draft Report prepared by RTI International and Transportation Research Institute, University of Michigan, July 2010.

The second change made to the ICMs has to do with the way in which the ICMs are applied. To date, we have applied the ICMs, as done in any analysis that relied on RPEs, as a pure multiplicative factor. This way, a direct manufacturing cost of, say, \$100 would be multiplied by an ICM of 1.24 to arrive at a marked up technology cost of \$124. However, as learning effects (discussed below) are applied to the direct manufacturing cost, the indirect costs are also reduced accordingly. Therefore, in year 2 the \$100 direct manufacturing cost might reduce to \$97 and the marked up cost would become \$120 ($\97×1.24). As a result, indirect costs have been reduced from \$24 to \$20. Given that indirect costs cover many things such as facility-related costs, electricity, etc., it is perhaps not appropriate to apply the ICM to the learned direct costs, at least not for those indirect cost elements unlikely to change with learning. The EPA-NHTSA team believes that it is appropriate only to allow warranty costs to decrease with learning since warranty costs are tied to direct manufacturing costs (since warranty typically involves replacement of actual parts which should be less costly with learning). However, the remaining elements of the indirect costs should remain constant year-over-year, at least until some of those indirect costs are no longer attributable to the rulemaking effort that imposed them (such as R&D).

As a result, the ICM calculation has become more complex with the analysis supporting this final action. We must first establish the year in which the direct manufacturing costs are considered “valid.” For example, a cost estimate might be considered valid today, or perhaps not until high volume production is reached which will not occur until MY 2015. That year is known as the base year for the estimated cost. That cost is the cost used to determine the “non-warranty” portion of the indirect costs. For example, the non-warranty portion of the loose diesel engine low complexity ICM in the short-term is 0.149 (the warranty versus non-warranty portions of the ICMs are shown in Table 2-3). For the improved water pump technology we have estimated a direct manufacturing cost of \$79 in MY 2014. So the non-warranty portion of the indirect costs would be \$11.77 ($\79×0.149). This value would be added to the learned direct manufacturing cost for each year through 2021. Beginning in 2022, when long-term indirect costs begin, the additive factor would become \$9.64 ($\79×0.122). Additionally, the \$79 cost in 2014 would become \$76.63 in MY 2015 due to learning ($\$79 \times (1-3 \text{ percent})$). So, while the warranty portion of the indirect costs would be \$0.47 ($\79×0.006) in 2014, they would decrease to \$0.46 ($\76×0.006) in 2015 as warranty costs decrease with learning. The resultant indirect costs for the water pump would be \$12.24 ($\$11.77 + \0.47) in MY 2014 and \$12.23 ($\$11.77 + \0.46) in MY2015, and so on for subsequent years.

Regulatory Impact Analysis

Table 2-3 Warranty and Non-Warranty Portions of ICMs

CLASS	COMPLEXITY	SHORT-TERM		LONG-TERM	
		WARRANTY	NON-WARRANTY	WARRANTY	NON-WARRANTY
HD Pickup Trucks and Vans	Low	0.012	0.230	0.005	0.187
	Medium	0.045	0.343	0.031	0.259
	High1	0.065	0.499	0.032	0.314
	High2	0.074	0.696	0.049	0.448
Loose diesel engines	Low	0.006	0.149	0.003	0.122
	Medium	0.022	0.213	0.016	0.165
	High1	0.032	0.249	0.016	0.176
	High2	0.037	0.398	0.025	0.265
Loose gasoline engines	Low	0.012	0.230	0.005	0.187
	Medium	0.045	0.343	0.031	0.259
	High1	0.065	0.499	0.032	0.314
	High2	0.074	0.696	0.049	0.448
Vocational Vehicles and Combination Tractors	Low	0.013	0.165	0.006	0.134
	Medium	0.051	0.252	0.035	0.190
	High1	0.073	0.352	0.037	0.233
	High2	0.084	0.486	0.056	0.312

There is some level of uncertainty surrounding both the ICM and RPE markup factors. The ICM estimates used in this final rulemaking group all technologies into three broad categories and treat them as if individual technologies within each of the three categories (low, medium, and high complexity) will have the same ratio of indirect costs to direct costs. This simplification means it is likely that the direct cost for some technologies within a category will be higher and some lower than the estimate for the category in general. More importantly, the ICM estimates have not been validated through a direct accounting of actual indirect costs for individual technologies. Rather, the ICM estimates were developed using adjustment factors developed in two separate occasions: the first, a consensus process, was reported in the RTI report; the second, a modified Delphi method, was conducted separately and reported in an EPA memo. Both these panels were composed of EPA staff members with previous background in the automobile industry; the memberships of the two panels overlapped but were not the same. The panels evaluated each element of the industry's RPE estimates and estimated the degree to which those elements would be expected to change in proportion to changes in direct manufacturing costs. The method and estimates in the RTI report were peer reviewed by three industry experts and subsequently by reviewers for the International Journal of Production Economics.¹¹ RPEs themselves are inherently difficult to estimate because the accounting statements of manufacturers do not neatly categorize all cost elements as either direct or indirect costs. Hence, each researcher developing an RPE estimate must apply a certain amount of judgment to the allocation of the costs. Moreover, RPEs for heavy- and medium-duty trucks and for engine manufacturers are not as well studied as they are for the light-duty automobile industry. Since empirical estimates of ICMs are ultimately derived from the same data used to measure RPEs, this affects both measures. However, the value of RPE has not been measured for specific technologies, or for groups of specific technologies. Thus, even if we assume that the examined technology accurately represents the average impact on all technologies in its representative category, applying a

single average RPE to any given technology by definition overstates costs for very simple technologies, or understates them for more advanced technologies in that group.

2.2.2 Learning Effects on Technology Costs

For some of the technologies considered in this analysis, manufacturer learning effects would be expected to play a role in the actual end costs. The “learning curve” or “experience curve” describes the reduction in unit production costs as a function of accumulated production volume. In theory, the cost behavior it describes applies to cumulative production volume measured at the level of an individual manufacturer, although it is often assumed—as both agencies have done in past regulatory analyses—to apply at the industry-wide level, particularly in industries that utilize many common technologies and component supply sources. Both agencies believe there are indeed many factors that cause costs to decrease over time. Research in the costs of manufacturing has consistently shown that, as manufacturers gain experience in production, they are able to apply innovations to simplify machining and assembly operations, use lower cost materials, and reduce the number or complexity of component parts. All of these factors allow manufacturers to lower the per-unit cost of production (*i.e.*, the manufacturing learning curve).¹²

NHTSA and EPA have a detailed description of the learning effect in the light-duty 2012-2016 MY vehicle rulemaking. Most studies of the effect of experience or learning on production costs appear to assume that cost reductions begin only after some initial volume threshold has been reached, but not all of these studies specify this threshold volume. The rate at which costs decline beyond the initial threshold is usually expressed as the percent reduction in average unit cost that results from each successive doubling of cumulative production volume, sometimes referred to as the learning rate. Many estimates of experience curves do not specify a cumulative production volume beyond which cost reductions would no longer occur, instead depending on the asymptotic behavior of the effect for learning rates below 100 percent to establish a floor on costs.

In past rulemaking analyses, as noted above, both agencies have used a learning curve algorithm that applied a learning factor of 20 percent for each doubling of production volume. NHTSA has used this approach in analyses supporting recent CAFE rules. In its analysis, EPA has simplified the approach by using an “every two years” based learning progression rather than a pure production volume progression (*i.e.*, after two years of production it was assumed that production volumes would have doubled and, therefore, costs would be reduced by 20 percent).

In the light-duty 2012-2016 MY vehicle rulemaking, the agencies employed an additional learning algorithm to reflect the volume-based learning cost reductions that occur further along on the learning curve. This additional learning algorithm was termed “time-based” learning simply as a means of distinguishing this algorithm from the volume-based algorithm mentioned above, although both of the algorithms reflect the volume-based learning curve supported in the literature.¹³ To avoid confusion, we are now referring to this learning algorithm as the “flat-portion” of the learning curve. This way, we maintain the clarity that all learning is, in fact, volume-based learning, the level of cost reductions depend only on where on the learning curve a technology’s learning progression is. We distinguish the flat-

Regulatory Impact Analysis

portion of the curve from the steep-portion of the curve to indicate the level of learning taking place in the years following implementation of the technology. The agencies have applied the steep-portion learning algorithm for those technologies considered to be newer technologies likely to experience rapid cost reductions through manufacturer learning and the flat-portion learning algorithm for those technologies considered to be mature technologies likely to experience minor cost reductions through manufacturer learning. As noted above, the steep-portion learning algorithm results in 20 percent lower costs after two full years of implementation (*i.e.*, the 2016 MY costs are 20 percent lower than the 2014 and 2015 model year costs). Once two steep-portion learning steps have occurred (for technologies having the steep-portion learning algorithm applied while flat-portion learning would begin in year 2 for technologies having the flat-portion learning algorithm applied), flat-portion learning at 3 percent per year becomes effective for 5 years. Beyond 5 years of learning at 3 percent per year, 5 years of learning at 2 percent per year, then 5 at 1 percent per year become effective.

Learning effects are applied to most but not all technologies because some of the expected technologies are already used rather widely in the industry and, presumably, learning impacts have already occurred. The steep-portion learning algorithm was applied for only a handful of technologies that are considered to be new or emerging technologies. Most technologies have been considered to be more established given their current use in the fleet and, hence, the lower flat-portion learning algorithm has been applied. The learning algorithms applied to each technology are summarized in Table 2-4.

Table 2-4 Learning Effect Algorithms Applied to Technologies Used in this Analysis

TECHNOLOGY	APPLIED TO	LEARNING ALGORITHM
Cylinder head improvements	Engines	Flat
Turbo efficiency improvements	Engines	Flat
EGR cooler efficiency improvements	Engines	Flat
Water pump improvements	Engines	Flat
Oil pump improvements	Engines	Flat
Fuel pump improvements	Engines	Flat
Fuel rail improvements	Engines	Flat
Fuel injector improvements	Engines	Flat
Piston improvements	Engines	Flat
Valve train friction reductions	Engines	Flat
Turbo compounding	Engines	Flat
Engine friction reduction	Engines	Flat
Coupled cam phasing	Engines	Flat
Stoichiometric gasoline direct injection	Engines	Flat
Low rolling resistance tires	Vocational vehicles	Flat
Low rolling resistance tires	Trucks	Flat
Aero (except Aero SmartWay Advanced)	Trucks	Flat
Aero SmartWay Advanced	Trucks	Steep
Weight reduction (via single wide tires and/or aluminum wheels)	Trucks	Flat
Auxiliary power unit	Trucks	Flat

Heavy-Duty GHG and Fuel Efficiency Standards FRM: Technologies, Cost, and Effectiveness

Air conditioning leakage	Trucks	Flat
--------------------------	--------	------

The learning effects discussed here impact the technology costs considered here in that those technology costs for which learning effects are considered applicable are changing throughout the period of implementation and the period following implementation. For example, some of the technology costs considered in this analysis are taken from the light-duty 2012-2016 MY vehicle rulemaking and scaled appropriately giving consideration to the heavier weights and loads in the heavy-duty segment. Many of the costs in the light-duty 2012-2016 MY vehicle rulemaking were consider “applicable” for the 2012 model year. If flat-portion learning were applied to those technologies, the 2013 cost would be 3 percent lower than the 2012 cost, and the 2014 model year cost 3 percent lower than the 2013 cost, etc. As a result, the 2014 model year cost presented in, for example, Section 2.3 would reflect those two years of flat learning and would not be identical to the 2012 model year cost presented in the light-duty 2012-2016 MY vehicle rulemaking.

2.3 Heavy-Duty Pickup Truck and Van (Class 2b and 3) Technologies and Costs

2.3.1 Gasoline Engines

Spark ignited (gasoline) engines used in Class 2b and 3 vehicles include engines offered in a manufacturer’s light-duty truck counterparts, as well as engines specific to the Class 2b and 3 segment. Based on 2010 MY specifications, these engines typically range in displacement between 5 and 7 liters, though smaller and larger engines have also been used in this market. The majority of these engines are a V8 configuration, although the V10 configuration is also marketed.

The engine technologies are based on the technologies described in the Light-Duty Vehicle Greenhouse Gas Emission Standards and Corporate Average Fuel Economy Standards Joint Technical Support Document.¹⁴ Some of the references come from the 2010 NAS Report, Technologies and Approaches to Reducing the Fuel Consumption of Medium and Heavy-Duty Vehicles. These technologies include engine friction reduction, cam phasing, cylinder deactivation and stoichiometric gas direct injection. Included with each technology description is an estimate of the improvement in fuel consumption and GHGs that is achievable through the use of the technology in heavy-duty pickup trucks and vans. Table 2-37 at the end of this chapter shows the total potential improvement in heavy-duty pickup and van fuel consumption and GHG emissions that can be achieved with the use of technologies described in this section.

2.3.1.1 Low Friction Lubricants

One of the most basic methods of reducing fuel consumption in both gasoline and diesel engines is the use of lower viscosity engine lubricants. More advanced multi-viscosity engine oils are available today with improved performance in a wider temperature band and with better lubricating properties. This can be accomplished by changes to the oil base stock (*e.g.*, switching engine lubricants from a Group I base oils to lower-friction, lower viscosity

Regulatory Impact Analysis

Group III synthetic) and through changes to lubricant additive packages (*e.g.*, friction modifiers and viscosity improvers). The use of 5W-30 motor oil is now widespread and auto manufacturers are introducing the use of even lower viscosity oils, such as 5W-20 and 0W-20, to improve cold-flow properties and reduce cold start friction. However, in some cases, changes to the crankshaft, rod and main bearings and changes to the mechanical tolerances of engine components may be required. In all cases, durability testing would be required to ensure that durability is not compromised. The shift to lower viscosity and lower friction lubricants will also improve the effectiveness of valvetrain technologies such as cylinder deactivation, which rely on a minimum oil temperature (viscosity) for operation.

Based on light-duty 2012-2016 MY vehicle rulemaking, and previously-received confidential manufacturer data, NHTSA and EPA estimated the effectiveness of low friction lubricants to be between 0 to 1 percent.

In the 2012-2016 light-duty FRM, the agencies estimated the cost of moving to low friction lubricants at \$3 per vehicle (2007\$). That estimate included a markup of 1.11 for a low complexity technology. For Class 2b and 3, we are using the same base estimate but have marked it up to 2009 dollars using the GDP price deflator and have used a markup of 1.24 for a low complexity technology to arrive at a value of \$4 per vehicle. As in the light-duty rule, learning effects are not applied to costs for this technology and, as such, this estimate applies to all model years.^{15,16}

2.3.1.2 Engine Friction Reduction

Manufacturers can reduce friction and improve fuel consumption by improving the design of engine components and subsystems. Approximately 10 percent of the energy consumed by a vehicle is lost to friction, and just over half is due to frictional losses within the engine. Examples include improvements in low-tension piston rings, piston skirt design, roller cam followers, improved crankshaft design and bearings, material coatings, material substitution, more optimal thermal management, and piston and cylinder surface treatments. Additionally, as computer-aided modeling software continues to improve, more opportunities for evolutionary friction reductions may become available.

All reciprocating and rotating components in the engine are potential candidates for friction reduction, and minute improvements in several components can add up to a measurable fuel economy improvement. The light-duty 2012-2016 MY vehicle rulemaking, 2010 NAS, NESCCAF and EEA reports as well as confidential manufacturer data suggested a range of effectiveness for engine friction reduction to be between 1 to 3 percent. NHTSA and EPA continue to believe that this range is accurate.

Consistent with the 2012-2016 light-duty FRM, the agencies estimate the cost of this technology at \$15 per cylinder compliance cost (2009\$), including the low complexity ICM markup value of 1.24. Learning impacts are not applied to the costs of this technology and, as such, this estimate applies to all model years. This cost is multiplied by the number of engine cylinders.

2.3.1.3 Variable Valve Timing

Variable valve timing (VVT) classifies a family of valve-train designs that alter the timing of the intake valve, exhaust valve, or both, primarily to reduce pumping losses, increase specific power, and control the level of residual gases in the cylinder. VVT reduces pumping losses when the engine is lightly loaded by controlling valve timing closer to the optimum needed to sustain horsepower and torque. VVT can also improve volumetric efficiency at higher engine speeds and loads. Additionally, VVT can be used to alter (and optimize) the effective compression ratio where it is advantageous for certain engine operating modes (*e.g.*, in the Atkinson Cycle).

VVT has now become a widely adopted technology in the light duty fleet: in MY 2007, over half of all new cars and light trucks had engines with some method of variable valve timing.¹⁷ Manufacturers are currently using many different types of variable valve timing, which have a variety of different names and methods. Therefore, the degree of further improvement across the fleet is limited by the level of valvetrain technology already implemented on the vehicles. The three major types of VVT are listed below.

Each of the implementations of VVT uses a cam phaser to adjust the camshaft angular position relative to the crankshaft position, referred to as “camshaft phasing.” The phase adjustment results in changes to the pumping work required by the engine to accomplish the gas exchange process. The majority of current cam phaser applications use hydraulically-actuated units, powered by engine oil pressure and managed by a solenoid that controls the oil pressure supplied to the phaser.

Based on a survey of the current powertrains being applied to the Class 2b and 3 segment and the level of powertrain sharing with the light duty vehicle market for these vehicles, the majority of light heavy duty gasoline engines in the 2010 Class 2b and 3 vehicle models are utilizing some form of cam phasing to achieve power and emission goals, and so this technology is considered to be in the baseline.

2.3.1.3.1 Coupled Cam Phasing for Overhead Valve (OHV) and Single Overhead Camshaft (SOHC) Engines

Valvetrains with coupled (or coordinated) cam phasing (CCP) can modify the timing of both the inlet valves and the exhaust valves an equal amount by varying the phasing of the camshaft across an engine’s range of operating speeds; also known as VVT. For engines configured as an overhead valve (OHV) or as a single overhead camshaft (SOHC) only one cam phaser is required per camshaft to achieve CCP

Consistent with the light-duty 2012-2016 MY vehicle rulemaking, the agencies continue to agree with the effectiveness values of 1 to 4 percent reduction in fuel consumption for this technology.

2.3.1.3.2 Intake Cam Phasing (ICP) for Dual Overhead Camshaft Engines (DOHC)

Valvetrains with ICP, which is the simplest of the cam phasing technologies, can modify the timing of the inlet valves by phasing the intake camshaft while the exhaust valve timing remains fixed. This requires the addition of a cam phaser on each bank of intake valves on the engine. An in-line 4-cylinder engine has one bank of intake valves, while V-configured engines have two banks of intake valves.

Some newer Class 2b and 3 market entries are offering dual overhead camshaft (DOHC) engine designs where two camshafts are used to operate the intake and exhaust valves independently. Currently, for the Class 2b and 3 segment, only intake camshaft phasing (ICP) technology is applied. Consistent with the light-duty 2012-2016 MY vehicle rulemaking, the agencies continue to agree with the effectiveness values of 1 to 2 percent reduction in fuel consumption for this technology.

2.3.1.3.3 Dual Cam Phasing (DCP) for Dual Overhead Camshaft Engines (DOHC)

The most flexible VVT design is dual (independent) cam phasing, where the intake and exhaust valve opening and closing events are controlled independently. This option allows the option of controlling valve overlap, which can be used as an internal EGR strategy. At low engine loads, DCP creates a reduction in pumping losses, resulting in improved fuel consumption. Increased internal EGR also results in lower engine-out NO_x emissions. The amount by which fuel consumption is improved depends on the residual tolerance of the combustion system. Additional improvements are observed at idle, where low valve overlap could result in improved combustion stability, potentially reducing idle fuel consumption. DCP requires two cam phasers on each bank of the engine.

Using 2010MY as the baseline, the agencies are not aware of DCP being applied to the Class 2b and 3 segment. However, the agencies note that multiple DCP equipped engines are currently available in the light duty counterparts to these vehicles implying this technology may crossover to the light heavy duty segment in the near future.

2.3.1.4 Cylinder Deactivation

In conventional spark-ignited engines throttling the airflow controls engine torque output. At partial loads, efficiency can be improved by using cylinder deactivation instead of throttling. Cylinder deactivation can improve engine efficiency by disabling or deactivating (usually) half of the cylinders when the load is less than half of the engine's total torque capability – the valves are kept closed, and no fuel is injected – as a result, the trapped air within the deactivated cylinders is simply compressed and expanded as an air spring, with reduced friction and heat losses. The active cylinders combust at almost double the load required if all of the cylinders were operating. Pumping losses are significantly reduced as long as the engine is operated in this “part-cylinder” mode.

Cylinder deactivation control strategy relies on setting maximum manifold absolute pressures or predicted torque within which it can deactivate the cylinders. Noise and vibration issues reduce the operating range to which cylinder deactivation is allowed, although manufacturers are exploring vehicle changes that enable increasing the amount of time that cylinder deactivation might be suitable. Some manufacturers may choose to adopt

active engine mounts and/or active noise cancellations systems to address Noise Vibration and Harshness (NVH) concerns and to allow a greater operating range of activation.

Effectiveness improvements scale roughly with engine displacement-to-vehicle weight ratio: the higher displacement-to-weight vehicles, operating at lower relative loads for normal driving, have the potential to operate in part-cylinder mode more frequently. While several manufacturers have adopted cylinder deactivation in their light-duty vehicles equipped with 8 cylinder engines, the same or similar engines for heavy-duty application do not utilize this technology. Manufacturers discovered that in most heavy-duty applications, the opportunity for benefits from this technology is greatly reduced, due to the regularly required high load operation for these work-oriented vehicles. Cylinder deactivation is thus not part of the technology package on which the standards this analysis for the HD pickup and van segment are predicated.

2.3.1.5 Stoichiometric Gasoline Direct Injection

Stoichiometric gasoline direct injection (SGDI) engines inject fuel at high pressure directly into the combustion chamber (rather than the intake port in port fuel injection). SGDI requires changes to the injector design, an additional high pressure fuel pump, new fuel rails to handle the higher fuel pressures, and changes to the cylinder head and piston crown design. Direct injection of the fuel into the cylinder improves cooling of the air/fuel charge within the cylinder, which allows for higher compression ratios and increased thermodynamic efficiency without the onset of combustion knock. Recent injector design advances, improved electronic engine management systems and the introduction of multiple injection events per cylinder firing cycle promote better mixing of the air and fuel, enhance combustion rates, increase residual exhaust gas tolerance and improve cold start emissions. SGDI engines achieve higher power density and match well with other technologies, such as boosting and variable valvetrain designs.

Several manufacturers have recently introduced vehicles with SGDI engines, including GM and Ford, who have announced their plans to increase dramatically the number of SGDI engines in their light-duty portfolios.

The light-duty 2012-2016 MY vehicle rulemaking estimated the range of effectiveness to be from 1 to 2 percent for SGDI. NHTSA and EPA reviewed this estimate for purposes of this HD vehicle rulemaking, and continue to find it accurate.

The NHTSA and EPA cost estimates for SGDI take into account the changes required to the engine hardware, engine electronic controls, ancillary and NVH mitigation systems. Consistent with the light-duty 2012-2016 MY vehicle rulemaking, the agencies estimate the cost of conversion to SGDI on a V8 engine at \$481 (2009\$) for the 2014MY. This estimate includes a medium complexity ICM of 1.39 and flat-portion of the curve learning. Note that this technology was considered low complexity in the proposal but has been upgraded to medium complexity for the final analysis as a result of a more detailed review of what it involves.

2.3.2 Diesel Engines

Diesel engines in this class of vehicle have emissions characteristics that present challenges to meeting federal Tier 2 NO_x emissions standards. It is a significant systems-engineering challenge to maintain the fuel consumption advantage of the diesel engine while meeting U.S. emissions regulations. Fuel consumption can be negatively impacted by emissions reduction strategies depending on the combination of strategies employed. Emission compliance strategies for diesel vehicles sold in the U.S. are expected to include a combination of improvements of combustion, air handling system, aftertreatment, and advanced system control optimization. These emission control strategies are being introduced on Tier 2 light-duty diesel vehicles today.

Some of the engine technologies are described in the Light-Duty Vehicle Greenhouse Gas Emission Standards and Corporate Average Fuel Economy Standards Joint Technical Support Document.¹⁸ Others are from the 2010 NAS Report, *Technologies and Approaches to Reducing the Fuel Consumption of Medium- and Heavy-Duty Vehicles*. Several key advances in diesel technology have made it possible to reduce emissions coming from the engine prior to aftertreatment. These technologies include engine friction and parasitic loss reduction, improved fuel systems (higher injection pressure and multiple-injection capability), advanced controls and sensors to optimize combustion and emissions performance, higher EGR levels and EGR cooling to reduce NO_x, and advanced turbocharging systems.

2.3.2.1 Low Friction Lubricants

Consistent with the discussion above for gasoline engines (see Section 2.3.1.1), the agencies are expecting some engine changes to accommodate low friction lubricants. Based on the light-duty 2012-2016 MY vehicle rulemaking, and previously-received confidential manufacturer data, NHTSA and EPA estimated the effectiveness of low friction lubricants to be between 0 to 1 percent.

In the 2012-2016 MY light-duty FRM, the agencies estimated the cost of moving to low friction lubricants at \$3 per vehicle (2007\$). That estimate included a markup of 1.11 for a low complexity technology. For Class 2b and 3, we are using the same base estimate but have marked it up to 2009 dollars using the GDP price deflator and have used a markup of 1.24 for a low complexity technology to arrive at a value of \$4 per vehicle. As in the light-duty 2012-2016 MY vehicle rulemaking, learning effects are not applied to costs for this technology and, as such, this estimate applies to all model years.^{19,20}

2.3.2.2 Engine Friction Reduction

Reduced friction in bearings, valve trains, and the piston-to-liner interface will improve efficiency. Friction reduction opportunities in the engine valve train and at its roller/tappet interfaces exist for several production engines. In virtually all production engines, the piston at its skirt/cylinder wall interface, wrist pin and oil ring/cylinder wall interface offer opportunities for friction reduction. Use of more advanced oil lubricant that could be available for production in the future may also eventually play a key role in reducing friction. Any friction reduction must be carefully developed to avoid issues with durability or

performance capability. Estimations of fuel consumption improvements due to reduced friction range from 0 percent to 2 percent.²¹

Consistent with the cost estimated for gasoline engines, the agencies estimate the cost of engine friction reduction at \$15 per cylinder compliance cost (2009\$), including the low complexity ICM of 1.24, for a MY 2014 vehicle (learning effects are not applied to engine friction reduction). This cost is multiplied by the number of engine cylinders.

2.3.2.3 Combustion and Fuel Injection System Optimization

More flexible fuel injection capability with higher injection pressure provides more opportunities to improve engine fuel efficiency, while maintaining the same emission level. Combustion system optimization features system level integration and match, which includes piston bowl, injector tip and the number of holes, and intake swirl ratio. Cummins reports a 9.1 percent improvement in fuel consumption compared to a 2007 baseline, while meeting Tier 2 Bin 5 emissions when the combustion and fuel injection system are integrated with other technologies, such as advanced and integrated aftertreatment technology, and advanced air handling system.²² Translating this improvement to the 2010 baseline HD pickup and van engine, this could result in 4-6 percent improvement assuming that 2010 baseline engine has 3-5 percent advantage in fuel economy over a 2007 engine baseline.

The cost for this technology includes costs associated with low temperature exhaust gas recirculation (see Section 2.3.2.4), improved turbochargers (see Section 2.3.2.5) and improvements to other systems and components. These costs are considered collectively in our costing analysis and termed “diesel engine improvements.” The agencies have estimated the cost of diesel engine improvements at \$148 based on the cost estimates for several individual technologies presented in Table 2-10 for light HD engines. Specifically, the direct manufacturing costs we have estimated are: improved cylinder head, \$9; turbo efficiency improvements, \$16; EGR cooler improvements, \$3; higher pressure fuel rail, \$10; improved fuel injectors, \$13; improved pistons, \$2; and reduced valve train friction, \$95. All values are in 2009 dollars and are applicable in the 2014MY. Applying a low complexity ICM of 1.24 results in a cost of \$184 (2009\$) applicable in the 2014MY. We consider the flat portion of the learning curve to be appropriate for these technologies.

2.3.2.4 Low Temperature Exhaust Gas Recirculation

Low temperature exhaust gas recirculation (EGR) could be one of the options to improve engine performance. Most medium-duty vehicle diesel engines sold in the U.S. market today use cooled EGR, in which part of the exhaust gas is routed through a cooler (rejecting energy to the engine coolant) before being returned to the engine intake manifold. EGR is a technology employed to reduce peak combustion temperatures and thus NO_x. Low-temperature EGR uses a larger or secondary EGR cooler to achieve lower intake charge temperatures, which tend to further reduce NO_x formation. Low-temperature EGR can allow changes such as more advanced injection timing that will increase engine efficiency slightly more than 1 percent (NESCCAF/ICCT, 2009, p. 62). Because low-temperature EGR reduces the engine’s exhaust temperature, it may not be compatible with exhaust energy recovery systems such as turbocompound or a bottoming cycle.

Regulatory Impact Analysis

The agencies' cost estimate for this technology is discussed in Section 2.3.2.3.

2.3.2.5 Turbocharger Technology

Compact two stage turbochargers can increase the boost level with wider operation range, thus improving engine thermal efficiency. Ford's new developed 6.7L Scorpion engine features a twin-compressor turbocharger²³. Cummins is also developing its own two stage turbochargers.²⁴ It is expected that this type of technology will continue to be improved by better system matching and development of higher compressor and turbine efficiency.

The agencies' cost estimate for this technology is discussed in Section 2.3.2.3.

2.3.2.6 Reduction of Parasitic Loads

Accessories that are traditionally gear- or belt-driven by a vehicle's engine can be optimized and/or converted to electric power. Examples include the engine water pump, oil pump, fuel injection pump, air compressor, power-steering pump, cooling fans, and the vehicle's air-conditioning system. Optimization and improved pressure regulation may significantly reduce the parasitic load of the water, air and fuel pumps. Electrification may result in a reduction in power demand, because electrically-powered accessories (such as the air compressor or power steering) operate only when needed if they are electrically powered, but they impose a parasitic demand all the time if they are engine-driven. In other cases, such as cooling fans or an engine's water pump, electric power allows the accessory to run at speeds independent of engine speed, which can reduce power consumption. Electrification of accessories can individually improve fuel consumption, but as a package on a hybrid vehicle it is estimated that 3 to 5 percent fuel consumption reduction is possible. The TIAX [2009, pg. 3-5] study used 2 to 4 percent fuel consumption improvement for accessory electrification, with the understanding that electrification of accessories will have more effect in short-haul/urban applications and less benefit in line-haul applications.

Consistent with the light-duty 2012-2016 MY vehicle rulemaking (where this technology was referred to as "improved accessories"), the agencies estimate the cost for this technology at \$93 (2009\$) for a 2014MY vehicle. This estimate includes a low complexity ICM of 1.24 and flat-portion of the curve learning.

2.3.2.7 Improved Aftertreatment Efficiency and Effectiveness

Selective Catalytic Reduction (SCR) systems are used by several manufacturers to control NO_x emissions. 2010 fuel consumption was reduced 3 to 4 percent when compared to 2009, depending upon the manufacturer [2009, TIAX]. In the proposal we estimated that additional improvements of 3 to 5 percent relative to 2010 may be reasonably expected as system effectiveness increases and accumulated knowledge is applied in calibration. We received no comments disagreeing with this assessment. Additionally, as SCR system effectiveness is improved, diesel particulate filters (DPFs) may be better optimized to reduced particulate loading (ability to run at higher engine out NO_x), reducing the associated pressure drop associated with their presence in the exhaust system. Such DPF changes may result in a 1.0 – 1.5 percent fuel consumption reduction²⁵

The agencies have estimated the cost of this technology at \$25 for each percentage improvement in fuel consumption from that of the baseline systems. This cost would cover the engineering and test cell related costs necessary to develop and implement the improved control strategies that would allow for the improvements in fuel consumption. Importantly, the engineering work involved would be expected to result in cost savings to the aftertreatment and control hardware (lower platinum group metal (PGM) loadings, lower reductant dosing rates, etc.). Those savings are considered to be included in the \$25 per percent estimate described here. Given the average 4 percent expected improvement in fuel consumption results in an estimated cost of \$119 (2009\$) for a 2014MY vehicle. This estimate includes a low complexity ICM of 1.24 and flat-portion of the curve learning from 2012 forward. We did not receive negative comments on this cost estimate.

2.3.3 Drivetrain

NHTSA and EPA have also reviewed the transmission technology estimates used in the light-duty 2012-2016 MY vehicle rulemaking. In doing so, NHTSA and EPA considered or reconsidered all available sources and updated the estimates as appropriate. The section below describes each of the transmission technologies considered for this rulemaking.

2.3.3.1 Improved Automatic Transmission Control (IATC) (Aggressive Shift Logic and Early Torque Converter Lockup)

Calibrating the transmission shift schedule to upshift earlier and quicker, and to lock up or partially lock up the torque converter under a broader range of operating conditions can reduce fuel consumption and CO₂ emissions. However, this operation can result in a perceptible degradation in noise, vibration, and harshness. The degree to which NVH can be degraded before it becomes noticeable to the driver is strongly influenced by characteristics of the vehicle, and although it is somewhat subjective, it always places a limit on how much fuel consumption can be improved by transmission control changes. Given that the Aggressive Shift Logic and Early Torque Converter Lockup are best optimized simultaneously due to the fact that adding both of them primarily requires only minor modifications to the transmission or calibration software, these two technologies are combined in the modeling.

2.3.3.2 Aggressive Shift Logic

During operation, an automatic transmission's controller manages the operation of the transmission by scheduling the upshift or downshift, and locking or allowing the torque converter to slip based on a preprogrammed shift schedule. The shift schedule contains a number of lookup table functions, which define the shift points and torque converter lockup based on vehicle speed and throttle position, and other parameters such as temperature. Aggressive shift logic (ASL) can be employed in such a way as to maximize fuel efficiency by modifying the shift schedule to upshift earlier and inhibit downshifts under some conditions, which reduces engine pumping losses and engine friction. The application of this technology does require a manufacturer to confirm that drivability, durability, and NVH are not significantly degraded.

Regulatory Impact Analysis

We consider this technology to be present in the baseline 6-speed automatic transmissions in the majority of Class 2b and 3 trucks in the 2010 model year timeframe, and thus do not include it in the package of technologies on whose use the stringency of the standard is predicated.

2.3.3.3 Early Torque Converter Lockup

A torque converter is a fluid coupling located between the engine and transmission in vehicles with automatic transmissions and continuously-variable transmissions (CVT). This fluid coupling allows for slip so the engine can run while the vehicle is idling in gear (as at a stop light), provides for smoothness of the powertrain, and also provides for torque multiplication during acceleration, and especially launch. During light acceleration and cruising, the inherent slip in a torque converter causes increased fuel consumption, so modern automatic transmissions utilize a clutch in the torque converter to lock it and prevent this slippage. Fuel consumption can be further reduced by locking up the torque converter at lower vehicle speeds, provided there is sufficient power to propel the vehicle, and noise and vibration are not excessive. If the torque converter cannot be fully locked up for maximum efficiency, a partial lockup strategy can be employed to reduce slippage. Early torque converter lockup is applicable to all vehicle types with automatic transmissions. Some torque converters will require upgraded clutch materials to withstand additional loading and the slipping conditions during partial lock-up. As with aggressive shift logic, confirmation of acceptable drivability, performance, durability and NVH characteristics is required to successfully implement this technology.

We consider this technology to be present in the baseline, 6-speed automatic transmissions in the majority of Class 2b and 3 trucks in the 2010 model year timeframe, and thus do not include it in the package of technologies on whose use the stringency of the standard is predicated.

2.3.3.4 Automatic 6- and 8-Speed Transmissions

Manufacturers can also choose to replace 4- and 5-speed transmission with 6- or 8-speed automatic transmissions. Additional ratios allow for further optimization of engine operation over a wider range of conditions, but this is subject to diminishing returns as the number of speeds increases. As additional planetary gear sets are added (which may be necessary in some cases to achieve the higher number of ratios), additional weight and friction are introduced. Also, the additional shifting of such a transmission can be perceived as bothersome to some consumers, so manufacturers need to develop strategies for smooth shifts. Some manufacturers are replacing 4- and 5-speed automatics with 6-speed automatics, and 7- and 8-speed automatics have also entered production, albeit in lower-volume applications in luxury and performance oriented cars.

As discussed in the light-duty 2012-2016 MY vehicle rulemaking, confidential manufacturer data projected that 6-speed transmissions could incrementally reduce fuel consumption by 0 to 5 percent from a baseline 4-speed automatic transmission, while an 8-speed transmission could incrementally reduce fuel consumption by up to 6 percent from a

Heavy-Duty GHG and Fuel Efficiency Standards FRM: Technologies, Cost, and Effectiveness

baseline 4-speed automatic transmission. GM has publicly claimed a fuel economy improvement of up to 4 percent for its new 6-speed automatic transmissions.²⁶

NHTSA and EPA reviewed and revised these effectiveness estimates based on usage and testing methods for Class 2b and 3 vehicles along with confidential business information. When combined with IATC, the agencies estimate the effectiveness for a conversion from a 4 to a 6-speed transmission to be 5.3 percent and a conversion from a 6 to 8-speed transmission to be 1.7 percent.

As for costs, the agencies have considered the recent study conducted by NAS (NAS 2010) which showed an incremental cost of \$210 for an 8 speed automatic transmission relative to a 6 speed automatic transmission (the baseline technology for 2010MY Class 2b & 3 pickups and vans). Considering this to be a valid cost for 2012MY and applying a low complexity ICM of 1.24 results in a cost of \$294 in 2012. Considering flat-portion of the curve learning to be appropriate for automatic transmissions and applying two years of learning results in a 2014MY cost of \$281 (2009\$). This technology is considered applicable to both gasoline and diesel trucks and vans.

2.3.3.5 Electric Power Steering/Electro-hydraulic Power Steering (EPS/EHPS)

Electric power steering (EPS) or Electrohydraulic power steering (EHPS) provides a potential reduction in CO₂ emissions and fuel consumption over hydraulic power steering because of reduced overall accessory loads. This eliminates the parasitic losses associated with belt-driven power steering pumps which consistently draw load from the engine to pump hydraulic fluid through the steering actuation systems even when the wheels are not being turned. EPS is an enabler for all vehicle hybridization technologies since it provides power steering when the engine is off. EPS may be implemented on most vehicles with a standard 12V system. Some heavier vehicles may require a higher voltage system which may add cost and complexity.

The 2010 light-duty final rule estimated a one to two percent effectiveness based on the 2002 NAS report, a Sierra Research report, and confidential manufacturer data. NHTSA and EPA reviewed these effectiveness estimates and found them to be accurate, thus they have been retained for this final rule.

NHTSA and EPA adjusted the EPS cost for the current rulemaking based on a review of the specification of the system. Adjustments were made to include potentially higher voltage or heavier duty system operation for Class 2b and 3. Accordingly, higher costs were estimated for systems with higher capability. After accounting for the differences in system capability and applying the ICM markup of low complexity technology of 1.24, the estimated costs for this rulemaking are \$115 for a MY 2014 truck or van (2009\$). As EPS systems are in widespread usage today, flat-portion of the curve learning is deemed applicable. EHPS systems are considered to be of equal cost and both are considered applicable to gasoline and diesel engines.

2.3.3.6 Hybrids

Commenters arguing for more stringent standards cited the 2010 NAS study (and an associated TIAX report) finding that technologies such as hybridization are feasible. However, in the ambitious timeframe we are focusing on for these rules, targeting as it does technologies implementable in the HD pickup and van fleet starting in 2014 and phasing in with normal product redesign cycles through 2018, our assessment shows that the standards we are establishing, which are not based on significant hybridization, are appropriate. More advanced technologies considered in the NAS report would be appropriate for consideration in future rulemaking activity.

2.3.4 Aerodynamics

Aerodynamic drag is an important aspect of the power requirements for Class 2b and 3 trucks. Because aerodynamic drag is a function of the cube of vehicle speed, small changes in the aerodynamics of a Class 2b and 3 can reduce drag, fuel consumption, and GHG emissions. Some of the opportunities to reduce aerodynamic drag in Class 2b and 3 vehicles are similar to those in Class 1 and 2 (*i.e.*, light-duty) vehicles. In general, these transferable features make the cab shape more aerodynamic by streamlining the airflow over the bumper, grill, windshield, sides, and roof. Class 2b and 3 vehicles may also borrow from light-duty vehicles certain drag reducing accessories (*e.g.*, streamlined mirrors, operator steps, and sun visors). The great variety of applications for Class 2b and 3 trucks result in a wide range of operational speed profiles (*i.e.*, in-use drive cycles) and functional requirements (*e.g.*, shuttle buses that must be tall enough for standing passengers, trucks that must have racks for ladders). This variety makes it challenging to develop aerodynamic solutions that consider the entire vehicle.

Consistent with the light-duty 2012-2016 MY vehicle rulemaking, the agencies have estimated the cost for this technology at \$58 (2009\$) including a low complexity ICM of 1.24. This cost is applicable in the 2014 model year to both gasoline and diesel trucks and vans and is considered to be on the flat-portion of the learning curve.

2.3.5 Tires

Typically, tires used on Class 2b/3 vehicles are not designed specifically for the vehicle. These tires are designed for broader use and no single parameter is optimized. Similar to vocational vehicles, the market has not demanded tires with improved rolling resistance thus far; therefore, manufacturers have not traditionally designed tires with low rolling resistance for Class 2b/3 vehicles. EPA and NHTSA believe that a regulatory program that incentivizes the optimization of tire rolling resistance, traction and durability can bring about GHG emission and fuel consumption reductions from this segment.

Based on the light-duty 2012-2016 MY vehicle rulemaking and the 2010 NAS report, the agencies have estimated the cost for low rolling resistance tires to be \$7 (2009\$) per Class 2b truck or van, and \$10 (2009\$) per Class 3 truck or van.²⁷ The higher cost for the Class 3 trucks and vans is due to the predominant use of dual rear tires and, thus, 6 tires per truck.

Due to the commodity-based nature of this technology, cost reductions due to learning are not applied. This technology is considered applicable to both gasoline and diesel.

2.3.6 Mass Reduction

Reducing a vehicle's mass, or down-weighting the vehicle, decreases fuel consumption by reducing the energy demand needed to overcome forces resisting motion, and rolling resistance. Manufacturers employ a systematic approach to mass reduction, where the net mass reduction is the addition of a direct component or system mass reduction plus the additional mass reduction that can be taken from indirect ancillary systems and components, as a result of full vehicle optimization, effectively compounding or obtaining a secondary mass reduction from a primary mass reduction. For example, use of a smaller, lighter engine with lower torque-output subsequently allows the use of a smaller, lighter-weight transmission and drive line components. Likewise, the compounded weight reductions of the body, engine and drivetrain reduce stresses on the suspension components, steering components, wheels, tires and brakes, allowing further reductions in the mass of these subsystems. The reductions in unsprung masses such as brakes, control arms, wheels and tires further reduce stresses in the suspension mounting points. This produces a compounding effect of mass reductions.

Estimates of the synergistic effects of mass reduction and the compounding effect that occurs along with it can vary significantly from one report to another. For example, in discussing its estimate, an Auto-Steel Partnership report states that "These secondary mass changes can be considerable—estimated at an additional 0.7 to 1.8 times the initial mass change."²⁸ This means for each one pound reduction in a primary component, up to 1.8 pounds can be reduced from other structures in the vehicle (*i.e.*, a 180 percent factor). The report also discusses that a primary variable in the realized secondary weight reduction is whether or not the powertrain components can be included in the mass reduction effort, with the lower end estimates being applicable when powertrain elements are unavailable for mass reduction. However, another report by the Aluminum Association, which primarily focuses on the use of aluminum as an alternative material for steel, estimated a factor of 64 percent for secondary mass reduction even though some powertrain elements were considered in the analysis.²⁹ That report also notes that typical values for this factor vary from 50 to 100 percent. Although there is a wide variation in stated estimates, synergistic mass reductions do exist, and the effects result in tangible mass reductions. Mass reductions in a single vehicle component, for example a door side impact/intrusion system, may actually result in a significantly higher weight savings in the total vehicle, depending on how well the manufacturer integrates the modification into the overall vehicle design. Accordingly, care must be taken when reviewing reports on weight reduction methods and practices to ascertain if compounding effects have been considered or not.

Mass reduction is broadly applicable across all vehicle subsystems including the engine, exhaust system, transmission, chassis, suspension, brakes, body, closure panels, glazing, seats and other interior components, engine cooling systems and HVAC systems. It is estimated that up to 1.25 kilograms of secondary weight savings can be achieved for every kilogram of weight saved on a vehicle when all subsystems are redesigned to take into account the initial primary weight savings.^{30,31}

Regulatory Impact Analysis

Mass reduction can be accomplished by proven methods such as:

- **Smart Design:** Computer aided engineering (CAE) tools can be used to better optimize load paths within structures by reducing stresses and bending moments applied to structures. This allows better optimization of the sectional thicknesses of structural components to reduce mass while maintaining or improving the function of the component. Smart designs also integrate separate parts in a manner that reduces mass by combining functions or the reduced use of separate fasteners. In addition, some “body on frame” vehicles are redesigned with a lighter “unibody” construction.
- **Material Substitution:** Substitution of lower density and/or higher strength materials into a design in a manner that preserves or improves the function of the component. This includes substitution of high-strength steels, aluminum, magnesium or composite materials for components currently fabricated from mild steel.
- **Reduced Powertrain Requirements:** Reducing vehicle weight sufficiently allows for the use of a smaller, lighter and more efficient engine while maintaining or increasing performance. Approximately half of the reduction is due to these reduced powertrain output requirements from reduced engine power output and/or displacement, changes to transmission and final drive gear ratios. The subsequent reduced rotating mass (*e.g.*, transmission, driveshafts/halfshafts, wheels and tires) via weight and/or size reduction of components are made possible by reduced torque output requirements.
- Automotive companies have largely used weight savings in some vehicle subsystems to offset or mitigate weight gains in other subsystems from increased feature content (sound insulation, entertainment systems, improved climate control, panoramic roof, etc.).
- Lightweight designs have also been used to improve vehicle performance parameters by increased acceleration performance or superior vehicle handling and braking.

Many manufacturers have already announced final future product plans reducing the weight of a vehicle body through the use of high strength steel body-in-white, composite body panels, magnesium alloy front and rear energy absorbing structures reducing vehicle weight sufficiently to allow a smaller, lighter and more efficient engine. Nissan has stated that it will be reducing average vehicle curb weight by 15 percent by 2015.³² Ford has identified weight reductions of 250 to 750 lb per vehicle as part of its implementation of known technology within its sustainability strategy between 2011 and 2020.³³ Mazda has stated that it plans to reduce vehicle weight by 220 pounds per vehicle or more as models are redesigned.^{34,35} Ducker International estimates that the average curb weight of light-duty vehicle fleet will decrease approximately 2.8 percent from 2009 to 2015 and approximately 6.5 percent from 2009 to 2020 via changes in automotive materials and increased change-over from previously used body-on-frame automobile and light-truck designs to newer unibody designs.³² While the opportunity for mass reductions available to the light-duty fleet may not in all cases be applied directly to the heavy-duty fleet due to the different designs for the expected duty cycles of a “work” vehicle, mass reductions are still available, particularly to areas unrelated to the components and systems necessary for the work vehicle aspects.

Heavy-Duty GHG and Fuel Efficiency Standards FRM: Technologies, Cost, and Effectiveness

Due to the payload and towing requirements of these heavy-duty vehicles, engine downsizing was not considered in the estimates for CO₂ reduction in the area of mass reduction and material substitution. NHTSA and EPA estimate that a 3 percent mass reduction with no engine downsizing results in a 1 percent reduction in fuel consumption. In addition, a 5 and 10 percent mass reduction with no engine downsizing result in an estimated CO₂ reduction of 1.6 and 3.2 percent respectively. These effectiveness values are 50 percent of the light-duty 2012-2016 MY vehicle rulemaking values due to the elimination of engine downsizing for this class of vehicle.

In the NPRM, EPA and NHTSA relied on three studies to estimate the cost of vehicle mass reduction. The NPRM used a value of \$1.32 per pound of mass reduction that was derived from a 2002 National Academy of Sciences study, a 2008 Sierra Research report, and a 2008 MIT study. The cost was estimated to be constant, independent of the level of mass reduction.

The agencies along with the California Air Resources Board (CARB) have recently completed work on an Interim Joint Technical Assessment Report (TAR) that considers light-duty GHG and fuel economy standards for model years 2017 through 2025 and have continued this work to support the light-duty vehicle NPRM, which is expected to be issued this fall. Based on new information from various industry and literature sources, the TAR report modified the mass reduction/cost relationship used in the 2012-2016 light-duty final rules to begin at the origin (zero cost at 0% mass reduction) and to have increasing cost with increasing mass reduction.³⁶ The resulting analysis showed costs for 5% mass reduction on light-duty vehicles to be near zero or cost parity.

In the proposal for heavy-duty vehicles, we estimated mass reduction costs based on the 2012-2016 light-duty analysis without accounting for the new work completed in the Interim Joint Technical Assessment and additional work the agencies have considered for the light-duty vehicle NPRM. Since the heavy-duty vehicle proposal, the agencies have been able to consider updated cost estimates in the context of both light-duty and heavy-duty vehicle bodies of work. While the agencies intend to discuss the additional work for the light-duty NPRM in much more detail in the documents for that rulemaking, we think it appropriate to explain here that after having considered a number of additional and highly-varying sources, the agencies believe that the cost estimates used in the TAR may have been lower than would be reasonable for HD pickups and vans, given their different and work-related uses and thus different construction as compared to the light-duty vehicles evaluated in the TAR. We do not believe that all of the weight reduction opportunities for light-duty vehicles can be applied to heavy-duty trucks. However, we do believe reductions in the following components and systems can be found that do not affect the payload and towing requirements of these heavy-duty vehicles; body, closure panels, glazing, seats and other interior components, engine cooling systems and HVAC systems.

The agencies have reviewed and considered many different mass reduction studies during the technical assessment for the heavy-duty vehicle GHG and fuel efficiency rulemaking. The agencies found that many of the studies on this topic vary considerably in their rigor, transparency, and applicability to the regulatory assessment. Having considered a variety of options, the agencies for this heavy-duty analysis have been unable to come up with a way to quantitatively evaluate the available studies. Therefore, the agencies have chosen a value within the range of the available studies that the agencies believe is reasonable. The studies and OEM confidential business information relied upon in determining the final mass reduction cost are summarized below in Figure 2-1. Each study relied upon by the agencies in this determination has also been placed in the agencies' respective dockets. See NHTSA-2010-0079; EPA-HQ-0AR-2010-0162.

Regulatory Impact Analysis

The agencies note that the NAS 2010 study provided estimates of mass reduction costs, but the agencies did not consider using the NAS 2010 study as the single source of mass reduction cost estimates because the NAS 2010 estimates were not based on literature reports that focused on trucks or were necessarily appropriate for MD/HD vehicles, and also because a variety of newer and more rigorous studies were available to the agencies than those relied upon by the NAS in developing its estimates. We note, however, that for a 5 percent reduction in mass, the NAS 2010 report estimates a per pound cost of mass reduction of \$1.65.

Figure 2-1: Mass Reduction Cost Data Considered for Final Rulemaking

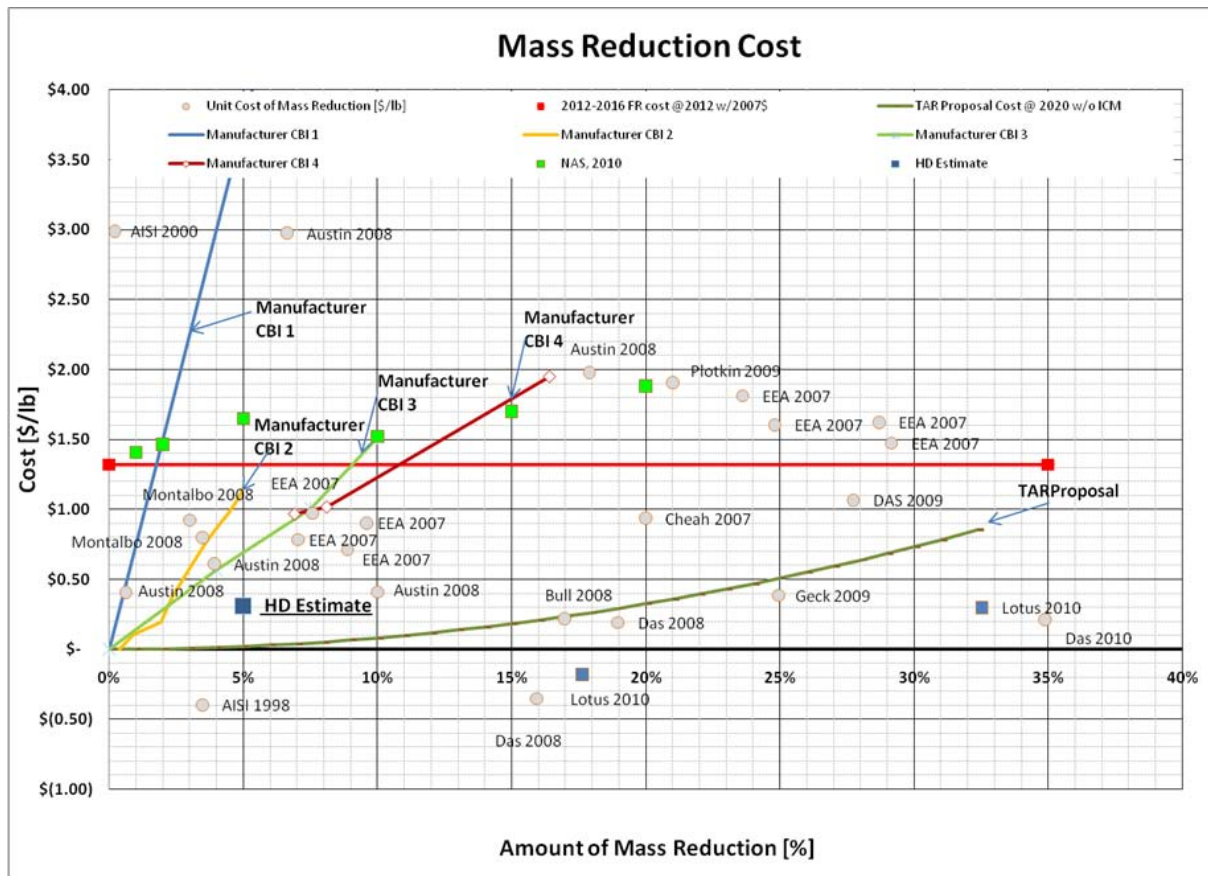

Thus, we are estimating the direct manufacturing costs for a 5 percent mass reduction of a 6,000 lb vehicle at a range of \$75-\$90 per vehicle. With additional margin for uncertainty, we arrive at a direct manufacturing cost of \$85-\$100, which is roughly in the upper middle of the range of values that resulted from the additional and highly-varying studies mentioned above that were considered in the agencies' review. We have broken this down for application to HD pickup trucks and vans as follows: Class 2b gasoline \$85, Class 2b diesel \$95, Class 3 gasoline \$90, and Class 3 diesel \$100. Applying the low complexity ICM of 1.24 results in estimated total costs for a 5 percent mass reduction applicable in the 2016 model year of: Class 2b gasoline \$108, Class 2b diesel \$121, Class 3 gasoline \$115, and Class 3 diesel trucks \$127. All mass reduction costs stated here are in 2009 dollars.

2.4 Heavy-Duty Engines

The regulatory structure for heavy-duty engines separates the compression ignition (or “diesel”) engines into three regulatory subcategories and the spark ignition (or “gasoline”) engines into a single regulatory subcategory. Therefore, the subsequent discussion will assess each type of engine separately.

The light-heavy-duty diesel engines typically range between 4.7 and 6.7 liters displacement, the medium-heavy-duty diesel engines typically have some overlap in displacement with the light-heavy-duty diesel engines and range between 6.7 and 9.3 liters. The heavy-heavy-duty diesel engines typically are represented by engines between 10.8 and 16 liters. The heavy-duty gasoline engines have ranged in the past between 4.8 and 8.1 liters.

2.4.1 Spark Ignition Engines

Spark ignition engines are certified for the heavy-duty market. These engines have historically ranged in displacement between five and eight liters and are either V8 or V10 configurations. As found in the 2010 NAS study, most are either V8 or V10 engines with port fuel injection, naturally aspirated with fixed valve timings. Most recently, the primary producers of the gasoline engines were limited to Ford and General Motors. The engines sold separately, which require an engine certificate in lieu of a chassis certificate, are the same as or very similar to the engines used in the pickup truck and vans. Therefore, NHTSA and EPA developed the baseline list of engine technologies and standards to reflect this commonality.

2.4.1.1 Baseline SI Engine CO₂ and Fuel Consumption

Similar to the gasoline engine used as the baseline in the light-duty 2012-2016 MY vehicle rulemaking (an assumption not questioned in the comments to that rulemaking), the agencies assumed the baseline engine in this segment to be a naturally aspirated, single overhead valve V8 engine. The following discussion of effectiveness is generally in comparison to 2010 baseline engine performance.

NHTSA and EPA developed the baseline fuel consumption and CO₂ emissions for the gasoline engines from manufacturer-reported CO₂ values used in the certification of non-GHG pollutants. The baseline engine for the analysis was developed to represent a 2011 model year engine, because this is the most current information available. The average CO₂ performance of the heavy-duty gasoline engines was 660 g/bhp-hour, which will be used as a baseline.

2.4.1.2 Gasoline Engine Technologies

The engine technologies projected for the gasoline heavy-duty engines are based on the technologies used in the Light-Duty Vehicle Greenhouse Gas Emission Standards and Corporate Average Fuel Economy Standards Joint Technical Support Document.³⁷ The effectiveness of the technology packages were evaluated using the EPA Lumped Parameter model HD Version 1.0.0.1.³⁸ The HD version of the Lumped Parameter model includes a subset of the technologies included in the Large Pickup Truck version of the Light-Duty

Regulatory Impact Analysis

rulemaking to recognize that some technologies will have limited effectiveness due to the higher operating weights of these trucks. The HD Lumped Parameter model also has reduced the effectiveness of several of the remaining individual technologies, again to recognize the higher test weights used in regulatory programs.

2.4.1.2.1 Engine Friction Reduction

In addition to low friction lubricants, manufacturers can also reduce friction and improve fuel consumption by improving the design of engine components and subsystems. Examples include improvements in low-tension piston rings, piston skirt design, roller cam followers, improved crankshaft design and bearings, material coatings, material substitution, more optimal thermal management, and piston and cylinder surface treatments. Additionally, as computer-aided modeling software continues to improve, more opportunities for evolutionary friction reductions may become available. All reciprocating and rotating components in the engine are potential candidates for friction reduction, and minute improvements in several components can add up to a measurable fuel economy improvement. The light-duty 2012-2016 MY vehicle rulemaking, 2010 NAS Report, and the NESCCAF and EEA reports, as well as confidential manufacturer data suggested a range of effectiveness for engine friction reduction to be between 1 to 3 percent. NHTSA and EPA continue to believe that this range is accurate.

NHTSA and EPA believe that the cost estimate is closer to the lower end of the model year (MY) 2011 CAFE final rule range and thus for this rulemaking are projecting \$10 per cylinder compliance cost (2009\$), plus a low complexity Indirect Cost Multiplier (ICM) markup value of 1.24, for a MY 2016 engine (learning effects are not applied to engine friction reduction). This cost is multiplied by the eight cylinders resulting in a cost of \$95 (2009\$) per engine for this technology.

2.4.1.2.2 Coupled Cam Phasing

Valvetrains with coupled (or coordinated) cam phasing (CCP) can modify the timing of both the inlet valves and the exhaust valves an equal amount by phasing the camshaft of a single overhead cam (SOHC) engine or an overhead valve (OHV) engine. For overhead cam engines, this requires the addition of a cam phaser on each bank of the engine so SOHC V-engines have two cam phasers. For overhead valve (OHV) engines, which have only one camshaft to actuate both inlet and exhaust valves, CCP is the only variable valve timing (VVT) implementation option available and requires only one cam phaser. Current overhead cam engines in the heavy duty sector contain a single camshaft per head which typically requires a phaser per cam or two per engine. Based on 2010 Light-Duty final rule, previously-received confidential manufacturer data, and the NESCCAF report, NHTSA and EPA estimated the effectiveness of CCP to be between 1 to 4 percent. NHTSA and EPA reviewed this estimate for purposes of this rulemaking, and continue to find it accurate.

Consistent with the 2010 light-duty 2012-2016 MY vehicle rulemaking, NHTSA and EPA estimate the cost of a cam phaser at \$49 (2009\$) in the 2014MY. This estimate includes

a low complexity ICM of 1.24. With two years of flat-portion of the curve learning this cost becomes \$46 (2009\$) in the 2016MY. The majority of heavy-duty gasoline loose engines are over-head valve engines (OHV) and, as such, would require only one cam phaser for coupled cam phasing. The most recently designed engines, both overhead valve and overhead cam installed in heavy-duty pickup trucks and vans contain coupled cam phasing and are expected in the future to replace any legacy loose engines.

2.4.1.2.3 Cylinder Deactivation

In conventional spark-ignited engines throttling the airflow controls engine torque output. At partial loads, efficiency can be improved by using cylinder deactivation instead of throttling. Cylinder deactivation (DEAC) can improve engine efficiency by disabling or deactivating (usually) half of the cylinders when the load is less than half of the engine's total torque capability – the valves are kept closed, and no fuel is injected – as a result, the trapped air within the deactivated cylinders is simply compressed and expanded as an air spring, with reduced friction and heat losses. The active cylinders combust at almost double the load required if all of the cylinders were operating. Pumping losses are significantly reduced as long as the engine is operated in this “part cylinder” mode.

Cylinder deactivation control strategy relies on setting maximum manifold absolute pressures or predicted torque within which it can deactivate the cylinders. NVH issues reduce the operating range to which cylinder deactivation is allowed, although manufacturers are exploring vehicle changes that enable increasing the amount of time that cylinder deactivation might be suitable. Some manufacturers may choose to adopt active engine mounts and/or active noise cancellations systems to address NVH concerns and to allow a greater operating range of activation. Cylinder deactivation has seen a recent resurgence thanks to better valvetrain designs and engine controls. General Motors and Chrysler Group have incorporated cylinder deactivation across a substantial portion of their V8-powered lineups in the light-duty market.

Effectiveness improvements scale roughly with engine displacement-to-vehicle weight ratio: the higher displacement-to-weight vehicles, operating at lower relative loads for normal driving, have the potential to operate in part-cylinder mode more frequently. Cylinder deactivation is less effective on heavily-loaded vehicles because they require more power and spend less time in areas of operation where only partial power is required. The technology also requires proper integration into the vehicles which is difficult in the vocational vehicle segment where often the engine is sold to a chassis manufacturer or body builder without knowing the type of transmission or axle used in the vehicle or the precise duty cycle of the vehicle. The cylinder deactivation requires fine tuning of the calibration as the engine moves into and out of deactivation mode to achieve acceptable NVH. Additionally, cylinder deactivation would be difficult to apply to vehicles with a manual transmission because it requires careful gear change control. NHTSA and EPA adjusted the 2010 light-duty final rule estimates using updated power to weight ratings of heavy-duty trucks and confidential business information and downwardly adjusted the effectiveness to 0 to 3 percent for these vehicles to reflect the differences in drive cycle and operational opportunities compared to

Regulatory Impact Analysis

light-duty vehicles Unlike light-duty, cylinder deactivation is not expected to penetrate the heavy-duty sector due to the unique duty cycle resulting in lower effectiveness.

2.4.1.2.4 Stoichiometric Gasoline Direct Injection (SGDI)

SGDI engines inject fuel at high pressure directly into the combustion chamber (rather than the intake port in port fuel injection). SGDI requires changes to the injector design, an additional high-pressure fuel pump, new fuel rails to handle the higher fuel pressures and changes to the cylinder head and piston crown design. Direct injection of the fuel into the cylinder improves cooling of the air/fuel charge within the cylinder, which allows for higher compression ratios and increased thermodynamic efficiency without the onset of combustion knock. Recent injector design advances, improved electronic engine management systems and the introduction of multiple injection events per cylinder firing cycle promote better mixing of the air and fuel, enhance combustion rates, increase residual exhaust gas tolerance and improve cold start emissions. SGDI engines achieve higher power density and match well with other technologies, such as boosting and variable valvetrain designs. NHTSA and EPA continue to agree with estimated effectiveness of SGDI in the range of 1 to 2 percent improvement for SGDI.

The NHTSA and EPA cost estimates for SGDI take into account the changes required to the engine hardware, engine electronic controls, ancillary and NVH mitigation systems.

The NHTSA and EPA cost estimates for SGDI take into account the changes required to the engine hardware, engine electronic controls, ancillary and NVH mitigation systems. In the proposal, consistent with the light-duty 2012-2016 MY vehicle rulemaking, the agencies estimated the cost of conversion to SGDI on a V8 engine at \$395 (2008\$) for the 2014MY including a low complexity ICM of 1.17. For this final analysis, based on further review, we have changed the complexity level of this technology to medium and, with the markup of 1.39 the cost becomes \$474 (2009\$) in the 2014MY. We consider flat-portion of the curve learning to be appropriate for this technology so the cost becomes \$452 (2009\$) for the 2016MY. SI Engine Technology Package

The average CO₂ performance of the two heavy-duty gasoline engines certified for 2010 and 2011 model years was 660 g CO₂/bhp-hour. The HD Lumped Parameter model analysis projects that the package of the three technologies (friction reduction, closed couple cam phasing, and stoichiometric direct injection) could reduce CO₂ emissions and fuel consumption by 5 percent. Therefore, the agencies are finalizing the standard in 2016 model year at 627 g CO₂/bhp-hr.

2.4.1.3 SI Engine Technology Cost

As shown in Table 2-5, the overall projected engine package cost for a 2016 model year engine is \$594(2009\$).

Table 2-5 Estimated 2016MY Costs for a Spark-Ignition HD Engine (2009\$)

	DIRECT MFG	ICM	MARKED UP
--	------------	-----	-----------

Heavy-Duty GHG and Fuel Efficiency Standards FRM: Technologies, Cost, and Effectiveness

	COST		COSTS
Engine Friction Reduction	\$76	1.24	\$95
Coupled Cam Phasing (OHV) ^a	\$37	1.24	\$46
Stoichiometric Gas Direct Injection	\$321	1.39	\$452
Total	\$435		\$594

^a Note: the direct manufacturing cost of cam phasing would be \$74 for engines with dual cams.

2.4.2 Diesel Engines

2.4.2.1 Baseline Engines

The agencies developed the baseline diesel engine as a 2010 model year engine with an aftertreatment system which meets EPA's 0.20 grams of NO_x/bhp-hr standard with a selective catalytic reduction (SCR) system along with EGR and meets the PM emissions standard with a diesel particulate filter (DPF) with active regeneration. The engine is turbocharged with a variable geometry turbocharger, based on the agencies' assessment of today's engines. The following discussion of technologies describes improvements over the 2010 model year baseline engine performance, unless otherwise noted.

The CO₂ performance over the FTP for the baseline engines were developed through manufacturer reporting of CO₂ in their non-GHG certification applications for 2010 model year. This data was carefully considered to ensure that the baseline represented an engine meeting the 0.20 g/bhp-hr NO_x standard. For those engines that were not at this NO_x level or higher, then the agencies derived a CO₂ correction factor to bring them to a 0.20 g/bhp-hr NO_x emissions. The CO₂ correction factor is derived based on available experimental data obtained from manufacturers and public literature. The agencies then sales-weighted the CO₂ performance to derive a baseline CO₂ performance for each engine subcategory.

In order to establish baseline SET performance for the Heavy Heavy-Duty and Medium Heavy-Duty Diesel Engines, several sources were considered. Some engine manufacturers provided the agencies with SET modal results or fuel consumption maps to represent their 2009 model year engine fuel consumption performance. As a supplement to this, complete engine map CO₂ data (including SET modes) acquired in EPA test cells were also considered. The pre-2010 maps are subsequently adjusted to represent 2010 model year engine maps by using predefined technologies, including SCR and other advanced systems that are being used in current 2010 production.

In summary, the baseline CO₂ performance for each diesel engine category is included in Table 2-6.

Table 2-6: Baseline CO₂ Performance (g/bhp-hr)

LHDD - FTP	MHDD - FTP	HHDD - FTP	HHDD - SET
630	630	584	490

The agencies used the baseline engine to assess the potential of each of the following technologies.

2.4.2.2 Combustion System Optimization

Continuous improvements on the fuel injection system allows more flexible fuel injection capability with higher injection pressure, which can provide more opportunities to improve engine fuel efficiency, while maintaining the same emission level. Combustion system optimization, featuring piston bowl, injector tip and the number of holes, in conjunction with the advanced fuel injection system, is able to further improve engine performance and fuel efficiency. At this point, all engine manufacturers are spearheading substantial efforts into this direction in the hope that their development efforts would be translated into production in the near futures. Some examples include the combustion development programs conducted by Cummins³⁹ and Detroit Diesel⁴⁰ funded by Department of Energy. Cummins and Detroit Diesel both claim that 10 percent thermal efficiency improvement at 2010 emission level is achievable. While their findings are still more towards research environment, their results do enhance the possibility that some of technologies they are developing could be applied to production in the time frame of 2017. The agencies have determined that up to a 2.5 percent reduction in fuel consumption and CO₂ emissions is feasible in the 2017 model year through the use of these technologies.

The cost for this technology includes costs associated with several individual technologies, specifically, improved cylinder head, turbo efficiency improvements, EGR cooler improvements, higher pressure fuel rail, improved fuel injectors and improved pistons. The cost estimates for each of these technologies are presented in Table 2-8 through Table 2-10 for heavy HD, medium HD and light HD engines, respectively. The agencies consider a low complexity ICM of 1.15 and flat-portion of the curve learning from 2014 forward to be appropriate for these technologies.

Significant progress on advanced engine control has been made in the past few years, including model based calibration. Detroit Diesel introduced the next generation model based control concept, achieving 4 percent thermal efficiency improvement while simultaneously reducing emissions in transient operations.⁴¹ Their model based concept features a series of real time optimizers with multiple inputs and multiple outputs. This controller contains many physical based models for engine and aftertreatment. It produces fully transient engine performance and emissions predictions in a real-time manner. Although this control concept may still not be mature in 2014 production, it would be a realistic estimate that this type of real time model control could be in production before 2017, thus significantly improving engine fuel economy. The agencies have included the costs of control development in the research and development costs applied separately to each engine manufacturer.

2.4.2.3 Turbocharging and Air Handling System

Many advanced turbocharger technologies can be potentially added into production in the time frame between 2014 and 2017, and some of them are already in production, such as mechanical or electric turbocompound, two-stage turbochargers with intercooler, and high efficient low speed compressor.

A turbocompound system extracts energy from the exhaust to provide additional power. Mechanical turbocompounding includes a power turbine located downstream of the

turbine which in turn is connected to the crankshaft to supply additional power. As noted in the 2010 NAS report, it typically includes a fluid coupling (to allow for speed variation and to protect the power turbine from engine torsional vibration) and a gear set to match power turbine speed to crankshaft speed. Turbocompound has been used in production by Detroit Diesel for their DD15 and DD16 engines and they claim a 3 to 5 percent fuel consumption reduction due to the system.⁴² The 2010 NAS report⁴³ includes published information from four sources on the fuel consumption reduction from mechanical turbocompounding ranging from 2.5 to 5 percent. Some of these differences may depend on the operating condition or duty cycle that was considered by the different researchers. The performance of a turbocompound system tends to be best at full load, and it can be much less effective, or even act as an energy sink, to suck the energy at light loads. Because of that, a clutch that can separate the engine crankshaft from turbocompound gear train could be put into production in order to overcome the drawbacks of turbocompound at light loads, thus improving fuel efficiency over the entire speed and load ranges. The agencies have assessed mechanical turbocompound technology effectiveness at up to 5 percent, as shown in Table 2-12. Incremental cost increases associated with the addition of mechanical turbocompounding are significant, due to the complexity of the mechanical power transmission system required to connect the power turbine to the drivetrain. Such costs are estimated to be \$1,049 inclusive of an RPE factor of 1.28 (*i.e.*, \$820 in direct manufacturing costs) in 2014 MY.⁴⁴

Electric turbocompound is another potential device, although it is still not as mature in terms of production compared to mechanical turbocompound. An electric turbocompound system uses a power turbine to drive an electrical generator which is used to power electric accessories or provide extra power to the engine. As noted in the 2010 NAS report,⁴⁵ electric turbocompound is a technology that fits particularly well with a hybrid electric powertrain for long-haul applications where regenerative braking opportunities are limited. The benefits of electric turbocompound and an electric hybrid powertrain can be additive. TIAX used a range of 4 to 5 percent for its estimates, which included the benefits of electric accessories.⁴⁶ The 2010 NAS report includes the benefit projections from three studies, as listed below. However, none of these systems have been demonstrated commercially.⁴⁵

- The NESCCAF/ICCT study modeled an electric turbocompound system and estimated benefits at 4.2 percent, including electrification of accessories.
- Caterpillar, Inc., as part of Department of Energy (DOE) funded work, modeled a system that showed 3 to 5 percent improvement⁴⁷
- John Deere investigated a system (off-highway) that offered 10 percent improvement.

Two-stage turbocharger technology has been used in production by Navistar and other manufacturers. Ford's new developed 6.7L diesel engine features a twin-compressor turbocharger. Higher boost with wider range of operations and higher efficiency can further enhance engine performance, thus fuel economy. It is expected that this type of technology will continue to be improved by better matching with system and developing higher compressor and turbine efficiency.

Regulatory Impact Analysis

For this analysis, we have estimated the cost of mechanical turbocompounding at \$875 (2009\$) based on the cost estimate noted above developed by ICF. This estimate includes a low complexity ICM of 1.15. This cost is applicable in the 2017MY when engines placed in day cab and sleeper cab tractors are expected to add this technology. Flat-portion of the curve learning is considered applicable to this technology. For the more basic technology of improving the turbo efficiency, the agencies have estimated a cost of \$18 (2009\$) including a low complexity ICM of 1.15. That estimate would be considered valid in the 2014MY and flat-portion of the learning curve would be applied going forward.

Higher efficiency air handling (air and exhaust transport) processes may also be produced in the 2014 and 2017 time frame. To maximize the efficiency of such processes, induction systems may be improved by manufacturing more efficiently designed flow paths (including those associated with air cleaners, chambers, conduit, mass air flow sensors and intake manifolds) and by designing such systems for improved thermal control. Improved turbocharging and air handling systems must include higher efficiency EGR systems and intercoolers that reduce frictional pressure loss while maximizing the ability to thermally control induction air and EGR. EGR systems that often rely upon an adverse pressure gradient (exhaust manifold pressures greater than intake manifold pressures) must be reconsidered and their adverse pressure gradients minimized. “Hybrid” EGR strategies which rely upon pressure gradients and EGR pumps may provide pathways for improvement. Other components that offer opportunities for improved flow efficiency include cylinder heads, ports and exhaust manifolds to further reduce pumping losses. Variable air breathing systems such as variable Valve Actuation may provide additional gains at different loads and speeds. The NESCCAF/ICCT study indicated up to 1.2 percent reduction could be achieved solely through improved EGR systems.

2.4.2.4 Engine Parasitic and Friction Reduction

Engine parasitic and friction reduction is another key technical area that can be further improved in production moving to 2014 and 2017 time frame. Reduced friction in bearings, valve trains, and the piston-to-liner interface will improve efficiency. Friction reduction opportunities in the engine valve train and at its roller/tappet interfaces exist for several production engines. The piston at its skirt/cylinder wall interface, wrist pin and oil ring/cylinder wall interface offers opportunities for friction reduction. Use of more advanced oil lubricant that could be available for production in the future can also play a key role in reducing friction. Any friction reduction must be carefully developed to avoid issues with durability or performance capability. Estimations of fuel consumption improvements due to reduced friction range from 0 percent to 2 percent.⁴⁸ The agencies determined the effectiveness of reduced friction and parasitic at 0 to 1.5 percent for 2014 model year and beyond. All fuel injection system manufacturers are working hard to reduce parasitic loss due to high pressure pumps and common rail flow loss in the hope that those development would add up further fuel efficiency improvement.

Incremental manufacturing costs increases associated with the reduction of parasitics and friction may include those associated with an optimized, electric water pump, replacing a mechanically driven water pump (\$100). Additionally, an improved mechanical oil pump with more efficient relief mechanism and optimized hydrodynamic design may incur costs

(\$5). A fuel pump capable of delivering higher pressures and with efficient regulation may require improved materials and more elaborate regulating hardware (\$5). Improved pistons with less friction generated at the skirt may require incrementally more precision in finish machine operations (\$3). Finally, a more efficient, reduced friction valve train will require more precise machining processes and an increased parts count (\$90). All costs were developed based on EPA's engineering judgment and are the same as proposal. The costs presented here are considered to include a retail price equivalent factor of 1.28.

Removing the 1.28 RPE factor from the above cost estimates and instead applying a low complexity ICM of 1.15 results in the following costs: electric water pump, \$91; improved mechanical oil pump, \$5, improved fuel pump, \$5; improved pistons, \$3; reduced friction valve train, \$109 for LHDD engines and \$82 for HHDD engines. All costs are in 2009 dollars and are applicable to the 2014MY. Flat-portion of the curve learning is considered applicable to all of these costs.

2.4.2.5 Integrated Aftertreatment System

All manufacturers use diesel particulate filter (DPF) to reduce particulate matter (PM). All except Navistar rely on SCR to reduce NO_x emissions. Periodic regeneration to remove loaded soot is required for all DPF. One way is to directly inject the fuel into exhaust stream, called active regeneration, and a diesel oxidation catalyst (DOC) or other device then oxidizes the fuel in the exhaust stream, providing the heat required for DPF regeneration and increasing the fuel consumption of the vehicle. The other method is to use NO₂, called passive regeneration, to directly react with soot at much lower exhaust temperature than active regeneration. Use of advanced thermal management could be made in production to eliminate active regeneration, thus significantly improving fuel efficiency. Volvo has announced in 2009 that their 2010 DPF+SCR system has eliminated active regeneration for on-highway vehicles.⁴⁹ All other manufacturers using SCR are working in the same direction, minimizing or eliminating active regeneration, thus improving fuel economy, providing efficiency improvements in the real world, although they are not reflected in the HD engine test procedure.

Higher SCR NO_x conversion efficiency will allow higher engine-out NO_x emissions (while still meeting the tailpipe NO_x standard due to the aftertreatment), and therefore, will give more room for engine system optimization, while maintaining the same or even less diesel engine fluid (DEF) consumption. Advanced model based control on DEF usage and slip can further improve DEF consumption, and thus fuel efficiency. For those manufacturers that use SCR as their NO_x reduction devices, properly integrated DPF and SCR system is essential, which is not only able to improve emissions reductions, but also to improve fuel efficiency through more advancing canning design, thus minimizing pressure drop across the system. Improvements in aftertreatment system efficiency should be technology cost neutral, requiring no increases in precious metal loading or manufacturing expense, and only require additional development costs.

The agencies have estimated the cost of additional improvements to the aftertreatment system at \$25 for each percentage improvement in fuel consumption. This estimate is based on the agencies' belief that this technology is, in fact, a very cost effective approach to

Regulatory Impact Analysis

improving fuel consumption. As such, \$25 per percent improvement is considered a reasonable cost. This cost would cover the engineering and test cell related costs necessary to develop and implement the improved control strategies that would allow for the improvements in fuel consumption. Importantly, the engineering work involved would be expected to result in cost savings to the aftertreatment and control hardware (lower platinum group metal (PGM) loadings, lower reductant dosing rates, etc.). Those savings are considered to be included in the \$25 per percent estimate described here. Given the 4 percent expected improvement in fuel consumption results in an estimated cost of \$117 (2009\$) for a 2014MY vehicle. This estimate includes a low complexity ICM of 1.15 and flat-portion of the curve learning from 2014 forward. Note that this cost is applied only to LHD diesel engines. The cost for this technology is considered separately for MHD and HHD diesel engines since the cost is considered largely one of research and development which probably results in lower actual part cost.

2.4.2.6 Electrification

Many accessories that are traditionally gear or belt driven by a vehicle's engine can be decoupled with the engine speed, so that those accessories can be tailored to a specific engine speed reducing parasitic loads, thus producing better efficiency. Examples include the engine water pump, oil pump, fuel injection pump, air compressor, power-steering pump, cooling fans, and the vehicle's air-conditioning system. TIAX's assessment of electrified accessories found that they could provide 0 to 3 percent improvement in fuel consumption.⁵⁰ The most tangible development toward production in 2017 time frame would be electric water and oil pumps. The agencies expect that about 0.5 to 1.0 percent thermal efficiency improvement could be achieved with electrification of these two pumps.

Costs for electrification are considered as part of the costs for improved water and oil pumps discussed in Section 2.4.2.4.

2.4.2.7 Waste Heat Recovery

Waste heat recovery uses exhaust gas or other heat sources (such as EGR or coolant) from the primary engine to develop additional power. Waste heat recovery systems have other names such as bottoming cycle or Rankine cycle. As described in the 2010 NAS report, a typical system consists of the following components: a feed pump to drive the working fluid from the condenser to the evaporator (or boiler); the evaporator, which transfers waste heat energy from the primary engine to the working fluid; an expander, which takes energy from the working fluid to make mechanical power; and a condenser that rejects unused heat energy from the bottoming cycle working fluid before starting a new cycle. TIAX estimated a 12 kWh waste heat recovery system would cost of \$8,400 per truck.⁵¹ Such costs include necessary power extraction unit and gearbox, heat exchangers and compressor. Alternatively, the waste heat recovery system could produce electrical power. This type of system would need to be combined with hybridization so that the electrical energy could be stored and used directly when needed to supplement engine power. The 2010 NAS report cited two studies related to waste heat recovery, as listed below.⁵²

Heavy-Duty GHG and Fuel Efficiency Standards FRM: Technologies, Cost, and Effectiveness

- Cummins has shown a projected increase of thermal efficiency from 49.1 to 52.9 percent (7.2 percent decrease in fuel consumption) using an organic Rankine cycle.⁵² Cummins reports recovering 2.5 thermal efficiency points from the exhaust and 1.3 thermal efficiency points from the coolant and EGR stream.
- The NESCCAF/ICCT report showed the effect of a steam bottoming cycle to reduce fuel consumption by up to 10 percent.

The agencies' assessment of this technology indicates that it currently exists only in the research phase and concluded that there is insufficient lead time between now and 2017 for this promising technology to be developed and applied generally to all heavy-duty engines. TIAX noted in their report to the NAS committee that the engine improvements beyond 2015 model year included in their report are highly uncertain, though they include Rankine cycle type waste heat recovery as applicable sometime between 2016 and 2020.⁵³ The Department of Energy, along with industry are both working to develop waste heat recovery systems for heavy-duty engines. At the Diesel Engine-Efficiency and Emissions Research (DEER) conference in 2010, Caterpillar presented details regarding their waste heat recovery systems development effort. In their presentation, Caterpillar clearly noted that the work is a research project and therefore does not imply commercial viability.⁵⁴ At the same conference, Concepts NREC presented a status of exhaust energy recovery in heavy-duty engines. The scope of Concepts NREC included the design and development of prototype parts.⁵⁵ Cummins, also in coordination with DOE, is also active in developing exhaust energy recovery systems. Cummins made a presentation to the DEER conference in 2009 providing an update on their progress which highlighted opportunities to achieve a 10 percent engine efficiency improvement during their research, but indicated the need to focus their future development on areas with the highest recovery opportunities (such as EGR, exhaust, and charge air).⁵⁶ Cummins also indicated that future development would focus on reducing the high additional costs and system complexity. Based upon the assessment of this information, the agencies did not include these technologies in determining the stringency of the final standards. However, we do believe the bottoming cycle approach represents a significant opportunity to reduce fuel consumption and GHG emissions in the future.

2.4.2.8 2014 Model Year HHD Diesel Engine Package

The agencies assessed the impact of technologies over each of the SET modes to project an overall improvement in the 2014 model year. The agencies considered improvements in parasitic and friction losses through piston designs to reduce friction, improved lubrication, and improved water pump and oil pump designs to reduce parasitic losses. The aftertreatment improvements are available through additional improvements to lower backpressure of the systems and further optimization of the engine-out NO_x levels. Improvements to the EGR system and air flow through the intake and exhaust systems, along with turbochargers, can also produce engine efficiency improvements. Lastly, an increase in combustion pressures and controls can reduce fuel consumption of the engine. The projected impact of each set of these technologies is included in Table 2-7. Based on the improvements listed in the table, the overall weighted reduction based on the SET mode weightings is

Regulatory Impact Analysis

projected at 3 percent. It should be pointed out that the improvements listed in Table 2-7 are not all additive, meaning that total benefits of individual technologies would not be equal to the benefits that are added up by each technology numerically.

Table 2-7: Projected Percent CO₂ Impact for SET Modes in 2014 Model Year

SET Mode	Speed/% Load	Parasitics, Friction	Aftertreatment Improvement	Turbocharger, Air Handling System	Advanced Controls, Combustion, & Fuel injection Improvements
1	Idle	-0.4	-0.4	-0.8	-0.8
2	A, 100	-0.8	-1.0	-0.8	-0.4
3	B, 50	-1.3	-1.3	-1.5	-2.1
4	B, 75	-0.8	-0.8	-0.8	-0.8
5	A, 50	-1.3	-1.0	-1.5	-2.1
6	A, 75	-0.6	-1.0	-1.3	-1.0
7	A, 25	-0.6	-0.4	-1.3	-1.3
8	B, 100	-0.8	-1.0	-0.8	-0.4
9	B, 25	-0.8	-0.8	-1.3	-1.3
10	C, 100	-0.8	-1.0	-0.8	-0.4
11	C, 25	-0.8	-1.0	-1.3	-0.8
12	C, 75	-1.0	-1.0	-1.0	-0.4
13	C, 50	-1.3	-1.3	-1.3	-0.8

The agencies derived the HHD diesel engine FTP technology effectiveness for the 2014 model year based on a similar approach. Using the same technologies as discussed for the HHD diesel engine SET above, the agencies project the reductions at 3 percent. It should be pointed out that individual technology improvement is not additive to each other due to the interaction of technology to technology.

The cost estimates for the complete HHD diesel engine packages are shown in Table 2-8.

Table 2-8 Technology and Package Costs for HHD Diesel Engines (2009\$)

Technology	2014	2015	2016	2017
Cylinder Head	\$6	\$6	\$6	\$6
Turbo efficiency	\$18	\$18	\$17	\$17
EGR cooler	\$4	\$4	\$3	\$3
Water pump	\$91	\$89	\$86	\$84
Oil pump	\$5	\$4	\$4	\$4
Fuel pump	\$5	\$4	\$4	\$4
Fuel rail	\$10	\$10	\$10	\$9
Fuel injector	\$11	\$11	\$10	\$10
Piston	\$3	\$3	\$3	\$3
Engine Friction Reduction of Valvetrain	\$82	\$80	\$78	\$76
Turbo-compounding (engines placed in combination tractors only)	\$0	\$0	\$0	\$875
HHDD Total (vocational vehicle engines)	\$234	\$228	\$222	\$216
HHDD Total (combination tractors)	\$234	\$228	\$222	\$1,091

Heavy-Duty GHG and Fuel Efficiency Standards FRM: Technologies, Cost, and Effectiveness

2.4.2.9 2014 Model Year LHD/MHD Diesel Engine Package

The agencies considered the same 2014 model year technology package developed for the HHD diesel engines for the LHD diesel and MHD diesel engines. The package includes parasitic and friction reduction, improved lubrication, aftertreatment improvements, EGR system and air flow improvements, and combustion pressure increase and controls to reduce fuel consumption of the engine. The agencies project that these improvements will produce a 5 percent reduction in fuel consumption and CO₂.

The cost estimates for the complete MHD diesel engines are shown in Table 2-9. The cost estimates for the complete LHD diesel engines are shown in Table 2-10.

Table 2-9 Technology and Package Costs for MHD Diesel Engines (2009\$)

Technology	2014	2015	2016	2017
Cylinder Head	\$6	\$6	\$6	\$6
Turbo efficiency	\$18	\$18	\$17	\$17
EGR cooler	\$4	\$4	\$3	\$3
Water pump	\$91	\$89	\$86	\$84
Oil pump	\$5	\$4	\$4	\$4
Fuel pump	\$5	\$4	\$4	\$4
Fuel rail	\$10	\$10	\$10	\$9
Fuel injector	\$11	\$11	\$10	\$10
Piston	\$3	\$3	\$3	\$3
Valve train friction reduction	\$82	\$80	\$78	\$76
Turbo-compounding (engines placed in combination tractors only)	\$0	\$0	\$0	\$875
MHDD Total (vocational vehicle engines)	\$234	\$228	\$222	\$216
MHDD Total (combination tractors)	\$234	\$228	\$222	\$1,091

Table 2-10 Technology and Package Costs for LHD Diesel Engines (2009\$)

Technology	2014	2015	2016	2017
Aftertreatment improvements	\$117	\$114	\$111	\$108
Cylinder Head	\$11	\$11	\$10	\$10
Turbo efficiency	\$18	\$18	\$17	\$17
EGR cooler	\$4	\$4	\$3	\$3
Water pump	\$91	\$89	\$86	\$84
Oil pump	\$5	\$4	\$4	\$4
Fuel pump	\$5	\$4	\$4	\$4
Fuel rail	\$12	\$12	\$11	\$11
Fuel injector	\$15	\$14	\$14	\$13
Piston	\$3	\$3	\$3	\$3
Valve train friction reduction	\$109	\$106	\$104	\$101
LHDD Total	\$388	\$378	\$368	\$358

Regulatory Impact Analysis

2.4.2.10 2014 Model Year Diesel Engine Standards

The agencies applied the 5 percent reduction for the LHDD/MHDD engines and the 3 percent reduction for the HHDD diesel engines based on the projected technology package improvements in 2014 model year to the 2010 model year baseline performance included in Table 2-6. The results are the final 2014 model year standards (and the equivalent voluntary fuel consumption standards), as shown in Table 2-11.

Table 2-11: 2014 Model Year Final Standards

	LHDD - FTP	MHDD - FTP	HHDD - FTP	MHDD- SET	HHDD - SET
CO ₂ Emissions (g CO ₂ /bhp-hr)	600	600	567	502	475
Fuel Consumption (gal/100 bhp-hr)	5.89	5.89	5.57	4.93	4.67

2.4.2.11 2017 Model Year HHDD Engine Package

The agencies assessed the impact of technologies over each of the SET modes to project an overall improvement in the 2017 model year. The agencies considered additional improvements in the technologies included in the 2014 model year package in addition to turbocompounding. The projected impact of each set of these technologies is included in Table 2-12. Based on the improvements listed in the table, the overall weighted reduction based on the SET mode weightings is projected at 6 percent.

Table 2-12: Projected CO₂ Improvements for SET Modes in 2017 Model Year

SET Mode	Speed/% Load	Turbocompounding with clutch	Parasitics, Friction	Aftertreatment Improvement	Turbocharger, Air Handling System	Advanced Controls, Combustion, & Fuel injection Improvements
1	Idle	0.00	-0.5	-0.5	-1.0	-1.0
2	A, 100	-4.50	-1.0	-1.3	-1.0	-0.5
3	B, 50	-2.50	-1.5	-1.5	-1.8	-2.5
4	B, 75	-4.00	-1.0	-1.0	-1.0	-1.0
5	A, 50	-2.00	-1.5	-1.3	-1.8	-2.5
6	A, 75	-4.00	-0.8	-1.3	-1.5	-1.3
7	A, 25	0.00	-0.8	-0.5	-1.5	-1.5
8	B, 100	-5.00	-1.0	-1.3	-1.0	-0.5
9	B, 25	0.00	-1.0	-1.0	-1.5	-1.5
10	C, 100	-5.00	-1.0	-1.3	-1.0	-0.5
11	C, 25	0.00	-1.0	-1.3	-1.5	-1.0
12	C, 75	-3.00	-1.3	-1.3	-1.3	-0.5
13	C, 50	-2.00	-1.5	-1.5	-1.5	-1.0

Heavy-Duty GHG and Fuel Efficiency Standards FRM: Technologies, Cost, and Effectiveness

The agencies derived the HHDD FTP technology package effectiveness for the 2017 model year based on a similar approach. However, the addition of turbocompounding shows a greater effectiveness on the SET cycle than the FTP cycle because of the steady state nature and amount of time spent at higher speeds and loads during the SET. Using the same technologies as discussed for the HHDD SET above, the agencies project the reductions at 5 percent for the FTP. Similar to Table 2-7, individual technology in Table 2-12 is not additive to each other due to the interaction of technology to technology.

The costs for the 2017 model year HHD diesel engines are shown in Table 2-8.

2.4.2.12 2017 Model Year LHD/MHD Diesel Engine Package

The agencies developed the 2017 model year LHD/MHD diesel engine package based on additional improvements in the technologies included in the 2014 model year package. The projected impact of these technologies provides an overall reduction of 9 percent over the 2010 model year baseline.

Costs for the 2017 model year are shown in Table 2-9 (MHD) and Table 2-10 (LHD).

2.4.2.13 2017 Model Year Diesel Engine Standards

The agencies applied the 8.6 percent reduction for the LHD/MHD diesel engines and the 5 percent reduction for the HHD diesel engines using the FTP and a 6.1 percent reduction for HHD diesel engines using the SET based on the projected technology package improvements in 2017 model year to the 2010 model year baseline performance included in Table 2-6. The results are the final 2017 model year standards (and the equivalent fuel consumption standards), as shown in Table 2-13.

Table 2-13 2017 Model Year Final Standards

	LHDD - FTP	MHDD - FTP	HHDD - FTP	MHDD- SET	HHDD - SET
CO ₂ Emissions (g CO ₂ /bhp-hr)	576	576	555	487	460
Fuel Consumption (gal/100 bhp-hr)	5.66	5.66	5.45	4.78	4.52

2.4.2.14 Optional HD Diesel Engine Phase-in Schedule

The agencies are finalizing an optional phase-in schedule for HD diesel engines which aligns with the timing of OBD requirements in 2013 and 2016 model years. The optional phase-in schedule requires that engines built in 2013 and 2016 model years achieve greater reductions than the engines built in those model years under the primary program, but less reduction in 2014 and 2015 model year engines. Overall, this phase-in schedule produces an equivalent CO₂ emissions and fuel consumption reduction as the primary program for the engines built in the 2013 through 2017 model year timeframe as shown in Table 2-14 and Table 2-15.

Regulatory Impact Analysis

Table 2-14: Lifetime CO₂ Emissions of Each Model Year Engine Installed in Tractors

	HHD SET ENGINES			MHD SET ENGINES		
	Primary Phase-in Standard (g/bhp-hr)	Optional Phase-in Standard (g/bhp-hr)	Difference in Lifetime CO ₂ Engine Emissions (MMT)	Primary Phase-in Standard (g/bhp-hr)	Optional Phase-in Standard (g/bhp-hr)	Difference in Lifetime CO ₂ Engine Emissions (MMT)
Baseline	490	490	--	518	518	--
2013 MY Engine	490	485	14	518	512	17
2014 MY Engine	475	485	-28	502	512	-28
2015 MY Engine	475	485	-28	502	512	-28
2016 MY Engine	475	460	42	502	487	42
2017 MY Engine	460	460	0	487	487	0
Net Reductions (MMT)			0			3

Table 2-15: Lifetime CO₂ Emissions Reduction of Each Model Year Engine Installed in Vocational Vehicles

	HHD FTP			LHD/MHD FTP		
	Primary Phase-in Standard (g/bhp-hr)	Optional Phase-in Standard (g/bhp-hr)	Difference in Lifetime CO ₂ Engine Emissions (MMT)	Primary Phase-in Standard (g/bhp-hr)	Optional Phase-in Standard (g/bhp-hr)	Difference in Lifetime CO ₂ Engine Emissions (MMT)
Baseline	584	584	--	630	630	--
2013 MY Engine	584	577	20	630	618	14
2014 MY Engine	567	577	-28	600	618	-22
2015 MY Engine	567	577	-28	600	618	-22
2016 MY Engine	567	555	34	600	576	29
2017 MY Engine	555	555	0	576	576	0
Net Reductions (MMT)			-3			0

2.5 Class 7 and 8 Day Combination Tractors

The regulatory category for Class 7 and 8 combination tractors involves nine regulatory subcategories.

Class 7 Day Cab with Low Roof

Class 7 Day Cab with Mid Roof

Class 7 Day Cab with High Roof

Class 8 Day Cab with Low Roof

Class 8 Day Cab with Mid Roof

Class 8 Day Cab with High Roof

Class 8 Sleeper Cab with Low Roof

Class 8 Sleeper Cab with Mid Roof

Class 8 Sleeper Cab with High Roof

The regulatory subcategories differentiate between tractor usages through using characteristics of the truck. The technologies considered to reduce fuel consumption and CO₂ emissions from tractors can be developed for all of the subcategories. However, the typical usage pattern may limit the penetration rate of the technology. For example, aerodynamic improvements can reduce the fuel consumption and CO₂ emissions of a tractor at high speeds. However, this technology could be a detriment to fuel consumption if applied to a tractor travelling at low speeds. The agencies discuss technologies, penetration rates, and costs for each regulatory subcategory in the sections below.

2.5.1 Aerodynamics

Up to 25 percent of the fuel consumed by a line-haul truck traveling at highway speeds is used to overcome aerodynamic drag forces, making aerodynamic drag a significant contributor to a Class 7 or 8 tractor's GHG emissions and fuel consumption.⁵⁷ Because aerodynamic drag varies by the square of the vehicle speed, small changes in the tractor aerodynamics can have significant impacts on GHG emissions and fuel efficiency of that vehicle. With much of their driving at highway speed, the benefits of reduced aerodynamic drag for Class 7 or 8 tractors can be significant.⁵⁸

The common measure of aerodynamic efficiency is the coefficient of drag (Cd). The aerodynamic drag force (*i.e.*, the force the vehicle must overcome due to air) is a function the Cd, the area presented to the wind (*i.e.*, the projected area perpendicular to the direction of travel or frontal area), and the cube of the vehicle speed. Cd values for today's fleet typically

range from greater than 0.80 for a classic body tractor to approximately 0.58 for tractors that incorporate a full package of widely, commercially available aerodynamic features.

2.5.1.1 Challenges of Tractor Aerodynamics

The aerodynamic efficiency of heavy-duty vehicles has gained increasing interest in recent years as fuel prices, competitive freight markets, and overall environmental awareness has focused owners and operators on getting as much useful work out of every gallon of diesel fuel as possible. While designers of heavy-duty vehicles and aftermarket products try to aerodynamically streamline heavy-duty vehicles, there are some challenges. Foremost is balancing the need to maximize the amount of freight that can be transported. For a tractor, this often means pulling a trailer that is as tall and as wide as motor safety laws permit, thereby presenting a large, drag-inducing area perpendicular to the wind (*i.e.*, projected frontal area). As a result, the tractor must also present a relatively large projected frontal area to smoothly manage the flow of air along the cab and transition it to trailer. In instances where the height of the cab is not properly matched with that of trailer, aerodynamic drag can be significantly increased by creating large wakes (when the trailer is much shorter than the cab) or presenting a large non-aerodynamic surface (when the trailer is taller than the cab). Aerodynamic design must also meet practical and safety needs such as providing for physical access and visual inspections of vehicle equipment. Because weight added to the vehicle impacts its overall fuel efficiency and GHG emissions and, in some circumstances the amount of freight the vehicle can carry, aerodynamic design and devices will sacrifice some benefit to overcoming their contribution to the vehicle weight. Aerodynamic designs and devices also must balance being as light and streamlined as possible with being durable enough to withstand the rigors a working, freight vehicle encounters while traveling or loading and unloading. Durability can be a significant concern for cabs designed for specialty applications, such as “severe duty” cabs that may operate on unimproved roads. In addition, absent mandatory requirements, aerodynamic features for heavy-duty vehicles must appeal to the owners and operators. Finally, because the behavior of airflow across the cab (and cab and trailer combination) is dependent upon the entire system, it is not possible to make inferences about the vehicle’s aerodynamic performance based upon the performance of individual components. This can make it difficult to assess the benefit of adding (or subtracting) individual aerodynamic features, and can discourage owners and operators from adopting aerodynamic technologies.

2.5.1.2 Technology to Reduce Aerodynamic Drag

Addressing aerodynamic drag in Class 7 and 8 tractors requires considering the entire vehicle as a system to include the tractor and trailer. The overall shape can be optimized to minimize aerodynamic drag and, in fact, the tractor body must have at least a moderately aerodynamic shape (and its relatively smooth flow) to benefit from add-on aerodynamic components. Whether integrated into the shape of the tractor body or as an add-on component to a generally aerodynamic tractor, there is a wide range of technologies available for Class 7 and 8 tractors. Table 2-16 describes several of these potential aerodynamic features and components.

Heavy-Duty GHG and Fuel Efficiency Standards FRM: Technologies, Cost, and Effectiveness

Table 2-16: Technologies to Address Aerodynamic Drag

LOCATION ON CAB	TECHNOLOGY TYPE	DESIGNED EFFECT
Front	Bumper, grill, hood, windshield	Minimize pressure created by front of vehicle moving ambient air to make way for truck
Side	Fuel tank fairings	Reduce surface area perpendicular to wind, minimize opportunity to trap airflow, and smooth surface
Top	Roof fairings (integrated) and wind visors (attached)	Transition air to flow smoothly over trailer and minimize surface area perpendicular to the wind (for tractor and trailer)
Rear	Side extending gap reducers	Transition air to flow smoothly over trailer and reduce entrapment of air in gap between tractor and trailer
Undercarriage	Underbelly treatment	Manage flow of air underneath tractor to reduce eddies and smoothly transition flow to trailer
Accessories	Mirrors, signal horns, exhaust	Reducing surface area perpendicular to travel and minimizing complex shapes that may induce drag
General	Active air management	Manage airflow by actively directing or blowing air into reduce pressure drag
General	Advanced, passive air management	Manage airflow through passive aerodynamic shapes or devices that keep flow attached to the vehicle (tractor and trailer)

2.5.1.3 Aerodynamics in the Current Fleet

Aerodynamics in the Class 7 and 8 tractors fleet currently on the road ranges from trucks with few modern aerodynamic features, to those that address the major areas of aerodynamic drag, to tractors applying more advanced techniques. Because they operate at highway speeds less of the time, Class 7 and 8 tractors configured as day cabs (*i.e.*, dedicated to regional routes) tend to have fewer aerodynamic features than cabs designed for line-haul applications. For tractors, it is useful to consider aerodynamics in the current fleet in terms of three packages: the “classic” truck body; the “conventional” truck body; and the “SmartWay” truck body.

“Classic” truck body: At the lower end of aerodynamic performance are tractors that have a “classic” truck body. These truck bodies prioritize looks or special duty capabilities (*e.g.*, clearance, durability on unimproved roads, and visual access to key vehicle components) and have remained relatively unchanged since the 1970’s. Typical applications are logging, waste hauling, and some agricultural related uses. These trucks incorporate few, if any, aerodynamic features and several that detract from aerodynamics including equipment such as bug deflectors, custom sunshades, air cleaners, b-pillar exhaust stacks, additional horns, lights and mirrors.

“Conventional” truck body: The conventional, modern truck capitalizes on a generally aerodynamic shape and avoids classic features that increase drag. The conventional, modern truck body has removed extra equipment (*e.g.*, bug deflectors, custom sunshades, additional signal horns, decorative lights), moved essential equipment out of the airflow (*e.g.*,

Regulatory Impact Analysis

b-pillar exhaust stacks and air cleaners), and streamlined fixed-position, essential equipment (*e.g.*, mirrors, steps, and safety lights).

“SmartWay” truck body: The SmartWay aerodynamic package builds off of the aerodynamic package required for a Class 8 sleeper cab high roof tractor to meet the SmartWay design specifications and represents the top aerodynamic package that is widely, commercially available. The SmartWay package is a fully aerodynamic truck package which has an overall streamlined shape, removes drag-inducing features (*i.e.*, those removed or moved in conventional, modern truck body), and adds components to reduce drag in the most significant areas on the tractor. This includes aerodynamic features at the front to the tractor (*e.g.*, streamlined bumper, grill, and hood), sides (*i.e.*, fuel tank fairings and streamlined mirrors), top (*i.e.*, roof fairings), and rear (*i.e.*, side extending gap reducers). Regional and line-haul applications often employ different approaches, such as removable, rooftop wind visors and fully integrated, enclosed roof fairings, respectively, based upon their intended operation.

More advanced aerodynamic features are possible and are the focus of product development, pilot and testing projects, and, in some cases, product lines that have seen limited fleet adoption. Advanced aerodynamic designs can further optimize the overall shape of the tractor and may add other advanced aerodynamic features (*e.g.*, underbody airflow treatment, down exhaust, and lowered ride height). Some advanced aerodynamic features, including those listed above, show promise but will likely need ongoing refinement as these technologies are tailored to specific applications and payback periods are reduced. Fleets whose line-haul operations permit are currently testing and using some advanced aerodynamic technologies today.

2.5.1.4 Aerodynamic Bins

The agencies have characterized the typical aerodynamic performance (expressed as CdA) and cost for select applications. To do so, it was necessary to represent the wide variety of tractor aerodynamic shapes – which are a collection of the shapes of the multitude of component parts – by developing aerodynamic packages. These are called Bins I, II, III, IV, and V.

Bin I aerodynamic package: As described as a classic truck in section 2.4.1.3, these trucks incorporate few, if any, aerodynamic features and several that detract from aerodynamics including equipment such as bug deflectors, custom sunshades, air cleaners, b-pillar exhaust stacks, additional horns, lights and mirrors may constitute a conventional vehicle. No cost for aerodynamics is assumed for this classic package.

Bin II package: As described in section 2.4.1.3 as a conventional tractor this tractor capitalizes on a generally aerodynamic shape and avoids classic features that increase drag. No cost for aerodynamics is assumed for the conventional package since there has been no addition of additional body work and these moderate modifications to the tractor shape would not likely require the redesign of other components.

Heavy-Duty GHG and Fuel Efficiency Standards FRM: Technologies, Cost, and Effectiveness

Bin III package: Based upon the design requirements of EPA's SmartWay Designated Tractors, this package has an overall streamlined shape, removes drag inducing features, and adds components (*i.e.*, aerodynamic mirrors, side fairings, aerodynamic bumpers, and side extending gap reducers) to reduce drag in the most significant areas on the tractor. The Bin III aerodynamics package does add some incremental cost above the classic and conventional packages.

Bin IV and Bin V packages: These packages include components similar to that found in the SmartWay package but with additional aerodynamic refinement. This can be a combination of more sophisticated shape and increased coverage of drag inducing elements. Where the Bin IV package represents a tractor using the most advanced aerodynamics available today, the Bin V package is designed to represent aerodynamics expected to be available in the near future. With more attention paid to aerodynamic performance than the conventional package, the Bin IV package is estimated to be slightly more expensive than the Bin III package. As a representation of the future aerodynamics, the Bin V package is estimated as being 50 percent more expensive than the Bin IV package.

The agencies developed the aerodynamic drag area, CdA, bin values for the tractor categories based on coastdown testing conducted by EPA using the enhanced coastdown test procedures adopted for the final rulemaking, as described in RIA Chapter 3.2.2.1.3. The agencies supplemented these results with the CdA information described in the proposal, which was based on a previous EPA coastdown program using slightly different test procedures conducted for the proposal and literature surveys. In addition to the absolute CdA values, the agencies used the results of a wind tunnel evaluation of aerodynamic components to help identify the appropriate width of bins. SAE 2006-01-3456 evaluated aerodynamic components on a Class 8 high roof tractor and found that side extenders provide a CdA reduction of 0.4 and tank and cab skirts provide a CdA reduction of 0.3.⁵⁹ The agencies considered that the results from the earlier test program and literature are based on test procedures that are not identical to those adopted for this program, and therefore placed more weight on the results from the latest EPA coastdown test program.

Regulatory Impact Analysis

Table 2-17: Tractor CdA Values

Truck	Expected Bin	Source	CdA (m ²)
Class 8 High Roof Sleeper Cab			
B-3JM2-2H-TXCR	Bin III	EPA Test Program	6.4
B-3JM2-4N-TXCR	Bin III-IV	EPA Test Program	5.7
B-3JM2-2K-TXCR	Bin III	EPA Test Program	6.3
C-3JM2-1B-TXCR	Bin III	EPA Test Program	6.2
C-3JE2-1F-TXCR	Bin II-III	EPA Test Program	6.7
International ProStar	Bin III-IV	ATDS ⁶⁰	5.3-5.5
Best Aero Truck	Bin III	DDC Spec Manager	6.0
Full Aero	Bin III	EPA PERE & MOVES Model	5.8
Roof Deflector	Bin II	EPA PERE & MOVES Model	6.4
International 9200i #1	Bin II	TRC	7.0
International 9200i #2	Bin II	NVFEL	6.9
CE-CERT	Bin II	EPA PERE & MOVES Model	7.3
No Aero Feature	Bin I	DDC Spec Manager	7.5
Baseline Truck	Bin I	McCallen, 1999	7.5
Class 8 Day Cab High Roof			
B-3XM2-4M-TBCR	Bin III	EPA Test Program	6.7
International ProStar	Bin III	ATDS	5.7
Aero Features	Bin III	SAE 2005-01-3512	6.0
Roof Fairing Only	Bin II	SAE 2005-01-3512	6.5
Class 8 Sleeper Cab Low Roof			
C-4XM7-1C-TGTW	Bin II	EPA Test Program	4.2
Class 8 Day Cab Low Roof			
International ProStar	Bin II	ATDS	4.7
Class 8 Sleeper Cab Mid Roof			
C-3JM3-2K-TGTW	Bin II	EPA Test Program	5.0

For high roof combination tractor compliance determination, a manufacturer would use the aerodynamic results (CdA) determined through testing to establish the appropriate bin, as defined in Table 2-18. The manufacturer would then input into GEM the Cd value specified for each bin. For example, if a manufacturer tests a Class 8 sleeper cab high roof tractor and the test produces a CdA value of 6.2, then the manufacturer would assign this tractor to the Class 8 Sleeper Cab High Roof Bin III. The manufacturer would then use the Cd value of 0.60 as the input to GEM.

Heavy-Duty GHG and Fuel Efficiency Standards FRM: Technologies, Cost, and Effectiveness

Table 2-18: Aerodynamic Input Definitions to GEM for High Roof Tractors

	CLASS 7		CLASS 8		
	Day Cab		Day Cab		Sleeper Cab
	High Roof		High Roof		High Roof
Aerodynamic Test Results (CdA in m ²)					
Bin I	≥ 8.0		≥ 8.0		≥ 7.6
Bin II	7.1-7.9		7.1-7.9		6.7-7.5
Bin III	6.2-7.0		6.2-7.0		5.8-6.6
Bin IV	5.6-6.1		5.6-6.1		5.2-5.7
Bin V	≤ 5.5		≤ 5.5		≤ 5.1
Aerodynamic Input to GEM (Cd)					
Bin I	0.79		0.79		0.75
Bin II	0.72		0.72		0.68
Bin III	0.63		0.63		0.60
Bin IV	0.56		0.56		0.52
Bin V	0.51		0.51		0.47

The CdA values in Table 2-19 are based on testing using the enhanced coastdown test procedures adopted for the final rulemaking, which includes aerodynamic assessment of the low and mid roof tractors without a trailer. The removal of the trailer significantly reduces the CdA value of mid roof tractors with tanker trailers because of the poor aerodynamic performance of the tanker trailer. The agencies developed the Cd input for each of the low and mid roof tractor bins to represent the Cd of the tractor, its frontal area, and the impact of the Cd value due to the trailer such that the GEM value is representative of a tractor-trailer combination, as it is for the high roof tractors.

Table 2-19: Aerodynamic Input Definitions to GEM for Low and Mid Roof Tractors

	CLASS 7		CLASS 8			
	Day Cab		Day Cab		Sleeper Cab	
	Low Roof	Mid Roof	Low Roof	Mid Roof	Low Roof	Mid Roof
Aerodynamic Test Results (CdA in m ²)						
Bin I	≥ 5.1	≥ 5.6	≥ 5.1	≥ 5.6	≥ 5.1	≥ 5.6
Bin II	≤ 5.0	≤ 5.5	≤ 5.0	≤ 5.5	≤ 5.0	≤ 5.5
Aerodynamic Input to GEM (Cd)						
Bin I	0.77	0.87	0.77	0.87	0.77	0.87
Bin II	0.71	0.82	0.71	0.82	0.71	0.82

The agencies have conducted sensitivity analysis of Cd values within GEM to determine the effectiveness of aerodynamic technologies, as shown in Figure 2-2. For a Class 8 sleeper cab with a high roof, the impact of moving from Bin II to Bin III is a 6.5 percent reduction in CO₂ emissions and fuel consumption.

Figure 2-2: CO₂ Emissions Impact of Coefficient of Drag for a Class 8 Sleeper Cab, High Roof

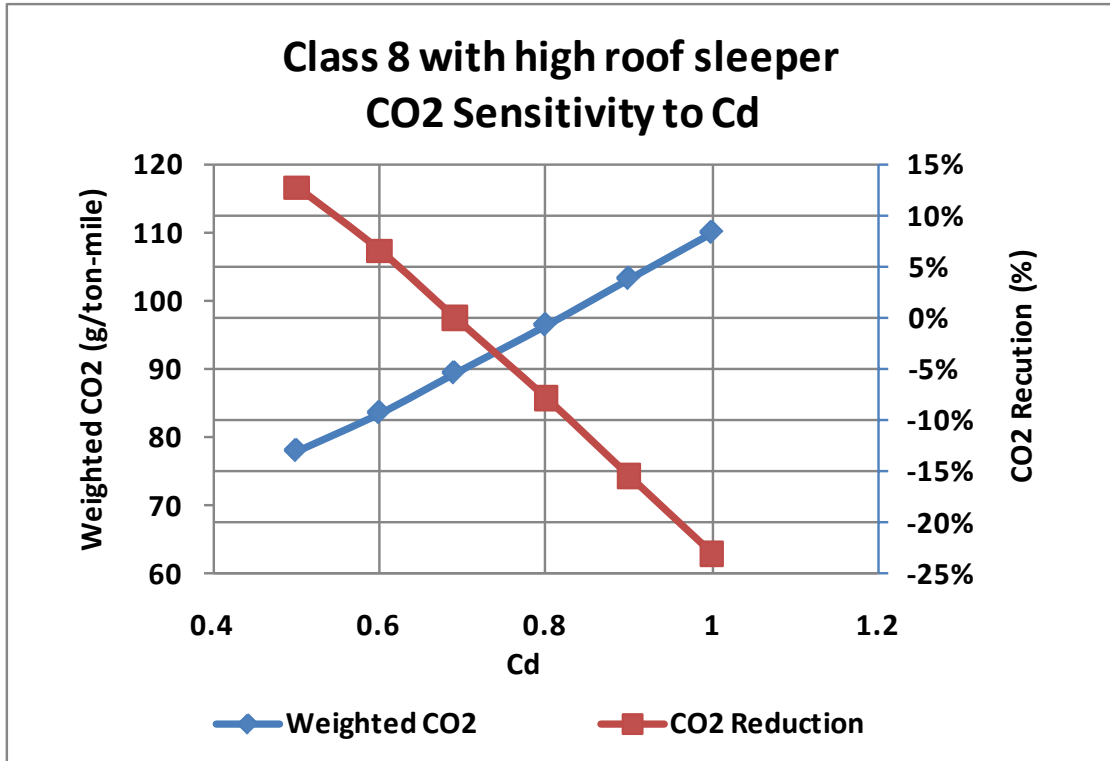

The agencies estimated the cost of the aerodynamic packages based on ICF’s price estimates.⁶¹ The agencies applied a 15 percent reduction to the prices to reflect savings due to a higher volume production which would be applicable to the tractor manufacturers. Although technologies such as roof fairings may already be in widespread use today, the ICF study researched retail prices that a consumer would pay for the purchase of a single item in addition to researching possible savings based on a large volume manufacturing. In addition, the agencies removed an RPE of 1.36 to obtain the direct manufacturer cost and then applied a low complexity ICM of 1.18 or a medium complexity ICM of 1.30 (for Bin V) to obtain the overall technology costs included in Table 2-20 and Table 2-21. In Table 2-22 and Table 2-23 the costs are shown including the expected penetration rates which range between 20 percent and 50 percent for most technologies shown.

Table 2-20 Estimated Aerodynamic Technology Costs for Class 7 & 8 Day Cabs for the 2014MY (2009\$)

	CLASS 7 DAYCAB		CLASS 8 DAYCAB	
	Low Roof	High Roof	Low Roof	High Roof
Bin I	\$0	\$0	\$0	\$0
Bin II	\$0	\$0	\$0	\$0
Bin III	\$1,126	\$1,155	\$1,126	\$1,155
Bin IV	\$2,273	\$2,303	\$2,273	\$2,303
Bin V	\$3,203	\$3,245	\$3,203	\$3,245

Heavy-Duty GHG and Fuel Efficiency Standards FRM: Technologies, Cost, and Effectiveness

Table 2-21 Estimated Aerodynamic Technology Costs for Class 8 Sleeper Cabs for the 2014MY (2009\$)

	LOW ROOF	MID ROOF	HIGH ROOF
Bin I	\$0	\$0	\$0
Bin II	\$0	\$0	\$0
Bin III	\$1,374	\$1,404	\$1,560
Bin IV	\$2,601	\$2,601	\$2,675
Bin V	\$3,664	\$3,664	\$3,769

Table 2-22 Estimated Aerodynamic Technology Costs for Class 7 & 8 Day Cabs for the 2014MY Inclusive of Penetration Rates (2009\$)

	CLASS 7 DAYCAB		CLASS 8 DAYCAB	
	Low Roof	High Roof	Low Roof	High Roof
Bin III	\$675	\$693	\$675	\$693
Bin IV	N/A	\$230	N/A	\$230

Table 2-23 Estimated Aerodynamic Technology Costs for Class 8 Sleeper Cabs for the 2014MY Inclusive of Penetration Rates (2009\$)

	LOW ROOF	MID ROOF	HIGH ROOF
Bin II	\$962	\$983	\$1,092
Bin IV	N/A	N/A	\$535

2.5.2 Tires

Tire rolling resistance is defined as the energy consumed by the tire per unit of distance traveled. Energy is consumed mainly by the deformation of the tires, known as hysteresis, but smaller losses are due to aerodynamic drag and other friction forces between the tire and road surface and the tire and wheel rim. About 90 percent of a tire’s rolling resistance comes from hysteresis. Collectively the forces that result in energy loss from the tires are referred to as rolling resistance. The share of truck energy required to overcome rolling resistance is estimated at nearly 13 percent for Class 8 trucks.⁶² Reducing a tire’s rolling resistance will reduce fuel consumption and lower emissions of CO₂ and other greenhouse gases. Low rolling resistance tires are commercially available from most tire manufacturers. The EPA SmartWay program identified test methods and established criteria to designate certain tires as “low rolling resistance” for use in the program’s emissions tracking system, verification program, and SmartWay vehicle specifications. Below is a discussion of EPA’s approach to quantifying tire rolling resistance and the emission reductions associated with reduced rolling resistance, and a discussion of single wide tires, retread tires, and replacement tires.

To measure a tire’s efficiency the vertical load supported by the tire must be factored because rolling resistance is a function of the load on a tire. EPA uses a tire’s rolling resistance coefficient (CRR), which is measured as the rolling resistance force over vertical load (kg/metric ton). The CRR baseline for today’s fleet is 7.8 kg/metric ton for the steer tire and 8.2 kg/metric ton for the drive tire, based on sales weighting of the top three

Regulatory Impact Analysis

manufacturers by market share. These values are based on new tires, since rolling resistance decreases as the tread wears.

Beginning in 2007, EPA began designating certain Class 8 sleeper-cab configurations as Certified SmartWay Tractors. In order for a tractor to be designated as Certified SmartWay, the tractor must be equipped with verified low rolling resistance tires (either dual or single wide), among other criteria. In order to be verified as a low rolling resistance tire, a steer tire must have a CRR less than 6.6 kg/metric ton and a drive tire must have a CRR less than 7.0 kg/metric ton. SmartWay-verified low rolling resistance tires are the best performing tires available based on fuel efficiency. The SmartWay program expects to decrease the maximum allowable rolling resistance coefficient by 10 percent between 2010 and 2014. As more low rolling resistance tires are sold, the baseline rolling resistance coefficient value will improve.

Research indicates the contribution to overall vehicle fuel efficiency by tires is approximately equal to the proportion of the vehicle weight on them.⁶³ On a fully loaded typical Class 8 long-haul truck (tractor and trailer), about 12.5 percent of the total tire energy loss attributed to rolling resistance is from the steer tires and about 42.5 percent is from the drive tires. When evaluating just the tractor, the proportionate amount of energy loss would be about 24 percent from the steer tires and 76 percent from the drive tires.

A tire's rolling resistance is a factor considered in the design of the tire, and is affected by the tread compound material, the architecture of the casing, tread design and the tire manufacturing process. Differences in rolling resistance of up to 50 percent have been identified for tires designed to equip the same vehicle.⁶⁴ It is estimated that 35 to 50 percent of a tire's rolling resistance is from the tread and the other 50 to 65 percent is from the casing.⁶³ Tires with increased CRR values are likely designed for treadwear and not fuel efficiency.

Research and testing have shown a 5 percent reduction of rolling resistance provides a fuel consumption reduction of 1 percent while maintaining similar traction and handling characteristics. Bridgestone found a 5 percent improvement in rolling resistance will produce a 1.3 to 1.7 percent improvement in fuel economy.⁶³ Assuming a truck achieves 6 miles per gallon and is driven 100,000 miles annually, a 1.5 percent improvement in fuel economy results in a fuel consumption reduction of 1.48 percent, which is in line with EPA's study. According to Bridgestone,⁶³ use of a fuel-efficient tire, compared to a non-fuel-efficient tire, will result in approximately a 12 percent improvement in fuel economy at 55 mph, and 9 percent improvement in fuel economy at 65 mph.

To further demonstrate the correlation between rolling resistance and fuel economy, Michelin modeled vehicle fuel consumption using two drive cycles and various rolling resistance values. One drive cycle incorporated several instances of stop and start that replicated driving a vehicle on a secondary road; the other drive cycle replicated driving on a highway at nearly uniform speed but with several elevation changes. Simulations were performed using a base case and for rolling resistance reductions of 10 percent and 20 percent for both the secondary roadway and highway drive cycles. Michelin's simulation modeling for the secondary road drive cycle predicts a 1.8 percent and a 3.6 percent improvement in

fuel economy as a result of the 10 percent and 20 percent reduction in rolling resistance, respectively.^{65,66} The simulation modeling for the highway drive cycle predicts a 2.6 percent and a 4.9 percent improvement in fuel economy as a result of the 10 percent and 20 percent reduction in rolling resistance, respectively.⁶⁵ The modeling demonstrates less of a benefit from reduced rolling resistance when a vehicle is operated on secondary roadways. Michelin's modeling predicts an improvement in fuel economy from a reduction in rolling resistance comparable to what Bridgestone demonstrated. A 5 percent reduction in rolling resistance results in a 1 percent improvement in fuel economy.

Proper tire inflation is critical to maintaining proper stress distribution in the tire, which reduces heat loss and rolling resistance. Tires with reduced inflation pressure exhibit more sidewall flexing and tread shearing, therefore, have greater rolling resistance than a tire operating at its optimal inflation pressure. Bridgestone tested the effect of inflation pressure and found a 2 percent variation in fuel consumption over a 40 psi range.⁶³ Generally, a 10 psi reduction in overall tire inflation results in about a 1 percent reduction in fuel economy.⁶⁷ To achieve the intended fuel efficiency benefits of low rolling resistance tires, it is critical that tires are maintained at the proper inflation pressure.

Tire rolling resistance is only one of several performance criteria that affect tire selection. The characteristics of a tire also influence durability, traction control, vehicle handling and comfort. A single performance parameter can easily be enhanced, but an optimal balance of all the criteria must be maintained. Tire design requires balancing performance, since changes in design may change different performance characteristics in opposing direction.⁶⁸ Truck tires are most often axle-specific in relation to these different performance criteria.⁶⁹ The same tire on different axles or used in different applications can have a different rolling resistance value. Any changes to a tire would generally be accompanied with additional changes to suspension tuning and/or suspension design.

The Center for Transportation Research at Argonne National Laboratory analyzed technology options to support energy use projections. The Center estimated the incremental cost of low rolling resistance tires of \$15 - \$20 per tire.⁸³ The ICF report estimated the cost of low rolling resistance steer and drive tires to be \$20 and \$43 per tire, respectively. The NAS panel estimated \$30 per tire. EPA and NHTSA project a cost of \$34 per tire or \$68 per tractor (2009\$) for low rolling resistance steer tires (2 per truck) for both Class 7 and 8 tractors including a low complexity ICM of 1.18, based on the cost estimates provided by ICF for low rolling resistance tires. For low rolling resistance drive tires, the agencies estimate truck-based costs of \$63 (2009\$) and \$126 (2009\$) for Class 7 and 8 tractors, respectively, including a low complexity ICM of 1.18. The higher Class 8 reflects the assumption of one drive axle for Class 7 tractors and two drive axles for Class 8 tractors. All costs are considered valid for the 2014MY and flat-portion of the curve learning would be considered appropriate for this technology.

2.5.2.1 Single Wide Tires

Low rolling resistance tires are offered for dual assembly and as single wide tires. They are typically only used on the drive axle of a tractor. A single wide tire is a larger tire with a lower profile. The common single wide sizes include 385/65R22.5, 425/65R22.5,

Regulatory Impact Analysis

445/65R22.5, 435/50R22.5 and 445/50R22.5. Generally, a single wide tire has less sidewall flexing compared to a dual assembly and therefore less hysteresis occurs. Compared to a dual tire assembly, single wide tires also produce less aerodynamic resistance or drag. Single wide tires can contribute to improving a vehicle's fuel efficiency through design as a low rolling resistance tire and/or through vehicle weight reduction.

According to one study, the use of fuel efficient single wide tires can reduce rolling resistance by 3.7 to 4.9 percent compared to the most equivalent dual tire.⁷⁰ An EPA study demonstrated an improvement in fuel economy of 6 percent at 55 mph on the highway, 13 percent at 65 mph on the highway and 10 percent on a suburban loop⁷¹ using single wide tires on the drive and trailer axles. EPA attributed the fuel economy improvement to the reduction in rolling resistance and vehicle weight reduction from using single wide tires. In 2008 the Department of Energy (DOE) compared the effect of different combinations of tires on the fuel efficiency of Class 8 trucks. The data collected based on field testing indicates that trucks with tractors equipped with single wide tires on the drive axle experience better fuel economy than trucks with tractors equipped with dual tires, independent of the type of tire on the trailer.⁷² This study in particular indicated a 6.2 percent improvement in fuel economy from single wide tires.

There is also a weight savings associated with single wide tires compared to dual tires. Single wide tires can reduce a tractor and trailer's weight by as much as 1,000 lbs. when combined with aluminum wheels. Bulk haulers of gasoline and other liquids recognize the immediate advantage in carrying capacity provided by the reduction in the weight of tires and have led the transportation industry in retrofitting their tractors and trailers⁷³.

New generation single wide tires, which were first introduced in 2000, are designed to replace a set of dual tires on the drive and/or trailer positions. They are designed to be interchangeable with the dual tires without any change to the vehicle⁷⁴. If the vehicle does not have hub-piloted wheels, there may be a need to retrofit axle components⁷³. In addition to consideration of hub / bearing / axle, other axle-end components may be affected by use of single wide tires. To assure successful operation, suitable components should be fitted as recommended by the vehicle manufacturer⁷⁵.

Current single wide tires are wider than earlier models and legal in all 50 states for a 5-axle, 80,000 GVWR truck⁷⁰. Single wide tires meet the "inch-width" requirements nationwide, but are restricted in certain states up to 17,500 lbs. on a single axle at 500 lbs/inch width limit, and are not allowed on single axle positions on certain double and triple combination vehicles⁷⁴. An inch-width law regulates the maximum load that a tire can carry as a function of the tire width. Typically single wide tires are optimized for highway operation and not for city or on/off highway operation. However, newer single wide tires are being designed for better scrub resistance, which will allow an expansion of their use. The current market share of single wide tires in combination tractor applications is 5 percent and the potential market is all combination tractors.⁷⁰ New generation single wide tires represent an estimated 0.5 percent of the 17.5 million tires sold each year in the U.S.⁷⁴.

The Center for Transportation Research at Argonne National Laboratory estimated incremental capital cost of single wide tires is \$30 - \$40 per tire.⁸³ ICF estimates the

Heavy-Duty GHG and Fuel Efficiency Standards FRM: Technologies, Cost, and Effectiveness

incremental price of low rolling resistance tires at \$20 for drive tires and \$43 for steer tires.⁷⁶ Based on the ICF estimates, the agencies project the incremental cost would be between \$120 and \$160 for four single wide tires replacing eight dual tires on a drive axle of a tractor.

2.5.2.2 Tire Rolling Resistance

Based on the rolling resistance of today’s tires and the rate of improvement that has been made in the recent past, the agencies are projecting the following tire rolling resistance performance for setting the final tractor standards, as shown in Table 2-24.

Table 2-24 Tire Rolling Resistance

	Class 7		Class 8				
	Day Cab		Day Cab		Sleeper Cab		
	Low/ Mid Roof	High Roof	Low/Mid Roof	High Roof	Low Roof	Mid Roof	High Roof
Steer Tires (Crr kg/metric ton)							
Baseline	7.8	7.8	7.8	7.8	7.8	7.8	7.8
	6.6	6.6	6.6	6.6	6.6	6.6	6.6
	5.7	5.7	5.7	5.7	5.7	5.7	5.7
Drive Tires (Crr kg/metric ton)							
Baseline	8.2	8.2	8.2	8.2	8.2	8.2	8.2
	7.0	7.0	7.0	7.0	7.0	7.0	7.0
	6.0	6.0	6.0	6.0	6.0	6.0	6.0

Reducing the coefficient of rolling resistance from 7.2 kg/metric ton to 6.5 kg/metric ton reduces the CO₂ emissions and fuel consumption by 3.7 percent, as shown in Figure 2-3 below.

Figure 2-3: Tire Rolling Resistance Impact on CO₂ Emissions of a Class 8 Sleeper Cab, High Roof

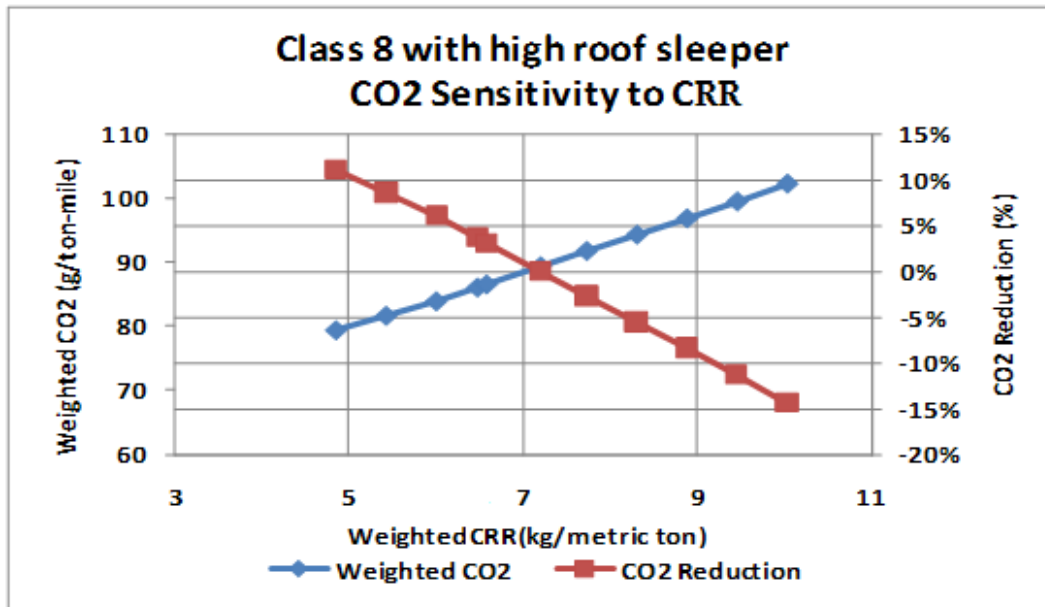

2.5.3 Weight Reduction

Mass reduction encompasses a variety of techniques ranging from improved design and better component integration to application of lighter and higher-strength materials. Mass reduction can be further compounded by reductions in engine power and ancillary systems (transmission, steering, brakes, suspension, etc.). Although common on light-duty passenger vehicles for fuel economy and performance increases, mass reduction on heavy-duty vehicles is more complex due to the size and duty cycle of the vehicles.

Reducing a vehicle’s mass decreases fuel consumption and GHG output by reducing the energy demand needed to overcome forces resisting motion, and rolling resistance. Passenger vehicle manufacturers employ a systematic approach to mass reduction, where the net mass reduction is the addition of a direct component or system mass reduction plus the additional mass reduction taken from indirect ancillary systems and components, effectively compounding or obtaining a secondary mass reduction from a primary mass reduction. For example, use of a smaller, lighter engine with lower torque-output subsequently allows the use of a smaller, lighter-weight transmission and drive line components. Likewise, the compounded weight reductions of the body, engine and drivetrain reduce stresses on the suspension components, steering components, wheels, tires and brakes, allowing further reductions in the mass of these subsystems. The reductions in unsprung masses such as brakes, control arms, wheels and tires further reduce stresses in the suspension mounting points. This produces a compounding ripple effect of possible mass reductions.

A fully loaded tractor-trailer combination can weigh up to 80,000 pounds or more. Reduction in overall vehicle weight could enable an increase in freight delivered on a ton-mile basis. Practically, this enables more freight to be delivered per truck and improves freight transportation efficiency. In certain applications, heavy trucks are weight-limited (*i.e.*

bulk cargo carriers), and reduced tractor and trailer weight allows direct increases in the quantity of material that can be carried.

Mass reduction can be accomplished by proven methods such as:

- **Smart Design:** Computer aided engineering (CAE) tools can be used to better optimize load paths within structures by reducing stresses and bending moments applied to structures. This allows better optimization of the sectional thicknesses of structural components to reduce mass while maintaining or improving the function of the component. Smart designs also integrate separate parts in a manner that reduces mass by combining functions or the reduced use of separate fasteners.
- **Material Substitution:** Substitution of lower density and/or higher strength materials into a design in a manner that preserves or improves the function of the component. This includes substitution of high-strength steels, aluminum, magnesium or composite materials for components currently fabricated from mild steel. Mass reduction through material substitution is currently broadly applied across both light- and heavy-duty applications in all vehicle subsystems such as aluminum engine block, aluminum transmission housing, high-strength steel body structure, etc.
- **Reduced Powertrain Requirements:** Reducing vehicle weight sufficiently can allow for the use of a smaller, lighter and more efficient engine while maintaining or increasing work or cargo requirements. The subsequent reduced rotating mass (*e.g.*, transmission, driveshafts/halfshafts, wheels and tires) via weight and/or size reduction of components are made possible by reduced torque output requirements.

Reduced mass in heavy-duty vehicles can benefit fuel efficiency and CO₂ emissions in two ways. If a truck is running at its gross vehicle weight limit with high density freight, more freight can be carried on each trip, increasing the truck's ton-miles per gallon. If the truck is carrying lower density freight and is below the GVWR (or GCW) limit, the total vehicle mass is decreased, reducing rolling resistance and the power required to accelerate or climb grades.

Mass reduction can be achieved by making components with lighter materials (high strength steel, aluminum, composites) or by eliminating components from the truck. A common component-elimination example is to use single wide tires and aluminum rims to replace traditional dual tires and rims, eliminating eight steel rims and eight tires. Although many gains have been made to reduce truck mass, many of the features being added to modern trucks to benefit fuel economy, such as additional aerodynamic features or idle reduction systems, have the effect of increasing truck weight, causing mass to stay relatively constant. Material and manufacturing technologies can also play a significant role in vehicle safety by reducing vehicle weight, and in the improved performance of vehicle passive and active safety systems. Although new vehicle systems, such as hybrid power trains, fuel cells and auxiliary power will present complex packaging and weight issues, this will further increase the need for reductions in the weight of the body, chassis, and power train components in order to maintain vehicle functionality.

Regulatory Impact Analysis

EPA's SmartWay transport web page discusses how the truck fuel consumption increases with the weight of the combination tractor. Many truck components are typically made of heavier material, such as steel. Heavier trucks require more fuel to accelerate and to climb hills, and may reduce the amount of cargo that can be carried.⁷⁷ Every 10 percent drop in truck weight reduces fuel use about 5 percent.⁷⁸ Generally, an empty truck makes up about one-third of the total weight of the truck. Using aluminum, metal alloys, metal matrix composites, and other lightweight components where appropriate can reduce empty truck weight (known as "tare weight"), improve fuel efficiency, and reduce greenhouse gas emissions. As an example, trimming 3,000 pounds from a heavy truck (about 4 percent of its loaded weight) with lighter-weight components could improve fuel economy by up to 3 percent and trucks that employ more weight saving options would save more. In addition, in weight-sensitive applications, lightweight components can allow more cargo and increased productivity. Another report by the National Commission on Energy Policy estimates that a fuel economy gain of 5.0 percent on certain applications could be achieved by vehicle mass reduction further illustrating the fuel economy gains possible on heavy-duty applications⁷⁹. A third report, estimated potential reductions in modal GHG emissions are 4.6 percent, however also states current light-weight materials are costly and are application and vehicle specific with further research and development for advanced materials are needed.⁸⁰

In support of the overall goal to cost-effectively enable trucks and other heavy vehicles to be more energy efficient and to use alternative fuels while reducing emissions, the 21st Century Truck Partnership seeks to reduce parasitic energy losses due to the weight of heavy vehicles without reducing vehicle functionality, durability, reliability, or safety, and to do so cost-effectively. Aggressive weight reduction goals vary according to the weight class of the vehicle with targets between 10 and 33 percent.⁸¹ The weight targets for each vehicle class depend on the performance requirements and duty cycle. It is important to note that materials or technologies developed for a particular vehicle class are not necessarily limited to that class. For example, materials developed for lightweight frames for pickup trucks, vans, or SUVs will eventually be used in Class 3-5 vehicles, and materials developed to meet the demanding performance requirements for Class 7 and 8 trucks will find application in smaller vehicles. Weight reduction must not in any way sacrifice the durability, reliability, and performance of the vehicle. Attaining these goals by reducing inertial loading will yield substantial benefits such as increased fuel efficiency with concomitant reductions in emissions, increased available payload capacity for some vehicles, reduced rolling resistance, and optimized safety structures and aerodynamic drag reduction systems.

A 2009 NESCCAF report evaluated the potential to reduce fuel consumption and CO₂ emissions by reducing weight from the baseline weight of 80,000 pounds. For the purpose of this calculation, the weight reduction could come either from carrying lighter freight or from a reduction in the empty weight of the truck. If the vehicle mass is reduced to 65,000 pounds, the fuel economy improves to 5.9 MPG from 5.4 MPG. The fuel savings and CO₂ reduction on the baseline vehicle amount to about 0.5 percent per 1,000 pounds of mass reduction.⁸² This result suggests that efforts to reduce the empty vehicle mass will have only a modest benefit on fuel economy, for long haul routes.

Argonne has also simulated the effect of mass reduction on the fuel economy of heavy trucks through the National Renewable Energy Laboratory's Advanced Vehicle Simulator

Heavy-Duty GHG and Fuel Efficiency Standards FRM: Technologies, Cost, and Effectiveness

Model, ADVISOR. The Argonne simulations relied on a few driving schedules developed by the West Virginia University (WVU) because there are no established driving schedules for heavy trucks. While simulating a Class 8 truck on the WVU Intercity Driving Schedule, a fuel economy gain of 0.6 percent was observed for each 1 percent mass reduction from 65,000 lb to 58,000 lb⁸³. The maximum speed during the simulation was 61 mph, and the average running speed (excluding stops) was 37.5 mph although most intercity Class 8 trucks average a much higher speed than 37.5 mph. Argonne assumed a 0.66 percent increase in fuel economy for each 1 percent weight reduction and total possible estimated fuel economy increases of 5–10 percent. While simulating a Class 6 truck on a WVU Suburban Driving Schedule, a fuel economy gain of 0.48 percent was observed for each 1 percent mass reduction from 22,600 lb to 21,800 lb. The maximum speed during the simulation was 44.8 mph, and the average running speed was 21.5 mph. The potential fuel economy gains for medium trucks, both heavy- and light-, were capped at 5 percent since they are less likely to be weight or volume limited, and so the use of expensive lightweight material would not be cost-effective.

The principal barriers to overcome in reducing the weight of heavy vehicles are associated with the cost of lightweight materials, the difficulties in forming and manufacturing lightweight materials and structures, the cost of tooling for use in the manufacture of relatively low-volume vehicles (when compared to automotive production volumes), and ultimately, the extreme durability requirements of heavy vehicles. While light-duty vehicles may have a life span requirement of several hundred thousand miles, typical heavy-duty commercial vehicles must last over 1 million miles with minimum maintenance, and often are used in secondary applications for many more years. This requires high strength, lightweight materials that provide resistance to fatigue, corrosion, and can be economically repaired. Additionally, because of the limited production volumes and the high levels of customization in the heavy-duty market, tooling and manufacturing technologies that are used by the light-duty automotive industry are often uneconomical for heavy vehicle manufacturers. Lightweight materials such as aluminum, titanium and carbon fiber composites provide the opportunity for significant weight reductions, but their material cost and difficult forming and manufacturing requirements make it difficult for them to compete with low-cost steels. In addition, although mass reduction is currently occurring on both vocational and line haul trucks, the addition of other systems for fuel economy, performance or comfort increases the truck mass offsetting the mass reduction that has already occurred, thus is not captured in the overall truck mass measurement.

Most truck manufacturers offer lightweight tractor models that are 1,000 or more pounds lighter than comparable models. Lighter-weight models combine different weight-saving options that may include:⁸⁴

- Cast aluminum alloy wheels can save up to 40 pounds each for total savings of 400 pounds
- Aluminum axle hubs can save over 120 pounds compared to ductile iron or steel
- Centrifuse brake drums can save nearly 100 pounds compared to standard brake drums
- Aluminum clutch housing can save 50 pounds compared to iron clutch housing
- Composite front axle leaf springs can save 70 pounds compared to steel springs
- Aluminum cab frames can save hundreds of pounds compared to standard steel frames

2.5.3.1 Derivation of Weight Technology Packages

The agencies see many opportunities for weight reduction in tractors. However, the empty curb weight of tractors varies significantly today. Items as common as fuel tanks can vary between 50 and 300 gallons each for a given truck model. Information provided by truck manufacturers indicates that there may be as much as a 5,000 to 17,000 pound difference in curb weight between the lightest and heaviest tractors within a regulatory subcategory (such as Class 8 sleeper cab with a high roof). Because there is such a large variation in the baseline weight among trucks that perform roughly similar functions with roughly similar configurations, there is not an effective way to quantify the exact CO₂ and fuel consumption benefit of mass reduction using GEM because of the difficulty in establishing a baseline. However, if the weight reduction is limited to specific components on the tractor, then both the baseline and weight differentials for these are readily quantifiable and well-understood.

In the NPRM, the agencies proposed basing the standard stringency on a 400 pound weight reduction in Class 7 and 8 tractors through the substitution of single wide tires and light-weight wheels for dual tires and steel wheels. This approach was taken since there is a large variation in the baseline weight among trucks that perform roughly similar functions with roughly similar configurations. Because of this, the only effective way to quantify the exact CO₂ and fuel consumption benefit of mass reduction using GEM is to estimate baseline weights for specific components that can be replaced with light weight components. Light-weight wheels are commercially available as are single wide tires and thus data on the weight reductions attributable to these two approaches is readily available.

The agencies received comments on this approach from Volvo, ATA, MEMA, Navistar, American Chemistry Council, the Auto Policy Center, Iron and Steel Institute, Arvin Meritor, Aluminum Association, and environmental groups and NGOs. Volvo and ATA stated that not all fleets can use single wide tires and if this is the case the 400 pound weight reduction cannot be met. A number of additional commenters – including American Chemistry Council, The Auto Policy Center, Iron and Steel Institute, Aluminum Association, Arvin Meritor, MEMA, Navistar, Volvo, and environmental and nonprofit groups – stated that manufacturers should be allowed to use additional light weight components in order to meet the tractor fuel consumption and CO₂ emissions standards. These groups stated that weight reductions should not be limited to wheels and tires. Some of the groups asked that cab doors, cab sides and backs, cab underbodies, frame rails, cross members, clutch housings, transmission cases, axle differential carrier cases, brake drums, and other components be allowed to be replaced with light-weight versions. Materials suggested for substitution included aluminum, light-weight aluminum, high strength steel, and plastic composites. The American Iron and Steel Institute stated there are opportunities to reduce mass by replacing mild steel – which currently dominates the heavy-duty industry – with high strength steel.

In addition, The American Auto Policy Center asked that manufacturers be allowed to use materials other than aluminum and high strength steel to comply with the regulations. DTNA asked that weight reduction due to engine downsizing be allowed to receive credit. Volvo requested that weight reductions due to changes in axle configuration be credited. They used the example of a customer selecting a 4 X 2 over a 6 X 4 axle tractor. In this case, they assert there would be a 1,000 pound weight savings from removing an axle.

Heavy-Duty GHG and Fuel Efficiency Standards FRM: Technologies, Cost, and Effectiveness

As proposed, many of the material substitutions could have been considered as innovative technologies. In response to the above summarized comments, the agencies evaluated whether additional materials and components could be used for compliance with the tractor weight reduction through the primary program. The agencies reviewed comments and data received in response to the NPRM and additional studies cited by commenters. A summary of this review is provided in the following paragraphs.

TIAX, in their report to the NAS, cited information from Alcoa identifying several mass reduction opportunities from material substitution in the tractor cab components which were similar to the ones identified by the Aluminum Association in their comments to this rulemaking.⁸⁵ TIAX included studies submitted by Alcoa showing the potential to reduce the weight of a tractor-trailer combination by 3,500 to 4,500 pounds.⁸⁶ In addition, the Department of Energy has several projects underway to improve the freight efficiency of Class 8 trucks which provide relevant data:⁸⁷ DOE reviewed prospective lightweighting alternative materials and found that aluminum has a potential to reduce mass by 40 to 60 percent, which is in line with the estimates of mass reductions of various components provided by Alcoa, and by the Aluminum Association in their comments and as cited in the TIAX report. These combined studies, comments, and additional data provided information on specific components that could be replaced with aluminum components.

With regard to high strength steel, the Iron and Steel Institute found that the use of high strength steel can reduce the weight of light duty trucks by 25 percent.⁸⁸ Approximately 10 percent of this reduction results from material substitution and 15 percent from vehicle re-design. While this study evaluated light-duty trucks, the agencies believe that a similar reduction could be achieved in heavy-duty trucks since the reductions from material substitution would likely be similar in heavy-trucks as in light-trucks. U.S. DOE, in the report noted above, identified opportunities to reduce mass by 10 percent through high strength steel.⁸⁹ This study was also for light-duty vehicles.

The agencies considered other materials such as plastic composites and magnesium substitutes but were not able to obtain weights for specific components made from these materials. We have therefore not included components made from these materials as possible substitutes in the primary program, but they may be considered through the innovative technology provisions. We may consider including these materials as part of the technology package on which standard stringency is predicated in a subsequent regulation if data becomes available.

The agencies also evaluated the potential of plastic composites and magnesium components to reduce heavy-duty vehicle weight. The agencies were not able to obtain weights for specific components made from these materials.

Based on this analysis, the agencies developed an expanded list of weight reduction opportunities for the final rulemaking, as listed in Table 2-25. The list includes additional components, but not materials, from those proposed in the NPRM. For high strength steel, the weight reduction value is equal to 10 percent of the presumed baseline component weight, as the agencies used a conservative value based on the DOE report. We recognize that there may be additional potential for weight reduction in new high strength steel components which

Regulatory Impact Analysis

combine the reduction due to the material substitution along with improvements in redesign, as evidenced by the studies done for light duty vehicles. In the development of the high strength steel component weights, we are only assuming a reduction from material substitution and no weight reduction from redesign, since we do not have any data specific to redesign of heavy-duty components nor do we have a regulatory mechanism to differentiate between material substitution and improved design. We are finalizing for wheels that both aluminum and light weight aluminum are eligible to be used as light-weight materials. Only aluminum can be used as a light-weight material for other components. The reason for this is data was available for light weight aluminum for wheels but was not available for other components.

The agencies received comments on the proposal from the American Chemistry Council highlighting the role of plastics and composites in heavy-duty vehicles. As they stated, composites can be low density while having high strength and are currently used in applications such as oil pans and buses. The DOE mass reduction program demonstrated for heavy vehicles proof of concept designs for hybrid composite doors with an overall mass savings of 40 percent; 30 percent mass reduction of a hood system with carbon fiber sheet molding compound; 50 percent mass reduction from composite tie rods, trailing arms, and axles; and superplastically formed aluminum body panels.⁹⁰ While the agencies recognize these opportunities, we do not believe the technologies have advanced far enough to quantify the benefits of these materials because they are very dependent on the actual composite material. The agencies may consider such lightweighting opportunities in future actions, but are not including them as part of the technology package underlying the tractor standard. Manufacturers which opt to pursue composite and plastic material substitutions may pursue credits through the innovative technology provisions.

With regard to Volvo's request that manufacturers be allowed to receive credit for trucks with fewer axles, the agencies recognize that truck options exist today which have less mass than other options. However, we believe the decisions to add or subtract such components will be made based on the intended use of the vehicle and not based on a crediting for the mass difference in our compliance program. It is not our intention to create a tradeoff between the right truck to serve a need (*e.g.* one with more or fewer axles) and compliance with our final standards. Therefore, we are not including provisions to credit (or penalize) vehicle performance based on the subtraction (or addition) of specific vehicle components configuration containing dual tires with steel wheels.

The agencies continue to believe that the 400 pound weight target is appropriate for setting the final combination tractor CO₂ emissions and fuel consumption standards. The agencies agree with the commenter that 400 pounds of weight reduction without the use of single wide tires may not be achievable for all tractor configurations. The agencies have extended the list of weight reduction components in order to provide the manufacturers with additional means to comply with the combination tractors and to further encourage reductions in vehicle weight. The agencies considered increasing the target value beyond 400 pounds given the additional reduction potential identified in the expanded technology list; however, lacking information on the capacity for the industry to change to these light weight components across the board by the 2014 model year, we have decided to maintain the 400 pound target. The agencies intend to continue to study the potential for additional weight

Heavy-Duty GHG and Fuel Efficiency Standards FRM: Technologies, Cost, and Effectiveness

reductions in our future work considering a second phase of truck fuel efficiency and GHG regulations.

Table 2-25: Weight Reductions

WEIGHT REDUCTION TECHNOLOGY		WEIGHT REDUCTION (LB PER TIRE/WHEEL)	
Single Wide Drive Tire with ...	Steel Wheel	84	
	Aluminum Wheel	139	
	Light Weight Aluminum Wheel	147	
Steer Tire or Dual Wide Drive Tire with ...	High Strength Steel Wheel	8	
	Aluminum Wheel	21	
	Light Weight Aluminum Wheel	30	
Weight Reduction Technologies		Aluminum Weight Reduction (lb.)	High Strength Steel Weight Reduction (lb.)
Door		20	6
Roof		60	18
Cab rear wall		49	16
Cab floor		56	18
Hood Support Structure		15	3
Fairing Support Structure		35	6
Instrument Panel Support Structure		5	1
Brake Drums – Drive (4)		140	11
Brake Drums – Non Drive (2)		60	8
Frame Rails		440	87
Crossmember - Cab		15	5
Crossmember – Suspension		25	6
Crossmember – Non Suspension (3)		15	5
Fifth Wheel		100	25
Radiator Support		20	6
Fuel Tank Support Structure		40	12
Steps		35	6
Bumper		33	10
Shackles		10	3
Front Axle		60	15
Suspension Brackets, Hangers		100	30
Transmission Case		50	12
Clutch Housing		40	10
Drive Axle Hubs (8)		160	4
Non Drive Front Hubs (2)		40	5
Driveshaft		20	5

Regulatory Impact Analysis

WEIGHT REDUCTION TECHNOLOGY	WEIGHT REDUCTION (LB PER TIRE/WHEEL)	
Transmission/Clutch Shift Levers	20	4

EPA and NHTSA are specifying the baseline vehicle weight for each regulatory vehicle subcategory (including the tires, wheels, frame, and cab components) in the GEM in aggregate based on weight of vehicles used in EPA's aerodynamic test program, but allow manufacturers to specify the use of light-weight components. GEM then quantifies the weight reductions based on the pre-determined weight of the baseline component minus the pre-determined weight of the component made from light-weight material. Manufacturers cannot specify the weight of the light-weight component themselves, only the material used in the substitute component. The agencies assume the baseline wheel and tire configuration contains dual tires with steel wheels, along with steel frame and cab components, because these represent the vast majority of new vehicle configurations today. The weight reduction due to replacement of components with light weight versions will be reflected partially in the payload tons and partially in reducing the overall weight of the vehicle run in the GEM. The specified payload in the GEM will be set to the prescribed payload plus one third of the weight reduction amount to recognize that approximately one third of the truck miles are travelled at maximum payload, as discussed below in the payload discussion. The other two thirds of the weight reduction will be subtracted from the overall vehicle weight prescribed in the GEM. The impact of vehicle mass reductions on a Class 8 combination tractor modeled in the GEM over the composite test cycle is shown in Figure 2-4. The figure depicts both the weighted CO₂ results and the percent CO₂ reduction for a sample Class 8 combination tractor at various weight reduction levels.

Figure 2-4: Weight Reduction Impact on Combination Tractor

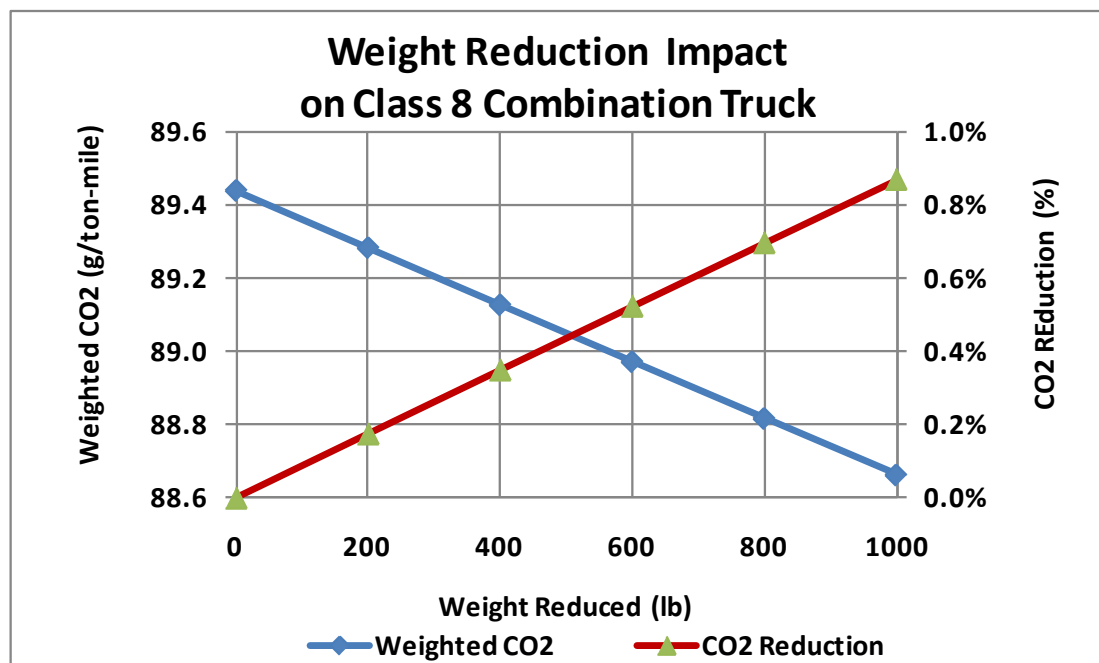

Heavy-Duty GHG and Fuel Efficiency Standards FRM: Technologies, Cost, and Effectiveness

The agencies have estimated costs for the wheel and tire weight reduction technologies. Those costs are shown in Table 2-26. The costs shown include a low complexity ICM of 1.18 and flat-portion of the curve learning would be considered appropriate for these technologies.

Table 2-26 Estimated Weight Reduction Technology Costs for Class 7 & 8 Tractors for the 2014MY (2009\$)

	CLASS 7 TRACTORS	CLASS 8 TRACTORS
Single Wide Tire (per tractor)	\$336	\$672
Aluminum Steer Wheel	\$546	\$546
Aluminum Wheels - dual	\$1,637	\$2,727
Aluminum Wheel – Single wide	\$654	\$1,308

Weight reductions will be reflected in GEM in two parts. The reason for evaluating the impact of weight reduction in this way is because weight reduction is most effective in combination tractors that are at maximum payload. Weight reduction in these tractors at maximum payload allows the tractor to carry additional freight. This additional freight reduces the fuel consumption on a ton-mile basis to a much greater extent than does reducing the weight of the tractor alone. The agencies estimated that one third of tractor miles are travelled at maximum payload. For this assessment, the agencies assumed the overall mass of the vehicle will be reduced by an amount equal to two-thirds of the mass reduction to account for the vehicles miles which are travelled at less than maximum payload. Second, the specified payload will be increased by the weight reduction amount discounted by two thirds to recognize that approximately one third of the truck miles are travelled at maximum payload.

2.5.4 Extended Idle

Class 8 heavy-duty diesel truck extended engine idling expends significant amounts of fuel in the United States. Department of Transportation regulations require a certain amount of rest for a corresponding period of driving hours, as discussed in Chapter 1. Extended idle occurs when Class 8 long haul drivers rest in the sleeper/cab compartment during rest periods as drivers find it more convenient and economical to rest in the truck cab itself. In many cases it is the only option available. During this rest period a driver will generally idle the truck in order to provide heating or cooling or run on-board appliances. During rest periods the truck's main propulsion engine is running but not engaged in gear and it remains in a stationary position. In some cases the engine can idle in excess of 10 hours. During this period of time, fuel consumption will generally average 0.8 gallons per hour.⁹¹ Average overnight fuel usage would exceed 8 gallons in this example. When multiplied by the number of long haul trucks without idle control technology that operate on national highways on a daily basis, the number of gallons consumed by extended idling would exceed 3 million gallons per day. Fortunately, a number of alternatives (idling reduction technologies) are available to alleviate this situation.

2.5.4.1 Idle Control Technologies

Idle reduction technologies in general utilize an alternative energy source in place of operating the main engine. By using these devices the truck driver can obtain needed power for services and appliances without running the engine. A number of these devices attach to the truck providing heat, air conditioning, or electrical power for microwave ovens, televisions, etc.

The idle control technologies (along with their typical hourly fuel rate) available today include the following:⁹²

- Auxiliary Power Unit (APU) powers the truck's heating, cooling, and electrical system. The fuel use of an APU is typically 0.2 gallons per hour.
- Fuel Operated Heater (FOH) provides heating services to the truck through small diesel fired heaters. The fuel use is typically 0.04 gallons per hour.
- Battery Air Conditioning Systems (BAC) provides cooling to the truck.
- Thermal Storage Systems provide cooling to trucks.

Another alternative involves electrified parking spaces, with or without modification to the truck. An electrified parking space system operates independently of the truck's engine and allows the truck engine to be turned off while it supplies heating, cooling, and electrical power. These systems provide off-board electrical power to operate either:

1. A single system electrification which requires no on-board equipment by providing an independent heating, cooling, and electrical power system, or
2. A dual system which allows driver to plug in on-board equipment.

In the first case, power is provided to stationary equipment that is temporarily attached to the truck. In the second, the truck is modified to accept power from the electrical grid to operate on-board truck equipment. The retail price of idle reduction systems varies depending on the level of sophistication. For example, on-board technologies such as APUs can retail for over \$7,000 while options such as electrified parking spaces require negligible up-front costs for equipment for the truck itself, but will accrue fees with usage.⁵

2.5.4.2 CO₂ Emissions and Fuel Consumption Idle Reduction Benefit

CO₂ emissions and fuel consumption during extended idling are significant contributors to emissions and fuel consumption from Class 8 sleeper cabs. The federal test procedure does evaluate idle emissions and fuel consumption as part of the drive cycle and related emissions measurement. However, long duration extended idle emissions and fuel consumption are not fully represented during the prescribed test cycle. To address the fact that real-world fuel and emissions savings can occur with idle reduction technologies that

Heavy-Duty GHG and Fuel Efficiency Standards FRM: Technologies, Cost, and Effectiveness

cannot be reflected on the test cycle, the agencies are adopting a credit mechanism for manufacturers who provide for idle control using an automatic engine shutdown (AES) system on the tractor. This credit recognizes the CO₂ reductions and fuel consumption savings attributed to idle control systems and allows truck manufacturers flexibility in product design and performance capabilities, compared to an alternative where the agencies would allow credits for specific idle control technologies.

For a manufacturer to qualify for the credit, the agencies are requiring that a truck have an automatic engine shutdown system enabled at time of purchase that shuts off the engine after five minutes of idling when it is in a parked position. To provide power while the engine is off, truck owners can obtain additional verified idle reduction technologies (IRT) on a new truck at the time of purchase from the manufacturer or install verified technology after purchase. This approach also allows for operational strategies such as electrified parking spaces, team drivers, and overnights spent in hotels to achieve real-world reductions of idling emissions and fuel consumption, while being assured through a tie-back to a verifiable technology - engine shutdown. With an AES system, it is reasonable to assume that one or several of the idle control technologies described above will also be employed in order to allow the driver to rest in the truck during the mandated rest periods.

The idle reduction credit value is based on the CO₂ emission and fuel consumption reduction from the technology when compared to main engine idling, as shown in Table 2-27. The agencies assume that the main engine consumes approximately 0.8 gal/hr during idling.⁹³ ACEEE argued that the agencies should use a fuel consumption rate of 0.47 gallon/hour for main engine idling based on a paper written by Kahn. MEMA argued that the agencies should use a main engine idling fuel consumption rate of 0.87 gal/hr, which is the midpoint of a DOE calculator reporting fuel consumption rates from 0.64 to 1.15 gal/hr at idling conditions, and between 800 and 1200 rpm with the air conditioning on and off, respectively. Having reviewed these comments and the sources provided, the agencies continue to believe that 0.8 gal/hr is the best estimate for a main engine idling fuel consumption rate. In the Kahn paper cited by ACEEE, the author states that while idling fuel consumption is 0.47 gal/hr on average for 600 rpm, CO₂ emissions increase by 25 percent with A/C on at 600 rpm, and increase by 165 percent between 600 rpm and 1,100 rpm with A/C on.⁹⁴ In addition, the presentation by Gaines, which is also mentioned, provides idling fuel consumption rates ranging between 0.6 and 1.2 gallon/hour. Drivers typically idle at speeds greater than 600 rpm for heating or cooling, to provide power for accessories such as interior lights, and protect the engine from damage. Finally, both the Gaines study and the NAS report cited in the RIA use 0.8 gallon/hour. Therefore, the agencies are adopting a main engine idle fuel consumption rate of 0.8 gallon/hour. Using a factor of 10,180 grams of CO₂ per gallon of diesel fuel, the CO₂ emissions from the main engine at idle is 8,144 g per hour.

The agencies assumed the average Class 8 sleeper cab spends 1,800 hours in extended idle per year to determine the idling emissions per year.⁹⁵ MEMA recommended using 2,500 hours per year for APU operation, citing the SmartWay website which uses 2,400 hours per year (8 hours per day and 300 days per year), and an Argonne study which assumed 7 hours per day and 303 days per year, which equals 2,121 hours per year. MEMA also cited the

Regulatory Impact Analysis

FMCSA 2010 driver guidelines, which reduce the number of hours driven per day by one to two hours, which would lead to 2,650 to 2,900 hours per year in total.

The agencies reviewed these and other studies to quantify idling operation. The 2010 NAS study assumes between 1,500 and 2,400 idling hours per year.⁹⁶ Gaines uses 1,800 hours per year.⁹⁷ Brodrick, et al. assumes 1,818 hours per year (6 hours per day for 303 days per year) based on an Argonne study and Freightliner fleet customers.⁹⁸ An EPA technical paper states between 1,500 and 2,400 hours per year.⁹⁹ Kahn uses 1,830 hours as the baseline extended idle case.¹⁰⁰ Based on the literature, the agencies are finalizing as proposed the use of 1,800 hours per year as reasonably reflecting the available range of information.

The agencies then assumed the average Class 8 sleeper cab travels 125,000 miles per year (500 miles per day and 250 days per year) and carries 19 tons of payload (the standardized payload finalized for Class 8 tractors) to calculate the baseline emissions as 6.2 grams of CO₂ per ton-mile. The agencies proposed that the fuel consumption of a diesel-fueled APU would be used to quantify the fuel consumption and CO₂ emissions reduction of engines using an AES. The agencies assumed APUs consume approximately 0.2 gallon of diesel fuel per hour.¹⁰¹ ACEEE argued that the agencies should use a fuel rate of 0.23 gal/hour for the APU (based on Gaines presentation). In response, the agencies reviewed the NAS study which lists 12 APUs and their associated fuel consumption, which ranged between 0.04 and 0.40 gal/hour. The average in the NAS report is 0.2 gal/hour.⁹⁶ Due to the range of fuel consumption of APUs and the precision of the available test information, the agencies are finalizing as proposed an APU fuel consumption of 0.2 gal/hr, which is consistent with ACEEE's comment.

The CO₂ emissions from the APU equate to 1.5 grams per ton-mile. Therefore, the agencies are finalizing an idle reduction credit of 5 g CO₂ per ton-mile (0.5 gal/1,000 ton-mile) which represents the difference in emissions and fuel consumption between the main engine idling and operation of an APU. Credits are based on the requirement that all Class 8 sleeper cabs shall be equipped with an automatic engine shutdown. The credit reflects a technology's fuel consumption in conjunction with a shutdown.

Table 2-27: Idle Emissions Reduction Calculation

	Idle Fuel Consumption (gal/hour)	Idle CO ₂ emissions per hour	Idle Hours per Year	Idle CO ₂ Emission per year (grams)	Miles Per Year	Payload (tons)	GHG Emissions Due to Idling (g/ton-mile)	GHG Reduction (g/ton-mile)	Fuel Consumption Reduction (gal/1,000 ton-mile)
Baseline	0.8	8,144	1,800	14,659,200	125,000	19	6.2		
Idle Reduction Technology	0.2	2,036	1,800	3,664,800	125,000	19	1.5	5	0.5

The agencies are finalizing an approach that allows manufacturers to provide an AES with a limited life to address concerns about resale value of trucks with an automatic engine shutoff. EMA/TMA specifically requested that manufacturers be allowed to program an

Heavy-Duty GHG and Fuel Efficiency Standards FRM: Technologies, Cost, and Effectiveness

“expiration date”, based on time or mileage, into the AES feature, after which it could be reprogrammed. EMA/TMA argued that the extended idle reduction technologies must have features that can be modified for unforeseen uses in the secondary market. EMA/TMA also requested that GEM be updated to accommodate an expiration date and its associated impact of emission reductions. As part of this provision, the agencies will discount the value of the AES based on the number of miles in which it is preset relative to the lifetime of the tractor. The agencies calculated the lifetime miles of a combination tractor based on EPA’s MOVES model as 1,258,788 miles. The lifetime value is weighted to take into account the survival rate of heavy-duty trucks, as shown in Table 2-28.

Table 2-28: Lifetime Miles of 2015 MY Combination Tractor

AGE	COMBINATION TRACTOR VMT PER YEAR
1	130,832
2	119,001
3	108,164
4	97,441
5	87,476
6	78,930
7	70,940
8	63,474
9	56,865
10	50,887
11	45,567
12	40,906
13	36,679
14	32,876
15	29,406
16	26,408
17	23,657
18	21,230
19	18,977
20	17,013
21	15,221
22	13,679
23	12,232
24	10,927
25	9,764
26	8,718
27	7,785
28	6,966
29	6,233
30	5,562

Regulatory Impact Analysis

The equation to derive the GEM input for IRT for systems with an AES expiration is shown in Equation 2-1.

Equation 2-1: Discounted IRT Equation for GEM Input

$$\text{GEM IRT Input} = 5 \text{ g CO}_2/\text{ton-mile} * (\text{miles at expiration} / 1,259,000 \text{ miles})$$

2.5.4.3 Automatic Engine Shutdown Overrides

The agencies explained in the proposal that we were unaware of reasons why extended idle reduction technologies could not be applied to all tractors with sleeper cabs, but welcomed comments. The agencies received comments from ATA, DTNA, EMA/TMA, Cummins, TRALA and CARB, generally in support of the AES technology but with strong concerns that override capabilities must be allowed to address safety, emergency, servicing and maintenance issues. Upon consideration of these comments, the agencies are adopting six override provisions. The California Air Resources Board (CARB) currently has an anti-idling rule for all medium-and heavy-duty vehicles, with several override provisions.¹⁰² The agencies find that four of CARB's override provisions are appropriate for the scope of this program – addressing long-term idling of Class 8 sleeper cab tractors - and are adopting similar provisions in this final HD National Program. CARB's anti-idling rule allows overrides for four of the situations named below: regeneration, engine/vehicle servicing, low coolant temperature and PTO operation. In addition, the agencies are adopting two override provisions that are not from CARB's rule: low battery state-of-charge and extreme ambient temperatures; which were requested by several of the industry commenters listed above.

The stringency of the final HD rules is predicated on all Class 8 sleeper cab tractors employing AES to reduce long-term idling of the main engine during mandated driver rest periods. The amount of reduced emissions and fuel savings by employing this IRT is described above, and presumes a default value based on the use of a diesel APU in lieu of main engine idle. While not mandating any IRT beyond the AES, the agencies anticipate an appropriate device or system would typically be installed as needed to provide an alternate source of power while the main engine is off, for the comfort and safety of the driver during mandated rest periods. As described above and in the preamble in Section III.A.2, truck manufacturers may obtain the AES credit without identifying an alternate power source. Having considered this issue further in response to comments, the agencies believe that the override provisions adopted in the final rules are necessary because they prevent undesirable engine operation, provide for service, maintenance or inspections, and protect driver safety should a tractor not have an alternate power source, or an adequate one for extreme conditions.

Two of the final override provisions requested by ATA, DTNA and EMA/TMA allow the automatic shutdown to be delayed for reasons related to engine servicing: when an exhaust emission control device undergoes regeneration, and when the engine/vehicle is undergoing servicing, maintenance or inspection. It is expected that the duration of each instance of these events would typically range from 30 to 60 minutes. It is not known whether or how often a regeneration event would occur during a driver rest period, as the frequency of these events depends on driving patterns and manufacturer settings. Nonetheless,

Heavy-Duty GHG and Fuel Efficiency Standards FRM: Technologies, Cost, and Effectiveness

regeneration and engine/vehicle servicing are both activities during which the agencies recognize that an automatic shutdown would be undesirable.

In response to comments received from EMA/TMA the agencies are adopting an AES override in the case that the vehicle's main battery state-of-charge is too low to restart the engine. In the event that the battery is drained excessively while the engine is off, and a backup battery is not functioning, the agencies recognize that allowing override of the AES may assist a driver in such an emergency situation. A main engine may be unable to start if its battery state of charge falls below a specified threshold. The agencies are aware that manufacturers already do program the engine controller to recognize a low battery situation and provide alerts or other signals as warranted. This override simply allows the main engine to idle temporarily if a backup system is not available to provide this power.

Another override that the agencies are adopting is for extreme ambient temperatures, which was also requested by commenters including ATA, DTNA, EMA/TMA, Cummins and TRALA. In the case where the cabin temperature cannot be maintained within a reasonable range due to extreme hot or cold ambient conditions, this provision will allow main engine idle for cabin heating or cooling purposes. If there is no auxiliary heating or cooling system installed, or if it is inadequate or fails, the agencies recognize that allowing override of the AES may assist in providing for driver safety, and possibly avoid adverse health impacts from unreasonable cabin conditions in unexpected situations. The agencies have not found regulations defining or governing acceptable tractor cabin or sleeper berth temperatures.¹⁰³ In general, temperatures below 50 degrees F can result in impaired dexterity. Temperature is not the sole indicator of unreasonable conditions, since environmental effects such as humidity and solar radiation, and individual conditions such as weight, cardiovascular health, and clothing also contribute to the safety of an individual.¹⁰⁴ Tractors with "arctic" packages are available on the market, with insulation properties that reduce demand from heating and cooling sources. Nonetheless, the agencies recognize that our rules do not specify cab design, nor do they mandate an auxiliary power source. Preliminary testing indicates that some devices may have trouble cooling or heating the cabin to the desired temperature for a duration of 10 hours with ambient temperatures at 100 or zero degrees F, respectively.¹⁰⁵ Thus, this override allows the main engine to idle if an auxiliary system is not able to provide needed heating or cooling.

The fifth override provision adopted is for the case where the engine coolant temperature is too low to protect the engine. ATA commented that this is one of the flexibilities the agencies should consider. Manufacturers specify acceptable temperature ranges for engine coolants, which if not heated sufficiently, may be too viscous to properly circulate. With engine block heaters and insulated lines, coolant temperature is normally maintained within acceptable levels, often above 60 degrees C (140 degrees F). The agencies are adopting this AES override for low coolant temperature, in the case that the main engine must be allowed to idle according the manufacturer's engine protection guidance. The agencies expect this provision will be effectuated rarely, and the duration of main engine idle will be short for each instance, with coolant temperatures rising quickly to acceptable levels.¹⁰⁶

Regulatory Impact Analysis

The sixth override provision adopted is for the case where the main engine must idle to operate a power take-off. ATA commented that this is one of the flexibilities the agencies should consider. The agencies understand that certain sleeper cab Class 8 tractors employ a power take-off to perform work such as pumping liquid cargo or tipping a container, or for cargo refrigeration. This override is offered because the fuel and emissions reductions targeted in this program are primarily those from extended idle during mandated driver rest periods, rather than periods performing useful work.

2.5.5 Vehicle Speed Limiters

As discussed above, the power required to move a vehicle increases as the vehicle speed increases. Travelling at lower speeds provides additional efficiency to the vehicle performance. Most vehicles today have the ability to electronically control the maximum vehicle speed through the engine controller. This feature is used today by fleets and owners to provide increased safety and fuel economy. Currently, these features are designed to be able to be changed by the owner and/or dealer.

The impact of this feature is dependent on the difference between the governed speed and the speed that would have been travelled, which is dependent on road type, state speed limits, traffic congestion, and other factors. The agencies will be assessing the benefit of a vehicle speed limiter by reducing the maximum drive cycle speed on the 65 mph Cruise mode of the cycle. The maximum speed of the drive cycle is 65 mph, therefore any vehicle speed limit with a setting greater than this will show no benefit for purposes of these regulations, but may still show benefit in the real world in states where the interstate truck speed limit is greater than the national average of 65.5 mph.

The benefits of this simple technology are widely recognized. The American Trucking Association (ATA) developed six recommendations to reduce carbon emissions from trucks in the United States. Their first recommendation is to enact a national truck speed limit of 65 mph and require that trucks manufactured after 1992 have speed governors set at not greater than 65 mph.¹⁰⁷ The SmartWay program includes speed management as one of their key Clean Freight Strategies and provides information to the public regarding the benefit of lower highway speeds.¹⁰⁸

Some countries have enacted regulations to reduce truck speeds. For example, the United Kingdom introduced regulations in 2005 which require new trucks used for goods movement to have a vehicle speed limiter not to exceed 90 km/hr (56 mph).¹⁰⁹ The Canadian Provinces of Ontario and Quebec developed regulations which took effect in January 2009 that requires on-highway commercial heavy-duty trucks to have speed limiters which limit the truck's speed to 105 km/hr (65 mph).¹¹⁰

Many truck fleets consider speed limiter application a good business practice in their operations. A Canadian assessment of heavy-duty truck speed limiters estimated that 60 percent of heavy truck fleets in North America use speed limiters.¹¹¹ Con Way Freight, Con Way Truckload, and Wal-Mart currently govern the speeds of their fleets between 62 and 65 mph.¹¹²

Heavy-Duty GHG and Fuel Efficiency Standards FRM: Technologies, Cost, and Effectiveness

A potential disbenefit of this technology is the additional time required for goods movement, or loss of productivity. The elasticity between speed reduction and productivity loss has not been well defined in industry. The Canadian assessment of speed limiters cited above found that the fuel savings due to the lower operating speeds outweigh any productivity losses. A general consensus among the OEMs is that a one percent decrease in speed might lower productivity by approximately 0.2 percent.¹¹²

In this final rulemaking, the agencies are allowing the use of vehicle speed limiters as a way of complying with the Class 7 and 8 combination tractor vehicle standards – that is, a VSL value is an optional input in the GEM. For purposes of these regulations, the agencies are assuming that there is no additional capital cost associated with a vehicle speed limiter. There are also no hardware requirements for this feature, only software control strategies. Nearly all heavy-duty engines today are electronically controlled and are capable of being programmed for a maximum vehicle speed. The only new requirement for truck manufacturers that the agencies are imposing through this rulemaking is to offer a vehicle speed limiter which is protected from tampering and cannot be changed by the fleet or truck owner. This technology is required to be used for the full useful life of the vehicle to obtain the GHG emissions reduction.

The vehicle speed limiter is technically applicable to all truck classes which operate at high speeds. However, due to the structure of the first phase of the Heavy-Duty truck program, it is only applicable to the Class 7-8 tractors. The benefits of the vehicle speed limiter are assessed through the use of alternate High Speed Cruise cycles. The baseline cycle contains a constant 65 mph cruise.

As discussed in much more detail in Section II.B.3.g of the final rulemaking, the agencies are providing some adjustments to the VSL requirements for the final rulemaking to accommodate flexibilities desired by the trucking industry. The agencies will continue to allow VSL credit for manufacturers who provide “soft top” and expiration features to be programmed into PCMs in order to provide additional flexibility for fleet owners and so that fleets who purchase used vehicles have the ability to have different VSL policies than the original owner of the vehicle.

The agencies are finalizing an approach which allows manufacturers to provide a vehicle speed limiter with a limited life to address concerns about resale value of trucks with a VSL. The agencies will discount the value of the vehicle speed limiter based on the number of miles in which it is preset relative to the lifetime of the tractor. The agencies calculated the lifetime miles of a combination tractor based on EPA’s MOVES model as 1,259,000 miles. The lifetime value is weighted to take into account the survival rate of heavy duty trucks, as shown above in Table 2-28. In using a soft top feature, a manufacturer will be required to provide to the agencies a functional description of the “soft top” control strategy including calibration values, the speed setting for both the hard limit and the soft top and the maximum time per day the control strategy could allow the vehicle to operate at the “soft top” speed limit at the time of certification and identify the use of the “soft top” VSL on the vehicle label. This information will be used to derive a factor to discount the VSL input used in GEM modeling to determine the fuel consumption and GHG emissions performance of the vehicle.

Regulatory Impact Analysis

The equation to derive the GEM input for VSL for systems with an expiration is the following, as shown in Equation 2-2.

Equation 2-2: Discounted VSL Equation

$$\text{VSL input for GEM} = \text{Expiration Factor} * [\text{Soft Top Factor} * \text{Soft Top VSL} + (1 - \text{Soft Top Factor}) * \text{VSL}] + (1 - \text{Expiration Factor}) * 65 \text{ mph}$$

The expiration factor is equal to the number of miles at expiration divided by 1,259,000 miles.

The soft top factor is equal to the maximum number of hours that a vehicle may travel at the soft top VSL in a 10 hour day divided by 7.3 hours for sleeper cabs or 3.9 hours for day cabs based on the agencies' drive cycle weighting factors. The number of hours spent travelling at each cycle is included in Table 2-29.

Heavy-Duty GHG and Fuel Efficiency Standards FRM: Technologies, Cost, and Effectiveness

Table 2-29: Soft Top Factor Calculations

	SLEEPER CAB	DAY CAB
VMT weighting of 65 mph cycle	0.86	0.64
VMT weighting of 55 mph cycle	0.09	0.17
VMT weighting of Transient cycle	0.05	0.19
Average speed of 65 mph cycle	65	65
Average Speed of 55 mph cycle	55	55
Average Speed of Transient cycle	15.3	15.3
Miles per day travelled at 65 mph	474.2	252.4
Miles per day travelled at 55 mph	49.6	67.0
Miles per day travelled at transient	27.6	74.9
Total miles per day	551	394
Hours per day spent at 65 mph	7.3	3.9
Hours per day spent at 55 mph	0.9	1.2
Hours per day spent at transient	1.8	4.9
Total hours per day	10.0	10.0

2.5.6 Automated Manual Transmission

Most heavy-duty trucks use manual transmissions with 8 to 18 gear ratios available. The most common transmissions for line haul applications have 10 ratios with an overdrive top gear. Torque-converter automatic transmissions, similar to those used in passenger cars, are used in some stop/go truck applications but are more expensive and do not have an efficiency advantage in line-haul applications. Automated manual transmissions have been available on the market for over 10 years now and are increasing in market share. Automated manuals have a computer to decide when to shift and use pneumatic or hydraulic mechanisms to actuate the clutch and hidden shift levers. An automated manual can shift as quickly as the best driver, and the shift schedule can be tailored to match the characteristics of the engine and vehicle. This reduces variability of fuel consumption and CO₂ emissions between drivers, with all drivers achieving results closer to those of the best drivers. In application, there would be a fuel economy improvement proportional to the number of non-fuel-conscious drivers in a fleet.¹¹³

2.5.7 Class 7 and 8 Tractor Baseline Assessment

The agencies developed the baseline tractor for each subcategory to represent an average 2010 model year tractor, as shown in Table 2-30. The approach taken by the agencies was to define the individual inputs to GEM. For example, the agencies evaluated the industry's tractor offerings and conclude that the average tractor contains a generally aerodynamic shape (such as roof fairings) and avoid classic features such as exhaust stacks at the b-pillar which increase drag. The agencies consider a baseline truck as having "conventional" aerodynamics. The baseline rolling resistance coefficient for today's fleet is 7.8 kg/metric ton for the steer tire and 8.2 kg/metric ton for the drive tire, based on sales weighting of the top three manufacturers based on market share.¹¹⁴ However, today there is a

Regulatory Impact Analysis

large spread in aerodynamics in the new tractor fleet. Trucks are sold that may reflect classic styling, or are sold with conventional or SmartWay aerodynamic packages.

Table 2-30 Class 7 and 8 Tractor Baseline Attributes

	CLASS 7			CLASS 8					
	Day Cab			Day Cab			Sleeper Cab		
	Low Roof	Mid Roof	High Roof	Low Roof	Mid Roof	High Roof	Low Roof	Mid Roof	High Roof
Aerodynamics (Cd)									
Baseline	0.77	0.87	0.73	0.77	0.87	0.73	0.77	0.87	0.70
Steer Tires (Crr kg/metric ton)									
Baseline	7.8	7.8	7.8	7.8	7.8	7.8	7.8	7.8	7.8
Drive Tires (Crr kg/metric ton)									
Baseline	8.2	8.2	8.2	8.2	8.2	8.2	8.2	8.2	8.2
Weight Reduction (lb)									
Baseline	0	0	0	0	0	0	0	0	0
Extended Idle Reduction (gram CO₂/ton-mile reduction)									
Baseline	N/A	N/A	N/A	N/A	N/A	N/A	0	0	0
Vehicle Speed Limiter									
Baseline	--	--	--	--	--	--	--	--	--
Engine									
Baseline	2010 MY 11L Engine	2010 MY 11L Engine	2010 MY 11L Engine	2010 MY 15L Engine	2010 MY 15L Engine	2010 MY 15L Engine	2010 MY 15L Engine	2010 MY 15L Engine	2010 MY 15L Engine

2.5.8 Class 7 and 8 Tractor Standards Derivation

As discussed in more detail in Section II.B and III.A of the preamble, EPA and NHTSA project that CO₂ emissions and fuel consumption reductions for combination tractors can be achieved through the increased penetration of aerodynamic technologies, low rolling resistance tires, weight reduction, extended idle reduction technologies, and vehicle speed limiters. The agencies believe that hybrid powertrains in line-haul applications will not be cost-effective in the time frame of the rulemaking. The NAS report stated that the effectiveness of hybrid powertrains installed in tractors is 10 percent, but 6 percent of it was attributed to idle reduction which is already addressed in the HD program, at a cost of \$25,000.¹¹⁵ The agencies also are not including drivetrain technologies in the standard setting process, as discussed in Section II.B.3.h.iv of the preamble, and instead are choosing to allow the continuation of the current truck specifying process that is working well today.

The agencies investigated the possibility of essentially forcing SmartWay technologies (aerodynamics, tires, and extended idle) into 100 percent of Class 7 and Class 8 tractors. However, as discussed below, the agencies realize that there are some restrictions which prevent 100 percent penetration. Therefore, the agencies took the approach of evaluating each technology and finalizing what we deem as the maximum feasible penetration into each tractor regulatory category. The next sections describe the effectiveness of the individual technologies, the costs of the technologies, the penetration rates of the technologies into the regulatory categories, and finally the derivation of the final standards.

Heavy-Duty GHG and Fuel Efficiency Standards FRM: Technologies, Cost, and Effectiveness

2.5.8.1 Technology Effectiveness

The agencies' assessment of the technology effectiveness was developed through the use of the GEM. Table 2-31 describes the model inputs for the range of Class 7 and 8 tractor technologies.

Table 2-31: GEM Inputs

	Class 7		Class 8				
	Day Cab		Day Cab		Sleeper Cab		
	Low / Mid Roof	High Roof	Low / Mid Roof	High Roof	Low Roof	Mid Roof	High Roof
Aerodynamics (Cd)							
Frontal Area (m ²)	6.0	9.8	6.0	9.8	6.0	7.7	9.8
Bin I	0.77 / 0.87	0.79	0.77 / 0.87	0.79	0.77	0.87	0.75
Bin II	0.71 / 0.82	0.72	0.71 / 0.82	0.72	0.71	0.82	0.68
Bin III		0.63		0.63			0.60
Bin IV		0.56		0.56			0.52
Bin V		0.51		0.51			0.47
Steer Tires (Crr kg/metric ton)							
Baseline	7.8	7.8	7.8	7.8	7.8	7.8	7.8
Level I	6.6	6.6	6.6	6.6	6.6	6.6	6.6
Level II	5.7	5.7	5.7	5.7	5.7	5.7	5.7
Drive Tires (Crr kg/metric ton)							
Baseline	8.2	8.2	8.2	8.2	8.2	8.2	8.2
Level I	7.0	7.0	7.0	7.0	7.0	7.0	7.0
Level II	6.0	6.0	6.0	6.0	6.0	6.0	6.0
Weight Reduction (lbs.)							
Control	400	400	400	400	400	400	400
Extended Idle Reduction (gram CO₂/ton-mile reduction)							
Control	N/A	N/A	N/A	N/A	5	5	5
Vehicle Speed Limiter							
Control	N/A	N/A	N/A	N/A	N/A	N/A	N/A

2.5.8.2 Class 7 and 8 Tractor Application Rates

Vehicle manufacturers often introduce major product changes together, as a package. In this manner the manufacturers can optimize their available resources, including engineering, development, manufacturing and marketing activities to create a product with multiple new features. In addition, manufacturers recognize that an engine and truck will need to remain competitive over its intended life and meet future regulatory requirements. In some limited cases, manufacturers may implement an individual technology outside of a

Regulatory Impact Analysis

vehicle's redesign cycle. For consistency with these industry practices, the agencies have created a set of vehicle technology packages for each regulatory subcategory.

With respect to the level of technology required to meet the standards, NHTSA and EPA established technology application caps. The first type of cap was established based on the application of common fuel consumption and CO₂ emission reduction technologies into the different types of tractors. For example, idle reduction technologies are limited to Class 8 sleeper cabs based on the assumption that day cabs are not used for overnight hoteling. Idle reduction technologies such as APUs and cabin heaters can reduce workday idling associated with day cabs. However, characterizing idling activity for this segment in order to quantify the benefits of idle reduction technology is complicated by the variety of duty cycles found in the sector. Idling in tractors used for pick-up and delivery construction, refuse, and other types of vocational vehicles varies significantly. Given the great variety of duty cycles and operating conditions of vocational vehicles and the timing of these rules, it is not feasible at this time to establish an accurate baseline for quantifying the expected improvements which could result from use of idle reduction technologies.

As described in the following paragraphs, the agencies applied a second type of constraint to most other technologies whereby technology penetration is limited based on factors such as market demands.

The impact of aerodynamics on a truck's efficiency increases with vehicle speed. Therefore, the usage pattern of the truck will determine the benefit of various aerodynamic technologies. Sleeper cabs are often used in line haul applications and drive the majority of their miles on the highway travelling at speeds greater than 55 mph. The industry has focused aerodynamic technology development, including SmartWay certified tractors, on these types of trucks. Therefore the agencies are finalizing the most aggressive aerodynamic technology penetration in this regulatory subcategory. All of the major manufacturers today offer at least one truck model that is SmartWay designated. The 2010 NAS Report found that manufacturers indicated that aerodynamic improvements which yield 3 to 4 percent fuel consumption reduction or 6 to 8 percent reduction in Cd values, beyond technologies used in today's SmartWay trucks are achievable.¹¹⁶ The final standards are predicted on an aerodynamic penetration rate for Class 8 sleeper cab high roof cabs of 20 percent of Bin IV, 70 percent Bin III, and 10 percent Bin II. The small percentage of Bin II tractor aerodynamics is for applications that do not qualify as vocational tractors but may still not be able to use features such as chassis skirts which are prone to damage in off-road applications.

Tire rolling resistance is only one of several performance criteria that affect tire selection. The characteristics of a tire also influence durability, traction control, vehicle handling and comfort. A single performance parameter can easily be enhanced, but an optimal balance of all the criteria must be maintained. Tire design requires balancing performance, since changes in design may change different performance characteristics in opposing direction. Similar to the discussion regarding lesser aerodynamic technology penetration in tractor segments other than sleeper cab high roof, the agencies believe that low rolling resistance tires should not be applied to 100 percent of all tractor segments. The agencies are instead basing the standards on application rates that vary by subcategory to reflect the on/off-road application of some tractors which require a different balancing of

Heavy-Duty GHG and Fuel Efficiency Standards FRM: Technologies, Cost, and Effectiveness

traction versus rolling resistance, but do not qualify for the off-road vocational tractor exemption.

Weight reductions can be achieved through single wide tires replacing dual tires and lighter weight wheel material or through the use of other light weight components as specified in Table 2-25. Single wide tires can reduce weight by over 160 pounds per axle. Aluminum wheels used in lieu of steel wheels will reduce weight by over 80 pounds for a dual wheel axle. Light weight aluminum steer wheels and aluminum single wide drive wheels and tires package will provide a 670 pound weight reduction over the baseline steel steer and dual drive wheels. In comments to the agencies, Volvo and ATA stated that not all fleets can use single wide tires and as a result they stated the weight reduction requirement should be reduced. In response, the agencies are finalizing as direct GEM inputs additional light weight components that can be used to achieve the 400 pound weight reduction for tractors. Additional weight reduction opportunities exist with the use of aluminum or light weight steel in steps, clutch housings, and other components listed in Table 2-25.

Idle reduction technologies provide significant reductions in fuel consumption and CO₂ emissions. There are several different technologies available to reduce idling, like auxiliary power units, diesel fired heaters, and battery powered units. Each of these technologies has a different level of fuel consumption and CO₂ emissions. Therefore, the emissions reduction value varies by technology. Also, our discussions with manufacturers indicate that idle technologies are sometimes installed in the factory, but it is also a common practice to have the units installed after the sale of the truck. Therefore, we would like to continue to incentivize this practice while providing some certainty that the overnight idle operations will be eliminated. Therefore, we are allowing the installation of only an automatic engine shutoff, without override capability, to qualify for idle emission reductions. We are finalizing a 100 percent penetration rate for this technology (and several override options not proposed, to account for driver safety and comfort concerns raised in the comments) and have estimated that 30 percent of the current fleet already employs this technology meaning that 70 percent are estimated to add this technology.

Consistent with proposal, vehicle speed limiters may be used as a technology to meet the standard, but this technology was not used as part of the technology package on which the standard is based. The comments received from stakeholders did not address the agencies' concerns discussed in the proposal, specifically the risk of requiring VSL in situations that are not appropriate from an efficiency perspective because it may lead to additional truck trips to deliver the same amount of freight.¹¹⁷ The agencies continue to believe that we are not in a position to determine how many additional trucks would benefit from the use of a VSL with a setting of less than 65 mph (a VSL with a speed set at or above 65 mph will show no CO₂ emissions or fuel consumption benefit on the drive cycles included in this program). We will monitor the industry's use of VSL in this program and may consider using this technology in standard setting in the future.

Table 2-32 provides the final application rates for each technology by regulatory subcategory.

Regulatory Impact Analysis

Table 2-32: Application Rates

	Class 7		Class 8				
	Day Cab		Day Cab		Sleeper Cab		
	Low/Mid Roof	High Roof	Low/Mid Roof	High Roof	Low Roof	Mid Roof	High Roof
Aerodynamics (Cd)							
Bin I	40%	0%	40%	0%	30%	30%	0%
Bin II	60%	30%	60%	30%	70%	70%	10%
Bin III		60%		60%			70%
Bin IV		10%		10%			20%
Bin V		0%		0%			0%
Steer Tires (Crr kg/metric ton)							
Baseline	40%	30%	40%	30%	30%	30%	10%
Bin I	50%	60%	50%	60%	60%	60%	70%
Bin II	10%	10%	10%	10%	10%	10%	20%
Drive Tires (Crr kg/metric ton)							
Baseline	40%	30%	40%	30%	30%	30%	10%
Bin I	50%	60%	50%	60%	60%	60%	70%
Bin II	10%	10%	10%	10%	10%	10%	20%
Weight Reduction (lbs.)							
Control	100%	100%	100%	100%	100%	100%	100%
Extended Idle Reduction (gram CO₂/ton-mile reduction)							
Control	Not Applicable	Not Applicable	Not Applicable	Not Applicable	100%	100%	100%
Vehicle Speed Limiter							
Control	--	--	--	--	--	--	--

The agencies used the technology inputs and technology application rates in GEM to develop the fuel consumption and CO₂ emissions standards for each subcategory of Class 7/8 combination tractors. The agencies derived a scenario truck for each subcategory by weighting the individual GEM input parameters included in Table 2-31 by the application rates in Table 2-32. For example, the Cd value for a Class 8 Sleeper Cab High Roof scenario case was derived as (10 percent x 0.66) + (70 percent x 0.58) + (20 percent x 0.50), which is equal to a Cd of 0.57. Similar calculations were done for tire rolling resistance, weight reduction, idle reduction, and vehicle speed limiters. To account for the two engine standards, EPA and NHTSA are finalizing the use of a 2014 model year fuel consumption map in GEM to derive the 2014 model year tractor standard and a 2017 model year fuel consumption map to derive the 2017 model year tractor standard.¹¹⁸ The agencies then ran GEM with a single set of vehicle inputs, as shown in Table 2-33, to derive the final standards for each subcategory. The final standards and percent reductions are included in Table 2-34.

Heavy-Duty GHG and Fuel Efficiency Standards FRM: Technologies, Cost, and Effectiveness

Table 2-33 Inputs to the GEM model for Class 7 and 8 Tractor Standard Setting

CLASS 7			CLASS 8					
Day Cab			Day Cab			Sleeper Cab		
Low Roof	Mid Roof	High Roof	Low Roof	Mid Roof	High Roof	Low Roof	Mid Roof	High Roof
Aerodynamics (Cd)								
0.73	0.84	0.65	0.73	0.84	0.65	0.73	0.84	0.59
Steer Tires (Crr kg/metric ton)								
6.99	6.99	6.87	6.99	6.99	6.87	6.87	6.87	6.54
Drive Tires (Crr kg/metric ton)								
7.38	7.38	7.26	7.38	7.38	7.26	7.26	7.26	6.92
Weight Reduction (lb)								
400	400	400	400	400	400	400	400	400
Extended Idle Reduction (gram CO₂/ton-mile reduction)								
N/A	N/A	N/A	N/A	N/A	N/A	5	5	5
Vehicle Speed Limiter								
--		--	--		--	--	--	--
Engine								
2014/17 MY 11L Engine	2014/17 MY 11L Engine	2014/17 MY 11L Engine	2014/17 MY 15L Engine	2014/17 MY 15L Engine	2014/17 MY 15L Engine	2014/17 MY 15L Engine	2014/17 MY 15L Engine	2014/17 MY 15L Engine

Table 2-34 Tractor Standards and Percent Reductions

	Class 7			Class 8					
	Day Cab			Day Cab			Sleeper Cab		
	Low Roof	Mid Roof	High Roof	Low Roof	Mid Roof	High Roof	Low Roof	Mid Roof	High Roof
2014 Model Year (voluntary for NHTSA program)									
2014 MY Voluntary Fuel Consumption Standard (gallon/1000 ton-mile)	10.5	11.7	12.2	8.0	8.7	9.0	6.7	7.4	7.3
2014 MY CO ₂ Standard (grams CO ₂ /ton-mile)	107	119	124	81	88	92	68	76	75
Percent Reduction	8%	7%	10%	8%	7%	11%	15%	14%	21%
2017 Model Year and later									
2017 MY Fuel Consumption Standard (gallon/1000 ton-mile)	10.2	11.3	11.8	7.8	8.4	8.7	6.5	7.2	7.1
2017 MY CO ₂ Standard (grams CO ₂ /ton-mile)	104	115	120	80	86	89	66	73	72
Percent Reduction	10%	10%	13%	10%	10%	13%	17%	17%	23%

Regulatory Impact Analysis

2.5.9 Class 7 and 8 Tractor Technology Costs

The technology costs associated with the tractor defined in Table 2-33 for each of the tractor subcategories are listed in Table 2-35.

Table 2-35 Estimated Class 7-8 Tractor Technology Costs, Inclusive of Markups and Penetration Rates, Applicable in the 2014MY (2009\$)

	Class 7		Class 8				
	Day Cab		Day Cab		Sleeper Cab		
	Low & Mid Roof	High Roof	Low & Mid Roof	High Roof	Low Roof	Mid Roof	High Roof
Aerodynamics							
Bin III & Bin IV	\$675	\$924	\$675	\$924	\$962	\$983	\$1,627
Steer Tires							
Low Rolling Resistance	\$68	\$68	\$68	\$68	\$68	\$68	\$68
Drive Tires							
Low Rolling Resistance	\$63	\$63	\$126	\$126	\$126	\$126	\$126
Weight Reduction							
Weight Package	\$1,200	\$1,536	\$1,980	\$1,980	\$3,275	\$3,275	\$1,980
Extended Idle Reduction							
Auxiliary Power Unit	N/A	N/A	N/A	N/A	\$3,819	\$3,819	\$3,819
Vehicle Speed Limiter							
Control	N/A	N/A	N/A	N/A	N/A	N/A	N/A

2.6 Class 2b-8 Vocational Vehicles

2.6.1 Tires

As discussed in more detail in Section III.D of the preamble, the range of rolling resistance of tires used on vocational vehicles (Class 2b – 8) today is large. The competitive pressure to improve rolling resistance of these tires has been less than that found in the Class 8 line haul tire market. Due to the drive cycles typical for these applications, tire traction and durability are weighed more heavily in a purchaser’s decision than rolling resistance. Therefore, the agencies believe that a regulatory program that incentivizes the optimization of tire rolling resistance, traction and durability can bring about GHG emission and fuel consumption reductions from this segment. It is estimated that low rolling resistance tires used on Class 3 – 6 trucks would improve fuel economy by 2.5 percent⁸³ relative to tires not designed for fuel efficiency.

Tires used on vocational vehicles (Class 2b – 8) typically carry less load than a Class 8 line haul vehicle. They are also designed for resistance to scrubbing and curb damage. Because they carry less load and high scrubbing, tires used on vocational vehicles are can retreaded as many as five times.

Heavy-Duty GHG and Fuel Efficiency Standards FRM: Technologies, Cost, and Effectiveness

Since the NPRM, the agencies have conducted additional research on tire rolling resistance for medium- and heavy-duty applications. EPA has conducted tire rolling resistance testing to help inform the final rulemaking.¹¹⁹

The testing measured the CRR of tires representing 16 different vehicle applications for Class 4 – 8 vocational vehicles. The testing included approximately 5 samples each of both steer and drive tires for each application. The tests were conducted by two independent tire test labs, Standards Testing Lab (STL) and Smithers-Rapra (Smithers).

Overall, a total of 156 medium- and heavy-duty tires were included in this testing, which was comprised of 88 tires covering various commercial vocational vehicle types, such as bucket trucks, school buses, city delivery vehicles, city transit buses and refuse haulers among others; 47 tires intended for application to tractors; and 21 tires classified as light-truck (LT) tires intended for Class 4 vocational vehicles such as delivery vans.

The test results for 88 commercial vocational vehicle tires (19.5” and 22.5” sizes) showed a test average CRR of 7.4 kg/metric ton, with results ranging from 5.4 to 9.8. To comply with the proposed vocational vehicle fuel consumption and GHG emissions standards using improved tire rolling resistance as the compliance strategy, a manufacturer would need to achieve an average tire CRR value of 8.1 kg/metric ton.¹²⁰ The measured average CRR of 7.4 kg/metric ton is thus better than the average value that would be needed to meet vocational vehicle standards. Of those eighty-eight tires tested, twenty tires had CRR values worse than 8.1 kg/metric ton, two were at 8.1 kg/metric ton, and sixty-six tires were better than 8.1 kg/metric ton. Additional data analyses examining the tire data by tire size to determine the range and distribution of CRR values within each tire size showed each tire size generally had tires ranging from approximately 6.0 to 8.5 kg/metric ton, with a small number of tires in the 5.3 – 5.7 kg/metric ton range and a small number of tires in a range as high as 9.3 – 9.8 kg/ton. Review of the data showed that for each tire size and vehicle type, the majority of tires tested would enable compliance with vocational vehicle fuel consumption and GHG emission standards.

Finally, the 21 LT tires intended for Class 4 vocational vehicles were comprised of two sizes; LT225/75R16 and LT245/75R16 with 11 and 10 samples tested, respectively. Some auto manufacturers have indicated that CRR values for tires fitted to these Class 4 vehicles typically have a higher CRR values than tires found on commercial vocational vehicles because of the smaller diameter wheel size and the ISO testing protocol.¹²¹ The test data showed the average CRR for LT225/75R16 tires was 9.1 kg/metric ton and the average for LT245/75R16 tires was 8.6 kg/metric ton. The range for the LT225/75R16 tires spanned 7.4 to 11.0¹²² and the range for the LT245/75R16 tires ranged from 6.6 to 9.8 kg/metric ton. Overall, the average for the tested LT tires was 8.9 kg/metric ton.

Analysis of the EPA test data for all vocational vehicles, including LT tires, shows the test average CRR is 7.7 kg/metric ton and with a standard deviation of 1.2 kg/metric ton. Review of the data thus shows that for each tire size and vehicle type, there are many tires available that would enable compliance with the proposed standards for vocational vehicles and tractors except for LT tires for Class 4 vocational vehicles where test results show the majority of these tires are worse than 8.1 kg/metric ton.

Regulatory Impact Analysis

The agencies also reviewed the CRR data from the tires that were tested at both the STL and Smithers laboratories to assess inter-laboratory and test machine variability. The agencies conducted statistical analysis of the data to gain better understanding of lab-to-lab correlation and developed an adjustment factor for data measured at each of the test labs. When applied, this correction factor showed that for 77 of the 80 tires tested, the difference between the original CRR and a value corrected CRR was 0.01 kg/metric ton. The values for the remaining three tires were 0.03 kg/metric ton, 0.05 kg/metric ton and 0.07 kg/metric ton. Based on these results, the agencies believe the lab-to-lab variation for the STL and Smithers laboratories would have very small effect on measured CRR values. Further, in analyzing the data, the agencies considered both measurement variability and the value of the measurements relative to proposed standards. The agencies concluded that although laboratory-to-laboratory and test machine-to-test machine measurement variability exists, the level observed is not excessive relative to the distribution of absolute measured CRR performance values and relative to the proposed standards. Based on this, the agencies concluded that the test protocol is reasonable for this program, but are making some revisions to the vehicle standards.

For vocational vehicles, the rolling resistance of each tire will be measured using the ISO 28850 test method for drive tires and steer tires planned for fitment to the vehicle being certified. Once the test CRR values are obtained, a manufacturer will input the CRR values for the drive and steer tires separately into the GEM where, for vocational vehicles, the vehicle load is distributed equally over the steer and drive tires. Once entered, the amount of GHG reduction attributed to tire rolling resistance will be incorporated into the overall vehicle compliance value. The following table provides the revised target CRR values for vocational vehicles for 2014 and 2017 model years that are used to determine the vehicle standards.

Table 2-36: Vocational Vehicle – Target CRR Values for GEM Input

	2014 MY	2017 MY
Tire Rolling Resistance (kg/metric ton)	7.7 kg/metric ton	7.7 kg/metric ton

These target values are being revised based on the significant availability of tires for vocational vehicles applications which have performance better than the originally proposed 8.1 kg/metric ton target. As just discussed, 63 of the 88 tires tested for vocational applications had CRR values better than the proposed target. The tires tested covered fitment to a wide range of vocational vehicle types and classes; thus agencies believe the original target value of 8.1 kg/metric ton was possibly too lenient after reviewing the testing data. Therefore, the agencies believe it is appropriate to reduce the proposed vehicle standard based on performance of a CRR target value of 7.7 kg/metric ton for non-LT tire type. As discussed previously, this value is the test average of all vocational tires tested (including LT) which takes a conservative approach over setting a target based on the average of only the non-LT Vocational tires tested. For LT tires, based on both the test data and the comments from AAPC and Ford Motor Company, the agencies recognize the need to provide an adjustment. In lieu of having two sets of Light Heavy-Duty vocational vehicle standards, the agencies are finalizing an adjustment factor which applies to the CRR test results for LT tires. The agencies developed an adjustment factor dividing the overall vocational test average CRR of 7.7 by the LT Vocational Average of 8.9. This yields an adjustment factor of 0.87. For LT

Heavy-Duty GHG and Fuel Efficiency Standards FRM: Technologies, Cost, and Effectiveness

vocational vehicle tires, the measured CRR values will be multiplied by the 0.87 adjustment factor before entering the values in the GEM for compliance.

The agencies have estimated the costs of low rolling resistance tires as shown in Table 2-37. These costs include a low complexity ICM of 1.18 and flat-portion of the curve learning would be considered appropriate for these technologies.

Table 2-37 Estimated Costs for Low Rolling Resistance Tires on Vocational Vehicles in the 2014MY (2009\$)

	LIGHT-HEAVY & MEDIUM-HEAVY	HEAVY-HEAVY
Low rolling resistance steer tires	\$68	\$68
Low rolling resistance drive tires	\$94	\$126
Package cost (including penetration rates)	\$81	\$97

2.6.2 Other Evaluated Technologies for Vocational Vehicles

2.6.2.1 Aerodynamics

Aerodynamic drag is an important aspect of the power requirements for Class 2b through 8 vocational vehicles. Because aerodynamic drag is a function of the cube of vehicle speed, small changes in the aerodynamics of a vocational vehicle reduces drag, fuel consumption, and GHG emissions. The great variety of applications for vocational vehicles result in a wide range of operational speed profiles (*i.e.*, in-use drive cycles), with many weighted toward lower speeds where aerodynamic improvement benefits are less pronounced. In addition, vocational vehicles have a wide variety of configurations (*e.g.*, utility trucks with aerial devices, transit buses, and pick-up and delivery trucks) and functional needs (*e.g.*, ground clearance, towing, and all weather capability). This specialization can make the implementation of aerodynamic features impractical and, where specialty markets are limited, make it unlikely that per-unit costs will lower with sales volume.

This technology is not expected as a result of the final standards.

2.6.2.2 Hybrid Powertrains

A hybrid electric vehicle (HEV) is a vehicle that combines two or more sources of propulsion energy, where one uses a consumable fuel (*i.e.* gasoline or diesel), and one is rechargeable (during operation, or by another energy source). Hybrid technology is established in the U.S. market and more manufacturers are adding hybrid models to their lineups. Hybrids reduce fuel consumption through three major mechanisms:

- Powertrain control strategy can be developed to operate the engine at or near its most efficient point most of the time.

Regulatory Impact Analysis

- The internal combustion engine can be optimized through downsizing or modifying the operating cycle. Power loss from engine downsizing can be mitigated by employing power assist from the secondary power source.
- Some of the energy normally lost as heat while braking can be captured and stored in the energy storage system for later use.
- The engine is turned off when it is not needed, such as when the vehicle is coasting or stopped, such as extending idle conditions.

Hybrid vehicles utilize some combination of the above mechanisms to reduce fuel consumption and CO₂ emissions. A final mechanism to reduce fuel consumption, available only to plug-in hybrids, is by substituting the petroleum fuel energy with energy from another source, such as the electric grid. Plug-in hybrids may be most suitable for some applications which travel short distances such as local pickup and delivery.

The effectiveness of fuel consumption and CO₂ reduction depends on the utilization of the above mechanisms and how aggressively they are pursued. One area where this variation is particularly prevalent is in the choice of engine size and its effect on balancing fuel efficiency and performance. Some manufacturers choose not to downsize the engine when applying hybrid technologies depending on the power from the hybrid system components. In these cases, performance is improved, while fuel efficiency improves significantly less than if the engine was downsized to maintain the same performance as the conventional version. While this approach of not downsizing the engine has been used in passenger cars occasionally, it is more likely to be used for trucks where towing, hauling and/or cargo capacity is an integral part of their performance requirements. In these cases, if the engine is downsized, the battery can be quickly drained during a long hill climb with a heavy load, leaving only a downsized engine to carry the entire load. Because cargo capability is critical truck attribute, manufacturers are hesitant to offer a truck with downsized engine which can lead to a significantly diminished towing performance with a low battery, and therefore engines are traditionally not significantly downsized for these vehicles.

In addition to the purely hybrid technologies, which decreases the proportion of propulsion energy coming from the fuel by increasing the proportion of that energy coming from electricity, there are other steps that can be taken to improve the efficiency of auxiliary functions (*e.g.*, power-assisted steering or air-conditioning) which also reduce CO₂ emissions and fuel consumption. Optimization of the auxiliary functions, together with the hybrid technologies, is collectively referred to as vehicle or accessory load electrification because they generally use electricity instead of engine power. Fuel efficiency gains achieved only through electrification are considered in a separate section although these improvements may be combined with the hybrid system.

A hybrid drive unit is complex and consists of discrete components such as the electric traction motor, transmission, generator, inverter, controller and cooling devices. Certain types of drive units may work better than others for specific vehicle applications or performance requirements. Several types of motors and generators have been developed for hybrid-electric drive systems, many of which merit further evaluation and development on specific

applications. Series HEVs typically have larger motors with higher power ratings because the motor alone propels the vehicle, which may be applicable to Class 3-5 applications. In parallel hybrids, the power plant and the motor combine to propel the vehicle. Motor and engine torque are usually blended through couplings, planetary gear sets and clutch/brake units. The same mechanical components that make parallel heavy-duty hybrid drive units possible can be designed into series hybrid drive units to decrease the size of the electric motor(s) and power electronics.

An electrical energy storage system is needed to capture energy from the generator, to store energy captured during vehicle braking events, and to return energy when the driver demands power. This technology has seen a tremendous amount of improvement over the last decade and recent years. Advanced battery technologies and other types of energy storage are emerging to give the vehicle its needed performance and efficiency gains while still providing a product with long life. The focus on the more promising energy storage technologies such as nickel metal-hydride (NiMH) and lithium technology batteries along with ultra capacitors for the heavy-duty fleet should yield interesting results after further research and applications in the light-duty fleet.

Heavy-duty hybrid vehicles also use regenerative braking for improved fuel economy, emissions, brake heat, and wear. A conventional heavy vehicle relies on friction brakes at the wheels, sometimes combined with an optional engine retarder or driveline retarder to reduce vehicle speed. During normal braking, the vehicle's kinetic energy is wasted when it is converted to heat by the friction brakes. The conventional brake configuration has large components, heavy brake heat sinks, and high temperatures at the wheels during braking, audible brake squeal, and consumable components requiring maintenance and replacement. Hybrid electric systems recover some of the vehicle's kinetic energy through regenerative braking, where kinetic energy is captured and directed to the energy storage system. The remaining kinetic energy is dissipated through conventional wheel brakes or in a driveline or transmission retarder. Regenerative braking in a hybrid electric vehicle can require integration with the vehicle's foundation (friction) braking system to maximize performance and safety. Today's systems function by simultaneously using the regenerative features and the friction braking system, allowing only some of the kinetic energy to be saved for later use. Optimizing the integration of the regenerative braking system with the foundation brakes will increase the benefits and is a focus for continued work. This type of hybrid regenerative braking system improves fuel economy, GHG emissions, brake heat, and wear.

In addition to electric hybrid systems, EPA is experimenting with a Class 6 hydraulic hybrid that achieves a fuel economy increase superior to that of an electric hybrid.¹²³ In this type of system, deceleration energy is taken from the drivetrain by an inline hydraulic pump/motor unit by pumping hydraulic fluid into high pressure cylinders. The fluid, while not compressible, pushes against a membrane in the cylinder that compresses an inert gas to 5,000 PSI or more when fully charged. Upon acceleration, the energy stored in the pressurized tank pushes hydraulic fluid back into the drivetrain pump/motor unit, allowing it to motor into the drivetrain and assist the vehicle's engine with the acceleration event. This heavy-duty truck hybrid approach has been demonstrated successfully, producing good results on a number of commercial and military trucks.

Regulatory Impact Analysis

Nevertheless, considering the diversity of the heavy-duty fleet along with the various types of hybridization, the results are diverse as well. The percentage savings that can be expected from hybridization is very sensitive to duty cycle. For this reason, analyses and efforts to promote hybrids often focus on narrow categories of vehicles. For vocational vehicles other than tractor-trailers, hybrid technologies are promising, because a large fraction of miles driven by these trucks are local and under stop-and-go conditions. One study claims hybridization could almost double fuel economy for Class 3-5 trucks and raise Class 6-7 fuel economy by 71 percent in city driving, at costs that will decline rapidly in the coming years with the incremental cost of the hybrid vehicles depending on the choice of technology and the year, the later being a surrogate for progress towards economies of scale and experience with the technology.⁷⁹ Another Argonne National Lab study considering only truck Classes 2 and 3 indicates possible fuel efficiency gains of 40 percent.⁸³ The Hybrid Truck Users Forum has published a selection of four types as good candidates for hybridization; Class 4-8 Specialty Trucks, including utility and fire trucks; Class 4-6 urban delivery trucks, including package and beverage delivery; Class 7 and 8 refuse collection; and Class 7 and 8 less-than-load urban delivery trucks. The average fuel economy increase over the five cycles is 93 percent for the Class 3-4 truck and 71 percent for the Class 6-7 vehicle.

Stop-and-go truck driving includes a fraction of idling conditions during which the truck base engine consumes fuel but produces no economically useful output (*e.g.*, movement of goods, or repositioning of the truck to a new location). Hybrid propulsion systems shut off the engine under idling conditions or situations of low engine power demand. Trucks that have high fractions of stop-and-go freight transport activities within their driving cycles, such as medium-duty package and beverage delivery trucks, may be appropriate candidates for hybridization. Long-haul trucks have a lower proportion of short-term idling or low engine power demand in their duty cycles because of traffic conditions or frequency stops compared to medium-duty trucks in local services. Based on the results of hybridization effects modeling, medium-duty trucks in local service (*e.g.*, delivery) can reduce energy use by 41.5 percent.¹²⁴ Another 2009 report states that a 10 percent fuel consumption decrease could be achieved if idle reduction benefits were realized and a 5 percent improvement considering for on-road only.¹²⁵

In heavy-duty hybrid research, the industry role will be represented by the heavy-hybrid team members (*e.g.* Allison Transmission, Arvin-Meritor, BAE Systems, and Eaton Corporation). The Department of Energy is pursuing heavy hybrid research through the Freedom CAR and Vehicle Technologies Program. The Department of Transportation (Federal Transit Administration) is playing a role in demonstration of these vehicles for the transit bus market. The Department of Defense is working with heavy hybrid equipment suppliers to develop and demonstrate hybrid vehicles for military applications, and has already made significant investments in hybrid technology to reduce fuel consumption and improve their ability to travel silently in combat situations. The Environmental Protection Agency has participated in the heavy hybrid arena through its work on mechanical hybrids for certain applications as discussed previously. The U.S. Department of Energy's 21st Century Truck Partnership (21CTP) has established challenging goals for improving fuel economy and pollutant emissions from heavy-duty vehicles including a diverse set of vehicles ranging from approximately 8,500 lb GVWR to 100,000+ lb GVWR.⁶²

Despite the significant future potential for hybrids discussed above, there are no simple solutions applicable for each heavy-duty hybrid application due to the large vocational vehicle fleet variation. A choice must be made relative to the requirements and priorities for the application. Challenges in motor subsystems such as gear reductions and cooling systems must be considered when comparing the specific power, power density, and cost of the motor assemblies. High speed motors can significantly reduce weight and size, but they require speed reduction gear sets that can offset some of the weight savings, reduce reliability and add cost and complexity. Air-cooled motors are simpler and generally less expensive than liquid-cooled motors, but they will be larger and heavier, and they require access to ambient air, which can carry dirt, water, and other contaminants. Liquid-cooled motors are generally smaller and lighter for a given power rating, but they may require more complex cooling systems that can be avoided with air-cooled versions. Various coolant options, including water, water-glycol, and oil, are available for liquid-cooled motors but must be further researched for long term durability. Electric motors, power electronics, electrical safety, regenerative braking, and power-plant control optimization have been identified as the most critical technologies requiring further research to enable the development of higher efficiency hybrid electric propulsion systems.

In addition, because manufacturers will incur expenses in bringing hybrids to market, and because buyers do not purchase vehicles on the basis of net lifetime savings (see Section VIII.A.4 of the preamble), the cost-effectiveness of hybrids may not in itself translate into market success, and measures to promote hybrids are needed until costs come down. Vocational vehicles have diverse duty cycles, and they are used to a far greater extent for local trips. Some of the technologies are much less effective for trucks that generally drive at low speeds and therefore have limited applicability. Conversely, these trucks are the best candidates for hybrid technology, because local trips typically involve a large amount of stop-and-go driving, which permits extensive capture of braking and deceleration energy.

In summary, many technologies that apply to cars do not apply to heavy-duty trucks and there is a common perception that investments in passenger car (light-duty vehicle) technology can easily benefit heavy-duty trucks. This group of vehicles is very diverse and includes tractor-trailers, refuse and dump trucks, package delivery vehicles and buses. The life expectancy and duty cycles for heavy-duty vehicles are about ten times more demanding than those for light-duty vehicles, technologies and solutions for the fleet must be more durable and reliable. Although a new generation of components is being developed for commercial and military HEVs, more research and testing are required.

Due to the complexity of the heavy-duty fleet, the variation of hybrid system reported fuel efficiency gains and the growing research and testing – vehicle hybridization is not mandated nor included in the model for calculation of truck fuel efficiency and GHG output. Vehicle hybridization is feasible on both tractor and vocational applications but must be tested on an individual basis to an applicable baseline to realize the system benefits and net fuel usage and GHG reductions.

2.6.2.2.1 EPA Testing of a Hybrid Transit Bus

Regulatory Impact Analysis

EPA conducted a hybrid transit bus test to gather experience in testing hybrids and evaluate the GHG emissions and fuel consumption benefits. This section provides an overview of the study and its results. However, as noted above, the agencies do not consider hybrid powertrains to be part of the basis for the standard during this first rulemaking.

Following coastdown testing, in-use emissions testing was conducted on each bus using portable emissions measurement systems meeting subpart J of 40 CFR 1065. Each bus was operated over two routes, which were meant to simulate normal transit bus operation. The first route was comprised entirely of typical urban stop/go driving, with a number of bus stops along the 4.75 mile route. The second route was comprised of roughly half urban driving and half highway operation, reaching a maximum speed of approximately 60 MPH. This route was approximately 5.75 miles in length.

Fuel economy could be calculated using two methods: through integration of the instantaneous fuel rate broadcast by the ECU (ECU method) or through a carbon balance of the exhaust gases (Carbon Balance Method). Both methods provided repeatable results, however the ECU method tended to consistently yield approximately 5 percent lower fuel consumption on both vehicles. This bias appears to be due to small differences in predicted fuel flow versus measured exhaust carbon, particularly during deceleration where the ECU predicts a complete fuel cut-off. Since the carbon balance method yields more conservative results, all fuel consumption data presented has been calculating using this method.

Figure 2-5 presents a comparison of the fuel economy of both buses over the two test routes. Each vehicle was tested at least 3 times over each route, and in several cases up to 10 repeats of each route were conducted. The error bars represent the standard deviation over the replicates of each route. Over both routes, the hybrid showed a significant fuel economy benefit over the conventional bus. Over route 1 (urban only), this benefit was greatest and approached 37 percent. Over route 2 (mixed urban/highway), fuel economy was still improved by over 25 percent. Much of this benefit is likely attributable to the regenerative braking and launch assist capability of the hybrid system since there is no idle shut-off of the engine. A secondary benefit to the regenerative braking system is a significant increase in brake service intervals, which was highlighted in discussions with a bus fleet operator.

Figure 2-5 Hybrid and Conventional Bus Fuel Economy (mpg)

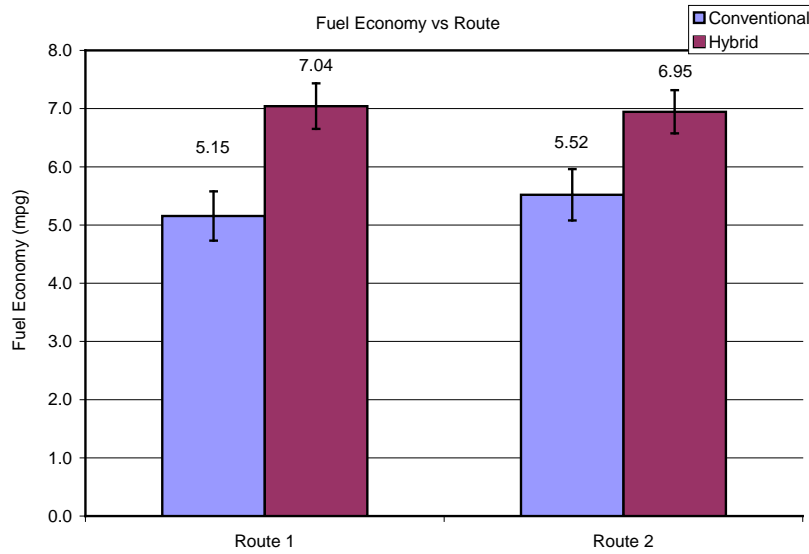

Figure 2-5 presents the CO₂ emissions over each route on a work-specific basis. For comparison, Figure 2-6 presents CO₂ normalized by the mileage travelled. Characterizing the CO₂ reduction due to the hybrid system, both methods show significant decreases in emissions. The work-specific basis may provide a more accurate comparison in this case, since environmental effects are better accounted for (*i.e.* driver aggressiveness, traffic, etc). This is evident when comparing the variation over the course of testing, represented by the standard deviation. The variability on a work-specific basis is nearly half that of using the distance-based metric.

Figure 2-6 Hybrid and Conventional Bus CO₂ Emission Rates (g/bhp-hr)

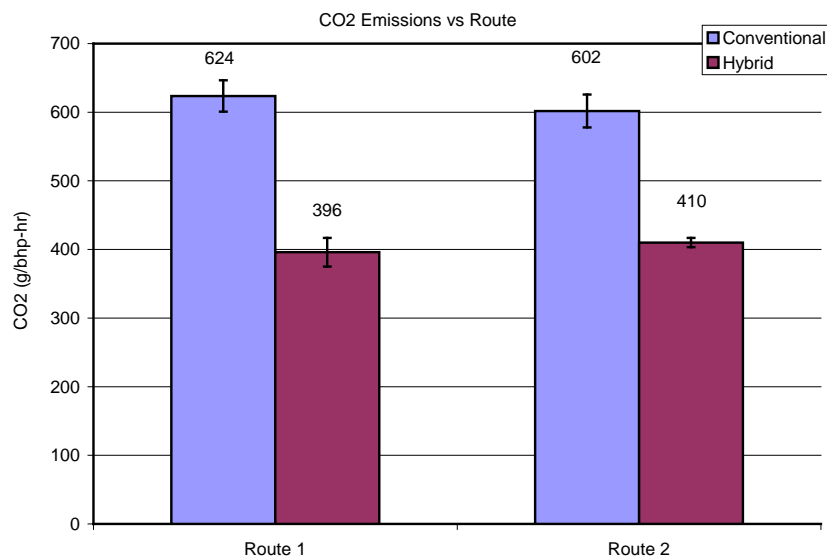

Figure 2-7 Hybrid and Conventional Bus CO₂ Emission Rates (g/mile)

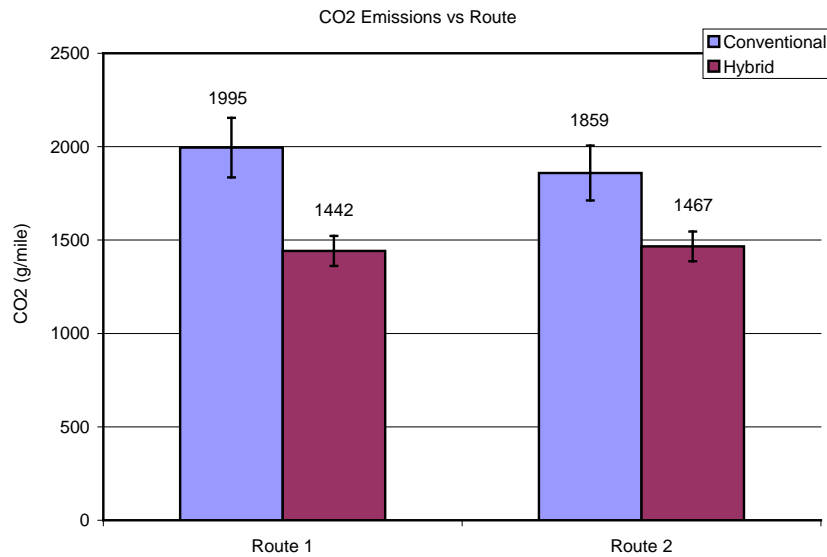
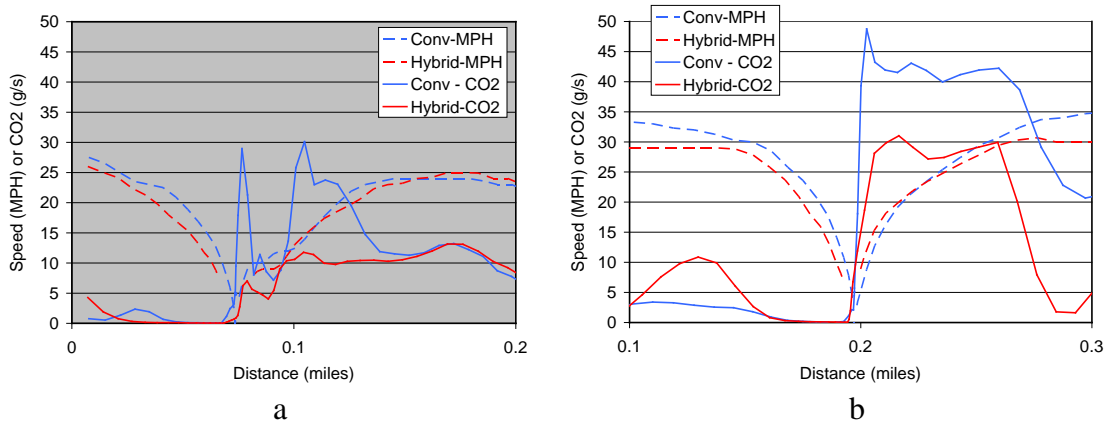
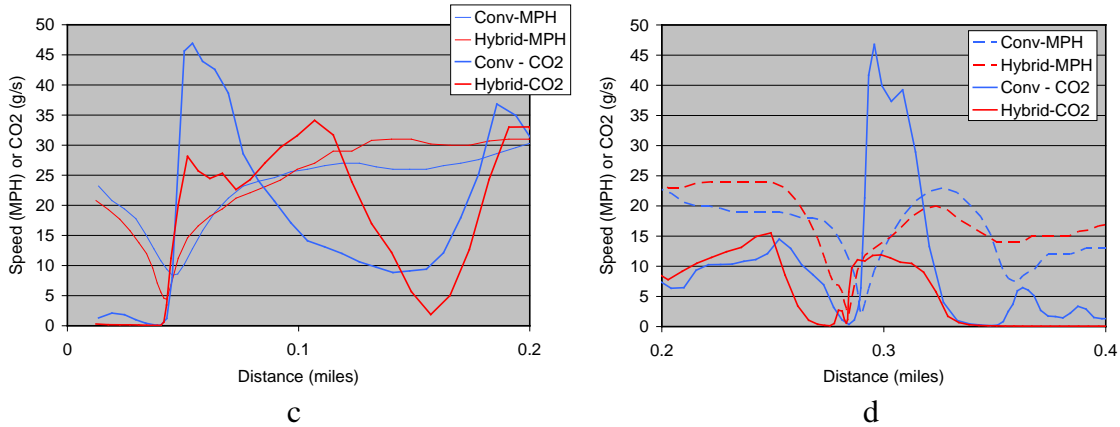

Figure 2-8 (a-d) compares the CO₂ emissions rate (in g/s) during typical launch (starting from a stop) events in both buses. Both vehicles showed a spike in CO₂ emissions when starting from a stop. However, this spike was much more attenuated with the hybrid bus, which demonstrates the ability of the launch assist system to reduce CO₂ emissions. The magnitude of this attenuation varied depending on the exact event, however reductions of over 50 percent were not uncommon. Also worth noting is that near the 0.35 mile mark on Figure 2-8-d (lower-right), the CO₂ emissions are near zero, suggesting that the vehicle is maintaining a speed of approximately 15 MPH solely on electric power.

Figure 2-8 Hybrid and Conventional Bus CO₂ Emission Rates (g/s)



Heavy-Duty GHG and Fuel Efficiency Standards FRM: Technologies, Cost, and Effectiveness



Other observations through this testing suggest significant complexity in the calibration of the hybrid powertrain, presumably with the intent of reducing fuel consumption. One example is the set of engine speed-torque points over a given route (see Figure 2-9). The calibration of the hybrid powertrain (red) shows distinct patterns for where the engine operates. First, the engine is less frequently loaded at, or near idle speed. Second, the engine frequently operates at 1200 RPM, which is the lowest speed at which peak torque is available. Third, when more power is required (beyond 100 percent torque at 1200 RPM), the engine tends to operate along the maximum torque curve as RPM is increased. Keeping engine speed as low as possible reduces frictional losses, thus increasing efficiency. In contrast, the speed-torque points of the conventional bus show a much more random distribution and propensity for operating at lower engine loads.

Figure 2-9 Hybrid and Conventional Bus Operating Map Comparison

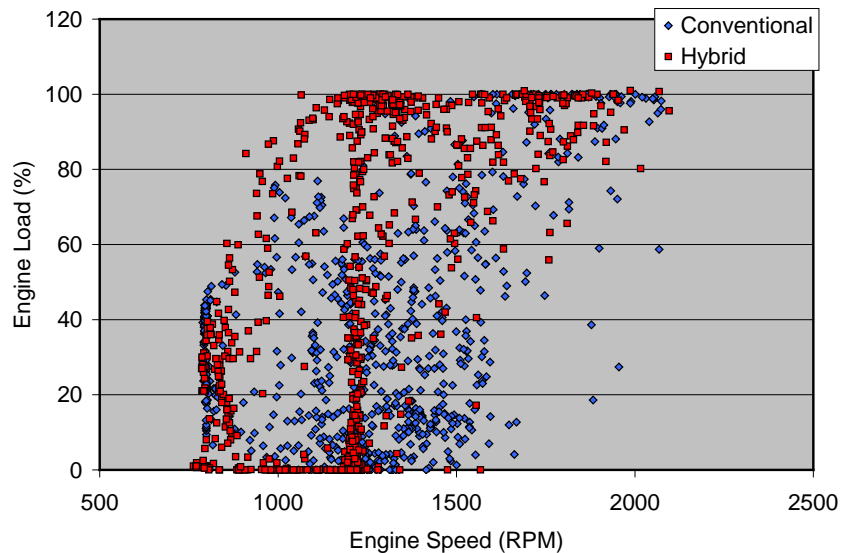

In summary, the hybrid powertrain has demonstrated significant opportunity in this testing for reduction of fuel consumption and CO₂ emissions in transit bus applications. Testing over typical bus routes showed up to a 37 percent reduction in both fuel consumption

Regulatory Impact Analysis

and CO₂ emissions. A summary of these findings is presented in Table 2-38. These reductions can be attributed to three features of the hybrid powertrain. First, electric launch assist facilitated through regenerative braking. Second, calibration of the engine to operate in the most efficient regions of the speed-torque map. Third, electric-only drive at lower speeds was witnessed occasionally.

Table 2-38 Hybrid Powertrain Benefit

		Conventional		Hybrid		Benefit	
		Avg	CoV	Avg	CoV	mpg or g/mile	percent
Route 1	MPG	5.15	8.2%	7.04	5.5%	1.89	37%
	CO ₂ (g/mile)	1995	8.0%	1442	5.5%	553	28%
	CO ₂ (g/bhp-hr)	624	3.7%	396	5.3%	228	37%
Route 2	MPG	5.52	8.0%	6.95	5.3%	1.43	26%
	CO ₂ (g/mile)	1859	7.9%	1467	5.5%	392	21%
	CO ₂ (g/bhp-hr)	602	4.0%	410	1.7%	192	32%

2.6.2.3 Additional Vocational Vehicle Technologies

The agencies assessed other vehicle technologies, such as idle reduction, advanced drivetrains, and weight reduction, and have concluded that they may have the potential to reduce fuel consumption and GHG emissions from at least certain vocational vehicles, but the agencies have not been able to estimate baseline fuel consumption and GHG emissions levels for each type of vocational vehicle and for each type of technology, given the wide variety of models and uses of vocational vehicles.

Idle reduction technologies such as APUs and cabin heaters can reduce workday idling associated with vocational vehicles. However, characterizing idling activity for the vocational segment in order to quantify the benefits of idle reduction technology is complicated by the variety of duty cycles found in the sector. Idling in school buses, fire trucks, pick-up trucks, delivery trucks, and other types of vocational vehicles varies significantly. Given the great variety of duty cycles and operating conditions of vocational vehicles and the timing of these rules, it is not feasible at this time to establish an accurate baseline for quantifying the expected improvements which could result from use of idle reduction technologies.

Similarly, for advanced drivetrains and advanced transmissions determining a baseline configuration, or a set of baseline configurations, is extremely difficult given the variety of trucks in this segment. The agencies do not believe that we can legitimately base standard stringency on the use of technologies for which we cannot identify baseline configurations, because absent baseline emissions and baseline fuel consumption, the emissions reductions achieved from introduction of the technology cannot be quantified.

For some technologies, such as weight reduction and improved auxiliaries – such as electrically driven power steering pumps and the vehicle’s air conditioning system -- the need to limit technologies to those under the control of the chassis manufacturer further restricted the agencies’ options for incorporating the technologies into the final rules. For example, lightweight components that are under the control of chassis manufacturers are limited to a very few components such as frame rails. Considering the fuel efficiency and GHG emissions reduction benefits that will be achieved by finalizing these rules in the timeframe proposed, rather than delaying in order to gain enough information to include additional technologies, the agencies have decided to finalize standards that do not assume the use of these technologies and will consider incorporating them in a later action applicable to later model years.

2.7 Air Conditioning

Air conditioning (A/C) systems contribute to GHG emissions in two ways – direct emissions through refrigerant leakage, and indirect exhaust emissions due to the extra load on the vehicle’s engine to provide power to the air conditioning system. Hydrofluorocarbon (HFC) refrigerants, which are powerful GHG pollutants, can leak from the A/C system. This includes the direct leakage of refrigerant as well as the subsequent leakage associated with maintenance and servicing, and with disposal at the end of the vehicle’s life. No other vehicle system has associated GHG leakage.¹²⁶ The current widely-used refrigerant – R134a, has a high global warming potential (GWP) of 1430.¹²⁷ Due to the high GWP of this HFC, a small leakage of the refrigerant has a much greater global warming impact than a similar amount of emissions of CO₂ or other mobile source GHGs.

Heavy-duty air conditioning systems today are similar to those used in light-duty applications. However, differences may exist in terms of cooling capacity (such as sleeper cabs have larger cabin volumes than day cabs), system layout (such as the number of evaporators), and the durability requirements due to longer truck life. However, the component technologies and costs to reduce direct HFC emissions are similar between the two types of vehicles.

The quantity of indirect GHG emissions from A/C use in heavy-duty trucks relative to the CO₂ emissions from driving the vehicle and moving freight is very small. Therefore, a credit approach for improved A/C system efficiency is not appropriate for this segment of vehicles because the value of the credit is too small to provide sufficient incentive to utilize feasible and cost-effective air conditioning leakage improvements. For the same reason, including air conditioning leakage improvements within the main standard would in many instances result in lost control opportunities. Therefore, EPA is finalizing that truck manufacturers be required to meet a low leakage requirement for all air conditioning systems installed in 2014 model year and later trucks, with one exception. EPA is not establishing leakage standards for Class 2b-8 Vocational Vehicles at this time due to the complexity in the build process and the potential for different entities besides the chassis manufacturer to be involved in the air conditioning system production and installation, with consequent difficulties in developing a regulatory system.

2.7.1 Refrigerant Leakage

Based on measurements from 300 European light-duty vehicles (collected in 2002 and 2003), Schwarz and Harnisch estimate that the average HFC direct leakage rate from modern A/C systems was estimated to be 53 g/yr.¹²⁸ This corresponds to a leakage rate of 6.9 percent per year. This was estimated by extracting the refrigerant from recruited vehicles and comparing the amount extracted to the amount originally filled (as per the vehicle specifications). The fleet and size of vehicles differs from Europe and the United States, therefore it is conceivable that vehicles in the United States could have a different leakage rate. The authors measured the average charge of refrigerant at initial fill to be about 747 grams (it is somewhat higher in the U.S. at 770g), and that the smaller cars (684 gram charge) emitted less than the higher charge vehicles (883 gram charge). Moreover, due to the climate differences, the A/C usage patterns also vary between the two continents, which may influence leakage rates.

Vincent et al., from the California Air Resources Board estimated the in-use refrigerant leakage rate to be 80 g/yr.¹²⁹ This is based on consumption of refrigerant in commercial fleets, surveys of vehicle owners and technicians. The study assumed an average A/C charge size of 950 grams and a recharge rate of 1 in 16 years (lifetime). The recharges occurred when the system was 52 percent empty and the fraction recovered at end-of-life was 8.5 percent.

Since the A/C systems are similar in design and operation between light- and heavy-duty vehicles, and emissions due to direct refrigerant leakage are significant in all vehicle types, EPA is finalizing a leakage standard which is a “percent refrigerant leakage per year” to assure that high-quality, low-leakage components are used in each air conditioning system design. The agency believes that a single “gram of refrigerant leakage per year” would not fairly address the variety of air conditioning system designs and layouts found in the heavy-duty truck sector. EPA is finalizing a standard of 1.50 percent leakage per year for Heavy-Duty Pickup Trucks and Vans and Class 7/8 Tractors. The final standard was derived from the vehicles with the largest system refrigerant capacity based on the Minnesota GHG Reporting database.¹³⁰ As shown in Figure 2-10, the average percent leakage per year of the 2010 model year vehicles in the upper quartile in terms of refrigerant capacity was 1.60 percent (for reference, in the light-duty 2012-2016MY vehicle rulemaking, the average was estimated to be 2.7 percent, based on a leakage rate of 20.7 g/yr and a system capacity of 770 g).

Heavy-Duty GHG and Fuel Efficiency Standards FRM: Technologies, Cost, and Effectiveness

Figure 2-10 Distribution of Percentage Refrigerant Loss Per Year - Vehicles in Upper Quartile of A/C System Refrigerant Capacity (from 2010 Minnesota Reporting Data).

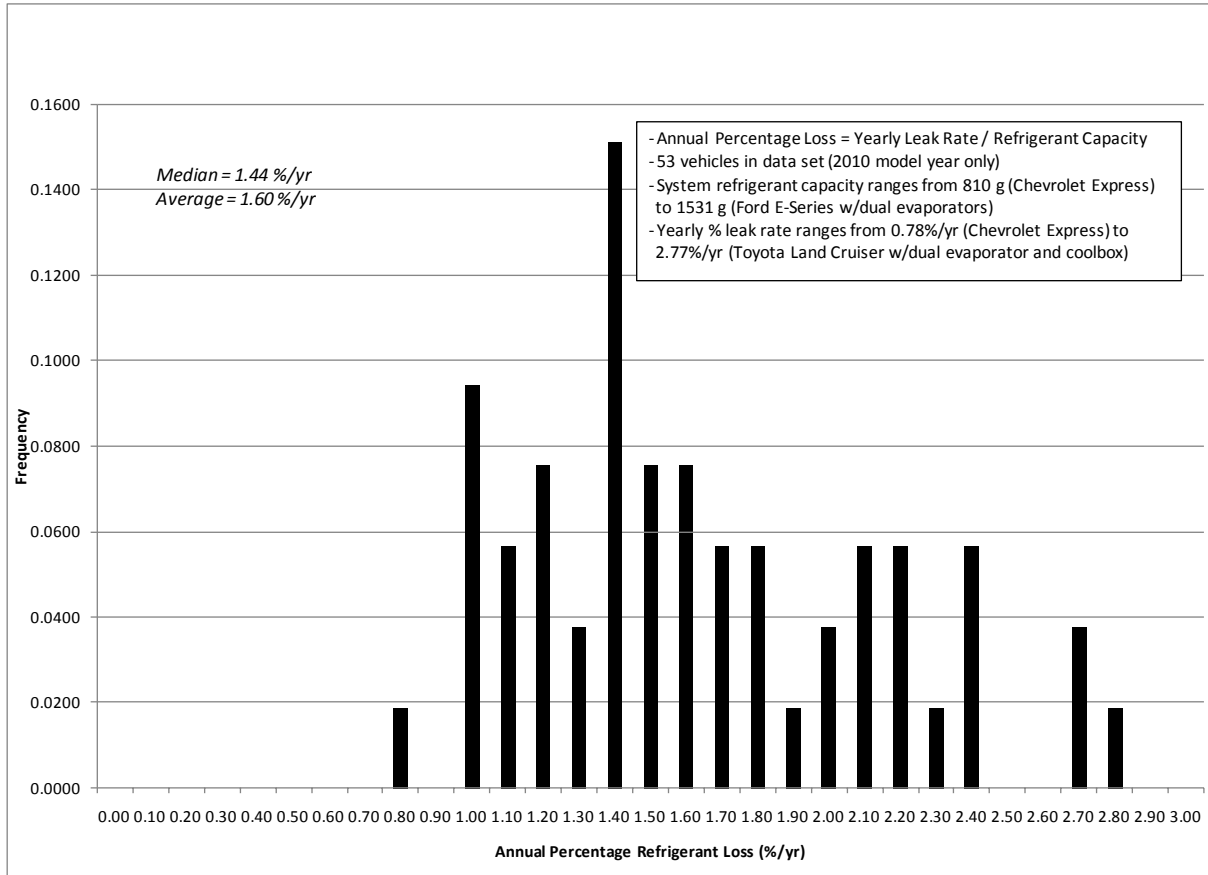

By requiring that all heavy-duty trucks achieve the leakage level of 1.50 percent per year, roughly half of the vehicles in the 2010 data sample would need to reduce their leakage rates, and an emissions reduction roughly comparable to that necessary to generate direct emission credits under the light-duty vehicle program would result. See 75 FR at 25426-247. We believe that a yearly system leakage approach will assure that high-quality, low-leakage, components are used in each A/C system design, and we expect that manufacturers will reduce A/C leakage emissions by utilizing improved, leak-tight components. Some of the improved components available to manufacturers are low-permeation flexible hoses, multiple o-ring or seal washer connections, and multiple-lip compressor shaft seals. The availability of low leakage components in the market is being driven by the air conditioning credit program in the light-duty GHG rulemaking (which applies to 2012 model year and later vehicles). EPA believes that reducing A/C system leakage is both highly cost-effective and technologically feasible. The cooperative industry and government Improved Mobile Air Conditioning (IMAC) program has demonstrated that new-vehicle leakage emissions can be reduced by 50 percent by reducing the number and improving the quality of the components, fittings, seals, and hoses of the A/C system.¹³¹ All of these technologies are already in commercial use and exist on some of today's systems.

Regulatory Impact Analysis

EPA requires that manufacturers demonstrate improvements in their A/C system designs and components through a design-based method. The method for calculating A/C Leakage is based closely on an industry-consensus leakage scoring method, described below. This leakage scoring method is correlated to experimentally-measured leakage rates from a number of vehicles using the different available A/C components. Under this approach, manufacturers would choose from a menu of A/C equipment and components used in their vehicles in order to establish leakage scores, which would characterize their A/C system leakage performance and calculate the percent leakage per year as this score divided by the system refrigerant capacity.

Consistent with the Light-Duty Vehicle Greenhouse Gas Emissions rulemaking, a manufacturer would compare the components of its A/C system with a set of leakage-reduction technologies and actions that is based closely on that being developed through IMAC and the Society of Automotive Engineers (as SAE Surface Vehicle Standard J2727, August 2008 version).¹³² See generally 75 FR at 25426. The SAE J2727 approach was developed from laboratory testing of a variety of A/C related components, and EPA believes that the J2727 leakage scoring system generally represents a reasonable correlation with average real-world leakage in new vehicles. Like the IMAC approach, our proposed approach would associate each component with a specific leakage rate in grams per year identical to the values in J2727 and then sum together the component leakage values to develop the total A/C system leakage. However, in the heavy-duty truck program, the total A/C leakage score is then divided the value by the total refrigerant system capacity to develop a percent leakage per year value.

2.7.2 System Efficiency

A program could also be developed that includes efficiency improvements. CO₂-equivalent emissions and fuel consumption are also associated with air conditioner efficiency, since air conditioners create load on the engine. See 74 FR at 49529. However, the agencies are not setting air conditioning efficiency standards for heavy-duty trucks, as the fuel consumption and CO₂ emissions due to air conditioning systems in heavy-duty trucks are minimal (compared to their overall fuel consumption and emissions of CO₂). For example, EPA conducted modeling of a Class 8 sleeper cab using GEM to evaluate the impact of air conditioning and found that it leads to approximately 1 gram of CO₂/ton-mile. Therefore, a projected 24 percent improvement of the air conditioning system (the level projected in the light-duty GHG rulemaking), would only reduce CO₂ emissions by less than 0.3 g CO₂/ton-mile, or approximately 0.3 percent of the baseline Class 8 sleeper cab CO₂ emissions.

2.8 Other Fuel Consumption and GHG Reducing Strategies

There are several other types of strategies available to reduce fuel consumption and GHG emissions from trucks. For the reader's reference, EPA and NHTSA identify several of these technologies and strategies below, but we note that they are outside the regulatory framework currently identified and will neither be required by final standards nor were they considered in determining the stringency of the final standards.

2.8.1 Auxiliaries for HD Tractors and Vocational Vehicles

The accessories on a truck engine, including the alternator, coolant and oil pumps are traditionally mechanically gear- or belt-driven by the base engine. In general, the effect of accessory power consumption in trucks is much less than in cars, but the mechanical auxiliaries operate whenever base engines are running, which can waste energy when the auxiliaries are not needed. The replacement of mechanical auxiliaries by electrically-driven systems can decouple mechanical loads from the base engine and reduce energy use. Since the average engine loads from mechanical auxiliaries are higher than those from a small generator that supplies electricity to electric auxiliaries, base engine fuel can be reduced. A reduction in CO₂ emissions and fuel consumption can be realized by driving them electrically and only when needed (“on-demand”). The heavy and medium trucks have several auxiliary systems:

- Air compressor,
- Hydraulic pumps,
- Coolant pump,
- Engine oil and fuel pumps,
- Fans, and
- Air conditioning compressor.

The systems listed above, although not inclusive, can be optimized by various methods reducing fuel consumption and GHG emissions:

- *Electric power steering (EPS)* – is an electrically-assisted steering system that has advantages over traditional hydraulic power steering because it replaces a continuously operated hydraulic pump, thereby reducing parasitic losses from the accessory drive.
- *Electric water pumps and electric fans* - can provide better control of engine cooling. For example, coolant flow from an electric water pump can be reduced and the radiator fan can be shut off during engine warm-up or cold ambient temperature conditions which will reduce warm-up time, reduce warm-up fuel enrichment, and reduce parasitic losses. Indirect benefit may be obtained by reducing the flow from the water pump electrically during the engine warm-up period, allowing the engine to heat more rapidly and thereby reducing the fuel enrichment needed during cold starting of the engine.
- *High efficiency alternators* - provide greater electrical power and efficiency at road speed or at idle than conventional original equipment replacement alternators that typically operate at 55 percent efficiency.
- *If electric power is not available* - there are still some technologies that can be applied to reduce the parasitic power consumption of accessories. Increased component efficiency is one approach, and clutches can be used to disengage the alternator and air compressor when they are not required. Many MD/HD engines incorporate clutched cooling fans which can be shut off during engine warm-up, thereby not requiring

Regulatory Impact Analysis

electric cooling fans. Air compressors that are rotating but not creating pressure absorb about half the power of a pumping compressor, and compressors normally only pump a small percentage of the time in long-haul trucks.

Several studies have documented the GHG reductions from electrification and/or optimization of truck auxiliaries. One study, based on a full-scaled test of a prototype truck that used a small generator to produce electricity, full electrification of auxiliaries reduces fuel use by 2 percent including extended idle and estimated potential reductions in modal GHG emissions are 1.4 percent. Another study recently completed by Ricardo discussed the advantages of electrification of engine accessories along with the potential to increase fuel economy citing examples such as variable flow water pumps and oil pumps.¹³³ Potential gains may be realized in the range of 1 to 3 percent but are highly dependent on truck type, size and duty cycle. In a NESCCAF study, the accessory power demand of a baseline truck was modeled as a steady state power draw of 5 kW, and 3 kW for more electrical accessories in individual vehicle configurations that included electric turbo compounding. The 2 kW savings versus average engine power of 100 to 200kW over a drive cycle nets roughly 1 to 2 percent savings compared to a baseline vehicle.

Accurate data providing power consumption values for each discrete accessory over a range of operating conditions was not available due to the variation of the truck fleet. Based on research and industry feedback, a simplified assumption for modeling was made that the average power demand for mechanically driven accessories is 5 kW, and the average power demand for electrically driven accessories is 3 kW. This provides a 2 kW advantage for the electrically driven accessories over the entire drive cycle represented and is estimated to provide a 1.5 percent improvement in efficiency and reduction in CO₂ emissions. As a comparison, the average load on a car engine over a drive cycle may be in the 10 to 20 kW range. At this level, a 2 kW reduction in accessory loads of a passenger vehicle makes a significant difference (approximately 10 percent). Given the higher loads experienced by truck engines, accessory demand is a much smaller share of overall fuel consumption. Accessory power demand determined by discrete components will not be included in the model at this time and a power draw of 5 kW for standard accessories and 3 kW for electrical accessories will be used. There is opportunity for additional research to improve upon this simple modeling approach by using actual measured data to improve the modeling assumptions.

2.8.2 Driver training

Driver training that targets fuel efficiency can help drivers recognize and change driving habits that waste fuel and increase harmful emissions. Even highly experienced truck drivers can boost their skills and enhance driving performance through driver training programs.¹³⁴

Driving habits that commonly waste fuel are high speed driving, driving at unnecessarily high rpm, excessive idling, improper shifting, too-rapid acceleration, unnecessarily frequent stops and starts, and poor route planning. Well-trained drivers can reduce fuel consumption by applying simple techniques to address vehicle and engine speed, shifting patterns, acceleration and braking habits, idling, and use of accessories.¹³⁵ Some

techniques include starting out in a gear that does not require using the throttle when releasing the clutch, progressive shifting (upshifting at the lowest possible rpm), anticipating traffic flow to reduce starts and stops, use of block shifting where possible (e.g., shifting from 2nd to 5th gear), using cruise control as appropriate, and coasting down or using the engine brake to slow the vehicle, instead of gearing down or using the brake pedal.

As discussed elsewhere in this chapter, idling can be eliminated by the use of auxiliary power units or other idle reduction solutions that provide power or heating and cooling to the cab at a much lower rate of energy consumption.

Better route planning that reduces unnecessary mileage and the frequency of empty backhauls, and takes into account factors like daily congestion patterns is another facet of a comprehensive driver training program. Such planning can be assisted through the use of logistics companies, which specialize in such efficiencies.

In its report, *Technologies and Approaches to Reducing the Fuel Consumption of Medium and Heavy-Duty Vehicles*, the National Research Council cited studies that found, on average, a five percent improvement in vehicle fuel efficiency due to driver training.¹ EPA's SmartWay Transport Partnership has documented the success of dozens of trucking companies' use of driver training programs. One company reported saving an average of 42 gallons per student, or 335,000 gallons of fuel per year; and, saving 837,000 gallons of fuel in the four years it has had its training program in place.¹³⁶ Trucking fleets can provide additional motivation to reward drivers for improved performance with incentive programs, which may be monetary or provide other forms of benefits and recognition. Successful programs are those that perform ongoing reviews of driver techniques, and provide assistance to improve and/or retrain drivers.

While EPA and NHTSA recognize the potential opportunity to reduce fuel consumption and greenhouse gas emissions by encouraging fuel-efficient driver habits, mandating driver training for all of the nation's truck drivers is beyond the scope of this regulation. However, in developing this regulation, the agencies did consider technologies that can provide some of the benefits typically addressed through driver training. Examples include automatic engine shutdown to reduce idling, automated or automated manual transmissions to optimize shifting, and speed limiters to reduce high speed operation. EPA will also continue to promote fuel-efficient driving through its SmartWay program. In addition to providing fact sheets on fuel efficient driving,¹³⁷ SmartWay is collaborating with Natural Resources Canada's FleetSmart program to develop a web-enabled "fuel efficient driver" training course for commercial truck drivers. Once the course is developed, it will complement the agencies' regulatory program by making fuel efficient driver training strategies available to any commercial truck driver.

2.8.2.1 Replacement Tires

Original equipment (OE) tires are designed and marketed for specific applications and vehicles. Their characteristics are optimized for the specific application and vehicle. Because they are not sold as OE, replacement tires are generally designed for a variety of applications and vehicle types that have different handling characteristics. The tires marketed to the

Regulatory Impact Analysis

replacement tire market tend to place greater emphasis on tread wear, and therefore often have higher rolling resistance than OE tires.

The market for replacement tires is individual vehicle owners and fleet owners and not the vehicle manufacturers. Many fleets report that the cost of fuel as opposed to driver pay is its number one cost. This has resulted in a greater demand for low rolling resistance replacement tires. Both heavy-duty and medium-duty truck fleets are looking for ways to reduce operational costs.

In 2007, EPA's SmartWay Transport Partnership introduced a means to distinguish tires based on their rolling resistance. Since 2007 the number of low rolling resistance tires available to vehicle owners and vehicle fleets has increased greatly, which is an indicator of an increase in demand. EPA expects this trend to continue. In addition, effective January 1, 2010, California Air Resource Board requires that all tractor-trailers hauling dry van trailers on any California road be equipped with SmartWay verified low rolling resistance tires; other states may adopt this requirement. EPA expects this requirement will drive the demand for low rolling resistance tires even further.

2.8.2.2 Retreaded Tires

The tread life of a tire is a measure of durability and some tires are designed specifically for greater durability. Commercial truck tires are designed to be retreaded, a process in which a new tread is bonded to the tire casing. The original tread of a tire will last anywhere from 100,000 miles to over 300,000 miles, depending on vehicle operation, original tread depth, tire axle position, and proper tire maintenance. Retreading can extend the tire's useful life by 100,000 miles or more.¹³⁸ In 2005, the Tire Industry Association estimated that approximately 17.6 million retreaded truck tires were sold in North America¹³⁹.

To maintain the quality of the casing and increase the likelihood of retreading, a tire should be retreaded before the tread depth is reduced to its legal limit. At any time, a steer tire must have a tread depth of at least 4/32 of an inch and a drive tire must have a tread depth of at least 2/32 of an inch (49 CFR § 393.75). To protect the casing, a steer tire is generally retreaded once the tread is worn down to 6/32 of an inch and a drive tire is retreaded once the tread is worn down to 8/32 of an inch.¹⁴⁰ Tires used on Class 8 vehicles are retreaded as many as three times.

Both the casing and the tread contribute to a tire's rolling resistance. It is estimated that 35 to 50 percent of a tire's rolling resistance is the result of the tread.⁶³ Differences in drive tire rolling resistance of up to 50 percent for the same casing with various tread compounds have been demonstrated. For example, a fuel efficient tread (as defined by the manufacturer) was added to two different casings resulting in an average increase in rolling resistance of 48 percent. When a nonfuel efficient tread (also defined by the manufacturer) was added to the same casings, the rolling resistance increased by 125 percent on average. This characterizes the effect of the tread on the rolling resistance of a tire.

Because tires can be retreaded multiple times, changes in the casing due to wear, damage and material aging may impact rolling resistance to a greater degree than would occur

in an original tire. Additionally, as evidenced above, if a tread compound different than the original tread is used, a retreaded tire can have higher or lower rolling resistance than the original tire. Since the agencies have no way of knowing whether the rolling resistance of retreaded tires will be higher or lower than the rolling resistance of the original tires, we similarly have no way of knowing whether low rolling resistance tire benefits will continue to accrue for a vehicle's entire lifetime.

There is a cost savings associated with retread tires. A new retread costs between \$150 and \$200, compared to a new tire which costs typically around \$400. Since retreads are not typically used on the steer axle position, this represents a savings of \$1,600 to \$2,000 per tractor.

2.8.3 Automatic Tire inflation and Tire Pressure Monitoring System

Underinflation of tires has the potential to reduce fuel economy by as much as two to three percent.¹ Although most truck fleets understand the importance of keeping tires properly inflated, it is likely that a substantial proportion of trucks on the road have one or more underinflated tires. An industry survey conducted in 2002 at two truck stops found that fewer than half of the tires checked were within five pounds per square inch (psi) of their recommended inflation pressure. Twenty-two percent of the vehicles checked had at least one tire underinflated by at least twenty psi, and four percent of the vehicles were running with at least one flat tire, defined as a tire underinflated by fifty psi or more. The survey also found mismatches in tire pressure exceeding five percent for dual tires on axle ends.¹⁴¹

A commercial vehicle tire condition study conducted by the Federal Motor Vehicle Safety Administration (FMCSA) in 2003 found similar indicators of poor tire inflation pressure maintenance in commercial fleets. The FMCSA concluded that only forty-four percent of all tires on commercial vehicles were inflated within 5 psi of the recommended pressure, while over seven percent of all tires in operation on commercial vehicles were underinflated by at least twenty psi. It was also determined that the rates of tires used in dual assemblies that differed in pressure by more than 5 psi was approximately twenty percent for tractor duals and twenty-five percent for trailer duals. Finally, the FMCSA concluded that there were significant differences in tire inflation maintenance practices between private and for-hire fleets, smaller and larger fleets, and local bus and motor coach fleets.¹⁴²

Proper tire inflation pressure can be maintained with a rigorous tire inspection and maintenance program or with the use of tire pressure and inflation systems. These systems monitor tire pressure; some also automatically keep tires inflated to a specific level. However, while the agencies recognize that such devices could have a beneficial effect on fuel economy, their use is not included in the regulatory framework. Notwithstanding the cited studies, the current level of underinflation of tires in the American truck fleet is not known,¹ which means that neither a baseline value nor an estimate of the fuel savings from the use of automatic tire inflation systems can be quantified with certainty and thus is not included as part of the technology package on which standard stringency is predicated. Through its SmartWay program, however, EPA does provide information on proper tire inflation pressure and on tire inflation and tire inflation pressure monitoring systems.¹⁴³

2.8.4 Engine Features

Previous sections 2.3.2.2 through 2.3.2.8 describe the technologies that can be tested in an engine test cell for certification purpose and could be potentially implemented in production before the time frame of 2017. Some other technologies that cannot be easily tested in an engine test cell, but can improve engine fuel economy, are still worth mentioning for the reader's reference. Examples include these technologies, such as driver rewards, load based speed control, gear down protection, and fan control offered by Cummins's PowerSpec.

The driver reward developed by Cummins monitors and averages the driver's trip fuel economy and trip idle percent time at regular intervals, seeking to modify driver behavior by offering incentives to use less fuel. Desirable driving habits, such as low percentage of idle time, and high MPG, are rewarded with higher limits on the road speed governor, cruise control or both. The load based speed control or other similar programs are designed to improve fuel economy, lower vehicle noise, and improve driver satisfaction by managing engine speed (rpm) based on real time operating conditions. During high power requirements, this type of technology enhances engine performance by providing the driver with an extended operating range. In addition to the fuel economy benefits from operating the engine at lower speeds, vehicle noise is lowered.

Gear down protection offered by Cummins is to promote increased fuel efficiency by encouraging the vehicle driver to operate as much as effectively possible in top gear where fuel consumption is lower. This can be done by limiting vehicle speed in lower gears. Maximizing time in top gear means the engine runs in a lower rpm range, where fuel efficiency is best with improved durability and without compromising performance. Difference between top gear and one gear down can be as much as 16 percent in fuel economy. More detailed descriptions of many technologies including those mentioned here can be viewed at Cummins's website.¹⁴⁴

Although these technologies mentioned in this section are not able to be tested in an engine test cell environment, thus being unable to be directly used for benefits of certification purpose, the agencies encourage manufacturers to continue improving the current and developing new technologies, thereby reducing fuel consumption and greenhouse gases in a broader way.

2.8.5 Logistics

Logistics encompasses a number of interrelated, mostly operational factors that affect how efficiently the overall freight transport system works. These factors include choice of mode, carrier and equipment; packaging type and amount; delivery time; points of origin and destination; route choice, including locations of ports and distribution hubs; and transportation tracking systems. These factors are controlled by the organizations that ship and receive goods. Due to the specialized nature of logistics management, organizations increasingly rely upon internal or outsourced business units to handle this function; many transportation providers offer logistics management services to their freight customers.

Because optimizing logistics is specific to each individual freight move, neither EPA nor NHTSA believed it is feasible to manage logistics through this regulation. However, implementing certain system-wide logistics enhancements on a national level could provide benefits. As described in the 2010 NAS Report,¹ a broader national approach could include enhanced telematics and intelligent transportation systems; changes to existing infrastructure to optimize modal choice; and increased truck capacity through changes to current truck weight and size limits. While such a broad transformation of our freight system is worthwhile to consider, implementing such system-wide changes falls outside the scope of this regulation. As the National Research Council noted,¹⁴⁵ due to its complex nature, logistics management is not readily or effectively addressed through any single approach or regulation; a number of complementary measures and alternatives are needed. Such measures can include initiatives that enable companies to better understand, measure and track the benefits of logistics optimization from an environmental and economic standpoint. The SmartWay program provides uniform tools and methodologies that companies can use to assess and optimize transportation supply chains, and that can complement any future regulatory and nonregulatory approaches.

2.8.6 Longer Combination Vehicles, Weight Increase

Longer combination vehicles (LCVs) are tractor-trailer combinations that tow more than one trailer, where at least one of the trailers exceeds the “pup” size (typically 24-28 feet). Because LCVs are capable of hauling more freight than a typical tractor-trailer combination, using LCVs reduces the number of truck trips needed to carry the same amount of freight. On a fleetwide basis, this saves fuel, reduces greenhouse gas emissions, and reduces per-fleet shipping costs. A typical non-LCV may tow a single trailer up to 53 feet in length, or tow two pup trailers, or even be a straight truck with a pup trailer connected via a draw bar. In contrast, the typical LCV may consist of a tractor towing two trailers of 45-48 feet, and occasionally 53 feet in length (a “turnpike double”), or one of that size and one pup (a “Rocky Mountain double”), or may tow three pups (a “triple”).

Trucks consisting of a two-axle tractor combined with two one-axle trailers up to 28.5 feet are permitted on all highways in the U.S. National Network, which consists of the interstate highway system and certain other roads. Individual states may permit longer LCVs to operate on roads that are not part of the National Network. They are allowed in 16 western states, but only on turnpikes in the five states east of the Mississippi that allow them; no new states were granted permitting authority for LCVs after 1991.¹⁴⁶ Regulations vary among states; some allow LCVs with more than three trailers, but only by permit. Longer length turnpike doubles are typically restricted to tolled turnpikes. Such restrictions are based on considerations of the difficulty of operation and on expected weather conditions. Other regulations on the types of LCVs allowed are seen in other countries; in Australia, where weather tends to be stable and dry and cross-country roads tend to be extremely long and flat, “road trains” of up to four trailers, usually with three axles per trailer, are permitted.

Some proponents of liberalized size and weight regulations project substantial benefits, estimating that highway freight productivity could be doubled and costs reduced. Despite the potential benefits of LCVs, as the National Research Council noted in its recent report, there are considerations that may make LCVs less cost-effective and less safe,

Regulatory Impact Analysis

compared to traditional tractor-trailer configurations. For example, if infrastructure (*e.g.*, bridges with sufficient capacity; roadways with adequate lane width and curb radii for turning to accommodate an LCV safely) are not available without traveling far from a more efficient route, or if there is insufficient opportunity for the LCV to make the most of the available volume in multiple trailers, then LCVs would not be cost-effective.

The increased vehicular weight of LCVs is both a safety issue and a road maintenance issue (see discussion below on increasing vehicle weight and legal load limits). The additional weight of extra trailers increases braking and stopping distance, and adds difficulty in maintaining speed in grade situations.

With additional regard to safety, LCVs might have trouble with offtracking (when the truck's front and rear wheels do not follow the same path, which can result in departing the lane boundaries—a particular problem with longer LCVs), and could increase the challenge of merging with and maneuvering in traffic. Lateral stability is a greater problem in LCVs, and leads to a greater chance of rollover, particularly when the individual trailers are shorter. Also, when a vehicle is passing a LCV on a two-lane road, the period of time spent in the opposing lane (up to 2-3 seconds) poses another safety problem.¹⁴⁷ Such safety considerations impact decisions regarding restrictions on the use of LCVs, even when they may otherwise be a cost-effective freight choice.

Related, moves to increase commercial vehicle weight limits concern not only relaxing limitations on the use of LCVs, but also increasing gross vehicle weight limits for single unit trucks and conventional tractor-trailer combinations, as well as increasing axle load limits and trailer lengths. Some analysts cite scenarios in which such relaxations result in increased highway freight productivity, while yielding significant reductions in shipping costs, congestion, and total vehicle miles traveled.¹⁴⁸ Increasing the weight limits allows commercial freight vehicles to carry heavier loads, reducing the number of trucks required to transport freight, which could potentially result in overall emissions and fuel consumption reductions.

Federal law limits gross vehicle weight for commercial vehicles operating in the Interstate Highway System to a maximum of 80,000 lbs. (maximum 20,000 lbs. per single axle, 34,000 lbs. per tandem axle), with permits available for certain oversize or overweight loads and exceptions allowing 400 lbs. more for tractors with idle reduction devices. Additional vehicle weight limitations have been set by state and local regulations. These limitations arise from considerations of infrastructure characteristics, traffic densities, economic activities, freight movement, mode options, and approach to transportation design. In some cases, state limits are higher (less stringent) than federal limits.¹⁴⁹ While these parameters are changeable, federal weight limits on vehicles have not changed since 1982, and limits set by states have been frozen since 1991.

In response to input from the freight transportation sector and other interested parties, the Department of Transportation, the Transportation Research Board, the General Accounting Office, and others have conducted studies examining the impacts of proposals related to liberalized weight limits. Regardless of the potential benefits of such action, the analyses predict premature degradation of infrastructure (*e.g.*, bridges, pavement, grades) as a

consequence. Increased costs required to maintain and upgrade the highway system would impose high burdens on already-strained public resources, raising serious questions about the desirability of relaxing weight limits, and about whether such expenditures provide adequate public good to justify them. Safety issues similar to those cited for LCVs enter into this debate, as do concerns with the effect on the efficiency of automotive travel, impacts on and net productivity of other shipping modes (particularly rail), and potential environmental and social costs.

The 2010 NAS Report recognized the complexities and potential trade-offs involved in increasing vehicle size and weight limits.¹ While it is useful to discuss the potential emission and energy benefits of heavier and longer trucks, the far-reaching policy ramifications extend well beyond the scope of this rulemaking.

2.8.7 Traffic Congestion Mitigation

There are a wide range of strategies to reduce traffic congestion. Many of them are aimed at eliminating light-duty vehicle trips such as mass transit improvements, commute trip reduction programs, ridesharing programs, implementation of high occupancy vehicle lanes, parking pricing, and parking management programs. While focused on reducing light-duty vehicle trips, these types of strategies would allow heavy- and medium-duty vehicles to travel on less congested roads and thereby use less fuel and emit less CO₂.

A second group of strategies would directly impact CO₂ emissions and fuel consumption from all types of vehicles. One example of these strategies is road pricing, including increasing the price of driving on certain roads or in certain areas during the most congested periods of the day. A second example is reducing the speed limits on roads and implementing measures to ensure that drivers obey the lower speed limits such as increased enforcement or adding design features that discourage excessive speeds.

Some strategies would be designed to effect trips made by heavy- and medium-duty trucks. These would include programs to shift deliveries in congested areas to off-peak hours. Another example is to modify land use so that common destinations are closer together, which reduces the amount of travel required for goods distribution.

These types of congestion relief strategies have been implemented in a number of areas around the country. They are typically implemented either by state or local governments or in some cases strategies to reduce commuting trips and scheduling off-peak deliveries have been implemented by private companies or groups of companies.

2.9 Summary of Technology Costs Used in this Analysis

Table 2-39 shows the technology costs used throughout this analysis for heavy-duty engines, vocational vehicles and combination tractors for the years 2014-2020. Table 2-40 shows the technology costs used throughout this analysis for Class 2b and 3 diesel and gasoline trucks for the years 2014-2020. These tables reflect the impact of learning effects on estimated technology costs. Refer to Table 2-2 for details on the ICMs applied to each technology and Table 2-4 for the type of learning applied to each technology. The costs shown in the tables

Regulatory Impact Analysis

do not include the penetration rates so do not always reflect the technology's contribution to the resultant package costs. One final note of clarification is that the terms "MHDDcomb" and "HHDDcomb" in the "Class" column refer specifically to engines placed in combination tractors (Class 7 and 8 day cabs and sleeper cabs).

Heavy-Duty GHG and Fuel Efficiency Standards FRM: Technologies, Cost, and Effectiveness

Table 2-39 Technology Effectiveness and Costs, Inclusive of Markups, by Year for Heavy-duty Diesel^A and Gasoline Engines, Vocational Vehicles, and Combination Tractors (2009\$)

Technology	Applied to	Truck type	Class	CO ₂ eq Effectiveness	2014	2015	2016	2017	2018	2019	2020
Aftertreatment improvements	Engine		LHDD	1-4%	\$117	\$114	\$111	\$108	\$105	\$103	\$101
Turbo efficiency improvements	Engine		LHDD	1-2%	\$18	\$18	\$17	\$17	\$16	\$16	\$16
Piston improvements	Engine		LHDD	0.5-2%	\$3	\$3	\$3	\$3	\$2	\$2	\$2
Optimized water pump	Engine		LHDD		\$91	\$89	\$86	\$84	\$82	\$81	\$79
Optimized oil pump	Engine		LHDD		\$5	\$4	\$4	\$4	\$4	\$4	\$4
Optimized fuel pump	Engine		LHDD		\$5	\$4	\$4	\$4	\$4	\$4	\$4
Valve train friction reductions	Engine		LHDD		\$109	\$106	\$104	\$101	\$98	\$97	\$95
Optimized fuel rail	Engine		LHDD	2-7%	\$12	\$12	\$11	\$11	\$11	\$10	\$10
Optimized fuel injector	Engine		LHDD		\$15	\$14	\$14	\$13	\$13	\$13	\$13
EGR cooler improvements	Engine		LHDD		\$4	\$4	\$3	\$3	\$3	\$3	\$3
Cylinder head improvements	Engine		LHDD		\$11	\$11	\$10	\$10	\$10	\$10	\$10
2014 MY LHDD Engine Package	Engine		LHDD	5%	\$388	\$378	\$368				
2017 MY LHDD Engine Package	Engine		LHDD	9%				\$358	\$349	\$343	\$337

^A The costs included in the table represent technology costs. The engineering costs of \$6.8 million per diesel engine manufacturer per year for a five year period are not included in the table.

Regulatory Impact Analysis

Technology	Applied to	Truck type	Class	CO ₂ eq Effectiveness	2014	2015	2016	2017	2018	2019	2020
Aftertreatment Improvements	Engine		MHDD	1-4%	In R&D	In R&D	In R&D	In R&D	In R&D	In R&D	In R&D
Turbo efficiency improvements	Engine		MHDD	1-2%	\$18	\$18	\$17	\$17	\$16	\$16	\$16
Piston improvements	Engine		MHDD	0.5-2%	\$3	\$3	\$3	\$3	\$2	\$2	\$2
Optimized water pump	Engine		MHDD		\$91	\$89	\$86	\$84	\$82	\$81	\$79
Optimized oil pump	Engine		MHDD		\$5	\$4	\$4	\$4	\$4	\$4	\$4
Optimized fuel pump	Engine		MHDD		\$5	\$4	\$4	\$4	\$4	\$4	\$4
Valve train friction reductions	Engine		MHDD		\$82	\$80	\$78	\$76	\$74	\$73	\$71
Optimized fuel rail	Engine		MHDD	2-7%	\$10	\$10	\$10	\$9	\$9	\$9	\$9
Optimized fuel injector	Engine		MHDD		\$11	\$11	\$10	\$10	\$10	\$10	\$10
EGR cooler improvements	Engine		MHDD		\$4	\$4	\$3	\$3	\$3	\$3	\$3
Cylinder head improvements	Engine		MHDD		\$6	\$6	\$6	\$6	\$6	\$6	\$6
2014 MY MHDD Engine Package	Engine		MHDD	5%	\$234	\$228	\$222				
2017 MY MHDD Engine Package	Engine		MHDD	9%				\$216	\$211	\$207	\$204
Aftertreatment Improvements	Engine		MHDDcomb	1-4%	In R&D	In R&D	In R&D	In R&D	In R&D	In R&D	In R&D
Turbo efficiency improvements	Engine		MHDDcomb	1-2%	\$18	\$18	\$17	\$17	\$16	\$16	\$16
Piston improvements	Engine		MHDDcomb	0.5-2%	\$3	\$3	\$3	\$3	\$2	\$2	\$2
Optimized water pump	Engine		MHDDcomb		\$91	\$89	\$86	\$84	\$82	\$81	\$79
Optimized oil pump	Engine		MHDDcomb		\$5	\$4	\$4	\$4	\$4	\$4	\$4
Optimized fuel pump	Engine		MHDDcomb		\$5	\$4	\$4	\$4	\$4	\$4	\$4
Valve train friction reductions	Engine		MHDDcomb		\$82	\$80	\$78	\$76	\$74	\$73	\$71
Optimized fuel rail	Engine		MHDDcomb	2-7%	\$10	\$10	\$10	\$9	\$9	\$9	\$9
Optimized fuel injector	Engine		MHDDcomb		\$11	\$11	\$10	\$10	\$10	\$10	\$10
EGR cooler improvements	Engine		MHDDcomb		\$4	\$4	\$3	\$3	\$3	\$3	\$3
Cylinder head improvements	Engine		MHDDcomb		\$6	\$6	\$6	\$6	\$6	\$6	\$6
Turbo mechanical-compounding	Engine		MHDDcomb	2.5-5%	--	--	--	\$875	\$852	\$838	\$824
2014 MY MHDD Engine	Engine		MHDDcomb	3%	\$234	\$228	\$222				

Heavy-Duty GHG and Fuel Efficiency Standards FRM: Technologies, Cost, and Effectiveness

Technology	Applied to	Truck type	Class	CO ₂ eq Effectiveness	2014	2015	2016	2017	2018	2019	2020
Package											
2017 MY MHDD Engine Package	Engine		MHDDcomb	6%				\$1,091	\$1,063	\$1,045	\$1,027
Aftertreatment Improvements	Engine		HHDD	1-4%	In R&D	In R&D	In R&D	In R&D	In R&D	In R&D	In R&D
Turbo efficiency improvements	Engine		HHDD	1-2%	\$18	\$18	\$17	\$17	\$16	\$16	\$16
Piston improvements	Engine		HHDD	0.5-2%	\$3	\$3	\$3	\$3	\$2	\$2	\$2
Optimized water pump	Engine	HHDD	\$91		\$89	\$86	\$84	\$82	\$81	\$79	
Optimized oil pump	Engine	HHDD	\$5		\$4	\$4	\$4	\$4	\$4	\$4	
Optimized fuel pump	Engine	HHDD	\$5		\$4	\$4	\$4	\$4	\$4	\$4	
Optimized fuel rail	Engine		HHDD	2-7%	\$10	\$10	\$10	\$9	\$9	\$9	\$9
Optimized fuel injector	Engine	HHDD	\$11		\$11	\$10	\$10	\$10	\$10	\$10	
Cylinder head improvements	Engine	HHDD	\$6		\$6	\$6	\$6	\$6	\$6	\$6	
EGR cooler improvements	Engine	HHDD	\$4		\$4	\$3	\$3	\$3	\$3	\$3	
2014 MY HHDD Engine Package	Engine		HHDD	3%	\$234	\$228	\$222				
2017 MY HHDD Engine Package	Engine		HHDD	5%				\$216	\$211	\$207	\$204
Aftertreatment Improvements	Engine		HHDDcomb	1-4%	In R&D	In R&D	In R&D	In R&D	In R&D	In R&D	In R&D
Turbo efficiency improvements	Engine		HHDDcomb	1-2%	\$18	\$18	\$17	\$17	\$16	\$16	\$16
Piston improvements	Engine		HHDDcomb	0.5-2%	\$3	\$3	\$3	\$3	\$2	\$2	\$2
Optimized water pump	Engine	HHDDcomb	\$91		\$89	\$86	\$84	\$82	\$81	\$79	
Optimized oil pump	Engine	HHDDcomb	\$5		\$4	\$4	\$4	\$4	\$4	\$4	
Optimized fuel pump	Engine	HHDDcomb	\$5		\$4	\$4	\$4	\$4	\$4	\$4	
Optimized fuel rail	Engine		HHDDcomb	2-7%	\$10	\$10	\$10	\$9	\$9	\$9	\$9
Optimized fuel injector	Engine	HHDDcomb	\$11		\$11	\$10	\$10	\$10	\$10	\$10	
Cylinder head improvements	Engine	HHDDcomb	\$6		\$6	\$6	\$6	\$6	\$6	\$6	
EGR cooler improvements	Engine	HHDD	\$4		\$4	\$3	\$3	\$3	\$3	\$3	
Turbo mechanical-compounding	Engine		HHDDcomb	2.5-5%	--	--	--	\$875	\$852	\$838	\$824
2014 MY HHDD Engine Package	Engine		HHDDcomb	3%	\$234	\$228	\$222				

Regulatory Impact Analysis

Technology	Applied to	Truck type	Class	CO ₂ eq Effectiveness	2014	2015	2016	2017	2018	2019	2020
2017 MY HHDD Engine Package	Engine		HHDDcomb	6%				\$1,091	\$1,063	\$1,045	\$1,027
Engine friction reduction	Engine		HDG	1-3%	--	--	\$95	\$95	\$95	\$95	\$95
Coupled valve timing	Engine		HDG	1-4%	--	--	\$46	\$45	\$44	\$43	\$43
Stoich GDI-V8	Engine		HDG	1-2%	--	--	\$452	\$442	\$433	\$426	\$420
HD Gasoline Engine Package – 2016 MY	Engine		HDG	5%	--	--	\$594	\$582	\$572	\$565	\$558
LRR steer tire 8.1	Truck	Vocational	LH	2-3%	\$68	\$68	\$56	\$56	\$47	\$46	\$45
LRR drive tire 8.1	Truck	Vocational	LH		\$94	\$94	\$78	\$78	\$65	\$64	\$62
2014MY Vehicle Package	Truck	Vocational	LH	3%	\$81	\$79	\$77	\$75	\$73	\$72	\$71
LRR steer tire 8.1	Truck	Vocational	MH	2-3%	\$68	\$68	\$56	\$56	\$47	\$46	\$45
LRR drive tire 8.1	Truck	Vocational	MH		\$94	\$94	\$78	\$78	\$65	\$64	\$62
2014MY Vehicle Package	Truck	Vocational	MH	3%	\$81	\$79	\$77	\$75	\$73	\$72	\$71
LRR steer tire 8.1	Truck	Vocational	HH	2%	\$68	\$68	\$56	\$56	\$47	\$46	\$45
LRR drive tire 8.1	Truck	Vocational	HH		\$126	\$126	\$104	\$104	\$87	\$85	\$83
2014MY Vehicle Package	Truck	Vocational	HH	2%	\$97	\$94	\$92	\$90	\$87	\$86	\$84
Aero-Bin III	Truck	Class7_DayCab	LowRoof	1-2%	\$1,126	\$1,097	\$1,068	\$1,041	\$1,015	\$997	\$981
LRR steer tire	Truck	Class7_DayCab	LowRoof	1-3%	\$68	\$66	\$64	\$63	\$61	\$60	\$59
LRR drive tire	Truck	Class7_DayCab	LowRoof		\$63	\$61	\$60	\$58	\$57	\$56	\$55
Weight reduction: Single-wide tire	Truck	Class7_DayCab	LowRoof	<1%	\$336	\$327	\$319	\$311	\$303	\$298	\$293
Weight reduction: Aluminum steer wheel	Truck	Class7_DayCab	LowRoof		\$546	\$532	\$518	\$505	\$492	\$484	\$476
Weight reduction: Aluminum single-wide wheel	Truck	Class7_DayCab	LowRoof		\$654	\$637	\$621	\$605	\$590	\$580	\$570
Air Conditioning Leakage	Truck	Class7_DayCab	LowRoof	<1%	\$22	\$21	\$21	\$20	\$20	\$19	\$19
2014MY Vehicle Package ^B	Truck	Class7_DayCab	LowRoof	3-4%	\$2,364	\$2,303	\$2,244	\$2,186	\$2,131	\$2,095	\$2,059

^B All vehicle package costs in the table include the proposed application rates of the individual technologies used to establish the proposed standards.

Heavy-Duty GHG and Fuel Efficiency Standards FRM: Technologies, Cost, and Effectiveness

Technology	Applied to	Truck type	Class	CO ₂ eq Effectiveness	2014	2015	2016	2017	2018	2019	2020
Aero-Bin III	Truck	Class7_DayCab	HighRoof	2-4%	\$1,155	\$1,126	\$1,097	\$1,069	\$1,041	\$1,024	\$1,007
Aero-Bin IV	Truck	Class7_DayCab	HighRoof	3-5%	\$2,303	\$2,303	\$1,907	\$1,907	\$1,590	\$1,552	\$1,515
LRR steer tire	Truck	Class7_DayCab	HighRoof	1-3%	\$68	\$66	\$64	\$63	\$61	\$60	\$59
LRR drive tire	Truck	Class7_DayCab	HighRoof		\$63	\$61	\$60	\$58	\$57	\$56	\$55
Weight reduction: Single-wide tire	Truck	Class7_DayCab	HighRoof	<1%	\$336	\$327	\$319	\$311	\$303	\$298	\$293
Weight reduction: Aluminum steer wheel	Truck	Class7_DayCab	HighRoof		\$546	\$532	\$518	\$505	\$492	\$484	\$476
Weight reduction: Aluminum single-wide wheel	Truck	Class7_DayCab	HighRoof		\$654	\$637	\$621	\$605	\$590	\$580	\$570
Air Conditioning Leakage	Truck	Class7_DayCab	HighRoof	<1%	\$22	\$21	\$21	\$20	\$20	\$19	\$19
2014MY Vehicle Package	Truck	Class7_DayCab	HighRoof	6-7%	\$2,612	\$2,551	\$2,451	\$2,394	\$2,306	\$2,266	\$2,226
Aero-Bin III	Truck	Class8_DayCab	LowRoof	1-2%	\$1,126	\$1,097	\$1,068	\$1,041	\$1,015	\$997	\$981
LRR steer tire	Truck	Class8_DayCab	LowRoof	1-3%	\$68	\$66	\$64	\$63	\$61	\$60	\$59
LRR drive tire	Truck	Class8_DayCab	LowRoof		\$126	\$123	\$120	\$116	\$114	\$112	\$110
Weight reduction: Single-wide tire	Truck	Class8_DayCab	LowRoof	<1%	\$672	\$654	\$638	\$621	\$605	\$595	\$585
Weight reduction: Aluminum steer wheel	Truck	Class8_DayCab	LowRoof		\$546	\$532	\$518	\$505	\$492	\$484	\$476
Weight reduction: Aluminum single-wide wheel	Truck	Class8_DayCab	LowRoof		\$1,308	\$1,275	\$1,242	\$1,210	\$1,179	\$1,160	\$1,140
Air Conditioning Leakage	Truck	Class8_DayCab	LowRoof	<1%	\$22	\$21	\$21	\$20	\$20	\$19	\$19
2014MY Vehicle Package	Truck	Class8_DayCab	LowRoof	3-4%	\$2,871	\$2,797	\$2,725	\$2,656	\$2,588	\$2,544	\$2,501
Aero-Bin III	Truck	Class8_DayCab	HighRoof	2-4%	\$1,155	\$1,126	\$1,097	\$1,069	\$1,041	\$1,024	\$1,007
Aero-Bin IV	Truck	Class8_DayCab	HighRoof	3-5%	\$2,303	\$2,303	\$1,907	\$1,907	\$1,590	\$1,552	\$1,515
LRR steer tire	Truck	Class8_DayCab	HighRoof	1-3%	\$68	\$66	\$64	\$63	\$61	\$60	\$59
LRR drive tire	Truck	Class8_DayCab	HighRoof		\$126	\$123	\$120	\$116	\$114	\$112	\$110
Weight reduction: Single-wide tire	Truck	Class8_DayCab	HighRoof	<1%	\$672	\$654	\$638	\$621	\$605	\$595	\$585
Weight reduction: Aluminum steer wheel	Truck	Class8_DayCab	HighRoof		\$546	\$532	\$518	\$505	\$492	\$484	\$476
Weight reduction: Aluminum single-wide wheel	Truck	Class8_DayCab	HighRoof		\$1,308	\$1,275	\$1,242	\$1,210	\$1,179	\$1,160	\$1,140

Regulatory Impact Analysis

Technology	Applied to	Truck type	Class	CO ₂ eq Effectiveness	2014	2015	2016	2017	2018	2019	2020
Air Conditioning Leakage	Truck	Class8_DayCab	HighRoof	<1%	\$22	\$21	\$21	\$20	\$20	\$19	\$19
2014MY Vehicle Package	Truck	Class8_DayCab	HighRoof	6-7%	\$3,119	\$3,045	\$2,933	\$2,863	\$2,763	\$2,715	\$2,668
Aero-Bin III	Truck	Class8_Sleeper Cab	LowRoof	3-5%	\$1,374	\$1,338	\$1,304	\$1,271	\$1,238	\$1,217	\$1,197
LRR steer tire	Truck	Class8_Sleeper Cab	LowRoof	1-3%	\$68	\$66	\$64	\$63	\$61	\$60	\$59
LRR drive tire	Truck	Class8_Sleeper Cab	LowRoof		\$126	\$123	\$120	\$116	\$114	\$112	\$110
Weight reduction: Single-wide tire	Truck	Class8_Sleeper Cab	LowRoof	<1%	\$672	\$654	\$638	\$621	\$605	\$595	\$585
Weight reduction: Aluminum steer wheel	Truck	Class8_Sleeper Cab	LowRoof		\$546	\$532	\$518	\$505	\$492	\$484	\$476
Weight reduction: Aluminum single-wide wheel	Truck	Class8_Sleeper Cab	LowRoof		\$1,308	\$1,275	\$1,242	\$1,210	\$1,179	\$1,160	\$1,140
Aux power unit (APU)	Truck	Class8_Sleeper Cab	LowRoof	5-6%	\$5,455	\$5,314	\$5,178	\$5,046	\$4,917	\$4,834	\$4,753
Air Conditioning Leakage	Truck	Class8_Sleeper Cab	LowRoof	<1%	\$22	\$21	\$21	\$20	\$20	\$19	\$19
2014MY Vehicle Package	Truck	Class8_Sleeper Cab	LowRoof	12-13%	\$8,271	\$8,057	\$7,850	\$7,650	\$7,455	\$7,329	\$7,206
Aero-Bin III	Truck	Class8_Sleeper Cab	MidRoof	3-5%	\$1,404	\$1,367	\$1,332	\$1,298	\$1,265	\$1,244	\$1,223
LRR steer tire	Truck	Class8_Sleeper Cab	MidRoof	1-3%	\$68	\$66	\$64	\$63	\$61	\$60	\$59
LRR drive tire	Truck	Class8_Sleeper Cab	MidRoof		\$126	\$123	\$120	\$116	\$114	\$112	\$110
Weight reduction: Single-wide tire	Truck	Class8_Sleeper Cab	MidRoof	<1%	\$672	\$654	\$638	\$621	\$605	\$595	\$585
Weight reduction: Aluminum steer wheel	Truck	Class8_Sleeper Cab	MidRoof		\$546	\$532	\$518	\$505	\$492	\$484	\$476
Weight reduction: Aluminum single-wide wheel	Truck	Class8_Sleeper Cab	MidRoof		\$1,308	\$1,275	\$1,242	\$1,210	\$1,179	\$1,160	\$1,140
Aux power unit (APU)	Truck	Class8_Sleeper Cab	MidRoof	5-6%	\$5,455	\$5,314	\$5,178	\$5,046	\$4,917	\$4,834	\$4,753
Air Conditioning Leakage	Truck	Class8_Sleeper Cab	MidRoof	<1%	\$22	\$21	\$21	\$20	\$20	\$19	\$19

Heavy-Duty GHG and Fuel Efficiency Standards FRM: Technologies, Cost, and Effectiveness

Technology	Applied to	Truck type	Class	CO ₂ eq Effectiveness	2014	2015	2016	2017	2018	2019	2020
2014MY Vehicle Package	Truck	Class8_Sleeper Cab	MidRoof	11-12%	\$8,291	\$8,078	\$7,870	\$7,669	\$7,474	\$7,347	\$7,224
Aero-Bin III	Truck	Class8_Sleeper Cab	HighRoof	3-5%	\$1,560	\$1,520	\$1,481	\$1,443	\$1,406	\$1,382	\$1,359
Aero-Bin IV	Truck	Class8_Sleeper Cab	HighRoof	4-7%	\$2,675	\$2,675	\$2,215	\$2,215	\$1,847	\$1,803	\$1,760
LRR steer tire	Truck	Class8_Sleeper Cab	HighRoof	1-3%	\$68	\$66	\$64	\$63	\$61	\$60	\$59
LRR drive tire	Truck	Class8_Sleeper Cab	HighRoof		\$126	\$123	\$120	\$116	\$114	\$112	\$110
Weight reduction: Single-wide tire	Truck	Class8_Sleeper Cab	HighRoof	<1%	\$672	\$654	\$638	\$621	\$605	\$595	\$585
Weight reduction: Aluminum steer wheel	Truck	Class8_Sleeper Cab	HighRoof		\$546	\$532	\$518	\$505	\$492	\$484	\$476
Weight reduction: Aluminum single-wide wheel	Truck	Class8_Sleeper Cab	HighRoof		\$1,308	\$1,275	\$1,242	\$1,210	\$1,179	\$1,160	\$1,140
Aux power unit (APU)	Truck	Class8_Sleeper Cab	HighRoof	5-6%	\$5,455	\$5,314	\$5,178	\$5,046	\$4,917	\$4,834	\$4,753
Air Conditioning Leakage	Truck	Class8_Sleeper Cab	HighRoof	<1%	\$22	\$21	\$21	\$20	\$20	\$19	\$19
2014MY Vehicle Package	Truck	Class8_Sleeper Cab	HighRoof	15-16%	\$7,641	\$7,458	\$7,188	\$7,016	\$6,775	\$6,658	\$6,543

Regulatory Impact Analysis

Table 2-40 Technology Effectiveness and Costs, Inclusive of Markups, by Year for HD Diesel and Gasoline Pickup Trucks & Vans (2009\$)

Technology	Applied to	CO ₂ eq Effectiveness	2014	2015	2016	2017	2018	2019
Low friction lubricants	All	0-1%	\$4	\$4	\$4	\$4	\$4	\$4
Engine friction reduction	HD Gasoline	1-3%	\$116	\$116	\$116	\$116	\$116	\$111
Stoich GDI V8	HD Gasoline	1-2%	\$481	\$470	\$460	\$460	\$460	\$425
8sp AT (relative to 6sp AT)	All	1.7%	\$281	\$275	\$269	\$269	\$269	\$248
Low RR Tires	All	1-2%	\$7	\$7	\$7	\$7	\$7	\$6
Aero1	All	1-2%	\$58	\$57	\$55	\$55	\$55	\$53
Electric/Electro-hydraulic Power steering	All	1-2%	\$115	\$112	\$109	\$109	\$109	\$105
DSL engine improvements	HD Diesel	4-6%	\$184	\$180	\$175	\$171	\$167	\$156
DSL aftertreatment improvements	HD Diesel	3-5%	\$119	\$116	\$114	\$114	\$114	\$109
Improved accessories	HD Diesel	1-2%	\$93	\$91	\$89	\$89	\$89	\$851
Mass Reduction (5%)	2b HD Gasoline	1.6%	\$108	\$106	\$103	\$103	\$103	\$99
Mass Reduction (5%)	2b HD Diesel	1.6%	\$121	\$118	\$115	\$115	\$115	\$110
Mass Reduction (5%)	3 HD Gasoline	1.6%	\$115	\$112	\$109	\$109	\$109	\$105
Mass Reduction (5%)	3 HD Diesel	1.6%	\$127	\$124	\$121	\$121	\$121	\$116
Air Conditioning Leakage	All	2%	\$21	\$21	\$20	\$19	\$19	\$18
Overall 2018 MY Package		12-17%					\$1,048	\$986

References

- ¹ Committee to Assess Fuel Economy Technologies for Medium- and Heavy-Duty Vehicles; National Research Council; Transportation Research Board (2010). “Technologies and Approaches to Reducing the Fuel Consumption of Medium- and Heavy-Duty Vehicles,” (hereafter, “NAS Report”). Washington, D.C., The National Academies Press. Available electronically from the National Academies Press Website at http://www.nap.edu/catalog.php?record_id=12845 (last accessed September 10, 2010).
- ² TIAX, LLC. “Assessment of Fuel Economy Technologies for Medium- and Heavy-Duty Vehicles,” Final Report to the National Academy of Sciences, November 19, 2009.
- ³ U.S. EPA. EPA Lumped Parameter Model HD Version 1.0.0.5, 2010. Docket #EPA-HQ-OAR-2010-0162.
- ⁴ NESCCAF, ICCT, Southwest Research Institute, and TIAX. Reducing Heavy-Duty Long Haul Combination Truck Fuel Consumption and CO₂ Emissions. October 2009.
- ⁵ ICF International. Investigation of Costs for Strategies to Reduce Greenhouse Gas Emissions for Heavy-Duty On-Road Vehicles. July 2010. Docket Identification Number EPA-HQ-OAR-2010-0162-0044.
- ⁶ RTI International. Automobile Industry Retail Price Equivalent and Indirect Cost Multipliers. February 2009. <http://www.epa.gov/otaq/ld-hwy/420r09003.pdf>; Rogozhin, A., et al., “Using indirect cost multipliers to estimate the total cost of adding new technology in the automobile industry,” International Journal of Production Economics (2009), doi:10.1016/j.ijpe.2009.11.031. The peer review for the RTI report is at <http://www.epa.gov/otaq/ld-hwy/420r09004.pdf>.
- ⁷ RTI International. Heavy Duty Truck Retail Price Equivalent and Indirect Cost Multipliers. July 2010.
- ⁸ Rogozhin, A., et al., “Using indirect cost multipliers to estimate the total cost of adding new technology in the automobile industry,” International Journal of Production Economics (2009), doi:10.1016/j.ijpe.2009.11.031.
- ⁹ Helfand, Gloria, and Todd Sherwood, “Documentation of the Development of Indirect Cost Multipliers for Three Automotive Technologies,” August 2009.
- ¹⁰ RTI International. Heavy Duty Truck Retail Price Equivalent and Indirect Cost Multipliers. July 2010.
- ¹¹ Rogozhin, A., et al., “Using indirect cost multipliers to estimate the total cost of adding new technology in the automobile industry,” International Journal of Production Economics (2009), doi:10.1016/j.ijpe.2009.11.031.
- ¹² See “Learning Curves in Manufacturing”, L. Argote and D. Epple, Science, Volume 247; “Toward Cost Buy down Via Learning-by-Doing for Environmental Energy Technologies, R. Williams, Princeton University, Workshop on Learning-by-Doing in Energy Technologies, June 2003; “Industry Learning Environmental and the Heterogeneity of Firm Performance, N. Balasubramanian and M. Lieberman, UCLA Anderson School of Management, December 2006, Discussion Papers, Center for Economic Studies, Washington DC.
- ¹³ See “Learning Curves in Manufacturing”, L. Argote and D. Epple, Science, Volume 247; “Toward Cost Buy down Via Learning-by-Doing for Environmental Energy Technologies, R. Williams,

Regulatory Impact Analysis

Princeton University, Workshop on Learning-by-Doing in Energy Technologies, June 2003; “Industry Learning Environments and the Heterogeneity of Firm Performance, N. Balasubramanian and M. Lieberman, UCLA Anderson School of Management, December 2006, Discussion Papers, Center for Economic Studies, Washington DC.

¹⁴ U.S. EPA and NHTSA, “Final Rulemaking to Establish Light-Duty Vehicle Greenhouse Gas Emission Standards and Corporate Average Fuel Economy Standards – Joint Technical Support Document,” 2010. Last viewed on June 3, 2010 at <http://www.epa.gov/otaq/climate/regulations/420r10901.pdf>

¹⁵ Note that throughout the cost estimates for this HD analysis, the agencies have used slightly higher markups than those used in the 2010-2016 light-duty FRM. The new, slightly higher ICMs include return on capital of roughly 6 percent, a factor that was not included in the light-duty analysis.

¹⁶ Note that the costs developed for low friction lubes for this analysis reflect the costs associated with any engine changes that would be required as well as any durability testing that may be required.

¹⁷ “Light-Duty Automotive Technology and Fuel Economy Trends: 1975 Through 2007”, EPA420-S-07-001, September 2007. Available at <http://www.epa.gov/oms/cert/mpg/fetrends/fetrends-archive.htm> (last accessed March 15, 2010).

¹⁸ U.S. EPA and NHTSA, “Final Rulemaking to Establish Light-Duty Vehicle Greenhouse Gas Emission Standards and Corporate Average Fuel Economy Standards – Joint Technical Support Document,” 2010. Last viewed on June 3, 2010 at <http://www.epa.gov/otaq/climate/regulations/420r10901.pdf>

¹⁹ Note that throughout the cost estimates for this HD analysis, the agencies have used slightly higher markups than those used in the 2010-2016 light-duty FRM. The new, slightly higher ICMs include return on capital of roughly 6 percent, a factor that was not included in the light-duty analysis.

²⁰ Note that the costs developed for low friction lubes for this analysis reflect the costs associated with any engine changes that would be required as well as any durability testing that may be required.

²¹ See TIAX, page 4-15.

²² Stanton, Donald. “Enabling High Efficiency Clean Combustion.” 2009 Semi-Mega Merit Review of the Department of Energy. May 21, 2009. Last accessed on August 25, 2010 at http://www1.eere.energy.gov/vehiclesandfuels/pdfs/merit_review_2009/advanced_combustion/ace_40_stanton.pdf.

²³ “All-new-Ford-engineered, Ford-tested, Ford-built diesel maximizes 2011 Super Duty productivity,” Ford press release, August 3, 2010. Available at: <http://www.media.ford.com> (last accessed June 27, 2011).

²⁴ Stanton, Donald. “Enabling High Efficiency Clean Combustion.” 2009 Semi-Mega Merit Review of the Department of Energy. May 21, 2009. Last accessed on August 25, 2010 at http://www1.eere.energy.gov/vehiclesandfuels/pdfs/merit_review_2009/advanced_combustion/ace_40_stanton.pdf.

²⁵ See TIAX, at page 4-10.

²⁶ “New Allison 1000 Transmission Offers Six-Speed Performance and Range Selection Mode,” GM press release, August 1, 2005. Available at: <http://www.media.gm.com> (last accessed June 27, 2011).

Heavy-Duty GHG and Fuel Efficiency Standards FRM: Technologies, Cost, and Effectiveness

- ²⁷ “Tires and Passenger Vehicle Fuel Economy,” Transportation Research Board Special Report 286, National Research Council of the National Academies, 2006, Docket EPA-HQ-OAR-2009-0472-0146.
- ²⁸ “Preliminary Vehicle Mass Estimation Using Empirical Subsystem Influence Coefficients,” Malen, D.E., Reddy, K. Auto-Steel Partnership Report, May 2007, Docket EPA-HQ-OAR-2009-0472-0169. Accessed on the Internet on May 30, 2009 at: <http://www.a-sp.org/database/custom/Mass%20Compounding%20-%20Final%20Report.pdf>
- ²⁹ “Benefit Analysis: Use of Aluminum Structures in Conjunction with Alternative Powertrain Technologies in Automobiles,” Bull, M. Chavali, R., Mascarini, A., Aluminum Association Research Report, May 2008, Docket EPA-HQ-OAR-2009-0472-0168. Accessed on the Internet on April 30, 2009 at: <http://www.autoaluminum.org/downloads/IBIS-Powertrain-Study.pdf>
- ³⁰ “Future Generation Passenger Compartment-Validation (ASP 241)” Villano, P.J., Shaw, J.R., Polewarczyk, J., Morgans, S., Carpenter, J.A., Yocum, A.D., in “Lightweighting Materials – FY 2008 Progress Report,” U.S. Department of Energy, Office of Energy Efficiency and Renewable Energy, Vehicle Technologies Program, May 2009, Docket EPA-HQ-OAR-2009-0472-0190.
- ³¹ “Preliminary Vehicle Mass Estimation Using Empirical Subsystem Influence Coefficients,” Malen, D.E., Reddy, K. Auto-Steel Partnership Report, May 2007, Docket EPA-HQ-OAR-2009-0472-0169. Accessed on the Internet on May 30, 2009 at: <http://www.a-sp.org/database/custom/Mass%20Compounding%20-%20Final%20Report.pdf>
- ³² “Lighten Up!,” Brooke, L., Evans, H. Automotive Engineering International, Vol. 117, No. 3, March 2009.
- ³³ “2008/9 Blueprint for Sustainability,” Ford Motor Company. Available at: <http://www.ford.com/go/sustainability> (last accessed February 8, 2010).
- ³⁴ “Mazda to cut vehicle fuel consumption 30 percent by 2015,” Mazda press release, June 23, 2009. Available at: <http://www.mazda.com/publicity/release/2008/200806/080623.html> (last accessed February 8, 2010).
- ³⁵ “Mazda: Don’t believe hot air being emitted by hybrid hype,” Greimel, H. Automotive News, March 30, 2009.
- ³⁶ “Interim Joint Technical Assessment Report: Light-Duty Vehicle Greenhouse Gas Emission Standards and Corporate Average Fuel Economy Standards for Model Years 2017-2025;” September 2010; available at <http://epa.gov/otaq/climate/regulations/ldv-ghg-tar.pdf> and in the docket for this rule.
- ³⁷ U.S. EPA and NHTSA, “Final Rulemaking to Establish Light-Duty Vehicle Greenhouse Gas Emission Standards and Corporate Average Fuel Economy Standards – Joint Technical Support Document,” 2010. Last viewed on June 3, 2010 at <http://www.epa.gov/otaq/climate/regulations/420r10901.pdf>
- ³⁸ U.S.EPA, EPA Lumped Parameter Model HD Version 1.0.0.5, 2010. Docket #EPA-HQ-OAR-2010-0162.
- ³⁹ Stanton, Donald. “Enabling High Efficiency Clean Combustion.” 2009 Semi-Mega Merit Review of the Department of Energy. May 21, 2009. Last accessed on August 25, 2010 at http://www1.eere.energy.gov/vehiclesandfuels/pdfs/merit_review_2009/advanced_combustion/ace_40_stanton.pdf.
- ⁴⁰ Zhang, H. Heavy Truck Engine Development & HECC. 2009 DOE Semi-Mega Merit Review, May 21, 2009. Last accessed on August 25, 2010 at

Regulatory Impact Analysis

http://www1.eere.energy.gov/vehiclesandfuels/pdfs/merit_review_2009/advanced_combustion/ace_42_zhang.pdf

⁴¹ Zhang, H. Detroit Diesel. “High Efficiency Clean Combustion for Heavy-Duty Engine.” August 6, 2008 presentation to DEER Conference. Last accessed on August 25, 2010 at http://www1.eere.energy.gov/vehiclesandfuels/pdfs/deer_2008/session5/deer08_zhang.pdf

⁴² See the NAS Report, page 53 cites Detroit Diesel Corporation, DD15 Brochure, DDC-EMC-BRO-0003-0408, April 2008.

⁴³ See the NAS Report, pages 53-54.

⁴⁴ Turbocompound costs derived from Investigation of Costs for Strategies to Reduce Greenhouse Gas Emissions from Heavy-Duty On-Road Vehicles. July 2010. Docket Identification Number EPA-HQ-OAR-2010-0162-0044. Page 82

⁴⁵ See the NAS Report, page 54.

⁴⁶ See TIAX, at page 3-5.

⁴⁷ Vuk, C. “Electric Turbo Compounding...A Technology Who’s Time Has Come.” 2006 DEER Conference. Last accessed on August 25, 2010 at http://www1.eere.energy.gov/vehiclesandfuels/pdfs/deer_2006/session6/2006_deer_vuk.pdf

⁴⁸ See TIAX, at page 4-15.

⁴⁹ FleetOwner.com. “SCR Will Eliminate Need for Active DPF Regeneration for Volvo Trucks Next Year.” March 2009. Last accessed on June 27, 2011 at <http://fleetowner.com/mid-america/volvo-trucks-scr-solution-0320/index1.html>

⁵⁰ See TIAX, at page 4-16.

⁵¹ See TIAX, at page 4-20.

⁵² See the NAS Report, page 57.

⁵³ See TIAX, at page 4-29.

⁵⁴ Kruiwyk, R. “An Engine System Approach to Exhaust Waste Heat Recovery.” Presented at DOE DEER Conference on September 29, 2010. Last viewed on May 11, 2011 at http://www1.eere.energy.gov/vehiclesandfuels/pdfs/deer_2010/wednesday/presentations/deer10_kruiwyk.pdf

⁵⁵ Cooper, D., N. Baines, N. Sharp. “Organic Rankine Cycle Turbine for Exhaust Energy Recovery in a Heavy Truck Engine.” Presented at the 2010 DEER Conference. Last viewed on May 11, 2011 at http://www1.eere.energy.gov/vehiclesandfuels/pdfs/deer_2010/wednesday/presentations/deer10_baines.pdf

⁵⁶ Nelson, C. “Exhaust Energy Recovery.” Presented at the DOE DEER Conference on August 5, 2009. Last viewed on May 11, 2011 at http://www1.eere.energy.gov/vehiclesandfuels/pdfs/deer_2009/session5/deer09_nelson_1.pdf

⁵⁷ Assumes travel on level road at 65 MPH. (21st Century Truck Partnership Roadmap and Technical White Papers, December 2006. U.S. Department of Energy, Energy Efficiency and Renewable Energy Program. 21CTP-003. p. 36.)

⁵⁸ Reducing Heavy-Duty Long Haul Combination Truck Fuel Consumption and CO2 Emissions, ICCT, October 2009

⁵⁹ SAE 2006-01-3456

⁶⁰ U.S. EPA. Heavy-Duty Coastdown Test Procedure Development. Docket # EPA-HQ-OAR-2010-0162-0144.

⁶¹ ICF. Investigation of Costs for Strategies to Reduce Greenhouse Gas Emissions from Heavy-Duty On-Road Vehicles. July 2010. Docket Identification Number EPA-HQ-OAR-2010-0162-0044.

⁶² 21st Century Truck Partnership, "Roadmap and technical White Papers", U.S. Department of Energy, Technical paper: 21CTP-0003, December 2006.

⁶³ "Tires & Truck Fuel Economy," A New Perspective. Bridgestone Firestone, North American Tire, LLC, Special Edition Four, 2008.

⁶⁴ "Michelin's Green Meters," Press Kit, October, 30, 2007. <http://www.michelin-green-meter.com/main.php?cLang=en> (Complete Press File, Viewed March 6, 2010)

⁶⁵ "Modeling of Fuel Consumption for Heavy-Duty Trucks and the Impact of Tire Rolling Resistance," Tim J. LaClair, Russell Truemner, SAE International, 2005-01-3550, 2005.

⁶⁶ "Modeling of Fuel Consumption for Heavy-Duty Trucks and the Impact of Tire Rolling Resistance," Tim J. LaClair, Russell Truemner, SAE International, 2005-01-3550, 2005.

⁶⁷ "Factors Affecting Truck Fuel Economy," Goodyear, Radial Truck and Retread Service Manual. Accessed February 16, 2010 at http://www.goodyear.com/truck/pdf/radialretserv/Retread_S9_V.pdf.

⁶⁸ "Tire Rolling Resistance, Its Impact on Fuel Economy, and Measurement Standards," Presentation by Tim J. LaClair of Michelin Americas Research & Development Corp. to the California Energy Commission, 2002.

⁶⁹ "Technology Roadmap for the 21st Century Truck Program. A Government-Industry Partnership," U.S. Department of Energy, 21CT-001, December 2000.

⁷⁰ "Energy Efficiency Strategies for Freight Trucking: Potential Impact on Fuel Use and Greenhouse Gas Emissions," J. Ang-Olson, W. Schroer, Transportation Research Record: Journal of the Transportation Research Board, 2002(1815):11-18.

⁷¹ "Effect of Single Wide Tires and Trailer Aerodynamics on Fuel Economy and NOx Emissions of Class 8 Line-Haul Tractor-Trailer," J. Bachman, A. Erb, C. Bynum, U.S. Environmental Protection Agency, SAE International, Paper Number 05CV-45, 2005.

⁷² "Class 8 Heavy Truck Duty Cycle Project Final Report," U.S. Department of Energy, Oak Ridge National Laboratory, ORNL/TM-2008/122, p. 21, December 2008. Accessed January 19, 2010 at http://cta.ornl.gov/cta/Publications/Reports/ORNL_TM_2008-122.pdf.

⁷³ "Are Ultra-Wide, Ultra-Low Aspect Ratio Tires the Next Big Thing?" K. Rohlwing, Today's Tire Industry, Vol. 1, Issue 1, July/August, July 2003.

⁷⁴ "New Generation Wide Base Single Tires," American Trucking Association, White paper presented at the International Workshop on the use of wide tires sponsored by Federal Highway Administration, Turner-Fairbank Highway Research Center, October 25-26, 2007, Revision 9, December 21, 2007, Accessed on February 3, 2010 at http://www.arc.unr.edu/Workshops/Wide_Tires/Wide_Base_Summary-v9-ATA-whitepaper.pdf

⁷⁵ "Recommended Practice: Guidelines for Outset Wide Base Wheels for Drive, Trailer and Auxiliary Axle Applications (Draft)," Technology and Maintenance Council, Council of American Trucking Associations, circulated September 28, 2009.

Regulatory Impact Analysis

⁷⁶ ICF. Investigation of Costs for Strategies to Reduce Greenhouse Gas Emissions from Heavy-Duty On-Road Vehicles. July 2010. Docket Identification Number EPA-HQ-OAR-2010-0162-0044.

⁷⁷ “SmartWay Transport Partnership: Innovative Carrier Strategies”, February 2004, EPA420-F-04-005, Accessed on the Internet on January 18, 2010 at: <http://www.epa.gov/smartway/transport/what-smartway/carrier-strategies.htm#weight>.

⁷⁸ Aluminum report

http://aluminumtransportation.org/downloads/info_kit/2011RicardoCVStudy.pdf

⁷⁹ “Energy Savings through Increased Fuel Economy for Heavy Duty Trucks”, Therese Langer, American Council for an Energy-Efficient Economy prepared for the National Commission on Energy Policy, February 11, 2004.

⁸⁰ “Best practices Guidebook for Greenhouse Gas Reductions in Freight Transportation”, H. Christopher Fey, Po-Yao Kuo, North Carolina State University prepared for the U.S. Department of Transportation, October 4, 2007.

⁸¹ 21st Century Truck Partnership, “Roadmap and technical White Papers”, U.S. Department of Energy, Technical paper: 21CTP-0003, December 2006.

⁸² “Reducing heavy-Duty long haul Combination Truck Fuel Consumption and CO2 Emissions”, NESCCAF, ICCT, SwRI, TIAX LLC, October 2009.

⁸³ “The Potential Effect of Future Energy-Efficiency and Emissions-Improving Technologies on Fuel Consumption of Heavy Trucks”, Argonne National Laboratory, Technical Report ANL/ESD/02-4, August 2002.

⁸⁴ U.S. EPA. <http://www.epa.gov/smartway/documents/weightreduction.pdf>

⁸⁵ See TIAX, at pages 4-62 through 4-64.

⁸⁶ Alcoa. “Improving Sustainability of Transport: Aluminum is Part of the Solution.” 2009

⁸⁷ Schutte, Carol. U.S. Department of Energy, Vehicle Technologies Program. “Losing Weight – an enabler for a Systems Level Technology Development, Integration, and Demonstration for Efficient Class 8 Trucks (SuperTruck) and Advanced Technology Powertrains for Light-Duty Vehicles”

⁸⁸ American Iron and Steel Institute. “A Cost Benefit Analysis Report to the North American Steel Industry on Improved Materials and Powertrain Architectures for 21st Century Trucks.”

⁸⁹ Schutte, Carol. U.S. Department of Energy, Vehicle Technologies Program. “Losing Weight – an enabler for a Systems Level Technology Development, Integration, and Demonstration for Efficient Class 8 Trucks (SuperTruck) and Advanced Technology Powertrains for Light-Duty Vehicles”

⁹⁰ Schutte, Carol. U.S. Department of Energy, Vehicle Technologies Program. “Losing Weight – an enabler for a Systems Level Technology Development, Integration, and Demonstration for Efficient Class 8 Trucks (SuperTruck) and Advanced Technology Powertrains for Light-Duty Vehicles”

⁹¹ Gaines, L., A. Vyas, J. Anderson. Estimation of Fuel Use by Idling Commercial Trucks. 2006. Page 9.

⁹² Gaines, L. and D. Santini. Argonne National Laboratory, Economic Analysis of Commercial Idling Reduction Technologies

⁹³ Gaines, L., A. Vyas, J. Anderson. Estimation of Fuel Use by Idling Commercial Trucks. 2006. Page 9.

Heavy-Duty GHG and Fuel Efficiency Standards FRM: Technologies, Cost, and Effectiveness

⁹⁴ Kahn, AB, M, N. Clark, G. Thompson, W.S. Wayne, M. Gautam, and D. Lyons. Idle Emissions from Heavy-Duty Diesel Vehicles: Review and Recent Data. 2006. Journal of Air and Waste Management Association. Page 1416.

⁹⁵ Gaines, L., A. Vyas, J. Anderson. Estimation of Fuel Use by Idling Commercial Trucks. 2006. Page 7.

⁹⁶ See the NAS Report, page 124.

⁹⁷ Gaines, L., A. Vyas, J. Anderson. Estimation of Fuel Use by Idling Commercial Trucks. 2006. Page 6.

⁹⁸ Brodrick, C., T. Lipman, M. Farshchi, H. Dwyer, S. Gouse III, D.B. Harris, and F. King, Jr. Potential Benefits of Utilizing Fuel Cell Auxiliary Power Units in Lieu of Heavy-Duty Truck Engine Idling. 2001. Page 3.

⁹⁹ Lim, Han. Study of Exhaust Emissions from Idling Heavy-Duty Diesel Trucks and Commercially Available Idle-Reducing Devices. EPA420-R-02-052. 2002. Page 2.

¹⁰⁰ Kahn, AB, M, N. Clark, G. Thompson, W.S. Wayne, M. Gautam, and D. Lyons. Idle Emissions from Heavy-Duty Diesel Vehicles: Review and Recent Data. 2006. Journal of Air and Waste Management Association. Page 1405.

¹⁰¹ See the NAS Report, page 122 says the best in class APU consumes 0.18 gallon per hour.

¹⁰² See Title 13, California Code of Regulations § 1956.8, Requirements to Reduce Idling Emissions From New and In-Use Trucks, available at <http://www.arb.ca.gov/regact/hdvidle/frorev.pdf>

¹⁰³ See http://www.osha.gov/SLTC/trucking_industry/index.html and <http://www.fmcsa.dot.gov/rules-regulations/administration/fmcsr/fmcsrruletext.aspx?reg=393.76>, accessed May 2011

¹⁰⁴ See http://www.ccohs.ca/oshanswers/phys_agents/heat_health.html, and http://www.coolantarctica.com/Antarctica%20fact%20file/science/cold_humans.htm, accessed May 2011

¹⁰⁵ Memorandum to docket EPA-HQ-OAR-2010-0162, "Override for Extreme Ambient Temperatures", regarding preliminary environmental chamber tests conducted on idle reduction technologies by the Texas Transportation Institute, July 2011.

¹⁰⁶ See

http://www.leonardbus.com/PageZoneSiteResources/LeonardBus.com/Resources/file/PDF_info/MX7%20Cold%20Starting.pdf; and

https://evaluate.internationaldelivers.com/service/bodybuilder/general/engine_feature/documents/NAVI_910DT_CAP_021211_MY2010_REV1.pdf, accessed May 2011

¹⁰⁷ American Trucking Association. Last viewed on January 29, 2010 at <http://www.trucksdeliver.org/recommendations/speed-limits.html>

¹⁰⁸ U.S. EPA SmartWay Transport Partnership. Last viewed on January 28, 2010 at <http://www.epa.gov/smartway/transport/documents/tech/reducedspeed.pdf>

¹⁰⁹ Department for Transport, Vehicle and Operator Services Agency. Last viewed on January 6, 2010 at <http://www.dft.gov.uk/vosa/newsandevents/pressreleases/2006pressreleases/28-12-06speedlimiterlegislation.htm>

Regulatory Impact Analysis

¹¹⁰ Transport Canada. Summary Report – Assessment of a Heavy Truck Speed Limiter Requirement in Canada. Last viewed on January 6, 2010 at <http://www.tc.gc.ca/eng/roadsafety/tp-tp14808-menu-370.htm>

¹¹¹ Transport Canada. Summary Report – Assessment of a Heavy-Truck Speed Limiter Requirement in Canada.

¹¹² See TIAx, page 4-98.

¹¹³ NESCCAF/ICCT. “Reducing Heavy-Duty Long Haul Combination Truck Fuel Consumption and CO₂ Emissions.” October, 2009]

¹¹⁴ US Environmental Protection Agency's *SmartWay Transport Partnership July 2010 e-update* accessed July 16, 2010, from <http://www.epa.gov/smartwaylogistics/newsroom/documents/e-update-july-10.pdf>

¹¹⁵ See the NAS Report, page 146.

¹¹⁶ See TIAx, at page 4-40.

¹¹⁷ See 75 FR at page 74223

¹¹⁸ As explained further in Section V below, EPA would use these inputs in GEM even for engines electing to use the alternative engine standard.

¹¹⁹ Bachman, Joseph. Memorandum to the Docket. Heavy-Duty Tire Evaluation. July 2011. See Docket EPA-HQ-OAR-2010-0162

¹²⁰ See 75 FR at 74244.

¹²¹ See comments to docket EPA-HQ-OAR-2010-0162-1761; Ford Motor Company

¹²² The agency notes the highest CRR values recorded for LT tires, of 11.0 and 10.9, were for two tires of the same size and brand. The nearest recorded values to these two tires were 9.8; substantially beyond the differences between other tires tested.

¹²³ Kargul, J. J., 2010, "Clean Automotive Technology. Cost-Effective Solutions for a Petroleum and Carbon Constrained World," Presentation made to National Academy of Sciences, Review of 21st Century Truck Program, September 8, 2010

¹²⁴ “Best practices Guidebook for Greenhouse Gas Reductions in Freight Transportation”, H. Christopher Fey, Po-Yao Kuo, North Carolina State University prepared for the U.S. Department of Transportation, October 4, 2007.

¹²⁵ “Reducing Heavy-Duty long haul Combination Truck Fuel Consumption and CO₂ Emissions”, NESCCAF, ICCT, SwRI, TIAx LLC, October 2009.

¹²⁶ The U.S. EPA has reclamation requirements for refrigerants in place under Title VI of the Clean Air Act.

¹²⁷ The global warming potentials (GWP) used in the NPRM analysis are consistent with 2007 Intergovernmental Panel on Climate Change (IPCC) Fourth Assessment Report (AR4). At this time, the 1996 IPCC Second Assessment Report (SAR) global warming potential values are used in the official U.S. greenhouse gas inventory submission to the United Nations Framework Convention on Climate Change (per the reporting requirements under that international convention, which were last updated in 2006).

- ¹²⁸ Schwarz, W., Harnisch, J. 2003. "Establishing Leakage Rates of Mobile Air Conditioners." Prepared for the European Commission (DG Environment), Doc B4-3040/2002/337136/MAR/C1.
- ¹²⁹ Vincent, R., Cleary, K., Ayala, A., Corey, R. 2004. "Emissions of HFC-134a from Light-Duty Vehicles in California." SAE 2004-01-2256.
- ¹³⁰ The Minnesota refrigerant leakage data can be found at <http://www.pca.state.mn.us/climatechange/mobileair.html#leakdata>.
- ¹³¹ Society of Automotive Engineers, "IMAC Team 1 – Refrigerant Leakage Reduction, Final Report to Sponsors," 2006.
- ¹³² Society of Automotive Engineers Surface Vehicle Standard J2727, issued August 2008, <http://www.sae.org>.
- ¹³³ "Review of Low Carbon Technologies for Heavy Goods Vehicles – Annex 1", Ricardo prepared for Department of Transport, Technology Paper RD.09/182601.7, Jun 2009
- ¹³⁴ U.S. Environmental Protection Agency Office of Transportation and Air Quality SmartWay Transport Partnership, A Glance at Clean Freight Strategies: Drivers Training EPA 420-F-04-008; February 2004.
- ¹³⁵ Ibid.
- ¹³⁶ Information from US EPA review of 2009 SmartWay Excellence Awards applications.
- ¹³⁷ U.S. Environmental Protection Agency Office of Transportation and Air Quality SmartWay Transport Partnership, A Glance at Clean Freight Strategies: Drivers Training EPA 420-F-04-008; February 2004.
- ¹³⁸ "Buses & Retread Tires," The Tire Retread & Repair Information Bureau, Pacific Grove, Ca., Accessed on January 27, 2010 at <http://www.retread.org/packet/index.cfm/ID/284.htm>.
- ¹³⁹ "What are Retreaders Doing to Improve Fuel Efficiency?" H. Inman, Tire Review, December 11, 2006, Accessed on February 18, 2010 at http://www.tirereview.com/Article/59777/what_are_retreaders_doing_to_improve_fuel_efficiency.asp
X.
- ¹⁴⁰ "Better Fuel Economy? Start with a Strong Tire Program," H. Inman, Fleet & Tire 2006, Tire Review, December 11, 2006, Accessed on February 18, 2010 at http://www.tirereview.com/Article/59776/better_fuel_economy_start_with_a_strong_tire_program.asp
X.
- ¹⁴¹ Technology and Maintenance Council of the American Trucking Associations, Tire Air Pressure Study, Tire Debris Prevention Task Force S.2 Tire & Wheel Study Group; May 2002.
- ¹⁴² "Commercial Vehicle Tire Condition Sensors," Federal Motor Carrier Safety Administration. Report No. FMCSA-PSV-04-002, November 2003.
- ¹⁴³ U.S. Environmental Protection Agency Office of Transportation and Air Quality SmartWay Transport Partnership, A Glance at Clean Freight Strategies: Automatic Tire Inflation Systems EPA 420-F-04-0010; February 2004.
- ¹⁴⁴ See Cummins PowerSpec website, available here: <http://www.powerspec.cummins.com/site/home/index.html>.
- ¹⁴⁵ Ibid.

Regulatory Impact Analysis

¹⁴⁶ “Comprehensive Truck Weight and Size Study: Summary Report,” U.S. DOT Federal Highway Traffic Administration, August 2000.

¹⁴⁷ “Comprehensive Truck Weight and Size Study: Summary Report,” U.S. DOT Federal Highway Traffic Administration, August 2000.

¹⁴⁸ U.S. Department of Transportation. “Comprehensive Truck Size and Weight Study,” Volume 3. August 2000.

¹⁴⁹ “Comprehensive Truck Weight and Size Study: Summary Report,” U.S. DOT Federal Highway Traffic Administration, August 2000.

Chapter 3: Test Procedures

Test procedures are a crucial aspect of the heavy-duty vehicle GHG and fuel consumption program. The final rulemaking is establishing several new test procedures for both engine and vehicle compliance. This chapter will describe the development process for the test procedures being finalized, including the assessment of engines, aerodynamics, rolling resistance, chassis dynamometer testing, powertrain testing and drive cycles.

3.1 Heavy-Duty Engine Test Procedure

The agencies are controlling heavy-duty engine fuel consumption and greenhouse gas emissions through the use of engine certification. The program will mirror existing engine regulations for the control of non-GHG pollutants in many aspects. The following sections provide an overview of the test procedures.

3.1.1 Existing Regulation Reference

Heavy-duty engines currently are certified for non-GHG pollutants using test procedures developed by EPA. The Heavy-Duty Federal Test Procedure (FTP) is a transient test consisting of second-by-second sequences of engine speed and torque pairs with values given in normalized percent of maximum form. The cycle was computer generated from a dataset of 88 heavy-duty trucks in urban operation in New York and Los Angeles. These procedures are well-defined and we believe appropriate also for the assessment of GHG emissions. EPA is concerned that we maintain a regulatory relationship between the non-GHG emissions and GHG emissions, especially for control of CO₂ and NO_x. Therefore, the agencies are adopting the same test procedures for the CO₂ and fuel consumption standards.

For 2007 and later Heavy-Duty engines, 40 CFR Parts 86 – “Control of Emissions from New and In-Use Highway Vehicles and Engines” and 1065 – “Engine Testing Procedures” detail the certification process. Part 86.007-11 defines the standard settings of Oxides of Nitrogen, Non-Methane Hydrocarbons, Carbon Monoxide, and Particulate. The duty cycles are defined in Part 86. The Federal Test Procedure engine test cycle is defined in Part 86 Appendix I. The Supplemental Emissions Test engine cycle is defined in §86.1360-2007(b). All emission measurements and calculations are defined in Part 1065, with exceptions as noted in §86.007-11. The data requirements are defined in § 86.001-23 and 1065.695.

The procedure for CO₂ measurement is presented in §1065.250. For measurement of CH₄ refer to §1065.260. For measurement of N₂O refer to §1065.275. We recommend that you use an analyzer that meets performance specifications shown in Table 1 of §1065.205. Note that your system must meet the linearity verification of §1065.307. To calculate the brake specific mass emissions for CO₂, CH₄ and N₂O refer to §1065.650. For CH₄ refer to §1065.660(a) to calculate the contamination correction.

3.1.2 Engine Dynamometer Test Procedure Modifications

3.1.2.1 Fuel Consumption Calculation

EPA and NHTSA will calculate fuel consumption, as defined as gallons per brake horsepower-hour, from the CO₂ measurement. The agencies are finalizing that manufacturers use 8,887 grams of CO₂ per gallon of gasoline and 10,180 g CO₂ per gallon of diesel fuel.

3.1.2.2 N₂O Measurement

EPA finalized that manufacturers would need to submit measurements of N₂O to be able to apply for a certificate of conformity with the N₂O standard. Engine emissions regulations do not currently require testing for N₂O, and most test facilities do not have equipment for its measurement. Manufacturers without this capability would need to acquire and install appropriate measurement equipment. For use commencing with MY 2015 engines and vehicles, EPA is permitting four N₂O measurement methods, all of which are commercially available today. EPA expects that most manufacturers would use either photo-acoustic measurement equipment (\$50,000) for standalone, existing FTIR instrumentation or upgrade existing emission measurement systems with NDIR analyzers (\$25,000) for each test cell that would need to be upgraded. For the cost projections for the rulemaking, EPA estimates that 75 percent of manufacturers will upgrade existing equipment and 25 percent will use standalone equipment.

3.1.2.3 CO₂ Measurement Variability

EPA and NHTSA evaluated two means to handle the CO₂ and fuel consumption measurement variability. The first is to use an approach similar to the LD GHG and Fuel Economy program where the agencies adopted a compliance factor that is applied to the measured value (see 75 FR May 7, 2010 at 25476). The second is an approach where the standard is set as a not to exceed standard. This would require manufacturers to set a design target set sufficiently below the standard to account for production variability and deterioration.

The agencies proposed an approach where manufacturers are allowed to determine their own compliance margin, but it must be at least two percent to account for the test-to-test variation. The agencies developed the proposed level, two percent, based on CO₂ measurement variability from several test programs. The programs included internal EPA round-robin testing, ACES¹, and the Gaseous MA program.² Table 3-1 summarizes the results from each of these programs. The agencies received comments and confidential business information from stakeholders which included data that showed testing and production variability of CO₂ emissions from heavy-duty engines measured over the HD engine duty cycles. The confidential data showed a test-to-test variability near the two percent level found by the agencies; however, the data also included production variability which was found to be approximately three percent. The agencies analyzed the data provided in comment in combination with the data used to derive the proposed levels. Based on this assessment, the agencies are adopting a three percent value that the manufacturers must use to determine the engine's family emission level (FEL).

Heavy-Duty GHG and Fuel Efficiency Standards FRM: Test Procedures

Table 3-1: Summary of CO₂ Measurement Variability

ENGINE	AFTERTREATMENT	TEST SITE	TEST	# OF TESTS	CoV (%)
Same Engine – Same Test Cell – Different Days					
11L	DPF	EPA HD05	Hot Transient	10	0.22%
11L	DPF	EPA HD05	RMC	7	0.12%
11L	DPF	EPA HD05	Cold/Soak/Hot	3	0.02%
9L	No DPF	EPA HD05	8 Mode	7	0.44%
12L	No DPF	EPA HD01	Hot Transient	8	0.09%
12L	No DPF	EPA HD05	Hot Transient	31	1.37%
6.7L	No DPF	EPA HD02	FTP	12	0.67%
13L	DPF	EPA HD05	FTP	11	0.37%
14L	DPF	SwRI	NTE	9	0.2%
14L	DPF	SwRI	13 Mode SET	6	0.2%
14L	DPF	CE-CERT	NTE	9	0.5%
14L	DPF	CE-CERT	13 Mode SET	6	0.5%
Engine A	DPF	SwRI (ACES)	FTP	3	0.1%
Engine B	DPF	SwRI (ACES)	FTP	3	0.4%
Engine C	DPF	SwRI (ACES)	FTP	3	0.6%
Engine D	DPF	SwRI (ACES)	FTP	3	0.5%
Same Engine – Different Test Cells – Different Days					
12L	No DPF	EPA HD01 & HD05	Hot Transient	39	1.58%
14L	DPF	SwRI & CE-CERT	NTE	18	1.4%
14L	DPF	SwRI & CE-CERT	13 Mode SET	12	1.2%

3.1.2.4 Regeneration Impact on Fuel Consumption and CO₂ Emissions

The current engine test procedures also require the development of regeneration emission rate and frequency factors to account for the emission changes during a regeneration event.³ We are excluding the CO₂ emissions and fuel consumption due to regeneration. Our assessment of the current non-GHG regulatory program indicates that engine manufacturers are already highly motivated to reduce the frequency of regeneration events due to the significant impact on NO_x emissions. In addition, market forces already exist which create incentives to reduce fuel consumption during regeneration.

3.1.2.5 Fuel Heating Value Correction

The agencies collected baseline CO₂ performance of diesel engines from testing which used fuels with similar properties. The agencies are finalizing a fuel-specific correction factor for the fuel's energy content in case this changes in the future. The agencies found the average energy content of the diesel fuel used at EPA's National Vehicle Fuel and Emissions Laboratory was 21,200 BTU per pound of carbon. This value is determined by dividing the Net Heating Value (BTU per pound) by the carbon weight fraction of the fuel used in testing.

Regulatory Impact Analysis

The existing regulations correct for gasoline fuel properties, as described in 40 CFR Part 86. The same correction can be used for the testing of complete pickup trucks and vans with gasoline fueled engines.

The agencies are not finalizing fuel corrections for alcohols because the fuel chemistry is homogeneous. The agencies are finalizing a fuel correction for natural gas.

3.1.2.6 Multiple Fuel Maps

Modern heavy-duty engines may have multiple fuel maps, commonly meant to improve performance or fuel efficiency under certain operating conditions. CO₂ emissions can also be different depending on which map is tested, so it is important to specify a procedure to properly deal with engines with multiple fuel maps. Consistent with criteria-pollutant emissions certification, engine manufacturers should submit CO₂ data from all fuel maps on a given test engine. This includes fuel map information as well as the conditions under which a given fuel map is used (*i.e.* transmission gear, vehicle speed, etc).

3.1.3 Engine Family Definition and Test Engine Selection

3.1.3.1 Criteria for Engine Families

The current regulations outline the criteria for grouping engine models into engine families sharing similar emission characteristics. A few of these defining criteria include bore-center dimensions, cylinder block configuration, valve configuration, and combustion cycle; a comprehensive list can be found in 40 CFR §86.096-24(a)(2). While this set of criteria was developed with criteria pollutant emissions in mind, similar effects on CO₂ emissions can be expected. For this reason, this methodology should continue to be followed when considering CO₂ emissions.

3.1.3.2 Emissions Test Engine

Manufacturers must select at least one engine per engine family for emission testing. The methodology for selecting the test engine(s) should be consistent with §86.096-24(b)(2) (for heavy-duty Otto cycle engines) and §86.096-24(b)(3) (for heavy-duty diesel engines). An inherent characteristic of these methodologies is selecting the engine with the highest fuel feed per stroke (primarily at the speed of maximum rated torque and secondarily at rated speed) as the test engine, as this is expected to produce the worst-case criteria pollutant emissions. To be consistent, however, it is recommended that the same methodology continue to be used for selecting test engines.

3.2 Aerodynamic Assessment

The aerodynamics of a Class 7/8 combination tractor is dependent on many factors, including the tractor design, trailer design, gap between the tractor and trailer, vehicle speed, wind speed, and many others. We believe that to fairly assess the aerodynamics of combination tractors certain aspects of the truck need to be defined, including the trailer, location of payload, and tractor-trailer gap.

3.2.1 Standardized Trailer Definition

We are finalizing to use a model input reflecting a standardized trailer for each subcategory of the Class 7 and 8 tractor subcategories based on tractor roof height. High roof tractors are designed to optimally pull box trailers. The height of the roof fairing is designed to minimize the height differential between the tractor and typical trailer to reduce the air flow disruption. Low roof tractors are designed to carry flatbed or low-boy trailers. Mid roof tractors are designed to carry tanker and bulk carrier trailers. High roof tractors are designed to optimally pull box trailers. However, we recognize that during actual operation tractors sometimes pull trailers that do not provide the optimal roof height that matches the tractor. In order to assess how often truck and trailer mismatches are found in operation, EPA conducted a study based on observations of traffic across the U.S.⁴ Data was gathered on over 4,000 tractor-trailer combinations using 33 live traffic cameras in 22 states across the United States. Approximately 95 percent of trucks were “matched” per our definition (*e.g.* box trailers were pulled by high roof tractors and flatbed trailers were pulled with low roof tractors). The amount of mismatch varied depending on the type of location. Over 99 percent of the tractors were observed to be in matched configuration in Indiana at the I-80/I-94/I-65 interchange, which is representative of long-haul operation. On the other hand, only about 90 percent of the tractors were matched with the appropriate trailer in metro New York City, where all mismatches consisted of a day cab and a tall container trailer. The study also found that approximately 3 percent of the tractors were traveling without a trailer or with an empty flatbed. The agencies therefore conclude that given this very limited degree of mismatch, it is reasonable to use a standardized definition which optimizes tractor-trailer matching. For purposes of compliance testing, the agencies are finalizing bob-tail testing for low roof and mid roof tractors to facilitate repeatability and reproducibility of test data in response to concerns raised by tractor manufacturers.

40 CFR Section 1037.501 prescribes the standardized trailer for each tractor subcategory (low, mid, and high roof) including trailer dimensions.

3.2.2 Aerodynamic Assessment

The aerodynamic drag of a vehicle is determined by the vehicle’s coefficient of drag (Cd), frontal area, air density and speed. The agencies are defining the input parameters to GEM which represent the frontal area and air density, while the speed of the vehicle would be determined in GEM through the drive cycles. The manufacturer would determine a truck’s Cd, a dimensionless measure of a vehicle’s aerodynamics, through testing which then would be input into the GEM model. Quantifying truck aerodynamics as an input to the GEM presents technical challenges because of the proliferation of truck configurations and the lack of a common industry-standard test method. Class 7 and 8 tractor aerodynamics are currently developed by manufacturers using coastdown testing, wind tunnel testing and computational fluid dynamics. The agencies are allowing manufacturers to use any of these three aerodynamic evaluation methods. The modified coastdown procedure will serve as the reference method with the other aerodynamic methods discussed serving as alternatives to the modified coastdown procedure.

Accordingly, the agencies pursued a test program focused on two goals: 1) to determine how Cd predictions compare between the modified coastdown procedure and alternative

methods and 2) determine the confidence level in data generated using alternative aerodynamic methods. The test program used a multifaceted approach that gathered the Cd from a single Class 8, high-roof, aero sleeper cab model from a single manufacturer across all of the aerodynamic methods (*e.g.*, modified coastdown reference method, full-scale wind tunnel, one-eighth scale wind tunnel, and computational fluid dynamics (CFD) analysis), as well as gathered the Cd for Class 8, high-roof, aero sleeper cab model from multiple manufacturers for individual or multiple aerodynamic methods. For the single model/manufacturer approach, we acquired a commercially-available Class 8, high-roof, aero sleeper cab tractor for coastdown and full-scale wind tunnel testing. We also located a source that had a 1/8th scale model of this same tractor for reduced-scale wind tunnel testing. Finally, an EPA contractor scanned and digitized the tractor and trailer for CFD analysis. Below is a discussion on the test program with results from coastdown, wind tunnel testing, and CFD analysis where available.

3.2.2.1 Coastdown Testing

For several decades, light-duty vehicle manufacturers have performed coastdown tests prior to vehicle certification. However, this practice is less common with heavy-duty vehicles, since the current heavy-duty certification process focuses on engine and not vehicle exhaust emissions, *i.e.*, NO_x, PM, NMHC, CO, so vehicle-based improvements have not been rewarded by the existing regulatory structure. In recent years, however, growing concerns over energy security, fuel efficiency and carbon footprint have prompted efforts to develop and improve design features or technologies related to the aerodynamic and mechanical components of heavy-duty (HD) vehicles. Lowering tire rolling resistance, aerodynamic drag, and driveline parasitic losses on HD vehicles could translate into significant long-term fuel savings as well as HD greenhouse gas emissions reductions, since vehicles with enhanced aerodynamic or mechanical features encounter lower road load force during transport, and thereby consume less fuel. The road load force can be captured by coasting a vehicle along a flat straightaway under a set of prescribed conditions. Such coastdown tests produce vehicle specific coastdown coefficients describing the road load as a function of vehicle speed.

The coefficients obtained are essential parameters for conducting chassis dynamometer tests as well as for assessing GHG and fuel consumption performance for Class 7/8 combination tractors *via* modeling. Because the existing coastdown test protocols, *i.e.*, SAE J1263 and SAE J2263, were established primarily from the light-duty perspective, the agencies realize that some aspects of this methodology might not be applicable or directly transferable to heavy-duty tractor applications.^{5,6} Therefore, it appears that some modifications to existing light-duty vehicle-focused coastdown protocols are necessary. Sections 3.2.2.1.1 and 3.2.2.1.2 describe the existing protocols and our modifications to the protocols, respectively.

3.2.2.1.1 Overview of SAE J1263

The Society of Automotive Engineers (SAE) publishes voluntary reports to advance the technical and engineering sciences. The agencies, in response to comments from the heavy-duty vehicle manufacturing industry, will base the coastdown procedure on the J1263 MAR2010 Surface Vehicle Recommended Practice publication by the SAE Technical Standards Board, which established a procedure for determination of road load measurement and dynamometer simulation using coastdown techniques.⁶

Heavy-Duty GHG and Fuel Efficiency Standards FRM: Test Procedures

The J1263 coastdown procedure stipulates that the coastdown runs need to be conducted on dry and level concrete or a rolled asphalt road and must not exceed 0.5% grade, under no rain or fog conditions, at an ambient temperature between 5 to 35°C (41 to 95°F), and average wind speed less than 16 km/h (10 mph) with wind gusts less than 20 km/h (12.3 mph) and average cross winds less than 8 km/h (5 mph).

The vehicle and tires should have at least 50% of the original tread depth remaining and a minimum of 3500 km (2175 mi) prior to testing. The tire pressure must be set and recorded before moving the vehicle. The vehicle and tires require preconditioning for a minimum of 30 minutes running at 80 km/h (49.7 mph). Calibration of the instrumentation can be done during preconditioning.

Vehicle regenerative braking shall be disabled during coastdown testing. The vehicle's windows and vents must be closed and the use of any accessory that can affect the engine speed shall be noted and duplicated during any subsequent dynamometer adjustments.

A minimum of 10 valid runs, 5 in each alternating direction, must be made. For each run the vehicle is accelerated to a speed 8 km/h (5 mph) above the high point of the coastdown speed range, the transmission is shifted into neutral gear, and measurements are taken until the vehicle speed reaches a speed less than the lower point of the coastdown speed range. Engage the transmission and accelerate for the next run; try to minimize the time between runs to avoid vehicle and ambient variations.

Lane changes should be avoided. If lane changes are necessary, they should be done as slowly as possible and over a distance of at least a half kilometer (a quarter mile). The run should be aborted if such a gradual change cannot be made.

The mass of the vehicle is recorded at the end of the test; including instrumentation, driver and any passengers.

The coefficients of the road load force equation are determined for each individual $V(t)$ coastdown and are then averaged over all pairs of coastdowns in each data set. Corrections are applied for wind (both parallel and perpendicular to the coastdown path), for the temperature dependence of rolling resistance, and for the density dependence of aerodynamic drag. The corrected coefficients are then used to construct the vehicle force-velocity equation characteristics of the vehicle under standard ambient conditions with no wind. This force is then corrected for inertial differences between the road test configuration and the dynamometer test configuration, and the resultant force is used to calculate the time to coast from 88 to 72 km/h (55 to 45 mph) on a chassis dynamometer.

The road load force equation is:

$$-M_e dV/dt = f_0 + f_2 V^2$$

where:

$$f_2 = \mu_0 \mu \hat{W} + 1/2 \rho C_D A$$

Regulatory Impact Analysis

$$f_0 = \mu_0 W + (f_2 - \mu_0 \mu' W) v_x^2 + 1/2 \rho C_{DY} A v_y^2$$

The coastdown time interval equation is:

$$t - t_0 = M_e / \sqrt{f_0 f_2} (\tan^{-1}(\sqrt{f_2/f_0} V_1) - \tan^{-1}(\sqrt{f_2/f_0} V_0))$$

where the units for M_e , f_0 , f_2 , V , and V_0 must be chosen so that the argument of the inverse tangent function is dimensionless and the resultant coastdown time is in seconds.

Compare each individual $V(t)$ trace and its analytical counterpart $V(f_0, f_2, t)$. If the root-mean-square difference (error) exceeds 0.40 km/h (0.25 mph) on any individual run, discard that run and the paired run in the opposite direction. Of the paired runs, the standard deviation of the f_0 's must be less than 11 N (2.5 lb) or 5% of the mean and the standard deviation of all the f_2 's must be less than $0.011 \text{ N}/(\text{km/h})^2$ ($0.001 \text{ lb}/[\text{mph}]^2$) or 3% of the mean. If less than three pairs comply with this criterion, the test run is invalid.

The calculation of 88 to 72 km/h coastdown time is:

$$\delta_t = t - t_0 = ((M_{IW} + M_{DLC})/3.6\sqrt{f_0' f_2'}) (\tan^{-1}(\sqrt{f_2'/f_0'} 88) - \tan^{-1}(\sqrt{f_2'/f_0'} 72))$$

Symbols:

A = Vehicle frontal area (m^2 or ft^2)

C_d = Aerodynamic drag coefficient (dimensionless)

C_{DY} = Crosswind aerodynamic drag coefficient (dimensionless)

f_0, f_2 = Coefficients of the zeroth and second order terms (respectively) in the road load force equation (N or lb and $\text{N}/[\text{km/h}^2]$ or lb/mph^2)

f_0', f_2' = Coefficients of the zeroth and second order terms (respectively) in the road load force equation (N or lb and $\text{N}/[\text{kmh}^2]$ or lb/mph^2) corrected to standard conditions

M_{DLC} = Total equivalent mass of drivetrain components (kg or slugs)

M_{IW} = Equivalent mass of dynamometer inertia simulation mechanism (IWC/g) (kg or slugs)

M_e = Total effective vehicle mass (kg or slugs)

$t-t_0$ = Coastdown time interval (seconds)

δ_t = Vehicle coastdown time on the chassis dynamometer(s)

V = Vehicle speed (km/h or mph)

V_1, V_0 = Final and initial speeds in the calculation of the coastdown time interval (km/h or mph)

v_x = Component of wind parallel to track (km/h or mph)

v_y = Component of wind perpendicular to track (km/h or mph)

W = Vehicle test weight (N or lb)

μ = Coefficient of rolling resistance (dimensionless)

μ_0 = Velocity-independent coefficient of rolling resistance (dimensionless)

μ' = Velocity-dependent coefficient of rolling resistance ($[\text{km/h}]^2$ or $[\text{mph}]^2$)

ρ = Air mass density (kg/m^3 or slugs/ft^3)

3.2.2.1.2 Modifications to SAE J1263

The agencies have assessed the feasibility of performing coastdown testing on heavy-duty trucks, primarily on Class 7 and 8 combination tractors. EPA, through its contractor Southwest Research Institute, conducted coastdown tests using SAE test methods J1263⁵ and J2263⁶ on three SmartWay-certified Class 8 tractor-trailers equipped with sleeper cabs during the period October 2008 through November 2009. Also, other contractors, Transportation Research Center in Ohio and Automotive Testing and Development Inc. in California performed

coastdown testing for the agencies on up to two dozen Class 2b-8 truck configurations in 2009-2011. EPA also gained firsthand experience of such testing by performing its own coastdown testing on one Class 6 and multiple Class 8 truck configurations at nearby locations using both SAE test methods. Details regarding these tests can be found in “Heavy-Duty Coastdown Test Procedure Development” and “Heavy-Duty Greenhouse Gas and Test Program 2 Summary” both contained in Docket Number EPA-HQ-OAR-2010-0162.⁷

3.2.2.1.2.1 Changes from Proposal

In the proposal of this rulemaking, EPA’s preferred coastdown procedure was based on SAE J2263 with a tractor boom-mounted anemometer. However, based on feedback from industry and other entities, the agency is finalizing a coastdown procedure based on SAE J1263.

We received feedback from tractor manufacturers indicating that air flow over the vehicle may be impacted due to a boom-mounted anemometer, such that such a test configuration for heavy-duty vehicles may not reflect real air flow over a tractor during normal driving. SAE J1263 and SAE J2263 test procedures both indicate that wind speed and direction must be monitored. SAE J2263 continues by suggesting that wind speed and direction “may be measured at the approximate mid-point of the vehicle’s front cross section and approximately 2 meters in front of it” by using, presumably, an on-board, tractor mounted anemometer. Wind speed and direction are monitored to evaluate the validity of test runs, constrained to preserve test-to-test comparison, and used in road load determination in SAE J2263. EPA studied the potential aerodynamic drag impacts of on-board anemometry by using CFD to evaluate a base case (*i.e.*, no on-board anemometry) and second case using an anemometer mounted on the front of the tractor using a boom. Figure 3-1 shows the tractor with the on-board anemometer.

Figure 3-1 Depiction of on-board anemometer setup evaluated by EPA

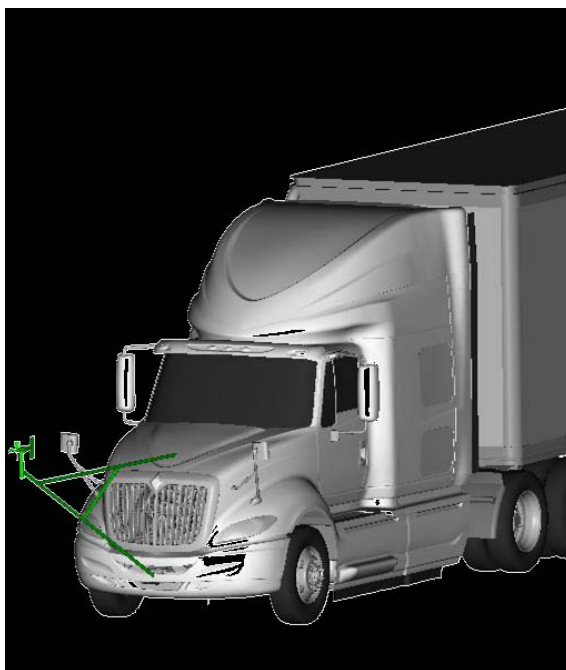

Regulatory Impact Analysis

CFD simulations using PowerFLOW, a commercially available CFD application using a Lattice-Boltzmann methodology, were conducted to evaluate potential aerodynamic differences between a tractor with and without a front-mounted anemometer. This evaluation was conducted at zero yaw and, depending upon the design of the boom and supporting structure, would likely yield different results at yaw. At zero yaw, the data indicated a relatively small impact to overall aerodynamic drag with the tractor-mounted anemometer simulation runs increasing drag by 0.8% relative to the baseline (no anemometer mounted). Drag development at the vehicle center line was impacted down the length of the combination tractor-trailer when introducing a tractor mounted boom. This can be seen in Figure 3-2. In addition, local flow disturbances did occur and can be visualized in Figure 3-3.

Figure 3-2 Drag development of combination tractor-trailer with tractor-mounted anemometer

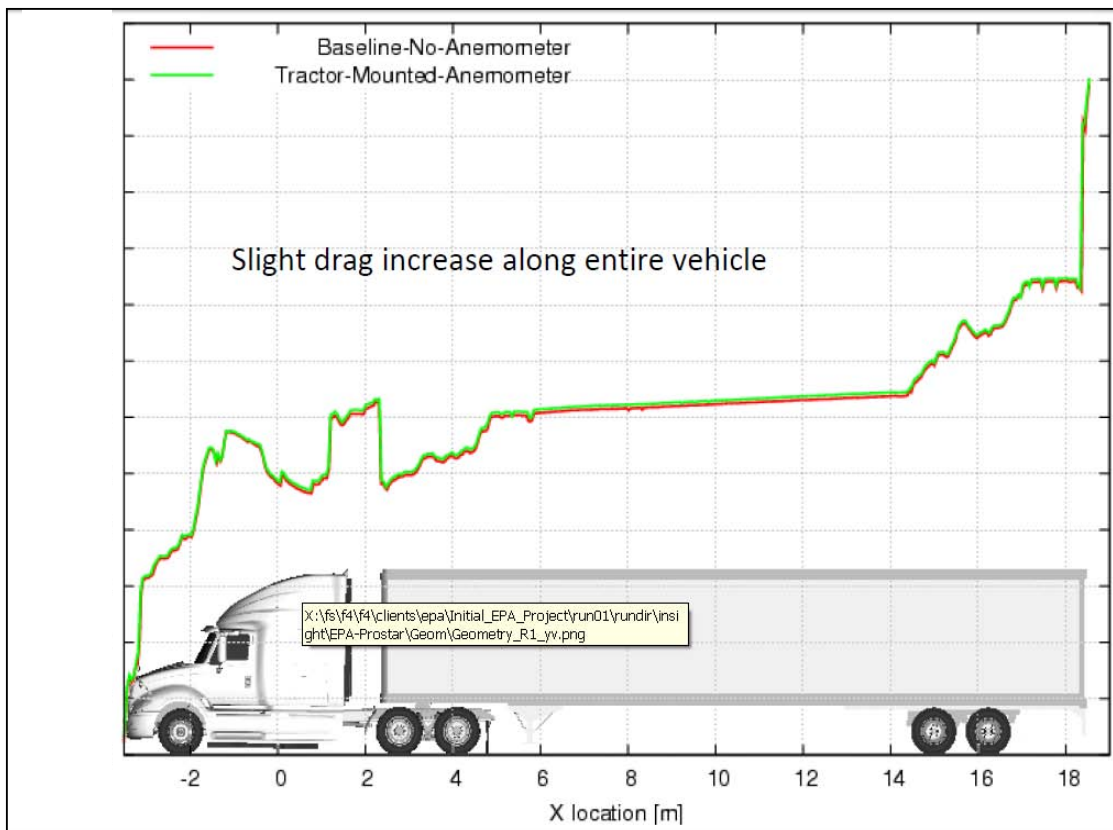
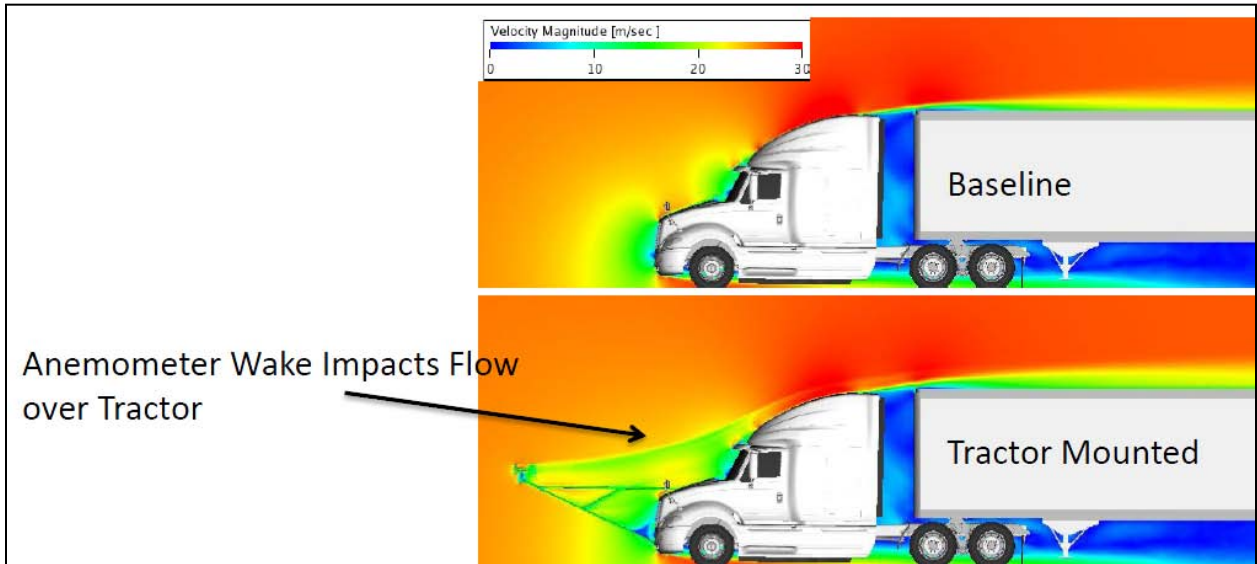

Figure 3-3 Visualization of flow over tractor with tractor-mounted boom anemometer



Overall, the results show that there are some relatively small but measurable drag impacts due to introducing an on-board anemometer mounted to the front of the tractor. In addition, mounting an anemometer will alter the drag development and flow structure down the length of the vehicle. The impacts on flow structure development are likely to be different for different base tractor shapes. As a result, EPA has decided to not use on-board anemometry in order to mitigate both systematic uncertainty that could result from introducing on-board testing equipment as well as uncertainty resulting from boom influences that may vary from truck-to-truck. The Agency feels that testing the truck without on-board anemometry is more representative of its in-use shape.

3.2.2.1.2.2 Modified SAE J1263 Procedure

Based on feedback from the heavy-duty vehicle manufacturing industry and other entities, the Agency is finalizing the recommendation to use a Modified SAE J1263 coastdown procedure.

The Modified SAE J1263 coastdown procedure varies from the SAE J1263 in only the following respects:

1. Coastdown data is to be gathered from a maximum speed of 113 km/h (70.2 mph) down 24 km/h (15 mph).
2. Average wind speed at the test site, during each coastdown run in each direction, must be < 10 mph (but the guideline is to conduct testing at predicted wind speeds \leq 6.0 mph).
3. All valid coastdown run times in each direction must be within 2 standard deviations of the mean of the valid coastdown run times in that direction. The run times are from 70 mph down to 15 mph.

Regulatory Impact Analysis

4. The grade of the test track or road must not be excessive or exceed road safety standards. If road grade is greater than 0.02% over the length of coastdown track or road, then the road grade as a function of distance along the length of track or road must be incorporated in the analysis. To calculate the force due to grade use section 11.5 of SAE J2263 (also described in Step 4 in Table 3-2).
5. In order to enhance coastdown test repeatability and mitigate the impact of mechanical loads, the tires on vehicle tractors and trailers shall meet the following requirements:
 - a. They shall either be SmartWay-Verified tires or, they shall have a rolling resistance of < 5.1 kg/ton based on ISO 28580. Note: See the following web page for more information concerning SmartWay-Verified tires: <http://www.epa.gov/smartway/transport/what-smartway/verified-technologies.htm>
 - b. They shall be mounted on steel rims.
 - c. They shall have accumulated $\geq 2,175$ miles of prior use (as specified for truck cabs in SAE J1263).
 - d. They shall have $\geq 50\%$ of their original tread depth (as specified for truck cabs in SAE J1263).
 - e. They shall have no apparent signs of chunking or uneven wear.
 - f. They shall not be retreads.
 - g. They shall be 295/75R22.5 or 275/80R22.5 dual tires.
6. Gather wind speed, direction, and time-of-day data using at least one stationary electro-mechanical anemometers and suitable data loggers, that meet the specifications of SAE J1263, as well as the additional specifications provided below, for the anemometer placed at track-side or road-side as described below:
 - a. Run the zero wind and zero angle calibration data collection.
 - b. The anemometer must have had its outputs recorded at a wind speed of 0.0 mph within 24 hours preceding each coastdown test in which it is used.
 - c. The location of the anemometer must be recorded, using a GPS measurement device, at track-side or road-side locations that correspond (approximately) to the midway distances along the portion of the track/road used for coastdowns.
 - d. The anemometer must be positioned trackside/roadside such that it will be ≥ 2.5 and < 3.0 vehicle widths from the location of the test vehicle's centerline as the test vehicle passes the location of that anemometer.

Heavy-Duty GHG and Fuel Efficiency Standards FRM: Test Procedures

- e. The anemometer is to be mounted at a height that is within ± 6 inches of half of the test vehicle's maximum height.
 - f. The anemometer is to be placed ≥ 50 feet from the nearest tree.
 - g. The anemometer is to be placed ≥ 25 feet from the nearest bush.
 - h. The height of the grass surrounding the stationary anemometer shall not exceed 10% of the height at which the anemometer is mounted, within a radius equal to the height at which the anemometer is mounted.
7. Mid-roof and low-roof tractors are usually not paired to run with a trailer; therefore, these tractors shall be tested in its bobtail configuration.
 8. Any box or tanker trailers used in coastdowns shall be tested empty (unloaded).
 9. After determining the valid runs in the test, data analysis should follow the steps described in Table 3-2 below to determine drag area C_dA .

Table 3-2 Data Analysis Steps for Determining C_dA from the Modified J1263 Coastdown Procedure.

Step 0: Only include data between 15 and 70 mph, inclusive.		$v = \text{vehicle speed}$
Step 1: Calculate acceleration.	_____	$a = \text{vehicle acceleration}$ $t = \text{time}$
Step 2: Inertial and Effective Mass (Add 125 lbm per tire to account for rotational inertia)	_____	$M = \text{vehicle mass}$ $M_{\text{inertial}} = \text{additional inertia from rotating components}$ $M_e = \text{effective mass}$ $n_{\text{tires}} = \text{number of tires in test configuration}$
Step 3: Calculate force.		$F = \text{force}$
Step 4: Perform regression (least squares) of force against vehicle speed squared. Do not include a linear vehicle speed term. Add grade effect to force if required.	_____ OR _____	$h = \text{altitude}$ $s = \text{travel distance}$ $g = \text{gravitational acceleration} = 9.81 \text{ m/s}^2$
Step 5: Temperature and pressure correction to 20°C and 98.21 kPa	_____	$T = \text{average ambient temperature during test in } ^\circ\text{C}$ $P = \text{average ambient pressure during test in kPa}$ Correction taken from SAE J2263 Section 12.9
Step 6: Calculate drag area	_____	$\rho = \text{density of air at reference conditions} = 1.17 \text{ kg/m}^3$

Regulatory Impact Analysis

In the proposal, the agencies conducted analyses with several forms of the force equation involving different combinations of wind speed, vehicle speed, and wind direction. Since we are finalizing our coastdown procedure based on SAE J1263 (which does not include onboard anemometry), our force equation was simplified to involve only vehicle speed. Also, in the proposal, we had proposed the use of a mixed model to determine drag area (and drag coefficient). However, we are finalizing in the procedure a least squares regression instead. This type of model is commonly available and widely used in most statistics, spreadsheet, or mathematical software, such as Excel, SAS, SPSS, or MATLAB. We verified that for a given set of coastdown data, a regression in SAS produced the same result as a regression in Excel. For a given force equation, the difference in drag area between a least squares regression result and a mixed model result is negligible since the drag area is based on a fixed effect (vehicle speed) rather than a random effect. This is not always true for the intercept A_m , which is analogous to rolling resistance, but the coastdowns will not be used to determine tire rolling resistance.

3.2.2.1.2.3 Modified SAE J1263 Testing

In the proposal, EPA had proposed a coastdown procedure similar to SAE J2263, which requires onboard anemometry. After receiving feedback from truck manufacturers and other entities, a modified SAE J1263 procedure (described above), which does not involve onboard anemometry, was developed to address concerns regarding variability. Subsequently, the agency gathered more coastdown data using this modified SAE J1263 test procedure.

The agency (via contractors URS Corporation and Automotive Testing and Development Services, Inc. (ATDS)) coasted down combination tractors on an actual road in Lancaster, CA and on a straightaway track at Ford's Arizona Proving Grounds. Several trucks were provided by the truck manufacturers and their identities were hidden from the agency such that an individual truck could not be matched to its manufacturer. Approximately 20 runs (10 in each direction) were performed for each test, but some runs were eliminated for certain tests due to excursions from the wind restrictions referred to above. If an individual run was outside these wind requirements, it was eliminated from analysis, along with the preceding run (if the run was even-numbered) or the following run (if it was odd-numbered). This was done to ensure that there was an equal number of runs in each direction and that every run had its opposite direction counterpart immediately preceding or following it. Two trackside/roadside anemometers were used on opposite ends of the track/road. The average and maximum wind speeds were calculated for each run to determine validity of the run with respect the wind restrictions.

The track in Arizona was not long enough to consistently do full coastdowns every run, so runs were split at this site. Based on track specifications, we assumed zero grade at this facility. For the Lancaster testing, we incorporated a constant grade of 0.2% — into our calculations, based on grade data provided by ATDS. The analysis described above was used to estimate drag areas for the various truck configurations (Table 3-3).

Heavy-Duty GHG and Fuel Efficiency Standards FRM: Test Procedures

Table 3-3 Summary of Results from Modified J1263 Testing

CAB TYPE	ROOF HEIGHT	AERO TYPE	TRAILER	CONFIGURATION ID	WEIGHT [LB]	C _d A [M ²]	STD ERROR	# OF VALID RUNS
Sleeper	High	Aero	53-ft box	B-3JM2-2H-TXCR	34,500	6.43	1.7%	20
				B-3JM2-4N-TXCR	33,640	5.71	2.0%	20
				B-3JM2-2K-TXCR	33,890	6.34	3.1%	12
				C-3JM2-2H-TXCR	34,500	6.97	1.7%	20
				C-3JM2-1B-TXCR	34,500	6.19	5.4%	4
Sleeper	High	Non-Aero	53-ft box	C-3JE2-1F-TXCR	33,920	6.72	2.0%	18
Day	High	Aero	53-ft box	B-3XM2-4M-TBCR	31,722	6.82	2.1%	18
Sleeper	Mid	Aero	Bobtail	C-3JM3-2K-TGTW	19,520	5.00	1.7%	20
Sleeper	Low	Aero	Bobtail	C-4XM7-1C-TGTW	14,700	4.21	1.8%	20

The “aero” configurations had most of the currently available aerodynamic tractor features, including roof and tank fairings, whereas the “non-aero” configurations did not have tank fairings.

As discussed in RIA Chapter 2.5.1, the results above were used to determine the aerodynamic bin tables that are used to determine the GEM inputs. While the agencies are requiring performing 16 valid runs, we were not able to reach 16 valid runs for some tests due to weather and time constraints. To collect as much data as possible on different trucks and truck configurations in the time since receiving feedback from industry, we included in these results tests where we could not collect 16 valid runs. In general, reducing the number of runs impacts the uncertainty (standard error) more than the mean of the C_dA value itself.

As a result of the additional testing and based on data provided in comments from stakeholders, the agencies have chosen to update the test article specifications for tractors and trailers, please see Table 3-4 Dry Van Test Article. Additionally, please see Table 3-5 for an update of the track and ambient conditions considered valid for heavy-duty vehicle coastdown testing. For special cases in which a trailer would be used for coastdown testing for mid-roof and low-roof tractors, the specifications for the tanker and flatbed trailers may be seen in Table 3-6 and Table 3-7, respectively.

Regulatory Impact Analysis

Table 3-4 Dry Van Test Article

53' Air Ride Dry Vans	
Length:	53 feet (636 inches) +/- 1 inch
Width:	102 inches +/- 0.5 inches
Height:	102 inches (162 inches or 13 feet, 6 inches (+0.0 inch/-1 inch) from the ground)
Capacity:	3800 cubic feet
Assumed trailer load/capacity:	45,000 lbs.
Suspension:	Any (see "trailer ride height" below)
Corners:	Rounded with a radius of 5.5 inches +/-0.5 inches
Bogie/Rear Axle Position:	Tandem axle (std), 146 inches +/-3.0 inches from rear axle centerline to rear of trailer. set to California position
Skin:	Generally smooth with flush rivets
Scuff band:	Generally smooth, flush with sides (protruding \leq 1/8 inch)
Wheels:	22.5 inches. Double wide. Std mudflaps
Doors:	Swing doors
Undercarriage/Landing Gear:	Std landing gear, no storage boxes, no tire storage, 105 inches +/- 4.0 inches from front of trailer to centerline of landing gear
Underride Guard	Equipped in accordance with per 49 CFR §393.86
<p>Tires for the Standard Trailer and the Tractor:</p> <ol style="list-style-type: none"> a. Size: 295/75R22.5 or 275/80R22.5 b. CRR<5.1 kg/metric ton (In addition, the CRR for trailer tires in GEM should be updated to 5.0 kg/metric ton.) c. Broken in per section 8.1 of SAE J1263 d. Pressure per section 8.5 of SAE J1263 e. No uneven wear f. No re-treads g. Should these tires or appropriate Smart Way tires not be available, the Administrator testing may include tires used by the manufacturer for certification. 	
<p>Test Conditions:</p> <ol style="list-style-type: none"> 1. Tractor-trailer gap: 45 inches +/- 2.0 inches 2. King pin setting: 36 inches +/- 0.5 inches from front of trailer to king pin center line 3. Trailer ride height: 115 inches +/-1.0 inches from top of trailer to fifth wheel plate, measured at the front of the trailer, and set within trailer height boundary from ground as described above 4. Mudflaps: Positioned immediately following wheels of last axle 	

Heavy-Duty GHG and Fuel Efficiency Standards FRM: Test Procedures

Table 3-5 Coastdown Track Specifications

COAST DOWN TRACK SPECIFICATIONS	
<i>Parameter</i>	<i>Range</i>
Coastdown speed range Average wind speed at the test site (for each run in each direction)	70 mph to 15 mph < 10 mph
Maximum wind speed (for each run in each direction)	<12.3 mph
Average cross wind speed (for each run in each direction at the site) All valid coastdown runs in one direction	< 5 mph Within 2 standard deviations of the other valid coastdown runs in that same direction
Grade of the test track	<.02% or account for the impact of gravity as described in SAE J2263 Equation 6.

Table 3-6 Tanker Trailer Specifications for Special Testing

TANKER	
Length:	42 feet ± 1 foot, overall 40 feet ± 1 foot, tank
Width:	96 inches ± 2
Height:	140 inches (overall, from ground)
Capacity:	7,000 gallons
Suspension:	Any (see “trailer ride height” below)
Tank:	Generally cylindrical with rounded ends.
Bogie:	Tandem axle (std). Set to furthest rear position.
Skin:	Generally smooth
Structures:	(1) Centered, manhole (20 inch opening), (1) ladder generally centered on side, (1) walkway (extends lengthwise)
Wheel fairings:	
Wheels:	24.5 inches. Double wide.
Tanker Operation	Empty

Regulatory Impact Analysis

Table 3-7 Flatbed Trailer Specifications for Special Testing

FLATBED	
Length:	53 feet
Width:	102 inches
Flatbed Deck Heights:	Front: 60 inches \pm 1/2 inch Rear: 55 inches \pm 1/2 inch
Wheels / Tires	22.5 inch diameter tire with steel or aluminum wheels
Bogie	Tandem axles, may be in "spread" configuration up to 10 feet \pm 2 inches. Air suspension
Load Profile: 25 inches from the centerline to either side of the load; Mounted 4.5 inches above the deck. Load height 31.5 inches above the load support. Trailer should be empty.	

3.2.2.2 Wind Tunnel Testing

As stated previously, the modified coastdown procedure described above is the reference method used to generate Cd values for the purpose of this rulemaking. However, due to the inability to control the environmental conditions, manufacturers also use wind tunnels to measure and validate aerodynamic performance. Therefore, we are allowing manufacturers to use wind tunnels as an alternative to the modified coastdown procedure.

For wind tunnel testing, we examined two types of wind tunnels primarily used in the industry: a full-scale wind tunnel (FSWT) that can accommodate a full-size tractor and trailer, in some cases a full length trailer (not evaluated in this test program) or a shorter length trailer, and a reduced-scale wind tunnel (RSWT) that can accommodate scale models of actual full size tractor-trailer combinations. Regardless of wind tunnel type, testing protocol typically consists of multiple baseline runs with a full yaw sweep. Within this run, there will also be a zero yaw measurement before, in the middle, and at the end of the yaw sweep as a quality check (*e.g.*, the wind tunnel test may be performed with Cd measurements in the following yaw angle sequence (degrees): 0, +1, +3, +6, +9, 0, -1, -3, -6, -9, 0).

Since wind tunnels are governed by SAE specifications, similar to the coastdown procedure, less emphasis was given to defining the specifications surrounding their use, as compared to CFD for instance. Therefore, the discussions below on wind tunnels are fairly succinct to ensure that proper protocols and procedures were followed to produce the results. Each source used for this test program has their own set of procedures and protocols and, for the purposes of this test program, only valid experiments and measurements were accepted and reported.

3.2.2.2.1 Full-Scale Wind Tunnel Testing

For full-scale wind tunnel testing, we used the National Resources Council-Canada (NRC-C) wind-tunnel in Ottawa, Ontario. The 9 meter (m) x 9 meter Low Speed Wind Tunnel facility is located on the National Research Council (NRC) campus adjacent to the Ottawa International Airport and has been in operation since 1970. The wind tunnel is a horizontal closed circuit atmospheric facility with a large test section (9.1 m wide x 9.1 m high x 22.9 m long (30 ft x 30 ft x 75 ft)). It is powered by an air-cooled 6.7 MW (9000 hp) DC motor that drives an 8-bladed fan. Its speed may be varied and set at any value from 0 to 230 rpm and can be maintained within ± 0.1 rpm. The maximum wind speed is about 55 m/s (180 ft/s).⁸The wind tunnel can accommodate a full-size tractor and a trailer of length up to 28 feet (see Figure 3-4 below).

Figure 3-4: Full-scale, fixed floor test in the NRC 9-meter wind tunnel (model tested for this program not shown).



For our test program, we assumed a base tractor-trailer gap of 45 inches as specified in this rulemaking. Baseline testing was performed using the as-received configuration with full aerodynamics package components on the tractor. The 28' trailer used for this testing was acquired from the tractor OEM and is the same trailer they use for testing in this facility. Using the results of this testing, we focused on the zero yaw C_d results since this will be required for compliance with the rulemaking. The key issues we examined were repeatability of the results from the full scale wind tunnel and acceptance of a single test from an OEM using a full scale wind tunnel test.

Below is a graph showing the results of the zero yaw C_d results as compared to the average of all of the zero yaw C_d results (see Figure 3-5). The deltas are well below 1% with an overall standard deviation of -0.0009 for all zero yaw C_d results, approximately 0.2% of the zero

Regulatory Impact Analysis

yaw Cd result average showing excellent agreement from test to test. This data confirms that the full-scale wind tunnel test is highly repeatable and, once a manufacturer has approval to use a certified facility, there is high confidence in the results from a single test on a tractor model.

Figure 3-5: Delta Between Individual Zero Yaw Cd Values and the Average of All Zero Yaw Cd Values for Full Scale Wind Tunnel Testing of Class 8, High Roof, Aero Tractor with a 28' Trailer in the NRC Wind Tunnel.

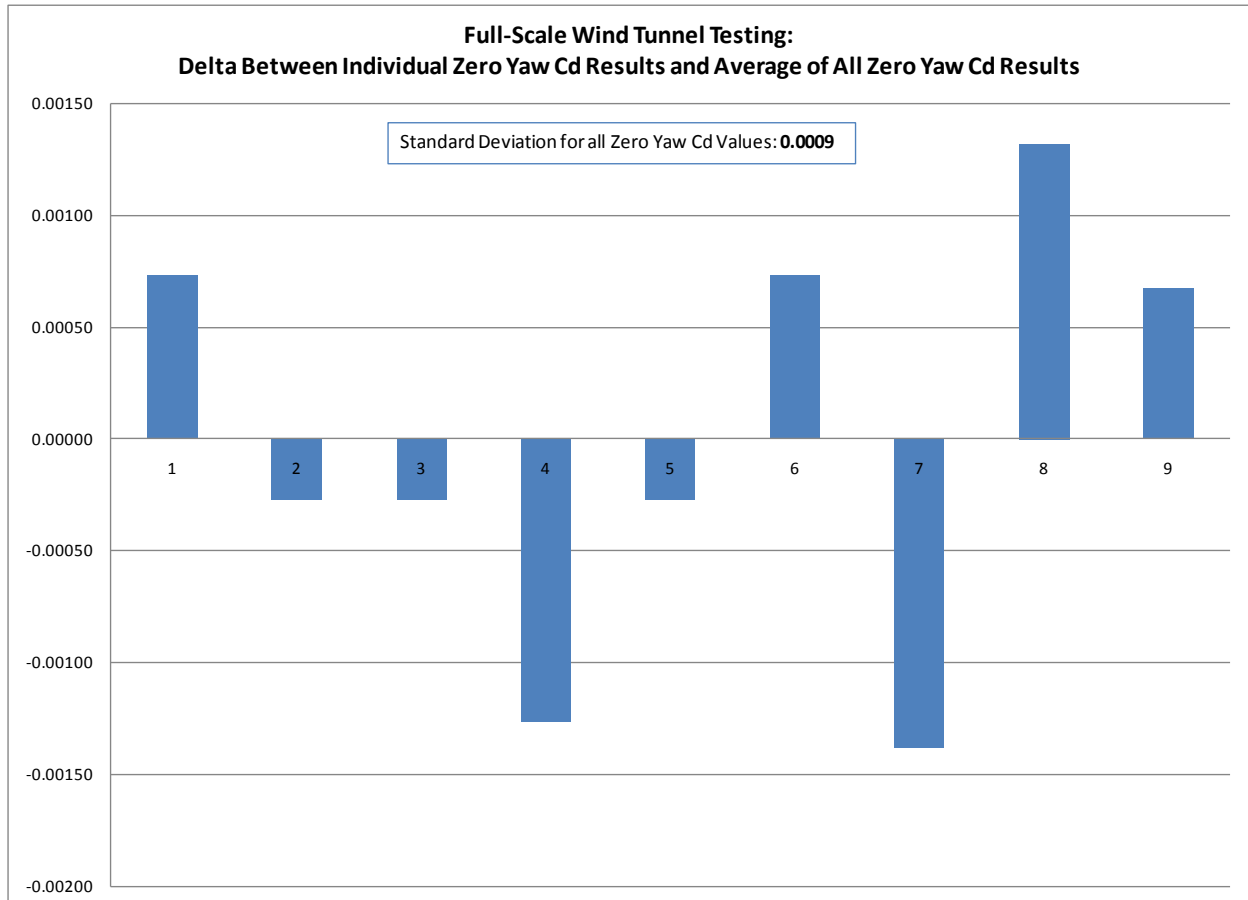

3.2.2.2.2 Reduced-Scale Wind Tunnel Testing

For reduced-scale wind tunnel testing, we used the Automotive Research Center (ARC) in Indianapolis Indiana. The ARC wind tunnel is a closed single return tunnel with 3/4 open-jet working section and moving ground plane (2.3 m wide x 2.1 m high x 5.5 m long (7.5 ft x 6.8 ft x 18 ft)). It is powered by an air-cooled 373kW (274 hp) variable speed DC motor that drives a 9-bladed fan with carbon fiber blades. Its speed may be varied and set at any value from 0 to 610 rpm. The maximum wind speed is about 50 m/s (164 ft/s).⁸ The wind tunnel can accommodate a model up to 50% scale (1/2 scale) for race car applications down to 12.5% scale (1/8th scale) for Class 8 tractor and trailer combinations. The wind tunnel is equipped with a moving ground plane (*i.e.*, rolling road), four-stage boundary layer suction system, and a top-mounting “Sting” system allowing for yawing of the model. For model development, ARC has in-house model developers and can create highly detailed scale models using original computer

aided design and engineering (CAD/CAE) drawings or using in-house scanning equipment to perform scanning and digitizing to create CAD/CAE drawings (see Figure 3-6 below).

Figure 3-6: 1/8th Scale Tractor-Trailer Model in ARC Reduced Scale Wind Tunnel.

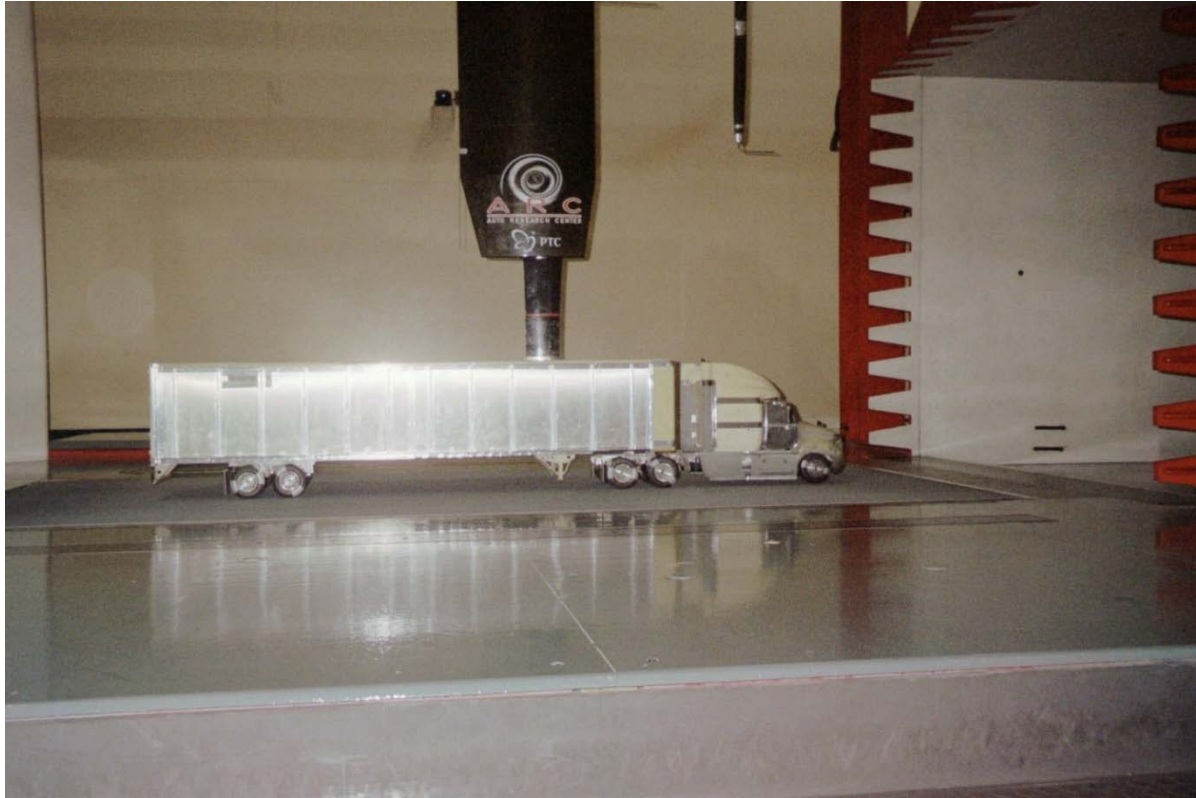

For our test program, we assumed a base tractor-trailer gap of 45 inches as specified in this rulemaking and the full aerodynamics package components that are sold on the full size version of the tractor. Using the results of this testing, we focused on the zero yaw C_d results since this will be required for compliance with the rulemaking. The key issues we examined were repeatability of the results from the reduced scale wind tunnel and acceptance of a single test from an OEM using a reduced scale wind tunnel test.

Below is a graph showing the results of the zero yaw C_d results as compared to the average of all of the zero yaw C_d results (see Figure 3-7). The deltas are well below 1% with an overall standard deviation of -0.0008 for all zero yaw C_d results and approximately 0.15% of the zero yaw C_d result average. This data confirms that the reduced-scale wind tunnel test is highly repeatable from test to test and, once a manufacturer has approval to use a certified facility, there is high confidence in the results from a single test on a tractor model.

Regulatory Impact Analysis

Figure 3-7: Delta Between Individual Zero Yaw Cd Values and the Average of all Zero Yaw Cd Values for Reduced-scale Wind Tunnel Testing of a 1/8th Scale, Class 8, High Roof, Aero Tractor with a 53' Trailer in the ARC Wind Tunnel.

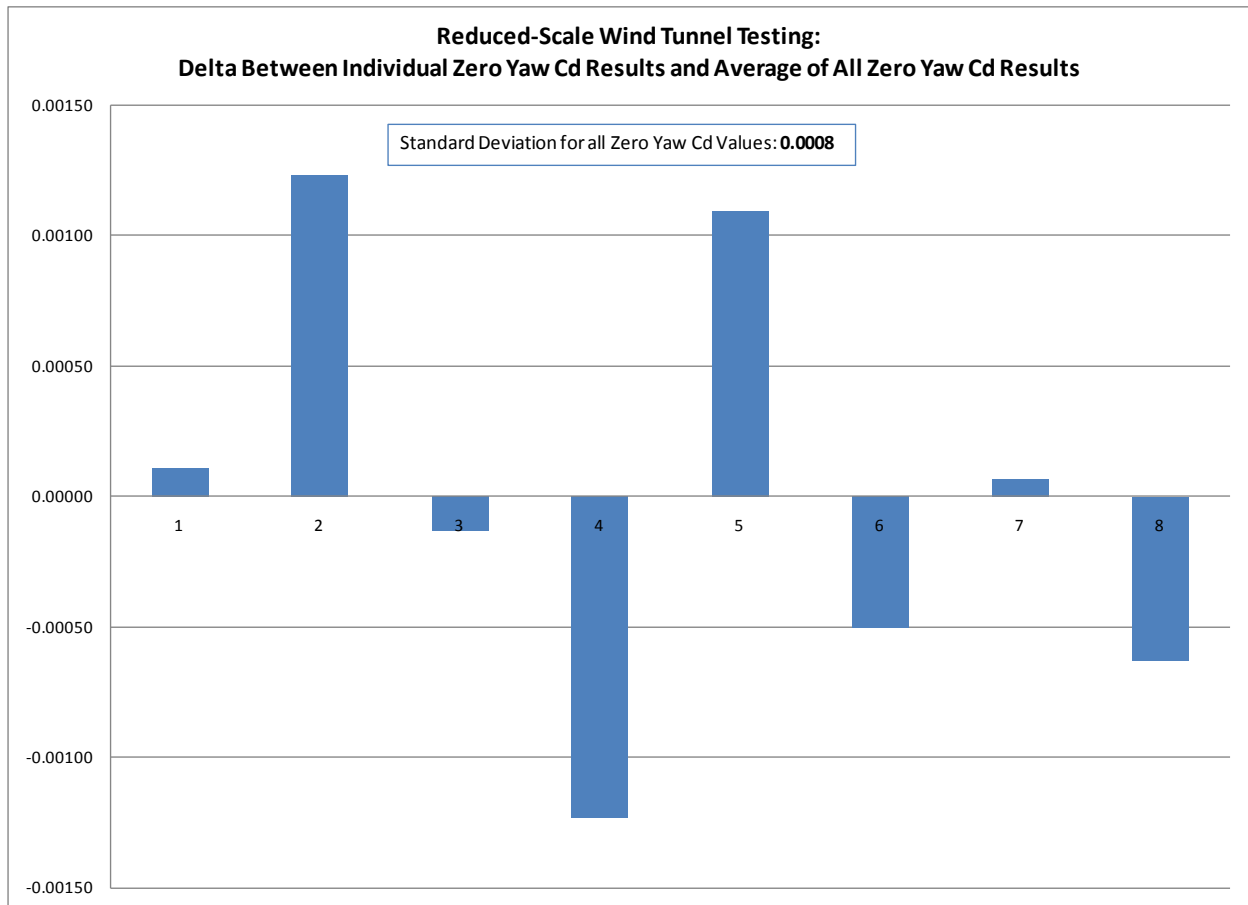

3.2.2.3 Computational Fluid Dynamics

Computational Fluid Dynamics, or CFD, capitalizes on today's computing power by modeling a full size vehicle and simulating the flows around this model to examine the fluid dynamic properties, in a virtual environment. CFD tools are used to solve either the Navier-Stokes equations that relate the physical law of conservation of momentum to the flow relationship around a body in motion or a static body with fluid in motion around it, or the Boltzmann equation that examines fluid mechanics and determines the characteristics of discrete, individual particles within a fluid and relates this behavior to the overall dynamics and behavior of the fluid. CFD analysis involves several steps: defining the model structure or geometry based on provided specifications to define the basic model shape; applying a closed surface around the structure to define the external model shape (wrapping or surface meshing); dividing the control volume, including the model and the surrounding environment, up into smaller, discrete shapes (gridding); defining the flow conditions in and out of the control volume and the flow relationships within the grid (including eddies and turbulence); and solving the flow equations based on the prescribed flow conditions and relationships.

This approach can be beneficial to manufacturers since they can rapidly prototype (*e.g.*, design, research, and model) an entire vehicle without investing in material costs; they can modify and investigate changes easily; and the data files can be re-used and shared within the company or with corporate partners.

For this test program, we scanned and digitized a full scale, Class 8, high-roof, aero tractor-trailer and supplied this information to three sources using commercially-available CFD code covering the two types of predominant CFD software code (*e.g.*, Navier-Stokes and Lattice-Boltzmann). The issue of repeatability is not an issue with CFD since it is software based and will yield the same number repeatedly once the boundary conditions and tractor-trailer geometry is defined. Therefore, the key issues we examined were the impact of model fidelity on the CFD analysis and the sensitivity of CFD analysis to variations in boundary and surface conditions in the control volume around and on, respectively, the tractor-trailer. Also, one of the secondary issues considered was the trade-off between analysis run time and cost versus model fidelity and boundary/surface condition definition.

In some cases, it was necessary to obtain additional engine bay, underbody and chassis details. Some of the CFD sources had a previous working relationship with the OEM and were able to develop highly detailed models while others used the simplified geometry that we provided. Although this creates a disparity when comparing results, it still provides valuable insight into the impact of model fidelity on CFD results. Also, the CFD analyses were performed assuming an open road condition to mimic coastdown testing. However, the environmental conditions from the coastdown tests were not provided to the sources for the CFD analysis. This further deviates the results of the CFD analysis from the coastdown values but also provides some insight into the worst-case results you can expect absent matching environmental conditions.

In addition, Source A indicated that the 1 millimeter (mm) cell size specified in the proposal was too fine due to cost and computing time and, therefore, recommended the use of 6 mm which was consistent with their software best practices. They also indicated that the cell size is typically increased by a factor of two. Accordingly, Source A performed the CFD analysis on the same model using cell sizes of 1.5mm, the size closest to our proposed 1mm, 3mm and 6mm to show the impact of cell size on Cd estimation, cost and CPU run time.

We were able to obtain CFD results from two out of the three sources for inclusion in this rulemaking. The data from the third source will be added to the rulemaking docket once it is available. The two included sources sell and support the two types of software code (*e.g.*, Navier-Stokes and Lattice-Boltzmann) currently available on the market. For the two available sources, the first source, Source A, had a highly detailed version of the model while the second source, Source B, used the much simpler version of the tractor geometry, in particular the underbody, chassis and suspension, in their analysis. Source B was able to refine the trailer geometry based on previous work so they were able to increase some areas of the model fidelity. In addition, due to cost constraints, we only performed a one-sided, positive angle yaw sweep analysis. Therefore, we will provide a comparison at the angles that are common to both analyses.

Regulatory Impact Analysis

Below are the results of the CFD analyses from Source A and Source B showing the absolute deltas and percent change for angles common to the two sources, using the 6mm case for Source A consistent with their best practices (see Table 3-8).

Table 3-8: Results from CFD Analysis for Two CFD Software Source Codes

YAW ANGLE	DELTA (SOURCE A Cd VALUE – SOURCE B Cd VALUE)	% CHANGE FROM SOURCE A VALUES
0	0.056	11.8
3	0.057	11.1
6	0.066	11.3
9	0.071	10.8

Despite the lack of consistent model details, base assumptions and software code differences, the 10.8 to 11.8 percent difference between the source results is in the realm of acceptability.

The data does show a consistent percentage change compared to the Source A values at all angles. This seems to indicate a structural bias at the algorithm level either due to the assumptions by the modeler or the level of model detail. Without further study, we are not able to isolate the source of this structural bias. However, it does highlight some areas that we need to address in this rulemaking. Therefore, we added some specificity to the language and the process for CFD analysis. First, for any method validation or compliance audit for a manufacturer choosing to use CFD, the manufacturer must supply 1) original CAD/CAE files of the tractor to support the development of a model with sufficient detail to ensure analysis accuracy and 2) the environmental conditions from the coastdown test used to develop the aerodynamic correction factor so that the analysis will closely match the real conditions experienced by the vehicle. Second, to ensure data consistency, a minimum set of characteristics and criteria must be included in this rulemaking for CFD analysis to ensure that the boundary and surface conditions are not too coarse and, thus, not representative of the real truck and environmental conditions. The latter point also overlaps with the key issue of boundary/surface condition sensitivity and the secondary issue of trade-offs between model fidelity and cost/run-time.

Therefore, we attempted to identify some of the critical parameters and define the appropriate ranges to achieve sufficient result accuracy yet minimize manufacturer burden via cost and CPU run-time. Following conversations with industry experts, we ultimately concentrated on a few key input parameters that have the majority of the influence on simulation outputs: mesh cell size used to define the surface of the model and the surrounding environment, the relationship between cell size and the proximity to the tractor trailer, and the overall number of elements in the volume. These parameters can be used to define the complexity of the simulation and, therefore become a skillful balance of creating a simulation with sufficient definition to be representative but not prohibitively expensive or time consuming. In addition, although the Navier-Stokes and Lattice-Boltzmann software codes use different approaches and denote this parameters differently, the definitions and assumptions for the inputs largely determines the accuracy of the outputs.

We worked with Source A to refine the range of values for these key parameters. In the proposal, we identified a maximum mesh cell size of 1mm on the surface, very near and in the surrounding environment for the tractor-trailer. As mentioned above, this is extremely rigorous and, instead, started with a mesh cell size of 1.5 mm as a starting point. They also performed the analysis using their best practices of 6mm and an interim point of 3mm to inform the overall trend.

In addition, they also informed us that this is only used at the localized areas/regions where high flow/high pressure regions are typically expected or occur. This means that areas such as the edges and surfaces perpendicular to the flow path receive the most cells while areas that experience relatively uninteresting flow phenomena far away from the model receive fewer cells. As a result, the emphasis placed on resolving flow conditions and dynamics in critical areas. Figure 3-8 and 3-9 show what this looks like when practically applied. Regions are assigned a number and each region has cell size that are more concentrated (*i.e.*, smaller in size and are thus more densely packed or closer together). Table 3-9 shows how the resolution would be distributed with most of the elements concentrated very close to the surface of the tractor-trailer where you expect laminar to turbulent flow transition and boundary layer build-up over the length of the vehicle.

Figure 3-8: Mesh Grid Preparation for CFD Analysis Showing Areas of Concentrated Cells in Regions where Flow Resolution is Critical.

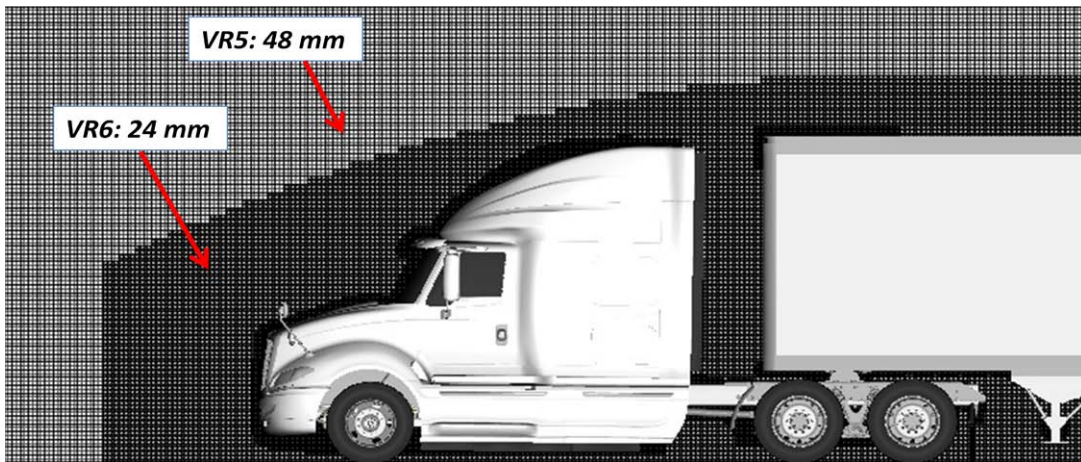

Regulatory Impact Analysis

Figure 3-9: Mesh Grid Preparation Showing Finer Levels of Cell Concentration in Critical Flow Areas/Regions.

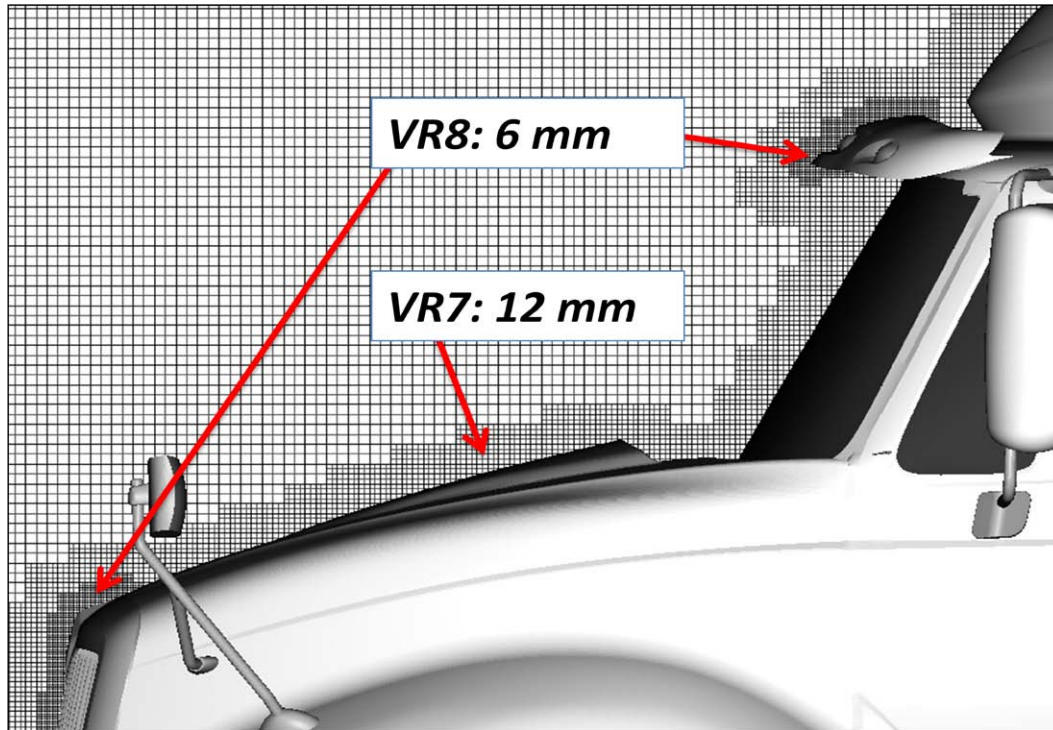

Table 3-9: Example of Distribution of Cell Sizes for CFD Analysis

VR Region	Lattice Size [mm]	# of Volume Elements	# of Surface Elements
0	1536	1,444,805	78,452
1	768	429,072	10,336
2	384	728,352	14,904
3	192	1,416,896	22,664
4	96	3,218,160	36,104
5	48	7,904,024	49,344
6	24	20,429,004	594,222
7	12	22,327,955	10,748,907
8	6	2,202,089	947,093
TOTALS		60,100,357	12,502,026

Heavy-Duty GHG and Fuel Efficiency Standards FRM: Test Procedures

With this backdrop, Source A performed CFD analyses, or “runs”, using 1.5mm, 3mm and 6mm in VR Region 8. Below are the results from the analyses for zero yaw angle in Table 3-10. The analysis was performed assuming an open road environment, moving ground plane, rotating tires and open grille to simulate operation of a tractor-trailer combination in the real world.

Table 3-10: Zero Yaw Angle Results from the CFD Analysis for Localized Cell Sizes of 1.5, 3.0 and 6.0mm.

Finest Cell Size (mm)	Cd Delta Change vs. cell size resolution
6	--
3	0.00421
1.5	0.02360

As the cell size decreases, there is an additive increase in the estimated Cd (*i.e.*, successive decrements in cell size produces additional difference in Cd). However, overall, the difference is relatively small between the cell size changes and only 2.77% between the 1.5mm and 6mm case.

We also looked at the 1.5mm and 6mm case at angles other than zero as shown below in Table 3-11. Over the range of yaw angles, the difference between Cd values for the 1.5mm and 6m cases are small with a maximum of 2.80%. Further, the Cd values begin to converge between the two cases as you increase the yaw angle. This may be due to the fact that as you yaw the vehicle, there is more surface area exposed to the flow and, as a result, the error in estimating a value increases and the equations become less sensitive to small changes in the inputs. However, there may be other factors at play here that are the subject of future study.

Table 3-11: Cd Values at Positive 0, 1, 3, 6, 9 Yaw Angles for the 1.5mm and 6mm Case.

Yaw Angle	Delta	% Difference
0	0.0136	2.77%
1	0.0139	2.80%
3	0.0062	1.21%
6	-0.0065	-1.14%
9	-0.0026	-0.39%

Although the Cd difference between the cell sizes is small, this increase in cell size comes at a high cost, specifically, a monetary and a run-time cost. Below is an estimate by Source A of the number hours need for the CPU to perform the analysis and the computational cost shown as a scaling factor (see Table 3-12). For the 1mm case on all surfaces and throughout the mesh grid, as proposed in the rulemaking, the cost increase by a factor of 1,374 and the necessary run time is 4,120,000 CPU using commercially available equipment. If you had access to a super-computer clusters like those used at military, national security, or space agencies, you could reduce this time but, otherwise, this is well beyond the capability of manufacturers in the heavy-duty truck industry. At the other end of the boundary, if you use a localized 6mm cell size applied to critical flow areas, this reduces the estimated run time to 3,000

Regulatory Impact Analysis

CPU hours. Therefore, it is clear from this data that the cost of decreasing cell size finer than 6mm far outweighs the benefit.

Table 3-12: Case size estimates of computational cost and computer run-time in CPU hours.

	Volume Element Size in Near Wall Regions			
	1 mm All Surfaces	1 mm Applied Local	6 mm All Surfaces	6 mm Applied Local
Est. Total # of Volume Elements	11.1 B	8.45 B	132 M	60 M
Est. Fine Equiv. Voxels	5.28 B	2.60 B	97.3 M	23 M
Factor Increase in Computational Cost	1374x	677x	42x	x
Estimated CPU hrs	4,120,000	2,030,000	127,000	3,000

With this information on finer cell sizes, we then considered the impact of coarser mesh sizes. In particular, we wanted to determine if there is a point where the cell size becomes too coarse and begins to compromise the accuracy analysis. Accordingly, Source A conducted the same analysis above with 9mm, 12mm, 15mm and 18mm as the finest cell size in VR Region 8 at zero, three and six degrees (see Figures 3-10, 3-11 and 3-12). For the zero yaw case, a cell size up to 9mm seems to be acceptable but, as you get to larger yaw angles, the 9mm case exceeds the error band for the analysis. Therefore, the 6mm cell size appears to be the best size to use as starting point for any yaw angle.

Figure 3-10: Cd Estimates at a 0 Degree Yaw Angle for Various Cell Sizes.

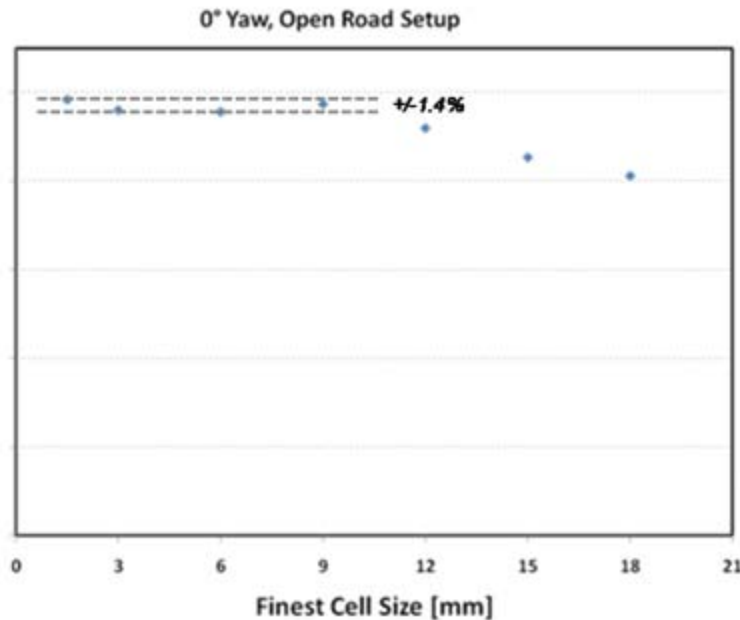

Figure 3-11: Cd Estimates at a 3 Degree Yaw Angle for Various Cell Sizes.

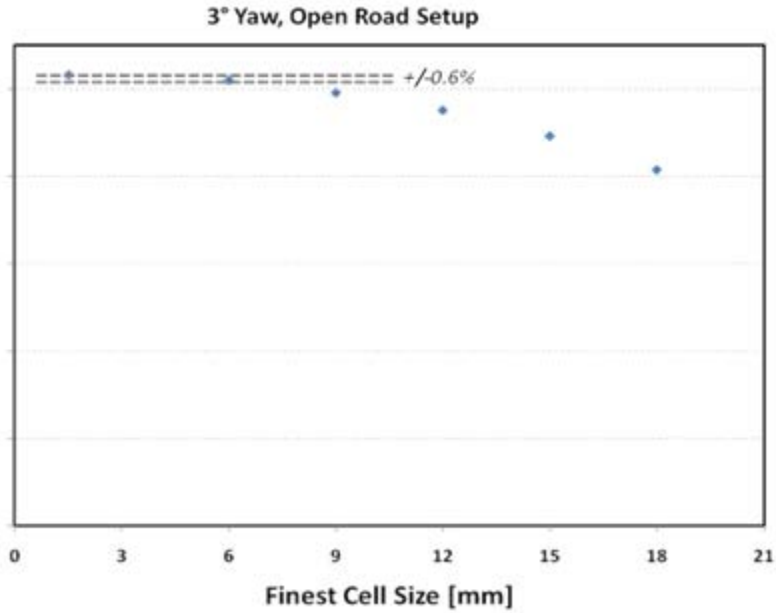
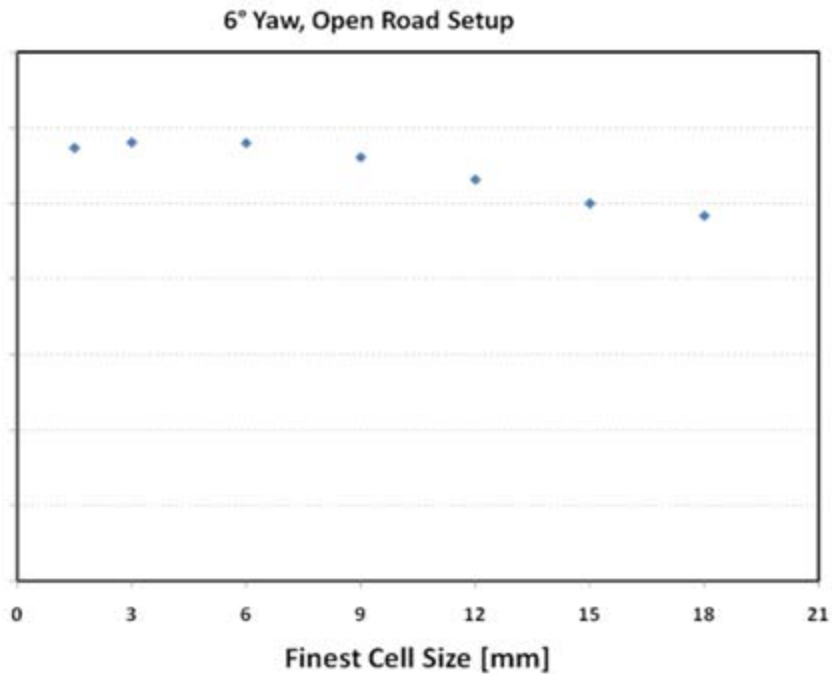

Figure 3-12: Estimates at a 6 Degree Yaw Angle for Various Cell Sizes.



Based on the CFD results, we set a maximum cell size for areas closer to the model with this size increasing as you move away from the tractor trailer model. For Lattice-Boltzmann-based CFD software code, the 6mm finest cell size at critical areas, 12mm as the next finest cell

Regulatory Impact Analysis

size near the surface, and increasing cell size as you move away from the surface is sufficient. For Navier-Stokes-based CFD software code, the concept is the same but the nomenclature and parameters are different. The Navier-Stokes-based CFD code uses a y^+ value calculated using the equation: $(u^* \times y) / \nu$, where u^* is the frictional velocity near the wall, y is the distance to the nearest wall, and ν is the fluid kinematic viscosity. The y^+ value determines where to put the first grid line by identifying the first point where the frictional stresses acting between the fluid and the wall are significant enough to cause velocity differences in the fluid (*i.e.*, the fluid adheres to the wall and the forces act on the fluid changing its velocity profile). Based on feedback from industry experts, this is typically in the range of 300 to ensure proper flow detail; we have used this value in this final rulemaking.

We also have defined the overall mesh grid size. Although the critical areas are on or near the surface, it is still important to define the surrounding conditions since downstream influences can have an upstream affect. Therefore we identified fifty million cells as the minimum number of cells in the entire mesh grid. This is consistent with the Source A analysis' total volume elements in Table 3-12 above.

Finally, for CFD analysis, we are allowing manufacturers to use criteria other than that in this rulemaking upon request and with prior approval. For example, as shown above in Figures 3-10 through 3-12, while 9mm is not appropriate for the model we analyzed, it may be adequate for some other model or manufacturer and the manufacturer could request to use this as the finest cell size in lieu of 6mm. The manufacturer may be required to supply data supporting that the increased finest cell size adequately captures the flow in the critical areas. Figures 3-13, 3-14 and 3-15 below are examples of additional information that a manufacturer might and are possible to provide to support their claim that the alternate criteria is equivalent to the regulatory criteria in identifying and capturing flow dynamics in critical areas.

Figure 3-13: Front View of Tractor-Trailer Model with Areas of Constant Total Pressure for Two Different Cell Sizes Isolated (example shown).

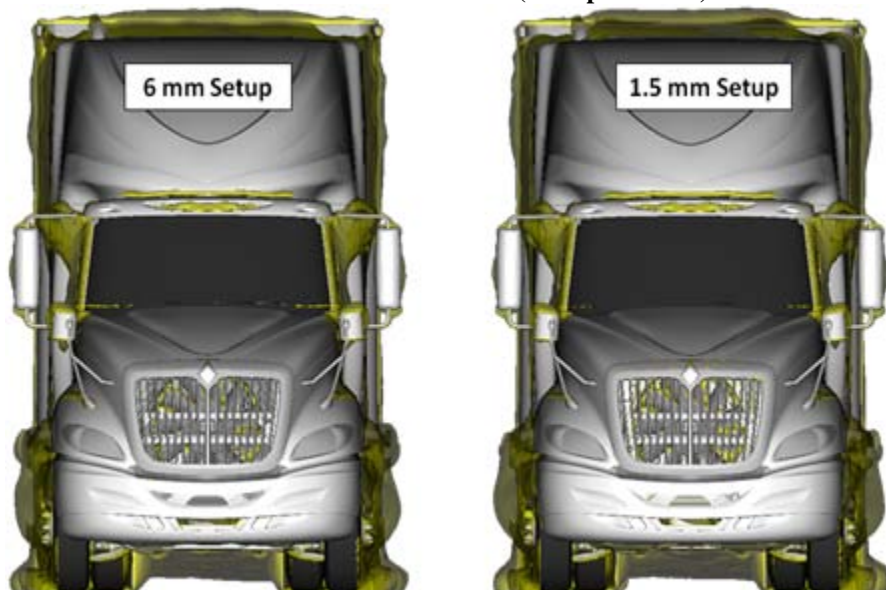

Figure 3-14: Side View of Tractor-Trailer Model with Flow Visualization for Two Different Cell Sizes (example shown).

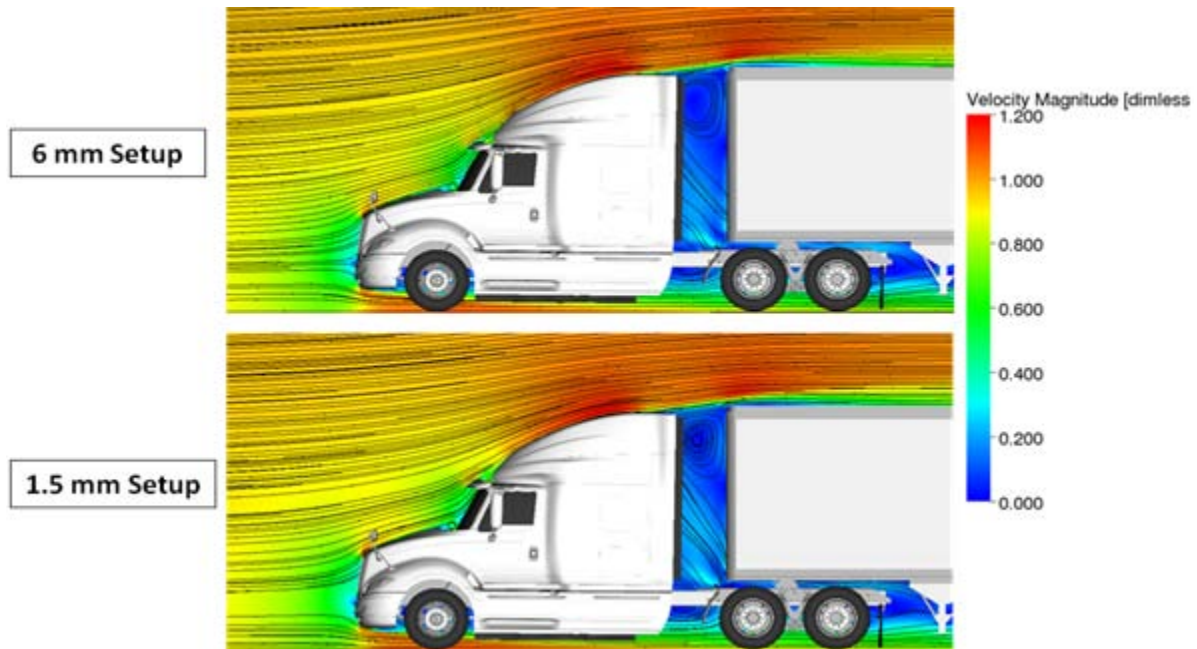
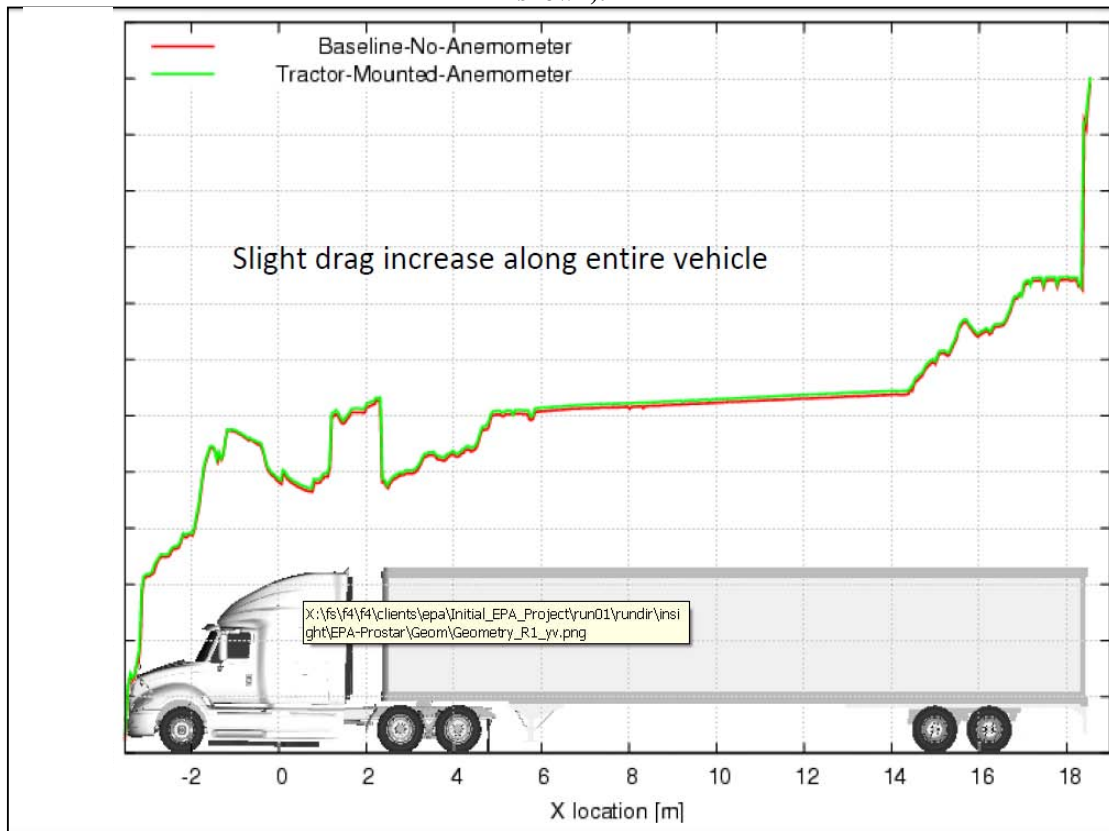

Figure 3-15: Side View Showing Drag Development over the Length of the Tractor-Trailer Model (example shown).



3.2.2.1 Aerodynamic Assessment: Comparison of Cd values from Modified Coastdown Reference Method and Alternative Aerodynamic Methods

The agencies are finalizing that the coefficient of drag assessment be a product of test data and modeling using good engineering judgment. This is a similar approach that EPA has provided as an option in testing light-duty vehicles where the manufacturers supply representative road load forces for the vehicle.⁹

The agencies are also interested in developing an acceptance demonstration process for aerodynamic testing in the final rulemaking. As part of the process, the manufacturer would have to demonstrate that the methodology used for aerodynamic assessment is acceptable prior to using it for aerodynamic assessment. In addition to the acceptance demonstration, alternative methods would also require correlation testing to the coastdown procedure using a reference vehicle. This process would provide confidence in the use of the alternative method once this rulemaking is implemented.

In addition, EPA and NHTSA recognize that wind conditions have a greater impact on real world CO₂ emissions and fuel consumption of heavy-duty trucks than occur with light-duty vehicles. As stated in the NAS report¹⁰, the wind average drag coefficient is about 15 percent higher than the zero degree coefficient of drag (Cd). The large ratio of the side area of a combination tractor and trailer to the frontal area illustrates that winds will have a significant impact on the drag. One disadvantage of the agencies' approach to aerodynamic assessment is that the test methods have varying degrees of ability to assess wind conditions. Wind tunnels and CFD are currently the only demonstrated tools to accurately assess the influence of wind speed and direction on a truck's aerodynamic performance while the coastdown test has limited ability in assessing yaw conditions. To address this issue, the agencies are finalizing to use coefficient of drag values which represent zero yaw (*i.e.*, representing wind from directly in front of the vehicle, not from the side). The agencies recognize that the results of using the zero yaw approach will produce fuel consumption results in the regulatory program which are slightly lower than in-use but we believe this approach is appropriate since not all manufacturers will use wind tunnels for the aerodynamic assessment.

Accordingly, we performed a cross method comparison between the cross for our aerodynamic test program, we coastdown tested the same tractor tr using the modified J1263 procedures as was tested in the full-scale wind tunnel and scanned and digitized for CFD analysis. In addition, although the 1/8th scale tractor model was not created using the exact tractor we procured, the 1/8th scale model and the tractor model type and aerodynamic components are identical. To understand the influence that using different tractor models has on Cd estimation (*i.e.*, truck-to-truck variability), we also recruited and coastdown tested another tractor of the same model using modified J1263 procedures. Further, we also performed coastdown testing at two different locations to understand the impact that source has on Cd estimation (*i.e.*, source-to-source variability). These are all aspects of aerodynamic assessment process once this rulemaking is implemented and, thus, we sought to investigate them.

Below is a graph showing the results of the Cd results from our cross method comparison (see figure 3-16). This data was normalized using a frontal area of 10.4 meters squared as

referenced in this rulemaking since each source assumes their own frontal area for Cd determination

Figure 3-16: Cd Results for Cross Method Comparison Using Normalized Frontal Area of 10.4 Meters Squared as Referenced in the Rulemaking.

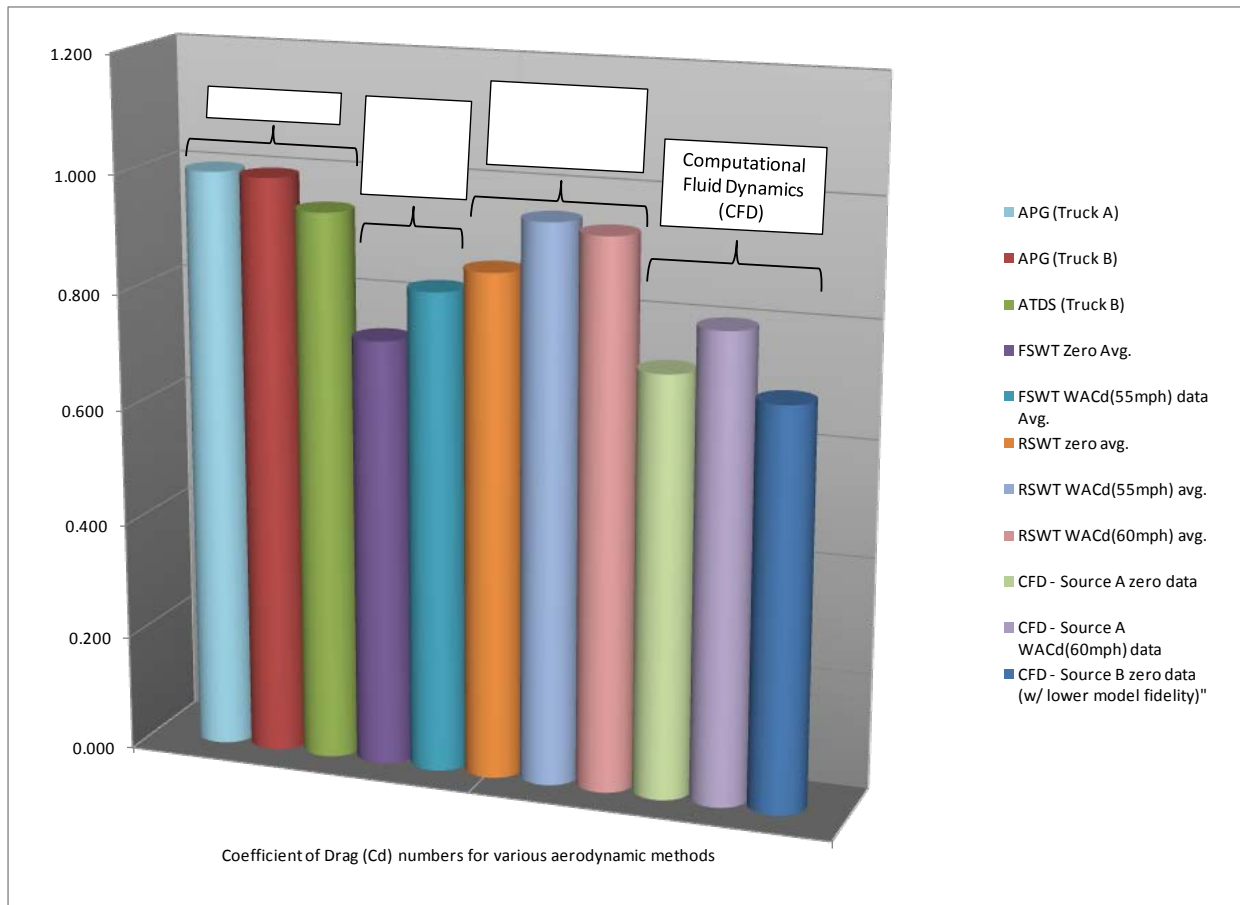

In general, the graph highlights that each method produces a different estimation of Cd. The differences between the aerodynamic methods, including attributes and short comings, were discussed in the preamble and so this outcome is not unexpected. Since the values do not have exact agreement, it would be difficult to accept each method on its own since some methods may produce lower results. Therefore, this graph highlights the need for two things: 1) the need for alternative aerodynamic methods such as wind tunnel and CFD to correlated to the modified J1263 coastdown reference method and 2) the need for a correction factor based on this correlation to be used for scaling purposes of other non-tested configurations if a manufacturer uses an alternative aerodynamic method. Both of these items have been addressed in this rulemaking.

A couple of conditions may also have contributed to some of the result divergence. For full scale wind tunnel testing, the use of 28 foot box trailer makes direct comparison difficult. This argues for some type of trailer correction to account for the 28 foot trailer use in lieu of a 53 foot box trailer, and additional research would need to be performed to quantify this factor. In addition, the full-scale wind tunnel is equipped with a static floor versus the other methods which

Regulatory Impact Analysis

have a moving road, in the case of coastdown, or can simulate a moving road, in the case of the reduced-scale wind tunnel and CFD. For CFD, the environmental conditions used in the analysis were very generic and did not exactly match the conditions during the coastdown test. Thus, as we have required in this rulemaking, the environmental conditions used for correlation between coastdown and CFD should match for comparison and accuracy purposes.

The graphs also shows that the coastdown test using the modified J1263 procedure can be repeatable for a single tractor model with a standard deviation of 0.0057 or a less than 1% difference between results, despite the fact that this represents two different trucks at two different locations. Further, the difference in results for Truck B at two different locations is 1.2% and the difference between Truck A and B tested at the same location (Arizona Proving Grounds) is a scant 0.4%. Based on these results, there does not appear to be an issue with source-to-source and truck-to-truck variability for the modified J1263 coastdown reference method. It should also be noted that for two of the three tests, the wind restrictions during the coastdown testing were exceeded. However, we are including this data for illustrative purposes. The same may be said for CFD which, despite using two different methodologies, modelers, best practices, and model detail, there is only a 5.1% difference between the results. For wind-tunnel testing, we did not have an opportunity to gather data from multiple sources. There are a limited number of full scale wind tunnels and, thus, availability is limited with a waiting list into the next year. Reduced-scale wind tunnels are more plentiful and there exists the opportunity to explore source-to-source availability in the future but considerations for model transport must be taken into account to ensure set up consistency and reduce model damage. The other trend is that the WACd values from the alternative methods are higher than the zero yaw values, and are closer to the modified J1263 coastdown reference method results. Since the coastdown only assumes zero yaw, this was the focus of this rulemaking. However, this highlights the need to account for manufacturer efforts to minimize drag in conditions other than when the wind direction relative to the tractor is head-on (*e.g.*, zero degrees yaw).

Therefore, we examined full yaw sweep data from the reduced-scale wind tunnel test for three manufacturer 1/8th scale models. CFD and full scale wind tunnel tests can be used to generate yaw sweeps as well but we only had data from one manufacturer's model for these methods and, thus, they are not shown. Below in Figure 3-17 are the yaw sweep graphs for three manufacturer vehicles in the reduced-scale wind tunnel with the WACd shown for comparison. Although the zero yaw Cd results are relatively close, their aerodynamic performance begins to diverge as the yaw angle is increased.

Figure 3-17: Full Yaw Sweeps and Wind-Average Coefficients of Drag (WACds) for Three Manufacturer, 1/8th Scale, Tractor Models in the Reduced Scale Wind Tunnel.

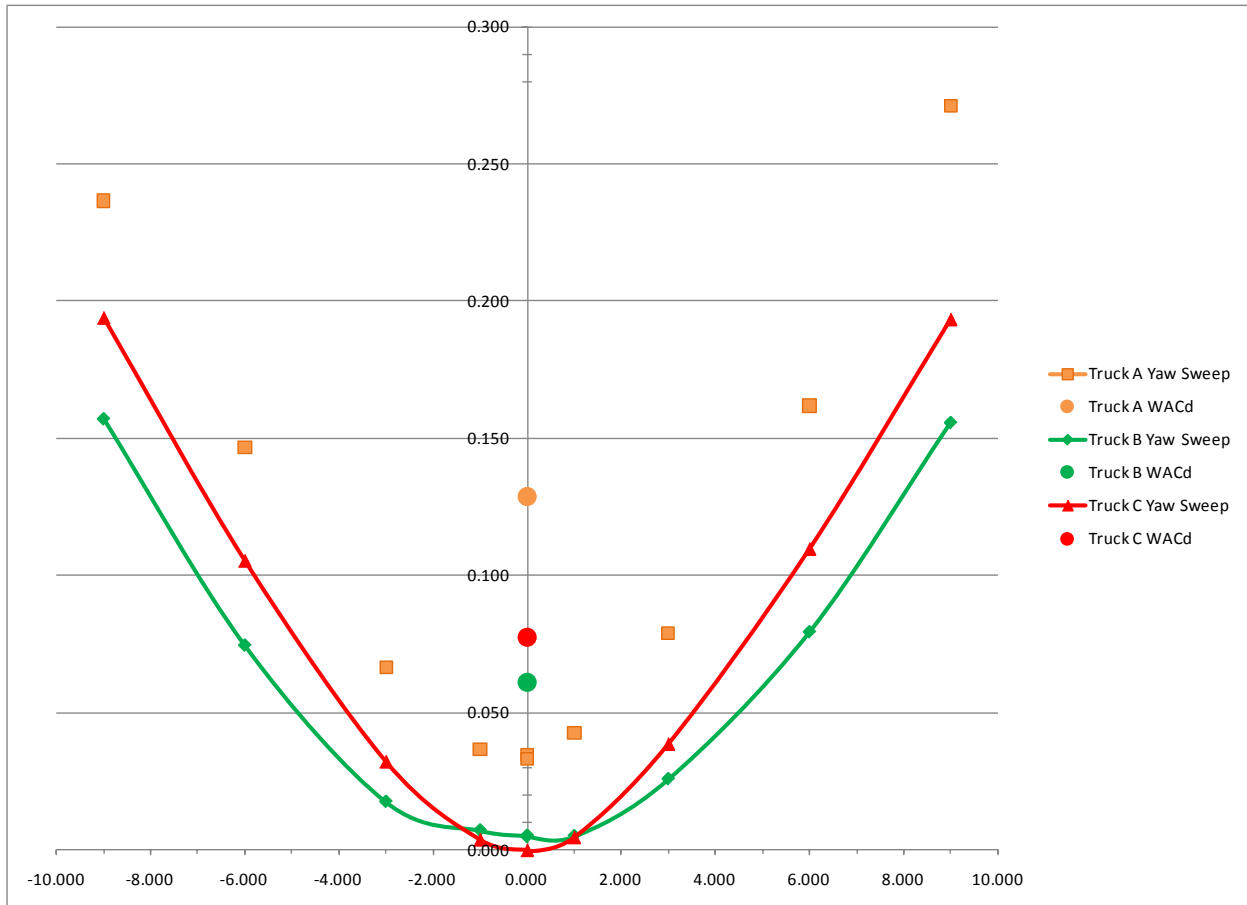

As a result of this data and comments we received, we are accounting for the use of additional yaw data to be considered for assigning a GHG emissions score. Specifically, we are allowing manufacturers to adjust their zero yaw inputs to the GEM model using the data from yaw sweeps similar to those shown in Figure 3-17. The manufacturer would ratio their yaw sweep and their zero yaw Cd data and compare this to the ratio of the average yaw sweep and average zero yaw Cd for the industry. If a manufacturer’s yaw sweep/zero yaw ratio is lower than this industry average, they would be eligible to adjust their zero yaw score using a special formula as described in 40 CFR §1037.520(b).

To reduce manufacturer burden, we are requiring the use of the average of positive six and negative six yaw degree Cds to adjust their zero yaw value. However, a manufacturer may use the full yaw sweep and the calculation in SAE J1252 to determine a WACd to use in lieu of the positive/negative six average. As shown in the graph, these values are similar in quantity with the WACd being slightly lower, such that a manufacturer that performs a full yaw sweep may see a slightly higher benefit.

In conclusion, the aerodynamic assessment test program was valuable in helping us understand the various aerodynamic methods and how they compare truck-to-truck and source-to-source variability, identification of key parameters for the alternative aerodynamic methods,

and the relationship of zero yaw to WACd. We encourage continued research in this area and hope that we can facilitate/participate in research efforts in some capacity.

3.3 Tire Rolling Resistance

The agencies are finalizing that the ISO 28580 test method be used to determine rolling resistance and the coefficient of rolling resistance. A copy of the test method can be obtained through the American National Standards Institute (<http://webstore.ansi.org/RecordDetail.aspx?sku=ISO+28580%3a2009>).

3.3.1 Reason for Using ISO 28580

The EPA SmartWay Partnership Program started to identify equipment and feature requirements for SmartWay-designated Class 8 over-the-road tractors and trailers in 2006. In order to develop a tire rolling resistance specification for SmartWay-designated commercial trucks, EPA researched different test methods used to evaluate tire rolling resistance, reviewing data and information from tire manufacturers, testing laboratories, the State of California, the Department of Transportation, truck manufacturers, and various technical organizations. After assessing this information, EPA determined that its SmartWay program would use the SAE J1269¹¹ tire rolling resistance method until the ISO 28580¹² method (at that time under development) was finalized, at which time the Agency would consider moving to this method for its SmartWay program.

During this same time period, the National Highway Traffic Safety Administration (NHTSA) conducted an evaluation of passenger vehicle tire rolling resistance test methods and their variability¹³. Five different laboratory test methods at two separate labs were evaluated. The NHTSA study focused on passenger tires; however, three of the four test methods evaluated can be used for medium-duty and heavy-duty truck tires. The methods evaluated were SAE J1269, SAE J2452¹⁴ (not applicable for medium-duty or heavy-duty truck tires), ISO 18164¹⁵ and ISO 28580. The NHTSA study showed significant lab to lab variability between the labs used. The variability was not consistent between tests or types of tire within the same test. The study concluded that a method to account for this variability is necessary if the rolling resistance value of tires is to be compared (NHTSA, 2009). Because of laboratory variability, NHTSA recommended that the use of ISO 28580 is preferred over the other test methods referenced.

The reason that ISO 28580 is preferred is that the test involves a laboratory alignment is between a “reference laboratory” and a “candidate laboratory.” The ISO technical committee involved in developing this test method also has the responsibility for determining the laboratory that will serve as the reference laboratory. The reference laboratory will make available an alignment tire that can be purchased by candidate laboratories. The candidate laboratory shall identify its reference machine. However, at this time, the reference laboratory and alignment tires have not been identified.

3.3.2 Measurement Method and Results

The ISO 28580 test method includes a specific methodology for “light truck, commercial truck and bus” tires, and it has 4 measurement methods, force, torque, deceleration, and power, all of which appear to be suitable for use.

The results of the ISO 28580 test are intended for use in vehicle simulation modeling, such as the model used to assess the effects of various technology options for national greenhouse gas and fuel economy requirements for commercial trucks (see chapter 4). The results are usually expressed as a rolling resistance coefficient and measured as kilogram per metric ton (kg/metric ton) or as dimensionless units. (1 kg/metric ton is the same as the dimensionless unit 0.001). The results are corrected for ambient temperature drum surface and drum diameter as specified in the test method.

3.3.3 Sample Size

The rolling resistance of tires within the same model and construction are expected to be relatively uniform. In the study conducted by NHTSA, only one individual tire had a rolling resistance value that was significantly different from the other tires of the same model. This means that only one tire within a model needs to be tested to obtain a representative value of rolling resistance for the model. The effect of test-to-test variability can be further reduced by conducting three replicate tests and using the average as the value for the rolling resistance coefficient. Tire models available in multiple diameters may have different values of rolling resistance for each diameter because larger diameter tires produce lower rolling resistance than smaller diameters under the same load and inflation conditions. If the size range within a tire model becomes large enough that a given tire size is no longer “substantially similar” in rolling resistance performance to all other tire sizes of that model, then good engineering judgment should be exercised as to whether the differently-sized tire shall be treated, for testing and vehicle simulation purposes, as a distinct tire model. For Class 8 tractors that typically use tires that fit on 22.5” or 24.5” wheels, this situation might occur with 17.5” tires, more commonly used on moving vans and other applications that require a low floor.

3.4 Drive Cycle

Drive cycles have a significant impact on the GHG emissions from a truck and how technologies are assessed. Every truck has a different drive cycle in-use. Therefore, it is very challenging to develop a uniform drive cycle which accurately assesses GHG improvements from technologies relative to their performance in the real world.

The drive cycle attributes that impact a vehicle’s performance include average speed, maximum speed, acceleration rates, deceleration rates, number of stops, road grade, and idling time. Average and maximum speeds are the attributes which have the greatest impact on aerodynamic technologies. Vehicle speed also impacts the effect of low rolling resistance tires. The effectiveness of extended idle reduction measures is determined by the amount of time spent idling. Lastly, hybrid technologies demonstrate the greatest improvement on cycles which include a significant amount of stop-and-go driving due to the opportunities to recover braking

Regulatory Impact Analysis

energy. In addition, the amount of power take-off operation will impact the effectiveness of some vocational hybrid applications.

The ideal drive cycle for a line-haul truck would account for significant amount of time spent cruising at high speeds. A pickup and delivery truck would contain a combination of urban driving, some number of stops, and limited highway driving. If the agencies finalize an ill-suited drive cycle for a regulatory subcategory, it may drive technologies where they may not see the in-use benefits. For example, requiring all trucks to use a constant speed highway drive cycle will drive significant aerodynamic improvements. However, in the real world a pickup and delivery truck may spend too little time on the highway to realize the benefits of aerodynamic enhancements. In addition, the extra weight of the aerodynamic fairings will actually penalize the GHG performance of that truck in urban driving and may reduce its freight carrying capability.

3.4.1 Drive Cycles Considered

The agencies carefully considered which drive cycles are appropriate for the different regulatory subcategories. We considered several drive cycles in the development of the rulemaking including EPA's MOVES model; the Light-Duty FTP75 and HWFEC; Heavy-Duty UDDS; World Wide Transient Vehicle Cycle (WTVC); Highway Line Haul; Hybrid Truck User Forum (HTUF) cycles; and California CARB's Heavy-Heavy-Duty Truck 5 Mode Cycle.

MOVES Medium-Duty and Heavy-Duty schedules were developed based on three studies. Eastern Research Group (ERG) instrumented 150 medium and heavy-duty vehicles, Battelle instrumented 120 vehicles instrumented with GPS, and Faucett instrumented 30 trucks to characterize their in-use operation.¹⁶ ERG then segregated the driving into freeway and non-freeway driving for medium and heavy-duty vehicles, and then further stratified vehicles trips according the predefined ranges of average speed covering the range of vehicle operation. Driving schedules were then developed for each speed bin by creating combinations of idle-to-idle "microtrips" until the representative target metrics were achieved. The schedules developed by ERG are not contiguous schedules which would be run on a chassis dynamometer, but are made up of non-contiguous "snippets" of driving meant to represent target distributions. This gives MOVES the versatility to handle smaller scale inventories, such as intersections or sections of interstate highway, independently.

The FTP75 and HWFEC drive cycles are used extensively for Light-Duty emissions and CAFE programs. Our assessment is that these cycles are not appropriate for HD trucks for two primary reasons. First, the FTP has 24 accelerations during the cycle which are too steep for a Class 8 combination tractor to follow. Second, the maximum speed is 60 mph during the HWFEC, while the national average truck highway speed is 65 mph.

The Heavy-Duty Urban Dynamometer Driving Cycle was developed to determine the Heavy-Duty Engine FTP cycle. The cycle was developed from CAPE-21 survey data which included information from 44 trucks and 3 buses in Los Angeles and 44 trucks and 4 buses in New York in 1977. The cycle was computer generated and weighted to represent New York non-freeway (254 sec), Los Angeles non-freeway (285 sec), Los Angeles freeway (267 sec), New York non-freeway (254 sec) to produce a nearly 50/50 weighting of highway cruise and

urban transient. We believe this cycle is not appropriate for our program for several reasons. The maximum speed on the UDDS is 58 mph which is low relative to the truck speed limits in effect today. The 50/50 weighting of cruise to transient is too low for combination tractors and too high for vocational vehicles and the single cycle does not provide flexibility to change the weightings. Lastly, the acceleration rates are low for today's higher power trucks.

The World Harmonized WTVC was developed by the UN ECE GRPE group. It represents urban, rural, and motorway operation. The cycle was developed based on data from 20 straight trucks, 18 combination tractors, and 11 buses total from Australia, Europe, Japan, and US. EPA has a desire to harmonize internationally, however, we believe this single cycle does not optimally cover the different types of truck operation in the United States and does not provide the flexibility to vary the weightings of a single cycle.

The Highway Line Haul schedule was created by Southwest Research Institute, using input from a group of stakeholders, including EPA, Northeastern States for Coordinated Air Use Management (NESCAUM), several truck and engine manufacturers, state organizations, and others, for a NESCAUM heavy truck fuel efficiency modeling and simulation project. The cycle is 103 miles long and incorporates grade and altitude. This cycle is a good representation of line haul operation. However, the grade and altitude changes cannot be incorporated into a chassis dynamometer or track test. The cycle is also too long for a typical chassis dynamometer test.

The Calstart-Weststart Hybrid Truck Users Forum is developing cycles to match the characteristics of trucks applications which are expected to be first to market for hybrids. The cycles include the Manhattan Bus Cycle, Orange County Bus Cycle, Class 4 Parcel Delivery, Class 6 Parcel Delivery, Combined International Local and Commuter Cycle (CILCC), Neighborhood Refuse, Utility Service, and Intermodal Drayage cycles. The cycles are very application-specific and appropriately evaluate each vocation. However, the use of these types of application specific cycles in a regulatory scheme will lead to a proliferation of cycles for every application, an outcome that is not desirable.

The CARB 5 Mode cycle was developed by California CARB from heavy-duty truck data gathered in 1997 through 2000.¹⁷ Data was collected from real world driving from randomly selected vehicles. The data was gathered from 140 heavy-duty trucks by Battelle and from 31 heavy-duty trucks in a study conducted by Jack Faucett and Associates. The final data set included 84 of these heavy duty trucks covering over 60,000 miles and 1,600 hours of activity. The cycles were developed to reflect typical in-use behavior as demonstrated from the data collected. The four modes (idle, creep, transient, and cruise) were determined as distinct operating patterns, which then led to the four drive schedules. The cycle is well accepted in the heavy-duty industry. It was used in the CRC E55/59 Study which is the largest HD chassis dynamometer study to date and used in MOVES and EMFAC to determine emission rate inputs; the EPA biodiesel study which used engine dynamometer schedules created from CARB cruise cycle; the HEI ACES Study: WVU developed engine cycles from CARB 4-mode chassis cycles; CE/CERT test; and by WVU to predict fuel efficiency performance on any drive cycle from CARB 5 mode results. The modal approach to the cycles provides flexibility in cycle weightings to accommodate a variety of truck applications. A downside of the cycle is that it was developed from truck activity in California only.

Regulatory Impact Analysis

3.4.2 Final Drive Cycles

The agencies analyzed the average truck speed limit on interstates and other freeways to identify the appropriate speed of the highway cruise cycles. State speed limits for trucks vary between 55 and 75 mph, depending on the state.¹⁸ The median urban and rural interstate speed limit of all states is 65 mph. The agencies also analyzed the speed limits in terms of VMT-weighting. The agencies used the Federal Highway Administration data on Annual Vehicle Miles for 2008 published in November 2009 to establish the vehicle miles travelled on rural and urban interstates broken down by state. The VMT-weighted national average speed limit is 63 mph based on the information provided in Table 3-13. Based on this analysis, we are setting the speed of the high speed cruise drive cycle at 65 mph.

Table 3-13: VMT-Weighted National Truck Speed Limit

STATE	RURAL INTERSTATE SPEED LIMITS	URBAN INTERSTATE SPEED LIMIT	RURAL INTERSTATE MILES	URBAN INTERSTATE AND OTHER FREEWAYS MILES	U.S. WEIGHTED VMT FRACTION RURAL	U.S. WEIGHTED VMT FRACTION URBAN	VMT WEIGHTED SPEED LIMIT
AL	70	65	5,643	7,950	0.6%	0.8%	0.968
AK	55	55	803	662	0.1%	0.1%	0.086
AZ	75	65	6,966	13,324	0.7%	1.4%	1.474
AR	65	55	4,510	4,794	0.5%	0.5%	0.591
CA	55	55	17,681	123,482	1.9%	13.1%	8.242
CO	75	65	4,409	11,745	0.5%	1.2%	1.161
CN	65	55	715	13,485	0.1%	1.4%	0.837
DE	55	55	-	1,694	0.0%	0.2%	0.099
DC	55	55	-	813	0.0%	0.1%	0.047
FLA	70	65	9,591	37,185	1.0%	3.9%	3.279
GA	70	55	9,433	21,522	1.0%	2.3%	1.958
HA	60	60	110	2,403	0.0%	0.3%	0.160
ID	65	65	2,101	1,250	0.2%	0.1%	0.231
IL	65	55	8,972	23,584	1.0%	2.5%	1.996
IN	65	55	7,140	10,850	0.8%	1.2%	1.126
IOWA	70	55	4,628	2,538	0.5%	0.3%	0.492
KA	75	75	3,242	5,480	0.3%	0.6%	0.694
KE	65	65	6,566	6,834	0.7%	0.7%	0.925
LA	70	70	5,489	7,708	0.6%	0.8%	0.981
ME	65	65	2,207	958	0.2%	0.1%	0.218
MA	65	65	3,484	18,792	0.4%	2.0%	1.537
MS	70	70	1,257	20,579	0.1%	2.2%	1.623
MI	60	60	5,245	20,931	0.6%	2.2%	1.667
MN	70	60	4,150	12,071	0.4%	1.3%	1.077
MS	70	70	4,103	4,004	0.4%	0.4%	0.602

Heavy-Duty GHG and Fuel Efficiency Standards FRM: Test Procedures

STATE	RURAL INTERSTATE SPEED LIMITS	URBAN INTERSTATE SPEED LIMIT	RURAL INTERSTATE MILES	URBAN INTERSTATE AND OTHER FREEWAYS MILES	U.S. WEIGHTED VMT FRACTION RURAL	U.S. WEIGHTED VMT FRACTION URBAN	VMT WEIGHTED SPEED LIMIT
MO	70	60	5,972	16,957	0.6%	1.8%	1.524
MT	65	65	2,350	343	0.2%	0.0%	0.186
NE	75	65	2,590	1,653	0.3%	0.2%	0.320
NV	75	65	1,826	5,286	0.2%	0.6%	0.510
NH	65	65	1,235	2,574	0.1%	0.3%	0.263
NJ	65	55	1,609	25,330	0.2%	2.7%	1.590
NM	75	65	4,530	2,667	0.5%	0.3%	0.545
NY	65	55	6,176	37,306	0.7%	4.0%	2.604
NC	70	70	5,957	19,216	0.6%	2.0%	1.871
ND	75	75	1,394	374	0.1%	0.0%	0.141
OH	65	65	9,039	27,830	1.0%	3.0%	2.544
OK	75	70	5,029	7,223	0.5%	0.8%	0.937
OR	55	55	4,109	5,734	0.4%	0.6%	0.575
PA	65	55	10,864	21,756	1.2%	2.3%	2.020
RI	65	55	404	2,948	0.0%	0.3%	0.200
SC	70	70	7,355	6,879	0.8%	0.7%	1.058
SD	75	75	1,960	648	0.2%	0.1%	0.208
TN	70	70	8,686	13,414	0.9%	1.4%	1.642
TX	70	70	15,397	71,820	1.6%	7.6%	6.481
UT	75	65	3,117	6,165	0.3%	0.7%	0.674
VT	65	55	1,216	443	0.1%	0.0%	0.110
VA	70	70	8,764	18,907	0.9%	2.0%	2.056
WA	60	60	4,392	15,816	0.5%	1.7%	1.287
WV	70	65	3,195	3,175	0.3%	0.3%	0.456
WI	65	65	5,197	9,139	0.6%	1.0%	0.989
WY	75	75	2,482	474	0.3%	0.1%	0.235

The drive cycle we are finalizing is a modified version of the California Air Resource Board (CARB) Heavy Heavy-Duty Truck 5 Mode Cycle. We are finalizing the use of the Transient mode, as defined by CARB. The cycle is 668 seconds long and travels 2.84 miles. The cycle contains 5 stops and contains 112 seconds idling. The maximum speed of the cycle is 47.5 mph with an average speed of 15.3 mph.

We are also finalizing to alter the High Speed Cruise and Low Speed Cruise modes to reflect only constant speed cycles at 65 mph and 55 mph respectively. Based on input from trucking fleets and truck manufacturers, we believe the latter is representative of in-use

Regulatory Impact Analysis

operation, wherein truck drivers use cruise control whenever the possible during periods of sustained higher speed driving.

3.4.3 Weightings of Each Cycle per Regulatory Subcategory

As mentioned above, the advantage of using a modal approach to drive cycles is that the standardized modes can be weighted differently to reflect the difference in operating conditions of various truck applications.

The development of the Class 8 sleeper cab cycle weightings is based on studies developed to characterize the operation of line haul trucks. The EPA MOVES model, a study conducted by University of California Riverside, an estimation of commercial truck idling conducted by Argonne National Lab, and a tire test on line haul trucks conducted by Oak Ridge National Lab were used in the weighting analysis.

The distribution of vehicle miles travelled (VMT) among different speed bins was developed for the EPA MOVES model from analysis of the Federal Highway Administration data. The data is based on highway vehicle monitoring data from FHWA used to develop the distribution of VMT among road types from 1999. The information on speed distributions on the different type of roads at different times of day came from traffic modeling of urban locations and chase car data in rural California. This data was used to characterize the fraction of VMT spent in high speed cruise versus transient operation.

The University of California Riverside and California Air Resource Board evaluated engine control module data from 270 trucks which travelled over one million miles to develop the heavy-duty diesel truck activity report in 2006.¹⁹ The study found that line haul trucks spend approximately 50% of the time cruising at speeds greater than 45 mph, 10% of time in transient stop-and-go driving, and 40% in extended idle operation. After removing the idle portion to establish weightings of only the motive operation, the breakdown looks like 82% of the time cruising at speeds greater than 45 mph and 18% in transient operation.

Argonne National Lab estimated the percentage of fuel consumed while idling for various combinations of trucks, such as sleeper cabs.²⁰ The estimation is based on FHWA's Highway Statistics and the Census Bureau's Vehicle In-Use Survey (VIUS). The study found that Class 8 sleeper cabs use an average of 6.8% of their fuel idling.

Oak Ridge National Laboratory evaluated the fuel efficiency effect of tires on Class 8 heavy trucks.²¹ The study collected fleet data related to real-world highway environments over a period of two years. The fleet consisted of six trucks which operate widely across the United States. In the Transportation Energy Data Book (2009)²² Table 5.11 was analyzed and found on average that the line haul trucks spent 5% of the miles at speeds less than 50 mph, 17% between 50 and 60 mph, and 78% of the miles at speeds greater than 60 mph. Table 3-14 and Table 3-15 summarize the studies and the agencies' final drive cycle weightings.

Table 3-14: Combination Tractor Drive Cycle Weighting

	MOVES		UCR		Final	
	All	Restricted Access	Short Haul	Long Haul	Sleeper Cab	Day Cab
> 60 mph	64%	86%	47% > 45 mph	81% > 45 mph	86% 65 mph Cruise	64% 65 mph Cruise
50-60 mph	17%	9%			9% 55 mph Cruise	17% 55 mph Cruise
< 50 mph	19%	5%	53%	5%	5% Transient	19% Transient

Table 3-15: Vocational Vehicle Drive Cycle Weighting

	MOVES Single Unit	UCR Medium-Duty	Final
> 60 mph	37%	16% > 45 mph	37% 65 mph Cruise
50-60 mph	21%		21% 55 mph Cruise
< 50 mph	42%	84%	42% Transient

The final drive cycle weightings for each regulatory category are included in Table 3-16.

Table 3-16: Drive Cycle Mode Weightings

	VOCATIONAL VEHICLES	DAY CABS	SLEEPER CABS
Transient	42%	19%	5%
55 mph Cruise	21%	17%	9%
65 mph Cruise	37%	64%	86%

3.5 Tare Weights and Payload

The total weight of a truck is the combination of the truck’s tare weight, a trailer’s tare weight (if applicable), and the payload. The total weight of a truck is important because it in part determines the impact of technologies, such as rolling resistance, on GHG emissions and fuel consumptions. As the HD program is designed, it is important that the agencies define weights which are representative of the fleet while recognizing that the final weights are not

Regulatory Impact Analysis

representative of a specific vehicle. The sections below describe the agencies' approach to defining each of these weights.

3.5.1 Truck Tare Weights

The tare weight of a truck will vary depending on many factors, including the choices made by the manufacturer in designing the truck (such as the use of lightweight materials, the cab configuration (such as day or sleeper cab), whether it has aerodynamic fairing (such as a roof fairing), and the specific options on the truck.

The Class 8 combination tractor tare weights were developed based on the weights of actual tractors tested in the EPA coastdown program. The empty weight of the Class 8 sleeper cabs with a high roof tested ranged between 19,000 and 20,260 pounds. The empty weight of the Class 8 day cab with a high roof tested was 17,840 pounds. The agencies derived the tare weight of the Class 7 day cabs based on the guidance of truck manufacturer. The agencies then assumed that a roof fairing weighs approximately 500 pounds. Based on this, the agencies are proposing the tractor tare weights as shown in Table 3-17.

Table 3-17: Tractor Tare Weights

MODEL TYPE	CLASS 8	CLASS 8	CLASS 8	CLASS 8	CLASS 8	CLASS 7	CLASS 7
Regulatory Subcategory	Sleeper Cab High Roof	Sleeper Cab Mid Roof	Sleeper Cab Low Roof	Day Cab High Roof	Day Cab Low Roof	Day Cab High Roof	Day Cab Low Roof
Tractor Tare Weight (lbs)	19,000	18,750	18,500	17,500	17,000	11,500	11,000

The agencies developed the empty tare weights of the vocational vehicles based on the EDF report²³ on GHG management for Medium-Duty Fleets. The EDF report found that the average tare weight of a Class 4 truck is 10,343 pounds, of a Class 6 trucks is 13,942 pounds, and a Class 8A as 23,525 pounds. The agencies are finalizing the following tare weights:

- Light Heavy (Class 2b-5) = 10,300 pounds
- Medium Heavy (Class 6-7) = 13,950 pounds
- Heavy Heavy (Class 8) = 23,500 pounds

3.5.2 Trailer Tare Weights

The trailer tare weights are based on measurements conducted during EPA's coastdown testing and information gathered by ICF in the cost report to EPA.²⁴

A typical 53 foot box (or van) trailer has an empty weight ranging between 13,500 and 14,000 pounds per ICF's findings. The box trailer tested by EPA in the coastdown testing weighed 13,660 pounds. Therefore, the agencies are defining the empty box trailer weight as 13,500 pounds.

Heavy-Duty GHG and Fuel Efficiency Standards FRM: Test Procedures

A typical flatbed trailer weighs between 9,760 and 10,760 per the survey conducted by ICF. EPA’s coastdown work utilized a flatbed trailer which weighed 10,480 pounds. Based on this, the agencies are defining a flatbed trailer weight of 10,500 pounds.

Lastly, a tanker trailer weight typically ranges between 9,010 and 10,500 pounds based on ICF findings. The tanker trailer used in the coastdown testing weighed 9,840 pounds. The agencies are defining the empty tanker trailer weight of 10,000 pounds.

3.5.3 Payload

The amount of payload by weight that a tractor can carry depends on the class (or GVWR) of the vehicle. For example, a typical Class 7 tractor can carry fewer tons of payload than a Class 8 tractor. Payload impacts both the overall test weight of the truck and is used to assess the “per ton-mile” fuel consumption and GHG emissions. The “tons” represent the payload measured in tons.

M.J. Bradley analyzed the Truck Inventory and Use Survey and found that approximately 9 percent of combination tractor miles travelled empty, 61 percent are “cubed-out” (the trailer is full before the weight limit is reached), and 30 percent are “weighed out” (operating weight equal 80,000 pounds which is the gross vehicle weight limit on the Federal Interstate Highway System or greater than 80,000 pounds for vehicles traveling on roads outside of the interstate system).²⁵ The Federal Highway Administration developed Truck Payload Equivalent Factors to inform the development of highway system strategies using Vehicle Inventory and Use Survey (VIUS) and Vehicle Travel Information System (VTRIS) data. Their results, as shown in Table 3-18, found that the average payload of a Class 8 truck ranged from 29,628 to 40,243 pounds, depending on the average distance travelled per day.²⁶ The same results found that Class 7 trucks carried between 18,674 and 34,210 pounds of payload also depending on average distance travelled per day.

Table 3-18: National Average Payload (lbs.) per Distance Travelled and Gross Vehicle Weight Group (VIUS)²⁷

	CLASS 3	CLASS 4	CLASS 5	CLASS 6	CLASS 7	CLASS 8
< 50 miles	3,706	4,550	8,023	10,310	18,674	29,628
51 to 100 miles	3,585	4,913	6,436	10,628	23,270	36,247
101 to 200 miles	4,189	6,628	8,491	12,747	30,180	39,743
201 to 500 miles	4,273	7,029	6,360	10,301	25,379	40,243
> 500 mile	3,216	8,052	6,545	12,031	34,210	40,089
Average	3,794	6,234	7,171	11,203	26,343	37,190

The agencies are prescribing a fixed payload of 25,000 pounds for Class 7 tractors and 38,000 pounds for Class 8 tractors for their respective test procedures. These payload values represent a heavily loaded trailer, but not maximum GVWR, since as described above the majority of tractors “cube-out” rather than “weigh-out.”

Regulatory Impact Analysis

NHTSA and EPA are also finalizing payload requirements for each regulatory subcategory in the vocational vehicle category. The payloads were developed from Federal Highway statistics based on the averaging the payloads for the weight classes of represented within each vehicle category.²⁸ The payload requirement is 5,700 pounds for the Light Heavy trucks based on the average payload of Class 3, 4, and 5 trucks from Table 3-18. The payload for Medium Heavy trucks is 11,200 pounds per the average payload of Class 6 trucks as shown in Table 3-18. Lastly the agencies are defining 38,000 pounds payload for the Heavy Heavy trucks based on the average Class 8 payload in Table 3-18.

3.5.4 Total Weight

In summary, the total weights of the combination tractors are shown in Table 3-19.

Table 3-19: Combination Tractor Total Weight

MODEL TYPE	CLASS 8	CLASS 8	CLASS 8	CLASS 8	CLASS 8	CLASS 8	CLASS 7	CLASS 7	CLASS 7
Regulatory Subcategory	Sleeper Cab High Roof	Sleeper Cab Mid Roof	Sleeper Cab Low Roof	Day Cab High Roof	Day Cab Mid Roof	Day Cab Low Roof	Day Cab High Roof	Day Cab Mid Roof	Day Cab Low Roof
Tractor Tare Weight (lbs)	19,000	18,750	18,500	17,500	17,100	17,000	11,500	11,100	11,000
Trailer Weight (lbs)	13,500	10,000	10,500	13,500	10,000	10,500	13,500	10,000	10,500
Payload (lbs)	38,000	38,000	38,000	38,000	38,000	38,000	25,000	25,000	25,000
Total Weight (lbs)	70,500	66,750	67,000	69,000	65,100	65,500	50,000	46,100	46,500

The total weights of the vocational vehicles are as shown in Table 3-20.

Table 3-20: Vocational Vehicle Total Weights

REGULATORY SUBCATEGORY	LIGHT HEAVY	MEDIUM HEAVY	HEAVY HEAVY
Truck Tare Weight (lbs)	10,300	13,950	27,000
Payload (lbs)	5,700	11,200	15,000
Total Weight (lbs)	16,000	25,150	42,000

3.6 Heavy-Duty Chassis Test Procedure

The agencies are finalizing a chassis test procedure for heavy-duty trucks (with GVWR greater than 14,000 pounds) in Code of Federal Regulations (CFR), title 40, part 1066. The chassis test procedure is one of the options for manufacturers to demonstrate advanced technology hybrid powertrain credits. The procedures are adapted from the optional complete federal vehicle emissions certification for light heavy-duty vehicles (*i.e.*, those with a GVWR of 8,500-14,000 pounds). Details of the light heavy-duty vehicle procedure are found in the Code of Federal Regulations (CFR), title 40, part 86.1816-05 through part 86.1816-07. Additional test procedures are described in 40 CFR §86.1863. The test method was further developed from the

Heavy-Duty GHG and Fuel Efficiency Standards FRM: Test Procedures

draft SmartWay test protocol²⁹, which includes a description of the procedures for determining the state of charge and net energy change for hybrid vehicles based on SAE test method J2711.³⁰

EPA, under the SmartWay program, conducted feasibility testing for the test method on Class 8 tractors. The testing evaluated track tests against chassis dynamometer tests, and measurement of CO₂ emissions by use of a standard test cell, a portable emissions monitoring system (PEMS), and calculation from gravimetric measurement of fuel consumption. Testing issues involving highly variable ambient conditions (*i.e.* wind speed, temperature, etc.) suggested that chassis dynamometer tests were preferable for obtaining consistent test results. Replicate results of the chassis dynamometer procedure demonstrate that the test precision is typically less than 5%, which is comparable to that of the similar light-duty chassis dynamometer test procedure, as shown in Table 3-21.

Table 3-21 Coefficients of Variation Reported for Chassis Dynamometer Tests Conducted Using the SmartWay Test Procedure.

METHOD OF EMISSIONS MEASUREMENT	TEST CELL			PEMS			GRAVIMETRIC		
	29	555	598	29	555	598	29	555	598
Truck number	29	555	598	29	555	598	29	555	598
UCT	12.7%	6.2%	1.6%	1.8%	0.8%	2.2%	3.9%	2.2%	2.0%
LSC	2.0%	3.9%	1.4%	1.2%	0.3%	0.7%	2.1%	3.7%	0.7%
HSC	1.3%	4.5%	1.0%	0.6%	0.5%	0.5%	1.7%	0.6%	1.2%

Coefficient of variation is the standard deviation of the test replicates divided by the mean of the test replicates.
 UCT – Urban Creep and Transient duty cycle
 LSC -- Low Speed Cruise duty cycle
 HSC -- High Speed Cruise duty cycle

The number of heavy-duty chassis dynamometers in the United States is limited. EPA’s investigation found 11 chassis dynamometer sites in North America, including the following:

- Air Resources Board Heavy-Duty Emissions Testing Laboratory in Los Angeles, California
- California Truck Testing Services in Richmond, California
- Colorado School of Mines, Colorado Institute for Fuels and Research in Golden, Colorado
- Environment Canada in Ottawa, Ontario, Canada
- Southwest Research Institute in San Antonio, Texas
- West Virginia University Transportable Heavy-Duty Vehicle Emissions Testing Laboratory
- National Renewable Energy Lab in Golden, Colorado
- University of Houston in Houston, Texas
- US EPA in Research Triangle Park (not in operation yet)
- Argonne National Lab (up to 14,000 lb.)
- National Vehicle Fuel and Emissions Lab in Ann Arbor, Michigan (up to 14,000 lb.)

3.7 Hybrid Powertrain Test Procedures

As discussed in Section II, the agencies see an opportunity to create incentives for use of hybrid powertrains in this rulemaking, to help drive the technology's advancement. EPA and NHTSA are finalizing two methods to demonstrate benefits of a hybrid powertrain – chassis and engine testing, and thereby generate credits through the use of such technology. The reduction in CO₂ emissions and fuel consumption demonstrated would be available to use as credits in any vehicle or engine subcategory. That is, unlike ABT credits, credits generated by use of this technology would be available for use anywhere in the heavy-duty vehicle and engine sector. We are finalizing the greater portability for these credits in order to create incentives to use this promising technology and thereby further its acceptance in the heavy-duty sector, with attendant GHG and fuel consumption reduction benefits.

The purpose of this testing provision is to allow for evaluation of greenhouse gas and fuel consumption reducing technologies that are available, but may lack broad market penetration beyond niche sectors. To effectively incentivize the introduction of this technology, as well as to accurately characterize its effectiveness, it is important to develop a standardized protocol as a basis for comparison. As described in the preamble for this rulemaking, the benefit of the hybridized version of the will be assessed based on a comparison to the conventional version. The basic methods considered for evaluation include full vehicle chassis testing of the hybrid system and powertrain evaluation in a configuration that does not include the full vehicle. The powertrain or “powerpack” testing may be undertaken in one of two ways. A powertrain test cell capable of accommodating the engine, complete hybrid system (including motor, power electronics, battery(ies), electronic control system, etc.), and the transmission may be used to evaluate post-transmission power pack systems. Engine dynamometer test cells may be used to assess the performance of the engine and hybrid power system with the control volume extending to just prior to the transmission. The distinction largely being the type of operation the engine – hybrid system can accommodate. When considering performance of any hybrid system, the durability of various emissions related system components will need to be included over the full regulatory useful life. While the industry and component manufacturers may be in the process of addressing battery technology and lifetime performance, any benefit associated with the hybrid system will be based on how this performance changes over the life of the hybrid system and vehicle.

Vehicle Chassis Dynamometer Testing

As a straightforward basis for addressing performance of hybrid systems for greenhouse gas emissions / fuel consumption reduction potential, the vehicle chassis dynamometer involves exercising the complete powertrain system within the vehicle for both conventional and hybrid systems. In this way, actual vehicle performance may be measured using prescribed duty cycles that have a real-world basis. The certification duty cycles considered for conventional heavy-duty vehicle certification may be applied to the hybrid vehicle system based on the chassis testing protocols. The A to B testing would be conducted as described in Figure 3-18 Example of A to B Testing for Chassis or Powertrain Dynamometers below.

Figure 3-18 Example of A to B Testing for Chassis or Powertrain Dynamometers

Conventional Vehicle	Hybrid Vehicle
<p>Curb wt: 21k lbs</p> <p>Payload: 1k lbs</p> <p>Test wt: 22k lbs</p> <p>Coastdown Wt: 22k lbs</p> <p>GVWR: 33k lbs</p>	<p>Curb wt: 22k lbs</p> <p>Payload: 1k lbs</p> <p>Test wt: 23k lbs</p> <p>Coastdown Wt: 23k lbs</p> <p>GVWR: 33k lbs</p>
A Test	B Test

This approach is meant to account for the differences in vehicle weight expected for vehicles equipped with hybrid power systems. In so doing, the capability (*e.g.* payload, etc.) is not diminished for testing purposes. The expectation is that the benefit associated with the use of hybrid system may be characterized by the tractive operation duty cycles and / or the Power-Take Off duty cycle meant to better reflect the idle work and emissions saved through the use of a hybrid energy system. Chassis dynamometer testing for hybrid vehicles will be conducted using test protocols of 40 CFR Part 1066, consistent with the charge-sustaining protocols described in SAE J2711 for correcting emissions and fuel economy for NEC of the RESS. To address the use of the power-take off and the GHG emissions related improvements associated with hybrid power systems, a separate duty as described in Table 3-23 is provided. To address improvements for the purposes of credit generation, a weighted composite emission level will be used.

Powertrain / Powerpack Evaluation

To address hybrid power system performance for pre-vehicle testing configurations, this may be accomplished in a powertrain test cell or converted engine dynamometer test cell. There are various hardware-in-the-loop simulations being contemplated and implemented today, however the focus of this discussion will be on basic powertrain / powerpack evaluation. Any pre-vehicle testing provision that incorporates the benefits of hybrid power systems, would need to address several factors including durability of those components, kinetic energy recovery, design variety that could be captured using a chassis dynamometer test, and the drive cycle to appropriately characterize the vehicle activity. The testing methodologies for pre-vehicle hybrid evaluation currently consist of two equally viable strategies with different implications with respect to how emissions improvements are characterized. The first system to be discussed is the pre-transmission powerpack evaluation which incorporates all of the hybrid system components that exist prior to the transmission in the vehicle. The control volume is drawn so as to include the battery, battery support and control systems, power electronics, the engine, and motor generator and hybrid control module. The performance of this system is an engine based evaluation in which emission rates are determined on a brake-specific work basis. As such, the

Regulatory Impact Analysis

duty cycles being considered to assess this system performance are engine speed and torque command cycles. The emissions results associated with the system performance for GHG pollutants may be measured on brake-specific basis as an absolute test result. This differs from the approach used for post-transmission testing methods which may be conducted in a powertrain test cell or using a chassis dynamometer. As this rulemaking does not contemplate changes to criteria pollutant standards, the duty cycles and measurement methods may be similar to the criteria pollutants, however the emission results for GHG may be based on this full system consideration, which is not the case for criteria pollutants. Engine certification for criteria pollutant standards remains unchanged. It is expected that pre-transmission, parallel hybrids would be the most likely choice for engine-based hybrid certification. Details related to pre-transmission hybrid test procedures may be found in 40 CFR 1036.525.

For powertrain testing to determine hybrid benefit, the components mentioned for powerpack testing would be included for powertrain testing, as well as the transmission integrated with the hybrid power system. It is expected that testing could be conducted in a powertrain test cell which would differ from the traditional engine test cell in that it would need to accommodate the additional rotational inertia and speeds associated with inclusion of the vehicle / hybrid transmission with an electric, alternating current dynamometer. Additionally, test cell control systems will need to address all relevant control factors including ways to integrate vehicle command data into the control strategy for the engine and hybrid transmission system. This could eventually include the need for vehicle and driver model inclusions into the control schema for the test cell and the test article. Details for post-transmission powerpack testing are available in 40 CFR 1037.550.

Emissions testing for vehicles and hybrid powertrains will require A to B testing to determine the improvement factor as described in Preamble Section IV using the GEM result for the base vehicle model as the basis for assessing the CO₂ performance improvement versus the appropriate vocational vehicle standard. Engine performance which includes the pre-transmission approach for hybrid certification will generate grams per brake-horsepower hour emissions result that should demonstrate improvement versus the base standard.

To address the greenhouse gas and fuel consumption impacts hybrid power has on vehicles outfitted with Power Take Off (PTO) systems, the PTO evaluation will be conducted assuming that the energy is generated on-board. PTO testing shall be conducted in a manner consistent with the charge sustaining approach identified in the previously described SAE protocol. This test will require performing replicate PTO cycle runs beginning with a fully charged RESS. The replicates will be run until the engine starts and returns the RESS to its previously fully charged state as indicated at the start of the test. Additionally, for purposes of emissions calculations, the duration of cycle time from the start of the test to the return of the RESS to the original state of charge shall be recorded. The total grams of GHG pollutant emissions divided by the cycle duration, the equivalent miles per hour and the payload as described in §1037.525 shall provide the emission rate for the GHG pollutant for purposes of the composite emissions performance for those hybrid systems seeking to quantify the hybrid performance benefit. At this time shore power based hybrid PTO operation may be tested the same way or addressed using innovative technology methods that include methods for quantifying the energy introduced to the system externally. This testing may be conducted in a charge depleting mode.

3.7.1 Chassis Dynamometer Evaluation

We are finalizing that heavy-duty hybrid vehicles be certified using an A to B test method using a chassis dynamometer for testing vehicles. This concept allows the hybrid manufacturer to directly quantify the benefit associated with use of their hybrid system on an application specific basis. The concept would entail exercising the conventional vehicle, identified as “A”, tested over the defined cycles. The “B” vehicle would be the hybrid version of vehicle “A”. To be considered an appropriate “B” vehicle it must be the same exact vehicle model as the “A” vehicle. As an alternative, if no specific “A” vehicle exists for the hybrid vehicle that is the exact vehicle model, the most similar vehicle model must be used for certification. The most similar vehicle is defined as a vehicle with the same footprint, same payload, same intended service class, and the same coefficient of drag. The baseline vehicle must be identical to the hybrid, with the exception being the presence of the hybrid vehicle. Should an identical vehicle not be available as a baseline, the baseline vehicle and hybrid vehicle must have equivalent power or the hybrid vehicle must have greater power. Additionally, the sales volume of the conventional vehicle from the previous model year (the vehicle being displaced by the hybrid), must be substantial such that there can be a reasonable basis to believe the hybrid certification and related improvement factor are authentic. Should no previous year baseline or otherwise existing baseline vehicle exist, the manufacturer shall produce / or provide a prototype equivalent test vehicle. For pre-transmission hybrid certification, drivetrain components will be not included in the testing as is the case for criteria pollutant engine certification today on a brake-specific basis. Manufacturers are expected to submit A to B test results for the hybrid vehicle certification being sought for each vehicle family. Manufacturers may choose the worst case performer as a basis for the entire family. The agencies continue to expect to use existing precedence regarding treatment of accessory loads for purposes of chassis testing. Accessory loads for A to B testing will not need to be accounted for differently for hybrid A to B chassis testing from criteria pollutant chassis testing. Based on the description of the hybrid engines and vehicles as found in 40 CFR 1036 and 1037.801, the agencies will not restrict hybrid configuration certification. The expectation is that hybrid engines and vehicles certified under the provisions for GHG will use certified engines that have not experienced tampering with the installation of the hybrid system and that the engines still comply with criteria pollutant program provisions.

To determine the benefit associated with the hybrid system for greenhouse gas (GHG) performance, the weighted CO₂ emissions results from the chassis test of each vehicle would define the benefit as described below:

1. $(CO_{2_A} - CO_{2_B}) / (CO_{2_A}) = \text{_____}$ (Improvement Factor)
2. Improvement Factor x GEM Result B = ____ (g/ton mile benefit)

Similarly, the benefit associated with the hybrid system for fuel consumption would be determined from the weighted fuel consumption results from the chassis tests of each vehicle as described below:

3. $(\text{Fuel Consumption}_A - \text{Fuel Consumption}_B) / (\text{Fuel Consumption}_A) = \text{_____}$
(Improvement Factor)
4. Improvement Factor x GEM Result B = ____ (gallon/ton mile benefit)

3.7.1.1 Chassis Dynamometer Drive Cycles

The agencies are finalizing two sets of duty cycles to evaluate the benefit depending on the vehicle application (such as delivery truck, bucket truck, or refuse truck). The key difference between these two sets of vehicles is that one does not operate a power take-off (PTO) unit while the other does.

A power take off (PTO) is a system on a vehicle that allows energy to be drawn from the vehicle's drive system and used to power an attachment or a separate machine. Typically in a heavy-duty truck, a shaft runs from the transmission of the truck and operates a hydraulic pump. The operator of the truck can select to engage the PTO shaft in order for it to do work, or disengage the PTO shaft when the PTO is not required to do work. The pressure and flow from this hydraulic fluid can be used to do work in implements attached to the truck. Common examples of this are utility trucks that have a lift boom on them, refuse trucks that pick up and compact trash, and cement trucks that have a rotating barrel. In each case the auxiliary implement is typically powered by a PTO that uses energy from the truck's primary drive engine.

In most PTO equipped trucks, it is necessary to run the primary drive engine at all times when the PTO might be needed. This is less efficient than an optimal system. Typical PTO systems require no more than 19 kW at any time, which is far below the optimal operation range of the primary drive engine of most trucks. Furthermore, in intermittent operations, the primary drive engine is kept running at all times in order to ensure that the PTO can operate instantaneously. This results in excess GHG emissions and fuel consumption due to idle time. Additionally, idling a truck engine for prolonged periods while operating auxiliary equipment like a PTO could cause the engine to cycle into a higher idle speed, wasting even more fuel. It would be possible to hybridize or change the operation of a conventional PTO equipped truck to lower the GHG emissions and fuel consumption in the real world. However, there is currently no method for an equipment manufacturer to demonstrate fuel consumption and GHG emissions reductions due to the application of advanced PTO technology. The finalized drive cycles do not allow for PTO operation to be included in the test protocol. We are adding a new optional PTO test to the standard set of test cycles in order for manufacturers of advanced PTO systems to demonstrate in the laboratory environment fuel consumption and GHG reductions that would be realized from their systems in the real world. For this reason, the EPA contracted Southwest Research Institute (SwRI) to study PTO systems on heavy-duty trucks with a goal of determining an appropriate test cycle.

We worked with SwRI to review the heavy-duty truck market to determine what types of trucks used PTO's and if the manufacturers thought that there was any possibility of commercial hybrid PTO applications. In some segments, manufacturers did not think a hybrid PTO was feasible. On the other hand, there are already utility and refuse trucks in existence that feature hybrid PTO units. We chose to study the behavior of conventional versions of these trucks in order to understand their typical operation.

We categorized the trucks based on the PTO opportunity. Trucks where limited PTO operation makes them infeasible due to low rates of return include dump trucks. Trucks where PTO operation is infeasible due to high power requirements include blower trucks, fire/emergency trucks, and concrete mixer trucks. Trucks where there is the possibility of PTO

operation but there was no commercial interest include tow trucks, grapple trucks, and snowplow trucks.

We selected one utility truck that was in a rental fleet. Over the course of several weeks this truck was rented to two different customers and used in two different environments. The first time the truck was rented it was used in a rural setting outside of San Antonio, Texas. The following week the truck was used in a more urban setting in Fort Worth, Texas. Data was taken from the truck as follows: - Engine Speed, Engine Fuel Rate, Vehicle Speed, PTO Pressure, and PTO Flow Rate.

From this data we were able to determine how often the truck’s engine was running, how often the PTO was engaged, and how often the boom of the utility truck was being manipulated by the user. The field data showed that when the truck was operated in the rural setting it had a much lower rate of utilization that when it was operated in the urban setting. Table 3-22 shows a breakdown of the operation of the truck in each setting.

Table 3-22 Utility Truck PTO Operation

	RURAL SETTING	URBAN SETTING
% Time PTO at “Idle”	90%	50%
% Time PTO working	10%	50%

In order to better understand the field operation of refuse trucks, EPA commissioned SwRI to study the operation of a refuse hauling truck. SwRI worked with Waste Management in Conroe Texas to instrument a typical PTO equipped neighborhood pickup refuse hauler. The truck that we instrumented was equipped with a side-load-arm (SLA). Southwest’s research revealed that approximately 20 percent of the trucks in the industry include an SLA, and the percentage of trucks with an SLA is increasing. Also, a truck with an SLA is able to service more homes per day than a standard truck, so as more SLA equipped trucks are added to the fleet, the total number of trucks will decrease.

The refuse truck was driven on its various routes over the course of a week and the data recorded. Though the truck operated on different streets and areas within the city of Conroe each day, the operation characteristics of the truck were uniform day-to-day.

Once the data was collected, definitions of power take-off (PTO) operations were identified as (1) pump “on” and idle (utility truck), and (2) compactor only, loader only, both compactor and loader, and idle (refuse truck). Steady-state pressure modes were identified by a statistical disjoint cluster analysis. Statistical frequency analyses of the in-field data were used to determine the relative proportion of time allocated to each steady-state mode. The loader and compactor pressure data from the refuse truck demonstrated cyclical behavior, therefore, a discrete Fourier transform using the fast Fourier transform (FFT) algorithm was performed on the loader and compactor data independently. The results of the FFT were used to determine the frequency of the modes in the test cycle. Information collected on population usage was used to weight different portions of the composite duty cycle (utility and refuse truck cycles) to reflect actual field PTO operations.

Regulatory Impact Analysis

Based upon the results of the data collection, we decided that a representative duty cycle for PTO operation would not begin until the engine was fully warmed up. In all cases the trucks were warmed up before driving, and then driven some distance to a location where the PTO was engaged. Thus, the traction engine was always fully warm before PTO operation commenced.

Based upon the data collection we believe that a representative PTO cycle should test a PTO that is at operating temperature. In the case of the utility truck, most of the operation is in an urban environment and about one-half of the operation time is loaded. Thus, the PTO would only operate in a “cold” state for less than 2% of a typical day. The refuse truck showed similar operation, the PTO was run continuously throughout the eight hour work day resulting in cold operation of the PTO for less than 2% of the typical day.

EPA and NHTSA are finalizing that truck manufacturers be able to test their PTO system and compare it to a baseline system to generate GHG emissions and fuel consumption credits. The manufacturer will need to test their system in an emissions cell capable of measuring GHG emissions. The PTO would be exercised by an auxiliary test bench and commanded to follow a prescribed cycle. The cycle will be determined by the type of PTO system that is under consideration. At this time, PTO cycles have been developed for utility trucks and refuse hauling trucks.

The agencies are finalizing a composite PTO cycle to allow PTO manufacturers to earn credits for GHG emissions. The cycle we are finalizing has been weighted based on the utility truck and refuse truck data in the SwRI report. It was determined that utility truck usage was approximately 20 percent rural and 80 percent urban. Furthermore, based on the field data obtained from the test trucks, the utility trucks are expected to use the PTO when performing boom operations 10 percent of the time in rural settings and 50 percent of the time in urban settings. The data from the refuse truck in the SwRI report was used to complete the refuse portion of the cycle. Because the refuse truck used in the data collection had two hydraulic circuits, one for the load arm and one for the compactor, there are two pressure traces, one for each circuit. Thus, the PTO duty cycle described in Table 3-23 reflects this.

Heavy-Duty GHG and Fuel Efficiency Standards FRM: Test Procedures

Table 3-23: PTO Duty Cycle

Cycle Simulation	Mode	Time	Normalized Pressure, Circuit 1 (%)	Normalized Pressure, Circuit 2 (%)
Utility	0	0	0.0	0.0
Utility	1	33	80.5	0.0
Utility	2	40	0.0	0.0
Utility	3	145	83.5	0.0
Utility	4	289	0.0	0.0
Refuse	5	361	0.0	13.0
Refuse	6	363	0.0	38.0
Refuse	7	373	0.0	53.0
Refuse	8	384	0.0	73.0
Refuse	9	388	0.0	0.0
Refuse	10	401	0.0	13.0
Refuse	11	403	0.0	38.0
Refuse	12	413	0.0	53.0
Refuse	13	424	0.0	73.0
Refuse	14	442	11.2	0.0
Refuse	15	468	29.3	0.0
Refuse	16	473	0.0	0.0
Refuse	17	486	11.2	0.0
Refuse	18	512	29.3	0.0
Refuse	19	517	0.0	0.0
Refuse	20	530	12.8	11.1
Refuse	21	532	12.8	38.2
Refuse	22	541	12.8	53.4
Refuse	23	550	12.8	73.5
Refuse	24	553	0.0	0.0
Refuse	25	566	12.8	11.1
Refuse	26	568	12.8	38.2
Refuse	27	577	12.8	53.4
Refuse	28	586	12.8	73.5
Refuse	29	589	0.0	0.0
Refuse	30	600	0.0	0.0

The protocol for testing the PTO system will be similar to chassis testing. The vehicle will be positioned such that the exhaust system can be attached to exhaust emission analyzers. This can be done using, but does not necessarily require a chassis dynamometer. The PTO system will be disconnected from the truck's work absorbing apparatus and connected to a bench

Regulatory Impact Analysis

that will provide energy absorption to the PTO system. For trucks with one hydraulic circuit in the PTO system, they will be hooked up to the utility/compactor side of the PTO bench. Trucks with two hydraulic circuits will be hooked up to both circuits on the PTO bench. A schematic of this bench can be seen in Appendix I. The vehicle will be pre-conditioned at ambient conditions and then the engine will be run until it is at operating temperature. The PTO will then be exercised until the working fluid and or driving mechanism of the PTO is up to operating temperature. The fully warmed up operating temperature may be defined by the manufacturer or may be assumed to be 150°C. The test will then commence. We believe that a “hot-start” test is appropriate because our data analysis found that trucks equipped with PTO’s are nearly always warmed up before the PTO is used, and that cold PTO operation makes up less than 2% of a PTO’s typical daily usage.

The PTO would be manipulated by the operator to the prescribed duty cycle. GHG emissions and fuel consumption will be measured as well as criteria pollutants. GHG emissions and fuel consumption would be reported to determine credits; criteria pollutants will simply be reported.

In order to gain credits the manufacturer would have to demonstrate how a truck with a conventional PTO system would perform over the same duty cycle. Both sets of data will need to be measured and reported to EPA and NHTSA in order to claim GHG emission and fuel consumption credits.

The first set of duty cycles would apply to the hybrid powertrains used to improve the motive performance of the vehicle (such as pickup and delivery trucks). The typical operation of these vehicles is very similar to the final drive cycles. Therefore, the agencies are using the vocational vehicle weightings for these vehicles, as shown in Table 3-24. We are using the regulatory vocational vehicle classifications for the ABT vocational vehicle classification. Hybrid vehicles used in applications such as utility and refuse trucks tend to have additional benefit associated with use of stored energy, which avoids main engine operation and related CO₂ emissions and fuel consumption. To appropriately address these alternative sources for benefits, exercising the conventional and hybrid vehicles using their PTO would help to quantify the benefit to GHG emissions and fuel consumption reductions. The duty cycle finalized to quantify the hybrid CO₂ and fuel consumption impact over this broader set of operation would be the three primary cycles plus a PTO duty cycle. The finalized weighting for the cycle is based on data gathered during the SwRI study. Based on fleet owner information, the agencies estimate that the utility trucks are used 20 percent of the time in rural operations and 80 percent of the time in urban operations. The SwRI study found that utility trucks spent 5.5 percent of the time operating the PTO in rural settings and 34.4 percent of the time on in urban settings. This produces an overall percent PTO on time for utility trucks of 28.6 percent. The study found that the refuse trucks have the PTO on 26.7 percent of the time. The agencies weighted each truck type’s percent on time based on 40 percent refuse trucks and 60 percent utility trucks to establish an overall 28 percent on-time. Therefore, the agencies are finalizing that the PTO cycle be weighted at 28 percent of the time and weight the other three cycles for the remaining 72 percent. The weightings for the hybrids without PTO are included in Table 3-24.

Heavy-Duty GHG and Fuel Efficiency Standards FRM: Test Procedures

Table 3-24: Drive Cycle Weightings for Hybrid Vehicles

	Transient	55 mph	65 mph
Vocational Vehicles without PTO	75%	9%	16%

Assuming 10 hours per day, the agencies split an average day into 7.2 hours of motive operation and 2.8 hours of PTO operation. To translate the gram per hour emissions rate during PTO to g/mile, the agencies calculated the average speed during the motive portion of the day as 27.1 mph with the information included in Table 3-25.

Table 3-25: Average Speed of Vocational Vehicles

VMT weighting of 65 mph cycle	0.37
VMT weighting of 55 mph cycle	0.21
VMT weighting of Transient cycle	0.42
Average speed of 65 mph cycle	65
Average Speed of 55 mph cycle	55
Average Speed of Transient cycle	15.3
Hours per day spent driving	7.2
Miles per day	195
Average speed per day	27.1

A manufacturer will convert the g/hour PTO result to an equivalent g/mile value based on the assumed fraction of engine operating time during which the PTO is operating (28%) and an assumed average vehicle speed while driving (27.1 mph). The conversion factor is: Factor = $(0.280)/(1.000-0.280)/(27.1 \text{ mph}) = 0.01435 \text{ hr/mi}$. The total cycle weighted emissions for a vocational vehicle with PTO would be determined using Equation 3-1. The regulatory provisions for addressing full cycle weighted performance may be found in 40 CFR 1037.525.

Equation 3-1: Cycle-Weighted PTO Emissions Results

Emissions (g/ton-mile) = (PTO emissions (g/hour) * 0.01435 (hr/mile) / payload (tons)) + 0.30 Transient (g/ton-mile) + 0.15 * 55 mph (g/ton-mile) + 0.27* 65 mph (g/ton-mile)

3.7.2 Engine Dynamometer Evaluation

The engine test procedure we are finalizing for hybrid evaluation involves exercising the conventional engine and hybrid-engine system based on an engine testing strategy. The basis for the system control volume, which serves to determine the valid test article, will need to be the most accurate representation of real world functionality. An engine test methodology would be considered valid to the extent the test is performed on a test article that does not mischaracterize criteria pollutant performance or actual system performance. Energy inputs should not be based on simulation data which is not an accurate reflection of actual real world operation. It is clearly important to be sure credits are generated based on known physical systems. This includes testing using recovered vehicle kinetic energy. Additionally, the duty cycle over which this engine-hybrid system will be exercised must reflect the use of the application, while not promoting a proliferation of duty cycles which prevent a standardized basis for comparing hybrid

Regulatory Impact Analysis

system performance. The agencies are finalizing the use of the Heavy-Duty Engine FTP cycle for evaluation of hybrid vehicles, which is the same test cycle finalized for engines used in vocational vehicles. It is important that introduction of clean technology be incentivized without compromising the program intent of real world improvements in GHG and fuel consumption performance.

Pre-Transmission Power-Pack Testing

Pre-transmission power-pack testing would involve the power system components included in the engine test cell up to the transmission (pre-gearbox) as the valid test article. The engine power would serve as the basis for assessing brake specific emissions performance for criteria pollutants as the agencies are not finalizing changes to the criteria pollutant standards. For GHG pollutant performance, the entire power system pre-gearbox can serve as the basis for the brake-specific emissions performance as seen in Figure 3-19. Testing using this method, as described previously, could utilize existing engine certification duty cycles. The applicability to the broader set of applications could be based largely on the approach taken with today's engine certification. Changes to how the engine certification would be conducted to address energy capture and idle operation will need to be evaluated as a complete protocol is developed. In conducting hybrid testing the Net Energy Change (NEC) of the RESS greater than 1% of the fuel energy must be correct according to SAE J2711 and described in 40 CFR 1066.501. It has been suggested to the agencies that energy capture for pre-transmission, parallel hybrid, power-pack testing could be based on one of the following three approaches: allow capture up to capability of system, place upper limit on energy captured over cycle based on available brake energy in real world cycles, or calculate second-by-second available regeneration torque based on FTP.³¹ To address the brake work capture limit, 40 CFR 1036.525 provides a procedure for determination of the maximum brake fraction. To avoid the need to delete extra brake work from positive work you may set an instantaneous brake limit target.

Figure 3-19 Pre-Transmission Parallel Hybrid Power Pack Test Configuration

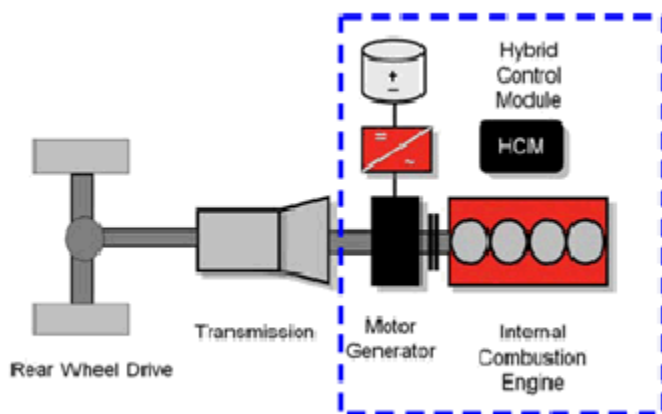

Source: Cummins Incorporated's White Paper: Regulation of emissions from commercial hybrid vehicles, August 9, 2010

Post-Transmission Power-Pack Testing

Post-transmission power-pack testing would involve the power system components included in the engine test cell up to and including the transmission (potentially still pre-gearbox) as the valid test article. The inclusion of the transmission in the hybrid system for certification potentially introduced a new entity to the certification and a new aspect to of test article control. With the additional components, the traditional FTP is not viable, in its current form for exercising a more complete powertrain. A vehicle-like duty cycle which provides the appropriate speeds and torques to more appropriately match field operation would be needed. The test article anticipated for this configuration, would more closely match complete hardware in the loop evaluation methods contemplated in other testing regimes. The ability to obtain actual performance results versus simulations of actual results in a test environment largely center on evaluating components with native intelligence rather than simulating their control system.

Figure 3-20 Hardware-in-the-Loop Post-Transmission Powerpack Test Configuration

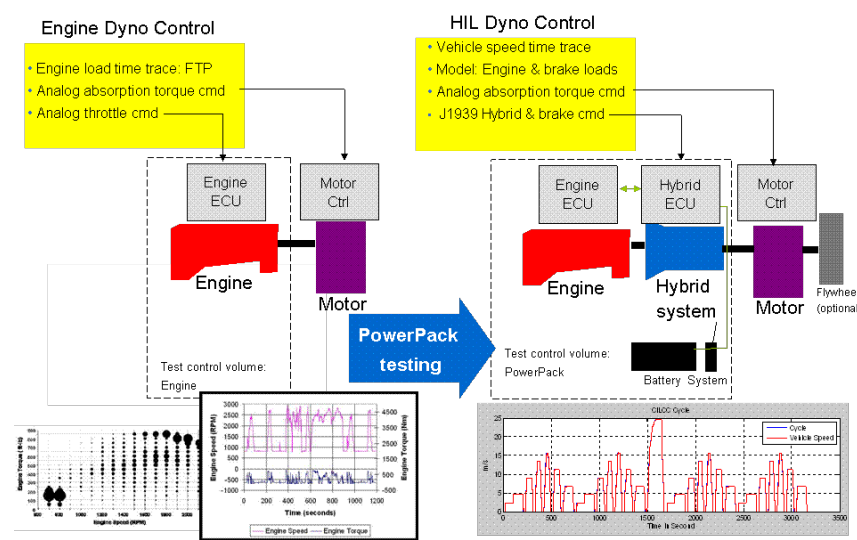

Source: Eaton Presentation to EPA, September 15, 2010

3.8 HD Pickup Truck and Van Chassis Test Procedure

The agencies are finalizing that HD pickup trucks and vans demonstrate compliance using a chassis test procedure. For each test vehicle from a family required to comply with the GHG and fuel consumption requirements, the manufacturer would supply representative road load forces for the vehicle at speeds between 15 km/hr (9.3 mph) and 115 km/hr (71.5 mph). The road load force would represent vehicle operation on a smooth level road, during calm winds, with no precipitation, at an ambient temperature of 20 degree C (68 degree F), and atmospheric pressure of 98.21 kPa. Road load force for low speed may be extrapolated.

Regulatory Impact Analysis

The dynamometer's power absorption would be set for each vehicle's emission test sequence such that the force imposed during dynamometer operation matches actual road load force at all speeds. Required test dynamometer inertia weight class selections are determined by the test vehicle test weight basis and corresponding equivalent weight.

3.8.1 LHD UDDS and HWFE Testing

The UDDS dynamometer run consists of two tests, a “cold” start test after a minimum 12-hour and a maximum 36-hour soak according to the provisions of Sec. 86.132 and 86.133, and a “hot” start test following the “cold” start by 10 minutes. Engine startup (with all accessories turned off), operation over the UDDS, and engine shutdown constitutes a complete cold start test. Engine startup and operation over the first 505 seconds of the driving schedule complete the hot start test. The driving schedule for the EPA Urban Dynamometer Driving Schedule is contained in Appendix I of 40 CFR part 86. The driving schedule is defined by a smooth trace drawn through the specified speed vs. time relationship. The schedule consists of a distinct non-repetitive series of idle, acceleration, cruise, and deceleration modes of various time sequences and rates.

The Highway Fuel Economy Dynamometer Procedure (HFET) consists of preconditioning highway driving sequence and a measured highway driving sequence. The HFET is designated to simulate non-metropolitan driving with an average speed of 48.6 mph and a maximum speed of 60 mph. The cycle is 10.2 miles long with 0.2 stop per mile and consists of warmed-up vehicle operation on a chassis dynamometer through a specified driving cycle. The Highway Fuel Economy Driving Schedule is set forth in Appendix I of 40 CFR Part 600. The driving schedule is defined by a smooth trace drawn through the specified speed versus time relationships.

Practice runs over the prescribed driving schedules may be performed at test point, provided an emission sample is not taken, for the purpose of finding the appropriate throttle action to maintain the proper speed-time relationship, or to permit sampling system adjustment. Both smoothing of speed variations and excessive accelerator pedal perturbations are to be avoided. The driver should attempt to follow the target schedule as closely as possible. The speed tolerance at any given time on the dynamometer driving schedules specified in Appendix I of parts 40 and 600 is defined by upper and lower limits. The upper limit is 2 mph higher than the highest point on trace within 1 second of the given time. The lower limit is 2 mph lower than the lowest point on the trace within 1 second of the given time. Speed variations greater than the tolerances (such as may occur during gear changes) are acceptable provided they occur for less than 2 seconds on any occasion. Speeds lower than those prescribed are acceptable provided the vehicle is operated at maximum available power during such occurrences.

3.8.2 LHD UDDS and HWFE Hybrid Testing

Since LHD chassis certified vehicles share test schedules and test equipment with much of Light-Duty Vehicle testing, EPA believes it is appropriate to reference SAE J1711 “Recommended Practice for Measuring the Exhaust Emissions and Fuel Economy of Hybrid-Electric Vehicles, Including Plug-in Hybrid Vehicles” instead of SAEJ2711 “Recommended

Practice for Measuring Fuel Economy and Emissions of Hybrid-Electric and Conventional Heavy-Duty Vehicles”.

3.8.2.1 Charge Depleting Operation – FTP or “City” Test and HFET or “Highway” Test

The EPA would like comment on incorporating by reference SAE J1711 chapters 3 and 4, as published June 2010, testing procedures for Light-Heavy-Duty chassis certified vehicles with the following exceptions and clarifications:

Test cycles will continue until the end of the phase in which charge sustain operation is confirmed. Charge sustain operation is confirmed when one or more phases or cycles satisfy the Net Energy Change requirements below. Optionally, a manufacturer may terminate charge deplete testing before charge sustain operation is confirmed provided that the Rechargeable Energy Storage System (RESS) has a higher State of Charge (SOC) at charge deplete testing termination than in charge sustain operation. In the case of Plug In Hybrid Electric Vehicles (PHEV) with an all electric range, engine start time will be recorded but the test does not necessarily terminate with engine start. PHEVs with all electric operation follow the same test termination criteria as blended mode PHEVs. Testing can only be terminated at the end of a test cycle. The Administrator may approve alternate end of test criteria.

For the purposes of charge depleting CO₂ and fuel efficiency testing, manufacturers may elect to report one measurement per phase (one bag per UDDS). Exhaust emissions need not be reported or measured in phases the engine does not operate.

End of test recharging procedure is intended to return the RESS to a full charge equivalent to pre test conditions. The recharge AC watt hours must be recorded throughout the charge time and soak time. Vehicle soak conditions must not be violated. The AC watt hours must include the charger efficiency. The measured AC watt hours are intended to reflect all applicable electricity consumption including charger losses, battery and vehicle conditioning during the recharge and soak, and the electricity consumption during the drive cycles.

Net Energy Change Tolerance (NEC), is to be applied to the RESS to confirm charge sustaining operation. The EPA intends to adopt the 1% of fuel energy NEC state of charge criteria as expressed in SAE J1711. The Administrator may approve alternate NEC tolerances and state of charge correction factors.

3.8.2.2 Hybrid Charge Sustaining Operation – FTP or “City” Test and HFET or “Highway” Test

The agencies are incorporating by reference SAE J1711 chapters 3 and 4 for definitions and test procedures, respectively, where appropriate, with the following exceptions and clarifications.

The agencies are adopting the 1% of fuel energy NEC state of charge criteria as expressed in SAEJ1711. The Administrator may approve alternate NEC tolerances and state of charge correction factors.

Regulatory Impact Analysis

Preconditioning special procedures are optional for traditional “warm” test cycles that are now required to test starting at full RESS charge due to charge depleting range testing. If the vehicle is equipped with a charge sustain switch, the preconditioning cycle may be conducted per 600.111 provided that the RESS is not charged. Exhaust emissions are not taken in preconditioning drives. Alternate vehicle warm up strategies may be approved by the Administrator.

State of Charge tolerance correction factors may be approved by the Administrator. RESS state of charge tolerances beyond the 1% of fuel energy may be approved by the Administrator.

The EPA is seeking comment on modifying the minimum and maximum allowable test vehicle accumulated mileage for both EVs and PHEVs. Due to the nature of PHEV and EV operation, testing may require many more vehicle miles than conventional vehicles. Furthermore, EVs and PHEVs either do not have engines or may use the engine for only a fraction of the miles driven.

Electric Vehicles and PHEVs are to be recharged using the supplied manufacturer method provided that the methods are available to consumers. This method could include the electricity service requirements such as service amperage, voltage, and phase. Manufacturers may employ the use of voltage regulators in order to reduce test to test variability with prior Administrator approval.

References

- ¹ Coordinating Research Council, Inc. Phase 1 of the Advanced Collaborative Emissions Study. June 2009.
- ² Fiest, M., C. Sharp, R. Mason, J. Buckingham. Determination of PEMS Measurement Allowances for Gaseous Emissions Regulated Under the Heavy-Duty Diesel Engine In-Use Testing Program. 2007. Table 122 and 123.
- ³ For more information, see CFR Title 40, § 86.004-28
- ⁴ U.S. EPA. Truck and Trailer Roof Height Match Analysis Memorandum from Amy Kopin to the Docket, August 9, 2010. Docket Identification Number EPA-HQ-OAR-2010-0162-0045.
- ⁵ SAE Recommended Practice 1263. *Road Load Measurement and Dynamometer Simulation Using Coastdown Techniques*. January 2009
- ⁶ SAE Recommended Practice J2263. *Road Load Measurement Using Onboard Anemometry and Coastdown Techniques*. December 2008.
- ⁷ “Heavy-Duty Coastdown Test Procedure Development,” Docket Number EPA-HQ-OAR-2010-0162-0144.
- ⁸ This information is available on the National Research Council-Canada website at <http://www.nrc-cnrc.gc.ca/eng/facilities/iar/9x9-wind-tunnel.html>.
- ⁹ For more information, see CFR Title 40, Part 86.129-00 (e)(1).
- ¹⁰ Committee to Assess Fuel Economy Technologies for Medium- and Heavy-Duty Vehicles; National Research Council; Transportation Research Board (2010). “Technologies and Approaches to Reducing the Fuel Consumption of Medium- and Heavy-Duty Vehicles.” Washington, D.C., The National Academies Press. Available electronically from the National Academies Press Website at http://www.nap.edu/catalog.php?record_id=12845 (last accessed September 10, 2010) Page 124. Finding 2-4 on page 39.
- ¹¹ SAE International, 2006, Rolling Resistance measurement Procedure for Passenger Car, Light Truck, and Highway Truck and Bus Tires, SAE J1269, 2006-09
- ¹² ISO, 2009, Passenger Car, Truck, and Bus Tyres – Methods of Measuring Rolling Resistance – Single Point Test and Correlation of Measurement Results: ISO 28580:2009(E), First Edition, 2009-07-01
- ¹³ NHTSA, 2009. “NHTSA Tire Fuel Efficiency Consumer Information Program Development: Phase 1 – Evaluation of Laboratory Test Protocols.” DOT HS 811 119. June. (www.regulations.gov, Docket ID: NHTSA-2008-0121-0019).
- ¹⁴ SAE International, 1999, Stepwise Coastdown Methodology for Measuring Tire Rolling Resistance. SAE J2452, 1999-06
- ¹⁵ ISO, 2005, Passenger Car, Truck, Bus, and Motorcycle Tyres – Methods of Measuring Rolling Resistance, ISO 18164:2005(E)
- ¹⁶ Based on MOVES analysis.
- ¹⁷ Gautam, M., N.Clark, W. Riddle, R. Nine, S. Wayne, H. Maldonado, A. Agrawal, M. Carlock. “Development and Initial Use of a Heavy-Duty Diesel Truck Test Schedule for Emissions Characterization.” SAE Paper 2002-01-1753. 2002.

Regulatory Impact Analysis

¹⁸ Governors Highway Safety Association. Speed Limit Laws May 2011. Last viewed on May 9, 2011 at http://www.ghsa.org/html/stateinfo/laws/speedlimit_laws.html

¹⁹ University of California Riverside. Analysis of Heavy Duty Diesel Truck Activity and Emissions Data. 2006.

²⁰ Gaines, L. “Estimation of Fuel Use by Idling Commercial Trucks”, Paper 06-2567. 2006.

²¹ Franzese, O., H. Knee, L. Slezak. Effect of Tires on Class-8 Heavy Truck Fuel Efficiency. July 2009. Last viewed on May 1, 2010 at <http://info.ornl.gov/sites/publications/files/Pub20686.pdf>

²² U.S. Department of Energy. “Transportation Energy Data Book. Edition 28 – 2009. Table 5.11. Last viewed on May 1, 2010 at http://cta.ornl.gov/data/tedb28/Edition28_Chapter05.pdf

²³ Environmental Defense Fund. “Greenhouse Gas Management for Medium-Duty Truck Fleets.” Viewed at http://edf.org/documents/10860_fleets-med-ghg-management.pdf. Page 6.

²⁴ ICF International. Investigation of Costs for Strategies to Reduce Greenhouse Gas Emissions for Heavy-Duty On-Road Vehicles. July 2010. Pages 4-16. Docket Identification Number EPA-HQ-OAR-2010-0162-0044.

²⁵ M.J. Bradley & Associates. Setting the Stage for Regulation of Heavy-Duty Vehicle Fuel Economy and GHG Emissions: Issues and Opportunities. February 2009. Page 35. Analysis based on 1992 Truck Inventory and Use Survey data, where the survey data allowed developing the distribution of loads instead of merely the average loads.

²⁶ The U.S. Federal Highway Administration. Development of Truck Payload Equivalent Factor. Table 11. Last viewed on March 9, 2010 at http://ops.fhwa.dot.gov/freight/freight_analysis/faf/faf2_reports/reports9/s510_11_12_tables.htm

²⁷ Excerpted from The U.S. Federal Highway Administration. Development of Truck Payload Equivalent Factor. Table 11. Last viewed on March 9, 2010 at http://ops.fhwa.dot.gov/freight/freight_analysis/faf/faf2_reports/reports9/s510_11_12_tables.htm

²⁸ The U.S. Federal Highway Administration. Development of Truck Payload Equivalent Factor. Table 11. Last viewed on March 9, 2010 at http://ops.fhwa.dot.gov/freight/freight_analysis/faf/faf2_reports/reports9/s510_11_12_tables.htm

²⁹ U.S. Environmental Protection Agency, SmartWay Fuel Efficiency Test Protocol for Medium and Heavy Duty Vehicles – Working Draft, EPA420-P-07-003, November 2007, <http://www.epa.gov/smartway/transport/documents/tech/420p07003.pdf>, site accessed September 16, 2009.

³⁰ SAE Recommended Practice for Measuring Fuel Economy and Emissions of Hybrid Electric and Heavy-Duty Vehicles, September 1, 2002

³¹ Cummins Incorporated, Regulation of Emissions from Commercial Hybrid Vehicles, August 2010

Chapter 4: Vehicle Simulation Model

4.1 Purpose and Scope

4.1.1 Methods to Assess a Vehicle's Greenhouse Gas Emissions

An important aspect of a regulatory program is to determine the fuel consumption environmental benefits of heavy-duty truck technologies through testing and analysis. There are several methods available today to assess fuel consumption and greenhouse gas emissions from trucks. Truck fleets today often use SAE J1321 test procedures to evaluate criteria pollutant emissions changes based on paired truck testing.¹ Light-duty trucks are assessed using chassis dynamometer test procedures.² Heavy-duty engines are evaluated with engine dynamometer test procedures.³ Most large truck manufacturers employ various computer simulation methods to estimate truck efficiency. Each method has advantages and disadvantages. This section will focus on the use of vehicle simulation modeling for assessing tailpipe GHG emissions and fuel consumption.

4.1.2 Simulation Model to Certify Vocational Vehicles and Combination Tractors

The agencies are finalizing the use of a simulation model as the primary tool to certify vocational vehicles and combination tractor (Class 2b through Class 8 heavy-duty vehicles, excluding heavy-duty pickups or vans). The advantages of modeling for these vehicles include:

- The simulation tool can model a wide range of vehicle types.
- The vehicle components can be easily changed to match the features of a given vehicle.
- The entire configuration of the vehicle can also be changed, so the same program can model a Class 4 pickup and delivery truck and a Class 7 or 8 combination truck with appropriate input parameter changes. This allows the agencies to use the same program to develop and certify all of the heavy-duty vehicles.
- The modeling tool also accommodates different drive cycles.
- It can significantly reduce truck manufacturer's burden to conduct heavy-duty chassis dynamometer tests.

4.1.3 Chapter Overview

The scope of this chapter will discuss vehicle simulation models and their feasibility, the vehicle simulation tool, and application of models to develop certification options.

4.2 Model Code Description

4.2.1 Engineering Foundations of the Model

A number of commercially available heavy-duty vehicle simulation tools are based on MATLAB/Simulink-based programs that can model a wide variety of vehicles, from medium-duty to Class 8 trucks.^{4,5} Generally, each vehicle component is depicted by a generic Simulink model that can be modified using an initialization file.⁶ The user utilizes pre-determined initialization files for a given component, or modifies them to reflect their particular situation. The following section describes the system required to model a heavy-duty non-hybrid vehicle. Once the vehicle has been specified, the user selects a drive cycle and runs the program.

EPA has developed a forward-looking MATLAB/Simulink-based model termed Greenhouse gas Emissions Model (GEM) for Class 2b-8 vehicle compliance. The GEM uses the same physical principles as many other existing vehicle simulation models to derive governing equations which describe driveline components, engine, and vehicle. These equations are then integrated in time to calculate transient speed and torque.

4.2.2 GEM Version 2.0 Enhancements

The agencies conducted a peer review of the GEM version submitted to public review with the NPRM. The peer review was conducted by RTI International and included four reviewers.⁷

The agencies also received comments from the Engine Manufacturers Association, along with other industry stakeholders, which identified some areas of concern with the GEM. In response, the agencies made changes as necessary. The agencies recognize a few comments were not addressed in the version of the GEM that is being finalized, but believe the areas that were not addressed have negligible impact on the performance of GEM, although the agencies will consider them for future GEM applications.

Based on the peer review and public comments, the agencies made the following changes to the model:

- New driver model was developed as described in Section 4.2.3
- Electric system model was simplified as described in Section 4.2.3
- Engine fuel map was modified to better characterize the low end of torque as described in Section 4.4.5
- Substantial enhancement in model validations and benchmarking were conducted against additional vehicle test data and against another commonly used industry standard vehicle model as described in Section 4.3.2
- Many improvements and modifications were made to the GEM graphic user interface described in Section 4.4.1

Heavy-Duty GHG and Fuel Efficiency Standards FRM: Vehicle Simulation Model

- Ambient conditions as the GEM input have been changed to follow standard SAE condition, as described in Section 4.2.3

Additional details regarding the peer review and EPA’s responses to the peer review comments can be found in the docket.⁷

4.2.3 Vehicle Model Architecture

Table 4-1 outlines the Class 2b-8 vehicle compliance model architecture, which is comprised of six systems: Ambient, Driver, Electric, Engine, Transmission, and Vehicle. With the exception of “Ambient” and “Driver,” each system consists of one or more component models. The function of each system and their respective component models, wherever applicable, is discussed in this section. As it will be seen, many changes and modifications described in this section have resulted from numerous constructive comments from the public comments and GEM peer reviews.⁷

Table 4-1: Vehicle Model Architecture

System	Component Models
Ambient	none
Driver	none
Electric	Accessory
Engine	Cylinder; Accessory (mechanical)
Transmission	Clutch; Gear
Vehicle	Chassis, Tire, Axle, Drive Shaft, Differential, Final Drive

Ambient – This system defines ambient conditions such as pressure, temperature, and road gradient, where vehicle operations are simulated. Several changes to the ambient conditions were made for version 2.0 so that the conditions are in accordance with standard SAE practices – air temperature of 25 degree Celsius, air pressure of 101.325 kilopascals, and air density based on the ideal gas law which results in a density of 1.20 kilograms per cubic meter. The original conditions in version 1.0 were 30 degree Celsius, 1 atm pressure, and air density of 1.15 kilogram per cubic meter. These changes have no discernable impact on the CO₂ emissions and fuel consumption results from the GEM.

Driver – The driver model was enhanced for the final rulemaking. The new model uses the targeted vehicle driving speed to estimate vehicle torque demand at any given time, and then the power required to drive the vehicle is derived to estimate the required accelerator and braking pedal positions. If the driver misses the vehicle speed target, a speed correction logic controlled by a PID controller is applied to adjust necessary accelerator and braking pedal positions in order to match targeted vehicle speed at every simulation time step. The enhanced driver model used in the final rulemaking with its feed-forward driver controls more realistically models driving behavior. This enhancement has minimal impact on the GEM results.

The “Electric” system in the proposed version had four individual components to model the electric system – starter, electrical energy system, alternator, and electrical accessory. For the final rulemaking, the GEM version 2.0 has a single electric system model with a constant power consumption level. It is modeled as a constant power consumption source as a function of

Regulatory Impact Analysis

the vehicle subcategory. It basically models the power loss associated with the starter, electric energy system, alternator and the electrical accessories. The simplification has a negligible impact on the fuel consumption and CO₂ emissions results.

The “Engine” system consists of two components: *Cylinder and Mechanical Accessory*

Cylinder – The cylinder model is based on a steady-state fuel map covering all engine speed and torque conditions and torque curves at wide open throttle (full load) and closed throttle (no load). The engine fuel map features three sets of data: engine speed, torque, and fueling rate at pre-specified engine speed and torque intervals. It is not a physics-based model and does not attempt to model in-cylinder combustion process. The engine torque and speed are used to select a fuel rate based on the fuel map. This map is adjusted automatically by taking into account three different driving modes: acceleration, braking, and coasting. The fuel map, torque curves, and the different driving modes are pre-programmed into GEM for several different default engines.

Mechanical Accessory – This term is modeled as a constant power consumption source. Most vehicles run a number of accessories that are driven *via* mechanical power from the engine. Some of these accessories are necessary for the vehicle to run, like the coolant pump, while others are only used occasionally and at the operator’s discretion, such as the air conditioning compressor. Some heavy-duty vehicles also use Power Take Off (PTO) to operate auxiliary equipment, like booms, and these will also be modeled as a mechanical accessory.

The manual “Transmission” system consists of two components: a *Clutch* and a *Gear*

Clutch – This component model simulates the clutch for a manual transmission.

Gear – A simple gearbox model is used for a manual transmission, and the number of gears and gear ratios is predefined in GEM. This component model consists of a map using gearbox speed and torque as inputs to model the efficiency of each gear.

The “Vehicle” system consists of six components: *Chassis, Tire, Axle, Drive Shaft, Differential and Final Drive*

Chassis and Tire – This portion models the shell of the vehicle including the tires. The drag coefficient, mass of the vehicle, frontal area and other parameters are housed in this component. For tire simulation, the user specifies the configuration of each axle on the vehicle, including the tire diameter and the rolling resistance.

Axle – The axle model is comprised of the behavior of each individual axle used by the simulated truck. Axles are categorized as steering, propulsion, and trailer, and are all user-selectable depending on the truck class.

Drive Shaft, Differential, and Final Drive – The gear ratio for the differential can be specified directly by the user. The efficiency is defined by a map based on the transmission output speed and torque. The final drive model uses the rotational speed, torque and inertia from the differential output to calculate the rotational speed, torque and inertia at the wheel axle.

4.2.4 Capability, Features, and Computer Resources

The EPA/NHTSA vehicle compliance tool is a flexible simulation platform that can model a wide variety of vehicles from Class 2b to Class 8 vehicles. The key to this flexibility is the MATLAB component files that can be modified or adjusted to accommodate vehicle-specific information. Parameters such as vehicle weight, fuel map settings, and tire radius, for instance, can all be changed in this fashion, although the agencies are controlling the changes. The final rulemaking predefines many of these parameters including the applicable drive cycles (the Transient mode, as defined by ARB in the HHDDT cycle, a constant speed cycle at 65 mph and a 55 mph constant speed mode), therefore manufacturers cannot select alternative drive cycles. Similarly, manufacturers cannot alter any predefined settings which are established by the agencies.

After running the simulation, GEM tracks information about each component and about the system as a whole. Information like CO₂ emissions, fuel consumption, and fidelity to the drive cycle are immediately available on the results screen. The output from each run can be saved as a comma-separated values (CSV) file or an Excel file.

The system requirements for the MATLAB version of GEM include a minimum RAM of 1 GB (4 GB is highly recommended), MATLAB, Simulink and Stateflow (version 2009b or later), and approximately 250 MB of disk storage.^{8,9,10} The simulation takes between 10 and 20 seconds per drive cycle, depending on the cycle duration. No separate license is required to run the program other than for MATLAB, Simulink, and Stateflow. Although the source code is available to users, all of the component initialization files, control strategies and the underlying MATLAB/Simulink/Stateflow-based models should remain fixed and should not be manipulated by the users when assessing their compliance. For these reasons, a stand-alone executable model independent of MATLAB/Simulink/Stateflow licenses has been created. Only the executable can be used when producing official truck certification results. The agencies are finalizing that the manufacturers submit both the input parameters and the modeling results.

4.3 Feasibility of Using a Model to Simulate Testing

4.3.1 Procedure for Model Validation

The agencies have assessed the predictive utility of the GEM model by comparing its prediction with actual test data. Validation is considered successful when the differences between the simulation and the test data are within the error limits of the test data. Before the model is validated, a quality assurance check for the input data needs to be made, which includes the following steps.

- Alignment of data from different sources such as dynamometer, emissions benches, portable emissions measurement systems, or engine control units;
- Ensuring that the vehicle and engine powertrain parameters, such as vehicle weight, transmission, driveline, tire, and inertia for various rotational parts etc., represent the actual vehicle being modeled;

Regulatory Impact Analysis

- Selection of the proper sensor when the same parameter is recorded by different sources and calibration of the sensors to the same reference value;
- Quantification of the uncertainty of each sensor.

After the operating conditions of the vehicle components have been successfully reproduced by the model, the final results of the vehicle simulation are compared with results of a representative vehicle test. If the difference is within the test error, the model can be considered validated and can be used for vehicle simulations.

In the past two years, the agencies have been striving to gather as much test data as possible from vocational vehicles and combination tractors. Although it would be optimal if the primary source of data for validating the GEM simulation tool comes from chassis dynamometer testing or real-world driving of these vehicles, the process involved in data acquisition for the wide-ranging heavy-duty vocational vehicle and combination tractor categories, which includes vehicle identification, procurement, coastdowns for generating dynamometer coefficients, emissions sampling, etc., has necessarily been tedious and time-consuming.^{11,12} Although the agencies are endeavoring to obtain test data for all categories of vocational vehicles and combination tractors, the agencies are also using additional approaches to further benchmark the GEM. One of these additional approaches is to compare GEM results with those of another well known industrial-standard simulation model. The agencies have selected the GT-Drive model developed by Gamma Technologies for this purpose.¹³

4.3.2 Validation and Benchmark of EPA and NHTSA Vehicle Compliance Model

At proposal, a high-roof Class 8 sleeper combination tractor, designated as “555” had been tested and used for model validation. Subsequent to the proposal, the agencies tested an additional combination tractor, a Class 7 day cab with a flatbed trailer to corroborate the validation conducted at proposal. Both tractors were tested on the chassis dynamometer using the drive cycles finalized for certification, *i.e.*, transient cycle and steady-state cycles with 65 and 55 mph cruise speeds. The tests were conducted for EPA by Southwest Research Institute (SwRI) in which emissions, fuel consumption, and engine operating parameters were measured in a heavy-duty chassis dynamometer test cell.¹⁴ The Class 8 combination tractor is a 2008 International Prostar equipped with a 2007 Cummins ISX engine, and this tractor was chassis tested using dynamometer set coefficients derived from onroad coastdown testing results obtained by SwRI on this same tractor combined with a 53 feet long box trailer, thus the resulting data reflect a high-roof sleeper tractor combined with a box trailer configuration. The Class 7 combination tractor is a 2009 International Prostar equipped with a 2009 Cummins ISX engine. A similar approach to the Class 8 mentioned above was used to test the vehicle. Tables 4-2 and 4-3 provide further details on these two combination tractors and the engines which were tested at SwRI and the parameters which were modeled in the GEM.

The validation work conducted on these vehicles is representative of the other Class 7 and 8 tractors. Many aspects of one tractor configuration (such as the engine, transmission, axle configuration, tire sizes, and control systems) are similar to those used on the manufacturer’s

Heavy-Duty GHG and Fuel Efficiency Standards FRM: Vehicle Simulation Model

sister models. For example, the powertrain configuration of a sleeper cab with any roof height is similar to the one used on a day cab with any roof height.

Table 4-2: Class 8 Truck 555 Tractor and Engine Specifications

Tractor / Model	International Prostar
Year Model	2008
Type	High Roof Sleeper
Engine OEM	Cummins ISX
Engine Family	7CEXH0912XAK
Displacement	15 liters
Horsepower Rating	408 @ 1,800 RPM
Final Drive	2.64
Transmission Model	Fuller FR15210B
Transmission Type	10 speed manual
Steer Axle Tires	Michelin XZA3
Tire Size	275 / 80 / 22.5
Front Rims / make	Accuride DOT T
Drive Axle Tires	Michelin XDA Energy
Tire Size	275 / 80 / 22.5
Drive Rims / Make	Accuride DOT T

Table 4-3: Class 7 Tractor and Engine Specifications

Tractor / Model	International Prostar
Year Model	2009
Type	Day Cab with Flatbed
Engine OEM	Cummins ISX
Engine Family	9CEXH0912XAK
Displacement	15 liters
Horsepower Rating	425 @ 1,800 RPM
Final Drive	3.73
Transmission Model	Eaton Fuller FRO-16210B
Transmission Type	10 speed manual
Steer Axle Tires	Good year
Tire Size	295/75R22.5

Table 4-4 and Table 4-5 compare the chassis test data with results from GEM for both Class 8 and Class 7 combination tractors.¹³ As shown in Tables 4-4 and 4-5, reasonably good comparisons are obtained. The predicted results are within the same range of variability as run-to-run variability exhibited in chassis dynamometer testing (± 5 percent for Truck Number 555; see RIA section 3.6).

Table 4-4: Fuel Economy (mpg) Comparison between Test Data and GEM Simulation Results for a Class 8 Tractor

Regulatory Impact Analysis

Cycle	ProStar @ SwRI (Chassis Test)	GEM (MPG)	GEM Error
ARB Transient	3.51	3.55	-1.14%
65 mph **	6.90	6.86	0.58%
55 mph **	8.20	8.10	1.22%

Table 4.5 Fuel Economy (mpg) Comparison between Test Data and GEM Simulation Results for a Class 7 Tractor

Cycle	ProStar @ SwRI (Chassis Test)	GEM (MPG)	GEM Error
ARB Transient	4.10	4.13	-0.73%
65 mph **	7.74	7.66	1.03%
55 mph **	9.12	9.20	-0.88%

The agencies also validated the GEM by comparing its results to those of another commonly used vehicle model. The agencies decided to use GT-Drive developed by Gamma Technologies for this purpose. Before this work, simulations derived from GT-Drive are first benchmarked against the experimental tests in the same manner as the GEM. Displayed in Tables 4-6 and 4-7 are the comparisons between GT-Drive and the same testing data used for the GEM. As can be seen, fairly good comparisons are achieved between the testing data and GT-Drive simulation results. More important, both GEM and GT-Drive demonstrate essentially equivalent levels of accuracy as compared to the experimental chassis test data.

Table 4-6: Fuel Economy (mpg) Comparison between Test Data and GT-Drive Simulation Results for a Class 8 Combination Tractor

Cycle	ProStar @ SwRI (Chassis Test)	GT-Drive (MPG)	GT-Drive Error
ARB Transient	3.51	3.52	-0.28%
65 mph **	6.90	6.92	-0.29%
55 mph **	8.20	8.23	-0.37%

Table 4.7 Fuel Economy (mpg) Comparison between Test Data and GT-Drive Simulation Results for a Class 7 Combination Tractor

Cycle	ProStar @ SwRI (Chassis Test)	GT-Drive (MPG)	GT-Drive Error
ARB Transient	4.10	4.13	-0.73%
65 mph	7.74	7.60	1.81%
55 mph	9.12	9.30	-1.97%

In the following, comprehensive comparisons between GT-Drive and GEM are made for all vehicle subcategories under certification consideration (*i.e.* vocational vehicles, and all of the subcategories for combination tractors). The validation of the vocational vehicle model is less challenging than combination tractors because the inputs are limited to the steer and drive tire rolling resistance. As shown in Table 4-8, good agreement between these two models is obtained. This comparison essentially demonstrates that both models produce very similar or even identical results.

Heavy-Duty GHG and Fuel Efficiency Standards FRM: Vehicle Simulation Model

Table 4-8 Comparisons between GEM and GT-Drive

	Cycle	GEM	GT-Drive	Error
Class 8 Combination - Sleeper Cab - High Roof	ARB Transient	3.47	3.53	-1.73%
	65 mph **	6.13	6.19	-0.98%
	55 mph **	7.36	7.38	-0.27%
Class 8 Combination - Sleeper Cab - Mid Roof	ARB Transient	3.6	3.66	-1.67%
	65 mph **	6.75	6.80	-0.74%
	55 mph **	7.96	7.99	-0.38%
Class 8 Combination - Sleeper Cab - Low Roof	ARB Transient	3.61	3.68	-1.94%
	65 mph **	7.31	7.39	-1.09%
	55 mph **	8.52	8.54	-0.23%
Class 8 Combination - Day Cab - High Roof	ARB Transient	3.51	3.57	-1.71%
	65 mph **	6.18	6.24	-0.97%
	55 mph **	7.42	7.44	-0.27%
Class 8 Combination - Day Cab - Low Roof	ARB Transient	3.66	3.72	-1.64%
	65 mph **	7.37	7.45	-1.09%
	55 mph **	8.61	8.63	-0.23%
Class 7 Combination - Day Cab - High Roof	ARB Transient	4.4	4.49	-2.05%
	65 mph **	6.65	6.74	-1.35%
	55 mph **	8.40	8.52	-1.43%
Class 7 Combination - Day Cab - Low Roof	ARB Transient	4.64	4.73	-1.94%
	65 mph **	8.16	8.19	-0.37%
	55 mph **	9.97	10.12	-1.50%
Heavy Heavy-Duty Vocational Vehicle (Class 8)	ARB Transient	3.48	3.47	0.29%
	65 mph **	5.69	5.69	0.00%
	55 mph **	6.81	6.78	0.44%
Medium Heavy-Duty Vocational Vehicle (Class 6-7)	ARB Transient	6.42	6.54	-1.87%
	65 mph **	7.37	7.41	-0.54%
	55 mph **	9.43	9.45	-0.21%
Light Heavy-Duty Vocational Vehicle (Class 2b-5)	ARB Transient	8.09	8.15	-0.74%
	65 mph **	8.44	8.48	-0.47%
	55 mph **	10.84	10.90	-0.55%

It should be mentioned that vehicle certification using the GEM is conducted on a relative basis, which compares the 2014 and 2017 vehicle model results with 2010 baseline results. The differences among all of these different year models are mainly in the engine fuel maps together with few standard inputs to the GEM, such as aerodynamic drag coefficient, rolling resistance, vehicle weight reduction, and extended idle reduction. Therefore, the benchmark carried out between GEM and GT-Drive shown in Table 4-8 and good correlations between GEM and vehicle testing data shown in Tables 4-4 and 4-5 provide a high confidence level of GEM as a qualitative tool. However, it is not recommended that the GEM be used as an absolute predictive tool for vehicle fuel consumption due to its many simplifications, but it is adequate for certification purposes. The agencies would not consider the GT-Drive model to be suitable for regulatory purposes since (among other factors) its code is proprietary so that the necessary degree of public transparency is lacking.

4.4 EPA and NHTSA Vehicle Compliance Model

Although several existing heavy-duty vehicle simulation models are widely accepted by the research community and industry, one drawback is that their codes are not designed for this regulatory program. For heavy-duty vehicles to be manufactured beginning in the 2014 MY timeframe, the compliance approach is done through simulation based on a few user input parameters, including rolling resistance, aerodynamic drag coefficient, and vehicle weight reductions. The comprehensive input structures of many commercially available models are more complicated than necessary for purposes of the final rulemaking and may present an unnecessarily steep learning curve to the users. Therefore, EPA and NHTSA have sought to develop internally a forward-looking, compliance-focused vehicle model which includes only those technical features required for compliance purposes. The model structure and input are straightforward. The model has been peer reviewed and appropriate suggestions were adopted when the model was upgraded for the final rulemaking. The following section describes this compliance model.

4.4.1 Graphical User Interface (GUI)

Linking the pre- and post-processing functions to the MATLAB/Simulink/Stateflow-based vehicle compliance model, a MATLAB-based Graphical User Interface (GUI) has also been constructed. This GUI allows the user to select truck type, input required parameters and look up the MATLAB/Simulink/Stateflow source models and script files.

In order to ensure that the compliance model is not inadvertently modified during truck certification, the Matlab/Simulink based model is further converted into a standalone executable program, allowing the user to run the program and conduct final certifications without requiring a Matlab/Simulink license. Upon providing all the information requested through a user-friendly GUI, the manufacturer then clicks “RUN” after which all their selections and entries are fed into the EPA/NHTSA compliance model without the user ever directly interacting with the underlying model source codes, built-in parameters, engine maps, etc. Figure 4-1 shows the GUI. It is flexible and easy to use for certification of heavy-duty vehicles in any of the twelve regulatory subcategories.

The GEM version released for the final rulemaking adds several enhancements requested by stakeholders. It includes the ability to conduct batch processing of several vehicle configurations through the “Multiple Configurations” option. This enhancement will significantly reduce the amount of time required to run multiple vehicle configurations. Version 2.0 also contains a feature which prevents a user from entering an input that is not valid for a specific regulatory subcategory. For instance, if a user selects one of the three vocational vehicle subcategories, then the only inputs available are the steer and drive tire rolling resistance. Lastly, the GEM v 2.0 contains a reduced number of Identification parameters required to conduct the simulation.

Figure 4-1: Graphical User Interface (GUI)

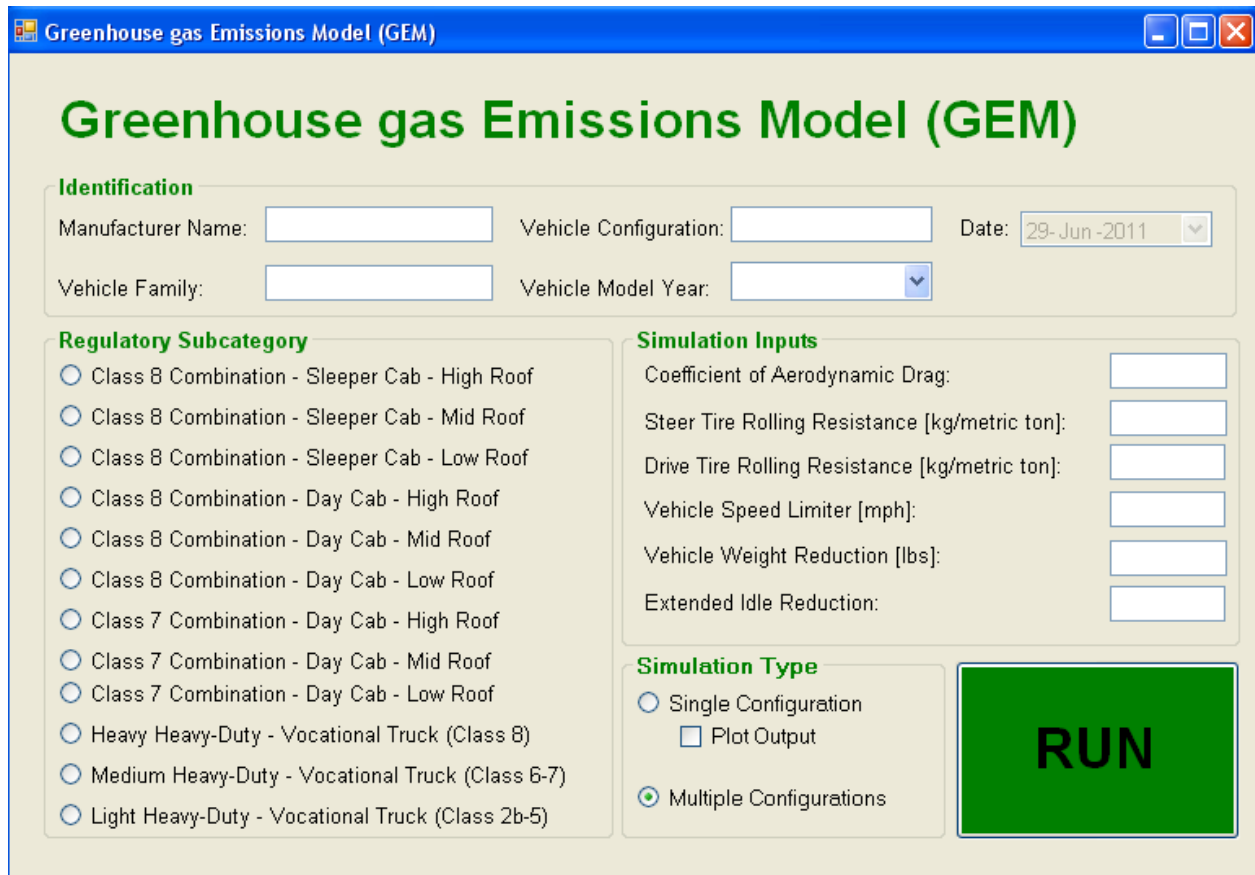

4.4.2 Vehicle Model

After the agencies established the list of required input parameters from vehicle manufacturers for tractor and vocational vehicle certification, EPA proceeded with the development of a heavy-duty truck simulation package which produces CO₂ emissions and fuel consumption output comparable to many sophisticated forward-looking models, but eliminates the multitude of features that are needed for research and development, but that are overly complicated and not required for certification purposes.

Truck models have been created in MATLAB/Simulink environment for vehicles with manual transmissions that match the gearing prescribed in the final rulemaking. MATLAB scripts have also been created for this final action, which control pre- and post-processing of truck simulations. The function of the MATLAB pre-processing scripts is to gather all the necessary component model parameters, including selection of appropriate agency-defined fuel maps based on model year as well as manufacturer inputs (*e.g.*, Cd, CRR, etc.). Once all the parameters are downloaded into the MATLAB workspace, the MATLAB/Simulink/Stateflow model is run to generate CO₂ emissions and fuel consumption for each of the three drive cycles after which the post-processing MATLAB scripts perform the calculation of individual cycle and cycle weighted fuel economy, fuel consumption and CO₂ emissions as per the EPA/NHTSA regulatory scheme in gallon/1000 ton-mile and gram CO₂/ton-mile and generate graphs

Regulatory Impact Analysis

displaying how the certifying vehicle follows the three drive cycle simulations. Based on the general truck usage pattern, EPA and NHTSA have defined three sets of cycle weighting factors for use in the twelve regulatory heavy-duty vehicle subcategories. Table 4-9 shows that these weightings are specific to sleeper cab (long distance, typically >500 miles cruising), day cab (<~100 miles cruising), and vocational vehicles (stop and go operation).

Table 4-9: Drive Cycle Weightings

DRIVE CYCLES & WEIGHTINGS:	SLEEPER CAB	DAY CAB	VOCATIONAL VEHICLE
Transient	5%	19%	42%
55 mph Cruise	9%	17%	21%
65 mph Cruise	86%	64%	37%

4.4.3 Standardized Model with Same Default Input Parameters for Each Vehicle Subcategory

With respect to combination tractors, as discussed in Chapter 2 of this RIA, EPA and NHTSA have identified many possible technologies which can achieve GHG emissions and fuel consumption benefits for Class 7 and 8 combination tractors. However, as noted in the preamble to the final rulemaking, some technologies may not be suited for some combination trucks' usage patterns. Others may be too complex to model. For example, it may be difficult to accurately model those improvements which are based on each manufacturer's proprietary control strategies. In developing a certification regime for the MY 2014-2017 period using GEM, EPA and NHTSA are finalizing three input parameters plus up to three adjustments to be used in the combination truck simulation models (see section 4.5.1). Potential improvements which are not finalized as part of the GEM model may be evaluated as a potential off-cycle credit opportunity.

For Class 2b through Class 8 vocational vehicles, the myriad vehicle types on the road today make it challenging to group them into manageable subcategories for compliance purposes. For reasons explained in Sections II and III of the preamble to the final rulemaking, the agencies are finalizing standards which reflect use of improved tire rolling resistance, along with improved engine performance. The input to GEM for vocational vehicles therefore can be only tire rolling resistance (see section 4.4.4 below). Most of these vehicles operate predominantly in an urban setting with transient (stop-and-go) rather than steady state operation. Improvements in vocational vehicle aerodynamic features are likely to generate little GHG emissions and fuel consumption benefits compared to those for combination tractors whose operation are often at high and continuous cruising speeds. On the other hand, advanced technologies such as hybrid systems are likely to result in greater fuel efficiency benefits for these vocational vehicle subcategories as these technologies have been shown to improve fuel efficiency for stop and go operations.¹⁵ Therefore, the agencies' final rulemaking seeks to encourage the production of hybrid systems for these vocational vehicles by means of credit opportunities, where vehicle performance for CO₂ emissions and fuel consumption will be assessed using test procedures outlined in Chapter 3 of this RIA. For non-hybrid conventional vocational vehicles, EPA and NHTSA have grouped vocational vehicles into three separate subcategories based on their shared attributes: light heavy-duty (LHD), medium heavy-duty

(MHD), and heavy heavy-duty (HHD), reflecting Classes 2b, 3, 4, or 5; Classes 6 or 7; and Class 8, respectively.

4.4.4 List of Required Vehicle-Specific Input Parameters for Class 7 and 8 Combination Tractor Models

The Class 7 and 8 combination tractor models developed by the agencies assume each Class 7-8 tractor is combined with a specific type of trailer that best matches the certifying tractor roof height. Combination tractors are certified using one of the nine regulatory subcategories, *i.e.*, three Class 7 day cabs, three Class 8 sleeper cabs, and three Class 8 day cab tractor models. Manufacturers are required to provide EPA and NHTSA with the following input parameters for certification:

1. Aerodynamic drag coefficient (Cd) per the assigned aerodynamic bin
2. Steer tire rolling resistance coefficient (CRR, steer tires)
3. Drive tire rolling resistance coefficient (CRR, drive tires)
4. Weight reductions through lower weight components as described in the Preamble Section II.B.3.e
5. Governed vehicle speed, if less than 65 mph
6. Idle reduction technology, if any, for Class 8 sleeper tractors only

The manufacturers are required to conduct appropriate testing to develop these inputs using the procedures described in Chapter 3 and Preamble Section V for Cd and CRR for both steer and drive tires.

It should be pointed out that aerodynamic drag coefficient (Cd) used as a GEM input may not be the same as the actual measurement if the actual measured frontal area of vehicle is not the same as the one defined by the agencies (see Tables 4-10 and 4-11). The vehicle frontal area shown in Tables 4-10 and 4-11 is pre-specified, and is only used in the GEM internally. The actual effect due to aerodynamic drag is the product of frontal area (A) and drag coefficient (Cd). A manufacturer will select the appropriate Cd value based on the Cd*A bin table provided in the regulations determined by the actual measured aerodynamic force.

4.4.5 List of Predefined Input Parameters for Class 7 and 8 Combination Tractor Models

Though many technologies can potentially achieve GHG emission and fuel consumption reductions, EPA and NHTSA realize that for the rulemaking's timeframe, some may be too complex to model for certification (*e.g.*, hybrid control) while others require standardization. For example, the calculation of CO₂ and fuel consumption benefits due to aerodynamic improvements is coupled with truck frontal area. To better capture the CO₂ emission and fuel consumption benefits in the simulation model as well as to avoid unintended consequences in the real world, the agencies have identified a set of parameters that are consistent across various

Regulatory Impact Analysis

manufacturers for this rulemaking period and are finalizing that these parameters be used as default inputs to the model. EPA and NHTSA are standardizing the tractor's frontal area, tractor – trailer combination weight and payload weight, gear box and its efficiency, final drive ratio, engine/transmission/wheel inertia, accessory load, axle base, tire radius, trailer tire coefficient of rolling resistance (CRR, trailer tires), and engine fuel map. The agencies are finalizing these standardized input parameters in the simulation model for all seven model subcategories of combination tractors. Tables 4-10 and 4-11 lists the specific values of these parameters, which were developed using EPA test data, manufacturer supplied information, and/or literature search.^{10,13}

(Table 4-10 follows on the next page)

Heavy-Duty GHG and Fuel Efficiency Standards FRM: Vehicle Simulation Model

Table 4-10: Class 8 Combination Tractor Modeling Parameters

MODEL TYPE	CLASS 8	CLASS 8	CLASS 8	CLASS 8	CLASS 8	CLASS 8
Regulatory Subcategory	Sleeper Cab High Roof	Sleeper Cab Mid Roof	Sleeper Cab Low Roof	Day Cab High Roof	Day Cab Mid Roof	Day Cab Low Roof
Fuel Map	15L - 455 HP					
Gearbox	10-speed Manual	10-speed Manual	10-speed Manual	10-speed Manual	10-speed Manual	10-speed Manual
Gearbox Ratio	14.8, 10.95, 8.09, 5.97, 4.46, 3.32, 2.45, 1.81, 1.35, 1					
Gearbox Efficiency	0.96, 0.96, 0.96, 0.96, 0.98, 0.98, 0.98, 0.98, 0.98, 0.98					
Engine Inertia (kg-m ²)	4.17	4.17	4.17	4.17	4.17	4.17
Transmission Inertia (kg-m ²)	5	5	5	5	5	5
All Axle Inertia (kg-m ²)	360	360	360	360	360	360
Loaded Tire Radius (m)	0.489	0.489	0.489	0.489	0.489	0.489
Tractor Tare Weight (lbs)	19,000	18,750	18,500	17,500	17,100	17,000
Trailer Weight (lbs)	13,500	10,000	10,500	13,500	10,000	10,500
Payload (lbs)	38,000	38,000	38,000	38,000	38,000	38,000
Total weight (lbs)	70,500	66,750	67,000	69,000	65,100	65,500
Total weight (kg)	31,978	30,277	30,391	31,298	29,529	29,710
Frontal Area (m ²)	10.4	7.7	6.9	10.4	7.7	6.9
Coefficient of Aerodynamic Drag	OEM Input	OEM Input	OEM Input	OEM Input	OEM Input	OEM Input
Axle Base	5	5	5	5	5	5
Electrical Accessory Power (W)	350	350	350	350	350	350
Mechanical Accessory Power (W)	1,000	1,000	1,000	1,000	1,000	1,000
Final Drive Ratio	2.64	2.64	2.64	2.64	2.64	2.64
Tire CRR (kg/metric ton)	$= 0.425 \times \text{Trailer CRR} + 0.425 \times \text{Drive CRR} + 0.15 \times \text{Steer CRR}$					
Trailer Tire CRR (kg/metric ton)	6	6	6	6	6	6
Steer Tire CRR (kg/metric ton)	OEM Input	OEM Input	OEM Input	OEM Input	OEM Input	OEM Input
Drive Tire CRR (kg/metric ton)	OEM Input	OEM Input	OEM Input	OEM Input	OEM Input	OEM Input
Vehicle Speed Limiter (mph)	OEM Input	OEM Input	OEM Input	OEM Input	OEM Input	OEM Input

Regulatory Impact Analysis

Table 4-11: Class 7 Combination Tractor Modeling Parameters

MODEL TYPE	CLASS 7	CLASS 7	CLASS 7
Regulatory Subcategory	Day Cab High Roof	Day Cab Mid Roof	Day Cab Low Roof
Fuel Map	11L - 350 HP		
Gearbox	10-speed Manual	10-speed Manual	10-speed Manual
Gearbox Ratio	11.06, 8.19, 6.05, 4.46, 3.34, 2.48, 1.83, 1.36, 1, 0.75		
Gearbox Efficiency	0.96, 0.96, 0.96, 0.96, 0.98, 0.98, 0.98, 0.98, 0.98, 0.98		
Engine Inertia (kg-m ²)	3.36	3.36	3.36
Transmission Inertia (kg-m ²)	5	5	5
All Axle Inertia (kg-m ²)	233.4	233.4	233.4
Loaded Tire Radius (m)	0.489	0.489	0.489
Tractor Tare Weight (lbs)	11,500	11,100	11,000
Trailer Weight (lbs)	13,500	10,000	10,500
Payload (lbs)	25,000	25,000	25,000
Total weight (lbs)	50,000	46,100	46,500
Total weight (kg)	22,680	20,910	21,092
Frontal Area (m ²)	10.4	7.7	6.9
Coefficient of Aerodynamic Drag	OEM Input	OEM Input	OEM Input
Axle Base	4	4	4
Electrical Accessory Power (W)	350	350	350
Mechanical Accessory Power (W)	1,000	1,000	1,000
Final Drive Ratio	3.73	3.73	3.73
Tire CRR (kg/metric ton)	= 0.425 × Trailer CRR + 0.425 × Drive CRR + 0.15 × Steer CRR		
Trailer Tire CRR (kg/metric ton)	6	6	6
Steer Tire CRR (kg/metric ton)	OEM Input	OEM Input	OEM Input
Drive Tire CRR (kg/metric ton)	OEM Input	OEM Input	OEM Input
Vehicle Speed Limiter (mph)	OEM Input	OEM Input	OEM Input

Frontal Area – For Class 8 sleeper and day cabs, the frontal areas for high, mid, and low roof tractors were estimated to be 10.4, 7.7 and 6.9 square meters, respectively. For Class 7 day

Heavy-Duty GHG and Fuel Efficiency Standards FRM: Vehicle Simulation Model

cab, the same frontal areas are applied. These values were developed from actual frontal area measurements conducted for EPA by Automotive Testing and Development Services, Inc. based in California.¹⁰

Truck Weight – It is assumed that the empty weight will vary by cab configuration and a standard weight for each category has been developed. For Class 8 trucks, the total weight ranges from 65,500 to 70,500 lbs, and for Class 7 trucks, 46,500 to 50,000 lbs. The payload capacity is assumed to be 19 and 12.5 tons for Class 8 and Class 7 trucks, respectively. The development of the truck weights are discussed in RIA Chapter 3.5.

Gear Box and Efficiency – The typical Class 8 and Class 7 combination tractors have 10 speed manual transmissions. The respective gear ratios for Class 8 and Class 7 combination tractors are: 14.8, 10.95, 8.09, 5.97, 4.46, 3.32, 2.45, 1.81, 1.35, 1 and 11.06, 8.19, 6.05, 4.46, 3.34, 2.48, 1.83, 1.36, 1, 0.75. The agencies based the gear ratios on the actual tractors tested at Southwest Research Institute.¹³ The same set of efficiencies is utilized for each of these models, ranging from 0.96 to 0.98. The efficiencies were based on an engineering judgment of the agencies.

Final Drive Ratio – As above, a typical configuration is a 10 speed manual transmission with a final drive ratio of approximately 2.64 and 3.73 for Class 8 and Class 7 tractors, respectively. The agencies based the final drive ratios on the actual tractors tested at Southwest Research Institute.¹³

Inertia – The engine inertia for Class 7 and Class 8 tractors are taken to be 3.36 and 4.17 kg-m², respectively, based on the agencies' engineering judgment. The transmission inertia for all combination tractors has changed from the proposed value of 0.2 kg-m² to 5 kg-m² based on the inputs obtained from transmission supplier proprietary data and also some consideration for better matching with transient data. The axle inertia for Class 8 and Class 7 tractors are 300 and 240 kg-m², respectively. The axle inertia values are based on agencies' engineering judgment of the actual rotational inertia measured for a Class 8 sleeper cab at SwRI.¹⁶

Accessory Load – The agencies are assuming that all combination tractors carry an electrical load of 350 watts and a mechanical load of 1,000 watts. The agencies are finalizing an electrical load of 350 watts instead of the proposed value of 360 to have better matching with testing data. This small change is not significant and has very little impact on the final results.

Axle Base – Typical Class 8 tractors have one steer and two drive axles, while typical Class 7 tractors have one steer and one drive axle. The trailer used for both Class 7 and Class 8 cabs in simulation modeling has two axles.^{10,13}

Tire Radius – The static loaded tire radius for all combination tractors is 489 mm (or 515 mm, unloaded). The value is based on the actual tires used during the Southwest Research Institute testing.¹³

Trailer Tire Coefficient of Rolling Resistance (CRR, trailer tires) – The agencies assume 6.0 kg/ton for all trailer tires. This value was developed through the SmartWay tire testing.¹⁷

Regulatory Impact Analysis

Engine Fuel Map – The agencies developed two new sets of representative engine maps which are to be used by manufacturers for modeling combination and vocational vehicle CO₂ emissions and fuel consumption. The agencies received comments regarding the fuel maps which questioned the effectiveness of the improvements in engine technologies as demonstrated in the 2017 and later model year vehicle models. Upon further review, the agencies found an area of the proposed fuel maps, specifically the low load area, which was extrapolated during the proposal and produced negative improvements. The agencies redeveloped the fuel maps for the final rulemaking to better predict the fuel consumption of engines in this area of the fuel consumption map. In addition, the agencies focused the technology path from 2014 to 2017 on the over-the-road conditions. The first set of fuel maps will be used for the 2014-16 model years and represents engines which meet the final primary 2014 MY engine standard (not the alternative standard). The second set will be used by truck manufacturers for the 2017 model year and later compliance where the fuel maps represent engines which meet the final 2017 model year engine standard. Each set consists of two separate maps, a 455 hp @ 1800 rpm (15 liter engine) and 350 hp @ 1800 rpm (11 liter engine), which will be used for certification of Class 8 and Class 7 combination tractors, respectively. The change to the fuel maps leads to lower CO₂ emissions and fuel consumption levels, but the change was taken into account when setting the final standards. The process for engine fuel map development is described as follows.

Each of these projected maps is created by merging 2007-2009 model year heavy-duty engine data supplied by the heavy-duty manufacturers with those collected at the EPA test site *via* engine dynamometer testing, as per 40 CFR Part 1065.¹⁸ The process of map generation is iterative and many factors are considered during data aggregation to ensure that the resulting, pre-2010 model year engine maps are consistent with those of the respective heavy-duty engine ratings sold in today's market. These pre-2010 maps are subsequently adjusted to represent 2010 model year engine maps by using predefined technologies including SCR and other advanced systems that are being used in current 2010 production. These 2010 engine maps are further transformed into 2014 engine maps by considering many potential technologies that could be used in the 2014 timeframe. These include, but are not limited to, further reductions in parasitic and friction losses, more advanced combustion, and progressively higher efficiency air/EGR handling and aftertreatment systems – the technology package on which the final 2014 MY engine standards is predicated. Lastly, the 2017 model year fuel maps are developed with a similar method used for generating 2014 model year maps, but with more aggressive improvements using the technology package on which the MY 2017 standards are premised (*i.e.* addition of turbocompounding to the MY 2014 technology package). Details of the evaluation process by which the technologies can reduce engine CO₂ emissions or fuel consumption are discussed in Chapter 2 of this RIA.

A typical engine fuel map consists of three columns – engine speed, torque, and fueling rate in grams per second. Table 4-12 shows a small subset of a representative engine map in such a format. Essentially, the fueling rate is a function of engine speeds and loads. Displayed in Figure 4-2 is an example of the fueling rate contour as a function of engine torque and speed for a Class 8 combination tractor with 455 hp rating. This map can be further processed to obtain other key engine performance information, such as brake specific fuel consumption (BSFC), as shown in Figure 4-3.

Table 4-12: A Small Subset of Fuel Map Input

SET MODE	SPEED (RPM)	TORQUE (NM)	FUEL RATE (g/s)
Idle	600	0	0.04
A100	1233	2100	14.77
B50	1514	1040	9.36
B75	1514	1559	13.72
A50	1233	1050	7.43
A75	1233	1575	10.78
A25	1233	525	4.26
B100	1514	2079	18.38
B25	1514	520	5.68
C100	1796	1805	19.71
C25	1796	451	6.94
C75	1796	1354	14.86
C50	1796	903	10.48

4-2 Fueling Rate (g/s) as a Function of Engine Torque and Speed for a Combination Tractor

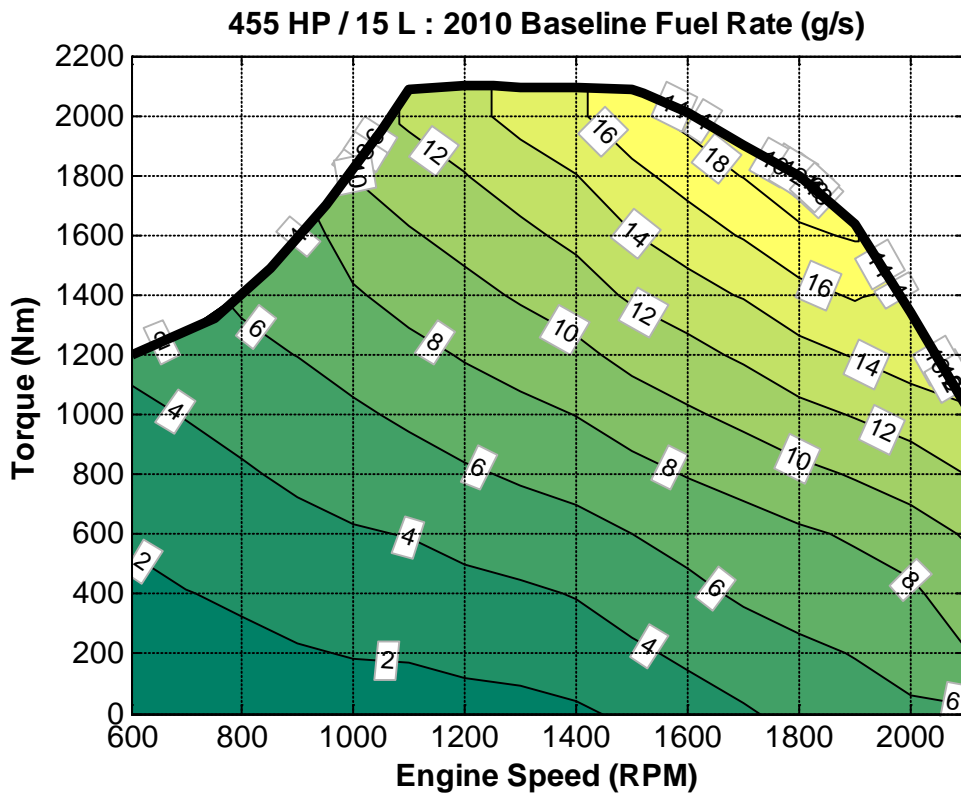
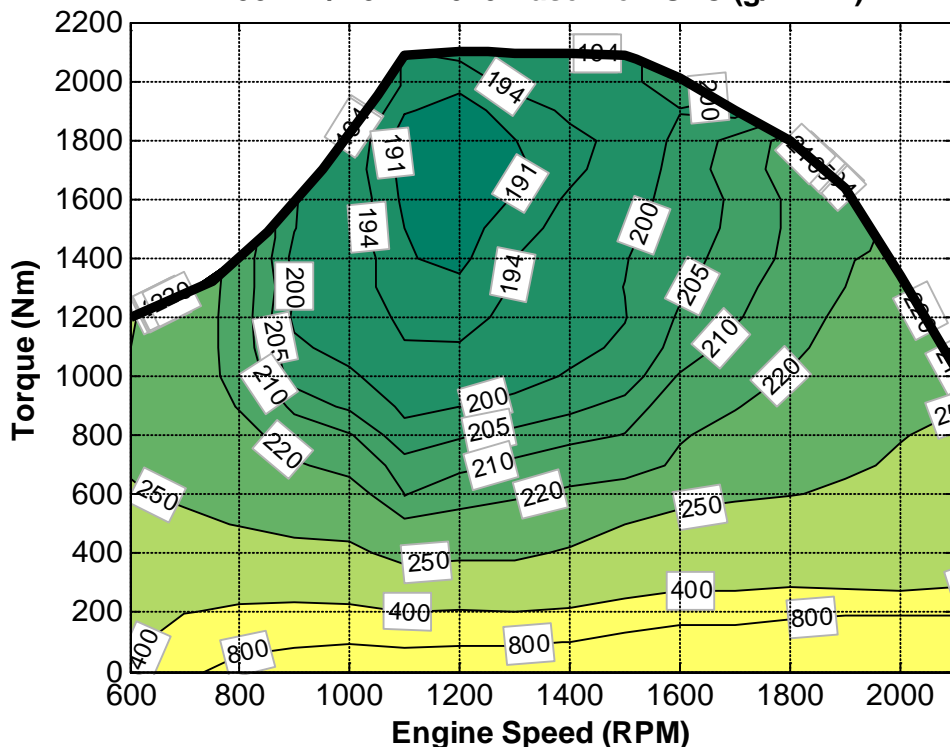

Figure 4-3: Class 8 Engine BSFC Map
 455 HP / 15 L : 2010 Baseline BSFC (g/kW-hr)



4.4.6 List of Predefined Input Parameters for Class 2b-8 Vocational Vehicle Models

Likewise, EPA and NHTSA standardized a set of parameters for the three Class 2b-8 vocational vehicle subcategories, which the agencies refer to as Vocational Light Heavy-Duty (VLHD), Vocational Medium Heavy-Duty (VMHD), and Vocational Heavy Heavy-Duty (VHHD). These predefined parameters include the coefficient of aerodynamic drag, truck frontal area, truck total and payload weight, the gear box and its efficiency, final drive ratio, engine/transmission/wheel inertia, accessory load, axle base, tire radius, and the engine fuel map. Standardized input parameters to be used in the simulation model for all three vocational vehicle subcategories have been developed using a combination of EPA test data, manufacturer supplied information, and/or literature search. The specific values of these parameters are listed in Table 4-13.

Coefficient of Aerodynamic Drag (Cd) – A Cd of 0.6 for both VLHD and VMHD models and 0.7 for VHHD, is adopted.

Frontal Area – For both VLHD and VMHD truck models, the frontal area is assumed to be 9 square meters, and for the VHHD model 9.8 square meters based on the agencies’ estimates from the combination tractor frontal area measurements.¹⁰

Heavy-Duty GHG and Fuel Efficiency Standards FRM: Vehicle Simulation Model

Truck Weight – The total weight is established at 16,000, 25,150, and 42,000 lbs for VLHD, VMHD, and VHHD models and the payload is 2.85, 5.6 and 7.5 tons, respectively, for VLHD, VMHD and VHHD truck models.¹⁹

Gear Box and Efficiency – A 10 speed manual transmission is adopted in the VHH truck model with gear ratios at: 14.8, 10.95, 8.09, 5.97, 4.46, 3.32, 2.45, 1.81, 1.35, 1. A six speed manual transmission is utilized for both VLH and VMH truck models with respective gear ratios of: 9.01, 5.27, 3.22, 2.04, 1.36, 1. Gear efficiencies of the 6 speed manual transmission range from 0.92 to 0.95.

Final Drive Ratio – The final drive ratios are 2.85, 3.36, and 2.64 (the actual final drive ratio for Truck 555) for the VLHD, VMHD, and VHHD truck models, respectively. The VLHD and VMHD final drive ratios are selected based on using a powertrain selection tool²⁰ and agencies' engineering judgment. The agencies are finalizing a 2.85 final drive ratio for VLHD vehicles, instead of the 3.25 ratio proposed in order that the engine will operate in a more fuel efficient area of the engine map during the simulation cycle, and a manner more typical of industry practice.

Inertia – For VHHD, it is assumed the same engine and transmission inertia values as those used for a Class 8 combination tractor, while the axle inertia is 168 kg-m². For both the VLHD and VMHD truck models, the engine, transmission and axle inertia values are 2.79, 0.5 and 90 kg-m², respectively.¹⁵

Accessory Load – It is estimated that VHHD vocational vehicles carry an electrical load of 350 watts, while VLHD and VMHD have a 300 watt electrical load. It is estimated that all vocational vehicles have a mechanical load of 1,000 watts. The final electrical load values differ from the proposed values to better match the test data, but these changes are insignificant and should have very little impact on final results.

Axle Base – It is assumed that both the VLHD and VMHD models have one steer and one drive axle, while the VHHD trucks have one steer and two drive axles based on typical configurations found in use.

Tire Radius – The static loaded tire radii for VLHD, VMHD, and VHHD trucks are 381, 395, and 489 mm, respectively.

Engine Fuel Map – In addition to the two sets of Class 7 and Class 8 combination tractor engine maps, two sets of engine maps have been created which will be used by manufacturers for modeling LHD and MHD vocational vehicle fuel consumption and CO₂ emissions. The map created for use in Class 8 combination tractor models (455 hp @ 1800 rpm) will also be used for the Vocational Heavy Heavy-Duty vehicle model. Two sets of LHD and MHD engine maps, a 200 hp @ 2000 rpm (7 liter engine) and 270 hp @ 2200 rpm (also 7 liter engine), will be used by manufacturers for certification of LHD and MHD vocational vehicles in the 2014-16 and in the 2017 and later model years, respectively.

The similar methodology used for generating representative the 2014 and 2017 model year Class 7 and Class 8 engine maps was also used for vocational vehicle engine map

Regulatory Impact Analysis

development. Figure 4-4 shows an example of the fueling rate contour as a function of engine torque and speed for a vocational vehicle with 200 hp rating.

Table 4-13: Vocational Vehicle Modeling Input Parameters

Model Type	Heavy Heavy-Duty	Medium Heavy-Duty	Light Heavy-Duty
Regulatory Subcategory	Vocational Vehicle (Class 8)	Vocational Vehicle (Class 6-7)	Vocational Vehicle (Class 2b-5)
Fuel Map	15L - 455 HP	7L - 270 HP	7L - 200 HP
Gearbox	10-speed Manual	6-speed Manual	6-speed Manual
Gearbox Ratio	14.8, 10.95, 8.09, 5.97, 4.46, 3.32, 2.45, 1.81, 1.35, 1	9.01, 5.27, 3.22, 2.04, 1.36, 1	9.01, 5.27, 3.22, 2.04, 1.36, 1
Gearbox Efficiency	0.96, 0.96, 0.96, 0.96, 0.98, 0.98, 0.98, 0.98, 0.98	0.92, 0.92, 0.93, 0.95, 0.95, 0.95	0.92, 0.92, 0.93, 0.95, 0.95, 0.95
Engine Inertia (kg-m ²)	4.17	2.79	2.79
Transmission Inertia (kg-m ²)	5	0.5	0.5
All Axle Inertia (kg-m ²)	200	60	60
Loaded Tire Radius (m)	0.489	0.389	0.378
Payload (lbs)	15000	11200	5700
Total weight (lbs)	42000	25150	16000
Total weight (kg)	19051	11408	7257
Frontal Area (m ²)	9.8	9.0	9.0
Coefficient of Aerodynamic Drag	0.7	0.6	0.6
Axle Base	3	2	2
Electrical Accessory Power (W)	350	300	300
Mechanical Accessory Power (W)	1000	1000	1000
Final Drive Ratio	2.64	3.36	2.85
Tire CRR (kg/ton)	= 0.5 × Drive CRR + 0.5 × Steer CRR		
Trailer Tire CRR (kg/metric ton)	Not applicable	Not applicable	Not applicable
Steer Tire CRR (kg/metric ton)	OEM Input	OEM Input	OEM Input
Drive Tire CRR (kg/metric ton)	OEM Input	OEM Input	OEM Input

Figure 4-4 Fueling Rate (g/s) as a Function of Engine Torque and Speed for a Vocational Vehicle

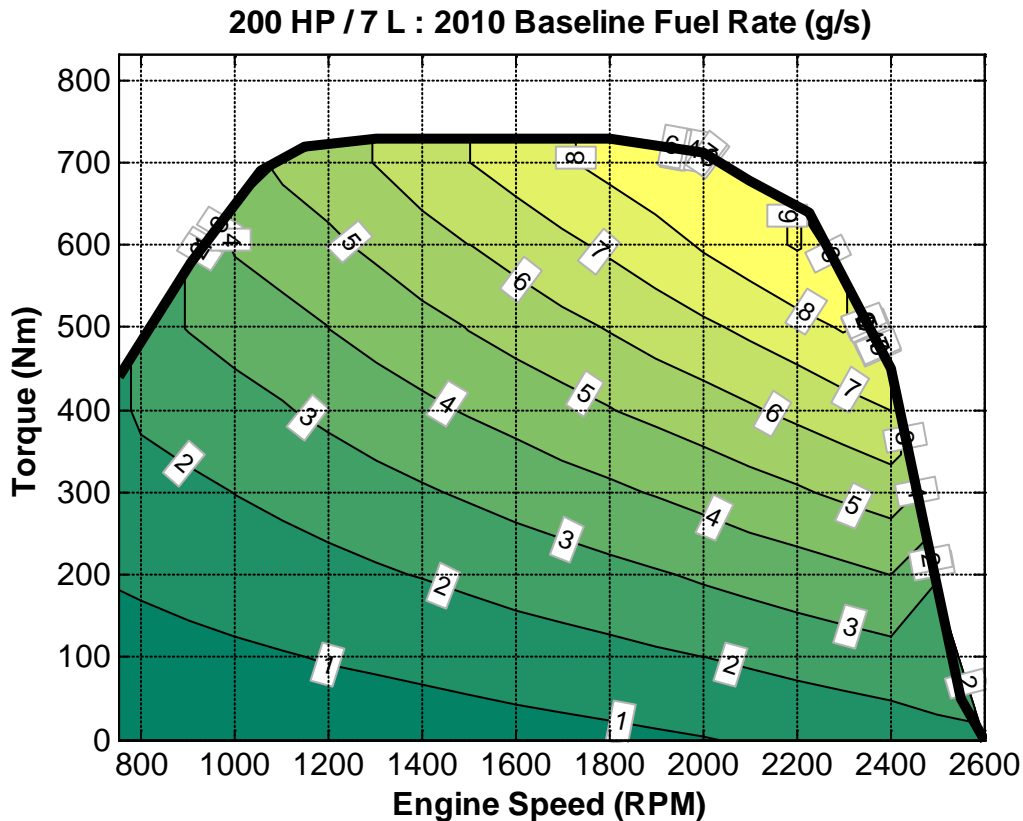

4.5 Application of Model for Certification

Vehicle manufacturers will demonstrate vehicle compliance using GEM for the following vehicle types.

- Class 7/8 Combination Tractors: Manufacturers use one of nine predefined combination tractor models to generate CO₂ emissions and fuel consumption.
- Class 2b-8 Vocational Vehicles: Manufacturers use one of three predefined vocational vehicle models to generate CO₂ emissions and fuel consumption.

4.5.1 Class 7 and 8 Combination Tractors – Use One of Nine Applicable Combination Tractor Models

As mentioned previously, EPA and NHTSA have defined three required input parameters and up to three allowable adjustments - the adjustments reflecting additional use of weight reduction, use of vehicle speed limiters, and/or use of idle reduction technologies. These parameters will be input to the simulation model to generate cycle-weighted CO₂ emissions and fuel consumption for certification. For Class 7 and 8 combination tractor certification, the manufacturer will provide this information in the graphical user interface.

Regulatory Impact Analysis

For example, if the manufacturer plans to produce a Class 7 or 8 combination tractor in the 2014 model year and beyond, appropriate testing will be conducted by the manufacturer to assess the vehicle aerodynamics and rolling resistance features as per test procedures described in Chapter 3 of this RIA and Preamble Section 2. The vehicle manufacturer needs to document the source of these test data for Cd and CRR (steer and drive tires) as part of the certification process.

If applicable, the vehicle manufacturer will further input specific values reflecting use of: (1) restricting the top speed of the vehicle to below 65 mph (2) reducing the vehicle weight to be less than the EPA-default body mass, and (3) installing special features on the vehicle to reduce extended idle (applicable to sleeper cabs only).

The quantification procedure to certify tractor CO₂ emissions and fuel consumption using these adjustments are the following:

Vehicle Speed Limiter (VSL) – If the manufacturer limits the vehicle in-use top speed to below 65 mph with a Vehicle Speed Limiter device, a cycle reflecting the vehicle top speed shall be substituted for the 65 mph drive cycle for quantifying CO₂ emissions and fuel consumption over the high speed cruising cycle. The agencies are providing flexibilities to manufacturers to provide vehicle speed limiters with “soft tops” which allow for temporary higher vehicle speeds along with the ability to set the vehicle speed limit for only a certain amount of miles. Details regarding these provisions and the calculations to appropriately discount the VSL input for these flexibilities can be found in the Preamble Section II.B.3.g.

Weight Reduction – If the manufacturer uses alternate material for wheels or other specified body and chassis components and/or installs single wide tires in lieu of duals, it is very likely that the empty weight of the certifying Class 7 and 8 tractor body mass is less than that listed in Table 4-10 and Table 4-11. Therefore, the manufacturer will be allowed to apply adjustments to the vehicle CO₂ emissions and fuel consumption calculation by reporting the difference between the EPA/NHTSA-defined tractor mass and the actual body mass. This adjustment is applied during the post-processing GHG emissions and fuel consumption calculation, in which one third of the mass reduction is added to the defined payload. This will essentially increase the denominator, *i.e.*, payload, for all three cycle outputs, resulting in less overall gram CO₂/ton-mile emissions or gallon/ton-mile fuel consumption.

Extended Idle Reduction Technology (applicable only to Class 8 sleeper cabs) – If the combination tractor is equipped with an extended idle reduction technology and an Automatic Engine Shutoff system, then the manufacturer will be allowed to select idle reduction in GEM which provides a grams/ton-mile CO₂ emissions reduction (and equivalent fuel consumption reduction) from the cycle-weighted CO₂ emissions and fuel consumption. Table 4-14 lists some examples of these extended idle reduction technologies. The agencies are providing a flexibility to manufacturers to enable the automatic engine shutoff for only a certain amount of miles to address potential resale value concerns. Details regarding this provision and the calculation to appropriately discount the idle reduction technology input for this flexibility are located in the Preamble Section II.B.3.f.

Table 4-14: Examples of Extended Idle Reduction Technologies

Automatic Engine Shutoff Only
Auxiliary Power Unit + Shutoff
Fuel Operated Heater + Shutoff
Thermal Storage Unit + Shutoff
Battery Air Conditioner + Shutoff
Truck Stop Electrification + Shutoff

4.5.2 Class 2b-8 Vocational Vehicles – Use One of Three Applicable Vocational Vehicle Models

For Class 2b-8 vocational vehicle certification in the 2014 MY and beyond timeframe, the manufacturer will conduct appropriate testing to assess the tire rolling resistance as per test procedures described in RIA Chapter 3 and Preamble Section V. The process for tire rolling resistance assessment is identical to that required for combination tractors, *i.e.* the manufacturer shall either conduct its own testing or obtain appropriate test results from the tire manufacturer. The vehicle manufacturer needs to document the source of these test data, *i.e.*, CRR as part of the certification process.

The adjustments available to Class 7 and 8 combination tractors for reducing CO₂ emissions and fuel consumption are not applicable to any of the vocational vehicle classes so that any further improvements in performance would be considered (potentially) as an off-cycle credit or advanced technology credit and will not be evaluated using the GEM.

References

- ¹ SAE International, Joint TMC/SAE Fuel consumption test procedure – Type II, SAE Surface Vehicle Recommended practice J1321, 1986
- ² Title 40 United States Code of Federal Regulations, Part 86 Subpart B, § 86.127 Test Procedures; Overview, 2010.
- ³ Title 40 United States Code of Federal Regulations, Part 86 Subpart N, § 86.1327 Engine Dynamometer Test Procedures; Overview, 2010.
- ⁴ Information regarding PSAT (Powertrain System Analysis Toolkit) can be found at http://www.transportation.anl.gov/modeling_simulation/PSAT
- ⁵ TruckSim software information can be found at <http://www.carsim.com/products/trucksim/index.php>
- ⁶ “Simulink® 7 Simulation and Model-Based Design,” 9320v06_Simulink7_v7.pdf, The MathWorks, September 2007.
- ⁷ “Peer Review of the Greenhouse gas Emissions Model (GEM) and EPA's Response to Comments,” Docket # EPA-HQ-OAR-2010-0162-3418, Publication Number: EPA-420-R-11-007, July 2011.
- ⁸ MatLab information (© 1994-2010 The MathWorks, Inc.) can be found at <http://www.mathworks.com/products/matlab>
- ⁹ Simulink information (© 1994-2010 The MathWorks, Inc.) <http://www.mathworks.com/products/simulink>
- ¹⁰ StateFlow information (© 1994-2010 The MathWorks, Inc.) <http://www.mathworks.com/products/stateflow>
- ¹¹ US EPA. Heavy-Duty Coastdown Test Procedure Development. Docket # EPA-HQ-OAR-2010-0162-0144.
- ¹² US EPA. Heavy-Duty Greenhouse Gas and Fuel Consumption Test Program Summary. Docket # EPA-HQ-OAR-2010-0162.
- ¹³ GT Drive information available at http://gtisoft.com/applications/a_Vehicle_driveline.php.
- ¹⁴ “Task Order No. 1104, Fuel Economy and Emission Testing Support Task” Southwest Research Institute Final Report 03-15847 for EPA Contract BPA 08-01 Task Order 1104.
- ¹⁵ Christenson, M. and Greuel, J., Evaluation of the Proposed SmartWay Fuel Efficiency Test Protocol for Medium- and Heavy-duty Vehicles, Report A: Conventional and Hybrid Utility Trucks, ERMS Report No. 08-38, 2009.
- ¹⁶ “Heavy-Duty Wheel and Tire Combination Rotational Inertia Study” Southwest Research Institute Final Report 03-15194.02 for EPA Contract BPA 08-01 Task Order 1103.
- ¹⁷ United States Environmental Protection Agency. *SmartWay Transport Partnership July 2010 e-update* accessed July 16, 2010, from <http://www.epa.gov/smartwaylogistics/newsroom/documents/e-update-july-10.pdf>
- ¹⁸ Title 40 United States Code of Federal Regulations, Part 1065 Subpart F, §1065.510 Engine Mapping, 2010.
- ¹⁹ “Greenhouse Gas Management for Medium-Duty Truck Fleets, A Framework for Improving Efficiency and Reducing Emissions,” 10860-fleets-med-ghg-management.pdf, <http://phharval.com>.
- ²⁰ Cummins Powerspec tool is available at <http://www.powerspec.cummins.com/site/home/index.html>

Chapter: 5 Emissions Impacts

5.1 Executive Summary

Climate change is widely viewed as the most significant long-term threat to the global environment. According to the Intergovernmental Panel on Climate Change, anthropogenic emissions of greenhouse gases (GHG) are very likely (90 to 99 percent probability) the cause of most of the observed global warming over the last 50 years. The primary GHGs of concern are carbon dioxide (CO₂), methane, nitrous oxide, hydrofluorocarbons, perfluorocarbons, and sulfur hexafluoride.¹ Mobile sources emitted 31 percent of all U.S. GHG in 2007 (transportation sources, which do not include certain off-highway sources, account for 28 percent) and have been the fastest-growing source of U.S. GHG since 1990.² Mobile sources addressed in the recent endangerment finding under CAA section 202(a)--light-duty vehicles, heavy-duty trucks, buses, and motorcycles--accounted for 23 percent of all U.S. GHG in 2007.³ Heavy-duty vehicles emit CO₂, methane, nitrous oxide, and hydrofluorocarbons and are responsible for nearly 19 percent of all mobile source GHGs (nearly 6% of all U.S. GHGs) and about 25 percent of Section 202(a) mobile source GHGs. For heavy-duty vehicles in 2007, CO₂ emissions represented more than 99 percent of all GHG emissions (including HFCs).²

This final action estimates anticipated impacts from the EPA vehicle CO₂ emission standards. The emissions from the GHGs carbon dioxide (CO₂), methane (CH₄), nitrous oxide (N₂O) and hydrofluorocarbons (HFCs) were quantified. In addition to reducing the emissions of greenhouse gases, this program would also influence the emissions of “criteria” air pollutants, including carbon monoxide (CO), fine particulate matter (PM_{2.5}) and sulfur dioxide (SO_x) and the ozone precursors hydrocarbons (VOC) and oxides of nitrogen (NO_x); and several air toxics (including benzene, 1,3-butadiene, formaldehyde, acetaldehyde, and acrolein).

Downstream (tailpipe) emission impacts were developed using EPA’s Motor Vehicle Emission Simulator (MOVES2010). Upstream (fuel production and distribution) emission changes resulting from the decreased fuel consumption predicted by the downstream models were calculated using a spreadsheet model based on emission factors from GREET.⁴ Based on these analyses, this program would lead to 76 million metric tons (MMT) of CO₂ equivalent (CO₂eq) of annual GHG reduction and 6.0 billion gallons of fuel savings in the year 2030.

The non-GHG impacts of the final rulemaking are driven by the increased use of auxiliary power units (APUs) and reduced emissions from upstream fuel production and distribution. Emissions of certain pollutants are further reduced through improved aerodynamics and tire rolling resistance. To a much smaller extent, rebound of vehicle miles traveled (VMT) increases emissions of all pollutants proportional to the VMT rebound amount. Table 5-1 summarizes these non-GHG emissions impacts from the heavy-duty sector.

Table 5-1 Impacts of Program on Heavy-Duty Non-GHG Emissions (Short Tons per year)

POLLUTANT	CALENDAR YEAR 2030	CHANGE VS. 2030 BASELINE
Δ 1,3-Butadiene	-0.5	-0.1%
Δ Acetaldehyde	-1,912	-40.2%
Δ Acrolein	-263	-40.0%
Δ Benzene	-359	-15.0%
Δ Carbon Monoxide	-55,579	-2.1%
Δ Formaldehyde	-6,282	-46.2%
Δ Oxides of Nitrogen	-245,129	-21.0%
Δ Particulate Matter (below 2.5 micrometers)	356	1.1%
Δ Oxides of Sulfur	-6,888	-10.1%
Δ Volatile Organic Compounds	-29,932	-16.0%

5.2 Introduction

5.2.1 Scope of Analysis

The standards affect both diesel- and gasoline-fueled heavy-duty vehicles. This analysis accounts for the direct downstream/tailpipe reduction of GHG as well upstream (fuel production and distribution) reductions of GHGs and non-GHGs. Total GHG impacts will also be determined by any VMT rebound effects, changes in fleet turnover, and changes in fuel consumption globally due to reduced petroleum prices. See Chapter 9 for a further discussion of these aspects of the analysis. The agencies also expect this program to impact downstream and upstream emissions of non-GHG air pollutants.

Emissions estimates for the four greenhouse gases carbon dioxide (CO₂), methane (CH₄), nitrous oxide (N₂O), and hydrofluorocarbons (HFC) are presented herein. Inventories for the non-GHG pollutants 1,3-butadiene, acetaldehyde, acrolein, benzene, carbon monoxide (CO), formaldehyde, oxides of nitrogen (NO_x), particulate matter below 2.5 micrometers (PM_{2.5}), oxides of sulfur (SO_x), and volatile organic compounds (VOC) are also presented.

5.2.2 Downstream Contributions

The largest source of GHG and other air pollutant reductions from this program is from tailpipe emissions produced during vehicle operation. Absolute reductions from tailpipe emissions are projected to grow over time as the fleet turns over to vehicles affected by the standards, meaning the benefit of the program will continue to grow as long as the older vehicles in the fleet are replaced by newer, lower CO₂-emitting vehicles.

As described herein, the downstream reductions in emissions due to the program are anticipated to be achieved through improvements in engine efficiency, road load reduction, and APU use during extended idling.

Changes in downstream GHG and other emissions at the fleet level will be affected by whether the regulations affect the timing of fleet turnover and total VMT, as discussed in Section VIII of the preamble. If the regulations spur firms to increase their purchase of new vehicles before efficiency standards are in place (“pre-buy”) or to delay their purchases once the standards are in place to avoid higher costs, then there will be a delay in achieving the full GHG and other emission reductions from improved fuel economy across the fleet. If the lower per-mile costs associated with higher fuel economy lead to an increase in VMT (the “rebound effect”), then total emission reductions will also be reduced. Chapter 9 of this RIA provides more detail on how the rebound effect is calculated in EPA’s analysis. The analysis discussed in this chapter incorporates the rebound effect into the estimates, though fleet turnover impacts are not estimated.

In addition, the agencies also recognize that this regulation would lower the world price of oil (the “monopsony” effect, further discussed in Chapter 9 of the RIA). Lowering oil prices could lead to an uptick in oil consumption globally, resulting in a corresponding increase in GHG emissions in other countries. This global increase in emissions could slightly offset some of the emission reductions achieved domestically as a result of the regulation. EPA does not provide quantitative estimates of the impact of the regulation on global petroleum consumption and GHG emissions in this RIA.

5.2.3 Upstream Contributions

In addition to downstream emission reductions, reductions are expected in the emissions associated with the processes involved in getting fuel to the pump, including the extraction and transportation of crude oil, the production, and the distribution of finished gasoline and diesel. Changes are anticipated in upstream emissions due to the expected reduction in the volume of fuel consumed. Less fuel consumed means less fuel transported, less fuel refined, and less crude oil extracted and transported to refineries. Thus, there should be reductions in the emissions associated with each of these steps in the fuel production and distribution process. Any changes in downstream reductions associated with changes in fleet turnover, VMT, and global petroleum consumption should be reflected in a corresponding change in upstream emissions associated with petroleum processing and distribution.

5.2.4 Global Warming Potentials

Throughout this document, in order to refer to the four inventoried greenhouse gases on an equivalent basis, Global Warming Potentials (GWPs) are used. In simple terms, GWPs provide a common basis with which to combine several gases with different heat trapping abilities into a single inventory (Table 5-2). When expressed in CO₂eq terms, each gas is weighted by its heat trapping ability relative to that of carbon dioxide. The GWPs used in this chapter are drawn from publications by the Intergovernmental Panel on Climate Change (IPCC).⁵

The global warming potentials (GWP) used in this analysis are consistent with the 2007 Intergovernmental Panel on Climate Change (IPCC) Fourth Assessment Report (AR4). At this time, the 1996 IPCC Second Assessment Report (SAR) global warming potential values are used in the official U.S. greenhouse gas inventory submission to the United Nations Framework

Regulatory Impact Analysis

Convention on Climate Change (per the reporting requirements under that international convention, which were last updated in 2006).

Table 5-2 Global Warming Potentials for the Inventory GHGs

GAS	GLOBAL WARMING POTENTIAL (CO₂eq)
CO ₂	1
CH ₄	25
N ₂ O	298
HFC	1,430

5.3 Program Analysis and Modeling Methods

5.3.1 Models Used

The Motor Vehicle Emissions Simulator, more commonly called MOVES, EPA's official mobile source emission inventory model, was the primary tool used to calculate downstream emissions inventories.⁶ The MOVES2010a version was used along with an internal 2010-October-6 default database. Some post-processing was done to MOVES output to ensure proper calculation of emissions inventories for each alternative.

This program affects heavy-duty vehicles. In MOVES, which categorizes vehicle types by their use, these vehicle types are represented by combination tractors, single unit tractors, refuse trucks, motor homes, transit buses, intercity buses, school buses, and light commercial trucks. Changes made to the default MOVES data for the baseline and the control case are described below in Section 5.3.2. All the input data and MOVES run spec files can be found in the docket.⁷

Upstream emissions were calculated using the same tools as were used for the Renewable Fuel Standard 2 (RFS2) rulemaking analysis.⁸ The estimate of emissions associated with production of gasoline and diesel from crude oil is based on emission factors in the "Greenhouse Gases, Regulated Emissions, and Energy Use in Transportation" model (GREET) developed by DOE's Argonne National Lab, and are consistent with those used for the Light-Duty Greenhouse Gas rulemaking.^{4,9} The actual calculation of the emission inventory impacts of the decreased gasoline production is done in EPA's spreadsheet model for upstream emission impacts. This model uses the decreased volumes of the crude based fuels and the various crude production and transport emission factors from GREET to estimate the net emissions impact of fuel use changes. As just noted, the analysis for this rulemaking assumes that all changes in volumes of fuel used affect only gasoline and diesel, with no effects on use of ethanol, or other renewable fuels.

5.3.2 Calculation of Downstream Emissions

5.3.2.1 Baseline (reference case)

Heavy-Duty GHG and Fuel Efficiency Standards FRM: Emissions Impacts

The baseline, or reference case, assumes no action and assumes constant 2010 model year performance of the HD fleet, as described in RIA Chapter 2. Since MOVES2010a vehicle sales and VMT inputs were developed from AEO2009, EPA first updated these data using relative sales and activity growth projections from AEO2011.¹⁰ The tables that were modified and included as user input tables for the baseline run were sourcetypeyear and hpmsvtypeyear. For HD pickups and vans, the agency updated sales projections for model years 2011 through 2018 using forecasts purchased from CSM Worldwide for the light-duty 2012-2016 MY vehicle rulemaking.¹¹ This update was done through modifying the base population, along with the sales growth factors for model years 2011 through 2018, in the sourcetypeyear table. The sales growth factors for the other model years were updated from AEO2011, as mentioned above. Also, extended idling PM rates were updated to match aged curb idling PM rates, a correction needed from the default emission rates. MOVES2010a defaults, including all other emission rates, were used for all other parameters to estimate the baseline emissions inventories. For combination tractors and vocational vehicles, the aerodynamic drag and tire rolling resistance coefficients were the default MOVES values that represent a fleet-wide average rolling resistance and aerodynamic drag (for each MOVES source/vehicle type), which assumes only a low level of adoption, if any, of low rolling resistance tires and advanced aerodynamic features. It also assumes that these fleet-wide coefficients do not change with future model years or by age.

For extended idling emission inventories, MOVES defaults were post-processed to account for increased use of auxiliary power units (APUs) for model year 2010 and later, which is not assumed in default MOVES. For all alternatives, the agencies assumed that about 30 percent of all combination long-haul tractors between model years 2010 through 2013 use an APU during extended idling. For alternatives where combination long-haul tractors are regulated, the agencies assumed that 100 percent of those trucks model year 2014 and later use APUs during extended idling. This assumption is based on the expectation that manufacturers will use APUs to meet the vehicle GHG standard for combination long-haul tractors. For alternatives where combination long-haul tractors are not regulated, the agencies assumed that 30 percent of those trucks model year 2014 and later use APUs during extended idling. A diesel fuel consumption rate of 0.2 gallons per hour for APUs and a factor 10.180 kg CO₂ per gallon diesel were assumed. EPA also considered that diesel APUs are regulated as non-road small engines for criteria (non-GHG) pollutants. Assuming that these APUs emit criteria pollutants at the EPA standard, Table 5-3 shows the emission rate of APUs, given an extended idle load demand of 4.5 kW (6 hp).¹² For SO₂, which is not regulated through engines, but rather through fuel, the agency assumed a diesel fuel sulfur level of 15 ppm and a diesel fuel density of 6.9 lb/gal. Total extended idle emissions were calculated by multiplying by the number of extended idle hours by the emission rates in Table 5-3.

Table 5-3 Estimated Emission Rates of non-GHG Pollutants from APUs

POLLUTANT	EMISSION RATE [g/hr]
CO	36
NO _x	26.88 ^a
VOC	6.72 ^a
PM	1.8
SO ₂	0.0188

CH ₄	0.0202 ^b
-----------------	---------------------

Notes:

^aNO_x rate was estimated to be 80%, and NMHC 20% of the total NO_x+NMHC rate (33.6 g/hr), based on the 2004 model year heavy-duty engine standard.¹³ VOC was estimated to be equal to NMHC for this analysis.

^bExtended idle methane (CH₄) emissions are assumed to be 0.3% of VOC emissions, based on existing MOVES methane-to-THC fractions for pre-DPF-equipped diesel engines.

5.3.2.2 Control Case

This case represents the final standard levels. The sales and VMT updates implemented in the baseline were also used in all the alternatives, including the control case, since the sales projections are projected for all future scenarios and are not affected by this program. To account for improvements of engine and vehicle efficiency, EPA developed several user inputs to run the alternatives in MOVES. Since MOVES does not calculate emissions based on engine Federal Test Procedure (FTP) cycle results, EPA used the percent reduction in engine CO₂ emissions expected from the program to develop energy inputs for the control case runs. Also, EPA used the percent reduction in aerodynamic drag coefficient and tire rolling resistance coefficient expected from each alternative to develop road load inputs. Runs were post-processed to calculate air toxics inventories for diesel vehicles and emissions and fuel consumption from APUs.

5.3.2.2.1 *Emission Rate and Road Load Inputs*

The form of the fuel consumption and CO₂ emissions standards varies by regulatory category. Heavy-duty engine standards are in terms of grams of CO₂ per brake horsepower-hour and gallons of fuel per 100 brake horsepower per hour. The form of the combination tractor and vocational vehicles is gallons per 1000 ton-mile and grams of CO₂ per ton-mile. For the vocational vehicles and combination tractors, the agencies have analyzed the impacts of the standards by evaluating the technologies applied to the engines and vehicles separately. Table 5-4 describes the improvements expected from the HD engine technologies which may be applied to meet the standards. These values remain unchanged between proposal and final rulemaking because no changes have been made to the HD engine CO₂ and fuel consumption standards. The reductions from the baseline were applied to the appropriate source bins in the MOVES emissionrate table.

Table 5-5 contains the combination long-haul tractor and vocational vehicle tire rolling resistance, coefficient of drag, and weight reductions expected from the technologies which could be used to meet the standards. The levels of reduction in the final rulemaking are greater for the long-haul combination tractors' rolling resistance and Cd due to the refined methodology of aggregating the three roof heights of sleeper cabs. In the NPRM, the agencies assumed that manufacturers sold equal number of sleeper cabs with low, mid, and high roof heights. For the final rulemaking, the agencies obtained sales distribution data from the manufacturers and attributed the reductions based on a sales mix assumption of 80 percent high roof, 15 percent mid roof, and 5 percent low roof sleeper cabs. The table also reflects the reduction in weight assumed in setting the final standards which was not evaluated in the NPRM. The value in the table reflects a 400 pound mass reduction. The short-haul combination tractors in the NPRM

Heavy-Duty GHG and Fuel Efficiency Standards FRM: Emissions Impacts

were evaluated using a day cab sales distribution assumption of equal number of each subcategory. For the final rulemaking, the agencies used a sales mix of 10 percent Class 7 low roof, 10 percent Class 7 high roof, 45 percent Class 8 low roof, and 35 percent Class 8 high roof based on feedback from the manufacturers. The short-haul values in the table reflect a modeling assumption that 8 percent of all tractors would be considered vocational tractors and therefore will only be required to meet the vocational vehicle standards and not show any aerodynamic or weight improvement. The vocational tractor population (assumed to be 9,773 vehicles in 2014 based on confidential sales information shared by a truck manufacturer) was applied entirely to short-haul tractor population which represents 19.7 percent of short-haul tractor population. The weight reduction applied to short-haul tractors is 321 pounds which is calculated from a 400 pound weight reduction reduced by 19.7 percent. The rolling resistance level in the NPRM was assumed to be reduced by 10 percent due to the proposed vocational vehicle standards. However, the tire rolling resistance reduction in the final rulemaking is assumed to be 5 percent based on the data derived in the tire testing program conducted by EPA. The reductions from the baseline summarized in Table 5-5 were applied to the corresponding source types in the MOVES sourceusetype table.

Table 5-4 Estimated Reductions in Engine CO₂ Emission Rates from this Program

GVWR CLASS	FUEL	MODEL YEARS	CO ₂ REDUCTION FROM BASELINE
HHD (8a-8b)	Diesel	2014-2016	3%
		2017+	6%
MHD (6-7) and LHD 4-5	Diesel	2014-2016	5%
		2017+	9%
	Gasoline	2016+	5%

Table 5-5 Estimated Reductions in Rolling Resistance and Aerodynamic Drag Coefficients from Reference Case for Alternative 3 (Model Years 2014 and Later)

TRUCK TYPE	REDUCTION IN TIRE ROLLING RESISTANCE COEFFICIENT FROM BASELINE	REDUCTION IN AERODYNAMIC DRAG COEFFICIENT FROM BASELINE	WEIGHT REDUCTION (LB)
Combination long-haul	9.6%	12.1%	400
Combination short-haul	7.0%	5.9%	321
Vocational vehicles (Single-unit trucks, refuse trucks, motor homes, buses, and light commercial trucks)	5.0%	0%	0

The HD pickup truck standards are evaluated in terms of grams of CO₂ per mile or gallons of fuel per 100 miles. Since nearly all HD pickup trucks and vans will be certified on a chassis dynamometer, the CO₂ reductions for these vehicles will not be represented as engine

Regulatory Impact Analysis

and road load reduction components, but total vehicle CO₂ reductions. Table 5-6 describes the estimated expected changes in engine and vehicle technologies from this final rulemaking, which were input into MOVES for estimating control case emissions inventories. Table 5-6 remains unchanged between proposal and final rulemaking because no changes have been made to the HD pickup truck and van CO₂ and fuel consumption standards.

Table 5-6 Estimated Total Vehicle CO₂ Reductions for HD Pickup Trucks and Vans

GVWR CLASS	FUEL	MODEL YEARS	CO ₂ REDUCTION FROM BASELINE
LHD 2b-3	Gasoline	2014	1.5%
		2015	2%
		2016	4%
		2017	6%
		2018+	10%
	Diesel	2014	2.3%
		2015	3%
		2016	6%
		2017	9%
		2018+	15%

Engine CO₂ reductions (Table 5-4) and HD pickup/van total vehicle CO₂ reductions (Table 5-6) were modified in the emissionrate table in MOVES. The percentage reductions were applied to the default energy rates. The improvements in tire rolling resistance and drag coefficient were modified in the sourceusetype table. The percentage reductions were applied to the road load coefficients. It was assumed that 100 percent of Class 7/8 combination long-haul tractors model year 2014 and later use APUs during extended idling. Emissions from APUs in the control case were calculated in the same way as the baseline (see Table 5-3)

5.3.2.2.2 VMT Inputs

The HPMSVtype table was modified to reflect VMT rebound. This table contains VMT growth factors from one calendar year to the next, starting from an absolute VMT estimate for calendar year 1999. For the control case, we increased the HD pickup/van absolute VMT by 1.18%, the vocational vehicle absolute VMT by 1.33%, and the combination tractor absolute VMT by 0.50% from baseline levels, based on the analysis in RIA Section 9.2. Since VMT growth is by calendar year and not model year, to ensure that only model years affected by the program experienced VMT rebound, the results from the baseline run were used in the control case inventories for model years prior to the rules' implementation.

5.3.2.2.3 Diesel Air Toxics Calculations

The composition of VOCs for heavy-duty diesel engines without model year 2007 and later emission controls versus those engines with such controls vary significantly. Thus, EPA

developed one set of toxic to VOC ratios for pre-2007 diesel engines and another set for 2007 and later engines. Since light-duty diesels comprise a very small portion of the fleet, the same ratios were applied to all diesel vehicle classes to streamline modeling.

EPA relied on a database compiled for the Coordinating Research Council (CRC E-75) and National Renewable Energy Laboratory (NREL) to develop toxic to VOC ratios for pre-2007 model year engines.¹⁴ This database was developed from a literature survey and included data from 13 different studies. The studies included in this database were conducted in a number of different countries, included heavy-duty and light-duty engines, a variety of diesel and biodiesel fuels, and a number of different operating modes and cycles. The methodology they used to develop ratios is described in detail in their technical report. Data from tests using non-conventional diesel fuel (Fischer-Tropsch, bioDiesel, ethanol-Diesel blends, emulsified fuel, European blends, and other obvious research fuels) were excluded, as were data from non-heavy-duty engines.

Toxic-to-VOC ratios for benzene, 1,3-butadiene, formaldehyde, acetaldehyde, and acrolein were developed by EPA from the CRC E-75 database. EPA relied on United States data from heavy-duty diesel engines running on conventional diesel fuels, collected on test cycles representative of real world operation. Some studies measured emissions over distance, while other studies measure emissions relative to engine work. For studies which measured emissions relative to distance, we calculated mean emissions per mile for toxics and VOC, then calculated a ratio of toxics to VOC. For studies which measured emissions relative to engine work, we calculated mean emissions per brake horsepower hour for toxics and VOC, then calculated a second ratio of toxics to VOC. We then calculated a composite ratio using sample size to weight the two ratios. The resulting ratios are provided Table 5-7.

For model year 2007 and later heavy-duty diesels, advanced emission controls change the composition of VOCs. For these engines, we relied on speciated emissions data from the Advanced Collaborative Emissions Study (ACES), directed by the Health Effects Institute and Coordinating Research Council, with participation from a range of government and private sector sponsors.¹⁵ Detailed emissions data from the study were provided to EPA at the request of the Coordinating Research Council. The data were collected on four engines on several test cycles with low sulfur diesel fuel. EPA used data from a 16-hour transient cycle. Toxic to VOC ratios obtained from the ACES data are provided in Table 5-7. Because diesel VOC estimates had not been updated in MOVES for model year 2007 and later heavy-duty diesel trucks, these data were also used to determine a VOC-to-total hydrocarbon (THC) ratio for those trucks. This ratio of 0.5327 was used in conjunction with the MOVES results for THC to estimate VOC emissions from model year 2007 and later heavy-duty diesel trucks.

All model year APUs were treated like pre-2007 engines with respect to toxics calculations because APUs are not equipped with the emission controls technology of model year 2007 and later engines.

Table 5-7 Air Toxics Ratios Post-Processed Against Hydrocarbon Results from MOVES

MODEL YEARS	POLLUTANT	RATIO to VOC
Pre-2007 engines and all model year APUs	Benzene	0.0078
	1,3-butadiene	0.0029
	Formaldehyde	0.0782
	Acetaldehyde	0.0356
	Acrolein	0.0066
2007 and later engines	Benzene	0.0129
	1,3-butadiene	0.0008
	Formaldehyde	0.2174
	Acetaldehyde	0.0693
	Acrolein	0.0100

5.3.3 Calculation of Upstream Emissions

The term "upstream emissions" refers to air pollutant emissions generated from all crude oil extraction, transport, refining, and finished fuel transport, storage, and distribution; this includes all stages prior to the final filling of vehicle fuel tanks at retail service stations. The details of the assumptions, data sources, and calculations that were used to estimate the emission impacts presented here can be found in the Technical Support Document and the docket memo, "Calculation of Upstream Emissions for the GHG Vehicle Rule," initially created for use in the light-duty 2012-2016 MY vehicle rulemaking.¹⁶

The agencies recognize the unique GHG emission characteristics associated with biofuels, and specifically that in the context of biofuels, "upstream emissions" include not only GHG emissions, but also any net biological sequestration that takes place. When considered on a lifecycle basis (including both tailpipe and upstream emissions), the net GHG emission impact of individual biofuels can vary significantly from both petroleum-based fuels and from one biofuel to another. EPA's Renewable Fuel Standard program, as modified by EISA, examined these differences in lifecycle emissions in detail. For example, EPA found that with respect to aggregate lifecycle emissions including non-tailpipe GHG emissions (such as feedstock growth, transportation, fuel production, and land use), lifecycle GHG emissions in 2022 for biodiesel from soy, using certain advanced production technologies, are about 50 percent less than diesel from petroleum.

The agencies note that to the extent future policy decisions involve upstream emissions, the agencies will need to consider the unique emission characteristics associated with biofuels. More broadly, the agencies recognize that biofuels, including biodiesel, will play an important role in reducing the nation's dependence on foreign oil, thereby increasing domestic energy security.

The results of the upstream analysis are shown in Table 5-10 and Table 5-12.

5.3.4 Calculation of HFC Emissions^A

EPA is finalizing as proposed air conditioning (A/C) leakage standards for HD pickup trucks and vans and combination tractors to reduce HFC emissions. The Vintaging Model, developed by the EPA Office of Atmospheric programs, produces HFC inventories for several categories of stationary and mobiles sources. However, it does not include air conditioning systems in medium and heavy duty trucks within its inventory calculations. For this rulemaking, we conducted an analysis based on the inputs to the Vintaging Model and the inputs to the MOVES analysis discussed in Chapter 5.3.2.1 above.

The general equation for calculating HFC emissions follows:

$$\text{HFC emissions}_{\text{Year } x} = \text{A/C Systems}_{\text{Year } x} \times \text{Average Charge Size} \times \text{HFC loss rate}$$

We determined the number of functioning A/C systems in each year based on the projected sales of vehicles, the fraction of vehicles with A/C systems, and the average lifetime of an air conditioning system. Sales were drawn from the MOVES analysis and we assumed that every vehicle had a functioning A/C system when sold based on feedback received from truck manufacturers. The Vintaging Model assumes that all light duty passenger vehicle A/C systems (in the U.S.) last exactly 12 years.¹⁷ For lack of better information, we assumed that heavy duty vehicles A/C systems last for the same period of time as light duty vehicles. Light, medium and heavy duty vehicles use largely the same components in their air conditioning systems, which would indicate similar periods of durability.

The charge size was determined using the Minnesota refrigerant leakage database.¹⁸ EPA sorted the data based on A/C charge size and evaluated only the largest 25 percent of A/C systems. The average charge size is 1,025 grams of refrigerant.

Due to the similarity in system design, we assumed that the light-duty vehicle emission rate in the Vintaging Model was applicable to the current analysis, as shown in Table 5-8. The Vintaging Model assumes that losses occur from three events: leak, service, and disposal. Although vehicle A/C systems are serviced during discrete events and not usually every year, emissions from those events are averaged over the lifetime of the A/C system in the Vintaging model. Leak and service emissions are considered “annual losses” and are applied every year; disposal is considered an “end of life loss” and is applied only once for each vintage of vehicles.^B

Table 5-8 Annual In-use Vehicle HFC134a Emission Rate from Vintaging Model

KIND OF LOSS	LOSS FRACTION
Leakage	8%
Maintenance /Servicing	10%
End of Life	43%

^A The U.S. has submitted a proposal to the Montreal Protocol which, if adopted, would phasedown production and consumption of HFCs.

^B The U.S. EPA has reclamation requirements for refrigerants in place under Title VI of the Clean Air Act.

Regulatory Impact Analysis

Of note, the Vintaging Model assumes that charge loss is replaced every year; *i.e.*, assuming an 18 percent rate of charge loss, a vehicle with a charge of 1,000 grams would lose a constant rate of 180 grams per year. While this loss rate is not accurate for any single vehicle, it is assumed accurate for the fleet as a whole. While other emissions, such as fugitive emissions at a production facility, leaks from cylinders in storage, etc., are not explicitly modeled, such emissions are accounted for within the average annual loss rate.

EPA's analysis of the MN database of MY 2010 vehicles suggests that many of the modeled vehicles likely contain some of the technology required to meet the leakage standard, and as a consequence are leaking less. We assume that these improvements are independent of EPA regulation, rather than a preemptive response to regulation. Consequently, this rulemaking does not take credit for these emission reductions. EPA requested better information on HFC leakage rates in modern vehicles, with a particular emphasis on in-use vehicles, in the proposal, but did not receive any comments.

Based on the MN 2010 database, we determined that it is possible to reduce the HFC emissions from these vehicles on average by 13 percent. EPA calculated this based on the assumption that vehicles currently in the fleet which meet the 2014MY standard would not make any additional improvements to reduce leakage. We also assumed that the systems which currently have leakage rates above the standard will reduce their leakage to the standard level. We then applied the 13 percent reduction to the baseline 18 percent leakage rate to develop a 15.6 percent leakage rate for 2014 MY and later vehicles to determine the reduction in emission rate which should be credited to this rulemaking.¹⁹

We calculated our emission reductions based on the difference between the baseline case of 2010 vehicle technology (discussed above) and the control scenario where the loss prevention technology has been applied to 100 percent of the new HD pickup trucks and vans and Class 7/8 tractors starting in 2014 model year, as required by the final standards.

Total HFC reductions are 305 metric tons over the MY 2010 baseline A/C system in 2030 and 417 metric tons in 2050. This is equivalent to a reduction of 122,338 metric tons of CO₂eq in 2018; 436,483 metric tons of CO₂eq emissions in 2030; and 596,396 metric tons CO₂eq in 2050.²⁰ The difference in the emissions reductions between the final rules and the proposal are due to changes in HD pickup truck and van and tractors sales projections, as detailed in above in Chapter 5.3.2.1.

EPA reviewed a study conducted by the Eastern Research Group (ERG) of R134a leaks in heavy-duty vehicles to California Air Resources Board.²¹ ERG delivered a presentation of the results during a CARB workshop held on January 6, 2011. The study included a total of 70 medium- and heavy-duty vehicles and off-road equipment, of which 18 of the samples were HD tractors ranging between 1990 and 2008 model years. The mobile air conditioning capacity in the tractors ranged between 1,080 grams to 1,950 grams. The study measured HFC leakage during sample times which ranged between 0.3 and 0.6 years. ERG then calculated an annualized in-use leakage rate with an assumed linear projection of measured leak rates to annual leak rates, which may be an over-estimate. The annualized leakage rate for tractors ranged between nearly 0 to nearly 1.5 grams leakage per gram of MAC capacity. These leakage rates did not include other leakage sources such as maintenance or end of life recovery. ERG found that

Heavy-Duty GHG and Fuel Efficiency Standards FRM: Emissions Impacts

the average of all MD and HD trucks and equipment which were 2006 MY or newer had an average leakage of 103 grams R134a per year. Based on these results, the agency believes that our estimates for HFC reductions may understate the benefits of the program we are finalizing today. The agency will continue to analyze this and other studies that may be conducted in the future.

5.4 Greenhouse Gas Emission Impacts

After all the MOVES runs and post-processing was completed, baseline and control case inventories were totaled for all vehicle types and emission processes to estimate total downstream GHG impacts of the program. Table 5-9 summarizes these downstream GHG impacts and fuel savings from baseline to control case for calendar year 2030. All emissions impacts reflect the heavy-duty sector only, and do not include emissions from light-duty vehicles or any other vehicle sector.

Table 5-9 Downstream GHG Impacts in 2030

POLLUTANT	CALENDAR YEAR 2030	% CHANGE vs. 2030 BASELINE
Δ CO ₂ (metric tons)	-60,710,570	-10.1%
Δ CH ₄ (metric tons CO ₂ eq)	-785,449	-53.8%
Δ N ₂ O (metric tons CO ₂ eq)	2,851	0.4%
Δ HFC (metric tons CO ₂ eq)	-436,483	-13%
Δ Total CO ₂ eq (metric tons)	-61,929,651	-10.3%
Δ Gasoline Fuel (billion gallons)	-0.349	-6.5%
Δ Diesel Fuel (billion gallons)	-5.67	-10.4%

Table 5-10 summarizes the upstream GHG impacts in 2030. The reductions in GHGs are proportional to the amount of fuel saved.

Table 5-10 Upstream GHG Impacts in 2030

POLLUTANT	CALENDAR YEAR 2030	% CHANGE vs. 2030 BASELINE
CO ₂ (metric tons)	-12,241,470	-10.2%
CH ₄ (metric tons CO ₂ eq)	-1,888,769	-10.2%
N ₂ O (metric tons CO ₂ eq)	-59,100	-10.2%
Total CO ₂ eq (metric tons)	-14,189,339	-10.2%

5.5 Non-Greenhouse Gas Emission Impacts

After all the MOVES runs and post-processing were completed, baseline and control case inventories were aggregated for all vehicle types and emission processes to estimate total downstream non-GHG impacts of the program. Table 5-11 summarizes these downstream non-GHG impacts for calendar year 2030. The non-GHG impacts of the program are driven by the increased use of APUs and, for certain pollutants, improved aerodynamics and tire rolling

Regulatory Impact Analysis

resistance. Use of APUs increases PM_{2.5} downstream inventories compared to the baseline case because APUs are not required to be equipped with diesel particulate filters, like the on-road engines are for model year 2007 and later. To a much smaller extent, VMT rebound increases emissions of all pollutants proportional to the VMT rebound amount.

Table 5-11 Downstream impacts for key non-GHG pollutants (Short tons)

POLLUTANT	CALENDAR YEAR 2030	% CHANGE vs. 2030 BASELINE
Δ 1,3-Butadiene	0.4	0.1%
Δ Acetaldehyde	-1,908	-40.5%
Δ Acrolein	-263	-40.2%
Δ Benzene	-341	-15.5%
Δ Carbon Monoxide	-52,299	-2.0%
Δ Formaldehyde	-6,255	-46.9%
Δ Oxides of Nitrogen	-235,052	-22.0%
Δ Particulate Matter (below 2.5 micrometers)	1,751	8.4%
Δ Oxides of Sulfur	-423	-8.7%
Δ Volatile Organic Compounds	-25,502	-19.1%

Non-GHG fuel production and distribution emission impacts of the program were estimated in conjunction with the development of life cycle GHG emission impacts, and the GHG emission inventories discussed above. The basic calculation is a function of fuel volumes in the analysis year and the emission factors associated with each process or subprocess. In general this life cycle analysis uses the same methodology as the Renewable Fuel Standard (RFS2) rulemaking. It relies partially on the GREET model, developed by the Department of Energy's Argonne National Laboratory (ANL), but takes advantage of additional information and models to significantly strengthen and expand on the GREET analysis.

Updates and enhancements to the GREET model assumptions include updated crude oil and gasoline transport emission factors that account for recent EPA emission standards and modeling, such as the Tier 4 diesel truck standards published in 2001 and the locomotive and commercial marine standards finalized in 2008²². In addition, GREET does not include air toxics. Thus emission factors for the following air toxics were added: benzene, 1,3-butadiene, formaldehyde, acetaldehyde, and acrolein. These upstream toxics emission factors were calculated from the 2002 National Emissions Inventory (NEI), a risk and technology review for petroleum refineries, speciated emission profiles in EPA's SPECIATE database, or the Mobile Source Air Toxics rulemaking (MSAT) inventory for benzene; these pollutant tons were divided by refinery energy use or gasoline distribution quantities published by the DOE Energy Information Administration (EIA) to get emission factors in terms of grams per million BTU of finished gasoline and diesel.

Results of these emission inventory impact calculations relative to the baseline for 2030 are shown in Table 5-12 for the criteria pollutants and individual air toxic pollutants.

Heavy-Duty GHG and Fuel Efficiency Standards FRM: Emissions Impacts

The program is projected to provide reductions in all pollutants associated with gasoline production and distribution as the projected fuel savings reduce the quantity of gasoline needed.

Table 5-12 Upstream Impacts for Key non-GHG Pollutants (Short Tons)

POLLUTANT	CALENDAR YEAR 2030	% CHANGE vs. 2030 BASELINE
Δ 1,3-Butadiene	-0.9	-10.1%
Δ Acetaldehyde	-3	-10.1%
Δ Acrolein	-0.5	-10.1%
Δ Benzene	-19	-9.3%
Δ Carbon Monoxide	-3,331	-10.1%
Δ Formaldehyde	-26	-10.1%
Δ Oxides of Nitrogen	-9,975	-10.1%
Δ Particulate Matter (below 2.5 micrometers)	-1,379	-10.1%
Δ Oxides of Sulfur	-6,395	-10.1%
Δ Volatile Organic Compounds	-4,367	-8.2%

5.6 Inventories Used for Air Quality Analyses

This section describes the processes used in calculating heavy-duty vehicle non-GHG inventories for the air quality (AQ) modeling analysis. Air quality modeling requires significant lead time, and consequently the air quality inventories were completed significantly before the inventories presented in this final action. Air quality modeling was done for calendar year 2030. This section describes the differences in heavy-duty vehicle non-GHG emissions inventories between the final rules and the air quality modeling.

5.6.1 Downstream Inventories

The downstream emission inventories for 2030 presented in this chapter are slightly different from the emissions inventories used in the air quality modeling presented in Chapter 8. Specifically, since the air quality modeling required a significant lead time, the inventories used for this analysis were calculated from inputs developed for the proposal.²³ Differences between the final and the air quality inventories are due mostly to regional temperature effects. The inventories for the final rules were run by year for the whole nation. This was sufficient for nationwide emissions estimates and assumes a uniform VMT-weighted average national temperature. The air quality inventories required a finer scale and were run by state and month. MOVES2010a was used in conjunction with an internal default database MOVESDB20100913, which contained performance updates from the MOVESDB20100826, the database originally released with MOVES2010a. Seasonal and regional variations in temperature and humidity were accounted for. The national inventories included Puerto Rico and the U.S. Virgin Islands, but the air quality inventories did not. The national inventories only included running exhaust, start exhaust, and extended idling exhaust emissions processes, whereas the air quality inventories included other minor emissions processes, such as crankcase exhaust.

Regulatory Impact Analysis

The MOVES output for air quality modeling was stratified into Source Classification Codes, the basis for stratification of inputs to the air quality modeling. The national inventories output was stratified by source type (vehicle type). Table 5-13 shows the aggregated downstream emissions inventories in 2030 from the heavy-duty vehicle sector for both the air quality modeling and final rulemaking. It should be noted that the air quality modeling inventories relied on state-supplied inventory projections for California. These projections do not reflect potential air quality benefits of the standards being finalized in this rulemaking. Onroad emission changes for California from this rulemaking would have included reductions in NO_x, VOCs, and SO₂ as well as some smaller increases in direct PM. Although full-scale photochemical modeling is necessary to accurately project air quality impacts, it is likely that the emissions changes in California would have resulted in a net benefit. As a result, the modeled inventory and air quality changes and the monetized benefits associated with this final action are likely an underestimate.

Table 5-13 Comparison of Calendar Year 2030 Heavy-Duty Vehicle Downstream Final Rulemaking National Inventories and Inventories Used for Air Quality (AQ) [Short tons]

POLLUTANT	REFERENCE			CONTROL		
	Final	AQ	Difference	Final	AQ	Difference
1,3-butadiene	305	364	19%	306	365	16%
Acetaldehyde	4,716	5,229	11%	2,808	3,364	17%
Acrolein	653	722	11%	391	465	16%
Benzene	2,199	2,563	17%	1,858	2,231	17%
CO	2,646,583	2,852,513	8%	2,594,341	2,803,402	7%
Formaldehyde	13,344	14,577	9%	7,089	8,462	16%
NO _x	1,068,212	1,144,571	7%	832,813	927,099	10%
PM _{2.5}	20,743	23,926	15%	22,503	24,158	7%
SO ₂	4,852	3,366	-31%	4,424	3,061	-45%
VOC	133,377	146,416	10%	108,112	121,825	11%

5.6.2 Upstream Inventories

Petroleum production includes crude oil extraction and transport to refineries. As in the nationwide analysis presented in the proposal as well as these final rules, we assumed that (a) 50% of the change in gasoline and diesel supply was projected to come from domestic refineries, and (b) 10% of the change in crude being used by domestic refineries would be domestic crude. Thus, using our assumption that 1.0 gallon less of gasoline equates to approximately 1.0 gallon less crude throughput, the reduction in crude extraction and transport would equal about 5% of the change in gasoline volume. To generate the emission inventory adjustment factors for air quality modeling these reductions were applied to the projected crude supply to US refineries, per AEO 2009 (stimulus version).²⁴ The resulting estimates are shown in Table 5-14. The percent reductions were applied to the NEI projected inventories for 2030. The 0.61% reduction was applied to all Source Classification Codes associated with petroleum extraction, and the 6.09% reduction was applied to all Source Classification Codes associated with gasoline and diesel refining.²⁵

Heavy-Duty GHG and Fuel Efficiency Standards FRM: Emissions Impacts

Table 5-14 Volumes and Reductions Associated with HD National Program in 2030

Crude Supply to US Refineries, per AEO2010	228 bgal
Reduction in Gasoline/Diesel Consumption	5.79 bgal
Reduction in Domestic-Refined Gasoline/Diesel Vol	2.89 bgal
Reduction in Domestic Refining of Crude (US & Imported Crude)	2.89 bgal
Reduction in Domestic-Refined Gasoline/Diesel from Domestic Crude	0.29 bgal
Reduction in Domestic Crude Production & Transport to refineries	0.29 bgal
Percent Reduction in Domestic Refining	1.27%
Percent Reduction in Domestic Crude Production & Transport	0.13%

References

- ¹ Intergovernmental Panel on Climate Change Working Group I. 2007. Climate Change 2007 - The Physical Science Basis. Contribution of Working Group I to the Fourth Assessment Report of the Intergovernmental Panel on Climate Change.
- ² U.S. Environmental Protection Agency. 2009. Inventory of U.S. Greenhouse Gas Emissions and Sinks: 1990-2007. EPA 430-R-09-004. Available at http://epa.gov/climatechange/emissions/downloads09/GHG2007entire_report-508.pdf
- ³ U.S. EPA. 2009 Technical Support Document for Endangerment and Cause or Contribute Findings for Greenhouse Gases under Section 202(a) of the Clean Air Act. Washington, DC. pp. 180-194. Available at <http://epa.gov/climatechange/endangerment/downloads/Endangerment%20TSD.pdf>
- ⁴ Argonne National Laboratory. The Greenhouse Gases, Regulated Emissions, and Energy Use in Transportation (GREET) Model versions 1.7 and 1.8. http://www.transportation.anl.gov/modeling_simulation/GREET/. Docket ID: EPA-HQ-OAR-2009-0472-0215
- ⁵ Intergovernmental Panel on Climate Change. Chapter 2. Changes in Atmospheric Constituents and in Radiative Forcing. September 2007. <http://www.ipcc.ch/pdf/assessment-report/ar4/wg1/ar4-wg1-chapter2.pdf>. Docket ID: EPA-HQ-OAR-2009-0472-0117
- ⁶ <http://www.epa.gov/otaq/models/moves/index.htm>
- ⁷ Memorandum to the Docket "Moves Inputs" Docket Number EPA-HQ-OAR-2010-0162
- ⁸ U.S. EPA. Draft Regulatory Impact Analysis: Changes to Renewable Fuel Standard Program. Chapters 2 and 3. May 26, 2009. Docket ID: EPA-HQ-OAR-2009-0472-0119
- ⁹ U.S. EPA. 2008. RFS2 Modified version of GREET1.7 Upstream Emissions Spreadsheet, October 31, 2008. Docket ID: EPA-HQ-OAR-2009-0472-0191
- ¹⁰ Annual Energy Outlook 2011. <http://www.eia.doe.gov/oiac/aeo/>
- ¹¹ Final Rulemaking to Establish Light-Duty Vehicle Greenhouse Gas Emission Standards and Corporate Average Fuel Economy Standards, Joint Technical Support Document. EPA-420-R-10-901, April 2010. <http://www.epa.gov/otaq/climate/regulations/420r10901.pdf>
- ¹² Tier 4, less-than-8 kW nonroad compression-ignition engine exhaust emissions standards assumed for APUs: <http://www.epa.gov/otaq/standards/nonroad/nonroadci.htm>
- ¹³ Heavy-duty highway compression ignition engine exhaust emission standards. For MY 2004, HD standard is 2.5 g/bhp-hr NO_x+NMHC, with a limit of 0.5 g/bhp-hr NMHC. <http://www.epa.gov/otaq/standards/heavy-duty/hdci-exhaust.htm> For MY 2004, HD standard is 2.5 g/bhp-hr NO_x+NMHC, with a limit of 0.5 g/bhp-hr NMHC.
- ¹⁴ Hsu, Y., and Mullen, M. 2007. Compilation of Diesel Emissions Speciation Data. Prepared by E. H. Pechan and Associates for the Coordinating Research Council. CRC Contract No. E-75, October, 2007. Available at www.crao.org.
- ¹⁵ Khalek, I., Bougher, T., and Merritt, P. M. 2009. Phase 1 of the Advanced Collaborative Emissions Study. Prepared by Southwest Research Institute for the Coordinating Research Council and the Health Effects Institute, June 2009. Available at www.crao.org.

¹⁶ Craig Harvey, EPA, “Calculation of Upstream Emissions for the GHG Vehicle Rule.” 2009. Docket ID: EPA-HQ-OAR-2009-0472-0216

¹⁷ This is in agreement with the IPCC report IPCC/TEAP 2005 *Safeguarding the Ozone Layer and the Global Climate System – Issues Related to Hydrofluorocarbons and Perfluorocarbons*, which indicates lifetimes (worldwide) of 9 to 12 years.

¹⁸ The Minnesota refrigerant leakage data can be found at <http://www.pca.state.mn.us/climatechange/mobileair.html#leakdata>

¹⁹ Using 18 percent as the base emission rate may overstate the net emission reductions. However, recent number from the ERG Report to CARB studying the leakage rate of heavy-duty vehicles are actually much larger (range of near 0 to 150 percent annually), and places an 18 percent annual loss rate well within the literature. However, (a) the net impact is very small, (b) these numbers have significant uncertainty, (c) it is unclear what the appropriate modification would be. No comments were received and EPA is not modifying the calculation methodology from the proposal.

²⁰ Using a Global Warming Potential of 1,430 for HFC-134a.

²¹ Eastern Research Group. “A Study of R134a Leaks in Heavy Duty Vehicles.” CARB Contract 06-342. Presented during CARB Seminar on January 6, 2011.

²² <http://www.epa.gov/otaq/marine.htm>, <http://www.epa.gov/otaq/locomotives.htm>

²³ Proposed Relumading to Establish Greenhouse Gas Emissions Standards and Fuel Efficiency Standards for Medium- and Heavy-Duty Engines and Vehicles, Draft Regulatory Impact Analysis, Chapter 5. EPA-420-D-10-901, October 2010. <http://www.epa.gov/otaq/climate/regulations/420d10901.pdf>

²⁴ Energy Information Administration. Annual Energy Outlook 2009. Supplemental Transportation Tables. April 2009. http://www.eia.doe.gov/oiaf/aeo/supplement/sup_tran.xls. EPA-HQ-OAR-2009-0472-0121

²⁵ U.S. EPA. 2009. “For LD GHG AQ Modeling, 2030 Control Case: Adjustments to Oil Refining, and Crude Production/Transport SCCs,” spreadsheet file: “Oil_Prod_Transp_Refine_2030_adjust.xls,” 11/6/2009.

Chapter 6: Results of Final and Alternative Standards

The heavy-duty truck segment is very complex. The sector consists of a diverse group of impacted parties, including engine manufacturers, chassis manufacturers, truck manufacturers, trailer manufacturers, truck fleet owners and the public. The final standards that the agencies have laid out today are largely shaped to maximize the environmental and fuel savings benefits of the program respecting the unique and varied nature of the sector. In developing this final rulemaking, we considered a number of alternatives that could have resulted in fewer or potentially greater GHG and fuel consumption reductions than the program we are finalizing. This section summarizes the alternatives we considered and presents assessments of technology costs, CO₂ reductions, and fuel savings associated with each alternative. The agencies reduced the number of alternatives analyzed in this final rulemaking from those analyzed in the draft EIS and at proposal because we did not receive any comments supporting standard setting for a smaller subset than HD pickup trucks, combination tractors, and vocational vehicles. As discussed below, the agencies have refined some of the alternatives presented in the draft EIS and at proposal in response to the comments received.

6.1 What Are the Alternatives that the Agencies Considered?

In developing alternatives, NHTSA must consider EISA's requirement for the MD/HD fuel efficiency program noted above. 49 U.S.C. 32902(k)(2) and (3) contain the following three requirements specific to the MD/HD vehicle fuel efficiency improvement program: (1) The program must be “designed to achieve the maximum feasible improvement”; (2) the various required aspects of the program must be appropriate, cost-effective, and technologically feasible for MD/HD vehicles; and (3) the standards adopted under the program must provide not less than four model years of lead time and three model years of regulatory stability. In considering these various requirements, NHTSA will also account for relevant environmental and safety considerations.

Each of the alternatives presented by NHTSA and EPA represents, in part, a different way the agencies could establish a HD program pursuant to EISA and the CAA. The agencies are finalizing Alternative 3. The alternatives below represent a broad range of approaches under consideration for finalizing the HD vehicle fuel efficiency and GHG emissions standards. The alternatives in order of increasing fuel efficiency and GHG emissions reductions are:

6.1.1 Alternative 1: No Action

A “no action” alternative assumes that the agencies would not issue a rulemaking regarding a MD/HD fuel efficiency improvement program, and is considered to comply with National Environmental Policy Act (NEPA) and to provide an analytical baseline against which to compare environmental impacts of the other regulatory alternatives.¹ The agencies refer to this as the “No Action Alternative” or as a “no increase” or “baseline” alternative. As described in RIA Chapter 5, this no-action alternative is considered the reference case. The estimated fleet-wide fuel efficiency of this reference case is included in Table 6-1.

Regulatory Impact Analysis

Table 6-1 Estimated Fleet-Wide Fuel Efficiency by Model Year for Alternative 1 (Baseline) [gallons/100 miles]

	MY 2010-2013	MY 2014	MY 2015	MY 2016	MY 2017	MY 2018
HD Pickups and Vans - gasoline	6.5	6.5	6.5	6.5	6.5	6.5
HD Pickups and Vans- diesel	7.6	7.5	7.5	7.5	7.5	7.5
Vocational – gasoline	11.3	11.3	11.3	11.3	11.3	11.3
Vocational – diesel	10.3	10.2	10.2	10.2	10.2	10.2
Comb. tractors	20.3	20.2	20.2	20.2	20.2	20.2

The no action alternative first presented in this final rulemaking is based on the assumption that the new vehicle fleet continues to perform at the same level as new 2010 vehicles. In this way, it provides a comparison between today's new trucks and the increased cost and reduced fuel consumption of future compliant vehicles.

The agencies recognize that there is substantial uncertainty in determining an appropriate baseline against which to compare the effects of the proposed action. The lack of prior regulation of HD fuel efficiency means that there is a lack of historic data regarding trends in this sector. Therefore, in this final rulemaking the agencies have also included an analysis using a baseline derived from annual projections developed by the U.S. Energy Information Administration (EIA) for the Annual Energy Outlook (AEO). For this alternative baseline, the agencies analyzed the new truck fuel economy projections for Light Commercial Trucks, along with the Medium- and Heavy-Duty Freight Vehicles developed in AEO 2011.² The agencies converted the fuel economy improvements into CO₂ emissions reductions relative to a 2010 model year (see RIA Chapter 6).

The baseline derived from the AEO forecast provides a comparison between the impacts of the proposed standards and EIA's projection of future new truck performance absent regulation. This alternative baseline is informative in showing one possible projection of future vehicle performance based on other factors beyond the regulation the agencies are finalizing today. The AEO forecast makes a number of assumptions that should be noted. AEO 2011 assumes improved fuel efficiency for 8500-10,000 heavy-duty pickups due to the light-duty 2012-2016 MY vehicle rulemaking. We project a similar capability for fuel economy improvement as AEO does for this class of vehicles; however, the agencies recognize that absent regulation manufacturers may decline to add the necessary technologies to reach the level of our proposed standards. For medium and heavy-duty vocational vehicles, AEO 2011 projects a small reduction in fuel efficiency over time (an increase in fuel consumption), similar to that achieved under the MY 2010 baseline. For Class 8 combination tractors, the AEO 2011 baseline projects an annual improvement of approximately 0.3 percent.

The agencies analyzed the new truck fuel economy projections for the Light Commercial Trucks, along with the Medium-Duty Freight Vehicles developed in AEO 2011.³ The agencies

Heavy-Duty GHG and Fuel Efficiency Standards FRM: Results of Final and Alternative Standards

converted the fuel economy improvements into CO₂ emissions reductions relative to a 2010 model year, as depicted in Table 6-2.

Table 6-2: CO₂ Emission Rate Change relative to 2010 MY vehicle

Model Year	HD Pickup Trucks & Vans	Vocational Vehicles - Gasoline	Vocational Vehicles - Diesel
2010	--	--	--
2011	0.05%	-0.14%	0.03%
2012	-1.11%	-0.22%	0.04%
2013	-1.68%	-0.26%	0.05%
2014	-2.57%	-0.30%	0.05%
2015	-4.45%	-0.35%	0.05%
2016	-6.38%	-0.41%	0.05%
2017	-8.50%	-0.49%	0.05%
2018	-10.52%	-0.61%	0.05%
2019	-10.97%	-0.76%	0.05%
2020	-11.65%	-0.95%	0.05%
2021	-12.25%	-1.19%	0.05%
2022	-12.24%	-1.45%	0.05%
2023	-12.23%	-1.74%	0.05%
2024	-12.26%	-2.02%	0.05%
2025	-12.32%	-2.28%	0.05%
2026	-12.42%	-2.51%	0.05%
2027	-12.54%	-2.70%	0.05%
2028	-12.68%	-2.84%	0.05%
2029	-12.83%	-2.91%	0.05%
2030	-12.99%	-2.91%	0.05%
2031	-13.13%	-2.91%	0.05%
2032	-13.27%	-2.91%	0.05%
2033	-13.35%	-2.91%	0.05%
2034	-13.43%	-2.91%	0.05%
2035	-13.51%	-2.91%	0.05%
2036	-13.63%	-2.91%	0.05%
2037	-13.74%	-2.91%	0.05%
2038	-13.86%	-2.91%	0.05%
2039	-13.98%	-2.91%	0.05%
2040	-14.10%	-2.91%	0.05%
2041	-14.22%	-2.91%	0.05%
2042	-14.34%	-2.91%	0.05%
2043	-14.46%	-2.91%	0.05%
2044	-14.57%	-2.91%	0.05%
2045	-14.69%	-2.91%	0.05%
2046	-14.81%	-2.91%	0.05%

Regulatory Impact Analysis

Model Year	HD Pickup Trucks & Vans	Vocational Vehicles - Gasoline	Vocational Vehicles - Diesel
2047	-14.93%	-2.91%	0.05%
2048	-15.05%	-2.91%	0.05%
2049	-15.17%	-2.91%	0.05%
2050	-15.29%	-2.91%	0.05%

The agencies also analyzed the new truck fuel economy projections for the Heavy-Duty Freight Vehicles developed in AEO 2011. In addition, the agencies obtained the Freight Truck Technology Penetration Table 146 from EIA and the technology effectiveness and costs developed by Argonne National Laboratory used in the National Energy Modeling System (NEMS) by EIA for this segment of vehicles. The agencies used this information to apportion the fuel economy improvements projected for combination tractors into four categories – engine, aerodynamic, tire rolling resistance, and weight improvements. The inputs to MOVES are included in Table 6-3 and Table 6-4.

Table 6-3: Inputs to MOVES for Short-Haul Combination Vehicle Improvements relative to 2010 MY

Model Year	Engine	Aerodynamics	Tire Rolling Resistance	Weight
2010	--	--	--	--
2011	-0.02%	0.00%	0.88%	0.00%
2012	0.02%	0.09%	2.19%	0.00%
2013	0.10%	0.12%	3.35%	0.00%
2014	0.26%	0.17%	4.44%	0.00%
2015	0.52%	0.23%	5.39%	0.00%
2016	0.91%	0.33%	6.36%	0.00%
2017	1.44%	0.47%	7.33%	0.00%
2018	2.08%	0.65%	8.30%	0.00%
2019	2.63%	0.87%	9.14%	0.00%
2020	3.35%	1.09%	9.82%	0.00%
2021	4.21%	1.27%	10.50%	0.00%
2022	4.98%	1.41%	11.11%	0.01%
2023	5.67%	1.45%	11.59%	0.01%
2024	6.24%	1.45%	11.93%	0.03%
2025	6.93%	1.45%	11.93%	0.05%
2026	7.61%	1.45%	11.94%	0.09%
2027	7.68%	1.45%	11.95%	0.15%
2028	7.68%	1.45%	11.97%	0.27%
2029	7.68%	1.45%	12.00%	0.45%
2030	7.68%	1.45%	12.06%	0.76%
2031	7.68%	1.45%	12.13%	1.21%
2032	7.68%	1.45%	12.24%	1.82%
2033	7.68%	1.45%	12.40%	2.53%
2034	7.68%	1.44%	12.59%	3.25%
2035	7.68%	1.44%	12.80%	3.86%

Heavy-Duty GHG and Fuel Efficiency Standards FRM: Results of Final and Alternative Standards

Model Year	Engine	Aerodynamics	Tire Rolling Resistance	Weight
2036	7.68%	1.44%	12.95%	3.86%
2037	7.68%	1.43%	13.10%	3.86%
2038	7.68%	1.43%	13.25%	3.86%
2039	7.68%	1.43%	13.40%	3.86%
2040	7.68%	1.42%	13.54%	3.86%
2041	7.68%	1.42%	13.69%	3.86%
2042	7.68%	1.42%	13.84%	3.86%
2043	7.68%	1.42%	13.99%	3.86%
2044	7.68%	1.41%	14.14%	3.86%
2045	7.68%	1.41%	14.29%	3.86%
2046	7.68%	1.41%	14.44%	3.86%
2047	7.68%	1.40%	14.59%	3.86%
2048	7.68%	1.40%	14.73%	3.86%
2049	7.68%	1.40%	14.88%	3.86%
2050	7.68%	1.40%	15.03%	3.86%

Table 6-4 Inputs to MOVES for Long-Haul Combination Vehicle Improvements relative to 2010 MY

Model Year	Engine	Aerodynamics	Tire Rolling Resistance	Weight
2010	--	--	--	--
2011	-0.02%	0.00%	0.48%	0.00%
2012	0.02%	0.08%	1.20%	0.00%
2013	0.10%	0.12%	1.83%	0.00%
2014	0.26%	0.17%	2.42%	0.00%
2015	0.52%	0.22%	2.93%	0.00%
2016	0.91%	0.32%	3.45%	0.00%
2017	1.44%	0.46%	3.97%	0.00%
2018	2.08%	0.64%	4.48%	0.00%
2019	2.63%	0.85%	4.93%	0.00%
2020	3.35%	1.06%	5.28%	0.00%
2021	4.21%	1.24%	5.64%	0.00%
2022	4.98%	1.38%	5.96%	0.01%
2023	5.67%	1.42%	6.21%	0.01%
2024	6.24%	1.42%	6.39%	0.03%
2025	6.93%	1.42%	6.39%	0.05%
2026	7.61%	1.42%	6.39%	0.09%
2027	7.68%	1.42%	6.40%	0.15%
2028	7.68%	1.42%	6.41%	0.27%
2029	7.68%	1.42%	6.43%	0.45%
2030	7.68%	1.42%	6.46%	0.76%
2031	7.68%	1.42%	6.50%	1.21%
2032	7.68%	1.42%	6.55%	1.82%
2033	7.68%	1.41%	6.63%	2.53%
2034	7.68%	1.41%	6.73%	3.25%

Regulatory Impact Analysis

Model Year	Engine	Aerodynamics	Tire Rolling Resistance	Weight
2035	7.68%	1.40%	6.84%	3.86%
2036	7.68%	1.40%	6.92%	3.86%
2037	7.68%	1.40%	7.00%	3.86%
2038	7.68%	1.40%	7.07%	3.86%
2039	7.68%	1.39%	7.15%	3.86%
2040	7.68%	1.39%	7.23%	3.86%
2041	7.68%	1.39%	7.30%	3.86%
2042	7.68%	1.39%	7.38%	3.86%
2043	7.68%	1.38%	7.46%	3.86%
2044	7.68%	1.38%	7.54%	3.86%
2045	7.68%	1.38%	7.61%	3.86%
2046	7.68%	1.37%	7.69%	3.86%
2047	7.68%	1.37%	7.77%	3.86%
2048	7.68%	1.37%	7.84%	3.86%
2049	7.68%	1.37%	7.92%	3.86%
2050	7.68%	1.36%	8.00%	3.86%

The estimated fleet-wide fuel efficiency for each of the vehicle categories in this alternative baseline are listed in Table 6-5.

Table 6-5: Estimated Fleet-Wide Fuel Efficiency by Model Year for Alternative 1a (AEO Baseline)
[gallons/100 miles]

	MY 2010-2013	MY 2014	MY 2015	MY 2016	MY 2017	MY 2018
HD Pickups and Vans - gasoline	6.5	6.3	6.2	6.1	5.9	5.8
HD Pickups and Vans- diesel	7.5	7.3	7.2	7.0	6.9	6.7
Vocational – gasoline	11.3	11.3	11.3	11.2	11.2	11.2
Vocational – diesel	10.3	10.2	10.2	10.2	10.2	10.2
Comb. tractors	20.4	20.2	20.1	20.0	19.8	19.6

6.1.2 Alternative 2: 12 Percent Less Stringent than the Preferred Alternative

Alternative 2 represents an alternative stringency level to the agencies' preferred approach. Like Alternative 3 (the preferred alternative as discussed below), Alternative 2 would set GHG emissions and fuel efficiency standards for Class 2b through 8 vocational vehicles and combination tractors and the engines installed in them and Class 2b and 3 HD pickup trucks and vans. The difference between Alternative 2 and 3 is the level of stringency for each of the categories. Alternative 2 represents a stringency level which is approximately 12 percent less stringent than the preferred approach. The agencies calculated the Alternative 2 stringency level

Heavy-Duty GHG and Fuel Efficiency Standards FRM: Results of Final and Alternative Standards

in order to meet two goals. First, we sought to create an alternative that regulated the same engine and vehicle categories as the preferred alternative, but at lower stringency (10-20 percent lower) than the preferred alternative. Second, we wanted an alternative that reflected removal of the least cost effective technology that we believed manufacturers would add last in order to meet the preferred alternative. In other words, we wanted an alternative that as closely as possible reflected the last increment in stringency prior to reaching our preferred alternative. Please see Table 2.39 in RIA Chapter 2 for a list of all of the technologies, their cost and relative effectiveness. The resulting Alternative 2 is based on the same technologies used in Alternative 3 except as follows for each of the three categories.

The combination tractor standard would be based on removal of the Bin IV aerodynamic package and weight reduction technologies which decreases the average combination tractor GHG emissions and fuel consumption reduction by approximately 1 percent. The road load impacts of this alternative are listed in Table 6-6.

Table 6-6 Estimated Reductions in Rolling Resistance and Aerodynamic Drag Coefficients from Reference Case for Alternative 2 (Model Years 2014 and Later)

TRUCK TYPE	REDUCTION IN TIRE ROLLING RESISTANCE COEFFICIENT FROM 2010 MY	REDUCTION IN AERODYNAMIC DRAG COEFFICIENT FROM 2010 MY	WEIGHT REDUCTION (LB)
Combination long-haul	9.6%	11%	0
Combination short-haul	7.0%	5.6%	0

The HD pickup truck and van standard would be based on removal of the 5 percent mass reduction technology which decreases the average truck reduction of fuel consumption and GHG emissions by approximately 1.6 percent. The estimated total vehicle CO₂ reductions for this alternative are listed in Table 6-7.

Table 6-7 Estimated Total Vehicle CO₂ Reductions for HD Pickup Trucks and Vans for Alternative 2

GVWR CLASS	FUEL	MODEL YEARS	CO ₂ REDUCTION FROM 2010 MY
LHD 2b-3	Gasoline	2014	1.3%
		2015	1.7%
		2016	3.4%
		2017	5.0%
		2018+	8.4%
	Diesel	2014	2.0%
		2015	2.7%
		2016	5.4%
		2017	8.0%
		2018+	13.4%

Regulatory Impact Analysis

The vocational vehicle standard would be based on removal of low rolling resistance tires. This alternative would also reduce the amount of technologies applied to diesel engines used in vocational vehicles such that the engines achieve a 3 percent reduction in 2014 model year and a 5 percent reduction in 2017 model year, both compared to a 2010 model year baseline. The road load inputs for vocational vehicles are included in Table 6-8. The engine reductions are included in Table 6-9.

Table 6-8 Estimated Reductions in Rolling Resistance from Reference Case for Alternative 2 (Model Years 2014 and Later)

TRUCK TYPE	REDUCTION IN TIRE ROLLING RESISTANCE COEFFICIENT FROM 2010 MY
Vocational Vehicle	0%

Table 6-9 Estimated Reductions in Engine CO₂ Emission Rate for Alternative 2

GVWR CLASS	FUEL	MODEL YEARS	CO ₂ REDUCTION FROM BASELINE
MHD (6-7) and LHD 4-5	Diesel	2014-2016	3%
		2017+	5%

The estimated fleet-wide fuel efficiency for Alternative 2 is listed in Table 6-10.

Table 6-10 Estimated Fleet-Wide Fuel Efficiency by Model Year for Alternative 2 [gallons/100 miles]

	MY 2010-2013	MY 2014	MY 2015	MY 2016	MY 2017	MY 2018
HD Pickups and Vans - gasoline	6.5	6.4	6.4	6.3	6.2	5.9
HD Pickups and Vans- diesel	7.6	7.4	7.3	7.1	6.9	6.5
Vocational – gasoline	11.3	11.3	11.3	10.7	10.7	10.7
Vocational – diesel	10.3	9.9	9.9	9.9	9.7	9.7
Comb. tractors	20.3	18.4	18.4	18.4	17.9	17.9

Heavy-Duty GHG and Fuel Efficiency Standards FRM: Results of Final and Alternative Standards

6.1.3 Alternative 3: Preferred Alternative and Final Standards

Alternative 3 represents the agencies' preferred approach. This alternative consists of the preferred fuel efficiency and GHG standards for HD engines, HD pickup trucks and vans, Class 2b through Class 8 vocational vehicles, and Class 7 and 8 combination tractors.

Details regarding modeling of this alternative are included in Chapter 5 as the control case. The estimated fleet-wide fuel efficiency of this alternative is included in Table 6-11.

Table 6-11 Estimated Fleet-Wide Fuel Efficiency by Model Year for Alternative 3 [gallons/100 miles]

	MY 2010-2013	MY 2014	MY 2015	MY 2016	MY 2017	MY 2018
HD Pickups and Vans - gasoline	6.5	6.4	6.4	6.2	6.1	5.8
HD Pickups and Vans - diesel	7.6	7.4	7.3	7.1	6.8	6.4
Vocational – gasoline	11.3	11.3	11.3	10.7	10.7	10.7
Vocational – diesel	10.3	9.8	9.8	9.8	9.4	9.4
Comb. tractors	20.3	18.3	18.3	18.3	17.7	17.7

6.1.4 Alternative 4: 20 Percent More Stringent than Preferred Alternative

Like Alternatives 2 and 3, this alternative would set GHG emissions and fuel efficiency standards for HD pickup trucks and vans and for Class 2b through 8 vocational vehicles and combination tractors and the engines installed in them. The difference between Alternative 3 and 4 is the level of stringency for each of the standards. Alternative 4 represents a stringency level which is 20 percent more stringent than the preferred approach. The agencies derived the stringency level based on similar goals as for Alternative 2. Specifically, we wanted an alternative that would reflect an incremental improvement over the preferred alternative based on adding the next most cost effective technology in each of the categories. In general, we thought these were the technologies most likely to be applied by manufacturers if a more stringent standard were set. However, as discussed in the feasibility discussion in Section III.A.2.vi, III.B, and III.C.2.v of the preamble to the final rules, we are not finalizing this level of stringency because we do not believe that there is adequate lead time for these technologies to be developed and introduced in the timeframe of this rulemaking. Reflecting that given unlimited resources it might be possible to introduce these technologies in this timeframe by, for example, constructing new factories in one to two years and otherwise operating entirely outside the normal redesign cycle, we are unable to estimate what those real costs might be (*e.g.* to build new factories in only one to two years), we have denoted the cost for this alternative with a +c. The +c is intended to make clear that the cost estimates we are showing do not include additional costs related to

Regulatory Impact Analysis

pulling ahead the development and expanding manufacturing base for these technologies. Nor have we estimated the cost of the capital to do so, or whether capital would be available. See 75 FR at 25,451 (May 7, 2010). The resulting Alternative 4 is based on the same technologies used in Alternative 3 except as follows for each of the three categories.

The combination tractor standard would be based on the addition of Rankine waste heat recovery (which, as the agencies have found will not be available in the time frame of this rulemaking; see Section III.A.2.b.ii of the preamble and Chapter 2.4.2.7 of this RIA) and 100 percent application of Bin IV aerodynamics to high roof sleeper cab combination tractors. The agencies assumed 59 percent of all combination tractors are long-haul tractors and of those, 80 percent are high roof sleeper cabs. The agencies assumed a 12 kWh waste heat recovery system would reduce CO₂ emissions by 6 percent at a cost of \$8,400 per truck.⁴ The estimated reduction in CO₂ emissions from the engine for this alternative is included in Table 6-12. The impact of 100 percent application of Bin IV aerodynamic technology package would lead to a total 20.7 percent reduction in Cd values for high roof sleeper cabs over a 2010 MY baseline tractor. The incremental cost of this technology over the preferred case is \$1,027 for each high roof sleeper cab tractor. The impact of the aerodynamic package on the road load is included in Table 6-13.

Table 6-12 Estimated Reductions in Engine CO₂ Emission Rates from this Alternative 4

GVWR CLASS	FUEL	MODEL YEARS	CO ₂ REDUCTION FROM 2010 MY
HHD (8a-8b) – Combination tractors only	Diesel	2014-2016	5.8%
		2017+	8.8%

Table 6-13 Estimated Reduction in Coefficient of Drag for Combination Long-Haul Tractors for this Alternative 4

TRUCK TYPE	REDUCTION IN AERODYNAMIC DRAG COEFFICIENT FROM 2010 MY
Combination long-haul	17.7%

The HD pickup truck and van standard would be based on the addition of turbo downsized gasoline engine technology which would bring the total reduction for gasoline HD pickup trucks and vans to 15 percent and match the level of reduction for the diesel pickup trucks (although, as noted in Section III.B.1 of the preamble, downsized engines may reduce towing utility and thus interfere with a chief purpose of these vehicles). The estimated total vehicle CO₂ reductions for this alternative are listed in Table 6-14. The estimated incremental cost increase to HD pickup trucks and vans to replace a stoichiometric gasoline direct injected V8 engine with coupled cam phasing used in Alternative 3 with a V6 stoichiometric gasoline direct injection DOHC, discrete valve lift and twin turbochargers is estimated to be \$1,743.⁵

Heavy-Duty GHG and Fuel Efficiency Standards FRM: Results of Final and Alternative Standards

Table 6-14 Estimated Total Vehicle CO₂ Reductions for HD Pickup Trucks and Vans for Alternative 4

GVWR CLASS	FUEL	MODEL YEARS	CO ₂ REDUCTION FROM 2010 MY
LHD 2b-3	Gasoline	2014	2.3%
		2015	3%
		2016	6%
		2017	9%
		2018+	15%
	Diesel	2014	2.3%
		2015	3%
		2016	6%
		2017	9%
		2018+	15%

The vocational vehicle standard would be based on the addition of hybrid powertrains to 6 percent of the vehicles. The agencies assumed a 32 percent per vehicle reduction in GHG emissions and fuel consumption due to the hybrid with a cost of \$26,667 per vehicle based on the average effectiveness and costs developed in the NAS report for box trucks, bucket trucks, and refuse haulers.⁶ The agencies project the hybrid penetration for this alternative, as described in Table 6-15.

Table 6-15 Hybrid Penetration for Vocational Vehicles for Alternative 4

	MY 2014	MY 2017
Vocational Vehicles	0%	6%

The estimated fleet-wide fuel efficiency for Alternative 4 is listed in Table 6-16.

Table 6-16 Estimated Fleet-Wide Fuel Efficiency by Model Year for Alternative 4 [gallons/100 miles]

	MY 2010-2013	MY 2014	MY 2015	MY 2016	MY 2017	MY 2018
HD Pickups and Vans - gasoline	6.5	6.4	6.3	6.1	5.9	5.5
HD Pickups and Vans- diesel	7.6	7.4	7.3	7.1	6.8	6.4
Vocational – gasoline	11.3	11.3	11.3	10.5	10.5	10.5
Vocational – diesel	10.3	9.5	9.5	9.5	9.0	9.0

Comb. tractors	20.3	17.7	17.7	17.7	17.2	17.2
----------------	------	------	------	------	------	------

6.1.5 Alternative 5: Maximum Technology Penetration plus Trailers

Alternative 5 builds on Alternative 4 through additional hybrid powertrain application rates in the HD sector and by adding a performance standard for fuel efficiency and GHG emissions of commercial trailers. This alternative includes all elements of Alternative 4, plus the application of additional hybrid powertrains to the pickup trucks, vans, vocational vehicles, and tractors. In addition, the agencies applied aerodynamic technologies to commercial box trailers, along with tire technologies for all commercial trailers.

The agencies set the hybrid penetration for each category, as described in Table 6-17. The agencies do not believe that it is possible to achieve hybrid technology penetration rates at or even near these levels in the timeframe of this rulemaking. However, we believe it is useful to consider what a future standard based on the use of such advanced technologies could achieve. As with Alternative 4, we include a +c in our cost estimates for this alternative to reflect additional costs not estimated by the agencies. The agencies assumed that a hybrid powertrain would provide a 32 percent reduction in CO₂ emissions and fuel consumption of a vocational vehicle at a projected cost of \$26,667 per vehicle, based on the average of the NAS report findings for box trucks, bucket trucks, and refuse vehicles.⁶ The agencies are projecting a cost of \$9,000 per vehicle for the HD pickup trucks and vans with an effectiveness of 18 percent, again based on the NAS report.⁶ The effectiveness of hybrid powertrains installed in tractors was assumed to be 10 percent at a cost of \$25,000 based on the NAS report.⁶ Lastly, the effectiveness of hybrid powertrains installed in tractors was assumed to be 10 percent at a cost of \$25,000 based on the NAS report.⁶

For the analysis of vocational vehicles in this alternative, the agencies assumed that hybrid technology would be applied only in diesel-fueled trucks. In HD pickups and vans, the agencies assumed that hybrid technology would be evenly divided between diesel and gasoline vehicles.

Table 6-17: Hybrid Penetration by Vehicle Class

	MY 2014	MY 2017
HD Pickup Trucks & Vans	10,000 units	50%
Vocational Vehicles	10,000 units	50%
Combination tractors	0%	5%

The combination tractor technology package for Alternative 5 includes the preferred alternative technologies, waste heat recovery (assuming, contrary to our technical finding, that the technology will be available) and Advanced SmartWay aerodynamic package used in Alternative 4, application of hybrid powertrains discussed above, in addition to a regulation for commercial trailers pulled by combination tractors. The agencies assumed a trailer program would mirror the SmartWay program and include tire and aerodynamic requirements. The agencies added low rolling resistance tires to all commercial trailers, which are assumed to have

Heavy-Duty GHG and Fuel Efficiency Standards FRM: Results of Final and Alternative Standards

15 percent lower rolling resistance than the baseline trailer tire and is equivalent to the target value required by SmartWay. The aerodynamics of the box trailers were assumed to improve the coefficient of drag for the combination tractor-trailer by 10 percent through the application of technologies such as trailer skirts and gap reducers.⁷ These technologies would result in further reductions in drag coefficient and rolling resistance coefficient from the MY 2010 baseline. The agencies assessed the benefits of a commercial trailer regulation by changing the road load associated with the combination tractors. Table 6-18 describes the road load reductions. As stated above for hybrids, the agencies do not believe that it is possible to achieve technology penetration rates at or even near these levels in the timeframe of this rulemaking. However, we believe it is useful to consider what a future standard based on the use of such technologies could achieve.

Table 6-18 Estimated Reductions in Rolling Resistance and Aerodynamic Drag Coefficients from Reference Case for Alternative 5 (Model Years 2014 and Later)

TRUCK TYPE	REDUCTION IN TIRE ROLLING RESISTANCE COEFFICIENT FROM 2010 MY	REDUCTION IN AERODYNAMIC DRAG COEFFICIENT FROM 2010 MY
Combination long-haul	14.9%	24%
Combination short-haul	12.3%	Same as Alt.3

The combination tractor costs for this alternative are equal to the costs in Alternative 4, plus \$25,000 for hybrid powertrains in ten percent of tractors, plus the costs of trailers. The costs for the trailer program of Alternative 5 were derived based on the assumption that trailer aerodynamic improvements would cost \$2,150 per trailer. This cost assumes side fairings and gap reducers and is based on the ICF cost estimate.⁸ The agencies applied the aerodynamic improvement to only box trailers, which represent approximately 60 percent of the trailer sales. The agencies used \$528 per trailer for low rolling resistance based on the agencies' estimate of \$66 per tire in the tractor program. Lastly, the agencies assumed the trailer volume is equal to three times the tractor volume based on the 3:1 ratio of trailers to tractors in the market today.

The fuel efficiency results for Alternative 5 are summarized in Table 6-19.

Table 6-19 Estimated Fleet-Wide Fuel Efficiency by Model Year for Alternative 5 [gallons/100 miles]

	MY 2010-2013	MY 2014	MY 2015	MY 2016	MY 2017	MY 2018
HD Pickups and Vans - gasoline	6.5	6.3	6.3	6.1	5.4	5.0
HD Pickups and Vans- diesel	7.6	7.3	7.3	7.1	6.2	5.8
Vocational – gasoline	11.3	11.3	11.3	10.5	10.5	10.5
Vocational – diesel	10.3	9.5	9.5	9.5	7.8	7.8

Regulatory Impact Analysis

Comb. tractors	20.3	17.4	17.4	17.4	16.8	16.8
----------------	------	------	------	------	------	------

6.2 How Do These Alternatives Compare in Overall GHG Emissions Reductions and Fuel Efficiency and Cost?

The agencies analyzed all five alternatives through MOVES to evaluate the impact of each alternative, as shown in Table 6-20. The table contains the annual CO₂ and fuel savings in 2030 and 2050 for each alternative (relative to the reference scenario of Alternative 1), presenting both the total savings across all regulatory categories, and for each regulatory category. Table 6-21 presents the annual technology costs associated with each alternative (relative to the reference scenario of Alternative 1) in 2030 and 2050 for each regulatory category. In addition, the total annual downstream impacts of NO_x, CO, PM, and VOC emissions in 2030 for each of the alternatives are included in Table 6-23.

Table 6-20: Annual CO₂ and Oil Reductions Relative to Alternative 1 in 2030 and 2050

	DOWNSTREAM CO ₂ REDUCTIONS (MMT)		OIL REDUCTIONS (BILLION GALLONS)	
	2030	2050	2030	2050
Alt. 1 Baseline	0	0	0	0
Alt. 1a AEO 2011 Baseline- Total	39	90	3.9	9.0
Tractors	29	73	2.9	7.1
HD Pickup Trucks	9	16	0.9	1.7
Vocational Vehicles	1	2	0.1	0.2
Alt. 2 Less Stringent- Total	54	78	5.4	7.7
Tractors	42	59	4.2	5.8
HD Pickup Trucks	7	11	0.8	1.2
Vocational Vehicles	5	7	0.4	0.7
Alt. 3 Preferred – Total	61	88	6.0	8.7
Tractors	45	63	4.4	6.2
HD Pickup Trucks	8	13	0.9	1.3
Vocational Vehicles	7	11	0.7	1.1
Alt. 4 More Stringent– Total	74	107	7.4	10.7
Tractors	53	74	5.2	7.3
HD Pickup Trucks	10	15	1.0	1.6
Vocational Vehicles	11	18	1.1	1.8
Alt. 5 Max Technology– Total	99	146	9.8	14.5
Tractors	61	85	6.0	8.3
HD Pickup Trucks	15	24	1.6	2.5
Vocational Vehicles	23	37	2.2	3.6

Heavy-Duty GHG and Fuel Efficiency Standards FRM: Results of Final and Alternative Standards

--	--	--	--

Table 6-21: Technology Cost Projections Relative to Alternative 1 for Each Alternative^a

	TECHNOLOGY COSTS (2009\$ MILLIONS)	
	2030	2050
Alt. 1 Baseline	\$0	\$0
Alt. 1a AEO 2011 Baseline- Total ^b	--	--
Tractors	--	--
HD Pickup Trucks	--	--
Vocational Vehicles	--	--
Alt. 2 Less Stringent - Total	\$1,676	\$2,440
Tractors	\$743	\$1,227
HD Pickup Trucks	\$817	\$1,029
Vocational Vehicles	\$117	\$185
Alt. 3 Preferred – Total	\$2,210	\$3,287
Tractors	\$1,076	\$1,777
HD Pickup Trucks	\$918	\$1,156
Vocational Vehicles	\$216	\$354
Alt. 4 More Stringent– Total	\$5,211+c	\$6,996+c
Tractors	\$1,953+c	\$3,225+c
HD Pickup Trucks	\$1,442+c	\$1,816+c
Vocational Vehicles	\$1,816+c	\$1,954+c
Alt. 5 Max Technology– Total	\$17,909+c	\$27,306+c
Tractors	\$2,747+c	\$4,292+c
HD Pickup Trucks	\$5,669+c	\$7,142+c
Vocational Vehicles	\$9,493+c	\$15,873+c

^a The +c is intended to make clear that the cost estimates we are showing do not include additional costs related to pulling ahead the development and expanding manufacturing base for these technologies.

^b The agencies did not conduct a cost analysis for the AEO2011 baseline.

The agencies also analyzed each alternative relative to an alternate baseline – EIA’s AEO 2011 forecast projection of future new truck performance absent regulation. This baseline provides another measure of the impacts of the standards and the alternatives. The agencies were not able to fully analyze the net benefits of the rule under this baseline because we do not have access to the underlying cost assumptions of EIA’s model. However, Table 6-22 presents estimated CO₂ and oil reductions for the rule and the alternatives, relative to EIA projections of what would occur without new regulation.

Regulatory Impact Analysis

Table 6-22 Annual CO₂ and Oil Reductions Relative to Alternative 1a in 2030 and 2050

	DOWNSTREAM CO ₂ REDUCTIONS (MMT)		OIL REDUCTIONS (BILLION GALLONS)	
	2030	2050	2030	2050
Alt. 2 Less Stringent- Total	17	0 ^a	1.6	0.5
Tractors	13	0 ^a	1.3	0 ^a
HD Pickup Trucks	0 ^a	0 ^a	0 ^a	0 ^a
Vocational Vehicles	4	0 ^a	0.3	0.5
Alt. 3 Preferred – Total	22	3	2.1	0.9
Tractors	16	0 ^a	1.5	0 ^a
HD Pickup Trucks	0 ^a	0 ^a	0 ^a	0 ^a
Vocational Vehicles	6	9	0.6	0.9
Alt. 4 More Stringent– Total	35	17	3.4	1.8
Tractors	24	1	2.3	0.2
HD Pickup Trucks	1	0 ^a	0.1	0 ^a
Vocational Vehicles	10	16	1.0	1.6
Alt. 5 Max Technology– Total	60	56	5.9	5.5
Tractors	32	12	3.1	1.2
HD Pickup Trucks	6	8	0.7	0.8
Vocational Vehicles	22	35	2.1	3.4

^a In cases where the alternative did not achieve reductions greater than the AEO baseline, the agencies substituted zero reductions.

Table 6-23 Downstream Impacts Relative to Alternative 1 of Key Non-GHGs for Each Alternative in 2030

	NO _x	CO	PM _{2.5}	VOC
Alt. 1 Baseline	0%	0%	0%	0%
Alt. 1a AEO 2011 Baseline	8.8%	1.0%	-3.8%	7.2%
Alt. 2 Less Stringent	-21.9%	-2.0%	8.4%	-19.0%
Alt. 3 Preferred	-22.0%	-2.0%	8.5%	-19.1%
Alt. 4 More Stringent	-22.5%	-2.0%	8.7%	-19.5%
Alt. 5 Max Technology	-22.9%	-2.1%	8.4%	-20.0%

Also, the agencies project the monetized net benefits associated with each alternative for the 2014 through 2018 MY vehicles over their lifetimes as shown in Table 6-24 and Table 6-25.

Heavy-Duty GHG and Fuel Efficiency Standards FRM: Results of Final and Alternative Standards

Table 6-24 Monetized Net Benefits Associated with Each Alternative Relative to Alternative 1 for Lifetime of 2014 through 2018 Model Year Vehicles(3% discount rate, Million 2009\$)

	ALT.1 BASELINE	ALT.2 LESS STRINGENT	ALT.3 PREFERRED	ALT.4 MORE STRINGENT	ALT.5 MAX TECHNOLOGY
Truck Program Costs ^d	\$0	\$5,900	\$8,100	\$20,700+c	\$37,200+c
Fuel Savings (pre-tax)	\$0	\$45,000	\$50,100	\$63,900	\$79,100
Energy Security Impacts (price shock)	\$0	\$2,400	\$2,700	\$3,400	\$4,200
Accidents, Congestion, Noise ^e	\$0	-\$1,300	-\$1,500	-\$1,600	-\$1,600
Refueling Savings	\$0	\$300	\$400	\$500	\$600
Non-CO ₂ GHG Impacts and Non-GHG Impacts ^c	N/A	N/A	N/A	N/A	N/A
Reduced CO ₂ Emissions at Each Assumed SCC Value ^{a,b}					
5% (avg SCC)	\$0	\$1,100	\$1,200	\$1,600	\$1,900
3% (avg SCC)	\$0	\$5,100	\$5,700	\$7,200	\$9,000
2.5% (avg SCC)	\$0	\$8,400	\$9,400	\$12,000	\$15,000
3% (95th percentile)	\$0	\$16,000	\$17,000	\$22,000	\$27,000
Monetized Net Benefits at Each Assumed SCC Value ^{a,b}					
5% (avg SCC)	\$0	\$41,600	\$44,800	\$47,100+c	\$47,000+c
3% (avg SCC)	\$0	\$45,600	\$49,300	\$52,700+c	\$54,100+c
2.5% (avg SCC)	\$0	\$48,900	\$53,000	\$57,500+c	\$60,100+c
3% (95th percentile)	\$0	\$56,500	\$60,600	\$67,500+c	\$72,100+c

Notes:

^a Net present value of reduced CO₂ emissions is calculated differently than other benefits. The same discount rate used to discount the value of damages from future emissions (SCC at 5, 3, and 2.5 percent) is used to calculate net present value of SCC for internal consistency. Refer to the SCC TSD for more detail.

^b Section VIII.G notes that SCC increases over time. Corresponding to the years in this table, the SCC estimates range as follows: for Average SCC at 5%: \$5-\$16; for Average SCC at 3%: \$22-\$46; for Average SCC at 2.5%: \$36-\$66; and for 95th percentile SCC at 3%: \$66-\$139. Section VIII.G also presents these SCC estimates.

^c Due to analytical and resource limitations, MY non-GHG emissions (direct PM, VOCs, NO₂ and SO₂) were not estimated for this analysis. Although EPA has not monetized changes in non-CO₂ GHGs, the value of any increases or reductions should not be interpreted as zero.

^d “+c” indicates additional costs not estimated in this rulemaking.

^e Negative sign represents an increase in Accidents, Congestion, and Noise.

Regulatory Impact Analysis

Table 6-25 Monetized Net Benefits Associated with Each Alternative Relative to Alternative 1 for Lifetime of 2014 through 2018 Model Year Vehicles(7% discount rate, Million 2009\$)

	ALT.1 BASELINE	ALT.2 LESS STRINGENT	ALT.3 PREFERRED	ALT.4 MORE STRINGENT	ALT.5 MAX TECHNOLOGY
Truck Program Costs ^d	\$0	\$5,900	\$8,100	\$20,700+c	\$37,200+c
Fuel Savings (pre-tax)	\$0	\$30,900	\$34,400	\$43,800	\$53,900
Energy Security Impacts (price shock)	\$0	\$1,600	\$1,800	\$2,300	\$2,900
Accidents, Congestion, Noise ^e	\$0	-\$900	-\$1,000	-\$1,100	-\$1,100
Refueling Savings	\$0	\$200	\$200	\$300	\$400
Non-CO ₂ GHG Impacts and Non-GHG Impacts ^c	N/A	N/A	N/A	N/A	N/A
Reduced CO ₂ Emissions at Each Assumed SCC Value ^{a,b}					
5% (avg SCC)	\$0	\$1,100	\$1,200	\$1,600	\$1,900
3% (avg SCC)	\$0	\$5,100	\$5,700	\$7,200	\$9,000
2.5% (avg SCC)	\$0	\$8,400	\$9,400	\$12,000	\$15,000
3% (95th percentile)	\$0	\$16,000	\$17,000	\$22,000	\$27,000
Monetized Net Benefits at Each Assumed SCC Value ^{a,b}					
5% (avg SCC)	\$0	\$27,000	\$28,500	\$26,200+c	\$20,800+c
3% (avg SCC)	\$0	\$31,000	\$33,000	\$31,800+c	\$27,900+c
2.5% (avg SCC)	\$0	\$34,300	\$36,700	\$36,600+c	\$33,900+c
3% (95th percentile)	\$0	\$41,900	\$44,300	\$46,600+c	\$45,900+c

Notes:

^a Net present value of reduced CO₂ emissions is calculated differently than other benefits. The same discount rate used to discount the value of damages from future emissions (SCC at 5, 3, and 2.5 percent) is used to calculate net present value of SCC for internal consistency. Refer to the SCC TSD for more detail.

^b Section VIII.G notes that SCC increases over time. Corresponding to the years in this table, the SCC estimates range as follows: for Average SCC at 5%: \$5-\$16; for Average SCC at 3%: \$22-\$46; for Average SCC at 2.5%: \$36-\$66; and for 95th percentile SCC at 3%: \$66-\$139. Section VIII.G also presents these SCC estimates.

^c Due to analytical and resource limitations, MY non-GHG emissions (direct PM, VOCs, NO₂ and SO₂) were not estimated for this analysis. Although EPA has not monetized changes in non-CO₂ GHGs, the value of any increases or reductions should not be interpreted as zero.

^d "+c" indicates additional costs not estimated in this rulemaking.

^e Negative sign represents an increase in Accidents, Congestion, and Noise.

Heavy-Duty GHG and Fuel Efficiency Standards FRM: Results of Final and Alternative Standards

Lastly, the agencies project the monetized net benefits associated with each alternative by vehicle class for the 2014 through 2018 MY vehicles over their lifetimes as shown in Table 6-26 through Table 6-28 at a 3 percent discount rate for HD pickup trucks & vans, vocational vehicles and combination tractors, respectively, and in Table 6-29 through Table 6-31 at a 7 percent discount rate for HD pickup trucks & vans, vocational vehicles and combination tractors, respectively.

Table 6-26 Monetized Net Benefits Associated with Each Alternative Relative to Alternative 1 for Lifetime of 2014 through 2018 Model Year HD Pickup Trucks & Vans (3% discount rate, Million 2009\$)

	ALT.1 BASELINE	ALT.2 LESS STRINGENT	ALT.3 PREFERRED	ALT.4 MORE STRINGENT	ALT.5 MAX TECHNOLOGY
Truck Program Costs ^d	\$0	\$1,780	\$1,970	\$3,220+c	\$9,890+c
Fuel Savings (pre-tax)	\$0	\$3,480	\$4,060	\$4,910	\$7,700
Energy Security Impacts (price shock)	\$0	\$190	\$220	\$270	\$420
Accidents, Congestion, Noise ^e	\$0	-\$330	-\$350	-\$370	-\$350
Refueling Savings	\$0	\$40	\$50	\$60	\$90
Non-CO ₂ GHG Impacts and Non-GHG Impacts ^c	N/A	N/A	N/A	N/A	N/A
Reduced CO ₂ Emissions at Each Assumed SCC Value ^{a,b}					
5% (avg SCC)	\$0	\$100	\$100	\$100	\$200
3% (avg SCC)	\$0	\$500	\$500	\$600	\$900
2.5% (avg SCC)	\$0	\$800	\$900	\$1,100	\$1,500
3% (95th percentile)	\$0	\$1,400	\$1,600	\$1,900	\$2,800
Monetized Net Benefits at Each Assumed SCC Value ^{a,b}					
5% (avg SCC)	\$0	\$1,700	\$2,110	\$1,750+c	-\$1,830+c
3% (avg SCC)	\$0	\$2,100	\$2,510	\$2,250+c	-\$1,130+c
2.5% (avg SCC)	\$0	\$2,400	\$2,910	\$2,750+c	-\$530+c
3% (95th percentile)	\$0	\$3,000	\$3,610	\$3,550+c	\$770+c

Notes:

^a Net present value of reduced CO₂ emissions is calculated differently than other benefits. The same discount rate used to discount the value of damages from future emissions (SCC at 5, 3, and 2.5 percent) is used to calculate net present value of SCC for internal consistency. Refer to the SCC TSD for more detail.

^b Section VIII.G notes that SCC increases over time. Corresponding to the years in this table, the SCC estimates range as follows: for Average SCC at 5%: \$5-\$16; for Average SCC at 3%: \$22-\$46; for Average SCC at 2.5%: \$36-\$66; and for 95th percentile SCC at 3%: \$66-\$139. Section VIII.G also presents these SCC estimates.

^c Due to analytical and resource limitations, MY non-GHG emissions (direct PM, VOCs, NO₂ and SO₂) were not estimated for this analysis. Although EPA has not monetized changes in non-CO₂ GHGs, the value of any increases or reductions should not be interpreted as zero.

^d "+c" indicates additional costs not estimated in this rulemaking.

^e Negative sign represents an increase in Accidents, Congestion, and Noise.

Regulatory Impact Analysis

Table 6-27 Monetized Net Benefits Associated with Each Alternative Relative to Alternative 1 for Lifetime of 2014 through 2018 Model Year Vocational Vehicles (3% discount rate, Million 2009\$)

	ALT.1 BASELINE	ALT.2 LESS STRINGENT	ALT.3 PREFERRED	ALT.4 MORE STRINGENT	ALT.5 MAX TECHNOLOGY
Truck Program Costs ^d	\$0	\$670	\$1,140	\$9,140+c	\$15,840+c
Fuel Savings (pre-tax)	\$0	\$3,420	\$5,420	\$8,930	\$14,270
Energy Security Impacts (price shock)	\$0	\$180	\$290	\$480	\$760
Accidents, Congestion, Noise ^e	\$0	-\$540	-\$650	-\$670	-\$500
Refueling Savings	\$0	\$40	\$60	\$110	\$170
Non-CO ₂ GHG Impacts and Non-GHG Impacts ^c	N/A	N/A	N/A	N/A	N/A
Reduced CO ₂ Emissions at Each Assumed SCC Value ^{a,b}					
5% (avg SCC)	\$0	\$100	\$100	\$200	\$300
3% (avg SCC)	\$0	\$400	\$600	\$1,000	\$1,500
2.5% (avg SCC)	\$0	\$700	\$1,100	\$1,700	\$2,600
3% (95th percentile)	\$0	\$1,300	\$1,900	\$3,100	\$4,700
Monetized Net Benefits at Each Assumed SCC Value ^{a,b}					
5% (avg SCC)	\$0	\$2,530	\$4,080	-\$90+c	-\$840+c
3% (avg SCC)	\$0	\$2,830	\$4,580	\$710+c	\$360+c
2.5% (avg SCC)	\$0	\$3,130	\$5,080	\$1,410+c	\$1,460+c
3% (95th percentile)	\$0	\$3,730	\$5,880	\$2,810+c	\$3,560+c

Notes:

^a Net present value of reduced CO₂ emissions is calculated differently than other benefits. The same discount rate used to discount the value of damages from future emissions (SCC at 5, 3, and 2.5 percent) is used to calculate net present value of SCC for internal consistency. Refer to the SCC TSD for more detail.

^b Section VIII.G notes that SCC increases over time. Corresponding to the years in this table, the SCC estimates range as follows: for Average SCC at 5%: \$5-\$16; for Average SCC at 3%: \$22-\$46; for Average SCC at 2.5%: \$36-\$66; and for 95th percentile SCC at 3%: \$66-\$139. Section VIII.G also presents these SCC estimates.

^c Due to analytical and resource limitations, MY non-GHG emissions (direct PM, VOCs, NO₂ and SO₂) were not estimated for this analysis. Although EPA has not monetized changes in non-CO₂ GHGs, the value of any increases or reductions should not be interpreted as zero.

^d "+c" indicates additional costs not estimated in this rulemaking.

^e Negative sign represents an increase in Accidents, Congestion, and Noise.

Heavy-Duty GHG and Fuel Efficiency Standards FRM: Results of Final and Alternative Standards

Table 6-28 Monetized Net Benefits Associated with Each Alternative Relative to Alternative 1 for Lifetime of 2014 through 2018 Model Year Combination Tractors (3% discount rate, Million 2009\$)

	ALT.1 BASELINE	ALT.2 LESS STRINGENT	ALT.3 PREFERRED	ALT.4 MORE STRINGENT	ALT.5 MAX TECHNOLOGY
Truck Program Costs ^d	\$0	\$3,300	\$4,950	\$8,430+c	\$11,540+c
Fuel Savings (pre-tax)	\$0	\$38,140	\$40,650	\$50,030	\$57,190
Energy Security Impacts (price shock)	\$0	\$2,030	\$2,160	\$2,660	\$3,040
Accidents, Congestion, Noise ^e	\$0	-\$450	-\$480	-\$590	-\$770
Refueling Savings	\$0	\$230	\$250	\$300	\$350
Non-CO ₂ GHG Impacts and Non-GHG Impacts ^c	N/A	N/A	N/A	N/A	N/A
Reduced CO ₂ Emissions at Each Assumed SCC Value ^{a,b}					
5% (avg SCC)	\$0	\$900	\$1,000	\$1,200	\$1,400
3% (avg SCC)	\$0	\$4,200	\$4,500	\$5,600	\$6,500
2.5% (avg SCC)	\$0	\$7,000	\$7,500	\$9,300	\$11,000
3% (95th percentile)	\$0	\$13,000	\$14,000	\$17,000	\$20,000
Monetized Net Benefits at Each Assumed SCC Value ^{a,b}					
5% (avg SCC)	\$0	\$37,550	\$38,630	\$45,170+c	\$49,670+c
3% (avg SCC)	\$0	\$40,850	\$42,130	\$49,570+c	\$54,770+c
2.5% (avg SCC)	\$0	\$43,650	\$45,130	\$53,270+c	\$59,270+c
3% (95th percentile)	\$0	\$49,650	\$51,630	\$60,970+c	\$68,270+c

Notes:

^a Net present value of reduced CO₂ emissions is calculated differently than other benefits. The same discount rate used to discount the value of damages from future emissions (SCC at 5, 3, and 2.5 percent) is used to calculate net present value of SCC for internal consistency. Refer to the SCC TSD for more detail.

^b Section VIII.G notes that SCC increases over time. Corresponding to the years in this table, the SCC estimates range as follows: for Average SCC at 5%: \$5-\$16; for Average SCC at 3%: \$22-\$46; for Average SCC at 2.5%: \$36-\$66; and for 95th percentile SCC at 3%: \$66-\$139. Section VIII.G also presents these SCC estimates.

^c Due to analytical and resource limitations, MY non-GHG emissions (direct PM, VOCs, NO₂ and SO₂) were not estimated for this analysis. Although EPA has not monetized changes in non-CO₂ GHGs, the value of any increases or reductions should not be interpreted as zero.

^d "+c" indicates additional costs not estimated in this rulemaking.

^e Negative sign represents an increase in Accidents, Congestion, and Noise.

Regulatory Impact Analysis

Table 6-29 Monetized Net Benefits Associated with Each Alternative Relative to Alternative 1 for Lifetime of 2014 through 2018 Model Year HD Pickup Trucks & Vans (7% discount rate, Million 2009\$)

	ALT.1 BASELINE	ALT.2 LESS STRINGENT	ALT.3 PREFERRED	ALT.4 MORE STRINGENT	ALT.5 MAX TECHNOLOGY
Truck Program Costs ^d	\$0	\$1,780	\$1,970	\$3,220+c	\$9,890+c
Fuel Savings (pre-tax)	\$0	\$2,180	\$2,550	\$3,090	\$4,830
Energy Security Impacts (price shock)	\$0	\$120	\$140	\$170	\$260
Accidents, Congestion, Noise ^e	\$0	-\$220	-\$230	-\$250	-\$230
Refueling Savings	\$0	\$30	\$30	\$40	\$60
Non-CO ₂ GHG Impacts and Non-GHG Impacts ^c	N/A	N/A	N/A	N/A	N/A
Reduced CO ₂ Emissions at Each Assumed SCC Value ^{a,b}					
5% (avg SCC)	\$0	\$100	\$100	\$100	\$200
3% (avg SCC)	\$0	\$500	\$500	\$600	\$900
2.5% (avg SCC)	\$0	\$800	\$900	\$1,100	\$1,500
3% (95th percentile)	\$0	\$1,400	\$1,600	\$1,900	\$2,800
Monetized Net Benefits at Each Assumed SCC Value ^{a,b}					
5% (avg SCC)	\$0	\$430	\$620	-\$70+c	-\$4,770+c
3% (avg SCC)	\$0	\$830	\$1,020	\$430+c	-\$4,070+c
2.5% (avg SCC)	\$0	\$1,130	\$1,420	\$930+c	-\$3,470+c
3% (95th percentile)	\$0	\$1,730	\$2,120	\$1,730+c	-\$2,170+c

Notes:

^a Net present value of reduced CO₂ emissions is calculated differently than other benefits. The same discount rate used to discount the value of damages from future emissions (SCC at 5, 3, and 2.5 percent) is used to calculate net present value of SCC for internal consistency. Refer to the SCC TSD for more detail.

^b Section VIII.G notes that SCC increases over time. Corresponding to the years in this table, the SCC estimates range as follows: for Average SCC at 5%: \$5-\$16; for Average SCC at 3%: \$22-\$46; for Average SCC at 2.5%: \$36-\$66; and for 95th percentile SCC at 3%: \$66-\$139. Section VIII.G also presents these SCC estimates.

^c Due to analytical and resource limitations, MY non-GHG emissions (direct PM, VOCs, NO₂ and SO₂) were not estimated for this analysis. Although EPA has not monetized changes in non-CO₂ GHGs, the value of any increases or reductions should not be interpreted as zero.

^d "+c" indicates additional costs not estimated in this rulemaking.

^e Negative sign represents an increase in Accidents, Congestion, and Noise.

Heavy-Duty GHG and Fuel Efficiency Standards FRM: Results of Final and Alternative Standards

Table 6-30 Monetized Net Benefits Associated with Each Alternative Relative to Alternative 1 for Lifetime of 2014 through 2018 Model Year Vocational Vehicles (7% discount rate, Million 2009\$)

	ALT.1 BASELINE	ALT.2 LESS STRINGENT	ALT.3 PREFERRED	ALT.4 MORE STRINGENT	ALT.5 MAX TECHNOLOGY
Truck Program Costs ^d	\$0	\$670	\$1,140	\$9,140+c	\$15,840+c
Fuel Savings (pre-tax)	\$0	\$2,280	\$3,630	\$5,970	\$9,410
Energy Security Impacts (price shock)	\$0	\$120	\$190	\$320	\$500
Accidents, Congestion, Noise ^e	\$0	-\$380	-\$450	-\$460	-\$350
Refueling Savings	\$0	\$30	\$40	\$70	\$110
Non-CO ₂ GHG Impacts and Non-GHG Impacts ^c	N/A	N/A	N/A	N/A	N/A
Reduced CO ₂ Emissions at Each Assumed SCC Value ^{a,b}					
5% (avg SCC)	\$0	\$100	\$100	\$200	\$300
3% (avg SCC)	\$0	\$400	\$600	\$1,000	\$1,500
2.5% (avg SCC)	\$0	\$700	\$1,100	\$1,700	\$2,600
3% (95th percentile)	\$0	\$1,300	\$1,900	\$3,100	\$4,700
Monetized Net Benefits at Each Assumed SCC Value ^{a,b}					
5% (avg SCC)	\$0	\$1,480	\$2,370	-\$3,040+c	-\$5,870+c
3% (avg SCC)	\$0	\$1,780	\$2,870	-\$2,240+c	-\$4,670+c
2.5% (avg SCC)	\$0	\$2,080	\$3,370	-\$1,540+c	-\$3,570+c
3% (95th percentile)	\$0	\$2,680	\$4,170	-\$140+c	-\$1,470+c

Notes:

^a Net present value of reduced CO₂ emissions is calculated differently than other benefits. The same discount rate used to discount the value of damages from future emissions (SCC at 5, 3, and 2.5 percent) is used to calculate net present value of SCC for internal consistency. Refer to the SCC TSD for more detail.

^b Section VIII.G notes that SCC increases over time. Corresponding to the years in this table, the SCC estimates range as follows: for Average SCC at 5%: \$5-\$16; for Average SCC at 3%: \$22-\$46; for Average SCC at 2.5%: \$36-\$66; and for 95th percentile SCC at 3%: \$66-\$139. Section VIII.G also presents these SCC estimates.

^c Due to analytical and resource limitations, MY non-GHG emissions (direct PM, VOCs, NO₂ and SO₂) were not estimated for this analysis. Although EPA has not monetized changes in non-CO₂ GHGs, the value of any increases or reductions should not be interpreted as zero.

^d "+c" indicates additional costs not estimated in this rulemaking.

^e Negative sign represents an increase in Accidents, Congestion, and Noise.

Regulatory Impact Analysis

Table 6-31 Monetized Net Benefits Associated with Each Alternative Relative to Alternative 1 for Lifetime of 2014 through 2018 Model Year Combination Tractors (7% discount rate, Million 2009\$)

	ALT.1 BASELINE	ALT.2 LESS STRINGENT	ALT.3 PREFERRED	ALT.4 MORE STRINGENT	ALT.5 MAX TECHNOLOGY
Truck Program Costs ^d	\$0	\$3,300	\$4,950	\$8,430+c	\$11,540+c
Fuel Savings (pre-tax)	\$0	\$26,420	\$28,170	\$34,710	\$39,680
Energy Security Impacts (price shock)	\$0	\$1,410	\$1,500	\$1,850	\$2,110
Accidents, Congestion, Noise ^e	\$0	-\$320	-\$340	-\$420	-\$550
Refueling Savings	\$0	\$160	\$170	\$210	\$240
Non-CO ₂ GHG Impacts and Non-GHG Impacts ^c	N/A	N/A	N/A	N/A	N/A
Reduced CO ₂ Emissions at Each Assumed SCC Value ^{a,b}					
5% (avg SCC)	\$0	\$900	\$1,000	\$1,200	\$1,400
3% (avg SCC)	\$0	\$4,200	\$4,500	\$5,600	\$6,500
2.5% (avg SCC)	\$0	\$7,000	\$7,500	\$9,300	\$11,000
3% (95th percentile)	\$0	\$13,000	\$14,000	\$17,000	\$20,000
Monetized Net Benefits at Each Assumed SCC Value ^{a,b}					
5% (avg SCC)	\$0	\$25,270	\$25,550	\$29,120+c	\$31,340+c
3% (avg SCC)	\$0	\$28,570	\$29,050	\$33,520+c	\$36,440+c
2.5% (avg SCC)	\$0	\$31,370	\$32,050	\$37,220+c	\$40,940+c
3% (95th percentile)	\$0	\$37,370	\$38,550	\$44,920+c	\$49,940+c

Notes:

^a Net present value of reduced CO₂ emissions is calculated differently than other benefits. The same discount rate used to discount the value of damages from future emissions (SCC at 5, 3, and 2.5 percent) is used to calculate net present value of SCC for internal consistency. Refer to the SCC TSD for more detail.

^b Section VIII.G notes that SCC increases over time. Corresponding to the years in this table, the SCC estimates range as follows: for Average SCC at 5%: \$5-\$16; for Average SCC at 3%: \$22-\$46; for Average SCC at 2.5%: \$36-\$66; and for 95th percentile SCC at 3%: \$66-\$139. Section VIII.G also presents these SCC estimates.

^c Due to analytical and resource limitations, MY non-GHG emissions (direct PM, VOCs, NO₂ and SO₂) were not estimated for this analysis. Although EPA has not monetized changes in non-CO₂ GHGs, the value of any increases or reductions should not be interpreted as zero.

^d "+c" indicates additional costs not estimated in this rulemaking.

^e Negative sign represents an increase in Accidents, Congestion, and Noise.

Heavy-Duty GHG and Fuel Efficiency Standards FRM: Results of Final and Alternative Standards

For completeness, the agencies present the values shown in Table 6-24 through Table 6-31 as annualized values in Table 6-32 through Table 6-39, respectively.

Table 6-32 Annualized Monetized Net Benefits Associated with Each Alternative Relative to Alternative 1 for Lifetime of 2014 through 2018 Model Year Vehicles (3% discount rate, Million 2009\$)

	ALT.1 BASELINE	ALT.2 LESS STRINGENT	ALT.3 PREFERRED	ALT.4 MORE STRINGENT	ALT.5 MAX TECHNOLOGY
Truck Program Costs ^d	\$0	\$260	\$360	\$920+c	\$1,650+c
Fuel Savings (pre-tax)	\$0	\$2,000	\$2,230	\$2,840	\$3,520
Energy Security Impacts (price shock)	\$0	\$110	\$120	\$150	\$190
Accidents, Congestion, Noise ^e	\$0	-\$60	-\$70	-\$70	-\$70
Refueling Savings	\$0	\$10	\$20	\$20	\$30
Non-CO ₂ GHG Impacts and Non-GHG Impacts ^c	N/A	N/A	N/A	N/A	N/A
Reduced CO ₂ Emissions at Each Assumed SCC Value ^{a,b}					
5% (avg SCC)	\$0	\$50	\$50	\$70	\$80
3% (avg SCC)	\$0	\$230	\$250	\$320	\$400
2.5% (avg SCC)	\$0	\$370	\$420	\$530	\$670
3% (95th percentile)	\$0	\$710	\$760	\$980	\$1,200
Monetized Net Benefits at Each Assumed SCC Value ^{a,b}					
5% (avg SCC)	\$0	\$1,850	\$1,990	\$2,090+c	\$2,090+c
3% (avg SCC)	\$0	\$2,030	\$2,190	\$2,340+c	\$2,410+c
2.5% (avg SCC)	\$0	\$2,170	\$2,360	\$2,560+c	\$2,670+c
3% (95th percentile)	\$0	\$2,510	\$2,690	\$3,000+c	\$3,210+c

Notes:

^a Net present value of reduced CO₂ emissions is calculated differently than other benefits. The same discount rate used to discount the value of damages from future emissions (SCC at 5, 3, and 2.5 percent) is used to calculate net present value of SCC for internal consistency. Refer to the SCC TSD for more detail.

^b Section VIII.G notes that SCC increases over time. Corresponding to the years in this table, the SCC estimates range as follows: for Average SCC at 5%: \$5-\$16; for Average SCC at 3%: \$22-\$46; for Average SCC at 2.5%: \$36-\$66; and for 95th percentile SCC at 3%: \$66-\$139. Section VIII.G also presents these SCC estimates.

^c Due to analytical and resource limitations, MY non-GHG emissions (direct PM, VOCs, NO₂ and SO₂) were not estimated for this analysis. Although EPA has not monetized changes in non-CO₂ GHGs, the value of any increases or reductions should not be interpreted as zero.

^d "+c" indicates additional costs not estimated in this rulemaking.

^e Negative sign represents an increase in Accidents, Congestion, and Noise.

Regulatory Impact Analysis

Table 6-33 Annualized Monetized Net Benefits Associated with Each Alternative Relative to Alternative 1 for Lifetime of 2014 through 2018 Model Year Vehicles (7% discount rate, Million 2009\$)

	ALT.1 BASELINE	ALT.2 LESS STRINGENT	ALT.3 PREFERRED	ALT.4 MORE STRINGENT	ALT.5 MAX TECHNOLOGY
Truck Program Costs ^d	\$0	\$260	\$360	\$920+c	\$1,650+c
Fuel Savings (pre-tax)	\$0	\$1,370	\$1,530	\$1,950	\$2,400
Energy Security Impacts (price shock)	\$0	\$70	\$80	\$100	\$130
Accidents, Congestion, Noise ^e	\$0	-\$40	-\$40	-\$50	-\$50
Refueling Savings	\$0	\$10	\$10	\$10	\$20
Non-CO ₂ GHG Impacts and Non-GHG Impacts ^c	N/A	N/A	N/A	N/A	N/A
Reduced CO ₂ Emissions at Each Assumed SCC Value ^{a,b}					
5% (avg SCC)	\$0	\$50	\$50	\$70	\$80
3% (avg SCC)	\$0	\$230	\$250	\$320	\$400
2.5% (avg SCC)	\$0	\$370	\$420	\$530	\$670
3% (95th percentile)	\$0	\$710	\$760	\$980	\$1,200
Monetized Net Benefits at Each Assumed SCC Value ^{a,b}					
5% (avg SCC)	\$0	\$1,200	\$1,270	\$1,160+c	\$920+c
3% (avg SCC)	\$0	\$1,380	\$1,470	\$1,410+c	\$1,240+c
2.5% (avg SCC)	\$0	\$1,520	\$1,630	\$1,630+c	\$1,510+c
3% (95th percentile)	\$0	\$1,860	\$1,970	\$2,070+c	\$2,040+c

Notes:

^a Net present value of reduced CO₂ emissions is calculated differently than other benefits. The same discount rate used to discount the value of damages from future emissions (SCC at 5, 3, and 2.5 percent) is used to calculate net present value of SCC for internal consistency. Refer to the SCC TSD for more detail.

^b Section VIII.G notes that SCC increases over time. Corresponding to the years in this table, the SCC estimates range as follows: for Average SCC at 5%: \$5-\$16; for Average SCC at 3%: \$22-\$46; for Average SCC at 2.5%: \$36-\$66; and for 95th percentile SCC at 3%: \$66-\$139. Section VIII.G also presents these SCC estimates.

^c Due to analytical and resource limitations, MY non-GHG emissions (direct PM, VOCs, NO₂ and SO₂) were not estimated for this analysis. Although EPA has not monetized changes in non-CO₂ GHGs, the value of any increases or reductions should not be interpreted as zero.

^d "+c" indicates additional costs not estimated in this rulemaking.

^e Negative sign represents an increase in Accidents, Congestion, and Noise.

Heavy-Duty GHG and Fuel Efficiency Standards FRM: Results of Final and Alternative Standards

Table 6-34 Annualized Monetized Net Benefits Associated with Each Alternative Relative to Alternative 1 for Lifetime of 2014 through 2018 Model Year HD Pickup Trucks & Vans (3% discount rate, Million 2009\$)

	ALT.1 BASELINE	ALT.2 LESS STRINGENT	ALT.3 PREFERRED	ALT.4 MORE STRINGENT	ALT.5 MAX TECHNOLOGY
Truck Program Costs ^d	\$0	\$80	\$90	\$140+c	\$440+c
Fuel Savings (pre-tax)	\$0	\$150	\$180	\$220	\$340
Energy Security Impacts (price shock)	\$0	\$10	\$10	\$10	\$20
Accidents, Congestion, Noise ^e	\$0	-\$10	-\$20	-\$20	-\$20
Refueling Savings	\$0	\$2	\$2	\$3	\$4
Non-CO ₂ GHG Impacts and Non-GHG Impacts ^c	N/A	N/A	N/A	N/A	N/A
Reduced CO ₂ Emissions at Each Assumed SCC Value ^{a,b}					
5% (avg SCC)	\$0	\$4	\$4	\$4	\$9
3% (avg SCC)	\$0	\$20	\$20	\$30	\$40
2.5% (avg SCC)	\$0	\$40	\$40	\$50	\$70
3% (95th percentile)	\$0	\$60	\$70	\$80	\$120
Monetized Net Benefits at Each Assumed SCC Value ^{a,b}					
5% (avg SCC)	\$0	\$80	\$90	\$80+c	-\$80+c
3% (avg SCC)	\$0	\$90	\$110	\$100+c	-\$50+c
2.5% (avg SCC)	\$0	\$110	\$130	\$120+c	-\$20+c
3% (95th percentile)	\$0	\$130	\$160	\$160+c	\$30+c

Notes:

^a Net present value of reduced CO₂ emissions is calculated differently than other benefits. The same discount rate used to discount the value of damages from future emissions (SCC at 5, 3, and 2.5 percent) is used to calculate net present value of SCC for internal consistency. Refer to the SCC TSD for more detail.

^b Section VIII.G notes that SCC increases over time. Corresponding to the years in this table, the SCC estimates range as follows: for Average SCC at 5%: \$5-\$16; for Average SCC at 3%: \$22-\$46; for Average SCC at 2.5%: \$36-\$66; and for 95th percentile SCC at 3%: \$66-\$139. Section VIII.G also presents these SCC estimates.

^c Due to analytical and resource limitations, MY non-GHG emissions (direct PM, VOCs, NO₂ and SO₂) were not estimated for this analysis. Although EPA has not monetized changes in non-CO₂ GHGs, the value of any increases or reductions should not be interpreted as zero.

^d “+c” indicates additional costs not estimated in this rulemaking.

^e Negative sign represents an increase in Accidents, Congestion, and Noise.

Regulatory Impact Analysis

Table 6-35 Annualized Monetized Net Benefits Associated with Each Alternative Relative to Alternative 1 for Lifetime of 2014 through 2018 Model Year Vocational Vehicles (3% discount rate, Million 2009\$)

	ALT.1 BASELINE	ALT.2 LESS STRINGENT	ALT.3 PREFERRED	ALT.4 MORE STRINGENT	ALT.5 MAX TECHNOLOGY
Truck Program Costs ^d	\$0	\$30	\$50	\$410+c	\$700+c
Fuel Savings (pre-tax)	\$0	\$150	\$240	\$400	\$630
Energy Security Impacts (price shock)	\$0	\$10	\$10	\$20	\$30
Accidents, Congestion, Noise ^e	\$0	-\$20	-\$30	-\$30	-\$20
Refueling Savings	\$0	\$2	\$3	\$5	\$8
Non-CO ₂ GHG Impacts and Non-GHG Impacts ^c	N/A	N/A	N/A	N/A	N/A
Reduced CO ₂ Emissions at Each Assumed SCC Value ^{a,b}					
5% (avg SCC)	\$0	\$4	\$4	\$9	\$13
3% (avg SCC)	\$0	\$20	\$30	\$40	\$70
2.5% (avg SCC)	\$0	\$30	\$50	\$80	\$120
3% (95th percentile)	\$0	\$60	\$80	\$140	\$210
Monetized Net Benefits at Each Assumed SCC Value ^{a,b}					
5% (avg SCC)	\$0	\$110	\$180	-\$4+c	-\$40+c
3% (avg SCC)	\$0	\$130	\$200	\$30+c	\$20+c
2.5% (avg SCC)	\$0	\$140	\$230	\$60+c	\$60+c
3% (95th percentile)	\$0	\$170	\$260	\$120+c	\$160+c

Notes:

^a Net present value of reduced CO₂ emissions is calculated differently than other benefits. The same discount rate used to discount the value of damages from future emissions (SCC at 5, 3, and 2.5 percent) is used to calculate net present value of SCC for internal consistency. Refer to the SCC TSD for more detail.

^b Section VIII.G notes that SCC increases over time. Corresponding to the years in this table, the SCC estimates range as follows: for Average SCC at 5%: \$5-\$16; for Average SCC at 3%: \$22-\$46; for Average SCC at 2.5%: \$36-\$66; and for 95th percentile SCC at 3%: \$66-\$139. Section VIII.G also presents these SCC estimates.

^c Due to analytical and resource limitations, MY non-GHG emissions (direct PM, VOCs, NO₂ and SO₂) were not estimated for this analysis. Although EPA has not monetized changes in non-CO₂ GHGs, the value of any increases or reductions should not be interpreted as zero.

^d "+c" indicates additional costs not estimated in this rulemaking.

^e Negative sign represents an increase in Accidents, Congestion, and Noise.

Heavy-Duty GHG and Fuel Efficiency Standards FRM: Results of Final and Alternative Standards

Table 6-36 Annualized Monetized Net Benefits Associated with Each Alternative Relative to Alternative 1 for Lifetime of 2014 through 2018 Model Year Combination Tractors (3% discount rate, Million 2009\$)

	ALT.1 BASELINE	ALT.2 LESS STRINGENT	ALT.3 PREFERRED	ALT.4 MORE STRINGENT	ALT.5 MAX TECHNOLOGY
Truck Program Costs ^d	\$0	\$150	\$220	\$370+c	\$510+c
Fuel Savings (pre-tax)	\$0	\$1,700	\$1,810	\$2,220	\$2,540
Energy Security Impacts (price shock)	\$0	\$90	\$100	\$120	\$140
Accidents, Congestion, Noise ^e	\$0	-\$20	-\$20	-\$30	-\$30
Refueling Savings	\$0	\$10	\$10	\$10	\$20
Non-CO ₂ GHG Impacts and Non-GHG Impacts ^c	N/A	N/A	N/A	N/A	N/A
Reduced CO ₂ Emissions at Each Assumed SCC Value ^{a,b}					
5% (avg SCC)	\$0	\$40	\$40	\$50	\$60
3% (avg SCC)	\$0	\$190	\$200	\$250	\$290
2.5% (avg SCC)	\$0	\$310	\$330	\$410	\$490
3% (95th percentile)	\$0	\$580	\$620	\$760	\$890
Monetized Net Benefits at Each Assumed SCC Value ^{a,b}					
5% (avg SCC)	\$0	\$1,670	\$1,720	\$2,010+c	\$2,210+c
3% (avg SCC)	\$0	\$1,820	\$1,870	\$2,200+c	\$2,440+c
2.5% (avg SCC)	\$0	\$1,940	\$2,010	\$2,370+c	\$2,640+c
3% (95th percentile)	\$0	\$2,210	\$2,300	\$2,710+c	\$3,040+c

Notes:

^a Net present value of reduced CO₂ emissions is calculated differently than other benefits. The same discount rate used to discount the value of damages from future emissions (SCC at 5, 3, and 2.5 percent) is used to calculate net present value of SCC for internal consistency. Refer to the SCC TSD for more detail.

^b Section VIII.G notes that SCC increases over time. Corresponding to the years in this table, the SCC estimates range as follows: for Average SCC at 5%: \$5-\$16; for Average SCC at 3%: \$22-\$46; for Average SCC at 2.5%: \$36-\$66; and for 95th percentile SCC at 3%: \$66-\$139. Section VIII.G also presents these SCC estimates.

^c Due to analytical and resource limitations, MY non-GHG emissions (direct PM, VOCs, NO₂ and SO₂) were not estimated for this analysis. Although EPA has not monetized changes in non-CO₂ GHGs, the value of any increases or reductions should not be interpreted as zero.

^d "+c" indicates additional costs not estimated in this rulemaking.

^e Negative sign represents an increase in Accidents, Congestion, and Noise.

Regulatory Impact Analysis

Table 6-37 Annualized Monetized Net Benefits Associated with Each Alternative Relative to Alternative 1 for Lifetime of 2014 through 2018 Model Year HD Pickup Trucks & Vans (7% discount rate, Million 2009\$)

	ALT.1 BASELINE	ALT.2 LESS STRINGENT	ALT.3 PREFERRED	ALT.4 MORE STRINGENT	ALT.5 MAX TECHNOLOGY
Truck Program Costs ^d	\$0	\$80	\$90	\$140+c	\$440+c
Fuel Savings (pre-tax)	\$0	\$100	\$110	\$140	\$210
Energy Security Impacts (price shock)	\$0	\$10	\$10	\$10	\$10
Accidents, Congestion, Noise ^e	\$0	-\$10	-\$10	-\$10	-\$10
Refueling Savings	\$0	\$1	\$1	\$2	\$3
Non-CO ₂ GHG Impacts and Non-GHG Impacts ^c	N/A	N/A	N/A	N/A	N/A
Reduced CO ₂ Emissions at Each Assumed SCC Value ^{a,b}					
5% (avg SCC)	\$0	\$4	\$4	\$4	\$9
3% (avg SCC)	\$0	\$20	\$20	\$30	\$40
2.5% (avg SCC)	\$0	\$40	\$40	\$50	\$70
3% (95th percentile)	\$0	\$60	\$70	\$80	\$120
Monetized Net Benefits at Each Assumed SCC Value ^{a,b}					
5% (avg SCC)	\$0	\$20	\$30	-\$3+c	-\$210+c
3% (avg SCC)	\$0	\$40	\$50	\$20+c	-\$180+c
2.5% (avg SCC)	\$0	\$50	\$60	\$40+c	-\$150+c
3% (95th percentile)	\$0	\$80	\$90	\$80+c	-\$100+c

Notes:

^a Net present value of reduced CO₂ emissions is calculated differently than other benefits. The same discount rate used to discount the value of damages from future emissions (SCC at 5, 3, and 2.5 percent) is used to calculate net present value of SCC for internal consistency. Refer to the SCC TSD for more detail.

^b Section VIII.G notes that SCC increases over time. Corresponding to the years in this table, the SCC estimates range as follows: for Average SCC at 5%: \$5-\$16; for Average SCC at 3%: \$22-\$46; for Average SCC at 2.5%: \$36-\$66; and for 95th percentile SCC at 3%: \$66-\$139. Section VIII.G also presents these SCC estimates.

^c Due to analytical and resource limitations, MY non-GHG emissions (direct PM, VOCs, NO₂ and SO₂) were not estimated for this analysis. Although EPA has not monetized changes in non-CO₂ GHGs, the value of any increases or reductions should not be interpreted as zero.

^d "+c" indicates additional costs not estimated in this rulemaking.

^e Negative sign represents an increase in Accidents, Congestion, and Noise.

Heavy-Duty GHG and Fuel Efficiency Standards FRM: Results of Final and Alternative Standards

Table 6-38 Annualized Monetized Net Benefits Associated with Each Alternative Relative to Alternative 1 for Lifetime of 2014 through 2018 Model Year Vocational Vehicles (7% discount rate, Million 2009\$)

	ALT.1 BASELINE	ALT.2 LESS STRINGENT	ALT.3 PREFERRED	ALT.4 MORE STRINGENT	ALT.5 MAX TECHNOLOGY
Truck Program Costs ^d	\$0	\$30	\$50	\$410+c	\$700+c
Fuel Savings (pre-tax)	\$0	\$100	\$160	\$270	\$420
Energy Security Impacts (price shock)	\$0	\$10	\$10	\$10	\$20
Accidents, Congestion, Noise ^e	\$0	-\$20	-\$20	-\$20	-\$20
Refueling Savings	\$0	\$1	\$2	\$3	\$5
Non-CO ₂ GHG Impacts and Non-GHG Impacts ^c	N/A	N/A	N/A	N/A	N/A
Reduced CO ₂ Emissions at Each Assumed SCC Value ^{a,b}					
5% (avg SCC)	\$0	\$4	\$4	\$9	\$13
3% (avg SCC)	\$0	\$20	\$30	\$40	\$70
2.5% (avg SCC)	\$0	\$30	\$50	\$80	\$120
3% (95th percentile)	\$0	\$60	\$80	\$140	\$210
Monetized Net Benefits at Each Assumed SCC Value ^{a,b}					
5% (avg SCC)	\$0	\$70	\$110	-\$140+c	-\$260+c
3% (avg SCC)	\$0	\$80	\$130	-\$100+c	-\$210+c
2.5% (avg SCC)	\$0	\$90	\$150	-\$70+c	-\$160+c
3% (95th percentile)	\$0	\$120	\$190	-\$10+c	-\$70+c

Notes:

^a Net present value of reduced CO₂ emissions is calculated differently than other benefits. The same discount rate used to discount the value of damages from future emissions (SCC at 5, 3, and 2.5 percent) is used to calculate net present value of SCC for internal consistency. Refer to the SCC TSD for more detail.

^b Section VIII.G notes that SCC increases over time. Corresponding to the years in this table, the SCC estimates range as follows: for Average SCC at 5%: \$5-\$16; for Average SCC at 3%: \$22-\$46; for Average SCC at 2.5%: \$36-\$66; and for 95th percentile SCC at 3%: \$66-\$139. Section VIII.G also presents these SCC estimates.

^c Due to analytical and resource limitations, MY non-GHG emissions (direct PM, VOCs, NO₂ and SO₂) were not estimated for this analysis. Although EPA has not monetized changes in non-CO₂ GHGs, the value of any increases or reductions should not be interpreted as zero.

^d "+c" indicates additional costs not estimated in this rulemaking.

^e Negative sign represents an increase in Accidents, Congestion, and Noise.

Regulatory Impact Analysis

Table 6-39 Annualized Monetized Net Benefits Associated with Each Alternative Relative to Alternative 1 for Lifetime of 2014 through 2018 Model Year Combination Tractors (7% discount rate, Million 2009\$)

	ALT.1 BASELINE	ALT.2 LESS STRINGENT	ALT.3 PREFERRED	ALT.4 MORE STRINGENT	ALT.5 MAX TECHNOLOGY
Truck Program Costs ^d	\$0	\$150	\$220	\$370+c	\$510+c
Fuel Savings (pre-tax)	\$0	\$1,170	\$1,250	\$1,540	\$1,760
Energy Security Impacts (price shock)	\$0	\$60	\$70	\$80	\$90
Accidents, Congestion, Noise ^e	\$0	-\$10	-\$20	-\$20	-\$20
Refueling Savings	\$0	\$10	\$10	\$10	\$10
Non-CO ₂ GHG Impacts and Non-GHG Impacts ^c	N/A	N/A	N/A	N/A	N/A
Reduced CO ₂ Emissions at Each Assumed SCC Value ^{a,b}					
5% (avg SCC)	\$0	\$40	\$40	\$50	\$60
3% (avg SCC)	\$0	\$190	\$200	\$250	\$290
2.5% (avg SCC)	\$0	\$310	\$330	\$410	\$490
3% (95th percentile)	\$0	\$580	\$620	\$760	\$890
Monetized Net Benefits at Each Assumed SCC Value ^{a,b}					
5% (avg SCC)	\$0	\$1,120	\$1,140	\$1,290+c	\$1,390+c
3% (avg SCC)	\$0	\$1,270	\$1,290	\$1,490+c	\$1,620+c
2.5% (avg SCC)	\$0	\$1,390	\$1,420	\$1,650+c	\$1,820+c
3% (95th percentile)	\$0	\$1,660	\$1,710	\$2,000+c	\$2,220+c

Notes:

^a Net present value of reduced CO₂ emissions is calculated differently than other benefits. The same discount rate used to discount the value of damages from future emissions (SCC at 5, 3, and 2.5 percent) is used to calculate net present value of SCC for internal consistency. Refer to the SCC TSD for more detail.

^b Section VIII.G notes that SCC increases over time. Corresponding to the years in this table, the SCC estimates range as follows: for Average SCC at 5%: \$5-\$16; for Average SCC at 3%: \$22-\$46; for Average SCC at 2.5%: \$36-\$66; and for 95th percentile SCC at 3%: \$66-\$139. Section VIII.G also presents these SCC estimates.

^c Due to analytical and resource limitations, MY non-GHG emissions (direct PM, VOCs, NO₂ and SO₂) were not estimated for this analysis. Although EPA has not monetized changes in non-CO₂ GHGs, the value of any increases or reductions should not be interpreted as zero.

^d "+c" indicates additional costs not estimated in this rulemaking.

^e Negative sign represents an increase in Accidents, Congestion, and Noise.

References

¹ NEPA requires agencies to consider a “no action” alternative in their NEPA analyses and to compare the effects of not taking action with the effects of the reasonable action alternatives to demonstrate the different environmental effects of the action alternatives. See 40 CFR 1502.2(e), 1502.14(d). CEQ has explained that “[T]he regulations require the analysis of the no action alternative even if the agency is under a court order or legislative command to act. This analysis provides a benchmark, enabling decision makers to compare the magnitude of environmental effects of the action alternatives. It is also an example of a reasonable alternative outside the jurisdiction of the agency which must be analyzed. [See 40 CFR 1502.14(c).] * * * Inclusion of such an analysis in the EIS is necessary to inform Congress, the public, and the President as intended by NEPA. [See 40 CFR 1500.1(a).]” Forty Most Asked Questions Concerning CEQ’s National Environmental Policy Act Regulations, 46 FR 18026 (1981) (emphasis added).

² U.S. Energy Information Administration. Annual Energy Outlook 2011 Early Release. Last viewed on March 29, 2011 at <http://www.eia.doe.gov/forecasts/aeo/>. See Supplemental Tables 7, 63, and 68.

³ U.S. Energy Information Administration. Annual Energy Outlook 2011 Early Release. Last viewed on March 29, 2011 at <http://www.eia.doe.gov/forecasts/aeo/>. See Supplemental Tables 7, 63, and 68.

⁴ TIAX, LLC. “Assessment of Fuel Economy Technologies for Medium- and Heavy- Duty Vehicles,” Final Report to the National Academy of Sciences, November 19, 2009. Page 4-20.

⁵ See Chapter 2 of this RIA, Table 2.39.

⁶ Committee to Assess Fuel Economy Technologies for Medium- and Heavy-Duty Vehicles; National Research Council; Transportation Research Board (2010). “Technologies and Approaches to Reducing the Fuel Consumption of Medium- and Heavy-Duty Vehicles,” (hereafter, “NAS Report”). Washington, D.C., The National Academies Press. Available electronically from the National Academies Press Website at http://www.nap.edu/catalog.php?record_id=12845 (last accessed September 10, 2010). See page 146.

⁷ The Cd improvement of 10 percent for trailer improvements was derived from the TIAX report, Table 4-26 on page 4-50.

⁸ Assumed retail prices of \$1,300 for side skirts and \$850 for gap reducers based on the ICF Cost Report, page 90.

Chapter 7: Truck Costs and Costs per Ton of GHG

7.1 Costs Associated with the Program

In this section, the agencies present our estimate of the costs associated with the program. The presentation here summarizes the costs associated with new technology expected to be added to meet the GHG and fuel consumption standards, including hardware costs to comply with the air conditioning (A/C) leakage program. The analysis summarized here provides our estimate of incremental costs on a per truck basis and on an annual total basis.

The presentation here summarizes the best estimate by EPA and NHTSA staff as to the technology mix expected to be employed for compliance. For details behind the cost estimates associated with individual technologies, the reader is directed to Section III of the preamble and to Chapter 2 of the RIA.

With respect to the cost estimates presented here, the agencies note that, because these estimates relate to technologies which are in most cases already available, these cost estimates are more easily found than estimates for technologies that do not yet exist.

7.1.1 Technology Costs per Truck

For the HD pickup trucks and vans, the agencies have used a methodology consistent with that used for our recent light-duty joint rulemaking since most of the technologies expected for HD pickup trucks and vans are consistent with those expected for the larger light-duty trucks. The cost estimates presented in the recent light-duty joint rulemaking were then scaled upward to account for the larger weight, towing capacity, and work demands of the trucks in these heavier classes. For details on that scaling process and the resultant costs for individual technologies, the reader is directed to Section III of the preamble and to Chapter 2 of the RIA. Note also that all cost estimates have been updated to 2009 dollars for this analysis while the recent light-duty joint rulemaking was presented in 2007 dollars.¹

For the loose heavy-duty gasoline engines, we have used engine-related costs from the HD pickup truck and van estimates since the loose heavy-duty gasoline engines are essentially the same engines as those sold into the HD pickup truck and van market.

For heavy-duty diesel engines, the agencies have estimated costs using a different methodology than that employed in the recent light-duty joint rulemaking establishing fuel economy and GHG standards for MYs 2012-2016. In the recent light-duty joint rulemaking, the fixed costs were included in the hardware costs via an indirect cost multiplier. As such, the hardware costs presented in that analysis, and in the cost estimates for HD pickup trucks and vans and HD gasoline engines, included both the actual hardware and the associated fixed costs. For this analysis, some of the fixed costs are estimated separately for HD diesel engines and are presented separately from the technology costs. These fixed costs are referred to as “Other Engineering Costs” as shown in Table 7-2 and described in the text surrounding that table.

Regulatory Impact Analysis

Importantly, once totaled both methodologies account for all the costs associated with the program. As noted above, all costs are presented in 2009 dollars.

The estimates of vehicle compliance costs cover the years leading up to – 2012 and 2013 – and including implementation of the program – 2014 through 2018. Also presented are costs for the years following implementation to shed light on the estimated long term (2022 and later) cost impacts of the program (note that engines and trucks will be required to continue meeting the final standards in 2019 and later model years absent further rulemaking action by the agencies). The year 2022 was chosen here consistent with the recent light-duty joint rulemaking. That year was considered long term in that analysis because the short-term and long-term markup factors described below are applied in five year increments with the 2012 through 2016 implementation span and the 2017 through 2021 span, both representing the short-term. Since many of the costs used in this analysis are based on costs in the recent light-duty joint rulemaking analysis, consistency with that analysis seems appropriate.

Individual technology cost estimates are presented in Chapter 2 of this RIA, and account for both the direct and indirect costs incurred. As described fully in Chapter 2 of this RIA, the agencies have also considered the impacts of manufacturer learning on the technology cost estimates.

The technology cost estimates discussed in Section III of the preamble and detailed in Chapter 2 of the RIA are used to build up technology package cost estimates. For each engine and truck category, a single package for each was developed capable of complying with the standards, and the costs for each package was generated. The technology packages and package costs are discussed in more detail in Chapter 2 of the RIA. The compliance cost estimates take into account all credits and trading programs and include costs associated with air conditioning controls.

Table 7-1 presents the average incremental costs per truck for this program. For HD pickups and vans, costs increase as the standards become more stringent in 2014 through 2018. Following 2018, costs then decrease going forward as learning effects result in decreased costs for individual technologies. By 2022, the long term ICMs take effect and costs decrease yet again. For vocational vehicles, cost trends are more difficult to discern as diesel engines begin adding technology in 2014, gasoline engines begin adding technology in 2016, and the trucks themselves begin adding technology in 2014. With learning effects, the costs, in general, decrease each year, except for heavy-duty gasoline engines since their standards go into effect in 2016 resulting in a cost increase for the vocational category in that year. Long term ICMs take effect in 2022 to provide more cost reductions. For combination tractors, costs generally decrease each year due to learning effects, with the exception of 2017 when the engines placed in sleeper cab tractors add turbo compounding. Following that, learning impacts result in cost reductions and the long term ICMs take effect in 2022 for further cost reductions. By 2030 and later, cost per truck estimates remain constant for all categories. Regarding the long term ICMs taking effect in 2022, the agencies consider this the point at which some indirect costs decrease or are no longer considered attributable to the program (*e.g.*, warranty costs go down). Costs per truck remain essentially constant thereafter.

Heavy-Duty GHG and Fuel Efficiency Standards FRM: Truck Costs and Costs per Ton of GHG

Table 7-1 Estimated Hardware Cost per Truck (2009\$)

YEAR	HD PICKUPS &	VOCATIONAL	COMBINATION TRACTORS
2014	\$165	\$329	\$6,019
2015	\$215	\$320	\$5,871
2016	\$422	\$397	\$5,677
2017	\$631	\$387	\$6,413
2018	\$1,048	\$378	\$6,215
2020	\$985	\$366	\$6,004
2030	\$977	\$311	\$5,075
2040	\$977	\$305	\$5,075
2050	\$977	\$304	\$5,075

As noted above, the fixed costs were estimated separately from the hardware costs for the HD diesel engines. Those fixed costs are not included in Table 7-1. The agencies have estimated the R&D costs at \$6.8 million per manufacturer per year for five years and the new test cell costs (to accommodate measurement of N₂O emissions) at \$63,087 per manufacturer. The test cell costs of N₂O emissions measurement has been adjusted for the final rulemaking to reflect comments which stated that approximately 75 percent of manufacturers would be required to update existing equipment while the other 25 percent would require new equipment. These costs apply individually for LHD, MHD and HHD diesel engines. Given the 14 manufacturers impacted by the standards, 11 of which are estimated to sell both MHD and HHD diesel engines and 3 of which are estimated to sell LHD diesel engines, we have estimated a five year annual R&D cost of \$170.3 million dollars (2 x 11 x \$6.8 million plus 3 x \$7.75 million for each year 2012-2016) and a one-time test cell cost of \$1.6 million dollars (2 x 11 x \$63,087 plus 3 x \$63,087 in 2013). Estimating annual sales of HD diesel engines at roughly 600,000 units results in roughly \$284 per engine per year for five years beginning in 2012 and ending in 2016. Again, these costs are not reflected in Table 7-1, but are included in Table 7-2 as “Other Engineering Costs”.

The certification and compliance program costs, for all engine and truck types, are estimated at \$6.5 million in the first year and \$2.3 million per year thereafter. These costs are detailed in the “Draft Supporting Statement for Information Collection Request” which is contained in the docket for this rulemaking.² The costs are higher in the first year due to capital expenses required to comply with new reporting burdens (facility upgrade costs are included in engineering costs as described above). Estimating annual sales of heavy-duty trucks at roughly 1.5 million units would result in just over \$4 per engine/truck in the first year and less than \$2 per engine/truck per year thereafter. These costs are not reflected in Table 7-1, but are included in Table 7-2 as “Compliance Program” costs.

7.1.2 Annual Costs of the Program

The costs presented here represent the incremental costs for newly added technology to comply with the program. Together with the projected increases in truck sales, the increases in per-truck average costs shown above result in the total annual costs presented in Table 7-2 below. The compliance program costs include items such as the burden for demonstrating compliance. For example, the combination tractor compliance costs include the measurement of aerodynamic performance, tire rolling resistance, and engine performance. Note that the costs

Regulatory Impact Analysis

presented in Table 7-2 do not include the savings that would occur as a result of the improvements to fuel consumption. Those impacts are presented in Chapter 7.2 below.

Table 7-2 Annual Costs Associated with the Program (Millions of 2009\$)

YEAR	HD PICKUPS & VANS	VOCATIONAL	COMBINATION TRACTORS	OTHER ENGINEERING COSTS ^A	COMPLIANCE PROGRAM COSTS	ANNUAL COSTS
2012	\$0	\$0	\$0	\$170	\$0.0	\$170
2013	\$0	\$0	\$0	\$172	\$0.0	\$172
2014	\$130	\$185	\$1,078	\$170	\$6.5	\$1,569
2015	\$157	\$170	\$922	\$170	\$2.3	\$1,422
2016	\$300	\$202	\$820	\$170	\$2.3	\$1,495
2017	\$447	\$198	\$951	\$0	\$2.3	\$1,598
2018	\$751	\$201	\$1,000	\$0	\$2.3	\$1,955
2020	\$754	\$202	\$1,001	\$0	\$2.3	\$1,959
2030	\$918	\$216	\$1,076	\$0	\$2.3	\$2,212
2040	\$1,024	\$281	\$1,372	\$0	\$2.3	\$2,679
2050	\$1,156	\$354	\$1,777	\$0	\$2.3	\$3,290
NPV, 3%	\$17,070	\$4,950	\$24,487	\$793	\$52	\$47,352
NPV, 7%	\$8,467	\$2,588	\$12,855	\$724	\$30	\$24,665

^A “Other Engineering Costs” are described in Section 7.1.1. These costs represent fixed costs for heavy-duty diesel engines.

7.2 Cost per Ton of GHG Emissions Reduced

The agencies have calculated the cost per ton of GHG (CO₂-equivalent, or CO₂eq) reductions associated with this rulemaking using the above costs and the GHG emissions reductions described in Chapter 5. These values are presented in Table 7-3 through Table 7-6 for HD pickup trucks & vans, Vocational vehicles, Combination tractors and the Program (*i.e.*, all engines and trucks), respectively. The cost per metric ton of GHG emissions reductions has been calculated in the years 2020, 2030, 2040, and 2050 using the annual vehicle compliance costs and emission reductions for each of those years. The value in 2050 represents the long-term cost per ton of the emissions reduced. The agencies have also calculated the cost per metric ton of GHG emission reductions including the savings associated with reduced fuel consumption (presented below in Tables 7-3 through 7-6). This latter calculation does not include the other benefits associated with this program such as those associated with criteria pollutant reductions or energy security benefits (discussed in Chapter 9). By including the fuel savings, the cost per ton is less than \$0 since the estimated value of fuel savings outweighs the program costs.

Heavy-Duty GHG and Fuel Efficiency Standards FRM: Truck Costs and Costs per Ton of GHG

Table 7-3 Annual Cost per Metric Ton of CO₂eq Reduced – HD Pickup Trucks & Vans (2009\$)

YEAR	PROGRAM COST	FUEL SAVINGS (PRE-TAX)	CO ₂ eq REDUCED	COST PER TON (WITHOUT FUEL)	COST PER TON (WITH FUEL SAVINGS)
2020	\$800	\$900	3	\$240	-\$30
2030	\$900	\$3,000	10	\$90	-\$200
2040	\$1,000	\$4,300	14	\$70	-\$240
2050	\$1,200	\$5,500	16	\$80	-\$270

Table 7-4 Annual Cost per Metric Ton of CO₂eq Reduced – Vocational Vehicles (2009\$)

YEAR	PROGRAM COST	FUEL SAVINGS (PRE-TAX)	CO ₂ EQ REDUCED	COST PER TON (WITHOUT FUEL)	COST PER TON (WITH FUEL SAVINGS)
2020	\$200	\$1,100	4	\$50	-\$210
2030	\$200	\$2,400	9	\$20	-\$250
2040	\$300	\$3,500	12	\$30	-\$270
2050	\$400	\$4,700	14	\$30	-\$310

Table 7-5 Annual Cost per Metric Ton of CO₂eq Reduced – Combination Tractors (2009\$)

YEAR	PROGRAM COST	FUEL SAVINGS (PRE-TAX)	CO ₂ EQ REDUCED	COST PER TON (WITHOUT FUEL)	COST PER TON (WITH FUEL SAVINGS)
2020	\$1,000	\$7,700	32	\$30	-\$210
2030	\$1,100	\$15,300	57	\$20	-\$250
2040	\$1,400	\$20,200	68	\$20	-\$280
2050	\$1,800	\$26,400	78	\$20	-\$320

Table 7-6 Annual Cost per Metric Ton of CO₂eq Reduced – Final Program (2009\$)

YEAR	PROGRAM COST	FUEL SAVINGS (PRE-TAX)	CO ₂ eq REDUCED	COST PER TON (WITHOUT FUEL)	COST PER TON (WITH FUEL SAVINGS)
2020	\$2,000	\$9,600	39	\$50	-\$190
2030	\$2,200	\$20,600	76	\$30	-\$240
2040	\$2,700	\$28,000	94	\$30	-\$270
2050	\$3,300	\$36,500	108	\$30	-\$310

7.3 Impacts of Reduction in Fuel Consumption

7.3.1 Gallons Reduced under the Rulemaking

The new fuel consumption and CO₂ standards will result in significant improvements in the fuel efficiency of affected trucks. Drivers of those trucks will see corresponding savings associated with reduced fuel expenditures. The agencies have estimated the impacts on fuel consumption for the fuel consumption and tailpipe CO₂ standards. To do this, fuel consumption is calculated using both current emission levels and the new CO₂ and fuel consumption standards. The difference between these estimates represents the net savings from the standards. Note that the total number of miles that vehicles are driven each year is different under each of the control case scenarios than in the reference case, due to the “rebound effect” which is discussed in Chapter 9. The agencies also note that drivers who drive more than our average estimates for vehicle miles traveled (VMT) will experience more fuel savings; drivers who drive less than our average VMT estimates will experience less fuel savings.

The expected impacts on fuel consumption are shown in Table 7-7. The gallons shown in this table reflect impacts from the new CO₂ and fuel consumption standards and include increased consumption resulting from the rebound effect.

Table 7-7 Fuel Consumption Reductions of the Program (Million gallons)

YEAR	GASOLINE				DIESEL			
	HD PICKUPS & VANS	VOC	COMB	TOTAL	HD PICKUPS & VANS	VOC	COMB	TOTAL
2012	0	0	0	0	0	0	0	0
2013	0	0	0	0	0	0	0	0
2014	1	0	0	1	4	38	431	473
2015	3	0	0	3	9	70	767	846
2016	11	4	0	14	24	97	1,050	1,171
2017	23	7	0	31	48	160	1,435	1,643
2018	47	11	0	58	92	219	1,813	2,123
2020	98	17	0	114	183	324	2,479	2,986
2030	309	39	0	348	567	654	4,450	5,670
2040	412	41	0	453	752	900	5,394	7,046
2050	476	45	0	522	867	1,062	6,229	8,158

7.3.2 Monetized Fuel Savings

Using the fuel consumption estimates presented above, the agencies can calculate the monetized fuel savings associated with the adopted standards. To do this, reduced fuel consumption is multiplied in each year by the corresponding estimated average fuel price in that year, using the reference case taken from the AEO 2011 through 2035. Fuel prices beyond 2035 were extrapolated from an average growth rate for the years 2017 to 2035. These estimates do not account for the significant uncertainty in future fuel prices; the monetized fuel savings will be understated if actual fuel prices are higher (or overstated if fuel prices are lower) than

Heavy-Duty GHG and Fuel Efficiency Standards FRM: Truck Costs and Costs per Ton of GHG

estimated. The Annual Energy Outlook (AEO) is a standard reference used by NHTSA and EPA and many other government agencies to estimate the projected price of fuel. This has been done using both the pre-tax and post-tax fuel prices. Since the post-tax fuel prices are the prices paid at fuel pumps, the fuel savings calculated using these prices represent the savings consumers would see. The pre-tax fuel savings are those savings that society would see. Assuming no change in fuel tax rates, the difference between these two columns represents the reduction in fuel tax revenues that will be received by state and federal governments- about \$200 million in 2014 and \$3 billion by 2050. These results are shown in Table 7-8. Note that in Chapter 9, the overall benefits and costs of the rulemaking are presented and, for that reason, only the pre-tax fuel savings are presented there.

Table 7-8 Estimated Monetized Fuel Savings (\$Millions of 2009\$)

YEAR	FUEL SAVINGS (PRE-TAX)	FUEL SAVINGS (POST-TAX)
2014	\$1,200	\$1,400
2015	\$2,200	\$2,600
2016	\$3,300	\$3,800
2017	\$4,800	\$5,500
2018	\$6,400	\$7,400
2020	\$9,600	\$10,900
2030	\$20,600	\$23,000
2040	\$28,000	\$30,600
2050	\$36,500	\$39,500
NPV, 3%	\$375,300	\$415,300
NPV, 7%	\$166,500	\$185,400

7.4 Key Parameters Used in the Estimation of Costs and Fuel Savings

This section briefly presents some of the parameters used in generating costs and fuel savings associated with the program. Table 7-9 presents estimated sales of complying vehicles by calendar year. Table 7-10 presents VMT by age for both the reference and control cases, where the control case includes rebound VMT. Table 7-11 presents AEO 2011 reference case fuel prices.

Regulatory Impact Analysis

Table 7-9 Estimated Calendar Year Sales by Truck Type

Calendar Year	HD Pickup Trucks & Vans	Vocational Vehicles	Combination Tractors	Total
2014	784,780	563,004	179,087	1,526,871
2015	729,845	529,533	157,103	1,416,481
2016	712,328	508,856	144,533	1,365,717
2017	708,054	511,068	148,286	1,367,408
2018	716,549	531,001	160,979	1,408,529
2019	735,105	546,611	168,313	1,450,029
2020	765,721	550,823	166,815	1,483,359
2021	787,933	565,299	171,117	1,524,349
2022	807,342	587,882	179,991	1,575,215
2023	822,170	605,769	186,985	1,614,924
2024	837,009	619,178	191,065	1,647,252
2025	853,222	630,394	193,564	1,677,180
2026	870,125	640,928	195,940	1,706,993
2027	884,235	651,936	198,634	1,734,805
2028	904,933	666,042	202,578	1,773,553
2029	926,609	679,826	207,013	1,813,448
2030	939,367	695,698	212,045	1,847,110
2031	950,482	759,850	217,485	1,927,817
2032	957,803	773,686	221,968	1,953,457
2033	964,913	787,125	226,261	1,978,299
2034	974,328	803,140	231,412	2,008,880
2035	986,240	821,951	237,484	2,045,675
2036	998,294	841,206	243,715	2,083,215
2037	1,010,497	860,916	250,108	2,121,521
2038	1,022,844	881,090	256,670	2,160,604
2039	1,035,349	901,744	263,403	2,200,496
2040	1,048,003	922,885	270,315	2,241,203
2041	1,060,814	944,528	277,406	2,282,748
2042	1,073,778	966,679	284,684	2,325,141
2043	1,086,901	989,359	292,152	2,368,412
2044	1,100,188	1,012,574	299,817	2,412,579
2045	1,113,637	1,036,341	307,684	2,457,662
2046	1,127,249	1,060,668	315,756	2,503,673
2047	1,141,023	1,085,571	324,039	2,550,633
2048	1,154,970	1,111,068	332,540	2,598,578
2049	1,169,090	1,137,164	341,265	2,647,519
2050	1,183,377	1,163,879	350,218	2,697,474

Heavy-Duty GHG and Fuel Efficiency Standards FRM: Truck Costs and Costs per Ton of GHG

Table 7-10 Annual Vehicle Miles Traveled by Age for the Reference and Control Cases

VEHICLE AGE	REFERENCE			CONTROL		
	HD Pickups and Vans	Vocational Vehicles	Combination Tractors	HD Pickups and Vans	Vocational Vehicles	Combination Tractors
0	11,682	21,245	133,005	11,819	21,528	133,670
1	11,695	19,366	119,291	11,833	19,623	119,887
2	11,645	17,764	107,612	11,783	18,001	108,151
3	11,511	16,269	96,713	11,646	16,486	97,197
4	11,301	14,852	86,619	11,434	15,050	87,052
5	11,046	13,527	77,482	11,176	13,707	77,869
6	10,748	12,322	69,265	10,874	12,486	69,611
7	10,422	11,272	62,051	10,545	11,422	62,362
8	10,058	10,342	55,709	10,177	10,479	55,988
9	9,669	9,478	49,920	9,783	9,604	50,170
10	9,267	8,729	44,653	9,376	8,845	44,876
11	8,851	8,031	40,063	8,955	8,138	40,263
12	8,459	7,415	35,971	8,559	7,514	36,151
13	8,071	6,871	32,261	8,166	6,963	32,423
14	7,684	6,345	28,794	7,774	6,429	28,937
15	7,312	5,864	25,776	7,398	5,942	25,905
16	6,966	5,425	23,066	7,048	5,497	23,181
17	6,639	5,030	20,716	6,718	5,097	20,820
18	6,336	4,700	18,521	6,411	4,763	18,613
19	6,059	4,375	16,581	6,130	4,433	16,663
20	5,809	4,060	14,812	5,878	4,114	14,886
21	5,589	3,811	13,292	5,655	3,862	13,358
22	5,402	3,566	11,868	5,466	3,614	11,928
23	5,254	3,354	10,590	5,316	3,399	10,643
24	5,146	3,153	9,456	5,207	3,195	9,503
25	5,082	2,962	8,439	5,142	3,001	8,481
26	5,066	2,797	7,533	5,126	2,834	7,571
27	5,064	2,667	6,739	5,124	2,702	6,772
28	5,062	2,513	6,027	5,122	2,546	6,057
29	5,060	2,392	5,376	5,120	2,424	5,403
30	5,058	2,300	4,804	5,118	2,331	4,828

Regulatory Impact Analysis

Table 7-11 AEO 2011 Reference Case Fuel Prices (2009\$/gallon)

Vehicle Age	Pre-Tax		Post-Tax	
	Gasoline	Diesel	Gasoline	Diesel
2014	\$2.64	\$2.57	\$3.05	\$3.02
2015	\$2.73	\$2.64	\$3.13	\$3.08
2016	\$2.78	\$2.75	\$3.18	\$3.19
2017	\$2.85	\$2.86	\$3.25	\$3.29
2018	\$2.91	\$2.95	\$3.30	\$3.38
2019	\$2.95	\$3.05	\$3.34	\$3.47
2020	\$2.99	\$3.10	\$3.38	\$3.52
2021	\$3.01	\$3.12	\$3.39	\$3.54
2022	\$3.07	\$3.20	\$3.45	\$3.61
2023	\$3.09	\$3.22	\$3.47	\$3.63
2024	\$3.14	\$3.30	\$3.52	\$3.71
2025	\$3.17	\$3.33	\$3.54	\$3.73
2026	\$3.19	\$3.35	\$3.56	\$3.75
2027	\$3.25	\$3.40	\$3.62	\$3.80
2028	\$3.26	\$3.43	\$3.63	\$3.82
2029	\$3.31	\$3.48	\$3.68	\$3.87
2030	\$3.28	\$3.44	\$3.64	\$3.83
2031	\$3.28	\$3.46	\$3.64	\$3.84
2032	\$3.29	\$3.47	\$3.65	\$3.85
2033	\$3.30	\$3.47	\$3.66	\$3.85
2034	\$3.34	\$3.50	\$3.69	\$3.87
2035	\$3.36	\$3.52	\$3.71	\$3.89
2036	\$3.38	\$3.56	\$3.73	\$3.93
2037	\$3.41	\$3.61	\$3.76	\$3.97
2038	\$3.44	\$3.65	\$3.79	\$4.01
2039	\$3.47	\$3.70	\$3.82	\$4.06
2040	\$3.51	\$3.74	\$3.85	\$4.10
2041	\$3.54	\$3.79	\$3.88	\$4.15
2042	\$3.57	\$3.84	\$3.91	\$4.19
2043	\$3.60	\$3.88	\$3.94	\$4.24
2044	\$3.63	\$3.93	\$3.97	\$4.28
2045	\$3.67	\$3.98	\$4.00	\$4.33
2046	\$3.70	\$4.03	\$4.03	\$4.38
2047	\$3.74	\$4.08	\$4.07	\$4.42
2048	\$3.77	\$4.13	\$4.10	\$4.47
2049	\$3.80	\$4.18	\$4.13	\$4.52
2050	\$3.84	\$4.23	\$4.16	\$4.57

References

¹ Light-Duty Vehicle Greenhouse Gas Emission Standards and Corporate Average Fuel Economy Standards; Final Rulemaking 75 Fed. Reg. 25323 (May 7, 2010).

² “Draft Supporting Statement for Information Collection Request,” Control of Greenhouse Gas Emissions from New Motor Vehicles: Proposed Heavy-Duty Engine and Vehicle Standards, EPA ICR Tracking Number 2394.01.

Chapter 8: Health and Environmental Impacts

8.1 Health and Environmental Effects of Non-GHG Pollutants

8.1.1 Health Effects Associated with Exposure to Non-GHG Pollutants

In this section we will discuss the health effects associated with non-GHG pollutants, specifically: particulate matter, ozone, nitrogen oxides (NO_x), sulfur oxides (SO_x), carbon monoxide and air toxics. These pollutants will not be directly regulated by the standards, but the standards will affect emissions of these pollutants and precursors.

8.1.1.1 Background on Particulate Matter

Particulate matter (PM) is a generic term for a broad class of chemically and physically diverse substances. It can be principally characterized as discrete particles that exist in the condensed (liquid or solid) phase spanning several orders of magnitude in size. Since 1987, EPA has delineated that subset of inhalable particles small enough to penetrate to the thoracic region (including the tracheobronchial and alveolar regions) of the respiratory tract (referred to as thoracic particles). Current National Ambient Air Quality Standards (NAAQS) use PM_{2.5} as the indicator for fine particles (with PM_{2.5} referring to particles with a nominal mean aerodynamic diameter less than or equal to 2.5 μm), and use PM₁₀ as the indicator for purposes of regulating the coarse fraction of PM₁₀ (referred to as thoracic coarse particles or coarse-fraction particles; generally including particles with a nominal mean aerodynamic diameter greater than 2.5 μm and less than or equal to 10 μm, or PM_{10-2.5}). Ultrafine particles (UFPs) are a subset of fine particles, generally less than 100 nanometers (0.1 μm) in aerodynamic diameter.

Particles span many sizes and shapes and consist of numerous different chemicals. Particles originate from sources and are also formed through atmospheric chemical reactions; the former are often referred to as “primary” particles, and the latter as “secondary” particles. In addition, there are also physical, non-chemical reaction mechanisms that contribute to secondary particles. Particle pollution also varies by time of year and location and is affected by several weather-related factors, such as temperature, clouds, humidity, and wind. A further layer of complexity comes from a particle’s ability to shift between solid/liquid and gaseous phases, which is influenced by concentration, meteorology, and temperature.

Fine particles are produced primarily by combustion processes and by transformations of gaseous emissions (*e.g.*, SO_x, NO_x and volatile organic compounds (VOCs)) in the atmosphere. The chemical and physical properties of PM_{2.5} may vary greatly with time, region, meteorology and source category. Thus, PM_{2.5} may include a complex mixture of different chemicals including sulfates, nitrates, organic compounds, elemental carbon and metal compounds. These particles can remain in the atmosphere for days to weeks and travel through the atmosphere hundreds to thousands of kilometers.¹

8.1.1.2 Particulate Matter Health Effects

This section provides a summary of the health effects associated with exposure to ambient concentrations of PM.^A The information in this section is based on the information and conclusions in the Integrated Science Assessment (ISA) for Particulate Matter (December 2009) prepared by EPA's Office of Research and Development (ORD).^B

The ISA concludes that ambient concentrations of PM are associated with a number of adverse health effects.^C The ISA characterizes the weight of evidence for different health effects associated with three PM size ranges: PM_{2.5}, PM_{10-2.5}, and UFPs. The discussion below highlights the ISA's conclusions pertaining to these three size fractions of PM, considering variations in both short-term and long-term exposure periods.

8.1.1.2.1 *Effects Associated with Short-term Exposure to PM_{2.5}*

The ISA concludes that cardiovascular effects and all-cause cardiovascular- and respiratory-related mortality are causally associated with short-term exposure to PM_{2.5}.² It also concludes that respiratory effects are likely to be causally associated with short-term exposure to PM_{2.5}, including respiratory emergency department (ED) visits and hospital admissions for chronic obstructive pulmonary disease (COPD), respiratory infections, and asthma; and exacerbation of respiratory symptoms in asthmatic children.

8.1.1.2.2 *Effects Associated with Long-term Exposure to PM_{2.5}*

The ISA concludes that there are causal associations between long-term exposure to PM_{2.5} and cardiovascular effects, such as the development/progression of cardiovascular disease (CVD), and premature mortality, particularly from cardiopulmonary causes.³ It also concludes that long-term exposure to PM_{2.5} is likely to be causally associated with respiratory effects, such as reduced lung function growth, increased respiratory symptoms, and asthma development. The ISA characterizes the evidence as suggestive of a causal relationship for associations between long-term PM_{2.5} exposure and reproductive and developmental outcomes, such as low birth weight and infant mortality. It also characterizes the evidence as suggestive of a causal relationship between PM_{2.5} and cancer incidence, mutagenicity, and genotoxicity.

8.1.1.2.3 *Effects Associated with PM_{10-2.5}*

The ISA summarizes evidence related to short-term exposure to PM_{10-2.5}. PM_{10-2.5} is the fraction of PM₁₀ particles that is larger than PM_{2.5}.⁴ The ISA concludes that available evidence

^A Personal exposure includes contributions from many different types of particles, from many sources, and in many different environments. Total personal exposure to PM includes both ambient and nonambient components; and both components may contribute to adverse health effects.

^B The ISA is available at <http://cfpub.epa.gov/ncea/cfm/recordisplay.cfm?deid=216546>

^C The ISA evaluates the health evidence associated with different health effects, assigning one of five "weight of evidence" determinations: causal relationship, likely to be a causal relationship, suggestive of a causal relationship, inadequate to infer a causal relationship, and not likely to be a causal relationship. For definitions of these levels of evidence, please refer to Section 1.5 of the ISA.

is suggestive of a causal relationship between short-term exposures to PM_{10-2.5} and cardiovascular effects, such as hospitalizations for ischemic heart disease. It also concludes that the available evidence is suggestive of a causal relationship between short-term exposures to PM_{10-2.5} and respiratory effects, including respiratory-related ED visits and hospitalizations and pulmonary inflammation. The ISA also concludes that the available literature suggests a causal relationship between short-term exposures to PM_{10-2.5} and mortality. Data are inadequate to draw conclusions regarding health effects associated with long-term exposure to PM_{10-2.5}.⁵

8.1.1.2.4 *Effects Associated with Ultrafine Particles*

The ISA concludes that the evidence is suggestive of a causal relationship between short-term exposures to UFPs and cardiovascular effects, including changes in heart rhythm and vasomotor function (the ability of blood vessels to expand and contract).⁶

The ISA also concludes that there is suggestive evidence of a causal relationship between short-term UFP exposure and respiratory effects. The types of respiratory effects examined in epidemiologic studies include respiratory symptoms and asthma hospital admissions, the results of which are not entirely consistent. There is evidence from toxicological and controlled human exposure studies that exposure to UFPs may increase lung inflammation and produce small asymptomatic changes in lung function. Data are inadequate to draw conclusions regarding health effects associated with long-term exposure to UFPs.⁷

8.1.1.3 Background on Ozone

Ground-level ozone pollution is typically formed by the reaction of VOCs and NO_x in the lower atmosphere in the presence of sunlight. These pollutants, often referred to as ozone precursors, are emitted by many types of pollution sources such as highway and nonroad motor vehicles and engines, power plants, chemical plants, refineries, makers of consumer and commercial products, industrial facilities, and smaller area sources.

The science of ozone formation, transport, and accumulation is complex. Ground-level ozone is produced and destroyed in a cyclical set of chemical reactions, many of which are sensitive to temperature and sunlight. When ambient temperatures and sunlight levels remain high for several days and the air is relatively stagnant, ozone and its precursors can build up and result in more ozone than typically occurs on a single high-temperature day. Ozone can be transported hundreds of miles downwind of precursor emissions, resulting in elevated ozone levels even in areas with low VOC or NO_x emissions.

The highest levels of ozone are produced when both VOC and NO_x emissions are present in significant quantities on clear summer days. Relatively small amounts of NO_x enable ozone to form rapidly when VOC levels are relatively high, but ozone production is quickly limited by removal of the NO_x. Under these conditions NO_x reductions are highly effective in reducing ozone while VOC reductions have little effect. Such conditions are called “NO_x-limited.” Because the contribution of VOC emissions from biogenic (natural) sources to local ambient ozone concentrations can be significant, even some areas where man-made VOC emissions are relatively low can be NO_x-limited.

Ozone concentrations in an area also can be lowered by the reaction of nitric oxide (NO) with ozone, forming nitrogen dioxide (NO₂); as the air moves downwind and the cycle continues, the NO₂ forms additional ozone. The importance of this reaction depends, in part, on the relative concentrations of NO_x, VOC, and ozone, all of which change with time and location. When NO_x levels are relatively high and VOC levels relatively low, NO_x forms inorganic nitrates (*i.e.*, particles) but relatively little ozone. Such conditions are called “VOC-limited.” Under these conditions, VOC reductions are effective in reducing ozone, but NO_x reductions can actually increase local ozone under certain circumstances. Even in VOC-limited urban areas, NO_x reductions are not expected to increase ozone levels if the NO_x reductions are sufficiently large. Rural areas are usually NO_x-limited, due to the relatively large amounts of biogenic VOC emissions in such areas. Urban areas can be either VOC- or NO_x-limited, or a mixture of both, in which ozone levels exhibit moderate sensitivity to changes in either pollutant.

8.1.1.4 Ozone Health Effects

Exposure to ambient ozone contributes to a wide range of adverse health effects.^D These health effects are well documented and are critically assessed in the EPA ozone air quality criteria document (ozone AQCD) and EPA staff paper.^{8,9} We are relying on the data and conclusions in the ozone AQCD and staff paper, regarding the health effects associated with ozone exposure.

Ozone-related health effects include lung function decrements, respiratory symptoms, aggravation of asthma, increased hospital and emergency room visits, increased asthma medication usage, and a variety of other respiratory effects. Cellular-level effects, such as inflammation of lungs, have been documented as well. In addition, there is suggestive evidence of a contribution of ozone to cardiovascular-related morbidity and highly suggestive evidence that short-term ozone exposure directly or indirectly contributes to non-accidental and cardiopulmonary-related mortality, but additional research is needed to clarify the underlying mechanisms causing these effects. In a recent report on the estimation of ozone-related premature mortality published by the National Research Council (NRC), a panel of experts and reviewers concluded that short-term exposure to ambient ozone is likely to contribute to premature deaths and that ozone-related mortality should be included in estimates of the health benefits of reducing ozone exposure.¹⁰ People who appear to be more susceptible to effects associated with exposure to ozone include children, asthmatics and the elderly. Those with greater exposures to ozone, for instance due to time spent outdoors (*e.g.*, children and outdoor workers), are also of concern.

Based on a large number of scientific studies, EPA has identified several key health effects associated with exposure to levels of ozone found today in many areas of the country. Short-term (1 to 3 hours) and prolonged exposures (6 to 8 hours) to ambient ozone concentrations have been linked to lung function decrements, respiratory symptoms, increased hospital admissions and emergency room visits for respiratory problems.^{11, 12, 13, 14, 15, 16}

^D Human exposure to ozone varies over time due to changes in ambient ozone concentration and because people move between locations which have notable different ozone concentrations. Also, the amount of ozone delivered to the lung is not only influenced by the ambient concentrations but also by the individuals breathing route and rate.

Repeated exposure to ozone can increase susceptibility to respiratory infection and lung inflammation and can aggravate preexisting respiratory diseases, such as asthma.^{17, 18, 19, 20, 21} Repeated exposure to sufficient concentrations of ozone can also cause inflammation of the lung, impairment of lung defense mechanisms, and possibly irreversible changes in lung structure, which over time could affect premature aging of the lungs and/or the development of chronic respiratory illnesses, such as emphysema and chronic bronchitis.^{22, 23, 24, 25}

Children and adults who are outdoors and active during the summer months, such as construction workers, are among those most at risk of elevated ozone exposures.²⁶ Children and outdoor workers tend to have higher ozone exposure because they typically are active outside, working, playing and exercising, during times of day and seasons (*e.g.*, the summer) when ozone levels are highest.²⁷ For example, summer camp studies in the Eastern United States and Southeastern Canada have reported statistically significant reductions in lung function in children who are active outdoors.^{28, 29, 30, 31, 32, 33, 34, 35} Further, children are more at risk of experiencing health effects from ozone exposure than adults because their respiratory systems are still developing. These individuals (as well as people with respiratory illnesses, such as asthma, especially asthmatic children) can experience reduced lung function and increased respiratory symptoms, such as chest pain and cough, when exposed to relatively low ozone levels during prolonged periods of moderate exertion.^{36, 37, 38, 39}

8.1.1.5 Background on Nitrogen Oxides and Sulfur Oxides

Sulfur dioxide (SO₂), a member of the sulfur oxide (SO_x) family of gases, is formed from burning fuels containing sulfur (*e.g.*, coal or oil), extracting gasoline from oil, or extracting metals from ore. Nitrogen dioxide (NO₂) is a member of the nitrogen oxide (NO_x) family of gases. Most NO₂ is formed in the air through the oxidation of nitric oxide (NO) emitted when fuel is burned at a high temperature. SO₂ and NO₂ can dissolve in water droplets and further oxidize to form sulfuric and nitric acid which react with ammonia to form sulfates and nitrates, both of which are important components of ambient PM. The health effects of ambient PM are discussed in Section 8.1.1.2. NO_x along with non-methane hydrocarbons (NMHC) are the two major precursors of ozone. The health effects of ozone are covered in Section 8.1.1.4.

8.1.1.6 Health Effects of SO₂

This section provides an overview of the health effects associated with SO₂. Additional information on the health effects of SO₂ can be found in the EPA Integrated Science Assessment for Sulfur Oxides.⁴⁰ Following an extensive evaluation of health evidence from epidemiologic and laboratory studies, the U.S. EPA has concluded that there is a causal relationship between respiratory health effects and short-term exposure to SO₂. The immediate effect of SO₂ on the respiratory system in humans is bronchoconstriction. Asthmatics are more sensitive to the effects of SO₂ likely resulting from preexisting inflammation associated with this disease. In laboratory studies involving controlled human exposures to SO₂, respiratory effects have consistently been observed following 5-10 min exposures at SO₂ concentrations ≥ 0.4 ppm in asthmatics engaged in moderate to heavy levels of exercise, with more limited evidence of respiratory effects among exercising asthmatics exposed to concentrations as low as 0.2-0.3 ppm. A clear concentration-response relationship has been demonstrated in these studies following exposures to SO₂ at concentrations between 0.2 and 1.0 ppm, both in terms of increasing severity of respiratory

Regulatory Impact Analysis

symptoms and decrements in lung function, as well as the percentage of asthmatics adversely affected.

In epidemiologic studies, respiratory effects have been observed in areas where the mean 24-hour SO₂ levels range from 1 to 30 ppb, with maximum 1 to 24-hour average SO₂ values ranging from 12 to 75 ppb. Important new multicity studies and several other studies have found an association between 24-hour average ambient SO₂ concentrations and respiratory symptoms in children, particularly those with asthma. Generally consistent associations also have been observed between ambient SO₂ concentrations and emergency department visits and hospitalizations for all respiratory causes, particularly among children and older adults (≥ 65 years), and for asthma. A limited subset of epidemiologic studies have examined potential confounding by copollutants using multipollutant regression models. These analyses indicate that although copollutant adjustment has varying degrees of influence on the SO₂ effect estimates, the effect of SO₂ on respiratory health outcomes appears to be generally robust and independent of the effects of gaseous and particulate copollutants, suggesting that the observed effects of SO₂ on respiratory endpoints occur independent of the effects of other ambient air pollutants.

Consistent associations between short-term exposure to SO₂ and mortality have been observed in epidemiologic studies, with larger effect estimates reported for respiratory mortality than for cardiovascular mortality. While this finding is consistent with the demonstrated effects of SO₂ on respiratory morbidity, uncertainty remains with respect to the interpretation of these associations due to potential confounding by various copollutants. The U.S. EPA has therefore concluded that the overall evidence is suggestive of a causal relationship between short-term exposure to SO₂ and mortality. Significant associations between short-term exposure to SO₂ and emergency department visits and hospital admissions for cardiovascular diseases have also been reported. However, these findings have been inconsistent across studies and do not provide adequate evidence to infer a causal relationship between SO₂ exposure and cardiovascular morbidity.

8.1.1.7 Health Effects of NO₂

Information on the health effects of NO₂ can be found in the EPA Integrated Science Assessment (ISA) for Nitrogen Oxides.⁴¹ The EPA has concluded that the findings of epidemiologic, controlled human exposure, and animal toxicological studies provide evidence that is sufficient to infer a likely causal relationship between respiratory effects and short-term NO₂ exposure. The ISA concludes that the strongest evidence for such a relationship comes from epidemiologic studies of respiratory effects including symptoms, emergency department visits, and hospital admissions. The ISA also draws two broad conclusions regarding airway responsiveness following NO₂ exposure. First, the ISA concludes that NO₂ exposure may enhance the sensitivity to allergen-induced decrements in lung function and increase the allergen-induced airway inflammatory response following 30-minute exposures of asthmatics to NO₂ concentrations as low as 0.26 ppm. In addition, small but significant increases in non-specific airway hyperresponsiveness were reported following 1-hour exposures of asthmatics to 0.1 ppm NO₂. Second, exposure to NO₂ has been found to enhance the inherent responsiveness of the airway to subsequent nonspecific challenges in controlled human exposure studies of asthmatic subjects. Enhanced airway responsiveness could have important clinical implications

for asthmatics since transient increases in airway responsiveness following NO₂ exposure have the potential to increase symptoms and worsen asthma control. Together, the epidemiologic and experimental data sets form a plausible, consistent, and coherent description of a relationship between NO₂ exposures and an array of adverse health effects that range from the onset of respiratory symptoms to hospital admission.

Although the weight of evidence supporting a causal relationship is somewhat less certain than that associated with respiratory morbidity, NO₂ has also been linked to other health endpoints. These include all-cause (nonaccidental) mortality, hospital admissions or emergency department visits for cardiovascular disease, and decrements in lung function growth associated with chronic exposure.

8.1.1.8 Health Effects of Carbon Monoxide

Information on the health effects of carbon monoxide (CO) can be found in the EPA Integrated Science Assessment (ISA) for Carbon Monoxide.⁴² The ISA concludes that ambient concentrations of CO are associated with a number of adverse health effects.^E This section provides a summary of the health effects associated with exposure to ambient concentrations of CO.^F

Human clinical studies of subjects with coronary artery disease show a decrease in the time to onset of exercise-induced angina (chest pain) and electrocardiogram changes following CO exposure. In addition, epidemiologic studies show associations between short-term CO exposure and cardiovascular morbidity, particularly increased emergency room visits and hospital admissions for coronary heart disease (including ischemic heart disease, myocardial infarction, and angina). Some epidemiologic evidence is also available for increased hospital admissions and emergency room visits for congestive heart failure and cardiovascular disease as a whole. The ISA concludes that a causal relationship is likely to exist between short-term exposures to CO and cardiovascular morbidity. It also concludes that available data are inadequate to conclude that a causal relationship exists between long-term exposures to CO and cardiovascular morbidity.

Animal studies show various neurological effects with in-utero CO exposure. Controlled human exposure studies report inconsistent neural and behavioral effects following low-level CO exposures. The ISA concludes the evidence is suggestive of a causal relationship with both short- and long-term exposure to CO and central nervous system effects.

A number of epidemiologic and animal toxicological studies cited in the ISA have evaluated associations between CO exposure and birth outcomes such as preterm birth or cardiac

^E The ISA evaluates the health evidence associated with different health effects, assigning one of five “weight of evidence” determinations: causal relationship, likely to be a causal relationship, suggestive of a causal relationship, inadequate to infer a causal relationship, and not likely to be a causal relationship. For definitions of these levels of evidence, please refer to Section 1.6 of the ISA.

^F Personal exposure includes contributions from many sources, and in many different environments. Total personal exposure to CO includes both ambient and nonambient components; and both components may contribute to adverse health effects.

Regulatory Impact Analysis

birth defects. The epidemiologic studies provide limited evidence of a CO-induced effect on preterm births and birth defects, with weak evidence for a decrease in birth weight. Animal toxicological studies have found associations between perinatal CO exposure and decrements in birth weight, as well as other developmental outcomes. The ISA concludes these studies are suggestive of a causal relationship between long-term exposures to CO and developmental effects and birth outcomes.

Epidemiologic studies provide evidence of effects on respiratory morbidity such as changes in pulmonary function, respiratory symptoms, and hospital admissions associated with ambient CO concentrations. A limited number of epidemiologic studies considered copollutants such as ozone, SO₂, and PM in two-pollutant models and found that CO risk estimates were generally robust, although this limited evidence makes it difficult to disentangle effects attributed to CO itself from those of the larger complex air pollution mixture. Controlled human exposure studies have not extensively evaluated the effect of CO on respiratory morbidity. Animal studies at levels of 50-100 ppm CO show preliminary evidence of altered pulmonary vascular remodeling and oxidative injury. The ISA concludes that the evidence is suggestive of a causal relationship between short-term CO exposure and respiratory morbidity, and inadequate to conclude that a causal relationship exists between long-term exposure and respiratory morbidity.

Finally, the ISA concludes that the epidemiologic evidence is suggestive of a causal relationship between short-term exposures to CO and mortality. Epidemiologic studies provide evidence of an association between short-term exposure to CO and mortality, but limited evidence is available to evaluate cause-specific mortality outcomes associated with CO exposure. In addition, the attenuation of CO risk estimates which was often observed in copollutant models contributes to the uncertainty as to whether CO is acting alone or as an indicator for other combustion-related pollutants. The ISA also concludes that there is not likely to be a causal relationship between relevant long-term exposures to CO and mortality.

8.1.1.9 Health Effects of Air Toxics

Motor vehicle emissions contribute to ambient levels of air toxics known or suspected as human or animal carcinogens, or that have noncancer health effects. The population experiences an elevated risk of cancer and other noncancer health effects from exposure to air toxics.⁴³ These compounds include, but are not limited to, benzene, 1,3-butadiene, formaldehyde, acetaldehyde, acrolein, diesel particulate matter and exhaust organic gases, polycyclic organic matter (POM), and naphthalene. These compounds were identified as national or regional risk drivers or contributors in the 2005 National-scale Air Toxics Assessment (NATA) and have significant inventory contributions from mobile sources. Although the 2005 NATA did not quantify cancer risks associated with exposure to diesel exhaust, EPA has concluded that diesel exhaust ranks with the other emissions that the 2005 NATA suggests pose the greatest relative risk. According to NATA for 2005, mobile sources were responsible for 43 percent of outdoor toxic emissions and over 50 percent of the cancer risk and noncancer hazard attributable to direct emissions from mobile and stationary sources.^G Data from the 2008 National Emissions

^G NATA also includes estimates of risk attributable to background concentrations, which includes contributions from long-range transport, persistent air toxics, and natural sources; as well as secondary concentrations, where

Heavy-Duty GHG and Fuel Efficiency Standards FRM: Health and Environmental Impacts

Inventory (NEI) and 2005 NATA show that almost fifty percent of national diesel PM emissions are attributable to heavy-duty vehicles.^{44,45}

Noncancer health effects can result from chronic,^H subchronic,^I or acute^J inhalation exposures to air toxics, and include neurological, cardiovascular, liver, kidney, and respiratory effects as well as effects on the immune and reproductive systems. According to the 2005 NATA, about three-fourths of the U.S. population was exposed to an average chronic concentration of air toxics that has the potential for adverse noncancer respiratory health effects. This will continue to be the case in 2030, even though toxics concentrations will be lower.⁴⁶

The NATA modeling framework has a number of limitations which prevent its use as the sole basis for setting regulatory standards. These limitations and uncertainties are discussed on the 2005 NATA website.⁴⁷ Even so, this modeling framework is very useful in identifying air toxic pollutants and sources of greatest concern, setting regulatory priorities, and informing the decision making process.

8.1.1.9.1 Diesel Exhaust PM

Heavy-duty diesel engines emit diesel exhaust (DE), a complex mixture comprised of carbon dioxide, oxygen, nitrogen, water vapor, carbon monoxide, nitrogen compounds, sulfur compounds and numerous low-molecular-weight hydrocarbons. A number of these gaseous hydrocarbon components are individually known to be toxic including aldehydes, benzene and 1,3-butadiene. The diesel particulate matter (DPM) present in diesel exhaust consists mostly of fine particles (< 2.5µm), including a significant fraction of ultrafine particles (< 0.1 µm). These particles have large surface areas which make them an excellent medium for adsorbing organics, and their small size makes them highly respirable and able to deposit deep in the lung. Diesel PM also contains numerous mutagenic and carcinogenic compounds associated with the particles (and also organic gases). In addition, while toxic trace metals emitted by heavy-duty diesel engines represent a very small portion of the national emissions of metals (less than one percent) and are a small portion of diesel PM (generally much less than one percent of diesel PM), we note that several trace metals of potential toxicological significance and persistence in the environment are emitted by diesel engines. These trace metals include chromium, manganese, mercury and nickel. In addition, small amounts of dioxins have been measured in highway engine diesel exhaust, some of which may partition into the particulate phase. Dioxins are a major health concern but diesel engines are a minor contributor to overall dioxin emissions.

toxics are formed via secondary formation. Mobile sources substantially contribute to long-range transport and secondarily formed air toxics.

^H Chronic exposure is defined in the glossary of the Integrated Risk Information (IRIS) database (<http://www.epa.gov/iris>) as repeated exposure by the oral, dermal, or inhalation route for more than approximately 10% of the life span in humans (more than approximately 90 days to 2 years in typically used laboratory animal species).

^I Defined in the IRIS database as exposure to a substance spanning approximately 10% of the lifetime of an organism.

^J Defined in the IRIS database as exposure by the oral, dermal, or inhalation route for 24 hours or less.

Regulatory Impact Analysis

Diesel exhaust varies significantly in chemical composition and particle sizes between different engine types (heavy-duty, light-duty), engine operating conditions (idle, accelerate, decelerate), and fuel formulations (high/low sulfur fuel).⁴⁸ Also, there are emission differences between on-road and nonroad engines because the nonroad engines are generally of older technology. After being emitted, diesel exhaust undergoes dilution as well as chemical and physical changes in the atmosphere. The lifetime for some of the compounds present in diesel exhaust ranges from hours to days.

A number of health studies have been conducted regarding diesel exhaust. These include epidemiologic studies of lung cancer in groups of workers and animal studies focusing on non-cancer effects specific to diesel exhaust exposure. Diesel exhaust PM (including the associated organic compounds which are generally high molecular weight hydrocarbon types but not the more volatile gaseous hydrocarbon compounds) is generally used as a surrogate measure for diesel exhaust.

8.1.1.9.1.1 Potential Cancer Effects of Exposure to Diesel Exhaust

Exposure to diesel exhaust is of specific concern because it has been judged by EPA to pose a lung cancer hazard for humans at environmental levels of exposure.

EPA's 2002 final "Health Assessment Document for Diesel Engine Exhaust" (the EPA Diesel HAD) classified exposure to diesel exhaust as likely to be carcinogenic to humans by inhalation at environmental exposures, in accordance with the revised draft 1996/1999 EPA cancer guidelines.^{49,50} In accordance with earlier EPA guidelines, exposure to diesel exhaust would similarly be classified as probably carcinogenic to humans (Group B1).^{51,52} A number of other agencies (National Institute for Occupational Safety and Health, the International Agency for Research on Cancer, the World Health Organization, California EPA, and the U.S. Department of Health and Human Services) have made similar classifications.^{53,54,55,56,57} The Health Effects Institute has prepared numerous studies and reports on the potential carcinogenicity of exposure to diesel exhaust.^{58,59,60}

More specifically, the EPA Diesel HAD states that the conclusions of the document apply to diesel exhaust in use today including both on-road and nonroad engines. The EPA Diesel HAD acknowledges that the studies were done on engines with generally older technologies and that "there have been changes in the physical and chemical composition of some DE [diesel exhaust] emissions (onroad vehicle emissions) over time, though there is no definitive information to show that the emission changes portend significant toxicological changes." Since the Diesel HAD was written there have been regulations finalized which impact the emissions from new diesel engines. For instance, the 2007 Heavy Duty Diesel rulemaking includes standards that both greatly reduce the mass of PM emitted and change the composition of the remaining mass.^K It will take many years for the percentage of highway diesel emissions which come from 2007 and later model year engines to be significant.

^K The Health Effects Institute (HEI) is using funding from EPA and others to characterize composition and potential health impacts of diesel emissions from new engines in their Advanced Collaborative Emissions Study (ACES).

For the Diesel HAD, EPA reviewed 22 epidemiologic studies on the subject of the carcinogenicity of exposure to diesel exhaust in various occupations, finding increased lung cancer risk, although not always statistically significant, in 8 out of 10 cohort studies and 10 out of 12 case-control studies which covered several industries. Relative risk for lung cancer, associated with exposure, ranged from 1.2 to 1.5, although a few studies show relative risks as high as 2.6. Additionally, the Diesel HAD also relied on two independent meta-analyses, which examined 23 and 30 occupational studies respectively, and found statistically significant increases of 1.33 to 1.47 in smoking-adjusted relative lung cancer risk associated with diesel exhaust. These meta-analyses demonstrate the effect of pooling many studies and in this case show the positive relationship between diesel exhaust exposure and lung cancer across a variety of diesel exhaust-exposed occupations.^{61,62,63}

EPA generally derives cancer unit risk estimates to calculate population risk more precisely from exposure to carcinogens. In the simplest terms, the cancer unit risk is the increased risk associated with average lifetime exposure of $1 \mu\text{g}/\text{m}^3$. EPA concluded in the Diesel HAD that it is not currently possible to calculate a cancer unit risk for diesel exhaust due to a variety of factors that limit the current studies, such as a lack of standard exposure metric for diesel exhaust and the absence of quantitative exposure characterization in retrospective studies.

In the absence of a cancer unit risk, the Diesel HAD sought to provide additional insight into the significance of the diesel exhaust-cancer hazard by estimating possible ranges of risk that might be present in the population. An exploratory analysis was used to characterize a possible risk range by comparing a typical environmental exposure level for highway diesel sources to a selected range of occupational exposure levels. The occupationally observed risks were then proportionally scaled according to the exposure ratios to obtain an estimate of the possible environmental risk. If the occupational and environmental exposures are similar, the environmental risk would approach the risk seen in the occupational studies whereas a much higher occupational exposure indicates that the environmental risk is lower than the occupational risk. A comparison of environmental and occupational exposures showed that for certain occupations the exposures are similar to environmental exposures while, for others, they differ by a factor of about 200 or more.

A number of calculations are involved in the exploratory analysis of a possible risk range, and these can be seen in the EPA Diesel HAD. The outcome was that environmental risks from diesel exhaust exposure could range from a low of 10^{-4} to 10^{-5} to as high as 10^{-3} , reflecting the range of occupational exposures that could be associated with the relative and absolute risk levels observed in the occupational studies. Because of uncertainties, the analysis acknowledged that the risks could be lower than 10^{-4} or 10^{-5} , and a zero risk from diesel exhaust exposure was not ruled out.

As mentioned in Section 8.1.1.9, EPA recently assessed air toxic emissions and their associated risk (the National-Scale Air Toxics Assessment or NATA for 2005), and concluded that diesel exhaust ranks with other emissions that the national-scale assessment suggests pose the greatest relative risk.⁶⁴ This national assessment estimates average population inhalation exposures to DPM for nonroad as well as on-highway sources. These are the sum of ambient levels in various locations weighted by the amount of time people spend in each of the locations.

Regulatory Impact Analysis

In summary, even though EPA does not have a specific carcinogenic potency with which to accurately estimate the carcinogenic impact of exposure to diesel exhaust, the likely hazard to humans together with the potential for significant environmental risks leads us to conclude that diesel exhaust emissions from heavy-duty diesel engines present public health issues of concern to this final action.

8.1.1.9.1.2 Other Health Effects of Exposure to Diesel Exhaust

Noncancer health effects of acute and chronic exposure to diesel exhaust emissions are also of concern to the EPA. The Diesel HAD established an inhalation Reference Concentration (RfC) specifically based on animal studies of diesel exhaust exposure. An RfC is defined by EPA as “an estimate of a continuous inhalation exposure to the human population, including sensitive subgroups, with uncertainty spanning perhaps an order of magnitude, which is likely to be without appreciable risks of deleterious noncancer effects during a lifetime.” EPA derived the RfC from consideration of four well-conducted chronic rat inhalation studies showing adverse pulmonary effects.^{65,66,67,68} The diesel RfC is based on a “no observable adverse effect” level of $144 \mu\text{g}/\text{m}^3$ that is further reduced by applying uncertainty factors of 3 for interspecies extrapolation and 10 for human variations in sensitivity. The resulting RfC derived in the Diesel HAD is $5 \mu\text{g}/\text{m}^3$ for diesel exhaust as measured by DPM. This RfC does not consider allergenic effects such as those associated with asthma or immunologic effects. There is growing evidence that exposure to diesel exhaust can exacerbate these effects, but the exposure-response data is presently lacking to derive an RfC. The EPA Diesel HAD states, “With DPM [diesel particulate matter] being a ubiquitous component of ambient PM, there is an uncertainty about the adequacy of the existing DE [diesel exhaust] noncancer database to identify all of the pertinent DE-caused noncancer health hazards.”

DPM is a component of the ambient particles studied in numerous epidemiologic studies. The conclusion that health effects associated with ambient PM in general are relevant to DPM is supported by studies that specifically associate observable human noncancer health effects with exposure to DPM. As described in the Diesel HAD, these studies identified some of the same health effects reported for ambient PM, such as respiratory symptoms (cough, labored breathing, chest tightness, wheezing), and chronic respiratory disease (cough, phlegm, chronic bronchitis and suggestive evidence for decreases in pulmonary function). Symptoms of immunological effects such as wheezing and increased allergenicity are also seen. Studies in rodents, especially rats, show the potential for human inflammatory effects in the lung and consequential lung tissue damage from chronic diesel exhaust inhalation exposure. The Diesel HAD concludes “that acute exposure to DE [diesel exhaust] has been associated with irritation of the eye, nose, and throat, respiratory symptoms (cough and phlegm), and neurophysiological symptoms such as headache, lightheadedness, nausea, vomiting, and numbness or tingling of the extremities.”⁶⁹ There is also evidence for an immunologic effect such as the exacerbation of allergenic responses to known allergens and asthma-like symptoms.^{70,71,72}

The Diesel HAD briefly summarizes health effects associated with ambient PM and discusses the $\text{PM}_{2.5}$ NAAQS. There is a much more extensive body of human data, which is also mentioned earlier in the health effects discussion for $\text{PM}_{2.5}$ (Section 8.1.1.2 of this RIA), showing a wide spectrum of adverse health effects associated with exposure to ambient PM, of

Heavy-Duty GHG and Fuel Efficiency Standards FRM: Health and Environmental Impacts

which diesel exhaust is an important component. The PM_{2.5} NAAQS is designed to provide protection from the non-cancer and premature mortality effects of PM_{2.5} as a whole.

8.1.1.9.1.3 Ambient Levels of Diesel Exhaust PM

Because DPM is part of overall ambient PM and cannot be easily distinguished from overall PM, we do not have direct measurements of DPM in the ambient air. DPM concentrations are estimated using ambient air quality modeling based on DPM emission inventories. DPM concentrations were recently estimated as part of the 2005 NATA.⁷³ Ambient impacts of mobile source emissions were predicted using the Assessment System for Population Exposure Nationwide (ASPEN) dispersion model.

Concentrations of DPM were calculated at the census tract level in the 2005 NATA. Figure 8-1 below summarizes the distribution of ambient DPM concentrations at the national scale. Areas with high concentrations are clustered in the Northeast, Great Lake States, California, and the Gulf Coast States, and are also distributed throughout the rest of the U.S. Table 8-1 presents a distribution of ambient DPM concentrations around the country. The median DPM concentration calculated nationwide is 0.53 µg/m³. Half of the DPM and diesel exhaust organic gases can be attributed to onroad diesels.

Figure 8-1 Estimated County Ambient Concentration of Diesel Particulate Matter

2005 NATA Estimated Tract Level Total Diesel PM Concentration

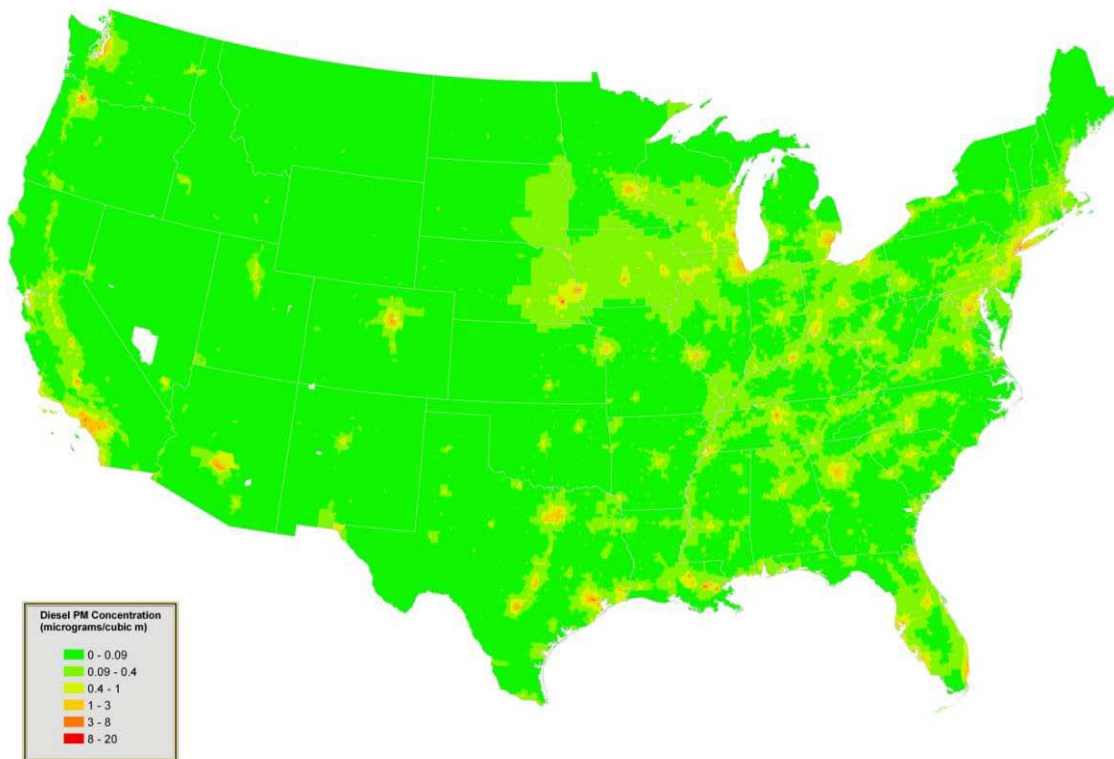

Regulatory Impact Analysis

Table 8-1 Distribution of Census Tract Ambient Concentrations of DPM at the National Scale in 2005 NATA^a

	Ambient Concentration ($\mu\text{g}/\text{m}^3$)
5 th Percentile	0.03
25 th Percentile	0.17
50 th Percentile	0.53
75 th Percentile	1.22
95 th Percentile	2.91
Onroad Contribution to Median Census Tract Concentrations	50%

Note:

^a This table is generated from data contained in the diesel particulate matter Microsoft Access database file found in the Tract-Level Pollutants section of the 2005 NATA webpage (<http://www.epa.gov/ttn/atw/nata2005/tables.html>).

8.1.1.9.1.4 Exposure to Diesel Exhaust PM

Exposure of people to diesel exhaust depends on their various activities, the time spent in those activities, the locations where these activities occur, and the levels of diesel exhaust pollutants in those locations. The major difference between ambient levels of diesel particulate and exposure levels for diesel particulate is that exposure levels account for a person moving from location to location, the proximity to the emission source, and whether the exposure occurs in an enclosed environment.

8.1.1.9.1.4.1 Occupational Exposures

Occupational exposures to diesel exhaust from mobile sources can be several orders of magnitude greater than typical exposures in the non-occupationally exposed population.

Over the years, diesel particulate exposures have been measured for a number of occupational groups resulting in a wide range of exposures from 2 to 1280 $\mu\text{g}/\text{m}^3$ for a variety of occupations. As discussed in the Diesel HAD, the National Institute of Occupational Safety and Health (NIOSH) has estimated a total of 1,400,000 workers are occupationally exposed to diesel exhaust from on-road and nonroad vehicles.

8.1.1.9.1.4.2 Elevated Concentrations and Ambient Exposures in Mobile Source Impacted Areas

Regions immediately downwind of highways or truck stops may experience elevated ambient concentrations of directly-emitted $\text{PM}_{2.5}$ from diesel engines. Due to the unique nature of highways and truck stops, emissions from a large number of diesel engines are concentrated in a small area. Studies near roadways with high truck traffic indicate higher concentrations of components of diesel PM than other locations.^{74,75,76} High ambient particle concentrations have also been reported near trucking terminals, truck stops, and bus garages.^{77,78,79} Additional discussion of exposure and health effects associated with traffic is included below in Section 8.1.1.10.

8.1.1.9.2 *Benzene*

The EPA's IRIS database lists benzene as a known human carcinogen (causing leukemia) by all routes of exposure, and concludes that exposure is associated with additional health effects, including genetic changes in both humans and animals and increased proliferation of bone marrow cells in mice.^{80,81,82} EPA states in its IRIS database that data indicate a causal relationship between benzene exposure and acute lymphocytic leukemia and suggest a relationship between benzene exposure and chronic non-lymphocytic leukemia and chronic lymphocytic leukemia. The International Agency for Research on Carcinogens (IARC) has determined that benzene is a human carcinogen and the U.S. Department of Health and Human Services (DHHS) has characterized benzene as a known human carcinogen.^{83,84}

A number of adverse noncancer health effects including blood disorders, such as preleukemia and aplastic anemia, have also been associated with long-term exposure to benzene.^{85,86} The most sensitive noncancer effect observed in humans, based on current data, is the depression of the absolute lymphocyte count in blood.^{87,88} In addition, recent work, including studies sponsored by the Health Effects Institute (HEI), provides evidence that biochemical responses are occurring at lower levels of benzene exposure than previously known.^{89,90,91,92} EPA's IRIS program has not yet evaluated these new data.

8.1.1.9.3 *1,3-Butadiene*

EPA has characterized 1,3-butadiene as carcinogenic to humans by inhalation.^{93,94} The IARC has determined that 1,3-butadiene is a human carcinogen and the U.S. DHHS has characterized 1,3-butadiene as a known human carcinogen.^{95,96,97} There are numerous studies consistently demonstrating that 1,3-butadiene is metabolized into genotoxic metabolites by experimental animals and humans. The specific mechanisms of 1,3-butadiene-induced carcinogenesis are unknown; however, the scientific evidence strongly suggests that the carcinogenic effects are mediated by genotoxic metabolites. Animal data suggest that females may be more sensitive than males for cancer effects associated with 1,3-butadiene exposure; there are insufficient data in humans from which to draw conclusions about sensitive subpopulations. 1,3-butadiene also causes a variety of reproductive and developmental effects in mice; no human data on these effects are available. The most sensitive effect was ovarian atrophy observed in a lifetime bioassay of female mice.⁹⁸

8.1.1.9.4 *Formaldehyde*

Since 1987, EPA has classified formaldehyde as a probable human carcinogen based on evidence in humans and in rats, mice, hamsters, and monkeys.⁹⁹ Substantial additional research since that time informs current scientific understanding of the health effects associated with exposure to formaldehyde. These include recently published research conducted by the National Cancer Institute (NCI) which found an increased risk of nasopharyngeal cancer and lymphohematopoietic malignancies such as leukemia among workers exposed to formaldehyde.^{100,101} In an analysis of the lymphohematopoietic cancer mortality from an extended follow-up of these workers, NCI confirmed an association between lymphohematopoietic cancer risk and peak formaldehyde exposures.¹⁰² A recent NIOSH study of garment workers also found increased risk of death due to leukemia among workers exposed to

Regulatory Impact Analysis

formaldehyde.¹⁰³ Extended follow-up of a cohort of British chemical workers did not find evidence of an increase in nasopharyngeal or lymphohematopoietic cancers, but a continuing statistically significant excess in lung cancers was reported.¹⁰⁴

In the past 15 years there has been substantial research on the inhalation dosimetry for formaldehyde in rodents and primates by the Chemical Industry Institute of Toxicology (CIIT, now renamed the Hamner Institutes for Health Sciences), with a focus on use of rodent data for refinement of the quantitative cancer dose-response assessment.^{105,106,107} CIIT's risk assessment of formaldehyde incorporated mechanistic and dosimetric information on formaldehyde. These data were modeled using a biologically-motivated two-stage clonal growth model for cancer and also a point of departure based on a Benchmark Dose approach. However, it should be noted that recent research published by EPA indicates that when two-stage modeling assumptions are varied, resulting dose-response estimates can vary by several orders of magnitude.^{108,109,110,111} These findings are not supportive of interpreting the CIIT model results as providing a conservative (health protective) estimate of human risk.¹¹² EPA research also examined the contribution of the two-stage modeling for formaldehyde towards characterizing the relative weights of key events in the mode-of-action of a carcinogen. For example, the model-based inference in the published CIIT study that formaldehyde's direct mutagenic action is not relevant to the compound's tumorigenicity was found not to hold under variations of modeling assumptions.¹¹³

Based on the developments of the last decade, in 2004, the working group of the IARC concluded that formaldehyde is carcinogenic to humans (Group 1), on the basis of sufficient evidence in humans and sufficient evidence in experimental animals - a higher classification than previous IARC evaluations. After reviewing the currently available epidemiological evidence, the IARC (2006) characterized the human evidence for formaldehyde carcinogenicity as "sufficient," based upon the data on nasopharyngeal cancers; the epidemiologic evidence on leukemia was characterized as "strong."¹¹⁴

Formaldehyde exposure also causes a range of noncancer health effects, including irritation of the eyes (burning and watering of the eyes), nose and throat. Effects from repeated exposure in humans include respiratory tract irritation, chronic bronchitis and nasal epithelial lesions such as metaplasia and loss of cilia. Animal studies suggest that formaldehyde may also cause airway inflammation – including eosinophil infiltration into the airways. There are several studies that suggest that formaldehyde may increase the risk of asthma – particularly in the young.^{115,116}

The above-mentioned rodent and human studies, as well as mechanistic information and their analyses, were evaluated in EPA's recent Draft Toxicological Review of Formaldehyde – Inhalation Assessment through the Integrated Risk Information System (IRIS) program. This draft IRIS assessment was released in June 2010 for public review and comment and external peer review by the National Research Council (NRC). The NRC released their review report in April 2011.¹¹⁷ The EPA is currently revising the draft assessment in response to this review.

8.1.1.9.5 *Acetaldehyde*

Acetaldehyde is classified in EPA's IRIS database as a probable human carcinogen, based on nasal tumors in rats, and is considered toxic by the inhalation, oral, and intravenous routes.¹¹⁸ Acetaldehyde is reasonably anticipated to be a human carcinogen by the U.S. DHHS in the 11th Report on Carcinogens and is classified as possibly carcinogenic to humans (Group 2B) by the IARC.^{119,120} EPA is currently conducting a reassessment of cancer risk from inhalation exposure to acetaldehyde.

The primary noncancer effects of exposure to acetaldehyde vapors include irritation of the eyes, skin, and respiratory tract.¹²¹ In short-term (4 week) rat studies, degeneration of olfactory epithelium was observed at various concentration levels of acetaldehyde exposure.^{122,123} Data from these studies were used by EPA to develop an inhalation reference concentration. Some asthmatics have been shown to be a sensitive subpopulation to decrements in functional expiratory volume (FEV1 test) and bronchoconstriction upon acetaldehyde inhalation.¹²⁴ The agency is currently conducting a reassessment of the health hazards from inhalation exposure to acetaldehyde.

8.1.1.9.6 *Acrolein*

Acrolein is extremely acrid and irritating to humans when inhaled, with acute exposure resulting in upper respiratory tract irritation, mucus hypersecretion and congestion. The intense irritancy of this carbonyl has been demonstrated during controlled tests in human subjects, who suffer intolerable eye and nasal mucosal sensory reactions within minutes of exposure.¹²⁵ These data and additional studies regarding acute effects of human exposure to acrolein are summarized in EPA's 2003 IRIS Human Health Assessment for acrolein.¹²⁶ Evidence available from studies in humans indicate that levels as low as 0.09 ppm (0.21 mg/m³) for five minutes may elicit subjective complaints of eye irritation with increasing concentrations leading to more extensive eye, nose and respiratory symptoms.¹²⁷ Lesions to the lungs and upper respiratory tract of rats, rabbits, and hamsters have been observed after subchronic exposure to acrolein.¹²⁸ Acute exposure effects in animal studies report bronchial hyper-responsiveness.¹²⁹ In a recent study, the acute respiratory irritant effects of exposure to 1.1 ppm acrolein were more pronounced in mice with allergic airway disease by comparison to non-diseased mice which also showed decreases in respiratory rate.¹³⁰ Based on these animal data and demonstration of similar effects in humans (*e.g.*, reduction in respiratory rate), individuals with compromised respiratory function (*e.g.*, emphysema, asthma) are expected to be at increased risk of developing adverse responses to strong respiratory irritants such as acrolein.

EPA determined in 2003 that the human carcinogenic potential of acrolein could not be determined because the available data were inadequate. No information was available on the carcinogenic effects of acrolein in humans and the animal data provided inadequate evidence of carcinogenicity.¹³¹ The IARC determined in 1995 that acrolein was not classifiable as to its carcinogenicity in humans.¹³²

8.1.1.9.7 *Polycyclic Organic Matter (POM)*

The term polycyclic organic matter (POM) defines a broad class of compounds that includes the polycyclic aromatic hydrocarbon compounds (PAHs). One of these compounds, naphthalene, is discussed separately below. POM compounds are formed primarily from combustion and are present in the atmosphere in gas and particulate form. Cancer is the major concern from exposure to POM. Epidemiologic studies have reported an increase in lung cancer in humans exposed to diesel exhaust, coke oven emissions, roofing tar emissions, and cigarette smoke; all of these mixtures contain POM compounds.^{L,133} Animal studies have reported respiratory tract tumors from inhalation exposure to benzo[a]pyrene and alimentary tract and liver tumors from oral exposure to benzo[a]pyrene. EPA has classified seven PAHs (benzo[a]pyrene, benz[a]anthracene, chrysene, benzo[b]fluoranthene, benzo[k]fluoranthene, dibenz[a,h]anthracene, and indeno[1,2,3-cd]pyrene) as Group B2, probable human carcinogens.^M Recent studies have found that maternal exposures to PAHs in a population of pregnant women were associated with several adverse birth outcomes, including low birth weight and reduced length at birth, as well as impaired cognitive development in preschool children (3 years of age).^{N,O} EPA has not yet evaluated these recent studies.

8.1.1.9.8 *Naphthalene*

Naphthalene is found in small quantities in gasoline and diesel fuels. Naphthalene emissions have been measured in larger quantities in both gasoline and diesel exhaust compared with evaporative emissions from mobile sources, indicating it is primarily a product of combustion. EPA released an external review draft of a reassessment of the inhalation carcinogenicity of naphthalene based on a number of recent animal carcinogenicity studies.¹³⁴ The draft reassessment completed external peer review.¹³⁵ Based on external peer review comments received, additional analyses are being undertaken. This external review draft does not represent official agency opinion and was released solely for the purposes of external peer review and public comment. The National Toxicology Program listed naphthalene as "reasonably anticipated to be a human carcinogen" in 2004 on the basis of bioassays reporting clear evidence of carcinogenicity in rats and some evidence of carcinogenicity in mice.¹³⁶ California EPA has released a new risk assessment for naphthalene, and the IARC has reevaluated naphthalene and re-classified it as Group 2B: possibly carcinogenic to humans.¹³⁷ Naphthalene also causes a number of chronic non-cancer effects in animals, including abnormal cell changes and growth in respiratory and nasal tissues.¹³⁸

^L Agency for Toxic Substances and Disease Registry (ATSDR). 1995. Toxicological profile for Polycyclic Aromatic Hydrocarbons (PAHs). Atlanta, GA: U.S. Department of Health and Human Services, Public Health Service. Available electronically at <http://www.atsdr.cdc.gov/ToxProfiles/TP.asp?id=122&tid=25>.

^M U.S. EPA (1997). Integrated Risk Information System File of indeno(1,2,3-cd)pyrene. Research and Development, National Center for Environmental Assessment, Washington, DC. This material is available electronically at <http://www.epa.gov/ncea/iris/subst/0457.htm>.

^N Perera, F.P.; Rauh, V.; Tsai, W.-Y.; et al. (2002) Effect of transplacental exposure to environmental pollutants on birth outcomes in a multiethnic population. *Environ Health Perspect.* 111: 201-205.

^O Perera, F.P.; Rauh, V.; Whyatt, R.M.; Tsai, W.Y.; Tang, D.; Diaz, D.; Hoepner, L.; Barr, D.; Tu, Y.H.; Camann, D.; Kinney, P. (2006) Effect of prenatal exposure to airborne polycyclic aromatic hydrocarbons on neurodevelopment in the first 3 years of life among inner-city children. *Environ Health Perspect* 114: 1287-1292.

8.1.1.9.9 *Other Air Toxics*

In addition to the compounds described above, other compounds in gaseous hydrocarbon and PM emissions from vehicles will be affected by today's final action. Mobile source air toxic compounds that would potentially be impacted include ethylbenzene, propionaldehyde, toluene, and xylene. Information regarding the health effects of these compounds can be found in EPA's IRIS database.^P

8.1.1.10 Exposure and Health Effects Associated with Traffic

Populations who live, work, or attend school near major roads experience elevated exposure concentrations to a wide range of air pollutants, as well as higher risks for a number of adverse health effects. While the previous sections of this RIA have focused on the health effects associated with individual criteria pollutants or air toxics, this section discusses the mixture of different exposures near major roadways, rather than the effects of any single pollutant. As such, this section emphasizes traffic-related air pollution, in general, as the relevant indicator of exposure rather than any particular pollutant.

Concentrations of many traffic-generated air pollutants are elevated for up to 300-500 meters downwind of roads with high traffic volumes.¹³⁹ Numerous sources on roads contribute to elevated roadside concentrations, including exhaust and evaporative emissions, and resuspension of road dust and tire and brake wear. Concentrations of several criteria and hazardous air pollutants are elevated near major roads. Furthermore, different semi-volatile organic compounds and chemical components of particulate matter, including elemental carbon, organic material, and trace metals, have been reported at higher concentrations near major roads.

Populations near major roads experience greater risk of certain adverse health effects. The Health Effects Institute published a report on the health effects of traffic-related air pollution.¹⁴⁰ It concluded that evidence is "sufficient to infer the presence of a causal association" between traffic exposure and exacerbation of childhood asthma symptoms. The HEI report also concludes that the evidence is either "sufficient" or "suggestive but not sufficient" for a causal association between traffic exposure and new childhood asthma cases. A review of asthma studies by Salam et al. (2008) reaches similar conclusions.¹⁴¹ The HEI report also concludes that there is "suggestive" evidence for pulmonary function deficits associated with traffic exposure, but concluded that there is "inadequate and insufficient" evidence for causal associations with respiratory health care utilization, adult-onset asthma, COPD symptoms, and allergy. A review by Holguin (2008) notes that the effects of traffic on asthma may be modified by nutrition status, medication use, and genetic factors.¹⁴²

The HEI report also concludes that evidence is "suggestive" of a causal association between traffic exposure and all-cause and cardiovascular mortality. There is also evidence of an association between traffic-related air pollutants and cardiovascular effects such as changes in heart rhythm, heart attack, and cardiovascular disease. The HEI report characterizes this evidence as "suggestive" of a causal association, and an independent epidemiological literature

^P U.S. EPA Integrated Risk Information System (IRIS) database is available at: www.epa.gov/iris

review by Adar and Kaufman (2007) concludes that there is “consistent evidence” linking traffic-related pollution and adverse cardiovascular health outcomes.¹⁴³

Some studies have reported associations between traffic exposure and other health effects, such as birth outcomes (*e.g.*, low birth weight) and childhood cancer. The HEI report concludes that there is currently “inadequate and insufficient” evidence for a causal association between these effects and traffic exposure. A review by Raaschou-Nielsen and Reynolds (2006) concluded that evidence of an association between childhood cancer and traffic-related air pollutants is weak, but noted the inability to draw firm conclusions based on limited evidence.¹⁴⁴

There is a large population in the U.S. living in close proximity of major roads. According to the Census Bureau’s American Housing Survey for 2007, approximately 20 million residences in the U.S., 15.6% of all homes, are located within 300 feet (91 m) of a highway with 4+ lanes, a railroad, or an airport.¹⁴⁵ Therefore, at current population of approximately 309 million, assuming that population and housing are similarly distributed, there are over 48 million people in the U.S. living near such sources. The HEI report also notes that in two North American cities, Los Angeles and Toronto, over 40% of each city’s population live within 500 meters of a highway or 100 meters of a major road. It also notes that about 33% of each city’s population resides within 50 meters of major roads. Together, the evidence suggests that a large U.S. population lives in areas with elevated traffic-related air pollution.

People living near roads are often socioeconomically disadvantaged. According to the 2007 American Housing Survey, a renter-occupied property is over twice as likely as an owner-occupied property to be located near a highway with 4+ lanes, railroad or airport. In the same survey, the median household income of rental housing occupants was less than half that of owner-occupants (\$28,921/\$59,886). Numerous studies in individual urban areas report higher levels of traffic-related air pollutants in areas with high minority or poor populations.^{146,147,148}

Students may also be exposed in situations where schools are located near major roads. In a study of nine metropolitan areas across the U.S., Appatova et al. (2008) found that on average greater than 33% of schools were located within 400 m of an Interstate, US, or state highway, while 12% were located within 100 m.¹⁴⁹ The study also found that among the metropolitan areas studied, schools in the Eastern U.S. were more often sited near major roadways than schools in the Western U.S.

Demographic studies of students in schools near major roadways suggest that this population is more likely than the general student population to be of non-white race or Hispanic ethnicity, and more often live in low socioeconomic status locations.^{150,151,152} There is some inconsistency in the evidence, which may be due to different local development patterns and measures of traffic and geographic scale used in the studies.¹⁴⁹

8.1.2 Environmental Effects Associated with Exposure to Non-GHG Pollutants

In this section we will discuss the environmental effects associated with non-GHG pollutants, specifically: particulate matter, ozone, NO_x, SO_x and air toxics.

Heavy-Duty GHG and Fuel Efficiency Standards FRM: Health and Environmental Impacts

8.1.2.1 Visibility Degradation

Emissions from heavy-duty vehicles contribute to poor visibility in the U.S. through their emissions of primary $PM_{2.5}$ and secondary $PM_{2.5}$ precursors such as NO_x . Airborne particles degrade visibility by scattering and absorbing light. Good visibility increases the quality of life where individuals live and work, and where they engage in recreational activities.

EPA is pursuing a two-part strategy to address visibility impairment. First, EPA developed the regional haze program (64 FR 35714) which was put in place in July 1999 to protect the visibility in Mandatory Class I Federal areas. There are 156 national parks, forests and wilderness areas categorized as Mandatory Class I Federal areas (62 FR 38680-38681, July 18, 1997). These areas are defined in CAA section 162 as those national parks exceeding 6,000 acres, wilderness areas and memorial parks exceeding 5,000 acres, and all international parks which were in existence on August 7, 1977. Second, EPA has concluded that $PM_{2.5}$ causes adverse effects on visibility in other areas that are not protected by the Regional Haze Rule, depending on $PM_{2.5}$ concentrations and other factors that control their visibility impact effectiveness such as dry chemical composition and relative humidity (*i.e.*, an indicator of the water composition of the particles), and has set secondary $PM_{2.5}$ standards to address these areas. The existing annual primary and secondary $PM_{2.5}$ standards have been remanded and are being addressed in the currently ongoing PM NAAQS review. The secondary $PM_{2.5}$ standards serve as a reasonable complement to the Regional Haze Program. Figure 8-2 shows the location of the 156 Mandatory Class I Federal areas.

Figure 8-2 Mandatory Class I Federal Areas in the U.S.



8.1.2.1.1 *Visibility Monitoring*

In conjunction with the U.S. National Park Service, the U.S. Forest Service, other Federal land managers, and State organizations in the U.S., the U.S. EPA has supported visibility monitoring in national parks and wilderness areas since 1988. The monitoring network was originally established at 20 sites, but it has now been expanded to 110 sites that represent all but one of the 156 Mandatory Federal Class I areas across the country (see Figure 8-2). This long-term visibility monitoring network is known as IMPROVE (Interagency Monitoring of Protected Visual Environments).

IMPROVE provides direct measurement of fine particles that contribute to visibility impairment. The IMPROVE network employs aerosol measurements at all sites, and optical and scene measurements at some of the sites. Aerosol measurements are taken for PM₁₀ and PM_{2.5} mass, and for key constituents of PM_{2.5}, such as sulfate, nitrate, organic and elemental carbon, soil dust, and several other elements. Measurements for specific aerosol constituents are used to calculate "reconstructed" aerosol light extinction by multiplying the mass for each constituent by its empirically-derived scattering and/or absorption efficiency, with adjustment for the relative humidity. Knowledge of the main constituents of a site's light extinction "budget" is critical for source apportionment and control strategy development. In addition to this indirect method of assessing light extinction, there are optical measurements which directly measure light extinction or its components. Such measurements are made principally with either a nephelometer to measure light scattering, some sites also include an aethalometer for light absorption, or at a few sites using a transmissometer, which measures total light extinction. Scene characteristics are typically recorded using digital or video photography and are used to determine the quality of visibility conditions (such as effects on color and contrast) associated with specific levels of light extinction as measured under both direct and aerosol-related methods. Directly measured light extinction is used under the IMPROVE protocol to cross check that the aerosol-derived light extinction levels are reasonable in establishing current visibility conditions. Aerosol-derived light extinction is used to document spatial and temporal trends and to determine how changes in atmospheric constituents would affect future visibility conditions.

Annual average visibility conditions (reflecting light extinction due to both anthropogenic and non-anthropogenic sources) vary regionally across the U.S. Visibility is typically worse in the summer months and the rural East generally has higher levels of impairment than remote sites in the West. Figures 9-9 through 9-11 in the PM ISA detail the percent contributions to particulate light extinction for ammonium nitrate and sulfate, elemental carbon (EC) and organic carbon (OC), and coarse mass and fine soil, by season.¹⁵³

8.1.2.2 Plant and Ecosystem Effects of Ozone

There are a number of environmental or public welfare effects associated with the presence of ozone in the ambient air.¹⁵⁴ In this section we discuss the impact of ozone on plants, including trees, agronomic crops and urban ornamentals.

The Air Quality Criteria Document for Ozone and related Photochemical Oxidants notes that, "ozone affects vegetation throughout the United States, impairing crops, native vegetation, and ecosystems more than any other air pollutant."¹⁵⁵ Like carbon dioxide (CO₂) and other

gaseous substances, ozone enters plant tissues primarily through apertures (stomata) in leaves in a process called “uptake.”¹⁵⁶ Once sufficient levels of ozone (a highly reactive substance), or its reaction products, reaches the interior of plant cells, it can inhibit or damage essential cellular components and functions, including enzyme activities, lipids, and cellular membranes, disrupting the plant's osmotic (*i.e.*, water) balance and energy utilization patterns.^{157,158} If enough tissue becomes damaged from these effects, a plant's capacity to fix carbon to form carbohydrates, which are the primary form of energy used by plants, is reduced,¹⁵⁹ while plant respiration increases. With fewer resources available, the plant reallocates existing resources away from root growth and storage, above ground growth or yield, and reproductive processes, toward leaf repair and maintenance, leading to reduced growth and/or reproduction. Studies have shown that plants stressed in these ways may exhibit a general loss of vigor, which can lead to secondary impacts that modify plants' responses to other environmental factors. Specifically, plants may become more sensitive to other air pollutants, more susceptible to disease, insect attack, harsh weather (*e.g.*, drought, frost) and other environmental stresses. Furthermore, there is evidence that ozone can interfere with the formation of mycorrhiza, essential symbiotic fungi associated with the roots of most terrestrial plants, by reducing the amount of carbon available for transfer from the host to the symbiont.^{160,161}

This ozone damage may or may not be accompanied by visible injury on leaves, and likewise, visible foliar injury may or may not be a symptom of the other types of plant damage described above. When visible injury is present, it is commonly manifested as chlorotic or necrotic spots, and/or increased leaf senescence (accelerated leaf aging). Because ozone damage can consist of visible injury to leaves, it can also reduce the aesthetic value of ornamental vegetation and trees in urban landscapes, and negatively affects scenic vistas in protected natural areas.

Ozone can produce both acute and chronic injury in sensitive species depending on the concentration level and the duration of the exposure. Ozone effects also tend to accumulate over the growing season of the plant, so that even lower concentrations experienced for a longer duration have the potential to create chronic stress on sensitive vegetation. Not all plants, however, are equally sensitive to ozone. Much of the variation in sensitivity between individual plants or whole species is related to the plant's ability to regulate the extent of gas exchange via leaf stomata (*e.g.*, avoidance of ozone uptake through closure of stomata)^{162,163,164} Other resistance mechanisms may involve the intercellular production of detoxifying substances. Several biochemical substances capable of detoxifying ozone have been reported to occur in plants, including the antioxidants ascorbate and glutathione. After injuries have occurred, plants may be capable of repairing the damage to a limited extent.¹⁶⁵

Because of the differing sensitivities among plants to ozone, ozone pollution can also exert a selective pressure that leads to changes in plant community composition. Given the range of plant sensitivities and the fact that numerous other environmental factors modify plant uptake and response to ozone, it is not possible to identify threshold values above which ozone is consistently toxic for all plants. The next few paragraphs present additional information on ozone damage to trees, ecosystems, agronomic crops and urban ornamentals.

Assessing the impact of ground-level ozone on forests in the United States involves understanding the risks to sensitive tree species from ambient ozone concentrations and

Regulatory Impact Analysis

accounting for the prevalence of those species within the forest. As a way to quantify the risks to particular plants from ground-level ozone, scientists have developed ozone-exposure/tree-response functions by exposing tree seedlings to different ozone levels and measuring reductions in growth as “biomass loss.” Typically, seedlings are used because they are easy to manipulate and measure their growth loss from ozone pollution. The mechanisms of susceptibility to ozone within the leaves of seedlings and mature trees are identical, though the magnitude of the effect may be higher or lower depending on the tree species.¹⁶⁶

Some of the common tree species in the United States that are sensitive to ozone are black cherry (*Prunus serotina*), tulip-poplar (*Liriodendron tulipifera*), and eastern white pine (*Pinus strobus*). Ozone-exposure/tree-response functions have been developed for each of these tree species, as well as for aspen (*Populus tremuloides*), and ponderosa pine (*Pinus ponderosa*). Other common tree species, such as oak (*Quercus* spp.) and hickory (*Carya* spp.), are not nearly as sensitive to ozone. Consequently, with knowledge of the distribution of sensitive species and the level of ozone at particular locations, it is possible to estimate a “biomass loss” for each species across their range.

Ozone also has been conclusively shown to cause discernible injury to forest trees.^{167,168} In terms of forest productivity and ecosystem diversity, ozone may be the pollutant with the greatest potential for regional-scale forest impacts. Studies have demonstrated repeatedly that ozone concentrations commonly observed in polluted areas can have substantial impacts on plant function.^{169,170}

Because plants are at the base of the food web in many ecosystems, changes to the plant community can affect associated organisms and ecosystems (including the suitability of habitats that support threatened or endangered species and below ground organisms living in the root zone). Ozone impacts at the community and ecosystem level vary widely depending upon numerous factors, including concentration and temporal variation of tropospheric ozone, species composition, soil properties and climatic factors.¹⁷¹ In most instances, responses to chronic or recurrent exposure in forested ecosystems are subtle and not observable for many years. These injuries can cause stand-level forest decline in sensitive ecosystems.^{172,173,174} It is not yet possible to predict ecosystem responses to ozone with much certainty; however, considerable knowledge of potential ecosystem responses has been acquired through long-term observations in highly damaged forests in the United States.

Air pollution can have noteworthy cumulative impacts on forested ecosystems by affecting regeneration, productivity, and species composition.¹⁷⁵ In the U.S., ozone in the lower atmosphere is one of the pollutants of primary concern. Ozone injury to forest plants can be diagnosed by examination of plant leaves. Foliar injury is usually the first visible sign of injury to plants from ozone exposure and indicates impaired physiological processes in the leaves.¹⁷⁶ However, not all impaired plants will exhibit visible symptoms.

Laboratory and field experiments have also shown reductions in yields for agronomic crops exposed to ozone, including vegetables (*e.g.*, lettuce) and field crops (*e.g.*, cotton and wheat). The most extensive field experiments, conducted under the National Crop Loss Assessment Network (NCLAN) examined 15 species and numerous cultivars. The NCLAN results show that “several economically important crop species are sensitive to ozone levels

typical of those found in the United States.”¹⁷⁷ In addition, economic studies have shown reduced economic benefits as a result of predicted reductions in crop yields associated with observed ozone levels.^{178,179,180}

Urban ornamentals represent an additional vegetation category likely to experience some degree of negative effects associated with exposure to ambient ozone levels. It is estimated that more than \$20 billion (1990 dollars) are spent annually on landscaping using ornamentals, both by private property owners/tenants and by governmental units responsible for public areas.¹⁸¹ This is therefore a potentially costly environmental effect. However, in the absence of adequate exposure-response functions and economic damage functions for the potential range of effects relevant to these types of vegetation, no direct quantitative analysis has been conducted.

8.1.2.2.1 *Recent Ozone Visible Foliar Injury Data for the U.S.*

In the U.S. the national-level visible foliar injury indicator is based on data from the U.S. Department of Agriculture (USDA) Forest Service Forest Inventory and Analysis (FIA) program. As part of its Phase 3 program, formerly known as Forest Health Monitoring, FIA examines ozone injury to ozone-sensitive plant species at ground monitoring sites in forest land across the country. For this indicator, forest land does not include woodlots and urban trees. Sites are selected using a systematic sampling grid, based on a global sampling design.^{182,183} At each site that has at least 30 individual plants of at least three ozone-sensitive species and enough open space to ensure that sensitive plants are not protected from ozone exposure by the forest canopy, FIA looks for damage on the foliage of ozone-sensitive forest plant species. Because ozone injury is cumulative over the course of the growing season, examinations are conducted in July and August, when ozone injury is typically highest. Monitoring of ozone injury to plants by the USDA Forest Service has expanded over time from monitoring sites in 10 states in 1994 to nearly 1,000 monitoring sites in 41 states in 2002.

There is considerable regional variation in ozone-related visible foliar injury to sensitive plants in the U.S. The U.S. EPA has developed an environmental indicator based on data from the USDA FIA program which examines ozone injury to ozone-sensitive plant species at ground monitoring sites in forest land across the country. The data underlying the indicator in Figure 8-3 is based on averages of all observations collected in 2002, the latest year for which data are publicly available at the time the study was conducted, and is broken down by U.S. EPA Region. Ozone damage to forest plants is classified using a subjective five-category biosite index based on expert opinion, but designed to be equivalent from site to site. Ranges of biosite values translate to no injury, low or moderate foliar injury (visible foliar injury to highly sensitive or moderately sensitive plants, respectively), and high or severe foliar injury, which would be expected to result in tree-level or ecosystem-level responses, respectively.^{184,185}

The highest percentages of observed high and severe foliar injury, those which are most likely to be associated with tree or ecosystem-level responses, are primarily found in the Mid-Atlantic and Southeast regions. In EPA Region 3 (which comprises the States of Pennsylvania, West Virginia, Virginia, Delaware, Maryland and Washington D.C.), 12% of ozone-sensitive plants showed signs of high or severe foliar damage, and in Regions 2 (States of New York, New Jersey), and 4 (States of North Carolina, South Carolina, Kentucky, Tennessee, Georgia, Florida, Alabama, and Mississippi) the values were 10% and 7%, respectively. The sum of high and

Regulatory Impact Analysis

severe ozone injury ranged from 2% to 4% in EPA Region 1 (the six New England States), Region 7 (States of Missouri, Iowa, Nebraska and Kansas), and Region 9 (States of California, Nevada, Hawaii and Arizona). The percentage of sites showing some ozone damage was about 45% in each of these EPA Regions.

Figure 8-3 Ozone Injury to Forest Plants in U.S. by EPA Regions, 2002^{a,b}

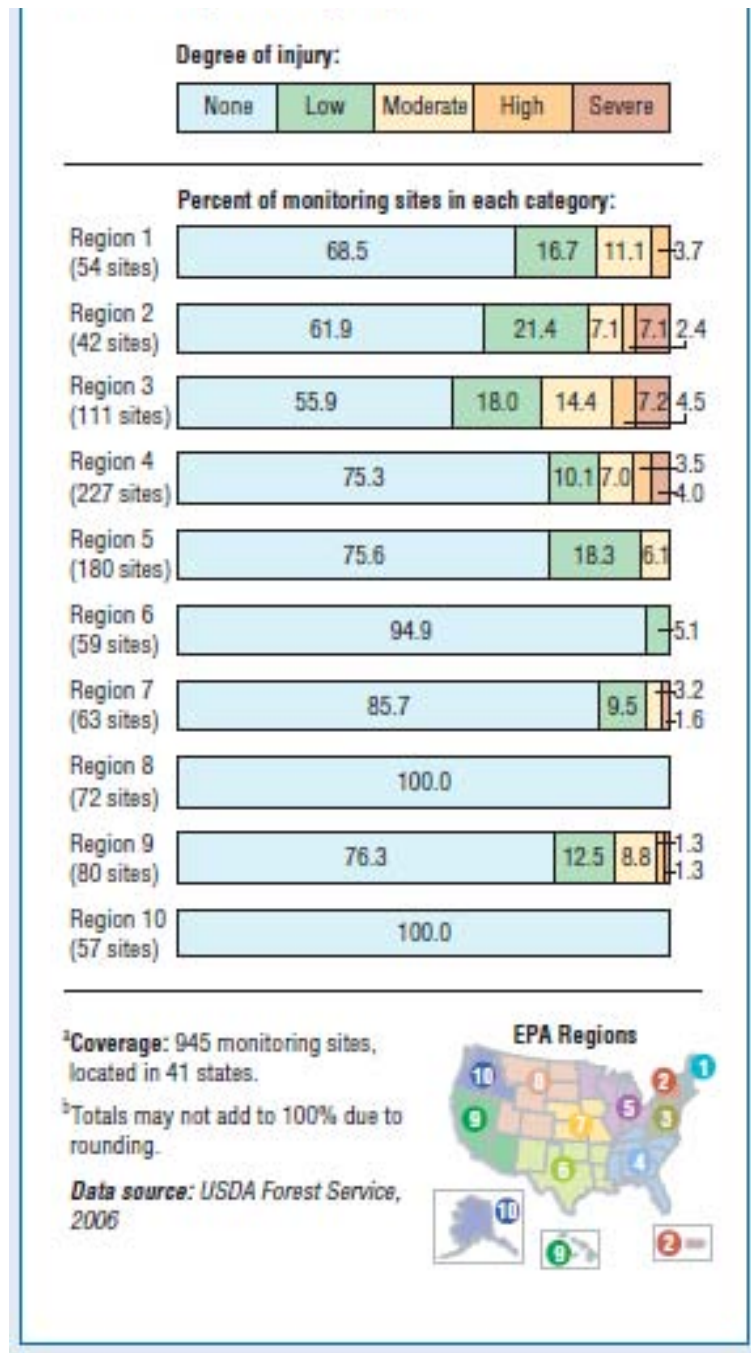

8.1.2.2.1.1 Indicator Limitations

The categories for the biosite index are subjective and may not necessarily be directly related to biomass loss or physiological damage to plants in a particular area. Ozone may have other adverse impacts on plants (*e.g.*, reduced productivity) that do not show signs of visible foliar injury.¹⁸⁶ The presence of diagnostic visible ozone injury on indicator plants does provide evidence that ozone is having an impact in an area. However, absence of ozone injury in an area does not necessarily mean that there is no impact from ozone exposure.

Field and laboratory studies were reviewed to identify the forest plant species in each region that are sensitive to ozone air pollution and exhibit diagnostic injury. Other forest plant species, or even genetic variants of the same species, may not show symptoms at ozone levels that cause effects on the selected ozone-sensitive species.

Because species distributions vary regionally, different ozone-sensitive plant species were examined in different parts of the country. These target species could vary with respect to ozone sensitivity, which might account for some of the apparent differences in ozone injury among regions of the U.S. Ozone damage to foliage may be reduced under conditions of low soil moisture, but most of the variability in the index (70%) was explained by ozone concentration.¹⁸⁷

Though FIA has extensive spatial coverage based on a robust sample design, not all forested areas in the U.S. are monitored for ozone injury. Even though the biosite data have been collected over multiple years, most biosites were not monitored over the entire period, so these data cannot provide more than a baseline for future trends.

8.1.2.3 Particulate Matter Deposition

Particulate matter contributes to adverse effects on vegetation and ecosystems, and to soiling and materials damage. These welfare effects result predominately from exposure to excess amounts of specific chemical species, regardless of their source or predominant form (particle, gas or liquid). The following characterizations of the nature of these environmental effects are based on information contained in the 2009 PM ISA and the 2005 PM Staff Paper as well as the Integrated Science Assessment for Oxides of Nitrogen and Sulfur- Ecological Criteria.^{188,189,190}

8.1.2.3.1 *Deposition of Nitrogen and Sulfur*

Nitrogen and sulfur interactions in the environment are highly complex. Both nitrogen and sulfur are essential, and sometimes limiting, nutrients needed for growth and productivity. Excesses of nitrogen or sulfur can lead to acidification, nutrient enrichment, and eutrophication of aquatic ecosystems.¹⁹¹

The process of acidification affects both freshwater aquatic and terrestrial ecosystems. Acid deposition causes acidification of sensitive surface waters. The effects of acid deposition on aquatic systems depend largely upon the ability of the ecosystem to neutralize the additional acid. As acidity increases, aluminum leached from soils and sediments, flows into lakes and

Regulatory Impact Analysis

streams and can be toxic to both terrestrial and aquatic biota. The lower pH concentrations and higher aluminum levels resulting from acidification make it difficult for some fish and other aquatic organisms to survive, grow, and reproduce. Research on effects of acid deposition on forest ecosystems has come to focus increasingly on the biogeochemical processes that affect uptake, retention, and cycling of nutrients within these ecosystems. Decreases in available base cations from soils are at least partly attributable to acid deposition. Base cation depletion is a cause for concern because of the role these ions play in acid neutralization, and because calcium, magnesium and potassium are essential nutrients for plant growth and physiology. Changes in the relative proportions of these nutrients, especially in comparison with aluminum concentrations, have been associated with declining forest health.

At current ambient levels, risks to vegetation from short-term exposures to dry deposited particulate nitrate or sulfate are low. However, when found in acid or acidifying deposition, such particles do have the potential to cause direct leaf injury. Specifically, the responses of forest trees to acid precipitation (rain, snow) include accelerated weathering of leaf cuticular surfaces, increased permeability of leaf surfaces to toxic materials, water, and disease agents; increased leaching of nutrients from foliage; and altered reproductive processes—all which serve to weaken trees so that they are more susceptible to other stresses (*e.g.*, extreme weather, pests, pathogens). Acid deposition with levels of acidity associated with the leaf effects described above are currently found in some locations in the eastern U.S.¹⁹² Even higher concentrations of acidity can be present in occult depositions (*e.g.*, fog, mist or clouds) which more frequently impacts higher elevations. Thus, the risk of leaf injury occurring from acid deposition in some areas of the eastern U.S. is high. Nitrogen deposition has also been shown to impact ecosystems in the western U.S. A study conducted in the Columbia River Gorge National Scenic Area (CRGNSA), located along a portion of the Oregon/Washington border, indicates that lichen communities in the CRGNSA have shifted to a higher proportion of nitrophilous species and the nitrogen content of lichen tissue is elevated.¹⁹³ Lichens are sensitive indicators of nitrogen deposition effects to terrestrial ecosystems and the lichen studies in the Columbia River Gorge clearly show that ecological effects from air pollution are occurring.

Some of the most significant detrimental effects associated with excess nitrogen deposition are those associated with a condition known as nitrogen saturation. Nitrogen saturation is the condition in which nitrogen inputs from atmospheric deposition and other sources exceed the biological requirements of the ecosystem. The effects associated with nitrogen saturation include: (1) decreased productivity, increased mortality, and/or shifts in plant community composition, often leading to decreased biodiversity in many natural habitats wherever atmospheric reactive nitrogen deposition increases significantly above background and critical thresholds are exceeded; (2) leaching of excess nitrate and associated base cations from soils into streams, lakes, and rivers, and mobilization of soil aluminum; and (3) fluctuation of ecosystem processes such as nutrient and energy cycles through changes in the functioning and species composition of beneficial soil organisms.¹⁹⁴

In the U.S. numerous forests now show severe symptoms of nitrogen saturation. These forests include: the northern hardwoods and mixed conifer forests in the Adirondack and Catskill Mountains of New York; the red spruce forests at Whitetop Mountain, Virginia, and Great Smoky Mountains National Park, North Carolina; mixed hardwood watersheds at Fernow Experimental Forest in West Virginia; American beech forests in Great Smoky Mountains

National Park, Tennessee; mixed conifer forests and chaparral watersheds in southern California and the southwestern Sierra Nevada in Central California; the alpine tundra/subalpine conifer forests of the Colorado Front Range; and red alder forests in the Cascade Mountains in Washington.

Excess nutrient inputs into aquatic ecosystems (*i.e.* streams, rivers, lakes, estuaries or oceans) either from direct atmospheric deposition, surface runoff, or leaching from nitrogen saturated soils into ground or surface waters can contribute to conditions of severe water oxygen depletion; eutrophication and algae blooms; altered fish distributions, catches, and physiological states; loss of biodiversity; habitat degradation; and increases in the incidence of disease.

Atmospheric deposition of nitrogen is a significant source of total nitrogen to many estuaries in the United States. The amount of nitrogen entering estuaries that is ultimately attributable to atmospheric deposition is not well-defined. On an annual basis, atmospheric nitrogen deposition may contribute significantly to the total nitrogen load, depending on the size and location of the watershed. In addition, episodic nitrogen inputs, which may be ecologically important, may play a more important role than indicated by the annual average concentrations. Estuaries in the U.S. that suffer from nitrogen enrichment often experience a condition known as eutrophication. Symptoms of eutrophication include changes in the dominant species of phytoplankton, low levels of oxygen in the water column, fish and shellfish kills, outbreaks of toxic alga, and other population changes which can cascade throughout the food web. In addition, increased phytoplankton growth in the water column and on surfaces can attenuate light causing declines in submerged aquatic vegetation, which serves as an important habitat for many estuarine fish and shellfish species.

Severe and persistent eutrophication often directly impacts human activities. For example, losses in the nation's fishery resources may be directly caused by fish kills associated with low dissolved oxygen and toxic blooms. Declines in tourism occur when low dissolved oxygen causes noxious smells and floating mats of algal blooms create unfavorable aesthetic conditions. Risks to human health increase when the toxins from algal blooms accumulate in edible fish and shellfish, and when toxins become airborne, causing respiratory problems due to inhalation. According to a NOAA report, more than half of the nation's estuaries have moderate to high expressions of at least one of these symptoms – an indication that eutrophication is well developed in more than half of U.S. estuaries.¹⁹⁵

8.1.2.3.2 *Deposition of Heavy Metals*

Heavy metals, including cadmium, copper, lead, chromium, mercury, nickel and zinc, have the greatest potential for impacting forest growth.¹⁹⁶ Investigation of trace metals near roadways and industrial facilities indicate that a substantial load of heavy metals can accumulate on vegetative surfaces. Copper, zinc, and nickel have been documented to cause direct toxicity to vegetation under field conditions. Little research has been conducted on the effects associated with mixtures of contaminants found in ambient PM. While metals typically exhibit low solubility, limiting their bioavailability and direct toxicity, chemical transformations of metal compounds occur in the environment, particularly in the presence of acidic or other oxidizing species. These chemical changes influence the mobility and toxicity of metals in the environment. Once taken up into plant tissue, a metal compound can undergo chemical changes,

Regulatory Impact Analysis

exert toxic effects on the plant itself, accumulate and be passed along to herbivores or can re-enter the soil and further cycle in the environment. Although there has been no direct evidence of a physiological association between tree injury and heavy metal exposures, heavy metals have been implicated because of similarities between metal deposition patterns and forest decline. This hypothesized relationship/correlation was further explored in high elevation forests in the northeastern U.S. These studies measured levels of a group of intracellular compounds found in plants that bind with metals and are produced by plants as a response to sublethal concentrations of heavy metals. These studies indicated a systematic and significant increase in concentrations of these compounds associated with the extent of tree injury. These data strongly imply that metal stress causes tree injury and contributes to forest decline in the northeastern United States.¹⁹⁷ Contamination of plant leaves by heavy metals can lead to elevated soil levels. Trace metals absorbed into the plant frequently bind to the leaf tissue, and then are lost when the leaf drops. As the fallen leaves decompose, the heavy metals are transferred into the soil.^{198,199} Upon entering the soil environment, PM pollutants can alter ecological processes of energy flow and nutrient cycling, inhibit nutrient uptake, change ecosystem structure, and affect ecosystem biodiversity. Many of the most important effects occur in the soil. The soil environment is one of the most dynamic sites of biological interaction in nature. It is inhabited by microbial communities of bacteria, fungi, and actinomycetes. These organisms are essential participants in the nutrient cycles that make elements available for plant uptake. Changes in the soil environment that influence the role of the bacteria and fungi in nutrient cycling determine plant and ultimately ecosystem response.²⁰⁰

The environmental sources and cycling of mercury are currently of particular concern due to the bioaccumulation and biomagnification of this metal in aquatic ecosystems and the potent toxic nature of mercury in the forms in which it is ingested by people and other animals. Mercury is unusual compared with other metals in that it largely partitions into the gas phase (in elemental form), and therefore has a longer residence time in the atmosphere than a metal found predominantly in the particle phase. This property enables mercury to travel far from the primary source before being deposited and accumulating in the aquatic ecosystem. The major source of mercury in the Great Lakes is from atmospheric deposition, accounting for approximately eighty percent of the mercury in Lake Michigan.^{201,202} Over fifty percent of the mercury in the Chesapeake Bay has been attributed to atmospheric deposition.²⁰³ Overall, the National Science and Technology Council identifies atmospheric deposition as the primary source of mercury to aquatic systems.²⁰⁴ Forty-four states have issued health advisories for the consumption of fish contaminated by mercury; however, most of these advisories are issued in areas without a mercury point source.

Elevated levels of zinc and lead have been identified in streambed sediments, and these elevated levels have been correlated with population density and motor vehicle use.^{205,206} Zinc and nickel have also been identified in urban water and soils. In addition, platinum, palladium, and rhodium, metals found in the catalysts of modern motor vehicles, have been measured at elevated levels along roadsides.²⁰⁷ Plant uptake of platinum has been observed at these locations.

8.1.2.3.3 *Deposition of Polycyclic Organic Matter*

Polycyclic organic matter (POM) is a byproduct of incomplete combustion and consists of organic compounds with more than one benzene ring and a boiling point greater than or equal to 100 degrees centigrade.²⁰⁸ Polycyclic aromatic hydrocarbons (PAHs) are a class of POM that contains compounds which are known or suspected carcinogens.

Major sources of PAHs include mobile sources. PAHs in the environment may be present as a gas or adsorbed onto airborne particulate matter. Since the majority of PAHs are adsorbed onto particles less than 1.0 µm in diameter, long range transport is possible. However, studies have shown that PAH compounds adsorbed onto diesel exhaust particulate and exposed to ozone have half lives of 0.5 to 1.0 hours.²⁰⁹

Since PAHs are insoluble, the compounds generally are particle reactive and accumulate in sediments. Atmospheric deposition of particles is believed to be the major source of PAHs to the sediments of Lake Michigan.^{210,211} Analyses of PAH deposition in Chesapeake and Galveston Bay indicate that dry deposition and gas exchange from the atmosphere to the surface water predominate.^{212,213} Sediment concentrations of PAHs are high enough in some segments of Tampa Bay to pose an environmental health threat. EPA funded a study to better characterize the sources and loading rates for PAHs into Tampa Bay.²¹⁴ PAHs that enter a water body through gas exchange likely partition into organic rich particles and can be biologically recycled, while dry deposition of aerosols containing PAHs tend to be more resistant to biological recycling.²¹⁵ Thus, dry deposition is likely the main pathway for PAH concentrations in sediments while gas/water exchange at the surface may lead to PAH distribution into the food web, leading to increased health risk concerns.

Trends in PAH deposition levels are difficult to discern because of highly variable ambient air concentrations, lack of consistency in monitoring methods, and the significant influence of local sources on deposition levels.²¹⁶ Van Metre et al. noted PAH concentrations in urban reservoir sediments have increased by 200-300% over the last forty years and correlate with increases in automobile use.²¹⁷

Cousins et al. estimate that more than ninety percent of semi-volatile organic compound (SVOC) emissions in the United Kingdom deposit on soil.²¹⁸ An analysis of PAH concentrations near a Czechoslovakian roadway indicated that concentrations were thirty times greater than background.²¹⁹

8.1.2.3.4 *Materials Damage and Soiling*

The effects of the deposition of atmospheric pollution, including ambient PM, on materials are related to both physical damage and impaired aesthetic qualities. The deposition of PM (especially sulfates and nitrates) can physically affect materials, adding to the effects of natural weathering processes, by potentially promoting or accelerating the corrosion of metals, by degrading paints, and by deteriorating building materials such as concrete and limestone. Only chemically active fine particles or hygroscopic coarse particles contribute to these physical effects. In addition, the deposition of ambient PM can reduce the aesthetic appeal of buildings and culturally important articles through soiling. Particles consisting primarily of carbonaceous

compounds cause soiling of commonly used building materials and culturally important items such as statues and works of art.

8.1.2.4 Environmental Effects of Air Toxics

Emissions from producing, transporting and combusting fuel contribute to ambient levels of pollutants that contribute to adverse effects on vegetation. Volatile organic compounds (VOCs), some of which are considered air toxics, have long been suspected to play a role in vegetation damage.²²⁰ In laboratory experiments, a wide range of tolerance to VOCs has been observed.²²¹ Decreases in harvested seed pod weight have been reported for the more sensitive plants, and some studies have reported effects on seed germination, flowering and fruit ripening. Effects of individual VOCs or their role in conjunction with other stressors (*e.g.*, acidification, drought, temperature extremes) have not been well studied. In a recent study of a mixture of VOCs including ethanol and toluene on herbaceous plants, significant effects on seed production, leaf water content and photosynthetic efficiency were reported for some plant species.²²²

Research suggests an adverse impact of vehicle exhaust on plants, which has in some cases been attributed to aromatic compounds and in other cases to nitrogen oxides.^{223,224,225} The impacts of VOCs on plant reproduction may have long-term implications for biodiversity and survival of native species near major roadways. Most of the studies of the impacts of VOCs on vegetation have focused on short-term exposure and few studies have focused on long-term effects of VOCs on vegetation and the potential for metabolites of these compounds to affect herbivores or insects.

8.2 Air Quality Impacts of Non-GHG Pollutants

8.2.1 Introduction

Chapter 5 of this RIA presents the projected emissions changes due to this final action. Once the emissions changes are projected the next step is to look at how the ambient air quality will be impacted by those emissions changes. Although the purpose of these rules is to address greenhouse gas emissions, this final action will also impact emissions of criteria and hazardous air pollutants. Sections 8.2.2 and 8.2.3 describe the air quality modeling methodology and results.

8.2.2 Air Quality Modeling Methodology

Air quality models use mathematical and numerical techniques to simulate the physical and chemical processes that affect air pollutants as they disperse and react in the atmosphere. Based on inputs of meteorological data and source information, these models are designed to characterize primary pollutants that are emitted directly into the atmosphere and secondary pollutants that are formed as a result of complex chemical reactions within the atmosphere. Photochemical air quality models have become widely recognized and routinely utilized tools for regulatory analysis by assessing the effectiveness of control strategies. These models are applied at multiple spatial scales - local, regional, national, and global. This section provides detailed information on the photochemical model used for our air quality analysis (the Community Multi-scale Air Quality (CMAQ) model), atmospheric reactions and the role of chemical mechanisms

in modeling, and model uncertainties and limitations. Further discussion of the modeling methodology is included in the Air Quality Modeling Technical Support Document (AQM TSD) found in the docket for this rulemaking. Results of the air quality modeling are presented in Section 8.2.3.

8.2.2.1 Modeling Methodology

A national-scale air quality modeling analysis was performed to estimate future year annual PM_{2.5} concentrations, 24-hour PM_{2.5} concentrations, 8-hour ozone concentrations, air toxics concentrations, and nitrogen and sulfur deposition levels for future years. The 2005-based CMAQ modeling platform was used as the basis for the air quality modeling of the future reference case and the future control scenario for this final rulemaking. This platform represents a structured system of connected modeling-related tools and data that provide a consistent and transparent basis for assessing the air quality response to projected changes in emissions. The base year of data used to construct this platform includes emissions and meteorology for 2005. The platform was developed by the U.S. EPA's Office of Air Quality Planning and Standards in collaboration with the Office of Research and Development and is intended to support a variety of regulatory and research model applications and analyses.

The CMAQ modeling system is a non-proprietary, publicly available, peer-reviewed, state-of-the-science, three-dimensional, grid-based Eulerian air quality grid model designed to estimate the formation and fate of oxidant precursors, primary and secondary PM concentrations, acid deposition, and air toxics, over regional and urban spatial scales for given input sets of meteorological conditions and emissions.^{226,227,228} The CMAQ model version 4.7 was most recently peer-reviewed in February of 2009 for the U.S. EPA.^Q The CMAQ model is a well-known and well-respected tool and has been used in numerous national and international applications.^{229,230,231} This 2005 multi-pollutant modeling platform used CMAQ version 4.7.1^R with a minor internal change made by the U.S. EPA CMAQ model developers intended to speed model runtimes when only a small subset of toxics species are of interest.

CMAQ includes many science modules that simulate the emission, production, decay, deposition and transport of organic and inorganic gas-phase and particle-phase pollutants in the atmosphere. We used CMAQ v4.7.1 which reflects updates to version 4.7 to improve the underlying science. These include aqueous chemistry mass conservation improvements, improved vertical convective mixing and lowered CB05 mechanism unit yields for acrolein from 1,3-butadiene tracer reactions which were updated to be consistent with laboratory measurements. Section 8.2.2.2 of this RIA discusses the chemical mechanism and Secondary organic aerosol (SOA) formation.

^Q Allen, D., Burns, D., Chock, D., Kumar, N., Lamb, B., Moran, M. (February 2009). Report on the Peer Review of the Atmospheric Modeling and Analysis Division, NERL/ORD/EPA. U.S. EPA, Research Triangle Park, NC., http://www.epa.gov/amad/peer/2009_AMAD_PeerReviewReport.pdf.

^R CMAQ version 4.7 was released on December, 2008. It is available from the Community Modeling and Analysis System (CMAS) as well as previous peer-review reports at: <http://www.cmascenter.org>.

Regulatory Impact Analysis

8.2.2.1.1 Model Domain and Configuration

The CMAQ modeling domain encompasses all of the lower 48 States and portions of Canada and Mexico. The modeling domain is made up of a large continental U.S. 36 kilometer (km) grid and two 12 km grids (an Eastern US and a Western US domain), as shown in Figure 8-4. The modeling domain contains 14 vertical layers with the top of the modeling domain at about 16,200 meters, or 100 millibars (mb).

Figure 8-4 Map of the CMAQ Modeling Domain

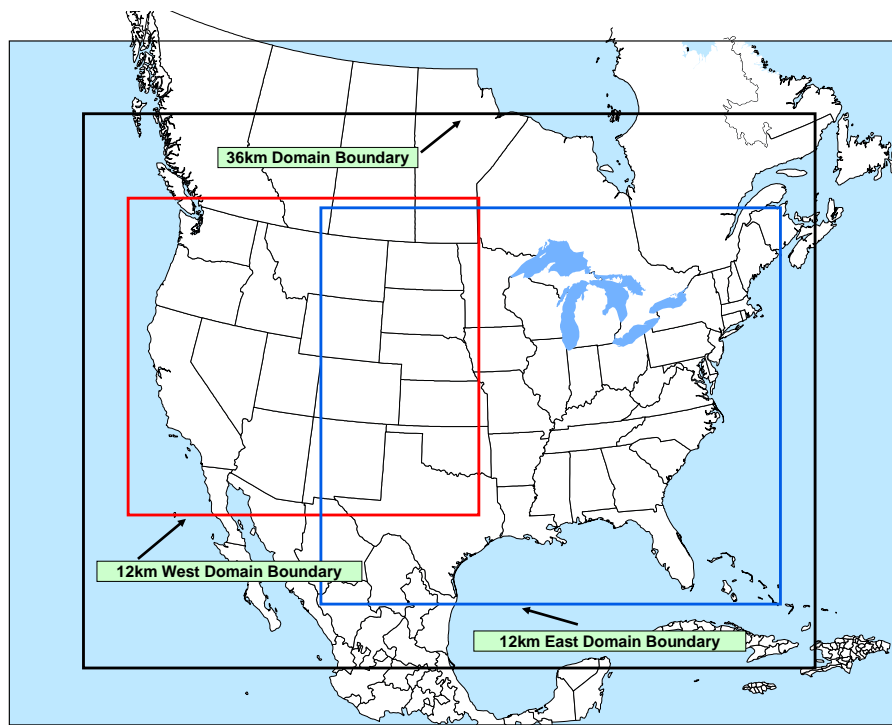

8.2.2.1.2 Model Inputs

The key inputs to the CMAQ model include emissions from anthropogenic and biogenic sources, meteorological data, and initial and boundary conditions. The CMAQ meteorological input files were derived from simulations of the Pennsylvania State University/National Center for Atmospheric Research Mesoscale Model²³² for the entire year of 2005 over model domains that are slightly larger than those shown in Figure 8-4. This model, commonly referred to as MM5, is a limited-area, nonhydrostatic, terrain-following system that solves for the full set of physical and thermodynamic equations which govern atmospheric motions.²³³ The meteorology for the national 36 km grid and the two 12 km grids were developed by EPA and are described in more detail within the AQM TSD. The meteorological outputs from MM5 were processed to create model-ready inputs for CMAQ using the Meteorology-Chemistry Interface Processor (MCIP) version 3.4, for example: horizontal wind components (*i.e.*, speed and direction), temperature, moisture, vertical diffusion rates, and rainfall rates for each grid cell in each vertical layer.²³⁴

The lateral boundary and initial species concentrations are provided by a three-dimensional global atmospheric chemistry model, the GEOS-CHEM model.²³⁵ The global GEOS-CHEM model simulates atmospheric chemical and physical processes driven by assimilated meteorological observations from the NASA's Goddard Earth Observing System (GEOS). This model was run for 2005 with a grid resolution of 2 degree x 2.5 degree (latitude-longitude) and 20 vertical layers. The predictions were used to provide one-way dynamic boundary conditions at three-hour intervals and an initial concentration field for the 36 km CMAQ simulations. The future base conditions from the 36 km coarse grid modeling were used as the initial/boundary state for all subsequent 12 km finer grid modeling.

The emissions inputs used for the 2005 base year and each of the future year base cases and control scenarios analyzed for this rule are summarized in Chapter 5 of this RIA.

8.2.2.1.3 *CMAQ Evaluation*

An operational model performance evaluation for ozone, PM_{2.5} and its related speciated components (*e.g.*, sulfate, nitrate, elemental carbon, organic carbon, etc.), nitrate and sulfate deposition, and specific air toxics (formaldehyde, acetaldehyde, benzene, 1,3-butadiene, and acrolein) was conducted using 2005 state/local monitoring data in order to estimate the ability of the CMAQ modeling system to replicate base year concentrations. Model performance statistics were calculated for observed/predicted pairs of daily/monthly/seasonal/annual concentrations. Statistics were generated for the following geographic groupings: domain wide, Eastern vs. Western (divided along the 100th meridian), and each Regional Planning Organization (RPO) region.^S The "acceptability" of model performance was judged by comparing our results to those found in recent regional PM_{2.5} model applications for other, non-EPA studies.^T Overall, the performance for the 2005 modeling platform is within the range or close to that of these other applications. The performance of the CMAQ modeling was evaluated over a 2005 base case. The model was able to reproduce historical concentrations of ozone and PM_{2.5} over land with low bias and error results. Model predictions of annual formaldehyde, acetaldehyde and benzene showed relatively small bias and error results when compared to observations. The model yielded larger bias and error results for 1,3 butadiene and acrolein based on limited monitoring sites. A more detailed summary of the 2005 CMAQ model performance evaluation is available within the AQM TSD found in the docket of this rule.

8.2.2.1.4 *Model Simulation Scenarios*

As part of our analysis for this rulemaking, the CMAQ modeling system was used to calculate daily and annual PM_{2.5} concentrations, 8-hour ozone concentrations, annual and seasonal (summer and winter) air toxics concentrations, and annual nitrogen and sulfur deposition total levels for each of the following emissions scenarios:

^S Regional Planning Organization regions include: Mid-Atlantic/Northeast Visibility Union (MANE-VU), Midwest Regional Planning Organization – Lake Michigan Air Directors Consortium (MWRPO-LADCO), Visibility Improvement State and Tribal Association of the Southeast (VISTAS), Central States Regional Air Partnership (CENRAP), and Western Regional Air Partnership (WRAP).

^T These other modeling studies represent a wide range of modeling analyses which cover various models, model configurations, domains, years and/or episodes, chemical mechanisms, and aerosol modules.

Regulatory Impact Analysis

- 2005 base year
- 2030 reference case projection
- 2030 control case projection

The emission inventories used in the air quality and benefits modeling are different from the final rule inventories due to the considerable length of time required to conduct the modeling. However, the air quality modeling inventories are generally consistent with the final emission inventories, so the air quality modeling adequately reflects the effects of the rule. The emission inventories used for air quality modeling are discussed in Section 5.6 of this RIA. The emissions modeling TSD, found in the docket for this rule (EPA-HQ-OAR-2010-0162), contains a detailed discussion of the emissions inputs used in our air quality modeling.

We use the predictions from the model in a relative sense by combining the 2005 base-year predictions with predictions from each future-year scenario and applying these modeled ratios to ambient air quality observations to estimate daily and annual PM_{2.5} concentrations, and 8-hour ozone concentrations for each of the 2030 scenarios. The ambient air quality observations are average conditions, on a site-by-site basis, for a period centered around the model base year (*i.e.*, 2003-2007).

The projected daily and annual PM_{2.5} design values were calculated using the Speciated Modeled Attainment Test (SMAT) approach. The SMAT uses a Federal Reference Method (FRM) mass construction methodology that results in reduced nitrates (relative to the amount measured by routine speciation networks), higher mass associated with sulfates (reflecting water included in FRM measurements), and a measure of organic carbonaceous mass that is derived from the difference between measured PM_{2.5} and its non-carbon components. This characterization of PM_{2.5} mass also reflects crustal material and other minor constituents. The resulting characterization provides a complete mass balance. It does not have any unknown mass that is sometimes presented as the difference between measured PM_{2.5} mass and the characterized chemical components derived from routine speciation measurements. However, the assumption that all mass difference is organic carbon has not been validated in many areas of the U.S. The SMAT methodology uses the following PM_{2.5} species components: sulfates, nitrates, ammonium, organic carbon mass, elemental carbon, crustal, water, and blank mass (a fixed value of 0.5 µg/m³). More complete details of the SMAT procedures can be found in the report "Procedures for Estimating Future PM_{2.5} Values for the CAIR Final Rule by Application of the (Revised) Speciated Modeled Attainment Test (SMAT)".²³⁶ For this latest analysis, several datasets and techniques were updated. These changes are fully described within the technical support document for the Final Transport Rule AQM TSD.²³⁷ The projected 8-hour ozone design values were calculated using the approach identified in EPA's guidance on air quality modeling attainment demonstrations.²³⁸

Additionally, we conducted an analysis to compare the absolute and percent differences between the 2030 control case and the 2030 reference cases for annual and seasonal formaldehyde, acetaldehyde, benzene, 1,3-butadiene, and acrolein, as well as annual nitrate and sulfate deposition. These data were not compared in a relative sense due to the limited observational data available.

8.2.2.2 Chemical Mechanisms in Modeling

This rule presents inventories for NO_x, VOC, CO, PM_{2.5}, SO₂, NH₃, and five air toxics: benzene, 1,3-butadiene, formaldehyde, acetaldehyde, and acrolein. The five air toxics are explicit model species in the CMAQv4.7 model with carbon bond 5 (CB05) mechanisms.²³⁹ In addition to direct emissions, photochemical processes mechanisms are responsible for formation of some of these compounds in the atmosphere from precursor emissions. For some pollutants such as PM, formaldehyde, and acetaldehyde, many photochemical processes are involved. CMAQ therefore also requires inventories for a large number of other air toxics and precursor pollutants. Methods used to develop the air quality inventories can be found in Chapter 5 of the RIA.

In the CB05 mechanism, the chemistry of thousands of different VOCs in the atmosphere are represented by a much smaller number of model species which characterize the general behavior of a subset of chemical bond types; this condensation is necessary to allow the use of complex photochemistry in a fully 3-D air quality model.²⁴⁰

CMAQ includes 63 inorganic reactions to account for the cycling of all relevant oxidized nitrogen species and cycling of radicals, including the termination of NO₂ and formation of nitric acid (HNO₃) without peroxyacetyl nitrate (PAN) formation.^U



The CB05 mechanism also includes more than 90 organic reactions that include alternate pathways for the formation of acetyl peroxy radical, such as by reaction of ethene and other alkenes, alkanes and aromatics. Alternate reactions of acetyl peroxy radical, such as oxidation of NO to form NO₂, which again leads to ozone formation, are also included.

Atmospheric reactions and chemical mechanisms involving several key formation pathways are discussed in more detail in the following sections.

8.2.2.2.1 *Acetaldehyde*

Acetaldehyde is the main photodegradation product of ethanol, as well as other precursor hydrocarbons. Acetaldehyde is also a product of fuel combustion. In the atmosphere, acetaldehyde can react with the OH radical and O₂ to form the acetyl peroxy radical [CH₃C(O)OO·].^V This radical species can then further react with nitric oxide (NO), to produce formaldehyde (HCHO), or with nitrogen dioxide (NO₂), to produce PAN [CH₃C(O)OONO₂]. An overview of these reactions and the corresponding reaction rates are provided below.^W Acetaldehyde can also react with the NO₃ radical, ground state oxygen atom (O³P) and chlorine, although these reactions are much slower.

^U All rate coefficients in this RIA are listed at 298 K and, if applicable, 1 bar of air.

^V Acetaldehyde is not the only source of acetyl peroxy radicals in the atmosphere. For example, dicarbonyl compounds (methylglyoxal, biacetyl, and others) also form acetyl radicals, which can further react to form peroxyacetyl nitrate (PAN).

^W All rate coefficients in this RIA are listed at 298 K and, if applicable, 1 bar of air.

Regulatory Impact Analysis

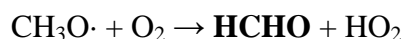
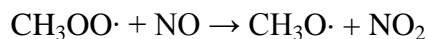
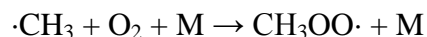
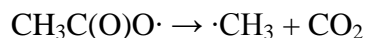
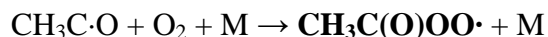

Acetaldehyde can also photolyze (hv), which predominantly produces $\cdot\text{CH}_3$ and HCO:



As mentioned above, $\cdot\text{CH}_3$ is oxidized in the atmosphere to produce formaldehyde (HCHO). Formaldehyde is also a product of hydrocarbon combustion. In the atmosphere, the most important reactions of formaldehyde are photolysis and reaction with the OH, with atmospheric lifetimes of approximately 3 hours and 13 hours, respectively.²⁴⁶ Formaldehyde can also react with the NO_3 radical, ground state oxygen atom (O^3P) and chlorine, although these reactions are much slower. Formaldehyde is removed mainly by photolysis whereas the higher aldehydes, those with two or more carbons such as acetaldehyde, react predominantly with OH radicals. The photolysis of formaldehyde is an important source of new hydroperoxy radicals (HO_2), which leads to ozone formation.



Acetaldehyde is represented explicitly in the CB05 chemical mechanism^{248,249} by the ALD2 model species, which can be both formed from other VOCs and can decay via reactions with oxidants and radicals. The reaction rates for acetaldehyde, as well as for the inorganic reactions that produce and cycle radicals, and the representative reactions of other VOCs have all been updated to be consistent with recommendations in the literature.²⁵⁰

The decay reactions of acetaldehyde are fewer in number and can be characterized well because they are explicit representations. In CB05, acetaldehyde can photolyze in the presence of sunlight or react with molecular oxygen (O^3P), hydroxyl radical (OH), or nitrate radicals. The reaction rates are based on expert recommendations,²⁵¹ and the photolysis rate is from IUPAC recommendations.

In CMAQ v4.7, the acetaldehyde that is formed from photochemical reactions is tracked separately from that which is due to direct emission and transport of direct emissions. In CB05, there are 25 different reactions that form acetaldehyde in molar yields ranging from 0.02 (ozone reacting with lumped products from isoprene oxidation) to 2.0 (cross reaction of acylperoxy

radicals, CXO3). The specific parent VOCs that contribute the most to acetaldehyde concentrations vary spatially and temporally depending on characteristics of the ambient air, but alkenes in particular are found to play a large role. The IOLE model species, which represents internal carbon-carbon double bonds, has high emissions and relatively high yields of acetaldehyde. The OLE model species, representing terminal carbon double bonds, also plays a role because it has high emissions although lower acetaldehyde yields. Production from peroxypropional nitrate and other peroxyacylnitrates (PANX) and aldehydes with 3 or more carbon atoms can in some instances increase acetaldehyde but because they also are a sink of radicals, their effect is smaller.

8.2.2.2.2 *Secondary Organic Aerosols*

SOA chemistry research described below has led to implementation of new pathways for SOA in CMAQ 4.7, based on recommendations of Edney et al. and the recent work of Carlton et al.^{252, 253} In previous versions of the CMAQ model, all SOA was treated as semi-volatile, whereas in CMAQ v4.7, non-volatile SOA are simulated as well, including SOA originating from aromatic oxidation under low-NO_x conditions.

8.2.2.2.2.1 *SOA Research*

SOA results when products of atmospheric transformation or photooxidation of a volatile organic compound (VOC) form or partition to the particle phase. Current research suggests SOA contributes significantly to ambient organic aerosol (OA) concentrations, and in Southeast and Midwest States may make up more than 50% (although the contribution varies from area to area) of the organic fraction of PM_{2.5} during the summer (but less in the winter).^{254,255} A wide range of laboratory studies conducted over the past twenty years show that anthropogenic aromatic hydrocarbons and long-chained alkanes, along with biogenic isoprene, monoterpenes, and sesquiterpenes, contribute to SOA formation.^{256,257,258,259,260} Anthropogenic SOA is a small portion of all SOA; most is biogenic and varies with season. Based on these laboratory results, SOA chemical mechanisms have been developed and integrated into air quality models such as the CMAQ model and have been used to predict OA concentrations.²⁶¹

Over the past 10 years, ambient OA concentrations have been routinely measured in the U.S. and some of these data have been used to determine, by employing source/receptor methods, the contributions of the major OA sources, including biomass burning and vehicular gasoline and diesel exhaust. Since mobile sources are a significant source of VOC emissions, currently accounting for almost 40% of anthropogenic VOC,²⁶² mobile sources are also an important source of SOA.

Toluene is an important contributor to anthropogenic SOA. Other aromatic compounds contribute as well, but the extent of their contribution has not yet been quantified. Mobile sources are the most significant contributor to ambient toluene concentrations as shown by analyses done for the 2005 National Air Toxics Assessment (NATA)²⁶³ and the Mobile Source Air Toxics (MSAT) Rule.²⁶⁴ 2005 NATA indicates that onroad and nonroad mobile sources accounted for almost 60% (1.46 µg/m³) of the total average nationwide ambient concentration of toluene (2.48 µg/m³), when the contribution of the estimated “background” is apportioned among source sectors.

Regulatory Impact Analysis

The amount of toluene in gasoline influences the amount of toluene emitted in vehicle exhaust and evaporative emissions, although, like benzene, some toluene is formed in the combustion process. In turn, levels of toluene and other aromatics in gasoline are potentially influenced by the amount of ethanol blended into the fuel. Due to the high octane quality of ethanol, it greatly reduces the need for and levels of other high-octane components such as aromatics including toluene (which is the major aromatic compound in gasoline). Since toluene contributes to SOA and the toluene level of gasoline is decreasing, it is important to assess the effect of these reductions on ambient PM.

In general, a review of the literature shows limited data on SOA concentrations, largely due to the lack of analytical methods for identifying and determining the concentrations of the highly polar organic compounds that make up SOA. The most widely applied method of estimating total ambient SOA concentrations is the EC tracer method using ambient data which estimates of the OC/EC ratio in primary source emissions.^{265,266} SOA concentrations have also been estimated using OM (organic mass) to OC (organic carbon) ratios, which can indicate that SOA formation has occurred, or by subtracting the source/receptor-based total primary organic aerosol (POA) from the measured OC concentration.²⁶⁷ Such methods, however, may not be quantitatively accurate and provide no information on the contribution of individual biogenic and anthropogenic SOA sources, which is critical information needed to assess the impact of specific sources and the associated health risk. These methods assume that OM containing additional mass from oxidation of OC comes about largely (or solely) from SOA formation. In particular, the contributions of anthropogenic SOA sources, including those of aromatic precursors, are required to determine exposures and risks associated with replacing fossil fuels with biofuels.

Upon release into the atmosphere, numerous VOC compounds can react with free radicals in the atmosphere to form SOA. While this has been investigated in the laboratory, there is relatively little information available on the specific chemical composition of SOA compounds themselves from specific VOC precursors. This absence of compositional data from the precursors has largely prevented the identification of aromatically-derived SOA in ambient samples which, in turn, has prevented observation-based measurements of the aromatic and other SOA contributions to ambient PM levels.

As a first step in determining the ambient SOA concentrations, EPA has developed a tracer-based method to estimate such concentrations.^{268,269} The method is based on using mass fractions of SOA tracer compounds, measured in smog chamber-generated SOA samples, to convert ambient concentrations of SOA tracer compounds to ambient SOA concentrations. This method consists of irradiating the SOA precursor of interest in a smog chamber in the presence of NO_x, collecting the SOA produced on filters, and then analyzing the samples for highly polar compounds using advanced analytical chemistry methods. Employing this method, candidate tracers have been identified for several VOC compounds which are emitted in significant quantities and known to produce SOA in the atmosphere. Some of these SOA-forming compounds include toluene, a variety of monoterpenes, isoprene, and β-caryophyllene, the latter three of which are emitted by vegetation and are more significant sources of SOA than toluene. Smog chamber work can also be used to investigate SOA chemical formation mechanisms.^{270,271,272,273}

Although these concentrations are only estimates, due to the assumption that the mass

fractions of the smog chamber SOA samples using these tracers are equal to those in the ambient atmosphere, there are presently no other means available for estimating the SOA concentrations originating from individual SOA precursors. Among the tracer compounds observed in ambient PM_{2.5} samples are two tracer compounds that have been identified in smog chamber aromatic SOA samples.²⁷⁴ To date, these aromatic tracer compounds have been identified, in the laboratory, for toluene and *m*-xylene SOA. Additional work is underway by the EPA to determine whether these tracers are also formed by benzene and other alkylbenzenes (including *o*-xylene, *p*-xylene, 1,2,4-trimethylbenzene, and ethylbenzene).

One caveat regarding this work is that a large number of VOCs emitted into the atmosphere, which have the potential to form SOA, have not yet been studied in this way. It is possible that these unstudied compounds produce SOA species which are being used as tracers for other VOCs. This means that the present work could overestimate the amount of SOA formed in the atmosphere by the VOCs studied to date. This approach may also estimate entire hydrocarbon classes (*e.g.*, all methylsubstituted-monoaromatics or all monoterpenes) and not individual precursor hydrocarbons. Thus the tracers could be broadly representative and not indicative of individual precursors. This is still unknown. Also, anthropogenic precursors play a role in formation of atmospheric radicals and aerosol acidity, and these factors influence SOA formation from biogenic hydrocarbons. This anthropogenic and biogenic interaction, important to EPA and others, needs further study. The issue of SOA formation from aromatic precursors is an important one to which EPA and others are paying significant attention. For benzene, smog chamber studies show that benzene forms SOA possibly through reactions with NO_x. Early smog chamber work suggests benzene might be relatively inert in forming SOA, although this study may not be conclusive.²⁷⁵ However, more recent work shows that benzene does form SOA in smog chambers.^{276,277} This new smog chamber work shows that benzene can be oxidized in the presence of NO_x to form SOA with maximum mass of SOA being 8-25% of the mass of benzene. As mentioned above, work is needed to determine if a tracer compound can be found for benzene SOA which might indicate how much of ambient SOA comes from benzene.

The aromatic tracer compounds and their mass fractions have also been used to estimate monthly ambient aromatic SOA concentrations from March 2004 to February 2005 in five U.S. Midwestern cities.²⁷⁸ The annual tracer-based SOA concentration estimates were 0.15, 0.18, 0.13, 0.15, and 0.19 µg carbon/m³ for Bondville, IL, East St. Louis, IL, Northbrook, IL, Cincinnati, OH and Detroit, MI, respectively, with the highest concentrations occurring in the summer. On average, the aromatic SOA concentrations made up 17 % of the total SOA concentration. Thus, this work suggests that we are finding ambient PM levels on an annual basis of about 0.15 µg/m³ associated with present toluene levels in the ambient air in these Midwest cities. Based on preliminary analysis of recent laboratory experiments, it appears the toluene tracer could also be formed during photooxidation of some of the xylenes.²⁷⁹

Over the past decade a variety of modeling studies have been conducted to predict ambient SOA levels, with most studies focusing on the contributions of biogenic monoterpenes and anthropogenic aromatic hydrocarbons. More recently, modelers have begun to include the contribution of the isoprene SOA to ambient OC concentrations.²⁸⁰ In general, the studies have been limited to comparing the sum of the POA and SOA concentrations with ambient OC concentrations. The general consensus in the atmospheric chemistry community appears to be

that monoterpene contributions, which are clearly significant, and the somewhat smaller aromatic contributions, are insufficient to account for observed ambient SOA levels.²⁸¹ Part of this gap has been filled recently by SOA predictions for isoprene. Furthermore, the identification in ambient SOA of a tracer compound for the sesquiterpene β -caryophyllene,²⁸² coupled with the high sesquiterpene SOA yields measured in the laboratory,²⁸³ suggests this class of hydrocarbons should be included in SOA chemical mechanisms. In addition, recent data on SOA formation from aromatic hydrocarbons suggest their contributions, while much smaller than biogenic hydrocarbons, could be larger than previously thought.^{284,285}

8.2.2.2.3 Ozone

A discussion of CB05 mechanisms for ozone formation can be found in Yarwood et al. (2005).²⁸⁶ One reaction pathway of note is the contribution of PAN to ground-level ozone formation. PAN is a reservoir and carrier of NO_x and is the product of acetyl radicals reacting with NO₂ in the atmosphere. One source of PAN is the photooxidation of acetaldehyde (Section 8.2.2.2.1), but any hydrocarbon having a methyl group has the potential for forming acetyl radicals and therefore PAN.^X PAN can undergo thermal decomposition with a lifetime of approximately 1 hour at 298K or 148 days at 250K.^Y

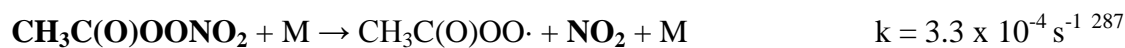

The reaction above shows how NO₂ is released in the thermal decomposition of PAN. NO₂ can also be formed in photodegradation reactions where NO is converted to NO₂ (see OH radical reaction of acetaldehyde in Section 3.4.1.2.1). In both cases, NO₂ further photolyzes to produce ozone (O₃).

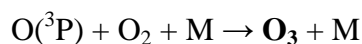

The temperature sensitivity of PAN allows it to be stable enough at low temperatures to be transported long distances before decomposing to release NO₂. NO₂ can then participate in ozone formation in regions remote from the original NO_x source.²⁸⁹

8.2.2.3 Modeling Uncertainties and Limitations

All the results presented below must be interpreted with the understanding that there are uncertainties in inventories, atmospheric processes in CMAQ, and other aspects of the modeling process. While it is beyond the scope of this Regulatory Impact Analysis to include a comprehensive discussion of all limitations and uncertainties associated with air quality modeling, several sources of uncertainty that impact analyses for this rule are addressed.

^X Many aromatic hydrocarbons, particularly those present in high percentages in gasoline (toluene, m-, o-, p-xylene, and 1,3,5-, 1,2,4-trimethylbenzene), form methylglyoxal and biacetyl, which are also strong generators of acetyl radicals (Smith, D.F., T.E. Kleindienst, C.D. McIver (1999) Primary product distribution from the reaction of OH with m-, p-xylene and 1,2,4- and 1,3,5-Trimethylbenzene. J. Atmos. Chem., 34: 339- 364.).

^Y All rate coefficients in this RIA are listed at 298 K and, if applicable, 1 bar of air.

A key source of uncertainty is the photochemical mechanisms in CMAQ 4.7. Pollutants such as ozone, PM, acetaldehyde, formaldehyde, acrolein, and 1,3-butadiene can be formed secondarily through atmospheric chemical processes. Since secondarily formed pollutants can result from many different reaction pathways, there are uncertainties associated with each pathway. Simplifications of chemistry must be made in order to handle reactions of thousands of chemicals in the atmosphere. Mechanisms for formation of ozone, PM, acetaldehyde and peroxyacetyl nitrate (PAN) are discussed in Section 8.2.2.2.

For PM, there are a number of uncertainties associated with SOA formation that should be addressed explicitly. As mentioned in Section 8.2.2.2.2, a large number of VOCs emitted into the atmosphere, which have the potential to form SOA, have not yet been studied in detail. In addition, the amount of ambient SOA that comes from benzene is uncertain. Simplifications to the SOA treatment in CMAQ have also been made in order to preserve computational efficiency. These simplifications are described in release notes for CMAQ 4.7 on the Community Modeling and Analysis System (CMAS) website.²⁹⁰

8.2.3 Air Quality Modeling Results

As described above, we performed a series of air quality modeling simulations for the continental U.S in order to assess the impacts of this action. We looked at impacts on future ambient PM_{2.5}, ozone, and air toxics levels, as well as nitrogen and sulfur deposition levels and visibility impairment. In this section, we present information on current levels of pollution as well as model projected levels of pollution for 2030.

Emissions and air quality modeling decisions are made early in the analytical process. For this reason, the inventories used in the air quality modeling and the benefits modeling, which are presented in Section 8.3, are slightly different than the final inventories presented in Section 5.5. However, the air quality inventories and the final inventories are generally consistent, so the air quality modeling adequately reflects the effects of this final action.

8.2.3.1 Ozone

As described in Section 8.1.1.3, ozone causes adverse health effects, and the EPA has set national standards to protect against those health effects. In this section, we present information on current and model-projected future ozone levels.

8.2.3.1.1 *Current Levels of Ozone*

Figure 8-5 shows a snapshot of ozone concentrations in 2008. The highest ozone concentrations were located in California. Thirty-two percent of the sites were above 0.075 ppm, the level of the 2008 standard.

Regulatory Impact Analysis

Figure 8-5 Ozone Concentrations (fourth highest daily maximum 8-hour concentration) in ppm for 2008^Z

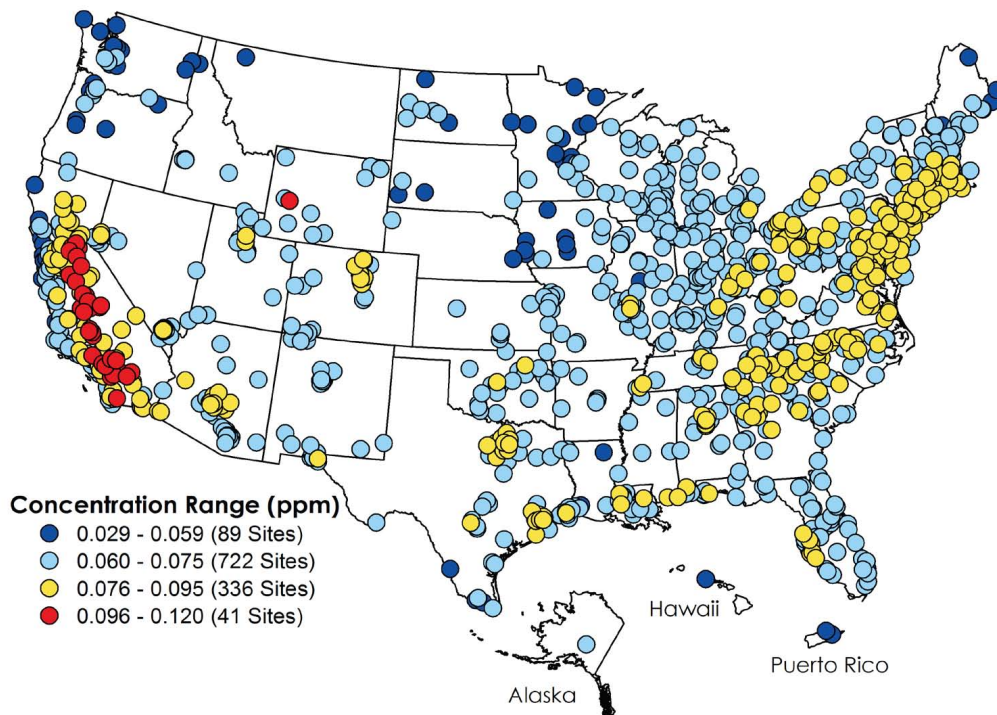

The primary and secondary NAAQS for ozone are 8-hour standards set at 0.075 ppm. The most recent revision to the ozone standards was in 2008; the previous 8-hour ozone standards, set in 1997, had been set at 0.08 ppm. In 2004, the U.S. EPA designated nonattainment areas for the 1997 8-hour ozone NAAQS (69 FR 23858, April 30, 2004). As of April 21, 2011, there are 44 8-hour ozone nonattainment areas for the 1997 ozone NAAQS composed of 242 full or partial counties with a total population of over 118 million. Nonattainment areas for the 1997 8-hour ozone NAAQS are pictured in Figure 8-6.

^Z From U.S. EPA, 2010. Our Nation's Air: Status and Trends through 2008. EPA-454/R-09-002. February 2010. Available at: <http://www.epa.gov/airtrends/2010/index.html>.

Figure 8-6 8-hour Ozone Nonattainment Areas

8-Hour Ozone Nonattainment Areas (1997 Standard)

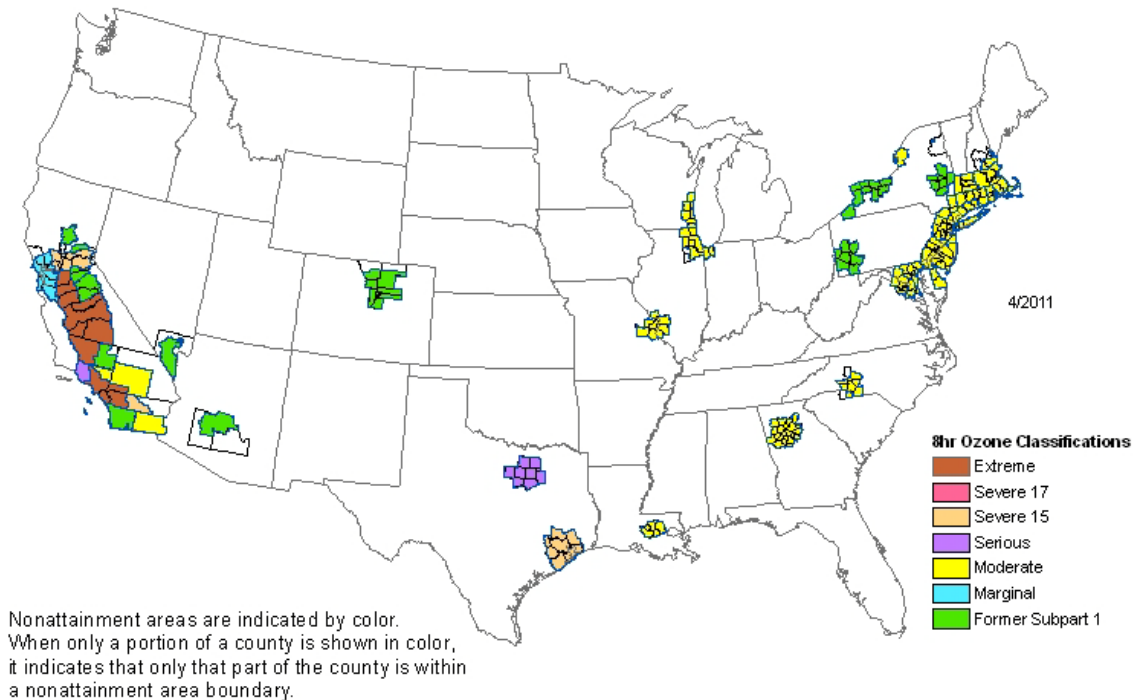

The following multi-state nonattainment area, Chicago-Gary-Lake County, IL-IN 8-hr Ozone area, has some states in the area that have been redesignated, but it is not considered a maintenance area until all states in the area are redesignated. The counties for this area are displayed as nonattainment areas:

On January 6, 2010, EPA proposed to reconsider the 2008 ozone NAAQS to ensure that they are requisite to protect public health with an ample margin of safety, and requisite to protect public welfare (75 FR 2938; January 19, 2010). EPA intends to complete the reconsideration by July 31, 2011. If, as a result of the reconsideration, EPA promulgates different ozone standards, the new 2011 ozone standards would replace the 2008 ozone standards and the requirement to designate areas for the replaced 2008 standards would no longer apply. Table 8-2 includes an estimate, based on 2007-09 air quality data, of the counties with design values greater than the 2008 ozone NAAQS.

Regulatory Impact Analysis

Table 8-2 Counties with Design Values Greater Than the Ozone NAAQS

	Number of Counties	Population ^a
1997 Ozone Standard: counties within the 44 areas currently designated as nonattainment (as of 4/21/11)	242	118,188,585
2008 Ozone Standard: additional counties that would not meet the 2008 NAAQS (based on 2006-2008 air quality data) ^b	82	23,714,274
Total	324	141,902,859

Notes:

^a Population numbers are from 2000 census data.

^b Area designations for the 2008 ozone NAAQS have not yet been made. Also, the county numbers in the table include only the counties with monitors violating the 2008 Ozone NAAQS. The numbers in this table may be an underestimate of the number of counties and populations that would be included in areas with multiple counties designated nonattainment.

States with ozone nonattainment areas are required to take action to bring those areas into compliance in the future. The attainment date assigned to an ozone nonattainment area is based on the area's classification. Most ozone nonattainment areas are required to attain the 1997 8-hour ozone NAAQS in the 2007 to 2013 time frame and then be required to maintain it thereafter.^{AA} In addition, there will be attainment dates associated with the designation of nonattainment areas for any 2011 NAAQS resulting from the reconsideration of the 2008 ozone NAAQS. The attainment dates would range from 3 to 20 years from designation, depending on the area's classification. The heavy-duty vehicle standards finalized here first apply to model year 2014 vehicles.

8.2.3.1.2 *Projected Levels of Ozone*

In the following sections, we describe projected ozone levels in the future with and without the heavy-duty standards. Our modeling indicates that there will be decreases in ozone design value concentrations in many areas of the country. Information on the air quality modeling methodology is contained in Section 8.2.1.1. Additional detail can be found in the air quality modeling technical support document (AQM TSD).

8.2.3.1.2.1 *Projected Levels of Ozone without this Final Action*

EPA has already adopted many emission control programs that are expected to reduce ambient ozone levels. These control programs include the New Marine Compression-Ignition

^{AA} The Los Angeles South Coast Air Basin 8-hour ozone nonattainment area is designated as severe and will have to attain before June 15, 2021. The South Coast Air Basin has requested to be reclassified as an extreme nonattainment area which will make their attainment date June 15, 2024. The San Joaquin Valley Air Basin 8-hour ozone nonattainment area is designated as serious and will have to attain before June 15, 2013. The San Joaquin Valley Air Basin has requested to be reclassified as an extreme nonattainment area which will make their attainment date June 15, 2024.

Heavy-Duty GHG and Fuel Efficiency Standards FRM: Health and Environmental Impacts

Engines at or Above 30 Liters per Cylinder Rule (75 FR 22895, April 30, 2010), the Marine Spark-Ignition and Small Spark-Ignition Engine Rule (73 FR 59034, October 8, 2008), the Locomotive and Marine Rule (73 FR 25098, May 6, 2008), the Clean Air Interstate Rule (70 FR 25162, May 12, 2005), the Clean Air Nonroad Diesel Rule (69 FR 38957, June 29, 2004), and the Heavy Duty Engine and Vehicle Standards and Highway Diesel Fuel Sulfur Control Requirements (66 FR 5002, January 18, 2001). As a result of these and other federal, state and local programs, 8-hour ozone levels are expected to improve in the future. However, even with the implementation of all current state and federal regulations, there are projected to be counties violating the ozone NAAQS well into the future.

The air quality modeling projects that in 2030, with all current controls in effect but excluding the emissions changes expected to occur as a result of this final action, at least 10 counties, with a projected population of over 30 million people, may not attain the 2008 8-hour ozone standard of 75 ppb. Since the emission changes from this final action go into effect during the period when some areas are still working to attain the ozone NAAQS, the projected emission changes will impact state and local agencies in their effort to attain and maintain the ozone standard. In the following section we discuss projected nonattainment areas and how they compare to the areas which are projected to experience ozone reductions from the heavy-duty standards.

8.2.3.1.2.2 Projected Levels of Ozone with this Final Action

This section summarizes the results of our modeling of ozone air quality impacts in the future with the heavy-duty standards. Specifically, we compare a 2030 reference scenario, a scenario without the heavy-duty standards, to a 2030 control scenario which includes the heavy-duty standards. Our modeling indicates ozone design value concentrations will decrease in many areas of the country as a result of this action. The decreases in ozone design values are likely due to projected tailpipe reductions in NO_x and projected upstream emissions decreases in NO_x and VOCs from reduced fuel production. Figure 8-7 presents the changes in 8-hour ozone design value concentrations in 2030 between the reference case and the control case.^{BB}

^{BB} An 8-hour ozone design value is the concentration that determines whether a monitoring site meets the 8-hour ozone NAAQS. The full details involved in calculating an 8-hour ozone design value are given in appendix I of 40 CFR part 50.

Regulatory Impact Analysis

Figure 8-7 Projected Change in 2030 8-hour Ozone Design Values Between the Reference Case and Control Case

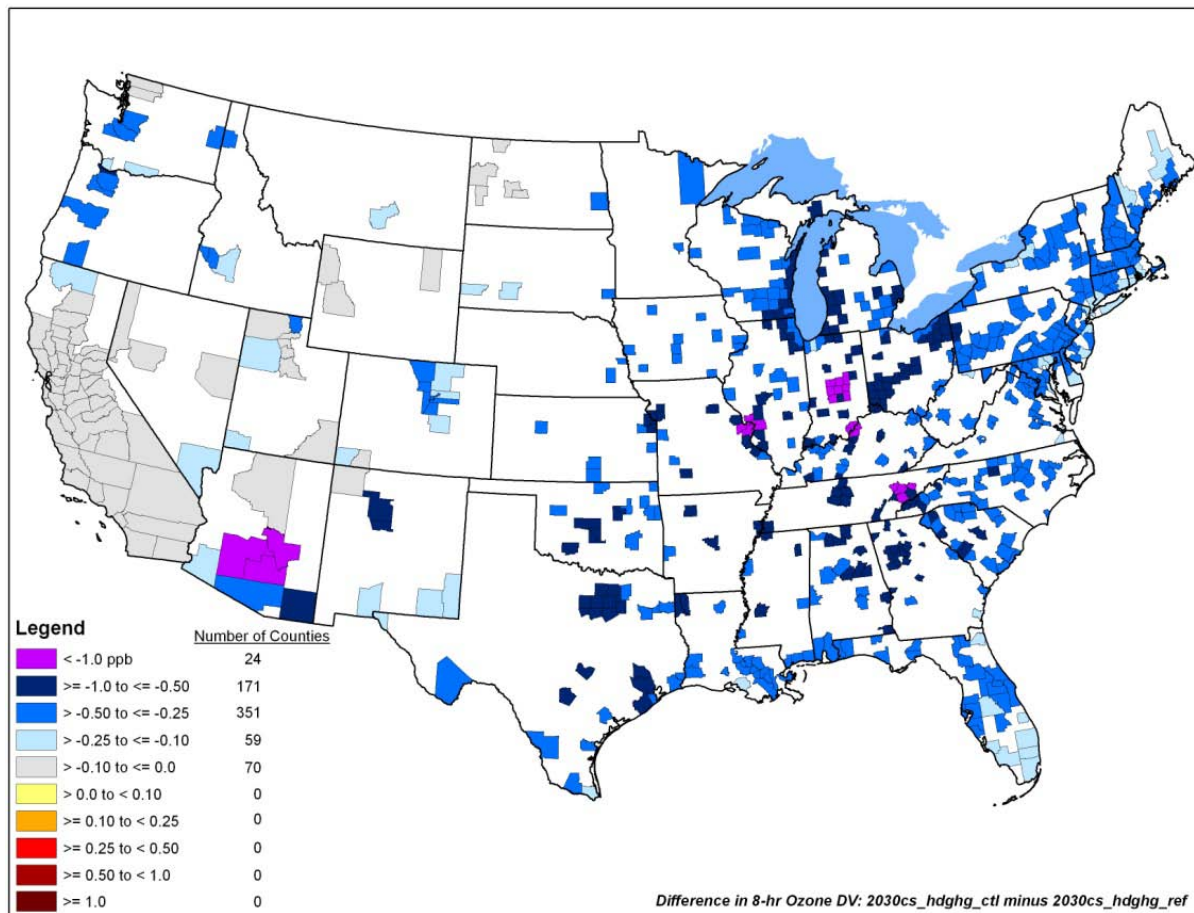

As can be seen in, the majority of the design value decreases are less than 1 ppb. However, there are some counties that will see 8-hour ozone design value decreases of more than 1 ppb; these counties are in southern Arizona, and the Midwest. The maximum projected decrease in an 8-hour ozone design value is 1.57 ppb in Jefferson County, Tennessee.

There are 10 counties, most of them in California, that are projected to have 8-hour ozone design values above the 2008 NAAQS in 2030 with the heavy-duty standards in place. Table 8-3 below presents the changes in design values for these counties.

Heavy-Duty GHG and Fuel Efficiency Standards FRM: Health and Environmental Impacts

Table 8-3 Change in Ozone Design Values (ppb) for Counties Projected to be Above the 2008 Ozone NAAQS in 2030

County Name	Change in 8-hour Ozone Design Value (ppb) ¹	Population in 2030 ^a
San Bernardino County, California	-0.0247	2,784,490
Riverside County, California	-0.0218	2,614,198
Los Angeles County, California	-0.0201	10,742,722
Kern County, California	-0.022	981,806
Harris County, Texas	-0.6646	5,268,889
Tulare County, California	-0.0207	528,663
Orange County, California	-0.0228	4,431,071
Fresno County, California	-0.0197	1,196,950
Suffolk County, New York	-0.189	1,705,822
Brazoria County, Texas	-0.5493	364,257

Note:

^a Population numbers based on Woods & Poole data. Woods & Poole Economics, Inc. 2001. Population by Single Year of Age CD.

Table 8-4 shows the average change in 2030 8-hour ozone design values for: (1) all counties with 2005 baseline design values, (2) counties with 2005 baseline design values that exceeded the 2008 ozone standard, (3) counties with 2005 baseline design values that did not exceed the 2008 standard, but were within 10% of it, (4) counties with 2030 design values that exceeded the 2008 ozone standard, and (5) counties with 2030 design values that did not exceed the standard, but were within 10% of it. Counties within 10% of the standard are intended to reflect counties that although not violating the standards, will also be impacted by changes in ozone as they work to ensure long-term maintenance of the ozone NAAQS. On a population-weighted basis, the average modeled future-year 8-hour ozone design values are projected to decrease by 0.39 ppb in 2030. On a population-weighted basis those counties that are projected to be above the 2008 ozone standard in 2030 will see a decrease of 0.16 ppb due to the heavy-duty standards.

Regulatory Impact Analysis

Table 8-4 Average Change in Projected 8-hour Ozone Design Value

Average ^a	Number of US Counties	2030 Population ^b	Change in 2030 design value (ppb)
All			-0.43
All, population-weighted	675	261,439,344	-0.39
Counties whose 2005 base year is violating the 2008 8-hour ozone standard			-0.47
Counties whose 2005 base year is violating the 2008 8-hour ozone standard, population-weighted	393	194,118,748	-0.41
Counties whose 2005 base year is within 10 percent of the 2008 8-hour ozone standard			-0.41
Counties whose 2005 base year is within 10 percent of the 2008 8-hour ozone standard, population-weighted	201	44,436,103	-0.34
Counties whose 2030 control case is violating the 2008 8-hour ozone standard			-0.16
Counties whose 2030 control case is violating the 2008 8-hour ozone standard, population-weighted	10	30,618,868	-0.15
Counties whose 2030 control case is within 10% of the 2008 8-hour ozone standard			-0.31
Counties whose 2030 control case is within 10% of the 2008 8-hour ozone standard, population-weighted	45	33,538,321	-0.28

Notes:

^a Averages are over counties with 2005 modeled design values

^b Population numbers based on Woods & Poole data. Woods & Poole Economics, Inc. 2001. Population by Single Year of Age CD.

Ground-level ozone pollution is formed by the reaction of VOCs and NO_x in the atmosphere in the presence of heat and sunlight. The science of ozone formation, transport, and accumulation is complex.²⁹¹ The projected ozone decreases which are seen in the air quality modeling for this final action are a result of the emissions changes due to the heavy-duty standards combined with the photochemistry involved, the different background concentrations of VOCs and NO_x in different areas of the country, and the different meteorological conditions in different areas of the country.

When VOC levels are relatively high, relatively small amounts of NO_x enable ozone to form rapidly. Under these conditions, VOC reductions have little effect on ozone and while NO_x reductions are highly effective in reducing ozone, conversely NO_x increases lead to increases in ozone. Such conditions are called “NO_x-limited.” Because the contribution of VOC emissions from biogenic (natural) sources to local ambient ozone concentrations can be significant, even some areas where man-made VOC emissions are relatively low can be NO_x-limited. Rural areas are usually NO_x-limited, due to the relatively large amounts of biogenic VOC emissions in such areas.

When NO_x levels are relatively high and VOC levels relatively low, NO_x forms inorganic nitrates (*i.e.*, particles) but relatively little ozone. Such conditions are called “NO_x-saturated.” Under these conditions, VOC reductions are effective in reducing ozone, but NO_x reductions can actually increase local ozone under certain circumstances.

8.2.3.2 Particulate Matter (PM_{2.5} and PM₁₀)

As described in Section 8.1.1.1, PM causes adverse health effects, and the EPA has set national standards to provide requisite protection against those health effects. In this section we present information on current and model-projected future PM levels.

8.2.3.2.1 *Current Levels of PM*

Figure 8-8 and Figure 8-9 respectively show a snapshot of annual and 24-hour PM_{2.5} concentrations in 2008. There are two National Ambient Air Quality Standards (NAAQS) for PM_{2.5}: an annual standard (15 µg/m³) and a 24-hour standard (35 µg/m³). In 2008, the highest annual average PM_{2.5} concentrations were in California, Arizona, and Hawaii and the highest 24-hour PM_{2.5} concentrations were in California and Virginia.

Figure 8-8 Annual Average PM_{2.5} Concentrations in µg/m³ for 2008^{CC}

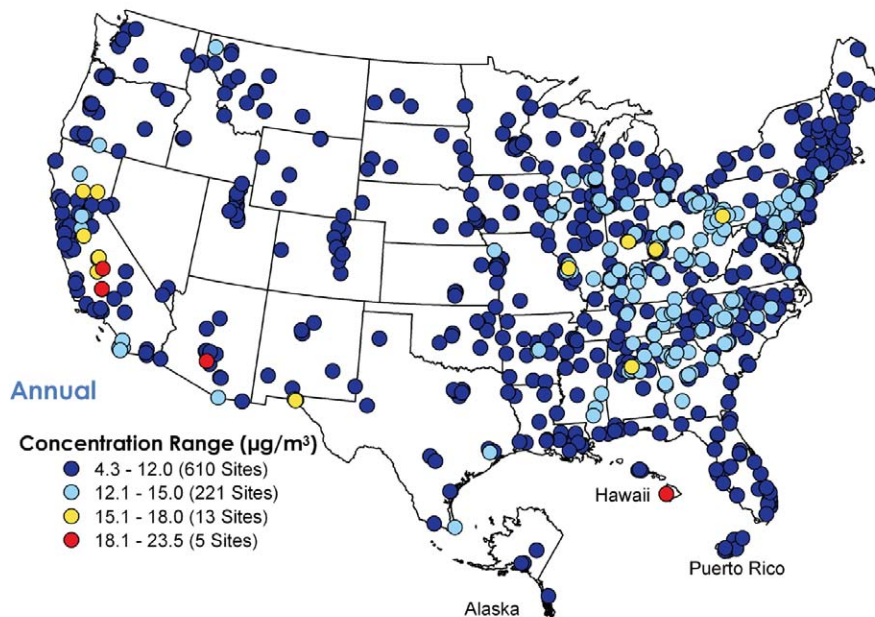

^{CC} From U.S. EPA, 2010. Our Nation’s Air: Status and Trends through 2008. EPA-454/R-09-002. February 2010. Available at: <http://www.epa.gov/airtrends/2010/index.html>.

Figure 8-9 24-hour (98th percentile 24-hour concentrations) PM_{2.5} Concentrations in µg/m³ for 2008^{DD}

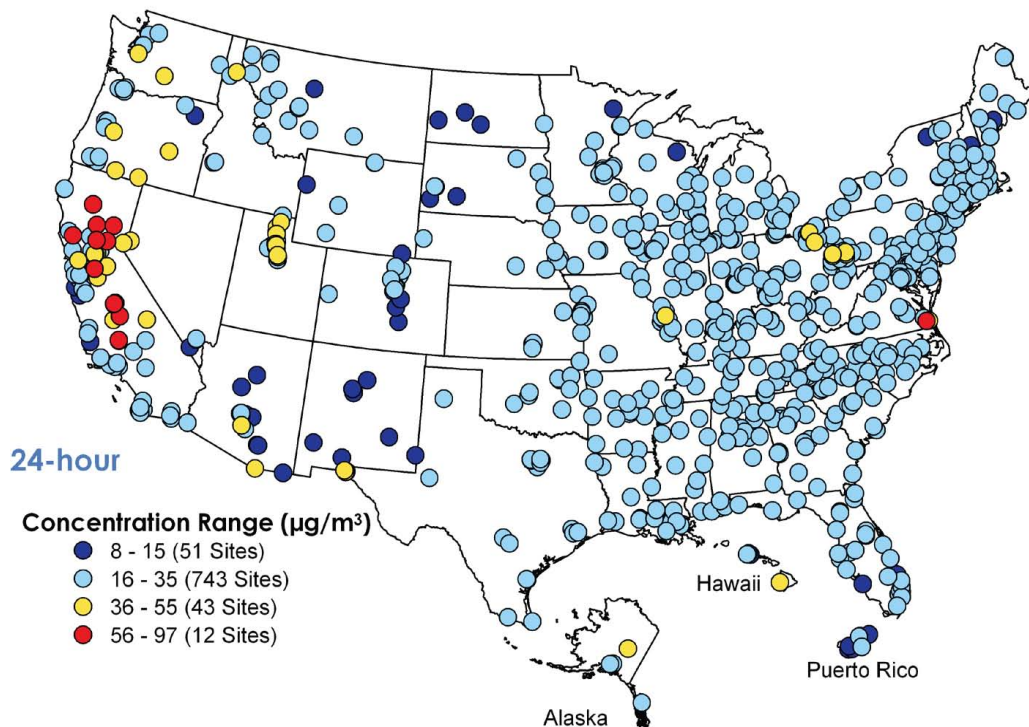

There are two National Ambient Air Quality Standards (NAAQS) for PM_{2.5}: an annual standard (15 µg/m³) and a 24-hour standard (35 µg/m³). The most recent revisions to these standards were in 1997 and 2006. In 2005 the U.S. EPA designated nonattainment areas for the 1997 PM_{2.5} NAAQS (70 FR 19844, April 14, 2005).^{EE} As of April 21, 2011, approximately 88 million people live in the 39 areas that are designated as nonattainment for the 1997 PM_{2.5} NAAQS. These PM_{2.5} nonattainment areas are comprised of 208 full or partial counties. Nonattainment areas for the 1997 PM_{2.5} NAAQS are pictured in Figure 8-10. On October 8, 2009, the EPA issued final nonattainment area designations for the 2006 24-hour PM_{2.5} NAAQS (74 FR 58688, November 13, 2009). These designations include 32 areas composed of 121 full or partial counties with a population of over 70 million. Nonattainment areas for the 2006 PM_{2.5} NAAQS are pictured in Figure 8-11. In total, there are 54 PM_{2.5} nonattainment areas composed of 245 counties with a population of 101 million people.

States with PM_{2.5} nonattainment areas will be required to take action to bring those areas into compliance in the future. Most 1997 PM_{2.5} nonattainment areas are required to attain the 1997 PM_{2.5} NAAQS in the 2010 to 2015 time frame and then required to maintain the 1997

^{DD} From U.S. EPA, 2010. Our Nation's Air: Status and Trends through 2008. EPA-454/R-09-002. February 2010. Available at: <http://www.epa.gov/airtrends/2010/index.html>.

^{EE} A nonattainment area is defined in the Clean Air Act (CAA) as an area that is violating an ambient standard or is contributing to a nearby area that is violating the standard.

Heavy-Duty GHG and Fuel Efficiency Standards FRM: Health and Environmental Impacts

PM_{2.5} NAAQS thereafter.²⁹² The 2006 24-hour PM_{2.5} nonattainment areas will be required to attain the 2006 24-hour PM_{2.5} NAAQS in the 2014 to 2019 time frame and then be required to maintain the 2006 24-hour PM_{2.5} NAAQS thereafter.²⁹³ The heavy-duty vehicle standards finalized here first apply to model year 2014 vehicles.

Figure 8-10 1997 PM_{2.5} Nonattainment Areas

PM-2.5 Nonattainment Areas (1997 Standard)

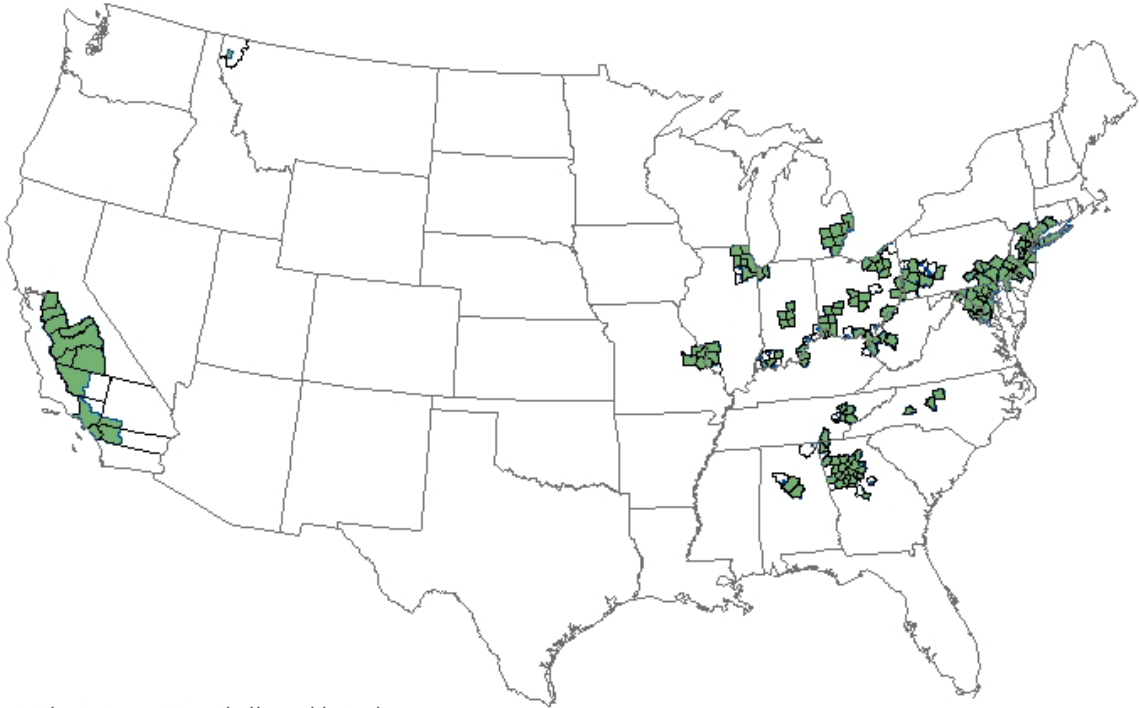

Nonattainment areas are indicated by color. When only a portion of a county is shown in color, it indicates that only that part of the county is within a nonattainment area boundary.

12/2010

Figure 8-11 2006 PM_{2.5} Nonattainment Areas

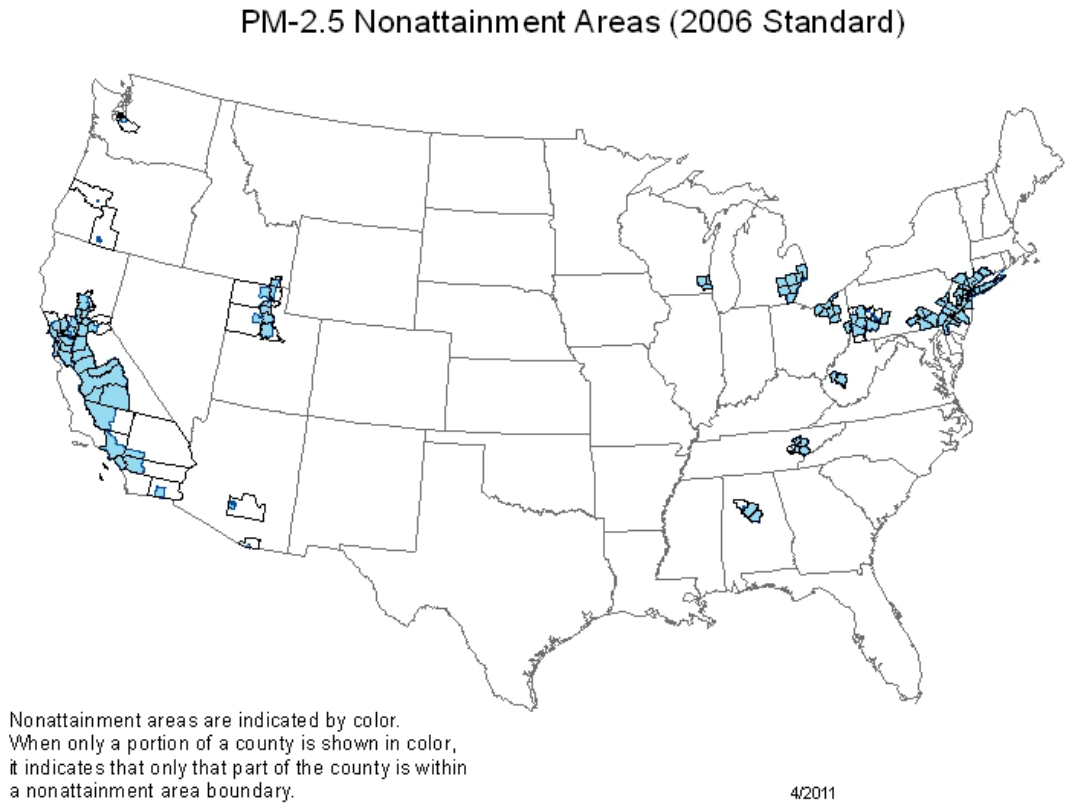

As of April 21, 2011, over 25 million people live in the 45 areas that are designated as nonattainment for the PM₁₀ NAAQS. There are 39 full or partial counties that make up the PM₁₀ nonattainment areas. Nonattainment areas for the PM₁₀ NAAQS are pictured in Figure 8-12.

Figure 8-12 PM₁₀ Nonattainment Areas

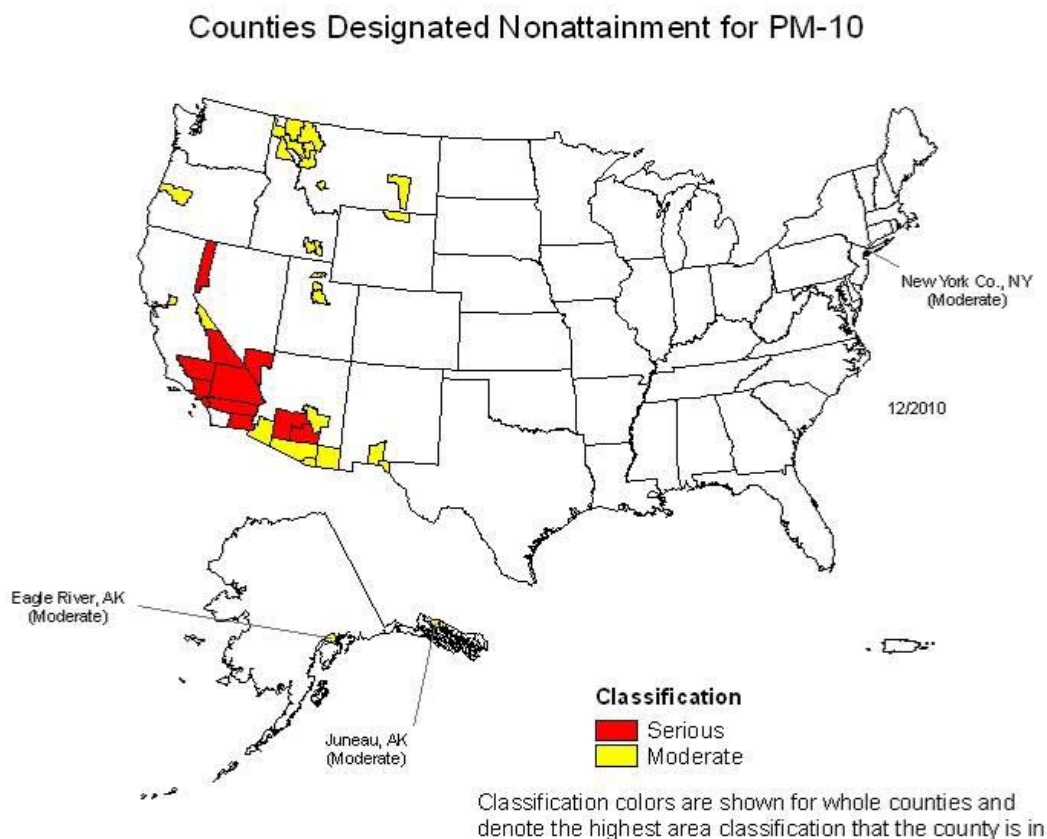

8.2.3.2.2 *Projected Levels of PM_{2.5}*

Generally, our modeling indicates that the heavy-duty standards will lead to small reductions in PM_{2.5} concentrations in some localized areas of the country. In the following sections we describe projected PM_{2.5} levels in the future, with and without the heavy-duty standards. Information on the air quality modeling methodology is contained in Section 8.2.2. Additional detail can be found in the air quality modeling technical support document (AQM TSD).

8.2.3.2.2.1 *Projected Levels of PM_{2.5} without this Final Action*

EPA has already adopted many mobile source emission control programs that are expected to reduce ambient PM levels. These control programs include the New Marine Compression-Ignition Engines at or Above 30 Liters per Cylinder Rule (75 FR 22895, April 30, 2010), the Marine Spark-Ignition and Small Spark-Ignition Engine Rule (73 FR 59034, October 8, 2008), the Locomotive and Marine Compression-Ignition Engine Rule (73 FR 25098, May 6, 2008), the Clean Air Nonroad Diesel (69 FR 38957, June 29, 2004), the Heavy Duty Engine and Vehicle Standards and Highway Diesel Fuel Sulfur Control Requirements (66 FR 5002, January

Regulatory Impact Analysis

18, 2001) and the Tier 2 Motor Vehicle Emissions Standards and Gasoline Sulfur Control Requirements (65 FR 6698, February 10, 2000). As a result of these and other federal, state and local programs, the number of areas that fail to meet the PM_{2.5} NAAQS in the future is expected to decrease. However, even with the implementation of all current state and federal regulations, there are projected to be counties violating the PM_{2.5} NAAQS well into the future.

The air quality modeling conducted projects that in 2030, with all current controls in effect but excluding the emissions changes expected to occur as a result of this final action, at least 4 counties, with a projected population of nearly 7 million people, may not attain the annual standard of 15 µg/m³ and at least 22 counties, with a projected population of over 33 million people, may not attain the 2006 24-hour standard of 35 µg/m³. Since the emission changes from this final action go into effect during the period when some areas are still working to attain the PM_{2.5} NAAQS, the projected emission changes will impact state and local agencies in their effort to attain and maintain the PM_{2.5} standard. In the following section we discuss projected nonattainment areas and how they compare to the areas which are projected to experience PM_{2.5} reductions or increases from the heavy-duty vehicle standards.

8.2.3.2.2 Projected Annual Average PM_{2.5} Design Values with this Final Action

This section summarizes the results of our modeling of annual average PM_{2.5} air quality impacts in the future due to the heavy-duty standards finalized in this action. Specifically, we compare a 2030 reference scenario, a scenario without the heavy-duty standards, to a 2030 control scenario which includes the heavy-duty standards. Our modeling indicates that the majority of the modeled counties will see decreases of less than 0.01 µg/m³ in their annual PM_{2.5} design values due to the heavy-duty standards. Figure 8-13 presents the changes in annual PM_{2.5} design values in 2030.^{FF}

^{FF} An annual PM_{2.5} design value is the concentration that determines whether a monitoring site meets the annual NAAQS for PM_{2.5}. The full details involved in calculating an annual PM_{2.5} design value are given in appendix N of 40 CFR part 50.

Heavy-Duty GHG and Fuel Efficiency Standards FRM: Health and Environmental Impacts

Figure 8-13 Projected Change in 2030 Annual PM_{2.5} Design Values Between the Reference Case and Control Case

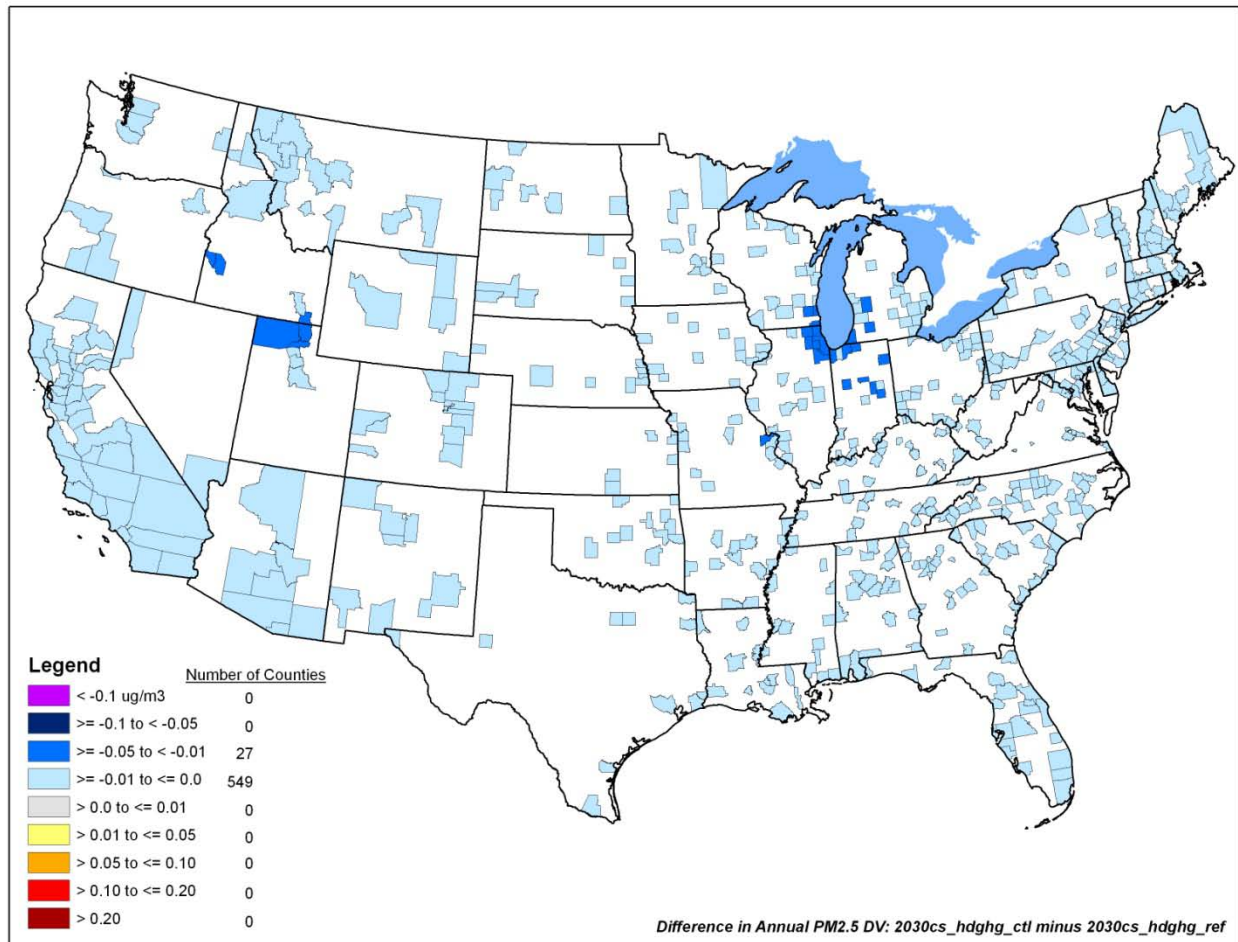

As shown in Figure 8-13, 27 counties will see decreases of between 0.01 µg/m³ and 0.05 µg/m³. These counties are in the upper Midwest, Utah, Idaho and Missouri. The maximum projected decrease in an annual PM_{2.5} design value is 0.03 µg/m³ in Allen County, Indiana and Canyon County, Idaho. The decreases in annual PM_{2.5} design values that we see in some counties are likely due to emission reductions related to lower fuel production at existing oil refineries and/or reductions in PM_{2.5} precursor emissions (NO_x, SO_x, and VOCs) due to improvements in road load. Additional information on the emissions reductions that are projected with this final action is available in Section 5.5.

There are 4 counties, all in California, that are projected to have annual PM_{2.5} design values above the NAAQS in 2030 with the heavy-duty standards in place. Table 8-5 below presents the changes in design values for these counties.

Regulatory Impact Analysis

Table 8-5 Change in Annual PM_{2.5} Design Values ($\mu\text{g}/\text{m}^3$) for Counties Projected to be Above the Annual PM_{2.5} NAAQS in 2030

County Name	Change in Annual PM _{2.5} Design Value ($\mu\text{g}/\text{m}^3$)	Population in 2030 ^a
Riverside Co., California	-0.01	2,614,198
San Bernardino Co., California	-0.01	2,784,489
Kern Co., California	-0.01	981,806
Tulare Co., California	0.00	528,662

Note:

^a Population numbers based on Woods & Poole data. Woods & Poole Economics, Inc. 2001. Population by Single Year of Age CD.

Average changes in 2030 annual PM_{2.5} design values for: (1) all counties with 2005 baseline design values, (2) counties with 2005 baseline design values that exceeded the annual PM_{2.5} standard, (3) counties with 2005 baseline design values that did not exceed the standard, but were within 10% of it, (4) counties with 2030 design values that exceeded the annual PM_{2.5} standard, and (5) counties with 2030 design values that did not exceed the standard, but were within 10% of it, are all between 0.00 and -0.01 $\mu\text{g}/\text{m}^3$. These statistics show either no change or a small decrease in annual PM_{2.5} design values in 2030.

8.2.3.2.2.3 Projected 24-hour Average PM_{2.5} Design Values with this Final Action

This section summarizes the results of our modeling of 24-hour PM_{2.5} air quality impacts in the future due to the heavy-duty standards. Specifically, we compare a 2030 reference scenario, a scenario without the heavy-duty standards, to a 2030 control scenario which includes the heavy-duty standards. Our modeling indicates that the majority of the modeled counties will see changes of between -0.05 $\mu\text{g}/\text{m}^3$ and 0 $\mu\text{g}/\text{m}^3$ in their 24-hour PM_{2.5} design values. Figure 8-14 presents the changes in 24-hour PM_{2.5} design values in 2030.^{GG}

^{GG} A 24-hour PM_{2.5} design value is the concentration that determines whether a monitoring site meets the 24-hour NAAQS for PM_{2.5}. The full details involved in calculating a 24-hour PM_{2.5} design value are given in appendix N of 40 CFR part 50.

Heavy-Duty GHG and Fuel Efficiency Standards FRM: Health and Environmental Impacts

Figure 8-14 Projected Change in 2030 24-hour PM_{2.5} Design Values Between the Reference Case and the Control Case

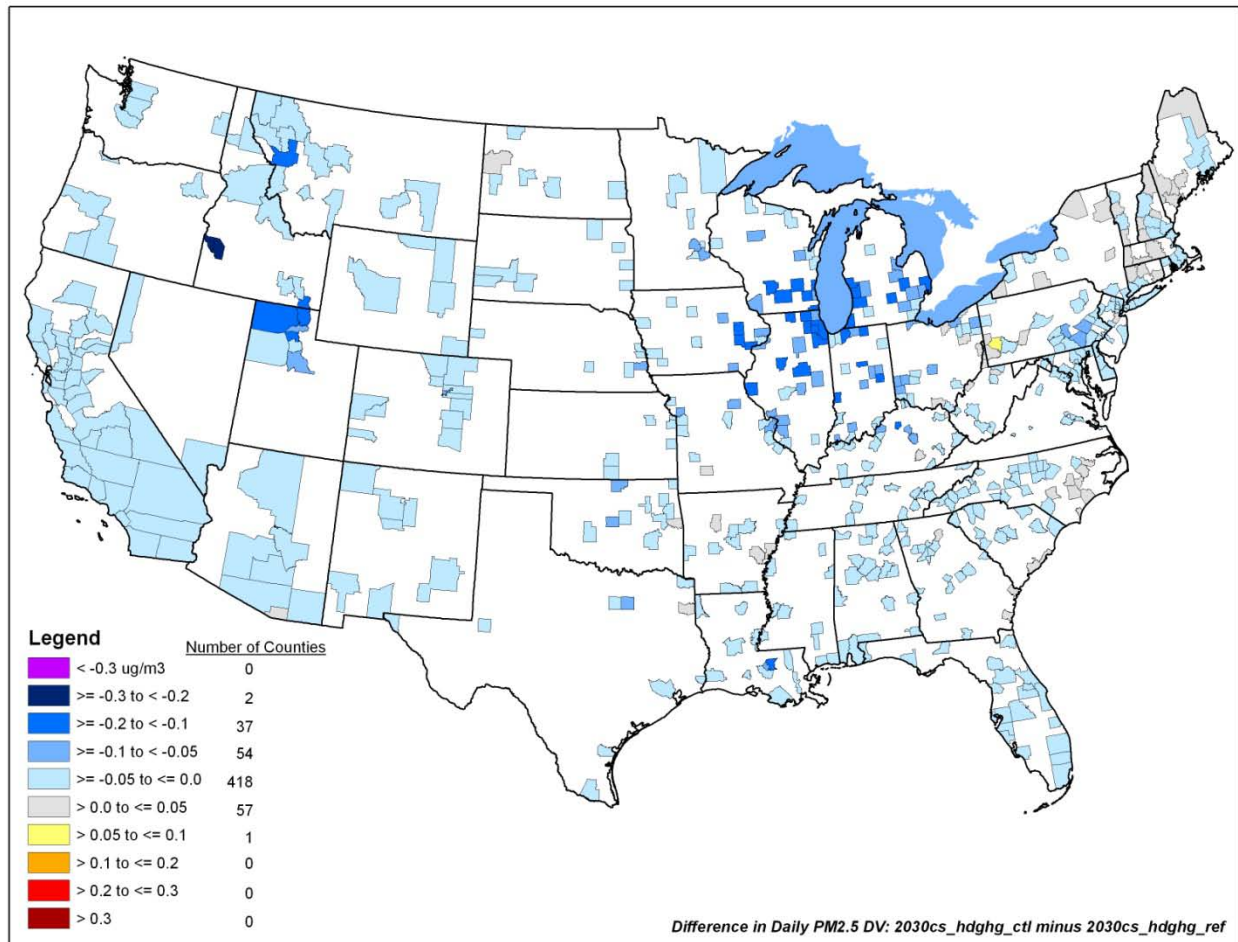

As shown in Figure 8-14, 39 counties will see decreases of more than 0.1 $\mu\text{g}/\text{m}^3$. These counties are in Idaho, Montana, northern Utah, and the upper Midwest. The maximum projected decrease in a 24-hour PM_{2.5} design value is 0.27 $\mu\text{g}/\text{m}^3$ in Canyon County, Idaho. The decreases in annual PM_{2.5} design values that we see in some counties are likely due to emission reductions related to lower fuel production at existing oil refineries and/or reductions in PM_{2.5} precursor emissions (NO_x, SO_x, and VOCs) due to improvements in road load. Additional information on the emissions reductions that are projected with this final action is available in Section 5.5.

There are also some counties that will see small, less than 0.1 $\mu\text{g}/\text{m}^3$, design value increases. These small increases in 24-hour PM_{2.5} design values are likely related to downstream emissions increases from APUs.

There are 22 counties, mainly in California, that are projected to have 24-hour PM_{2.5} design values above the NAAQS in 2030 with the heavy-duty standards in place. Table 8-6 below presents the changes in design values for these counties.

Regulatory Impact Analysis

Table 8-6 Change in 24-hour PM_{2.5} Design Values (µg/m³) for Counties Projected to be Above the 24-hour PM_{2.5} NAAQS in 2030

County Name	Change in 24-hour PM _{2.5} Design Value (µg/m ³)	Population in 2030 ^a
Kern County, California	-0.02	981,806
Riverside County, California	-0.01	2,614,198
San Bernardino County, California	-0.01	2,784,489
Fresno County, California	-0.01	1,196,949
Kings County, California	-0.01	195,067
Sacramento County, California	0.00	1,856,970
Los Angeles County, California	-0.02	10,742,722
Tulare County, California	0.00	528,662
Lane County, Oregon	-0.03	460,992
Cache County, Utah	-0.14	141,446
Allegheny County, Pennsylvania	0.06	1,234,930
Stanislaus County, California	-0.01	688,245
Lake County, Montana	-0.01	40,126
Orange County, California	-0.02	4,431,070
Salt Lake County, Utah	-0.05	1,431,946
Ravalli County, Montana	-0.03	63,914
Klamath County, Oregon	-0.02	77,199
Butte County, California	0.00	287,235
Missoula County, Montana	-0.13	141,264
Lincoln County, Montana	-0.01	20,454
Pierce County, Washington	0.00	1,082,578
Santa Clara County, California	0.00	2,320,199

Note:

^a Population numbers based on Woods & Poole data. Woods & Poole Economics, Inc. 2001. Population by Single Year of Age CD.

Table 8-7 shows the average change in 2030 24-hour PM_{2.5} design values for: (1) all counties with 2005 baseline design values, (2) counties with 2005 baseline design values that exceeded the 24-hour PM_{2.5} standard, (3) counties with 2005 baseline design values that did not exceed the standard, but were within 10% of it, (4) counties with 2030 design values that exceeded the 24-hour PM_{2.5} standard, and (5) counties with 2030 design values that did not exceed the standard, but were within 10% of it. Counties within 10% of the standard are intended to reflect counties that although not violating the standards, will also be impacted by changes in PM_{2.5} as they work to ensure long-term maintenance of the 24-hour PM_{2.5} NAAQS. On a population-weighted basis, the average modeled future-year 24-hour PM_{2.5} design values are projected to decrease by 0.03 µg/m³ due to the heavy-duty standards. On a population-weighted basis, 24-hour PM_{2.5} design values in those counties that are projected to be above the 24-hour PM_{2.5} standard in 2030 will see a slightly smaller decrease of 0.01 µg/m³.

Heavy-Duty GHG and Fuel Efficiency Standards FRM: Health and Environmental Impacts

Table 8-7 Average Change in Projected 24-hour PM_{2.5} Design Values

Average ^a	Number of US Counties	2030 Population ^b	Change in 2030 design value (µg/m ³)
All			-0.03
All, population-weighted	569	245,111,194	-0.03
Counties whose 2005 base year is violating the 2006 24-hour PM _{2.5} standard			-0.04
Counties whose 2005 base year is violating the 2006 24-hour PM _{2.5} standard, population-weighted	108	91,473,982	-0.04
Counties whose 2005 base year is within 10 percent of the 2006 24-hour PM _{2.5} standard			-0.04
Counties whose 2005 base year is within 10 percent of the 2006 24-hour PM _{2.5} standard, population-weighted	140	53,989,989	-0.03
Counties whose 2030 control case is violating the 2006 24-hour PM _{2.5} standard			-0.02
Counties whose 2030 control case is violating the 2006 24-hour PM _{2.5} standard, population-weighted	22	33,322,461	-0.01
Counties whose 2030 control case is within 10% of the 2006 24-hour PM _{2.5} standard			-0.01
Counties whose 2030 control case is within 10% of the 2006 24-hour PM _{2.5} standard, population-weighted	8	6,466,868	-0.01

Note:

^a Averages are over counties with 2005 modeled design values

^b Population numbers based on Woods & Poole data. Woods & Poole Economics, Inc. 2001. Population by Single Year of Age CD.

8.2.3.3 Air Toxics

8.2.3.3.1 *Current Levels of Air Toxics*

The majority of Americans continue to be exposed to ambient concentrations of air toxics at levels which have the potential to cause adverse health effects.²⁹⁴ The levels of air toxics to which people are exposed vary depending on where people live and work and the kinds of activities in which they engage, as discussed in detail in U.S. EPA's most recent Mobile Source Air Toxics (MSAT) Rule.²⁹⁵ In order to identify and prioritize air toxics, emission source types and locations which are of greatest potential concern, U. S. EPA conducts the National-Scale Air Toxics Assessment (NATA). The most recent NATA was conducted for calendar year 2005, and was released in March 2011.²⁹⁶ NATA for 2005 includes four steps:

- 1) Compiling a national emissions inventory of air toxics emissions from outdoor sources

Regulatory Impact Analysis

- 2) Estimating ambient concentrations of air toxics across the United States
- 3) Estimating population exposures across the United States
- 4) Characterizing potential public health risk due to inhalation of air toxics including both cancer and noncancer effects

Figure 8-15 and Figure 8-16 depict estimated tract-level carcinogenic risk and noncancer respiratory hazard from the assessment. The respiratory hazard is dominated by a single pollutant, acrolein.

According to the NATA for 2005, mobile sources were responsible for 43 percent of outdoor toxic emissions and over 50 percent of the cancer risk and noncancer hazard attributable to direct emissions from mobile and stationary sources.^{HH,II,297} Formaldehyde is the largest contributor to cancer risk of all 80 pollutants quantitatively assessed in the 2005 NATA, and mobile sources were responsible for over 40 percent of primary formaldehyde emissions in 2005. Over the years, EPA has implemented a number of mobile source and fuel controls which have resulted in VOC reductions, which also reduced formaldehyde, benzene and other air toxic emissions.

^{HH} NATA also includes estimates of risk attributable to background concentrations, which includes contributions from long-range transport, persistent air toxics, and natural sources; as well as secondary concentrations, where toxics are formed via secondary formation. Mobile sources substantially contribute to long-range transport and secondarily formed air toxics.

^{II} NATA relies on a Gaussian plume model, Assessment System for Population Exposure Nationwide (ASPEN), to estimate toxic air pollutant concentrations. Projected air toxics concentrations presented in this final action were modeled with CMAQ 4.7.1.

Figure 8-15 Tract Level Average Carcinogenic Risk, 2005 NATA

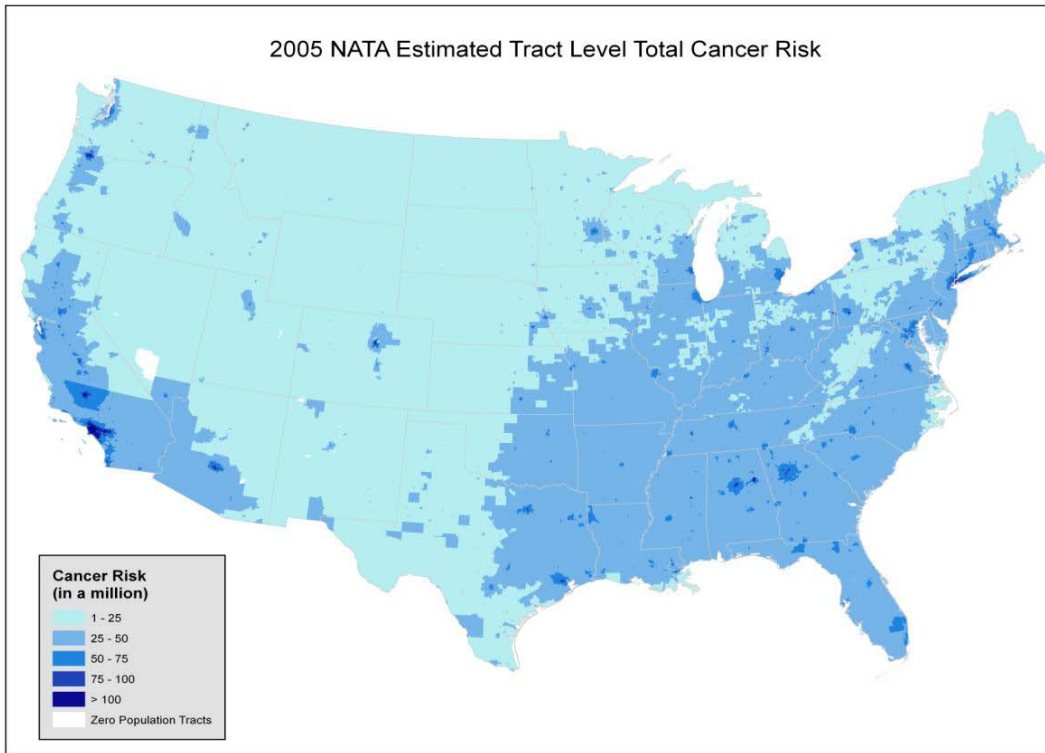
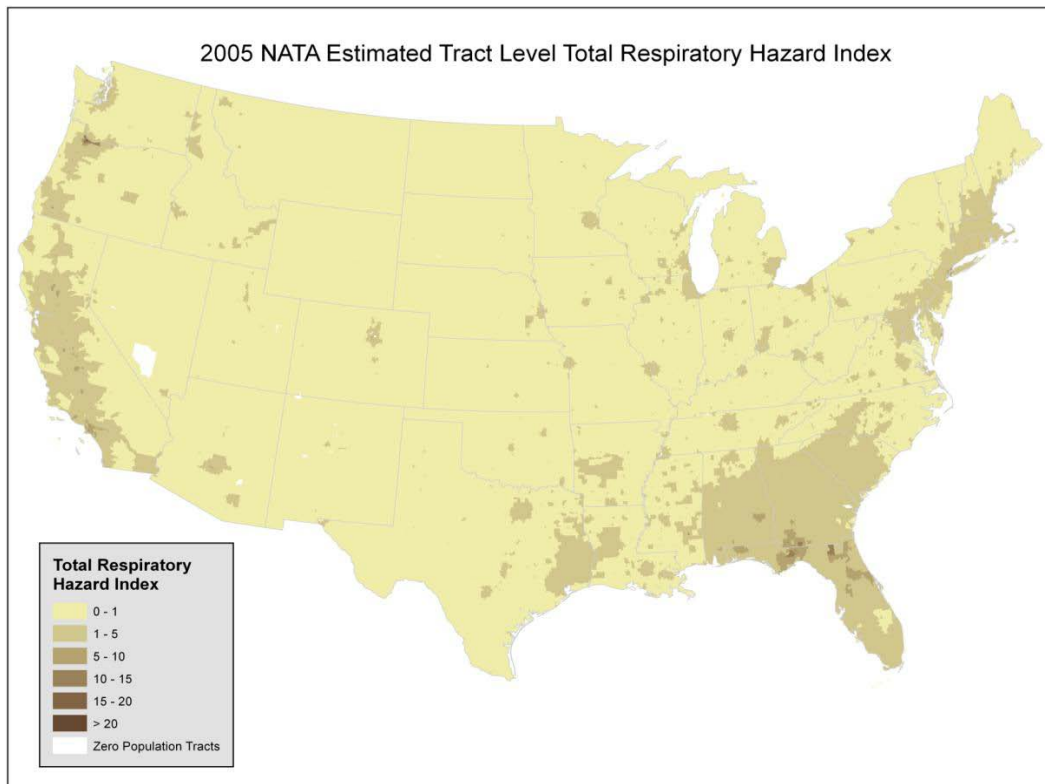

Figure 8-16 County Level Average Noncancer Hazard Index, 2002 NATA



8.2.3.3.2 *Projected Levels of Air Toxics*

In this section, we describe results of our modeling of air toxics levels in the future with the standards finalized in this action. Although there are a large number of compounds which are considered air toxics, we focused on those which were identified as national and regional-scale cancer and noncancer risk drivers or contributors in the 2005 NATA assessment and were also likely to be significantly impacted by the standards. These compounds include benzene, 1,3-butadiene, formaldehyde, acetaldehyde, and acrolein. Information on the air quality modeling methodology is contained in Section 8.2.1.

It should be noted that EPA has adopted many mobile source emission control programs that are expected to reduce ambient air toxics levels. These control programs include the Heavy-duty Onboard Diagnostic Rule (74 FR 8310, February 24, 2009), Small SI and Marine SI Engine Rule (73 FR 59034, October 8, 2008), Locomotive and Commercial Marine Rule (73 FR 25098, May 6, 2008), Mobile Source Air Toxics Rule (72 FR 8428, February 26, 2007), Clean Air Nonroad Diesel Rule (69 FR 38957, June 29, 2004), Heavy Duty Engine and Vehicle Standards and Highway Diesel Fuel Sulfur Control Requirements (66 FR 5002, January 18, 2001) and the Tier 2 Motor Vehicle Emissions Standards and Gasoline Sulfur Control Requirements (65 FR 6698, February 10, 2000). As a result of these programs, the ambient concentration of air toxics in the future is expected to decrease. The reference case and control case scenarios include these controls.

Our modeling indicates that the heavy-duty standards have relatively little impact on national average ambient concentrations of the modeled air toxics. Annual percent changes in ambient concentrations are generally less than 1% for benzene and acetaldehyde and less than 5% for formaldehyde and 1,3-butadiene. The acrolein changes range from <1% to up to 50% in a few limited areas, although absolute concentrations changes are small. We have included air toxics concentration maps in the air quality modeling technical support document (AQM TSD) in the docket for this final action.

Because overall impacts are small, we concluded that assessing exposure to ambient concentrations and conducting a quantitative risk assessment of air toxic impacts was not warranted. However, to assess the impact of projected changes in air quality with the heavy-duty standards, we developed population metrics that show population experiencing increases and decreases in annual ambient concentrations across the modeled air toxics. Table 8-8 illustrates the percentage of the population impacted by changes of various magnitudes in annual ambient concentrations between the reference case and the control case.

Heavy-Duty GHG and Fuel Efficiency Standards FRM: Health and Environmental Impacts

Table 8-8 Percent of Total Population Impacted by Changes in Annual Ambient Concentrations of Toxic Pollutants Between the Reference and Control Cases in 2030

Percent Change	Acetaldehyde	Acrolein	Benzene	1,3-Butadiene	Formaldehyde
-100					
>-100 to <=-50					
>-50 to <=-10		3.12%			
>-10 to <=-5		13.98%			0.07%
>-5 to <=-2.5		18.67%			1.89%
>-2.5 to <=-1	0.18%	30.91%	0.14%		15.16%
> -1 to <1	99.82%	33.31%	99.86%	99.98%	82.88%
>=1 to <2.5				0.02%	
>=2.5 to <5					
>=5 to <10					
>=10 to <50					
>=50 to <100					
>=100					

8.2.3.4 Deposition of Nitrogen and Sulfur

8.2.3.4.1 *Current Levels of Nitrogen and Sulfur Deposition*

Over the past two decades, the EPA has undertaken numerous efforts to reduce nitrogen and sulfur deposition across the U.S. Analyses of long-term monitoring data for the U.S. show that deposition of both nitrogen and sulfur compounds has decreased over the last 17 years although many areas continue to be negatively impacted by deposition. Deposition of inorganic nitrogen and sulfur species routinely measured in the U.S. between 2005 and 2007 were as high as 9.6 kilograms of nitrogen per hectare (kg N/ha) averaged over three years and 20.8 kilograms of sulfur per hectare (kg S/ha) averaged over three years. Figure 17 and Figure 18 show that annual total deposition (the sum of wet and dry deposition) decreased between 1989-1999 and 2005-2007 due to sulfur and NO_x controls on power plants and motor vehicles and reformulated fuels in the U.S. The data show that reductions were more substantial for sulfur compounds than for nitrogen compounds. These numbers are generated by the U.S. national monitoring network and they likely underestimate nitrogen deposition because neither ammonia nor organic nitrogen is measured. In the eastern U.S., where data are most abundant, total sulfur deposition decreased by about 44% between 1990 and 2007, while total nitrogen deposition decreased by 25% over the same time frame.²⁹⁸

Regulatory Impact Analysis

Figure 8-17 Total Sulfur Deposition in the Contiguous U.S., 1989-1991 and 2005 -2007

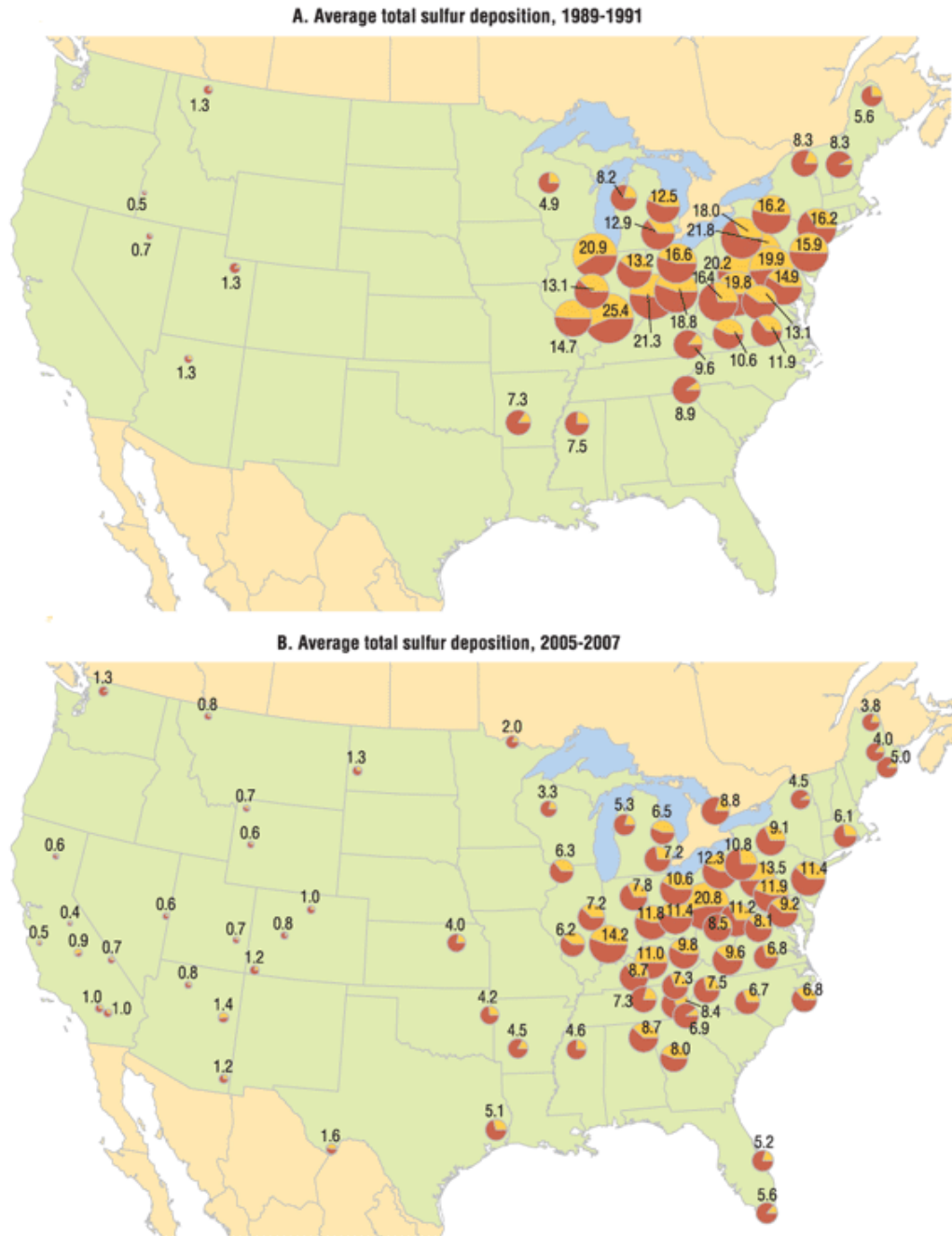

^aCoverage: 37 monitoring sites in 1989-1991 and 72 monitoring sites in 2005-2007.

Data source: NADP, 2008; U.S. EPA, 2008

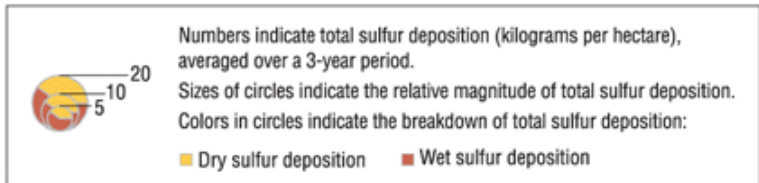

Heavy-Duty GHG and Fuel Efficiency Standards FRM: Health and Environmental Impacts

Figure 8-18 Total Nitrogen Deposition in the Contiguous U.S., 1989-1991 and 2005-2007

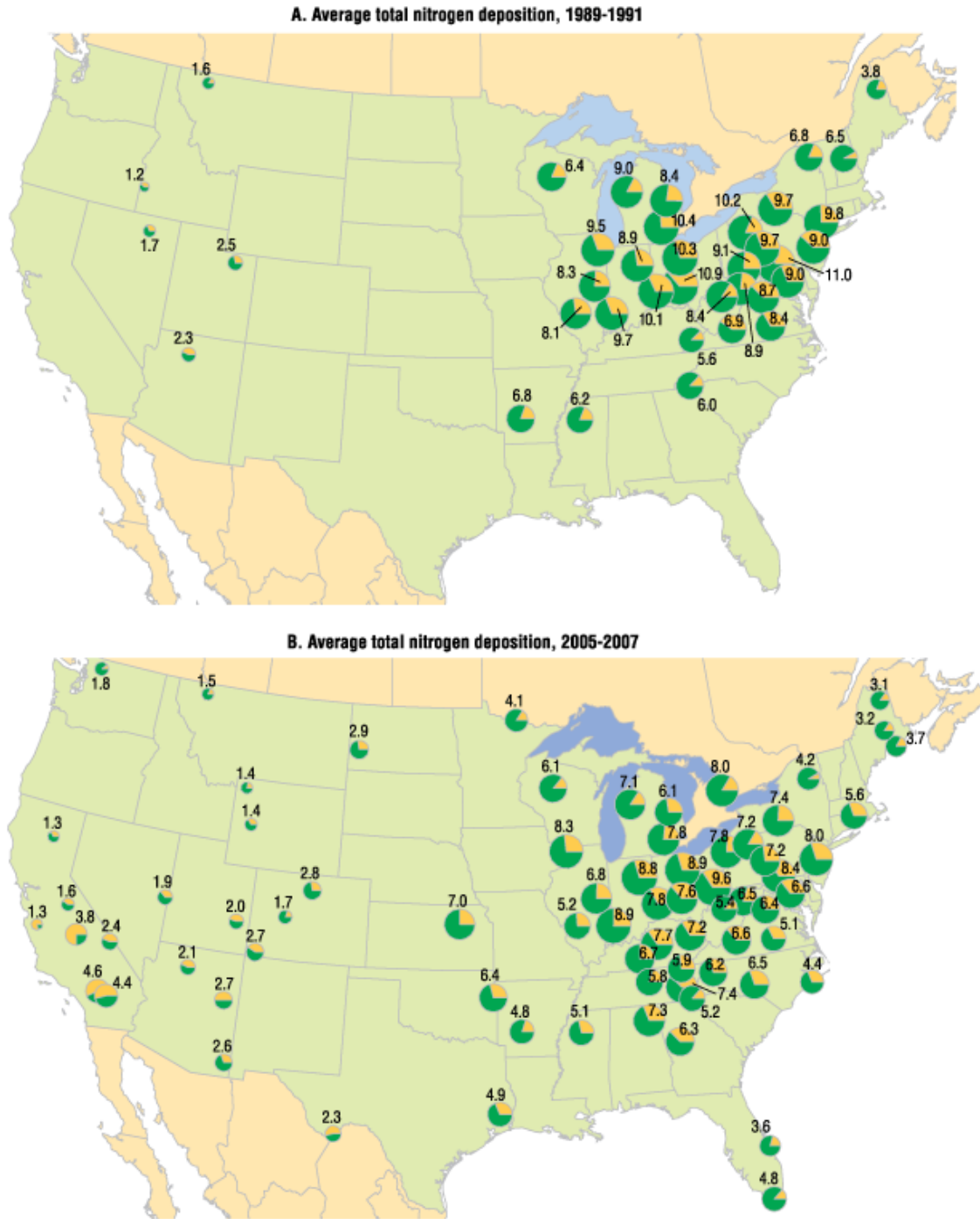

^a Coverage: 37 monitoring sites in 1989-1991 and 72 monitoring sites in 2005-2007.

Data source: NADP, 2008; U.S. EPA, 2008



Numbers indicate total nitrogen deposition (kilograms per hectare), averaged over a 3-year period.
 Sizes of circles indicate the relative magnitude of total nitrogen deposition.
 Colors in circles indicate the breakdown of total nitrogen deposition:
■ Dry nitrogen deposition ■ Wet nitrogen deposition

Regulatory Impact Analysis

8.2.3.4.2 Projected Levels of Nitrogen and Sulfur Deposition

Our air quality modeling projects decreases in nitrogen deposition, especially in the upper Midwest. Figure 8-19 shows that for nitrogen deposition the heavy-duty standards will result in annual percent decreases of more than 2% in some areas. The decreases in nitrogen deposition are likely due to projected tailpipe reductions in NO_x and projected upstream emissions decreases in NO_x from reduced gasoline production. The remainder of the country will see only minimal changes in nitrogen deposition, ranging from decreases of less than 0.5% to increases of less than 0.5%.

Figure 8-19 Percent Change in Annual Total Nitrogen over the U.S. Modeling Domain as a Result of the Final Standards

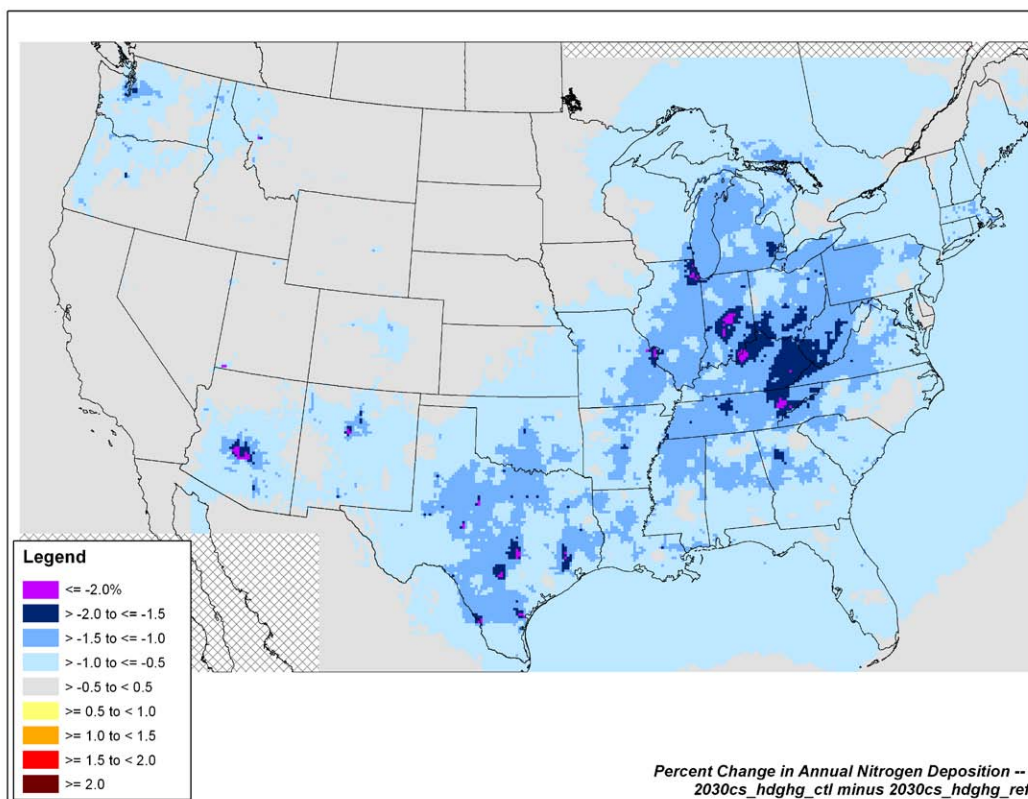

Our air quality modeling does not show substantial overall nationwide impacts on the annual total sulfur deposition occurring across the U.S. as a result of the heavy-duty standards required by this final action. The impacts of the heavy-duty standards on sulfur deposition are minimal, ranging from decreases of up to 0.5% to increases of up to 0.5%.

8.2.3.5 Visibility Degradation

8.2.3.5.1 Current Visibility Levels

Designated PM_{2.5} nonattainment areas indicate that, as of April 21, 2011, approximately 101 million people live in nonattainment areas for the PM_{2.5} NAAQS. Thus, at least these

populations would likely be experiencing visibility impairment, as well as many thousands of individuals who travel to these areas. In addition, while visibility trends have improved in mandatory class I federal areas, these areas continue to suffer from visibility impairment. In eastern areas, the background average visual range is between 45 and 90 miles while recent data indicates that average visual range for the worst days was 24 miles in 2008. In western areas, the background average visual range is between 120 and 180 miles while recent data indicates that average visual range for the worst days was 64 miles in 2008.^{299,300} In summary, visibility impairment is experienced throughout the U.S., in multi-state regions, urban areas, and remote mandatory class I federal areas.

8.2.3.5.2 *Projected Visibility Levels*

Air quality modeling conducted for the final action was used to project visibility conditions in 138 mandatory class I federal areas across the U.S. in 2030. The results show that all the modeled areas will continue to have annual average deciview levels above background in 2030.^{JJ} The results also indicate that the majority of the modeled mandatory class I federal areas will see very little change in their visibility. Some mandatory class I federal areas will see improvements in visibility due to the heavy-duty standards and a few mandatory class I federal areas will see visibility decreases. The average visibility at all modeled mandatory class I federal areas on the 20% worst days is projected to improve by 0.01 deciviews, or 0.06%, in 2030. The greatest improvement in visibilities will be seen in Craters of the Moon (New Mexico) and the Hells Canyon Wilderness (Oregon). Craters of the Moon will see a 0.46% improvement (0.06 DV) and the Hells Canyon Wilderness will see a 0.40% improvement (0.07 DV) in 2030 due to the heavy-duty standards. The following four areas will see a degradation of 0.01 DV in 2030 as a result of the heavy-duty standards: Chiricahua (New Mexico), 0.08% degradation; San Gabriel Wilderness (California), 0.06% degradation; San Jacinto Wilderness (California), 0.05% degradation; and Roosevelt Campobello International Park (Maine), 0.05% degradation. Table 8-9 contains the full visibility results from 2030 for the 138 analyzed areas.

^{JJ} The level of visibility impairment in an area is based on the light-extinction coefficient and a unitless visibility index, called a “deciview”, which is used in the valuation of visibility. The deciview metric provides a scale for perceived visual changes over the entire range of conditions, from clear to hazy. Under many scenic conditions, the average person can generally perceive a change of one deciview. The higher the deciview value, the worse the visibility. Thus, an improvement in visibility is a decrease in deciview value.

Regulatory Impact Analysis

Table 8-9 Visibility Levels in Deciviews for Individual U.S. Class I Areas on the 20% Worst Days for Several Scenarios

CLASS 1 AREA (20% WORST DAYS)	STATE	2005 BASELINE VISIBILITY	2030 BASELINE	2030 HD GHG	NATURAL BACKGROUND
SIPSEY WILDERNESS	AL	29.62	21.78	21.76	11.39
CANEY CREEK WILDERNESS	AR	26.78	20.91	20.88	11.33
UPPER BUFFALO WILDERNESS	AR	27.09	21.33	21.30	11.28
CHIRICAHUA NM	AZ	13.33	12.84	12.85	6.92
CHIRICAHUA WILDERNESS	AZ	13.33	12.86	12.86	6.91
GALIURO WILDERNESS	AZ	13.33	12.72	12.71	6.88
GRAND CANYON NP	AZ	11.85	11.04	11.04	6.95
MAZATZAL WILDERNESS	AZ	13.80	12.55	12.53	6.91
MOUNT BALDY WILDERNESS	AZ	11.27	10.77	10.77	6.95
PETRIFIED FOREST NP	AZ	13.73	12.93	12.93	6.97
PINE MOUNTAIN WILDERNESS	AZ	13.80	12.53	12.52	6.92
SAGUARO NM	AZ	14.53	13.67	13.67	6.84
SIERRA ANCHA WILDERNESS	AZ	14.37	13.33	13.32	6.92
SUPERSTITION WILDERNESS	AZ	14.01	12.83	12.81	6.88
SYCAMORE CANYON WILDERNESS	AZ	15.34	14.60	14.59	6.96
AGUA TIBIA WILDERNESS	CA	23.09	19.37	19.37	7.17
ANSEL ADAMS WILDERNESS (MINARETS)	CA	14.90	14.10	14.10	7.12
CARIBOU WILDERNESS	CA	14.19	13.30	13.29	7.29
CUCAMONGA WILDERNESS	CA	19.35	16.64	16.64	7.17
DESOLATION WILDERNESS	CA	12.52	11.90	11.90	7.13
EMIGRANT WILDERNESS	CA	17.37	16.60	16.60	7.14
HOOVER WILDERNESS	CA	11.92	11.38	11.37	7.12
JOHN MUIR WILDERNESS	CA	14.90	14.00	14.00	7.14
JOSHUA TREE NM	CA	19.40	17.06	17.04	7.08
KAISER WILDERNESS	CA	14.90	13.78	13.78	7.13
KINGS CANYON NP	CA	23.41	22.03	22.02	7.13
LASSEN VOLCANIC NP	CA	14.19	13.29	13.29	7.31
LAVA BEDS NM	CA	14.77	13.78	13.78	7.49

**Heavy-Duty GHG and Fuel Efficiency Standards FRM: Health and Environmental
Impacts**

CLASS 1 AREA (20% WORST DAYS)	STATE	2005 BASELINE VISIBILITY	2030 BASELINE	2030 HD GHG	NATURAL BACKGROUND
MOKELUMNE WILDERNESS	CA	12.52	11.88	11.88	7.14
PINNACLES NM	CA	18.22	15.93	15.93	7.34
POINT REYES NS	CA	22.89	21.49	21.49	7.39
REDWOOD NP	CA	18.66	17.81	17.79	7.81
SAN GABRIEL WILDERNESS	CA	19.35	16.60	16.61	7.17
SAN GORGONIO WILDERNESS	CA	21.80	19.59	19.58	7.10
SAN JACINTO WILDERNESS	CA	21.80	18.43	18.44	7.12
SAN RAFAEL WILDERNESS	CA	19.04	17.11	17.11	7.28
SEQUOIA NP	CA	23.41	21.55	21.55	7.13
SOUTH WARNER WILDERNESS	CA	14.77	14.00	14.00	7.32
THOUSAND LAKES WILDERNESS	CA	14.19	13.27	13.27	7.32
VENTANA WILDERNESS	CA	18.22	16.73	16.72	7.32
YOSEMITE NP	CA	17.37	16.61	16.61	7.14
BLACK CANYON OF THE GUNNISON NM	CO	10.18	9.48	9.48	7.06
EAGLES NEST WILDERNESS	CO	9.38	8.76	8.76	7.08
FLAT TOPS WILDERNESS	CO	9.38	8.96	8.95	7.07
GREAT SAND DUNES NM	CO	12.49	11.98	11.98	7.10
LA GARITA WILDERNESS	CO	10.18	9.73	9.72	7.06
MAROON BELLS- SNOWMASS WILDERNESS	CO	9.38	8.93	8.93	7.07
MESA VERDE NP	CO	12.78	12.18	12.18	7.09
MOUNT ZIRKEL WILDERNESS	CO	10.19	9.74	9.74	7.08
RAWAH WILDERNESS	CO	10.19	9.72	9.71	7.08
ROCKY MOUNTAIN NP	CO	13.54	12.99	12.98	7.05
WEMINUCHE WILDERNESS	CO	10.18	9.70	9.70	7.06
WEST ELK WILDERNESS	CO	9.38	8.89	8.89	7.07
EVERGLADES NP	FL	22.48	19.02	19.02	11.15
OKEFENOKEE	GA	27.24	21.77	21.75	11.45
WOLF ISLAND	GA	27.24	21.39	21.38	11.42
CRATERS OF THE MOON NM	ID	14.19	13.18	13.12	7.13

Regulatory Impact Analysis

CLASS 1 AREA (20% WORST DAYS)	STATE	2005 BASELINE VISIBILITY	2030 BASELINE	2030 HD GHG	NATURAL BACKGROUND
SAWTOOTH WILDERNESS	ID	14.33	14.13	14.13	7.15
MAMMOTH CAVE NP	KY	31.76	23.02	22.99	11.53
ACADIA NP	ME	23.19	19.42	19.42	11.45
MOOSEHORN	ME	21.94	18.79	18.79	11.36
ROOSEVELT CAMPOBELLO INTERNATIONAL PARK	ME	21.94	18.78	18.79	11.36
ISLE ROYALE NP	MI	21.33	18.74	18.72	11.22
SENEY	MI	24.71	21.00	20.96	11.37
VOYAGEURS NP	MN	19.82	17.22	17.20	11.09
HERCULES-GLADES WILDERNESS	MO	27.15	22.25	22.22	11.27
ANACONDA-PINTLER WILDERNESS	MT	13.91	13.59	13.58	7.28
BOB MARSHALL WILDERNESS	MT	14.54	14.16	14.16	7.36
CABINET MOUNTAINS WILDERNESS	MT	14.15	13.61	13.61	7.43
GATES OF THE MOUNTAINS WILDERNESS	MT	11.67	11.31	11.31	7.22
GLACIER NP	MT	19.13	18.29	18.29	7.56
MEDICINE LAKE	MT	17.78	17.09	17.08	7.30
MISSION MOUNTAINS WILDERNESS	MT	14.54	14.04	14.04	7.39
RED ROCK LAKES	MT	10.94	10.50	10.49	7.14
SCAPEGOAT WILDERNESS	MT	14.54	14.13	14.13	7.29
SELWAY-BITTERROOT WILDERNESS	MT	13.91	13.64	13.64	7.32
UL BEND	MT	14.92	14.54	14.54	7.18
LINVILLE GORGE WILDERNESS	NC	29.40	21.21	21.20	11.43
SHINING ROCK WILDERNESS	NC	28.72	21.03	21.01	11.45
LOSTWOOD	ND	19.50	18.14	18.13	7.33
THEODORE ROOSEVELT NP	ND	17.69	16.35	16.34	7.31
GREAT GULF WILDERNESS	NH	22.13	17.78	17.78	11.31
PRESIDENTIAL RANGE- DRY RIVER WILDERNESS	NH	22.13	17.74	17.74	11.33
BRIGANTINE	NJ	29.28	22.53	22.52	11.28

Heavy-Duty GHG and Fuel Efficiency Standards FRM: Health and Environmental Impacts

CLASS 1 AREA (20% WORST DAYS)	STATE	2005 BASELINE VISIBILITY	2030 BASELINE	2030 HD GHG	NATURAL BACKGROUND
BANDELIER NM	NM	11.87	10.89	10.88	7.02
BOSQUE DEL APACHE	NM	13.89	12.75	12.73	6.97
CARLSBAD CAVERNS NP	NM	16.98	15.35	15.34	7.02
GILA WILDERNESS	NM	13.32	12.78	12.78	6.95
PECOS WILDERNESS	NM	10.10	9.55	9.55	7.04
SALT CREEK	NM	18.20	16.71	16.70	6.99
SAN PEDRO PARKS WILDERNESS	NM	10.39	9.80	9.79	7.03
WHEELER PEAK WILDERNESS	NM	10.10	9.36	9.35	7.07
WHITE MOUNTAIN WILDERNESS	NM	13.52	12.61	12.61	6.98
JARBIDGE WILDERNESS	NV	12.13	11.86	11.86	7.10
WICHITA MOUNTAINS	OK	23.79	19.42	19.37	11.07
CRATER LAKE NP	OR	14.04	13.41	13.41	7.71
DIAMOND PEAK WILDERNESS	OR	14.04	13.34	13.33	7.77
EAGLE CAP WILDERNESS	OR	18.25	17.31	17.28	7.34
GEARHART MOUNTAIN WILDERNESS	OR	14.04	13.53	13.53	7.46
HELLS CANYON WILDERNESS	OR	18.73	17.40	17.33	7.32
KALMIOPSIS WILDERNESS	OR	16.31	15.52	15.51	7.71
MOUNT HOOD WILDERNESS	OR	14.79	13.53	13.50	7.77
MOUNT JEFFERSON WILDERNESS	OR	15.93	15.19	15.18	7.81
MOUNT WASHINGTON WILDERNESS	OR	15.93	15.19	15.18	7.89
MOUNTAIN LAKES WILDERNESS	OR	14.04	13.35	13.34	7.57
STRAWBERRY MOUNTAIN WILDERNESS	OR	18.25	17.34	17.30	7.49
THREE SISTERS WILDERNESS	OR	15.93	15.25	15.24	7.87
CAPE ROMAIN	SC	27.14	20.67	20.66	11.36
BADLANDS NP	SD	16.73	15.40	15.40	7.30
WIND CAVE NP	SD	15.96	14.76	14.75	7.24
GREAT SMOKY MOUNTAINS NP	TN	30.43	22.57	22.54	11.44

Regulatory Impact Analysis

CLASS 1 AREA (20% WORST DAYS)	STATE	2005 BASELINE VISIBILITY	2030 BASELINE	2030 HD GHG	NATURAL BACKGROUND
JOYCE-KILMER- SLICKROCK WILDERNESS	TN	30.43	22.29	22.26	11.45
BIG BEND NP	TX	17.39	15.75	15.74	6.93
GUADALUPE MOUNTAINS NP	TX	16.98	15.30	15.29	7.03
ARCHES NP	UT	11.04	10.43	10.42	6.99
BRYCE CANYON NP	UT	11.73	11.18	11.18	6.99
CANYONLANDS NP	UT	11.04	10.53	10.51	7.01
CAPITOL REEF NP	UT	10.63	10.27	10.27	7.03
JAMES RIVER FACE WILDERNESS	VA	29.32	21.02	21.00	11.24
SHENANDOAH NP	VA	29.66	21.27	21.27	11.25
LYE BROOK WILDERNESS	VT	24.17	18.05	18.04	11.25
ALPINE LAKE WILDERNESS	WA	17.35	15.65	15.62	7.86
GLACIER PEAK WILDERNESS	WA	13.78	12.72	12.72	7.80
GOAT ROCKS WILDERNESS	WA	12.88	11.73	11.72	7.82
MOUNT ADAMS WILDERNESS	WA	12.88	11.78	11.77	7.78
MOUNT RAINIER NP	WA	17.56	16.18	16.17	7.90
NORTH CASCADES NP	WA	13.78	12.71	12.70	7.78
OLYMPIC NP	WA	16.14	14.96	14.95	7.88
PASAYTEN WILDERNESS	WA	15.39	14.51	14.51	7.77
DOLLY SODS WILDERNESS	WV	29.73	20.82	20.81	11.32
OTTER CREEK WILDERNESS	WV	29.73	20.93	20.92	11.33
BRIDGER WILDERNESS	WY	10.93	10.60	10.60	7.08
FITZPATRICK WILDERNESS	WY	10.93	10.60	10.60	7.09
GRAND TETON NP	WY	10.94	10.45	10.44	7.09
NORTH ABSAROKA WILDERNESS	WY	11.12	10.81	10.81	7.09
TETON WILDERNESS	WY	10.94	10.55	10.54	7.09
WASHAKIE WILDERNESS	WY	11.12	10.82	10.82	7.09
YELLOWSTONE NP	WY	10.94	10.47	10.46	7.12

8.3 Quantified and Monetized Non-GHG Health and Environmental Impacts

This section presents EPA’s analysis of the non-GHG health and environmental impacts that can be expected to occur as a result of the HD National Program. GHG emissions are predominantly the byproduct of fossil fuel combustion processes that also produce criteria and hazardous air pollutants. The vehicles that are subject to the standards are also significant sources of mobile source air pollution such as direct PM, NO_x, VOCs and air toxics. The standards will affect exhaust emissions of these pollutants from vehicles. They will also affect emissions from upstream sources related to changes in fuel consumption. Changes in ambient ozone, PM_{2.5}, and air toxics that will result from the standards are expected to affect human health in the form of premature deaths and other serious human health effects, as well as other important public health and welfare effects.

It is important to quantify the health and environmental impacts associated with the final program because a failure to adequately consider these ancillary co-pollutant impacts could lead to an incorrect assessment of their net costs and benefits. Moreover, co-pollutant impacts tend to accrue in the near term, while any effects from reduced climate change mostly accrue over a time frame of several decades or longer.

This section is split into two sub-sections: the first presents the PM- and ozone-related health and environmental impacts associated with final program in calendar year (CY) 2030; the second discusses the PM-related co-benefits associated with the model year (MY) analysis of the program.^{KK}

8.3.1 Quantified and Monetized Non-GHG Human Health Benefits of the 2030 Calendar Year Analysis

This analysis reflects the impact of the HD National Program in 2030 compared to a future-year reference scenario without the program in place. Overall, we estimate that the final rules will lead to a net decrease in PM_{2.5}-related health impacts (see Chapter 8.2.3 for more information about the air quality modeling results). While the PM-related air quality impacts are relatively small, the decrease in population-weighted national average PM_{2.5} exposure results in a net decrease in adverse PM-related human health impacts (the decrease in national population weighted annual average PM_{2.5} is 0.005 µg/m³).

The air quality modeling also projects decreases in ozone concentrations (see Chapter 8.2.3). The overall decrease in population-weighted national average ozone exposure results in

^{KK} EPA typically analyzes rule impacts (emissions, air quality, costs and benefits) in the year in which they occur; for this analysis, we selected 2030 as a representative future year. We refer to this analysis as the “Calendar Year” (CY) analysis. EPA also conducted a separate analysis of the impacts over the model year lifetimes of the 2014 through 2018 model year vehicles. We refer to this analysis as the “Model Year” (MY) analysis. In contrast to the CY analysis, the MY lifetime analysis shows the impacts of the program on each of these MY fleets over the course of their lifetime.

Regulatory Impact Analysis

decreases in ozone-related health impacts (population weighted maximum 8-hour average ozone decreases by 0.164 ppb).

We base our analysis of the program's impact on human health in 2030 on peer-reviewed studies of air quality and human health effects.^{301,302} Our benefits methods are also consistent with recent rulemaking analyses such as the final Transport Rule,³⁰³ the final 2012-2016 MY Light-Duty Vehicle Rule,³⁰⁴ and the final Portland Cement National Emissions Standards for Hazardous Air Pollutants (NESHAP) RIA.³⁰⁵ To model the ozone and PM air quality impacts of this final action, we used the Community Multiscale Air Quality (CMAQ) model (see Section 7.2.1). The modeled ambient air quality data serves as an input to the Environmental Benefits Mapping and Analysis Program version 4.0 (BenMAP).^{LL} BenMAP is a computer program developed by the U.S. EPA that integrates a number of the modeling elements used in previous analyses (*e.g.*, interpolation functions, population projections, health impact functions, valuation functions, analysis and pooling methods) to translate modeled air concentration estimates into health effects incidence estimates and monetized benefits estimates.

The range of total monetized ozone- and PM-related health impacts is presented in. We present total benefits based on the PM- and ozone-related premature mortality function used. The benefits ranges therefore reflect the addition of each estimate of ozone-related premature mortality (each with its own row in) to estimates of PM-related premature mortality. These estimates represent EPA's preferred approach to characterizing a best estimate of benefits. As is the nature of Regulatory Impact Analyses (RIAs), the assumptions and methods used to estimate air quality benefits evolve to reflect the Agency's most current interpretation of the scientific and economic literature.

^{LL} Information on BenMAP, including downloads of the software, can be found at <http://www.epa.gov/ttn/ecas/benmodels.html>.

Heavy-Duty GHG and Fuel Efficiency Standards FRM: Health and Environmental Impacts

Table 8-10: Estimated 2030 Monetized PM-and Ozone-Related Health Benefits^a

2030 Total Ozone and PM Benefits – PM Mortality Derived from American Cancer Society Analysis and Six-Cities Analysis ^a			
Premature Ozone Mortality Function	Reference	Total Benefits (Billions, 2009\$, 3% Discount Rate) ^{b,c}	Total Benefits (Billions, 2009\$, 7% Discount Rate) ^{b,c}
Multi-city analyses	Bell et al., 2004	Total: \$1.3 - \$2.4 PM: \$0.74 - \$1.8 Ozone: \$0.55	Total: \$1.2 - \$2.2 PM: \$0.67 - \$1.6 Ozone: \$0.55
	Huang et al., 2005	Total: \$1.6 - \$2.7 PM: \$0.74 - \$1.8 Ozone: \$0.91	Total: \$1.6 - \$2.5 PM: \$0.67 - \$1.6 Ozone: \$0.91
	Schwartz, 2005	Total: \$1.6 - \$2.6 PM: \$0.74 - \$1.8 Ozone: \$0.83	Total: \$1.5 - \$2.5 PM: \$0.67 - \$1.6 Ozone: \$0.83
Meta-analyses	Bell et al., 2005	Total: \$2.4 - \$3.5 PM: \$0.74 - \$1.8 Ozone: \$1.7	Total: \$2.4 - \$3.3 PM: \$0.67 - \$1.6 Ozone: \$1.7
	Ito et al., 2005	Total: \$3.1 - \$4.2 PM: \$0.74 - \$1.8 Ozone: \$2.4	Total: \$3.0 - \$4.0 PM: \$0.67 - \$1.6 Ozone: \$2.4
	Levy et al., 2005	Total: \$3.1 - \$4.2 PM: \$0.74 - \$1.8 Ozone: \$2.4	Total: \$3.1 - \$4.0 PM: \$0.67 - \$1.6 Ozone: \$2.4

Notes:

^aTotal includes premature mortality-related and morbidity-related ozone and PM_{2.5} benefits. Range was developed by adding the estimate from the ozone premature mortality function to the estimate of PM_{2.5}-related premature mortality derived from either the ACS study (Pope et al., 2002) or the Six-Cities study (Laden et al., 2006).

^bNote that total benefits presented here do not include a number of unquantified benefits categories. A detailed listing of unquantified health and welfare effects is provided in Table 8-2.

^cResults reflect the use of both a 3 and 7 percent discount rate, as recommended by EPA's Guidelines for Preparing Economic Analyses and OMB Circular A-4. Results are rounded to two significant digits for ease of presentation and computation.

The benefits in Table 8-10 include all of the human health impacts we are able to quantify and monetize at this time. However, the full complement of human health and welfare effects associated with PM and ozone remain unquantified because of current limitations in methods or available data. We have not quantified a number of known or suspected health effects linked with ozone and PM for which appropriate health impact functions are not available or which do not provide easily interpretable outcomes (*e.g.*, changes in heart rate variability). Additionally, we are unable to quantify a number of known welfare effects, including reduced acid and particulate deposition damage to cultural monuments and other materials, and environmental benefits due to reductions of impacts of eutrophication in coastal areas. These are listed in Table 8-11. As a result, the health benefits quantified in this section are likely underestimates of the total benefits attributable to the final program.

Regulatory Impact Analysis

Table 8-11: Human Health and Welfare Effects of Pollutants Affected by the HD National Program

<i>Pollutant/ Effect</i>	<i>Quantified and monetized in primary estimate</i>	<i>Unquantified</i>
PM: health^a	Premature mortality based on cohort study estimates ^b and expert elicitation estimates Hospital admissions: respiratory and cardiovascular Emergency room visits for asthma Nonfatal heart attacks (myocardial infarctions) Lower and upper respiratory illness Minor restricted activity days Work loss days Asthma exacerbations (among asthmatic populations) Respiratory symptoms (among asthmatic populations) Infant mortality	Low birth weight, pre-term birth and other reproductive outcomes Pulmonary function Chronic respiratory diseases other than chronic bronchitis Non-asthma respiratory emergency room visits UVb exposure (+/-) ^c
PM: welfare		Visibility in Class I areas in SE, SW, and CA regions Household soiling Visibility in residential areas Visibility in non-class I areas and class 1 areas in NW, NE, and Central regions UVb exposure (+/-) ^c Global climate impacts ^c
Ozone: health	Premature mortality based on short-term study estimates Hospital admissions: respiratory Emergency room visits for asthma Minor restricted activity days School loss days	Chronic respiratory damage Premature aging of the lungs Non-asthma respiratory emergency room visits UVb exposure (+/-) ^c
Ozone: welfare	Decreased outdoor worker productivity	Yields for: --Commercial forests --Fruits and vegetables, and --Other commercial and noncommercial crops Damage to urban ornamental plants Recreational demand from damaged forest aesthetics Ecosystem functions UVb exposure (+/-) ^c Climate impacts
CO: health		Behavioral effects

Heavy-Duty GHG and Fuel Efficiency Standards FRM: Health and Environmental Impacts

Nitrate Deposition: welfare		<p>Commercial fishing and forestry from acidic deposition effects</p> <p>Commercial fishing, agriculture and forestry from nutrient deposition effects</p> <p>Recreation in terrestrial and estuarine ecosystems from nutrient deposition effects</p> <p>Other ecosystem services and existence values for currently healthy ecosystems</p> <p>Coastal eutrophication from nitrogen deposition effects</p>
Sulfate Deposition: welfare		<p>Commercial fishing and forestry from acidic deposition effects</p> <p>Recreation in terrestrial and aquatic ecosystems from acid deposition effects</p> <p>Increased mercury methylation</p>
HC/Toxics: health^d		<p>Cancer (benzene, 1,3-butadiene, formaldehyde, acetaldehyde)</p> <p>Anemia (benzene)</p> <p>Disruption of production of blood components (benzene)</p> <p>Reduction in the number of blood platelets (benzene)</p> <p>Excessive bone marrow formation (benzene)</p> <p>Depression of lymphocyte counts (benzene)</p> <p>Reproductive and developmental effects (1,3-butadiene)</p> <p>Irritation of eyes and mucus membranes (formaldehyde)</p> <p>Respiratory irritation (formaldehyde)</p> <p>Asthma attacks in asthmatics (formaldehyde)</p> <p>Asthma-like symptoms in non-asthmatics (formaldehyde)</p> <p>Irritation of the eyes, skin, and respiratory tract (acetaldehyde)</p> <p>Upper respiratory tract irritation and congestion (acrolein)</p>
HC/Toxics: welfare		<p>Direct toxic effects to animals</p> <p>Bioaccumulation in the food chain</p> <p>Damage to ecosystem function</p> <p>Odor</p>

Notes:

^a In addition to primary economic endpoints, there are a number of biological responses that have been associated with PM health effects including morphological changes and altered host defense mechanisms. The public health impact of these biological responses may be partly represented by our quantified endpoints.

^b Cohort estimates are designed to examine the effects of long term exposures to ambient pollution, but relative risk estimates may also incorporate some effects due to shorter term exposures (see Kunzli et al., 2001 for a discussion of this issue).³⁰⁶ While some of the effects of short term exposure are likely to be captured by the cohort estimates, there may be additional premature mortality from short term PM exposure not captured in the cohort estimates included in the primary analysis.

^c May result in benefits or disbenefits.

^d Many of the key hydrocarbons related to this action are also hazardous air pollutants listed in the CAA.

Regulatory Impact Analysis

While there will be impacts associated with air toxic pollutant emission changes that result from this final action, we do not attempt to monetize those impacts. This is primarily because currently available tools and methods to assess air toxics risk from mobile sources at the national scale are not adequate for extrapolation to incidence estimations or benefits assessment. The best suite of tools and methods currently available for assessment at the national scale are those used in the National-Scale Air Toxics Assessment (NATA). The EPA Science Advisory Board specifically commented in their review of the 1996 NATA that these tools were not yet ready for use in a national-scale benefits analysis, because they did not consider the full distribution of exposure and risk, or address sub-chronic health effects.³⁰⁷ While EPA has since improved these tools, there remain critical limitations for estimating incidence and assessing benefits of reducing mobile source air toxics.

As part of the second prospective analysis of the benefits and costs of the Clean Air Act,³⁰⁸ EPA conducted a case study analysis of the health effects associated with reducing exposure to benzene in Houston from implementation of the Clean Air Act. While reviewing the draft report, EPA's Advisory Council on Clean Air Compliance Analysis concluded that "the challenges for assessing progress in health improvement as a result of reductions in emissions of hazardous air pollutants (HAPs) are daunting...due to a lack of exposure-response functions, uncertainties in emissions inventories and background levels, the difficulty of extrapolating risk estimates to low doses and the challenges of tracking health progress for diseases, such as cancer, that have long latency periods."³⁰⁹ EPA continues to work to address these limitations; however, we did not have the methods and tools available for national-scale application in time for the analysis of the final action.^{MM}

EPA is also unaware of specific information identifying any effects on listed endangered species from the small fluctuations in pollutant concentrations associated with this program (see Chapter 5.6). Furthermore, our current modeling tools are not designed to trace fluctuations in ambient concentration levels to potential impacts on particular endangered species.

8.3.1.1 Human Health and Environmental Impacts

Table 8-12 and Table 8-13 present the annual PM_{2.5} and ozone health impacts in the 48 contiguous U.S. states associated with the HD National Program in 2030. For each endpoint presented in Table 8-12 and Table 8-13, we provide both the point estimate and the 90% confidence interval.

Using EPA's preferred estimates, based on the American Cancer Society (ACS) and Six-Cities studies and no threshold assumption in the model of mortality, we estimate that the final action will result in between 78 and 200 cases of avoided PM_{2.5}-related premature deaths

^{MM} In April, 2009, EPA hosted a workshop on estimating the benefits of reducing hazardous air pollutants. This workshop built upon the work accomplished in the June 2000 Science Advisory Board/EPA Workshop on the Benefits of Reductions in Exposure to Hazardous Air Pollutants, which generated thoughtful discussion on approaches to estimating human health benefits from reductions in air toxics exposure, but no consensus was reached on methods that could be implemented in the near term for a broad selection of air toxics. Please visit <http://epa.gov/air/toxicair/2009workshop.html> for more information about the workshop and its associated materials.

Heavy-Duty GHG and Fuel Efficiency Standards FRM: Health and Environmental Impacts

annually in 2030. As a sensitivity analysis, when the range of expert opinion is used, we estimate between 26 and 260 fewer premature mortalities in 2030.

The range of ozone impacts is based on changes in risk estimated using several sources of ozone-related mortality effect estimates. This analysis presents six alternative estimates for the association based upon different functions reported in the scientific literature, derived from both the National Morbidity, Mortality, and Air Pollution Study (NMMAPS) (Bell et al., 2004; Huang et al., 2005; Schwartz, 2005) and from a series of recent meta-analyses (Bell et al., 2005, Ito et al., 2005, and Levy et al., 2005). This approach is not inconsistent with recommendations provided by the NRC in their recent report (NRC, 2008) on the estimation of ozone-related mortality risk reductions, “The committee recommends that the greatest emphasis be placed on estimates from new systematic multicity analyses that use national databases of air pollution and mortality, such as in the NMMAPS, without excluding consideration of meta-analyses of previously published studies.”³¹⁰ For ozone-related premature mortality in 2030, we estimate a range of between 54 to 240 fewer premature mortalities.

Following these tables, we also provide a more comprehensive presentation of the distributions of incidence generated using the available information from empirical studies and expert elicitation. Table 8-14 presents the distributions of the reduction in PM_{2.5}-related premature mortality based on the C-R distributions provided by each expert, as well as that from the data-derived health impact functions, based on the statistical error associated with the ACS study (Pope et al., 2002) and the Six-Cities study (Laden et al., 2006). The 90% confidence interval for each separate estimate of PM-related mortality is also provided.

In 2030, the effect estimates of nine of the twelve experts included in the elicitation panel fall within the empirically-derived range provided by the ACS and Six-Cities studies. Only one expert falls below this range, while two of the experts are above this range. Although the overall range across experts is summarized in these tables, the full uncertainty in the estimates is reflected by the results for the full set of 12 experts. The twelve experts’ judgments as to the likely mean effect estimate are not evenly distributed across the range illustrated by arraying the highest and lowest expert means.

Table 8-12: Estimated PM_{2.5}-Related Health Impacts^a

Health Effect	2030 Annual Reduction in Incidence (5 th % - 95 th %ile)
Premature Mortality – Derived from epidemiology literature ^b Adult, age 30+, ACS Cohort Study (Pope et al., 2002)	78 (30 – 130)
Adult, age 25+, Six-Cities Study (Laden et al., 2006)	200 (110 – 290)
Infant, age <1 year (Woodruff et al., 1997)	0 (0 – 1)
Chronic bronchitis (adult, age 26 and over)	53 (10 – 97)
Non-fatal myocardial infarction (adult, age 18 and over)	150 (54 – 240)

Regulatory Impact Analysis

Hospital admissions - respiratory (all ages) ^c	20 (10 – 30)
Hospital admissions - cardiovascular (adults, age >18) ^d	45 (32 – 52)
Emergency room visits for asthma (age 18 years and younger)	81 (48 – 120)
Acute bronchitis, (children, age 8-12)	130 (0 – 270)
Lower respiratory symptoms (children, age 7-14)	1,600 (750 – 2,400)
Upper respiratory symptoms (asthmatic children, age 9-18)	1,200 (370 – 2,000)
Asthma exacerbation (asthmatic children, age 6-18)	1,400 (160 – 4,000)
Work loss days	9,700 (8,500 – 11,000)
Minor restricted activity days (adults age 18-65)	57,000 (48,000 – 66,000)

Notes:

^a Incidence is rounded to two significant digits. Estimates represent incidence within the 48 contiguous United States.

^b PM-related adult mortality based upon the American Cancer Society (ACS) Cohort Study (Pope et al., 2002) and the Six-Cities Study (Laden et al., 2006). Note that these are two alternative estimates of adult mortality and should not be summed. PM-related infant mortality based upon a study by Woodruff, Grillo, and Schoendorf, (1997).^{NN}

^c Respiratory hospital admissions for PM include admissions for chronic obstructive pulmonary disease (COPD), pneumonia and asthma.

^d Cardiovascular hospital admissions for PM include total cardiovascular and subcategories for ischemic heart disease, dysrhythmias, and heart failure.

^{NN} Woodruff, T.J., J. Grillo, and K.C. Schoendorf. 1997. "The Relationship Between Selected Causes of Postneonatal Infant Mortality and Particulate Air Pollution in the United States." *Environmental Health Perspectives* 105(6):608-612.

Heavy-Duty GHG and Fuel Efficiency Standards FRM: Health and Environmental Impacts

Table 8-13: Estimated Ozone-Related Health Impacts^a

Health Effect	2030 Annual Reduction in Incidence (5th% - 95th%ile)
Premature Mortality, All ages ^b	
Multi-City Analyses	
Bell et al. (2004) – Non-accidental	54 (23 – 84)
Huang et al. (2005) – Cardiopulmonary	90 (43 – 140)
Schwartz (2005) – Non-accidental	82 (34 – 130)
Meta-analyses:	
Bell et al. (2005) – All cause	170 (96 – 250)
Ito et al. (2005) – Non-accidental	240 (160 – 320)
Levy et al. (2005) – All cause	240 (180 – 310)
Hospital admissions- respiratory causes (adult, 65 and older) ^c	510 (69 – 870)
Hospital admissions -respiratory causes (children, under 2)	320 (160 – 470)
Emergency room visit for asthma (all ages)	230 (0 – 630)
Minor restricted activity days (adults, age 18-65)	300,000 (150,000 – 450,000)
School absence days	120,000 (52,000 – 170,000)

Notes:

^a Incidence is rounded to two significant digits. Estimates represent incidence within the 48 contiguous U.S.

^b Estimates of ozone-related premature mortality are based upon incidence estimates derived from several alternative studies: Bell et al. (2004); Huang et al. (2005); Schwartz (2005) ; Bell et al. (2005); Ito et al. (2005); Levy et al. (2005). The estimates of ozone-related premature mortality should therefore not be summed.

^c Respiratory hospital admissions for ozone include admissions for all respiratory causes and subcategories for COPD and pneumonia.

Regulatory Impact Analysis

Table 8-14: Results of Application of Expert Elicitation: Annual Reductions in Premature Mortality in 2030 Associated with the Final Action

Source of Mortality Estimate	2030 Primary Option		
	5th Percentile	Mean	95th Percentile
Pope et al. (2002)	30	78	130
Laden et al. (2006)	110	200	290
Expert A	39	210	390
Expert B	17	160	350
Expert C	29	160	350
Expert D	23	110	180
Expert E	130	260	400
Expert F	100	150	210
Expert G	0	93	170
Expert H	0	120	270
Expert I	25	160	280
Expert J	38	130	280
Expert K	0	26	130
Expert L	7	100	220

8.3.1.2 Monetized Estimates of Impacts of Changes in Non-GHG Pollutants

Table 8-15 presents the estimated monetary value of changes in the incidence of ozone and PM_{2.5}-related health effects. Total aggregate monetized benefits are presented in Table 8-16. All monetized estimates are presented in 2009\$. Where appropriate, estimates account for growth in real gross domestic product (GDP) per capita between 2000 and 2030.^{OO} The monetized value of PM_{2.5}-related mortality also accounts for a twenty-year segmented cessation lag.^{PP} To discount the value of premature mortality that occurs at different points in the future,

^{OO} Our analysis accounts for expected growth in real income over time. Economic theory argues that WTP for most goods (such as environmental protection) will increase if real incomes increase. Benefits are therefore adjusted by multiplying the unadjusted benefits by the appropriate adjustment factor to account for income growth over time. For growth between 2000 and 2030, this factor is 1.23 for long-term mortality, 1.27 for chronic health impacts, and 1.08 for minor health impacts. For a complete discussion of how these adjustment factors were derived, we refer the reader to the PM NAAQS regulatory impact analysis.⁹ Note that similar adjustments do not exist for cost-of-illness-based unit values. For these, we apply the same unit value regardless of the future year of analysis.

^{PP} Based in part on prior SAB advice, EPA has typically assumed that there is a time lag between changes in pollution exposures and the total realization of changes in health effects. Within the context of benefits analyses, this term is often referred to as “cessation lag”. The existence of such a lag is important for the valuation of premature mortality incidence because economic theory suggests that benefits occurring in the future should be discounted. In this analysis, we apply a twenty-year distributed lag to PM mortality reductions. This method is consistent with the most recent recommendation by the EPA’s Science Advisory Board. Refer to: EPA – Science Advisory Board, 2004. Advisory Council on Clean Air Compliance Analysis Response to Agency Request on Cessation Lag. Letter from the Health Effects Subcommittee to the U.S. Environmental Protection Agency Administrator, December.

Heavy-Duty GHG and Fuel Efficiency Standards FRM: Health and Environmental Impacts

we apply both a 3% and 7% discount rate. We also use both a 3% and 7% discount rate to value PM-related nonfatal heart attacks (myocardial infarctions).^{QQ}

In addition to omitted benefits categories such as air toxics and various welfare effects, not all known PM_{2.5}- and ozone-related health and welfare effects could be quantified or monetized. The estimate of total monetized health benefits of the final program is thus equal to the subset of monetized PM_{2.5}- and ozone-related health impacts we are able to quantify plus the sum of the nonmonetized health and welfare benefits. Our estimate of total monetized benefits in 2030 for the final program, using the ACS and Six-Cities PM mortality studies and the range of ozone mortality assumptions, is between \$1.3 and \$4.2 billion, assuming a 3 percent discount rate, or between \$1.2 and \$4.0 billion, assuming a 7 percent discount rate. As the results indicate, total benefits are driven primarily by the reduction in PM_{2.5}- and ozone-related premature fatalities each year.

The next largest benefit is for reductions in chronic illness (chronic bronchitis and nonfatal heart attacks), although this value is more than an order of magnitude lower than for premature mortality. Hospital admissions for respiratory and cardiovascular causes, minor restricted activity days, and work loss days account for the majority of the remaining benefits. The remaining categories each account for a small percentage of total benefit; however, they represent a large number of avoided incidences affecting many individuals. A comparison of the incidence table to the monetary benefits table reveals that there is not always a close correspondence between the number of incidences avoided for a given endpoint and the monetary value associated with that endpoint. For example, there are many more work loss days than PM-related premature mortalities, yet work loss days account for only a very small fraction of total monetized benefits. This reflects the fact that many of the less severe health effects, while more common, are valued at a lower level than the more severe health effects. Also, some effects, such as hospital admissions, are valued using a proxy measure of willingness-to-pay (*e.g.*, cost-of-illness). As such, the true value of these effects may be higher than that reported here.

^{QQ} Nonfatal myocardial infarctions (MI) are valued using age-specific cost-of-illness values that reflect lost earnings and direct medical costs over a 5-year period following a nonfatal MI.

Regulatory Impact Analysis

Table 8-15: Estimated Monetary Value of Changes in Incidence of Health and Welfare Effects (in millions of 2009\$) ^{a,b}

		2030
PM _{2.5} -Related Health Effect		(5 th and 95 th %ile)
Premature Mortality – Derived from Epidemiology Studies ^{c,d} ,	Adult, age 30+ - ACS study (Pope et al., 2002) 3% discount rate	\$680 (\$87 - \$1,800)
	7% discount rate	\$620 (\$79 - \$1,600)
	Adult, age 25+ - Six-Cities study (Laden et al., 2006) 3% discount rate	\$1,800 (\$250 - \$4,300)
	7% discount rate	\$1,600 (\$220 - \$3,900)
	Infant Mortality, <1 year – (Woodruff et al. 1997)	\$2.5 (\$0 - \$9.4)
Chronic bronchitis (adults, 26 and over)		\$29 (\$2.4 - \$96)
Non-fatal acute myocardial infarctions 3% discount rate		\$16 (\$3.7 - \$38)
7% discount rate		\$16 (\$3.4 - \$38)
Hospital admissions for respiratory causes		\$0.31 (\$0.15 - \$0.45)
Hospital admissions for cardiovascular causes		\$1.3 (\$0.83 - \$1.8)
Emergency room visits for asthma		\$0.03 (\$0.02 - \$0.05)
Acute bronchitis (children, age 8–12)		\$0.01 (\$0 - \$0.03)
Lower respiratory symptoms (children, 7–14)		\$0.03 (\$0.01 - \$0.06)
Upper respiratory symptoms (asthma, 9–11)		\$0.04 (\$0.01 - \$0.08)
Asthma exacerbations		\$0.08 (\$0.009 - \$0.23)
Work loss days		\$1.6 (\$1.4 - \$1.8)
Minor restricted-activity days (MRADs)		\$3.6 (\$2.1 - \$5.2)
Ozone-related Health Effect		

Heavy-Duty GHG and Fuel Efficiency Standards FRM: Health and Environmental Impacts

Premature Mortality, All ages – Derived from Multi-city analyses	Bell et al., 2004	\$520 (\$69 - \$1,300)
	Huang et al., 2005	\$880 (\$120 - \$2,200)
	Schwartz, 2005	\$800 (\$100 - \$2,000)
Premature Mortality, All ages – Derived from Meta-analyses	Bell et al., 2005	\$1,700 (\$240 - \$4,100)
	Ito et al., 2005	\$2,300 (\$350 - \$5,500)
	Levy et al., 2005	\$2,400 (\$350 - \$5,500)
Hospital admissions- respiratory causes (adult, 65 and older)		\$13 (\$1.7 - \$22)
Hospital admissions- respiratory causes (children, under 2)		\$3.4 (\$1.8 - \$5.0)
Emergency room visit for asthma (all ages)		\$0.09 (\$0 - \$0.23)
Minor restricted activity days (adults, age 18-65)		\$19 (\$8.6 - \$32)
School absence days		\$11 (\$5.0 - \$16)

Notes:

^a Monetary benefits are rounded to two significant digits for ease of presentation and computation. PM and ozone benefits are nationwide.

^b Monetary benefits adjusted to account for growth in real GDP per capita between 1990 and the analysis year (2030).

^c Valuation assumes discounting over the SAB recommended 20 year segmented lag structure. Results reflect the use of 3 percent and 7 percent discount rates consistent with EPA and OMB guidelines for preparing economic analyses.

Regulatory Impact Analysis

Table 8-16: Total Monetized Ozone and PM-related Benefits Associated with the Final Program in 2030

Total Ozone and PM Benefits (billions, 2009\$) – PM Mortality Derived from the ACS and Six-Cities Studies					
3% Discount Rate			7% Discount Rate		
Ozone Mortality Function	Reference	Mean Total Benefits	Ozone Mortality Function	Reference	Mean Total Benefits
Multi-city	Bell et al., 2004	\$1.3 - \$2.4	Multi-city	Bell et al., 2004	\$1.2 - \$2.2
	Huang et al., 2005	\$1.6 - \$2.7		Huang et al., 2005	\$1.6 - \$2.5
	Schwartz, 2005	\$1.6 - \$2.6		Schwartz, 2005	\$1.5 - \$2.5
Meta-analysis	Bell et al., 2005	\$2.4 - \$3.5	Meta-analysis	Bell et al., 2005	\$2.4 - \$3.3
	Ito et al., 2005	\$3.1 - \$4.2		Ito et al., 2005	\$3.0 - \$4.0
	Levy et al., 2005	\$3.1 - \$4.2		Levy et al., 2005	\$3.1 - \$4.0
Total Ozone and PM Benefits (billions, 2009\$) – PM Mortality Derived from Expert Elicitation (Lowest and Highest Estimate)					
3% Discount Rate			7% Discount Rate		
Ozone Mortality Function	Reference	Mean Total Benefits	Ozone Mortality Function	Reference	Mean Total Benefits
Multi-city	Bell et al., 2004	\$0.84 - \$2.9	Multi-city	Bell et al., 2004	\$0.81 - \$2.7
	Huang et al., 2005	\$1.2 - \$3.3		Huang et al., 2005	\$1.2 - \$3.1
	Schwartz, 2005	\$1.1 - \$3.2		Schwartz, 2005	\$1.1 - \$3.0
Meta-analysis	Bell et al., 2005	\$2.0 - \$4.1	Meta-analysis	Bell et al., 2005	\$2.0 - \$3.8
	Ito et al., 2005	\$2.6 - \$4.7		Ito et al., 2005	\$2.6 - \$4.5
	Levy et al., 2005	\$2.7 - \$4.8		Levy et al., 2005	\$2.6 - \$4.5

8.3.1.3 Methodology

8.3.1.3.1 Human Health Impact Functions

Health impact functions measure the change in a health endpoint of interest, such as hospital admissions, for a given change in ambient ozone or PM concentration. Health impact functions are derived from primary epidemiology studies, meta-analyses of multiple epidemiology studies, or expert elicitations. A standard health impact function has four components: (1) an effect estimate from a particular study; (2) a baseline incidence rate for the health effect (obtained from either the epidemiology study or a source of public health statistics

such as the Centers for Disease Control); (3) the size of the potentially affected population; and (4) the estimated change in the relevant ozone or PM summary measures.

A typical health impact function might look like:

$$\Delta y = y_0 \cdot (e^{\beta \cdot \Delta x} - 1),$$

where y_0 is the baseline incidence (the product of the baseline incidence rate times the potentially affected population), β is the effect estimate, and Δx is the estimated change in the summary pollutant measure. There are other functional forms, but the basic elements remain the same. The following subsections describe the sources for each of the first three elements: size of the potentially affected populations; PM_{2.5} and ozone effect estimates; and baseline incidence rates. We also describe the treatment of potential thresholds in PM-related health impact functions. Section 7.2 describes the ozone and PM air quality inputs to the health impact functions.

8.3.1.3.2 *Potentially Affected Populations*

The starting point for estimating the size of potentially affected populations is the 2000 U.S. Census block level dataset.³¹¹ Benefits Modeling and Analysis Program (BenMAP) incorporates 250 age/gender/race categories to match specific populations potentially affected by ozone and other air pollutants. The software constructs specific populations matching the populations in each epidemiological study by accessing the appropriate age-specific populations from the overall population database. BenMAP projects populations to 2030 using growth factors based on economic projections.³¹²

8.3.1.3.3 *Effect Estimate Sources*

The most significant quantifiable benefits of reducing ambient concentrations of ozone and PM are attributable to reductions in human health risks. EPA's Ozone and PM Criteria Documents^{313,314} and the World Health Organization's 2003 and 2004^{315,316} reports outline numerous human health effects known or suspected to be linked to exposure to ambient ozone and PM. EPA recently evaluated the ozone and PM literature for use in the benefits analysis for the final 2008 Ozone NAAQS and final 2006 PM NAAQS analyses. We use the same literature in this analysis; for more information on the studies that underlie the health impacts quantified in this RIA, please refer to those documents.

It is important to note that we are unable to separately quantify all of the possible PM and ozone health effects that have been reported in the literature for three reasons: (1) the possibility of double counting (such as hospital admissions for specific respiratory diseases versus hospital admissions for all or a sub-set of respiratory diseases); (2) uncertainties in applying effect relationships that are based on clinical studies to the potentially affected population; or (3) the lack of an established concentration-response (CR) relationship. Table 8-17 lists the health endpoints included in this analysis.

Regulatory Impact Analysis

Table 8-17: Health Impact Functions Used in BenMAP to Estimate Impacts of PM_{2.5} and Ozone Reductions

<i>ENDPOINT</i>	<i>POLLUTANT</i>	<i>STUDY</i>	<i>STUDY POPULATION</i>
Premature Mortality			
Premature mortality – daily time series	O ₃	<u>Multi-city</u> Bell et al (2004) (NMMAPS study) ³¹⁷ – Non-accidental Huang et al (2005) ³¹⁸ - Cardiopulmonary Schwartz (2005) ³¹⁹ – Non-accidental <u>Meta-analyses:</u> Bell et al (2005) ³²⁰ – All cause Ito et al (2005) ³²¹ – Non-accidental Levy et al (2005) ³²² – All cause	All ages
Premature mortality —cohort study, all-cause	PM _{2.5}	Pope et al. (2002) ³²³ Laden et al. (2006) ³²⁴	>29 years >25 years
Premature mortality, total exposures	PM _{2.5}	Expert Elicitation (IEc, 2006) ³²⁵	>24 years
Premature mortality — all-cause	PM _{2.5}	Woodruff et al. (1997) ³²⁶	Infant (<1 year)
Chronic Illness			
Chronic bronchitis	PM _{2.5}	Abbey et al. (1995) ³²⁷	>26 years
Nonfatal heart attacks	PM _{2.5}	Peters et al. (2001) ³²⁸	Adults (>18 years)
Hospital Admissions			
Respiratory	O ₃	Pooled estimate: Schwartz (1995) - ICD 460-519 (all resp) ³²⁹ Schwartz (1994a; 1994b) - ICD 480-486 (pneumonia) ^{330,331} Moolgavkar et al. (1997) - ICD 480-487 (pneumonia) ³³² Schwartz (1994b) - ICD 491-492, 494-496 (COPD) Moolgavkar et al. (1997) – ICD 490-496 (COPD)	>64 years
		Burnett et al. (2001) ³³³	<2 years
	PM _{2.5}	<u>Pooled estimate:</u> Moolgavkar (2003)—ICD 490-496 (COPD) ³³⁴ Ito (2003)—ICD 490-496 (COPD) ³³⁵	>64 years
	PM _{2.5}	Moolgavkar (2000)—ICD 490-496 (COPD) ³³⁶	20–64 years
	PM _{2.5}	Ito (2003)—ICD 480-486 (pneumonia)	>64 years
	PM _{2.5}	Sheppard (2003)—ICD 493 (asthma) ³³⁷	<65 years
Cardiovascular	PM _{2.5}	Pooled estimate: Moolgavkar (2003)—ICD 390-429 (all cardiovascular) Ito (2003)—ICD 410-414, 427-428 (ischemic heart disease, dysrhythmia, heart failure)	>64 years
	PM _{2.5}	Moolgavkar (2000)—ICD 390-429 (all cardiovascular)	20–64 years

Heavy-Duty GHG and Fuel Efficiency Standards FRM: Health and Environmental Impacts

Asthma-related ER visits	O ₃	Pooled estimate: Peel et al (2005) ³³⁸ Wilson et al (2005) ³³⁹	All ages All ages
Asthma-related ER visits (con't)	PM _{2.5}	Norris et al. (1999) ³⁴⁰	0–18 years
Other Health Endpoints			
Acute bronchitis	PM _{2.5}	Dockery et al. (1996) ³⁴¹	8–12 years
Upper respiratory symptoms	PM _{2.5}	Pope et al. (1991) ³⁴²	Asthmatics, 9–11 years
Lower respiratory symptoms	PM _{2.5}	Schwartz and Neas (2000) ³⁴³	7–14 years
Asthma exacerbations	PM _{2.5}	Pooled estimate: Ostro et al. (2001) ³⁴⁴ (cough, wheeze and shortness of breath) Vedal et al. (1998) ³⁴⁵ (cough)	6–18 years ^a
Work loss days	PM _{2.5}	Ostro (1987) ³⁴⁶	18–65 years
School absence days	O ₃	Pooled estimate: Gilliland et al. (2001) ³⁴⁷ Chen et al. (2000) ³⁴⁸	5–17 years ^b
Minor Restricted Activity Days (MRADs)	O ₃	Ostro and Rothschild (1989) ³⁴⁹	18–65 years
	PM _{2.5}	Ostro and Rothschild (1989)	18–65 years

Notes:

^a The original study populations were 8 to 13 for the Ostro et al. (2001) study and 6 to 13 for the Vedal et al. (1998) study. Based on advice from the Science Advisory Board Health Effects Subcommittee (SAB-HES), we extended the applied population to 6 to 18, reflecting the common biological basis for the effect in children in the broader age group. See: U.S. Science Advisory Board. 2004. Advisory Plans for Health Effects Analysis in the Analytical Plan for EPA's Second Prospective Analysis –Benefits and Costs of the Clean Air Act, 1990–2020. EPA-SAB-COUNCIL-ADV-04-004. See also National Research Council (NRC). 2002. *Estimating the Public Health Benefits of Proposed Air Pollution Regulations*. Washington, DC: The National Academies Press.

^b Gilliland et al. (2001) studied children aged 9 and 10. Chen et al. (2000) studied children 6 to 11. Based on recent advice from the National Research Council and the EPA SAB-HES, we have calculated reductions in school absences for all school-aged children based on the biological similarity between children aged 5 to 17.

In selecting epidemiological studies as sources of effect estimates, we applied several criteria to develop a set of studies that is likely to provide the best estimates of impacts in the U.S. To account for the potential impacts of different health care systems or underlying health status of populations, we give preference to U.S. studies over non-U.S. studies. In addition, due to the potential for confounding by co-pollutants, we give preference to effect estimates from models including both ozone and PM over effect estimates from single-pollutant models.^{350,351}

8.3.1.3.4 Baseline Incidence Rates

Epidemiological studies of the association between pollution levels and adverse health effects generally provide a direct estimate of the relationship of air quality changes to the *relative risk* of a health effect, rather than estimating the absolute number of avoided cases. For example, a typical result might be that a 100 ppb decrease in daily ozone levels might, in turn, decrease hospital admissions by 3 percent. The baseline incidence of the health effect is necessary to convert this relative change into a number of cases. A baseline incidence rate is the estimate of

Regulatory Impact Analysis

the number of cases of the health effect per year in the assessment location, as it corresponds to baseline pollutant levels in that location. To derive the total baseline incidence per year, this rate must be multiplied by the corresponding population number. For example, if the baseline incidence rate is the number of cases per year per 100,000 people, that number must be multiplied by the number of 100,000s in the population.

Table 8-18 summarizes the sources of baseline incidence rates and provides average incidence rates for the endpoints included in the analysis. Table 8-19 presents the asthma prevalence rates used in this analysis. For both baseline incidence and prevalence data, we used age-specific rates where available. We applied concentration-response functions to individual age groups and then summed over the relevant age range to provide an estimate of total population benefits. In most cases, we used a single national incidence rate, due to a lack of more spatially disaggregated data. Whenever possible, the national rates used are national averages, because these data are most applicable to a national assessment of benefits. For some studies, however, the only available incidence information comes from the studies themselves; in these cases, incidence in the study population is assumed to represent typical incidence at the national level. Regional incidence rates are available for hospital admissions, and county-level data are available for premature mortality. We have projected mortality rates such that future mortality rates are consistent with our projections of population growth.³⁵²

(see Table 8-18 on the next page)

Heavy-Duty GHG and Fuel Efficiency Standards FRM: Health and Environmental Impacts

Table 8-18: Baseline Incidence Rates and Population Prevalence Rates for Use in Impact Functions, General Population

<i>Endpoint</i>	<i>Parameter</i>	<i>Rates</i>	
		<i>Value</i>	<i>Source</i>
Mortality	Daily or annual mortality rate projected to 2020	Age-, cause-, and county-specific rate	CDC Wonder (2006–2008) ³⁵³ U.S. Census bureau
Hospitalizations	Daily hospitalization rate	Age-, region-, state-, county- and cause-specific rate	2007 HCUP data files ^{a,354}
Asthma ER Visits	Daily asthma ER visit rate	Age-, region-, state-, county- and cause-specific rate	2007 HCUP data files ^a
Chronic Bronchitis	Annual prevalence rate per person		1999 NHIS (American Lung Association, 2002, Table 4) ³⁵⁵
	Aged 18–44	0.0367	
	Aged 45–64	0.0505	
	Aged 65 and older	0.0587	
	Annual incidence rate per person	0.00378	Abbey et al. (1993, Table 3)
Nonfatal Myocardial Infarction (heart attacks)	Daily nonfatal myocardial infarction incidence rate per person, 18+	Age-, region-, state-, and county- specific rate	2007 HCUP data files ^a ; adjusted by 0.93 for probability of surviving after 28 days (Rosamond et al., 1999)
Asthma Exacerbations	Incidence among asthmatic African-American children daily wheeze daily cough daily dyspnea	0.076	Ostro et al. (2001)
		0.067	
		0.037	
Acute Bronchitis	Annual bronchitis incidence rate, children	0.043	American Lung Association (2002, Table 11) ³⁵⁶
Lower Respiratory Symptoms	Daily lower respiratory symptom incidence among children ^b	0.0012	Schwartz et al. (1994, Table 2)
Upper Respiratory Symptoms	Daily upper respiratory symptom incidence among asthmatic children	0.3419	Pope et al. (1991, Table 2)
Work Loss Days	Daily WLD incidence rate per person (18–65)		1996 HIS (Adams, Hendershot, and Marano, 1999, Table 41); ³⁵⁷ U.S. Bureau of the Census (2000) ³⁵⁸
	Aged 18–24	0.00540	
	Aged 25–44	0.00678	
	Aged 45–64	0.00492	
School Loss Days	Rate per person per year, assuming 180 school days per year	9.9	National Center for Education Statistics (1996) ³⁵⁹ and 1996 HIS (Adams et al., 1999, Table 47);
Minor Restricted-Activity Days	Daily MRAD incidence rate per person	0.02137	Ostro and Rothschild (1989, p. 243)

Notes:

^a Healthcare Cost and Utilization Program (HCUP) database contains individual level, state and regional-level hospital and emergency department discharges for a variety of ICD codes.

^b Lower respiratory symptoms are defined as two or more of the following: cough, chest pain, phlegm, and wheeze.

Table 8-19: Asthma Prevalence Rates Used for this Analysis

Population Group	Asthma Prevalence Rates	
	Value	Source
All Ages	0.0780	American Lung Association (2010, Table 7)
< 18	0.0941	
5-17	0.1070	
18-44	0.0719	
45-64	0.0745	
65+	0.0716	
African American, 5 to 17	0.1776	American Lung Association (2010, Table 9)
African American, <18	0.1553	American Lung Association ^b

Notes:

^a See ftp://ftp.cdc.gov/pub/Health_Statistics/NCHS/Datasets/NHIS/2000/.

^b Calculated by ALA for U.S. EPA, based on NHIS data (CDC, 2008).³⁶⁰

8.3.1.3.5 *PM_{2.5}-Related Premature Mortality “Lowest Measured Level” (LML) Assessment*

Based on our review of the current body of scientific literature, EPA estimated PM-related mortality without applying an assumed concentration threshold. EPA’s Integrated Science Assessment for Particulate Matter (U.S. EPA, 2009),³⁶¹ which was recently reviewed by EPA’s Clean Air Scientific Advisory Committee (U.S. EPA-SAB, 2009; U.S. EPA-SAB, 2009),^{362,363} concluded that the scientific literature consistently finds that a no-threshold log-linear model most adequately portrays the PM-mortality concentration-response relationship while recognizing potential uncertainty about the exact shape of the concentration-response function. Consistent with this finding, we have conformed the threshold sensitivity analysis to the current state of the PM science and improved upon our previous approach for estimating the sensitivity of the benefits estimates to the presence of an assumed threshold by incorporating a new “Lowest Measured Level” (LML) assessment.

This approach summarizes the distribution of avoided PM mortality impacts according to the baseline (*i.e.* pre-HD National Program) PM_{2.5} levels experienced by the population receiving the PM_{2.5} mortality benefit Figure 8-20. We identify on this figure the lowest air quality levels measured in each of the two primary epidemiological studies EPA uses to quantify PM-related mortality. This information allows readers to determine the portion of PM-related mortality benefits occurring above or below the LML of each study; in general, our confidence in the estimated PM mortality decreases as we consider air quality levels further below the LML in the two epidemiological studies. While the LML analysis provides some insight into the level of uncertainty in the estimated PM mortality benefits, EPA does not view the LML as a threshold and continues to quantify PM-related mortality impacts using a full range of modeled air quality concentrations.

The large proportion of the avoided PM-related impacts we estimate in this analysis occur among populations exposed at or above the LML of each study (Figure 8-20), increasing our confidence in the PM mortality analysis. Approximately 60% of the avoided impacts occur at or above an annual mean PM_{2.5} level of 10 µg/m³ (the LML of the Laden et al. 2006 study); about 97% occur at or above an annual mean PM_{2.5} level of 7.5 µg/m³ (the LML of the Pope et al. 2002 study). As we model mortality impacts among populations exposed to levels of PM_{2.5}

Heavy-Duty GHG and Fuel Efficiency Standards FRM: Health and Environmental Impacts

that are successively lower than the LML of each study our confidence in the results diminishes. However, the analysis above confirms that the great majority of the impacts occur at or above each study's LML.

As an example, when considering mortality impacts among populations living in areas with an annual mean PM level of $8 \mu\text{g}/\text{m}^3$, we would place greater confidence in estimates drawn from the Pope et al. 2002 study, as this air quality level is above the LML of this study. Conversely, we would place equal confidence when estimating mortality impacts among populations living in locations where the annual mean PM levels are above $10 \mu\text{g}/\text{m}^3$ because this value is at or above the LML of each study.

While the LML of each study is important to consider when characterizing and interpreting the overall level PM-related benefits, EPA believes that both cohort-based mortality estimates are suitable for use in air pollution health impact analyses. When estimating PM mortality impacts using risk coefficients drawn from the Laden et al. analysis of the Harvard Six Cities and the Pope et al. analysis of the American Cancer Society cohorts there are innumerable other attributes that may affect the size of the reported risk estimates—including differences in population demographics, the size of the cohort, activity patterns and particle composition among others. The LML assessment presented here provides a limited representation of one key difference between the two studies.

Figure 8-20: Cumulative Percentage of Total PM-related Mortalities Avoided by Baseline Air Quality Level

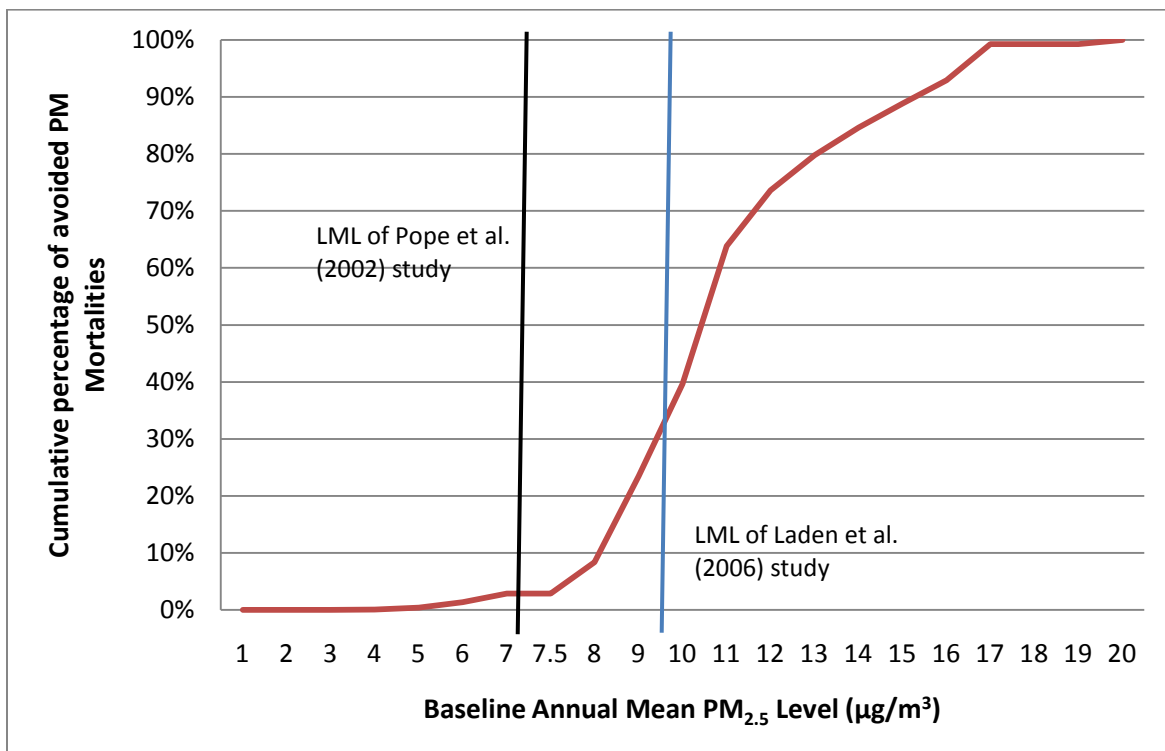

Regulatory Impact Analysis

8.3.1.3.6 Economic Values for Health Outcomes

Reductions in ambient concentrations of air pollution generally lower the risk of future adverse health effects for a large population. Therefore, the appropriate economic measure is willingness-to-pay (WTP) for changes in risk of a health effect rather than WTP for a health effect that would occur with certainty (Freeman, 1993).³⁶⁴ Epidemiological studies generally provide estimates of the relative risks of a particular health effect that is avoided because of a reduction in air pollution. We converted those to units of avoided statistical incidence for ease of presentation. We calculated the value of avoided statistical incidences by dividing individual WTP for a risk reduction by the related observed change in risk. For example, suppose a pollution-reduction regulation is able to reduce the risk of premature mortality from 2 in 10,000 to 1 in 10,000 (a reduction of 1 in 10,000). If individual WTP for this risk reduction is \$100, then the WTP for an avoided statistical premature death is \$1 million (\$100/0.0001 change in risk).

WTP estimates generally are not available for some health effects, such as hospital admissions. In these cases, we used the cost of treating or mitigating the effect as a primary estimate. These cost-of-illness (COI) estimates generally understate the true value of reducing the risk of a health effect, because they reflect the direct expenditures related to treatment, but not the value of avoided pain and suffering (Harrington and Portney, 1987; Berger, 1987).^{365,366} We provide unit values for health endpoints (along with information on the distribution of the unit value) in Table 8-20. All values are in constant year 2007 dollars, adjusted for growth in real income out to 2030 using projections provided by Standard and Poor's. Economic theory argues that WTP for most goods (such as environmental protection) will increase if real income increases. Many of the valuation studies used in this analysis were conducted in the late 1980s and early 1990s. Because real income has grown since the studies were conducted, people's willingness to pay for reductions in the risk of premature death and disease likely has grown as well. We did not adjust cost of illness-based values because they are based on current costs. Similarly, we did not adjust the value of school absences, because that value is based on current wage rates. For details on valuation estimates for PM-related endpoints, see the 2006 PM NAAQS RIA.³⁶⁷ For details on valuation estimates for ozone-related endpoints, see the 2008 Ozone NAAQS RIA.³⁶⁸

Table 8-20: Unit Values for Economic Valuation of Health Endpoints (2007\$)

Health Endpoint	Central Estimate of Value Per Statistical Incidence		Derivation of Distributions of Estimates
	2000 Income Level	2030 Income Level	
Premature Mortality (Value of a Statistical Life)	\$7,900,000	\$9,400,000	EPA currently recommends a central VSL of \$6.3m (2000\$) based on a Weibull distribution fitted to 26 published VSL estimates (5 contingent valuation and 21 labor market studies). The underlying studies, the distribution parameters, and other useful information are available in Appendix B of EPA's current Guidelines for Preparing Economic Analyses (U.S. EPA, 2000).
Chronic	\$430,000	\$520,000	The WTP to avoid a case of pollution-related CB is

Heavy-Duty GHG and Fuel Efficiency Standards FRM: Health and Environmental Impacts

Bronchitis (CB)			calculated as where x is the severity of an average CB case, WTP_{13} is the WTP for a severe case of CB, and $\$$ is the parameter relating WTP to severity, based on the regression results reported in Krupnick and Cropper (1992). The distribution of WTP for an average severity-level case of CB was generated by Monte Carlo methods, drawing from each of three distributions: (1) WTP to avoid a severe case of CB is assigned a 1/9 probability of being each of the first nine deciles of the distribution of WTP responses in Viscusi et al. (1991); (2) the severity of a pollution-related case of CB (relative to the case described in the Viscusi study) is assumed to have a triangular distribution, with the most likely value at severity level 6.5 and endpoints at 1.0 and 12.0; and (3) the constant in the elasticity of WTP with respect to severity is normally distributed with mean = 0.18 and standard deviation = 0.0669 (from Krupnick and Cropper [1992]). This process and the rationale for choosing it is described in detail in the Costs and Benefits of the Clean Air Act, 1990 to 2010 (U.S. EPA, 1999).
Nonfatal Myocardial Infarction (heart attack)			No distributional information available. Age-specific cost-of-illness values reflect lost earnings and direct medical costs over a 5-year period following a nonfatal MI. Lost earnings estimates are based on Cropper and Krupnick (1990). Direct medical costs are based on simple average of estimates from Russell et al. (1998) and Wittels et al. (1990). Lost earnings: Cropper and Krupnick (1990). Present discounted value of 5 years of lost earnings: age of onset: at 3% at 7%
<u>3% discount rate</u>	\$84,955	\$84,955	
Age 0–24	\$95,713	\$95,713	25–44 \$8,774 \$7,855
Age 25–44	\$100,811	\$100,811	45–54 \$12,932 \$11,578
Age 45–54	\$176,602	\$176,602	55–65 \$74,746 \$66,920
Age 55–65	\$84,955	\$84,955	
Age 66 and over			
<u>7% discount rate</u>	\$84,170	\$84,170	Direct medical expenses: An average of:
Age 0–24	\$93,802	\$93,802	1. Wittels et al. (1990) (\$102,658—no discounting)
Age 25–44	\$98,366	\$98,366	2. Russell et al. (1998), 5-year period (\$22,331 at 3% discount rate; \$21,113 at 7% discount rate)
Age 45–54	\$166,222	\$166,222	
Age 55–65	\$84,171	\$84,171	
Age 66 and over			
Hospital Admissions			
Chronic Obstructive Pulmonary Disease (COPD)	\$17,106	\$17,106	No distributional information available. The COI estimates (lost earnings plus direct medical costs) are based on ICD-9 code-level information (e.g., average hospital care costs, average length of hospital stay, and weighted share of total COPD category illnesses) reported in Agency for Healthcare Research and Quality (2000) (www.ahrq.gov).
Asthma Admissions	\$11,366	\$11,366	No distributional information available. The COI estimates (lost earnings plus direct medical costs) are based on ICD-9 code-level information (e.g., average hospital care costs, average length of hospital stay, and weighted share of total asthma category illnesses) reported in Agency for Healthcare Research and Quality (2000) (www.ahrq.gov).
All Cardiovascular	\$28,760	\$28,760	No distributional information available. The COI estimates (lost earnings plus direct medical costs) are based on ICD-9 code-level information (e.g., average hospital care costs, average length of hospital stay, and weighted share of total cardiovascular category illnesses) reported in Agency for

Regulatory Impact Analysis

			Healthcare Research and Quality (2000) (www.ahrq.gov).
All respiratory (ages 65+)	\$24,157	\$24,157	No distributions available. The COI point estimates (lost earnings plus direct medical costs) are based on ICD-9 code level information (<i>e.g.</i> , average hospital care costs, average length of hospital stay, and weighted share of total COPD category illnesses) reported in Agency for Healthcare Research and Quality, 2000 (www.ahrq.gov).
All respiratory (ages 0–2)	\$10,402	\$10,402	No distributions available. The COI point estimates (lost earnings plus direct medical costs) are based on ICD-9 code level information (<i>e.g.</i> , average hospital care costs, average length of hospital stay, and weighted share of total COPD category illnesses) reported in Agency for Healthcare Research and Quality, 2000 (www.ahrq.gov).
Emergency Room Visits for Asthma	\$385	\$385	No distributional information available. Simple average of two unit COI values: (1) \$311.55, from Smith et al. (1997) and (2) \$260.67, from Stanford et al. (1999).
Respiratory Ailments Not Requiring Hospitalization			
Upper Respiratory Symptoms (URS)	\$30	\$32	Combinations of the three symptoms for which WTP estimates are available that closely match those listed by Pope et al. result in seven different “symptom clusters,” each describing a “type” of URS. A dollar value was derived for each type of URS, using mid-range estimates of WTP (IEc, 1994) to avoid each symptom in the cluster and assuming additivity of WTPs. In the absence of information surrounding the frequency with which each of the seven types of URS occurs within the URS symptom complex, we assumed a uniform distribution between \$9.2 and \$43.1.
Lower Respiratory Symptoms (LRS)	\$19	\$20	Combinations of the four symptoms for which WTP estimates are available that closely match those listed by Schwartz et al. result in 11 different “symptom clusters,” each describing a “type” of LRS. A dollar value was derived for each type of LRS, using mid-range estimates of WTP (IEc, 1994) to avoid each symptom in the cluster and assuming additivity of WTPs. The dollar value for LRS is the average of the dollar values for the 11 different types of LRS. In the absence of information surrounding the frequency with which each of the 11 types of LRS occurs within the LRS symptom complex, we assumed a uniform distribution between \$6.9 and \$24.46.
Asthma Exacerbations	\$52	\$54	Asthma exacerbations are valued at \$45 per incidence, based on the mean of average WTP estimates for the four severity definitions of a “bad asthma day,” described in Rowe and Chestnut (1986). This study surveyed asthmatics to estimate WTP for avoidance of a “bad asthma day,” as defined by the subjects. For purposes of valuation, an asthma exacerbation is assumed to be equivalent to a day in which asthma is moderate or worse as reported in the Rowe and Chestnut (1986) study. The value is assumed have a uniform distribution between \$15.6 and \$70.8.
Acute Bronchitis	\$430	\$470	Assumes a 6-day episode, with the distribution of the daily value specified as uniform with the low and high values based on those recommended for related respiratory symptoms in Neumann et al. (1994). The low daily estimate of \$10 is the sum of the mid-range values recommended by

Heavy-Duty GHG and Fuel Efficiency Standards FRM: Health and Environmental Impacts

			IEc (1994) for two symptoms believed to be associated with acute bronchitis: coughing and chest tightness. The high daily estimate was taken to be twice the value of a minor respiratory restricted-activity day, or \$110.
Work Loss Days (WLDs)	Variable (U.S. median = \$130)	Variable (U.S. median = \$130)	No distribution available. Point estimate is based on county-specific median annual wages divided by 50 (assuming 2 weeks of vacation) and then by 5—to get median daily wage. U.S. Year 2000 Census, compiled by Geolytics, Inc.
Minor Restricted Activity Days (MRADs)	\$61	\$66	Median WTP estimate to avoid one MRAD from Tolley et al. (1986). Distribution is assumed to be triangular with a minimum of \$22 and a maximum of \$83, with a most likely value of \$52. Range is based on assumption that value should exceed WTP for a single mild symptom (the highest estimate for a single symptom—for eye irritation—is \$16.00) and be less than that for a WLD. The triangular distribution acknowledges that the actual value is likely to be closer to the point estimate than either extreme.
School Absence Days	\$90	\$90	No distribution available

8.3.1.3.7 Manipulating Air Quality Modeling Data for Health Impacts Analysis

In Chapter 8-2, we summarized the methods for and results of estimating air quality for the program. These air quality results are in turn associated with human populations to estimate changes in health effects. For the purposes of this analysis, we focus on the health effects that have been linked to ambient changes in ozone and PM_{2.5} related to emission reductions estimated to occur due to the implementation of the program. We estimate ambient PM_{2.5} and ozone concentrations using the Community Multiscale Air Quality model (CMAQ). This section describes how we converted the CMAQ modeling output into full-season profiles suitable for the health impacts analysis.

General Methodology

First, we extracted hourly, surface-layer PM and ozone concentrations for each grid cell from the standard CMAQ output files. For ozone, these model predictions are used in conjunction with the observed concentrations obtained from the Aerometric Information Retrieval System (AIRS) to generate ozone concentrations for the entire ozone season.^{RR,SS} The predicted changes in ozone concentrations from the future-year base case to future-year control scenario serve as inputs to the health and welfare impact functions of the benefits analysis (*i.e.*, BenMAP).

^{RR} The ozone season for this analysis is defined as the 5-month period from May to September.

^{SS} Based on AIRS, there were 961 ozone monitors with sufficient data (*i.e.*, 50 percent or more days reporting at least nine hourly observations per day [8 am to 8 pm] during the ozone season).

Regulatory Impact Analysis

To estimate ozone-related health effects for the contiguous United States, full-season ozone data are required for every BenMAP grid-cell. Given available ozone monitoring data, we generated full-season ozone profiles for each location in two steps: (1) we combined monitored observations and modeled ozone predictions to interpolate hourly ozone concentrations to a grid of 12-km by 12-km population grid cells for the contiguous 48 states, and (2) we converted these full-season hourly ozone profiles to an ozone measure of interest, such as the daily 8-hour maximum.^{TT,UU}

For PM_{2.5}, we also use the model predictions in conjunction with observed monitor data. CMAQ generates predictions of hourly PM species concentrations for every grid. The species include a primary coarse fraction (corresponding to PM in the 2.5 to 10 micron size range), a primary fine fraction (corresponding to PM less than 2.5 microns in diameter), and several secondary particles (*e.g.*, sulfates, nitrates, and organics). PM_{2.5} is calculated as the sum of the primary fine fraction and all of the secondarily formed particles. Future-year estimates of PM_{2.5} were calculated using relative reduction factors (RRFs) applied to 2002 ambient PM_{2.5} and PM_{2.5} species concentrations. A gridded field of PM_{2.5} concentrations was created by interpolating Federal Reference Monitor ambient data and IMPROVE ambient data. Gridded fields of PM_{2.5} species concentrations were created by interpolating EPA speciation network (ESPN) ambient data and IMPROVE data. The ambient data were interpolated to the CMAQ 12 km grid.

The procedures for determining the RRFs are similar to those in EPA's draft guidance for modeling the PM_{2.5} standard (EPA, 2001).³⁶⁹ The guidance recommends that model predictions be used in a relative sense to estimate changes expected to occur in each major PM_{2.5} species. The procedure for calculating future-year PM_{2.5} design values is called the "Speciated Modeled Attainment Test (SMAT)." EPA used this procedure to estimate the ambient impacts of the final program.

Table 8-21 provides those ozone and PM_{2.5} metrics for grid cells in the modeled domain that enter the health impact functions for health benefits endpoints. The population-weighted average reflects the baseline levels and predicted changes for more populated areas of the nation. This measure better reflects the potential benefits through exposure changes to these populations.

Table 8-21: Summary of CMAQ-Derived Population-Weighted Ozone and PM_{2.5} Air Quality Metrics for Health Benefits Endpoints Associated with the HD National Program

Statistic ^a	2030	
	Baseline	Change ^b
Ozone Metric: National Population-Weighted Average (ppb) ^c		
Daily Maximum 8-Hour Average Concentration	42.4778	0.1643
PM _{2.5} Metric: National Population-Weighted Average (ug/m ³)		
Average Concentration	8.5164	0.0049

^{TT} The 12-km grid squares contain the population data used in the health benefits analysis model, BenMAP.

^{UU} This approach is a generalization of planar interpolation that is technically referred to as enhanced Voronoi Neighbor Averaging (EVNA) spatial interpolation. See the BenMAP manual for technical details, available for download at <http://www.epa.gov/air/benmap>.

Notes:

^a Ozone and PM_{2.5} metrics are calculated at the CMAQ grid-cell level for use in health effects estimates. Ozone metrics are calculated over relevant time periods during the daylight hours of the “ozone season” (*i.e.*, May through September).

^b The change is defined as the base-case value minus the control-case value.

^c Calculated by summing the product of the projected CMAQ grid-cell population and the estimated CMAQ grid cell seasonal ozone concentration and then dividing by the total population.

Emissions and air quality modeling decisions are made early in the analytical process. For this reason, the emission control scenarios used in the air quality and benefits modeling are slightly different than the final emission inventories estimated for the final program. Please refer to Chapter 5.6 for more information about the inventories used in the air quality modeling that supports the health impacts analysis.

8.3.1.4 Methods for Describing Uncertainty

In any complex analysis using estimated parameters and inputs from numerous models, there are likely to be many sources of uncertainty and this analysis is no exception. As outlined both in this and preceding chapters, many inputs were used to derive the estimate of benefits for the remedy, including emission inventories, air quality models (with their associated parameters and inputs), epidemiological health effect estimates, estimates of values (both from WTP and COI studies), population estimates, income estimates, and estimates of the future state of the world (*i.e.*, regulations, technology, and human behavior). Each of these inputs may be uncertain and, depending on its role in the benefits analysis, may have a disproportionately large impact on estimates of total benefits. For example, emissions estimates are used in the first stage of the analysis. As such, any uncertainty in emissions estimates will be propagated through the entire analysis. When compounded with uncertainty in later stages, small uncertainties in emission levels can lead to large impacts on total benefits.

The National Research Council (NRC) (2002, 2008)^{370,371} highlighted the need for EPA to conduct rigorous quantitative analysis of uncertainty in its benefits estimates and to present these estimates to decision makers in ways that foster an appropriate appreciation of their inherent uncertainty. In general, the NRC concluded that EPA’s general methodology for calculating the benefits of reducing air pollution is reasonable and informative in spite of inherent uncertainties. Since the publication of these reports, EPA’s Office of Air and Radiation (OAR) continues to make progress toward the goal of characterizing the aggregate impact of uncertainty in key modeling elements on both health incidence and benefits estimates in two key ways: Monte Carlo analysis and expert-derived concentration-response functions. In this analysis, we use both of these two methods to assess uncertainty quantitatively, as well as provide a qualitative assessment for those aspects that we are unable to address quantitatively.

First, we used Monte Carlo methods for characterizing random sampling error associated with the concentration response functions from epidemiological studies and random effects modeling to characterize both sampling error and variability across the economic valuation functions. Monte Carlo simulation uses random sampling from distributions of parameters to characterize the effects of uncertainty on output variables, such as incidence of premature mortality. Specifically, we used Monte Carlo methods to generate confidence intervals around

Regulatory Impact Analysis

the estimated health impact and dollar benefits. The reported standard errors in the epidemiological studies determined the distributions for individual effect estimates.

Second, because characterization of random statistical error omits important sources of uncertainty (*e.g.*, in the functional form of the model—*e.g.*, whether or not a threshold may exist), we also incorporate the results of an expert elicitation on the relationship between premature mortality and ambient PM_{2.5} concentration (Roman et al., 2008).³⁷² Use of the expert elicitation and incorporation of the standard errors approaches provide insights into the likelihood of different outcomes and about the state of knowledge regarding the benefits estimates. However, there are significant unquantified uncertainties present in upstream inputs including emission and air quality. Both approaches have different strengths and weaknesses, which are fully described in Chapter 5 of the PM NAAQS RIA (U.S. EPA, 2006).

In benefit analyses of air pollution regulations conducted to date, the estimated impact of reductions in premature mortality has accounted for 85% to 95% of total monetized benefits. Therefore, it is particularly important to attempt to characterize the uncertainties associated with reductions in premature mortality. The health impact functions used to estimate avoided premature deaths associated with reductions in ozone have associated standard errors that represent the statistical errors around the effect estimates in the underlying epidemiological studies. In our results, we report credible intervals based on these standard errors, reflecting the uncertainty in the estimated change in incidence of avoided premature deaths. We also provide multiple estimates, to reflect model uncertainty between alternative study designs.

For premature mortality associated with exposure to PM, we follow the same approach used in the RIA for 2006 PM NAAQS (U.S. EPA, 2006), presenting two empirical estimates of premature deaths avoided, and a set of twelve estimates based on results of the expert elicitation study. Even these multiple characterizations, including confidence intervals, omit the contribution to overall uncertainty of uncertainty in air quality changes, baseline incidence rates, populations exposed and transferability of the effect estimate to diverse locations. Furthermore, the approach presented here does not yet include methods for addressing correlation between input parameters and the identification of reasonable upper and lower bounds for input distributions characterizing uncertainty in additional model elements. As a result, the reported confidence intervals and range of estimates give an incomplete picture about the overall uncertainty in the estimates. This information should be interpreted within the context of the larger uncertainty surrounding the entire analysis.

In 2006 the EPA requested an NAS study to evaluate the extent to which the epidemiological literature to that point improved the understanding of ozone-related mortality. The NAS found that short-term ozone exposure was likely to contribute to ozone-related mortality (NRC, 2008) and issued a series of recommendations to EPA, including that the Agency should:

1. Present multiple short-term ozone mortality estimates, including those based on multi-city analyses such as the National Morbidity, Mortality and Air Pollution Study (NMMAPS) as well as meta-analytic studies.
2. Report additional risk metrics, including the percentage of baseline mortality attributable to short-term exposure.

Heavy-Duty GHG and Fuel Efficiency Standards FRM: Health and Environmental Impacts

3. Remove reference to a no-causal relationship between ozone exposure and premature mortality.

The quantification and presentation of ozone-related premature mortality in this chapter is responsive to these NRC recommendations and generally consistent with EPA's recent ozone reconsideration analysis (U.S. EPA, 2010).³⁷³

Some key sources of uncertainty in each stage of both the PM and ozone health impact assessment are the following:

- gaps in scientific data and inquiry;
- variability in estimated relationships, such as epidemiological effect estimates, introduced through differences in study design and statistical modeling;
- errors in measurement and projection for variables such as population growth rates;
- errors due to misspecification of model structures, including the use of surrogate variables, such as using PM₁₀ when PM_{2.5} is not available, excluded variables, and simplification of complex functions; and
- biases due to omissions or other research limitations.

In Table 8-22 we summarize some of the key uncertainties in the benefits analysis.

Table 8-22: Primary Sources of Uncertainty in the Benefits Analysis

<i>1. Uncertainties Associated with Impact Functions</i>
<ul style="list-style-type: none"> - The value of the ozone or PM effect estimate in each impact function. - Application of a single impact function to pollutant changes and populations in all locations. - Similarity of future-year impact functions to current impact functions. - Correct functional form of each impact function. - Extrapolation of effect estimates beyond the range of ozone or PM concentrations observed in the source epidemiological study. - Application of impact functions only to those subpopulations matching the original study population.
<i>2. Uncertainties Associated with CMAQ-Modeled Ozone and PM Concentrations</i>
<ul style="list-style-type: none"> - Responsiveness of the models to changes in precursor emissions from the control policy. - Projections of future levels of precursor emissions, especially ammonia and crustal materials. - Lack of ozone and PM_{2.5} monitors in all rural areas requires extrapolation of observed ozone data from urban to rural areas.
<i>3. Uncertainties Associated with PM Mortality Risk</i>
<ul style="list-style-type: none"> - Limited scientific literature supporting a direct biological mechanism for observed epidemiological evidence. - Direct causal agents within the complex mixture of PM have not been identified. - The extent to which adverse health effects are associated with low-level exposures that occur many times in the year versus peak exposures. - The extent to which effects reported in the long-term exposure studies are associated with historically higher levels of PM rather than the levels occurring during the period of study. - Reliability of the PM_{2.5} monitoring data in reflecting actual PM_{2.5} exposures.
<i>4. Uncertainties Associated with Possible Lagged Effects</i>
<ul style="list-style-type: none"> - The portion of the PM-related long-term exposure mortality effects associated with changes in annual PM levels that would occur in a single year is uncertain as well as the portion that might occur in subsequent years.
<i>5. Uncertainties Associated with Baseline Incidence Rates</i>
<ul style="list-style-type: none"> - Some baseline incidence rates are not location specific (e.g., those taken from studies) and therefore may not accurately represent the actual location-specific rates. - Current baseline incidence rates may not approximate well baseline incidence rates in 2030. - Projected population and demographics may not represent well future-year population and demographics.
<i>6. Uncertainties Associated with Economic Valuation</i>

Regulatory Impact Analysis

- Unit dollar values associated with health and welfare endpoints are only estimates of mean WTP and therefore have uncertainty surrounding them.
- Mean WTP (in constant dollars) for each type of risk reduction may differ from current estimates because of differences in income or other factors.

7. Uncertainties Associated with Aggregation of Monetized Benefits

- Health and welfare benefits estimates are limited to the available impact functions. Thus, unquantified or unmonetized benefits are not included.

8.3.2 Non-GHG Human Health Benefits of the Model Year (MY) Analysis

As described in Chapter 5, the final standards will reduce emissions of several criteria and toxic pollutants and precursors. EPA typically analyzes rule impacts (emissions, air quality, costs and benefits) in the year in which they occur; for the analysis of non-GHG ambient air quality and health impacts, we selected 2030 as a representative future year since resource and time constraints precluded EPA from considering multiple calendar years. We refer to this analysis as the “Calendar Year” (CY) analysis because the benefits of the program reflect impacts across all regulated vehicles in a calendar year.

EPA also conducted a separate analysis of the impacts over the model year lifetimes of the 2014 through 2018 model year vehicles. We refer to this analysis as the “Model Year” (MY) analysis (see Chapter 6). In contrast to the CY analysis, the MY analysis estimates the impacts of the program on each MY fleet over the course of its lifetime. Due to analytical and resource limitations, however, MY non-GHG emissions (direct PM, VOCs, NO₂ and SO₂) were not estimated for this analysis. Because MY impacts are measured in relation to only the lifetime of a particular vehicle model year (2014, 2015, 2016, 2017, and 2018), and assumes no additional controls to model year vehicles beyond 2018, the impacts are smaller than if the impacts of all regulated vehicles were considered. We therefore expect that the non-GHG health-related benefits associated with the MY analysis will be smaller than those estimated for the CY analysis, both in a given year (such as 2030) and in present value terms across a given time period (such as 2014 – 2050).

8.4 Changes in Atmospheric CO₂ Concentrations, Global Mean Temperature, Sea Level Rise, and Ocean pH Associated with the Program’s GHG Emissions Reductions

8.4.1 Introduction

Based on modeling analysis performed by the EPA, reductions in CO₂ and other GHG emissions associated with this final program will affect future climate change. Since GHGs are well-mixed in the atmosphere and have long atmospheric lifetimes, changes in GHG emissions will affect atmospheric concentrations of greenhouse gases and future climate for decades to millennia, depending on the gas. This section provides estimates of the projected change in atmospheric CO₂ concentrations based on the emission reductions estimated for this program’s preferred alternative, compared to the reference case. In addition, this section analyzes the response to the changes in GHG concentrations of the following climate-related variables: global

mean temperature, sea level rise, and ocean pH. See Chapter 5 for the estimated net reductions in global emissions over time by GHG.

8.4.2 Estimated Projected Change in Atmospheric CO₂ Concentrations, Global Mean Surface Temperature and Sea Level Rise

To assess the impact of the emissions reductions from the preferred alternative, EPA estimated changes in projected atmospheric CO₂ concentrations, global mean surface temperature and sea-level rise to 2100 using the GCAM (Global Change Assessment Model, formerly MiniCAM), integrated assessment model^{vv,374} coupled with the MAGICC (Model for the Assessment of Greenhouse-gas Induced Climate Change) simple climate model.^{ww,375,376} GCAM was used to create the globally and temporally consistent set of climate relevant emissions required for running MAGICC. MAGICC was then used to estimate the projected change in relevant climate variables over time. Given the magnitude of the estimated emissions reductions associated with the program, a simple climate model such as MAGICC is appropriate for estimating the atmospheric and climate response.

8.4.2.2 Methodology

Emissions reductions associated with this program were evaluated with respect to a baseline reference case. An emissions scenario was developed by applying the estimated emissions reductions from the program's preferred alternative relative to the Flat baseline to the GCAM reference (no climate policy) scenario (used as the basis for the Representative Concentration Pathway RCP4.5).³⁷⁷ Specifically, the annual CO₂, N₂O, HFC-134a, and CH₄ emissions reductions from Chapter 5 were applied as net reductions to the GCAM global baseline net emissions for each GHG. The CO, SO₂, VOCs, and NO_x emissions reductions were only provided for 2018, 2030, and 2050 (see Chapter 5), and reductions of these substances were assumed to begin in 2014. EPA linearly scaled emissions reductions for these pollutants between the 0 input value in 2013 and the value supplied for 2018 to produce the reductions between 2014 and 2018. A similar scaling was used for 2019-2029 and 2031-2050. The emissions reductions past 2050 for all emissions were scaled with total U.S. road transportation fuel consumption from the GCAM reference scenario. This was chosen as a simple scale factor given that both direct and upstream emissions changes are included in the emissions reduction

^{vv} GCAM is a long-term, global integrated assessment model of energy, economy, agriculture and land use that considers the sources of emissions of a suite of greenhouse gases (GHG's), emitted in 14 globally disaggregated regions, the fate of emissions to the atmosphere, and the consequences of changing concentrations of greenhouse related gases for climate change. GCAM begins with a representation of demographic and economic developments in each region and combines these with assumptions about technology development to describe an internally consistent representation of energy, agriculture, land-use, and economic developments that in turn shape global emissions.

^{ww} MAGICC consists of a suite of coupled gas-cycle, climate and ice-melt models integrated into a single framework. The framework allows the user to determine changes in greenhouse-gas concentrations, global-mean surface air temperature and sea-level resulting from anthropogenic emissions of carbon dioxide (CO₂), methane (CH₄), nitrous oxide (N₂O), reactive gases (CO, NO_x, VOCs), the halocarbons (*e.g.* HCFCs, HFCs, PFCs) and sulfur dioxide (SO₂). MAGICC emulates the global-mean temperature responses of more sophisticated coupled Atmosphere/Ocean General Circulation Models (AOGCMs) with high accuracy.

Regulatory Impact Analysis

scenario provided. Road transport fuel consumption past 2050 does not change significantly and thus emissions reductions remain relatively constant from 2050 through 2100.

The GCAM reference scenario³⁷⁸ depicts a world in which global population reaches a maximum of more than 9 billion in 2065 and then declines to 8.7 billion in 2100 while global GDP grows by an order of magnitude and global energy consumption triples. The reference scenario includes no explicit policies to limit carbon emissions, and therefore fossil fuels continue to dominate global energy consumption, despite substantial growth in nuclear and renewable energy. Atmospheric CO₂ concentrations rise throughout the century and reach 760 to 820 ppmv by 2100, depending on climatic parameters, with total radiative forcing increasing more than 5 Watts per square meter (W/m²) above 1990 levels by 2100. Forest land declines in the reference scenario to accommodate increases in land use for food and bioenergy crops. Even with the assumed agricultural productivity increases, the amount of land devoted to crops increases in the first half of the century due to increases in population and income (higher income drives increases in land-intensive meat consumption). After 2050 the rate of growth in food demand slows, in part due to declining population. As a result the amount of cropland and also land use change (LUC) emissions decline as agricultural crop productivity continues to increase.

The GCAM reference scenario uses non-CO₂ and pollutant emissions implemented as described in Smith and Wigley (2006); land-use change emissions as described in Wise et al. (2009); and updated base-year estimates of global GHG emissions. This scenario was created as part of the Climate Change Science Program (CCSP) effort to develop a set of long-term global emissions scenarios that incorporate an update of economic and technology data and utilize improved scenario development tools compared to the IPCC *Special Report on Emissions Scenarios* (SRES) (IPCC 2000).

Using MAGICC 5.3 v2,³⁷⁹ the change in atmospheric CO₂ concentrations, global mean temperature, and sea level were projected at five-year time steps to 2100 for both the reference (no climate policy) scenario and the emissions reduction scenario specific to the preferred alternative of this program. To capture some of the uncertainty in the climate system, the changes in projected atmospheric CO₂ concentrations, global mean temperature and sea level were estimated across the most current Intergovernmental Panel on Climate Change (IPCC) range of climate sensitivities, 1.5°C to 6.0°C.^{xx} The range as illustrated in Chapter 10, Box 10.2, Figure 2 of the IPCC's Working Group I is approximately consistent with the 10-90% probability distribution of the individual cumulative distributions of climate sensitivity.³⁸⁰ Other uncertainties, such as uncertainties regarding the carbon cycle, ocean heat uptake, or aerosol forcing, were not addressed.

^{xx} In IPCC reports, equilibrium climate sensitivity refers to the equilibrium change in the annual mean global surface temperature following a doubling of the atmospheric equivalent carbon dioxide concentration. The IPCC states that climate sensitivity is "likely" to be in the range of 2°C to 4.5°C, "very unlikely" to be less than 1.5°C, and "values substantially higher than 4.5°C cannot be excluded." IPCC WGI, 2007, *Climate Change 2007 - The Physical Science Basis*, Contribution of Working Group I to the Fourth Assessment Report of the IPCC, <http://www.ipcc.ch/>.

MAGICC calculates the forcing response at the global scale from changes in atmospheric concentrations of CO₂, CH₄, N₂O, HFCs, and tropospheric ozone. It also includes the effects of temperature changes on stratospheric ozone and the effects of CH₄ emissions on stratospheric water vapor. Changes in CH₄, NO_x, VOC, and CO emissions affect both O₃ concentrations and CH₄ concentrations. MAGICC includes the relative climate forcing effects of changes in sulfate concentrations due to changing SO₂ emissions, including both the direct effect of sulfate particles and the indirect effects related to cloud interactions. However, MAGICC does not calculate the effect of changes in concentrations of other aerosols such as nitrates, black carbon, or organic carbon, making the assumption that the sulfate cooling effect is a proxy for the sum of all the aerosol effects. Therefore, the climate effects of changes in PM_{2.5} emissions and precursors (besides SO₂) which were presented in Chapter 5 were not included in the calculations in this chapter. MAGICC also calculates all climate effects at the global scale. This global scale captures the climate effects of the long-lived, well-mixed greenhouse gases, but does not address the fact that short-lived climate forcers such as aerosols and ozone can have effects that vary with location and timing of emissions. Black carbon in particular is known to cause a positive forcing or warming effect by absorbing incoming solar radiation, but there are uncertainties about the magnitude of that warming effect and the interaction of black carbon (and other co-emitted aerosol species) with clouds. While black carbon is likely to be an important contributor to climate change, it would be premature to include quantification of black carbon climate impacts in an analysis of the program's standards at this time.

To compute the changes in atmospheric CO₂ concentration, global mean temperature, and sea level rise specifically attributable to the impacts of the program, the difference in emissions between the program and the baseline scenario was subtracted from the GCAM reference emissions scenario. As a result of the program's emissions reductions from the preferred alternative relative to the baseline case, the concentration of atmospheric CO₂ is projected to be reduced by approximately 0.691 to 0.787 parts per million by volume (ppmv), the global mean temperature is projected to be reduced by approximately 0.0017-0.0042°C, and global mean sea level rise is projected to be reduced by approximately 0.017-0.040 cm by 2100. For sea level rise, the calculations in MAGICC do not include the possible effects of accelerated ice flow in Greenland and/or Antarctica. Figure 8-21 provides the results over time for the estimated reductions in atmospheric CO₂ concentration associated with the program compared to the two baseline cases. Figure 8-22 provides the estimated change in projected global mean temperatures associated with the program. Figure 8-23 provides the estimated reductions in global mean sea level rise associated with the program. The range of reductions in global mean temperature and sea level rise due to uncertainty in climate sensitivity is larger than that for CO₂ concentrations because CO₂ concentrations are only weakly coupled to climate sensitivity through the dependence on temperature of the rate of ocean absorption of CO₂, whereas the magnitude of temperature change response to CO₂ changes (and therefore sea level rise) is more tightly coupled to climate sensitivity in the MAGICC model.

Regulatory Impact Analysis

Figure 8-21: Estimated Projected Reductions in Atmospheric CO₂ Concentrations (parts per million by volume) from the Baseline for the Preferred Alternative of the Heavy-Duty Program (climate sensitivity (CS) cases ranging from 1.5-6°C)

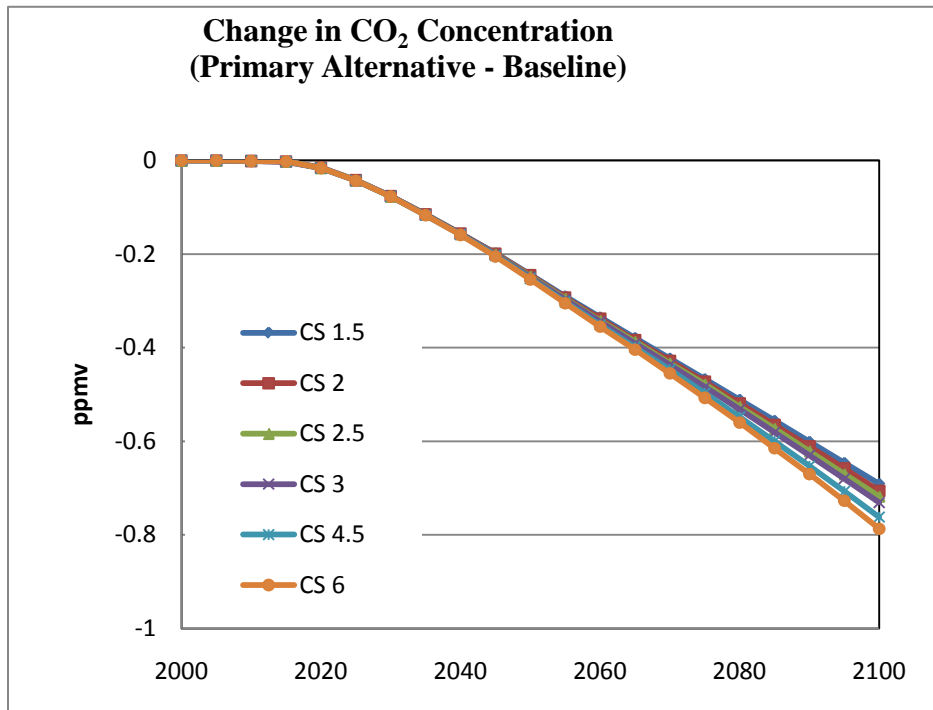

Figure 8-22: Estimated Projected Reductions in Global Mean Surface Temperatures from the Baseline for the Preferred Alternative of the Heavy-Duty Program (climate sensitivity (CS) cases ranging from 1.5-6°C)

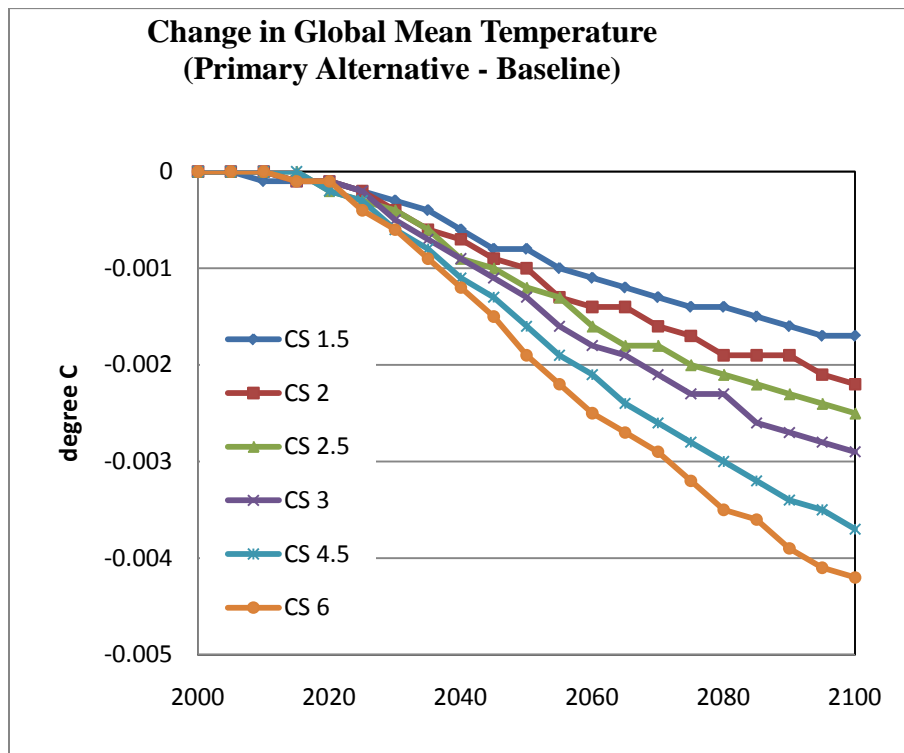
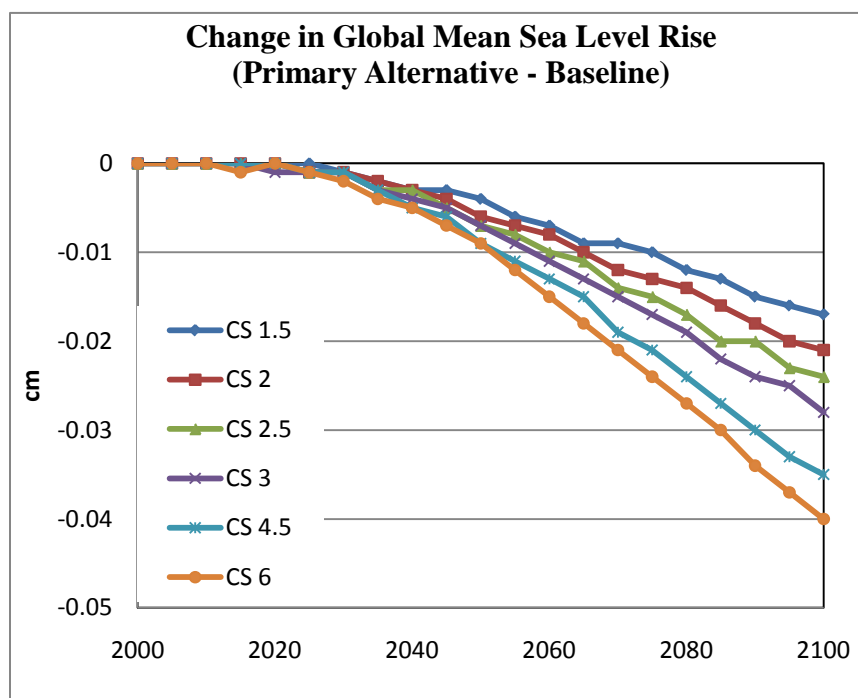

Figure 8-23: Estimated Projected Reductions in Global Mean Sea Level Rise from the Baseline for the Preferred Alternative of the Heavy-Duty Program (climate sensitivity (CS) cases ranging from 1.5-6°C)



The results in Figure 8-22 and 8-23 show reductions in the projected global mean temperature and sea level respectively, across all climate sensitivities. The projected reductions are small relative to the change in temperature (1.8 – 4.8 °C) and sea level rise (27 – 51 cm) from 1990 to 2100 from the MAGICC simulations for the GCAM reference case. However, this is to be expected given the magnitude of emissions reductions expected from the program in the context of global emissions. Again, it should be noted that the calculations in MAGICC do not include the possible effects of accelerated ice flow in Greenland and/or Antarctica: the recent NRC report estimated a likely sea level increase for the A1B SRES scenario of 0.5 to 1.0 meters.³⁸¹

8.4.3 Estimated Projected Change in Ocean pH

For this program, EPA analyzes another key climate-related variable and calculates projected change in ocean pH for tropical waters. For this analysis, changes in ocean pH are related to the change in the atmospheric concentration of CO₂ resulting from the emissions reductions associated with the preferred alternative. EPA used the program developed for CO₂ System Calculations CO2SYS,³⁸² version 1.05, a program which performs calculations relating parameters of the CO₂ system in seawater. The program was developed by Ernie Lewis at Brookhaven National Laboratory and Doug Wallace at the Institut für Meereskunde in Germany, supported by the U.S. Department of Energy, Office of Biological and Environmental Research, under Contract No. DE-ACO2-76CH00016.

The program uses two of the four measurable parameters of the CO₂ system [total alkalinity (TA), total inorganic CO₂ (TC), pH, and either fugacity (fCO₂) or partial pressure of

Regulatory Impact Analysis

CO₂ (pCO₂)] to calculate the other two parameters given a specific set of input conditions (temperature and pressure) and output conditions chosen by the user. EPA utilized the DOS version (Lewis and Wallace, 1998)³⁸³ of the program to compute pH for three scenarios: the reference scenario at a climate sensitivity of 3 degrees for which the CO₂ concentrations was calculated to be 784.868 in 2100, the preferred alternative relative to the baseline with a CO₂ concentration of 784.137, and a calculation for 1990 with a CO₂ concentration of 353.660.

Using the set of seawater parameters detailed below, the EPA calculated pH levels for the three scenarios. The reference scenario pH was 7.7888, the preferred emissions alternative relative to the baseline scenario pH was 7.7891 resulting in a difference of +0.0003 pH units. For comparison, the difference between the reference scenario in 2100 and the pH in 1990 was -0.30 pH units.

The CO₂SYs program required the input of a number of variables and constants for each scenario for calculating the result for both the reference case and the program's emissions reduction baseline cases. EPA used the following inputs, with justification and references for these inputs provided in brackets:

- 1) Input mode: Single-input [This simply means that the program calculates pH for one set of input variables at a time, instead of a batch of variables. The choice has no effect on results].
- 2) Choice of constants: Mehrbach et al. (1973)³⁸⁴, refit by Dickson and Millero (1987)³⁸⁵
- 3) Choice of fCO₂ or pCO₂: pCO₂ [pCO₂ is the partial pressure of CO₂ and can be converted to fugacity (fCO₂) if desired]
- 4) Choice of KSO₄: Dickson (1990)³⁸⁶ [Lewis and Wallace (1998)³⁸⁷ recommend using the equation of Dickson (1990) for this dissociation constant. The model also allows the use of the equation of Khoo et al. (1977).³⁸⁸ Switching this parameter to Khoo et al. (1977) instead of Dickson (1990) had no effect on the calculated result].
- 5) Choice of pH scale: Total scale [The model allows pH outputs to be provided on the total scale, the seawater scale, the free scale, and the National Bureau of Standards (NBS) scale. The various pH scales can be interrelated using equations provided by Lewis and Wallace (1998)].

The program provides several choices of constants for saltwater that are needed for the calculations. EPA calculated pH values using all choices and found that in all cases the choice had an indistinguishable effect on the results. In addition, EPA ran the model using a variety of other required input values to test whether the model was sensitive to these inputs. EPA found the model was not sensitive to these inputs in terms of the incremental change in pH calculated for each climate sensitivity case. The input values are derived from certified reference materials of sterilized natural sea water (Dickson, 2003, 2005, and 2009).³⁸⁹ Based on the projected atmospheric CO₂ concentration reductions that would result from this program's baseline case (0.731 ppmv for a climate sensitivity of 3.0), the modeling program calculates an increase in ocean pH of approximately 0.0003 pH units in 2100. Thus, this analysis indicates the projected decrease in atmospheric CO₂ concentrations from the preferred alternative yields an increase in ocean pH. Table 8-23 contains the projected changes in ocean pH based the change in atmospheric CO₂ concentrations which were derived from the MAGICC modeling.

Heavy-Duty GHG and Fuel Efficiency Standards FRM: Health and Environmental Impacts

Table 8-23: Impact of the Program’s GHG Emissions Reductions On Ocean pH

CLIMATE SENSITIVITY	DIFFERENCE IN CO ₂ ^a	YEAR	PROJECTED CHANGE
3.0	-0.731	2100	0.0003

Note:

^a Represents the change in atmospheric CO₂ concentrations in 2100 based on the difference from the preferred alternative relative to the base case from the GCAM reference scenario used in the MAGICC modeling.

8.4.4 Summary of Climate Analyses

EPA’s analysis of the impact of the program’s emissions reductions from this program on global climate conditions is intended to quantify these potential reductions using the best available science. While EPA’s modeling results of the impact of this program alone show small differences in climate effects (CO₂ concentration, global mean temperature, sea level rise, and ocean pH), in comparison to the total projected changes, they yield results that are repeatable and directionally consistent within the modeling frameworks used. The results are summarized in Table 8-24, Impact of GHG Emissions Reductions On Projected Changes in Global Climate Associated with the Program.

These projected reductions are proportionally representative of changes to U.S. GHG emissions in the transportation sector. While not formally estimated for this program, a reduction in projected global mean temperature and sea level rise implies a reduction in the risks associated with climate change. The figures for these variables illustrate that across a range of climate sensitivities projected global mean temperature and sea level rise increase less in the preferred alternative scenario than in the reference (no climate policy) case. The benefits of GHG emissions reductions can be characterized both qualitatively and quantitatively, some of which can be monetized (see Chapter 8.5). There are substantial uncertainties in modeling the global risks of climate change, which complicates quantification and cost-benefits assessments. Changes in climate variables are a meaningful proxy for changes in the risk of all potential impacts—including those that can be monetized, and those that have not been monetized but can be quantified in physical terms (*e.g.*, water availability), as well as those that have not yet been quantified or are extremely difficult to quantify (*e.g.*, forest disturbance and catastrophic events such as collapse of large ice sheets and subsequent sea level rise).

Table 8-24: Impact of GHG Emissions Reductions On Projected Changes in Global Climate Associated with the Program (based on a range of climate sensitivities from 1.5-6°C)

VARIABLE	UNITS	YEAR	PROJECTED CHANGE
Atmospheric CO₂ Concentration	ppmv	2100	-0.691 to -0.787
Global Mean Surface Temperature	° C	2100	-0.0017 to -0.0042
Sea Level Rise	cm	2100	-0.017 to -0.040
Ocean pH	pH units	2100	+0.0003 ^a

Notes:

^a The value for projected change in ocean pH is based on a climate sensitivity of 3.0.

References

- ¹ U.S. EPA (2009). Integrated Science Assessment for Particulate Matter (Final Report). U.S. Environmental Protection Agency, Washington, DC, EPA/600/R-08/139F, 2009. Docket EPA-HQ-OAR-2010-0162.
- ² U.S. EPA (2009). Integrated Science Assessment for Particulate Matter (Final Report). U.S. Environmental Protection Agency, Washington, DC, EPA/600/R-08/139F, 2009. Section 2.3.1.1. Docket EPA-HQ-OAR-2010-0162.
- ³ U.S. EPA (2009). Integrated Science Assessment for Particulate Matter (Final Report). U.S. Environmental Protection Agency, Washington, DC, EPA/600/R-08/139F, 2009. Section 2.3.1.2. Docket EPA-HQ-OAR-2010-0162.
- ⁴ U.S. EPA (2009). Integrated Science Assessment for Particulate Matter (Final Report). U.S. Environmental Protection Agency, Washington, DC, EPA/600/R-08/139F, 2009. Section 2.3.4. Docket EPA-HQ-OAR-2010-0162.
- ⁵ U.S. EPA (2009). Integrated Science Assessment for Particulate Matter (Final Report). U.S. Environmental Protection Agency, Washington, DC, EPA/600/R-08/139F, 2009. Table 2-6. Docket EPA-HQ-OAR-2010-0162.
- ⁶ U.S. EPA (2009). Integrated Science Assessment for Particulate Matter (Final Report). U.S. Environmental Protection Agency, Washington, DC, EPA/600/R-08/139F, 2009. Section 2.3.5.1. Docket EPA-HQ-OAR-2010-0162.
- ⁷ U.S. EPA (2009). Integrated Science Assessment for Particulate Matter (Final Report). U.S. Environmental Protection Agency, Washington, DC, EPA/600/R-08/139F, 2009. Table 2-6. Docket EPA-HQ-OAR-2010-0162.
- ⁸ U.S. EPA. (2006). *Air Quality Criteria for Ozone and Related Photochemical Oxidants* (Final). EPA/600/R-05/004aF-cF. Washington, DC: U.S. EPA. Docket EPA-HQ-OAR-2010-0162.
- ⁹ U.S. EPA. (2007). *Review of the National Ambient Air Quality Standards for Ozone: Policy Assessment of Scientific and Technical Information, OAQPS Staff Paper*. EPA-452/R-07-003. Washington, DC, U.S. EPA. Docket EPA-HQ-OAR-2010-0162
- ¹⁰ National Research Council (NRC), 2008. *Estimating Mortality Risk Reduction and Economic Benefits from Controlling Ozone Air Pollution*. The National Academies Press: Washington, D.C. Docket EPA-HQ-OAR-2010-0162.
- ¹¹ Bates, D.V., Baker-Anderson, M., Sizto, R. (1990). Asthma attack periodicity: a study of hospital emergency visits in Vancouver. *Environ. Res.*, 51,51-70. Docket EPA-HQ-OAR-2010-0162.
- ¹² Thurston, G.D., Ito, K., Kinney, P.L., Lippmann, M. (1992). A multi-year study of air pollution and respiratory hospital admissions in three New York State metropolitan areas: results for 1988 and 1989 summers. *J. Exposure Anal. Environ. Epidemiol.*, 2,429-450. Docket EPA-HQ-OAR-2010-0162.
- ¹³ Thurston, G.D., Ito, K., Hayes, C.G., Bates, D.V., Lippmann, M. (1994) Respiratory hospital admissions and summertime haze air pollution in Toronto, Ontario: consideration of the role of acid aerosols. *Environ. Res.*, 65, 271-290. Docket EPA-HQ-OAR-2010-0162.
- ¹⁴ Lipfert, F.W., Hammerstrom, T. (1992). Temporal patterns in air pollution and hospital admissions. *Environ. Res.*, 59,374-399. Docket EPA-HQ-OAR-2010-0162.

Heavy-Duty GHG and Fuel Efficiency Standards FRM: Health and Environmental Impacts

- ¹⁵ Burnett, R.T., Dales, R.E., Raizenne, M.E., Krewski, D., Summers, P.W., Roberts, G.R., Raad-Young, M., Dann, T., Brook, J. (1994). Effects of low ambient levels of ozone and sulfates on the frequency of respiratory admissions to Ontario hospitals. *Environ. Res.*, 65, 172-194. Docket EPA-HQ-OAR-2010-0162.
- ¹⁶ U.S. EPA. (2006). *Air Quality Criteria for Ozone and Related Photochemical Oxidants* (Final). EPA/600/R-05/004aF-cF. Washington, DC: U.S. EPA. Docket EPA-HQ-OAR-2010-0162.
- ¹⁷ U.S. EPA. (2006). *Air Quality Criteria for Ozone and Related Photochemical Oxidants* (Final). EPA/600/R-05/004aF-cF. Washington, DC: U.S. EPA. Docket EPA-HQ-OAR-2010-0162.
- ¹⁸ Devlin, R. B., McDonnell, W. F., Mann, R., Becker, S., House, D. E., Schreinemachers, D., Koren, H. S. (1991). Exposure of humans to ambient levels of ozone for 6.6 hours causes cellular and biochemical changes in the lung. *Am. J. Respir. Cell Mol. Biol.*, 4, 72-81.
- ¹⁹ Koren, H. S., Devlin, R. B., Becker, S., Perez, R., McDonnell, W. F. (1991). Time-dependent changes of markers associated with inflammation in the lungs of humans exposed to ambient levels of ozone. *Toxicol. Pathol.*, 19, 406-411. Docket EPA-HQ-OAR-2010-0162.
- ²⁰ Koren, H. S., Devlin, R. B., Graham, D. E., Mann, R., McGee, M. P., Horstman, D. H., Kozumbo, W. J., Becker, S., House, D. E., McDonnell, W. F., Bromberg, P. A. (1989). Ozone-induced inflammation in the lower airways of human subjects. *Am. Rev. Respir. Dis.*, 39, 407-415. Docket EPA-HQ-OAR-2010-0162.
- ²¹ Schelegle, E.S., Siefkin, A.D., McDonald, R.J. (1991). Time course of ozone-induced neutrophilia in normal humans. *Am. Rev. Respir. Dis.*, 143, 1353-1358. Docket EPA-HQ-OAR-2010-0162.
- ²² U.S. EPA. (1996). *Air Quality Criteria for Ozone and Related Photochemical Oxidants*. EPA600-P-93-004aF. Washington, D.C.: U.S. EPA. Docket EPA-HQ-OAR-2010-0162.
- ²³ Hodgkin, J.E., Abbey, D.E., Euler, G.L., Magie, A.R. (1984). COPD prevalence in nonsmokers in high and low photochemical air pollution areas. *Chest*, 86, 830-838. Docket EPA-HQ-OAR-2010-0162.
- ²⁴ Euler, G.L., Abbey, D.E., Hodgkin, J.E., Magie, A.R. (1988). Chronic obstructive pulmonary disease symptom effects of long-term cumulative exposure to ambient levels of total oxidants and nitrogen dioxide in California Seventh-day Adventist residents. *Arch. Environ. Health*, 43, 279-285. Docket EPA-HQ-OAR-2010-0162.
- ²⁵ Abbey, D.E., Petersen, F., Mills, P.K., Beeson, W.L. (1993). Long-term ambient concentrations of total suspended particulates, ozone, and sulfur dioxide and respiratory symptoms in a nonsmoking population. *Arch. Environ. Health*, 48, 33-46. Docket EPA-HQ-OAR-2010-0162.
- ²⁶ U.S. EPA. (2007). *Review of the National Ambient Air Quality Standards for Ozone: Policy Assessment of Scientific and Technical Information, OAQPS Staff Paper*. EPA-452/R-07-003. Washington, DC, U.S. EPA. Docket EPA-HQ-OAR-2010-0162.
- ²⁷ U.S. EPA. (2006). *Air Quality Criteria for Ozone and Related Photochemical Oxidants* (Final). EPA/600/R-05/004aF-cF. Washington, DC: U.S. EPA. Docket EPA-HQ-OAR-2010-0162.
- ²⁸ U.S. EPA. (2006). *Air Quality Criteria for Ozone and Related Photochemical Oxidants* (Final). EPA/600/R-05/004aF-cF. Washington, DC: U.S. EPA. Docket EPA-HQ-OAR-2010-0162.
- ²⁹ Avol, E.L., Trim, S. C., Little, D.E., Spier, C.E., Smith, M. N., Peng, R.-C., Linn, W.S., Hackney, J.D., Gross, K.B., D'Arcy, J.B., Gibbons, D., Higgins, I.T.T. (1990 June). *Ozone exposure and lung function in children attending a southern California summer camp*. Paper no. 90-150.3. Paper presented at the 83rd

Regulatory Impact Analysis

annual meeting and exhibition of the Air & Waste Management Association, Pittsburgh, PA. Docket EPA-HQ-OAR-2010-0162.

³⁰ Higgins, I. T.T., D'Arcy, J. B., Gibbons, D. I., Avol, E. L., Gross, K.B. (1990). Effect of exposures to ambient ozone on ventilatory lung function in children. *Am. Rev. Respir. Dis.*, 141, 1136-1146. Docket EPA-HQ-OAR-2010-0162.

³¹ Raizenne, M.E., Burnett, R.T., Stern, B., Franklin, C.A., Spengler, J.D. (1989) Acute lung function responses to ambient acid aerosol exposures in children. *Environ. Health Perspect.*, 79,179-185. Docket EPA-HQ-OAR-2010-0162.

³² Raizenne, M.; Stern, B.; Burnett, R.; Spengler, J. (1987 June) *Acute respiratory function and transported air pollutants: observational studies*. Paper no. 87-32.6. Paper presented at the 80th annual meeting of the Air Pollution Control Association, New York, NY. Docket EPA-HQ-OAR-2010-0162.

³³ Spektor, D. M., Lippmann, M. (1991). Health effects of ambient ozone on healthy children at a summer camp. In: Berglund, R. L.; Lawson, D. R.; McKee, D. J., eds. *Tropospheric ozone and the environment: papers from an international conference*; March 1990; Los Angeles, CA. Pittsburgh, PA: Air & Waste Management Association; pp. 83-89. (A&WMA transaction series no. TR-19). Docket EPA-HQ-OAR-2010-0162.

³⁴ Spektor, D. M., Thurston, G.D., Mao, J., He, D., Hayes, C., Lippmann, M. (1991). Effects of single- and multiday ozone exposures on respiratory function in active normal children. *Environ. Res*, 55,107-122. Docket EPA-HQ-OAR-2010-0162.

³⁵ Spektor, D. M., Lippman, M., Lioy, P. J., Thurston, G. D., Citak, K., James, D. J., Bock, N., Speizer, F. E., Hayes, C. (1988). Effects of ambient ozone on respiratory function in active, normal children. *Am. Rev. Respir. Dis.*, 137, 313-320. Docket EPA-HQ-OAR-2010-0162.

³⁶ U.S. EPA. (2006). *Air Quality Criteria for Ozone and Related Photochemical Oxidants* (Final). EPA/600/R-05/004aF-cF. Washington, DC: U.S. EPA. Docket EPA-HQ-OAR-2010-0162.

³⁷ Hazucha, M. J., Folinsbee, L. J., Seal, E., Jr. (1992). Effects of steady-state and variable ozone concentration profiles on pulmonary function. *Am. Rev. Respir. Dis.*, 146, 1487-1493. Docket EPA-HQ-OAR-2010-0162.

³⁸ Horstman, D.H., Ball, B.A., Folinsbee, L.J., Brown, J., Gerrity, T. (1995) Comparison of pulmonary responses of asthmatic and nonasthmatic subjects performing light exercise while exposed to a low level of ozone. *Toxicol. Ind. Health.*, 11(4), 369-85.

³⁹ Horstman, D.H.; Folinsbee, L.J., Ives, P.J., Abdul-Salaam, S., McDonnell, W.F. (1990). Ozone concentration and pulmonary response relationships for 6.6-hour exposures with five hours of moderate exercise to 0.08, 0.10, and 0.12 ppm. *Am. Rev. Respir. Dis.*, 142, 1158-1163. Docket EPA-HQ-OAR-2010-0162.

⁴⁰ U.S. EPA (2008). *Integrated Science Assessment (ISA) for Sulfur Oxides – Health Criteria* (Final Report). EPA/600/R-08/047F. Washington, DC,: U.S.EPA. Retrieved on March 19, 2009 from <http://cfpub.epa.gov/ncea/cfm/recordisplay.cfm?deid=198843>. Docket EPA-HQ-OAR-2010-0162.

⁴¹ U.S. EPA (2008). *Integrated Science Assessment for Oxides of Nitrogen – Health Criteria* (Final Report). EPA/600/R-08/071. Washington, DC,: U.S.EPA. Retrieved on March 19, 2009 from <http://cfpub.epa.gov/ncea/cfm/recordisplay.cfm?deid=194645>. Docket EPA-HQ-OAR-2010-0162.

⁴² U.S. EPA, 2010. *Integrated Science Assessment for Carbon Monoxide* (Final Report). U.S. Environmental Protection Agency, Washington, DC, EPA/600/R-09/019F, 2010. <http://cfpub.epa.gov/ncea/cfm/recordisplay.cfm?deid=218686>. Docket EPA-HQ-OAR-2010-0162.

Heavy-Duty GHG and Fuel Efficiency Standards FRM: Health and Environmental Impacts

- ⁴³ U.S. EPA. (2011) Summary of Results for the 2005 National-Scale Assessment. www.epa.gov/ttn/atw/nata2005/05pdf/sum_results.pdf. Docket EPA-HQ-OAR-2010-0162.
- ⁴⁴ U.S. EPA (2011) 2005 National-Scale Air Toxics Assessment. <http://www.epa.gov/ttn/atw/nata2005>. Docket EPA-HQ-OAR-2010-0162.
- ⁴⁵ U.S. EPA. (2008) National Emissions Inventory Data and Documentation. <http://www.epa.gov/ttn/chief/net/2008inventory.html>. Docket EPA-HQ-OAR-0162.
- ⁴⁶ U.S. EPA (2010). Final Rulemaking to Establish Light-Duty Vehicle Greenhouse Gas Emission Standards and Corporate Average Fuel Economy Standards: Regulatory Impact Analysis. Chapter 7, section 7.2.2.3.2. This material is available electronically at <http://www.epa.gov/oms/climate/regulations/420r10009.pdf>. Docket EPA-HQ-OAR-2010-0162.
- ⁴⁷ U.S. EPA (2011) 2005 National-Scale Air Toxics Assessment. <http://www.epa.gov/ttn/atw/nata2005>. Docket EPA-HQ-OAR-2010-0162.
- ⁴⁸ U.S. EPA (2002) Health Assessment Document for Diesel Engine Exhaust. EPA/600/8-90/057F Office of Research and Development, Washington DC. Pp1-1 1-2. This document is available electronically at <http://cfpub.epa.gov/ncea/cfm/recordisplay.cfm?deid=29060>. Docket EPA-HQ-OAR-2010-0162.
- ⁴⁹ U.S. EPA (2002). *Health Assessment Document for Diesel Engine Exhaust*. EPA/600/8-90/057F Office of Research and Development, Washington DC. Retrieved on March 17, 2009 from <http://cfpub.epa.gov/ncea/cfm/recordisplay.cfm?deid=29060>. pp. 1-1 1-2. Docket EPA-HQ-OAR-2010-0162.
- ⁵⁰ U.S. EPA. (1999). *Guidelines for Carcinogen Risk Assessment*. Review Draft. NCEA-F-0644, July. Washington, DC: U.S. EPA. Retrieved on March 19, 2009 from <http://cfpub.epa.gov/ncea/cfm/recordisplay.cfm?deid=54932>. Docket EPA-HQ-OAR-2010-0162.
- ⁵¹ U.S. EPA. (1986). *Guidelines for carcinogen risk assessment*. EPA/630/R-00/004. Washington, DC: U.S. EPA. Retrieved on March 19, 2009 from <http://cfpub.epa.gov/ncea/cfm/recordisplay.cfm?deid=54933>. Docket EPA-HQ-OAR-2010-0162.
- ⁵² National Institute for Occupational Safety and Health (NIOSH). (1988). *Carcinogenic effects of exposure to diesel exhaust. NIOSH Current Intelligence Bulletin 50*. DHHS (NIOSH) Publication No. 88-116. Atlanta, GA: Centers for Disease Control. Retrieved March 19, 2009 from http://www.cdc.gov/niosh/88116_50.html. Docket EPA-HQ-OAR-2010-0162.
- ⁵³ International Agency for Research on Cancer - IARC. (1997). *Silica, some silicates, coal dust and para-aramid fibrils. In Monographs on the evaluation of carcinogenic risks to humans. Vol. 68*. Lyon, France: IARC, pp. 362-375. Docket EPA-HQ-OAR-2010-0162.
- ⁵⁴ National Institute for Occupational Safety and Health (NIOSH). (1988). *Carcinogenic effects of exposure to diesel exhaust. NIOSH Current Intelligence Bulletin 50*. DHHS (NIOSH) Publication No. 88-116. Atlanta, GA: Centers for Disease Control. Retrieved March 19, 2009 from http://www.cdc.gov/niosh/88116_50.html. Docket EPA-HQ-OAR-2010-0162.
- ⁵⁵ World Health Organization International Program on Chemical Safety (1996). Diesel fuel and exhaust emissions. In *Environmental Health Criteria Vol. 171*. Geneva: World Health Organization. Retrieved March 19, 2009 from <http://www.inchem.org/documents/ehc/ehc/ehc171.htm>. pp.172-176. Docket EPA-HQ-OAR-2010-0162.
- ⁵⁶ California Environmental Protection Agency (Cal EPA, OEHHA). (1998). *Health risk assessment for diesel exhaust*. Public and Scientific Review Draft. Sacramento, CA: Cal EPA. Retrieved March 19, 2009 <ftp://ftp.arb.ca.gov/carbis/regact/diesltac/partb.pdf> Docket EPA-HQ-OAR-2010-0162.

Regulatory Impact Analysis

- ⁵⁷ National Toxicology Program (NTP). (2000). *9th Report on Carcinogens*. Research Triangle Park, NC: Public Health Service, U.S. Department of Health and Human Services. Available from: <http://ntp-server.niehs.nih.gov>.
- ⁵⁸ Health Effects Institute (HEI). (1995). *Diesel exhaust: a critical analysis of emissions, exposure, and health effects*. A Special Report of the Institute's Diesel Working Group. Cambridge, MA: Health Effects Institute.
- ⁵⁹ Health Effects Institute (HEI). (1999). *Diesel emissions and lung cancer: epidemiology and quantitative risk assessment*. A special report of the Institute's Diesel Epidemiology Expert Panel. Cambridge, MA: Health Effects Institute (HEI). Docket EPA-HQ-OAR-2010-0162.
- ⁶⁰ Health Effects Institute (HEI). (2002). *Research directions to improve estimates of human exposure and risk assessment*. A special report of the Institute's Diesel Epidemiology Working Group. Cambridge, MA: Health Effects Institute. Docket EPA-HQ-OAR-2010-0162.
- ⁶¹ U.S. EPA (2002). *Health Assessment Document for Diesel Engine Exhaust*. EPA/600/8-90/057F Office of Research and Development, Washington DC. Retrieved on March 17, 2009 from <http://cfpub.epa.gov/ncea/cfm/recordisplay.cfm?deid=29060>. pp. 9-11. Docket EPA-HQ-OAR-2010-0162.
- ⁶² Bhatia, R., Lopipero, P., Smith, A. (1998). Diesel exhaust exposure and lung cancer. *Epidemiology*, 9(1), 84-91. Docket EPA-HQ-OAR-2010-0162.
- ⁶³ Lipsett, M. Campleman, S. (1999). Occupational exposure to diesel exhaust and lung cancer: a meta-analysis. *Am J Public Health*, 80(7), 1009-1017. Docket EPA-HQ-OAR-2010-0162.
- ⁶⁴ U.S. EPA (2011) 2005 National-Scale Air Toxics Assessment. <http://www.epa.gov/ttn/atw/nata2005>. Docket EPA-HQ-OAR-2010-0162.
- ⁶⁵ Ishinishi, N. Kuwabara, N. Takaki, Y., et al. (1988). *Long-term inhalation experiments on diesel exhaust*. In: *Diesel exhaust and health risks. Results of the HERP studies*. Ibaraki, Japan: Research Committee for HERP Studies; pp.11-84. Docket EPA-HQ-OAR-2010-0162.
- ⁶⁶ Heinrich, U., Fuhst, R., Rittinghausen, S., et al. (1995). Chronic inhalation exposure of Wistar rats and two different strains of mice to diesel engine exhaust, carbon black, and titanium dioxide. *Inhal Toxicol*, 7, 553-556. Docket EPA-HQ-OAR-2010-0162.
- ⁶⁷ Mauderly, J.L., Jones, R.K., Griffith, W.C., et al. (1987). Diesel exhaust is a pulmonary carcinogen in rats exposed chronically by inhalation. *Fundam. Appl. Toxicol.*, 9, 208-221. Docket EPA-HQ-OAR-2010-0162.
- ⁶⁸ Nikula, K.J., Snipes, M.B., Barr, E.B., et al. (1995). Comparative pulmonary toxicities and carcinogenicities of chronically inhaled diesel exhaust and carbon black in F344 rats. *Fundam. Appl. Toxicol*, 25,80-94. Docket EPA-HQ-OAR-2010-0162.
- ⁶⁹ U.S. EPA (2002). *Health Assessment Document for Diesel Engine Exhaust*. EPA/600/8-90/057F Office of Research and Development, Washington DC. Retrieved on March 17, 2009 from <http://cfpub.epa.gov/ncea/cfm/recordisplay.cfm?deid=29060>. p. 9-9. Docket EPA-HQ-OAR-2010-0162.
- ⁷⁰ Reger, R., Hancock, J., Hankinson, J., et al. (1982). Coal miners exposed to diesel exhaust emissions. *Ann Occup Hyg*, 26, 799-815. Docket EPA-HQ-OAR-2010-0162.
- ⁷¹ Attfield, MD. (1978). The effect of exposure to silica and diesel exhaust in underground metal and nonmetal miners. In Kelley, W.D., (ed.), *Industrial hygiene for mining and tunneling: proceedings of a topical symposium*; Cincinnati, OH: The American Conference of Governmental Industrial Hygienists, Inc. Docket EPA-HQ-OAR-2010-0162.

Heavy-Duty GHG and Fuel Efficiency Standards FRM: Health and Environmental Impacts

- ⁷² Wade, J.F., III, Newman, L.S. (1993) Diesel asthma: reactive airways disease following overexposure to locomotive exhaust. *J Occup Med*, 35, 149-154. Docket EPA-HQ-OAR-2010-0162.
- ⁷³ U.S. EPA (2011) 2005 National-Scale Air Toxics Assessment. <http://www.epa.gov/ttn/atw/nata2005>. Docket EPA-HQ-OAR-2010-0162.
- ⁷⁴ Zhu, Y.; Hinds, W.C.; Kim, S.; Shen, S.; Sioutas, C. (2002) Study of ultrafine particles near a major highway with heavy-duty diesel traffic. *Atmospheric Environment* 36: 4323-4335. Docket EPA-HQ-OAR-2010-0162.
- ⁷⁵ Lena, T.S.; Ochieng, V.; Holguín-Veras, J.; Kinney, P.L. (2002) Elemental carbon and PM_{2.5} levels in an urban community heavily impacted by truck traffic. *Environ Health Perspect* 110: 1009-1015. Docket EPA-HQ-OAR-2010-0162.
- ⁷⁶ Soliman, A.S.M.; Jacko, J.B.; Palmer, G.M. (2006) Development of an empirical model to estimate real-world fine particulate matter emission factors: the Traffic Air Quality model. *J Air & Waste Manage Assoc* 56: 1540-1549. Docket EPA-HQ-OAR-2010-0162.
- ⁷⁷ Davis, M.E.; Smith, T.J.; Laden, F.; Hart, J.E.; Ryan, L.M.; Garshick, E. (2006) Modeling particle exposure in U.S. trucking terminals. *Environ Sci Technol* 40: 4226-4232. Docket EPA-HQ-OAR-2010-0162.
- ⁷⁸ Miller, T.L.; Fu, J.S.; Hromis, B.; Storey, J.M. (2007) Diesel truck idling emissions – measurements at a PM_{2.5} hot spot. Proceedings of the Annual Conference of the Transportation Research Board, paper no. 07-2609. Docket EPA-HQ-OAR-2010-0162.
- ⁷⁹ Ramachandran, G.; Paulsen, D.; Watts, W.; Kittelson, D. (2005) Mass, surface area, and number metrics in diesel occupational exposure assessment. *J Environ Monit* 7: 728-735. Docket EPA-HQ-OAR-2010-0162.
- ⁸⁰ U.S. EPA. 2000. Integrated Risk Information System File for Benzene. This material is available electronically at: <http://www.epa.gov/iris/subst/0276.htm>. Docket EPA-HQ-OAR-2010-0162.
- ⁸¹ International Agency for Research on Cancer, IARC monographs on the evaluation of carcinogenic risk of chemicals to humans, Volume 29, Some industrial chemicals and dyestuffs, International Agency for Research on Cancer, World Health Organization, Lyon, France 1982. Docket EPA-HQ-OAR-2010-0162.
- ⁸² Irons, R.D.; Stillman, W.S.; Colagiovanni, D.B.; Henry, V.A. (1992) Synergistic action of the benzene metabolite hydroquinone on myelopoietic stimulating activity of granulocyte/macrophage colony-stimulating factor in vitro, *Proc. Natl. Acad. Sci.* 89:3691-3695. Docket EPA-HQ-OAR-2010-0162.
- ⁸³ International Agency for Research on Cancer (IARC). 1987. Monographs on the evaluation of carcinogenic risk of chemicals to humans, Volume 29, Supplement 7, Some industrial chemicals and dyestuffs, World Health Organization, Lyon, France. Docket EPA-HQ-OAR-2010-0162.
- ⁸⁴ U.S. Department of Health and Human Services National Toxicology Program 11th Report on Carcinogens available at: <http://ntp.niehs.nih.gov/go/16183>. Docket EPA-HQ-OAR-2010-0162.
- ⁸⁵ Aksoy, M. (1989). Hematotoxicity and carcinogenicity of benzene. *Environ. Health Perspect.* 82: 193-197. EPA-HQ-OAR-2010-0162
- ⁸⁶ Goldstein, B.D. (1988). Benzene toxicity. *Occupational medicine. State of the Art Reviews.* 3: 541-554. Docket EPA-HQ-OAR-2010-0162.
- ⁸⁷ Rothman, N., G.L. Li, M. Dosemeci, W.E. Bechtold, G.E. Marti, Y.Z. Wang, M. Linet, L.Q. Xi, W. Lu, M.T. Smith, N. Titenko-Holland, L.P. Zhang, W. Blot, S.N. Yin, and R.B. Hayes (1996) Hematotoxicity

Regulatory Impact Analysis

among Chinese workers heavily exposed to benzene. *Am. J. Ind. Med.* 29: 236-246. Docket EPA-HQ-OAR-2010-0162.

⁸⁸ U.S. EPA 2002 Toxicological Review of Benzene (Noncancer Effects). Environmental Protection Agency, Integrated Risk Information System (IRIS), Research and Development, National Center for Environmental Assessment, Washington DC. This material is available electronically at <http://www.epa.gov/iris/subst/0276.htm>. Docket EPA-HQ-OAR-2010-0162.

⁸⁹ Qu, O.; Shore, R.; Li, G.; Jin, X.; Chen, C.L.; Cohen, B.; Melikian, A.; Eastmond, D.; Rappaport, S.; Li, H.; Rupa, D.; Suramaya, R.; Songnian, W.; Huifant, Y.; Meng, M.; Winnik, M.; Kwok, E.; Li, Y.; Mu, R.; Xu, B.; Zhang, X.; Li, K. (2003). HEI Report 115, Validation & Evaluation of Biomarkers in Workers Exposed to Benzene in China. Docket EPA-HQ-OAR-2010-0162.

⁹⁰ Qu, Q., R. Shore, G. Li, X. Jin, L.C. Chen, B. Cohen, et al. (2002). Hematological changes among Chinese workers with a broad range of benzene exposures. *Am. J. Industr. Med.* 42: 275-285. Docket EPA-HQ-OAR-2010-0162.

⁹¹ Lan, Qing, Zhang, L., Li, G., Vermeulen, R., et al. (2004). Hematotoxicity in Workers Exposed to Low Levels of Benzene. *Science* 306: 1774-1776. Docket EPA-HQ-OAR-2010-0162.

⁹² Turtletaub, K.W. and Mani, C. (2003). Benzene metabolism in rodents at doses relevant to human exposure from Urban Air. Research Reports Health Effect Inst. Report No.113. Docket EPA-HQ-OAR-2010-0162.

⁹³ U.S. EPA. 2002. Health Assessment of 1,3-Butadiene. Office of Research and Development, National Center for Environmental Assessment, Washington Office, Washington, DC. Report No. EPA600-P-98-001F. This document is available electronically at <http://www.epa.gov/iris/supdocs/buta-sup.pdf>. Docket EPA-HQ-OAR-2010-0162.

⁹⁴ U.S. EPA. 2002 "Full IRIS Summary for 1,3-butadiene (CASRN 106-99-0)" Environmental Protection Agency, Integrated Risk Information System (IRIS), Research and Development, National Center for Environmental Assessment, Washington, DC <http://www.epa.gov/iris/subst/0139.htm>. Docket EPA-HQ-OAR-2010-0162.

⁹⁵ International Agency for Research on Cancer (IARC) (1999) Monographs on the evaluation of carcinogenic risk of chemicals to humans, Volume 71, Re-evaluation of some organic chemicals, hydrazine and hydrogen peroxide and Volume 97 (in preparation), World Health Organization, Lyon, France. Docket EPA-HQ-OAR-2010-0162.

⁹⁶ International Agency for Research on Cancer (IARC) (2008) Monographs on the evaluation of carcinogenic risk of chemicals to humans, 1,3-Butadiene, Ethylene Oxide and Vinyl Halides (Vinyl Fluoride, Vinyl Chloride and Vinyl Bromide) Volume 97, World Health Organization, Lyon, France. Docket EPA-HQ-OAR-2010-0162.

⁹⁷ U.S. Department of Health and Human Services National Toxicology Program 11th Report on Carcinogens available at: <http://ntp.niehs.nih.gov/go/16183>. Docket EPA-HQ-OAR-2010-0162.

⁹⁸ Bevan, C.; Stadler, J.C.; Elliot, G.S.; et al. (1996) Subchronic toxicity of 4-vinylcyclohexene in rats and mice by inhalation. *Fundam. Appl. Toxicol.* 32:1-10. Docket EPA-HQ-OAR-2010-0162.

⁹⁹ U.S. EPA. 1987. Assessment of Health Risks to Garment Workers and Certain Home Residents from Exposure to Formaldehyde, Office of Pesticides and Toxic Substances, April 1987. Docket EPA-HQ-OAR-2010-0162.

- ¹⁰⁰ Hauptmann, M.; Lubin, J. H.; Stewart, P. A.; Hayes, R. B.; Blair, A. 2003. Mortality from lymphohematopoietic malignancies among workers in formaldehyde industries. *Journal of the National Cancer Institute* 95: 1615-1623. Docket EPA-HQ-OAR-2010-0162.
- ¹⁰¹ Hauptmann, M.; Lubin, J. H.; Stewart, P. A.; Hayes, R. B.; Blair, A. 2004. Mortality from solid cancers among workers in formaldehyde industries. *American Journal of Epidemiology* 159: 1117-1130. Docket EPA-HQ-OAR-2010-0162.
- ¹⁰² Beane Freeman, L. E.; Blair, A.; Lubin, J. H.; Stewart, P. A.; Hayes, R. B.; Hoover, R. N.; Hauptmann, M. 2009. Mortality from lymphohematopoietic malignancies among workers in formaldehyde industries: The National Cancer Institute cohort. *J. National Cancer Inst.* 101: 751-761. Docket EPA-HQ-OAR-2010-0162.
- ¹⁰³ Pinkerton, L. E. 2004. Mortality among a cohort of garment workers exposed to formaldehyde: an update. *Occup. Environ. Med.* 61: 193-200. Docket EPA-HQ-OAR-2010-0162.
- ¹⁰⁴ Coggon, D, EC Harris, J Poole, KT Palmer. 2003. Extended follow-up of a cohort of British chemical workers exposed to formaldehyde. *J National Cancer Inst.* 95:1608-1615. Docket EPA-HQ-OAR-2010-0162.
- ¹⁰⁵ Conolly, RB, JS Kimbell, D Janszen, PM Schlosser, D Kalisak, J Preston, and FJ Miller. 2003. Biologically motivated computational modeling of formaldehyde carcinogenicity in the F344 rat. *Tox Sci* 75: 432-447. Docket EPA-HQ-OAR-2010-0162.
- ¹⁰⁶ Conolly, RB, JS Kimbell, D Janszen, PM Schlosser, D Kalisak, J Preston, and FJ Miller. 2004. Human respiratory tract cancer risks of inhaled formaldehyde: Dose-response predictions derived from biologically-motivated computational modeling of a combined rodent and human dataset. *Tox Sci* 82: 279-296. Docket EPA-HQ-OAR-2010-0162.
- ¹⁰⁷ Chemical Industry Institute of Toxicology (CIIT).1999. Formaldehyde: Hazard characterization and dose-response assessment for carcinogenicity by the route of inhalation. CIIT, September 28, 1999. Research Triangle Park, NC. Docket EPA-HQ-OAR-2010-0162.
- ¹⁰⁸ U.S. EPA. Analysis of the Sensitivity and Uncertainty in 2-Stage Clonal Growth Models for Formaldehyde with Relevance to Other Biologically-Based Dose Response (BBDR) Models. U.S. Environmental Protection Agency, Washington, D.C., EPA/600/R-08/103, 2008. Docket EPA-HQ-OAR-2010-0162.
- ¹⁰⁹ Subramaniam, R; Chen, C; Crump, K; .et .al. (2008) Uncertainties in biologically-based modeling of formaldehyde-induced cancer risk: identification of key issues. *Risk Anal* 28(4):907-923. Docket EPA-HQ-OAR-2010-0162.
- ¹¹⁰ Subramaniam RP; Crump KS; Van Landingham C; et. al. (2007) Uncertainties in the CIIT model for formaldehyde-induced carcinogenicity in the rat: A limited sensitivity analysis–I. *Risk Anal*, 27: 1237–1254. Docket EPA-HQ-OAR-2010-0162.
- ¹¹¹ Crump, K; Chen, C; Fox, J; .et .al. (2008) Sensitivity analysis of biologically motivated model for formaldehyde-induced respiratory cancer in humans. *Ann Occup Hyg* 52:481-495. Docket EPA-HQ-OAR-2010-0162.
- ¹¹² Crump, K; Chen, C; Fox, J; .et .al. (2008) Sensitivity analysis of biologically motivated model for formaldehyde-induced respiratory cancer in humans. *Ann Occup Hyg* 52:481-495. Docket EPA-HQ-OAR-2010-0162.

Regulatory Impact Analysis

- ¹¹³ Subramaniam RP; Crump KS; Van Landingham C; et. al. (2007) Uncertainties in the CIIT model for formaldehyde-induced carcinogenicity in the rat: A limited sensitivity analysis–I. *Risk Anal*, 27: 1237–1254. Docket EPA-HQ-OAR-2010-0162.
- ¹¹⁴ International Agency for Research on Cancer (2006) Formaldehyde, 2-Butoxyethanol and 1-tert-Butoxypropan-2-ol. Monographs Volume 88. World Health Organization, Lyon, France. Docket EPA-HQ-OAR-2010-0162.
- ¹¹⁵ Agency for Toxic Substances and Disease Registry (ATSDR). 1999. Toxicological profile for Formaldehyde. Atlanta, GA: U.S. Department of Health and Human Services, Public Health Service. <http://www.atsdr.cdc.gov/toxprofiles/tp111.html>. Docket EPA-HQ-OAR-2010-0162.
- ¹¹⁶ WHO (2002) Concise International Chemical Assessment Document 40: Formaldehyde. Published under the joint sponsorship of the United Nations Environment Programme, the International Labour Organization, and the World Health Organization, and produced within the framework of the Inter-Organization Programme for the Sound Management of Chemicals. Geneva. Docket EPA-HQ-OAR-2010-0162.
- ¹¹⁷ Committee to Review EPA’s Draft IRIS Assessment of Formaldehyde; National Research Council, “Review of the Environmental Protection Agency’s Draft IRIS Assessment of Formaldehyde,” 2011. Available here: http://www.nap.edu/catalog.php?record_id=13142.
- ¹¹⁸ U.S. EPA (1988). Integrated Risk Information System File of Acetaldehyde. Research and Development, National Center for Environmental Assessment, Washington, DC. This material is available electronically at <http://www.epa.gov/iris/subst/0290.htm>. Docket EPA-HQ-OAR-2010-0162.
- ¹¹⁹ U.S. Department of Health and Human Services National Toxicology Program 11th Report on Carcinogens available at: <http://ntp.niehs.nih.gov/go/16183>. Docket EPA-HQ-OAR-2010-0162.
- ¹²⁰ International Agency for Research on Cancer (IARC). 1999. Re-evaluation of some organic chemicals, hydrazine, and hydrogen peroxide. IARC Monographs on the Evaluation of Carcinogenic Risk of Chemical to Humans, Vol 71. Lyon, France. Docket EPA-HQ-OAR-2010-0162.
- ¹²¹ U.S. EPA (1988). Integrated Risk Information System File of Acetaldehyde. This material is available electronically at <http://www.epa.gov/iris/subst/0290.htm>. Docket EPA-HQ-OAR-2010-0162.
- ¹²² U.S. EPA. (2003). Integrated Risk Information System File of Acrolein. Research and Development, National Center for Environmental Assessment, Washington, DC. This material is available electronically at <http://www.epa.gov/iris/subst/0364.htm>. Docket EPA-HQ-OAR-2010-0162.
- ¹²³ Appleman, L.M., R.A. Woutersen, and V.J. Feron. (1982). Inhalation toxicity of acetaldehyde in rats. I. Acute and subacute studies. *Toxicology*. 23: 293-297. Docket EPA-HQ-OAR-2010-0162.
- ¹²⁴ Myou, S.; Fujimura, M.; Nishi K.; Ohka, T.; and Matsuda, T. (1993) Aerosolized acetaldehyde induces histamine-mediated bronchoconstriction in asthmatics. *Am. Rev. Respir. Dis.* 148(4 Pt 1): 940-943. Docket EPA-HQ-OAR-2010-0162.
- ¹²⁵ U.S. EPA. (2003) Toxicological review of acrolein in support of summary information on Integrated Risk Information System (IRIS) National Center for Environmental Assessment, Washington, DC. EPA/635/R-03/003. p. 10. Available online at: <http://www.epa.gov/ncea/iris/toxreviews/0364tr.pdf>. Docket EPA-HQ-OAR-2010-0162.
- ¹²⁶ U.S. EPA. (2003) Toxicological review of acrolein in support of summary information on Integrated Risk Information System (IRIS) National Center for Environmental Assessment, Washington, DC.

Heavy-Duty GHG and Fuel Efficiency Standards FRM: Health and Environmental Impacts

EPA/635/R-03/003. Available online at: <http://www.epa.gov/ncea/iris/toxreviews/0364tr.pdf>. Docket EPA-HQ-OAR-2010-0162.

¹²⁷ U.S. EPA. (2003) Toxicological review of acrolein in support of summary information on Integrated Risk Information System (IRIS) National Center for Environmental Assessment, Washington, DC. EPA/635/R-03/003. p. 11. Available online at: <http://www.epa.gov/ncea/iris/toxreviews/0364tr.pdf>. Docket EPA-HQ-OAR-2010-0162.

¹²⁸ U.S. EPA. (2003). Integrated Risk Information System File of Acrolein. Office of Research and Development, National Center for Environmental Assessment, Washington, DC. This material is available at <http://www.epa.gov/iris/subst/0364.htm>. Docket EPA-HQ-OAR-2010-0162.

¹²⁹ U.S. EPA. (2003) Toxicological review of acrolein in support of summary information on Integrated Risk Information System (IRIS) National Center for Environmental Assessment, Washington, DC. EPA/635/R-03/003. p. 15. Available online at: <http://www.epa.gov/ncea/iris/toxreviews/0364tr.pdf>. Docket EPA-HQ-OAR-2010-0162.

¹³⁰ Morris JB, Symanowicz PT, Olsen JE, et al. 2003. Immediate sensory nerve-mediated respiratory responses to irritants in healthy and allergic airway-diseased mice. *J Appl Physiol* 94(4):1563-1571. Docket EPA-HQ-OAR-2010-0162.

¹³¹ U.S. EPA. (2003). Integrated Risk Information System File of Acrolein. Research and Development, National Center for Environmental Assessment, Washington, DC. This material is available at <http://www.epa.gov/iris/subst/0364.htm>. Docket EPA-HQ-OAR-2010-0162.

¹³² International Agency for Research on Cancer (IARC). 1995. Monographs on the evaluation of carcinogenic risk of chemicals to humans, Volume 63. Dry cleaning, some chlorinated solvents and other industrial chemicals, World Health Organization, Lyon, France. Docket EPA-HQ-OAR-2010-0162.

¹³³ U.S. EPA (2002). *Health Assessment Document for Diesel Engine Exhaust*. EPA/600/8-90/057F Office of Research and Development, Washington DC. <http://cfpub.epa.gov/ncea/cfm/recorddisplay.cfm?deid=29060>. Docket EPA-HQ-OAR-2010-0162.

¹³⁴ U. S. EPA. 1998. Toxicological Review of Naphthalene (Reassessment of the Inhalation Cancer Risk), Environmental Protection Agency, Integrated Risk Information System, Research and Development, National Center for Environmental Assessment, Washington, DC. This material is available electronically at <http://www.epa.gov/iris/subst/0436.htm>. Docket EPA-HQ-OAR-2010-0162.

¹³⁵ Oak Ridge Institute for Science and Education. (2004). External Peer Review for the IRIS Reassessment of the Inhalation Carcinogenicity of Naphthalene. August 2004. <http://cfpub.epa.gov/ncea/cfm/recorddisplay.cfm?deid=84403>. Docket EPA-HQ-OAR-2010-0162.

¹³⁶ National Toxicology Program (NTP). (2004). 11th Report on Carcinogens. Public Health Service, U.S. Department of Health and Human Services, Research Triangle Park, NC. Available from: <http://ntp-server.niehs.nih.gov>. Docket EPA-HQ-OAR-2010-0162.

¹³⁷ International Agency for Research on Cancer (IARC). (2002). Monographs on the Evaluation of the Carcinogenic Risk of Chemicals for Humans. Vol. 82. Lyon, France. Docket EPA-HQ-OAR-2010-0162.

¹³⁸ U. S. EPA. 1998. Toxicological Review of Naphthalene, Environmental Protection Agency, Integrated Risk Information System, Research and Development, National Center for Environmental Assessment, Washington, DC. This material is available electronically at <http://www.epa.gov/iris/subst/0436.htm> Docket EPA-HQ-OAR-2010-0162.

Regulatory Impact Analysis

- ¹³⁹ Zhou, Y.; Levy, J.I. (2007) Factors influencing the spatial extent of mobile source air pollution impacts: a meta-analysis. *BMC Public Health* 7: 89. doi:10.1186/1471-2458-7-89. Docket EPA-HQ-OAR-2010-0162.
- ¹⁴⁰ HEI Panel on the Health Effects of Air Pollution. (2010) Traffic-related air pollution: a critical review of the literature on emissions, exposure, and health effects. [Online at www.healtheffects.org]. Docket EPA-HQ-OAR-2010-0162.
- ¹⁴¹ Salam, M.T.; Islam, T.; Gilliland, F.D. (2008) Recent evidence for adverse effects of residential proximity to traffic sources on asthma. *Current Opin Pulm Med* 14: 3-8. Docket EPA-HQ-OAR-2010-0162.
- ¹⁴² Holguin, F. (2008) Traffic, outdoor air pollution, and asthma. *Immunol Allergy Clinics North Am* 28: 577-588. Docket EPA-HQ-OAR-2010-0162.
- ¹⁴³ Adar, S.D.; Kaufman, J.D. (2007) Cardiovascular disease and air pollutants: evaluating and improving epidemiological data implicating traffic exposure. *Inhal Toxicol* 19: 135-149. Docket EPA-HQ-OAR-2010-0162.
- ¹⁴⁴ Raaschou-Nielsen, O.; Reynolds, P. (2006) Air pollution and childhood cancer: a review of the epidemiological literature. *Int J Cancer* 118: 2920-2929. Docket EPA-HQ-OAR-2010-0162.
- ¹⁴⁵ U.S. Census Bureau (2008) American Housing Survey for the United States in 2007. Series H-150 (National Data), Table 1A-6. [Accessed at <http://www.census.gov/hhes/www/housing/ahs/ahs07/ahs07.html> on January 22, 2009] Docket EPA-HQ-OAR-2010-0162.
- ¹⁴⁶ Lena, T.S.; Ochieng, V.; Carter, M.; Holguín-Veras, J.; Kinney, P.L. (2002) Elemental carbon and PM_{2.5} levels in an urban community heavily impacted by truck traffic. *Environ Health Perspect* 110: 1009-1015. Docket EPA-HQ-OAR-2010-0162.
- ¹⁴⁷ Wier, M.; Sciammas, C.; Seto, E.; Bhatia, R.; Rivard, T. (2009) Health, traffic, and environmental justice: collaborative research and community action in San Francisco, California. *Am J Public Health* 99: S499-S504. Docket EPA-HQ-OAR-2010-0162.
- ¹⁴⁸ Forkenbrock, D.J. and L.A. Schweitzer, Environmental Justice and Transportation Investment Policy. Iowa City: University of Iowa, 1997. Docket EPA-HQ-OAR-2010-0162.
- ¹⁴⁹ Appatova, A.S.; Ryan, P.H.; LeMasters, G.K.; Grinshpun, S.A. (2008) Proximal exposure of public schools and students to major roadways: a nationwide US survey. *J Environ Plan Mgmt*. Docket EPA-HQ-OAR-2010-0162.
- ¹⁵⁰ Green, R.S.; Smorodinsky, S.; Kim, J.J.; McLaughlin, R.; Ostro, B. (2004) Proximity of California public schools to busy roads. *Environ Health Perspect* 112: 61-66. Docket EPA-HQ-OAR-2010-0162.
- ¹⁵¹ Houston, D.; Ong, P.; Wu, J.; Winer, A. (2006) Proximity of licensed child care facilities to near-roadway vehicle pollution. *Am J Public Health* 96: 1611-1617. Docket EPA-HQ-OAR-2010-0162.
- ¹⁵² Wu, Y.; Batterman, S. (2006) Proximity of schools in Detroit, Michigan to automobile and truck traffic. *J Exposure Sci Environ Epidemiol* 16: 457-470. Docket EPA-HQ-OAR-2010-0162.
- ¹⁵³ U.S. EPA (2009). Integrated Science Assessment for Particulate Matter (Final Report). U.S. Environmental Protection Agency, Washington, DC, EPA/600/R-08/139F, 2009. *pg 9-19 through 9-23*. Docket EPA-HQ-OAR-2010-0162.

Heavy-Duty GHG and Fuel Efficiency Standards FRM: Health and Environmental Impacts

- ¹⁵⁴ U.S. EPA. 1999. *The Benefits and Costs of the Clean Air Act, 1990-2010*. Prepared for U.S. Congress by U.S. EPA, Office of Air and Radiation, Office of Policy Analysis and Review, Washington, DC, November; EPA report no. EPA410-R-99-001. Docket EPA-HQ-OAR-2010-0162.
- ¹⁵⁵ U.S. EPA (2006). *Air Quality Criteria for Ozone and Related Photochemical Oxidants* (Final). U.S. EPA, Washington, DC, EPA/600/R-05/004aF-cF, 2006. Docket EPA-HQ-OAR-2010-0162.
- ¹⁵⁶ Winner, W.E., and C.J. Atkinson. 1986. "Absorption of air pollution by plants, and consequences for growth." *Trends in Ecology and Evolution* 1:15-18. Docket EPA-HQ-OAR-2010-0162.
- ¹⁵⁷ U.S. EPA (2006). *Air Quality Criteria for Ozone and Related Photochemical Oxidants* (Final). U.S. EPA, Washington, DC, EPA/600/R-05/004aF-cF, 2006. Docket EPA-HQ-OAR-2010-0162.
- ¹⁵⁸ Tingey, D.T., and Taylor, G.E. (1982) Variation in plant response to ozone: a conceptual model of physiological events. In M.H. Unsworth & D.P. Omrod (Eds.), *Effects of Gaseous Air Pollution in Agriculture and Horticulture*. (pp.113-138). London, UK: Butterworth Scientific. Docket EPA-HQ-OAR-2010-0162.
- ¹⁵⁹ U.S. EPA (2006). *Air Quality Criteria for Ozone and Related Photochemical Oxidants* (Final). U.S. EPA, Washington, DC, EPA/600/R-05/004aF-cF, 2006. Docket EPA-HQ-OAR-2010-0162.
- ¹⁶⁰ U.S. EPA (2006). *Air Quality Criteria for Ozone and Related Photochemical Oxidants* (Final). U.S. EPA, Washington, DC, EPA/600/R-05/004aF-cF, 2006. Docket EPA-HQ-OAR-2010-0162.
- ¹⁶¹ U.S. EPA (2006). *Air Quality Criteria for Ozone and Related Photochemical Oxidants* (Final). U.S. EPA, Washington, DC, EPA/600/R-05/004aF-cF, 2006. Docket EPA-HQ-OAR-2010-0162.
- ¹⁶² U.S. EPA (2006). *Air Quality Criteria for Ozone and Related Photochemical Oxidants* (Final). U.S. EPA, Washington, DC, EPA/600/R-05/004aF-cF, 2006. Docket EPA-HQ-OAR-2010-0162.
- ¹⁶³ Ollinger, S.V., Aber, J.D., Reich, P.B. (1997). Simulating ozone effects on forest productivity: interactions between leaf canopy and stand level processes. *Ecological Applications*, 7, 1237-1251. Docket EPA-HQ-OAR-2010-0162.
- ¹⁶⁴ Winner, W.E. (1994). Mechanistic analysis of plant responses to air pollution. *Ecological Applications*, 4(4), 651-661. Docket EPA-HQ-OAR-2010-0162.
- ¹⁶⁵ U.S. EPA (2006). *Air Quality Criteria for Ozone and Related Photochemical Oxidants* (Final). U.S. EPA, Washington, DC, EPA/600/R-05/004aF-cF, 2006. Docket EPA-HQ-OAR-2010-0162.
- ¹⁶⁶ Chappelka, A.H., Samuelson, L.J. (1998). Ambient ozone effects on forest trees of the eastern United States: a review. *New Phytologist*, 139, 91-108. Docket EPA-HQ-OAR-2010-0162
- ¹⁶⁷ U.S. EPA (2006). *Air Quality Criteria for Ozone and Related Photochemical Oxidants* (Final). U.S. EPA, Washington, DC, EPA/600/R-05/004aF-cF, 2006. Docket EPA-HQ-OAR-2010-0162.
- ¹⁶⁸ Fox, S., Mickler, R. A. (Eds.). (1996). *Impact of Air Pollutants on Southern Pine Forests, Ecological Studies*. (Vol. 118, 513 pp.) New York: Springer-Verlag.
- ¹⁶⁹ De Steiguer, J., Pye, J., Love, C. (1990). Air Pollution Damage to U.S. Forests. *Journal of Forestry*, 88(8), 17-22. Docket EPA-HQ-OAR-2010-0162.
- ¹⁷⁰ Pye, J.M. (1988). Impact of ozone on the growth and yield of trees: A review. *Journal of Environmental Quality*, 17, 347-360. Docket EPA-HQ-OAR-2010-0162.
- ¹⁷¹ U.S. EPA (2006). *Air Quality Criteria for Ozone and Related Photochemical Oxidants* (Final). U.S. EPA, Washington, DC, EPA/600/R-05/004aF-cF, 2006. Docket EPA-HQ-OAR-2010-0162.

Regulatory Impact Analysis

- ¹⁷² U.S. EPA (2006). *Air Quality Criteria for Ozone and Related Photochemical Oxidants* (Final). U.S. EPA, Washington, DC, EPA/600/R-05/004aF-cF, 2006. Docket EPA-HQ-OAR-2010-0162.
- ¹⁷³ McBride, J.R., Miller, P.R., Laven, R.D. (1985). Effects of oxidant air pollutants on forest succession in the mixed conifer forest type of southern California. In: *Air Pollutants Effects On Forest Ecosystems, Symposium Proceedings, St. P*, 1985, p. 157-167. Docket EPA-HQ-OAR-2010-0162.
- ¹⁷⁴ Miller, P.R., O.C. Taylor, R.G. Willhour. 1982. *Oxidant air pollution effects on a western coniferous forest ecosystem*. Corvallis, OR: U.S. Environmental Protection Agency, Environmental Research Laboratory (EPA600-D-82-276). Docket EPA-HQ-OAR-2010-0162.
- ¹⁷⁵ U.S. EPA (2006). *Air Quality Criteria for Ozone and Related Photochemical Oxidants* (Final). U.S. EPA, Washington, DC, EPA/600/R-05/004aF-cF, 2006. Docket EPA-HQ-OAR-2010-0162.
- ¹⁷⁶ Grulke, N.E. (2003). The physiological basis of ozone injury assessment attributes in Sierran conifers. In A. Bytnerowicz, M.J. Arbaugh, & R. Alonso (Eds.), *Ozone air pollution in the Sierra Nevada: Distribution and effects on forests*. (pp. 55-81). New York, NY: Elsevier Science, Ltd. Docket EPA-HQ-OAR-2010-0162.
- ¹⁷⁷ U.S. EPA (2006). *Air Quality Criteria for Ozone and Related Photochemical Oxidants* (Final). U.S. EPA, Washington, DC, EPA/600/R-05/004aF-cF, 2006. Docket EPA-HQ-OAR-2010-0162.
- ¹⁷⁸ Kopp, R. J., Vaughn, W. J., Hazilla, M., Carson, R. (1985). Implications of environmental policy for U.S. agriculture: the case of ambient ozone standards. *Journal of Environmental Management*, 20, 321-331. Docket EPA-HQ-OAR-2010-0162.
- ¹⁷⁹ Adams, R. M., Hamilton, S. A., McCarl, B. A. (1986). The benefits of pollution control: the case of ozone and U.S. agriculture. *American Journal of Agricultural Economics*, 34, 3-19. Docket EPA-HQ-OAR-2010-0162.
- ¹⁸⁰ Adams, R. M., Glycer, J. D., Johnson, S. L., McCarl, B. A. (1989). A reassessment of the economic effects of ozone on U.S. agriculture. *Journal of the Air Pollution Control Association*, 39, 960-968. Docket EPA-HQ-OAR-2010-0162.
- ¹⁸¹ Abt Associates, Inc. 1995. *Urban ornamental plants: sensitivity to ozone and potential economic losses*. U.S. EPA, Office of Air Quality Planning and Standards, Research Triangle Park. Under contract to RADIANT Corporation, contract no. 68-D3-0033, WA no. 6. pp. 9-10. Docket EPA-HQ-OAR-2010-0162.
- ¹⁸² White, D., Kimerling, A.J., Overton, W.S. (1992). Cartographic and geometric component of a global sampling design for environmental monitoring. *Cartography and Geographic Information Systems*, 19, 5-22. Docket EPA-HQ-OAR-2010-0162.
- ¹⁸³ Smith, G., Coulston, J., Jepsen, E., Prichard, T. (2003). A national ozone biomonitoring program—results from field surveys of ozone sensitive plants in Northeastern forests (1994-2000). *Environmental Monitoring and Assessment*, 87, 271-291. Docket EPA-HQ-OAR-2010-0162.
- ¹⁸⁴ Coulston, J.W., Riitters, K.H., Smith, G.C. (2004). A preliminary assessment of the Montréal process indicators of air pollution for the United States. *Environmental Monitoring and Assessment*, 95, 57-74. Docket EPA-HQ-OAR-2010-0162.
- ¹⁸⁵ U.S. EPA. (2006). *Air Quality Criteria for Ozone and Related Photochemical Oxidants*. EPA/600/R-05/004aF-cF. Docket EPA-HQ-OAR-2010-0162.
- ¹⁸⁶ U.S. EPA (2006). *Air Quality Criteria for Ozone and Related Photochemical Oxidants*. EPA/600/R-05/004aF-cF. Docket EPA-HQ-OAR-2010-0162.

Heavy-Duty GHG and Fuel Efficiency Standards FRM: Health and Environmental Impacts

- ¹⁸⁷ Smith, G., Coulston, J., Jepsen, E., Prichard, T. (2003). A national ozone biomonitoring program—results from field surveys of ozone sensitive plants in Northeastern forests (1994-2000). *Environmental Monitoring and Assessment*, 87, 271-291. Docket EPA-HQ-OAR-2010-0162.
- ¹⁸⁸ U.S. EPA (2009). Integrated Science Assessment for Particulate Matter (Final Report). U.S. Environmental Protection Agency, Washington, DC, EPA/600/R-08/139F, 2009. Docket EPA-HQ-OAR-2010-0162.
- ¹⁸⁹ U.S. EPA (2005) Review of the National Ambient Air Quality Standard for Particulate Matter: Policy Assessment of Scientific and Technical Information, OAQPS Staff Paper. EPA-452/R-05-005. Docket EPA-HQ-OAR-2010-0162.
- ¹⁹⁰ U.S. EPA, 2008. Integrated Science Assessment for Oxides of Nitrogen and Sulfur- Ecological Criteria (Final). U.S. EPA, Washington D.C., EPA/600/R-08/082F. Docket EPA-HQ-OAR-2010-0162.
- ¹⁹¹ U.S. EPA, 2008. Integrated Science Assessment for Oxides of Nitrogen and Sulfur- Ecological Criteria (Final). U.S. EPA, Washington D.C., EPA/600/R-08/082F. Docket EPA-HQ-OAR-2010-0162.
- ¹⁹² Environmental Protection Agency (2003). Response Of Surface Water Chemistry to the Clean Air Act Amendments of 1990. National Health and Environmental Effects Research Laboratory, Office of Research and Development, U.S. Environmental Protection Agency. Research Triangle Park, NC. EPA 620/R-03/001. Docket EPA-HQ-OAR-2010-0162.
- ¹⁹³ Fenn, M.E. and Blubaugh, T.J. (2005) Winter Deposition of Nitrogen and Sulfur in the Eastern Columbia River Gorge National Scenic Area, USDA Forest Service. Docket EPA-HQ-OAR-2010-0162.
- ¹⁹⁴ Galloway, J. N.; Cowling, E. B. (2002). Reactive nitrogen and the world: 200 years of change. *Ambio* 31: 64–71. Docket EPA-HQ-OAR-2010-0162.
- ¹⁹⁵ Bricker, Suzanne B., et al., National Estuarine Eutrophication Assessment, Effects of Nutrient Enrichment in the Nation’s Estuaries, National Ocean Service, National Oceanic and Atmospheric Administration, September, 1999. Docket EPA-HQ-OAR-2010-0162.
- ¹⁹⁶ Smith, W.H. 1991. “Air pollution and Forest Damage.” *Chemical Engineering News*, 69(45): 30-43. Docket EPA-HQ-OAR-2010-0162.
- ¹⁹⁷ Gawel, J.E.; Ahner, B.A.; Friedland, A.J.; and Morel, F.M.M. 1996. “Role for heavy metals in forest decline indicated by phytochelatin measurements.” *Nature*, 381: 64-65. Docket EPA-HQ-OAR-2010-0162.
- ¹⁹⁸ Cotrufo, M.F.; DeSanto, A.V.; Alfani, A.; et al. 1995. “Effects of urban heavy metal pollution on organic matter decomposition in *Quercus ilix* L. woods.” *Environmental Pollution*, 89: 81-87. Docket EPA-HQ-OAR-2010-0162.
- ¹⁹⁹ Niklinska, M.; Laskowski, R.; Maryanski, M. 1998. “Effect of heavy metals and storage time on two types of forest litter: basal respiration rate and exchangeable metals.” *Ecotoxicological Environmental Safety*, 41: 8-18. Docket EPA-HQ-OAR-2010-0162.
- ²⁰⁰ U.S. EPA (2009). Integrated Science Assessment for Particulate Matter (Final Report). U.S. Environmental Protection Agency, Washington, DC, EPA/600/R-08/139F, 2009. Section 9.4.5.2. Docket EPA-HQ-OAR-2010-0162
- ²⁰¹ Mason, R.P. and Sullivan, K.A. 1997. “Mercury in Lake Michigan.” *Environmental Science & Technology*, 31: 942-947. (from Delta Report “Atmospheric deposition of toxics to the Great Lakes”). Docket EPA-HQ-OAR-2010-0162.

Regulatory Impact Analysis

- ²⁰² Landis, M.S. and Keeler, G.J. 2002. "Atmospheric mercury deposition to Lake Michigan during the Lake Michigan Mass Balance Study." *Environmental Science & Technology*, 21: 4518-24. Docket EPA-HQ-OAR-2010-0162.
- ²⁰³ U.S. EPA. 2000. EPA453/R-00-005, "Deposition of Air Pollutants to the Great Waters: Third Report to Congress," Office of Air Quality Planning and Standards, Research Triangle Park, North Carolina. Docket EPA-HQ-OAR-2010-0162.
- ²⁰⁴ National Science and Technology Council (NSTC) 1999. "The Role of Monitoring Networks in the Management of the Nation's Air Quality." Docket EPA-HQ-OAR-2010-0162.
- ²⁰⁵ Callender, E. and Rice, K.C. 2000. "The Urban Environmental Gradient: Anthropogenic Influences on the Spatial and Temporal Distributions of Lead and Zinc in Sediments." *Environmental Science & Technology*, 34: 232-238. Docket EPA-HQ-OAR-2010-0162.
- ²⁰⁶ Rice, K.C. 1999. "Trace Element Concentrations in Streambed Sediment Across the Conterminous United States." *Environmental Science & Technology*, 33: 2499-2504. Docket EPA-HQ-OAR-2010-0162.
- ²⁰⁷ Ely, JC; Neal, CR; Kulpa, CF; et al. 2001. "Implications of Platinum-Group Element Accumulation along U.S. Roads from Catalytic-Converter Attrition." *Environ. Sci. Technol.* 35: 3816-3822. Docket EPA-HQ-OAR-2010-0162.
- ²⁰⁸ U.S. EPA. 1998. EPA454/R-98-014, "Locating and Estimating Air Emissions from Sources of Polycyclic Organic Matter," Office of Air Quality Planning and Standards, Research Triangle Park, North Carolina. Docket EPA-HQ-OAR-2010-0162.
- ²⁰⁹ U.S. EPA. 1998. EPA454/R-98-014, "Locating and Estimating Air Emissions from Sources of Polycyclic Organic Matter," Office of Air Quality Planning and Standards, Research Triangle Park, North Carolina. Docket EPA-HQ-OAR-2010-0162.
- ²¹⁰ Simcik, M.F.; Eisenreich, S.J.; Golden, K.A.; et al. 1996. "Atmospheric Loading of Polycyclic Aromatic Hydrocarbons to Lake Michigan as Recorded in the Sediments." *Environmental Science and Technology*, 30: 3039-3046. Docket EPA-HQ-OAR-2010-0162.
- ²¹¹ Simcik, M.F.; Eisenreich, S.J.; and Liroy, P.J. 1999. "Source apportionment and source/sink relationship of PAHs in the coastal atmosphere of Chicago and Lake Michigan." *Atmospheric Environment*, 33: 5071-5079. Docket EPA-HQ-OAR-2010-0162.
- ²¹² Arzayus, K.M.; Dickhut, R.M.; and Canuel, E.A. 2001. "Fate of Atmospherically Deposited Polycyclic Aromatic Hydrocarbons (PAHs) in Chesapeake Bay." *Environmental Science & Technology*, 35, 2178-2183. Docket EPA-HQ-OAR-2010-0162.
- ²¹³ Park, J.S.; Wade, T.L.; and Sweet, S. 2001. "Atmospheric distribution of polycyclic aromatic hydrocarbons and deposition to Galveston Bay, Texas, USA." *Atmospheric Environment*, 35: 3241-3249. Docket EPA-HQ-OAR-2010-0162.
- ²¹⁴ Poor, N.; Tremblay, R.; Kay, H.; et al. 2002. "Atmospheric concentrations and dry deposition rates of polycyclic aromatic hydrocarbons (PAHs) for Tampa Bay, Florida, USA." *Atmospheric Environment* 38: 6005-6015. Docket EPA-HQ-OAR-2010-0162.
- ²¹⁵ Arzayus, K.M.; Dickhut, R.M.; and Canuel, E.A. 2001. "Fate of Atmospherically Deposited Polycyclic Aromatic Hydrocarbons (PAHs) in Chesapeake Bay." *Environmental Science & Technology*, 35, 2178-2183. Docket EPA-HQ-OAR-2010-0162.

Heavy-Duty GHG and Fuel Efficiency Standards FRM: Health and Environmental Impacts

- ²¹⁶ U.S. EPA. 2000. EPA453/R-00-005, "Deposition of Air Pollutants to the Great Waters: Third Report to Congress," Office of Air Quality Planning and Standards, Research Triangle Park, North Carolina. Docket EPA-HQ-OAR-2010-0162.
- ²¹⁷ Van Metre, P.C.; Mahler, B.J.; and Furlong, E.T. 2000. "Urban Sprawl Leaves its PAH Signature." *Environmental Science & Technology*, 34: 4064-4070. Docket EPA-HQ-OAR-2010-0162.
- ²¹⁸ Cousins, I.T.; Beck, A.J.; and Jones, K.C. 1999. "A review of the processes involved in the exchange of semi-volatile organic compounds across the air-soil interface." *The Science of the Total Environment*, 228: 5-24. Docket EPA-HQ-OAR-2010-0162.
- ²¹⁹ Tuhackova, J. et al. (2001) Hydrocarbon deposition and soil microflora as affected by highway traffic. *Environmental Pollution*, 113: 255-262. Docket EPA-HQ-OAR-2010-0162.
- ²²⁰ U.S. EPA. 1991. Effects of organic chemicals in the atmosphere on terrestrial plants. EPA/600/3-91/001. Docket EPA-HQ-OAR-2010-0162.
- ²²¹ Cape JN, ID Leith, J Binnie, J Content, M Donkin, M Skewes, DN Price AR Brown, AD Sharpe. 2003. Effects of VOCs on herbaceous plants in an open-top chamber experiment. *Environ. Pollut.* 124:341-343. Docket EPA-HQ-OAR-2010-0162.
- ²²² Cape JN, ID Leith, J Binnie, J Content, M Donkin, M Skewes, DN Price AR Brown, AD Sharpe. 2003. Effects of VOCs on herbaceous plants in an open-top chamber experiment. *Environ. Pollut.* 124:341-343. Docket EPA-HQ-OAR-2010-0162.
- ²²³ Viskari E-L. 2000. Epicuticular wax of Norway spruce needles as indicator of traffic pollutant deposition. *Water, Air, and Soil Pollut.* 121:327-337. Docket EPA-HQ-OAR-2010-0162.
- ²²⁴ Ugrekhelidze D, F Korte, G Kvesitadze. 1997. Uptake and transformation of benzene and toluene by plant leaves. *Ecotox. Environ. Safety* 37:24-29. Docket EPA-HQ-OAR-2010-0162.
- ²²⁵ Kammerbauer H, H Selinger, R Rommelt, A Ziegler-Jons, D Knoppik, B Hock. 1987. Toxic components of motor vehicle emissions for the spruce *Picea abies*. *Environ. Pollut.* 48:235-243. Docket EPA-HQ-OAR-2010-0162.
- ²²⁶ Byun, D.W., Ching, J. K.S. (1999). *Science algorithms of the EPA models-3 community multiscale air quality (CMAQ) modeling system*. Washington, DC: U.S. Environmental Protection Agency, Office of Research and Development. Docket EPA-HQ-OAR-2010-0162.
- ²²⁷ Byun, D.W., Schere, K.L. (2006). Review of the Governing Equations, Computational Algorithms, and Other Components of the Models-3 Community Multiscale Air Quality (CMAQ) Modeling System. *Journal of Applied Mechanics Reviews*, 59(2), 51-77. Docket EPA-HQ-OAR-2010-0162.
- ²²⁸ Dennis, R.L., Byun, D.W., Novak, J.H., Galluppi, K.J., Coats, C.J., and Vouk, M.A. (1996). The next generation of integrated air quality modeling: EPA's Models-3, *Atmospheric Environment*, 30, 1925-1938. Docket EPA-HQ-OAR-2010-0162.
- ²²⁹ Hogrefe, C., Biswas, J., Lynn, B., Civerolo, K., Ku, J.Y., Rosenthal, J., et al. (2004). Simulating regional-scale ozone climatology over the eastern United States: model evaluation results. *Atmospheric Environment*, 38(17), 2627-2638. Docket EPA-HQ-OAR-2010-0162.
- ²³⁰ Lin, M., Oki, T., Holloway, T., Streets, D.G., Bengtsson, M., Kanae, S. (2008). Long-range transport of acidifying substances in East Asia-Part I: Model evaluation and sensitivity studies. *Atmospheric Environment*, 42(24), 5939-5955. EPA-HQ-OAR-2010-0162.
- ²³¹ U.S. Environmental Protection Agency. (2008). *Technical support document for the final locomotive/marine rule: Air quality modeling analyses*. Research Triangle Park, N.C.: U.S.

Regulatory Impact Analysis

Environmental Protection Agency, Office of Air Quality Planning and Standards, Air Quality Assessment Division. Docket EPA-HQ-OAR-2010-0162.

²³² Grell, G., Dudhia, J., Stauffer, D. (1994). *A Description of the Fifth-Generation Penn State/NCAR Mesoscale Model (MM5), NCAR/TN-398+STR.*, 138 pp, National Center for Atmospheric Research, Boulder CO. Docket EPA-HQ-OAR-2010-0162.

²³³ Grell, G., Dudhia, J., Stauffer, D. (1994). *A Description of the Fifth-Generation Penn State/NCAR Mesoscale Model (MM5), NCAR/TN-398+STR.*, 138 pp, National Center for Atmospheric Research, Boulder CO. EPA-HQ-OAR-2010-0162.

²³⁴ Byun, D.W., Ching, J. K.S. (1999). *Science algorithms of EPA Models-3 Community Multiscale Air Quality (CMAQ) modeling system*, EPA/600/R-99/030, Office of Research and Development). Please also see: <http://www.cmascenter.org/>. Docket EPA-HQ-OAR-2010-0162.

²³⁵ Le Sager, P. Yantosca, B., Carouge, C. (2008). *GEOS-CHEM v8-01-02 User's Guide*, Atmospheric Chemistry Modeling Group, Harvard University, Cambridge, MA, December 18, 2008. Docket EPA-HQ-OAR-2010-0162.

²³⁶ U.S. EPA, (2004), *Procedures for Estimating Future PM_{2.5} Values for the CAIR Final Rule by Application of the (Revised) Speciated Modeled Attainment Test (SMAT)- Updated 11/8/04*. Docket EPA-HQ-OAR-2010-0162.

²³⁷ U.S. EPA, (2011), Final Transport Rule Air Quality Modeling TSD. Docket EPA-HQ-OAR-2010-0162.

²³⁸ U.S. EPA (2007) *Guidance on the Use of Models and Other Analyses For Demonstrating Attainment of Air Quality Goals for Ozone, PM_{2.5}, and Regional Haze*; EPA-454/B-07-002; Research Triangle Park, NC; April 2007. Docket EPA-HQ-OAR-2010-0162.

²³⁹ Yarwood G, Rao S, Yocke M, Whitten GZ (2005) Updates to the Carbon Bond Chemical Mechanism: CB05. Final Report to the US EPA, RT-0400675, December 8, 2005. http://www.camx.com/publ/pdfs/CB05_Final_Report_120805.pdf. Docket EPA-HQ-OAR-2010-0162.

²⁴⁰ Dodge, M.C., 2000. Chemical oxidant mechanisms for air quality modeling: critical review. *Atmospheric Environment* 34, 2103-2130. Docket EPA-HQ-OAR-2010-0162.

²⁴¹ Atkinson, R., Baulch, D.L., Cox, R.A., Crowley, J.N., Hampson, R.F. Jr., Hynes, R.G., Jenkin, M.E., Kerr, J.A., Rossi, M.J., Troe, J. (2005) Evaluated Kinetic and Photochemical Data for Atmospheric Chemistry - IUPAC Subcommittee on Gas Kinetic Data Evaluation for Atmospheric Chemistry. July 2005 web version. <http://www.iupac-kinetic.ch.cam.ac.uk/index.html>. Docket EPA-HQ-OAR-2010-0162.

²⁴² Atkinson, R., Baulch, D.L., Cox, R.A., Crowley, J.N., Hampson, R.F. Jr., Hynes, R.G., Jenkin, M.E., Kerr, J.A., Rossi, M.J., Troe, J. (2005) Evaluated Kinetic and Photochemical Data for Atmospheric Chemistry - IUPAC Subcommittee on Gas Kinetic Data Evaluation for Atmospheric Chemistry. July 2005 web version. <http://www.iupac-kinetic.ch.cam.ac.uk/index.html>. Docket EPA-HQ-OAR-2010-0162.

²⁴³ Atkinson, R., Baulch, D.L., Cox, R.A., Crowley, J.N., Hampson, R.F. Jr., Hynes, R.G., Jenkin, M.E., Kerr, J.A., Rossi, M.J., Troe, J. (2005) Evaluated Kinetic and Photochemical Data for Atmospheric Chemistry - IUPAC Subcommittee on Gas Kinetic Data Evaluation for Atmospheric Chemistry. July 2005 web version. <http://www.iupac-kinetic.ch.cam.ac.uk/index.html>. Docket EPA-HQ-OAR-2010-0162.

²⁴⁴ Atkinson, R., Baulch, D.L., Cox, R.A., Crowley, J.N., Hampson, R.F. Jr., Hynes, R.G., Jenkin, M.E., Kerr, J.A., Rossi, M.J., Troe, J. (2005) Evaluated Kinetic and Photochemical Data for Atmospheric Chemistry - IUPAC Subcommittee on Gas Kinetic Data Evaluation for Atmospheric Chemistry. July 2005 web version. <http://www.iupac-kinetic.ch.cam.ac.uk/index.html>. Docket EPA-HQ-OAR-2010-0162.

Heavy-Duty GHG and Fuel Efficiency Standards FRM: Health and Environmental Impacts

- ²⁴⁵ Sander, S.P., Friedl, R.R., Golden, D.M., Kurylo, M.J., Huie, R.E., Orkin, V.L., Moortgat, G.K., Ravishankara, A.R., Kolb, C.E., Molina, M.J., Finlayson-Pitts, B.J. (2003) Chemical Kinetics and Photochemical Data for use in Atmospheric Studies, Evaluation Number 14. NASA Jet Propulsion Laboratory <http://jpldataeval.jpl.nasa.gov/index.html>. Docket EPA-HQ-OAR-2010-0162.
- ²⁴⁶ J.G. Calvert, A. Mellouki, J.J. Orlando, M.J. Pilling, and T.J. Wallington, 2011. The mechanisms of atmospheric oxidation of the oxygenates. Oxford University Press, New York/Oxford.
- ²⁴⁷ Sander, S.P., Friedl, R.R., Golden, D.M., Kurylo, M.J., Huie, R.E., Orkin, V.L., Moortgat, G.K., Ravishankara, A.R., Kolb, C.E., Molina, M.J., Finlayson-Pitts, B.J. (2003) Chemical Kinetics and Photochemical Data for use in Atmospheric Studies, Evaluation Number 14. NASA Jet Propulsion Laboratory <http://jpldataeval.jpl.nasa.gov/index.html>. Docket EPA-HQ-OAR-2010-0162.
- ²⁴⁸ Yarwood, G., Rao, S., Yocke, M., Whitten, G.Z., 2005. Updates to the Carbon Bond Mechanism: CB05. Final Report to the US EPA, RT-0400675. Yocke and Company, Novato, CA. Docket EPA-HQ-OAR-2010-0162.
- ²⁴⁹ Luecken, D.J., Phillips, S., Sarwar, G., Jang, C., 2008b. Effects of using the CB05 vs. SAPRC99 vs. CB4 chemical mechanism on model predictions: Ozone and gas-phase photochemical precursor concentrations. *Atmospheric Environment* 42, 5805-5820. Docket EPA-HQ-OAR-2010-0162.
- ²⁵⁰ Sander, S.P., Friedl, R.R., Golden, D.M., Kurylo, M.J., Huie, R.E., Orkin, V.L., Moortgat, G.K., Ravishankara, A.R., Kolb, C.E., Molina, M.J., Finlayson-Pitts, B.J., 2003. Chemical Kinetics and Photochemical Data for use in Atmospheric Studies, Evaluation Number 14. NASA Jet Propulsion Laboratory. Docket EPA-HQ-OAR-2010-0162.
- ²⁵¹ Sander, S.P., Friedl, R.R., Golden, D.M., Kurylo, M.J., Huie, R.E., Orkin, V.L., Moortgat, G.K., Ravishankara, A.R., Kolb, C.E., Molina, M.J., Finlayson-Pitts, B.J., 2003. Chemical Kinetics and Photochemical Data for use in Atmospheric Studies, Evaluation Number 14. NASA Jet Propulsion Laboratory. Docket EPA-HQ-OAR-2010-0162.
- ²⁵² Edney, E. O., T. E. Kleindienst, M. Lewandowski, and J. H. Offenberg, 2007. Updated SOA chemical mechanism for the Community Multi-Scale Air Quality model, EPA 600/X-07/025, U.S. EPA, Research Triangle Park, NC. Docket EPA-HQ-OAR-2010-0162.
- ²⁵³ Carlton, A.G., B. J. Turpin, K. Altieri, S. Seitzinger, R. Mathur, S. Roselle, R. J. Weber, (2008), CMAQ model performance enhanced when in-cloud SOA is included: comparisons of OC predictions with measurements, *Environ. Sci. Technol.* 42 (23), 8798–8802. Docket EPA-HQ-OAR-2010-0162.
- ²⁵⁴ Lewandowski M, M Jaoui , JH Offenberg , TE Kleindienst, EO Edney, RJ Sheesley, JJ Schauer (2008) Primary and secondary contributions to ambient PM in the midwestern United States, *Environ Sci Technol* 42(9):3303-3309. <http://pubs.acs.org/cgi-bin/article.cgi/esthag/2008/42/i09/html/es0720412.html>. Docket EPA-HQ-OAR-2010-0162.
- ²⁵⁵ Kleindienst TE, M Jaoui, M Lewandowski, JH Offenberg, EO Edney (2007) Estimates of the contributions of biogenic and anthropogenic hydrocarbons to secondary organic aerosol at a southeastern U.S. location, *Atmos Environ* 41(37):8288-8300. Docket EPA-HQ-OAR-2010-0162.
- ²⁵⁶ Offenberg JH, CW Lewis, M Lewandowski, M Jaoui, TE Kleindienst, EO Edney (2007) Contributions of Toluene and α -pinene to SOA Formed in an Irradiated Toluene/ α -pinene/ NO_x /Air Mixture: Comparison of Results Using ^{14}C Content and SOA Organic Tracer Methods, *Environ Sci Technol* 41: 3972-3976. Docket EPA-HQ-OAR-2010-0162.
- ²⁵⁷ Pandis, S.N., Harley, R.A., Cass, G.R., Seinfeld, J.H. (1992) Secondary organic aerosol formation and transport. *Atmos Environ* 26, 2269–2282. Docket EPA-HQ-OAR-2010-0162.

Regulatory Impact Analysis

- ²⁵⁸ Takekawa, H. Minoura, H. Yamazaki, S. (2003) Temperature dependence of secondary organic aerosol formation by photo-oxidation of hydrocarbons. *Atmos Environ* 37: 3413–3424. Docket EPA-HQ-OAR-2010-0162.
- ²⁵⁹ Kleeman, M.J., Ying, Q., Lu, J., Mysliwiec, M.J., Griffin, R.J., Chen, J., Clegg, S. (2007) Source apportionment of secondary organic aerosol during a severe photochemical smog episode. *Atmos Environ* 41: 576–591. Docket EPA-HQ-OAR-2010-0162.
- ²⁶⁰ Robinson, A. L.; Donahue, N. M.; Shrivastava, M.; Weitkamp, E. A.; Sage, A. M.; Grieshop, A. P.; Lane, T. E.; Pierce, J. R.; Pandis, S. N. (2007) Rethinking organic aerosol: Semivolatile emissions and photochemical aging. *Science* 315: 1259-1262. Docket EPA-HQ-OAR-2010-0162.
- ²⁶¹ Byun DW, Schere, KL (2006) Review of the Governing Equations, Computational Algorithms, and Other Components of the Models-3 Community Multiscale Air Quality (CMAQ) Modeling System, *J Applied Mechanics Reviews* 59: 51-76. Docket EPA-HQ-OAR-2010-0162.
- ²⁶² U. S. EPA (2010) Our Nations Air, Status and Trends through 2008. EPA 454/R-09-002, February 2010. <http://www.epa.gov/airtrends/2010>. Docket EPA-HQ-OAR-2010-0162.
- ²⁶³ U. S. EPA. (2011) 2005 National-Scale Air Toxics Assessment. <http://www.epa.gov/ttn/atw/nata2005/risksum.html>. Docket EPA-HQ-OAR-2010-0162.
- ²⁶⁴ U. S. EPA (2007) Regulatory Impact Analysis for the Control of Hazardous Air Pollutants from Mobile Sources Rule, Chapter 3, Air Quality and Resulting Health and Welfare Effects of Air Pollution from Mobile Sources. 72 FR 8428, February 26, 2007. <http://www.epa.gov/otaq/regs/toxics/420r07002.pdf>. Docket EPA-HQ-OAR-2010-0162.
- ²⁶⁵ Turpin, B.J., Huntzicker, J.J., Larson, S.M., Cass, G.R. (1991) Los Angeles Summer Midday Particulate Carbon: Primary and Secondary Aerosol. *Environ Sci Technol* 25: 1788-1793. Docket EPA-HQ-OAR-2010-0162.
- ²⁶⁶ Turpin, B.J., Huntzicker, J.J. (1995) Identification of Secondary Organic Aerosol Episodes and Quantitation of Primary and Secondary Organic Aerosol Concentrations During SCAQS. *Atmos Environ* 29(23): 3527-3544. Docket EPA-HQ-OAR-2010-0162.
- ²⁶⁷ Bae M-S, Schauer JJ, Turner JR (2006) Estimation of the Monthly Average Ratios of Organic Mass to Organic Carbon for Fine Particulate Matter at an Urban Site, *Aerosol Sci Technol* 40(12): 1123-1139. <http://dx.doi.org/10.1080/02786820601004085>. Docket EPA-HQ-OAR-2010-0162.
- ²⁶⁸ Kleindienst TE, M Jaoui, M Lewandowski, JH Offenberg, EO Edney (2007) Estimates of the contributions of biogenic and anthropogenic hydrocarbons to secondary organic aerosol at a southeastern U.S. location. *Atmos Environ* 41(37):8288-8300. Docket EPA-HQ-OAR-2010-0162.
- ²⁶⁹ Offenberg JH, CW Lewis, M Lewandowski, M Jaoui, TE Kleindienst, EO Edney (2007) Contributions of Toluene and α -pinene to SOA Formed in an Irradiated Toluene/ α -pinene/ NO_x /Air Mixture: Comparison of Results Using ^{14}C Content and SOA Organic Tracer Methods, *Environ Sci Technol* 41: 3972-3976. Docket EPA-HQ-OAR-2010-0162.
- ²⁷⁰ Claeys M, R Szmigielski, I Kourtchev, P Van der Veken, R Vermeylen, W Maenhaut, M Jaoui, TE Kleindienst, M Lewandowski, JH Offenberg, EO Edney (2007) Hydroxydicarboxylic acids: Markers for secondary organic aerosol from the photooxidation of α -pinene. *Environ Sci Technol* 41(5): 1628-1634. Docket EPA-HQ-OAR-2010-0162.
- ²⁷¹ Edney EO, TE Kleindienst, M Jaoui, M Lewandowski, JH Offenberg, W Wang, M Claeys (2005) Formation of 2-methyl tetrols and 2-methylglyceric acid in secondary organic aerosol from laboratory

irradiated isoprene/NO_x/SO₂/air mixtures and their detection in ambient PM_{2.5} samples collected in the Eastern United States. *Atmos Environ* 39: 5281-5289. Docket EPA-HQ-OAR-2010-0162.

²⁷² Jaoui M, TE Kleindienst, M Lewandowski, JH Offenber, EO Edney (2005) Identification and quantification of aerosol polar oxygenated compounds bearing carboxylic or hydroxyl groups. 2. Organic tracer compounds from monoterpenes. *Environ Sci Technol* 39: 5661-5673. Docket EPA-HQ-OAR-2010-0162.

²⁷³ Kleindienst TE, TS Conver, CD McIver, EO Edney (2004) Determination of secondary organic aerosol products from the photooxidation of toluene and their implications in ambient PM_{2.5}. *J Atmos Chem* 47: 70-100. Docket EPA-HQ-OAR-2010-0162.

²⁷⁴ Kleindienst TE, TS Conver, CD McIver, EO Edney (2004) Determination of secondary organic aerosol products from the photooxidation of toluene and their implication in ambient PM_{2.5}. *J Atmos Chem* 47: 70-100. Docket EPA-HQ-OAR-2010-0162.

²⁷⁵ Izumi L, T Fukuyama (1990) Photochemical aerosol formation from aromatic hydrocarbons in the presence of NO_x. *Atmos Environ* 24A: 1433. Docket EPA-HQ-OAR-2010-0162.

²⁷⁶ Martin-Reviago M, K Wirtz (2005) Is benzene a precursor for secondary organic aerosol? *Environ Sci Technol* 39: 1045-1054. Docket EPA-HQ-OAR-2010-0162.

²⁷⁷ Ng, N. L., Kroll, J. H., Chan, A. W. H., Chabra, P. S., Flagan, R. C., Seinfeld, J. H., Secondary organic aerosol formation from *m*-xylene, toluene, and benzene, *Atmospheric Chemistry and Physics Discussion*, 7, 3909-3922, 2007. Docket EPA-HQ-OAR-2010-0162.

²⁷⁸ Lewandowski M, M Jaoui, JH Offenber, TE Kleindienst, EO Edney, RJ Sheesley, JJ Schauer (2008) Primary and secondary contributions to ambient PM in the midwestern United States, *Environ Sci Technol* 42(9):3303-3309. <http://pubs.acs.org/cgi-bin/article.cgi?esthag/2008/42/i09/html/es0720412.html>. Docket EPA-HQ-OAR-2010-0162.

²⁷⁹ Kleindienst TE, M Jaoui, M Lewandowski, JH Offenber, EO Edney (2007) Estimates of the contributions of biogenic and anthropogenic hydrocarbons to secondary organic aerosol at a southeastern U.S. location. *Atmos Environ* 41(37):8288-8300. Docket EPA-HQ-OAR-2010-0162.

²⁸⁰ Henze DK, JH Seinfeld (2006) Global secondary organic aerosol from isoprene oxidation. *Geophys Res Lett* 33: L09812. doi:10.1029/2006GL025976. Docket EPA-HQ-OAR-2010-0162.

²⁸¹ Henze DK.;J Seinfeld (2006) Global secondary organic aerosol from isoprene oxidation. *Geophys. Res. Lett* 33 L09812. doi:10.1029/2006GL025976. Docket EPA-HQ-OAR-2010-0162.

²⁸² Jaoui M, M Lewandowski, TE Kleindienst, JH Offenber, EO Edney (2007) β-Caryophyllinic acid: An atmospheric tracer for β-caryophyllene secondary organic aerosol. *Geophys Res Lett* 34: L05816. doi:10.1029/2006GL028827. Docket EPA-HQ-OAR-2010-0162.

²⁸³ Griffin RJ, DR Cocker III, RC Flagan, JH Seinfeld (1999) Organic aerosol formation from oxidation of biogenic hydrocarbons, *J Geophys Res* 104: 3555-3567. Docket EPA-HQ-OAR-2010-0162.

²⁸⁴ Ng NL, JH Kroll, AWH Chan, PS Chabra, RC Flagan, JH Seinfeld (2007) Secondary organic aerosol formation from *m*-xylene, toluene, and benzene. *Atmos Chem Phys* 7: 3909-3922. Docket EPA-HQ-OAR-2010-0162.

²⁸⁵ Hildebrandt1, L., Donahue1, N. M, Pandis1, S. N. (2009) High formation of secondary organic aerosol from the photo-oxidation of toluene. *Atmos Chem Phys* 9: 2973-2986. Docket EPA-HQ-OAR-2010-0162.

Regulatory Impact Analysis

- ²⁸⁶ Yarwood G, Rao S, Yocke M, Whitten GZ (2005) Updates to the Carbon Bond Chemical Mechanism: CB05. Final Report to the US EPA, RT-0400675, December 8, 2005. http://www.camx.com/publ/pdfs/CB05_Final_Report_120805.pdf. Docket EPA-HQ-OAR-2010-0162.
- ²⁸⁷ Atkinson, R., Baulch, D.L., Cox, R.A., Crowley, J.N., Hampson, R.F. Jr., Hynes, R.G., Jenkin, M.E., Kerr, J.A., Rossi, M.J., Troe, J. (2005) Evaluated Kinetic and Photochemical Data for Atmospheric Chemistry - IUPAC Subcommittee on Gas Kinetic Data Evaluation for Atmospheric Chemistry. July 2005 web version. <http://www.iupac-kinetic.ch.cam.ac.uk/index.html>. Docket EPA-HQ-OAR-2010-0162.
- ²⁸⁸ Sander, S.P., Friedl, R.R., Golden, D.M., Kurylo, M.J., Huie, R.E., Orkin, V.L., Moortgat, G.K., Ravishankara, A.R., Kolb, C.E., Molina, M.J., Finlayson-Pitts, B.J. (2003) Chemical Kinetics and Photochemical Data for use in Atmospheric Studies, Evaluation Number 14. NASA Jet Propulsion Laboratory. <http://jpldataeval.jpl.nasa.gov/index.html>. Docket EPA-HQ-OAR-2010-0162.
- ²⁸⁹ Finlayson-Pitts BJ, Pitts JN Jr. (1986) Atmospheric Chemistry: Fundamentals and Experimental Techniques, Wiley, New York.
- ²⁹⁰ CMAS 2008. Release Notes for CMAQ v4.7. http://www.cmascenter.org/help/model_docs/cmaq/4.7/RELEASE_NOTES.txt Docket EPA-HQ-OAR-2010-0162.
- ²⁹¹ U.S. EPA. Air Quality Criteria for Ozone and Related Photochemical Oxidants (Final). U.S. EPA, Washington, DC, EPA/600/R-05/004aF-cF, 2006. Docket EPA-HQ-OAR-2010-0162.
- ²⁹² U.S. EPA. (2007). PM_{2.5} National Ambient Air Quality Standard Implementation Rule (Final). Washington, DC: U.S. EPA. 72 FR 20586, April 25, 2007. Docket EPA-HQ-OAR-2010-0162.
- ²⁹³ PM Standards Revision – 2006: Timeline. Docket EPA-HQ-OAR-2010-0162. <http://www.epa.gov/PM/naqsrev2006.html#timeline> Docket EPA-HQ-OAR-2010-0162.
- ²⁹⁴ U. S. Environmental Protection Agency (2007). Control of Hazardous Air Pollutants from Mobile Sources; Final Rule. 72 FR 8434, February 26, 2007. Docket EPA-HQ-OAR-2010-0162.
- ²⁹⁵ U. S. Environmental Protection Agency (2007). Control of Hazardous Air Pollutants from Mobile Sources; Final Rule. 72 FR 8434, February 26, 2007. Docket EPA-HQ-OAR-2010-0162.
- ²⁹⁶ U.S. EPA. (2011) 2005 National-Scale Air Toxics Assessment. <http://www.epa.gov/ttn/atw/nata2005/>. Docket EPA-HQ-OAR-2010-0162
- ²⁹⁷ U.S. EPA. (2011) Summary of Results for the 2005 National-Scale Assessment. http://www.epa.gov/ttn/atw/nata2005/05pdf/sum_results.pdf. Docket EPA-HQ-OAR-2010-0162.
- ²⁹⁸ U.S. EPA. U.S. EPA's Report on the Environment (Final Report). U.S. Environmental Protection Agency, Washington, D.C., EPA/600/R-07/045F (NTIS PB2008-112484). Docket EPA-HQ-OAR-2010-0162. Updated data available online at: <http://cfpub.epa.gov/eroe/index.cfm?fuseaction=detail.viewInd&ch=46&subtop=341&lv=list.listByChapter&r=201744>
- ²⁹⁹ EPA, 2002. Latest Findings on National Air Quality, 2002 Status and Trends. EPA 454/K-03-001. Docket EPA-HQ-OAR-2010-0162.
- ³⁰⁰ U.S. EPA. U.S. EPA's Report on the Environment (Final Report). U.S. Environmental Protection Agency, Washington, D.C., EPA/600/R-07/045F (NTIS PB2008-112484). Docket EPA-HQ-OAR-2010-0162. Updated data available online at: <http://cfpub.epa.gov/eroe/index.cfm?fuseaction=detail.viewInd&ch=46&subtop=341&lv=list.listByChapter&r=201744>

Heavy-Duty GHG and Fuel Efficiency Standards FRM: Health and Environmental Impacts

³⁰¹ U.S. Environmental Protection Agency. (2006). *Final Regulatory Impact Analysis (RIA) for the Proposed National Ambient Air Quality Standards for Particulate Matter*. Prepared by: Office of Air and Radiation. Retrieved March, 26, 2009 at <http://www.epa.gov/ttn/ecas/ria.html>. EPA-HQ-OAR-2009-0472-0240

³⁰² U.S. Environmental Protection Agency. (2008). *Final Ozone NAAQS Regulatory Impact Analysis*. Prepared by: Office of Air and Radiation, Office of Air Quality Planning and Standards. Retrieved March, 26, 2009 at <http://www.epa.gov/ttn/ecas/ria.html>. EPA-HQ-OAR-2009-0472-0238

³⁰³ U.S. EPA, (2011), Final Transport Rule. Final Rule signed on July 6, 2011. Available online at: <http://www.epa.gov/airtransport/>

³⁰⁴ U.S. Environmental Protection Agency. (2010). *Final Rulemaking to Establish Light-Duty Vehicle Greenhouse Gas Emission Standards and Corporate Average Fuel Economy Standards: Regulatory Impact Analysis*, Assessment and Standards Division, Office of Transportation and Air Quality, EPA-420-R-10-009, April 2010. Available on the internet: <http://www.epa.gov/otaq/climate/regulations/420r10009.pdf>

³⁰⁵ U.S. Environmental Protection Agency (U.S. EPA). 2010. Regulatory Impact Analysis: National Emission Standards for Hazardous Air Pollutants from the Portland Cement Manufacturing Industry. Office of Air Quality Planning and Standards, Research Triangle Park, NC. Augues. Available on the Internet at < <http://www.epa.gov/ttn/ecas/regdata/RIAs/portlandcementfinalria.pdf> >. EPA-HQ-OAR-2009-0472-0241

³⁰⁶ Kunzli, N., S. Medina, R. Kaiser, P. Quenel, F. Horak Jr, and M. Studnicka. 2001. Assessment of Deaths Attributable to Air Pollution: Should We Use Risk Estimates Based on Time Series or on Cohort Studies? *American Journal of Epidemiology* 153(11):1050-55.

³⁰⁷ Science Advisory Board. 2001. NATA – Evaluating the National-Scale Air Toxics Assessment for 1996 – an SAB Advisory. <http://www.epa.gov/ttn/atw/sab/sabrev.html>.

³⁰⁸ U.S. Environmental Protection Agency (U.S. EPA). 2011. *The Benefits and Costs of the Clean Air Act from 1990 to 2020*. Office of Air and Radiation, Washington, DC. March. Available on the Internet at <<http://www.epa.gov/air/sect812/feb11/fullreport.pdf>>.

³⁰⁹ U.S. Environmental Protection Agency—Science Advisory Board (U.S. EPA-SAB). 2008. *Benefits of Reducing Benzene Emissions in Houston, 1990–2020*. EPA-COUNCIL-08-001. July. Available at <[http://yosemite.epa.gov/sab/sabproduct.nsf/D4D7EC9DAEDA8A548525748600728A83/\\$File/EPA-COUNCIL-08-001-unsigned.pdf](http://yosemite.epa.gov/sab/sabproduct.nsf/D4D7EC9DAEDA8A548525748600728A83/$File/EPA-COUNCIL-08-001-unsigned.pdf)>.

³¹⁰ National Research Council (NRC). 2008. *Estimating Mortality Risk Reduction and Economic Benefits from Controlling Ozone Air Pollution*. National Academies Press. Washington, DC.

³¹¹ GeoLytics Inc. (2002). *Geolytics CensusCD® 2000 Short Form Blocks*. CD-ROM Release 1.0. GeoLytics, Inc. East Brunswick, NJ. Available: <http://www.geolytics.com/> [accessed 29 September 2004]

³¹² Woods & Poole Economics Inc. 2008. *Population by Single Year of Age CD*. CD-ROM. Woods & Poole Economics, Inc. Washington, D.C. EPA-HQ-OAR-2009-0472-0011

³¹³ U.S. Environmental Protection Agency. (2006). *Air quality criteria for ozone and related photochemical oxidants (second external review draft)*. Research Triangle Park, NC: National Center for Environmental Assessment; report no. EPA/600R-05/004aB-cB, 3v. Available: <http://cfpub.epa.gov/ncea/cfm/recordisplay.cfm?deid=137307>[March 2006] EPA-HQ-OAR-2009-0472-0099, EPA-HQ-OAR-2009-0472-0100, EPA-HQ-OAR-2009-0472-0101

Regulatory Impact Analysis

- ³¹⁴ U.S. Environmental Protection Agency, 2004. *Air Quality Criteria for Particulate Matter Volume II of II*. National Center for Environmental Assessment, Office of Research and Development, U.S. Environmental Protection Agency, Research Triangle Park, NC EPA/600/P-99/002bF. EPA-HQ-OAR-2009-0472-0097
- ³¹⁵ World Health Organization (WHO). (2003). *Health Aspects of Air Pollution with Particulate Matter, Ozone and Nitrogen Dioxide: Report on a WHO Working Group*. World Health Organization. Bonn, Germany. EUR/03/5042688.
- ³¹⁶ Anderson HR, Atkinson RW, Peacock JL, Marston L, Konstantinou K. (2004). *Meta-analysis of time-series studies and panel studies of Particulate Matter (PM) and Ozone (O3): Report of a WHO task group*. Copenhagen, Denmark: World Health Organization.
- ³¹⁷ Bell, M.L., et al. (2004). Ozone and short-term mortality in 95 US urban communities, 1987-2000. *JAMA*, 2004. 292(19): p. 2372-8. EPA-HQ-OAR-2009-0472-1662
- ³¹⁸ Huang, Y.; Dominici, F.; Bell, M. L. (2005) Bayesian hierarchical distributed lag models for summer ozone exposure and cardio-respiratory mortality. *Environmetrics*. 16: 547-562. EPA-HQ-OAR-2009-0472-0233
- ³¹⁹ Schwartz, J. (2005) How sensitive is the association between ozone and daily deaths to control for temperature? *Am. J. Respir. Crit. Care Med*. 171: 627-631. EPA-HQ-OAR-2009-0472-1678
- ³²⁰ Bell, M.L., F. Dominici, and J.M. Samet. (2005). A meta-analysis of time-series studies of ozone and mortality with comparison to the national morbidity, mortality, and air pollution study. *Epidemiology*. 16(4): p. 436-45. EPA-HQ-OAR-2009-0472-0222
- ³²¹ Ito, K., S.F. De Leon, and M. Lippmann (2005). Associations between ozone and daily mortality: analysis and meta-analysis. *Epidemiology*. 16(4): p. 446-57. EPA-HQ-OAR-2009-0472-0231
- ³²² Levy, J.I., S.M. Chemerynski, and J.A. Sarnat. (2005). Ozone exposure and mortality: an empiric bayes metaregression analysis. *Epidemiology*. 16(4): p. 458-68. EPA-HQ-OAR-2009-0472-0236
- ³²³ Pope, C.A., III, R.T. Burnett, M.J. Thun, E.E. Calle, D. Krewski, K. Ito, and G.D. Thurston. (2002). "Lung Cancer, Cardiopulmonary Mortality, and Long-term Exposure to Fine Particulate Air Pollution." *Journal of the American Medical Association* 287:1132-1141. EPA-HQ-OAR-2009-0472-0263
- ³²⁴ Laden, F., J. Schwartz, F.E. Speizer, and D.W. Dockery. (2006). Reduction in Fine Particulate Air Pollution and Mortality. *American Journal of Respiratory and Critical Care Medicine*. 173: 667-672. EPA-HQ-OAR-2009-0472-1661
- ³²⁵ Industrial Economics, Incorporated (IEc). (2006). *Expanded Expert Judgment Assessment of the Concentration-Response Relationship Between PM2.5 Exposure and Mortality. Peer Review Draft*. Prepared for: Office of Air Quality Planning and Standards, U.S. Environmental Protection Agency, Research Triangle Park, NC. August. EPA-HQ-OAR-2009-0472-0242
- ³²⁶ Woodruff, T.J., J. Grillo, and K.C. Schoendorf. (1997). The Relationship Between Selected Causes of Postneonatal Infant Mortality and Particulate Air Pollution in the United States. *Environmental Health Perspectives*. 105(6):608-612. EPA-HQ-OAR-2009-0472-0382
- ³²⁷ Abbey, D.E., B.L. Hwang, R.J. Burchette, T. Vancuren, and P.K. Mills. (1995). Estimated Long-Term Ambient Concentrations of PM(10) and Development of Respiratory Symptoms in a Nonsmoking Population. *Archives of Environmental Health*. 50(2): 139-152. EPA-HQ-OAR-2009-0472-0432
- ³²⁸ Peters, A., D.W. Dockery, J.E. Muller, and M.A. Mittleman. (2001). Increased Particulate Air Pollution and the Triggering of Myocardial Infarction. *Circulation*. 103:2810-2815. EPA-HQ-OAR-2009-0472-0239

Heavy-Duty GHG and Fuel Efficiency Standards FRM: Health and Environmental Impacts

- ³²⁹ Schwartz J. (1995). Short term fluctuations in air pollution and hospital admissions of the elderly for respiratory disease. *Thorax*. 50(5):531-538.
- ³³⁰ Schwartz J. (1994a). PM(10) Ozone, and Hospital Admissions For the Elderly in Minneapolis St Paul, Minnesota. *Arch Environ Health*. 49(5):366-374. EPA-HQ-OAR-2009-0472-1673
- ³³¹ Schwartz J. (1994b). Air Pollution and Hospital Admissions For the Elderly in Detroit, Michigan. *Am J Respir Crit Care Med*. 150(3):648-655. EPA-HQ-OAR-2009-0472-1674
- ³³² Moolgavkar SH, Luebeck EG, Anderson EL. (1997). Air pollution and hospital admissions for respiratory causes in Minneapolis St. Paul and Birmingham. *Epidemiology*. 8(4):364-370. EPA-HQ-OAR-2009-0472-1673
- ³³³ Burnett RT, Smith-Doiron M, Stieb D, Raizenne ME, Brook JR, Dales RE, et al. (2001). Association between ozone and hospitalization for acute respiratory diseases in children less than 2 years of age. *Am J Epidemiol*. 153(5):444-452. EPA-HQ-OAR-2009-0472-0223
- ³³⁴ Moolgavkar, S.H. (2003). "Air Pollution and Daily Deaths and Hospital Admissions in Los Angeles and Cook Counties." In *Revised Analyses of Time-Series Studies of Air Pollution and Health*. Special Report. Boston, MA: Health Effects Institute.
- ³³⁵ Ito, K. (2003). "Associations of Particulate Matter Components with Daily Mortality and Morbidity in Detroit, Michigan." In *Revised Analyses of Time-Series Studies of Air Pollution and Health*. Special Report. Health Effects Institute, Boston, MA. EPA-HQ-OAR-2009-0472-1674
- ³³⁶ Moolgavkar, S.H. (2000). Air Pollution and Hospital Admissions for Diseases of the Circulatory System in Three U.S. Metropolitan Areas. *Journal of the Air and Waste Management Association* 50:1199-1206. EPA-HQ-OAR-2009-0472-1664
- ³³⁷ Sheppard, L. (2003). Ambient Air Pollution and Nonelderly Asthma Hospital Admissions in Seattle, Washington, 1987-1994. In *Revised Analyses of Time-Series Studies of Air Pollution and Health*. Special Report. Boston, MA: Health Effects Institute. EPA-HQ-OAR-2009-0472-0318
- ³³⁸ Peel, J. L., P. E. Tolbert, M. Klein, et al. (2005). Ambient air pollution and respiratory emergency department visits. *Epidemiology*. Vol. 16 (2): 164-74. EPA-HQ-OAR-2009-0472-1663
- ³³⁹ Wilson, A. M., C. P. Wake, T. Kelly, et al. (2005). Air pollution, weather, and respiratory emergency room visits in two northern New England cities: an ecological time-series study. *Environ Res*. Vol. 97 (3): 312-21. EPA-HQ-OAR-2009-0472-0246
- ³⁴⁰ Norris, G., S.N. YoungPong, J.Q. Koenig, T.V. Larson, L. Sheppard, and J.W. Stout. (1999). An Association between Fine Particles and Asthma Emergency Department Visits for Children in Seattle. *Environmental Health Perspectives* 107(6):489-493. EPA-HQ-OAR-2009-0472-0318
- ³⁴¹ Dockery, D.W., J. Cunningham, A.I. Damokosh, L.M. Neas, J.D. Spengler, P. Koutrakis, J.H. Ware, M. Raizenne, and F.E. Speizer. (1996). Health Effects of Acid Aerosols On North American Children-Respiratory Symptoms. *Environmental Health Perspectives* 104(5):500-505. EPA-HQ-OAR-2009-0472-0225
- ³⁴² Pope, C.A., III, D.W. Dockery, J.D. Spengler, and M.E. Raizenne. (1991). Respiratory Health and PM₁₀ Pollution: A Daily Time Series Analysis. *American Review of Respiratory Diseases* 144:668-674. EPA-HQ-OAR-2009-0472-1672
- ³⁴³ Schwartz, J., and L.M. Neas. (2000). Fine Particles are More Strongly Associated than Coarse Particles with Acute Respiratory Health Effects in Schoolchildren. *Epidemiology* 11:6-10.

Regulatory Impact Analysis

- ³⁴⁴ Ostro, B., M. Lipsett, J. Mann, H. Braxton-Owens, and M. White. (2001). Air Pollution and Exacerbation of Asthma in African-American Children in Los Angeles. *Epidemiology* 12(2):200-208.
- ³⁴⁵ Vedal, S., J. Petkau, R. White, and J. Blair. (1998). Acute Effects of Ambient Inhalable Particles in Asthmatic and Nonasthmatic Children. *American Journal of Respiratory and Critical Care Medicine* 157(4):1034-1043. EPA-HQ-OAR-2009-0472-1671
- ³⁴⁶ Ostro, B.D. (1987). Air Pollution and Morbidity Revisited: A Specification Test. *Journal of Environmental Economics Management* 14:87-98. EPA-HQ-OAR-2009-0472-1670
- ³⁴⁷ Gilliland FD, Berhane K, Rappaport EB, Thomas DC, Avol E, Gauderman WJ, et al. (2001). The effects of ambient air pollution on school absenteeism due to respiratory illnesses. *Epidemiology* 12(1):43-54. EPA-HQ-OAR-2009-0472-1675
- ³⁴⁸ Chen L, Jennison BL, Yang W, Omaye ST. (2000). Elementary school absenteeism and air pollution. *Inhal Toxicol* 12(11):997-1016. EPA-HQ-OAR-2009-0472-0224
- ³⁴⁹ Ostro, B.D. and S. Rothschild. (1989). Air Pollution and Acute Respiratory Morbidity: An Observational Study of Multiple Pollutants. *Environmental Research* 50:238-247. EPA-HQ-OAR-2009-0472-0364
- ³⁵⁰ U.S. Science Advisory Board. (2004). *Advisory Plans for Health Effects Analysis in the Analytical Plan for EPA's Second Prospective Analysis –Benefits and Costs of the Clean Air Act, 1990—2020*. EPA-SAB-COUNCIL-ADV-04-004. EPA-HQ-OAR-2009-0472-4664
- ³⁵¹ National Research Council (NRC). (2002). *Estimating the Public Health Benefits of Proposed Air Pollution Regulations*. Washington, DC: The National Academies Press.
- ³⁵² Abt Associates, Inc. October 2005. *Methodology for County-level Mortality Rate Projections*. Memorandum to Bryan Hubbell and Zachary Pekar, U.S. EPA.
- ³⁵³ Centers for Disease Control: Wide-ranging OnLine Data for Epidemiologic Research (CDC Wonder) (data from years 1996-1998), Centers for Disease Control and Prevention (CDC), U.S. Department of Health and Human Services, Available on the Internet at <<http://wonder.cdc.gov>>.
- ³⁵⁴ Agency for Healthcare Research and Quality (AHRQ). 2000. HCUPnet, Healthcare Cost and Utilization Project.
- ³⁵⁵ American Lung Association. 1999. Chronic Bronchitis. Available on the Internet at <<http://www.lungusa.org/diseases/lungchronic.html>>.
- ³⁵⁶ American Lung Association. 2002. Trends in Asthma Morbidity and Mortality. American Lung Association, Best Practices and Program Services, Epidemiology and Statistics Unit. Available on the Internet at <<http://www.lungusa.org/data/asthma/ASTHMAdt.pdf>>.
- ³⁵⁷ Adams PF, Hendershot GE, Marano MA. 1999. Current Estimates from the National Health Interview Survey, 1996. *Vital Health Stat* 10(200):1-212.
- ³⁵⁸ U.S. Bureau of Census. 2000. Population Projections of the United States by Age, Sex, Race, Hispanic Origin and Nativity: 1999 to 2100. Population Projections Program, Population Division, U.S. Census Bureau, Washington, DC. Available on the Internet at <<http://www.census.gov/population/projections/nation/summary/np-t.txt>>.
- ³⁵⁹ National Center for Education Statistics (NCHS). 1996. The Condition of Education 1996, Indicator 42: Student Absenteeism and Tardiness. U.S. Department of Education. Washington, DC.

Heavy-Duty GHG and Fuel Efficiency Standards FRM: Health and Environmental Impacts

- ³⁶⁰ Centers for Disease Control: Wide-ranging OnLine Data for Epidemiologic Research (CDC Wonder) (data from years 1996-1998), Centers for Disease Control and Prevention (CDC), U.S. Department of Health and Human Services, Available on the Internet at <<http://wonder.cdc.gov>>.
- ³⁶¹ U.S. Environmental Protection Agency (U.S. EPA). 2009. Integrated Science Assessment for Particulate Matter (Final Report). EPA-600-R-08-139F. National Center for Environmental Assessment – RTP Division. December. Available on the Internet at <<http://cfpub.epa.gov/ncea/cfm/recordisplay.cfm?deid=216546>>.
- ³⁶² U.S. Environmental Protection Agency - Science Advisory Board (U.S. EPA-SAB). 2009. Consultation on EPA's Particulate Matter National Ambient Air Quality Standards: Scope and Methods Plan for Health Risk and Exposure Assessment. EPA-COUNCIL-09-009. May. Available on the Internet at <[http://yosemite.epa.gov/sab/SABPRODUCT.NSF/81e39f4c09954fcb85256ead006be86e/723FE644C5D758DF852575BD00763A32/\\$File/EPA-CASAC-09-009-unsigned.pdf](http://yosemite.epa.gov/sab/SABPRODUCT.NSF/81e39f4c09954fcb85256ead006be86e/723FE644C5D758DF852575BD00763A32/$File/EPA-CASAC-09-009-unsigned.pdf)>.
- ³⁶³ U.S. Environmental Protection Agency - Science Advisory Board (U.S. EPA-SAB). 2009. Review of EPA's Integrated Science Assessment for Particulate Matter (First External Review Draft, December 2008). EPA-COUNCIL-09-008. May. Available on the Internet at <[http://yosemite.epa.gov/sab/SABPRODUCT.NSF/81e39f4c09954fcb85256ead006be86e/73ACCA834AB44A10852575BD0064346B/\\$File/EPA-CASAC-09-008-unsigned.pdf](http://yosemite.epa.gov/sab/SABPRODUCT.NSF/81e39f4c09954fcb85256ead006be86e/73ACCA834AB44A10852575BD0064346B/$File/EPA-CASAC-09-008-unsigned.pdf)>.
- ³⁶⁴ Freeman(III), AM. 1993. The Measurement of Environmental and Resource Values: Theory and Methods. Washington, DC: Resources for the Future.
- ³⁶⁵ Harrington, W., and P.R. Portney. 1987. Valuing the Benefits of Health and Safety Regulation. *Journal of Urban Economics* 22:101-112.
- ³⁶⁶ Berger, M.C., G.C. Blomquist, D. Kenkel, and G.S. Tolley. 1987. Valuing Changes in Health Risks: A Comparison of Alternative Measures. *The Southern Economic Journal* 53:977-984.
- ³⁶⁷ U.S. Environmental Protection Agency (U.S. EPA). 2006. Regulatory Impact Analysis, 2006 National Ambient Air Quality Standards for Particulate Matter, Chapter 5. Office of Air Quality Planning and Standards, Research Triangle Park, NC. October. Available on the Internet at <<http://www.epa.gov/ttn/ecas/regdata/RIAs/Chapter%205--Benefits.pdf>>.
- ³⁶⁸ U.S. Environmental Protection Agency (U.S. EPA). 2008. Regulatory Impact Analysis, 2008 National Ambient Air Quality Standards for Ground-level Ozone, Chapter 6. Office of Air Quality Planning and Standards, Research Triangle Park, NC. March. Available at <<http://www.epa.gov/ttn/ecas/regdata/RIAs/6-ozoneriachapter6.pdf>>.
- ³⁶⁹ U.S. EPA, (2001), "Guidance for Demonstrating Attainment of Air Quality Goals for PM_{2.5} and Regional Haze", http://www.epa.gov/ttn/scram/guidance_sip.htm, Modeling Guidance, DRAFT-PM
- ³⁷⁰ National Research Council (NRC). 2002. Estimating the Public Health Benefits of Proposed Air Pollution Regulations. Washington, DC: The National Academies Press.
- ³⁷¹ National Research Council (NRC). 2008. Estimating Mortality Risk Reduction and Economic Benefits from Controlling Ozone Air Pollution. National Academies Press. Washington, DC.
- ³⁷² Roman, Henry A., Katherine D. Walker, Tyra L. Walsh, Lisa Conner, Harvey M. Richmond, Bryan J. Hubbell, and Patrick L. Kinney. 2008. Expert Judgment Assessment of the Mortality Impact of Changes in Ambient Fine Particulate Matter in the U.S. *Environ. Sci. Technol.*, 42(7):2268-2274.
- ³⁷³ U.S. Environmental Protection Agency (U.S. EPA) 2010. Regulatory Impact Analysis, National Ambient Air Quality Standards for Ozone, Office of Air Quality Planning and Standards, Research

Regulatory Impact Analysis

Triangle Park, NC. October. Available on the Internet at < <http://www.epa.gov/ttn/ecas/regdata/RIAs/6-ozoneriachapter6.pdf>>.

³⁷⁴ Brenkert A, S. Smith, S. Kim, and H. Pitcher, 2003: Model Documentation for the MiniCAM. PNNL-14337, Pacific Northwest National Laboratory, Richland, Washington.

³⁷⁵ Wigley, T.M.L. and Raper, S.C.B. 1992. Implications for Climate And Sea-Level of Revised IPCC Emissions Scenarios *Nature* 357, 293-300. Raper, S.C.B., Wigley T.M.L. and Warrick R.A. 1996. in *Sea-Level Rise and Coastal Subsidence: Causes, Consequences and Strategies* J.D. Milliman, B.U. Haq, Eds., Kluwer Academic Publishers, Dordrecht, The Netherlands, pp. 11-45.

³⁷⁶ Wigley, T.M.L. and Raper, S.C.B. 2002. Reasons for larger warming projections in the IPCC Third Assessment Report *J. Climate* 15, 2945-2952.

³⁷⁷ Thompson AM, KV Calvin, SJ Smith, GP Kyle, A Volke, P Patel, S Delgado-Arias, B Bond-Lamberty, MA Wise, LE Clarke and JA Edmonds. 2010. "RCP4.5: A Pathway for Stabilization of Radiative Forcing by 2100." *Climatic Change* (in review)

³⁷⁸ Clarke, L., J. Edmonds, H. Jacoby, H. Pitcher, J. Reilly, R. Richels, (2007) Scenarios of Greenhouse Gas Emissions and Atmospheric Concentrations. Sub-report 2.1A of Synthesis and Assessment Product 2.1 by the U.S. Climate Change Science Program and the Subcommittee on Global Change Research (Department of Energy, Office of Biological & Environmental Research, Washington, DC., USA, 154 pp.).

³⁷⁹ Wigley, T.M.L. 2008. MAGICC 5.3.v2 User Manual. UCAR – Climate and Global Dynamics Division, Boulder, Colorado. <http://www.cgd.ucar.edu/cas/wigley/magicc/>

³⁸⁰ Meehl, G.A. et al. (2007) Global Climate Projections. In: *Climate Change 2007: The Physical Science Basis*. Contribution of Working Group I to the Fourth Assessment Report of the Intergovernmental Panel on Climate Change [Solomon, S., D. Qin, M. Manning, Z. Chen, M. Marquis, K.B. Averyt, M. Tignor and H.L. Miller (eds.)]. Cambridge University Press, Cambridge, United Kingdom and New York, NY, USA.

³⁸¹ National Research Council, 2011. *Climate Stabilization Targets: Emissions, Concentrations, and Impacts over Decades to Millennia*. Washington, DC: National Academies Press.

³⁸² Lewis, E., and D. W. R. Wallace. 1998. Program Developed for CO₂ System Calculations. ORNL/CDIAC-105. Carbon Dioxide Information Analysis Center, Oak Ridge National Laboratory, U.S. Department of Energy, Oak Ridge, Tennessee.

³⁸³ Lewis, E., and D. W. R. Wallace. 1998. Program Developed for CO₂ System Calculations. ORNL/CDIAC-105. Carbon Dioxide Information Analysis Center, Oak Ridge National Laboratory, U.S. Department of Energy, Oak Ridge, Tennessee.

³⁸⁴ Mehrbach, C., C. H. Culberson, J. E. Hawley, and R. N. Pytkowicz. 1973. Measurement of the apparent dissociation constants of carbonic acid in seawater at atmospheric pressure. *Limnology and Oceanography* 18:897-907.

³⁸⁵ Dickson, A. G. and F. J. Millero. 1987. A comparison of the equilibrium constants for the dissociation of carbonic acid in seawater media. *Deep-Sea Res.* 34, 1733-1743. (Corrigenda. *Deep-Sea Res.* 36, 983).

³⁸⁶ A. G. Dickson. 1990. Thermodynamics of the dissociation of boric acid in synthetic sea water from 273.15 to 318.15 K. *Deep-Sea Res.* 37, 755-766.

³⁸⁷ Lewis, E., and D. W. R. Wallace. 1998. Program Developed for CO₂ System Calculations. ORNL/CDIAC-105. Carbon Dioxide Information Analysis Center, Oak Ridge National Laboratory, U.S. Department of Energy, Oak Ridge, Tennessee.

³⁸⁸ Khoo, K.H., R.W. Ramette, C.H. Culberson, and R. G. Bates. 1977. Determination of hydrogen ion concentrations in seawater from 5 to 40°C: Standard potentials at salinities from 20 to 45‰. *Analytical Chemistry* 49(1): 29-34.

³⁸⁹ Dickson, A. G. 2003. Certificate of Analysis – Reference material for oceanic CO₂ measurements (Batch #62, bottled on August 21, 2003). Certified by Andrew Dickson, Scripps Institution of Oceanography. November 21, 2003.

Dickson, A. G. 2005. Certificate of Analysis – Reference material for oceanic CO₂ measurements (Batch #69, bottled on January 4, 2005). Certified by Andrew Dickson, Scripps Institution of Oceanography. July 12, 2005.

Dickson, A. G. 2009. Certificate of Analysis – Reference material for oceanic CO₂ measurements (Batch #100, bottled on November 13, 2009). Certified by Andrew Dickson, Scripps Institution of Oceanography. February 10, 2010.

Chapter 9. Economic and Other Impacts

9.1 Framework for Benefits and Costs

The net benefits of the HD National Program consist of the effects of the program on:

- the engine and truck program costs,
- fuel savings associated with reduced fuel usage resulting from the program,
- greenhouse gas emissions,
- other air pollutants,
- noise, congestion, accidents resulting from truck use,
- refueling savings,
- energy security impacts,
- increased driving due to the “rebound” effect.

The benefits and costs of this rule are analyzed using 3 percent and 7 percent discount rates. These rates are intended to represent the social opportunity costs of capital; they are not necessarily the discount rates that private decision-makers use.

9.2 Conceptual Framework for Evaluating Impacts

This regulation is motivated primarily by the goals of reducing emissions of greenhouse gases and promoting U.S. energy security by reducing consumption and imports of petroleum-based fuels. These motivations involve classic externalities, meaning that private decisions do not incorporate all of the costs associated with these problems; these costs are not borne completely by the households or businesses whose actions are responsible for them. In the absence of some mechanism to “internalize” these costs – that is, to transfer their burden to individuals or firms whose decisions impose them – individuals and firms will consume more petroleum-based fuels than is socially optimal. Externalities are a classic motivation for government intervention in markets. These externalities, as well as effects due to changes in emissions of other pollutants and other impacts, are discussed in Sections VIII.H – VIII.K in the preamble to the final rules.

In some cases, these classic externalities are by themselves enough to justify the costs of imposing fuel efficiency standards. For some discount rates and some projected social costs of carbon, however, the reductions in these external costs are less than the costs of new fuel saving technologies needed to meet the standards. (See Tables 9-25 and 9-26 in the RIA.) Nevertheless, this regulation reduces trucking companies’ fuel costs; according to our estimates, these savings in fuel costs are *by themselves* sufficient to pay for the technologies over periods of time considerably shorter than vehicles’ expected lifetimes under the assumptions used for this

Regulatory Impact Analysis

analysis (e.g., AEO 2011 projected fuel prices). If these estimates are correct, then the *entire* value of the reductions in external costs represents additional net benefits of the program, beyond those resulting from the fact that the value of fuel savings exceeds the costs of technologies necessary to achieve them.

It is often asserted that there are cost-effective fuel-saving technologies that markets do not take advantage of. This is commonly known as the “energy gap” or “energy paradox.” Standard economic theory suggests that in normally functioning competitive markets, interactions between vehicle buyers and producers would lead producers to incorporate all cost-effective technology into the vehicles that they offer, without government intervention. Unlike in the light-duty vehicle market, the vast majority of vehicles in the medium- and heavy-duty truck market are purchased and operated by businesses with narrow profit margins, and for which fuel costs represent a substantial operating expense.

Even in the presence of uncertainty and imperfect information – conditions that hold to some degree in every market – we generally expect firms to attempt to minimize their costs in an effort to survive in a competitive marketplace, and therefore to make decisions that are in the best interest of the company and its owners and/or shareholders. In this case, the benefits of the rules would be due exclusively to reducing the economic costs of externalities resulting from fuel production and consumption. However, as discussed in Section VIII.E of the preamble to the final rules, the agencies have estimated that the application of fuel-saving technologies in response to the final standards would, on average, yield significant private returns to truck owners (see Table VIII-9 through VIII-11 in the preamble to the final rules). The agencies have also estimated that the application of these technologies would be significantly lower in the absence of the final standards (*i.e.*, under the “no action” regulatory alternative), meaning that truck buyers and operators ignore opportunities to make investments in higher fuel efficiency that appear to offer significant cost savings.

As discussed in the NPRM, there are several possible explanations in the economics literature for why trucking companies do not adopt technologies that would be expected to increase their profits: there could be a classic market failure in the trucking industry – market power, externalities, or asymmetric or incomplete (*i.e.*, missing market) information; there could be institutional or behavioral rigidities in the industry (union rules, standard operating procedures, statutory requirements, loss aversion, etc.), whereby participants collectively do not minimize costs; or the engineering estimates of fuel savings and costs for these technologies might overstate their benefits or understate their costs in real-world applications.

To try to understand why trucking companies have not adopted these seemingly cost-effective fuel-saving technologies, the agencies surveyed published literature about the energy paradox, and held discussions with numerous truck market participants. The proposal discussed five categories of possible explanations derived from these sources. Collectively, these five hypotheses may explain the apparent inconsistency between the engineering analysis, which finds a number of cost-effective methods of improving fuel efficiency, and the observation that many of these technologies are not widely adopted.

These hypotheses include imperfect information in the original and resale markets, split incentives, uncertainty about future fuel prices, and adjustment and transactions costs. As the

discussion indicated, some of these explanations suggest failures in the private market for fuel-saving technology in addition to the externalities caused by producing and consuming fuel that are the primary motivation for the rules. Other explanations suggest market-based behaviors that may imply additional costs of regulating truck fuel efficiency that are not accounted for in this analysis. As noted above, an additional explanation – adverse effects on other vehicle attributes -- did not elicit supporting information in the public comments. Anecdotal evidence from various segments of the trucking industry suggests that many of the hypotheses discussed here may play a role in explaining the puzzle of why truck purchasers appear to under-invest in fuel efficiency, although different explanations may apply to different segments, or even different companies. The published literature does not appear to include empirical analysis or data related to this question.

The agencies invited comment on these explanations, and on any data or information that could be used to investigate the role of any or all of these five hypotheses in explaining this energy paradox as it applies specifically to trucks. Some comments expressed dissatisfaction about the explanations presented; they argued that these arguments were not sufficient to explain the phenomenon. These comments argued that the truck owners and operators are better judges of the appropriate amount of fuel efficiency than are government agencies; they choose not to invest because of warranted skepticism about these technologies. The agencies also requested comment and information regarding any other hypotheses that could explain the appearance that cost-effective fuel-saving technologies have not been widely incorporated into trucks. The following discussion summarizes the fuller discussion provided in the NPRM and includes discussion of the comments received.

9.2.1 Information Issues in the Original Sale Markets

One potential hypothesis for why the trucking industry does not adopt what appear to be inexpensive fuel saving technologies is that there is inadequate or unreliable information available about the effectiveness of many fuel-saving technologies for new vehicles. If reliable information on the effectiveness of many new technologies is absent, truck buyers will understandably be reluctant to spend additional money to purchase vehicles equipped with unproven technologies.

This lack of information can manifest itself in multiple ways. For instance, the problem may arise purely because collecting reliable information on technologies is costly (also see 9.2.5 below on transaction costs). Moreover, information has aspects of a public good, in that no single firm has the incentive to do the costly experimentation to determine whether or not particular technologies are cost-effective, while all firms benefit from the knowledge that would be gained from that experimentation. Similarly, if multiple firms must conduct the same tests to get the same information, costs could be reduced by some form of coordination of information gathering.

While its effect on information is indirect, we expect the requirement for the use of new technologies included in this program will circumvent these information issues, resulting in their adoption, thus providing more readily available information about their benefits. The agencies appreciate, however, that the diversity of truck uses, driving situations, and driver behavior will

lead to variation in the fuel savings that individual trucks or fleets experience from using specific technologies.

One commenter noted that the SmartWay program targets semi-truck owners and thus should have the largest impact on that sector, rather than vocational or medium-duty trucks. However, the gap between actual investment in fuel efficiency and the agencies' estimates of optimal investment is largest for combination tractors. Some of the difference in magnitude is likely to be due to the higher vehicle miles traveled for semi-trucks compared to medium-duty and vocational vehicles: more driving means more fuel savings. Additionally, not even a majority of semi-trucks are owned by participants in SmartWay; non-participants are unlikely to get all the benefits of participants. Other explanations, noted below, are also likely to play a role. This observation may also suggest some limitations of improved information provision as a means of addressing the "efficiency gap."

9.2.2 Information Issues in the Resale Market

In addition to issues in the new vehicle market, a second hypothesis for why trucking companies may not adopt what appear to be cost-effective technologies to save fuel is that the resale market may not adequately reward the addition of fuel-saving technology to vehicles to ensure their original purchase by new truck buyers. This inadequate payback for users beyond the original owner may contribute to the short payback period that new purchasers appear to expect.¹ The agencies requested data and information on the extent to which costs of fuel saving equipment can be recovered in the resale truck market. No data were received. One reviewer disputed this theory on the basis that people are willing to pay more for better vehicles, new or used. It is not clear, however, whether buyers of used vehicles can tell which are the better vehicles.²

Some of this unwillingness to pay for fuel-saving technology may be due to the extension of the information problems in the new vehicle market into resale markets. Buyers in the resale market have no more reason to trust information on fuel-saving technologies than buyers in the original market. Because actual fuel efficiency of trucks on the road depends on many factors, including geography and driving styles or habits, even objective sources such as logs of truck performance for used vehicles may not provide reliable information about the fuel efficiency that potential purchasers of used trucks will experience.

A related possibility is that vehicles will be used for different purposes by their second owners than those for which they were originally designed, and the fuel-saving technology is therefore of less value.

It is possible, though, that the fuel savings experienced by the secondary purchasers may not match those experienced by their original owners if the optimal secondary new use of the vehicle does not earn as many benefits from the technologies. One commenter asks whether the fuel-saving technology is undervalued because it is unproven or overrated. In that case, the premium for fuel-saving technology in the secondary market should accurately reflect its value to potential buyers participating in that market, even if it is lower than its value in the original market, and the market has not failed. Because the information necessary to optimize use in the secondary market may not be readily available or reliable, however, buyers in the resale market

may have less ability than purchasers of new vehicles to identify and gain the advantages of new fuel-saving technologies, and may thus be even less likely to pay a premium for them.

For these reasons, purchasers' willingness to pay for fuel efficiency technologies may be even lower in the resale market than in the original equipment market. Even when fuel-saving technologies will provide benefits in the resale markets, purchasers of used vehicles may not be willing to compensate their original owners fully for their remaining value. As a result, the purchasers of original equipment may expect the resale market to provide inadequate appropriate compensation for the new technologies, even when those technologies would reduce costs for the new buyers. This information issue may partially explain what appears to be the very short payback periods required for new technologies in the new vehicle market.

9.2.3 Split Incentives in the Medium- and Heavy-Duty Truck Industry

A third hypothesis explaining the energy paradox as applied to trucking involves split incentives. When markets work effectively, signals provided by transactions in one market are quickly transmitted to related markets and influence the decisions of buyers and sellers in those related markets. For instance, in a well-functioning market system, changes in the expected future price of fuel should be transmitted rapidly to those who purchase trucks, who will then reevaluate the amount of fuel-saving technology to purchase for new vehicles. If for some reason a truck purchaser will not be directly responsible for future fuel costs, or the individual who will be responsible for fuel costs does not decide which truck characteristics to purchase, then those price signals may not be transmitted effectively, and incentives can be described as "split."

One place where such a split may occur is between the owners and operators of trucks. Because they are generally responsible for purchasing fuel, truck operators have strong incentives to economize on its use, and are thus likely to support the use of fuel-saving technology. However, the owners of trucks or trailers are often different from operators, and may be more concerned about their longevity or maintenance costs than about their fuel efficiency, when purchasing vehicles. As a result, capital investments by truck owners may be channeled into equipment that improves vehicles' durability or reduces their maintenance costs, rather than into fuel-saving technology. If operators can choose freely among the trucks they drive, competition among truck owners to employ operators would encourage owners to invest in fuel-saving technology. However, if truck owners have more ability to choose among operators, then market signals for improved fuel savings that would normally be transmitted to truck owners may be muted. Truck fleets that rent their vehicles may provide an example: renters may observe the cost of renting the truck, but not its fuel efficiency; if so, then the purchasers will aim for vehicles with lower costs, to lower the cost of the rental. It might be possible to test this theory by comparing the fuel efficiency of trucks by owner-operators with those that are leased by operators. The agencies have not had the data to conduct such a test.

One commenter noted that there are always tradeoffs in an investment decision: a purchaser may prefer to invest in other vehicle attributes than fuel efficiency. In an efficient market, however, a purchaser should invest in fuel-saving technology as long as the increase in fuel-saving technology costs less than the expected fuel savings. This result should hold regardless of the level of investment in other attributes, unless there are constraints on a

purchaser's access to investment capital. The agencies believe that truck fleets do have an incentive to make investments in fuel efficiency, and that this assumption is reflected in the regulatory analysis. The agencies also believe, however, that sufficient evidence suggests that truck fleets are not availing themselves of all the opportunities for efficiency improvements.

In addition, the NAS report notes that split incentives can arise between tractor and trailer operators.³ Trailers affect the fuel efficiency of shipping, but trailer owners do not face strong incentives to coordinate with truck owners. EPA and NHTSA are not regulating trailers in this action.

By itself, information provision may be inadequate to address the potential underinvestment in fuel efficiency resulting from such split incentives. In this setting, regulation may contribute to fuel savings that otherwise may be difficult to achieve.

9.2.4 Uncertainty About Future Cost Savings

Another hypothesis for the lack of adoption of seemingly fuel saving technologies may be uncertainty about future fuel prices or truck maintenance costs. When purchasers have less than perfect foresight about future operating expenses, they may implicitly discount future savings in those costs due to uncertainty about potential returns from investments that reduce future costs. In contrast, the immediate costs of the fuel-saving or maintenance-reducing technologies are certain and immediate, and thus not subject to discounting. In this situation, both the expected return on capital investments in higher fuel efficiency and potential variance about its expected rate may play a role in a firm's calculation of its payback period on such investments.

In the context of energy efficiency investments for the home, Metcalf and Rosenthal (1995) and Metcalf and Hassett (1995) observe that households weigh known, up-front costs that are essentially irreversible against an unknown stream of future fuel savings.⁴ Notably, in this situation, requiring households to adopt technologies more quickly may make them worse off by imposing additional risk on them.

Greene et al (2009) also finds support for this explanation in the context of light-duty fuel economy decisions: a loss-averse consumer's expected net present value of increasing the fuel economy of a passenger car can be very close to zero, even if a risk-neutral expected value calculation shows that its buyer can expect significant net benefits from purchasing a more fuel-efficient car.⁵ Supporting this hypothesis is a finding by Dasgupta et. al (2007) that consumers are more likely to lease than buy a vehicle with higher maintenance costs because it provides them with the option to return it before those costs become too high.⁶ However, the agencies know of no studies that have estimated the impact of uncertainty on perceived future savings for medium- and heavy-duty vehicles.

Purchasers' uncertainty about future fuel prices implies that mandating improvements in fuel efficiency can reduce the expected utility associated with truck purchases. This is because adopting such regulation requires purchasers to assume a greater level of risk than they would in its absence, even if the future fuel savings predicted by a risk-neutral calculation actually materialize. One commenter expressed support for this argument. Thus the mere existence of

uncertainty about future savings in fuel costs does not by itself assure that regulations requiring improved fuel efficiency will necessarily provide economic benefits for truck purchasers and operators. On the other hand, because risk aversion reduces expected returns for businesses, competitive pressures can reduce risk aversion: risk-neutral companies can make higher average profits over time. Thus, significant risk aversion is unlikely to survive competitive pressures.

9.2.5 Adjustment and Transactions Costs

Another hypothesis is that transactions costs of changing to new technologies (how easily drivers will adapt to the changes, *e.g.*) may slow or prevent their adoption. Because of the diversity in the trucking industry, truck owners and fleets may like to see how a new technology works in the field, when applied to their specific operations, before they adopt it. One commenter expressed support for this argument. If a conservative approach to new technologies leads truck buyers to adopt new technologies slowly, then successful new technologies are likely to be adopted over time without market intervention, but with potentially significant delays in achieving fuel saving, environment, and energy security benefits.

In addition, there may be costs associated with training drivers to realize the potential fuel savings enabled by new technologies, or with accelerating fleet operators' scheduled fleet turnover and replacement to hasten their acquisition of vehicles equipped with new fuel-saving technologies. Here, again, there may be no market failure; requiring the widespread use of these technologies may impose adjustment and transactions costs not included in this analysis. As in the discussion of the role of risk, these adjustment and transactions costs are typically immediate and undiscounted, while their benefits are future and uncertain; risk or loss aversion may further discourage companies from adopting new technologies.

To the extent that there may be transactions costs associated with the new technologies, then regulation gives all new truck purchasers a level playing field, because it will require all of them to adjust on approximately the same time schedule. If experience with the new technologies serves to reduce uncertainty and risk, the industry as a whole may become more accepting of new technologies. This could increase demand for future new technologies and induce additional benefits in the legacy fleet through complementary efforts such as SmartWay.

9.2.6 Additional Hypotheses

In the public comments, two additional ideas were raised for the lack of adoption of what appears to be cost-effective fuel-saving technology. The first suggestion is that tighter diesel emissions standards caused fuel efficiency for diesel trucks to decline in the past decade. Because engine manufacturers would have to invest heavily (both financially and with personnel) in emissions reduction technologies, they would not invest in fuel efficiency. The costs associated with the decline in fuel efficiency due to the emissions regulations were accounted for in that rulemaking.

A second suggestion is that a truck may be a "positional good" – that is, a good whose value depends on how it compares to the goods owned by others. If trucks confer status on their owners or operators, and if that status depends on easily observable characteristics, then owners may invest disproportionately in status-granting characteristics rather than less visible

Regulatory Impact Analysis

characteristics, such as fuel efficiency. Because status depends on comparisons to others, an “arms race” may develop in which all parties spend additional money on visible characteristics but may not manage to make themselves better off. In this case, regulation may improve welfare: by increasing the requirements for non-positional fuel efficiency, regulation could reduce expenditures made purely for competition rather than actual increase in welfare. In a competitive business, cost reduction provides a major opportunity cost to investing in status rather than in fuel-saving technology; thus, this argument may play less of a role in the heavy-duty market than in the consumer market for vehicles.

Both these hypotheses leave open the question, though, why additional investments were not made in fuel efficiency if they would provide rapid payback. Truck purchasers should, in principle, be willing to buy additional fuel-saving technology as long as it is cost-effective, regardless of other vehicle attributes. Limited access to capital, if it is a problem in this sector, might provide some reason for the “crowding out” of the purchase of fuel-saving technology. The agencies received no evidence indicating that constrained access to capital might explain the efficiency gap in this market.

9.2.7 Summary

On the one hand, commercial vehicle operators are under competitive pressure to reduce operating costs, and thus their purchasers would be expected to pursue and rapidly adopt cost-effective fuel-saving technologies. On the other hand, the short payback period required by buyers of new trucks is a symptom that suggests some combination of uncertainty about future cost savings, transactions costs, and imperfectly functioning markets. In addition, widespread use of tractor-trailer combinations introduces the possibility that owners of trailers may have weaker incentives than truck owners or operators to adopt fuel-saving technology for their trailers. The market for medium- and heavy-duty trucks may face these problems, both in the new vehicle market and in the resale market.

Provision of information about fuel-saving technologies through voluntary programs such as SmartWay will assist in the adoption of new cost-saving technologies, but diffusion of new technologies can still be obstructed. Those who are willing to experiment with new technologies expect to find cost savings, but those may be difficult to prove. As noted above, because individual results of new technologies vary, new truck purchasers may find it difficult to identify or verify the effects of fuel-saving technologies. Those who are risk-averse are likely to avoid new technologies out of concerns over the possibility of inadequate returns on the investment, or with other adverse impacts. Competitive pressures in the freight transport industry can provide a strong incentive to reduce fuel consumption and improve environmental performance. However, not every driver or trucking fleet operating today has the requisite ability or interest to access the technical information, some of which is already provided by SmartWay, nor the resources necessary to evaluate this information within the context of his or her own freight operation.

It is unclear, as discussed above, whether some or many of the technologies would be adopted in the absence of the program. To the extent that they would have been adopted, the costs and the benefits attributed to those technologies may not in fact be due to the program and may therefore be overstated. Both baselines used project substantially less adoption than the

agencies consider to be cost-effective. The agencies will continue to explore reasons for this slow adoption of cost-effective technologies.

9.3 Rebound Effect

The VMT rebound effect refers to the fraction of fuel savings expected to result from an increase in fuel efficiency that is offset by additional vehicle use. If truck shipping costs decrease as a result of lower fuel costs, an increase in truck VMT may occur. Unlike the light-duty rebound effect, the heavy-duty (HD) rebound effect has not been extensively studied. Because the factors influencing the HD rebound effect are generally different from those affecting the light-duty rebound effect, much of the research on the light-duty sector is not likely to apply to the HD sectors. One of the major differences between the HD rebound effect and the light-duty rebound effect is that HD vehicles are used primarily for business purposes. Since these businesses are profit driven, decision makers are highly likely to be aware of the costs and benefits of different operating and shipping decisions, both in the near-term and long-term. Therefore, both truck operators and shippers are likely to take into account changes in the overall operating costs per mile when making operating and shipping decisions that affect truck usage.

Another difference from the light-duty case is that, as discussed in the recent NAS Report, when calculating the change in trucking costs that causes the rebound effect, all components of truck operating costs should be considered. The cost of labor and fuel generally constitute the two largest shares of truck operating costs, depending on the price of petroleum, distance traveled, type of truck, and commodity.⁷⁸ See Figure 9-1. In addition, the equipment depreciation costs associated with the purchase or lease of the truck is also a significant component of total operating costs. Even though vehicle purchases are lump-sum costs, they are likely to be considered as operating costs by trucking firms, and these costs are, in many cases, expected to be passed onto the final consumers of shipping services. By partially offsetting the reduction in fuel costs resulting from higher fuel efficiency, higher vehicle purchase or lease prices could thus help temper the magnitude of the fuel economy rebound effect relative to that for light-duty vehicles, in which vehicle depreciation costs may not be considered an operating cost by vehicle owners.

When calculating the net change in operating costs, both the increase in new vehicle costs and the decrease in fuel costs per mile should be taken into consideration. The higher the net cost savings, the higher the expected rebound effect. Conversely, if the upfront vehicle costs outweighed future cost savings and total costs increased, shipping costs would rise, which would likely result in a decrease in truck VMT. In theory, other cost changes resulting from any requirement to achieve higher fuel economy, such as changes in maintenance costs or insurance rates, should also be taken into account, although information on potential changes in these elements of truck operating costs is extremely limited.

Figure 9-1: Cost Per Mile Summary

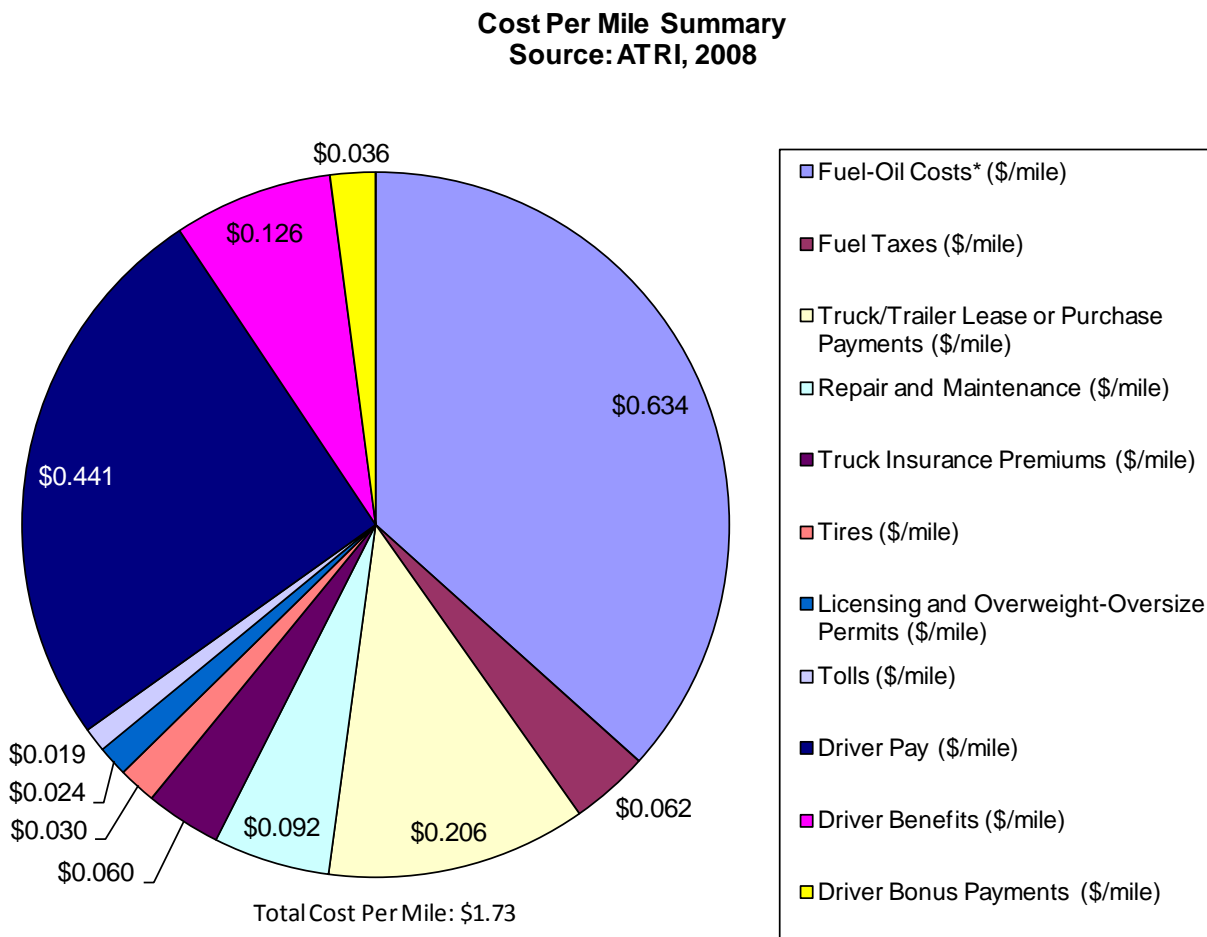

* Based on \$4.79/gallon diesel in 2008

The following sections describe the factors affecting the rebound effect, different methodologies for estimating the rebound effect, and examples of different estimates of the rebound effect to date. According to the NAS study, it is “not possible to provide a confident measure of the rebound effect,” yet NAS concluded that a rebound effect likely exists and that “estimates of fuel savings from regulatory standards will be somewhat misestimated if the rebound effect is not considered.” While we believe the HD rebound effect needs to be studied in more detail, we have attempted to capture the potential impact of the rebound effect in our analysis. For this rule, we have used a rebound effect for single unit trucks of 15 percent, a rebound effect for medium-duty (2b and 3) trucks of 10 percent, and a rebound effect for combination tractors of 5 percent. That is, we assume that for every 1 percent decrease in operating costs for trucks (\$/mile), we anticipate a 0.15 percent, 0.10 percent, and 0.05 percent increase in VMT for single unit trucks, MD trucks, and combination tractors, respectively. For this rule, we do not discern between short-run and long-run rebound effects, although these effects may differ, as discussed below. These VMT impacts are reflected in the estimates of total GHG and other air pollution reductions presented in Chapter 5 of the RIA.

9.3.1 Factors Affecting the Magnitude of the Rebound Effect

The HD rebound effect is driven by the interaction of several different factors. In the short-run, decreasing the fuel cost per mile of operating trucks could lead to a decrease in delivered prices for products shipped by truck. Lower delivered prices could stimulate additional demand for those products, which would then result in an increase in truck usage and VMT. In the long-run, shippers could reorganize their logistics and distribution networks to take advantage of lower truck shipping costs. For example, shippers may shift away from other modes of shipping such as rail, barge, or air. In addition, shippers may also choose to reduce the number of warehouses, reduce load rates, and make smaller, more frequent shipments, all of which could also lead to an increase in HD VMT. Finally, the benefits of the fuel savings could ripple through the economy, which could in turn increase overall demand for goods and services shipped by trucks, and therefore increase HD VMT.

Conversely, if a fuel efficiency regulation leads to net increases in the cost of trucking because fuel savings do not fully offset the increase in upfront vehicle costs, then the price of trucking services could rise, spurring a decrease in HD VMT and a shift to alternative shipping modes. These effects would also ripple through the economy.

As discussed in Section VIII of the preamble, the magnitude of the rebound effect is likely to be determined by the extent of market failures that affect demand for fuel economy in HD fleets, such as split incentives and imperfect information, as well as rational firm responses to the tradeoff between higher certain upfront vehicle costs and lower but uncertain future expenditures on fuel.

9.3.2 Options for Quantifying the Rebound Effect

As described in the previous section, the fuel economy rebound effect for heavy-duty vehicles has not been studied as extensively as the rebound effect for light-duty vehicles, and virtually no research has been conducted on the medium-duty truck rebound effect. In this rule, we discuss four options for quantifying the rebound effect.

9.3.2.1 Aggregate Estimates

The aggregate approximation approach quantifies the overall change in truck VMT as a result of a percentage change in freight rates. It is important to note that most of the aggregate estimates measure the change in freight demanded (tons or ton-miles), rather than a change in fuel consumption or VMT. The change in tons or ton-miles is more accurately characterized as a freight elasticity. Therefore, it may not be entirely appropriate to interpret these freight elasticities as measures of the rebound effect, although these terms are sometimes used interchangeably in the literature.⁹ Given these caveats, freight elasticity estimates rely on estimates of aggregate price elasticity of demand for trucking services, given a percentage change in trucking prices, which is generally referred to as an “own price elasticity.” Estimates of trucking own-price elasticities vary widely (from positive 1.72 to negative 7.92), though a 2004 literature survey found aggregate elasticity estimates generally fall in the range of -0.5 to -1.5.¹⁰ See Figure 9-2. In other words, given an own price elasticity of -1.5, a 10 percent decrease in trucking prices leads to a 15 percent increase in truck shipping demand.

Regulatory Impact Analysis

Another challenge of estimating the rebound effect using freight elasticities is that these values appear to vary substantially based on the demand elasticity measure (*e.g.*, ton or ton-mile), the model specification (*e.g.*, linear functional form or log linear), the length of the trip, and the type of cargo. In general, elasticity estimates of longer trips tend to be larger than elasticity estimates for shorter trips. In addition, elasticities tend to be larger for lower-value commodities compared to higher-value commodities. Although these factors explain some of the differences in estimates, much of the observed variation cannot be explained quantitatively. For example, a recent study that controlled for these variables only accounted for about half of the observed variation.¹¹

Another important variable influencing freight elasticity estimates is whether potential mode shifting is taken into account. Although the total demand for freight transport is generally determined by economic activity, there is often the choice of shipping freight on modes other than truck. This is because the United States has extensive rail, waterway and air transport networks in addition to an extensive highway network; these networks often closely parallel each other and are often viable choices for freight transport for many long-distance routes within the continent. If rates go down for one mode, there will be an increase in demand for that mode and some demand will be shifted from other modes. This “cross-price elasticity” is a measure of the percentage change in demand for shipping by another mode (*e.g.*, rail) given a percentage change in the price of trucking. Aggregate estimates of cross-price elasticities also vary widely, and there is no general consensus on the most appropriate value to use for analytical purposes. The NAS report cites values ranging from 0.35 to 0.59.¹² Other reports provide significantly different cross-price elasticities, ranging from 0.1¹³ to 2.0.¹⁴

Heavy-Duty GHG and Fuel Efficiency Standards FRM: Economic and Other Impacts

Figure 9-2: Elasticity of Demand Estimates for Truck Freight Showing Low/High Elasticity Values Based on Various Study Elements

Author/Date	Evaluation based on ...	Least Elastic	Description of Least Elastic Value	Most Elastic	Description of Most Elastic Value	Region	Demand Units of Measurement	Commodity
Abdelwahab (1998)	Commodity	-0.75	Construction materials	-1.40	Textile products	U.S. ICC Official	Probability of mode choice	Varies
Spady & Friedlaender (1980)	Commodity	-0.15	Wood and wood products	-5.06	Electrical Machinery	U.S. ICC Southern	ton-miles	Varies
Spady & Friedlaender (1980)	Commodity	-1.00	Food Products	-3.55	Electrical Machinery	U.S. ICC Average	ton-miles	Varies
Oum (1980)	Commodity	-0.41	Metallic products	-1.07	Fuel oil except gasoline	Canada	ton-miles	Varies
Winston (1981)	Commodity	-0.14	Lumber, wood and Furniture	-2.96	Transport Equipment	USA	tons	Varies
Li et al. (2011)	Commodity	-1.09	Other (Commodity Category)	-1.30	Natural Resources	USA, Italy & India	tonne-km	Varies
Campisi and Gastaldi (1996)	Commodity	-0.27	Petroleum products	-1.37	Minerals	Italy	tonnes	Various
Friedlaender and Spady (1981)	Commodity	-0.59	Petroleum products	-1.72	Wood	USA	tonne-km	Various
Bonilla (2008)	Commodity	-0.43	Oil and Coal	-1.75	Building materials	Denmark	tonne-km	Varies
Rich et al (2011)	Competition	-0.08	All O-D pairs	-0.11	O-D Pairs where competing modes available	Scandinavia	tonne-km	Agricultural products
Beuthe et al. (2001)	Demand measure	-0.58	tonnes	-1.06	tonne-km	Belgium	tonne, tonne-km	Aggregate
Li et al. (2011)	Demand measure	-1.02	tonnes	-1.30	tonne-km	USA, Italy & India	tonne, tonne-km	Natural Resources
Beuthe et al. (2001)	Distance	-1.06	<300 km	-1.31	>300 km	Belgium	tonne-km	Aggregate
Winston (1981)	Distance	-0.34	<900 miles (average)	-1.56	>900 miles (average)	USA	tons	Varies
Christidis and Leduc (2009)	Distance	-0.21	< 800 km	-1.15	> 1500 km	EU	tons	All
Oum (1992)	Model form	-0.69	Translog	-1.34	Log-linear	Various	ton, ton-miles	Aggregate
Graham and Glaister (2004)	Model form	-0.048	Linear	-1.34	Log-linear	Various	Various	Various
Li et al. (2011)	Panel vs. CS	-0.93	Panel Translog	-1.30	CS Translog	USA, Italy & India	tonne-km	Natural Resources
Abdelwahab (1998)	Region	-0.80	U.S. ICC Official	-2.18	U.S. ICC Southwestern	Various U.S.	Probability of mode choice	Metal products
Spady & Friedlaender (1980)	Region	-1.66	US ICC Mountain-Pacific	-5.06	U.S. ICC Southern	Various U.S.	ton-miles	Electrical Machinery
Li et al. (2011)	Region	-0.86	Canada	-1.96	Australia	Various	tonne-km	Natural Resources
Graham and Glaister (2004)	All elasticity	1.72	Least elastic end of range	-7.92	Most elastic end of range	Various	Various	Various

When considering intermodal shift, one of the most relevant kinds of shipments are those that are competitive between rail and truck modes. These trips generally include long-haul shipments greater than 500 miles, which weigh between 50,000 and 80,000 pounds (the legal road limit in many states). Special kinds of cargo like coal and short-haul deliveries are of less interest because they are generally not economically transferable between truck and rail modes, and they would not be expected to shift modes except under an extreme price change. However, the total amount of freight that could potentially be subject to mode shifting has also not been studied extensively.

9.3.2.2 Sector-Specific Estimates

Given the limited data available regarding the HD rebound effect, the aggregate approach greatly simplifies many of the assumptions associated with calculations of the rebound effect. In reality, however, responses to changes in fuel efficiency and new vehicle costs will vary significantly based on the commodities affected. A detailed, sector specific approach, would be expected to more accurately reflect changes in the trucking market in response to the standards in this rule. For example, input-output tables could be used to determine the trucking cost share of the total delivered price of a commodity. Using the change in trucking prices described in the aggregate approach, the product-specific demand elasticities could be used to calculate the change in sales and shipments for each product. The change in shipment increases could then be weighted by the share of the trucking industry total, and then summed to get the total increase in trucking output. A simplifying assumption could then be made that the increase in output results in an increase in VMT. To the best of our knowledge, this type of detailed data has not yet been collected, therefore we were unable to use this methodology for estimating the rebound effect for this rule.

9.3.2.3 Econometric Estimates

Similar to the methodology used to estimate the light-duty rebound effect, the HD rebound effect could be modeled econometrically by estimating truck demand as a function of economic activity (*e.g.*, GDP) and different input prices (*e.g.*, vehicle prices, driver wages, and fuel costs per mile). This type of econometric model could be estimated for either truck VMT or ton-miles as a measure of demand. The resulting elasticity estimates could then be used to determine the change in trucking demand, given the change in fuel cost and truck prices per mile from these standards. One of the challenges associated with an econometric analysis is the potential for omitted variable bias, which could either overstate or understate the potential rebound effect if the omitted variable is correlated with the controlled variables.

9.3.2.4 Other Modeling Approaches

Regulation of the heavy-duty vehicle industry has been studied in more detail in Europe, as the European Commission (EC) has considered allowing longer and heavier trucks for freight transport. Part of the analysis considered by the EC relies on country-specific modeling of changes in the freight sector that would result from changes in regulations.¹⁵ This approach attempts to explicitly calculate modal shift decisions and impacts on GHG emissions. Although similar types of analysis have not been conducted extensively in the U.S., research is currently underway that explores the potential for intermodal shifting in the U.S. For example, Winebrake

and Corbett have developed the Geospatial Intermodal Freight Transportation (GIFT) model, which evaluates the potential for GHG emissions reductions based on mode shifting, given existing limitations of infrastructure and other route characteristics in the U.S.¹⁶ This model connects multiple road, rail, and waterway transportation networks and embeds activity-based calculations in the model. Within this intermodal network, the model assigns various economic, time-of-delivery, energy, and environmental attributes to real-world goods movement routes. The model can then calculate different network optimization scenarios, based on changes in prices and policies.¹⁷ However, more work is needed in this area to determine whether this type of methodology is appropriate for the purposes of capturing the rebound effect.

9.3.3 Estimates of the Rebound Effect

The aggregate methodology was used by Cambridge Systematics, Inc. (CSI) to show several examples of the magnitude of the rebound effect.¹⁸ In their paper commissioned by the NAS in support of the HD report, CSI calculated an effective rebound effect for two different technology cost and fuel savings scenarios associated with an example Class 8 combination tractor. Scenario 1 increased average fuel economy from 5.59 mpg to 6.8 mpg, with an additional cost of \$22,930. Scenario 2 increased the average fuel economy to 9.1 mpg, at an incremental cost of \$71,630 per vehicle. Both of these scenarios were based on the technologies and targets from a recent Northeast States Center for a Clean Air Future (NESCCAF) and International Council on Clean Transportation (ICCT) report.¹⁹ The CSI examples provided estimates using a range of own price elasticities (-0.5 to -1.5) and cross-price elasticities (0.35 to 0.59) from the literature. For these calculations, CSI assumed 142,706 million miles of truck VMT and 1,852 billion ton-miles were affected. The truck VMT was based on the Bureau of Transportation Statistics (BTS) highway miles for combination tractors in 2006, and the rail ton-miles were based on the 2006 BTS total railroad miles. This assumption may overstate the potential rebound effect, since not all highway miles and rail ton miles are in direct competition. However, this assumption appears to be reasonable in the absence of more detailed information on the percentage of total miles and ton-miles that are subject to potential mode shifting.

For CSI's calculations, all costs except fuel costs and vehicle costs were taken from the 2008 ATRI study. It is not clear from the report how the new vehicle costs were incorporated into the per mile operating costs calculations. For example, in both the ATRI report and the CSI report, assumptions about depreciation, useful life, and the opportunity cost of capital are not explicitly discussed.

Based on these two scenarios, CSI found a rebound effect of 11-31 percent for Scenario 1 and 5-16 percent for Scenario 2 when the fuel savings from reduced rail usage were not taken into account ("First rebound effect"). When the fuel savings from reduced rail usage were included in the calculations, the overall rebound effect was between 9-13 percent for Scenario 1 and 3-15 percent for Scenario 2 ("Second Rebound Effect"). See Table 9-1.

CSI included a number of caveats associated with these calculations. Namely, the elasticity estimates derived from the literature are "heavily reliant on factors including the type of demand measures analyzed (vehicle-miles of travel, ton-miles, or tons), geography, trip lengths, markets served, and commodities transported." Furthermore, the CSI example only focused on Class 8 trucks and did not attempt to quantify the potential rebound effect for any

Regulatory Impact Analysis

other truck classes. Finally, these scenarios were characterized as “sketches” and were not included in the final NAS report. In fact, the NAS report asserted that it is “not possible to provide a confident measure of the rebound effect”, yet concluded that a rebound effect likely exists and that “estimates of fuel savings from regulatory standards will be somewhat misestimated if the rebound effect is not considered.”

Table 9-1 Range of Rebound Effect Estimates from Cambridge Systematics Aggregate Assessment

	Scenario 1 (6.8 mpg, \$22,930)	Scenario 2 (9.1 mpg, \$71,630)
“First Rebound Effect” (increase in truck VMT resulting from decrease in operating costs)	11-31%	5-16%
“Second Rebound Effect” (net fuel savings when decreases from rail are taken into account)	9-13 %	3-15%

As an alternative, using the econometric approach, NHTSA has estimated the rebound effect in the short-run and long run for single unit (Class 4-7) and combination (Class 8) trucks. As shown in Table 9-2, the estimates for the long-run rebound effect are larger than the estimates in the short run, which is consistent with the theory that shippers have more flexibility to change their behavior (*e.g.*, restructure contracts or logistics) when they are given more time. In addition, the estimates derived from the national data also showed larger rebound effects compared to the state data.²⁰

One possible explanation for the difference in the estimates is that the national rebound estimates are capturing some of the impacts of changes in economic activity. Historically, large increases in fuel prices are highly correlated with economic downturns, and there may not be enough variation in the national data to differentiate the impact of fuel price changes from changes in economic activity. In contrast, some states may see an increase in output when energy prices increase (*e.g.*, large oil producing states such as Texas and Alaska), therefore the state data may be more accurately isolating the impact of fuel price changes from that of changes in economic activity. It is important to note that these estimates of the rebound effect reflect the partial effects of fuel prices and fuel economy changes on truck usage, but not the effect of truck prices. Therefore, these estimates do not take into account the partially offsetting impacts of increases in new vehicle costs that are likely to result from regulations requiring higher fuel economy. For example, if the increase in new vehicle prices associated with increased fuel economy offset half of the resulting savings in fuel costs, then the effective rebound effect would be half of the value shown in Table 9-2.

Table 9-2 Range of Rebound Effect Estimates from NHTSA Econometric Analysis

Truck Type	National Data		State Data	
	Short Run	Long Run	Short Run	Long Run
Single Unit	13-22%	28-45%	3-8%	12-21%
Combination	N/A	12-14%	N/A	4-5%

Heavy-Duty GHG and Fuel Efficiency Standards FRM: Economic and Other Impacts

As discussed throughout this section, there are multiple methodologies for quantifying the rebound effect, and these different methodologies produce a large range of potential values of the rebound effect. However, for the purposes of quantifying the rebound effect for this program, we have used a rebound effect with respect to changes in fuel costs per mile on the lower range of the long-run estimates. Given the fact that the long-run state econometric estimates are generally more consistent with the aggregate estimates, for this program we have chosen a rebound effect for vocational vehicles of 15 percent that is within the range of estimates from both methodologies. Similarly, we have chosen a rebound effect for combination tractors of 5 percent.

To date, no estimates of the HD pickup truck and van (Class 2b and 3) rebound effect have been cited in the literature. Since these vehicles are used for very different purposes than heavy-duty vehicles, it does not necessarily seem appropriate to apply one of the heavy-duty estimates to the HD pickup trucks and vans. These vehicles are more similar in use to large light-duty vehicles, so for the purposes of our analysis, we have chosen to apply the light-duty rebound effect of 10 percent used in the recent final rule establishing fuel economy and GHG standards for MYs 2012-2016 light-duty vehicles to this class of vehicles.

9.3.4 Application of the Rebound Effect to VMT Estimates

It should be noted that the NHTSA econometric analysis attempts to isolate the rebound effect with respect to changes in the fuel cost per mile driven. As described previously, the rebound effect should be a measure of the change in VMT with respect to the change in overall operating costs. Therefore, NHTSA's rebound estimates with respect to fuel costs per mile must be "scaled" to apply to total operating costs. For example, we assumed the elasticity of Class 8 truck use with respect to fuel cost per mile driven is -0.05 (which corresponds to a 5 percent fuel economy rebound effect), and that fuel costs average 45 percent of total truck operating costs; therefore, the elasticity of truck use with respect to total operating costs is $-0.05/0.45 = -0.11$. This calculation would correspond to an "overall" rebound effect value – that is, a rebound effect with respect to total truck operating costs – of -11 percent. In other words, cutting fuel costs per mile by 10 percent would correspond to only a 4.5 percent decline in total truck operating costs, so the elasticity of truck use with respect to total operating costs would have to be 2.3 times (100%/45%) larger than the elasticity of truck use with respect to fuel cost alone, in order to produce the same response in truck VMT ($4.5\% * -0.11 = 10\% * -0.05$). We conducted similar calculations for 2b/3 trucks assuming fuel costs are on average 21 percent of total operating costs, and for vocational vehicles assuming fuel costs are on average 25 percent of total operating costs. Furthermore, due to timing constraints we assumed an "average" incremental technology cost including indirect costs, as shown in Table 9-3, based on the estimates developed for the NPRM, which differ slightly from the values included in RIA Chapter 7.

Table 9-3: Technology Costs Used to Determine the Rebound Effect of Each Alternative

Vehicle Category	Alternative 2	Alternative 3 (Preferred Case)	Alternative 4	Alternative 5
Combination Tractors	\$3,909	\$5,901	\$10,048	\$17,040
HD Pickup Trucks and Vans	\$918	\$1,411	\$2,283	\$6,783
Vocational Vehicles	\$253	\$359	\$1,959	\$13,692

Regulatory Impact Analysis

For the purposes of this rulemaking, we made several additional simplifying assumptions when applying the overall rebound effect to each class of truck. For example, we assumed that per mile vehicle costs were based on the new vehicle cost (*e.g.*, \$100,000 for the reference case Class 8 combination tractor) divided by the total lifetime number of expected vehicle miles (*e.g.*, 1.26 million miles for a Class 8 combination tractor, 288,000 miles for 2b/3 trucks, and 334,000 miles for vocational vehicles). We recognize that this calculation implicitly assumes that truck depreciation is strictly a function of usage, and that it does not take into account the opportunity cost of alternative uses of capital. As a result, the new vehicle cost per mile assumptions used in these calculations represent a smaller percentage of total operating costs compared to the ATRI and CSI examples. Furthermore, this assumption implies that the new vehicle buyer and the used vehicle buyer value fuel economy in the same way. Although anecdotal evidence suggests fuel efficiency may not be taken into account in the used vehicle market, this phenomenon is not well understood and therefore not taken into account in this analysis. Other simplifying assumptions include the use of an average cost rather than a marginal cost. Some shippers may use a marginal cost to determine whether to increase their fuel usage, however we do not have any data on when shippers might use a marginal cost calculation rather than an average cost calculation. Although using a marginal cost might be more appropriate for calculating the rebound effect, we do not have a methodology for calculating the marginal cost.²¹

In the costs and benefits summarized in Chapter 9.8, we have not taken into account any potential fuel savings or GHG emission reductions from the rail, air or water-borne shipping sectors due to mode shifting. However, we have provided CSI's example calculations in Table 9-1. The rebound effect values used in the cost and benefit analysis fall within the range of the "second rebound effect" identified in the CSI analysis, which does account for offsetting savings from reduced rail shipping.

In addition, we have not attempted to capture how current market failures might impact the rebound effect. The direction and magnitude of the rebound effect in the HD truck market are expected to vary depending on the existence and types of market failures affecting the fuel economy of the trucking fleet. If firms are already accurately accounting for the costs and benefits of these technologies and fuel savings, then these regulations would increase their net costs, because trucks would already include all cost-effective fuel saving technologies. As a result, the rebound effect would actually be negative and truck VMT would *decrease* as a result of these regulations.

However, if firms are not optimizing their behavior today due to factors such as lack of reliable information (see preamble Section VIII.A. of the preamble to the final rules for further discussion), it is more likely that truck VMT would increase. If firms recognize their lower net costs as a result of these regulations and pass those costs along to their customers, then the rebound effect would increase truck VMT. This response assumes that trucking rates include both truck purchase costs and fuel costs, and that the truck purchase costs included in the rates spread those costs over the full expected lifetime of the trucks. If those costs are spread over a shorter period, as the expected short payback period implies, then those purchase costs will inhibit reduction of freight rates, and to the extent that they do so the rebound effect will be proportionally smaller.

As discussed in more detail in preamble Section VIII.A of the final rules, if there are market failures such as split incentives, estimating the rebound effect may depend on the nature of the failures. For example, if the original purchaser cannot fully recoup the higher upfront costs through fuel savings before selling the vehicle nor pass those costs onto the resale buyer, the firm would be expected to raise shipping rates. A firm purchasing the truck second-hand might lower shipping rates if the firm recognizes the cost savings after operating the vehicle, leading to an increase in VMT. Similarly, if there are split incentives and the vehicle buyer is not the same entity that purchases the fuel, then there would theoretically be a positive rebound effect. In this scenario, fuel savings would lower the net costs to the fuel purchaser, which would result in a larger increase in truck VMT.

If all of these scenarios occur in the marketplace, their consequences for the rebound effect will depend on the extent and magnitude of their relative effects, which are also likely to vary across truck classes (for instance, split incentives may be a much larger problem for Class 7 and 8 combination tractor than they are for heavy-duty pickup trucks).

9.4 Monetized CO₂ Impacts

We assigned a dollar value to reductions in carbon dioxide (CO₂) emissions using recent estimates of the “social cost of carbon” (SCC). The SCC is an estimate of the monetized damages associated with an incremental increase in carbon emissions in a given year. It is intended to include (but is not limited to) changes in net agricultural productivity, human health, property damages from increased flood risk, and the value of ecosystem services due to climate change. The SCC estimates used in this analysis were developed through an interagency process that included EPA, DOT/NHTSA, and other executive branch entities, and concluded in February 2010. We first used these SCC estimates in the benefits analysis for the final joint EPA/DOT Rulemaking to establish Light-Duty Vehicle Greenhouse Gas Emission Standards and Corporate Average Fuel Economy Standards; see that rulemaking’s preamble for discussion about application of the SCC (75 FR 25324; 5/7/10). The SCC Technical Support Document (SCC TSD) provides a complete discussion of the methods used to develop these SCC estimates.²²

The interagency group selected four SCC values for use in regulatory analyses, which we have applied in this analysis: \$5, \$22, \$36, and \$67 per metric ton of CO₂ emissions in 2010, in 2009 dollars.^{23,24} The first three values are based on the average SCC from three integrated assessment models, at discount rates of 5, 3, and 2.5 percent, respectively. SCCs at several discount rates are included because the literature shows that the SCC is quite sensitive to assumptions about the discount rate, and because no consensus exists on the appropriate rate to use in an intergenerational context. The fourth value is the 95th percentile of the SCC from all three models at a 3 percent discount rate. It is included to represent higher-than-expected impacts from temperature change further out in the tails of the SCC distribution. Low probability, high impact events are incorporated into all of the SCC values through explicit consideration of their effects in two of the three models as well as the use of a probability density function for equilibrium climate sensitivity. Treating climate sensitivity probabilistically results in more high temperature outcomes, which in turn lead to higher projections of damages.

Regulatory Impact Analysis

The SCC increases over time because future emissions are expected to produce larger incremental damages as physical and economic systems become more stressed in response to greater climatic change. Note that the interagency group estimated the growth rate of the SCC directly using the three integrated assessment models rather than assuming a constant annual growth rate. This helps to ensure that the estimates are internally consistent with other modeling assumptions. Table 9-4 presents the SCC estimates used in this analysis.

When attempting to assess the incremental economic impacts of carbon dioxide emissions, the analyst faces a number of serious challenges. A recent report from the National Academies of Science (NRC 2009) points out that any assessment will suffer from uncertainty, speculation, and lack of information about (1) future emissions of greenhouse gases, (2) the effects of past and future emissions on the climate system, (3) the impact of changes in climate on the physical and biological environment, and (4) the translation of these environmental impacts into economic damages.²⁵ As a result, any effort to quantify and monetize the harms associated with climate change will raise serious questions of science, economics, and ethics and should be viewed as provisional.

The interagency group noted a number of limitations to the SCC analysis, including the incomplete way in which the integrated assessment models capture catastrophic and non-catastrophic impacts, their incomplete treatment of adaptation and technological change, uncertainty in the extrapolation of damages to high temperatures, and assumptions regarding risk aversion. The limited amount of research linking climate impacts to economic damages makes the interagency modeling exercise even more difficult. The interagency group hopes that over time researchers and modelers will work to fill these gaps and that the SCC estimates used for regulatory analysis by the Federal government will continue to evolve with improvements in modeling. Additional details on these limitations are discussed in the SCC TSD.

In light of these limitations, the interagency group has committed to updating the current estimates as the science and economic understanding of climate change and its impacts on society improves over time. Specifically, the interagency group has set a preliminary goal of revisiting the SCC values in the next few years or at such time as substantially updated models become available, and to continue to support research in this area.

Applying the global SCC estimates, shown in Table 9-4, to the estimated reductions in domestic CO₂ emissions for the final program, we estimate the dollar value of the climate related benefits for each analysis year. For internal consistency, the annual benefits are discounted back to net present value terms using the same discount rate as each SCC estimate (*i.e.* 5 percent, 3 percent, and 2.5 percent) rather than 3 percent and 7 percent.^A The SCC estimates are presented in and the associated CO₂ benefit estimates for each calendar year are shown in Table 9-5.

^A It is possible that other benefits or costs of proposed regulations unrelated to CO₂ emissions will be discounted at rates that differ from those used to develop the SCC estimates.

Heavy-Duty GHG and Fuel Efficiency Standards FRM: Economic and Other Impacts

Table 9-4: Social Cost of CO₂, 2012 – 2050^a (in 2009\$ per Metric Ton)

Year	Discount Rate and Statistic			
	5% Average	3% Average	2.5% Average	3% 95 th percentile
2012	\$5.284	\$23.06	\$37.53	\$70.14
2015	\$5.93	\$24.58	\$39.57	\$74.03
2020	\$7.01	\$27.10	\$42.98	\$83.17
2025	\$8.53	\$30.43	\$47.28	\$93.11
2030	\$10.05	\$33.75	\$51.58	\$103.06
2035	\$11.57	\$37.08	\$55.88	\$113.00
2040	\$13.09	\$40.40	\$60.19	\$122.95
2045	\$14.63	\$43.34	\$63.59	\$131.66
2050	\$16.18	\$46.27	\$66.99	\$140.37

^a The SCC values are dollar-year and emissions-year specific.

Table 9-5: Upstream and Downstream CO₂ Benefits for the Given SCC Value, Calendar Year Analysis^a (Millions of 2009\$)

YEAR	5% (AVERAGE SCC = \$5 IN 2012)	3% (AVERAGE SCC = \$23 IN 2012)	2.5% (AVERAGE SCC = \$38 IN 2012)	3% (95 TH PERCENTILE = \$70 IN 2012)
2012	\$0	\$0	\$0	\$0
2013	\$0	\$0	\$0	\$0
2014	\$33	\$141	\$227	\$429
2015	\$63	\$262	\$422	\$800
2016	\$93	\$379	\$608	\$1,157
2017	\$134	\$539	\$862	\$1,648
2018	\$179	\$709	\$1,131	\$2,172
2019	\$221	\$867	\$1,379	\$2,659
2020	\$264	\$1,021	\$1,619	\$3,133
2021	\$310	\$1,177	\$1,858	\$3,609
2022	\$357	\$1,331	\$2,093	\$4,080
2023	\$404	\$1,484	\$2,324	\$4,547
2024	\$451	\$1,634	\$2,548	\$5,002
2025	\$499	\$1,781	\$2,767	\$5,450
2026	\$546	\$1,924	\$2,978	\$5,884
2027	\$593	\$2,061	\$3,180	\$6,302
2028	\$640	\$2,197	\$3,378	\$6,712
2029	\$686	\$2,331	\$3,573	\$7,119
2030	\$734	\$2,467	\$3,770	\$7,532
2031	\$780	\$2,592	\$3,949	\$7,910
2032	\$823	\$2,710	\$4,117	\$8,268
2033	\$866	\$2,826	\$4,282	\$8,619
2034	\$911	\$2,944	\$4,449	\$8,975
2035	\$955	\$3,061	\$4,614	\$9,330
2036	\$1,000	\$3,179	\$4,779	\$9,685
2037	\$1,045	\$3,296	\$4,944	\$10,040
2038	\$1,091	\$3,414	\$5,109	\$10,395
2039	\$1,136	\$3,532	\$5,273	\$10,751
2040	\$1,182	\$3,650	\$5,437	\$11,108
2041	\$1,229	\$3,759	\$5,583	\$11,437

Regulatory Impact Analysis

YEAR	5% (AVERAGE SCC = \$5 IN 2012)	3% (AVERAGE SCC = \$23 IN 2012)	2.5% (AVERAGE SCC = \$38 IN 2012)	3% (95 TH PERCENTILE = \$70 IN 2012)
2042	\$1,276	\$3,870	\$5,729	\$11,770
2043	\$1,324	\$3,983	\$5,878	\$12,107
2044	\$1,373	\$4,097	\$6,029	\$12,452
2045	\$1,422	\$4,212	\$6,180	\$12,796
2046	\$1,473	\$4,328	\$6,333	\$13,145
2047	\$1,524	\$4,446	\$6,488	\$13,500
2048	\$1,575	\$4,566	\$6,644	\$13,858
2049	\$1,628	\$4,687	\$6,802	\$14,220
2050	\$1,682	\$4,810	\$6,963	\$14,590
NPV ^b	\$9,045	\$46,070	\$78,037	\$140,432

^aThe SCC values are dollar-year and emissions-year specific.

^bNote that net present value of reduced GHG emissions is calculated differently than other benefits. The same discount rate used to discount the value of damages from future emissions (SCC at 5, 3, 2.5 percent) is used to calculate net present value of SCC for internal consistency. Refer to SCC TSD for more detail.

We also conducted a separate analysis of the CO₂ benefits over the model year lifetimes of the 2014 through 2018 model year vehicles. In contrast to the calendar year analysis, the model year lifetime analysis shows the lifetime impacts of the program on each of these MY fleets over the course of its lifetime. Full details of the inputs to this analysis can be found in RIA chapter 5. The CO₂ benefits of the full life of each of the five model years from 2014 through 2018 are shown in Table 9-6 through Table 9-9 for each of the four different social cost of carbon values. The CO₂ benefits are shown for each year in the model year life and in net present value. The same discount rate used to discount the value of damages from future emissions (SCC at 5, 3, 2.5%) is used to calculate net present value of SCC for internal consistency.

(see Table 9-6 on the next page)

Heavy-Duty GHG and Fuel Efficiency Standards FRM: Economic and Other Impacts

Table 9-6: Upstream and Downstream CO₂ Benefits for the 5% (Average SCC) Value, Model Year Analysis^a
(Millions of 2009\$)

YEAR	MY 2014	MY 2015	MY 2016	MY 2017	MY 2018	SUM
2012	\$0	\$0	\$0	\$0	\$0	\$0
2013	\$0	\$0	\$0	\$0	\$0	\$0
2014	\$34	\$0	\$0	\$0	\$0	\$34
2015	\$32	\$31	\$0	\$0	\$0	\$63
2016	\$30	\$29	\$31	\$0	\$0	\$91
2017	\$28	\$28	\$30	\$47	\$0	\$133
2018	\$26	\$26	\$28	\$44	\$54	\$178
2019	\$24	\$24	\$26	\$41	\$51	\$166
2020	\$22	\$22	\$24	\$39	\$48	\$155
2021	\$20	\$20	\$23	\$36	\$46	\$145
2022	\$18	\$19	\$21	\$33	\$43	\$134
2023	\$17	\$17	\$19	\$31	\$40	\$123
2024	\$15	\$15	\$17	\$28	\$37	\$112
2025	\$13	\$14	\$16	\$26	\$33	\$102
2026	\$12	\$12	\$14	\$23	\$31	\$92
2027	\$11	\$11	\$13	\$21	\$28	\$83
2028	\$9	\$10	\$11	\$19	\$25	\$74
2029	\$8	\$9	\$10	\$17	\$23	\$66
2030	\$7	\$7	\$9	\$15	\$20	\$57
2031	\$6	\$6	\$8	\$13	\$18	\$51
2032	\$5	\$6	\$7	\$11	\$15	\$44
2033	\$4	\$5	\$6	\$10	\$14	\$39
2034	\$4	\$4	\$5	\$9	\$12	\$33
2035	\$3	\$4	\$4	\$7	\$10	\$29
2036	\$3	\$3	\$4	\$6	\$9	\$25
2037	\$2	\$3	\$3	\$5	\$8	\$21
2038	\$2	\$2	\$3	\$5	\$7	\$18
2039	\$2	\$2	\$2	\$4	\$6	\$15
2040	\$1	\$1	\$2	\$3	\$5	\$13
2041	\$1	\$1	\$2	\$3	\$4	\$11
2042	\$1	\$1	\$1	\$2	\$3	\$9
2043	\$1	\$1	\$1	\$2	\$3	\$8
2044	\$1	\$1	\$1	\$2	\$2	\$7
2045	\$0	\$1	\$1	\$1	\$2	\$5
2046	\$0	\$0	\$1	\$1	\$2	\$4
2047	\$0	\$0	\$0	\$1	\$2	\$3
2048	\$0	\$0	\$0	\$0	\$2	\$2
2049	\$0	\$0	\$0	\$0	\$0	\$0
2050	\$0	\$0	\$0	\$0	\$0	\$0
NPV, 5%	\$200	\$200	\$200	\$300	\$300	\$1,200

^aThe SCC values are dollar-year and emissions-year specific.

Regulatory Impact Analysis

Table 9-7: Upstream and Downstream CO₂ Benefits for the 3% (Average SCC) SCC Value, Model Year Analysis^a (Millions of 2009\$)

YEAR	MY 2014	MY 2015	MY 2016	MY 2017	MY 2018	SUM
2012	\$0	\$0	\$0	\$0	\$0	\$0
2013	\$0	\$0	\$0	\$0	\$0	\$0
2014	\$143	\$0	\$0	\$0	\$0	\$143
2015	\$131	\$129	\$0	\$0	\$0	\$261
2016	\$123	\$120	\$128	\$0	\$0	\$371
2017	\$114	\$112	\$120	\$188	\$0	\$534
2018	\$104	\$104	\$111	\$174	\$215	\$708
2019	\$94	\$94	\$102	\$161	\$199	\$651
2020	\$85	\$86	\$94	\$149	\$186	\$600
2021	\$76	\$78	\$86	\$138	\$173	\$551
2022	\$69	\$70	\$78	\$125	\$160	\$501
2023	\$61	\$62	\$70	\$113	\$145	\$452
2024	\$54	\$56	\$63	\$102	\$132	\$406
2025	\$48	\$49	\$56	\$92	\$119	\$364
2026	\$42	\$44	\$50	\$82	\$108	\$325
2027	\$37	\$38	\$44	\$73	\$97	\$289
2028	\$32	\$33	\$39	\$65	\$86	\$255
2029	\$28	\$29	\$34	\$57	\$77	\$225
2030	\$23	\$25	\$29	\$49	\$66	\$193
2031	\$20	\$21	\$26	\$43	\$58	\$168
2032	\$17	\$18	\$22	\$37	\$51	\$146
2033	\$15	\$16	\$19	\$32	\$44	\$126
2034	\$12	\$13	\$16	\$28	\$38	\$108
2035	\$10	\$11	\$14	\$24	\$33	\$92
2036	\$9	\$10	\$12	\$20	\$28	\$78
2037	\$7	\$8	\$10	\$17	\$24	\$66
2038	\$6	\$7	\$8	\$15	\$20	\$56
2039	\$5	\$6	\$7	\$12	\$17	\$47
2040	\$4	\$5	\$6	\$10	\$15	\$40
2041	\$3	\$4	\$5	\$9	\$12	\$33
2042	\$3	\$3	\$4	\$7	\$10	\$28
2043	\$2	\$3	\$3	\$6	\$9	\$23
2044	\$3	\$2	\$3	\$5	\$7	\$20
2045	\$0	\$3	\$2	\$4	\$6	\$15
2046	\$0	\$0	\$3	\$4	\$5	\$12
2047	\$0	\$0	\$0	\$4	\$4	\$9
2048	\$0	\$0	\$0	\$0	\$5	\$5
2049	\$0	\$0	\$0	\$0	\$0	\$0
2050	\$0	\$0	\$0	\$0	\$0	\$0
NPV, 3%	\$1,100	\$900	\$900	\$1,300	\$1,500	\$5,700

^aThe SCC values are dollar-year and emissions-year specific.

Heavy-Duty GHG and Fuel Efficiency Standards FRM: Economic and Other Impacts

Table 9-8: Upstream and Downstream CO₂ Benefits for the from 2.5% (Average SCC) SCC Value, Model Year Analysis^a (Millions of 2009\$)

YEAR	MY 2014	MY 2015	MY 2016	MY 2017	MY 2018	SUM
2012	\$0	\$0	\$0	\$0	\$0	\$0
2013	\$0	\$0	\$0	\$0	\$0	\$0
2014	\$230	\$0	\$0	\$0	\$0	\$230
2015	\$212	\$208	\$0	\$0	\$0	\$420
2016	\$197	\$193	\$205	\$0	\$0	\$595
2017	\$183	\$180	\$191	\$300	\$0	\$853
2018	\$166	\$165	\$177	\$278	\$343	\$1,129
2019	\$150	\$150	\$163	\$256	\$317	\$1,035
2020	\$135	\$136	\$149	\$237	\$294	\$951
2021	\$121	\$123	\$136	\$217	\$273	\$870
2022	\$108	\$109	\$123	\$197	\$251	\$787
2023	\$96	\$98	\$109	\$177	\$228	\$708
2024	\$84	\$87	\$98	\$159	\$206	\$634
2025	\$74	\$77	\$88	\$142	\$185	\$566
2026	\$65	\$68	\$78	\$127	\$167	\$504
2027	\$57	\$59	\$69	\$113	\$149	\$446
2028	\$49	\$52	\$60	\$100	\$132	\$393
2029	\$43	\$45	\$53	\$87	\$117	\$345
2030	\$36	\$38	\$45	\$75	\$101	\$295
2031	\$31	\$33	\$39	\$65	\$89	\$257
2032	\$26	\$28	\$34	\$57	\$77	\$222
2033	\$22	\$24	\$29	\$49	\$67	\$190
2034	\$19	\$20	\$25	\$42	\$58	\$163
2035	\$16	\$17	\$21	\$36	\$50	\$139
2036	\$13	\$14	\$18	\$30	\$43	\$118
2037	\$11	\$12	\$15	\$26	\$36	\$100
2038	\$9	\$10	\$13	\$22	\$31	\$84
2039	\$8	\$8	\$11	\$18	\$26	\$71
2040	\$6	\$7	\$9	\$15	\$22	\$59
2041	\$5	\$6	\$7	\$13	\$18	\$49
2042	\$4	\$5	\$6	\$11	\$15	\$41
2043	\$3	\$4	\$5	\$9	\$13	\$34
2044	\$4	\$3	\$4	\$7	\$11	\$30
2045	\$0	\$4	\$3	\$6	\$9	\$23
2046	\$0	\$0	\$4	\$5	\$8	\$17
2047	\$0	\$0	\$0	\$6	\$6	\$13
2048	\$0	\$0	\$0	\$0	\$8	\$8
2049	\$0	\$0	\$0	\$0	\$0	\$0
2050	\$0	\$0	\$0	\$0	\$0	\$0
NPV, 2.5%	\$1,800	\$1,600	\$1,500	\$2,100	\$2,400	\$9,400

^aThe SCC values are dollar-year and emissions-year specific.

Regulatory Impact Analysis

Table 9-9: Upstream and Downstream CO₂ Benefits for the 3% (95th Percentile) SCC Value, Model Year Analysis^a (Millions of 2009\$)

YEAR	MY 2014	MY 2015	MY 2016	MY 2017	MY 2018	SUM
2012	\$0	\$0	\$0	\$0	\$0	\$0
2013	\$0	\$0	\$0	\$0	\$0	\$0
2014	\$435	\$0	\$0	\$0	\$0	\$435
2015	\$401	\$394	\$0	\$0	\$0	\$795
2016	\$375	\$368	\$391	\$0	\$0	\$1,133
2017	\$349	\$343	\$366	\$574	\$0	\$1,632
2018	\$320	\$318	\$340	\$533	\$659	\$2,168
2019	\$288	\$290	\$314	\$493	\$611	\$1,996
2020	\$261	\$263	\$289	\$458	\$570	\$1,841
2021	\$235	\$239	\$263	\$422	\$531	\$1,690
2022	\$210	\$213	\$239	\$383	\$489	\$1,535
2023	\$187	\$191	\$214	\$347	\$445	\$1,385
2024	\$165	\$171	\$192	\$311	\$405	\$1,244
2025	\$146	\$151	\$173	\$280	\$365	\$1,115
2026	\$128	\$134	\$153	\$251	\$329	\$995
2027	\$112	\$117	\$136	\$223	\$296	\$884
2028	\$98	\$102	\$119	\$198	\$263	\$781
2029	\$85	\$89	\$105	\$174	\$234	\$687
2030	\$72	\$76	\$90	\$150	\$202	\$589
2031	\$62	\$65	\$78	\$131	\$178	\$514
2032	\$53	\$56	\$67	\$114	\$156	\$445
2033	\$44	\$48	\$58	\$98	\$135	\$383
2034	\$38	\$41	\$50	\$84	\$117	\$329
2035	\$32	\$34	\$42	\$72	\$101	\$281
2036	\$27	\$29	\$36	\$62	\$86	\$239
2037	\$22	\$24	\$30	\$52	\$73	\$202
2038	\$19	\$20	\$25	\$44	\$62	\$171
2039	\$15	\$17	\$21	\$37	\$53	\$144
2040	\$13	\$14	\$18	\$31	\$44	\$120
2041	\$10	\$12	\$15	\$26	\$37	\$101
2042	\$9	\$10	\$12	\$22	\$32	\$84
2043	\$7	\$8	\$10	\$18	\$27	\$70
2044	\$8	\$6	\$9	\$15	\$22	\$61
2045	\$0	\$8	\$7	\$13	\$19	\$47
2046	\$0	\$0	\$9	\$11	\$16	\$35
2047	\$0	\$0	\$0	\$13	\$13	\$26
2048	\$0	\$0	\$0	\$0	\$16	\$16
2049	\$0	\$0	\$0	\$0	\$0	\$0
2050	\$0	\$0	\$0	\$0	\$0	\$0
NPV, 3%	\$3,300	\$2,900	\$2,800	\$4,000	\$4,500	\$17,000

^a The SCC values are dollar-year and emissions-year specific.

9.5 Additional Impacts

9.5.1 Noise, Congestion, and Accidents

Section 9.3 discusses the likely sign of the rebound effect. If net operating costs of the vehicle decline, then we expect a positive rebound effect. Increased vehicle use associated with a positive rebound effect also contributes to increased traffic congestion, motor vehicle accidents, and highway noise. Depending on how the additional travel is distributed throughout the day and on where it takes place, additional vehicle use can contribute to traffic congestion and delays by increasing traffic volumes on facilities that are already heavily traveled during peak periods. These added delays impose higher costs on drivers and other vehicle occupants in the form of increased travel time and operating expenses. Because drivers do not take these added costs into account in deciding when and where to travel, they must be accounted for separately as a cost of the added driving associated with the rebound effect.

Increased vehicle use due to a positive rebound effect may also increase the costs associated with traffic accidents. Drivers may take account of the potential costs they (and their passengers) face from the possibility of being involved in an accident when they decide to make additional trips. However, they probably do not consider all of the potential costs they impose on occupants of other vehicles and on pedestrians when accidents occur, so any increase in these “external” accident costs must be considered as another cost of additional rebound-effect driving. Like increased delay costs, any increase in external accident costs caused by added driving is likely to depend on the traffic conditions under which it takes place, since accidents are more frequent in heavier traffic (although their severity may be reduced by the slower speeds at which heavier traffic typically moves).

Finally, added vehicle use associated with a positive rebound effect may also increase traffic noise. Noise generated by vehicles causes inconvenience, irritation, and potentially even discomfort to occupants of other vehicles, to pedestrians and other bystanders, and to residents or occupants of surrounding property. Because these effects are unlikely to be taken into account by the drivers whose vehicles contribute to traffic noise, they represent additional externalities associated with motor vehicle use. Although there is considerable uncertainty in measuring their value, any increase in the economic costs of traffic noise resulting from added vehicle use should be included together with other increased external costs from the rebound effect.

EPA and NHTSA rely on estimates of congestion, accident, and noise costs caused by pickup trucks and vans, single unit trucks, buses, and combination tractors developed by the Federal Highway Administration to estimate the increased external costs caused by added driving due to the rebound effect.²⁶ The FHWA estimates are intended to measure the increases in costs from added congestion, property damages and injuries in traffic accidents, and noise levels caused by various classes of trucks that are borne by persons other than their drivers (or “marginal” external costs). EPA and NHTSA employed estimates from this source previously in the analysis accompanying the light-duty 2012-2016 vehicle rulemaking. The agencies continue to find them appropriate for this analysis after reviewing the procedures used by FHWA to develop them and considering other available estimates of these values.

Regulatory Impact Analysis

FHWA’s congestion cost estimates for trucks, which are weighted averages based on the estimated fractions of peak and off-peak freeway travel for each class of trucks, already account for the fact that trucks make up a smaller fraction of peak period traffic on congested roads because they try to avoid peak periods when possible. FHWA’s congestion cost estimates focus on freeways because non-freeway effects are less serious due to lower traffic volumes and opportunities to re-route around the congestion. The agencies, however, applied the congestion cost to the overall VMT increase, though the fraction of VMT on each road type used in MOVES range from 27 to 29 percent of the vehicle miles on freeways for vocational vehicles and 53 percent for combination tractors. The results of this analysis potentially overestimate the congestions costs associated with increased truck use, and thus lead to a conservative estimate of benefits.

EPA and NHTSA estimated the costs of additional vocational vehicle travel using a weighted average of 15 percent of the FHWA estimate for bus costs and 85 percent of the FHWA estimate for single unit truck costs to reflect the make-up of this segment. The low, mid, and high cost estimates from FHWA updated to 2009 dollars are included in Table 9-10.

Table 9-10 Low-Mid-High Cost Estimates (2009\$/mile)

Noise			
	High	Middle	Low
Pickup Truck, Van	\$0.002	\$0.001	\$0.000
Vocational Vehicle	\$0.025	\$0.009	\$0.003
Combination Tractor	\$0.052	\$0.020	\$0.006
Accidents			
	High	Middle	Low
Pickup Truck, Van	\$0.083	\$0.027	\$0.014
Vocational Vehicle	\$0.059	\$0.019	\$0.010
Combination Tractor	\$0.070	\$0.022	\$0.010
Congestion			
	High	Middle	Low
Pickup Truck, Van	\$0.145	\$0.049	\$0.013
Vocational Vehicle	\$0.327	\$0.111	\$0.029
Combination Tractor	\$0.319	\$0.108	\$0.029

The agencies are using FHWA’s “Middle” estimates for marginal congestion, accident, and noise costs caused by increased travel from trucks.²⁷ This approach is consistent with the current methodology used in the light-duty 2012-2016 vehicle rulemaking analysis. These costs are multiplied by the annual increases in vehicle miles travelled from the rebound effect to yield the estimated increases in congestion, accident, and noise externality costs during each future year.

EPA and NHTSA use the aggregate per mile costs, as shown in Table 9-11 in 2009 dollars. Table 9-12 presents total monetized estimates of external costs associated with noise, accidents, and congestion.

Heavy-Duty GHG and Fuel Efficiency Standards FRM: Economic and Other Impacts

Table 9-11 Combined Costs of Congestion, Accidents and Noise (2009\$ per mile)

Pickup Truck, Van	\$0.077
Vocational Vehicle	\$0.140
Combination Tractor	\$0.150

Table 9-12: Annual External Costs Associated with the Heavy-Duty Vehicle Program (Millions of 2009\$)

YEAR	Class 2b&3	Vocational	Combination	Total
2012	\$0	\$0	\$0	\$0
2013	\$0	\$0	\$0	\$0
2014	\$8	\$21	\$18	\$46
2015	\$15	\$38	\$31	\$84
2016	\$22	\$55	\$43	\$120
2017	\$29	\$71	\$54	\$153
2018	\$36	\$85	\$64	\$186
2019	\$43	\$99	\$74	\$217
2020	\$51	\$112	\$83	\$246
2021	\$58	\$123	\$91	\$272
2022	\$65	\$134	\$98	\$297
2023	\$71	\$144	\$105	\$320
2024	\$77	\$152	\$111	\$341
2025	\$83	\$161	\$117	\$361
2026	\$88	\$168	\$122	\$378
2027	\$93	\$175	\$127	\$394
2028	\$97	\$182	\$131	\$409
2029	\$101	\$188	\$134	\$424
2030	\$105	\$195	\$138	\$437
2031	\$108	\$203	\$142	\$453
2032	\$111	\$210	\$145	\$466
2033	\$114	\$217	\$147	\$478
2034	\$117	\$223	\$150	\$490
2035	\$119	\$229	\$153	\$501
2036	\$122	\$235	\$156	\$512
2037	\$124	\$241	\$158	\$523
2038	\$126	\$246	\$161	\$533
2039	\$128	\$251	\$163	\$542
2040	\$130	\$256	\$166	\$551
2041	\$132	\$260	\$168	\$561
2042	\$134	\$265	\$171	\$569
2043	\$136	\$269	\$173	\$578
2044	\$138	\$274	\$176	\$587
2045	\$140	\$278	\$178	\$596
2046	\$141	\$282	\$181	\$604
2047	\$143	\$286	\$183	\$612
2048	\$145	\$290	\$186	\$621
2049	\$146	\$294	\$188	\$629
2050	\$148	\$298	\$191	\$638
NPV, 3%	\$1,818	\$3,620	\$2,492	\$7,929
NPV, 7%	\$832	\$1,680	\$1,184	\$3,695

9.5.2 Savings due to Reduced Refueling Time

Reducing the fuel consumption of heavy-duty trucks will either increase their driving range before they require refueling, or lead truck manufacturers to offer, and truck purchasers to buy, smaller fuel tanks. Keeping the fuel tank the same size will allow truck operators to reduce the frequency with which drivers typically refuel their vehicles, by extending the upper limit on the distance they can travel before requiring refueling. Alternatively, if truck purchasers and manufacturers respond to improved fuel economy by reducing the size of fuel tanks, the smaller tank will require less time to fill during each refueling stop.

Because refueling time represents a time cost of truck operation, these time savings should be incorporated into truck purchasers' decisions about how much fuel-saving technology they purchase as part of their choices of new vehicles. The savings calculated here thus raise the same questions discussed in preamble Section VIII.A and RIA Chapter 9.1: does the apparent existence of these savings reflect failures in the market for fuel economy, or does it reflect costs that are not addressed in this analysis? The response to these questions could vary across truck segment. See those sections for further analysis of this question.

No direct estimates of the value of extended vehicle range or reduced fuel tank size are readily available. Instead, this analysis calculates the reduction in the annual amount of time a driver of each type of truck will spend filling its fuel tank; this reduced time could result either from fewer refueling events, if new trucks' fuel tanks stay the same size, or from less time spent filling the tank during each refueling stop, if new trucks' fuel tanks are made proportionately smaller. As discussed in Section 9.3 in this RIA, the average number of miles each type of truck is driven annually will increase under the regulation, as truck operators respond to lower fuel costs (the "rebound effect"). The estimates of refueling time with the regulation in effect allow for this increase in truck use. However, EPA's estimate of the rebound effect does not account for any reduction in net operating costs from lower refueling time. Because the rebound effect should measure the change in VMT with respect to the net change in overall operating costs, refueling time costs would ideally factor into this calculation. The effect of this omission is expected to be minor because refueling time savings are small relative to the value of reduced fuel expenditures.

The savings in refueling time are calculated as the total amount of time the driver of a typical truck in each class will save each year as a consequence of pumping less fuel into the vehicle's tank. The calculation does not include any reduction in time spent searching for a fueling station or other time spent at the station; it is assumed that time savings occur only when truck operators are actually refueling their vehicles.

The calculation uses the reduced number of gallons consumed by truck type and divides that value by the fuel dispense rate (shown in Table 9-13) to determine the number of hours saved in a given year. The calculation then applies DOT-recommended values of travel time savings to convert the resulting time savings to their economic value. The DOT-recommended value of travel time per vehicle-hour for truck drivers is \$22.36 in 2009\$ (converted from \$18.10 in 2000\$).²⁸ The inputs used in the analysis are included Table 9-13. The savings associated with reduced refueling time for trucks of each type throughout its lifetime are shown in Table

Heavy-Duty GHG and Fuel Efficiency Standards FRM: Economic and Other Impacts

9-14. The aggregate savings associated with reduced refueling time are shown in Table 9-15 for vehicles sold in 2014 through 2050.

Table 9-13: Inputs to Calculate Refueling Time Savings

	HD PICKUP TRUCK AND VAN	VOCATIONAL VEHICLE	TRACTOR
Fuel Dispensing Rate (gallon/minute) ²⁹	10	10	20

Table 9-14: Lifetime Refueling Savings for a 2018MY Truck of Each Type (2009\$)

	PICKUP TRUCKS AND VANS	VOCATIONAL VEHICLES	TRACTORS
3% Discount Rate	\$31	\$34	\$341
7% Discount Rate	\$19	\$22	\$223

The aggregate savings of the vehicles sold in 2014 through 2050 are listed in Table 9-15.

Table 9-15 Annual Refueling Savings (dollar values in Millions of 2009\$)

Year	CLASS 2B&3		VOCATIONAL		COMBINATION		Total Savings
	Hours Saved	Savings	Hours Saved	Savings	Hours Saved	Savings	
2012	0	\$0	0	\$0	0	\$0	\$0
2013	0	\$0	0	\$0	0	\$0	\$0
2014	7,876	\$0	63,732	\$1	359,414	\$8	\$10
2015	20,994	\$0	116,078	\$3	638,836	\$14	\$17
2016	57,718	\$1	168,357	\$4	874,937	\$20	\$25
2017	118,936	\$3	278,409	\$6	1,195,891	\$27	\$36
2018	231,532	\$5	382,156	\$9	1,510,573	\$34	\$47
2020	467,693	\$10	568,156	\$13	2,065,797	\$46	\$69
2030	1,460,256	\$33	1,154,155	\$26	3,708,140	\$83	\$141
2040	1,939,991	\$43	1,567,826	\$35	4,495,207	\$101	\$179
2050	2,239,008	\$50	1,845,231	\$41	5,190,689	\$116	\$207
NPV, 3%		\$541		\$468		\$1,467	\$2,476
NPV, 7%		\$231		\$210		\$685	\$1,126

9.6 The Effect of Safety Standards and Voluntary Safety Improvements on Vehicle Weight

Safety standards developed by NHTSA in previous rulemakings may make compliance with the fuel efficiency and CO₂ emissions standards more difficult or may reduce the projected benefits of the program. The primary way that safety regulations can impact fuel efficiency and CO₂ emissions is through increased vehicle weight, which reduces the fuel efficiency (and thus increases the CO₂ emissions) of the vehicle. Using MY 2010 as a baseline, this section discusses the effects of other government regulations on MYs 2014-2016 medium and heavy-duty vehicle fuel efficiency and CO₂ emissions. At this time, no known safety standards will affect new models in MY 2017 or 2018. NHTSA's estimates are based on cost and weight tear-down studies of a few vehicles and cannot possibly cover all the variations in the manufacturers' fleets. NHTSA also requested, and various manufacturers provided, confidential estimates of increases in weight resulting from safety improvements. Those increases are shown in subsequent tables.

We have broken down our analysis of the impact of safety standards that might affect the MYs 2014-2016 fleets into three parts: 1) those NHTSA final rules with known effective dates, 2) proposed rules or soon-to-be proposed rules by NHTSA with or without final effective dates, and 3) currently voluntary safety improvements planned by the manufacturers.

9.6.1 Weight Impacts of Required Safety Standards

NHTSA has undertaken several rulemakings in which several standards would become effective for medium- and heavy-duty (MD/HD) vehicles between MY 2014 and MY 2016. We will examine the potential impact on MD/HD vehicle weights for MYs 2014-2016 using MY 2010 as a baseline.

1. FMVSS 119, Heavy Truck Tires Endurance and High Speed Tests
2. FMVSS 121, Air Brake Systems Stopping Distance
3. FMVSS 214, Motor Coach Lap/Shoulder Belts
4. MD/HD Vehicle Electronic Stability Control Systems

9.6.1.1 FMVSS 119, Heavy Truck Tires Endurance and High Speed Tests

NHTSA tentatively determined that the FMVSS No. 119 performance tests developed in 1973 should be updated to reflect the increased operational speeds and duration of truck tires in commercial service. A Notice of Proposed Rulemaking (NPRM) was issued December 7, 2010 (75 FR 60036). It proposed to increase significantly the stringency of the endurance test and to add a new high speed test. The data in the large truck crash causation study (LTCCS) that preceded that NPRM found that J and L load range tires were having proportionately more problems than the other sizes and the agency's test results indicate that H, J, and L load range tires are more likely to fail the proposed requirements among the targeted F, G, H, J and L load range tires.³⁰ To address these problems, the H and J load range tires could potentially use improved rubber compounds, which would add no weight to the tires, to reduce heat retention and improve the durability of the tires. The L load range tires, in contrast, appear to need to use high tensile strength steel chords in the tire bead, carcass and belt areas, which would enable a weight reduction with no strength penalties. Thus, if the update to FMVSS No. 119 was

finalized, we anticipate no change in weight for H and J load range tires and a small reduction in weight for L load range tires. This proposal could become a final rule with an effective date of MY 2016.

9.6.1.2 FMVSS No. 121, Airbrake Systems Stopping Distance

FMVSS No. 121 contains performance and equipment requirements for braking systems on vehicles with air brake systems. The most recent major final rule affecting FMVSS No. 121 was published on July 27, 2009, and became effective on November 24, 2009 (MY 2009). The final rule requires the vast majority of new heavy truck tractors (approximately 99 percent of the fleet) to achieve a 30 percent reduction in stopping distance compared to currently required levels. Three-axle tractors with a gross vehicle weight rating (GVWR) of 59,600 pounds or less must meet the reduced stopping distance requirements by August 1, 2011 (MY 2011), while two-axle tractors and tractors with a GVWR above 59,600 pounds must meet the reduced stopping distance requirements by the later date of August 1, 2013 (MY 2013). NHTSA determined that there are several brake systems that can meet the requirements established in the final rule, including installation of larger S-cam drum brakes or disc brake systems at all positions, or hybrid disc and larger rear S-cam drum brake systems.

According to data provided by a manufacturer (Bendix) in response to the NPRM, the heaviest drum brakes weigh more than the lightest disc brakes, while the heaviest disc brakes weigh more than the lightest drum brakes. For a three-axle tractor equipped with all disc brakes, then, the total weight could increase by 212 pounds or could decrease by 134 pounds compared to an all-drum-braked tractor, depending on which disc or drum brakes are used for comparison. The improved brakes may add a small amount of weight to the affected vehicles for MYs 2014-2016, resulting in a slight increase in fuel consumption.

9.6.1.3 FMVSS No. 208, Motor coach Lap/Shoulder Belts

NHTSA is proposing lap/shoulder belts for all motorcoach seats. About 2,000 motorcoaches are sold per year in the United States. Based on preliminary results from the agency's cost/weight teardown studies of motor coach seats,³¹ NHTSA estimates that the weight added by 3-point lap/shoulder belts ranges from 5.96 to 9.95 pounds per 2-person seat. This is the weight only of the seat belt assembly itself, and does not include changing the design of the seat, reinforcing the floor, walls or other areas of the motor coach. Few current production motor coaches have been installed with lap/shoulder belts on their seats, and the number of vehicles with these belts already installed could be negligible. Assuming a 54 passenger motor coach, the added weight for the 3-point lap/shoulder belt assembly would be in the range of 161 to 269 pounds ($27 * (5.96 \text{ to } 9.95)$) per vehicle. This proposal could become a final rule with an effective date of MY 2016.

9.6.2 Electronic Stability Control Systems (ESC) for Medium- and Heavy-Duty (MD/HD) Vehicles

The purpose of an ESC system for MD/HD vehicles is to reduce crashes caused by rollover or by directional loss-of-control. ESC monitors a vehicle's rollover threshold and lateral stability using vehicle speed, wheel speed, steering wheel angle, lateral acceleration, side slip

Regulatory Impact Analysis

and yaw rate data and upon sensing an impending rollover or loss of directional control situation automatically reduces engine throttle and applies braking forces to individual wheels or sets of wheel to slow the vehicle down and regain directional control. ESC is not currently required in MD/HD vehicles, but could be proposed to be required in these vehicles by NHTSA. FMVSS No. 105, Hydraulic and electric brake systems, requires multipurpose passenger vehicles, trucks and buses with a GVWR greater than 4,536 kg (10,000 pounds) to be equipped with an antilock brake system (ABS). All MD/HD vehicles having a GVWR of more than 10,000 pounds, are required to have ABS installed by that standard.

In addition to the existing ABS functionality, ESC requires sensors including a yaw rate sensor, lateral acceleration sensor, steering angle sensor and brake pressure sensor along with a brake solenoid valve. According to data provided by Meritor WABCO, the weight of an ESC system for the model 4S4M tractor is estimated to be around 55.5 pounds, and the weight of the ABS only is estimated to be 45.5 pounds. Thus, we estimate the added weight for the ESC for the vehicle to be 10 (55.5 – 45.5) pounds.

9.6.3 Summary – Overview of Anticipated Weight Increases

Table 9-16 summarizes estimates made by NHTSA regarding the weight added by the above discussed standards or likely rulemakings. NHTSA estimates that weight additions required by final rules and likely NHTSA regulations effective in MY 2016 compared to the MY 2010 fleet will increase motor coach vehicle weight by 171-279 pounds and will increase other heavy-duty truck weights by 10 pounds.

Table 9-16: Weight Additions Due to Final Rules or Likely NHTSA Regulations: Comparing MY 2016 to the MY 2010 Baseline Fleet

Standard Number	Added Weight in pounds MD/HD Vehicle	Added Weight in kilograms MD/HD Vehicle
119	0	0
121	0 ^a	0 ^a
208 Motor coaches only	161-269	73-122
MD/HD Vehicle Electronic Stability Control Systems	10	4.5
Total Motor coaches	171- 279	77.5-126.5
Total All other MD/HD vehicles	10	4.5

Note: NHTSA's final rule on Air Brakes, docket NHTSA-2009-0083, dated July 27, 2009, concluded that a small amount of weight would be added to the brake systems but a weight value was not provided.

9.6.4 Effects of Vehicle Mass Reduction on Safety

NHTSA and EPA have been considering the effect of vehicle weight on vehicle safety for the past several years in the context of our joint rulemaking for light-duty vehicle CAFE and

Heavy-Duty GHG and Fuel Efficiency Standards FRM: Economic and Other Impacts

GHG standards, consistent with NHTSA's long-standing consideration of safety effects in setting CAFE standards. Combining all modes of impact, the latest analysis by NHTSA for the MYs 2012-2016 final rule³² found that reducing the weight of the heavier light trucks (LT > 3,870) had a positive overall effect on safety, reducing societal fatalities.

In the context of the current rulemaking for HD fuel consumption and GHG standards, one would expect that reducing the weight of medium-duty trucks similarly would, if anything, have a positive impact on safety. However, given the large difference in weight between light-duty vehicles and medium-duty trucks, and even larger difference between light-duty vehicles and heavy-duty vehicles with loads, the agencies believe that the impact of weight reductions of medium- and heavy-duty trucks would not have a noticeable impact on safety for any of these classes of vehicles.

However, the agencies recognize that it is important to conduct further study and research into the interaction of mass, size and safety to assist future rulemakings, and we expect that the collaborative interagency work currently on-going to address this issue for the light-duty vehicle context may also be able to inform our evaluation of safety effects for the final HD vehicle rule. We intend to continue monitoring this issue going forward, and may take steps in a future rulemaking if it appears that the MD/HD fuel efficiency and GHG standards have unforeseen safety consequences. The American Chemistry Council stated in comments to the agencies that plastics and plastic composite materials provide a new way to lighten vehicles while maintaining passenger safety. They added that properties of plastics including strength to weight ratio, energy absorption, and flexible design make these materials well suited for the manufacture of medium- and heavy-duty vehicles. They submitted supporting analyses with their comments. The National School Transportation Association stated that added structural integrity requirements increase weight of school buses, and thus decrease fuel economy. They asked that if there are safety and fuel economy trade-offs manufacturers should be able to receive a waiver from the regulation requirements. Since no weight reduction is required for school buses – or any other vocational vehicle – the agencies do not believe this is an issue with the current regulation.

9.7 Petroleum, Energy and National Security impact

9.7.1 Security Impacts

The HD National Program is designed to reduce fuel consumption and GHG emissions in medium- and heavy-duty (HD) vehicles, which will result in improved fuel efficiency and, in turn, help to reduce U.S. petroleum imports. A reduction of U.S. petroleum imports reduces both financial and strategic risks caused by potential sudden disruptions in the supply of imported petroleum to the U.S. This reduction in risk is a measure of improved U.S. energy security. This section summarizes the agencies' estimates of U.S. oil import reductions and energy security benefits of the final HD National Program. Additional discussion of this issue can be found in Chapter VIII of the preamble.

The agencies recognize that potential national and energy security risks exist due to the possibility of tension over oil supplies. Much of the world's oil and gas supplies are located in countries facing social, economic, and demographic challenges, thus making them even more

Regulatory Impact Analysis

vulnerable to potential local instability. For example, in 2010 just over 40 percent of world oil supply came from OPEC nations, and this share is not expected to decline in the AEO 2011 projections through 2030. Approximately 28 percent of global supply is from Persian Gulf countries alone. As another measure of concentration, of the 137 countries/principalities that export either crude oil or refined petroleum product, the top 12 have recently accounted for over 55 percent of exports.³³ Eight of these countries are members of OPEC, and a 9th is Russia.^B In a market where even a 1-2 percent supply loss raises prices noticeably, and where a 10 percent supply loss could lead to a significant price shock, this regional concentration is of concern.” Historically, the countries of the Middle East have been the source of eight of the ten major world oil disruptions³⁴, with the 9th originating in Venezuela, an OPEC member.

Because of U.S. dependence on oil, the military could be called on to protect energy resources through such measures as securing shipping lanes from foreign oil fields. To maintain such military effectiveness and flexibility, the Department of Defense identified in the Quadrennial Defense Review that it is “increasing its use of renewable energy supplies and reducing energy demand to improve operational effectiveness, reduce greenhouse gas emissions in support of U.S. climate change initiatives, and protect the Department from energy price fluctuations.”³⁵ The Department of the Navy has also stated that the Navy and Marine Corps rely far too much on petroleum, which “degrades the strategic position of our country and the tactical performance of our forces. The global supply of oil is finite, it is becoming increasingly difficult to find and exploit, and over time cost continues to rise.”³⁶ In remarks given to the White House Energy Security Summit on April 26, 2011, Deputy Secretary of Defense William J. Lynn, III noted the direct impact of energy security on military readiness and flexibility. According to Deputy Secretary Lynn, “Today, energy technology remains a critical element of our military superiority. Addressing energy needs must be a fundamental part of our military planning.”³⁷

Thus, to the degree to which the final rule reduces reliance upon imported energy supplies or promotes the development of technologies that can be deployed by either consumers or the nation’s defense forces, the United States could expect benefits related to national security, reduced energy costs, and increased energy supply. These benefits are why President Obama has identified this rule as a key component for improving energy efficiency and putting America on a path to reducing oil imports in the Blueprint for a Secure Energy Future.³⁸

Although the agencies recognize that there clearly is a benefit to the United States from reducing dependence on foreign oil, the agencies have been unable to calculate the monetary benefit that the United States will receive from the improvements in national security expected to result from this rule. In contrast, the other portion of the energy security premium, the U.S. macroeconomic disruption and adjustment cost that arises from U.S. petroleum imports is included in the energy security benefits estimated for this program. To summarize, the agencies have included only the macroeconomic disruption portion of the energy security benefits to estimate the monetary value of the total energy security benefits of this program. The agencies have calculated energy security in very specific terms, as the reduction of both financial and

^B The other three are Norway, Canada, and the EU, an exporter of product.

strategic risks caused by potential sudden disruptions in the supply of imported petroleum to the U.S. Reducing the amount of oil imported reduces those risks, and thus increases the nation's energy security.

9.7.2 Impact on U.S. Petroleum Imports

In 2008, U.S. petroleum import expenditures represented 21 percent of total U.S. imports of all goods and services.³⁹ In 2008, the United States imported 66 percent of the petroleum it consumed, and the transportation sector accounted for 70 percent of total U.S. petroleum consumption. This compares roughly to 37 percent of petroleum from imports and 55 percent consumption of petroleum in the transportation sector in 1975.⁴⁰ It is clear that petroleum imports have a significant impact on the U.S. economy. Requiring lower GHG-emitting heavy-duty vehicles and improved fuel economy in the U.S. is expected to lower U.S. petroleum imports.

EPA used the MOVES model to estimate the reduced consumption in fuel due to this rule. A detailed explanation of the MOVES model can be found in Chapter 5 of this RIA. Based on a detailed analysis of differences in fuel consumption, petroleum imports, and imports of refined petroleum products and crude oil among the Reference Case, High Economic Growth, and Low Economic Growth Scenarios presented in AEO 2011, NHTSA and EPA estimate that approximately 50 percent of the reduction in fuel consumption resulting from adopting improved fuel GHG standards and fuel economy standards is likely to be reflected in reduced U.S. imports of refined fuel, while the remaining 50 percent would be expected to be reflected in reduced domestic fuel refining. Of this latter figure, 90 percent is anticipated to reduce U.S. imports of crude petroleum for use as a refinery feedstock, while the remaining 10 percent is expected to reduce U.S. domestic production of crude petroleum. Thus, on balance, each gallon of fuel saved as a consequence of improved fuel heavy-duty GHG standards and fuel economy standards is anticipated to reduce total U.S. imports of crude petroleum or refined fuel by 0.95 gallons.^c

Based upon the fuel savings estimated by the MOVES model and the 95 percent oil import factor, the reduction in U.S. oil imports from this rule are estimated for the years 2020, 2030, 2040, and 2050 (in millions of barrels per day (MMBD)) in Table 9-17 below.

^c This figure is calculated as $0.50 + 0.50 \times 0.9 = 0.50 + 0.45 = 0.95$.

Regulatory Impact Analysis

Table 9-17 U.S. Oil Import Reductions Resulting from the Heavy-Duty Vehicle Rule in 2020, 2030, 2040, and 2050 (in MMBD)

Year	MMBD
2020	0.202
2030	0.393
2040	0.489
2050	0.566

For comparison purposes, Table 9-18 shows the U.S. imports of crude oil in 2020 and 2030 as projected by DOE in the Annual Energy Outlook 2011 Early Release Reference Case.⁴¹

Table 9-18 Projected U.S. Imports of Crude Oil in 2020 and 2030 (in MMBD)

2020	8.38
2030	8.32

9.7.3 Background on U.S. Energy Security

U.S. energy security is broadly defined as protecting the U.S. economy against circumstances that result in significant short- and long-term increases in energy costs. Most discussion of U.S. energy security revolves around the topic of the economic costs of U.S. dependence on oil imports. The U.S.'s energy security problem is that the U.S. relies on imported oil from potentially unstable sources. In addition, oil exporters have the ability to raise the price of oil by exerting monopoly power through the formation of a cartel, the Organization of Petroleum Exporting Countries (OPEC). Finally, these factors contribute to the vulnerability of the U.S. economy to episodic oil supply shocks and price spikes. In 2008, U.S. net expenditures for imports of crude oil and petroleum products were \$326 billion (in 2007\$, see Figure 9-3).

Figure 9-3: U.S. Expenditures on Crude Oil from 1970 through 2008⁴²

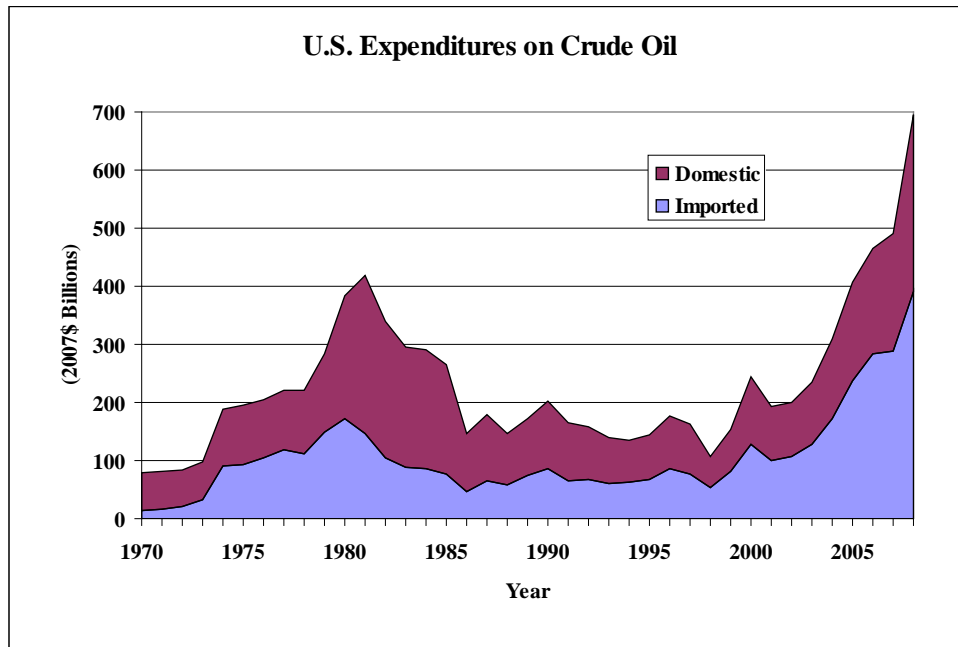

One effect of the HD National Program is that it promotes more efficient use of transportation fuels in the U.S. The result is that it reduces U.S. oil imports, which reduces both financial and strategic risks associated with a potential disruption in supply or a spike in the cost of a particular energy source. This reduction in risks is a measure of improved U.S. energy security. For this rule, an “oil premium” approach is utilized to identify those energy security related impacts which are not reflected in the market price of oil, and which are expected to change in response to an incremental change in the level of U.S. oil imports.

9.7.3.1 Methodology Used to Estimate U.S. Energy Security Benefits

In order to understand the energy security implications of reducing U.S. oil imports, EPA has worked with Oak Ridge National Laboratory (ORNL), which has developed approaches for evaluating the social costs and energy security implications of oil use. The energy security estimates provided below are based upon a methodology developed in a peer-reviewed study entitled, “*The Energy Security Benefits of Reduced Oil Use, 2006-2015*,” completed in March 2008. This study is included as part of the docket for this rulemaking.⁴³ This ORNL study is an updated version of the approach used for estimating the energy security benefits of U.S. oil import reductions developed in a 1997 ORNL Report by Leiby, Paul N., Donald W. Jones, T. Randall Curlee, and Russell Lee, entitled “*Oil Imports: An Assessment of Benefits and Costs*.”⁴⁴

When conducting this analysis, ORNL considered the full cost of importing petroleum into the U.S. The full economic cost is defined to include two components in addition to the purchase price of petroleum itself. These are: (1) the higher costs for oil imports resulting from the effect of U.S. import demand on the world oil price and on OPEC market power (*i.e.*, the “demand” or “monopsony” costs); and (2) the risk of reductions in U.S. economic output and disruption to the U.S. economy caused by sudden disruptions in the supply of imported oil to the

Regulatory Impact Analysis

U.S. (*i.e.*, macroeconomic disruption/adjustment costs). Maintaining a U.S. military presence to help secure stable oil supply from potentially vulnerable regions of the world was not included in this analysis because its attribution to particular missions or activities is difficult (as discussed further below).

The literature on the energy security for the last two decades has routinely combined the monopsony and the macroeconomic disruption components when calculating the total value of the energy security premium. However, in the context of using a global value for the Social Cost of Carbon (SCC) the question arises: how should the energy security premium be used when some benefits from the rule, such as the benefits of reducing greenhouse gas emissions, are calculated using a global value? Monopsony benefits represent avoided payments by the U.S. to oil producers in foreign countries that result from a decrease in the world oil price as the U.S. decreases its consumption of imported oil. Although there is clearly a benefit to the U.S. when considered from a domestic perspective, the decrease in price due to decreased demand in the U.S. also represents a loss to other countries.

Given the redistributive nature of this monopsony effect from a global perspective, it is excluded in the energy security benefits calculations for this program. In contrast, the other portion of the energy security premium, the U.S. macroeconomic disruption and adjustment cost that arises from U.S. petroleum imports, does not have offsetting impacts outside of the U.S., and, thus, is included in the energy security benefits estimated for this program. To summarize, the agencies have included only the macroeconomic disruption portion of the energy security benefits to estimate the monetary value of the total energy security benefits of this program. Section VIII.I of the preamble to the final rules contains more discussion of how the monopsony and macroeconomic disruption/adjustment components are treated for this analysis.

As part of the process for developing the ORNL energy security estimates, EPA sponsored an independent, expert peer review of the 2008 ORNL study. A report compiling the peer reviewers' comments is provided in the docket.⁴⁵ In addition, EPA worked with ORNL to address comments raised in the peer review and to develop estimates of the energy security benefits associated with a reduction in U.S. oil imports. In response to peer reviewer comments, ORNL modified its model by changing several key parameters involving OPEC supply behavior, the responsiveness of oil demand and supply to a change in the world oil price, and the responsiveness of U.S. economic output to a change in the world oil price.

For this rulemaking, ORNL further updated the energy security premium by incorporating the most recent oil price forecast and energy market trends from the AEO 2011 (Early Release) into its model. In order for the energy security premium to be used in EPA's MOVES model, ORNL developed energy security premium estimates for a number of different years (*i.e.*, 2020, 2030, and 2035), Table 9-19 provides estimates for energy security premium for the years 2020, 2030 and 2035,⁴⁶ as well as a breakdown of the components of the energy security premium for each year. The components of the energy security premium and their values are discussed below.

Table 9-19 Energy Security Premium in 2020, 2030 and 2035 (2009\$/Barrel)

Heavy-Duty GHG and Fuel Efficiency Standards FRM: Economic and Other Impacts

Year (range)	Monopsony (Range)	Macroeconomic Disruption/Adjustment Costs (Range)	Total Mid-Point (Range)
2020	\$11.29 (\$3.86 - \$21.32)	\$7.11 (\$3.50 - \$11.40)	\$18.41 (\$9.70 - \$28.94)
2030	\$11.17 (\$3.92 - \$20.58)	\$8.32 (\$4.04 - \$13.33)	\$19.49 (\$10.49 - \$29.63)
2035	\$10.56 (\$3.69 - \$19.62)	\$8.71 (\$3.86 - \$14.35)	\$19.27 (\$10.32 - \$29.13)

9.7.3.2 Effect of Oil Use on the Long-Run Oil Price

The first component of the full economic costs of importing petroleum into the U.S. follows from the effect of U.S. import demand on the world oil price over the long-run. Because the U.S. is a sufficiently large purchaser of foreign oil supplies, its purchases can affect the world oil price. This monopsony power means that increases in U.S. petroleum demand can cause the world price of crude oil to rise, and conversely, that reduced U.S. petroleum demand can reduce the world price of crude oil. Thus, one benefit of decreasing U.S. oil purchases, due to the increased availability and use of other transportation fuels, is the potential decrease in the crude oil price paid for all crude oil purchased.

The demand or monopsony effect can be readily illustrated with an example. If the U.S. imports 10 million barrels per day at a world oil price of \$50 per barrel, its total daily bill for oil imports is \$500 million. If a decrease in U.S. imports to 9 million barrels per day causes the world oil price to drop to \$49 per barrel, the daily U.S. oil import bill drops to \$441 million (9 million barrels times \$49 per barrel). While the world oil price only declines \$1, the resulting decrease in oil purchase payments of \$59 million per day (\$500 million minus \$441 million) is equivalent to an incremental benefit of \$59 per barrel of oil imports reduced, or \$10 more than the newly-decreased world price of \$49 per barrel. This additional \$10 per barrel “import cost premium” represents the incremental external benefits to the U.S. for avoided import costs beyond the price paid oil purchases. This additional benefit arises only to the extent that reduction in U.S. oil imports affects the world oil price. ORNL estimates this component of the energy security benefit in 2020 to be \$11.29/barrel, with a range of \$3.86/barrel to \$21.32/barrel of imported oil reduced.

It is important to note that the decrease in global petroleum prices resulting from this rulemaking could spur increased consumption of petroleum in other sectors and countries, leading to a modest uptick in GHG emissions outside of the United States. This increase in global fuel consumption could offset some portion of the GHG reduction benefits associated

with the rule. The agencies have not quantified this increase in global GHG emissions in the RIA.

9.7.4 Macroeconomic Disruption Adjustment Costs

The second component of the oil import premium, “macroeconomic disruption/adjustment costs,” arises from the effect of oil imports on the expected cost of disruptions. A sudden increase in oil prices triggered by a disruption in world oil supplies has two main effects: (1) it increases the costs of oil imports in the short-run and (2) it can lead to macroeconomic contraction, dislocation and Gross Domestic Product (GDP) losses. ORNL estimates the composite estimate of these two factors that comprise the macroeconomic disruption/adjustment costs premium to be \$7.11/barrel in 2020, with a range of \$3.50/barrel to \$11.40/barrel of imported oil reduced.

There are two main effects of macroeconomic disruption/adjustment costs. The first is the short-run price increase from an oil shock. The oil price shock results in a combination of real resource shortages, costly short-run shifts in energy supply, behavioral and demand adjustments by energy users, and other response costs. Unlike pure transfers, the root cause of the disruption price increase is a real resource supply reduction due, for example, to disaster or war. Regions where supplies are disrupted, such as the U.S., suffer very high costs. Businesses’ and households’ emergency responses to supply disruptions and rapid price increases consume real economic resources.

While households and businesses can reduce their petroleum consumption, invest in fuel switching technologies, or use futures markets to insulate themselves in advance against the potential costs of rapid increases in oil prices, when deciding how extensively to do so, they are unlikely to account for the effect of their petroleum consumption on the magnitude of costs that supply interruptions and accompanying price shocks impose on others. As a consequence, the U.S. economy as a whole will not make sufficient use of these mechanisms to insulate itself from the real costs of rapid increases in energy prices and outlays that usually accompany oil supply interruptions. Therefore, the ORNL estimate of macroeconomic disruption/adjustment costs that the agencies use to value energy security benefits includes the increased oil import costs stemming from oil price shocks that are unanticipated and not internalized by advance actions of U.S. consumers.

The second main effect of macroeconomic disruption/adjustment costs is the macroeconomic losses during price shocks that reflect both aggregate output losses and “allocative” losses. The former are a reduction in the level of output that the U.S. economy can produce fully using its available resources; and the latter stem from temporary dislocation and underutilization of available resources due to the shock, such as labor unemployment and idle plant capacity. The aggregate output effect, a reduction in “potential” economic output, will last so long as the price is elevated. It depends on the extent and duration of any disruption in the world supply of oil, since these factors determine the magnitude of the resulting increase in prices for petroleum products, as well as whether and how rapidly these prices return to their pre-disruption levels.

In addition to the aggregate contraction, there are “allocative” or “adjustment” costs associated with dislocated energy markets. Because supply disruptions and resulting price increases occur suddenly, empirical evidence shows they also impose additional costs on businesses and households which must adjust their use of petroleum and other productive factors more rapidly than if the same price increase had occurred gradually. Dislocational effects include the unemployment of workers and other resources during the time needed for their intersectoral or interregional reallocation, and pauses in capital investment due to uncertainty. These adjustments temporarily reduce the level of economic output that can be achieved even below the “potential” output level that would ultimately be reached once the economy’s adaptation to higher petroleum prices is complete. The additional costs imposed on businesses and households for making these adjustments reflect their limited ability to adjust prices, output levels, and their use of energy, labor and other inputs quickly and smoothly in response to rapid changes in prices for petroleum products.

Since future disruptions in foreign oil supplies are an uncertain prospect, each of the disruption cost components must be weighted by the probability that the supply of petroleum to the U.S. will actually be disrupted. Thus, the “expected value” of these costs – the product of the probability that a supply disruption will occur and the sum of costs from reduced economic output and the economy’s abrupt adjustment to sharply higher petroleum prices – is the relevant measure of their magnitude. Further, when assessing the energy security value of a policy to reduce oil use, it is only the change in the expected costs of disruption that results from the policy that is relevant. The expected costs of disruption may change from lowering the normal (*i.e.*, pre-disruption) level of domestic petroleum use and imports, from any induced alteration in the likelihood or size of disruption, or from altering the short-run flexibility (*e.g.*, elasticity) of petroleum use.

In summary, the steps needed to calculate the disruption or security premium are: 1) determine the likelihood of an oil supply disruption in the future; 2) assess the likely impacts of a potential oil supply disruption on the world oil price; 3) assess the impact of the oil price shock on the U.S. economy (in terms of import costs and macroeconomic losses); and 4) determine how these costs change with oil imports. The value of price spike costs avoided by reducing oil imports becomes the oil security portion of the premium.

9.7.4.1.1 Cost of Existing U.S. Energy Security Policies

The last often-identified component of the full economic costs of U.S. oil imports are the costs to the U.S. taxpayers of existing U.S. energy security policies. The two primary examples are maintaining the Strategic Petroleum Reserve (SPR) and maintaining a military presence to help secure a stable oil supply from potentially vulnerable regions of the world. The SPR is the largest stockpile of government-owned emergency crude oil in the world. Established in the aftermath of the 1973-74 oil embargo, the SPR provides the U.S. with a response option should a disruption in commercial oil supplies threaten the U.S. economy. It also allows the U.S. to meet part of its International Energy Agency obligation to maintain emergency oil stocks, and it provides a national defense fuel reserve. While the costs for building and maintaining the SPR are more clearly related to U.S. oil use and imports, historically these costs have not varied in response to changes in U.S. oil import levels. Thus, while SPR is factored into the ORNL analysis, the cost of maintaining the SPR is excluded.

Regulatory Impact Analysis

U.S. military costs are excluded from the analysis performed by ORNL because their attribution to particular missions or activities is difficult. Most military forces serve a broad range of security and foreign policy objectives. Attempts to attribute some share of U.S. military costs to oil imports are further challenged by the need to estimate how those costs might vary with incremental variations in U.S. oil imports.

9.7.4.2 Energy Security Benefits of this Program

Using the same methodology as the peer-reviewed model, but updating the analysis using AEO 2011 world oil price values and the estimated fuel savings from the rule using the MOVES model, EPA has calculated the energy security benefits of the rule for the years 2020, 2030, 2040, and 2050^D. Since the Agency is taking a global perspective with respect to valuing greenhouse gas benefits from the rule, only the macroeconomic adjustment/disruption portion of the energy security premium is used in the energy security benefits estimates present below. These results are shown below in Table 9-20.

Table 9-20 U.S. Energy Security Benefits of the Heavy-Duty Vehicle Rulemaking in 2020, 2030, 2040 and 2050 (in millions of 2009\$)

YEAR	BENEFITS
2020	\$499
2030	\$1,132
2040	\$1,477
2050	\$1,710

9.8 Summary of Benefits and Costs

In this section, the agencies present a summary of technology costs, fuel savings, benefits, and net benefits of the program. Table 9-21 shows the estimated annual monetized costs of the program for the indicated calendar years. The table also shows the net present values of those costs for the calendar years 2012-2050 using both 3 percent and 7 percent discount rates.^E Table 9-22 shows the estimated annual monetized fuel savings of the final program. The table also shows the net present values of those fuel savings for the same calendar years using both 3 percent and 7 percent discount rates. In this table, the aggregate value of fuel savings is calculated using pre-tax fuel prices since savings in fuel taxes do not represent a reduction in the value of economic resources utilized in producing and consuming fuel. Note that fuel savings shown here result from reductions in fleet-wide fuel use. Thus, they grow over time as an increasing fraction of the fleet meets the 2018 standards.

^D In order to determine the energy security benefits for beyond 2035, world oil prices were extrapolated from an average growth rate for the years 2017 to 2035. This is shown in the spreadsheet labeled "AEO2011 Price Projects_with_final_release.xlsx", which is in the Docket for this rule.

^E For the estimation of the stream of costs and benefits, we assume that after implementation of the MY 2014-2017 standards, the 2017 standards apply to each year out to 2050.

Heavy-Duty GHG and Fuel Efficiency Standards FRM: Economic and Other Impacts

Table 9-21 Estimated Monetized Costs of the Program (Millions of 2009\$)^a

	2020	2030	2040	2050	NPV, YEARS 2012-2050, 3% DISCOUNT RATE	NPV, YEARS 2012-2050, 7% DISCOUNT RATE
Technology Costs	\$2,000	\$2,200	\$2,700	\$3,300	\$47,400	\$24,700

^a Technology costs for separate truck segments can be found in Chapter 7.

Table 9-22 Estimated Monetized Fuel Savings of the Program (Millions of 2009\$)^a

	2020	2030	2040	2050	NPV, Years 2012-2050, 3% Discount Rate	NPV, Years 2012-2050, 7% Discount Rate
Fuel Savings (pre-tax)	\$9,600	\$20,600	\$28,000	\$36,500	\$375,300	\$166,500

Note:

^a Fuel savings for separate truck segments can be found in Chapter 7.

Table 9-23 presents estimated annual monetized benefits for the indicated calendar years. The table also shows the net present values of those benefits for the calendar years 2012-2050 using both 3 percent and 7 percent discount rates. The table shows the benefits of reduced CO₂ emissions—and consequently the annual quantified benefits (*i.e.*, total benefits)—for each of four SCC values estimated by the interagency working group. As discussed in Section 8.5, there are some limitations to the SCC analysis, including the incomplete way in which the integrated assessment models capture catastrophic and non-catastrophic impacts, their incomplete treatment of adaptation and technological change, uncertainty in the extrapolation of damages to high temperatures, and assumptions regarding risk aversion.

In addition, these monetized GHG benefits exclude the value of reductions in non-CO₂ GHG emissions (CH₄, N₂O, HFC) expected under this program. Although EPA has not monetized the benefits of reductions in non-CO₂ GHGs, the value of these reductions should not be interpreted as zero. Rather, the net reductions in non-CO₂ GHGs will contribute to this rule's climate benefits, as explained in Section III.F of the preamble.

Table 9-23 Monetized Benefits Associated with the Program (Millions of 2009\$)

	2020	2030	2040	2050	NPV, YEARS 2012-2050, 3% DISCOUNT RATE ^A	NPV, YEARS 2012-2050, 3% DISCOUNT RATE ^A
Reduced CO ₂ Emissions at each assumed SCC value ^b						
5% (avg SCC)	\$300	\$700	\$1,200	\$1,700	\$9,000	\$9,000
3% (avg SCC)	\$1,000	\$2,500	\$3,600	\$4,800	\$46,100	\$46,100
2.5% (avg SCC)	\$1,600	\$3,800	\$5,400	\$7,000	\$78,000	\$78,000
3% (95th percentile)	\$3,100	\$7,500	\$11,100	\$14,600	\$140,400	\$140,400
Energy Security Impacts (price shock)	\$500	\$1,100	\$1,500	\$1,700	\$19,800	\$8,800
Accidents, Noise,	-\$200	-\$400	-\$600	-\$600	-\$7,900	-\$3,700

Regulatory Impact Analysis

Congestion ^f						
Refueling Savings	\$100	\$100	\$200	\$200	\$2,500	\$1,100
Non-GHG Impacts ^{c,d}	B	\$2,800	\$2,800	\$2,800	\$25,300	\$9,100
Non-CO ₂ GHG Impacts ^c	n/a	n/a	n/a	n/a	n/a	n/a
Total Annual Benefits at each assumed SCC value ^b						
5% (avg SCC)	\$700	\$4,300	\$5,100	\$5,800	\$48,700	\$24,300
3% (avg SCC)	\$1,400	\$6,100	\$7,500	\$8,900	\$85,800	\$61,400
2.5% (avg SCC)	\$2,000	\$7,400	\$9,300	\$11,100	\$117,700	\$93,300
3% (95th percentile)	\$3,500	\$11,100	\$15,000	\$18,700	\$180,100	\$155,700

^a Note that net present value of reduced CO₂ emissions is calculated differently than other benefits. The same discount rate used to discount the value of damages from future emissions (SCC at 5, 3, 2.5 percent) is used to calculate net present value of SCC for internal consistency. Refer to the SCC TSD for more detail.

^b Section 8.5 of the RIA notes that SCC increases over time. Corresponding to the years in this table (2020-2050), the SCC estimates range as follows: for Average SCC at 5%: \$7-\$16; for Average SCC at 3%: \$27-\$46; for Average SCC at 2.5%: \$43-\$67; and for 95th percentile SCC at 3%: \$83-\$140. Section VIII.F also presents these SCC estimates.

^c Note that "B" indicates unquantified criteria pollutant benefits in the year 2020. For the analysis of the final program, we only modeled the rule's PM_{2.5}- and ozone-related impacts in the calendar year 2030. For the purposes of estimating a stream of future-year criteria pollutant benefits, we assume that the benefits out to 2050 are equal to, and no less than, those modeled in 2030 as reflected by the stream of estimated future emission reductions. The NPV of criteria pollutant-related benefits should therefore be considered a conservative estimate of the potential benefits associated with the final program.

^d Non-GHG-related health and welfare impacts (related to PM_{2.5} and ozone exposure) range between \$110 and \$340 million in 2030, 2040, and 2050. \$200 was chosen as the mid-point of this range for the purposes of estimating total benefits across all monetized categories.

^e The monetized GHG benefits presented in this analysis exclude the value of changes in non-CO₂ GHG emissions expected under this program (see RIA Chapter 5). Although EPA has not monetized changes in non-CO₂ GHGs, the value of any increases or reductions should not be interpreted as zero.

^f Negative sign represents an increase in Accidents, Noise, and Congestion.

Table 9-24 presents estimated annual net benefits for the indicated calendar years. The table also shows the net present values of those net benefits for the calendar years 2012-2050 using both 3 percent and 7 percent discount rates. The table includes the benefits of reduced CO₂ emissions (and consequently the annual net benefits) for each of four SCC values considered by EPA.

Table 9-24 Monetized Net Benefits Associated with the Program (Millions of 2009\$)

	2020	2030	2040	2050	NPV, 3%	NPV, 7%
Technology Costs	\$2,000	\$2,200	\$2,700	\$3,300	\$47,400	\$24,700
Fuel Savings	\$9,600	\$20,600	\$28,000	\$36,500	\$375,300	\$166,500
Monetized Annual Benefits at each assumed SCC value						
5% (avg SCC)	\$700	\$4,300	\$5,100	\$5,800	\$48,700	\$24,300
3% (avg SCC)	\$1,400	\$6,100	\$7,500	\$8,900	\$85,800	\$61,400
2.5% (avg SCC)	\$2,000	\$7,400	\$9,300	\$11,100	\$117,700	\$93,300
3% (95th percentile)	\$3,500	\$11,100	\$15,000	\$18,700	\$180,100	\$155,700
Monetized Net Benefits at each assumed SCC value						
5% (avg SCC)	\$8,300	\$22,700	\$30,400	\$39,000	\$376,600	\$166,100
3% (avg SCC)	\$9,000	\$24,500	\$32,800	\$42,100	\$413,700	\$203,200
2.5% (avg SCC)	\$9,600	\$25,800	\$34,600	\$44,300	\$445,600	\$235,100
3% (95th percentile)	\$11,100	\$29,500	\$40,300	\$51,900	\$508,000	\$297,500

Heavy-Duty GHG and Fuel Efficiency Standards FRM: Economic and Other Impacts

EPA also conducted a separate analysis of the total benefits over the model year lifetimes of the 2014 through 2018 model year vehicles. In contrast to the calendar year analysis presented in Table 9-21 through Table 9-24, the model year lifetime analysis shows the impacts of the program on vehicles produced during each of the model years 2014 through 2018 over the course of their expected lifetimes. The net societal benefits over the full lifetimes of vehicles produced during each of the five model years from 2014 through 2018 are shown in Table 9-25 and Table 9-26 at both 3 percent and 7 percent discount rates, respectively.

Table 9-25 Monetized Technology Costs, Fuel Savings, Benefits, and Net Benefits Associated with the Lifetimes of 2014-2018 Model Year Trucks (Millions of 2009\$; 3% Discount Rate)

	2014MY	2015MY	2016MY	2017MY	2018MY	SUM
Truck Program Costs	\$1,600	\$1,400	\$1,500	\$1,600	\$2,000	\$8,100
Pre-tax Fuel Savings	\$9,300	\$8,300	\$8,100	\$11,500	\$12,900	\$50,100
Energy Security	\$500	\$400	\$400	\$600	\$700	\$2,700
Accidents, Noise, Congestion ^c	-\$300	-\$300	-\$300	-\$300	-\$300	-\$1,500
Refueling Savings	\$60	\$60	\$60	\$80	\$100	\$400
Non-CO ₂ GHG Impacts and Non-GHG Impacts ^{a,b}	n/a	n/a	n/a	n/a	n/a	n/a
Reduced CO ₂ emissions at each assumed SCC value						
5% (avg SCC)	\$200	\$200	\$200	\$300	\$300	\$1,200
3% (avg SCC)	\$1,100	\$900	\$900	\$1,300	\$1,500	\$5,700
2.5% (avg SCC)	\$1,800	\$1,600	\$1,500	\$2,100	\$2,400	\$9,400
3% (95th percentile)	\$3,300	\$2,900	\$2,800	\$4,000	\$4,500	\$17,000
Monetized Net Benefits at each assumed SCC value						
5% (avg SCC)	\$8,200	\$7,300	\$7,000	\$10,600	\$11,700	\$44,800
3% (avg SCC)	\$9,100	\$8,000	\$7,700	\$11,600	\$12,900	\$49,300
2.5% (avg SCC)	\$9,800	\$8,700	\$8,300	\$12,400	\$13,800	\$53,000
3% (95th percentile)	\$11,300	\$10,000	\$9,600	\$14,300	\$15,900	\$60,600

Notes:

^a The monetized GHG benefits presented in this analysis exclude the value of changes in non-CO₂ GHG emissions expected under this program (see RIA Chapter 5). Although EPA has not monetized changes in non-CO₂ GHGs, the value of any increases or reductions should not be interpreted as zero.

^b Due to analytical and resource limitations, MY non-GHG emissions (direct PM, VOCs, NO₂ and SO₂) were not estimated for this analysis.

^c Negative sign represents an increase in Accidents, Noise, and Congestion.

Table 9-26 Monetized Technology Costs, Fuel Savings, Benefits, and Net Benefits Associated with the Lifetimes of 2014-2018 Model Year Trucks (Millions of 2009\$; 7% Discount Rate)

	2014MY	2015MY	2016MY	2017MY	2018MY	SUM
Truck Program Costs	\$1,600	\$1,400	\$1,500	\$1,600	\$2,000	\$8,100
Pre-tax Fuel Savings	\$6,900	\$5,900	\$5,600	\$7,600	\$8,300	\$34,400
Energy Security	\$400	\$300	\$300	\$400	\$400	\$1,800
Accidents, Noise, Congestion ^c	-\$200	-\$200	-\$200	-\$200	-\$200	-\$1,000
Refueling Savings	\$50	\$40	\$40	\$60	\$60	\$200
Non-CO ₂ GHG Impacts and Non-GHG Impacts ^{a,b}	n/a	n/a	n/a	n/a	n/a	n/a
Reduced CO ₂ emissions at each assumed SCC value						
5% (avg SCC)	\$200	\$200	\$200	\$300	\$300	\$1,200
3% (avg SCC)	\$1,100	\$900	\$900	\$1,300	\$1,500	\$5,700

Regulatory Impact Analysis

2.5% (avg SCC)	\$1,800	\$1,600	\$1,500	\$2,100	\$2,400	\$9,400
3% (95th percentile)	\$3,300	\$2,900	\$2,800	\$4,000	\$4,500	\$17,000
Monetized Net Benefits at each assumed SCC value						
5% (avg SCC)	\$5,800	\$4,800	\$4,400	\$6,600	\$6,900	\$28,500
3% (avg SCC)	\$6,700	\$5,500	\$5,100	\$7,600	\$8,100	\$33,000
2.5% (avg SCC)	\$7,400	\$6,200	\$5,700	\$8,400	\$9,000	\$36,700
3% (95th percentile)	\$8,900	\$7,500	\$7,000	\$10,300	\$11,100	\$44,300

Notes:

^a The monetized GHG benefits presented in this analysis exclude the value of changes in non-CO₂ GHG emissions expected under this program (see RIA Chapter 5). Although EPA has not monetized changes in non-CO₂ GHGs, the value of any increases or reductions should not be interpreted as zero.

^b Due to analytical and resource limitations, MY non-GHG emissions (direct PM, VOCs, NO₂ and SO₂) were not estimated for this analysis.

^c Negative sign represents an increase in Accidents, Noise, and Congestion.

The agencies have also conducted an uncertainty analysis that considers the impacts on the net benefits of the rule if certain costs are actually lower or higher than estimated in the primary analysis. The cost elements altered and how are shown in Table 9-27.

Heavy-Duty GHG and Fuel Efficiency Standards FRM: Economic and Other Impacts

Table 9-27 Uncertainty Analysis Cost Elements Considered and How They Were Altered

COST ELEMENT	LOW END	HIGH END	HOW APPLIED
Fuel prices	AEO2011 Low oil price case	AEO2011 High oil price case	All fuel savings
Indirect cost multipliers	-20%	+20%	Calculating all indirect costs associated with adding new technology
Aero costs	-10%	+10%	All direct manufacturing costs (DMC) associated with aero technology
APU costs	-10%	+10%	DMC for APU units on combination tractors
Turbo/compounding costs	-10%	+10%	DMC for turbo/compounding on combination tractors

Notes:

^a Net present value of reduced CO₂ emissions is calculated differently than other benefits. The same discount rate used to discount the value of damages from future emissions (SCC at 5, 3, 2.5 percent) is used to calculate net present value of SCC for internal consistency. Refer to the SCC TSD for more detail.

^b Section VIII.G of the preamble notes that SCC increases over time. Corresponding to the years in this table, the SCC estimates range as follows: for Average SCC at 5%: \$5-\$16; for Average SCC at 3%: \$22-\$46; for Average SCC at 2.5%: \$36-\$66; and for 95th percentile SCC at 3%: \$66-\$139. Section VIII.G also presents these SCC estimates.

^c The monetized GHG benefits presented in this analysis exclude the value of changes in non-CO₂ GHG emissions expected under this program (see RIA Chapter 5). Although EPA has not monetized changes in non-CO₂ GHGs, the value of any increases or reductions should not be interpreted as zero.

^d Due to analytical and resource limitations, MY non-GHG emissions (direct PM, VOCs, NO₂ and SO₂) were not estimated for this analysis.

^e Negative sign represents an increase in Accidents, Congestion, and Noise.

See the Low End uncertainty analysis in Tables 9-28 and 9-29 at a 3 percent and 7 percent discount rate, respectively. The High End Case analysis is shown in Table 9-30 and 9-31 at a 3 percent and 7 percent discount rate, respectively.

Table 9-28 Monetized Technology Costs, Fuel Savings, Benefits, and Net Benefits Associated with the Lifetimes of 2014-2018 Model Year Trucks for the Low End Uncertainty Analysis (Millions of 2009\$; 3% Discount Rate)

	2014MY	2015MY	2016MY	2017MY	2018MY	SUM
Truck Program Costs	\$1,500	\$1,300	\$1,400	\$1,500	\$1,800	\$7,500
Pre-tax Fuel Savings	\$5,900	\$5,100	\$4,900	\$6,800	\$7,600	\$30,200
Energy Security	\$500	\$400	\$400	\$600	\$700	\$2,700
Accidents, Noise, Congestion ^e	-\$300	-\$300	-\$300	-\$300	-\$300	-\$1,500
Refueling Savings	\$60	\$60	\$60	\$80	\$100	\$360
Non-CO ₂ GHG Impacts and Non-GHG Impacts ^{a,b}	n/a	n/a	n/a	n/a	n/a	n/a
Reduced CO ₂ emissions at each assumed SCC value						
5% (avg SCC)	\$200	\$200	\$200	\$300	\$300	\$1,200
3% (avg SCC)	\$1,100	\$900	\$900	\$1,300	\$1,500	\$5,700
2.5% (avg SCC)	\$1,800	\$1,600	\$1,500	\$2,100	\$2,400	\$9,400
3% (95th percentile)	\$3,300	\$2,900	\$2,800	\$4,000	\$4,500	\$17,000

Regulatory Impact Analysis

	2014MY	2015MY	2016MY	2017MY	2018MY	SUM
Monetized Net Benefits at each assumed SCC value						
5% (avg SCC)	\$4,860	\$4,160	\$3,860	\$5,980	\$6,600	\$25,460
3% (avg SCC)	\$5,760	\$4,860	\$4,560	\$6,980	\$7,800	\$29,960
2.5% (avg SCC)	\$6,460	\$5,560	\$5,160	\$7,780	\$8,700	\$33,660
3% (95th percentile)	\$7,960	\$6,860	\$6,460	\$9,680	\$10,800	\$41,260

Notes:

^a Net present value of reduced CO₂ emissions is calculated differently than other benefits. The same discount rate used to discount the value of damages from future emissions (SCC at 5, 3, 2.5 percent) is used to calculate net present value of SCC for internal consistency. Refer to the SCC TSD for more detail.

^b Section VIII.G of the preamble notes that SCC increases over time. Corresponding to the years in this table, the SCC estimates range as follows: for Average SCC at 5%: \$5-\$16; for Average SCC at 3%: \$22-\$46; for Average SCC at 2.5%: \$36-\$66; and for 95th percentile SCC at 3%: \$66-\$139. Section VIII.G also presents these SCC estimates.

^c The monetized GHG benefits presented in this analysis exclude the value of changes in non-CO₂ GHG emissions expected under this program (see RIA Chapter 5). Although EPA has not monetized changes in non-CO₂ GHGs, the value of any increases or reductions should not be interpreted as zero.

^d Due to analytical and resource limitations, MY non-GHG emissions (direct PM, VOCs, NO₂ and SO₂) were not estimated for this analysis.

^e Negative sign represents an increase in Accidents, Congestion, and Noise.

Table 9-29 Monetized Technology Costs, Fuel Savings, Benefits, and Net Benefits Associated with the Lifetimes of 2014-2018 Model Year Trucks for the Low End Uncertainty Analysis (Millions of 2009\$; 7% Discount Rate)

	2014MY	2015MY	2016MY	2017MY	2018MY	SUM
Truck Program Costs	\$1,500	\$1,300	\$1,400	\$1,500	\$1,800	\$7,500
Pre-tax Fuel Savings	\$4,400	\$3,700	\$3,400	\$4,600	\$4,900	\$20,900
Energy Security	\$400	\$300	\$300	\$400	\$400	\$1,800
Accidents, Noise, Congestion ^e	-\$200	-\$200	-\$200	-\$200	-\$200	-\$1,000
Refueling Savings	\$50	\$40	\$40	\$60	\$60	\$250
Non-CO ₂ GHG Impacts and Non-GHG Impacts ^{a,b}	n/a	n/a	n/a	n/a	n/a	n/a
Reduced CO ₂ emissions at each assumed SCC value						
5% (avg SCC)	\$200	\$200	\$200	\$300	\$300	\$1,200
3% (avg SCC)	\$1,100	\$900	\$900	\$1,300	\$1,500	\$5,700
2.5% (avg SCC)	\$1,800	\$1,600	\$1,500	\$2,100	\$2,400	\$9,400
3% (95th percentile)	\$3,300	\$2,900	\$2,800	\$4,000	\$4,500	\$17,000
Monetized Net Benefits at each assumed SCC value						
5% (avg SCC)	\$3,350	\$2,740	\$2,340	\$3,660	\$3,660	\$15,650
3% (avg SCC)	\$4,250	\$3,440	\$3,040	\$4,660	\$4,860	\$20,150
2.5% (avg SCC)	\$4,950	\$4,140	\$3,640	\$5,460	\$5,760	\$23,850
3% (95th percentile)	\$6,450	\$5,440	\$4,940	\$7,360	\$7,860	\$31,450

Heavy-Duty GHG and Fuel Efficiency Standards FRM: Economic and Other Impacts

Notes:

^a Net present value of reduced CO₂ emissions is calculated differently than other benefits. The same discount rate used to discount the value of damages from future emissions (SCC at 5, 3, 2.5 percent) is used to calculate net present value of SCC for internal consistency. Refer to the SCC TSD for more detail.

^b Section VIII.G of the preamble notes that SCC increases over time. Corresponding to the years in this table, the SCC estimates range as follows: for Average SCC at 5%: \$5-\$16; for Average SCC at 3%: \$22-\$46; for Average SCC at 2.5%: \$36-\$66; and for 95th percentile SCC at 3%: \$66-\$139. Section VIII.G also presents these SCC estimates.

^c The monetized GHG benefits presented in this analysis exclude the value of changes in non-CO₂ GHG emissions expected under this program (see RIA Chapter 5). Although EPA has not monetized changes in non-CO₂ GHGs, the value of any increases or reductions should not be interpreted as zero.

^d Due to analytical and resource limitations, MY non-GHG emissions (direct PM, VOCs, NO₂ and SO₂) were not estimated for this analysis.

^e Negative sign represents an increase in Accidents, Congestion, and Noise.

Table 9-30 Monetized Technology Costs, Fuel Savings, Benefits, and Net Benefits Associated with the Lifetimes of 2014-2018 Model Year Trucks for the High End Uncertainty Analysis (Millions of 2009\$; 3% Discount Rate)

	2014MY	2015MY	2016MY	2017MY	2018MY	SUM
Truck Program Costs	\$1,700	\$1,500	\$1,600	\$1,700	\$2,100	\$8,600
Pre-tax Fuel Savings	\$13,600	\$12,000	\$11,800	\$16,700	\$18,800	\$72,900
Energy Security	\$500	\$400	\$400	\$600	\$700	\$2,700
Accidents, Noise, Congestion ^e	-\$300	-\$300	-\$300	-\$300	-\$300	-\$1,500
Refueling Savings	\$60	\$60	\$60	\$80	\$100	\$360
Non-CO ₂ GHG Impacts and Non-GHG Impacts ^{a,b}	n/a	n/a	n/a	n/a	n/a	n/a
Reduced CO ₂ emissions at each assumed SCC value						
5% (avg SCC)	\$200	\$200	\$200	\$300	\$300	\$1,200
3% (avg SCC)	\$1,100	\$900	\$900	\$1,300	\$1,500	\$5,700
2.5% (avg SCC)	\$1,800	\$1,600	\$1,500	\$2,100	\$2,400	\$9,400
3% (95th percentile)	\$3,300	\$2,900	\$2,800	\$4,000	\$4,500	\$17,000
Monetized Net Benefits at each assumed SCC value						
5% (avg SCC)	\$12,360	\$10,860	\$10,560	\$15,680	\$17,500	\$67,060
3% (avg SCC)	\$13,260	\$11,560	\$11,260	\$16,680	\$18,700	\$71,560
2.5% (avg SCC)	\$13,960	\$12,260	\$11,860	\$17,480	\$19,600	\$75,260
3% (95th percentile)	\$15,460	\$13,560	\$13,160	\$19,380	\$21,700	\$82,860

Notes:

^a Net present value of reduced CO₂ emissions is calculated differently than other benefits. The same discount rate used to discount the value of damages from future emissions (SCC at 5, 3, 2.5 percent) is used to calculate net present value of SCC for internal consistency. Refer to the SCC TSD for more detail.

^b Section VIII.G of the preamble notes that SCC increases over time. Corresponding to the years in this table, the SCC estimates range as follows: for Average SCC at 5%: \$5-\$16; for Average SCC at 3%: \$22-\$46; for Average SCC at 2.5%: \$36-\$66; and for 95th percentile SCC at 3%: \$66-\$139. Section VIII.G also presents these SCC estimates.

^c The monetized GHG benefits presented in this analysis exclude the value of changes in non-CO₂ GHG emissions expected under this program (see RIA Chapter 5). Although EPA has not monetized changes in non-CO₂ GHGs, the value of any increases or reductions should not be interpreted as zero.

^d Due to analytical and resource limitations, MY non-GHG emissions (direct PM, VOCs, NO₂ and SO₂) were not estimated for this analysis.

^e Negative sign represents an increase in Accidents, Congestion, and Noise.

Regulatory Impact Analysis

Table 9-31 Monetized Technology Costs, Fuel Savings, Benefits, and Net Benefits Associated with the Lifetimes of 2014-2018 Model Year Trucks for the High End Uncertainty Analysis (Millions of 2009\$; 7% Discount Rate)

	2014MY	2015MY	2016MY	2017MY	2018MY	SUM
Truck Program Costs	\$1,700	\$1,500	\$1,600	\$1,700	\$2,100	\$8,600
Pre-tax Fuel Savings	\$10,100	\$8,600	\$8,100	\$11,100	\$12,000	\$49,900
Energy Security	\$400	\$300	\$300	\$400	\$400	\$1,800
Accidents, Noise, Congestion ^c	-\$200	-\$200	-\$200	-\$200	-\$200	-\$1,000
Refueling Savings	\$50	\$40	\$40	\$60	\$60	\$250
Non-CO ₂ GHG Impacts and Non-GHG Impacts ^{a,b}	n/a	n/a	n/a	n/a	n/a	n/a
Reduced CO ₂ emissions at each assumed SCC value						
5% (avg SCC)	\$200	\$200	\$200	\$300	\$300	\$1,200
3% (avg SCC)	\$1,100	\$900	\$900	\$1,300	\$1,500	\$5,700
2.5% (avg SCC)	\$1,800	\$1,600	\$1,500	\$2,100	\$2,400	\$9,400
3% (95th percentile)	\$3,300	\$2,900	\$2,800	\$4,000	\$4,500	\$17,000
Monetized Net Benefits at each assumed SCC value						
5% (avg SCC)	\$8,850	\$7,440	\$6,840	\$9,960	\$10,460	\$43,550
3% (avg SCC)	\$9,750	\$8,140	\$7,540	\$10,960	\$11,660	\$48,050
2.5% (avg SCC)	\$10,450	\$8,840	\$8,140	\$11,760	\$12,560	\$51,750
3% (95th percentile)	\$11,950	\$10,140	\$9,440	\$13,660	\$14,660	\$59,350

Notes:

^a Net present value of reduced CO₂ emissions is calculated differently than other benefits. The same discount rate used to discount the value of damages from future emissions (SCC at 5, 3, 2.5 percent) is used to calculate net present value of SCC for internal consistency. Refer to the SCC TSD for more detail.

^b Section VIII.G of the preamble notes that SCC increases over time. Corresponding to the years in this table, the SCC estimates range as follows: for Average SCC at 5%: \$5-\$16; for Average SCC at 3%: \$22-\$46; for Average SCC at 2.5%: \$36-\$66; and for 95th percentile SCC at 3%: \$66-\$139. Section VIII.G also presents these SCC estimates.

^c The monetized GHG benefits presented in this analysis exclude the value of changes in non-CO₂ GHG emissions expected under this program (see RIA Chapter 5). Although EPA has not monetized changes in non-CO₂ GHGs, the value of any increases or reductions should not be interpreted as zero.

^d Due to analytical and resource limitations, MY non-GHG emissions (direct PM, VOCs, NO₂ and SO₂) were not estimated for this analysis.

^e Negative sign represents an increase in Accidents, Congestion, and Noise.

Table 9-32 and Table 9-33 show similar model year estimates to those provided above in Tables 9-25 and 9-26, but reflect specific differences in the NHTSA HD program over the 3 mandatory model years of that program. These include no HD diesel engine impacts prior to MY 2017, assumption of the NHTSA phase-in schedule for HD pickup trucks and vans which achieves 3 year phase-in stability (67%-67%-67%-100% in MY 2016-2019 respectively), the inclusion of combination tractors from MY 2016 forward, and the exclusion of recreational vehicles, which are not regulated by NHTSA.

Heavy-Duty GHG and Fuel Efficiency Standards FRM: Economic and Other Impacts

Table 9-32: Monetized Technology Costs, Fuel Savings, Benefits, and Net Benefits Associated with the Lifetimes of 2016-2018 Model Year Trucks (Millions, 2009\$; 3% Discount Rate)

	2016 MY	2017 MY	2018 MY	Sum
Technology Costs	\$1,500	\$1,600	\$1,700	\$5,200
Fuel Savings (pre-tax)	\$5,500	\$10,900	\$11,500	\$27,900
Energy Security Impacts (price shock)	\$300	\$600	\$600	\$1,500
Accidents, Congestion, Noise ^e	-\$300	-\$300	-\$300	-\$900
Refueling Savings	\$40	\$80	\$80	\$200
Non-CO ₂ GHG Impacts and Non-GHG Impacts ^{c,d}	n/a	n/a	n/a	n/a
Reduced CO ₂ Emissions at each assumed SCC value ^{a, b}				
5% (avg SCC)	\$100	\$300	\$300	\$700
3% (avg SCC)	\$600	\$1,200	\$1,300	\$3,100
2.5% (avg SCC)	\$1,000	\$2,000	\$2,200	\$5,200
3% (95th percentile)	\$1,900	\$3,800	\$4,000	\$9,700
Monetized Net Benefits at each assumed SCC value ^{a, b}				
5% (avg SCC)	\$4,100	\$10,000	\$10,500	\$24,200
3% (avg SCC)	\$4,600	\$10,900	\$11,500	\$26,600
2.5% (avg SCC)	\$5,000	\$11,700	\$12,400	\$28,700
3% (95th percentile)	\$5,900	\$13,500	\$14,200	\$33,200

Notes:

^a Net present value of reduced CO₂ emissions is calculated differently than other benefits. The same discount rate used to discount the value of damages from future emissions (SCC at 5, 3, 2.5 percent) is used to calculate net present value of SCC for internal consistency. Refer to the SCC TSD for more detail.

^b Section VIII.G of the preamble notes that SCC increases over time. Corresponding to the years in this table, the SCC estimates range as follows: for Average SCC at 5%: \$5-\$16; for Average SCC at 3%: \$22-\$46; for Average SCC at 2.5%: \$36-\$66; and for 95th percentile SCC at 3%: \$66-\$139. Section VIII.G also presents these SCC estimates.

^c The monetized GHG benefits presented in this analysis exclude the value of changes in non-CO₂ GHG emissions expected under this program (see RIA Chapter 5). Although EPA has not monetized changes in non-CO₂ GHGs, the value of any increases or reductions should not be interpreted as zero.

^d Due to analytical and resource limitations, MY non-GHG emissions (direct PM, VOCs, NO₂ and SO₂) were not estimated for this analysis.

^e Negative sign represents an increase in Accidents, Congestion, and Noise.

Regulatory Impact Analysis

Table 9-33 Monetized Technology Costs, Fuel Savings, Benefits, and Net Benefits Associated with the Lifetimes of 2016-2018 Model Year Trucks (Millions, 2009\$; 7% Discount Rate)

	2016 MY	2017 MY	2018 MY	Sum
Technology Costs	\$1,500	\$1,600	\$1,700	\$5,200
Fuel Savings (pre-tax)	\$3,800	\$7,200	\$7,300	\$18,300
Energy Security Impacts (price shock)	\$200	\$400	\$400	\$1,000
Accidents, Congestion, Noise ^e	-\$200	-\$200	-\$200	-\$600
Refueling Savings	\$30	\$50	\$50	\$130
Non-CO ₂ GHG Impacts and Non-GHG Impacts ^{c,d}	n/a	n/a	n/a	n/a
Reduced CO ₂ Emissions at each assumed SCC value ^{a, b}				
5% (avg SCC)	\$100	\$300	\$300	\$700
3% (avg SCC)	\$600	\$1,200	\$1,300	\$3,100
2.5% (avg SCC)	\$1,000	\$2,000	\$2,200	\$5,200
3% (95th percentile)	\$1,900	\$3,800	\$4,000	\$9,700
Monetized Net Benefits at each assumed SCC value ^{a, b}				
5% (avg SCC)	\$2,400	\$6,200	\$6,200	\$14,300
3% (avg SCC)	\$2,900	\$7,100	\$7,200	\$16,700
2.5% (avg SCC)	\$3,300	\$7,900	\$8,100	\$18,800
3% (95th percentile)	\$4,200	\$9,700	\$9,900	\$23,300

Notes:

^a Net present value of reduced CO₂ emissions is calculated differently than other benefits. The same discount rate used to discount the value of damages from future emissions (SCC at 5, 3, 2.5 percent) is used to calculate net present value of SCC for internal consistency. Refer to the SCC TSD for more detail.

^b Section VIII.G of the preamble notes that SCC increases over time. Corresponding to the years in this table, the SCC estimates range as follows: for Average SCC at 5%: \$5-\$16; for Average SCC at 3%: \$22-\$46; for Average SCC at 2.5%: \$36-\$66; and for 95th percentile SCC at 3%: \$66-\$139. Section VIII.G also presents these SCC estimates.

^c The monetized GHG benefits presented in this analysis exclude the value of changes in non-CO₂ GHG emissions expected under this program (see RIA Chapter 5). Although EPA has not monetized changes in non-CO₂ GHGs, the value of any increases or reductions should not be interpreted as zero.

^d Due to analytical and resource limitations, MY non-GHG emissions (direct PM, VOCs, NO₂ and SO₂) were not estimated for this analysis.

^e Negative sign represents an increase in Accidents, Congestion, and Noise.

9.9 Employment Impacts

9.9.1 Introduction

Although analysis of employment impacts is not part of a cost-benefit analysis (except to the extent that labor costs contribute to costs), employment impacts of federal rules are of particular concern in the current economic climate of sizeable unemployment. The recently issued Executive Order 13563, “Improving Regulation and Regulatory Review” (January 18, 2011), states, “Our regulatory system must protect public health, welfare, safety, and our environment while promoting economic growth, innovation, competitiveness, and job creation”

Heavy-Duty GHG and Fuel Efficiency Standards FRM: Economic and Other Impacts

(emphasis added). Although EPA and NHTSA did not undertake an employment analysis of the proposed rules, several commenters suggested that we undertake an employment analysis for the final rulemaking. Consistent with Executive Order 13563, we have provided a discussion of the potential employment impacts of the Heavy-Duty National Program.

In recent rulemakings, EPA has generally focused its employment analysis on the regulated sector and the suppliers of pollution abatement equipment. However, in this rule, the agencies are offering qualitative assessment for related industries of interest. For the regulated sector, the agencies rely on Morgenstern et al. for guidance.⁴⁷ Our general conclusion is that employment impacts in the regulated sector (truck and engine manufacturing) and the parts sectors depend on a combination of factors, some of which are positive, and some of which can be positive or negative. In the related industries, the analysis concludes that effects on employment in the transport and shipping sectors are ambiguous; the fuel supplying sectors may face reduced employment; and there may be increased general employment due to reduction in costs that may be passed along to the transport industry and thus to the public. Because measuring employment effects depends on a variety of inputs and assumptions, some of which are known with more certainty than others, and because we did not include employment analysis in the NPRM and provide opportunity for public comment on the methods, we here present a qualitative discussion. Because the discussion is qualitative, and we thus do not know magnitudes (and, in some cases, directions), we do not sum the net effects on employment. We also note that the employment effects may be different in the immediate implementation phase than in the ongoing compliance phase; this analysis focuses on the longer-term effects rather than the immediate effects.

When the economy is at full employment, an environmental regulation is unlikely to have much impact on net overall U.S. employment; instead, labor would primarily be shifted from one sector to another. These shifts in employment impose an opportunity cost on society, approximated by the wages of the employees, as regulation diverts workers from other activities in the economy.⁴⁸ In this situation, any effects on net employment are likely to be transitory as workers change jobs. For example, some workers may need to be retrained or require time to search for new jobs, while shortages in some sectors or regions could bid up wages to attract workers.^F

It is also true that, if a regulation comes into effect during a period of high unemployment, a change in labor demand due to regulation may affect net overall U.S. employment because the labor market is not in equilibrium. Either negative or positive effects are possible. Schmalensee and Stavins⁴⁹ point out that net positive employment effects are possible in the near term when the economy is at less than full employment due to the potential hiring of idle labor resources by the regulated sector to meet new requirements (*e.g.*, to install new equipment) and new economic activity in sectors related to the regulated sector. In the longer run, the net effect on employment is more difficult to predict and will depend on the way in which the related industries respond to the regulatory requirements. As Schmalensee and

^F Although the employment level would not change substantially, there would be costs to the workers associated with shifting from one activity to another. Jacobson, Louis S., Robert J. LaLonde, and Daniel G. Sullivan, "Earnings Losses of Displaced Workers." *American Economic Review* 83(4) (1993): 685-709.

Regulatory Impact Analysis

Stavins note, it is possible that the magnitude of the effect on employment could vary over time, region, and sector, and positive effects on employment in some regions or sectors could be offset by negative effects in other regions or sectors. For this reason, they urge caution in reporting partial employment effects since it can “paint an inaccurate picture of net employment impacts if not placed in the broader economic context.”

This rulemaking is expected to have a relatively small effect on net employment in the United States through the regulated sector – the truck and engine manufacturer industry – and several related sectors, specifically, industries that supply the truck and engine manufacturing industry (*e.g.*, truck parts), the trucking industry itself, other industries involved in transporting goods (*e.g.*, rail and shipping); the petroleum refining sector, and the retail sector. According to the U.S. Bureau of Labor Statistics, about 1.25 million people were employed in the truck transportation industry and about 675,000 people were employed in the motor vehicle parts industry between 2010 and 2011.⁵⁰ Although heavy-duty vehicles (HD) account for approximately 4 percent of the vehicles on the road, these vehicles consume more than 20 percent of on-road gasoline and diesel fuel use. As discussed in Chapter 5 of this RIA, this rulemaking is predicted to reduce the amount of fuel these vehicles use, and thus affect the petroleum refinery industry. The petroleum refinery industry employed about 65,000 people in the U.S. in 2009, the most recent year that employment estimates are available for this sector.⁵¹ Finally, since the net reduction in cost associated with these rules is expected to lead to lower transportation and shipping costs, in a competitive market a substantial portion of those cost savings will be passed along to consumers, who then will have additional discretionary income (how much of the cost is passed along to consumers depends on market structure and the relative price elasticities).

Determining the direction of employment effects even in the regulated industry may be difficult due to the presence of competing effects that lead to an ambiguous adjustment in employment as a result of environmental regulation. Morgenstern, Pizer and Shih⁵² identify three separate ways that employment levels may change in the regulated industry in response to a new (or more stringent) regulation.

- *Demand effect:* higher production costs due to the regulation will lead to higher market prices; higher prices in turn reduce demand for the good, reducing the demand for labor to make that good. In the authors’ words, the “extent of this effect depends on the cost increase passed on to consumers as well as the demand elasticity of industry output.”
- *Cost effect:* As go up, plants add more capital and labor (holding other factors constant), with potentially positive effects on employment; in the authors’ words, as “production costs rise, more inputs, including labor, are used to produce the same amount of output.”
- *Factor-shift effect:* post-regulation production technologies may be more or less labor-intensive (*i.e.*, more/less labor is required per dollar of output). In the authors’ words, “environmental activities may be more labor intensive than conventional production,” meaning that “the amount of labor per dollar of output will rise,” though it is also possible that “cleaner operations could involve automation and less employment, for example.”

The “demand effect” is expected to have a negative effect on employment, the “cost effect” to have a positive effect on employment, and the “factor-shift effect” has an ambiguous effect on employment. Without more information with respect to the magnitudes of these competing effects, it is not possible to predict the total effect environmental regulation will have on employment levels in a regulated sector.

Morgenstern et al. estimated the effects on employment of spending on pollution abatement for four highly polluting/regulated industries (pulp and paper, plastics, steel, and petroleum refining). They conclude that increased abatement expenditures generally have *not* caused a significant change in employment in those sectors. More specifically, their results show that, on average across the industries studied, each additional \$1 million spent on pollution abatement results in a (statistically insignificant) net increase of 1.5 jobs. While the specific sectors Morgenstern et al. examined are different than the sectors considered here, the methodology that Morgenstern et al. developed is useful in this context.

9.9.2 Overview of Affected Sectors

The above discussion focuses on employment changes in the regulated sector, but the regulated sector is not the only source of changes in employment. In these rules, the regulated sectors are truck and engine manufacturers; they are responsible for meeting the standards set in these rules. The effects of these rules are also likely to have impacts beyond the directly regulated sector. Some of the related sectors which these rules are also likely to impact include: motor vehicle parts producers, to the extent that the truck and engine industries purchase components rather than manufacture them in-house; shipping and transport, because many companies in this sector purchase trucks and their operating costs will be affected by both higher truck prices and fuel savings; oil refineries due to reduced demand for petroleum-based fuels; and the final retail market, which is where any net cost reductions due to fuel savings are ultimately expected to be experienced. We acknowledge that there may be impacts in other sectors that are not discussed here, but we have sought to include the sectors where we think the impacts are most direct. The following discussion describes the direction of impacts on employment in these industries. The effects of the HD rule on net U.S. employment depend, not only on their relative magnitudes, but also on employment levels in the overall economy. As previously discussed, in a full-employment economy these sector-specific impacts will be mostly offset by employment changes elsewhere in the economy and would not be expected to result in a net change in jobs. However, in an economy with significant unemployment these changes may affect net employment in the U.S.

9.9.2.1 Truck and Engine Manufacturers

The regulated sector consists of truck and engine manufacturers. Employment associated with manufacturing trucks and engines may be affected by the demand, cost, and factor-shift effects.

9.9.2.1.1 Demand Effect

The demand effect depends on the effects of this rulemaking on HD vehicle sales. If vehicle sales increase, then more people will be required to assemble trucks and their

Regulatory Impact Analysis

components. If vehicle sales decrease, employment associated with these activities will unambiguously decrease. The effects of this rulemaking on HD vehicle sales depend on the perceived desirability of the new vehicles. Unlike in Morgenstern et al.'s study, where the demand effect decreased employment, there are countervailing possibilities in the HD market due to the fuel savings resulting from this program. On one hand, this rulemaking will increase vehicle costs; by itself, this effect would reduce vehicle sales. In addition, while decreases in vehicle performance would also decrease sales, this rule is not expected to have any negative effect on vehicle performance. On the other hand, this rulemaking will reduce the fuel costs of operating the vehicle; by itself, this effect would increase vehicle sales, especially if potential buyers have an expectation of higher fuel prices. The agencies have not made an estimate of the potential change in vehicle sales. However, as discussed in Preamble Section VIII.E.5, the agencies have estimated an increase in vehicle miles traveled (*i.e.*, VMT rebound) due to the reduced operating costs of trucks meeting these new standards. Since increased VMT is most likely to be met with more drivers and more trucks, our projection of VMT rebound is suggestive of an increase in vehicle sales and truck driver employment (recognizing that these increases may be partially offset by a decrease in manufacturing and sales for equipment of other modes of transportation such as rail cars or barges).

As discussed in Preamble Section VIII.A., the agencies find that the reduction in fuel costs associated with this rulemaking outweigh the increase in vehicle cost. This finding is puzzling insofar as market forces should lead truck manufacturers and buyers to install all cost-effective fuel-saving technology, but the agencies find that they have not. Preamble Section VIII.A discusses various hypotheses that have been suggested to explain this phenomenon. Some of the explanations suggest that vehicle manufacturers and buyers will benefit from the rulemaking, and vehicle sales will increase; others suggest that the opposite might occur. The agencies do not have strong evidence supporting one specific explanation over another. As a result, the agencies do not suggest a direction for changes in employment due to changes in vehicle sales. However, some in the heavy-duty industry indicate the potential for an increase in jobs. As stated by Tom Linebarger (President and Chief Operating Officer of Cummins) and Fred Krupp (President of the Environmental Defense Fund), "Finally, strong environmental standards play a crucial role in getting innovations to market that will create economic opportunity for American companies and jobs for American workers. . . . It helps that Cummins and other forward-thinking businesses view this as an opportunity to innovate and increase international market share."⁵³

9.9.2.1.2 *Cost Effect*

The truck and engine manufacturing sector has great flexibility in how to respond to the requirement for reduced greenhouse gases and increasing fuel efficiency, with a broad suite of technologies being available to achieve the standards. These technologies are described in detail in Chapter 2 of this RIA. Among these technologies, a distinction can be made between technologies that can be "added on" to conventional trucks versus those that replace features of a conventional truck. "Added on" features, such as auxiliary power units, require additional labor to install the technologies on trucks, thus clearly increasing labor demand (the "cost effect"). The pure cost effect always increases employment, though the net effect on the regulated industry depends on its effects in combination with the demand and factor-shift effects.

9.9.2.1.3 *Factor-Shift Effect*

For “replacement” technologies, the predicted impact on labor demand from regulation depends on the change in the amount of labor used build and to install one type of technology compared to another. In some cases, the new technologies are predicted to be more complex than the existing technologies and may therefore require additional labor installation inputs. In other cases, the opposite may be true: labor intensity may be lower for some replacement technologies.

Most of the technologies that are expected to be used to meet these standards are replacement technologies. For example, almost all of the engine improvements involve replacement technologies that are not expected to significantly change the labor requirements. Similarly, regulations of the chassis on vocational vehicles will only require the installation of a different type of tire, which is also not expected to have large labor intensity impacts. Therefore, the potential magnitude of the factor shift effect is expected to be relatively small, though perhaps slightly positive due to the additional labor needed to install more complex technologies.

9.9.2.1.4 Summary for the Truck and Engine Manufacturing Sector

For the truck and engine manufacturing sector, the demand effect may result in either increased or decreased employment; the cost effect is expected to increase employment; and the factor-shift effect is expected to have a small, possibly slightly positive effect on employment in this sector. The net effect on employment in this sector depends on the sum of these factors.

9.9.2.2 Motor Vehicle Parts Manufacturing Sector

Some vehicle parts are made in-house and would be included directly in the regulated sector. Others are made by independent suppliers and are not directly regulated, but they will be affected by the rules as well. The parts manufacturing sector will be involved primarily in providing “add-on” parts, or components for replacement parts built internally. If demand for these parts increases due to the increased use of these parts, employment effects in this sector are expected to be positive. If the demand effect in the regulated sectors is significantly negative enough, it is possible that demand for other parts may decrease. As noted, the agencies do not predict a direction for the demand effect.

9.9.2.2.1 *Transport and Shipping Sectors*

Although not directly regulated by these rules, employment effects in the transport and shipping sector are likely to result from these regulations. If the overall cost of shipping a ton of freight decreases because of increased fuel efficiency (taking into account the increase in upfront purchasing costs), in a perfectly competitive industry these costs savings will be passed along to customers. With lower prices, demand for shipping would lead to an increase in demand for truck shipping services (consistent with the VMT rebound effect analysis) and therefore an increase in employment in the truck shipping sector. In addition, if the relative cost of shipping freight via trucks becomes cheaper than shipping by other modes (*e.g.*, rail or barge), then employment in the truck transport industry is likely to increase. If the trucking industry is more labor intensive than other modes, we would expect this effect to lead to an overall increase in

Regulatory Impact Analysis

employment in the transport and shipping sectors. Such a shift would, however, be at the expense of employment in the sectors that are losing business to trucking. The first effect – a gain due to lower shipping costs – is likely to lead to a net increase in employment. The second effect, due to mode-shifting, may increase employment in trucking, but decreases in other shipping sectors.

9.9.2.2.2 *Fuel Suppliers*

In addition to the effects on the trucking industry and related truck parts sector, these rules will result in reductions in fuel use that lower GHG emissions. Fuel saving, principally reductions in liquid fuels such as diesel and gasoline, will affect employment in the fuel suppliers industry sectors, principally the Petroleum Refinery sector.⁵⁴

Expected fuel consumption reductions by fuel type, and by heavy-duty vehicle type, can be found in Table 7-7 in RIA Chapter 7. These reductions reflect impacts from the new fuel efficiency and GHG standards and include increased consumption from the rebound effect. These fuel savings are monetized in Table 7-8 in RIA Chapter 7 by multiplying the reduced fuel consumption in each year by the corresponding estimated average fuel price in that year, using the Reference Case from the AEO 2011. In 2014, the pre-tax fuel savings is \$1.2 billion (2009\$). While these figures represent a level of fuel savings for purchasers of fuel, it also represents a loss in value of output for the petroleum refinery industry. Since 50 percent of the fuel would have been refined in the U.S., the loss in output to the U.S. Petroleum Refinery sector is \$600 million (2009\$), which will result in reduced sectoral employment.⁵⁵ Because this sector is very capital-intensive, the employment effect is not expected to be large.

9.9.2.2.3 *Fuel Savings*

As a result of this rulemaking, it is anticipated that trucking firms will experience fuel savings. Fuel savings lower the costs of transportation goods and services. In a competitive market, the fuel saving that initially accrue to trucking firms are likely to be passed along as lower transportation costs that, in turn, could result in lower prices for final goods and services. Alternatively, the savings could be kept internally in firms for investments or for returns to firm owners. In either case, the savings will accrue to some segment of consumers: either owners of trucking firms or the general public. In both cases, the effect will be increased spending by consumers in other sectors of the economy, creating jobs in a diverse set of sectors, including retail and service industries.

As mentioned above, the value of fuel savings from this rulemaking is projected to be \$1.2 billion (2009\$) in 2014, according to Table 7-8. If all those savings are spent, the fuel savings will stimulate increased employment in the economy through those expenditures. If the fuel savings accrue primarily to firm owners, they may either reinvest the money or take it as profit. Reinvesting the money in firm operations would increase employment directly. If they take the money as profit, to the extent that these owners are wealthier than the general public, they may spend less of the savings, and the resulting employment impacts would be smaller than if the savings went to the public. Thus, while fuel savings are expected to decrease employment in the refinery sector, they are expected to increase employment through increased consumer expenditures.

9.9.3 Summary of Employment Impacts

The net employment effects of this rulemaking are expected to be found throughout several key sectors: truck and engine manufacturers, the trucking industry, truck parts manufacturing, fuel production, and consumers. For the regulated sector, the demand effect may result in either increased or decreased employment, depending on the net effect on HD vehicle sales; the cost effect is expected to increase employment in the regulated sector; and the factor-shift effect is expected to have a small, possibly slightly positive effect on employment, though we cannot definitively say this is the case without quantification. The net effect depends on the combination of these effects. Increased expenditures by truck and engine parts manufacturers are expected to require increased labor to build parts, though this effect also depends on any changes overall demand, and on in the labor intensity of production of new parts; increased complexity of technologies may imply increased labor inputs for some parts, though others might be less labor-intensive. It is possible, if access to capital markets is limited, that this rule might displace other HD sector investment, which would reduce employment associated with those activities. Lower prices for shipping are expected to lead to an increase in demand for truck shipping services and, therefore, an increase in employment in that sector, though this effect may be offset somewhat by changes in employment in other shipping sectors. Reduced fuel production implies less employment in the fuel provision sectors. Finally, any net cost savings would be expected to be passed along to some segment of consumers: either the general public or the owners of trucking firms, who are expected then to increase employment through their expenditures. Given the job creation as a result of the \$1.2B (2009\$) in fuel savings in 2014 and the possible employment increases in the manufacturing and parts sectors, we find it highly unlikely that there would be significant net job losses related to this policy. Given the current level of unemployment, net positive employment effects are possible, especially in the near term, due to the potential hiring of idle labor resources by the regulated sector to plan for and meet new requirements. In the future, when full employment is expected to return, any changes in employment levels in the regulated sector due to this program are mostly expected to be offset by changes in employment in other sectors.

References

- ¹ Committee to Assess Fuel Economy Technologies for Medium- and Heavy-Duty Vehicles; National Research Council; Transportation Research Board (2010). “Technologies and Approaches to Reducing the Fuel Consumption of Medium- and Heavy-Duty Vehicles,” (hereafter, “NAS 2010”). Washington, D.C. The National Academies Press. Available electronically from the National Academies Press Website at http://www.nap.edu/catalog.php?record_id=12845 (last accessed September 10, 2010).
- ² Akerlof, George A. “The Market for ‘Lemons’” Quality Uncertainty and the Market Mechanism,” *Quarterly Journal of Economics* 84(3) (1970): 488-500 points out that asymmetric information – the seller has better information than the buyer – can potentially lead to complete failure of a market, even when both buyers and sellers would benefit from trade.
- ³ See NAS 2010, page 182.
- ⁴ Metcalf, G., and D. Rosenthal (1995). “The ‘New’ View of Investment Decisions and Public Policy Analysis: An Application to Green Lights and Cold Refrigerators,” *Journal of Policy Analysis and Management* 14: 517–531. Hassett and Metcalf (1995). “Energy Tax Credits and Residential Conservation Investment: Evidence from Panel Data” *Journal of Public Economics* 57 (1995): 201-217. Metcalf, G., and K. Hassett (1999). “Measuring the Energy Savings from Home Improvement Investments: Evidence from Monthly Billing Data.” *The Review of Economics and Statistics* 81(3): 516-528.
- ⁵ Greene, D., J. German, and M. Delucchi (2009). “Fuel Economy: The Case for Market Failure” in *Reducing Climate Impacts in the Transportation Sector*, Sperling, D., and J. Cannon, eds. Springer Science.
- ⁶ Dasgupta, S., S. Siddarth, and J. Silva-Risso (2007). “To Lease or to Buy? A Structural Model of a Consumer’s Vehicle and Contract Choice Decisions.” *Journal of Marketing Research* 44: 490 – 502.
- ⁷ American Transportation Research Institute, *An Analysis of the Operational Costs of Trucking*, December 2008 (Docket ID: EPA-HQ-OAR-2010-0162-0007).
- ⁸ Transport Canada, *Operating Cost of Trucks, 2005*. See <http://www.tc.gc.ca/eng/policy/report-acg-operatingcost2005-2005-e-2-1727.htm>, accessed on July 16, 2010 (Docket ID: EPA-HQ-OAR-2010-0162-0006).
- ⁹ Memo from Energy and Environmental Research Associates, LLC Regarding HDV Rebound Effect, dated June 8, 2011.
- ¹⁰ Graham and Glaister, “Road Traffic Demand Elasticity Estimates: A Review,” *Transport Reviews* Volume 24, 3, pp. 261-274, 2004 (Docket ID: EPA-HQ-OAR-2010-0162-0005).
- ¹¹ Li, Z., D.A. Hensher, and J.M. Rose, *Identifying sources of systematic variation in direct price elasticities from revealed preference studies of inter-city freight demand*. Transport Policy, 2011
- ¹² Committee to Assess Fuel Economy Technologies for Medium- and Heavy-Duty Vehicles; National Research Council; Transportation Research Board (2010). *Technologies and Approaches to Reducing the Fuel Consumption of Medium- and Heavy-Duty Vehicles*. (“The NAS Report”) Washington, D.C., The National Academies Press. Available electronically from the National Academy Press Website at <http://www.nap.edu/catalog>. See also 2009 Cambridge Systematics, Inc., Draft Final Paper commissioned by the NAS in support of the medium-duty and heavy-duty report. *Assessment of Fuel Economy Technologies for Medium and Heavy Duty Vehicles: Commissioned Paper on Indirect Costs and Alternative Approaches* (Docket ID: EPA-HQ-OAR-2010-0162-0009).
- ¹³ Friedlaender, A. and Spady, R. (1980) A derived demand function for freight transportation, *Review of Economics and Statistics*, 62, pp. 432–441 (Docket ID: EPA-HQ-OAR-2010-0162-0004).
- ¹⁴ Christidis and Leduc, “Longer and Heavier Vehicles for freight transport,” European Commission Joint Research Center’s Institute for Prospective Technology Studies, 2009 (Docket ID: EPA-HQ-OAR-2010-0162-0010).
- ¹⁵ Christidis and Leduc, 2009.
- ¹⁶ Winebrake, James and James J. Corbett (2010). “Improving the Energy Efficiency and Environmental Performance of Goods Movement,” in Sperling, Daniel and James S. Cannon (2010) *Climate and Transportation Solutions: Findings from the 2009 Asilomar Conference on Transportation and Energy Policy*. See <http://www.its.ucdavis.edu/events/2009book/Chapter13.pdf> (Docket ID: EPA-HQ-OAR-2010-0162-0011)

Heavy-Duty GHG and Fuel Efficiency Standards FRM: Economic and Other Impacts

¹⁷ Winebrake, J. J.; Corbett, J. J.; Falzarano, A.; Hawker, J. S.; Korfmacher, K.; Ketha, S.; Zilora, S., Assessing Energy, Environmental, and Economic Tradeoffs in Intermodal Freight Transportation, *Journal of the Air & Waste Management Association*, 58(8), 2008 (Docket ID: EPA-HQ-OAR-2010-0162-0008).

¹⁸ Cambridge Systematics, Inc.. 2009.

¹⁹ Northeast States Center for a Clean Air Future, Southeast Research Institute, TIAX, LLC., and International Council on Clean Transportation, *Reducing Heavy-Duty Long Haul Truck Fuel Consumption and CO2 Emissions*, September 2009. See http://www.nescaum.org/documents/heavy-duty-truck-ghg_report_final-200910.pdf

²⁰ NHTSA's estimates of the rebound effect are derived from econometric analysis of national and state VMT data reported in Federal Highway Administration, *Highway Statistics*, various editions, Tables VM-1 and VM-4.

Specifically, the estimates of the rebound effect reported in Table 9-2 are ranges of the estimated short-run and long-run elasticities of annual VMT by single-unit and combination trucks with respect to fuel cost per mile driven. (Fuel cost per mile driven during each year is equal to average fuel price per gallon during that year divided by average fuel economy of the truck fleet during that same year.) These estimates are derived from time-series regression of annual national aggregate VMT for the period 1970-2008 on measures of nationwide economic activity, including aggregate GDP, the value of durable and nondurable goods production, and the volume of U.S. exports and imports of goods, and variables affecting the price of trucking services (driver wage rates, truck purchase prices, and fuel costs), and from regression of VMT for each individual state over the period 1994-2008 on similar variables measured at the state level.

²¹ Memo from Energy and Environmental Research Associates, LLC Regarding HDV Rebound Effect, dated June 8, 2011.

²² Docket ID EPA-HQ-OAR-2009-0472-114577, *Technical Support Document: Social Cost of Carbon for Regulatory Impact Analysis Under Executive Order 12866, Interagency Working Group on Social Cost of Carbon*, with participation by Council of Economic Advisers, Council on Environmental Quality, Department of Agriculture, Department of Commerce, Department of Energy, Department of Transportation, Environmental Protection Agency, National Economic Council, Office of Energy and Climate Change, Office of Management and Budget, Office of Science and Technology Policy, and Department of Treasury (February 2010). Also available at <http://epa.gov/otaq/climate/regulations.htm>

²³ The interagency group decided that these estimates apply only to CO₂ emissions. Given that warming profiles and impacts other than temperature change (e.g. ocean acidification) vary across GHGs, the group concluded "transforming gases into CO₂-equivalents using GWP, and then multiplying the carbon-equivalents by the SCC, would not result in accurate estimates of the social costs of non-CO₂ gases" (SCC TSD, pg 13).

²⁴ The SCC estimates were converted from 2007 dollars to 2008 dollars using a GDP price deflator (1.021) and again to 2009 dollars using a GDP price deflator (1.009) obtained from the Bureau of Economic Analysis, National Income and Product Accounts Table 1.1.4, *Prices Indexes for Gross Domestic Product*.

²⁵ National Research Council (2009). *Hidden Costs of Energy: Unpriced Consequences of Energy Production and Use*. National Academies Press. See docket ID EPA-HQ-OAR-2009-0472-11486.

²⁶ These estimates were developed by FHWA for use in its 1997 *Federal Highway Cost Allocation Study*; see <http://www.fhwa.dot.gov/policy/hcas/final/index.htm> (last accessed July 21, 2010).

²⁷ See Federal Highway Administration, 1997 *Federal Highway Cost Allocation Study*, <http://www.fhwa.dot.gov/policy/hcas/final/index.htm>, Tables V-22, V-23, and V-24 (last accessed July 21, 2010).

²⁸ See Table 4. Last viewed on September 9, 2010 at http://ostpxweb.dot.gov/policy/Data/VOTrevision1_2-11-03.pdf. Note that we assume the value of travel time is constant out to 2050, which is a conservative assumption since it is likely this value will increase due to income growth in the future.

²⁹ Passenger vehicle fuel dispensing rate per EPA regulations, last viewed on August 4, 2010 at <http://www.epa.gov/oms/regs/ld-hwy/evap/spitback.txt>

³⁰ "Preliminary Regulatory Impact Analysis, FMVSS No. 119, New Pneumatic Tires for Motor Vehicles with a GVWR of More Than 4,536 kg (10,000 pounds), June 2010.

³¹ Cost and Weight Analysis of Two Motorcoach Seating Systems: One With and One Without Three-Point Lap/Shoulder Belt Restraints, Ludtke and Associates, July 2010.

³² "Final Regulatory Impact Analysis, Corporate Average Fuel Economy for MY 2012 - MY 2016 Passenger Cars and Light Trucks", NHTSA, March 2010, (Docket No. NHTSA-2009-0059-0344.1).

³³ Based on data from the CIA, combining various recent years,

Regulatory Impact Analysis

<https://www.cia.gov/library/publications/the-world-factbook/rankorder/2176rank.html>.

³⁴ IEA 2011 “IEA Response System for Oil Supply Emergencies.”

³⁵ U.S. Department of Defense. 2010. Quadrennial Defense Review Report. Secretary of Defense: Washington, D.C. 128 pgs.

³⁶ The Department of the Navy’s Energy Goals (http://www.navy.mil/features/Navy_EnergySecurity.pdf) (Last accessed May 31, 2011).

³⁷ U.S. Department of Defense, Speech: Remarks at the White House Energy Security Summit. Tuesday, April 26, 2011. (<http://www.defense.gov/speeches/speech.aspx?speechid=1556>) (Last accessed May 31, 2011).

³⁸ The White House, *Blueprint for a Secure Energy Future* (March 30, 2011)

(http://www.whitehouse.gov/sites/default/files/blueprint_secure_energy_future.pdf) (Last accessed May 27, 2011).

³⁹ U.S. Bureau of Economic Analysis, U.S. International Transactions Accounts Data, as shown on June 14, 2010.

⁴⁰ U.S. Department of Energy, Annual Energy Review 2008, Report No. DOE/EIA-0384(2008), Tables 5.1 and 5.13c, June 26, 2009.

⁴¹ AEO 2011, EIA, Imported Liquids by Source.

⁴² For historical data through 2006: EIA Annual Energy Review, various editions. For data 2006-2008: EIA Annual Energy Outlook (AEO) 2009 (Update Reference (Stimulus) Base Case). See file "aeostimtab_11.xls" available at <http://www.eia.doe.gov/oiaf/servicerpt/stimulus/aeostim.html>

⁴³ Leiby, Paul N. "Estimating the Energy Security Benefits of Reduced U.S. Oil Imports," Oak Ridge National Laboratory, ORNL/TM-2007/028, Final Report, 2008.

⁴⁴ Leiby, Paul N., Donald W. Jones, T. Randall Curlee, and Russell Lee, *Oil Imports: An Assessment of Benefits and Costs*, ORNL-6851, Oak Ridge National Laboratory, November, 1997.

⁴⁵ *Peer Review Report Summary: Estimating the Energy Security Benefits of Reduced U.S. Oil Imports*, ICF, Inc., September 2007.

⁴⁶ AEO 2011 forecasts energy market trends and values only to 2035. The post-2035 energy security premium values are assumed to be equal to the 2035 estimate.

⁴⁷ Morgenstern, Richard D., William A. Pizer, and Jhih-Shyang Shih. “Jobs Versus the Environment: An Industry-Level Perspective.” *Journal of Environmental Economics and Management* 43 (2002): 412-436.

⁴⁸ Schmalensee, Richard, and Robert N. Stavins. “A Guide to Economic and Policy Analysis of EPA’s Transport Rule.” White paper commissioned by Excelon Corporation, March 2011.

⁴⁹ Ibid.

⁵⁰ U.S. Bureau of Labor Statistics seasonally-adjusted Current Employment Statistics Survey for the Truck Transportation Industry (NAICS 484) and the Motor Vehicle Parts Manufacturing Industry (NAICS 3363).

⁵¹ U.S. Census Bureau, 2009 Annual Survey of Manufactures, Published December 3, 2010.

⁵² Morgenstern, Richard D., William A. Pizer, and Jhih-Shyang Shih. “Jobs Versus the Environment: An Industry-Level Perspective.” *Journal of Environmental Economics and Management* 43 (2002): 412-436.

⁵³ Tom Linebarger (President and Chief Operating Officer of Cummins) and Fred Krupp (President of the Environmental Defense Fund), "Clear rules can create better engines, clean air," Indianapolis Star, October 28, 2010, p. 19; included as part of Cummins' comments on the rule, Docket Number EPA-HQ-OAR-2010-0162-1765.1[1] .

⁵⁴ North American Industry Classification System (NAICS) Code 32411.

⁵⁵ EPA and NHTSA estimate that approximately 50 percent of the reduction in fuel consumption resulting from adopting improved fuel GHG standards and fuel efficiency standards is likely to be reflected in reduced U.S. imports of refined fuel, while the remaining 50 percent is expected to be reflected in reduced domestic fuel refining. Of this latter figure, 90 percent is anticipated to reduce U.S. imports of crude petroleum for use as a refinery feedstock, while the remaining 10 percent is expected to reduce U.S. domestic production of crude petroleum. Because we do not expect to see a significant reduction in crude oil production in the U.S., we do not expect this rule to have a significant impact on the Oil and Gas Extraction industry sector in the U.S. (NAICS 211000). For more information, refer to Chapter 9.7 on the energy security impacts from the rule.

Chapter: 10: Small Business Flexibility Analysis

The Regulatory Flexibility Act, as amended by the Small Business Regulatory Enforcement Fairness Act of 1996 (SBREFA), generally requires an agency to prepare a regulatory flexibility analysis for any rulemaking subject to notice-and-comment rulemaking requirements under the Administrative Procedure Act or any other statute. This requirement does not apply if the agency certifies that the rulemaking will not have a significant economic impact on a substantial number of small entities.

The following discussion provides an overview of small entities in the heavy-duty vehicle and engine market. Small entities include small businesses, small organizations, and small governmental jurisdictions. For the purposes of assessing the impacts of the rulemaking on small entities, a small entity is defined as: (1) a small business that meets the definition for business based on the Small Business Administration’s (SBA) size standards (see Table 10-1); (2) a small governmental jurisdiction that is a government of a city, county, town, school district or special district with a population of less than 50,000; and (3) a small organization that is any not-for-profit enterprise which is independently owned and operated and is not dominant in its field. Table 10-1 provides an overview of the primary SBA small business categories potentially affected by this regulation.

Table 10-1 Primary Small Business NAICS Categories Affected by this Rulemaking

	NAICS CODES ¹	DEFINED BY SBA AS A SMALL BUSINESS IF LESS THAN OR EQUAL TO: ²
Engine Equipment Manufacturer	333618	1,000 employees
Automobile Manufacturer	336111	1,000 employees
Light Truck and Utility Vehicle Manufacturer	336112	1,000 employees
Heavy-Duty Truck Manufacturer	336120	1,000 employees
Motor Vehicle Body Manufacturing	336211	1,000 employees

We compiled a list of engine manufacturers, vehicle manufacturers, and body manufacturers that would be potentially affected by the rulemaking from the EPA database for engine certification, Ward’s Automotive Database, and the M.J. Bradley’s Heavy Duty Vehicle Market Analysis. We then identified companies that appear to meet the definition of small business provided in the table above based on the number of employees based on company information included in Hoover’s. Based on this assessment, the agencies identified the following:

- two tractor manufacturers³ which comprise less than 0.5 percent of the total heavy-duty combination tractors in the U.S. based on Polk Registration Data from 2003 through 2007;⁴

Regulatory Impact Analysis

- ten chassis manufacturers⁵ less than 0.5 percent of the total heavy-duty combination tractors in the U.S. based on Polk Registration Data from 2003 through 2007;⁶ and
- three heavy duty engine manufacturers⁷ which comprise less than 0.1 percent of total heavy-duty engine based on 2008 and 2009 model year engine certification data submitted to EPA for non-GHG emissions standards.

The exemption from the standards established under this final action would have a negligible impact on the GHG emissions and fuel consumption reductions otherwise due to the standards.

EPA has not conducted an Initial Regulatory Flexibility Analysis for this rulemaking because we are certifying that the rulemaking would not have a significant economic impact on a substantial number of small entities. EPA is exempting manufacturers, domestic and foreign, meeting SBA's size definitions of small business as described in 13 CFR § 121.201. EPA will instead consider appropriate GHG standards for these entities as part of a future regulatory action.

To ensure that EPA and NHTSA are aware of which companies would be exempt, the agencies are finalizing as proposed to require that such entities submit a declaration to EPA containing a detailed written description of how that manufacturer qualifies as a small entity under the provisions of 13 CFR § 121.201.

References

¹ North American Industry Classification System

² According to SBA's regulations (13 CFR Part 121), businesses with no more than the listed number of employees or dollars in annual receipts are considered "small entities" for RFA purposes.

³ The agencies have identified Ottawa Truck, Inc. and Kalmar Industries USA as two potential small tractor manufacturers

⁴ M.J. Bradley. Heavy Duty Vehicle Market Analysis. May 2009.

⁵ The agencies have identified Lodal, Indiana Phoenix, Autocar LLC, HME, Giradin, Azure Dynamics, DesignLine International, Ebus, Krystal Koach, and Millenium Transit Services LLC as potential small business chassis manufacturers.

⁶ M.J. Bradley. Heavy Duty Vehicle Market Analysis. May 2009.

⁷ The agencies have identified Baytech Corporation, Clean Fuels USA, and BAF Technologies, Inc. as three potential small businesses

Chapter 11: Trailers

A central theme throughout our HD Program is the recognition of the diversity and complexity of the heavy-duty vehicle segment. Trailers are an important part of this segment and are no less diverse in the range of functions and applications they serve. They are the primary vehicle for moving freight in the United States. The type of freight varies from retail products to be sold in stores, to bulk goods such as stones, to industrial liquids such as chemicals, to equipment such as bulldozers. Semi-trailers come in a large variety of styles – box, refrigerated box, flatbed, tankers, bulk, dump, grain, and many others. The most common type of trailer is the box trailer, but even box trailers come in many different lengths ranging from 28 feet to 53 feet or greater, and in different widths, heights, depths, materials (wood, composites, and/or aluminum), construction (curtain side or hard side), axle configuration (sliding tandem or fixed tandem), and multiple other distinct features. NHTSA and EPA believe trailers impact the fuel consumption and CO₂ emissions from combination tractors and the agencies see opportunities for reductions. Unlike trucks and engines, EPA and NHTSA have very limited experience related to regulating trailers for fuel efficiency or emissions. Likewise, the trailer manufacturing industry has only the most limited experience complying with regulations related to emissions and none with regard to EPA or NHTSA certification and compliance procedures.

The agencies broadly solicited comments on controlling fuel efficiency and GHG emissions through eventual trailer regulations as we described in the notice of proposed rulemaking which could set the foundation of a future rulemaking for trailers. 75 FR at 74345-351 (although this was a solicitation for comment regarding future action outside the present rulemaking).

The general theme of the comments received was that technologies exist today that can improve trailer efficiency. We received several comments from stakeholders which encouraged the agencies to set fuel efficiency and GHG emissions standards for trailers in this rulemaking. The agencies also received comments supporting a delay in trailer regulations. Specifically, IPI commented that the agencies should regulate trailers at least to some degree, arguing that the agencies' reasoning for not doing so was insufficient and requesting a plan and schedule in the final rulemaking for the future regulation of trailers. One commenter recognized that there are well over 100 trailer manufacturers in the U.S., with almost all being small businesses. They stressed the need for the agencies to reach out to the trailer industry and associations prior to developing a regulatory program for this industry. In addition, they stated that time is needed to develop sufficient research into the area. None of the commenters that supported trailer regulation in this action addressed the complexities of the trailer industry, nor a method to measure trailer aerodynamic improvements.

In the NPRM, the agencies discussed relatively conceptual approaches to how a future trailer regulation could be developed; however, we did not provide a proposed test procedure or proposed standard. The agencies proposed to delay the regulation of trailers, as the inclusion would not be feasible at this time due to the diversity and complexity of the trailer industry, as well as a lack of critical information from the SmartWay program, industry and other key stakeholders. Additionally, since a number of trailer manufacturing entities are

small businesses, EPA and NHTSA need to allow sufficient time to convene a SBREFA panel to conduct the proper outreach to the potentially impacted stakeholders. NHTSA and EPA agree that the regulation of trailers, when appropriate, is likely to provide fuel efficiency benefits. We continue to believe that both agencies must perform a more comprehensive assessment of the trailer industry, and therefore that their inclusion at this time is not feasible. Until that time, the SmartWay Transport Partnership Program will continue to encourage the development and use of technologies to reduce fuel consumption and CO₂ emissions from trailers.

11.1 Overview

A trailer is a vehicle designed to haul cargo while being pulled by another powered motor vehicle. It may be constructed to rest upon the tractor that tows it (a semi-trailer), or be constructed so no part of its weight rests on the tractor (a full trailer or a semitrailer equipped with an auxiliary front axle called a “converter dolly.”) The most common configuration of large freight trucks consists of a Class 7 or 8 tractor hauling one or more semi-trailers. A truck in this configuration is called a “tractor-trailer.” The semi-trailer is attached to the tractor by a coupling consisting of a horseshoe-shaped coupling device called a *fifth wheel* on the rear of the towing vehicle, and a *coupling pin* (or *king pin*) on the front of the semi-trailer or converter dolly. A tractor can also pull an ocean container mounted on an open-frame chassis, which when driven together on the road functions as a trailer. The Department of Transportation issues federal regulations that govern trailer length (separately or in combination), width, height, and weight, as well as trailer safety requirements (lights, reflective materials, bumpers, turn signals, tire and rim specifications, brakes, load-securing devices, tow balls, etc.) The Truck Trailer Manufacturers Association, an industry trade group for manufacturers of Class 7 and 8 truck trailers, also provides technical bulletins covering many aspects of trailer manufacture. Each trailer, like any other road vehicle, must have a Vehicle Identification Number (VIN).

11.1.1 Trailer Types

There are numerous types of trailers hauled by Class 7 and 8 tractors that are designed to handle any freight transport need. Dry box van trailers are enclosed trailers that can haul most types of mixed freight. Despite their similar shape and purpose, box trailers can vary widely in size and configuration although most are commonly found in 28’, 48’, and 53’ lengths and 102” or 96” widths. Drop floor trailers have a lowered floor, often seen in moving vans. Other van trailers are curtain-sided with tarp or have roll up doors on the sides, as seen in beverage haulers. Another type of specialty box trailer is the refrigerated van trailer (reefer). This is an enclosed, insulated trailer that hauls temperature sensitive freight, with a transportation refrigeration unit (TRU) mounted in the front of the trailer powered by a small (9-36 hp) diesel engine. Enclosed box trailers – whether dry van, reefer, curtainside, drop floor, or other configuration, can have different axle configurations (single axle, fixed tandem, sliding tandem, tag-along axle) and door types (roll up, side-by-side). Figure 11-1 shows an example of a dry freight van semi-trailer with side-by-side doors.

Figure 11-1 Example Dry Box Van Trailer



Source: <http://www.wabashnational.com/Images/popups/DuraPlatePop.jpg>

Flatbed trailers are platform-type trailers which also come in different configurations from standard flatbed platform trailers to gooseneck and drop deck flatbeds which are built such that the trailer platform is lower to the ground than the hitch would normally allow. There are also a number of other specialized trailers such as grain trailers (with and without hoppers), dump trailers (frameless, framed, bottom dump, demolition), automobile hauler trailers (open or enclosed), livestock trailers (belly or straight), dry bulk and liquid tanker trailers, construction and heavy-hauling trailers (tilt bed, hydraulic), even trailers designed to travel on both highways and railroad tracks. Figure 11-2 shows an example of a drop-deck platform trailer.

Figure 11-2 Example Drop-Deck Trailer



Source: <http://www.transcraft.com/Transcraft/images/products/D-Eagle.jpg>

The most common type of trailer in use today is the dry van trailer. Figure 11-3 shows the various trailer types and their share of the trucking market. Despite considerable improvements in suspension, material, safety, durability, and other advancements, the basic shape of the van trailer has not changed much over the past decades, although its dimensions have increased incrementally from what used to be the industry's standard length of 40' to today's standard 53' long van trailer. The van trailer's boxy shape – while not particularly aerodynamic – is designed to maximize cargo volume hauling capacity, since the majority of freight shipped by truck cubes out (is volume-limited) before it grosses out (is weight-limited). EPA's SmartWay program has demonstrated that adding aerodynamic features to

Regulatory Impact Analysis

van trailer designs and the use of low rolling resistance tires can substantially reduce fuel consumption from tractor trailers. SmartWay verifies aerodynamic equipment and low rolling resistance tires for use on SmartWay-certified trailers, which can be new or retrofit.

Figure 11-3 Trailer Types and Volumes (Source: ICCT Report)

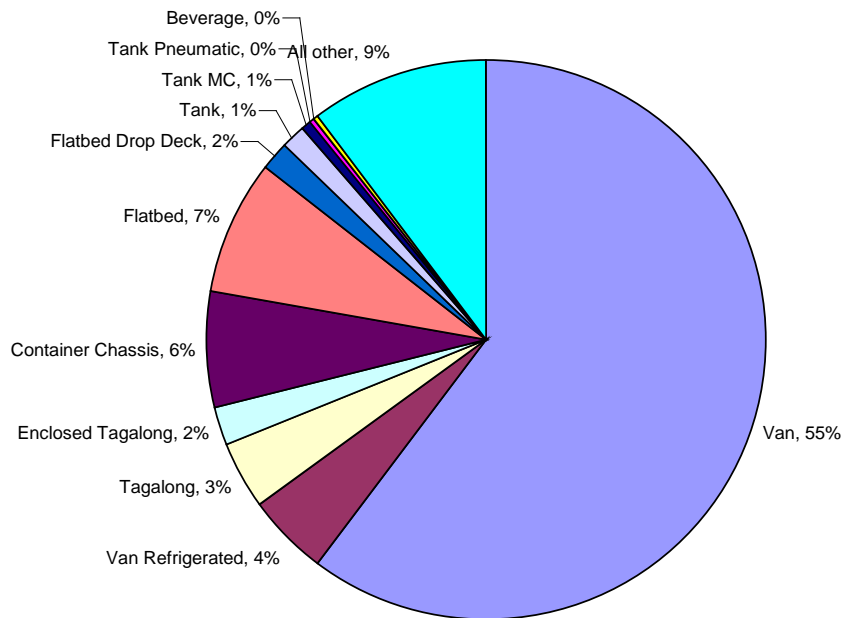

11.1.2 Trailer Manufacturers

This diverse variety of van, platform, tanker and specialty trailers are produced by a large number of trailer manufacturers. The twelve manufacturers with the largest overall North American output are: Utility Trailer Manufacturing, Great Dane Limited Partnership, Wabash National Corporation, Hyundai Translead, Timpte Inc., Wilson Trailer Company, Stoughton Trailers, Heil Trailer International, Fontaine Trailer Company, MANAC, Vanguard National Trailer Corporation, and Polar Tank Trailer. Trailer manufacturing is still done mostly by hand, although the various trailer parts can be mass-produced and even shipped from abroad for assembly in the U.S. Altogether, 30-some companies account for most of this industry's manufacturing base, although there are dozens and dozens additional manufacturers producing for niche trailer markets. Despite this variety, trailers are far less mechanically complex than are the trucks that haul them. This low barrier to entry for trailer manufacturing accounts in part for the large numbers of trailer manufacturers. Nearly half of all trailer manufacturers – including those that might be considered “large” in their industry segment -- meet SBA's definition of a small business.

The trailer industry was particularly hard hit by the recent recession. Trailer manufacturers saw deep declines in new trailer sales of 46 percent in 2009; some trailer manufacturers saw sales drop as much as 71 percent. This followed overall trailer industry declines of over 30 percent in 2008. The 30 largest trailer manufacturers saw sales decline 72% overall from their highest recent sales volumes, from 277,992 in 2006, to only 78,258 in 2009.¹ Several trailer manufacturers shut down entire production facilities and a few went out of business altogether. Of the most common trailer types of trailers sold, refrigerated trailers were the least affected; platform trailers were the most affected. As of mid-2010, the trailer industry has yet to recover from the devastating effects of the economic downturn.

11.1.3 Trailer Operations

Trailers are the primary vehicle for moving freight in the United States. Despite their significance to the goods movement industry and opportunities to improve fuel efficiency and reduce greenhouse gas emissions from trailer improvements, the broad diversity of the trailer industry and its end-user practices make this a challenging industry to address and engage.

Truck drivers and trucking fleets frequently do not control all or even any of the trailers that they haul. Trailers can be owned by freight customers, large equipment leasing companies, third party logistics companies (3PLS), and even other trucking companies. Containers on chassis, which function as trailers, are rarely owned by truck operators. Rather, they are owned or leased by ocean-going shipping companies, port authorities or others. This distinction between who hauls the freight and who owns the equipment in which it is hauled means that truck owners and operators have limited ability to be selective about the trailers they carry, and very little incentive or ability to take steps to reduce the fuel use of trailers that they neither own or control.

The ratio of the number of trailers in the fleet relative to the number of tractors in the legacy fleet is typically three-to-one.² At any one time, two trailers are typically parked while one is on the road. For certain private fleets, this ratio can be greater, as high as six-to-one. This means that on average a trailer will travel only one third of the miles travelled by a tractor. Lower annual mileage combined with the less complex machinery of a trailer mean that trailers do not need to be purchased as frequently as the trucks that haul them. The initial owner may keep a trailer for a decade or even longer; typically, the initial owner of a Class 7 or 8 tractor keeps his or her vehicle for three to six years. Less frequent procurement cycles result in slower turnover of trailers in the in-use fleet, with many older trailers still in use.

For refrigerated trailers, the story is slightly different. These trailers are used more intensely and accumulate more annual miles than other trailers. Over time, refrigerated trailers can also develop problems that interfere with their ability to keep freight temperature-controlled. For example, the insulating material inside a refrigerated trailer's walls can gradually lose its thermal capabilities due to aging or damage from forklift punctures. The door seals on a refrigerated trailer can also become damaged or loose with age, which greatly affects the insulation characteristics of the trailer, similar to how the door seal on a home refrigerator can reduce the efficiency of that appliance. As a result of age-related problems and more intense usage, refrigerated trailers tend to have shorter procurement cycles than dry

van trailers, which means a faster turnover rate, although still not nearly as fast as for trucks in their first use.

11.2 Why are the agencies considering the regulation of trailers?

Trailers impact the aerodynamic drag, rolling resistance, and overall weight of the combination tractor-trailer. TIAX, LLC performed an evaluation of SmartWay trailer technologies, and found that they provide the opportunity to reduce fuel consumption and greenhouse gas emissions from tractor trailers by up to 10 to 12 percent for aerodynamics and 3 to 6 percent for lower rolling resistance tires.³ Reductions of this magnitude are larger than can be readily accomplished from improvements in engine design and are roughly of the same magnitude as reductions possible through improvements in truck designs. Not only do trailers represent a significant opportunity for reductions as discussed later in this section, but we have strong reason to believe that these reductions would not occur absent regulation as noted in the recent NAS report.

The NAS report notes:

A perplexing problem for any option, regarding Class 8 vehicles, is what to do about the trailer. The trailer market represents a clear barrier with split incentives, where the owner of the trailer often does not incur fuel costs, and thus has no incentive to improve aerodynamics of the trailer itself or to improve the integration of the trailer with the tractor or truck.⁴

In other words, trailers affect the fuel efficiency of shipping, but they do not face strong uniform incentives to coordinate with truck owners. In principle, if truck owners had the ability to choose what trailers they accepted, they could require trailers with fuel-saving technologies; in practice, though, truck owners have limited practical ability to be selective about what trailers they accept.

In this setting, information provision may be inadequate to address the related problems of split incentives and thin markets. Regulation aimed at trailer manufacturers can contribute fuel savings and GHG reductions that otherwise may be difficult to achieve.

11.3 What does the trailer industry look like?

11.3.1 Trailer Types

There are approximately 5.6 million HD trailers on the roads today⁵. In general, it is common to have roughly 3 trailers for every tractor to facilitate efficiency in loading and unloading operations. Serving a wide range of needs, this trailer fleet is necessarily comprised of a wide range of trailer types including box van (including refrigerated units), shipping container (*e.g.*, 20 and 40 foot ocean-going container) chassis, flat bed (including drop deck units), dump, tanker, and specialty (*e.g.*, grain, livestock, auto-carriers). Types of trailers can be further subdivided by their length and height. The market is dominated by box (or van) trailers, which made up approximately 63 percent of the new trailers registered

between 2003 and 2007.⁶ The top ten new trailer registrations are included in by type are listed in Table 11-1.

Table 11-1: Trailer Registrations

Trailer Type	Percentage of Registrations (2003-2007) ⁶
Box	63%
Flatbed (Platform)	8%
Container Chassis	7%
Refrigerated Van	5%
Dump	3%
Grain	2%
Flatbed Drop Deck	2%
Tank	1%
Lowbed	1%
Livestock	1%

The remaining 6.5 percent of the trailer registrations consisted of livestock, transfer, hazardous chemical tanks, hoppers, gooseneck livestock, lowbed drop deck, beverage, special, dry bulk tanker, logging, wood chip, and other types of trailers. Within each of these main trailer categories there are distinctions among trailer construction, materials, dimension, mass, and functionality, all of which can impact a trailer’s contribution to truck fuel consumption and greenhouse gas emissions.

11.3.2 Trailer Fleet Size Relative to the Tractor Fleet

The industry generally recognizes that the ratio of the number of trailers in the fleet relative to the number of tractors is typically three-to-one.⁷ Typically at any one time, two trailers are parked while one is being transported. For certain private fleets, this ratio can be greater, as high as six-to-one. This characteristic of the fleet impacts the cost effectiveness of trailer technologies because a trailer on average will only travel one third of the miles travelled by a tractor.

11.3.3 Trailer Owners

Trailer ownership is distinct from that of the tractors. Trailers are often owned by shippers or by leasing companies, not by the trucking fleets. A special type of “trailer” is a shipping container used for intermodal surface movement to transport freight from ocean going liner vessels to inland destinations via truck, rail or barge. When hauled by a truck, the container is loaded on a specialty piece of equipment called a “chassis.” This consists of a frame and axle/wheel assemblies on which the container is mounted, so that when the chassis and container are assembled the unit serves the same function as a road trailer.⁸ Container chassis are sometimes owned by specialty companies and are leased to ports, fleets, and shippers. Trailers that are purchased by fleets are typically kept much longer than are the tractors, so trucks and trailers have different purchasing cycles. Because of the disconnect

between owners, the trailer owners may not benefit directly from fuel consumption and GHG emission reductions.

11.3.4 Trailer Builders

While approximately ten companies manufacture approximately 80 percent of the trailers sold, the entire trailer market includes a large number of trailer producers.⁹ Only 14 manufacturers have an annual sales volume of greater than 3,000 trailers with many specializing in a type of trailer (*e.g.*, grain, dump, tanker). The top ten builders of with the largest market share of trailer sales in 2009 include Utility Trailer Manufacturing, Great Dane, Wabash National, Hyundai Translead, Timpte, Wilson Trailer, Stoughton Trailers, Heil Trailer, Fontaine Trailer, and MANAC.¹⁰ However, nearly half of all trailer manufacturers are considered small businesses by the Small Business Administration definition.¹¹

Therefore, the agencies will be required to convene a Small Business Regulatory Enforcement Fairness Act (SBREFA) panel to conduct the proper outreach to all stakeholders impacted by any future regulation for trailers.

Although trailer manufacturing is an important sector within the commercial vehicle manufacturing industry, trailers are far less mechanically complex than are the trucks that haul them. This means that trailer manufacturing has a low barrier to entry compared to automotive or truck manufacturers. The agencies can envision that any regulation would require significant effort to maintain a level playing field within the market to reduce the incentive to work around the regulation.

11.4 What technologies are available to reduce fuel consumption and GHG emissions from trailers?

There are opportunities to reduce the fuel consumption and GHG emissions impact of the trailer through aerodynamics, tires, and tare weight reductions to some extent in most types of trailers. In addition, refrigerated trailers have opportunities to both reduce the fuel consumption and CO₂ emissions of the Trailer Refrigeration Unit (TRU) and reduce GHG emissions through reduced refrigerant leakage. There are additional opportunities being developed for improvements in suspension systems, trailer structure, dump hoists and other features, depending upon the type of trailer and its intended function.

11.4.1 Aerodynamics

Trailer aerodynamic technologies to date have focused on the box, van trailers – the largest segment of the trailer fleet. This focus on box, van trailers may also be partially attributed to the complexity of the shape of the non-box, van trailers which, in many cases, transport cargo that is in the windstream (*e.g.*, flatbeds that carry heavy equipment, car carriers, and loggers). For non-box, van trailers you could have a different aerodynamic shape with every load. While some technologies exist to address aerodynamic drag for non-box, van trailers, it has been either experimental or not widely commercially available.

Heavy-Duty GHG and Fuel Efficiency Standards FRM: Trailers

Current trailer aerodynamic technologies for box trailers are estimated to provide approximately 10-12 percent reductions in drag when used as a package.¹² For box trailers, trailer aerodynamic technologies have addressed drag at the front of the trailer (*i.e.*, vortex traps, leading edge fairings), underneath the trailer (*i.e.*, side skirts, wheel fairings) and the trailer rear (*i.e.*, afterbodies). These technologies are commercially available and have seen moderate adoption rates. More recent trailer aerodynamic innovations channel air flow around the sides and under the trailer using underbody air deflectors (“underbelly treatment”). Table 11-2 lists technologies that the EPA SmartWay program has evaluated for use on box, van trailers. In general, the performance of these technologies is dependent upon the smooth transition of airflow from the tractor to the trailer. Overall shape can be optimized to minimize trailer aerodynamic drag, just as shape can reduce tractor aerodynamic drag.

Table 11-2: Aerodynamic Technologies for Trailers

Location on Trailer	Technology Type	Designed Effect
Front	Vortex trap	Reduce drag induced by cross-flow through gap between tractor and trailer
Front	Front fairings	Smoothly transition air to flow from tractor to the trailer
Rear	Afterbody (boat tail and rear fairings)	Reduce pressure drag induced by the trailer wake
Undercarriage	Side skirts	Manage flow of air underneath tractor to reduce eddies and wake
Undercarriage	Underbelly treatment	Manage flow of air underneath tractor to reduce eddies and wake
Accessories	General	Reducing surface area perpendicular to travel and minimizing complex shapes that may induce drag
General	Advanced, passive air management	Manage airflow through passive aerodynamic shapes or devices that keep flow attached to the vehicle (tractor and trailer)

The agencies’ initial assessment of the incremental costs of aerodynamics is included in Table 11-3. The costs represent a high volume retail price of the components based on information developed for the NAS report¹² and the ICF cost contract.¹³

Table 11-3: Aerodynamic Technology Costs

Technology	Cost Estimate
Trailer Side Skirts	\$1300 - 1600
Gap Fairing	\$850
Trailer Aerocone	\$1000
Boat Tails	\$1960
Air Tabs	\$180

Some of these technologies, such as side skirts, may be applicable to other trailer types.

11.4.2 Tires

Beginning in 2007, EPA began designating certain new dry freight box van trailers for on the road use of 53 feet or greater length Certified SmartWay Trailers. Older or pre-owned trailers could also be certified if properly retrofitted. In order for a trailer to be designated as Certified SmartWay, the trailer must be equipped with verified low rolling resistance trailer tires (either dual or single-wide), among other things.

The rolling resistance coefficient (CRR) baseline for today's fleet is 6.1 kg/ton for the trailer tire, based on sales weighting of the top three manufacturers based on market share. This value is based on new trailer tires, since rolling resistance decreases as the tread wears. To achieve the intended emissions benefit, SmartWay established the maximum allowable CRR for the trailer tire 15% below the baseline or 5.5 kg/ton. Similar to combination tractor tires, LRR tires are available as either dual tires or as single wide-base tires for trailers.

Research indicates the contribution to overall vehicle fuel efficiency by tires is approximately equal to the proportion of the vehicle weight on them.¹⁴ On a fully loaded typical Class 8 long-haul tractor and trailer, 42.5 percent of the total tire energy loss attributed to rolling resistance is from the trailer tires. The TIAX assessment of single wide based tires on the trailer found that they provide approximately a 3 percent fuel consumption benefit over a standard dual tire package.¹⁵

Based on the ICF report, EPA and NHTSA estimate the incremental retail cost for LRR tires as \$78 per tire.¹³ The agencies also estimate that the incremental cost to replace a pair of dual tires with a single wide based tire is \$216, however, the cost can be reduced when the wheel replacement cost is considered, since half the number of tires and wheels are needed.

The inflation pressure of tires also impacts the rolling resistance. Underinflation causes an increase in rolling resistance and fuel consumption. Trailer systems, such as tire pressure monitoring or automatic tire inflation, can help drivers insure that they are traveling with properly inflated tires. Estimates vary, but TIAX estimates on average that a trailer automatic tire inflation system could provide a 0.6% benefit to fuel consumption for a cost of approximately \$300 to \$400.¹⁶

11.4.3 Weight Reduction

Reduction in trailer tare (or empty) weight can lead to fuel efficiency reductions in two ways. For applications which are not limited by the weight limit, the overall weight of the tractor and trailer combination would be reduced and would lead to improved fuel efficiency. For the applications which limit the payload due to the weight restrictions, the lower trailer weight would allow additional payload to be transported during the truck's trip. Weight reduction opportunities in trailers exist in both the structural components and in the wheels and tires. Material substitution (replacing steel with aluminum) is feasible for

components such as roof posts, bows, side posts, cross members, floor joists, and floors. Similar material substitution is feasible for wheels. Weight reduction opportunities also exist through the use of single wide based tires replacing two dual tires.

The agencies' assessment of the ICF report¹³ indicates that the expected incremental retail prices of the lightweighted components are as included in Table 11-4.

Table 11-4: Trailer Lightweighting Costs

Component	Cost
Roof Posts/Bows	\$120
Side Posts	\$525
Cross Members/Floor Joists	\$400
Floor	\$1,500
Wheels	\$1,500

11.4.4 Opportunities in Refrigerated Trailers

Refrigeration units are used in van trailers to transport temperature sensitive products. A traditional TRU is powered by a nonroad diesel engine. There are GHG reduction opportunities in refrigerated trailers through the use of electrical trailer refrigeration units and highly reflective trailer coatings.

Highly reflective materials, such as reflective paints or translucent white fiberglass roofs, can reflect the solar radiation and decrease the cooling demands on the trailer's refrigeration unit. A reflective composite roof can cost approximately \$800, the addition of reflective tape to a trailer roof would cost approximately \$450.

Hybrid trailer refrigeration units utilize a diesel engine which drives a generator which in turn powers the compressor and fans. The cost of this unit is approximately \$4,000.

11.5 What approaches could the agencies consider for evaluating fuel efficiency and GHG emissions contributions from trailers?

Building from EPA's SmartWay experience, EPA and NHTSA have considered several options to demonstrate GHG and fuel consumption reductions from trailer technologies.

11.5.1 Metric

There are several metrics that the agencies envision could be appropriate used to evaluate the fuel consumption and CO₂ emissions due to trailers. The agencies are finalizing the use of a ton-mile metric with a prescribed payload for the vocational vehicle and tractor regulatory categories and subcategories. A similar approach could be applied to trailer evaluation, which would account for aerodynamic improvements, tire improvements, and trailer lightweighting. However, a ton-mile metric does not necessarily capture the capacity aspect of trailers. Box trailers provide benefits to freight efficiency through an increase in

either cubic volume or pallet-equivalent. Certain box van trailers including drop frame moving van trailers and high cube trailers are specially designed to maximize cubic capacity.

11.6 Potential Approaches to Evaluate GHG Emissions and Fuel Consumption Reducing Technologies

11.6.1 Design-Based Specification Approach

The SmartWay certification for tractors and dry box van trailers began as a design-based specification, developed on the basis of test results for APUs, and engines) that have been demonstrated to improve fuel efficiency and reduce emissions.

11.6.2 Modeling Approach

As the agencies are using for the evaluation of tractors and vocational vehicles, a similar simulation model approach could also be applied to trailers. A simulation-based model would require the trailer manufacturer input parameters similar to the ones finalized in the tractor program – coefficient of drag, tire rolling resistance, and weight. The agencies envision that a standardized tractor would be required to fairly assess the tractor-trailer system. Both agencies have years of successful experience with vehicle simulation modeling. EPA, DOE, DOT, Commerce and others used vehicle simulation modeling to jumpstart technology scenarios for the Partnership for a New Generation of Vehicles Program, a large public-private research program aimed at developing advanced fuel-efficient passenger vehicle designs. Those same agencies used vehicle simulation modeling for a similar purpose in the 21st Century Truck Partnership, a sister program to develop advanced fuel-efficient commercial truck designs. EPA used vehicle simulation modeling to characterize various technology scenarios for its initial design of the SmartWay program and to conduct analyses on its test data, test cycles, and related data. This experience has demonstrated to the technical staff at EPA and DOT that vehicle simulation modeling can be a reliable and feasible tool to assess vehicle performance.

11.6.3 Whole Vehicle Testing – Chassis, Track or On-Road Test

Complete vehicle testing is commonly conducted on chassis dynamometers, tracks, or on the road. Light-duty vehicles are tested on chassis dynamometers to demonstrate compliance with EPA and NHTSA regulations associated with emissions and fuel efficiency, respectively. Heavy-duty truck manufacturers often use paired truck test, such as prescribed in SAE J1321,¹⁷ to evaluate the difference between two trucks. The current SmartWay verification program allows for a modified SAE J1321 test to be used to evaluate the fuel consumption performance of trailers due to improvements in aerodynamic design. Heavy-duty truck fleets today commonly use long term on-road testing to evaluate trucks, trailers, and technologies.

A chassis dynamometer test is a test conducted indoors on a hydrokinetic chassis dynamometer. The chassis dynamometer option in this test procedure incorporates many of the methods and requirements established in the federal light-duty vehicle and ‘light’ heavy-duty vehicle emissions certification chassis test procedure. Chassis dynamometers may be

found at vehicle test laboratories; typically, facilities used for emissions and vehicle fuel efficiency testing. Because the test is conducted on a chassis dynamometer, rolling resistance, aerodynamic drag and inertial road load power requirements must be determined ahead of time, with coastdown tests and calculations to determine the proper horsepower absorption setting for the chassis dynamometer.

A track test is a complete vehicle test conducted on an outside test track. Test tracks may be found at vehicle proving grounds or other facilities specifically designed for vehicle or tire performance testing. Because the test involves the vehicle being operated on a road surface in a manner similar to that of on-road driving, rolling resistance, aerodynamic drag, and inertial road load power requirements are incorporated in the test measurement, and do not have to be determined beforehand with a coastdown test and calculations. Although the result of a track test reflects real-world vehicle performance better than a chassis dynamometer test, by directly evaluating the impacts of road effects such as aerodynamic drag of tractors and trailers and rolling resistance effects of tires, variability of ambient conditions may result in greater variability of test results.¹⁸ Therefore, any protocol should include specification of ambient conditions as well as specifications for measurement of fuel consumption.

The TMC/SAE Fuel Consumption test is a standardized on-road test procedure for comparing the in-service fuel consumption of two conditions of a test vehicle or one test vehicle to another.¹⁹ The procedure uses an unchanging control vehicle run in tandem with the test vehicle. The result of the test is the percent difference in fuel consumption between two test vehicles.

11.7 What actions are already being taken to improve the efficiency of trailers?

11.7.1 SmartWay Certified Trailers

Beginning in 2007, EPA began designating certain new dry freight box van trailers for on the road use of 53 feet or greater length Certified SmartWay Trailers. Older or pre-owned trailers could also be certified if properly retrofitted. In order for a trailer to be designated as Certified SmartWay, the trailer must be equipped with aerodynamic devices such as trailer skirts and gap reducers along with verified LRR trailer tires (either dual or single-wide). Trailer manufacturers can also test trailers using a modified J1321 test method to assess the fuel-saving impact of the aerodynamic features. Trailers that meet or exceed the minimum threshold for reduction in fuel consumption and that are equipped with SmartWay-verified LRR tires are eligible for SmartWay designation. Information about SmartWay certified trailers, the test methods, and verified trailer equipment is at the US EPA SmartWay web site, <http://www.epa.gov/smartway>.

11.7.2 California AB32

The California requirement to reduce GHG emissions from trailers became effective in 2010.²⁰ It requires that all new 2011 model year dry van trailers are SmartWay certified or demonstrate a 5 percent aerodynamic and a 1.5 percent tire improvement. Compliance is

Regulatory Impact Analysis

demonstrated through the use of SmartWay certified components or a SAE paired-truck test to demonstrate improvements. California is also requiring retrofit of existing van trailers phasing in starting in 2011. Information on the California program can be found at the California Environmental Protection Agency Air Resources Board web site, <http://www.arb.ca.gov/cc/hdghg/hdghg.htm>.

References

- ¹ Trailer Body Builders, 2009 North American Truck Trailer Output (Table - March 2010), and 2008 North American Truck Trailer Output (Table - March 2009), both tables accessed August 2, 2010, at <http://trailer-bodybuilders.com/trailer-output/output/2009-trailer-output-0301/>. Also, Polk Commercial Vehicle Solutions, Commercial Vehicle Market Intelligence Report (March, 2009), accessed August 2, 2010, at http://www.polk.com/KC/PolkAR_CVR_200905.pdf
- ² TIAX. LLC. “Assessment of Fuel Economy Technologies for Medium- and Heavy-Duty Vehicles,” Final Report to the National Academy of Sciences, November 19, 2009. Page 4-49.
- ³ See TIAX, pages 4-50 and 4-57.
- ⁴ Committee to Assess Fuel Economy Technologies for Medium- and Heavy-Duty Vehicles; National Research Council; Transportation Research Board (2010). “Technologies and Approaches to Reducing the Fuel Consumption of Medium- and Heavy-Duty Vehicles.” Washington, D.C., The National Academies Press. Available electronically from the National Academies Press Website at http://www.nap.edu/catalog.php?record_id=12845 (last accessed September 10, 2010). at p. 8-8.
- ⁵ U.S. Department of Transportation, Federal Highway Administration. Federal Highway Statistics. “Trailer and Semitrailer Registrations – 2008” Table MV-11 located at www.fhwa.dot.gov/policyinformation/statistics/2008/mv11.cfm
- ⁶ M.J. Bradley. Heavy-duty Vehicle Market Analysis. May 2009.
- ⁷ See TIAX, at page 4-49.
- ⁸ Per 46 CFR § 340.2.
- ⁹ Trailer Body Builders. Last viewed on August 18, 2010 at http://trailer-bodybuilders.com/trailer-output/output/2008_trailer_output_table/
- ¹⁰ Trailer-Body Builders.com. 2009 North American Truck Trailer Output. Available at http://trailer-bodybuilders.com/trailer-output/output/2009_trailer_output_table/
- ¹¹ Per SBA definition for NAICS 336212, companies with less than 500 employees are considered small businesses.
- ¹² See TIAX, at page 4-50.
- ¹³ ICF. Investigation of Costs for Strategies to Reduce Greenhouse Gas Emissions for Heavy-Duty On-Road Vehicles. July 2010. Page 96.
- ¹⁴ Bridgestone Firestone, North American Tire, LLC. “Tires & Truck Fuel Economy,” A New Perspective. Special Edition Four, 2008
- ¹⁵ See TIAX, at page 4-56.
- ¹⁶ See TIAX, at page 4-58.
- ¹⁷ Society of Automotive Engineers. Joint TMC/SAE Fuel Consumption Test Procedure – Type II. SAE J1321. October 1986.
- ¹⁸ However, it has been demonstrated that even tests conducted in laboratories have differences in repeatability within a given laboratory and differences in reproducibility among laboratories. See “Interlaboratory Crosscheck of Heavy-duty Vehicle Chassis Dynamometers” Final Report CRC Project No. E-55-1, May, 2002.
- ¹⁹ See SAE, Note 17, above.
- ²⁰ California Air Resources Board. Available at <http://www.arb.ca.gov/regact/2008/ghghdv08/ghghdv08.htm>, accessed September 17, 2010.