

The Architecture of the Department of Defense

A Military Style Guide

Michelle Michael and Adam Smith
with Jennifer Sin

The Architecture of the Department of Defense

A Military Style Guide

Michelle Michael

*Department of the Navy
Naval Facilities Engineering Command Southeast (EV23)
PO Box 30, Building 903
NAS Jacksonville
Jacksonville, FL 32212-0030*

Adam Smith and Jennifer Sin

*Construction Engineering Research Laboratory (CERL)
U.S. Army Engineer Research and Development Center (ERDC)
2902 Newmark Drive
Champaign, IL 61822-1076*

Prepared for: **DoD Legacy Resource Management Program**
*3400 Defense Pentagon
Room 5C646
Washington, DC 20301*

Final Report

Approved for public release; distribution is unlimited.

Cover Page Photos

Left: San Diego Naval Hospital, California.

Middle: Chapel at the U.S. Air Force Academy, Colorado.

Right: Quarters at Fort Lawton, Washington.

DISCLAIMER: The contents of this report are not to be used for advertising, publication, or promotional purposes. Citation of trade names does not constitute an official endorsement or approval of the use of such commercial products. All product names and trademarks cited are the property of their respective owners. The findings of this report are not to be construed as an official Department of the Army position unless so designated by other authorized documents.

DESTROY THIS REPORT WHEN NO LONGER NEEDED. DO NOT RETURN IT TO THE ORIGINATOR.

Acknowledgements

The Architecture of the Department of Defense: A Military Style Guide was made possible with assistance from and general guidance of the Department of Defense (DoD) Legacy Resource Management Program, under project number 10-129.

The project team would like to thank the support of their commands and supervisors: Naval Facilities Engineering Command Southeast (NAVFAC SE) Historic Preservation Officer, Len Winter, and the Engineer Research and Development Center (ERDC) Construction Engineering Research Laboratory (CERL) Land and Heritage Conservation Branch Chief Christopher White. Thanks is extended to the installation staff at Barksdale Air Force Base, specifically Gary Mackey, staff at Naval Air Station Pensacola, FL, specifically Carrie Bourgeois, and staff at Joint Reserve Base New Orleans, specifically Danny Nichols, for taking the time to give tours and answer questions. The Style Guide would not have been a success without the patient and thoughtful review of Carrie Bourgeois, Archaeologist, NAVFAC SE, NAS Pensacola, FL; R. Criss Helmkamp, Cultural Resources Manager (CRM), Fort Knox, KY; Kristin Leahy, Architectural Historian with the Army Environmental Command; Chris McDaid, CRM, Joint Base Langley-Eustis, VA; Heather McDonald, Architectural Historian and Community Planner, NAVFAC Mid-Atlantic; John Rose, Installation Architect, Fort Bragg, NC; Deborah

Tharp, Command CRM, HQ AETC/A7C, Randolph AFB, TX; Megan Tooker, Landscape Architect, ERDC/CERL; and Professor John C. Waters, Historic Preservation Program, University of Georgia.

Michelle Michael and Adam Smith would like to express their gratitude to Jennifer Sin for her patience and “get it done” spirit that ensured the completion and ultimate success of this project.

There will be a limited number of printed booklets and an electronic version will be available on the Defense Environmental Information Exchange (DENIX). An honest attempt was made for this booklet to be as comprehensive and user-friendly as possible. The surface of the military architectural inventory has only been scratched and many examples have been omitted. Inevitably, something will be left out. If something has been left out that you feel is important, please let us know and, if we have the honor of updating this booklet in the future, it will be added.

Table of Contents

Acknowledgements	iii
Introduction	1
Georgian 1700-1850	8
Federal 1780-1825	10
Classical Revival 1780-1850	12
Greek Revival 1820-1875	14
Renaissance Revival 1820-1865	16
Gothic Revival 1840-1895	18
Italianate 1850-1890	20
Octagon 1830-1860	22
Second Empire 1860-1895	24
Civil War 1861-1865	26
Stick 1860-1890	28
Queen Anne 1880-1910	30
Shingle 1880-1905	32
Romanesque Revival 1870-1900	34
Rustic 1870-1940	36
Beaux Arts 1885-1940	38
Neoclassical Revival 1895-1950	40
Colonial Revival 1880-1940	42

Prairie 1900-1940	44
Bungalow 1900-1935	46
World War I 1917-1919	48
Spanish Revival 1915-1940	50
French Revival 1915-1940	52
Dutch Colonial Revival 1880-1940	54
Tudor Revival 1900-1945	56
Georgian Revival 1880-1940	58
Art Deco 1920-1945	60
Art Moderne 1920-1945	62
International (Early) 1925-1948	64
World War II 1939-1945	66
Minimal Traditional 1935-1955	68
Ranch 1935-1975	69
International (Late) 1946-1965	70
Mid-Century Modern 1950-1975	72
New Formalism 1965-1975	74
Expressionism 1965-1975	75
Brutalism 1965-1980	76
Architecture in DoD since Mid-Century	77

Table of Contents cont.

Bibliography	81
Photo Credits	83
Locations	85
Glossary	87
Index	100

Introduction

A trip to the local or online bookstore reveals thousands of books on military history and hundreds of books on historic architecture, but the two have not been joined to form a military architecture book. This Department of Defense (DoD) Legacy Resource Management Program project, *The Architecture of the Department of Defense: A Military Style Guide*, attempts to chronicle the evolution of military architectural styles and provides guidance for their identification, therefore promoting the stewardship of DoD's historic architecture while supporting the military's mission. This project is also the culmination of knowledge from several Legacy projects and the idea of two architectural historians who work within DoD.

In 2007, Michelle Michael, at that time working at Fort Bragg in North Carolina (now with NAVFAC SE), had the privilege of managing and co-authoring the *Design Guidelines for Department of Defense Historic Buildings and Districts*. That project included an architectural style section but also revealed the need for more study on the styles of military architecture. In fact, during one of the project briefings, an Air Force officer commented that there should be a book. Thus, this idea was born.

Adam Smith, an architectural historian with ERDC/CERL in Champaign, Illinois, has worked on dozens of historic building projects within DoD, including historic contexts, architectural surveys, National Register of

Historic Places eligibility reports, and various military building historic contexts.

This project showcases the wealth of historic architecture within the fence line of military installations (both open and closed). There is also a need for this publication from a regulatory standpoint. DoD is a Federal agency and is responsible for the stewardship of historic properties under the National Historic Preservation Act of 1966. However, there are only a handful of architectural historians within DoD. Many cultural resources managers do not have architectural or architectural history backgrounds. Yet, they are tasked with communicating with architects, planners, State Historic Preservation Officers (SHPO), and other interested parties regarding significant character-defining features and architectural integrity. A glossary of architectural terms and character-defining features is included in this guide, beginning on page 87.

This Style Guide is intended to provide guidance to those managers and to assist them with identifying character-defining features and communicating effectively with SHPO, planners, project managers, and commanders. It is also important to note that inclusion in this book does not signify a building's eligibility for listing in the National Register of Historic Places. Determining National Register eligibility requires significant research and context development—simply saying that a building is a good example of a specific type

or style of architecture is not enough information to determine eligibility. For more information regarding National Register eligibility, consult National Register Bulletin 15, *How to Apply the National Register Criteria for Evaluation*, available on the National Park Service website at <http://www.nps.gov/nr/publications/bulletins/pdfs/nrb15.pdf>.

What are Architectural Influences?

The architectural influence of a building is evident in its shape, materials, details, and other features that distinguish one building from another. Many architectural influences are found throughout the United States. These evolved as national trends and regional tastes changed. Architectural influences can indicate the time or period of a building's construction, as well as the trends of the country and region at that time. Buildings on military installations are no exception and their architectural influences reflect the historical evolution of the installation, the military service, and DoD. These influences have been categorized into styles to attempt to identify significant features and to simplify the architectural identification. It is important to note that the evolution of styles within DoD does not match the civilian dates for the style exactly. More often than not, the military examples are later than their civilian counterparts. Date ranges for each style are listed solely for reference purposes, since a building can reflect a given style even if it is built outside of the period. For example, the Main Post Chapel at Fort Lewis, Washington, is a 20th-century example constructed

decades after the influence reached prominence. This building was executed in the Romanesque Revival style but was constructed in 1934, approximately thirty years after the style reached popularity.

The National Park Service (NPS) has outlined a methodology for identifying architectural influence and character-defining features in Preservation Brief 17, *Architectural Character: Identifying the Visual Aspects of Historic Buildings as an Aid to Preserving Their Character*. Referencing the NPS guide in combination with using this Style Guide is recommended.



The Main Post Chapel (1934) at Fort Lewis, Washington, exhibits features from the Romanesque Revival style, including the prominent gable front, round-arched arcade, and round-arched cornice.

Architectural Influences in Military Architecture

Military installations contain a diverse collection of buildings, representing a unique architectural record of military acquisitions and construction as the military evolved over time. Military architecture, as a whole, represents the different eras of military history, as well as historical and geographical influences from various regions of the United States.

This booklet will assist users with the identification of the decorative and functional features associated with a building that contribute to its architectural integrity. The two main categories of military architecture are military constructed and military acquired. Military-constructed buildings typically involved the use of standardized plans for specific building types and usually exhibit a particular architectural influence. Military-acquired buildings were built independently of the military but were acquired by the military after construction. They typically represent local building traditions, as well as regional design variations of an architectural influence. This project will not include many examples of military-acquired architecture. There are several books referencing civilian examples that discuss architectural style, history, and methods for identification and evaluation. To identify a military-acquired building, please consult with your SHPO for a list of books that provide information on state and local trends in architectural style. This project is limited to mostly military-constructed buildings and their architectural influences are discussed.

Military Constructed – Architectural Influences and Building Types

The majority of buildings on military installations represent a particular building type and/or architectural influence due to the utilization of standardized plans. Each branch of the military developed standardized plans to accommodate the needs of their forces in a cost-effective manner. The plans created a template for installation layouts, public works systems, building types, and landscaping.

The military designers responsible for the development of these plans were influenced by the popular planning and architectural trends occurring in the United States. Often, the military employed civilian architects, landscape architects, and planners who also applied popular trends to their designs. As a result, standardized plans for buildings incorporated contemporary architectural influences and their associated features in elements like the overall form of the building, exterior and interior decorative details, and floor plans. For instance in the 1860s, the Army developed its first set of standardized plans for housing, consisting of designs employing the fashionable architectural influences of that time period—Gothic Revival (1840-1895), Italianate (1850-1890), and Queen Anne (1880-1910). Although the plans applied architectural influences to the design of the buildings, often the plans were simplified or adapted to reduce construction costs and to increase efficiency. For this reason, buildings might depict only a few features,

rather than fully representing an influence with all of its decorative and functional features. An example is the Band Hall Building at Fort Sam Houston, Texas (page 35). The building's overall appearance is not dominated by the Romanesque Revival influence; however, the building depicts elements of the influence, including its masculine stone arches above the front windows and line of rectangular windows. Even though the building does not depict all of the features of Romanesque Revival, it still is considered an example of the influence, albeit a simplified version.

Buildings can also represent stylistic mixtures in which elements of different architectural influences are combined in the design of one building. These buildings could have been originally built as stylistic mixtures or later remodeled to attempt a more contemporary design. For example, a building may have been constructed with the massing and form of the Greek Revival with a central entrance flanked by a transom and sidelights; however, the windows are two-over-two instead of six-over-six, and the porch has slender, chamfered posts instead of classically-inspired posts. This building would be a transition between the Greek Revival and Italianate, which is not uncommon. A second example of style combinations may be a Federal-style building that exhibits a later porch addition from the Queen Anne era. If in doubt, consult the individual building files in the public works or civil engineering office for the building; the original plans and subsequent plans, if available, will provide

a concrete history and evolution of the building.

Significant or character-defining features of an architectural influence can also be inside the building. It was not within the scope of this project to include interiors; however, these features should not be overlooked. Many interior features include decorative wooden elements such as floors, baseboards, door and window surrounds, crown moldings, chair rails, built-ins, stairs, stair balustrades, mantels, and wainscots. Plaster walls and ornament are also common in 19th and early 20th century buildings. In mid-20th century buildings, terrazzo floors, mosaic tile, glass block, metal balustrades, and wall screens may be original to the building. Additionally, general floor plan and structural features, such as support columns, may also be significant. This is a broad definition of

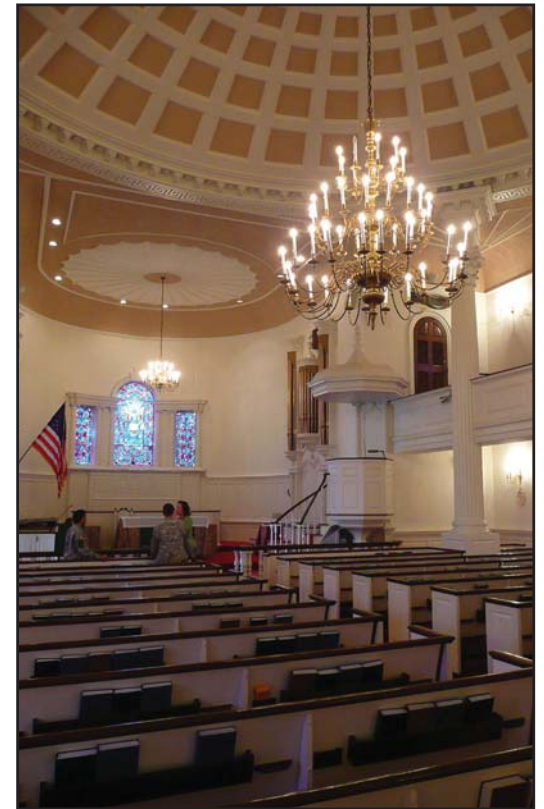

Interior of the Main Post Chapel (1932) at Fort Bragg, North Carolina.

interior features since each building is unique in regard to existing interior features and must be treated in a case-by-case manner. Many interiors within DoD have been altered; however, if original features are suspected to exist within a building, first inspect the original plans, and consult with an architectural historian or SHPO.

Windows are a primary element when identifying architectural styles and influences. In many cases, windows have been replaced at least once, and sometimes multiple times. This Style Guide includes many examples of era-appropriate windows; however, for a window replacement project, consult the original plans for the building to find the original window type. As mentioned, many original plans are available in public works and civil engineering offices; these will provide the best documentary evidence of identifying original window types. Always consult with an architectural historian and the SHPO before making recommendations on window replacement projects.

Even though standardized plans provided a sense of uniformity, the plans were meant to be adapted by installations to accommodate differences in climate and locally-available materials (see images on page 5 and 6). For instance, Army plans historically stressed that each post should have a military atmosphere but they should also integrate the local character and traditions. This policy was usually met through variations of plans in terms of building materials, massing, size,



The duplex (top, 1932) is a French Revival adaptation at Barksdale Air Force Base, Louisiana, but the standardized plan is the same as the duplex (bottom, 1939) in the Colonial Revival style in stone at Fort Huachuca, Arizona. This plan was also executed in wood, red brick, yellow brick, and stucco at other installations.



These officers' quarters duplexes are also of the same standardized plan, only the duplex (top, ca. 1905) is in wood at Fort Lawton, Washington, and the duplex (bottom, ca. 1905) is in red brick at Madison Barracks, New York.

and ornamentation. For example there are examples of the same duplex at many installations, but the plan has been altered by style or materials to reflect the architecture of the overall installation.

Other aspects of standardized plans are those that were developed for specific building types such as housing, hospitals, chapels, headquarters, classrooms, recreation facilities, hangars, storehouses, and power plants. These plans included specific architectural features needed to accommodate the function of the building type. For instance, many of the earlier plans for hospitals incorporated porches into their design whereas some hangar designs included corner towers and all had full-width doors (see images on page 7). Although most of the plans for building types, such as officer housing and headquarters, were designed with an associated architectural influence, several building types, including storehouses, hangars, and other support facilities, sometimes were not represented by an architectural influence or style. In these cases, the buildings still have character-defining features, like the orientation, roof form, massing, and window types, but those features are associated with the building type rather than an architectural influence.

Furthermore, the troop build-ups associated with World War I and World War II brought about temporary building construction with standardized plans that reduced construction costs and shortened



construction time. These buildings were utilitarian in character and exhibited features important to the building's function rather than architectural style. These buildings are discussed in depth on pages 26, 48, and 66. Standardized plans, war-era temporary buildings, and design guidelines are all topics of previous projects that, when used in combination with this guide, will hopefully provide productive guidance as the study of the evolution of architecture within DoD continues.



The old hospital (top, ca. 1905) at Fort Sam Houston, Texas, with an entrance porch and double-story porch allowing access from the former wards and a hangar (bottom, ca. 1930) at Randolph Air Force Base, Texas, with form, corner towers, and full-width doors as defining features.



Gabled ends, covered loading docks, horizontal massing, and roof ventilators are characteristic of storage and warehouse buildings, as shown at this concrete storehouse building (ca. 1918) at St. Julien's Creek Annex (NSA Norfolk Naval Shipyard), Virginia.

Georgian 1700-1850

The earliest recognized architectural style in the DoD inventory is the Georgian style. During this early period in American history, many carpenters and builders were migrating to the New World. They brought with them the popular styles of the time. The Georgian influence is seen most often in the northern cities and some early southern coastal towns. The civilian examples of the style can be simple or grand.

The style is characterized by a prominent entrance bay, sometimes in the form of a projecting pavilion (full-height gabled entrance bay), strict symmetry, hip roof and/or hip dormers, double-hung sash windows, and an entrance which can be heavily embellished or have a simple surround. A simple surround may lack dentil moldings or pediment, but it is important to note that simple details such as flat arches, flush arches, or other understated detail will still draw attention to the entrance. In civilian examples, many have dentil moldings and quoins. The military examples are more restrained with simple embellishment, and some are on a raised basement. Porches are rare and are typically later additions.



Top: Commandant's Quarters (ca. 1825) at Fort Snelling, Minnesota, exhibits a central pavilion (projecting central entrance bay) and prominent entrance.

Bottom: Strict symmetry—if a building is cut in half, one side will mirror the other.

Georgian 1700-1850

Defining Features

Strict symmetry

Prominent entrance

Central pavilion

Decorative door surround

Dentil moldings

Double-hung wood sash

6/6, 9/9, or 12/12 windows

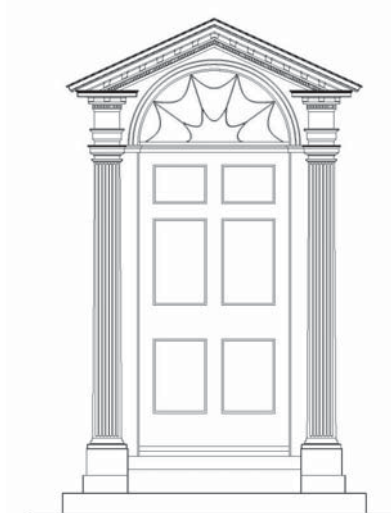

Top Left: An example of a Georgian door surround.

Top Right: This building exhibits a door surround with simple embellishment.

Bottom left: 12/12 and 6/6 windows.

Bottom Right: The pedimented central pavilion and 9/9 windows of the Administration Building (ca. 1850) at Fort Delaware, Delaware, are defining features of the Georgian style.



Federal 1780-1825

The Federal style is the American interpretation of the Adam style. It originated in Scotland by the three Adam brothers where they maintained the symmetry of the Georgian and Classical Revival styles, but introduced a more vertical orientation and delicate execution of details. It is characterized by the use of a central entrance, often adorned by sidelights and a fanlight. If built on a raised basement, it typically has a central stair or a double stair that flanks the entrance. Civilian examples will frequently boast dentil moldings and corner quoins. Practicing restraint, most military interpretations are simplified and austere in comparison to civilian examples.



Top: Quarters 100 (ca. 1820) at the U.S. Military Academy, New York, uses symmetry and sidelights that flank the entrance, which are defining features of the Federal style. The porch is a later addition.

Bottom Left: Quarters 1 (ca. 1819) at Fort Monroe, Virginia, is typical of the Federal style with no roof overhang on the side. The double-story porch is a later addition.

Bottom Right: The fanlight and sidelights of the officers' quarters (ca. 1824) at Fort Washington, Maryland, are typical of the Federal style.



Federal 1780-1825

Defining Features

Symmetrical massing

Vertical orientation

Hip roof, hip dormers, or side-gable roof

Little or no roof overhang
(flush eave and/or flush gable)

Fanlight over the entrance(s)

Sidelights sometimes flank the entrance

Double-hung wood sash

6/9, 9/9, 8/12, or 12/12 windows



This officers' quarters (ca. 1824) at Fort Washington exhibits many of the defining features from the Federal style.

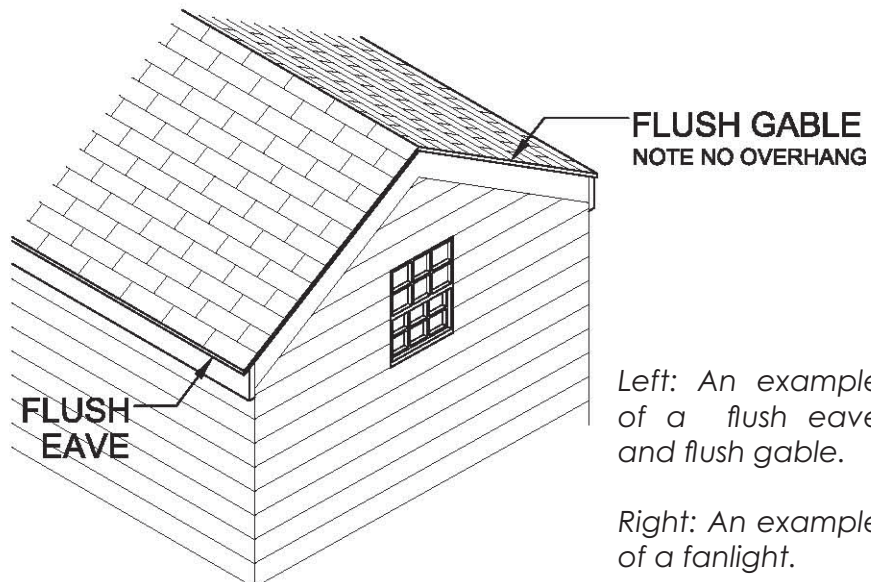

Left: An example of a flush eave and flush gable.

Right: An example of a fanlight.

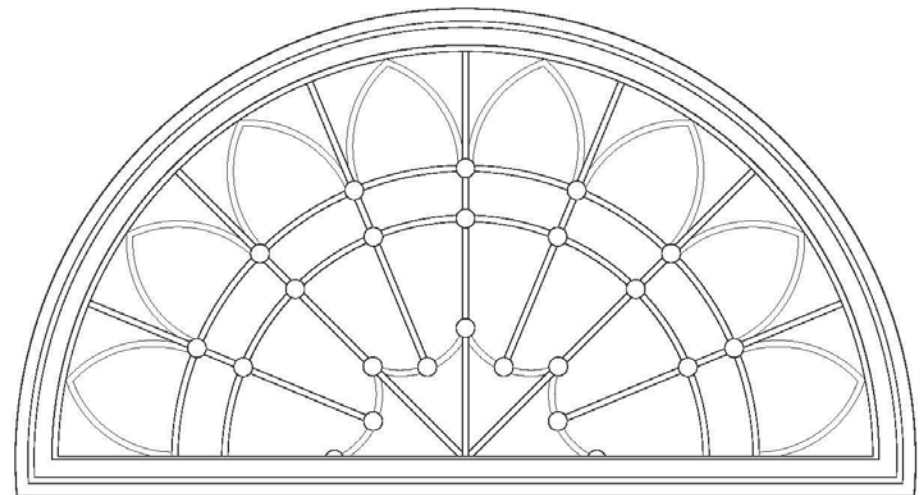

Classical Revival 1780-1850

Classical Revival was the result of a new wave of architects coming from Europe and of American architects touring Europe. The crown jewel of the style interpreted in America is the U.S. Capitol, completed in 1827. Classical Revival was the style of a new nation, heavily influenced by the nation's third president, Thomas Jefferson, who served from 1801 to 1809. Jefferson studied the architecture of Europe through his travels and the architectural treatises of the time. In the southern United States, this style is sometimes referred to as "Jeffersonian Classicism."

Greek and Roman design precedents influenced Classical Revival architects. Classical Revival elements include a full-height, temple-front columned portico, of usually two or more stories, strict symmetry, low domes, and raised basements. Windows continue to be double-hung sash, but are longer with usually a nine-over-nine light configuration. Other character-defining features include fanlights and elliptical, arched, and ocular windows.

Top: Building 1 (1830) at the Naval Medical Clinic at Portsmouth, Virginia, is an example of the Classical Revival with a raised basement.

Bottom: The Naval Home (1826) at Philadelphia, Pennsylvania, has a raised basement and Ionic columns, typical of the Classical Revival style.

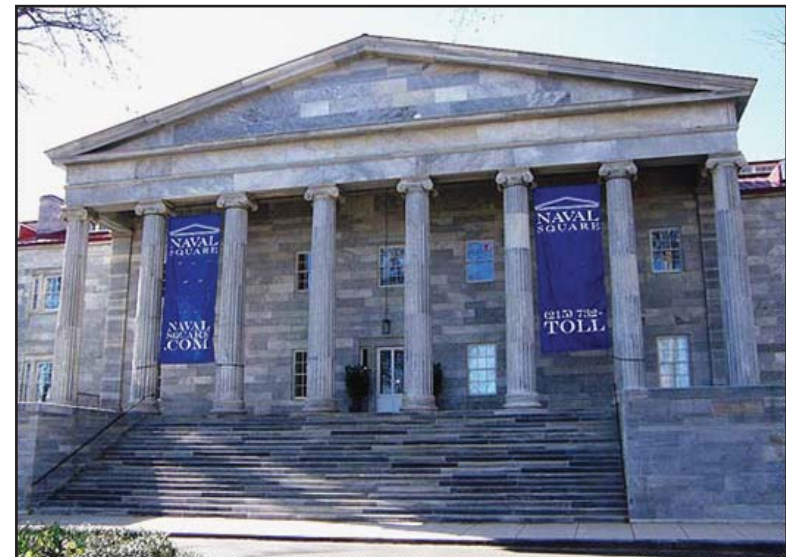

Classical Revival 1780-1850

Defining Features

Symmetrical massing
Monumental portico (porch)
Pediment portico with entablature
Tuscan, Doric, Ionic, Corinthian,
or Composite columns
Hip roof or hip dormers
Low domes
Raised basements
Double-hung wood sash
6/6, 6/9, 9/6 or 9/9 windows

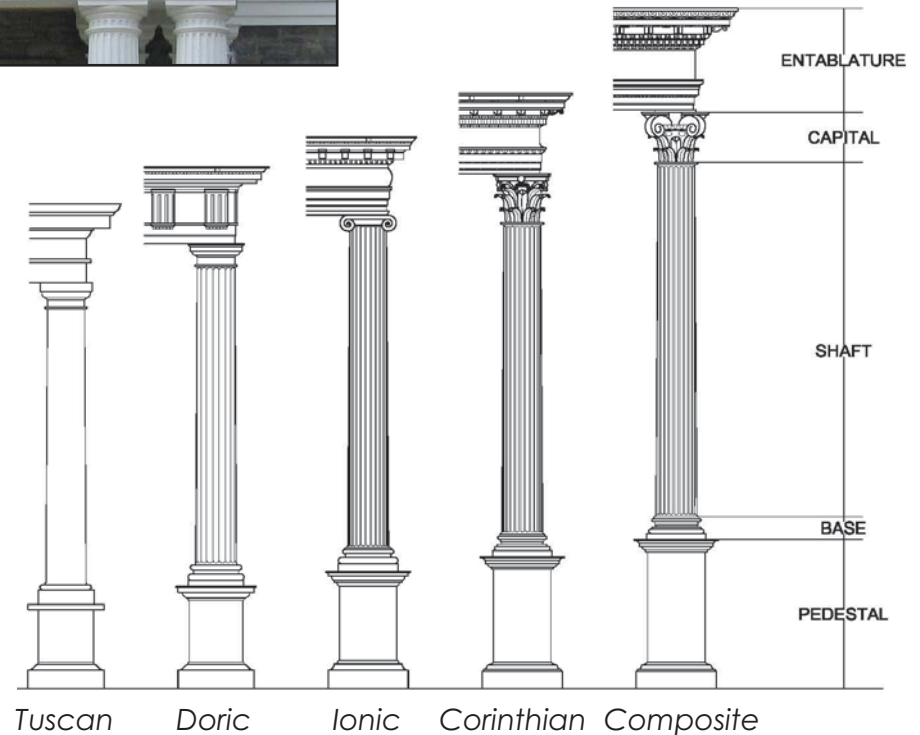

Above: The classical orders of columns.

Left and Top: The Old Cadet Chapel (1836) at the U.S. Military Academy, New York, and its detail show a central portico and Doric columns, defining features of the Classical Revival style.

Greek Revival 1820-1875

Greek Revival influences in architecture were promoted by an early architect, Benjamin Latrobe. He came to the United States from England in 1796 and designed the first Greek Revival building, the Bank of Pennsylvania. The style, in its purest form, combines a fully-columned temple front, pediment, and entablature while maintaining the strictest of symmetry, modeled after the Parthenon constructed in ancient Greece. Interpreted in vernacular examples, classical columns of Doric, Ionic, or Corinthian orders are the most popular and entrances are capped by a transom and sometimes flanked by sidelights. Pediment and/or entablature are usually evident as a roof, porch, or entrance treatment. Typically, a wide band just under the roofline, called a cornice, is interpreted as an entablature. Windows are double-hung sash with six-over-six, nine-over-six, six-over-nine, or nine-over-nine light configurations. The military examples range from the very plain to the restrained with little, if any, embellishment. The front gable of this style, common in civilian houses, was not typically used on military buildings.

Top: The Commandant's Quarters (ca. 1848) at Sackets Harbor Navy Yard, New York, illustrates the Greek Revival style with a later two-story porch addition. The door surround, 6/6 windows, vertical massing, and roof overhang are all characteristic of the style.

Bottom: An example of a Greek Revival door surround with transom and sidelights.

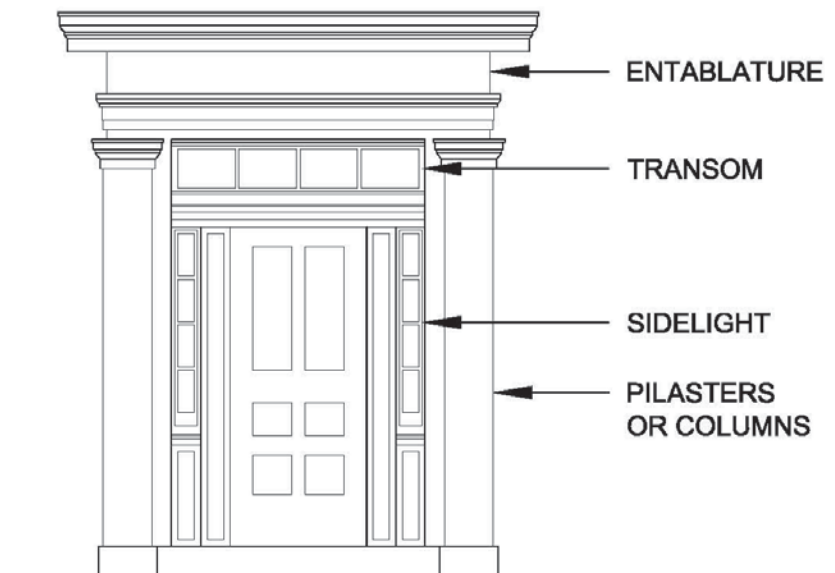

Greek Revival 1820-1875

Defining Features

Symmetrical massing

Vertical orientation

Hip roof, hip dormers, or side-gable roof

Roof overhangs eaves

Flat transom over the entrance(s)

Sidelights sometimes flank the entrance

Double-hung wood sash

6/6 or 6/9 windows



The Lieutenant's Quarters (ca. 1849) at Sackets Harbor Navy Yard (below left) has features that include a flat transom over entrance doors and 6/6 windows, while the Quartermaster's Quarters (1835) at Jackson Barracks, Louisiana (below right) has Tuscan columns, symmetrical massing, and flat transoms.

Building 34 (1873) at Naval Air Station Pensacola, Florida, is a late example of the style with features that include a hip roof, symmetrical massing, and flat transom over the entrance doors. The windows reflect the late date and a move to Italianate.

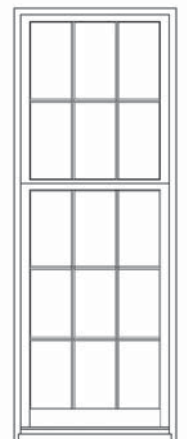
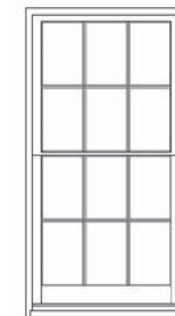

Above: 6/6 window
Right: 6/9 window

Renaissance Revival 1820-1865

Italian and French Renaissance buildings influenced the formation of the Renaissance Revival style. Forms are heavier, usually in masonry, with more elaborate structural detailing, yet they maintain the symmetry of the earlier Classical Revival styles. The round arch is employed in this style, as well as tall, slender windows, and on some examples, towers with battlements. This style is one of the few that is similar in both civilian and military buildings; most have a prominent entrance tower, strict symmetry, hip roof or hip dormers, round-arched entrance or entrance bay, round-arched windows, quoins, and elaborate cornices. This style was particularly popular in the military for arsenal design.



Top: The Storehouse (1863) at Fort Hayes, Ohio (originally Columbus Arsenal), is dominated by the central tower. Other defining features include the symmetry, hip roof, cornice, and use of round arches in the windows and entrance.

Bottom Left: A detail view of the Storehouse's pilasters and cornice.

Bottom Right: The Storehouse (1864) at Indianapolis Arsenal, Indiana, with a hip roof, prominent tower, and round-arched entrance.

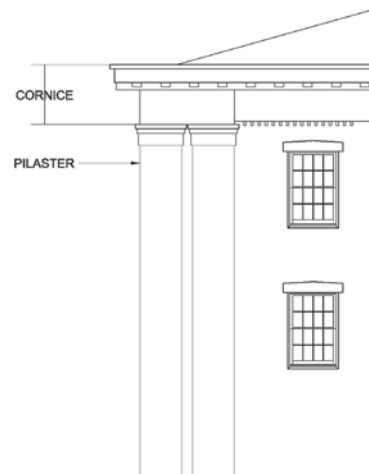

Renaissance Revival 1820-1865

Defining Features

Hip roof or hip dormers

Towers

Beltcourse

Quoins

Water table

Round-arched doors

Round-arched windows

Window hoods

6/6 or 8/8 windows



The Storehouse (1827) at Augusta Arsenal, Georgia, has the dominant tower with round-arched entrance. Apart from the window hoods, the features of the tower are shown below.



The Gate House (ca. 1864) at the Indianapolis Arsenal is characterized by a round-arched door, round-arched windows, and round-arched porch bays.

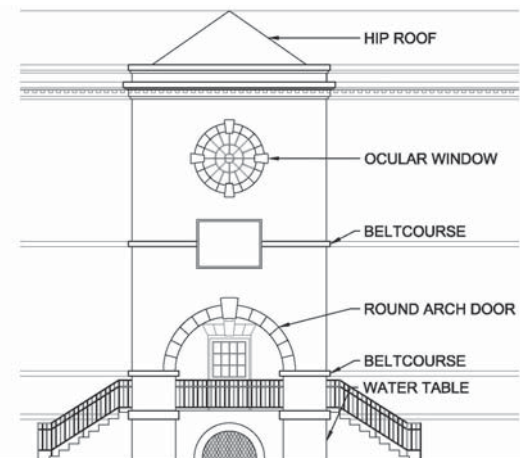

The defining features of the Renaissance Revival style is shown in the tower elevation drawing of the Augusta Arsenal.

Gothic Revival 1840-1895

Gothic Revival is the first departure from Classical Revival architecture in this country. Architect Alexander Jackson Davis (1803-1892) and landscape architect Andrew Jackson Downing (1815-1852) advocated for rural, picturesque architecture that was popular in England. While examples of Davis's and Downing's were primarily residential, the influence was interpreted into many forms, including the Carpenter Gothic, Collegiate Gothic, and the High Victorian Gothic. Common identifying features of Gothic Revival are steeply-pitched roofs (usually with steep cross-gables), intricately-carved vergeboards (bargeboards) along the eaves and gable edges, and pointed arches, also known as Gothic-style windows.

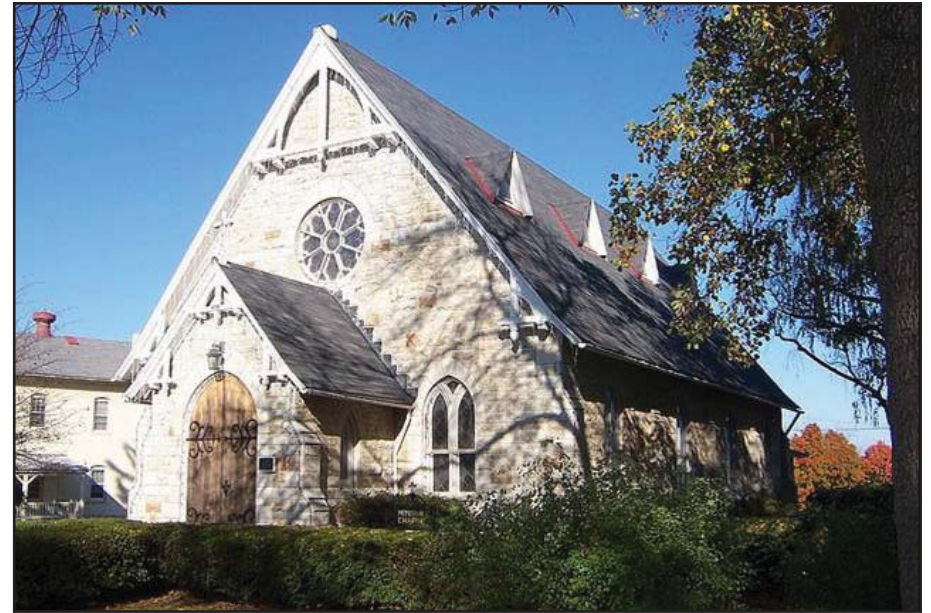

The Memorial Chapel (1878) at Fort Leavenworth, Kansas, was built from local limestone.



Quarters 102 (1857) at the U.S. Military Academy, New York, with fretwork on vergeboard.



Carpenter Gothic chapel (1858) with board-and-batten siding at Fort Monroe, Virginia.



Gothic Revival officers' quarters (ca. 1889) at Fort Monroe with pointed arches and quatrefoils.

Gothic Revival 1840-1895

Defining Features

Steep gable roofs

Vergeboard (bargeboard)
in gable peak

Pointed arch doors

Vertical board doors

Decorative iron strap hinges

Pointed arch windows

(lancet, Gothic windows)

Diamond pane windows

2/2 windows



Both of these doors have pointed arch forms and vertical board construction. The one on the right also has the decorative iron strap hinges.

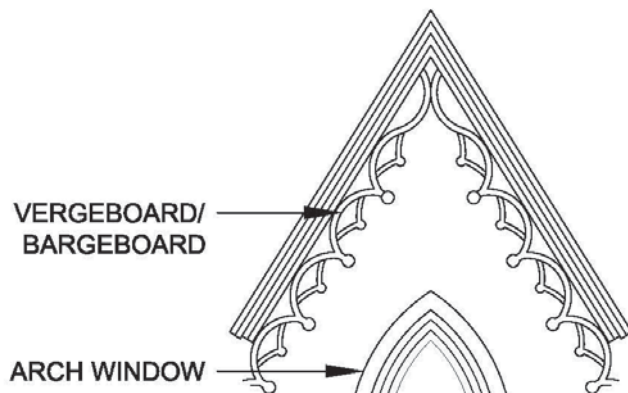

An example of a Gothic Revival vergeboard, also called a bargeboard.



Pershing Barracks (1891) at the U.S. Military Academy is an example of Collegiate Gothic.

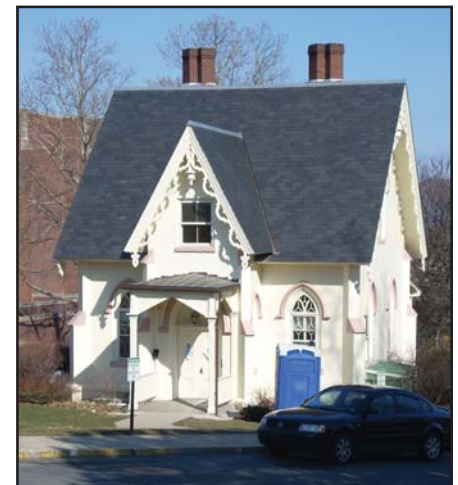

Quarters 146 (1859) at the U.S. Military Academy with fretwork on vergeboard.

Italianate 1850-1890

The Italianate style was popularized, like its contemporary, the Gothic Revival style, by the popular pattern books of architect Alexander Jackson Davis (1803-1892). The Italianate is recognized in cities and towns by towers, broad roofs with overhanging bracketed eaves, elaborate porches, round-arched windows, and double-leaf doors. The style interprets the villas found in the Italian countryside. In urban centers, the style was widely accepted and interpreted into the form of rowhouses with bracketed eaves and cornices, arched windows, and decorative stoops often adorned with ornamental ironwork. Military examples are found often in residential buildings but are simplified. Embellishment is limited to arched windows, simple lintels, double-leaf arched doors, transoms, porches with turned balustrades and columns, and bracketed cornices and eaves.

Top: This officer's quarters (ca. 1885) at F.E. Warren Air Force Base, Wyoming, exemplifies the restrained Italianate style implemented by the military. A slight hip roof, bracketed cornice, round-arched windows, double-leaf door with round-arched transom, 2/2 windows, and a decorative porch balustrade are all defining features of this style.

Bottom: Commanding General's Quarters (1879) at Omaha Barracks, Nebraska, with brackets and emphasized lintels.



Italianate 1850-1890

Defining Features

Side-gable and pyramidal roofs

Hip roof or hip dormers

Bracketed eaves and cornices

Elaborate porches

Turned and sawn woodwork

Arched doors

Transoms over doors

Window hoods

Bay windows

2/2 windows

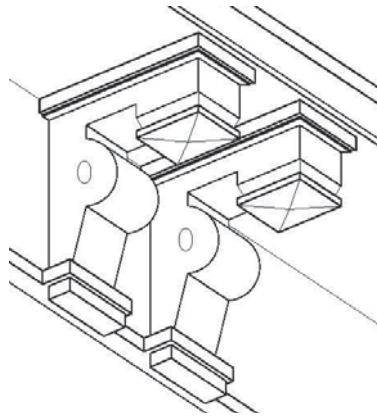

An example of a typical pair of brackets.

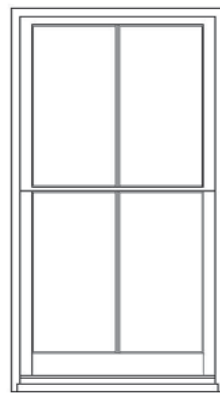

2/2 window



The Stillwell House (1888) at Fort Sam Houston, Texas, is defined by the broad roof, bracketed cupola, and double-leaf entrance.



The Headquarters Building (1879) at Omaha Barracks has a bracketed cornice and an elaborate porch.

Octagon 1830-1860

Octagons became briefly popular between 1830 and 1860. In 1849, Orson Fowler published a book entitled *The Octagon House: A Home for All*, which widely circulated the concept of the eight-sided house. The octagon shape had been used in earlier styles, especially the Federal style, which frequently used the octagon or oval shape for public rooms. Many of the details associated with the Octagon are similar to the Italianate style, and the Octagon is sometimes referred to as a subtype of the Italianate. In addition to the eight sides, character-defining features can include a pyramidal roof, cupola, overhanging bracketed eaves, elaborate wraparound porches, and wide cornices. Very few military examples exist but range from elaborate administration or residential buildings to simple utilitarian buildings.

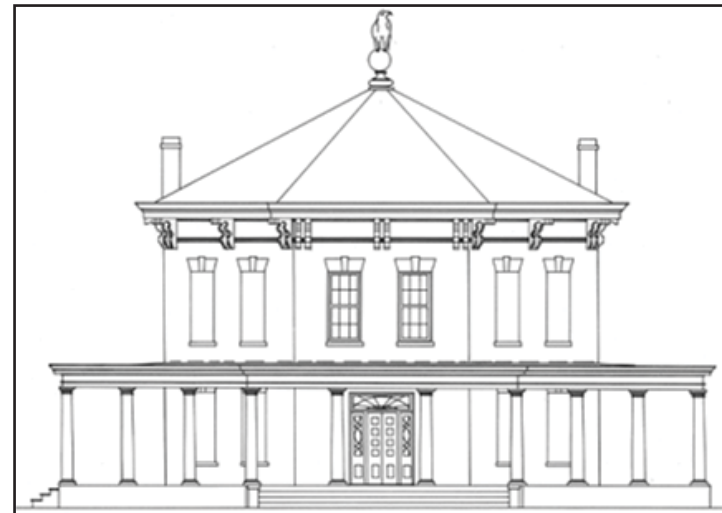

Top and Bottom: Building 16 (1852) at the Naval Air Station Pensacola, Florida, is one of few, if not only, high style examples of the Octagon. The porches have been infilled, but it still conveys its character-defining features. The drawing to the right is the original drawing of Building 16, illustrating its original form.

Octagon 1830-1860

Defining Features

- Octagon shape
- Pyramidal roof, hip roof, or hip dormers
- Bracketed eaves and cornices
- Elaborate porches
- Turned and sawn woodwork
- Window hoods
- Multi-light double sash windows



Building 3 (1835) at Naval Support Activity Norfolk Naval Shipyard, Virginia, has the character-defining features of the geometrical shape, pyramidal roof, and cupola of the style.

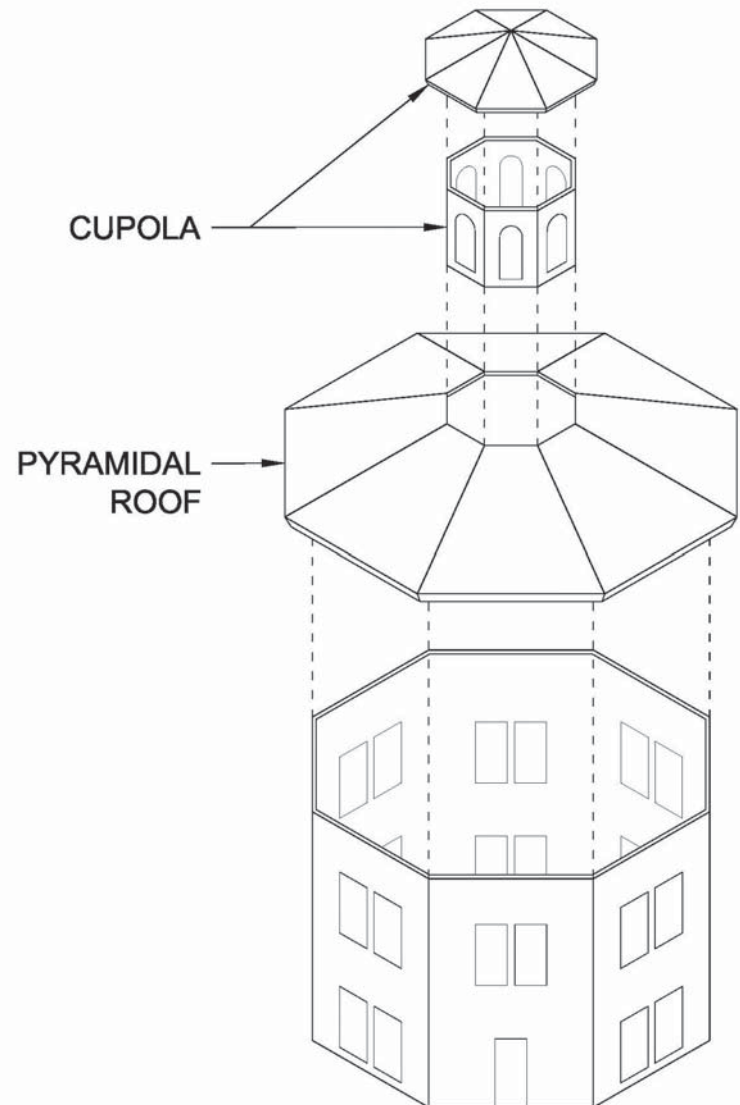

An exploded axonometric view of the relationship between the pyramidal roof and the cupola, both characteristic features of the Octagon style.

Second Empire 1860-1895

The country's affection for asymmetry and the picturesque details seen in the Gothic Revival and Italianate styles continued with the Second Empire style. The most identifiable feature of the influence is the mansard roof, made popular by 17th century French Renaissance architect Francois Mansart. The roof is typically pierced by dormer windows, and due to its height and construction, usually provides a full floor of space. Roofs were finished with wood or slate shingles or patterned shingles. Asymmetry and towers are indicative of the style. Civilian examples boast heavy bracketed cornices, decorative window hoods, window sills, and quoins. Porches are adorned by chamfered posts and turned balustrades. Military examples are less ornate but equally impressive. It is not unusual for military examples to maintain symmetrical massing and to be void of bracketed cornices and heavy window hoods.



Above: The hospital (1890s) at Fort Hayes, Ohio, illustrates a variation on the style with only the central portion boasting a mansard roof.

Top Right and Bottom Right: Historic and modern photographs of the Naval Hospital (1866) at Washington, D.C., an example of a military interpretation of the Second Empire Style.



Second Empire 1860-1895

Defining Features

Mansard roof

Quoins

Bracketed cornices

Turned and chamfered woodwork

Double-leaf door

Transoms over doors

Dormer windows

Decorative window hoods

2/2 windows



Top: This officer's quarters (ca. 1885) at the Presidio of San Francisco, California, is a simple version of the Second Empire. The wood-shingled mansard roof pierced by dormers identifies this as Second Empire; however, the first floor multi-light windows and 1/1 window configuration is in keeping with the later Queen Anne style, indicating that this is a late transitional example of the Second Empire.

Bottom: Historic photograph of the second Naval Hospital (ca. 1870) in Philadelphia, Pennsylvania, with mansard roof and ornamented dormers.

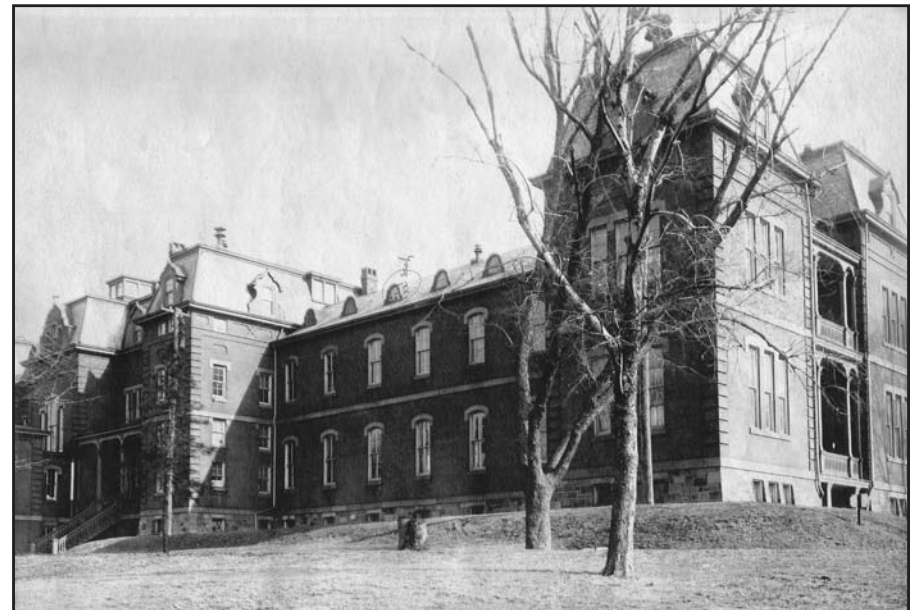

Civil War 1861-1865

After the exuberance of the Italianate and the Second Empire periods, the abrupt entry into the Civil War brought the spare type of mass-produced, standardized plans to the military (mostly the Army). Whereas high-design once was utilized for barracks and officers' quarters, most buildings during this period were constructed of rough-sawn wood planks (usually in a vertical placement), with roofs of the same planks. Typically, roofs were ventilator monitor roofs. Most buildings were moved or dismantled after the end of the war and there are no existing examples.

Top: Example of temporary construction barracks at a camp in Louisiana.

Bottom Left: Example of a two-company barracks at Camp Nelson, Kentucky.

Bottom Right: Bakery at Camp Nelson.

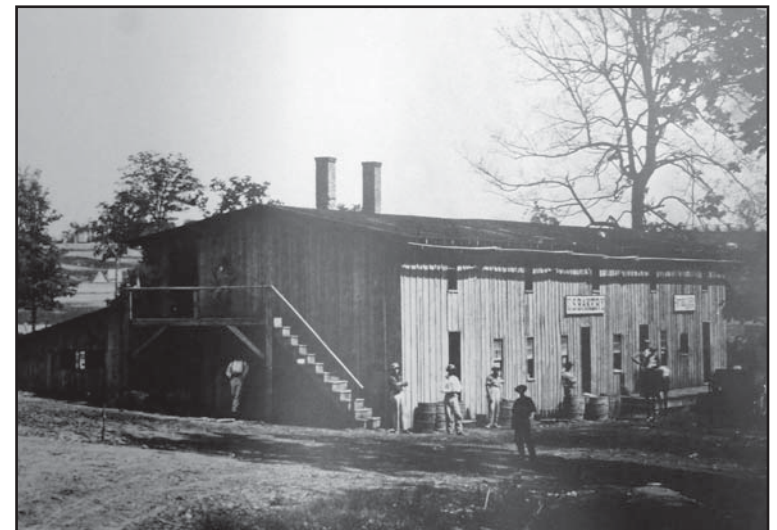

Civil War 1861-1865

Defining Features

Gable roof

Wood roofs

Roof ventilators (full-length or partial)

Vertical wall sheathing

6/6 windows

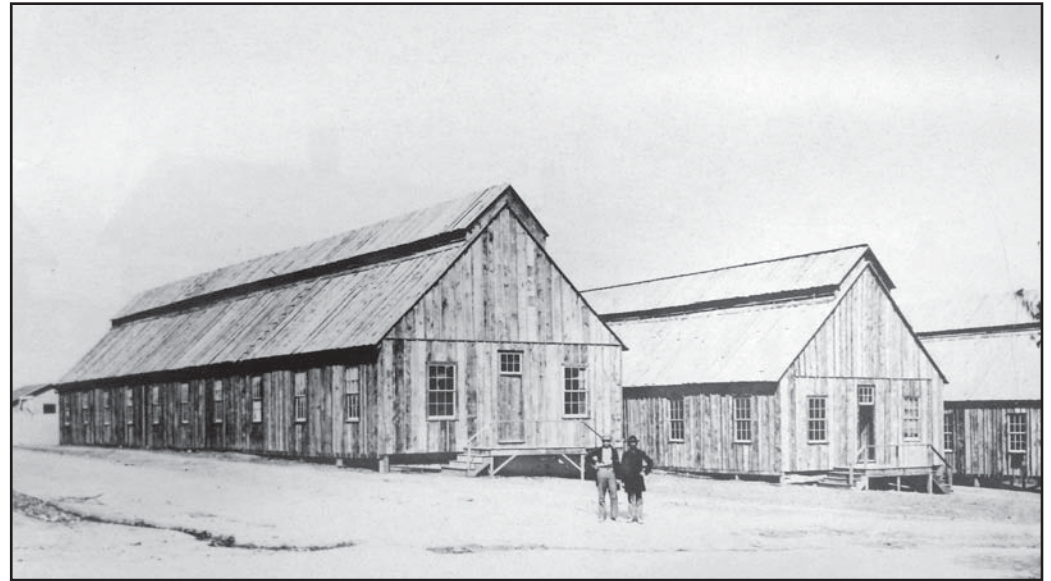

Top: Barracks at unknown camp.

Bottom Left: Barracks at Jeffersonville, Indiana.

Bottom Right: Barracks at unknown camp.

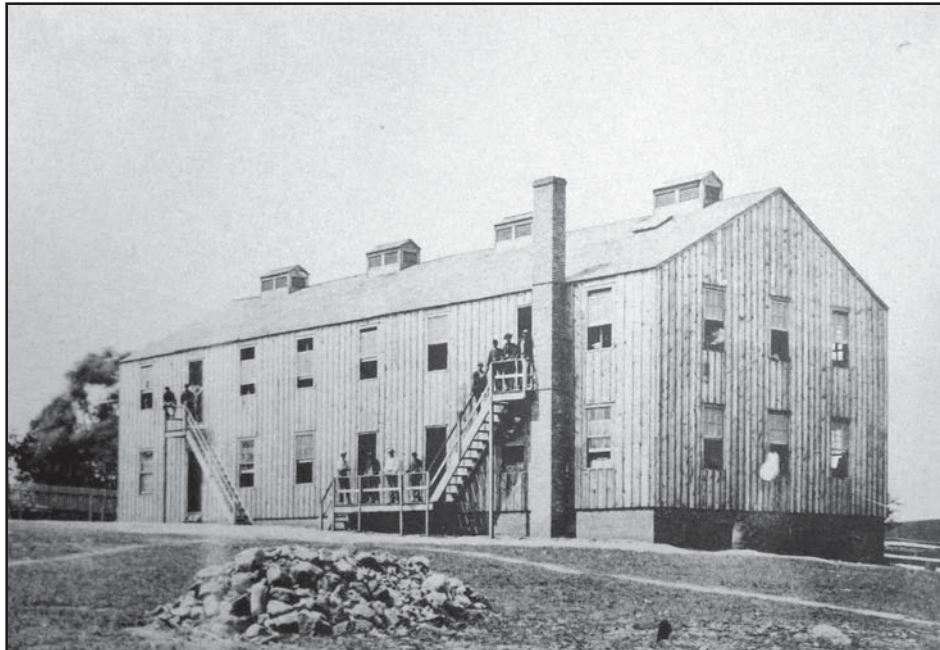

Stick 1860-1890

The Stick style evolved from the Carpenter Gothic style and is typically executed in wood. The style became popular in northeastern vacation homes with ample porches and windows. The asymmetry associated with the picturesque continues in the Stick. The name of the style is derived from the wood materials and use of half-timbering that loosely mimics the structural system of the building. Civilian and military examples rarely have all of the character-defining features in one example. Features may include half-timbering, decorative trussing, multi-light windows, and overhanging eaves with simple elbow brackets and/or exposed rafter ends. A common identifying feature is the dominant front gable. Military examples are rare and usually residential. Transitional examples blend the earlier Gothic Revival or the later Queen Anne with the Stick.



Top: This officer's quarters (1885) at the Presidio of San Francisco, California, exhibits many character-defining features of the Stick style, specifically the cross-bracing on the porch, elbow brackets under the eaves, asymmetrical massing, and multi-light windows.

Bottom, Right: An example of a multi-light-over-one window.

Bottom, Far Right: Detail of the Presidio of San Francisco's cross-bracing porch posts supporting the balustrade.

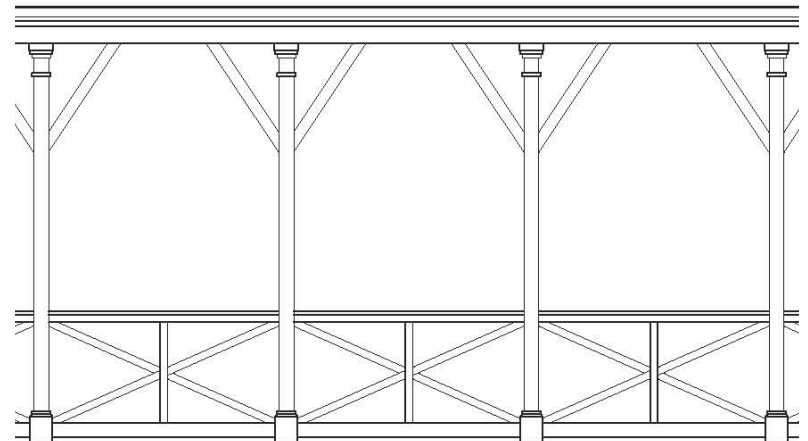
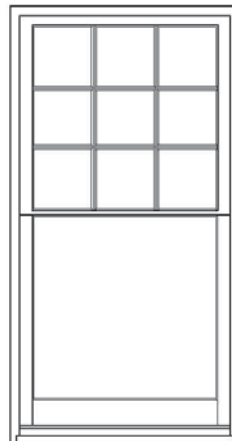

Stick 1860-1890

Defining Features

- Asymmetrical massing
- Dominant wood materials
- Dominant front gable
- Overhanging eaves
- Exposed rafter ends
- Elbow brackets under eaves
- Half-glazed doors
- Transoms over doors
- Multi-light/1 windows



The Old Point Comfort Light Keeper's House (1891) at Fort Monroe, Virginia, built by the Light House Service, displays shingle siding, a prominent front gable, half-timbering in the gable, and exposed brackets of the Stick style.



Left: Elbow bracket under eave at a Stick-style officer's quarters at the Presidio of San Francisco.

Right: The chapel (ca. 1884) at Fort Douglas, Utah, exhibits the steep roof and pointed arch windows of the Gothic Revival and the half-timbering of the Stick style.

Far Right: Two examples of gable trusses used in the Stick style.

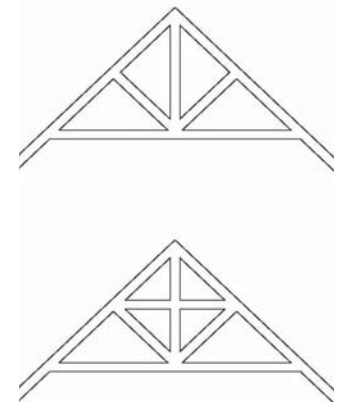

Queen Anne 1880-1910

The Gilded Age in America was defined by the excesses of the wealthy. This love for ornamentation is illustrated in the architecture of the era, including the Queen Anne style. The Gilded Age was also a time of rapid industrialization in this country. The Industrial Age introduced mass-produced woodwork and building materials that were ideal for use on Queen Anne-style buildings. Turned spindles and brackets for porches and turrets, wood shingles for wall sheathing, and balustrades were all used in this style to boast of the country's abilities. Masonry was also used as the dominant building material in some Queen Anne examples.

The Queen Anne style is seldom seen in military architecture. When seen, military examples follow civilian examples closely and are equally decorative. Both wood and masonry examples of the style were constructed on military installations during the period.

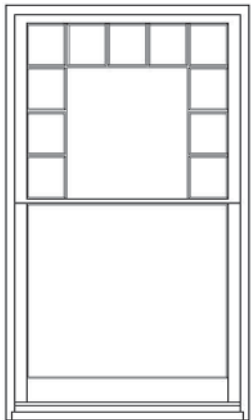

Left: An example of a Queen Anne multi-light-over-one window.

Top: This officer's quarters (1886) at Vancouver Barracks, Washington, displays many defining features of the Queen Anne style including asymmetrical massing, elaborate wraparound porch, turret, multi-light windows, and varying types of woodwork.

Bottom: Commanding Officer's quarters (1888) at Fort Logan, Colorado, is an example of Queen Anne constructed with brick and an open third-floor porch.



Queen Anne 1880-1910

Defining Features

Asymmetrical massing

Multiple materials

Gable front

Round or square towers/turrets

Elaborate one-story porches

Ornamental spindles and brackets

Half-glazed doors

Transoms over doors

Bay windows

1/1 or multi-light windows

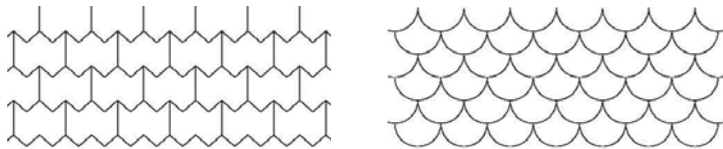

Above: Typical Queen Anne-style shingles: sawtooth (left) and fish-scale (right).

Top right: Another view of the Queen Anne-style officers' quarters at Vancouver Barracks showing the emphasis on the tower and its open porch at the top.

Bottom: Queen Anne-style porch on an Italianate officers' quarters (1850s) at Governors Island, New York.



Shingle 1880-1905

The architectural firm of McKim, Mead, and White popularized the Shingle style in architecture during the last decades of the 19th century. The style moved away from the ornamentation of the Queen Anne and Victorian era and toward an architecture that related more to the landscape. The dominant feature is the use of shingles as a continuous wall material. The use of flared eaves was also typical in this style. Made popular by northern beach retreats, few examples are seen in military buildings.



Top: St. Peter's Chapel (1901) at the Mare Island Naval Shipyard, California, is one of the few military examples of the Shingle style. The chapel's asymmetrical massing and continuous use of shingles for the roof and wall material is typical of the style.

Bottom: Examples of shingle patterns.

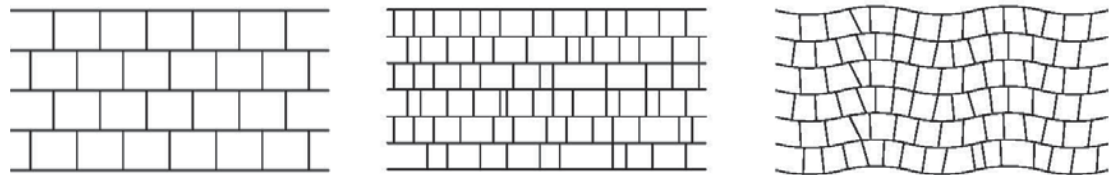

Shingle 1880-1905

Defining Features

Asymmetrical massing
Wood shingle siding
Steeply-pitched roof
Cross-gables
Overhanging eaves
Flared eaves
Irregular roofline
Gable front
Porches
Multi-light/1 windows

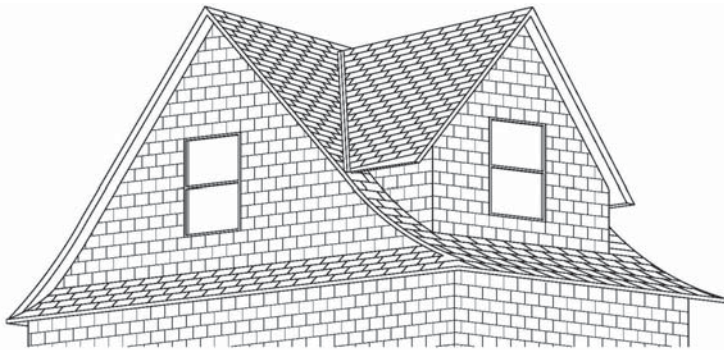

An example of a cross-gable roof and continuous wall shingles.



Porch and gable front at St. Peter's Chapel.

Romanesque Revival 1870-1900

The Romanesque Revival style blended influences from the Queen Anne and Shingle styles together with the heavy use of masonry and round arches. The style was made popular by architect Henry Hobson Richardson, who used masonry and low, broad arches in significant buildings like the Allegheny County Courthouse in Pittsburgh, Pennsylvania, and Trinity Church in Boston, Massachusetts. Richardson's successful interpretation of the style earned the name "Richardsonian Romanesque." The military implemented the style during the last decades of the 19th century; however, brick was the dominant building material in military examples, using various colors of brick or brick in combination with stone to execute the ornamentation.



Top: The Commanding General's quarters (1890) at Fort Sheridan, Illinois, closely resembles civilian examples of the style. Domed towers, multiple roof shapes and heights, multiple materials, and asymmetrical massing are typical of the style.

Left: Water Tower (1889) at Fort Sheridan, with corner buttresses and rusticated arch.

Right: Post Office (1898) at Fort Monroe, Virginia, with tower and round arches.



Romanesque Revival 1870-1900

Defining Features

Hip, pyramidal, or gable roofs

Domed and conical towers

Use of brick or rough hewn (rusticated) stone

Broad arches over doors

Round arches

Patterned or textured masonry over windows

Groups of windows



Top Left: Officer's quarters (1890) at Fort Sheridan, with rounded entrance arch.

Top Right: The Band Hall Building (ca. 1900) at Fort Sam Houston, Texas, illustrates the minimalist approach to the style while maintaining character-defining features such as multiple textures and materials, the dominant round-arched entrance, and flanking windows.

Left: The Jeffersonville Quartermaster Depot (1874), Indiana, illustrates a restrained military example of the style.

Right: Main entrance to the Post Office at Fort Monroe.

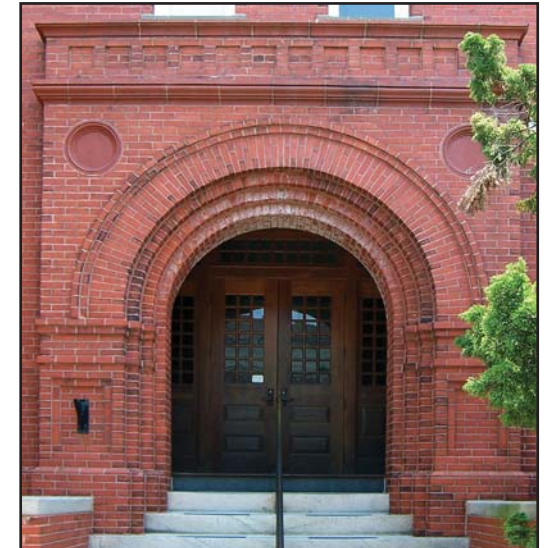

Rustic 1870-1940

The desire of wealthy Americans to “rough it” is the impetus for the development of the Rustic style. It is also known as the “Adirondack” style because of its popularity in that region of New York. The use of log, stone, and clapboard ensured the style’s blend with the surrounding landscape. The style was widely adopted by the National Park Service for lodges and buildings within the national parks. Examples of the style still exist in Yellowstone, Yosemite, and the Grand Canyon National Parks. The style spread to the state parks during the Depression with the assistance of the Civilian Conservation Corps (CCC), who constructed buildings and structures across the country. In addition to the primary building materials of log, stone, and clapboard, buildings typically have steep sloping roofs pierced by shed roof dormers, wide roof overhangs with scroll-sawn rafter tails, and heavy brackets. Military examples closely resemble civilian examples of the style.

Top: The Military Museum (1918) at Fort Lewis, Washington, is one of the few Rustic examples within DoD. It was built for the Salvation Army and acquired by the Army in 1921.

Bottom: The former NCO Club (1937) at the Presidio of San Francisco, California, conveys the Rustic style through the use of a wood-frame structure, stone base, and horizontal log siding.



Rustic 1870-1940

Defining Features

- Steep sloping roof
- Wide overhanging eaves
- Large elbow brackets
- Exposed rafters
- Scroll-sawn rafter tails
- Recessed porch
- Shed roof dormers
- Paired and single windows
- 6/6 or multi-light windows



The Federal Prison inmates (Fort Lewis) built this service station (1938) at Fort Lewis out of stone in the Rustic style.

Left: Example of a shed roof dormer (eave of dormer parallel to eave of main roof).

Right: Example of a scroll-sawn rafter tail.

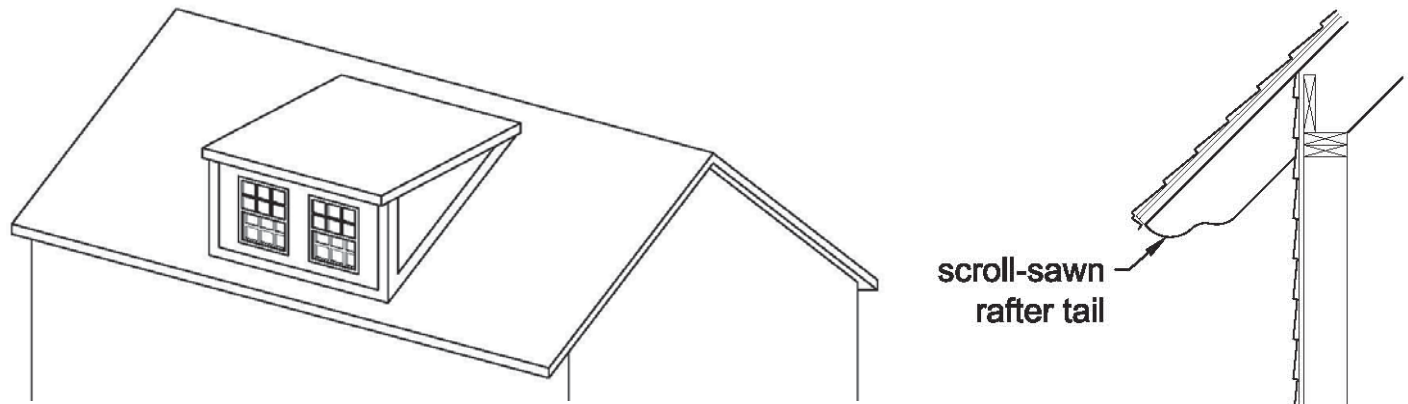

Beaux Arts 1885-1940

The École des Beaux-Arts, an academy in Paris, France, shaped the art and architecture of France and Europe beginning in the 17th century. During the turn of the 20th century, fortunate American architects traveled to France to study at the Academy. Beaux Arts, which translates to “Fine Arts,” is the American translation of the French architectural influence popularized during this time. The exuberant style is similar in both civilian and military examples. Features are layered to define the style. Masonry building materials create the foundation, embellished by arcaded entrances, pilasters, and paired columns, as well as balustraded windows and rooftops further accented by modillions and cartouches.



Commandant's Quarters (ca. 1896) at Naval Station Kitsap Bremerton, Washington.



The old Brooks Army Medical Center (1937) at Fort Sam Houston, Texas, features a Churrigueresque interpretation of the Beaux Arts, illustrated by masonry materials, arcades, pilasters, balustrade windows, cartouches, and roof balustrades.

Beaux Arts 1885-1940

Defining Features

Flat or mansard roof

Roof balustrades

Masonry walls

Quoins, pilasters and/or columns

Rusticated first story

Arcades

Applied ornament

festoons, swags, cartouches

Pedimented or bracketed windows

Window balustrades



Top: Heating plant (1909) at Charleston Navy Yard, South Carolina, with pilasters and arcade-like windows, defining features of the Beaux Arts style.



Bottom: Bancroft Hall (1905) at the U.S. Naval Academy, Maryland, illustrates the Beaux Arts style with rusticated masonry, paired columns, rooftop balustrade, modillion course, brackets, and mansard and flat roofs.

Neoclassical Revival 1895-1950

Neoclassical Revival, was prevalent in American architecture during the last few years of the 19th century and the first half of the 20th century. It is a restrained version of the Beaux Arts with a connection to the early 19th century style. A full-height portico or porch is the dominant feature. In early examples, the columns were classically inspired, whereas later residential examples may have simple square posts. Though not as popular as the Colonial Revival style, it did show longevity, lasting to the mid-century mark. In military architecture, it was often used for residential and administration buildings.

Top: Officer's quarters (1900) at Mare Island Naval Shipyard, California.

Bottom left: Gift Chapel (1909) at Fort Sam Houston, Texas.

Bottom right: Headquarters (ca. 1926) at Fort Belvoir, Virginia.



Neoclassical Revival 1895-1950

Defining Features

Symmetry

Hip roof, hip dormers, or side-gable roof

Roof balustrades

Dentil moldings

Full-height portico or porch

Classical columns (early)

Square posts (late)

Entrance with fanlight or transom
and sidelights



Right: The dominant full-height portico with classical columns, dentil moldings, quoins, symmetry, and classically-inspired entrance are all elements of the early Neoclassical as seen in these commander's quarters examples (ca. 1909) from Fort Monroe, Virginia, (top) and F.E. Warren Air Force Base, Wyoming (bottom).

Colonial Revival 1880-1940

Colonial Revival is an umbrella term used to describe the period revivals that dominated architectural style during the last decades of the 19th century through the middle of the 20th century. The style transitioned from the Queen Anne and sometimes displayed a subtle blending of the two styles. The style is typically asymmetrical with front gables and wraparound porches, but with less ornament and more simple detailing, like classical columns. Closer to the turn of the century, it became more formalized, harking back to the symmetry of the Georgian and Federal styles. The new "Colonial" illustrated symmetry but was exaggerated and more complicated than earlier styles. Military examples range from simply detailed to extravagant, depending on the building type and importance to the installation hierarchy. These period revivals were also incorporated into the standardized plans for the military and therefore, it is not uncommon to see the same building at several different installations executed with different materials. The Colonial Revival was used in military architecture until World War II.

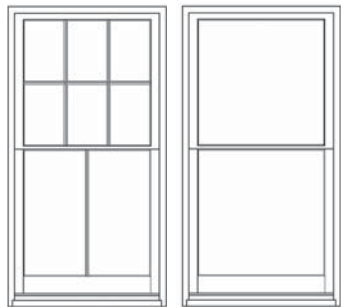

Left: An example of a 6/2 window and a 1/1 window.

Right, Top & Bottom: These officers' quarters duplexes (ca. 1905) at Vancouver Barracks, Washington, with gable roofs, one-story porches, and symmetrical massing are indicative of the Colonial Revival.

Colonial Revival 1880-1940

Defining Features

Usually two stories

Hip roof, hip dormer, or gable roof

Full-width porch or entry portico

Paneled door

Decorative door surround

Fanlight or transom and sidelights

Paired windows

2/2, 6/1, 6/2, or 6/6 windows



The Post Commander's Quarters (ca. 1930) at Fort Lewis, Washington, maintains the gable roof, gable dormers, rooftop balustrade, and double-hung windows of the Colonial Revival style.



An officer's quarters (ca. 1900) at Fort Hancock, New Jersey, with decorated dormers and full-width porch.



These two quadraplexes (ca. 1905) are identical in plan and design, but subtle differences have been incorporated to fit into the installations they serve. The Fort Sam Houston, Texas, example (left) has yellow-colored brick while the Fort Monroe, Virginia, example (right) is in red brick and boasts a roof-top balustrade.



Prairie 1900-1940

The Prairie style of architecture was created by a group of architects in Illinois known as the Prairie School. The most famous of these architects was Frank Lloyd Wright, who promoted the ideals of the Prairie School, which included truth in the materials and integration with the landscape. While Wright's examples of the style are the most famous, many local architects successfully interpreted the style in examples across the country. Civilian examples have horizontal expression, low-profile hip roofs and hip dormers, and wide overhanging eaves. The most common form adopted from the Prairie School is the American Foursquare, which is a two-story house form with hip roof, full-width porch, and dormer. Few examples of the Prairie style exist within the military inventory. Those that do exist are very simple and restrained, and most exhibit horizontal massing and wide eaves.

Top: This one-story officer's quarters (ca. 1930) is an example at Hickam Air Force Base, Hawaii. It has the low hip roof, horizontal massing, wide eaves, and bands of windows common to the style.

Bottom: Officer's quarters (1937) at Charleston Navy Yard, South Carolina.



Prairie 1900-1940

Defining Features

Horizontal massing

Full-width porch

Low hip roof

Overhanging eaves

Exposed rafter ends

Hip dormer windows

Bands of windows

1/1, 3/1 vertical, 4/1 vertical windows



Top: This quarters (ca. 1910) at Fort McPherson, Georgia, closely resembles the American Foursquare examples found across the country. The hip roof with flared ends, hip dormer with band of windows, and two-over-two facade configuration are characteristic of the style.

Bottom, Left to Right: Examples of a 3/1 vertical, 4/1 vertical, and two Prairie-style windows (also applicable to the Queen Anne, Colonial Revival, and Bungalow styles).



Bungalow 1900-1935

The Arts and Crafts Movement in England began a focus towards traditional craftsmanship and the use and promotion of natural materials. This ideal was promoted in the United States by Gustav Stickley in his magazine *Craftsman*, published from 1901 to 1916. An architectural firm in California, Greene and Greene, adapted the style and produced the most sophisticated examples. The style was widely adapted throughout the country in the forms of small houses and bungalows ranging from simple cottages to Craftsman-style houses. There are only a few examples in military-designed buildings. However, there are many military-acquired examples, which are termed Bungalow here due to the lack of pure Craftsman-style buildings in DoD. The style is characterized by gable front, side-gable, and hip roofs or hip dormers with wide overhanging eaves, exposed rafter ends, elbow brackets, and full-width porches supported by brick, block, or stuccoed piers with battered square posts.

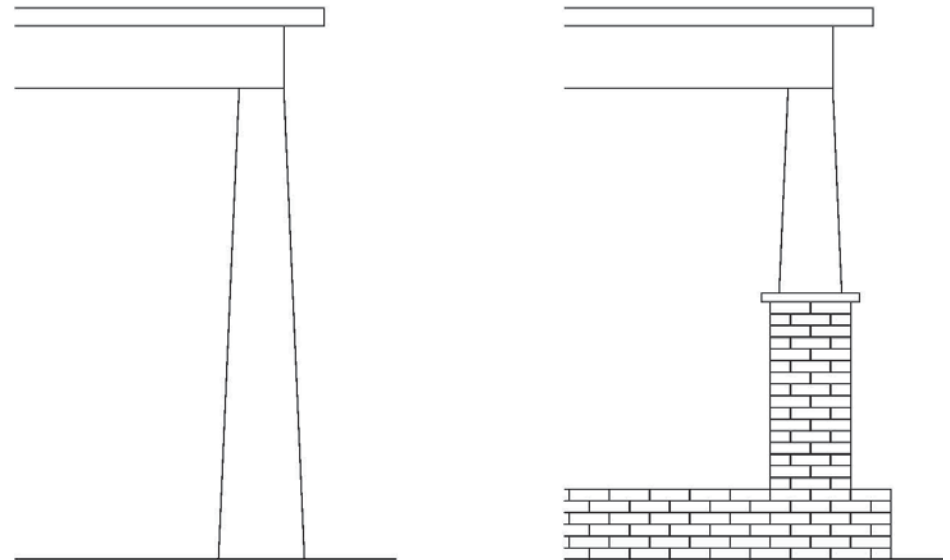

Top: This bungalow (ca. 1920) at Camp Bullis, Texas, was built by two soldiers who incorporated native materials, a wide roof overhang, and exposed rafter ends into the design of the house.

Bottom: Bungalow porch detail examples of a battered post (left) and a battered post on a straight pier (right).

Bungalow 1900-1935

Defining Features

Gable roof, hip roof, or hip dormers

Overhanging eaves

Exposed rafter ends

Elbow brackets

Materials in natural state

Broad porches

Masonry piers with battered posts

3/1 or 4/1 vertical windows



Left: An example of a 4/1 vertical light window.

Top Right: This quarters (ca. 1926) on Kelly Air Force Base, Texas, is an excellent example of the Bungalow. Note the elbow brackets under the overhanging eaves and the battered posts. The wide porch has been altered by enclosures but is still easily interpreted.

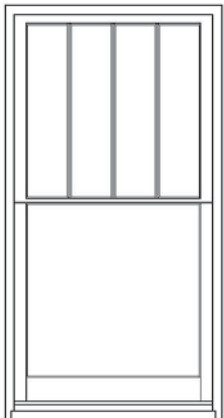

Bottom Right: The Fort Lewis, Washington, example (ca. 1935) is more restrained with only overhanging eaves and size indicating the Bungalow style.



World War I 1917-1919

When the United States declared war against Germany in January 1917, troop housing accommodated 124,000 men. The War Department authorized the Army Quartermaster General to construct 32 new cantonments for the Army and the National Guard, to be completed by September 1917. Constructed solely of wood, these standardized temporary buildings were utilized at the Army cantonments, while the National Guard cantonments had tents. Most structures were completed by the end of November 1917, housing a total of 1.5 million soldiers. Typical temporary buildings were barracks, latrines, regimental headquarters, warehouses, hospitals, theaters, and chapels. In addition to the new cantonments, the War Department expanded existing forts by constructing temporary buildings wherever needed. The Navy Department, for the most part, did not need many new installations; however, temporary buildings were constructed on as much open space as possible during this period.

Top: A historic view of Camp McClellan, Alabama (ca. 1918).

Bottom: Historic photograph of barracks at Camp Hancock, Georgia (ca. 1918).

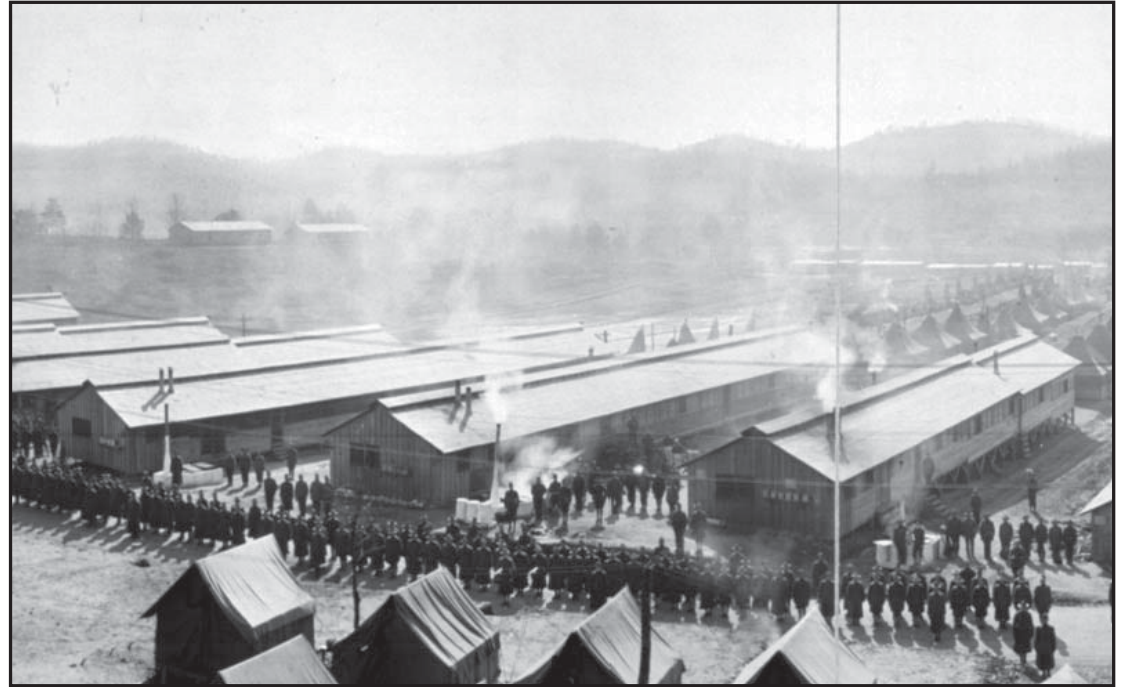

World War I 1917-1919

Defining Features

- Full-length ventilators
- Short-length ventilators
- Rolled roofing
- Horizontal siding
- 6/6 windows

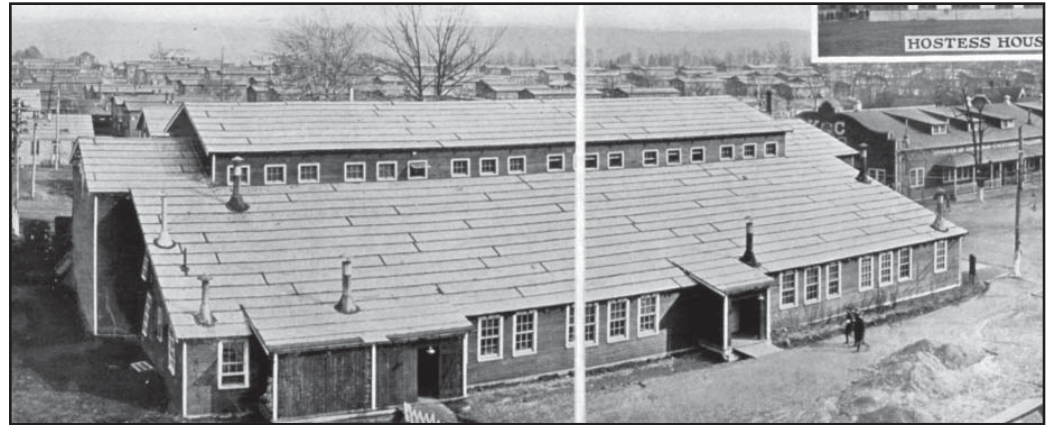

Historic photograph of a recreation building at Camp Merritt, New Jersey (ca. 1918).

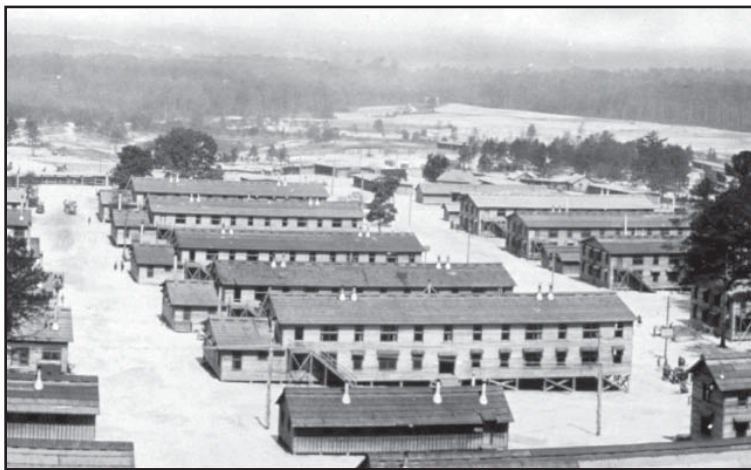

Historic photograph of Camp Jackson, South Carolina (ca. 1918).



Historic photograph of a barracks at Camp Custer, Michigan (ca. 1918).

Spanish Revival 1915-1940

Spanish Revival became popular after the Panama-California Exposition in San Diego in 1915 designed by Bertram Goodhue. The Spanish Revival style was characterized by low roof forms, clay tile roofing, stucco wall surfaces, and arches. Common roof forms include side-gable, cross-gable, hip, combination hip and gable, and flat roofs. Military architecture adapted the Spanish Revival, sometimes referred to as Mission Revival, Spanish Eclectic, or Spanish Colonial Revival, especially on former World War I Army camps. Many of these camps became permanent installations immediately following World War I and this style was the primary architectural influence.



Above: The old Post Theater (1934) at Fort Huachuca, Arizona, with a curvilinear and decorated roofline.

Top: The San Diego Naval Hospital (1925), California, was designed by Bertram Goodhue in the Spanish Revival style.

Bottom: Chapel (1939) at Randolph Air Force Base, Texas, an elaborate entrance flanked by bell towers.



Spanish Revival 1915-1940

Defining Features

Low roof

Clay roof tiles

Little or no roof overhang

Smooth wall surface, usually stucco

Arched openings or blind arches

Top: Sage Hall, the theater (ca. 1935) at Fort Bliss, Texas, is characterized by clay tile, stucco wall surface, arcaded porch, and arched motif on the dominant gable front.

Bottom: The Spanish Revival was used widely for housing, including this NCO quarters (ca. 1935) at Fort Bragg, North Carolina, (left) and officers' quarters (ca. 1935) at Fort Benning, Georgia (right).



French Revival 1915-1940

French Revival is one of the period revivals of the 20th century. Men who returned to the United States after serving in World War I had seen the architecture of the French countryside. This knowledge, combined with photographs in news magazines, enabled architects to implement the style, most often in residential architecture. The civilian style is characterized by high hip roofs or hip dormers, smooth wall surfaces, quoins, towers, and tall chimneys, sometimes with chimney pots. Military examples closely mirror civilian examples and are found at only a few installations.

All three of these quarters (ca. 1930) are at Maxwell Air Force Base, Alabama. With subtle differences, they all are influenced by the French Revival.



French Revival 1915-1940

Defining Features

Prominent entrance

High hip roof or hip dormers

Eaves slightly flare at ends

Brick, stone, or stucco

Quoins

Arched openings

Balustraded porches and balconies

6/6 or 8/8 windows



Much of the architecture (ca. 1932) at Barksdale Air Force Base, Louisiana, is influenced by the French Revival style including this duplex (top), the fire station (bottom left), and the Officers' Club (bottom right).



Dutch Colonial Revival 1880-1940

Dutch, or Gambrel, Colonial Revival is another subtype of the Colonial Revival. This architectural influence maintains many of the Colonial Revival features but is easily identified by the use of a gambrel roof. The gambrel roof can be a side-gambrel, front-gambrel, or cross-gambrel. Side-gambrel roofs are typically pierced by shed roof dormers. Commercial examples of Dutch Colonial Revival are rare in contrast to the popular residential use of the style. On military installations, the style was implemented for residential use, usually noncommissioned officer housing, and often in the duplex form.



Above: Senior officer's quarters (1921) at the Naval Support Facility in Dahlgren, Virginia.

Top Right: Well-known architect Albert Kahn designed these NCO quarters (ca. 1920) at Joint Base Langley-Eustis, Virginia, with 6/6 and 8/8 double-hung windows.

Bottom Right: NCO quarters (1890) at Fort Sheridan, Illinois, featuring a dominant cross-gable gambrel roof.



Dutch Colonial Revival 1880-1940

Defining Features

Symmetrical massing

Gambrel roof

Side or cross-gambrel roof

Shed roof dormers

Entry portico

Double-hung windows

3/1 vertical, 4/1 vertical, 6/6, or 8/8 windows

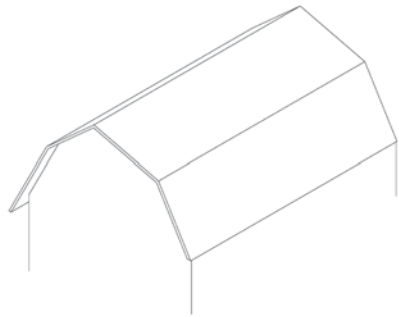

Above: An example of a gambrel roof.

Top and Bottom: These houses (1905) at Naval Base Kitsap Bremerton, Washington, utilize the side gambrel roof, with a large gambrel wall dormer as the focal point. Subtle differences, like the window treatment in the dormer, add variety to the standard plan.



Tudor Revival 1900-1945

Tudor Revival style is influenced by the English architecture of the 17th and 18th centuries. The half-timbering is cosmetic, rather than the structural half-timbering of the influence. The style was initially popular for manor houses. By the 1930s, it became exceedingly popular for middle-class homes and was found throughout the country in historic neighborhoods. Military examples range from high-style to modestly-detailed, and are most often found in residential examples.

All of these quarters (ca. 1934) at Joint Base Langley-Eustis, Virginia, were designed by architect Albert Kahn in the Tudor Revival style (top, bottom left & right in both single-family and duplex examples).



Tudor Revival 1900-1945

Defining Features

- Half-timbering
- Patterned masonry
- Use of multiple materials
- Steeply-pitched roof
- Dominant cross-gables
- Large chimneys
- Entry porticos
- Tall, narrow windows
- Pairs or groups of windows
- Casement windows
- Double-hung windows
- Multi-light windows

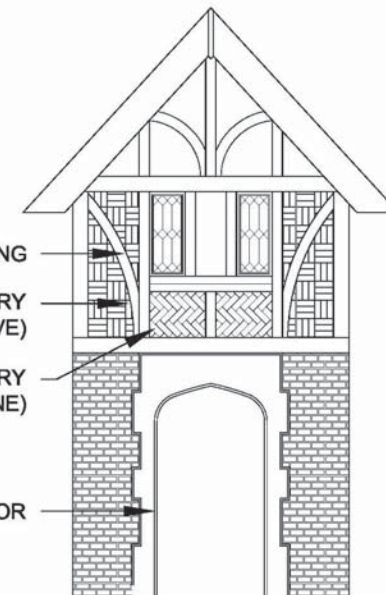

Top: This example (1931) of the Tudor Revival style at Naval Base Kitsap Bremerton, Washington, is a restrained example. The steep cross-gable roof, casement windows, and arched entrance with contrasting stone detail are the character-defining features that illustrate the Tudor influence.

Bottom: The defining features of the Tudor style are shown in this partial elevation.

Georgian Revival 1880-1940

Georgian Revival is a subtype of the Colonial Revival that gained widespread popularity during the period revivals of the early 20th century. The strict symmetry of the historic Georgian model, as well as implementation of the pavilion or suggestion of the pavilion, is implemented in the revival, but in a much larger way. In the civilian world, these buildings were popular for residential, municipal, and academic design. In the military world, Georgian Revival was incorporated into hospitals, headquarters, barracks, and housing. Especially at the former World War I Army camps, the Georgian Revival was adapted most frequently in standardized plans.



The Post Exchange (1905) at Madison Barracks, New York, (top) and the Mess Hall (1928) at Walter Reed Army Medical Center, D.C., (bottom) are typical of the Georgian Revival. Resting on a raised basement, the building's slightly projecting central pavilion dominates the symmetrical facade and is accentuated by pilasters and dentil moldings.

Bottom Left: The Headquarters Building (1930) at Fort Lewis, Washington, is a more elongated version using quoins rather than pilasters, and round arches in accents and dormers.



Georgian Revival 1880-1940

Defining Features

Gable roof, hip roof, or hip dormer

Central projecting pavilion

Decorative door surround

Pilasters and/or quoins

Raised basement

Flat arches over windows

6/6 or 8/8 windows



Top: Quarters 1 (1936) at Fort Belvoir, Virginia, is another interpretation of the Georgian Revival, but with flat roof entry portico, side-gable rather than hip roof, and gabled roof dormers.

Bottom: The Post Hospital (1935) on Governors Island, New York, also exhibits the Georgian Revival style, again restrained with a raised basement, central pavilion, pilasters, and belt courses.



Art Deco 1920-1945

Art Deco was inspired by the 1925 Exposition Internationale des Arts Decoratifs et Industriels Modernes held in Paris, which introduced works that abandoned ancient styles and strove for modern interpretation of the Machine Age. Details, such as reeded or fluted towers, columns, or pilasters, that convey a sense of verticality are common, as are stylized motifs, geometric patterns, and the use of chevrons. Some civilian examples are very elaborate, using multi-colored materials, such as terra cotta, and layers of stylized designs. Military examples are typically restrained with minimal ornamentation and only a few characteristic features.



Top: The museum (ca. 1941) at Peterson Air Force Base, Colorado was originally the terminal for the Colorado Springs Municipal Airport. It is a rare example of the high style Art Deco in the military inventory. The reeded pilasters, stylized motifs, and chevron cornice, all in terra cotta, are representative of the style.

Bottom: The Illinois National Guard Armory (1930s) at Champaign, Illinois, (left) evokes the Art Deco, as does the eagle from barracks (1930s) at Kelly Air Force Base, Texas, (center) and the central tower, curved canopy, and stylized sculptures on the Beaufort Naval Hospital (ca. 1947), South Carolina (right).



Art Deco 1920-1945

Defining Features

Vertical massing or elements

Flat roofs

Smooth wall surface

Reeding or fluting around doors and windows

Zigzags, chevrons, geometric and stylized motifs

Casement windows



The theater (1941) at Naval Air Station Corpus Christi, Texas, is a restrained example of the style. It has a flat roof, smooth wall surface, and vertical emphasis at the entrance consistent with the style.



The building (1941) on the left at Naval Base Kitsap Bremerton, Washington, is a very restrained example, but maintains the emphasis at the entrance. The detail on the right is a close-up of the curved handles of the same building's doors, also an Art Deco detail.



Photography and Armament School Building (1942) at Lowry Air Force Base in Denver, Colorado. The vertical entrance and bands of windows are defining features of the Art Deco.

Art Moderne 1920-1945

Art Moderne and Streamlined Modern are forms of the Art Deco style. The style is more horizontal than Art Deco and is defined by curved walls, metal windows (sometimes in banks or ribbons), and horizontal lines or bands meant to simulate the air stream wrapping around the building, hence the term "streamlined." This element was applied to cars and boats as well as buildings. Civilian examples are seen frequently on gas stations, car dealerships, theaters, and residential architecture. Military examples include administration, residential, and retail buildings.



Top: This building (ca. 1940) at Naval Air Station Alameda, California, is an example of the Art Moderne; the curved walls, smooth walls, and series of bands are all indicative of the style.

Bottom: This duplex (ca. 1935) at Kelly Air Force Base, Texas, does not have the curved walls usually seen in the Moderne style, but it does have the horizontal massing, flat roof, smooth surface, and bands at the entrance.



Art Moderne 1920-1945

Defining Features

Horizontal massing

Flat roof

Curved walls

Recessed lines or bands

Glass block

Bands or banks of windows

Casement or steel windows



Top: This building (1930s) at Fort Bragg, North Carolina, is in the streamlined modern style, with curved walls, banks of steel windows, and horizontal massing.

Bottom: The Materials Testing Building (1930s) at the Brooklyn Navy Yard, New York, is typical of the Art Moderne style with its curved walls and bands of windows.

International (Early) 1925-1948

While Americans were building period houses influenced by architecture of the past, European architects like Le Corbusier, Walter Gropius, and Mies van der Rohe were stretching the limits of materials and technology. In 1932, the Museum of Modern Art in New York City opened a show called "Modern Architecture." American architect Phillip Johnson organized the exhibit, which showed similar works from architects in fifteen countries, classified as the "International Style." The style experimented with the use of materials as structural systems and the premise that "less is more." International Style architecture turned away from historical references and ornament. Steel, concrete, and glass were the building materials used most often. There are few examples of Early International on military installations.



Top: The Thermo-Con House (1948) at Fort Belvoir, Virginia, was designed by Albert Kahn and uses the experimental Thermo-Con material, which expanded as it cured. The house is designed in the International Style, exhibited by the flat roof with overhanging eaves, smooth wall surface, and cantilevered canopies.

Bottom: This quarters at Mare Island Naval Shipyard, California, has many of the characteristics of New Federalism with smooth wall surfaces, overhanging eaves, and ribbon windows.



International (Early) 1925-1948

Defining Features

- Flat roof
- Overhanging eaves
- Cantilevers
- Smooth wall surface
- Lack of ornament
- Ribbon of windows
- Casement windows
- Lack of windows



Above: The theater (1942) at Mare Island Naval Shipyard is a good example of the International Style; the flat roof, smooth wall surface, cantilevered canopy and absence of openings help define the style.

Left: A Tourmaline House (1946) at Yuma Proving Ground, Arizona, designed by R.G. LeTourneau to form a concrete house in one day.

Right: The Mars Tower (1943) at Fort Monroe, Virginia, is influenced by the International Style, evident by the use of smooth wall materials, spiral staircase, simple pipe railing, cantilevered decks, and ribbon windows.



World War II 1939-1945

By 1939, most of the World War I cantonments had been either dismantled or transformed into permanent installations. Several World War I temporary standardized plans had been updated to a new 700-series by 1928, but little more was done until 1935. In that year, the Chief of Staff of the Construction Division of the Quartermaster Corps ordered a complete revision and completion of the 700-series plans, which was subsequently completed in 1937. Similar to the World War I temporary buildings, the 700-series consisted of barracks, headquarters, regimental headquarters, warehouses, recreation buildings, day rooms, mess halls, hospitals, theaters, and chapels. The 700-series buildings were constructed of wood (sometimes out of brick or concrete block), primarily with drop-lap siding, six-over-six double-hung windows, and asphalt roofs. The 800-series that followed updated several of the building plans with stronger structure, increased livable space, and removal of unnecessary elements, such as the aqua media, the roof which continues around all four sides just above the ground story windows. These standardized building series were widely used as the Army expanded from 200,000 soldiers in 1939 to over 5 million by 1942, due to mobilization for World War II.



Top: 700-series barracks (1941) at Fort Leonard Wood, Missouri, has the unique aqua media between the two floors and a canopy over the second-floor windows.

Bottom: 700-series mess hall (1941) at Fort Leonard Wood.

World War II 1939-1945

Defining Features

Asphalt roofing

Flush eaves

Aqua media

Drop-lap siding

Water table

Skirting

6/6 windows



Top: The aqua media and canopy over the second-floor windows were dropped from the design of the 800-series barracks (1942) at Fort McCoy, Wisconsin.

Bottom: Detail of water table and skirting on a 700-series barracks (1941) at Fort Leonard Wood, Missouri.

Minimal Traditional 1935-1955

Minimal Traditional style accurately reflects its time in history. The style carries architectural influences from the earlier period revivals, especially the Tudor Revival, only scaled back with fewer ornamental details. For instance, many examples have the gable front, like the Tudor Revival, only scaled back without the steepness. This style was used only for residential design in civilian and military buildings.

Top: Minimal Traditional style is illustrated in this senior officer's quarters (1941) at Naval Air Station Corpus Christi, Texas.

Bottom: Minimal Traditional style was used for most of the Wherry Housing of the 1940s and 1950s as illustrated in this house at Fort Bragg, North Carolina.



Defining Features

Restrained traditional details

Horizontal massing

Dominant gable front

Gable roof, hip roof, or hip dormer

Little or no roof overhang

Double-hung windows

Single, paired, or triple windows



Ranch 1935-1975



Ranch style originated in California in the 1930s and became the dominant residential style in the country during the 1950s and 1960s. The major difference between Ranch and Minimal Traditional is the roof overhang. Ranch style is typically a rambling one-story form with low roof and engaged carport or garage. Like Minimal Traditional, the Ranch style was used only for residential design in civilian and military examples.

Left, Top and Bottom: Many of the Capehart-Wherry-style houses built at Fort Gordon, Georgia, in the 1960s were in the Ranch style.

Right: 2/2 horizontal window.



Defining Features

- Horizontal massing
- Gable roof or hip roof
- Moderate roof overhang
- Hip dormers
- Engaged garage and carport
- Bands of windows
- Picture windows
- 1/1 or 2/2 horizontal windows

International (Late) 1946-1965

The first International Exhibition of Modern Architecture (1932) at the Museum of Modern Art in New York City coined the term International Style. The focus of the style is on the expression of volume rather than on mass, emphasis on balance rather than on preconceived symmetry, and the expulsion of applied ornament. The use of glass and the glass curtain wall became increasingly popular. In DoD, the modern movement and the adaptation of the International Style to it was exemplified at the U.S. Air Force Academy. The prolific and influential architecture firm of Skidmore, Owings, and Merrill (SOM) were commissioned to complete the work at the Academy. The firm successfully married a very modern campus to the rugged landscape of the Colorado Rockies. Although an extremely popular style in the civilian world, outside of the U.S. Air Force Academy, there are very few examples of the International Style in the military.



Top: The International vocabulary of Sijan Hall (1968) at the U.S. Air Force Academy, Colorado, is a juxtaposition, as well as a blending, with the surrounding Rocky Mountains of Colorado Springs.

Bottom: Gunnery Mates Service School (1953), designed by William Priestley and Bruce Graham of SOM, at the Great Lakes Naval Training Center, Illinois.

International (Late) 1946-1965

Defining Features

- Box-shaped
- Flat roof
- Structure is the ornament
- Exposed structural systems
- Cantilevers
- Smooth walls
- Glass curtain walls
- Metal windows



The administration building (top, 1957) and the Heat Plant (bottom left, 1958) at the U.S. Air Force Academy illustrate all of the character-defining features of the International Style. The officer's quarters at Fort Huachuca, Arizona (bottom right, 1958) is a residential example.

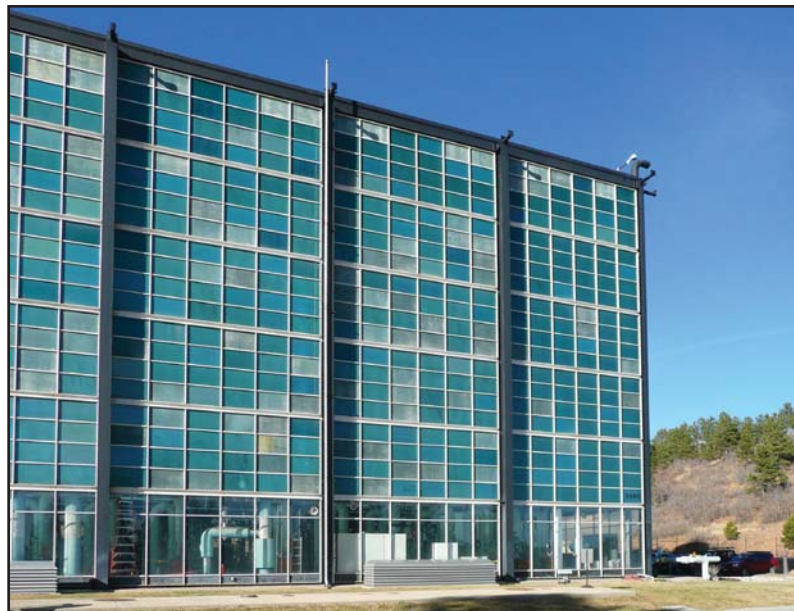

Mid-Century Modern 1950-1975

The Mid-Century Modernism movement was evident throughout the country, especially in the larger cities of Chicago, New York, and Washington, D.C. This movement also captured the imagination of local and regional architects, who interpreted it in smaller cities and towns. The Mid-Century Modern style experimented with different forms, especially roof forms. These forms are curved, slanted, diagonal, or folded and are typically executed in concrete or metal. Concrete block screens or metal screens were also used as decoration in combination with the concrete, steel, and glass buildings. The military implemented the style as more and more buildings were designed by nationally or regionally-known architects.



Top: The Chapel (1962) at the U.S. Air Force Academy, Colorado, is considered a masterpiece of Mid-Century Modern architecture.

Bottom: Two examples of Mid-Century Modern entrance canopies.

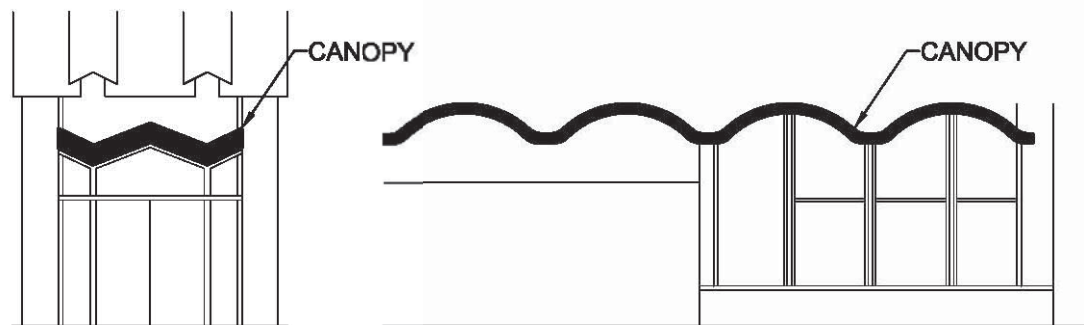

Mid-Century Modern 1950-1975

Defining Features

Flat, pyramidal, multiple barrel, or spire roof

Structure is the ornament

Exposed structural systems

Round, folded, inverted concrete forms

Glass curtain walls



The Jewish Chapel (1975) at Naval Station Pearl Harbor, Hawaii, implements a concrete arcade in the Mid-Century Modern vocabulary to add interest and function.

Bottom Left: The chapel (1957) at Marine Corps Air Station Miramar, California, is a basic concrete box, but its glass and inverted concrete facade continues into the interior of the nave.



Bottom Right: The design of the chapel at Joint Base Myer-Henderson Hall, Virginia, has a modified pyramidal roof and, with its glazed eaves, allows substantial light into the sanctuary.



New Formalism 1965-1975

Formalism, sometimes called Neo-Formalism or New Formalism, was a modern view on the formal ideals of traditional architecture. Symmetrical massing, monumental full-height porches, or entries with columns are updated with clean lines and restrained of any ornament. Paired with high-quality materials, such as marble and stone, this was a popular style at mid-century for banks and municipal buildings. As with the Mid-Century Modern, the military implemented this style with buildings designed by nationally and regionally known architects. Military buildings that utilized New Formalism were typically the more public buildings like headquarters, post exchanges, commissaries, libraries, and clubs.



Above: The symmetry, columns, and clean lines of the Library (1966) at Fort Gordon, Georgia, are typical of New Formalism.

Bottom, Left and Right: Signal Corps Headquarters (1970) at Fort Gordon.

Defining Features

- Symmetrical massing
- High-quality materials
- Flat roofs
- Wide, overhanging eaves
- Smooth wall surface
- Engaged porches
- Columns



Expressionism 1965-1975



Expressionism, like many architectural influences, was popularized in Europe. It was defined by sweeping and curving concrete forms. In this country, the style is illustrated in high-profile buildings like the TWA terminal at JFK Airport in New York. The government interpretation of the style is much more restrained. Some buildings do showcase the sweeping curved forms, usually in the roofline, but most maintain a conservative balance of symmetrical use of concrete, steel, and glass to define the style.

Top: The uniformity of solids and voids as shown in the regular concrete bays of the Administration Building (early 1970s) at Charleston Navy Yard, South Carolina, is typical of Expressionism.



Bottom: The Naval Health Clinic (1973) at Charleston, South Carolina, is a combination of influences; the body of the building is Expressionist, while it sits on a Brutalist base.

Defining Features

- Uniformity of solids and voids
- Use of curved rooflines & wall surfaces
- Faceted surfaces
- Arches and vaults at the base

Brutalism 1965-1980

Brutalism influence was conceived in England, but became popular in this country as a departure from the steel and glass of the 1950s International Style. Architects employed heavy and textured concrete forms and structures to create a form of architecture that is often viewed by the public as oppressive. Brutalism may not be appreciated by the public, but it is a unique and often ground-breaking combination of engineering and architecture.

Top, Bottom Left and Right: Building 2 (1977) at the Walter Reed Army Medical Center was designed in the Brutalist genre. Note the weighty concrete upper stories carefully placed on the glass and pier foundation of the first floor.



Defining Features

- Massive appearance
- Unwelcoming entrance
- Flat roof
- Exposed concrete walls
- Recessed windows



Architecture in DoD since Mid-Century

In the 1950s, 1960s, and 1970s, the majority of buildings on DoD Installations were still being constructed with standardized plans. During these decades, whole barracks complexes were planned and designed using standard plans. Typical barracks communities included the barracks buildings or unaccompanied personnel housing (UPH), mess halls or dining facilities, company or unit headquarters, supply areas, and motor pools. In-depth histories about these complexes are included in the *Unaccompanied Personnel Housing (UPH) During the Cold War (1946-1989)*, prepared by R. Christopher Goodwin & Associates for the U.S. Army Environmental Center, December 2003, and *Air Force and Navy Unaccompanied Personnel Housing (UPH) During the Cold War Era (1946-1989)*, prepared by R. Christopher Goodwin & Associates for NAVFAC and the United States Air Force Center for Environmental Excellence.

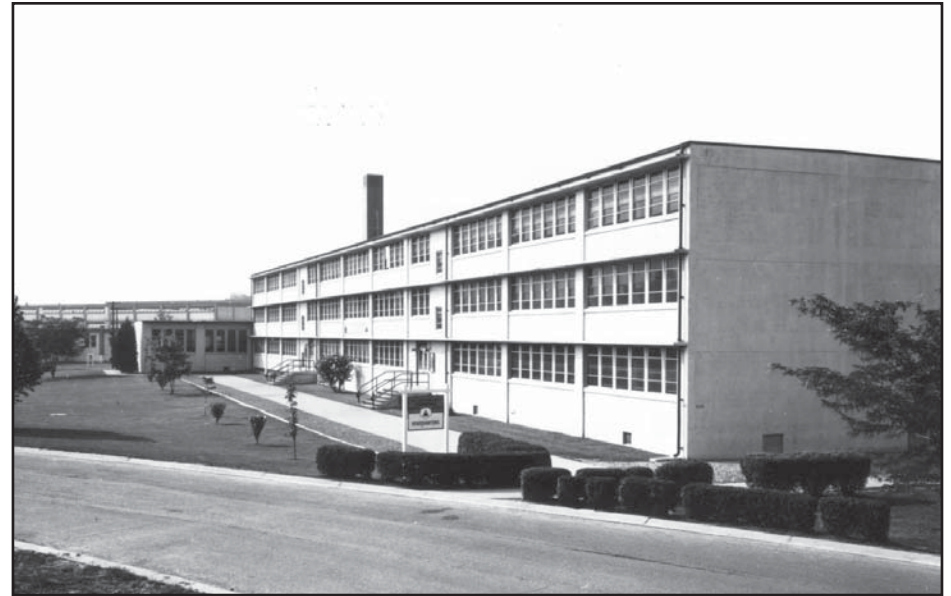

Top: This Korean-era barracks was built of concrete and steel and was known as the “Hammerhead” barracks, because in plan and from the air, it resembles a hammer.

Bottom: This barracks at Fort Leonard Wood, Missouri, was built in the 1960s. Included in the Cold War UPH, this building type was known as the “Rolling Pin,” which is what the form resembled in plan and from the air.



Also between the conclusion of World War II and the 1960s, family housing was privatized and was developed under the Wherry Act and Capehart Act. Wherry housing followed the Minimal Traditional style, while Capehart housing ranged from Ranch-style duplexes to two-story apartment-like buildings. A full history of this housing is available in *For Want of Home: A Historic Context for Wherry and Capehart Military Family Housing*, prepared by V.J. Temme in 1998 for the U.S. Army Environmental Center, and *Housing an Air Force and a Navy: The Wherry and Capehart Solutions to the Postwar Family Housing Shortage (1949-1962)*, prepared by R. Christopher Goodwin & Associates for the Air Force and Navy in June 2007.

While standardized plans were the norm during this period, many high-profile buildings, such as headquarters, officers' clubs, and schools were designed by nationally, regionally, or locally-known architects. These architects were knowledgeable about current influences and excited to leave a lasting mark on the era's military installations. Regionally or locally-significant architects have contributed to the architecture of DoD. At Fort Bragg in North Carolina, for example, regional architects or local architects designed several schools, a field house, the U.S. Army John F. Kennedy Special Warfare Center and School, and a Non-Commissioned Officers' Club. These buildings were designed within current architectural trends but were individualized by the designer. These

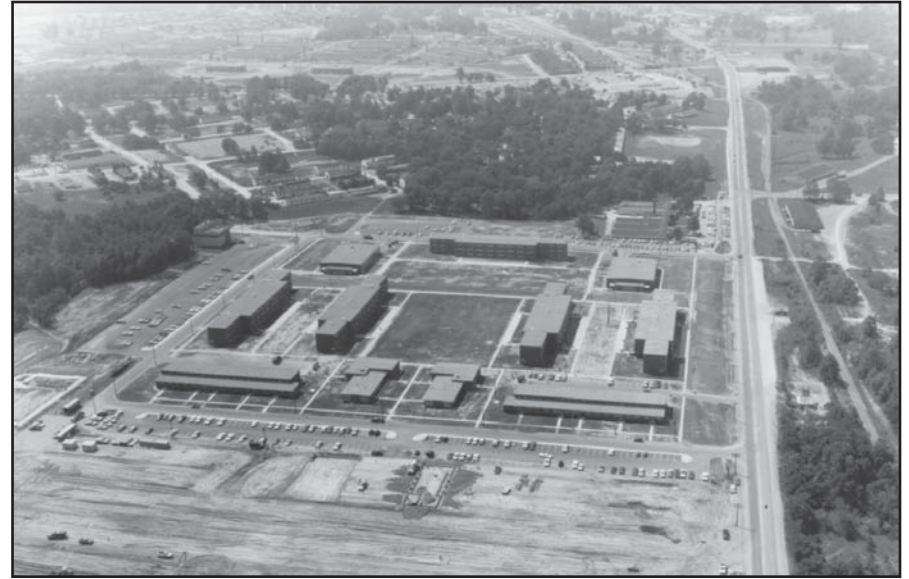

Top: This aerial of Fort Knox, Kentucky, illustrates the construction of the 1960s-era Rolling Pin Barracks.

Bottom: A Capehart-era quarters (1962) at Fort Huachuca, Arizona.

are just a few examples at one installation of regional and local architects obtaining large commissions for DoD design projects.

The 1980s and early 1990s saw only one new Army cantonment constructed at Fort Drum, New York. Small base planning and development did go on but at a limited pace and certainly not at the rate of the mid-century decades. During the mid to late 1990s, a new commitment to the troops was realized. Barracks modernization projects began either renovating existing buildings or demolishing existing and constructing new ones. These plans for barracks communities instituted a campus feel on many installations, incorporating open field areas and dining facilities within the barracks compounds.

In the first decade of the 21st century, the military adopted several trends used in the civilian construction world, including the “design-build” process and Building Information Modeling (BIM). The design-build process was instituted to address the large volume of planned work while eliminating cost overruns. No longer were standardized plans adapted to a given installation. Standardized plans are only used as a guide in this process. The military sets the functional requirements for a given building type like barracks or mess halls and defines certain measurable parameters such as square footage, height, and materials, but it is up to the design-build contractor to design within



Both buildings above were designed using BIM technology and principles. NAS JRB New Orleans, Louisiana, (top) and a rendering of the Louisville Army Reserve Building, Kentucky (bottom).

the parameters. In these cases, the designer is also the builder. BIM is an advanced computer modeling program for whole building design—planning, constructing, and operating a facility through the use of a digital representation.

Since 2001, several events have molded military construction and will shape the future of architecture. The use of BIM and modular design and materials will influence architectural style of the present and future. Traditional architectural details, such as cornices, will give way to details addressing sustainable features, such as sun shading. Whole-wall panels of thin brick, insulated concrete or other light-weight materials will be used rather than having masons build the courses or pour concrete on site. Security and force protection has become a major consideration for base planning since September 11, 2001. Planners and architects must consider hardening buildings and eliminating opportunities for disaster when designing buildings. In recent years, the movement towards greater energy-efficiency has played a large part in building design as well. Sustainable programs, such as Leadership in Energy & Environmental Design (LEED) standards, an internationally-recognized green building certification system developed by the U.S. Green Building Council, have been implemented, along with the military's commitment to increase energy-efficiency. These measures, combined with modular construction and security requirements, shape the architecture of



Modular construction, energy, and security requirements were all implemented in the design and construction of Marshall Hall on Fort Bragg, North Carolina, completed in 2011.

today. Those factors will also influence us as we assess the significance of these buildings within today's context, fifty years from now.

Bibliography

- Blumenson, J. J.-G.** *Identifying American Architecture: A Pictorial Guide to Styles and Terms, 1600-1945*. New York, NY: W.W. Norton & Company, 1977.
- Bruegmann, R.** (Ed.). *Modernism at Mid-Century: The Architecture of the United States Air Force Academy*. Chicago, IL: The University of Chicago Press, 1994.
- Carley, R.** *The Visual Dictionary of American Domestic Architecture*. New York, NY: Henry Holt and Company, 1994.
- Cragoe, C. D.** *How to Read Buildings, A Crash Course in Architectural Styles*. New York, NY: Rizzoli International Publications, Inc., 2008.
- Goodwin, R. C., Cannon, D. K., Hirrel, L., Grandine, K. E., Kuranda, K. M., Usher, B. M., McAloon, H. B., & Williams, M. R.** *National Historic Context for Department of Defense Installations, 1790-1940*. Frederick, MD: R. Christopher Goodwin & Associates, Inc., 1995.
- Grashof, B. C.** *A Study of United States Army Family Housing Standardized Plans*. Atlanta, GA: Center for Architectural Conservation, College of Architecture, Georgia Institute of Technology, 1986.
- Harris, C. M.** (Ed.). *Illustrated Dictionary of Historic Architecture*. New York, NY: Dover Publications, Inc., 1983.
- Kuranda, K. M., Doerrfeld, D. A., Heidenrich, C., & Gatewood, R.** *Air Force and Navy Unaccompanied Personnel Housing During the Cold War Era (1946-1989)*. Frederick, MD: R. Christopher Goodwin & Associates, Inc., 2011.
- Kuranda, K. M., Grandine, K., Cleven, B., Davis, T. W., & Patch, N.** *Historic Context for Army Fixed-Wing Airfield 1903-1989*. Frederick, MD: R. Christopher Goodwin & Associates, Inc., 2002.
- Kuranda, K. M., Cleven, B., Patch, N., Grandine, K., & Heidenrich, C.** *Unaccompanied Personnel Housing (UPH) During the Cold War (1946-1989)*. Frederick, MD: R. Christopher Goodwin & Associates, Inc., 2003.
- Loechl, S. K., Ensore, S. I., and Tooker, M. W.** *Guidelines for Identifying and Evaluating Historic Military Landscapes*. Champaign, IL: Engineer Research and Development Center, 2009.
- McAlester, V. and L.** *A Field Guide to American Houses*. New York, NY: Alfred A. Knopf, 1988.
- McAlester, V. and L.** *Great American Houses and their Architectural Styles*. New York, NY: Abbeville Press, 1994.
- McDonald, H. L. and Michael, M. A.** *Design Guidelines for Department of Defense Historic Buildings and Districts*. Washington, D.C.: DoD Legacy Resource Management Program, 2008.
- National Park Service.** *National Register Bulletin 15: How to Apply the National Register Criteria for Evaluation*. Washington, D.C.: National Park Service, 1990. Available at <http://www.nps.gov/nr/publications/bulletins/pdfs/nrb15.pdf>.
- Nelson, L. H.** *Preservation Brief 17: Architectural Character - Identifying the Visual Aspects of Historic Buildings as an Aid to Preserving Their Character*. Washington, D.C.: National Park Service, 1988.

Bibliography cont.

Poppeliers, J. C. and Chambers, S. A. Jr. *What Style Is It?* Hoboken, NJ: John Wiley & Sons, 2003.

Rifkind, C. *A Field Guide to American Architecture.* New York, NY: Penguin Books, 1980.

Robinson, J. H. and Foell, S. S. *Growth, Efficiency, and Modernism: GSA Buildings of the 1950s, 60s, and 70s.* U.S. General Services Administration, Office of the Chief Architect, Center for Historic Buildings, 2003.

Smith, A., Stone, S., Tooker, M. W., & McAllister, B. *Military Chapel Historic Context.* Champaign, IL: Engineer Research and Development Center, 2008.

Smith, A., Stone, S., Tooker, M. W., & McAllister, B. *Military Theatre Historic Context.* Champaign, IL: Engineer Research and Development Center, 2008.

Temme, V. J. *For Want of Home: A Historic Context for Wherry and Capehart Military Family Housing,* prepared for the U.S. Army Environmental Center, 1998.

Trachtenberg, M. and Hyman, I. *Architecture from Prehistory to Post-Modernism/The Western Tradition.* The Netherlands: Henry N. Abrams, 1986.

Venzon, A. C. and Miles, P. L. *The United States in the First World War: An Encyclopedia.* New York, NY: Garland Publishing, Inc., 1995.

Wasch, D. S., Bush, P., Landreth, K., & Glass, J. *World War II and the U.S. Army Mobilization Program: A History of 700 and 800 Series Cantonment Construction.* Washington, DC: DoD Legacy Resource Management Program, 1991.

Whelan, D. C., Hirrel, L., Dod, W. T., Tucker, J. H., & Grandine, K. *Historic Context for Department of Defense, WWII Permanent Construction.* Frederick, MD: R. Christopher Goodwin & Associates, Inc., 1997.

Photo Credits

All photos contained in the style book were taken by Michelle Michael, Heather McDonald, or Adam Smith unless listed below with appropriate credit.

Page 9, Bottom Right: Photo used with permission from Breandán Mackie at flickr.com.

Page 22, Library of Congress HABS FLA, 17-PENSA, 61-.

Page 24, Above: National Archives at College Park RG92-F-16 Box 4.

Page 24, Top Right: National Archives at College Park RG71-CA Box 519.

Page 25, Bottom: National Archives at College Park RG71-CA Box 389.

Page 26, Top: National Archives at College Park RG165-C vol. 23.

Page 26, Bottom Left: National Archives at College Park RG165-C-181.

Page 26, Bottom Right: National Archives at College Park RG 165-C vol. 23.

Page 27, Top: National Archives at College Park RG 165-C vol. 1.

Page 27, Bottom Left: National Archives at College Park RG 165-C vol. 27.

Page 27, Bottom Right: National Archives at College Park RG 165-C vol. 1.

Page 45, Fort McPherson, GA CRMP.

Page 48, Top: Library of Congress PAN US MILITARY - Army no. 61 (F size) [P&P].

Page 48, Bottom: Library of Congress PAN US MILITARY - Camps no. 9 (F size) [P&P].

Page 49, Top: Library of Congress PAN US MILITARY - Camps no. 58 (F size) [P&P].

Page 49, Bottom Left: Library of Congress PAN US MILITARY - Camps no. 128 (E size) [P&P].

Page 49, Bottom Right: Library of Congress PAN US MILITARY - Camps no. 78 (E size) [P&P].

Page 51, Fort Benning, AL CRMP.

Page 63, Top Right: U.S. Army Photo by Larry Stevens, FORSCOM Public Affairs.

Page 63, Bottom Right: Photo used with permission from Joseph Hoffheimer at flickr.com.

Page 65, Bottom Left: Meg McDonald (Environmental Sciences Division, U.S. Army Garrison, Yuma Proving Ground).

Page 67, Top: Library of Congress HABS WIS,41-SPAR.V,1-A-.

Page 68, Bottom: National Archives at College Park RG71-CP Box 21m.

Page 70, Bottom: Fort Bragg, NC CRMP.

Photo Credits cont.

Page 77, Top: National Archives at College Park RG111-SC 641555.

Page 77, Bottom: National Archives at College Park RG111-SC 583481.

Page 78, Top: National Archives at College Park RG111-SC 640444.

Page 80, U.S. Army Photo by Larry Stevens, FORSCOM Public Affairs.

Locations

Augusta Arsenal, Georgia; closed in 1955 (today: Augusta State University)

Barksdale Air Force Base, Louisiana; open

Brooklyn Navy Yard, New York; closed in 1966

Camp Bullis, Texas; open (today: part of Joint Base San Antonio)

Camp Custer, Michigan; open

Camp Hancock, Georgia; closed in 1918

Camp Jackson (Fort Jackson), South Carolina; open

Camp McClellan (also Fort McClellan), Alabama; closed in 1999

Camp Merritt, New Jersey; closed in 1920

Camp Nelson, Kentucky; closed unknown date

Charleston Navy Yard, South Carolina; closed in 1996

F.E. Warren Air Force Base, Wyoming; open

Fort Belvoir, Virginia; open

Fort Benning, Georgia; open

Fort Bliss, Texas; open

Fort Bragg, North Carolina; open

Fort Delaware, Delaware; closed in 1947 (today: Fort Delaware State Park)

Fort Douglas, Utah; partly closed (today: Army Reserve and University of Utah)

Fort Gordon, Georgia; open

Fort Hancock, New Jersey; closed in 1974 (today: Gateway National Recreation Area)

Fort Hayes (also Columbus Arsenal and Columbus Barracks), Ohio; closed in 1976 (today: Columbus School District's Fort Hayes Metropolitan Education Center)

Fort Huachuca, Arizona; open

Fort Knox, Kentucky; open

Fort Lawton, Washington; closed in 1911 (today: Seattle Discovery Park)

Fort Leavenworth, Kansas; open

Fort Leonard Wood, Missouri; open

Fort Lewis, Washington; open (today: part of Joint Base Lewis-McChord)

Fort Logan, Colorado; closed in 1961 (today: Mental Health Institute at Fort Logan)

Fort McPherson, Georgia; closed 2011

Fort Monroe, Virginia; closed in 2011 (today: part National Monument)

Joint Base Myer-Henderson Hall (also Fort Myer), Virginia; open

Fort Omaha (also Sherman Barracks and Omaha Barracks), Nebraska; closed in 1976 (today: Metropolitan Community College, Omaha)

Fort Sam Houston, Texas; open (today: part of Joint Base San Antonio)

Fort Sheridan, Illinois; closed in 1993

Fort Snelling, Minnesota; closed in 1946 (today: Fort Snelling State Park)

Locations cont.

Fort Washington, Maryland; closed in 1946 (today: Fort Washington National Park)

Governors Island (also Fort Jay and Fort Columbus), New York; closed in 1966

Great Lakes Naval Training Center, Illinois; open

Hickam Air Force Base, Hawaii; open (today: part of Joint Base Pearl Harbor)

Illinois National Guard, Champaign, Illinois; open

Indianapolis Arsenal, Indiana; closed in 1903 (today: Arsenal Technical High School)

Jeffersonville General Hospital, Indiana; closed in 1865

Jeffersonville Quartermaster Depot, Indiana; closed in 1958

Joint Base Langley-Eustis, Virginia; open

Kelly Air Force Base, Texas; closed in 2001

Lowry Air Force Base Denver, Colorado; closed in 1994

Madison Barracks, New York; closed in 1947

Mare Island Naval Shipyard, California; closed in 1996

Marine Corps Air Station Miramar (also NAS Miramar), California; open

Maxwell Air Force Base, Alabama; open

Naval Air Station Alameda, California; closed in 1997

Naval Air Station Corpus Christi, Texas; open

Naval Air Station-Joint Reserve Base New Orleans, Louisiana; open

Naval Air Station Pensacola, Florida; open

Naval Base Pearl Harbor, Hawaii (today: part of Joint Base Pearl Harbor)

Naval Health Clinic, Beaufort, South Carolina; open

Naval Health Clinic, Charleston, South Carolina; closed in 2011

Naval Home, Philadelphia, Pennsylvania; closed in 1976

Naval Hospital, Philadelphia, Pennsylvania; closed in 1976

Naval Hospital, Washington, D.C.; closed in 1922

Naval Medical Clinic, Portsmouth, Virginia; open

Naval Station Kitsap Bremerton, Washington ; open

Naval Support Activity Norfolk Naval Shipyard, Virginia; open

Naval Support Facility Dalgren, Virginia; open

Peterson Air Force Base, Colorado; open

Presidio of San Francisco, California; closed in 1995 (today: National Park)

Randolph Air Force Base, Texas; open

Sackets Harbor Navy Yard, New York; closed in 1947 (today: Sackets Harbor Battlefield State Park)

San Diego Naval Hospital, California; open (given to San Diego in the 1980s)

U.S. Air Force Academy, Colorado; open

U.S. Military Academy, New York; open

U.S. Naval Academy, Maryland; open

Vancouver Barracks (also Fort Vancouver), Washington; closed 1947 (today: partly the Fort Vancouver National Historic Site)

Walter Reed Medical Center, Washington D.C.; closed in 2011

Glossary

The following architectural terms have been compiled from a variety of sources, including *Landmark Yellow Pages* by the National Trust for Historic Preservation; *Glossary of Architectural Terms* by John C. Waters and the National Alliance of Preservation Commissions; *Design Guidelines for Raleigh Historic Districts* by the Raleigh Historic District Commission; *An Illustrated Glossary of Early Southern Architecture and Landscape* edited by Carl R. Lounsbury; and *Guidelines for Identifying and Evaluating Historic Military Landscapes* by USACERL. For additional definitions of military terms, please consult the Department of Defense Dictionary of Military and Associated Terms (available at: <http://www.dtic.mil/doctrine/jel/doddict/>).



Aqua Media—A roof which continues around all four sides just above the ground story windows. A typical feature of WWII temporary buildings of the 700 Series; also referred to as a skirt roof.



Arcade—A series of arches supported on columns or on square or rectangular piers.



Arch—A structure formed of wedge-shaped stones, bricks, or other objects laid so as to maintain one another firmly in position.

Architrave—The lowest element in the entablatures of the Ionic and Corinthian columnar orders (see drawing on page 13).



Ashlar—A dressed or squared stone; the masonry built of such hewn stone.

Asymmetry—Building's facade lacks balance or symmetry.



Attic Vent—In houses, a screened or louvered opening, sometimes in decorative shapes, located on gables or soffits. Victorian styles sometimes feature sheet soffits or metal ventilators mounted on the roof ridge above the attic.



Balcony—A platform enclosed with a low parapet, railing, or balustrade and projecting from a wall, usually in front of a window or other opening.

Baluster—A turned or rectangular upright supporting a stair handrail or forming part of a balustrade.



Balustrade—An entire railing system including a top rail and its balusters, and often a bottom rail.

Band—Flat trim running horizontally in a wall to denote a division in the wall plane or a change in level; a narrow, horizontal band projecting from the exterior walls of a building, usually defining the location of interior floor levels (see drawing on page 17); also referred to as band course, bandmold, belt, beltcourse.

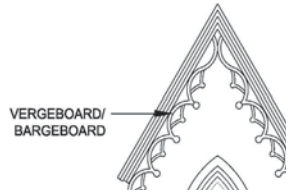

Bargeboard—A board, often ornately curved, attached to the projecting edges of a gable roof; also referred to as vergeboard.

Barrel Roof—A roof of semi-cylindrical section; see *Roof*.

Bay—One unit of a building that consists of a series of similar units; commonly defined as the number of vertical divisions within a building's facade (e.g., windows and door openings, or the areas between the columns or piers).



Bay Window—A large window or series of windows projecting from the outer wall of a building and forming a recess within.

Beltcourse—See *Band* and *String Course*.



Blind Arch—An arch that does not contain an opening for a window or door but is set against or indented within a wall.



Board and Batten—Closely applied vertical boards, the joints of which are covered by vertical, narrow, wooden strips.



Bond—The laying of bricks or stones regularly in a wall according to a recognized pattern for strength. Masonry bond is essential to brickwork when wire reinforcement is not used.



Boxed Eaves—Enclosed eaves with boards nailed to form a fascia and soffit, sometimes enriched by moldings.

Brace—A diagonal stabilizing member of a building frame.

Bracket—A projecting support used under cornices, eaves, balconies, or windows to provide structural or purely visual support (see drawing on page 21).

Buttress—A vertical mass of masonry projecting from or built against a wall to give additional strength at the point of maximum stress.



Cantilever—A bracket or horizontal beam that is only anchored at one end that supports a part of a building, a balcony or a roof.

Capital—The uppermost part, or head, of a column or pilaster (see drawing on page 13).

Cartouche—An ornamental tablet, often inscribed or decorated, and framed with elaborate scroll-like carving; a modillion of curved form.

Casement—A hinged window frame that opens horizontally like a door.



Casing—The exposed trim molding, framing, or lining around a door or a window; may be either flat or molded.

Castellated—Having a battlemented or crenulated parapet or roof; see *Crenulation*.

Cast Iron—Iron that has been shaped by being melted and cast in a mold.

Chamfer—A beveled edge or corner.



Chamfered Post—A square post with the edges of its corners cut away or beveled.

Churrigueresque—A highly-ornamented Spanish Revival style, named after architect Jose Churriguera.

Clapboard—A long, narrow board with one edge thicker than the other, overlapped to cover the outer walls of frame structures; also known as weatherboard.

Clipped Gable—A gable roof of which the peak is truncated for decorative effect, often the roof overhangs the missing peak.

Column—A vertical shaft or pillar that supports or appears to support a load; in Classical architecture, the column consists of three parts: base, shaft, and capital.

Colonnade—A small-scale column, generally employed as a decorative element on mantels, overmantels, and porticos.



Common Bond—A method of laying brick wherein one course of headers is laid for every three, five, or seven courses of stretchers.

Composite Order—The last of the classical orders which combines characteristics of both the Ionic order and the Corinthian order (see drawing on page 13).

Coping—The cap or the top course of a masonry wall.



Corbel—In masonry, a projection or one of a series of projections, each stepped progressively farther forward with increasing height, anchored in a wall, story, column or chimney; a bracket or block projecting from the face of a wall that generally supports a cornice, beam, or arch.

Corinthian Order—The most slender and ornate of the classical Greek orders of columns, characterized by a slim, fluted column with bell-shaped capital decorated with stylized acanthus leaves (see drawing on page 13).



Corner Board—One of the narrow vertical boards at the corner of a traditional wooden frame building, into which the clapboards abut.

Cornice—A molding at the edge of a roof; a molding that covers the angle formed by ceiling and wall; the uppermost section of an entablature.

Course—A horizontal row of stones or bricks in a wall.

Cresting—An openwork ornament along a horizontal edge or ridge.



Crenulation—Alternating indentations and raised sections of a parapet, creating a tooth-like profile; also referred to as a battlement.

Cross-gable Roof—Where one gable-ending roof intersects another gable-ending roof; see *Roof*.



Crown—A decorative crown is something curved to form a half-circle, top, or chief ornament.



Cupola—A small vault on top of a roof, sometimes spherical in shape, or sometimes square with a mansard or conical roof.



Dentil—A small, rectangular block used in a series below the cornice in the Ionic, Corinthian, Composite, and sometimes Doric orders.

Doric Order—A classical order of column characterized by simple, unadorned capitals supporting a frieze of vertically grooved tablets or triglyphs set at intervals (see drawing on page 13).



Dormer Window—An upright window lighting the space in a roof; when it is in the same place as the wall, it is called a wall dormer, when it rises from the slope of the roof, a roof dormer.

Double-hung Sash Window—A window with two sashes, one above the other, arranged to slide vertically past each other.



Double-leaf—An opening with two vertical doors that meet in the middle of the opening when closed; also referred to as a double door.

Dressed—Descriptive of stone, brick, or lumber that has been prepared, shaped, or finished by cutting, planing, rubbing, or sanding one or more of its faces.

Drip Molding—Molding that has a projecting edge that is channeled beneath to prevent water from running back against the surface of a wall.



Drop-lap Siding—Wooden siding with a concave upper edge that fits into a corresponding rabbet in the siding above; also referred to as German siding.

Eave—The part of a sloping roof that projects beyond a wall.



Engaged Porch—A porch whose roof is continuous structurally with that of the main section of the building.

English Bond—A method of laying brick wherein one course is laid with stretchers and the next with headers, thus bonding the double thickness of brick together and forming a high-strength bond of alternating courses of stretchers and headers.

Entablature—The horizontal part of an architectural order that is supported on columns and composed of architrave, frieze, and cornice (see drawing on page 13).

Facade—The exterior face of a building that is the architectural front, sometimes distinguished from the other faces by elaboration of architectural ornamental details.

Fanlight—A window, often semi-circular, over a door with radiating muntins suggestive of a fan (see drawing on page 11).

Fascia—A flat board with a vertical face that forms the trim along the edge of a flat roof, or along the horizontal (or eave side) of a pitched roof. The rain gutter is often mounted on it.

Fenestration—The windows and doors and their openings in a building.



Finial—A formal ornament at the top of a canopy, gable, pinnacle, streetlight, etc.



Flared Eaves—An eave that projects upward.



Flat Arch—An arch formed on a straight horizontal plane; also referred to as a jack arch.

Flemish Bond—A method of laying brick wherein headers and stretchers alternate in each course and wherein vertically, headers are placed over stretchers to form a bond and give a distinctive cross pattern.

Flush Siding—Wooden siding that lies on a single plane; commonly applied horizontally, except when applied vertically to accent an architectural feature.

Fluting—A system of vertical grooves (flutes) in the shaft of an Ionic, Corinthian, or Composite column. Doric columns have portions of the cylindrical surface of the columns separating the flutes (see drawing on page 13).

Foil—A rounded or leaf-like ornament found in windows, niches, etc.

Foundation—The supporting portion of a structure below the first-floor construction, or below grade, including footings.

French Window—A long window reaching to floor level and opening in two leaves like a pair of doors.

Frieze—The intermediate member of a classical entablature, usually ornamented; also a horizontal decorative panel (see drawing on page 13).

Front-gable Roof—A double-sloping roof (gable) with the front entry located on triangular shape side; see *Roof*.

Gable—The vertical, triangular shape at the end of a building formed by a double-sloping roof.

Gable-on-Hip—A hip roof in which the hips are not carried all the way to the ridge; instead, each end roof surface turns vertically near the top so as to form a small gable that is perpendicular to the ridge.



Garland—A curved, hanging festoon of leaves or flowers used as an applied ornamental device.

Glazing—Setting glass in an opening; the glass of an opening using glass.

Gambrel Roof—A gable roof, more or less symmetrical, having four inclined surfaces with the pair meeting at the ridge having a shallower pitch (see drawing on page 55); see *Roof*.

Gingerbread—Thin, curvilinear ornamentation produced with machine-powered saws.

Glazed Header—A brick having a glossy, dark coating, ranging in color from gray-green to almost black, formed on the outer surface through direct exposure to flame and intense heat during firing process; often used in Flemish bond brickwork for decorative purposes by laying the brick so the glazed headers form a pattern in the wall.



Half-glazed Door—A door consisting of glass for half of the surface, typically the upper half, with wood panel or panels below.

Half-timbering—A construction method of wood framing with spaces filled with masonry (see drawing on page 57).

Header—A brick laid across the thickness of a wall to bond together different widths of a wall; the exposed end of a brick.

Hip Roof—A roof without gables, each of whose sides, generally four, lies in a single plane and joins the others at an apex or ridge; also referred to as a hipped roof, see *Roof*.

Hood—A rounded, projecting molding above a door, window, or archway to throw off rain.

Jack Arch—See *Flat Arch*.

Jamb—The vertical sides of an opening, usually for a door or a window.

Jerkin Head Roof—A roof whose end has been formed into a shape midway between a gable and a hip, resulting in a truncated or “clipped” appearance; also referred to as a clipped gable.

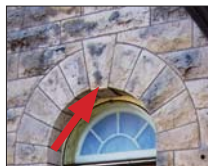

Keystone—The central unit of an arch shaped in a wedge form.

Knee Brace—A non-structural, diagonal member used as exterior ornamentation, extending from the facade to the eave of a building.



Lattice—A network, often diagonal, of interlocking lath or other thin strips, used as screening, especially in the base of a porch.

Light—A section of a window, the pane or glass; see *Pane*.

Light Configuration—The configuration of the lights in a window (see drawing on page 28 for an example of a six-over-one light configuration).



Lintel—A horizontal structural or ornamental member over an opening that generally carries the weight of the wall above it, often of stone or wood.



Lunette—A semicircular opening.



Mansard Roof—A modification of the hip roof in which each side has two planes, the upper being more shallow; see *Roof*.

Massing—The physical volume or bulk of a building.



Modillion—A horizontal bracket, often in the form of a plain block, used for ornamenting or sometimes supporting the underside of a cornice.

Molding—A decorative band having a constant profile or having a pattern in low relief, generally used in cornices or as trim around openings.

Mullion—A vertical member separating windows, doors, or panels set in a series.

Muntin—A secondary framing member to hold panes within a window, window wall, or glazed door; an intermediate vertical member that divides the panels of a door.



Newel Post—A tall and often ornamental post at the head or foot of a stair, supporting the handrail.

Ocular Window—A round or circular window without tracery that typically appears in the gable of a building.

Oriel Window—A bay window projecting from an upper story; a subsidiary bay or a corbelled, enclosed feature either exterior or interior.



Palladian Window—A window design featuring a central arch opening flanked by lower, square-headed openings separated by columns, pilasters, piers, or narrow vertical panels.

Pane—A framed section of a window or door that is usually filled with a sheet of glass or other transparent material; see *Light*.

Panel—A thin, flat piece of wood framed by stiles and rails, as in a door or fitted into grooves of thicker material with molded edges for decorative wall treatment.

Pantile—A roofing tile with the shape of an “S” laid on its side.

Parapet—A wall section rising above the roofline; a low wall, sometimes battlemented, placed to protect any spot where there is a sudden drop.



Pavilion—A wing or central unit which projects from a larger architectural unit and is usually accented by special decorative treatment.



Pediment—A triangular gable bounded on all sides by a continuous cornice.



Pilaster—A flat-faced representation of a column, projecting from a wall.

Piloti—One of several ground-level columns that raises a building up, creating functional space below.

Pitch—The angle of a roof, or the proportion between the height and the span of the roof.

Pointed Arch—An arch with a pointed apex.

Porch—An exterior appendage to a building, forming a covered approach or vestibule to a doorway.



Porte Cochere—A large, covered entrance porch through which vehicles can pass.

Portico—A small entrance porch consisting of a roof supported by open columns.

Post and Lintel—A structural system in which the main support is provided by vertical members, called posts, that are carrying horizontal members, called lintels.

Pressed Metal—Thin sheets of metal molded into decorative designs and used to cover exterior walls, interior walls, or ceilings.

Projection—A section of a building that extends outward from the surface, either vertically or horizontally.



Quatrefoil—A round pattern, sometimes in a window or vent, which is composed of four equal lobes, like a four-petaled flower.



Quoins—Heavy blocks, generally of stone or wood, cut in emulation of stone, and used at the corners of buildings to reinforce and ornament masonry walls, or used in wood as a decorative feature only.

Rafters—Structural timbers rising from the plate at the top of a wall to the ridge of the roof and supporting the roof covering.

Rafter Ends—The ends of structural timbers rising from the plate at the top of a wall to the ridge of the roof (rafters) which can be exposed; also referred to as rafter tails (see drawing on page 37).

Rail—The horizontal cross pieces of a door.

Railing—A structure made of rails and upright members that is used as a guard or barrier or for support; also referred to as a balustrade.

Raised Basement—The substructure or foundation of a building that is above ground rather than under ground.

Raised Panels—A portion of a flat surface, as in the panel of a door or wainscoting, that is distinctly set off from the surrounding area by a molding or other device and is raised above the surrounding area.

Rake—Trim members that run parallel to a roof slope and form the finish between the wall and a gable roof extension.



Ribbon—One of a horizontal series of three windows or more, separated only by mullions, that forms a horizontal band across the facade of a building.

Roof—The upmost covering and protection of a building that can be made of materials like wood, slate, terra cotta,

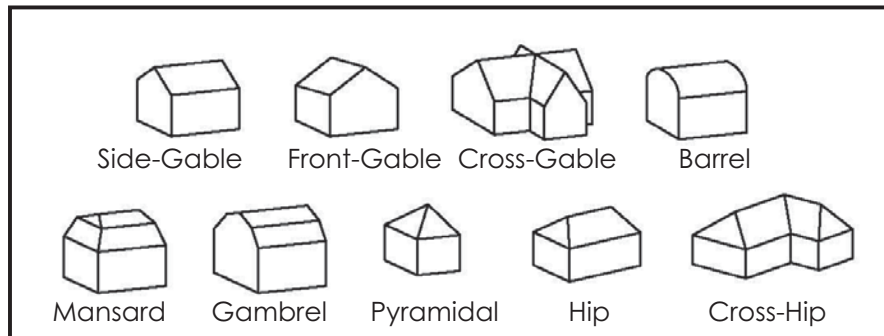

metal, asphalt shingle, and rolled tar and asphalt, in shapes as illustrated below.

Roof Line—The top edge of a roof.

Roofing Tile—A tile for roofing, usually of burnt clay; available in many configurations and types, such as plain tiles, single-lap tiles, and interlocking tiles.



Rustification—The treatment of stone masonry that deeply cuts back the joints between the blocks. The surfaces of the blocks may be smoothly dressed, textured, or extremely rough or quarry-faced.

Sailor Course—On brick or masonry buildings, a band or row consisting of front-facing, upright bricks.



Sawnwork—Ornamentation in cutout planking, formed with a bandsaw. Popular in the 1880s and the 1890s, this decorative detailing is flat.

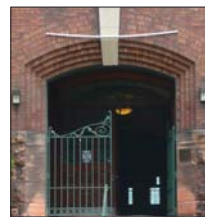

Segmental Arch—An arch formed on a segment of a circle or an ellipse.

Shingle—A roofing unit of wood, asphalt, slate, tile, or other material cut to stock lengths, widths, and thicknesses; used as an exterior covering on roofs and applied in an overlapping fashion.

Shoulder—The sloping shelf or ledge created on the side of a masonry chimney where the width of the chimney changes.

Shutters—Small wooden louvered or solid panels hinged on the exterior of windows, and sometimes doors, to be operable.

Side-gable Roof—A double-sloping roof (gable) with the front entry located on the nontriangular shape side; see *Roof*.

Sidelights—A vertical line of small glass panes flanking a doorway.

Sill—The lowest horizontal member in a wall opening.

Single-hung Window—A window with two sashes, one above the other, designed so that the top sash is stationary and the bottom slides vertically to open.

Soffit—The exposed undersurface of any overhead component of a building, such as an arch, balcony, beam, cornice, lintel, or vault.

Soldier Course—On a brick or masonry building, a band or row consisting of side-facing upright bricks.

Spindlework—Intricately-turned woodwork or trim; sometimes referred to as gingerbread.

Spire—A conical, sharp-pointed termination to an object.

Stepped Gable—A gable concealing the end of a roof with a stepped parapet.

Stile—The vertical crosspieces of a door.

Stretcher—A brick or a stone laid with its length parallel to the length of the wall.

String Course—A projecting course of bricks or other material forming a narrow horizontal strip across the wall of a building, usually to delineate the line between stories; also referred to as a beltcourse.

Stucco—An exterior finish, usually textured, composed of portland cement, lime, and sand mixed with water. Older-type stucco may be mixed from softer masonry cement rather than Portland cement.

Surround—The molded trim around a door or window opening.

Temple Front—A part of a facade resembling the front of a Classical temple, in which columns or pilasters carry an entablature and pediment.

Terra Cotta—A fine-grained, brown-red clay used for roof tiles, floor tiles, and decoration.

Textured Siding—Wood cut in various flat patterns, such as half-rounds or scallops, and applied to portions of facades to create a picturesque or romantic look. Surface textures are often found in diamond, scallop, staggered butt, or composite patterns.

Three-part Window—A window having a wide rectangular sash at its center and a narrower sash on each side; also referred to as a Palladian window.

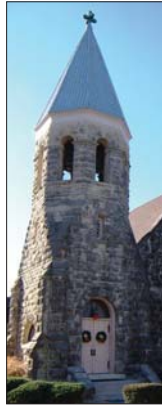

Tower—A vertical projection.

Trim—The finish material on a building, such as moldings, applied around openings or at the floors and the ceilings of rooms.

Truss—A rigid triangular framework consisting of chords, struts, or other supporting members.

Tuscan Order—The simplest and oldest of the classical Greek orders of architecture, characterized by a smooth column with simple capitals and bases (see drawing on page 13).



Turret—A small tower, usually corbelled from a corner.



Trabeated Entrance—A standard classical entrance featuring an over transom and sidelights (see drawing on page 14).

Veranda (Verandah)—A covered porch or balcony extending along the outside of a building.

Tracery—An ornamental division of an opening, especially a large window, usually made with wood.

Vergeboard—A board, often ornately curved, attached to the projecting edges of a gable roof; also referred to as a bargeboard.

Transom—A light or window over a door or entranceway.

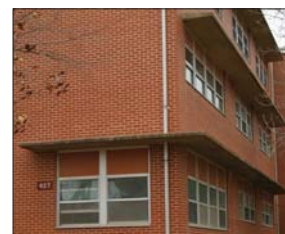

Visor Roof—Narrow roof segments cantilevered from the wall.

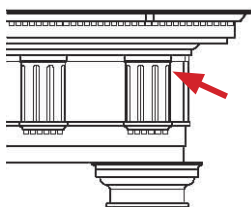

Triglyph—The characteristic ornament of the Doric frieze, consisting of slightly raised blocks of three vertical bands separated by V-shaped grooves.

Water Table—A sloping horizontal surface at the foundation level, employed to repel water away from the foundation.

Weatherboard—Wooden clapboard siding.

Wing—A part of a building projecting on one side or behind; also a separate, detached structure flanking the central or main section.

Wrought Iron—Iron that is rolled or hammered into shape, but never melted.

Index

A

Adirondack. See Rustic
Aqua Media 67
Arcade 2, 39, 73
Art Deco 60, 61, 62
Art Moderne 60, 62, 63

B

Balustrade 20, 28, 38, 39, 43, 87, 96
Bargeboard. See Vergeboard
Battered Post 46
Beaux Arts 38, 39
Beltcourse 17
Brutalism 76
Bungalow 46, 47

C

Canopy 60, 65, 66, 67, 91
Cantilever 89
Civil War 26, 27
Classical Revival 10, 12, 13, 16
Colonial Revival 42, 43, 50, 54, 55, 58
Composite 13, 90, 92
Corinthian 13, 87, 90, 92
Cornice 2, 14, 16, 20, 21, 60, 90, 91, 94, 97
Cross-Gable Roof 90
Cross-Hip Roof 96
Cupola 21, 22, 23

D

Dentil 9
Doric 13, 90, 92, 98
Dormer 25, 91

Double-Hung Wood Sash 9, 11, 13, 15
Drop-Lap Siding 67
Dutch Colonial Revival 54, 55

E

Entablature 13, 14, 89, 90, 92, 97
Expressionism 75

F

Fanlight 11, 43
Federal 1, 4, 10, 11, 22, 42
Flush Eaves 67
French Revival 52, 53
Front-Gable Roof 92

G

Gable 11, 15, 19, 29, 31, 33, 35, 47, 49
Gable Front 2, 33, 46, 51, 68
Gambrel Colonial Revival. See Dutch Colonial Revival
Gambrel Roof 54, 55
Georgian 8, 9, 10, 42, 58, 59
Georgian Revival 58, 59
Gothic Revival 3, 18, 19, 20, 24, 28, 29
Greek Revival 4, 14, 15

H

Half Timbering 57
Hip Dormer. See Hip Roof
Hip Roof 8, 15, 16, 20, 23, 44, 45, 47, 53, 59, 68, 69, 92, 93

I

International (Early) 64, 65
International (Late) 70, 71
International Style 64, 65, 70, 71, 76
Ionic 12, 13, 14, 87, 90, 92

Italianate 3, 15, 20, 21, 22, 24

M

Mansard Roof 24, 25, 39
Mid-Century Modern 72, 73
Minimal Traditional 68, 69
Modillion 39, 89

N

Neoclassical Revival 40, 41
New Federalism 65
New Formalism 74

O

Octagon 22, 23

P

Patterned Masonry 57
Pavilion 8, 58, 59
Pediment 13, 14, 94
Pilasters 16, 38, 39, 58, 59, 60, 94, 97
Pointed Arch 19
Portico 13, 40, 41, 43, 55, 59
Prairie 44, 45
Pyramidal Roof 22, 23, 73

Q

Queen Anne 3, 4, 25, 28, 30, 31, 32, 34, 42, 45

R

Rafter Tail 37
Raised Basement 8, 10, 12, 58, 59
Ranch 69
Renaissance Revival 16, 17
Ribbon Windows 64, 65
Richardsonian Romanesque 34

Romanesque Revival 4, 34, 35
Rose Window 19
Round Arch 17, 21
Rustic 36, 37

S

Second Empire 24, 25
Shingle 32, 33, 34
Side-Gable Roof 11, 15, 41
Sidelight 11, 15, 43
Skirting 67
Spanish Revival 50, 51
Stick 28, 29
Stucco 5, 50, 51, 53, 97

T

Towers 17
Transom 14, 15, 20
Tudor Revival 56, 57
Tuscan 13, 98

V

Ventilator 26
Vergeboard 18, 19, 88

W

Water Table 17, 98
World War I 6, 48, 49, 50, 52, 58, 66
World War II 42, 66, 67



DoD Legacy Resource Management Program
3400 Defense Pentagon
Room 5C646
Washington, DC 20301



Naval Facilities Engineering Command Southeast (NAVFAC SE)
Bldg 903, P. O. Box 30
NAS Jacksonville
Jacksonville, FL 32212-0030



**US Army Corps
of Engineers®**
Engineer Research and
Development Center

Construction Engineering Research Laboratory (CERL)
U.S. Army Engineer Research and Development Center (ERDC)
2902 Newmark Drive
Champaign, IL 61822-1076

ERDC/CERL B-11-2