

DMDC

Information and Technology for Better Decision Making

DoD Common Access Card (CAC) Issuance Process

Presented by:
**Defense Manpower Data Center
Access Card Office**



July 2005

CAC Issuance

- **Real-time Automated Personnel Identification System (RAPIDS) is smart card issuing system**
- **Defense Enrollment Eligibility Reporting System (DEERS) provides initial data to RAPIDS for card issuance**
- **PKI Local Registration Authority (LRA) integrated into RAPIDS infrastructure**

CAC Issuance

- **CACs are issued from over 1,300 issuance sites world-wide from RAPIDS terminals**
- **Architecture of end-to-end CAC system involves a myriad of systems and networks along with support**
 - Helpdesk
 - Field Service Support and Training
 - Engineering Support
- **Only people vetted and in the authoritative database (DEERS) are issued ID cards**
 - Moving back the fixing of identity
 - DEERS lockdown

DoD Distributed Issuance Infrastructure

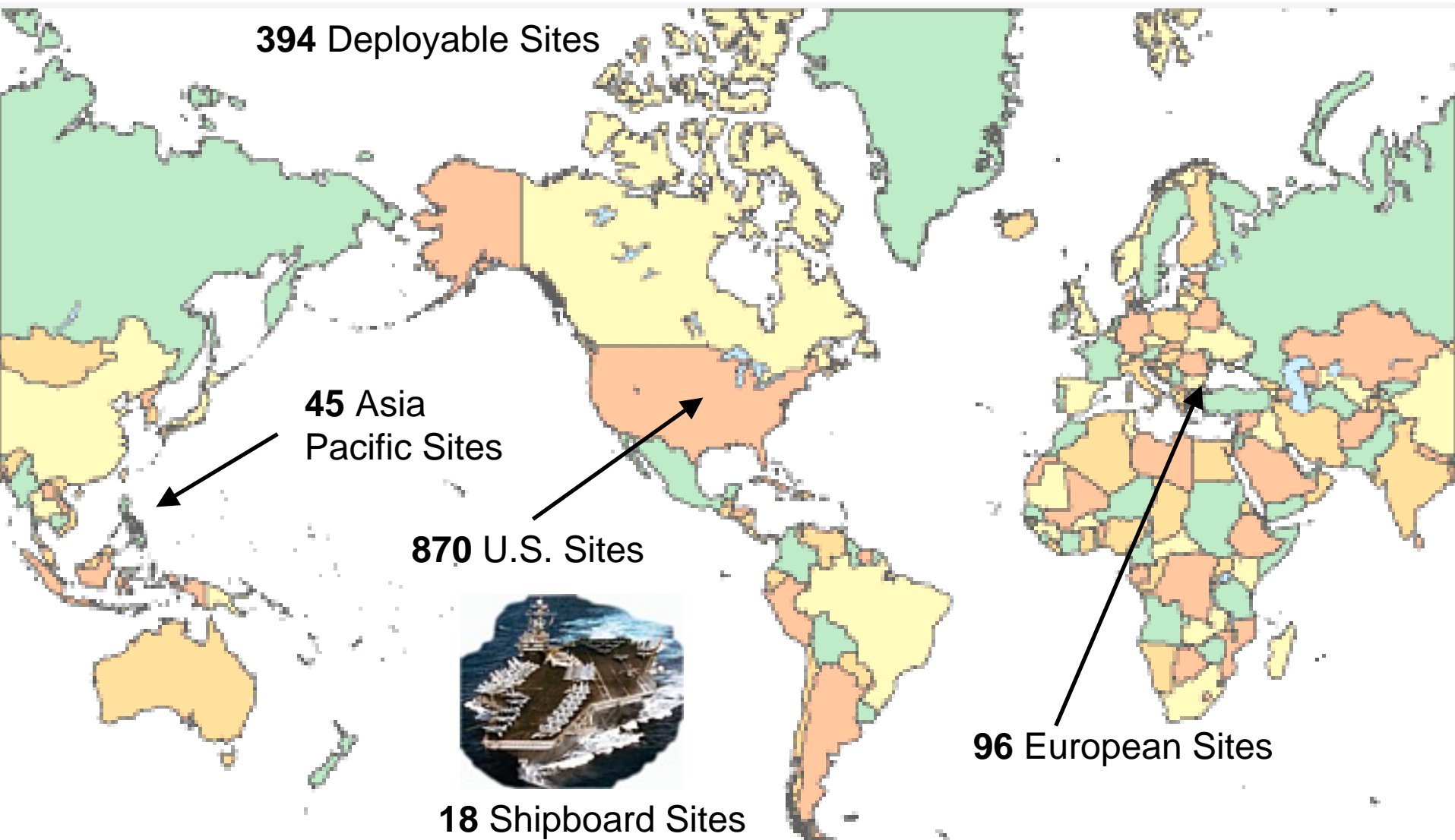

1,425 Sites Deployed Worldwide as of June 2005

CAC Issuance Components

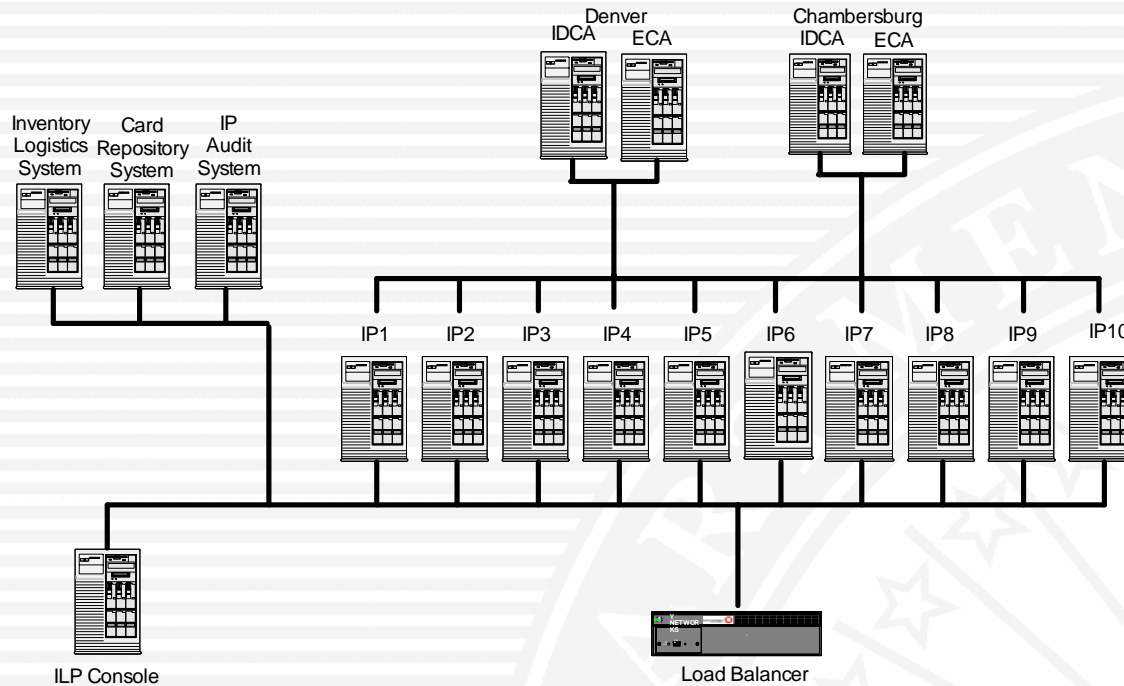

- **Load Balancer** - balances production RAPIDS workstations across the 10 Issuance Portals.
- **Issuance Portal (IP)** - dedicated to the initialization and issuance of the CAC, the applications that reside on the CAC, and the keys and credentials needed to securely use/issue the CAC.

CAC Issuance Components

- **Card Repository System (CRS)** - Manages the real estate and the capabilities of the Integrated Circuit Chips of the CACs
- **Inventory Logistics Portal (ILP)** - Manages the logistics of maintaining and replenishing CAC stock inventory quantities for individual CAC issuing sites and the DMDC organization
- **IP Audit System** - Records the commands requested by a RAPIDS system and the outcome of those commands
- **Inventory Logistics Console (ILC)** - Provides DMDC management and SSM's the ability to maintain the ILP through the use of a GUI

Authenticate User

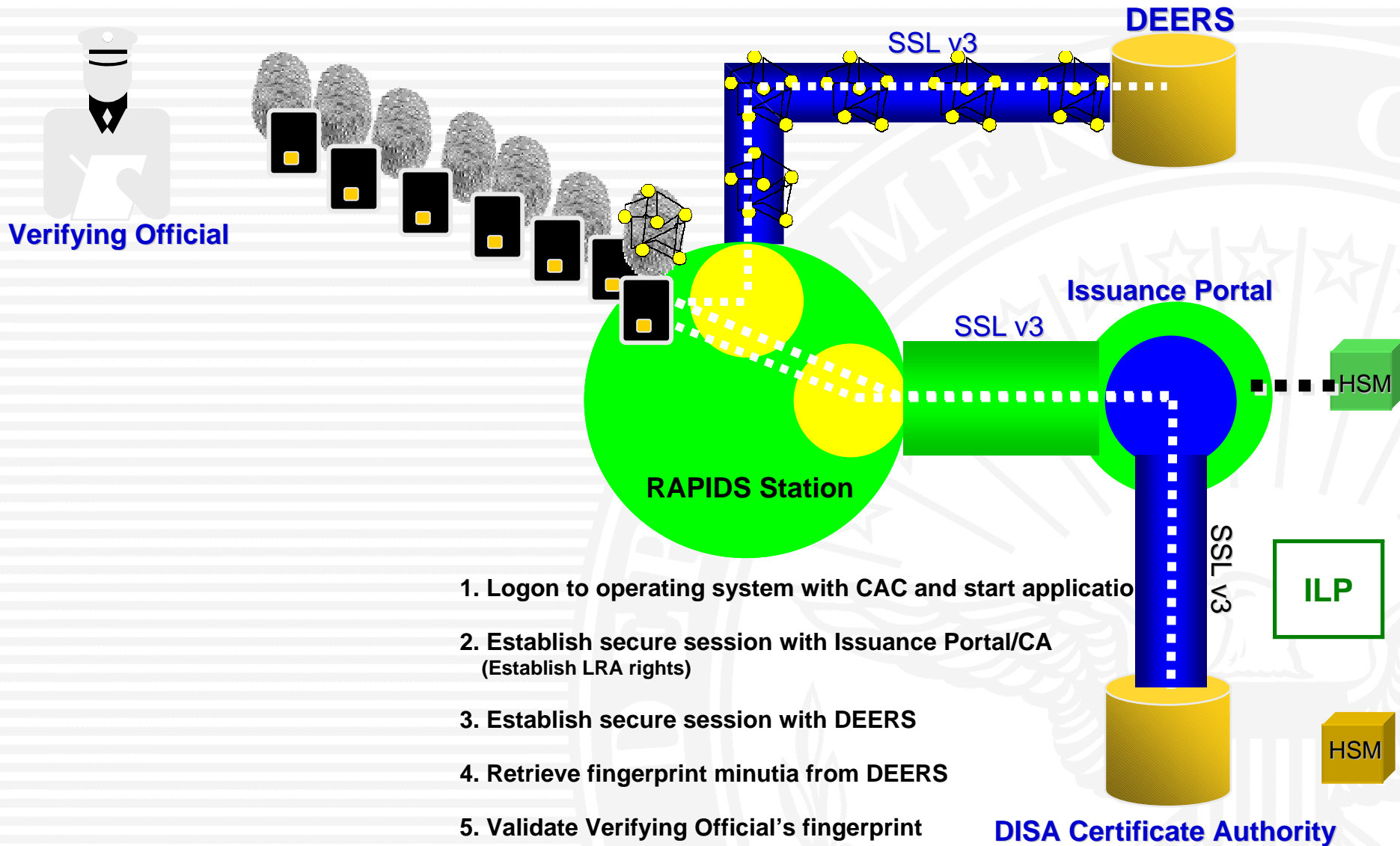

Capture Data & Print Card

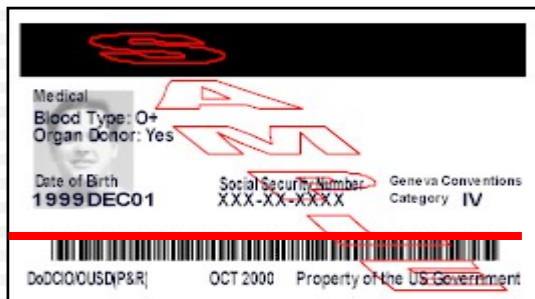

123456

1. Retrieve data from DEERS
2. Update DEERS data.
3. Capture or verify fingerprint
4. Take photograph.
5. Obtain PIN
6. Print card
7. Verify bar code(s)

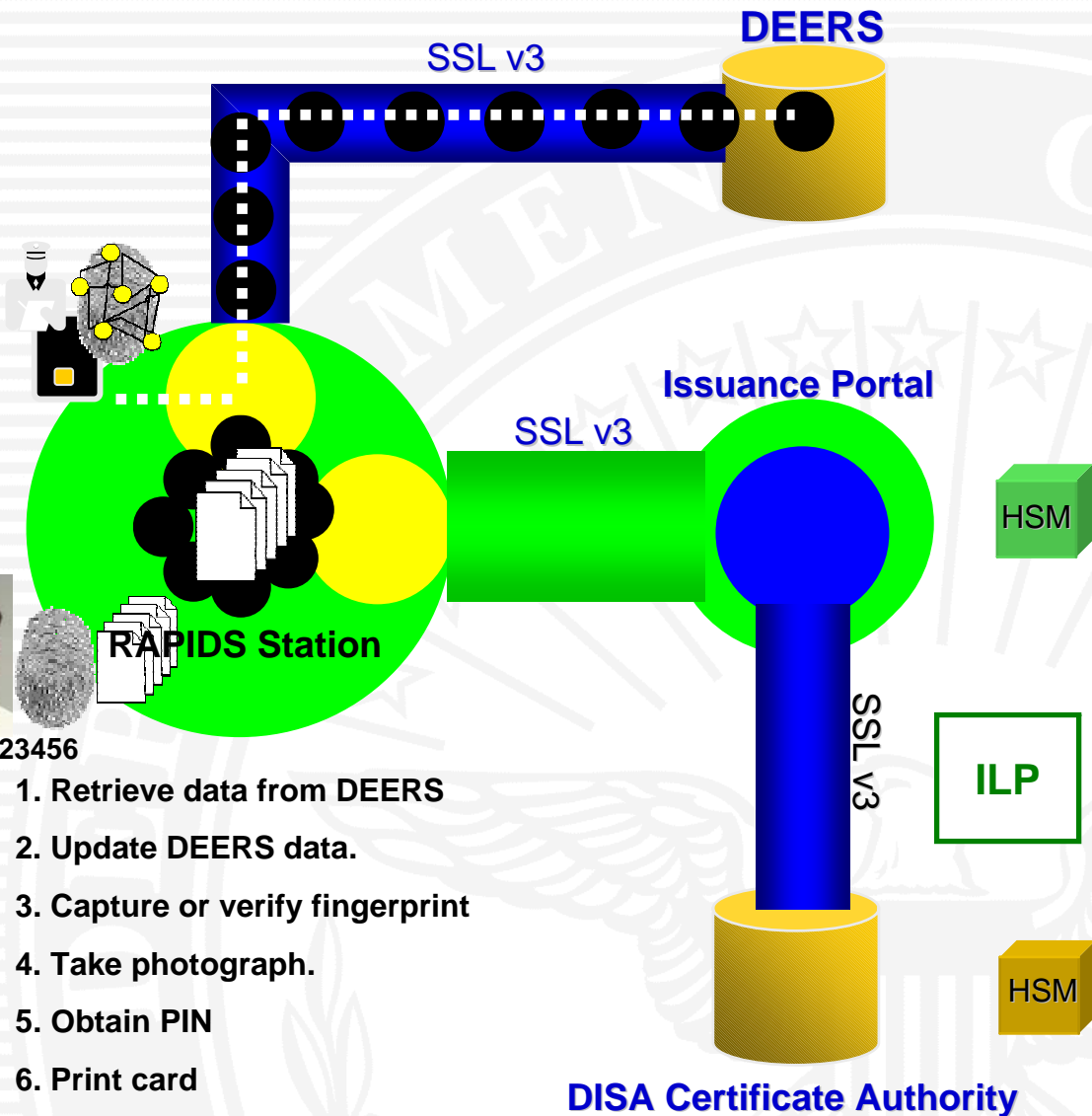

Create Channel & Install Applets

1. Check card status and site in ILP
2. Create Global Platform Secure Channel
3. Load applets (may have been done by manufacturer)

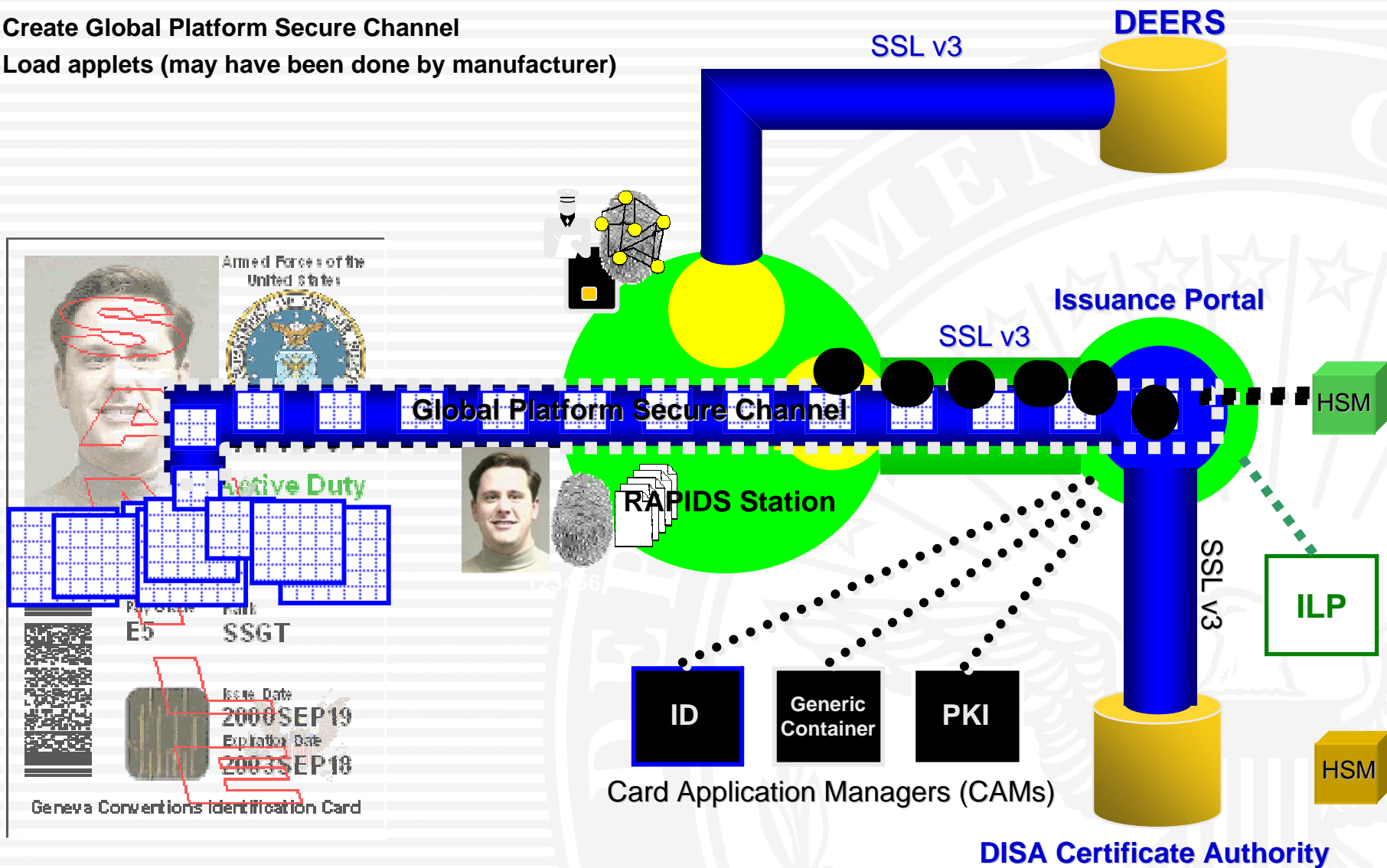

Instantiate Applets

1. Check card status and site in ILP
2. Create Global Platform Secure Channel
3. Load applets (may have been done by manufacturer)
4. Instantiate applets

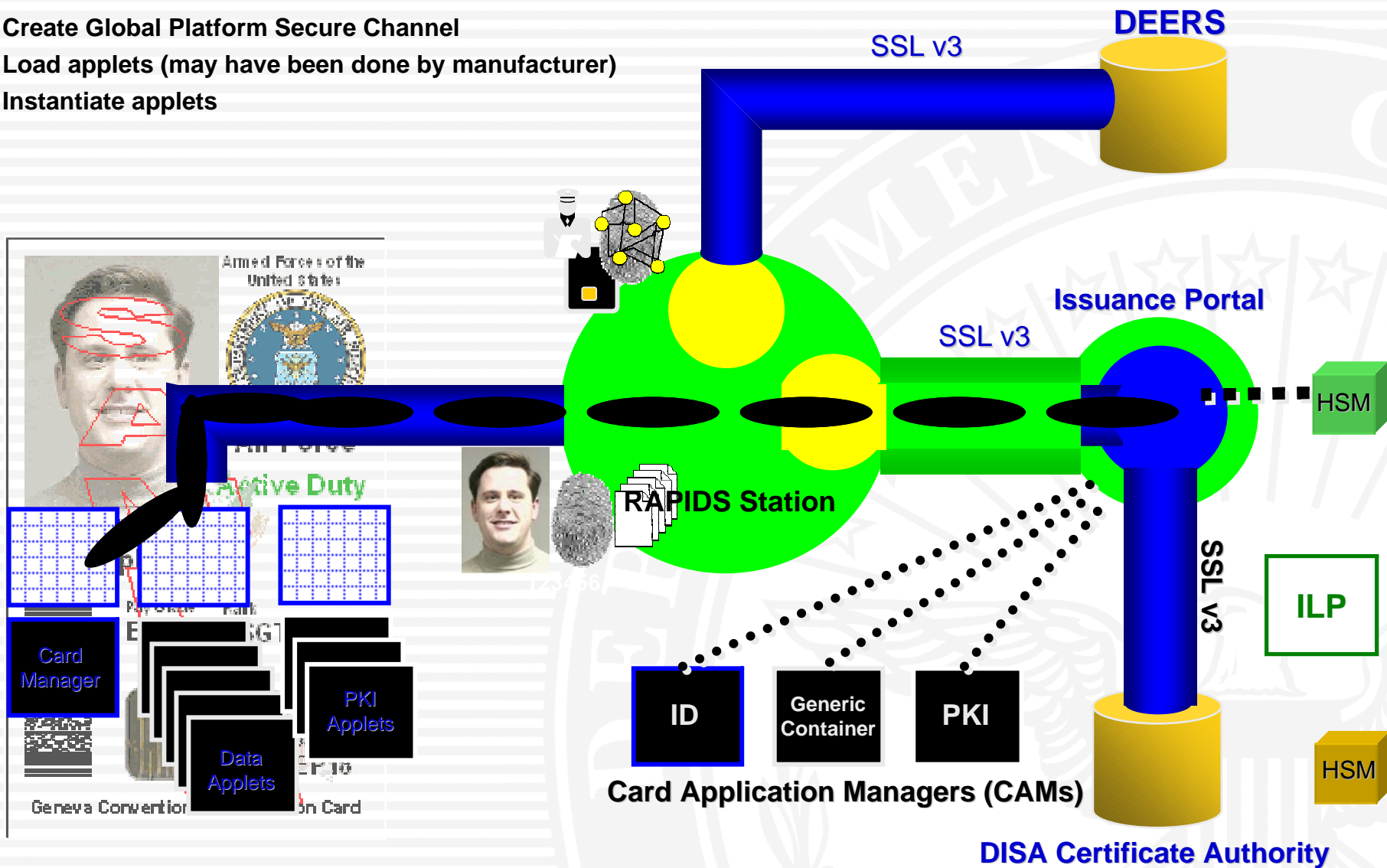

Set PIN

1. Check card status and site in ILP
2. Create Global Platform Secure Channel
3. Load applets (may have been done by manufacturer)
4. Instantiate applets
5. Set PIN

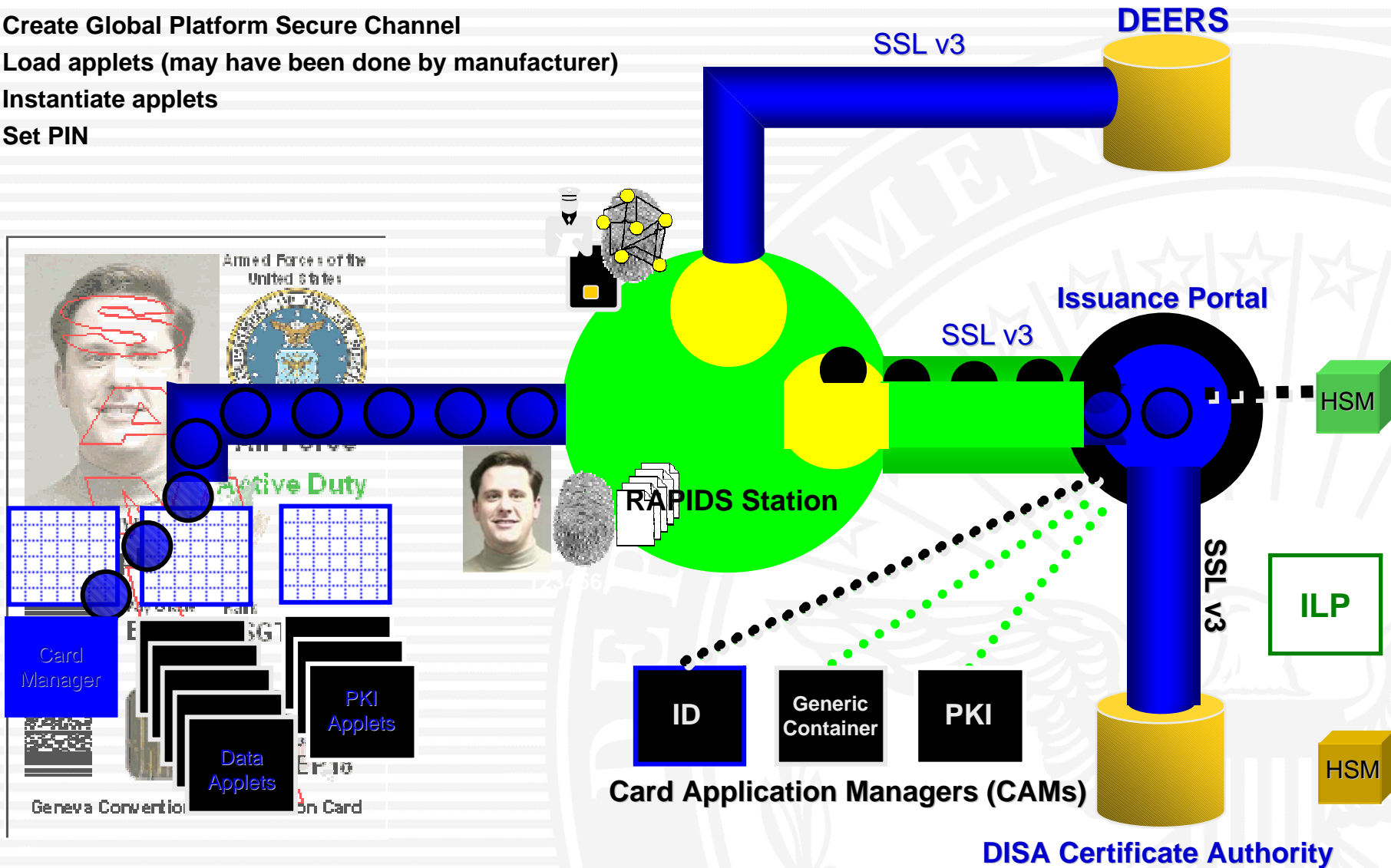

Set Generic Container Applet Data

1. Check card status and site in ILP
2. Create Global Platform Secure Channel
3. Load applets (may have been done by manufacturer)
4. Instantiate applets
5. Set PIN
6. Populate data applets

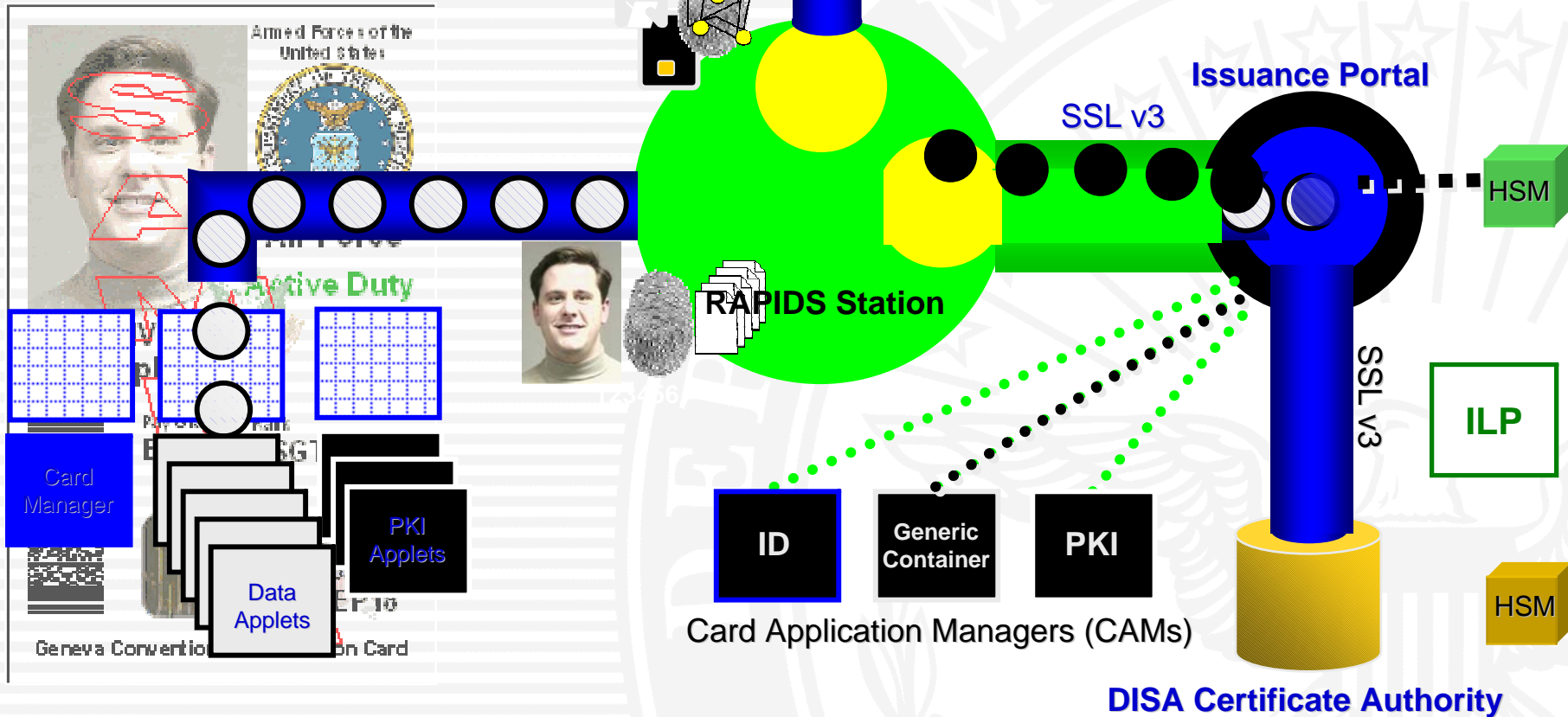

DISA Certificate Authority

ID Certificate

1. Check card status and site in ILP
2. Create Global Platform Secure Channel
3. Load applets (may have been done by manufacturer)
4. Instantiate applets
5. Set PIN
6. Populate data applets
7. Request PKI certificates

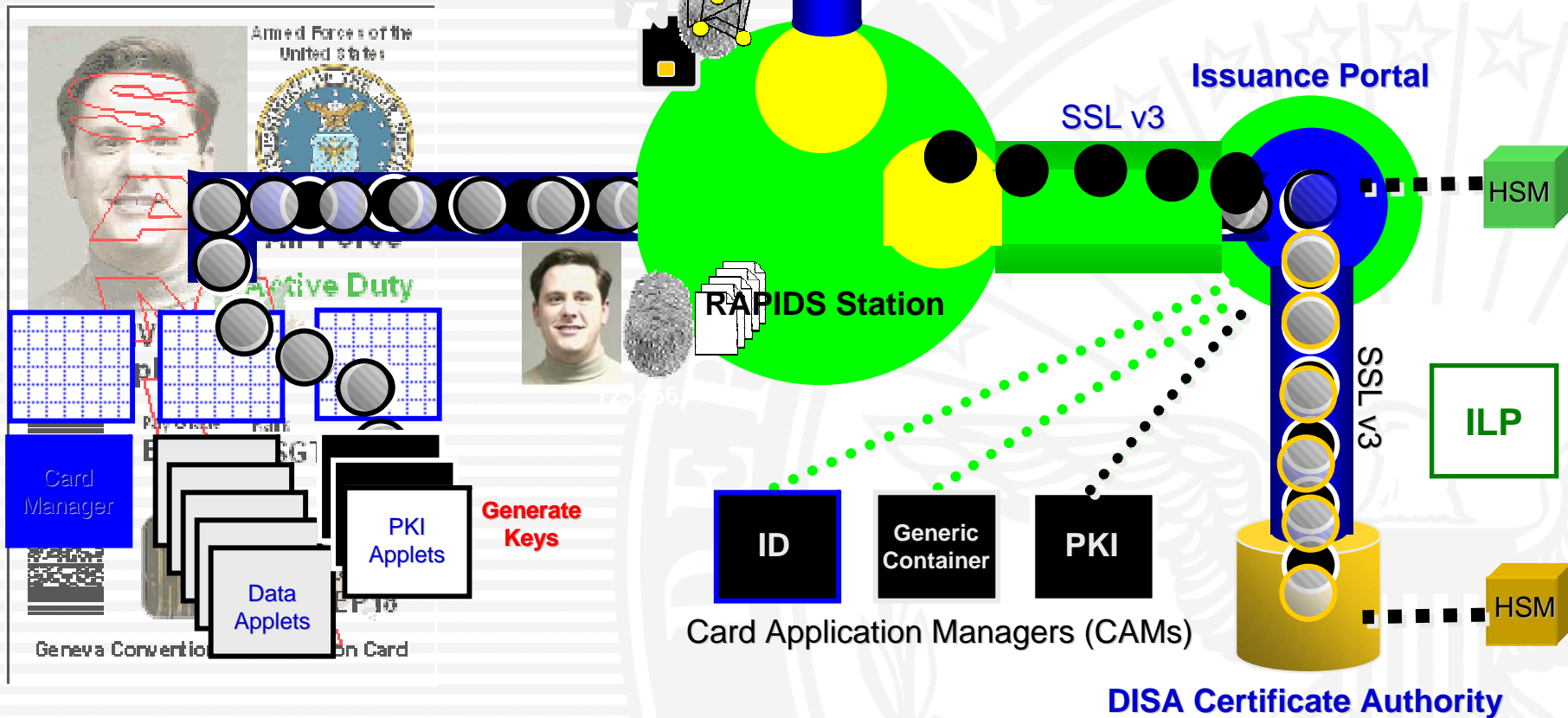

Email Signing Certificate

1. Check card status and site in ILP
2. Create Global Platform Secure Channel
3. Load applets (may have been done by manufacturer)
4. Instantiate applets
5. Set PIN
6. Populate data applets
7. Request PKI certificates

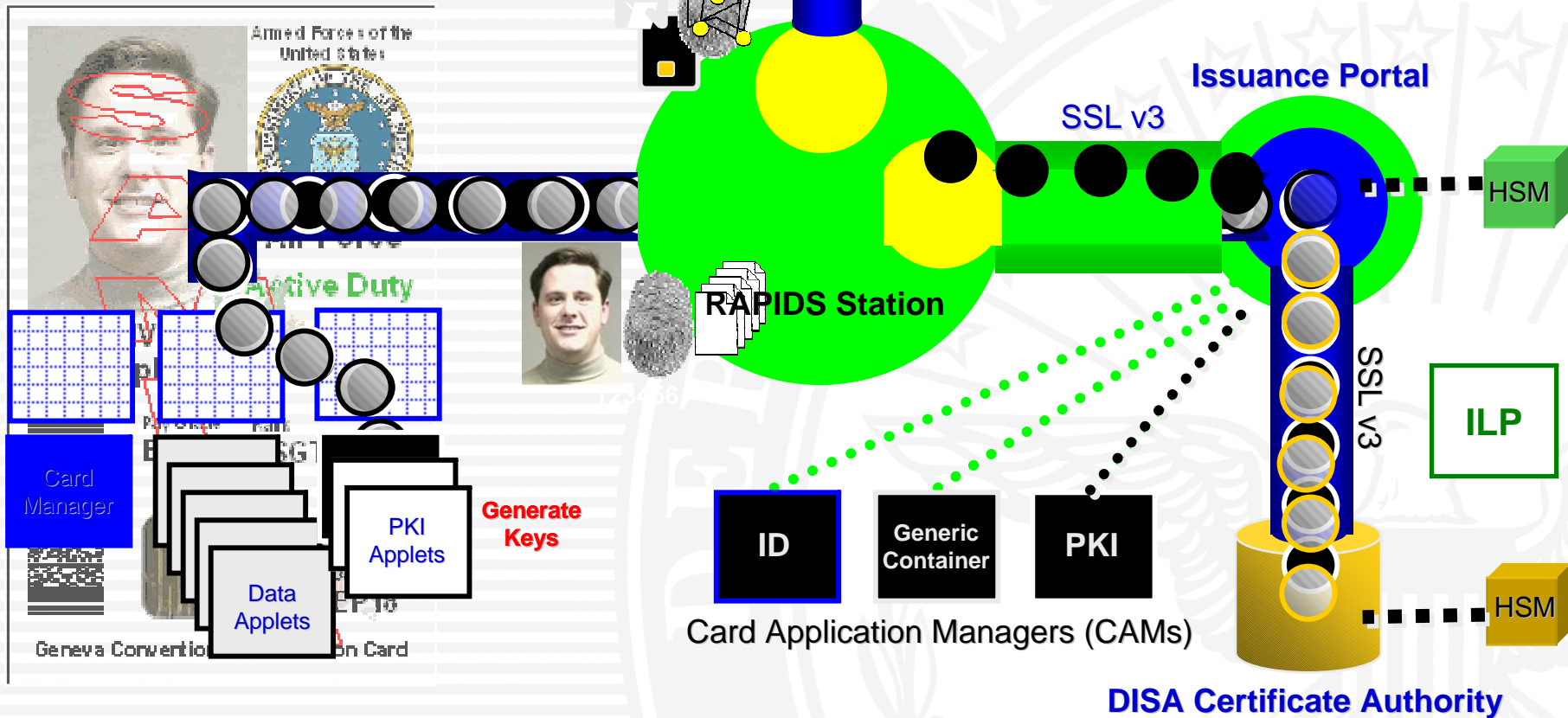

Post Processing

- 8. Mark card as issued in the ILP
- 9. Update DEERS with ID Card, Photograph and Fingerprint Info.

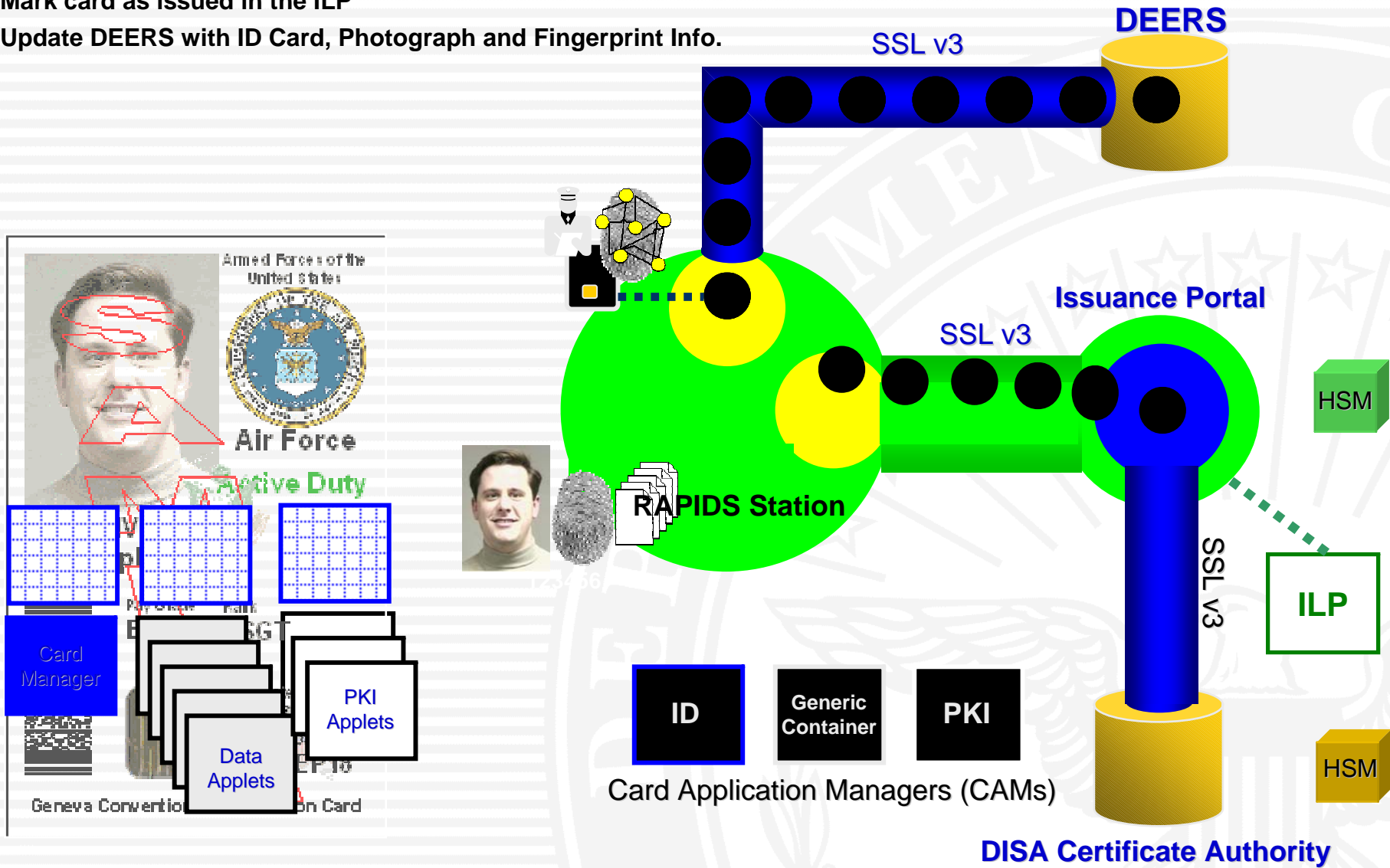

Questions?

cacsupport@osd.pentagon.mil

www.dmdc.osd.mil/smartcard