

# **PARACHUTE RIGGER HANDBOOK**

**2005**

**U.S. DEPARTMENT OF TRANSPORTATION  
FEDERAL AVIATION ADMINISTRATION  
Flight Standards Service**





## **PREFACE**

This operational handbook introduces the basic skills necessary for acquiring a parachute rigger certificate. It is developed by the Flight Standards Service, Airman Testing Standards Branch, in cooperation with various aviation educators and industry.

This handbook is primarily intended to assist individuals who are preparing for the parachute rigger airman knowledge test and the oral and practical test. The material presented in this handbook is appropriate for senior and master parachute riggers. The handbook contains information on regulations and human factors, design and construction, materials, operations, inspection and packing, hand tools, sewing machines, the parachute loft, repairs, alterations, and manufacture.

This handbook conforms to training and certification concepts established by the Federal Aviation Administration (FAA). There are different ways of teaching, as well as performing specific rigging procedures, and many variations in the explanations of repairs, alterations, and manufacture of parachutes. The discussion and explanations reflect commonly used practices and principles. This handbook provides a basic knowledge that can serve as a foundation on which to build further knowledge. Occasionally the word “must” or similar language is used where the desired action is deemed critical. The use of such language is not intended to add to, interpret, or relieve a duty imposed by Title 14 of the Code of Federal Regulations (14 CFR).

It is essential for persons using this handbook to also become familiar with and apply the pertinent parts of 14 CFR and appropriate technical standards. Performance standards for demonstrating competence required for parachute riggers are prescribed in the appropriate practical test standard.

This handbook is available for download from the Flight Standards Service web site at <http://av-info.faa.gov>. The current Flight Standards Service airman training and testing material and subject matter knowledge codes for all airman certificates and ratings can also be obtained from the Flight Standards Service web site, as well as information about availability of printed copies.

The FAA greatly acknowledges the valuable assistance provided by many individuals and organizations throughout the aviation community whose expertise contributed to the preparation of this handbook. This handbook contains material and pictures of various products often used by industry. It is presented here as a means of communicating information to be used for training purposes only. The FAA neither endorses nor recommends any specific trademark item in this handbook.

This handbook is published by the U.S. Department of Transportation, Federal Aviation Administration, Airman Testing Standards Branch, AFS-630, P.O. Box 25082, Oklahoma City, OK 73125. Comments regarding this handbook should be sent in e-mail form to [AFS630comments@faa.gov](mailto:AFS630comments@faa.gov).

AC 00-2, *Advisory Circular Checklist*, transmits the current status of FAA advisory circulars and other flight information publications. This checklist is available via the Internet at [http://www.faa.gov/aba/html\\_policies/ac00\\_2.html](http://www.faa.gov/aba/html_policies/ac00_2.html).



# CONTENTS

## Chapter 1—Regulations and Human Factors

Parachute Rigger Certificates .....	1-1
Eligibility and Requirements .....	1-1
Earning a Parachute Rigger Certificate .....	1-2
Testing .....	1-2
Alternate Means of Qualifying for a Parachute Rigger Certificate .....	1-2
Retesting .....	1-4
Responsibilities of a Certificated Parachute Rigger .....	1-5
Facilities and Tools .....	1-6
Performance Standards .....	1-6
Currency Requirements .....	1-6
Record Keeping .....	1-6
Sealing the Parachute.....	1-8
Regulatory Compliance .....	1-8
14 CFR Part 1—Definitions .....	1-8
14 CFR Part 21 Subpart O—Technical Standard Orders (TSO) .....	1-8
14 CFR Part 39—Airworthiness Directives .....	1-8
14 CFR Part 91—General Operating and Flight Rules .....	1-8
14 CFR Part 105 Subpart C—Parachute Equipment and Packing .....	1-8
Rigging Ethics .....	1-9
Certification Specifications.....	1-9
Pilot vs Parachute Size.....	1-9
Parachute Service Life .....	1-9

## Chapter 2—Design and Construction

Component Parts .....	2-1
Main Parachute .....	2-1
Reserve Parachute.....	2-1
Emergency Parachute.....	2-1
Harness/Container.....	2-1
Pilot Chutes and Bridles for the Main and Reserve Parachutes .....	2-2
Ripcords or Equivalent Devices for the Main and Reserve Parachutes.....	2-2
Deployment Devices for the Main and Reserve Parachutes.....	2-2
Main Parachute Release Mechanism and Associated Handles or Static Lines .....	2-2
Risers, Main or Reserve, When Not Integral With the Harness or Canopy, and Their Associated Steering Toggles.....	2-2
Other Harness/Container Assembly Components .....	2-2
TSO Standards.....	2-2
Canopy Design .....	2-3
Nomenclature.....	2-3
Construction Concepts and Techniques.....	2-4
Operational Theory .....	2-4
Materials .....	2-4
Damage .....	2-4
Containers.....	2-5
Configuration .....	2-5
Modern Design Concepts .....	2-6

Harness Design .....	2-7
Bridles and Deployment Devices .....	2-9
Deployment Types .....	2-10
Type 1: Canopy First Deployment.....	2-10
Type 2: Two-Stow Diaper or Half Diaper.....	2-10
Type 3: Ascuitto or Piglet-Style Flat Diaper.....	2-10
Type 4: Handbury or Preserve Full Diaper .....	2-10
Type 5: Free Bag.....	2-11
Type 6: Sleeves .....	2-11
Securing the Deployment Device .....	2-11
Bridles .....	2-12
Pilot Chutes .....	2-14
Spring-Loaded Pilot Chutes.....	2-14
Hand Deploy Pilot Chutes .....	2-15
Automatic Activation Devices and Reserve Static Lines .....	2-16
Automatic Activation Devices .....	2-16
Operation .....	2-16
Reserve Static Line Systems.....	2-17
RSL Designs .....	2-17
Main Riser Attachment.....	2-18
Ripcord Cable Routing .....	2-19
RSL Lanyard and Container Mount .....	2-19
Joint Efficiency .....	2-20
 <b>Chapter 3—Materials</b>	
Specifications .....	3-1
Fabrics .....	3-1
Webbing and Tapes.....	3-6
Cords, Lines, and Threads .....	3-10
Hardware .....	3-13
Plastics and Synthetics .....	3-22
Fasteners.....	3-23
Housings.....	3-25
Ripcords, Cables, and Swages.....	3-26
Miscellaneous .....	3-28
 <b>Chapter 4—Operations</b>	
Sport Parachute Main Packing Techniques .....	4-1
Deployment and Inflation Characteristics.....	4-7
Main Pilot Chute.....	4-7
Bridle Length .....	4-8
Rubber Bands.....	4-8
Assembly of the Main Canopy to the Harness and Container.....	4-8
Assembly of Components and Compatibility .....	4-10
Volume .....	4-10
Deployment Type.....	4-11
TSO Certification and Placard Limitations .....	4-11

## **Chapter 5—Inspection and Packing**

Identification.....	5-1
Inspection .....	5-1
Component Compatibility .....	5-3
Round Canopies and Pilot Emergency Systems .....	5-5
Straightening the Canopy .....	5-6
Damage Identification .....	5-7
Pilot Chute and Bridle .....	5-7
Reserve Canopy .....	5-7
Suspension Lines and Connector Links.....	5-8
Harness .....	5-9
Container.....	5-10
Ripcord .....	5-10
Airing and Drying.....	5-11
Ram-Air Reserves and Sport Piggyback Systems.....	5-11
Pilot Chute and Free Bag/Bridle.....	5-11
Ram-Air Reserve Canopy.....	5-11
Canopy Assembly and Line Continuity.....	5-12
Inspection.....	5-14
Harness .....	5-14
Container .....	5-15
Ripcord .....	5-16
Rigging and Repairs .....	5-16
Packing .....	5-17
Round Canopy into a Pilot Emergency Parachute System .....	5-17
Layout.....	5-18
Pleating the Canopy.....	5-19
Fold the Skirt .....	5-22
Closing the Diaper and Stowing the Lines .....	5-22
Skirt or Diaper Placement.....	5-24
Accordion Folding the Canopy.....	5-24
Closing the Container .....	5-27
Ripcord Pull Force.....	5-28
Sealing the Parachute.....	5-30
Ram-Air Reserve into a Sport Piggyback System.....	5-32
Assembling the Reserve System.....	5-32
Step 1. Layout, and Setting Up Packing Clamps.....	5-33
Step 2. Stacking and Pleating the Reserve Canopy .....	5-34
Step 3. Setting the Brakes.....	5-36
Step 4. Folding the Canopy .....	5-36
Step 5. Placing the Canopy into the Deployment Bag and Stowing the Lines.....	5-38
Step 6. Placing the Bag into the Container and Closing the Container.....	5-40
Documentation .....	5-43

## **Chapter 6—Hands Tools, Sewing Machines, and the Parachute Loft**

Hand Tools.....	6-1
Hand Tools Description .....	6-2
Sewing Machines.....	6-12

Identification and Nomenclature .....	6-14
Sewing Theory .....	6-17
Needles .....	6-18
Operation .....	6-19
Installing the Needle and Threading the Machine .....	6-19
Machine Maintenance.....	6-20
Sewing Machine Attachments .....	6-20
The Parachute Loft .....	6-22
<b>Chapter 7—Repairs, Alterations, and Manufacture</b>	
Repair Techniques .....	7-1
<b>Section 1—Canopy and Lines</b> .....	7-3
7.1.1 Seam Restitching .....	7-5
7.1.2 Canopy Ripstop Tape Repair .....	7-7
7.1.3 Round and Square Canopy—Basic Patch.....	7-9
7.1.4 Round Canopy—Panel Replacement.....	7-13
7.1.5 Square Canopy—Partial Panel Replacement.....	7-15
7.1.6 Square Canopy—Rib Repair .....	7-19
7.1.7 Square Canopy—Pilot Chute Attachment Point Repair .....	7-23
7.1.8 Round Canopy—Noncontinuous Line Replacement.....	7-25
7.1.9 Square Canopy—Main Line Replacement .....	7-27
7.1.10 Square Canopy—Line Splice .....	7-29
7.1.11 Square Canopy—Control Line Replacement .....	7-31
7.1.12 Square Canopy—Crossport Repair.....	7-35
7.1.13 Square Canopy—Trim Check and Retrim.....	7-37
<b>Section 2—Container</b> .....	7-39
7.2.1 Container Fabric Panel Repair .....	7-41
7.2.2 Container Grommet Replacement .....	7-45
7.2.3 Container Velcro® Replacement .....	7-47
7.2.4 Container Plastic Stiffener Replacement .....	7-49
7.2.5 Main Container Side Flap Replacement .....	7-51
7.2.6 Bottom of Container Pocket Replacement .....	7-53
7.2.7 3-Ring Release Housing Replacement .....	7-55
<b>Section 3—Harness and Risers</b> .....	7-57
7.3.1 Chest Strap Replacement.....	7-59
7.3.2 Lower Leg Strap Shortening.....	7-63
7.3.3 Ripcord Pocket Velcro® Replacement .....	7-65
7.3.4 Articulated Upper Leg Hardware Replacement.....	7-67
7.3.5 Standard Harness Main Lift Web Replacement.....	7-69
7.3.6 Main Riser 3-Ring Locking Loop Replacement.....	7-75
7.3.7 Main Riser Steering Toggle Velcro® Replacement .....	7-77
<b>Section 4—Accessory Components</b> .....	7-79
7.4.1 Reserve Pilot Chute Repair—Mesh, Tackings, and Bad Grommet .....	7-81
7.4.2 Reserve Free Bag Repair—Grommet Pullout .....	7-83
7.4.3 Main Pilot Chute Repair—Top Canopy Reinforcing .....	7-85
7.4.4 Main Pilot Chute Collapsible Bridle Replacement.....	7-87
7.4.5 Main Deployment Bag Repair—Closing Flap Grommet Pullout.....	7-91

<b>Section 5—Alterations</b> .....	7-93
7.5.1 Articulated Harness Main Lift Web Resizing .....	7-95
7.5.2 Leg Pad Resizing .....	7-97
7.5.3 Automatic Activation Device Installation .....	7-99
<b>Section 6—Manufacturing</b> .....	7-103
7.6.1 Main and Reserve Closing Loop Manufacture .....	7-105
7.6.2 Main Deployment Bag.....	7-109
7.6.3 Bottom of Container Pocket .....	7-113
<b>Section 7—Miscellaneous</b> .....	7-115
7.7.1 Hand Tacking Techniques.....	7-117
7.7.2 Cleaning and Washing Procedures.....	7-119
<b>Appendix I—Technical Documents</b>	
PIA TS-100—Standardized Nomenclature for Ram-Air Inflated Gliding Parachutes .....	A-3
PIA TS-108—Parachute Canopy Fabric Pull Test, Non-Destructive Method.....	A-19
TSO C23d—Personnel Parachute Assemblies .....	A-25
SAE AS 8015B—Minimum Performance Standards for Parachute Assemblies and Components, Personnel ...	A-27
TSO C23c—Personnel Parachute Assemblies .....	A-37
SAE AS 8015A—Minimum Performance Standards for Parachute Assemblies and Components, Personnel ...	A-39
TSO C23b—Parachutes.....	A-45
NAS 804—Specification—Parachutes .....	A-47
<b>Glossary</b> .....	<b>G-1</b>
<b>Index</b> .....	<b>I-1</b>







A **parachute rigger** has a critical responsibility to anyone who uses a parachute. For many, a special meaning can be attributed to ensuring the safety of a piece of equipment that may save their life or that of a friend. For others, attention to detail may keep a stranger safe during recreational activities, such as sky diving or other sport parachuting events. This chapter explains what parachute riggers do and what is required to earn a parachute rigger certificate. In addition, this chapter covers relevant human factor issues and ethical standards.

The term “parachute rigger” originally came from its use in rigging ships and sails. Those individuals who organized and repaired the sails, lines, and ropes of the ships were called riggers. When **parachutes** were developed in the early 20<sup>th</sup> century, the term came to refer to those who sewed the canopies and lines. The term eventually became used in conjunction with parachutes. In the early days, anyone with the knowledge of sewing and materials could make or repair parachutes. As the aviation industry grew and matured, the need for trained individuals to pack and maintain the parachutes grew as well. In order to protect the pilots and public who flew in airplanes and relied on parachutes, the Government began to license these individuals. Rigging then, in reference to parachutes, came to mean: the final adjustment and alignment of the various component sections to provide the proper **aerodynamic** reaction.

## PARACHUTE RIGGER CERTIFICATES

Parachutes intended for emergency use in civil aircraft in the United States, including the reserve parachute of a dual parachute system to be used for intentional **jumping**, must be packed, maintained, or altered by a person who holds an appropriate and current parachute rigger certificate. The certificate is issued under **Title 14 of the Code of Federal Regulations (14 CFR) part 65, subpart F**. These regulations do not apply to an individual who packs the main parachute of a dual parachute pack to be used for intentional jumping. These regulations also do not apply to parachutes packed, maintained, or altered for use of the Armed Forces.

Any person who holds a parachute rigger certificate must present it for inspection if requested by the **Administrator**

or an authorized representative of the National Transportation Safety Board (NTSB), or any federal, state, or local law enforcement officer. A sample certificate is shown in figure 1-1.

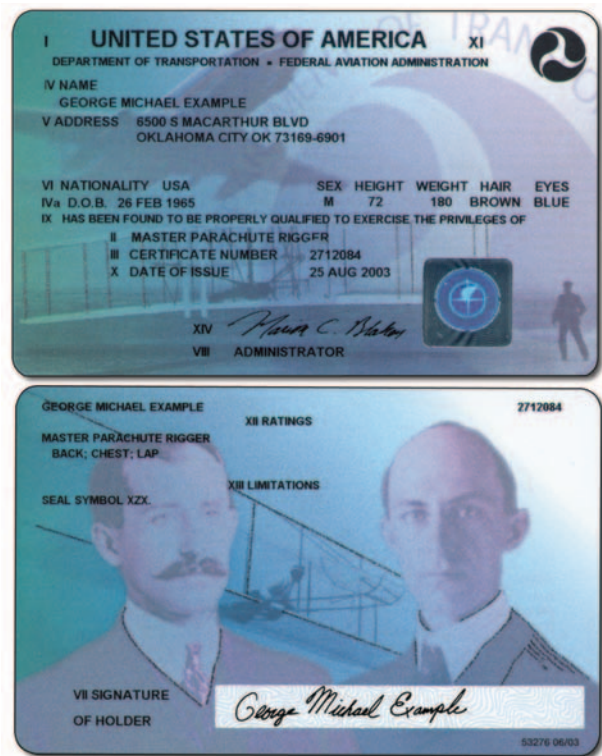


Figure 1-1. Airman's Certificate—Master Parachute Rigger.

## ELIGIBILITY AND REQUIREMENTS

To be eligible for a parachute rigger certificate issued by the Federal Aviation Administration (FAA), individuals must be at least 18 years of age; be able to read, write, speak, and understand the English language; and comply with other requirements of 14 CFR part 65, subpart F, which governs the certification of parachute riggers.

There are two parachute rigger certificates available in the United States: senior and master. The **senior parachute rigger** candidate must pack a minimum of 20 parachutes of one type and be able to demonstrate the ability to maintain and make minor repairs. The **master parachute rigger** candidate must have 3 years of

experience as a parachute rigger and have packed at least 100 parachutes of two type ratings in common use. There are four type **ratings** that may be placed on a parachute rigger certificate: back, chest, seat, and lap. Of these, the first three are used today. The lap rating applies to parachutes that are basically obsolete. A senior parachute rigger is considered a journeyman technician, and the master parachute rigger is considered an expert.

The two types of certificates differ in the level of experience and responsibility. A senior parachute rigger may pack, as well as maintain, a parachute by making **minor repairs**. A master parachute rigger has all the privileges of the lesser certificate plus the ability to make **major repairs** and alter parachutes according to approved data. A major repair is one that, if improperly done, can appreciably affect the **airworthiness** of the parachute. An example of this might be replacing a damaged canopy panel or altering a harness by changing the size of a main lift web. A minor repair is anything other than a major repair, such as a small patch on a canopy or the replacement of a defective or worn connector link.

To Whom It May Concern:

This is to certify that David D. Wolf has packed in excess of 20 back-type parachutes under my supervision in accordance with the manufacturer's instructions and all applicable FAA directives. In addition, he has demonstrated a sound knowledge of the parachute, its construction, packing, maintenance, and use, as well as subparts A & F of 14 CFR part 65.

Sincerely Yours,  
Joe Smith  
Master parachute rigger #123456789

Figure 1-2. Certification letter signing off a parachute rigger candidate for FAA testing.

## EARNING A PARACHUTE RIGGER CERTIFICATE

When an applicant meets the requirements and demonstrates sufficient knowledge and skills as outlined in 14 CFR part 65, subpart F, the supervising parachute rigger (either a senior or master parachute rigger) "signs off" the trainee's logbook and provides a letter to the FAA, which will allow the applicant to take the necessary tests. Figure 1-2 is an example of this letter.

## TESTING

The applicant should take a letter similar to the one depicted in figure 1-2, the applicant's logbook, and any

other necessary identification to the nearest FAA Flight Standards District Office (FSDO) or International Field Office (IFO). An FAA Aviation Safety Inspector (airworthiness) will examine these documents for completeness and eligibility. The applicant will be asked to fill out FAA Form 8610-2, Airman Certificate and/or Rating Application. When the inspector has determined that the applicant is eligible to take the test, he or she will sign the FAA Form 8610-2. [Figure 1-3] Once this is done, the applicant may then go to any of the designated FAA airman knowledge testing centers to take the airman knowledge test.

The knowledge test consists of 50 multiple-choice questions that are not designed to be tricky or misleading. They cover all basic rigging and packing subject areas in addition to 14 CFR part 65 regulations. A minimum score of 70 percent is required to pass the test. The test is scored immediately on conclusion of the test and a certified airman knowledge test report is issued to the applicant. [Figure 1-4 on page 1-4] After passing the test, the candidate may then make an appointment for taking the oral and practical portion of the test with a **Designated Parachute Rigger Examiner (DPRE)**.

Under 14 CFR part 183, DPREs are master parachute riggers who have attended an FAA course and are authorized to conduct oral and practical tests for the Administrator. In many cases, these individuals are full time professionals who work in the parachute industry. Upon the successful completion of the oral and practical tests, in most cases, the DPRE will issue a temporary parachute rigger certificate [Figure 1-5 on page 1-5] and a seal symbol to the candidate. In some FSDO jurisdictions, the district office may issue the temporary certificate and/or seal symbol. The seal symbol consists of three letters or numbers or a combination of both. [Figure 1-6 on page 1-5] The seal symbol is very important; it will serve as the identifying mark for that individual parachute rigger, and is used to seal any parachute that he/she packs.

## ALTERNATE MEANS OF QUALIFYING FOR A PARACHUTE RIGGER CERTIFICATE

Active duty military personnel and civilian personnel, who work for the military as parachute riggers, may qualify for a senior parachute rigger certificate under 14 CFR, section 65.117, Special Certification Rule. If they meet the practical requirements, they need only take a special 25-question test.

A senior parachute rigger applying for a master parachute rigger certificate only needs to take the oral and practical test. A person with 3 years' experience as a parachute rigger, but not holding a senior parachute rigger certificate, must take both the knowledge test and the





**AIRMAN CERTIFICATE AND/OR RATING APPLICATION**

- MECHANIC
- AIRFRAME
- POWERPLANT

REPAIRMAN

- PARACHUTE RIGGER
- SENIOR
- MASTER
- SEAT
- CHEST
- BACK
- LAP

(Specify Rating)

APPLICATION FOR:  ORIGINAL ISSUANCE  ADDED RATING

I. APPLICANT INFORMATION

A. NAME (First, Middle, Last) <b>John Quincy Adams</b>					K. PERMANENT MAILING ADDRESS 1012 College Street Hales Corners Wisconsin 53130				
B. SOCIAL SECURITY NO. 555-55-5555		C. DOB (Mo., Day, Yr.) 09-27-70		D. HEIGHT 72 IN.	E. WEIGHT 185				
F. HAIR Brown		G. EYES Green		H. SEX M	I. NATIONALITY (Citizenship) U.S.A.				
J. PLACE OF BIRTH Braintree, Massachusetts					M. DO YOU NOW OR HAVE YOU EVER HELD AN FAA AIRMAN CERTIFICATE? <input checked="" type="checkbox"/> NO <input type="checkbox"/> YES				
L. HAVE YOU EVER HAD AN AIRMAN CERTIFICATE SUSPENDED OR REVOKED? <input checked="" type="checkbox"/> NO <input type="checkbox"/> YES (If "Yes," explain on an attached sheet keying to appropriate item number)					SPECIFY TYPE: _____ DATE OF FINAL CONVICTION _____				
N. HAVE YOU EVER BEEN CONVICTED FOR VIOLATION OF ANY FEDERAL OR STATE STATUTES PERTAINING TO NARCOTIC DRUGS, MARIJUANA, AND DEPRESSANT OR STIMULANT DRUGS OR SUBSTANCES? <input checked="" type="checkbox"/> NO <input type="checkbox"/> YES									

II. CERTIFICATE OR RATING APPLIED FOR ON BASIS OF

<input checked="" type="checkbox"/> A. CIVIL EXPERIENCE		<input type="checkbox"/> B. MILITARY EXPERIENCE		<input type="checkbox"/> C. LETTER OF RECOMMENDATION FOR REPAIRMAN (Attach copy)	
D. GRADUATE OF APPROVED COURSE					
(1) NAME AND LOCATION OF SCHOOL					
(2) SCHOOL NO.		(3) CURRICULUM FROM WHICH GRADUATED		(4) DATE	
E. STUDENT HAS MADE SATISFACTORY PROGRESS AND IS RECOMMENDED TO TAKE THE ORAL/PRACTICAL TEST (FAR 65.80)					
(1) SCHOOL NAME		NO.		(2) SCHOOL OFFICIAL'S SIGNATURE	
F. SPECIAL AUTHORIZATION TO TAKE MECHANIC'S ORAL/PRACTICAL TEST (FAR 65.80)		(1) DATE AUTH.	(2) DATE AUTH. EXPIRES	(3) FAA INSPECTOR SIGNATURE	(4) FAA DIST. OFC.

III. RECORD OF EXPERIENCE

A. MILITARY COMPETENCE OBTAINED IN		(1) SERVICE	(2) RANK OR PAY LEVEL	(3) MILITARY SPECIALTY CODE	
B. APPLICANTS OTHER THAN FAA CERTIFICATED SCHOOL GRADUATES, LIST EXPERIENCE RELATING TO CERTIFICATE AND RATING APPLIED FOR. (Continue on separate sheet, if more space is needed)					
DATES—MONTH AND YEAR		EMPLOYER AND LOCATION		TYPE WORK PERFORMED	
FROM	TO				
C. PARACHUTE RIGGER APPLICANTS: INDICATE BY TYPE HOW MANY PARACHUTES PACKED		SEAT	CHEST	BACK	LAP
			25	30	
		FOR MASTER RATING ONLY		PACKED AS A —	
				<input type="checkbox"/> SENIOR RIGGER <input type="checkbox"/> MILITARY RIGGER	

**IV. APPLICANT'S CERTIFICATION**

I CERTIFY THAT THE STATEMENTS BY ME ON THIS APPLICATION ARE TRUE

A. SIGNATURE **John Q. Adams** B. DATE **9/25/**

**V. I FIND THIS APPLICANT MEETS THE EXPERIENCE REQUIREMENTS OF FAR 65 AND IS ELIGIBLE TO TAKE THE REQUIRED TESTS.**

DATE **9/25/** INSPECTOR'S SIGNATURE **Susan D. Wagner** FAA DISTRICT OFFICE **AGL-12**

FOR FAA USE ONLY											
Emp.	reg.	D.O.	seal	con	iss	Act	lev	TR	s.h.	Srch	#/te
LIMITATIONS											

Figure 1-3. FAA Form 8610-2—Airman Certificate and/or Rating Application.

**U.S. DEPARTMENT OF TRANSPORTATION  
Federal Aviation Administration**

**Airman Knowledge Test Report**

NAME:	APPLICANT ID:	
EXAM: Parachute Rigger Senior (RIG)	EXAM ID:	
EXAM DATE: 04/20/2004	EXAM SITE:	
SCORE: 96	GRADE: PASS	TAKE: 1

Below are subject matter knowledge codes in which questions were answered incorrectly. For code descriptions see the latest version of AC 60-25 Reference Materials and Subject Matter Knowledge Codes for Airman Knowledge Testing, available via the internet: <http://afs600.faa.gov>  
A single code may represent more than one incorrect response.

L90 P38

EXPIRATION DATE: 04/30/2006

**DO NOT LOSE THIS REPORT**

-----  
Authorized instructor's statement. (If Applicable)

I have given Mr./Ms. \_\_\_\_\_ additional instruction in each subject area shown to be deficient and consider the applicant competent to pass the test.

Last \_\_\_\_\_ Initial \_\_\_\_\_ Cert. No. \_\_\_\_\_ Type \_\_\_\_\_  
(Print clearly)

Signature \_\_\_\_\_

FRAUDULENT ALTERATION OF THIS FORM BY ANY PERSON IS A BASIS FOR SUSPENSION OR REVOCATION OF ANY CERTIFICATES OR RATINGS HELD BY THAT PERSON.

ISSUED BY: ADMINISTRATOR  
FEDERAL AVIATION ADMINISTRATION

**Figure 1-4. Sample Airman Knowledge Test Report.**

oral and practical test. Any parachute rigger, senior or master, who wishes to add additional ratings to his/her certificate, needs to take only a practical test for the type rating sought. No additional knowledge test is necessary.

**RETESTING**

If the applicant fails the knowledge test, he/she may retake the test under the following conditions:

An applicant may apply for retesting by presenting his/her failed test report-

- (a) 30 days after the date the applicant failed the test; or
- (b) before 30 days have expired if the applicant presents a signed statement from an airman holding the certificate and rating sought by the applicant, certifying that the airman has given the applicant additional instruction in each of the subjects failed and that the airman considers the applicant ready for retesting.

I. UNITED STATES OF AMERICA DEPARTMENT OF TRANSPORTATION – FEDERAL AVIATION ADMINISTRATION						III. CERTIFICATE NO. 800690402
ii. <b>TEMPORARY AIRMAN CERTIFICATE</b>						
THIS CERTIFIES THAT						
iv. MARTIN HOFFMANN						
v. 4715 N. TUMBLEWEED RD, PO BOX 904 ELOY, AZ 85231						
DATE OF BIRTH	HEIGHT	WEIGHT	HAIR	EYES	SEX	NATIONALITY VI.
04-02-69	70 IN.	150	BLACK	BROWN	M	GERMANY
ix. has been found to be properly qualified and is hereby authorized in accordance with the conditions of issuance on the reverse of this certificate to exercise the privileges of						
SENIOR PARACHUTE RIGGER						
RATINGS AND LIMITATIONS						
xii. BACK ONLY						
xiii. SEAL SYMBOL: TOT						
THIS IS <input checked="" type="checkbox"/> AN ORIGINAL ISSUANCE <input type="checkbox"/> A REISSUANCE OF THIS GRADE OF CERTIFICATE				DATE OF SUPERSEDED AIRMAN CERTIFICATE		
BY DIRECTION OF THE ADMINISTRATOR				EXAMINER'S DESIGNATION NO. OR INSPECTOR'S REG. NO.		
x. DATE OF ISSUANCE		x. SIGNATURE OF EXAMINER OR INSPECTOR		526980680		
10-13-00		Toni B. Frost TONI B. FROST		DATE DESIGNATION EXPIRES		
				10-31-01		
vii. AIRMAN'S SIGNATURE <i>Martin Hoffmann</i>						
FAA Form 8060-4 (8-79) USE PREVIOUS EDITION						

Figure 1-5. FAA Form 8060-4—Temporary Airman Certificate.

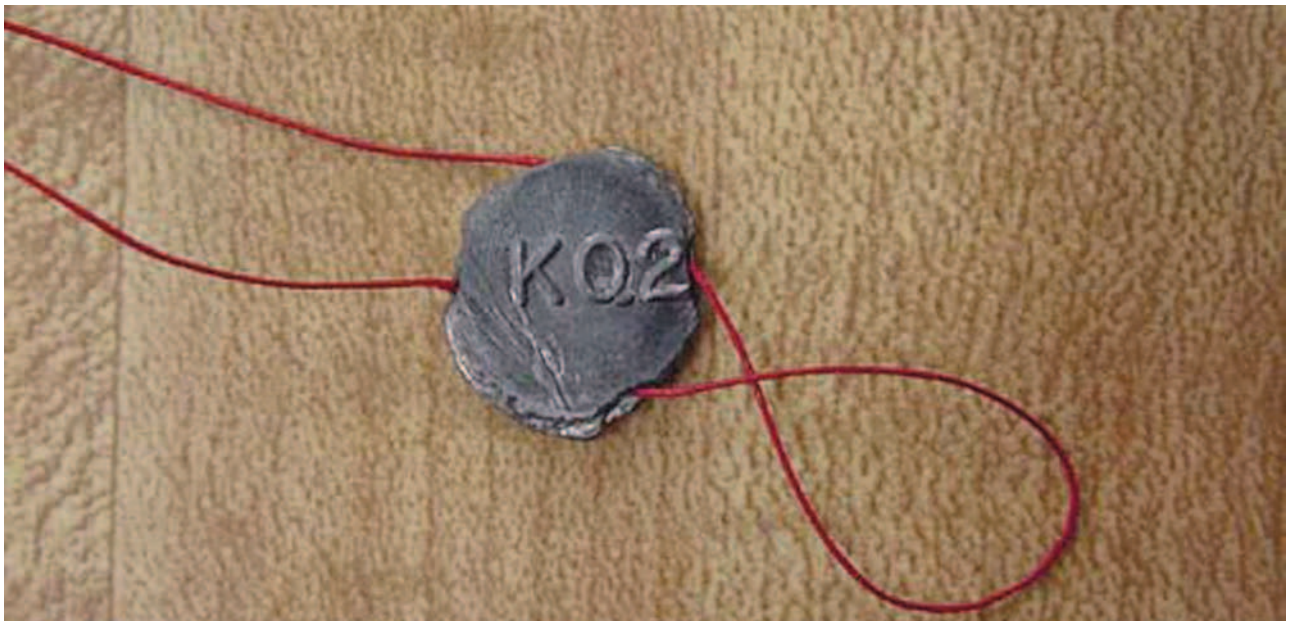


Figure 1-6. Parachute Rigger's Seal.

It is also possible for candidates who pass the test, but receive a marginal score, to retake the test with the anticipation of getting a higher score. In this case, the candidate must wait a minimum of 30 days from the date the last test was taken to retake a passed test. Prior to retesting, the individual must give his/her current airman test report to the proctor. The most recent test taken will reflect the official score.

## RESPONSIBILITIES OF A CERTIFICATED PARACHUTE RIGGER

Parachute riggers have a broad range of responsibilities that include facilities and equipment, performance standards, records, and use of their seal. The following describes the responsibilities of a certificated parachute rigger.



## FACILITIES AND TOOLS

Issuance of a parachute rigger certificate is just the first step toward becoming a professional parachute rigger. As the uncertificated person gains experience packing, he or she should also begin to acquire an inventory of tools and manuals necessary to exercise the privileges of a certificate. In compliance with 14 CFR, section 65.127, there are several items necessary before the parachute rigger can exercise the privileges of his/her certificate. One of these requirements is a smooth table top that is at least 3 feet wide by 40 feet long; however, this is necessary only if the parachute rigger is going to pack round parachutes. With square reserve parachutes gaining widespread use in the skydiving community in recent years, some parachute riggers are specializing in packing only square reserve parachutes. A table can be used for packing this type of parachute, but the manufacturer may specify any smooth, clean surface with a size that accommodates the canopy. In this case, a clean, carpeted floor will do the job and a table may not be necessary. According to 14 CFR, subsection 65.127(b), the parachute rigger needs suitable housing that is adequately heated, lighted, and ventilated for drying and airing parachutes. This is subject to interpretation by the parachute rigger and the Administrator since the standards fluctuate based on location and time of year.

A parachute rigger must have enough tools and equipment to pack and maintain the types of parachutes for which he/she is rated to service. This may include only the basic tools of a packing fid, temporary pin, and pull-up cord if this is all that the manufacturer says is necessary to pack its product. However, there is a broad selection of tools necessary for a well-equipped parachute rigger to possess. These are covered in detail in Chapter 6—Hand Tools, Sewing Machines, and the Parachute Loft.

## PERFORMANCE STANDARDS

A number of **performance standards** are defined in 14 CFR, section 65.129 to guide the parachute rigger's performance of the duties that fall under the certificate. The parachute rigger may not:

- Pack, maintain, or alter any parachute unless he/she is rated for that type.
- Pack a parachute that is not safe for emergency use.
- Pack a parachute that is not thoroughly dried and aired.
- Alter a parachute in a manner not specifically authorized by the Administrator or the manufacturer of the parachute.

The last item in this list is one that has been abused by many master parachute riggers over the years. The master parachute rigger must have Administrator or manufacturer approval, in writing, to be in compliance with this regulation.

Aside from the necessary tools, 14 CFR, subsection 65.129(f) states that parachute riggers may exercise the privileges of the certificate only if they understand the current manufacturer's instructions for the operation involved. This means that parachute riggers must possess a copy of the instructions or have access to them during the operation. If they do not have a copy, but the owner of the parachute provides them, then the parachute rigger may pack or maintain the parachute.

A variation on this theme is accessing the packing instruction via the Internet. Many manufacturers provide manuals via their Web sites. If the parachute riggers do not download the actual instruction, they must show that they had access during the packing of the parachute. For example, a laptop computer may not have a printer attached, but could still meet this requirement.

Parachute riggers are not necessarily required to download the instructions to a hard drive or disk as long as they are able to access the manual in real time. However, if a problem is identified with the parachute rigger's pack job at a later date, the parachute rigger would need to prove to the Administrator that he/she had access to the instructions. Without a hardcopy or downloaded computer files, it would appear that the parachute rigger had not met the rule requirement.

## CURRENCY REQUIREMENTS

Once an individual obtains a parachute rigger certificate, it is valid for life unless surrendered, suspended, or revoked. If the individual intends to work as a parachute rigger and not just have the certificate, it is necessary that he/she maintains currency as a practicing parachute rigger. These currency requirements include at least one of the following.

- Performing parachute rigger duties for at least 90 days within the preceding 12 months.
- Demonstrating to the Administrator the ability to perform those duties.

## RECORD KEEPING

Maintaining proper records of parachute rigger activities is an important responsibility. This is necessary for the protection of the parachute rigger, the user of the parachute, and the satisfaction of the Administrator. Under 14 CFR, section 65.131, certificated parachute riggers must document the packing, **maintenance**, and **alteration** of parachutes they have performed or supervised. These records normally are documented in a parachute rigger's **logbook**. The following information must be documented:

- Parachute type and make.
- Serial number.
- Name and address of the owner.

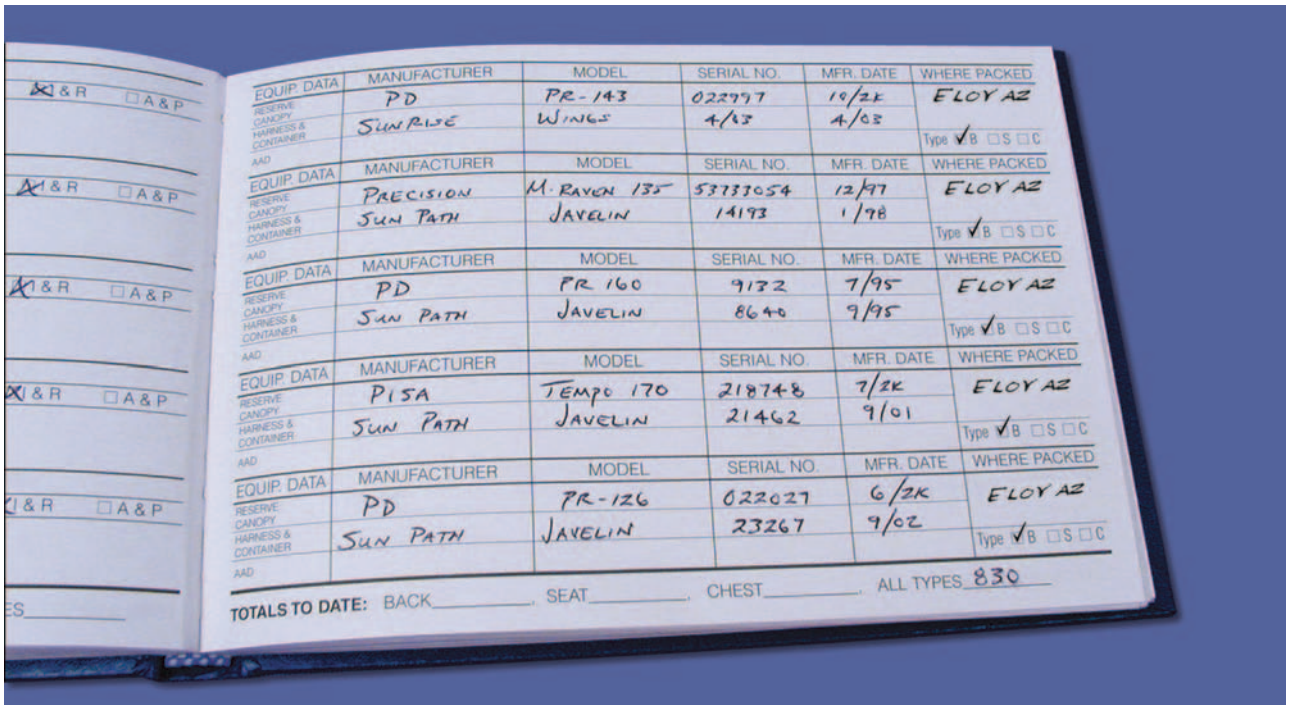


Figure 1-7. Parachute Rigger Logbook Page.

- Kind and extent of work performed.
- Date and location of work performed.
- Results of any drop tests.
- Date and location of packing.
- A notation of any defects found on inspection.
- Parachute rigger certificate number.
- Parachute rigger name and signature.

These records must be kept for a minimum of 2 years. Figure 1-7 shows a sample of a logbook page. In addition, each parachute rigger must note on the parachute packing record or data card [Figure 1-8] the following information.

While not required on the data card, it has become commonplace for the parachute rigger to note the work performed as well. This is usually noted as A & P for

DATE		LOCATION	SIGNATURE & CERTIFICATE NUMBER OF RIGGER
SEPT 1 2008		ELOY AZ	SANDY RIGGERS #2105206
WORK PERFORMED / REMARKS INSPECT & REPACK			
DATE	LOCATION	SIGNATURE & CERTIFICATE NUMBER OF RIGGER	
DATE	LOCATION	SIGNATURE & CERTIFICATE NUMBER OF RIGGER	
DATE	LOCATION	SIGNATURE & CERTIFICATE NUMBER OF RIGGER	
DATE	LOCATION	SIGNATURE & CERTIFICATE NUMBER OF RIGGER	
DATE	LOCATION	SIGNATURE & CERTIFICATE NUMBER OF RIGGER	
DATE	LOCATION	SIGNATURE & CERTIFICATE NUMBER OF RIGGER	

**PARACHUTE LOGBOOK & DATA CARD**

This log should be kept with the parachute assembly at all times. When it becomes full, it should remain with the assembly or stored in a secure place. The owner should keep a photocopy of this page in the event the parachute is lost or stolen.

**OWNER INFORMATION:**

NAME: JOE SMITH  
 STREET or P.O. BOX: 123 MAPLE DR.  
 CITY, STATE, ZIP or PROVINCE, POSTAL CODE: MIDDLETOWN MA 00010  
 TELEPHONE: 413-555-1212

**EQUIPMENT INFORMATION:**

RIGGING INNOVATIONS TALON T5  
HARNES & CONTAINER MANUFACTURER & MODEL  
21512      MAY 2002  
HARNES & CONTAINER SERIAL NUMBER & DATE OF MANUFACTURE  
 PRECISION AERODYNAMICS SUPER RAVEN150  
AUXILIARY / EMERGENCY CANOPY MANUFACTURER & MODEL  
29218222      AUG 1998  
AUXILIARY / EMERGENCY CANOPY SERIAL NUMBER & DATE OF MANUFACTURE  
 AIRTEC CYPREG  
AUTOMATIC OPENER (AAD) MANUFACTURER & MODEL, IF ANY  
50D017325DC822-ZX      JULY 1998  
AUTOMATIC OPENER (AAD) SERIAL NUMBER & DATE OF MANUFACTURE

**WARNING!**  
 USE OF THIS PARACHUTE MAY RESULT IN SERIOUS INJURY OR DEATH. PARACHUTES SOMETIMES MALFUNCTION, EVEN WHEN PROPERLY CONSTRUCTED, PACKED AND USED. READ ALL INSTRUCTIONS AND MANUALS PRIOR TO DONNING. SOME COUNTRIES HAVE REGULATIONS REGARDING THE MAINTENANCE AND USE OF PARACHUTES.

Figure 1-8. Parachute Packing Record or Data Card.

assemble and pack or I & R for inspect and repack. Professional parachute riggers often use an ink stamp on the data card that indicates name, certificate number, seal symbol, and provides an area for signature. This allows the customer or other parachute riggers to read the name (some signatures are illegible) and to correlate the last entry with the seal on the parachute.

### SEALING THE PARACHUTE

As noted previously, each certificated parachute rigger is issued a seal symbol with which each parachute is sealed once he/she packs it in a manner prescribed by the manufacturer. This ensures that no one tampers with the parachute and the owner knows that it is ready for use.

## REGULATORY COMPLIANCE

As with other airman certificates, there are additional parts of 14 CFR that are of direct concern to the parachute rigger in addition to those already mentioned. It is important that the parachute rigger have a thorough understanding of these parts in order to avoid any inadvertent non-compliance: 14 CFR parts 1, 21, 39, 91, 105, and 183.

### 14 CFR PART 1—DEFINITIONS

This part provides legal definitions for words and abbreviations under this title. One of the more important terms in this part is that of the Administrator. The Administrator is the administrative head of the Federal Aviation Administration or any employee of the Federal Aviation Administration to whom authority has been delegated. The parachute rigger is most likely to come in contact with two individuals who may act on the Administrator's behalf.

The first is the Aviation Safety Inspector from the local Flight Standards District Office (FSDO) or International Field Office (IFO). This employee of the Federal Aviation Administration is responsible for enforcement of the Code of Federal Regulations in aviation matters. The Aviation Safety Inspector (airworthiness type) has jurisdictional responsibility in such matters as: compliance with the rule, approving data for major repairs or alterations, investigation of accidents, overseeing airshows and demo jumps, or any aviation related matter.

The second is the local Designated Parachute Rigger Examiner (DPRE). This private person is empowered to conduct practical tests for the Administrator.

### 14 CFR PART 21 SUBPART O—TECHNICAL STANDARD ORDERS (TSO)

A **Technical Standard Order** (TSO) is issued by the Administrator and is a minimum performance standard for specified articles, such as parachutes. It is important that the parachute rigger understand the TSO process and the various levels of TSO approval under which parachutes are manufactured. Every parachute rigger

should read and become familiar with the technical standard orders for parachutes, the 23 series (C23b, C23c, C23d). This is important to the parachute rigger in determining certification compatibility when he/she is assembling approved components.

### 14 CFR PART 39—AIRWORTHINESS DIRECTIVES

This part specifically deals with **Airworthiness Directives (ADs)**. An AD is an amendment to the Code of Federal Regulations. An AD must be complied with before using an affected product. In the case of a parachute, when:

- an unsafe condition exists in a product.
- the condition is likely to exist or develop in other products of the same type or design.

Under 14 CFR part 39, “No person may operate a product to which an airworthiness directive applies except in accordance with the requirements of that airworthiness directive.”

In recent years, there have been a number of parachute ADs issued by the Administrator. These ADs prescribe certain actions to be taken by the parachute rigger in order to ensure the safety and function of parachutes that have been found in some manner to be defective. If the parachute rigger does not comply with the AD, the parachute rigger cannot pack, maintain, or alter the affected parachute. ADs are mailed to each certificated parachute rigger on the FAA listing. If the parachute rigger has moved and not complied with the requirements for an address change, the rigger may not receive the AD. This introduces an additional problem. Under 14 CFR part 65, subpart A—General, section 65.21, airmen must register their change of address within 30 days of moving or they are not able to exercise the privileges of their certificate.

### 14 CFR PART 91—GENERAL OPERATING AND FLIGHT RULES

Section 91.307 deals with parachutes and parachuting. This section defines an “approved parachute” and states the repack time for parachutes. Both of these are of vital interest to the parachute rigger.

### 14 CFR PART 105 SUBPART C—PARACHUTE EQUIPMENT AND PACKING

This part deals with the use of parachutes in the United States. The following areas are of interest to parachute riggers:

- Main parachutes used for intentional jumping must be packed by the person jumping or by a U.S. certificated parachute rigger.



- The auxiliary parachute must be packed by a certified and appropriately rated parachute rigger.
- If the parachute is made from synthetic materials, it must be packed within 120 days of its use. If it is made from materials subject to mold or **mildew**, then it must be packed within 60 days of use.
- If a main static line is used, it must meet certain requirements as to its use and configuration.
- An approved parachute is defined as a parachute manufactured under a type certificate or a Technical Standard Order (C-23 series), or a personnel-carrying U.S. military parachute (other than a high altitude, high speed, or ejection type) identified by a Navy Air Facility, an Army Air Field, and Air Force-Navy drawing number, an Army Air Field order number, or any military designation or specification number.

## RIGGING ETHICS

As parachute riggers gain additional experience, they are occasionally faced with situations that involve less than ideal circumstances. Some examples are: if a new jumper purchases old or damaged equipment that may or may not be airworthy, or if a pilot purchases an acrobatic plane that has a parachute that is far too small for his/her weight. These situations involve more than just the technical knowledge for a parachute rigger certificate.

In the case of the pilot above, depending on which TSO the parachute is certified, there may be a weight and speed limitation for the system. For example, TSO C23c category B has a limitation of 254-pound exit weight and a speed limitation of 150 knots. Imagine a pilot who weighs 225 pounds and his airplane regularly exceeds the 150-knot envelope during maneuvering. If this pilot brings a parachute to a parachute rigger for repacking, the first thing the parachute rigger should notice is the size of the pilot. When the parachute rigger inspects the parachute, he notices that it has a 22-foot diameter round canopy. The parachute rigger finds that with the pilot at 225 pounds, his clothes at 5 pounds, and the parachute at 20 pounds, he is at 250 pounds or just under the limit. However, in looking at the owner's manual, the parachute rigger cannot find any information in the weight-carrying limit of the canopy. In addition, this particular parachute was made by a company that is no longer in business. The parachute appears to be in good condition visually but is 30 years old. In this situation, the parachute rigger is faced with a number of questionable areas that are detailed below.

## CERTIFICATION SPECIFICATIONS

The practical circumstances surrounding the above pilot's use of the parachute is at the maximum limits of the certification specifications of the parachute. If he does not eat a big breakfast or gain much weight before using the parachute, he might stay under the weight limit. The speed limitation will probably be exceeded on a regular basis during acrobatic maneuvers. If he needs to use the parachute at some point, there should be enough of a safety margin built into the design and testing of the parachute to be sufficient.

## PILOT VS PARACHUTE SIZE

With 250 pounds under a 22-foot diameter canopy, the pilot probably will drop from the sky at an excessive **rate of descent**. A common assumption in this situation is that it is unlikely he will need to use the parachute, but if he does, will it save his life?

## PARACHUTE SERVICE LIFE

There is no service life on the parachute; it may be considered airworthy as long as it meets its technical standard order. While the parachute appears to be in good condition, there are not many non-destructive tests available to the parachute rigger in the field to make this determination. It may be possible to drop test the parachute, but the cost would probably outweigh the value of the system. It is up to the parachute rigger to make the determination as to the airworthiness of the parachute system. When the parachute rigger seals the parachute and signs the data card, the rigger is saying it is ready, thereby putting the customer's life on the line.

What should the parachute rigger do? This is not just a theoretical situation—it is one that has been experienced many times by many parachute riggers. All of the above information plus economic factors complicate the parachute rigger's decision. If the rigger does not pack the parachute, the pilot may take it down the road to another parachute rigger for a second opinion who may not have the same standards. An added factor is liability exposure. If the parachute rigger signs off on a questionable parachute and an accident occurs later, the rigger may be exposed to disciplinary action from the Administrator in addition to civil action in the courts. There are no hard and fast rules in these situations, but instead, the parachute rigger must exercise the best judgment the rigger can summon based on experience and the information at hand.

Most professional parachute riggers would refuse to pack the parachute described in the scenario above, due to a combination of age, the size of the individual, and the potential use parameters.





It is important for the aspiring rigger to understand basic design parameters and construction techniques of modern parachute systems. The master rigger must have a thorough understanding of these areas to perform any desired or necessary alterations. An understanding of how the systems or components were originally designed, and why they were constructed as they were, is essential. Any proposed alteration may degrade the function and/or structural integrity of the assembly or component, thereby causing it to fail.

The design parameters for certificated parachutes are set forth in Federal Aviation Administration (FAA) documents, specifically within the Technical Standard Order (TSO) system. Parachute certification standards fall within the TSO C23 series. Currently, there are three TSO documents under which parachutes are manufactured. They are C23b, C23c, and C23d. Appendix I explains these standards in detail. Military parachutes are manufactured and certified under a military drawing system; however, some manufacturers have certified them under the TSO system as well.

## COMPONENT PARTS

Parachute assemblies and component parts are identified in the following discussion. The appropriate nomenclature, as well as the commonly accepted names, are defined below.

### MAIN PARACHUTE

The **main parachute** assembly, excluding the harness, is used in conjunction with a reserve parachute assembly as the primary parachute assembly for a premeditated jump. The main canopy consists of everything from the main riser connector links to the bridle attachment point (excluding the steering toggles). The major parts are the suspension lines and the canopy, as shown in figure 2-1.

### RESERVE PARACHUTE

The **reserve parachute** is worn in conjunction with a main parachute used for premeditated jumps. The reserve parachute consists of everything from the reserve riser connector links to the bridle attachment point (excluding the steering toggles). The major parts are the canopy, **suspension lines**, and any type of deployment device that is sewn to the canopy or lines.



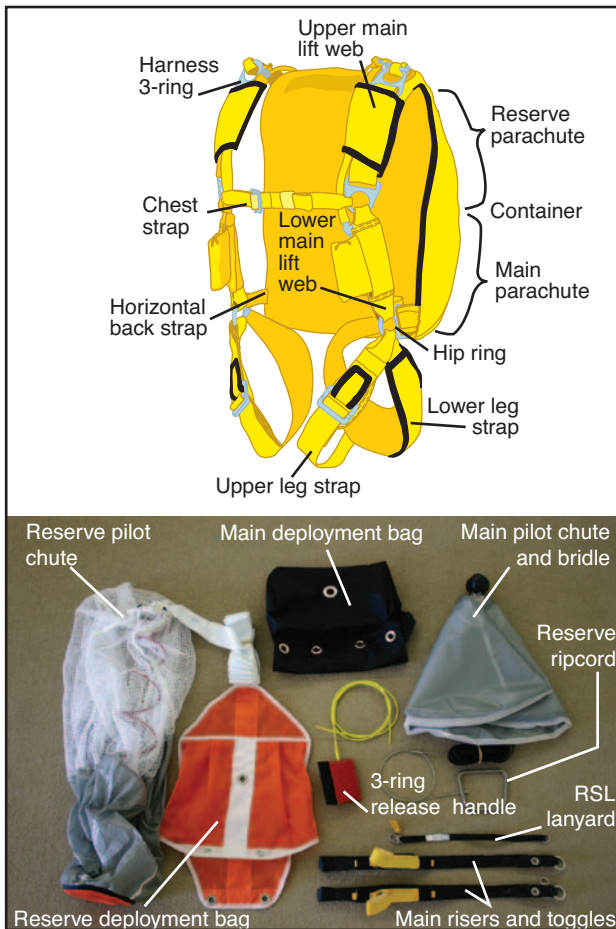
Figure 2-1. Component parts of a main parachute assembly.

### EMERGENCY PARACHUTE

The **emergency parachute**, excluding the harness, is worn for emergency, unpremeditated use only. The canopy may be identical to the reserve parachute.

### HARNESS/CONTAINER

The harness and container assembly includes all the remaining parts necessary to complete an airworthy parachute system except for the canopies. The basic harness/container assembly is what remains when all items that can be removed without unstitching have been removed. Most sport parachute assemblies have the harness and containers integrated into one assembly, but many military assemblies may be disassembled into separate harness and container subassemblies. The following



**Figure 2-2. Subcomponents of the harness/container assembly.**

items are subcomponents of the harness/container assembly and are shown in figure 2-2.

### PILOT CHUTES AND BRIDLES FOR THE MAIN AND RESERVE PARACHUTES

The **pilot chute** is a small parachute or similar device, which enters the airstream when released to act as a drag device and withdraw the canopy from the container. As such, it maintains tension on the canopy and lines during the **deployment** process. Pilot chutes are either spring-loaded or manually thrown into the airstream as a “hand deployed” pilot chute. Some military or emergency pilot chutes are ballistically deployed. A bridle is a piece of line or webbing that connects the canopy or deployment device to the pilot chute.

### RIPCORDS OR EQUIVALENT DEVICES FOR THE MAIN AND RESERVE PARACHUTES

The **ripcord** is a device for securing the container closed prior to use. It usually consists of a handle, a flexible cable, one or more pins, and a device for securing the cable to the handle. Some modern ripcords use a stiffened cable instead of a pin.

### DEPLOYMENT DEVICES FOR THE MAIN AND RESERVE PARACHUTES

**Deployment devices** are designed to provide an orderly and controlled deployment of the parachute during use.

Typical devices include bags, sleeves, pockets, straps, and sliders.

### MAIN PARACHUTE RELEASE MECHANISM AND ASSOCIATED HANDLES OR STATIC LINES

The main parachute release mechanism has two parts. One part is attached to the harness and the other to the risers. These types may utilize a separate release handle. In addition, the reserve may employ a static line to activate it.

### RISERS, MAIN OR RESERVE, WHEN NOT INTEGRAL WITH THE HARNESS OR CANOPY, AND THEIR ASSOCIATED STEERING TOGGLES

**Risers** are part of the suspension system between the lines and the harness or load. Generally made of webbing, emergency parachutes usually have the risers integral to the harness. Risers used on sport or military systems used for intentional jumping have release mechanisms installed. Steering **toggles** are usually design specific to the riser for the type of canopy installed.

### OTHER HARNESS/CONTAINER ASSEMBLY COMPONENTS

Other components designed to function as part of the harness/container assembly, such as **closing loops**, also may be used. Closing loops used with automatic activation devices (AADs) on reserve or emergency parachutes are usually design specific to ensure proper operation of the system.

## TSO STANDARDS

The original TSO C23b for parachutes came into existence in 1949. The specifications were revised in 1984 to C23c and again in 1994 to C23d. The TSO is a simple two-page document that specifies the requirements for certification. This document also references a performance standard that the parachute must meet. C23b parachutes were tested to standards under National Aircraft Standards Specifications **NAS-804**. When the TSO was revised in 1984, the specification document was drafted under the auspices of the Society of Automotive Engineers (SAE) S-17 committee as Aerospace Standard AS-8015. When the TSO was revised again in 1994, the revised document became AS-8015b with the original as AS-8015a. Figure 2-3 is a table showing the pertinent points of each of the TSO certifications. For a more thorough study of the documents, refer to Appendix I.

The TSO system consists of two parts. The first is the performance standards listed above. This ensures that the parachute will perform as specified. The second is the production approval, which ensures that the manufacturer is able to produce the parachute as designed and tested. While minor design changes are allowed, any major design change must be submitted to the FAA for approval



TSO DOCUMENTS					
TSO Number	C23b		C23c		C23d
Performance Standard	NAS-804		AS-8015a		AS-8015b
Effective dates	1949-1984		1984-1994		1994-Present
Performance Specifications	Low Speed	3000 lb	Category A	Wt: 300 lb Speed: 150 kts	Variable- Maximum operating weight x 1.2 Maximum operating speed x 1.2
	Standard Category	5000 lb	Category B	Wt: 300 lb Speed: 175 kts	
			Category C	Wt: 300 lb Speed: 230 kts	
Placard Limitations	Low speed	3000 lb	Category A	Wt: 198 lb Speed: 130 kts	Placard with average peak force measured during the strength drops.
	Standard Category	5000 lb	Category B	Wt: 254 lb Speed: 150 kts	
			Category C	Wt: 254 lb Speed: 175 kts	
Number of drop tests	28		68		68

Figure 2-3. TSO comparisons.

before implementation. A major change is any that will affect the fit, form, or function of the parachute.

For the aspiring rigger, the primary purpose of knowing the TSO system is determining the compatibility of components when assembling the parachute system. This is necessary in order to ensure that, besides fitting together properly, the performance standards are compatible. Under Advisory Circular (AC) 105-2—*Sport Parachute Jumping*, “the assembly or mating of separately approved components may be made by a certificated and appropriately rated parachute rigger or parachute loft in accordance with the manufacturer’s instructions and without further authorization by the manufacturer or the FAA.” Under these guidelines, there are certain parameters that must be met. One of them is to ensure that “the strength of the harness must always be equal to or greater than the maximum force generated by the canopy during the certification tests.” Full knowledge of the TSO documents ensures that the above requirements are met.

## CANOPY DESIGN

Accomplished design skills are not necessary for the rigger to properly service parachutes. The skills involved to become a designer can take several years of training and practice. It is necessary, however, that the rigger understands some of the basic concepts to relate the performance characteristics to the design theory of the components involved. For the average rigger, these concepts are accepted as those proven and tested in the finished product. The following are specific areas that the rigger should understand to determine the identity, function, and assembly of parachute components and their interaction.

## NOMENCLATURE

All riggers should become familiar with Parachute Industry Association (PIA) Technical Standard 100 (TS-

100), *Standardized Nomenclature for Ram-Air Inflated Gliding Parachutes* (See Appendix I). This document is the official language and terminology used for **ram-air parachutes**. It specifies the parts of the parachute, the various construction methods, and the seam configurations used. This is necessary for the rigger to understand the manuals and repair procedures provided by the manufacturers for their products.

Figure 2-4 identifies the components of a typical round emergency parachute. The nomenclature of this design

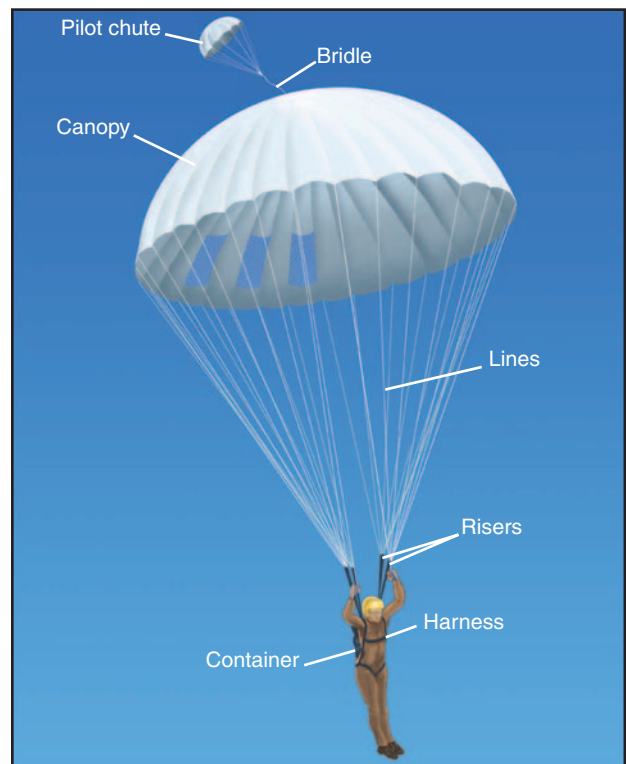


Figure 2-4. Round parachute assembly.

has remained constant for several decades with a few exceptions. While some riggers who skydive think that the square parachute has replaced it, the round parachute still has many uses and in certain instances fulfills some mission requirements better than the square. Poynter's Parachute Manual, Volume 1, Chapter 8, provides an excellent discussion of the design parameters and characteristics of round parachutes for those needing more technical background.

## CONSTRUCTION CONCEPTS AND TECHNIQUES

TS-100 describes the various ram-air construction methods such as half-cell chordwise, full-cell "I" beam chordwise, full-cell interlocking "T" chordwise, and spanwise configurations. When learning the various construction methods, the beginning rigger can become confused as to how the **seams** are folded together. Seeing the schematic diagrams of the various configurations can help in the repair sequence.

Round parachute construction is divided into two primary techniques: bias and block construction. **Bias construction** is most prevalent in the early parachutes and military designs. It is generally the stronger of the two techniques due to its ability to stretch more during opening. In bias construction, the fabric is cut and sewn so that the **warp** and filler threads are at 45 degrees to the centerline of the gore. A typical example is the 28' C-9 canopy.

**Block construction** is where the warp threads of the panels are parallel to the hem of the canopy. Block construction gained in popularity in the lightweight sport reserves of the 1970s and 1980s. They were easier to build and packed smaller. An example of this design is the Phantom/Aerostar canopies, manufactured by National Parachute Industries, Inc.

## OPERATIONAL THEORY

The rigger must have knowledge of how the parachute functions. Without this, the rigger may not be able to assemble the correct components so that they function as a complete assembly. While the manufacturer may specify what components are to be used with their particular design, with the vast numbers of products on the market today, there are an infinite number of combinations being used by the skydiving community. While seeming to be compatible with each other, many designs have subtle differences that affect their performance and operation.

## MATERIALS

The materials used in construction have changed over the last several years. This has resulted in better performance and durability. The use of incorrect materials can have a detrimental effect on the opening, flying, and landing characteristics of the parachute. The growth in popularity of the ram-air canopies in the 1970s required new fabrics for the designs to function. Very low **permeability** fabric was necessary for the canopy to remain inflated and main-

tain the aerodynamic airfoil shape. To reduce the drag created by the suspension lines, newer lightweight, and high-strength materials were used. First Dacron®, followed by Kevlar®, and now Spectra® and Vectran®. While reducing the line bulk and drag, these materials have introduced newer problems into the designs.

The ultra-low permeability fabrics inflate faster, and have almost zero stretch. As a result, the opening forces increase considerably. These effects have contributed to newer packing and deployment methods to reduce the loads on the parachutist and harness. These, in turn, affect the design of the container systems. Using this as an example, the rigger can see the chain of cause and effect in the design process. Complete coverage of materials is presented in chapter 3 of this handbook.

## DAMAGE

Damage patterns identified during the inspection of canopies can highlight problems caused from packing or incorrect use. By being able to identify these patterns, the rigger can provide the user with correct technique and, thereby, prevent possible injury or death. In addition, the rigger can provide valuable feedback to the manufacturer of potentially serious problems with new designs once they have been subjected to real world conditions. While manufacturers conduct extensive testing programs before



Figure 2-5. Conventional containers.



Figure 2-6. Piggyback containers.

releasing new products to the market, very often, subtle problems do not arise until the parachute has been in the field for an extended period of time.

## CONTAINERS

The **container** component assembly of the parachute system is that part which encloses the canopy(s) and lines, the deployment device if used, and the pilot chute. It is held closed by the use of **cones** or loops, which are secured by **ripCORD pins** or **locking pins** such as are used on hand deploy systems. Containers may consist of single units as are used on pilot emergency systems, or multiple units such as are used on skydiving piggyback systems. The term “**pack**” is used interchangeably with container. The harness and container assembly may be called the pack and harness. The term “**packtray**” is used to refer to the bottom panel or **section** of the container where the lines may be stowed during packing.

Early containers were simply a bag-shaped unit that the canopy was stuffed into and then tied closed. The parachute was **static line** deployed and the parachutist simply fell away from the balloon or aircraft allowing the canopy to deploy. With the advent of manually deployed free fall systems, the need for a more secure and tailored design became evident.

Originally, the parachute systems were identified by the position at which they were located in relation to the body



Figure 2-7. Tandem container system.

of the user. These were the **back parachute**, **seat parachute**, **chest parachute**, and **lap parachute**. The containers were usually rectangular in shape with four closing flaps. These configurations were primarily dictated by the need to fit the assembly into the cockpit of the aircraft.

With the growth of **skydiving**, the container configurations and the associated terminology changed. The original location of the main parachute on the back and the reserve on the chest became known as the “conventional” configuration. [Figure 2-5] The original tandem configuration with both the main and reserve on the back became known as a “**piggyback**” [Figure 2-6], and the introduction of a two-person parachute system became the new “**tandem**.” [Figure 2-7]

## CONFIGURATION

When canopies were packed into early bag-type containers, they always wanted to assume a spherical or round shape. For the container to remain flat, it was necessary to tailor the fabric and then use frames or bow stiffeners to keep it flat and compress the pilot chute. Back designs utilized multiple cones and pins, usually three or four to maintain the length and width. Seat containers were usually more square and thicker since they were held in place by the seat pan. Most use two cones and pins for closing. The same was used for chest and lap



parachutes. Many military systems still utilize these basic configurations today.

With the introduction of skydiving in the 1960s, most equipment was of modified military designs, and the first generation of commercial products were simply colored versions of these designs. In the 1970s, skydiving canopies had progressed to ram-air designs, which were smaller in volume and had different deployment requirements. Container designs evolved to meet these requirements. The introduction of the hand deploy pilot chute was probably the most influential concept in the evolving container design. Cones were replaced by fabric closing loops, and main ripcords and pins were replaced by hand deploy bridles and locking pins. It was no longer necessary to compress the spring-loaded pilot chute inside the container. Thru closing loops were used to compress the pack and make it thinner to conform to the body shape. The use of **deployment bags** and other devices helped provide shaping to the container. This was true for both square and round canopies.

Today, most modern container designs have completely done away with frames and bow stiffeners. This has resulted in smaller, more flexible, more comfortable, and more efficient container designs. Instead of metal stiffeners, nylon plastic is used to reinforce the container flaps for backing the grommets. The nylon is lighter, easier to work with, and cheaper. Many of the modern military



Figure 2-8. Modern military container.

designs now follow the design concepts pioneered by the sport industry as they have proven better and more cost effective. Figure 2-8 shows the similarity to a sport piggyback system.

## MODERN DESIGN CONCEPTS

The containers of today do more than simply enclose the canopy and deployment device. Sport containers in particular need to be designed so that they contribute to the deployment needs of the specific parachute. Piggyback designs have separate requirements for the main and reserve containers.

The reserve container is generally small, tight, and mostly wedge-shaped. Virtually all popular sport systems are designed around the use of a ram-air canopy. The deployment method of choice is a Type 5 deployment bag. In the early days of the ram-air reserve, there were certain container design requirements specified by the manufacturer. These were:

1. A hesitator loop configuration secures the bridle and holds the bag in until the reserve pilot chute is deployed and under drag. [Figure 2-9]

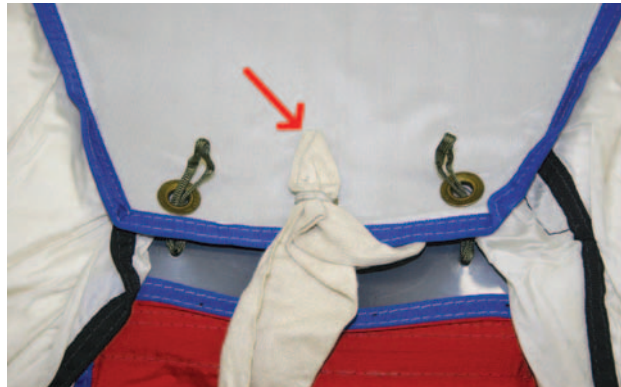


Figure 2-9. Square reserve hesitator loop configuration.

2. Nonrestrictive corners to allow the bag to be lifted off by the bridle in the event of a horseshoe-type malfunction. [Figure 2-10]



Figure 2-10. Nonrestrictive container corners.



These requirements were adhered to for many years. Today, containers achieve the required holding and deployment needs through design tailoring. The bottom corners of the reserve container are designed so that the bag is held in place while the pilot chute and bridle deploy and then releases the bag to the airstream. At the same time, the bag can still deploy quickly in the event of a horseshoe-type malfunction.

The main container is less restrictive than the reserve in holding the main canopy in place during deployment. This is important so that there is no tendency for the bag to twist or be unstable on deployment. With many of the main canopies used today, if the bag is unstable, it results in the main canopy opening unevenly and causing spins and possible malfunctions. Along with the main bag, the main risers must be able to deploy evenly for the same reasons.

In the early days of skydiving, the primary body position was a stable, face-to-earth position. This resulted in the main container being behind the parachutist out of the airflow. One of the primary problems faced during those days was the high incidence of pilot chute hesitations. This was the result of the container designs and the relatively poor performance of the available pilot chutes. The advent of the hand deploy pilot chutes reduced the incidence of hesitations.

In the face-to-earth position, the primary purpose of the container is to hold the canopy and pilot chute closed and then allow it to open during deployment. Today, body positions experienced during **free fall** range from head-down to feet-to-earth and everything in between. Where speeds formerly experienced ranged from 110 mph to maybe 140 mph, today speeds in a head-down position can exceed 200 mph. This has changed the container dynamics to ensure a more secure system and increased protection from the wind blast. These changes have resulted in more secure and streamlined configurations to accommodate these new requirements. Figure 2-11 shows a modern container design shaped to meet the high-speed airflows of today.

An additional area that needs to be addressed when designing piggyback systems is the main riser covers. In the early days of sport piggyback designs, the main risers were held in position by webbing keepers. As the sport progressed, the use of fully enclosed main riser covers became the norm. In their attempt to protect the main risers during high-speed free fall, some designs tend to restrict the deployment of the reserve container in the event of a “total” main pack **malfunction**. When this happens and the main container remains closed, the main riser covers do not open. Because of this, there is additional restriction over the upper corners of the reserve container. This contributes to higher reserve bag release forces when deployed. In severe cases, this can result in a



Figure 2-11. Voodoo™ container profile.

reserve pilot chute in tow with potential serious consequences. The balance between sufficient main riser protection and the need for full reserve deployment freedom can be an important design feature.

## HARNES DESIGN

According to Poynter’s Parachute Manual, “the **harness** is an arrangement of cotton, linen, nylon, or Dacron® webbing, which is designed to conform to the shape of the load (usually the body) to be carried in order to secure it properly so that the opening forces and the weight of the load are evenly distributed during opening and descent.”

The earliest harness was nothing more than a swing seat that the parachutist sat on and then held onto the risers or suspension straps. It soon became apparent that if the openings were anywhere uneven, it could be very precarious for the parachutist. While the sling seat worked for the ride down, it was necessary to add additional straps to secure the parachutist. These straps included the leg, back, and chest straps. The standard harness configuration is equipped to secure a torso, head, arms and legs with straps. Others have been added over time



Figure 2-12. Military harness.

for additional purposes such as survival kits or cushions. Figure 2-12 shows a basic military style harness. This harness configuration has seven points of adjustment to allow fitting of most military personnel.

Most of the early parachute systems had the harness detachable from the containers. This allowed interchangeability for various models. In the 1970s, skydiving systems began to integrate the harness into a true harness/container assembly. This was accomplished by sandwiching the harness between the container and **backpad** and sewing them together. Figure 2-13 shows one of the earliest custom systems called the “Super Swooper.” This harness was the precursor of today’s sport harnesses.

As skydiving and the sport parachute industry has grown, most of the equipment is now custom-built for each individual. The standard piggyback harness configuration of today is a fixed main **lift web** with adjustments only at the chest and **leg straps**. [Figure 2-14] Elimination of the extra hardware and webbing has resulted in a dramatic reduction in weight of modern systems. Along with this has been an increase in comfort and flexibility. One of the most innovative designs adopted in recent years is the “articulated” harness. This design incorporates metal rings at the hip junction and the chest-strap attachment. [Figure 2-15] These rings allow a full range of motion



Figure 2-13. Super Swooper harness.



Figure 2-14. Standard piggyback harness.





Figure 2-15. Articulated harness configuration.

both in the air and on the ground and increase the fit and comfort of the harness. An added benefit is that this style of harness is stronger under high **shock loads**. This is due to the natural alignment of the webbing during the opening process. With a nonarticulated harness, the webbing junctions warp and load unevenly. [Figure 2-16] Because of this, point loading occurs, stitching breaks, and the junction can fail with disastrous results.

In recent years and with the increasing popularity of vertical skydiving or “freeflying,” greater speeds are experi-



Figure 2-16. Standard harness junction warping.

enced with corresponding higher loads on the harnesses. For many years, harnesses were overbuilt as they were basically copies of military designs. As the sport has progressed, equipment has been made lighter and smaller.

## BRIDLES AND DEPLOYMENT DEVICES

In the early days of parachutes, the lines and canopy were stowed in the container. During the deployment process, the canopy was extracted first, followed by the lines. This was known as a “canopy first” deployment. If the canopy inflated before tension was applied to the lines, a malfunction was highly likely. Over the years, it was learned that the deployment process needed to be controlled to prevent malfunctions.

At the start of the Second World War, with the advent of airborne paratroops, the main canopy was deployed from a **direct bag static line system**. In this system, the main canopy was packed in a bag, which was permanently attached to the static line. After deployment, the bag and static line remained with the aircraft. This system is still used today with some modifications. For emergency parachutes, the military adopted the “quarter bag” in the 1950s for use with high-speed emergency systems. [Figure 2-17] This was fairly complicated to pack but effective in controlling the parachute during opening.

In the early 1960s, the **sleeve** was developed and soon became popular for sport parachuting or skydiving. With the growth of skydiving and the increased use of the reserve parachute, it soon became obvious that the reserve parachute needed to be controlled more. In the mid 1970s, the two-stow diaper was developed for use with emergency and reserve parachutes. This design was soon followed by the three-stow **diaper** and the piglet-style diaper invented by Hank Ascuitto. During this time period, the deployment bag became the preferred method of deploying the increasingly popular ram-air or square canopies. In 1977, Para-Flite, Inc., introduced the first ram-air reserve canopy, which utilized the “**free bag**” deployment system. This design continues to this day virtually unchanged as the preferred method of deploying square reserve canopies.



Figure 2-17. Quarter bag.



Figure 2-18. Slider.

**Reefing** devices slow down and stage the opening sequences of canopies, resulting in lower opening forces. This is particularly critical at higher speeds where the excessive “**G**” forces experienced may injure or kill the user. The most common reefing device used today is the “**slider**.” [Figure 2-18] This device consists of a piece of fabric with grommets or rings at the corners through which the line groups pass. This restricts the inflation of the canopy and slows down the opening. While other methods have been developed for military or aerospace applications, the slider is the preferred method of reefing ram-air canopies. Without this device, skydiving would not be as developed as it is today.

## DEPLOYMENT TYPES

There are currently six different types of deployment methods.

### TYPE 1: CANOPY FIRST DEPLOYMENT

With this method, the lines are stowed vertically or horizontally in the container. Examples of this method are the T-7A chest pack or the B-12 back parachute. [Figure 2-19]



Figure 2-19. Type 1 deployment – T-7A reserve.

### TYPE 2: TWO-STOW DIAPER OR HALF DIAPER

This method utilizes split line groups. Two stows from one line group lock the diaper, compensated by offsetting stows of the other line group in the container with the remainder of the lines stowed in the container. Examples



Figure 2-20. Type 2 deployment – Strong Enterprises, Inc., Lo-Po reserve.

of this method are the early Strong 26’ Lo-Po and the Pioneer “K” series reserves. [Figure 2-20]

### TYPE 3: ASCUITTO OR PIGLET-STYLE FLAT DIAPER

This deployment features a full diaper with all lines stowed left to right or perpendicular to the **radial seam**. Examples of this method are the Piglet, Phantom, and Security Aero Conical (SAC) canopies. [Figure 2-21]



Figure 2-21. Type 3 deployment – Phantom canopy.

### TYPE 4: HANDBURY OR PRESERVE FULL DIAPER

This features a choker-type diaper which wraps around the canopy skirt. It is locked with three stows and all lines are stowed on the diaper parallel to the radial seam. Examples of this method are the Preserve series canopies, Strong Lo-Po Lite, and the Hobbit square reserve. [Figure 2-22] The military quarter bag is basically a version of the Type 4 method.



Figure 2-22. Type 4 deployment – Preserve diaper.



## TYPE 5: FREE BAG

With a free bag, the canopy is stowed in the bag, and lines are either stowed on or in the bag. They were originally used on the Safety Flyer reserve. This is the dominant and preferred method for virtually all modern square reserves. [Figure 2-23]



Figure 2-23. Type 5 deployment – Free Bag.

## TYPE 6: SLEEVES

This includes a fabric tube which encloses the full length of the folded canopy. Lines are stowed on the sleeve. They were originally used on early sport canopies, particularly the Para-Commander. [Figure 2-24] A modern version known as a “slag” is used on some ram-air canopies.



Figure 2-24. Type 6 deployment – PC sleeve.

An additional deployment method is the “tail pocket.” This is a fabric pocket sewn on the tail of a ram-air canopy in which the lines are stowed. [Figure 2-25]



Figure 2-25. Tail pocket.

## SECURING THE DEPLOYMENT DEVICE

With all deployment methods, it is necessary to properly fold or stow the canopy and secure the deployment device with the lines. The early parachutes utilized **hesitator loops** to secure the lines. [Figure 2-26] This method is still used today in many military systems.



Figure 2-26. Hesitator loops.

In modern designs that utilize types 1 through 4 and 6, the preferred method of locking the deployment device is rubber bands. The specification for standard rubber bands is MIL-R-1832. Type 1 are natural rubber and are 1/2" x 2". These were designed for use with the thicker Type III nylon lines such as on the 28' C-9 canopy. Many of the newer lightweight, round canopies use smaller diameter and fewer lines. Consequently, the standard rubber bands do not work well. Some manufacturers supply smaller diameter rubber bands to be used with their canopies. It is extremely important to utilize the correct size rubber bands.

With the introduction of the free bag system in 1977, Para-Flite, Inc., used a BUNA-N “O” ring to secure the locking stows. [Figure 2-27] During testing of the free bag system, they found inconsistent holding and breaking strengths of rubber bands. They wanted the locking stows to release at a consistent force to prevent bag lock. The “O” rings provided this. A couple of years later, the “O” rings were upgraded to a thicker diameter model. In 1983,



Figure 2-27. Para-Flite “O” rings.

Para-Flite, Inc. replaced the “O” rings with the Safety Stow®. The Safety Stow® is a continuous loop of elastic shock cord that runs through a webbing channel and through two grommets to secure the first two locking stows. [Figure 2-28] In the event of any restriction on the locking stow, as the loop stretches, it allows first one side to release and then the opposite side. This design is a considerable improvement over separate rubber bands or “O” rings and is used on most free bags today.



Figure 2-28. Safety Stow®.

It is important to maintain the rubber bands or Safety Stow®. Rubber bands are susceptible to heat degradation and dry out. If they break prematurely during use, the parachute may malfunction. Natural rubber bands also react to natural brass grommets and may become gummy and sticky, causing the lines to stick to the diaper or bag. [Figure 2-29] The BUNA-N “O” rings should be replaced with the Safety Stow®. The Safety Stow® should be inspected for broken stitching or internal rubber strands. [Figure 2-30]



Figure 2-29. Old rubber bands.



Figure 2-30. Bad Safety Stow®.

## BRIDLES

The **bridle** is a cord or webbing strap, which is used to connect the pilot chute to the canopy or deployment device. Main and reserve bridles, while sharing the same function, operate differently.

Early bridles were simply a length of suspension line tied off to the two components. It was soon learned that the length of the bridle affected the function of the pilot chute and the opening characteristics of the canopy. If the bridle is too short, the pilot chute cannot launch properly. If too long, the **snatch force** is increased. On most round emergency and reserve parachute assemblies, the length and type of the bridle is fixed for optimum performance. The rigger cannot change the configuration of the bridle without approval of the manufacturer.

There are two basic types of round canopy bridles. The first is a **tubular nylon** bridle that is tied on. The second is a pre-sewn bridle with loops at each end. The loop of one end is passed thru the attach point on the pilot chute and then back thru itself forming a lark’s head knot. The other loop of the bridle is then similarly attached to the canopy **apex**. [Figure 2-31] With this type, it is essential for the loop to remain loose to ensure the bridle is free floating and self-centering around the apex lines. Hand tack the loop to ensure this. [Figure 2-32]



Figure 2-31. Pre-sewn round bridles.



Figure 2-32. Hand tack floating bridle loop.

Square reserve bridles are generally built into the free bag. The bridle material is usually 2" wide or more for high drag. The original concept of the free bag is to allow the square reserve to deploy if the reserve pilot chute is captured resulting in a horseshoe-type malfunction. The



high-drag bridle would then pull the reserve bag off the parachutist's back and allow the canopy to deploy free from the bag. In the late 1980s, assistor pockets were added to the bridles for additional drag as square reserves became bigger and heavier. [Figure 2-33]

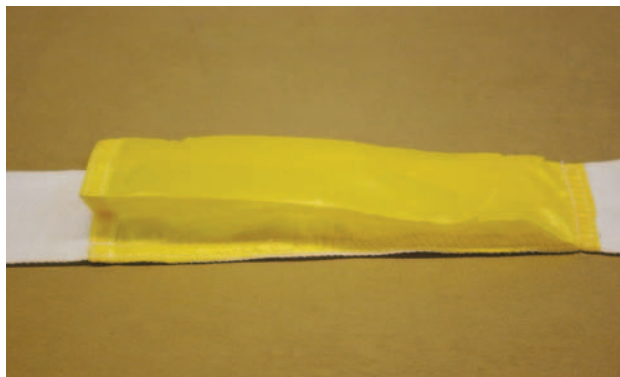


Figure 2-33. Free Bag assistor pocket.

Early main bridles were simply longer versions of the reserve bridles. This was necessary to compensate for the “burble” created in free fall by the parachutist. In the mid 1970s and with the advent of the hand deploy pilot chute, the length of the bridle was critical in order to allow proper extraction of the locking pin that secured the pack closed.

In recent years and with the almost total use of ram-air parachutes, the need for collapsible main pilot chutes has become widespread. As the main canopies have become smaller and faster, the drag of the inflated main pilot chute after opening can have an adverse effect on canopy performance. This problem has been solved through the use of a collapsible pilot chute/bridle system. There are two primary designs used to accomplish this.

The first is the “bungee” collapsible configuration. This consists of a length of elastic shock cord inside a tape sheath on the bridle near the pilot chute end. [Figure 2-34] When relaxed, it holds the apex of the pilot chute collapsed. When the pilot chute is deployed into the airstream, the airflow inflates the pilot chute which



Figure 2-34. Bungee collapsible bridle.

deploys the canopy. After opening, the elastic pulls the apex down again and collapses the pilot chute, reducing the drag. While this system works, its main drawback is that certain airspeeds are needed to inflate the pilot chute.

The second type is the “kill-line collapsible” configuration. This consists of a bridle with a full length channel through which passes a line of Kevlar® or Spectra®. [Figure 2-35] The bridle is “cocked” and the lower end of the bridle is collapsed during packing. This allows the pilot chute to inflate immediately. During the deployment sequence, as the canopy inflates, the lower end is stretched to length and the centerline pulls the apex of the pilot chute down and collapses it. This configuration has become almost universal in use for skydiving today. The only drawback is if the user forgets to cock the bridle during packing. This will result in a collapsed pilot chute and a pilot chute in tow. In the early days of use of the kill-line bridle, this was a problem but has become less frequent today. A properly made bridle will have a colored “eye” at the locking pin location to show if it is cocked and the centerline is set correctly. [Figure 2-36]



Figure 2-35. Kill-line collapsible bridle.

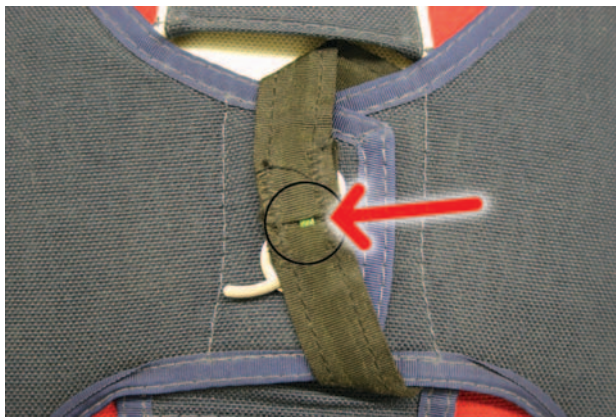


Figure 2-36. Kill-line “Eye.”

The kill-line configuration is used almost exclusively on tandem systems due to the high speeds involved and the size of the drogue pilot chutes. The bridles are usually

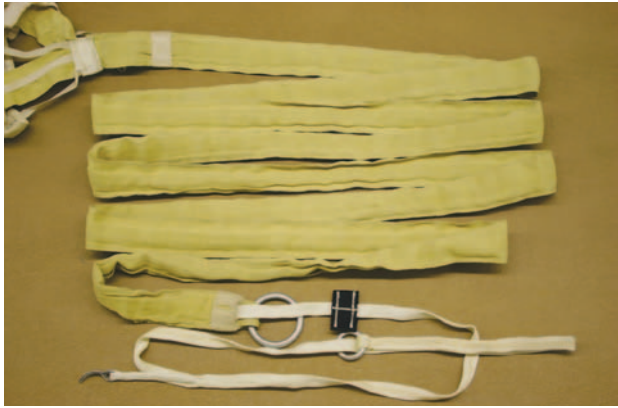


Figure 2-37. Tandem main collapsible bridle.

made from 2" Kevlar® tape and have tubular nylon centerlines. [Figure 2-37]

Another method of collapsing the pilot chute is to install a No. 8 grommet in the deployment bag and allow the bag to float on the bridle. After the canopy deploys, the bag slides up the bridle, inverts, and covers the pilot chute. This is commonly called the “poor man’s collapsible pilot chute system.” The drawback to this design is the high wear on the bridle and pilot chute mesh.

## PILOT CHUTES

A **pilot chute** is a small parachute, which is used to deploy the main or reserve parachute. In the earliest uses of parachutes, the parachute was static line deployed. With the advent of manually operated or “free fall” parachutes, the need for a pilot chute was quickly recognized.

There are two basic types of pilot chutes. The first is the spring-loaded design. This uses a collapsible spring, which is compressed in the parachute container and held closed with the ripcord. When the ripcord is pulled, the pack opens and the pilot chute launches into the airstream. The pilot chute provides drag and pulls the canopy from the pack as the parachutist or load falls away. During this process, the pilot chute also provides tension on the lines of the deploying canopy and helps the opening sequence. Spring-loaded pilot chutes are used primarily for emergency and reserve parachutes. In addition, they are used in military free fall and training systems for the main parachute.

The second type of pilot chute is the “hand deploy” design. This type consists of the pilot chute canopy but does not have a spring to launch it. Instead, the parachutist extracts the folded pilot chute from a pouch or the container and launches it into the airstream. The pack is held closed by a locking pin attached to the bridle of the pilot chute. As the pilot chute inflates, it extracts the pin from the locking loop and pulls the parachute from the pack. The rest of the opening process is similar to the spring-loaded pilot chute. This configuration came into popularity in the mid 1970s and is now the primary method of deployment in skydiving.

## SPRING-LOADED PILOT CHUTES

Spring-loaded pilot chutes date from the 1920s. However, it wasn’t until 1940 that the **spiral vane pilot chute** was invented. This design used a spiral spring that is easy to collapse and pack. The most common type of spiral vane pilot chute used today is the MA-1 model. [Figure 2-38] This is used in several military parachute assemblies. In the early days of skydiving, military pilot chutes such as the MA-1 and others were popular. Soon commercial designs were introduced that improved on the MA-1 with better launch and drag characteristics. These included the Grabber® and Hot Dog® pilot chutes. Both of these were primarily for use with main parachutes.

With the advent of the hand deploy pilot chute for the main, most of the improvement in spring-loaded pilot chute design has focused on its use in the reserve or emergency parachutes. This has paralleled the improvements



Figure 2-38. MA-1 pilot chute.



in container design and the increased use of AADs. Both of these require better pilot chutes than in the past.

One example for reserve use is the Magnum® pilot chute designed by National Parachute Industries. [Figure 2-39] With its unique shape, it provides maximum drag at low speeds such as are experienced during cutaways. Its design has been licensed by other manufacturers for use in their assemblies. Additional designs include the Vector II reserve pilot chute and the Stealth pilot chute. The Vector II design is a “ballute” configuration that eliminates the use of mesh. In the event of an unstable launch on its side, the mass of fabric is sufficient to lift the pilot chute and deploy the parachute. The Stealth pilot chute uses a conventional mesh design but has a unique spring/cap configuration that allows the pilot chute to virtually disappear when packed, hence the name.

### HAND DEPLOY PILOT CHUTES

The hand deploy pilot chute was invented by Bill Booth in 1976. There are two types of hand deploy designs. One is the throw-out pilot chute (TOP) configuration. This is the type where the pilot chute pulls the locking pin located on the bridle. [Figure 2-40] The original design had the pilot chute pouch mounted on the **belly band**.



Figure 2-39. Magnum pilot chute.

Today the primary location is an elastic/Spandex® pocket mounted on the bottom of the main container (BOC). [Figure 2-41]

The second type is the pull-out pilot chute (POP) configuration. This design has the pilot chute packed in the container, which is locked with a straight locking pin attached to a short lanyard and handle. [Figure 2-42] This handle is usually mounted on the bottom corner of the



Figure 2-40. TOP bridle/pin configuration.



Figure 2-41. BOC pocket location.



Figure 2-42. POP handle and lanyard.

main container. The parachutist grasps the handle and pulls the locking pin from the locking loop and brings the pilot chute into the airstream. The handle is usually attached to the bottom of the pilot chute and as soon as the chute enters the airstream, the **handle** is pulled from the parachutist's hand. This makes for a positive deployment. The main drawback to this system is losing the handle due to it being dislodged while moving around in the aircraft or in the air.

## AUTOMATIC ACTIVATION DEVICES AND RESERVE STATIC LINES

Safety considerations have led to the development of automatic activation devices and reserve static line systems. These devices allow for automatic deployment of the main or reserve parachutes in the event of an emergency.

### AUTOMATIC ACTIVATION DEVICES

**Automatic activation devices (AADs)** are devices which activate the parachute automatically. Modern systems combine a barometric sensor with a rate of descent sensor so that the system is fully automatic once turned on and calibrated. The activation may be by either pulling the ripcord pin(s) or cutting the locking loop(s), causing the pilot chute to release. Most older models use a mechanical or pyrotechnic pin pulling technique. Newer models use a pyrotechnic loop cutting design.

For many years, AADs were primarily used by the military and student parachutists. The designs were bulky, expensive, and, to a degree, inconsistent. The installations themselves were cumbersome and awkward. In the early 1990s a new generation of AADs became available. The CYbernetic Parachute Release System (CYPRES®) uses modern parachute release technology. It is small, reliable, computer based, and uses a pyrotechnic loop cutter. It has an auto-off feature that turns the unit off after 14 hours of operation to conserve power. It also has the ability to calibrate the unit for operation at altitudes other than the calibrating ground level. Based on these concepts, other companies have developed similar systems and as a result, changed the approach to the design and use of AADs. Today, most sport parachutists use an AAD and some countries mandate their use by all parachutists.

The following describes the operation and installation requirements of the CYPRES® model AAD. Most other designs are compatible with the CYPRES® installation requirements.

### OPERATION

The CYPRES® system is a barometrically controlled microprocessor that activates a pyrotechnic cutter that cuts the container locking loop. When calibrated to ground level, the barometric sensor activates the unit firing the cutter when the descending parachutist reaches an

altitude of approximately 750 feet **AGL** and exceeds a rate of descent of 115 feet per second.

The CYPRES® consists of three parts: (1) the battery and processing unit, (2) the control unit, and (3) the cutter. [Figure 2-43] The processing unit is generally located in a stowage pouch installed in the reserve container of the parachute system. [Figure 2-44] The control unit is contained in a vinyl pocket located either under the **pin protector flap** or in the upper backpad area. [Figure 2-45]



Figure 2-43. CYPRES®.



Figure 2-44. CYPRES® container pouch.



Figure 2-45. CYPRES® control unit vinyl pocket.





Figure 2-46. CYPRES® cutter location.

The cutter(s) may be located at the base of the pilot chute or on a flap over the pilot chute. [Figure 2-46] Each parachute system has its own particular requirements, and it is imperative that the rigger have the appropriate manuals for installation.

### RESERVE STATIC LINE SYSTEMS

A **reserve static line (RSL)** system is a backup device for activating the reserve after a **cutaway** is performed. It usually consists of a line, webbing, or cable, which connects one or both main risers to the reserve handle, housing, or cable. The most common design used today has a ring through which the reserve ripcord cable is routed. The riser end attaches to a ring on the riser(s) with a snap shackle for quick release capability. When the risers are jettisoned, the lanyard pulls the cable, releasing the ripcord pin(s), and activates the reserve. This results in a minimum loss of altitude during the cutaway procedure. The use of an RSL has saved many lives over the years due to low cutaways.

Though originally developed in 1964, the RSL concept did not become popular until the advent of student piggy-back systems and ram-air canopies. Through the use of an RSL system, the student parachutist need only pull the canopy release handle in the event of a partial malfunction, and the main canopy is cutaway and the reserve activates. In 1990, the Parachute Industry Association urged manufacturers to include RSLs as a standard feature on all harness/container systems. Many did and this resulted in an increase of RSL use for several years.

In recent years and with the widespread acceptance of newer types of AADs, many parachutists feel that they no longer need an RSL. In reality, both systems complement each other. The AAD functions if the individual does not activate the main parachute. However, it is altitude and rate of descent (ROD) dependent. Below a certain altitude, if the ROD is not met, the AAD will not function. Consequently, if a cutaway is performed below the activation altitude, it may take some time for the descending parachutist to reach the ROD necessary to initiate activation, thereby necessitating rapid manual activation of the reserve. However, if an RSL is also installed, it would

cause an immediate activation of the reserve as the main parachute disconnects and moves away from the parachutist.

In the last few years, as canopy design has resulted in smaller and more sensitive canopies, many parachutists have elected not to use an RSL. The rationale is that in a violently spinning malfunction, which some of these highly loaded canopies are prone to do, it is preferable to cutaway and regain stability prior to pulling the reserve. This reduces the chance of an entanglement with the deploying reserve. While this scenario has happened, it is a rare occurrence. Statistics show that many lives have been saved by using an RSL.

### RSL DESIGNS

There are four primary design configurations of RSLs in use today.

1. A single side RSL where the lanyard is attached to only one main riser, usually the left side. [Figure 2-47] Only the one side is required to release to activate the system. This is the most common design in use today due to its simplicity.



Figure 2-47. Single side RSL configuration.

2. A dual side RSL where both main risers are connected with a **cross connector** which is in turn connected to the RSL lanyard. [Figure 2-48] Both risers need to be released for the system to function.



Figure 2-48. Dual side RSL configuration.

- The LOR system developed by the French. This incorporates two lanyards, one from each riser, that are attached to individual curved pins that secure the reserve container with a dual locking loop. [Figure 2-49] Both risers must be released for the system to function.

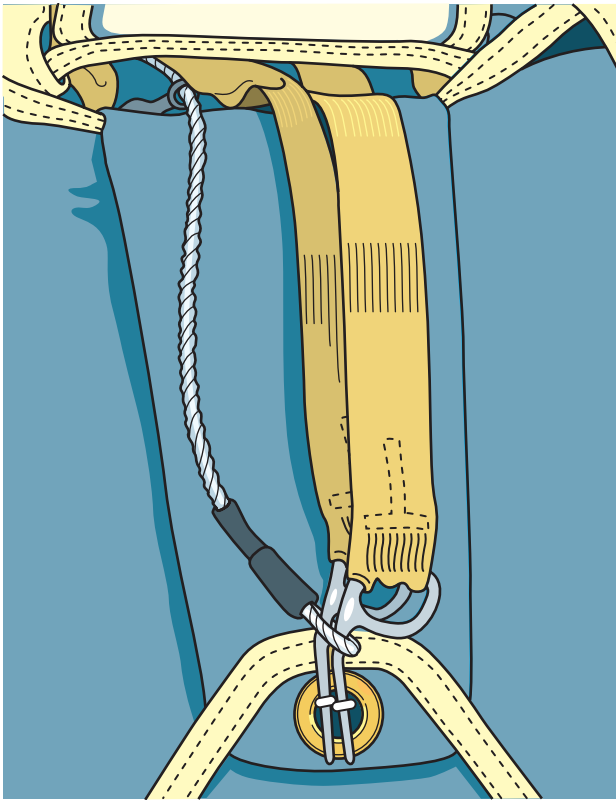


Figure 2-49. LOR system.

- The Collins Lanyard/Skyhook™ system. This design utilizes a special lanyard which is attached to the bridle of the reserve free bag. [Figure 2-50] Cutting away results in the free bag being pulled directly out of the container by the main risers and results in very little altitude loss.

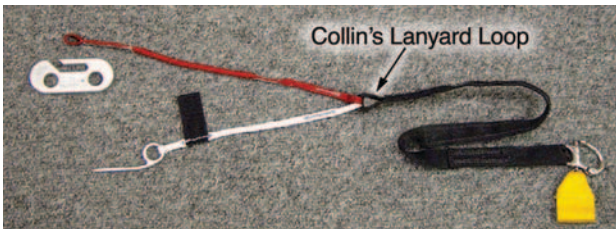


Figure 2-50. Skyhook™ system.

Since the early 1990s, most (if not all) manufacturers provide an RSL installation on their equipment either as standard or optional. If the rigger has a system without an RSL and the owner wishes to have one installed, the rigger should check with the manufacturer as to the availability of a retrofit kit or return it to the manufacturer for installation. Because the installation of an RSL is an alter-

ation to the original design, the rigger needs approval either from the manufacturer or the FAA.

Because of the nature of the RSL system, it is imperative that the rigger thoroughly understands the individual concepts. Unless he/she understands this, and has the required manufacturer's instructions, the rigger should not attempt to assemble and pack a system with an RSL installation. The following describes the basic design and function of a single side RSL installation on a one-pin reserve container.

### MAIN RISER ATTACHMENT

The main risers must have an attachment location for the lanyard. In this example, a small ring is installed near the lower hardware end of the riser on the inboard side. [Figure 2-51] It is desirable to locate the ring as close to the lower end as possible so that the pivot arc of the riser does not load the lanyard. This allows the riser end of the lanyard end to be as short as possible. If there is excess lanyard, it is difficult to stow and it is possible for the lanyard to become snagged and unseated. It is important that the correct risers with attachment ring be installed. While many risers have a ring installation, not all are installed at the correct location. Consequently, the lanyard length will not match the factory dimensions. This can result in premature reserve activation when the main is deployed.



Figure 2-51. Main riser RSL ring attachment.

Most RSL lanyard designs have a snap shackle or similar release device mounted at the riser end of the lanyard. [Figure 2-52] This allows the user to disconnect the lanyard under certain circumstances. The most common one involves landing in high winds where the parachutist may



Figure 2-52. Snap shackle on RSL lanyard.



wish to cutaway the main canopy to prevent being dragged. If the lanyard were not released, the reserve would be deployed as the main is cutaway.

### RIPCORD CABLE ROUTING

The routing of the **ripcord cable** from the handle to the pin determines where the lanyard connects to the cable. Most RSL attachments connect with the ripcord cable either at the yoke area or just above the ripcord pin. Generally, there is a double ring installation where the cable end of the lanyard is located. [Figure 2-53] On this particular installation, the connection is at the shoulder yoke area.



Figure 2-53. Double ring container installation.

### RSL LANYARD AND CONTAINER MOUNT

These two components are interactive. That is, the design of the container directly affects the design of the lanyard. Once the two above locations are determined, then the routing of the lanyard can be completed. It was originally thought that the lanyard should have a long length to allow acceleration during activation to pull the ripcord cable. This has not proven to be true and most manufacturers keep their lanyards as short as possible to prevent snagging and easier stowing.

In the past, a Velcro® pathway was used for routing the lanyard. This was either on the shoulder yoke or the reserve riser. Experience has shown that the use of Velcro® generally results in high wear and eventual damage to the webbing. [Figure 2-54] On this design, the lan-



Figure 2-54. RSL Velcro® riser damage.

yard is stiffened with a short piece of coated cable and stowed in two pockets located on the yoke area. [Figure 2-55] It is secure and has no wear points. The ripcord end of the lanyard is routed to the dual guide ring attachment location and the ripcord cable routed through the rings. [Figure 2-56] The ripcord cable is then routed to the reserve closing loop.



Figure 2-55. RSL lanyard without Velcro®.



Figure 2-56. Ripcord cable routing thru rings.

Figure 2-57 shows the RSL lanyard and ripcord cable at the moment of riser extension and just as the cable is



Figure 2-57. RSL lanyard extension.

loaded. A point that the rigger should be aware of is the “pigtail” configuration of the reserve ripcord that results from the use of the RSL. [Figure 2-58] Because of the sliding of the ring along the ripcord cable, a curling effect is imparted to the cable. This is a clear indication that the RSL lanyard activated the reserve. The rigger should carefully inspect the ripcord cable for any broken strands.

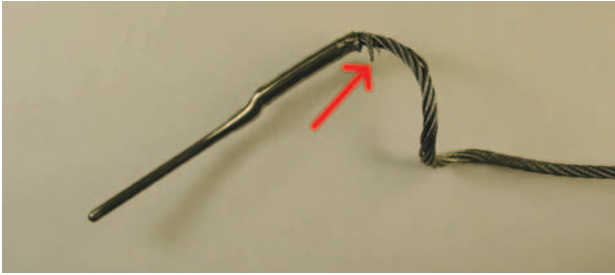


Figure 2-58. Ripcord cable pigtail.

If any are found, the ripcord should be replaced. If not, the cable can be straightened and returned to service.

With the single side RSL, it is imperative that the main riser with the RSL attachment leave after the opposite riser. If the opposite riser stays connected while the RSL deploys the reserve, there is the possibility of a main/reserve entanglement. To ensure the correct staging

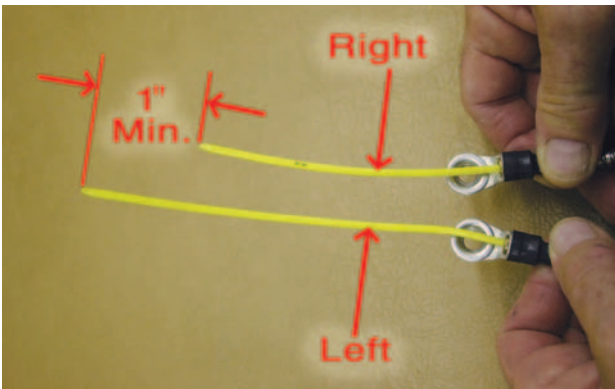


Figure 2-59. Cutaway cable length differential.

of the cutaway, the release cable of the RSL side must be longer than the cable on the opposite riser. A minimum of 1" is the standard differential. [Figure 2-59]

## JOINT EFFICIENCY

**Joint efficiency** is the percentage of the measurement of strength when applied to the junction or fabrication of two or more materials. An example is the **cross seam** in a canopy **gore** where two **panels** of fabric are joined. The strength of the seam needs to be greater than the strength of the fabric. To achieve this, there are several factors that need to be considered in the design. These include the following:

- **Fabric**—The weight and weave of the fabric affects the type of junction used.
- **Thread type**—This is affected by the weight of the fabric. Generally, the lighter the fabric, the smaller the thread used. Accordingly, a smaller needle is used in order not to damage the weave of the fabric.
- **Stitch type**—This is determined by the type of seam needed for the design. For the French fell seam normally used in joining the panels of a canopy, the 301 straight stitch is used.
- **Stitches per inch**—This has a direct correlation to the size of the thread used and the stitch type. There is a fine balance between the security of the seam and over stitching. Too many stitches per inch will dramatically affect the strength of the seam by perforating the material. The number of rows of stitching also affects this. While more rows generally increase the strength of the seam, too many perforate the material as well.
- **Thread tension**—As lighter fabric and thread are used, the thread tension balance becomes more important.
- **Reinforcing**—The addition of reinforcing through the use of tapes, **cords**, etc., adds to the strength of the seam. However, their use may also reduce the elasticity of the seam at the same time.

Some of the previous factors also can affect heavier materials such as tapes and webbings. In working with webbings in harness design, most construction methods have tended to overbuild the junctions. This has been done primarily because the materials have readily accepted heavier threads and stitch patterns.

An area that needs to be addressed is that of **restitching** webbing. Until recently, there was not much study done to determine how much strength is lost in this process. G.S. Dunker, a parachute engineer, conducted a study that evaluated the variables introduced when restitching webbing junctions. Some of these variables included the following:

- The treatment or conditioning of the webbing. Condition R webbing has a resin treatment to make it stiffer as opposed to condition U or untreated webbing.
- The size and condition of the needle used in the sewing. Larger needles make larger holes. A blunt needle or one whose point is damaged will do more damage to the webbing and weaken it.
- The size of the thread used.

- The stitch pattern used and length. A W-W pattern is stronger than a box X pattern.
- The number of times the webbing is re-sewn.

All of these affect the ultimate strength of the webbing junction or stitch pattern. Taking into consideration the above variables, tests were conducted in measuring the strength of a simple lap junction. The results showed that there was little difference between the un-sewn sample and the first re-sewn test. The greatest difference was

between the first and second re-sewn sample, with approximately an eight percent decrease in the strength of the junction. There was minimal drop in strength in succeeding tests. Initial conclusions were that if the disassembly process was done carefully with little damage done to the webbing, the re-sewing process had minimal effect on the ultimate strength of the re-sewn junction. The study is titled "*The Prediction of Junction Efficiency for Parachute Harnesses: Experimentations in Breaking Strengths and Wear Characteristics*," Arizona State University, May 2001.





## Chapter 3

# Materials

The correct identification and use of the various materials in parachute manufacturing and repair are of vital importance to all riggers. Just as important as acquiring knowledge of tools and machines, the language of materials is a necessary part of a rigger's job comprehension. In doing repairs or alterations, the rigger must be able to identify the types of materials used in order to duplicate the original manufacture or ensure the correct level of safety necessary. Some materials may look similar, but there can be subtle differences between them that make a major difference in their strength or durability.

It is not the intent of this chapter to present information on every type of material or hardware ever used in parachutes. For those materials used in obsolete or military surplus parachutes, there are reference sources, such as *The Parachute Manual* by Poynter, for the rigger to use to identify older materials. The intent of this chapter is to present as much information as possible on the modern materials used in today's parachute systems.

Most riggers operate quite successfully at a basic level of material knowledge. There are certain materials that are in common use on most parachute systems, and in dealing with these on a regular basis, the rigger becomes very familiar with their use and characteristics. It is necessary that the rigger know their correct type, nomenclature, strength, and common use. In dealing with other riggers, manufacturers, and suppliers, the rigger is then able to identify the referenced material in order to obtain the appropriate repair part or describe the use of the material to others. All of this is part of the parachute "language" required for the rigger to operate under.

## SPECIFICATIONS

All certificated parachute systems built under Government approval programs require most, if not all, materials used in their construction to have some form of specification approval. The most common of these systems is the **military specification (MIL-SPEC)** system. In addition, there are other Government specifications, such as Federal Standards, and commercial specifications in use. The MIL-SPEC system is the one with which most riggers are familiar. Contrary to popular perception, not all materials for use in parachute manufacturing must be MIL-SPEC. Any specification may be used, providing the manufacturer can prove compliance with this specification, and that the specification is acceptable to the FAA for use in the parachute system. As a rule, the MIL-SPEC

system has proven the most readily available and accepted method.

In recent years, the Government has been accepting more commercial specifications in lieu of MIL-SPEC items. In 2002, the Parachute Industry Association (PIA) adopted approximately 270 parachute related specifications, drawings, standards, and test methods. The PIA takes responsibility for the continued maintenance and revision of these specifications. As the specifications are revised, they keep their original identification number, but the PIA prefix precedes them. For instance, MIL-W-4088 webbing becomes PIA-W-4088. Through the involvement of the PIA Specifications Committee, the revised specifications, including new digital drawings, are made available to the industry.

The MIL-SPEC or PIA-SPEC system of identification consists of the initial letters MIL or PIA with a middle letter such as W for webbing or wire, then the identification or serial number of the specification. In addition, there may be a revision letter such as A, B, C, D, etc. In the case of PIA-W-4088D, this is the fourth revision.

The materials and hardware listed herein are only a small part of those available but the most commonly used in the majority of today's rigging profession. By learning the specifications and uses of these materials, the rigger establishes a sound basis for the repair and maintenance of modern parachutes.

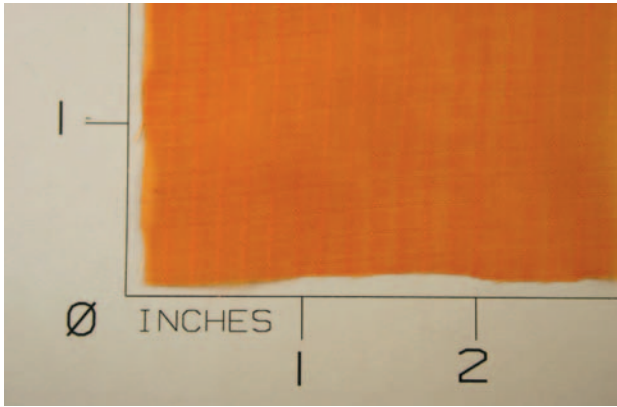
To promote the latest specifications, the PIA nomenclature is called out unless otherwise noted. In the past, the common method to denote the various types of webbings, cords, etc., was to use the Roman numeral for the type (i.e., Type VIII for Ty-8, Type XVII for Ty-17, etc.). For this book, the standard is the Arabic numeral (i.e., Ty-7, etc.).

Many of the figures in this chapter use a neutral background with an XY grid for reference. The numbers are one-inch increments for a proportional reference.

## FABRICS

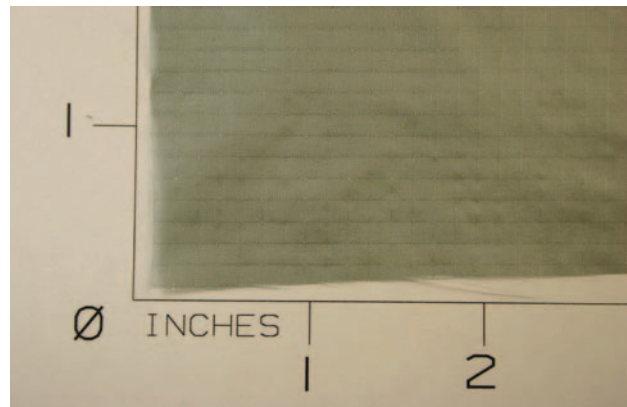
Fabrics for use in the manufacturing of parachutes are predominately **nylon**. The major differences include the **weave, weight, and finish**. The various types of materials include canopy fabric, pack cloths, mesh, elastic fabrics, stiffener materials, and foams.

Canopy fabrics are primarily **ripstop nylon**. Ripstop weave is a plain weave with heavier **threads** woven into the material resulting in a boxlike pattern. The heavier thread inhibits the tearing process and results in stronger fabrics. [Figures 3-1 through 3-6]



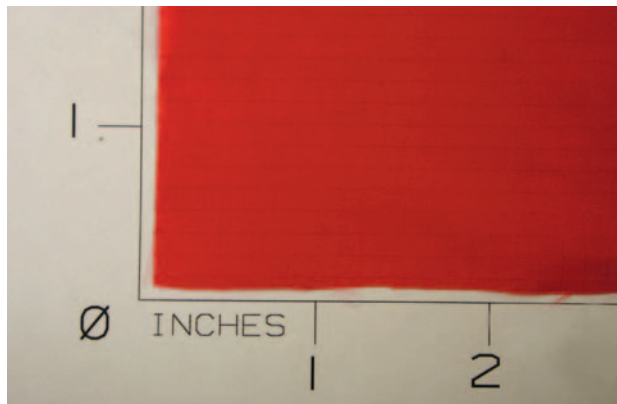
**Figure 3-1. Cloth, parachute, nylon, Ty-1.**

Specification: PIA-C-7020, 1.1 oz  
 Tear/breaking strength: 5 lb/42 lb  
 Identification: 120 x 120 balanced weave  
 Common use: 24', 26', 28' military canopies  
 Comment: Standard colors: white, orange, olive green, sand



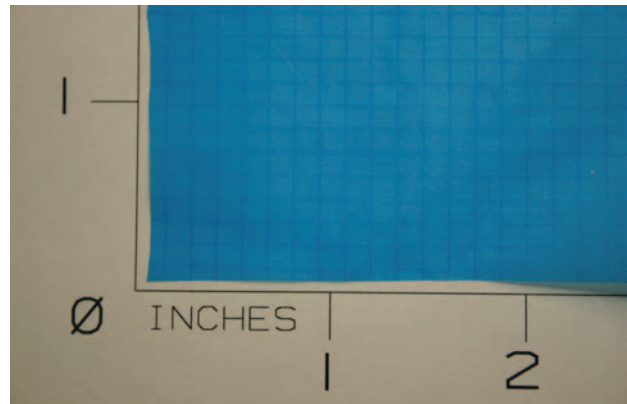
**Figure 3-3. Cloth, parachute, nylon, Ty-1, Lo-Po, .5-3 cfm.**

Specification: PIA-C-44378, 1.12 oz  
 Tear/breaking strength: 5 lb/45 lb  
 Identification: Ripstop nylon  
 Common use: Ram-air canopies and some round reserves  
 Comment: F-111™, Exacta-chute™



**Figure 3-2. Cloth, parachute, nylon, Ty-3, 30-50 cfm.**

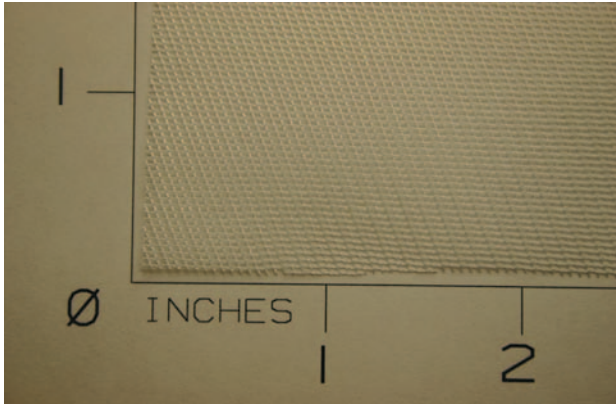
Specification: PIA-C-44378, 1.2 oz  
 Tear/strength: 5 lb/45 lb  
 Identification: Ripstop nylon  
 Common use: Lopo reserve canopies  
 Comment: N/A



**Figure 3-4. Cloth, parachute, nylon, Ty-1, zero porosity.**

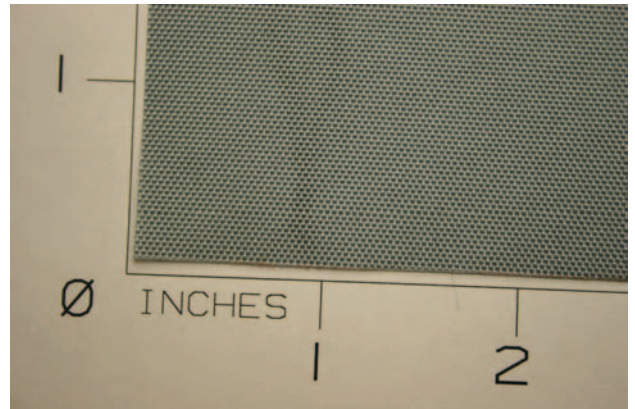
Specification: Commercial, 1.13 oz, 0 cfm, silicone coated  
 Tear/breaking strength: 12.6 lb/43 lb  
 Identification: Ripstop nylon  
 Common use: Sport main canopies and some reserves  
 Comment: Trade names include Zero P3™, Soar-Coat™.

The composition of most containers is from either nylon duck (para-pak) for military systems or Cordura® for sport systems. Most sport containers also utilize a thin foam lining on the inside of the flaps to smooth out the fabric and absorb wear and tear. Other fabrics, such as mesh, Spandex®, and ballistic fabric, serve specialized purposes. [Figures 3-7 through 3-15]



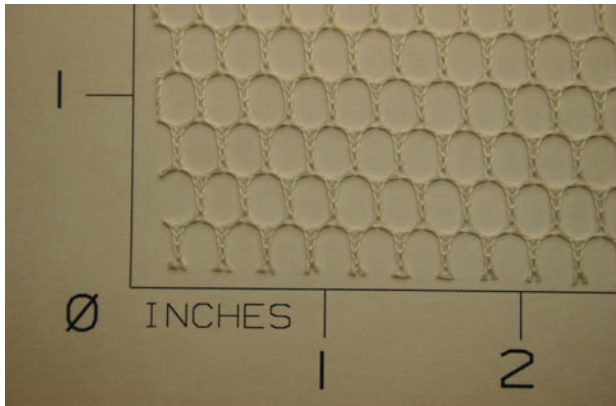
**Figure 3-5. Cloth, netting, nylon (marquisette).**

Specification: PIA-C-26643  
 Tear/breaking strength: 3 lb/25-35 lb  
 Identification: N/A  
 Common use: Military pilot chutes  
 Comment: Ph: 6-8



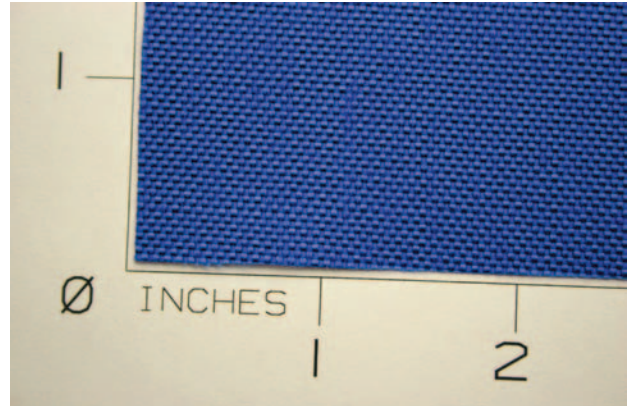
**Figure 3-7. Cloth, duck, nylon (para-pak).**

Specification: PIA-C-7219 class 3, 7.25 oz, 420 denier  
 Tear/breaking strength: 20 lb/275-325 lb  
 Identification: 1-1 plain weave  
 Common use: Military containers  
 Comment: Commercial para-pak is 400 denier with a urethane coating on the inside.



**Figure 3-6. Cloth, mesh, large hole, nylon.**

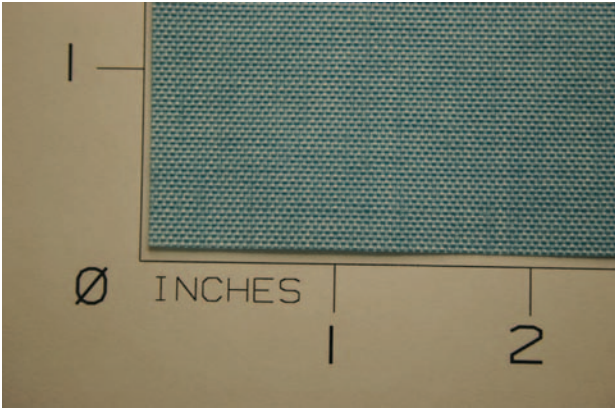
Specification: Commercial, No. 94040  
 Strength: N/A  
 Identification: N/A  
 Common use: Sport pilot chutes, some round reserves  
 Comment: Ph: 6-8, 96" wide



**Figure 3-8. Cloth, nylon, Cordura®.**

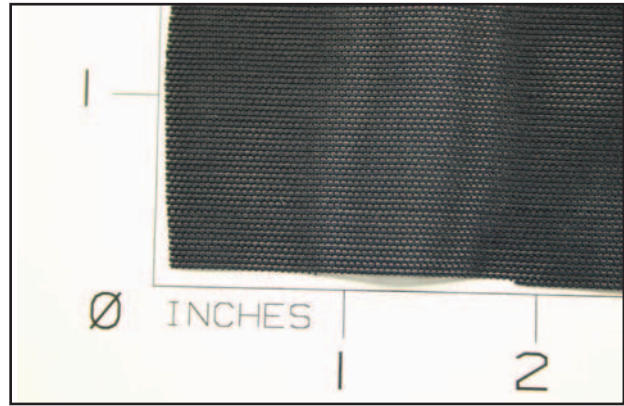
Specification: MIL-C-43734, class 3  
 Strength: 1000 denier  
 Identification: N/A  
 Common use: Sport and military container systems  
 Comment: Has a urethane coating on the inside.





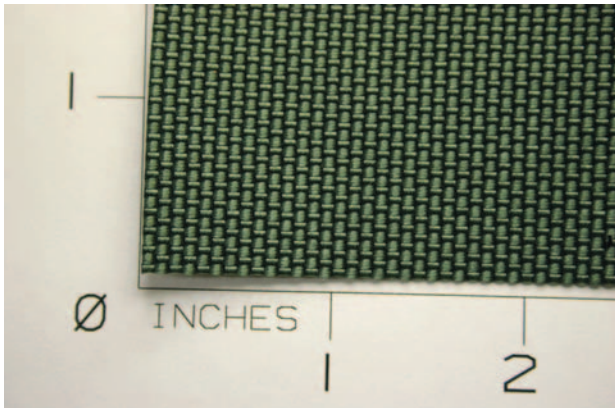
**Figure 3-9. Cloth, nylon, Cordura®.**

Specification: MIL-C-43734  
 Strength: 500 denier  
 Identification: N/A  
 Common use: Sport container systems  
 Comment: N/A



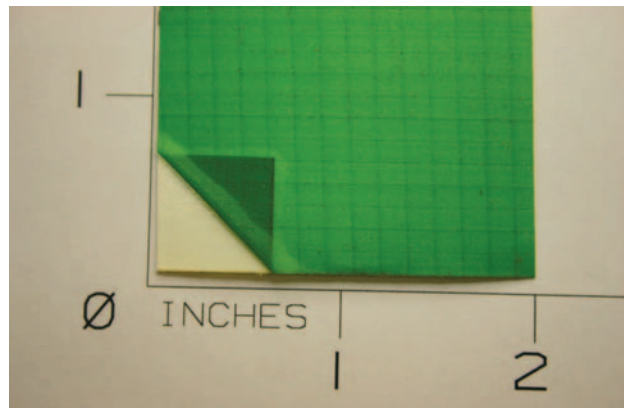
**Figure 3-11. Elastic fabric, Spandex®.**

Specification: Commercial  
 Strength: N/A  
 Identification: N/A  
 Common use: Main pilot chute pockets  
 Comment: N/A



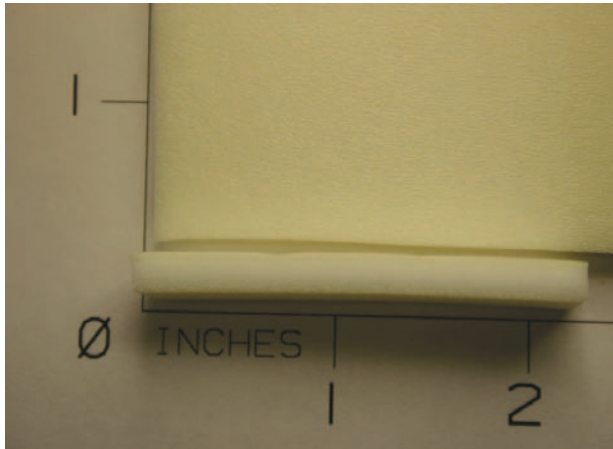
**Figure 3-10. Cloth, duck, nylon, ballistic.**

Specification: PIA-C-3953, class 2  
 Strength: 1100 lb, 20 oz/yd  
 Identification: 3 x 4 basket weave  
 Common use: Stiffening material for containers  
 Comment: Uses a melamine resin for stiffness.



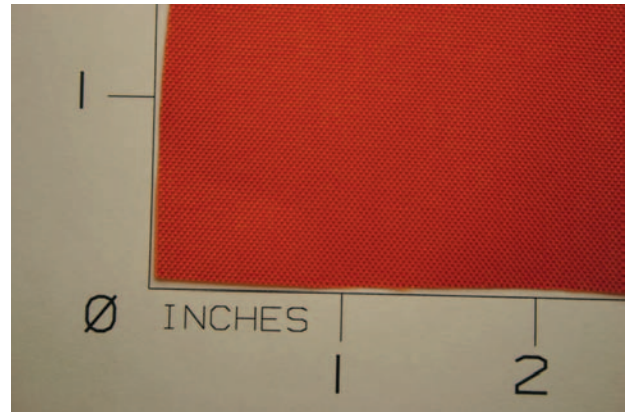
**Figure 3-12. Pressure sensitive adhesive tape — ripstop tape.**

Specification: PIA-T-43618  
 Strength: 60-75 lb  
 Identification: Ripstop weave fabric with adhesive backing, various colors  
 Common use: Field canopy repair  
 Comment: May degrade canopy fabric over time.



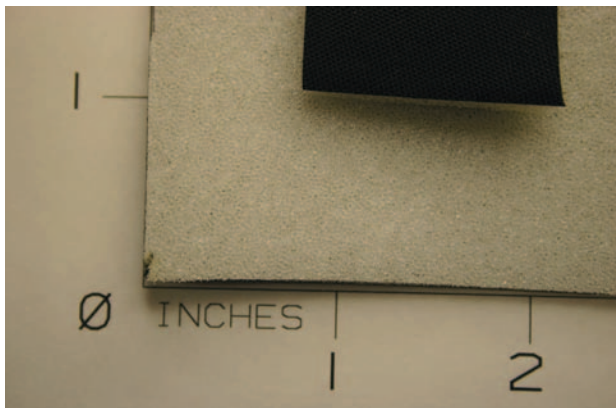
**Figure 3-13. Foam, Volara®.**

Specification: Commercial  
 Strength: N/A  
 Identification: N/A  
 Common use: Padding for leg and back pads  
 Comment: Various thicknesses: 1/8" and 3/16" most common.



**Figure 3-15. Oxford cloth, 200 denier.**

Specification: Commercial  
 Strength: N/A  
 Identification: Taffeta weave  
 Common use: Reserve deployment bags  
 Comment: N/A



**Figure 3-14. Foam, ester liner.**

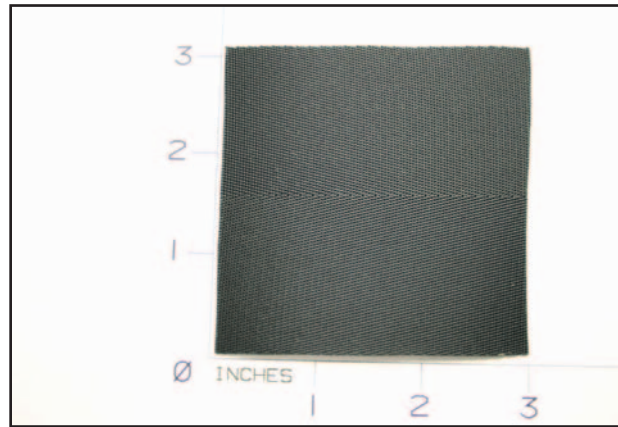
Specification: Commercial  
 Strength: N/A  
 Identification: 1/8" thickness  
 Common use: Lining of container systems  
 Comment: Bonded to various fabrics such as Oxford cloth.



## WEBBING AND TAPES

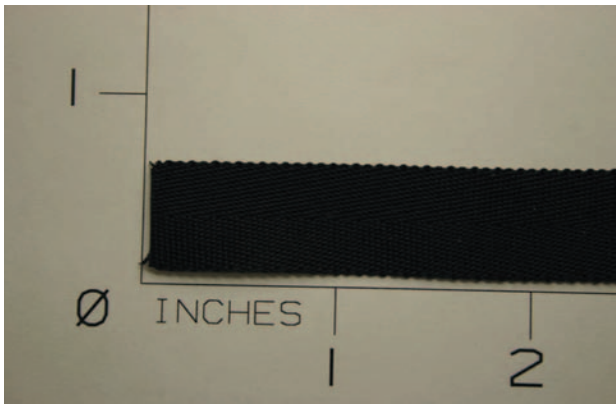
While many **webbing** and tapes have the same specifications, they still have different designations. The difference is a common rule of thumb where anything 1" or wider and over 1000-lb strength is webbing. Anything less is a tape. There are, however, some examples that fall outside of this criterion.

The primary use for webbing is for load bearing purposes such as harnesses and risers. **Tapes** are for use as support and reinforcing for canopies and containers. Most webbing and tapes, when manufactured, are left in their natural, untreated condition (condition U), or treated with a synthetic resin named Merlon, for stiffness (condition R). A newer treatment, called "Ecco," is similar to a light condition R. This is a newer treatment that is ecologically friendlier than using Merlon. It also results in a medium stiffness that is easier to sew. This is for use primarily in the lighter weight tapes such as 3/4" Ty-3. [Figures 3-16 through 3-31]



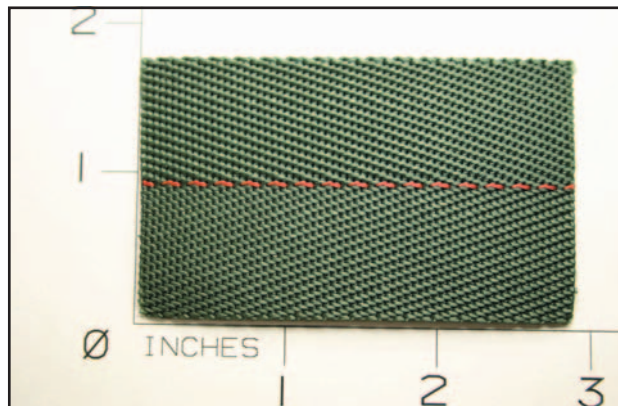
**Figure 3-17. 3" Ty-4 Tape.**

Specification: PIA-W-4088  
 Strength: 1800 lb  
 Identification: 2/2 HB twill, 3" width, some slider edge tapes  
 Common use: **Confluence wraps**, container reinforcing  
 Comment: Not to be confused with 5038 Ty-4 square weave.



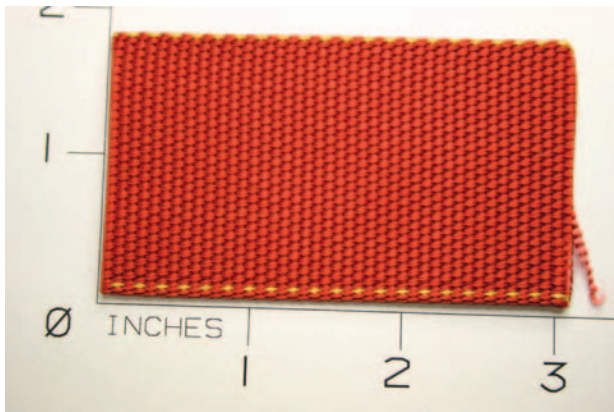
**Figure 3-16. 9/16" Ty-1 Tape.**

Specification: PIA-W-4088  
 Strength: 500 lb  
 Identification: 2/2 HB twill, 9/16" width, no color code  
 Common use: Stow band retainer loops on main deployment bags  
 Comment: N/A



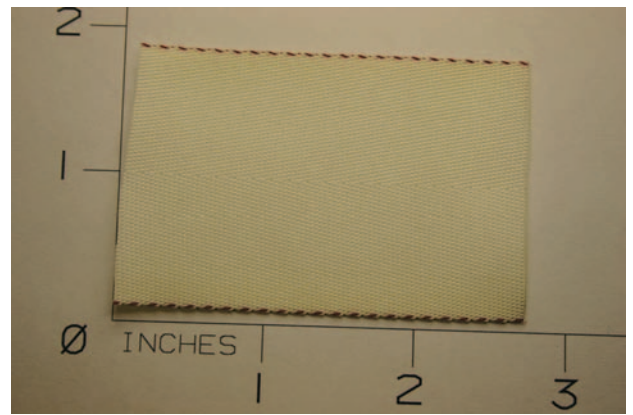
**Figure 3-18. Ty-6 Webbing.**

Specification: PIA-W-4088  
 Strength: 2500 lb  
 Identification: 2/2 HB twill, 1 23/32" width, red centerline  
 Common use: Buffer strips, harness attachment straps on Navy containers  
 Comment: N/A



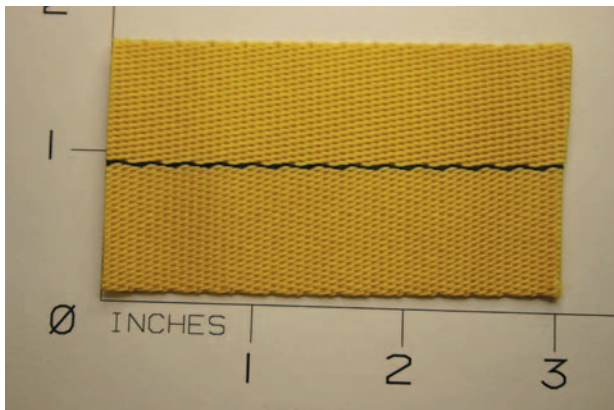
**Figure 3-19. Ty-7 Webbing.**

Specification: PIA-W-4088  
 Strength: 6000 lb  
 Identification: Double plain weave, 1 23/32" width, with yellow lines at each selvage edge  
 Common use: Modern sport harness, risers  
 Comment: More widely used than Ty-13 and more colors available.



**Figure 3-21. Ty-12 Webbing.**

Specification: PIA-W-4088  
 Strength: 1200 lb  
 Identification: 2/2 HB twill, 1 23/32" width, red lines at each selvage  
 Common use: Harness buffers, confluence wraps  
 Comment: N/A



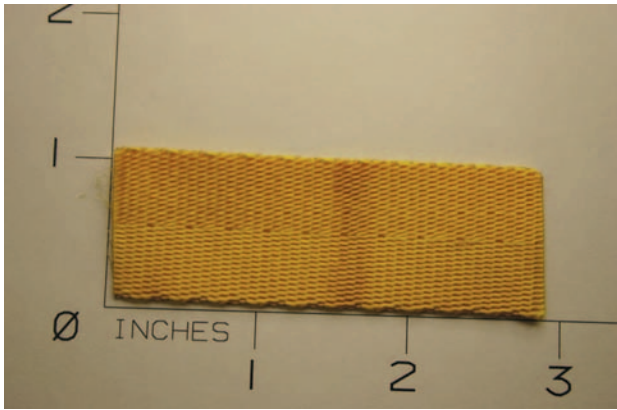
**Figure 3-20. Ty-8 Webbing.**

Specification: PIA-W-4088  
 Strength: 4000 lb  
 Identification: 2/2 HB twill, 1 23/32" width, black centerline  
 Common use: Main risers, harness construction  
 Comment: One of the most common webbings in use today.



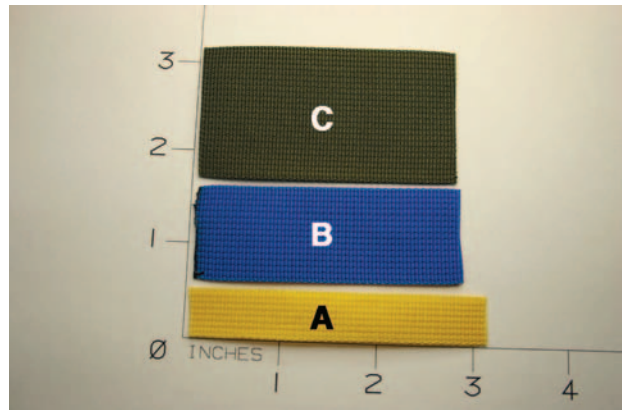
**Figure 3-22. Ty-13 Webbing.**

Specification: PIA-W-4088  
 Strength: 7000 lb  
 Identification: Double plain weave, 1 23/32" width, and black lines at each selvage edge  
 Common use: Sport harnesses, military harnesses  
 Comment: N/A



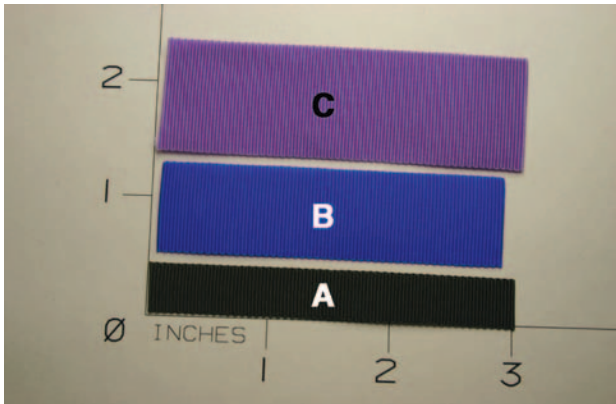
**Figure 3-23. Ty-17 Webbing.**

Specification: PIA-W-4088  
 Strength: 2500 lb  
 Identification: 2/2 HB twill, 1" width, no color code  
 Common use: Sport main risers, chest straps, carry handles  
 Comment: N/A



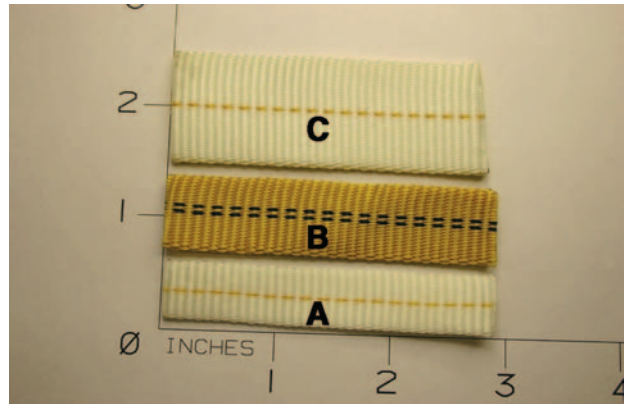
**Figure 3-25. Ty-4 Tape.**

Specification: PIA-T-5038  
 Strength: A. 1/2", 550 lb; B. 1", 1000 lb; C. 1 1/2", 1500 lb  
 Identification: Plain weave, various widths  
 Common use: Bridles, reinforcing, buffers  
 Comment: One of the most versatile tapes available, called "square weave."



**Figure 3-24. Ty-3 Tape.**

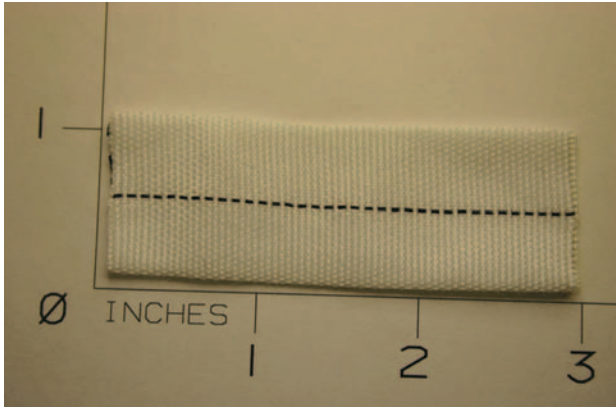
Specification: PIA-T-5038  
 Strength: A. 3/8", 200 lb; B. 3/4", 400 lb; C. 1", 525 lb  
 Identification: Ribbon weave, various widths as above  
 Common use: Binding tape, canopy-reinforcing tapes, and line attachment tapes  
 Comment: One of the most common tapes in use; condition U, R, and Ecco are the current treatments.



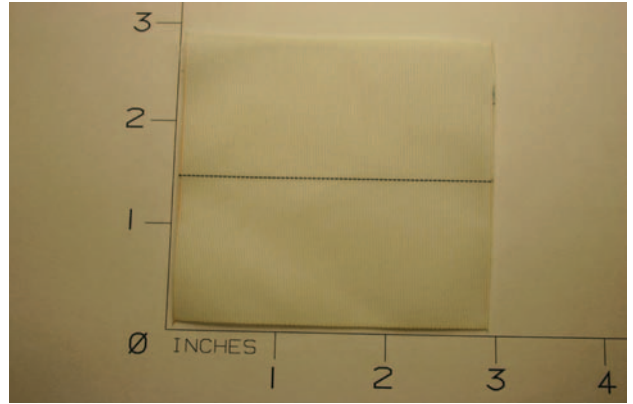
**Figure 3-26. Tubular webbing.**

Specification: PIA-W-5625  
 Strength: A. 1/2", 1000 lb; B. 5/8", 2250 lb; C. 1", 4000 lb  
 Identification: Various widths, yellow or black lines at the center or edges  
 Common use: Bridles, static lines  
 Comment: N/A

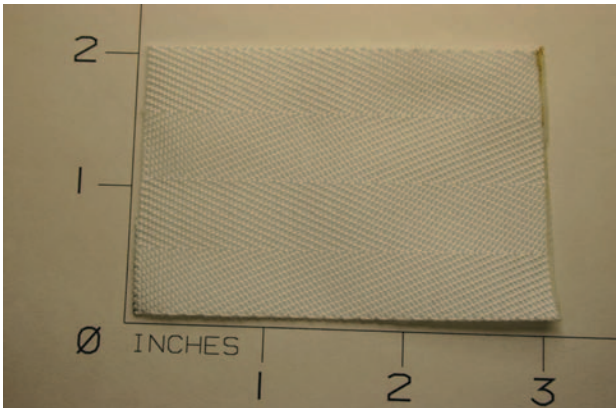




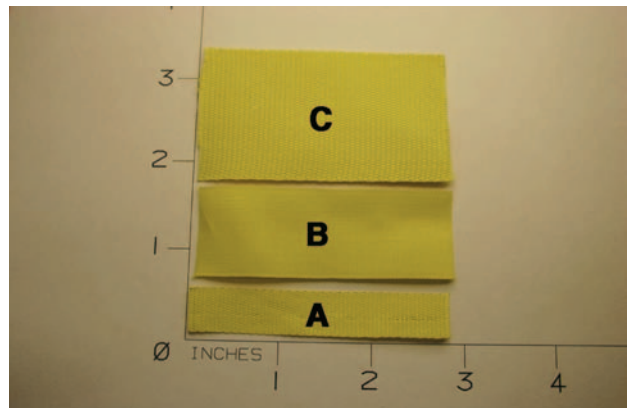
**Figure 3-27. Ty-1, 1" Parachute construction tape.**  
 Specification: PIA-T-6134  
 Strength: 525 lb  
 Identification: Plain tubular, 1" width, black line at center  
 Common use: Lower lateral bands for round canopies  
 Comment: N/A



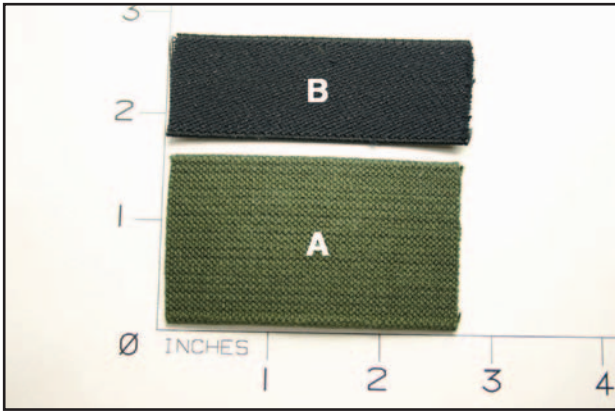
**Figure 3-29. Tape, nylon, 3".**  
 Specification: Commercial, No. 7282  
 Strength: N/A  
 Identification: Black dotted line down center of tape  
 Common use: Slider reinforcing  
 Comment: N/A



**Figure 3-28. Tape, polyester, 2".**  
 Specification: Commercial, No. 1655  
 Strength: 1200 lb  
 Identification: Herringbone weave, 2"  
 Common use: Reserve free bag bridles  
 Comment: N/A

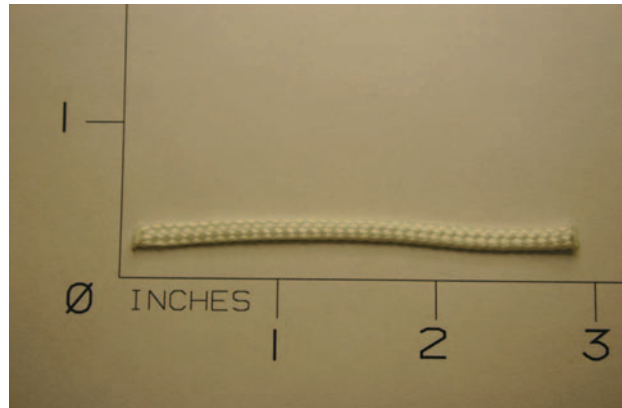


**Figure 3-30. Kevlar® tape.**  
 Specification: PIA-T-87130  
 Strength: A. 550 lb; B. 525 lb; C. 3000 lb  
 Identification: N/A  
 Common use: Tandem drogue bridles, canopy reinforcing  
 Comment: A. Ty-1 Class 2; B. Ty-6 Class 2; C. Ty-9 Class 5.



**Figure 3-31. Cotton elastic webbing.**

Specification: PIA-W-5664  
 Strength: N/A  
 Identification: A. 1 1/2"; B. 1"  
 Common use: Harness keepers and ripcord pockets  
 Comment: N/A

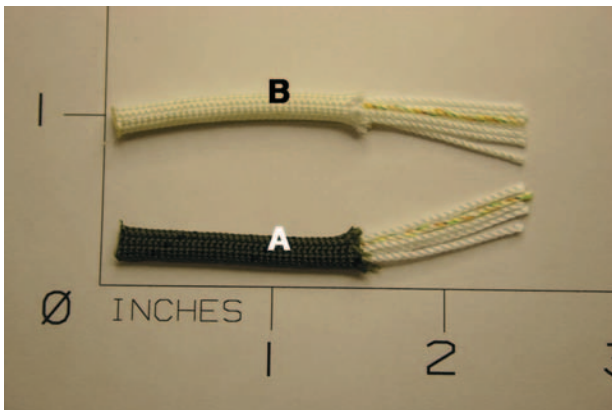


**Figure 3-33. Cord, nylon, Ty-1a.**

Specification: PIA-C-7515  
 Strength: 400 lb  
 Identification: Braided line  
 Common use: Several sport round reserves  
 Comment: N/A

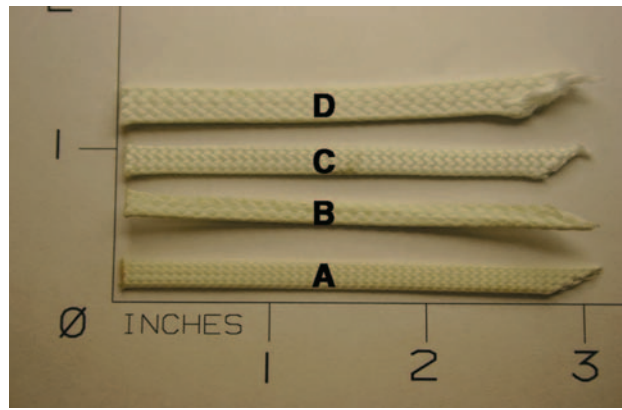
## CORDS, LINES, AND THREADS

The most common uses of cord and lines are the suspension lines of the canopy. There are many different types in use. Today, the most common are nylon, Dacron, and Spectra®. The rigger needs to know the different types and their uses. Each may have special techniques to work with them. [Figures 3-32 through 3-42]



**Figure 3-32. Cord, nylon, Ty-2 and Ty-3.**

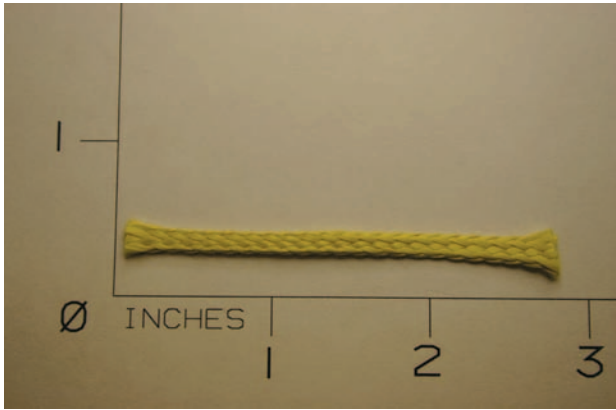
Specification: PIA-C-5040  
 Strength: A. 400 lb; B. 550 lb  
 Identification: Sheath and core construction  
 Common use: Ty-2 used on T-10 canopies; Ty-3 used on 24" and 28" canopies  
 Comment: A. Ty-2; B. Ty-3



**Figure 3-34. Cord, Dacron.**

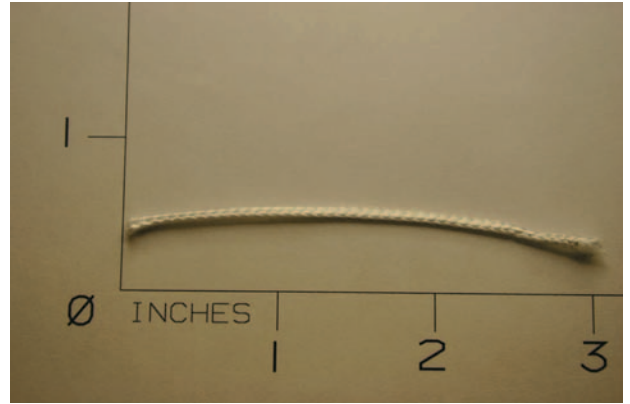
Specification: Commercial  
 Strength: A. 400 lb; B. 500 lb; C. 600 lb; D. 900 lb  
 Identification: Braided hollow line  
 Common use: Ram-air canopies  
 Comment: N/A





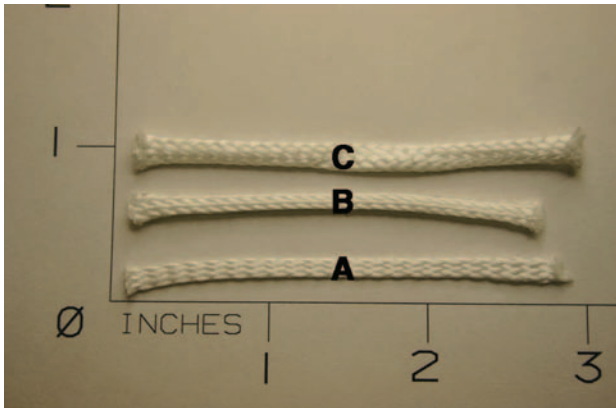
**Figure 3-35. Cord, Kevlar®.**

Specification: PIA-C-87129  
 Strength: 700 lb  
 Identification: Braided, untreated  
 Common use: Early ram-air canopies  
 Comment: N/A



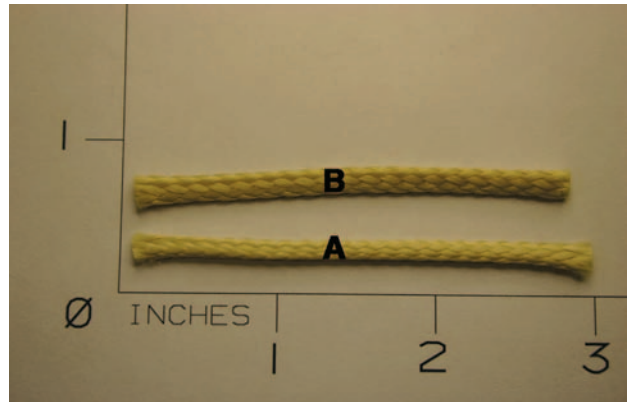
**Figure 3-37. Cord, Spectra®.**

Specification: Commercial  
 Strength: 300 lb  
 Identification: Braided, untreated  
 Common use: CYPRES® closing loops  
 Comment: N/A



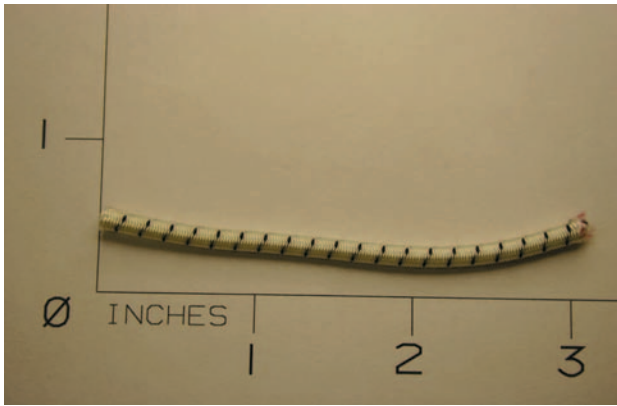
**Figure 3-36. Cord, Spectra®.**

Specification: Commercial  
 Strength: A. 725 lb; B. 940 lb; C. 1800 lb  
 Identification: Braided line  
 Common use: Modern ram-air canopies  
 Comment: N/A



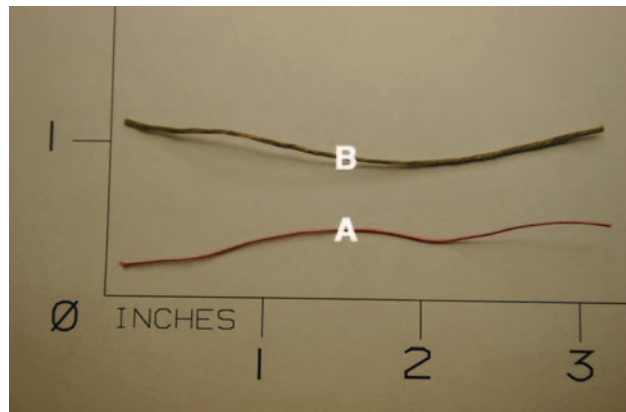
**Figure 3-38. Cord, Vectran® LCP.**

Specification: Commercial  
 Strength: A. 1000 lb; B. 1600 lb  
 Identification: Braided  
 Common use: Strong tandem main canopies  
 Comment: N/A



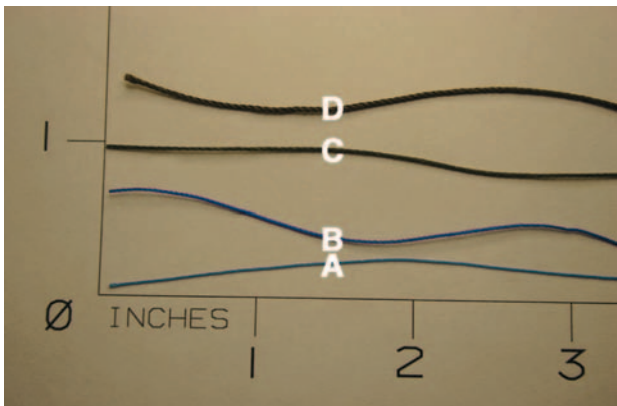
**Figure 3-39. Cord, elastic.**

Specification: MIL-C-5650  
 Strength: N/A  
 Identification: 1/8" diameter  
 Common use: Safety Stows on free bag systems  
 Comment: Commonly known as "shockcord."



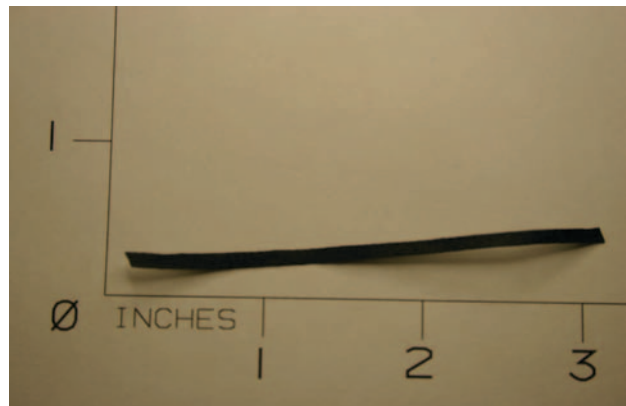
**Figure 3-41. A. Thread, cotton, 24/4; B. Thread, cotton, 3-cord.**

Specification: V-T-276  
 Strength: A. 4.5 lb; B. 16 lb  
 Identification: N/A  
 Common use: 24/4 sealing reserves, 3-cord-hand tacking, break tackings  
 Comment: N/A



**Figure 3-40. Thread, nylon.**

Specification: V-T-295  
 Strength: A. E/8.5 lb; B. FF/16 lb; C. 3 cord/24 lb; D. 5 cord/40 lb  
 Identification: As marked  
 Common use: E thread for canopy and general sewing  
 FF for container reinforcing  
 3 cord for light harness construction  
 5 cord for general harness construction  
 Comment: These are the most common threads used.



**Figure 3-42. Thread, nylon, flat braided (supertack).**

Specification: MIL-T-43435  
 Strength: 80-90 lb  
 Identification: Black or white colors  
 Common use: Hand tacking  
 Comment: N/A

## HARDWARE

**Hardware**, as defined in the context of parachutes, is “all metal parts associated with parachutes, their systems, and their suspended loads.” Most riggers identify hardware as the snaps, adapters, rings, links, and releases commonly used on harnesses. In addition to these components, other hardware includes items such as lightweight links and snaps, ripcords and handles, stiffeners, grommets, springs, and snap fasteners. [Figures 3-44 through 3-78]

Most load bearing hardware consists of drop forged alloy steel, sheet alloy steel, or forged aluminum alloy. Lightweight hardware may be stamped from the sheet alloy steel, or in rare instances, cast. The majority of the load bearing hardware is forged carbon steel with either cadmium or zinc plating.

In recent years, there has been a movement to produce newer design hardware of stainless steel. This removes the problem of plating and the environmental problems associated with it. However, stainless is harder on the forging dies and the finishing processes take longer. Consequently, stainless hardware is generally more expensive than carbon steel.

All specification hardware has the appropriate number stamped or marked on it. The **MS** prefix is on those with the MIL-SPEC certification. All with the newer PIA certification have the mark with the PS (Parachute Standards) prefix. [Figure 3-43] Most of the current hardware has the mark with the MS prefix. As current stocks deplete, the mark on new production is with the PS prefix.



**Figure 3-43. Parachute standards marking example.**



**Figure 3-44. Snap, B-12.**

Specification: MS22044

Proof load: 2500 lb

Identification: As marked

Common use: Leg snaps on sport harnesses, USAF B-12 assembly

Comment: Used with small frame adjustable “V” ring.



**Figure 3-45. Ejector snap, non-adjustable.**

Specification: MS22017

Proof load: 2500 lb

Identification: As marked

Common use: Military harnesses

Comment: Use with large frame “V” rings.





**Figure 3-46. Snap, quick fit.**

Specification: MS22043  
 Proof load: 2500 lb  
 Identification: As marked  
 Common use: Aviator emergency parachute system  
 Comment: Snap portion is the same as the B-12 snap.



**Figure 3-48. Snap, parachute chest type pack.**

Specification: MS70121  
 Proof load: 5000 lb  
 Identification: As marked  
 Common use: Army troop reserves  
 Comment: Must be mated with the larger "D" rings for both compatibility and strength.



**Figure 3-47. Snap, quick fit ejector.**

Specification: MS22018  
 Proof load: 2500 lb  
 Identification: As marked  
 Common use: Navy NB-6 and NB-8 assemblies  
 Comment: Do not use with shallow frame "V" ring.



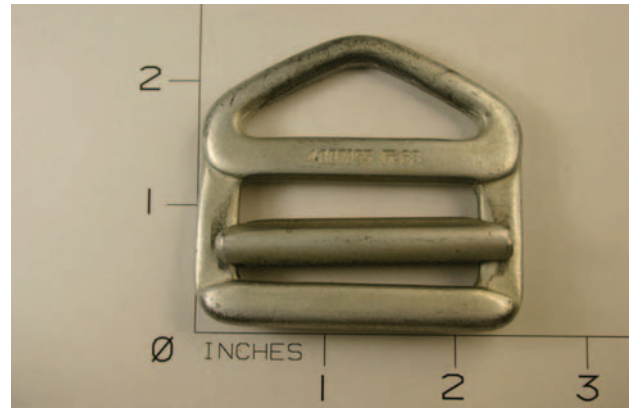
**Figure 3-49. Snap, quick connector, parachute harness.**

Specification: MS22042  
 Proof load: 5000 lb  
 Identification: As marked  
 Common use: Navy chest assemblies, strong tandem passenger harness  
 Comment: N/A



**Figure 3-50. "D" ring harness, old style.**

Specification: MS22046-1  
 Proof load: 5000 lb  
 Identification: As marked  
 Common use: Army T-10 harness  
 Comment: N/A



**Figure 3-52. "V" ring, quick fit, shallow frame.**

Specification: MS70113  
 Proof load: 2500 lb  
 Identification: As marked  
 Common use: B4 harnesses  
 Comment: Do not use with quick ejector snaps.



**Figure 3-51. "D" ring harness, new style.**

Specification: 11-1-485  
 Proof load: 5000 lb  
 Identification: As marked  
 Common use: MC1-1B assemblies  
 Comment: Replaces old style D ring MS22046-1.



**Figure 3-53. "V" ring, quick fit, large frame.**

Specification: MS27765  
 Proof load: 2500 lb  
 Identification: As marked  
 Common use: Used with ejector snaps  
 Comment: N/A



**Figure 3-54. Adapter, quick fit, small frame.**

Specification: MS70114  
 Proof load: 2500 lb  
 Identification: As marked  
 Common use: Military harnesses, sport harnesses  
 Comment: N/A



**Figure 3-56. Adapter, quick fit, reversible.**

Specification: MS22019  
 Proof load: 2500 lb  
 Identification: As marked  
 Common use: Navy harnesses  
 Comment: Does not grip as well as MS70114 and MS22040.



**Figure 3-55. Adapter, quick fit, large frame.**

Specification: MS22040  
 Proof load: 2500 lb  
 Identification: As marked  
 Common use: Military harnesses, sport harness thread-thru leg strap configuration  
 Comment: N/A



**Figure 3-57. Adapter, 2 piece.**

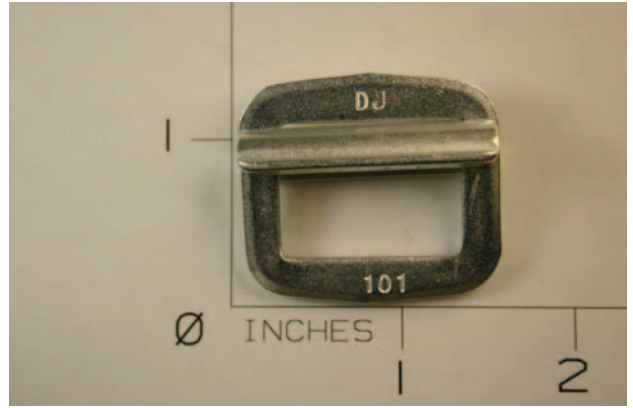
Specification: Commercial  
 Proof load: 2500 lb, stainless steel  
 Identification: SP-888  
 Common use: Sport harness leg strap adapters  
 Comment: Manufactured by Wichard in France.





**Figure 3-58. Adapter, quick fit.**

Specification: Commercial  
 Proof load: 2500 lb  
 Identification: DJ-SSA, stainless steel  
 Common use: Harness and leg strap adapters  
 Comment: A smaller version of the MS70114 adapter.



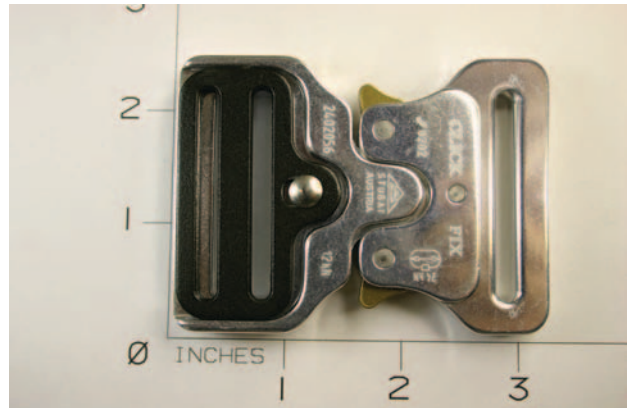
**Figure 3-60. Adapter, quick fit, 1".**

Specification: Commercial spec  
 Proof load: 500 lb  
 Identification: As marked  
 Common use: Sport harness chest straps  
 Comment: Mates well with Ty-17 webbing.



**Figure 3-59. Adapter, quick fit, lightweight.**

Specification: MS70101  
 Proof load: 500 lb  
 Identification: As marked  
 Common use: Sport harness chest straps  
 Comment: Very common; many uses.



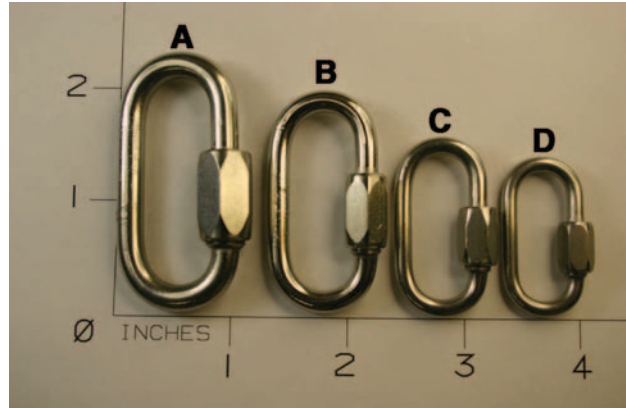
**Figure 3-61. Adapter, quick fit release.**

Specification: Commercial  
 Proof load: 13 kn  
 Identification: As marked  
 Common use: Chest adapter release  
 Comment: Forged aluminum.



**Figure 3-62. Link, removable connector.**

Specification: MS22002  
 Proof load: 3000 lb  
 Identification: As marked  
 Common use: C-9 canopies  
 Comment: N/A



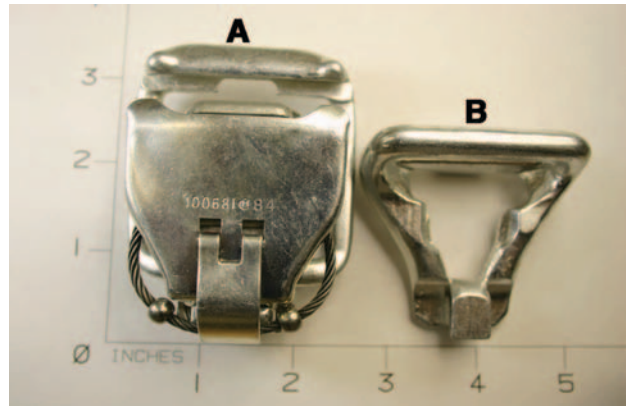
**Figure 3-64. Link, Rapide®.**

Specification: Commercial  
 Proof load/  
 SWL: As marked on the link  
 Identification: "Mallion Rapide®" markings  
 Common use: Ram-air canopies, modern round reserves  
 Comment: A. No. 6; B. No. 5; C. No. 4;  
 D. No. 3.5.



**Figure 3-63. Link, removable connector, speed.**

Specification: MS22021  
 Proof load: 3000 lb  
 Identification: As marked  
 Common use: Navy and Air Force canopies  
 Comment: N/A



**Figure 3-65. Release, parachute canopy quick disconnect, Capewell.**

Specification: 60B4312 (assembly)  
 Proof load: 5000 lb  
 Identification: As marked  
 Common use: Military harnesses  
 Comment: A. 60B4313/female.  
 B. 60J4328/male.



**Figure 3-66. Ring, harness, 3-ring.**

Specification: Commercial  
 Proof load: 2500 lb  
 Identification: RW-1, 445  
 Common use: 3-ring release systems  
 Comment: No. 445 shown.



**Figure 3-68. Ring, riser, small, 3-ring.**

Specification: Commercial  
 Proof load: 250 lb  
 Identification: RW-3  
 Common use: 3-ring release systems  
 Comment: Upper riser ring.



**Figure 3-67. Ring, riser, middle, 3-ring.**

Specification: Commercial  
 Proof load: 500 lb  
 Identification: RW-2  
 Common use: 3-ring release systems  
 Comment: Bottom riser ring.



**Figure 3-69. Ring, riser, mini, 3-ring.**

Specification: Commercial  
 Proof load: 250 lb  
 Identification: RW-4  
 Common use: 3-ring release systems  
 Comment: Small ring of mini 3-ring systems, riser guide rings.





**Figure 3-70. Ring, harness, tandem.**

Specification: Commercial  
 Proof load: 5000 lb  
 Identification: N/A  
 Common use: Tandem harness assemblies  
 Comment: Manufactured by Parachutes de France and Strong Enterprises.



**Figure 3-72. Ring, harness, "O".**

Specification: Commercial  
 Proof load: 2500 lb  
 Identification: 5010  
 Common use: Articulated harness ring, tandem drogue release  
 Comment: N/A



**Figure 3-71. Ring, harness, replaceable, 3-ring.**

Specification: Commercial  
 Proof load: 2500 lb  
 Identification: RW-6  
 Common use: Replaceable 3-ring harness ring  
 Comment: Replaces soft RW-1/82 and 83 harness rings.



**Figure 3-73. Ring, harness, mini.**

Specification: Commercial  
 Proof load: 2500 lb  
 Identification: 444, RW-8  
 Common use: 3-ring harness ring  
 Comment: Sport harnesses.



**Figure 3-74. Ring, quick fit.**

Specification: Commercial  
 Proof load: 2500 lb  
 Identification: 555, RI-1  
 Common use: Sport student harness, pilot emergency harness  
 Comment: N/A



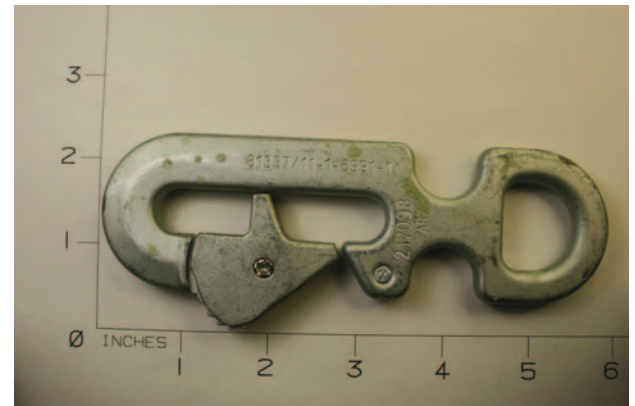
**Figure 3-76. Snap, static line, old style.**

Specification: MS-70120  
 Proof load: 1750 lb  
 Identification: As marked  
 Common use: Military and sport static lines  
 Comment: N/A



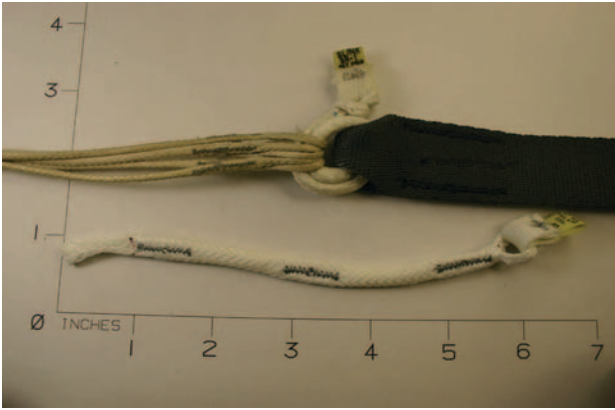
**Figure 3-75. Snap shackle.**

Specification: Commercial  
 Proof load: A. Bronze, 800 lb; B. Stainless steel, 1765 lb  
 Identification: As marked  
 Common use: RSL lanyard release  
 Comment: Made in bronze and stainless steel.



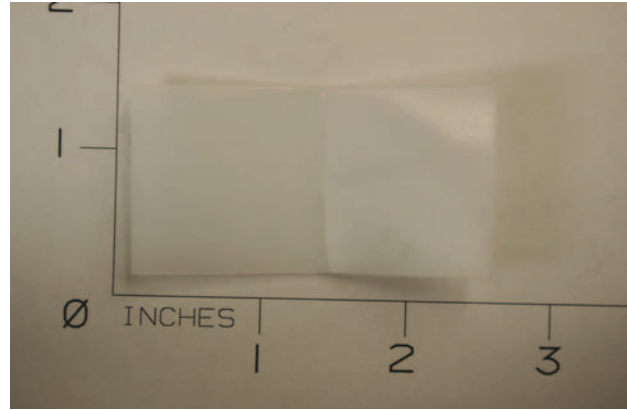
**Figure 3-77. Snap, static line, new style.**

Specification: 11-1-6991-1  
 Proof load: 1750 lb  
 Identification: As marked  
 Common use: Military static lines  
 Comment: N/A



**Figure 3-78. Soft link.**

Specification: N/A  
 Strength: N/A  
 Identification: As marked  
 Common use: Replacement for Rapide® links on main and reserve canopies  
 Comment: N/A

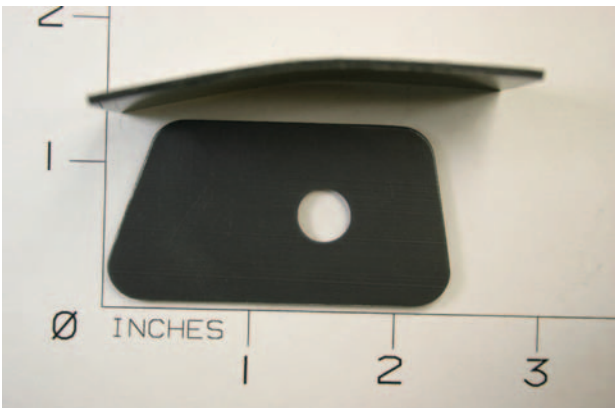


**Figure 3-80. Polyethylene, high density (HDPE).**

Specification: Commercial  
 Strength: N/A  
 Identification: .040", .060"  
 Common use: Stiffeners in container systems  
 Comment: Used in older systems. Deforms easily.

## PLASTICS AND SYNTHETICS

The term “plastic” used here is a generic term for synthetic materials. The use of these materials is primarily for stiffeners in containers. They replace the metal stiffeners used in military systems. High density polyethylene (HDPE) was the first material used followed by Lexan®. Time has proven that moly disulfide (MDS) filled nylon is superior to the other materials and has become the most commonly used stiffener material. Today, the use of Lexan® is primarily in clear windows in pin protector flaps. [Figures 3-79 through 3-83]



**Figure 3-79. Molydisulfide Nylon — MDS (Nylatron®).**

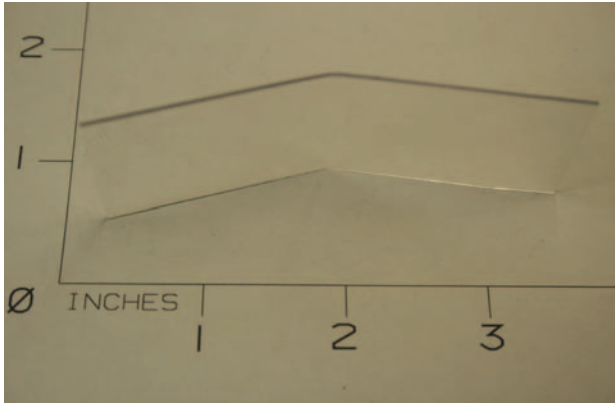
Specification: Commercial  
 Strength: N/A  
 Identification: .025", .040", .060"  
 Common use: Stiffeners in container systems  
 Comment: The preferred material in modern container systems.



**Figure 3-81. HDPE tubing, 1 1/2".**

Specification: Commercial  
 Strength: N/A  
 Identification: Orange color  
 Common use: Hand deploy handles, pinless student ripcords  
 Comment: N/A





**Figure 3-82. Polycarbonate — Lexan®.**

Specification: Commercial  
 Strength: N/A  
 Identification: .030", .060"  
 Common use: Windows in container systems, stiffeners in older systems  
 Comment: Breaks easily.



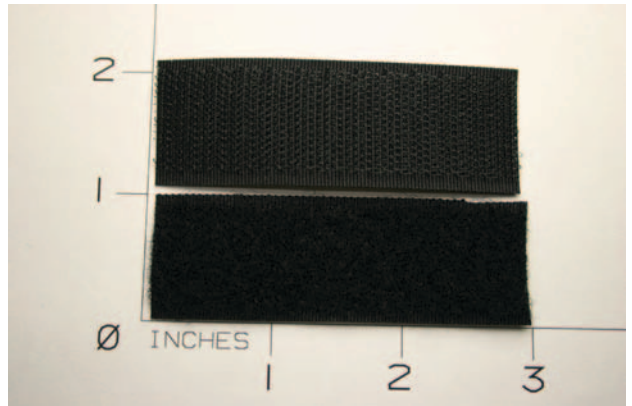
**Figure 3-83. Vinyl.**

Specification: Commercial  
 Strength: N/A  
 Identification: N/A  
 Common use: Transparent windows for CYPRES® control units  
 Comment: N/A

## FASTENERS

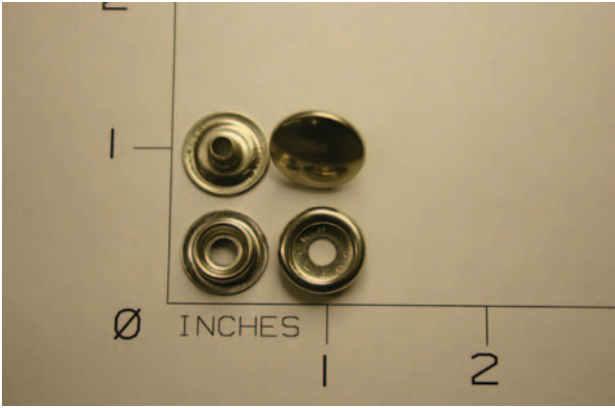
Fasteners are various types of devices designed to hold parts or components together or allow them to be held open or closed. The most common designs are hook and loop fasteners (**Velcro®**), **snaps**, **grommets**, and **slide fasteners (zippers)**.

Of all these, Velcro® and grommets play a major part in parachute manufacture. The use of Velcro® is primarily for protector flap closure designs, while grommets are for use in pack closing systems. Both fasteners are subject to extreme wear and tear in their normal use. Consequently, routine maintenance involves the repair and replacement of these items. [Figures 3-84 through 3-88]



**Figure 3-84. Fastener tape, hook and pile, nylon (Velcro®).**

Specification: PIA-F-21840  
 Strength: Varies according to use and type  
 Identification: Different widths from 5/8" to 3", 1" most common  
 Common use: Closure flaps, bridles, toggles  
 Comment: An extremely versatile fastener material.



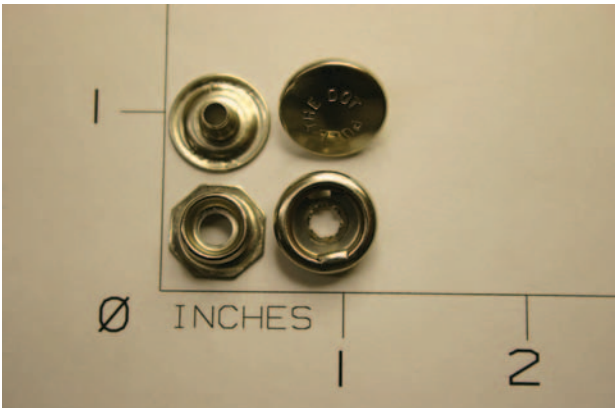
**Figure 3-85. DOT Fasteners, Durable.**

Specification: PIA-F-10884  
 Strength: N/A  
 Identification: N/A  
 Common use: General purpose snap  
 Comment: Open when pulled from any direction.



**Figure 3-87. Grommets.**

Specification: MIL-G-16491  
 Strength: N/A  
 Identification: As marked  
 Common use: Container closure systems, 3-ring risers, deployment bags  
 Comment: Rolled rim spur grommets are the most common grommets used in modern parachute systems.



**Figure 3-86. DOT Fasteners, Pull-the-dot.**

Specification: PIA-F-10884  
 Strength: N/A  
 Identification: Button marked with "pull-the-dot" markings  
 Common use: Military container closure flaps  
 Comment: Open only when pulled from one particular side.

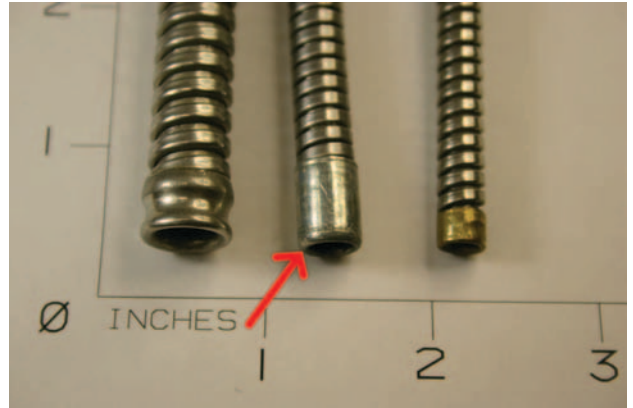


**Figure 3-88. Interlocking slide fasteners (zippers).**

Specification: V-F-106, AN229  
 Strength: N/A  
 Identification: N/A  
 Common use: Some military containers, carry bags, jumpsuits  
 Comment: Most modern zippers are nylon vs. metal. Nylon comes in rolls and can be cut to fit.

# HOUSINGS

**Housings** are spiral-wound flexible tubing. Almost all are stainless steel. Their design is to route, house, and protect the ripcord cable. They are anchored at the container end and at the ripcord pocket or mount at the other end. Most housings are compressible only, but some military housings used with seat parachutes are expandable as well. With the advent of modern sport systems, smaller diameter housing for ripcords is more common. In addition, the 3-ring release system has introduced an even smaller housing for use with the coated release cables. Housings are measured under slight tension. [Figures 3-89A through 3-89C]



**Figure 3-89B. Housing, flexible, ripcord.**

Specification: Commercial  
Strength: N/A  
Identification: ID approximately .26"  
Common use: Most modern sport systems  
Comment: Brass or steel ferrules.



**Figure 3-89A. Housing, flexible, ripcord.**

Specification: PIA-H-7750  
Strength: N/A  
Identification: ID approximately .375"  
Common use: Military parachute assemblies  
Comment: N/A



**Figure 3-89C. Housing, flexible, 3-ring.**

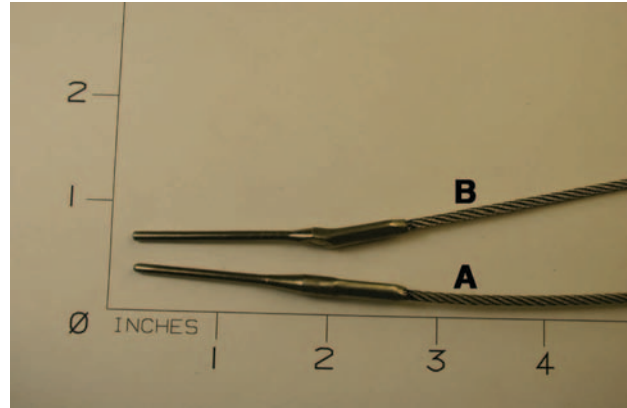
Specification: Commercial  
Strength: N/A  
Identification: .18" ID  
Common use: 3-ring release systems  
Comment: Brass ferrules.



## RIPCORDS, CABLES, AND SWAGES

The standard ripcord used today on most parachute systems consists of a metal handle, stainless steel cable, a terminal ball, and one or more pins swaged onto the cable. The handles come in various shapes and sizes. The terminal ball may be of several configurations such as a ball and shank design. The pins usually are one of two basic designs, either the elbow pin or the terminal pin. This basic configuration is used primarily on reserve and emergency parachute systems. Main ripcords may also consist of plastic handles and nylon coated cable without pins.

On modern sport parachutes, the hand deploy pilot chute replaced the conventional ripcord, by either throw-out or pull-out. These configurations use the curved or straight locking pins attached to the pilot chute bridle. [Figures 3-90 through 3-96]



**Figure 3-91. A. Pin, ripcord, terminal; B. Pin, ripcord, elbow.**

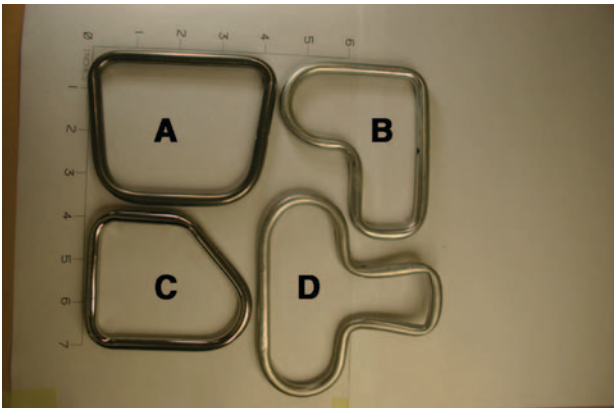
Specification: A. 55A6480  
B. MS70107

Strength: N/A

Identification: N/A

Common use: Ripcords

Comment: N/A



**Figure 3-90. Handle, steel, ripcord.**

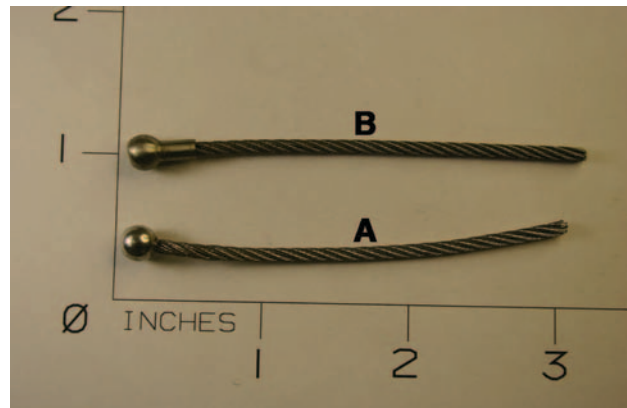
Specification: MS70106

Strength: N/A

Identification: As marked

Common use: Ripcord assemblies

Comment: A. Modern trapezoidal.  
B. Martin Baker.  
C. Helwedge.  
D. Cloverleaf.



**Figure 3-92. A. Ball, terminal; B. Ball and shank.**

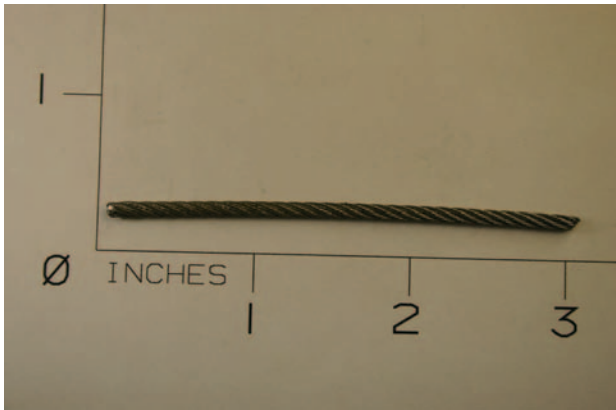
Specification: A. MS70093; B. MS20664

Strength: A. 736 lb  
B. 920 lb

Identification: N/A

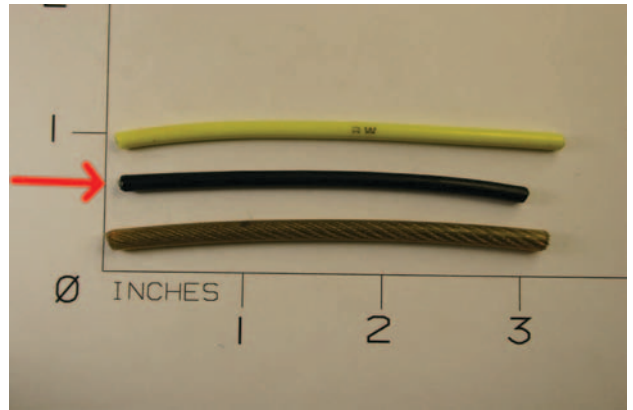
Common use: Ripcords

Comment: N/A



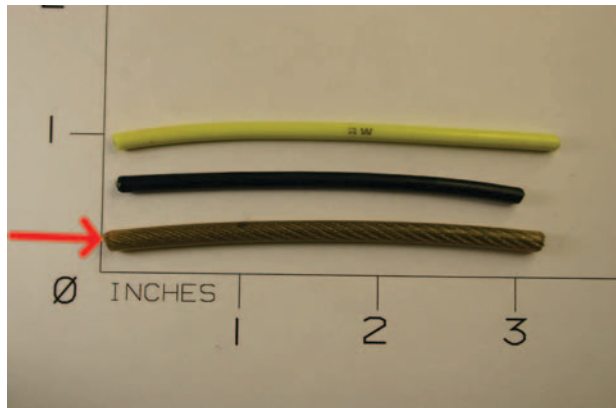
**Figure 3-93. 7x7 S/S cable.**

Specification: MIL-W-5424  
 Strength: 920 lb  
 Identification: N/A  
 Common use: Ripcord cable  
 Comment: N/A



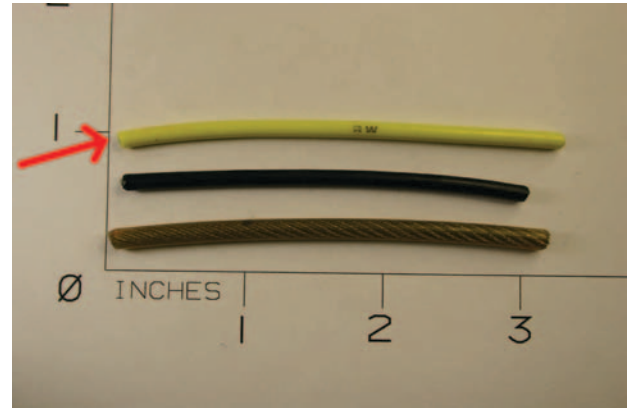
**Figure 3-94B. Black pinless r/c cable.**

Specification: 1/16" 7x7 galvanized, nylon coated to 1/8"  
 Strength: N/A  
 Identification: Shiny black  
 Common use: Pinless main ripcords for student systems  
 Comment: The nylon coating is very hard to prevent the loop from cutting into the coating.



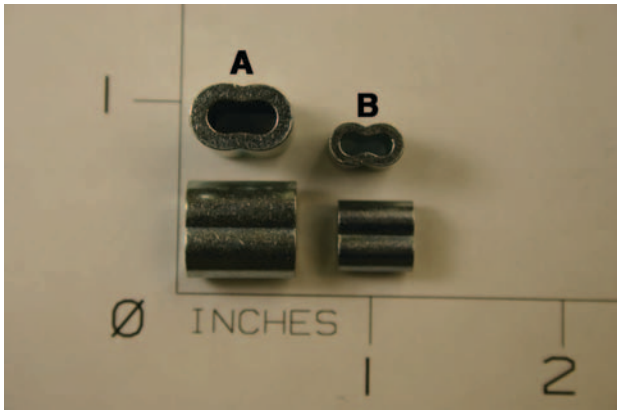
**Figure 3-94A. Static line cable.**

Specification: 3/32" 7x7 galvanized, nylon coated to 5/32"  
 Strength: N/A  
 Identification: Translucent  
 Common use: Main static line flex-pin, tandem release cables  
 Comment: Softer nylon than the black cable.



**Figure 3-94C. 3-ring cable.**

Specification: 1/16" 7x7 galvanized, Lolon F coated to 1/8"  
 Strength: N/A  
 Identification: Yellow color  
 Common use: 3-ring release cables  
 Comment: Some are marked with "RW" on cable.

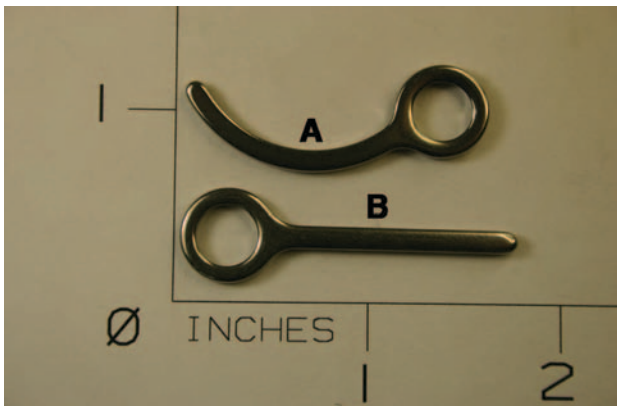


**Figure 3-95. Nicopress swage, 3/32" and 3/16".**

Specification: N/A  
 Strength: N/A  
 Identification: N/A  
 Common use: 3-ring release cables and ripcord cables  
 Comment: A. 3/32"; B. 3/16"

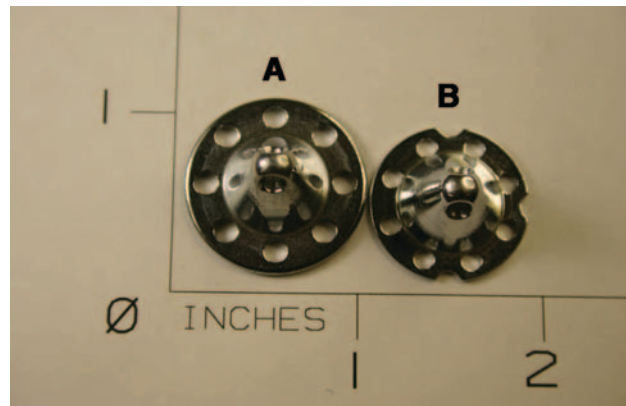
## MISCELLANEOUS

The miscellaneous category includes remaining items that do not fit in any of the other categories. [Figures 3-97 through 3-108]



**Figure 3-96. A. Release pin, curved; B. Release pin, straight.**

Specification: Commercial, stainless steel  
 Strength: N/A  
 Identification: N/A  
 Common use: A. Throw-out pilot chute bridles  
 B. Pull-out pilot chute bridles  
 Comment: N/A



**Figure 3-97. Cones.**

Specification: A. NPU 56-039  
 B. MS27763  
 Strength: N/A  
 Identification: MS27763 has three notches in the base.  
 Common use: NPU 56-039 used with Navy stiffeners  
 MS27763 used on many different containers  
 Comment: MS27763 is the most common cone used.



**Figure 3-98. A. Eyes; B. Hooks.**

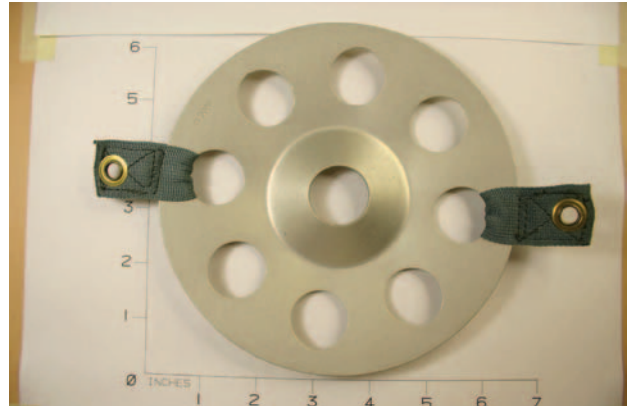
Specification: A. 43A21915  
 B. MS90295

Strength: N/A

Identification: N/A

Common use: Military container systems and pack opening bands (POB)

Comment: These are the standard combination used with POBs and eyes.



**Figure 3-100. Disc assembly, pilot chute ejector.**

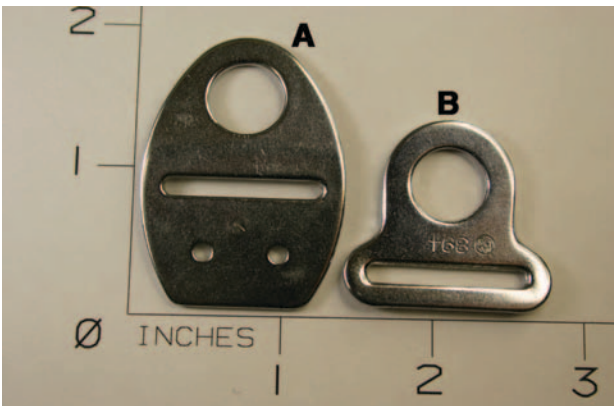
Specification: 53B7105

Strength: N/A

Identification: As marked

Common use: Used with MA-1 pilot chutes

Comment: N/A



**Figure 3-99. End tabs.**

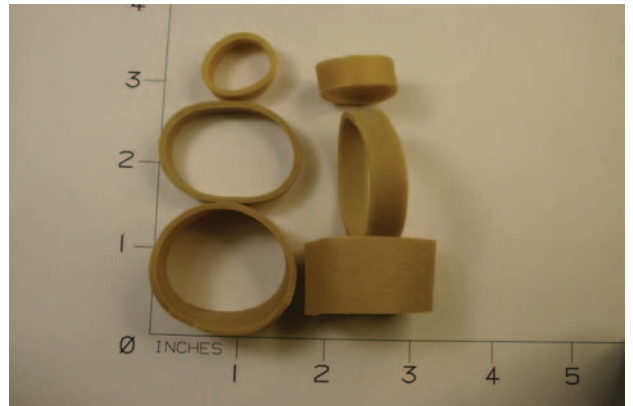
Specification: A. AN 6572  
 B. MS70092

Strength: N/A

Identification: N/A

Common use: A. Navy seat packs  
 B. Army chest packs

Comment: N/A



**Figure 3-101. Rubber bands, parachute suspension line.**

Specification: MIL-R-1832

Strength: 45 lb new

Identification: N/A

Common use: Line stows

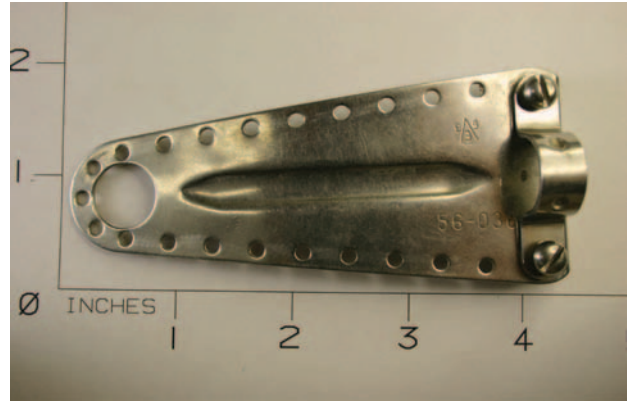
Comment: Commercial bands most common, several sizes.





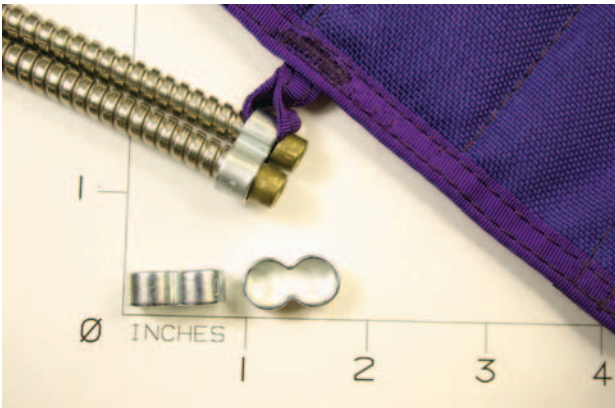
**Figure 3-102. Clamp, housing, single.**

Specification: Commercial  
 Strength: N/A  
 Identification: 11.0R  
 Common use: Securing ripcord housings  
 Comment: N/A



**Figure 3-104. Stiffener, housing, Navy.**

Specification: 60A113C29-1  
 Strength: N/A  
 Identification: As marked  
 Common use: NB-6 and NB-8 Navy back parachutes  
 Comment: N/A



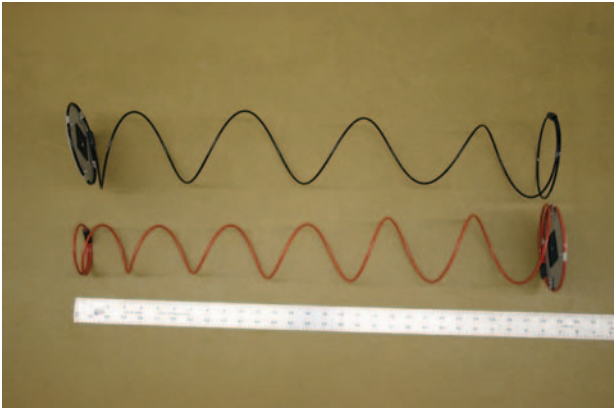
**Figure 3-103. Clamp, housing, double.**

Specification: Commercial  
 Strength: N/A  
 Identification: 0809/2  
 Common use: Securing 3-ring housings  
 Comment: N/A



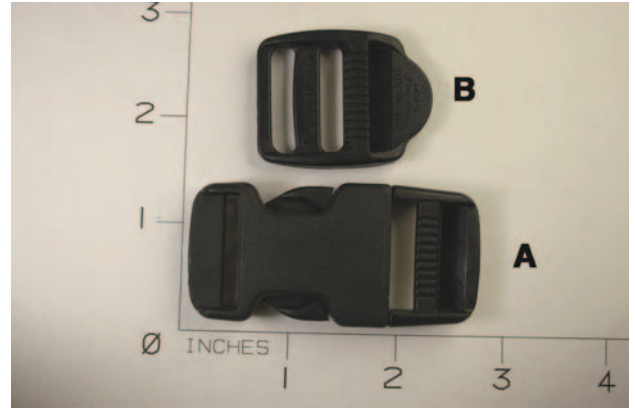
**Figure 3-105. Stiffener, housing, Air Force.**

Specification: 56C6392  
 Strength: N/A  
 Identification: As marked  
 Common use: Air Force parachutes, B-12, etc.  
 Comment: N/A



**Figure 3-106. Spring, pilot chute.**

Specification: Commercial  
 Strength: N/A  
 Identification: N/A  
 Common use: Reserve pilot chutes  
 Comment: N/A



**Figure 3-108. Nylon hardware.**

Specification: Commercial  
 Strength: N/A  
 Identification: As marked  
 Common use: Lightweight, non-load bearing uses  
 Comment: A. Sidelock; B. Adjuster.



**Figure 3-107. Washers, locking, loop.**

Specification: Commercial  
 Strength: N/A  
 Identification: As marked  
 Common use: Used on CYPRES® locking loops and main locking loops  
 Comment: N/A





Certificated parachute riggers represent a professional cadre within the parachute community. According to Title 14 of the Code of Federal Regulations (14 CFR) part 65, subsection 65.129(f)(1), “No certificated parachute rigger may exercise the privileges of his certificate and type rating unless he understands the current manufacturer’s instructions for the operation involved and has performed duties under his certificate for at least 90 days within the preceding 12 months.”

Manufacturers of main parachutes have packing techniques that they have developed for their products. Most of them follow established methods in common use. Experience has shown that if the packing techniques required for a specific main are too complex, the market may not receive them favorably.

### SPORT PARACHUTE MAIN PACKING TECHNIQUES

The most common packing method used today is the Proper Ram-air Orientation (PRO) packing. Figures 4-1 thru 4-32 show this technique. There are several variations to this technique designed for special purposes. Free fall cameramen may require a slower opening to reduce the **opening shock**. **Canopy Relative Work (CRW)** parachutists may want faster sub-terminal openings. The rigger should be able to provide guidance to the parachutist for the type of opening required.



Figure 4-1. Prepare the slider. If collapsible, make sure the drawstring(s) is cocked.



Figure 4-2. Grasp the line groups between your fingers.



Figure 4-3. Run your hands up the lines pushing the slider ahead of them. Spread the line groups and shake out canopy.



Figure 4-4. Make sure the canopy is orientated with the nose to rear and tail to front. This view is shown from the top of the canopy looking down and towards the packer.





Figure 4-5. Transfer all the lines to one hand.



Figure 4-8. Clear the stabilizers on each side.



Figure 4-6. Starting with the cell nearest your legs, flake the nose.



Figure 4-9. View from front with slider moved upward for clarity. Note how the attachment tapes of each line group fall together.



Figure 4-7. Grasp all the cells and tuck them between your legs.



Figure 4-10. Separate and clear material between line groups.



Figure 4-11. Square the slider between the line groups.



Figure 4-13. Grasp the center of the tail seam with the same hand that holds the lines. With the other hand, pull the tail seam downward. Repeat for the other side.



Figure 4-12. Grasp the center of the tail.



Figure 4-14. Pull both side seams together at the bottom.



Figure 4-15. Roll both seams together tightly starting at the bottom.





Figure 4-16. Hold the rolled tail between the legs and roll the upper material tightly against the lines.



Figure 4-19. Keeping the lines taut, lay the canopy bundle on the floor.



Figure 4-17. Smooth the air out of the rolled canopy.



Figure 4-20. Triangular shape on the floor. Make sure the slider is securely wrapped in the tail.



Figure 4-18. Take the free hand and place it under the rolled canopy bundle.



Figure 4-21. If used, cock the kill-line bridle.





Figure 4-22. Check the collapsed bridled.



Figure 4-25. Fold the top of the canopy bundle back towards the lines for a second "S" fold.



Figure 4-23. Dress the canopy bundle slightly wider than the deployment bag.



Figure 4-26. Complete the "S" fold.



Figure 4-24. Make a short "S" fold at the slider end of the bundle.



Figure 4-27. Place one corner of the canopy stack in the bag.





Figure 4-28. Place the other side of the canopy in the bag.



Figure 4-31. Secure the remainder of the mouth locking stows.



Figure 4-29. Canopy fully in the bag.



Figure 4-32. Stow the remainder of the lines on the side bag stows.



Figure 4-30. Secure the center locking stow with the line group.

When packing reserves and emergency parachutes, the rigger must adhere to the manufacturer's instructions and is not allowed to deviate from them. When packing main parachutes, the manufacturer may specify a certain packing method but then gives guidance and leeway for alternative methods to use to vary the opening according to the needs of the parachutist.

## DEPLOYMENT AND INFLATION CHARACTERISTICS

Main canopies have changed dramatically over the last several years and, consequently, different opening problems have emerged. One of the most common problems encountered is hard openings. The most effective method employed to reduce hard openings is to roll the nose of the canopy to close off the openings in the leading edge during the initial inflation process. This rolling technique varies from a single roll to several rolls. Figure 4-33 shows this technique. If this does not solve the opening problem, riggers should contact the manufacturer for advice. Most manufacturers are very cooperative and have considerable expertise in working with their products.



Figure 4-33. Rolling the nose of the canopy.

In the event the manufacturer cannot resolve the problem, it may be necessary for the rigger to modify the slider size, or deployment brake settings. Of these options, the easiest to do is to change the brake setting. Reducing the brake setting results in less pressure on the canopy during opening, thereby reducing the opening force. The negative effect of reducing the brake setting is an increase in opening surge. The new brake setting must find the balance of these results that best fit the user. If changing the brake setting does not work, then the rigger may wish to increase the size of the slider to slow the openings. This usually means replacing the slider with a larger one. This has the effect of increasing the drag on the slider and restricting the canopy inflation.

As canopies age and accumulate substantial jumps on them, many begin to develop slow openings, commonly known as “**sniveling**.” If the canopy was originally packed with the nose rolled, reducing the number of rolls may speed up the openings. However, many times the slow openings are due to other causes. One of the most common is the canopy getting out of trim due to the stretch of the suspension lines. The rigger should check the trim of the canopy against the manufacturer’s specifications and either re-trim the canopy

or re-line it. This has a pronounced effect of improving the openings as well as the flying characteristics, particularly on canopies made from zero porosity (ZP) fabric.

The effect on fabric that originally had a **porosity** (permeability) of 0-3 cfm or 0-5 cfm, such as PIA-C-44378, may not be as dramatic. With these canopies, changing the brake setting and increasing it by pulling down the tail will speed up the inflation of the canopy. The rigger must be careful not to set the brakes so deeply as to place the canopy in a stall during opening. If this does not work, then decreasing the size of the slider or the fabric type of the slider may help speed up the openings. Some of these problems, while appearing to be main canopy related, are traceable to other components of the parachute system such as the deployment bag, bridle, or pilot chute.

### MAIN PILOT CHUTE

Hand deploy pilot chutes are generally made from either the PIA-C-44378 (F-111) fabric or more commonly, zero porosity (ZP) fabric. The PIA-C-44378 fabric begins as a very low porosity fabric but as it is used, the permeability increases. As this happens, the drag of the pilot chute decreases. Consequently, the ability of the pilot chute to lift the weight of the canopy decreases and the speed of the opening is affected. Experience has shown that pilot chutes made from this type of fabric exhibit a decrease in performance at around 500 jumps under normal use.

Pilot chutes made from the ZP fabric last considerably longer than those made from F-111. However, there has been some disagreement concerning the use of the two different fabrics in pilot chutes. One canopy manufacturer advocates the use of F-111 type fabric only. They believe the ZP fabric contributes to hard openings. Most parachutists like ZP pilot chutes because they last longer.

The size of the pilot chute has a direct correlation to the type of opening experienced. In the early days of hand deploy chutes, a 36" F-111 pilot chute was standard on most systems. As the canopies became smaller and lighter, pilot chutes became smaller as well. Today, 24-26", 30", and 33" pilot chutes are all common.

Several factors dictate the size of the pilot chute used. The first is the weight of the canopy. Another factor is the main container closing configuration. Some systems are designed to hold the deployment bag so securely that it literally has to be jerked from the container. This type requires a larger pilot chute than the type of container that allows unrestricted extraction of the bag. This same problem can develop when an individual packs an oversized main canopy into the main container. Usually, a larger deployment bag is needed to hold the additional



volume. When the bag is forcibly stuffed into the container, the bag can be restricted from being pulled smoothly from the container.

If the pilot chute is too small, a pilot chute in tow can result. If the parachutist puts a larger pilot chute on the system, the bag can be extracted from the container, but the increased size of the pilot chute contributes to increased snatch force during the opening sequence. This results in perceived hard openings. Therefore, the size of the pilot chute and the deployment bag can have considerable effect on the opening characteristics of the main parachute.

## BRIDLE LENGTH

The length of the bridle has an effect primarily on the deployment of the main pilot chute. The bridle must be long enough to place the deployed pilot chute past the turbulence caused by the parachutist. If the bridle is too short, the pilot chute will stay in the parachutist's burble. The length of the bridle from the locking pin to the pilot chute averages around 7 feet. Recent years have seen the growth of the use of the "Birdman" flying suits. Because of the increased surface area and the decreased free fall speeds, the use of a longer bridle has become common, with a 9-foot length working well. Along with the longer bridle, containers have been modified to allow the bottom to open fully and the main bag to be extracted rearward towards the feet due to the more horizontal trajectory of the parachutist.

## RUBBER BANDS

The rubber stow bands play an important part of the deployment sequence, and serve two important functions. First, they hold the mouth of the deployment bag closed and prevent premature deployment of the main canopy. Secondly, they hold the line stows securely to allow a clean, orderly deployment of the lines. With the advent of smaller diameter lines, such as 550 Spectra® and HMA®, smaller diameter rubber bands have been developed to properly secure these lines. If the smaller rubber bands are not available, many parachutists double stow the larger rubber bands around the small lines. There are other products such as Tube Stoes®, which are designed to replace rubber bands and last longer. Figure 4-34 shows the various rubber bands and Tube Stoes®. In addition to the correct rubber bands, the length of the line stows is important as well. In the past, 1" stows were common, but today, 3" stows are recommended by several manufacturers. Figure 4-35 shows the comparison between the two lengths. The main point to remember is that the lines must be stowed neatly and securely.

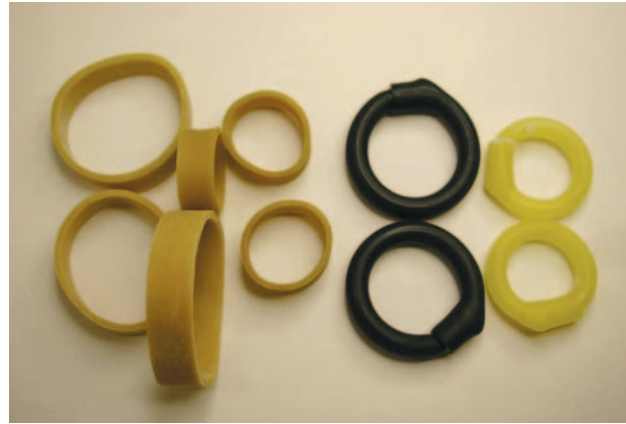


Figure 4-34. Rubber bands and Tube Stoes®.



Figure 4-35. Line stow length comparison.

## ASSEMBLY OF THE MAIN CANOPY TO THE HARNESS AND CONTAINER

The rigger should be familiar with the various types of **canopy releases** currently in use. In skydiving, the most common release is the 3-ring release system. It was originally developed in 1976 for skydiving, but has since become the dominant release system for intentional jumping, both civilian and military.

Riggers must be familiar with the assembly of the 3-ring release since they may have to connect new canopies to the harness and container, or have to disconnect the main canopy to untangle it after landing. Figures 4-36 thru 4-43 show the correct assembly sequence.





Figure 4-36. 3-ring layout.



Figure 4-40. 3-ring loop from rear.



Figure 4-37. 3-ring middle thru large ring.

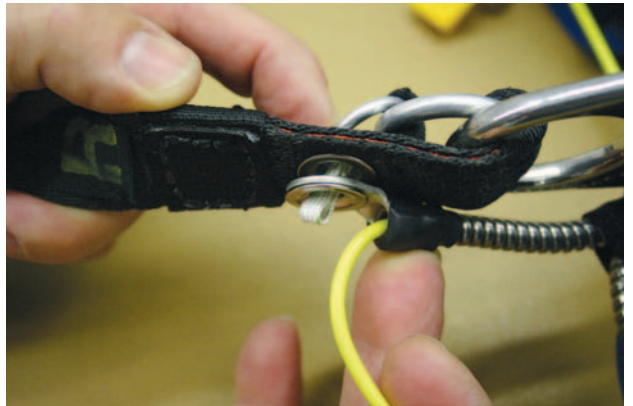


Figure 4-41. 3-ring housing over loop (rear).

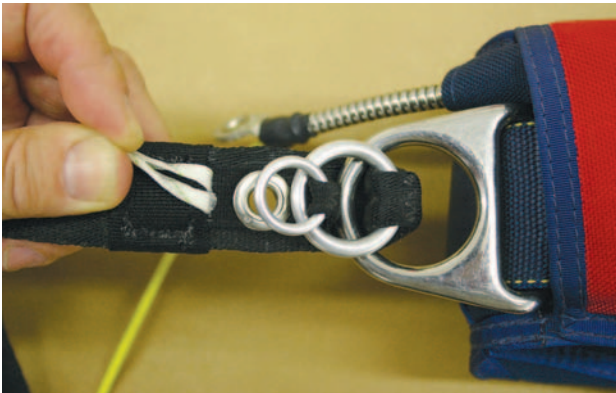


Figure 4-38. 3-ring small thru middle ring.



Figure 4-42. 3-ring cable thru loop.



Figure 4-39. 3-ring loop over top ring.



Figure 4-43. 3-ring finished from front.

The rigger must also be able to inspect the 3-ring release to determine any wear. In particular, the following areas need to be inspected:

- Harness 3-ring attachment. [Figure 4-44] Check for wear on the webbing and any damage to the ring or chipping of the plating.



Figure 4-44. Harness 3-ring inspection.

- Main riser rings. Check for webbing wear, hardware plating, grommet wear, and locking loop wear/damage. [Figure 4-45]



Figure 4-45. Riser release end.

- Release housings. Check for damage to terminal endings and grommet. Check for obstructions or dirt in housing. Check security of the housing tacking to the harness. [Figure 4-46]
- 3-ring release handle. Check the cable for cleanliness and cracks, and ensure that the cable ends are sealed; inspect the Velcro® on the handle. [Figure 4-47]

Any questions concerning the particular harness 3-ring installation should be referred to the harness and container manufacturer.



Figure 4-46. Release housings.

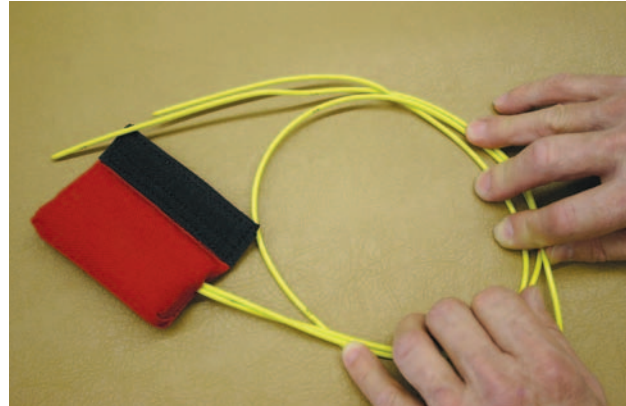


Figure 4-47. 3-ring release handle.

## ASSEMBLY OF COMPONENTS AND COMPATIBILITY

Advisory Circular (AC) 105-2—*Sport Parachute Jumping* states that, “the assembly or mating of approved parachute components from different manufacturers may be made by a certificated and appropriately rated parachute rigger or parachute loft in accordance with the parachute manufacturer’s instructions and without further authorization by the manufacturer or the FAA. Specifically, when various parachute components are interchanged, the parachute rigger should follow the canopy manufacturer’s instructions as well as the parachute container manufacturer’s instructions. However, the container manufacturer’s instructions take precedence when there is a conflict between the two.” This allows the rigger to assemble different canopies to different harness and container systems. This is an important ability for today’s rigger in that there are dozens of possible combinations.

Determining compatibility is more than simply determining the volume compatibility of a canopy to a container size. Other factors, which need to be considered, are the deployment type, TSO certification, and placard limitations.

## VOLUME

The most important criteria in determining compatibility is the volume of the canopy. The canopy has to



fit into the container in such a manner as to not place undue stress on the system when packing, and to be extracted by the pilot chute during deployment. The container manufacturer usually provides a volume chart of their systems stating what the volumes are for the various model sizes. The canopy manufacturer should provide the volumes of the canopy models. Measuring canopy volumes has proven to be an imprecise science as there are various methods that can be used. The most common method involves placing the canopy in a tubular chamber and compressing it with a standard amount of weight for a set time. The displaced volume is then measured. Figure 4-48 shows the official Parachute Industry Association (PIA) volume chamber. The PIA has measured canopy volumes since 1984 and publishes a chart of canopy volumes in their TS-104, *Canopy Volume Study*. While some canopy manufacturers disagree with the resultant numbers, most container manufacturers and riggers agree that it is an independent test method and use this chart to determine volume compatibility.



Figure 4-48. PIA volume chamber.

## DEPLOYMENT TYPE

Chapter 2—Design and Construction, described the different types of canopy deployment devices. In some instances, the container system needs to be of a specific configuration to accommodate a certain deployment device. An example of this would be where a

round canopy utilizing a Type 1 configuration is packed into a pilot emergency parachute system. In this case the pilot chute is compressed directly onto the floor of the container system. [Figure 4-49] This same canopy can be packed into a sport reserve container, but the sport rig has two internal or staging flaps that compress and hold the canopy in place and are locked together by the bridle. [Figure 4-50] The pilot chute is then packed on top of the internal flaps. The rigger needs to know and understand these differences to determine how the two components interface for compatibility.



Figure 4-49. Type 1 deployment in a pilot emergency rig.



Figure 4-50. Type 1 deployment in a sport piggyback.

## TSO CERTIFICATION AND PLACARD LIMITATIONS

This area is one where many riggers have some confusion. According to AC 105-2, “the strength of the harness must always be equal to or greater than the maximum force generated by the canopy during certification tests.”

In the case where the harness is certificated under TSO-C23b and the canopy under TSO-C23c, the maximum generated force of the canopy must not exceed the certificated category force of the harness



and container; i.e., Low Speed Category (3,000 pounds) and Standard Category (5,000 pounds). In this instance, no additional marking on the container is necessary.

In the case where the canopy is certificated under TSO-C23b and the harness under TSO-C23c, the strength of the harness must be equal to or greater than the certificated category force of the canopy.

For the current TSO-C23d, the average peak force measured during the strength drops must be placarded on the outside of the harness. In this case, the strength of the canopy must not exceed that of the harness.

All of the above areas must be considered by the rigger when making the determination as to whether a particular canopy and rig combination is compatible. If there is any doubt, the rigger should contact the rig manufacturer for guidance.



For most people, parachute rigging is all about packing parachutes. Rigging and packing may be synonymous, but there is a distinct difference. In its truest form, parachute rigging is the practice of assembling a parachute system with its various components into an operative assembly. Packing is the practice of folding the parachute canopy in an organized manner such that it fits into the container system and allows the canopy to open when the user activates the system.

There are five distinct stages involved in packing the parachute. They are:

1. Identification.
2. Inspection.
3. Rigging and/or repairs.
4. Packing.
5. Documentation.

## IDENTIFICATION

The first thing the rigger should do when a customer brings a parachute in for packing or repair is to confirm that the owner's information is correct on the packing data card. This ensures that the rigger's logbook entry is accurate. In a commercial loft, a work order is filled out with all the correct information about the customer and the parachute. Many modern lofts input this information into a computer database for tracking their customers. This data is then used to send automatic repack notices to customers. This ensures that the reserve or emergency parachute is legal to use when the customer needs it.

## INSPECTION

The owner should bring the parachute to the rigger in its packed condition. This practice should be encouraged for several reasons. The canopy is a fragile item and is subject to damage or contamination if left exposed to the elements, and the container is designed to protect the canopy from damage. The parachute should be opened only in the controlled environment of the parachute loft. This is so the entire system can be examined externally for signs of damage or contamination before it is opened. Next, the owner needs to

don the parachute and pull the ripcord as in a real life scenario to understand the correct fitting of the harness and how to activate the system properly. This gives the owner a great degree of confidence that the parachute will work when needed. Doing so also lets the owner know that the parachute will indeed be repacked and not just "pencil packed."

Generally, customers leave the parachute to be repacked; however, riggers should encourage their customers to stay and observe the repack. Many riggers encourage this behavior since it results in a more educated individual. In a busy loft environment, however, a scheduled appointment might be needed to allow for the increased time necessary to explain the process. If the customer decides to watch the repacking, the rigger should allow at least twice the usual time for the project. This allows the customer to ask questions, which results in a more educated and safer parachute user. Another benefit of this is that the customer gets to see the effort it takes to service a parachute.

Figure 5-1 on page 5-2 shows a packing flow chart that details the sequence of events the rigger should follow from receiving the parachute to collecting the money from the customer.

Upon completion of the visual inspection, there are two options for continuing. If there are no visual indications of damage or contamination, move on to the next step of opening the parachute. If something suspicious is found, or if there is a hole in the container or discoloration to the container fabric, the rigger needs to see if the damage penetrated into the canopy. To do so, note the location and check internally after opening the parachute.

If owners are participating in the inspection, it is a good idea to have them backed against the packing table or similar surface when they pull the ripcord so the canopy will not fall out on the floor. This keeps the canopy clean, but it also lets the rigger control the extraction of the canopy from the container. It is good practice to hold the canopy in the container while the owner takes off the pack. Placing the **rig** on the table allows the rigger to thor-

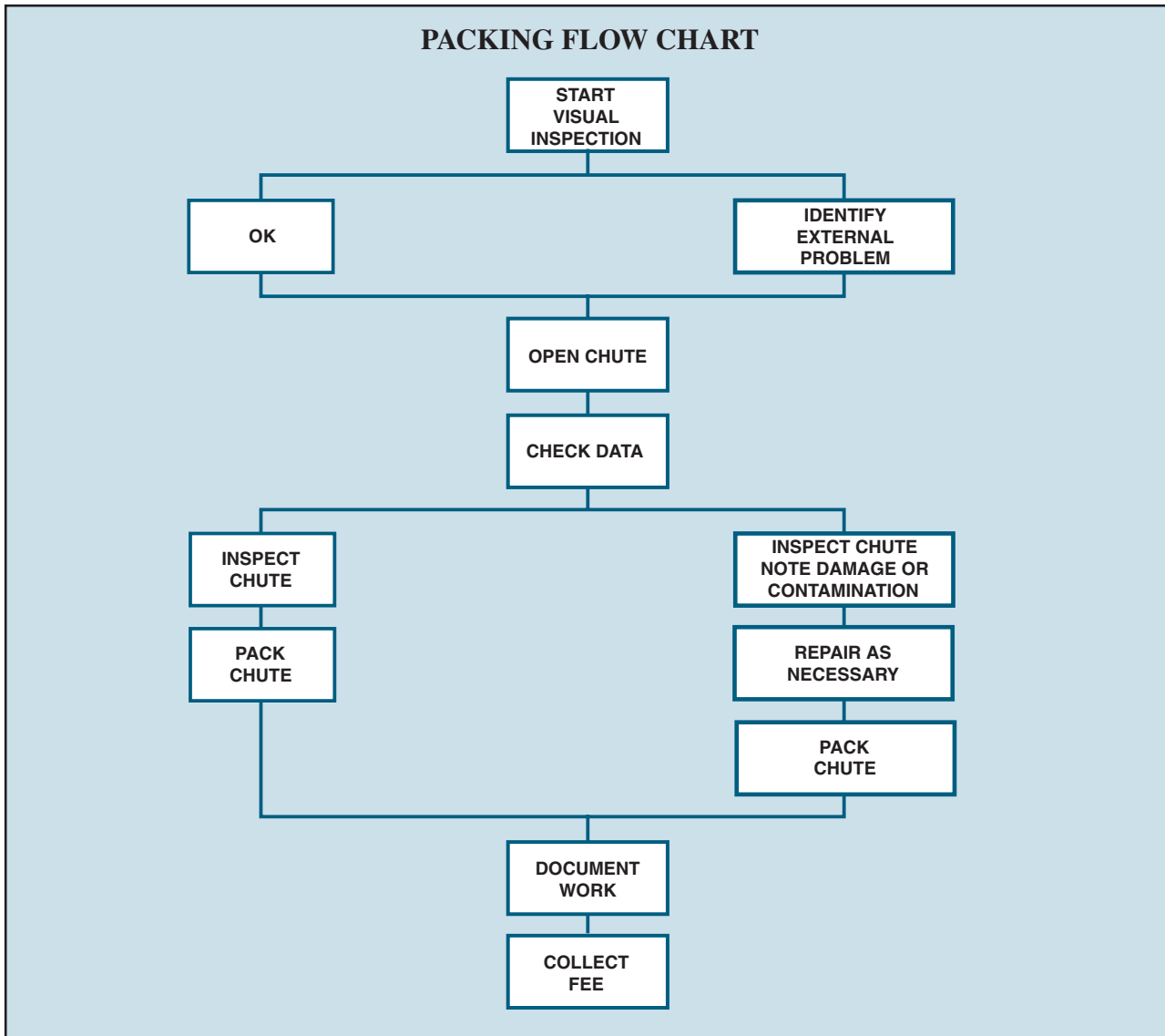


Figure 5-1. Packing flow chart.

oroughly examine the previous pack job and to check those areas previously identified as damaged or contaminated.

During the examination of the parachute for damage or contamination, the rigger should also look at how the previous rigger packed the canopy. Particularly in regard to pilot emergency parachutes, riggers sometimes exercise great latitude in interpreting the packing instructions in order to make the parachute as comfortable as possible for the pilot. Each rigger makes the determination as to what is the correct packing method. If the present rigger finds that the last pack job was in error, the individual responsible needs to be notified of the findings.

The rigger next should verify the make, model, and serial number of the parachute. Sometimes the canopy may have been changed in an assembly, particularly in a sport rig. For **sport rigs** and some emergency rigs, be

sure to check the Automatic Activation Device (AAD). The newest data cards provide space for information on the AAD to include service cycle and date of last battery replacement. With the recent widespread acceptance of AADs, this is one area the rigger cannot overlook.

The battery life cycle and the unit service life cycle, and how they interface with the repack cycle of the parachute, are very important things to consider. The major question the rigger must ask is: If the battery or unit service life expires during the upcoming repack cycle, should the rigger pack the parachute and seal it, thereby certifying it for the next 120-day repack cycle? A comparable situation would be if an **airframe and powerplant mechanic** signs off an annual inspection on an aircraft. The mechanic is saying that the aircraft is airworthy at that time. However, the mechanic is not responsible for the future status of the aircraft if the emergency locator transmitter (ELT) is due for battery



service during the next year that the annual is valid. That responsibility lies with the aircraft owner. This scenario can be reasonably extended to the AAD and parachute. Generally, however, most riggers refuse to pack the parachute if the battery or unit life cycle expires during the 120-day repack cycle.

Some AAD manufacturers have specific rules regarding battery and repack expiration dates. For example, the manufacturer might mandate that if the battery life expires during the 120-day **repack cycle**, then the rigger is not to pack it unless the batteries are replaced or the unit is removed from the assembly. Regarding the 4-year service cycle, there is a 90-day grace period for servicing. If the 120-day repack cycle expires within that 90-day period, then the rigger may repack and recertify the assembly. If the repack cycle extends past the 90-day period, then the rigger should not pack the assembly with the AAD. In any case, the rigger should follow the directions of the AAD manufacturer for that particular make and model of AAD.

The rigger must make sure to have the latest revision of the packing instructions as well as any pertinent service bulletins from the manufacturer or Airworthiness Directives (AD) issued by the FAA. The rigger may have a set of packing instructions that specifies a certain method for folding the canopy. However, the manufacturer may have changed the method and issued a revision to the manual or a complete new one. If the rigger is not completely sure that he/she has the latest information, then it's time to use the most valuable tool in their inventory—the telephone. A quick call to the manufacturer is all it takes to get the latest information. Most manufacturers publish their service bulletins in hard copy format and on their Web site. In addition, the Parachute Industry Association (PIA) also has a listing of service bulletins at [www.pia.com](http://www.pia.com). It is most important that all riggers make an effort to maintain a comprehensive library of packing instructions and their associated service bulletins. Under Title 14 of the Code of Federal Regulations (14 CFR) part 65, subsection 65.129(e), the certificated rigger may not “pack, maintain, or alter a parachute in any manner that deviates from procedures approved by the Administrator or the manufacturer of the parachute.” In addition, 14 CFR, subsection 65.129(f) also states that the certificated rigger may not “exercise the privileges of his certificate and type rating unless he understands the current manufacturer’s instructions for the operation involved.”

### COMPONENT COMPATIBILITY

Once the rigger has all of the current manuals and information, the inspection can continue. This covers not just the canopy but also the entire assembly. In addition to looking for damage or contamination to the system, the rigger must make sure that all of the component parts are compatible and approved by the manufacturer. Figure 5-2

shows a sample parts list for a typical sport parachute, having dual parachutes in a single harness system (a piggyback). This parts list delineates exactly what parts are used in the assembly of the system. The rigger should check each component part and its identifying label or stamp against the parts list. Mismatched component parts are among the most frequent problems found in the field. Many riggers are under the impression they can freely interchange component parts, but this may be done only within certain limits. Paragraph 11(a) of Advisory Circular (AC) 105-2C, *Sport Parachute Jumping*, states: “The assembly or mating of approved parachute components from different manufacturers may be made by a certificated and appropriately rated parachute rigger or parachute loft in accordance with the parachute manufacturer’s instructions and without further authorization by the manufacturer or the FAA. Specifically, when various parachute components are interchanged, the parachute rigger should follow the canopy manufacturer’s instructions as well as the parachute container manufacturer’s instructions. However, the container manufacturer’s instructions take precedence when there is a conflict between the two.” In figure 5-2, note the bold print at the bottom of the page: “NO SUBSTITUTION OF COMPONENT PARTS IS AUTHORIZED!” This manufacturer specifically states that you cannot use anything other than Original Equipment Manufacturer (OEM) parts. Substituting other parts places the rigger in violation of the Code of Federal Regulations.

Sample Parts List		
QUANTITY	DESCRIPTION	Part Number
1	HARNESS/CONTAINER ASSEMBLY	6111-(4)
	CONTAINER ASSEMBLY	4111-(4)
	HARNESS ASSEMBLY	5115-(3)
1	STEALTH RESERVE PILOT CHUTE	2237-( )
1	SQUARE RESERVE FREEBAG AND BRIDLE	2119-( )
1	SAFETY STOW LOOP	2911-(2)
1	RESERVE RIPCORD	2511-(3)/2515-( )
2	RESERVE STEERING TOGGLES	2611-(2)
1	RESERVE CLOSING LOOP	2913-(4)
1	MAIN CLOSING LOOP	2913-(7)
2	MAIN RISERS	2421-(3 )
2	MAIN TOGGLES	2621-(5)a
1	3-RING RELEASE HANDLE	2521-( )
1	MAIN DEPLOYMENT BAG	2129-( )
1	MAIN PILOT CHUTE	
	T.O.P.	2241-( )
	P.O.P.	2242-( )
1	MAIN BRIDLE	
	T.O.P.- KILL LINE	2323-(1)
	P.O.P.- KILL LINE	2323-(2)
1	RSL LANYARD	2811-(8)
1	OWNER'S MANUAL AND REGISTRATION CARD	1311-(4)
<b>NO SUBSTITUTION OF COMPONENT PARTS IS AUTHORIZED!</b>		

Figure 5-2. Sample parts list.

A common problem found in the field concerns reserve ripcords. Several manufacturers of sport rigs use a one-pin ripcord with a mini trapezoidal handle and a cable length 27-29 inches long. Depending on the actual container it goes into, it's possible to use one manufacturer's ripcord in another container as long as the rigger feels there is sufficient excess cable for safety reasons. However, imagine one ripcord is 27 inches overall and is used in a system that is approved under Technical Standard Order (TSO) C-23b and is rated at 300 pounds.

Another ripcord is 28 inches overall and is used in a system approved under TSO C-23c, and is rated at 600 pounds for use with a Reserve Static Line (RSL) installation. The problem here is the mating of different TSO standard components. Installing the first ripcord in the second container with an RSL lanyard may be degrading the safety aspect of the system. So how does the rigger tell which is which? The ripcord approved under TSO C-23b will have minimal markings, perhaps only a manufacturer's part number. The ripcord approved under TSO C-23c will have several markings on the handle as required by the TSO. It should have the manufacturer's part number, manufacturer's identification, TSO-C23c, and the batch or serial number or date of manufacture. [Figure 5-3] In reality, as long as the cable lengths are compatible, the function of the ripcord will probably work. The problem surfaces in the event of a problem or incident involving the system. At this point, the FAA could find the mismatched component and take action against the rigger who packed the parachute.



Figure 5-3. Reserve ripcord with TSO markings.

A bigger problem surfaces when the rigger substitutes a reserve deployment bag made by another manufacturer. Most reserve deployment bags are compatible with the appropriate container based on dimensions and volume. If the deployment bag does not fit correctly, there can be a problem with proper functioning of the system. These are two examples of the more common compatibility issues that are regularly found in the field. There are others that the rigger may encounter and need to address as well. The best solution is for the rigger to follow the manufacturer's parts list strictly to ensure the safety of the parachute system.

After the rigger has determined that all of the component parts are compatible, he/she can now commence the actual inspection of the parachute assembly. Figure 5-4 shows a typical pilot emergency parachute assembly with a round canopy laid out on the **packing table**. Make sure the canopy is straight and the apex lines are even. Then apply firm tension to the canopy and lines using a tension board. The standard is to start at the top of the assembly.

This assembly in figure 5-4 can be broken down into six separate areas. They are:

1. Pilot chute and bridle.
2. Canopy and deployment device.
3. Suspension lines and connector links.

5-4

4. Container.
5. Harness including risers.
6. Ripcord.

Inspection/packing checklists allow riggers to track their progress as they do their inspection. [Figure 5-5] It is desirable for riggers to complete their inspection uninterrupted, which ensures that the inspection process is followed and nothing gets overlooked. This rarely happens, however, due to normal interruptions such as phone calls or customer questions. Using the inspection checklist ensures that after an interruption, the rigger is able to



Figure 5-4. Round canopy pilot emergency parachute assembly.



continue at the proper spot without missing anything. This checklist is divided into seven sections that make it usable for all types of parachute assemblies. It includes an area for counting the tools at the beginning and end of the inspection and packing procedure. This ensures that no tools are overlooked or left in the parachute. While this may sound implausible to some, it has happened over the years, sometimes with fatal consequences.

## ROUND CANOPIES AND PILOT EMERGENCY SYSTEMS

The first thing the rigger should check is the continuity of the canopy to make sure it is straight. Do so by laying the

system on the table as if the wearer were lying face down, head toward the canopy. (On some models, such as military seat parachutes, it may be face down with the feet towards the canopy.) Make sure to follow the manufacturer's instructions. Ensure that the canopy is right side out (i.e., the data panel faces out) and the gore numbers are readable on the outside. Attach the required tension devices and apply light tension. Standing at the canopy, split the riser line groups and grasp the two gores that separate them. The top panel should have line number 1 and the last line of the sequence depending on the number of lines on the canopy. Starting with number 1, the lines will run in sequence counterclockwise around the canopy.

**Sample Inspection Form**  
**Parachute Assembly Inspection Form**

**A Harness and Container**  
 ! Note: Count all Tools Before Starting Assembly Qty:  
 manufacturer:  
 model:  
 date of manufacture:  
 serial no:  
 Initial After Each Item If No Discrepancies Are Found Initials

1. Main lift web
2. Chest and leg straps
3. Harness hardware and connectors
4. 3-ring release
5. Pilotchute pocket
6. Reserve ripcord, handle pocket, cable housing
7. Cutaway handle, attachment point, cable housing and channels
8. Container flaps and grommets
9. Closing loop length (main and reserve)
10. Comments:

**B Main Canopy and Pilotchute**  
 manufacturer:  
 model:  
 date of manufacture:  
 serial no:  
 Initial After Each Item If No Discrepancies Are Found Initials

1. Risers and 3-Ring
2. Connector links and slider bumpers
3. Slider grommets, tapes, fabric
4. A-lines and attachment points
5. B-lines and attachment points
6. C-lines and attachment points
7. D-lines and attachment points
8. Steering lines and toggles
9. Canopy cells and cross-ports
10. Slider stops (on canopy)
11. Bridle line, d-bag stop, pin
12. Pilotchute and handle or pud
13. Deployment bag
14. Comments:

**C Square Reserve Canopy and Pilotchute**  
 Initial After Each Item If No Discrepancies Are Found Initials

1. Risers
2. Connector links
3. Slider & Grommets
4. A-lines and attachment points
5. B-lines and attachment points
6. C-lines and attachment points
7. D-lines and attachment points
8. Steering lines and toggles
9. Canopy cells and cross ports
10. Slider stops (on canopy)
11. Deployment bag and safety a
12. Bridle line
13. Pilotchute
14. Packing data card and inform
15. Comments:

**D Assembly of Square Reserve Canopy**  
 Initial After Each Item If No Discrepancies Are Found Initials

1. Inspection of canopy and co
2. Continuity of all lines
3. Slider on correctly
4. Rapide link barrels tightene
5. Steering lines tied to toggle
6. Steering line length equal to
7. Safety stow on deployment
8. Packing data card filled out
9. Packed according to manua
10. Reserve pin sealed
11. Fill out warning label
12. Comments:

**E Round Reserve Canopy and Pilotchute**  
 Initial After Each Item If No Discrepancies Are Found Initials

1. Connector links
2. Suspension Lines
3. Steering lines and toggles
4. Canopy
5. Diaper
6. Bridle
7. Pilotchute
8. Packing data card and inform
9. Comments:

**F Assembly of Reserve Canopy to Cont**  
 Initial After Each Item If No Discrepancies Are Found Initials

1. Inspection of canopy and co
2. Continuity of all lines
3. Connector links, tightened
4. Steering lines & toggles no
5. Reserve bridle installed an
6. Pilotchute installed correct
7. Packing data card filled out
8. Packed according to manua
9. Reserve pin sealed
10. Fill out warning label
11. Comments:

**G Assembly of Main Canopy to Container**  
 Initial After Each Item If No Discrepancies Are Found Initials

1. Inspection of canopy and Cont
2. Continuity of all lines
3. Slider on correctly
4. Release handle cables are pro
5. Rapide link barrels tightened an
6. Steering lines tied to toggles or
7. Steering line length equal to ea
8. (d-bag, bridle and pilotchute an
9. Packing data card filled out
10. Fill out warning label
11. Comments:

! Note: Count all tools after a completed to ensure that none are left in the container.

Signature:  
 Print Name and Seal Symbol:  
 Signature:  
 Print Name and Seal Symbol:  
 General Comments:

Figure 5-5. Inspection form.



(See figure 5-6 for typical line sequences.) The four lines attached to these two gores comprise the standard “four-line check” for a round canopy. By running these four lines from the canopy to the connector links, the rigger can make a quick check of straightness. If the rigger was the last person to pack the parachute, he/she may feel this is sufficient to ensure continuity. However, most riggers do a full check of all the lines, even on their own pack jobs.

### STRAIGHTENING THE CANOPY

If a rigger finds lines out of sequence or the canopy is inside out, it becomes necessary to remove any twists, tangles, or turns. There are two things to remember when encountering this situation. First, if the parachute was originally straight and the entanglement occurred from handling, it is possible to untangle the parachute without disconnecting anything. Second, if the parachute was assembled incorrectly in the first place, it will be virtually impossible to straighten it without disassembling it. These two scenarios become particularly acute when the rigger is brought a parachute for repacking and it was assembled incorrectly. At first the rigger assumes it to be correct, but when a correct continuity cannot be done, it becomes very frustrating, and the rigger may spend an excessive amount of time trying to straighten the canopy.

The rigger should always start at the top or apex end of the canopy. Make sure that the top gore with the data panel is facing up. Follow the gore to the apex so that the upper lateral band is on the outside. Attach the apex to the upper tension device. Next, flake the gores in sequence to see if the canopy is straight. Split the canopy so the left and right line groups are separate at the skirt of the canopy. [Figure 5-7] Pick up the two center gores and grasp the four lines. [Figure 5-8] These will be line number 1 and the last line of the sequence. Run these lines down toward the risers and/or container. On most canopies, these lines will run to the inside, top connector



Figure 5-7. Round canopy—split gores.

link of a four-link system or to the inside of a two-link system. [Figure 5-9] If these lines are correct, continue the checking of the line continuity.

If the lines are not straight, release the risers from the harness, if possible. If not, take one of the two top lines and untangle it until the line runs straight back to the canopy without going around any of the other lines. Untangle the risers and harness/container until the rest of the lines are straight. Repeat with the other riser, if applicable. Attach the rest of the connector links to the tension device and do a thorough continuity check from the canopy to the connector links. If the lines were incorrectly assembled, disconnect the link from the riser, remove the lines, and reinstall them onto the connector link in the correct order. Reinstall the connector link to the riser. Check the entire canopy for correct continuity. Make sure the connector link is tightened properly.

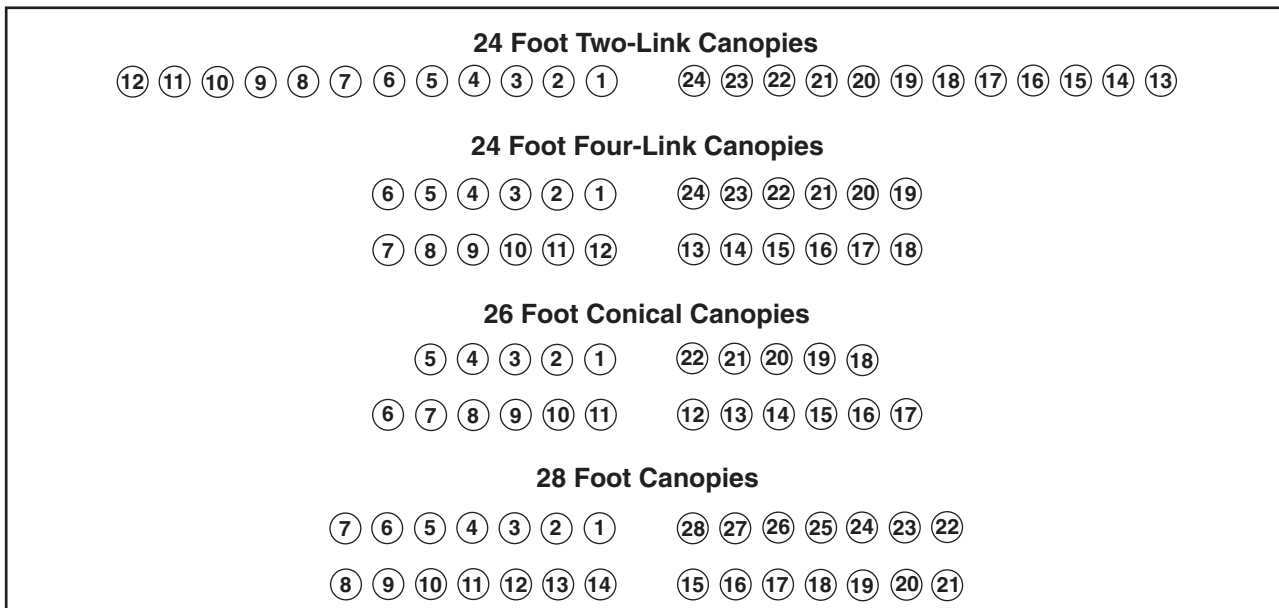


Figure 5-6. Line continuity chart.



Figure 5-8. Round canopy—four-line check at canopy.

### DAMAGE IDENTIFICATION

During the inspection process, the rigger may identify various discrepancies in the materials and/or the assemblies. While the following inspection processes call out what to look for, the specific descriptions and treatment of the damage are provided in Chapter 7—Repairs, Alterations, and Manufacture.

### PILOT CHUTE AND BRIDLE

1. Check the spring shape and tension; it should not have an excessive bend to the length of the spring. There should be no kinks in the wire or sharp edges or burrs. The swages should be smooth and tight. Check the tension of the spring against the manufacturer’s specifications. Most current springs have between 20-30 pounds of tension, but some run as high as 40-45 pounds. Too strong a spring is rarely an issue, but too weak often is a problem. Some manufacturers specify a testing method and frequency of testing.

2. Check the canopy cap for security to the canopy portion along the stitching and seams. If it has a grommet in the cap or an alignment strap, check the grommets for tightness and smooth edges on the inside. Sharp edges can cut the locking loop. Check the alignment strap for centering and tacking.

3. Check the canopy fabric for any holes, burns, stains, or other damage. Check the seams for loose stitching and look over the mesh portion, if used. Small holes may be allowed, but consult the manufacturer’s manual. Check the attachment loop at the base of the pilot chute for security. Check any hand tacking, if used, to secure the spring to the base of the pilot chute.

4. If the parachute uses a sewn-on bridle, check the stitching. If it is a tied-on model, check the knots and any hand tacking called out in the instructions. Be sure to check the length against the parts list. Make sure the canopy end of the bridle is looped around the apex lines and not around a tension loop. If a floating loop is called out, make sure the locator tacking is secure.

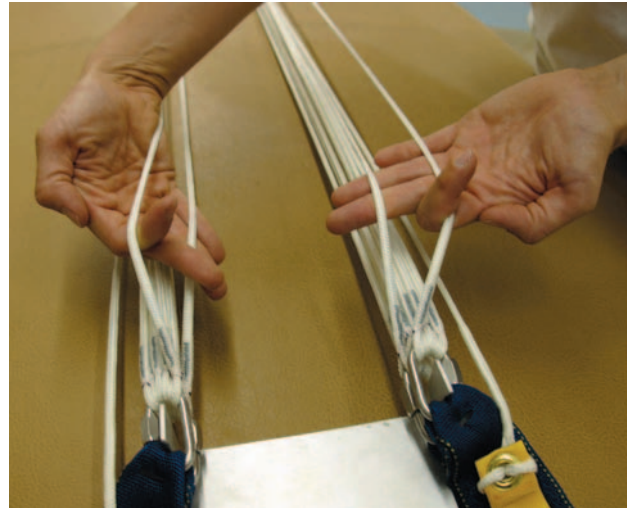


Figure 5-9. Round canopy—four-line check at four-link system.

### RESERVE CANOPY

If available, use a canopy **damage chart** appropriate to the canopy for documenting your inspection for repair of any damage found. Figure 5-10 shows a typical chart for round canopies.

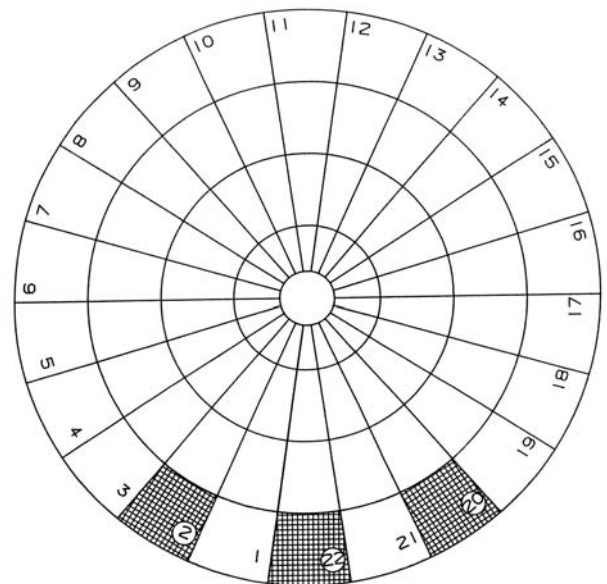


Figure 5-10. Round canopy damage chart.

1. Check the apex lines for damage and continuity as well as the upper lateral band. If there is a tension loop, make sure it is secure. If there is a vent collar ring, check the elasticity of the material.

2. Inspect gores and panel fabrics by starting at the top center gore of the canopy, working your way up one gore while inspecting the fabric, seams, tapes, and lines. When you reach the apex, pull the next radial seam toward you, stretching out the fabric, and work your way down the gore to the lower lateral band. [Figure 5-11 on page 5-8] This method is the most efficient use of your time and physical efforts. Work your way around the canopy, inspecting each gore from top to bottom.





Figure 5-11. Round canopy gore inspection.

3. The manufacturer may call for the tensile testing of the fabric after inspection of the canopy for obvious visual damage. This is very important because there was a fabric deterioration problem with certain parachutes several years ago. An AD was issued, and while the exact cause was never determined, a side benefit was the development and adoption of a non-destructive fabric pull test method. This method was adopted by the Parachute Industry Association (PIA) as Technical Standard TS-108, *Parachute Canopy Fabric Pull Test, Non-Destructive Method*. This method of testing canopy fabric for strength has been adopted by several canopy manufacturers as suitable for testing their canopies. However, the rigger must be careful in using this test method. The proper equipment is essential for accurate testing and the type of material must be known in order to test to the correct strength. The testing equipment is shown in figure 5-12. The full standard can be found in Appendix I of this handbook.



Figure 5-12. TS-108 test equipment.

4. Along with the pull test, the AD also requires testing the canopy mesh with a solution of Bromo Cresol Green indicator to determine the presence of an acid condition. The Bromo Cresol Green indicator is a dark blue liquid in its standard state. It turns yellow when it contacts acid—the stronger the acid, the brighter the yellow. If the test is positive, the canopy will need to be treated to neutralize the condition. The AD highlights the manufacturer’s service bulletin as to how to comply with this test and procedure.

5. If the canopy has a deployment device such as a diaper, check that it is securely attached, particularly after use. Check the grommets, line stow bands, elastics, or other line stow devices. Pay particular attention to where the stitching attaches to the canopy fabric. This area can be particularly prone to damage during opening.

## SUSPENSION LINES AND CONNECTOR LINKS

1. The lines, their attachment points, and the associated stitching should be checked for damage or missing stitches. With the older sheath and core nylon lines such as Ty-III found on military surplus canopies, the **zigzag** stitching at the links are prone to raveling. The more modern noncontinuous line canopies use Dacron® or nylon braided lines. The common attachment at the links for these lines uses the “finger-trap” method to secure the lines to the link, with a **bar tack** securing the lines. Most manufacturers now use a contrasting color thread for the bar tack in order to make inspection easier. Make sure all bar tacks are in place. Figure 5-13 shows both methods of line attachment to the links.

2. There are three basic types of separable **connector links** in common use today for round canopies. They are the standard “L” bar type, MS-22002; the Navy speed link,



Figure 5-13. Connector link line attachment methods.



MS-22021; and the Quick link, commonly called the Maillon Rapide® link, named after the French company that first manufactured them. [Figure 5-14] The older military surplus canopies are usually found with the two types of MIL-SPEC connector links. Modern sport canopies usually are found with the Rapide® links because of their compatibility with the modern low bulk suspension lines.



Figure 5-14. Three types of connector links.

3. With the MIL-SPEC links, check the tightness of the screws that hold the links together. With the speed links, make sure the knurled side of the end cap is facing up and the plates face **outboard** on the riser. The screw should be checked for tightness at each repack.

4. If the canopy is equipped with Rapide® links, they should be oriented on the riser with the barrel inboard and to the bottom so it tightens upward. The link should be tightened hand tight, then approximately one quarter turn further. The actual force recommended for a number 5 link is approximately 30 foot-pounds. Most riggers do not possess the force gauge to measure this, so they use the quarter turn guide. After tightening the links, a “telltale” should be applied to the barrel. [Figure 5-15] A telltale is a marker, usually nail polish, that provides a breakable seal to show if the barrel has moved. If the seal is broken, the rigger knows the link may be loose. In doing a repack, if the telltale is intact, the rigger should not loosen the link and retighten it because continual tightening can strip the threads, causing the link to fail.

## HARNESSES

1. Starting at the riser end, check the webbing for any wear or damage and inspect the stitching at the riser ends.

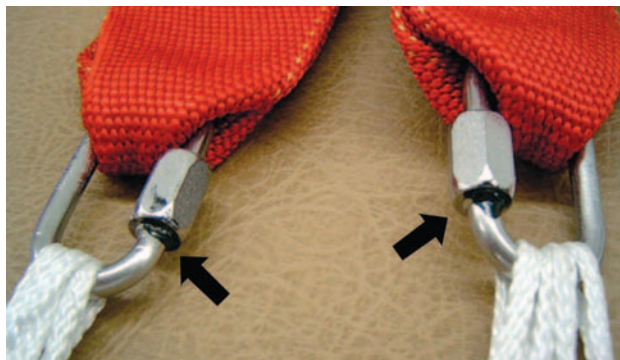


Figure 5-15. Telltale marker.

If the canopy has steering lines and a guide ring on the riser, make sure the ring is secure and the steering line is attached to the steering toggle correctly. With a round canopy, make sure the steering line has sufficient slack in it when under tension. If the line is too tight, it can fail at opening because of too much stretch.

2. Continue down the risers. If canopy releases are installed, check their operation. With the Capewell cable release, open the release and make sure there is no dirt or sand in the mechanism. Also, check for wear, particularly on the cable ring.

3. Check all of the harness webbing for wear both from chafing, abrasion, and sunlight degradation. Pay particular attention to the buffer and **chafing strips** where used to prevent wear from the hardware. These buffers are there to provide early warning before the load bearing webbing starts to wear. Check the elastic keepers so the running ends of the straps can be properly stowed.

4. Check all of the hardware, paying particular attention to the leg snaps. Quick ejectors are particularly prone to failure of the springs. Obviously, those with broken springs should be replaced. B-12 snaps are prone to having the gate sides bent to the point they will not close properly. This gate may be repaired with a screwdriver and pliers. [Figure 5-16] Straightening the side of the gate allows the snap to close properly.



Figure 5-16. B-12 snap gate repair.

5. An area of concern for many riggers, one for which there is not much guidance, is how much plating wear and associated corrosion of the hardware is allowable. This depends on the location of the damage. If it is a solid ring or buckle, and the damage has occurred from dragging or abrasion in an area that is not in contact with webbing, one solution is to clean the rust with a fine emery cloth and cover it with clear nail polish. This keeps the area from continued rusting. It will not, however, prevent further damage caused by the original rusting. If the rusting is caused by two pieces of hardware interacting with each other, the problem is more serious. If allowed to continue,

the rust pattern may cause the two pieces to fuse together under the most severe conditions. In this case, the hardware must be removed and replaced. If the hardware in contact with webbing, such as a leg strap adapter, becomes corroded, it must be replaced. This problem frequently arises when the parachute is exposed to salt water and not properly rinsed. The hardware will rust inside the leg strap webbing causing accelerated wear and must definitely be replaced. [Figure 5-17]



Figure 5-17. Rusty leg snap hardware.

6. The ripcord housing and pocket should be checked for wear and fit of the ripcord. On the housing, check the ends and the **ferrules**. On more modern assemblies, these ferrules are brass and more susceptible to wear than the MIL-SPEC types. Look inside to make sure there are no obstructions to interfere with the ripcord. The ripcord pocket may be elastic, Velcro®, or a military style with a spring to hold in the ripcord. Whichever type, make sure the ripcord is held securely, yet at the same time make sure it is not too tight so the ripcord can be removed easily. Also, check the tackings that hold the housing and pocket.

## CONTAINER

1. As stated in the beginning of this chapter, the initial external inspection of the container should alert the rigger to any damage inside. Note any holes, abrasion, or fraying of the pack material.

2. Check the grommets for sharp edges and pulling out of the material from under the grommet. Cones should have the stitching secure. Check the plating on the cones in the area of the eye. Sharp edges can cause a cone lock. Eyelets should have the tacking secure. Snap fasteners should be securely set in the material. Check for wear and security of the opposing parts. Make sure that “**pull-the-dot**” types are set correctly for direction. Stiffeners, both metal and plastic, should not be bent or cracked. There should be no sharp edges. **Pack opening bands** (POBs), if used, should be in good shape and not stretched out. Make sure the hooks are in good shape, too. On the military style POBs, it may be necessary to retack the pull tabs at

5-10

the end. Metal frames, if used, should be straight. Buffers at the corners should be in good condition. Tackings, if used, should be secure.

3. The container-**closing loop** is an extremely important part of the container system. A worn loop may fail, which would cause a **premature opening** of the container. With the parachute still in a packed condition, check for the correct length. If the loop is made too long or stretched during use, the pilot chute can extend and move off center. This may result in a poor launch or a pack job that is uncomfortable for the user. After determining that the loop is of the correct material and length, check the eye(s) of the loop on the inside for wear. It is not uncommon for the loop to appear to be in good condition when viewed from the outside, but worn partially through when examined from the inside. [Figure 5-18] Many riggers simply replace the loops at each repack, regardless of the condition.



Figure 5-18. Worn closing loop.

## RIPCORD

There are a number of things that need to be inspected to approve the ripcord:

1. Check the pin(s) for straightness, smoothness, cracks or other damage.
2. Check the cable for fraying, kinks, or severe bends.
3. Check the swage for wear and security. Look for signs of movement on the cable.
4. Check the handle for wear, damage, rust or abuse.



Any damage or discrepancies found during the inspection should be noted and the appropriate repair performed by a certificated and appropriately rated rigger according to the manufacturer's instructions or approved manuals.

### AIRING AND DRYING

During the inspection process, the rigger must determine the condition of the canopy and system regarding dryness and moisture. In the "old days" it was necessary for the parachute to be aired and dried for 24 hours prior to packing it. According to 14 CFR, subsection 65.129(c), "No certificated parachute rigger may pack a parachute that has not been thoroughly dried and aired." This determination is at the discretion of the rigger.

## RAM-AIR RESERVES AND SPORT PIGGYBACK SYSTEMS

The following inspection procedures share much with the previous section on round canopies. The differences between ram-air reserves and sport piggyback systems are identified in the following section. Inspect as follows:

### PILOT CHUTE AND FREE BAG/BRIDLE

1. The rigger should inspect the pilot chute in the same manner as in the section on round canopies.

2. The free bag should be checked to include all grommets, especially those bags that have a through loop configuration. Any sharpness in this area can result in a damaged closing loop. For those free bags that utilize a Safety-Stow<sup>®</sup> locking system, make sure the elastic loop is of the correct size, the elastic is in good shape, and the zigzag stitching is secure. Many riggers fabricate these loops in the field, which, in most cases, is an unauthorized procedure. The Safety-Stow<sup>®</sup> loop is an integral part of the approved reserve deployment system and is manufactured under an approved quality control system from approved materials. The rigger should use only OEM approved parts for this.

3. Check the bridle for any damage or wear. For those bridles that have assistor pockets, make sure the stitching is secure and the pockets are not damaged. Check the Velcro<sup>®</sup> on the line stow pocket for wear and security. If the Velcro<sup>®</sup> does not hold securely, the parachute can experience "line dump" during deployment, possibly causing a malfunction or out of sequence deployment. Some deployment bags use rubber bands to stow the lines. If this is the case, check their condition and replace them if necessary.

4. There are still older ram-air canopies in the field that did not use a free bag but a diaper deployment system. If this is the case, the diaper should be inspected the same as that on a round canopy. Be sure to use the correct type and length of bridle, since it is generally not the same as a round bridle.

## RAM-AIR RESERVE CANOPY

Figure 5-19 shows a typical ram-air reserve and harness and container system layout. The terminology used in describing the parts of the ram-air canopy is called out in PIA Technical Standard TS-100, *Standardized Nomenclature for Ram-air Inflated Gliding Parachutes*, which can be found in the Appendix I of this handbook.



Figure 5-19. Ram-air/piggyback layout.

1. When inspecting and assembling ram-air canopies, begin with the upper surface of the canopy. [Figure 5-20 on page 5-12] Work your way up and down the top panel of the cells looking for any damage or contamination. Check the seams for loose stitching and packing tabs if used, for security.

2. Check the trailing edge seam for secure stitching, paying particular attention to the line attachment tapes and their associated bar tacks. Next, look at the interior of the cells, carefully checking the crossports for damage or fraying of the edges of the fabric.

3. Now proceed to the lower surface of the canopy. Carefully check all the seams and the line attachment tapes and bar tacks.





Figure 5-20. Ram-air canopy hanger—top skin inspection.

4. Some manufacturers require the use of PIA Technical Standard TS-108, *Canopy Fabric Pull Test* at certain intervals. In addition, the manufacturer's warning/TSO label may require that the rigger mark the label to signify each time it is repacked and after each use. [Figure 5-21] This label will be found on the upper surface, trailing edge of the canopy. It is important to comply with this requirement, not only because the manufacturer requires it, but also it establishes the trail of use for the canopy, which allows future riggers (and the manufacturer) to track its use and condition over time. Some riggers feel that they are doing their customers a favor by not marking the boxes in order to show it has little use when it comes to selling it. Since most individuals have a specific rigger pack their parachute on a regular basis, it does not take a lot of detective work to inspect the rigger's logbook to see how many times they have packed any particular parachute.

### CANOPY ASSEMBLY AND LINE CONTINUITY

The first task is to check the line continuity of the canopy. The following method may be used by riggers who do not have access to a canopy hanger. Figure 5-22 shows examples of a seven-cell and nine-cell canopy when viewed from the bottom as by the jumper when in flight. The examples show the line attachment nomenclature referred to in the continuity check. Figure 5-23 shows the standard canopy nomenclature as referred to in the continuity check.

1. First, lay out the canopy on its left side, the slider spanwise with its tape down, and lay out the container with the harness up.
2. If slider bumpers are used, thread one bumper over each riser and down a few inches.
3. Place the slider on the risers spanwise, with its tape facing the canopy.

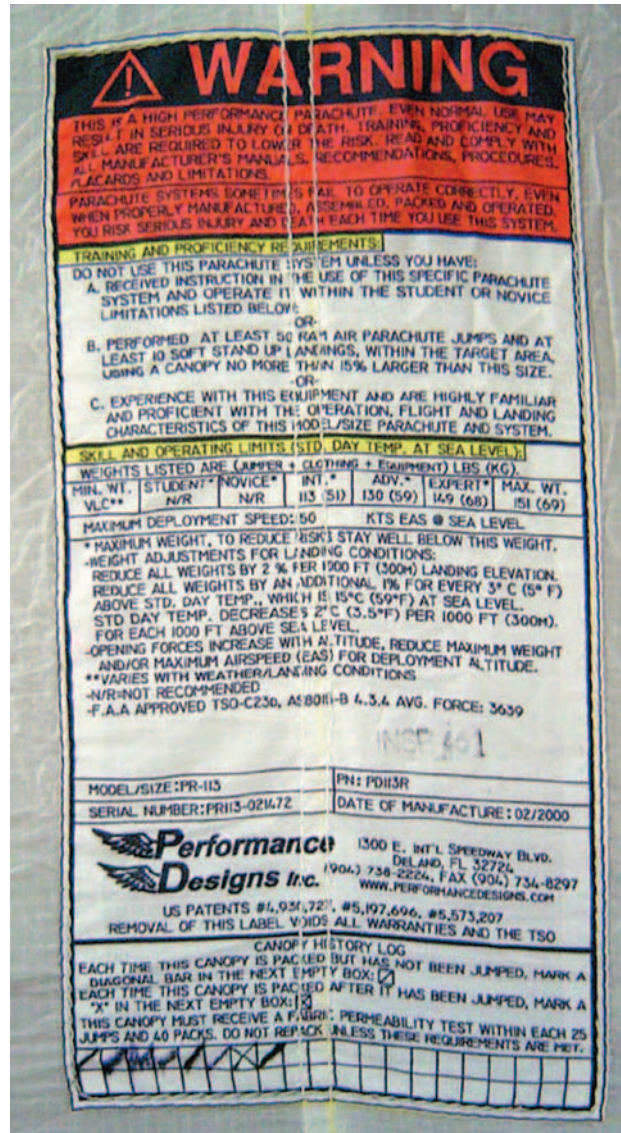


Figure 5-21. PIA warning label.

4. Locate the leading edge and A line attachment. Follow the line 8A (10A) to the outboard side of its link and attach the link to the right riser, finger tight.
5. Pick up line 1A at the canopy attach point. Follow it down to the outboard side of its link and attach the link to the left front riser, finger tight.
6. Turn the container over, harness down, and orient the rear risers to receive their respective links. This simplifies C/D link attachment.
7. Rotate the leading edge under the rest of the canopy. Split the aft section along with its associated control line groups to make the C/D links easily accessible for routing and installation.
8. Locate the data panel at the center cell's upper surface trailing edge. From this center reference point, follow the trailing edge to the left stabilizer and pick up line 1D.

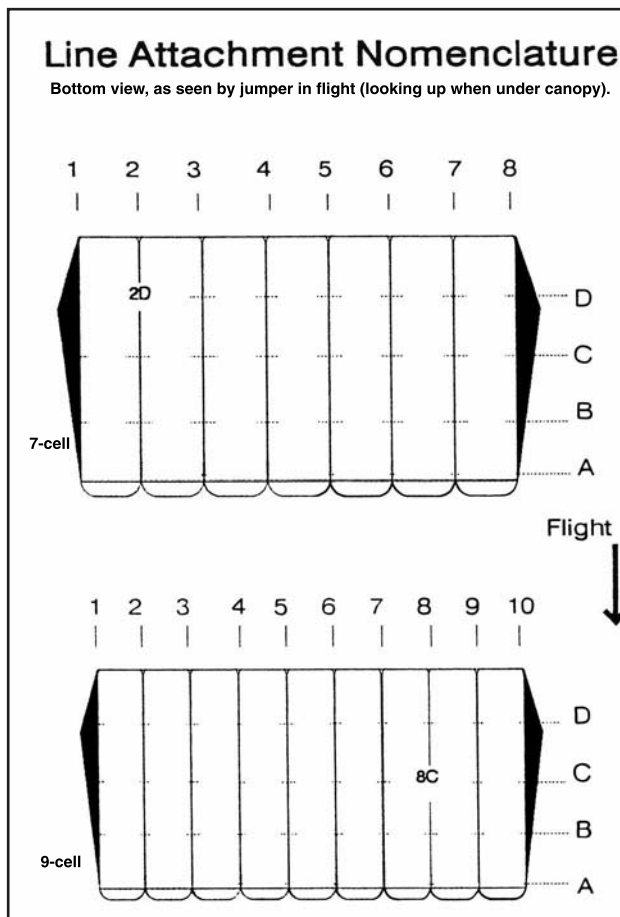


Figure 5-22. Line attachment nomenclature drawing.

9. Route this line to the outboard side of its link and attach the link to the left rear riser, finger tight.

10. Again from the center reference, follow the trailing edge to the right stabilizer and pick up line 8D (10D).

11. Route this line to the outboard side of its link and attach the link to the right rear riser, finger tight.

12. Return to the center reference point of the trailing edge. Locate and pick up the left side upper control lines consecutively. Verify their continuity to the junction with the lower control line.

13. Removing twists as you go, follow the left lower control line to its running end. Route it through the appropriate slider grommet, and then through the guide ring.

14. Remove the toggle from the riser and route the running end of the lower control line through the toggle attachment loop or grommet.

15. Slide the toggle up to the mark on the control line. Secure it with an **overhand knot** tied closely to the toggle.

16. The control line attachment for the right side is done in a similar manner.

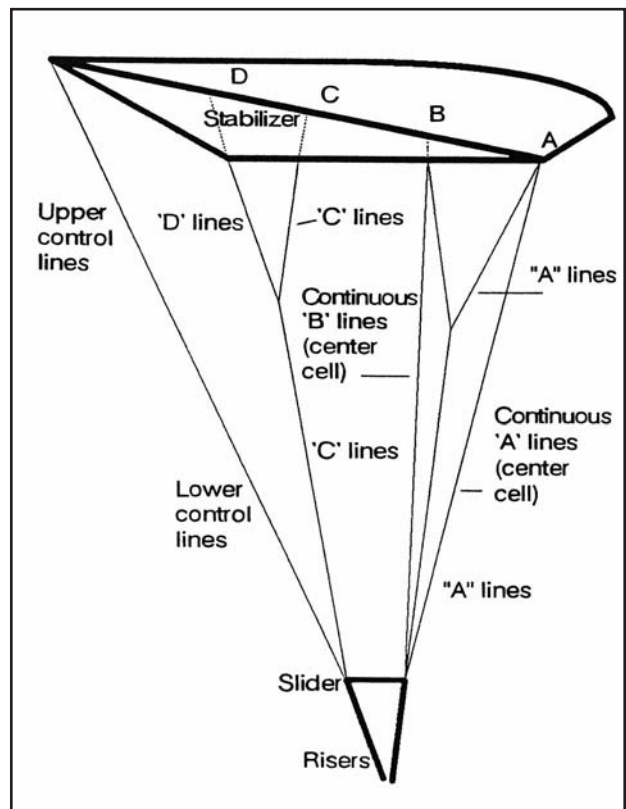


Figure 5-23. Ram-air canopy layout and nomenclature.

17. When the **control line** installation is complete, compare the two toggle settings under equal tension to ensure their uniformity.

18. At this time, verify the continuity of the control line system. Begin at the trailing edge on each side, ensuring that all twists have been removed from the upper and lower control lines. Check that the lower control lines have been properly routed through their appropriate slider grommets and that the toggles have been properly secured equidistant from the trailing edge.

19. Separate the aft section and control line groups to their respective sides and locate the center reference point at the trailing edge.

20. Following the trailing edge control surface outboard will lead the rigger to the left stabilizer's bottom seam and the attachment point of line 1D.

21. Holding D lines 1,2,3, and 4 (1,2,3,4,5) in your right hand and D lines 5,6,7, and 8(6,7,8,9,10) in your left hand, verify the continuity of the C and D lines through the cascades to their respective rear risers.

22. Gather in the control lines and flip the canopy over so the leading edge faces up. Verify this orientation by locating the attachment points of A lines 1 and 8(10).

23. In the same direction you flipped the canopy, rotate the container system harness up.



24. Pick up the front riser groups, follow them to the canopy, and separate.

25. Pick up A lines 8,7,6, and 5 (10, 9,8,7,6). If you have continuous center cell lines, follow the bottom seam down and pick up line 5B (6B). Verify continuity of the A and B lines, through the cascades, to the right front riser.

26. Pick up A lines 1,2,3, and 4 (and 5). If you have continuous center cell lines, follow the bottom seam down and pick up line 4B (5B). Verify continuity through the cascades to the left front riser. The continuity check is now complete.

27. Tighten the connector links with an appropriate size wrench. Do not over tighten! Inspect the links for any marks or damage possibly done during the tightening process. Mark the barrel of the connector links with a tell-tale mark.

28. Move the slider upward from the risers onto the suspension lines.

29. Move the slider bumpers upwards and into position over the connector links. Hand tack the bumpers in place according to the type used.

## INSPECTION

1. Starting at the lower surface of the canopy, check the line attachment loops and their associated bar tacks. Follow the line downward to the cascade junction, if applicable, and check the bar tack at this location. Continue down the line to the connector links and check the bottom loop and bar tack.

2. Starting at the top and working your way downward, inspect the steering lines. Check all junctions and bar tacks, paying particular attention to the brake loops. Check the security of the steering toggles to ensure the correct attachment method is followed. If the toggles are improperly tied, they may come off when the jumper deploys the brakes. Make sure the toggle matches the size of the brake loops. If they are too large, they may hang up and not release when needed. For compatibility, the toggles should be those supplied with the harness and container.

3. If Rapide® links are used on the canopy, check them as set forth in the section on round canopies. The link orientation and tightness will be the same. Some canopy manufacturers provide and prescribe the use of “slider bumpers” with their canopies. These are made from either webbing or from vinyl or rubber tubing and are designed to protect the grommets of the slider from impacting the connector links during deployment. If these bumpers are used, it is recommended that they be tacked in such a manner that they cannot slide up the lines and interfere with the slider during deployment. [Figure 5-24]

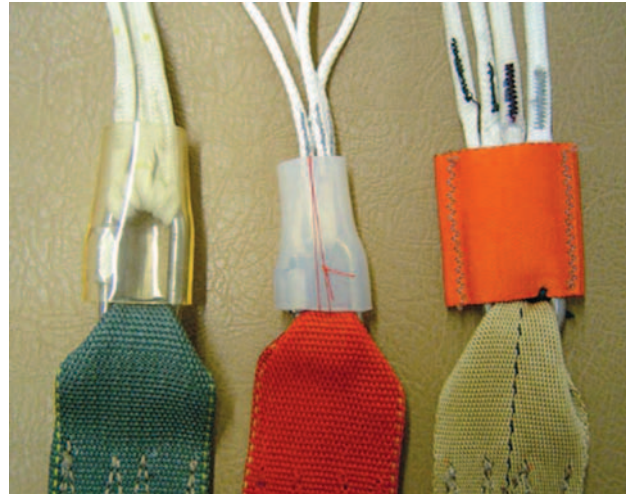


Figure 5-24. Slider bumpers.

4. A new type of connector link, called the “soft link,” has been approved for use with certain reserve canopies. [Figure 5-25] Manufactured from Spectra® line, they loop through the bottom of the suspension line and the end of the reserve riser. The strength of these soft links far exceeds that of the metal links when installed properly. If installed on the reserve, the rigger should have the manufacturer’s instructions to ensure the correct installation.

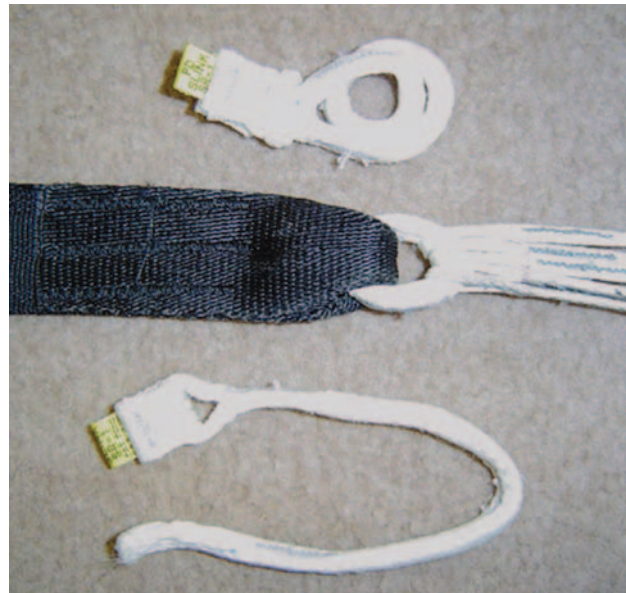


Figure 5-25. Soft links.

## HARNESS

1. When inspecting the harness, start at the riser end, checking the condition of the webbing and stitching. Pay particular attention to the security of the steering line guide rings and the method of stowing the excess steering line. If these guide rings fail, it can result in fatal consequences to the user.

2. Check all of the hardware on the harness in the same manner detailed in the pilot emergency parachute section in this chapter (page 5-5).



3. Check the canopy release system for wear and operation. The release in almost universal use today is the 3-Ring® release system. [Figure 5-26] With this system, it is imperative that the rigger also checks the release cable housings for security and cleanliness. Without proper maintenance, this system can be subject to hard pull forces and the inability to release properly. Since the successful operation of the reserve deployment is somewhat dependent on cleanly releasing the main, a properly operating release system is necessary. The primary areas for inspection are the release locator Velcro® on the harness and the cable housings. Check the housing ends for sharp edges on the inside of the grommets. If the housings are tacked to the harness, make sure these are secure. If the customer did not bring the main canopy with the reserve, the rigger should encourage the customer to at least bring the 3-Ring® release handle in for inspection and service.



Figure 5-26. 3-Ring® release system.

## CONTAINER

In addition to those container areas referenced under the pilot emergency system, the sport piggyback container has features unique to this configuration.

1. Check the installation of the AAD, if one is installed, making sure the stowage pockets, cutter mounts, and control unit are secure. Check that the cables are routed correctly. If they are exposed, they may get snagged during packing and damaged or disconnected. Upon completion, inspect the condition of the closing loop.

2. Check the Reserve Static Line (RSL). The RSL is not considered part of the certified reserve system, but if it is installed, the rigger is responsible for the entire RSL assembly since it is attached to the ripcord handle, cable, or housing. This includes the cable housings for tacking and security, any guide rings used, and the RSL lanyard itself. Check the release or snap shackle, if used, and any Velcro® or other positioning or locating methods. An area

frequently overlooked is the RSL attachment ring on the main risers, which are frequently replaced. [Figure 5-27] In many cases, the attachment ring does not match up to the original design. The rigger should inspect the release handle for proper cable lengths. If the design has only one riser attached to the RSL, it is imperative that the cables be trimmed to release the side opposite the lanyard first so that the reserve is not deployed before the risers are separated from the harness.



Figure 5-27. RSL/riser attachment.

3. Check the main deployment system, of which there are three basic types in use today. The first is a ripcord similar to the pilot emergency system. The second type is the throw-out pilot chute (TOP). The third is the pull-out pilot chute (POP).

- a. Next, inspect the main ripcord system. Check the ripcord and main pilot chute the same as with the pilot emergency system. Inspect the ripcord pocket for proper holding of the ripcord handle.
- b. For throw-out pilot chutes, inspect the pilot chute fabric and mesh for holes. Check the TOP handle at the top of the pilot chute for security, paying special attention to the tape holding the handle, which is particularly prone to wear. Check the bridle attachment to the pilot chute. If it is of a centerline collapsible design, check the centerline for wear and stretch, and make sure the length of the bridle is correct. Check the curved locking pin for wear or damage as well as the tape, which attaches it to the bridle. [Figure 5-28 on page 5-16] Check the pilot chute pocket for fit and wear. Most of today's installations are what is known as a "bottom of container" (BOC) configuration. It is particularly important that the elastic material from which the pocket is made is in good condition. A loose pocket can result in a premature deployment of the main parachute.

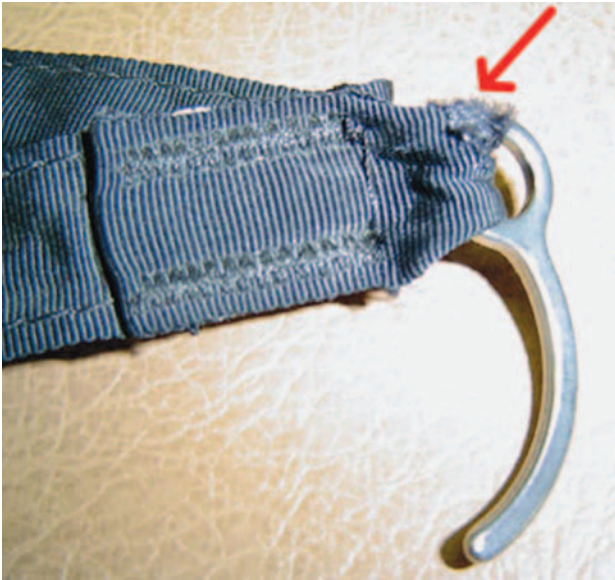


Figure 5-28. TOP bridle with worn pin tape.

- c. If repacking a pull-out parachute, check the pilot chute and bridle in the same manner of the throw-out parachute inspection. Check the lanyard and handle for wear.
- 4. If Velcro® is used on the main pin protector flap, be sure to inspect its condition. If a plastic closing flap or tongue is used, check for deformation or breakage. [Figure 5-29]

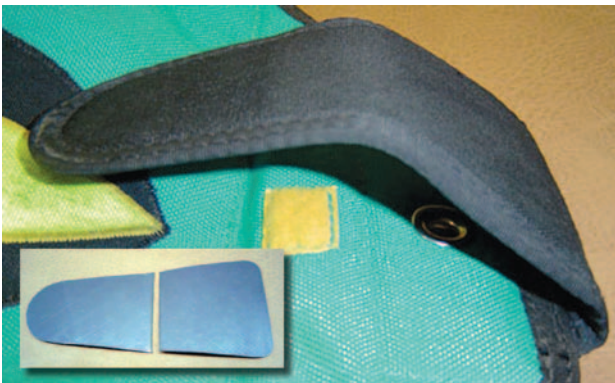


Figure 5-29. Main pin protector flap plastic breakage.

- 5. If Velcro® is used on the main riser covers, be sure to check its condition. If plastic, check for breakage and deformation. If the plastic is excessively deformed, it is a sign that the covers do not fit properly and may open prematurely, causing problems.
- 6. For the container-closing loop, the same criteria applies as in the pilot emergency parachute. In addition, make sure the loop material is the same as specified in the owner's manual, especially if an AAD is installed. With certain AADs, a particular type of knot and washer to be used is specified as well.

## RIPCORD

All the areas mentioned in the pilot emergency parachute section apply to the sport rig. In addition, some assemblies utilize a ripcord which has a webbing loop handle, or a "pillow" type handle similar to the 3-Ring® release handle. [Figure 5-30] It is important that the rigger check these handles for proper markings and fit to the assembly. Make sure that there is sufficient slack in the cable to allow no loading of the pin in any attitude or position that the wearer may conceivably get into. Most, if not all of these style handles utilize Velcro® to secure them to the harness. Make sure the Velcro® is in good condition for holding ability but not so much as to inhibit the pull force.

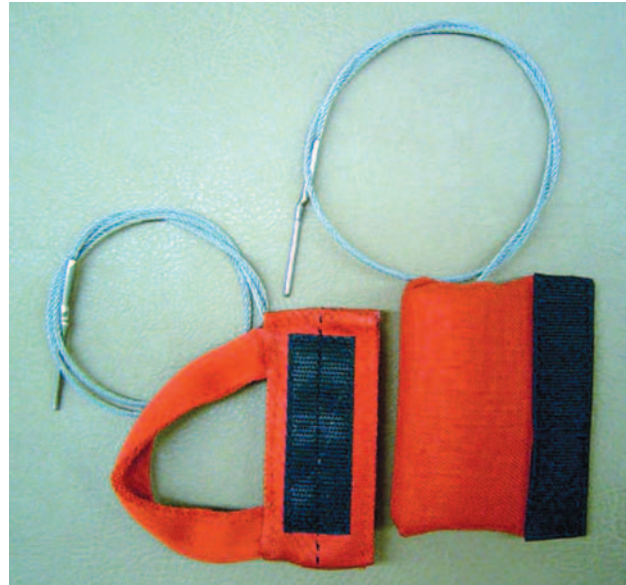


Figure 5-30. Loop and pillow ripcords.

Remember, while both the pilot emergency parachute and sport piggyback assemblies share many areas in common, each has peculiar requirements for its use. It is important for the rigger to recognize these and handle each system accordingly.

## RIGGING AND REPAIRS

When the entire assembly inspection is complete, the rigger will have a list of the discrepancies found during the procedure. At this point, a determination must be made on how to remedy these defects. For senior riggers, certain remedial action may be outside the scope of their certificate. If so, those riggers need to find an appropriately certificated and rated rigger to do the work, or return the parachute to the manufacturer for repair. In the case of major canopy or harness work, this may be the best solution regardless. Aside from the qualification limitations of the rigger, the manufacturer may be better equipped to perform major repair or overhaul. They have the original patterns, templates, and design data as well as the certified materials. In addition, their labor rate is



probably less than what the rigger may charge the customer, particularly if he/she has not done this repair before. The factory has the experience and practice that will result in the repair looking “just like new.” While some riggers may look at any given project with anticipation, they also need to look at what is best for the customer.

Many times, the master rigger has a repair facility and stocks it with the necessary materials. In most cases, these materials come from sources with no traceability as to their origin. The manufacturer is required to use only those materials that have been tested, certified, and approved to meet the standards of their **quality control** system under the TSO system. During one recent routine inspection and repack, the rigger found severe failure of the harness stitching at the main lift web/leg strap junction. Upon further examination, it was determined that the thread used to sew the harness was not nylon. The harness was returned to the manufacturer, who then determined that the thread was indeed cotton and not the required nylon. The thread broke at approximately 10 pounds vs. 45 pounds for 5-cord nylon. Further investigation revealed that the harness was originally manufactured with a harness size 3 inches shorter. There were telltale marks left from where the original harness was stitched. This modification was evidently performed by someone who either was not qualified to perform the work or had gotten a batch of the wrong thread by mistake and did not recognize the difference. Attempts to find out who did the alteration were unsuccessful. The manufacturer repaired the harness at no charge and returned it to the customer. To preclude this type of problem, many professional riggers and lofts establish good working relationships with the manufacturers and procure certain materials from them. They keep these marked and in a separate area, and use them only on the appropriate projects.

Another area of concern is a master rigger who does major alterations without proper approval of the manufacturer. The rigger may do major repairs to return the assembly to its original condition without further authorization of the Administrator or manufacturer, but alterations are another story. 14 CFR, subsection 65.129(e) states that “No certificated parachute rigger may pack, maintain, or alter a parachute in any manner that deviates from the procedures approved by the Administrator or the manufacturer of the parachute.” There are a number of common alterations seen in the field. Among them are: harness re-sizing, AAD installations, RSL retrofits, chest strap relocation, and others. The manufacturer’s approval can vary from a verbal message over the phone to a formal engineering procedure complete with drawings and specifications. If the work is done correctly, the truth probably lies somewhere in the middle. If riggers want to ensure they are following code, they should obtain some

form of written approval from the manufacturer in whatever form they will provide.

The bottom line is that the purpose of the system is to provide an infrastructure that ensures the safety of the public. Professional riggers strive to do the “right thing” both morally and legally.

## PACKING

As stated before, packing is the heart of the rigging profession. Once riggers satisfy all the necessary inspection requirements, they may then proceed with the packing process. This section describes a generic round parachute packing method into a modern back type pilot emergency system. The steps for doing this are common to most parachutes of similar types. Once the basics are mastered, it is a simple matter of following the manufacturer’s instructions for other makes and models.

### ROUND CANOPY INTO A PILOT EMERGENCY PARACHUTE SYSTEM

The steps for packing this type of parachute are broken down into the following:

1. Layout.
2. Flaking and pleating the canopy.
3. Folding the skirt and the long fold.
4. Closing the diaper and stowing the lines.
5. Skirt or diaper placement.
6. Accordion fold of the canopy into the container.
7. Closing the container.

Before beginning, the rigger must have the necessary tools to pack the parachute. The packing manual includes a list of tools necessary for the procedure. Figure 5-31 shows the recommended tools needed to pack the parachute described in this section. Don’t forget to count your tools before beginning!



Figure 5-31. Round parachute packing tools.



## LAYOUT

1. The parachute must be positioned on the table face down with the wearer's head toward the canopy. The rear of the canopy faces up. Normally the data panel is on the middle gore that faces up. [Figure 5-32]

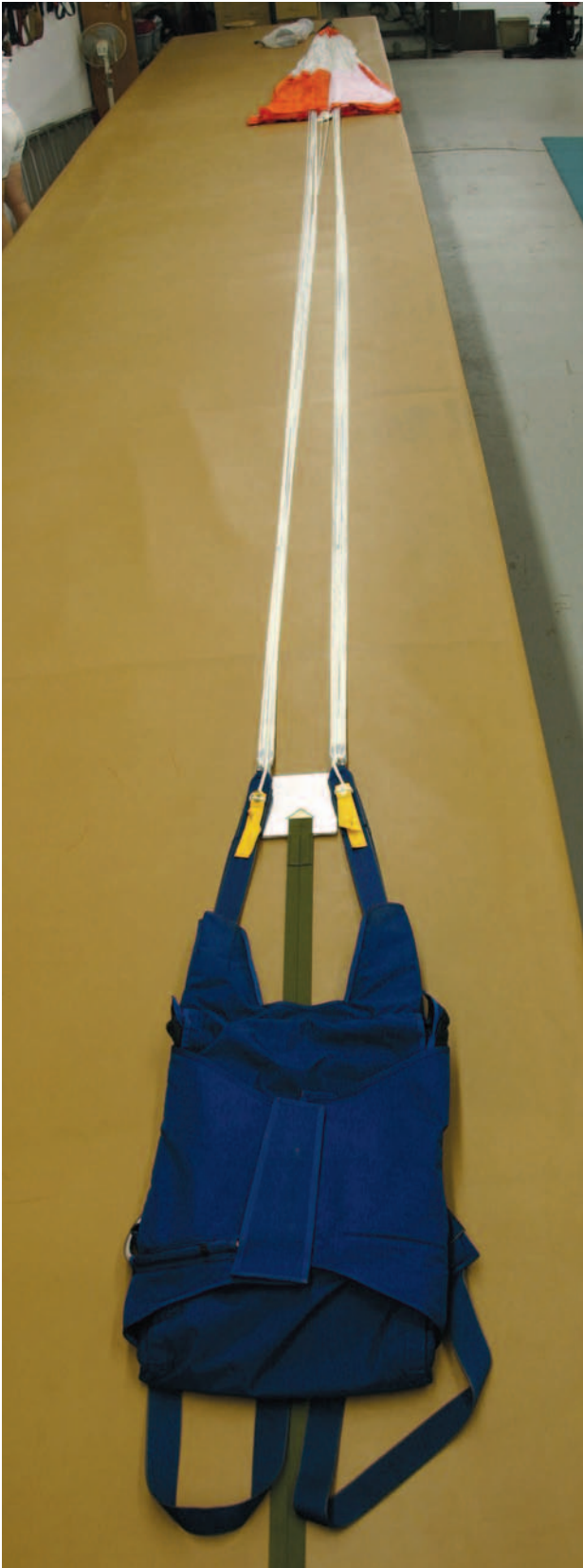


Figure 5-32. Round parachute assembly on packing table.

2. Attach the canopy tension loop to the upper table tension device, then attach the connector links or risers to a tension board or similar device at the bottom of the table. [Figure 5-33] Be sure to apply light tension.

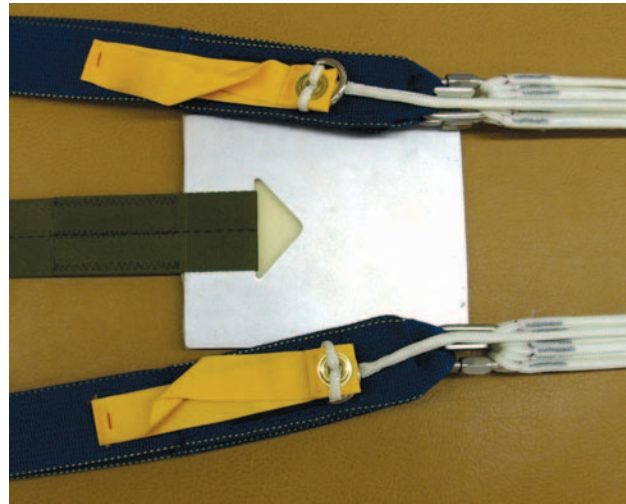


Figure 5-33. Riser and connector links attached to the tension board.

3. Straighten the apex of the canopy making sure the lower lateral band or skirt is somewhat even. [Figure 5-34] Apply additional tension to the canopy and lines.



Figure 5-34. Straightening the canopy apex.

## PLEATING THE CANOPY

1. Flake the canopy in the normal manner with an equal number of gores to each side. Figures 5-35 thru 5-41 show the proper technique.



Figure 5-35. Flaking 1.



Figure 5-36. Flaking 2.



Figure 5-37. Flaking 3.





Figure 5-38. Flaking 4.



Figure 5-39. Flaking 5.



Figure 5-40. Flaking 6.





Figure 5-41. Flaking 7.

2. **Pleat** the canopy with an equal number of gores to each side. Make sure the canopy skirt is even. [Figures 5-42 thru 5-44]



Figure 5-42. Pleating 1.



Figure 5-43. Pleating 2.



Figure 5-44. Pleating 3.



Figure 5-45. Folding.

### FOLD THE SKIRT

1. Fold the **skirt** so it is parallel to the radial seams. [Figure 5-45]

2. Fold the canopy lengthwise in thirds and then fold once more to the center in what is commonly called “fifths.” [Figures 5-46 thru 5-48] Place packing weights on the canopy to hold it in place.

### CLOSING THE DIAPER AND STOWING THE LINES

1. Pull the container towards the canopy and form a loop of suspension lines above the top of the diaper. [Figure 5-49] Be sure to leave enough room to close the diaper.



Figure 5-46. 5ths 1.



Figure 5-47. 5ths 2.



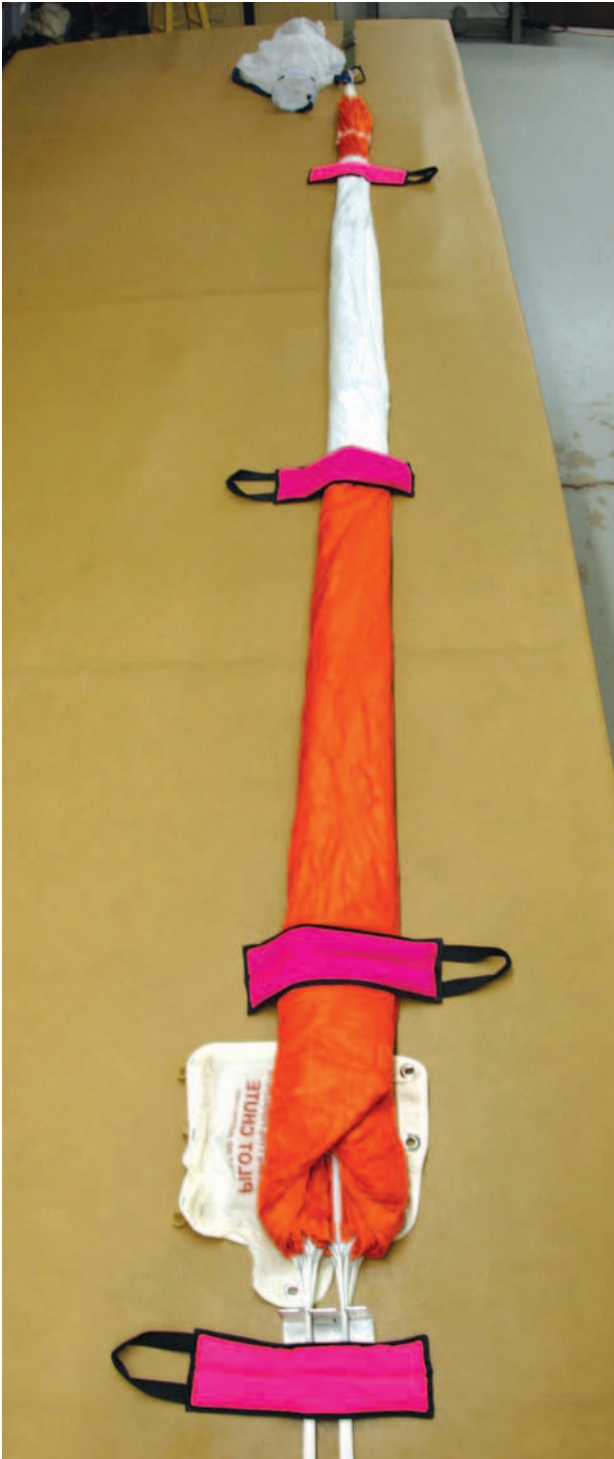


Figure 5-48. 5ths 3.

2. Close the diaper starting with the top grommet. Lock the grommet with a bight of line no more that 1.5 inches long. [Figure 5-50] Close the middle grommet in the same manner. [Figure 5-51]

3. Close the bottom grommet over the bottom rubber band and then the **end flap** grommet over the side grommet. [Figure 5-52 on page 5-24] Close with a bight of line no longer than 1.5 inches long.



Figure 5-49. Locking stow 1.



Figure 5-50. Locking stow 2



Figure 5-51. Locking stow 3.

4. Finish stowing the remainder of the suspension lines using bights no more than 1.5 inches long. [Figure 5-53 on page 5-24]





Figure 5-52. Locking stow 4.



Figure 5-53. Line stows.

#### SKIRT OR DIAPER PLACEMENT

1. Lay the risers in the container and close the riser covers. Insert pull-up cords into both ends of the closing loop.
2. Turn the skirt of the canopy 90 degrees and lay one edge of the diaper even with the top edge and inside the pack tray. [Figure 5-54]

#### ACCORDION FOLDING THE CANOPY

1. Fold the canopy toward the bottom of the container leaving enough to fill the upper corner of the container.
2. Fold the canopy toward the bottom of the container and leave approximately 4 inches of canopy past the bottom. [Figure 5-55]



Figure 5-54. Diaper stow.



Figure 5-55. S fold 1.



3. Fold the canopy back towards the top of the container and spread the canopy sideways to fill out the width of the container. [Figure 5-56] Make two folds between the lower edge of the diaper and the lower end of the closing loop. [Figure 5-57]



Figure 5-56. S fold 2.



Figure 5-57. S fold 3.



4. Lay the remainder of the canopy and apex across the middle of the container and fold in an appropriate manner to fill the empty area of the container on the pack tray stiffener below the diaper. [Figure 5-58]



Figure 5-58. Apex location 1.

### CLOSING THE CONTAINER

1. Close the bottom flap of the container first, threading the pull-up cord through the grommet at the upper end of the bottom flap. Place the canopy protector flaps into position as shown in figure 5-59.

2. Close the top flap, being sure to push the canopy and diaper into the corners of the container while closing. Thread the upper pull-up cord through the upper grommet on the top flap.



Figure 5-59. Apex location 2.

3. Thread the lower pull-up cord through the lower grommet on the top flap making sure the canopy protector flaps are in position. [Figure 5-60] Pull the lower pull-up cord through both grommets until the closing loop appears and install a temporary pin.

4. Pull the upper pull-up cord through the grommet until the upper closing loop appears and install a temporary pin. [Figure 5-61]

5. Compress the pilot chute between the rubber bumpers and make sure the pilot chute canopy fabric is tucked into the coils of the spring. Thread the pull-up cords through the grommets in the grommet strap. Removing one temporary pin at a time, pull up the closing loops and secure the pilot chute in place with two temporary pins. [Figure 5-62] Close the Velcro® on the top and bottom flaps.

6. Close the right **side flap**. Close the left side flap and install the ripcord pins. [Figure 5-63]

7. Seal the last pin according to the manufacturer's instructions or in an approved manner.

### RIPCORD PULL FORCE

The correct packing is the most important aspect of repacking a parachute, but the cosmetic appearance of the container is important as well. This is true both for a pilot emergency and a sport piggyback system. Pilots want their parachute as snug and as flat as possible to keep the



Figure 5-60. Closing bottom flap.



Figure 5-61. Upper temp pin seated.





Figure 5-62. Pilot chute seated in position.



Figure 5-63. Ripcord pins in place.



parachute comfortable when in use. Skydivers want theirs as snug and streamlined as possible so it stays closed during free fall. The key to these requirements is to make sure the pilot chute is held down securely. To do that, the closing loop needs to be as short as the rigger can make it and still meet the requirements for the maximum pull force. Under the TSO system, the maximum allowable pull force for the ripcord is 22 pounds. Most riggers develop a feel for the closing of the container and what the resultant force will be. However, new riggers need to check their packing technique to measure the pull force, which is done without a seal or thread.

Start by having someone put on the parachute to replicate the real shape and conformity of the parachute system. To pull the ripcord while the parachute is lying on the table is not realistic. The rigger then takes the ripcord handle from the pocket and attaches a calibrated scale to it. [Figure 5-64] Ideally, a recording scale should be used to register the maximum force during the pull. Next, the rigger needs to pull the ripcord in a smooth, quick motion, duplicating the motion of the user and the test requirements of the TSO. Take note of the force required to pull the ripcord pin(s) clear of the locking loop(s) and activate the system. If the force is less than 22 pounds, the rigger can then re-close the container and seal the ripcord. If the force is over 22 pounds, the rigger must make whatever adjustments are needed, such as lengthening the locking loop or re-stowing the canopy, to achieve a pull force below 22 pounds.

### SEALING THE PARACHUTE

As stated in 14 CFR, section 65.133, “Each certificated parachute rigger must have a seal with an identifying mark prescribed by the Administrator, and a seal press. After packing a parachute, he shall seal the pack with his seal in accordance with the manufacturer’s recommendation for that type of parachute.” Most manuals simply say to “seal the parachute.” The following describes a commonly approved method.



Figure 5-64. Ripcord pull test.

Take a length of seal thread approximately 20 inches long. Fold in half and make two lark’s head knots around the ripcord cable adjacent to the shank of the ripcord pin. [Figure 5-65] Pass one end of the thread through the seal and then under the pin on the opposite side of the locking loop or cone. [Figure 5-66] Bring the end back through the second hole in the seal and tie a knot with the other end of the thread. [Figure 5-67] Leave enough slack in the thread to allow for movement of the pin without



Figure 5-65. Lark’s head the thread on the cable.



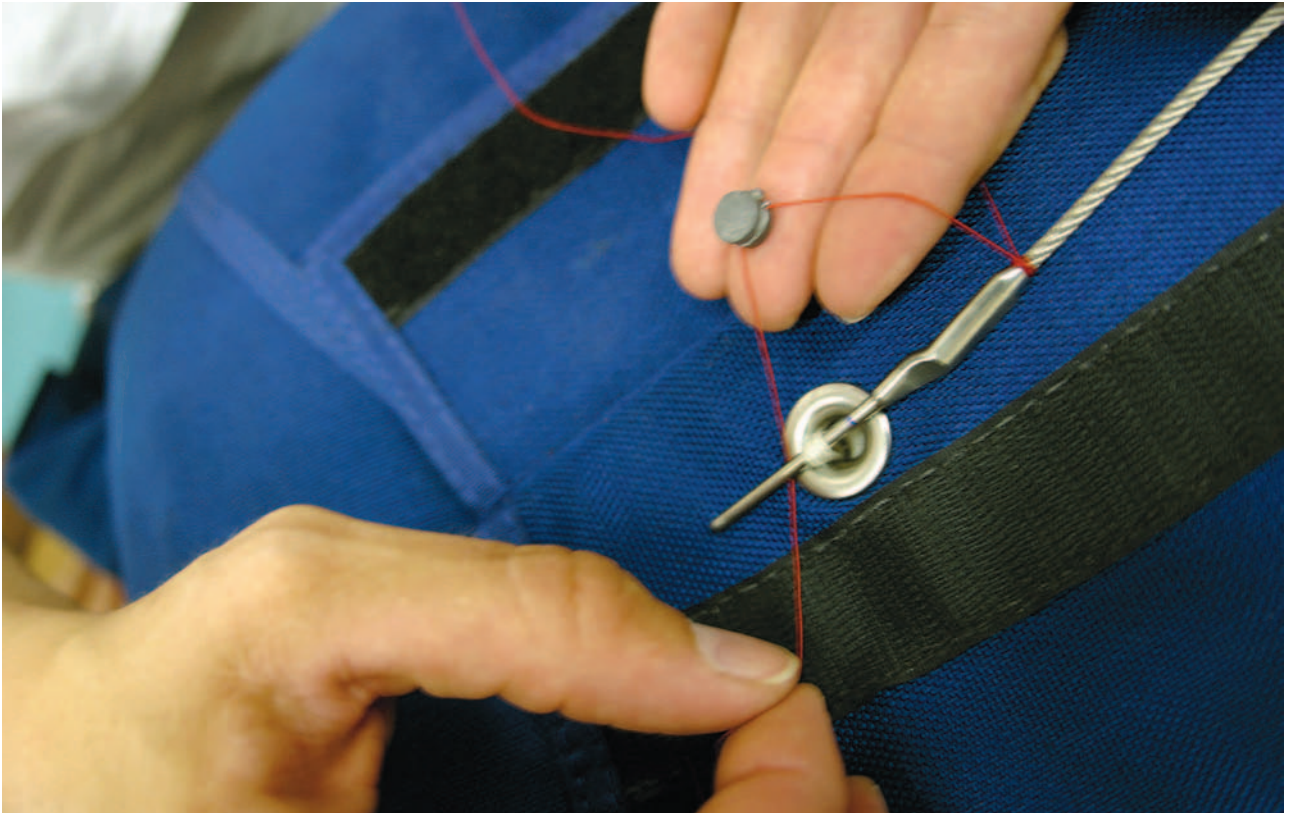


Figure 5-66. Threading the seal thread.

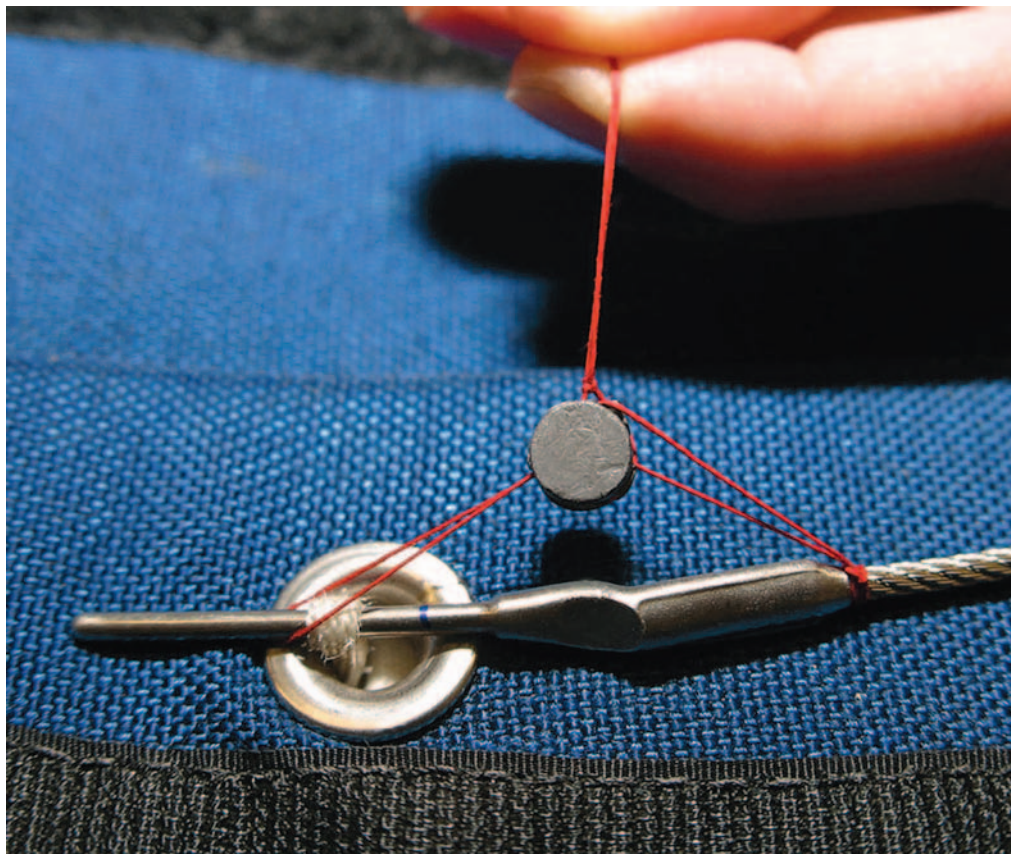


Figure 5-67. Positioning the seal.



**Figure 5-68. Compressing the seal.**

breaking the thread. However, make sure the pin cannot be extracted from the locking loop without breaking the thread. Slide the seal over the knot and compress the seal with the seal press. [Figure 5-68] Trim the excess thread.

Count all of your tools. Fill in the appropriate information on the packing data card and the rigger's logbook. Place the data card in the packing data card pocket.

## **RAM-AIR RESERVE INTO A SPORT PIGGYBACK SYSTEM**

In the preceding text, the discussion centered on a parachute system that was already assembled. This next section focuses on the assembly of a ram-air parachute system, the component parts, and the process from the assembly stage through to packing. While this section provides guidance and an overview of packing a ram-air canopy into a sport piggyback system, it is imperative that the rigger receive proper training from a certificated and properly rated rigger who has been trained to pack ram-air reserves. 14 CFR, subsection 65.129(f) states, "No certificated parachute rigger may exercise the privileges of his certificate and type rating unless he understands the current manufacturer's instructions for the operation involved..."

The following procedure is typical of many current 1-pin container systems. While this configuration comprises the majority of those manufactured today, there are other designs still in use that require different techniques. The

rigger must become thoroughly familiar with the other configurations before attempting to assemble and pack these systems.

### **ASSEMBLING THE RESERVE SYSTEM**

The following components are necessary to assemble the harness and container to the ram-air reserve:

1. The harness, container, and associated parts to include the reserve pilot chute and free bag, reserve ripcord, reserve steering toggles, reserve closing loop, and RSL, if desired.
2. Reserve canopy.
3. AAD, if desired.

Before progressing, the necessary tools must be available. The packing manual should include a recommended tools list. However, based on the rigger's experience and packing technique, the numbers and types of tools needed to pack this system may vary. Figure 5-69 shows the tools needed to pack the following ram-air parachute assembly using the technique described.

### **COUNT YOUR TOOLS BEFORE BEGINNING!**

Begin the assembly procedure in the following manner:

1. Connect the canopy to the risers of the harness, ensuring line continuity is correct.



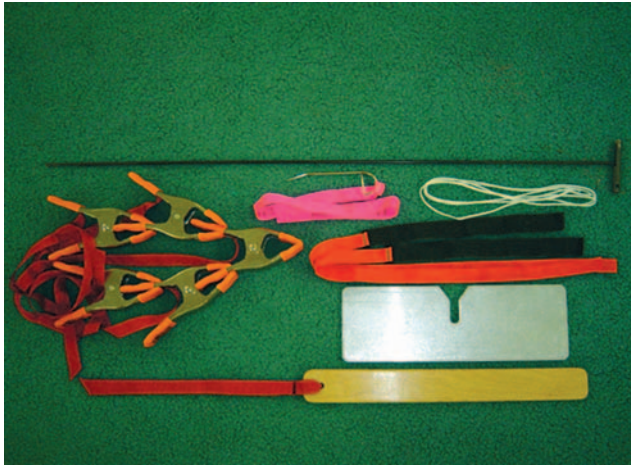


Figure 5-69. Ram-air canopy packing tools.

2. Tighten the connector links and seal with a telltale mark.
3. If used, install and secure the connector link bumpers per the canopy manufacturer's instructions.
4. Route the control lines through the slider grommets and guide rings on the rear of the riser. Fasten the steering toggles in the required manner. [Figure 5-70]



Figure 5-70. Tying toggles.

5. Install the AAD, if desired, according to the manufacturer's instructions.
6. Install a closing loop of the correct type and length.
7. Attach the reserve free bag to the reserve pilot chute.

The steps for packing this type of parachute are broken down into the following:

1. Layout, and setting up packing clamps.
2. Stacking and pleating the reserve canopy.
3. Setting the deployment brakes.

4. Folding the canopy.
5. Placing the canopy into the deployment bag, and stowing the lines.
6. Placing the bag into the container and closing the container.

#### STEP 1. LAYOUT, AND SETTING UP PACKING CLAMPS

1. Anchor the risers at the connector links including the steering lines. [Figure 5-71]

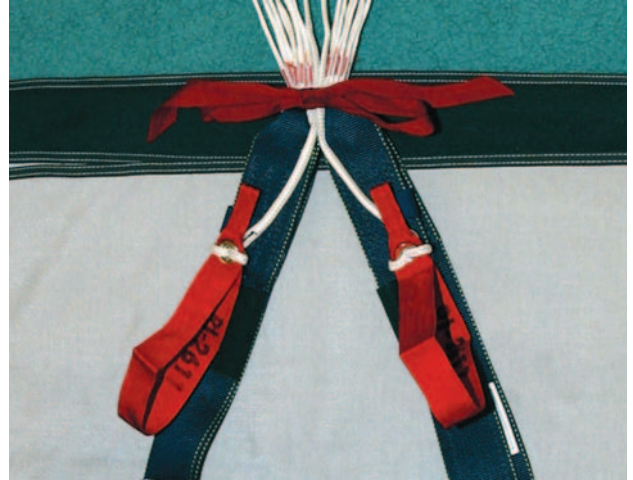


Figure 5-71. Anchor risers.

2. Place packing weight on top of it.
3. Pull the slider down to the connector links. Make sure the tapes face upward toward the canopy. [Figure 5-72]



Figure 5-72. Pull slider down.

4. Lay the canopy on its right side. (Note: A mirror image of the layout is permissible).
5. Flake the canopy so the top seams are even. Place a clamp on the top of the canopy in line with each line attachment point as in figure 5-73 on page 5-34.

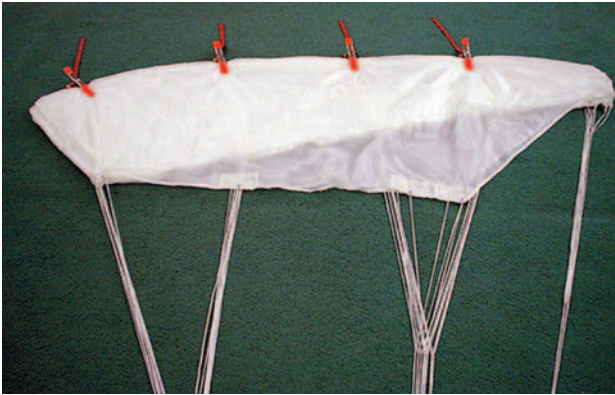


Figure 5-73. Clamps on top of canopy.

## STEP 2. STACKING AND PLEATING THE RESERVE CANOPY

Note: The canopy stack should look like figure 5-74.

It is imperative that the rigger maintains control over the packing process at all times. In particular, it is important to keep the lines taut and straight and to keep the center “wind channel” of the canopy stack clear and the line attachment tabs stacked neatly.

1. Pull tension on the “A” lines. Split the leading edge in half. [Figure 5-75]
2. Fold half under “A” lines. [Figures 5-76 and 5-77]
3. Pick up the “B” lines by the clamp and hold vertically over the “A” clamp. [Figure 5-78] Note the spread of the leading edge panels.
4. Lower the “B” clamp and material down to the “A” clamp. [Figure 5-79] Spread the cells equally to both sides. Keep the center cell in the middle.

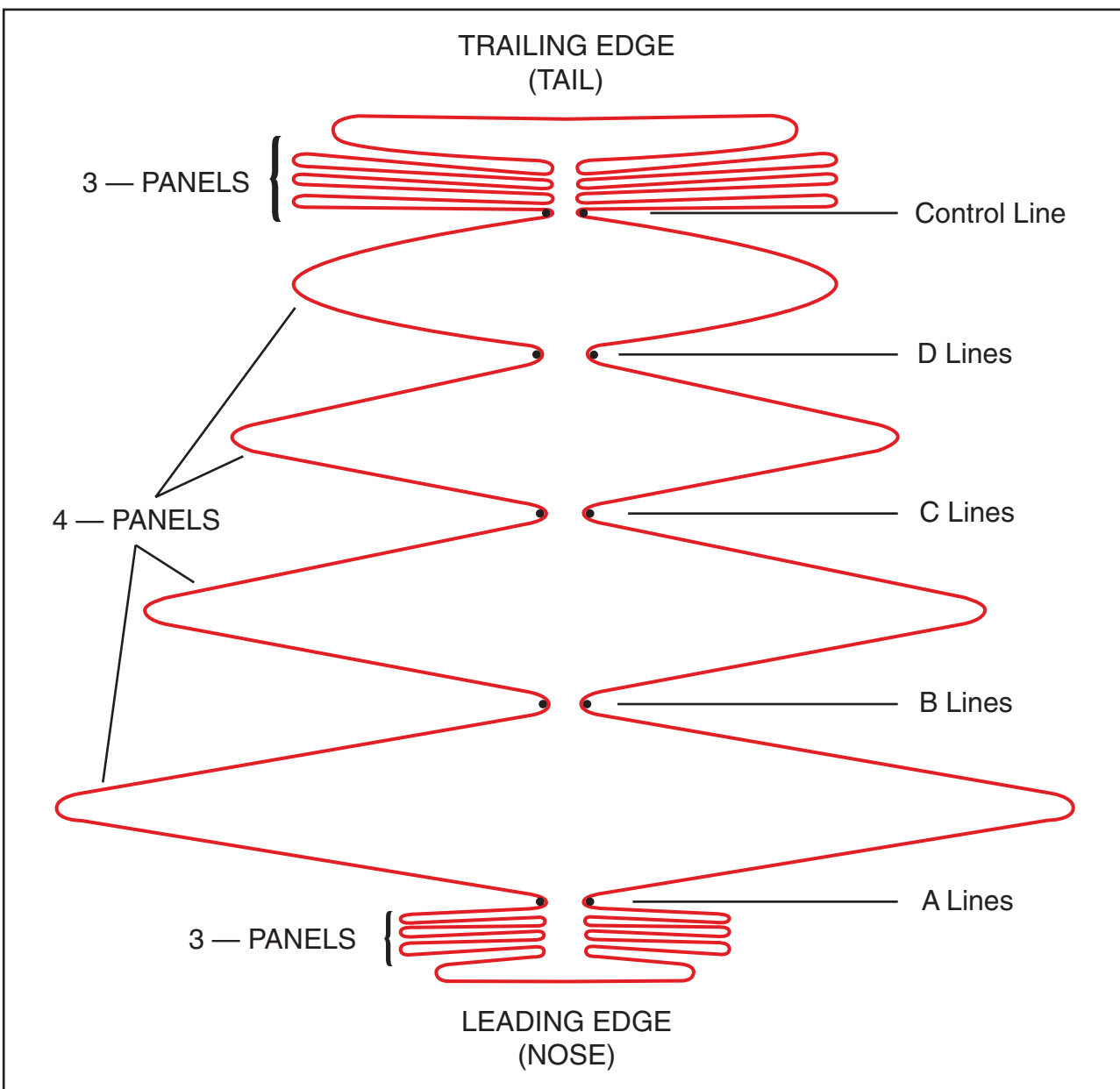


Figure 5-74. Drawing of canopy stack.





Figure 5-75. Split the leading edge.



Figure 5-76. Fold half under "A" lines.



Figure 5-77. Smooth panels under "A" lines.



Figure 5-78. Hold "B" clamp vertically over "A" clamp.



Figure 5-79. Lower "B" clamp to "C" clamp, spreading the cells.

5. Repeat this step with the "C" [Figure 5-80] and the "D" line groups. [Figure 5-81]



Figure 5-80. Repeat with "C" lines.



Figure 5-81. Repeat with "D" lines.



6. Split the trailing edge and separate the control lines into right and left groups. [Figure 5-82]



Figure 5-82. Split the trailing edge.

7. Remove the “D” clamp. Hold down the “D” lines at the line attachment point and pull down the control lines. [Figure 5-83] Do not disturb the center of the canopy stack.



Figure 5-83. Pull down the trailing edge.

### STEP 3. SETTING THE BRAKES

1. Set the deployment brakes and stow the excess line in the Velcro® keepers. [Figure 5-84]



Figure 5-84. Set the deployment brakes.

2. The finished toggles should look like figure 5-85.



Figure 5-85. Completed brakes.

### STEP 4. FOLDING THE CANOPY

1. Fold all the trailing edge to one side, then pull the stabilizer panel taut. [Figure 5-86]



Figure 5-86. Pull stabilizer taut.



2. Flake the trailing edge of the canopy starting with the outboard control lines. Fold each cell in half on top of the “D” line group [Figure 5-87] until you get to the center.



**Figure 5-87. Flake the tail.**

3. Repeat with the opposite side.
4. Pull the slider up to the slider stops.
5. Remove remaining clamps from top of canopy. Make sure all suspension lines are in the center of the canopy stack. [Figure 5-88]



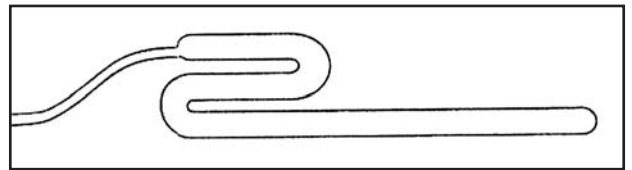
**Figure 5-88. Lines are taut in the center.**

6. Fold the center of the trailing edge back to expose the center of the “wind channel.” [Figure 5-89]



**Figure 5-89. Fold tail back for wind channel.**

7. Create an “S” fold in the stack. [Figure 5-90]



**Figure 5-90. “S” fold drawing.**

8. Position a packing paddle a third of the way up from the bottom of the canopy length on top of the stack. [Figure 5-91]



**Figure 5-91. Packing paddle at 1/3rd location.**

9. Place a gun cleaning rod at half the distance between the bottom and the packing paddle under the stack.



10. Pull the rod up and move the canopy with paddle towards container. [Figure 5-92]



Figure 5-92. Creating the "S" fold.

11. Pull the top center cell panel down to the bottom of the stack.

12. Wrap the center cell around the folded canopy with the left and right about halfway to the center, then secure with clamps, starting at the bottom. [Figure 5-93] The width of the folded canopy should be the width of the D-bag plus 2 inches (5cm).



Figure 5-93. Wrap tail, two clamps.

13. Continue to wrap the center cell around the canopy stack and secure with additional clamps. [Figure 5-94]

#### STEP 5. PLACING THE CANOPY INTO THE DEPLOYMENT BAG, AND STOWING THE LINES

1. Lift the base of the folded canopy and slide the reserve bag underneath. The grommets in the tongue of the bag should be even with the bottom of the stack. [Figure 5-95]



Figure 5-94. Finish wrapping tail, four clamps.



Figure 5-95. Bag positioned under canopy.

2. Make a second "S" fold to match figure 5-96.



Figure 5-96. Second "S" fold.

3. Split the loose fabric at the top to form two "ears." [Figure 5-97]





**Figure 5-97. Split fabric and form "ears."**

4. Gather the center cell material along the middle seam until you reach the bottom. Roll the material under, but do not cover the center cell. [Figure 5-98]



**Figure 5-98. Gather and roll center seam fabric.**

5. Hold down the center cell material and then shape the molar folds. [Figure 5-99]



**Figure 5-99. Shape molar folds.**

6. Fold the ends of the molar folds under to create the bulk necessary to fill the top of the reserve bag. [Figure 5-100]



**Figure 5-100. Fold molar ends under.**

7. When placing the canopy in the bag, allow the folded canopy to stick out 2-3 inches at the mouth of the bag to fill the corners of the reserve container. [Figure 5-101]



**Figure 5-101. Place canopy in bag.**

8. Close bag and secure with the locking stows. [Figure 5-102 on page 5-40]
9. Shape the bag. The shape of the bag should reflect the desired shape of the reserve container.
10. Cover any exposed hook Velcro® to avoid contact with the lines.





Figure 5-102. Close bag and secure locking stows.

11. Stow the lines neatly leaving sufficient line between the bag and riser ends. [Figure 5-103]



Figure 5-103. Stow lines.

12. Thread the pull-up cord through the closing loop.

**STEP 6. PLACING THE BAG INTO THE CONTAINER AND CLOSING THE CONTAINER**

1. Place reserve risers into the pack tray. Spread the risers with the rear riser to the outside to minimize the bulk against the back pad. [Figure 5-104]
2. Place the reserve bag into the container and S-fold the bridle in the center of the bag. [Figure 5-105]
3. Fold the top yoke portion of the bag over the bridle. [Figure 5-106]

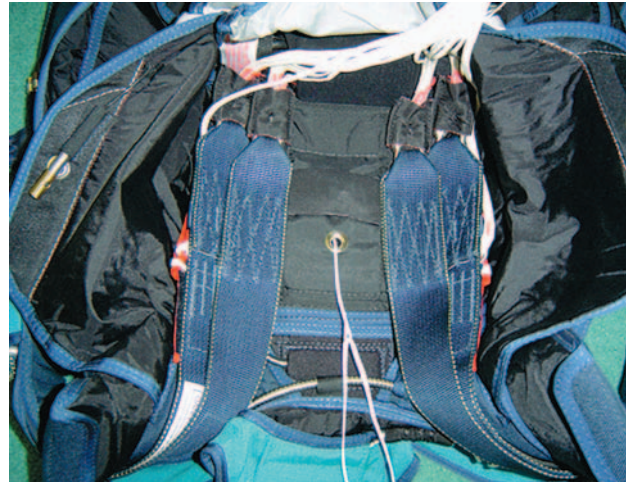


Figure 5-104. Place risers in the pack tray and spread.

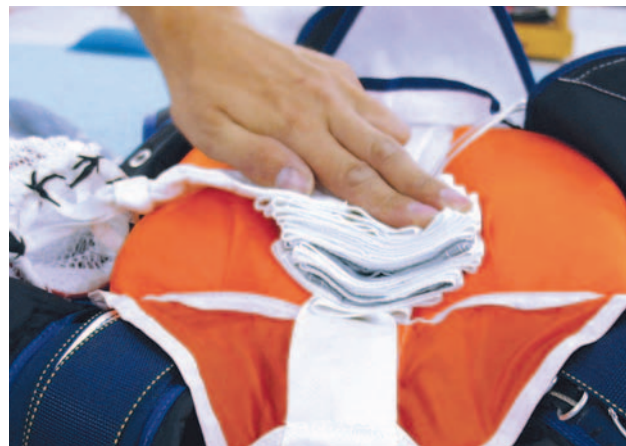


Figure 5-105. "S" fold the bridle on bag.



Figure 5-106. Fold the yoke over the bridle.

4. Secure in place with a clamp. [Figure 5-107]
5. Use the gun cleaning rod to thread the pull-up cord through the pilot chute. [Figure 5-108]





Figure 5-107. Secure yoke/bridle with clamp.

6. Center the base of the pilot chute on the center grommet of the deployment bag.
7. Compress the pilot chute while stuffing fabric and mesh between the spring coils.
8. Position the cap of the pilot chute with the arrow facing toward the top or bottom of the container. [Figure 5-109] Secure with a temporary pin.
9. If an AAD such as a CYPRES® is installed, route the pull-up cord through the cutter first, then through the right (#1) side flap grommet. [Figure 5-110]



Figure 5-108. Gun rod through the pilot chute.



Figure 5-110. Route pull-up cord through cutter and right flap.



Figure 5-109. Position pilot chute.



10. Next thread the left (#2) side flap grommet. Simultaneously close the side flaps. [Figure 5-111] Secure with a temporary pin.



Figure 5-111. Close right and left flaps simultaneously.



Figure 5-112. Close #3 bottom flap.

11. Close the bottom flap (#3) and secure with a temporary pin. [Figure 5-112]

Note: At this point, you should only be able to pull 1/4 – 1/2 inch of loop through the first three flaps. If you can pull more, the loop is too long. Open container and shorten loop.

12. Close flap #4 and insert ripcord pin. [Figure 5-113]

CAUTION: Place the closing plate on the bottom edge of the inner top flap. This will protect the plastic stiffener if you are kneeling on the pin protector flap.



Figure 5-113. Close flap #4 and insert ripcord pin.

The rigger should determine how tight the closing loop is, and decide whether to perform a pull test.

**WARNING: MAXIMUM ALLOWABLE PULL FORCE ON THE RESERVE RIPCORD IS 22 POUNDS (10 KG)**

13. Once you are satisfied that the pull force is less than 22 pounds (10 kg), seal the ripcord and log the pack job.
14. Place the data card in the data card pocket. [Figure 5-114]

**COUNT YOUR TOOLS!**



Figure 5-114. Place data card in pocket.

15. Complete the placard data on the orange warning label. Failure to do so will void the TSO.

## DOCUMENTATION

One of the most important parts of the packing process is the requirement to keep proper records. 14 CFR, section 65.131 specifies the information the rigger is required to document. There are two forms of required records. The first is the rigger's logbook. While the exact format is up to the rigger, there are commercially produced logbooks available that provide space for the required notations. The second required record is the parachute data card. Both of these items have been addressed in Chapter 1—Regulations and Human Factors.

There are several items of interest regarding the parachute data card. In the past, the data cards usually had information only for the identity of the parachute canopy, which

is the primary component of the assembly. In recent years, with the growth of sport parachuting, this configuration is no longer standard. With the proliferation of many makes and models of canopies and harness and containers, and the ability to interchange components, it is necessary to document the harness and container as well. The data card shown in Chapter 1, Figure 1-8 has multiple identification spaces. With the widespread use of AADs, it has now become necessary to document the information required by the manufacturer such as the service cycle and battery life. The newest cards have provisions for this information.

With the ability to interchange components, what does the rigger do when a reserve canopy is removed from an assembly? Where does the data card go? This is a somewhat gray area, but the common practice is for the card to remain with the canopy. If the harness and container have had work done that requires documentation, it may be necessary for the rigger to fill out a duplicate card with the appropriate notations as to the work done on the harness. Riggers should make sure that they note that this card is a copy of the original.

Finally, riggers are tasked with noting their name and certificate number on the data card. In many cases, this information is illegible. Riggers who take pride and responsibility in their profession, and the work they do, have no hesitation in letting the public know who did the work. Accordingly, many riggers have a permanent ink stamp with their name, certificate number, and seal symbol that they use to stamp the card and then countersign it. This is the mark of a truly professional rigger. While the seal symbol is not required on the data card, it allows anyone to check the signature against the seal on the parachute.





## Chapter 6

# Hand Tools, Sewing Machines, and the Parachute Loft

Riggers are taught that there are three things necessary to do a proper job: knowledge to do the work, the correct materials, and the right tools. The job cannot be done correctly without all three of these essentials. The right tools include various types of sewing machines as well as a wide variety of specialized hand tools.

The importance of learning the names and nomenclature of rigging tools and equipment cannot be overemphasized. Just as learning the language of a foreign country allows an individual to live and operate efficiently within a society, learning the language of the rigger allows new riggers to operate and interact within their profession. Without the necessary vocabulary, a rigger will not be able to work with other riggers and, more importantly, will not present a professional image to customers.

### HAND TOOLS

A new senior rigger must acquire enough tools to pack and maintain the types of parachutes for which he/she is rated. In the course of training, the rigger candidate will be exposed to various tools and individual rigging techniques. Some riggers adhere to a minimalist philosophy and use as few tools as necessary. This may initially consist simply of

a packing paddle, a pull-up cord, and a temporary locking pin. With some types of parachutes, these may be all the tools needed to pack them. Other riggers develop techniques that utilize an array of tools designed to make the job easier or the end result neater. Some manufacturers have designed specialized tools to make their particular parachute easier to pack and maintain. Each rigger will develop a suitable technique and then obtain the tools to support it.

In the past, the list of tools needed to pack and maintain military surplus parachutes was limited. Since most military parachutes were simply variants of the same canopy designs, common tools could be used across the board. In today's high-tech world, some of these original tools are still used along with a number of newer designs.

All riggers need to create a tool kit tailored for their particular situation. Figure 6-1 shows a commercially available field rigger kitbag with tools. Many riggers are "weekend" riggers, meaning they have a regular job during the week and work as a rigger on the weekend. This is typical of many skydiving riggers. Other riggers work full time in a loft or manufacturing environment.



Figure 6-1. Field rigger kitbag with tools.

Depending on their needs, riggers will have a different approach towards their tools. The weekend rigger may travel to a **drop zone (DZ)** where the primary job is packing. Therefore, the tool kit will be more basic as the purpose of this kit is not to take the whole loft to the DZ. The rigger who works in a full-time loft may have a more comprehensive tool kit since it does not have to be hauled around. For the weekend rigger, there are several field rigger kitbags available commercially which will hold a full assortment of tools. Many riggers design and build custom kitbags tailored around their individual requirements. Doing this is an excellent way to show off sewing skills while at the same time creating a needed tool kit.

Figure #	DESCRIPTION
6-3	Rigger's tool belt
6-4	Seam rippers
6-5	Hemostats or clamp
6-6	Scalpel or Exacto® knife
6-7	Thread snips
6-8	Butane cigarette lighter
6-9	6-inch stainless steel rule
6-10	Fabric marking pencils & felt tip markers
6-11	Scissors
6-12	Finger-trapping needle
6-13	Finger-trapping wire
6-14	Packing paddles and packing fid
6-15	Pull-up cords
6-16	Locking pull-up cord
6-17	Molar strap
6-18	Temporary locking pins (temp pins)
6-19	Velcro® line protectors
6-20	Closing plate
6-21	T-bar positive leverage device
6-22	T-handle bodkin
6-23	Pilot chute threading tool
6-24	Pilot chute locking rod
6-25	Line separator (suspension line holder)
6-26	Connector link separator tool
6-27	Shot bags
6-28	Seal press
6-29	Lead seals and seal thread
6-30	Rigger's logbook
6-31	Packing data card
6-32	Note pad
6-33	Rubber bands
6-34	Hand tacking needles
6-35	Straight & T pins
6-36	Navy end tab
6-37	Waxed nylon "supertack"
6-38	3-Cord cotton thread — waxed
6-39	Tape measure
6-40	Shoulder strap hook
6-41	Pony clamps
6-42	6-inch adjustable wrench
6-43	Screwdriver — multi-tip
6-44	Needle nose pliers
6-45	Cable cutters
6-46	Ripstop roller
6-47	Beeswax
6-48	Spring scale and fabric testing clamps
6-49	Hot knife element w/cutting tip, basting tip, and stand
6-50	Hot glue gun
6-51	Tension board assembly w/apex tiedown
6-52	Size "O" rolled rim spur grommet handset
6-53	Hole punches
6-54	Cutting pad
6-55	Rawhide mallet
6-56	Binding tool

Figure 6-2. Rigger's tool list.

To stock the tool kit, figure 6-2 shows a list of necessary tools that have been proven useful for today's rigger. The list of tools is broken down into two different categories. Category 1, items 6-3 through 6-49 are mandatory tools. Category 2, items 6-50 through 6-56 are optional tools as most of them are for use in the loft.

## HAND TOOLS DESCRIPTION

The tool belt [Figure 6-3] is one of the most useful items the rigger can have. Most tool belts are custom built by the riggers themselves and include a selection of tools that are frequently used around the loft. It always seems that the tool the rigger needs at a particular moment is at the other end of the packing table or on another sewing machine. The use of a tool belt makes riggers more efficient as they are not always looking for and having to retrieve their tools. A well-designed tool belt will hold the following tools as a minimum: scissors, thread snips, 6-inch ruler, marking pencils and pens, butane cigarette lighter, seam ripper, Exacto® knife or scalpel, and finger-trapping needles. Other tools can be added according to the tastes and needs of the individual rigger.

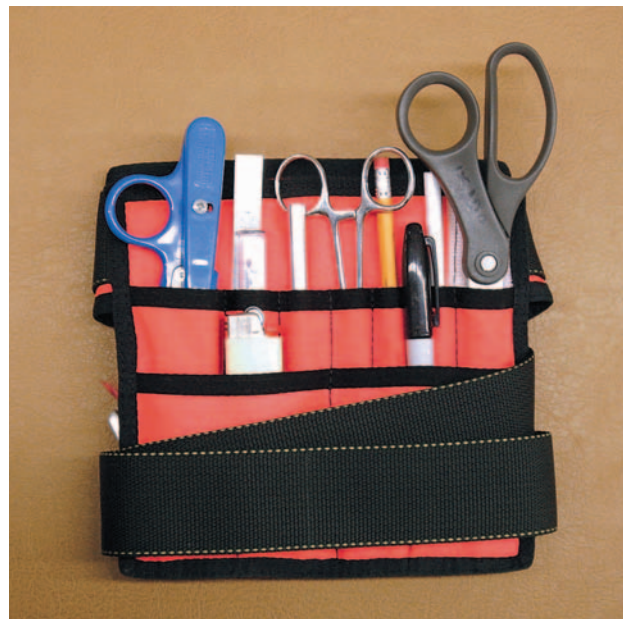


Figure 6-3. Rigger's tool belt.

- **Seam ripper**—A small tool used in the sewing industry for “picking” stitches and ripping out seams. It has a pointed sharp end and an inside cutting edge for slicing through thread. [Figure 6-4]



Figure 6-4. Seam rippers.



- **Hemostats or clamp**—Tools used by riggers for many clamping or retrieving operations. This tool was originally a medical device for clamping off veins and arteries during surgery. Two or three sizes should be obtained as well as both straight and curved models. [Figure 6-5]



Figure 6-5. Hemostats or clamps.

- **Scalpel or Exacto® knife**—A tool used for delicate cutting of materials or thread. The Exacto® knife is preferred as the handles come in various sizes and with a wide selection of blades. [Figure 6-6]



Figure 6-6. Scalpel or Exacto® knife.

- **Thread snips**—A tool used in the sewing industry for **trimming** or “snipping” thread when sewing. Handier and easier to use than scissors as the point is finer and allows more precise cutting of the thread. The ergonomic design takes some getting used to, but proves superior in the long term. The stainless steel models are best, but some riggers prefer the plastic ones, which have replaceable blades. [Figure 6-7]



Figure 6-7. Thread snips.

- **Butane cigarette lighter**—A tool used for burning thread ends to seal the thread and keep stitches from raveling. It is also used for searing tapes, lines, and light webbing. [Figure 6-8]



Figure 6-8. Butane cigarette lighter.

- **6-inch stainless steel rule**—A tool used for making fine measurements during work. At a minimum, the scale should read to 1/16 inch and have a dual (English/metric) readout. Certain models have one rounded end. This model can be used for removing cut stitches from work by rubbing the rounded end against the thread thereby lifting it and making it easier to remove. [Figure 6-9]



Figure 6-9. 6-inch stainless steel rule.

- **Fabric marking pencils and felt tip markers**—Tools used for marking webbing, tapes, and fabric. In particular, Dixon #134s are used in the parachute industry. Other types have been found to contain abrasives and compounds that, when used on canopy fabric, weaken the material. This particular brand of pencil has been found to have minimal effect on the fabric. Various colors such as white, yellow, and red are useful. Fine point felt tip markers are used for marking certain materials, such as Dacron® or Spectra® line, which do not show the Dixon markers. Black, red, and blue are most common. [Figure 6-10]



Figure 6-10. Fabric marking pencils and felt tip markers.



- **Scissors**—A tool used for cutting all types of materials used in the parachute industry. A high-quality scissors is lightweight, ergonomic, and comes in right-hand and left-hand models. [Figure 6-11]



Figure 6-11. Scissors.

- **Finger-trapping needle**—A tool used for inserting suspension line into a “finger-trap” configuration. They are actually a heavy-duty threaded needle commonly called a “fid.” Plastic ones are available commercially, but the best ones are custom made from stainless steel or aluminum knitting needles. Cut to length, they are then drilled and tapped with screw threads in the flat end. The size 2, 6, and 8 needles are the most popular for the current line sizes. [Figure 6-12]

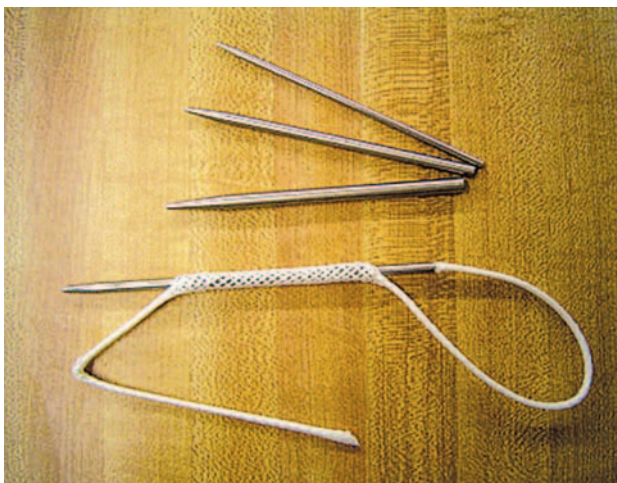


Figure 6-12. Finger-trapping needle.

- **Finger-trapping wire**—A tool used to finger trap line too small to use a needle on. It is made from a wooden or plastic dowel with a wire loop made from safety wire. [Figure 6-13]

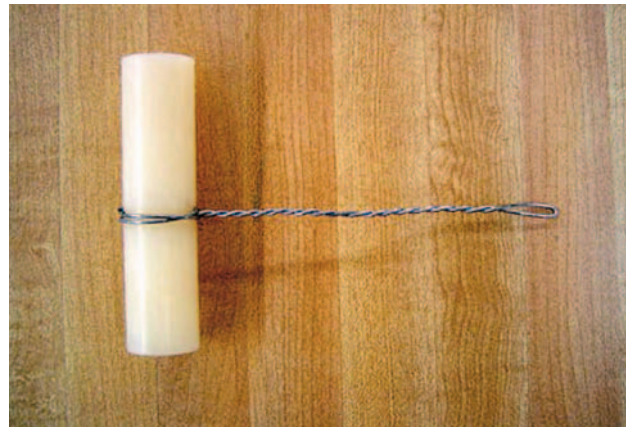


Figure 6-13. Finger-trapping wire.

- **Packing paddle**—A tool used for dressing the pack of the parachute when packing. This tool is made from either wood or aluminum. The MIL-SPEC paddle has rounded ends and is 1 9/16" x 12" long and tapers in thickness from 1/4" to 3/16". The wooden commercial paddle is 1 3/4" x 15" long. [Figure 6-14 (A)]

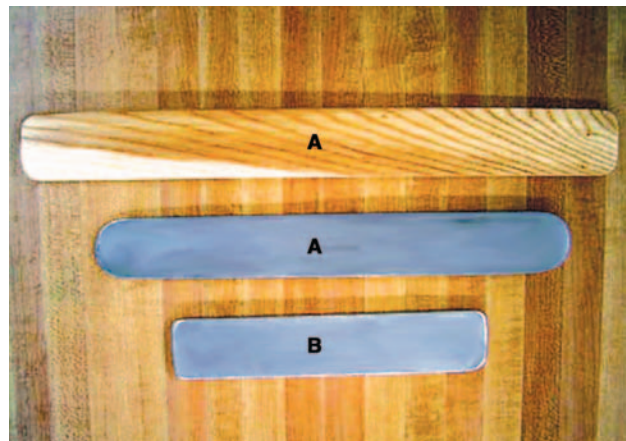


Figure 6-14. Packing paddles and packing fid.

- **Packing fid**—A tool, similar to the packing paddle, used also for dressing the parachute pack and tucking in flaps. The fid is approximately 1 9/16" x 8" long and tapers from 1/4" to 1/8". It is made from aluminum and was originally a U.S. Navy tool. Many riggers have both the fid and the paddle, but usually develop a preference for one or the other. [Figure 6-14 (B)]

- **Pull-up cords**—Tools used to “pull-up” the locking loop of parachute containers when closing and pinning them. They are made from lengths of suspension line or Ty-3 tape. [Figure 6-15]

- **Locking pull-up cord**—A tool used to lock the thickness of a two-grommet reserve deployment bag when packing the reserve canopy. Made from 72 inches of



Figure 6-15. Pull-up cords.

red Ty-3 suspension line and a size 94 Cordlok nylon fastener. May be used on one-pin or two-pin reserve bags. [Figure 6-16]



Figure 6-16. Locking pull-up cord.

- **Molar strap**—A tool used to control the folded reserve canopy prior to inserting it in the reserve free bag. Made from Ty-8 webbing and a Camlok nylon buckle. The webbing should be at least 48" long and brightly colored to serve as a flag against leaving it on the canopy. [Figure 6-17]

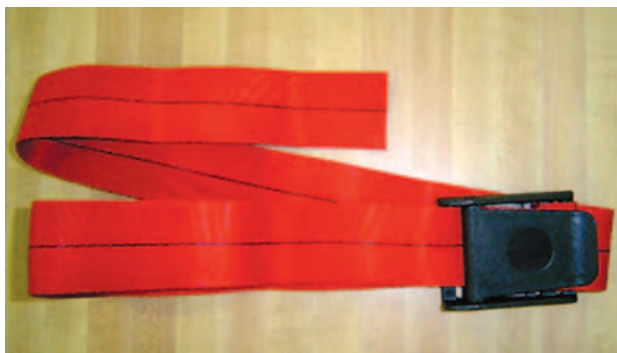


Figure 6-17. Molar strap.

- **Temporary locking pins (temp pins)**—Tools used to secure the pack in the temporarily closed condition

prior to inserting the ripcord pins. All pins should have long, brightly colored flags attached for recognition. [Figure 6-18]

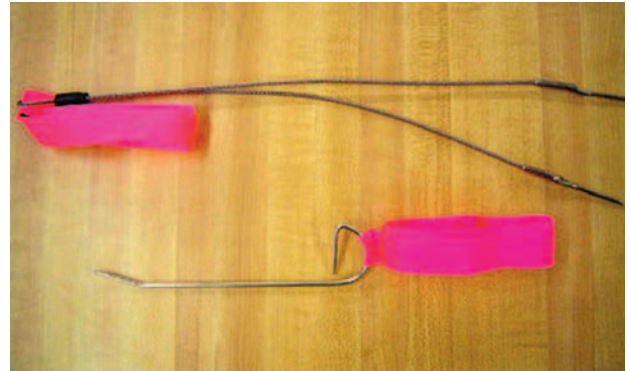


Figure 6-18. Temporary locking pins (temp pins).

- **Velcro® line protectors**—Tools used to cover the hook Velcro® on the line stow pocket of reserve free bags during the line stow process. They are made from pieces of 1" loop Velcro® with Ty-3 tape flags attached. [Figure 6-19]



Figure 6-19. Velcro® line protectors.

- **Closing plate**—A tool used for closing one-pin containers. Made from 1/4" aluminum with a "v" shaped notch for pulling the closing loop up through the pack flaps while compressing the container. [Figure 6-20]

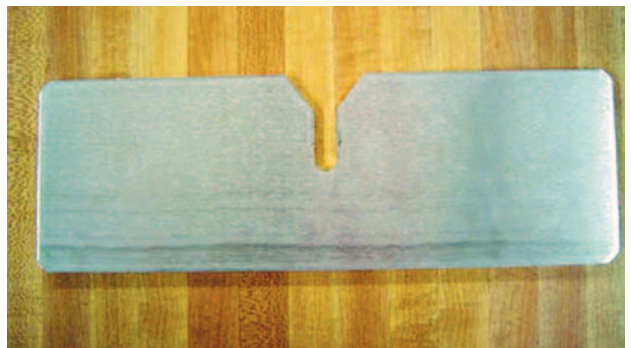


Figure 6-20. Closing plate.

- **T-bar positive leverage device**—A tool used to produce a "cranking" action to wind up the pull-up cord thereby increasing leverage when closing the container. It must be used carefully as it is possible that



too much force can be applied, damaging the container or creating too much force on the pin. [Figure 6-21]

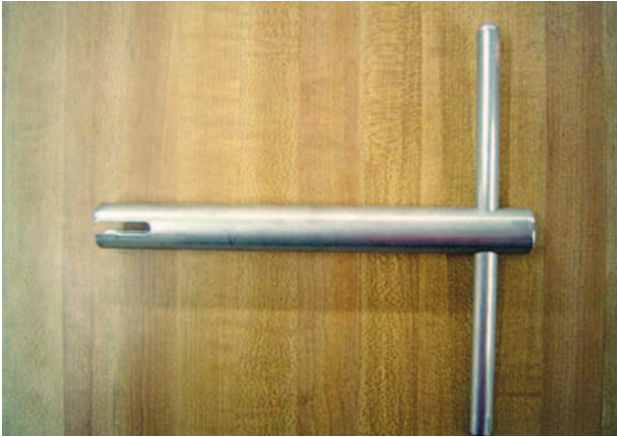


Figure 6-21. T-bar positive leverage device.

- **T-handle bodkin**—A tool used primarily for closing container systems that have external pilot chutes. A minimum of two is needed for the tool kit. [Figure 6-22]



Figure 6-22. T-handle bodkin.

- **Pilot chute threading tool**—A tool used for threading the pull-up cord through a one-pin pilot chute. A .22 caliber gun-cleaning rod works well. The best is a U.S. military surplus M-16 cleaning rod. It is made from steel, as opposed to aluminum, and breaks down into sections and a package that is 8" long. [Figure 6-23]



Figure 6-23. Pilot chute threading tool.

- **Pilot chute locking rod**—A tool used to hold the reserve pilot chute such as an MA-1 compressed on

the pilot chute **launching disc**. It is a tempered steel rod approximately 18" x 3/16". [Figure 6-24]

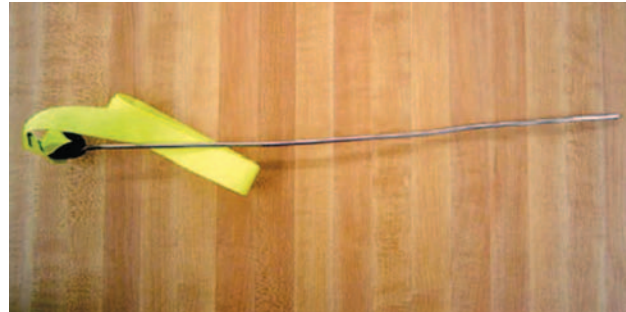


Figure 6-24. Pilot chute locking rod.

- **Line separator (suspension line holder)**—A tool used to keep the suspension lines of the canopy in order while pleating. Made from aluminum with three “fingers” and two slots. [Figure 6-25]

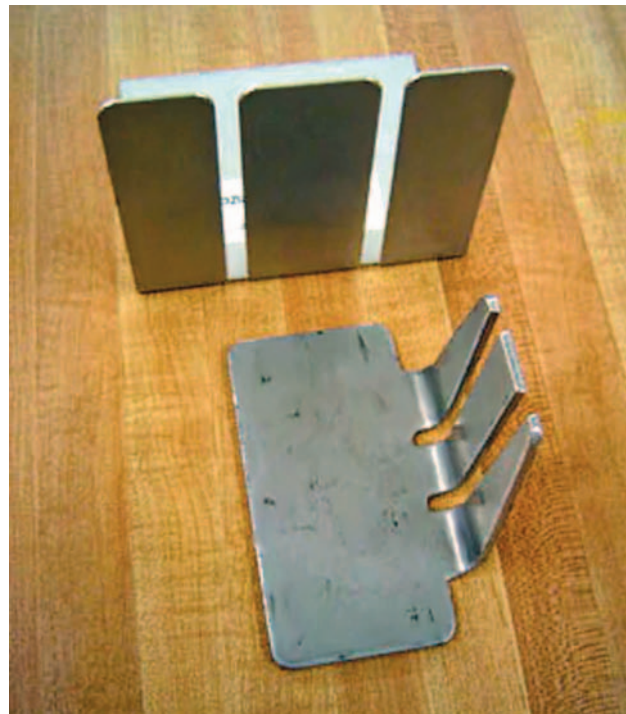


Figure 6-25. Line separator (suspension line holder).

- **Connector link separator tool**—A tool used to separate military style connector links, such as MS-22002 and MS-70118. Military P/N 11-1-176. [Figure 6-26]



Figure 6-26. Connector link separator tool.



- **Shot bags**—Tools used to hold the canopy and suspension lines in place while folding. Packing weight made from nylon fabric and filled with lead shot for weight. These should be brightly colored to prevent leaving in the parachute. Weight varies from 2-5 pounds according to needs. A minimum of four is needed. [Figure 6-27]

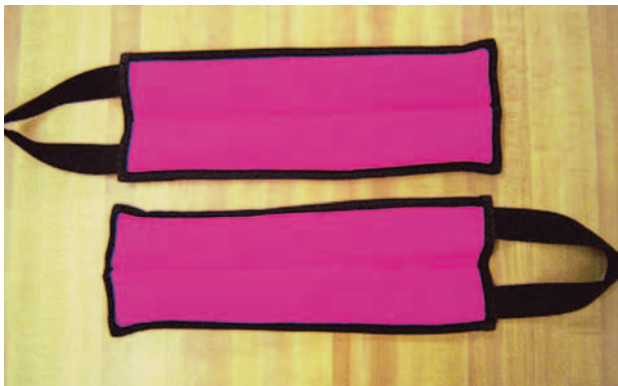


Figure 6-27. Shot bags.

- **Seal press**—A tool used for compressing lead seals when sealing the parachute under 14 CFR, section 65.133. The die of the press has the rigger's seal symbol engraved in the face for identifying the seal. [Figure 6-28]



Figure 6-28. Seal press.

- **Lead seals and seal thread**—Components used with the seal press to seal the parachute, usually 3/8" diameter. The thread is used to seal the parachute in accordance to 14 CFR, section 65.133. A cotton thread, usually ticket 20/4 with a tensile strength of 4.7 pounds. Also used as **safety tie** where required. [Figure 6-29]
- **Rigger's logbook**—A logbook used by riggers to meet the record keeping requirements of 14 CFR, section 65.131. [Figure 6-30]
- **Packing data card**—A card used to fulfill the record keeping requirements of 14 CFR, subsection 65.131(c)



Figure 6-29. Lead seals and seal thread.



Figure 6-30. Rigger's logbook.

that is normally made of Ty-Vek® material and is kept with the parachute. [Figure 6-31]

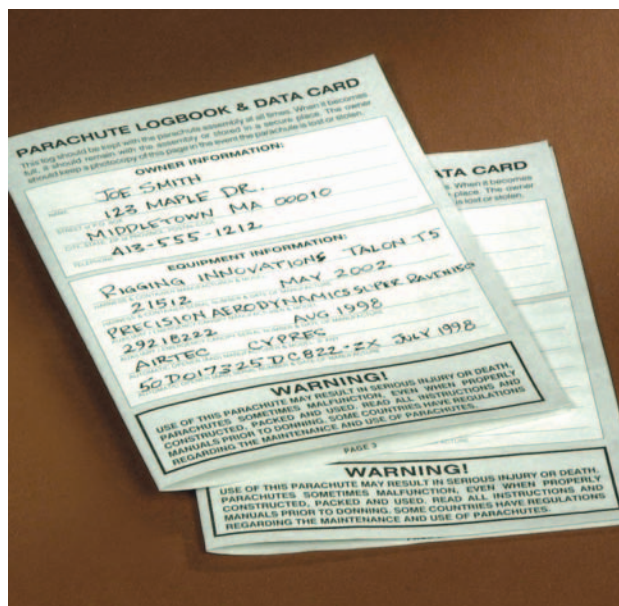


Figure 6-31. Packing data cards.



- **Note pad**—A pad used for recording miscellaneous information or making sketches when working on parachutes. [Figure 6-32]



Figure 6-32. Note pad.

- **Rubber bands**—Bands used for stowing suspension lines, bridles, or static lines. Three sizes are common today. Besides the normal 2-inch size, there is a smaller 1-inch size for the newer microline and a larger one used for tandem parachutes. [Figure 6-33]

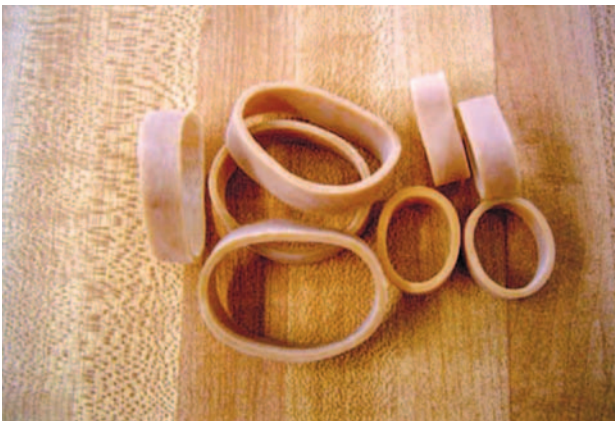


Figure 6-33. Rubber bands.

- **Hand tacking needles**—A variety of sizes of straight and curved needles used for general sewing are necessary for every tool kit. [Figure 6-34]



Figure 6-34. Hand tacking needles.

- **Straight and T pins**—Tools used when doing canopy patches to pin the fabric together. The T pins are used for heavier duty work such as container repair. [Figure 6-35]

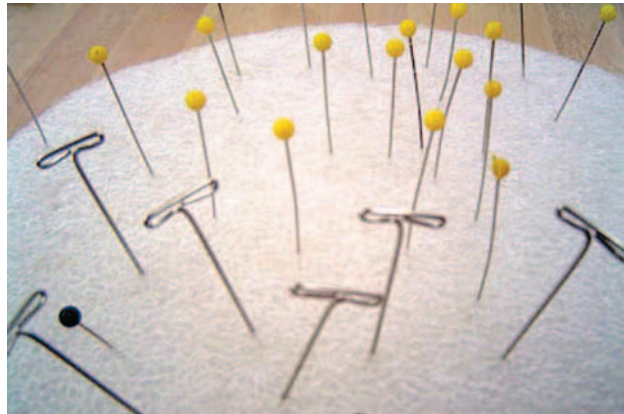


Figure 6-35. Straight and T pins.

- **Navy end tab**—A tool used for assisting in hand tacking thick materials. This is a container end tab from a U.S. Navy seat pack, modified with a “dimple.” The dimple allows the needle to be pushed through the material, and the holes in the tab allow gripping the needle to pull it through. [Figure 6-36]



Figure 6-36. Navy end tab.

- **Waxed nylon “supertack”**—Cord used for hand tacking requirements because it has superior knot holding properties. It is a waxed, flat, braided nylon cord that serves as a modern replacement for 6-cord nylon. Typically 80-90 pounds tensile strength, a 50-pound version is also available. This cord is available in black and white. [Figure 6-37]
- **3-cord cotton thread—waxed**—Thread used for hand tacking and break tacking on the risers and connector links of emergency parachutes. Its tensile strength is 16 pounds. The color is usually natural. [Figure 6-38]
- **Tape measure**—A tool used for general measurement of items such as suspension lines and bridles. A good quality tape measure at least 25 feet long is necessary.





Figure 6-37. Waxed nylon “supertack.”



Figure 6-38. 3-cord cotton thread—waxed.

If possible, get one with dual measurements (English/metric). [Figure 6-39]



Figure 6-39. Tape measure.

- **Shoulder strap hook**—A packing assist device used to apply tension to the pull-up cord using upper-body strength thereby freeing both hands to pin the container. [Figure 6-40]



Figure 6-40. Shoulder strap hook.

- **Pony clamps**—Tools used for clamping material to hold it as a third hand. Also used as a packing assistant when packing square reserves. [Figure 6-41]



Figure 6-41. Pony clamps.

- **6-inch adjustable wrench**—A tool used for tightening Rapide® links and other jobs. A good adjustable



wrench serves in place of several different sized wrenches. [Figure 6-42]



Figure 6-42. 6-inch adjustable wrench.

- **Screwdriver—Multi-tip**—A tool used for L-bar connector links and general use. A good quality screwdriver with interchangeable tips is the most versatile model. [Figure 6-43]



Figure 6-43. Screwdriver—Multi-tip.

- **Needle nose pliers**—A tool used for heavy-duty gripping and pulling such as for needles in webbing. [Figure 6-44]



Figure 6-44. Needle nose pliers.

- **Cable cutters**—A tool used for cutting stainless steel cable and trimming the 3-ring release cable to length. A good quality cable cutter such as the Felco™ model C7 cuts the cable cleanly. Electricians pliers or diagonal cutters flatten the ends of the wire. [Figure 6-45]

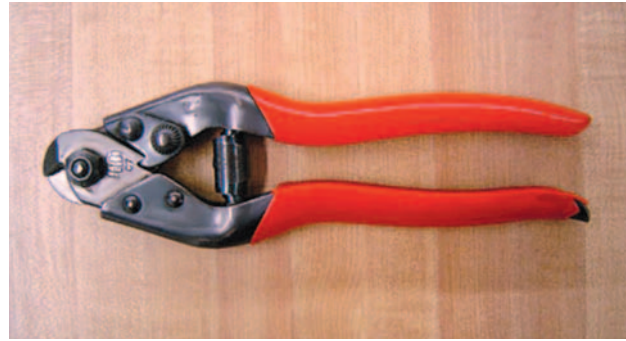


Figure 6-45. Cable cutters.

- **Ripstop roller**—A tool used for applying **ripstop tape** for canopy repairs. It removes air bubbles and **wrinkles**. A standard wallpaper roller works well. [Figure 6-46]



Figure 6-46. Ripstop roller.

- **Beeswax**—Wax used for waxing 6-cord nylon or any regular thread for hand tacking. [Figure 6-47]



Figure 6-47. Beeswax.

- **Spring scale and fabric testing clamps**—The spring scale is used for measuring the ripcord pull force on reserve and emergency parachutes. With a minimum rating of 50 pounds, it is also used in conjunction with the fabric testing clamps to measure fabric strength or reserve canopies in accordance with *Parachute Industry Association (PIA) TS-108*. [Figure 6-48]

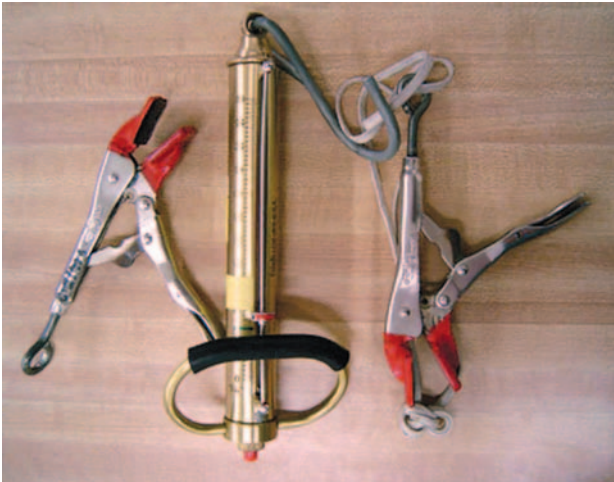


Figure 6-48. Spring scale and fabric testing clamps.

- **Hot knife element with cutting tip, basting tip, and stand**—A tool used for cutting and searing synthetic materials such as nylon, Dacron®, and Spectra®. The basting tip is used for fusing canopy material in place prior to sewing during canopy repairs. The stand is necessary to keep the hot elements from causing a fire. [Figure 6-49]



Figure 6-49. Hot knife element with cutting tip, basting tip, and stand.

- **Hot glue gun**—A tool used to replace staples and hand basting in harness work. This modern tool has changed harness repair and construction techniques. [Figure 6-50]
- **Tension board assembly with apex tiedown**—A tool used on the round packing table to apply tension to the canopy when packing. There are two models available. One is for military style L-bar connector links and another, smaller one for Rapide® style connector links. The straps should have a quick release feature to release tension easily. [Figure 6-51]
- **Size “O” rolled rim spur grommet handset**—A tool used for doing container repairs. The “O” stainless

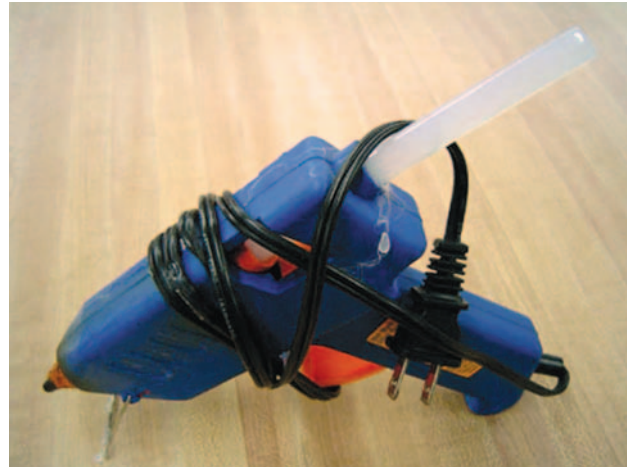


Figure 6-50. Hot glue gun.



Figure 6-51. Tension board assembly with apex tiedown.

steel model from Stimpson Co., Inc. is the most useful grommet set because it has a replaceable **die** insert section, which will wear out in time and can therefore be replaced. It is also the highest quality. The stainless steel set will work for both brass and stainless steel grommets. [Figure 6-52]



Figure 6-52. Size “O” rolled rim spur grommet handset.



- **Hole punches**—Tools used for punching holes for grommets. Various sizes. [Figure 6-53]



Figure 6-53. Hole punches.

- **Cutting pad**—A tool used with hole punches. The best are plastic, as these do not damage the punch. [Figure 6-54]

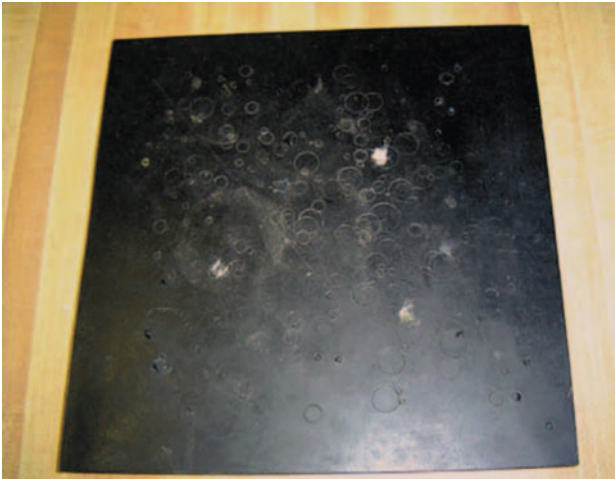


Figure 6-54. Cutting pad.

- **Rawhide mallet**—A tool used when punching holes and using grommet handsets. This is the only tool to use as the rawhide does not damage the other tools, and the weight makes the job easier and more consistent. The #2 size at 4 pounds is the most common. [Figure 6-55]



Figure 6-55. Rawhide mallet.

- **Binding tool**—A tool used for turning corners when binding material such as para-pak or Cordura®. The model shown in figure 6-56 is actually a soldering tool from an electronics repair store. The plastic handle has been replaced with a metal one. This is almost the perfect configuration for its use.



Figure 6-56. Binding tool.

The above tools will provide the rigger with the means to pack and maintain most of the common parachutes in use today. There are numerous other tools, both old and new, that individuals may wish to acquire for specialized parachutes. In particular, there are older styles and military parachutes that cannot be packed without specialized tools designed specifically for them. At the same time, the profession is constantly developing new tools to make the job easier.

## SEWING MACHINES

After the senior rigger has put together a personal tool kit, the next step is to acquire a selection of **sewing machines** in order to do minor repairs of defects found during inspection prior to packing. For example, if you find a small hole in the canopy, a sewing machine will be necessary to make the correct repair. For this, a lightweight single needle machine is the perfect beginning. As your sewing skills progress, additional specialized machines can be added as space and finances allow. Always remember, only those repairs allowed under your certificate may be performed.

A bit of advice for those individuals who wish to buy their own sewing machines: buy the best and newest machines you can afford. Avoid old machines! They're usually worn out, and parts may be hard to get, causing them to be counterproductive. Buy self-lubricating machines as opposed to ones you need to oil manually. **Always** get machines with a reverse mechanism. Get an adjustable "K leg" stand and table. This allows you to set the height of the table to best fit your physical needs. Large people bending over a short table for any length of time will understand the need for this feature. If the rigger is buying a new machine, it is possible to order an oversize table top in place of the standard 20" x 48" size. This allows better control over harness and containers so they don't overlap the table.

When buying any machine, particularly from a sewing machine dealer, get the operator's manual and the parts manual for the machine. The operator's manual tells you how to set up and operate the machine. The parts manual is indispensable when the need to order parts arises. The average person could never figure out the names of some



of the parts, which makes it necessary to refer to the part number. Without the parts manual, this is impossible. In fact, some companies and individuals refuse to take delivery of new machines if the manuals are not with them.

Experience has shown that the average rigger who wishes to set up a loft needs three initial machines: a lightweight single needle such as a Singer 31-15 or Mitsubishi DB-130 [Figure 6-57] for canopy repair and lightweight maintenance; a double needle such as a Singer 212W140 or Mitsubishi LT2-220 [Figure 6-58] with a binder or tapping attachment for binding material and light manufacture; and a medium-duty double throw (308) zigzag machine such as a Bernina Model 217 [Figure 6-59] for suspension line repair and replacement.



Figure 6-57. Mitsubishi DB-130.



Figure 6-58. Mitsubishi LT2-220.

For those individuals on a tight budget or with space constraints, a good idea is to buy a double needle machine first. By removing one needle and bobbin, the machine will perform excellently as a single needle machine. Replace the needle and bobbin, and the machine again is a double needle. This gives the rigger two machines for the price and space of one. A good zigzag machine will also do multiple duty. Its primary purpose is for zigzag sewing. However, adjusting the stitch regulator allows the rigger to do an acceptable job sewing bar tacks. By changing the stitch length and adjusting the width to the narrowest setting, some machines will do good straight stitching such as the Pfaff model 138.



Figure 6-59. Bernina Model 217.

For those riggers who advance to master rigger and wish to really get into the profession, they will need additional specialized machines such as a medium-duty, single needle, compound feed machine like a Consew 226R or a Juki LU-563. [Figure 6-60] This type of machine is used for doing container repairs and light harness work. The next machine should be a heavy-duty harness machine such as a Singer 7-33 or Consew 733R. [Figure 6-61] These machines specialize in sewing 5-cord nylon or heavier thread used in the manufacture and repair of parachute harnesses.



Figure 6-60. Juki LU-563.



Figure 6-61. Consew 733R.

Lastly, a bar tack machine such as a Pfaff 3334 [Figure 6-62] or Singer 69 class allows fast, strong, professional repairs and is invaluable in line replacement and manufacturing. This selection of machines provides the rigger with the ability to undertake virtually any repair or **modification** needed on today's parachutes. Remember, all sewing machine manufacturers build models that fit within the various duty types. Those models mentioned are only representative for that category.

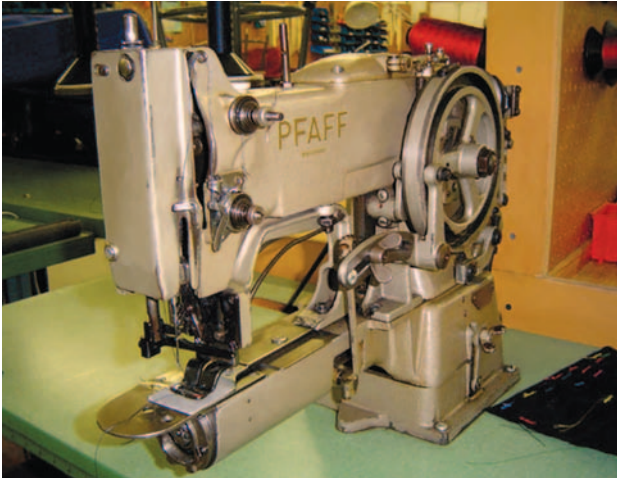


Figure 6-62. Pfaff 3334.

Figure 6-63 shows the comparative models of various types of machines currently available.

### IDENTIFICATION AND NOMENCLATURE

The purpose of the following information is NOT to make you an accomplished sewing machine expert and repairman. You should learn the basics about what makes your sewing machines work and how to perform routine maintenance and service. If you don't, you will suffer needless frustration for simple problems, and it will cost you excessively in down time and service repair bills. The information on troubleshooting provides you with the basic knowledge needed to keep your machines running. Some individuals find that they have an affinity for repairing and maintaining sewing machines. For those of you who do not, cultivate relationships with these people carefully. They will be most valuable to you.

Figure 6-64 shows the front view of a modern light-duty single needle machine. The numbers correspond with the description.

SEWING MACHINE MODEL COMPARISON								
Make	Single needle light duty drop feed	Single needle medium duty needle feed	Single needle compound feed	Two needle feed	Zigzag medium duty	Bar tack	Harness machine heavy duty	Harness machine extra heavy duty
Model								
Singer	31-15	111W151	111W155	112W116	17W15	68 or 69 class	7-33	97-10
Consew	292R	N/A	206RB-4	333RB-1	199R-2A	N/A	733-R2	N/A
Juki	DLN-415		LU-563	LH-515				
Brother		B-791						
Mitsubishi	DB-130	DY-340-12	LU2-400	LT2-220	LZ-780-11			
Pfaff					138	3334		
Bernina	—	—	—	—	217	—	—	—

Figure 6-63. Sewing machine model comparison.



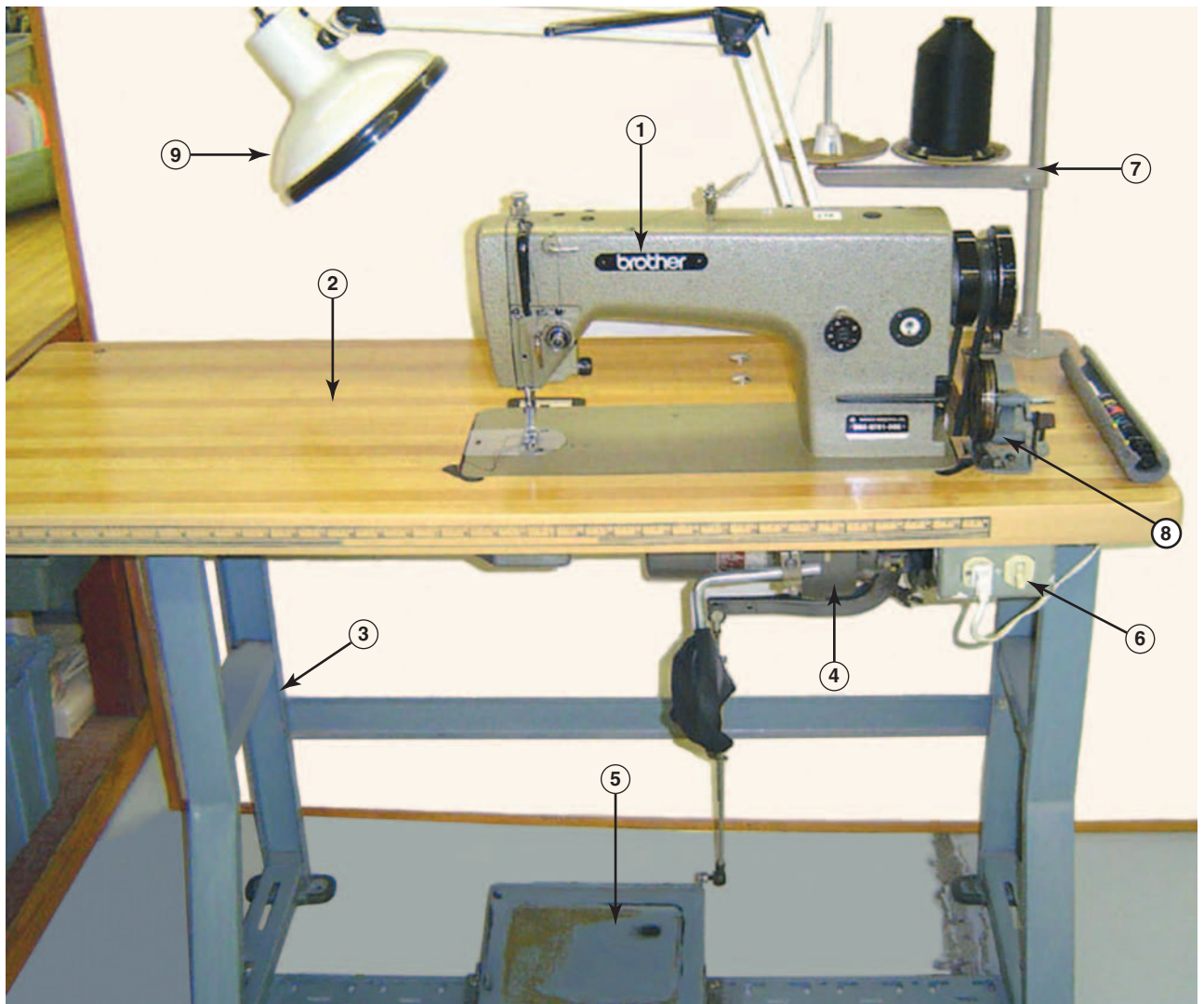


Figure 6-64. Front view of a modern light-duty single needle machine.

1. **Machine head**—This is the actual machine assembly.
2. **Table top**—This holds the head in position and the motor underneath.
3. **Stand**—This supports the table top.
4. **Motor**—This powers the sewing machine.
5. **Treadle**—This is the “gas pedal” which operates the motor. Pushing forward makes motor start and pushing backward stops the motor.
6. **On/off switch**—Controls power to the motor.
7. **Thread stand**—This holds the spools of thread for both the sewing machine and the bobbin winder.
8. **Bobbin winder**—This feeds the thread to the bobbin during the winding process.
9. **Light**—A good light is necessary to observe the sewing operation.



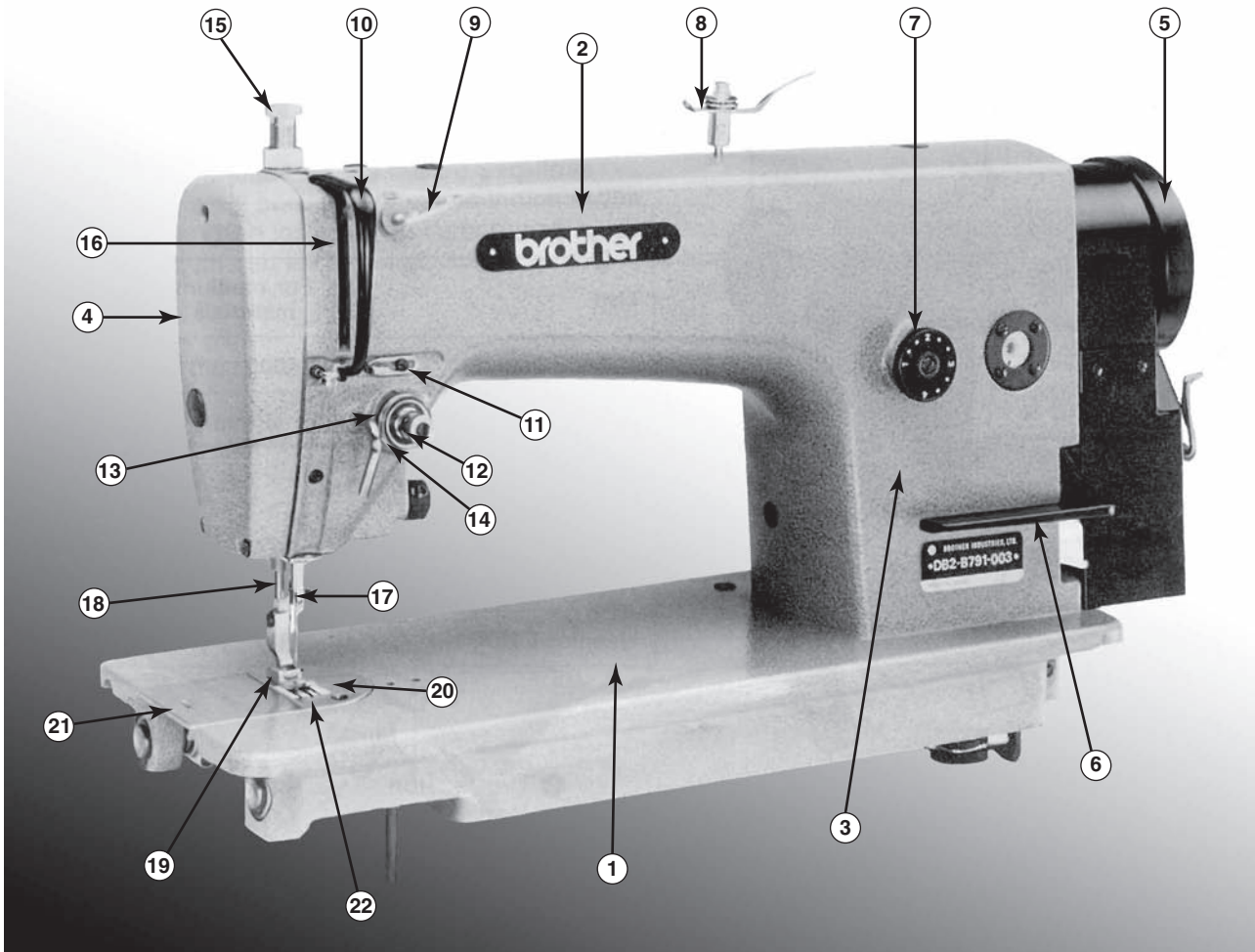


Figure 6-65. Closeup of head.

Figure 6-65 shows a closeup of the head only. Only those parts, which the rigger must deal with on a regular basis in order to operate and maintain the machine, are shown. For those individuals who wish to become more involved in the machine, a thorough study of the operator's manual and parts manual is encouraged. The following numbers correspond with the part description.

1. **Bed**—The base of the machine.
2. **Arm**—The upper casing of the machine.
3. **Uprise**—The upright part of the machine that joins the base and the arm.
4. **Faceplate**—The cover that protects the needle bar and presser bar mechanisms.
5. **Balance wheel**—The pulley assembly that drives the machine via the motor and belt.
6. **Reverse lever**—The mechanism that, when depressed, reverses the sewing operation of the machine.
7. **Stitch regulator**—The adjuster that controls the length of the stitch. The larger the number, the longer the stitch, and the smaller the number, the shorter the stitch.
8. **Pre-tension thread guide**—The assembly that provides initial thread tension and thread straightening before the thread reaches the main upper thread tension assembly.
9. **Thread retainer**—Provides direct guidance for the thread to the upper tension assembly.
10. **Thread take-up cover**—Covers the thread take-up lever and protects the operator.
11. **Right arm thread guide**—Provides thread guidance from the upper tension assembly to the thread take-up lever.
12. **Upper tension regulating thumbscrew**—Regulates pressure of the tension discs on the thread.
13. **Thread controller spring**—Provides for the correct amount of slack in the needle thread when the needle

is descending so that the needle does not cut the thread.

14. **Tension discs**—Provide tension on the upper thread.
15. **Presser bar tension nut**—Regulates the pressure of the presser foot on the material.
16. **Thread take-up lever**—Provides for slack in the needle thread after the stitch is formed and pulls the correct amount of thread from the spool for the next stitch.
17. **Needle bar**—Holds the needle and carries the upper thread downward through the material to where the stitch is formed.
18. **Presser foot bar**—Holds the presser foot in place to hold pressure on the material.
19. **Presser foot**—Holds the material in place while the feed dog moves the material forward for the next stitch.
20. **Needle plate**—Surrounds the feed dog and protects the material during the movement process.
21. **Slide plate**—Covers the area of the bed to the left of the feed dog and provides access to the bobbin assembly.
22. **Feed dog**—Feeds the material through the machine from the underside.

## SEWING THEORY

Once the rigger has become familiar with the parts of the machines, it is time to begin to understand the operation and theory of how the machines sew. The primary form of stitch pattern is what is called a 301 **lockstitch**. It is formed by two threads, one from the top and one from the bottom. The **needle** carries the thread from the top through the material, and the **bobbin** holds the thread on the bottom. The hook catches a small loop in the upper thread and carries it around the bobbin, and the two threads interlock between themselves to form the stitch. Figures 6-66 through 6-70 show the sequence in forming the stitch.

There are two types of principles of operation in sewing machines. They are the “oscillating” hook and the “rotary” hook. With the oscillating type, the bobbin and hook are positioned in a vertical plane to the bed of the machine. The hook rocks back and forth in a half revolution to complete the stitch. With the rotary type, the bobbin and hook may be either vertical or horizontal, and the hook makes two complete revolutions to complete one stitch. The oscillating models are generally slower in operation while the rotary is the high-speed model. Aside

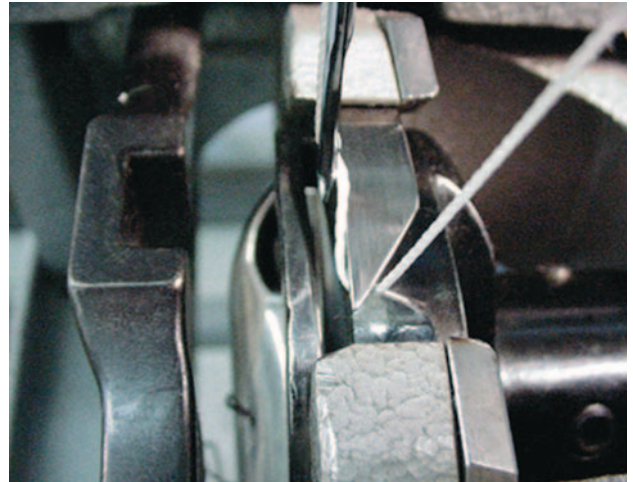


Figure 6-66. First in sequence in forming a stitch.

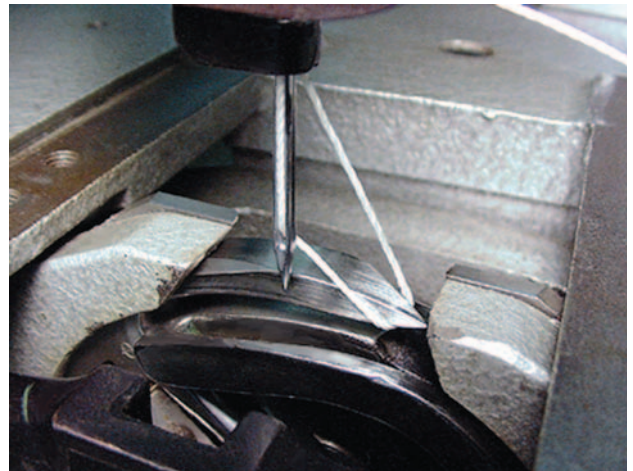


Figure 6-67. Second in sequence in forming a stitch.



Figure 6-68. Third in sequence in forming a stitch.

from the larger heavy-duty machines, most new machines are rotary in operation. Figure 6-71 on page 6-18 shows an oscillating hook and figure 6-72 shows a rotary hook.

There are three types of feed mechanisms to move material through the machines. The first and simplest is called a “drop feed” machine. With this type of feed, a feed dog



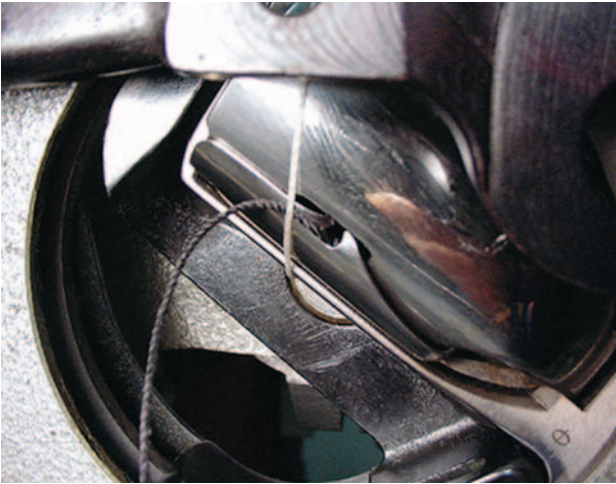


Figure 6-69. Fourth in sequence in forming a stitch.



Figure 6-70. Fifth in sequence in forming a stitch.



Figure 6-71. Oscillating hook.

on the bottom rises up to press the material against the presser foot from the top and moves it along while the needle bar and needle move up and down penetrating the material and forming the stitch. This is generally the lightest duty of machines. The Singer 31-15 and Mitsubishi DB-130 are typical of a drop feed.

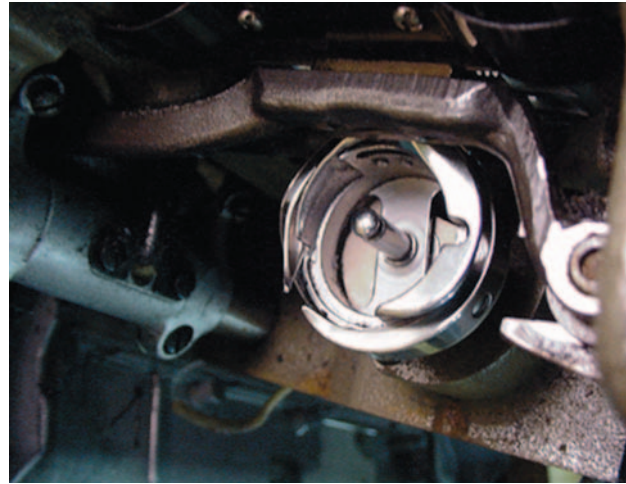


Figure 6-72. Rotary hook.

The second type of machine is the “needle feed” machine. With this type, the needle bar moves in addition to the feed dog and helps move the material. This is a medium-duty machine. The Brother B-791 is an example.

The third type of machine is a “compound feed” machine. This is a combination of the drop feed and needle feed along with an alternating presser foot. This is a more positive feed machine and is generally a medium-duty to heavy-duty machine. The Juki LU-563 and Consew 733R are good examples.

## NEEDLES

The needle is one of the smallest parts of the machine but is probably the most important. It is the source of the perfect stitch and also the most aggravation. The use of the correct type and size of needle is most important in proper operation of a sewing machine. Improper needles will cause a machine to produce poor stitching and may damage the material, or the machine might not sew at all. Using the wrong needle can also damage the machine. Figure 6-73 shows the parts of a needle. Without getting into the advanced aspects of needle technology, there are a few simple things for the rigger to know.

1. There are three types of points—round, diamond, and twist. Round is used for cloth as it separates the fibers of the cloth as it passes through. The diamond is used for leather as it cuts the material.
2. Each type of needle has a number to identify its size. A typical description would be “16 x 95, size 20”. The 16 is the size or diameter of the shank. The 95 is the length and also describes the type of point. Odd numbers denote round points and even, diamond points. The size 20 is the diameter of the shaft.
3. The rigger should always follow the instructions in the operator’s manual for the proper needle, installation, and threading.



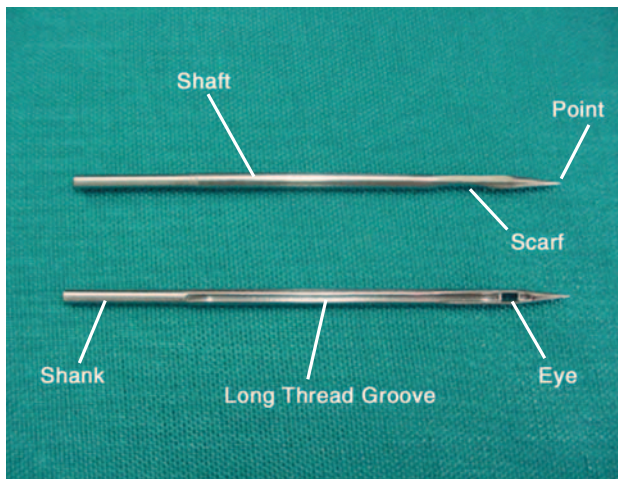


Figure 6-73. Parts of a needle.

### OPERATION

Before you first sit down in front of the machine, check to see that the power cord is plugged in.

Many of the modern machines are self-lubricating and have an oil reservoir in a pan below the head. Make sure there is oil of the correct type and to the correct level.

Next, remove the bobbin case and bobbin from the machine and the upper thread from the needle. This allows you to check to see if the bobbin case is clear and free in operation.

Without turning the power on, depress the treadle lightly to release the clutch. Turn the balance wheel or drive pulley TOWARD you and cycle the needle up and down several times to see if the machine turns freely. Listen for any sounds that seem abnormal and notice any feeling of tightness or binding of the machine.

If everything seems normal, re-thread the needle. Take a full bobbin, place it in the bobbin case [Figure 6-74], and install it in the shuttle of the machine [Figure 6-75].

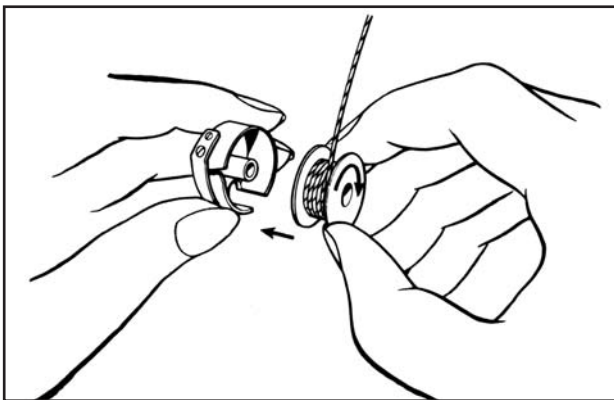


Figure 6-74. Bobbin case.

Cycle the needle down and pick up the bobbin thread. A correctly threaded and timed machine will pick up the bobbin thread on the first cycle.

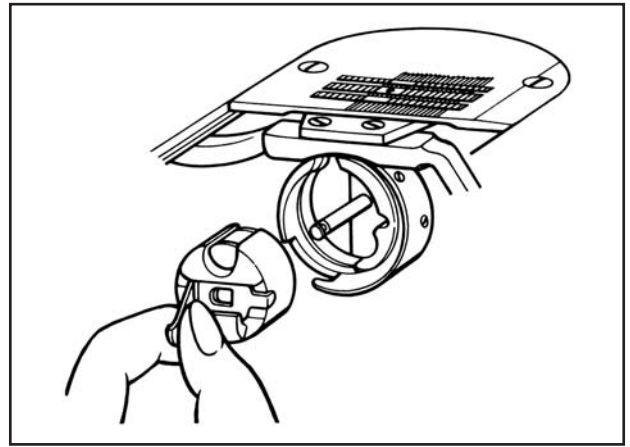


Figure 6-75. Shuttle of the machine.

### INSTALLING THE NEEDLE AND THREADING THE MACHINE

All single needle type machines have the needle positioned in the needle bar with the long thread groove facing to the left. Make sure that the needle is installed all the way up to the stop in the needle groove of the needle bar. Check that the long thread groove faces left [Figure 6-76] and that the needle clamp screw is tight.

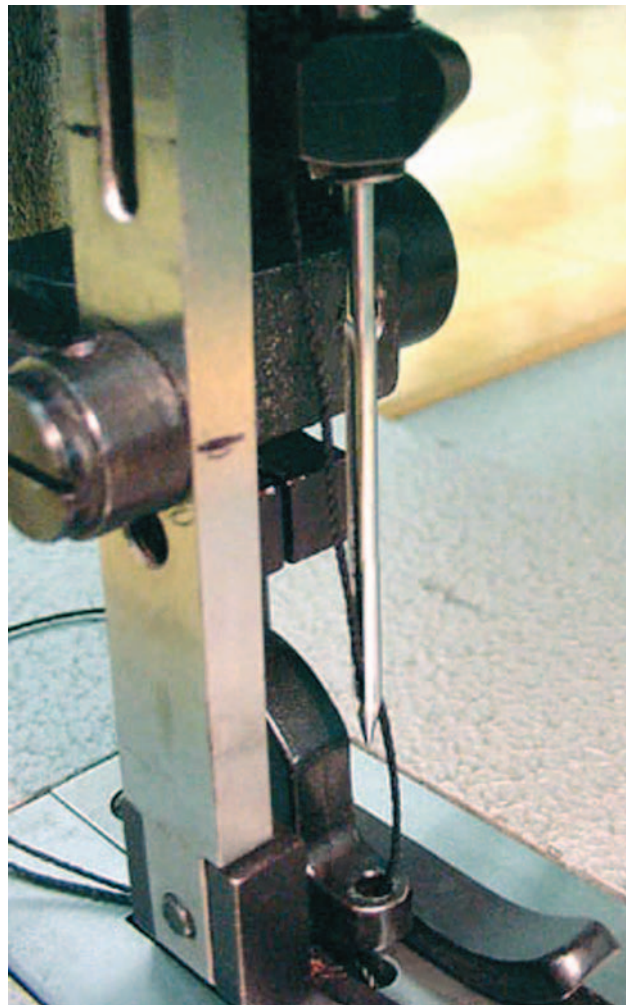


Figure 6-76. Needle with left orientation.

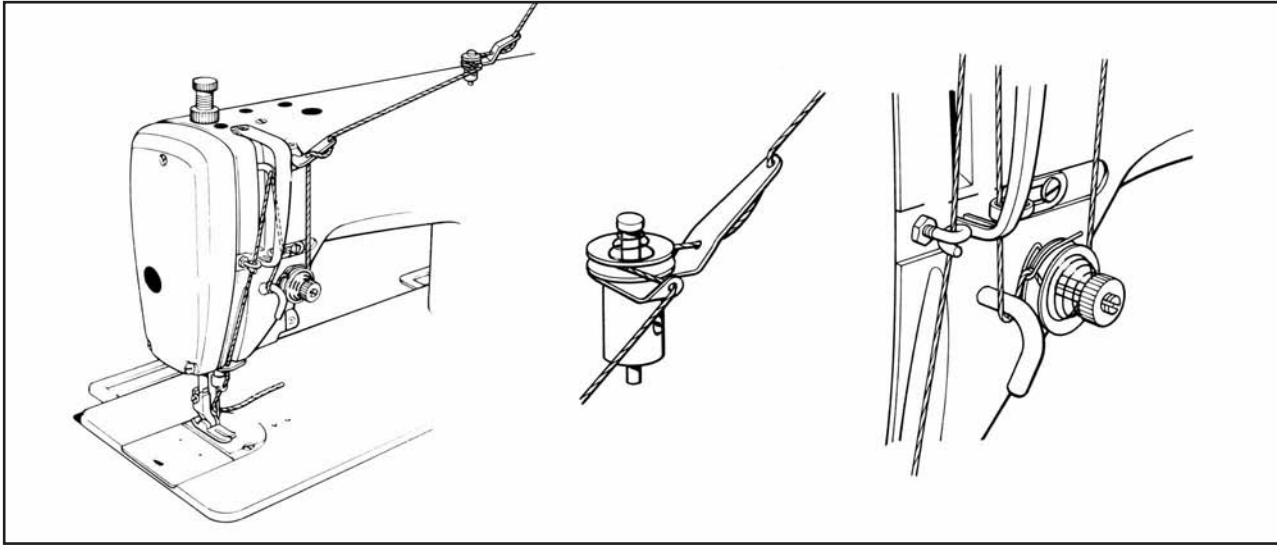


Figure 6-77. Thread the machine.

Take a cone of thread and place it on the thread stand. Route the thread upward through the guide at the top of the stand and then to the pre-tension thread guide on top of the arm of the machine. Thread the machine according to figure 6-77. Most modern machines use a similar method of threading. However, there may be additional thread guides of different shapes to route the thread through. This is why the rigger should have a copy of the operator's manual for proper threading of each machine.

Once the machine is threaded correctly, take a sample of material suitable for the type of machine, thread, and needle. Form several layers and place it under the presser foot. Lower the presser foot while holding the upper and lower threads securely to the rear of the presser foot. Turn the balance wheel again and run a few stitches by hand to see if the machine sews properly. If everything works as expected, turn the power on and begin sewing. If you are unfamiliar with this particular machine, begin slowly until you get the feel of the clutch and speed of the machine.

If the machine does not sew correctly, consult the troubleshooting guide [Figure 6-78] to determine what the problem is and how to remedy it.

### MACHINE MAINTENANCE

The most important part of maintaining your sewing machines is to keep them clean and lubricated. Each machine should be wiped down daily with a clean rag to remove oil and dirt. The amount of use each machine gets will dictate the cleaning required. However, on at least a weekly schedule the moving parts should be cleaned with a small brush to remove dust, lint, dirt, and threads. An air hose or bottle is useful in blowing dirt out of places the brush cannot reach. Be careful when doing this as small particles can be propelled through the air and can strike the eyes. At the very least, the dirt can be blown onto other machines and work.

After cleaning, each machine should be lubricated to ensure smooth operation. For those machines which are self-lubricating, check the level and condition of the oil in the reservoir. For these machines, a #1 white oil, with a higher viscosity should be used. Depending on the amount of use, the oil should be changed every 6 months to a year. In no case should the oil be changed less than once a year. For machines that require manual lubrication, a #2 white oil should be used as it has a lower viscosity to better adhere to the moving parts. This should be done daily at the end of the workday. Oiling the machine at this time allows the oil to seep downward through the mechanisms and collect on the bottom. In the morning before use, take a clean rag and wipe off the excess oil so it does not stain the parachute materials. Pay particular attention to the shuttle race. Keeping this well lubricated will ensure smooth operation and a quieter machine. One item that tends to get overlooked is the bobbin winder. The shaft of the winder has a small hole in the top and a drop of oil should be added at least once a week to keep it free.

### SEWING MACHINE ATTACHMENTS

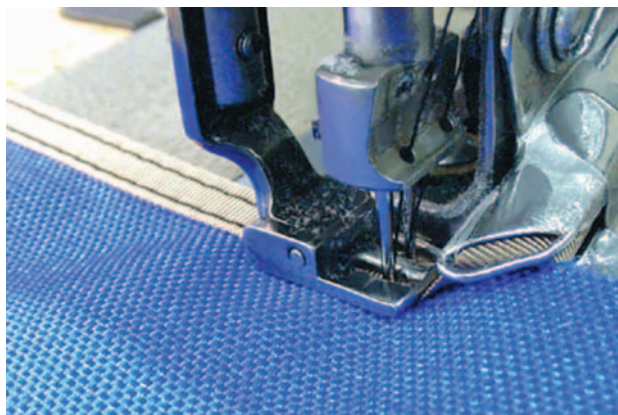
The most common attachment that the rigger will use is a tape folder or "binder." This attachment folds tape, typically 3/4" Ty-3, used for binding the edges of container, bags, or any material needing an edge binder. Used in conjunction with a double needle machine, it folds the tape in half for a professional appearance and greatly speeds up the work. [Figure 6-79] There are two types of folders. One is a straight folder where the tape is fed straight into the machine under the presser foot. [Figure 6-80] This folder is used for most straight binding, has minimal adjustments, and is the least expensive usually costing around \$35. The second type of folder is a right angle folder. [Figure 6-81 on page 6-22] The best models of these are custom built by companies that specialize in attachments. They utilize special feed dogs, throat plates, and presser feet in addition to the folder. This type of folder is hinged to

## Troubleshooting chart for light duty drop feed machine

TROUBLE	PROBABLE CAUSE	REMEDY
Needle breakage	Incorrect class and variety of needle being used	Use correct class and variety needle
	Needle loose in clamp	Tighten needle clamp screw
	Needle too small for fabric	Use larger needle
	Operator pulling on fabric	Allow machine to feed material
Needle thread breakage	Thread too heavy for needle	Use larger needle or smaller thread
	Right twist thread being used	Use left twist thread
	Machine incorrectly threaded	Check machine for proper threading
	Needle thread tension too tight	Loosen needle thread tension
	Thread take-up spring out of adjustment	Adjust thread take-up spring
	Burr on bobbin case, shuttle point or tension discs	Smooth with emery cloth
	Thread rubbing against presser foot	Adjust presser foot
	Needle is bent or has blunt point	Replace needle
Bobbin thread breakage	Bobbin tension too tight	Adjust bobbin tension
	Bobbin incorrectly threaded	Thread bobbin to revolve clockwise
	Bobbin wound too fully to revolve freely	Remove some of the bobbin thread
	Rounds of bobbin thread lapped over one another	Ensure bobbin thread is straight when winding bobbin
	Bobbin case is dirty	Clean and lubricate bobbin case
Skipped stitches	Machine out of time	Time needle to shuttle
	Thread controller spring out of adjustment	Adjust thread controller spring
Drawing of seam	Both needle and bobbin tension too tight	Loosen needle and bobbin tension
Stitches piled up	Stitch regulator out of adjustment	Adjust stitch regulator
	Pressure on presser foot too tight	Loosen presser foot adjustment screw
Feed dog striking throat plate	Feed dog set too high	Lower feed dog to correct height

**Figure 6-78. Troubleshooting guide.**

swing out of the way for changing bobbins. Most machines have several adjustments that allow for fine tuning the folder for optimum performance depending on the tape used. Folders cost several hundred dollars.



**Figure 6-79. Material with binding tape.**

Another type of attachment is used to feed reinforcing tape such as 3/8" Ty-3 onto a canopy seam. This is a simple guide, which is attached to the presser foot and feeds



**Figure 6-80. Straight binder.**

the tape evenly to the needles. Yet another attachment is a seam **folder** used to make a **French fell seam** in canopy construction. Figure 6-82 on page 6-22 shows both of the above attachments used in conjunction with each other. Over the years, the sewing industry has developed literally





Figure 6-81. Right angle binder.

hundreds of different attachments to speed up and improve the sewing process.



Figure 6-82. Tape feeder and French seam folder.

## THE PARACHUTE LOFT

The term “loft” comes from earlier times when the area used to pack and maintain parachutes was usually situated in the aircraft hangar above the aircraft. Hence, the term “loft.” The name has continued to this day and is synonymous with the parachute workshop.

Under 14 CFR, subsection 65.127(b), a rigger must have: “Suitable housing that is adequately heated, lighted, and ventilated for drying and airing parachutes.” Under 14 CFR, subsection 65.127(d), the rigger must have: “Adequate housing facilities to perform his duties and to protect his tools and equipment.” All of this only makes sense in that the properties stipulated are those that are best suited for storing and maintaining parachutes. Although these regulations have been in effect for over 40 years and were originally intended to apply to parachutes with organic fibers in them, they still apply today. From the practical side, keeping yourself and the parachute warm promotes efficient work habits. Good lighting means that you can properly inspect the parachute. Ventilated means that the parachute is properly dried before packing. Keeping your tools clean, dry, and serviceable means that you can do the correct job on the parachute.

Most individuals have been to automotive garages where there was oil on the floor and parts strewn everywhere. In contrast, modern professional garages sometimes look like hospital facilities in their cleanliness and organization. Where would you take your car? The same is true with the loft, as depicted in figure 6-83. A clean, organized, and well-designed loft inspires customer confidence in the rigger’s ability to work on the parachute.

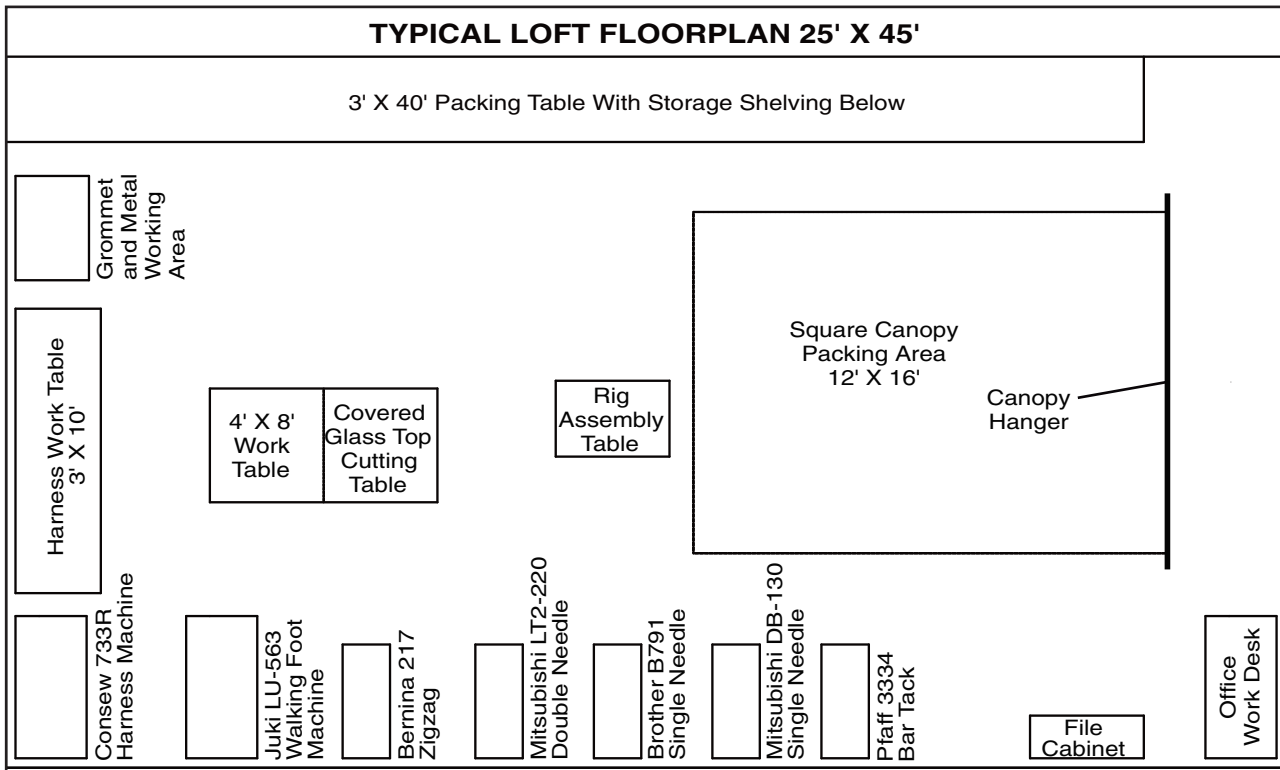


Figure 6-83. Loft drawing.



Figure 6-84. Canopy hanger.

The loft facility houses the sewing machines and other equipment over and above the hand tools that all riggers should have. A full-service loft will have the following areas:

1. **Packing and inspection area.** A main part of the loft layout is a suitable packing area. According to 14 CFR, subsection 65.127(a), the rigger must have: “A smooth top table at least 3 feet wide by 40 feet long.” Technically this is still required, and is used primarily for round canopies. However, with today’s square parachutes, the accepted practice is to pack on the floor on a suitable covering such as carpet. If the rigger is packing round parachutes, a packing table is a necessity as it makes the rigger’s job easier and more comfortable. If there is no packing table, then there needs to be an open area big enough to lay out the square parachute. While not expressly required, most lofts will have a canopy hanger [Figure 6-84] for inspection, airing, and assembling square canopies.

Along with the canopy hanger, an assembly and inspection table [Figure 6-85] is extremely useful. It allows the harness and container to be assembled to the canopy without laying it on the floor. The assembly table allows the correct distance from the floor to mate with the canopy and provides an ideal storage area for the packing tools, wrenches, other equipment, and materials needed for assembly. Figure 6-86 shows a complete layout of the canopy hanger and layout table.



Figure 6-85. Assembly and inspection table.



Figure 6-86. Canopy and table layout.



2. **Work area including layout tables and sewing machines.** The work and layout tables are ideally 4 x 8 feet for optimum space usage. Any canopy layout can be done on the packing table. The work tables should be adjacent to the sewing machines for minimum walking distance between them. Many lofts will have a small table along the walls against which the sewing machines are placed. This allows storage of materials and other items needed during the sewing operation. The right end of the sewing machine table is placed against this table so that the left, or open end, is available to lay canopies or containers on.

3. **Harness table and machines.** Because of the nature of harness work, there are many specialized materials and tools unique to harness work. The table [Figure 6-87] will house the hot knife, hot glue gun, templates, and rulers. The harness machine should be adjacent to the harness table for maximum efficiency.



Figure 6-87. Harness work table.

4. **Cutting table.** The cutting table is used for cutting canopy fabric for canopy repairs, para-pak or Cordura® for container repairs, or for cutting anything for general manufacturing. Ideally, this cutting table will have a glass surface for use with a hot knife. One of the best designs utilizes a 4 x 4 feet glass surface that is hidden below a wooden cover that can be removed when needed and protects the glass when not in use. This table serves dual duty as a work table. [Figure 6-88]

5. **Metal working area.** It is important to segregate the metal working area from the rest of the loft. Because of the nature of the work, metal working creates considerable contamination with metal shavings and other particles injurious to parachute fabrics. The metal working area will have drills, grinders, swaging tools, Nicopress® tools, and other tools needed for repairing or overhauling metal components.



Figure 6-88. Glass top table with cover.

[Figure 6-89] The grommetting area [Figure 6-90] should be adjacent to the metal working area, since several of the tools used to remove grommets will be found there. The grommet machine or handsets are kept in this area. Parachute containers or other parts needing grommets are brought to this area for work.



Figure 6-89. Metal working area.

6. **Office area.** The office area will handle the administrative and record keeping functions of the loft. It will have a desk, file cabinets, library or bookshelves, telephone/fax machine, and computer. All work orders will be processed through here.





Figure 6-90. Grommet area.

7. **Materials storage area.** The storage area may be a separate room, a pegboard [Figure 6-91], or cabinets on the walls where thread, tapes, and webbing are



Figure 6-91. Pegboard wall storage.

stored. Rolls of fabric may be stored under the work or packing tables or on wall racks.

All of the above may be practical for the full-time professional loft, but for the individual rigger there may be certain space constraints. Many riggers take over their garage, which makes a perfectly suitable loft with some cleaning and remodeling.





Packing is the mainstay of the parachute rigger, but an equally important part is the repair and maintenance of the parachute and its related systems. When the parachute is new, it is expected to function as designed. As it is used and ages, however, it begins to wear and its condition changes, which, over time, could result in a malfunction of the system. It is the rigger's responsibility to identify any condition that might result in the parachute being non-airworthy and therefore dangerous. In the course of training, the rigger candidate will learn to identify those conditions that may be unsafe. The trainee will also learn how to undertake the necessary repairs to return the parachute to its original, airworthy configuration.

As stated in Chapter 1—Regulations and Human Factors, it is imperative that riggers be able to distinguish between minor and major repairs. This ensures that riggers do not exceed the limitations of their certificate or endanger the parachute user. The basic rule for repairs is to return the damaged parachute or component to its original airworthy configuration. However, in many instances, the remanufacture of the parachute may not be practical or cost effective. In these cases, there are approved repair techniques riggers can use to return the parachute to service. These techniques form an important part of the rigger's store of knowledge.

## REPAIR TECHNIQUES

The following procedures use a format that provides the rigger with all of the necessary information to complete the repair properly. It has been used by at least one manufacturer to provide the necessary documentation to riggers in the field to perform major repairs or alterations on that manufacturer's equipment. The procedures provide the following information to the rigger:

1. Applicable products—Those parts of the parachute that the procedure addresses.
2. Description—Brief explanation of the repair or alteration.
3. Materials—Those items needed to perform the procedure.
4. Machines—Those machines required to do the procedure. In addition to the machines, there may be special attachments required to do the work properly.
5. Equipment—Additional tools needed (in addition to the sewing machines).
6. Procedure—The step by step guide through the repair. This may include a disassembly and reassembly procedure. Disassembly may be straightforward, but the reassembly instructions may provide special tips or procedures to accomplish the task.
7. Inspection—The final inspection of the finished repair. This is a very critical part. In many cases, the rigger is doing the work alone. Within the manufacturing environment, the persons doing the work generally do not inspect their own work. This is given over to dedicated inspection personnel. For the private rigger, there may be no one around to inspect the work. In the case of simple repairs, it is easy for the rigger to inspect the finished job. For more extensive repairs, such as a harness main lift web replacement, there can be several areas that need to be addressed such as dimensions, stitching, and hardware orientation. By having an inspection checklist, the rigger can be assured of not missing any critical area.

Each of the seven sections in this chapter has a list that describes common repair procedures today's rigger might use. While not necessarily encompassing everything, the techniques used in these repairs can be expanded upon to address almost any other scenario that might be encountered. If the rigger encounters a repair that he or she is not familiar with, then the rigger should contact the manufacturer for further direction and guidance. The rigger should also remember that each procedure is just one method of accomplishing a given repair. There might be more than one or an individual might develop a different technique to achieve the same results.

No matter what techniques or procedures that are followed, remember that there are three basic requirements to follow for any proper repair procedure.

1. The first is the knowledge to do the job. This includes the required certification and authorization.
2. The second is the proper equipment, such as sewing machines or hand tools.



3. Third is the availability of the proper materials.

The individual may be a master rigger with a complete parachute loft at his/her disposal, but without the materials as used in the original manufacture, the correct repair cannot be made. By following these simple guidelines, riggers are always able to determine whether or not they can do the job properly.

Most of today's manufacturers provide guidance for the repair and maintenance of their products. These instructions are the official guidelines that the rigger must follow.

The four primary areas of parachute repair and maintenance are: canopy and lines; container; harness and risers; and accessory components. These areas are summarized within the seven sections of this chapter as follows:

Section 1. Canopy and lines.....	7-3
Section 2. Container.....	7-39
Section 3. Harness and Risers.....	7-57
Section 4. Accessory Components.....	7-79
Section 5. Alterations.....	7-93
Section 6. Manufacturing.....	7-103
Section 7. Miscellaneous.....	7-115



There are two general categories of canopies: round and square. While there are other canopy types, their construction and repair techniques generally follow those of the round and square canopies. Figure 7-1 shows a round canopy repair table, created from current military manuals, and describes the types and limits of canopy repairs, most of which pertain to military or surplus canopies. It must be mentioned that all of the services

differ in their approach to methods of repair. Those called out in this book are methods that have been proven to be practical and efficient and commonly accepted throughout the parachute industry. The techniques are similar with only minor differences in seam dimensions and tolerances. While these limits are practical from the technical point of view, the economic cost may not be in many cases.

<b>ROUND CANOPY REPAIRS AND LIMITATIONS</b>		
<b>Type</b>	<b>Limits</b>	
	<b>Certificated</b>	<b>Non-certificated</b>
Restitching	No limit as to length and number.	No limit as to length and number.
Ripstop tape	Holes or tears not exceeding .5" and snags. Limit: 3 per panel, 10 per canopy.	No limit as to size or number.
Basic patch	Size limit: 50% of panel. Limit: 3 per panel, 15 per canopy.	No limit as to size or number.
Panel patch	Limit: 9 per canopy.	No limit.
Radial seams	Size limit: 12". No more than 4 per canopy.	No limit as to size or number.
Lateral bands Upper	Damage size limit: 2". Limit: 1 per canopy.	No limit as to size or number.
Lower	Damage size limit: 36". Limit: 4 per canopy.	No limit as to size or number.
V-tabs	No limit.	No limit.
Pocket bands	No limit.	No limit.
Vent collar ring	No limit.	No limit.
Vent collars	No limit.	No limit.
Suspension lines Continuous line	No limit.	No limit.
Noncontinuous line	No limit.	No limit.
Line splice	Not allowed.	Limit: 1 per line. 8 per canopy.

Figure 7-1. Table of round canopy repairs and limitations.

Figure 7-2 shows a table of square canopy repairs and limitations. These are for reference only and not all manufacturers allow the same types of repairs. The

rigger should consult with the proper manufacturer's manual for what repairs are allowed on that particular canopy.

<b>SQUARE CANOPY REPAIRS AND LIMITATIONS</b>		
<b>Type</b>	<b>Limits</b>	
	<b>Certificated</b>	<b>Non-certificated</b>
Restitching	No limit as to length and number.	No limit as to length and number.
Ripstop tape	Not allowed.	No limit as to size or number.
Basic patch	Size limit: 50% of panel or rib. Limit: 3 per cell panel, 15 per canopy.	No limit as to size or number.
Panel patch	Limit: 1 per canopy.	No limit.
Suspension lines	No limit.	No limit.
Line splice	Not allowed.	Limit: 1 per line. 8 per canopy.

**Figure 7-2. Table of square canopy repairs and limitations.**

7.1 The following are the repairs found in Section 1 of this chapter.

- |       |   |        |   |
|-------|---|--------|---|
| 7.1.1 | Seam restitching                                  | 7.1.8  | Round canopy—Noncontinuous line replacement |
| 7.1.2 | Canopy ripstop tape repair                        | 7.1.9  | Square canopy—Main line replacement         |
| 7.1.3 | Round and square canopy—Basic patch               | 7.1.10 | Square canopy—Line splice                   |
| 7.1.4 | Round canopy—Panel replacement                    | 7.1.11 | Square canopy—Control line replacement      |
| 7.1.5 | Square canopy—Partial panel replacement           | 7.1.12 | Square canopy—Crossport repair              |
| 7.1.6 | Square canopy—Rib repair                          | 7.1.13 | Square canopy—Trim check and retrim         |
| 7.1.7 | Square canopy—Pilot chute attachment point repair |        |   |



# Parachute Repair Procedure

**TITLE:** 7.1.1 Seam Restitching

**NUMBER OF PAGES:** 1

**APPLICABLE PRODUCTS:** All canopies; round and square; main and reserve.

**DESCRIPTION:** Replacement of broken or damaged seam threads.

**AUTHORIZED REPAIRMEN:** FAA Senior or Master Parachute Rigger

**MATERIALS:** E thread—color to match original

**MACHINES:** 301 Straight Stitch—Light Duty 7-11 SPI  
308 Zigzag—Medium Duty 7-11 SPI

**EQUIPMENT:**

Scissors

Seam ripper

## PROCEDURE

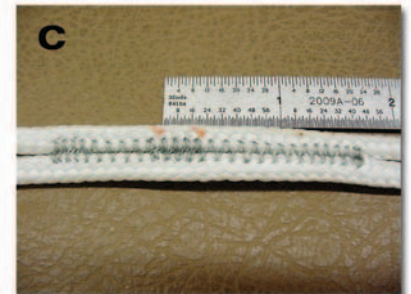
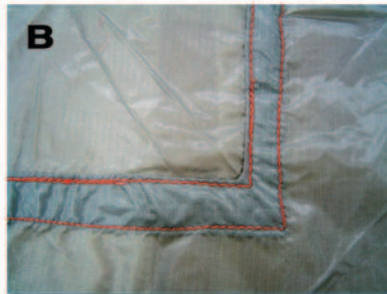
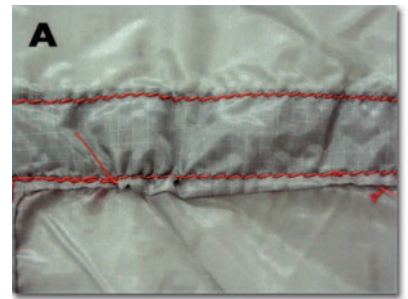
**1.0** On lightweight material, the rigger should first set up the machine with similar material and thickness to set the tension of the machine before sewing the actual parachute.

**1.1** Inspect the damaged thread or seam area. If the thread is merely broken or frayed, overstitch the seam with a minimum of 1.25" at each end.

**1.2** If the seam is gathered or bunched up [Figure A], it may be necessary to cut the thread in order to smooth out the seam and then overstitch the damaged area with a minimum of 1.25" each end [Figure B].

**1.3** If the restitching was done on a radial seam of a round canopy, which has a tape or suspension line within the seam, make sure you did not catch the tape or line in the stitching.

**1.4** For zigzag stitching, such as on suspension lines, a .25" overstitch on each end is standard [Figure C].



**2.0 INSPECTION:**

**2.1** Check that the seam tension and stitch length match the original. Make sure to check top and bottom.

**2.2** Make sure that you have not captured any adjacent fabric in the seam. This is a common mistake on square canopies where you may have three panels joining together.

**2.3** On radial seams, slide the seam material up and down over the tape or line to check for free movement.



# Parachute Repair Procedure

**TITLE:** 7.1.2 Canopy Ripstop Tape Repair

**NUMBER OF PAGES:** 2

**APPLICABLE PRODUCTS:** All main canopies. Reserve canopies as specified by the manufacturer.

**DESCRIPTION:** Using ripstop tape for temporary or minor canopy repairs.

**AUTHORIZED REPAIRMEN:** FAA Senior or Master Parachute Rigger

**MATERIALS:** Ripstop tape—color to match fabric

E thread—[Optional]

**MACHINES:** 301 Straight Stitch—Medium Duty 7-11 SPI [Optional]

**EQUIPMENT:**

Scissors

Shot bags

Wallpaper roller

Scotch tape (optional)

## PROCEDURE

**1.0** **Note:** Ripstop tape has in the past been a commonly used repair material. Time has shown, however, that the adhesive used can be detrimental to the strength of the fabric over the long term. Consequently, most manufacturers do not recommend its use on certificated canopies. In addition, some of the modern, coated fabrics do not accept the use of the ripstop tape without additional sewing to help hold it in place.

1.1 Spread out the canopy on a smooth surface.

1.2 Smooth out the damaged area and hold in place with the shot bags [Figure A].

1.3 Inspect the damaged area.

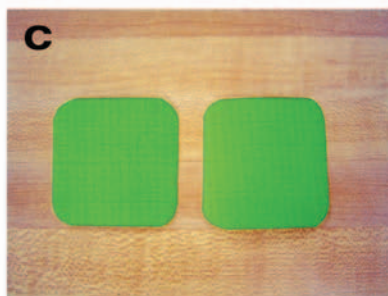
1.4 Trim any loose threads and smooth any loose fabric back into place.

1.5 For small holes, a single-side patch will suffice. For holes up to .5" in diameter, or a tear, a double-sided patch is necessary.

1.6 If the damage is a tear, the two sides must be positioned so the edges touch. Use scotch tape to temporarily hold the edges together [Figure B].

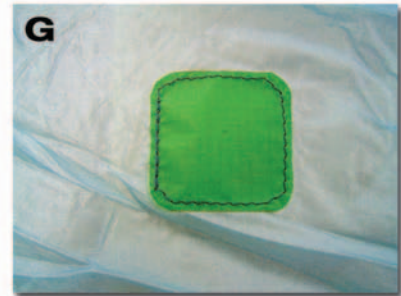
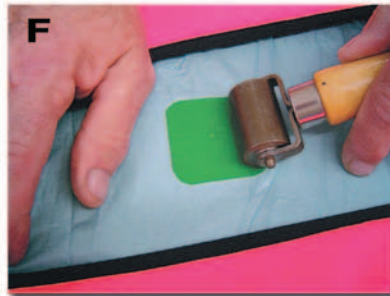
1.7 For a hole, cut a piece of ripstop tape 2" square. For a double-sided patch, cut two pieces [Figure C]. For a tear, cut the tape approximately 2" longer than the length of the tear and cut two pieces.

1.8 For the single-side patch, round the corners with approximately a 1/8" radius. For the double-sided patches, place the two pieces face to face and round the corners of both pieces at the same time. This ensures a perfect match and alignment [Figure D].





- 1.9 For the 2 x 2" patch, peel back one edge of the paper backing and center the tape over the damaged area. Press the exposed adhesive side of the tape to the fabric and smoothly peel the rest of the paper from the fabric with one hand while smoothing the fabric with the other hand [Figure E].
- 1.10 Use the wallpaper roller to smooth out the patch and remove any air bubbles from the patch [Figure F].
- 1.11 For a double-side patch, turn the canopy or damaged material inside out. Align the second piece of ripstop with the edges of the first and repeat the process. Again smooth out the tape with the roller.
- 1.12 If the patch is to be a temporary one, the repair is complete. If, however, it is to be permanent, it may be advisable to sew around the edge of the patch. In this case, use the single needle machine and sew approximately 1/8" in from the edge of the tape. Overstitch a minimum of 1.25" [Figure G].



## **2.0 INSPECTION:**

- 2.1 The ripstop should be centered over the damaged area.
- 2.2 The tape should be smooth with no air bubbles.
- 2.3 Double-sided patches must be aligned.
- 2.4 If sewn, tension, edge spacing, and over stitch must be correct.

# Parachute Repair Procedure

**TITLE:** 7.1.3 Round and Square Canopy – Basic Patch

**NUMBER OF PAGES:** 3

**APPLICABLE PRODUCTS:** All canopies; round and square; main and reserve.

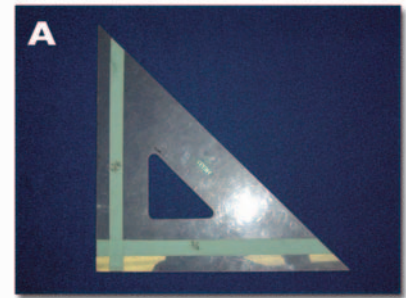
**DESCRIPTION:** Application of a basic canopy patch.

**AUTHORIZED REPAIRMEN:** FAA Senior or Master Parachute Rigger

**MATERIALS:** E thread—color to match  
Fabric—type and color to match

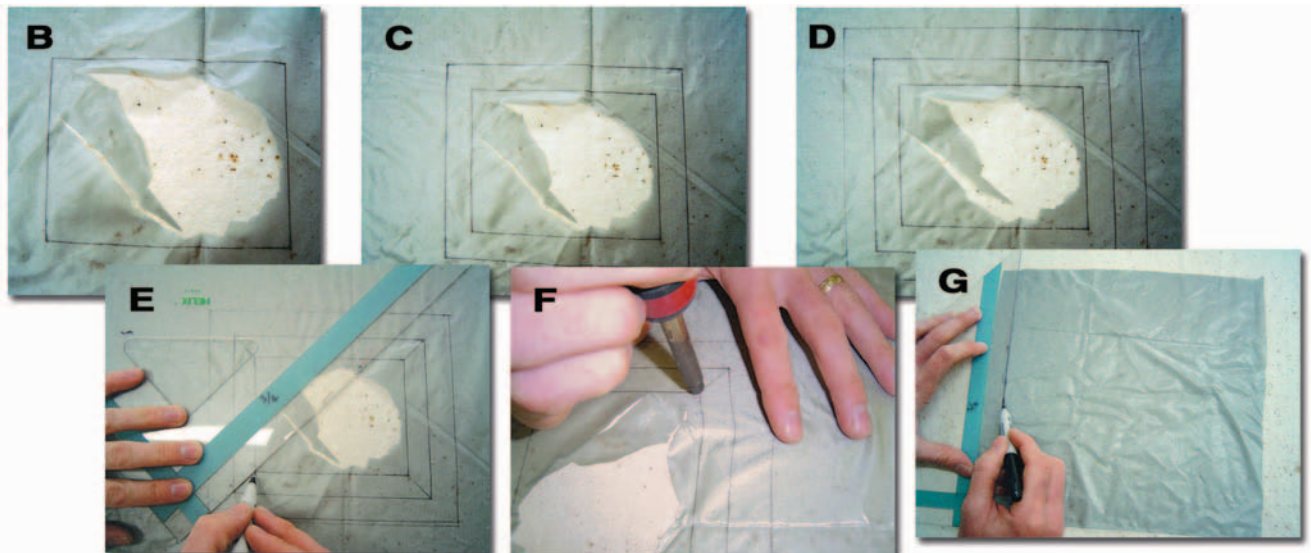
**MACHINES:** 301 Straight Stitch—Light Duty 7-11 SPI

**EQUIPMENT:**  
Scissors  
Seam ripper  
Marking pencil  
6" ruler  
Patching square [Figure A]  
Pin board  
Straight pins  
Basting iron

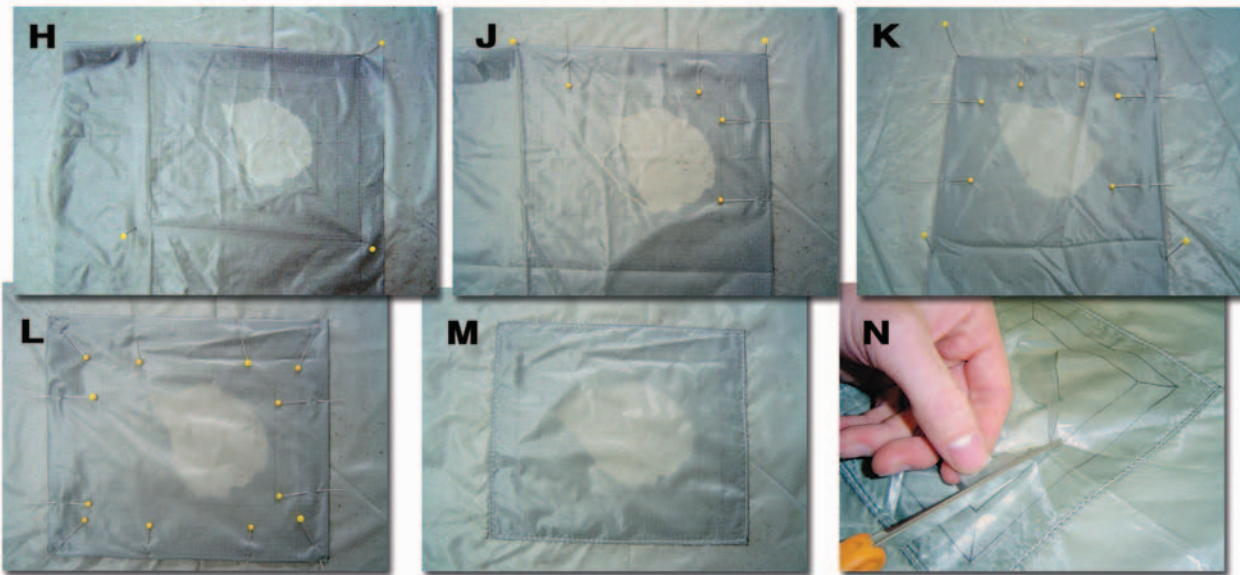


## PROCEDURE

- 1.0** **Note:** Round canopies have the patch installed on the inside of the canopy. Square canopies may have the patch applied to either inside or outside. Follow the manufacturer's instructions.
- 1.1 Turn the canopy inside out and place on the repair table over the pin board. Smooth the canopy fabric out. Pin the fabric to the pin board leaving a suitable distance around the damaged area to work with.
- 1.2 Mark the damaged area line with the marking pencil [Figure B]. Make sure the marked area aligns with the weave of the ripstop fabric.
- 1.3 Using the patching square, mark a parallel line 5/8" outside of the damaged area line [Figure C]. This will be the patch fold line.
- 1.4 Again using the patching square, mark a parallel line 3/4" outside of the 5/8" line [Figure D].
- 1.5 Draw a line from the corners of the 5/8" line to the corners of the 3/4" line [Figure E].



- 1.6 Take the basting iron and make a basting hole at the ends of the corner lines [Figure F]. These holes will precisely mark the extent of the corner cuts and prevent unnecessary raveling of the corners. In addition, if the canopy is made from dark colored material such as black, when the rigger turns the patch over to do the inside folds, because the pencil marks do not show through the dark material, the corners will be precisely defined for remarking the lines on the inside.
- 1.7 Take the repair material and cut a patch piece approximately 3" larger in both directions than the dimensions created by the 3/4" line perimeter. Make sure that two of the adjacent edges are cut square with the weave of the fabric and form a right angle.
- 1.8 Take the patching square and draw a line 3/4" in and parallel to the two even edges [Figure G].
- 1.9 Take one edge of the patch and fold on one line. Lay it on the canopy and align the fold along the 3/4" line and match up the corners. Pin or baste the patch in place [Figure H].
- 1.10 Fold the second side of the patch back at the 3/4" line and pin in place [Figure J].
- 1.11 Take the third side of the patch and fold back at the 3/4" line. Take the patching square and measure 3/4" back from the fold. Trim the patch material at this line. Fold the patch UNDER at the 3/4" line and pin in place [Figure K].
- 1.12 Take the last side of the patch and repeat step 1.11 [Figure L].
- 1.13 The basic patch should now be pinned in place.
- 1.14 Using the single needle machine, sew the outside of the patch in place with the seam approximately 1/16" from the edge of the patch [Figure M]. Overstitch a minimum of 1.25". Carefully release tension on the thread without pulling on the canopy fabric. Doing so will result in pulled and distorted fabric. Trim the thread.



- 1.15 Remove the canopy from the machine.
- 1.16 Carefully trim the damaged fabric, cutting along the damaged area line [Figure N]. Next cut the diagonal lines connecting the corners [Figure O]. Cut all the way to the basting hole at the inside corner.
- 1.17 Fold the fabric along the patch fold line and pin in place [Figure P]. This edge should be parallel to the outside seam. Sew around the inside of the patch approximately 1/16" from the edge and again overstitch the ends a minimum of 1.25" [Figure Q].
- 1.18 Release tension on the threads and trim. Remove the canopy from the machine. Inspect completed patch.





**2.0 INSPECTION:**

- 2.1 The ripstop weave of the patch should align with the weave of the canopy.
- 2.2 The patch should be square with good sharp corners.
- 2.3 Stitching should be even and parallel with the outside edge of the patch.
- 2.4 Inside corners should be square with no raw material showing. Inside row of stitching should be parallel with the outside row.
- 2.5 Tension should be even from both inside and outside view.
- 2.6 Overstitch of the ends should be minimum of 1.25".



# Parachute Repair Procedure

**TITLE:** 7.1.4 Round Canopy – Panel Replacement

**NUMBER OF PAGES:** 2

**APPLICABLE PRODUCTS:** All round canopies; main and reserve.

**DESCRIPTION:** Complete replacement of a panel section of a gore of a round canopy.

**AUTHORIZED REPAIRMEN:** FAA Master Parachute Rigger

**MATERIALS:** E thread—color to match  
Fabric—type and color to match

**MACHINES:** 301 Straight Stitch—Light Duty 7-11 SPI

**EQUIPMENT:**

Scissors  
Seam ripper  
Marking pencil  
6" ruler  
Large pin board  
Straight pins

## PROCEDURE

**1.0** **Note:** This process of replacing the panel is in reality a panel patch and is similar to that used in making a basic canopy patch. Because of the time and difficulty involved in removing and replacing the actual panel, that technique is best left to the canopy manufacturer. This technique is the more commonly accepted practice for major panel repair. The major issue to be dealt with in this technique is that of the amount of shrinkage that occurs during the repair. The larger the area of the panel, the more shrinkage there will be. The following procedure will describe a panel replacement on a block constructed, noncontinuous line canopy. A bias constructed canopy will be similar but more “fullness” will need to be allowed for in the cutting of the panel and sewing.

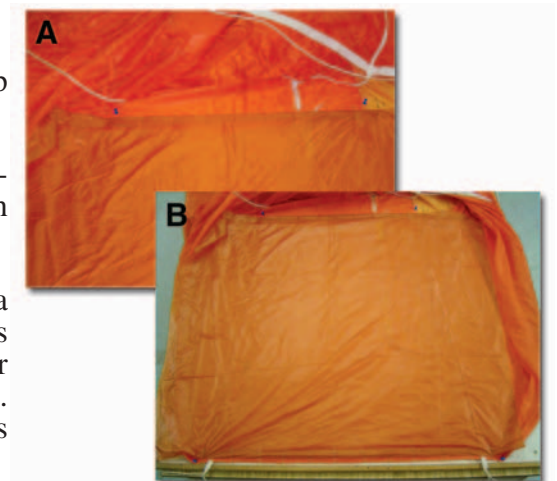
1.1 Lay the canopy out inside out on the pin board. Pin the canopy in place placing tension on the seams and making sure they are straight.

1.2 Cut a piece of fabric larger than the damaged panel by approximately 6" around all sides. Make sure that the weave of the panel matches that of the canopy. For a block constructed canopy, the **bolt** of fabric will run parallel down the radial seams of the canopy. For a bias constructed canopy, the bolt will run parallel to the **diagonal seams**.

1.3 Trim one side of the panel to align the ripstop weave with the cross seam.

1.4 Fold over the edge of the panel fabric approximately 3/4" and pin in place aligning the edge with the outside of the cross seam [Figure A].

1.5 Smooth out the panel fabric over the damaged area and align the opposite edge over the opposite cross seam. Cut the panel fabric approximately 1" wider than the panel. Fold the edge under and pin in place. You will now have the top and bottom cross seams of the panel in place [Figure B].





- 1.6 Stitch the outside row of stitching starting and finishing approximately 1" short of the radial seams.
- 1.7 Take the panel fabric along the radial seam and trim approximately 3/4" from the outside edge of the radial seam. Fold under and pin in place. Repeat for the opposite radial seam [Figure C].
- 1.8 Overstitch the end of the cross seam that was left open a minimum of 2" and proceed to and down the radial seam and then over stitch the open end of the cross seam. Repeat for the opposite side. It is advisable to hold a bit of tension on the seams as you sew to minimize the shrinkage.
- 1.9 Turn the canopy right side out. Trim out the damaged panel along the seams [Figure D], leaving approximately 5/8". Also trim the excess edge of the panel as needed.
- 1.10 Fold the edge of the canopy under the panel to create the seam and pin in place.
- 1.11 Sew the inside of the panel seam in place. Again, hold tension on the fabric as you sew to minimize shrinkage.
- 1.12 Remove the canopy from the machine being careful not to pull on the threads. Trim the threads. Inspect the panel.



## **2.0 INSPECTION:**

- 2.1 Check the weave alignment of the fabric panel to the canopy.
- 2.2 Check for proper thread tension all around.
- 2.3 Seams should be straight and parallel.
- 2.4 The resulting size of the panel should match approximately that of adjacent panels allowing for shrinkage.

# Parachute Repair Procedure

**TITLE:** 7.1.5 Square Canopy – Partial Panel Replacement

**NUMBER OF PAGES:** 3

**APPLICABLE PRODUCTS:** Most main and reserve canopies.

**DESCRIPTION:** Replacement of a partial panel(s) in a canopy where the extent of the damage necessitates more than a single large or multiple small patches.

**AUTHORIZED REPAIRMEN:** FAA Master Parachute Rigger

**MATERIALS:** E thread  
Fabric—type and color to match

**MACHINES:** 301 Straight Stitch—Light Duty 7-11 SPI  
308 Zigzag—Medium Duty 7-11 SPI [Optional]  
1" x 42 stitch bar tack [Optional]

**EQUIPMENT:**

Scissors  
Seam ripper  
Marking pencil  
36" ruler  
Pin board or large cardboard box folded flat  
Straight pins  
Scotch tape or equivalent

## PROCEDURE

**Note:** The repair described in the following procedure is a major tear across the bottom surface of the canopy and includes damage to a non-load-bearing rib.

### **1.0 DISASSEMBLY:**

- 1.1 Determine the extent of the damage. Mark out the damaged area across the panel, following the weave of the fabric. Unpick the loaded seams that hold the damaged fabric for at least 8-10" past the damage area mark. It is always easier to unpick more of the seam to allow better access to the damaged area. Restitching the seam is one of the easiest operations. Fighting the canopy is not.
  - 1.1.2 Unpick the non-loaded seam the same distance as the loaded seams.
  - 1.1.3 Lay the canopy on the floor, take the pin board or cardboard box and position it under the damaged area. Take the scotch tape and tape the raw edges of the tear together to stabilize the panel [Figure A].
  - 1.1.4 Pin the damaged panel to the pin board. Don't overstretch the fabric but make sure to take all the slack out and that the panel is square. In this instance, the canopy had spanwise reinforcing tapes, which were used to stabilize the canopy [Figure B]. However, one of them was damaged, and will require replacement.



- 1.2 Mark a line on the fabric at least 2" from the damage area [Figure C] on both sides of the damaged panel.

## **2.0 REASSEMBLY:**

- 2.1 Cut a piece of fabric approximately 6" wider and longer than the damaged panel area. Make sure that one of the edges is straight and even with the weave of the fabric. Trim one of the adjacent sides at 90 degrees to the straight edge.
- 2.2 Mark a line parallel to the straight edge at .75" from the edge. Center the new panel on the damaged one. Fold the fabric on this line and pin in place along the damage line [Figure D]. Smooth the new panel fabric over the damaged panel to the opposite side. Trim the new panel .75" longer than the damage line. Fold the fabric at the line and pin in place [Figure E].

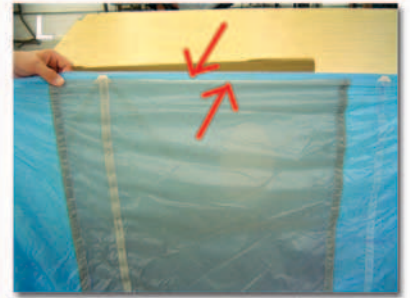
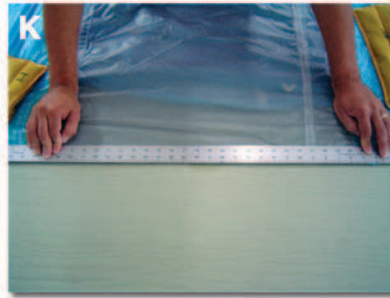
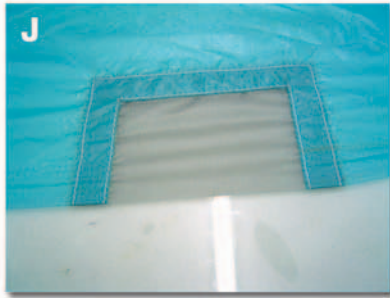


- 2.3 Check the tension of the two panels. They should be equal.
- 2.4 Take a straightedge and mark the location of the spanwise reinforcing tape [Figure F].
- 2.5 Sew the panel along the outer edge at .12" from the folded edge.
- 2.6 Turn the panel inside out. Trim the damaged panel at .62" from the edge of the panel edge [Figure G].
- 2.7 Fold the fabric under to create a French fell seam. Sew a stitch row .12" from the folded edge.
- 2.8 Sew a piece of reinforcing tape on the bottom of the replacement panel along the line for the spanwise reinforcing tape [Figure H].



- 2.9 Repair the non-load-bearing rib with a three-sided patch [Figure J].
- 2.10 Draw a line along the edge of the partial panel on each side from the point where the old panel meets the new one. Trim the fabric along this line [Figure K].
- 2.11 Check the tension of the new partial panel piece against the edges of the other panels that formed the original seam. They should all be equal [Figure L].





2.12 Refold the original seam with the three panel edges and stitch as per the original seam [Figure M]. Overstitch a minimum of 2" on each end.

2.13 If a line attachment has been removed for the repair, the tab must be replaced. Make sure that the line/tab does not have a twist in it. Locate it at the correct location and re-attach as per original.



**3.0 INSPECTION:**

3.1 Check the fabric tension of the replaced panel. It should be equal to that in the remainder of the cell.

3.2 Spanwise reinforcing tape should be straight and sewn.

3.3 Seams should be folded correctly and thread tension even along both rows of stitching.

3.4 Line should be attached correctly and have no twists.



# Parachute Repair Procedure

**TITLE:** 7.1.6 Square Canopy – Rib Repair

**NUMBER OF PAGES:** 3

**APPLICABLE PRODUCTS:** Square canopies; main and reserve.

**DESCRIPTION:** Rib repair on a square canopy.

**AUTHORIZED REPAIRMEN:** FAA Master Parachute Rigger

**MATERIALS:** E thread  
Fabric—type and color to match  
Reinforcing tape—type and color as per original

**MACHINES:** 301 Straight Stitch—Medium Duty 7-11 SPI  
1" x 42 stitch bar tack  
Double needle with puller attachment [Optional]  
SPI to match original

**EQUIPMENT:**

Scissors  
Seam ripper  
Marking pencil  
Ruler  
Pin board  
Straight pins  
Patching square

## PROCEDURE

**Note:** Repairing a rib of a square canopy is similar to doing a partial panel repair. The biggest difference comes when the rib is either [1] a “loaded” rib or one with support tapes for the line attachment points, or [2] a crossport is damaged and needs to be repaired and recut. In this case, the crossport area needs replacement [Figure A].

**1.0 DISASSEMBLY:**

- 1.1 Determine the extent of the damaged area and unpick the top and bottom seams to access the rib [Figure B]. In most cases, restitching the rib to the top and bottom panels is fairly straightforward. Because of this, opening up the seam for a good distance (18" plus either side of the proposed patch) will allow easier access and sewing.
- 1.2 Pin the damaged rib to the pin board to stabilize the material for marking. Mark out the damaged portion of the panel, following the weave of the fabric [Figure C]. This will be the patch fold lines and the limits of the partial rib panel. Note that the tears of the crossports have been taped together and that the crossport has been pinned down to stabilize the fabric during the marking process.
- 1.3 Using the patching square, mark a parallel line .75" inside the patch fold lines and then another one .62" inside the second line [Figure D]. The inner lines will be the trim lines for the rib patch.

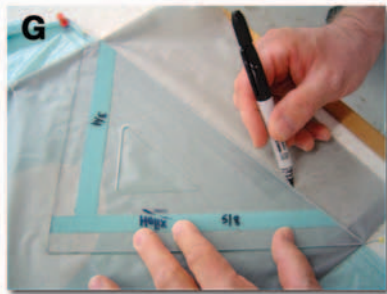






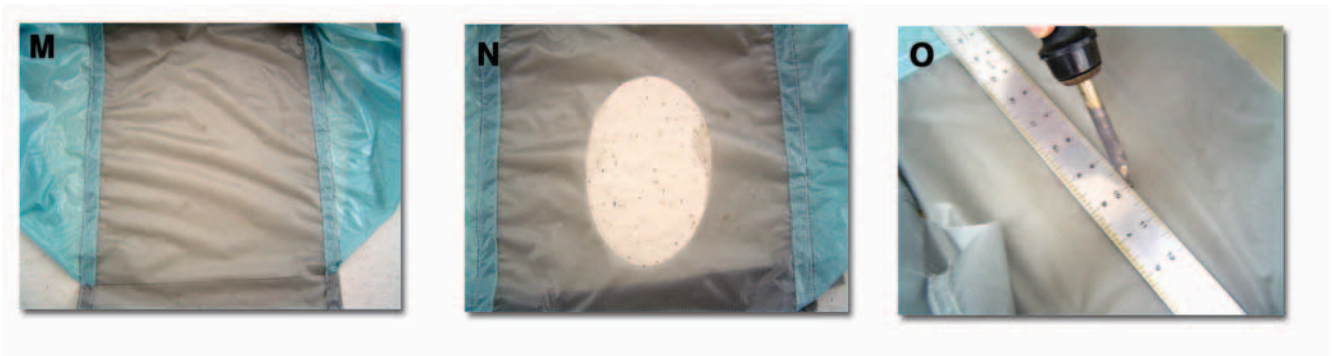
**2.0 REASSEMBLY:**

- 2.1 Cut a piece of fabric approximately 4" wider and longer than the damaged panel area. Make sure that one of the width edges is straight and even with the weave of the fabric.
- 2.2 Fold the straight edge .75" from the edge and pin in place across the damage line. Make sure the fabric is centered on the existing panel.
- 2.3 Remove the pins from the crossport area and smooth the new panel fabric over the damaged panel.
- 2.4 Fold the new fabric outwards at the patch fold mark and pin in place. Use the patching square to mark a line at .75" in from the fold line [Figure E].
- 2.5 Trim the repair panel at the inner line [Figure F], fold under and pin in place.
- 2.6 Check the tension of the two panels. They should be equal. Mark the top and bottom edges [Figure G] and the crossport location [Figure H].



- 2.7 Remove the rib from the pin board. Sew the two outboard seams approximately .06" from the edge with the single needle [Figure J].
- 2.8 Trim the original damaged panel to the trim lines [Figure K]. Fold the fabric under to create a French fell seam. Repeat with the opposite seam [Figure L].





- 2.9 Sew the inside row to complete the seam [Figure M].
- 2.10 Cut the new crossport to match the original location and shape [Figure N].
- 2.11 Trim the top and bottom edges as marked [Figure O].
- 2.12 Pin the top seam back onto the top panel. Sew in place with either the single needle or if available, with the double needle machine and puller [Figure P]. Repeat with the bottom seam.
- 2.13 Inspect finished work [Figure Q].



**3.0 INSPECTION:**

- 3.1 Seam alignment should be straight.
- 3.2 Check the tension of the replaced rib material.
- 3.3 Make sure the seams are restitched correctly.
- 3.4 Verify that the crossport is cut correctly.
- 3.5 The line attachment tape must be replaced correctly with no twists in the suspension line.





# Parachute Repair Procedure

**TITLE:** 7.1.7 Square Canopy – Pilot Chute Attachment Point Repair

**NUMBER OF PAGES:** 2

**APPLICABLE PRODUCTS:** Square main canopies.

**DESCRIPTION:** Repair of the main canopy pilot chute attachment point.

**AUTHORIZED REPAIRMEN:** FAA Master Parachute Rigger

**MATERIALS:** E thread  
Fabric—type and color to match  
Reinforcing tape—type and color to match  
Reinforcing fabric—type and color to match

**MACHINES:** 301 Straight Stitch—Medium Duty 7-11 SPI  
308 Zigzag—Medium Duty 7-11 SPI  
1" x 42 stitch bar tack

**EQUIPMENT:**  
Scissors  
Seam ripper  
Marking pencil  
12" ruler

## PROCEDURE

**Note:** This repair is quite common. If the canopy is inspected regularly, the beginnings of the damage will be noticed and a simple restitching will solve the problem. However, many times it is not and the resultant damage is quite extensive requiring repair of the rib as well as the top panel.

### **1.0 DISASSEMBLY:**

1.1 Inspect the damaged area to determine the extent of the damage [Figure A]. If the stitching that holds the attachment point to the canopy is simply coming loose, restitch as per the original.

1.2 If the canopy fabric is damaged, then turn the canopy inside out. The center rib should have a reinforced area that brackets the attachment point [Figure B].

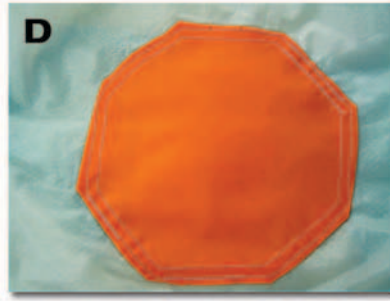
1.3 Detach the top of the rib from the top surface of the cell where the attachment point is located [Figure C]. If the rib is damaged, then a rib repair will be needed.



1.4 Usually the top skin of the cell will need to be repaired. Again, depending on the extent of the damage, either perform a patch on the panel or a partial panel replacement.

## **2.0 REASSEMBLY:**

- 2.1 After the top skin is repaired, a new reinforcement patch will need to be installed on the center of the cell so that it is centered over the attachment point.
- 2.2 Take the pre-cut reinforcement panel and sew it in place with two rows of the single needle machine. The corners should be folded in at a 45 degree angle to eliminate any point loading on the corners [Figure D].
- 2.3 Reattach the rib to the top surface of the canopy as per the original configuration.
- 2.4 Install a new pilot chute attachment tape and ring at the appropriate location [Figure E].



## **3.0 INSPECTION:**

- 3.1 Check that rib and panel repairs have been made as needed.
- 3.2 Verify the new top reinforcing panel is in place with two rows of single needle stitching.
- 3.3 Check the new attachment tape and ring for the appropriate stitch pattern.

# Parachute Repair Procedure

**TITLE:** 7.1.8 Round Canopy – Noncontinuous Line Replacement

**NUMBER OF PAGES:** 2

**APPLICABLE PRODUCTS:** Round canopies; main and reserve.

**DESCRIPTION:** Replacement of a suspension line on a round canopy with noncontinuous line configuration.

**AUTHORIZED REPAIRMEN:** FAA Master Parachute Rigger

**MATERIALS:** E thread  
Suspension line—type and color to match

**MACHINES:** 308 Zigzag—Medium Duty 7-11 SPI  
1" x 42 stitch bar tack [Optional]

**EQUIPMENT:**

Packing table  
Scissors  
Seam ripper or scalpel  
Marking pencil  
6" ruler  
60 pound **fish scale** or equivalent  
Finger-trapping needle

## PROCEDURE

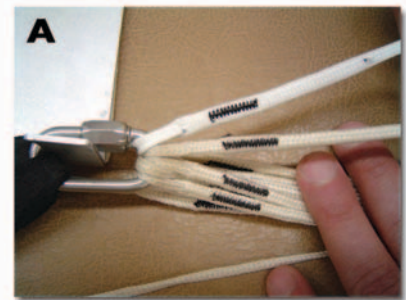
**Note:** The most common need for this type of repair today is as a result of the suspension line of the reserve being damaged during packing or occasionally during use after landing. The newer, light-weight braided lines are very susceptible to being snagged on the hook portion of Velcro® closures on the container if care is not taken by the rigger.

**1.0 DISASSEMBLY:**

- 1.1 Lay the canopy out on the packing table. Straighten the canopy ensuring the apex is straight and even tension on the lines.
- 1.2 Remove the damaged line from the canopy.

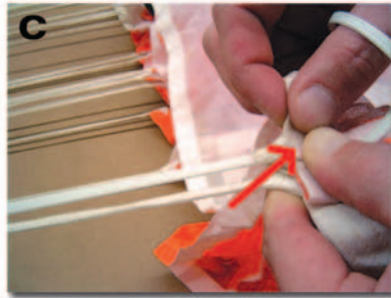
**2.0 REASSEMBLY:**

- 2.1 Cut a new line from the same material as the original approximately 36" longer than the damaged line.
- 2.2 Pre-stretch the line by applying approximately 10 percent of its rated strength for a minimum of 15 minutes.
- 2.3 Attach the line to the connector link in the same manner as the original. Most of the newer canopies use braided line and a finger-trap attachment technique [Figure A]. Zigzag or bar tack the line, whichever is appropriate.





- 2.4 Run the free end of the line to the canopy. If the canopy utilizes a V-tab configuration, route the line through the V-tab [Figure B].
- 2.5 Pull the V-tab down until it is even with the rest of the skirt. Mark the line at the edge of the skirt and pin in place [Figure C].
- 2.6 Sew the line to the canopy with the zigzag machine duplicating the original manufacture [Figure D]. Trim the excess line from the canopy.
- 2.7 Return the canopy to the packing table, straighten, and apply tension. Check the trim of the replaced line against the others.



**3.0 INSPECTION:**

- 3.1 Verify the line length is the same as the original with the same tension.
- 3.2 The connector link and canopy ends must be sewn correctly.

# Parachute Repair Procedure

**TITLE:** 7.1.9 Square Canopy – Main Line Replacement

**NUMBER OF PAGES:** 2

**APPLICABLE PRODUCTS:** Square main canopies.

**DESCRIPTION:** Replacement of main suspension lines of square canopies.

**AUTHORIZED REPAIRMEN:** FAA Senior or Master Parachute Rigger

**MATERIALS:** E thread

**MACHINES:** 308 Zigzag—Medium Duty 7-11 SPI  
1" x 42 stitch bar tack [Optional]

**EQUIPMENT:**

- Scissors
- Seam ripper or scalpel
- Marking pencil
- 6" ruler
- Finger-trapping needle
- 60 pound fish scale or equivalent

## PROCEDURE

---

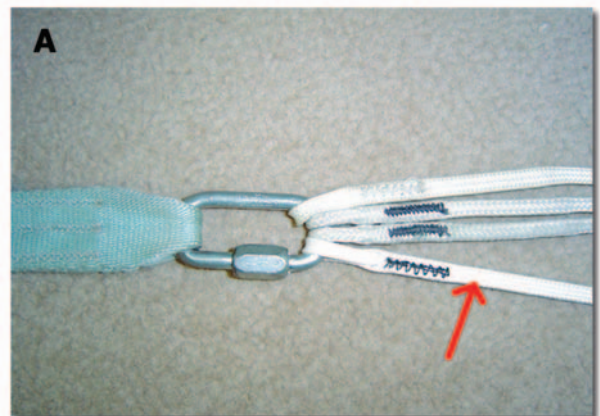
**Note:** Many of the modern canopies are using Spectra® or other aramid fibers in place of nylon or Dacron lines. These materials are stronger, lighter, and less bulky. An example is the 825 pound Spectra® line common on many main canopies. The strength is higher but the bulk is smaller than the 525 pound Dacron used in the past. Accordingly, the techniques needed to work this material are more refined and precise.

**1.0 DISASSEMBLY:**

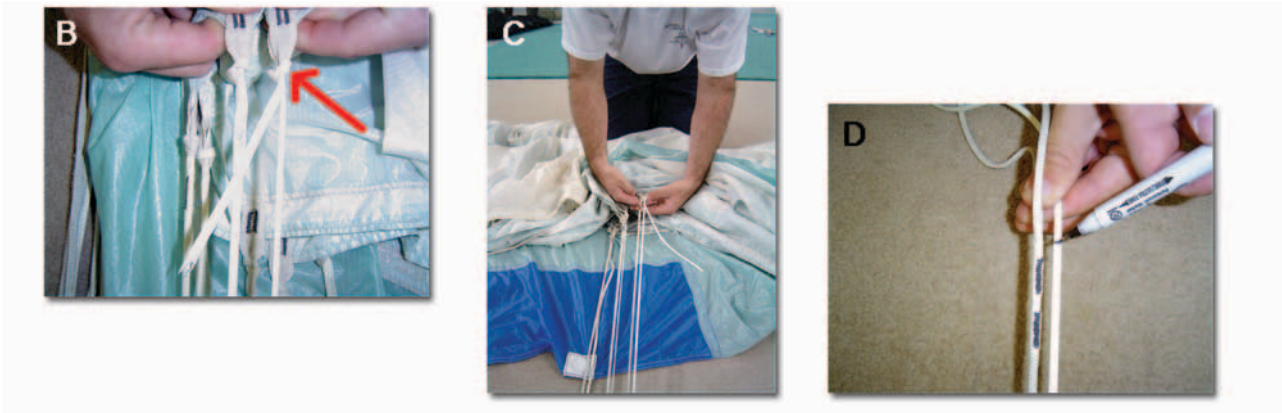
- 1.1 Lay the canopy out on one side and straighten the lines.
- 1.2 Remove the damaged line. If the cascade is undamaged, remove the cascade line from the junction of the main line. If the cascade is damaged, remove it as well.

**2.0 REASSEMBLY:**

- 2.1 Cut a new main line approximately 24" longer than the old one.
- 2.2 Finger-trap a loop at the connector link end [Figure A]. Make sure that the size of the loop duplicates the original or adjacent lines. If the loop is made too small, there may be difficulty in changing connector links or risers as needed. Sew the finger-trap with either a zigzag or bar tack.



- 2.3 Pre-tension the line. With Spectra®<sup>®</sup>, load the line with approximately 30 pounds for 30 seconds. Place the line on the connector link.
- 2.4 Feed the running end of the line through the slider and directly to the line attachment tape on the canopy. Make sure that there are no twists to the line or it is around the other lines. Run through the attachment tape and re-create the original knot [Figure B].
- 2.5 Tension the line using adjacent lines for reference [Figure C].
- 2.6 Mark the location for the entry point for the cascade line [Figure D].
- 2.7 Cut a piece of line approximately 18" longer than the original cascade.



- 2.8 Finger-trap the cascade into the main line and sew with either a zigzag or bar tack [Figure E].
- 2.9 Attach the main line to the line attachment loop as per the original knot configuration.
- 2.10 Tension the line against the adjacent lines and secure the knot [Figure F]. Repeat with the cascade.
- 2.11 Finger-trap the running end of the lines and sew with either a zigzag or bar tack [Figure G].



### **3.0 INSPECTION:**

- 3.1 Check the length of the main line and the cascade line under tension against adjacent lines.
- 3.2 Check stitching such as zigzag or bar tacks.
- 3.3 Check line continuity.



# Parachute Repair Procedure

**TITLE:** 7.1.10 Square Canopy – Line Splice

**NUMBER OF PAGES:** 2

**APPLICABLE PRODUCTS:** Square main canopies.

**DESCRIPTION:** Line splices for all square main canopies with braided type suspension line.

**AUTHORIZED REPAIRMEN:** FAA Senior or Master Parachute Rigger

**MATERIALS:** E thread—color to match  
Suspension line—type and color to match

**MACHINES:** 308 Zigzag—Medium Duty 7-11 SPI

**EQUIPMENT:**

Scissors  
Seam ripper  
Marking pencil  
6" ruler  
Finger-trapping needle or wire  
Hot knife  
Small safety pins

## PROCEDURE

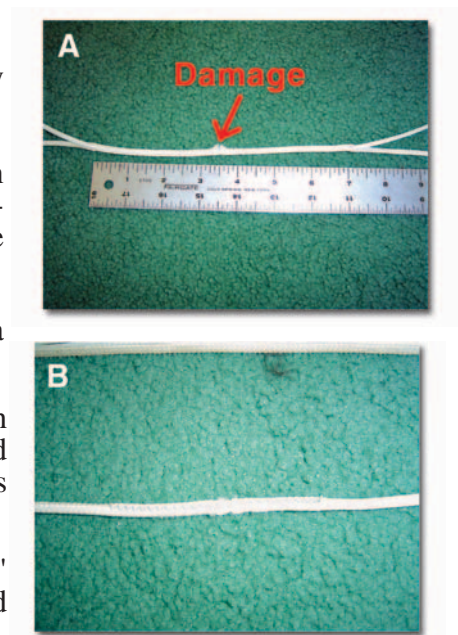
**Note:** This procedure consists of two types of splice. The first is an internal. The second is a joining splice. The internal splice is used when there is minor damage to the line but the line is still intact. The joining splice is used only when there is not sufficient line available to affect a full replacement. In an emergency, used line can be used to make the splice. This type of repair is not acceptable for repairs on certificated canopies.

**1.0 DISASSEMBLY:**

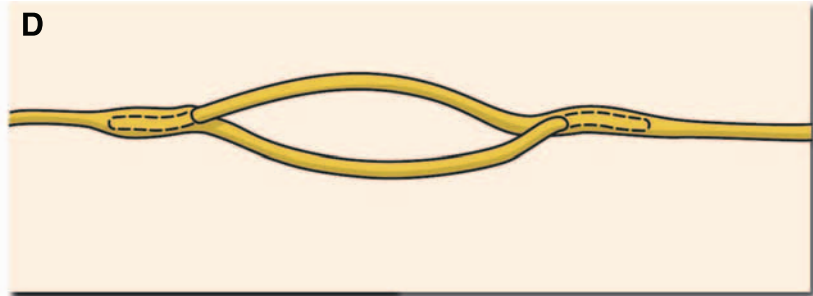
- 1.1 Lay out the canopy and straighten the lines.
- 1.2 Inspect the line to determine the damage.

**2.0 REASSEMBLY:**

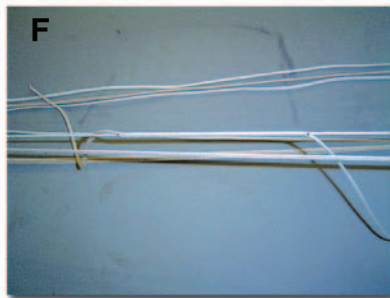
- 2.1 For an internal splice, take a piece of line approximately 12" longer than the damaged area.
- 2.2 Using a finger-trapping needle or wire, finger-trap a section of line inside the damaged area so that it overlaps the damaged area a minimum of 3" in each direction. Make sure the ends of the line are cut on a taper [Figure A].
- 2.3 Use the zigzag machine to overstitch the damaged area a minimum of 1" on each end [Figure B].
- 2.4 For a joining splice, mark each end of the separated line with two marks. The first mark is made at 10" from the end and the second mark is placed at 16" from the end. Trim the ends with a hot knife.
- 2.5 Next take a piece of line for the splice approximately 36" long. Trim one on an angle with the hot knife. Mark one end of the line at 10" and 16".



- 2.6 Using a finger-trapping needle or wire, insert the end of the splice line into the main line at the 10" mark on the main line and out at the 16" mark. Pull the splice line up until the two 10" marks align [Figure C]. Pin the splice with a safety pin to prevent movement.
- 2.7 Next take the end of the main line and finger-trap the end directly into the splice line approximately .25" from where it enters the main line and then exit at the 16" mark.
- 2.8 Figure D shows the resultant configuration.
- 2.9 Take the blank end of the splice line and finger-trap it into the other end of the main line at the 10" mark and exit at the 16" mark.



- 2.10 Have one person apply tension on the main line. Adjust the finger-trap tension to provide the correct length of the line against the adjacent lines [Figure E]. The spliced line should have slightly less tension to allow for the last finger-trap.
- 2.11 Take the running end of the main line and finger-trap it into the splice line approximately .25" from the insertion point as was done with the lower splice. Exit at the 16" mark.
- 2.12 Pull the finger-trapped sections tight [Figure F]. Again check the length of the line against the adjoining lines. If the length is correct, trim the excess lines so that they disappear into the finger-trap.
- 2.13 Sew the finger-trapped sections with the zigzag machine set for 5-7 stitches per inch [Figure G].



**3.0 INSPECTION:**

- 3.1 Check the length of the line against adjacent lines for trim.
- 3.2 Check the zigzag overstretch of the finger-trap sections.

# Parachute Repair Procedure

**TITLE:** 7.1.11 Square Canopy – Control Line Replacement

**NUMBER OF PAGES:** 4

**APPLICABLE PRODUCTS:** Square main canopies.

**DESCRIPTION:** Replacement of the control line assemblies on square main canopies.

**AUTHORIZED REPAIRMEN:** FAA Senior or Master Parachute Rigger

**MATERIALS:** E thread—color to match  
Suspension line—type and color to match. Most control line assemblies utilize two or more types of line: one for the upper control lines and a stronger one for the lower control lines.

**MACHINES:** 308 Zigzag—Medium Duty 7-11 SPI  
1" x 42 stitch bar tack [Optional]

**EQUIPMENT:**  
Scissors  
Seam ripper  
Marking pencil  
6" ruler  
Tape measure  
Small safety pins w/marker flags

## PROCEDURE

**Note:** Some manufacturers provide line measurements for their canopies in their owner’s manuals. If so, the rigger should thoroughly measure the control line assembly and compare the measurements against those in the manual. Over time and use, the control lines have a tendency to stretch and change dimensions. At the same time, the rigger needs to compare the right and left side assemblies against each other for any differences. It is not uncommon for the left and right control lines to be different lengths, having been changed to remove a slight turn or change the opening characteristics.

Figure A is a sample chart that the rigger can fill in to document the various dimensions needed to repair or replace control lines.

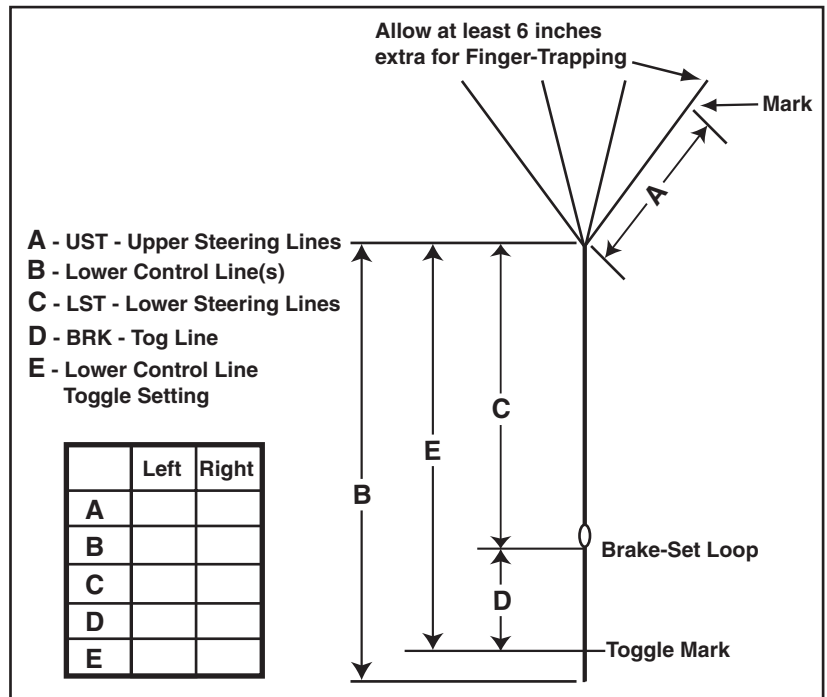


Figure A



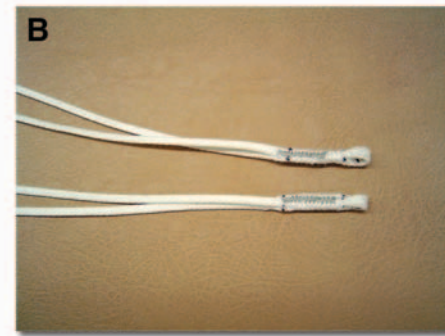
## **1.0 DISASSEMBLY:**

- 1.1 After measuring the control lines, remove them from one side only. Leave the other side for a reference to check the new lines against both for measurements and construction.

## **2.0 REASSEMBLY:**

- 2.1 Determine how many upper control lines there are on the canopy. Four is the most common and this procedure will use this number for the example. With four upper control lines, there are really two continuous lines forming the assembly. Each pair of upper lines is folded in the middle to form two legs of the upper assembly. Each line is therefore measured at twice the A dimension plus 12". If the upper control lines have different lengths, make sure to use the longest measurement to determine the cut length for A (Refer to Figure A).

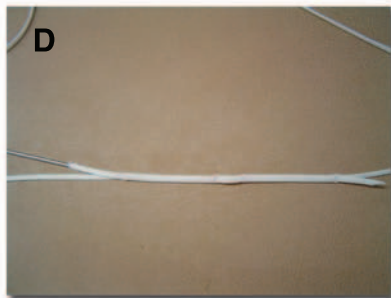
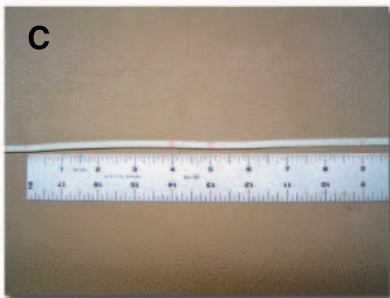
- 2.1.2 Using a finger-trapping needle or wire, finger-trap a loop at the center of each of the lines, so the result is a line with a loop at the center with two legs extending from it [Figure B]. The eye of the loop should be no more than .25" with the finger-trapped portion 1" long. Bar tack or zigzag the finger-trapped section.



- 2.1.3 There are two types of lower control line configurations: a continuous line and a noncontinuous line. The continuous line is one piece with a brake loop finger-trapped into it at the proper location. The noncontinuous line consists of two pieces which form the upper lower and lower lower control line as well as the brake loop. The continuous line configuration is found primarily on the older generation main canopies and on many of today's reserve canopies. The noncontinuous configuration is found on most of the modern main canopies due to the ease of replacement because of wear. Paragraphs 2.2 thru 2.2.3 will describe the continuous line design. Paragraphs 2.3 thru 2.3.11 will describe the noncontinuous method.

## **2.2 CONTINUOUS LINE METHOD:**

- 2.2.1 Take a piece of line used for the lower control line and cut a line equal to the B dimension in Figure A plus 12". On this line, measure from one end 8" plus the C dimension from Figure A and mark at that location. This will be the bottom of the brake loop. Mark the brake loop location according to Figure C.
- 2.2.2 Take another piece of the lower brake loop line approximately 12" long. Finger-trap the brake loop assembly according to Figure D. Make sure the ends are scissor cut and tapered. Bar tack or zigzag the assembly [Figure E].



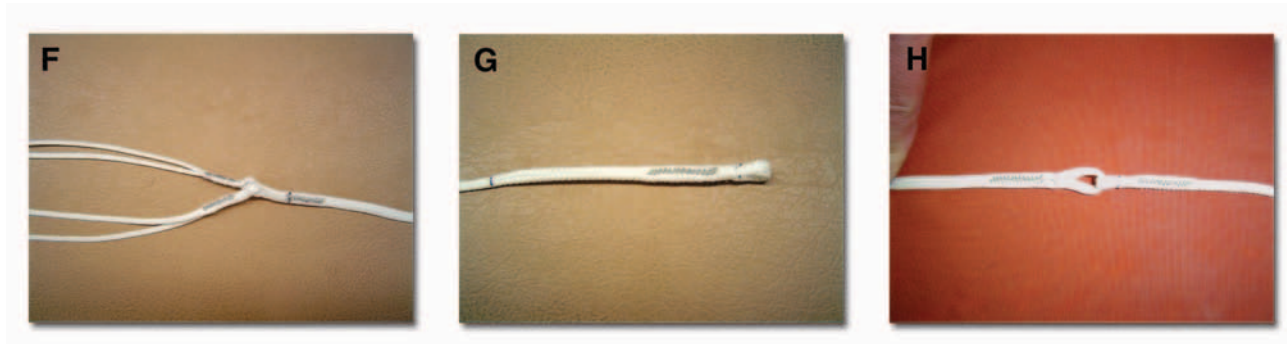
2.2.3 Measure and mark the C dimension from the bottom of the brake loop. Run the bitter end of the lower control line thru the eyes of two of the upper control lines and finger-trap the line back into itself [Figure F]. Adjust the finger-trap to allow for shrinkage. This completes the continuous line method of lower control line fabrication.

### **2.3 NONCONTINUOUS LINE METHOD:**

2.3.1 Take a piece of line used for the lower control line and cut it at the C dimension from Figure A plus 12". Mark at 6" from one end and finger-trap a loop .5-1" long as per Figure G.

2.3.2 Take a second piece of control line material and cut it to the D dimension from Figure A plus 12" additional. Mark at 6" from one end.

2.3.3 Finger-trap this line thru the loop at the end of the upper lower control line. Make sure there is a minimum of 4" finger-trapped in the line and that the lower loop is tight against the upper loop.



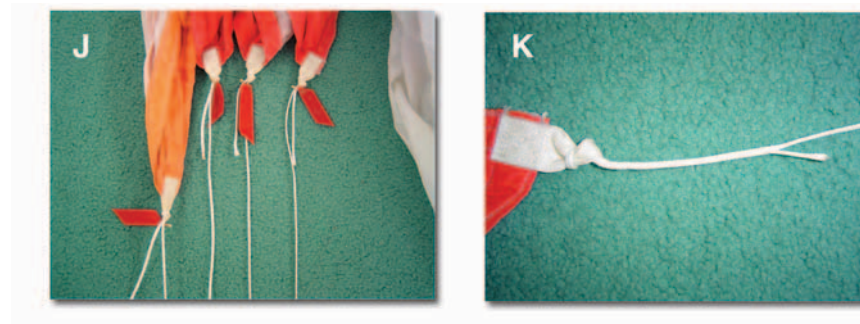
2.3.4 Bar tack or zigzag the finger-trapped portions to secure them [Figure H].

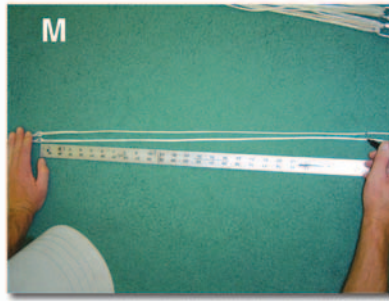
2.3.5 Measure and mark the C dimension from the bottom of the brake loop. Run the bitter end of the lower control line thru the eyes of two of the upper control lines and finger-trap the line back into itself. Adjust the finger-trap to allow for shrinkage. This completes the noncontinuous line method of lower control line fabrication.

2.3.6 Measure the upper control lines according to dimension A plus .5". If the upper control lines are of uneven dimensions, make sure that they are marked accordingly.

2.3.7 Lay the canopy on the floor with the trailing edge flat and straight and the line attachment tabs exposed. Lay the upper control lines so that they run to the correct attachment points and route them through the tabs [Figure J].

2.3.8 Make sure that the lines do not have a twist in them and finger-trap the lines back into themselves with a minimum of a 4" finger-trap. Leave the running ends exposed [Figure K]. Do not trim the excess line.





- 2.3.9 Anchor the brake loop securely and apply tension through the complete control line assembly. Measure the dimension A plus B starting at the outside corner of the trailing edge. Adjust the tension of the finger-trap to allow for shrinkage. Pin the finger-trapped section with a marker flag [Figure L]. Repeat with each upper control line until complete.
- 2.3.10 After setting the dimension for each upper control line, bar tack or zigzag each section. Trim the excess so that the end retreats into the line.
- 2.3.11 Measure the dimension D on the lower control line to set the toggle location [Figure M]. If the canopy is on risers, route the lower control line thru the guide ring and tie the steering toggle in place.

### **3.0 INSPECTION:**

- 3.1 Check finished dimensions against original dimensions according to Figure A.
- 3.2 Check that all finger-trapped junctions are secured with either a bar tack or zigzag.
- 3.3 Make sure that there are no twists in the lines.
- 3.4 Check that the steering toggles (if used) are tied on securely.



# Parachute Repair Procedure

**TITLE:** 7.1.12 Square Canopy – Crossport Repair

**NUMBER OF PAGES:** 2

**APPLICABLE PRODUCTS:** Square main canopies with crossports.

**DESCRIPTION:** Repair of damaged crossports in square main canopies.

**AUTHORIZED REPAIRMEN:** FAA Senior or Master Parachute Rigger

**MATERIALS:** E thread—color to match  
Fabric—type and color to match

**MACHINES:** 301 Straight Stitch—Medium Duty 7-11 SPI

**EQUIPMENT:**

Scissors  
Seam ripper or scalpel  
Marking pencil  
6" ruler  
Pin board  
Straight pins  
Patching triangle  
Hot knife

## PROCEDURE

**Note:** There is no limit as to how many crossports may be repaired on a main canopy. Reserve canopies are another matter. The number and authority to repair crossports on a reserve varies between manufacturers. Before attempting to repair the crossports of a reserve, first check with the manufacturer.

**1.0 DISASSEMBLY:**

1.1 Many times, when the crossport is damaged, there is extensive gathering and distortion of the fabric. Before progressing, smooth out the fabric to reshape the rib as close as possible to its original shape.

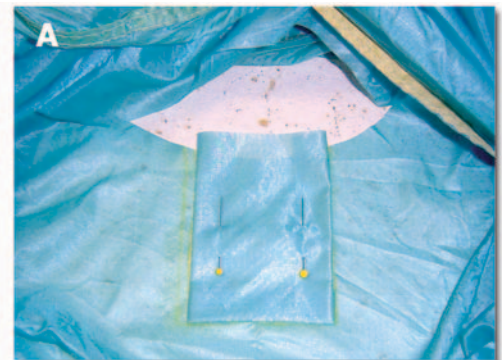
**2.0 REASSEMBLY:**

2.1 The basic idea of the crossport repair is a three-sided patch sewn the same as a standard French fell seam patch. The fourth side is open and recut to the shape of the crossport [Figure A]. However, if the damage is extensive enough, it may be advisable to patch the complete crossport area and then recut the crossport in its original shape with a hot knife.

2.2 Pin the rib to the pin board.

2.3 Mark out the damaged area as you would a standard patch. Lay the patch material in place and pin.

2.4 Sew the patch in place with a seam  $\frac{1}{16}$ " from the edge.



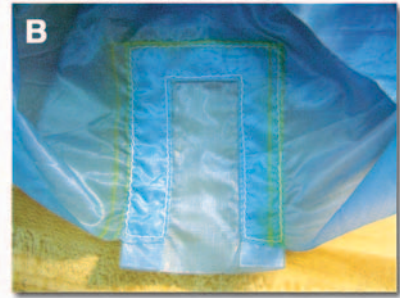
2.5 Turn the patch over, fold the seam, and sew as a standard patch [Figure B].

2.6 Lay the repaired rib on a suitable surface and recut the crossport shape in the exposed edge of the patch material with the hot knife [Figure C].

**3.0 INSPECTION:**

3.1 Verify the seams of the patch are even and thread tension is correct.

3.2 Hot knifed edge of the crossport must be smooth and even.



# Parachute Repair Procedure

**TITLE:** 7.1.13 Square Canopy – Trim Check and Retrim

**NUMBER OF PAGES:** 2

**APPLICABLE PRODUCTS:** Square main canopies.

**DESCRIPTION:** Retrimming the suspension lines of main canopies to return to the original trim specs.

**AUTHORIZED REPAIRMEN:** FAA Senior or Master Parachute Rigger

**MATERIALS:** E thread

**MACHINES:** 308 Zigzag—Medium Duty 7-11 SPI or  
1" x 42 stitch bar tack [Optional]

**EQUIPMENT:**

- Scissors
- Seam ripper or scalpel
- Marking pencil
- 6" ruler
- 25' Tape measure
- Pony clamp

## PROCEDURE

**Note:** Checking and retrimming main canopies is a common requirement for riggers. All canopies and all kinds of suspension lines get out of trim in time with use. The rigger that knows how to quickly check the trim on a customer's canopy, and then determine how much work it will take to return it to the original configuration, is performing a valuable service. In most cases, as long as the suspension lines are in good condition, retrimming a canopy will add hundreds of jumps to the life of the canopy and return the performance to almost as good as when new.

This chart and procedure are tailored to apply to normal ram-air canopies. Certain designs, such as elliptical canopies, may have nonstandard trim measurements that require more detailed measurements. The rigger should consult the manufacturer's manuals or technical data for these canopies.

### **1.0 DISASSEMBLY:**

1.1 The first thing the rigger must do is to complete a measurement of the lines of the canopy. Figure A shows a matrix for measuring the lines of the canopy. Simply fill in the boxes for each dimension measured.

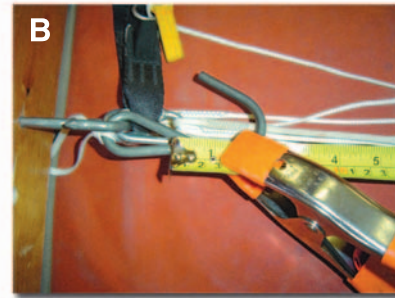
1.2 Start by laying the canopy on the left side, anchor the connector links, and flake it out as if for packing. Most canopy lines are measured from the inside of the connector links, which is called the "zero" point.

Line	10	9	8	7	6	5	4	3	2	1
A										
B										
C										
D										
UST	Left					Right				
	1	2	3	4	5	5	4	3	2	1
LST										
BK-TOG										

Figure A



- 1.3 Anchor the end of the tape measure even with the zero mark at the end of the lines using the pony clamp [Figure B].
- 1.4 Start with the top outside right front corner line of the canopy. This line will be line 1A. Depending on the number of cells to the canopy, on a 7-cell canopy, the left corner line will be line 8A. On a 9-cell canopy, this line will be line 10A. Make sure that the canopy is oriented correctly so that the measurement sequence follows the boxes on the chart.



- 1.5 Measure all the A lines first, then proceed to the B, C and D line groups. The lines should be measured under approximately 10 pounds of tension. As the rigger moves through the lines and changes riser groups, the end of the tape measure should be moved to the corresponding connector link and re-clamped.
- 1.6 Measure the control line groups and fill in the boxes.

## **2.0 REASSEMBLY:**

- 2.1 Compare the measurements to the original line lengths as in the manual.
- 2.2 Depending on the type of canopy and type of line used, most canopies tend to have the center A lines stretch due to the load on opening. The outside lines that attach to the stabilizers and the control lines, tend to shrink due to the friction generated by the slider on opening. The key concept to remember is that the length of the lines is not the critical dimension. What is most important is the trim differential, which determines the angle of attack of the canopy. The trim differential is the difference in the line length between the A,B, C, and D lines. The most accurate method of measuring this is to use the A lines as the base dimension and then measure A-B, A-C, and A-D. This method takes into consideration the tolerance allowed. This dimension is what makes the canopy open and fly correctly. If the overall length of the lines is 2-3" longer or shorter, but the trim is correct, there will probably be no appreciable effect on the canopy. With this in mind, it may be desirable to in effect "short-line" the canopy during the trim process in order to not have to replace any main lines.
- 2.3 Because of the fact that the cascaded main lines may stretch at different rates, the adjustment to be made to the lines that have stretched (i.e., gotten longer) will need to be done at the canopy end and not at the connector link.
- 2.4 Remove the bar tacks or zigzag stitching at the canopy end of the lines.
- 2.5 Adjust the line length as needed to return to the original dimensions. Re-tie the knots or finger-trap as necessary and re sew as per the original.
- 2.6 For the lines that may have shrunk in length, it may be possible to gain as much as 2-3" of line adjustment by utilizing the extra line that is finger-trapped into each line attachment point. Depending on the type of line used on the canopy, the amount of excess line finger-trapped may vary. Dacron lines can have as little as 2-3" inserted into the finger-trap and hold securely. The smaller and more slippery Spectra® line is recommended to have at least 6" of line inserted into the finger-trap. So, depending on the amount of line that is needed to be gained for the trim adjustment, the rigger may be able to adjust each end of the line to gain the necessary adjustment.
- 2.7 If this needed line can be gained, remove the bar tacks or zigzag at each end of the line and reattach after adjusting the length. Before permanently attaching, the rigger should simply tie the lines in place and check the trim. If everything is within limits, then re-tie or finger-trap and restitch with bar tacks or zigzag as per the original.

## **3.0 INSPECTION:**

- 3.1 Check final trim dimensions against original.
- 3.2 Check continuity so there are no twists or crossed lines.
- 3.3 Verify all junctions are either knotted or finger-trapped and sewn as per the original.



Container repairs share some techniques with canopy repairs, such as single-side patches. Most repairs, however, involve replacement of panels or flaps, Velcro®, grommets, plastic stiffeners, worn binding tape, and broken hand tackings. Even more so than canopy repairs, the cosmetic results of the container repair are most important to the customer, and thus the rigger. A shoddy repair to the container is immediately obvious each time the user puts on the parachute. Even if it is functional, it has to look good to instill confidence in the user.

7.2 The following are repairs found in Section 2 of this chapter.

- 7.2.1 Container fabric panel repair
- 7.2.2 Container grommet replacement
- 7.2.3 Container Velcro® replacement
- 7.2.4 Container plastic stiffener replacement
- 7.2.5 Main container side flap replacement
- 7.2.6 Bottom of container (BOC) pocket replacement
- 7.2.7 3-ring release housing replacement





# Parachute Repair Procedure

**TITLE:** 7.2.1 Container Fabric Panel Repair

**NUMBER OF PAGES:** 3

**APPLICABLE PRODUCTS:** All types of parachute container systems.

**DESCRIPTION:** Application of a patch repair to container panels.

**AUTHORIZED REPAIRMEN:** FAA Senior or Master Parachute Rigger

**MATERIALS:** E thread—color to match  
Fabric—type and color to match  
Nylon tapes—assorted types and widths such as Ty-3, Ty-4, or Ty-12

**MACHINES:** 301 Straight stitch—Medium Duty 7-11 SPI  
308 Zigzag—Medium Duty 7-11 SPI

**EQUIPMENT:**

Scissors  
Seam ripper or scalpel  
Marking pencil  
6" ruler  
Hot knife  
Hot glue gun  
Butane lighter  
Ripstop tape (optional)  
Straight pins

## PROCEDURE

**Note:** Besides holding the canopy, the container's main function is to protect the canopy from damage. To that end, a certain amount of wear and damage is to be expected. The most common repairs involve restitching broken threads and binding tape repairs. Other damage involves tears, punctures, and fabric abrasion. The appropriate repair will vary according to need. There are five primary repair procedures to basic panel repairs. They are: restitching, binding tape repair, hidden patches, overlay patches, and single-side fabric patches.

**1.0 DISASSEMBLY:**

- 1.1 Remove all extraneous parts from the container, including canopies, handles, toggles, etc.
- 1.2 Inspect the damaged area to determine which repair method is appropriate.

**2.0 REASSEMBLY:**

**2.1 RESTITCHING.**

- 2.1.1 Using the same type and color of thread, sew directly over the original stitching. The amount of overstitch may vary according to location. If the affected area is completely exposed and accessible, overstitch the ends of the damaged area a minimum of 1.25". If this is not possible, then backstitch a minimum of 3 stitches to lock the ends. Repair complete.

**2.2 BINDING TAPE REPAIR OR SPLICE.**

- 2.2.1 Many times the binding tape will be worn through due to bridle abrasion or other wear patterns [Figure A]. Rather than remove the panel and rebind it, a practical and cost effective repair is to overlay a section of new binding over the damaged area.



- 2.2.2 Cut a piece of binding tape a minimum of 1" longer than the damaged area. Scissor cut the tape and then lightly sear with the butane lighter [Figure B]. If the tape is cut with a hot knife and then folded, the cut edge will crack at the hot-knifed end. Searing with the lighter results in a more flexible end. Fold the tape in half lengthwise to form a crease. Take a marking pencil and mark the crease [Figure C].
- 2.2.3 Overlay the new tape over the damaged area and mark the start of where the new tape begins and covers the damaged area completely [Figure D].



- 2.2.4 Overstitch the original tape on the inside row up to the point where the new tape is to start. Leave the needle in the material. Place the folded tape over the damaged area and hold tightly in place. Make sure that the edge is pushed up against the original and the end is against the needle [Figure E]. The next stitch should catch the new tape.
- 2.2.5 Stitch the new piece and overstitch the end a minimum of 1.25" or 3 stitches. Repeat with the outside row of stitches. Repair complete.
- 2.3 HIDDEN PATCHES. This type of repair has never had a name, but it is self-descriptive. It works well on tears and punctures. Done properly, it is a very cosmetic and cost effective repair.
- 2.3.1 Take a piece of adhesive tape and place on the outside of the damaged area to hold the edges together [Figure F].
- 2.3.2 Turn the panel inside out, take the glue gun and glue a small piece of Ty-3 tape 1" longer over the damaged area [Figure G]. Do not fold the ends under. Remove the adhesive tape from the outside.



- 2.3.3 Stitch around the outer perimeter of the Ty-3 tape using matching colored thread to the container fabric. If necessary, increase the upper thread tension so that the outside (bottom) thread shows good tension.
- 2.3.4 Take the zigzag machine, again with matching color thread, and set the stitch width to its widest setting and 7-11 SPI length. Overstitch the exposed edges of the cut area to draw them together [Figure H]. Repair complete.
- 2.4 OVERLAY PATCHES. These are similar to a fabric patch but use a piece of tape or webbing to cover the damaged area. In effect it is the same as the hidden patch but usually larger and is on the outside of the panel. It is a sturdy patch but not very cosmetic.
- 2.4.1 Using a hot knife, cut a piece of tape or webbing such as Ty-12, big enough to cover the damaged area. Allow enough to fold the cut ends under. Fold the ends under and glue down to itself [Figure J].

- 2.4.2 Lay the patch in place over the damaged area and mark the corners with a marking pencil [Figure K].



- 2.4.3 Take a straight pin and transfer the corners of the patch area through to the inside [Figure L].
- 2.4.4 If on a main container, take a piece of Ty-3 tape big enough to match the outside patch as marked. Cover the inside of the damaged area with the tape.
- 2.4.5 Pin or glue the tape patch to the inside as marked. Use the single needle to sew around the patch over stitching the ends a minimum of 1".
- 2.4.6 Take the zigzag machine and stitch the edges of the damaged area together as in 2.3.4 [Figure M]. Repair complete.



- 2.5 **SINGLE-SIDE FABRIC PATCHES.** For most fabric patches on a container panel, there is not enough area to perform a proper French fell seam patch. Consequently, the single-side patch is the most common technique used. By using matching fabric and thread, a large damaged area may be covered to affect the necessary repair. While called a single-side patch, in effect it is an enlarged version of the overlay patch. A smaller piece of webbing or fabric is used to cover the damaged area on the inside and the outside is covered with the single-side patch. This technique is used where there may be large holes or widespread damage and replacement of the panel not practical.

- 2.5.1 Duplicate steps 2.4.1 thru 2.4.5 but substitute webbing for the inside patch and use container fabric for the outside patch.
- 2.5.2 Fold the edges of the outside patch under a minimum of .5". Stitch around the perimeter approximately .12" from the edge. Run a second row of stitches approximately .25" inside and parallel to the first. [Figure N] This will give added strength to the patch and an appearance of a French fell seam patch. Repair complete.

### **3.0 INSPECTION:**

- 3.1 Check thread tensions, stitches per inch, and over stitch lengths.
- 3.2 Damaged area must be covered completely.
- 3.3 For the overlay and single-side patches, make sure the stitch patterns catch both sides of the patch materials completely.





# Parachute Repair Procedure

**TITLE:** 7.2.2 Container Grommet Replacement

**NUMBER OF PAGES:** 2

**APPLICABLE PRODUCTS:** All types of containers that use grommets.

**DESCRIPTION:** Replacement of damaged grommets of all types.

**AUTHORIZED REPAIRMEN:** FAA Senior or Master Parachute Rigger

**MATERIALS:** E thread—color to match  
Grommets—size, type, and material to match

**MACHINES:** 301 Straight stitch—Medium Duty 7-11 SPI  
308 Zigzag—Medium Duty 7-11 SPI

**EQUIPMENT:**  
Scissors  
Seam ripper or scalpel  
Marking pencil  
6" ruler  
Grommet die set—Size to match grommets  
Leather mallet  
Grommet cutting board  
Hole punch to match grommet size  
Basting tip (optional)  
Diagonal wire cutters—8" minimum

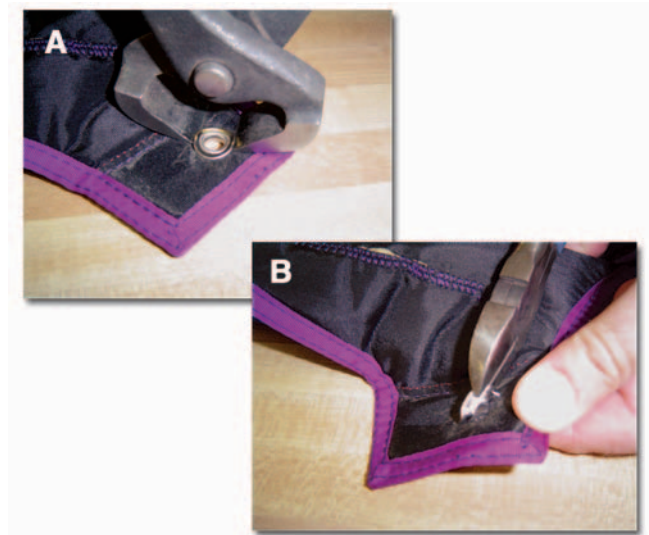
## PROCEDURE

**Note:** There are many types of grommets used in parachute container manufacture. Older style military surplus containers used flat grommets made of brass with a chrome finish, which were designed to work with cones. Most modern container systems use rolled rim spur grommets and washers. The most common size is the “O.” For many years, regular brass grommets were used and then nickel plated ones became the norm. In recent years, stainless steel has come to be the preferred type due to the ability to resist deformation and corrosion. Today, there are two types of “O” stainless grommets. The first is the regular or “short shank.” Recently, a long shank version has become available. It has proven to be very versatile and popular. This repair procedure will focus primarily on the “O” spur grommet and washer, but the technique can be applied to all types of grommets.

### **1.0 DISASSEMBLY:**

1.1 **GROMMET REPLACEMENT.** This is for replacing a damaged grommet or changing from brass to stainless steel.

1.2 Use the cutters to remove the grommet. If the grommet is set into a fabric/webbing base, fold the material back to expose the washer. Using the diagonal cutter, cut through the washer [Figure A] and then peel it back from the grommet [Figure B]. Grasp the grommet and peel it from the material.



## **2.0 REASSEMBLY:**

- 2.1 GROMMET REPLACEMENT. If the hole is intact and undamaged, simply insert the replacement grommet into the material from the correct side, and set with the grommet die. Make sure that the grommet is set sufficiently so that there is no exposed edge to snag lines or material.
- 2.2 MATERIAL REPAIR AND GROMMET REPLACEMENT. If, after removing the grommet, the fabric is damaged so that the grommet cannot be set properly, use the zigzag machine to stitch around the perimeter of the hole, reducing its size [Figure C].
  - 2.2.1 Take the basting tip and pass it through the hole, searing the material [Figure D]. This will solidify the frayed and raw edge of the damaged material.
  - 2.2.2 Set the grommet in the repaired hole [Figure E].



## **3.0 INSPECTION:**

- 3.1 Check the grommet orientation.
- 3.2 Grommet must be set tightly.
- 3.3 There should be no sharp edges on inside of grommet.



# Parachute Repair Procedure

**TITLE:** 7.2.3 Container Velcro® Replacement

**NUMBER OF PAGES:** 2

**APPLICABLE PRODUCTS:** Most parachute assemblies that use Velcro®.

**DESCRIPTION:** Main riser cover Velcro® replacement.

**AUTHORIZED REPAIRMEN:** FAA Senior or Master Parachute Rigger

**MATERIALS:** E thread—color to match  
Velcro®—color, width, and type to match

**MACHINES:** 301 Straight Stitch—Medium Duty 7-11 SPI

**EQUIPMENT:**

Scissors  
Seam ripper or scalpel  
Marking pencil  
6" ruler

## PROCEDURE

**Note:** The name Velcro® is a trade name for what is known as “pressure sensitive hook and loop fastener.” It is a commonly used material for closure systems. Before the advent of Velcro®, snaps and zippers were the preferred method of closing containers. Velcro® changed how the parachute industry designed products. In the late 1970s and early 1980s, there was a tendency to overdo the use of Velcro® and problems with durability and interaction with other materials became known. Since then, the use of Velcro® has been reduced to those applications where it is superior to other methods and can be easily replaced.

### **1.0 DISASSEMBLY:**

1.1 Identify the nature of the use of the Velcro®. Before you remove the piece, note how it is attached to the container. Some designs are such that several layers of construction have to be reversed to get to the location where the Velcro® was sewn on. If this is the case, the rigger may have to make a very expensive repair to replace a small piece of Velcro®.

### **2.0 REASSEMBLY:**

- 2.1 Cut the replacement Velcro® to size. Velcro® is normally scissor cut, not cut with a hot knife.
- 2.2 Position the Velcro® and stitch around the perimeter at .12" from the edge. For any pieces 1" in width or wider, sew a row of stitching down the center [Figure A]. This prevents the center from being pulled up from the material and loading the outside row of stitching [Figure B].
- 2.3 Some applications have the Velcro® sewn to a piece of tape for support. Again, if it is 1" or more wide, sew down the center to prevent lifting.
- 2.4 Depending on the application, the mating loop piece of Velcro® may be wider than the hook to provide additional protection. That is, the hook may be .75" wide and the loop 1" wide.



**3.0 INSPECTION:**

- 3.1 Check that thread tension is correct.
- 3.2 Verify orientation is correct.
- 3.3 Check that center stitching is used where needed.



# Parachute Repair Procedure

**TITLE:** 7.2.4 Container Plastic Stiffener Replacement

**NUMBER OF PAGES:** 2

**APPLICABLE PRODUCTS:** All types of containers which use plastic stiffeners.

**DESCRIPTION:** Replacement of damaged plastic stiffeners of all types.

**AUTHORIZED REPAIRMEN:** FAA Senior or Master Parachute Rigger

**MATERIALS:** E thread—color to match  
Grommets—size, type, and material to match  
Plastic stiffeners—type and thickness to match

**MACHINES:** 301 Straight stitch—Medium Duty 7-9 SPI  
308 Zigzag—Medium Duty 7-11 SPI

**EQUIPMENT:**

Scissors  
Seam ripper or scalpel  
Marking pencil  
6" ruler  
Grommet die set—Size to match grommets  
Leather mallet  
Grommet cutting board  
Hole punch to match grommet size  
Basting tip  
Diagonal wire cutters—8" minimum  
Heavy shears or tin snips  
Electric drill & 3/8" drill bit  
Feeler gauge—.010"

## PROCEDURE

**Note:** The term “plastic,” when used in conjunction for the materials used as stiffeners in modern parachute containers, is a misnomer. In reality, the composition of the material varies. The most common material used today is MDS nylon, molydisulfide nylon. In addition, Lexan®, a clear polycarbonate material and HDPE, high density polyethylene, are also used. The most common thicknesses used are .025", .040", and .060", which are standard commercial thicknesses commonly available.

Stiffeners are used primarily as backing for grommets to spread the load placed on closing flaps. Instead of focusing the load on the diameter of the grommet, it is spread out across the length of the stiffener, resulting in a smoother flap and container. Consequently, replacing plastic stiffeners almost always requires replacing the grommet as well. Usually the plastic breaks at the grommet location because the hole for the grommet is the weak point. The following procedure shows the replacement of the bottom main flap stiffener of a Javelin container.



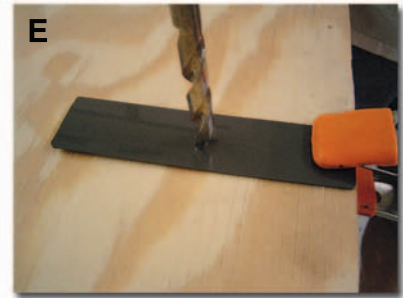
### **1.0 DISASSEMBLY:**

- 1.1 Unpick the stitching that holds the binding tape to the bottom flap [Figure A]. Remove the grommet.
- 1.2 Remove the stitching that holds the stiffener in position. Remove the stiffener.



## **2.0 REASSEMBLY:**

- 2.1 Use the original stiffener as a template to cut a new stiffener [Figure B]. While many of the older containers use HDPE or other materials, most of the newer designs use MDS nylon because of its superior properties. Because of this, many riggers use MDS exclusively for replacing any stiffeners.



- 2.1.1 Mark out the outline of the original stiffener on the MDS. Mark the center of the hole for the grommet very precisely.
- 2.1.2 Use the basting tip to mark the center of the hole for the grommet. Push the tip through the MDS until the shoulder of the tip makes an indentation in the MDS [Figures C, D, E]. This forms a pilot hole for the drill.
- 2.1.3 Using heavy shears or tin snips, cut the MDS nylon to shape. Clip the corners to remove the sharp ends and if the edges are sharp or rough, sand them with sandpaper.
- 2.1.4 Secure the MDS against a piece of wood and drill a 3/8" hole. While this hole may seem big for the shank of the grommet, when installed and the material is punched, it will be the right size. A common mistake is to make the hole too small and when the grommet is set, it cracks the plastic.
- 2.2 Insert the stiffener in between the layers of fabric of the bottom flap and let it float inside.
- 2.3 Baste the two layers of fabric together with the single needle.
- 2.4 Restitch the binding to the bottom flap [Figure F].
- 2.5 Slide the stiffener to the edge of the flap and align the hole in the stiffener with the hole in the fabric. Use an "O" grommet to align the holes [Figure G].
- 2.6 Stitch the stiffener in place as per the original installation.
- 2.7 Insert the grommet with the correct orientation, and set with the grommet set [Figure H]. Make sure that the grommet is set sufficiently so there is no exposed edge to snag the lines or material. Use the feeler gauge to check the gap under the edge of the grommet [Figure J]. It should be no more than .010". If more, hit the set again to tighten the grommet.



## **3.0 INSPECTION:**

- 3.1 Verify the stiffener backing is resewn.
- 3.2 Check the grommet orientation.
- 3.3 The grommet must be set tightly and measured.
- 3.4 There should be no sharp edges on the inside of the grommet.

# Parachute Repair Procedure

**TITLE:** 7.2.5 Main Container Side Flap Replacement

**NUMBER OF PAGES:** 2

**APPLICABLE PRODUCTS:** Most modern container systems.

**DESCRIPTION:** Replacement of a main container side flap.

**AUTHORIZED REPAIRMEN:** FAA Senior or Master Parachute Rigger

**MATERIALS:** E thread—color to match  
Ty-3 3/4" tape—color to match  
Replacement flap

**MACHINES:** 301 Straight Stitch—Medium Duty 5-9 SPI  
308 Zigzag—Medium Duty 7-11 SPI  
301 Double needle with tape folder 5-9 SPI  
1" x 42 stitch bar tack

**EQUIPMENT:**

Scissors  
Seam ripper or scalpel  
Marking pencil  
6" ruler  
Hot knife

## PROCEDURE

**Note:** The following technique is typical of many modern container systems. This procedure addresses only the disassembly of the container and replacement of the factory made part. It does not address the manufacture of a replacement part.

**1.0 DISASSEMBLY:**

- 1.1 Remove all extraneous parts from the harness/container assembly.
- 1.2 Open the bottom corner of the main container on the appropriate side.
- 1.3 It will be necessary to remove the Ty-3 binding tape on the inside seam joining the main body to the side flap. Depending on the container construction configuration, there are two options how to do this.
  - 1.3.1 Option 1, the salvage method. With this method, the binding tape is left undamaged and sewn back in place after replacing the flap. A slower method, but good if the rigger doesn't have the necessary replacement tape.
  - 1.3.2 Using a seam ripper, unpick the two rows of stitching that holds the side flap to the main container [Figure A]. Start at the lower corner and continue until approximately 2" past where the side flap joins the riser cover.
  - 1.3.3 Remove the side flap.
- 1.4 Option 2, the replacement tape method. With this method, the binding tape is destroyed during the removal process and replaced with new. A faster method, but new tape is required.



1.4.1 Use a hot knife to melt the stitching that holds the binding tape that attaches the side flap to the main container [Figure B]. When doing this, have the side of the tape that faces the damaged side flap facing up in case you slip so the wrong flap won't be damaged. Proceed to the point where the side flap stops. Trim the melted tape at this point.

1.4.2 Using a seam ripper, unpick the tape approximately 2" past the end of the side flap. Remove the side flap.

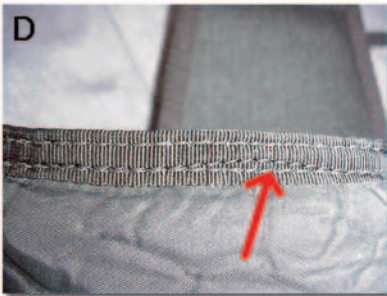


## **2.0 REASSEMBLY:**

2.1 Take the new flap and sew it in place on the main container starting approximately .38" from the corner [Figure C]. On this design and others like it, the lower end of the main riser cover is unstitched during removal of the main flap. When sewing the new flap in place, make sure that the side flap is sewn to the main container first and then the riser cover on top of it. Look at the opposite side to see which is on top and duplicate.

2.2 If option 1 was used, take the original binding tape, fold over the seam and sew in place with two rows of stitching. Note that there is a second row of stitching sewn directly on top of the inside row of stitching for reinforcement [Figure D]. This is very important.

2.3 If option 2 was used, it will be necessary to replace the binding tape with new. Stitch down the loose end of the binding tape at the top and then overlap the tape by approximately 2" using the double needle machine and tape binder [Figure E]. Overstitch the inside row for reinforcement.



2.4 Trim the bottom end of the binding tape at the corner.

2.5 Note that the junction of the side flap and riser cover is overstitched and reinforced as needed [Figure F].

2.6 Close the bottom of the container as per the original and reinforce as required.

## **3.0 INSPECTION:**

3.1 Check that the flap is installed correct side out.

3.2 Check the inside binding for reinforcing stitching.

3.3 The side flap/riser cover should be stitched and reinforced.

3.4 The container bottom must be closed correctly and reinforced.



# Parachute Repair Procedure

**TITLE:** 7.2.6 Bottom of Container (BOC) Pocket Replacement

**NUMBER OF PAGES:** 1

**APPLICABLE PRODUCTS:** Any main container with a BOC pocket configuration.

**DESCRIPTION:** Installation of a BOC pocket to the main container.

**AUTHORIZED REPAIRMEN:** FAA Senior or Master Parachute Rigger

**MATERIALS:** E thread—color to match

**MACHINES:** 301 Straight Stitch—Medium Duty 7-9 SPI  
308 Zigzag—Medium Duty 7-11 SPI

**EQUIPMENT:**

Scissors  
Seam ripper or scalpel  
Marking pencil  
T-Pins

## PROCEDURE

**Note:** The following technique is typical of many modern container systems. This procedure addresses only the disassembly of the container and replacement of a factory made replacement part. It does not address the manufacture of a replacement part. Depending on the size of the container assembly, it may be possible to do the replacement of the BOC pocket with the reserve packed. However, the smaller the system, the more difficult it will be. If the container cannot be placed under the machine, then remove the reserve canopy.

**1.0 DISASSEMBLY:**

- 1.1 Mark the location of the corners of the BOC pocket on the container with a marking pencil.
- 1.2 Open the lower right corner of the main container [Figure A].
- 1.3 Remove the old BOC pocket.



**2.0 REASSEMBLY:**

- 2.1 Locate the new BOC pocket on the container at the marks of the old pocket and pin in place with T-pins [Figure B].
- 2.2 Stitch around the perimeter of the pocket with the single needle machine. Backstitch at the corners for reinforcing [Figure C].
- 2.3 Restitch the corner of the main container as per the original configuration.



**3.0 INSPECTION:**

- 3.1 Check the orientation of the pocket with the opening to the right (unless for left-handed deployment).
- 3.2 Check the stitching and corner reinforcing.





# Parachute Repair Procedure

**TITLE:** 7.2.7 3-Ring Release Housing Replacement

**NUMBER OF PAGES:** 2

**APPLICABLE PRODUCTS:** All harness and container systems equipped with a 3-ring release system.

**DESCRIPTION:** Replacement of damaged or missing 3-ring release housings.

**AUTHORIZED REPAIRMEN:** FAA Senior or Master Parachute Rigger

**MATERIALS:** Nylon supertack  
3-ring housings of the correct length  
Heat shrink tubing—1/2" diameter  
Owner's Manual for the harness and container assembly, if available

**MACHINES:** None

**EQUIPMENT:**  
Scissors  
Seam ripper or scalpel  
Marking pencil  
6" ruler  
Hand tacking needle  
Heat gun  
Crimping tool (optional)

## PROCEDURE

**Note:** Replacement of the 3-ring housings may be necessary due to wear, damage, or stretching of the housings. Correct installation and tacking of the housings are important to ensure proper operation of the 3-ring release system.

### **1.0 DISASSEMBLY:**

- 1.1 Inspect the original installation to determine the exact routing of the housings. Some systems have dedicated channels and/or loops through which they are routed. In others, the housings are routed under or over back straps or reserve ripcord housings. If necessary, draw a diagram of the routing or take a picture so that the replacement housings are routed correctly.
- 1.2 Remove any tackings or clamps that hold the housings together and/or to the container. Remove the housings from the system.

### **2.0 REASSEMBLY:**

- 2.1 Install the replacement housings into their respective locations as per the original installation. Usually the longer housing is installed first and then the shorter one.
- 2.2 Make sure that the flat side of the housing terminal end is orientated outward so that it lays flat against the rear of the main riser when the 3-ring release is assembled correctly [Figure A].





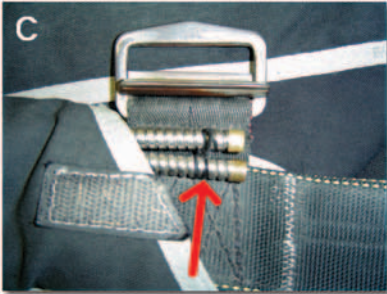
2.3 Align the handle end of the housings and secure as per the original installation. This may be with either a double clamp [Figure B] or hand tacking. Figure C shows a typical method of using supertack to secure the housings together.

2.4 If hand tacking is used, it is desirable to cover the tacking with heat shrink tubing. Place a length of tubing over the housing ends and shrink using the heat gun [Figure D].

2.5 Secure the double housing to the container/back pad or pocket assembly. Depending on the manufacturer, it may be necessary to provide a certain amount of “float” to the housings in order that the loop of the riser is not loaded or under tension when the main canopy is deployed. If available, consult the owner’s manual for correct positioning and tacking.

Some systems use a double clamp to secure the housings together as well as to the container or pockets. If these are used, inspect the clamp to make sure that it was not damaged when removing the housings and can be reused. Crimp the housings, making sure that the clamp is tight so the housings cannot work loose [Figure E].

2.6 Route the release cables through the housings to make sure there are no obstructions.



### **3.0 INSPECTION:**

3.1 Check for correct routing of the housings.

3.2 Verify correct orientation of the terminal ends.

3.3 Housings should be secured together at the handle ends.

3.4 Housings should be secured to the container/back pad or pockets with either clamps or supertack.

3.5 There should be sufficient slack or “float” in the housings.

3.6 Housings should be clear.



Harness repairs are almost always a major repair. Consequently, they are master rigger work. About the only repairs open to a senior rigger are replacement of ripcord pockets and Velcro®; and replacement of hand tackings for ripcords, comfort pads, 3-ring housings, and other hardware. Major harness repairs are the most critical maintenance operations a rigger can perform on a parachute assembly. Even seemingly innocuous repairs, if done incorrectly, can have fatal consequences. Depending on the type of harness design, repairs to the harness main lift web or leg straps involve major repair or remanufacture.

According to Title 14 of the Code of Federal Regulations subsections 65.129 (e) and (f), “No certificated parachute rigger may – (e) Pack, maintain, or alter a parachute in any manner that deviates from procedures approved by the Administrator or the manufacturer of the parachute; or (f) Exercise the privileges of his certificate and type rating unless he understands the current manufacturer's instructions for the operation involved...” In other words, because this operation is a major repair, the person doing the work must be a currently certificated master parachute rigger with the appropriate ratings.

In the past, many master riggers felt that they were empowered to undertake almost any task. The attitude was, “We can lift the TSO label, build a new harness, and put the TSO label back on.” This is not the case. Just because an individual has a master rigger license does not mean he or she is qualified to undertake a complex repair.

There are four primary areas of concern that need to be addressed in any repair program. They are:

1. Inspection, damage identification, and repair planning.
2. Teardown and cleanup.
3. Preparation and reconstruction.
4. Quality Control inspection and record keeping.

Main risers are components that are subject to extreme wear and tear. The only items that are practical for repair are the 3-ring locking loops and the toggle mounting/Velcro® assembly. Once the webbing begins to show wear, it is more practical to replace than repair them.

- 7.3 The following are repairs found in Section 3 of this chapter.
  - 7.3.1 Chest strap replacement
  - 7.3.2 Lower leg strap shortening
  - 7.3.3 Ripcord pocket Velcro® replacement
  - 7.3.4 Articulated upper leg hardware replacement
  - 7.3.5 Standard harness main lift web replacement
  - 7.3.6 Main riser 3-ring locking loop replacement
  - 7.3.7 Main riser steering toggle Velcro® replacement





# Parachute Repair Procedure

**TITLE:** 7.3.1 Chest Strap Replacement

**NUMBER OF PAGES:** 3

**APPLICABLE PRODUCTS:** Most standard harness configurations.

**DESCRIPTION:** Replacement of chest strap due to damage or for lengthening.

**AUTHORIZED REPAIRMEN:** FAA Master Parachute Rigger

**MATERIALS:** E thread  
5-cord nylon thread

**MACHINES:** 301 Straight Stitch—Medium Duty 7-11 SPI  
Heavy-duty harness machine—Singer 7-33 or equivalent—stitch length to match the original  
308 Zigzag—Medium Duty 7-11 SPI

**EQUIPMENT:**

- Scissors
- Seam ripper or scalpel
- Marking pencil
- Ruler
- Hot glue gun
- Hot knife

## PROCEDURE

**Note:** This procedure deals with the longer side of the chest strap, usually the left, which is threaded through the chest adapter or through an adjustable V-ring. Replacing the opposite side would mirror this process.

**1.0 DISASSEMBLY:**

- 1.1 Examine the chest strap/main lift web (MLW) junction to determine if the backpad needs to be removed from the harness to access the junction. If so, remove the pad from the harness to allow access to the junction [Figure A].
- 1.2 Many harnesses have the reserve ripcord housing located on the left side. The housing needs to be disconnected at this location. It is usually secured to a loop located at the chest strap junction. During the replacement process, this loop will be removed and may be reused if in good condition.
- 1.3 Remove the harness stitching and any other stitching from the junction making sure not to damage the main lift web [Figure B].



1.4 Remove the old chest strap webbing from the main lift web. Pay particular attention to the end of the webbing. While most chest straps are installed at right angles to the main lift web, some have an angle cut at the end for better fit. If the webbing has an angle, make sure to duplicate it.

1.5 Clean the junction area of old thread, as well as any glue residue on the inside of the main lift web.

1.6 Take the marking pencil and mark the points of the stitch pattern for the reassembly [Figure C]. Most chest straps are installed with a 3-point W-W in a horizontal orientation, but the rigger should duplicate the original design.



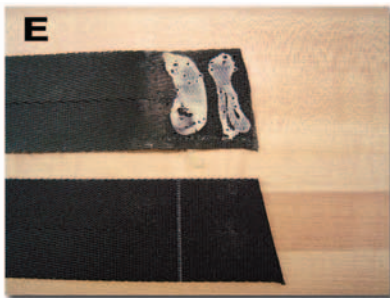
1.7 If the procedure is a replacement of a damaged chest strap, then it should be replaced to the original length. If so, then remove the rolled stop end so that the finished length may be determined. If the chest strap is to be lengthened, then an appropriate length of webbing will need to be determined. The finished length should be measured from the outside of the main lift web plus 3.50" [Figure D].

## **2.0 REASSEMBLY:**

2.1 Cut a piece of webbing to the appropriate length. If needed, cut the MLW end of the strap at an angle [Figure E].

2.2 Insert the end of the webbing into the MLW junction. Align the end of the chest strap with the outside edge of the MLW. Insert the housing loop back into the junction as well. Lightly glue the MLW to the chest strap [Figure F]. Do not use too much glue.

2.3 Some harnesses are pre-sewn along the edges with a medium duty machine and E thread. If so, duplicate this.

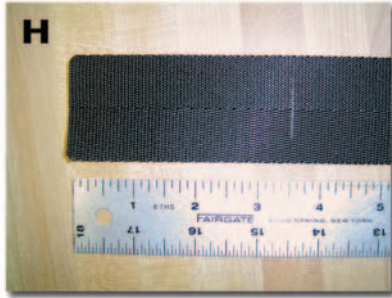


2.4 Using the harness machine and 5-cord nylon thread, sew the junction as marked with the original pattern [Figure G].

2.5 Mark the length of the chest strap to include enough needed for the stop end. If the chest strap is to be configured for a thread-thru adapter, an additional 3.50" will be needed for the roll back.

2.6 After determining the cut length, place a mark at 3.50" on the BACK side of the chest strap. Fold to this mark [Figure H] and then fold the webbing one more time for three layers [Figure J].

2.7 Using the zigzag machine, sew across the center of the stop end fold. This will result in a loose fold that will jam against the adapter in the event of slippage of the chest strap [Figure K].



- 2.8 If the MLW was attached to the backpad assembly, reattach as per the original configuration. If the backpad is attached in such a manner that does not allow inspection of the back side of the MLW, inspect the stitching at this time before reattaching the backpad.
- 2.9 Reinstall the ripcord housing and secure.
- 3.0 INSPECTION:**
- 3.1 Inspect the harness stitching for correct stitch length, tension, and appropriate pattern.
- 3.2 Reattach the MLW to the backpad as needed.
- 3.3 The stop end must be sewn and oriented correctly.
- 3.4 Verify the chest strap is the correct length.
- 3.5 The ripcord housing must be reinstalled and tacked.





# Parachute Repair Procedure

**TITLE:** 7.3.2 Lower Leg Strap Shortening

**NUMBER OF PAGES:** 2

**APPLICABLE PRODUCTS:** All harness configurations.

**DESCRIPTION:** Shortening of the lower leg straps.

**AUTHORIZED REPAIRMEN:** FAA Master Parachute Rigger

**MATERIALS:** 5-cord nylon thread—color to match original

**MACHINES:** Heavy-duty harness machine—Singer 7-33 or equivalent 5-7 SPI

**EQUIPMENT:**

Seam ripper or scalpel

Marking pencil

Ruler

Hot knife

## PROCEDURE

**Note:** The shortening of the leg strap, while a relatively straightforward process, is an extremely important procedure. If done improperly, it could result in the harness fitting improperly or the leg straps to come unthreaded and the user to fall out during opening.

**1.0 DISASSEMBLY:**

1.1 If the leg strap is of the thread-thru configuration, unthread the webbing from the leg adapter. If the leg strap has an adjustable “V” ring used in conjunction with a snap, disconnect the “V” ring from the snap. Lay the leg strap out flat.

1.2 Remove the harness stitching from the rolled end of the webbing.

1.3 Measure the required distance from the end of the strap that is required for shortening and mark accordingly [Figure A].

1.4 Trim the webbing at the mark using the hot knife.



**2.0 REASSEMBLY:**

2.1 For the thread-thru configuration, place a mark at 3.50" from the end of the webbing on the bottom of the webbing [Figure B]. This will be the “fold to” mark for the first fold of the webbing. Fold one more time for a total of three layers of webbing [Figure C].

2.2 Sew the rolled stop end according to Figure D with the harness machine.



2.3 For the “V” ring configuration, place a mark at 2.00" from the top end of the webbing. This will also be the “fold to” mark for the first fold. Make two additional folds for a total of four layers.

2.4 Sew the rolled stop end according to Figure E with the harness machine.



**3.0 INSPECTION:**

3.1 Check the stitching for the correct pattern and thread tension.

3.2 For the thread-thru configuration, make sure there is no twist to the leg strap and thread the webbing through the leg adapter. The rolled end should face outward.

3.3 For the “V” ring configuration, connect the “V” ring to the snap. The rolled stop end should also face outward.



# Parachute Repair Procedure

**TITLE:** 7.3.3 Ripcord Pocket Velcro® Replacement

**NUMBER OF PAGES:** 2

**APPLICABLE PRODUCTS:** Any harness configuration with a Velcro® style ripcord pocket configuration.

**DESCRIPTION:** Replacement of the Velcro® of the ripcord pocket.

**AUTHORIZED REPAIRMEN:** FAA Senior or Master Parachute Rigger

**MATERIALS:** E thread—color to match original  
Hook and loop Velcro®—width and length to match original

**MACHINES:** 301 Straight Stitch—Medium Duty 7-11 SPI  
308 Zigzag—Medium Duty 7-11 SPI

**EQUIPMENT:**

Scissors  
Seam ripper or scalpel  
Marking pencil  
6" ruler  
Glue gun

## PROCEDURE

**1.0 DISASSEMBLY:**

1.1 Depending on the configuration, it may be necessary to remove the ripcord housing from its attachment point on the harness for access to the pocket. If the harness is attached to the backpad, disconnect this as well.

1.2 Remove the E thread stitch pattern that forms the pocket on the main lift web (MLW) [Figure A].

1.3 Mark the ends of the old Velcro® and remove from the inside of the webbing. Note which side of the webbing the hook and loop are located.



**2.0 REASSEMBLY:**

2.1 Cut the replacement Velcro® to the correct length.

2.2 Glue the Velcro® pieces to their respective locations on the inside of the webbing.

2.3 Using the single needle machine, sew around the perimeter of the Velcro® as well as a row of stitching down the center [Figure B]. Repeat for the opposite side.



2.4 Resew the pocket with two rows of single needle stitching with E thread [Figure C].



- 2.5 Reattach the harness to the backpad.
- 2.6 Reinstall the ripcord housing to the harness.

**3.0 INSPECTION:**

- 3.1 Verify the correct orientation of the Velcro® in the pocket.
- 3.2 The correct stitch pattern must be used for the Velcro®.
- 3.3 Verify the ripcord pocket is re sewn.
- 3.4 The backpad must be reattached (if needed).
- 3.5 The ripcord housing must be reinstalled.

# Parachute Repair Procedure

**TITLE:** 7.3.4 Articulated Upper Leg Hardware Replacement

**NUMBER OF PAGES:** 2

**APPLICABLE PRODUCTS:** Most articulated harness configurations.

**DESCRIPTION:** Replacement of the upper leg strap hardware.

**AUTHORIZED REPAIRMEN:** FAA Master Parachute Rigger

**MATERIALS:** E thread—color to match  
 5-cord nylon thread—color to match  
 Ty-8 webbing—color to match  
 Ty-12 webbing  
 Ty-4 1" tape  
 Replacement adapter—MS-22040

**MACHINES:** 301 Straight Stitch—Medium Duty 7-11 SPI  
 308 Zigzag—Medium Duty 7-11 SPI  
 Heavy-duty harness machine, Singer 7-33 or equivalent, stitch to match the original.

**EQUIPMENT:**  
 Scissors  
 Seam ripper or scalpel  
 Marking pencil  
 Ruler  
 Glue gun  
 4-point W-W pattern template

## PROCEDURE

**Note:** The following procedure is required when the knurling on the friction bar has worn to the point that the leg strap would slip on opening. In addition, the webbing at the ring location shows wear and is replaced at the same time. This procedure is typical for a Flexon and Talon 2 articulated harness configuration.

### 1.0 DISASSEMBLY:

- 1.1 Remove the leg pad assembly.
- 1.2 Remove the leg strap by cutting the webbing.

### 2.0 REASSEMBLY:

- 2.1 Use Figure A to cut a replacement leg strap and parts.

5	5010 RING	1	RW-0	---
4	ADJUSTABLE ADAPTER	1	MS-22040	---
3	RING BUFFER	1	TY-4	3.00"
2	ADAPTER BUFFER	1	TY-12	3.25"
1	UPPER LEG STRAP	1	TY-8	10.50"
NO.	DESCRIPTION	REQD	MATERIAL	SIZE

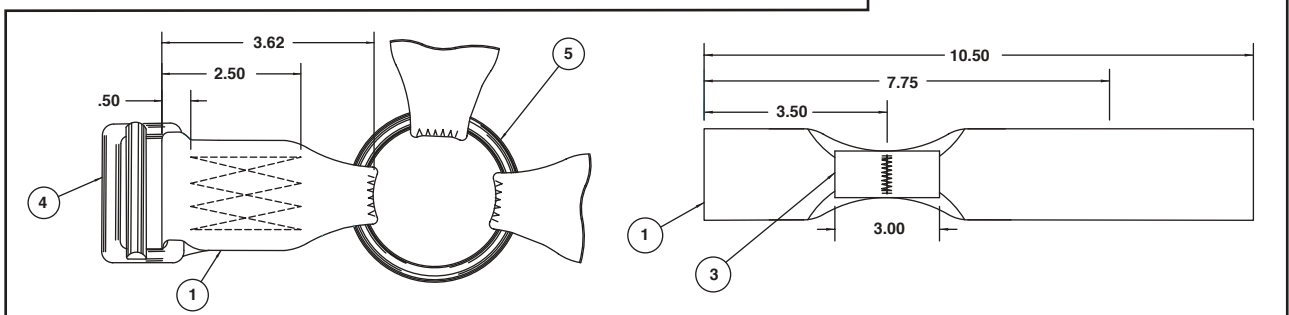
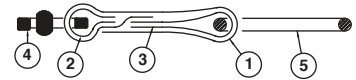


Figure A



2.2 Take the Ty-8 webbing and sew a bowtie fold with the Ty-4 tape buffer at the 3.50" mark [Figure B].

2.3 Turn the adapter upside down and install the Ty-8 webbing as shown and glue in place [Figure C].

2.4 Install the bowtie around the ring and glue in place [Figure D]. The picture shows the inside orientation of the harness.

2.5 Double check the correct orientation of the hardware [Figure E].



2.6 Mark the stitch pattern [Figure F].

2.7 Sew the webbing with the harness machine in a 4-point W-W pattern [Figure G].

2.8 Reinstall the leg pad. Route the upper pad flap through the adapter from the bottom [Figure H] and zigzag.



2.9 Fold the bottom pad under and zigzag in place [Figure J]. Note that the ends of the upper and lower pads are offset to reduce the thickness to be sewn.

### **3.0 INSPECTION:**

3.1 Verify the hardware orientation is correct.

3.2 Verify the stitch pattern is correct.

3.3 The leg pad must be reinstalled correctly.



# Parachute Repair Procedure

**TITLE:** 7.3.5 Standard Harness Main Lift Web Replacement

**NUMBER OF PAGES:** 5

**APPLICABLE PRODUCTS:** Most standard harness configurations.

**DESCRIPTION:** Complete replacement of one side of a standard harness main lift web.

**AUTHORIZED REPAIRMEN:** FAA Master Parachute Rigger

**MATERIALS:**

E thread—color to match	Ty-4 1" tape—color to match
5-cord nylon thread—color to match	Ty-3 tape—color to match
Ty-7 webbing—color to match	1 1/2" Velcro®—hook and loop
Ty-8 webbing—color to match	1" Velcro®—hook and loop
Ty-12 webbing—color to match	

**MACHINES:**

- 301 Straight Stitch—Medium Duty 7-11 SPI
- 308 Zigzag—Medium Duty 7-11 SPI
- Heavy-duty harness machine—Singer 7-33 or equivalent 5-7 SPI

**EQUIPMENT:**

Hot knife and cutting glass	Marking pencils
Hot glue gun	Scissors and thread snips
Measuring rulers: 6", 18", and 36"	Exacto® knife or scalpel
Sewing pattern templates	Hemostats

**BACKGROUND.** The following steps provide an overview of the procedure to follow.

**STEP ONE.**

The first thing the rigger must do is to inspect the parachute harness to identify the make and model and determine the extent of the damage. In some cases, particularly for older designs, it may not be practical or economically feasible to repair the harness. If the rigger determines that repair is practical, he/she must then establish a repair plan for the project. There are two reasons for this. One, that the project is done logically and efficiently. And two, if not having done this type of repair before, having contacted the manufacturer for guidance, the rigger can explain what he/she intends to do to effect the repair.

The rigger must make detailed measurements of the harness. Figure A shows a typical harness configuration and the needed dimensions. On a situation where one side of the harness is intact and can be used for reference, the rigger still needs dimensions to work against to determine how much material to order or bill to the job. If both sides of the harness are damaged, great care must be taken to ensure the correct measurements of the final repair.

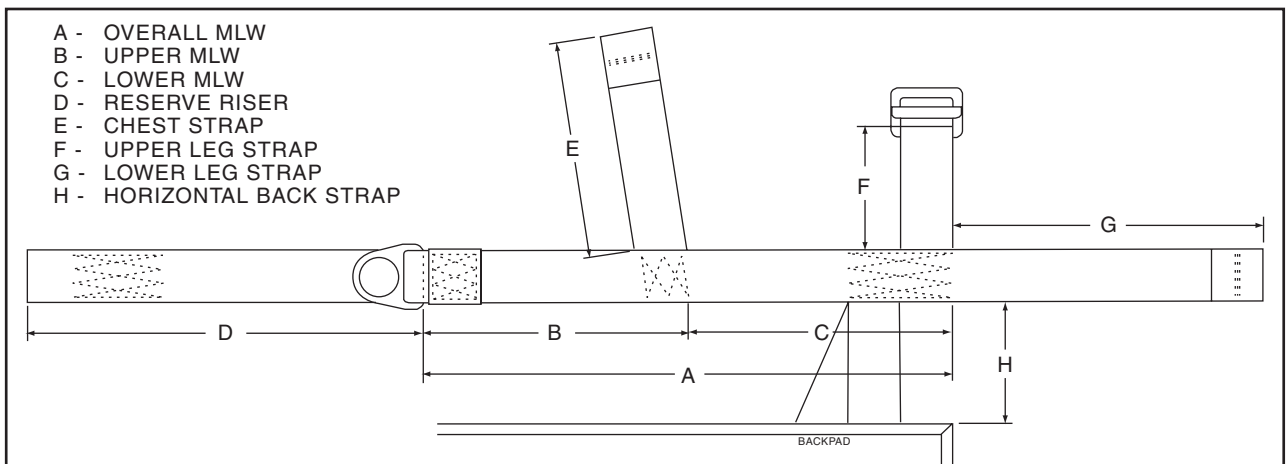


Figure A

## STEP TWO.

Teardown and cleanup is the second most important part of the process. It is important that all the old thread, glue, and damaged webbing are removed. Leaving any of these in place and sewing over them will result in a poor appearance. Also, it is not uncommon to find additional damage or wear at this point that was not identified during the initial inspection process.

## STEP THREE.

After the teardown and cleanup, the replacement webbing can be measured, cut, and pre-sewn in preparation for installation to the harness assembly. The construction sequence is followed. In certain cases, it may be desirable to replace not just damaged parts but worn ones to give the final result a more cosmetic appearance. An example is when replacing a main lift web, it does not look good to reuse the old chest strap webbing when the main lift web is new material.

## STEP FOUR.

After the repair is completed, a thorough quality control program is undertaken. This is especially critical in a situation where the rigger is working alone and there is no one to rely on for cross-checking the work. All the critical points of the repair must be identified and checked as well as the finished dimensions.

# PROCEDURE

---

## **1.0 DISASSEMBLY:**

- 1.1 Remove all housings, leg pads, and any other parts that may interfere with the work from the harness.

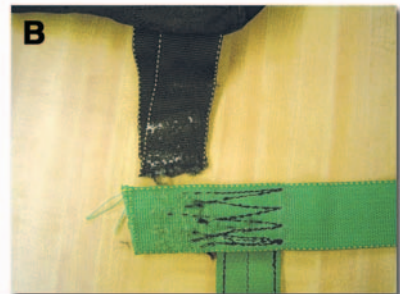
Disassemble the leg strap/horizontal back strap junction [Figure B].

Disconnect the upper main lift web (MLW) from the yoke portion of the backpad if necessary.

- 1.2 Disassemble the junction of the diagonal back strap and main lift web at the 3-ring attachment point [Figure C]. Be very careful not to damage the diagonal back strap. If it is damaged, it is a major project to replace this on most assemblies.

- 1.3 Lay out the main lift web assembly and check the measurements against the initial dimensions. Check against the opposite side MLW for symmetry.

- 1.4 If this side of the harness has a TSO or identification label attached, carefully remove it for use on the new assembly. If it is damaged, it may be necessary to get a new label to replace it. Contact the manufacturer for guidance. They may require the rigger to return the old label in exchange for a new one.



## **2.0 REASSEMBLY:**

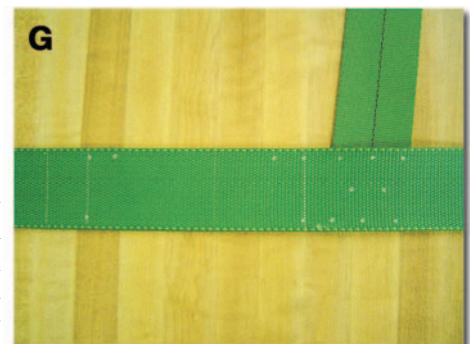
- 2.1 Note that this configuration consists primarily of two main pieces of webbing. The front MLW is TY-7 webbing and the rear is TY-8.
- 2.2 Measure the new webbing for the main lift webs. Add 5" for the riser end fold back and allow at least 6" extra for shrinkage. While this may sound like a lot, nothing is more discouraging than to get to the end of the project and find that the webbing is short by an inch or two. A couple inches of scrap is a small price to pay at this point.





- 2.3 Starting at one end of the webbing, measure the riser end configuration. Fold back and glue in place. If there is a toggle stow loop on the old harness, do not forget to glue in place before sewing [Figure D]. Mark the 4 point W-W pattern and sew with the harness machine and 5-cord nylon thread.
- 2.4 Install the steering line guide ring with a duplicate stitch pattern as per the original [Figure E]. In some instances, the manufacturer may have used a special bar tack or other stitch pattern to attach the ring. If the rigger does not have the same machine, it will be necessary to contact the manufacturer for an acceptable alternative. This should have been identified in phase one. Check the distance from the end of the riser to the top of the ring. The industry standard is 4", but there may be special dimensions for some applications.
- 2.5 Install the toggle Velcro® keepers as per the original [Figure F]. Complete any other sewing needed such as the end of the toggle stow loop.
- 2.6 If needed, reattach the TSO label at the appropriate location. If the label is the original one and is made from material such as Ty-vek®, try to follow the original needle holes to avoid perforating the material. Too many holes will cause the label to tear out.
- 2.7 Working from the measurement diagram in Figure A, mark the location of the 3-ring.
- 2.8 Working downward, mark the location of the chest strap, the ripcord pocket, and the bottom of the upper leg strap [Figure G]. NOTE: It will be necessary to allow for a certain amount of shrinkage during the sewing process. There will be four areas of shrinkage to allow for:
  1. The harness stitching at the 3-ring.
  2. The harness stitching at the chest strap.
  3. The ripcord pocket.
  4. The harness stitching at the leg strap junction.

The standard rule of thumb for the sum of these patterns is approximately .75" for the length. In other words, the marked length of the MLW should be .75" longer than the desired finished length. Most of the shrinkage will be in the ripcord pocket and the leg strap junction. If the rigger has not done this operation before, he/she may want to build a sample MLW to check the measurements and the resultant shrinkage.



- 2.9 Sew the Velcro® in place for the ripcord pocket [Figure H].
- 2.10 Glue the chest strap in place. In this instance, don't forget the housing loop.
- 2.11 Using the single needle, pre-sew the front and rear main lift webs. Use of the sewing pattern in Figure J will accomplish this and at the same time will create the ripcord pocket. Sew the chest strap 3-point W-W with the harness machine [Figure K].

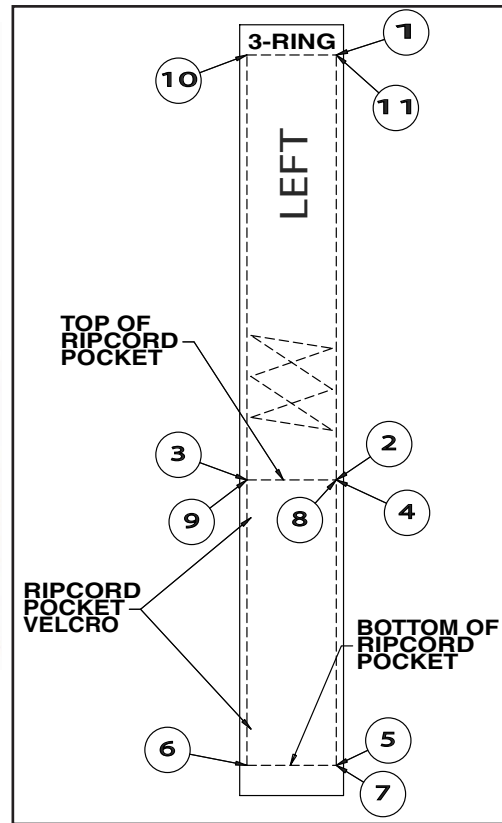
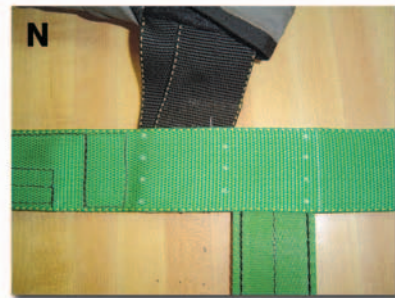


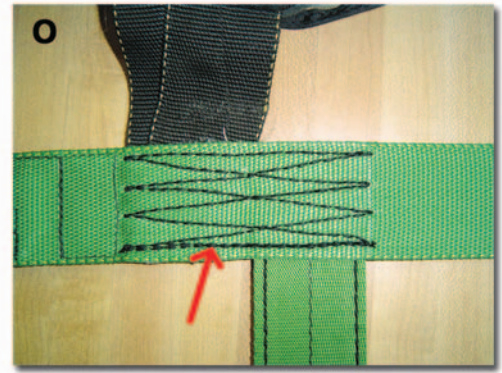
Figure J

- 2.12 Reassemble the upper diagonal back strap and the 3-ring hardware by threading the rear riser through the large ring followed by the front riser.



- 2.13 Position the 3-ring at the mark on the main lift web and glue in place. Install the Ty-12 confluence wrap below the 3-ring and mark the 4-point W-W pattern [Figure L].
- 2.14 Sew the confluence wrap with the harness machine [Figure M].
- 2.15 Re-create the leg junction. Glue the upper leg strap in place first and then the horizontal back strap second [Figure N].

2.16 Mark the 4-point W-W and then sew with the harness machine. Start the stitch pattern at the front side of the MLW and complete with the overstretch the full length of the pattern [Figure O]. This will provide additional reinforcing at the upper leg strap/MLW location.



2.17 Measure the length of the lower leg strap allowing 3.50" for the rolled stop end. Trim to length and then install the stop end with the harness machine.

2.18 Reattach the backpad to the upper MLW using the 308 zigzag machine.

2.19 Reinstall the leg pads using the 308 zigzag machine.

2.20 Reinstall the ripcord and 3-ring housings and hand tack in place.

**3.0 INSPECTION:**

3.1 Check the finished dimensions against the original dimensions in Figure A. If only one side has been replaced, check the new MLW against the opposite side for comparison. The generally accepted tolerances for this type of construction are  $\pm .25"$ . In particular, reserve riser length and the overall MLW length are the most important. If either of these are mismatched to their opposites, then the flight of the canopies may be affected.

3.2 Start inspecting from the riser end working down. Use the inspection chart in Figure P as a guide for the inspection points.

After the inspection, all appropriate paperwork must be completed. This includes the rigger's logbook, the packing data card for the parachute, and any shop or business forms or log.

HARNES INSPECTION			
CHECK	INSP	DATE	INSPECTION POINTS
			1. COLOR
			2. SIZING: RISERS, MLW, CHEST, LEG STRAP, HZ
			3. 3-RING SIZE
			4. LEG HARDWARE- ORIENTATION, TYPE
			5. RESERVE RISER ENDS- 4-PT W-W, GUIDE RINGS, TOGGLE STOW LOOPS
			6. CHEST STRAP - 3-PT W-W EA SIDE
			7. ARTICULATED HARNES RING JUNCTION- BUFFERS
			8. UPPER LEG STRAP- 4-POINT W-W, BUFFERS, HARDWARE ORIENTATION
			9. LOWER LEG STRAP- STITCH PATTERN, BUFFERS, STOP END
			10. TSO LABEL AND ORIENTATION
			11. HARNES STITCHING- SPI, BACKSTITCH, STOP ENDS, TENSION
			12. RIPCORD POCKET- PRESENT, SECURE FIT

Figure P





# Parachute Repair Procedure

**TITLE:** 7.3.6 Main Riser 3-Ring Locking Loop Replacement

**NUMBER OF PAGES:** 2

**APPLICABLE PRODUCTS:** All 3-ring riser assemblies.

**DESCRIPTION:** Replacement of the 3-ring riser locking loop.

**AUTHORIZED REPAIRMEN:** FAA Senior or Master Parachute Rigger

**MATERIALS:** E thread  
5-cord nylon thread—color to match  
Ty-IIa nylon cord or equivalent

**MACHINES:** 308 Zigzag—Medium Duty 10 SPI  
Heavy-duty harness machine—Singer 7-33 or equivalent

**EQUIPMENT:**

Scissors  
Seam ripper or scalpel  
Marking pencil  
6" ruler  
Glue gun  
Hot knife

## PROCEDURE

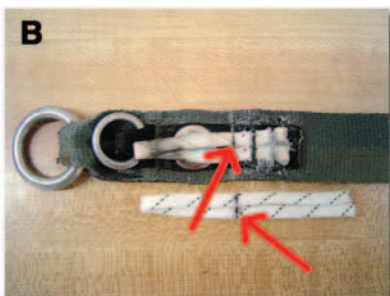
**1.0 DISASSEMBLY:**

- 1.1 Mark the locking loop at the bottom edge of the confluence wrap [Figure A].
- 1.2 Place a mark at the bottom of the confluence wrap and carefully remove the confluence wrap from the riser.
- 1.3 Remove the old locking loop.



**2.0 REASSEMBLY:**

- 2.1 Cut a new loop the length of the old one plus 2.00".
- 2.2 Fold the new loop in half and lay alongside the old loop. Transfer the marks from the old loop to the new one [Figure B].
- 2.3 Align the marks on the loop with the mark at the bottom of the confluence wrap on the riser [Figure C]. Glue the loop in place.
- 2.4 Sew the loop with the 308 zigzag machine [Figure D]. Set the stitch width at approximately 1/8" and 10 SPI.



- 2.5 Trim the excess loop off at the top [Figure E].
- 2.6 Reinstall the confluence wrap using the harness machine [Figure F].

**3.0 INSPECTION:**

- 3.1 Before installing the confluence wrap, make sure the zigzag stitching is complete.
- 3.2 The loop length should be the same as the old loop.
- 3.3 The confluence wrap must be reinstalled.





# Parachute Repair Procedure

**TITLE:** 7.3.7 Main Riser Steering Toggle Velcro® Replacement

**NUMBER OF PAGES:** 1

**APPLICABLE PRODUCTS:** Most main risers with a Velcro® toggle installation.

**DESCRIPTION:** Replacement of the Velcro® toggle keeper on main risers.

**AUTHORIZED REPAIRMEN:** FAA Senior or Master Parachute Rigger

**MATERIALS:** E thread  
Velcro® of the appropriate width and type

**MACHINES:** 301 Straight Stitch—Medium Duty 7-11 SPI

**EQUIPMENT:**  
Scissors  
Seam ripper or scalpel  
Marking pencil  
6" ruler

## PROCEDURE

**NOTE:** The term “Velcro®” is used in a generic fashion for hook and loop fastener. While the rigger should replace the Velcro® to match the original configuration, this installation has proven superior for its holding ability and the secure line stow configuration.

### **1.0 DISASSEMBLY:**

1.1 Mark the location of the old Velcro® [Figure A].

1.2 Remove the old Velcro®.



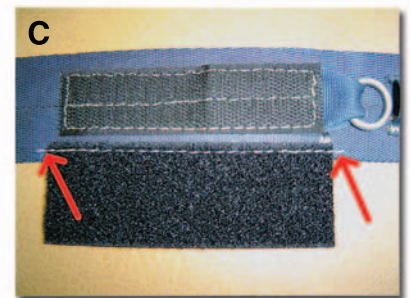
### **2.0 REASSEMBLY:**

2.1 Cut a new piece(s) of Velcro® to match the original.

2.2 Position the Velcro® to the original location.

2.3 Sew the hook Velcro® with a single needle machine. Sew an additional row of stitching down the center of the Velcro® [Figure B]. This keeps the center from lifting during use and tearing out the edge stitching.

2.4 Position the loop line stow Velcro® to match the hook and sew along the edge, over stitching the ends [Figure C].



### **3.0 INSPECTION:**

3.1 Check that the location of Velcro® is the same as the original.

3.2 Check stitch patterns and center stitching.





Accessory components are comprised of the reserve pilot chute, reserve deployment bag or device, main deployment bag, main pilot chute and bridle, main and reserve toggles, reserve static line (RSL) lanyard, 3-ring release handle, and reserve ripcord.

The reserve components generally do not suffer much wear due to their infrequent use. In addition, with their frequent inspection during the repack cycle, any necessary repairs become obvious and are taken care of before they become major problems.

1. Metal ripcords usually are not repairable and must be replaced when they are damaged.
2. Reserve pilot chutes experience torn mesh, minor canopy damage, broken hand tackings, and damaged grommets in the cap.

The reserve free bag may have the grommets in the closing flap pull out of the material. The high-drag bridle is a critical area and is usually not repairable.

The RSL lanyard is another critical item that is usually not repairable, except for the replacement of a defective snap shackle.

Main components, on the other hand, are subject to extensive wear and tear. Most jumpers do not take time to inspect their main components on a regular basis and generally operate on a “repair as broken” basis. By the time the rigger sees the components, it is easier and more cost effective to replace than to repair them. However, there are regular wear trends that the rigger can make their customers aware of so they can look for them and have them taken care of.

7.4 The following are repairs to accessory components, found in Section 4 of this chapter.

- 7.4.1 Reserve pilot chute repair—Mesh, tackings, and bad grommet
- 7.4.2 Reserve free bag repair—Grommet pullout
- 7.4.3 Main pilot chute repair—Top canopy reinforcing
- 7.4.4 Main pilot chute collapsible bridle replacement
- 7.4.5 Main deployment bag repair—Closing flap grommet pullout





# Parachute Repair Procedure

**TITLE:** 7.4.1 Reserve Pilot Chute Repair – Mesh, Tackings, and Bad Grommet

**NUMBER OF PAGES:** 2

**APPLICABLE PRODUCTS:** Most reserve pilot chutes.

**DESCRIPTION:** Replacement of cap grommet.

**AUTHORIZED REPAIRMEN:** FAA Master Parachute Rigger

**MATERIALS:** Nylon supertack  
Stainless steel sheet grommet—same as original

**MACHINES:** N/A

**EQUIPMENT:**

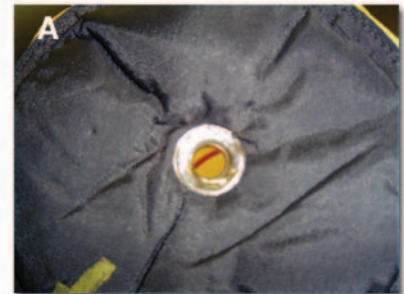
Scissors  
Seam ripper or scalpel  
Hand tacking needle  
Grommet set  
Diagonal cutters

## PROCEDURE

**Note:** The canopy fabric portion of a reserve pilot chute would be repaired as necessary with similar patching techniques as used on a canopy. The mesh portion, however, may be subject to different techniques. Another area of common damage is the thru grommet in the top of the pilot chute. The following procedure describes the replacement of the grommet in the top of the pilot chute. Figure A shows a damaged grommet.

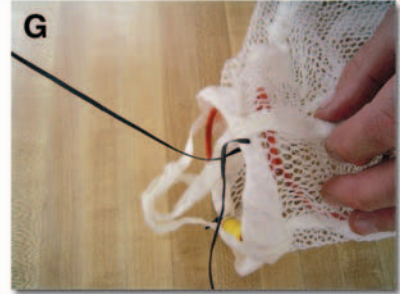
### **1.0 DISASSEMBLY: Grommet replacement.**

- 1.1 Remove the hand tackings used to secure the base of the pilot chute to the spring [Figure B].
- 1.2 Turn the pilot chute upside down and push the canopy down until the grommet is exposed [Figure C].
- 1.3 Using diagonal cutters, remove the damaged grommet being careful not to damage the fabric of the cap [Figure D].



**2.0 REASSEMBLY:**

- 2.1 Using the handset, set a new grommet. Be careful not to catch any fabric during the process [Figure E].
- 2.2 Reposition the canopy over the spring. Grasp the skirt at the bottom end of the spring. Make sure that the radial tapes run directly from the bottom to the cap in a straight line [Figure F]. If the tapes “barberpole” around the spring, the pilot chute may not inflate properly on launch.
- 2.3 Hand tack the bottom of the canopy to the bottom of the spring [Figure G].



**3.0 INSPECTION:**

- 3.1 Verify the grommet is secure.
- 3.2 Tapes should be straight.
- 3.3 Tackings should be secure.

**4.0 DISASSEMBLY: Mesh repair.**

- 4.1 Remove the tackings used to secure the base of the pilot chute to the spring.
- 4.2 For small holes, turn the mesh inside out and zigzag the edges together.

**5.0 REASSEMBLY:**

- 5.1 Reattach the bottom of the pilot chute to the spring with hand tacking.

**6.0 INSPECTION:**

- 6.1 Tapes should be straight.
- 6.2 Tackings should be secure.



# Parachute Repair Procedure

**TITLE:** 7.4.2 Reserve Free Bag Repair – Grommet Pullout

**NUMBER OF PAGES:** 2

**APPLICABLE PRODUCTS:** Most reserve free bags.

**DESCRIPTION:** General repair to the reserve free bag.

**AUTHORIZED REPAIRMEN:** FAA Master Parachute Rigger

**MATERIALS:** E thread  
1 1/2" Ty-3 tape  
Grommets to match the original type and size

**MACHINES:** 301 Straight Stitch—Medium Duty 7-11 SPI

**EQUIPMENT:**

Scissors  
Seam ripper or scalpel  
Marking pencil  
6" ruler  
Hot knife  
Grommet set  
Hole punch

## PROCEDURE

**Note:** Most reserve free bag designs are fairly robust. The most common types of damage seen are the pulling out of the grommets in the tongue of the bag [Figure A] and tearing out of fabric from the binding tape due to overstressing during packing. Damage to the bridle portion of the free bag is generally not repairable nor allowed by most manufacturers. Consequently, any damage in this area would necessitate the replacement of the bag. The following procedure deals with the repair of the tongue area and replacement of the grommets.

**1.0 DISASSEMBLY:**

- 1.1 Remove the grommets from the tongue [Figure B].
- 1.2 Remove the binding from the tongue area by unpicking the stitching [Figure C].

**2.0 REASSEMBLY:**

- 2.1 Cut two pieces of 1 1/2" Ty-3 tape and overlay them on each side of the damaged area. Sew around the edges of the tape and down the center to secure it [Figure D].



- 2.2 Trim the ends of the tape to match the shape of the tongue.
- 2.3 Using the single needle machine, reapply the binding tape around the edge of the tongue [Figure E].
- 2.4 Punch new holes over the exact position as the original ones [Figure F].
- 2.5 Insert new grommets [Figure G].



**3.0 INSPECTION:**

- 3.1 Reinforcing tape must be secure.
- 3.2 Binding must be resewn.
- 3.3 Grommets must be set and secure.

# Parachute Repair Procedure

**TITLE:** 7.4.3 Main Pilot Chute Repair – Top Canopy Reinforcing

**NUMBER OF PAGES:** 1

**APPLICABLE PRODUCTS:** Most main hand deploy pilot chutes.

**DESCRIPTION:** Repair of the apex area of a hand deploy pilot chute.

**AUTHORIZED REPAIRMEN:** FAA Senior or Master Parachute Rigger

**MATERIALS:** E thread  
3/4" Ty-3 tape

**MACHINES:** 301 Straight Stitch—Medium Duty 7-11 SPI

**EQUIPMENT:**

Scissors  
Seam ripper or scalpel  
Marking pencil  
6" ruler  
Hot knife

## PROCEDURE

**Note:** Most repairs of the main pilot chute consist of fabric or mesh repairs and may be repaired similar to canopy procedures. The most common damage seen on main pilot chutes is in the area of the apex and the hand deploy handle [Figure A]. This area is subject to fairly severe stress and strain. The following procedure deals with the apex area repair. It should be noted that if the repair is too complex, it's probably more cost effective to replace rather than repair the pilot chute.

**1.0 DISASSEMBLY:**

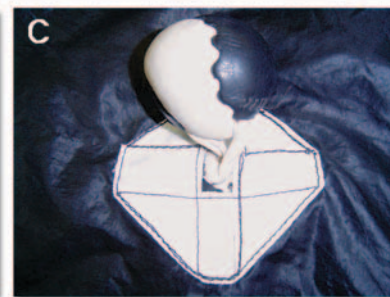
1.1 Working through the hole in the base, turn the pilot chute inside out. Unpick the seam at the junction of the canopy and mesh and between two of the radial tapes [Figure B]. This will allow good access to the apex area.



**2.0 REASSEMBLY:**

2.1 Take a piece of 3/4" Ty-3 tape and overlay the reinforcing material at the apex, covering the damaged area [Figure C].

2.2 Resew the canopy and mesh panels as per the original. Turn the pilot chute right side out.



**3.0 INSPECTION:**

3.1 Damaged area must be covered.

3.2 Canopy seam must be restitched correctly.





# Parachute Repair Procedure

**TITLE:** 7.4.4 Main Pilot Chute Collapsible Bridle Replacement

**NUMBER OF PAGES:** 3

**APPLICABLE PRODUCTS:** Most kill-line pilot chute bridle configurations.

**DESCRIPTION:** Replacement of the bridle of a kill-line collapsible pilot chute.

**AUTHORIZED REPAIRMEN:** FAA Senior or Master Parachute Rigger

**MATERIALS:** E thread  
Replacement bridle

**MACHINES:** 301 Straight Stitch—Medium Duty 7-11 SPI  
1" x 42 stitch bar tack  
308 Zigzag—Medium Duty 7-11 SPI [Optional]

**EQUIPMENT:**

Scissors  
Seam ripper or scalpel  
Green felt tip marker  
6" ruler  
Hemostats  
Pony clamp  
Hot glue gun

## PROCEDURE

**Note:** There are three basic main bridle configurations: One, a standard non-collapsible bridle. Two, a bungee collapsible bridle. Three, a centerline or “kill-line” collapsible bridle. The standard bridle is a simple design and any damage usually results in the replacement of the bridle. The exception to this is if the tape attaching the curved pin is worn. The replacement of the tape is a simple task. The most common bridle in use today is the kill-line collapsible type. The replacement of the bridle is described in the following procedure.

**1.0 DISASSEMBLY:**

1.1 Remove the old bridle from the pilot chute [Figure A].

**2.0 REASSEMBLY:**

2.1 Thread the loop ends of the bridle through the bottom support tapes of the pilot chute [Figure B].

2.2 Glue the ends in place with the glue gun [Figure C].

2.3 Bar tack the bridle along the sides. Do not capture the centerline [Figure D].



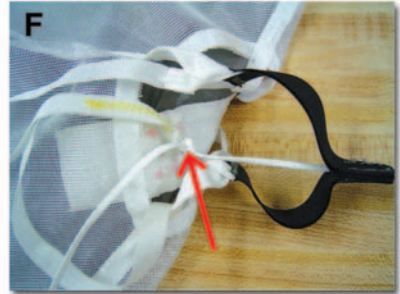
2.4 Align the bridle tapes on the center of the pilot chute attachment tapes and bar tack in place [Figure E].



2.5 Check the trim of the pilot chute centerline. When the centerline is taut, the apex should be even with or no more than 1" below the skirt of the canopy.

2.6 Anchor the bag end of the pilot chute at the bag stop. Grasp the Spectra® centerline and pull to “cock” the bridle.

2.7 Route the free end of the Spectra® centerline up through the center of the pilot chute and through the loop of the pilot chute centerline at the apex. Grasp the handle of the pilot chute and apply tension so that the centerline of the pilot chute and the bridle are equal. Pinch the Spectra® line so that the location will not move. Secure with 2 half hitches [Figure F].



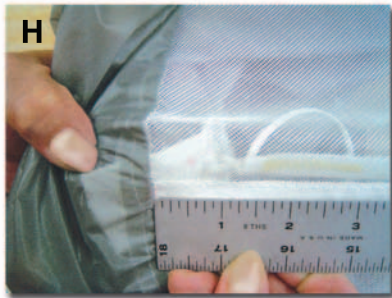
2.8 Change the anchor point to the end of the bridle. Stretch the bridle so that the pilot chute is collapsed. Lay the pilot chute out with the mesh exposed and secure the radial tapes with the pony clamp at the mesh/fabric seam [Figure G]. Pull moderate tension on the pony clamp and check the location of the apex of the pilot chute at the opening of the bridle.



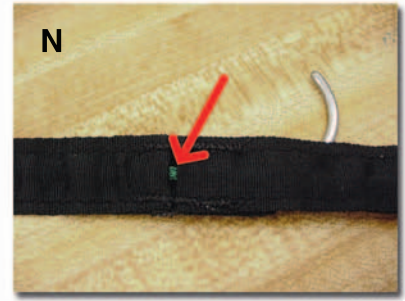
2.9 Again anchor the bridle at the bag stop and cock the bridle. Check the position of the apex of the pilot chute. It should be within 1" of the skirt [Figure H].

2.10 Finger-trap the running end of the Spectra® centerline for a distance of 3" [Figure J]. Bar tack or zigzag to secure. Trim the excess line.

2.11 Cock the bridle. Take the hemostats and grasp the Spectra® centerline at the eye of the bridle [Figure K].







- 2.12 Pull the centerline out to expose approximately 3" each side of the hemostats. Take the green felt tip marker and place a mark at the hemostat location and 1" either side [Figure L]. Color the line between the marks and on both sides [Figure M].
- 2.13 Pull the bridle tight to reposition the centerline and check the green color of the eye [Figure N].

### **3.0 INSPECTION:**

- 3.1 Check the bar tack at the pilot chute loops and at the base.
- 3.2 Verify the Spectra<sup>®</sup> centerline is knotted, finger-trapped and sewn.
- 3.3 Verify the colored eye location of the centerline is marked green.



# Parachute Repair Procedure

**TITLE:** 7.4.5 Main Deployment Bag Repair – Closing Flap Grommet Pullout

**NUMBER OF PAGES:** 2

**APPLICABLE PRODUCTS:** All main deployment bags.

**DESCRIPTION:** Repair of main deployment bag.

**AUTHORIZED REPAIRMEN:** FAA Senior or Master Parachute Rigger

**MATERIALS:** E thread  
Ty-4 tape or equivalent.  
Grommets to match original

**MACHINES:** 301 Straight Stitch—Medium Duty 7-11 SPI  
308 Zigzag—Medium Duty 7-11 SPI

**EQUIPMENT:**

Scissors  
Seam ripper or scalpel  
Marking pencil  
6" ruler  
Grommet set  
Hole punch

## PROCEDURE

**NOTE:** The most common repair needed to a main deployment is the repair of the closing flap in the area of the grommets. The grommets work loose and pull out, damaging the material. The tongue will need reinforcing and new grommets.

**1.0 DISASSEMBLY:**

- 1.1 Remove grommets from the tongue of the bag.
- 1.2 Unpick the binding along the edge of the grommet reinforcing tape [Figure A].



**2.0 REASSEMBLY:**

- 2.1 Overlay a piece of 1.5" Ty-4 tape on the top of the bag tongue and sew down [Figure B].
- 2.2 Punch new holes through the Ty-4 from the back side in the same location as the original location.
- 2.3 Overlay the back side of the tongue with a piece of 1.5" Ty-3 tape and sew down [Figure C]. Punch new holes through the tape.
- 2.4 Sew down the binding tape and rebind as needed [Figure D].





2.5 Set new grommets in the original locations [Figure E].

**3.0 INSPECTION:**

3.1 Verify stitching is secure.

3.2 Verify new grommets are secure.





In the “old days” when military surplus equipment was common, there were a number of alterations available to make the surplus equipment suitable for sport use. Since then, however, the sport has progressed and purpose-built sport equipment is now the rule, so most equipment does not need any specialized alterations for use. Most alterations now deal primarily with harness size adjustments for individuals, or they are designed to enhance the performance of the parachute.

In the past, alterations were often done by well-intentioned individuals who knew how to do them but in most cases did not have the authority to perform them. The common attitude was, “I’m a master rigger; I can do anything.” As long as the work was done reasonably well and no one got hurt, this was an accepted practice. While there may be a few individuals who still adhere to that philosophy, as a whole, the rigging profession is much more aware of limitations in regard to alterations. Under Title 14 of the Code of Federal Regulations (14 CFR), subsection 65.129(d), “No certificated parachute rigger may – (d) Alter a parachute in a manner that is not specifically authorized by the Administrator or the manufacturer.” In today’s world, manufacturers are much more concerned with the alterations being performed on their products. With the advent of the Internet and other means of high-speed communications, riggers have much more access to the manufacturer and are more likely to communicate with them as to what can be done. Also, due to liability issues, many riggers are reluctant to undertake alterations without the manufacturer’s approval.

What constitutes the manufacturer’s approval for an alteration? To be safe, the rigger should always have something in writing that specifically addresses the alteration the rigger wishes to perform. There should be a two way line of communication for this. One, the rigger should specifically request from the manufacturer the authority to perform the alteration. This should include serial number, make, and model of the product involved, and a description of the alteration. Two, in return, the rigger should receive, in writing, authorization to perform the alteration. The manufacturer specifies the form of this authorization, but it should have the date, the rigger’s name and certificate number, and a reference to the rigger’s original request. This fulfills the requirements of the regulations and protects both parties involved.

In certain cases, a rigger might want to perform an alteration on a product for which the manufacturer is no longer in business. This is commonly known as an orphaned product. If this occurs, the rigger should obtain approval from the Administrator. Refer to Advisory Circular (AC) 105-2—*Sport Parachute Jumping*. Alterations to approved parachutes must be performed only by a certificated and appropriately rated master parachute rigger, a parachute manufacturer, or any other manufacturer that the Administrator considers competent. To receive approval from the Administrator, a person qualified to alter a parachute would first contact the FAA Flight Standards District Office (FSDO) to discuss the proposed alteration with an FAA inspector. The inspector requires a description of the proposed alteration along with a sample, technical data, and proposed test data to ensure that the altered parachute meets all applicable requirements. After discussing the proposed alteration, the two parties agree on a suitable plan of action. The individual then drafts an application, in letter form, addressed to the local FSDO. Along with the letter, the following information needs to be attached:

1. A clear description of the alteration.
2. Technical information that includes drawings and photographs, materials used, stitch patterns, and location of altered components.
3. A means of identifying the altered parachute such as model and serial number and identification of the person having performed the alteration.

After the inspector reviews the application, if he/she is satisfied, he/she indicates approval by date stamping, signing, and placing the FSDO identification stamp on the letter of application. Upon receiving this approval, the master rigger can then perform the alteration.

7.5 The following are alterations found in Section 5 of this chapter. (\* Denotes approval needed by the Administrator or the Manufacturer)

- 7.5.1 \* Articulated harness main lift web resizing
- 7.5.2 Leg pad resizing
- 7.5.3 \* Automatic Activation Device (AAD) installation





# Parachute Repair Procedure

**TITLE:** 7.5.1 Articulated Harness Main Lift Web (MLW) Resizing

**NUMBER OF PAGES:** 2

**APPLICABLE PRODUCTS:** Most articulated harness configurations.

**DESCRIPTION:** Resizing of an articulated harness.

**AUTHORIZED REPAIRMEN:** FAA Master Parachute Rigger

**MATERIALS:** E thread  
5-cord nylon thread  
Ty-7 webbing, or as original  
Ty-4 1" tape

**MACHINES:** 308 Zigzag—Medium Duty 7-11 SPI  
Heavy-duty harness machine, Singer 7-33 or equivalent 4-6 SPI

**EQUIPMENT:**  
Scissors  
Seam ripper or scalpel  
Marking pencil  
18" ruler  
Hot glue gun

## PROCEDURE

**Note:** Resizing of a harness is usually considered an alteration. However, because of the simplicity of the procedure, most manufacturers do not object to a qualified master rigger performing the procedure. It would be wise, however, for the rigger to contact the manufacturer for permission before undertaking the procedure. The following procedure is shown on a Voodoo™ system.

### **1.0 DISASSEMBLY:**

- 1.1 Measure the main lift web to check if the harness is even.
- 1.2 Remove the ripcord pocket/MLW cover [Figure A].
- 1.3 Measure the lower MLW [Figure B].
- 1.4 Remove the lower MLW [Figure C].



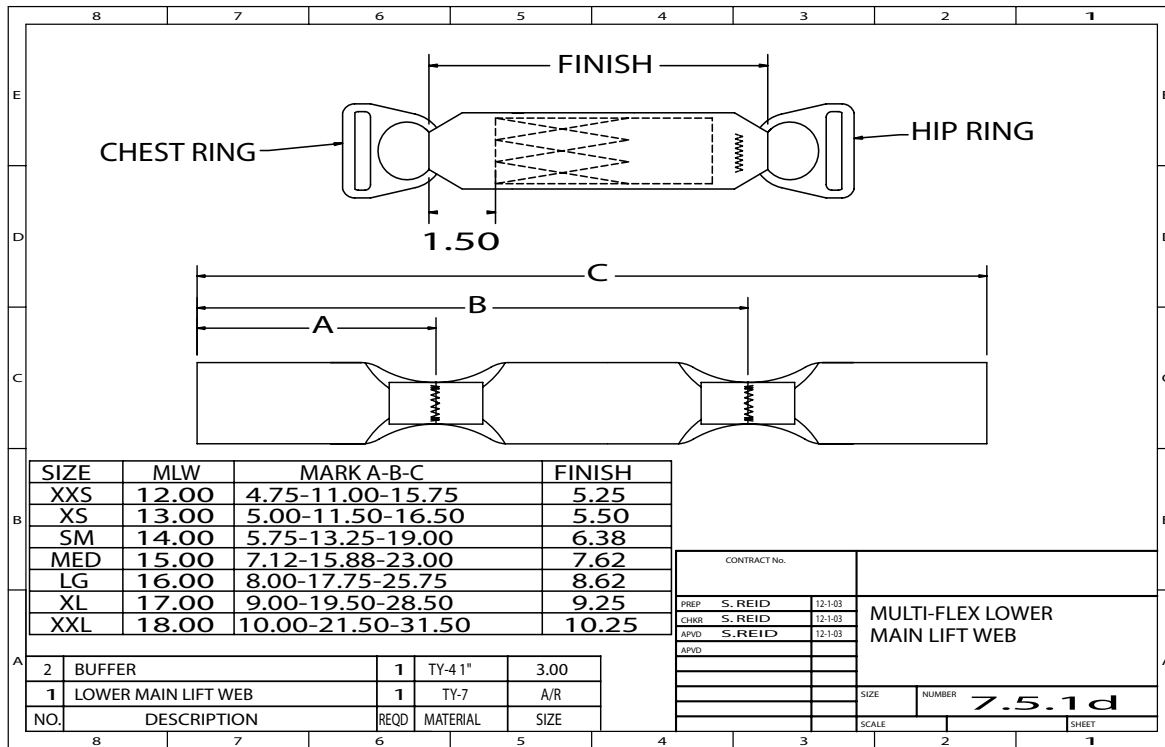


Figure D

**2.0 REASSEMBLY:**

- 2.1 Measure the webbing for the lower main lift web [Figure D].
- 2.2 Zigzag the bowtie folds as marked including the Ty-4 buffers [Figure E].
- 2.3 Glue the MLW in place. Make sure that the open end of the webbing is on the rear and oriented up towards the chest strap.
- 2.4 Mark the stitch pattern on the MLW and sew with the harness machine. Use a 3" W-W pattern at the top as shown in Figure F. Include a box pattern on the lower section of the MLW.
- 2.5 Reattach the ripcord pocket/MLW cover [Figure G].



**3.0 INSPECTION:**

- 3.1 Check that the new harness dimensions are correct and symmetrical.
- 3.2 Verify the harness stitching is correct for SPI and tension.
- 3.3 The ripcord pocket/MLW cover must be reattached.

# Parachute Repair Procedure

**TITLE:** 7.5.2 Leg Pad Resizing

**NUMBER OF PAGES:** 2

**APPLICABLE PRODUCTS:** Most harness leg pad configurations.

**DESCRIPTION:** Shortening the length of the leg pad.

**AUTHORIZED REPAIRMEN:** FAA Senior or Master Parachute Rigger

**MATERIALS:** E thread

**MACHINES:** 301 Straight Stitch—Medium Duty 7-11 SPI  
301 Double needle with tape folder 7-11 SPI  
1" x 42 stitch bar tack

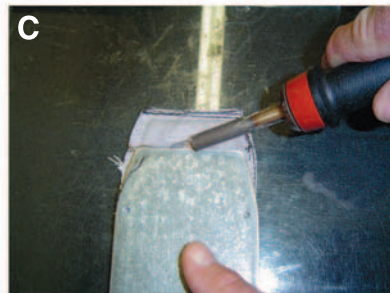
**EQUIPMENT:**

- Scissors
- Seam ripper or scalpel
- Marking pencil
- 6" ruler
- Hot knife

## PROCEDURE

### **1.0 DISASSEMBLY:**

- 1.1 Measure the amount that the pad is to be shortened and mark on the sleeve of the pad [Figure A].
- 1.2 Remove all bar tacks or zigzag stitching from the binding.
- 1.3 Using the hot knife, remove the binding from the pad [Figure B].
- 1.4 Unpick the sleeve from the body of the pad. Fold the pad under and using the hot knife, shorten the sleeve by the required amount.
- 1.5 Measure the pad and mark. Trim with the hot knife [Figure C].



### **2.0 REASSEMBLY:**

- 2.1 Using the double needle machine and binder, bind the end of the sleeve [Figure D].
- 2.2 Sew the sleeve to the pad and pre-sew the foam with the single needle.



2.3 Trim the ends of the tape.

2.4 Rebind the pad starting at the upper corner [Figure E]. Make sure the inside curve of the pad is fully captured by the binding.

2.5 Bar tack at the original locations [Figure F].



### **3.0 INSPECTION:**

3.1 Verify the length is correct.

3.2 Check that the bar tacks are at the original location.

# Parachute Repair Procedure

**TITLE:** 7.5.3 Automatic Activation Device (AAD) Installation

**NUMBER OF PAGES:** 3

**APPLICABLE PRODUCTS:** Most 1-pin sport piggyback systems.

**DESCRIPTION:** Installation of a CYPRES® AAD to a 1-pin sport piggyback harness and container system.

**AUTHORIZED REPAIRMEN:** FAA Master Parachute Rigger

**MATERIALS:** E thread—color to match  
CYPRES® installation kit  
Spandex® fabric [Optional]

**MACHINES:** 301 Straight Stitch—Medium Duty 7-11 SPI  
308 Zigzag—Medium Duty 7-11 SPI

**EQUIPMENT:**

Scissors  
Seam ripper or scalpel  
Marking pencil  
12" ruler  
Hot knife  
Wallpaper roller

## PROCEDURE

**Note:** The following procedure is representative of a typical installation of the CYPRES® AAD into a modern 1-pin reserve container system. While providing guidance for this operation, it is imperative that the rigger possesses the proper instructions from both the harness-container manufacturer and the AAD manufacturer.

### **1.0 DISASSEMBLY:**

1.1 Open the right side corner of the reserve container [Figure A]. While this might not be needed on some size containers, it generally makes the installation of the pocket easier and it's not that hard to close the corner back up.



### **2.0 REASSEMBLY:**

2.1 Mark the center of the container wall at the bottom [Figure B].

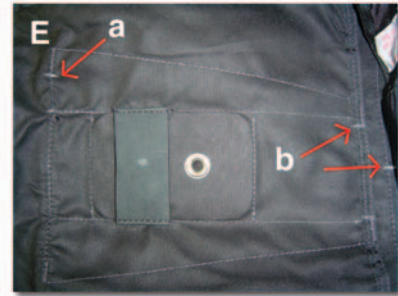
2.2 Mark the center of the Spandex® portion of the CYPRES® pocket [Figure C]. Do not mark the center of the entire pocket. The Spandex® must be centered on the wall to allow for the correct positioning of the CYPRES® processing unit.

2.3 Align the marks and the pocket as close to the bottom of the wall as possible [Figure D].



2.4 Sew around the pocket with the single needle machine. Backstitch .5" at each of the corners for reinforcing.

2.5 Next, install or create a cable channel for the control cable. Some systems such as the one shown, can be modified to provide the channel. Others need to use the adhesive backed channel provided with the CYPRES® kit.



## 2.6 BUILT-IN CHANNEL MODIFICATION CONFIGURATION.

2.6.1 Mark the bottom and top of the pack tray cover as shown [Figure E]. Place a hand tack at the A position. Unpick the stitching between the corner bar tack and the hand tack at the A position. Also, unpick the stitching between the B bar tacks.



2.6.2 There is now a built-in channel to slide the control cable thru and stow the excess cable as well [Figure F].

## 2.7 ADHESIVE CHANNEL INSTALLATION.

2.7.1 Measure the distance along the long axis of the reserve container from the bottom of the pocket location to the top of the container near the planned location for the control unit [Figure G].



2.7.2 Cut a piece of the adhesive backed channel to the same length. Remove the adhesive covering and position the channel in place. Roll the channel with the wallpaper roller to secure the adhesive.

2.8 Locate the position for the control pocket. Unpick the stitching that holds the main container to the backpad [Figure H].



2.9 Insert the pocket with the mouth towards the channel opening and restitch the container to the backpad [Figure J]. Make sure the control head will fit into the pocket.

## 2.10 CUTTER CHANNEL AND ELASTIC INSTALLATION.

The location of the cutter will be specified by the container manufacturer's instructions and should be strictly adhered to. The following location is specified for the Talon system.



2.10.1 Lay the CYPRES® unit on the pocket and route the cutter/cable assembly out the top of the pocket and in as direct a line to the side flap as possible. It will be necessary to cut a hole in the bottom launching flap to access the side flap.

2.10.2 Where the cable will pass through the bottom launching flap as close to the wall as possible, place a line approximately .5" long [Figure K]. Take the hot knife and cut a single slit the length of the mark. DO NOT CUT ANY OTHER MATERIAL!



2.10.3 Route the cable thru the slit and then along the side flap as shown [Figure L].

2.10.4 Place marks along the binding showing the start and finish locations for the cable channel. Again, the rigger can use the adhesive backed channel or make a channel out of the Spandex® material as shown [Figure M].



- 2.10.5 Route the cutter thru the channel and out the end nearest the side flap grommet.
- 2.10.6 Slide the cutter elastic over the cutter and position the cutter over the grommet with the hole to the outside of the grommet and the elastic facing inwards on the flap. Mark the corners of the cutter as shown [Figure N].
- 2.10.7 Remove the CYPRES® from the container completely. Position the elastic sleeve to the marks and sew in place with the zigzag machine [Figure O].
- 2.11 Re-close the corner of the reserve container as per the original.



**3.0 INSPECTION:**

- 3.1 Verify the CYPRES® pocket is sewn with the Spandex® pocket centered on the wall.
- 3.2 Control cable channel must be installed.
- 3.3 Control unit pocket must be installed.
- 3.4 Cutter cable channel must be installed.
- 3.5 Cutter elastic must be installed.
- 3.6 Verify the reserve container corner is closed, as necessary.
- 3.7 Check the fit of CYPRES® in the entire installation.
- 3.8 Log installation data on the packing data card. Remember, this is an alteration.





There might come times when it is more practical for the rigger to manufacture replacement parts in order to return a system to operation. The items listed in section 7.6 are those that are either main component parts or the reserve closing loop, which is simple to make and usually within the purview of the senior rigger to do so. It is important for the rigger to recognize just what parts are legal to make. One item some riggers make, but one in which they are not usually approved to do so, is the Safety Stow™ for the reserve free bag. As part of the TSO-C23d component, it is manufactured from approved materials and under an approved Quality Control system. As simple as this item is, if it is not manufactured according to the original configuration, there is a very good chance for a failure of the reserve deployment system. The best rule of thumb to follow is this: If the component is part of the approved assembly, then it is probably not something that may be manufactured in the field. The common exception to this rule is the reserve closing loop.

The rigger who is undertaking the manufacture of these components needs to have, at the minimum, the following sewing machines: medium duty single needle, double needle machine with a binding attachment, and a zigzag machine. In addition, the rigger needs grommet setting tools and a basic selection of webbings, materials and fabrics.

7.6 The following are outlines of construction procedures for the manufacture of the listed items found in Section 6 of this chapter.

- 7.6.1 Main and reserve closing loop manufacture
- 7.6.2 Main deployment bag
- 7.6.3 Bottom of Container (BOC) pocket





# Parachute Repair Procedure

**TITLE:** 7.6.1 Main and Reserve Closing Loop Manufacture

**NUMBER OF PAGES:** 3

**APPLICABLE PRODUCTS:** All harness and containers that utilize a fabric closing loop configuration.

**DESCRIPTION:** Fabrication of fabric closing loops.

**AUTHORIZED REPAIRMEN:** FAA Senior or Master Parachute Rigger

**MATERIALS:** E thread  
Loop material—725# Spectra®

**MACHINES:** 301 Straight Stitch—Medium Duty 7-11 SPI  
308 Zigzag—Medium Duty 7-11 SPI  
1" x 42 stitch bar tack [Optional]

**EQUIPMENT:**

- Scissors
- Seam ripper or scalpel
- Marking pencil
- 18" ruler
- Hot knife
- Finger-trapping needle or fid
- Finger-trapping wire

## PROCEDURE

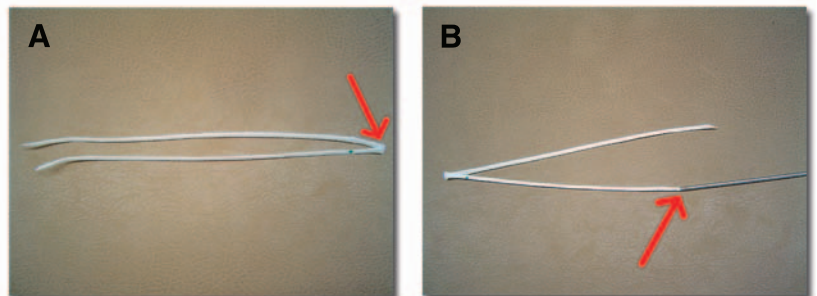
**Note:** The terms “locking loops” and “closing loops” are synonymous, and are used interchangeably. Fabric locking loops have become the preferred method of closing most modern parachute containers. Dating from the mid 1970s, the most common material was Type-III suspension line. It was soon recognized that other materials such as Dacron® were superior for this use. Today Spectra® is widely used for reserve locking loops while Dacron® has remained preferred for main loops due to its durability. The following technique will demonstrate the fabrication of a 1-pin and a 2-pin loop.

### **1.0 PREPARATION: 1-Pin Loop.**

- 1.1 Measure the length of the original loop. If the stop knot is too tight to untie, allow extra length (you can always cut it down, but you can't glue it back on).
- 1.2 Cut an appropriate length of material and hot knife one end on an angle.

### **2.0 FABRICATION:**

- 2.1 Fold the line in half and mark the center [Figure A].
- 2.2 Place a mark at 1" from the center on the hot knifed end.
- 2.3 Take the finger-trapping fid and screw it onto the hot knifed end [Figure B].



- 2.4 Insert the pointed end of the fid into the line at the farthest mark by separating the weave of the material so that the fid then passes through the length of the braided line and out the scissor cut end [Figure C].
- 2.5 Draw the line through until the two marks are aligned. This will result in a loop eye of approximately .5" [Figure D].
- 2.6 Pinch the eye of the loop with one hand and smooth the material from the eye to the end. Hot knife the running end.
- 2.7 For short loops used with a main container, simply tie an overhand knot in the loop for the required length. A metal washer is used to keep the loop from pulling through the grommet [Figure E].

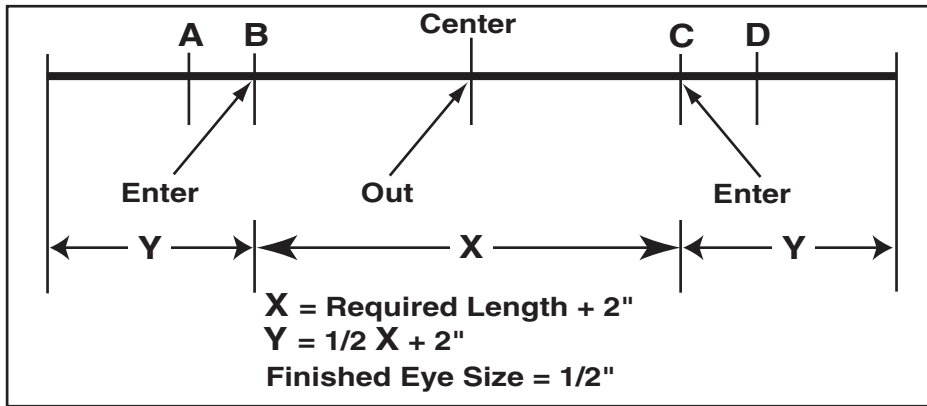
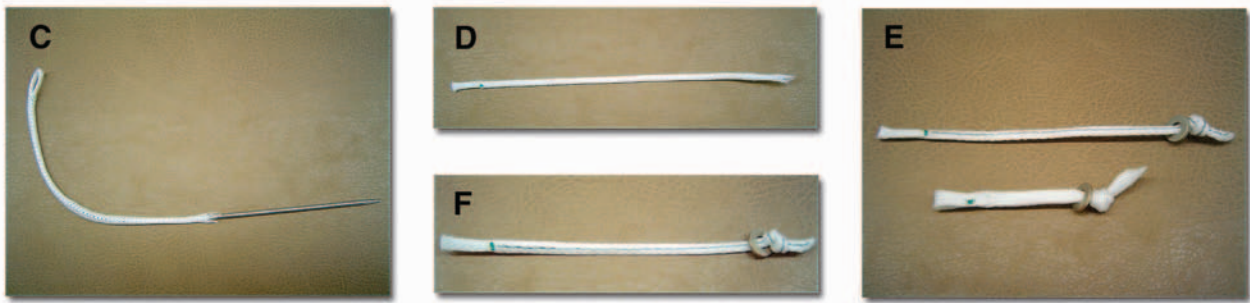


Figure G

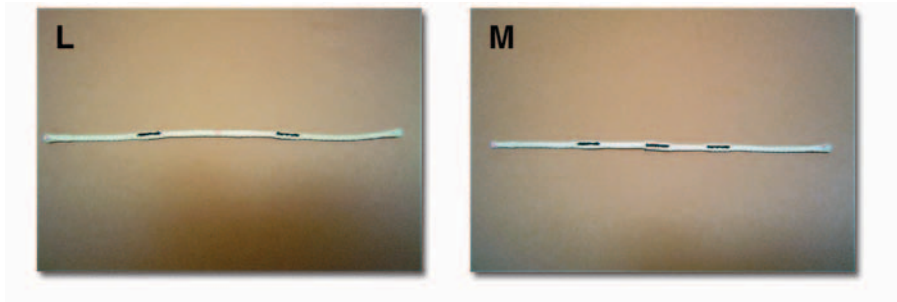
- 2.8 If the loop is to be used with a reserve container, it may be required to sew the finger-trapped part of the loop for security. If this is the case, simply sew the length of the finger-trapped portion of the loop with a single needle machine before hot knifing the end. Start at the running end and sew towards the eye of the loop. Stop sewing approximately .12" from the eye and then backstitch a minimum of 1" [Figure F]. Trim the end with the hot knife.

**3.0 FABRICATION: 2-Pin Loop.**

- 3.1 Measure and mark the line according to Figure G. Cut both ends with the scissors.
- 3.2 Using the finger-trapping wire, finger-trap one end to form the loop and have the running end exit approximately 1" past the center mark [Figure H].
- 3.3 Repeat with the opposite end. Exit again past the center so that the two lines overlap at the center [Figure J].







- 3.4 Pull the loop tight to remove any slack.
- 3.5 Bar tack or zigzag the loop ends [Figure K].
- 3.6 Trim the running ends [Figure L].
- 3.7 Bar tack or zigzag the center overlap junction [Figure M].
- 3.8 Measure the finished loop.
- 4.0 INSPECTION:**
- 4.1 Check the loop length.
- 4.2 Verify stitching is secure and backstitched.



# Parachute Repair Procedure

**TITLE:** 7.6.2 Main Deployment Bag

**NUMBER OF PAGES:** 3

**APPLICABLE PRODUCTS:** All sport systems that utilize a main deployment bag.

**DESCRIPTION:** Fabrication of a main deployment bag.

**AUTHORIZED REPAIRMEN:** FAA Senior or Master Parachute Rigger

**MATERIALS:**

- E thread
- Nylon para-pak fabric
- Ty-3 3/4" nylon binding tape
- Ty-1 9/16" nylon tape
- Ty-4 1" nylon webbing
- Ty-4 1 1/2" nylon webbing
- Ty-12 nylon webbing
- #3 Rolled rim spur brass grommets
- #5 Rolled rim spur grommet

**MACHINES:**

- 301 Straight Stitch—Medium Duty 5-9 SPI
- 301 Double needle with tape folder 5-9 SPI
- 1" x 42 stitch bar tack

**EQUIPMENT:**

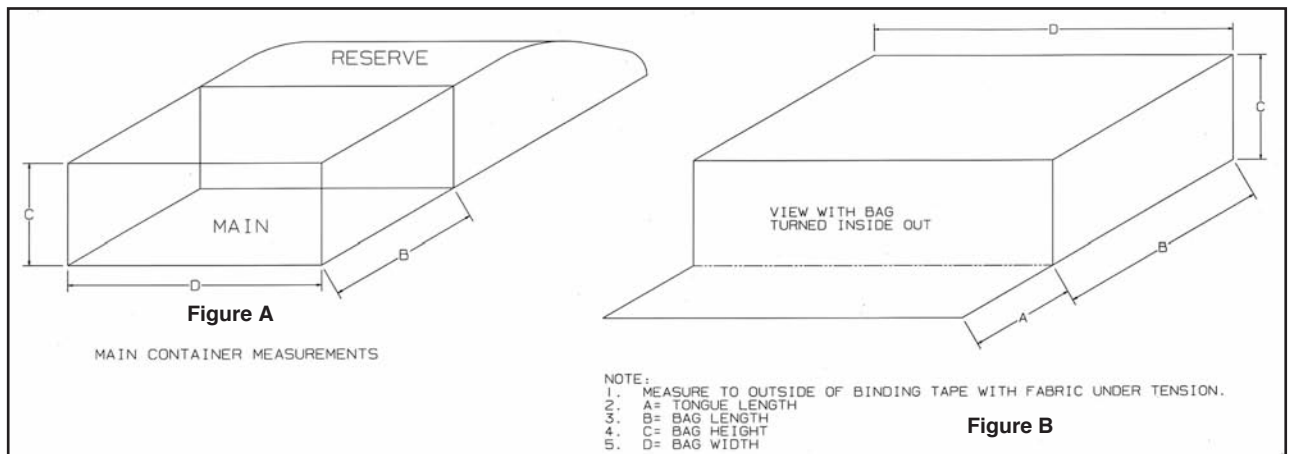
- Scissors
- Marking pencil
- 36" ruler
- Carpenter's square
- Hot knife
- #3 & #5 Spur grommet sets

**Note:** This procedure allows for either [1] duplicating an existing main bag, or [2] measuring a container to determine the correct size bag required.

## PROCEDURE

### 1.0 LAYOUT:

1.1 Measure the container according to Figure A or measure an existing bag according to Figure B.





- 1.2 Transfer these dimensions to Figure C.
- 1.3 Lay out bag pattern on the para-pak according to Figure C.
- 1.4 Cut para-pak and all required tapes and webbings.

**2.0 ASSEMBLY:**

- 2.1 Fold Ty-12 to center and sew to the inside of the bag fabric at the top grommet location [Figure D].
- 2.2 Sew 1 1/2" Ty-4 tape at the outside tongue location [Figure E].
- 2.3 Sew 1" Ty-4 tape at the outside mouth location. At the same time, sew down the two side stow band tapes and the three mouth stow band tapes [Figure F].
- 2.4 Bind the mouth of the bag with the double needle binding machine. Leave the tapes long at the ends.

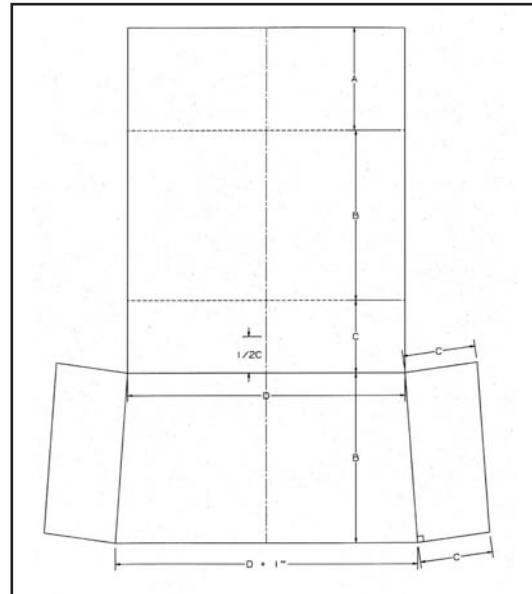
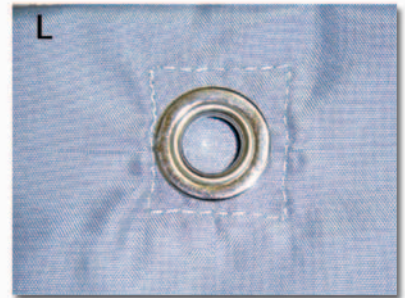


Figure C

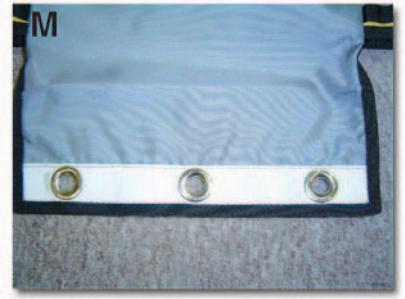


- 2.5 With the bag inside out, match the edge of the mouth with the alignment marks on the tongue [Figure G].
- 2.6 Trim the excess tapes at the edge of the bag.
- 2.7 Starting at the inside corner of the bag, bind the inside seam [Figure H].





- 2.8 Trim the inside ends of the binding leaving a 2" tail. [Figure J]  
Double the tail back and bar tack.
- 2.9 Bar tack the stow loops at the appropriate locations [Figure K].
- 2.10 Install a #5 grommet at the top center of the bag. Orient the grommet from the inside with the washer on the outside [Figure L].
- 2.11 Install the three #3 grommets in the tongue of the bag with the grommets from the outside and the washers on the inside [Figure M].



**3.0 INSPECTION:**

- 3.1 Sewing should be straight.
- 3.2 Binding should be secure.
- 3.3 Verify all bar tacks are in place.
- 3.4 Grommets should be oriented correctly and secure.





# Parachute Repair Procedure

**TITLE:** 7.6.3 Bottom of Container (BOC) Pocket

**NUMBER OF PAGES:** 2

**APPLICABLE PRODUCTS:** All containers that have a BOC pocket configuration.

**DESCRIPTION:** Fabrication of a BOC pocket.

**AUTHORIZED REPAIRMEN:** FAA Senior or Master Parachute Rigger

**MATERIALS:**

- E thread
- Para-pak fabric
- Spandex® or equivalent elastic fabric
- 5/8" elastic tape
- Ty-3 3/4" binding tape

**MACHINES:**

- 301 Straight Stitch—Medium Duty 7-11 SPI
- 301 Double needle with tape folder 7-11 SPI
- 1" x 42 stitch bar tack

**EQUIPMENT:**

- Scissors
- Marking pencil
- 18" ruler
- Carpenter's square
- Hot knife

## PROCEDURE

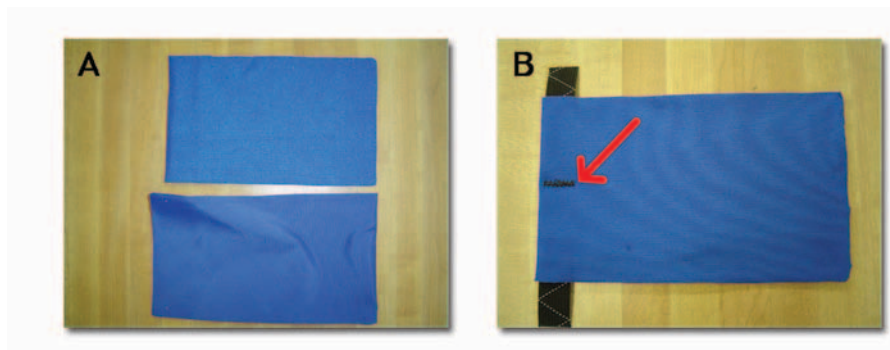
---

### **1.0** LAYOUT:

- 1.1 Draw the shape of the BOC pocket on the para-pak fabric to the size required to fit the pilot chute. This will be the base panel.
- 1.2 Fold the Spandex® fabric in half and cut to the same size as the base panel. This will be the pocket panel. Make sure the grain of the fabric is parallel with the length of the pocket for stretch. Trim 1/2" off the end opposite the fold [Figure A].

### **2.0** ASSEMBLY:

- 2.1 Open the sides of the pocket at the folded end and insert the length of elastic tape. Sew the tape in place with the single needle on both sides.
- 2.2 Mark the center of the mouth and bar tack the elastic reinforcing as shown [Figure B].



- 2.3 Lay the pocket on the para-pak base and sew in place [Figure C]. (Hint—Sewing with the Spandex<sup>®</sup> on the bottom and the para-pak on top will minimize stretch from the presser foot.)
- 2.4 Bind the pocket, starting at the bottom corner opposite the mouth of the pocket [Figure D].
- 2.5 Bar tack the mouth of the pocket securing the elastic reinforcing on both sides [Figure E].
- 2.6 The pocket is now complete and ready for installation.



**3.0 INSPECTION:**

- 3.1 Verify that the size is correct.
- 3.2 Binding should be secure.
- 3.3 Verify the bar tacks are in place at the center of the pocket and at the sides.



7.7 The following are miscellaneous procedures used in repairs and alterations found in Section 7 of this chapter.

7.7.1 Hand tacking techniques

7.7.2 Cleaning and washing procedures





# Parachute Repair Procedure

**TITLE:** 7.7.1 Hand Tacking Techniques

**NUMBER OF PAGES:** 2

**APPLICABLE PRODUCTS:** Any systems requiring hand tacking.

**DESCRIPTION:** Securing housings, hardware, etc., with hand tackings.

**AUTHORIZED REPAIRMEN:** FAA Senior or Master Parachute Rigger

**MATERIALS:** Nylon supertack tacking thread

**MACHINES:** None

**EQUIPMENT:**

Scissors

Assorted hand tacking needles

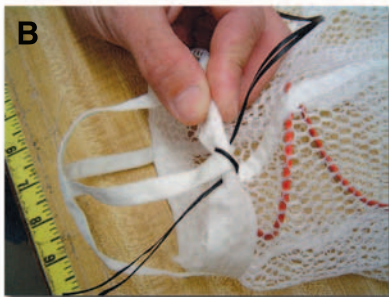
Modified navy end tab

## PROCEDURE

**Note:** Hand tacking is an integral part of rigging skills. There are numerous places where components or parts are joined. Hardware, housings, cones, and other parts require hand tacking to secure them to their positions. The following examples show typical tacking techniques.

### **1.0 PILOT CHUTE:**

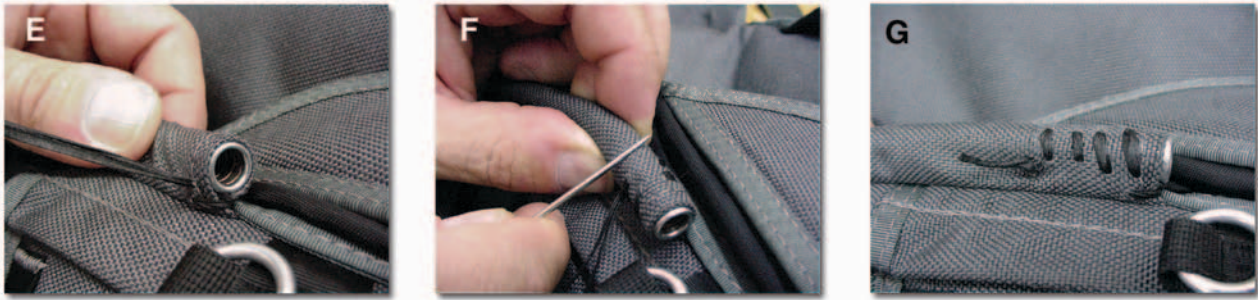
- 1.1 Take the needle and supertack and pass it through the reinforcing tape at the bottom of the pilot chute mesh capturing the spring coil [Figure A].
- 1.2 Cross over the radial seam reinforcing tape and again pass the needle through the reinforcing tape and capturing the spring coil as before [Figure B].
- 1.3 Secure the ends of the supertack with a surgeon's knot and locking knot [Figure C]. Trim to a 3/4" tail.



### **2.0 HOUSING:**

- 2.1 Position the housing end flush with the end of the housing channel.
- 2.2 Take the needle and supertack and tie an overhand knot approximately 1" from the end.
- 2.3 Pass the needle through the inside of the housing channel and then around the outside below the housing end [Figure D]. The purpose is to choke the end of the channel so that the housing does not protrude from the end.

- 2.4 Next take the needle and pass it through the top of the channel fabric over the housing [Figure E].
- 2.5 Take the needle and locate the grooves in the housing [Figure F]. Make three loops through the channel, trapping the supertack in the grooves [Figure G].



- 2.6 Secure the running end with a surgeon's knot and locking knot.
- 2.7 Twist the supertack together and trim with a 3/4" tail.



**3.0 HARDWARE:**

- 3.1 Take the needle and doubled supertack and pass it through the leg pad from the bottom next to the edge of the leg snap [Figure H].
- 3.2 Pass the supertack over the bar of the snap and down through the pad [Figure J].
- 3.3 Continue with two more turns over the bar keeping the tackings next to each other [Figure K].
- 3.4 Secure the two ends on the bottom of the pad with a surgeon's knot and locking knot [Figure L].
- 3.5 Twist the ends together and trim to a 3/4" tail.





# Parachute Repair Procedure

**TITLE:** 7.7.2 Cleaning and Washing Procedures

**NUMBER OF PAGES:** 2

**APPLICABLE PRODUCTS:** Most harness and container systems.

**DESCRIPTION:** Cleaning and washing parachute components.

**AUTHORIZED REPAIRMEN:** FAA Senior or Master Parachute Rigger

**MATERIALS:** Woolite® or similar mild liquid soap  
LOTS of clean fresh water

**MACHINES:** Jumbo tumbler type commercial washing machine. It is not recommended to do this in your home washing machine.

**EQUIPMENT:**

Medium stiffness scrub brush  
Large pillowcase or laundry bag  
Wash tub  
Assortment of rags  
Extra laundry

---

**BACKGROUND**

This procedure applies only to harness and container systems. Most canopy manufacturers do not approve of washing their products to clean them. Doing so may alter the performance characteristics of the canopy. Follow the instructions in the owner's manual for each make and model of canopy.

**COLORFASTNESS.** It is important to check for colorfastness of certain types of materials. Colored E thread and Ty-3 binding tape have shown a tendency for their colors to run when wet or damp. Red is particularly prone to doing so. Before using the following procedures, the rigger or owner should check for colorfastness. Do so by wetting a small area of the container including the binding tape and then lay a damp piece of WHITE cotton t-shirt on the wet area. Leave for 30 minutes. Check to see if any color has transferred to the cotton fabric. If not, then it is PROBABLY OK to wash the rig. Remember, this procedure in no way guarantees that the colors will NOT run.

---

## PROCEDURE

**1.0 DISASSEMBLY:**

1.1 Remove all canopies, AADs, and component parts such as toggles, RSL, ripcords, bags, and elastic keepers as well as the packing data card.

**2.0 HAND WASHING:**

2.1 Soak the rig in lukewarm water. Apply straight Woolite® or soap onto the dirtiest areas and scrub with the brush. Soak in lukewarm water for 20 minutes.

2.2 Scrub the rig vigorously all over. Soak for another 20 minutes.

2.3 Repeat step 2.2. For particularly dirty rigs, empty the first batch of soapy water and wash in a fresh batch of soapy water.

2.4 Squeeze out as much soapy water as possible. Immerse in fresh, clean, cool water and rinse several times until no further soap comes out.

- 2.5 Hang to dry out of direct sunlight. The use of a fan directly onto the rig will greatly speed up the drying process.

### **3.0 MACHINE WASHING:**

Wrap the hardware of the rig with the rags to pad them so they don't beat the inside of the machine.

- 3.1 Soak the rig in lukewarm water and apply Woolite® or other soap directly onto the dirtiest parts. Scrub these parts vigorously. Allow these parts to absorb the Woolite® during the time traveling to the laundromat.
- 3.2 Place the rig into the pillowcase or laundry bag and add extra padding such as some of your extra laundry. Levi's® work exceptionally well for this. Tie off the pillowcase or bag to hold everything in. Place in the washing machine, add more washing and Woolite® and wash in warm water.
- 3.3 Run through at least two rinse cycles or hand rinse several times until no soap comes out.
- 3.4 Hang to dry out of direct sunlight. The use of a fan onto the rig will greatly speed up the drying process.

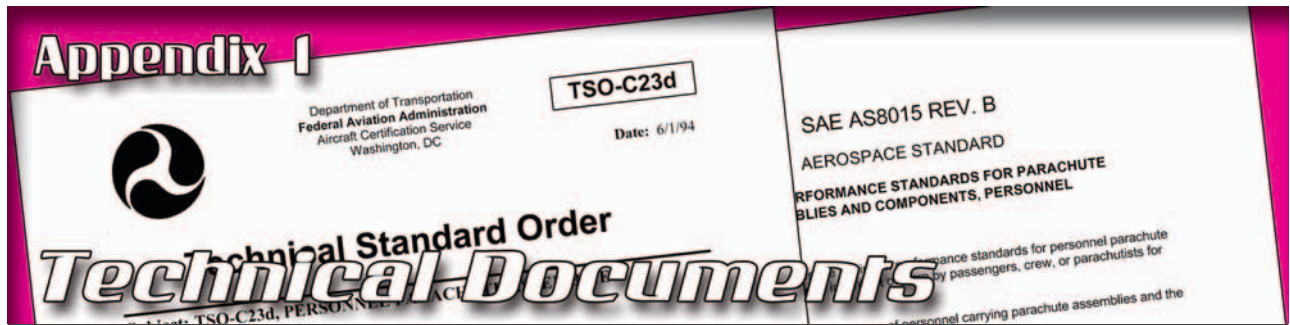
### **4.0 SCOTCHGARD:**

The use of Scotchgard® brand fabric protector has become commonplace in recent years. This fabric treatment seals the pores of the fabric against dirt and other stains. Scotchgard® is NOT a magical “silver bullet” against dirt. However, it has shown good results in keeping lighter colored fabric cleaner longer under normal use. Grinding in on grass or asphalt or other heavy abuse will still stain and/or damage the rig materials.

Scotchgard® is not harmful to today's container fabrics such as para-pak and Cordura®. There are currently several Scotchgard® formulas. The standard fabric and upholstery formula is in the **RED CAN** [Figure A]. Do not use the rug and carpet formula in the blue can.

After the rig is completely dry, hang it in a well ventilated location. **FOLLOWING THE DIRECTIONS ON THE CAN**, apply the protector to the entire **OUTER SURFACE** of the rig. For those areas such as the inside of the leg pads, backpad, and bottom of the main container, and light colored panels such as white, etc., apply a second coat after the first has dried. Do not intentionally spray the hardware, housings, and clear vinyl CYPRES® window. After the rig has dried, it may then be reassembled and placed back into service.





## CONTENTS

### Appendix I—Technical Documents

PIA TS-100—Standardized Nomenclature for Ram-Air Inflated Gliding Parachutes .....	A-3
PIA TS-108—Parachute Canopy Fabric Pull Test, Non-Destructive Method .....	A-19
TSO C23d—Personnel Parachute Assemblies .....	A-25
SAE AS 8015B—Minimum Performance Standards for Parachute Assemblies and Components, Personnel .....	A-27
TSO C23c—Personnel Parachute Assemblies .....	A-37
SAE AS 8015A—Minimum Performance Standards for Parachute Assemblies and Components, Personnel .....	A-39
TSO C23b—Parachutes .....	A-45
NAS 804—Specification—Parachutes .....	A-47





# PIA Technical Standard 100

## Parachute Industry Association Publications

January 23, 1984 TS-100

---

### Standardized Nomenclature for Ram-Air Inflated Gliding Parachutes

#### Introduction

This Technical Standard was adopted by the Parachute Industry Association (PIA) on January 23, 1984. In view of the fact that the member companies of the PIA are responsible for the production of approximately 90% of the ram-air parachutes in the world, it is anticipated that this document will become the defacto standard for the rest of the parachute community as well. Provisions have been made for periodic revisions of this document; inputs concerning revisions and additions are welcome and should be submitted to:

#### **Parachute Industry Association, Inc.**

Attention: Technical Committee Chairman  
3833 West Oakton Street  
Skokie, IL 60076  
telephone: 847-674-9742  
fax: 847-674-9743

The construction details shown on the accompanying drawing are not intended to imply that the information provided is the only way to manufacture the part.

#### Definitions

**Airfoil Section Area:** The cross sectional area of a given rib (airfoil) section; must specify which rib and cut and/or finished area. Used for calculations of pack volume and internal volume of canopy. Figure 3a.

**Angle of Attack:** The angle formed between the flight path and the chord line. The Greek letter alpha ( $\alpha$ ) is used to denote the angle of attack. Figure 5.

**Angle of Trim:** The angle formed between the reference line and the trim line; or also found as the angle formed between the plumb line and the trim line minus 90 is called the

angle of trim or trim angle. The 90 value is used to rotate the plumb line into an orientation that is equivalent to aircraft usage. Figure 5.

**Angle of Incidence:** The angle formed between the reference line and the chord line; or also found as the angle formed between the plumb line and the chord line minus 90 is called the angle of incidence. The 90 value is used to rotate the plumb line into an orientation that is equivalent to aircraft usage. Figure 5.

**Aspect Ratio:** Standard definition;  $\text{Span}^2/\text{area}$ ; which for a rectangular planform reduces to  $\text{span}/\text{chord}$ .

**Cascade Line:** A suspension line that joins another line (usually in the same set) below the canopy surface but above the connector link which results in a shorter total line length for the parachute. Figure 1.

**Cell:** The compartment formed by the top and bottom surfaces and two adjacent load bearing ribs. Each cell is usually divided by a non-load bearing rib to form two half cells. Cells are numbered from left-to-right by full-cell number; use left (L) and right (R) to designate the appropriate half cell. Figure 1.

**Chord:** Standard definition: The chord is measured (in a straight line) from the farthest forward point to farthest aft point on the airfoil section. Measured with the canopy laid flat on side with very light tension and as many wrinkles removed as practical. If the chord is not constant, an average chord may be specified or the chord at each loaded rib may be specified; must also specify design (cut dimensions less seam allowance) or finished dimensions. Figure 2.

**Control Lines:** Control Lines (also known as steering or brake lines) are used to steer and modulate the forward speed of the parachute. Control lines are usually fastened to the trailing edge of the canopy, usually in distinct left and right groups, and are commonly constructed as upper and lower sections; the upper section typically consists of two to five lines per side that converge and join to a single lower control line per side. The lower portion of each set of the control lines is usually routed through a guide ring on the back of the corresponding rear riser and fastened to a control toggle. Control lines are named by left or right sets and numbered sequentially from outside to inside and are usually attached to the trailing edge at the intersection of the rib seams which are also numbered sequentially (at the trailing edge only) from the outside to the inside. Note that the seam number and the control line number attached to it do not necessarily have to match: e.g. control lines 1,2,3,4 may be attached to seams 1, 3, 5, 7. Figure 1, 3a.

**Control Line Deflection:** Control inputs should be expressed in inches deflected downward from the full up position. Alternately, control deflections may be expressed as a percentage of the full control stroke required to stall (steady state) the parachute: i.e. 100% = stall, 0% = no deflection. Note that full-flight setting, toggle length, riser length and suspension line lengths (and trim) can affect the available control stroke; any



specifications for control stroke should also include the specifications for the above items. Figure 3a.

**Construction, Chordwise:** This is the most common type of ram-air parachute construction. The top and bottom surfaces are assembled from panels that run from front to rear (chordwise) and are joined to the ribs and each other using a variety of sewn seams. Listed below are several variations on this method.

**Construction, Full-Cell Chordwise:** Top and bottom surfaces are cut to the full width of the cell (plus seam allowance). There are two basic types of full-cell construction:

**I-Beam:** Full-cell construction in which the top and bottom surfaces are joined to each other at the seams with the loaded ribs. The non-loaded ribs are typically joined to the top and bottom surfaces between the loaded ribs using a flat rolled seam. Figure 4b.

**Interlocking T-Beam:** Full-cell construction in which the top surfaces are joined to each other at the seams with the non-loaded ribs and the bottom surfaces are joined to each other at the seams with the loaded ribs. Note that this technique will have a half-cell panel at each end of the top surface. Figure 4c.

**Half-Cell Chordwise:** Top and bottom surfaces are cut to the width of the half-cells and joined to each other at all rib seams. Figure 4c.

**Construction, Spanwise:** The top and bottom surfaces are assembled from panels that run from side to side (spanwise) across the full width of the canopy. This usually requires three or four panels each for the top and bottom surfaces. Figure 4d.

**Cross-Ports:** Small holes (usually 5 to 15" maximum diameter) cut in the rib sections to balance the air pressure within the cells across the full span of the canopy. Cross-ports are not cut in the outboard rib sections on either end. Figure 2.

**Deployment Brakes:** (D-brakes) Used to prevent canopy surge during opening and to provide more reliable openings. The deployment brakes are usually set by pulling the control lines (and thus the trailing edge of the canopy) down to a predetermined point and temporarily fastening them into place at that point; after opening, the user can either leave the deployment brakes set or release them to allow the canopy to achieve full glide. The deployment brake setting should be referenced to the bottom of the leading edge; such as four inches above the bottom of the leading edge, three inches below, etc. Measurements should be taken from the bottom of the rib seam at the line attachment point to the trailing edge at the control line attachment point, with the trailing edge folded over to the leading edge so that the trailing edge lines lay on top of the leading edge lines. If the upper control lines are not all the same length, the reference line must be specified.

**Flares, Suspension Line Attachment:** Flares are used on some canopies to eliminate the load tapes on the ribs. The flares usually take the form of a catenary curve between the line attachment locations. Figure 3b.

**Full-Flight Setting:** The setting of the trailing edge with the control toggles in the full up positions should be given as a distance above or below the bottom of the leading edge (same reference method as deployment brakes). Also note that the reference control line must be specified: e.g. upper control line #3 set to 4" above the bottom of the leading edge. Figure 3a.

**Glide Path (Flight Path) Angle:** The angle formed between the glide path of the parachute/payload and the horizon. Note that gliding flight has a negative value by convention. The Greek letter gamma ( $\gamma$ ) is used to denote the flight path angle.

**Pilot Chute Controlled Reefing (PCR):** Any of the several types of ram air parachute reefing systems that use the drag of the pilot chute to modulate the opening rate of the canopy. Due to the wide variety of implementations, one should give a brief description of the system and operation when referring to PCR systems.

**Planform:** Defined as the overall shape of the wing using the top view perpendicular to the chord line with the canopy laid flat.

**Planform Area:** Defined as the product of the finished chord times the finished span of the canopy.

**Plumb Line:** The plumb line is the straight line formed by using the quarter chord point and the connector links (all stacked on top of each other) as endpoints. This is equivalent to (but rotated 90°) to the centerline used in aircraft as the reference line. The plumb line is used only to locate a reference system that may be quickly and easily determined for any parachute.

**Projected Area:** The area of the inflated canopy as view from above, perpendicular to the chord line at the centerline of the parachute. Due to canopy curvature and cell inflation bulging the projected area is always smaller than the planform area.

**Quarter Chord Point:** The quarter chord point is located 25% of the distance from the leading edge to the trailing edge along the chord line, which is the straight line between the farthest forward and farthest aft points on the airfoil section.

**Reference Line:** The reference line passes through the quarter chord point at a right angle to the plumb line. Usage is equivalent to aircraft practice of using the aircraft centerline as a reference line.

**Ribs:** The sections of fabric installed between the top and bottom surfaces of the canopy and used to establish the airfoil shaped of the canopy. Most canopies have both loaded and non-loaded ribs. The suspension lines are attached to the loaded ribs at the line attachment points. Loaded ribs are numbered from left- to-right to correspond to the suspension line number; non-loaded ribs are numbered from left-to-right to correspond to full-cell number. Figure 2.



**Riser Specifications:** Should include overall length (specify finished or cut), type of webbing, type of connector links to be used, stitch patterns, thread, riser release mechanism, etc. The normal position for the control line guide ring is on the back side of the rear risers; the top of the control ring should be located 4" ( 1/16) from the canopy end of the riser. Risers using Velcro to hold the control toggles in place should use the hook Velcro on the riser and the loop Velcro on the toggle; the hook Velcro should be 1" x 5" and should start 1" below the bottom of the guide ring, centered under the ring. Figure 1.

**Slider (Sail Slider):** Used as a reefing device on ram-air parachutes. During deployment, the canopy is reefed as the spreading force of the canopy is resisted by the slider which is held up against the lower surface of the canopy by the airflow. Usually consists of a rectangular section of canopy cloth reinforced on the edges with lightweight webbing or tape with a large grommet or D-ring installed at each corner. Suspension lines (and control lines) from the individual riser groups are routed through the corresponding grommet in the slider. During packing, the slider is pulled up against the bottom of the canopy. Figure 1.

**Slider Stops:** Small pieces of rigid material (plastic, phenolic, etc.) that are installed on the lower edges of the stabilizer panels to prevent the grommets on the slider from riding up over the stabilizer material and damaging the stabilizers or the slider. A corresponding item known as a slider bumper is installed at the lower end of the suspension lines to prevent damage to the slider grommets caused by the slider contacting the connector links.

**Stabilizer Panels:** Stabilizer panels are installed on the ends of the canopy and act much as an end plate on an aircraft wing; stabilizers typically run from near the leading edge to near the trailing edge of the canopy; on many canopies the stabilizer is rolled into the outside lower rib seam during construction. Figure 2.

**Span:** Measured parallel to the leading edge of the top surface, 6" behind the leading edge, with minimal tension (5 lb. or less); if the length of the trailing edge is not the same as the length of the leading edge, an average span or separate leading and trailing edge dimensions may be given and must be specified. Measurements shall be made with 10 pounds-force (or less) tension on the area being measured; at standard atmospheric conditions. Figure 2.

**Suspension Lines:** Carry the load from the canopy surface to the risers. The lines are numbered by set number from left-to-right and by row letter from front to rear. For example, a canopy with seven cells will normally have eight sets of (usually) three or four rows; thus:

- **Line 1A** is the left front suspension line.
- **Line 8A** is the right front suspension line.
- **Line 1D** is the left rear suspension line (with four rows).
- **Line 8B** is in the second row on the right side.



**Note that some canopies may have cascaded lines in order to reduce bulk; i.e. B cascade to A; D cascade to C. The names of the lines are the same.**

**Suspension Line Lengths:** May be given as a leading edge line length and trim dimensions or as a complete set of dimensions. Trim dimensions should be given as a difference in length between one row of lines and the next; A to B, B to C, C to D, etc. For canopies that do not have all the lines in a given row set to the same length the trim dimensions should be given as a complete set of lengths for the line set. Normally all the lines in a given row are the same length; thus, a specification giving leading edge line length, trim dimensions, cascade lengths (as required), deployment brake setting, full flight setting, and upper/lower control line lengths is sufficient to determine all the line lengths on the parachute. Specifications for trim/length dimensions should also include a total overall tolerance for the trim dimensions to avoid accumulation of tolerances. Note that the trim measurements should be taken from the bottom of the rib seam at the line attachment point in order to avoid problems due to differences in the length of the line attachment tapes, type or knot, etc. Figures 1, 2, 3a.

**Tapes, Reinforcement:** Different types of tape may be used in each of the locations described below (all Figure 2):

- **Load Tapes:** Also known as V-tapes on those canopies which place the tapes in a "V" pattern. Found on the loaded ribs only. Used to distribute loads from the line attachment tapes into the canopy.
- **Rib Leading Edge Tapes:** Found in the leading edge of each rib section.
- **Leading Edge Tapes:** Found in the leading edge of the top and bottom surfaces.
- **Trailing Edge Tape:** Found in the trailing edge seam; usually rolled into the seam.
- **Line Attachment Tapes:** Sewn to the bottom edge of the loaded ribs in alignment with the load tapes; used to transfer the load from the lines to the load tapes. Some canopies use line attachment tapes that continue onto the loaded rib thus taking the place of the load tapes.
- **Cross Tapes:** Reinforcing tapes that run spanwise on the top or bottom surface to distribute concentrated loads into the canopy.
- **Bridle Attachment Tapes:** Used to attach the pilot chute bridle to the top (usually) of the canopy. Most often is tied into the other reinforcing tapes in the canopy in order to distribute the loads.

**Trim Line:** The trim line is the straight line formed using the farthest forward and farthest aft line attachment points (not control line attachment points) as endpoints. Note that this eliminates the effects of a curved bottom surface when specifying trim angle; however, the trim measurements are still required for an accurate specification. The trailing edge may be used as the aft reference point only if it is not used as a control surface or deployment aid.

**Toggles, Control:** Control (steering) toggles are attached to the bottom end of the lower control lines to allow the jumper an adequate handhold on the control lines. May consist

of a wide variety of configurations of webbing or hard plastic T-handles. Where required or critical, a drawing of the control toggle should be supplied. Figure 1.

**Trim Measurements:** See suspension lines measurements. Figure 3a.

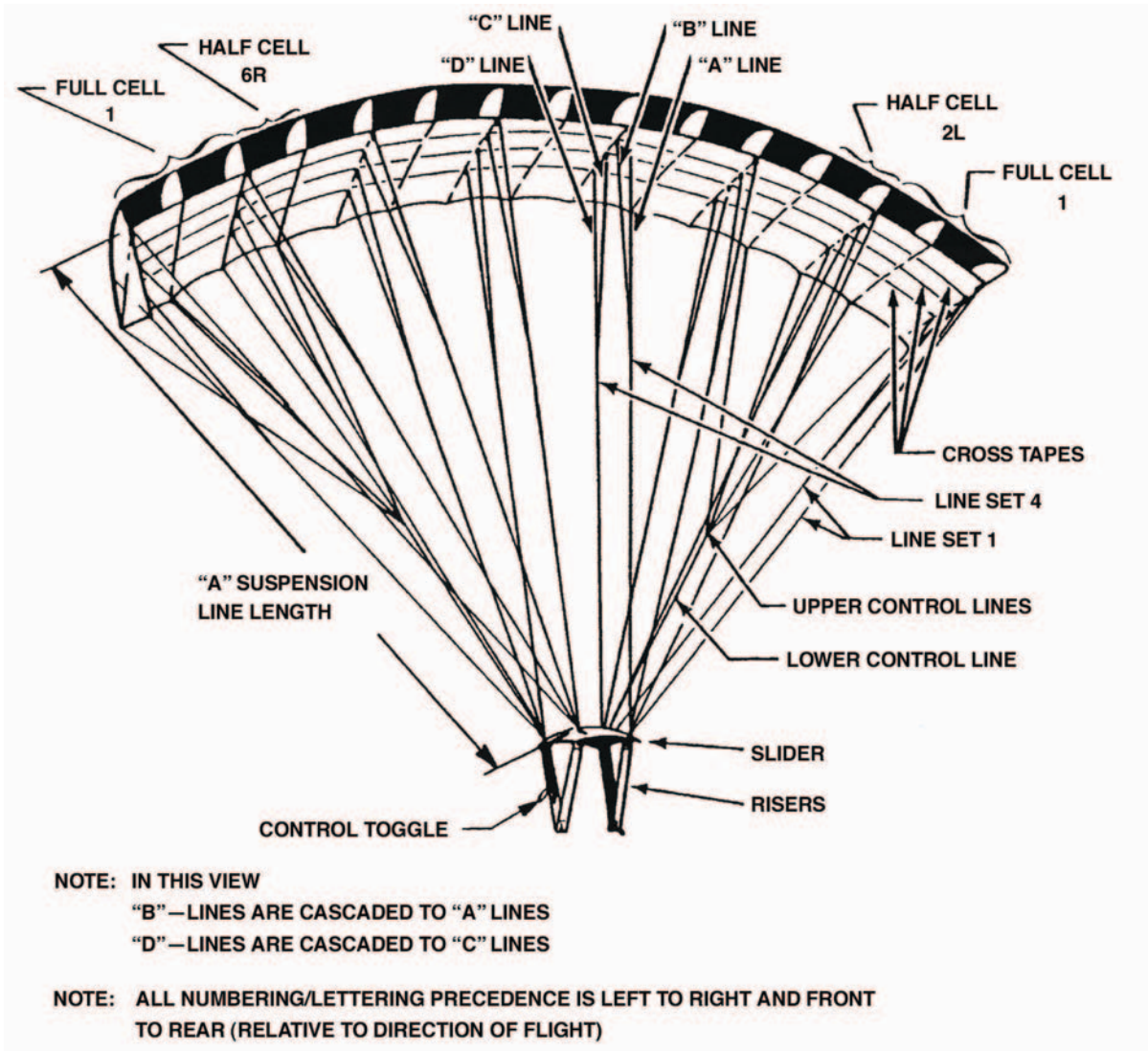


FIGURE 1



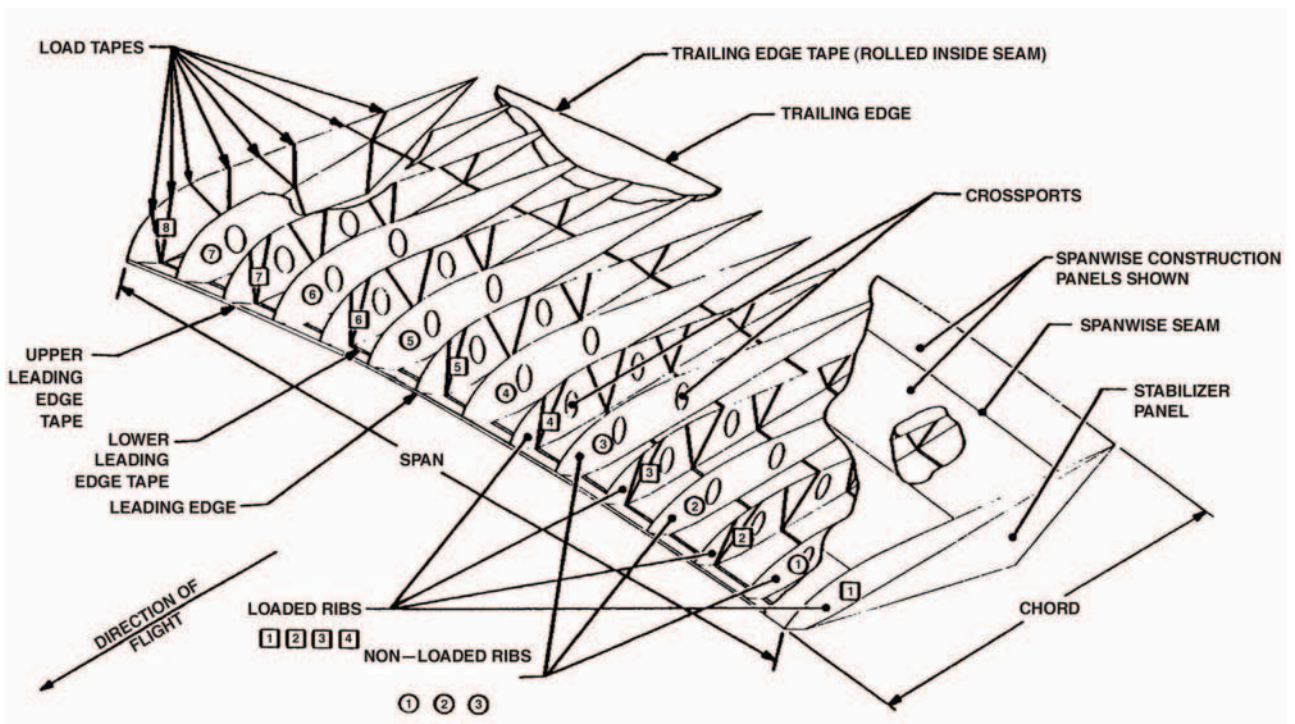


FIGURE 2

LOADED RIB WITH DIRECTLY ATTACHED SUSPENSION LINES SHOWING  
SUSPENSION LINE MEASUREMENTS AND TRIM DIMENSIONS

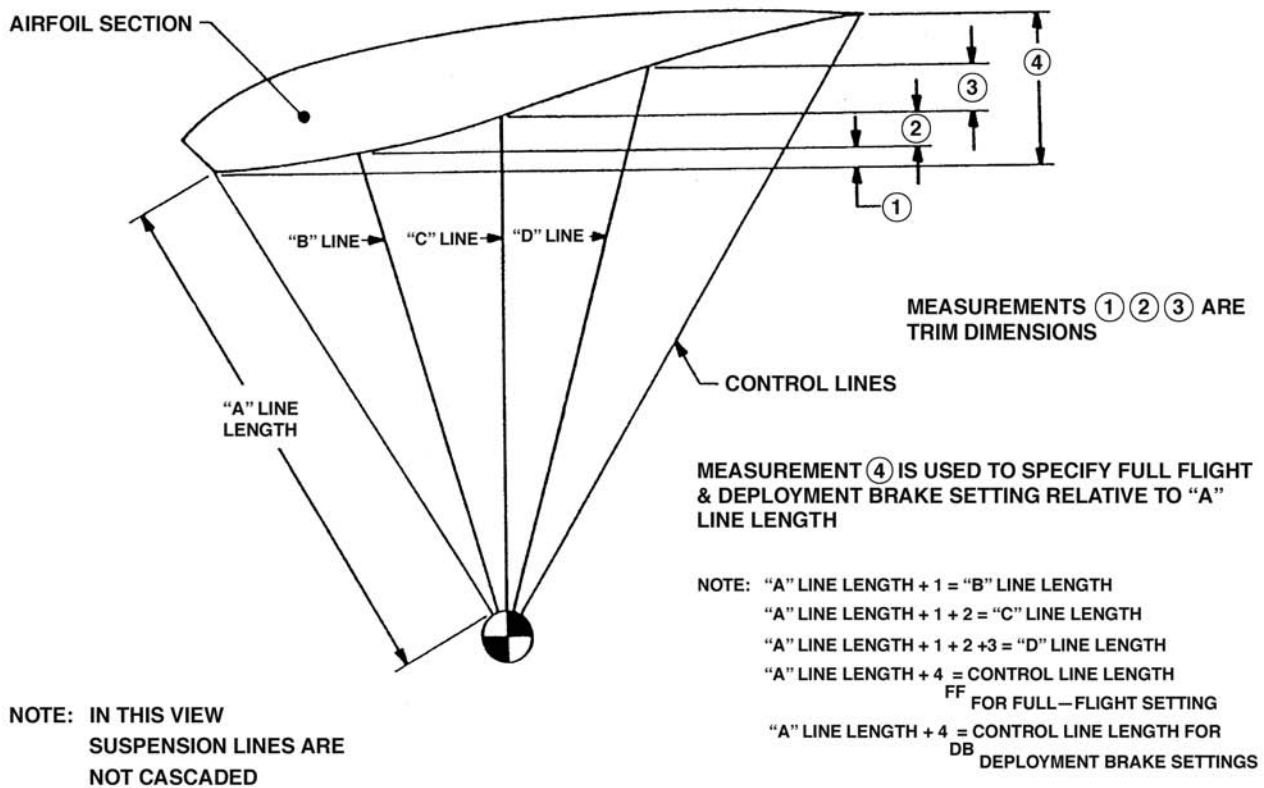
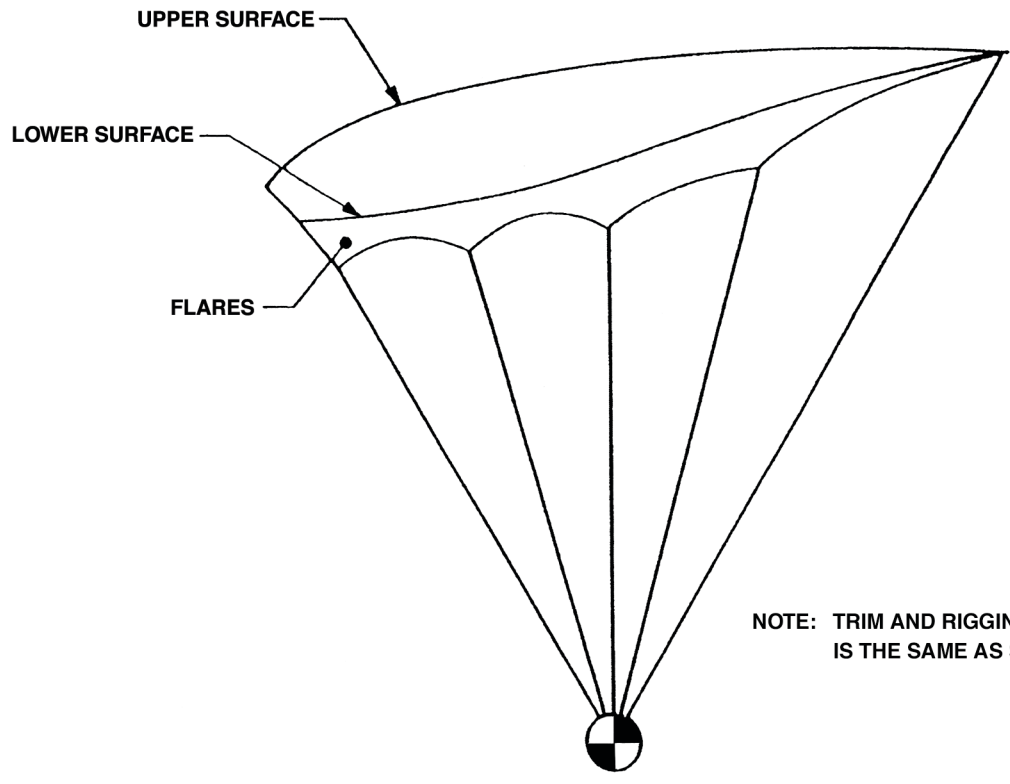


FIGURE 3A

**LOADED RIB USING FLARES FOR SUSPENSION LINE ATTACHMENTS**



**NOTE: TRIM AND RIGGING INFORMATION IS THE SAME AS SHOWN IN FIGURE 3a.**

**FIGURE 3B**



HALF CELL CHORDWISE CONSTRUCTION

SECTION VIEW FROM FRONT

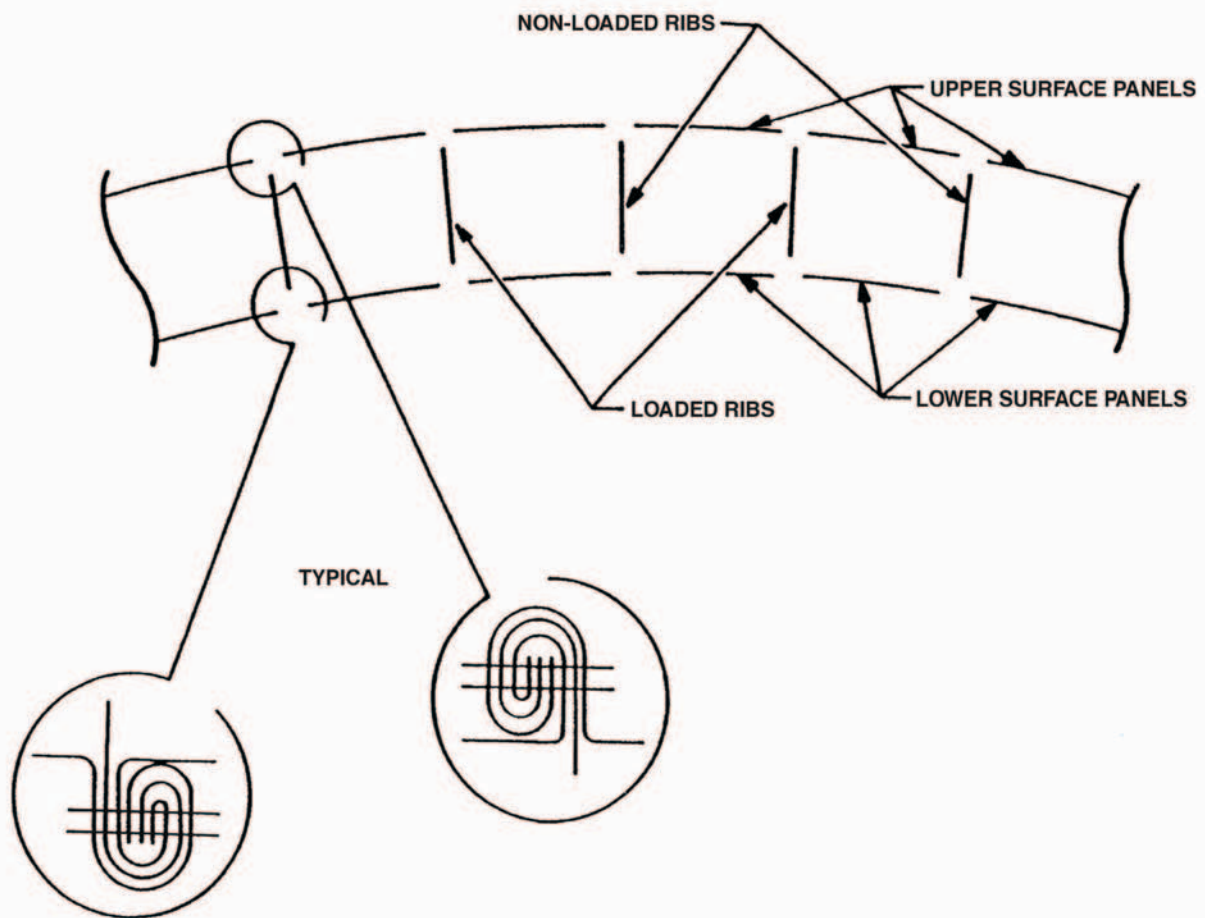


FIGURE 4A

**FULL CELL CHORDWISE CONSTRUCTION "I" BEAM**  
**SECTION VIEW FROM FRONT**

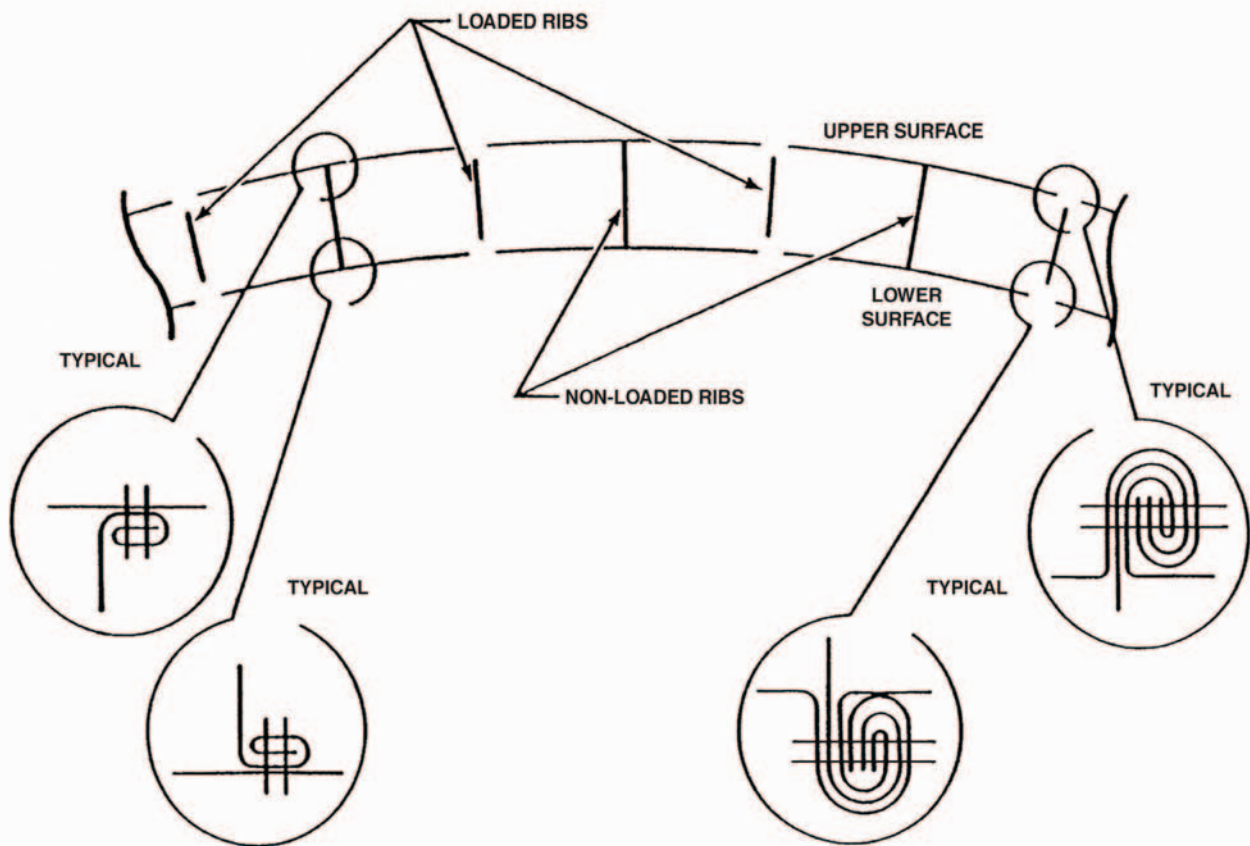


FIGURE 4B

FULL CELL CONSTRUCTION  
INTERLOCKING "T" BEAM  
SECTION VIEW FROM FRONT

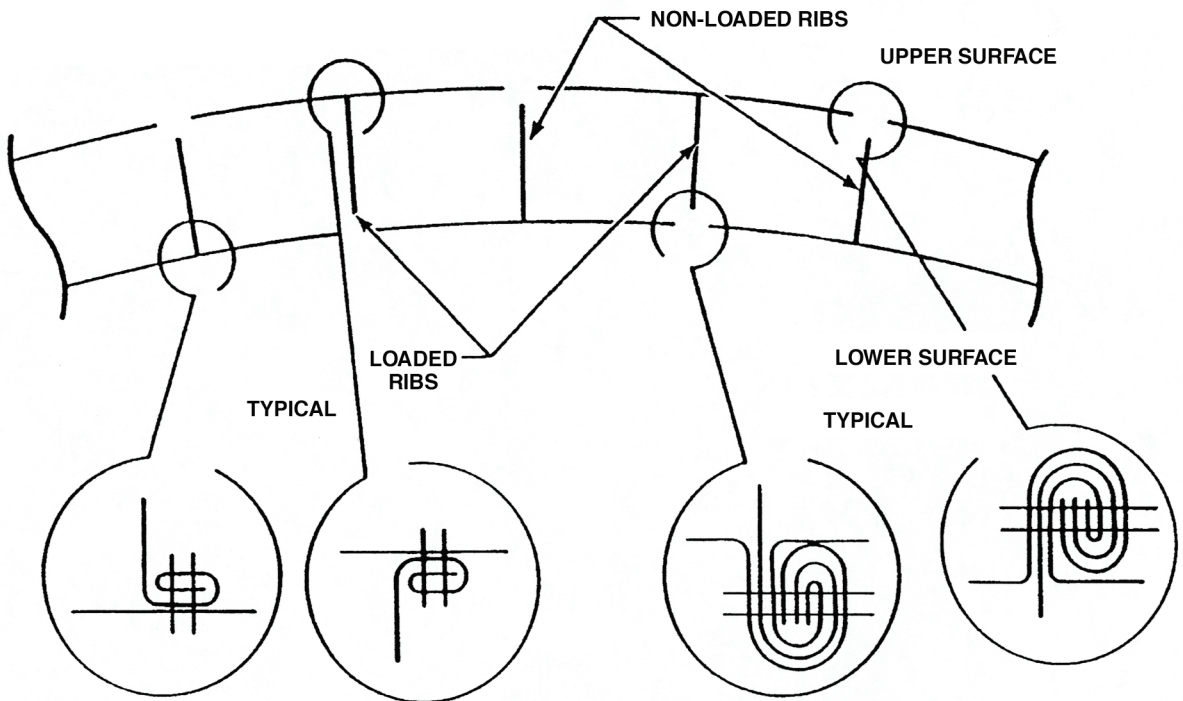


FIGURE 4C



**SPANWISE CONSTRUCTION**  
**SECTION VIEW FROM FRONT**

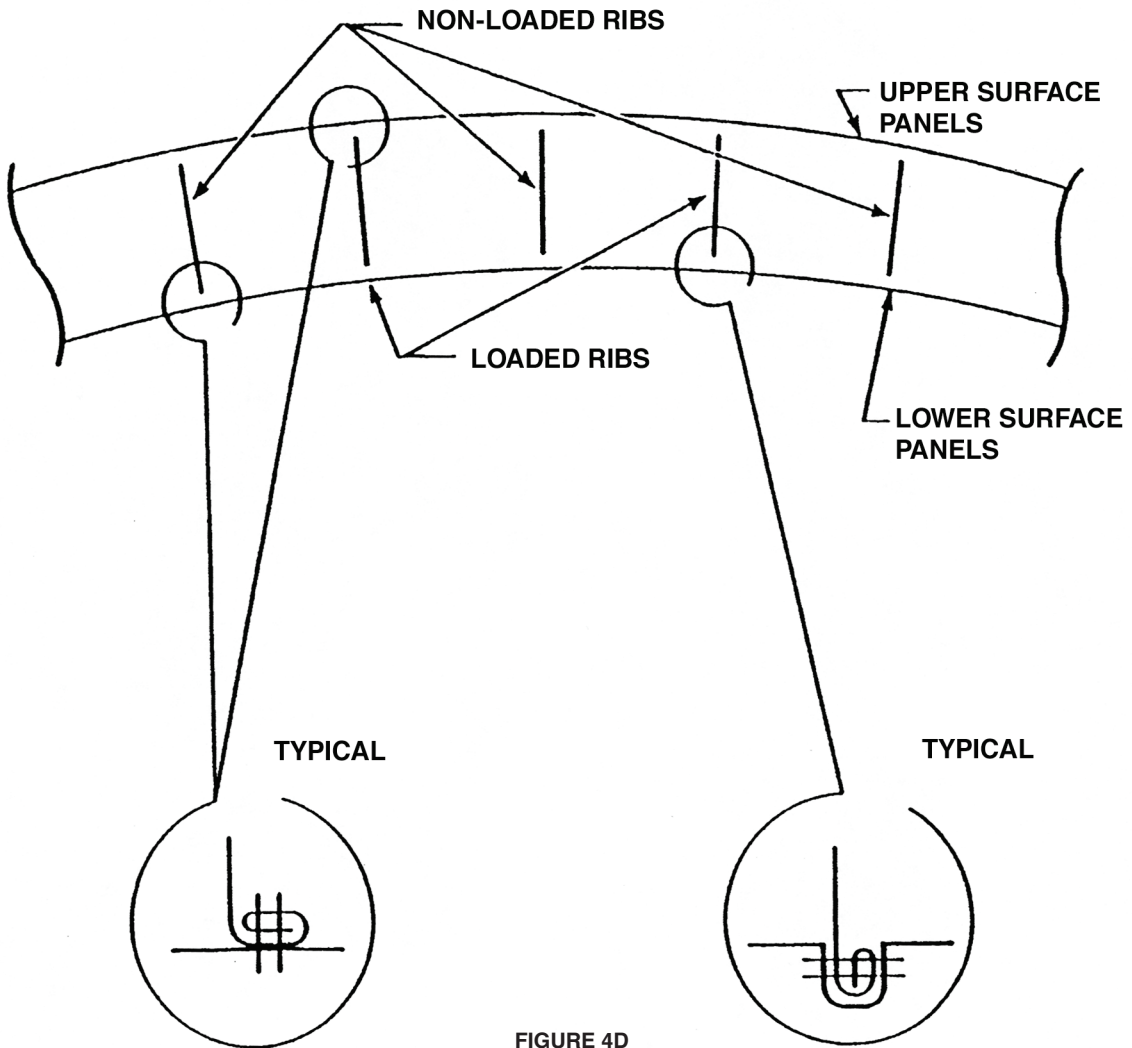


FIGURE 4D

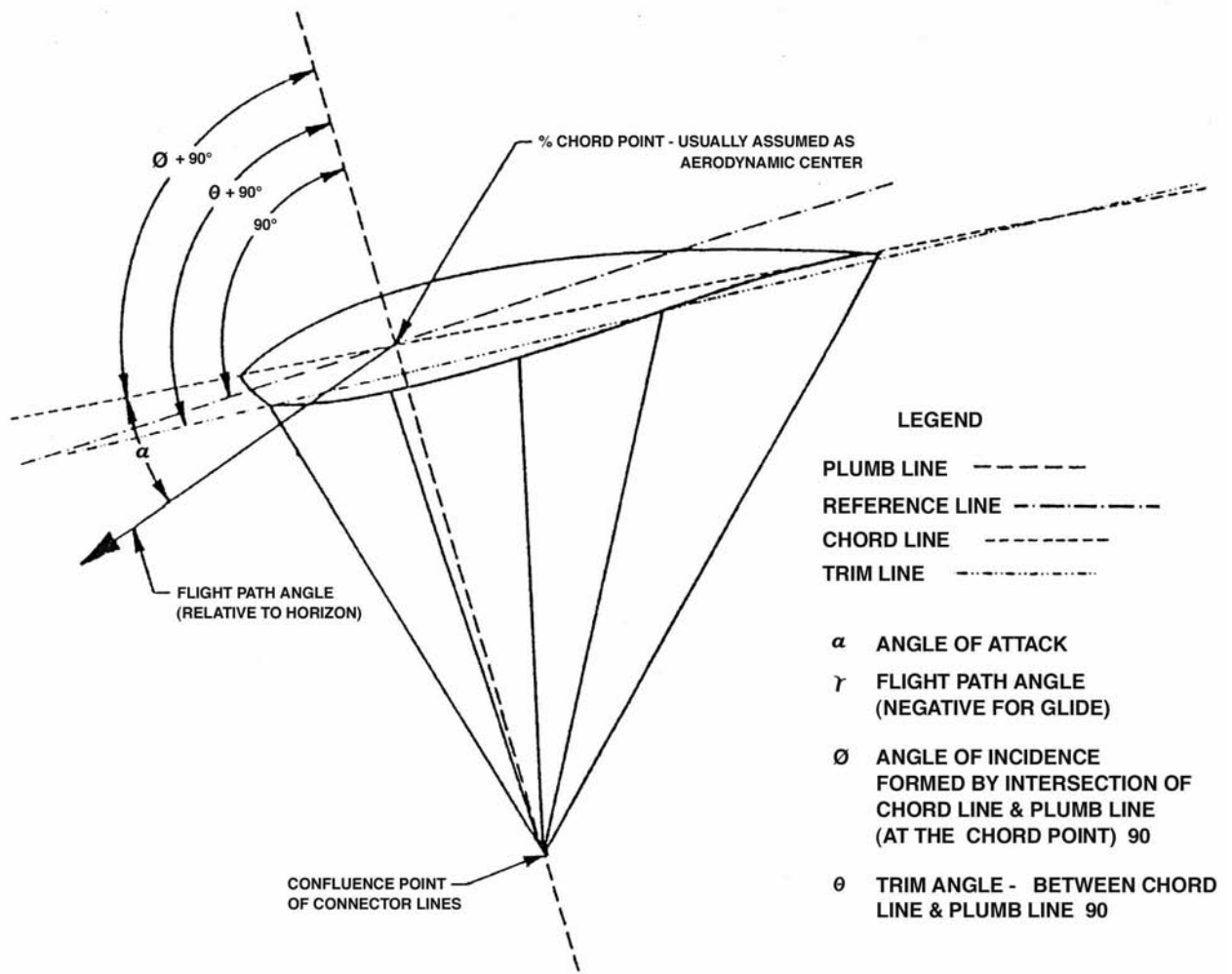


FIGURE 5

# PIA-Technical Standard 108

## Parachute Industry Association Publications

December 12, 1992 TS-108

---

### **Parachute Canopy Fabric Pull Test, Non-Destructive Method**

#### **Background:**

The purpose of this test method is to provide a simple, standardized, non-destructive method of verifying the strength of parachute fabric. Although this test is non-destructive caution should be exercised as this test could be damaging to the fabric, if the clamps are not tight and it may affect the fabric permeability. This method is readily usable in the field and is designed to replace the old "Riggers' Thumb Test". This test was first devised in response to the "acid-mesh" discovery in the mid-1980's, but is now the accepted method for all parachutes requiring fabric strength tests. Reasons for testing may vary from fabric age, chemical contamination, UV exposure or discoloration of a suspicious origin, such as grease.

#### **Tools Required and Possible Source:**

##### **(2 ea.) Locking Fabric Clamps:**

Para-Gear Equipment Co. (800) 323-0437

Aerostar International, P/N 51406M, (605) 331-3500

Aero Store (609) 893-1722

**(AR) MIL-I-6903C, Type IV Parachute Ink:** See 5a, page 2.

##### **(1 ea.) Spring Scale, 50 lb. (22 Kg.) minimum capacity:**

Para-Gear or Aero Store.

This scale must be calibrated in an approved manner at least once a year. It must be identified with a serial number and written verification of calibration must be kept on file. A stick on label or something similar should be affixed to the scale showing the date calibrated and date due next calibration. If the scale is damaged in any manner, such as dropping, it must be pulled from service and tagged as unserviceable until such time as it's recalibrated and returned to service.

#### **Test Procedures:**

These test procedures were originally written to address the acid-mesh problem of the mid-1980's that came under factory service bulletins or FAA AD's. However the test is designed to be used on any canopy. The procedures for non-mesh related testing will be the same only the areas being tested will differ. A minimum of 2 areas should be tested on a canopy, but not less than 2 pull tests on each separate color (1 in the warp direction and 1 in the fill direction). It is recommended that fabric pull tests begin when placing a canopy into service and continue every year thereafter, for the life of the parachute.



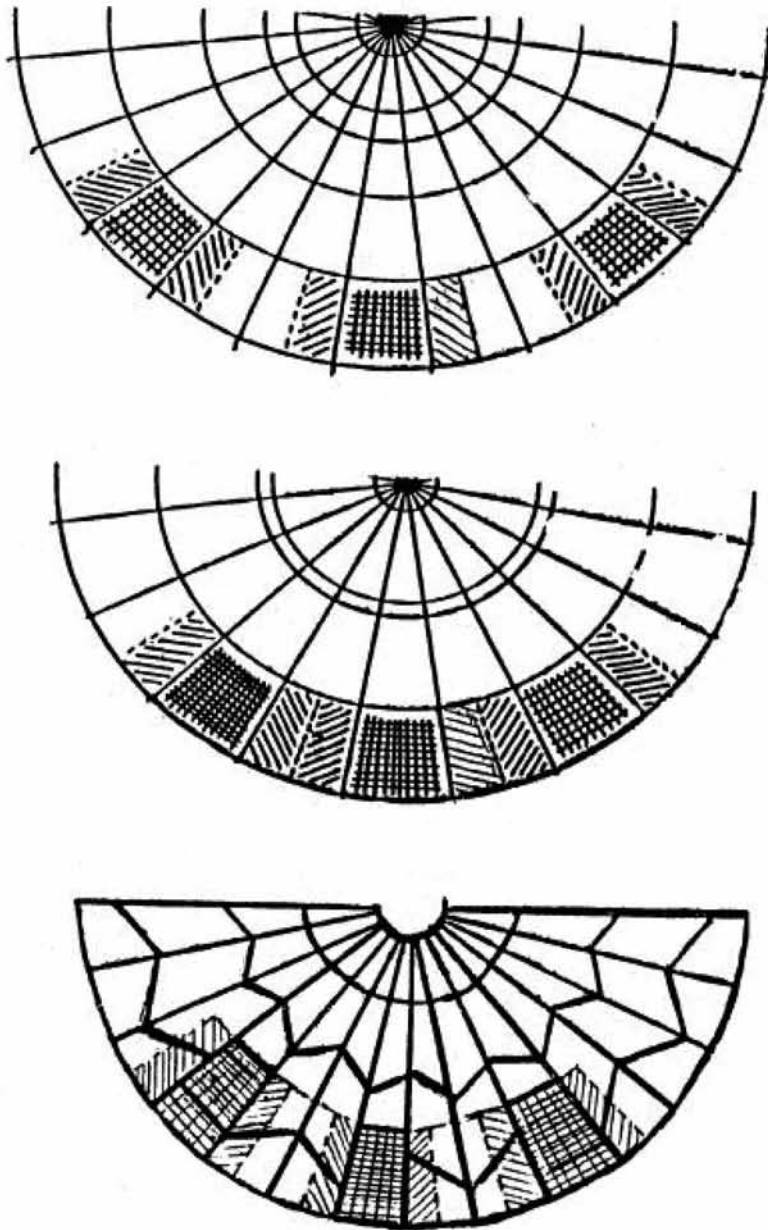
**When testing fabric next to the mesh proceed as follows:**

1. Locate the mesh vents in the canopy and determine the fabric areas which are in contact with the mesh when the canopy is packed. These areas are shown as the diagonally shaded lines in (Figure 1), for typical tri-vent canopies.
2. This non-destructive test does not supersede service bulletins issued by canopy manufacturers for their products or FAA AD's. A minimum of 1 pull test should be performed on each panel of material that comes in contact with the mesh, when the canopy is packed. Alternate your tests from the warp to fill direction on the panels. This could be as few as four tests or as many as twelve tests on some bias constructed canopies, such as the G.Q. Security SAC. The area to be tested must be visibly marked for future reference and to insure that you do not retest the same area. Refer to (figure 4), for examples of how to mark the parachute to be tested.
3. After the marking ink has dried attach the locking fabric clamps (figure 2) to the ripstop fabric as shown in (figure 3). The distance between the clamps should be 3" plus or minus 1/4" (7.5 cm.) and the clamps must be aligned so that the ripstop pattern is parallel to the edge of the jaws. Lock the clamps very securely. This will prevent slippage and possible damage to the fabric.
  - a). If the area to be tested is too small to allow 3" plus or minus 1/4" between the jaws of the clamps, such as the apex area, you can reduce the distance between the jaws to 2" plus or minus 1/4" (7.5 cm.).
4. Pass a short length of suspension line or other suitable material through the eye of one clamp and secure it to the packing table or other object which will allow a 40 lb.(18 kg.) load without movement. Pass the hook from the spring scale through the other fabric clamp eye and slowly apply a gradual 40 lb.(18 kg.) load and hold for 3 seconds.
5. The area tested must be stamped with the results of your test, (see figure 5). The color must be in contrast to the area tested. It must include the pounds or kg. pulled to, the date tested, the word pass or fail and the loft or name and number of the individual performing the test. After completing the tests the remarks section of the packing data card should reflect your results. As an example: Passed 40 lb. pull tests, your name and number, date and where performed. In addition your master logbook should also be noted in a like manner.
  - a). The most common color parachute ink is **strata-blue**. Another color is **orange-yellow**. With these two colors you will be able to visibly mark any area to be tested. **Use only MIL-I-6903C, Type IV Parachute Ink**. A possible source for this ink is listed below:

American Writing Ink Co. (617) 482-9167  
33 Farnsworth St.  
Boston, MA. 02210

Strata-Blue-----P/N 7510-00-286-5362  
Orange-Yellow----- P/N 7510-00-634-6583

Below are diagrams of typical tri-vent modifications.



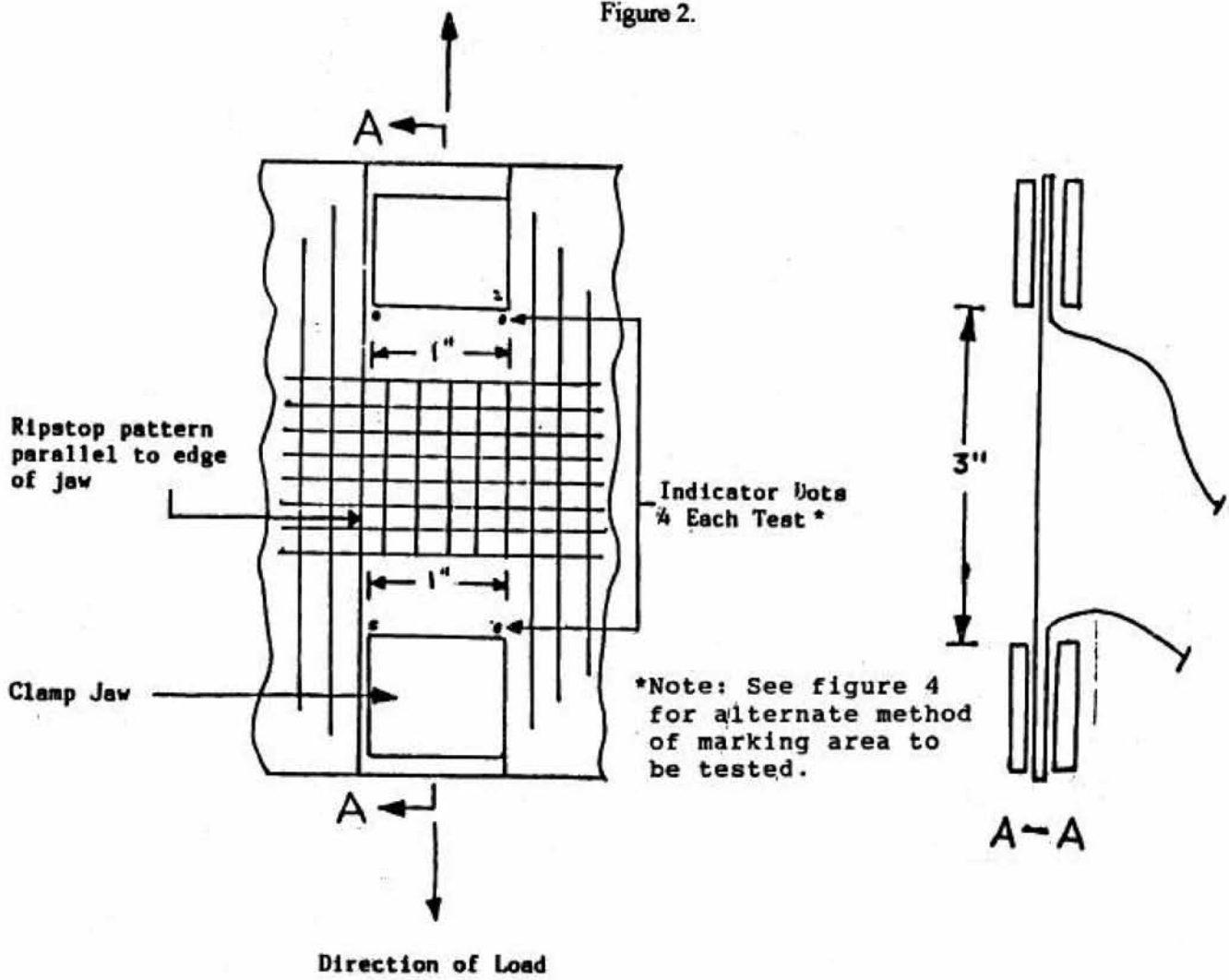
Diagonally shaded areas show fabric that comes in contact with mesh or may contact mesh.

Figure 1.



Fabric Clamp (Rubber Padded/Square Jaw)

Figure 2.



\*Note: See figure 4 for alternate method of marking area to be tested.

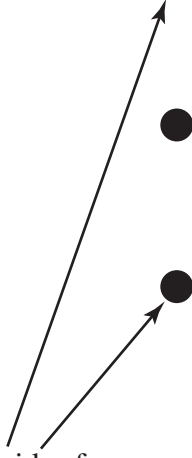
How to Attach Clamps

Figure 3.



40LB. TENSILE TEST:  
DATE:  
LOFT (AND/OR) NAME AND NUMBER

- 40LB. TENSILE TEST:  
DATE:  
LOFT (AND/OR) NAME AND NUMBER
- 



**NOTE:** This method uses the corner dots or the right angles as the guides for fabric clamps.

Examples of actual size canopy markings  
Figure 4

40LB. TENSILE TEST: PASSED  
DATE: DEC 25 1992  
LOFT (AND/OR) NAME AND NUMBER

Example of completed test  
Figure 4





# Technical Standard Order

---

**Subject: TSO-C23d, PERSONNEL PARACHUTE ASSEMBLIES**

a. Applicability.

(1) Minimum Performance Standards. This technical standard order (TSO) prescribes the minimum performance standard that personnel parachute assemblies must meet in order to be identified with the applicable TSO marking. New models of personnel parachute assemblies that are to be so identified and that are manufactured on or after the date of this TSO must meet the standards set forth in Society of Automotive Engineers, Inc. (SAE) Aerospace Standard (AS) Document No. AS 8015B, "Minimum Performance Standards for Parachute Assemblies and Components, Personnel," dated July 7, 1992.

b. Marking. Each personnel parachute assembly or separate sub-assembly must be marked in accordance with 14 CFR part 21, section 21.607(d) and paragraph 4.2 of SAE AS 8015B. This marking requirement applies to any previously approved major component/sub-assembly used in this TSO.

c. Data Requirements.

(1) In addition to the requirement in part 21, section 21.605, the manufacturer shall furnish the manager of the Aircraft Certification Office (ACO), FAA having geographical purview of the manufacturer's facilities, one copy each of the following technical data:

(i) A complete description of the personnel parachute assemblies, including detail drawings, material identification and specifications.

(ii) Operating instructions and limitations, to include donning, retention, adjustment, and deployment.

(iii) Installation instructions and limitations.

(iv) A report of the tests conducted in accordance with SAE AS 8015B for qualification and approval of personnel parachute assemblies.



(v) Detailed maintenance instructions, including specific guidance on the limits of wear and damage permissible to webbing material that would warrant replacement.

(vi) The quality control inspection and functional test specification to be used to ensure each production article complies with this TSO, as required by part 21, section 21.605(a)(3) and part 21, section 21.143(a)(3).

(2) The manufacturer must furnish to the user of the article one copy of the data and information specified in paragraphs c(l)(ii) and c(l)(v). This data and information is necessary for proper installation and use and for continued airworthiness of the product or article.

“The conditions and test required for TSO approval of this article are minimum performance standards. It is the responsibility of those desiring to install the article either on or within a specific type or class of aircraft to determine that the aircraft installation conditions are within the TSO standards. The article may be installed only if further evaluation by the applicant (user/installer) documents an acceptable installation and is approved by the Administrator.”

d. Availability of Referenced Documents.

(1) Copies of SAE AS 8015B may be purchased from the Society of Automotive Engineers, Inc., Department 331, 400 Commonwealth Drive, Warrendale, PA 15096.

(2) Federal Aviation Regulations, part 21, subpart O, may be purchased from the Superintendent of Documents, U.S. Government Printing Office, Washington, DC 20402-9325.

(3) Advisory Circular 20- 110, “Index of Aviation Technical Standard Orders,” may be obtained from the U.S. Department of Transportation, General Services Section, M-443.2, Washington, DC 20590.

/S/ John K. McGrath  
Manager, Aircraft Engineering Division  
Aircraft Certification Service

# SAE AS8015 REV. B

## AEROSPACE STANDARD

### MINIMUM PERFORMANCE STANDARDS FOR PARACHUTE ASSEMBLIES AND COMPONENTS, PERSONNEL

#### 1. SCOPE:

This document defines the minimum performance standards for personnel parachute assemblies to be carried in aircraft or worn by passengers, crew, or parachutists for emergency use.

This document covers three types of personnel carrying parachute assemblies and the operating limitations for each:

#### 1.1 Types:

1.1.1 Single harness reserve parachute assembly (and components thereof).

1.1.2 Emergency parachute assembly (and components thereof).

1.1.3 Dual harness reserve parachute assembly (and components thereof).

#### 1.2 Maximum Operating Limits, General:

Parachute assemblies, or components, may be certificated for any operating weight limit equal to or greater than 220 lb (100 kg), and for any pack opening airspeed equal to or greater than 150 KEAS (277.8 km/h).

1.2.1 Dual Harness Reserve Parachute Assembly: The maximum operating weight need not be the same for each harness; however, the maximum operating limits must not be less than 400 lb (181.4 kg), 200 lb (90.7 kg) in each harness, and 175 KEAS (324.1 km/h).

#### 2. REFERENCES

#### 2.1 Definitions:

2.1.1 GENERAL: For purposes of this document a parachute assembly normally, but not exclusively consists of the following major components:

- a. Deployment initiation device (pilot chute, drogue, or functional equivalent);  
bridle, if applicable.
- b. Deployment control device (sleeve, bag, diaper, or functional equivalent), if used
- c. Canopy(s) (includes suspension lines, connector links if used, and reefing device, if used)
- d. Riser(s), if used, when not integral with harness and/or canopy

- e. Stowage container
  - f. Harness(es)
  - g. Primary actuation device (ripcord or functional equivalent, including reserve static line, if used)
- 2.1.2 SINGLE HARNESS RESERVE PARACHUTE ASSEMBLY: A certificated parachute assembly (including the reserve deployment initiation device, deployment control device, canopy, risers, stowage container, harness, and actuation device) that is worn in conjunction with a main parachute assembly used for premeditated jumps.
- 2.1.3 MAIN PARACHUTE ASSEMBLY: A noncertificated parachute assembly (excluding the reserve deployment initiation device, deployment control device, canopy, risers, stowage container, harness, and actuation device) that is worn in conjunction with a certificated reserve parachute assembly as the primary parachute (the one intended for use) for premeditated jumps.
- 2.1.4 EMERGENCY PARACHUTE ASSEMBLY: A certificated parachute assembly worn for emergency, unpremeditated use only.
- 2.1.5 DUAL HARNESS RESERVE PARACHUTE ASSEMBLY: A certificated parachute assembly that is used for a premeditated jump by two people: A parachutist in command and a passenger (each in own harness), utilizing one main parachute assembly and one reserve parachute assembly.
- 2.1.6 FAILURE OF A PARACHUTE ASSEMBLY OR COMPONENT: The term "failure" in this document shall mean any change in a component or assembly that adversely affects its airworthiness.
- 2.1.7 FUNCTIONALLY OPEN: Functionally open shall mean a parachute sufficiently deployed to provide a rate of descent equal to or less than the limit specified in 4.3.7.
- 2.1.8 RESERVE STATIC LINE: A device connected to the main canopy that is capable of actuating the reserve parachute assembly following a breakaway from the main canopy.
- 2.1.9 MAXIMUM OPERATING WEIGHT: The maximum operating weight is the total weight of all individuals or dummies and their equipment.
- 2.1.10 MAXIMUM OPERATING SPEED: The maximum operating speed equals the maximum pack open speed in KEAS.

### 3. MATERIALS AND WORKMANSHIP:

Materials and workmanship shall be of a quality which documented experience and/or tests have conclusively demonstrated to be suitable for the manufacture of parachutes. All materials shall remain functional for storage and use from -40 to +200°F (-40 to +93.3 °C), and from 0 to 100% relative humidity. All plated ferrous parts shall be treated to minimize hydrogen embrittlement.



#### 4. DETAIL REQUIREMENTS

##### 4.1 Design and Construction:

- 4.1.1 Materials: All materials shall be designed to support the proof loads specified in the applicable specification, drawing, or standard, without yielding. In the absence of an applicable specification, drawing, or standard for a particular material, successful completion of the 4.3 tests shall be considered adequate evidence of suitability.
- 4.1.2 Stitching: Stitching shall be of a type that will not ravel when broken.
- 4.1.3 Main Parachute Assembly: The main parachute assembly when installed but not deployed shall not interfere with the proper function of the reserve parachute assembly.
- 4.1.4 Primary Actuation Device/Ripcord/Reserve Static Line: The primary actuation device/ripcord/reserve static line, including all joints, shall withstand the test loads of 4.3.1 without failure and shall meet the functional requirements of 4.3.2.
- 4.1.5 Harness Release: The harness shall be so constructed that the parachutist can separate himself from the reserve canopy and/or harness assemblies unaided.

On a dual harness reserve parachute assembly: The parachutist in command must be able to separate himself and the passenger from the reserve canopy and/or harness assemblies unaided.

- 4.1.6 Main Parachute Release: A device capable of releasing the main parachute assembly from the harness of a reserve parachute assembly is optional. If used, the main parachute assembly release shall meet the applicable functional requirements of 4.3.2.
- 4.1.7 Dual Harness Reserve Parachute Assembly, Reserve Static Line: A reserve static line, or functionally equivalent device, is required on dual harness reserve parachute assemblies.
- 4.1.8 Dual Harness Parachute Assembly, Drogue Release: On dual harness parachute assemblies the use of a drogue is optional. If a drogue is used, it shall meet the functional requirements of 4.3.2.

##### 4.2 Marking:

Except as noted below, the following information shall be legibly and permanently marked on each major component in a location subject to a minimum of obliteration:

- a. Part number, including dash numbers
- b. Manufacturer's name and address
- c. Date of manufacture (month and year) and serial number
- d. FAA TSO-C23 ( )
- e. Maximum operating limits (see 1.2 and 4.3.4)

NOTE: These items need not be marked at the same location on the component as long as all of the pertinent information is permanently marked and readily available.

- 4.2.1 Stowage Container: The information in 4.2 shall be marked on or attached to the outside of the parachute stowage container (pack), and a space provided to mark the information from 4.2.3 and 4.2.4. The lowest maximum operating weight of any component in the assembly (canopy, harness, etc.) and the lowest maximum operating speed of any component (canopy, harness, etc.) shall be marked on the outside of the stowage container (pack) in such a location as to be readily visible to the user during donning of the parachute assembly and subject to a minimum of obliteration during use. Such markings shall be in a block type face, in a minimum size of 3/8 in (9.5 mm) tall (27 point type). The other information required by 4.2, 4.2.3, and/or 4.2.4 may be marked in another location, if desired. In addition, the stowage container shall be provided with a parachute data card pocket constructed such that the card will not be easily lost but will be readily accessible.
- 4.2.2 Primary Actuation Device/Ripcord: The following information shall be marked on the primary actuation device/ripcord:
- a. Part number, including dash number
  - b. Manufacturer's identification
  - c. TSO-C23 ( )
  - d. Batch, serial number, or date of manufacture (month and year)
- 4.2.3 Canopy: In addition to 4.2 the following shall be marked on the canopy.
- a. Average peak force measured during 4.3.4 tests.
  - b. "Approved for use with emergency parachute assemblies and single harness reserve parachute assemblies without main parachute release only", for canopies that have not passed the test specified in 4.3.6.2.
  - c. "Approved for use with single harness reserve parachute assemblies equipped with or without a main parachute release", for canopies which have passed the test specified in 4.3.6.2.
  - d. "Approved for use with dual harness reserve parachute assemblies equipped with a main parachute release", for canopies which have passed the test specified in 4.3.6.2.
- 4.2.4 Harness: In addition to 4.2 marking, the following data shall be marked on the harness:
- a. Average peak force measured during 4.3.4 tests

#### 4.3 Qualification Tests:

The following minimum performance standards shall be met. There shall be no failure to meet any of the requirements during the qualification tests of this section. In case of a



failure, the cause must be found, corrected, and all affected tests repeated. The packing method must be specified and the same packing method must be used for all tests.

- 4.3.1 Primary Actuation Device/Ripcord Test: The ripcord, including all joints, shall not fail under a straight tension test load of 300 lbf (1337.7 N) applied for not less than 3 s. The reserve static line, if used, must not fail under a straight tension test load of 600 lbf (2667.3 N) for not less than 3 s. If the ripcord is to be static line operated, the test shall be 600 lbf (2667.3 N) for not less than 3 s. The pins, if used, shall not yield under a 8 lbf (35.6 N) load applied to the cable (or equivalent) perpendicular to the axis of the pin, for not less than 3 s. The pin shall be supported for 0.5 in (12.7 mm) maximum at the end farthest from the cable attachment. The pin(s) shall be deemed to have passed this test if the primary actuation device/ripcord which it (they) is (are) a part of then passes the tests specified in 4.3.2.4.
- 4.3.2 Human Factors and Actuation Force Tests: An anthropometrically diverse group of individuals from the intended user group shall be employed for all human factors tests in 4.3.2.
- 4.3.2.1 Primary Actuation Device/Ripcord, Human Factors Tests: The primary actuation device/ripcord shall be ground tested by a representative user group of no less than 6 male and 6 female subjects. They shall be able to operate the actuation device without difficulty. The ripcord, or equivalent, shall be sealed in accordance with FAR 65.133 for these tests.
- 4.3.2.1.1 Single harness reserve parachute assemblies shall be tested with the main compartment(s) both full and empty. The tests shall be conducted by the user in a suspended harness<sup>1</sup> (3 male/3 female), and while standing upright (3 male/3 female); (24 tests total).
- 4.3.2.1.2 Emergency parachute assemblies shall be tested while standing upright only (6 male/6 female); (12 tests total).
- 4.3.2.1.3 Dual harness reserve parachute assemblies shall be tested with the passenger attached as follows: Main compartment(s) both full and empty; with the user in a suspended harness<sup>1</sup> (3 male/3 female), with the user suspended by the drogue bridle (3 male/3 female) and while standing upright (3 male/3 female). These tests shall be repeated without the passenger attached; (72 tests total)<sup>2</sup>.
- 4.3.2.2 Main Canopy Release, Human Factors Tests: The main canopy release, if used, shall be ground tested in a suspended harness<sup>1</sup> by a representative group of no less than 6 male and 6 female subjects; (12 tests total). They shall be able to operate the release without any undue difficulty.  
Dual harness reserve parachute assemblies shall be tested while in a suspended harness<sup>1</sup> and while suspended by the drogue bridle with and without a passenger attached by a representative group of no less than 6 male and 6 female subjects; (48

---

<sup>1</sup> "In a suspended harness" shall mean suspended by the risers of the main canopy.

<sup>2</sup> Dual harness reserve parachute assemblies while being tested with an attached passenger are required to be tested/operated by the parachutist in command. If passenger operated devices are used, all 4.3.2.2 and 4.3.2.3 tests with a test subject in the passenger harness must be repeated with the passenger operating the device.



tests total). They shall be able to operate the release device without any undue difficulty.<sup>2</sup>

- 4.3.2.3 Drogue Release, Human Factors Tests: The drogue release (if used) shall be ground tested by a representative group of no less than 6 male and 6 female subjects. They shall be able to operate the release device without any undue difficulty. The drogue release shall be tested with the test subject(s) suspended by the drogue bridle (6 male/6 female), and with an additional test subject, if used, in the passenger harness (6 male/6 female); (24 tests total)<sup>2</sup>.
- 4.3.2.4 Primary Actuation Device/Ripcord, Actuation Force Tests: A load at the ripcord handle, or equivalent, of not less than 5 lbf (22.2 N), applied in the direction giving the lowest pull force, nor more than 22 lbf (97.9 N), applied in the direction giving the highest pull force under normal design operations, shall result in a positive and quick deployment initiation on all tests. A minimum of 10 pull tests is required. For chest type parachute assemblies, the maximum pull force shall be 15 lbf (66.7 N).
- 4.3.2.5 Main Canopy Release, Actuation Force Tests: While in a suspended harness (with additional ballast as required to equal twice the maximum operating weight), a force at the main canopy release handle, or equivalent (if used), of not less than 5 lbf (22.2 N) (applied in the direction requiring the least force), nor more than 22 lbf (97.9 N) (applied in the direction requiring the greatest force under normal design operations), shall result in a positive and quick release of the main canopy on all tests. A minimum of 12 pull tests is required.
- 4.3.2.6 Drogue Release, Actuation Force Tests: A force at the drogue release handle (if used), or equivalent, of not less than 5 lbf (22.2 N) (applied in the direction requiring the least force), nor more than 22 lbf (97.9 N) (applied in the direction requiring the greatest force under normal design operations), while suspending the maximum operating weight, shall result in a positive and quick release of the drogue on all tests. A minimum of 12 tests is required.
- 4.3.3 Compressed Pack and Environmental Tests: Three drops shall be made to the lowest applicable direct drop speed in 4.3.6 except that prior to the test the parachute assembly shall be subjected to the following preconditioning: (These tests may be combined with other tests.)
  - 4.3.3.1 Precondition for 16 h at not less than +200 °F (93.3 °C), stabilize to ambient and test drop.
  - 4.3.3.2 Precondition for 16 h at not greater than -40 °F (-40 °C), stabilize to ambient and test drop.
  - 4.3.3.3 Precondition for not less than 400 continuous hours with a 200 lbf (889.6 N) or greater load applied to compress the pack in a manner similar to that most likely to be encountered in actual use. Test drop within 1 h after removing the load.
- 4.3.4 Strength Test: No material(s) or device(s) that attenuates shock loads and is not an integral part of the parachute assembly or component being certificated may be used. Tests may be conducted for either a complete parachute assembly or separate components. There shall be no evidence of material, stitch, or functional failure that

will affect airworthiness. The same canopy, harness, component, and/or riser(s) shall be used for all 4.3.4 tests. Opening forces shall be measured on all 4.3.4 tests. The parachute must be functionally open within the number of seconds calculated for 4.3.6 tests. Parachute assemblies shall be tested in accordance with the following schedule:

- a. Test weight = Maximum operating weight limit x 1.2
- b. Test speed = Maximum operating speed limit x 1.2

However, test weight must be not less than 264 lb (119.7 kg) and the test speed must be not less than 180 KEAS (333.4 km/h) for reserve and emergency parachute assemblies; for dual harness parachute assemblies for test weight must not be less than 480 lb (217.7 kg) and the test speed must not be less than 210 KEAS (388.9 km/h).

- 4.3.4.1 Emergency Parachute Assembly: Three drops shall be made with weight and speed in accordance with 4.3.4. Where easily detachable hardware (such as snap and ring) is used to attach the canopy or riser(s) to the harness, a cross connector must be used and one of the above drops shall be with only one attachment engaged to test the cross connector and hardware.
- 4.3.4.2 Canopy to be Used With a Single or a Dual Harness Reserve Parachute Assembly (Alternate Test for 4.3.4.1): Three drops shall be made with a suspended weight and speed in accordance with 4.3.4. A test vehicle (e.g., a bomb) may be used. The canopy, deployment device (if used), a pilot chute (if used), and riser(s) (if used) shall be tested as a unit. The riser(s), or equivalent, shall be secured to the test vehicle in the same manner that it is intended to attach to the harness. Where easily detachable hardware (such as snap and ring) is intended to attach the canopy or riser(s) to the harness, one of the above drops shall be made with only one attachment engaged to test the cross connector and hardware.
- 4.3.5 Functional Test (Twisted Lines): A minimum of 5 drops shall be made with a weight not more than the maximum operating weight dummy or person<sup>3</sup> in each harness. The airspeed at the time of pack opening shall be 60 KEAS (111.1 km/h). Three twists in the same direction (360° each) shall be purposely packed in the suspension lines adjacent to the lowest attachment point to the canopy. The parachute must be functionally open within the time calculated for 4.3.6 tests +1 s from the time of pack release.
- 4.3.6 Functional Test (Normal Pack All Types): For all 4.3.6 tests the maximum allowable opening time for parachute canopies with a maximum operating weight of 250 lb (113.4 kg) or less, is 3 s from the moment of pack opening. For parachutes with a maximum operating weight of greater than 250 lb (113.4 kg) the maximum allowable opening time shall be increased by 0.01 s for every pound of maximum operating weight in excess of 250 lb (113.4 kg).

---

<sup>3</sup> A person's or individual's body weight may be increased to equal the maximum operating weight by using a weight belt or similar device.



Alternatively altitude loss instead of time may be measured and the maximum allowable altitude loss may be calculated as follows.

For all 4.3.6 tests the maximum allowable altitude loss for parachutes with a maximum operating weight of 250 lb (113.4 kg) or less is 300 ft (91.5 m) from the altitude at pack opening. For parachutes with a maximum operating weight of greater than 250 lb (113.4 kg) the maximum allowable altitude loss shall be increased by 1 ft for every pound of maximum operating weight in excess of 250 lb (113.4 kg).

NOTE: Altitude loss measurements must be measured along a vertical trajectory only. However, the deviation from the vertical produced by a gliding main parachute descending with a vertical velocity of less than 20 FPS (6.1 m/s) shall be acceptable.

- 4.3.6.1 Direct Drop Tests: There shall be a minimum of 48 drops with a weight not more than the maximum operating weight. There shall be a minimum of 6 dummy drops at the maximum operating weight. The airspeed at the time of pack opening shall be as outlined in the test table. The airspeeds are in KEAS (km/h). The parachute canopy must be functionally open within the time obtained in 4.3.6 from the time of pack opening.
- 4.3.6.2 Breakaway Drop Tests: Eight drops shall be made by a person weighing not more than the maximum operating weight by breaking away from an open and normally functioning main parachute canopy with a vertical velocity of less than 20 FPS (6.1 m/s) at the time of breakaway and actuating the reserve pack within 2 s of the breakaway. If a reserve static line is part of the assembly, no less than 4 of the breakaway drops shall be made with the reserve static line actuating the reserve pack. The parachute canopy must be functionally open within the time +2 s, or altitude, obtained in 4.3.6 from the time of breakaway.
- 4.3.6.3 Emergency Parachute Assembly: There shall be a minimum of 48 drops with a weight not more than the maximum operating weight. There shall be a minimum of 6 dummy drops at the maximum operating weight. The airspeed at the time of pack opening shall be as outlined in the table. The parachute canopy must be functionally open within the time obtained in 4.3.6 from the time of pack opening. The airspeeds are in KEAS (km/h).



TABLE 1

	KEAS (km/h) 60 (111.1)	KEAS (km/h) 85 (157.4)	KEAS (km/h) 110 (203.7)	
Main Compartment Full	7	7	7	Live or Dummy
Main Compartment Empty	7	7	7	Live or Dummy
Main Compartment Full	1	1	1	Dummy
Main Compartment Empty	1	1	1	Dummy

NOTE: Reference to full and empty main compartments do not apply to emergency parachute assemblies.

- 4.3.7 Rate of Descent Tests, All Types: There shall be not less than 6 drops, with an individual and/or dummy in each harness weighing not less than the maximum operating weight<sup>4</sup>. The average rate of descent shall not exceed 24 ft/s (7.3 m/s), and the total velocity shall not exceed 36 ft/s (11.0 m/s), in an unaltered post deployment configuration, corrected to standard sea level altitude conditions. The rate of descent measurement shall be taken over a minimum interval of 100 ft (30.5 m). These tests may be combined with other tests in this section.
- 4.3.8 Stability Test, All Types: There shall be not less than 6 drops, with a dummy weighing one half the maximum operating weight. The oscillations shall not exceed 15° from the vertical, in an unaltered postdeployment configuration. These tests may be combined with other tests in this section.
- 4.3.9 Live Drop Tests, All Types: There shall be a minimum of 4 live drop tests with an individual weighing not more than the maximum operating weight in each harness<sup>4</sup>. Two drops shall include a freefall of not more than 3 s and 2 drops shall include a freefall of at least 20 s. These tests may be conducted in conjunction with functional and/or rate of descent tests when practical. The user(s) must suffer no significant discomfort from the opening shock and must be able to disengage himself (themselves) unaided from the harness after landing. For this test the standard harness may be altered to permit attachment of a certificated reserve parachute assembly (less harness) provided that such alteration does not interfere with the normal operation of the parachute assembly being tested. Reserve parachute assemblies shall be tested with the main compartment(s) full and empty, except dual harness reserve parachute assemblies.

## 5 COMPONENT QUALIFICATIONS:

- 5.1 Parachutes may be qualified as complete assemblies or as separate components (such as a canopy, a stowage container [pack], and/or a riser[s]). The airworthiness of a parachute assembly, including other separately approved nonoriginal components, is the responsibility of the manufacturer who performs the certificating tests for the parachute assembly. The manufacturer shall publish and make available a list of interchangeable components which have passed the following tests in 4.3 when tested in conjunction with the assembly or component(s) being certificated.

<sup>4</sup> A person's or individual's body weight may be increased to equal the maximum operating weight by using a weight belt or similar device.

- 5.1.1 Canopy Including Suspension Lines: 4.3.3, 4.3.4.1 (or 4.3.4.2), 4.3.5, 4.3.6, 4.3.7, 4.3.8, 4.3.9
- 5.1.2 Deployment Device: 4.3.3, 4.3.4.1 (or 4.3.4.2), 4.3.5, 4.3.6, 4.3.9
- 5.1.3 Pilot Chute (Including Bridle): 4.3.3, 4.3.4.1 (or 4.3.4.2), 4.3.5, 4.3.6, 4.3.9
- 5.1.4 Stowage Container (Pack): 4.3.2.1, 4.3.2.3, 4.3.3, 4.3.6, 4.3.4.1 (or 4.3.4.2), 4.3.5, 4.3.9
- 5.1.5 Harness: 4.3.4.1, 4.3.6, 4.3.9
- 5.1.6 Actuation Device (Ripcord and/or Reserve Static Line): 4.3.1, 4.3.2, 4.3.6.2, 4.3.9
- 5.1.7 Actuation Device (Reserve Static Line): 4.3.1, 4.3.6.2
- 5.1.8 Riser(s): 4.3.4.1 (or 4.3.4.2), 4.3.6, 4.3.9



## Technical Standard Order

---

Subject: TSO-C23c, PERSONNEL PARACHUTE ASSEMBLIES

(a) Applicability

(1) Minimum Performance Standard. This Technical Standard Order (TSO) prescribes the minimum performance standard that personnel parachute assemblies must meet in order to be identified with the applicable TSO marking. This TSO has been prepared in accordance with the procedural rules set fourth in Subpart O of the Federal Aviation Regulations, Part 21. Personnel parachute assemblies that are to be so identified and that are manufactured on or after the date of this TSO must meet the standard set fourth in society of Automotive Engineers, Inc. (SAE), Aerospace Standard (AS) 8015A, Minimum Performance Standard for Parachute Assemblies and Components, Personnel, dated September 30, 1982, as amended and supplemented by this TSO.

(b) Markings. None in addition to the marking specified in Federal Aviation Regulations (FAR)/21.607(d).

(c) Data Requirements.

In addition to FAR/21.605, the manufacturer must furnish the Manager, Aircraft Certification Office (ACO), Federal Aviation Administration (FAA), having purview of the manufacturer s facilities, one copy each of the following technical data:

- (1) Operating instructions.
- (2) Equipment limitations.
- (3) Inspection and test procedures applicable to this product.
- (4) Specifications.
- (5) Maintenance procedures.
- (6) Manufacturer's TSO qualification test report.

(d) Previously Approved Equipment. Personnel parachute assemblies approved prior to the date of this TSO may continue to be manufactured under the provisions of the original approval.



(e) Availability of Reference Documents.

(1) Copies of SAE AS 8015A may be purchased from the Society of Automotive Engineers, Inc., Department 331, 400 Commonwealth Drive, Warrendale, Pennsylvania 15096.

(2) Federal Aviation Regulations, Part 21, Subpart O and Advisory Circular 20-110, Index of Aviation Technical Standard Orders, may be reviewed at the FAA Headquarters in the Office of Airworthiness, Aircraft Engineering Division (AWS-110) and at all ACO s.

M.C. BEARD  
Director of Airworthiness

# SAE AS8015 REV. A

## AEROSPACE STANDARD

### **MINIMUM PERFORMANCE STANDARDS FOR PARACHUTE ASSEMBLIES AND COMPONENTS, PERSONNEL**

#### 1. SCOPE:

This specification defines the minimum performance standards for personnel parachute assemblies to be carried in aircraft or worn by passengers, crew, or parachutists for emergency use.

This specification covers two types and three weight/speed categories of personnel carrying parachute assemblies:

#### 1.1 Types:

1.1.1 Reserve parachute assembly (The term reserve and auxiliary are used synonymously).

1.1.2 Emergency parachute assembly.

1.2 Weight/Speed Ranges: The weights and speeds are maximum for each category.

1.2.1 Category A: 90 kg (198 lb)/130 knots.

1.2.2 Category B: 115 kg (254 lb)/150 knots.

1.2.3 Category C: 115 kg (254 lb)/175 knots.

#### 2. Definitions:

2.1 RESERVE PARACHUTE ASSEMBLY: A parachute assembly which is worn in conjunction with a main parachute assembly used for a premeditated jump.

2.2 MAIN PARACHUTE ASSEMBLY: A parachute assembly, excluding the harness, that is used in conjunction with a reserve parachute assembly as the primary parachute assembly (the one intended for use) for premeditated jumps.

2.3 TANDEM (PIGGYBACK) PARACHUTE ASSEMBLY: A parachute assembly having a reserve and a main parachute, stowed separately, but in compartments on the same side of the body.

2.4 EMERGENCY PARACHUTE ASSEMBLY: An emergency parachute assembly worn for emergency, unpremeditated use only.

2.5 GENERAL: For purposes of this specification a parachute assembly normally consists of seven major components:

1. Canopy (includes suspension lines).
2. Deployment device (sleeve, bag, or equivalent), if used.
3. Pilot chute (including bridle), if used.
4. Riser(s), if used, when not integral with harness and/or canopy.
5. Stowage container (pack).
6. Harness.
7. Primary actuation device (ripcord assembly or equivalent)

### 3. MATERIAL AND WORKMANSHIP:

3.1 Materials and workmanship shall be of a quality which documented experience and/or tests have conclusively demonstrated to be suitable for the manufacture of parachutes. All materials shall remain functional for storage and use from -40 to +93.3 °C (-40 to +200 °F). All plated ferrous parts shall be treated to minimize hydrogen embrittlement.

### 4. DETAIL REQUIREMENTS

#### 4.1 Design and Construction:

4.1.1 Fittings: All fittings shall be designed to support the proof loads specified in the applicable specification, drawing, standard, etc., without yielding.

4.1.2 Stitching: Stitching shall be of a type that will not ravel when broken.

4.1.3 Primary Actuation Device/Ripcord: The primary actuation device/ripcord, including joints between the handle and the release, shall withstand the test loads of 4.3.1 without failure and shall meet the functional requirements of 4.3.2. The actuation grip shall be located as to be readily visible and accessible.

4.1.4 Harness Release: The harness shall be so constructed that the rider can separate himself from the canopy and/or harness assembly unaided.

4.1.5 Main Canopy Release: A quick releasing device between the harness of a reserve parachute assembly and the main canopy is mandatory.

4.2. Marking: Except as noted below, the following information shall be legibly and permanently marked on each major component in a location subject to a minimum of obliteration:

- Part number, including dash numbers
- Manufacturer's name and address
- Date of manufacture and/or serial number
- FAA TSO-C23c
- Category A, B, C placards (see table)



- 4.2.1 Stowage Container: The information in 4.2 shall be marked on or attached to the outside of the parachute stowage container (pack). In addition, the stowage container shall be provided with a parachute data card pocket constructed such that the card will not be easily lost but will be readily accessible.
- 4.2.2 Canopy: In addition to the above information, the canopy markings shall include the canopy serial number.
- 4.2.3 Primary Actuation Device/Ripcord: The following information shall be marked on the primary actuation device/ripcord:
- Part number, including dash number
  - Manufacturer's identification
  - TSO-C23c
  - Batch or serial number, and/or date of manufacture
- 4.2.4 Documents: The manufacturer shall provide all necessary instructions and/or manuals.
- 4.3 Qualification Tests: The following minimum performance standards shall be met. There shall be no failure to meet any of the requirements during the qualification of this section. In case of a failure, the cause must be found, corrected, and all affected tests repeated.
- 4.3.1 Ripcord Test: The ripcord, including all joints between the handle and the release, shall not fail under a straight tension test load of 1335 N (300 lbf) applied for not less than three seconds. If the ripcord is to be static line operated, the test shall be 2670 N (600 lbf) for not less than three seconds. The pins, if used, shall not yield under a 36 N (8 lbf) load applied to the cable (or equivalent) perpendicular to the axis of the pin. The pin shall be supported for 13 mm (.5 in.) maximum at the end farthest from the cable attachment.
- 4.3.2 Pull Test, Primary Actuation Device/Ripcord: Reserve parachute assemblies shall be tested both with the main compartment(s) full and empty.
- 4.3.2.1 Human Factors: The primary actuation device shall be ground tested by use of a representative group of no less than five male and five female subjects. They shall be able to operate the actuation device without undue difficulty while in a suspended harness. The ripcord, or equivalent, shall be sealed for these tests.
- 4.3.2.2 Pull Tests: A load AT THE RIPCORD HANDLE of not less than 23 N (5 lbf) (applied in the direction giving the lowest pull load) nor more than 97 N (22 lbf) [APPLIED IN THE DIRECTION GIVING THE HIGHEST PULL LOAD UNDER NORMAL DESIGN OPERATIONS] shall be required to cause a positive and quick functioning of the parachute assembly on all tests. A minimum of ten pull tests is required. For chest-type parachute assemblies, the maximum pull force shall be 66 N (15 lbf)

- 4.3.3 Compressed Pack and Environmental Test: Three drops shall be made to the lowest applicable speed phase in 4.3.6 except that prior to the test the parachute assembly shall be subjected to the following conditioning:
- 4.3.3.1 Four hundred continuous hours with a 890 N (200 lbf) load applied to compress the pack. Sixteen hours at 93.3 °C (+200 °F) without the 890 N (200 lbf) load. Immediately re-apply 890 N (200 lbf) load and stabilize to ambient and test drop.
- 4.3.3.2 Sixteen hours at -40 °C (-40 °F) without the 890 N (200 lbf) load. Immediately apply 890 N (200 lbf) load and stabilize to ambient and test drop.

These tests may be combined with 4.3.6 when practical.

- 4.3.4 Strength Test: No material(s) or device(s) that attenuates shock loads and is not an integral part of the parachute assembly or component being certificated may be used. Tests may be conducted for either a complete parachute assembly or a separate canopy. There shall be no evidence of material, stitch, or functional failure that will affect airworthiness. The same canopy, harness and/or riser(s) shall be used for all 4.3.4 tests. Parachute assemblies may be tested in accordance with Category A, B, or C.
- 4.3.4.1 Parachute Assembly: Three drops shall be made with a 136 kg (300 lb) man-shaped dummy. The velocity of the dummy shall be in accordance with category A, B, or C schedule (see Table 1). Where easily detachable hardware (such as snap and ring) is used to attach the canopy or riser(s) to the harness, a cross connector must be used and one test shall be with only one attachment engaged to test the cross connector and hardware.
- 4.3.4.2 Canopy (Alternate Test for 4.3.4.1): Three drops shall be made with a suspended weight of 136 kg (300 lb) and a velocity in accordance with Category A, B, or C schedule (see Table 1). A test vehicle (e.g., a bomb) may be used. The canopy, deployment device (if used), a pilot chute (if used), and riser(s) (if used) shall be tested as a unit. The riser(s), or equivalent, shall be secured to the test vehicle in the same manner that it is intended to attach to the harness. Where easily detachable hardware (such as snap and ring) is intended to attach the canopy or riser(s) to the harness, one drop shall be made with only one attachment engaged to test the cross connector and hardware.
- 4.3.5 Functional Test (Twisted Lines): A minimum of five drops shall be made with a 77 kg (170 lb) dummy or person. The indicated airspeed at the time of release shall be 60 knots. Three twists (360° each) shall purposely be packed in the suspension lines adjacent to the lowest attachment point to the canopy. The parachute must be fully open within four seconds from the time of pack release.
- 4.3.6 Functional Test (Normal Pack): There shall be a minimum of 48 drops from an aircraft with a 77 kg (170 lb) dummy or person. The indicated airspeed at the time of pack release shall be as follows for 16 drops each: 60, 85, and 110 knots IAS. In addition, reserve parachute assemblies shall be dropped 8 times by breaking away



from an open and normally functioning main parachute canopy and releasing the reserve pack within two seconds of breakaway. The parachute canopy must be fully open within three seconds from the time of pack release. These tests may be live jumps by a 77 kg (170 lb) individual except that at least two dummy drops shall be made at 60, 85, and 110 knots IAS. Reserve parachute assemblies shall be tested with the main compartment(s) full and empty (24 tests full).

- 4.3.7 Rate of Descent Tests: There shall be at least 6 drops, of which at least 3 shall be dummy drops, from an aircraft with a 77 kg (170 lb) (min) individual and/or dummy. The average rate of descent shall not exceed 6.4 m (21 ft) per second for that last 30 m (98 ft) corrected to standard sea level altitude conditions. A method shall be employed for direct and accurate measurement of rate of descent such as the use of a weighted cord or cable by which the descent may be timed for the last 30 m (98 ft) from the time of ground impact of the weight to ground impact of the dummy. The oscillation shall not exceed 15 from the vertical. These tests may be combined with other tests in this section.
- 4.3.8 Live Drop Tests: There shall be a minimum of 4 live drop tests from an aircraft with an individual weighing 77 kg (170 lb) (PLUS the weight of the certificated reserve parachute assembly). Two drops shall include a freefall of not more than three seconds and two drops shall include a freefall of at least 15 seconds. These tests may be conducted in conjunction with functional and/or rate of descent tests when practical. (The user must suffer no significant discomfort from the opening shock and must be able to disengage himself unaided from the harness after landing.) For this test the standard harness may be altered to permit attachment of a certificated reserve parachute assembly (less harness) provided that such alteration does not interfere with the normal operation of the parachute assembly being tested. Reserve parachute assemblies shall be tested with the main compartment(s) both full and empty.

## 5. COMPONENT QUALIFICATION:

- 5.1 Parachutes may be qualified as complete assemblies or as components (e.g., just the harness/container assembly). The airworthiness of a parachute assembly, including other separately approved, non-original components, is the responsibility of the manufacturer who performs the certifying tests for the parachute assembly. The manufacturer shall publish and make available a list of interchangeable components which have passed the following tests in 4.3 when tested in conjunction with the assembly or component(s) being certificated.



TABLE 1  
CATEGORIES A, B, OR C SCHEDULE

CATEGORY A TEST	136 kg (300 lb) at 150 knots.
Placard:	CATEGORY A: This parachute is limited to use by persons up to 90 kg (198 lb) fully equipped, and up to 130 knots.
CATEGORY B TEST	136 kg (300 lb) at 175 knots.
Placard:	CATEGORY B: This parachute is limited to use by persons up to 115 kg (254 lb) fully equipped, and up to 150 knots.
CATEGORY C TEST	136 kg (300 lb) at 230 knots.
Placard:	CATEGORY C: This parachute is limited to use by persons up to 115 kg (254 lb) fully equipped, and up to 175 knots.

SPEEDS ARE GIVEN IN KEAS, AND ARE INTENDED TO BE AT PACK OPENING.

- 5.1.1 Canopy Including Suspension Lines: 4.3.2, 4.3.3, 4.3.4.1 (or 4.3.4.2), 4.3.5, 4.3.6, 4.3.7, 4.3.8
- 5.1.2 Deployment Device: 4.3.2, 4.3.3, 4.3.4.1, (or 4.3.4.2), 4.3.5
- 5.1.3 Pilot Chute (Including Bridle): 4.3.2, 4.3.3, 4.3.4.1 (or 4.3.4.2), 4.3.5, 4.3.6, 4.3.8
- 5.1.4 Stowage Container (Pack): 4.3.2, 4.3.3, 4.3.6
- 5.1.5 Harness: 4.3.4.1, 4.3.6, 4.3.8
- 5.1.6 Actuation Device (Ripcord): 4.3.1, 4.3.2, 4.3.6, 4.3.8
- 5.1.7 Riser(s): 4.3.4.1 or 4.3.4.2, 4.3.6, 4.3.8

FEDERAL AVIATION AGENCY

Washington 25, D. C.

TECHNICAL STANDARD ORDER

Regulations of the Administrator

Part 514

SUBJECT: PARACHUTES

TSO-C23b

---

Technical Standard Orders for Aircraft Materials,  
Parts, Processes, and Appliances

Part 514 contains minimum performance standards and specifications of materials, parts, processes, and appliances used in aircraft and implements the provisions of sections 3.18, 4a.31, 4b.18, 6.18 and 7.18 of the Civil Air Regulations. The regulation uses the Technical Standard Order system which, in brief, provides for FAA-industry cooperation in the development of performance standards and specifications which are adopted by the Administrator as Technical Standard Orders, and a form of self-regulation by industry in demonstrating compliance with these orders.

Part 514 consists of two subparts. Subpart A contains the general requirements applicable to all Technical Standard Orders. These provisions are summarized below for the convenient reference of the public. Subpart B contains the technical standards and specifications to which a particular product must conform, and each Technical Standard Order is set forth in the appropriate section of Subpart B. The subject Technical Standard Order is printed below. ANY TECHNICAL STANDARD ORDER MAY BE OBTAINED BY SENDING A REQUEST TO FAA, WASHINGTON 25, D. C.

SUBPART A--GENERAL

This subpart provides, in part, that a manufacturer of an aircraft material, part, process, or appliance for which standards are established in Subpart B, prior to its distribution for use on a civil aircraft of the United States, shall furnish a written statement of conformance certifying that the material, part, process, or appliance meets the applicable performance standards established in this part. The statement of conformance must be signed by a person duly authorized by the manufacturer, and furnished to the Chief, Engineering and Manufacturing Division, Bureau of Flight Standards, Federal Aviation Agency, Washington 25, D. C.

Subpart A also requires appropriate marking of materials, parts, processes, and appliances as follows:

- (a) Name and address of the manufacturer responsible for compliance,
- (b) Equipment name, or type or model designation,
- (c) Weight to the nearest pound and fraction thereof,
- (d) Serial number and/or date of manufacture, and
- (e) Applicable Technical Standard Order (TSO) number.

In addition, Subpart A provides that no deviation will be granted from the performance standards established in Subpart B, and that the Administrator may take appropriate action in the event of noncompliance with Part 514.

SUBPART B

¶ 514.33 Parachutes - TSO-C23b--(a) Applicability--(1) Minimum performance standards. Minimum performance standards are hereby established for parachutes which are to be used in civil aircraft of the United States. New models of parachutes manufactured for use in civil aircraft of the United States on or after March 29, 1962, shall meet the minimum performance standards of National Aircraft Standards Specification 804 dated August 24, 1949,<sup>1/</sup> with the exceptions covered in subparagraph (2) of this paragraph. Parachutes approved prior to March 29, 1962, may continue to be manufactured under the provisions of the original approval.

(2) Exceptions. (i) The auxiliary parachute used in combination with a standard parachute shall be designed for use in combination with the specific main parachute.

(ii) For the purpose of testing an auxiliary type parachute used in combination with a standard parachute the speed specified in Section 4.3.8 of NAS Specification 804 shall be 25 feet per second instead of 21 feet per second.

(b) Marking. The auxiliary parachute and its pack shall be marked "Auxiliary Parachute" in addition to the other marking requirements contained in Subpart A.

(c) Data requirements. (1) The manufacturer shall maintain a current file of complete design data.

(2) The manufacturer shall maintain a current file of complete data describing the inspection and test procedures applicable to his product. (See paragraph (d) of this section.)

(d) Quality control. Each parachute shall be produced under a quality control system, established by the manufacturer, which will assure that each parachute is in conformity with the requirements of this section. This system shall be described in the data required under paragraph (c)(2) of this section. A representative of the Administrator shall be permitted to make such inspections and tests at the manufacturer's facility as may be necessary to determine compliance with the requirements of this section.

(e) Effective date. March 29, 1962.

---

<sup>1/</sup>Copies may be obtained from the National Standards Association, 616 Washington Loan and Trust Building, Washington 4, D. C.



# NATIONAL AIRCRAFT STANDARDS COMMITTEE

AIRCRAFT INDUSTRIES ASSOCIATION OF AMERICA, INC., 610 SHOREHAM BUILDING, WASHINGTON 5, D. C.

## SPECIFICATION - PARACHUTES

This specification defines the minimum performance and safety standards for parachutes to be used in certificated aircraft.

### 1. APPLICABLE SPECIFICATIONS

1.1 None.

### 2. TYPES

2.1 This specification covers two types of man-carrying parachutes for use in certificated civil aircraft

Standard Type Parachute  
Low Speed Type Parachute (Up to 150 miles per hour).

### 3. MATERIAL AND WORKMANSHIP

3.1 Materials shall be of a quality which experience and/or tests have conclusively demonstrated to be suitable for use in parachutes. Workmanship shall be consistent with high-grade parachute manufacturing practice.

3.1.1 Canopy Material: The fabric used in the canopy construction shall be free from harmful gums, starches and other foreign material. It shall also be free from avoidable imperfections in manufacture and from defects or blemishes affecting its strength or durability and shall have been finished without application of excessive heat. The canopy material shall have sufficient resilience to insure proper opening of the canopy under conditions outlined in 4.3.5.

3.1.2 Fitting Materials: Fittings shall be fabricated from carbon steel, alloy steel, or corrosion-resisting material. Fittings made from metals that are not corrosion-resisting shall be plated or otherwise protected, to resist corrosion during the normal life of the parachute. The use of dissimilar metals, especially brass, copper, or steel in intimate metal-to-metal contact with aluminum or aluminum alloy, shall be avoided, wherever possible.

### 4. DETAIL REQUIREMENTS

#### 4.1 Design and Construction

4.1.1 Fittings: All fittings shall be designed to carry their full rated load without yielding.

APPROVAL DATE 8-24-49 REVISION

TITLE	CLASSIFICATION SPECIFICATION
SPECIFICATION - PARACHUTES	NAS 804 Sheet 1 of 5

THIS DRAWING SUPERCEDES ALL ANTECEDENT STANDARD DRAWINGS FOR THE SAME PRODUCT, AND SHALL BECOME EFFECTIVE FOR VENDOR MANUFACTURERS NOT LATER THAN 6 MONTHS AFTER THE LATEST DATE OF APPROVAL SHOWN.

# NATIONAL AIRCRAFT STANDARDS COMMITTEE

AIRCRAFT INDUSTRIES ASSOCIATION OF AMERICA, INC., 610 SHOREHAM BUILDING, WASHINGTON 5, D. C.

- 4.1.2 Suspension Lines: All suspension lines of a given model parachute shall be marked under equal tension to show points of attachment.
- 4.1.3 Stitching: Stitching shall be of a type that will not ravel when broken.
- 4.1.4 Rip Cord: The rip cord, including joints between the handle and the release, shall be designed to withstand the tension test load of 4.3.1.
- 4.1.5 Pack Opening Device: No more than 22 pounds pull shall be required to cause the positive and quick functioning of the pack opening device.
- 4.1.6 Harness Release: The harness shall be so constructed that the rider can release himself and drop clear in case of a water landing, but a quick-attachable or quick-releasing device between the harness and the parachute is not mandatory.

## 4.2 Marking

- 4.2.1 Pack: The following information shall be legibly and permanently marked on or attached to the outside of the parachute pack by use of a name plate, identification label or stenciled letters.

Manufacturer's name  
Model number or model name\*  
Parachute serial number  
Date of manufacture  
National Aircraft Standard Number (NAS804)

\*Note: Special designation or identification of low speed type parachutes must be indicated on the outside pack by stenciling in red letters one inch high the following: "Low Speed Parachute" and in red letters one-half inch high, "Limited to Use in Airplane Under 150 MPH."

- 4.2.2 Canopy: Each parachute canopy shall be legibly and permanently marked, preferably adjacent to the skirt, with the same information as in 4.2.1.
- 4.2.3 Harness: The parachute model number or model name and date of manufacture shall be stenciled on all harnesses. This marking shall be placed inside the back strap of the harness or other suitable location where it will be subject to minimum of obliteration.

REVISION  
8-24-49  
APPROVAL DATE

TITLE	CLASSIFICATION SPECIFICATION
SPECIFICATION - PARACHUTES	NAS 804 Sheet 2 of 5

THIS DRAWING SUPERCEDES ALL ANTECEDENT STANDARD DRAWINGS FOR THE SAME PRODUCT, AND SHALL BECOME EFFECTIVE FOR VENDOR MANUFACTURERS NOT LATER THAN 6 MONTHS AFTER THE LATEST DATE OF APPROVAL SHOWN.



# NATIONAL AIRCRAFT STANDARDS COMMITTEE

AIRCRAFT INDUSTRIES ASSOCIATION OF AMERICA, INC., 610 SHOREHAM BUILDING, WASHINGTON 5, D. C.

- 4.2.4 Inspection Data Pocket:** Each parachute outfit shall be provided with an inner and an outer pocket for keeping a record card containing space for recording the date of repacking or repair and the rigger's name and serial number. The inner pocket shall be located in the center of the packed container, tray or frame and the outer pocket placed externally in an easily accessible position. If the inner record card can be read from the outside of the pack because of the use of transparent materials, only the inner pocket need be provided.
- 4.3 Qualification Tests:** 100% performance in qualification tests 4.3.1 through 4.3.8 is required.
- 4.3.1 Rip Cord Tension Test:** The rip cord, including joints between the handle and the release, shall not fail under a straight tension test load of 300 pounds applied for not less than three seconds.
- 4.3.2 Pull Test - Pack Opening Device:** The pack opening device shall be tested by use of an accurate spring balance to indicate its positive and quick-functioning with no more than 22 pounds pull.
- 4.3.3 Functional Test (Normal Pack):** Twelve drops at least six of which shall be from an airplane with a 170-pound dummy man, from an altitude of not more than 500 feet. The indicated air speed at the time of release shall be 70 miles per hour. No twists shall purposely be packed in the suspension lines. The parachute must be fully open within three seconds from time of release.
- 4.3.4 Functional Test (Twisted Lines):** Five drops with a 170-pound dummy man, from an altitude of not more than 500 feet. The indicated air speed at the time of release shall be 70 miles per hour. Three twists shall purposely be packed in the suspension lines near the skirt. The parachute must be fully open within four seconds from time of release.
- 4.3.5 Compressed Pack Test:** This test is required only when canopy materials other than pongee, silk or nylon are used (Ref. 3.1.1). Three drops with the conditions stated in 4.3.3 except that prior to the tests the parachutes completely packed shall be subjected continuously to a 200-pound weight for 400 hours and then dropped without being repacked.

REVISION  
APPROVAL DATE 8-24-49

TITLE	CLASSIFICATION SPECIFICATION
SPECIFICATION - PARACHUTES	NAS 804 Sheet 3 of 5

THIS DRAWING SUPERCEDES ALL ANTECEDENT STANDARD DRAWINGS FOR THE SAME PRODUCT, AND SHALL BECOME EFFECTIVE FOR VENDOR MANUFACTURERS NOT LATER THAN 6 MONTHS AFTER THE LATEST DATE OF APPROVAL SHOWN.



# NATIONAL AIRCRAFT STANDARDS COMMITTEE

AIRCRAFT INDUSTRIES ASSOCIATION OF AMERICA, INC., 610 SHOREHAM BUILDING, WASHINGTON 5, D. C.

## 4.3.6 Strength Test

4.3.6.1 Standard Type Parachute: Three drops with a parachute of the same type at an altitude of not more than 500 feet shall be made with a dummy weight and indicated air speed to give the equivalent of 5000 lbs. shock load. (See Table I.) No twists shall purposely be packed in the suspension lines. The weight shall be attached to the harness. No external shock absorbers or material which may act as such shall be permitted. The parachute shall show no failure of any material.

Table I

<u>Speed - MPH</u>	<u>Total Weight (Incl. Chute) - lbs.</u>
150	660
175	500
200	400
225	325
250	275
275	225
300	200
325	175
350	160
375	150

\* Data computed for 28 ft. Standard Flat-Type Parachute based on USAF Parachute Handbook Section V.

4.3.6.2 Low Speed Type Parachute: Three drops with a parachute of the same type at an altitude of not more than 500 feet shall be made with a dummy weight and indicated air speed to give the equivalent of 3000 lbs. shock load. No twists shall purposely be packed in the suspension lines. The weight shall be attached to the harness. No external shock absorbers or material which may act as such shall be permitted. The parachute shall show no failure of any material.

Table II

<u>Speed - MPH</u>	<u>Total Weight (Incl. Chute) - lbs.</u>
100	750
125	525
150	375
175	300
200	235
225	200

\* Data computed for 28 ft. Standard Flat-Type Parachute based on USAF Parachute Handbook Section V.

REVISION  
APPROVAL DATE 8-24-49

TITLE	CLASSIFICATION
SPECIFICATION - PARACHUTES	SPECIFICATION <b>NAS 804</b> Sheet 4 of 5

THIS DRAWING SUPERCEDES ALL ANTECEDENT STANDARD DRAWINGS FOR THE SAME PRODUCT, AND SHALL BECOME EFFECTIVE FOR VENDOR MANUFACTURERS NOT LATER THAN 6 MONTHS AFTER THE LATEST DATE OF APPROVAL SHOWN.

# NATIONAL AIRCRAFT STANDARDS COMMITTEE

AIRCRAFT INDUSTRIES ASSOCIATION OF AMERICA, INC., 610 SHOREHAM BUILDING, WASHINGTON 5, D. C.

4.3.7 Live Drop Tests: Two live drop tests from an airplane with a man weighing approximately 170 pounds, including the weight of an additional certificated auxiliary parachute, from an altitude of 2000 feet on a comparatively still day. The rider must suffer no discomfort from the opening shock and must be able to disengage himself unaided from the harness after landing. For this test the standard harness may be altered to permit attachment of an auxiliary parachute provided that such alteration does not interfere with the normal operation of the parachute and harness equipment being tested.

4.3.8 Rate of Descent Test: At least six drops from an airplane with a 170-pound dummy man. The average rate of descent shall not exceed 21 feet per second for the last 100 feet under standard sea level altitude conditions. A method shall be employed for direct and accurate measurement of rate of descent for the last 100 feet, such as the use of a weighted cord or cable by which the descent may be timed from the time of ground impact of the weight to ground impact of the parachute.

REVISION

APPROVAL DATE 8-24-49

TITLE	CLASSIFICATION SPECIFICATION
SPECIFICATION - PARACHUTES	NAS 804 Sheet 5 of 5

THIS DRAWING SUPERCEDES ALL ANTECEDENT STANDARD DRAWINGS FOR THE SAME PRODUCT, AND SHALL BECOME EFFECTIVE FOR VENDOR MANUFACTURERS NOT LATER THAN 6 MONTHS AFTER THE LATEST DATE OF APPROVAL SHOWN.







## A

**ACCORDION FOLDING**—The folding of the canopy for stacking in the container prior to closing.

**ADMINISTRATOR**—The Federal Aviation Administrator or any person to whom he/she has delegated his/her authority in the matter concerned.

**ADVISORY CIRCULAR**—The Federal Aviation Administration (FAA) issues advisory circulars (ACs) to provide guidance and information in a designated subject area or to show a method acceptable to the Administrator for complying with a related Code of Federal Regulation (CFR). Each AC is issued with a number corresponding to the subject it addresses in the Code of Federal Regulations. Unless incorporated into a regulation by reference, the contents of an AC are not binding on the public.

**AERODYNAMICS**—The study of the behavior of moving air and the forces that it produces as it passes over or around certain shaped objects such as wings, propellers, or parachute canopies.

**AGL**—Above ground level.

**AIRFRAME AND POWER-PLANT MECHANIC**—Any person certificated by the FAA to perform maintenance or inspections on an aircraft's airframe or powerplant.

**AIRWORTHINESS DIRECTIVES (ADs)**—Issued by the Federal Aviation Administration (FAA) to notify owners and users of aeronautical products of unsafe conditions and the mandatory corrections under which the product may continue to be used. Each AD is an amendment to Title 14, Code of Federal Regulations, part 39; as such, it is part of the Federal Public Laws.

**AIRWORTHINESS**—A complete parachute assembly is considered airworthy when it conforms to its TSO and/or properly altered condition, and is in condition for safe operation.

**ALTERATION**—A change to the original configuration or any other major change to any portion of the parachute from its original manufacture specifications.

**APEX**—The center and topmost point of a round parachute canopy.

**APPROVED**—An item which in its present form has received official certification from the FAA.

**ASSISTOR POCKET**—Air scoops at the top of a sleeve, which provide drag and aid in anchoring the sleeve as the canopy is pulled out. Also, fabric pockets on the bridle of a free bag, which aid in the deployment of the bag in the event of a horseshoe-type malfunction.

**AUTOMATIC ACTIVATION DEVICE (AAD)**—A device for automatically releasing the reserve or emergency parachute. Utilizes barometric and rate of descent sensors.

**AUXILIARY PARACHUTE**—A reserve parachute.

## B

**BACK PARACHUTE**—A parachute which is worn on the back.

**BACKSTITCH**—Used to anchor a row of stitching by turning the material and sewing over the stitching for a short distance.

**BACKPAD**—A foam-filled pad placed between the harness and the wearer which provides comfort and/or holds the harness in place.

**BACK STRAP**—A part of the harness which extends across the wearer's back. It may be diagonal, horizontal, or vertical, and may or may not be adjustable.

**BAG, DEPLOYMENT**—A container, usually fabric, and usually enclosed in a parachute pack containing a parachute canopy.

**BAR TACK**—A concentrated series of zigzag-like stitches used to reinforce points of stress.

**BECKET**—A piece of tape or webbing sewn to a parachute or pack to form a loop through which a cord or thread may be passed.

**BEESWAX**—A wax, usually mixed 1:1 with paraffin and heated. Webbing is dipped into it to prevent fraying.

**BELLYBAND**—A reserve tie-down strap.

**BIAS CONSTRUCTION**—Construction where the warp and filler threads of the material are at 45 degrees to the centerline of the gore.

**BIAS CUT**—A diagonal cut across a piece of fabric. Canopy fabric may be cut on the bias and assembled so that both warp and fill threads run at a 45 degree angle to the vertical centerline of the gore.

**BLOCK CONSTRUCTION**—An arrangement of the gores such that the warp threads are parallel to the peripheral hem.

**BOBBIN**—A small spool used to hold thread. Commonly found in sewing machines.

**BODKIN**—A large-eyed needle, flat or round, and usually blunt, used to draw tape, ribbon, elastic, or cord through a loop or hem. Used to pull pack opening bands through containers.

**BOLT**—A compact package or roll of fabric.

**BREAK TIE**—Any tie or tacking designed to break under a specified amount of stress.

**BREAKAWAY**—The jettisoning of the malfunctioned main parachute by activating riser releases and deployment of the reserve parachute. Also known as cutaway.

**BREAKCORD**—A thread or tape tied between parachute components that is intended to break under the desired load during deployment.

**BRIDLE**—A line which attaches the pilot chute to the apex of the canopy or to a sleeve or bag.

**BUNGEES**—Pack opening bands.

**BURBLE**—The turbulent and unstable airflow behind a falling object such as a skydiver in free fall.

## C

**CABLE, RIPCORDER**—A flexible cable joining the locking pins and the ripcord handle.

**CALENDAR**—The process where a machine with heated rollers is used to finish fabric. The heat and pressure process lowers permeability by forcing the fibers between each other and flattening them.

### CANOPY RELATIVE

**WORK (CRW)**—A skydiving discipline, where the parachutists fly their open canopies in a formation formed by grasping the canopies or lines using the hands or legs.

### CANOPY RELEASES

Devices which allow immediate release of the parachute canopy. They disconnect the harness main lift webs from the risers.

**CANOPY**—The umbrella-like surface of a parachute and its framework of cords, called suspension

lines, from which the load is suspended. The drag surface of the decelerator.

**CENTERLINE**—Lines which run from the risers to the apex of a canopy and are used to pull the apex down such as on a Para Commander.

**CENTER PULL**—A ripcord design for chest parachutes.

**CERTIFICATED**—A personnel parachute holding an FAA TSO certificate. Also used to refer to other FAA-approved parachutes, such as Government surplus personnel models, which were manufactured under military contract.

**CFM**—Cubic feet per minute. A measure of permeability.

**CHAFING STRIP**—A light piece of webbing positioned between the load bearing webbing and a piece of hardware which acts as a buffer between the two.

**CHEST PARACHUTE**—A parachute worn on the wearer's chest.

**CHUCK**—The upper part of the tool used to install fastener or grommet parts.

**CHUTE**—A contraction of the term "parachute," and used interchangeably with it.

**CLAMP**—A medical hemostat used by riggers for picking threads or retrieving small objects.

**CLOSING LOOPS**—Fabric or cord loops used to secure the container closed. Used in place of locking cones.

**CLOTH**—A pliable fabric, woven, felted, or knitted from any filament; commonly fabric of woven cotton, woolen, silk, nylon, rayon, or linen fiber.

**CLOVERLEAF HANDLE**—A ripcord handle with a cloverleaf shape. Commonly found on chest parachutes.

**COCKING**—Setting the collapsible bridle for operation.

**CONE, LOCKING**—A cone shaped metal device used in conjunction with end tabs and ripcord pins to hold the container flaps closed.

**CONFLUENCE WRAP**—A piece of webbing which wraps around the confluence of two or more pieces of webbing. Prevents the stitching from splitting. Most common use is on main risers and the 3-ring harness ring installation.

**CONNECTOR SNAP, QUICK**—A large hook-shaped, spring-loaded snap, two of which are used to quickly attach the chest-type parachute to the two D-rings on the harness.

**CONNECTOR STRAP, CROSS**—A short length of webbing sewn across a lift web assembly between the snaps of a chest parachute. This webbing is designed to prevent a “streamer” if only one side of the left web assembly is engaged to the harness. Also known as a spreader bar.

**CONTAINER**—That portion of the parachute assembly which holds the canopy in place after being folded. This is not to be confused with the term “pack.”

**CONTAMINATION**—Where foreign materials or substances come into contact with parachute materials and possibly cause degradation or weakening of the materials.

**CORDS**—Suspension lines.

**CROSS CONNECTOR STRAP**—A webbing strap attached between the risers to prevent

the collapse of the canopy in the event one riser becomes disconnected.

**CROSS SEAM**—A seam joining sections of a panel.

**CUTAWAY**—The cutting of risers or suspension lines to release the deployed canopy while the parachutist is still in the air. Also known as breakaway.

## D

**DAISY CHAIN**—A method of gathering the suspension lines when field packing a parachute so as to reduce the possibility of their becoming entangled.

**DAMAGE CHART**—A graphic representation of a canopy used to identify and mark damaged areas for repair.

**DART**—A short, tapered seam.

**DATA POCKET**—Small patch pockets sewed to the inside and outside surfaces of a parachute container for carrying the parachute record card.

**DECELERATE**—To slow down. A free-falling body will decrease its rate of descent due to pressure of the atmosphere against its frontal area. This resistance will gradually increase as the falling body nears the earth due to increasing atmospheric pressure.

**DENIER**—A unit of measurement of silk in which the size of yarn is quoted as its weight per length. This is determined by weighing 9,000 meters and quoting the size of the yarn in grams. Thus, if 9,000 meters weigh 30 grams, the size of the yarn is then known as 30 denier.

**DEPLOYMENT DEVICE**—A sleeve or bag.

**DEPLOYMENT**—That portion of a parachute’s operation occurring from the moment of pack opening to the instant the suspension lines are fully stretched but prior to the inflation of the canopy. Also known as development.

**DESIGNATED PARACHUTE RIGGER EXAMINER (DPRE)**—A master parachute rigger appointed by the Administrator to conduct oral and practical tests required for the certification of parachute riggers.

**DIAGONAL SEAM**—A French fell seam of the canopy which joins two sections of a gore. Diagonal seams meet the centerline of the gore at angles of 45 degrees and 135 degrees.

**DIAMETER**—The greatest distance across a flat canopy, from skirt to skirt, measured when the canopy is lying flat. This measurement designates the size of the parachute in feet.

**DIAPER**—Generally, a fabric panel secured by the suspension lines which is sewn to and wrapped around the canopy. Used to control and reduce opening forces. Found mostly on round reserves.

**DIE**—The lower part of the tool used in a press to install snap fasteners or grommets.

**DIRECT BAG STATIC LINE SYSTEM**—A static line deployment system where the bag is attached to the static line and the canopy deploys free into the airstream.

**DOUBLE THROW ZIGZAG STITCHING**—Stitching in which the needle makes a center stitch between each left and right stitch. Also known as a No. 308 stitch.



**DOUBLE-W**—A three-point cross-stitch.

**D-RING**—A metal fitting shaped like a D into which snap connectors are hooked.

**DROP TEST**—Dropping a dummy or other load from an aircraft in flight or otherwise simulating a live jump to prove serviceability of a parachute.

**DROP ZONE (DZ)**—A specified area upon which personnel or equipment are dropped by parachute.

**DRYING TOWER**—A facility where parachutes are suspended for airing and drying.

## DUAL PARACHUTE

**PACKS**—A sport assembly consisting of a main and a reserve parachute.

**DUMMY (PARACHUTE)**—Torso-shaped dummy of variable weight used for testing parachutes; may be of fixed or articulated construction.

**DUMMY DROP**—A parachute test using a dummy as the suspended load.

**DURABLE DOT FASTENER**—The common snap fastener used for closing flaps, etc.

## E

### EMERGENCY

**PARACHUTE**—A certificated parachute intended for emergency use.

**END FLAP**—The fabric on the end of a pack as opposed to the side, used to enclose and protect the canopy.

**END TABS**—Metal tabs on the end flap of the pack (principally chest and seat containers) used to secure it closed.

**EYE**—A small steel-wire loop attached to the parachute pack, into which a hook on a pack-opening elastic is fastened.

## F

**FABRIC, CANOPY**—The fabric used in the fabrication of parachute canopies. It is light in weight and woven to withstand the impact of air pressure when the parachute opens. The canopy fabric is woven from nylon yarns usually in a ripstop weave.

**FASTENER, SLIDE**—A zipper.

**FASTENER, SNAP**—Metal fastening device that usually consists of four parts: button, socket, stud, and eyelet. Device is manufactured in various shapes and sizes.

**FASTENER, TAPE**—Velcro®.

### FEDERAL AVIATION ADMINISTRATION

**(FAA)**—An organization within the Department of Transportation. The FAA establishes aviation rules and regulations as well as enforces those policies. The purpose of the FAA is to set the standards for civil aircraft in the interest of public safety.

**FEED DOG**—A mechanical device located under the throat plate of a sewing machine which feeds the material through a sewing machine.

**FERRULE**—Device which provides a strong and smooth finish on the ends of a ripcord housing.

**FID**—A small flat, tapered bar of metal or wood used to insert the corner flaps into the container when packing.

**FINGER TRAP**—A method of attaching or splicing lines by inserting one line into another. Used primarily on hollow braided lines.

**FINISH**—The condition of the parachute fabric caused by the application of heat and pressure whereby the fibers are forced closer together. This treatment is used to determine the permeability of the fabric.

**FISH SCALE**—A spring scale used to measure the ripcord pull force or fabric strength test.

**FOLDER**—A device used as an attachment to a sewing machine to guide and fold fabric.

**FORCE**—A push or pull which tends to change the velocity or direction of a body's motion.

**FORGING**—A high-pressure shaping of hot metal. The process used to make parachute hardware.

**FORWARD SPEED**—The rate at which a parachute moves horizontally in a mass of air.

**FOUR LINE CHECK**—On a round canopy, the four lines that run to the top center and bottom center gores. Used to check the line continuity. On a 28-foot canopy, they are lines 1, 14, 15, and 28.

**FPS**—Feet per second.

**FREE BAG**—A type 5 reserve deployment device used with ram-air canopies. Not attached to the canopy, it is designed to allow deployment of the canopy in the event of a horse-shoe-type malfunction.

**FREE FALL**—A parachute jump in which the parachute is activated manually at the discretion of the parachutist.

**FRENCH FELL SEAM (LSC-2)**—A plain overlap in which the material is folded over on itself and stitched so as to prevent raveling.

**FRICTION BURNS**—The result of two textile surfaces rubbing together rapidly and generating frictional heat which reduces the tensile strength of the textile and causes deterioration of the individual threads; it occurs primarily during parachute deployment and initial inflation.

## G

**G FORCE**—The measure or value of the gravitational pull of the earth as modified by the earth's rotation, equal to acceleration of a freely moving body at the rate of 32.16 feet per second. Example: If a 100-pound load places a 300-pound stress on the parachute during opening, the shock is 3 Gs.

**GAUGE**—The space between needles on a sewing machine.

**GLIDE**—The horizontal movement of the canopy.

**GORE**—That portion of the canopy contained between two adjacent suspension lines and the area between them, extending from the apex of the canopy to the skirt.

**GROMMET**—A metal eyelet, used as a reinforcement around a hole in fabric. Grommets are used on pack flaps to fit over locking cones or loops.

**GROSS WEIGHT**—The complete weight of the parachute assembly.

## H

**H.A.L.O.**—High Altitude, Low Opening.

**HANDLE**—Ripcord handpull or grip.

**HARDWARE**—All metal parts associated with parachutes, parachute systems, and their suspended loads.

**HARNESS**—An arrangement of cotton, linen, or nylon webbing which is designed to conform to the shape of the load to be carried in order to secure it properly so that the opening shock and the weight of the load are evenly distributed during descent.

**HESITATOR LOOP**—One of a series of webbing loops which hold the suspension lines in an orderly position in the container when the parachute is packed and which pay the lines out in sequence (hesitate) for orderly deployment.

**HOT KNIFE**—An electrically heated cutting tool used to cut and sear webbing and fabrics.

**HOUSING CLAMP STIFFENER**—A metal plate sewn to the top flap of the main parachute container and used to hold the ripcord cable housing in place and to give rigidity to the housing. Designed to provide stiff separation between the housing and the top cone for an automatic opener.

**HYGROSCOPIC**—A substance or material that absorbs water readily from its surroundings.

## I

**INITIAL LAYOUT**—Process in which the canopy is stretched out on the table with the top center gore on top in preparation for securing proper layout.

**INSPECTION**—A step by step procedure for examining a parachute prior to packing to identify any damage or non-airworthy condition.

**INVERSION**—State in which the canopy has been turned completely inside out. Also see partial inversion.

## J

**JOINT EFFICIENCY**—The comparison of the strength of the junction or joining materials against the original materials.

**JUMPING**—To engage in a premeditated parachute jump.

## K

**KEEPER, HARNESS**—Elastic webbing used to hold harness straps in place.

**KICKER PLATE**—A launching disc which is placed under the pilot chute.

**KILL-LINE COLLAPSIBLE BRIDLE**—A main pilot chute bridle configuration whereby the pilot chute is collapsed by use of a retractable centerline after it has deployed the parachute.

**KNOT, CLOVE HITCH**—A type of knot used for attaching the suspension lines of a parachute to the connector links.

**KNOT, OVER HAND**—A simple knot tied in each running end of a piece of cord above a square knot or surgeon's knot to prevent the ends from slipping back through the knot.

**KNOT, SQUARE**—A strong knot for joining two cords or lines, which does not slip or loosen easily.

**KNOT, SURGEON'S**—A type of knot commonly used for tying nylon threads or cords in place of a square knot to prevent mis-tying.

## L

**L/D**—Lift to drag ratio.

**LAP PARACHUTE**—A parachute which rests in the lap of the wearer and attaches to the harness with risers to snaps and D rings on the front. Resembles a chest parachute with long risers. Not in current use.

**LATERAL BAND**—Lower (in the periphery) or upper (in the vent hem), a reinforcement web.

**LAUNCHING DISC**—A kicker plate placed under the pilot chute.

**LEG STRAP**—That part of the harness webbing which encircles the wearer's leg. The leg straps can be adjusted to fit the user.

**LIFE CYCLE**—Service life. The time that a parachute may be considered usable.

**LIFT WEB (MAIN)**—The portion of the harness from the shoulder to the hip area. Generally from the canopy releases to the leg strap junction.

**LIFT WEBS**—The front portion of the harness from the shoulder to the leg strap junction. Includes the risers if there are no riser releases.

**LIFT**—The force perpendicular to drag which helps reduce vertical descent.

**LINE EXTENSION**—When the lines are fully deployed. Prior to line stretch.

**LINE SEPARATOR**—A tool used to separate and hold the lines of a round parachute during the packing process.

**LINE STOWING**—The process of drawing the suspension lines into suspension line retaining loops in the parachute pack; accomplished to prevent entanglement or twisting of the lines during opening of the parachute. Stows may be held by retaining loops or rubber bands.

**LINE STRETCH**—Occurs during deployment, after the lines are fully extended. Follows snatch force and line extension.

**LINE, GUIDE OR CONTROL**—One or more parachute lines that run from a slot or orifice in a steerable canopy to the harness providing better steerability.

**LINE, STATIC**—A line, cable, or webbing, one end of which is fastened to the pack, the other to some part of the launching vehicle; used to open a pack or to deploy a canopy.

**LINE-OVER**—A type of deployment malfunction. It occurs when one or more suspension lines pass over the top of the canopy during deployment preventing complete, normal inflation. Not to be confused with "partial inversions."

**LINES, SUSPENSION**—Cords or webbing of silk, nylon, cotton, rayon, or other textile materials which connect the drag surface of the parachute to the harness. They are the means by which the wearer or weight is hung or suspended from the inflated canopy.

**LINK, CONNECTOR, SEPARABLE**—Any connector link comprised of readily separable elements, which may be used to facilitate assembly of parachute canopies to a riser system.

**LINK, CONNECTOR**—Usually identified as a small, rectangular metal fitting used to connect ends of risers or lift webs to suspension lines. The suspension lines are tied and sewn above one part of the link, the webs being stitched about the lower part. The design of the link may vary in size and shape according to the intended use.

**LOCKSTITCH**—Type of stitching used in manufacturing parachutes. This type of stitch is formed by two threads. A loop of the thread is passed through the material where it is entered by the supply of the other thread. The loop of the first thread is drawn into the material to the extent that the loop or lock is approximately halfway between the two surfaces of the material. Also known as a type 301 stitch.

**LOFT**—A facility for the repair and maintenance of parachutes.

**LOGBOOK**—A format for complying with 14 CFR part 65, subsection 65.131(a) in regards to recording the work done by the rigger on parachutes.

**LOOPS, HESITATOR**—Retain the suspension lines in a neat and orderly arrangement in the parachute pack. These loops are made in varying sizes and materials.

## M

**MACHINE HEAD**—The entire metal housing which supports the moving parts and bearings of the machine.

**MAIN PARACHUTE**—A parachute assembly, excluding the harness, that is used in conjunction with a reserve parachute assembly as the primary assembly for a premeditated jump.



**MAIN SEAM**—That which joins two adjacent gores in a canopy. Also known as a radial seam.

**MAIN SLING, HARNESS**—The main load-carrying member of the harness formed by two lengths of webbing, beginning at the shoulder adapter or D-ring, continuing down across the seat and up the other side, ending at the opposite adapter or D-ring.

**MAINTENANCE**—Inspection, overhaul, repair, preservation and replacement of parts but excludes preventative maintenance.

**MAJOR REPAIR**—A repair that, if improperly done, might appreciably affect weight, balance, structure strength, performance, powerplant operation, flight characteristics or other qualities affecting airworthiness; or that is not according to accepted practices or cannot be done by elementary operations.

**MALFUNCTION OR DEFECT REPORT**—FAA Form 8330-2 used to report serious defects or other recurring unairworthy conditions of parachutes or aircraft.

**MALFUNCTION**—The complete or partial failure of the parachute canopy to effect proper opening and descent. Some malfunctions are canopy damage, twisted suspension lines, inversion or semi-inversion of the canopy, a line over, etc.

**MARQUSETTE**—Netting.

**MASS**—The quantity of matter in an object.

**MASTER PARACHUTE RIGGER**—An individual certified by the FAA to pack, maintain and alter parachutes. The highest classification of parachute rigger.

**MAXIMUM OPERATING WEIGHT**—The total weight of the parachutist and all equipment that exits the aircraft with the jumper.

**MILDEW**—A type of fungus or mold which forms on fabric and leather in damp environments. Mildew weakens some materials and if it appears on a parachute canopy, the areas must be cleaned, repaired, or replaced.

**MILITARY SPECIFICATION (MS)** — A specification (MIL-SPEC) set by military agencies and used for the procurement of military supplies and equipment.

**MINOR REPAIR**—A repair other than a major repair.

**MODIFICATION**—1. A change. 2. Often refers to the removing of canopy area to effect steerability and forward glide.

**MOUTH LOCK**—A device which holds the mouth of the canopy closed until the lines are deployed.

**MPH**—Miles per hour.

**MSL**—Mean Sea Level.

**MS**—Military Specification under the MS system.

## N

**NAS-804**—National Aircraft Standards Specifications Number 804; this is the minimum performance standards required by Technical Standard Order, TSO-C23b, for parachute assemblies manufactured under this TSO.

**NAS**—National Aircraft Standards.

**NEEDLE**—A small, slender, pointed piece of steel with a hole for thread used for sewing.

**NICOPRESS**—A copper sleeve used to join cables to form loops or splices.

**NYLON, RIPSTOP**—A type of weave designed to prevent tears from spreading. Extra numbers of yarns are closely woven into the cloth intermittently across the width and across the length.

**NYLON, TUBULAR**—Sleeve-like weave, seamless, and pressed flat, similar in appearance to tape, but stronger and hollow in the center.

**NYLON**—A synthetic material of protein-like structure derived from coal, air, and water, which is adapted for fashioning into filaments of extreme toughness, strength, and elasticity, and used in the manufacture of parachutes.

## O

**OPENING SHOCK**—The decelerating force exerted on the load following that of the snatch force. Caused by the acceleration of the canopy and the air mass associated with it.

**OPENING TIME**—The time elapsing between the opening of a parachute pack and the opening of the canopy to its fullest extent.

**OPENING, PREMATURE**—Any accidental opening of the parachute prior to the intended time.

**OSCILLATION**—Pendulum-like swinging of the suspended load beneath the inflated canopy. Usually the result of trapped air escaping under the lower lateral band.

**OUTBOARD**—Meaning facing to the outside such as a ripcord facing to the side of the jumper rather than toward the breastbone.

**OVERHAND KNOT**—A simple knot tied separately in each end of a piece of cord above a square, surgeon's, or other knot to prevent the end from slipping through the lower knot.

## P

**PACK**—A synonymous term for the parachute container.

**PACK OPENING BAND**—A cloth covered steel spring assembly with hooks at each end, used to expedite the opening of the pack by rapidly pulling the flaps away from the canopy.

**PACK STIFFENER**—Generally, metal stiffeners used in military assemblies to give shape and form to the pack.

**PACK TRAY**—The portion of the container or deployment device where the lines are stowed.

**PACKING BAR**—A long, flat bar of metal or wood used in the folding of the canopy of a parachute during the packing process and to aid in closing the container. Also known as a long bar, paddle, or fid.

**PACKING HOOK**—A special hook-like tool used to draw the suspension lines into place in the hesitator loops. Pull-up cords are sometimes used for this purpose.

**PACKING PADDLE**—A flat, narrow piece of metal or wood used to form the packed container. Also known as a packing bar, or fid.

**PACKING TABLE**—A table used in packing parachutes, normally 3 feet wide by 40 feet long with a smooth top surface.

**PACKING**—The operation of folding the canopy and enclosing it in the container.

**PANEL**—A subdivision of a gore. Also known as a section.

**PARACHUTE INDUSTRY ASSOCIATION (PIA)**—An international trade organization composed of parachute manufacturers, dealers, riggers and others involved in the parachute industry.

**PARACHUTE PACK**—Such as a back pack or chest pack, means the parachute assembly less the harness. That is, it means the container, canopy, suspension lines, pilot chute risers and connector links. The terms "pack" and "container" are not synonymous in the terminology of this part.

**PARACHUTE RECORD CARD**—A card kept in the record pocket, which records the packing intervals of the parachute and other important information as required under 14 CFR subsection 65.131(c). Also known as the "packing data card."

**PARACHUTE RIGGER**—A person certified by the Federal Aviation Administration who is authorized to perform packing and maintenance on parachutes.

**PARACHUTE STANDARD (PS)**—PIA Specification for parachute materials.

**PARACHUTE, STATIC LINE OPERATED**—A parachute operated by a length of webbing after a jumper has fallen the length of the static line. The ripcord

pins are pulled from the pack, the parachute opens, and a "break tie" breaks, freeing the parachute.

**PARACHUTE**—An umbrella-like device designed to trap a large volume of air in order to slow the descent of a falling load attached to the parachute. The word "parachute" is formed from the French words "para," for shield and "chute," to fall. Thus, "parachute" literally means "to defend from a fall."

**PARTIAL INVERSION**—A type of deployment malfunction. It occurs when one or more gore sections near the skirt become inverted during deployment and form a small pocket which inflates, causing a partial inversion of the canopy. The condition may or may not work out or may become a complete inversion; i.e., the canopy turns completely inside-out. It is the skirt, not the line, which is "over;" not to be confused with a "line-over." Also known as a "Mae West."

**PATCHING**—Method of repair by covering a hole or tear in a canopy or pack.

**PERFORMANCE STANDARDS**—The specifications which define the minimum performance and safety standards for certifying parachutes. There are three standards that have been used or are in use. They are NAS-804, AS-8015A, and AS-8015B.

**PERMEABILITY**—The mass rate of flow or the volume rate of flow per unit projected area of cloth for a prescribed pressure differential. In the U.S., permeability is measured in cubic feet of air through one square foot per minute at 1/2" of water pressure. Sometimes confused with porosity.

**PERSONNEL PARACHUTES**—Parachutes designed expressly for human use as opposed to cargo drops or aircraft deceleration.

**PIGGYBACK**—A single harness, dual parachute system used for intentional parachute jumping where both parachutes are mounted on the back of the jumper.

**PILOT CHUTE ASSIST SYSTEM**—A connection of breakcord or Velcro® between the static line and the pilot chute of a sport parachute which pulls the pilot chute out of the pack and then separates.

**PILOT CHUTE**—A small parachute used to accelerate deployment; constructed in much the same manner as the main canopy and from similar material. Some types of pilot chutes are equipped with a spring-operated, quick-opening device. The frame is compressed so as to open immediately when released from the pack.

**PIN PROTECTOR FLAP**—A flap which covers the locking pins and cones to prevent the pack from being opened by any means other than the ripcord.

**PINS, LOCKING**—Straight or curved metal pins used with a throw-out or pull-out pilot chute for securing the container closed.

**PLATE, TENSION**—A device hooked into the connector links in order to put tension on the canopy while packing.

**PLEAT**—A fold sewn in the fabric.

**POCKET, DATA**—A small patch pocket sewed to a parachute pack for carrying the parachute packing data card.

**POCKET, RIPCORD HANDLE**—Elastic or spring edged pocket that holds ripcord handle in an accessible position on the harness. The chest-type pocket consists of a piece of straight elastic webbing serving the same purpose.

**POROSITY**—The ratio of void or interstitial area to total area of a cloth expressed in percent. The ratio of open space to covered area of a drag surface. Used for ring slot, ribbon, ring sail, and rotafoil canopies. Not to be confused with permeability.

**PREMATURE OPENING**—Opening of a parachute before the user is clear of the aircraft; any accidental opening of a parachute.

**PREPACK INSPECTION**—The inspection made on the parachute prior to its packing.

**PRESSER FOOT**—The part of the sewing machine above the feed dog that holds the fabric in place.

**PREVENTATIVE MAINTENANCE (PM)**—The systematic care, servicing, and inspection of equipment and facilities for the purpose of maintaining them in a serviceable condition and detecting and correcting incipient failures. Simple or minor preservation operations and the replacement of small standard parts not involving complex assembly operations.

**PROOF LOAD**—The testing of an item for conformance with strength requirements.

**PROPER LAYOUT**—Process by which the canopy and suspension lines are arranged on the packing table for inspection and packing.

**PULL THE DOT**—A particular type of snap fastener that can only be opened or closed by pulling in one direction designated by an indented dot on the button.

**PULL-UP CORDS**—Nylon cords of varying length used to pull up the sides and ends of the container flaps over the container cones, and to pull the cones through the grommets. They are also used to pull the suspension lines into place in some types of containers.

## Q

**QUALITY CONTROL**—A method of describing the inspection and test procedures necessary to ensure that each article produced conforms to the type design and is in a condition for safe operation.

## R

**RADIAL SEAM**—A seam joining two gores which extends in a radial direction from the vent to the skirt hem.

**RAM-AIR PARACHUTE**—Generally, a rectangular, double surface canopy with airfoil shaped ribs inflated by the air flowing into the front openings to produce an airfoil shape.

**RATE OF DESCENT**—The vertical velocity, in feet per second, of a fully-opened parachute.

**RATING**—A statement that, as a part of a certificate, sets forth special conditions, privileges, or limitations.

**RAVEL (UNRAVEL)**—To separate, untwist, or unwind, leaving a frayed or ragged edge. “Unravel” is often used with the same meaning, although grammatically incorrect.

**RAW EDGE**—The unfinished edge of the material; liable to raveling.

**REEFING**—A temporary restriction of the skirt of a parachute to a diameter less than the fully inflated diameter. Reefing is used to decrease drag area, and/or to obtain stability.

**REINFORCEMENTS**—Commonly strong tape or webbing used to strengthen parts of the canopy, container, or harness.



**RELATIVE HUMIDITY**—Ratio of the amount of water vapor present in the air to that which the air would hold at saturation at the same temperature.

**RELEASE, BAROMETRIC PRESSURE**—A device of the automatic opening of a free-fall parachute operating on the differences of barometric pressure.

**RELEASE, RISER**—A canopy release.

**REPACK CYCLE**—The time that a certificated parachute is considered to be airworthy before being inspected and repacked. The current U.S. repack cycle is 120 days.

**RESERVE PARACHUTE**—The second or “auxiliary” parachute worn by a person making a premeditated jump.

**RESERVE STATIC LINE (RSL)**—A backup device for activating the reserve after a cutaway. Usually a line, webbing or cable, which connects the main risers with the ripcord handle, housing, or cable.

**RESTITCHING**—The process of sewing directly over base or broken stitching.

**RETAINER BAND**—A rubber band used to hold folded suspension lines or static lines to the parachute pack.

**RIGGER ROLL**—To prepare an unpacked parachute for storage by rolling the canopy into a ball with the suspension lines around it.

**RIGGING, PARACHUTE**—The process of inspecting, repairing, and replacing minor parts of a parachute assembly, and of repacking the

parachute so that it is ready for immediate use. Parachute rigging also includes fitting and adjusting the harness.

**RIG**—To pack. A set of sport parachute equipment. To assemble a parachute.

**RING, V**—Used in conjunction with snaps to fasten the harness around the wearer. Larger than the newer triangle ring.

**RIPCORD CABLE**—A flexible metal cable 3/32" diameter made of 49 strands of stainless steel wire. The cable runs from the ripcord grip to the locking pins. It is housed in a flexible, protective tube.

**RIPCORD HOUSING CLAMP**—A metal clamp located on the outside of the end flap of back and seat-type parachutes. The clamp secures the ripcord cable and power cable of the actuator.

**RIPCORD HOUSING**—A flexible tubing in which the ripcord is installed for protection and to provide a free path for the ripcord.

**RIPCORD PIN, LOCKING**—A small metal prong, slightly smaller in diameter than the ripcord cable and fastened to it by means of a swage fitting or serving and solder. One pin is attached to the end of the cable and the others (when two or more are used) are set at intervals on the cable. The spacing of the pins is dependant on the distance between the cones on the container flap. The locking pins pass through the locking cones of the flaps and thus serve to lock the container until such time as the pins are withdrawn.

**RIPCORD**—A locking device which secures the pack in a closed condition and by which the release of the parachute is effected. It may consist of a handle, cable, locking pins and a cable swage.

**RIPSTOP NYLON**—Nylon fabric woven in intermittent box form with additional closely-picked yarns.

**RIPSTOP TAPE**—Ripstop nylon fabric with a pressure sensitive adhesive. Used to repair small tears in canopies.

**RISER**—That portion of the suspension system between the lower end of a group of suspension lines and the point of attachment to the load.

**ROLL PACKING**—A method of packing a ram-air parachute whereby the nose and the tail are rolled towards the center of the canopy.

**ROUTINE INSPECTION**—A visual inspection of all parts of a packed parachute which may be checked without opening the parachute.

## S

**S.A.E.**—Society of Automotive Engineers.

**SADDLE**—The part of the harness positioned under the seat of the wearer.

**SAFETY TIE**—The thread used in sealing a parachute.

**SCISSORS**—A cutting instrument with two opposing blades.

**SEAL PRESS**—A mechanical press used for compressing lead seals to seal parachutes in accordance with 14 CFR subsection 65.133.

**SEAM RIPPER**—A small tool used for picking or cutting threads in sewing operations.

**SEAM, DIAGONAL**—The diagonal or horizontal seams which join the section of each gore.

**SEAM, RADIAL**—A seam extending from the skirt to the apex, joining two gores. A portion of the suspension lines may be concealed in the tube formed by the radial seam.

**SEAMS**—Where two pieces of fabric are joined together.

**SEAR**—Damage to fabric or lines by heat generated through rubbing. The melting of webbing, fabric or line of nylon to prevent fraying.

**SEAT PARACHUTE**—Parachute positioned below the back of the wearer. Forms part of the seat cushion in the aircraft.

**SECTION**—Any one of the pieces of cloth which, when assembled, form one gore of a parachute canopy. Also known as a panel.

**SELVAGE EDGE**—The edge of cloth which is so woven as to prevent raveling.

**SENIOR PARACHUTE RIGGER**—An individual certified by the FAA to pack and maintain parachutes. A journeyman level classification of parachute rigger.

**SEPARATOR, LINE**—A slotted metal or wood device used to hold suspension lines at the canopy skirt after separation into groups during packing.

**SEWING MACHINE KNEE LIFTER**—A knee operated mechanism which lifts the presser foot of a sewing machine.

**SEWING MACHINE UPRISE**—The upright part of the head (generally located on the right side of the head) that houses a portion of the moving parts that transmit motion through mechanical shafts and linkages to the mechanisms in the base of the machine.

**SEWING MACHINE**—A machine with a mechanically driven needle used for sewing.

**SEWING PATTERN**—A design outlined in drawings for joining parts.

**SHOCK CORD**—A straight elastic cord comprised of continuous strands of rubber encased in a braided cover. Used today primarily for Safety Stow® loops on free bags.

**SHOCK LOAD**—The maximum force exerted on the canopy by inflation. This maximum force may be the snatch force or it may be the opening shock.

**SHOCK, OPENING**—The maximum force developed during inflation of the canopy. Follows the snatch force.

**SHOT BAG**—A parachute packing tool. A rectangular bag filled with shot and used to hold folded gores in position during packing.

**SHOULDER STRAP**—That part of the harness webbing which crosses the wearer's back diagonally between the shoulder blades and the horizontal backstrap.

**SIDE FLAP**—A fabric extension on each of the long sides of the pack which fold over to enclose the canopy.

**SILK**—A fiber produced by the silk worm.

**SINGLE POINT RELEASE**—A harness release which has a single closure such as the T-10 type; also, a canopy release system operated by one hand or action.

**SINGLE THROW ZIGZAG**—A machine zigzag stitch from left to right to left, etc. Also known as a 304 stitch.

**SKIRT**—The reinforced hem forming the periphery of a canopy.

**SKYDIVING**—A popular name for sport parachuting.

**SLAG**—A type 6 deployment device. A short sleeve configuration used on ram-air parachutes.

**SLEEVE**—A tapered, fabric tube in which the canopy is placed to control deployment. A deployment device.

**SLIDE FASTENER**—Zipper.

**SLIDERS**—A reefing device usually for ram-air canopies. Comprised of a fabric panel with grommets at the corners through which pass the suspension lines of the canopy.

**SNAG**—A fabric imperfection.

**SNAP, CONNECTOR, QUICK**—A hook-shaped, spring-loaded snap which snaps over a D-ring to connect two webbings.

**SNAP, HARNESS, EJECTOR TYPE**—A harness snap that attaches to the V-ring to secure two parts of the harness together. An ejector arm expels the V-ring when the finger-grip lever is pulled outward.

**SNATCH FORCE**—The shock produced on the load when the parachute assembly fully strings out and becomes suddenly accelerated to the same speed as the load. Comes just prior to opening shock.

**SNIVELING**—Slow opening of a parachute.

**SPEC**—Specification, MIL-SPEC, (military specification).

**SPIRAL VANE PILOT CHUTE**—A pilot chute with a cone-shaped, cloth-covered coil spring used in free-type parachute assemblies.

**SPLICING**—The process of joining together, as the interweaving of strands, overlapping and stitching of materials.

**SPLIT SADDLE**—The lower part of a harness which has independent leg straps; no saddle cross strap.

**SPORT PARACHUTING**—The making of premeditated parachute jumps for pleasure.

**SPORT RIG**—A skydiving harness and container system.

**SQUARE KNOT**—A knot in which the terminal and standing parts are together and parallel to each other.

**SQUARE PARACHUTE**—A gliding or ram-air canopy, having a square or rectangular shape.

**STAND**—A sewing machine table.

**STATIC LINE SYSTEM**—A parachute system which is attached to the aircraft with a line and automatically deploys the parachute.

**STRAPS**—The webbing components of a harness.

**SWAGES**—The ball or other device used at the end of a ripcord to secure the cable to the handle.

## T

**TAIL POCKET**—A deployment device sewn onto the tail of a ram-air canopy used to stow the suspension lines.

**TANDEM**—A dual harness, dual parachute system for use by two people under the same main parachute.

**TAPES**—Narrow woven ribbons used for reinforcing parachutes.

**TECHNICAL STANDARD ORDER**—A minimum performance standard for specified articles

such as materials, parts, processes, or appliances used on civil aircraft.

**THREAD**—A thin continuous filament made by spinning fibers and combining the strands.

**TITLE 14 OF THE CODE OF FEDERAL REGULATIONS (14 CFR)**—The rules, regulations, and guidelines established by the FAA to govern the operation of aircraft, airways, airmen, and the safe operation of civil aircraft.

**TOGGLE**—A knob or webbing loop at the end of the steering line for grasping by the parachutist.

**TRIMMING**—Clipping or paring to reduce to a neat orderly state.

**TUCK**—A shortening of material caused by pulling fabric up in folds and stitching across the gathered fabric.

## U

**ULTIMATE LOAD**—Maximum load that can be applied without causing any part of the structure to fail.

**ULTRAVIOLET LIGHT DAMAGE**—Degradation of nylon fabric by exposure to sunlight or fluorescent lights. Identified by a yellowish color on white fabric or excessive fading to colored fabric.

**UNITED STATES PARACHUTE ASSOCIATION**—A nonprofit division of the National Aeronautic Association (NAA) which governs sport parachuting activities in the U.S.

## V

**VELCRO®**—The commercial name for hook and pile nylon tape fastener.

**VELOCITY**—A vector quantity that includes both magnitude (speed) and direction relation to a given frame of reference; also the time rate of change of position.

**VENT CAP**—A piece of fabric sewn to the upper lateral band and covering the vent. Also known as a vent patch.

**VENT**—The opening at the top, or peak, of the canopy.

**V-RING**—A metal fitting shaped in the form of a closed letter V, used with snaps to secure or attach a load to a parachute.

## W

**WARP**—The threads which run parallel to the selvage edge of cloth; those which are crossed by the filling threads.

**WEAVE**—The forming of a textile by interlacing yarns. The making or manufacturing of cloth on a loom by interlacing warp and filling yarns.

**WEBBING**—A stout, close-woven tape used for straps, belts, harnesses, etc.

**WEIGHT (FABRIC)**—The weight of fabric measured in ounces per square yard.

**WEIGHT**—Gravitational force on a mass.

**WRINKLES**—A series of small pleats.

## Z

**ZIGZAG**—A stitch formation of alternating left and right throw stitches, usually made on a sewing machine which moves the needle bar alternately left and right during sewing.

**ZIPPER**—A slide fastener.





**A**

ACCESSORY COMPONENT REPAIRS, 7-79  
 ACCORDION FOLDING, 5-24  
 ADMINISTRATOR, 1-1, 1-8  
 AEROSPACE STANDARDS (AS),  
     SAE AS 8015B, A-27  
     SAE AS 8015A, A-39  
 AIRING, 5-11  
 AIRWORTHINESS DIRECTIVES, 1-8  
 ALTERATIONS, 7-1, 7-65  
 ASSEMBLY, 5-32  
     assembly of components  
     and compatibility, 4-10 thru 4-12  
     assembly of the main canopy to the harness and  
     container, 4-8 thru 4-10  
 AUTOMATIC ACTIVATION DEVICES, 2-16

**B**

BEESWAX, 6-10  
 BINDING TOOL, 6-12  
 BRAKES, 5-36  
 BRIDLE, 2-2, 2-9, 2-12, 4-8, 5-7, 5-11  
 BRIDLE LENGTH, 4-8

**C**

CABLES, 3-26  
 CANOPY, 4-1, 5-6, 5-7, 5-11, 5-12, 5-24, 5-38  
 CANOPY ASSEMBLY, 5-12  
 CANOPY DESIGN, 2-3  
 CANOPY RELATIVE WORK, 4-1  
 CANOPY RELEASES, 4-8  
 CANOPY REPAIRS, 7-3  
 CERTIFICATES, 1-1  
 CERTIFICATION SPECIFICATIONS, 1-9  
 CLAMP, 6-3  
 CLOSING CONTAINER, 5-27, 5-40  
 CLOSING DIAPER, 5-22  
 CLOSING PLATE, 6-5  
 COMPATIBILITY, 5-3  
 COMPONENT COMPATIBILITY, 5-3  
 COMPONENTS, 2-1

CONFIGURATION, 2-5  
 CONNECTOR LINK SEPARATOR, 6-6  
 CONNECTOR LINKS, 5-8  
 CONSTRUCTION, 2-1, 2-4  
 CONTAINER, 2-1, 2-2, 2-4, 5-10, 5-15, 5-40  
 CONTAINER MOUNT, 2-19  
 CONTAINER REPAIRS, 7-39  
 CORDS, 3-10  
 CURRENCY REQUIREMENTS, 1-6  
 CUTTING PAD, 6-12

**D**

DAMAGE IDENTIFICATION, 5-7  
 DATA CARD, 1-7, 6-7  
 DEFINITIONS, (CFR) 1-8  
 DEPLOYMENT AND INFLATION CHARACTERISTICS, 4-7  
 DEPLOYMENT BAG, 5-38, 5-41  
 DEPLOYMENT DEVICES, 2-2, 2-9, 2-11  
 DEPLOYMENT TYPES, 2-10, 4-11  
     ascuitto, 2-10  
     canopy first, 2-10  
     free bag, 2-11  
     half diaper, 2-10  
     handbury, 2-10  
     piglet-style flat diaper, 2-10  
     preserve full diaper, 2-10  
     sleeves, 2-11  
     two-stow diaper, 2-10  
 DESIGN, 2-1, 2-3, 2-6, 2-7  
 DIAPER PLACEMENT, 5-24  
 DOCUMENTATION, 5-43  
 DRYING, 5-11

**E**

EARNING A PARACHUTE RIGGER  
     CERTIFICATE, 1-2, 1-4  
 EMERGENCY PARACHUTE SYSTEM, 2-1,  
     5-5, 5-17  
 EQUIPMENT, 1-8

ETHICS, 1-9  
EXACTO® KNIFE, 6-3

## F

FABRICS, 3-1  
FACILITIES AND TOOLS, 1-6  
FASTENERS, 3-13  
FINGER-TRAPPING NEEDLE, 6-4  
FINGER-TRAPPING WIRE, 6-4  
FOLD THE SKIRT, 5-22  
FOLDING, 5-36  
FREE BAG, 5-11

## G

GENERAL OPERATING AND FLIGHT  
RULES, 1-8  
GROMMET HANDSET, 6-11

## H

HAND DEPLOY PILOT CHUTES, 2-15  
HAND TACKING NEEDLES, 6-8  
HAND TOOLS, 6-1

- beeswax, 6-10
- binding tool, 6-12
- clamp, 6-3
- closing plate, 6-5
- connector link separator, 6-6
- cutting pad, 6-12
- Exacto® knife, 6-3
- finger-trapping needle, 6-4
- finger-trapping wire, 6-4
- grommet handset, 6-11
- hand tacking needles, 6-8
- hemostats, 6-3
- hole punches, 6-12
- hot knife, 6-11
- lead seals, 6-7
- line separator, 6-6
- locking rod, pilot chute, 6-6
- logbook, 6-7
- molar strap, 6-5
- navy end tab, 6-8
- packing data card, 6-7
- packing fid, 6-4
- packing paddle, 6-4
- pony clamps, 6-9
- pull-up cords, 6-4
- rawhide mallet, 6-12
- ripstop roller, 6-10

scalpel, 6-3  
seal press, 6-7  
seal thread, 6-7  
seam ripper, 6-2  
shot bags, 6-7  
spring scale, 6-10  
t-bar, 6-5  
temporary locking pins, 6-5  
tension board assembly, 6-11  
testing clamps, 6-10  
t-handle bodkin, 6-6  
thread snips, 6-3  
threading tool, pilot chute, 6-6  
Velcro® line protectors, 6-5  
waxed nylon, 6-8

HANDLES, 2-2  
HARDWARE, 3-13  
HARNESS, 2-1, 2-2, 5-9, 5-14  
HARNESS DESIGN, 2-7  
HARNESS REPAIRS 7-57  
HEMOSTATS, 6-3  
HOLE PUNCHES, 6-12  
HOT KNIFE, 6-11  
HOUSINGS, 3-25

## I

IDENTIFICATION, 5-1  
INSPECTION, 5-1, 5-14  
INSPECTION FORM, 5-5

## J

JOINT EFFICIENCY, 2-20

## L

LANYARD, 2-19  
LAYOUT, 5-18, 5-33  
LEAD SEALS, 6-7  
LINE CONTINUITY, 5-12  
LINE SEPARATOR, 6-6  
LINES, 3-10  
LINES REPAIRS, 7-29  
LOCKING ROD, PILOT CHUTE, 6-6  
LOFT, 6-1  
LOGBOOK, 6-7

## M

MAIN PARACHUTE, 2-1, 2-2  
MAIN PILOT CHUTE, 4-7  
MAIN RISER ATTACHMENT, 2-18  
MANUFACTURE, 7-1  
MATERIAL SPECIFICATIONS, 3-1

## MATERIALS, 2-4, 3-1

- cables, 3-26
- cords, 3-10
- fabrics, 3-1
- fasteners, 3-13
- hardware, 3-13
- housings, 3-25
- lines, 3-10
- ripcords, 3-26
- swages, 3-26
- tapes, 3-6
- threads, 3-10
- webbing, 3-6

## MOLAR STRAP, 6-5

## N

NAS 804, A-47

NAVY END TAB, 6-8

NOMENCLATURE, 2-3

## O

OPENING SHOCK, 4-1

OPERATION, 2-16

OPERATIONAL THEORY, 2-4

## P

PACKING, 1-8, 5-1, 5-17

PACKING CLAMPS, 5-33

PACKING DATA CARD, 6-7

PACKING FID, 6-4

PACKING FLOW CHART, 5-2

PACKING PADDLE, 6-4

PARACHUTE EQUIPMENT AND

PACKING, 1-8

PARACHUTE RIGGER CERTIFICATES, 1-1

PARACHUTE SIZE, 1-9

PERFORMANCE STANDARDS, 1-6

PERFORMANCE STANDARDS,

SAE AS 8015B, A-27

SAE AS 8015A, A-39

PIA TS-100, A-3

PIA TS-108, A-19

PIGGYBACK SYSTEM, 5-11, 5-32

PILOT CHUTES, 2-2, 2-14, 5-7, 5-11

PILOT CHUTES, HAND DEPLOY, 2-15

PILOT EMERGENCY PARACHUTE SYSTEM, 5-5,  
5-17

PILOT VS PARACHUTE SIZE, 1-9

PLEATING THE CANOPY, 5-19, 5-34

PONY CLAMPS, 6-9

POROSITY, 4-7

PULL FORCE, 5-28

PULL-UP CORDS, 6-4

## R

RAM-AIR RESERVES, 5-11, 5-32

RATINGS, 1-2

RAWHIDE MALLETT, 6-12

RECORD KEEPING, 1-6

REGULATORY COMPLIANCE, 1-8

RELEASE MECHANISM, 2-2

REPAIR TECHNIQUES, 7-1

accessory components, 7-79

canopy, 7-3

container, 7-39

harness, 7-57

lines, 7-3

risers, 7-57

REPAIRS, 5-16, 7-1

RESERVE CANOPY, 5-7, 5-34

RESERVE PARACHUTE SYSTEM, 2-1, 2-2,  
5-32

RESERVE STATIC LINE DESIGN, 2-17

RESERVE STATIC LINE LANYARD, 2-19

RESERVE STATIC LINES, 2-16, 2-17

RESPONSIBILITIES OF A PARACHUTE

RIGGER, 1-5

RETESTING, 1-4

RIGGING, 5-16

RIPCORDER, 2-2, 2-19, 3-26, 5-10, 5-16

RIPCORDER CABLE ROUTING, 2-19

RIPCORDER PULL FORCE, 5-28

RIPSTOP ROLLER, 6-10

RISERS, 2-2, 2-18

RISERS REPAIRS, 7-57

ROUND CANOPIES, 5-5, 5-17

RUBBER BANDS, 4-8

## S

SAE AS 8015A, A-39

SAE AS 8015B, A-27

SCALPEL, 6-3

SEAL PRESS, 6-7

SEAL THREAD, 6-7

SEALING, 5-30

SEALING THE PARACHUTE, 1-8, 5-30

SEAM RIPPER, 6-2

SERVICE LIFE, 1-9

SETTING BRAKES, 5-36

SETTING UP, 5-33

SEWING MACHINES, 6-1, 6-12

attachments, 6-20

identification, 6-14

maintenance, 6-20

needles, 6-18

nomenclature, 6-14

operation, 6-19

theory, 6-17

SHOT BAGS, 6-7



SIZE, 1-9  
SKIRT, 5-22  
SKIRT PLACEMENT, 5-24  
SPECIFICATIONS, 3-1, A-47  
SPORT PARACHUTE MAIN PACKING  
TECHNIQUES, 4-1 THRU 4-6  
SPORT PIGGYBACK SYSTEMS, 5-11, 5-32  
SPRING SCALE, 6-10  
SPRING-LOADED PILOT CHUTES, 2-14  
STACKING, 5-34  
STATIC LINES, 2-2  
STEERING TOGGLES, 2-2  
STOWING LINES, 5-22, 5-38  
STRAIGHTENING THE CANOPY, 5-6  
SUSPENSION LINES, 5-8  
SWAGES, 3-26

## T

TAPES, 3-6  
T-BAR, 6-5  
TECHNICAL STANDARD ORDERS, 1-8,  
2-2, 4-11  
TSO C23B, A-45  
TSO C23C, A-37  
TSO C23D, A-25  
TECHNICAL STANDARDS, (TS)  
PIA TS-100, A-3  
PIA TS-108, A-19  
TEMPORARY LOCKING PINS, 6-5  
TENSION BOARD ASSEMBLY, 6-11  
TESTING, 1-2

TESTING CLAMPS, 6-10  
T-HANDLE BODKIN, 6-6  
THREAD SNIPS, 6-3  
THREADING TOOL, PILOT CHUTE, 6-6  
THREADS, 3-10  
TITLE 14 OF THE CODE OF FEDERAL  
REGULATIONS, 1-1, 1-8  
14 CFR Part 1, 1-8  
14 CFR Part 21, 1-8  
14 CFR Part 39, 1-8  
14 CFR Part 65, 4-1  
14 CFR Part 91, 1-8  
14 CFR Part 105, 1-8  
TOGGLES, 2-2  
TOOLS, 6-1  
TSO C23B, A-45  
TSO C23C, A-37  
TSO C23D, A-25  
TSO CERTIFICATION AND PLACARD  
LIMITATIONS, 4-11

## V

VELCRO® LINE PROTECTORS, 6-5

## W

WAXED NYLON, 6-8  
WEBBING, 3-6