

ADVANCE COPY FOR USE IN  
ORDNANCE OFFICE ONLY.  
REGULAR DISTRIBUTION WILL  
BE MADE BY YOUR LOCAL  
ADJUTANT GENERAL OR  
POST ADJUTANT.

*JA*

AUG 6

1943

TM 9-306

DECLASSIFIED

Auth: ~~SECRET~~ 785097

BY ~~MMF~~ - NARS 11-5-78

WAR DEPARTMENT

~~U.S. Army Military History Institute~~ TECHNICAL MANUAL

75-MM GUN M1897A4  
MOUNTED IN COMBAT VEHICLES

10 JUNE 1943

~~FOR ORDNANCE OFFICE USE ONLY~~

UNCLASSIFIED

REGRADED \_\_\_\_\_ BY AUTHORITY

OF E.O. 10501

BY BAKERS ON 24 MAR 92

# 75-MM GUN M1897A4 MOUNTED IN COMBAT VEHICLES

Prepared under the direction of the  
Chief of Ordnance

## CONTENTS

	Paragraphs	Pages
CHAPTER 1. INTRODUCTION .....	1- 4	2- 4
CHAPTER 2. GUN AND MOUNT.....	5-56	5- 64
SECTION I. Description and functioning of gun	5- 7	5- 7
II. Description and functioning of re- coil mechanism .....	8	8- 11
III. Description and functioning of gun mount .....	9-15	12- 18
IV. Operation .....	16-25	19- 26
V. Lubrication .....	26-29	27- 29
VI. Care and preservation.....	30-41	30- 39
VII. Inspection and adjustment.....	42-43	40- 43
VIII. Malfunctions and corrections....	44-45	44- 46
IX. Disassembly and assembly.....	46-56	47- 64
CHAPTER 3. SIGHTING EQUIPMENT .....	57-60	65- 75
CHAPTER 4. AMMUNITION .....	61-73	76- 94
CHAPTER 5. SUBCALIBER EQUIPMENT .....	74-80	95-101
CHAPTER 6. ORGANIZATIONAL SPARE PARTS AND ACCESSORIES .....	81-82	102-103
CHAPTER 7. PREPARATION OF MATERIEL FOR USE UNDER EXTREME CONDI- TIONS .....	83-87	104-106
CHAPTER 8. REFERENCES .....	88-90	107-109
INDEX .....		110-114

**75-MM GUN M1897A4 MOUNTED IN COMBAT VEHICLES**

**Chapter 1**

**INTRODUCTION**

	Paragraph
Scope .....	1
Characteristics .....	2
Differences among models .....	3
Data .....	4

**1. SCOPE.**

a. This manual is published for the information of the using arms and services.

b. In addition to a description of the 75-mm Gun M1897A4 and 75-mm Gun Mounts M3 and M5 this manual contains technical information required for the identification, use, and care of the materiel.

c. Disassembly, assembly, and such repairs as may be handled by using arm personnel may be undertaken only under the supervision of an officer or the chief mechanic.

d. In all cases where the nature of the repair, modification, or adjustment is beyond the scope or facilities of the unit, the responsible ordnance service should be informed so that trained personnel with suitable tools and equipment may be provided, or proper instructions issued.

**2. CHARACTERISTICS.**

a. The 75-mm Gun Motor Carriages M3 and M3A1 mount the 75-mm Gun M1897A4 with Recoil Mechanism M1897A7 and 75-mm Gun Mounts M3 and M5. The 75-mm Gun Motor Carriages M3 and M3A1 are employed chiefly as tank destroyers and the gun is used in direct fire only. Gun is mounted in the approximate center of the vehicle and fires forward.

b. An armor plate gun shield is mounted on the gun carriages. This supplements the protection given to gun and crew by the armor plate windshield and door shields, and by the armored hull.

c. The name of the manufacturer, year of manufacture, model and serial number are stamped in the name plate on right front of cradle.

**3. DIFFERENCES AMONG MODELS.**

a. The original French 75-mm Gun M1897 has had many modifications over the years. However, aside from refinements in barrel

## INTRODUCTION

and recoil mechanism, and modernization of the carriage, the materiel is basically unchanged in design and effectiveness.

b. The 75-mm Gun M1897A4 with Recoil Mechanism M1897A7 and 75-mm Gun Mount M3 are used in the 75-mm Gun Motor Carriage M3. The 75-mm Gun Mount M3 is a 75-mm Gun Carriage M2A3 (field piece) modified by the elimination of wheels, axle, and equalizers.

c. The 75-mm Gun M1897A4 with Recoil Mechanism M1897A7 and 75-mm Gun Mount M5 are used in the 75-mm Gun Motor Carriage M3A1. The 75-mm Gun Mount M5 is a 75-mm Gun Carriage M2A2 (field piece) modified by the elimination of wheels, axle, and equalizers.

d. On the 75-mm Gun Mount M3 (fig. 13), elevating and traversing handwheels are provided on the left side of the mount and an elevating handwheel is provided on the right side. On the 75-mm Gun Mount M5, only a traversing handwheel is provided on the left side of the mount and an elevating handwheel on the right side (fig. 14).

## 4. DATA.

### a. 75-mm Gun M1897A4 and 75-mm Gun Mounts M3 and M5.

Weight of barrel with breech mechanism . . . . . 1,035 lb

Weight of cradle, recoil mechanism, and holding cradle . . . . . 440 lb

Length of bore . . . . . 34.5 calibers

#### Rifling:

Twist . . . . . Uniform, right; one turn in 25.6 calibers;  
24 grooves; 0.02 in. deep

Diameter of bore between lands . . . . . 2.95 in.

Maximum pressure . . . . . 36,000 lb per sq in.

#### Muzzle velocity with High-explosive Shell M48:

Supercharge . . . . . 1,950 ft per sec.

Normal charge . . . . . 1,500 ft per sec.

Reduced charge . . . . . 950 ft per sec.

Maximum range (approx.) . . . . . 8,300 yd

#### Rate of fire:

Short bursts (per min) . . . . . 6 rounds

Prolonged firing (per min) . . . . . 3 rounds

Approximate life . . . . . 10,000 rounds

Breech mechanism, type . . . . . Eccentric screw  
(Nordenfelt)

Firing mechanism, type . . . . . Lanyard, percussion hammer

**75-MM GUN M1897A4 MOUNTED IN COMBAT VEHICLES**

Recoil mechanism, type .....	Hydropneumatic, constant floating piston
Oil, capacity .....	3½ pt OIL, recoil, heavy, with low pour point
Length of recoil, normal .....	46 in.
Gas pressure at 70 F.....	1,710 lb per sq in.
Equilibrators, type .....	Spring
Elevation .....	29°
Depression .....	Minus 10°
Traverse to the right of centerline .....	21°
Traverse to the left of centerline .....	19°
Sighting system, direct fire only .....	Telescope M33

Chapter 2

GUN AND MOUNT

Section I

DESCRIPTION AND FUNCTIONING OF GUN

	Paragraph
Barrel assembly .....	5
Breechblock .....	6
Firing mechanism .....	7

5. BARREL ASSEMBLY (fig. 1).

a. The gun is of the built-up type. It consists of tube, breech hoop, inner locking hoop, outer locking hoop, jacket, muzzle hoop, and gun slide bearings.

b. The tube is rifled with a uniform right-hand twist, one turn in 25.6 calibers. From rear to front, three supports, the jacket support, intermediate support, and muzzle support, are pinned to the tube and serve to hold the gun slide bearings in alignment. The recoil indicator (figs. 1 and 5), for determining length of recoil, is assembled to the intermediate support of the right side. A fourth support, the breech support, is pinned to the breech hoop in front of the recoil lug.

c. The breech hoop extends to the rear of tube. The breechblock threads into the breech hoop (fig. 33). The breech hoop also contains pockets for the arms of the extractor and the extractor spindle on which the extractor pivots.

d. A breechblock stop (fig. 15) is hinged between two projections on the left of the breech hoop, limiting rotation of breechblock in the open position. A projection on the lower right of the breech hoop stops the breechblock in the closed position (fig. 17). Just above this projection the breechblock latch catch is inserted and held in place by three headless screws.

e. The rear sight (fig. 15) is fitted into a dovetailed seat in the rear face of the breech hoop at top center and is secured by a blind screw. Although the sight is no longer used, the rim of this sight still acts as a cam to trip the breechblock latch when the breechblock is being opened. This frees the breechblock catch so that it can engage the breechblock latch catch when the breechblock is closed.

f. Two leveling plates (fig. 15) are inserted in the top of the breech hoop near the breech. These were designed as a seat, parallel with the axis of the bore, for the gunner's quadrant. The gunner's

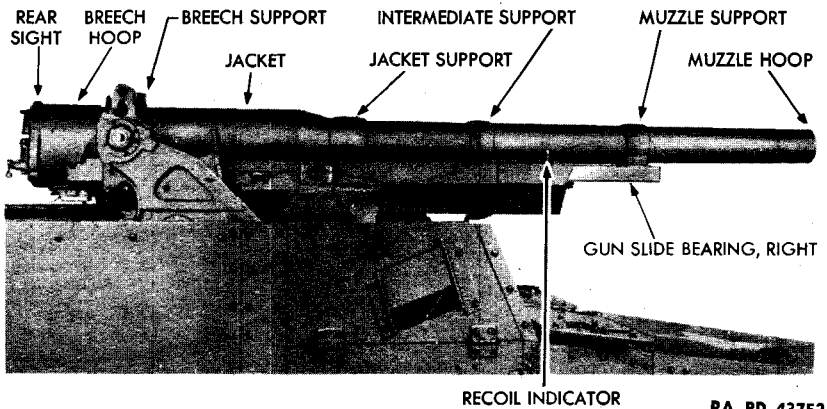
**75-MM GUN M1897A4 MOUNTED IN COMBAT VEHICLES**

RA PD 43752

**Figure 1 — Gun — Side View (Shield Removed)**

quadrant is not used in the operations of the tank destroyer. Nevertheless, it is important to protect the leveling plates from damage and to preserve them for possible future use.

g. On the under side of the breech hoop is the recoil lug (fig. 13). This contains a rectangular cut-out for the piston rod coupler key which locks the gun to the recoil system. A vertical hole in the recoil lug houses the safety bolt (figs. 25 and 33).

h. The gun slide bearings (figs. 1 and 5) guide the gun in recoil and counterrecoil. Steel bearing strip rails are dovetailed into the four supports on both sides and pinned rigidly to the jacket support. A bronze bearing strip is secured by rivets and pins to the outer side, top, and bottom of each rail. Assembly of rail and bearing forms the gun slide bearing.

## 6. BREECHBLOCK (figs. 13, 25, and 29).

a. This is the Nordenfelt eccentric screw type. It is opened and closed by means of the operating handle and rotates in an arc of 156 degrees. Stops limit the movement in each direction. When the breechblock is closed, it is locked automatically until released by recoil of gun or by pressure of thumb on rear end of operating handle plunger.

b. An eccentric loading hole (fig. 16), opposite the bore of the gun when breech is open, permits loading of ammunition; but when breechblock is rotated to the firing position, the chamber is tightly closed by the solid portion of breechblock.

c. The gun cannot be fired until the breechblock is rotated to firing position; only at that point is the firing pin in line with the

## DESCRIPTION AND FUNCTIONING OF GUN

primer. Rotation of breechblock to the loading position automatically ejects the empty cartridge case. A small vent (fig. 16) extends upward at an angle from the rear face of the block to the front end of the firing pinhole. This provides an outlet for gases that may escape to the interior of the breechblock because of a leaky primer or other causes.

d. The buttress threads of the breechblock (fig. 25) prevent block from being jammed by pressure of the cartridge case when the gun is fired. The V-grooves across the threads are designed to collect dirt which gathers on threads during firing, thus preventing interference with the smooth operation of the breechblock.

### 7. FIRING MECHANISM.

a. To fire the piece, pull lanyard sharply down and to the right, and release lanyard. This allows the hammer to be thrown forward against the firing pin by means of the firing rack spring with sufficient force to explode the primer.

b. Safety piece is provided to prevent accidental firing. The safety piece screws into the threaded recess in the breechblock arm and may be located at two different points. These two points are marked "SAFE" and "FIRE" on the outer surface of the breechblock arm. (On guns of French manufacture, these two points are marked "TIR" and "ROUTE.")



**75-MM GUN M1897A4 MOUNTED IN COMBAT VEHICLES****Chapter 2 — GUN AND MOUNT (Cont'd)****Section II****DESCRIPTION AND FUNCTIONING OF RECOIL MECHANISM**

Paragraph

Recoil mechanism ..... 8

**8. RECOIL MECHANISM.**

a. This is the hydropneumatic constant-recoil type with a floating piston. The entire mechanism is housed in two cylinders bored in the cradle.

b. The front end of the recoil cylinder is closed by the respirator, the rear end by the recoil stuffing box head through which the recoil piston rod slides.

c. The front end of the counterrecoil cylinder is closed by the cylinder front head. The rear end is closed by the oil index assembly and rear head assembly. This cylinder contains the floating piston which separates the nitrogen gas in the forward end from the oil in the rear end.

d. The respirator, which is the only part of recoil mechanism removable by the using arms, allows air to enter the recoil cylinder when the piston moves to the rear with the recoiling gun. It throttles escaping air when the piston moves forward again. It works in the following manner: Three small holes of different sizes are located in the valve. All may be closed at zero, or by turning the adjusting cap to the right; either one, two, or three of the holes may be opened as indicated by numbers inscribed above the adjusting cap.

e. The oil index, which is located beneath the recoil lug with rear sealing plate of the counterrecoil cylinder, indicates the recoil oil reserve.

f. A filling and drain hole is located in right side of the cradle near the rear. This leads into the port between recoil and counterrecoil cylinders. Oil is added, by means of the oil screw filler, through the filling and drain hole in order to establish the oil reserve. Oil may be withdrawn through the same hole using the oil release.

**DESCRIPTION AND FUNCTIONING OF RECOIL MECHANISM**

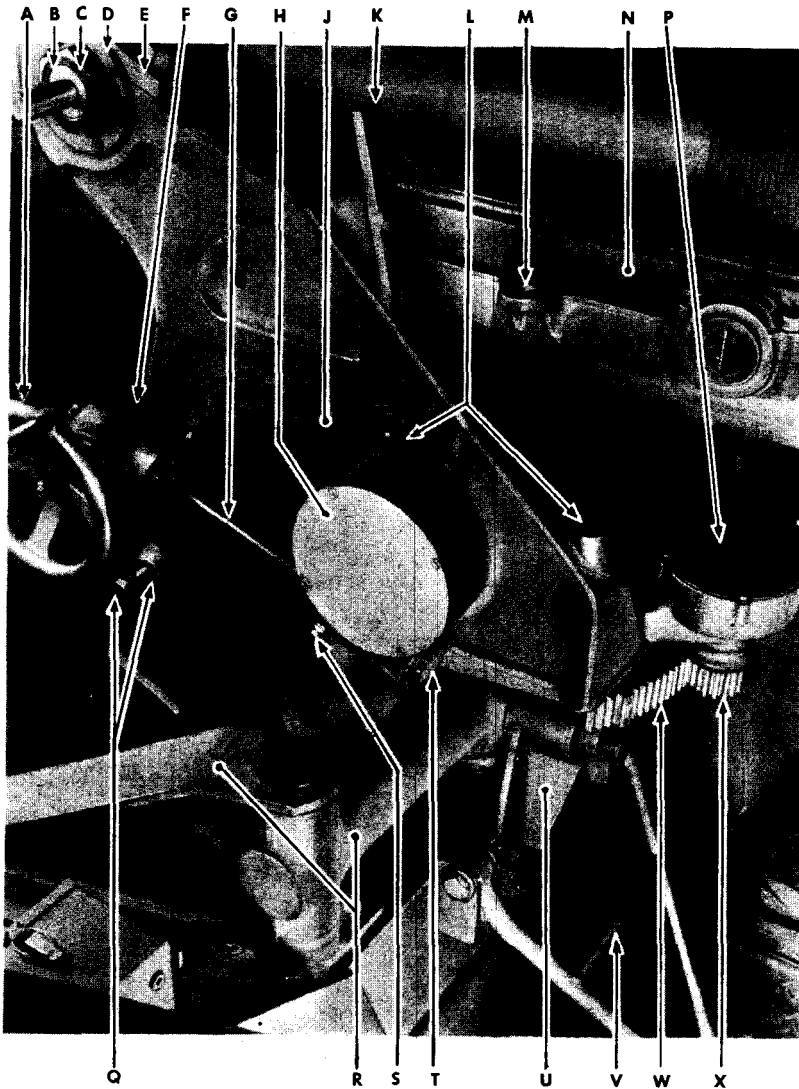

- |  |  |   |
|--|--|---|
| <p>A—ELEVATING HANDWHEEL<br/>         B—HOLDING CRADLE TRUNNION<br/>         C—CRADLE TRUNNION NUT<br/>         D—TRUNNION BEARING PLATE<br/>         E—TRUNNION CAP<br/>         F—LUBRICATION FITTING<br/>         G—ELEVATING GEAR SHAFT<br/>         H—ELEVATING GEAR CASE</p> | <p>J—CARRIAGE<br/>         K—GUN SHIELD BRACKET<br/>         L—GUN SHIELD BRACKETS<br/>         M—SUBCALIBER MOUNT BRACKET<br/>         N—CRADLE<br/>         P—TRANSVERSING GEAR CASE<br/>         Q—GUN SHIELD BRACKET AND CAP SCREW</p> | <p>R—CARRIAGE SUPPORT<br/>         S—LUBRICATION FITTING<br/>         T—BALL BEARING RETAINER<br/>         U—CARRIAGE SUPPORT BRACE<br/>         V—CRADLE LOCK (RELEASED)<br/>         W—TRAVERSING RACK<br/>         X—TRAVERSING PINION</p> |
|--|--|---|

RA PD 43753

**Figure 2 — Top Carriage — Right Side (Gun Shield Removed)**

**75-MM GUN M1897A4 MOUNTED IN COMBAT VEHICLES**

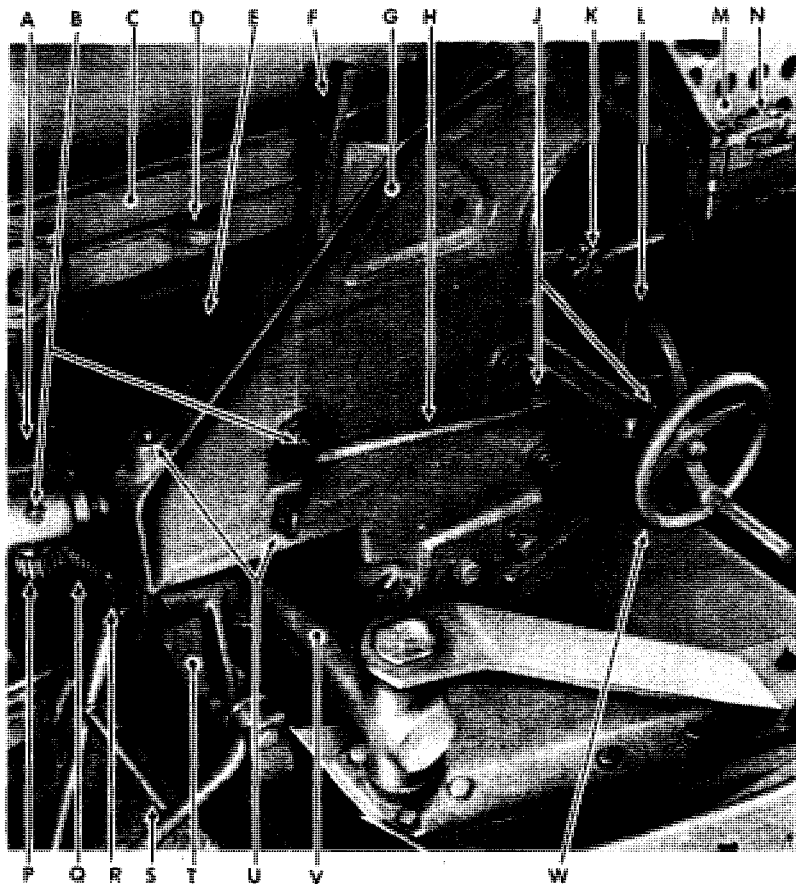

- A—TRAVERSING GEAR CASE
- B—LUBRICATION FITTINGS
- C—CRADLE
- D—SUBCALIBER MOUNT BRACKET
- E—ELEVATING ARC
- F—GUN SHIELD BRACKET
- G—CARRIAGE
- H—TRAVERSING HANDWHEEL SHAFT
- J—OIL CUPS
- K—SHOULDER GUARD LOCKING KNOB
- L—TRAVERSING HANDWHEEL

- M—SHOULDER GUARD
- N—TELESCOPE MOUNT
- P—TRAVERSING PINION
- Q—TRAVERSING RACK
- R—TRAVERSING RACK STOP
- S—CRADLE LOCK (RELEASED)
- T—CARRIAGE SUPPORT BRACE
- U—GUN SHIELD BRACKETS
- V—CARRIAGE SUPPORT
- W—ELEVATING HANDWHEEL

RA PD 43770

**Figure 3 — Top Carriage — Left Side (Gun Shield Removed)**

**DESCRIPTION AND FUNCTIONING OF RECOIL MECHANISM**

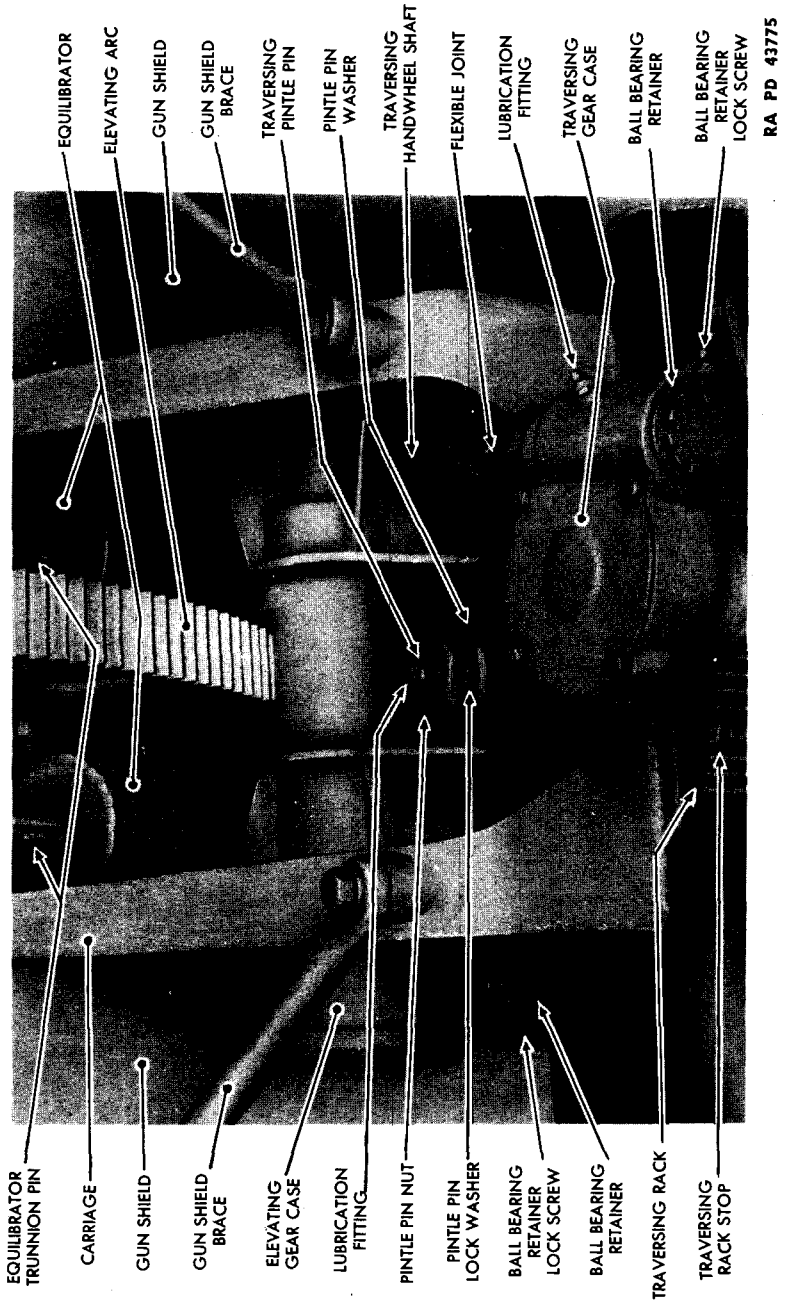

**Figure 4 — Traversing Pintle Pin**

**75-MM GUN M1897A4 MOUNTED IN COMBAT VEHICLES**

**Chapter 2 — GUN AND MOUNT (Cont'd)**

**Section III**

**DESCRIPTION AND FUNCTIONING OF GUN MOUNT**

	Paragraph
General .....	9
75-mm gun mounts M3 and M5 .....	10
Cradle lock .....	11
Equilibrator .....	12
Cradle .....	13
Elevating mechanism .....	14
Traversing mechanism .....	15

**9. GENERAL.**

a. With the modification of the 75-mm Gun Carriages M2A3 and M2A2 (field pieces) for installation in the 75-mm Gun Motor Carriages M3 and M3A1, axles and equalizers are eliminated and the bottom carriage simply becomes the carriage support (figs. 2 and 3). This is bolted to the gun mount in the motor carriage.

**10. 75-MM GUN MOUNTS M3 AND M5.**

a. The Mounts M3 and M5 are of welded built-up steel construction and form the connection between the recoil mechanism holding cradle and the carriage support. The traversing pintle (fig. 4) permits carriage to pivot on the carriage support when piece is traversed. The upper portion of the carriage carries the trunnion bearings in which the recoil mechanism holding cradle pivots when gun is elevated or depressed. The top of each trunnion bearing is closed by a trunnion cap held in place by cap screws (fig. 2). Sight mounts, assembled in the cradle trunnions, provide seats for the telescope mount on the left and the range quadrant on the right, where the range quadrant is used.

b. The recoil mechanism holding cradle, which is used primarily to obtain a rear trunnion mounting for the gun, should be considered an integral part of the cradle since both are assembled into a single unit by ordnance. Bearings at the front end of the holding cradle provide seats for the cradle center trunnions. At the rear end of the holding cradle, the cradle is supported on brackets and secured by studs.

**11. CRADLE LOCK.**

a. The cradle lock (figs. 10 and 11) prevents vertical and lateral movement of cradle and gun when the vehicle is traveling. It must

**DESCRIPTION AND FUNCTIONING OF GUN MOUNT**

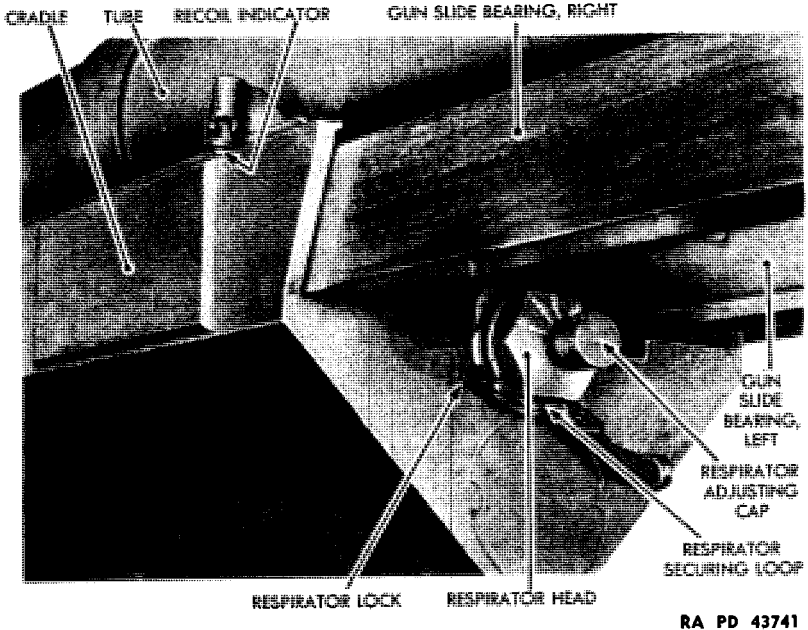

RA PD 43741

**Figure 5 — Recoil Indicator and Respirator**

always be locked when traveling. To engage the welded A-shaped lock with the cradle lock pin, make sure the cradle lock handle points forward horizontally. Then raise the welded lock and depress the gun until the U-end of the lock slips up over the squared sides of the cradle lock pin. Turn cradle lock handle straight up and engage it with the latching turnbuckle (fig. 10). The cradle lock has to be released and lowered to the floor to put the gun in firing position.

**12. EQUILIBRATOR.**

a. Two spring-type equilibrators (figs. 30 and 31) neutralize unbalanced weight and reduce the manual effort required to elevate the gun through the lower elevations. The equilibrators may be dismantled (par. 51), for inspection and cleaning, or adjustment of spring tension but they must not be disassembled by the using arms.

**13. CRADLE.**

a. The cradle (fig. 5) is a steel forging which carries the gun, guides it in the recoil, and houses the recoil mechanism. Two channels, extending lengthwise in the upper part of the cradle body, provide slides for the movement of the gun slide bearings. The upper cylinder with respirator head is the recoil cylinder. Immediately

**75-MM GUN M1897A4 MOUNTED IN COMBAT VEHICLES**

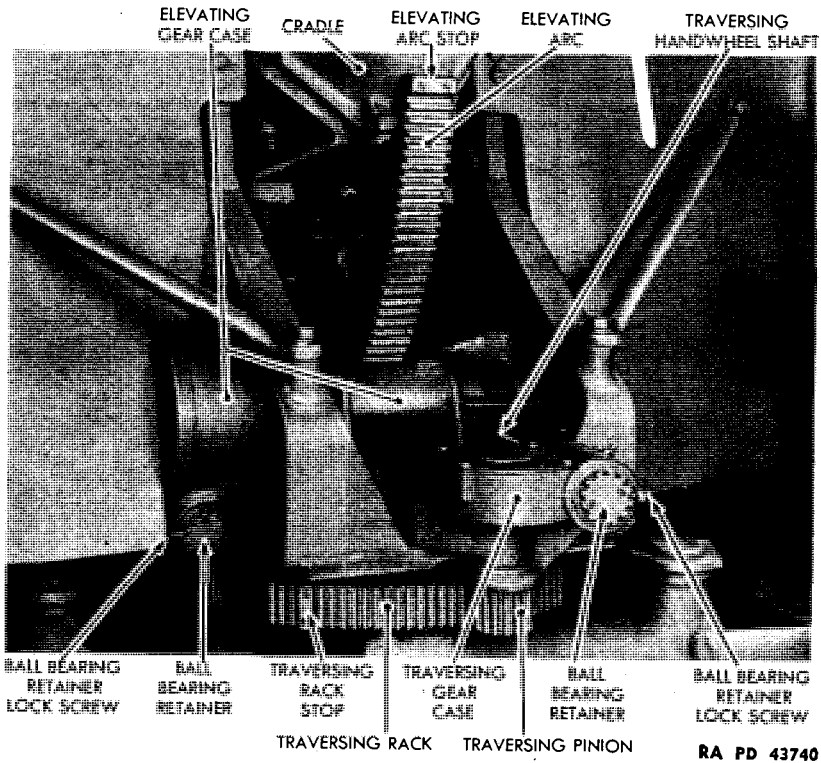
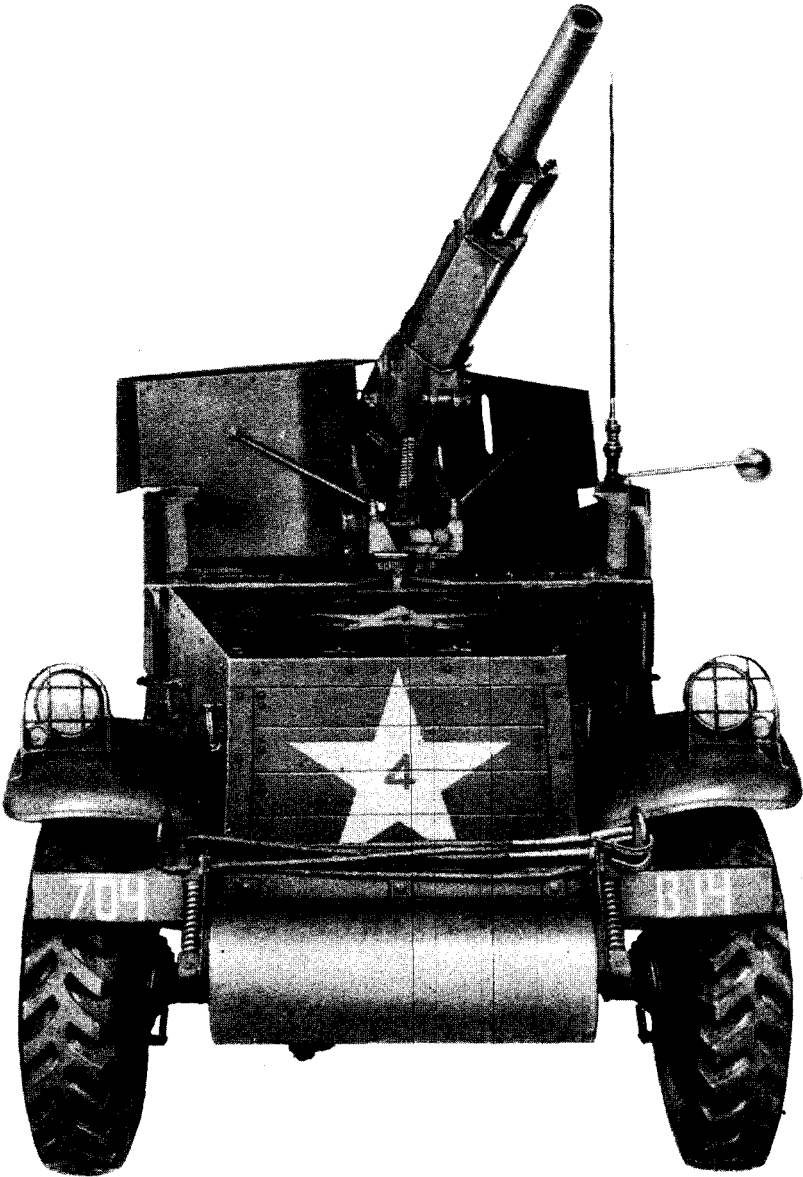

**Figure 6 — Elevating Arc and Traversing Rack**

below it is the recuperator cylinder. The recoil indicator determines the length of recoil, normally about 46 inches. At the rear upper-right side of the cradle (fig. 32) is cut an index mark which is used in connection with the reference marks immediately above on the right side of the breech ring. These show the limits within which the gun may be out of battery when fired without injury to the recoil mechanism.

b. The piston rod coupler, recoil lug, and coupler key (figs. 32 and 36) provide the only direct connection between gun and carriage. The coupler assembly is a forging having two wings and a seat for the shield-shaped piston rod nut (fig. 36). The wings have rectangular slots which line up with the rectangular slot in the gun lug (fig. 32). Inserted in these slots, the coupler key locks the recoil piston rod to the gun. The rear face of the coupler key has a sloping cam groove in which the lug of the safety bolt engages (fig. 25). The lower face of the coupler key has a spring latch to lock it in position.

**DESCRIPTION AND FUNCTIONING OF GUN MOUNT**



RA PD 43777

**Figure 7 — Maximum Traverse — 21 Degrees Right,  
19 Degrees Left of Centerline**



**75-MM GUN M1897A4 MOUNTED IN COMBAT VEHICLES**

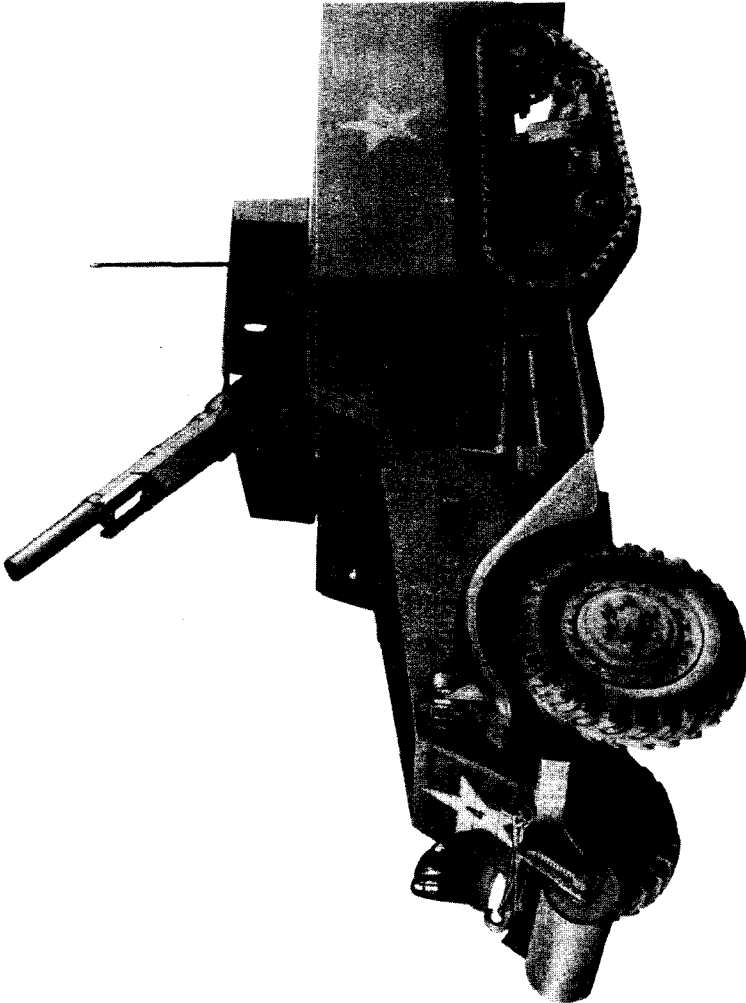

RA PD 43763

**Figure 8 — Maximum Elevation — 29 Degrees**

## DESCRIPTION AND FUNCTIONING OF GUN MOUNT

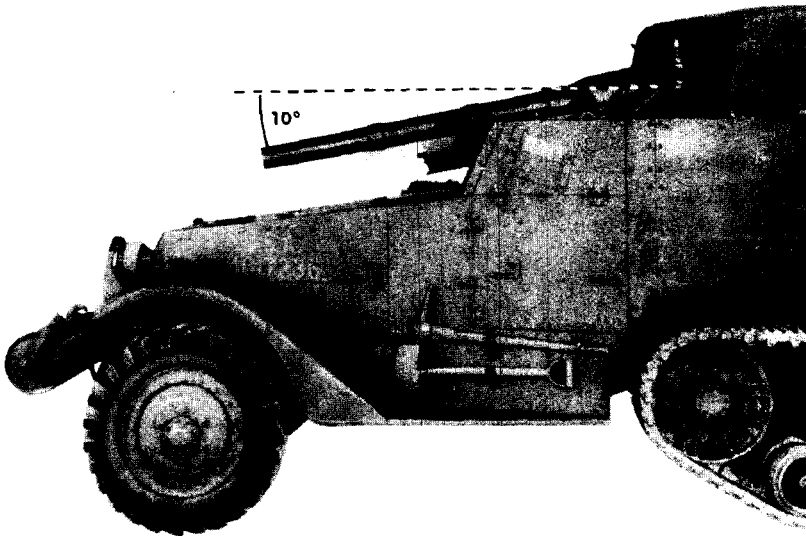

RA PD 43762

*Figure 9 — Maximum Depression of Gun*

### 14. ELEVATING MECHANISM.

a. The elevating mechanism on the Gun Mount M3 is controlled through two handwheels, one on each side of the gun (fig. 13). A handwheel on the left, close to the traversing handwheel, permits one man to sight and lay the piece. The elevating mechanism on the Gun Mount M5 is controlled by one handwheel on the right side of the gun (fig. 14).

b. The elevating arc is attached to the lower surface of the recoil mechanism holding cradle. It is a segment gear with stops at the top and bottom to control maximum elevation and depression. It is operated by the elevating pinion, which is mounted on roller bearings housed in the elevating gear case. This case is welded transversely within the frame of the carriage.

c. On the right of the elevating pinion is the elevating worm wheel which meshes with the elevating worm. The elevating worm is turned by the elevating handwheel through two meshing bevel gears, which are mounted on ball bearings in the elevating handwheel gear case. The elevating handwheel is keyed to the tapered end of a shaft projecting from the elevating handwheel gear.

d. Covers on the elevating handwheel gear case and the right end of the elevating gear case permit access for repairs, cleaning, and lubrication (fig. 2) by ordnance maintenance personnel only. How-

## **75-MM GUN M1897A4 MOUNTED IN COMBAT VEHICLES**

ever, the ball bearing retainer may be loosened or tightened by the using arms if there is too much play or if the mechanism is hard to operate.

### **15. TRAVERSING MECHANISM.**

a. There is one traversing handwheel, on the left side of either gun mount, which traverses the piece 21 degrees right or 19 degrees left of the centerline (figs. 13 and 14).

b. Traverse is accomplished by turning the top carriage on its pivot, the traversing pintle pin. The stationary traversing rack is bolted to the carriage support. The traversing pinion, turning in it, moves with the traversing gear case which is bolted to the carriage. Stops at each end of the traversing rack limit the movement of the traversing pinion.

c. Movement of the traversing handwheel, through the handwheel shaft, turns the traversing worm which drives the traversing worm wheel. This worm wheel is keyed on the traversing pinion which is meshed with the teeth on the traversing rack. The worm and worm wheel are contained in the traversing gear case. They and the pinion are mounted on ball bearings.

d. A cover on the traversing gear case permits access for cleaning, repair, and lubrication by ordnance personnel (fig. 6). However, the ball bearing retainer may be tightened or loosened by the using arms if there is too much play or if the mechanism is difficult to work.

**Chapter 2 — GUN AND MOUNT (Cont'd)**

**Section IV**

**OPERATION**

	Paragraph
Placing gun in firing position.....	16
To operate breech mechanism.....	17
To traverse .....	18
To elevate .....	19
Points to be observed before firing.....	20
Points to be observed during firing.....	21
To load .....	22
To fire .....	23
To unload .....	24
Placing gun in traveling position.....	25

**16. PLACING GUN IN FIRING POSITION.**

a. Remove gun covers and stow them out of the way in the proper place assigned to them. Stow all equipment not needed for operation of gun.

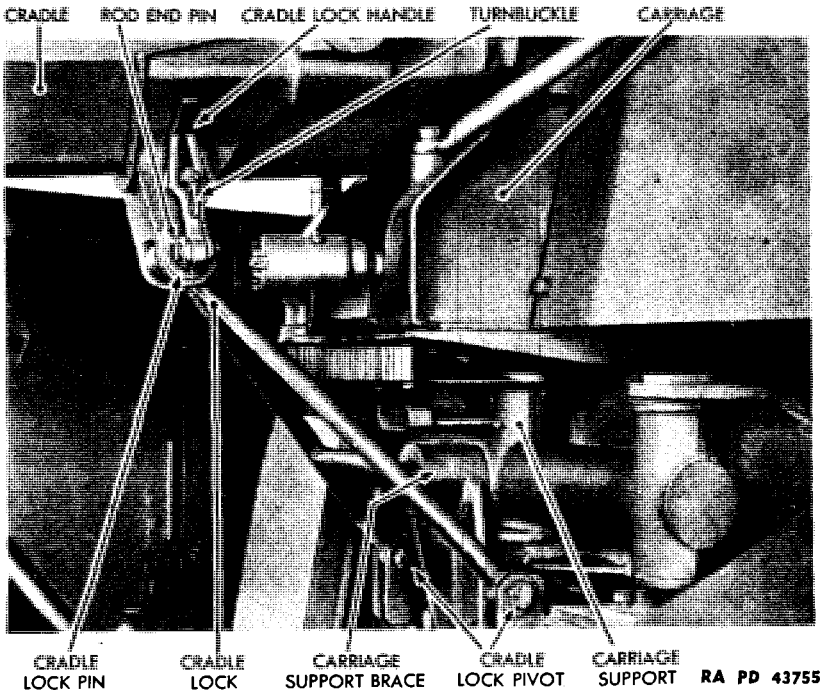

**Figure 10 — Cradle Lock in Traveling Position**

**75-MM GUN M1897A4 MOUNTED IN COMBAT VEHICLES**

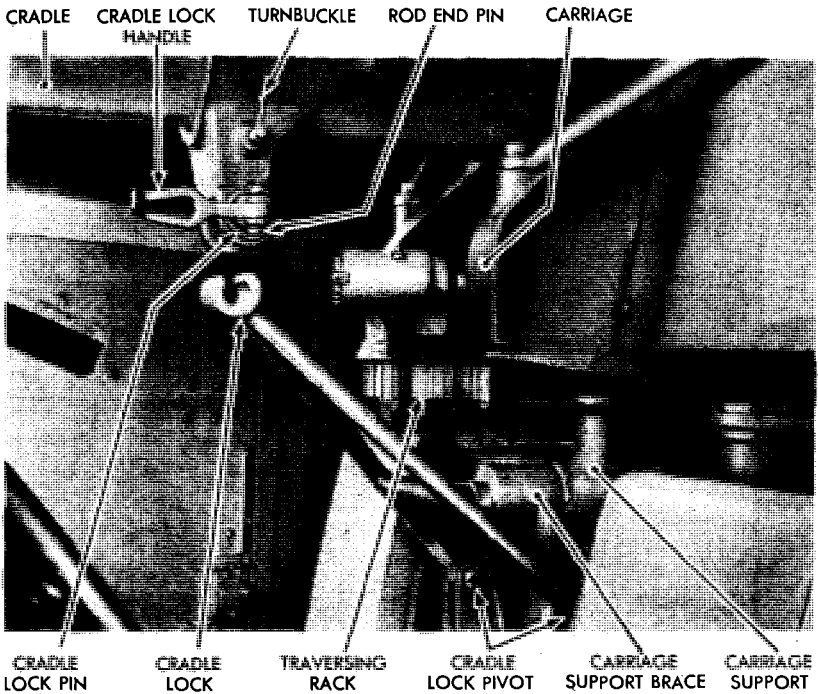

RA PD 43744

**Figure 11 — Cradle Lock Released to Put Gun in Firing Position**

b. Release cradle traveling lock (fig. 10) by swinging the turnbuckle straight up to disengage the cradle lock handle. Turn cradle lock handle left 90 degrees to release the welded lock from the cradle lock pin (fig. 11). Lower cradle lock to the floor.

c. Release right and left gun shield latches (fig. 12).

d. Install Telescope M33 in Mount M36 on left side of gun.

e. Elevate and traverse gun to make sure the mechanisms are working freely. Note precautions (par. 43).

f. Open and inspect breech.

**17. TO OPERATE BREECH MECHANISM.**

a. **To Open Breech.** Unlatch breechblock latch by pressing on operating handle plunger with the thumb. Grasp operating handle with both hands toward the forward position. This will protect the little finger of left hand from danger of injury by crushing between the pawl and rear sight. Pull upward and push over to left until breechblock arm stops against breechblock stop.

## OPERATION

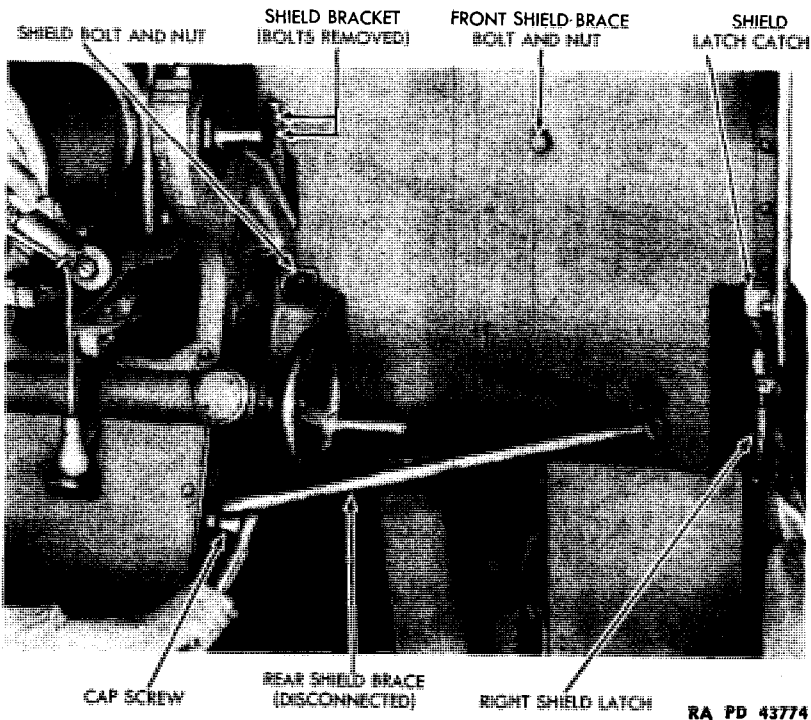

**Figure 12 — Releasing Gun Shield**

**b. To Close Breech.** As shell is injected, it pushes the extractor forward. This gives a slight motion to the breechblock toward the right. The man who is holding the operating handle, waiting to close breech, feels this motion and immediately closes breechblock. To close breech, grasp operating handle as in opening the breech, and pull to the right and down until breechblock arm strikes projection stop on lower right on breech face. At the end of travel, the breechblock latch springs into the grooves in the latch catch in breech face of the gun, latching the breech mechanism in closed position.

### 18. TO TRAVERSE.

**a.** The traversing handwheel is on the left side of either mount (figs. 13 and 14). Traversing is accomplished by turning the traversing handwheel either to the right or to the left.

### 19. TO ELEVATE.

**a.** The elevating mechanism (fig. 13) is controlled through two handwheels, one on either side of the Gun Mount M3, and by one

**75-MM GUN M1897A4 MOUNTED IN COMBAT VEHICLES**

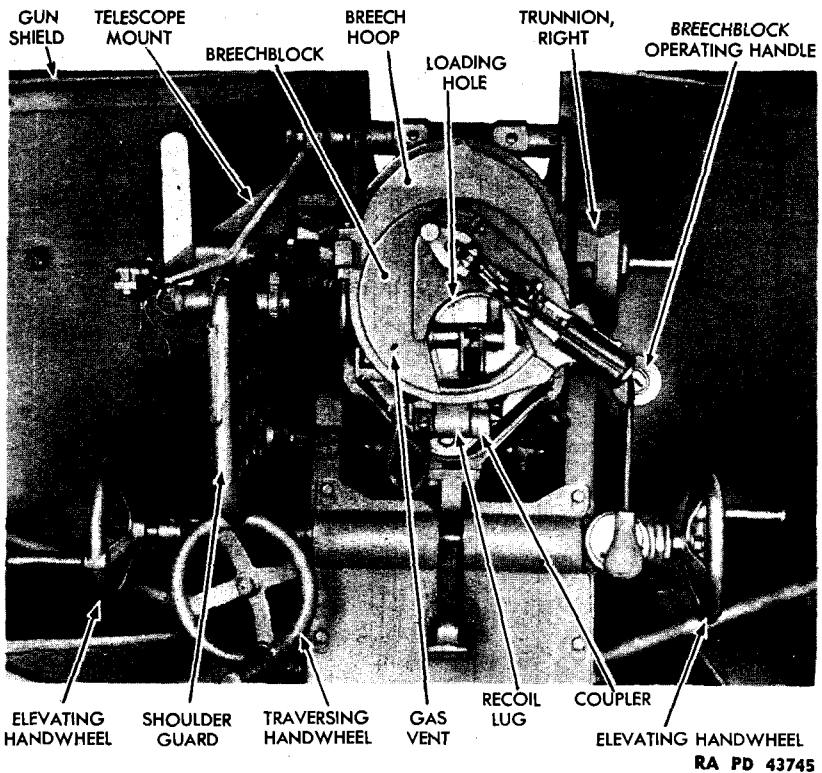

**Figure 13 — Gun M1897A4 and Gun Mount M3 — Rear View**

handwheel only (fig. 14) on the right side of the Gun Mount M5. Elevation and depression are accomplished by turning the elevating handwheels. With a duplicate handwheel on the left of the Gun Mount M3, it is possible for one man to sight, elevate, and traverse the piece without moving from one side of gun to other side.

**20. POINTS TO BE OBSERVED BEFORE FIRING.**

**a. Lubrication.** All points should be thoroughly lubricated as prescribed in paragraph 27.

**b. Precaution.**

(1) Keep respirator and air throttling holes (fig. 21) clean and unobstructed.

(2) There should be little, if any, leakage of oil around recoil piston head (fig. 21). Report excessive oil leakage to ordnance officer.

(3) A full oil reserve must be maintained when gun is operated.

## OPERATION

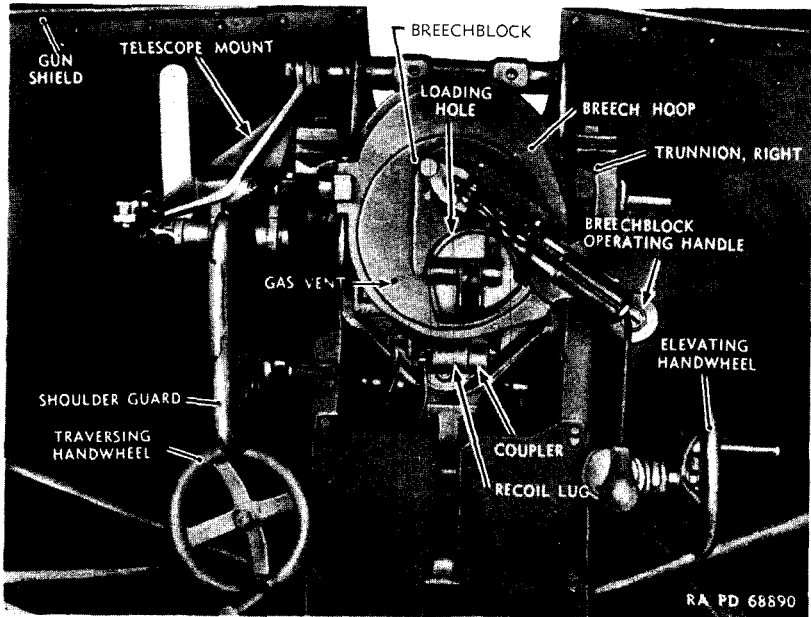

**Figure 14 — Gun M1897A4 and Gun Mount M5 — Rear View**

### 21. POINTS TO BE OBSERVED DURING FIRING.

a. **General.** If the gun fails to fire when the lanyard is pulled, the following safety precautions must be observed:

- (1) Stand clear of the path of recoil.
- (2) Keep the gun at firing elevation. Do not depress the piece.
- (3) Keep the gun directed in traverse either on the target or on a safe place in the field of fire.
- (4) The breech will not be opened until at least 10 minutes after the last unsuccessful attempt to fire the piece.
- (5) If firing a high explosive shell in peace time, all members of the gun section will be required to take shelter each time the piece is fired.

#### b. **Precautions.**

- (1) Opening the breech automatically ejects the empty cartridge case which should be removed immediately from vehicle.
- (2) The oil index should be checked frequently, and a full oil reserve maintained.
- (3) Although a full oil reserve may be indicated, the index is not functioning if the gun returns to battery with shock, or if it does not



## 75-MM GUN M1897A4 MOUNTED IN COMBAT VEHICLES

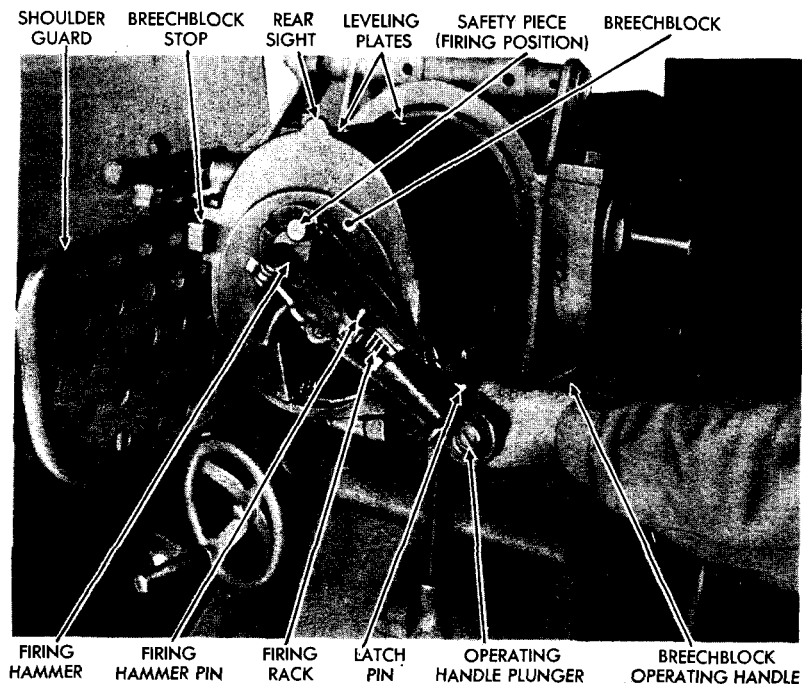

RA PD 43702

**Figure 15 — Opening Breechblock**

travel the prescribed distance, or if it does not return to battery. For nonfunctioning of index, see paragraph 35.

(4) The gun slide bearings should be oiled occasionally during the firing period.

(5) Whenever the rate of fire permits, the bore should be examined for fouling and for copper deposits. If present, use bore brush to remove loose particles. Excessive copper deposits must be reported to ordnance maintenance personnel.

(6) When using equipment, see that it is placed where it will not interfere with the action of gun or crew.

(7) If enemy shell bursts near weapon, make sure no damage has been done which might make continued firing dangerous.

c. During firing the action of the recoil mechanism should be noted, and the following operations checked:

- (1) Gun recoils its prescribed distance of 46 inches.
- (2) Gun returns to battery without shock.
- (3) Leakage of oil from filling and drain holes and front of the recoil cylinder is not excessive.

**OPERATION**

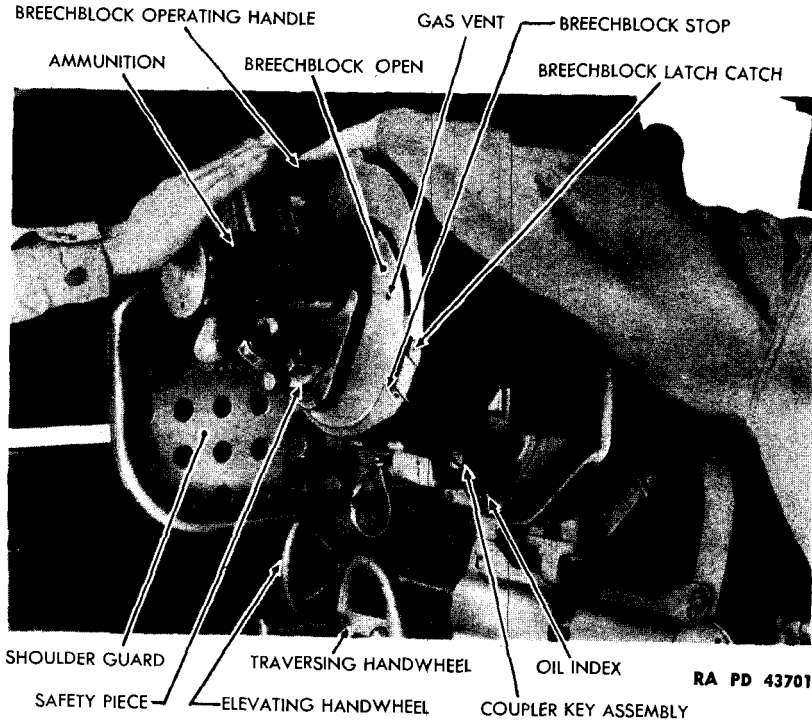

**Figure 16 — Loading Gun**

**22. TO LOAD.**

a. It is desirable, although not always possible (especially if only two men handle the gun), to load the gun from the *left* side (fig. 16). From this side the *right* hand can be used to snap the shell into the breech without placing the body in line of recoil. The breechblock should be opened and closed from the *right* side using the *left* hand, thus placing body out of line of recoil (figs. 16 and 17).

**23. TO FIRE.**

a. At the command "**FIRE**" the lanyard is pulled sharply and released. Pulling the lanyard compresses the firing rack spring. Releasing the lanyard permits this spring to furnish the necessary force for the firing hammer to explode the primer.

**24. TO UNLOAD.**

a. There are times when it is necessary to unload the piece—on receipt of orders to cease firing or because of misfire. Simply open the

## 75-MM GUN M1897A4 MOUNTED IN COMBAT VEHICLES

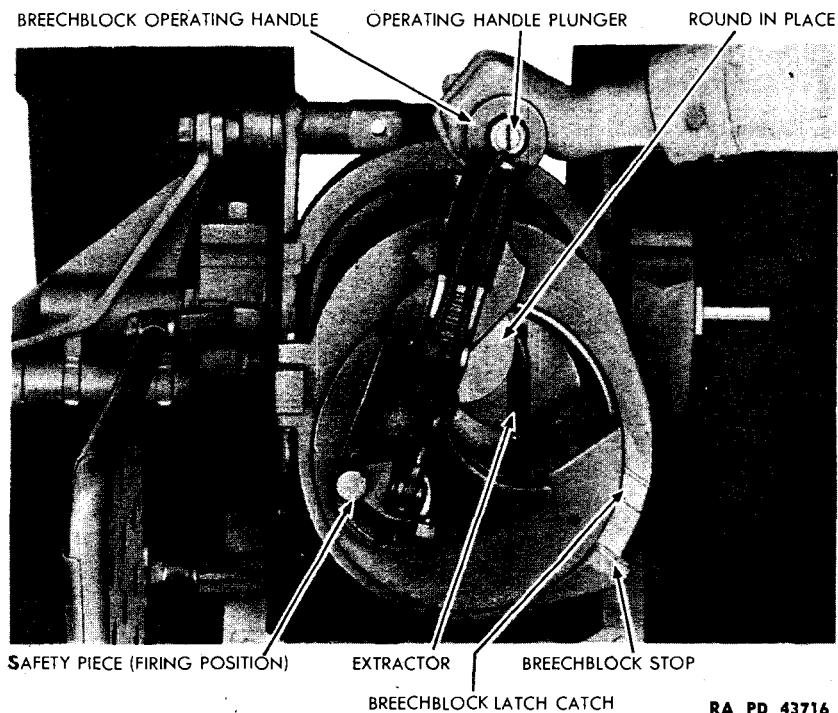

**Figure 17 — Closing Breechblock**

breech slowly and catch the round as it is ejected. When a misfire occurs or an extractor breaks, it may be necessary to use the unloading rammer. **NOTE:** The rammer will be used to unload a live shell only under the car commander's supervision and with extreme caution.

### 25. PLACING GUN IN TRAVELING POSITION.

- a. Cover the telescope, remove it from its mount, and place it in proper stowage case.
- b. Secure the cradle lock (figs. 10 and 11).
- c. Latch gun shield to vehicle, both right and left side (fig. 12).
- d. In order to hold gun firmly in battery during traveling, excess recoil oil should be added to the system until the index projects as far as it will go beyond the rear sealing plate. Filling from a no-reserve status requires about one screw filler of oil (fig. 20).
- e. Install gun covers.

**Chapter 2 — GUN AND MOUNT (Cont'd)**

**Section V**

**LUBRICATION**

	Paragraph
Introduction .....	26
Lubrication guide .....	27
Special lubrication and service instructions.....	28
Reports and records.....	29

**26. INTRODUCTION.**

a. Lubrication is an essential part of preventive maintenance, determining to a great extent the serviceability of parts and assemblies.

**27. LUBRICATION GUIDE.**

a. **General.** Lubrication instructions for this materiel are consolidated in a lubrication guide (fig. 18). These specify the points to be lubricated, the periods of lubrication, and the lubricant to be used. In addition to the items on the guide, other small moving parts, such as hinges and latches, must be lubricated at frequent intervals.

b. **Supplies.** In the field it may not be possible to supply a complete assortment of lubricants called for by the lubrication guide to meet the recommendations. It will be necessary to make the best use of those available, subject to inspection by the officer concerned, in consultation with responsible ordnance personnel.

c. **Lubrication Notes.** The following notes apply to the lubrication guide (fig. 18). All note references in the guide itself are to the subparagraph below having the corresponding number:

(1) **ELEVATING AND TRAVERSING GEAR CASES.** Lubricate these units with **GREASE, O.D., No. 0**, where temperatures above plus 32 degrees prevail, and with **GREASE, O.D., No. 00**, where continued temperatures below plus 32 degrees are expected. In most localities, this will necessitate a change of lubricant twice yearly. When changing from one grade to another, it is essential that the old lubricant be thoroughly removed from the housing and enclosed parts.

(2) **TRAVERSING GEAR SHAFT LOWER BEARING.** These bearings must be washed with **SOLVENT**, dry-cleaning, and repacked with **GREASE, O.D. (seasonal grade)**, when servicing the traversing gear case.

(3) **CRADLE TRUNNION BEARINGS.** Because small quantities of grit accumulate in the trunnion bearing housing, the bearings must be cleaned once each year.

**75-MM GUN M1897A4 MOUNTED IN COMBAT VEHICLES**

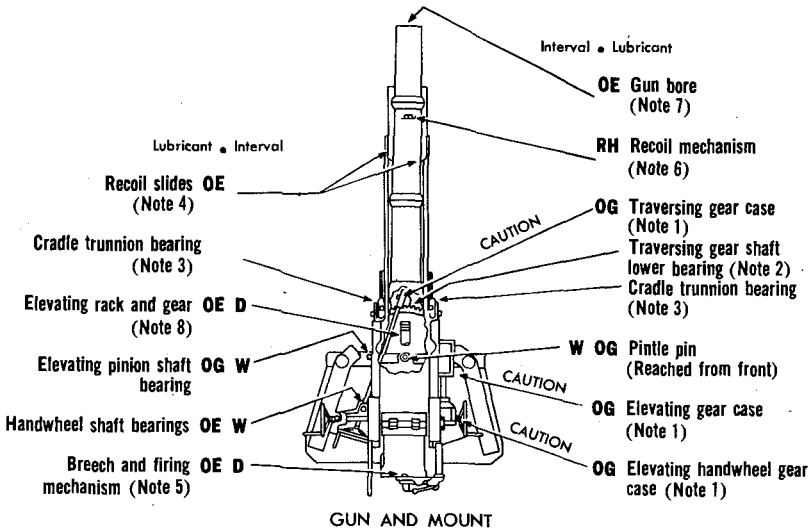

**KEY**

<p><b>OE</b>—OIL, engine SAE 30 (above + 32°) SAE 10 (below + 32°)</p>	<p><b>OG</b>—GREASE, O.D. No. 0 (above + 32°) No. 00 (below + 32°)</p>	<p><b>D</b>—DAILY <b>W</b>—WEEKLY</p>
--	--	---

Preliminary lubrication instructions based on pilot model only.

RA PD 43784

**Figure 18 — Lubrication Guide for Gun and Mount**

- (a) Remove bearings. Scrub bearings and housings with SOLVENT, dry-cleaning. Dry.
- (b) Repack with GREASE, O.D. (seasonal grade).
- (4) RECOIL SLIDES. Keep exposed surfaces coated with OIL, engine (seasonal grade). Clean and oil before firing.
- (5) BREECH AND FIRING MECHANISM. Clean and oil all moving parts and exposed metal surfaces with OIL, engine (seasonal grade), daily. Perform operation before and after firing. CAUTION: To insure easy breech operation and to avoid misfiring in cold weather, clean with SOLVENT, dry-cleaning. Dry. Lubricate with OIL, lubricating, for aircraft instruments and machine guns.
- (6) RECOIL OIL. For instructions on quantity and application of recoil fluid, refer to paragraph 35.
- (7) GUN BORE. Clean and coat with OIL, engine (seasonal grade), after firing.
- (8) TRAVERSING AND ELEVATING RACKS AND GEARS. Clean and apply OIL, engine (seasonal grade), daily. The teeth of elevating arc and traversing rack and gears will be kept covered with a thin coat

## LUBRICATION

of oil. Dust and grit will adhere to this oily film. Therefore, clean teeth and apply fresh oil before elevating or traversing gun to prevent rapid wear of both racks and gears. If dust is present when gun is operated, allow gears to remain dry until action is over. If surfaces are dry, there will be less wear than when they are coated with a lubricant contaminated by grit.

(9) **OILCAN POINTS.** Lubricate elevating and traversing handwheel handles, latches, and hinges with OIL, engine (seasonal grade), daily.

### 28. SPECIAL LUBRICATION AND SERVICE INSTRUCTIONS.

**a. Fittings and Oilers.** Clean before applying lubricant. Where bearings can be seen, lubricate armament fittings until new grease is forced from the bearing. **CAUTION:** Lubricate fittings and oilers after washing vehicle. Do not use high-pressure washing system for cleaning artillery materiel.

**b. Intervals.** The intervals indicated at points on lubrication guide are for normal service. For extreme conditions of service, rain, snow, heat, or dust, reduce intervals on guide by one-third or one-half, or more, if conditions warrant.

### 29. REPORTS AND RECORDS.

**a. Reports.** If lubrication instructions are closely followed, proper lubricants used, and satisfactory results are not obtained, a report will be made to the ordnance officer responsible for the maintenance of the materiel.

**b. Records.** A complete record of lubrication servicing will be kept in the Artillery Gun Book for the materiel.

**75-MM GUN M1897A4 MOUNTED IN COMBAT VEHICLES****Chapter 2 — GUN AND MOUNT (Cont'd)****Section VI****CARE AND PRESERVATION**

	Paragraph
General .....	30
Gun .....	31
Breech mechanism .....	32
Firing mechanism .....	33
Gun mount .....	34
Recoil mechanism .....	35
Recoil oil .....	36
Preservation of spare parts and accessories .....	37
Cleaning and preserving materials .....	38
Paints and related materials .....	39
Miscellaneous materials and tools .....	40
Storage of weapon .....	41

**30. GENERAL.**

a. Keeping all parts of the materiel in proper condition for immediate service is of vital importance. The correct use of lubricants, cleaning and preserving materials and paints will enable the using arms to keep the materiel in proper working condition.

b. Extreme care must be used to insure that all moving parts of the various mechanisms are properly lubricated. Lubrication instructions as outlined in section V should be scrupulously observed. Frequent inspections of the adequacy of lubrication are necessary. Be sure that the lubricant used is reaching the place for which it is intended.

c. Rust, dirt, grit, gummed oil, and water cause rapid deterioration of the mechanisms and unpainted surfaces. Rust should be removed from bearing surfaces with CLOTH, crocus, which is the coarsest abrasive to be used by the using arms for this purpose. All bearing surfaces and exposed gears should be clean and kept free from dirt, grit, etc. Wiping rags and SOLVENT, dry-cleaning, are for this purpose. Clean nonbearing surfaces with water, but exercise care that no water is forced into the enclosed bearings on the carriage. When the gun is not in use, it must be protected by covers.

d. Should a shell burst near the gun, be sure, before firing the next round, that the weapon has not been damaged to a dangerous degree. Serious damage should be reported to the ordnance officer.

## CARE AND PRESERVATION

### 31. GUN.

**a. General.** Never allow dust or dirt to accumulate on, in, or around gun and gun mount. Being abrasive, dirt is particularly detrimental to highly polished parts such as bearings and gears, and may cause dangerous, destructive wear. Keep the piece and the vehicle clean.

#### **b. Precautions When Removing Parts for Inspection or Replacement.**

(1) Thoroughly clean grit and dirt from parts which are to be removed.

(2) Make sure tools and hands are clean and free from grit.

(3) Be careful that shirt, shirt sleeves, and other parts of clothing do not brush dirt into assemblies or openings in parts.

(4) Clean parts thoroughly before oiling and assembling.

(5) Never use a steel hammer directly on any part of the gun or gun carriage. If copper hammer or lead hammer is not available, use a block of wood as a buffer.

#### **c. Precautions When Washing Gun or Gun Mount.**

(1) High-pressure hose must never be used.

(2) Water must not be played directly on the breechblock, or on the several shaft and trunnion bearings.

(3) Carefully dry parts which have become wet during the washing operation; then oil them in the manner described in section V of this chapter.

#### **d. Care of Bore.**

(1) During firing, whenever the rate of fire will permit, examine the bore for fouling and for metal deposits on the lands and in the grooves. Clean with bore brush as necessary. If copper deposits are excessive, or if there is undue erosion at the origin of rifling, notify the ordnance officer.

(2) After firing, wash the bore with a solution of ½-pound SODA ASH or 1 pound sal soda and 1 gallon of water. Swab with clean cloth or burlap. Then oil the bore lightly with OIL, engine, SAE 10, when below plus 32 degrees and OIL, engine, SAE 30, when above plus 32 degrees.

**e. Storage Precautions.** When materiel is not in use, or when traveling, gun covers must be used. Further instructions for storage when materiel is to be used for a considerable length of time are given in paragraph 41.

**f. Lubrication.** Lubrication instructions are given in section V.



## 75-MM GUN M1897A4 MOUNTED IN COMBAT VEHICLES

### 32. BREECH MECHANISM.

a. **Examination of Breech Mechanism.** Make frequent examination of the breech recess and the pressure side of breechblock for rough spots and abrasions. If the breechblock does not turn smoothly, or if more than normal effort is required for operation, remove and examine breechblock. Make sure that V-grooves across the threads are clean (fig. 25). Inspect parts carefully for signs of rust. Examine the threads for burrs, and report damage, if any, to the ordnance officer.

#### b. Care of Breech Mechanism.

(1) Immediately after firing, remove and disassemble the breechblock for inspection, cleaning, and oiling (pars. 47 and 48). Through careful examination at such time, it is often possible to anticipate replacement of parts.

(2) When gun is not in use, periodically remove and disassemble breechblock. Clean and apply COMPOUND, rust-preventive, light, and assemble.

(3) In removing COMPOUND, rust-preventive, light, scrape off the greater part. Remove remaining COMPOUND, rust-preventive, light, with SOLVENT, dry-cleaning, used on a rag or waste.

### 33. FIRING MECHANISM.

a. The parts require the same attention as the breech mechanism. Therefore, frequent disassembly for the purpose of cleaning and oiling is required.

b. Fouling of the firing pin or the use of a thicker oil than authorized will cause absorption of the energy of the firing rack spring and firing hammer and may result in misfire. This is especially true in cold weather.

c. Wear in this mechanism is negligible. Deformation may be on the rear end of the firing pin. This wear may cause sticking in the safety piece. If the firing pin is examined after each firing, replacement can be anticipated.

### 34. GUN MOUNT.

a. **Tightness of Parts.** Loose parts can quickly become broken parts. Inspect carriage, carriage support, and gun shield. Make sure that all parts are tightly bolted.

b. **Lubrication.** Make sure that all parts of gun carriage are properly lubricated. Instructions for lubrication, including the method and frequency of lubrication, are given in section V of this chapter.

c. **Cleanliness of Parts.** Bearing surfaces, revolving parts, springs, gear teeth, screw threads, and exterior parts must be clean and free

## CARE AND PRESERVATION

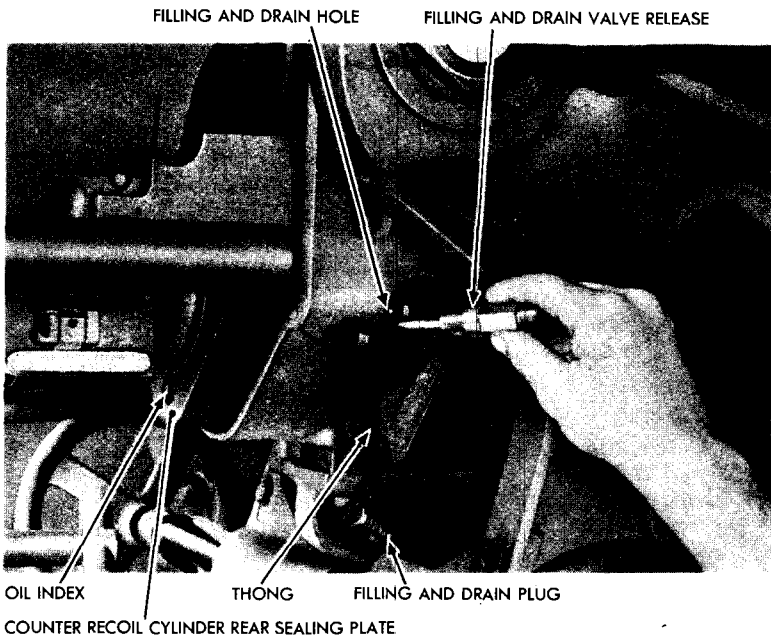

RA PD 43708

**Figure 19 — Inserting Filling and Drain Valve Release**

from dirt. Pay particular attention to exposed gear teeth and bearing surfaces. In disassembly and assembly operations, precautions must be taken to prevent the entrance of foreign matter.

### 35. RECOIL MECHANISM.

#### a. To Reduce or Exhaust the Oil Reserve.

- (1) Remove the filling and drain plug (fig. 19).
- (2) Screw the filling and drain valve release into threaded opening, and the oil will flow out through the release. Catch oil in a clean receptacle and return it immediately to its special container.
- (3) When oil index begins to recede, unscrew the release and wait until index stops moving. If it still projects beyond the rear sealing plate, repeat operation. If it is desired to establish a fresh reserve, let all the oil flow out before removing the filling and drain valve release.

#### b. To Add to the Oil Reserve.

- (1) Load oil screw filler with recoil oil.
- (2) Clamp oil screw filler assembly to top section of gun shield (fig. 20).

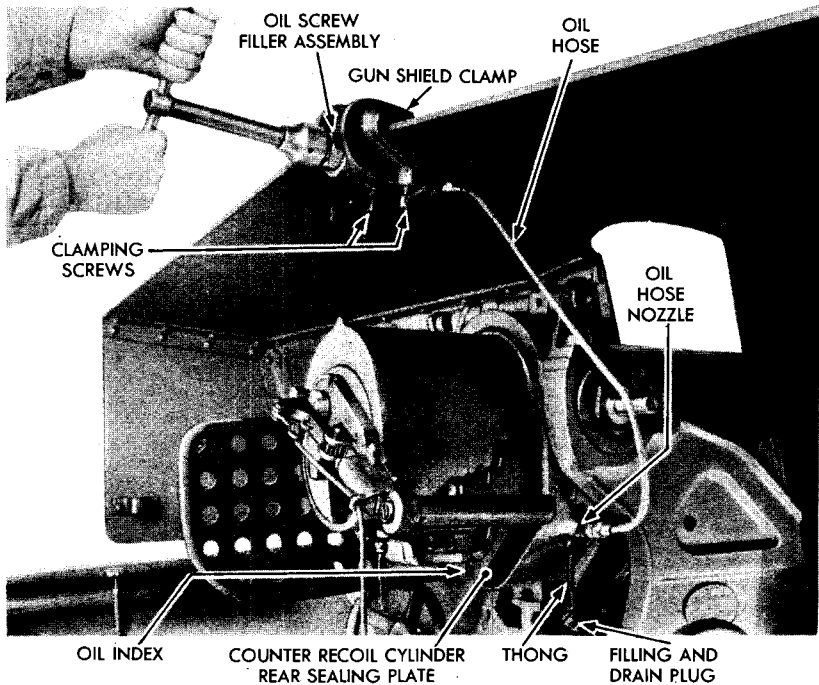
**75-MM GUN M1897A4 MOUNTED IN COMBAT VEHICLES**

RA PD 43780

**Figure 20 — Adding Recoil Oil to Oil Reserve**

(3) Screw nozzle end of oil hose part way into filling and drain hole and turn filler screw a few revolutions to force out any air which may be in the assembly. Then tighten up on the nozzle and inject oil until index shows a full reserve. **NOTE:** When operating oil screw filler, use both hands to protect the screw threads.

**c. Check Recoil Piston Head for Oil Leakage.**

- (1) Remove respirator (fig. 21).
- (2) Clean front part of the recoil cylinder and check for oil leakage around piston. If there is excess leakage, do not fire piece. Report to ordnance maintenance personnel.
- (3) Clean respirator, making sure that air throttling holes are unobstructed.

**d. Malfunction of Oil Index.**

- (1) The index does not move when reserve oil is injected or extracted.
- (2) Packing around the index may be too tight.
- (3) Index may be "frozen" or broken.

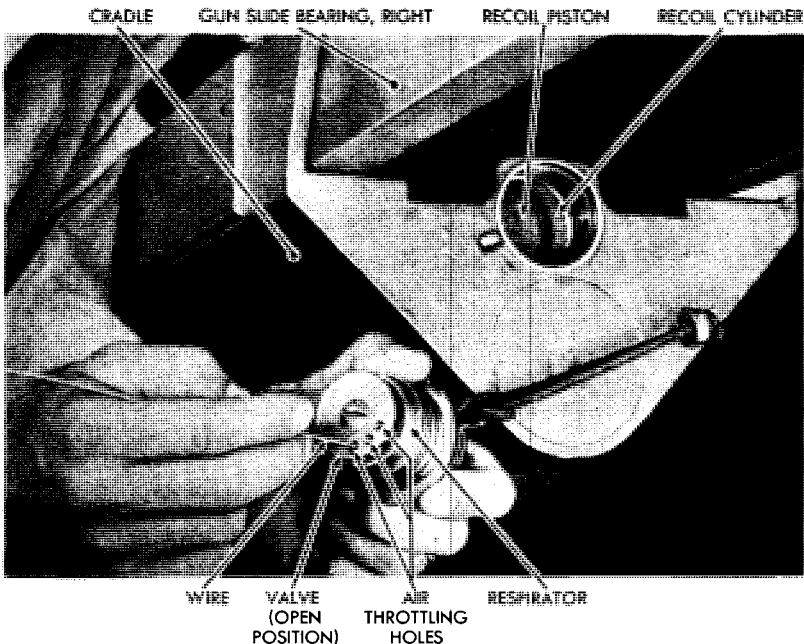
**CARE AND PRESERVATION**

RA PD 43742

**Figure 21 — Cleaning and Inspection of Respirator****e. To Test Oil Index.**

(1) Using filling and drain valve release (fig. 19), drain all the oil that will run out.

(2) Remove filling and drain valve release and inject new recoil oil (fig. 20). At the same time, tap index lightly with a piece of wood on each turn of the oil filler.

(3) If index does not move after half the capacity of the oil screw filler has been injected, something is wrong with the mechanism. Notify ordnance personnel.

(4) However, if oil index starts to function, bring the reserve to indicate full, and then drain off about three times to make sure the index will continue to work.

**f. Emergency Firing.** Firing without reference to the action of the index may sometimes be necessary in emergencies. Proceed in this manner:

(1) Insert filling and drain valve release and extract all reserve oil.

### **75-MM GUN M1897A4 MOUNTED IN COMBAT VEHICLES**

(2) Refill recoil mechanism with one and one-half fills of the oil screw filler.

(3) Unscrew hose nozzle and screw in filling and drain plug.

(4) Proceed with firing.

(5) When gun begins to return to battery with shock, heat has expanded oil and some of it should be drained off.

(6) If mechanism is losing oil around packing, firing may continue until gun fails to return to battery. Then new oil should be added.

### **36. RECOIL OIL.**

a. **General.** Only the prescribed OIL, recoil, heavy, with a low pour point is to be used. It must never be mixed with any other type of oil.

#### **b. Care of Recoil Oil.**

(1) Recoil oil should be kept in an identified, tightly closed container and should never be exposed to excessive heat. When oil is drained from recoil mechanism, a clean, dry receptacle will be used. Oil must be poured from this immediately into its special container.

(2) If oil has been exposed to dust or dirt, strain through a clean cloth before injecting it into recoil mechanism. Dirt or water makes it unfit for use.

(3) If water shows in tests of oil which has been exposed to air, or is present because of condensation on inside walls of a partly filled container, do not use; get new oil.

#### **c. Testing Oil for Water.**

(1) Fill a clean, pint glass bottle with recoil oil and allow to settle. Water will sink to the bottom. Invert the bottle and hold it to the light. If water is present, drops or bubbles may be seen slowly sinking in the oil. Oil that is cloudy indicates presence of moisture.

(2) An even better test, if practical, is to fill a shallow pan with the oil and heat to boiling. Water, if present, will appear on the surface as tiny bubbles.

### **37. PRESERVATION OF SPARE PARTS AND ACCESSORIES** (fig. 22).

a. Gun spare parts which are provided for replacement by the using arms, must be kept clean, dry, and lightly oiled to prevent rust. Store parts in the proper equipment box until needed (except for periodic inspection). They should be as complete as possible at all times.

### CARE AND PRESERVATION

RA PD 43772

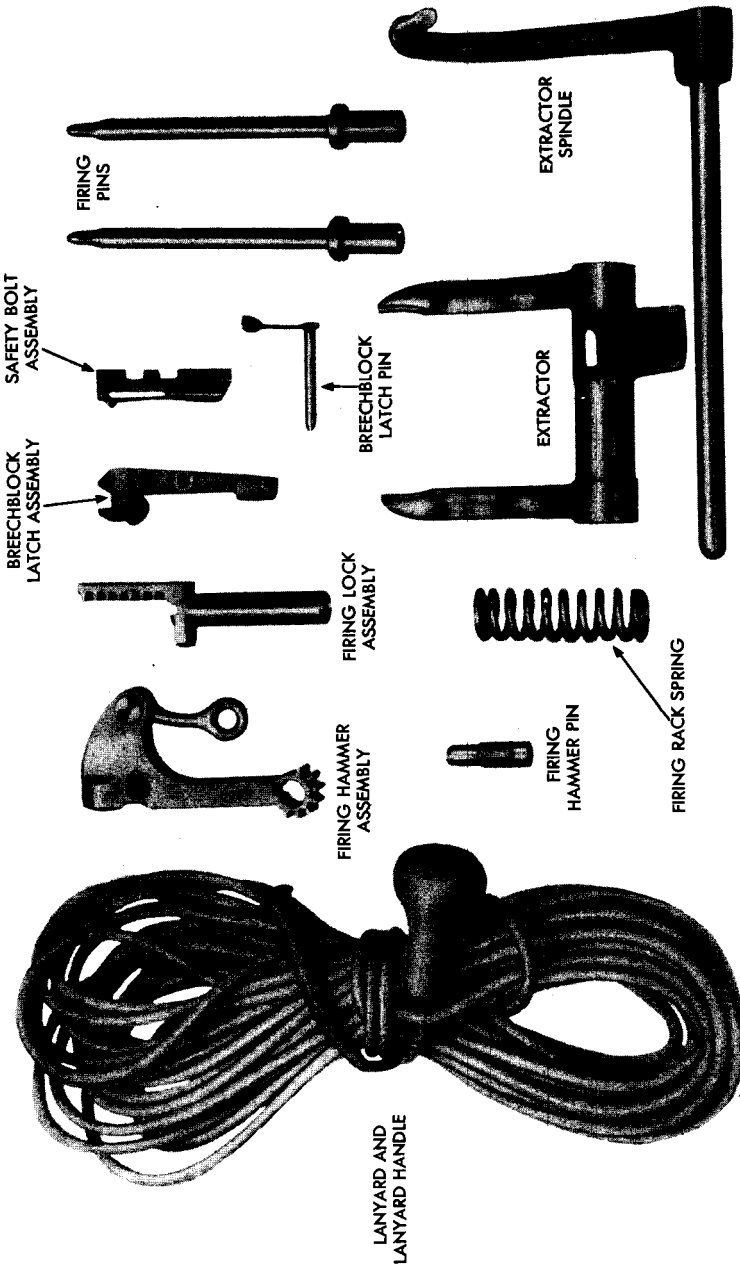

Figure 22 — Gun Spare Parts

## 75-MM GUN M1897A4 MOUNTED IN COMBAT VEHICLES

b. Accessories when not in use, must be stored in the brackets and receptacles provided. Make periodic inspection to determine their condition. Keep accessories clean, oiled, painted, or repaired according to their nature and/or condition.

### 38. CLEANING AND PRESERVING MATERIALS.

a. The following cleansers, abrasives and preservatives are required for use with this materiel. See SNL K-1 and TM 9-850 for detailed information.

#### (1) CLEANERS AND ABRASIVES.

AMMONIA, carbonate  
AMMONIUM, persulphate  
AMMONIUM, 28 percent, 16-oz  
BURLAP, jute (8-oz, 40 in. wide)  
CLOTH, abrasive, aluminum-oxide  
CLOTH, crocus  
NAPHTHALENE, flake  
PAPER, flint  
PAPER, lens, tissue  
PATCHES, cut (canton flannel)  
POLISH, metal paste  
REMOVER, paint and varnish  
SODA ASH  
SODA, caustic (lye)  
SPONGES  
WASTE, cotton, white

#### (2) LUBRICATING AND PRESERVING MATERIALS.

COMPOUND, rust-preventive, light  
GREASE, graphited, medium  
GREASE, graphited, soft (aircraft)  
GREASE, O.D.  
OIL, lubricating, for aircraft instruments and machine guns  
OIL, neutral  
PETROLATUM

### 39. PAINTS AND RELATED MATERIALS.

a. The following paints and related materials are required for use with this materiel. See SNL K-1 and TM 9-850 for detailed information.

ENAMEL, synthetic, gloss-red  
ENAMEL, synthetic, olive-drab, lusterless  
ENAMEL, synthetic, stenciling, blue-drab, lusterless  
ENAMEL, white  
LACQUER

## CARE AND PRESERVATION

LEAD, red, dry

MIXTURE, liquid, for red lead paint

PAINT, stencil, white

THINNER (for ENAMEL, synthetic, olive-drab, lusterless)

TURPENTINE

### 40. MISCELLANEOUS MATERIALS AND TOOLS.

a. The following miscellaneous materials and tools are required for use with this materiel. See SNL K-1 and TM 9-850 for detailed information.

#### BRUSH:

Artist, camel's-hair, rd., No. 1

Flowing, skunk's-hair, No. 3 (2-in.)

Sash-tool, oval, No. 1

Sash-tool, oval, No. 3

Scratch, wire, painter's, curved back, handled, 14- x  $\frac{7}{8}$ -in.

Stencil, No. 1

b. The bristles of brushes are subject to attack by moths. Brushes in storage should be protected by NAPHTHALENE, flake.

c. Camel's-hair brushes, after being thoroughly cleaned with turpentine, should be laid flat on a horizontal surface (not in water). Other paint brushes should be cleaned after use and kept with bristles submerged in fresh water.

### 41. STORAGE OF WEAPON.

a. If the piece is to be stored or unused for a considerable period of time (in or out of vehicle), clean the bore, breechblock, and breech, and all bright and unpainted surfaces of the gun and gun carriage with SOLVENT, dry-cleaning; then coat with COMPOUND, rust-preventive, medium.

b. When weapon is returned to service, remove the COMPOUND, rust-preventive, light. Scrape off the greater part of it. Remove remainder with SOLVENT, dry-cleaning, on rags or waste. Then oil the parts as required.



**75-MM GUN M1897A4 MOUNTED IN COMBAT VEHICLES**

**Chapter 2 — GUN AND MOUNT (Cont'd)**

**Section VII**

**INSPECTION AND ADJUSTMENT**

	<b>Paragraph</b>
Inspection and adjustment of gun.....	42
Inspection and adjustment of gun mount.....	43

**42. INSPECTION AND ADJUSTMENT OF GUN.**

a. The following instructions should be carefully observed:

<b>Parts to be Inspected in Order of Inspection</b>	<b>Points to Observe</b>
Gun.	Note general appearance, smoothness of operation of breech mechanism in opening and closing, action of operating handle plunger and firing mechanism with lanyard. Note condition of bore for copper deposits on lands and in grooves, and erosion at origin of rifling. Examine breech recess for scored and bruised threads and leveling plates for burs or other defects. Examine gun slide bearings or rollers for burs, dents, cleanliness, proper lubrication, and rigidity of the assembly. The bronze slides of the Gun M1897A4 should fit the rails tightly, but the rails should be able to move longitudinally from their anchor at the jacket support. Insure that barrel supports and jacket and muzzle hoops are tight. Examine safety bolt assembly for deformed lug and for condition of the spring.
Breech mechanism.	Disassemble and clean breech mechanism. Examine breechblock for any defects, also firing pin. Examine firing ham-

## INSPECTION AND ADJUSTMENT

Parts to be Inspected in Order of Inspection	Points to Observe
Breech mechanism— <i>Con't</i>	mer and firing rack for burs or bruises. Test action of firing rack spring by pulling lanyard. Note striking force of firing hammer.
Breechblock assembly.	Inspect for scored or bruised threads. Examine for looseness of arm and handle. Then remove and disassemble breechblock (pars. 47 and 48) and clean the parts thoroughly.
Extractor spindle.	Examine for scoring or binding.
Extractor tang.	Examine for breakage or deformation.
Extractor.	Examine for battered or broken lips, scoring and binding.
Safety piece assembly.	Examine for bruised threads and deformed firing hammer stop screw.
Firing pin.	Examine for deformed point. Point should be rounded.
Firing hammer.	Examine for deformed, broken or burred teeth.
Firing rack spring assembling pin.	Examine for deformed projections.
Firing rack assembly.	Examine firing rack teeth and firing rack screw for breakage, burs and deformation.
Firing rack spring.	Examine the spring for breakage or weakness.
Breechblock latch pin.	Examine for binding or breakage.
Breechblock latch assembly.	Examine for worn or broken breechblock latch and for weak or broken breechblock latch pawl spring.
Breechblock latch spring.	Examine for breakage or weakness.
Operating handle plunger screw.	Examine for worn or burred threads.
Operating handle plunger block.	Examine for broken or worn projections.

## 75-MM GUN M1897A4 MOUNTED IN COMBAT VEHICLES

Parts to be Inspected in Order of Inspection	Points to Observe
Operating handle plunger.	Examine for condition of threads and for dents or burs which may retard its action.
Gun slide bearings.	Examine for burs, dents, cleanliness, proper lubrication, and rigidity of the bronze bearing and rail assembly.
Barrel supports.	Examine for tightness of assembly to barrel.
Jacket.	Examine for tightness of assembly.
Muzzle hoop.	Examine for tightness.

### 43. INSPECTION AND ADJUSTMENT OF GUN MOUNT.

General appearance.	Inspect for condition of paint, for cleanliness and lubrication.
Recoil mechanism.	With the filling and drain valve release, withdraw all the oil reserve. Note action of oil index and condition of the withdrawn oil. Inject a new full reserve and see that oil index moves out as oil is forced into system. Examine filling and drain plug hole, oil index recess, and front end of recoil cylinder for oil leakage. The presence of only a few drops of oil in any of these places will not cause malfunctioning; but if there is excessive leakage, it must be reported to ordnance maintenance personnel immediately. Examine respirator for cleanliness, functioning of the valve, lubrication, and condition of threads. The throttling holes must be free from dirt. Inspect respirator gasket for wear or damage. Inspect the bearing surfaces of cradle slides for rough spots and cleanliness and lubrication.

## INSPECTION AND ADJUSTMENT

Parts to be Inspected in Order of Inspection	Points to Observe
Elevating mechanism.	Elevate and depress gun through full extent of its travel. Note whether the mechanism operates freely and without undue backlash. If play exceeds one-quarter turn of handwheel, notify ordnance maintenance personnel. Examine elevating arc for broken or deformed teeth. See that stops are in place and tight.
Traversing mechanism.	Traverse carriage to its right and left limits and check for smoothness of operation and backlash. If play exceeds one-quarter turn of handwheel, notify ordnance maintenance personnel. Examine traversing rack for broken or deformed teeth and rigidity of the stops. Check the teeth in traversing pinion.
Equilibrators.	Examine equilibrator trunnions and trunnion bearings for cleanliness and lubrication, and the outer surfaces of inner and outer cylinders for deformation of walls.
Cradle lock.	If lock is in traveling position, test first for play; then unlatch it and check for ease of operation, proper lubrication, and presence of burs on lock or cradle lock pin.
Gun shield.	Examine shield bolts and studs for tightness, and shield side latches for condition of springs and clips.

**75-MM GUN M1897A4 MOUNTED IN COMBAT VEHICLES**

**Chapter 2 — GUN AND MOUNT (Cont'd)**

**Section VIII**

**MALFUNCTIONS AND CORRECTIONS**

	Paragraph
Breech and firing mechanism.....	44
Recoil mechanism .....	45

**44. BREECH AND FIRING MECHANISM.**

**a. Lack of Momentum in Swing of Firing Hammer.**

Cause	Correction
Broken or weak firing-rack spring.	Replace spring (par. 48).

**b. Misfire (Failure to Fire When Proper Percussion on Primer is Obtained).**

Defective primer.	Replace round, observing safety precautions (par. 24).
-------------------	--

**c. Failure to Fire Until After Several Percussions on Primer (Primer Struck Weakly).**

Firing rack and hammer not working freely.	Disassemble firing mechanism (par. 48) and examine all parts for burs or rough bearing surfaces. Remove burs on rough spots with CLOTH, crocus, or oilstone. Clean off dirt and gummy oil with SOLVENT, dry-cleaning. Dry and coat with oil.
--	--

Weak firing rack spring. Deformed firing pin.	Replace spring (par. 48). Replace firing pin (par. 48).
---	---

Friction on lanyard.	Allow less slack when firing with long lanyard.
----------------------	---

**d. Failure to Fire; No Percussion on Primer.**

Safety piece not in firing position.	Set safety piece plunger in the hole marked "FIRE."
--------------------------------------	---

Breechblock not fully closed.	Close breechblock.
-------------------------------	--------------------

Broken firing pin.	Replace firing pin (par. 48).
--------------------	-------------------------------

**e. Failure to Extract Cartridge Case.**

Broken extractor.	Remove case by ramming it out (par. 24). Examine edge of chamber for deformities or burs. Replace extractor.
-------------------	--

## MALFUNCTIONS AND CORRECTIONS

### f. Pawl Fails to Operate.

<b>Cause</b>	<b>Correction</b>
Broken pawl spring or broken breechblock latch spring.	If latch spring is broken, replace it. If pawl spring is broken, replace breechblock latch assembly (par. 48).

### g. Breechblock Does Not Rotate Freely.

Lack of lubrication or an excess of dirt and gummy oil.	Remove breechblock (par. 47). Clean threads and recess with SOLVENT, dry-cleaning, wipe dry, coat lightly with engine oil and assemble.
Burs or roughness of threads of breechblock or breech recess.	Remove and clean as above. If threads are found to be burred, report to ordnance officer.

### h. Safety Bolt Can be Pushed Down by Hand After Coupler Key is Withdrawn.

Broken or weak safety bolt spring, or spring does not engage in notch.	Replace with new safety bolt assembly (par. 53), or refer to ordnance maintenance personnel for correction.
--	---

### i. Safety Bolt Does Not Remain in Upper Position When Coupler Key is Withdrawn.

Same causes as above. Same procedure as above.

### j. Safety Bolt Fails to Rise When Coupler Key is Withdrawn.

Safety bolt lug is shorn off.	Replace safety bolt assembly (par. 53). NOTE: Safety bolt cannot rise when breechblock is closed. If coupler key is forced out with breech closed, safety bolt lug will be sheared off.
-------------------------------	---

## 45. RECOIL MECHANISM.

### a. Oil Index Not Functioning.

Index stuck or sluggish because of dirt, paint or overtight packing.	Withdraw all reserve oil (par. 35); then inject approximately one-half capacity of oil screw filler (par. 35). Tap oil index lightly as oil is being added. If it still fails to function, notify ordnance. For firing without reference to oil index, see paragraph 35 f.
--	--

**75-MM GUN M1897A4 MOUNTED IN COMBAT VEHICLES**

**b. Failure of Gun to Return to Battery.**

<b>Cause</b>	<b>Correction</b>
Insufficient oil reserve.	Withdraw all reserve oil (par. 35); then insert sufficient oil to bring oil index even with rear face of rear sealing plate (par. 35).
Dirt or obstruction on cradle slides or gun slide bearings, damaged slides or bearings, damaged piston or piston rod, excessive internal friction or low nitrogen pressure.	Clean and lubricate slides and bearings. If this fails to correct the trouble, notify ordnance to remove and repair recoil mechanism.

**c. Gun Returns to Battery with Shock.**

Air from recoil cylinder escaping too rapidly through respirator.	Adjust respirator to use smaller air vent (par. 8). Withdraw all reserve oil; then insert sufficient oil to bring oil index even with rear face of rear sealing plate (par. 35).
---	--

**Chapter 2 — GUN AND MOUNT (Cont'd)**

**Section IX**

**DISASSEMBLY AND ASSEMBLY**

	Paragraph
General .....	46
Removal of breechblock.....	47
Disassembly of breechblock.....	48
Assembly of breechblock.....	49
Installation of breechblock.....	50
Removal of equilibrators.....	51
Installation of equilibrators.....	52
Dismounting the gun.....	53
Mounting the gun.....	54
Removal of gun shield.....	55
Installation of gun shield.....	56

**46. GENERAL.**

a. Wear, breakage, cleaning, and inspection make necessary the occasional disassembly of various parts of the gun and mount. This work comes under two headings: that which may be performed by the battery personnel with the equipment furnished; and that which must be performed by trained ordnance personnel.

b. In general, the battery personnel may do the disassembling required for replacing those parts indicated in Standard Nomenclature List No. C-12 as permitted to be issued to the battery. Such disassembling should be done in the manner prescribed herein. Any difficulty which cannot be overcome by the prescribed method must be brought to the attention of ordnance personnel.

c. The battery personnel will not attempt to disassemble any part of the recoil mechanism not authorized in this manual. They will not do any filing on the sighting equipment or on the parts of the gun other than that outlined in this Technical Manual or the Field Manual. They will not do any filing on any mount part except by order of a responsible officer.

d. The use of a wrench or screwdriver which does not fit the part snugly should be avoided. It will not only fail to tighten the part properly but will damage the nuts, bolt heads, and screwheads. There is also danger of spreading the wrenches and rendering them useless.

e. After any item has been disassembled, it should be inspected and any worn or broken parts replaced. Evidence of undue wear or



## 75-MM GUN M1897A4 MOUNTED IN COMBAT VEHICLES

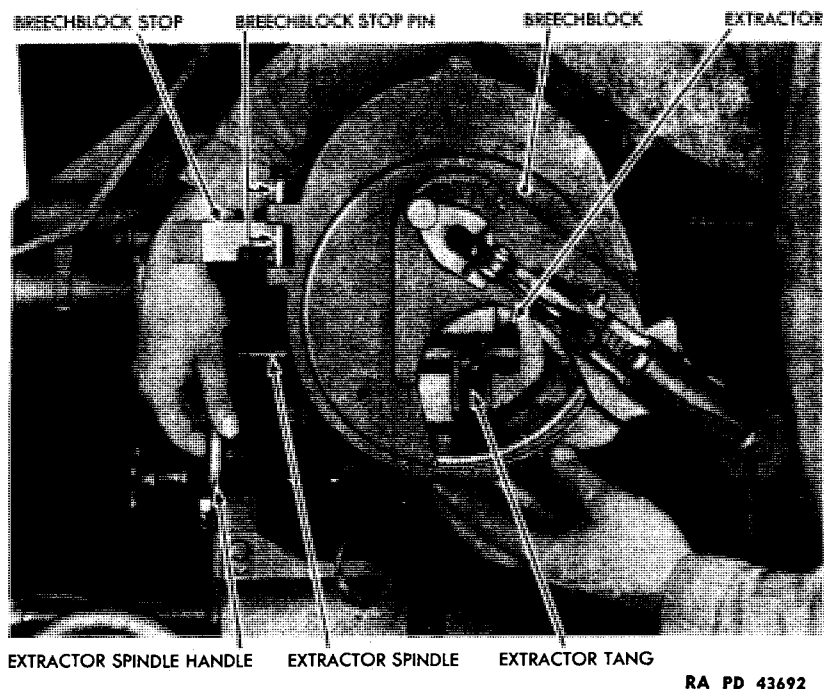

**Figure 23 — Removing Extractor Tang**

breakage should be reported to the ordnance personnel. Before re-assembling, all bearings, sliding surfaces, threads, etc., should be thoroughly cleaned and lubricated. The assembly of subassemblies should generally be completed before attempting the assembly of the larger mechanisms.

### 47. REMOVAL OF BREECHBLOCK.

a. Remove shoulder guard (fig. 15). Loosen locking knob at lower bracket. Swing shoulder guard up and lift it from the top hanger pin.

b. With breech closed and locked, release the breechblock stop (fig. 23) by turning the breechblock stop pin until it can be pulled up through the keyway in the stop. Swing the hinged stop outward to release extractor spindle.

c. Swing extractor spindle arm down and pull spindle far enough to the left to release extractor tang (fig. 23). Always remove tang before starting to unscrew breechblock, catching it with the hand as it is released from spindle to keep it from falling out of the breech. Push extractor spindle back into its seat. Then raise spindle arm into the lug so that it will be out of the way (fig. 24).

**DISASSEMBLY AND ASSEMBLY**

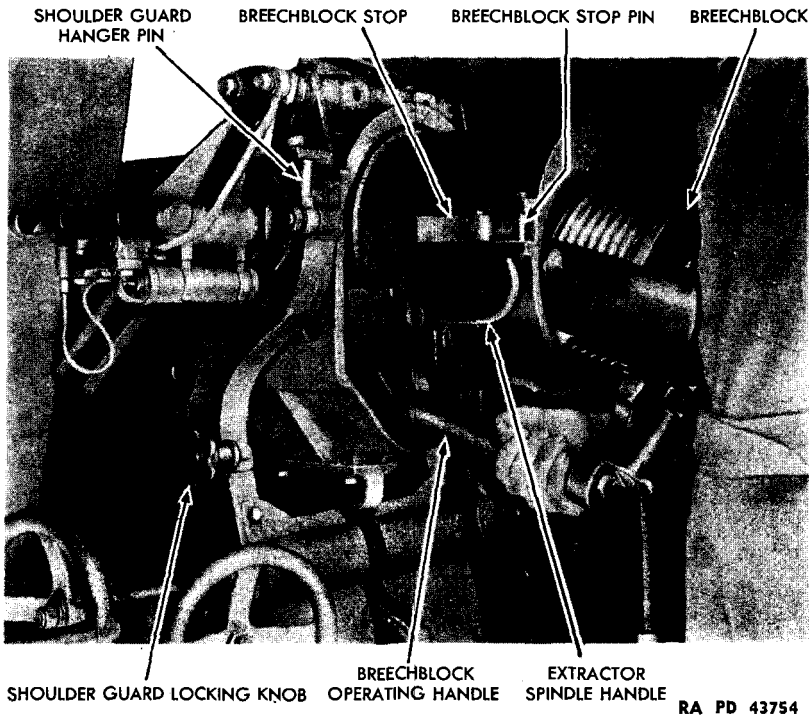

RA PD 43754

**Figure 24 — Removing Breechblock from Gun**

d. Push in on operating handle plunger to release breechblock latch from the latch catch (fig. 17). Unscrew breechblock counterclockwise and lift out at approximately  $6\frac{3}{4}$  turns, firmly gripping the operating handle and cradling the breechblock in the arm (fig. 24). Place breechblock on a clean work bench if available. If disassembly is to be done in vehicle, first spread clean (or dustless) cloth on equipment box or wherever work is to be done.

e. Turn extractor spindle handle down, withdraw spindle from left, and remove extractor (fig. 26).

**48. DISASSEMBLY OF BREECBLOCK (fig. 29).**

a. Pull firing hammer to rear; pull safety piece knob outward; unscrew safety piece and remove.

b. Take out firing pin, first pressing the firing hammer assembly as far as it will go into the safety piece recess.

c. Lift out firing hammer pin.

d. Remove firing hammer assembly.

**75-MM GUN M1897A4 MOUNTED IN COMBAT VEHICLES**

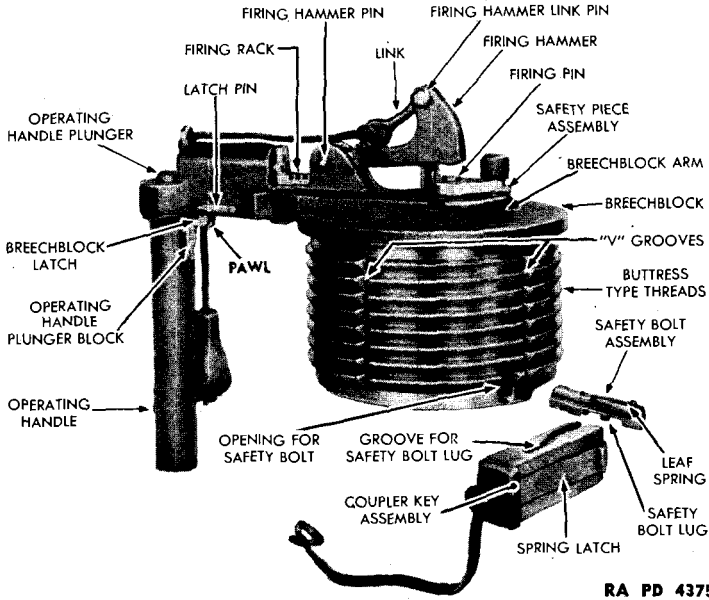

RA PD 43750

**Figure 25 — Breechblock, Coupler Key, and Safety Bolt Assemblies**

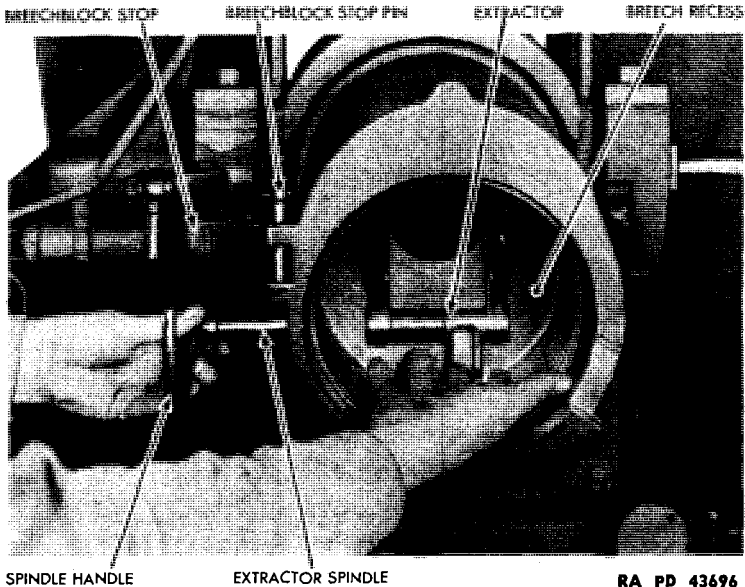

RA PD 43696

**Figure 26 — Removing Extractor**

**DISASSEMBLY AND ASSEMBLY**

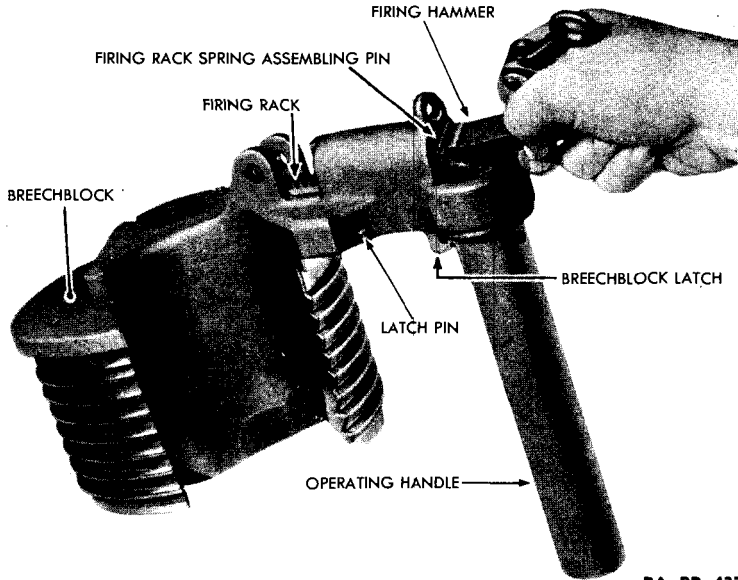

RA PD 43709

**Figure 27 — Removal of Firing Rack Spring Assembling Pin**

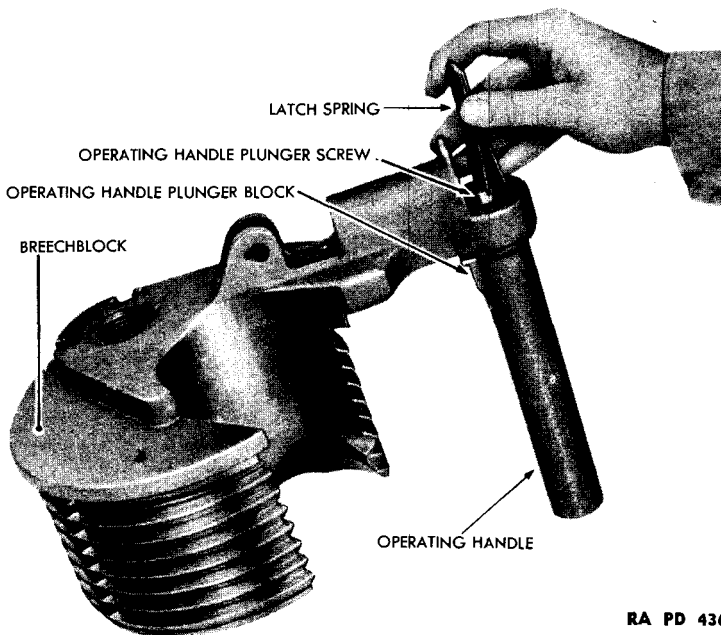

RA PD 43690

**Figure 28 — Removal of Operating Handle Plunger Screw**

75-MM GUN M1897A4 MOUNTED IN COMBAT VEHICLES

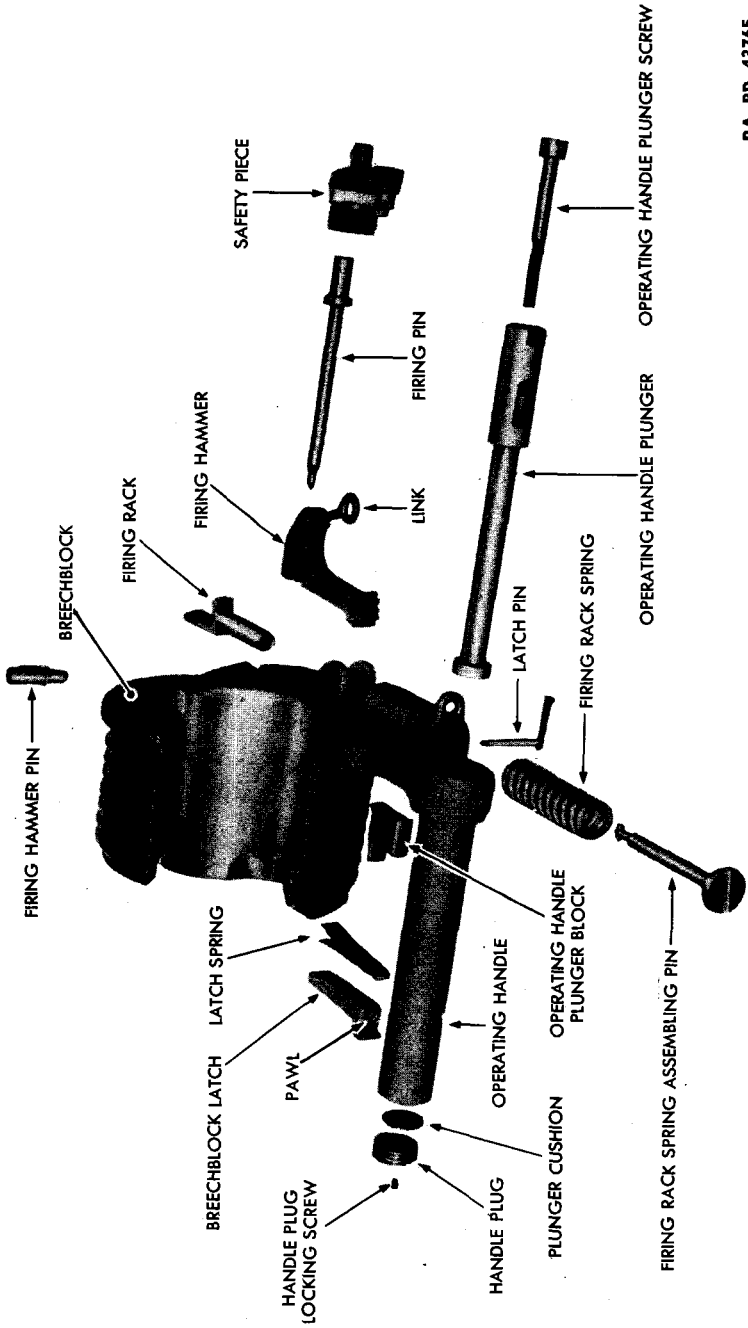

RA PD 43765

Figure 29 — Breechblock Assembly — Exploded View

## DISASSEMBLY AND ASSEMBLY

e. Remove lanyard from firing hammer pin by withdrawing it through eye of breechblock arm.

f. Using firing hammer as a tool (fig. 27), turn the firing rack assembling pin one-quarter turn, and remove the firing rack assembly and firing rack spring.

g. Rotate breechblock latch pin one-quarter turn, and remove. Take out breechblock latch assembly and latch spring.

h. Using latch spring as a tool (fig. 28), unscrew operating handle plunger screw and remove from handle. Take out operating handle plunger block and operating handle plunger.

i. Clean parts thoroughly and examine for burrs and cracks. Test springs for tension. Smooth up roughened surfaces with CLOTH, crocus. Replace badly worn or broken parts. Coat lightly with OIL, engine, SAE 30, above plus 32 degrees and OIL, engine, SAE 10, below plus 32 degrees. Then assemble carefully.

### 49. ASSEMBLY OF BREECHBLOCK.

a. Insert operating handle plunger in handle; then insert operating plunger block in handle.

b. Using latch spring as a tool (fig. 28), screw in operating handle screw. This holds the operating plunger in place.

c. Insert latch spring in breechblock arm, making sure that the open ends of the spring are toward the breechblock.

d. Insert breechblock latch assembly in breechblock arm.

e. Insert breechblock latch pin.

f. Insert firing rack and firing rack spring in firing rack housing.

g. Insert firing rack assembling pin in housing. Using the firing hammer assembly as a tool (fig. 27), push pin in and turn it 90 degrees so that it is properly engaged in the locking slot.

h. Install firing hammer assembly, making sure that the cutaway section in the second tooth engages the screw in the firing rack assembly.

i. Insert firing hammer pin.

j. Place firing pin in recess.

k. Screw in the safety piece assembly while holding the firing hammer up out of the way.

l. Attach lanyard assembly through the eye in breechblock and to firing hammer link.

## 75-MM GUN M1897A4 MOUNTED IN COMBAT VEHICLES

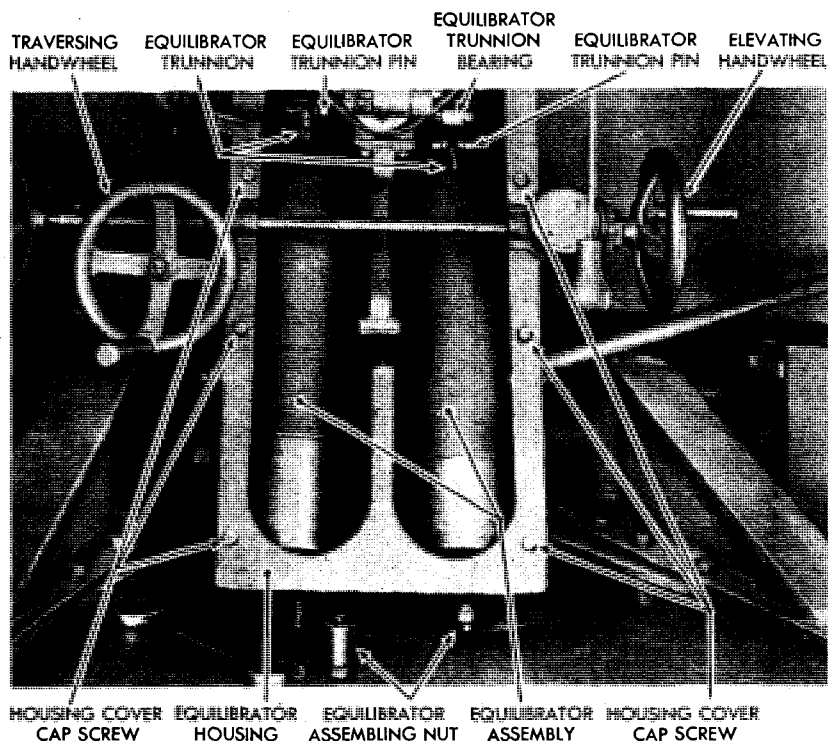

RA PD 43773

**Figure 30 — Removal of Equilibrators**

### 50. INSTALLATION OF BREECHBLOCK.

a. Place extractor in position. Insert extractor spindle from left, through extractor. Rotate extractor spindle upward to lock extractor in place.

b. Cradle breechblock in arm; then place in position and screw in clockwise approximately  $6\frac{3}{4}$  turns (fig. 24). Pull out on operating handle plunger to fasten breechblock latch in latch catch.

c. Pull spindle arm down from lug in which it was placed. Pull extractor spindle back out from its seat (fig. 23). Place extractor tang in position; then push spindle back into position. Rotate extractor spindle arm back up and into lug.

d. Swing hinged breechblock stop inward, locking extractor spindle in place. Install breech lock stop pin, locking breechblock stop (fig. 23).

e. Place shoulder guard on top hanger pin. Swing shoulder guard down to position. Tighten locking knob at lower bracket (fig. 24).

**DISASSEMBLY AND ASSEMBLY**

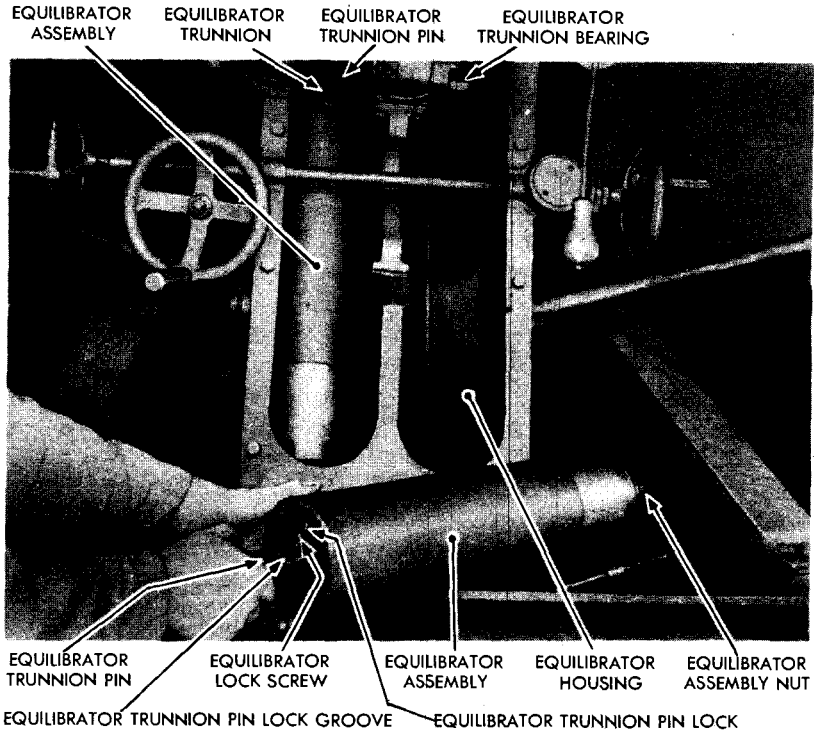

RA PD 43767

**Figure 31 — Adjusting Equilibrator Tension**

**51. REMOVAL OF EQUILIBRATORS.**

**a. Equipment.**

**SCREWDRIVER**

**WRENCH**, open-end, 3/4-in.

**WRENCH**, socket, 9/16-in.,  
with ratchet handle

**b. Procedure.**

**(1) INSTALL ASSEMBLING NUTS.**

**WRENCH**, open-end, 3/4-in.

Place one of the assembling nuts on the threaded bottom end of one of the equilibrators rods (fig. 30). Turn the assembling nut all the way up before attempting to remove equilibrator from housing (3/4-in. open-end wrench). **NOTE:** Although two nuts are furnished, it is advisable to remove equilibrators one at a time, using the remaining equilibrator to help elevate and depress the gun.

**(2) REMOVE SLOTTED COVER.**

**WRENCH**, socket, 9/16-in., with ratchet handle

Loosen the six cap screws (with washers) which fasten the slotted cover to equilibrator housing (9/16-in. socket wrench with ratchet



**75-MM GUN M1897A4 MOUNTED IN COMBAT VEHICLES**

handle). Push up on cover until large holes in cover clear the cap screws. Then remove cover. It is not necessary to remove cap screws.

**(3) REMOVE EQUILIBRATOR.**

Depress gun until equilibrator trunnion (fig. 30) is free from equilibrator trunnion bearing; then lift out the equilibrator. **NOTE:** If the assembling nut were not on the end of equilibrator rod, the trunnion would keep its seat in the bearing through the tremendous pressure of equilibrator spring. The assembling nut is not to be touched while equilibrator is dismantled.

**(4) ADJUST EQUILIBRATOR.****SCREWDRIVER**

If equilibrator tension needs adjustment (fig. 31), loosen the equilibrator trunnion pin lock screw (screwdriver). Push the trunnion pin lock up out of the trunnion pin lock groove. Turn trunnion pin in or out by hand until desired tension is obtained. Screwing the trunnion pin out gives greater tension. **CAUTION:** Do not expose more than 2 inches of the trunnion pin threads. Furthermore, as the force exerted by each of the equilibrators has been balanced by ordnance maintenance personnel, changes made by the using arms should maintain the same relative extension of trunnion pins.

**(5) CLEAN AND INSPECT EQUILIBRATOR.**

Clean equilibrator housing. Clean equilibrator. Oil trunnion pin threads, trunnion, and bearing surfaces. Oil outer surface of equilibrator inner cylinder lightly. Install equilibrator, elevating gun until trunnion is accurately and firmly seated in the trunnion bearing. Remove assembling nut at bottom of trunnion rod.

**(6) REMOVE SECOND EQUILIBRATOR.**

Repeat the above operations to remove and clean the second equilibrator.

**52. INSTALLATION OF EQUILIBRATORS.****a. Equipment.**

**WRENCH**, open-end, 3/4-in.

**WRENCH**, socket, 9/16-in.,  
with ratchet handle

**b. Procedure.****(1) PLACE EQUILIBRATOR IN POSITION.**

Insert bottom end of equilibrator (equilibrator rod end with assembly nut installed) into the hole in bottom of equilibrator housing.

**(2) FIX EQUILIBRATOR POSITION.**

Hold top of equilibrator so that trunnion is alined with trunnion bearing (fig. 30). Then elevate the gun carefully, lowering the trunnion bearing, until the trunnion is accurately seated in the bearing. Elevate the gun further to release pressure from the assembling nut.

## DISASSEMBLY AND ASSEMBLY

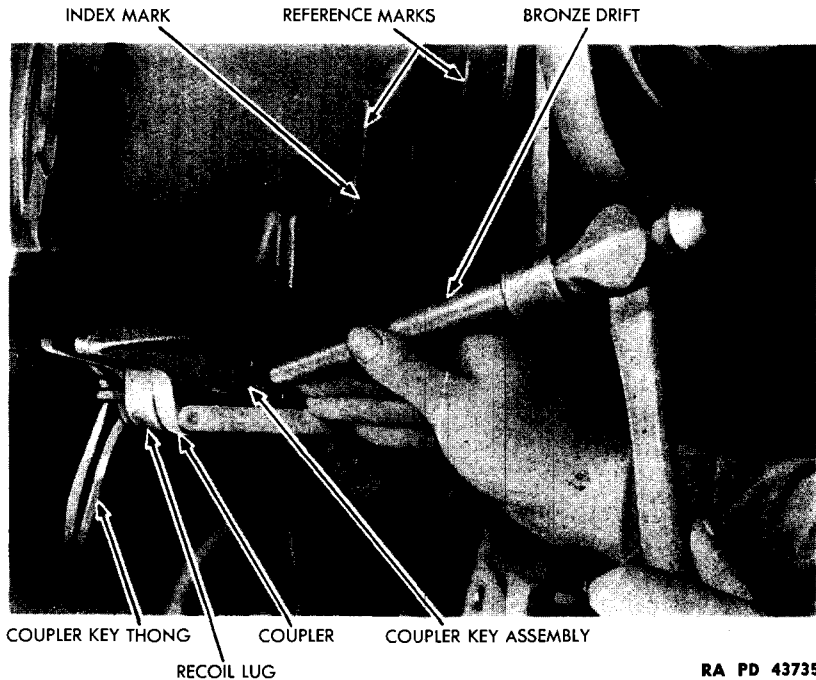

**Figure 32 — Removing Coupler Key Assembly**

**(3) REMOVE ASSEMBLING NUT.**

**WRENCH**, open-end,  $\frac{3}{4}$ -in.

Remove the assembling nut from the threaded bottom end of the equilibrator rod (fig. 30).

**(4) INSTALL SECOND EQUILIBRATOR.**

Repeat the above operations to install the second equilibrator.

**(5) INSTALL EQUILIBRATOR HOUSING COVER.**

**WRENCH**, socket,  $\frac{9}{16}$ -in., with ratchet handle

Place equilibrator housing cover on the housing so that the large holes clear the partly loosened cap screws. Slide cover up under the cap screw heads. Tighten the six cap screws ( $\frac{9}{16}$ -in. socket wrench with ratchet handle).

### 53. DISMOUNTING THE GUN.

**a. Equipment.**

**DRIFT**, bronze,  $\frac{1}{2}$ -in. point  
**HAMMER**, machinist's

**TIMBER**, 4-in. x 6-in. x 8-ft  
(2)  
**WRENCH**, open-end,  $\frac{3}{4}$ -in.

## 75-MM GUN M1897A4 MOUNTED IN COMBAT VEHICLES

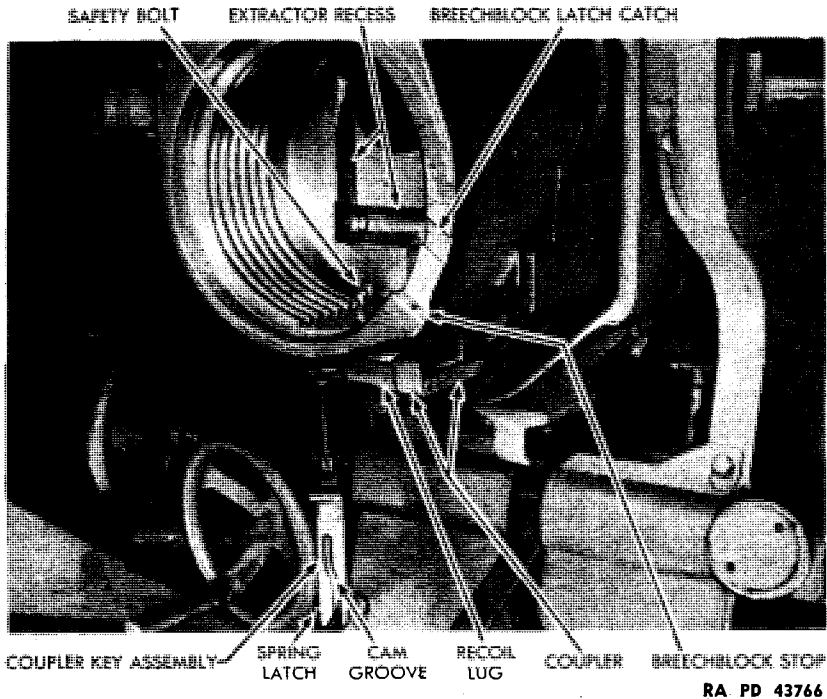

**Figure 33 — Coupler Key Removed, Safety Bolt in Locking Position**

### b. Procedure.

- (1) Install the two equilibrator assembling nuts on both of the equilibrator rods (par. 51).
- (2) Remove breechblock. See paragraph 47.
- (3) Remove extractor spindle and extractor.
- (4) Close breechblock stop and fasten with the stop pin.
- (5) See that gun is in battery position.
- (6) Set gun at zero-degree elevation or even depress it a few degrees to keep it from sliding from cradle when coupler key is removed.

#### (7) REMOVE COUPLER KEY.

**DRIFT**, bronze, 1/2-in. point      **HAMMER**, machinist's

Remove coupler key, from right to left. First push up on the coupler key latch to disengage it from the coupler assembly. If key will not push out by hand, tap it out lightly (bronze drift and hammer), taking care not to damage latch (fig. 32).

#### (8) REMOVE SAFETY BOLT.

**DRIFT**, bronze, 1/2-in. point      **HAMMER**, machinist's

**DISASSEMBLY AND ASSEMBLY**

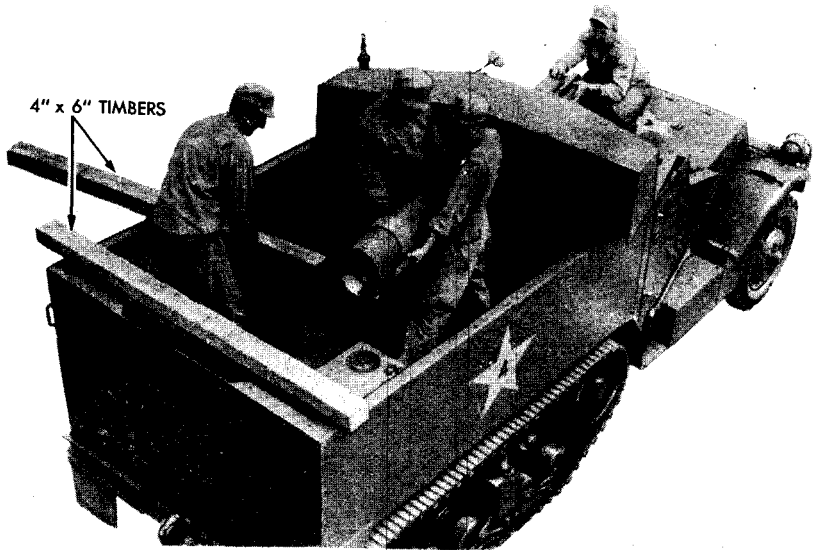

RA PD 43748

**Figure 34 — Sliding the Gun from the Cradle**

Remove safety bolt (fig. 33). Push up on it from the bottom. If necessary, tap it lightly (bronze drift and hammer). **NOTE:** The safety bolt prevents firing if coupler key should be removed while breechblock is in gun. Removal of the coupler key causes safety bolt to rise and engage in a hole in breechblock when breech is open (fig. 33), thus preventing breechblock from being closed. If coupler key is removed when breechblock is closed, the safety bolt lug will be sheared off.

**(9) PARTIALLY REMOVE GUN.**

Elevate gun slightly. With one man pushing gun from muzzle end and other members of crew pulling from rear, slide gun out to not more than three-quarters of its slide length (fig. 34). This brings the intermediate support (fig. 1) to rear ends of cradle slides.

**(10) BLOCK UP GUN.**

**TIMBER, 4-in. x 6-in. x 8-ft (2)**

Place one of the 4-inch by 6-inch by 8-foot timbers under gun in front of recoil lug and rest ends of the timber on sides of body. Elevate cradle sufficiently to rest the gun on the timber. Slide gun back until center of gravity is over the timber. Then place the other

## 75-MM GUN M1897A4 MOUNTED IN COMBAT VEHICLES

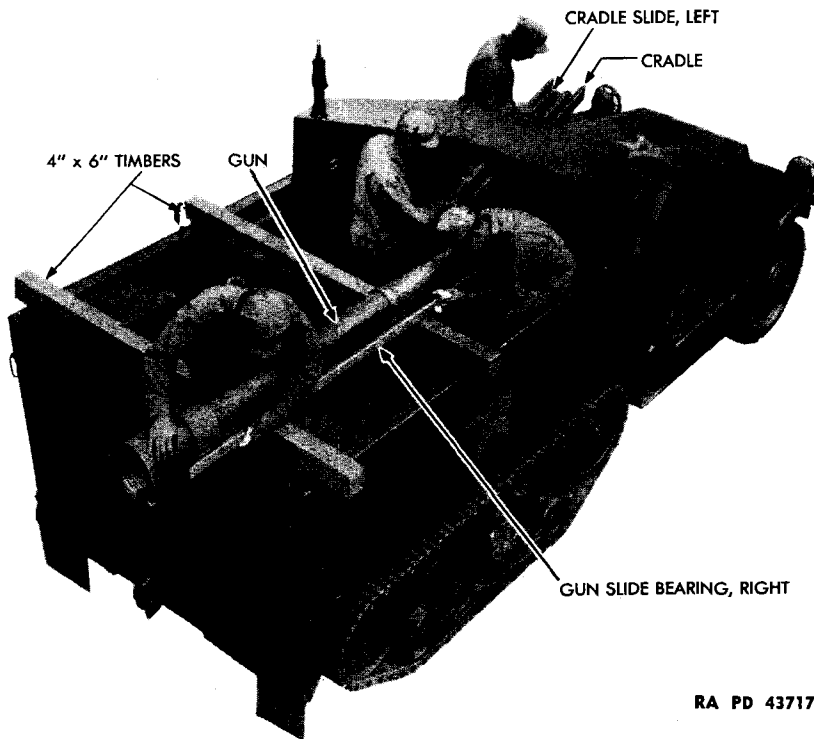

RA PD 43717

**Figure 35 — Gun Removed for Cleaning and Inspection**

timber under gun in front of recoil lug. Keep moving gun and timbers back, making sure that gun slide bearings do not slip off timbers.

**(11) REMOVE GUN.**

Slide tube back until muzzle is clear of carriage (fig. 35).

**(12) INSPECT GUN.**

Inspect gun slide bearings and cradle bearing surfaces (fig. 36) for burrs and roughness. Use **CLOTH**, crocus, if necessary. Clean thoroughly and oil lightly as directed (par. 28). Examine coupler assembly and fiber piston rod stop washer carefully (fig. 36). If either appears damaged, report to the ordnance officer.

### **54. MOUNTING THE GUN.**

**a. Equipment.**

**TIMBER**, 4-in. x 6-in. x 8-ft (2)

**b. Procedure.**

(1) With gun on timbers, slide gun forward. Move timbers forward as much as is necessary to keep them under the gun slide bearings (fig. 34).

## DISASSEMBLY AND ASSEMBLY

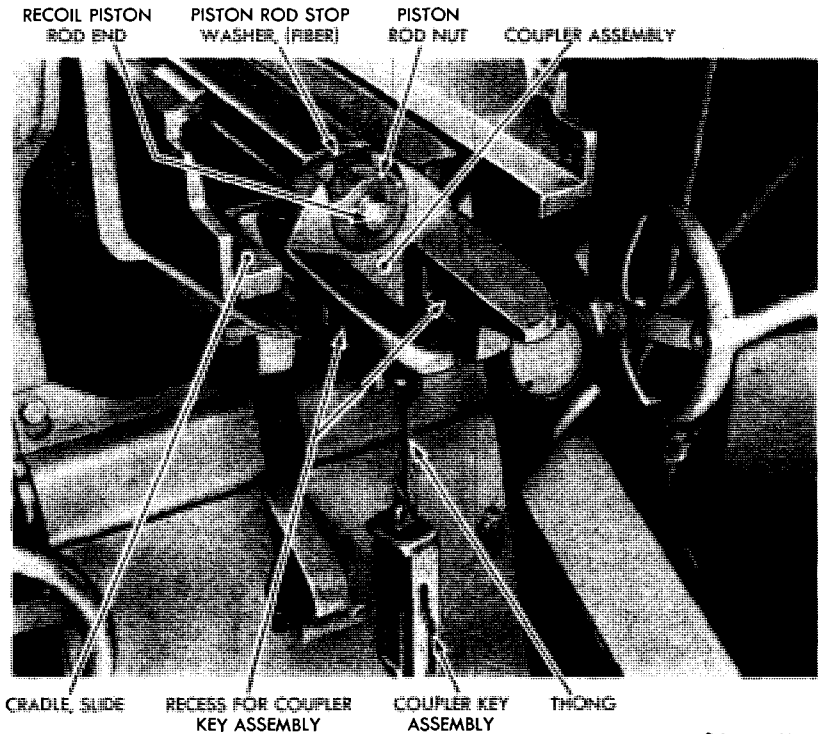

RA PD 43718

**Figure 36 — The Coupler and Coupler Key Assemblies**

(2) Traverse and elevate or depress the cradle as much as is necessary to bring cradle bearings in alignment with the gun slide bearings. With one man at the elevating and traversing handwheels, the other members of the crew will carefully push and guide the gun into battery.

(3) Insert safety bolt in its breech recess (fig. 33) with lug facing muzzle end (fig. 25).

(4) Insert coupler key, from left to right, with the spring latch down and cam groove to the rear (fig. 33). Make sure it is latched when all the way in.

(5) Open the breechblock stop.

(6) Install extractor and extractor spindle (par. 50).

(7) Install breechblock, screwing it in clockwise—all the way—until the breechblock latch engages the latch catch on the breechblock hoop and breechblock hoop and breechblock are locked (par. 50).

(8) Install extractor tang by withdrawing the extractor spindle far enough to permit it to engage hole in the tang (par. 50). Push spindle all the way to right and turn spindle handle up in locking position.

**75-MM GUN M1897A4 MOUNTED IN COMBAT VEHICLES**

(9) Close the breechblock stop and fasten it with the breechblock stop pin, locking extractor spindle in place.

**55. REMOVAL OF GUN SHIELD.**

**NOTE:** Generally the gun shield is removed only when subcaliber equipment is to be used. As subcaliber equipment is not taken into the field, a shop or vehicle hoist should be available and is recommended for lifting the shield. However, in emergencies the vehicle crew is able to remove the shield unaided.

**a. Equipment.**

- |                                      |                                    |
|--------------------------------------|------------------------------------|
| BAR, pinch                           | WRENCH, open-end,                  |
| CHAIN, lifting                       | $\frac{3}{4}$ - x 1-in.            |
| HANDLE, ratchet                      | WRENCH, socket, $\frac{5}{8}$ -in. |
| HOIST, shop or vehicle               | WRENCH, socket, $\frac{3}{4}$ -in. |
| WRENCH, open-end,                    | WRENCH, socket, 1-in.              |
| $\frac{5}{8}$ - x $\frac{3}{4}$ -in. |                                    |

**b. Procedure.**

(1) **RELEASE GUN SHIELD** (fig. 12).

- |                                      |                                    |
|--------------------------------------|------------------------------------|
| WRENCH, open-end, $\frac{5}{8}$ -in. | WRENCH, socket, $\frac{5}{8}$ -in. |
| WRENCH, open-end, $\frac{3}{4}$ -in. | WRENCH, socket, $\frac{3}{4}$ -in. |
| WRENCH, open-end, 1-in.              | WRENCH, socket, 1-in.              |

(a) Release the right and left shield latches.

(b) Remove the five bolts and nuts and the two cap screws which are used to attach gun shield, front and rear, to either side of the mount ( $\frac{5}{8}$ -in.,  $\frac{3}{4}$ -in., and 1-in. socket and open-end wrenches). Loosen but do not remove the inside lower bolt and nut on each side until ready to lift shield from gun. It will be necessary for one man in front of shield to hold the bolts while the nuts are being removed at the rear.

(c) Remove shield braces to safe place and replace bolts and nuts and cap screws in their several holes for safekeeping.

(2) **REMOVE SHIELD FROM GUN** (fig. 37).

- |                |                        |
|----------------|------------------------|
| BAR, pinch     | HOIST, shop or vehicle |
| CHAIN, lifting |                        |

(a) Make loop with chain around center part of top section of shield and attach to hoist.

(b) Take up slack in chain until hoist supports weight of shield; then remove the two remaining bolts and nuts, replacing them in brackets for safekeeping.

(c) Lift shield a trifle more; then, using a pinch bar, pry the slightly overlapping part of the front shield section from mount.

(d) Lift shield clear of gun and mount and remove from vehicle.

DISASSEMBLY AND ASSEMBLY

RA PD 43776

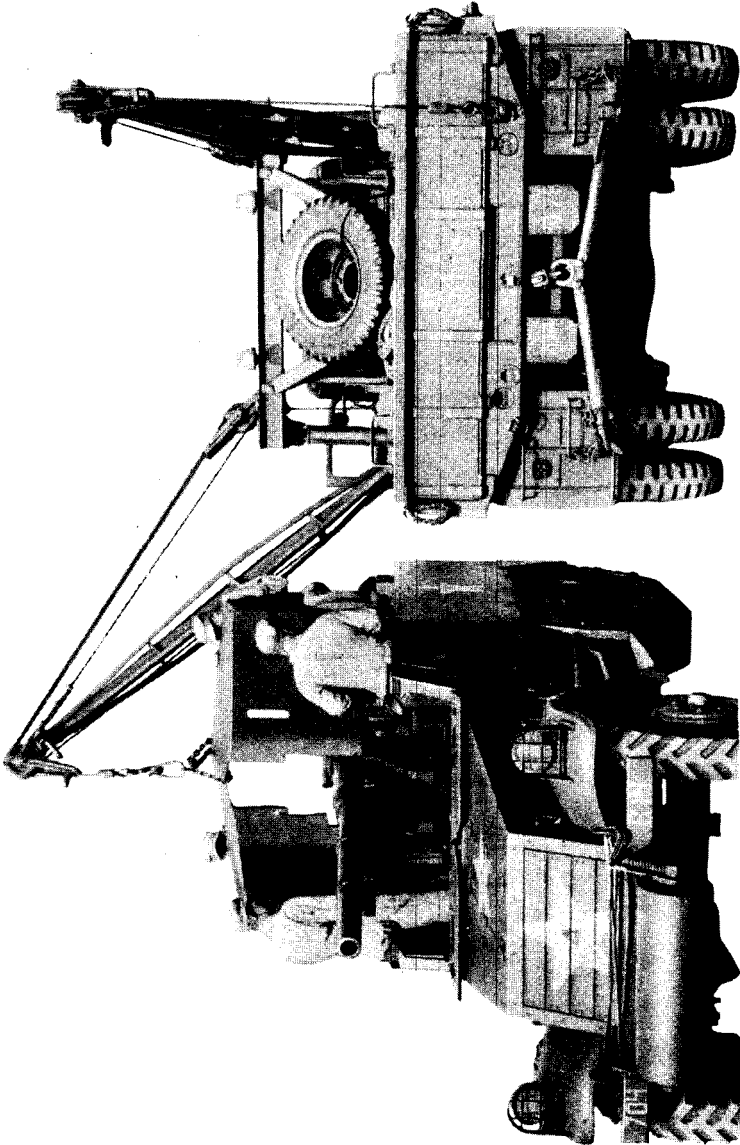

Figure 37 — Removing Shield from the Gun



**75-MM GUN M1897A4 MOUNTED IN COMBAT VEHICLES**

**56. INSTALLATION OF GUN SHIELD.**

**a. Equipment.**

- |                                     |                                   |
|-------------------------------------|-----------------------------------|
| BAR, pinch, medium                  | WRENCH, open-end,<br>3/4- x 1-in. |
| CHAIN, lifting                      |                                   |
| HANDLE, ratchet                     | WRENCH, socket, 5/8-in.           |
| HOIST, shop or vehicle              | WRENCH, socket, 3/4-in.           |
| WRENCH, open-end,<br>5/8- x 3/4-in. | WRENCH, socket, 1-in.             |

**b. Procedure.**

**(1) INSTALL CHAIN HOIST.**

- |                |                        |
|----------------|------------------------|
| CHAIN, lifting | HOIST, shop or vehicle |
|----------------|------------------------|

Make loop with chain around center part of top section of shield and attach to hoist.

**(2) LIFT GUN SHIELD IN POSITION.**

- BAR, pinch

(a) Lift shield to clean gun and then lower into straddling position (fig. 37).

(b) Keeping tension on chain, pry the overlapping edge of shield so that it clears the flange on the gun mount.

**(3) ATTACH GUN SHIELD.**

- |                                     |   |
|-------------------------------------|---|
| WRENCH, open-end,<br>5/8- x 3/4-in. | WRENCH, socket,<br>with ratchet handle                                      |
| WRENCH, open-end,<br>3/4- x 1-in.   | WRENCH, socket, 5/8-in.<br>WRENCH, socket, 3/4-in.<br>WRENCH, socket, 1-in. |

Push shield into position, alining bolt and cap screw holes, but maintaining tension on the chain until a few of the bolts and nuts are assembled on each side. Install the five bolts and nuts and two cap screws which secure the shield and shield braces to the several brackets (5/8-in., 3/4-in., and 1-in. socket and open-end wrenches) (fig. 12). Remove lifting chain.

Chapter 3

**SIGHTING EQUIPMENT**

	Paragraph
General .....	57
Care and preservation .....	58
Telescope mount M36 and telescope M33 .....	59
Procedure for bore sighting .....	60

**57. GENERAL.**

a. The sighting equipment for the 75-mm gun on the 75-mm Gun Motor Carriages M3 and M3A1 is the Telescope Mount M36 and the Telescope M33. The equipment is designed to point the gun in azimuth and elevation for direct fire only. Arrangement of the equipment is shown in figures 38 and 39.

b. Bore sighting equipment is furnished for use during the bore sighting operation for verification and alinement of sights.

c. The telescope mount is equipped with the Instrument Light M17 for illuminating the telescope reticle when the equipment is used at night.

d. A telescope cover is furnished to cover both ends of the telescope when the telescope is not in use.

**58. CARE AND PRESERVATION.**

**a. General.**

(1) The instructions given hereunder supplement instructions pertaining to individual instruments included in this section.

(2) Fire control and sighting instruments are, in general, rugged and suited to the purpose for which they have been designed. They will not, however, stand rough handling or abuse. Inaccuracy or malfunctioning may result from such mistreatment.

(3) To prevent misalignment when installing the telescope, wipe the locating surfaces of the telescope and telescope holder with a clean cloth.

(4) Disassembly and assembly by the using arms are permitted only to the extent authorized in the paragraphs dealing with the individual instruments. Unnecessary turning of screws or other parts not incident to the use of the instrument is expressly forbidden.

(5) Keep the instrument as dry as possible. Do not put an instrument in its carrying case when wet.

(6) When not in use, place the instruments in the carrying cases, if cases are provided, or keep them in the condition indicated for traveling.

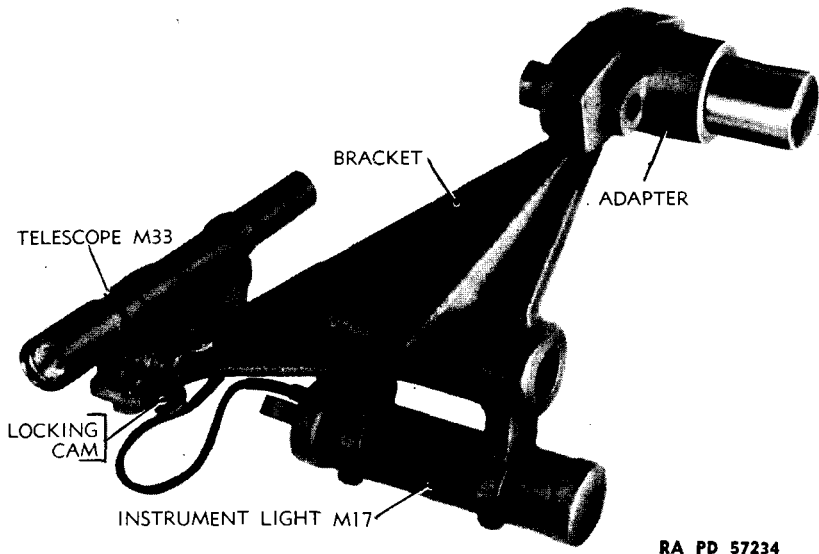
**75-MM GUN M1897A4 MOUNTED IN COMBAT VEHICLES**

RA PD 57234

**Figure 38 — Telescope Mount M36 with Telescope M33 and Instrument Light M17**

(7) Any instruments which indicate incorrectly or fail to function properly after the authorized tests and adjustments have been made are to be turned in for repair by ordnance personnel. Adjustments other than those expressly authorized in the paragraph dealing with the individual instruments are not to be performed by the using arms.

(8) Painting of fire control or sighting equipment by the using arms is not permitted.

(9) Remove the dry cells from the instrument light, to prevent corrosion, when the instrument is not to be used for an extended period.

#### **b. Optical Parts.**

(1) To obtain satisfactory vision, it is necessary that the exposed surfaces of the lenses and other parts be kept clean and dry. Corrosion and etching of the surface of the glass can be prevented or greatly retarded by keeping the glass clean and dry.

(2) Under no condition will polishing pastes or abrasives be used for polishing lenses and windows.

(3) For wiping optical parts, use only **PAPER**, lens, tissue, especially intended for cleaning optical glass. Use of cleaning cloths is not permitted. To remove dust, brush the glass lightly with a clean **BRUSH**, artist, camel's-hair, and rap the brush against a hard body

SIGHTING EQUIPMENT

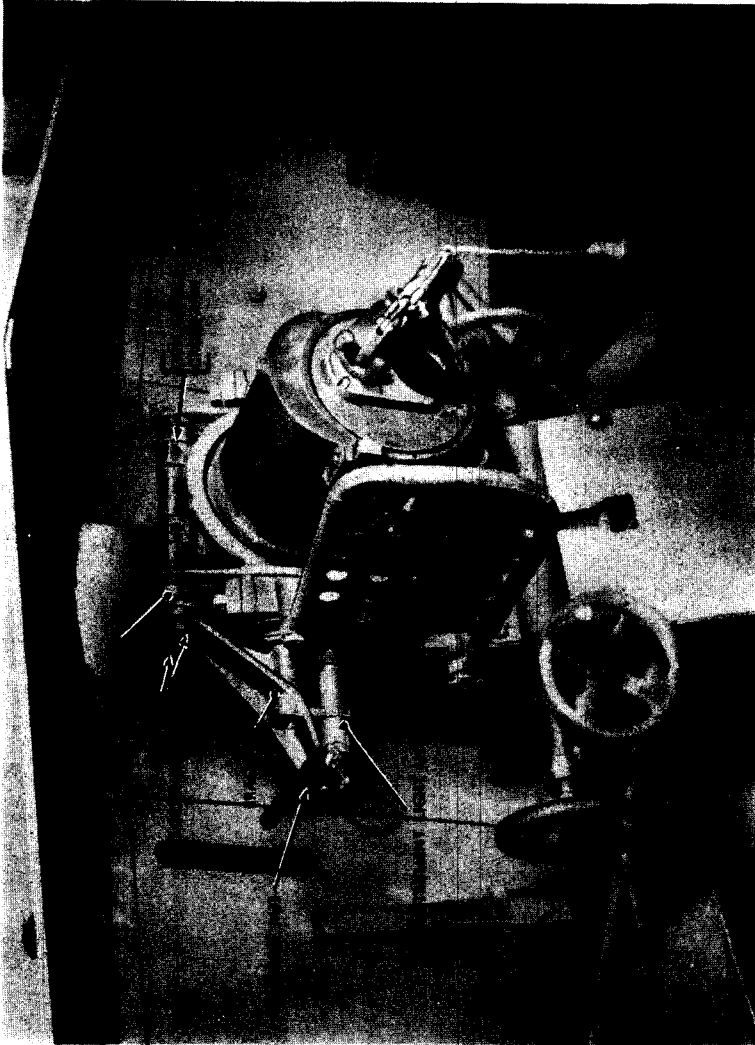

RA PD 57238

**Figure 39 — 75-mm Gun Motor Carriage M3, Showing Telescope Mount M36, Telescope M33, and Instrument Light M17**

**75-MM GUN M1897A4 MOUNTED IN COMBAT VEHICLES**

in order to knock out the small particles of dust that cling to the hairs. Repeat this operation until all dust is removed. With some instruments an additional brush with coarse bristles is provided for cleaning mechanical parts. It is essential that each brush be used only for the purpose intended.

(4) Exercise particular care to keep optical parts free from oil and grease. Do not wipe the lenses or windows with the fingers. To remove oil or grease from optical surfaces, apply SOAP, liquid, lens cleaning, with a tuft of PAPER, lens, tissue, and then wipe the surface dry with clean PAPER, lens, tissue. If SOAP, liquid, lens cleaning is not available, breathe heavily on the glass and wipe off with clean PAPER, lens, tissue. Repeat this operation several times until the glass is clean.

(5) Moisture may condense on the optical parts of the instrument when the temperature of the parts is lower than that of the surrounding air. This moisture, if not excessive, can be removed by placing the instrument in a warm place. Heat from strongly concentrated sources must not be applied directly, as it may cause unequal expansion of parts, thereby resulting in breakage of optical parts or inaccuracies in observation.

**59. TELESCOPE MOUNT M36 AND TELESCOPE M33.**

a. **Telescope Mount M36** (fig. 40). The Telescope Mount M36 (fig. 39) is essentially a device for mounting the telescope and for positioning it accurately in a vertical and horizontal plane. The Telescope Mount M36 fits over the left cradle trunnion and moves with the gun when the gun is elevated or depressed (figs. 39 and 40). The telescope mount supports the Telescope M33 and contains adjusting mechanisms for alining the telescope in deflection and elevation. On its under side is a spring clip bracket, holding the Instrument Light M17 (figs. 39 and 40).

b. **Telescope M33** (fig. 41). The Telescope M33 is a one-power telescope with a field of view of 11 degrees. The reticle can be lighted for night sighting. The reticle pattern (fig. 42) is graduated for deflection and range. The deflection (horizontal) graduations are spaced every 5 mils up to 40 mils on each side of the center. The range (vertical) graduations are numbered in 400 yard intervals up to 1,600 yards. The identifying number 75-B-4-2C on the reticle is the firing table reference and refers to; SHELL, H. E., Mk. I, with FUZE, M46 or M47, at normal charge. In sighting, the gunner should keep his eye at a distance of 4½ inches from the end of the telescope to get distinct reticle marking and a full field of view. A rubber eye shield fits over the eyepiece end of the telescope, and a rubber shield fits over the objective end of the telescope.

**SIGHTING EQUIPMENT**

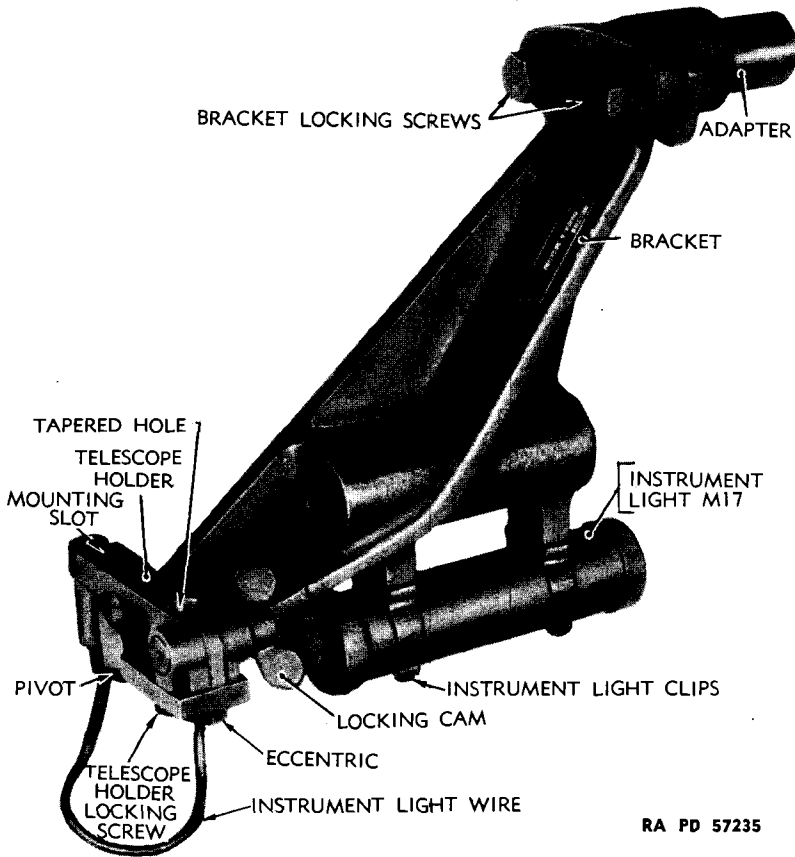

RA PD 57235

**Figure 40 — Telescope Mount M36**

The above rubber shields are furnished to protect the telescope objective and eyelens from rain and fog. These shields are supplied on present production of the telescope and will be supplied for all units now in the field.

(1) **OPERATION.** When the telescope has been alined with the axis of gun bore (par. 60), there are no further adjustments. The car commander calls out the lead and the range; the gunner, sighting through the telescope, elevates and traverses the gun until the target is alined at the lead and range on the reticle. This operation points the gun for firing.

(2) **PREPARATION FOR TRAVEL.**

(a) Remove the telescope from the telescope holder, place the telescope cover over both ends of the telescope, and place the tele-

75-MM GUN M1897A4 MOUNTED IN COMBAT VEHICLES

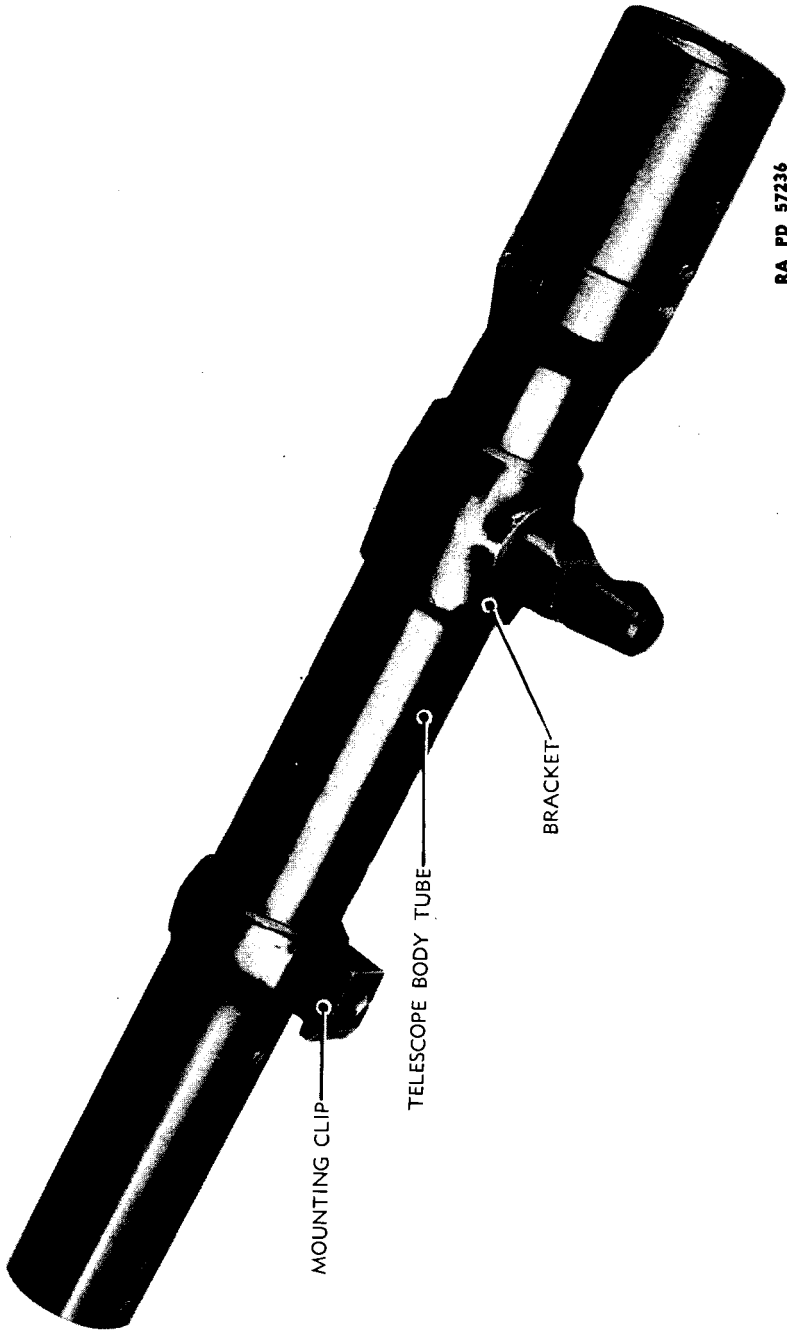

RA PD 57236

Figure 41 — Telescope M33

## SIGHTING EQUIPMENT

scope in the box prescribed for that purpose. To remove the telescope from the telescope holder, turn the locking cam (fig. 40) one-quarter turn counterclockwise and give the telescope a slight pull upward at the eyepiece end. Lift the telescope out of the tapered hole (fig. 40); then draw backward slightly to remove the telescope clip (fig. 40) from the slots and remove the telescope.

(b) Place a thin film of OIL, lubricating, for aircraft instruments and machine guns, on the locating surfaces of the telescope holder.

### 60. PROCEDURE FOR BORE SIGHTING.

a. **General.** The purpose of the bore sighting operation is to test the alinement of the sighting equipment for parallelism with the gun bore and to provide a basis for adjustment if the sighting equipment is found to be out of alinement.

#### b. Equipment for Bore Sighting.

(1) **BORE SIGHTS.** The line through the center of the gun bore is the reference line from which all adjustments are made. The bore sights issued with the gun are used to determine this line. The bore sights consist of a breech bore sight and muzzle bore sight. The breech bore sight is a disk which fits accurately in the breech chamber of the gun. The model of the cannon for which it is to be used is engraved on the disk. It has four large holes and one small hole drilled in it. The large holes are used for finding the aiming point. The small hole in the center of the disk is used for final accurate sighting of the gun bore. The muzzle bore sight includes a quantity of black linen cord to be stretched tightly across the muzzle, vertically and horizontally in the witness marks thereon, and a web belt to be buckled around the muzzle to hold the cords in place. If the issue bore sights are not available, the removal of the firing mechanism from the breechblock and the use of the firing pin holes as a peep sight may be substituted for the breech sight. In lieu of the muzzle sight, crossed strings may be attached across the muzzle by securing them with a rubber band, shoe string, tape, or web belt.

(2) **TESTING TARGET.** Either a sharply defined distant aiming point or a testing target (fig. 43) may be used in the adjustment procedure for alinement of the telescope with the axis of the gun bore. If testing target is not available it can be constructed as follows: Measure and record the horizontal and vertical distances from the center of the bore to the optical center of the telescope. On the 75-mm Gun Motor Carriages M3 and M3A1, the gun and telescope centers are on the same horizontal line and there is a distance of  $16\frac{7}{16}$  inches between the vertical centerline of the gun and the vertical centerline of the telescope (fig. 43). Construct the testing target on cardboard or some other suitable material by setting two



**75-MM GUN M1897A4 MOUNTED IN COMBAT VEHICLES**

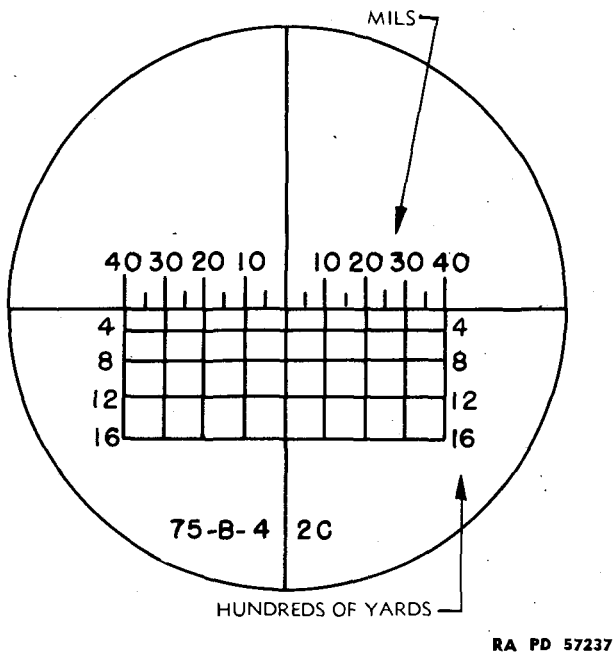

**Figure 42 — Reticle Pattern of Telescope M33**

points apart horizontally and vertically by the same amount that the optical center of the telescope is offset from the axis of the bore. Mark these aiming points plainly for the telescope and for the bore. Be careful to place the aiming for the telescope on the proper side (left) of the aiming point for the bore. Indicate the top of the testing target so that it will not be reversed accidentally.

(3) **WRENCH.** A double-end box wrench,  $\frac{5}{8}$ - and  $\frac{9}{16}$ -inch, is used to tighten or loosen the adjustments on the telescope mount.

**c. Preliminary Settings.**

(1) It is important that the line through the cradle trunnions, crosswise to the gun bore, be fairly level for bore sighting. The trunnions will generally be level when the vehicle is on level ground.

(2) Alinement of telescope can be performed either by use of a testing target or by use of a sharply defined distant point. The use of the testing target establishes the telescope line of sight parallel to the gun bore. The use of a distant aiming point results in a line of sight which converges toward the line of the gun bore. The more distant the point, the more nearly parallel will be the line of sighting and the axis of the bore. If the aiming point is chosen about 1,000 yards or more distant, the line of sight and the axis of the bore will

### SIGHTING EQUIPMENT

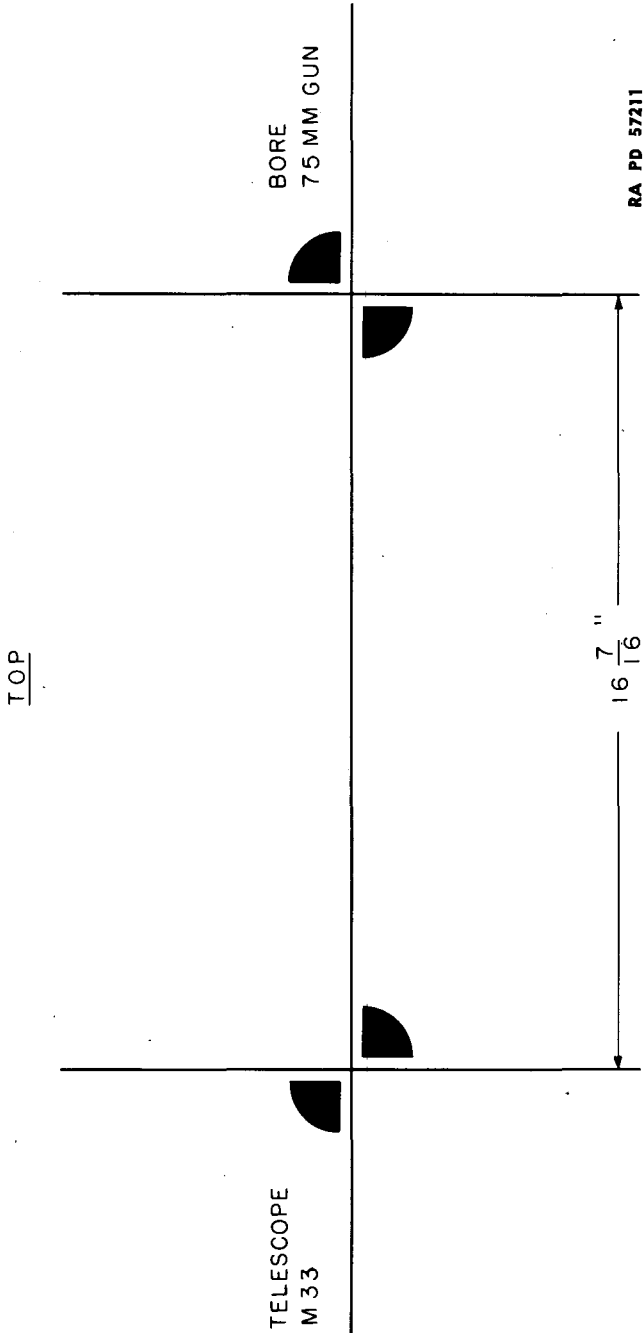

**Figure 43 — Testing Target for 75-mm Gun M1897A4 and Telescope M33, on the Gun Motor Carriage M3 and M3A1**

**75-MM GUN M1897A4 MOUNTED IN COMBAT VEHICLES**

be near enough to parallel for all practical purposes. Choice of method will depend on time and facilities available. The aiming point may be used whenever the testing target is not available, but its use is necessarily restricted to open terrain and clear weather. The testing target can be used at night and requires only an open space of 120 feet or less.

(3) When using the testing target, line it up with the gun in the following manner. Hang the target on a support about 80 to 120 feet in front of the gun. The more distant the target, the less will be the error produced by inaccuracies in measuring the aiming points. The face of the target should be square with the gun bore. The horizontal edge of the target should be level. (If the gun trunnions are slightly out of level, the horizontal edge of the target should be out of level by the same amount and in the same direction. This measurement is avoided by leveling the gun trunnions at the start.) Move the testing target while maintaining the previous alinement, until the "BORE" aiming point is seen through the bore sights, centered in the gun bore. When this alinement has been obtained, do not shift the gun or testing target until the bore sighting has been completed.

**d. Verification of Telescope M33.** With the gun and testing target set as described in the preceding steps of this paragraph, sight the testing target through the bore sight and also through the telescope. The bore sight cross lines must be in direct line with the cross lines marked "BORE" on the testing target. The telescope reticle cross lines must be in direct line with the cross lines marked "TELESCOPE" on the testing target. If the telescope does not line up in this manner, proceed as directed in the following subparagraphs:

**e. Alinement in Azimuth.** With the testing target set as described in the preceding subparagraphs proceed as follows:

(1) Loosen the telescope holder locking screw (fig. 40).

(2) Turn the eccentric (fig. 40), swinging the telescope right or left until the deflection line (vertical line) on the telescope reticle lines up with the deflection line (vertical line) on the testing target, marked "TELESCOPE." When this adjustment is correct, tighten the telescope holder locking screw.

**f. Alinement in Elevation.**

(1) Loosen the two cap screws at the top of the telescope bracket (fig. 40). The two screw holes in the bracket are slotted to permit adjustment.

(2) Swing the bracket forward or backward as necessary to bring the zero range line (horizontal line) on the telescope reticle in line

### **SIGHTING EQUIPMENT**

with the telescope aiming point on the testing target. When this adjustment is correct, tighten the cap screws.

g. If the above procedure is carried out correctly, the telescope reticle cross lines will line up with the cross lines marked "TELESCOPE" on the target, and the cross lines on the muzzle of the gun will line up with the cross lines marked "BORE" on the target.

**75-MM GUN M1897A4 MOUNTED IN COMBAT VEHICLES****Chapter 4****AMMUNITION**

	Paragraph
General .....	61
Nomenclature .....	62
Firing tables .....	63
Classification .....	64
Identification .....	65
Care, handling, and preservation.....	66
Authorized ammunition .....	67
Preparation for firing.....	68
Ammunition data .....	69
Fuzes .....	70
Packing .....	71
Subcaliber ammunition .....	72
Field report of accidents.....	73

**61. GENERAL.**

a. Ammunition for GUN, 75-mm, M1897A4, is issued in the form of fuzed and unfuzed rounds of fixed ammunition. The term "fixed" signifies that the propelling charge is not adjustable and that the round is loaded into the gun as a unit. Generally, fixed ammunition is characterized by the rigid crimping of the cartridge case to the projectile. A complete round consists of all the ammunition components required to fire a weapon once.

**62. NOMENCLATURE.**

a. Standard nomenclature is used herein in all references to specific items of issue. Its use for all purposes is mandatory.

**63. FIRING TABLES.**

a. For applicable firing tables, see chapter 8.

**64. CLASSIFICATION.**

a. Dependent upon the type of projectile, the ammunition for this gun may be classified as armor-piercing, high-explosive, chemical, practice, blank, or drill. The armor-piercing types are used to penetrate armor plate; they are either solid shot, or relatively thick-walled shell containing a comparatively small amount of high explosive and a base fuze. Both types contain a tracer to provide a means of observ-

## AMMUNITION

ing the projectile's path in flight. High-explosive shells are relatively thin-walled, containing a comparatively large filler of high explosive, and are designed for the most effective fragmentation and blast at the target. Chemical shells contain a chemical filler, that is, a chemical agent which produces either a toxic or an irritating physiological effect, a screening smoke, an incendiary action, or a combination of these. Practice ammunition is provided for training in marksmanship; the round for this gun has an inert (sand-loaded) projectile. Blank ammunition, which contains no projectile, is provided for saluting and simulated fire. Dummy ammunition is completely inert and simulates service ammunition. It is designed for training in handling and servicing the gun.

### 65. IDENTIFICATION.

**a. General.** Ammunition is completely identified by painting and marking (including an ammunition lot number) on the ammunition items and original packing containers. Other essential information may be obtained from the marking, for example, on the projectile, the kind of filler.

**b. Mark or Model.** To identify a particular design, a model designation is assigned at the time the model is classified as an adopted type. This model designation becomes an essential part of the nomenclature and is included in the marking of the item. The present system of model designation consists of the letter "M" followed by an Arabic numeral. Modifications are indicated by adding the letter "A" and the appropriate Arabic numeral. Thus "M2A1" indicates the first modification of an item for which the original model designation was "M2." Prior to July 1, 1925, it was the practice to assign mark numbers—that is, the word "Mark," abbreviated "Mk." followed by a Roman numeral.

**c. Ammunition Lot Number.** At the time of manufacture, a lot number is assigned to every ammunition component. Where the size of the item permits, this lot number is stamped on the item itself. In addition, an *ammunition lot number* is assigned to each complete round of fixed ammunition at the time it is assembled. This ammunition lot number is marked on each round—usually on the base of the cartridge case—and on all packing containers. The lot number is required for all purposes of record, including reports on condition, functioning, and accidents in which the ammunition is involved. To provide for the most uniform functioning, all of the components in any one lot are manufactured under as nearly identical conditions as practicable. For example, in the case of fixed ammunition, all of the rounds in any one lot are assembled so as to consist of: projectiles of one lot number (one type and one weight zone), fuzes of one lot number, primers of one lot number, and propellant powder of one

**75-MM GUN M1897A4 MOUNTED IN COMBAT VEHICLES**

lot number. Therefore, to obtain the greatest accuracy in any firing, successive rounds should be from the same ammunition lot, whenever practicable.

**d. Weight Zone Markings.** Small variations in weights occur during manufacture of different lots of shell containing explosive and chemical. When ballistic corrections are necessary for such variations in weight, the projectiles are grouped in weight zones so that the corrections provided in firing tables may be applied. The weight zone of the projectile is indicated thereon by crosses of the same color as the original markings. For 75-mm guns, there are one, two, three, or more crosses dependent upon the type and weight of the projectiles, two crosses indicating "normal" or "standard" weight, that is, the weight for which weight corrections are not necessary. A weight zone lighter than one cross is indicated by an "L." The armor-piercing projectiles for this weapon do not have weight-zone markings.

**e. Painting and Marking.**

(1) **PAINTING.** Artillery projectiles are painted primarily to prevent rust. Secondary purposes are to provide, by the color, a ready means of identification as to type, and for camouflage. Projectiles for the 75-mm guns are painted as follows:

- High explosive (and armor-piercing with explosive) .....Olive drab, marking in yellow
- Armor-piercing without explosive. .Black, marking in white
- Chemical .....Gray, two green bands indicate persistent gas; one yellow band, smoke. Marking is in same color as band.
- Practice .....Blue, marking in white
- Drill or dummy (inert).....Unpainted\*

(2) **MARKING.** For purposes of identification the following is marked on the service rounds for 75-mm guns:

(a) *On the Projectile.*

- Caliber and type of cannon in which fired.
- Kind of filler, for example, "TNT," "HS GAS," etc.
- Model projectile.
- Weight zone marking (except on armor-piercing projectiles).
- Lot number of filled projectile. Ordinarily the projectile lot number is not required after the complete round is assembled, hence it is stenciled below the rotating band, in which position it is covered by the neck of the cartridge case.

---

\*Unpainted because of cadmium-plated and bronze parts. Dummy ammunition usually is painted black, with marking in white, in accordance with the basic color scheme (TM 9-1900).

## AMMUNITION

(b) *On the Body of Cartridge Case.* The following marking appearing on the body of the cartridge is stenciled in black:

“REDUCED” between two black bands indicates reduced propelling charge.

“NORMAL” below one black band indicates normal propelling charge.

“SUPER” indicates supercharge.

NOTE: There is no marking on the body of the cartridge case of armor-piercing projectiles.

(c) *On the Base of Cartridge Case.* The following marking appearing on the base of the cartridge case is stenciled in black, unless otherwise indicated:

Ammunition lot number and loader's initials.

Model of projectile.

Caliber and model of cartridge case (stamped in the metal).

Cartridge case lot number, initials or symbol of cartridge case manufacturer, and year of manufacture (stamped in the metal).

“REDUCED” with two diametrical stripes at right angles indicating reduced charge.

“NORMAL” with one diametrical stripe indicating normal charge.

“SUPER” indicating supercharge.

(d) *On the Fuze (Stamped in the Metal).*

Type and model of fuze.

Loader's initials.

Month and year loaded.

Loader's lot number.

Action, as required, for example, “SQ,” “DELAY,” time in seconds.



**75-MM GUN M1897A4 MOUNTED IN COMBAT VEHICLES**

c. Ammunition should be protected from mud, sand, dirt, and water. If it gets wet or dirty, wipe it off at once. Verdigris or light corrosion should be wiped off. Ammunition should not be polished, however, to make it look better or brighter.

d. Explosive ammunition must be handled with appropriate care at all times. The explosive elements in primers and fuzes are particularly sensitive to undue shock and high temperature.

e. Do not attempt to disassemble any fuze.

f. Do not remove protection or safety devices from fuzes until just before use.

g. Rounds or components of rounds prepared for firing but not fired will be returned to their original condition and packings, and appropriately marked. Such ammunition will be used first in subsequent firings in order that stocks of opened packings may be kept at a minimum.

h. Do not handle duds. Because their fuzes are armed, and hence extremely dangerous, duds will not be moved or turned, but will be destroyed in place in accordance with TM 9-1900.

i. Blank ammunition with loose or broken closing cap will not be used or fired but will be reported to the ordnance officer for disposition.

**67. AUTHORIZED AMMUNITION.**

a. Rounds authorized for GUN, 75-mm, M1897A4, are listed in Table I below. It will be noted that the nomenclature (standard nomenclature) completely identifies the round as to type, model, and fuze assembled or for which it is adapted. The number in parenthesis following the nomenclature refers to the assemblies listed in Table II.

**TABLE I. AUTHORIZED AMMUNITION****FOR GUN, 75-MM, M1897A4****Service Ammunition**

**PROJECTILE**, fixed, A.P.C., M61, supercharge, w/FUZE, B.D., M66A1, and **TRACER**, 75-mm gun (1)

**PROJECTILE**, fixed, A.P.C., M61, supercharge, w/TRACER, 75-mm gun (2)

**SHELL**, fixed, gas, persistent, HS, Mk. II, normal charge, unfuzed, 75-mm gun (adapted for PDF Mk. III, M35, or M46) (3)

**SHELL**, fixed, gas, persistent, NC, Mk. II, normal charge, unfuzed, 75-mm gun (adapted for FUZE, P.D., Mk. III, M35, or M46) (4)

**SHELL**, fixed, H.E., M48, normal charge, w/FUZE, P.D., M48, 75-mm gun (5)

**AMMUNITION**

**TABLE I. (Cont'd)**

**Service Ammunition**

- SHELL, fixed, H.E., M48, normal charge, w/FUZE, P.D., M48A1, 75-mm gun (6)
- SHELL, fixed, H.E., M48, normal charge, w/FUZE, P.D., M54, 75-mm gun (7)
- SHELL, fixed, H.E., M48, reduced charge, w/FUZE, P.D., M48, 75-mm gun (8)
- SHELL, fixed, H.E., M48, reduced charge, w/FUZE, P.D., M48A1, 75-mm gun (9)
- SHELL, fixed, H.E., M48, reduced charge, w/FUZE, P.D., M54, 75-mm gun (10)
- SHELL, fixed, H.E., M48, supercharge, w/FUZE, P.D., M48, 75-mm gun (11)
- SHELL, fixed, H.E., M48, supercharge, w/FUZE, P.D., M48A1, 75-mm gun (12)
- SHELL, fixed, H.E., M48, supercharge, w/FUZE, P.D., M54, 75-mm gun (13)
- SHELL, fixed, H.E., Mk. I, flashless, reduced charge, unfuzed, 75-mm gun (adapted for FUZE, P.D., M46 or M47)# (14)
- SHELL, fixed, H.E., Mk. I, flashless, unfuzed, 75-mm gun (adapted for PDF Mk. III, Mk. IV-Star, M35, M46, or M47)#† (15)
- SHELL, fixed, H.E., Mk. I, reduced charge, unfuzed, 75-mm gun (adapted for FUZE, P.D., M46, or M47)# (16)
- SHELL, fixed, H.E., Mk. I, unfuzed, 75-mm gun (adapted for PDF Mk. III, Mk. IV-Star, M35, M46; or M47)#† (17)
- SHELL, fixed, smoke, FM, Mk. II, normal charge, unfuzed, 75-mm gun (adapted for PDF Mk. III, M35, or M46) (18)
- SHELL, fixed, smoke, FS, Mk. II, normal charge, unfuzed, 75-mm gun (adapted for PDF Mk. III, M35, or M46) (19)
- SHELL, fixed, smoke, phosphorus, WP, Mk. II, normal charge, unfuzed, 75-mm gun (adapted for PDF Mk. III, M35, or M46) (20)
- SHOT, fixed, A.P., M72, supercharge, w/TRACER, 75-mm gun# (21)
- SHRAPNEL, fixed, Mk. I, 75-mm gun\*‡ (22)
- SHRAPNEL, fixed, Mk. I, flashless, 75-mm gun\*‡ (23)

# Substitute standard.

† Issue for training will be from existing supply.

‡ Fitted with FUZE, combination, 21-sec., M1907M.

\* Issue for training will be in the following ratio: 90 percent, Grade IIR, for impact fire; 10 percent, Grade I, for high burst ranging. Prior to issue, boxes of Grade IIR shrapnel will be marked "FOR IMPACT FIRE ONLY." In addition, if boxes are opened, the ammunition data cards will be marked "FOR IMPACT FIRE ONLY."

## 75-MM GUN M1897A4 MOUNTED IN COMBAT VEHICLES

TABLE I. (Cont'd)

### Practice Ammunition

SHELL, fixed, practice, sand-loaded, Mk. I, w/inert PDF Mk. IV or M47, 75-mm gun (24)  
SHELL, fixed, practice, sand-loaded, M48, normal charge, w/FUZE, inert or dummy, M—, 75-mm gun<sup>1</sup>

### Blank Ammunition

AMMUNITION, blank (single pellet charge), 75-mm guns, M1897-16-17, and 3-in. field guns, M1902-04-05 (25)  
AMMUNITION, blank (double pellet charge), 75-mm guns, M1897-16-17, 75-mm how., M1 and M1A1, and 3-in. field guns, M1902-04-05 (26)

### Drill Ammunition

CARTRIDGE, drill, M7, 75-mm guns, M1897-16-17, and T6\*\*<sup>2</sup> (27)  
CARTRIDGE, drill, M16, 75-mm guns, M1897-16-17, and T6 (28)

### Subcaliber Ammunition

SHELL, fixed, practice, Mk. IIA1, w/FUZE, base, practice, M38, 37-mm gun, M1916

## 68. PREPARATION FOR FIRING.

a. **General.** Fuzed rounds, once removed from the packing, are ready for firing. In the case of unfuzed rounds, it is necessary after removal from packing material, to remove the adapter closing plug from the projectile and assemble the fuze as described in paragraph 70. **NOTE:** If for any reason the ammunition is not fired, reset the fuze "SAFE" or remove fuze and replace the adapter closing plug as the case may be, and restore the round to its original condition and packing.

## 69. AMMUNITION DATA.

a. Information on the ammunition is given in Table II. The assembly number in the table refers to the number in parentheses following each ammunition item listed in paragraph 67.

---

\*\*ADAPTER, drill cartridge, M7 (drg. 72-3-66M) is required for drill with FUZE, P.D., M46 or M47.

<sup>1</sup> Standard when gun is used for subcaliber purposes. FUZE, dummy, M59, or an inert service fuze may be assembled to the shell.

<sup>2</sup> Fitted with FUZE, inert, combination, 21-sec., M1907M.

**AMMUNITION**

**TABLE II**  
**AMMUNITION DATA**

Assembly No.		PROJECTILE					COMPLETE ROUND			FUZE		PROPELLING CHARGE		PERCUSSION PRIMER	
Figure No.	Kind	Type	Model	Weight Filled (lb.)	Filter		Approx. Weight (lb.)	Approx. Length (in.)	Type and Model	Action	Type of Charge and Kind of Powder	Weight (lb.)	Model	Type	
					Kind	Weight (lb.)									
<b>Service Ammunition</b>															
1	44	PROJECTILE	A.P.C.	M61	14.96	EXP. D		19.92	26.28	B.D., M66A1	Delay	Supercharge FNH	2.00	M31A2	150-gr.
2		PROJECTILE	A.P.C.	M61	14.40	*		19.36	26.28	—	—	Supercharge FNH	2.00	M31	150-gr.
3		SHELL	H5 Gas	Mk. II	12.33	H5 Gas		15.91#	26.60	P.D., M46†	SQ	Normal FNH	1.35	M22A2	65-gr.
4		SHELL	NC Gas	Mk. II		NC Gas			26.60	P.D., M46†	SQ	Normal			
5	46	SHELL	H. E.	M48	14.60	TNT		18.70	26.6	P.D., M48	SQ or Delay	Normal FNH	1.15	M22A1	75-gr.
6		SHELL	H. E.	M48	14.60	TNT		18.70	26.6	P.D., M48A1	SQ or Delay	Normal FNH	1.15	M22A1	75-gr.
7		SHELL	H. E.	M48	14.60	TNT		18.71	26.63	P.D., M54	Time and SQ	Normal FNH	1.15	M22A1	75-gr.
8	46	SHELL	H. E.	M48	14.60	TNT		18.14	26.6	P.D., M48	SQ or Delay	Reduced FNH	0.59	M22A1	75-gr.
9		SHELL	H. E.	M48	14.60	TNT		18.14	26.6	P.D., M48A1	SQ or Delay	Reduced FNH	0.59	M22A1	75-gr.
10		SHELL	H. E.	M48	14.60	TNT		18.15	26.63	P.D., M54	Time and SQ	Reduced FNH	0.59	M22A1	75-gr.
11	46	SHELL	H. E.	M48	14.60	TNT		19.56	26.6	P.D., M48	SQ or Delay	Supercharge FNH	2.00	M31	150-gr.
12		SHELL	H. E.	M48	14.60	TNT		19.56	26.6	P.D., M48A1	SQ or Delay	Supercharge FNH	2.00	M31	150-gr.
13		SHELL	H. E.	M48	14.60	TNT		19.57	26.63	P.D., M54	Time and SQ	Supercharge FNH	2.00	M31	150-gr.
14		SHELL	H. E.	Mk. I	12.41	TNT		15.25#	26.35	P.D., M46 or P.D., M47	SQ	Reduced FNH	0.56	M22A2	65-gr.
15		SHELL	H. E.	Mk. I	12.41	TNT		16.04#	26.35	P.D., M46‡ or P.D., M47‡	SQ	FNH	1.35	M22A2	65-gr.
16		SHELL	H. E.	Mk. I	12.41	TNT		15.25#	26.35	P.D., M46 or P.D., M47	SQ	Reduced NH	0.56	M22A2	65-gr.
17		SHELL	H. E.	Mk. I	12.41	TNT		16.04#	26.35	P.D., M46‡ or P.D., M47‡	SQ	NH	1.35	M22A2	65-gr.
18		SHELL	FM Smoke	Mk. II		FM Smoke			26.60	P.D., M46†	SQ	Normal FNH	1.35	M22A1	75-gr.

P.D.—Point-detonating.

SQ—Superquick.

B.D.—Base-detonating.

\* Contains no filler but is fitted with tracer.

# Unfuzed, fitted with adapter closing plug.

† Either FUZE, P.D., Mk. III or M35 may also be used.

‡ Either FUZE P.D., Mk. III, Mk. IV-Star, or M35 may also be used.

75-MM GUN M1897A4 MOUNTED IN COMBAT VEHICLES

TABLE II (Cont'd)  
AMMUNITION DATA

Figure No.	PROJECTILE				COMPLETE ROUND			FUZE		PROPELLING CHARGE		PERCUSSION PRIMER			
	Kind	Type	Model	Weight as Fired (lb)	Weight (lb)	Kind	Filler	Approx. Weight (lb)	Approx. Length (in.)	Type and Model	Action	Type of Charge Kind of Powder	Weight (lb)	Model	Type
<b>Service Ammunition (Cont'd)</b>															
19	SHELL	FS Smoke	Mk. II	12.90	1.90	FS Smoke		16.48	26.60	P.D., M46†	SQ	Normal FNH	1.35	M22A2	65-gr.
20	SHELL	WP Smoke	Mk. II	12.82	1.81	WP Smoke		16.40	26.60	P.D., M46†	SQ	Normal FNH	1.35	M22A1	75-gr.
21	SHOT	A. P.	M72	13.94	*			18.80	20.81	—	—	Supercharge FNH	1.90	M31A2	150-gr.
22	SHRAPNEL	—	Mk. I	15.98	—	—	—	20.45	23.45	Comb., 21-sec., M1907M	Time or Perc.	NC	1.60	Mk. I	49-gr.
23	SHRAPNEL	—	Mk. I	15.98	—	—	—	20.45	23.45	Comb., 21-sec., M1907M	Time or Perc.	FNH	1.72	M1B1	100-gr.
<b>Practice Ammunition</b>															
24	SHELL	Practice	Mk. I	11.95	##	Sand		16.15	23.77	Inert P. D., M47†	—	FNH	1.35	M22A1	75-gr.
<b>Blank Ammunition</b>															
25	—	Blank	—	—	—	—	—	2.68	7.25	—	—	Single Pellet Blk. Pdr.	0.43	M1B1A1	100-gr.
26	—	Blank	—	—	—	—	—	3.11	7.25	—	—	Double Pellet Blk. Pdr.	0.86	M1B1A1	100-gr.
<b>Drill Ammunition</b>															
27	CARTRIDGE	Drill	M7	**	—	—	—	20.38	23.42	Comb., 21-sec., M1907M	Inert	—	—	—	—
28	CARTRIDGE	Drill	M	**	—	—	—	23.35	23.35	Comb., 21-sec., M1907M	Inert	—	—	—	—

P.D., Point-detonating.  
 \* Contains no filler but is fitted with tracer.  
 † Either FUZE, P.D., Mk. III or M35 may also be used.  
 ‡ Either FUZE, P.D., Mk. III, Mk. IV-Star, or M35 may also be used.  
 § Or FUZE, inert, P.D., Mk. IV may be used.  
 ## Add amount necessary to bring weight of projectile to 11.85 pounds.  
 #\*\* Equals weight of complete round, the projectile and cartridge case being one unit.

Perc.—Percussion. SQ—Superquick. Blk. Pdr.—Black Powder. gr.—grain

# AMMUNITION

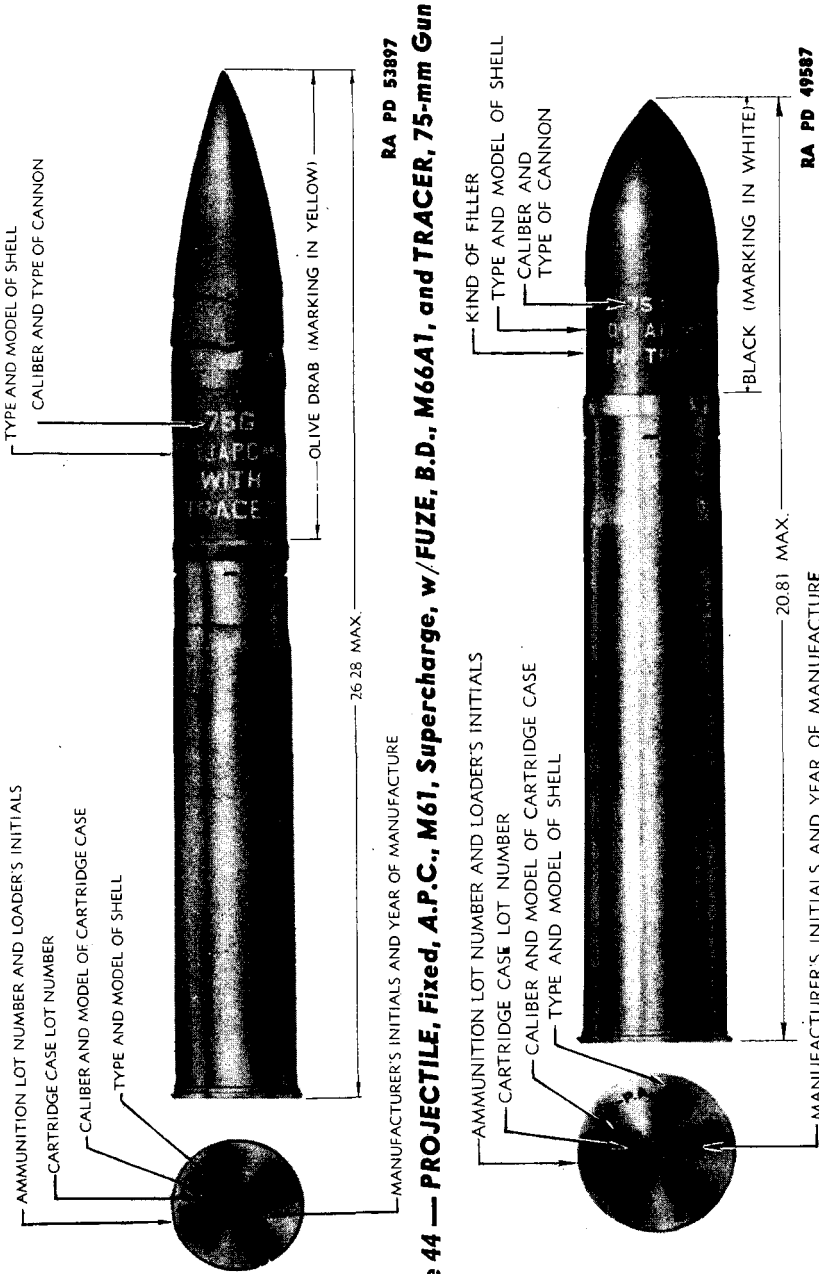

**Figure 45 — SHOT, Fixed, A.P., M72, Supercharge, w/TRACER, 75-mm Gun**

75-MM GUN M1897A4 MOUNTED IN COMBAT VEHICLES

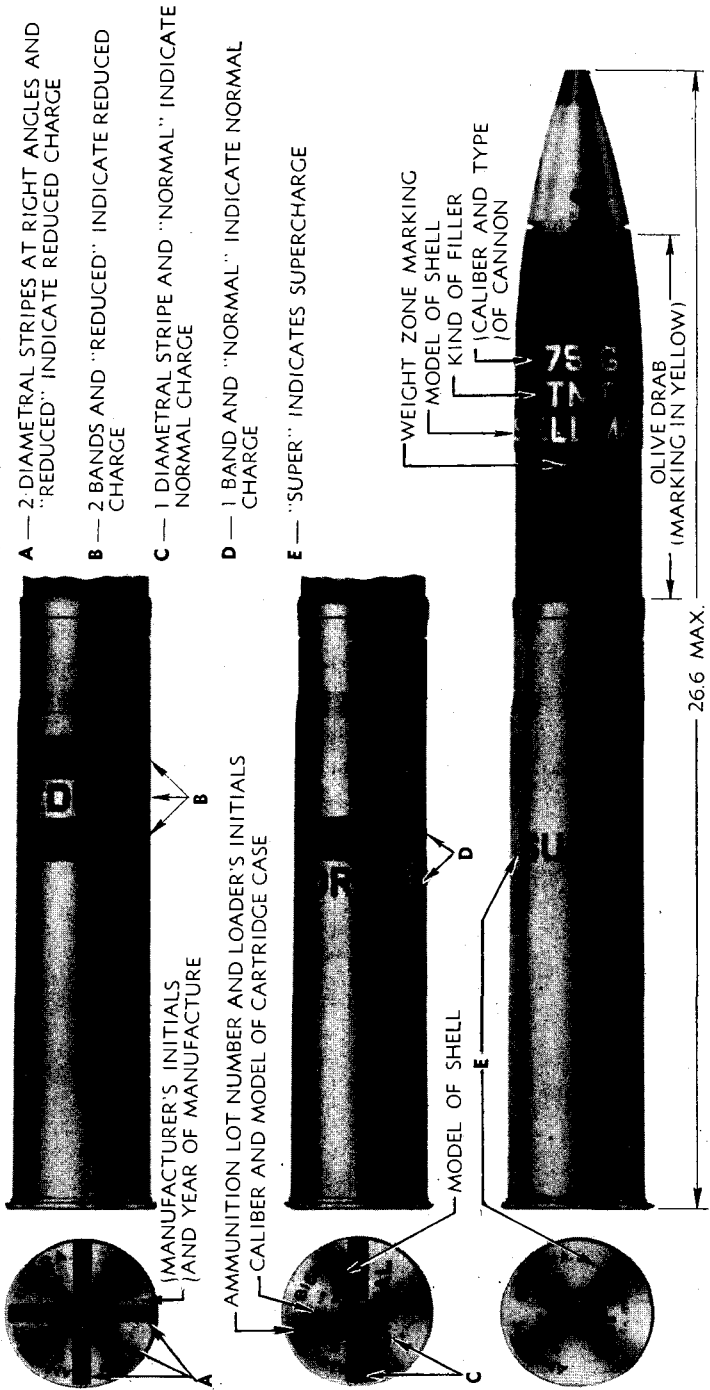

RA PD 495898

Figure 46 — Marking of Complete Round Indicating Reduced, Normal and Supercharge

AMMUNITION

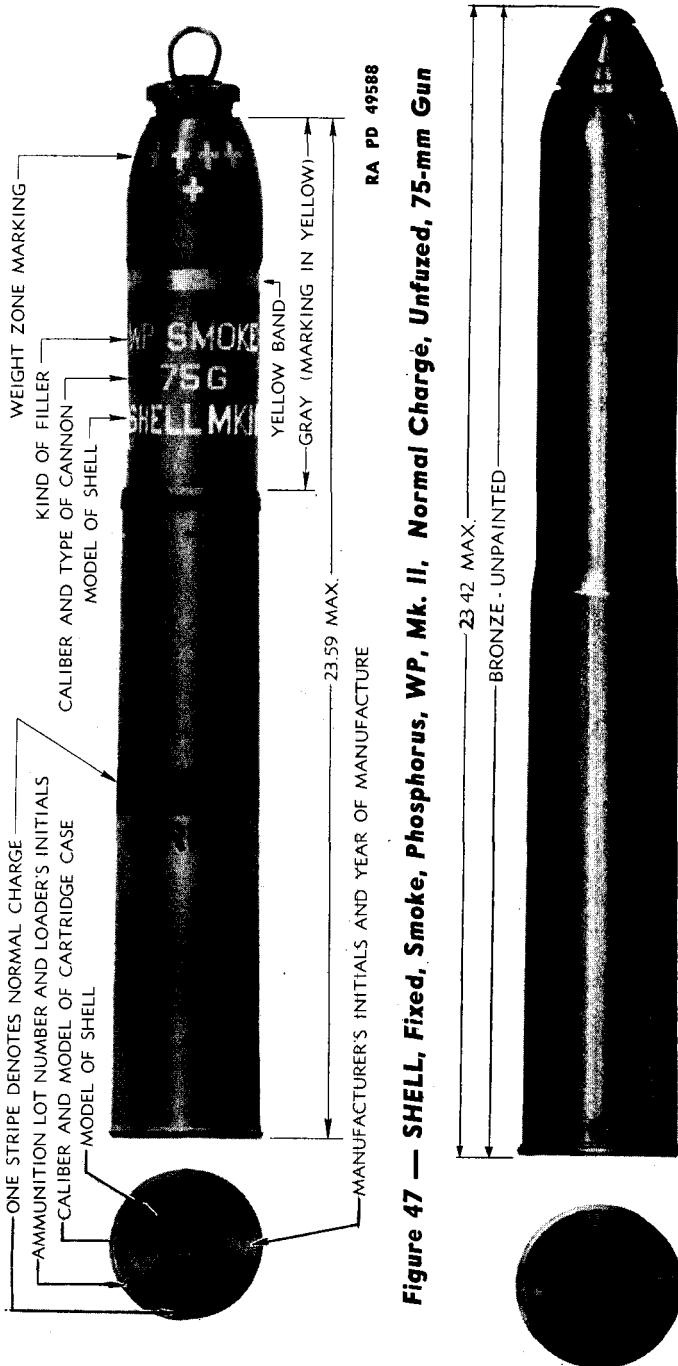

**Figure 47 — SHELL, Fixed, Smoke, Phosphorus, WP, Mk. II, Normal Charge, Unfuzed, 75-mm Gun**

**Figure 48 — CARTRIDGE, Drill, M7, 75-mm Guns, M1897-16-17 and T6**



**75-MM GUN M1897A4 MOUNTED IN COMBAT VEHICLES**

**70. FUZES.**

**a. General.** A fuze is a mechanical device used with a projectile to explode it at the time and under the circumstances desired.

**b. Classification.** Fuzes may be classified according to the manner of functioning as "time" or "impact." Time fuzes contain a timing element in the form of a compressed black powder train or a mechanism similar to clockwork which is set by means of a graduated time ring to explode the shell a certain number of seconds after firing. Impact fuzes function upon striking a resistant object. Impact fuzes may be classified, according to their time of functioning after impact, as superquick or delay. According to their location on the projectile, fuzes are known as point-detonating (P.D.) or base-detonating (B.D.).

**c. Boresafe Fuzes.** Certain fuzes are considered "boresafe." A boresafe (detonator-safe) fuze is one in which the explosive train is so interrupted that, prior to firing and while the projectile is still in the bore of the cannon, premature functioning of the bursting charge is prevented should any of the more sensitive elements, primer and/or detonator, malfunction. The fuzes, used with the ammunition described herein, are considered boresafe or nonboresafe as follows:

<b>Boresafe</b>	<b>Nonboresafe</b>
FUZE, P. D., M48	FUZE, P. D., Mk. III, superquick without interrupter
FUZE, P. D., M48A1	FUZE, P. D., Mk. III, superquick with interrupter
FUZE, P. D., M54	FUZE, P. D., Mk. IIIA, superquick without interrupter
	FUZE P. D., Mk. IIIA, superquick with interrupter
	FUZE, P. D., Mk. IV-Star, short delay
	FUZE, P. D., M35
	FUZE, P. D., M46
	FUZE, P. D., M47
	FUZE, combination, 21-sec., M1907M
	FUZE, B. D., M66A1

**CAUTION:** Fuzes will not be disassembled. Any attempt to disassemble fuzes in the field is dangerous and is prohibited except under specific directions from the Chief of Ordnance.

**d. FUZE, P. D., M48A1.**

(1) **DESCRIPTION.** This fuze contains two actions, superquick and delay. Although both actions are initiated on impact, the functioning of the shell depends upon the setting of the fuze. However, it should be noted that if the fuze is set for superquick action, and this action fails, the projectile will function with delay action rather than become

## AMMUNITION

a dud. On the side of the fuze, near the base, is a slotted "setting sleeve" and two registration lines; the line parallel to the axis of the fuze is marked "SQ" (superquick), the other at right angles thereto is marked "DELAY." As shipped, the fuze is set "SQ." To set the fuze for delay action, it is necessary to turn the setting sleeve so that the slot is alined with "DELAY." (A delay pellet, 0.15-second, incorporated in the delay action train, provides for the delay action.) The setting may be made or changed at will with a screwdriver or similar instrument at any time before firing. This can be done even in the dark by noting the position of the slot, parallel to the fuze axis for "SQ," and at right angles thereto for "DELAY."

(2) **PREPARATION FOR FIRING.** Prior to firing, it is only necessary to set the fuze as described above, and this only when delay action is required since the fuze is set superquick as shipped.

e. **FUZE, P. D., M48.** This fuze differs from FUZE, P. D., M48A1, primarily in that a delay pellet giving 0.05-second delay is incorporated in the delay action. Otherwise the description given above applies equally to this fuze.

f. **FUZE, P. D., M54.**

(1) **DESCRIPTION.** This fuze is a combination time and superquick type. A safety pull wire extends through the fuze to secure the time plunger during shipment. The fuze contains two actions, time and superquick. The superquick action is always operative and will function on impact unless prior functioning has been caused by time action. Therefore, to set the fuze for superquick action, it is required that the time action be set either at safe (S) or for a time longer than the expected time of flight. The time train ring, graduated for 25 seconds, is similar to that of the powder time train fuzes. To prevent extremely short time action, an internal safety feature prevents the time action from functioning should the fuze be set for less than 0.4 second. Therefore, when setting for time action, the setting should always be greater than this minimum of 0.4 second. The fuze as shipped is set safe (S); prior to firing, the fuze is set for the required time by means of a fuze setter.

(2) **PREPARATION FOR FIRING.** Prior to firing, with either superquick or time setting, the safety pull wire must be withdrawn from the fuze (pull lower end of the wire from the hole and slide wire off the end of the fuze). If superquick action is required, the graduated time train ring can be left as shipped set at safe (S), or for a time greater than the expected time of flight. If time action is required, the graduated time train ring is set for the required time of burning by means of a fuze setter. **NOTE:** If, after setting the fuze preparatory to firing, the round is not fired, the fuze will be reset safe (S) and the safety pull wire replaced in its proper position before the round is returned to its packing container.

**75-MM GUN M1897A4 MOUNTED IN COMBAT VEHICLES****g. FUZE, Combination, 21-sec., M1907M.**

(1) **DESCRIPTION.** This fuze is a combination percussion type used with shrapnel. The fuze contains two actions, percussion and time. The percussion action is always operative and will function on impact unless prior functioning has been caused by the time action. When percussion action is required, it is only necessary to set the graduated time ring at safe (S) or for a time longer than the expected time of flight. The time train ring is similar to that of other powder time train fuzes and is graduated for 21.2 seconds. The fuze is set for time by means of a fuze setter. In the particular case of zero setting, canister effect is obtained, that is, the fuze functions just beyond the muzzle of the cannon with the result that the shrapnel balls are projected from the shrapnel case somewhat similar to shot expelled from a shotgun. Because the powder time train is adversely affected by moisture, every effort will be made to keep the fuze dry.

(2) **PREPARATION FOR FIRING.** The waterproof cover must first be removed. If percussion action is required, the graduated time ring is set safe (S) or for a time greater than the expected time of flight. If time action is required, set the time train ring by means of a fuze setter as described above. **NOTE:** As shipped, the fuze is set safe.

**h. FUZE, P. D., M46.**

(1) **DESCRIPTION.** This fuze, a superquick type, is a modification of the Mk. III type (subpar. k, below). The firing mechanism has been modified to eliminate the spiral and split rings. A lighter firing pin is supported on a brass cup which is sufficiently strong to resist the setback produced by the acceleration in the gun, but which is crushed when the firing pin is driven into the primer on impact. This fuze is suitable for use with either normal or reduced charge rounds.

(2) **PREPARATION FOR FIRING.** To fuze the round, proceed as follows:

(a) Remove adapter closing plug from projectile.

(b) Inspect fuze cavity and threads. They should be free of foreign matter which would interfere with the proper assembly of the fuze.

(c) Screw fuze into adapter by hand. (It is essential that the felt washer provided with the fuze be under the detonator socket flange when fuze is screwed into the adapter.) Tighten with fuze wrench. The complete round is then ready for firing.

**i. FUZE, P. D., M47.**

(1) **DESCRIPTION.** This fuze, a delay type, is ballistically identical to FUZE, P. D., M46. It can be distinguished from the latter fuze,

## AMMUNITION

however, by the marking and blackened head, the FUZE, P. D., M46, having a white head. To provide for delay action, a delay pellet, about 0.05 second, is incorporated in the explosive train between the upper and lower detonator.

(2) **PREPARATION FOR FIRING.** To fuze the round, proceed as described in subparagraph h, above.

**j. FUZE, P. D., Mk. III, Superquick, without Interrupter.** Except for the fact that this fuze has no interrupter, it is the same as the Mk. III, superquick, with interrupter. With this exception, the description and preparation for firing in subparagraph k, below, applies.

### **k. FUZE, P. D., Mk. III, Superquick, with Interrupter.**

(1) **DESCRIPTION.** This fuze is of the direct action type intended to detonate with the least possible penetration of the target. It should not be used in ammunition with a reduced charge since its use at this lower velocity causes the projectile to become unstable in flight.

(2) **PREPARATION FOR FIRING.** To assemble the fuze to the round, proceed as follows:

(a) Remove adapter closing plug from the projectile.

(b) Inspect fuze cavity and threads. They should be free of any foreign matter which would interfere with the proper assembly of the fuze.

(c) Use only those fuzes on which the original waterproof seal of the lead foil cap is unbroken. Screw fuzes into the adapter by hand. (It is essential that the felt washer provided with the fuze be under the detonator socket flange when fuze is assembled to the adapter.) Tighten with fuze wrench.

(d) Before loading the round into the gun, remove waterproof cap by pulling on the exposed loose end of tape. Examine spiral (brass ribbon) and safety pin to see that they are in good condition. When either is damaged or missing, the fuze will be removed and replaced by a serviceable fuze. The complete round is then ready for firing. (The unserviceable fuze will be disposed of.)

**l. FUZE, P. D., Mk. IIIA, Superquick, without Interrupter.** This fuze may be distinguished from the Mk. III, superquick, without interrupter, by the "A" in the model designation stamped on the body of the fuze. Otherwise, the only difference between these two fuzes is the arrangement of the upper detonator.

**m. FUZE, P. D., Mk. IIIA, Superquick, with Interrupter.** This fuze may be distinguished from the Mk. III, superquick, with interrupter, by the "A" in the model designation stamped on the body of the fuze. Otherwise, the only difference between these two fuzes is the arrangement of the upper detonator.

**75-MM GUN M1897A4 MOUNTED IN COMBAT VEHICLES**

**n. FUZE, P. D., Mk. IV-Star, Short Delay.** This fuze will be replaced by FUZE, P. D., M47 (subpar. i, above). Pending replacement, the Mk. IV, short delay will be used as provided for in existing instructions.

**o. FUZE, P. D., M35.**

(1) **DESCRIPTION.** This fuze is a modified Mk. III, superquick type. It differs from the Mk. III in that it is somewhat shorter and a sleeve has been added to hold the spiral (brass ribbon) in position. The sleeve is held in place by a pin which is sheared by setback in firing, thereby freeing the spiral. For safety in transportation, a spring clip, designated "sleeve support," is used. This fuze, like the Mk. III, is unsuitable for use in reduced charge rounds since its use at this lower velocity causes the projectile to become unstable in flight.

(2) **PREPARATION FOR FIRING.** To assemble the fuze to the round, proceed as follows:

(a) Remove adapter closing plug from the projectile.

(b) Inspect fuze cavity and threads. They should be free of foreign matter which would interfere with the proper assembly of the fuze.

(c) Screw fuze into adapter by hand. (It is essential that the felt washer provided with the fuze be under the detonator socket flange when fuze is assembled to the adapter.) Tighten with fuze wrench.

(d) By means of a pull on the ring, remove sleeve support. The complete round is then ready for firing.

**p. FUZE, B. D., M66A1.** Because this fuze is assembled in the base of the projectile (PROJECTILE, A.P.C., M61) it is known as a base-detonating (B.D.) fuze. It functions upon impact with non-delay action. A tracer composition is incorporated in the fuze body and functions independently of the fuze mechanism. Because of its location the fuze is not visible.

**71. PACKING.**

**a. Data.** Standard packing for the service rounds consists of an individual fiber container packed three in a bundle. Bundles are crated for overseas shipments. Certain rounds also are packed in individual containers, four in a box approximately  $30\frac{3}{4} \times 9\frac{11}{16} \times 9\frac{11}{16}$  inches. Dimensions of crated bundles are approximately  $32\frac{3}{8} \times 10\frac{5}{8} \times 1\frac{7}{32}$  inches. The weight varies, depending on the type and model of ammunition contained, from about 80 to 85 pounds. Complete packing data is published in SNL R-1, SNL R-3, SNL R-5, and SNL R-6.

**b. Marking for Shipment.**

(1) Packings for shipment are marked as follows:

(a) Name and address of consignee (or code marking).

**AMMUNITION**

- (b) List and description of contents.
  - (c) Ammunition Identification Code (A. I. C.) as published in SNL's and OFSB 3-14.
  - (d) Gross weight in pounds, displacement in cubic feet.
  - (e) The number of the package.
  - (f) The letters "U.S." in several conspicuous places.
  - (g) Order number, contract number, or shipping number.
  - (h) Ordnance insignium and escutcheon.
  - (i) Name or designation of consignor preceded by the word "From."
  - (j) Lot number.
  - (k) Month and year packed.
  - (l) Inspector's stamp.
- (2) In addition, the adhesive sealing strips on fiber containers are in the same color as the projectile, in accordance with the basic color scheme, except that a yellow strip, with marking in black (the earlier color scheme) indicates a high-explosive projectile.

**72. SUBCALIBER AMMUNITION.**

**a. General.** The SHELL, fixed, practice, Mk. IIA1, w/FUZE, base, practice, M38, 37-mm gun, M1916, is standard for use in the GUN, 37-mm, M1916, when used in subcaliber mount with the GUN, 75-mm, M1897A4. The ammunition is issued in the form of fixed complete rounds. The projectile is fitted with a base fuze and contains a low-explosive filler of black powder and graphite which serves as a spotting charge. The complete round may be identified by the marking thereon.

**b. Packing.** Three packings are provided:

	Weight (lb)	Volume (cu ft)
60 rounds per box, w/o metal liner, for domestic shipments .....	115	1.60
<i>Over-all dimensions of box (in.)</i>		
$21\frac{1}{2} \times 12\frac{11}{16} \times 10\frac{5}{32}$		
60 rounds per metal-lined box, for overseas shipments .....	129	1.99
<i>Over-all dimensions of box (in.)</i>		
$23\frac{5}{16} \times 13\frac{5}{16} \times 11\frac{1}{16}$		
In individual fiber containers, 40 containers (40 rounds) per box .....	90.2	1.36
<i>Over-all dimensions of box (in.)</i>		
$18\frac{1}{8} \times 11\frac{7}{8} \times 10\frac{20}{32}$		

**75-MM GUN M1897A4 MOUNTED IN COMBAT VEHICLES**

**73. FIELD REPORT OF ACCIDENTS.**

a. When an accident involving the use of ammunition occurs during training practice, the procedure prescribed in section VII, AR 750-10, will be observed by the ordnance officer under whose supervision the ammunition is maintained or issued. Where practicable, reports covering malfunctions of ammunition in combat will be made to the Chief of Ordnance, giving the type of malfunction, type of ammunition, the lot number of the complete rounds or separate-loading components, and condition under which fired.

Chapter 5

**SUBCALIBER EQUIPMENT**

	Paragraph
General .....	74
Breechblock and breech mechanism.....	75
Recoil mechanism .....	76
Subcaliber mount M7 .....	77
Mounting the subcaliber equipment.....	78
Bore sighting .....	79
Dismounting the subcaliber equipment.....	80

**74. GENERAL.**

a. Subcaliber equipment is used for training purposes only. It is not taken into the theater of operations. It provides practice in laying and firing the 75-mm gun. Its use saves wear and tear on the larger piece during practice, and a saving is also effected in ammunition. The actual handling, loading, and range obtained are different, but the results are adequate for instructional purposes.

b. Subcaliber equipment consists of 37-mm Subcaliber Gun M1916, Subcaliber Mount M7, and accessories. This section is concerned only with the description and identification of the equipment, the method to be followed in mounting it on the 75-mm Gun M1897A4 and the 75-mm Gun Mounts M3 and M5, and with bore sighting.

c. Operation of the various parts, disassembly and assembly, inspection, malfunctions, precautions, lubrication, and other detailed information are fully covered in the section on subcaliber equipment in TM 9-305.

**75. BREECHBLOCK AND BREECH MECHANISM.**

a. Breechblock is the Nordenfelt type and somewhat similar, except for size, to that in the 75-mm gun. It screws into the breech ring and rotates through an angle of 156 degrees. The axis of the breech recess is below the axis of the bore.

b. The breechblock is operated by the breechblock lever which, when moved to the left, causes the breechblock to rotate to the open position. This carries the eccentric loading hole in the breechblock to a position in line with the bore. It also operates the extractor which extracts and ejects the cartridge case. The breechblock closes to the right, which places the firing pin in line with the cartridge percussion cap, and releases the safety bolt.

c. The safety bolt prevents firing if breechblock is not fully closed.



## 75-MM GUN M1897A4 MOUNTED IN COMBAT VEHICLES

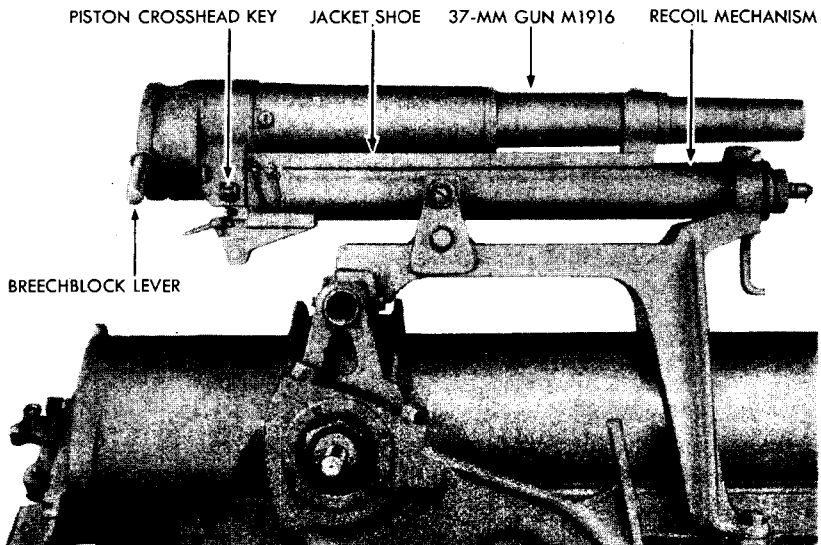

RA PD 43768

**Figure 49 — Subcaliber Equipment Installed**

d. The firing mechanism consists of firing pin, firing pin spring, rocker, rocker pin, rocker pin latch, and rocker plunger. All are housed in the breechblock. When the trigger crank lever is pressed down, the firing pin strikes the percussion cap and fires the gun.

### 76. RECOIL MECHANISM (fig. 51).

a. The recoil mechanism is held in a cradle on which the gun slides during recoil and counterrecoil. It consists of recoil and counterrecoil mechanism and counterrecoil buffer.

b. The recoil mechanism checks the backward movement of gun in a gradual manner. The counterrecoil mechanism returns gun to battery for further firing. The counterrecoil buffer slows down and stops the returning action without damage to system or gun.

c. The filling plug is at the front; the drain plug, at the upper right rear.

### 77. SUBCALIBER MOUNT M7 (fig. 50).

a. This consists mainly of a three-legged bracket which gives rigid support to the 37-mm subcaliber gun and recoil mechanism.

**SUBCALIBER EQUIPMENT**

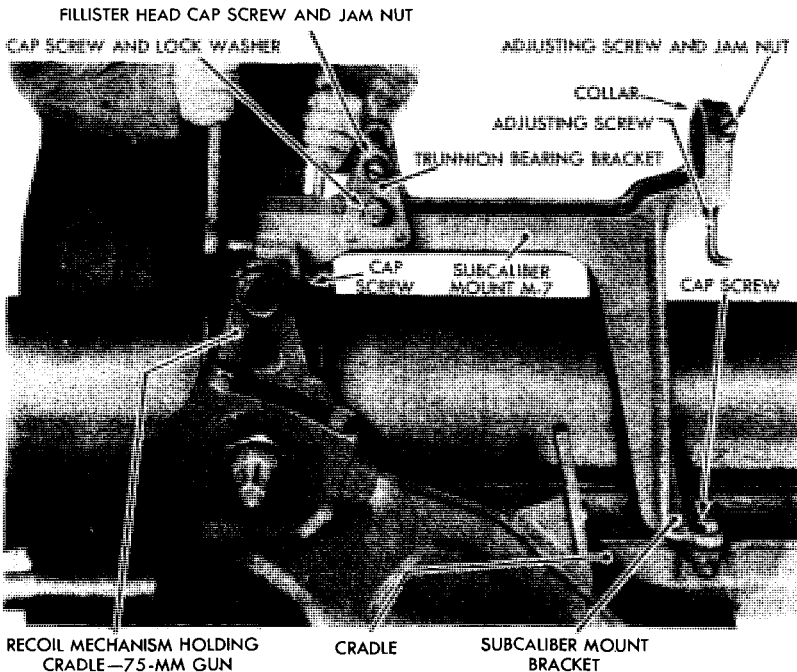

RA PD 43782

**Figure 50 — Installing Subcaliber Mount M7**

b. The front legs straddle the "75" and are fastened to the "75" cradle. The rear leg is attached to the recoil mechanism holding cradle of the 75-mm gun directly above cradle trunnion.

c. The triangular trunnion bearing bracket is provided with fillister-head cap screws and jam nuts, first, to keep the gun cradle in position and second, to permit adjustment for deflection.

d. The two fillister-head cap screws, with jam nuts, in the collar are provided for adjustment of the 37-mm gun elevation primarily, but the two top screws can also effect deflection.

**78. MOUNTING THE SUBCALIBER EQUIPMENT.**

**a. Equipment.**

- SCREWDRIVER, heavy-duty
- WRENCH, open-end, 1/2-in.
- WRENCH, open-end, 5/8-in.

- WRENCH, socket, 1/2-in., with ratchet handle
- WRENCH, socket, 5/8-in., with ratchet handle

**b. Procedure.**

(1) Install Subcaliber Mount M7 (fig. 50). Place mount in position, insert the four cap screws, and turn up the nuts by hand

**75-MM GUN M1897A4 MOUNTED IN COMBAT VEHICLES**

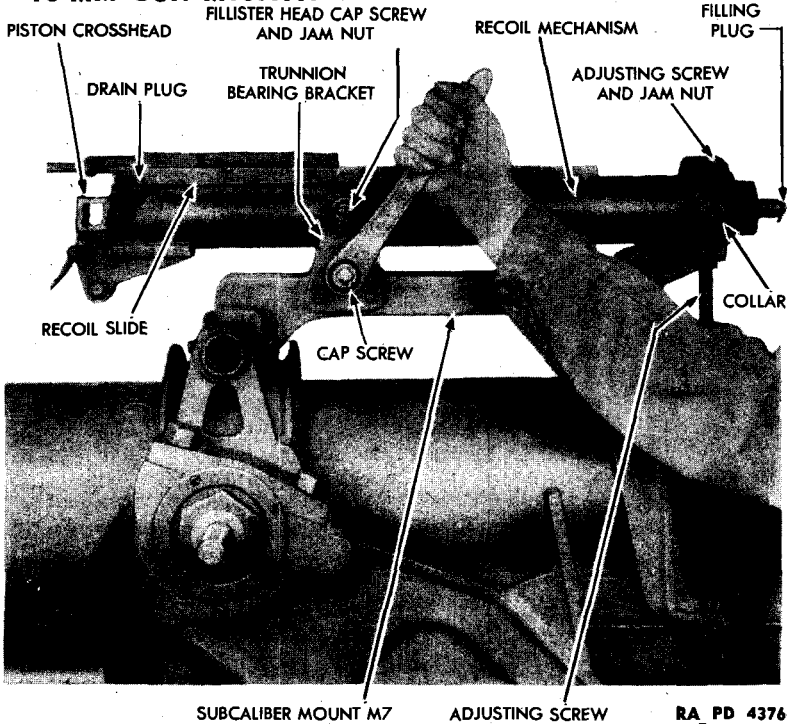

**Figure 51 — Installing Recoil Mechanism on Subcaliber Mount M7**

as far as they will go. Turn up front cap screws with a  $\frac{5}{8}$ -inch socket wrench with ratchet handle, holding the nuts with a  $\frac{5}{8}$ -inch open-end wrench. Use a  $\frac{1}{2}$ -inch socket wrench with the ratchet handle and a  $\frac{1}{2}$ -inch open-end wrench to tighten the two cap screws in the rear support.

**(2) INSTALL RECOIL MECHANISM (fig. 51).**

**WRENCH**, socket,  $\frac{1}{2}$ -in., with ratchet handle

(a) First remove trunnion bearing bracket cap screw with  $\frac{1}{2}$ -inch socket wrench and remove bracket.

(b) Relieve tension on jam nuts of adjusting screws in the collar at front of mount.

(c) Insert front end of recoil mechanism through the collar on mount. Place trunnion of recoil mechanism in trunnion bearing of left support bracket. Then assemble right trunnion bearing bracket over the recoil mechanism trunnion, and using a  $\frac{1}{2}$ -inch socket wrench with ratchet handle, tighten up the cap screw.

(d) Tighten the fillister-head cap screws in the trunnion bearing and the adjusting screws in the collar just enough to hold mechanism in place.

## SUBCALIBER EQUIPMENT

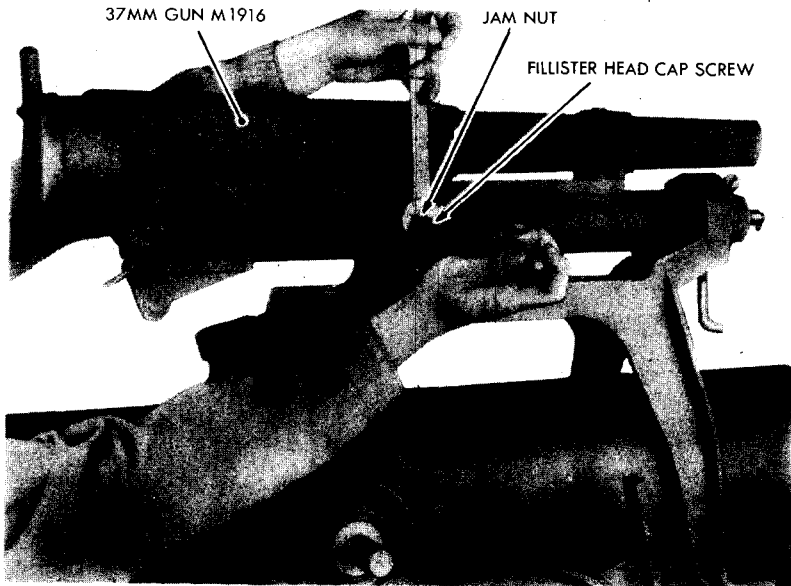

RA PD 43739

**Figure 52 — Adjusting Subcaliber Gun for Deflection**

**(3) INSTALL 37-MM GUN.**

(a) From the rear, align the jacket shoe guides with recoil slides and push gun into battery, carefully maintaining alinement.

(b) Insert piston cross head key from left to right, locking gun in place (figs. 49 and 51).

### **79. BORE SIGHTING.**

**a. Equipment.**

**SCREWDRIVER**

**WRENCH, open-end, 1/2-in.**

**b. Procedure.**

(1) As 75-mm gun has already been alined with Telescope M33, it is only necessary here to aline the bore of the 37-mm gun with that of the 75-mm gun.

(2) Make a testing target by wrapping two pieces of black tape of equal width around an aiming post. The lower edges should be exactly 14.375 inches apart for the Mount M7.

(3) By using the aiming post as a testing target it will not be necessary to level the 75-mm gun. The aiming post can be canted to conform with angle of gun, so that the vertical line of the bore of the 75-mm gun will coincide with the side of aiming post. This testing target should be placed about 50 feet from gun.

## 75-MM GUN M1897A4 MOUNTED IN COMBAT VEHICLES

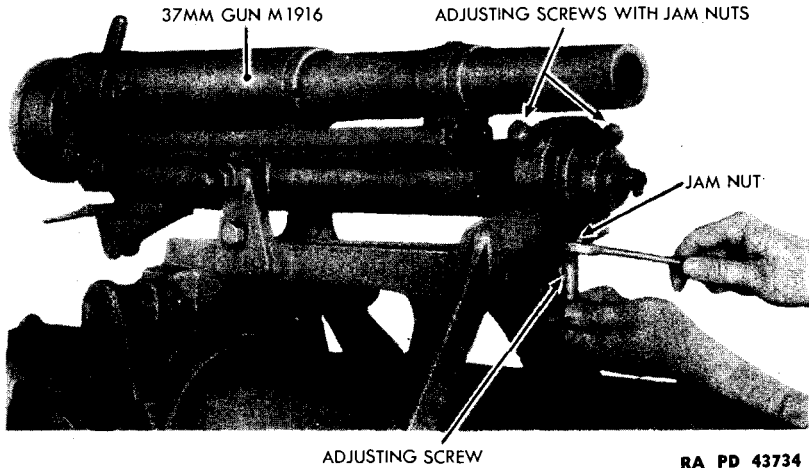

**Figure 53 — Adjusting Subcaliber Gun for Elevation**

(4) Use bore sights to line up bore of the "75" with lower edge of the lower tape on testing target.

(5) Using the proper bore sights, sight the "37" on the lower edge of upper tape on testing target.

(6) To adjust 37-mm gun for deflection (fig. 52), use a 1/2-inch open-end wrench to release jam nuts at top of trunnion bearing brackets on either side of gun. Then with a heavy-duty screwdriver, adjust the fillister-head cap screws to move gun to right or left as necessary. **CAUTION:** Do not set jam nuts up tight until corrections have also been made for elevation.

(7) To adjust for elevation (fig. 53), turn the three adjusting screws in the collar as necessary, noting that the two upper screws also effect deflection.

(8) When deflection and elevation are correct, set jam nuts up tight.

### 80. DISMOUNTING THE SUBCALIBER EQUIPMENT.

**NOTE:** Before leaving range, dismount the 37-mm gun, recoil mechanism, and mount. If desirable, the gun may be removed with the recoil mechanism. The dismounting is quickly done.

#### a. Equipment.

**SCREWDRIVER**, heavy-duty

**WRENCH**, open-end, 1/2-in.

**WRENCH**, open-end, 5/8-in.

**WRENCH**, socket, 1/2-in.,  
with ratchet handle

**WRENCH**, socket, 5/8-in.,  
with ratchet handle

## SUBCALIBER EQUIPMENT

### b. Procedure.

#### (1) REMOVE THE 37-MM GUN.

(a) Release the striker at the left and take out piston ironhead key by pressing upon the latch and pushing key out from right and left (fig. 49).

(b) Draw gun back from cradle by grasping muzzle with left hand and breech with the right hand.

#### (2) REMOVE RECOIL MECHANISM.

SCREWDRIVER, heavy-duty                      WRENCH, socket, 1/2-in.,  
WRENCH, open-end, 1/2-in.                      with ratchet handle

(a) Loosen the jam nuts and fillister-head screws in the collar and trunnion bearing brackets (1/2-in. open-end wrench and heavy-duty screwdriver) (fig. 51).

(b) Remove the trunnion bearing bracket on the right-hand side (1/2-in. socket wrench with ratchet handle).

(c) Lift recoil mechanism from mount and slide to rear until recoil cylinder is free from collar.

#### (3) REMOVE THE MOUNT.

WRENCH, open-end, 1/2-in.                      WRENCH, socket, 1/2-in.,  
WRENCH, open-end, 5/8-in.                      with ratchet handle  
WRENCH, socket, 5/8-in.,  
with ratchet handle

(a) Disassemble the four nuts and cap screws which fasten the mount to the 75-mm gun cradle (fig. 50).

(b) When equipment is dismounted, assemble trunnion bearing bracket and all cap screws, lock washers, and nuts on the equipment to keep items from being lost.

## 75-MM GUN M1897A4 MOUNTED IN COMBAT VEHICLES

### Chapter 6

## ORGANIZATIONAL SPARE PARTS AND ACCESSORIES

	Paragraph
Organizational spare parts .....	81
Accessories .....	82

### 81. ORGANIZATIONAL SPARE PARTS.

a. A set of spare parts is supplied with the 75-mm gun and mounts for those parts most likely to become broken, worn, or otherwise unserviceable. The set should be kept complete at all times by requisitioning new parts for those used. For listing of organizational spare parts for the 75-mm Gun M1897A4 and the Gun Mount M3, see SNL C-48, Organizational Spare Parts and Equipment; for the 75-mm Gun M1897A4 and the Gun Mount M5, see SNL C-49, Organizational Spare Parts and Equipment.

b. Care of spare parts is covered in chapter 2, section VI.

### 82. ACCESSORIES.

a. Accessories include the tools and equipment required for the disassembling and assembling that the using arms is authorized to perform, and for cleaning and preserving the 75-mm gun and mounts. Accessories should not be used for purposes other than those prescribed and when not in use should be properly stored.

b. There are a number of accessories, the names or general characteristics of which indicate their use. Others embodying special features or having special uses are described as follows.

(1) ARTILLERY GUN BOOK. The Artillery Gun Book (O.O. Form 5825) is used for the purpose of keeping an accurate record of the materiel. It must always remain with the materiel regardless of where it may be sent. The book is divided as follows: record of assignment, battery commander's daily gun record, inspector's record of examination, as well as forms to be filled out in case of premature explosions. This book should be in the possession of the organization at all times, and its completeness of records and its whereabouts are the responsibility of the battery commander. It must also contain date of issuance of the materiel, by whom used, and the place where issued. If a new gun is installed on the mount, all data with reference to sights, mounts, etc., must be copied into the new book before the old book is relinquished.

NOTE: Record of assignment data must be removed and destroyed prior to entering combat.

**ORGANIZATIONAL SPARE PARTS AND ACCESSORIES**

(2) **BORE BRUSH M10.** The bore brush is furnished with a staff and is used for swabbing and cleaning the bore of the gun.

(3) **EQUILIBRATOR ASSEMBLING NUT.** This is an elongated hexagonal nut used to retain the equilibrator in an assembled unit when removing or replacing the equilibrator.

(4) **FILLING AND DRAIN VALVE RELEASE.** This release has a long shank which opens the filling and drain valve to allow the reserve oil to drain from the recoil mechanism.

(5) **FUZE WRENCH M7.** The fuze wrench is used to tighten the fuze in the projectile before firing and for interchanging fuzes. The screwdriver portion of the wrench is used for setting the fuze to either "SQ" ("superquick") or "DELAY."

(6) **OIL SCREW FILLER.** The oil screw filler is a high-pressure filling device used to replenish the recoil mechanism with oil. A screw type plunger forces the recoil oil into the recoil mechanism. Extreme care should be used in order not to break the threaded nozzle of the filler or to distort the threads. The handle should be centered and both hands used in order to assure an even stroke.



## 75-MM GUN M1897A4 MOUNTED IN COMBAT VEHICLES

## Chapter 7

PREPARATION OF MATERIEL FOR USE UNDER  
EXTREME CONDITIONS

	Paragraph
General .....	83
Tropical climates .....	84
Arctic climates .....	85
Excessively moist or salty atmosphere.....	86
Excessively sandy or dusty conditions.....	87

**83. GENERAL.**

a. Because of the different climates in which this materiel may be expected to operate, special instructions are given in this section for three regions, namely: Arctic, temperate, and tropical.

b. By "Arctic" is meant a climate usually experienced in Alaska, Newfoundland, Labrador or Iceland. By "temperate" is meant a climate usually experienced in continental United States or Hawaii. By "tropical" is meant a climate usually experienced in Panama, the Philippines, and Cuba.

c. In certain cases, the prescribed instructions may not apply; for example, a tropical climate may be experienced in a temperate region. In cases of this nature, the instructions as to the classification of climate in which the materiel is operating is left to the judgment of the ordnance officer. He is cautioned, however, that only extended and not temporary periods of climatic conditions govern the classification.

d. Manufacturing arsenals and plants should lubricate the materiel at assembly for the climate in which the gun and mount is going to be used.

e. Materiel, previously lubricated for a colder climate than the one in which the materiel is to be used, should be relubricated with lubricants prescribed for use in that climate. Removal of lighter cold-temperature lubricants is not necessary unless contaminated with dirt or water.

f. Materiel, previously lubricated for a warmer climate than the one in which the materiel is to be used, should be completely cleaned of all lubricants and relubricated with the lubricants prescribed for use in that climate.

## PREPARATION OF MATERIEL FOR USE UNDER EXTREME CONDITIONS

### 84. TROPICAL CLIMATES.

**a. Lubrication.** Lubricate the gun and mount with prescribed lubricants for temperatures over 32 F as prescribed in paragraph 27. In extremely hot climates, lubricate more frequently.

**b. Inspection and Care.**

(1) Materiel should be inspected frequently when being operated in hot, moist areas. Mount covers and other items which may deteriorate from mildew, etc., or be attacked by insects or vermin should be aired and dried frequently.

(2) Ammunition should be kept out of the direct rays of the sun. Moisture-resistant seals should not be broken until ammunition is to be used.

### 85. ARCTIC CLIMATES.

**a. Lubrication.** When preparing the gun and mount for use in Arctic climates, all heavier lubricants must be removed and gear cases, etc., flushed out with SOLVENT, dry-cleaning, before applying lighter lubricants. Lubricate as described in paragraph 27.

**b. Recoil Mechanism.** Recoil fluids should not be diluted nor should light and heavy recoil oils be mixed. If the use of a light recoil oil is recommended, drain the recoil mechanism completely and refill.

**c. Operation.**

(1) Do not allow ice to form around the pedestal that will retard the operations of placing the mount in traveling position.

(2) Keep platform free of ice and snow to prevent injury to personnel caused by an insecure footing.

(3) Do not clean the gun bore with solutions that may freeze. Bore should be inspected frequently for frosting or congealed lubricants.

(4) When active, exercise the gun at intervals that will insure satisfactory operation when required.

(5) Sighting and fire control instruments are normally lubricated for operation over a wide range of temperatures. When active, exercise the materiel at intervals that will insure satisfactory operation when required. If the instruments do not function properly, the ordnance maintenance personnel should be notified.

### 86. EXCESSIVELY MOIST OR SALTY ATMOSPHERE.

**a.** When the materiel is active, clean and relubricate exposed metal surfaces such as the gun bore, breech mechanism, slide rails, etc., more frequently, as water will emulsify with oils and greases and destroy their rust-preventive qualities. Inspect parts frequently for corrosion.

### **75-MM GUN M1897A4 MOUNTED IN COMBAT VEHICLES**

b. Mount covers and other items that may deteriorate from dampness should be inspected frequently and dried as often as possible.

c. When the materiel is inactive, the unpainted parts should be covered with a film of COMPOUND, rust-preventive, light. The bore of the tube and the breech mechanism should be kept heavily oiled and should be inspected frequently for rust. The mount cover should be in place on the mount if in the traveling position.

### **87. EXCESSIVELY SANDY OR DUSTY CONDITIONS.**

a. When the gun is active in dusty areas, remove lubricants from sliding parts, elevating rack and pinion, as they will pick up sand or dust, forming an abrasive which will cause rapid wear. Lubricate parts after action.

b. Inspect and lubricate the materiel more frequently when operating in sandy areas.

c. Keep the mount covered when practical. Cover the gun breech mechanism and muzzle as often as rate of fire permits.

**Chapter 8**

**REFERENCES**

	Paragraph
Standard nomenclature lists .....	88
Explanatory publications .....	89
Firing tables .....	90

**88. STANDARD NOMENCLATURE LISTS.**

**a. Ammunition.**

- Ammunition, blank, for pack, light and medium field artillery ..... SNL R-5
- Ammunition, fixed and semifixed, all types, for pack, including subcaliber light and medium field artillery, including complete round data ..... SNL R-1
- Ammunition instruction material for pack, light and medium field artillery..... SNL R-6
- Service fuzes and primers for pack, light and medium field artillery ..... SNL R-3

**b. Armament Materiel.**

- Gun, 75-mm, M1897A4; and mount, gun, 75-mm, M3 ..... SNL C-48
- Gun, 75-mm, M1897A4; and mount, gun, 75-mm, M5 ..... SNL C-49
- Major items of pack, light and medium field artillery; and armament of these calibers for airplane and combat vehicles..... SNL C-1

- c. Cleaning, preserving and lubricating materials:**  
recoil fluids, special oils, and miscellaneous related items ..... SNL K-1

- d. Lights, instrument, all types.**..... SNL F-205

- e. Telescope, M33; and mount, telescope, M36, for 75-mm gun motor carriages M3 and M3A1..** SNL F-236

Current Standard Nomenclature Lists are as tabulated here. An up-to-date list of SNL's is maintained as the "Ordnance Publications for Supply Index" ..... OPSI

**89. EXPLANATORY PUBLICATIONS.**

**a. Ammunition.**

- Ammunition for combat vehicles..... TM 9-1910
- Ammunition, general ..... TM 9-1900

**75-MM GUN M1897A4 MOUNTED IN COMBAT VEHICLES**

Field artillery and field mortar ammunition . . . . . OFSB 3-3  
Qualification in arms and ammunition training allowances . . . . . AR 775-10  
Range regulations for firing ammunition for training and target practice . . . . . AR 750-10

**b. Armament Materiel.**

75-mm gun materiel M1897 and modifications . . . . . TM 9-305

**c. Decontamination.**

Chemical decontamination materials and equipment . . . . . TM 3-220  
Decontamination, 1941 . . . . . TC 38  
Defense against chemical attack . . . . . FM 21-40

**d. Fire Control.**

Auxiliary fire control instruments (field glasses, eyeglasses, telescopes, and watches) . . . . . TM 9-575  
Sighting and fire control instruments—lubrication—general . . . . . OFSB 6-9

**e. Lubrication.**

Cleaning, preserving, lubricating, and welding materials and similar items issued by the Ordnance Department . . . . . TM 9-850

**90. FIRING TABLES.**

**a. Gun, 75-mm, M1897A4.**

Firing tables and trajectory charts . . . . . SNL F-69  
Projectile, fixed, A.P.C., M61, supercharge, w/tracer, 75-mm gun . . . . . FT 75-B-4  
Shell, fixed, gas, persistent, HS, Mk. II, normal charge, unfuzed, 75-mm gun . . . . . FT 75-B-4  
Shell, fixed, gas, persistent, NC, Mk. II, normal charge, unfuzed, 75-mm gun . . . . . FT 75-B-4  
Shell, fixed, H.E., M48, normal charge, w/fuze, P.D., M48, 75-mm gun . . . . . FT 75-Z-2  
Shell, fixed, H.E., M48, normal charge, w/fuze, P.D., M54, 75-mm gun . . . . . FT 75-Z-2  
Shell, fixed, H.E., M48, reduced charge, w/fuze, P.D., M48, 75-mm gun . . . . . FT 75-Z-2  
Shell, fixed, H.E., M48, reduced charge, w/fuze, P.D., M54, 75-mm gun . . . . . FT 75-Z-2  
Shell, fixed, H.E., M48, supercharge, w/fuze, P.D., M48, 75-mm gun . . . . . FT 75-Z-2

**REFERENCES**

- Shell, fixed, H.E., M48, supercharge, w/fuze, P.D., M54, 75-mm gun . . . . . FT 75-Z-2
  - Shell, fixed, H.E., Mk. I, flashless, reduced charge, unfuzed, 75-mm gun . . . . . FT 75-B-4
  - Shell, fixed, H.E., Mk. I, flashless, unfuzed, 75-mm gun . . . . . FT 75-B-4
  - Shell, fixed, H.E., Mk. I, reduced charge, unfuzed, 75-mm gun . . . . . FT 75-B-4
  - Shell, fixed, H.E., Mk. I, unfuzed, 75-mm gun . . . . . FT 75-B-4
  - Shell, fixed, smoke, FM, Mk. II, normal charge, unfuzed, 75-mm gun . . . . . FT 75-B-4
  - Shell, fixed, smoke, FS, Mk. II, normal charge, unfuzed, 75-mm gun . . . . . FT 75-B-4
  - Shell, fixed, smoke, phosphorous, WP, Mk. II, normal charge, unfuzed, 75-mm gun . . . . . FT 75-B-4
  - Shot, fixed, A.P., M72, supercharge, w/tracer, 75-mm gun . . . . . Not available
  - Shrapnel, fixed, Mk. I, 75-mm gun . . . . . FT 75-B-4
  - Shrapnel, fixed, Mk. I, flashless, 75-mm gun . . . . . FT 75-B-4
  - Shell, fixed, practice, Mk. II, w/fuze, M38, 37-mm gun, M1916 . . . . . FT 37-O-1
  - Shell, fixed, practice, sand-loaded, Mk. I, 75-mm gun . . . . . FT 75-B-4
- Current firing tables are as tabulated here. An up-to-date list of firing tables is maintained in . . . . . SNL F-69



INDEX

<b>C—Cont'd</b>	Page No.	Page No.	
Cautions:			
before firing the gun .....	22	recoil mechanism .....	8, 96
bore sighting .....	100	subcaliber mount M7 .....	96-97
during firing of gun .....	23-24	telescope mount M36 and tele-	
lubricating fittings and oilers..	29	scope M33 .....	68-69
removing parts for inspection or		Differences among models .....	2-3
replacement .....	31	Disassembly	
storage .....	31	breechblock .....	49-53
washing gun or mount.....	31	general discussion of .....	47-48
Characteristics of mount .....	2	Dismounting the gun .....	57-60
Classification:		Dusty or sandy conditions, prepara-	
ammunition .....	76-77	tion of materiel for use under..	106
fuzes .....	88		
Cleaners and abrasives .....	38	<b>E</b>	
Cleaning:		Elevating and traversing gear cases,	
equilibrator .....	56	lubrication .....	27
gun bore .....	28	Elevating mechanism	
traversing and elevating racks		description and functioning..	17-18
and gears .....	28-29	inspection and adjustment ...	43
Cleaning and preserving materials	38	Elevating racks and gears, lubri-	
Closing the breech .....	21	cation .....	28-29
Coupler assembly, description and		Elevating the mount .....	21-22
functioning .....	14	Elevating worm, description and	
Cradle, description and		functioning .....	17
functioning .....	13-14	Elevation, alinement of sighting	
Cradle lock		equipment in .....	74-75
description and functioning..	12-13	Emergency firing .....	35-36
inspection and adjustment.....	43	Equilibrator	
Cradle trunnion bearing.....	27-28	description and functioning ...	13
		inspection and adjustment ....	43
<b>D</b>		installation .....	56-57
Data		removal .....	55-56
ammunition .....	82	Extreme conditions, preparation of	
gun and mount .....	3-4	materiel for use under	
packing ammunition .....	92	arctic climates .....	105
Description and functioning		general discussion of .....	104
breechblock and breech mech-		moist or salty atmosphere..	105-106
anism .....	95-96	sandy or dusty conditions.....	106
gun		tropical climates .....	105
barrel assembly .....	5-6		
breechblock .....	6-7	<b>F</b>	
firing mechanism .....	7	Field report of ammunition ac-	
gun mount		cidents .....	94
cradle .....	13-14	Firing, points to be observed	
cradle lock .....	12-13	before .....	22
elevating mechanism .....	17-18	during .....	23
equilibrator .....	13	Firing, preparation of ammunition	
traversing mechanism .....	18	for .....	82
oil screw filler .....	103		



**75-MM GUN M1897A4 MOUNTED IN COMBAT VEHICLES**

<b>F—Cont'd</b>	<b>Page No.</b>	<b>Page No.</b>	
Firing mechanism		Gun, 37-mm	
care and preservation . . . . .	32	installation . . . . .	99
description and functioning . . .	7	removal . . . . .	101
inspection and adjustment . . . .	41		
lubrication . . . . .	28	<b>I</b>	
malfunctions and corrections . . .	44-45	Identification of ammunition (See	
Firing position, placing gun in . .	19-20	identification <i>under</i> Ammunition)	
Firing tables . . . . .	76	Inspection	
Firing the gun . . . . .	25	ammunition . . . . .	105
Fittings and oilers, lubrication . .	29	breech mechanism . . . . .	40-41
Functioning (See Description and		equilibrator . . . . .	56
functioning)		gun . . . . .	40-42, 60, 105
Fuzes . . . . .	88-92	gun mount . . . . .	42-43
boresafe . . . . .	88-89	precautions when removing parts	
classification . . . . .	88	for . . . . .	31
		Intervals of lubrication . . . . .	29
<b>G</b>		<b>L</b>	
Guide, lubrication . . . . .	27-29	Loading the gun . . . . .	25
Gun, 75-mm, M1897A4		Lot number, ammunition . . . . .	77-78
assembly and disassembly . . . .	48-64	Lubricating and preserving ma-	
care and preservation . . . . .	31	terials . . . . .	38
data . . . . .	3-4	Lubrication	
description and functioning . . . .	5-7	guide . . . . .	27-29
differences among models . . . . .	2-3	gun mount . . . . .	32
dismounting . . . . .	57-60	in arctic climates . . . . .	105
firing . . . . .	25	reports and records . . . . .	29
inspection and adjust-		special lubrication and service	
ment . . . . .	40-42, 60	instructions . . . . .	29
loading . . . . .	25	tropical climates . . . . .	105
lubrication . . . . .	27-29, 105	<b>M</b>	
malfunctions and corrections . . .	46	Malfunctions and corrections	
mounting . . . . .	60-62	breech and firing mechanism . . .	44-45
operation . . . . .	19-24	oil index . . . . .	34
organizational spare parts and		recoil mechanism . . . . .	45-46
accessories . . . . .	102-103	Marking ammunition for ship-	
placing in firing position . . . .	19-20	ment . . . . .	92-93
placing in traveling position . . .	26	Model of ammunition . . . . .	77
precautions in washing . . . . .	31	Models, differences among . . . . .	2-3
preparation of materiel for use		Moist or salty atmosphere, prepa-	
under extreme conditions . . . .	104-106	ration of materiel for use in . . . .	105-106
unloading . . . . .	25-26	Mount, gun, 75-mm, M3 and M5	
Gun Book, Artillery . . . . .	29, 102	assembly and disassembly . . . .	48-64
Gun bore, cleaning and lubricating	28	care and preservation . . . . .	32-33
Gun mount (See Mount, gun, 75-		characteristics . . . . .	2
mm, M3 and M5)		data . . . . .	3-4
Gun shield		description and functioning . . .	12-18
inspection and adjustment . . . .	43	differences among models . . . . .	3
installation . . . . .	64	elevating . . . . .	21-22
removal . . . . .	62	inspection and adjustment . . . .	42-43

## INDEX

<b>M—Cont'd</b>	Page No.	Page No.
Mount, gun, 75-mm, M3 and M5 — Cont'd		
lubrication . . . . .	32, 105	
operation . . . . .	19-24	
organizational spare parts and accessories . . . . .	102-106	
precautions in washing . . . . .	31	
preparation of materiel for use under extreme conditions	104-106	
removal . . . . .	101	
traversing . . . . .	21	
Mount, subcaliber (See under Subcaliber equipment)		
Mounting the gun . . . . .	60-62	
Muzzle velocity . . . . .	3	
<b>N</b>		
Notes on lubrication . . . . .	27-29	
Nomenclature, standard, for ammunition . . . . .	76	
<b>O</b>		
Oil		
capacity . . . . .	4	
testing for water . . . . .	36	
Oil index		
malfunctions and corrections . . . . .	34, 45-46	
testing . . . . .	35	
Oil reserve		
adding oil to . . . . .	33-34	
reducing or exhausting . . . . .	33	
Oil screw filler, description and functioning . . . . .	103	
Oilcan points . . . . .	29	
Oilers and fittings, lubrication . . . . .	29	
Opening the breech . . . . .	20	
Operation		
breech mechanism . . . . .	20-21	
gun		
elevating . . . . .	21-22	
firing . . . . .	25	
points to be observed before	22	
points to be observed during . . . . .	23-24	
loading . . . . .	25	
placing in firing position . . . . .	19-20	
placing in traveling position . . . . .	26	
unloading . . . . .	25-26	
in arctic climates . . . . .	105	
telescope mount M36 and telescope M33 . . . . .	69	
traversing the mount . . . . .	21	
Optical parts, care and preservation . . . . .	66-68	
Organizational spare parts and accessories . . . . .	102-103	
care and preservation . . . . .	36-38	
<b>P</b>		
Packing		
ammunition . . . . .	92-93	
subcaliber ammunition . . . . .	93	
Painting and marking ammunition . . . . .	78-79	
Paints and related materials . . . . .	38-39	
Precautions (See Cautions)		
Preservation (See Care and preservation)		
<b>R</b>		
Recoil mechanism		
care and preservation		
adding to the oil reserve . . . . .	33-34	
malfunctions of oil index . . . . .	34	
reducing or exhausting the oil reserve . . . . .	33	
testing oil index . . . . .	35-36	
description and functioning . . . . .	8, 96	
inspection and adjustment . . . . .	42	
installation . . . . .	98	
malfunctions and corrections . . . . .	45-46	
removal . . . . .	101	
use in arctic climates . . . . .	105	
Recoil oil, use and care of . . . . .	36	
Recoil slides, lubrication . . . . .	28	
Recuperator cylinder, description and functioning . . . . .	14	
Reports and records of lubrication	29	
Respirator (recoil mechanism), description and functioning . . . . .	8	
"ROUTE" marking on breechblock	7	
<b>S</b>		
Salty or moist atmosphere, preparation of materiel for use in . . . . .	105-106	
Sandy or dusty conditions, preparation of materiel for use in . . . . .	106	
Shield (See Gun shield)		
Shipment, marking ammunition for . . . . .	92-93	

**75-MM GUN M1897A4 MOUNTED IN COMBAT VEHICLES**

S—Cont'd	Page No.	Page No.
Sighting equipment		
care and preservation.....	65-68	
general discussion of.....	65	
procedure for bore sighting..	71-75	
telescope mount M36 and tele-		
scope M33 .....	68-71	
Spare parts and acces-		
sories .....	36-38, 102-103	
Standard nomenclature for am-		
munition .....	76	
Storage precautions .....	31	
Storage of weapon.....	39	
Subcaliber ammunition .....	93	
Subcaliber equipment		
bore sighting .....	99-100	
breechblock and breech mech-		
anism .....	95-96	
general discussion of.....	95	
dismounting .....	100-101	
mounting .....	97-99	
recoil mechanism .....	96	
subcaliber mount M7.....	96-97	
<b>T</b>		
Tables		
authorized rounds of ammuni-		
tion .....	80-82	
data on projectiles.....	83-84	
Telescope mount M36 and tele-		
scope M33		
		description .....
		operation .....
		preparation for travel.....
		68-69
		69
		69-71
		<b>Test(-ing)</b>
		oil for water.....
		oil index .....
		target (bore sighting)....
		71-72, 74
		"TIR" marking on breechblock...
		7
		Tools and miscellaneous materials
		39
		Traveling position, placing gun in
		26
		Traversing and elevating racks and
		gears, lubrication .....
		28-29
		Traversing gear shaft lower bear-
		ing, lubrication .....
		27
		Traversing mechanism
		description and functioning....
		inspection and adjustment....
		43
		Traversing the mount.....
		18, 21
		Tropical climates, preparation of
		materiel for use in.....
		105
<b>U</b>		
		Unloading the gun.....
		25-26
<b>V</b>		
		Verification of telescope M33....
		74
<b>W</b>		
		Weight zone markings of ammuni-
		tion .....
		78

[ A.G. 300.7 (1 July 1943)  
O.O. 461/43936 O.O. (14 July 1943) ]

BY ORDER OF THE SECRETARY OF WAR:

G. C. MARSHALL,  
*Chief of Staff.*

OFFICIAL:

J. A. ULIO,  
*Major General,*  
*The Adjutant General.*

DISTRIBUTION: R 9(4); Bn 9(2); C 9 and 18(8)

(For explanation of symbols, see FM 21-6)