



U.S. Department
of Transportation

**Federal Aviation
Administration**

Advisory Circular

Subject: Standards for Airport Markings

Date: 9/3/2010

AC No: 150/5340-1K

Initiated by: AAS-100

Change:

1. PURPOSE. This advisory circular (AC) contains the Federal Aviation Administration (FAA) standards for markings used on airport runways, taxiways, and aprons.

2. CANCELLATION. This AC cancels AC 150/5340-1J, Standards for Airport Markings, dated April 29, 2005, and subsequent changes, dated March 31, 2008, and June 6, 2008. This AC also cancels the Signs and Marking Supplement (SAMS).

3. APPLICATION. The FAA recommends the guidelines and standards contained herein for the marking of airport runways, taxiways, and aprons. The use of these standards is the only method of compliance with the marking of runways, taxiways, and aprons for airports certificated under Title 14 Code of Federal Regulations Part 139, *Certification of Airports* (Part 139). These standards are to be used on all new airport projects that are under development and are to be implemented at all Part 139 certificated airports. Further, use of this AC is mandatory for all projects funded with federal grant monies through the Airport Improvement Program (AIP) and with revenue from the Passenger Facility Charge (PFC) Program. (See Grant Assurance No. 34, "Policies, Standards, and Specifications" and PFC Assurance No. 9, "Standards and Specifications.")

4. NATIONAL TRANSPORTATION SAFETY BOARD SAFETY RECOMMENDATION. The National Transportation Safety Board (NTSB) in response to pilots landing on taxiways adjacent to runways, requested that the FAA conduct research and development to identify visual aid enhancement solutions for use with taxiways that experience repeated taxiway landing problems (reference: Item A-04-49 of NTSB Safety Recommendation letter, dated June 25, 2004).

a. Results. The FAA evaluated the non-standard surface markings requested by NTSB, namely an enlarged, reoriented surface paint "A" taxiway location sign, a serpentine marking running along the taxiway centerline, and the inscriptions "TAXIWAY" and "TAXI ONLY." The investigation determined that all proposals had some deficiencies. For example, serpentine markings were found not to be significantly visible from the air. The smaller, length inscription "TAXI" by itself in the phrase "TAXI ONLY" was sufficient to perform the same intended task. See report DOT/FAA/AR-TN 07/54, Identification Techniques to Reduce Confusion Between Taxiways and Adjacent Runways, for details. See paragraph 5.16 of this advisory circular for the usage of the non-standard marking "TAXI."

b. Other Observations. The report further concluded "...that airport geometry is a major causal factor in such incidents" One rectifying solution for troublesome airport geometry was the use of green-colored aviation grade artificial turf that would visually change the shape of the taxiway environment. One application is masking the squared paved corner of the entrance taxiway so that it creates the effect of a curved taxiway, i.e., minimize its visual size in comparison to the squared runway end. See paragraph 5.16 of this advisory circular for additional information. AC 150/5370-15, Airside

Applications for Artificial Turf, latest edition, provides guidance for the use of aviation grade artificial turf in areas adjacent to the operational areas of the airport. This solution is not for runway environment applications because: “Sufficient data are not available on the performance of artificial turf in the case of high-speed veer offs...” (see paragraph 5 of AC 150/5370-15A).

5. EXPLANATION OF PRINCIPAL CHANGES. This AC incorporates new surface marking criteria, extensive text and format changes, and new and revised figures, as described below:

a. Adds color-coded text boxes to emphasize safety initiatives, solutions to painting difficulties, and general remarks.

- Green (Painting) – explains painting precautions and solutions, such as when proportioning is permissible for runway surface markings.
- Red (Safety) – emphasizes safety initiatives.
- Gray (General) – contains general remarks.

b. Incorporates all applicable surface marking supplements from SAMS.

c. Adds new definitions (paragraph 1.2).

d. Adds a new subparagraph, “Painted Numbering System for Record Keeping of Surface Painted Markings” (paragraph 1.3(f)). This practice was added to assist airport operators in identifying surface markings in their Sign Plan needing maintenance, scheduling painting, etc.

e. Adds new table 1-1 that provides general guidelines for determining when to add black borders to light-colored pavements (paragraph 1.4).

f. Adds a new warning box about dispensing glass beads during painting applications and, in particular, when painting surface painted holding position signs (paragraph 1.4(b)).

g. Revises table 2-1 criteria (paragraph 2.1).

h. Deletes all text related to the former FAA threshold marking scheme. This revision adopts the standards and recommended practices contained in International Civil Aviation Organization (ICAO) Annex 14, Volume I, Aerodrome Design and Operations. Adds new table 2-2, which shows the number of symmetrical runway threshold stripes required for standard runway widths and new text for painting non-standard runway widths (paragraph 2.5(d)).

i. Adds new text to emphasize the co-located relationship between the aiming point marking and PAPI and other NAVAIDs (paragraphs 2.2 and 2.6).

j. Adds new criteria for the width of and separation between aiming point markings for various standard runway widths (paragraph 2.6(d)).

k. Adds new table 2-3 and new text for table 2-4 about painting touchdown zone markings for runway ends having single or dual precision approaches (paragraph 2.7).

l. Clarifies text for marking runways with and without aligned taxiways (paragraph 2.9).

m. Adds Engineered Materials Arresting System (EMAS) to blast pads and stopways as facilities to be marked with chevrons (paragraph 2.10). Adds new painting criteria for stopways for Airplane Design Group I – exclusively small airplane runways (paragraph 2.10(d)).

n. Includes a new Chapter 3 that consolidates the six different applications of holding position markings and different painting schemes, with a new pattern designation, i.e., Pattern A, B, and C surface markings for holding positions. The pattern designation is more in line with the standards and recommended practices contained in ICAO Annex 14, Volume I.

o. Adds new and revised text for painting the enhanced taxiway centerline marking (paragraph 4.3).

p. Adds new criteria for painting NO-TAXI islands with continuous taxiway edge markings for wide taxiway entrances (paragraph 4.4) as a means to reduce runway incursions.

q. Adds new criteria and revised text for surface painted holding position signs (paragraph 4.5). The new criteria apply to Airplane Design Groups I and II, requiring a single surface painted holding position sign centered on the taxiway centerline instead of a single surface painted holding position sign to the left of centerline or dual surface painted holding position signs (paragraph 4.5(b)(4) and new figure C-15).

r. Adds a new table 4-1, “Placement of Repetitive Surface Painted Holding Position Signs and NO-TAXI Islands on Taxiway Entrances of over 200 feet (61 m) in Width” (paragraph 4.5).

s. Adds new criteria for the minimum height of surface painted holding position signs for Airplane Design Groups III – VI and for Airplane Design Groups I – II (paragraph 4.5(d) and figures C-5, C-6, C-7, and C-8).

t. Adds a new green-colored box explaining when to stack surface painted holding position signs on narrow taxiway widths (paragraph 4.5(d) and new figure C-15).

u. Adds new and revised text about the geographic position marking (paragraph 4.11).

v. Drops a proposed new surface marking for areas designated by the Transportation Security Administration (TSA) and the airport operator as a security identification display area (SIDA) (reassigned paragraph 5.15 to cover markings for aircraft deicing facilities and removed proposed figure C-14). TSA accepted the task to address future markings for the airside.

w. Adds a new paragraph 5.15, “Aircraft Deicing Facility Markings,” to reference markings for aircraft deicing facilities in accordance with AC 150/5300-14, Design of Aircraft Deicing Facilities.

x. Adds new paragraph 5.16, Interim Surface Markings for Taxiways Mistaken as Runways, in response to NTSB Safety Letter.

y. Revises figures 1 and 2 to show only one threshold marking scheme (formerly referred to as Configuration B) and drops painting method Configuration A per paragraph 2.5. The single marking scheme conforms with ICAO Annex 14, Volume I.

z. Adds new text to figure 8 emphasizing that the width of a stopway only equals the runway width, but the width of a blast pad includes both the runway width and the shoulders.

aa. Adds new figure 12a showing that the Pattern B application for POFZ holding position marking differs from the ILS/MLS holding position marking by turning 90 degrees on certain taxiway or holding bay geometries.

bb. Adds new figures C-2 and C-3 from SAMS.

cc. All figures in this advisory circular are full scale AutoCAD drawings saved as MS Word versions. For some figures, certain details may appear to be missing (missing or broken lines) when either printed or viewed on a computer monitor. To view all the details in these figures, use the appropriate ZOOM function provided in MS Word or Adobe Reader. In some instances, where there is a large surface area, a ZOOM value of over 250% may be necessary to view all details. Both this advisory circular and the original AutoCAD files for all figures are available for download at the FAA web site:

http://www.faa.gov/airports/resources/advisory_circulars/index.cfm/go/document.list/parentTopicID/85.

6. COMPLIANCE DATES FOR SPECIFIC SURFACE PAINTED MARKINGS FOR 14 CODE OF FEDERAL REGULATION (CFR) PART 139 CERTIFICATED AIRPORTS. The compliance dates for the enhanced taxiway centerline marking and the surface painted holding position sign are found within the red-coded Safety Boxes in paragraphs 4.3(a) and 4.5(a), respectively. See these paragraphs for the applicable compliance dates.

7. METRIC UNITS. To promote an orderly transition to metric units, the text and figures include both English and metric dimensions. The metric conversions are based on operational significance and may not be exact equivalents of the English dimensions. Until there is an official changeover to the metric system, the English dimensions govern.

8. ADVISORY CIRCULAR (AC) AND ORDER REFERENCES. All references to FAA ACs and Orders are to the most recent versions, which are available from the FAA website at <http://www.faa.gov>.



Michael J. O'Donnell
Director of Airport Safety and Standards

TABLE OF CONTENTS

CHAPTER 1. SURFACE MARKINGS FOR AIRFIELD PAVEMENTS AND PAVED AIRFIELD ROADWAYS.	1
1.1. GENERAL	1
1.2. DEFINITIONS	1
1.3. SURFACE MARKING PRACTICES	2
1.4. REQUIREMENTS AND RECOMMENDATIONS FOR ENHANCED CONSPICUITY OF SURFACE MARKINGS	3
CHAPTER 2. SURFACE MARKINGS FOR RUNWAYS.	7
2.1. APPLICATION	7
2.2. INTERRUPTION OF RUNWAY SURFACE MARKINGS	8
2.3. RUNWAY LANDING DESIGNATOR MARKING	9
2.4. RUNWAY CENTERLINE MARKING	11
2.5. RUNWAY THRESHOLD MARKING	12
2.6. RUNWAY AIMING POINT MARKING	13
2.7. RUNWAY TOUCHDOWN ZONE MARKING	15
2.8. RUNWAY SIDE STRIPE MARKING	18
2.9. RUNWAY DISPLACED THRESHOLD MARKING	19
2.10. CHEVRON MARKINGS FOR BLAST PADS, STOPWAYS, AND EMAS	20
2.11. RUNWAY SHOULDER MARKING	21
CHAPTER 3. HOLDING POSITION MARKINGS.	23
3.1. APPLICATIONS OF HOLDING POSITION MARKINGS	23
3.2. CASE 1 AND CASE 2 – APPLICATIONS OF PATTERN A FOR THE RUNWAY HOLDING POSITION MARKING ON RUNWAYS	23
3.3. CASE 3 – APPLICATIONS OF PATTERN A FOR THE RUNWAY HOLDING POSITION MARKING ON TAXIWAYS	25
3.4. CASE 4 – APPLICATIONS OF PATTERN B FOR THE ILS/MLS HOLDING POSITION MARKING	27
3.5. CASE 5 – APPLICATIONS OF PATTERN B FOR PRECISION OBSTACLE FREE ZONE (POFZ) HOLDING POSITION MARKING	28
3.6. CASE 6 – APPLICATIONS FOR PATTERN C FOR THE TAXIWAY/TAXIWAY INTERSECTION INTERMEDIATE HOLDING POSITION MARKING	29
CHAPTER 4. SURFACE MARKINGS FOR TAXIWAYS.	31
4.1. APPLICATION	31
4.2. TAXIWAY CENTERLINE MARKINGS	31
4.3. ENHANCED TAXIWAY CENTERLINE MARKING	33
4.4. TAXIWAY EDGE MARKING	36
4.5. SURFACE PAINTED HOLDING POSITION SIGNS	38
4.6. SURFACE PAINTED TAXIWAY DIRECTION SIGNS	43
4.7. SURFACE PAINTED TAXIWAY LOCATION SIGNS	44
4.8. SURFACE PAINTED GATE DESTINATION SIGNS	45
4.9. SURFACE PAINTED APRON ENTRANCE POINT SIGNS	46
4.10. TAXIWAY SHOULDER MARKINGS	47
4.11. GEOGRAPHIC POSITION MARKINGS	47

CHAPTER 5. OTHER SURFACE MARKINGS.....	51
5.1. APPLICATION.....	51
5.2. VEHICLE ROADWAY MARKINGS.....	51
5.3. VERY HIGH FREQUENCY OMNIDIRECTIONAL RANGE (VOR) RECEIVER CHECKPOINT MARKING.....	51
5.4. NON-MOVEMENT AREA BOUNDARY MARKING.....	52
5.5. MARKINGS FOR THRESHOLDS TEMPORARILY RELOCATED DURING CONSTRUCTION.....	54
5.6. MARKING AND LIGHTING OF PERMANENTLY CLOSED RUNWAYS AND TAXIWAYS.....	54
5.7. TEMPORARILY CLOSED RUNWAYS AND TAXIWAYS.....	54
5.8. CONVERTING A RUNWAY TO A TAXIWAY.....	55
5.9. INTERMITTENT USE OF A TAXIWAY AS A RUNWAY.....	56
5.10. CLOSED OR ABANDONED AIRPORTS.....	57
5.11. HELIPORT MARKINGS.....	57
5.12. VERTIPOINT MARKINGS.....	57
5.13. MARKING FOR ARRESTING GEAR.....	57
5.14. HAZARDOUS CONSTRUCTION AREAS.....	57
5.15. AIRCRAFT DEICING FACILITY MARKINGS.....	57
5.16. INTERIM SURFACE MARKINGS FOR TAXIWAYS MISTAKEN AS RUNWAYS.....	57
APPENDIX A. INSCRIPTIONS FOR SIGNS AND GEOGRAPHIC POSITION MARKINGS.....	87
APPENDIX B. EXAMPLES OF MARKINGS OUTLINED IN BLACK.....	93
APPENDIX C. ENHANCED MARKINGS FOR RUNWAY HOLDING POSITION.....	97
1. GENERAL.....	97
2. APPLICABILITY.....	97
3. ENHANCED TAXIWAY CENTERLINE MARKINGS.....	98
4. ENHANCED RUNWAY HOLDING POSITION MARKINGS.....	101
5. SURFACE PAINTED HOLDING POSITION SIGNS.....	102
6. ADDITIONAL GUIDELINES FOR APPLICATION.....	106

FIGURES

Figure 1-1. Example of DFW Painted Numbering System for Surface Painted Markings.....	3
Figure 5-1. Precautionary Placement of Non-movement Boundary Marking.....	53
Figure 5-2. TAXI Marking Location Facing Runway Approach End.....	58
Figure 5-3. TAXI Marking Dimensions.....	59
Figure 5-4. Aviation Grade Artificial Turf Installation.....	59
Figure 1. Precision Runway Markings.....	61
Figure 2. Non-precision Runway.....	62
Figure 3. Visual Runway Markings.....	63
Figure 4. Example of Conflicting Markings on Crossing Runways.....	64
Figure 5. Runway Designation Numerals and Letters.....	65
Figure 6. Displaced Threshold Markings.....	66
Figure 7. Marking for Aligned Taxiway with Runway Without a Displaced Threshold.....	67
Figure 8. Markings for Blast Pads and Stopways.....	68
Figure 9. Markings for Aligned Taxiway Preceding a Displaced Threshold.....	69
Figure 10. Markings for Blast Pad Preceding a Displaced Threshold.....	70

Figure 11. Runway Shoulder Markings	71
Figure 12. Holding Position Marking Details	72
Figure 12a. Holding Position Marking Details	73
Figure 13. Taxiway Markings	74
Figure 14. Taxiway Markings	75
Figure 15. Taxiway Markings	76
Figure 16. Methods for Taxiway Centerline Marking	77
Figure 17. Surface Painted Signs	78
Figure 18. Surface Painted Gate Identification Signs	79
Figure 19. Multiple Gate Signs	80
Figure 20. Surface Painted Apron Entrance Point Signs	81
Figure 21. Taxiway Shoulder Markings	82
Figure 22. Geographic Position Markings	83
Figure 23. Vehicle Roadway Markings	84
Figure 24. VOR Receiver Checkpoint Markings	85
Figure 25. Closed Runway and Taxiway Markings	86
Figure A - 1. Pavement Markings ABCDEFGH	87
Figure A - 2. Pavement Markings IJKLMNOP	88
Figure A - 3. Pavement Markings QRSTUVWX	89
Figure A - 4. Pavement Markings YZ123456	90
Figure A - 5. Pavement Markings 7890-,↑	91
Figure B - 1. Runway Holding Position Marking	93
Figure B - 2. ILS/MLS Holding Position Marking	93
Figure B - 3. Continuous Taxiway Edge Line Marking	94
Figure B - 4. Dashed Taxiway Edge Line Marking	94
Figure B - 5. Alternate Outlining Method for Dashed Taxiway Edge Line Marking	94
Figure B - 6. Taxiway Centerline Marking	94
Figure B - 7. Intermediate Holding Position Markings	95
Figure B - 8. Non-movement Area Boundary Marking	95
Figure C - 1. Enhanced Taxiway Centerline Markings	98
Figure C - 2. Dashed Lines at Converging Taxiway Centerlines	98
Figure C - 3. Converging, Straight, and Curved Enhanced Taxiway Centerlines Intersecting with Holding Position Marking	99
Figure C - 4. Enhanced Runway Holding Position Markings on Taxiways	101
Figure C - 5. Surface Painted Holding Position Signs For Taxiway Widths Greater Than 35 Feet (10.5 m)	102
Figure C - 6. Surface Painted Holding Position Sign for Taxiway Widths Equal to Or Less Than 35 Feet (10.5 m)	103
Figure C - 7. Surface Painted Holding Position Signs when Taxiway Centerline is not Perpendicular to Runway Holding Position Marking	104
Figure C - 8. Surface Painted Holding Position Signs Co-Located with Geographic Position Marking	105
Figure C - 9. Two Taxiway Centerlines Converging at a Runway Holding Position Marking	106
Figure C - 10. Intersection of Two Taxiways at Runway End	107
Figure C - 11. Intersection of Three Converging Taxiway Centerlines	108
Figure C - 12. Intersection of Multi-Taxiway Centerlines with Less than 150 Feet (45.7 m) Between Taxiways	109
Figure C - 13. Two Taxiway Centerlines Intersecting a Runway Holding Position Marking	110

Figure C - 14. Intersection of Stub Taxiway and Runway.....	111
Figure C - 15. Narrow Taxiway Stacked Surface Painted Holding Position Sign.....	112
Figure C - 16. Enhanced Taxiway Centerlines When a Taxiway Connects Closely Spaced Runways...	113

TABLES

Table 1-1. General Guidelines for Determining Light-Colored Pavements	3
Table 2-1. Minimum Required Runway Surface Marking Schemes for Paved Runways	7
Table 2-2. Number of Runway Threshold Stripes for Standard Runway Widths	13
Table 2-3. Pairs of Touchdown Zone Markings Required When Installed From One Threshold	16
Table 2-4. Pairs of Touchdown Zone Markings Required When Installed From Both Thresholds	17
Table 4-1. Placement of Repetitive Surface Painted Holding Position Signs and NO-TAXI Islands on Taxiway Entrances of over 200 feet (61 m) in Width.....	41

CHAPTER 1. SURFACE MARKINGS FOR AIRFIELD PAVEMENTS AND PAVED AIRFIELD ROADWAYS.

1.1. GENERAL. This chapter provides the standards for surface markings used on paved airfield pavements (runways, taxiways, aprons) and paved airfield roadways. The standards for the surface markings assume that runways, taxiways, and aprons are built in accordance to the standard dimensions and layouts (e.g., clearances, fillets) in Advisory Circular (AC) 150/5300-13, Airport Design. The airport operator should expect difficulties when painting surface markings on non-standard infrastructure, such as a runway with a non-standard width. To assist airport operators, this advisory circular offers a few workable solutions for existing non-standard situations. Surface markings for large airplane parking positions and surface markings for unpaved airfield runways will be addressed at a future date in additional chapters.

NOTE: All figures in this AC are reduced versions of DWG files compatible with MS Word. Use the zoom feature in MS Word or Adobe Reader to view detail in any figure.

1.2. DEFINITIONS. The following definitions apply to terms used in this AC.

a. Certified Airport. An airport that has been issued an Airport Operating Certificate by the FAA under the authority of 14 CFR Part 139, *Certification of Airports*.

b. Commercial Service Airports and Passenger Enplanements. Defined in FAA Order 5100.38, Airport Improvement Program Handbook.

c. Displaced Threshold. A threshold that is located at a point on the runway other than the designated beginning of the runway.

d. Movement Area. The runways, taxiways, and other areas of an airport that are used for taxiing, takeoff, and landing of aircraft, exclusive of loading ramps and aircraft parking areas (reference 14 CFR Part 139).

e. Non-precision Runway. A runway end having an instrument approach procedure that provides course guidance without vertical path guidance. See Appendix 16, New Instrument Approach Procedures, in AC 150/5300-13, Airport Design, for additional information.

f. Precision Runway. A runway end having an instrument approach procedure that provides course and vertical path guidance conforming to Instrument Landing System (ILS) or Microwave Landing System (MLS) precision approach standards in International Civil Aviation Organization (ICAO) Annex 10, Compliance Statement, Aeronautical Telecommunications. See AC 150/5300-13 for additional information about precision approaches.

g. Threshold. The beginning of that portion of the runway that is available for landing. In some instances, the landing threshold may not coincide with the end of the opposite direction runway (see "Displaced Threshold").

h. Visual Runway. A runway end without an existing or planned (on the Airport Layout Plan) straight-in instrument approach procedure.

1.3. SURFACE MARKING PRACTICES. The following subparagraphs address common practices used in airport markings.

a. Increasing the Friction Coefficient of Surface Markings. AC 150/5370-10, Standards for Specifying Construction of Airports, Item P-620, Runway and Taxiway Painting, provides airport operators information to increase the friction coefficient of surface markings. Common practices include the spreading of silica sand on the marked surface immediately after painting and the use of glass beads in the marking materials. Glass beads or silica sand are required when durable markings (epoxy and methacrylate based paints) are used. These paints are usually applied at 18 – 30 mils in dry thickness.

b. Paint Color Specifications, Requirements for Surface Preparation, Paint Application Rates and Methods, and Requirements for Preformed Thermal Plastic Markings. AC 150/5370-10 provides the paint color specifications, requirements for surface preparation, paint application rates, the various methods for applying paint, and the performance requirements for using only preformed thermoplastic markings. **Precaution:** Reflective tapes such as those commonly used for highways and city street applications are not to be used on the airside because of the potential for foreign object damage caused by loosened painted tape.

c. Striated Markings. Striated markings, which may be used in areas subject to frost heave, consist of painted stripes 4 inches (10 cm) to 8 inches (20 cm) in width that are separated by unpainted stripes. The width of the unpainted stripe may not exceed the width of the painted stripe. The width of the painted and unpainted stripes must be the same throughout the specific marking. Each edge of the marking must be a painted stripe. That is, a painted stripe is to begin and end within the width of the markings. **Precaution:** Because striated markings offer reduced visibility compared to non-striated markings, more frequent maintenance is required to maintain an acceptable level of visibility. Hence, striated markings are never used on Category II and Category III runways.

d. Temporary Markings. When selecting a material for temporary markings, consider the difficulty of removing the temporary marking when it is no longer needed. Some airports have had some success using water-based paint. Striated markings may also be used for temporary markings, but they are never used to denote a closed runway or other closed pavement or for Category II or Category III runways.

e. Removal of Markings. Pavement markings that are no longer needed are not to be painted over but instead are to be physically removed. Removal of markings is achieved by water blasting, shot blasting, sand blasting, chemical removal, or other acceptable means that do not harm the pavement. The FAA does not endorse painting over the old markings because this practice merely preserves the old marking, which in some cases have misled pilots, and requires additional maintenance. **Precaution:** Special consideration should be placed on the size and shape of removal areas when removing runway markings associated with the relocation of a runway threshold or its displacement so that the resulting area of discolored pavement resulting from the removal process does not result in the continued visual appearance of a marked pavement. That is, the size and shape of the removal area(s) need to be much larger than the marking to be removed.

f. Painted Numbering System for Record Keeping of Surface Painted Markings. To facilitate the daily inspection, scheduled maintenance, necessary repairs, etc. for surface markings the airport operator may use a numbering system or alphanumeric system that is located in a corner of the surface marking. Figure 1-1 shows a numbering system adopted by Dallas/Fort Worth (DFW) International Airport for identifying each surface marking listed in their Sign Plan. If employed, the

height of the inscription should be small and inconspicuous to all viewers except an individual standing next to the surface marking.

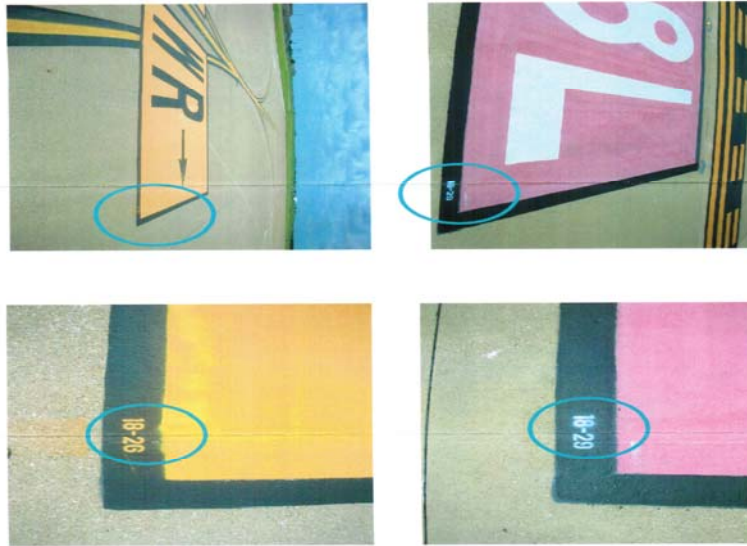

Figure 1-1. Example of DFW Painted Numbering System for Surface Painted Markings

1.4. REQUIREMENTS AND RECOMMENDATIONS FOR ENHANCED CONSPICUITY OF SURFACE MARKINGS. Surface markings that cannot be seen by pilots and other individuals operating on paved airfield surfaces are useless. Two proven techniques that help airport operators enhance the conspicuity of surface markings are (1) outlining surface markings with black borders on light-colored pavements and (2) placing glass beads in paint. However, glass beads are not to be used in black paint. Table 1-1 serves as a general guide for determining when existing asphalt concrete surfaces or asphalt treated surfaces may be classified as a light-colored pavement, i.e., when to outline a required surface marking with a black border.

Table 1-1. General Guidelines for Determining Light-Colored Pavements

Painting a Black Border			
Pavement Surface Type	Age of Pavement Surface ¹		
	New	Up to 2 years old	Over 2 years old
Portland Cement Concrete Surfaces	Yes	Yes	Yes
Asphalt Concrete Surfaces	No	No	Yes
Asphalt Treated Surfaces	No	No	Yes

Note 1: This table serves only as a general guide since an existing asphalt pavement at one airport location may not experience the same rate of surface color deterioration as at another airport location.

a. Technique 1 – Outlining Surface Markings with Black Borders on Light-Colored Pavements. The degree of contrast (conspicuity) between surface markings on light-color pavements, in particular on concrete and older asphalt pavements, can be increased by outlining all edges of the surface

marking with a black border. Appendix B provides illustrations of recommended patterns for various surface markings outlined in black. Black borders, except for enhanced taxiway centerline applications, should be at least 6 inches (15 cm) or greater in width to enhance the conspicuity of certain painted surface markings on light-color pavements. The borders for the outside dashes of the enhanced taxiway centerline marking can range from 3 to 6 inches (7.5 – 15 cm).

(1) Surface Markings that Require Black Borders.

- (i) All holding position markings used on runways, taxiways, and holding bays and used to indicate ILS/MLS or precision obstacle free zone (POFZ) critical areas (per paragraphs 3.2, 3.3, 3.4, and 3.5) and the non-movement area boundary marking (per paragraph 5.4).
- (ii) Intermediate holding position marking for taxiway/taxiway intersections (per paragraph 3.6).
- (iii) All taxiway centerline markings on taxi routes designated as surface movement guidance and control system (SMGCS) routes (per paragraph 4.2).
- (iv) Enhanced taxiway centerline marking (per paragraph 4.3).
- (v) Surface painted holding position sign marking (per paragraph 4.5).
- (vi) Geographic position marking (per paragraph 4.11).

(2) Surface Markings Recommended for Black Borders. This advisory circular strongly recommends outlining all other markings not listed in paragraph 1.4(a)(1), particularly taxiway centerlines per paragraph 4.2.

b. Technique 2 – Use of Glass Beads on Permanent Pavement Markings. Glass beads identified in Item P-620 of AC 150/5370-10 are an effective means of enhancing the conspicuity of surface markings when aircraft and vehicles operate at night, during low-visibility conditions, or when the pavement surface is wet. Due to the additional increase in marking conspicuity caused by certain glass beads, the FAA recommends that runway holding position markings contain either Type III or Type IV glass beads as determined by the airport operator. If Type IV glass beads that have a larger diameter are used, then they should only be applied in higher-built materials, such as TT-P-1952E-Type III waterborne paint, epoxy, methyl methacrylate, or preformed thermoplastic. **Precaution:** As previously stated, glass beads should never be used in black paint.

Glass Bead Requirement Paragraph 620-3.5, Application, per AC 150/5370-10 (General)
Glass beads shall be distributed upon the marked areas at the locations shown on the plans to receive glass beads <i>immediately after application of the paint</i> . A dispenser shall be furnished that is properly designed for attachment to the marking machine and suitable for dispensing glass beads. Glass beads shall be applied at the rate(s) shown in Table 1 of AC 150/5370-10. Glass beads shall not be applied to black paint. Glass beads shall adhere to the cured paint or all marking operations shall cease until corrections are made.

(1) Surface Markings that Require Glass Beads.

(i) All holding position markings used on runways, taxiways, and holding bays and used to indicate ILS/MLS or POFZ critical areas (per paragraphs 3.2, 3.3, 3.4, and 3.5).

(ii) Runway threshold marking (per paragraph 2.5).

(iii) Runway threshold bar marking (per paragraph 2.9(a)).

(iv) Runway aiming point marking (per paragraph 2.6).

(v) Runway landing designator marking (per paragraph 2.3).

(vi) Runway touchdown zone marking (per paragraph 2.7).

(vii) Runway centerline marking (per paragraph 2.4).

(viii) Taxiway centerline marking (per paragraph 4.2).

(ix) Enhanced taxiway centerline marking (per paragraph 4.3).

(x) Geographic position marking (per paragraph 4.11).

(xi) Surface painted signs for holding position signs (paragraph 4.5), taxiway direction signs (paragraph 4.6), taxiway location signs (paragraph 4.7), gate destination signs (paragraph 4.8), and apron entrance point signs (paragraph 4.9).

(xii) Non-movement area boundary marking (per paragraph 5.4).

(2) Surface Markings Recommended for Glass Beads.

(i) Runway side stripe marking (per paragraph 2.8).

(ii) Taxiway edge marking (per paragraph 4.4).

(iii) Runway displaced threshold marking (per paragraph 2.9).

(iv) Runway demarcation bar marking (per paragraph 2.9(c)).

Blank Page

CHAPTER 2. SURFACE MARKINGS FOR RUNWAYS.

2.1. APPLICATION. The minimum requirements for surface marking schemes used for runways are a direct function of the approach category for each runway threshold and the existence of displaced thresholds, stopways, blast pads, or extra wide shoulders. Runways having the same approach category off both runway thresholds will show the same surface marking scheme from threshold to threshold (with some exceptions, such as the runway designator.) In comparison, runways with different approach categories will show two different surface marking schemes. The complete runway surface marking schemes required by a runway combine table 2-1 requirements with the physical structure and usage of the runway.

a. Table 2-1 identifies the minimum required surface marking schemes for paved runways according to their threshold approach category. Figures 1, 2, 3, and 5 provide the dimensional standards for the surface marking schemes. An airport operator may paint a runway with additional surface marking schemes than required, such as a visual runway with runway side stripes or the aiming point marking, if deemed necessary by the FAA. Furthermore, surface markings beyond those described in table 2-1 are required to support particular operations, such as a displaced threshold, or to identify runway related features, such as blast pads or stopways.

Table 2-1. Minimum Required Runway Surface Marking Schemes for Paved Runways

Runway Surface Marking Scheme	Threshold Approach Category		
	Visual Approach	Non-precision Approach (Approaches with vertical guidance not lower than $\frac{3}{4}$ -statute mile visibility)	Precision Approach (Approaches with vertical guidance lower than $\frac{3}{4}$ -statute mile visibility)
Landing Designator (par. 2.3)	X	X	X
Centerline (par. 2.4)	X	X	X
Threshold (par. 2.5)	Note 1	X	X
Aiming Point (par. 2.6)	Note 2	Note 3	X
Touchdown Zone (par. 2.7)			X
Side Stripes (par. 2.8)	Note 4	Note 4	X

Note 1: Required on runways serving approach categories C and D airplanes and for runways used, or intended to be used, by international commercial air transport.

Note 2: Required on 4,200-foot (1,280 m) or longer runways serving approach categories C and D airplanes.

Note 3: Required on 4,200-foot (1,280 m) or longer instrumented runways.

Note 4: Used when the full runway pavement width may not be available for use as a runway.

b. Runways with a displaced threshold, blast pad, stopway, or extra wide shoulders require additional marking schemes not identified in table 2-1. These surface marking schemes and others not in

table 2-1 are discussed separately in this advisory circular. See AC 150/5300-13 for detailed information about the location of displaced thresholds, blast pads, and stopways.

**Application of Proportioning Runway Markings
for Non-Standard Runway Widths
(Painting)**

The dimensional size for the runway surface marking promulgated by this advisory circular is based on the assumption that the runway has a standard runway width as prescribed by AC 150/5300-13. For convenience, the standard widths are shown in table 2-2 below.

Airport operators with non-standard runway widths may, *for specified surface markings*, proportionally adjust the marking's width to be less than the standard scheme. Under substandard conditions, the width of marking is in direct proportion to the available runway width. However, the corresponding length for the marking is never reduced.

Subsequent paragraphs in this advisory circular will specify, via a green-shaded, solution box, those runway surface markings that may be proportioned. The absence of a green-shaded, solution box in a subsequent paragraph implies that that runway surface marking, such as the runway centerline, is not to be decreased in width even if other nearby runway surface markings are proportionally adjusted.

2.2. INTERRUPTION OF RUNWAY SURFACE MARKINGS. At the intersection of two runways, the surface markings of one runway are, with the possible exception of runway side stripes (such as closed V-shaped runways), fully displayed through the intersection while the surface markings of the other runway are completely interrupted. This process of removing runway surface markings from one runway establishes an order of precedence among the different runways.

a. Order of Precedence. The order of precedence for displaying the runway surface marking schemes of one runway over the other runway at the intersection of these runways should follow this order:

- (1) Precision approach runway, Category III.
- (2) Precision approach runway, Category II.
- (3) Precision approach runway, Category I.
- (4) Non-precision approach runway.
- (5) Visual runway.

For an intersection of runways of the same precedence, the preferred higher precedence runway is the one having the lowest approach minimums or the runway end most often used.

b. Lesser Precedence Runways. The manner in which a lesser precedence runway intersects a higher precedence runway may require the shifting or complete removal of certain surface markings that fall within the intersection. As shown in figure 4, the most affected surface markings are the runway centerline, runway side stripes, aiming point markings, and runway touchdown zone markings. The latter two runway markings may have implications when shifted or removed. See paragraphs 2.2(c) and 2.6 for shifting an aiming point marking, and see paragraph 2.7 for removing touchdown zone markings.

c. Consequences When Shifting the Aiming Point Markings. Figure 4 shows one possible conflict that could occur when the aiming point markings are relocated.

(1) When the aiming point markings of a given runway that are in the intersection of two runways need to be moved more than 200 feet (61 m) away from the existing threshold, the airport operator will have to displace the existing threshold or designate a new runway end (threshold) in order to retain the distance between the threshold and the aiming point marking as illustrated in the bottom illustration of figure 4. The *preferred* distance to be maintained between the newly designated threshold and the shifted aiming point marking is 1,020 feet (311 m); see paragraph 2.6.

(2) Runways with an approach landing aid, such as Precision Approach Path Indicators (PAPIs) or Visual Approach Slope Indicators (VASIs), which are co-located with the aiming point markings, can be negatively affected when an excessive shifting of the aiming point marking occurs. The consequence could be a non-compatible threshold crossing height for landing airplanes. When the aiming point markings are shifted more than 60 feet (18.3 m), the co-located PAPI or VASI should be evaluated for relocation to provide a correct vertical guidance to pilots. See paragraph 7.5, Design (of Economy Approach Aids) and table 7.1, Threshold Crossing Heights, of AC 150/5340-30, Design and Installation Details for Airport Visual Aids, to determine if the impact of shifted aiming point markings warrants a relocation of the co-located PAPI (or other runway approach aids).

(3) For landing safety, the FAA requires that whenever the distance between the threshold and aiming point markings is 1,220 feet (372 m) or more, the airport operators place a note in the Airport/Facility Directory (A/FD) to inform pilots about the increased distance existing between the threshold and the aiming point markings.

d. Closed V-Shaped Runway Ends Configuration. The closed V-shaped runway ends configuration is a pavement geometry where two runway ends commence from the same location but proceed in different directions. This undesirable geometry requires a special shifting procedure of the runway landing designator marking of the lesser precedence runway further down the runway than prescribed by paragraph 2.3. The special procedure is as follows. On the lesser order runway, locate the point on its runway centerline that is perpendicular to the inside common corner of the two intersecting runways. Once this base point is located, move this base point 20 feet (6.5 m) down the runway centerline to relocate the bottom of the letter or number(s) used for the runway landing designator. For an intersection of runways of the same precedence, the preferred higher precedence runway is the one having the lowest approach minimums or the runway end most often used.

Wrong-Runway Takeoffs Mitigation (Safety)

In an effort to eliminate the possibility of a “wrong-runway” takeoff operation by pilots, the airport operator should reconstruct closed V-shaped runway geometries to a different geometry, possibly an X-shaped geometry.

2.3. RUNWAY LANDING DESIGNATOR MARKING.

a. Purpose. The runway landing designator marking identifies a runway end.

b. Location. Runway landing designator marking(s) must be located from the runway threshold per figures 1, 2, and 3 or from the displaced threshold per figure 6. All these figures show the start location for both types of thresholds.

c. Color. Runway landing designator markings are white. See paragraph 1.4, *Requirements and Recommendations for Enhanced Conspicuity of Surface Markings*, for required and recommended techniques to enhance visibility of this surface marking.

d. Characteristics.

(1) A runway landing designator marking consists of a single number or two numbers. When parallel runways exist, the number(s) are further supplemented with a letter.

(2) A single-digit runway landing designation number is never preceded by a zero.

(3) For single runways, dual parallel runways, and triple parallel runways, the designator number is the whole number nearest the one-tenth of the magnetic azimuth along the runway centerline when viewed from the direction of approach. For example, where the magnetic azimuth along the runway centerline is 183 degrees, the runway designator marking would be 18; for a magnetic azimuth of 87 degrees, the runway designation marking would be 9. For a magnetic azimuth ending in the number "5" such as 185 degrees, the runway designator marking can be either 18 or 19.

(4) On four or more parallel runways, one set of adjacent runways is numbered to the nearest one-tenth of the magnetic azimuth and the other set of adjacent runways is numbered to the *next* nearest one-tenth of the magnetic azimuth.

(5) For parallel runways, each runway landing designator number must be supplemented by a letter, in the order shown from left to right when viewed from the direction of approach as prescribed by the following marking criteria. Different labeling patterns than those prescribed below are permissible under certain circumstances as identified in subparagraph 2.3(d)(6).

(i) Two parallel runways having a magnetic azimuth of 182 degrees – the runways would be designated "18L," "18R."

(ii) Three parallel runways having a magnetic azimuth of 87 degrees – the runways would be designated "9L," "9C," "9R."

(iii) Four parallel runways having a magnetic azimuth of 324 degrees – the runways would be designated "32L," "32R," "33L," "33R."

(iv) Five parallel runways having a magnetic azimuth of 138 degrees – the runways would be designated "13L," "13R," "14L," "14C," "14R" or "14L," "14R," "13L," "13C," "13R." Other combinations exist for this case. See paragraph 2.3(d)(6).

(v) Six parallel runways having a magnetic azimuth of 83 degrees – the runways would be designated "8L," "8C," "8R," "9L," "9C," "9R." Other combinations exist for this case. See paragraph 2.3(d)(6).

(vi) Seven parallel runways having a magnetic azimuth of 85 degrees – the runways would be designated "8L," "8C," "8R," "9L," "9C," "9R," "10." Other combinations exist for this case. See paragraph 2.3(d)(6).

(6) There are certain runway placements where the surface marking schemes for parallel runways provided in subparagraph 2.3(d)(5) may not be appropriate because their orientation may lead to pilot confusion. For example, the marking scheme recommended for parallel runways on the same side of a terminal is to follow subparagraph 2.3(d)(5). However, when two parallel runways are separated by a large terminal or several terminals, it is preferable to designate the runways as non-parallel runways to avoid pilot confusion. Another case that may cause pilot confusion is a turf runway that is parallel to paved visual runway but at a great distance from a higher precedence paved runway. In general, the airport operator should carefully choose how to mark parallel runways to eliminate pilot confusion.

(7) The appearance of the letters and numbers used for runway landing designator markings are in the form and proportion as shown in figure 5. The spacing between numbers and letters are as shown in figures 1, 2, 3, and 5. However, with the exception of the numerals 6 and 9, all numerals and the letters L, C, and R are 60 feet (18.3 m) in height. Numerals 6 and 9, which are 63 feet (18.9 m) in height, follow the Rule of 69. That is, although the numerals 6 and 9 are taller, the 3-foot tips of the numerals are ignored so that their separations from the threshold markings, the letters L-C-R, the first runway centerline, and the start of the runway threshold remain as shown in figures 1, 2, and 3.

**Application of Proportioning Runway Markings
for Airplane Design Group (ADG) I Runway Width
(Painting)**

Due to the space limitations on very narrow runways, the size and spacing of the numbers and letters are reduced only when necessary such that the painted runway landing designator is no closer than 2 feet (0.6 m) from the runway edge or runway side stripes. For example, this problem may occur when painting certain dual-numbered runway landing designators spaced 15 feet (4.5 m) apart on an ADG I runway width of 60 feet (18.3 m). In such cases, first reduce the 15-foot (4.5-m) spacing to 10 feet (3.1 m) and retain the size of numerals and letter per figure 5. Second, reduce the 15-foot (4.5-m) spacing to 10 feet (3.1 m) and reduced the size of numerals and letter proportionally to maintain the 2-foot (0.6 m) edge or runway side stripe clearance.

2.4. RUNWAY CENTERLINE MARKING.

a. Purpose. The runway centerline marking identifies the physical center of the runway width and provides alignment guidance to pilots during takeoff and landing operations. For lighting provisions, see AC 150/5340-30.

b. Location. A runway centerline marking is located along the physical center of the runway width and spaced between the runway landing designation markings as shown in figures 1, 2, and 3.

c. Color. The runway centerline marking is white. See paragraph 1.4 for required and recommended techniques to enhance this surface marking.

d. Characteristics. A runway centerline marking consists of a line of uniformly spaced stripes and gaps and of uniform width.

(1) The stripes are 120 feet (36.5 m) in length and the gaps are 80 feet (24.3 m) in length.

(2) The minimum width of the stripes is:

- 36 inches (90 cm) for precision runways.
- 18 inches (45 cm) for non-precision runways.
- 12 inches (30 cm) for visual runways.

(3) To accommodate varying runway lengths, all adjustments to the uniform pattern of runway centerline stripes and gaps are made near the runway midpoint (defined as the distance between the two thresholds or displaced thresholds). Under such cases, reduce the lengths of both the stripes and gaps starting from midpoint and proceed toward the runway thresholds. Reduced stripes must be at least 80 feet (24 m) in length, and the reduced gaps must be at least 40 feet (12.3 m) in length. The affected stripes and gaps within the section should show a uniform pattern.

2.5. RUNWAY THRESHOLD MARKING.

a. Purpose. A runway threshold marking, which commences 20 feet (6 m) from the actual start point of runway threshold, closely identifies the actual beginning point of the runway threshold used for landings. For lighting provisions, see AC 150/5340-30.

b. Location. The runway threshold marking starts 20 feet (6 m) from the actual start point of the runway threshold as shown in figures 1 and 2. This value remains the same even though a 10-foot (3-m) white threshold bar is introduced, such as for displaced thresholds or the addition of a blast pad or stopway as shown in figure 8. Previously, when a displaced threshold was painted or a blast pad or stopway added, the 20-foot (6-m) dimension was increased to 30 feet (9 m) to accommodate the requirement for painting the runway threshold bar. When a runway is completely remarked, the newly painted displaced threshold and threshold bar markings are 10 feet (3 m) apart as shown in figure 6.

c. Color. The components of a runway threshold marking are white. See paragraph 1.4 for required and recommended techniques to enhance this surface marking.

d. Characteristics. The runway threshold marking consists of a pattern of longitudinal stripes of uniform dimensions spaced symmetrically about the runway centerline. The number of longitudinal stripes and their spacing is determined by the runway width.

(1) Table 2-2 provides the number of longitudinal stripes for runways having standard runway widths as defined by AC 150/5300-13. Figure 1 illustrates the pattern for a 150-foot (45-m) wide runway. See paragraph 2.5(d)(3) for painting guidance applicable to non-standard runway widths.

Table 2-2. Number of Runway Threshold Stripes for Standard Runway Widths

Standard runway widths	Number of symmetrical stripes
60 feet (18.3 m)	4
75 feet (22.9 m)	6
100 feet (30.5 m)	8
150 feet (45.7 m)	12
200 feet (61 m)	16

(2) For standard runway widths, the longitudinal stripes are 150 feet (45.7 m) long and 5.75 feet (1.75 m) wide with the outer edges spaced (stripe-gap) 5.75 feet (1.75 m) apart. However, the two longitudinal stripes nearest the runway centerline are doubled spaced, i.e., outer edges of the nearest pair are 11.5 feet (3.5 m) apart. Figure 1 illustrates the stripe-gap pattern for 150-foot (46 m) wide runways. The stripe-gap pattern allows sufficient room to paint runway side stripes without interfering with the outermost longitudinal stripes.

**Application of Proportioning Runway Markings
for Non-Standard Runway Widths
(Painting)**

For standard 75-foot (23-m) wide runways that use 36-inch (90-cm) wide runway side stripes, the stripe-gap pattern of 5.75 feet (1.75 m) is reduced to 5.50 feet (1.68 m).

(3) For non-standard runway widths, the same stripe-gap pattern is continued from the runway centerline until the outermost longitudinal stripe is not closer than 4 feet (1.2 m) from the runway edge. For example, for a non-standard 125-foot (38-m) wide runway, the stripe-gap pattern yields a total of 10 longitudinal stripes symmetrical about the runway centerline. In no case should the stripe-gap pattern exceed 92 feet (27 m) on either side of the runway centerline. The value of 92 feet (27 m) is the width for the pattern used on the standard 200-foot (61-m) wide runways.

(4) When there is pavement in excess of 5 feet (1.5 m) prior to the actual start of the runway threshold and (a) pilots may confuse the pavement as part of the actual runway or (b) the pavement does not have the same load bearing capacity as the runway, then painting of a runway threshold bar per paragraph 2.9 is required. In contrast, if the installation of landing threshold lights requires pavement to support the light fixtures and the supportive pavement abuts the start point of the runway threshold, then the supportive pavement is not considered a part of the runway. In this instance, the painting of a runway threshold bar is not required.

2.6. RUNWAY AIMING POINT MARKING.

a. Purpose. A runway aiming point marking provides a visual aiming point for landing operations.

b. Location. The *preferred* beginning of the aiming point marking starts 1,020 feet (311 m) from the runway threshold as shown in figures 1, 2, and 3. However, this *preferred* separation is not adequate for all cases as partially discussed below.

Note: The term *preferred* assumes the following conditions: standard visual glide slope of 3 degrees; no obstacle in the approach area affecting the obstacle clearance surface of the PAPI; standard threshold crossing heights per table 7-1, *Threshold Crossing Heights*, of AC 150/5340-30; sufficient runway length so not to force the placement of the aiming point marking; no rapid terrain drop off near the approach threshold that encounters severe turbulence; no elevation differences between the threshold and the installation zone of the PAPI.

(1) Intersecting Runways. A separation tolerance of plus or minus 200 feet (61 m) is allowed when it is necessary to shift the aiming point marking to avoid overlapping aiming point markings at dual runway intersection as shown in figure 4 and discussed in paragraph 2.2(c). However, depending on the threshold crossing heights and the available runway approach aids, the shifting of the aiming point markings may negatively impact the threshold crossing heights for approaching airplanes. One potential impact of the shift is to the co-located runway approach aids, such as the PAPI, in which the previous vertical guidance offered by the aiming point marking to pilots is now incompatible with the threshold crossing height associated with the runway approach aid. Under such conditions, adjustment in the location of the affected runway approach aid may be necessary after an evaluation so that the co-located relationship between the PAPI (and other approach aids) and the shifted aiming point marking permits an acceptable landing operation for both landing aids.

(2) Compatible Threshold Crossing Heights. See paragraph 7.5, *Design (of Economy Approach Aids)* and table 7-1, *Threshold Crossing Heights*, of AC 150/5340-30 to determine if the impact of a relocated aiming point marking warrants relocating the co-located PAPI (or other runway approach aids).

c. Color. The runway aiming point marking is white. See paragraph 1.4 for required and recommended techniques to enhance this surface marking.

d. Characteristics.

(1) The runway aiming point marking consists of two conspicuous rectangular markings, 150 feet (45.7 m) in length for runways of at least 4,200 feet (1,280 m) in length between the thresholds (or a displaced threshold(s)) and 100 feet (30.5 m) in length for lesser lengths between the thresholds (or a displaced threshold(s)), that are located symmetrically on each side of the runway centerline as shown in figures 1, 2, and 3. See table 2-2 for the dimensions of standard runway widths per AC 150/5300-13.

(2) The width of each rectangular marking is as follows:

- (i)** 30 feet (9.1 m) for standard runway widths of 150 feet (45.7 m) or greater.
- (ii)** 20 feet (6 m) for standard runway widths of 100 feet (30.5 m).
- (iii)** 15 feet (5 m) for standard runway widths of 75 feet (22.9 m).
- (iv)** 12 feet (3.7 m) for a standard runway width of 60 feet (18.3 m).

(3) The lateral spacing between the inner sides of the runway aiming point markings is as follows:

- (i)** For runways of 150 feet (45.7 m) or more in width, the lateral spacing between the inner sides of the rectangular bars centered on the runway centerline is 72 feet (21.9 m).

(ii) For runways of 100 feet (30.5 m) in width, the lateral spacing between the inner sides of the rectangular bars centered on the runway centerline is 48 feet (14.6 m).

(iii) For runways of 75 feet (22.9 m) in width, the lateral spacing between the inner sides of the rectangular bars centered on the runway centerline is 36 feet (11.0 m).

(iv) For runways of 60 feet (18.3 m) in width, the lateral spacing between the inner sides of the rectangular bars centered on the runway centerline is 28.8 feet (8.8 m).

**Application of Proportioning Runway Markings
for Non-Standard Runway Widths
and for Standard Runway Widths less than 150 feet (45.7 m)
(Painting)**

For runways with widths below 150 feet (45.7 m), the width of the rectangular bars and their lateral spacing between the inner sides of the rectangular bars are adjusted in proportion to the available runway width by using the 150-foot (45.7 m) width runway parameters to determine the percentage decrease in lateral spacing and width of each marking. For example, a non-standard 70-foot wide runway would apply $70/150 = 0.467$ to obtain a lateral spacing of $72 \times 0.467 = 33.6$ feet (10.25 m) between the pair and an individual width of $30 \times 0.467 = 14$ feet (4.27 m).

If runway side stripes are also painted, which are not reduced, then the adjustment should add the width of the corresponding runway side stripes plus a minimum 1-foot (0.3-m) clearance between the outer edge of the aiming point marking and the runway side stripe.

Lateral spacing – in no case is the lateral spacing less than 30 feet (9.1 m) except for runways less than 75 feet (22.9 m).

Lengths – in all cases, the length of the aiming point marking remains unchanged.

2.7. RUNWAY TOUCHDOWN ZONE MARKING.

a. Purpose. For landing operations, the touchdown zone marking identifies the touchdown zone along a precision runway in 500-foot (152-m) increments. For lighting provisions, see AC 150/5340-30.

a. Location. The touchdown zone marking consists of symmetrically arranged pairs of rectangular bars in groups of one, two, and three along the runway centerline as shown in figure 1. As shown, there are five groupings with the aiming point marking serving as an independent, sixth pair.

(1) The touchdown zone marking scheme maintains a 900-foot (275-m) “no-marking zone” from the midpoint of the runway back toward the threshold. That is, those pairs of surface markings that extend within 900 feet (275 m) of the runway midpoint are eliminated. The intent of this painting practice is to preserve a 1,800-foot (550-m) unmarked area so pilots do not confuse the surface markings during a landing with the surface markings for the other approach procedure. The same practice applies equally to a displaced threshold, i.e., the midpoint is located between the thresholds or displaced thresholds and not the runway ends. Taking this into consideration, the painted pattern for the runway touchdown zone marking depends on the (a) authorized approach off each runway and (b) the available length between the runway thresholds or displaced threshold, i.e., the midpoint. The surface marking patterns for the two possible cases are provided in table 2-3 (case #1) and table 2-4 (case #2).

Case #1 – Only one runway end requires the runway touchdown zone marking scheme. Apply table 2-3 criteria, which take into account the “no-marking zone” of 900 feet (275 m) from the midpoint back toward the threshold.

Table 2-3. Pairs of Touchdown Zone Markings Required When Installed From One Threshold

Distance Between Thresholds (or displaced thresholds)	Markings for Precision Approach End (includes displaced threshold)	Other Runway End Visual or Non-precision
6,065 ft (1849 m) or greater ¹	Full set of markings	Aiming point marking
5,565 ft (1697 m) to 6,064 ft (1848 m)	Less one pair of rectangular bar markings ²	Aiming point marking
5,065 ft (1544 m) to 5,564 ft (1696 m)	Less two pairs of rectangular bar markings	Aiming point marking
4,565 ft (1391 m) to 5,064 ft (1543 m)	Less three pairs of rectangular bar markings	Aiming point marking
<p>Note 1: The value of 6,065 feet is derived as follows. For the non-precision or visual runway end, the table assumes the 900-foot “no-marking zone” criterion plus the length of a <i>preferred</i> aiming point marking, which starts 1,020 feet from the start of the threshold to obtain a length of 1,920 feet. Add to this the length of the aiming point marking. Per paragraph 2.6(d)(1), the length of the aiming point marking is either 150 feet or 100 feet. This table uses a length of 150 feet because all the entries in column #1 are greater than 4,200 feet. Therefore, adding 150 feet to 1,920 feet obtains a length of 2,070 feet. For the precision end, which equals 3,995 feet, it assumes the 900-foot “no-marking zone” followed by the standard 75-foot-long rectangular bar for a total length of 975 feet. Add to this value the full 3,000-foot touchdown zone marking scheme and the 20-foot separation between the actual starting point of the runway threshold (or displaced threshold) and the bottom edge of threshold marking to obtain 3,995 feet. Summing the values 3,995 and 2,070 yields 6,065 feet.</p>		
<p>Note 2: Each reduction in a pair of rectangular bar markings from the precision end equates to a 500-foot (152-m) reduction between the thresholds.</p>		
<p>The painting rationale for this table is to ignore the midpoint between the thresholds so the precision instrumented landing is favored over non-precision or visual landings. That is, the length of the non-precision/visual side of the runways always remains at 2,070 feet in length to promote the painting of a full set of touchdown zone markings.</p>		

Case #2 – Both runway ends require runway touchdown zone markings. Apply table 2-4 criteria, which take into account the “no-marking zones” of 1,800 feet (550 m) from the threshold-to-threshold midpoint.

Table 2-4. Pairs of Touchdown Zone Markings Required When Installed From Both Thresholds

Distance Between Thresholds (or displaced thresholds)	Markings for Each Threshold (or displaced threshold)
7,990 ft (2436 m) or greater ¹	Full set of markings
6,990 ft (2130 m) to 7,989 ft (2435 m)	Less one pair of rectangular bars from each side nearest to the runway midpoint ²
5,990 ft (1826 m) to 6,989 ft (2129 m)	Less two pairs of rectangular bars from each side nearest to the runway midpoint ²
4,990 ft (1521 m) to 5,989 ft (1825 m)	Less three pairs of rectangular bars from each side nearest to the runway midpoint ²
<p>Note 1: The value of 7,990 feet is derived as follows. Proceed from the runway midpoint in one direction, and you will have the 900-foot “no-marking zone” criterion followed by the standard 75-foot long rectangular bar for a total length of 975 feet. Add to this value the full 3,000-foot touchdown zone marking scheme plus the 20-foot separation between the actual starting point of the runway threshold (or displaced threshold) and the edge of threshold marking to obtain 3,995 feet. Double this value for both directions to obtain 7,990 feet.</p> <p>Note 2: Each reduction in a pair of rectangular bar markings from both sides equates to a 1,000-foot (305-m) reduction between the thresholds.</p> <p>The painting rationale for this table is to preserve the midpoint between the thresholds, thereby promoting an equal treatment of painting pairs of rectangular bar markings for both sides.</p>	

(2) Because the location of the aiming point marking may be adjusted from the threshold to accommodate different approach slopes and/or heights over the threshold and to possibly take into account non-zero runway gradients, the location of an adjusted aiming point marking will vary. Please see AC 150/5340-30. Under such conditions, an adjusted aiming point will, in most cases, continue to be located between the first and the second touchdown zone markings. However, when the accumulative effect of the adjustments is severe (defined as when a touchdown zone marking coincides with or is within 160 feet (48.8 m) of the adjusted aiming point marking), that touchdown zone marking must not be painted. For the pilot community, this practice permits the aiming point marking to retain its prominent visual landing aid as compared to a touchdown zone marking.

c. Color. All rectangular bars are white. See paragraph 1.4 for required and recommended techniques to enhance this marking.

d. Characteristics.

(1) For runway widths of 150 feet (45.7 m) or greater, each rectangular bar is 75 feet (22.9 m) long and 6 feet (1.8 m) wide. The lateral spacing between the inner sides of the rectangular bars on the same side of the runway centerline is 5 feet (1.5 m).

(2) For runway widths less than 150 feet (45.7 m), the length of the marking remains unchanged, but the width and the lateral spacing between the markings are reduced proportionally to the decrease in runway width by using 150-foot (45.7 m) parameters to determine the percentage decrease.

(3) The lateral spacing between the inner sides of the rectangular bars centered along the runway centerline is equal to that of the aiming point marking (criteria repeated below from paragraph

2.6(d)(3)). In all cases, the length of the rectangular bars (and the aiming point markings) remains unchanged. See table 2-2 for the dimensions of standard runway widths.

(i) For runways of 150 feet (45.7 m) or more in width, the lateral spacing between the inner sides of the rectangular bars centered on the runway centerline is 72 feet (21.6 m).

(ii) For runways of 100 feet (30.5 m) in width, the lateral spacing between the inner sides of the rectangular bars centered on the runway centerline is 48 feet (14.6 m).

(iii) For runways of 75 feet (22.9 m) in width, the lateral spacing between the inner sides of the rectangular bars centered on the runway centerline is 36 feet (11.0 m).

(iv) For runways of 60 feet (18.3 m) in width, the lateral spacing between the inner sides of the rectangular bars centered on the runway centerline is 28.8 feet (8.8 m).

**Application of Proportioning Runway Markings
for Non-Standard Runway Widths
(Painting)**

For runways with widths below 150 feet (45.7 m), the width of the rectangular bars and their lateral spacing between the inner sides of the rectangular bars are adjusted in proportion to the available runway width by using the 150-foot (45.7 m) width runway parameters to determine the percentage decrease in lateral spacings and width of the marking. For example, a non-standard 70-foot wide runway would apply $70/150 = 0.467$ to obtain a lateral spacing for the centered pair of $72 \times 0.467 = 33.6$ feet (10.25 m), a lateral spacing for other pairs of $5 \times 0.467 = 2.3$ ft (0.7 m), and a width of $6 \text{ feet} \times 0.467 = 2.8$ feet (0.85 m). This adjustment must be such that the inner sides of the innermost rectangular bars to the runway centerline align themselves with the inner side of the aiming point marking. Given that the runway side stripes are painted, the adjustment should be such that the clearance between the runway side strip and the outer edge of the three-bar grouping is a minimum of 1-foot (0.3 m). In no case should the three-bar group be painted further out from the runway centerline than the aiming point marking.

2.8. RUNWAY SIDE STRIPE MARKING.

a. Purpose. The runway side stripe marking provides enhanced visual contrast between the runway edge and the surrounding terrain or runway shoulders and delineates the width of suitable paved area for runway operations. For lighting provisions, see AC 150/5340-30.

b. Location. The runway side stripe marking consists of two parallel stripes, one placed along each edge of the usable runway with the outer edge of each stripe approximately on the edge of the paved useable runway. For extra wide runways, such as military runways converted for public use, the maximum distance between the outer edges of the parallel stripes is 200 feet (61 m). Figure 1 illustrates the runway side stripe marking.

c. Color. The stripes of the runway side stripe marking are white. See paragraph 1.4 for required and recommended techniques to enhance this marking.

d. Characteristics. The runway side stripe marking has a minimum width of 36 inches (90 cm) for runways of 100 feet (30.5 m) or wider in width and at least 18 inches (45 cm) on smaller width runways (see table 2-2 for standard runway widths).

(1) For runways with a displaced threshold, the side stripes continue through the paved area prior to the displaced threshold as shown in figure 6. This continuation of the side stripes is required because this paved area is used for takeoffs and landing rollouts from the other direction.

(2) Where an aligned taxiway, as shown in figures 7 and 9, precedes a runway threshold, both side stripes will terminate. The point of termination of the side stripes is determined by the taxiway geometry. The FAA recommends that airport operators not construct new aligned taxiways. The FAA further recommends that existing aligned taxiways be removed or reconfigured into usable runways, for example, as shown in figures 6 and 10.

(3) When a taxiway connects to a runway or the runway has turn pads or turnarounds, the runway side stripe marking remains continuous between the runway and these adjoining infrastructures.

(4) For intersecting runways, see guidance in paragraph 2.2, *Interruption of Runway Surface Markings*.

2.9. RUNWAY DISPLACED THRESHOLD MARKING. The marking scheme for a runway with a displaced threshold, when required by paragraph 2.1, includes a runway threshold bar and arrowheads with and without arrow shafts. Figures 6, 9, and 10 illustrate the various applications of displaced thresholds and the requirement for additional marking components. For lighting provisions, see AC 150/5340-30.

a. Runway Threshold Bar Marking.

(1) **Purpose.** The runway threshold bar marking delineates the beginning section of the runway available for landing from the unusable section on the approach side of the displaced threshold.

(2) **Location.** The runway threshold bar marking is an elongated rectangular bar that is located perpendicular to the runway centerline and on the landing portion of the runway. The outboard edge of the marking is aligned with the location labeled “start of runway displaced threshold” as shown in figure 6.

(3) **Color.** The runway threshold bar marking is white. See paragraph 1.4 for required and recommended techniques to enhance this marking.

(4) **Characteristics.** The runway threshold bar marking is 10 feet (3.1 m) in width and extends between the runway edges or between the runway side stripe markings.

b. Arrow Marking. The arrow marking (arrowheads with and without arrow shafts) performs three possible functions, that is, two cases for displaced thresholds and one case for a runway threshold with an aligned taxiway.

(1) Purposes.

(i) Figure 6 illustrates the predominant case in which the threshold is displaced from the runway end. In this case white arrowheads with and without arrow shafts are required to identify the portion of the *runway* before the displaced threshold to provide centerline guidance for pilots during approaches, takeoffs, and landing rollouts from the opposite direction.

(ii) Figure 9 illustrates the rare case in which a displaced threshold is preceded by an *aligned taxiway*. In this case white arrowheads with and without arrow shafts and yellow arrowheads

without arrow shafts are required to identify the runway portion from the aligned taxiway portion. Furthermore, a yellow runway demarcation bar is required to identify the start of the runway. See paragraph 2.9(c) for runway demarcation bar criteria.

(iii) Figure 7 illustrates the rare case in which a runway threshold is preceded by an *aligned taxiway*. In this case yellow arrowheads without arrow shafts are required to identify the runway portion from the aligned taxiway portion.

General Comment
Airport operators should avoid the (1) conversion of a runway section into an aligned taxiway and (2) construction of a new aligned taxiway.

(2) Locations.

(i) For the predominant case, arrow shafts and arrowheads are located on the portion of the *runway* before the displaced threshold.

(ii) For the rare cases, only arrowheads are used on the portion of the *aligned taxiway* before the threshold bar marking or the demarcation bar marking.

(3) Colors.

(i) For the predominant case, the arrow shaft and arrowhead are white. See paragraph 1.4 for required and recommended techniques to enhance these markings.

(ii) For the rare cases, the arrowhead is yellow.

(4) **Characteristics.** The dimensions and spacing requirements for arrow shafts and arrowheads are as shown in figure 6 (function one), figure 7 (function two), and figure 9 (function three).

c. Runway Demarcation Bar Marking.

(1) **Purpose.** A demarcation bar delineates a runway with a displaced threshold from a blast pad, stopway, or an aligned taxiway that precedes the runway.

(2) **Location.** The demarcation bar is an elongated rectangular bar on a blast pad, stopway, or an aligned taxiway that is perpendicular to the runway centerline at the point of intersection with the start of the runway as shown in figure 10. In another application, as shown in figure 9, the portion of *aligned taxiway* before the demarcation bar is not part of the usable runway.

(3) **Color.** The demarcation bar marking is yellow. See paragraph 1.4 for required and recommended techniques to enhance this marking.

(4) **Characteristics.** The demarcation bar marking is 3 feet (0.9 m) wide and extends across the entire width of the blast pad, stopway, or aligned taxiway.

2.10. CHEVRON MARKINGS FOR BLAST PADS, STOPWAYS, AND EMAS.

a. **Purposes.** The chevron marking identifies paved blast pads, stopways, and EMAS (engineered materials arresting systems) in relation to the end of the runway. For lighting provisions, see

AC 150/5340-30, and for EMAS design, see AC 150/5220-22, Engineered Materials Arresting Systems for Aircraft Overruns.

b. Location. The chevron marking is located on the blast pad and stopway that are aligned with and contiguous to the runway end as shown in figures 8 and 10. The chevron scheme for an EMAS installation is also centered along the extended runway centerline (not shown in figures 8 and 10).

c. Color. Chevron markings are yellow. See paragraph 1.4 for required and recommended techniques to enhance this marking.

d. Characteristics. Dimensionally, stopways equal the width of the runway while blast pads equal the runway width plus the shoulder widths (see AC 150/5300-13). The dimensions and spacing requirements for chevron markings are shown in figure 8. The recommended minimum length for a stopway is 150 feet (45.7 m) to allow for at least two chevron stripes. For cases where (1) standard length blast pads, per AC 150/5300-13, are installed off runway ends used exclusively by small airplanes (Airplane Design Group I – small) or (2) existing stopways are less than 150 feet (45.7 m) in length on runway widths of 75 feet (22.9 m) or less, the width of the chevrons and the spacing between the chevrons shown in figure 8 can be reduced by two-thirds. The intent of the reduction in dimensions is to provide pilots with at least two visible chevrons.

2.11. RUNWAY SHOULDER MARKING.

a. Purpose. The runway shoulder marking is used, when needed, as a supplement to further delineate a paved runway shoulder that pilots have mistaken or are likely to mistake as usable runway. This marking is used only in conjunction with the runway side stripe marking.

b. Location. The runway shoulder marking is located between the runway side stripe and the outer edge of the paved shoulder as shown in figure 11.

c. Color. Runway shoulder markings are yellow. See paragraph 1.4 for required and recommended techniques to enhance this marking.

d. Characteristics. The runway shoulder marking consists of stripes 3 feet (0.9 m) in width and spaced 100 feet (30.5 m) apart along the edge of the runway. The stripes start at the runway midpoint, are slanted at an angle of 45 degrees to the runway centerline, and are oriented as shown in figure 11.

Blank Page

CHAPTER 3. HOLDING POSITION MARKINGS.

3.1. APPLICATIONS OF HOLDING POSITION MARKINGS. The purposes for the different holding position markings are to prevent aircraft and vehicles from entering into critical areas associated with a runway and navigational aids or to control traffic at the intersection of taxiways. This advisory circular describes six operational situations (cases) using three different holding position marking schemes. Cases 1, 2, and 3 employ the same marking scheme referred to as Pattern A – runway holding position marking. Cases 4 and 5 employ a different marking scheme referred to as Pattern B – ILS/MLS or POFZ holding position marking. The latter operational situation, Case 5, uses Pattern B in which it usually appears as an L-shaped ladder. Case 6 uses a different marking scheme referred to as Pattern C – intermediate holding position marking for taxiway/taxiway intersections. Figures 12 and 12a show the four different marking patterns.

- **Case 1:** In terms of taxiing on a runway, an aircraft will need to hold short of an intersecting runway (see paragraph 3.2).
- **Case 2:** In terms of landing on a runway used for land and hold short operations (LAHSO), the aircraft will need to hold short of an intersecting runway or, in some rare cases, at a specified hold spot on the landing runway (see paragraph 3.2).
- **Case 3** (most common application for Cases 1, 2, and 3): In terms of taxiing on a taxiway, an aircraft will need to hold short prior to entering an active runway (see paragraph 3.3).
- **Case 4:** In terms of taxiing on a taxiway, an aircraft will need to hold short before entering the critical area of an Instrument Landing System (ILS)/Microwave Landing System (MLS) (see paragraph 3.4).
- **Case 5:** In terms of taxiing on a taxiway, an aircraft will need to hold short before entering the critical area of a Precision Obstacle Free Zone (POFZ) (see paragraph 3.5). Although the surface marking pattern is the same as Case 4, the pattern in many applications is L-shaped, instead of only linear in shape.
- **Case 6:** In terms of taxiing on a taxiway, an aircraft will need to hold short of a taxiway/taxiway intersection (see paragraph 3.6).

3.2 CASE 1 AND CASE 2 – APPLICATIONS OF PATTERN A FOR THE RUNWAY HOLDING POSITION MARKING ON RUNWAYS.

a. Purpose. Pattern A when painted on a runway, as shown in figure 12, identifies the location where a pilot (or vehicle driver) is to stop and hold when (1) the runway is operationally closed for an interval of time so that ATCT can control taxiing operations through a runway/runway intersection or (2) the runway is used for land and hold short operations (LAHSO). For necessary corresponding signage and lighting provisions, see AC 150/5340-18, Standards for Airport Sign Systems, and AC 150/5340-30, Design and Installation Details for Airport Visual Aids.

**Safety Initiatives
(Safety)**

Note 1: Land and hold short operations (LAHSO) require a letter of agreement between the airport operator and the airport traffic control tower (ATCT).

Note 2: Paragraph 405, *Parallel Taxiway*, of AC 150/5300-13 states that a *basic airport* consists of a runway with a full-length parallel taxiway. Since the design standard for a full-length parallel taxiway reduces both wrong-runway takeoffs and runway incursions, we do not recommend the use of an operationally closed runway as a taxiway, especially when a parallel taxiway exists. Such an operation can potentially confuse pilots because this taxiing operation introduces yellow-colored taxiway surface markings onto the runway itself. Hence, to avoid the potential for operational errors by pilots, the airport operator should take measures to meet the full-length parallel taxiway design standard. In some cases, the operational capacity for a given runway could indicate the need for dual parallel taxiways to avoid this type of taxiing operation.

Note 3: To avoid a runway incursion event at runway /runway intersections when an operationally closed runway is used as a taxiway, the intersection must have the runway holding position marking and corresponding signs whether or not pilots taxi through the runway /runway intersection. Additionally, this marking should only be used in those instances where documentation supports the need for the operational use of the runway as a taxiway. The operational use of a runway as a taxiway must be described in a Letter of Agreement with the ATCT.

b. Location. In all Case 1 and Case 2 applications, the location of the runway holding position marking is at or beyond the edge of the runway safety area of the intersecting runway as provided by AC 150/5300-13. The criteria given below assume that the center lines of the intersecting runways are perpendicular. Hence, for runway /runway intersections that are non-perpendicular, additional distance may be required to ensure that all airplane features, such as wingtips, remain outside the runway safety area of the intersecting runway.

(1) Operationally Closed Runways Used for Taxiing Operations. The location of the runway holding position marking on operationally closed runway is in accordance with the holdline criteria per table 2-1 or table 2-2 in AC 150/5300-13 for the intersecting runway's airport reference code.

(2) Runways Used for LAHSO.

(i) The location of the runway holding position marking on the runway used for LAHSO is in accordance with the holdline criteria per table 2-1 or table 2-2 in AC 150/5300-13 for the intersecting runway's airport reference code. On rare cases the location of the runway holding position marking for LAHSO is based on a *predetermined hold-short point* along the landing runway to protect an approach/departure flight path or to overcome painting difficulties as described below in subparagraph 3.2(b)(2)(ii). In no case should the location of the predetermined hold-short point be within the holdline criteria in table 2-1 or table 2-2 in AC 150/5300-13 for the intersecting runway's airport reference code.

Certain airfield geometries for runways that are used for taxiing or LAHSO operations have intersecting taxiway(s) that hamper the painting of the runway holding position marking (and accompanying necessary signage) in accordance with the applicable holdline criterion. One such geometry occurs when a crossing taxiway or its fillet intersects the same area indicated by table 2-1 or table 2-2 of AC 150/5300-13. One solution is to move the hold-short point further away from the runway/runway intersection so that both the marking and the installed signage clear the common crossing area. Under this solution (1) the marking is always painted at a greater distance than the holdline criteria

and (2) the required corresponding signage retains only the runway designations, i.e., never uses a taxiway designation.

c. Color. The Pattern A marking scheme, as shown in figure 12, is yellow and, when painted on light-colored pavements, is outlined in black. See paragraph 1.4 and table 1-1 for required and recommended techniques to enhance this surface marking on light-colored pavements.

d. Characteristics.

(1) The marking is identical to the runway holding position marking installed *on a taxiway* as described in paragraph 3.3 and shown in figure 12. The solid lines, as compared to the dashed lines, are always on the side where the aircraft is to hold.

(2) The marking is installed perpendicular to the runway centerline and interrupts all runway markings except for the runway designation marking. If the runway holding position marking should interrupt the mentioned exceptions, then paint the runway holding position marking further away than specified by AC 150/5300-13 to avoid any interruption of these specified markings. The painting practice is to avoid “over striping” existing runway surface markings.

(3) The runway holding position marking extends across the full width of the runway but not onto the runway shoulders or onto any intersecting taxiway fillet.

3.3. CASE 3 – APPLICATIONS OF PATTERN A FOR THE RUNWAY HOLDING POSITION MARKING ON TAXIWAYS.

a. Purposes. Pattern A when painted on a taxiway as shown in figure 12 serves several roles. For a taxiway that intersects a runway at an airport with an operating airport traffic control tower (ATCT), the Pattern A marking scheme identifies the location on a taxiway where pilots and vehicle drivers are to stop until they receive a clearance from ATCT to proceed onto the runway. Under this role, Pattern A may be supplemented with the Geographic Position Marking as part of the airport’s Surface Movement Guidance Control System (SMGCS) Plan as described in paragraph 4.11 and as shown in figure C-8. For a taxiway that intersects a runway at an airport without an operating airport traffic control tower, Pattern A identifies the location where a pilot and vehicle drivers are to stop to ensure that they have adequate separation with other aircraft before proceeding onto the runway. For a taxiway that does not intersect a runway but crosses through a runway approach area or the runway safety area, the Pattern A marking scheme identifies the location on a taxiway where pilots and vehicle drivers are to stop to receive clearance from the airport traffic control tower before proceeding through the protected area. This application serves to stop a taxiing aircraft from penetrating the runway safety area (a runway incursion) or any of several airspace surfaces, for example, those used to define the runway threshold, runway inner approach obstacle free zone, or the runway inner transitional obstacle free zone. If the marking is located closer than prescribed by AC 150/5300-13, such as when the taxiing aircraft penetrates a Terminal Instrument Procedures (TERPS) surface, then the airport operator can expect higher approach minimums to the impacted runway end. AC 150/5300-13 includes a discussion of these airspace surfaces. Except as specified in paragraph 3.2, the runway holding position marking must not be used for any other situations than the roles described in this paragraph. For signage and lighting provisions, see AC 150/5340-18 and AC 150/5340-30.

b. Location. Pattern A for the runway holding position marking is located as follows.

(1) For a taxiway that intersects a runway, the Pattern A runway holding position markings must be located on all such taxiways in accordance with the holdline criteria per table 2-1 or table 2-2 in AC 150/5300-13 for the runway's airport reference code. Since the location is based on the approach visibility minimums, approach category, and airplane design group, the airport operator should use the lowest approach visibility minima and critical aircraft intended to use the runway. Pattern A is used also on turnarounds and holding bays as shown in figures 4-8 and 4-9 of AC 150/5300-13, especially for airports with an airport traffic control tower or for any runways used at night and in low-visibility conditions. Locating a runway holding position marking other than what is required by this paragraph must be approved by the FAA.

(2) For a taxiway not intersecting a runway but crossing through a runway safety area or a runway approach surface, the Pattern A runway holding position markings must be located on all such taxiways in accordance with the more protective area obtained by either the holdline criteria per table 2-1 or table 2-2 in AC 150/5300-13 for the runway's airport reference code or the boundary of the approach surface's critical area. The Pattern A marking must extend across the entire width of the taxiway. Locating a Pattern A runway holding position marking other than what is required by this paragraph must be approved by the FAA Airports Regional Office or Airports District Office.

(3) The Pattern A marking must extend across the entire width of the taxiway. For taxiways having taxiway edge markings, discontinue the taxiway edge marking as shown in figure 21 so that the Pattern A marking continues to the edge of the defined taxiway width. For taxiways that serve Airplane Design Groups (ADG) V or VI airplanes as defined by AC 150/5300-13, the marking is further extended onto both paved shoulders as shown in figure C-4. For both airplane design groups, the length of the marking from the taxiway centerline onto the paved shoulder measures 62.5 feet (19 m). The 62.5-foot (19-m) measurement takes into account the downward viewing angle from the cockpit while the pilots are seated in the normal position as well as other safety factors, such as aircraft wander from the taxiway centerline. For taxiways with widths greater than 75 feet (22.9 m), the runway holding position marking is extended 25 feet (7.5 m) [$62.5 \text{ viewing angle minus } (1/2)(75) \text{ standard taxiway width equals } 25 \text{ feet}$] onto the paved taxiway shoulders. Only those taxiway entrances to a runway that serve ADGs V or VI are to be further enhanced. Typical airplane models within ADGs V and VI include the Airbus 330-200/-300, A-340-200/-300/-500/-600, A-380, Boeing-747-100/-200/-400, B-777-200/-300, and B-787-8/-9.

**14 Code of Federal Regulation (CFR) Part 139 Certificated Airports
Runway Incursion Mitigation Requirement
(Safety)**

The extended runway holding position marking, as illustrated in figure C-4, is mandatory and is the only acceptable means of compliance for 14 CFR Part 139 certificated airports serving ADGs V and VI airplanes. The enhanced runway holding position marking applies only to those taxiway entrances for a given runway that serve these airplane design groups. Since the compliance date of June 30, 2008, has passed, all new taxiway entrances serving ADGs V and VI airplanes must be painted accordingly prior to opening the taxiway. This surface painted marking is part of the taxiway centerline marking standard under 14 CFR Section 139.311(a)(2).

c. Color. The Pattern A marking scheme, as shown in figure 12, is yellow and, when painted on light-colored pavements, outlined in black. See paragraph 1.4 and table 1-1 for required and recommended techniques to enhance this surface marking.

d. Characteristics. Pattern A for the runway holding position marking consists of a set of two continuous lines, two dashed lines, and three spaces that are all parallel, run the width of the paved taxiway, measure 12 inches (30 cm) in width, and are separated as shown in figure 12. At airports that do not have an operating ATCT and are not certificated under 14 CFR Part 139, the width and separation measurement may be reduced from 12 inches (30 cm) to 6 inches (15 cm). For clarification, all airports certificated under 14 CFR Part 139, whether or not there is an operating ATCT, are required to use the 12-inch measurement.

(1) The orientation of Pattern A is for the solid continuous lines to be painted on the side where the aircraft and vehicles will hold before proceeding to the runway. That is, dashed lines are painted closer to the runway.

(2) Pattern A is painted perpendicular to the taxiway centerline but may be canted from the perpendicular in unique situations, such as an extremely acute, angled taxiway. For such unique situations, it may be necessary to install additional runway holding position signs, runway guard lights, or stop bars to emphasize the location of the surface painted runway holding position marking.

(3) Pattern A on converging taxiways as shown in figure C-13 meet at an angle when two or more taxiways intersect the same runway hold line. On any angled taxiway to the runway, consideration must be given to locate the painted marking so no portion of an aircraft, e.g., wing tip or tail, penetrates the runway safety area or any protected surface. See AC 150/5300-13 for detailed requirements and information about clearance requirements by aircraft on taxi routes.

(4) For taxiways with taxiway edge markings, the taxiway edge markings must be removed for the width of the Pattern A marking.

(i) If the runway holding position marking is outlined in black, then the taxiway edge markings abut the black outline on both sides of this marking. That is, it abuts the black border of the solid yellow line on one side and abuts the black border of the dashed yellow line on the other side.

(ii) If the runway holding position marking is not outlined in black, then the taxiway edge markings abut the holding position marking on both sides. That is, the taxiway edge markings abut the solid yellow line on one side and abut the dashed yellow line on the other side.

(5) For ADGs V and VI taxiways having a light fixture or a sign located on the taxiway shoulder that aligns with the extended runway holding position marking, as shown in figure C-4, the extended runway holding position marking should extend no closer than 5 feet (1.5 m) to the edge of the light fixture or sign.

(6) For ADGs V and VI taxiways whose taxiway shoulder markings interfere with or are within 10 feet (3.1 m) from the extended runway holding position marking, as shown in figure C-4, are to be removed (omitted) from that location.

3.4. CASE 4 – APPLICATIONS OF PATTERN B FOR THE ILS/MLS HOLDING POSITION MARKING.

a. Purposes. Pattern B for the ILS/MLS holding position marking as shown in figure 12 identifies the location on a taxiway or holding bay where a pilot or vehicle driver is to stop when they have received instructions from the airport traffic control tower (ATCT) to hold before entering an ILS/MLS critical area. The intent of the marking is to protect the signal of the ILS/MLS navigational aid

by identifying the holding position for CAT I operations and protecting the approved TERPS for CAT II/III operations. For signage and lighting provisions, see AC 150/5340-18 and AC 150/5340-30.

b. Location. Pattern B for the ILS/MLS holding position marking is located on the taxiway or holding bay at the boundary of the ILS/MLS critical area and, as appropriate, at the holding position for CAT I and CAT II/III operations.

(1) Where the distance between an ILS/MLS holding position (Pattern B) marking and the runway holding position (Pattern A) marking on a taxiway is 50 feet (15 m) or less, paint only one pattern, provided it will not adversely affect capacity. In this case, it is preferable to move the runway holding position (Pattern A) marking back to the where the ILS/MLS holding position (Pattern B) would have been painted. This preference is selected for taxiways serving ADG V or ADG VI airplanes in which the marking is extended onto the taxiway shoulders.

(2) If a taxiway or holding bay penetrates both an ILS/MLS critical area and the Precision Obstacle Free Zone (POFZ) critical area (see Pattern B, figure 12a), such as when the threshold is displaced, paint only one pattern instead of two patterns only if the single pattern can protect both critical areas. The pattern to be painted is the one whose location offers the most conservative, protective boundary (for example, farthest from the runway).

(3) The FAA Airports Regional Office or Airports District Office will designate the ILS/MLS critical area and POFZ boundaries and, as appropriate, determine the correct holding position location for CAT II/III operations for the airport operator. See AC 150/5300-13 for general information about the ILS/MLS and POFZ critical areas.

(4) The Pattern B marking for ILS/MLS applications must extend across the entire width of the taxiway or holding bay as shown in figure 12.

c. Color. The Pattern B marking scheme as shown in figure 12 is yellow and, when used on light-colored pavements, outlined in black. See paragraph 1.4 and table 1-1 for required and recommended techniques to enhance this surface marking.

d. Characteristics. Pattern B for the ILS/MLS holding position marking consists of a set of two parallel lines that are 2 feet (0.6 m) wide and spaced 4 feet (1.2 m) apart. These parallel lines are connected by perpendicular sets of two lines that are 1 foot (0.3 m) wide and spaced 1 foot (0.3 m) apart and repeat every 10 feet (3 m) (see Figure 12). Figure 12 provides the discontinuation (separation) of an ILS/MLS holding position marking with an intersecting taxiway centerline or taxiway edge stripe markings. At airports that do not have an ATCT and are not certificated under 14 CFR Part 139, the airport operator may reduce the dimension for the width of the parallel yellow lines and spaces from 2 feet (0.6 m) to 1 foot (0.3 m) and from 4 feet (1.2 m) to 2 feet (0.6 m). For clarification, all airports certificated under 14 CFR Part 139, whether or not there is an operating ATCT, are required to use the larger measurements.

3.5. CASE 5 – APPLICATIONS OF PATTERN B FOR PRECISION OBSTACLE FREE ZONE (POFZ) HOLDING POSITION MARKING.

a. Purposes. Pattern B for the POFZ holding position marking as shown in figure 12a identifies the location on a taxiway or holding bay where a pilot or vehicle driver is to stop when they have received instructions from the airport traffic control tower (ATCT) to hold before entering the POFZ critical area. The marking is used also at non-towered airport where the runway end has an approved vertical guidance

of $\frac{3}{4}$ -statute mile approach visibility minimum or less. The intent of the marking is to protect the authorized landing minima (TERPS) for a given runway end. See AC 150/5300-13 for detailed information about the POFZ critical area. For signage and lighting provisions, see AC 150/5340-18 and AC 150/5340-30.

b. Location. Pattern B for the POFZ holding position marking is located on the taxiway or holding bay at the boundary of the POFZ critical area as defined by AC 150/5300-13 and, when appropriate, at the holding position for CAT I and CAT II/III operations. Figure 15 shows the most common application for this marking which is L-shaped. Because of the variety of taxiway entrance/holding bay geometries, the Pattern B marking must not be painted over a surface painted holding position sign.

(1) Certain airfield geometries may cause a taxiway or holding bay to penetrate both an ILS/MLS critical area and the Precision Obstacle Free Zone (POFZ) critical area, such as when the threshold is displaced. Under such situations, paint only one pattern instead of two patterns only if the single pattern can protect both critical areas. The pattern to be painted is the one whose location offers the most conservative, protective boundary (for example, farthest from the runway). Under this application the ILS/MLS holding position (Pattern B) marking or POFZ holding position (Pattern B) marking, which now serves a dual function, cannot be replaced with, or used in lieu of, a runway holding position (Pattern A) marking.

(2) The FAA Airports Regional Office or Airports District Office will designate the ILS/MLS critical area and POFZ boundaries and, as appropriate, determine the correct holding position location for CAT II/III operations for the airport operator.

(3) The Pattern B marking for POFZ applications must extend across only those portions of a taxiway or holding bays that run along the boundary of the POFZ as shown in figures 12a and 15.

c. Color. The Pattern B marking scheme is yellow and, when used on light-colored pavements, outlined in black. See paragraph 1.4 and table 1-1 for required and recommended techniques to enhance this surface marking.

d. Characteristics. Pattern B for the POFZ holding position marking consists of a set of two parallel lines that are 2 feet (0.6 m) wide and spaced 4 feet (1.2 m) apart. These parallel lines are connected by perpendicular sets of two lines that are 1 foot (0.3 m) wide and spaced 1 foot (0.3 m) apart and repeated every 10 feet (3 m). Figure 12, provides the discontinuation (separation) of a POFZ holding position marking, which follows the same criteria as the ILS/MLS holding position marking, with an intersecting taxiway centerline or taxiway edge stripe markings. Figure 15 illustrates the general separation of a Pattern B marking from an entrance taxiway serving a runway. At airports that do not have an ATCT and are not certificated under 14 CFR Part 139, the airport operator may reduce the dimension for the width of the parallel yellow lines and spaces from 2 feet (0.6 m) to 1 foot (0.3 m) and from 4 feet (1.2 m) to 2 feet (0.6 m). For clarification, all airports certificated under 14 CFR Part 139, whether or not there is an operating ATCT, are required to use the larger measurements.

3.6. CASE 6 – APPLICATIONS FOR PATTERN C FOR THE TAXIWAY/TAXIWAY INTERSECTION INTERMEDIATE HOLDING POSITION MARKING.

a. Purpose. Pattern C for the intermediate holding position marking, as shown in figure 12a for taxiway/taxiway intersections, is used to support the operational need by the airport traffic control tower

to manage taxiing aircraft through a congested intersection or for other reasons deemed necessary by the FAA. For example, figure 14 shows the intersection between a taxiway and a holding pad used for taxiing aircraft. Pilots when instructed by the airport traffic control tower to "hold short of (taxiway designation)" must stop so no part of the aircraft extends beyond the boundary of the intermediate holding position marking. For signage and lighting provisions, see AC 150/5340-18 and AC 150/5340-30.

b. Location. For the taxiway being marked, the intermediate holding position marking for taxiway/taxiway intersection is located according to the taxiway centerline to fixed or movable object criteria in table 2-3 of AC 150/5300-13 for the most demanding airplane design group serving the airport (as defined in AC 150/5300-13).

c. Color. The intermediate holding position marking is yellow and, when used on light-colored pavements, outlined in black. See paragraph 1.4 and table 1-1 for required and recommended techniques to enhance this surface marking.

d. Characteristics. The intermediate holding position marking for taxiway /taxiway intersections consist of a single dashed line extending across the width of the taxiway per figure 12a and figure B-7. The single dash lines are 1 foot (0.3 m) wide, 3 feet (0.9 m) long, and spaced 3 feet (0.9 m) apart. As shown in figure 12a, all intersecting taxiway centerlines are spaced 6 to 12 inches (15 cm to 30 cm) on either side of this marking.

CHAPTER 4. SURFACE MARKINGS FOR TAXIWAYS.

4.1. APPLICATION. All taxiways regardless of their width have a centerline marking, and whenever a taxiway intersects a runway, the taxiway should have a surface painted runway holding position marking. For 14 CFR Part 139 certificated airports, all taxiways that intersect a runway must have a surface painted runway holding position signs(s) and an enhanced taxiway centerline marking. Taxiway edge markings are installed wherever there is a need to separate the taxiway from a pavement that is not intended for aircraft use or to delineate the edge of the taxiway that is not otherwise clearly visible. Examples of other taxiway surface markings that should be installed when appropriate and deemed necessary by the FAA (in some cases, with input from the tower manager of the airport traffic control tower (ATCT)) include the Pattern A, B, and C holding position markings discussed in Chapter 3, the intermediate holding position markings for taxiway/taxiway intersections, geographic position marking, and the taxiway shoulder marking.

4.2. TAXIWAY CENTERLINE MARKINGS. All taxiways regardless of their width have a surface painted taxiway centerline.

a. Purpose. The taxiway centerline marking provides pilots continuous visual guidance to permit taxiing along a designated path. See AC 150/5300-13 for standard fillet design, AC 150/5340-30 for lighting provisions and AC 150/5340-18 for signage provisions.

b. Location. On a straight section of a taxiway, the taxiway centerline marking is located along the physical centerline of the paved taxiway. This statement assumes the taxiway was built to standard, i.e., symmetrical with a taxiway centerline. On curved sections of a taxiway, the taxiway centerline marking continues from the centerline marking of the straight portion of the taxiway along a curved centerline defined as the Radius of Taxiway Turn in table 4-2 of AC 150/5300-13.

(1) For taxiways that intersect other taxiways, the adequacy of the fillet design determines the centerline painting scheme as shown in figure 16. The recommended design is cockpit-over-centerline steering which reduces the number of airplane main gear excursions from the taxiway.

(i) At taxiway intersections with fillets that do not meet the fillet design standards of AC 150/5300-13—that is, judgmental over-steering is performed by pilots—the centerline marking continues straight through the intersection as shown at the top of figure 16. This practice applies to intersecting taxiways that are or are not of the same airport reference code.

(ii) Where adequate fillets exist, that is, the fillets are designed to the most demanding aircraft, the taxiway centerline marking follows the taxiway curve as shown on the bottom of figure 16 to permit cockpit-over-centerline steering operations. This practice applies to intersecting taxiways that are or are not of the same airport reference code.

Note: AC 150/5300-13 states that cockpit-over-centerline steering as compared to judgmental over-steering is the preferred methodology for painting taxiway centerlines in taxiway intersections. To reduce taxiway excursions on turns, airport operators are encouraged to (1) construct standard fillets and (2) paint taxiway centerlines according to cockpit-over-centerline design.

(2) For taxiways that intersect runways, different painting requirements or restrictions apply.

(i) For a taxiway that intersects a runway *at a runway end*, as shown in figures 14 and 15, the taxiway centerline is terminated either at the runway edge or at the outer edge of the runway side stripe. However, the taxiway centerline (lead-on and lead-off) will continue onto the runway under the following conditions:

(1) Where there is a displaced threshold, as shown in figures 6 and 10, the taxiway centerline marking continues onto the displaced area of the runway and extends parallel to the displaced threshold markings (arrow heads and arrow shafts) for a distance of 200 feet (61 m) beyond the point of tangency or terminates at the point of contact with the displaced threshold bar, whichever is less. As shown in figure 6 the lead-on and lead-off taxiway centerlines are 3 feet (1 m) from the runway arrow markings as measured near-edge to near-edge. This lead-on or lead-off taxiway centerline line is interrupted for all runway markings with some exceptions (see paragraph 4.2(b)(2)(i)(2)).

(2) For low-visibility taxiing operations, when the runway visual range (RVR) is below 1,200 feet (366 m), the taxiway centerline marking continues across all runway markings with the exception of the runway designation marking and, unless required by a SMGCS Plan, the runway threshold marking (longitudinal stripes). The painted taxiway centerline marking must follow the path of the in-pavement lighting criteria of AC 150/5340-30. That is, if the in-pavement lighting is curved, the painted taxiway centerline is curved. In this situation, the taxiway centerline marking continues onto the runway and extends parallel to the runway centerline marking for a distance of 200 feet (61 m) beyond the point of tangency and is 3 feet (1 m) from the runway centerline as measured near-edge to near-edge. For some airfield geometry, such as an airfield with parallel runways with several parallel taxiways, the painted taxiway centerline at the runway end is painted straight through the runway end and curved onto the runway. See AC 150/5340-30 for the different RVR in-pavement lighting requirements and recommendations associated with various airfield configurations.

(ii) For taxiways that intersect a runway at any *other locations than at the runway end*, as shown in figure 14, the taxiway centerline marking curves onto the runway and extends parallel to the runway centerline marking for a distance of 200 feet (61 m) beyond the point of tangency with the runway centerline or terminates at the point of contact with the displaced threshold bar, whichever is less. As shown in figures 14 and 15, these lead-on and lead-off taxiway centerlines are 3 feet (1.0 m) from the runway centerline when measured near-edge to near-edge.

(1) For taxiways that cross a runway, which are either perpendicular to or non-perpendicular to the runway centerline, and are normally used as crossing taxi routes, the taxiway centerline marking may continue across the runway but is interrupted for all runway markings with some exceptions (see paragraph 4.2(b)(2)(ii)(2)).

(2) For low-visibility taxiing operations, when the RVR is below 1,200 feet (366 m), the taxiway centerline marking continues across all runway markings with the exception of the runway designation marking and, unless required by the SMGCS Plan, the runway threshold marking (longitudinal stripes), aiming point marking, and the touchdown zone markings.

c. **Color.** The taxiway centerline marking is yellow. See paragraph 1.4 and table 1-1 for required and recommended techniques to enhance this marking.

Painting Notice: Over the years, some airport operators have installed other colors to denote various taxiing routes on the movement areas. These surface markings are non-standard. In an attempt to circumvent the yellow color standard, these different colored centerline markings have sometimes been referred to as supplemental markings or some other ambiguous term. Regardless of what they are called, these surface markings are non-standard and require specific approval by the FAA Director of Airport Safety and Standards. Regarding aircraft deicing facilities that are located in non-movement area, taxiway/taxilane centerlines are painted in accordance with AC 150/5300-14, Design of Aircraft Deicing Facilities.

d. Characteristics.

(1) Width. The taxiway centerline marking width, which is either 6 inches (15 cm) or 12 inches (30 cm), is based on the type of taxiing operation as described below. Uniform width must be maintained for the entire length of the taxiway except under the following conditions.

(i) The taxiway or part of the taxiway is designated as a SMGCS taxi route. Under this designation, the width of the taxiway centerline must be 12 inches (30 cm) wide and, on light-colored pavement, further outlined in black. The taxiway centerline width of any remaining section of the taxiway that is *not part of the designated SMGCS taxi route* may change abruptly at that point or at the intersection with other taxiway centerline markings, for example, reduced from 12 inches (30 cm) to 6 inches (15 cm).

(ii) A confusing intersection of taxiways is better served by the designation of a preferred taxi route through the confused intersection by painting a wider centerline width. The FAA recommends that airport operators take measures to realign or reconstruct confusing taxiway intersections.

(iii) Airport operators may, if deemed necessary to provide pilots a better visual clue of the location of troublesome taxiway exits from the runway, increase 6-inch (15-cm) wide taxiway centerline markings before the aircraft hold side at the runway holding position location to 12-inch (30-cm) wide lead-off taxiway centerline markings on the runway side.

(2) Discontinuity of the Taxiway Centerline Marking Along the Taxiway. The taxiway centerline marking of a taxiway remains continuous except when it intersects (1) a runway holding position marking (the taxiway connects to a runway), (2) an intermediate holding position marking (intersection of taxiways), (3) an ILS/MLS or POFZ holding position marking, or (4) non-movement area boundary marking (paragraph 5.4). Figures 12 and 12a illustrate the marking details for most of these conditions.

4.3 ENHANCED TAXIWAY CENTERLINE MARKING.

a. Purposes. The enhanced taxiway centerline marking provides supplemental visual cues to alert pilots of an upcoming runway holding position marking (Pattern A) for minimizing the potential for runway incursions. To reinforce situational awareness before entering a runway, this safety enhancement is only used on those taxiways that directly enter a runway. For example, this safety enhancement would not be painted on a runway or used at all Pattern A applications, such as case 1 or case 2 (paragraph 3.2), situations as shown in figure C-16, or a taxiway that goes through the runway safety area but not onto the

runway itself. The same restriction is valid for case 4 Pattern B applications, such as, a taxiway through an approach area.

**14 Code of Federal Regulation (CFR) Part 139 Certificated Airports
Runway Incursion Mitigation Requirement
(Safety)**

The enhanced taxiway centerline marking, as illustrated in figure C-1, is mandatory and the only acceptable means of compliance for all 14 CFR Part 139 certificated airports. All entrance taxiways with a runway holding position marking are to have the enhanced taxiway centerline marking. Painting this safety enhancement should be completed in the shortest period of time, preferably concurrently for all taxiway entrances to a given runway. The intent of this revision is to avoid pilot confusion by eliminating the previous three different applications of this safety enhancement at 14 CFR Part 139 certificated airports.

Compliance dates vary as follows: (1) for commercial service airports with annual passenger enplanements of 1.5 million or more, June 30, 2008. Beyond this deadline, all new taxiway entrances must be painted accordingly prior to opening the taxiway; (2) for commercial service airports with less than 1.5 million annual passenger enplanements but more than 370,000 annual passenger enplanements, December 31, 2009. Beyond this deadline, all new taxiway entrances must be painted accordingly prior to opening the taxiway; and (3) for all other commercial service airports and non-commercial service airports certificated under 14 CFR Part 139, December 31, 2010. Beyond this deadline, all new taxiway entrances must be painted accordingly prior to opening the taxiway.

This surface painted marking is part of the taxiway centerline marking standard under 14 CFR Section 139.311(a)(2).

b. Location. Taxiway centerlines are enhanced for 150 feet (45.7 m) prior to a Pattern A – runway holding position marking, as shown in figure C-1, except for the situations described in paragraph 4.3(d). The portion of the taxiway centerline between the runway holding position marking and the runway itself is not enhanced. If the location of taxiway centerline lights and their housings interfere with the painting of the enhanced taxiway centerline, then lights and their housing can be covered up temporarily during the painting process, i.e., lights need not be relocated or housing painted to accommodate this requirement.

c. Color. The enhanced taxiway centerline marking is yellow and must use glass beads. See paragraph 1.4 and table 1-1 for required and recommended techniques to enhance this marking. If a black border is required, the border on the outside of the dashes can be 3 to 6 inches (7.5 – 15 cm) in width. All black borders never use glass beads.

d. Characteristics. The standard painted enhanced taxiway centerline marking consists of two parallel lines of yellow dashes one on each side of the existing taxiway centerline as shown in figures C-1 and C-6. For both applications, the first dashes start 6 to 12 inches (15–30 cm) from the runway holding position marking. For figure C-1 applications, the marking runs for a length of 9 feet (2.7 m) with a 6-inch (15-cm) width and are followed with a gap of 3 feet (0.9 m) between the dashes. For figure C-6 applications, the first and second set of dashes are 6 to 12 inches (15 - 30 cm) from the runway holding position marking and the surface painted holding position sign. For both cases, the standard painted pattern has a total length of 150 feet (45.7 m). For Figure C-1 applications, the standard pattern consists of 12 sets of 9-foot (2.75-m) dashes plus 3-foot (0.9-m) spaces and ends with a 6-foot (1.8-m) dash for a total length of 150 feet (45.7 m). However, because of the varieties of existing taxiway geometries and the placement of a runway holding position marking, the standard painted pattern is not always painted. The painting patterns for the most common taxiway geometries are described in this section below.

(1) Taxiway Serving Two Closely Spaced Runways. Figure C-16 illustrates how to paint enhanced taxiway centerline markings for a taxiway that connects two closely spaced runways. Each enhancement terminates at the runway edge unless the full 150-foot (46-m) length can be painted. Figure C-16 illustrates situations in which one enhancement is fully painted, one enhancement terminates at the outer edge of the runway side stripe, and the other enhancements terminate at the edge of the runway (figure C-16 uses an unpainted reference line to terminate the enhancements to Runway 1/19).

(2) Taxiway/Taxiway Intersections and Merging Intersections. Figures C-11 (Note 2), C-12 (Note 1), and C-14 illustrate that if the taxiway centerline to be enhanced intersects another straight taxiway (taxiway/taxiway intersection) that is located within 150 feet (45.7 m) of a runway holding position marking, the enhancement must terminate 5 feet (1.5 m) prior to the point where the other taxiway centerline crosses the taxiway centerline that is being enhanced. In comparison, on a taxiway, as shown in figures C-11 (Note 1) and C-13, where the enhancement is 150 feet (45.7 m) or less and emerges with a straight or curved taxiway centerline, the enhancement terminates at the point of tangency with the other taxiway centerline.

(3) Single, Straight-In, Enhanced Taxiway Centerline Marking Intersecting a Runway Holding Position Marking at Angles of 90 Degrees. Figures C-10 and C-12 (Note 3) show the standard painted patterns, i.e., the enhanced taxiway centerline measures 150 feet (45.7 m) in length. In comparison, figure C-13 shows a painted pattern for Runway 16/34 in which an enhancement terminates at the point of tangency with the other taxiway centerline marking.

(4) Straight-In, Enhanced Taxiway Centerline Markings Intersecting a Runway Holding Position Marking at Angles Other than 90 Degrees. Figures C-3 (details A – D) and C-7 show standard painted patterns. When a straight-in enhancement intersects the runway holding position marking at an angle other than 90 degrees, the first dashes of the enhancement on either side of the taxiway centerline will start and stop at different locations. In this case, use the taxiway centerline as a guide to paint the enhancements as shown in details A – D of figure C-3. This painting pattern will show both dashes starting 6 to 12 inches (15 to 30 cm) from the first solid bar of the runway holding position marking and ending at the same location. The finished pattern will show for the first set of dashes, one dash longer than 9 feet (2.7 m) and the other dash shorter than 9 feet (2.7 m).

(5) Single Taxiway Centerline Serving Two Runway Holding Position Markings. If a taxiway centerline intersects two runway holding position markings as shown in figure C-12 (Note 2) and measures less than 150 feet (45.7 m) in length, then the entire taxiway centerline is enhanced only between the two runway holding position markings. In no case will the lacking length of the enhancement be painted between the runway itself and the runway holding position markings. To paint this enhancement, start with the 9-foot (2.75-m) dashes from each runway holding position marking (see paragraph 4.3(d)(6)(ii) for painting practice). Next, continue painting the pattern from each starting point until both enhancements meet at the midpoint of the curved taxiway centerline. It is okay if the dashes or the spaces at the midpoint are less than the length specified in the standard. The intent here is to maintain the pattern of long dashes and shorter spaces on each side of the centerline.

(6) Dual Holding Position Markings. If an ILS/MLS or a POFZ (Pattern B) holding position marking is within 150 feet (45.7 m) of a runway holding position marking (Pattern A), the enhanced taxiway centerline remains within the confines of the two holding position markings, i.e., the enhancement does not proceed beyond the ILS/MLS or the POFZ holding position marking. Under this situation, the enhanced taxiway centerline terminates 3 feet (0.9 m) before the ILS/MLS and the POFZ holding position markings.

(7) Curved and Multiple Taxiway Centerlines Converging Prior to or Intersecting a Runway Holding Position Marking. Various geometries exist such as those shown in figures C-9, C-10, C-11, and C-12. Below are the most common geometries and the recommended painting patterns.

(i) Intersecting and Convergent Taxiway Centerlines. As shown in figures C-2 and C-3 (Detail B), where two taxiway centerlines intersect or converge before or at the runway holding position marking, the outside dashes continue, with the possible exception of the first set of dashes, to maintain the 9-foot (2.75-m) pattern along the point of convergence. Depending on the geometry, the first inside dashes may be less than 9 feet (2.7 m) but must be aligned with the outside dashes, i.e., the inside dashes stop with and possibly start with the outside dashes. As noted in figure C-3 (Detail B), it is permissible to omit inside dashes that measure less than 5 feet (1.5 m). Detail B also illustrates that the inside dashes can overlap each other.

(ii) Curved Taxiway Centerlines Intersecting a Runway Holding Position Marking. As shown in figure C-3 (Detail D), when a taxiway centerline is curved, the dashes on either side of the taxiway centerline would start and stop at different locations when maintaining the 9-foot (2.75-m) length. Therefore, in order to correct this mismatch, apply the following painting practice, which takes all measurements from the taxiway centerline:

(a) Each dash in the first set of dashes along with the taxiway centerline will start at the same distance, 6 to 12 inches (15 to 30 cm) from the first solid bar of the runway holding position marking.

(b) To locate the end point of the first set of dashes, first measure 9 feet (2.7 m) along the taxiway centerline. Next, draw an imaginary line that is perpendicular to the tangent of the taxiway centerline and mark the ends of the first dashes on each side of the taxiway centerline.

(c) Measure an additional 3 feet (0.9 m) along the curved taxiway centerline. Next, draw an imaginary line perpendicular to the tangent of the curve and mark the starting point for the second set of dashes. The ending point for this set is found by measuring 9 feet (2.7 m) along the center of the curved taxiway centerline. An imaginary line perpendicular to the tangent at this point will mark the end of the second set of dashes.

(d) Repeat the procedure for the remaining curved portion of the taxiway centerline, remembering that the last set of dashes only measures 6 feet (1.8 m).

4.4. TAXIWAY EDGE MARKING.

a. Purposes. The taxiway edge marking, a dual continuous or dashed marking, is used along a taxi route when it is deemed necessary by the airport operator or the FAA to (1) alert pilots where the demarcation line exists between usable pavement for taxi operations and unusable pavement and (2) identify the edge(s) of a taxi route located on sizeable paved areas that can be crossed over by the pilot. Two marking schemes for the taxiway edge marking are available to the airport operator to indicate whether the pilot is allowed to cross the taxiway edge. Figures 13, B-3, and B-4 illustrate these marking variations. For lighting provisions, see AC 150/5340-30.

(1) Continuous Taxiway Edge Marking. The continuous taxiway edge marking is used to delineate the taxiway edge from the shoulder or some other contiguous paved surface that is not intended for use by pilots. Continuous taxiway edge markings are never used in any operational situation that permits a pilot to cross this surface marking, for example, a taxilane on a terminal or cargo apron.

(2) Dashed Taxiway Edge Marking. The dashed taxiway edge marking is used where there is an operational need to define the edge(s) of a taxi route on or contiguous to a sizeable paved area that permits pilots to cross over this surface marking. A common application for this surface marking is a taxi route along the outer edge of a terminal apron. Regardless of the taxi route's site, the location for painting the dashed taxi edge marking must be in accordance with table 4-1 of AC 150/5300-13 using standard taxiway widths after obtaining standard taxiway/taxilane object free area widths for locating the taxiway centerline. In other words, these dashed taxiway edge marking (the stripe pattern) are never used to provide wing tip clearances for other moving or parked airplanes found, for example, operating on aprons. For this separation situation the airport operator may use the non-movement area boundary marking to indicate adequate clearance (taxiway/taxilane object free area).

b. Location. The taxiway edge marking is located such that the outer edge of the continuous line or dashed stripe defines the edge of the usable pavement.

c. Color. Both taxiway edge marking schemes are yellow. If black borders are necessary, the black borders on the outside of the marking can be 6 inches (15 cm) in width and never use glass beads.

d. Characteristics.

(1) The outermost edge of both marking schemes, as measured from the taxiway centerline, must be painted at a distance equal to one-half the taxiway width per table 4-1 of AC 150/5300-13.

(2) The continuous taxiway edge marking consists of dual, continuous lines with each line being at least 6 inches (15 cm) in width and spaced 6 inches (15 cm) apart (edge to edge) as shown in figure B-3. This continuous marking must be used to designate NO-TAXI islands as shown in figure 17. Although it is preferable for the inner portion of NO-TAXI islands to be unpaved, for example, grass covered, the inner area may be painted green or painted with striated yellow markings per paragraph 1.3(c). Placement of the striated yellow stripes is perpendicular to and abuts the continuous taxiway edge marking. The length, which may be governed by the shape of the NO-TAXI island, should be 5 feet (1.5 m) for ADGs I and II; 15 feet (4.5 m) for ADG III; 20 feet (6.0 m) for ADG IV; and 25 feet (7.6 m) for ADGs V and VI. Width and separation between striated yellow stripes follow paragraph 1.3(c) criteria. One other option to enhance NO-TAXI islands is to apply artificial turf for the portion of the area between the standard taxiway shoulder widths as prescribed by AC 150/5300-13.

(3) The dashed taxiway edge marking consists of dual, dashed yellow stripes that are at least 6 inches (15 cm) in width and spaced 6 inches (15 cm) apart (edge to edge) as shown in figures B-4 or B-5. The dashed stripes are 15 feet (4.5 m) in length with 25-foot (7.5-m) gaps as shown in figure 13. This marking is never used to designate NO-TAXI islands.

**Runway Incursion Mitigation Requirement
(Safety)**

Recorded runway incursion data associated with multi-taxi entrance designs to a runway that do not use "NO-TAXI islands" between the adjacent taxiway entrances have experienced a higher rate of runway incursions as compared to entrances with NO-TAXI islands. To reduce the possibility of runway incursions, all designs for a direct entrance to a runway that use two or more taxiway entrances must use "NO-TAXI islands" that are outlined with the continuous taxiway edge marking. AC 150/5300-13 prescribes and illustrates only bypass taxiway entrance designs that have NO-TAXI islands as part of the design.

(4) For the case where the taxiway edge marking intersects a holding position marking (Pattern A), then when holding position marking:

(i) is outlined in black, the taxiway edge markings should abut the black outlines on both sides of the runway holding position marking, i.e., the borders for the yellow dash and yellow solid line.

(ii) is not outlined in black, the taxiway edge markings should abut the yellow holding position marking on both sides, i.e., the yellow dash and yellow solid line.

4.5. SURFACE PAINTED HOLDING POSITION SIGNS.

a. Purposes. This surface painted sign provides supplemental visual cues that alert pilots and vehicle drivers of an upcoming holding position location and the associated runway designator(s) as another method to minimize the potential for a runway incursion and, for certain airport geometries, wrong runway takeoffs. Several applications of this surface painted sign for taxiways are shown in figures C-5 (non-centered), C-6 (centered) and C-15 (stacked). The surface painted holding position sign is used only on those taxiways (not runways) with a Pattern A or B holding position marking that enter a runway. Taxiways that do not lead directly onto the runway, such as a taxiway that crosses through an approach area, are not to have this surface painted sign. In regards to Pattern B, certain taxi/runway geometries, for example figure 15, under specific landing operations do occur in which this surface painted sign is necessary to protect both the runway entrance environment and the ILS/MLS or the POFZ critical area. Figure 15 shows the POFZ critical area overlapping the holding bay at the entrance to the runway.

14 Code of Federal Regulation (CFR) Part 139 Certificated Airports Runway Incursion Mitigation (Safety)

The surface painted holding position sign (SPHPS), as illustrated in figures C-5 or C-6 for existing taxiway widths, is mandatory and the only means of compliance for all 14 CFR Part 139 certificated airports regardless of the number of runways at the airport. The intent of this requirement is to eliminate the various practices among 14 CFR Part 139 certificated airports in which pilots would (1) see the surface painted holding position sign at all taxiway entrances to a runway, (2) only see the marking on extra wide taxiway entrances over 200 feet (61 m) in width, or (3) see none at all at single runway airports. In turn, this all-inclusive application will reduce human confusion among pilots and drivers that may contribute to runway incursions.

This surface painted sign is mandatory on the left side of the taxiway centerline for ADGs III–VI and centered over the taxiway centerline for ADGs I and II even if a vertical runway holding position sign exists. For ADGs III–VI, the surface painted sign for the right side of the taxiway centerline, which is highly recommended for taxiway entrances serving airplane operations that require two person crews, may be eliminated when a taxiway centerline is closer than 45 feet (13.7 m) from the edge of the taxiway *and* a mandatory vertical runway holding position sign is in clear view (either left or right of the taxiway centerline).

The surface painted holding position sign is part of the standard signage requirements under 14 CFR Section 139.311(b)(1)(ii) with compliance dates as follows. For 14 CFR Part 139 certificated airports with two or more runways, December 31, 2010 (unchanged per Change 1 of AC 150/5340-1J, dated March 31, 2008). For 14 CFR Part 139 certificated airports with one runway, *effective 2 years from the issue date of this AC.*

b. Location. The location (and number) of the SPHPS is determined by the width of the taxiway entrance and the number of taxiway centerlines that intersect the same holding position marking. Although the design of all taxiway entrances to a runway should have been based on a single airplane design group, i.e., all taxiway entrances have the same standard width, some existing runways have varied taxiway widths serving more than one airplane design group. In such cases, the taxiway's airplane design group for that taxiway entrance will determine the location (and number) of the surface painted marking. For example, a runway with an airport reference code of C-IV has one taxiway entrance built to the smaller airplane design group (ADG) I. For this entrance a single, centered surface painted marking as shown in figure C-6 is painted while the other larger ADG IV taxiway entrances are painted differently.

(1) The SPHPS must not be painted on a runway, including runways that are temporarily used by ATCT as a taxiway.

(2) In all cases, the SPHPS is never painted onto the taxiway shoulders.

(3) In reference to the holding position marking (Pattern A), the surface painted holding position sign is always painted prior to and runs parallel to the holding position marking at a distance of 2 to 4 feet (0.6 to 1.2 m) as shown in figures C-5, C-6, and C-7. The location takes into account the direction of taxiing and should allow sufficient clearance for in-pavement runway guard lights and/or stop bars.

(4) When a single taxiway centerline intersects the holding position marking (Pattern A), the surface painted holding position sign is located as follows:

(i) For taxiway widths that are greater than 35 feet (10.5 m) (ADGs III – VI), one or two surface markings are placed 3 to 10 feet (0.9 to 3.1 m) from the center of the taxiway centerline. With a few exceptions, one surface marking must be painted on the left side of the taxiway centerline. The left side rather than the right side is used because not all aircraft that may use this entrance require two-person crews. The surface painted sign for the right side of the taxiway centerline, which is highly recommended for taxiway entrances serving airplane operations that require two-person crews, may be eliminated when a taxiway centerline is closer than 45 feet (13.7 m) from the edge of the taxiway and a mandatory vertical runway holding position sign is in clear view (from either left or right of the taxiway centerline.) Any airport with a taxiway entrance to a runway with *insufficient lead-on length* (see safety box under Condition 2 of paragraph 4.5(b)(5) for definition) to the runway holding position marking, such as figure C-11, must have two surface painted holding position signs, one on each side of the taxiway centerline marking. Because of the variety in taxiway geometries, such as shown in figures C-9 through C-12 and C-14, the taxiway centerline may or may not be perpendicular to the holding position marking. If the taxiway centerline is perpendicular, then placement of the surface painted holding position sign is in accordance with figure C-5. If the taxiway centerline is not perpendicular, then placement is in accordance with figure C-7.

(ii) For taxiway widths of 35 feet (10.5 m) or less (ADGs I and II), one surface marking is centered directly over the taxiway center. If the taxiway centerline is perpendicular to the holding position marking (Pattern A), then placement of the surface painted holding position sign is as shown in figure C-6. If the taxiway centerline is not perpendicular, then placement is still centered over the taxiway centerline, but oriented to run parallel to the holding position marking. That is, its placement would appear in like fashion when two such markings are painted as shown in figure C-7. **NOTE:** This new criterion becomes effective 2 years from the issue date of this advisory circular. That is, airport operators with required off-centered SPHPS have up to 2 years to center the taxiway SPHPS.

(5) When two or more taxiway centerlines intersect or converge within 15 feet (4.5 m) of the holding position marking (Pattern A), there might not be enough space for two or more surface painted holding position signs. Figures C-3, C-12, and C-16 are examples of layouts where it is not possible to paint all the required surface painted holding position signs for each converging taxiway centerline. In these cases, a surface painted holding position sign may be omitted on one side of the taxiway centerline as shown in figures C-9 and C-12 for ADGs III–VI standard taxiway widths. In the case of ADGs I–II standard taxiway widths, a single surface painted holding position sign must be centered over the two converging taxiways where separate surface markings would have overlapped each other. These and other types of geometries will require individual site assessment by the airport operator to determine the number of surface painted holding position signs that are required by this advisory circular and fit properly into the available space. In terms of proper spacing between two taxiway centerlines, a surface painted holding position sign should be approximately equidistant from both taxiway centerlines at a distance of no less than 3 feet (0.9 m) or more than 10 feet (3.1 m) from either taxiway centerline as measured from the center of the taxiway centerlines to the nearest border of the surface painted holding position sign. For difficult taxiway geometries, the airport operator should consult their FAA Regional Airports Division Office or the Airports District Office (ADO) before painting any markings. For such requests, the airport operator should provide information about the rate of usage by each taxiway centerline, aircraft types, and the available space for painting.

Wrong-Runway Takeoff Mitigation (Safety)

If an airport has a taxiway entrance that simultaneously serves two or more runways, the surface painted holding position sign must show all runway designators plus directional arrows. The directional arrows must approximate the orientation of the runways.

The surface painted holding position sign is part of the standard signage requirements under 14 CFR Section 139.311(b)(1)(ii) with compliance dates as follows. For 14 CFR Part 139 certificated airports with two or more runways, December 31, 2010 (unchanged per Change 1 of AC 150/5340-1J, dated March 31 2008). For 14 CFR Part 139 certificated airports with one runway, *effective 2 years from the issue date of this AC.*

Runway Incursion Mitigation Extra-Wide Taxiway Entrances (Safety)

Condition 1.

Any airport with a taxiway entrance to a runway having a width greater than 200 feet (61 m) as measured along its runway holding position marking requires the following surface markings. First, a surface painted holding position sign must be painted on the left side of the taxiway centerline (or centered over the taxiway centerline for ADGs I and II standard taxiway widths). Second, depending on how excessive the width, a “repetitive pattern” of additional surface painted holding position signs must be painted in accordance with table 4-1 below. This second requirement is in direct response to documented runway incursions associated with extra-wide taxiway entrances to a runway.

The repetitive pattern of table 4-1 relates the spacing of the additional markings to the viewing angles of pilots and to the painting of future parallel taxiway entrances according to AC 150/5300-13. In other words, when the airport operator decides to paint additional parallel

taxiway entrances, the criterion in table 4-1 would already have in place the required surface painted holding position sign within the proper distance of the newly painted taxiway centerlines (or centered over the taxiway centerline for ADGs I and II).

When the airport operator paints additional parallel taxiway entrances, then the repetitive pattern is completed by painting a NO-TAXI island as shown in figure 17 at each midpoint between parallel taxiway centerlines. See paragraph 4.4(d) Safety Box for the marking scheme to paint NO-TAXI islands.

Table 4-1. Placement of Repetitive Surface Painted Holding Position Signs and NO-TAXI Islands on Taxiway Entrances of over 200 feet (61 m) in Width

Airplane Design Group (ADG) Category ¹	Distance between adjacent surface painted holding position signs ² as measured from the same outer edge ³ Feet (meters)	Midpoint distance for a NO-TAXI island between parallel taxiway centerlines ⁴ as measured from either taxiway centerline Feet (meters)
ADG I	69 (21)	34.5 (10.5)
ADG II	105 (32)	52.5 (16)
ADG III	152 (46.5)	76 (23.25)
ADG IV	215 (65.5)	107.5 (32.75)
ADG V	267 (81)	133.5 (40.5)
ADG VI	324 (99)	162 (49.5)

Note 1: The term Airplane Design Group Category is defined in AC 150/5300-13.

Note 2: Each entry equals the taxiway centerline to parallel taxiway centerline value listed in table 2-3 of AC 150/5300-13.

Note 3: The listed value assumes that the existing surface painted holding position sign is used as the starting point to measure and paint additional surface markings either on the left side of the taxiway centerline (figure C-5) or directly centered over the taxiway centerline (figure C-6). For taxiways with dual surface markings, such as shown in figure C-5, the measurement should still be from the left-side surface marking. If there is no left-side surface marking, use the center of the taxiway centerline and add 3 to 10 feet (0.9 – 3.1 m) to the listed value in table 4-1. This numeric range is the dimension letter B used in figure C-5.

Note 4: Each entry is half of the taxiway centerline to parallel taxiway centerline value listed in table 2-3 of AC 150/5300-13.

Condition 2.

Any ADG III–VI airport with a taxiway entrance to a runway with *insufficient lead-on length* to the runway holding position marking must have two surface painted holding position signs, one on each side of the taxiway centerline marking.

The term “insufficient lead-on-length” is defined as follows:

- (1) For the case of a perpendicular taxiway centerline intersecting the holding position marking, such as shown in figures C-5, C-12 curve #3, and C-14, the design airplane for that runway is unable to line up its entire fuselage perpendicular to the runway holding position marking.
- (2) For the case of a non-perpendicular taxiway centerline intersecting the holding position marking, such as shown in figures C-7 and C-9, the design airplane for that runway is unable to line up its entire fuselage on a straight section of the entrance taxiway centerline while holding at the runway holding position marking.

Three quick, visual indications of this undesirable design condition are (1) taxiway centerlines, such as shown in figure C-9, that only curve into the runway holding position marking; (2) holding position markings, such as shown in figure C-14, that are painted in or near the region where taxiway fillets are constructed; and (3) an enhanced taxiway centerline that measures far less than 150 feet (45.7 m) in length.

Figures C-9 through C-12 provide some examples on how to paint left-of-centerline and right-of-centerline surface painted holding position signs.

The surface painted holding position sign is part of the standard signage requirements under 14 CFR Part 139.311(b)(1)(ii) with compliance dates as follows. For 14 CFR Part 139 certificated airports with two or more runways, December 31, 2010 (unchanged per Change 1, dated March 31 2008). For 14 CFR Part 139 certificated airports with one runway, *effective 2 years from the issue date of this AC*.

c. Color. The surface painted holding position sign has a red background with a white inscription and, on light-colored pavements, is outlined in black. Although this marking supplements the mandatory runway holding position sign, the black outline that surrounds the white alphanumeric inscription on the signs is not required for the surface painted holding position sign.

d. Characteristics.

(1) The standard height of the inscription and its location are as follows:

(i) For taxiway widths that are greater than 35 feet (10.5 m) (ADGs III – VI), the inscription is 12 feet (3.7 m), but may be reduced in accordance with the criteria in figure C-5.

(ii) For taxiways widths of 35 feet (10.5 m) or less (ADGs I and II), the inscription is in accordance with the criteria in figure C-6.

**Solutions for Difficult Placements
Stacked Surface Painted Holding Position Signs
(Painting)**

For taxiway entrances or a taxiway entrance with a complex geometry that requires a lengthy inscription (a single surface marking) for two or more runways and that will not fit properly between the existing taxiway centerline and the taxiway edge, the airport operator should reduce the inscription height. Under this solution, the lowest allowable height for the

inscription for ADGs III–VI standard taxiway widths is 6 feet (1.8 m) and for ADGs I–II standard taxiway widths is 3 feet (0.9 m). This painting solution may be necessary for smaller standard taxiway widths whose entrance taxiways support two runway ends. If this solution fails, the single marking may then be broken into two separate markings, one marking per runway, but stacked one above the other as shown in figure C-15. Under this solution, the airport operator should fit the stacked markings such that (1) the height of the inscription is increased toward the standard height and (2) the separation between the stacked inscriptions is 2 to 4 feet (0.6 to 1.2 m). See figure C-15 for the recommended order of appearance for stacked surface painted holding position signs.

Note: All other unaffected runway holding positions that do not require a reduced inscription height must use the standard inscription height. The intent of this note is to maintain uniformity in visual cues across the United States.

(2) The inscription must be identical to the runway holding position sign by using the same numbers, letters, and arrows. The appearance of the letters, numbers, and arrows must be per Appendix A.

(3) The background is rectangular and extends horizontally and vertically beyond the extremities of the inscription for a minimum of 7.5 inches (19 cm) for ADGs I–II standard taxiway widths and 15 inches (38 cm) for ADGs III–VI standard taxiway widths.

(4) The surface painted holding position sign is at least 2 feet (0.6 m) from the edge of the inside taxiway edge marking or from the edge of the paved taxiway when there are no taxiway edge markings.

4.6. SURFACE PAINTED TAXIWAY DIRECTION SIGNS.

a. Purpose. The surface painted taxiway direction sign is used with an arrow to provide directional guidance at an intersection when it is not possible to provide a taxiway direction sign in accordance with AC 150/5340-18. An exception is where operational experience has indicated that its presence at a troublesome taxiway intersection can assist flight crews in better ground navigation. For signage provisions, see AC 150/5340-18.

b. Location. The edge of the surface painted taxiway direction sign (excluding the border if used) is 3 feet (0.9 m) from the edge of the taxiway centerline and is located on the side of the taxiway centerline that the aircraft travels as shown in figure 17. That is, markings that indicate left turns are located on the left-hand side of the taxiway centerline while markings indicating right turns are located on the right-hand side of the taxiway centerline.

(1) The surface painted taxiway direction sign is *not* painted on runways, including runways that are operationally used as a taxiway, or painted between the runway holding position marking (Pattern A) and the runway.

(2) For crisscrossing taxiways, such as two taxiways crisscrossing at 90 degrees to each other, a surface painted taxiway direction sign is combined with arrows to indicate the different travelling directions at the intersection. Under this application, the single marking is located on the left side of the taxiway centerline.

(i) When it is not practicable to install a taxiway direction sign along the side of the taxiway, paint a surface painted taxiway direction sign and locate it at the same distance from the intersection as specified in AC 150/5300-13, table 2-3, fixed/movable object criterion.

(ii) When a surface painted taxiway direction sign supplements a taxiway direction sign installed along the side of the taxiway, the surface painted direction sign may be located at or within the distances specified in AC 150/5300-13, table 2-3, fixed/movable object criterion, and the point of divergence of the painted taxiway centerlines.

(3) A surface painted taxiway direction sign is not co-located with a surface painted holding position sign.

(4) The surface painted taxiway direction sign is *not* painted on runways, including runways that are operationally used as a taxiway.

c. Color. The surface painted taxiway direction sign has a yellow background with a black inscription that includes an arrow(s). See paragraph 1.4 and table 1-1 for required and recommended techniques to enhance this marking. On light-colored pavements, a 6-inch (15 cm) black border completely surrounds its perimeter.

d. Characteristics.

(1) The black inscription is 12 feet (3.7 m) in height. However, the height may be reduced if necessary to the minimum height of 9 feet (2.7 m).

(2) Each black inscription must be accompanied by an arrow oriented to show the approximate direction of a turn.

(3) The black inscription with the arrow(s) must conform in appearance to the letters, numbers, and symbols in Appendix A.

(4) The yellow background is rectangular and extends a minimum of 15 inches (38 cm) horizontally and vertically beyond the extremities of the black inscription, which includes the arrow head(s).

(5) A 6-inch (15-cm) wide vertical black stripe separates two black inscriptions when more than one inscription is included on the same side of the taxiway centerline.

(6) See paragraph 4.7(d)(4) when collocating a surface painted taxiway direction sign with a surface painted taxiway location sign.

4.7. SURFACE PAINTED TAXIWAY LOCATION SIGNS.

a. Purposes. The surface painted taxiway location sign identifies the taxiway upon which the aircraft is located. When deemed necessary by the FAA this marking is used to supplement other signs located along the taxiway system where operational experience has indicated that its presence can assist flight crews in better ground navigation. For signage provisions, see AC 150/5340-18.

b. Location. The surface painted taxiway location sign is located normally on the right side of the taxiway centerline in the direction of travel as shown in figure 17. The edge (excluding the border if

used) of the surface painted taxiway location sign should be 3 feet (0.9 m) from the edge of the taxiway centerline.

(1) When adequate pavement width exists, a surface painted taxiway location sign may be located on the left side of the taxiway centerline if it is co-located to the left of a surface painted holding position sign (paragraph 4.5). In this case, the two surface painted signs will mimic the mandatory holding position signs. Under this application, if the co-located surface painted taxiway location sign and the mandatory holding position sign serve two converging taxiways, then the surface painted taxiway location sign should be located to the left of the surface painted holding position sign (in the direction of taxiing).

(2) The surface painted taxiway location sign is *not* painted on runways, including runways that are operationally used as a taxiway, or painted between the runway holding position marking (Pattern A) and the runway.

c. Color. The surface painted taxiway location sign has a black background with a yellow inscription and a yellow border around its perimeter for all pavement surfaces. See paragraph 1.4 and table 1-1 for required and recommended techniques to enhance this marking.

d. Characteristics.

(1) The yellow inscription is 12 feet (3.7 m) in height. However, the height may be reduced if necessary to the minimum height of 9 feet (2.7 m).

(2) The yellow inscription never contains an arrow and must conform in appearance to the letters, numbers, and symbols in Appendix A.

(3) The background is rectangular and extends a minimum of 15 inches (38 cm), which includes the 6-inch (15-cm) yellow border, horizontally and vertically beyond the extremities of the yellow inscription.

(4) When a surface painted taxiway location sign is collocated with a surface painted taxiway direction sign on any pavement surface, paint the inscriptions for both markings of equal height.

4.8. SURFACE PAINTED GATE DESTINATION SIGNS.

a. Purpose. The surface painted gate destination sign is used, when necessary, to assist pilots in locating their assigned terminal gate. The marking is especially useful for low-visibility operations.

b. Location. The surface painted gate destination sign may be installed in non-movement areas or movement areas that are in the proximity of terminal building(s) per the examples in figures 18 and 19. The markings are located adjacent to taxiway centerlines on the same side in which a turn will be made while traveling toward the assigned gate.

c. Color. The surface painted gate destination sign has a solid yellow background with a black inscription. On light-colored pavements, a 6-inch (15-cm) black border may be used.

d. Characteristics.

(1) For surface painted gate destination signs containing only a single row of several gate designations as shown in figure 18, the black inscriptions must have a maximum height of 4 feet (1.2 m).

(2) For surface painted gate destination signs containing more than one row of gate designations, shown as an option in figure 19, the inscriptions must have a minimum height of 3 feet (0.9 m). There is no maximum height size for a surface painted gate destination sign containing more than one row of inscriptions.

(3) The background of the marking is rectangular and extends a minimum of 15 inches (38 cm) horizontally and vertically beyond the extremities of the inscriptions.

(4) The black inscription must conform in appearance to the letters, numbers, and other symbols in Appendix A.

(5) A range of gates that are sequential should be indicated with a single “dash”. For example, a series of gates A1 through A4 are indicated as “A1 - A4”.

(6) A range of gates that are non-sequential should be separated by commas. For example, the gates B1, B3, and B6 are indicated as “B1, B3, B6”.

4.9. SURFACE PAINTED APRON ENTRANCE POINT SIGNS.

a. Purpose. The surface painted apron entrance point sign is used, when necessary, to assist pilots in locating their position along the edges of a large, continuous apron serving the terminal gates. The marking is especially useful for identifying both the entrances and exits in and along the terminal complex. To facilitate shorter, less confusing verbal communication and movement of ground traffic, the surface painted apron entrance point sign is sometimes referred to as the “ramp spot” at some airports.

b. Location. The surface painted apron entrance point sign may be painted in non-movement areas or movement areas that are in the proximity of an apron leading to the concourses or terminal buildings as shown in figure 20. The marking, located 7 feet (2.1 m) from taxiway centerline(s), is on the same side of the centerline to which a turn will be made to travel toward the assigned gate.

c. Color. The surface painted apron entrance point sign has a yellow background with a black inscription. The color of the border depends on the pavement color. Concrete or light-colored pavement should use a black border, while dark pavements should use a white border.

d. Characteristics.

(1) The surface painted apron entrance point sign consists of three 9-foot (2.7-m) diameter circles each located 7 feet (2.1 m) from the associated taxiway/apron centerline. As shown in figure 20, two circles are located on either side of the entrance taxiway centerline(s) that continues toward the gate and ends with the third circle.

(2) For taxiways that do not turn but continue forward, only the third circle is painted. For complex taxiways where two converging taxiway centerlines cross the non-movement boundary marking in very close proximity to each other, the airport operator may paint a single marking near the non-movement boundary marking that is between the two converging taxiway centerlines. That is, the single marking is not overlapping the taxiway centerlines. For a single taxiway centerline that diverges into two

separate taxiway centerlines just prior to the non-movement boundary marking, paint a single marking on the taxiway centerline prior to its splitting into different taxiway centerlines.

(3) Each circle is comprised of an inner 8-foot (2.7-m) diameter yellow circle with a 6-inch (15-cm) outer ring that is black in color for concrete and light-colored pavements and is white in color for asphalt pavements.

(4) The inscription is either numeric or alpha-numeric. For the situation that consists of three circles, the inscription for gate designation within each of the three circles should match.

(5) The black inscription inside each circle should only be a number, black in color and 4 feet (1.2 m) in height.

(6) The appearance of the inscription numbers must conform to the scale of letters, numbers, and other symbols in Appendix A.

4.10. TAXIWAY SHOULDER MARKINGS.

a. Purpose. Aprons, holding bays, and taxiways are sometimes provided with paved shoulders or stabilization per paragraph 803 of AC 150/5300-13 to prevent ground erosion attributed to jet blast or water runoff or to minimize engine damage caused by foreign object debris. Although these shoulders are not intended for use by aircraft, conditions may exist along a taxi route that confuse pilots and cause them to use the shoulders. For example, a particular taxiway curve with an extra-wide paved shoulder may confuse pilots as to which side of the painted taxiway edge marking stripe is intended for their use. Where such conditions exist, the airport operator should paint taxiway shoulder markings to indicate the non-usable (deceptive) area to pilots. Figure 21 illustrates this surface marking.

b. Location. The taxiway shoulder marking is painted using a perpendicular reference line drawn from the taxiway centerline. The start and stop points, and separation gaps, for painting the marking are described below.

(1) Referring to figure 21 on straight sections, the taxiway shoulder markings will be placed perpendicular at each point of intersection with the defined edge of paved taxiway or the taxiway edge marking with additional markings being uniformly placed between the two start and finish markings. The spacing of the markings, centerline-to-centerline, will not exceed 100 feet (30.5 m) between two adjacent markings as shown in figure 21.

(2) Referring to figure 21 on curved sections, the taxiway shoulder markings will be uniformly spaced along the curve. The first and last markings are placed perpendicular at the point of curvature and point of tangency of the curve. The spacing of the markings, centerline-to-centerline, will not exceed 50 feet (15 m) between two adjacent markings measured at the *largest gap* of the radially-spaced markings. Two cases exist for the *largest gap* of the radially-spaced markings.

(i) **Case 1.** For a taxiway that intersects a paved area as shown in figure 21, both curved shoulders are referred to as “inboard” shoulders. Under this case use a 50-foot (15-m) centerline-to-centerline separation (maximum separation) as measured along the *inner edge* of the curved shoulder that abuts the paved taxiway. Notice that in case 1 both curved shoulders are categorized as inboard shoulders.

(ii) **Case 2.** For a taxiway that makes a turn prior to connecting another paved area, as shown in figure 9, then one curved shoulder is referred to as an “inboard” shoulder and the other as an “outboard” shoulder. Placement of the taxiway shoulder marking along the inboard shoulder is measured as described above. For the outboard shoulder use the same maximum 50-foot (15-m) centerline-to-centerline placement of the taxiway shoulder marking but as measured along the *outer edge* of the curved shoulder that abuts the ground.

c. Color. The taxiway shoulder marking is yellow. For NO-TAXI islands with a stabilized interior, it is acceptable to paint the stabilized interior green in color instead of painting yellow taxiway shoulder markings. If this option is used, it is acceptable to paint both the interior area and the shoulder area green.

d. Characteristics. The area is marked with 3-foot (1-m) wide yellow stripes that start with the edge of the paved taxiway or the edge of the taxiway edge marking (paint over the black border if present) and extended to within 5 feet (1.5 m) of the edge of the paved/stabilized shoulder area or 25 feet (7.5 m) in length, whichever length is less.

4.11. GEOGRAPHIC POSITION MARKINGS.

a. Purpose. The geographic position marking (GPM), as shown in figure 22, is used repeatedly along a designated taxi route to serve as an indicator of a location (*a spot*) so that pilots can confirm holding points or report their location while taxiing during periods of low-visibility operations. The referred to low-visibility operations are those taxiing operations prior to takeoff or after landing that occur when the runway visual range (RVR) is below 1,200 feet (366 m). Operationally, these sequentially numbered holding points differ from a reporting point. For example, one of the GPM (*the spot*) may be used only as a reporting point when ATCT is sequencing airplanes along the Surface Movement Guidance and Control System (SMGCS) route—when the first airplane reports to ATCT it is passing spot #3, ATCT would then clear the next airplane up to the next open spot. Note: see AC 120-57, Surface Movement Guidance and Control System, and AC 150/5340-18 for signage and lighting provisions.

b. Location. The repeated marking is located along a low-visibility taxi route identified by the airport’s SMGCS Plan. Each marking is positioned to the left of the taxiway centerline in the direction of taxi.

(1) All geographic position markings used operationally by the airport traffic control tower to designate a specific hold point along the low-visibility taxi route are co-located with the intermediate holding position marking (Pattern C) for taxiway/taxiway intersections as shown in figure 22. For a taxi route designated for use in visibilities below 600 RVR, the geographic position marking must be collocated with the intermediate holding position marking as well as a clearance bar consisting of three yellow lights. When the GPM is not used operationally for hold points, i.e., the spot is always used as a reporting point for sequencing operations, the painting of an intermediate holding position marking and the installation of the clearance bar are optional.

(2) The geographic position marking is never located at a runway holding position marking (Pattern A) location that immediately enters the runway used for the departure. However, the GPM may be located at a runway holding position for other runway(s) that the designated low-visibility taxi route happens to cross prior to arriving at the departure runway.

(3) A taxiway /taxiway intermediate holding position marking should be used with the geographic position marking, except for a GPM that is located at a runway holding position for the runway that will not be used for takeoff.

(4) The airport operator in coordination with the FAA Regional Airports Division Office or the Airports District Office will determine where the geographic position markings are deemed necessary. Generally, the geographic position markings are sequentially numbered holding points along a designated taxi route. To offer airport operators greater flexibility in developing a labeling scheme benefitting ATCT, the inscription scheme may, if approved by the FAA, take into account the specific taxiway intersections. For example, a geographic position marking that is located near Taxiway B2 may be labeled “2B” while another geographic position marking associated with Taxiway E4 is labeled “4E.”

c. Color. The geographic position marking, as shown in figure 22, is a 7-foot (2-m) diameter pink circle with a black inscription surrounded by two 6-inch (15-cm) wide rings, one white and one black. When the geographic position marking is painted on concrete or other light-colored pavements, the white ring is inside the black outer ring. When the geographic position marking is installed on asphalt or other dark-colored pavements, the white ring becomes the outer ring and the black ring becomes the inner ring. See paragraph 1.4 and table 1-1 for required and recommended techniques to enhance this marking.

d. Characteristics. The GPM is designated with a black inscription that may be a single number or a number-plus-letter combination. Since the basic marking reappears along the designated low-visibility SMGCS taxi route, each inscription must correspond to the sequential position identified by the SMGCS Plan. The sequential process for inscriptions is as follows.

(1) The number used for the inscription must correspond to its sequential position along the SMGCS taxi route, i.e., 1, 2, 3, etc.

(2) When a number plus a letter combination is used for the inscription, the letter indicates the taxiway’s letter designation on which the marking is located. For example, the inscription 2B, implies the second marking along Taxiway B. Additionally, the number always precedes the letter for all inscriptions.

(3) If a GPM is located on a taxiway with an alphanumeric designation, only the letter portion of the taxiway designation is used for all the inscriptions. For example, if the fourth location on the SMGCS taxi route is located on Taxiway A7, the inscription for this location would read “4A”.

(4) The inscription inside the GPM is centered within the circle.

(5) The inscription has a height of 4 feet (1.2 m).

(6) The numbers and letters used in the inscription are scaled to those in Appendix A.

Blank Page

CHAPTER 5. OTHER SURFACE MARKINGS.

5.1. APPLICATION. The surface markings in this section are used, as appropriate, on airports.

5.2. VEHICLE ROADWAY MARKINGS.

a. Purpose. The three distinct vehicle roadway markings contained in this paragraph are used to delineate roadways located on or that cross paved areas used by aircraft (aircraft maneuvering areas) so that collisions and other mishaps are averted. Markings for roadways not located on aircraft maneuvering areas, such as airport service roads, should conform, whenever possible, to the U.S. Department of Transportation's Manual on Uniform Traffic Control Devices. For roadway signage provisions for either case, see AC 150/5340-18.

b. Location. Vehicle roadways are delineated on aircraft maneuvering areas where there is a need to define a pathway for vehicle operations. A minimum separation of 2 feet (0.6 m) must be maintained between the roadway edge marking described below and the non-movement area boundary marking (see paragraph 5.4). All vehicle roadway markings are interrupted when crossing any taxiway and runway markings.

c. Color. Vehicle roadway markings are white.

d. Characteristics.

(1) Vehicle roadway markings consist of (a) roadway edge lines to delineate each edge of the roadway, (b) a dashed line to separate lanes within the edges of the roadway, and, where appropriate, (c) a roadway stop line (bar). The roadway edge lines, which are either solid lines or zipper-style, and the dashed lines are all 6 inches (15 cm) wide, except that zipper-style edges are 12 inches (30 cm) wide and 4 feet (1.2 m) long. See figure 13 for details of the zipper-style marking. The dashed line for lane separation is 15 feet (4.5 m) in length and spaced 25 feet (7.5 m) apart. The roadway stop line (bar) is 2 feet (0.6 m) wide and extends across its appropriate lane. See figure 23 for illustrations and details.

(2) In lieu of the solid lines for roadway edge lines, zipper-style markings may be used to delineate the edges of the vehicle roadway wherever the airport's SMGCS working group or the airport operator determines the roadway edges need enhanced delineation.

(3) Every roadway lane that feeds vehicle traffic onto or across a taxi route must have a solid roadway stop line (bar). The placement of the stop line (bar) is in accordance with the criteria for taxiway centerline to fixed/movable object in table 2-3 of AC 150/5300-13 for the largest airplane design group serving the airport. This placement generally ensures adequate vehicle clearance from taxiing aircraft. However, the airport operators should evaluate if the effects of jet blasts by turning aircraft operations on vehicle traffic require a larger setback.

5.3. VERY HIGH FREQUENCY OMNIDIRECTIONAL RANGE (VOR) RECEIVER CHECKPOINT MARKING.

a. Purpose. The VOR receiver checkpoint marking is used by pilots to check their aircraft instruments with navigational aid signals. It consists of a painted circle with a painted directional arrow that is aligned toward the azimuth of the VOR facility. The location of the marking indicates a point on the airport where sufficient signal strength from a VOR facility exists so a pilot can check the aircraft

VOR equipment against the radial azimuth indicated by the painted directional arrow. For the accompanying signage provisions, see AC 150/5340-18.

b. Location. FAA Flight Inspection personnel determine the location for the VOR receiver checkpoint marking(s) and issue information for checkpoint descriptions in flight publications. In general, the VOR receiver checkpoint marking preferably is located on an airport apron but could be on a taxiway; it is never on a runway. The location(s) should also allow easy access to align the aircraft with the marking without unduly obstructing other airport traffic. VOR receiver checkpoint markings should not be established at distances less than one-half mile (0.8 km) from the facility, nor on unpaved areas.

c. Color. The VOR receiver checkpoint marking is a painted circle of the size and colors shown in figure 24.

d. Characteristics. The VOR receiver checkpoint marking is a painted circle with an arrow that is accompanied with an associated information sign.

(1) The VOR receiver checkpoint is a circle 10 feet (3.1 m) in diameter with a yellow arrow aligned toward the azimuth of the VOR facility.

(2) The arrow should extend to the full width of the inner circle.

(3) The black interior of the circle is surrounded by a 6-inch (15-cm) wide yellow ring contiguous to a 6-inch (15-cm) wide white outer ring per figure 24.

(4) When installed on concrete or other light-colored pavements, the interior of the circle is painted black.

5.4. NON-MOVEMENT AREA BOUNDARY MARKING.

a. Purpose. The non-movement area boundary marking is used to delineate the movement areas under direct control by the airport traffic control tower from the non-movement areas that are not under their control. This marking should be used only when there is a need for such delineation. Prior to its implementation, a letter of agreement should be formalized between the airport operator and airport traffic control tower that specifies the location(s) of the boundaries. Secondary purpose: The primary users of this marking are airport operators with an airport traffic control tower. However, some airport operators without an airport traffic control tower have effectively used this surface marking on terminals and other aprons to separate vehicle traffic, equipment traffic, etc. from the areas where aircraft taxi, such as, when aircraft enter/exit an aircraft parking area located off the terminal. Thus, airports without an airport traffic control tower may use the surface marking to help delineate aircraft traffic routes, aircraft parking limits, etc.

b. Location. A non-movement area boundary marking is located on the boundary between the movement and non-movement area as shown in figure 13. To provide adequate clearance for the wings of taxiing aircraft, the marking should never coincide with the edge of a taxiway. In this regard, the non-movement area boundary marking is set back in accordance with the taxiway centerline to fixed/movable object criteria of table 2-3 of AC 150/5300-13. However, the airport operators should evaluate if the effects of jet blasts by turning aircraft operations on equipment, personnel, or vehicle traffic require a larger setback. Taxiway instead of taxiway clearance criteria is given because this marking is painted in nearly all cases on terminal aprons, cargo areas, and aircraft parking areas where aircraft taxi at lower speeds.

Mitigation of Wrong Runway Takeoffs (Safety)

Precaution should be taken not to paint a non-movement area boundary marking on the outer edges of an apron that is transitioning into a taxiway that leads directly to a runway. Under certain runway/taxiway geometries, such as shown in figure 5-1, placement of this surface marking where dual parallel taxiways support a runway have resulted in pilots taking off on a parallel taxiway. The concern of such usage is that pilots who expect a nearby runway holding position marking after leaving an apron will confuse these two markings because of their visual similarities, i.e., single dash/single line versus dual dashes/dual lines. It is recommended that the non-movement boundary marking not be located on or just prior to a taxiway that leads directly to a runway.

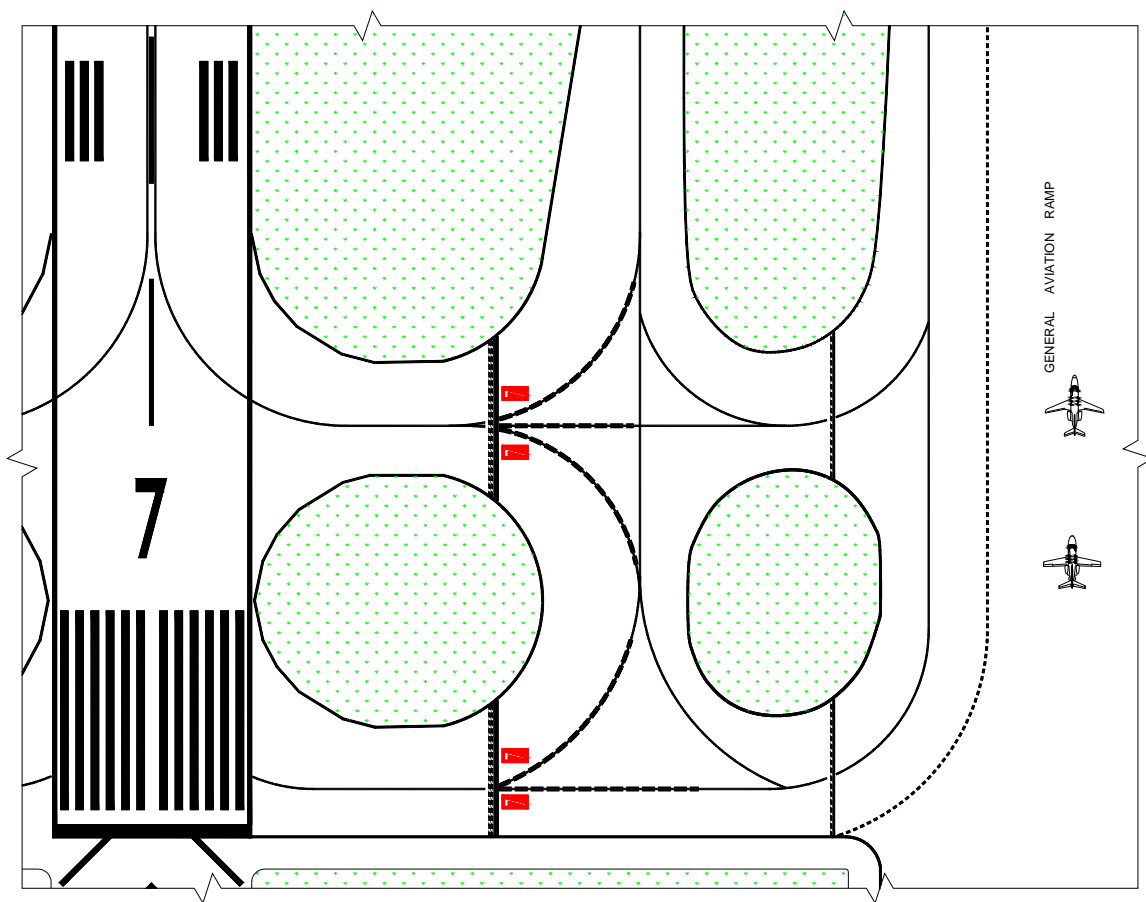

NOTE: DO NOT SCALE DRAWING. THE RUNWAY IDENTIFICATION MARKINGS HAVE BEEN ENLARGED FOR CLARITY.

Figure 5-1 Precautionary Placement of the Non-movement Boundary Marking

c. Color. The non-movement area boundary marking is yellow and will be outlined in black on light-colored pavements.

d. Characteristics.

(1) The non-movement area boundary marking consists of two yellow lines, one solid and one dashed as shown in figure 13. The solid line is located on the side of the non-movement area while the dashed line is located on the side of the movement area.

(2) Each line is 6 inches (15 cm) in width with 6-inch (15-cm) spacing between lines. In the event of circumstances where pilots may have difficulty discerning the edge of a movement area, the width of the lines and spaces may be doubled to 12 inches (30 cm). In both applications, the dashes are 3 feet (0.9 m) in length with 3-foot (0.9-m) spacing between dashes.

(3) If a taxiway centerline intersects a non-movement area boundary marking, then the taxiway centerline is interrupted so that it is 6 to 12 inches (15 to 30 cm) from both sides of the non-movement area boundary marking.

5.5. MARKINGS FOR THRESHOLDS TEMPORARILY RELOCATED DURING CONSTRUCTION. See AC 150/5370-2, Operational Safety on Airports During Construction, for provisions for marking and lighting a threshold temporarily relocated during construction.

5.6. MARKING AND LIGHTING OF PERMANENTLY CLOSED RUNWAYS AND TAXIWAYS. Permanently closed paved areas are indicated by the use of an "X". Figure 25 provides the detail criteria for the "X" marking.

a. For runways and taxiways that are permanently closed, the lighting circuits are disconnected. For closed runways, all markings for runway thresholds, runway designations, touchdown aiming points, and touchdown zones are obliterated.

b. For closed runways, only solid yellow "X" markings are painted (never striated "X" markings) at each end of the runway and at 1,000-foot (305-m) intervals.

c. For a closed runway that intersects an active runway, a solid yellow "X" marking should be placed on the closed runway near the sides of the open intersecting runway. In most cases, two "X" markings are required, i.e., one "X" per each side of the open intersecting runway.

d. For closed taxiways, a yellow "X" marking is placed at each entrance of the closed taxiway.

e. In terms of pattern selection from figure 25, the larger alternate pattern is preferable over the smaller pattern *for closed runways* because this pattern is seen more readily from aircraft on final approach. *For closed taxiways*, the smaller pattern is preferable over the larger alternative pattern unless taxiing pilots have difficulty seeing the marking and are entering the closed taxiway or have reported near landings on the closed taxiway.

5.7. TEMPORARILY CLOSED RUNWAYS AND TAXIWAYS. The following procedures are to be followed when it is necessary to temporarily close a runway or a taxiway. See AC 150/5370-2 for requirements and guidelines.

a. For temporarily closed runways, the airport operator has two options when it is necessary to provide a visual indication that a runway is temporarily closed.

(1) Option 1. The airport operator places an “X” only at each end of the runway over the runway designation markings or, when required by construction activity, just off the runway end. The “X” is yellow in color and conforms to the dimensions specified in figure 25. Since the “X” is used temporarily, they are usually made of some easily removable material, such as plywood or fabric, rather than painted on the pavement surface. Any materials used for a temporary “X” should provide a solid appearance, for example, not flap in the wind, say by using a ground anchored device. Since the “X” will usually be placed over white runway markings, their visibility can be enhanced by a 6-inch (15-cm) black border.

(2) Option 2. The airport operator uses a raised-lighted “X” on each runway end in lieu of the Option 1 markings to indicate the runway is temporarily closed. The preferred location of the raised-lighted “X” is within 250 feet (76 m) of the runway end. However, it may be located in the safety area on the extended runway centerline.

b. For temporarily closed taxiways, the airport operator has two options when it is necessary to provide a visual indication that a taxiway is temporarily closed.

(1) Option 1. Usually this type of closure is treated as a hazardous area so the guidance in paragraph 5.14 applies.

(2) Option 2. As an alternative, the airport operator may install the same yellow “X” shown in figure 25 for those entrances leading into the temporarily closed taxiway.

c. If the runway or taxiway will be closed during the nighttime, the runway and taxiway lights will normally be disconnected so they can not be illuminated unless such illumination is needed to perform maintenance operations on or adjacent to the runway, e.g., snow removal.

General Comment
<p>NOTE: The airport operator is responsible for determining (1) the need for a visual indication that a runway or taxiway is temporarily closed and (2) the safest place to put the “X” or “X”s or other indicators per paragraph 5.14. In making these determinations, the airport operator should consider such things as the reason for the closure, duration of the closure, airfield configuration, and the existence and hours of operation of the airport traffic control tower and construction crews.</p>

5.8. CONVERTING A RUNWAY TO A TAXIWAY. The following actions are necessary to convert a runway permanently to a taxiway. Operationally, once this conversion is invoked, aircraft are not permitted to land or take off from the taxiway.

a. All runway markings found on the runway are obliterated or replaced with the appropriate taxiway markings. For example, the runway landing designation numbers are obliterated, and the white runway centerline is converted to a yellow taxiway centerline.

b. All runway related signage and lighting fixtures found on or along the runway must be removed and/or replaced with the appropriate taxiway signage and lighting to indicate the existence of the converted taxiway. For example, runway edge lights are converted to blue edge lights, and runway centerline lighting fixtures are converted to green. (It may be possible to do both actions by changing the lens color.) See AC 150/5345-56, Specification for L-890 Airport Lighting Control and Monitoring System (ALCMS), for information about taxiway edge lights; Specification for L-853 Runway and Taxiway Retroreflective Markers in AC 150/5345-53, Airport Lighting Equipment Certification Program, for retroreflectors; and AC 150/5340-30 for information about taxiway centerline lighting requirements.

c. All markings associated with the converted runway but not painted on the runway, such as the runway holding position markings found on entrance taxiways, are obliterated and replaced with the appropriate taxiway markings. Additionally, runway related signage and lighting fixtures found off the runway must be removed and/or replaced with the appropriate taxiway signage and lighting to indicate the existence of the converted taxiway.

d. In terms of documentation, airport operators must update their Airport Layout Plan as well as other appropriate documents to indicate the presence of the new taxiway and the permanent closure of the runway. Both the Airport/Facility Directory (A/FD) and the Airport Master Record (FAA Form 5010) need to indicate the conversion to a permanent taxiway.

General Comment

NOTE: The “X” closure marking is never used on this type of conversion since the converted pavement is intended to be an active, new taxiway.
--

5.9. INTERMITTENT USE OF A TAXIWAY AS A RUNWAY. The intermittent use of a taxiway as a runway is a type of conversion where the converted taxiway is either used only as a runway or used as a runway for a specified time of the day or night. In both of these applications, the airport operator must properly re-mark affected pavements (including provisions for signage and lighting). One required restriction for any conversions is that the converted pavement cannot be marked simultaneously with a yellow taxiway centerline and a white runway designation number. Other re-marking actions are listed below. The FAA recommends a Safety Management System risk assessment to determine if other necessary actions need to be implemented.

General Comment

NOTE: For airports subject to National Environmental Policy Act (NEPA) requirements, any proposal to use a taxiway as a runway should include a review of the potential environmental consequences of such an action. The airport operator should contact the FAA Airports Regional Office or Airports District Office for NEPA guidance.
--

a. Pavement used as a runway during the day should at a minimum be painted with the visual runway markings identified in table 2-1, that is, the white landing designation number(s) and a white centerline. Furthermore, converted pavement used as a runway at night that is to be lighted should have runway lighting installed per AC 150/5345-30.

b. If the pavement is to be used ONLY as a taxiway at night, blue edge lights should be installed per AC 150/5340-30.

c. In terms of documentation, airport operators must update their Airport Layout Plan as well as other appropriate documents to indicate the presence of the new runway. If the runway is to be used ONLY as a taxiway at night and has blue edge lighting, this runway must be listed as unlighted along with an appropriate annotation in both the Airport/Facility Directory (A/FD) and the Airport Master Record (FAA Form 5010) indicating the runway is closed to nighttime operations and that the blue lights are provided for taxiing aircraft.

d. Since the pavement is now considered a runway, any taxiways intersecting the designated runway must have appropriate runway holding position markings (including provisions for signage and lighting) painted per this AC including criteria from AC 150/5340-18, and AC 150/5340-30.

5.10. CLOSED OR ABANDONED AIRPORTS. When all runways are closed temporarily, the airport beacon is turned off and the runways are marked per paragraph 5.7. When an airport is abandoned and all runways are closed permanently, the runways are marked per paragraph 5.6, the airport beacon is disconnected, and an “X” is placed in the segmented circle or at a central location if no segmented circle exists. For additional details, see AC 150/5370-2.

5.11. HELIPORT MARKINGS. Information on markings for heliports is in AC 150/5390-2, Heliport Design.

5.12. VERTIPOINT MARKINGS. Information on markings for vertiports is in AC 150/5390-3, Vertiport Design.

5.13. MARKING FOR ARRESTING GEAR. Information on marking for arresting gear is in AC 150/5220-9, Aircraft Arresting Systems on Civil Airports.

5.14. HAZARDOUS CONSTRUCTION AREAS. Marking of hazardous areas due to construction, in which no part of an aircraft may enter, are marked in accordance with AC 150/5370-2.

5.15. AIRCRAFT DEICING FACILITY MARKINGS. Information on markings for aircraft deicing facilities is in AC 150/5300-14, Design of Aircraft Deicing Facilities.

5.16. INTERIM SURFACE MARKINGS FOR TAXIWAYS MISTAKEN AS RUNWAYS. This advisory circular recognizes the use of the non-standard surface marking “TAXI” as an interim measure only for those taxiways that have *repeated* landing incidents. Figures 5-2 and 5-3 provide location and characteristics for this application. In practice “TAXI” extends across the entire pavement including any paved shoulder as shown in the figures. The color is yellow with a 12 inch (30.5 cm) wide black border along the sides of each letter and a 4-foot (1.2 m) black border on the tops and bottoms of the letters. Figure 5-4 illustrates the combined application with aviation grade artificial turf. See FAA Engineering Brief No. 72A, Positive Identification Of Runways For Landing, which provides guidance for identifying situations where a taxiway could be mistaken for a runway and provides other mitigation strategies for dealing with this problem.

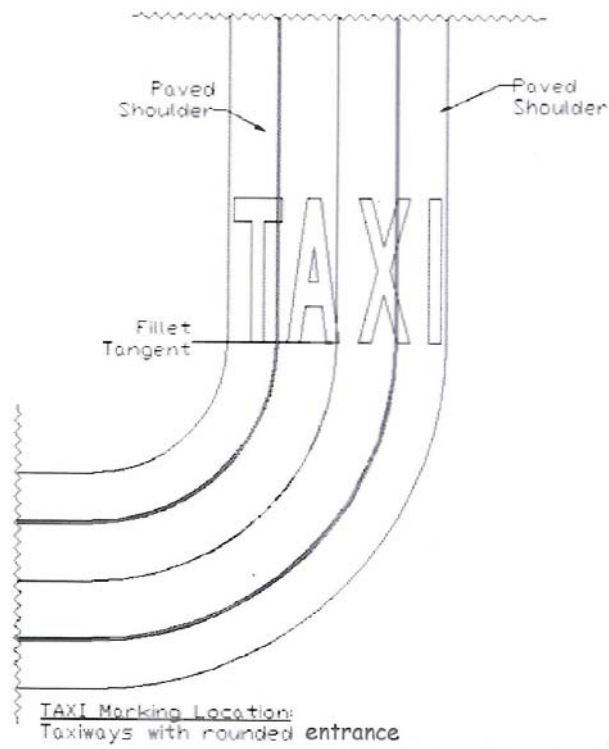
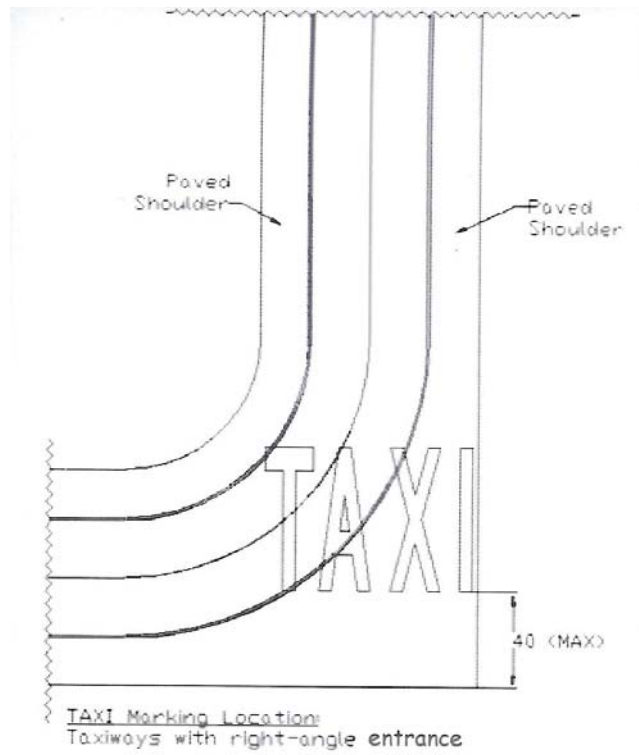
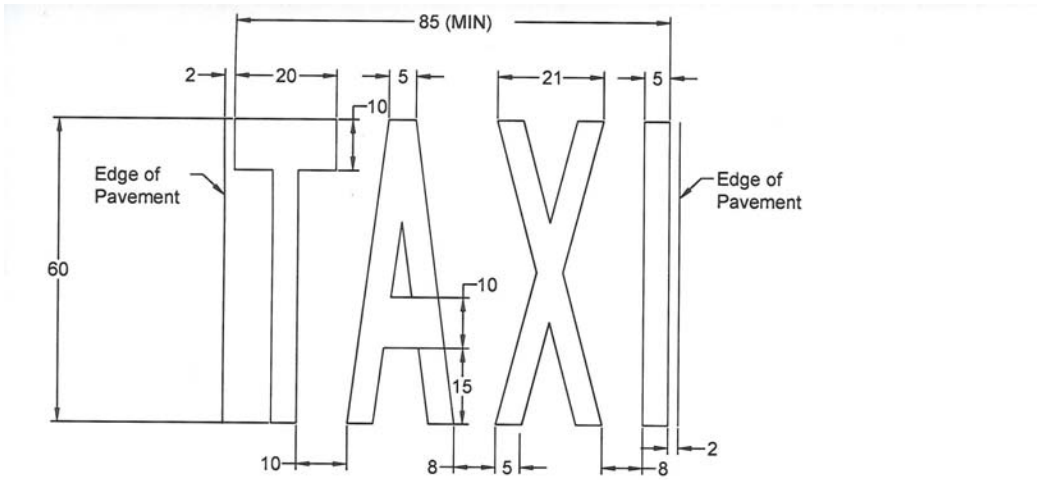

Figure 5-2. TAXI Marking Location Facing Runway Approach End



Note: These are minimum dimensions (in feet). If the existing taxiway plus paved shoulder is not wide enough to accommodate these markings, then provide a paved pad or wider shoulder in the area where the marking is to be installed.

Figure 5-3. TAXI Marking Dimensions

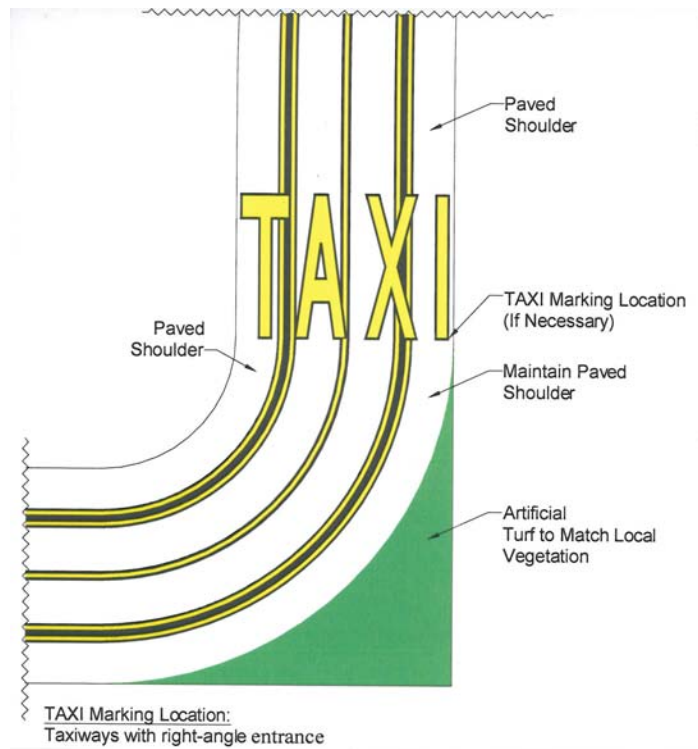

Figure 5-4. Aviation Grade Artificial Turf Installation

All figures except figures 5-2, 5-3, and 5-4 in this advisory circular are full scale AutoCAD drawings saved as MS Word versions. For some figures, certain details may appear to be missing (missing or broken lines) when either printed or viewed on a computer monitor. To view all the details in these figures, use the appropriate ZOOM function provided in MS Word or Adobe Reader. In some instances, where there is a large surface area, a ZOOM value of over 250% may be necessary to view all details. Both this advisory circular and the original AutoCAD files for all figures are available for download at the FAA web site:

http://www.faa.gov/airports/resources/advisory_circulars/index.cfm/go/document.list/parentTopicID/85

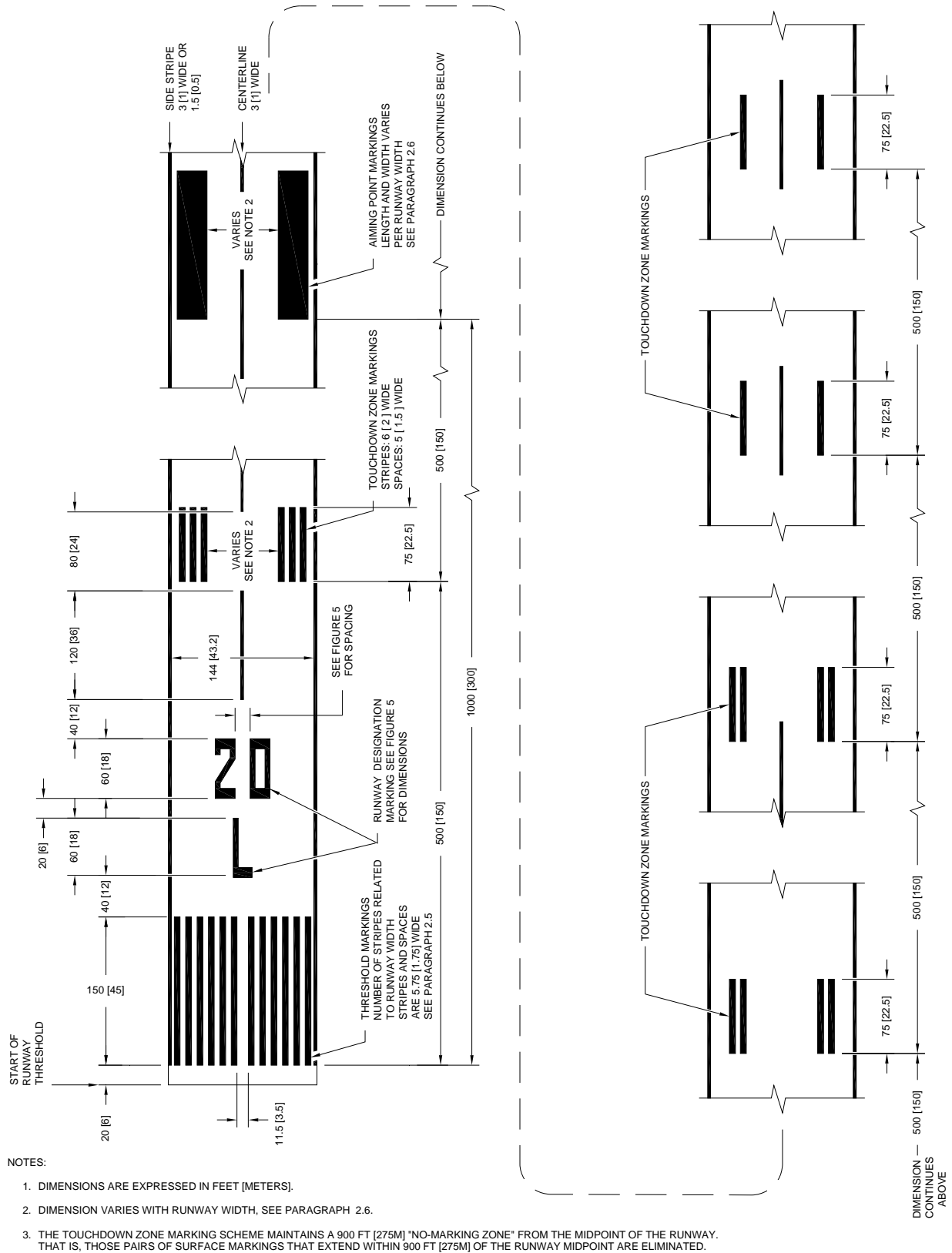
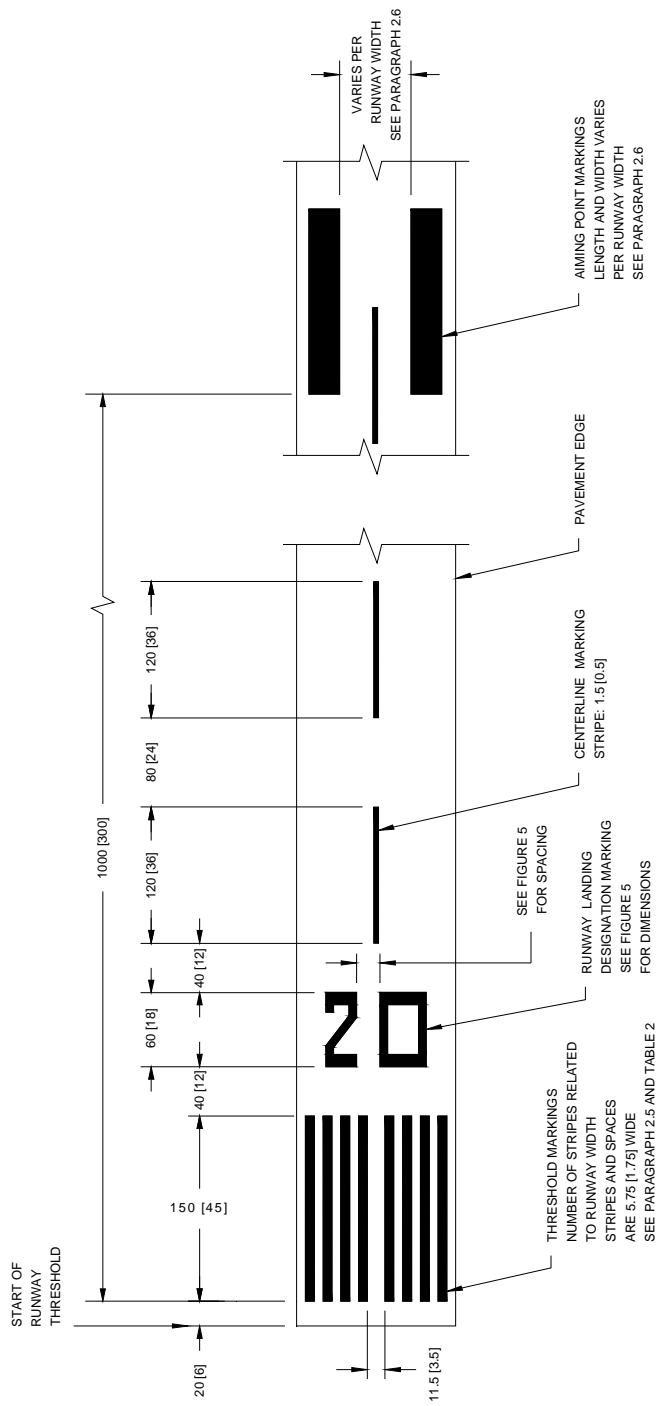

Figure 1. Precision Runway Markings



NOTES:

1. DIMENSIONS ARE EXPRESSED IN FEET [METERS].

Figure 2. Non-precision Runway

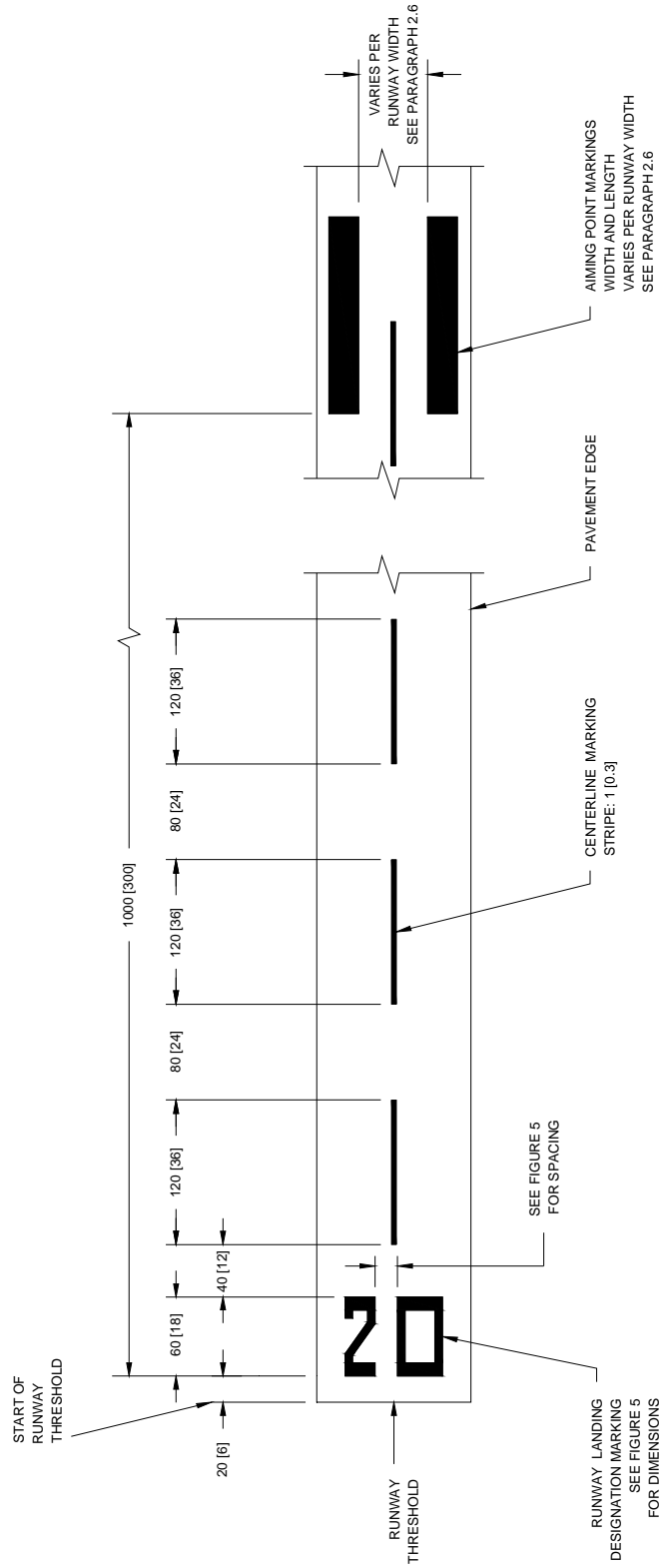

NOTES:

1. DIMENSIONS ARE EXPRESSED IN FEET [METERS].

Figure 3. Visual Runway Markings

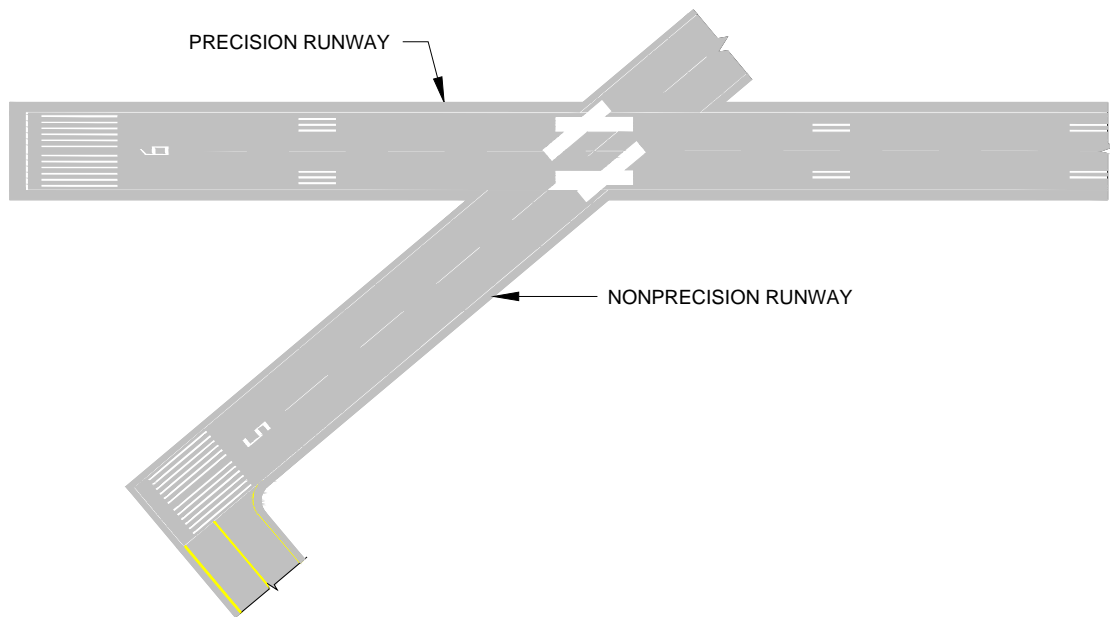

EXAMPLE OF CONFLICTING RUNWAY MARKINGS

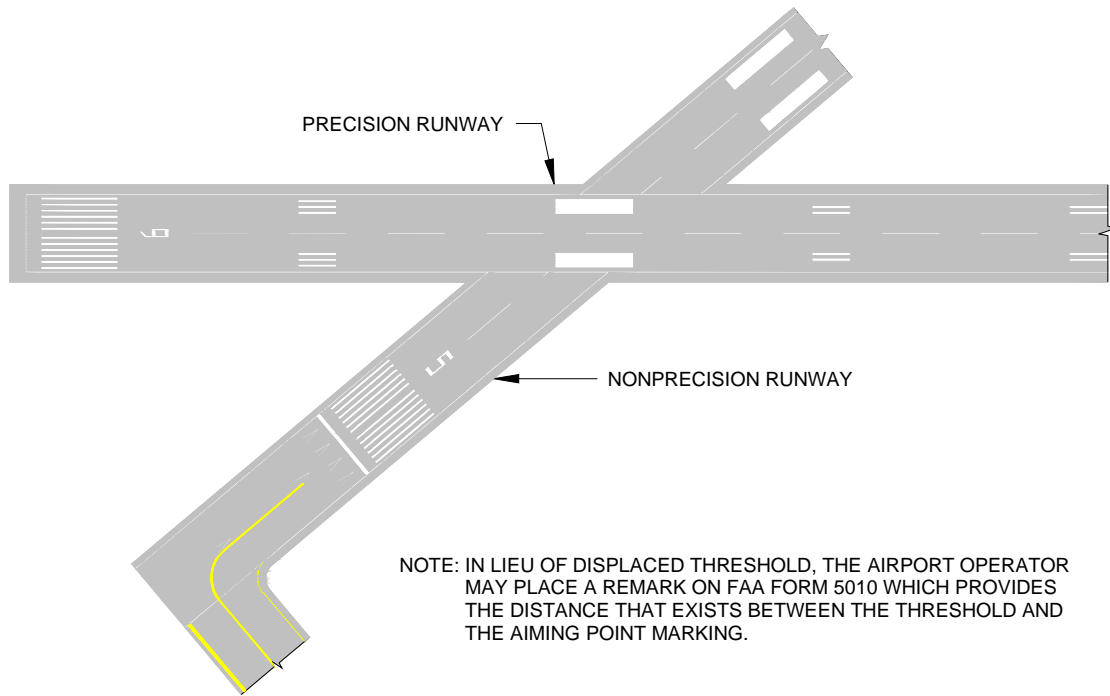

NOTE: IN LIEU OF DISPLACED THRESHOLD, THE AIRPORT OPERATOR MAY PLACE A REMARK ON FAA FORM 5010 WHICH PROVIDES THE DISTANCE THAT EXISTS BETWEEN THE THRESHOLD AND THE AIMING POINT MARKING.

ONE SOLUTION:
THRESHOLD AND AIMING POINT OF THE LOWER PRECEDENCE RUNWAY DISPLACED TO MAINTAIN THE REQUIRED DISTANCE FROM THE AIMING MARKING TO THE THRESHOLD

Enlarge figure for greater detail.

Figure 4. Example of Conflicting Markings on Crossing Runways

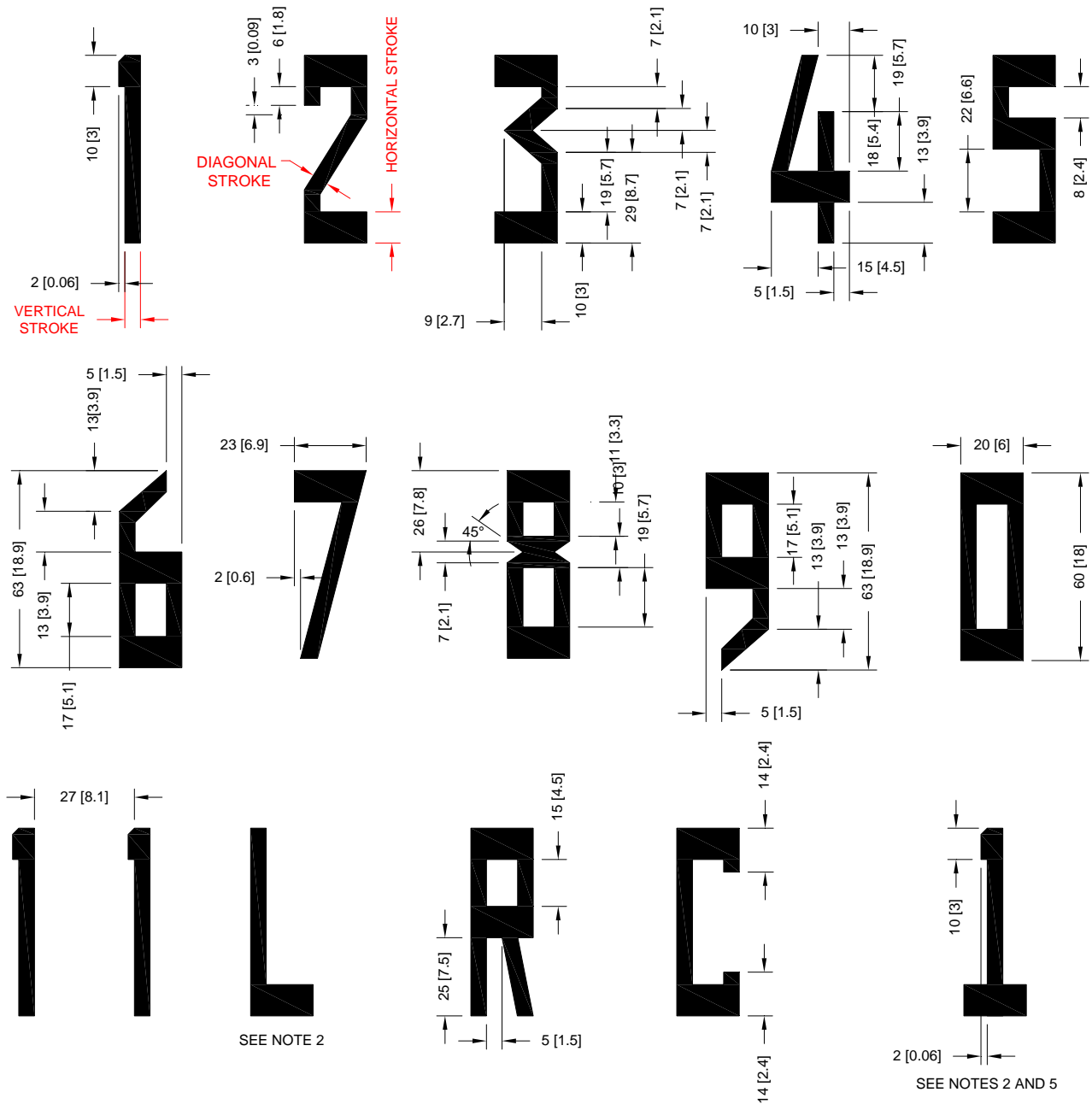

NOTES :

1. DIMENSIONS ARE EXPRESSED: FEET [METERS].
2. ALL CHARACTERS SHALL HAVE THESE CHARACTERISTICS (UNLESS OTHERWISE SPECIFIED):
 60 [18] HIGH
 20 [6] WIDE
 VERTICAL STROKE OF 5 [1.5]
 HORIZONTAL STROKE OF 10 [30]
 DIAGONAL STROKE OF 5 [1.5]
3. ALL NUMERALS EXCEPT THE NUMBER ELEVEN AS SHOWN ARE HORIZONTALLY SPACED 15 [4.5] APART.
4. SINGLE DIGITS MUST NOT BE PRECEDED BY A ZERO.
5. THE NUMERAL "1", WHEN USED ALONE, CONTAINS A HORIZONTAL STROKE AS SHOWN TO DIFFERENTIATE IT FROM THE RUNWAY CENTERLINE MARKING.
6. SINGLE DESIGNATIONS ARE CENTERED ON THE RUNWAY PAVEMENT CENTERLINE. FOR DOUBLE DESIGNATIONS, THE CENTER OF THE OUTER EDGES OF THE TWO NUMERALS IS CENTERED ON THE RUNWAY PAVEMENT CENTERLINE.
7. WHERE THE RUNWAY DESIGNATION CONSISTS OF A NUMBER AND A LETTER, THE NUMBER AND LETTER ARE LOCATED ON THE RUNWAY CENTERLINE IN A STACKED ARRANGEMENT AS SHOWN IN FIGURE 1.

Figure 5. Runway Designation Numerals and Letters

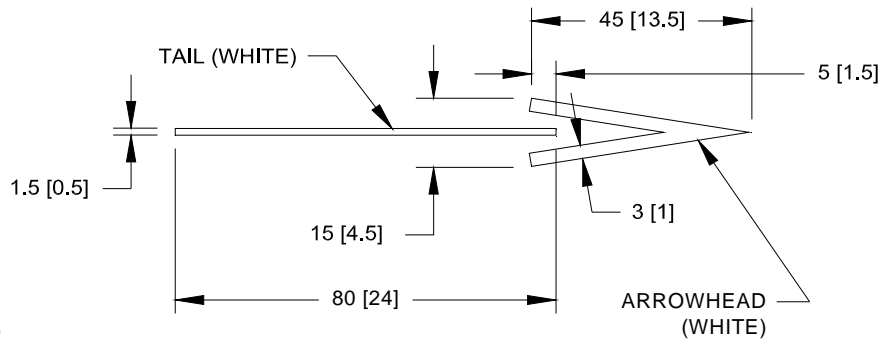
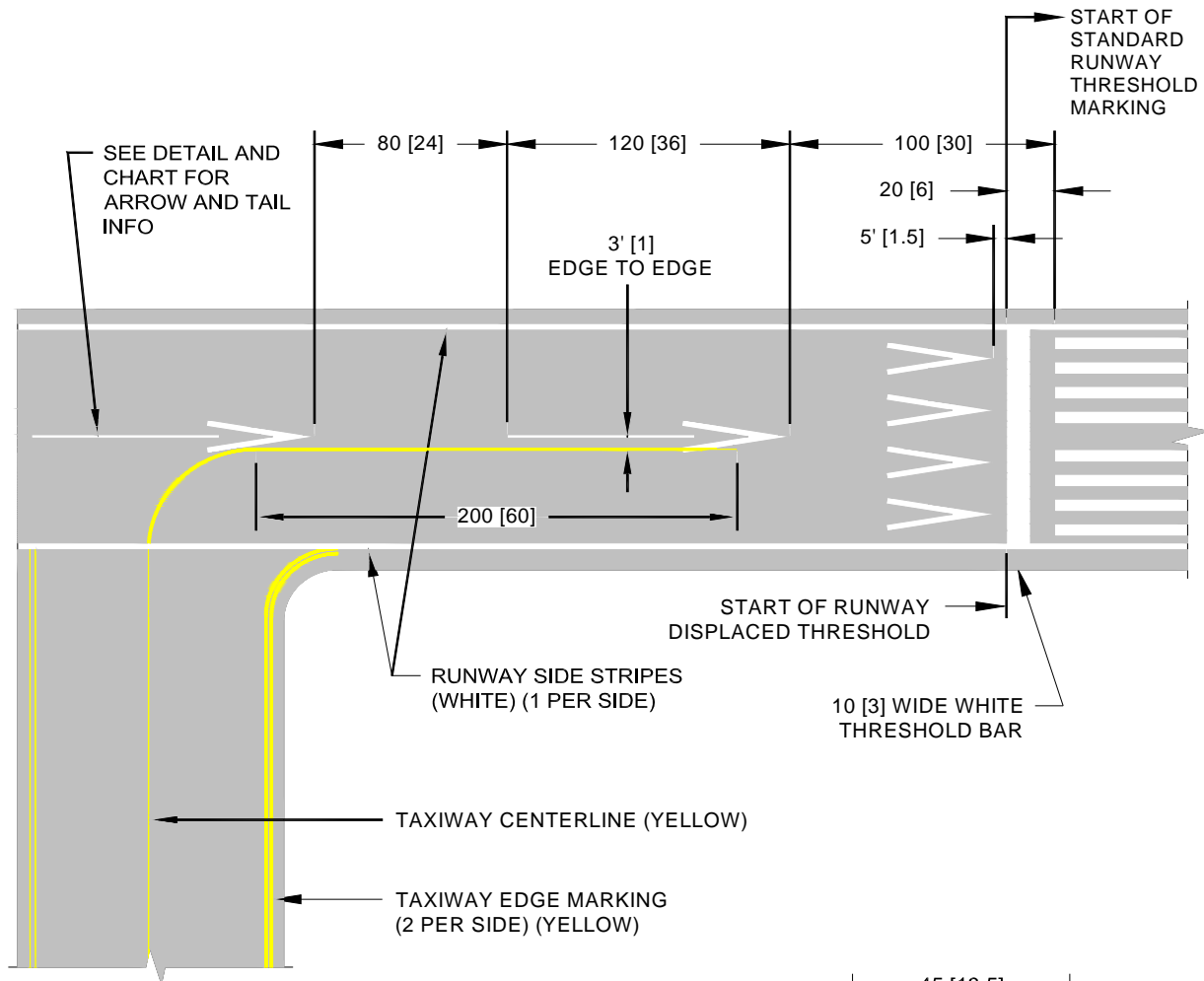

NOTES:

1. DIMENSIONS ARE IN: FEET [METERS]
2. RUNWAY SIDE STRIPES, WHEN USED ON THE RUNWAY, EXTEND INTO THE DISPLACED AREA.
3. RUNWAY MARKINGS (EXCEPT HOLDING POSITION MARKINGS) INCLUDING THOSE IN THE DISPLACED THRESHOLD ARE WHITE.

RUNWAY WIDTH	NUMBER OF ARROWHEADS	SPACING BETWEEN ARROWHEADS (W = RUNWAY WIDTH)	SPACING TO RUNWAY EDGE
≥ 100 [30]	4	W/4	W/8
< 100 [30]	3	W/3	W/6
< 60 [18]	2	W/2	W/4

Figure 6. Displaced Threshold Markings

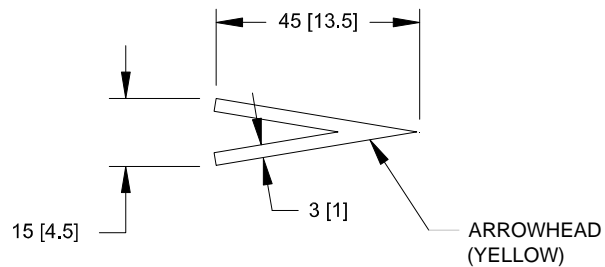
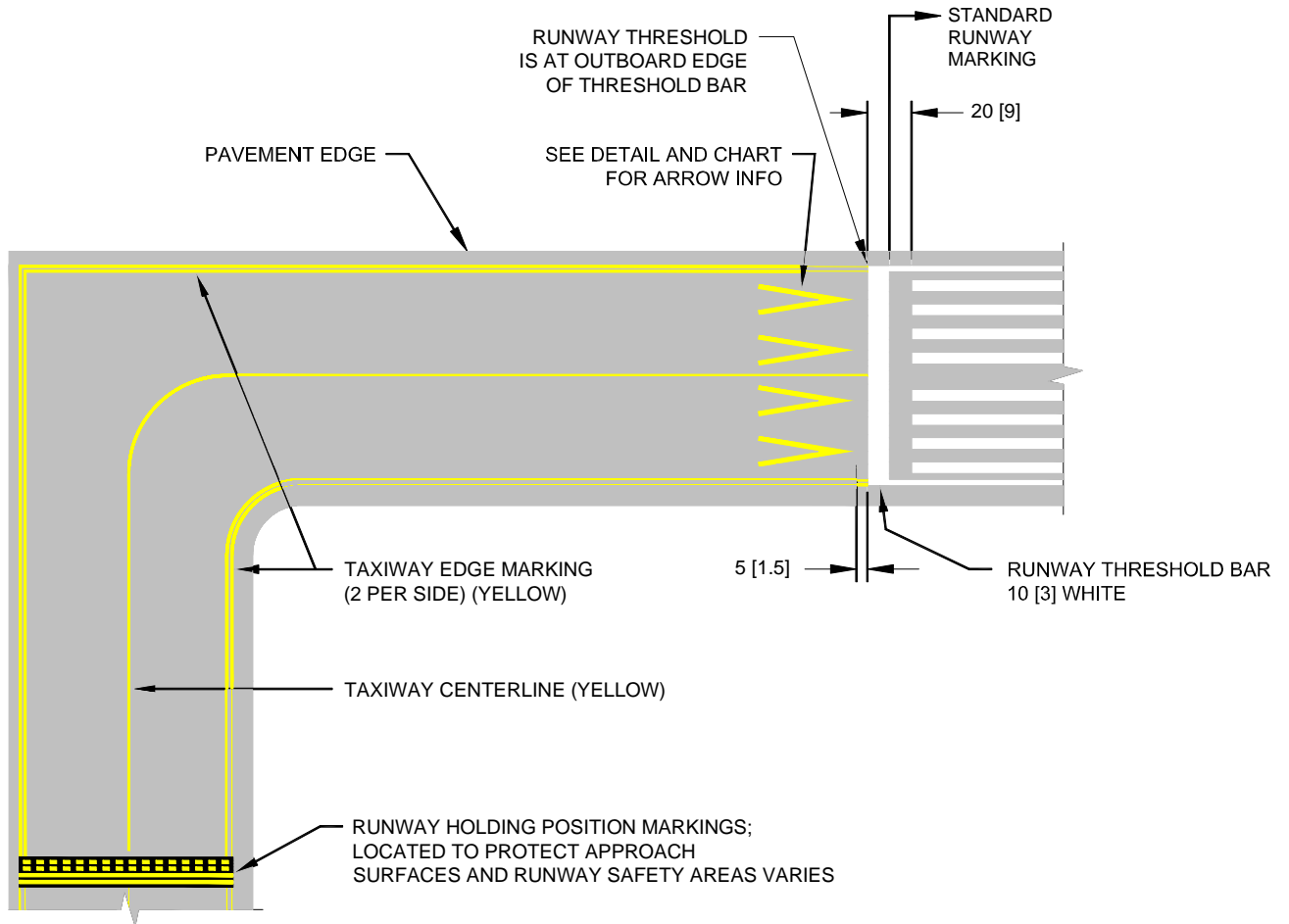

NOTES:

1. DIMENSIONS ARE IN: FEET [METERS]

RUNWAY WIDTH	NUMBER OF ARROWHEADS	SPACING BETWEEN ARROWHEADS (W = RUNWAY WIDTH)	SPACING TO RUNWAY EDGE
≥ 100 [30]	4	W/4	W/8
< 100 [30]	3	W/3	W/6
< 60 [18]	2	W/2	W/4

Figure 7. Marking for Aligned Taxiway with Runway Without a Displaced Threshold

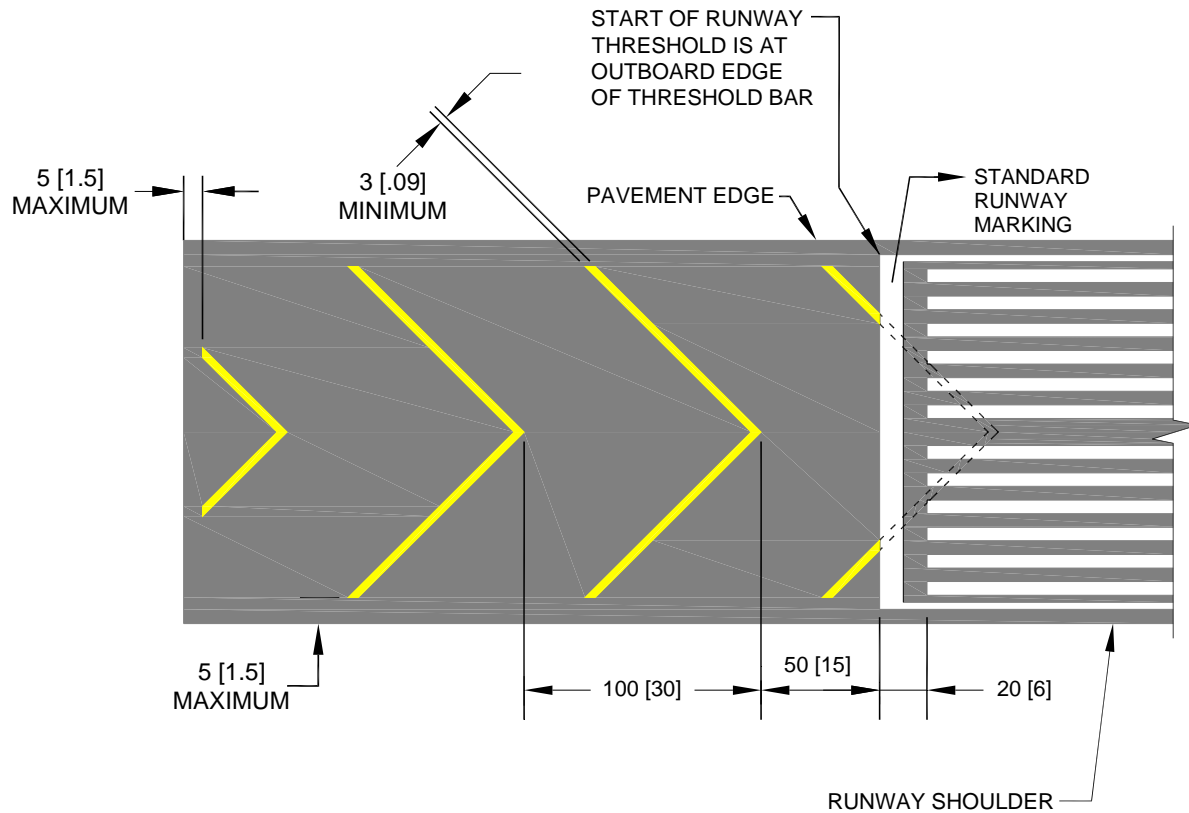

NOTES:

1. DIMENSIONS ARE IN: FEET [METERS].
2. THE WIDTHS OF THE STOPWAYS AND BLAST PADS ARE NOT THE SAME. STOPWAYS EQUAL RUNWAY WIDTH. BLAST PADS EQUAL RUNWAY WIDTH PLUS RUNWAY SHOULDERS. SEE AC 150/5300-13
3. 50 FT [15M] SPACING MAY BE USED WHEN LENGTH OF AREA IS LESS THAN 250 FT [7.5M] IN WHICH CASE THE FIRST FULL CHEVRON STARTS AT THE INDEX POINT (INTERSECTION OF RUNWAY CENTERLINE AND RUNWAY THRESHOLD).
4. CHEVRONS ARE PAINTED YELLOW AND AT AN ANGLE OF 45° TO THE RUNWAY CENTERLINE.
5. CHEVRON SPACING MAY BE DOUBLED IF LENGTH OF AREA EXCEEDS 1000 FT [300M]

Figure 8. Markings for Blast Pads and Stopways

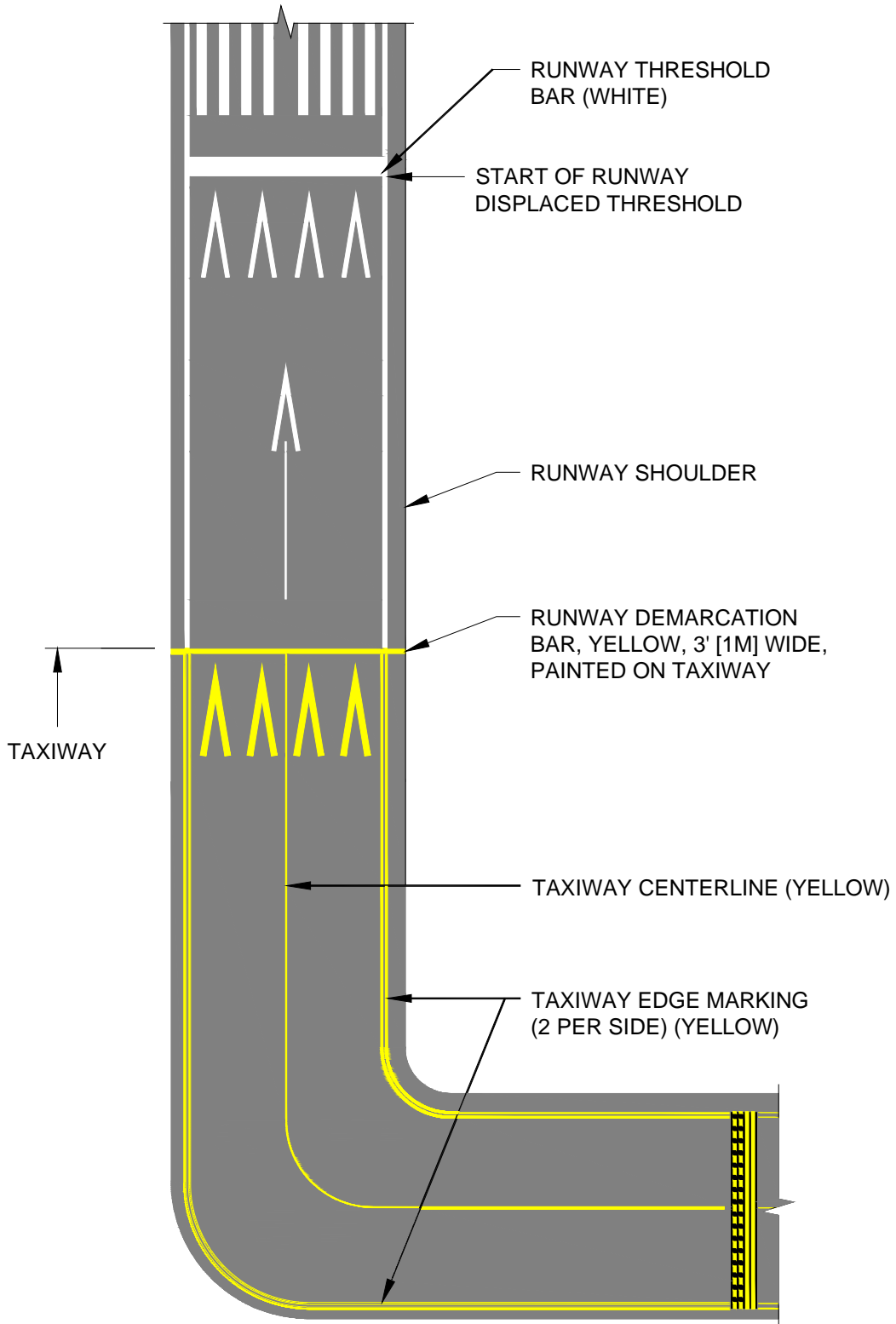
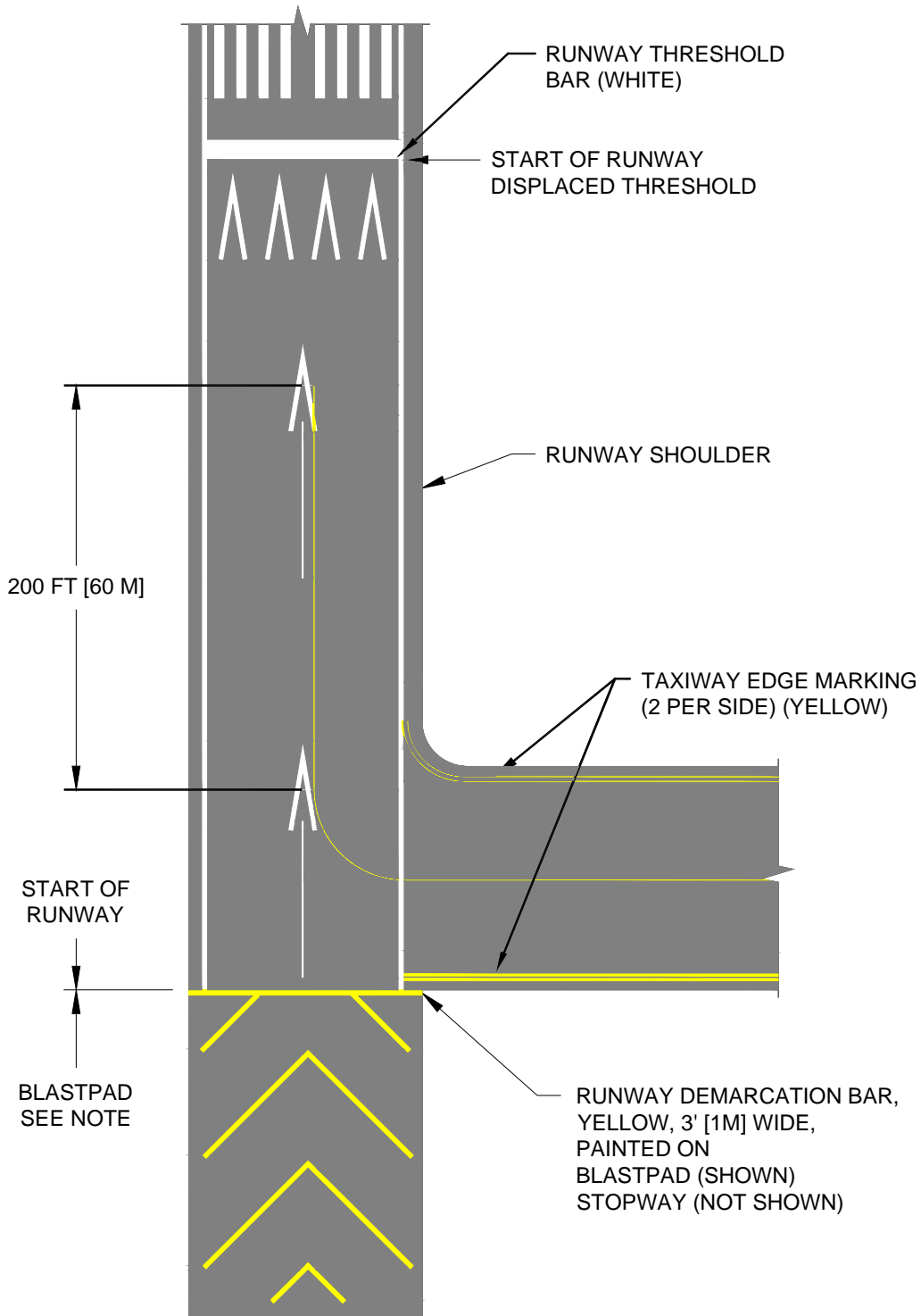
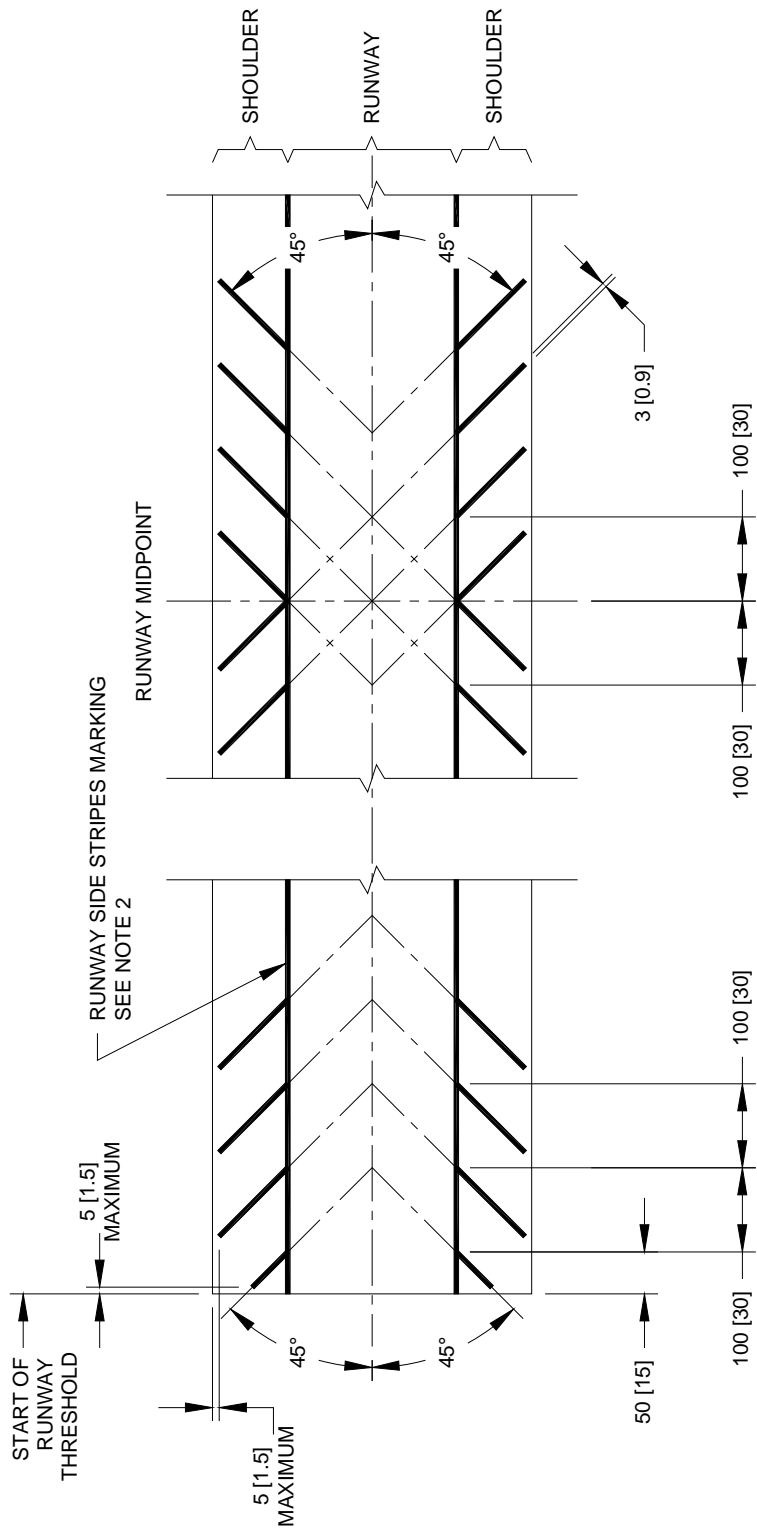

Figure 9. Markings for Aligned Taxiway Preceding a Displaced Threshold



NOTE: STOPWAY WIDTH EQUALS RUNWAY WIDTH.
 BLASTPAD WIDTH EQUALS RUNWAY WIDTH PLUS RUNWAY SHOULDERS.

Figure 10. Markings for Blast Pad Preceding a Displaced Threshold



NOTES:

1. DIMENSIONS ARE IN: FEET [METERS].
2. RUNWAY SHOULDER MARKINGS ARE USED ONLY IN CONJUNCTION WITH RUNWAY SIDE STRIPE MARKINGS.
3. RUNWAY SHOULDER MARKINGS ARE PAINTED YELLOW.

Figure 11. Runway Shoulder Markings

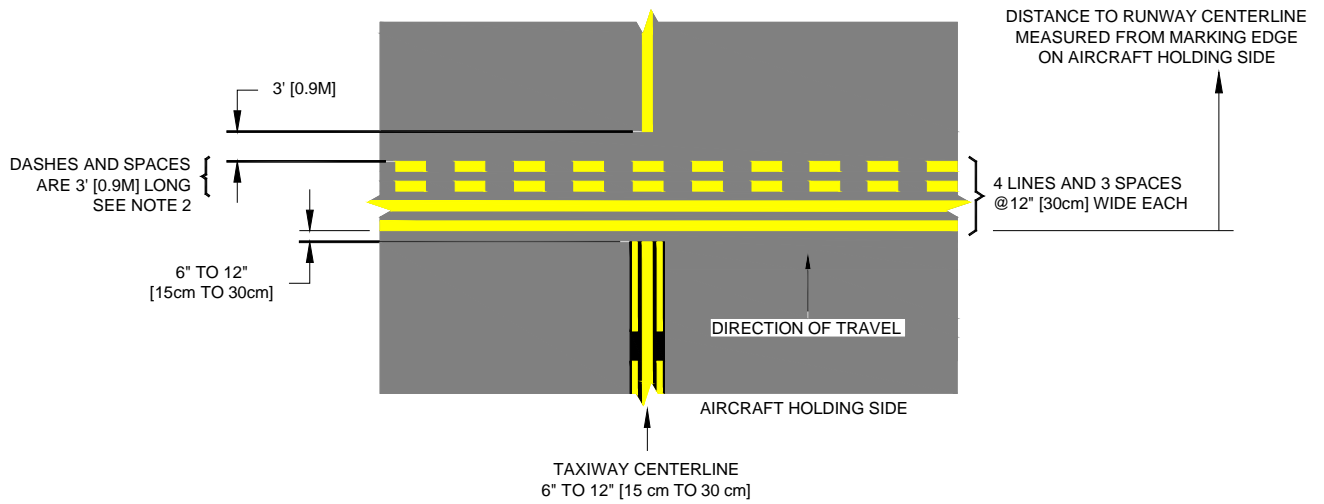

PATTERN A - RUNWAY HOLDING POSITION MARKING

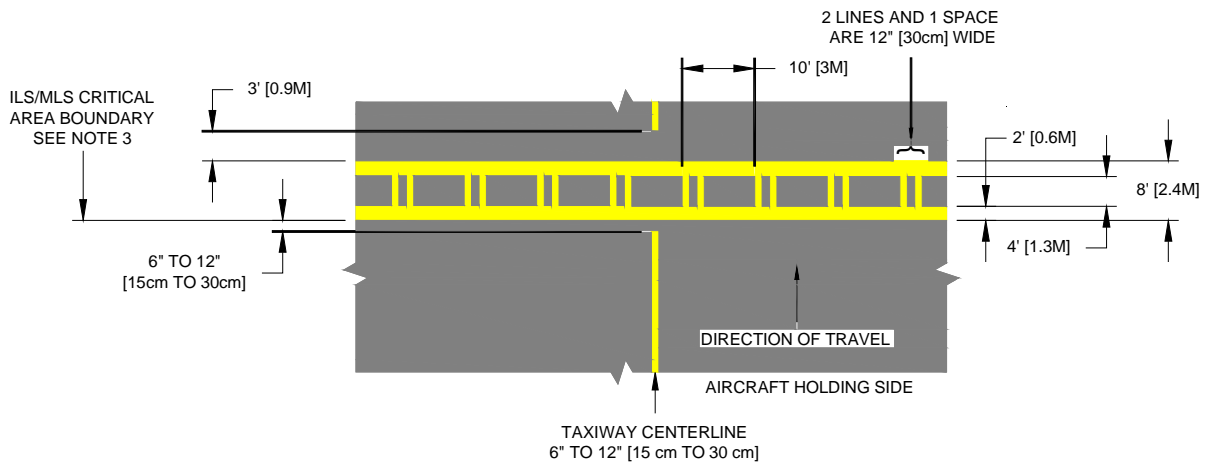

PATTERN B - ILS/MLS HOLDING POSITION MARKING

NOTES:

1. UNLESS OTHERWISE NOTED ALL LINES ARE YELLOW.
2. SEE PARAGRAPH 3.3 FOR REDUCTIONS.
3. SEE PARAGRAPH 3.4 FOR REDUCTIONS.
4. DIMENSIONS SHOWN DO NOT ACCOUNT FOR OUTLINE MARKING IN BLACK PAINT WHEN ON LIGHT-COLORED PAVEMENT. SEE PARAGRAPH 1.4 AND APPENDIX B.

Figure 12. Holding Position Marking Details

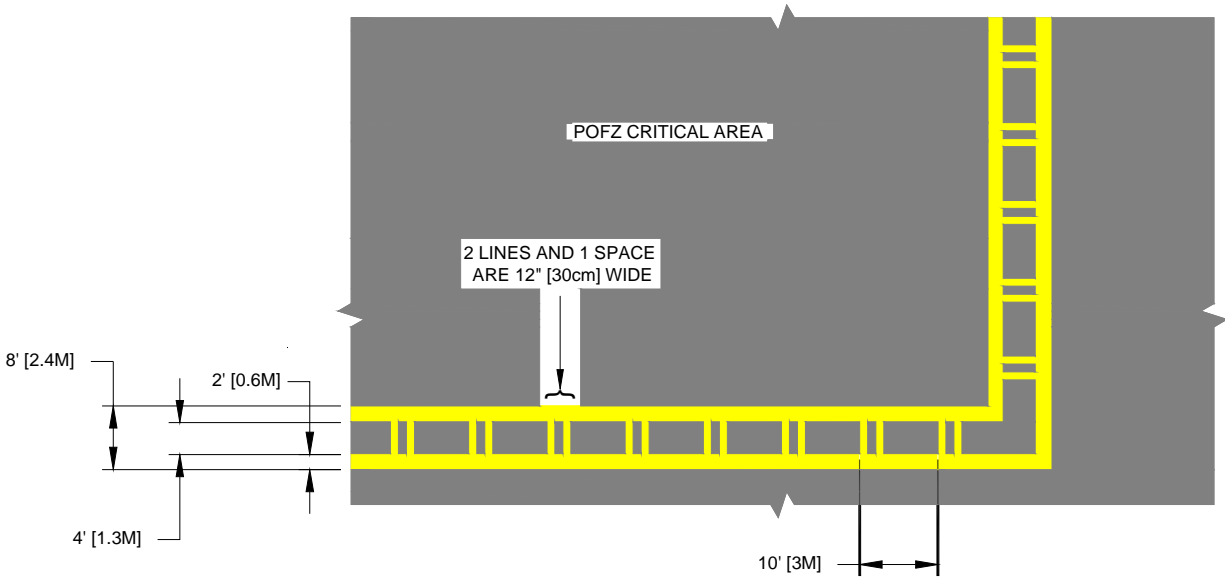

PATTERN B - POFZ MARKING

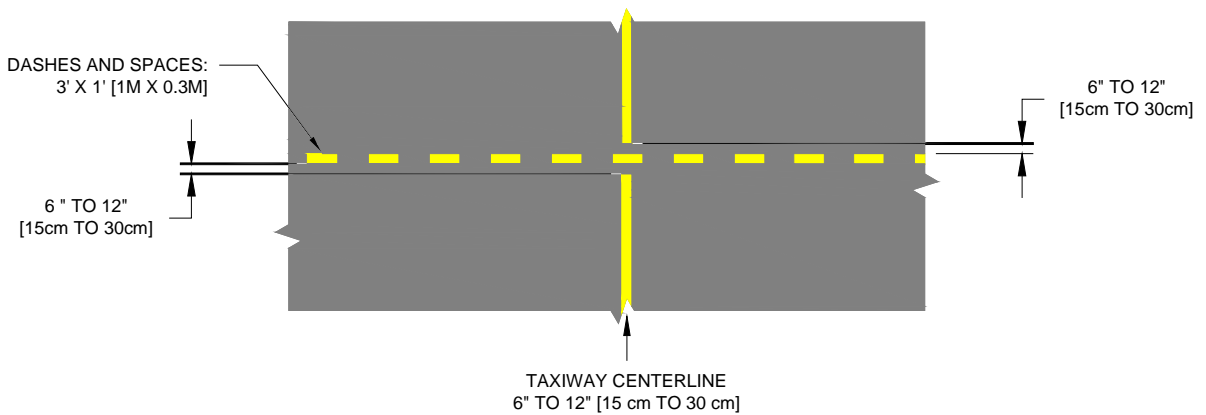

PATTERN C - INTERMEDIATE HOLDING POSITION MARKING FOR TAXIWAY/TAXIWAY INTERSECTIONS

NOTES:

1. UNLESS OTHERWISE NOTED ALL LINES ARE YELLOW.
2. DIMENSIONS SHOWN DO NOT ACCOUNT FOR OUTLINE MARKING IN BLACK PAINT WHEN ON LIGHT-COLORED PAVEMENT. SEE PARAGRAPH 1.4 AND APPENDIX B.

Figure 12a. Holding Position Marking Details

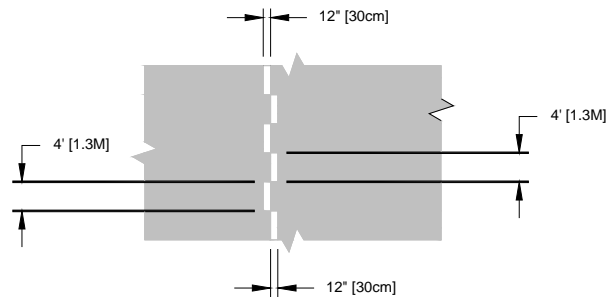

ROADWAY EDGE STRIPES, WHITE, ZIPPER STYLE

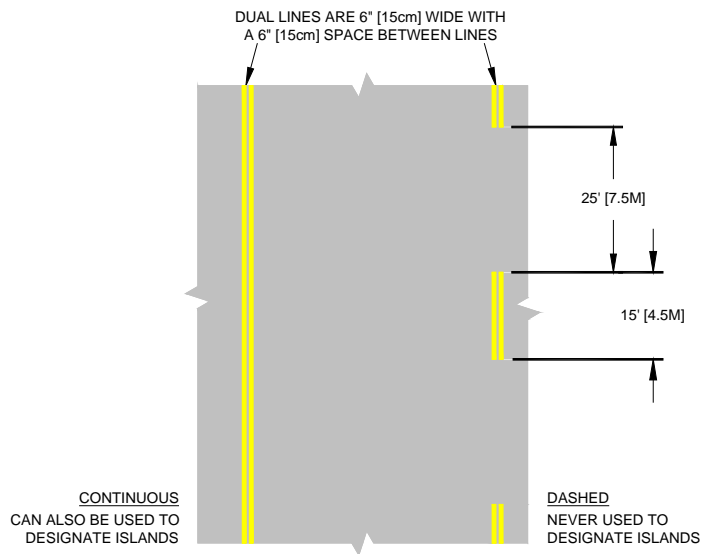

TAXIWAY EDGE MARKINGS - 2 CASES

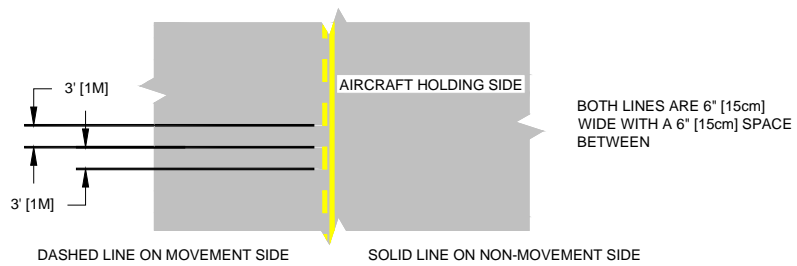

NON-MOVEMENT AREA MARKINGS

NOTES:

1. UNLESS OTHERWISE NOTED ALL LINES ARE YELLOW.
2. DIMENSIONS SHOWN DO NOT ACCOUNT FOR BLACK OUTLINE OF ENHANCED TAXIWAY MARKING. SEE PARAGRAPH 1.4 AND APPENDIX B.

Figure 13. Taxiway Markings

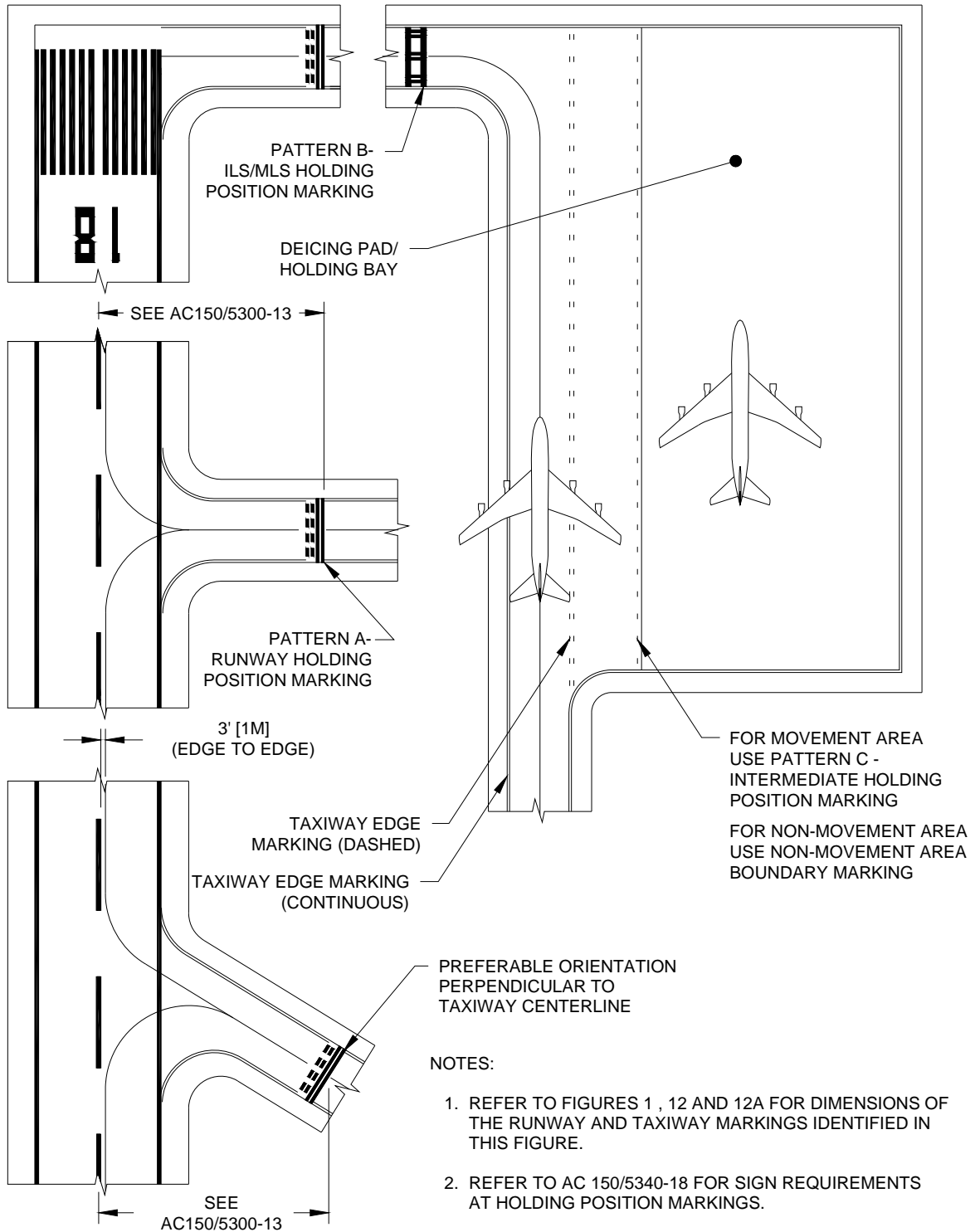
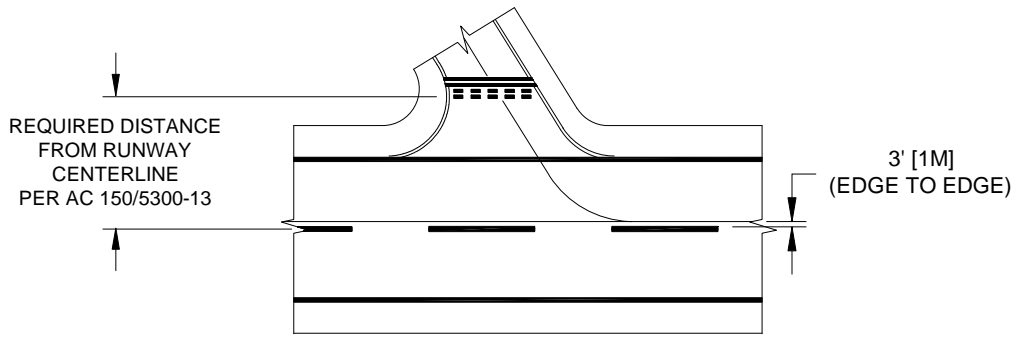
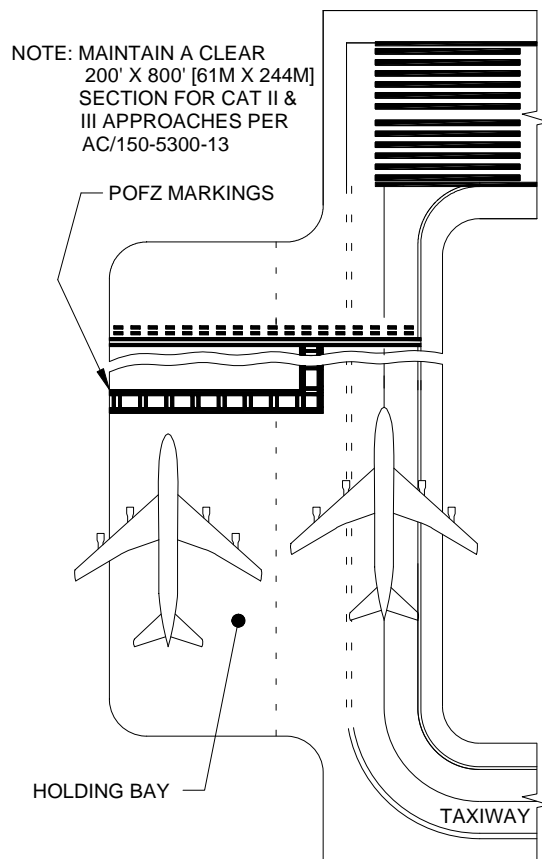

Figure 14. Taxiway Markings



EXAMPLE OF PATTERN A HOLDING POSITION MARKINGS NOT AT RIGHT ANGLE TO TAXIWAY CENTERLINE. THE PREFERABLE ORIENTATION (FIGURE 14) IS TO BE PERPENDICULAR TO THE TAXIWAY CENTERLINE. HOWEVER, WHEN THE ANGLE IS VERY ACUTE, AND PART OF THE AIRCRAFT IS IN THE RUNWAY SAFETY AREA, USE THIS METHOD



NOTES:

1. REFER TO FIGURES 1, 12 AND 12A FOR DIMENSIONS OF THE RUNWAY AND TAXIWAY MARKINGS IDENTIFIED IN THIS FIGURE.
2. REFER TO AC 150/5340-18 FOR SIGN REQUIREMENTS AT HOLDING POSITION MARKINGS.

EXAMPLE WHERE PATTERN B POFZ HOLDING POSITION MARKINGS EXTENDING ACROSS HOLDING BAY

Figure 15. Taxiway Markings

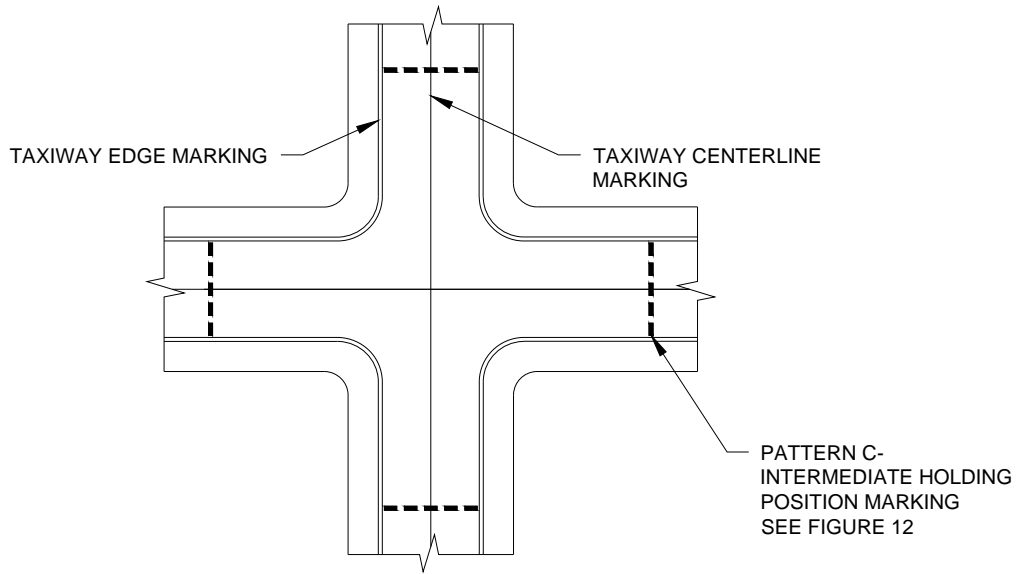

TAXIWAY CENTERLINE MARKING AT INTERSECTION HAVING LESS THAN STANDARD FILLETS AND REQUIRING JUDGMENTAL OVERSTEERING

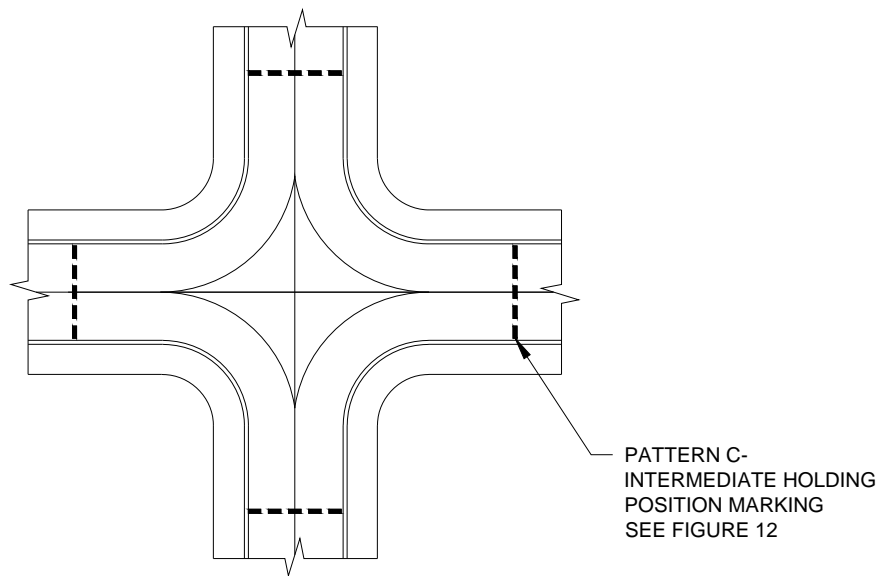

TAXIWAY CENTERLINE MARKING AT INTERSECTION HAVING STANDARD FILLETS PERMITTING COCKPIT-OVER-CENTERLINE STEERING (RECOMMENDED)

NOTE: REFER TO FIGURE 11 and 12 FOR DIMENSIONS OF THE TAXIWAY MARKING IDENTIFIED IN THIS FIGURE.

Figure 16. Methods for Taxiway Centerline Marking

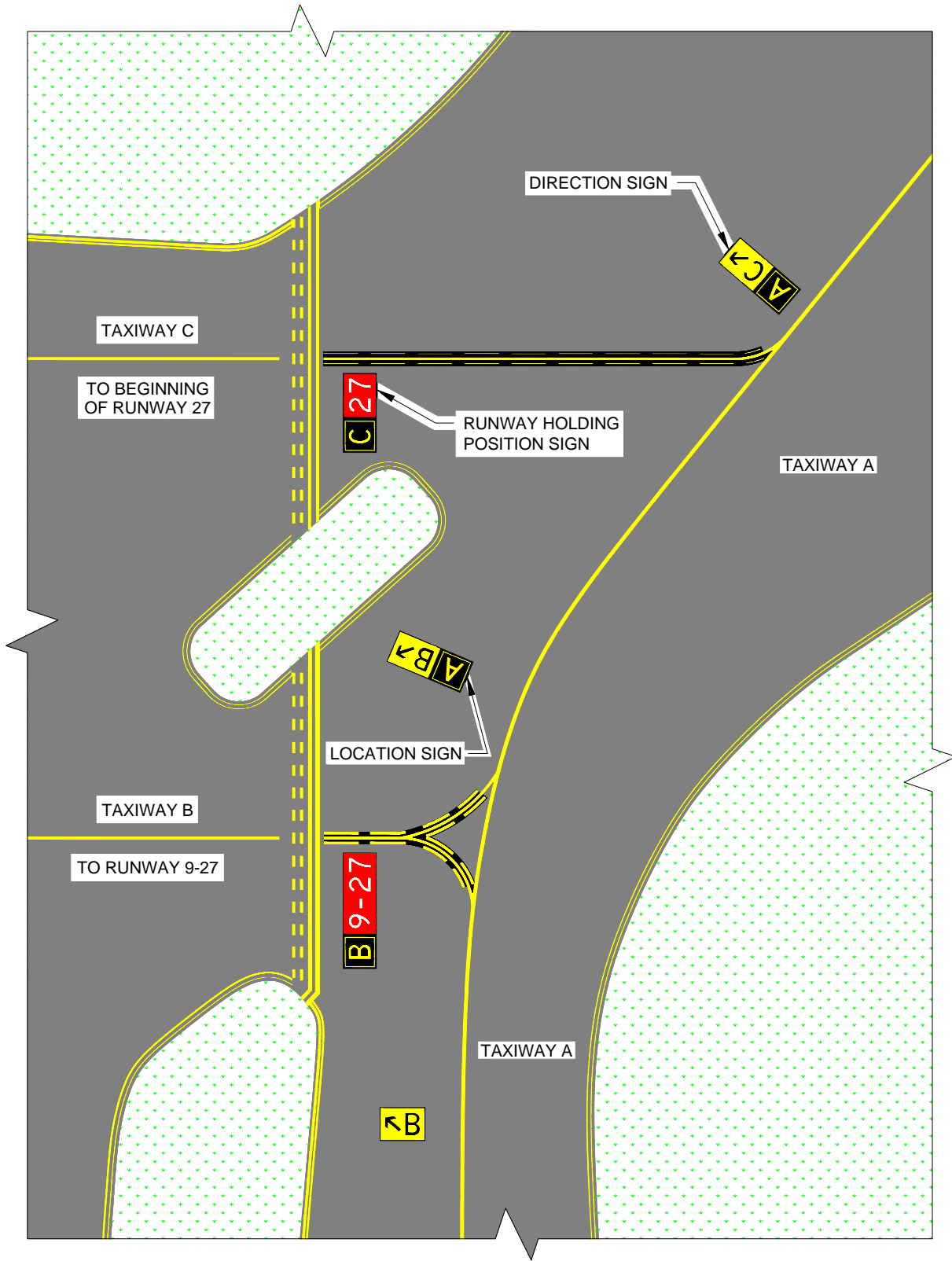

Figure 17. Surface Painted Signs

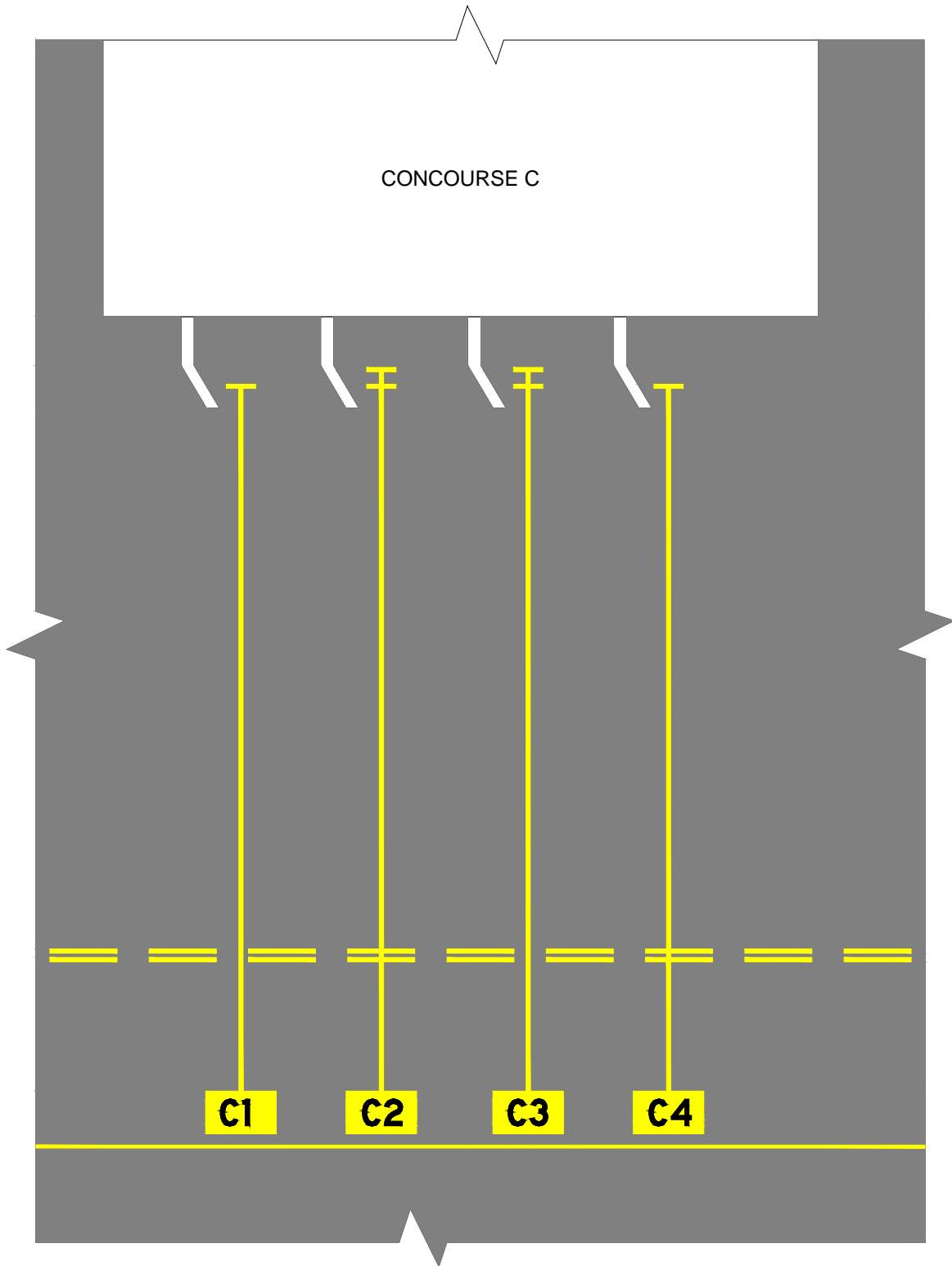

Figure 18. Surface Painted Gate Identification Signs

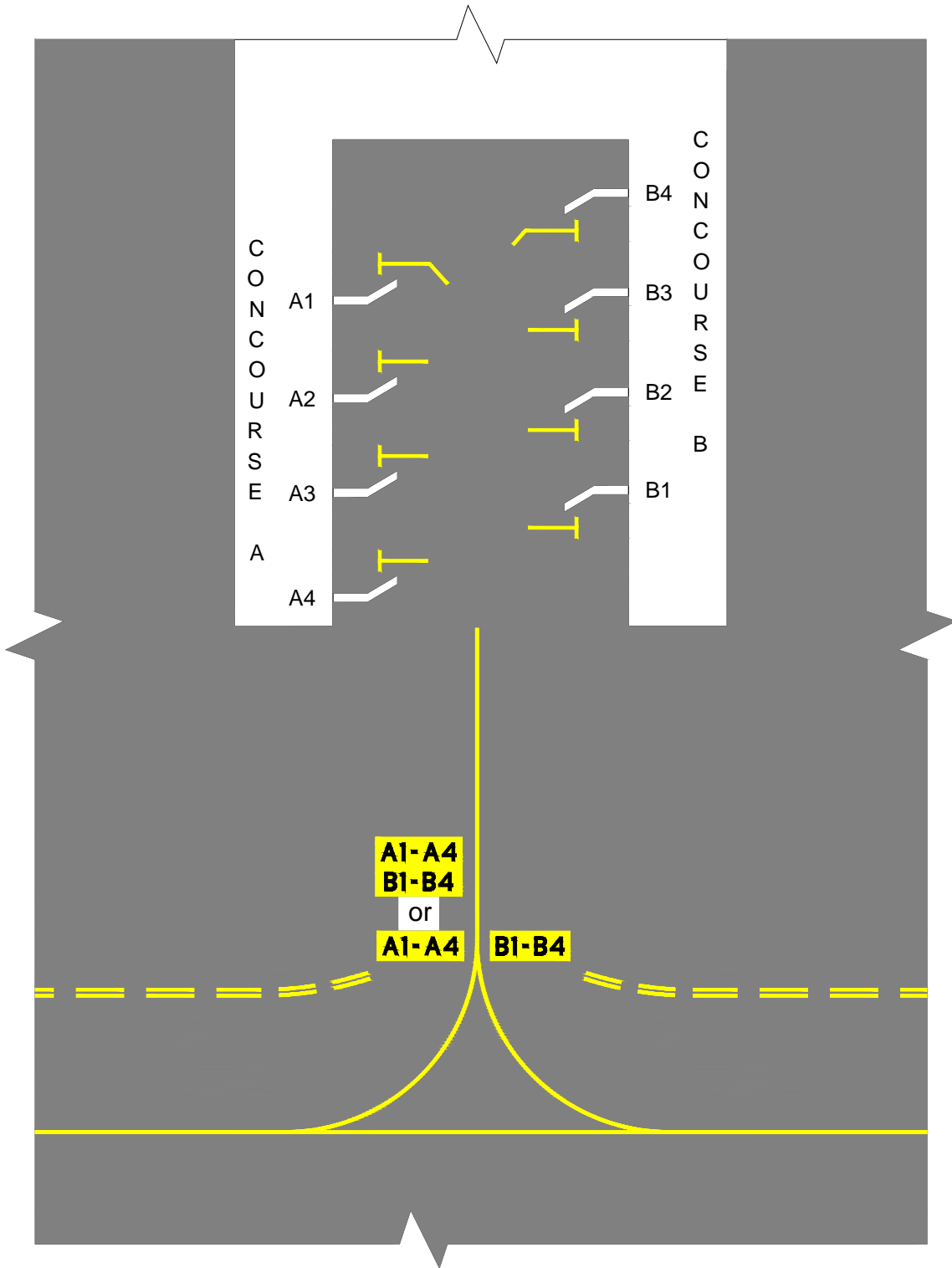
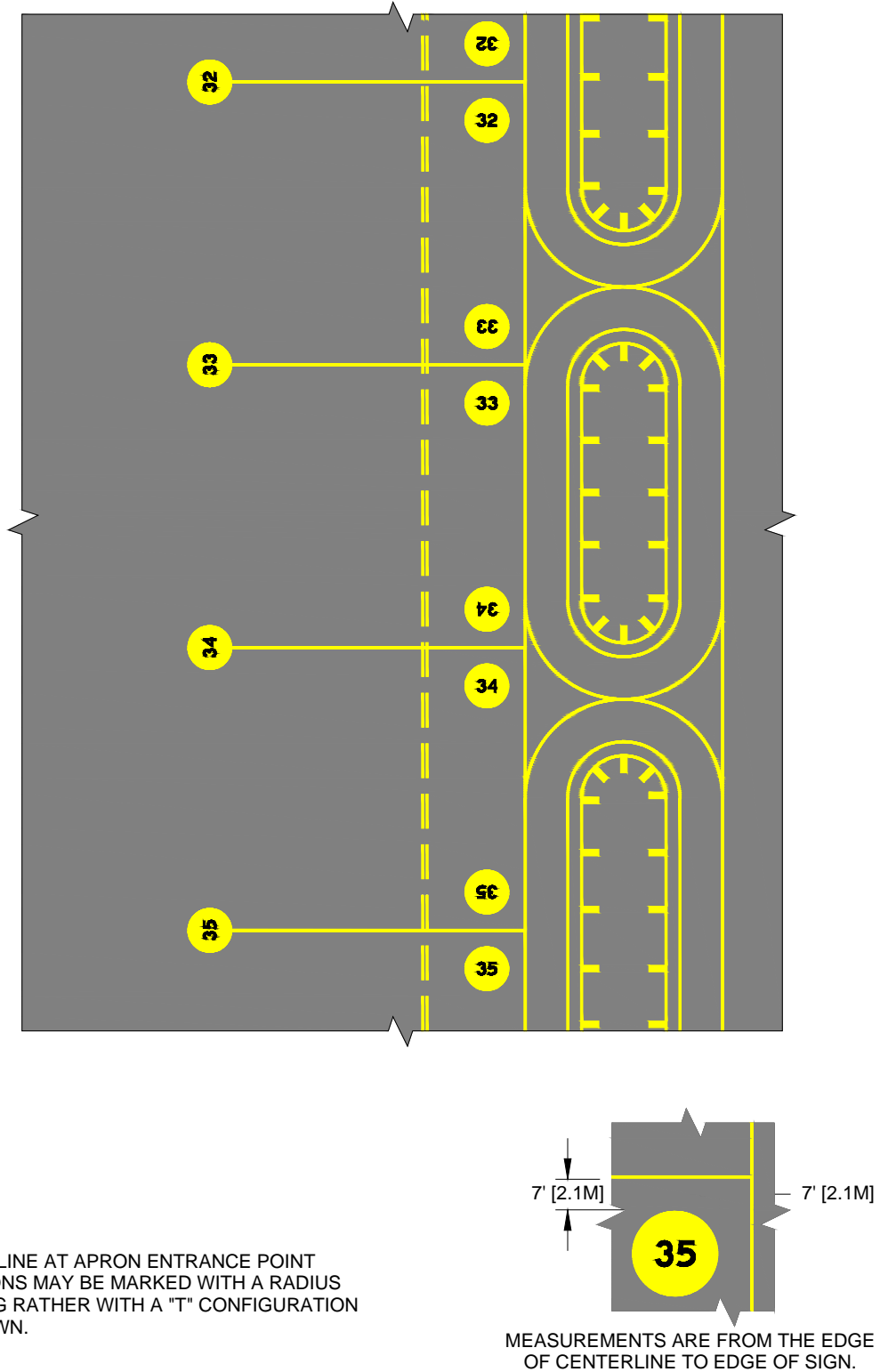

Figure 19. Multiple Gate Signs



NOTE:
CENTERLINE AT APRON ENTRANCE POINT
LOCATIONS MAY BE MARKED WITH A RADIUS
MARKING RATHER WITH A "T" CONFIGURATION
AS SHOWN.

MEASUREMENTS ARE FROM THE EDGE
OF CENTERLINE TO EDGE OF SIGN.

Figure 20. Surface Painted Apron Entrance Point Signs

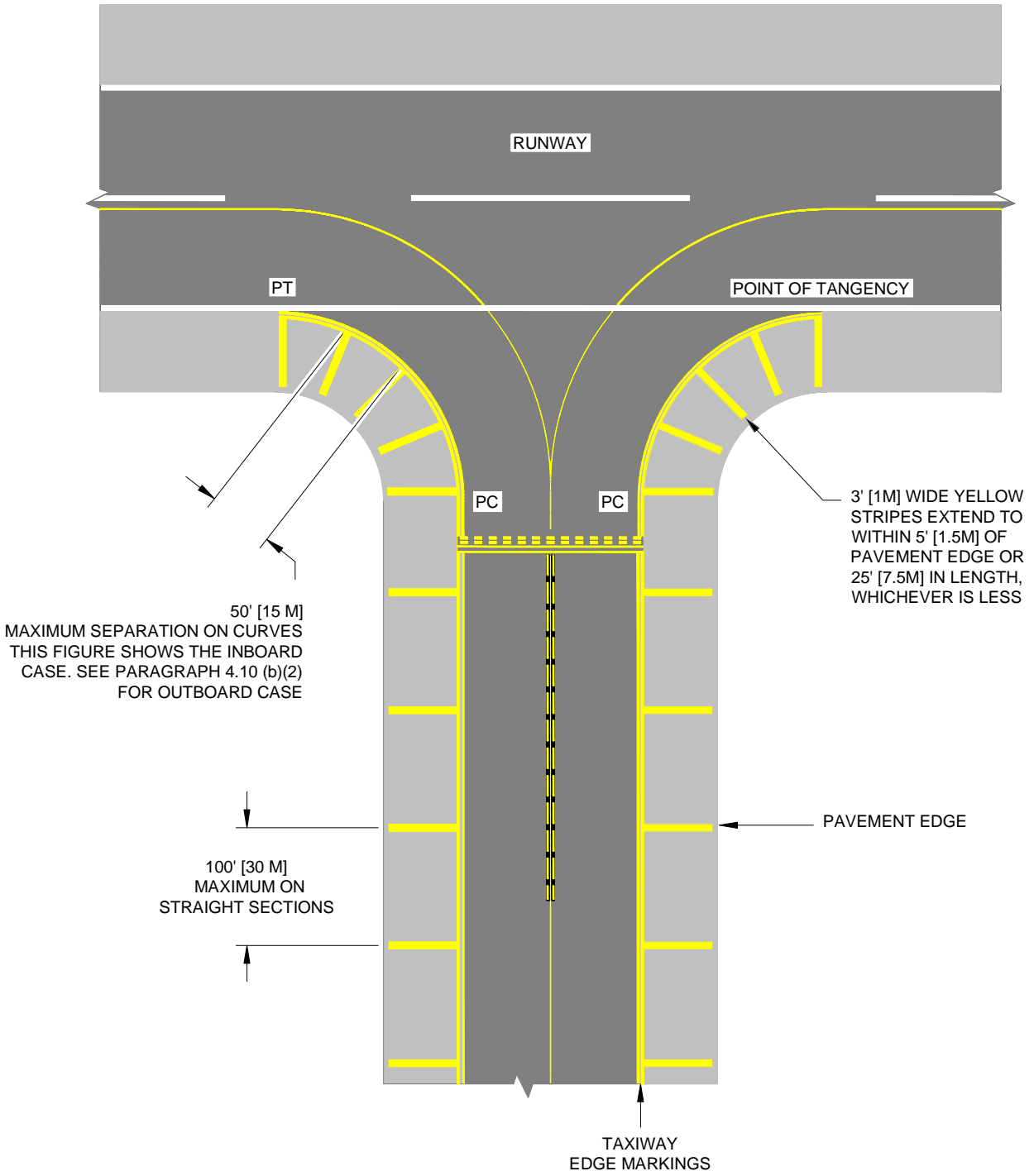

Figure 21. Taxiway Shoulder Markings

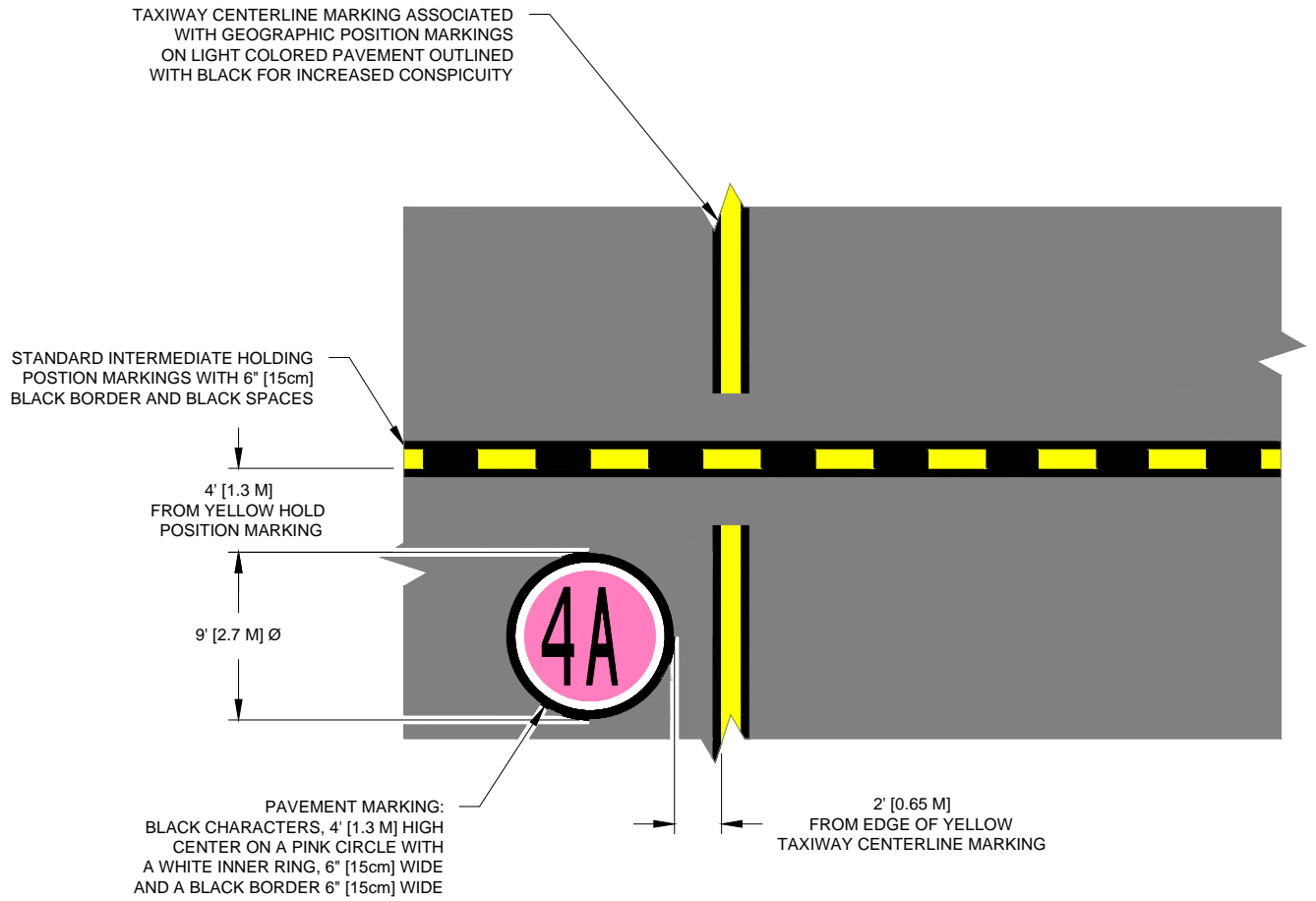

Figure 22. Geographic Position Markings

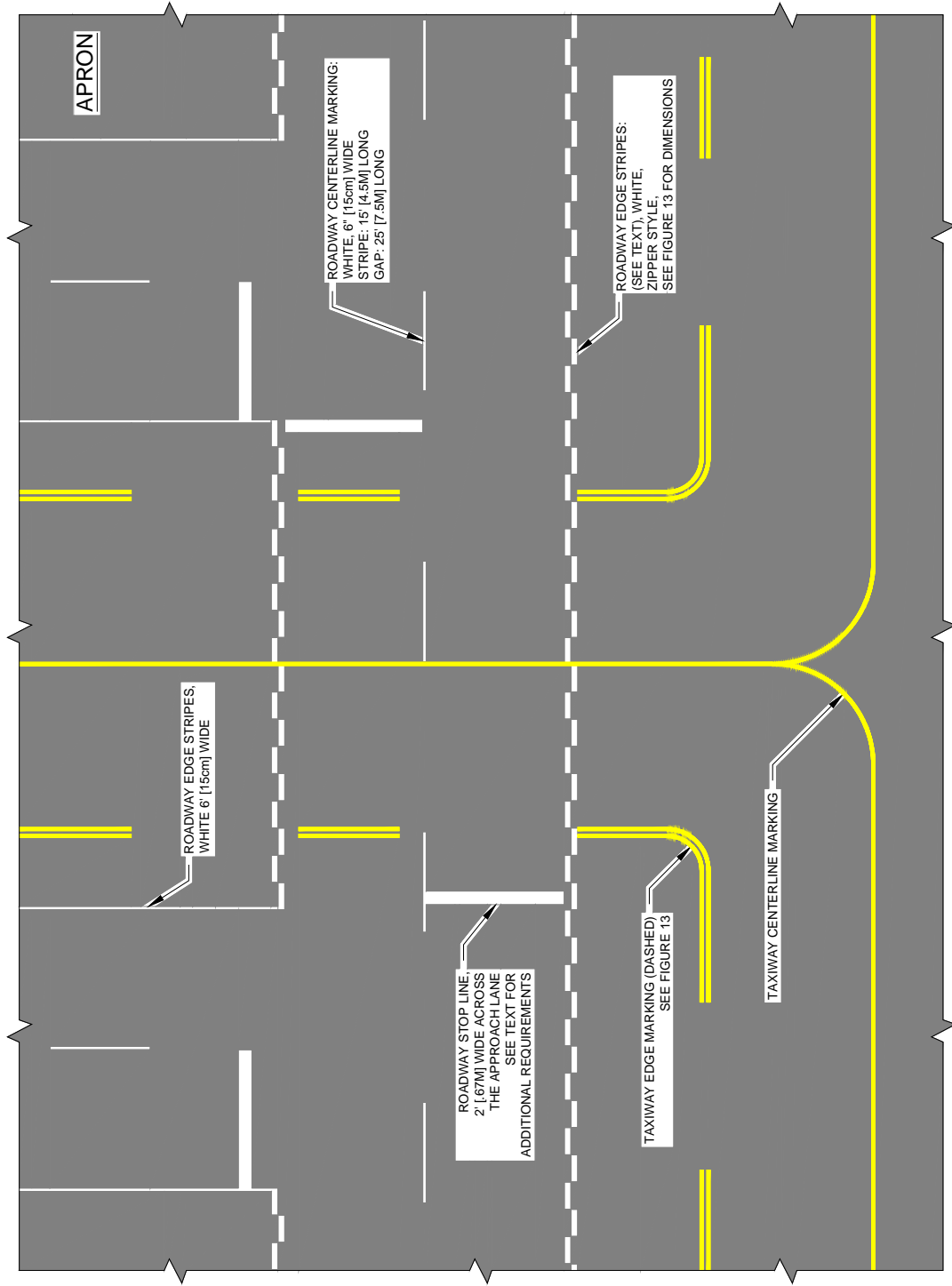
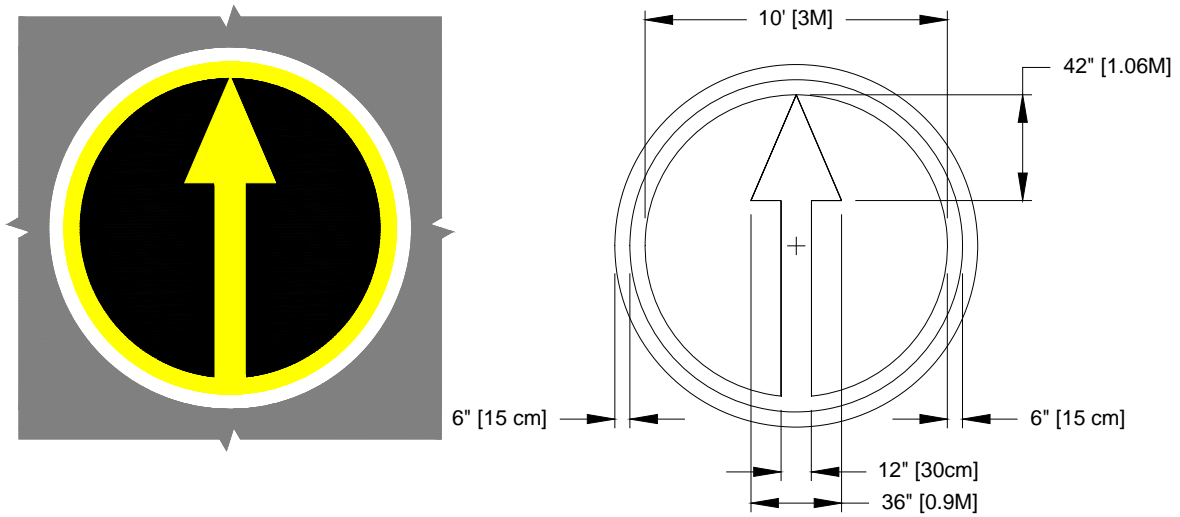

Figure 23. Vehicle Roadway Markings



NOTES:

1. ARROW IS TO BE ALIGNED TOWARD THE FACILITY.
2. INTERIOR OF CIRCLE IS TO BE PAINTED BLACK ON CONCRETE SURFACES ONLY.
3. CIRCLE MAY BE BORDERED ON INSIDE AND OUTSIDE WITH A 6" [15cm] BLACK BAND IF NECESSARY FOR CONTRAST.



NOT A MARKING - INFORMATION SIGN, SEE AC 150/5340-18

Figure 24. VOR Receiver Checkpoint Markings

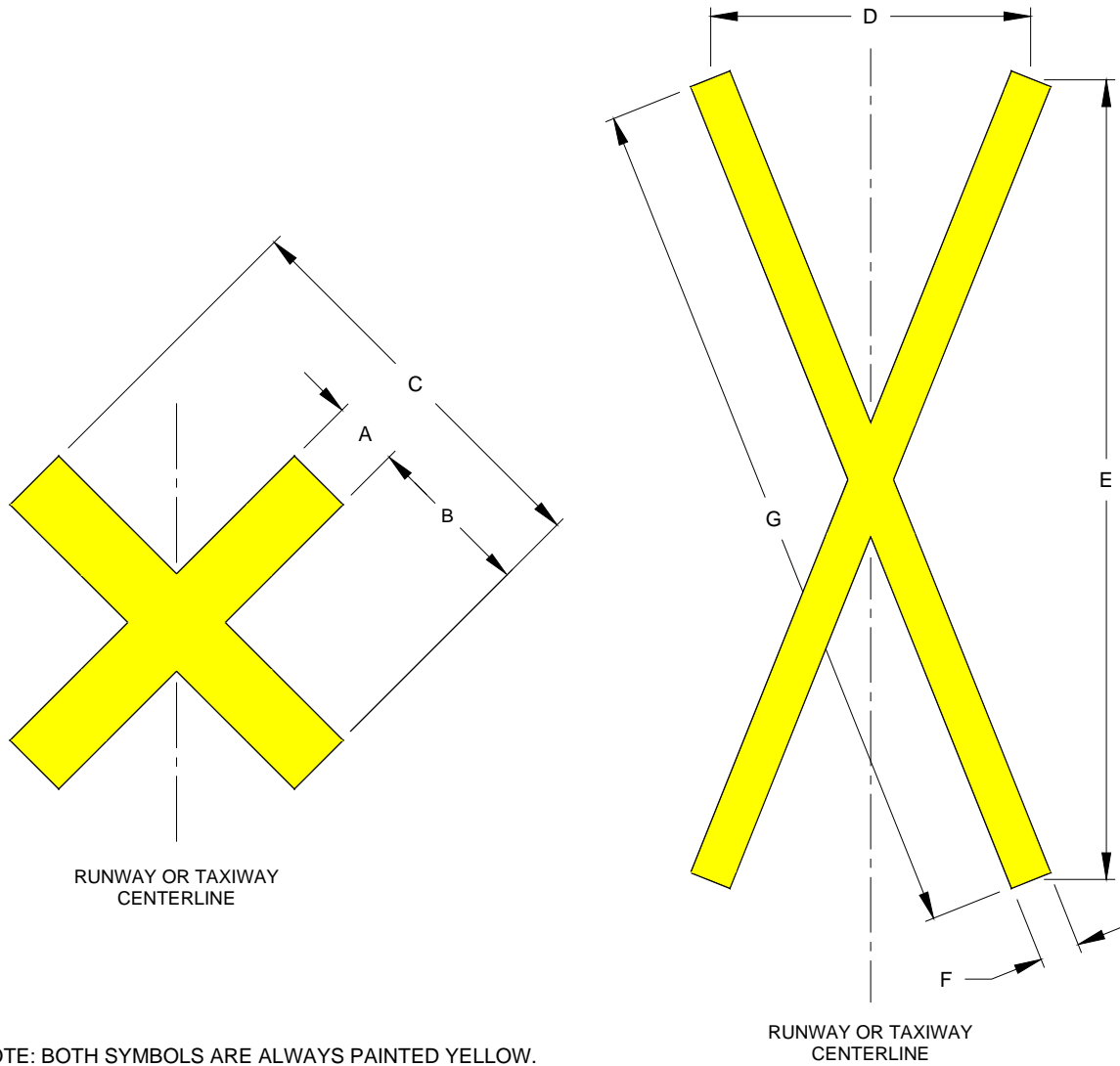

NOTE: BOTH SYMBOLS ARE ALWAYS PAINTED YELLOW.

ALTERNATE

SYMBOL TYPE \ DIMENSION	A	B	C	D	E	F	G
CLOSED RUNWAY	10' [3M]*	25' [7.5M]	60' [18M]	-	-	-	-
CLOSED RUNWAY (ALTERNATE)	-	-	-	48 [14.4M]	120 [36M]	6 [1.8M]	129.25' [39M]
CLOSED TAXIWAY	5' [1.5M]**	12.5' [3.8M]	30' [9M]	-	-	-	-
CLOSED TAXIWAY (ALTERNATE)	-	-	-	24 [7.2M]	60 [18M]	3 [0.9M]	64.6 [20M]

* FOR TEMPORARY SYMBOL THIS DIMENSION MAY BE CHANGED TO 8' [2.4M]

** FOR TEMPORARY SYMBOL THIS DIMENSION MAY BE CHANGED TO 4' [1.2M]

Figure 25. Closed Runway and Taxiway Markings

APPENDIX A. INSCRIPTIONS FOR SIGNS AND GEOGRAPHIC POSITION MARKINGS

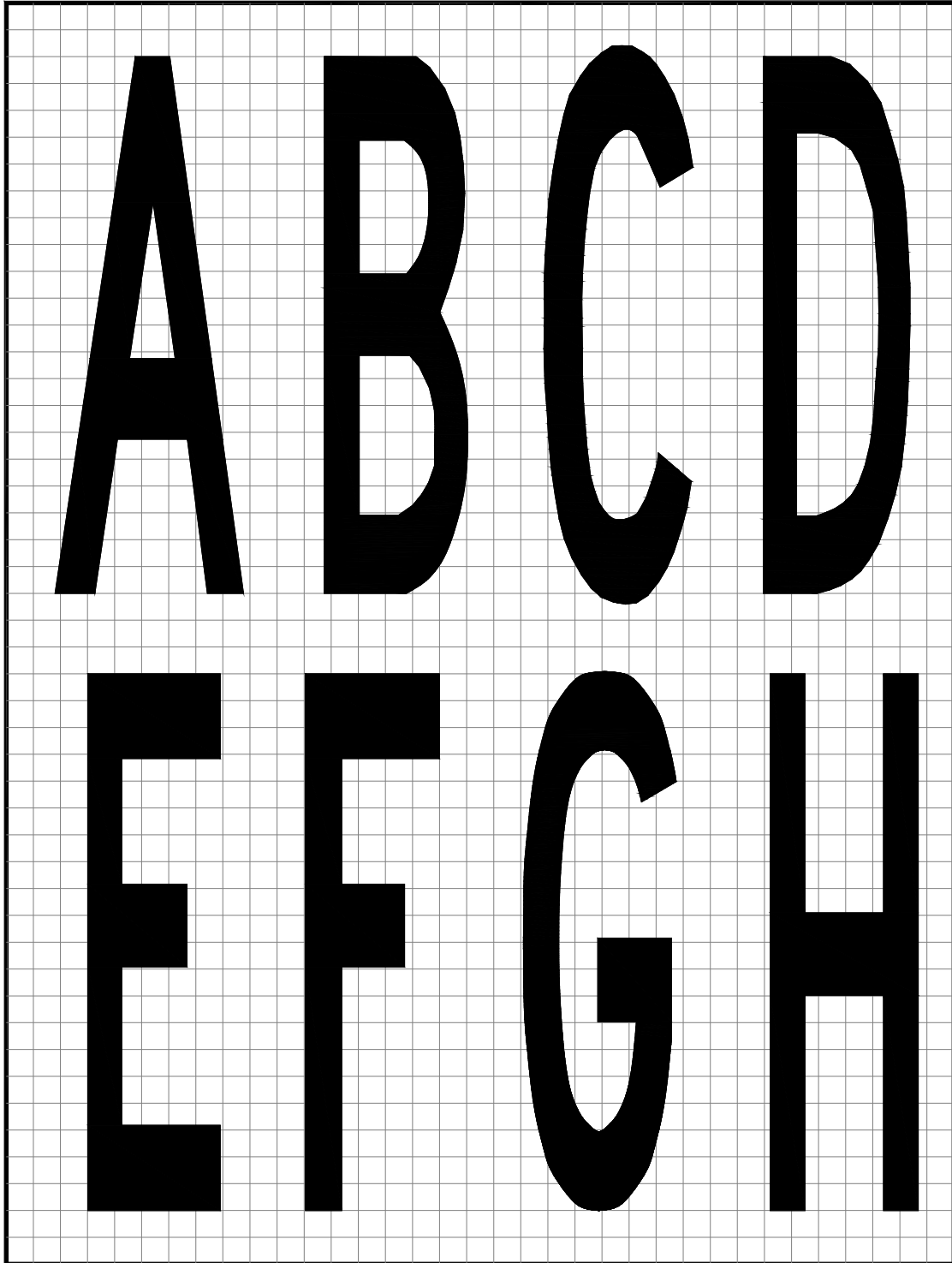

Figure A - 1. Pavement Markings ABCDEFGH

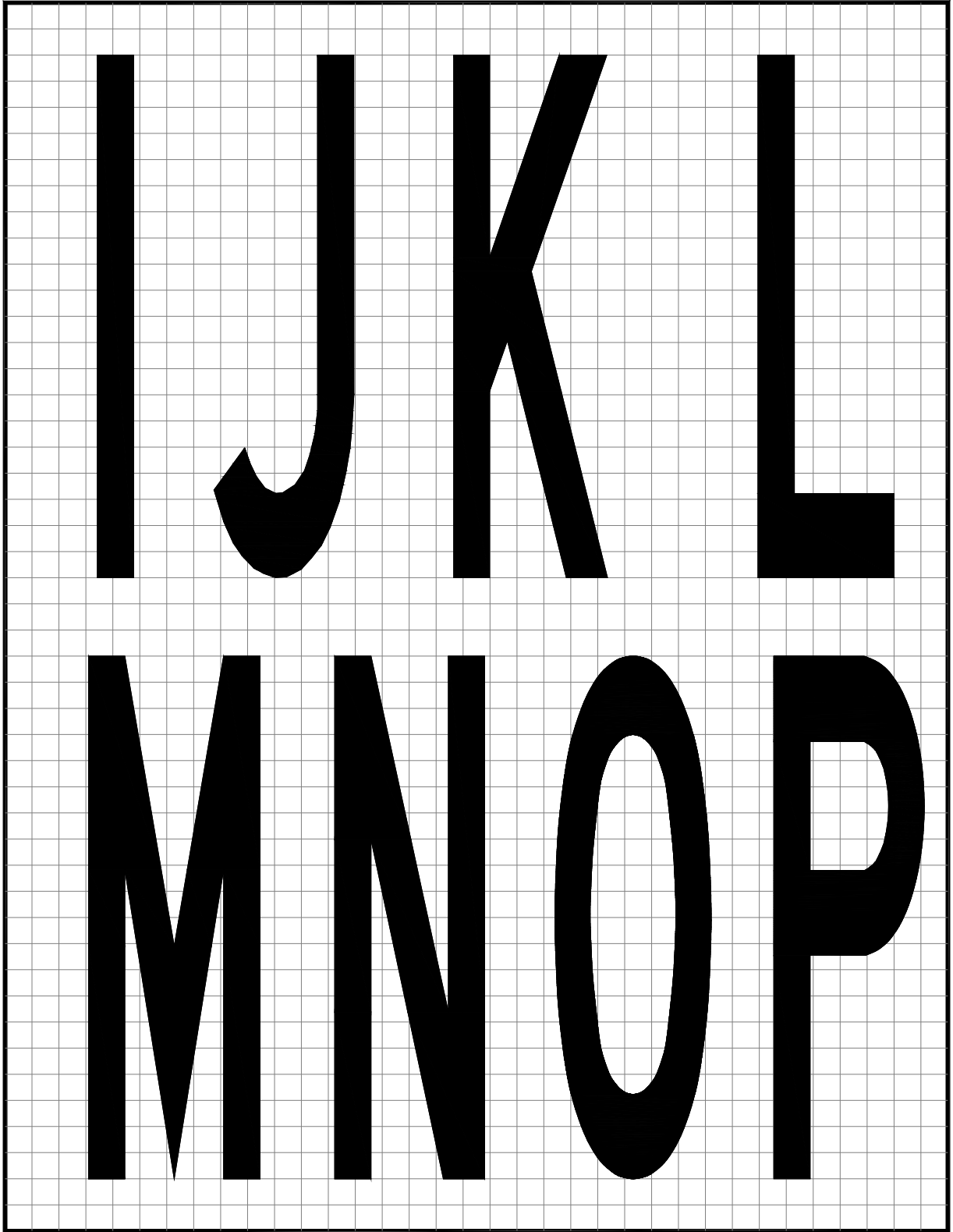

Figure A - 2. Pavement Markings IJKLMNOP

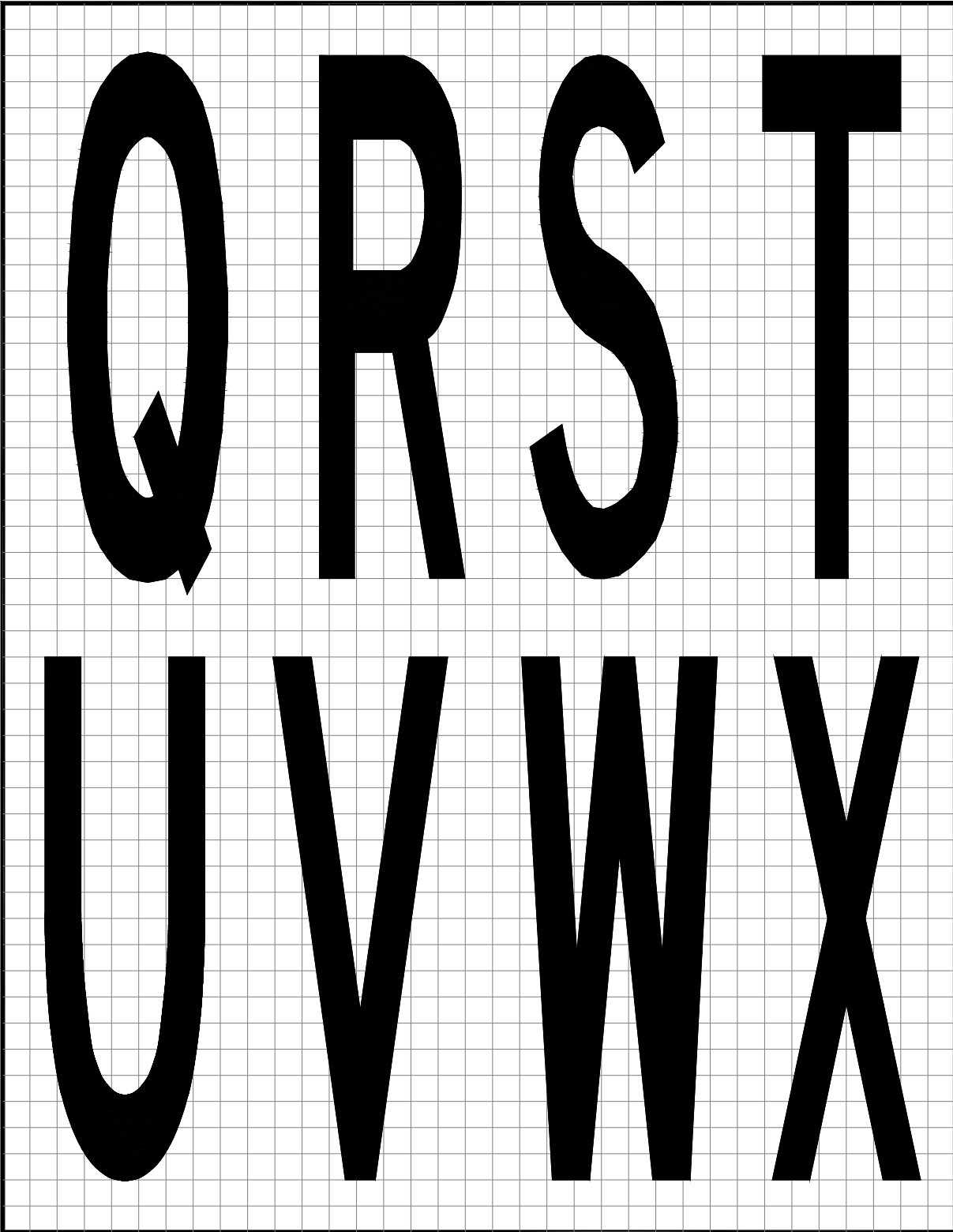

Figure A - 3. Pavement Markings QRSTUVWX

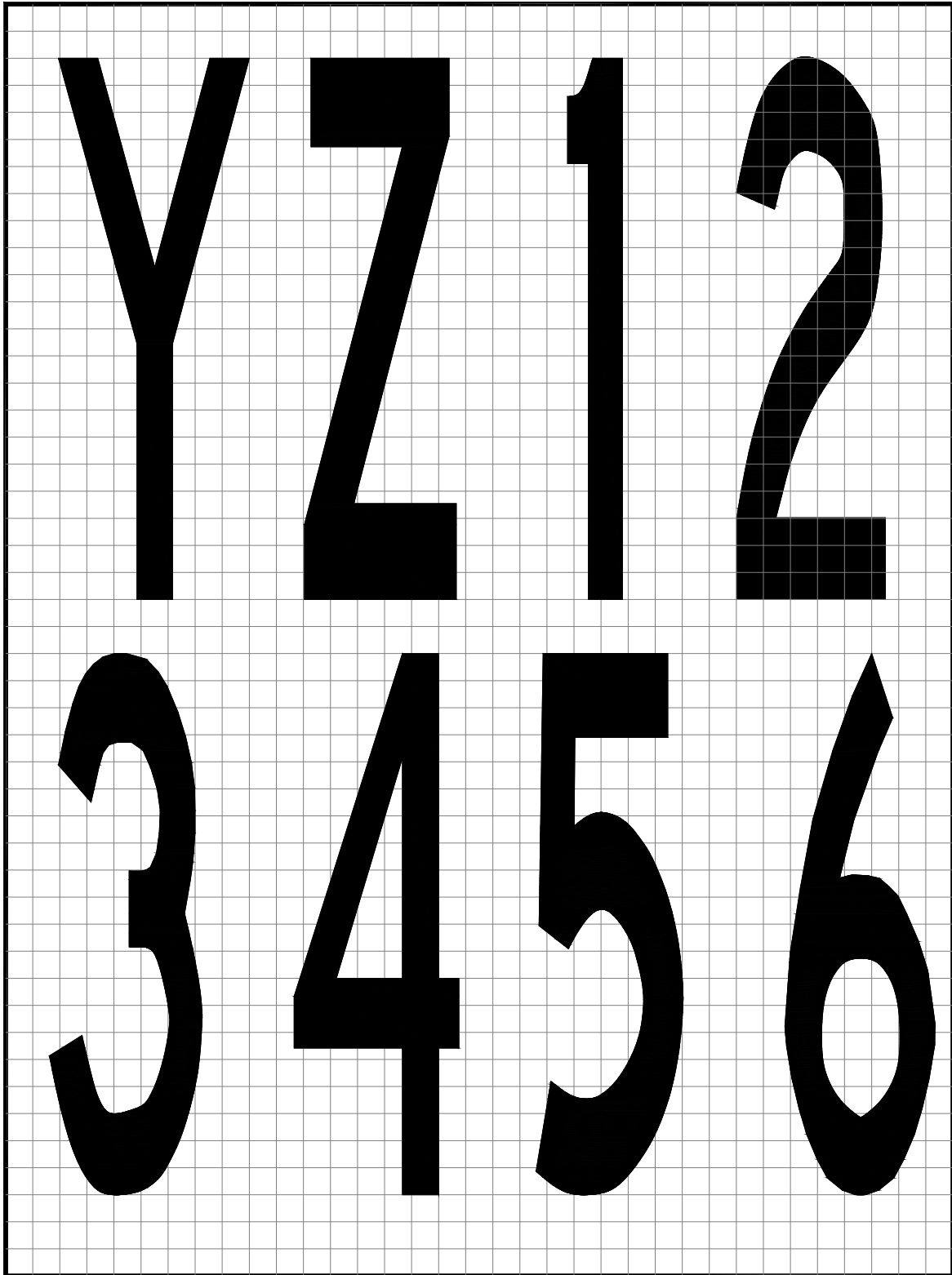

Figure A - 4. Pavement Markings YZ123456

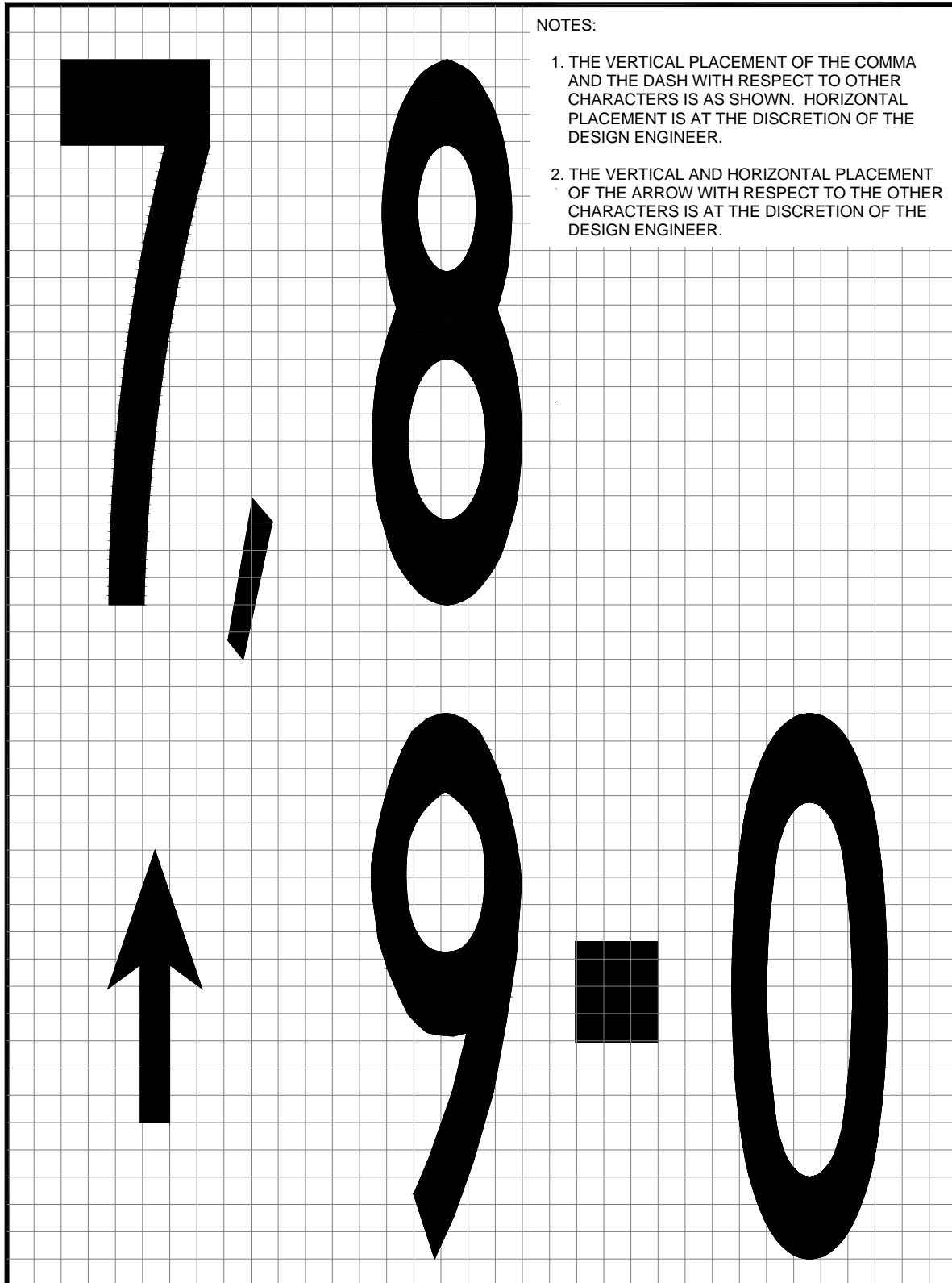

Figure A - 5. Pavement Markings 7890-,↑

Blank Page

APPENDIX B. EXAMPLES OF MARKINGS OUTLINED IN BLACK

This appendix illustrates the acceptable lay out for various markings outlined in black. The black paint extends at least 6 inches (15 cm) beyond the outside edge of the markings. All spaces between paint lines in markings composed of two or more lines or dashes are painted in black as illustrated in the figures below. An alternate outlining pattern is provided for dashed taxiway edge line markings. These figures are not drawn to scale.

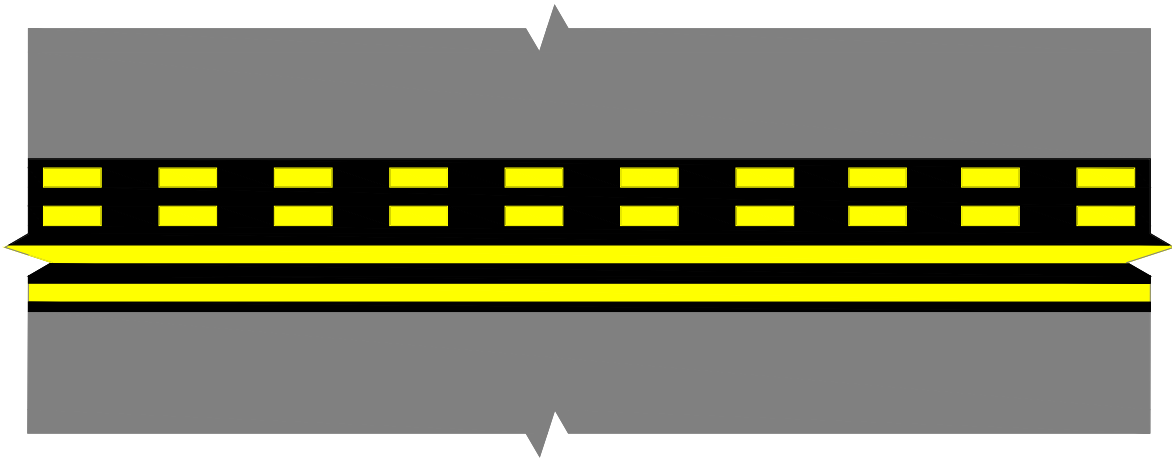

Figure B - 1. Runway Holding Position Marking

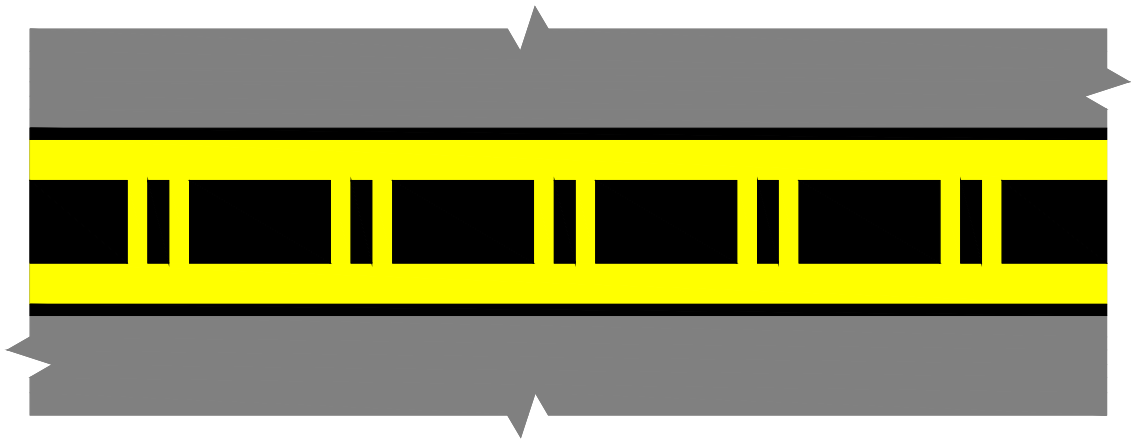

Figure B - 2. ILS/MLS Holding Position Marking

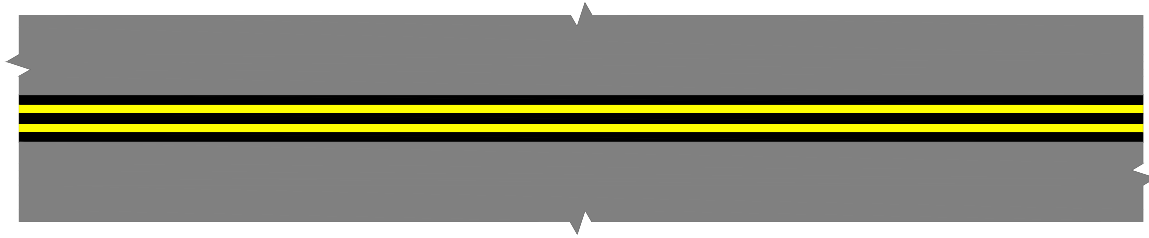

Figure B - 3. Continuous Taxiway Edge Line Marking

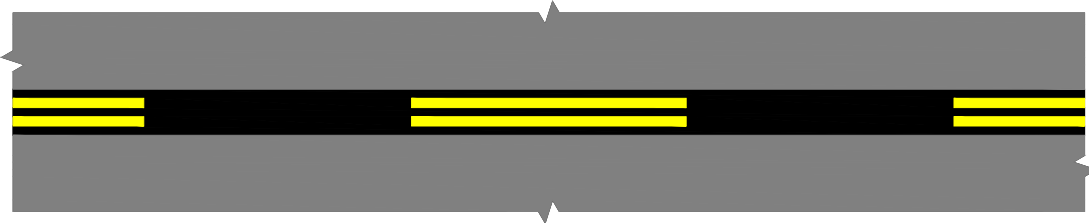

Figure B - 4. Dashed Taxiway Edge Line Marking

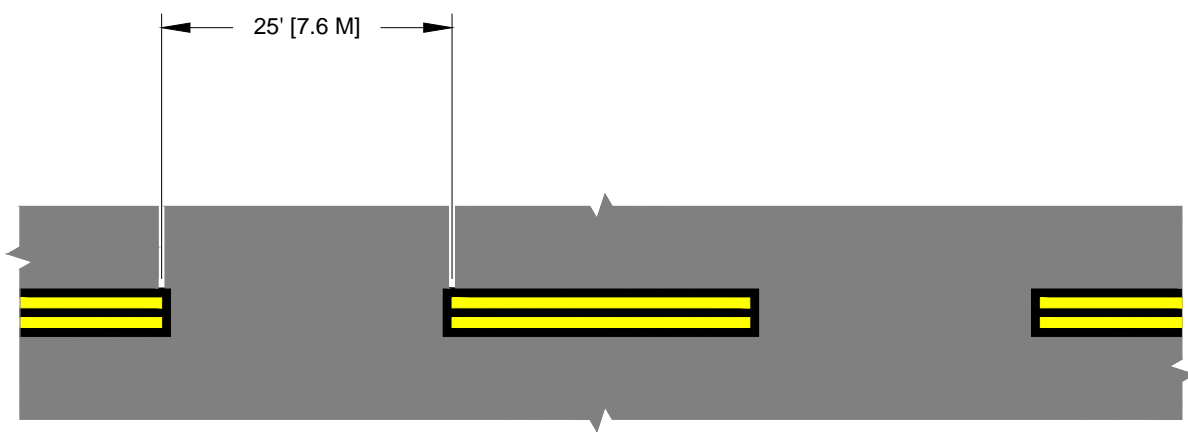

Figure B - 5. Alternate Outlining Method for Dashed Taxiway Edge Line Marking

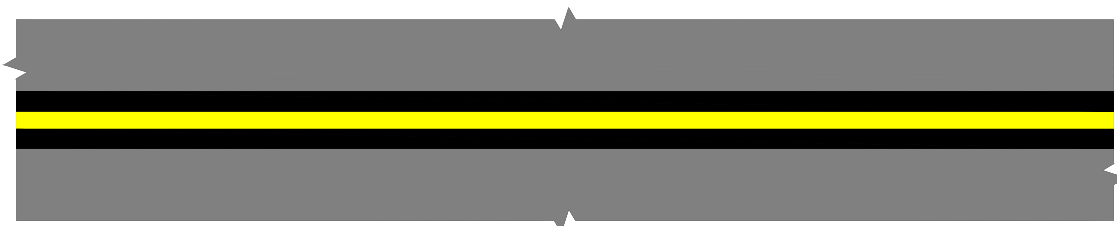

Figure B - 6. Taxiway Centerline Marking

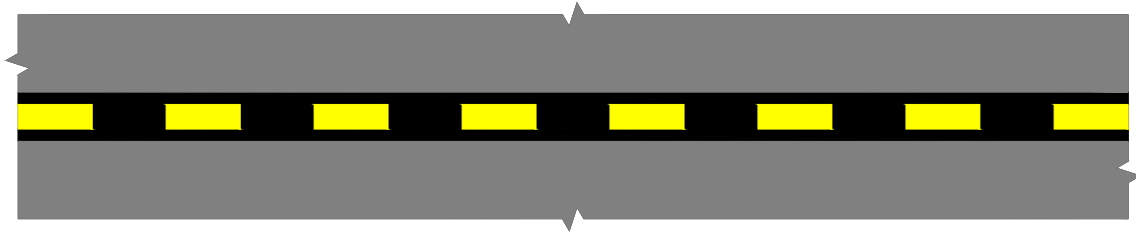

Figure B - 7. Intermediate Holding Position Markings

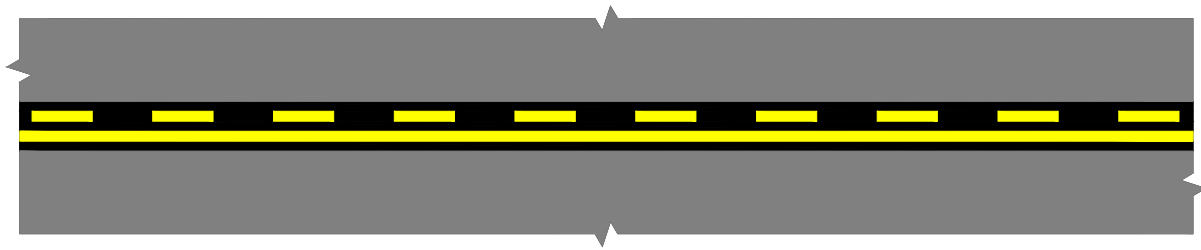

Figure B - 8. Non-movement Area Boundary Marking

Blank Page

APPENDIX C. ENHANCED MARKINGS FOR RUNWAY HOLDING POSITION

1. GENERAL.

Enhanced taxiway markings are intended to provide additional visual cues to taxiing pilots to help them identify the location of the runway holding position. This appendix provides standards for these enhanced markings and guidance, including examples, on where to use the enhanced markings.

The figures included in this appendix are not drawn to scale.

2. APPLICABILITY.

The guidelines and standards for enhanced taxiway markings contained in this appendix may be used as a runway incursion prevention initiative. They may be used in combination or separately with existing taxiway markings. However, all intersections at an airport must use the same combination of markings.

3. ENHANCED TAXIWAY CENTERLINE MARKINGS.

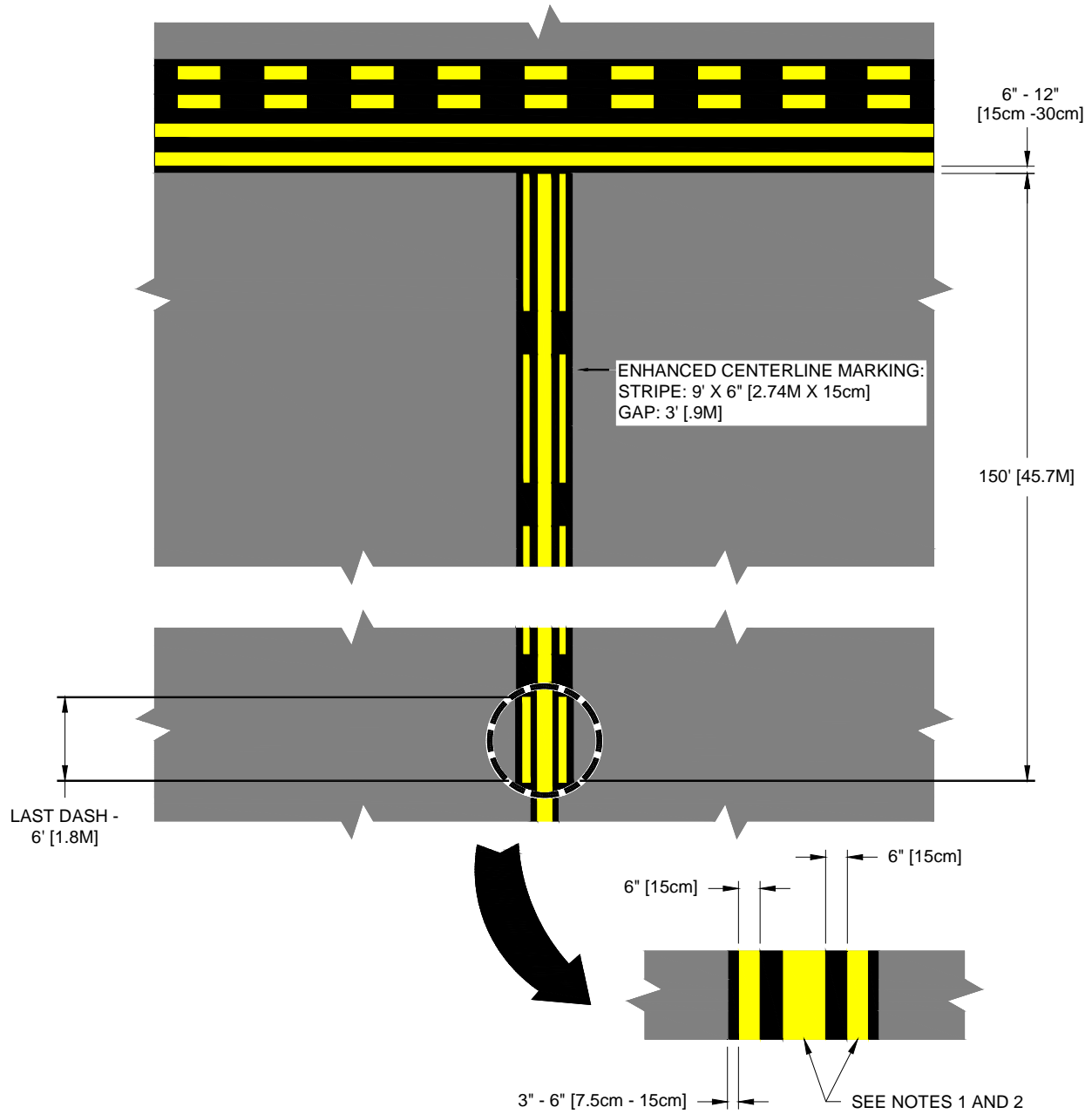

NOTES:

1. DASHED LINES FOR THE ENHANCED TAXIWAY CENTERLINE MARKING ARE 6" [15cm] IN WIDTH AND SEPARATED 6" [15cm] FROM THE TAXIWAY CENTERLINE. THIS APPLIES TO BOTH 6" [15 cm] AND 12" [30 cm] TAXIWAY CENTERLINE MARKINGS.
2. THE TAXIWAY CENTERLINE MARKINGS MAY BE SHIFTED LEFT OR RIGHT TO AVOID INTERFERENCE WITH THE TAXIWAY CENTERLINE LIGHTS.

Figure C - 1. Enhanced Taxiway Centerline Markings

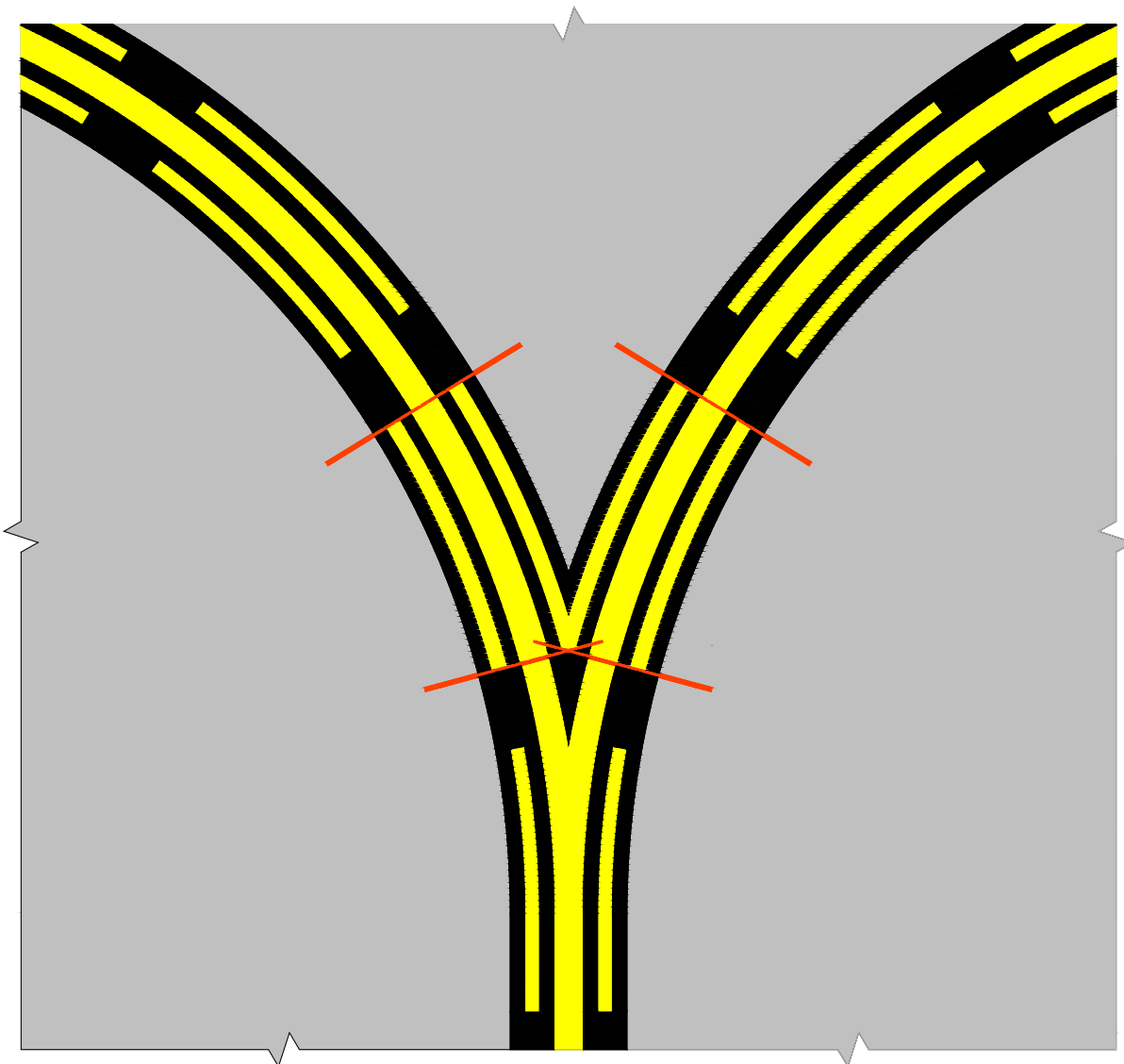

NOTE:
AS SHOWN IN THIS CASE THE V -SHAPED INNER DASHES START AND STOP WITH THE OUTSIDE
9 FOOT [3 M] DASHES. HOWEVER THIS MAY NOT ALWAYS BE THE CASE FOR THE INNER DASHES.
IF THE V-SHAPED ARE LESS THAN 5 FEET [1.5 M] THEY MAY BE OMITTED.

Figure C - 2. Dashed Lines at Converging Taxiway Centerlines

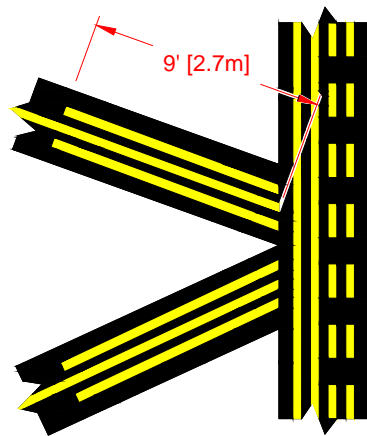

DETAIL A
Example of two straight enhanced taxiway centerline markings intersecting the runway holding position marking.

PARTIAL INNER DASHES INCLUDED BECAUSE THEY EXCEED 5 FEET IN LENGTH. ACCEPTABLE TO OMIT ANY DASHES THAT ARE LESS THAN 5' [1.5m] IN LENGTH.

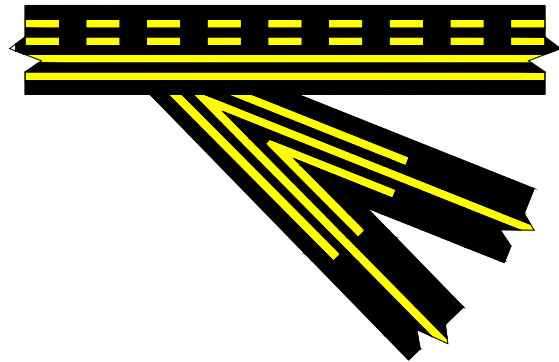

DETAIL B
Example of converging enhanced taxiway centerline markings intersecting at an angle of less than 90° with runway holding position marking.

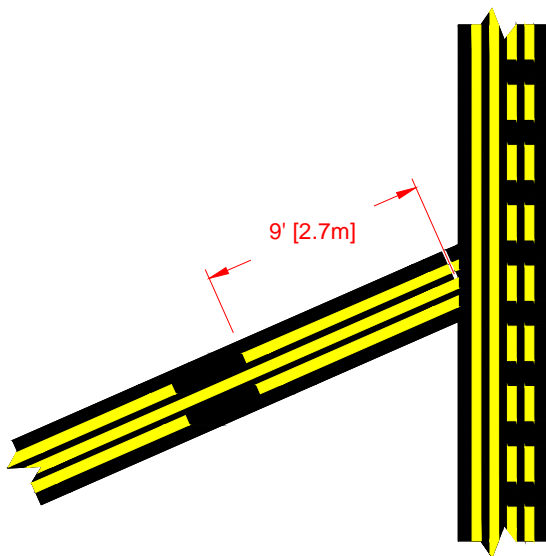

DETAIL C
Example of straight enhanced taxiway centerline markings intersecting with runway holding position marking.

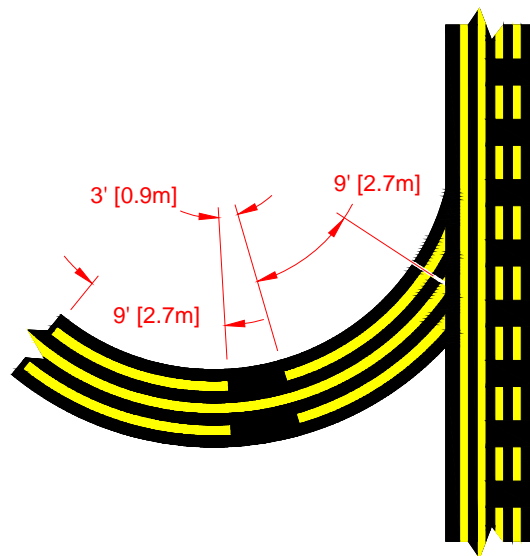

DETAIL D
Example of curved enhanced taxiway centerline markings intersecting with runway holding position marking.

NOTE: ALL MEASUREMENTS ARE TAKEN ALONG THE CENTER OF THE CENTERLINE.

Figure C - 3. Converging, Straight, and Curved Enhanced Taxiway Centerlines Intersecting with Holding Position Marking

4. ENHANCED RUNWAY HOLDING POSITION MARKINGS.

The enhanced runway holding position marking, applicable only to those taxiway entrances that serve Airplane Design Group (ADG) V or VI airplanes, measures 125 feet (38 m) from one paved shoulder to the other paved shoulder, i.e., 62.5 feet (19 m) from the main taxiway centerline. Figure C-4 illustrates the enhanced surface marking on a standard 75-foot (23-m) wide taxiway with a standard 35-foot (10.5-m) wide taxiway shoulder for ADG V. For taxiways wider than 75 feet (22.9 m) that serve ADG V or VI aircraft, the holding position line is extended so it is 25 feet (7.5 m) on both paved taxiway shoulders.

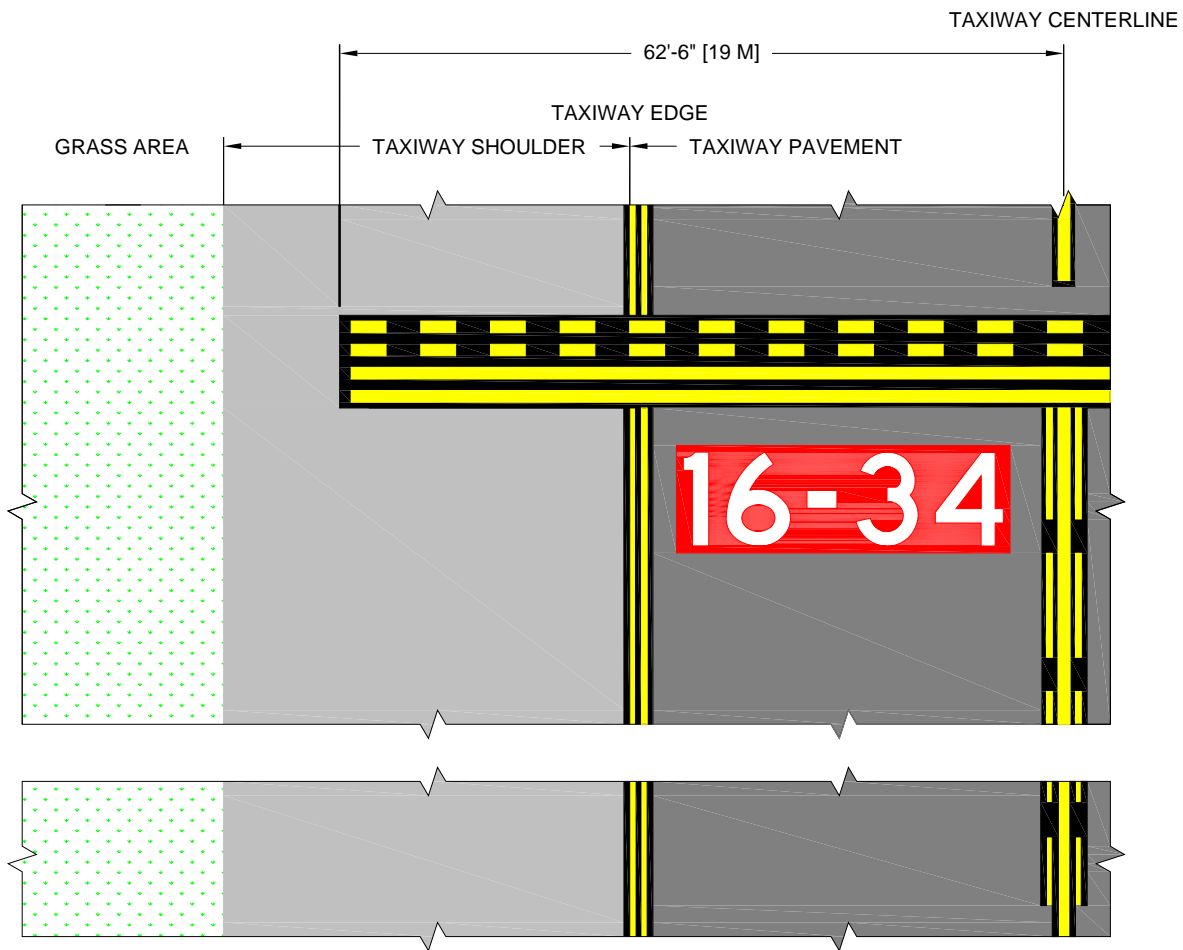

Figure C - 4. Enhanced Runway Holding Position Markings on Taxiways

5. SURFACE PAINTED HOLDING POSITION SIGNS.

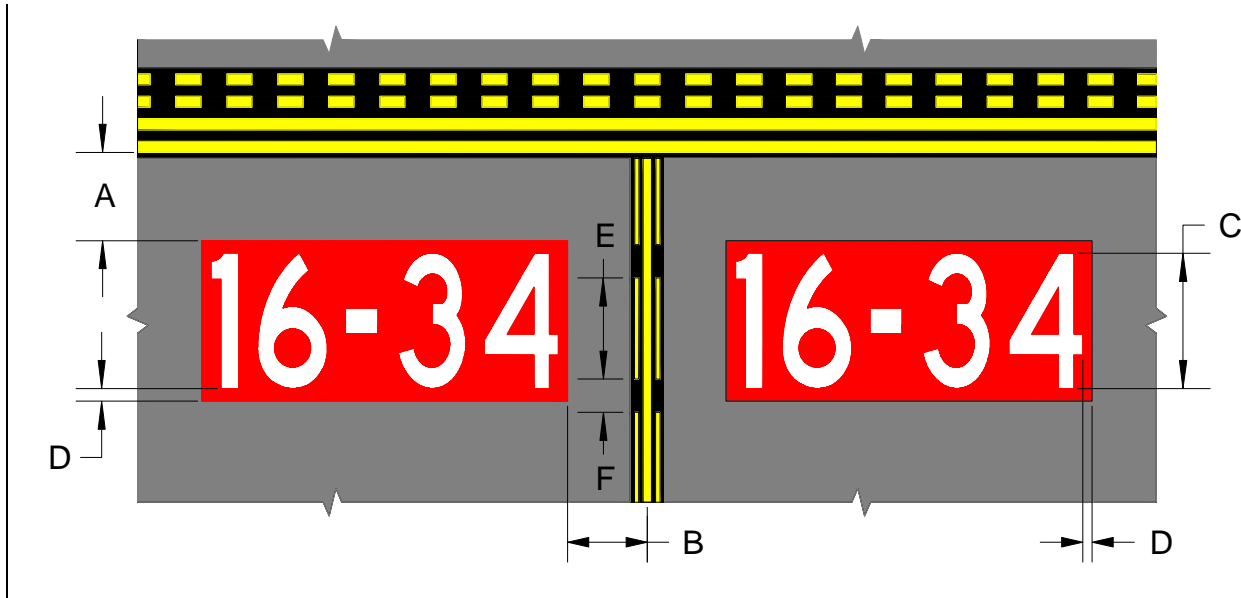

Figure C - 5. Surface Painted Holding Position Signs for Taxiway Widths Greater Than 35 Feet (10.5 m)

Dimension Letter	Dimension feet (meters)	Notes
A	2 – 4 (0.67 – 1.34)	
B	3 – 10 (0.91 – 3.0)	
C	9 – 12 (2.75 – 3.7)	Inscriptions must have a height of 12 feet (3.7 m); however, the height may be reduced, as necessary, to the minimum height of 9 feet (2.75 m). In special situations, the surface painted marking may be reduced to less than 9 feet (2.75 m) in order to fit the marking appropriately. Examples of special situations include taxiways with widths narrower than 75 feet (22.9 m) or taxiways that need to display multiple runway designations with arrows. In all cases, inscriptions follow Appendix A inscription criteria. All other taxiway entrances to the same runway not needing the reduction are to maintain the 12 foot (3.7 m) height dimension. For practicality, the lowest height reduction is 6 feet (1.8 m). In all cases, the dimension D is not reduced.
D	15 inches (38 cm)	
E	9 (2.75)	
F	3 (0.91)	

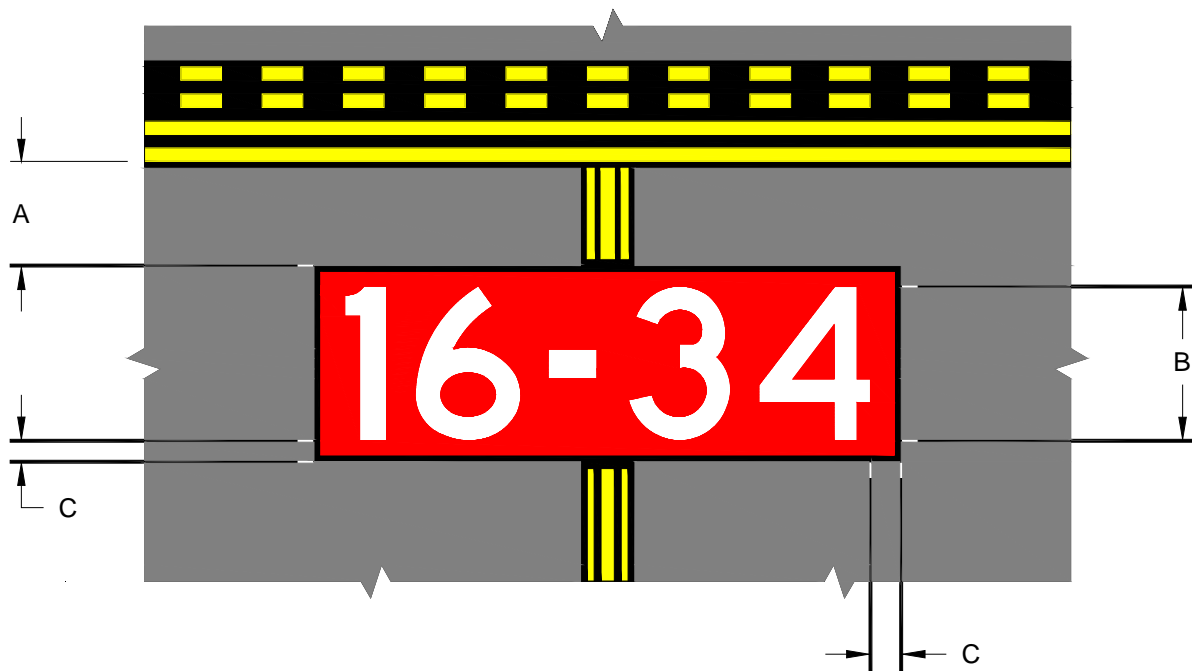

Figure C - 6. Surface Painted Holding Position Sign for Taxiway Widths Equal to or Less Than 35 Feet (10.5 m)

Dimension Letter	Dimension feet (meters)	Notes
A	2 – 3 (0.67 – 0.91)	
B 6	(1.8)	Inscriptions follow Appendix A inscription criteria. The size of the sign inscription is scaled to fit taxiways 35 feet (10.5 m) or less in width for Airplane Design Groups I and II. Reference AC 150/5300-13. In special situations, the surface marking may be reduced to less than 6 feet (1.8 m) in order to fit the marking appropriately. Examples of special situations include taxiways that need to display multiple runway designations with arrows. In all cases, the inscriptions follow Appendix A inscription criteria. All other taxiway entrances to the same runway not needing the reduction are to maintain the 6-foot (1.8-m) height dimension. For practicality, the lowest height reduction is 3 feet (0.91 m).
C	7.5 in (19 cm)	
NOTE		The dimensions for the enhanced taxiway centerline are in Figure C-1. The spacing between the enhanced taxiway centerline and the surface painted holding position sign is 6 -12 inches (15 – 30 cm) see figure C-1.

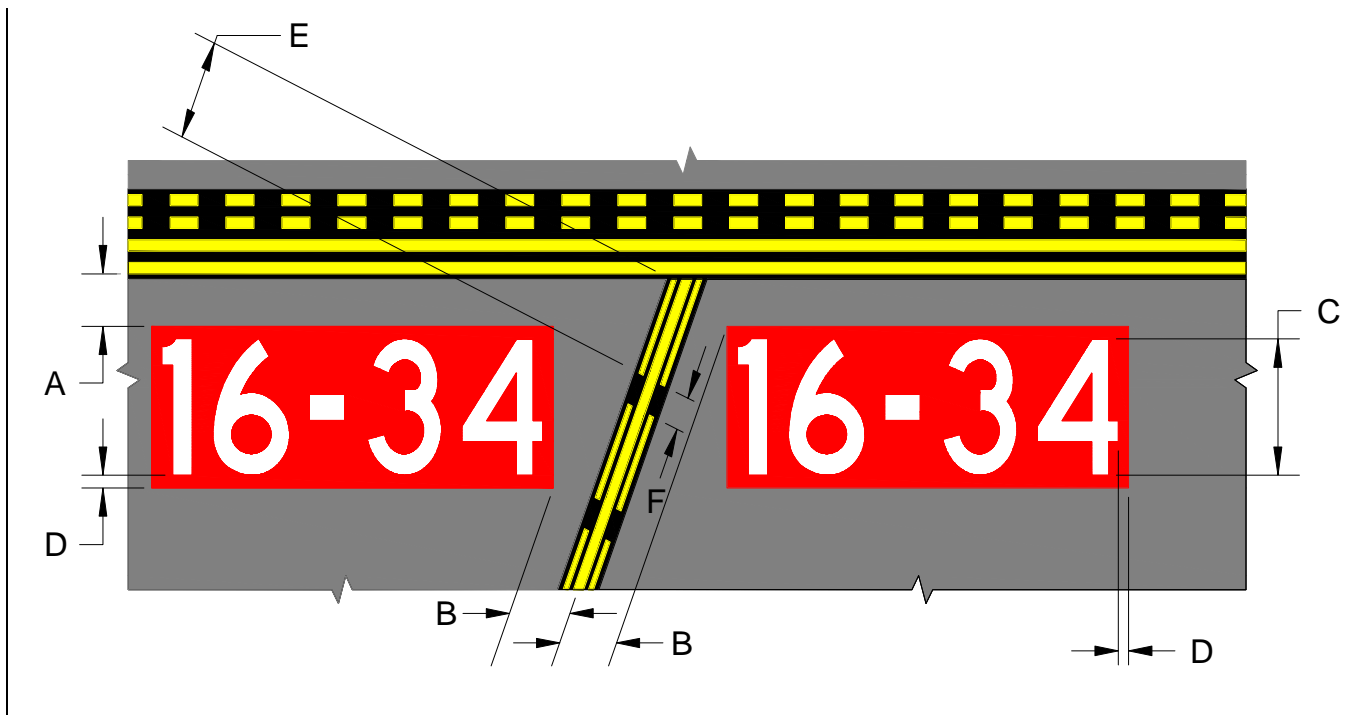

Figure C - 7. Surface Painted Holding Position Signs when Taxiway Centerline is not Perpendicular to Runway Holding Position Marking

Dimension Letter	Dimension feet (meters)	Notes
A	2 – 4 (0.67 – 1.34)	
B	3 – 10 (0.91 – 3.0)	
C	9 – 12 (2.75 – 3.7)	Inscriptions must have a height of 12 feet (3.7 m); however, the height may be reduced, as necessary, to the minimum height of 9 feet (2.75 m). In special situations, the surface painted marking may be reduced to less than 9 feet (2.75 m) in order to fit the marking appropriately. Examples of special situations include taxiways with widths narrower than 75 feet (22.9 m) or taxiways that need to display multiple runway designations with arrows. In all cases, inscriptions follow Appendix A inscription criteria. All other taxiway entrances to the same runway not needing the reduction are to maintain the 12-foot (3.7-m) height dimension. For practicality, the lowest height reduction is 6 feet (1.8 m). In all cases, the dimension D is not reduced.
D	15 inches (38 cm)	
E	9 (2.75)	
F	3 (0.91)	

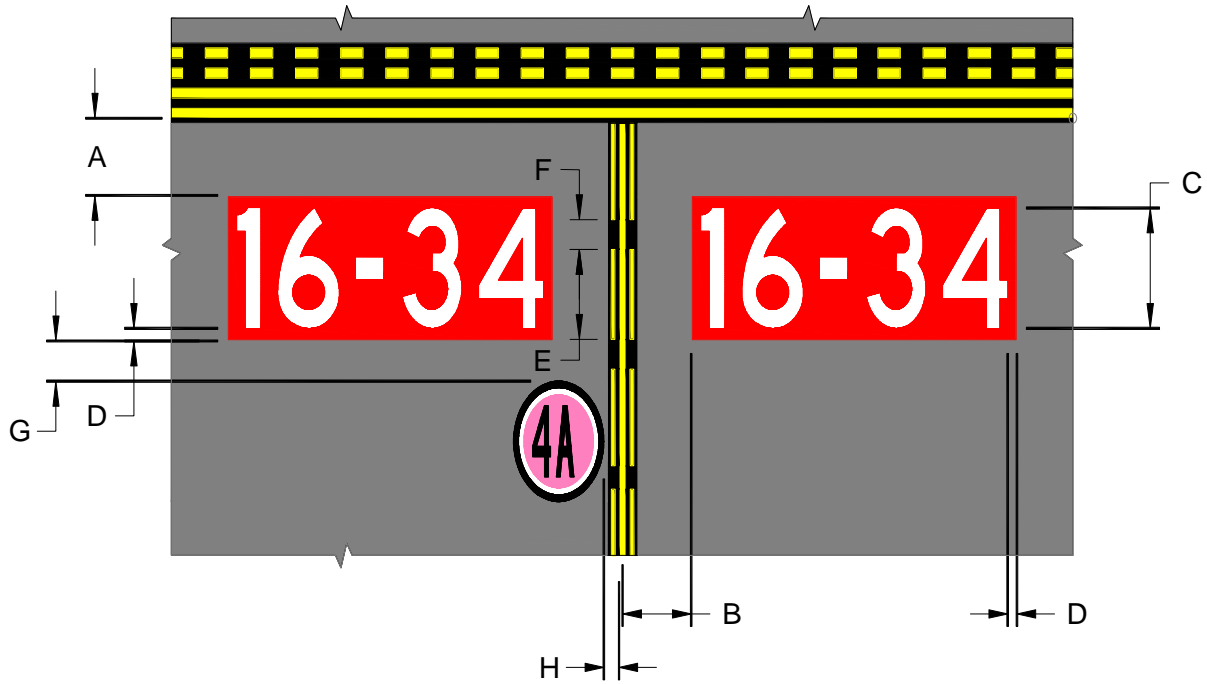

Figure C - 8. Surface Painted Holding Position Signs Co-Located with Geographic Position Marking

Dimension Letter	Dimension feet (meters)	Notes
A	2 – 4 (0.67 – 1.34)	
B	3 – 10 (0.91 – 3.0)	
C	9 – 12 (2.75 – 3.7)	Inscriptions must have a height of 12 feet (3.7 m); however, the height may be reduced, as necessary, to the minimum height of 9 feet (2.75 m). In special situations, the surface painted marking may be reduced to less than 9 feet (2.75 m) in order to fit the marking appropriately. Examples include taxiways with widths narrower than 75 feet (22.9 m) or taxiways that need to display multiple runway designations with arrows. In all cases, the inscriptions follow Appendix A inscription criteria. All other taxiway entrances to the same runway not needing the reduction are to maintain the 12-foot (3.7-m) height dimension. For practicality, the lowest height reduction is 6 feet (1.8 m). In all cases, the dimension D is not reduced.
D	15 inches (38 cm)	
E	9 (2.75)	
F	3 (0.91)	
G	4 (1.3)	From edge of red border
H	2 (0.65)	From outermost edge of main yellow taxiway centerline

Note: Because the geographic position marking cannot be located at a runway holding position for the low-visibility runway (see paragraph 4.11), this figure applies only where the designated taxi route for low-visibility operations crosses a runway that is not itself the low-visibility runway.

6. ADDITIONAL GUIDELINES FOR APPLICATION.

The following illustrations provide examples of various runway holding position locations using the enhanced markings. The figures included in this appendix are not drawn to scale.

a. Two Taxiway Centerlines Converging at a Runway Holding Position Marking. Where two taxiway centerlines converge at a runway holding position marking, the surface painted holding position signs must be installed parallel to the runway holding position marking. As shown in figure C-9, only one sign on either side of the two taxiway centerlines is practical.

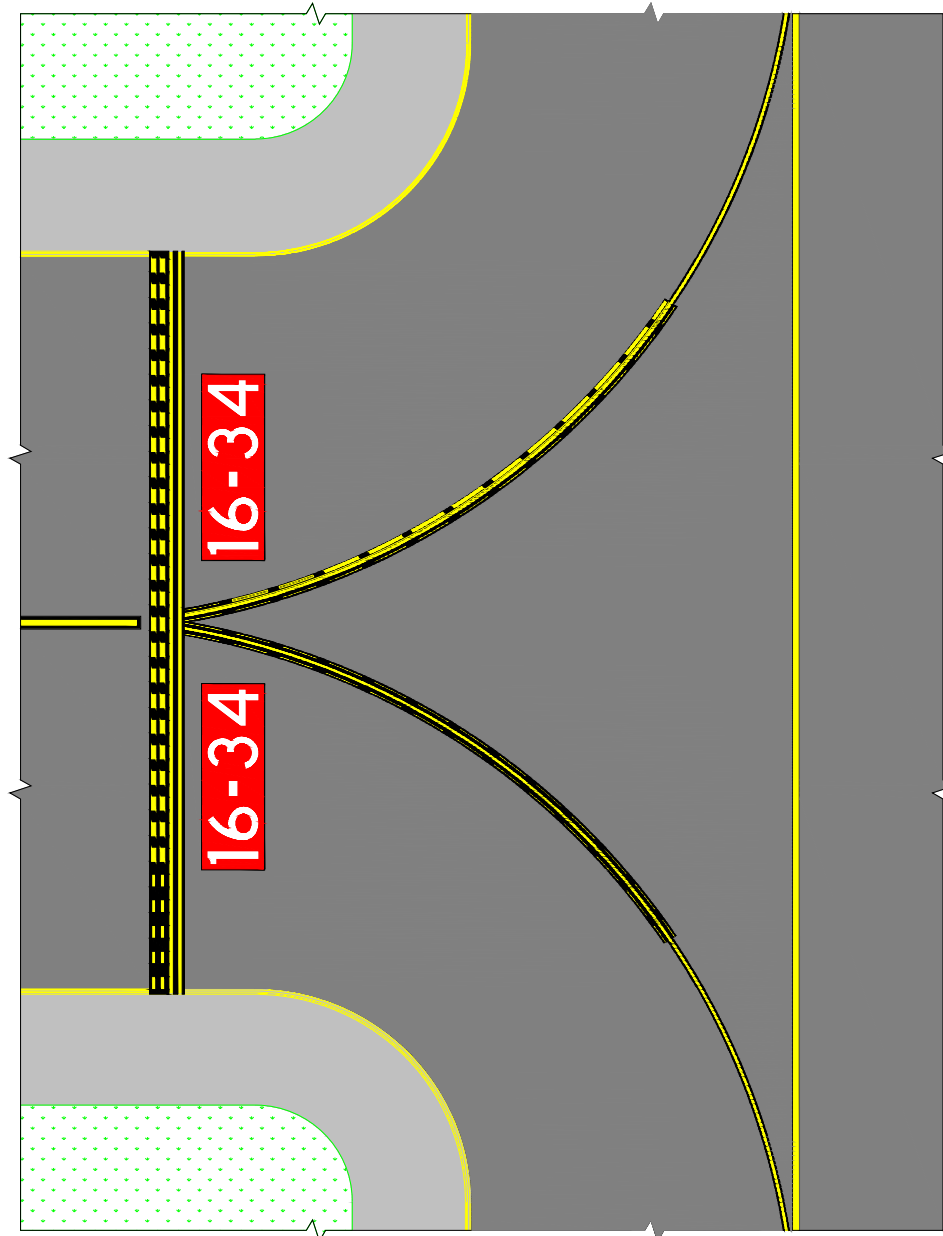

Figure C - 9. Two Taxiway Centerlines Converging at a Runway Holding Position Marking

b. Intersection of Two Taxiways at Runway End. In the case of two converging taxiway centerlines, surface painted holding position signs containing a single runway designator must be positioned parallel to the runway holding position marking, as shown in figure C-10.

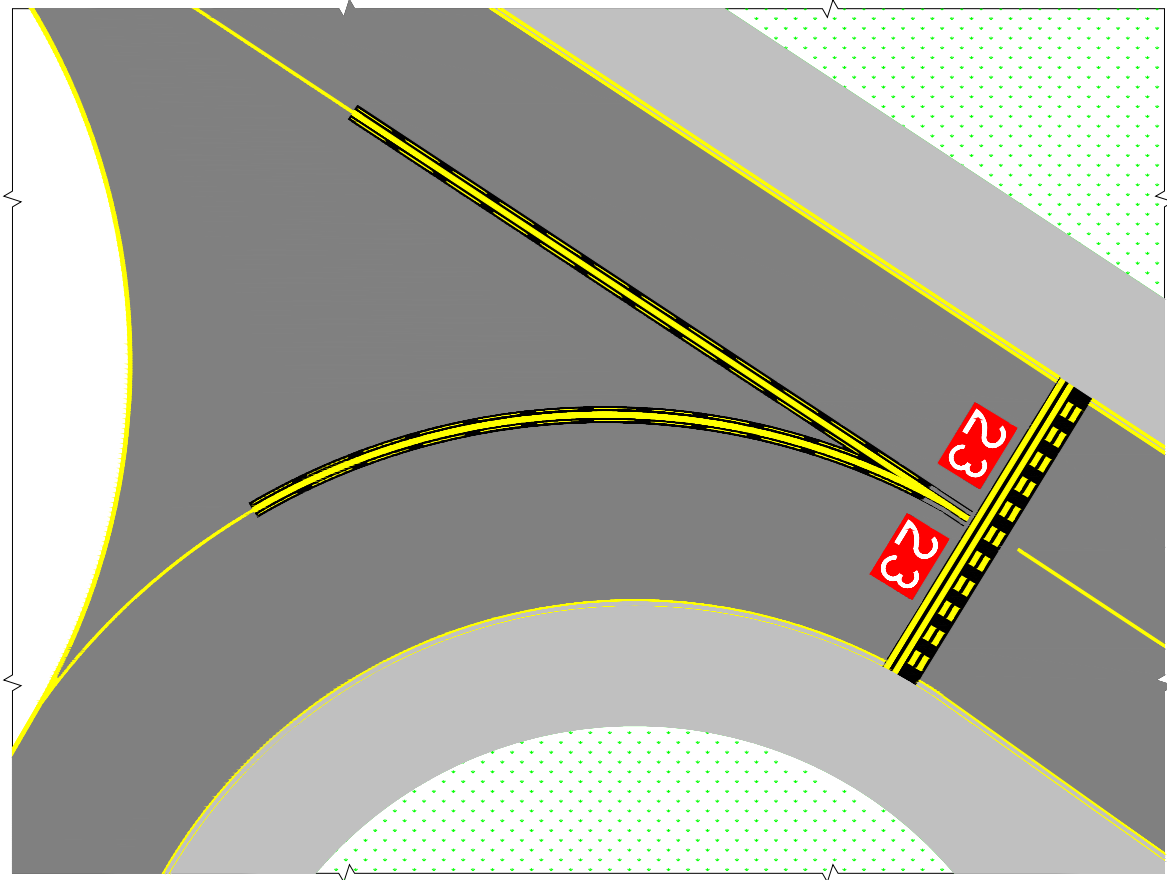
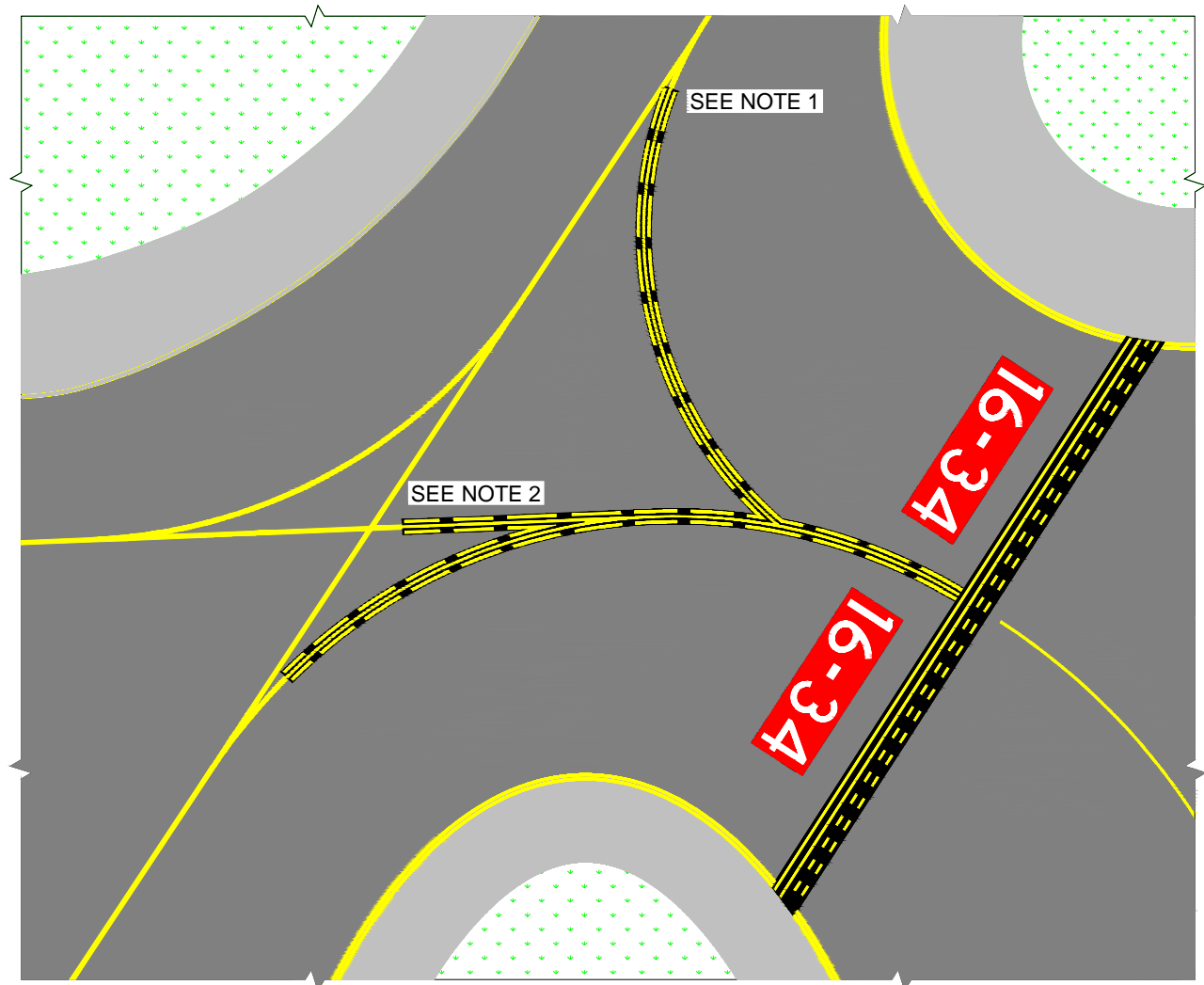

Figure C - 10. Intersection of Two Taxiways at Runway End

c. Intersection of Three Converging Taxiway Centerlines. Figure C-11 illustrates taxiway centerline configurations when there are three converging centerlines.



NOTES:

1. ENHANCEMENT IS TANGENT TO MERGING CURVE.
2. ENHANCEMENT TERMINATES 5 FEET [1.5m] FROM INTERSECTION.

Figure C - 11. Intersection of Three Converging Taxiway Centerlines

d. Intersection of Multi-Taxiway Centerlines with Less than 150 Feet (45.7 m) Between Taxiways. Figure C-12 illustrates different taxiway centerline configurations when there are three

converging centerlines, less than 150 feet (45.7 m) between the runway holding position markings, and potential difficulty in positioning surface painted holding position signs in the available space.

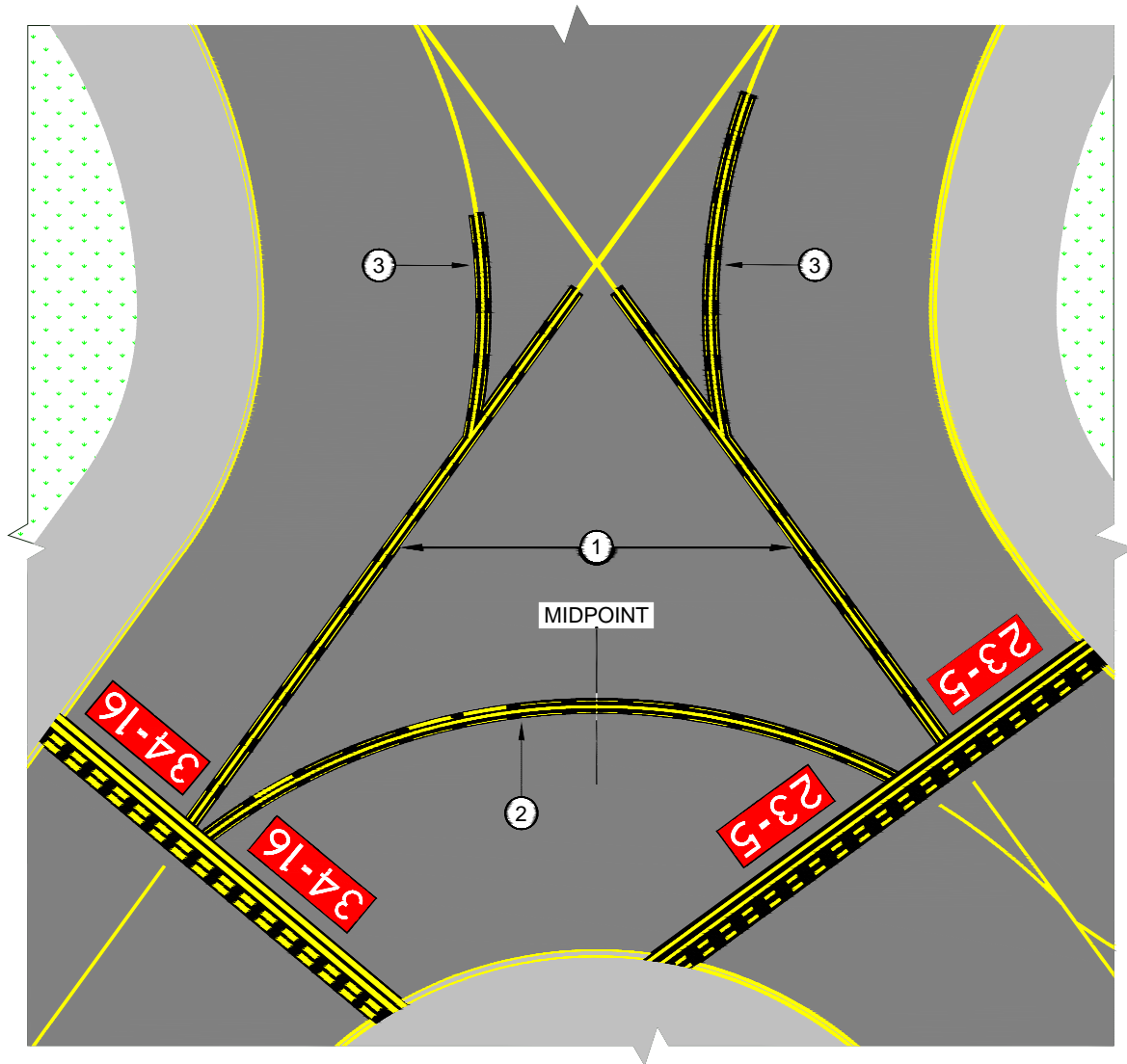

NOTES:

1. Illustrates perpendicular taxiway centerlines less than 150 feet (45.7 m) (see paragraph 4.3d).
2. Illustrates a curved taxiway centerline between two runway holding position markings with less than 150 feet (45.7 m) along the taxiway centerline (see paragraph 4.3d).
3. Illustrates a converging taxiway centerline curving toward two runway holding positions.

Figure C - 12. Intersection of Multi-Taxiway Centerlines with Less than 150 Feet (45.7 m) Between Taxiways

e. **Two Taxiway Centerlines Intersecting a Runway Holding Position Marking.** Figure C-13 illustrates an angled runway holding position marking that is intersected by two taxiway centerlines.

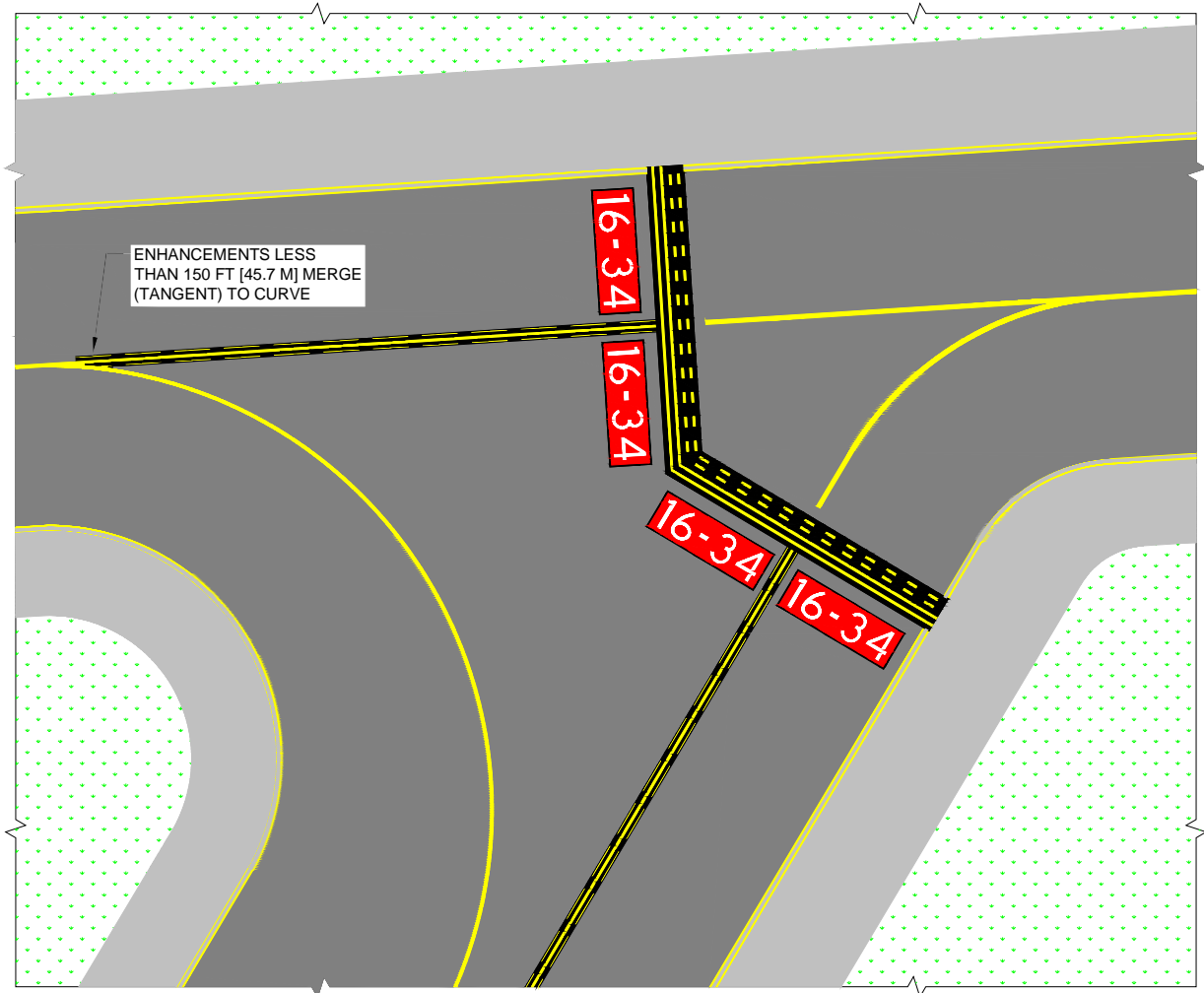

Figure C - 13. Two Taxiway Centerlines Intersecting a Runway Holding Position Marking

f. Intersection of Stub Taxiway and Runway. Figure C-14 illustrates a solution for a stub taxiway that is less than 150 feet (45.7 m) long, with a 90- degree turn and angled taxiway shoulder areas. Per paragraph 4.3d, the enhancement terminates 5 feet (1.5 m) from a taxiway/taxiway intersection.

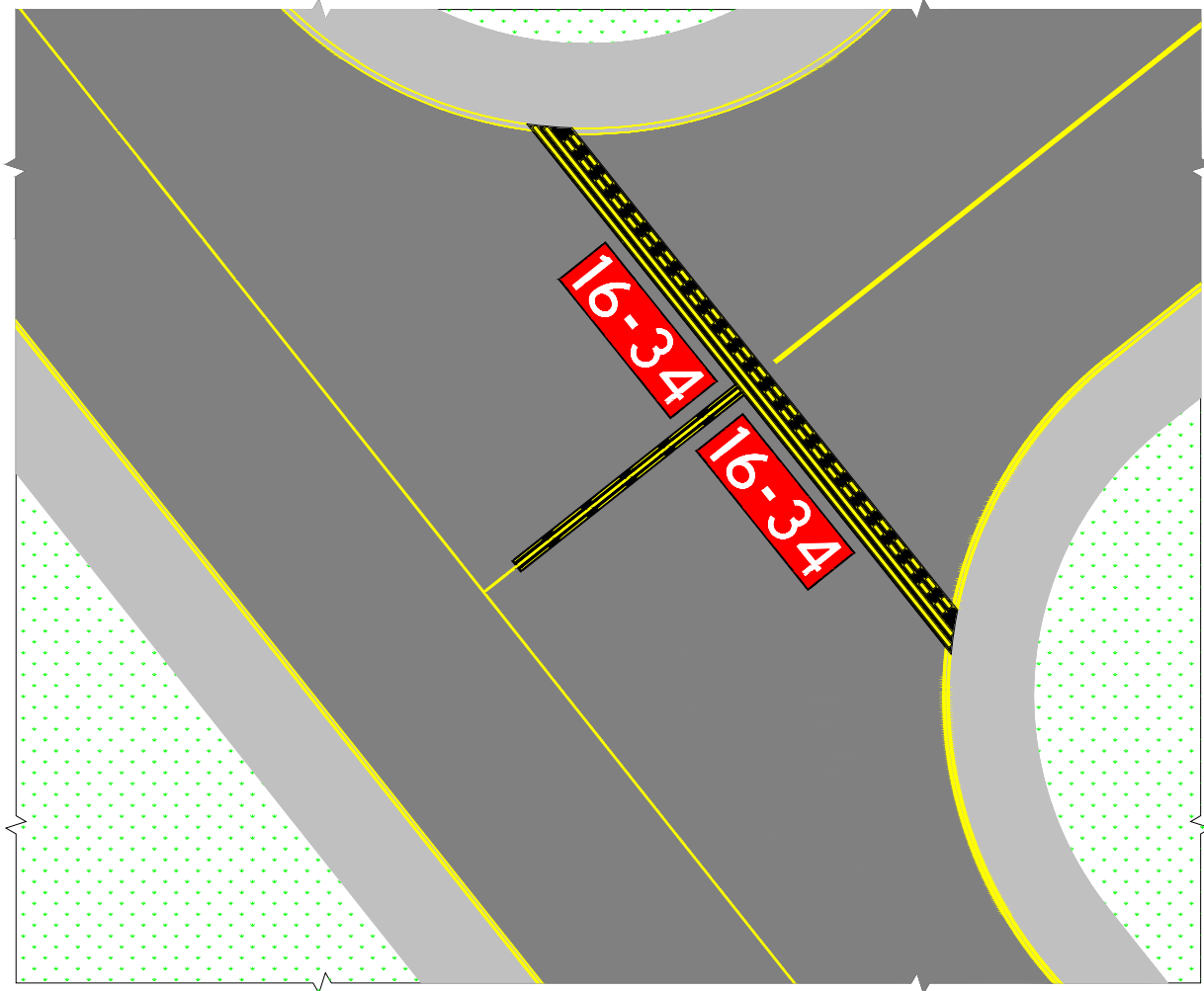
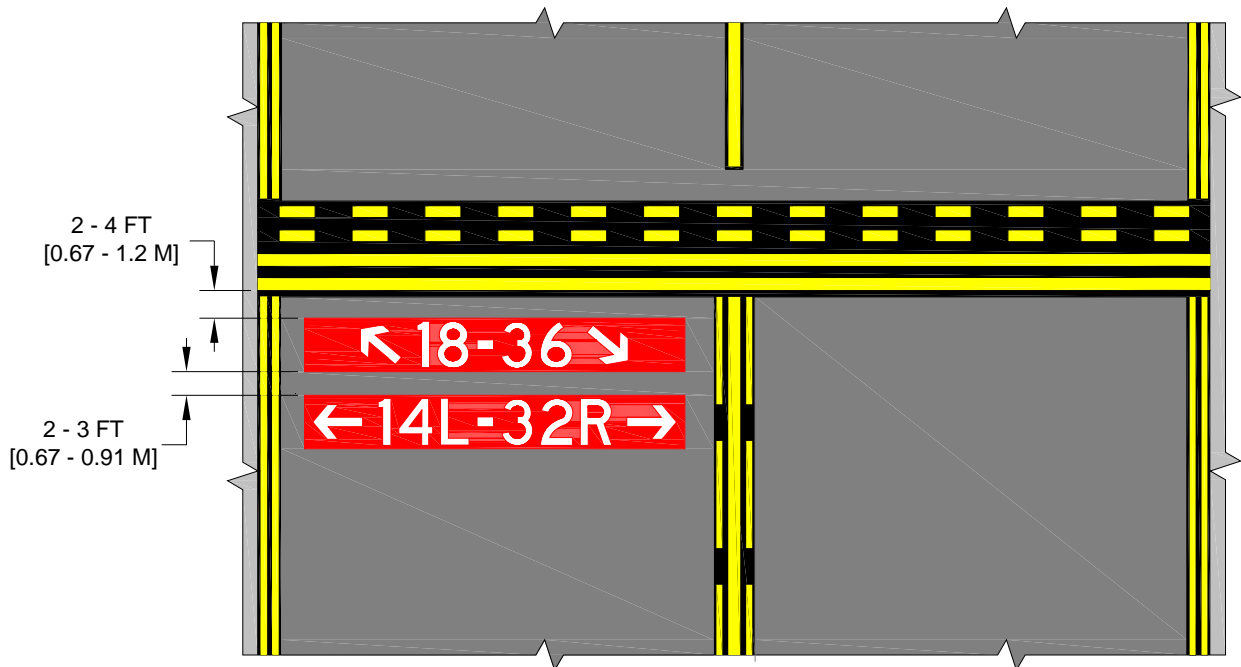

Figure C - 14. Intersection of Stub Taxiway and Runway



NOTES:

1. STACKED SURFACE PAINTED HOLDING POSITION SIGNS FOR NARROW TAXIWAYS - ONLY TO BE USED PER PARAGRAPH 4.5 (d)(1)(ii).
2. THE RECOMMENDED ORDER OF APPEARANCE FOLLOWS:
 - (A) IF THE "STACKED" SURFACE PAINTED HOLDING POSITION SIGNS ARE FOR A TAXIWAY THAT CLEARLY ACCESSES ONE RUNWAY (FOR EXAMPLE, RWY 14L/32R) BEFORE ANOTHER RUNWAY (RWY 18/36), THEN THE ORDER OF APPEARANCE IS FROM "BOTTOM UP" AS SHOWN ABOVE.
 - (B) IF THE "STACKED" SURFACE PAINTED HOLDING POSITION SIGNS ARE FOR A TAXIWAY THAT EQUALLY OFFERS ACCESS TO TWO OR MORE RUNWAYS, THEN FOLLOW A "CLOCKWISE" ORDER OF APPEARANCE AS VIEWED FOR THE HOLDING POSITION. HENCE, THE BOTTOM SURFACE PAINTED HOLDING POSITION SIGN IS THE FIRST RUNWAY AS VIEWED FROM THE HOLDING POSITION. THIS PRACTICE FOLLOWS THE SIGNAGE CONVENTION.

Figure C - 15. Narrow Taxiway Stacked Surface Painted Holding Position Sign

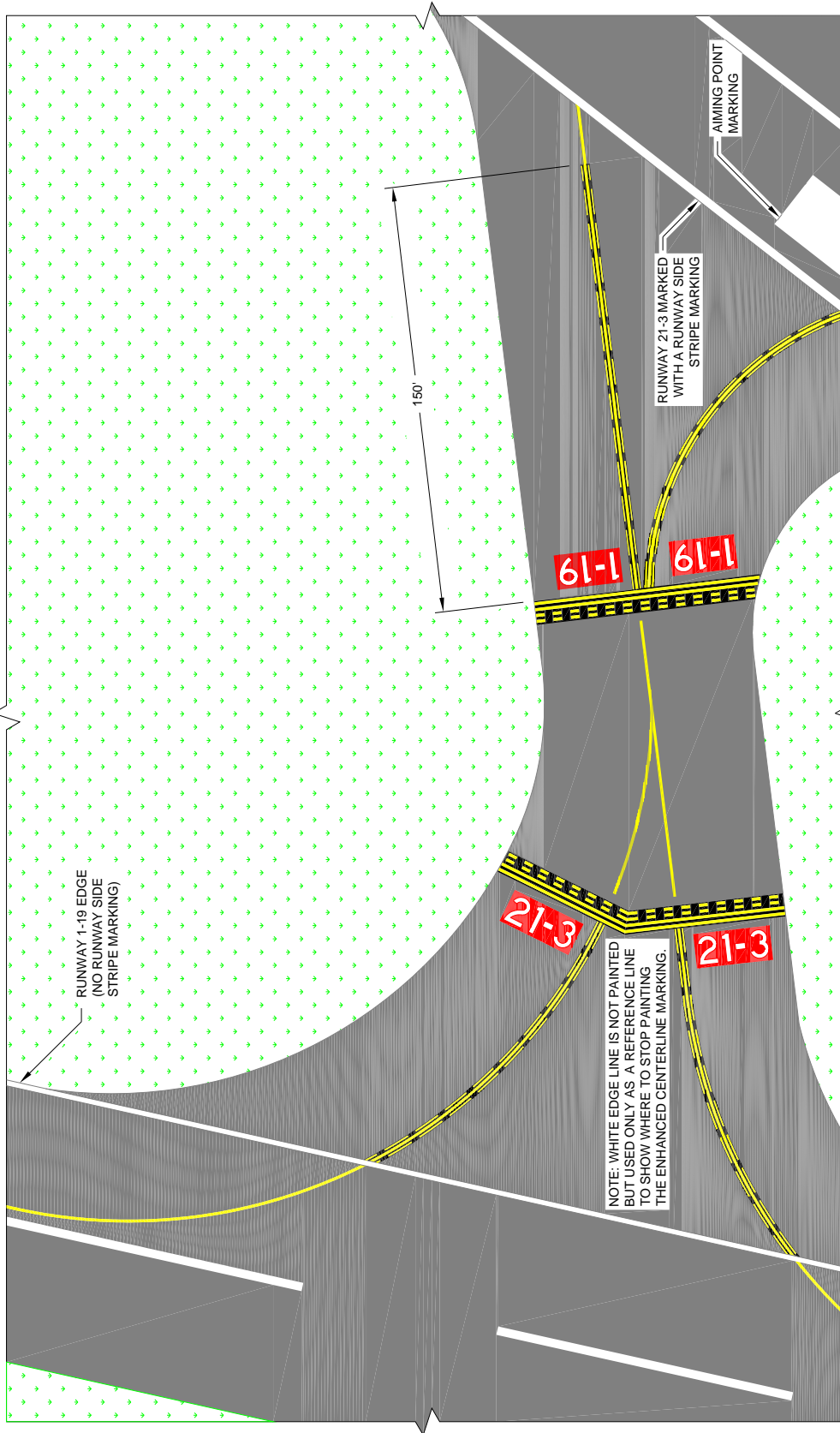

Figure C - 16. Enhanced Taxiway Centerlines When a Taxiway Connects Closely Spaced Runways

Blank Page