

11. Handling Drums and Other Containers

Contents

Introduction	11-1
Inspection	11-3
Planning	11-3
Handling	11-4
Drums Containing Radioactive Waste	11-5
Drums that May Contain Explosive or Shock-Sensitive Wastes	11-5
Bulging Drums	11-6
Drums Containing Packaged Laboratory Wastes (Lab Packs)	11-6
Leaking, Open, and Deteriorated Drums	11-6
Buried Drums	11-6
Opening	11-8
Sampling	11-10
Characterization	11-10
Staging	11-11
Bulking	11-13
Shipment	11-14
Special Case Problems	11-14
Tanks and Vaults	11-14
Vacuum Trucks	11-15
Elevated Tanks	11-15
Compressed Gas Cylinders	11-15
Ponds and Lagoons	11-15
References	11-16

Introduction

Accidents may occur during handling of drums and other hazardous waste containers. Hazards include detonations, fires, explosions, vapor generation, and physical injury resulting from moving heavy containers by hand and working around stacked drums, heavy equipment, and deteriorated drums. While these hazards are always present, proper work practices-such as minimizing handling and using equipment and procedures that isolate workers from hazardous substances-can minimize the risks to site personnel.

This chapter defines practices and procedures for safe handling of drums and other hazardous waste containers. It is intended to aid the Project Team Leader in setting up a waste container handling program. In addition to reading this chapter, the Project Team Leader should also be aware of all pertinent regulations. OSHA regulations (29 CFR Parts 1910 and 1926) include general requirements and standards for storing, containing, and handling chemicals and containers, and for maintaining equipment used for handling materials. EPA regulations (40 CFR Part 265) stipulate requirements for types of containers, maintenance of containers and containment structures, and design and maintenance of storage areas. DOT regulations (49 CFR Parts 171 through 178) also stipulate requirements for containers and procedures for shipment of hazardous wastes.

Containers are handled during characterization and removal of their contents and during other operations. A flow chart showing one set of possible procedures for drum handling is given in Figure 11-1. Guidance

for safely performing the procedures shown in Figure 11-1 is provided in the following sections of this chapter. The final section, *Special Case Problems*, describes the handling of tanks, vaults, vacuum trucks, elevated tanks, and compressed gas cylinders.

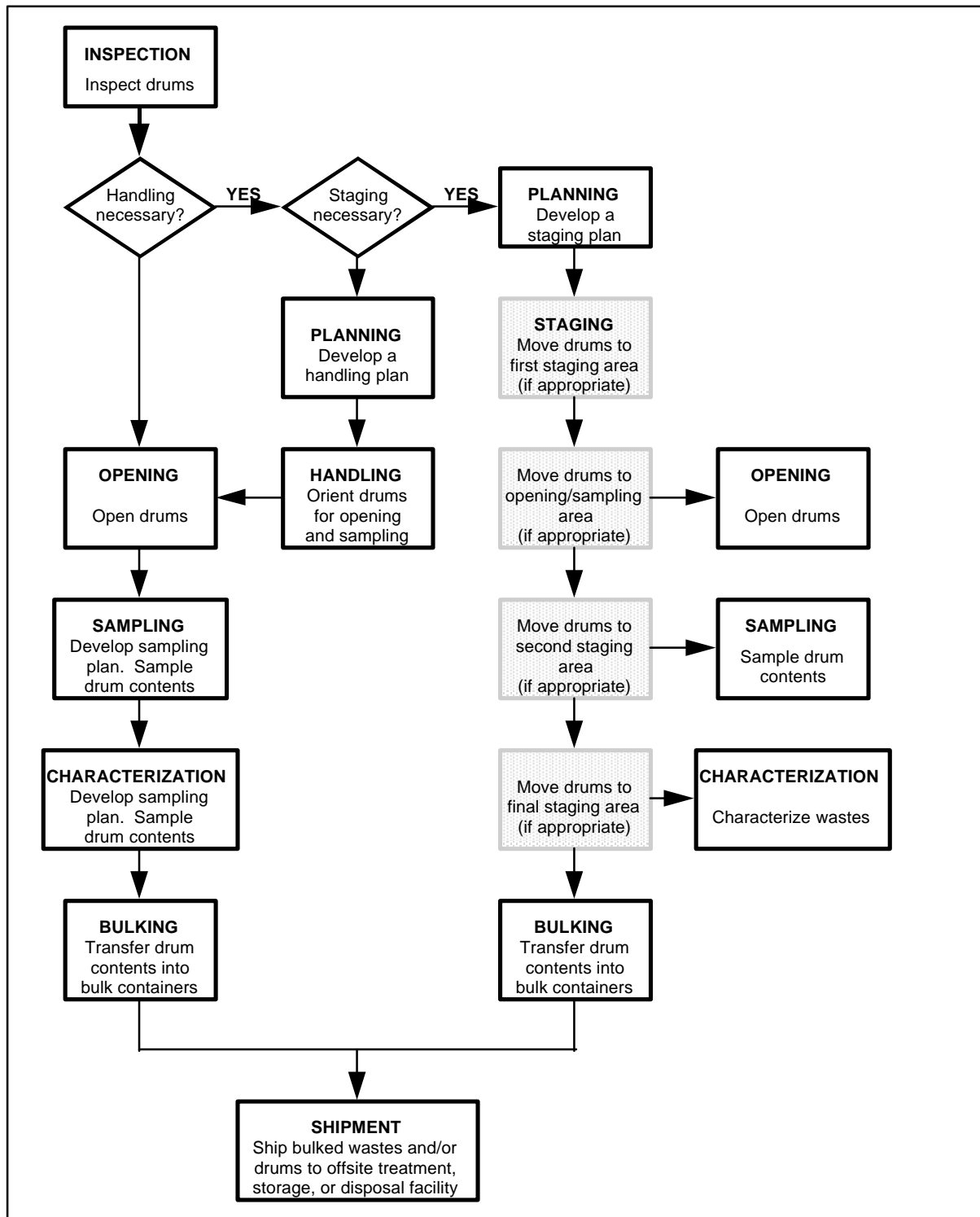

Figure 11-1. Flow Chart for Drum Handling. (Dashed boxes indicate optional steps. Number of staging areas necessary is site specific.)

Inspection

The appropriate procedures for handling drums depend on the drum contents. Thus, prior to any handling, drums should be visually inspected to gain as much information as possible about their contents. The inspection crew should look for:

- Symbols, words, or other marks on the drum indicating that its contents are hazardous, e.g., radioactive, explosive, corrosive, toxic, flammable.
- Symbols, words, or other marks on a drum indicating that it contains discarded laboratory chemicals, reagents, or other potentially dangerous materials in small-volume individual containers (see Table 11-1).
- Signs of deterioration such as corrosion, rust, and leaks.
- Signs that the drum is under pressure such as swelling and bulging.
- Drum type (see Table 11-1).
- Configuration of the drumhead (see Table 11-2).

Conditions in the immediate vicinity of the drums may provide information about drum contents and their associated hazards. Monitoring should be conducted around the drums using instruments such as a gamma radiation survey instrument, organic vapor monitors, and a combustible gas meter.

The results of this survey can be used to classify the drums into preliminary hazard categories, for example:

- Radioactive.
- Leaking/deteriorated.
- Bulging.
- Explosive/shock-sensitive.
- Contains small-volume individual containers of laboratory wastes or other dangerous materials.

As a precautionary measure, personnel should assume that unlabelled drums contain hazardous materials until their contents are characterized. Also, they should bear in mind that drums are frequently mislabeled-particularly drums that are reused. Thus, a drum's label may not accurately describe its contents.

If buried drums are suspected, ground-penetrating systems, such as electromagnetic wave, electrical resistivity, ground-penetrating radar, magnetometry, and metal detection, can be used to estimate the location and depth of the drums. Table 11-1. Special Drum Types and Their Associated Hazards

Planning

Since drum handling is fraught with danger, every step of the operation should be carefully planned, based on all the information available at the time. The results of the preliminary inspection can be used to determine (1) if any hazards are present and the appropriate response, and (2) which drums need to be moved in order to be opened and sampled. A preliminary plan should be developed which specifies the extent of handling necessary, the personnel selected for the job, and the most appropriate procedures based on the hazards associated with the probable drum contents as determined by visual inspection. This plan should be revised as new information is obtained during drum handling.

Table 11-1. Special Drum Types and Their Associated Hazards

Polyethylene or PVC-Lined Drums	Often contain strong acids or bases. If the lining is punctured, the substance usually quickly corrodes the steel, resulting in a significant leak or spill.
Exotic Metal Drums (e.g., aluminum, nickel, stainless steel, or other unusual metal)	Very expensive drums that usually contain an extremely dangerous material.
Single-Walled Drums Used as a Pressure Vessel	These drums have fittings for both product filling and placement of an inert gas, such as nitrogen. May contain reactive, flammable, or explosive substances.
Laboratory Packs	Used for disposal of expired chemicals and process samples from university laboratories, hospitals, and similar institutions. Individual containers within the lab pack are often not packed in absorbent material. They may contain incompatible materials, radioisotopes, shock-sensitive, highly volatile, highly corrosive, or very toxic exotic chemicals. Laboratory packs can be an ignition source for fires at hazardous waste sites.

Handling

The purpose of handling is to (1) respond to any obvious problems that might impair worker safety, such as radioactivity, leakage, or the presence of explosive substances, (2) unstack and orient drums for sampling, and (3) if necessary, to organize drums into different areas on site to facilitate characterization and remedial action (see *Staging* in this chapter). Handling may or may not be necessary, depending on how the drums are positioned at a site.

Since accidents occur frequently during handling, particularly initial handling, drums should only be handled if necessary. Prior to handling, all personnel should be warned about the hazards of handling, and instructed to minimize handling as much as possible and to avoid unnecessary handling. In all phases of handling, personnel should be alert for new information about potential hazards. These hazards should be responded to before continuing with more routine handling operations. Overpack drums (larger drums in which leaking or damaged drums are placed for storage or shipment [see 49 CFR Part 173.3(c)]) and an adequate volume of absorbent should be kept near areas where minor spills may occur. Where major spills may occur, a containment berm adequate to contain the entire volume of liquid in the drums should be constructed before any handling takes place. If the drum contents spill, personnel trained in spill response should be used to isolate and contain the spill.

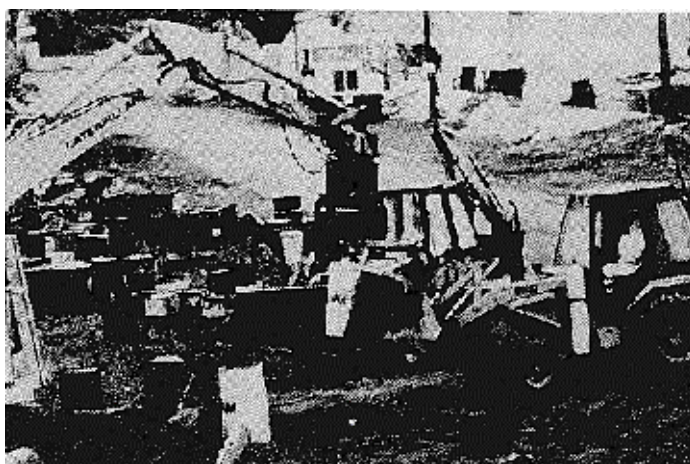

Backhoe with drum grapple.

Several types of equipment can be used to move drums: (1) A drum grappler attached to a hydraulic excavator; (2) a small front-end loader, which can be either loaded manually or equipped with a bucket sling; (3) a rough terrain forklift; (4) a roller conveyor equipped with solid rollers; and (5) drum carts designed specifically for drum handling. Drums are also sometimes moved manually. The drum grappler is the preferred piece of equipment for drum handling. It keeps the operator removed from the drums so that there is less likelihood of injury if the drums detonate or rupture. If a drum is leaking, the operator can stop the leak by rotating the drum and immediately placing it into an overpack. In case of an explosion, grappler claws help protect the operator by partially deflecting the force of the explosion.

The following procedures can be used to maximize worker safety during drum handling and movement:

- Train personnel in proper lifting and moving techniques to prevent back injuries.
- Make sure the vehicle selected has sufficient rated load capacity to handle the anticipated loads, and make sure the vehicle can operate smoothly on the available road surface.
- Air condition the cabs of vehicles to increase operator efficiency; protect the operator with heavy splash shields.
- Supply operators with appropriate respiratory protective equipment when needed. Normally either a combination SCBA/SAR with the air tank fastened to the vehicle, or an airline respirator and an escape SCBA are used because of the high potential hazards of drum handling. This improves operator efficiency and provides protection in case the operator must abandon the equipment.
- Have overpacks ready before any attempt is made to move drums.
- Before moving anything, determine the most appropriate sequence in which the various drums and other containers should be moved. For example, small containers may have to be removed first to permit heavy equipment to enter and move the drums.
- Exercise extreme caution in handling drums that are not intact and tightly sealed.
- Ensure that operators have a clear view of the roadway when carrying drums. Where necessary, have ground workers available to guide the operator's motion.

Drums Containing Radioactive Waste

- If the drum exhibits radiation levels above background (see Table 6-2) immediately contact a health physicist. Do *not* handle any drums that are determined to be radioactive until persons with expertise in this area have been consulted.

Drums that May Contain Explosive or Shock-Sensitive Waste

- If a drum is suspected to contain explosive or shock-sensitive waste as determined by visual inspection, seek specialized assistance before any handling.
- If handling is necessary, handle these drums with *extreme caution*.
- Prior to handling these drums, make sure all nonessential personnel have moved a safe distance away.
- Use a grappler unit constructed for explosive containment for initial handling of such drums.
- Palletize the drums prior to transport. Secure drums to pallets.
- Use an audible siren signal system, similar to that employed in conventional blasting operations, to signal the commencement and completion of explosive waste handling activities.
- Maintain continuous communication with the Site Safety Officer and/or the command post until drum handling operations are complete.

Bulging Drums

- Pressurized drums are extremely hazardous. Wherever possible, do not move drums that may be under internal pressure, as evidenced by bulging or swelling.
- If a pressurized drum has to be moved, whenever possible handle the drum with a grappler unit constructed for explosive containment. Either move the bulged drum only as far as necessary to allow seating on firm ground, or carefully overpack the drum. Exercise extreme caution when working with or adjacent to potentially pressurized drums.

Drums Containing Packaged Laboratory Wastes (Lab Packs)

Laboratory packs (i.e., drums containing individual containers of laboratory materials normally surrounded by cushioning absorbent material) can be an ignition source for fires at hazardous waste sites. They sometimes contain shock-sensitive materials. Such containers should be considered to hold explosive or shock-sensitive wastes until otherwise characterized. If handling is required, the following precautions are among those that should be taken:

- Prior to handling or transporting lab packs, make sure all non-essential personnel have moved a safe distance away.
- Whenever possible, use a grappler unit constructed for explosive containment for initial handling of such drums.
- Maintain continuous communication with the Site Safety Officer and/or the command post until handling operations are complete.
- Once a lab pack has been opened, have a chemist inspect, classify, and segregate the bottles within it, without opening them, according to the hazards of the wastes. An example of a system for classifying lab pack wastes is provided in Table 11-3. The objective of a classification system is to ensure safe segregation of the lab packs' contents. Pack these bottles with sufficient cushioning and absorption materials to prevent excessive movement of the bottles and to absorb all free liquids, and ship them to an approved disposal facility.
- If crystalline material is noted at the neck of any bottle, handle it as a shock-sensitive waste, due to the potential presence of picric acid or other similar material, and get expert advice before attempting to handle it.
- Palletize the repacked drums prior to transport. Secure the drums to pallets.

Leaking, Open, and Deteriorated Drums

- If a drum containing a liquid cannot be moved without rupture, immediately transfer its contents to a sound drum using a pump designed for transferring that liquid.
- Using a drum grappler, place immediately in overpack containers:
- Leaking drums that contain sludges or semi-solids.
- Open drums that contain liquid or solid waste.
- Deteriorated drums that can be moved without rupture.

Buried Drums

- Prior to initiating subsurface excavation, use ground penetrating systems to estimate the location and depth of the drums (see *Inspection* in this chapter).
- Remove soil with great caution to minimize the potential for drum rupture.
- Have a dry chemical fire extinguisher on hand to control small fires.

**Table 11-3. Example of Lab Pack Content
Classification System for Disposal**

CLASSIFICATION	EXAMPLES
Inorganic acids	Hydrochloric Sulfuric
Inorganic bases	Sodium hydroxide Potassium hydroxide
Strong oxidizing agents	Ammonium nitrate Barium nitrate Sodium chlorate Sodium peroxide
Strong reducing agents	Sodium thiosulfate Oxalic acid Sodium sulphite
Anhydrous organics and organometallics	Tetraethyl lead Phenylmercuric chloride
Anhydrous inorganics and metal hydrides	Potassium hydride Sodium hydride Sodium metal Potassium
Toxic organics	PCBs Insecticides
Flammable organics	Hexane Toluene Acetone
Inorganics	Sodium carbonate Potassium chloride
Inorganic cyanides	Potassium cyanide Sodium cyanide Copper cyanide
Organic Cyanides	Cyanoacetamide
Toxic metals	Arsenic Cadmium Lead Mercury

Opening

Drums are usually opened and sampled in place during site investigations. However, remedial and emergency operations may require a separate drum opening area (see *Staging* in this chapter). Procedures for opening drums are the same, regardless of where the drums are opened. To enhance the efficiency and safety of drum-opening personnel, the following procedures should be instituted.

- If a supplied-air respiratory protection system is used, place a bank of air cylinders outside the work area and supply air to the operators via airlines and escape SCBAs. This enables workers to operate in relative comfort for extended periods of time.
- Protect personnel by keeping them at a safe distance from the drums being opened. If personnel must be located near the drums, place explosion-resistant plastic shields between them and the drums to protect them in case of detonation. Locate controls for drum opening equipment, monitoring equipment, and fire suppression equipment behind the explosion resistant plastic shield.
- If possible, monitor continuously during opening. Place sensors of monitoring equipment, such as colorimetric tubes, dosimeters, radiation survey instruments, explosion meters, organic vapor analyzers, and oxygen meters, as close as possible to the source of contaminants, i.e., at the drum opening.
- Use the following remote-controlled devices for opening drums:
 - Pneumatically operated impact wrench to remove drum bungs.
 - Hydraulically or pneumatically operated drum piercers (see Figure 11-2).
 - Backhoes equipped with bronze spikes for penetrating drum tops in large-scale operations (see Figure 11-3).
- Do not use picks, chisels and firearms to open drums.
- Hang or balance the drum opening equipment to minimize worker exertion.
- If the drum shows signs of swelling or bulging, perform all steps slowly. Relieve excess pressure prior to opening and, if possible, from a remote location using such devices as a pneumatic impact wrench or hydraulic penetration device. If pressure must be relieved manually, place a barrier such as explosion-resistant plastic sheeting between the worker and bung to deflect any gas, liquid, or solids which may be expelled as the bung is loosened.
- Open exotic drums and polyethylene or polyvinyl chloride-lined (PVC-lined) drums through the bung by removal or drilling. Exercise extreme caution when manipulating these containers.
- Do not open or sample individual containers within laboratory packs.
- Reseal open bungs and drill openings as soon as possible with new bungs or plugs to avoid explosions and/or vapor generation. If an open drum cannot be resealed, place the drum into an overpack. Plug any openings in pressurized drums with pressure-venting caps set to a 5-psi (pounds per square inch) release to allow venting of vapor pressure.
- Decontaminate equipment after each use to avoid mixing incompatible wastes.

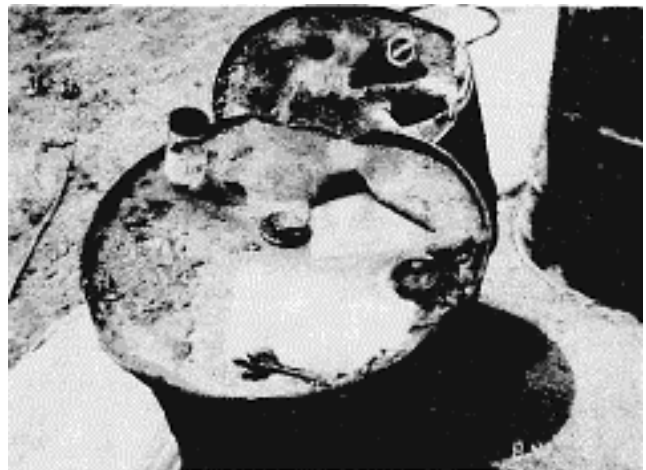

Two drums with rusted bungs were opened by backhoes with bronze spikes and now await sampling. Drum in foreground has been labeled "150" for sample documentation purposes.

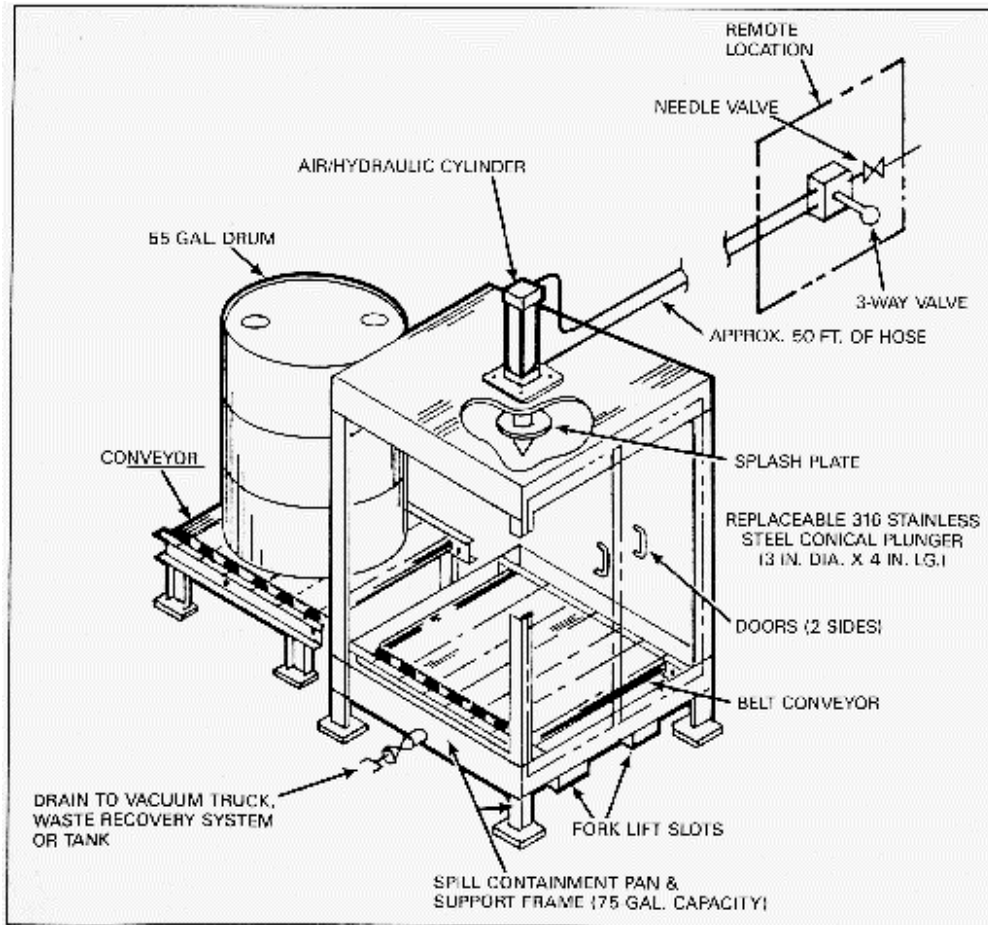

Figure 11-2. Air/Hydraulic-Operated Single-Drum Puncture Device. Source: Reference [1].

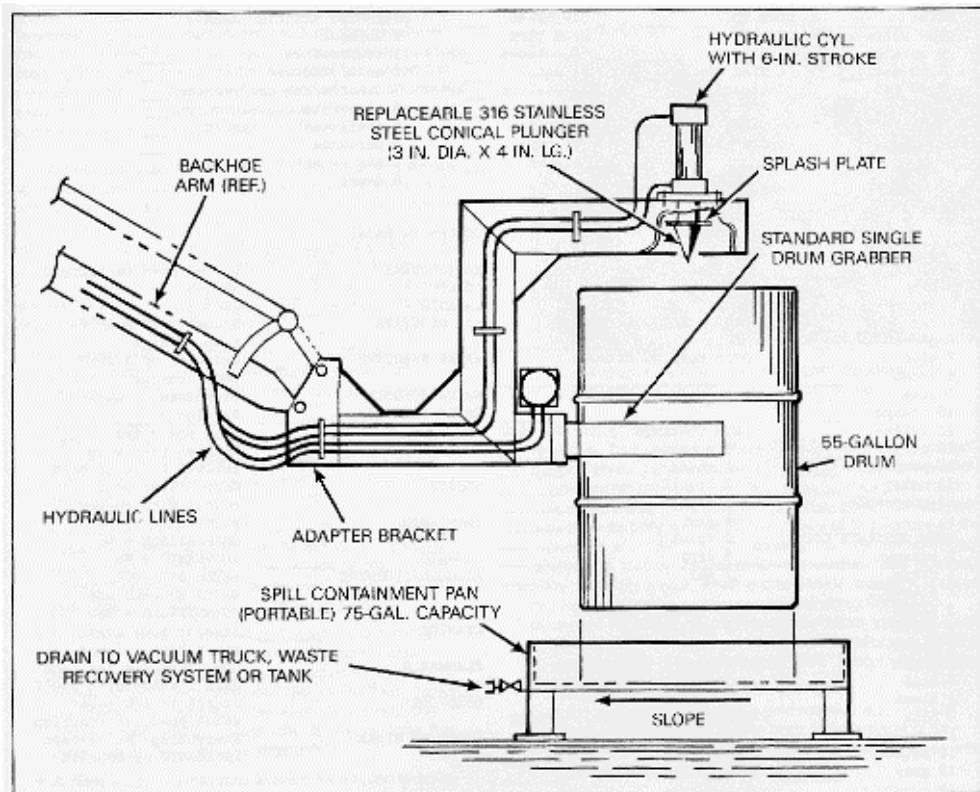

Figure 11-3. Backhoe-Mounted Drum Puncture Device. Source: Reference [1].

Sampling

Drum sampling can be one of the most hazardous activities to worker safety and health because it often involves direct contact with unidentified wastes. Prior to collecting any sample, develop a sampling plan:

- Research background information about the waste.
- Determine which drums should be sampled.
- Select the appropriate sampling device(s) and containers.
- Develop a sampling plan which includes the number, volume, and locations of samples to be taken.
- Develop Standard Operating Procedures for opening drums, sampling, and sample packaging and transportation. Some guidance in designing proper sampling procedures can be found in References [2] and [3].
- Have a trained health and safety professional determine, based on available information about the wastes and site conditions, the appropriate personal protection to be used during sampling, decontamination, and packaging of the sample.

When manually sampling from a drum, use the following techniques:

- Keep sampling personnel at a safe distance while drums are being opened. Sample only after opening operations are complete.
- Do *not* lean over other drums to reach the drum being sampled, unless absolutely necessary.
- Cover drum tops with plastic sheeting or other suitable non-contaminated materials to avoid excessive contact with the drum tops.
- *Never* stand on drums. This is extremely dangerous. Use mobile steps or another platform to achieve the height necessary to safely sample from the drums.
- Obtain samples with either glass rods or vacuum pumps. Do *not* use contaminated items such as discarded rags to sample. The contaminants may contaminate the sample and may not be compatible with the waste in the drum. Glass rods should be removed prior to pumping to minimize damage to pumps.

Characterization

The goal of characterization is to obtain the data necessary to determine how to safely and efficiently package and transport the wastes for treatment and/or disposal. If wastes are bulked, they must be sufficiently characterized to determine which of them can be safely combined (see *Bulking* later in this chapter). As a first step in obtaining these data, standard tests should be used to classify the wastes into general categories, including auto-reactives, water reactives, inorganic acids, organic acids, heavy metals, pesticides, cyanides, inorganic oxidizers, and organic oxidizers. In some cases, further analysis should be conducted to more precisely identify the waste materials. See Figure 11-4 for an example of a characterization sheet for drums.

When possible, materials should be characterized using an onsite laboratory. This provides data as rapidly as possible, and minimizes the time lag before appropriate action can be taken to handle any hazardous materials. Also, it precludes any potential problems associated with transporting samples to an offsite laboratory (e.g., sample packaging, waste incompatibility, fume generation).

If samples must be analyzed off site, samples should be packaged on site in accordance with DOT regulations (49 CFR) and shipped to the laboratory for analysis.

SITE: _____	DRUM NO. _____	SAMPLE NO. _____	SCREENING RESULTS (AREA):
DRUM SIZE:	DRUM OPENING:	DRUM TYPE:	0 unknown _____
0 unknown _____	0 unknown _____	0 unknown _____	1 radioactive _____
1 55 gal. _____	1 ring top _____	1 metal _____	2 acid/oxidizer _____
2 30 gal. _____	2 closed top _____	2 plastic _____	3 caustic/reducer/cyanide _____
3 other _____	3 open top _____	3 fiber _____	4 flammable organic _____
specify _____	4 other _____	4 glass _____	5 nonflammable organic _____
	specify _____	5 other _____	6 peroxide _____
		specify _____	7 air or water reactive _____
			8 inert _____
DRUM COLOR: PRI SEC	DRUM CONDITION:	SCREENING DATA:	
0 unknown _____	0 unknown _____		YES NO
1 cream _____	1 good _____	RADIOACTIVE _____	> 1 mR over background
2 clear _____	2 fair _____	ACIDIC _____	pH < 3
3 black _____	3 poor _____	CAUSTIC _____	pH > 12
4 white _____	DRUM MARKING KEYWORD 1 _____	AIR REACTIVE _____	Reaction of > 10°F temp. change
5 red _____	DRUM MARKING KEYWORD 2 _____	WATER REACTIVE _____	Reaction of > 10°F temp. change
6 green _____	DRUM MARKING KEYWORD 3 _____	WATER SOLUBLE _____	Dissolves in water
7 blue _____	DRUM CONTENTS STATE: PRI SEC	WATER BATH OVA _____	Reading = _____
8 brown _____	0 unknown _____	COMBUSTIBLE _____	> 10 ppm = Yes
9 pink _____	1 solid _____	HALIDE _____	Catches fire when torched in water bath
10 orange _____	2 liquid _____	INORGANIC _____	Green flame when heated with copper
11 yellow _____	3 sludge _____	ORGANIC _____	WATER BATH OVA and COMBUSTIBLE = No
12 gray _____	4 gas _____	ALCOHOL/ALDEHYDE _____	INORGANIC = No
13 purple _____	5 trash _____	CYANIDE _____	WATER BATH OVA, WATER SOLUBLE and COMBUSTIBLE = Yes
14 amber _____	6 dirt _____	FLAMMABLE _____	Draeger tube over water bath > 2 ppm
15 green-blue _____	7 gel _____	OXIDIZER _____	COMBUSTIBLE = Yes, and SETA flashpoint < 140°F
DRUM CONTENTS COLOR:	DRUM CONTENT AMOUNT:	INERT OR OTHER _____	Starch iodine paper shows positive reaction
0 unknown _____	0 unknown _____		Everything "No" except INORGANIC or ORGANIC
1 cream _____	1 full _____		
2 clear _____	2 part _____		
3 black _____	3 empty _____		
4 white _____	CHEMICAL ANALYSIS: YES NO		
5 red _____	radiation _____		
6 green _____	ignitable _____		
7 blue _____	water reactive _____		
8 brown _____	cyanide _____		
9 pink _____	oxidizer _____		
10 orange _____	organic vapor _____ ppm		
11 yellow _____	pH _____		
12 gray _____			
13 purple _____			
14 amber _____			
15 green-blue _____			

Figure 11-4. Sample Drum Characterization Sheet. Source: EPA Region VII Emergency Planning and Response Branch. (This figure is provided only as an example. Values were selected by EPA Region VII and should be modified as appropriate.)

Staging

Although every attempt should be made to minimize drum handling, drums must sometimes be staged (i.e. moved in an organized manner to predesignated areas) to facilitate characterization and remedial action, and to protect drums from potentially hazardous site conditions (e.g., movement of heavy equipment and high temperatures that might cause explosion, ignition, or pressure buildup). Staging involves a trade-off between the increased hazards associated with drum movement and the decreased hazards associated with the enhanced organization and accessibility of the waste materials.

The number of staging areas necessary depends on sitespecific circumstances such as the scope of the operation, the accessibility of drums in their original positions, and the perceived hazards. Investigation usually involves little, if any, staging; remedial and emergency operations can involve extensive drum staging. The extent of staging must be determined individually for each site, and should always be kept to a minimum. Up to five separate areas have been used (see Figure 11-5):

- An *initial staging area* where drums can be (1) organized according to type, size, and suspected contents, and (2) stored prior to sampling.
- An *opening area* where drums are opened, sampled, and resealed. Locate this area a safe distance from the original waste disposal or storage site and from all staging areas to prevent a chain reaction in case of fire or explosion.
- During large-scale remedial or emergency tasks, a separate *sampling area* may be set up at some distance from the opening area to reduce the number of people present in the opening area, and to limit potential casualties in case of an explosion
- A *second staging area*, also known as a holding area, where drums are temporarily stored after sampling pending characterization of their contents. Do *not* place unsealed drums with unknown contents in the second staging area in case they contain incompatible materials. (Either remove the contents or overpack the drum.)
- A *final staging area*, also known as a bulking area, where substances that have been characterized are bulked for transport to treatment or disposal facilities.
 - Locate the final staging area as close as possible to the site's exit.
 - Grade the area and cover it with plastic sheeting. Construct approximately 1-foot-high (0.3-m-high) dikes around the entire area.
 - Segregate drums according to their basic chemical categories (acids, heavy metals, pesticides, etc.) as determined by characterization. Construct separate areas for each type of waste present to preclude the possibility of intermingling incompatible chemicals when bulking.

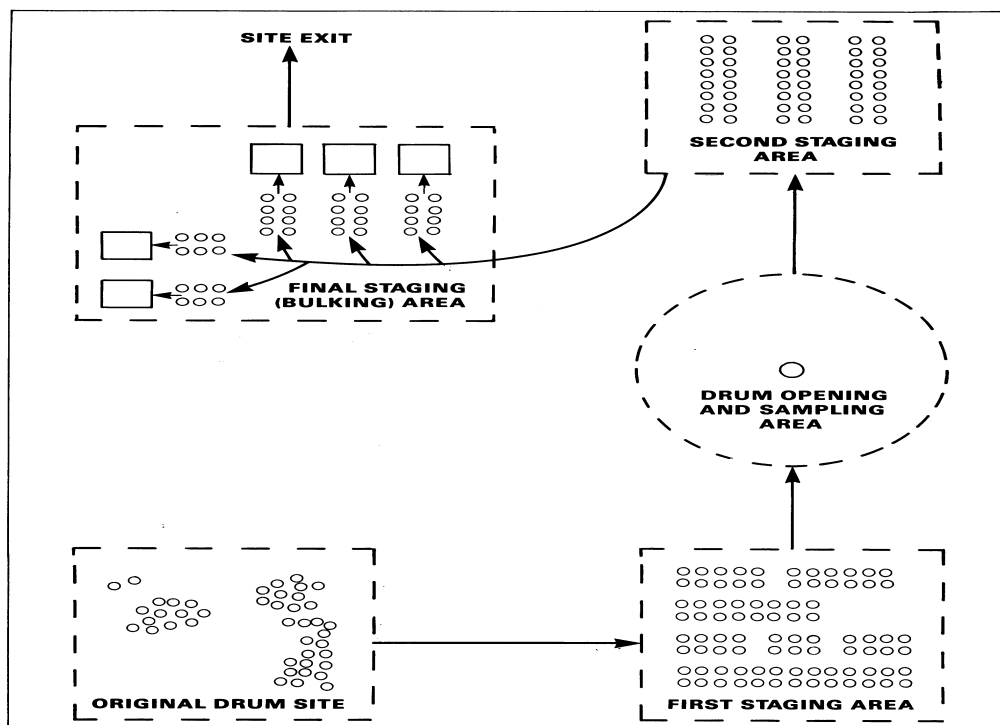

Figure 11-5. Possible Staging Areas at a Hazardous Waste Site.

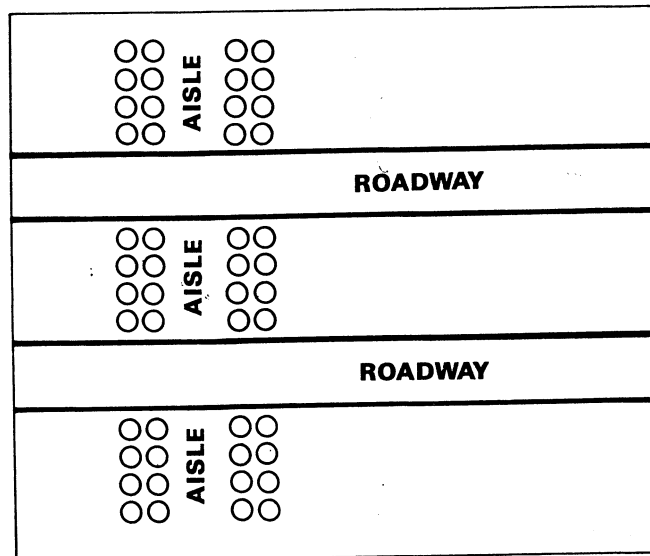

Figure 11-6. Sample Drum Staging Layout. Source: Reference [1].

Bulking

Wastes that have been characterized are often mixed together and placed in bulk containers such as tanks or vacuum trucks for shipment to treatment or disposal facilities. This increases the efficiency of transportation. Bulking should be performed only after thorough waste characterization by trained and experienced personnel. The preliminary tests described earlier under *Characterization* provide only a general indication of the nature of the individual wastes. In most cases, additional sampling and analysis to further characterize the wastes, and compatibility tests (in which small quantities of different wastes are mixed together under controlled conditions and observed for signs of incompatibility such as vapor generation and heat of reaction) should be conducted. Bulking is performed at the final staging area using the following procedures:



Crushed drums awaiting landfill. Note the staging of drums on the left in a row two drums wide.

- Inspect each tank trailer and remove any residual materials from the trailer prior to transferring any bulked materials. This will prevent reactions between incompatible chemicals.
- To move hazardous liquids, use pumps that are properly rated (see National Fire Protection Association [NFPA] 70 Articles 500-503 and NFPA 497M) and that have a safety relief valve with a splash shield. Make sure the pump hoses, casings, fittings, and gaskets are compatible with the material being pumped.
- Inspect hose lines before beginning work to ensure that all lines, fittings, and valves are intact with no weak spots.
- Take special precautions when handling hoses as they often contain residual material that can splash or spill on the personnel operating the hoses. Protect personnel against accidental splashing. Protect lines from vehicular and pedestrian traffic.
- Store flammable liquids in approved containers.

Shipment

Shipment of materials to offsite treatment, storage, or disposal facilities involves the entry of waste hauling vehicles into the site. U.S. Department of Transportation (DOT) regulations (49 CFR Parts 171-178) and EPA regulations (40 CFR Part 263) for shipment of hazardous wastes must be complied with. The following guidelines can enhance the safety of these operations:

- Locate the final staging (bulking) area as close as possible to the site exit.
- Prepare a circulation plan that minimizes conflict between cleanup teams and waste haulers. Install traffic signs, lights, and other control devices as necessary.
- Provide adequate area for onsite and hauling vehicles to turn around. Where necessary, build or improve onsite roads.
- Stage hauling vehicles in a safe area until ready for loading with drivers remaining in cab. Minimize the time that drivers spend in hazardous areas.
- Outfit the driver with appropriate protective equipment.
- If drums are shipped, tightly seal the drums prior to loading. Overpack leaking or deteriorated drums prior to shipment. (Under most circumstances, overpack drums used for hazardous wastes may not be reused [49 CFR Part 173.3(c)]). Make sure that truck bed and walls are clean and smooth to prevent damage to drums. Do not double stack drums. Secure drums to prevent shifting during transport.
- Keep bulk solids several inches below the top of the truck container. Cover loads with a layer of clean soil, foam, and/or tarp. Secure the load to prevent shifting or release during transport.
- Weigh vehicles periodically to ensure that vehicle and road weight limits are not exceeded.
- Decontaminate vehicle tires prior to leaving the site to ensure that contamination is not carried onto public roads.
- Check periodically to ensure that vehicles are not releasing dust or vapor emissions off site.
- Develop procedures for responding quickly to offsite vehicle breakdown and accidents to ensure minimal public impact.

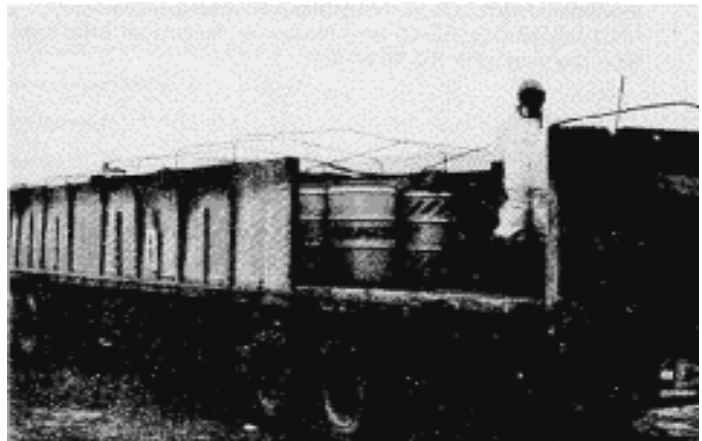

Single-stacked overpack drums awaiting transport off site. Worker suited in Level C personal protective equipment will spread a tarp over the drums to protect them during transport.

Special Case Problems

Tanks and Vaults

For tanks and vaults, which are often found on hazardous waste sites, the following procedures are recommended:

- In general, when opening a tank or vault follow the same procedures as for a sealed drum. If necessary, vent excess pressure if volatile substances are stored. Place deflecting shields

between workers and the opening to prevent direct contamination of workers by materials forced out by pressure when the tank is opened.

- Guard manholes or access portals to prevent personnel from falling into the tank.
- Identify the contents through sampling and analysis. If characterization indicates that the contents can be safely moved with the available equipment, vacuum them into a trailer for transportation to a disposal or recycling facility.
- Empty and decontaminate the tank or vault before disposal.
- If it is necessary to enter a tank or vault (i.e., confined spaces) for any reason (e.g., to clean off solid materials or sludges on the bottom or sides of the tank or vault), the following precautions should be taken [4]:
 - Ventilate thoroughly prior to entry.
 - Disconnect connecting pipelines.
 - Prior to entry, take air samples to prove the absence of flammable or other hazardous vapors and to demonstrate that adequate levels of oxygen exist.
 - Equip the entry team with appropriate respiratory protection, protective clothing, safety harnesses, and ropes.
 - Equip a safety observer with appropriate respiratory protection, protective clothing, a safety harness, and ropes.
 - Establish lifeline signals prior to entry so that the worker and safety observer can communicate by tugs on the rope.
 - Have an additional person available in the immediate vicinity to assist the safety observer if needed.
 - Instruct the safety observer not to enter the space until additional personnel are on scene.

Vacuum Trucks

- Wear appropriate protective clothing and equipment when opening the hatch.
- If possible, use mobile steps or suitable scaffolding consistent with 29 CFR Part 1910 Subpart D. Avoid climbing up the ladder and walking across the tank catwalk.
- If the truck must be climbed, raise and lower equipment and samples in carriers to enable workers to use two hands while climbing.
- If possible, sample from the top of the vehicle. If it is necessary to sample from the drain spigot, take steps to prevent spraying of excessive substances. Have all personnel stand off to the side. Have sorbent materials on hand in the event of a spill.

Elevated Tanks

In general, observe the safety precautions described for vacuum trucks. In addition:

- Use a safety line and harness.
- Maintain ladders and railings in accordance with OSHA requirements (29 CFR Part 1910 Subpart D).

Compressed Gas Cylinders

- Obtain expert assistance in moving and disposing of compressed gas cylinders.
- Handle compressed gas cylinders with extreme caution. The rupture of a cylinder may result in an explosion, and the cylinder may become a dangerous projectile.
- Record the identification numbers on the cylinders to aid in characterizing their contents.

Ponds and Lagoons

- Drowning is a very real danger for personnel suited in protective equipment because the weight of protective equipment increases an individual's overall density and severely impairs their

swimming ability. Where there is danger of drowning, provide necessary safety gear such as lifeboats, tag lines, railings, nets, safety harnesses, and flotation gear.

- Wherever possible, stay on shore. Avoid going out over the water.
- Be aware that some solid wastes may float and give the appearance of solid cracked mud. Caution should be exercised when working along shorelines.

References

1. Mayhew, Joe J.; G.M. Sodear; and D.W. Carroll. 1982. A Hazardous Waste Site Management Plan. Chemical Manufacturers Association, Inc., Washington DC.
2. deVera, E.R.; B.R Simmons; R.D. Stephens; and D.L. Storm. 1980. Samplers and Sampling Procedures for Hazardous Waste Streams. EPA-600/2-80-018. U.S. Environmental Protection Agency, Cincinnati, OH.
3. U.S. EPA. 1984. Characterization of Hazardous Waste Sites-A Methods Manual: Volume II. Available Sampling Methods. Second edition. EPA 600/ 4-84-076.
4. NIOSH. 1979. Criteria for a Recommended Standard: Working in Confined Spaces. NIOSH No. 80-106. Also available from U.S. Government Printing Office (#017-033-00353-0) and National Technical Information Service (PB-80-183015).

12. Site Emergencies

Contents

Introduction	12-1
Planning	12-2
Personnel	12-3
Onsite Personnel	12-3
Offsite Personnel	12-5
Federal Response Organizations	12-5
Training	12-7
Emergency Recognition and Prevention	12-8
Communications	12-8
Internal Communications	12-8
External Communications	12-9
Site Mapping	12-10
Safe Distances and Refuges	12-10
Safe Distances	12-10
Public Evacuation	12-11
Refuges (Safety Stations)	12-11
Site Security and Control	12-12
Personal Locator Systems	12-12
Evacuation Routes and Procedures	12-13
Decontamination	12-14
Equipment	12-14
Medical Treatment/First Aid	12-17
Emergency Response Procedures	12-17
Notification	12-17
Size-Up	12-18
Rescue/Response Action	12-19
Follow-Up	12-20
Documentation	12-20
References	12-21

Introduction

The nature of work at hazardous waste sites makes emergencies a continual possibility, no matter how infrequently they may actually occur. Emergencies happen quickly and unexpectedly and require immediate response. At a hazardous waste site, an emergency may be as limited as a worker experiencing heat stress, or as vast as an explosion that spreads toxic fumes throughout a community. Any hazard on site can precipitate an emergency: chemicals, biologic agents, radiation or physical hazards may act alone or in concert to create explosions, fires, spills, toxic atmospheres, or other dangerous and harmful situations. Table 12-1 lists common causes of site emergencies.

Table 12-1. Causes of Emergencies at Hazardous Waste Sites

Worker-Related

- Minor accidents (slips, trips, falls).
- Chemical exposure.
- Medical problems (host stress, heat stroke, aggravation of pro-existing conditions).
- Personal protective equipment failure or source failure, tearing or permeation of protective clothing, facepiece fogging).
- Physical injury (injuries from hot or flying objects, loose clothing entangling in machinery, serious falls, vehicle accidents).
- Electrical (burns, shock, electrocution).

Waste-Related

- Fire.
- Explosion.
- Leak.
- Release of toxic vapors.
- Reaction of incompatible chemicals.
- Collapse of containers.
- Discovery of radioactive materials.

Site emergencies are characterized by their potential for complexity: uncontrolled toxic chemicals may be numerous and unidentified; their effects may be synergistic. Hazards may potentiate one another—for example, a flammable spill feeding a fire. Rescue personnel attempting to remove injured workers may themselves become victims. This variability means that advance planning, including anticipation of different emergency scenarios and thorough preparation for contingencies, is essential to protect worker and community health and safety.

This chapter outlines important factors to be considered when planning for and responding to emergencies. It defines the nature of site emergencies, lists the types of emergencies that may occur, and outlines a Contingency Plan and its components, which include personnel roles, lines of authority, training, communication systems, site mapping, site security and control, refuges, evacuation routes, decontamination, a medical program, step-by-step emergency response procedures, documentation, and reporting to outside agencies. Backup information is detailed in other chapters of the manual.

Planning

When an emergency occurs, decisive action is required. Rapidly made choices may have far-reaching, long-term consequences. Delays of minutes can create life-threatening situations. Personnel must be ready to immediately rescue or respond; equipment must be on hand and in good working order. In order to handle emergencies effectively, planning is essential. For this purpose, a Contingency Plan should be developed.

A Contingency Plan is a written document that sets forth policies and procedures for responding to site emergencies. It should incorporate the following:

- Personnel:
 - Roles.
 - Lines of authority.
 - Training.
 - Communication.

- Site:
 - Mapping.
 - Security and control.
 - Refuges.
 - Evacuation routes.
 - Decontamination stations.
- Medical/first aid.
- Equipment.
- Emergency procedures.
- Documentation.
- Reporting.

Overall, a Contingency Plan should:

- Be designed as a discrete section of the Site Safety Plan.
- Be compatible and integrated with the pollution response, disaster, fire, and emergency plans of local, state, and federal agencies.
- Be rehearsed regularly using drills and mock situations.
- Be reviewed periodically in response to new or changing site conditions or information.

Personnel

This component of the plan includes not only onsite and offsite personnel with specific emergency response roles, but also others who may be on site, such as contractors, other agency representatives, and visitors. Emergency personnel and their responsibilities are covered in detail in Chapter 3 as part of the overall organizational structure. This information is summarized in Table 12-2.

Emergency personnel may be deployed in a variety of ways. Depending on the nature and scope of the emergency, the size of the site, and the number of personnel, the emergency response cadre can include individuals, small or large teams, or several interacting teams. Although deployment is determined on a site-by-site basis, pertinent general guidelines and recommendations are listed below. In all cases the organizational structure should show a clear chain-of-command, every individual should know his or her position and authority, and the chain-of-command must be flexible enough to handle multiple emergencies, such as a rescue and a spill response or two rescues with a fire and spill response.

Onsite Personnel

The Contingency Plan should identify all individuals and teams who will participate in emergency response and define their roles. All personnel, whether directly involved in emergency response or not, should know their own responsibilities in an emergency. They must also know the names of those in authority, and the extent of that authority.

Leader

- In an emergency situation, one person must be able to assume total control and decision-making on site. This leader must:
 - Be identified in the emergency response plan. This person may be, for example, the Project Team Leader, Site Safety Officer, or Field Team Leader.
 - Be backed up by a specified alternate(s).

- Have the authority to resolve all disputes about health and safety requirements and precautions.
- Be authorized to seek and purchase supplies as necessary.
- Have control over activities of everyone entering the site, for example, contractors, fire departments, and police.
- Have the clear support of management.

Table 12-2. Personnel Involved in Emergency Response

<p>Project Team Leader</p> <ul style="list-style-type: none"> • Directs emergency response operations. • Serves as liaison with appropriate government officials. <p>Site Safety Officer</p> <ul style="list-style-type: none"> • Recommends that work be stopped if any operation threatens worker or public health or safety. • Knows emergency procedures, evacuation routes, and the appropriate telephone numbers including: the ambulance, medical facility, poison control center, fire department, and police department. • Notifies local public emergency officials. • Provides for emergency medical care on site. <p>Command Post Supervisor</p> <ul style="list-style-type: none"> • Notifies emergency support personnel by telephone or radio in case rescue operations are required. • Assists the Site Safety Officer in a rescue, if necessary. <p>Rescue Team</p> <ul style="list-style-type: none"> • An emergency rescue team stands by, partially dressed in protective gear, near the Exclusion Zone ready to rescue any workers whose health or safety is endangered. • State emergency response personnel (varies among states). <p>Decontamination Station Officers</p> <ul style="list-style-type: none"> • Perform emergency decontamination. <p>24-Hour Medical Team</p> <ul style="list-style-type: none"> • Transportation and treatment of victims by ambulance personnel, personnel at local clinics or hospitals, and physicians. <p>Communication Personnel</p> <ul style="list-style-type: none"> • Local emergency service networks provide communication links for mutual aid. • Civil Defense organizations and local radio and television stations provide information to the public during an emergency. <p>Environmental Scientists</p> <ul style="list-style-type: none"> • Predict the immediate and future movement of released hazardous substances through the geologic and hydrologic environment and air. • Assess the effect of this movement on groundwater quality, surface water quality, and air quality. • Determine the probable movement of released toxic gases. • Estimate the expected concentration of gases in the community and the expected duration of exposure. • Predict the exposure levels of people and the ecosystem to the materials. <p>Hazardous Chemicals Experts</p> <ul style="list-style-type: none"> • Provide immediate advice to those at the scene of a chemical-related emergency. <p>Firefighters</p> <ul style="list-style-type: none"> • Respond to fires that occur at a site; rescue victims. <p>Meteorologists</p> <ul style="list-style-type: none"> • Provide meteorological information needed by environmental scientists. <p>Public Safety Personnel</p>
--

- The county sheriff, industrial security forces, the National Guard, and the police control site access, crowds, and traffic.

Public Evacuation Personnel

- Civil Defense organizations plan evacuations.
- The National Guard and other military, the Red Cross, the Salvation Army, and municipal transportation systems mobilize transit equipment and assist in evacuations.

On-Scene Coordinator

- Coordinates federal response activities.

Teams

Although individuals (e.g., the Site Safety Officer) may perform certain tasks in emergencies, in most cases teams provide greater efficiency and safety. Teams composed of onsite personnel may be created for specific emergency purposes, such as decontamination, rescue, and entry. Rescue teams can be used during a particularly dangerous operation, or at large sites with multiple work parties in the Exclusion Zone. Their sole function is to remain near hazardous work areas, partially dressed in protective gear, ready for full suiting and immediate rescue of any endangered worker. These teams should be capable of administering cardiopulmonary resuscitation (CPR) and emergency first aid. Other teams can be formed for responding to containment emergencies and fire-fighting until offsite assistance arrives.

Offsite Personnel

These may include individual experts such as meteorologists or toxicologists (see Table 12-2). and representatives or groups from local, state, and federal organizations offering rescue, response, or support (see Table 12-3 for a listing of typical organizations). As part of advance planning, site personnel should:

- Make arrangements with individual experts to provide guidance as needed.
- Make arrangements with the appropriate agencies (e.g., local fire department, state environmental agency, EPA regional office) for support.
- Alert these authorities to the types of emergencies that may arise.
- Determine their estimated response time and resources.
- Identify backup facilities.
- Provide training and information about hazards on site and special procedures for handling them.
- Establish a contact person and means of notification at each agency.

Federal Response Organizations

Site emergencies involving significant chemical releases should be coordinated with federal response organizations. The federal government has established a National Contingency Plan (NCP) to promote the coordination and direction of federal and state response systems, and to encourage the development of local government and private capabilities to handle chemical emergencies involving chemical releases.

To implement the NCP, a national organization was established, including a National Response Team (NRT), a network of Regional Response Teams (RRTs), a cadre of On-Scene Coordinators (OSCs), and a National Response Center (NRC). The NRC is the national terminal point for receipt of notification of significant chemical releases, and the OSCs are the interface between the onsite personnel and the federal response organizations. The OSC is the federal official responsible for ensuring that necessary response actions are taken to protect the public and the

environment from the effects at a chemical release. Many federal agencies have specific technical expertise which is available to assist the OSC.

If a significant chemical release occurs at a hazardous waste site, the National Response Center in Washington, D.C., should be contacted (Telephone: 800-424-8802). The NRC will activate federal response under the National Contingency Plan.

Table 12-3. Examples of Agencies and Groups Involved in Emergencies

AGENCY OR GROUP	RESCUE ^a	RESCUE ^b	SUPPORT ^c
FEDERAL			
Army Corps of Engineers			•
Coast Guard ^d		•	•
Department of Defense ^d		•	•
Department of Transportation			•
Environmental Protection Agency (EPA) ^d		•	•
Federal Aviation Administration (FAA)			•
Federal Emergency Management Agency (FEMA)			•
National Institute for Occupational Safety and Health (NIOSH)			•
Occupational Safety and Health Administration (OSHA)			•
STATE			
Civil Defense			•
Department of Health			•
Department of Labor			•
Environmental Agency		•	•
Office of the Attorney General			•
State Police	•		•
LOCAL			
Ambulance and rescue services	•	•	•
Cleanup contractor	•	•	•
Disposal companies	•	•	
Fire department	•	•	•
Hospital			•
Police	•		•
Red Cross			•
Salvation Army			•
Transporters			•
Utility companies (electric, gas, water, phone)			•

^aRescue = extricating and/or providing on-the-spot emergency treatment to victims.

^bResponse = controlling and stabilizing hazardous conditions.

^cSupport = providing technical assistance, equipment, and/or resources.

^dThis agency may provide an On-Scene Coordinator (OSC), depending on the jurisdiction.

Training

Since immediate, informed response is essential in an emergency, all site personnel and others entering the site (visitors, contractors, offsite emergency response groups, other agency representatives) must have some level of emergency training. Any training program should:

- Relate directly to site-specific, anticipated situations.
- Be brief and repeated often.
- Be realistic and practical.
- Provide an opportunity for special skills to be practiced regularly.
- Feature drills frequently (e.g., site-specific mock rescue operations).
- Ensure that training records are maintained in a training logbook.

Everyone entering the site must be made aware of the hazards and of hazardous actions which are forbidden or should be avoided (e.g., smoking). They must also know what to do in case of an emergency.

Visitors should be briefed on basic emergency procedures such as decontamination, emergency signals, and evacuation routes.

Personnel without defined emergency response roles (e.g., contractors, federal agency representatives) must still receive a level of training that includes at a minimum:

- Hazard recognition.
- Standard Operating Procedures.
- Signaling an emergency: the alarm used, how to summon help, what information to give and who to give it to.
- Evacuation routes and refuges.
- The person or station to report to when an alarm sounds.

Onsite emergency personnel, who have emergency roles in addition to their ordinary duties, must have a thorough understanding of emergency response. Training should be directly related to their specific roles and should include subjects such as:

- Emergency chain-of-command.
- Communication methods and signals.
- How to call for help.
- Emergency equipment and its use.
- Emergency evacuation while wearing protective equipment.
- Removing injured personnel from enclosed spaces.
- Offsite support and how to use it.

These personnel should obtain certification in first aid and CPR, and practice treatment techniques regularly, with an emphasis on:

- Recognizing and treating chemical and physical injuries.
- Recognizing and treating heat and cold stress.

Offsite emergency personnel such as local firefighters and ambulance crews often are first responders and run a risk of acute hazard exposure equal to that of any onsite worker. These personnel should be informed of ways to recognize and deal effectively with onsite hazards. Lack of information may inadvertently worsen an emergency by improper actions (e.g., spraying water on a water-reactive chemical and causing an explosion). Inadequate knowledge of the onsite

emergency chain-of-command may cause confusion and delays. Site management should, at a minimum, provide offsite emergency personnel with information about:

- Site-specific hazards.
- Appropriate response techniques.
- Site emergency procedures.
- Decontamination procedures.

Emergency Recognition and Prevention

On a day-to-day basis, individual personnel should be constantly alert for indicators of potentially hazardous situations and for signs and symptoms in themselves and others that warn of hazardous conditions and exposures. Rapid recognition of dangerous situations can avert an emergency. Before daily work assignments, regular meetings should be held. Discussion should include:

- Tasks to be performed.
- Time constraints (e.g., rest breaks, air tank changes).
- Hazards that may be encountered, including their effects, how to recognize symptoms or monitor them, concentration limits, or other danger signals.
- Emergency procedures.

After daily work assignments, a debriefing session should be held to review work accomplished and problems observed.

Communications

In an emergency, crucial messages must be conveyed quickly and accurately. Site staff must be able to communicate information such as the location of injured personnel, orders to evacuate the site, and notice of blocked evacuation routes, even through noise and confusion. Outside support sources must be reached, help obtained, and measures for public notification ensured, if necessary. To do this, a separate set of internal emergency signals should be developed and rehearsed daily. External communication systems and procedures should be clear and accessible to all workers.

Internal Communications

Internal emergency communication systems are used to alert workers to danger, convey safety information, and maintain site control. Any effective system or combination may be employed. Radios or field telephones are often used when work teams are far from the Command Post. Alarms or short clear messages can be conveyed by audible signals, e.g., bullhorns, megaphones, sirens, bells, whistles, or visual signals such as colored flags, flares, lights, and hand or whole-body movements. The primary system must have a backup. For example, hand signals may be used as a backup if radio communications fail. All internal systems should be:

- Clearly understood by all personnel.
- Checked and practiced daily.
- Intrinsically safe (spark-free).

A special set of emergency signals should be set up. These should be:

- Different from ordinary signals
- Brief and exact.

- Limited in number so that they are easily remembered.

Examples include: stop, evacuate, help, all clear. Any set of signals may be used to convey these messages as long as all personnel understand their meaning. See Table 12-4 for examples.

When designing and practicing communication systems, remember that:

- Background noise on site will interfere with talking and listening.
- Wearing personal protective equipment will impede hearing and limit vision (e.g., the ability to recognize hand and body signals).
- Inexperienced radio users may need practice in speaking clearly.

Table 12-4. Sample Internal Emergency Communication Signals

DEVICES ^a AND SIGNALS	EXAMPLE
Radio (citizen's band or FM)	Established code words.
Noisemakers, including:	One long blast: Evacuate area by nearest emergency exit.
Bell	
Compressed air horn	Two shot blasts: Localized problem (not dangerous to workers).
Megaphone	
Siren	Two long blasts: all clear.
Whistle	
Visual signal, including:	Hand clutching throat: Out of air/can't breath.
Hand signals	Hands on top of head: Need assistance
Whole body movements	Thumbs up: OK/I'm alright/I understand
	Thumbs down: No/negative
	Grip partner's wrist or both hands around partner's waist: Leave area immediately.

^aAll devices and equipment used in the Exclusion and Contamination Reduction Zones must be intrinsically safe and not capable of sparking.

External Communications

Offsite sources must be contacted to get assistance or to inform officials about hazardous conditions that may affect public or environmental safety. The telephone is the most common mode of offsite communication; phone hook-ups are considered a necessity at all but the most remote sites.

- The National Response Center (NRC) (Telephone: 800-424-8802) should be contacted in the event of a significant chemical release. The NRC will contact the appropriate federal On-Scene Coordinator.
- All personnel must be familiar with the protocol (phone number or emergency code, contact person) for contacting public emergency aid teams such as fire departments, ambulance units, and hospitals.

- If there is no site telephone system, all personnel must know the location of the nearest public telephone. A supply of telephone change and the necessary phone numbers must be readily available.

Site Mapping

Detailed information about the site is essential for advance planning. For this purpose, a site map is a valuable tool. It serves as a graphic record of the locations and types of hazards, a reference source, and a method of documentation. This map can be a duplicate of the one developed for the Site Safety Plan (see Chapter 3), but it should focus on potential areas where emergencies may develop. Pins and colored flags can be used to mark changes in personnel deployment, hazard areas, and equipment locations. The map should highlight:

- Hazard areas, especially potential IDLH conditions.
- Site terrain: topography, buildings, barriers.
- Evacuation routes.
- Site accessibility by land, sea, and air.
- Work crew locations.
- Changes (e.g., work activities, vandalism, accidents).
- Offsite populations or environments at potential risk.

The map can be used for planning and training. It can serve as a basis for developing potential emergency scenarios and alternative response strategies.

When an emergency occurs, the problem areas should be pinpointed on the map. Pertinent information such as weather and wind conditions, temperature, and forecast - should be added. The map can then be used to design the emergency plan, e.g., to define zones; determine evacuation routes; and identify emergency first-aid, decontamination, and Command Post stations. When using the map for such purposes, the accuracy of the data obtained and the potential for over or underestimating a hazard should be considered.

Even if the emergency develops so fast that the map cannot be used for on-the-spot planning, prior familiarity with it will aid in making informed decisions.

Safe Distances and Refuges

Safe Distances

No single recommendation can be given for evacuation or safe distances because of the wide variety of hazardous substances and releases found at sites. For example, a "small" chlorine leak may call for an isolation distance of only 140 feet (43 meters), while a "large" leak may require an evacuation distance of 1 mile (1.6 kilometers) or more, depending on the wind direction [1].

Safe distances can only be determined at the time of an emergency, based on a combination of site- and incident-specific factors. However, planning and outlining potential emergency scenarios will help familiarize personnel with points to consider. Factors that influence safe distances include:

- The toxicological properties of the substance.
- The physical state of the substance.

- The quantity released.
- The rate of release.
- The method of release.
- The vapor pressure of the substance.
- Vapor density relative to air.
- Wind speed and direction.
- Atmospheric stability.
- The height of release.
- Air temperature and temperature change with altitude.
- Local topography (e.g., barriers may enhance or retard a cloud or plume, and attenuate a blast).

Public Evacuation

If an incident may threaten the health or safety of the surrounding community, the public will need to be informed and possibly evacuated from the area. Site management should plan for this in coordination with the appropriate local, state and federal groups, such as the Federal Emergency Management Agency, the Civil Defense, county sheriff, local radio and television stations, municipal transportation systems, National Guard, and police.

Refuges (Safety Stations)

Onsite refuges (safety stations) can be set up for localized emergencies that do not require site evacuation. These refuges should only be used for essential needs, such as short rest breaks, emergency response strategy meetings, or temporary relief during mild cases of muscle strain and heat stress. The refuge should be located in a relatively safe, but not necessarily "clean" area, e.g., along the upwind fence line in specially cleared places or on the periphery of the Exclusion Zone.¹ The refuge should never be used for activities such as eating, drinking, or air changes. Typical items located in a refuge area include:

- A sitting/resting area that should be shaded if possible.
- Water for decontamination.
- Wind indicator.
- Communication system with the Command Post. First-aid supplies, e.g., eyewash, stretcher, blanket.
- Special monitoring devices (e.g., extra detector tubes and personal monitors).
- Bolt cutters.
- Fire extinguishers.
- Hand tools.

Other refuges can be set up in the Support Zone, or in the case of site-wide evacuations, offsite at the safe exit destination. These will provide for emergency needs such as first aid for injured personnel, clean dry clothing and wash water for chemical exposure victims, and communications with the Command Post. In a sitewide evacuation, they can be used to house evacuation exit equipment, thereby reducing security problems. These refuges should be stocked with such items as:

- Decontamination supplies.
- Oxygen and/or air.
- Water.
- Special testing equipment (e.g., pH paper, cyanide paper).

- First-aid supplies.
- Communication system.

Site Security and Control

In an emergency, the Project Team Leader (or designated representative) must know who is on site and must be able to control the entry of personnel into the hazardous areas to prevent additional injury and exposure. Only necessary rescue and response personnel should be allowed into the Exclusion Zone.

One control technique is a checkpoint or series of checkpoints through which all personnel entering or exiting the site must Pass, e.g., a Support Zone checkpoint and an Exclusion Zone checkpoint. Identification or authorization must be presented to a Checkpoint Control Manager, who records each person's:

- Name (and affiliation if offsite personnel).
- Status (in or out).
- Time of entry.
- Anticipated exit time.
- Zones or areas to be entered.
- Team or "buddy."
- Task being performed.
- Location of task.
- Protective equipment worn; air time left.
- Rescue and response equipment used.

The emergency area Checkpoint Control Manager should inform the Project Team Leader if a person remains in the emergency area beyond his or her anticipated exit time.

Personal Locator Systems

In an emergency, it is vital for the Project Team Leader (or designee) and rescue personnel to rapidly determine where workers are located and who may be injured. A passive locator system (i.e, a written record of the location of all personnel on site at any time) could be used to help find personnel in an emergency. Any such system should be:

- Graphic (such as a drawing with a written key).
- Roughly drawn to scale, with the scale and visible landmarks included.
- Kept current.
- Easy to locate.
- Stored outside the Exclusion Zone.

A good passive locator system is a site map with flags or color-headed pins identifying each worker.

Active locator systems can also be used. These are worn or carried by individual personnel, and are activated by actions such as flipping a switch, a decrease in air supply, or a fall. They have the advantage of precisely locating Individuals.

Evacuation Routes and Procedures

A severe emergency, such as a fire or explosion, may cut workers off from the normal exit near the Command Post. Therefore, alternate routes for evacuating victims and endangered personnel should be established in advance, marked, and kept clear. Routes should be directed (1) from the Exclusion Zone through an upwind Contamination Reduction Zone to the Support Zone, and (2) from the Support Zone to an offsite location in case conditions necessitate a general site evacuation. The following guidelines will help in establishing safe evacuation routes.

- Place the evacuation routes in the predominantly upwind direction of the Exclusion Zone. (At a very large site, or one with many obstacles, some exits may be placed in the downwind fence line, normally an undesirable location. If this is done, workers must know that they are not "out" until they reach the designated safety area.)
- Run the evacuation routes through the Contamination Reduction Zone. Even if there is not enough time to process the evacuees through decontamination procedures, there should be a mechanism for accounting for all personnel.
- Consider the accessibility of potential routes. Take into account obstructions such as locked gates, trenches, pits, tanks, drums, or other barriers, and the extra time or equipment needed to maneuver around or through them.
- Develop two or more routes that lead to safe areas and that are separate or remote from each other. Multiple routes are necessary in case one is blocked by a fire, spill, or vapor cloud. These routes must not overlap because if a common point were obstructed by a fire or other emergency, all intersecting routes would be blocked.
- Mark routes "safe" or "not safe" on a daily basis according to wind direction and other factors.
- Mark evacuation routes with materials such as barricade tape, flagging, or traffic cones. Equally important, mark areas that do not offer safe escape or that should not be used in an emergency, such as low ground, which can fill with gases or vapors, or routes blocked by natural barriers, such as cliffs or streams.
- Consider the mobility constraints of personnel wearing protective clothing and equipment. They will have difficulty crossing even small streams and going up and down banks.
 - Place ladders across any cut or excavation that is more than 3 feet (1 meter) deep. For long cuts, place ladders at least every 25 feet (7.5 meters), and for deep cuts, place plywood or planks on top of ladders.
 - Provide ladders for rapid descent from areas or structures elevated more than 3 feet (1 meter). Use only ladders capable of supporting a 250-lb (114-kg) load.
 - Secure ladders to prevent slipping.
 - Place standard cleated ramps ("chickenboard") across ditches and other similar obstacles. Add a railing and toe boards if the board is narrow or steeply sloped.
 - Check the toe and body clearance of ladders to make sure that personnel wearing protective clothing and SCBA can use them.
 - Check the clearance of access ports, such as crawlspaces, hatches, manholes, and tunnels to make sure that personnel wearing a protective ensemble can get through. In any case, access ports should be at least 3 feet (1 meter) in diameter where possible. (Standard tank manways are smaller.)
- Make escape routes known to all who go on site.

Decontamination

When planning for decontamination in medical emergencies, procedures should be developed for:

- Decontaminating the victim.
- Protecting medical personnel.
- Disposing of contaminated protective equipment and wash solutions.

These activities should be coordinated. The decision whether or not to decontaminate a victim is based on the type and severity of the illness or injury and the nature of the contaminant. For some emergency victims, immediate decontamination may be an essential part of life-saving first aid. For others, decontamination may aggravate the injury or delay life-saving treatment. If decontamination does not interfere with essential treatment, it should be performed. Figure 12-1 is a decision aid for emergency decontamination.

- If decontamination can be done:
 - Wash, rinse and/or cut off protective clothing and equipment.
- If decontamination cannot be done:
 - Wrap the victim in blankets, plastic, or rubber to reduce contamination of other personnel.
 - Alert emergency and offsite medical personnel to potential contamination; instruct them about specific decontamination procedures if necessary.
 - Send along site personnel familiar with the incident.

See Chapter 9, *Decontamination*, for details on decontamination techniques and procedures.

Equipment

In an emergency, equipment will be necessary to rescue and treat victims, to protect response personnel, and to mitigate hazardous conditions on site (e.g., to contain chemicals or fight fires). Some regular equipment can double for emergency use. Because of its high cost, most heavy equipment (e.g., bulldozers, drum movers, pumps) employed in emergencies will also be used for regular work assignments. All equipment should be in working order, fueled, and available when an emergency occurs. Provide safe and unobstructed access for all firefighting and emergency equipment at all times. Consider adopting the following work procedures:

- Refuel all heavy equipment when there is still one-half to one-quarter of a tank of fuel left.
- Require all equipment repairs to take place at the time the problem is discovered.
- Separate two similar pieces of equipment (e.g., two front-loaders or a bulldozer and a front-loader); park each at a different spot on site and do not use them at the same time in a hazardous area unless absolutely necessary. (This will minimize the possibility of both pieces of equipment being damaged in the same explosion or fire.)

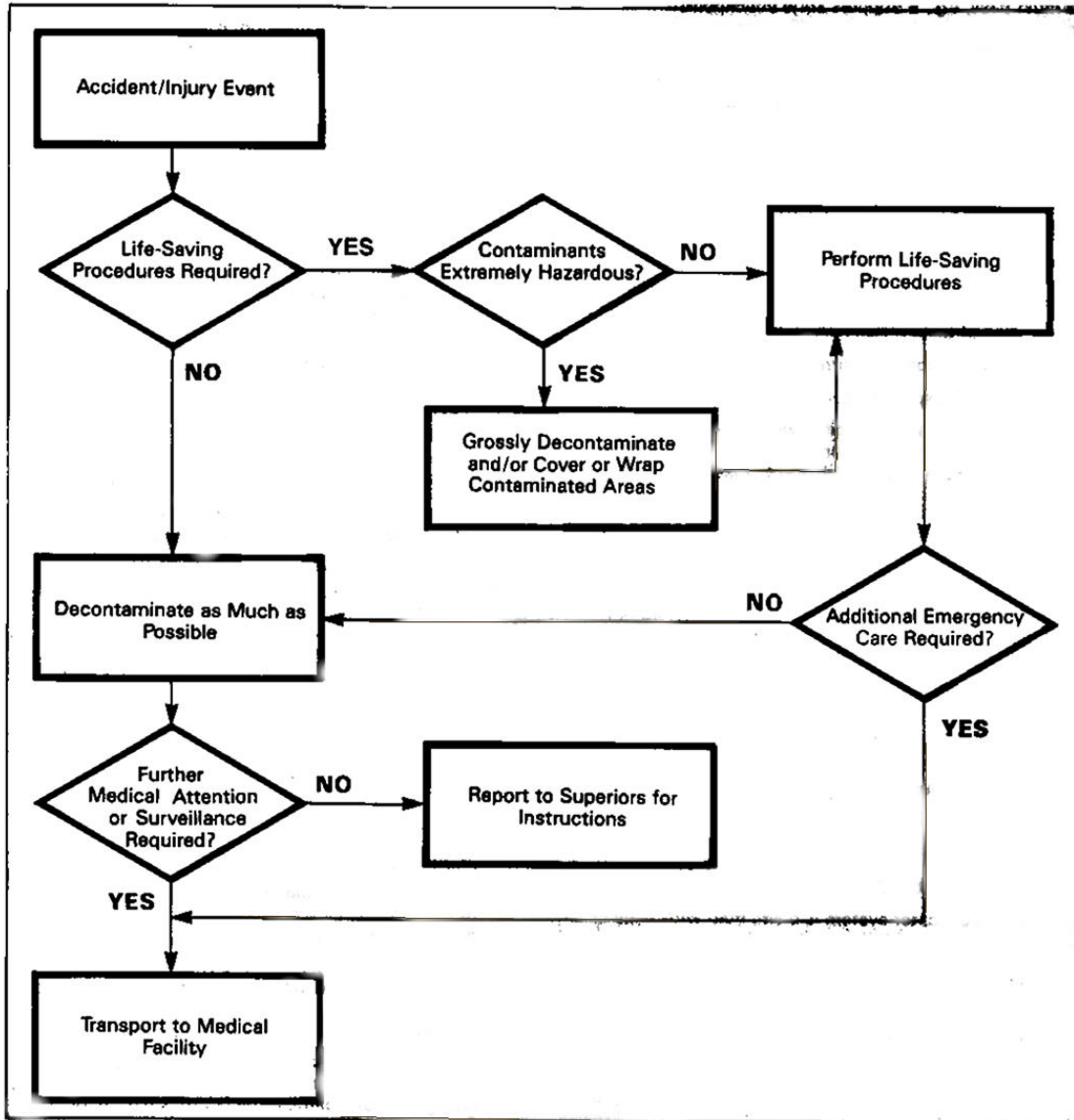

Figure 12-1. Decision Aid for Emergency Decontamination.

For personal protective equipment:

- Refill all empty self-contained breathing apparatus (SCBA) tanks and prepare them for emergencies immediately after normal use.
- Stock higher levels of protective equipment than required for anticipated hazards (e.g., a site where Level C equipment is normally used [see Table 8-6] should have Level A and B equipment available for emergencies).

Basic equipment that should be available at any site is listed in Table 12-5. Special equipment should be obtained depending on the specific types of emergencies that may occur at a particular site and the capabilities of backup offsite personnel. For example, if the nearest fire department is small and only carries one bucket of foaming solution because of its high cost and short shelf-life, a site may need to stock a large quantity of foam. When determining the type and quantity of special equipment, the following factors should be considered:

- The types of emergencies that may arise. For each emergency, consider a probable and a worst-case scenario.
- The types of hazards that site personnel may be exposed to and the appropriate containment, mitigative, and protective measures.
- The capabilities and estimated response times of offsite emergency personnel.
- The number of site personnel who could be victims during an emergency.
- The probable number of personnel available for response.

Table 12-5. Onsite Equipment and Supplies for Emergency Response

PERSONAL PROTECTION	MEDICAL	HAZARD MITIGATION
<ul style="list-style-type: none"> • Escape SCBA or SCBA, which can be brought to the victim to replace or supplement his or her SCBA. • Personal protective equipment and clothing specialized for known site hazards. 	<ul style="list-style-type: none"> • Air splints • Antiseptics • Blankets • Decontamination solutions appropriate for onsite chemical hazards • Emergency eye wash • Emergency showers or wash stations • Ice • Reference books containing basic first-aid procedures and information on treatment of specific chemical injuries • Resuscitator • Safety harness • Stretchers • Water, in portable containers • Wire basket litter (Stokes litter) which can be used to carry a victim in bad weather and on a difficult terrain, allows easy decontamination of the victim, and is itself easy to decontaminate 	<ul style="list-style-type: none"> • Fire-fighting equipment and supplies • Spill-containment equipment, such as absorbents and oil booms • Special hazardous-use tools such as remote pneumatic impact wrenches, non-sparking wrenches and picks • Containers to hold contaminated materials.

Medical Treatment/First Aid

In emergencies, toxic exposures and hazardous situations that cause injuries and illnesses will vary from site to site. Medical treatment may range from bandaging of minor cuts and abrasions to life-saving techniques. In many cases, essential medical help may not be immediately available. For this reason, it is vital to train onsite emergency personnel in on-the-spot treatment techniques, to establish and maintain telephone contact with medical experts (e.g., toxicologists), and to establish liaisons with local hospitals and ambulance services. Guidelines for establishing an emergency medical program are detailed in Chapter 5. When designing this program, these essential points should be included:

- Train a cadre of personnel in emergency treatment such as first aid and CPR. Training should be thorough, frequently repeated, and geared to site-specific hazards.
- Establish liaison with local medical personnel, for example: 24-hour on-call physician, medical specialists, local hospitals, ambulance service, and poison control center. Inform and educate these personnel about site-specific hazards so that they can be optimally helpful if an emergency occurs. Develop procedures for contacting them; familiarize all onsite emergency personnel with these procedures.
- Set up onsite emergency first-aid stations; see that they are well supplied and restocked immediately after each emergency.

Emergency Response Procedures

Response operations usually follow a sequence that starts with the notification of trouble and continues through the preparation of equipment and personnel for the next emergency. This process is illustrated in Figure 12-2.

Notification

Alert personnel to the emergency. Sound a site alarm to:

- Notify personnel.
- Stop work activities if necessary.
- Lower background noise in order to speed communication.
- Begin emergency procedures.

Notify onsite emergency response personnel about the emergency and include essential information:

- What happened.
- Where it happened.
- Whom it happened to.
- When it happened.
- How it happened.
- The extent of damage.
- What aid is needed.

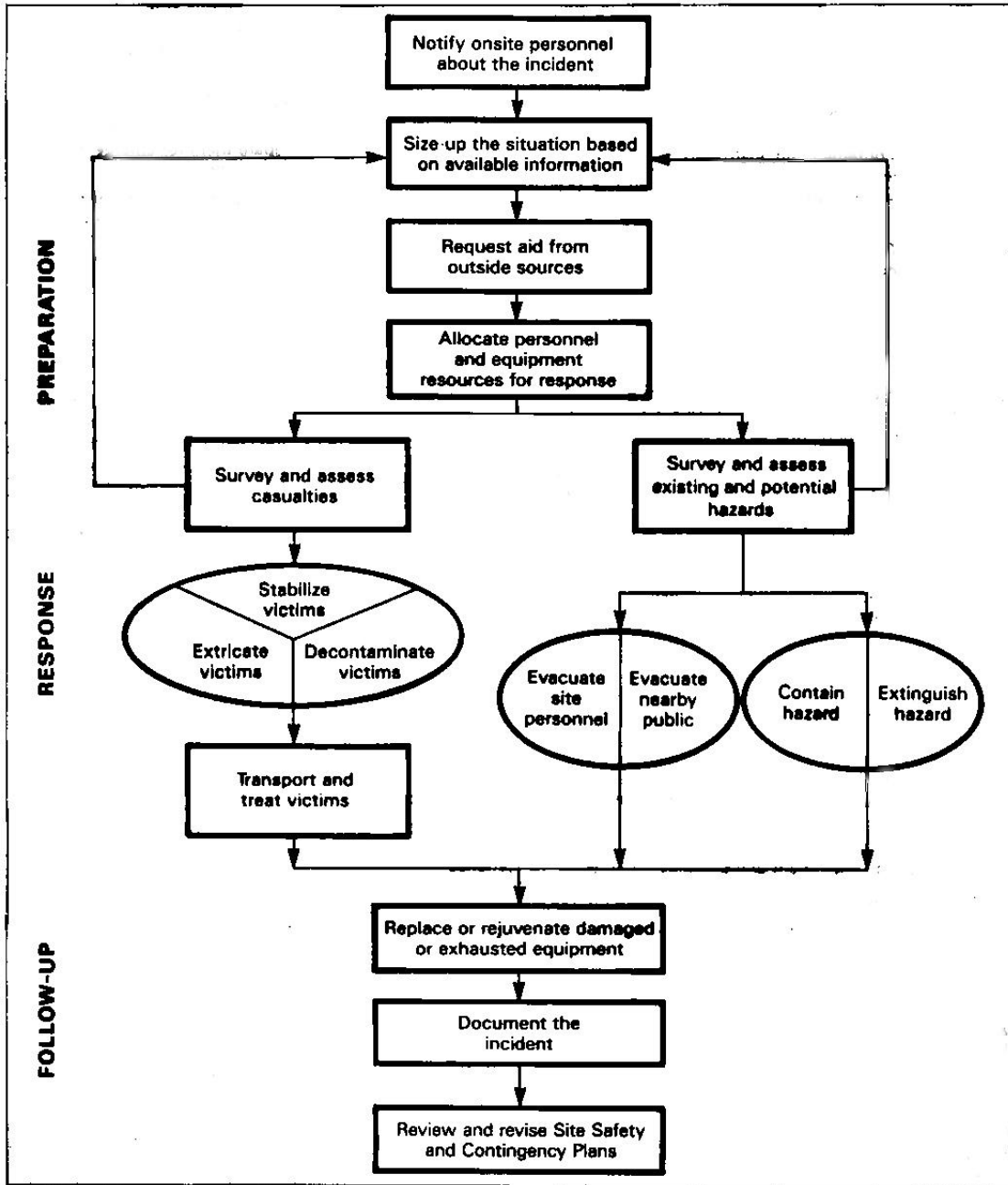

Figure 12-2. Emergency Response Operations.

Size-Up

Available information about the incident and emergency response capabilities should be evaluated. The following information should be determined, to the extent possible:

- What happened:
 - Type of incident.
 - Cause of incident.

- Extent of chemical release and transport.
- Extent of damage to structures, equipment, and terrain.
- Casualties:
 - Victims (number, location, and condition).
 - Treatment required.
 - Missing personnel.
- What could happen. Consider:
 - Types of chemicals on site.
 - Potential for fire, explosion, and release of hazardous substances.
 - Location of all personnel on site relative to hazardous areas.
 - Potential for danger to offsite population or environment.
- What can be done. Consider:
 - Equipment and personnel resources needed for victim rescue and hazard mitigation.
 - Number of uninjured personnel available for response.
 - Resources available on site.
 - Resources available from outside groups and agencies.
 - Time for outside resources to reach the site.
 - Hazards involved in rescue and response.

Rescue/Response Action

Based on the available information, the type of action required should be decided and the necessary steps implemented. Some actions may be done concurrently. No one should attempt emergency response or rescue until backup personnel and evacuation routes have been identified. Rescue/response actions may include:

- Enforce the buddy system: Allow no one to enter an, Exclusion Zone or hazardous area without a partner. At all times, personnel in the Exclusion Zone should be in line-of-sight or communications contact with the Command Post Supervisor or designee.
- Survey casualties:
 - Locate all victims and assess their condition.
 - Determine resources needed for stabilization and transport.
- Assess existing and potential hazards to site personnel and to the offsite population. Determine:
 - Whether and how to respond.
 - The need for evacuation of site personnel and offsite population.
 - The resources needed for evacuation and response.
- Allocate resources. Allocate onsite personnel and equipment to rescue and incident response operations.
- Request aid. Contact the required offsite personnel or facilities, such as the ambulance, fire department, and police.
- Control. Bring the hazardous situation under complete or temporary control; use measures to prevent the spread of the emergency.
- Extricate. Remove or assist victims from the area.
- Decontaminate. Use established procedures to decontaminate uninjured personnel in the Contamination Reduction Zone. If the emergency makes this area unsafe, establish a new decontamination area at an appropriate distance. Decontaminate victims before or after stabilization as their medical condition indicates (see Figure 12-1 for decision aid).
- Stabilize. Administer any medical procedures that are necessary before the victims can be moved. Stabilize or permanently fix the hazardous condition (e.g., repack; empty filled runoff dikes). Attend to what caused the emergency and anything (e.g., drums, tanks) damaged or endangered by the emergency.

- Transport. Take measures to minimize chemical contamination of the transport vehicle and ambulance and hospital personnel. Adequately protected rescuers should decontaminate the victims before transport. If this is not possible, cover the victims with adequate sheeting. Before transportation, determine the level of protection necessary for transport personnel. Provide them with disposable coveralls, disposable gloves, and supplied air, as necessary, for their protection. If appropriate, have response personnel accompany victims to the medical facility to advise on decontamination.
- Evacuate:
 - Move site personnel to a safe distance upwind of the incident.
 - Monitor the incident for significant changes. The hazards may diminish, permitting personnel to reenter the site, or increase and require public evacuation.
 - Inform public safety personnel when there is a potential or actual need to evacuate the offsite population. Do not attempt large-scale public evacuation. This is the responsibility of government authorities (see Table 12-3).

Follow-Up

Before normal site activities are resumed, personnel must be fully prepared and equipped to handle another emergency.

- Notify appropriate government agencies as required. For example, OSHA must be notified if there have been any fatalities or five or more hospitalizations.
- Restock all equipment and supplies. Replace or repair damaged equipment. Clean and refuel equipment for future use.
- Review and revise all aspects of the Contingency Plan according to new site conditions and lessons learned from the emergency response. When reviewing the information, consider typical questions such as:
 - Cause: What caused the emergency?
 - Prevention: Was it preventable? If so, how?
 - Procedures: Were inadequate or incorrect orders given or actions taken? Were these the result of bad judgment, wrong or insufficient information, or poor procedures? Can procedures or training be improved?
 - Site profile: How does the incident affect the site profile? How are other site cleanup activities affected?
 - Community: How is community safety affected?
 - Liability: Who is liable for damage payments?

Documentation

The Project Team Leader should initiate the investigation and documentation of the incident. This is important in all cases, but especially so when the incident has resulted in personal injury, onsite property damage, or damage to the surrounding environment. Documentation may be used to help avert recurrences, as evidence in future legal action, for assessment of liability by insurance companies, and for review by government agencies. Methods of documenting can include a written transcript taken from tape recordings made during the emergency or a bound field book (not a looseleaf book) with notes. The document must be:

- Accurate: All information must be recorded objectively.
- Authentic: A chain-of-custody procedure should be used. Each person making an entry must date and sign the document. Keep the number of documenters to a minimum (to avoid confusion and because they may have to give testimony at hearings or in court). Nothing should be erased. If details change or revisions are needed, the person making the notation should mark a horizontal line through the old material and initial the change.

- Complete: At a minimum, the following should be included:
 - Chronological history of the incident.
 - Facts about the incident and when they became available.
 - Title and names of personnel; composition of teams.
 - Actions: decisions made and by whom; orders given: to whom, by whom, and when; and actions taken: who did what, when, where, and how.
 - Types of samples and test results; air monitoring results.
 - Possible exposures of site personnel.
 - History of all injuries or illnesses during or as a result of the emergency.

Reference

1. U.S. Department of Transportation. 1984. DOT 1984 Emergency Response Guidebook. DOT P5800.3. U.S. Department of Transportation, Washington, DC.