



Occupational Safety
and Health Administration

U.S. Department of Labor

www.osha.gov

Guidelines for Poultry Processing

OSHA 3213-09N
2004

Ergonomics for the Prevention of Musculoskeletal Disorders

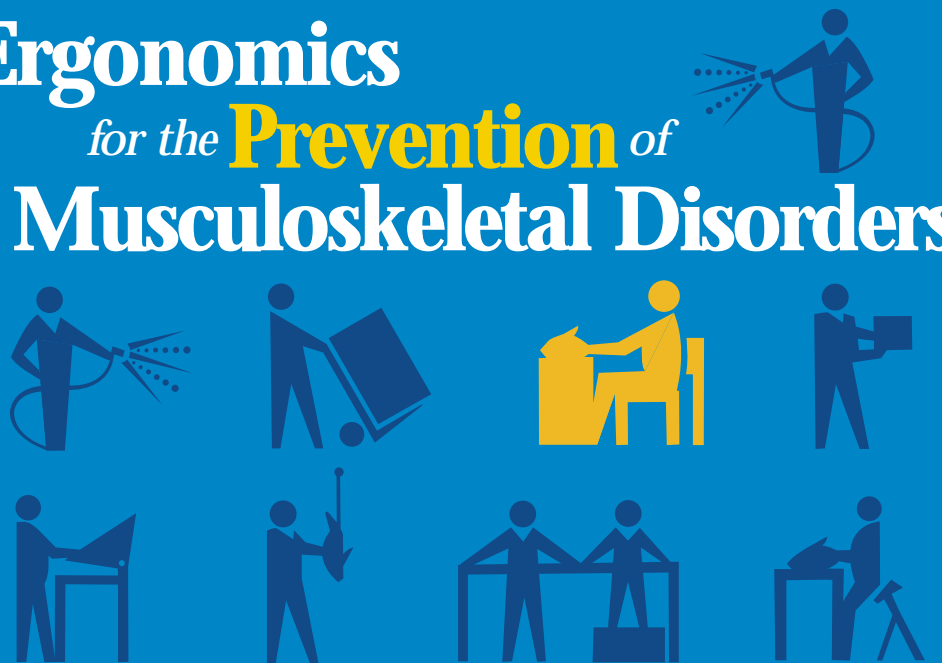



**Occupational Safety
and Health Administration**

U.S. Department of Labor

www.osha.gov

OSHA's role is to assure the safety and health of America's workers by setting and enforcing standards; providing training, outreach and education; establishing partnerships; and encouraging continual improvement in workplace safety and health.



**Occupational Safety
and Health Administration**

U.S. Department of Labor

www.osha.gov

Guidelines for Poultry Processing

Ergonomics for the Prevention of Musculoskeletal Disorders

U.S. Department of Labor

Occupational Safety and Health Administration

OSHA 3213-09N

2004

Contents

Executive Summary	3
Introduction	4
Ergonomics Process	5
Providing Management Support	5
Involving Employees	5
Providing Training	5
Identifying Problems	7
Implementing Solutions	8
Addressing Reports of Injuries	8
Evaluating Ergonomics Efforts	9
Implementing Solutions	10
Workstations	11
Tools	16
Manual Materials Handling	18
Personal Protective Equipment	21
Additional Sources of Information	22
References	23

Executive Summary

These guidelines provide recommendations for poultry processing facilities to reduce the number and severity of work-related musculoskeletal disorders (MSDs). In preparing these recommendations, OSHA reviewed existing practices and programs as well as available scientific information on ergonomics, and reflected comments received from representatives of trade and professional associations, labor organizations, individual firms and other interested parties. These guidelines are designed specifically for the poultry processing industry; however, other industries may find the recommendations and solutions presented useful.

More remains to be learned about the relationship between workplace activities and the development of MSDs. However, OSHA believes that the experiences of many poultry processing facilities provide a basis for taking action to better protect workers. As the understanding of these injuries develops and information and technology improve, the recommendations made in this document may be modified.

These guidelines are drawn in part from OSHA's *Ergonomics Program Management Guidelines for Meatpacking Plants* (meatpacking guidelines). Employers and employees in the poultry processing industry have told OSHA that many of the elements of the meatpacking guidelines have been successfully implemented in a number of poultry processing facilities. These stakeholders suggested that this document reflect the meatpacking guidelines to avoid disrupting the effective programs employers have already

implemented. While the two guidelines are similar, they also differ in some respects. The poultry guidelines include more examples of practical ergonomic solutions than the meatpacking guidelines do, use the terms "musculoskeletal disorder" and "MSD" instead of "cumulative trauma disorder" and "CTD", and are formatted to closely resemble OSHA's more recent ergonomics guidelines.

The heart of these guidelines is the description of various solutions that have been implemented by poultry processors. OSHA recommends that poultry processors consider these solutions in the context of a systematic process that includes the elements described in the pages that follow. Such a process will make it more likely that the solutions implemented in a particular workplace will be successful in reducing injuries and will be cost effective.

OSHA recognizes that small employers in particular may not have or need as comprehensive a process as would result from implementation of every action described in this document. OSHA also realizes that many small employers may need assistance in implementing an appropriate ergonomics process and wants them to know that the free OSHA consultation service is available to help them with ergonomics and other safety and health issues. The consultation services are independent of OSHA's enforcement activity. Information about the OSHA consultation service can be found on OSHA's website at www.osha.gov.

These guidelines are advisory in nature and informational in content. They are not a new standard or regulation and do not create any new OSHA duties. Under the OSH Act, the extent of an employer's obligation to address ergonomic hazards is governed by the general duty clause. 29 U.S.C. 654(a)(1). An employer's failure to implement the guidelines is not a violation, or evidence of a violation of the general duty clause. Furthermore, the fact that OSHA has developed this document is not evidence of an employer's obligations under the general duty clause; the fact that a measure is recommended in this document but not adopted by an employer is not evidence of a violation of the general duty clause. In addition, the recommendations contained herein were developed with the idea that they could be adapted to the needs and resources of each individual place of employment. Thus, implementation of the guidelines may differ from site to site depending on the circumstances at each particular site.

Introduction

In the mid-1980s, the poultry processing industry began to focus on the problem of work-related musculoskeletal disorders (MSDs). MSDs include injury to the nerves, tendons, muscles and supporting structures of the hands, wrists, elbows, shoulders, neck and low back (1, 2). In 1986, members of the poultry processing industry developed a guideline advocating training, the process of ergonomics and medical intervention as a means to reduce the occurrence of MSDs and their associated costs (3).

In August 1993, OSHA published its *Ergonomics Program Management Guidelines for Meatpacking Plants* (meatpacking guidelines) (4). The meatpacking guidelines specifically recommended that employers implement an ergonomics process to identify and correct ergonomics-related problems in their worksites. While the meatpacking guidelines were directed primarily to meatpacking plants, many poultry processing facilities initiated ergonomics programs based upon the recommendations contained in the meatpacking guidelines.

The poultry processing industry has reduced occupational injuries and illnesses by almost half over the last 10 years (5). Despite these efforts, MSDs are still prevalent in the poultry processing industry. According to the Bureau of Labor Statistics, of the 3,000 cases with days away from work that occurred in 2002, over 30% (976 cases) involved MSDs (6, 7). Many poultry processing jobs involve physically demanding work. Some poultry workers make over 25,000 cuts per day processing chickens and turkeys.

These processing tasks involve factors, including repetition, force, awkward and static postures and vibration, which have been identified as increasing the risk of incurring injury. Many of the operations in poultry processing occur with a chilled product or in a cold environment. Cold temperatures in combination with the risk factors may also increase the potential for MSDs to develop (1). Excessive exposure to these risk factors can lead to MSDs (2).

In these guidelines, we use the term MSD to refer to a variety of injuries and illnesses that occur from repeated use or overexertion, including:

- Carpal tunnel syndrome;
- Tendinitis;
- Rotator cuff injuries (a shoulder problem);
- Epicondylitis (an elbow problem);
- Trigger finger; and
- Muscle strains and low back injuries.

Employers should consider an MSD to be work-related if an event or exposure in the work environment either caused or contributed to the MSD, or significantly aggravated a pre-existing MSD as required by OSHA's recordkeeping rule (29 CFR 1904). For example, when an employee develops carpal tunnel syndrome, the employer needs to look at the hand activity required for the job and the amount of time spent doing the activity. If an employee develops carpal tunnel syndrome and his or her job requires frequent hand activity, or forceful exertions or sustained awkward hand positions, then the problem may be work-related. If the job requires very little hand activity, then the disorder may not be work-related.

Activities outside of the workplace that involve substantial physical demands may also cause or contribute to MSDs (1). In addition, development of MSDs may be related to genetic causes, gender, age and other factors (1). Finally, there is evidence that reports of MSDs may be linked to certain psychosocial factors such as job dissatisfaction, monotonous work and limited job control (1, 2). These guidelines address only physical factors in the workplace that are related to the development of MSDs.

These guidelines present recommendations for the workplace and work practices with the goal of reducing work-related MSDs. Poultry processors can usually meet this goal by changing work methods, equipment, or workstations. Many changes can be made without significantly increasing costs and many ergonomic changes result in increased efficiency by reducing the time needed to perform a task. Many poultry processing companies have already instituted programs that reduce MSDs, reduce workers' compensation costs and improve efficiency (8, 9).

Ergonomics Process

Many employers in the poultry processing industry have implemented OSHA's recommendations contained in the 1993 meatpacking guidelines. OSHA does not intend for these guidelines to disrupt the effective programs employers have established based on those recommendations. However, these guidelines are specifically tailored to poultry processing operations and update and expand on the meatpacking guidelines while remaining consistent with them. For example, the Implementing Solutions section below describes some specific solutions that poultry processing employers can consider implementing in their facilities. These solutions reflect the over 10 years of innovation in poultry processing since the meatpacking guidelines were published. At the same time, these guidelines provide some additional information that is specifically tailored to the jobs and processes in the poultry processing industry. For example, in the Implementing Solutions section below, OSHA describes 22 specific solutions that poultry processing employers can consider implementing in their facilities.

Providing Management Support

Strong management support is critical to the effective implementation of the ergonomics process. OSHA recommends that management support be visible to all employees. In general, management can provide visible support by:

- Consistently communicating the importance of employee safety and health;
- Assigning and communicating responsibility for the various aspects of the ergonomics process to appropriate managers, supervisors and other employees;
- Committing adequate resources to the ergonomics process;
- Integrating production processes and production improvements with safety and health concerns; and
- Ensuring that all managers and employees are accountable for carrying out their responsibilities under the ergonomics process.

"The red meat guidelines have been, and continue to be, a reliable set of tools in [MSD] management." Tyson Foods (10).

Involving Employees

An effective ergonomics process also includes active employee involvement. Involving employees provides additional problem-solving capabilities and hazard identification assistance to the ergonomics process. Involving employees in the ergonomics process also leads to greater acceptance when workplace modifications are made. The following are some ways to involve employees in the ergonomics process:

- Implement a procedure that encourages prompt and accurate reporting of MSDs as well as of their early indications.
- Develop a system to engage employees in the design of work, equipment and procedures, the reporting of workplace hazards, and training.
- Establish an employee complaint or suggestion procedure designed to allow employees to raise ergonomic issues without fear of reprisal.
- Request employee feedback on workplace modifications.
- Form employee groups to identify problems, analyze tasks and recommend solutions.

"The impact of our Ergonomics Program on our workforce has been huge. The program has provided the platform to help us reduce our incident rate and lost time rate over the last three years." ConAgra Foods, Refrigerated Foods Group, Turkey Business Unit (11).

Providing Training

Training is also an important element of the ergonomics process. Training ensures that

employees are informed about ergonomic concerns in the workplace and how to minimize the risk of injury. Training should be provided by individuals who have experience in ergonomics in the poultry processing industry. Training should also be provided in a manner and language that all employees can understand.

OSHA recommends that all employees receive general training on ergonomic issues. This training can be integrated into initial safety and health training. In general, this training should include:

- The procedures for reporting work-related injuries and illnesses as required by OSHA's injury and illness recording and reporting regulation (29 CFR 1904);
- The company's ergonomics process;
- How to identify ergonomic risk factors;
- The policies and procedures for avoiding injury, including proper work practices and use of equipment;
- How to recognize MSDs and their early indications; and
- The advantages of addressing early indications of MSDs before serious injury has developed.

OSHA also recommends that poultry processing employees receive job-specific training on ergonomic issues. At a minimum, OSHA recommends that the following employees receive such training: employees at risk of injury, supervisors, managers, engineers and maintenance personnel, as well as health care providers.

Employees at Risk of Injury

In addition to the general training, OSHA recommends that employees at risk of injury receive hands-on ergonomics training prior to being placed in a full-time production job. Many poultry processing facilities already use dedicated process lines for the purpose of providing hands-on training to new or reassigned employees. These training lines are an ideal setting to provide ergonomics training to workers. At a minimum, OSHA recommends that these employees be trained in the following areas:

- Care, use, and handling techniques for knives;
- Use of any special tools and devices;
- Use of safety equipment, including personal protective equipment (PPE), as they relate to MSD prevention (such as the proper fit of gloves); and
- Use of proper lifting techniques and lifting devices.

Supervisors

In order to effectively manage the ergonomics process and to ensure that all employees are following safe work practices, supervisors should receive the same training as the employees at risk of injury. OSHA recommends that supervisors receive additional training on how to recognize hazardous work practices, how to correct such practices, how to ensure the ergonomics process is effectively implemented and how to track ergonomic corrections. Supervisors should also be instructed on how to determine if employees need additional training in safe work practices, and how to monitor workers on restricted duty.

Managers

Managers must be familiar with the ergonomics process and their responsibilities in that process. OSHA also recommends that managers receive sufficient training in the ergonomic issues associated with their areas of responsibility, so that they can effectively implement the ergonomics process.

Engineers and Maintenance Personnel

OSHA recommends that these personnel be trained in how to prevent and correct ergonomic problems through job and workstation design and proper maintenance. OSHA recommends that plant engineers and maintenance personnel be trained in the ergonomic issues associated with the tools used in their job tasks.

Health Care Providers

Many poultry processors employ health care providers to deliver occupational health services. OSHA recommends that these health care

providers receive training in the prevention, early recognition, evaluation, treatment, and rehabilitation of MSDs. OSHA also recommends that these health care providers be familiar with the various jobs in the poultry processing facility so that they are aware of the types of ergonomic problems employees may face when performing certain job tasks.

Identifying Problems

OSHA recommends that poultry processing facilities establish a three-step process to systematically identify ergonomic problems. This process should account not only for current workplace conditions, but also for planned changes to existing and new facilities, processes, materials, and equipment. The three-step process for identifying ergonomic problems in poultry processing facilities includes:

- Gathering information from available sources;
- Conducting initial workplace surveys to determine which jobs need a closer analysis; and
- Performing ergonomic job hazard analyses of those workstations with identified risk factors.

Gathering Information from Available Sources

The first step in identifying ergonomic problems should be a review and analysis of available information. Information about problems or potential problems can be obtained from a variety of sources, including the OSHA 300 and 301 reports, first aid logs, reports of workers' compensation claims, accident and near-miss investigation reports and insurance company reports. Employers can also gain useful information from employee interviews and surveys, as well as from reviews and observations of workplace conditions.

Conducting an Initial Workplace Survey

The second step is to conduct an initial workplace survey. An initial workplace survey is typically performed with an ergonomics check-

list to look for relevant workplace risk factors. According to poultry processing employers (8), the most important risk factors in poultry processing facilities are:

- Repetition – performing the same motion or series of motions continually or frequently.
- Force – the amount of physical effort required to perform a task (such as heavy lifting) or to maintain control of equipment or tools.
- Awkward and static postures – assuming positions that place stress on the body, such as reaching above shoulder height, kneeling, squatting, leaning over a worktable, twisting the torso while lifting, as well as holding or using tools (e.g., knives or scissors) in a non-neutral or fixed position.
- Vibration – utilizing hand-held power tools that can increase the stress on the hands and arms.

Cold temperatures in combination with the above risk factors may also increase the potential for MSDs to develop (1). Many of the operations in poultry processing occur with a chilled product or in a cold environment.

Not all of these risk factors will be present in every job, nor is the existence of one or all of these factors necessarily sufficient to cause injury. Employers, however, should examine these factors when screening and analyzing jobs, operations, or workstations to determine which risk factor(s) is present. Jobs and tasks that have multiple risk factors have a higher probability of causing MSDs (2).

Performing Ergonomic Job Hazard Analyses

The third step is to conduct a job hazard analysis of those jobs identified above as potentially hazardous. In many cases, job assessments can be accomplished by observation and discussing with employees the tasks they are performing. Discussing tasks with employees helps to ensure that a complete picture of the process is obtained. An adequate analysis should identify all risk factors present in each studied task (12).

Implementing Solutions

Examples of potential solutions for various concerns are included in the Implementing Solutions section of these guidelines. Poultry processors may need to modify workstations, purchase equipment, and change work practices to achieve their ergonomic goals. Simple, low-cost solutions are often available to solve problems. For example, carts or cut outs can be used to reduce exposure to risk factors. Employers should consider ergonomic issues when designing new plants or redesigning existing plants. At that time, major changes are easier to implement, and ergonomic design elements can be incorporated at little or no additional cost.

Addressing Reports of Injuries

Even in poultry processing facilities with effective safety and health programs, injuries and illnesses may occur. Early reporting, diagnosis, and intervention can limit injury severity, improve the effectiveness of treatment, minimize the likelihood of disability or permanent damage, and reduce workers' compensation claims (3, 9, 12). Many employers have found that early reporting, combined with appropriate medical treatment and/or work restrictions, can help employees recover fully without more serious and costly consequences (3, 9, 10, 12). OSHA's injury and illness recording and reporting regulation (29 CFR 1904) requires employers to keep records of work-related injuries and illnesses. Employees may not be discriminated against for reporting a work-related injury or illness (29 U.S.C. 660(c)).

OSHA recommends that employers implement a process that addresses the following areas:

- ***Injury and illness recordkeeping.*** Complete, descriptive, and accurate injury and illness records can be used to identify problem areas and evaluate progress.
- ***Early recognition and reporting.*** Early reporting of potential MSD problems provides an opportunity to assess possible problems and take action before injuries and illnesses occur (3, 10, 12, 13).
- ***Systematic evaluation and referral.*** Some employers have found that a defined process or protocol for evaluating employee reports, providing conservative treatment and work restrictions, and referring employees for medical attention provides an effective and consistent approach for minimizing the severity of MSDs (3, 8, 10, 12).
- ***Conservative treatment.*** If provided early in the development of an MSD, conservative treatment may eliminate the need for more invasive medical procedures. Conservative treatment may include rest, hot or cold therapy, nonsteroidal anti-inflammatory agents, exercise, or night splints, depending on the nature and severity of the problem (3, 10, 13).
- ***Conservative return to work (restricted duty).*** Restricted work or light duty are among the most helpful treatments for MSDs. These assignments, if properly selected, allow the worker to continue to perform productive work for the employer while continuing to ensure recovery. Some MSDs require weeks (or months, in rare cases) of restricted work to allow for complete recovery (3, 10, 12).
- ***Systematic monitoring.*** Systematic follow-up of employee reports provides an opportunity to reinforce good work practices, modify conservative treatment plans, adjust work restrictions, or refer the employee for medical attention (3, 12).
- ***Medical resources.*** Employing health care professionals, or establishing permanent relationships with outside health care professionals, allows the employer to quickly and effectively respond to employee reports,

"Effective medical management, especially early intervention, can virtually remove severity in work-related [MSDs]." Tyson Foods (10).

evaluate employees, make referral recommendations, provide treatment and monitor the recovery of injured employees (3, 10, 12).

Of these, early reporting of signs and symptoms of MSDs and conservative return to work programs are particularly important. OSHA recommends employers encourage employees to report early indications of MSDs before more serious MSDs develop.

Some poultry processing facilities employ a health care professional with training in the prevention and treatment of MSDs to receive and address reports of injuries. Some of these facilities report that they fully integrate the health care professional into their ergonomics efforts. OSHA recommends that these health care providers, at a minimum, conduct periodic, systematic workplace walkthroughs to remain knowledgeable about operations and work practices at the workplace, to identify potential light duty jobs and to maintain close contact with the employees.

Evaluating Ergonomics Efforts

Procedures and mechanisms to evaluate the implementation of the ergonomics process and to monitor progress are also important. Evaluation and follow-up are central to continuous improvement and long-term success. OSHA recommends that the ergonomics process be regularly evaluated to determine whether it is meeting its goals and objectives. Such evaluations should include input from managers, supervisors, and employees who review the goals and objectives identified, suggest changes in the program, and evaluate the effectiveness of implemented solutions. Evaluation techniques can include methods such as:

- Trend analysis of injury and illness rates and workers' compensation reports;
- Employee surveys and interviews; and
- Surveys of job/worksites changes.

Any deficiencies identified through the evaluation should be addressed.

Implementing Solutions

The ergonomic solutions for poultry processing include engineering changes to workstations and equipment, work practices, personal protective equipment (PPE), and administrative actions. The recommended solutions presented in the following pages are not intended to be an exhaustive list, nor does OSHA expect that all of them will be used in any given facility. Poultry processing facilities are encouraged to develop innovative ergonomic solutions that are appropriate to their facilities. As with the meatpacking guidelines, OSHA recommends that employers use engineering techniques, where feasible, as the preferred method of dealing with ergonomic problems in poultry processing facilities. However, OSHA recognizes that a variety of solutions may be needed in any given facility.

OSHA recommends that employers train employees to use proper work practices. Proper work practices include proper use and maintenance of pneumatic and power tools, good cutting techniques, proper lifting techniques and good knife care. Using and maintaining effective PPE is also important. For example, good fitting thermal gloves can help with cold conditions while maintaining the ability to grasp items easily.

Many poultry processors have found that administrative solutions can be used to reduce the duration, frequency, and degree of exposure to risk factors. Some examples of administrative solutions used effectively by poultry processors follow:

- Job rotation may alleviate physical fatigue and stress of a particular set of muscles and tendons. To set up a job rotation system, employers typically classify the nature and extent of exertions of each task, and then create a schedule that rotates between high and low repetitions within the line and/or between bending and stretching movements in the same work area or whole plant as appropriate to reduce exposure. Also consider the body parts used and rotate so that body parts used repetitively or in awkward postures can either rest completely or work at slower rates and in better postures. Use a rotation schedule to address tasks considered to be high risk

(e.g., using vibrating hand tools or deboning activities) or to minimize exposure to cold.

- Staffing “floaters” provide periodic breaks between scheduled breaks.
- New employees, reassigned employees, employees returning from an extended time off for vacation or some other purpose in poultry processing facilities often will need a conditioning, or break-in period to get them accustomed to an activity and strengthen them for the physically demanding work they will be performing. To accommodate this, OSHA recommends that new and reassigned employees be gradually integrated into a full workload. OSHA also recommends that employees be assigned to an experienced trainer for job training and evaluation during the conditioning period.
- Allowing pauses relieves fatigued muscles and allows employees to rest affected muscle groups during that time period.
- Cross-train employees so that sufficient support is available for peak production, to cover breaks, to institute job enlargement programs and to provide additional rotation alternatives.
- Performing routine and preventive maintenance on equipment assures that the equipment is working properly.

When combined with exposure to other risk factors, cold can increase the risk of developing an MSD. Employers typically limit cold exposure by providing a warm, dry area and allowing frequent, short breaks to allow workers to warm up. It is also important to use appropriate clothing and personal protective equipment when working in cold environments.

The solutions on the following pages are not intended to be an exhaustive list, and are only examples of ergonomic solutions. Individual poultry processing facilities should try to use these ideas as a starting point as they look for other innovative methods that will meet their facility’s needs.

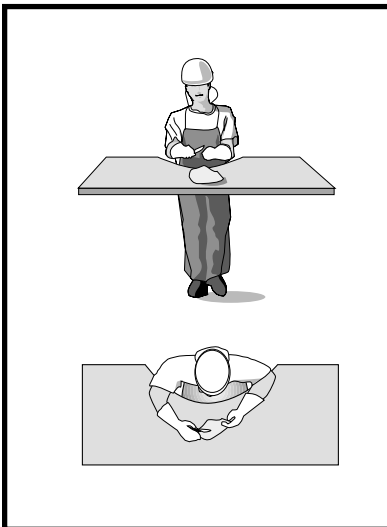

WORKSTATIONS - Cut Outs

DESCRIPTION:

Removal of a section of work surface to allow the employee to get closer to items located at the workstation.

WHEN TO USE:

Where excessive leaning or reaching is required to access material at a workstation.

POINTS TO REMEMBER:

- Placing items closer to the employee minimizes excessive reaching and bending. Maximum reach should not exceed arm's length with the torso upright.
- Placing the employee closer to the work through recessed designs at the knee and foot also reduces reaching and bending.
- Providing cutouts can increase the amount of useable space for placement of poultry parts, tools, supplies and other items.
- Ensure that workstation edges are rounded to avoid discomfort from direct contact.

WORKSTATIONS - Baggers and Other Packaging Systems

DESCRIPTION:

Mechanisms and fixtures used to place whole birds or poultry products into packaging, and packages into shipping containers.

WHEN TO USE:

When packaging, finished product.

POINTS TO REMEMBER:

- Auto baggers allow whole birds or parts to slide sideways or vertically into bags. These systems may automatically count or weigh parts for inventory needs.
- Semi-automated systems may require manual placement of the bag while products drop or slide into the bag, and may use a fan to automatically open bags in preparation for loading.
- Filled bags may be automatically crimped or fastened closed.
- Many systems are designed to allow employees to alternate hands.
- A hoist system is recommended to reload plastic film.
- If a hand scoop is used, it should have a bent handle to keep the wrist in a neutral posture. The handle should be rubber or roughened plastic for easier grip.
- Packaged meats may be dropped directly into packing boxes and then sent to autopackers for sealing, labeling and palletizing.

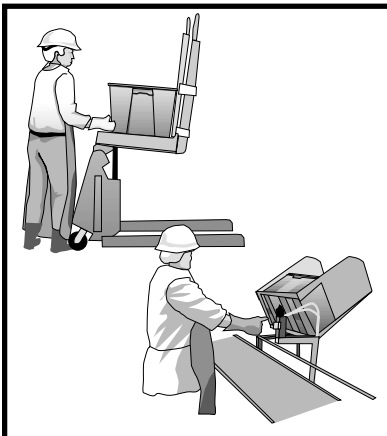
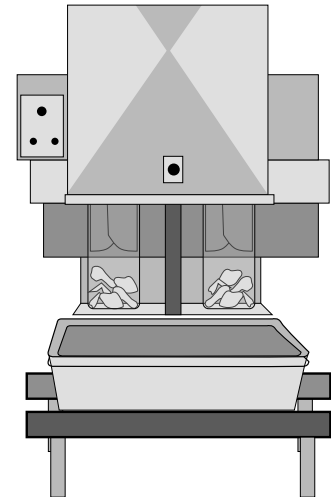

WORKSTATIONS - Tilters and Dumpers

DESCRIPTION:

Mechanical device that tilts or inverts a container in order to release its contents.

WHEN TO USE:

For unloading the contents of a container into a machine, new container, waste receptacle, or onto a workstation.

POINTS TO REMEMBER:

- May eliminate the need for shoveling, especially for ice.
- The position of the tilter or dumper can be adjusted to minimize bending and reaching.
- Use wheeled carts to transfer containers to the tilter or dumper.

WORKSTATIONS – Chutes

DESCRIPTION:

Tunnel-type mechanism attached to a hole in the workstation surface into which poultry parts or other items can be dropped and transported.

WHEN TO USE:

For transport of separated poultry parts or other items. Items may drop directly into a container or into a vacuum system for transport.

POINTS TO REMEMBER:

- Chute openings should be appropriate to the size of the part handled, so it does not interfere with the processing task, and does not require extended reach.
- Delivering and placing parts closer to the employee minimizes excessive reaching and bending. Maximum reach should not exceed arm's length with the torso upright.



WORKSTATIONS – Diverters

DESCRIPTION:

Mechanical device that directs material on a conveyor or slide.

WHEN TO USE:

Where excessive leaning or reaching is required to access material on a conveyor or slide.

POINTS TO REMEMBER:

- Delivering and placing parts closer to the employee minimizes reaching and bending. Maximum reach should not exceed arm's length with the torso upright.
- Can be adjusted to split poultry parts delivery onto either side of a conveyor, slide, or work area so that employees can work on both sides of the line.

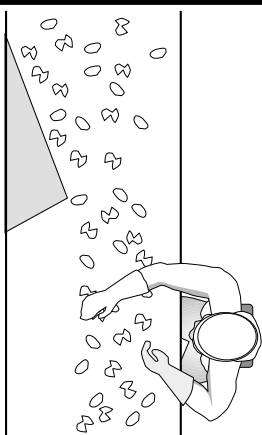

WORKSTATIONS – Scales

DESCRIPTION:

Embedded scales that incorporate weighing into the production process to eliminate unnecessary handling of poultry, poultry parts, processed meats, and waste.

WHEN TO USE:

When operations require that materials be weighed.

POINTS TO REMEMBER:

- A scale can be recessed into the floor so that carts can be rolled onto it for weighing without pushing carts uphill.
- Locate scales within easy reach, in the work area rather than at another work area behind the employee. Recess the scale to the same height as the countertop so that poultry can be placed on and removed from the scale without lifting.
- For boxed goods, a scale incorporated into the packing station can determine weight during initial loading and eliminate reweighing later.
- Scales can also be incorporated into conveyor and shackle systems.

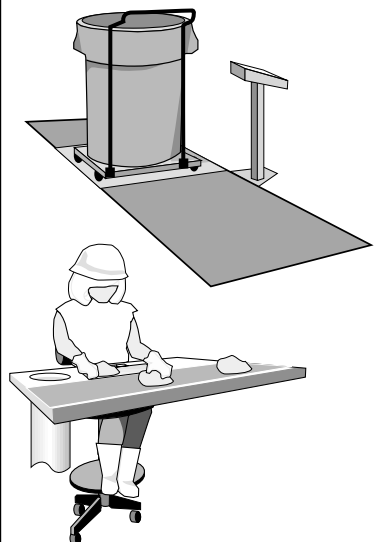

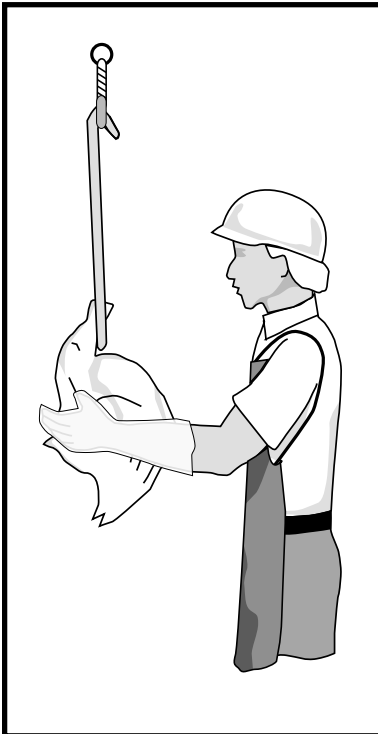

WORKSTATIONS – Shackles

DESCRIPTION:

Mechanical devices used to position and stabilize poultry parts for processing and transporting to other work areas.

WHEN TO USE:

In all hanging processes.

POINTS TO REMEMBER:

- Automatic rehangers can reduce manual handling associated with hanging birds.
- Provide a rack or other support surface to hold the weight of the bird so that the legs can be easily placed into the shackles.
- Ensure that shackle length can adequately hold the bird to minimize the need for rehanging.
- Consider a rail or guide bar behind the birds to minimize bird movement and reaching by employees.
- Orient shackles so employees have direct access with minimal forward reach and no trunk twisting, while holding and lifting the bird.
- Design the conveyor system to move the legs toward the shackle for easy placement into the shackle while supporting the weight of the bird. Preferably, the bird and shackles are automatically aligned.
- Provide adequate spacing between shackles to prevent birds from tangling. Adequate spacing of shackles may reduce rework and the need to separate birds.

WORKSTATIONS - Jigs, Fixtures, Mandrills, and Other Devices for Positioning Product

DESCRIPTION:

Mechanical devices used to position and stabilize poultry parts for processing.

WHEN TO USE:

In cutting and deboning operations where proper positioning of the product will minimize excessive use of force or awkward postures.

POINTS TO REMEMBER:

- Design a clamping device to hold the bird's breast securely when cutting or deboning, ensuring that the device does not damage the product. Once the bird has been stabilized, the employee is able to use a 2-handed method to pull meat off the bone. The device may be of mechanical or vacuum design.
- Clamps reduce gripping with the non-cutting hand. Height adjustability within the clamp allows the employee to work without awkward arm postures. Devices should be adjustable to at least 2 different angles to allow an in-line knife to be used without awkward arm postures.
- For tendon removal, the tip of the tendon can be placed into a vise that uses a mechanical arm to pull and separate it from the meat, leaving the meat in good condition. The vise reduces holding and pinching with the hand.

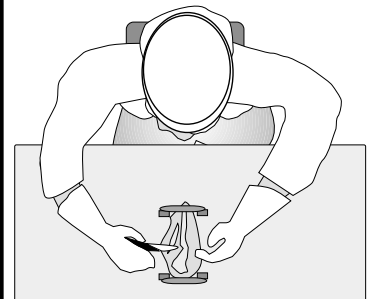

WORKSTATIONS - Seats, Stools, and Backrests

DESCRIPTION:

Support devices for employees at fixed workstations.

WHEN TO USE:

At all stationary sitting and standing positions.

POINTS TO REMEMBER:

- Selecting the most appropriate support device promotes neutral body postures and reduces fatigue during seated, sit/stand and standing tasks.
- The use of these devices should not result in extended forward reaching, bending, or trunk twisting.

Recommendations for Chairs:

- Chairs with backrests may be provided for tasks that require visual or tactile inspection as well as other disassembly or processing tasks. The chair should be adjustable to accommodate both the task being performed and the size of the employee.
- Tall chairs should include a mechanism for mounting and dismounting such as a footring. Prolonged use of a footring may obstruct bloodflow to the leg, therefore a footrest should be provided for long duration use.
- Footrest surface area should be deep enough to support the whole foot and large enough to allow some sideward and forward movement for position changes. Position the footrest to prevent an excessively bent or straight knee posture. A slight open angle of the knee is preferred. Height adjustability of the footrest is preferred. Select an adjustment mechanism that does not result in posture, force, or sanitation problems. Teach employees when and how to make proper adjustments.
- Where height adjustability is not provided, select at least 2 fixed height footrests to accommodate the smallest height person. Recess the upper footrest slightly so it does not become an obstacle for the lower footrest.
- Seat pan depth should support the thigh but should not touch the back of the knee.
- Seat angle should support the thigh evenly.
- The backrest should be height adjustable and large enough to support the upper and lower back. The shape of the backrest should provide support for the inward curve of the low back.
- Armrests may interfere with task requirements. Where used, armrests should be adjustable for height and width.

Recommendations for Sit/Stand Stools:

- A high stool or angled seat provides a surface on which the employee can lean, shift weight, and change trunk angle.
- With an angled seat, only leaning can occur. With a flat seat, the employee may plant one foot on the floor and rest the other thigh on the seat for support.
- The base should be fixed so that it does not move unintentionally.

Recommendations for Backrests or Leaning Devices:

- Another type of leaning device is an independent back support without a seat that is stationary, stable, and height adjustable. It should provide adequate support for both the upper and lower back. Provide clearance for required cleaning and sanitation. Many of the recommendations above also apply to backrests or leaning devices.
- Position the device to prevent forward trunk bending.
- Ensure clearance behind devices so as not to obstruct passage of other employees walking past the workstation.

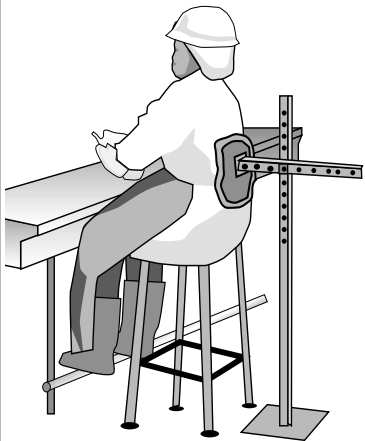

WORKSTATIONS – Rework

DESCRIPTION:

Designated workstation or work area designed for evisceration and cutting.

WHEN TO USE:

For damaged birds that require extra handling to remove unwanted parts.

POINTS TO REMEMBER:

- Transporting these poultry parts away from the normal processing line allows the employee adequate time to closely examine and remove unwanted parts without interrupting the line.
- Use pneumatic or mechanical cutting devices where appropriate to minimize hand forces.
- The use of fixtures and/or a slightly forward slanted table may be appropriate to position poultry parts so that work can be completed using neutral body postures.
- May be used as an alternative work area or part of rotation plan since work is self-paced and slower than conventional assembly lines.

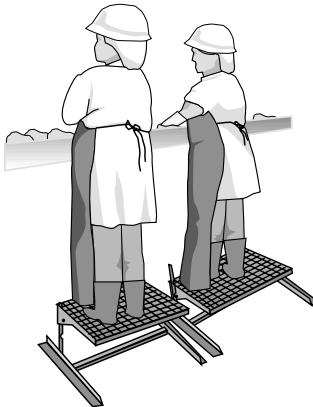
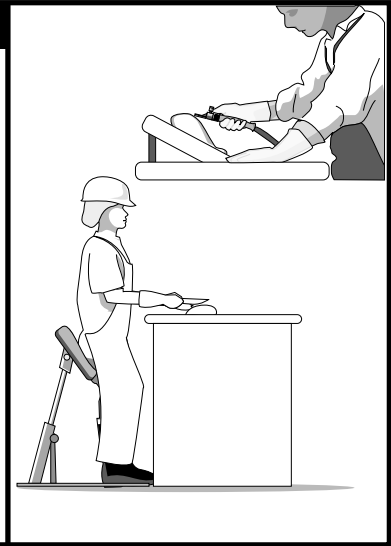

WORKSTATIONS - Workheight and Angle Adjustments

DESCRIPTION:

Properly adjusted work surfaces.

WHEN TO USE:

At all workstations.

POINTS TO REMEMBER:

- Proper workstation height minimizes excessive forward trunk bending and lifting of the arms when cleaning, preparing, and packing whole birds and poultry parts.
- Proper hand height improves comfort and productivity.

Table height recommendations:

- For close visual inspection, position table so that hands are slightly higher than elbow height and below shoulder level.
- For light assembly (e.g., placing parts in boxes) position table height so that hands are slightly below elbow height. (Note: Table height may need to be lowered further to accommodate the height of a packing box.)
- For work requiring heavy force (e.g., some cutting or deboning), the table should be below elbow height, unless close visual inspection is required.
- Powered adjustable height work surfaces that are positioned for use by individual employees can be spring-loaded or electrically powered by a motor.
- Tables designed for taller employees should have standing platforms or height adjustable features to accommodate shorter employees. Teach employees how and when to adjust height. Provide adjustment controls that can be operated without causing a posture, force, or sanitation problem.

Floor design recommendations:

- Provide standing platforms to prevent reaching above shoulder height.
- Provide adequate clearance so employees can take a step sideways along the conveyor when necessary and so the whole foot is supported when placed slightly forward or behind the body.
- A railing on the back edge of the platform that is open on both ends may be added to reduce fall hazards. Provide a platform depth that allows unobstructed passage behind employees when they are at their workstations.
- Provide non-slip flooring in areas that become wet or soiled with animal fat.
- Use perforated rather than slatted flooring where possible. Where slats are used, they should be flat and wide to minimize pressure points on the feet.
- Non-slip anti-fatigue mats that can be easily removed for cleaning may be added to solid floor for comfort.

TOOLS - Handle and Design

DESCRIPTION:

Designs that minimize exposure to risk factors when using hand tools.

WHEN TO USE:

For all hand tool applications.

POINTS TO REMEMBER:

- Handles should be perpendicular to the line of action, of adequate diameter to allow a power grip, extend at least the length of the palm, and have a non-slip surface.
- Angled and pistol grip handles are advised for cuts made with a downward stroke. These knives may not be widely used, however they keep the wrist in neutral while allowing for sufficient downward force to make a smooth cut.
- Inline handles are best for horizontal cuts (e.g., when parts are resting flat on a tabletop).

Temperature and vibration:

- Handles should help prevent transmission of cold from the tool to the hand and should work well when wet or covered with slippery material.
- Dead blow hammers partially filled with shot reduce repercussion into the hand.

Handle dimensions:

- Tools should comfortably fit the employee's hand (not too wide or too narrow).
- Length should be slightly longer than the palm with or without gloves.

Handle options:

- Heavy tools should have 2 handles or be suspended or counterbalanced.
- A wraparound handle allows the tool to stay on the hand with minimal effort.
- A handle guard may be added to certain tools to prevent the hand from slipping forward onto the blade.

Reducing force:

- Keep finger pinch to a minimum, especially for repetitive work.
- Textured handles improve grip, reduce hand force and should be washable in warm water to remove grease build-up.
- Avoid concentrated pressure on small parts of the fingers (e.g., forceful opening of scissors) or on the palm of the hand.

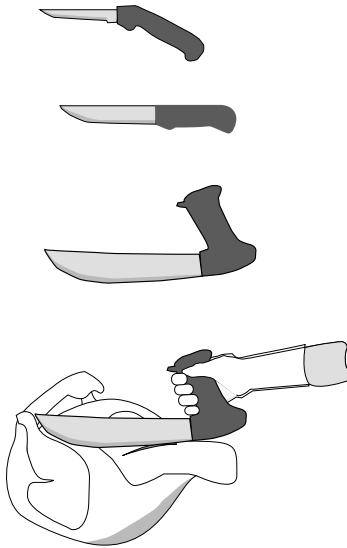

TOOLS - Spray Nozzles

DESCRIPTION:

Designs that minimize hand force.

WHEN TO USE:

For all sanitation operations using spray nozzles for long time periods.

POINTS TO REMEMBER:

- Avoid single finger activation, especially using the index finger.
- Investigate options for hand actuators that are compatible with the shape, width, and size of the hand.
- Provide swivel handles for hoses such as those used for water.
- Provide pistol grip handles for spraying high-pressure hoses.
- Use the entire finger rather than just the fingertip to activate the trigger, minimizing tendon irritation.
- Consider systems that can be activated by either the hand or foot so the employee can switch at will when fatigue occurs.

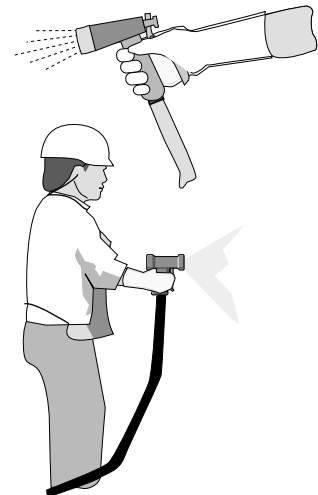

TOOLS - Selection

DESCRIPTION:

Powered and manual tools for cutting, deboning and other operations.

WHEN TO USE:

For nearly all tasks in poultry processing, including evisceration, venting, deboning, filleting, peeling gizzards, and separation of internal organs.

POINTS TO REMEMBER:

- Hand tools should be selected so that handle angle allows the wrist to work in a neutral posture.
- The addition of a universal joint between handle and blade may improve wrist posture.
- Spring-loaded handles eliminate thumb force required to open blades for sequential cuts.
- Spring force should be designed to minimize hand fatigue.
- A circular or electric saw is effective for cutting whole birds and breasts in half.
- Powered (pneumatic) or spring-loaded shears and pneumatic wheels with blades or manual knives are preferred for cutting smaller parts (e.g., trimming and eviscerating).
- Shears are preferred for heart and liver removal.
- Knives are preferred for deboning and filleting.
- A specialized tool has been developed for cleaning gizzards (a powered hand-held device with a small bladed wheel).
- An inline thigh popper reduces required hand forces when compared to the traditional manual technique.

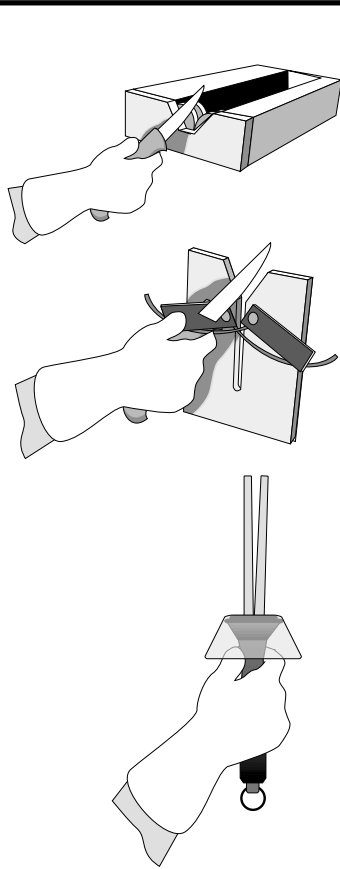
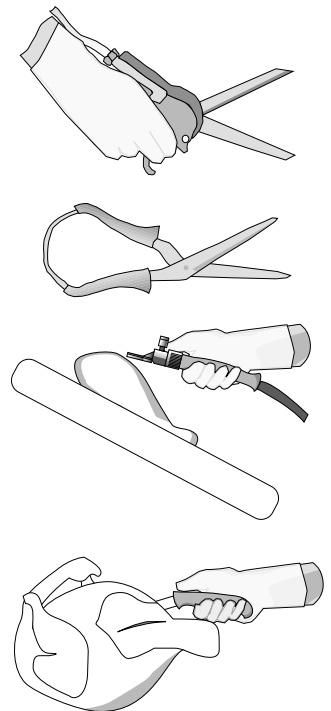

TOOLS - Use and Care of Knives, Saws, and Scissors

DESCRIPTION:

Procedures for maintaining knives, saws, and scissors in optimal functioning condition.

WHEN TO USE:

For all knife, saw, and scissors use.

POINTS TO REMEMBER:

- The sharper the edge, the lower the force (and possibly repetitions) required to complete the task. Sharpening blades is a highly skilled task that requires specialized training and is usually completed away from the production area. Options for maintaining a sharp edge include having several knives assigned to an employee, trading out knives quickly and easily, and keeping the blade free of metal fragments or burrs.
- Keeping the blade free of metal fragments or burrs requires constant attention. Employees may be taught to manually "steel" or use a mousetrap for deburring or removing metal fragments. These fragments make it harder to cut product and may even cause damage. Both methods of deburring require running the full length of the blade edge along a honing stone or other file-type mechanism. Manual steeling is a two-handed operation requiring the employee to hold the honing mechanism in one hand and knife in the other, both unsupported. A customized tool can be developed that has one straight handle and two in-line steels positioned to ensure that the knife contacts both steels evenly. The mousetrap (with attached honing mechanism) is fixed to a stationary surface (such as a table or rail) or portable surface (such as a scabbard) and requires only a one-handed operation.
- Deburr or change knives if product damage becomes apparent, an increase in muscle force is required, or if the blade contacts bone, glove, or other hard objects.

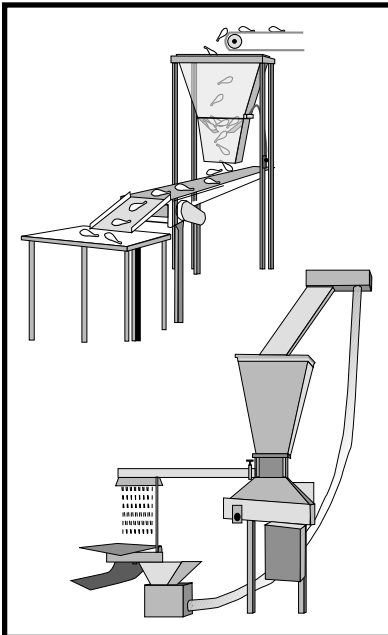

MANUAL MATERIALS HANDLING - Hoppers and Augers

DESCRIPTION:

Container used to hold and dispense contents into a machine, a new container, or onto a workstation through an open gate or using a screw-type mechanism.

WHEN TO USE:

When storage of product or other items is required at a workstation.

POINTS TO REMEMBER:

- Hoppers are generally preferred for dispensing larger objects such as poultry parts, whereas augers are generally preferred for smaller product such as ice, spices, and tenderizers in predetermined quantity to match recipe or packaging units.
- Hoppers are loaded from the top of the unit and have a gate to drop contents in bulk or pre-measured quantities, whereas augers have screw-type mechanisms that lift smaller particles from a transport container and dispense in pre-measured quantities.
- Operation can be automatic or employee initiated with activation controls located to avoid reaching and bending.
- May replace the need for shoveling, especially for ice.
- To load hoppers and avoid additional lifting, consider devices such as mechanical lifters, dumpers, augers, and conveyors.

MANUAL MATERIALS HANDLING - Carts and Hand Trucks

DESCRIPTION:

Wheeled devices designed to transport materials.

WHEN TO USE:

For transporting containers of whole birds, bird parts, processed meats, waste products, or supplies between work areas.

POINTS TO REMEMBER:

- A small lip around the edges is helpful to prevent items from slipping off.
- Ensure that the top stack height does not obstruct vision.
- Optimal shelf height range should be between knuckle (with arms at side) and shoulder height.
- Pushing is preferred to pulling.
- Balance loads and keep loads within manufacturer's weight restrictions.
- Handles that are vertical, with some horizontal adjustability, will allow all employees to push with hands at elbow height and shoulder width apart. A swing-out design may be useful to improve access.
- Manually pushed carts and hand trucks should have full bearing wheels made of a material designed for the floor surface in the facility as well as brakes that are easy to operate. Brakes prevent unintentional movement of the cart or hand truck when left unattended or when loading. Larger wheels are generally easier to push. Rear swivel and front fixed wheel design improves ease of pushing, especially if the cart is long. In some designs, a third set of non-swivel wheels is placed centrally to add stability and improve ease of turning.
- Carts may be designed for general use or for specialized applications. Specialty carts that have contours or clamps to hold specific supplies (e.g., rolls of plastic) may be designed to aid in supply transfer directly to the machine or work surface that uses that product.
- Large bucket-type containers on carts should have an angled front to allow tipping for removal of contents (e.g., utility tilt trucks).
- Lift tables and height adjustable pallet stands that rotate allow parts and supplies to be positioned at proper working heights. They may be used in conjunction with staging for vacuum systems and a variety of other workstations. These devices improve working posture by reducing unnecessary bending and reaching.
- Pallet jacks may be manual or motorized. The motorized version is preferred for frequent or long-distance travel.



MANUAL MATERIALS HANDLING - Racks and Shelves

DESCRIPTION:

Rack and shelf design to optimize manual access.

WHEN TO USE:

Shelf systems can be configured to minimize excessive lifting, carrying, and awkward postures associated with storage of any item used or produced at a workstation.

POINTS TO REMEMBER:

- For items that will be manually lifted, shelf height should be from approximately knuckle (with arms at side) to shoulder height. Store heavy and frequently used items in this range. Storage of lightweight and infrequently used items above and below this range is acceptable. Labels on shelves may help to quickly and easily identify materials to be lifted or carried.
- Bulk packages of supplies that are transported by mechanical devices can be stacked and stored as needed. However, once packages are opened and removed manually, placement on shelves should follow the recommendations listed above.
- Avoid closely spaced shelves as they limit visual and hand access.

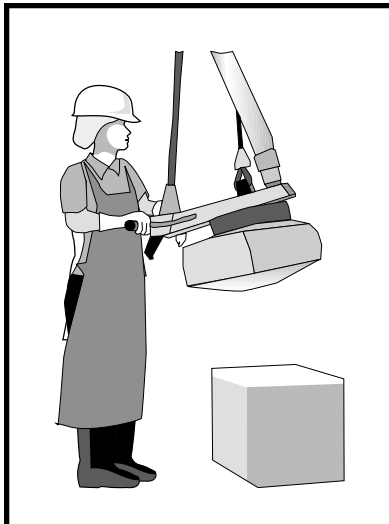

MANUAL MATERIALS HANDLING - Vacuum Systems

DESCRIPTION:

Vacuum systems for lifting and transport of materials.

WHEN TO USE:

Vacuum systems can be used for lifting and transporting poultry parts, boxes of product, spice bags, ice, and other materials. Applications of vacuum systems include:

- Lifting of individual boxes and placement onto racks or pallets for storage or transport.
- Vacuum systems connected to chutes or transport tubes can transport individual poultry parts or collect poultry parts in a container.

POINTS TO REMEMBER:

- Vacuum entry points can be placed at individual work areas to gather product for transport to chillers or other holding areas for further processing or packaging.
- Vacuum systems can be designed specifically to handle internal transport of hearts, livers, gizzards, and necks from harvesting area to giblet handling area.

MANUAL MATERIALS HANDLING - Belt and Overhead Conveyors

DESCRIPTION:

Mechanical systems such as belt-driven sheets of textured fabric or suspended shackles/hooks that continually move product.

WHEN TO USE:

For processing and cutting tasks, placing bags and smaller packages in boxes, and loading or unloading trucks. Eliminates lifting and carrying when transporting whole birds and parts through and between processing areas.

POINTS TO REMEMBER:

- Ensure that required forward reach does not extend beyond arm's length in front of the body.
- Overhead conveyors should be designed so that the employee can grasp birds without reaching higher than mid-chest level. This can be accomplished by lowering the line or providing access for employees at their work area.
- Belt conveyors should be installed so that employees can grasp birds or bird parts while keeping their elbows close to the torso. The conveyor speed should allow sufficient time for the task being performed.
- Conveyors can be designed to reorient birds or bird parts.

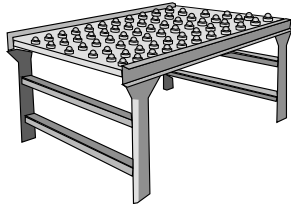
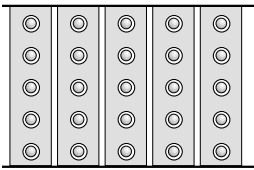
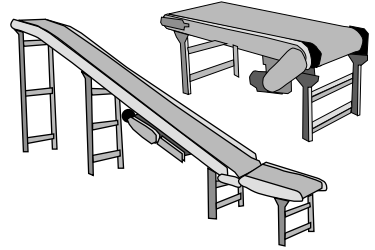

MANUAL MATERIALS HANDLING - Roller Tables

DESCRIPTION:

Tabletop or work surface embedded with rollers or ball bearings to reduce friction and force when sliding items.

WHEN TO USE:

Recommended for transporting boxes, bins, and other containers over relatively short distances.

POINTS TO REMEMBER:

- Rollers are preferred for transport in a linear direction whereas ball bearings are preferred when change of direction is required.
- Pushing or sliding containers eliminates lifting and carrying that can be strenuous to the hands, arms, and back.
- Appropriate for product in containers, but not loose parts due to sanitation issues.

PERSONAL PROTECTIVE EQUIPMENT - Selection Considerations

DESCRIPTION:

Clothing and other work accessories designed to create a barrier against workplace hazards that take ergonomic considerations into account.

WHEN TO USE:

When selecting personal protective equipment for processing operations.

POINTS TO REMEMBER:

- Protective clothing should be selected for the specific task performed.
- Employees should be provided with a variety of options for rubber gloves worn under mesh gloves for optimal fit, dexterity, and flexibility.
- Mesh gloves can include small barbs on the palm surface to reduce finger force when pinching and pulling meat away from bone. A mesh or cut resistant glove and forearm sleeve should be worn on the hand that does not hold the knife to protect against accidental cuts.
- Gloves should minimize the loss of tactile sensitivity.
- Gloves should provide increased friction between the hand and the material being handled.
- Use non-slip and waterproof footwear with well-cushioned insteps and insoles.

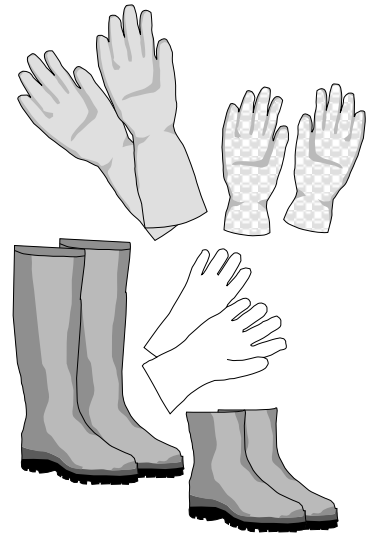

Additional Sources of Information

OSHA's Training Institute in Arlington Heights, Illinois, offers courses on various safety and health topics, including ergonomics. Courses are also offered through Training Institute Education Centers located throughout the country. For a schedule of courses, contact the OSHA Training Institute, 2020 South Arlington Heights Road, Arlington Heights, IL 60005, (847) 297-4810, or visit OSHA's training resources webpage at www.osha.gov/fso/ote/training/training_resources.html.

There are many states and territories that operate their own occupational safety and health programs under a plan approved by OSHA (23 cover both private sector, state and local government employees, and three only cover public employees). Information is available on OSHA's website at www.osha.gov/fso/osp/index.html on how to contact a state plan directly for information

about specific state initiatives and compliance assistance applicable to the poultry processing industry.

A free consultation service is available to provide occupational safety and health assistance to small businesses. OSHA Consultation is funded primarily by federal OSHA, but delivered by the 50 state governments, the District of Columbia, Guam, Puerto Rico and the Virgin Islands. The states offer the expertise of highly qualified occupational safety and health professionals to employers who request help to establish and maintain a safe and healthful workplace. Developed for small and medium-sized employers in hazardous industries or with hazardous operations, the service is provided at no cost to the employer and is confidential. Information on OSHA Consultation can be found at www.osha.gov/dcsp/smallbusiness/consult.html.

References

- (1) National Research Council and Institute of Medicine. 2001. *Musculoskeletal Disorders and the Workplace — Low Back and Upper Extremities*. National Academy of Sciences. Washington, DC: National Academies Press.
- (2) *Musculoskeletal Disorders and Workplace Factors: A Critical Review of Epidemiologic Evidence for Work-Related Musculoskeletal Disorders of the Neck, Upper Extremity, and Low Back*. Cincinnati, OH: U.S. Department of Health and Human Services, Public Health Service, Centers for Disease Control and Prevention, National Institute for Occupational Safety and Health, DHHS. 1997. (NIOSH Publication No. 97-141.)
- (3) Poultry Industry Task Force. 1986. The Medical Ergonomics Training Program: A Guide for the Poultry Industry. (OSHA Docket GE2003-2, Exhibit 4-2.)
- (4) U.S. Department of Labor, Occupational Safety and Health Administration. 1993 (Reprinted). *Ergonomics Program Management Guidelines for Meatpacking Plants*.
- (5) Bureau of Labor Statistics. 2002. <http://data.bls.gov/cgi-bin/dsrv?sh>. “Occupational injuries and illnesses: industry data (1989-2001).” Series ID SHU30201531 and SHU30201532, Poultry slaughtering and processing. (OSHA Docket GE2003-2, Exhibit 4-8.)
- (6) Bureau of Labor Statistics. <http://www.bls.gov/iif/oshsum.htm#01SummaryTables>. Table 2. “Numbers of nonfatal occupational injuries and illnesses by industry and case types, 2002.” (OSHA Docket GE2003-2, Exhibit 4-10.)
- (7) Bureau of Labor Statistics. Special report prepared by BLS for OSHA. Table 1. “Number, median days, and incidence rate of nonfatal occupational injuries and illnesses with days away from work involving musculoskeletal disorders by selected industries, 2002.” (OSHA Docket GE2003-2, Exhibit 4-9.)
- (8) Reports of OSHA site visits to poultry processing facilities. (OSHA Docket GE2003-2, Exhibit 4-5.)
- (9) Jones, Ronald J. “Corporate Ergonomics Program of a Large Poultry Processor.” *AIHA Journal* (58). February 1997.
- (10) Document submitted to OSHA by Tyson Foods. (OSHA Docket GE2003-2, Exhibit 4-6.)
- (11) Document submitted to OSHA by ConAgra Turkey Company (Butterball). (OSHA Docket GE2003-2, Exhibit 4-7.)
- (12) *Elements of Ergonomics Programs: A Primer Based on Evaluations of Musculoskeletal Disorders*. Cincinnati, OH: U.S. Department of Health and Human Services, Public Health Service, Centers for Disease Control and Prevention, National Institute for Occupational Safety and Health, DHHS. 1997. (NIOSH Publication No. 97-117).
- (13) Kaplan, S.J., Glickel, S.Z., Eaton, R.G. “Predictive Factors in the Non-Surgical Treatment of Carpal Tunnel Syndrome.” *The Journal of Hand Surgery*. February 1990. Vol. 15-B, No. 1.

