



DUKE COGEMA  
STONE & WEBSTER

Mr. William F. Kane, Director  
Office of Nuclear Material Safety and Safeguards  
U.S. Nuclear Regulatory Commission  
Washington, DC 20555

19 December 2000  
DCS-NRC-000031

Attention: Document Control Desk

Subject: Docket Number 070-03098  
Duke Cogema Stone & Webster  
Mixed Oxide (MOX) Fuel Fabrication Facility  
Environmental Report

Dear Mr. Kane:

Enclosed are 25 copies (including one signed original) of the Environmental Report (ER) for the Duke Cogema Stone & Webster (DCS) Mixed Oxide (MOX) Fuel Fabrication Facility. This ER is being submitted pursuant to 10 CFR Parts 51 and 70 in support of our upcoming request for construction authorization and eventual application for a special nuclear material possession-and-use license under 10 CFR Part 70.

This ER represents the environmental evaluation based on the current design of the MOX Fuel Fabrication Facility and makes use of the two previous, but broader Department of Energy (DOE) Environmental Impact Statements and Records of Decision related to this facility. The DOE Environmental Impact Statements extensively evaluated the programmatic impacts related to MOX fuel fabrication. A copy of the most recent of these documents, *Surplus Plutonium Disposition Final Environmental Impact Statement*, was previously provided to NRC. A copy of the predecessor document, *Storage and Disposition of Weapons-Usable Fissile Materials Final Programmatic Environmental Impact Statement*, can be provided to NRC upon request.

This ER does not duplicate the analyses presented in the previous DOE Environmental Impact Statements. Where an issue or impact was adequately evaluated in the previous DOE Environmental Impact Statements, the attached ER does not reanalyze the issue but, rather, summarizes the issue and incorporates discussion of that issue by reference to the appropriate DOE document. Neither does the ER reanalyze decisions made by DOE in the Records of Decision for the two previous Environmental Impact Statements.

This ER presents impact analyses that are specific to the current design of the MOX Fuel Fabrication Facility and the proposed location of that facility on the Savannah River Site. Where appropriate, site-specific data have been updated from those presented in the two previous DOE Environmental Impact Statements.

PO Box 31847  
Charlotte, NC 28231-1847

400 South Tryon Street, WC-32G  
Charlotte, NC 28202

NIMSSCI Public 1/25 cys at DCD

Mr. William F. Kane  
DCS-NRC-000031  
19 December 2000  
Page 2 of 2

If you have any questions, please feel free to contact Mr. Peter S. Hastings, Licensing Manager, at (704) 373-7820 or Ms. Mary Birch, Environment, Safety and Health Manager, at (704) 382-1401.

Sincerely,

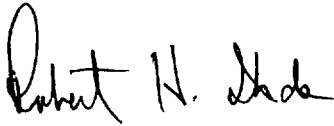

Robert H. Ihde  
President & CEO

Enclosure: Mixed Oxide Fuel Fabrication Facility Environmental Report

xc (without enclosure):

Mary L. Birch, DCS  
Edward J. Brabazon, DCS  
R. James Brackett, DCS  
Lionel Gaiffe, DCS  
Yawar H. Faraz, USNRC/HQ  
Peter S Hastings, DCS  
James V. Johnson, USDOE/MD  
Eric J. Leeds, USNRC/HQ  
John E. Matheson, DCS  
Toney A. Mathews, DCS  
Andrew Persinko, USNRC/HQ  
Luis A. Reyes, USNRC/RII  
Robert C. Selby, USDOE/CH  
Michael F. Weber, USNRC/HQ  
PRA/EDMS: Corresp\Outgoing\NRC\Licensing\DCS-NRC-000031

Duke Cogema Stone & Webster

# Mixed Oxide Fuel Fabrication Facility Environmental Report

Docket Number 070-03098

Prepared by  
Duke Cogema Stone & Webster  
400 South Tryon Street  
Charlotte, NC 28202

Under  
U. S. Department of Energy  
Contract DE-AC02-99-CH10888

Nuclear Q/A Yes  No

UCNI Yes  No

Proprietary Yes  No

Controlled Document Number 1

Duke Cogema Stone & Webster

**Mixed Oxide Fuel Fabrication Facility  
Environmental Report**

Docket Number 070-03098

Submitted by  
Duke Cogema Stone & Webster  
400 South Tryon Street  
Charlotte, NC 28202

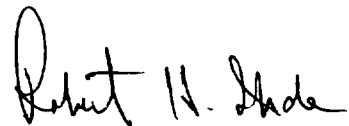

---

Robert H. Ihde  
President and CEO

**REVISION DESCRIPTION SHEET**

REVISION NUMBER	PAGES REVISED AND DESCRIPTION
0	Original Issue

## EXECUTIVE SUMMARY

This Environmental Report was prepared by Duke Cogema Stone & Webster, the applicant, for a 10 CFR Part 70 license to possess and use special nuclear material in a Mixed Oxide Fuel Fabrication Facility for the U.S. Department of Energy on the Savannah River Site near Aiken, South Carolina, in accordance with applicable regulations of the U.S. Nuclear Regulatory Commission. The Department of Energy will own the Mixed Oxide Fuel Fabrication Facility and has contracted with Duke Cogema Stone & Webster to design, construct, functionally test, operate, and ultimately deactivate the facility. Duke Cogema Stone & Webster (a Limited Liability Company owned by Duke Engineering & Services, Inc.; COGEMA, Inc.; and Stone & Webster, Inc., a Shaw Group Company) will be the license holder for the Mixed Oxide Fuel Fabrication Facility. The facility is an integral part of the overall U.S. Government's strategy for the disposition of surplus plutonium in accordance with the following:

- *Nonproliferation and Export Control Policy* (White House 1993)
- *Joint Statement by the President of the Russian Federation and the President of the United States on the Non-Proliferation of Weapons of Mass Destruction and the Means of Their Delivery* (White House 1994)
- *Joint Statement of Principles for Management and Disposition of Plutonium Designated as No Longer Required for Defense Purposes* (White House 1998).

The recent *Agreement Between the Government of the United States of America and the Government of the Russian Federation Concerning the Management and Disposition of Plutonium Designated as No Longer Required for Defense Purposes and Related Cooperation* (White House 2000) commits the United States to convert 28.2 tons (25.57 metric tons) of plutonium to mixed oxide fuel and irradiate it in power reactors.

This Environmental Report will be used by the Nuclear Regulatory Commission in support of its effort to prepare an Environmental Impact Statement in connection with the licensing of the Mixed Oxide Fuel Fabrication Facility. Issuance of a Nuclear Regulatory Commission license to possess special nuclear material at the Mixed Oxide Fuel Fabrication Facility is an essential component of the United States Government's overall surplus plutonium disposition strategy.

This Environmental Report and the Nuclear Regulatory Commission's subsequent Environmental Impact Statement are not the first environmental evaluations performed in connection with the Government's surplus plutonium disposition strategy. The Department of Energy conducted extensive environmental evaluations of alternatives for implementing this strategy in the following documents:

- *Storage and Disposition of Weapons-Usable Fissile Materials Final Programmatic Environmental Impact Statement* (DOE 1996b)
- *Storage and Disposition of Weapons-Usable Fissile Materials Final Programmatic Environmental Impact Statement Record of Decision* (DOE 1997c)

- *Surplus Plutonium Disposition Final Environmental Impact Statement* (DOE 1999c)
- *Surplus Plutonium Disposition Final Environmental Impact Statement Record of Decision* (DOE 2000b).

These environmental evaluations considered over 100 alternatives for storage and disposition of surplus plutonium and highly enriched uranium. This Environmental Report has adopted and utilizes, as appropriate, many of the results of the evaluations already performed by the Department of Energy.

In reviewing this Environmental Report, it is important to consider both the scope of the environmental determinations already made by the Department of Energy and the scope of the proposed action presently before the Nuclear Regulatory Commission for decision on the basis of environmental (as well as safety and security) considerations. The extensive evaluations previously performed by the Department of Energy have determined the following:

- There is a need for an effective national program for the disposition of surplus United States' plutonium.
- That need should be addressed through a hybrid strategy of immobilization of 18.7 tons (17 metric tons) of plutonium and irradiation of 36.4 tons (33 metric tons) of plutonium.
- A mixed oxide fuel fabrication facility designed to process and manufacture 36.4 tons (33 metric tons) of plutonium on a schedule consistent with the disposition strategy of the United States Government should be established.
- The fuel fabrication facility should be constructed on the Department of Energy's Savannah River Site in F Area.

These determinations were made based upon over five years of extensive environmental analysis. What the Department of Energy's analyses did not fully address were all of the site-specific impacts associated with the licensing, construction, and operation of the Mixed Oxide Fuel Fabrication Facility on the Savannah River Site. These impacts, along with the cumulative impacts of other activities that could affect the environment, are addressed in this Environmental Report.

The proposed action evaluated in this Environmental Report is the issuance of a 10 CFR Part 70 license to Duke Cogema Stone & Webster for the possession and use of special nuclear material at the Mixed Oxide Fuel Fabrication Facility on the Savannah River Site. The impacts of this proposed action are compared to the impacts from a reasonable range of alternatives. These alternatives include (1) a No Action Alternative (i.e., denial of the Part 70 license on the basis of environmental considerations); (2) certain siting alternatives within F Area at the Savannah River Site (the selection of F Area having already been decided by the Department of Energy); and (3) certain facility design alternatives.

The results of the analyses in this Environmental Report can be summarized as follows. The proposed action will satisfy the need for the establishment and operation of a Mixed Oxide Fuel

Fabrication Facility in support of the Government's overall surplus plutonium disposition strategy. The No Action Alternative will not satisfy that need. Consideration of reasonable siting alternatives demonstrates that there is no other site that is obviously superior to the proposed site. Consideration of reasonable design alternatives demonstrates that none have substantial environmental advantages over the proposed design. After weighing the environmental, economic, technical, and other benefits against environmental costs associated with the proposed action, and considering available alternatives, this Environmental Report demonstrates that, subject to the completion of the Nuclear Regulatory Commission's review of safety and security considerations, the action called for is the issuance of the proposed license by the Nuclear Regulatory Commission.

The following discussion summarizes the analyses leading to the aforementioned results. The Mixed Oxide Fuel Fabrication Facility will be located in F Area of the Department of Energy-owned Savannah River Site. Other plutonium disposition facilities owned by the Department of Energy and operated by its Management and Operating Contractor will also be located in F Area near the fuel fabrication facility. The proposed facilities will use various existing sitewide infrastructure and services, such as security, emergency management, radiation monitoring, environmental monitoring, and waste management.

Related to the proposed action, the Department of Energy will construct and operate a facility for disassembling nuclear weapon pits and converting the recovered plutonium, as well as plutonium from other sources, into plutonium dioxide for disposition. The Pit Disassembly and Conversion Facility will be located near the Mixed Oxide Fuel Fabrication Facility and will provide the plutonium dioxide feedstock for the fuel fabrication facility. Although the Pit Disassembly and Conversion Facility is not part of this proposed action, its environmental impacts are addressed in this Environmental Report as part of the discussion on cumulative impacts.

As part of the overall plutonium disposition strategy, the Department of Energy is also constructing the Plutonium Immobilization Plant near the Pit Disassembly and Conversion Facility and the Mixed Oxide Fuel Fabrication Facility. The Plutonium Immobilization Plant will immobilize plutonium that cannot be converted to mixed oxide fuel. The immobilized plutonium will be incorporated into high-level radioactive waste canisters at the Defense Waste Processing Facility, also located at the Savannah River Site. The Plutonium Immobilization Plant is not part of the proposed action for this Environmental Report. Like the Pit Disassembly and Conversion Facility, the impacts of the Plutonium Immobilization Plant are included in this Environmental Report as part of the discussion on cumulative impacts.

The Mixed Oxide Fuel Fabrication Facility is designed to convert up to 36.4 tons (33 metric tons) of plutonium oxide to mixed oxide fuel. The mixed oxide fuel will be transported to and irradiated in four commercial nuclear power reactors: two units at the Catawba Nuclear Station near York, South Carolina, and two units at the McGuire Nuclear Station near Huntersville, North Carolina. The environmental impacts of feedstock and product transport are considered in this Environmental Report. The environmental impacts of irradiating the mixed oxide fuel in these reactors were evaluated as part of the *Surplus Plutonium Disposition Final Environmental Impact Statement*, issued in November 1999 (DOE 1999c). In January 2000 the Department of Energy issued the *Surplus Plutonium Disposition Final Environmental Impact Statement Record*



*of Decision* (DOE 2000b). The irradiation of the mixed oxide fuel is not part of this proposed licensing action but will be the subject of a separate Nuclear Regulatory Commission licensing action and environmental review. Nevertheless, the impacts of such irradiation are addressed as cumulative impacts in this Environmental Report.

The Mixed Oxide Fuel Fabrication Facility is designed for 20 years of operation beginning in 2006. Any significant delay in the schedule that will impact the projected operational date of the facility could jeopardize the availability of the mission reactors to irradiate the fuel. After the surplus plutonium is converted to mixed oxide fuel, the facility will be deactivated and turned over to the Department of Energy.

Approximately 17 ac (6.9 ha) of the 41-ac (16.6-ha) Mixed Oxide Fuel Fabrication Facility site will be developed with buildings, facilities, or paving. The remaining 24 ac (9.7 ha) will be landscaped in either grass or gravel. The protected area inside the double fence Perimeter Intrusion Detection and Assessment System occupies approximately 14 ac (5.7 ha) and is roughly square in shape. There are no wetlands or other critical habitat that will be affected by the construction or operation of the Mixed Oxide Fuel Fabrication Facility.

The mixed oxide fuel fabrication process and plant design are based on the COGEMA MELOX and La Hague Plutonium Finishing Facilities located in Marcoule and La Hague, France, respectively. The plant design has been modified to meet appropriate United States regulations and standards. The fuel fabrication subprocess is similar to what is operating in MELOX, while the aqueous polishing subprocess is similar to what is operating in La Hague.

The Mixed Oxide Fuel Fabrication Facility consists of an aqueous polishing and fuel fabrication building, secured warehouse, and various support buildings. Aqueous polishing is performed to remove impurities from the plutonium and produces most, but not all, of the liquid waste that will be transferred to the existing Savannah River Site waste treatment facilities. Extensive reuse of reagents in the process results in a significant reduction of waste generated from the process. The mixed oxide fuel fabrication process blends plutonium and uranium oxides, converts the mixed oxide powder to fuel pellets, loads fuel pellets into rods, and bundles the rods into fuel assemblies. This process produces solid scrap material, which is recycled in the overall process. Airborne emissions are collected from process ventilation (gloveboxes and equipment) and from building ventilation in the fuel fabrication building. Those emissions are treated, filtered, monitored, and released. Small amounts of contaminated solid waste are produced during maintenance activities at the Mixed Oxide Fuel Fabrication Facility.

The radiation protection and waste management programs for the Mixed Oxide Fuel Fabrication Facility are guided by the principles of dose minimization through As Low As Reasonably Achievable (ALARA) design and administrative programs, waste minimization, and pollution prevention. Liquid and solid wastes will be transferred to the appropriate Savannah River Site waste management facilities and will meet applicable waste acceptance criteria for those facilities.

The principal benefit of the proposed action is to implement the joint United States and Russian Federation Agreement to convert 28.2 tons (25.57 metric tons) of surplus plutonium to mixed

oxide fuel into a form that meets the *Spent Fuel Standard* recommended by the National Academy of Sciences. In addition to the benefit of implementing the United States and Russian Federation Agreement, the proposed action also results in the consumption of surplus depleted uranium from current stockpiles and additional benefits to the local community around the Savannah River Site by providing approximately 400 full-time jobs over the lifetime of the project. The jobs will have a definite, although somewhat non-quantifiable, economic benefit to these communities by counterbalancing current job losses in the area.

Because the Mixed Oxide Fuel Fabrication Facility does not use process storage or treatment ponds, there will not be any liquid effluent released to the environment, so there are no expected impacts on surface water or groundwater. The MFFF site will have a stormwater collection and routing system that will discharge through the existing Savannah River Site stormwater National Pollutant Discharge Elimination System outfall or new outfalls. There may be slight temporary impacts from construction runoff, but these impacts should disappear once construction is completed.

The Mixed Oxide Fuel Fabrication Facility will have emergency and standby diesel generators that will be tested periodically, which will result in criteria pollutant emissions during the testing periods. Incremental increases in ambient concentrations of these criteria pollutants will be well below the ambient air quality standards for southwestern South Carolina. The mixed oxide fuel fabrication process also will release small quantities of nitrogen oxides. The annual releases are accounted for in the nitrogen dioxide projections for the facility. Radiological dose to the public will be well below the criteria of the Nuclear Regulatory Commission and U.S. Environmental Protection Agency and below background radiation levels.

The construction and operation of the Mixed Oxide Fuel Fabrication Facility will have no impacts on sensitive ecological areas. The construction of the facility will require the excavation and recovery of an archaeological site. Although the site is not expected to contain any human or sacred artifacts, the excavation and recovery of the artifacts would represent a benefit through the preservation of the artifacts.

The greatest impact of operations at the Mixed Oxide Fuel Fabrication Facility will be the amount of waste generated. The Mixed Oxide Fuel Fabrication Facility will generate a liquid high alpha activity waste, which is a new waste form for the Savannah River Site. With the exception of liquid high alpha activity waste, the amounts generated are a small fraction of annual waste generation at the Savannah River Site. The liquid high alpha activity waste generated by the Mixed Oxide Fuel Fabrication Facility will be transferred to the F-Area Tank Farm. This amount of waste represents a small increase in the amount of waste currently in the tank farm.

Cumulative impacts in the geographic vicinity of the Mixed Oxide Fuel Fabrication Facility and the Savannah River Site are dominated by the impacts of existing activities at the Savannah River Site. The Savannah River Site is currently in substantial compliance with all federal, state, and local air quality regulations and would continue to remain well within compliance, even with the consideration of the cumulative effects of all surplus plutonium disposition activities. All three surplus plutonium disposition facilities would cause the cumulative dose to the public from

all Savannah River Site activities to increase by about 2.6%. All wastes from the fuel fabrication facility represent very small (<10%) additions to the current Savannah River Site waste generation rates and should not represent any significant cumulative impact.

The cumulative impacts resulting from transport of feedstock and mixed oxide fuel are also low. The total dose to the transportation workers associated with the uranium hexafluoride and uranium oxide shipments is estimated to be 0.94 and 0.69 person-rem, respectively. The dose to the public associated with the uranium hexafluoride and uranium oxide shipments is estimated to be 0.17 and 0.11 person-rem, respectively. The cumulative dose to the transportation workers associated with the mixed oxide fuel shipments is estimated to be 9.8 person-rem and the dose to the public is estimated to be 2.12 person-rem.

The incident-free dose per shipment (in person-rem) for the plutonium recycle shipments in NUREG-0170 (NRC 1977c) was calculated to be 0.17, versus a maximum of 0.03 person-rem per shipment for the mixed oxide fuel shipments from the Mixed Oxide Fuel Fabrication Facility to the mission reactor sites. The dose to the maximally exposed individual for the person in traffic next to a shipment of mixed oxide fuel is 2.0 mrem. These doses are a small fraction of the 360-mrem annual dose received from natural background radiation and is consistent with the conclusions of NUREG-0170.

This Environmental Report relied on the mission reactor impacts analysis provided in the *Surplus Plutonium Disposition Final Environmental Impact Statement* (DOE 1999c). The Environmental Impact Statement determined that there should be no change in impacts to the environment during normal operations at the mission reactors resulting from the irradiation of mixed oxide fuel. This conclusion is reinforced by operating experience from Electricite de France, which operates mixed oxide fuel power plants in France.

Because the mixed oxide fuel that will be produced by the Mixed Oxide Fuel Fabrication Facility represents less than 1% of the domestic commercial nuclear fuel use, financial impacts to commercial fuel facilities should be minimal.

Although the proposed action does have environmental impacts, the impacts are small and consequently acceptable. The environmental impacts are outweighed by the benefit of enhancing nuclear weapons reductions.

The No Action Alternative is the denial of a license to possess and use special nuclear material in a Mixed Oxide Fuel Fabrication Facility at the Savannah River Site. Because of previous Department of Energy decisions in the *Surplus Plutonium Disposition Final Environmental Impact Statement Record of Decision* (DOE 2000b), the consequence of the No Action Alternative is continued storage of surplus plutonium at existing sites. The No Action Alternative does not meet the need of implementing the joint United States and Russian Federation Agreement to convert 28.2 tons (25.57 metric tons) of surplus plutonium to mixed oxide fuel. The primary benefit of the No Action Alternative is the avoidance of impacts associated with the proposed action. This avoidance is most significant in the area of waste generation.

In the *Surplus Plutonium Disposition Final Environmental Impact Statement* (DOE 1999c), the Department of Energy evaluated several combinations of facilities and sites. In the subsequent Record of Decision (DOE 2000b), the Department of Energy decided to locate the Mixed Oxide Fuel Fabrication Facility in F Area at the Savannah River Site. Subsequent to the Record of Decision, the Department of Energy investigated several sites within F Area for the fuel fabrication facility and other surplus plutonium disposition facilities.

Environmental impacts associated with facility operations (i.e., land use, water use, radiological and nonradiological emissions, and waste generation) are unaffected by the selection of any site within F Area. The selected site does not have wetlands or critical habitat; some alternative sites included wetlands. The selected site does not exhibit any groundwater plumes or substantial contamination; some alternative sites do exhibit groundwater contamination. However, the selected site will require mitigation of an archaeological site, while some alternative sites would have avoided the archaeological site. In the final evaluation, none of the alternative sites were obviously superior to the selected site.

One of the bases for selection of Duke Cogema Stone & Webster as the contractor was the their proposal to use a proven design (the COGEMA process) based on actual operations of similar facilities in France. The COGEMA design represents the results of several iterations of process design and operating experience over several years of mixed oxide fuel production in France. This design optimizes both production and safety. The selection of Duke Cogema Stone & Webster and the contractual arrangements with the Department of Energy established the basic design of the facility and process. In the process of adapting the COGEMA design, based on the MELOX and La Hague facilities, to meet United States regulations, codes, and standards, Duke Cogema Stone & Webster considered several design alternatives. In each case, the design alternatives selected resulted in lower environmental impact.

The conclusion of the environmental analysis conducted in this Environmental Report is that the environmental impacts are outweighed by the reductions in weapons-grade plutonium stockpiles achieved in Russia and the United States through effective implementation of the national program for disposition of surplus plutonium.

**This page intentionally left blank.**

**TABLE OF CONTENTS**

EXECUTIVE SUMMARY .....ES-1

LIST OF FIGURES ..... vii

LIST OF TABLES..... ix

LIST OF APPENDICES..... xii

LIST OF ACRONYMS AND ABBREVIATIONS ..... xiii

METRIC CONVERSION CHART ..... xviii

1. PROPOSED ACTION AND ALTERNATIVES ..... 1-1

    1.1 DESCRIPTION OF THE PROPOSED ACTION..... 1-1

    1.2 RELATED ACTIONS..... 1-3

        1.2.1 F-Area Infrastructure Upgrades..... 1-3

        1.2.2 Irradiation of MOX Fuel ..... 1-3

        1.2.3 Pit Disassembly and Conversion..... 1-3

        1.2.4 Plutonium Immobilization..... 1-4

        1.2.5 Lead Assemblies..... 1-4

        1.2.6 Transportation ..... 1-5

        1.2.7 Transport and Disposal of Spent MOX Fuel..... 1-5

        1.2.8 Decommissioning the Surplus Plutonium Disposition Facilities..... 1-5

    1.3 ALTERNATIVES PREVIOUSLY EVALUATED BY DOE ..... 1-5

        1.3.1 Storage and Disposition of Weapons-Usable Fissile Materials Final  
        Programmatic Environmental Impact Statement (S&D PEIS) ..... 1-6

        1.3.2 Surplus Plutonium Disposition Final Environmental Impact Statement  
        (SPD EIS)..... 1-8

    1.4 ALTERNATIVES CONSIDERED IN THIS ENVIRONMENTAL REPORT ..... 1-9

    1.5 PROJECT SCHEDULE ..... 1-9

2. PURPOSE OF THE PROPOSED ACTION ..... 2-1

    2.1 BACKGROUND INFORMATION..... 2-1

    2.2 NEED FOR THE FACILITY..... 2-2

3.	DESCRIPTION OF THE MOX FUEL FABRICATION FACILITY .....	3-1
3.1	GENERAL FACILITY ARRANGEMENT.....	3-1
3.1.1	MOX Fuel Fabrication Building .....	3-2
3.1.2	Reagent Process Building.....	3-3
3.1.3	Emergency Diesel Generator Building.....	3-3
3.1.4	Standby Diesel Generator Building.....	3-4
3.1.5	Secured Warehouse Building .....	3-4
3.1.6	Administration Building.....	3-5
3.1.7	Technical Support Building.....	3-6
3.2	MOX FUEL FABRICATION PROCESS.....	3-7
3.2.1	Plutonium Polishing .....	3-7
3.2.2	Material Recovery and Recycling .....	3-9
3.2.3	MOX Fuel Fabrication .....	3-9
3.2.4	Process Ventilation Offgas Treatment System.....	3-11
3.2.5	Building and Glovebox Ventilation Systems.....	3-11
3.3	WASTE MANAGEMENT SYSTEMS .....	3-14
3.3.1	Airborne Emissions Management .....	3-14
3.3.2	Liquid Waste Management.....	3-14
3.3.3	Facility Solid Waste Management .....	3-17
4.	DESCRIPTION OF THE AFFECTED ENVIRONMENT.....	4-1
4.1	SITE LOCATION AND LAYOUT .....	4-1
4.1.1	Site Location.....	4-1
4.1.2	Site Layout .....	4-2
4.2	LAND USE .....	4-3
4.2.1	General Site Description.....	4-3
4.2.2	Proposed Facility Location.....	4-5
4.3	GEOLOGY.....	4-5
4.3.1	Regional Geology.....	4-5
4.3.2	MFFF Site-Specific Geology .....	4-10
4.4	HYDROLOGY.....	4-11
4.4.1	Water Use.....	4-12

4.4.2	Surface Water Hydrology .....	4-13
4.4.3	Groundwater Hydrology .....	4-16
4.5	METEOROLOGY AND AIR QUALITY .....	4-19
4.5.1	Onsite Meteorological Conditions.....	4-19
4.5.2	Existing Levels of Air Pollution.....	4-23
4.5.3	Impact of Local Terrain and Large Bodies of Water on Meteorological Conditions .....	4-24
4.6	ECOLOGY .....	4-25
4.6.1	Nonsensitive Habitat .....	4-25
4.6.2	Sensitive Habitat.....	4-27
4.7	NOISE .....	4-28
4.7.1	General Site Description.....	4-28
4.7.2	Proposed Facility Location.....	4-29
4.8	REGIONAL HISTORIC, SCENIC, AND CULTURAL RESOURCES .....	4-29
4.8.1	Historic Resources.....	4-29
4.8.2	Prehistoric Resources .....	4-29
4.8.3	Visual Resources .....	4-30
4.8.4	Native American Resources .....	4-31
4.9	REGIONAL DEMOGRAPHY.....	4-31
4.9.1	Permanent Population.....	4-32
4.9.2	Transient Population.....	4-33
4.10	SOCIOECONOMIC CHARACTERISTICS AND COMMUNITY SERVICES.....	4-34
4.10.1	Local Socioeconomic Characteristics.....	4-34
4.10.2	Regional Economic Characteristics.....	4-34
4.10.3	Community Services .....	4-35
4.10.4	Environmental Justice .....	4-37
4.11	CURRENT RISK FROM IONIZING RADIATION .....	4-38
4.12	EXISTING SRS INFRASTRUCTURE .....	4-38
4.13	EXISTING SRS WASTE MANAGEMENT INFRASTRUCTURE.....	4-39
4.13.1	Overview of Waste Inventories and Activities.....	4-39
4.13.2	Transuranic and Mixed Transuranic Waste.....	4-40



4.13.3	Low-Level Radioactive Waste .....	4-40
4.13.4	Mixed Low-Level Radioactive Waste.....	4-41
4.13.5	Hazardous Waste.....	4-41
4.13.6	Nonhazardous Waste.....	4-42
4.13.7	Waste Minimization .....	4-42
5.	ENVIRONMENTAL CONSIDERATIONS .....	5-1
5.1	IMPACT OF SITE PREPARATION AND FACILITY CONSTRUCTION .....	5-1
5.1.1	Land Use.....	5-1
5.1.2	Geology .....	5-2
5.1.3	Water Use and Quality .....	5-2
5.1.4	Air Quality.....	5-3
5.1.5	Ecology.....	5-4
5.1.6	Noise.....	5-5
5.1.7	Regional Historic, Scenic, and Cultural Resources.....	5-6
5.1.8	Socioeconomics.....	5-7
5.1.9	Environmental Justice .....	5-8
5.1.10	Impacts from Ionizing Radiation.....	5-8
5.1.11	Infrastructure .....	5-9
5.1.12	Construction Waste .....	5-9
5.1.13	Facility Accidents.....	5-10
5.2	EFFECTS OF FACILITY OPERATION .....	5-10
5.2.1	Impacts on Land Use and Site Geology .....	5-10
5.2.2	Impacts on Surface Water Use and Quality.....	5-10
5.2.3	Impacts on Groundwater Quality .....	5-11
5.2.4	Impacts on Ambient Air Quality .....	5-11
5.2.5	Ecological Impacts .....	5-12
5.2.6	Impacts from Facility Noise.....	5-12
5.2.7	Impacts on Historic, Scenic, and Cultural Resources.....	5-13
5.2.8	Socioeconomic Impacts.....	5-13
5.2.9	Environmental Justice Impacts.....	5-14
5.2.10	Impacts from Ionizing Radiation.....	5-15

5.2.11	Impacts to SRS Infrastructure .....	5-19
5.2.12	Waste Management Impacts.....	5-20
5.3	DEACTIVATION .....	5-20
5.3.1	Introduction .....	5-20
5.3.2	Design Features to Facilitate Deactivation.....	5-22
5.3.3	Administrative Features to Facilitate Deactivation .....	5-24
5.3.4	Projected Environmental Impacts of Deactivation.....	5-24
5.3.5	Accessibility of Land After Deactivation.....	5-25
5.4	TRANSPORTATION .....	5-25
5.4.1	Plutonium Oxide Feedstock .....	5-25
5.4.2	Uranium Dioxide Feedstock.....	5-25
5.4.3	MOX Fuel.....	5-27
5.4.4	Radioactive Wastes .....	5-28
5.4.5	Comparison with NUREG-0170 .....	5-28
5.5	FACILITY ACCIDENTS .....	5-29
5.5.1	Environmental Risk Assessment Method.....	5-29
5.5.2	Environmental Risk Assessment Summary .....	5-29
5.5.3	Evaluation of Facility Workers .....	5-40
5.5.4	Conclusions .....	5-40
5.6	CUMULATIVE IMPACTS .....	5-40
5.6.1	Impacts from SRS Activities.....	5-41
5.6.2	Impacts from Other Nearby Actions .....	5-42
5.6.3	Transportation Impacts.....	5-42
5.6.4	Impacts Related to Fuel Irradiation at Mission Reactor Sites .....	5-42
5.6.5	Impacts to Commercial Fuel Fabrication .....	5-43
5.7	ALTERNATIVES TO THE PROPOSED ACTION.....	5-43
5.7.1	No Action Alternative .....	5-44
5.7.2	Site Selection.....	5-45
5.7.3	Design Alternatives .....	5-50
5.8	SHORT-TERM USES AND LONG-TERM ENVIRONMENTAL PRODUCTIVITY .....	5-53

5.9	RESOURCES COMMITTED.....	5-54
5.9.1	Resources Committed During Construction.....	5-54
5.9.2	Resources Committed During Operation.....	5-55
5.10	ENVIRONMENTAL MONITORING PROGRAM.....	5-55
6.	ANALYSIS OF ENVIRONMENTAL IMPACTS OF PROPOSED ACTION AND ALTERNATIVES.....	6-1
6.1	PROPOSED ACTION.....	6-1
6.2	NO ACTION ALTERNATIVE.....	6-3
6.3	SITING ALTERNATIVES.....	6-3
6.4	DESIGN ALTERNATIVES.....	6-4
7.	STATUS OF COMPLIANCE WITH FEDERAL AND STATE ENVIRONMENTAL REGULATIONS.....	7-1
7.1	UNITED STATES GOVERNMENT.....	7-1
7.1.1	U.S. Nuclear Regulatory Commission (NRC).....	7-1
7.1.2	U.S. Environmental Protection Agency (EPA).....	7-1
7.1.3	U.S. Army Corps of Engineers (COE).....	7-2
7.1.4	U.S. Department of Energy (DOE).....	7-2
7.1.5	U.S. Department of Transportation (DOT).....	7-2
7.1.6	U.S. Department of Interior (DOI).....	7-2
7.1.7	U.S. Department of Agriculture (USDA).....	7-3
7.2	STATE OF SOUTH CAROLINA.....	7-3
7.2.1	South Carolina Department of Health and Environmental Control (SCDHEC).....	7-3
7.2.2	South Carolina Department of History and Archives.....	7-7
7.2.3	South Carolina Department of Natural Resources (SCDNR).....	7-7
7.3	AIKEN COUNTY.....	7-7
7.4	PERMIT AND APPROVAL STATUS AND CONSULTATIONS.....	7-7
7.4.1	Permit and Approval Status.....	7-7
7.4.2	Agency Consultations.....	7-8
8.	REFERENCES.....	8-1

**LIST OF FIGURES**

Figure 3-1.	Site Layout.....	3-23
Figure 3-2.	Conceptual General Arrangement of the Aqueous Polishing Area .....	3-25
Figure 3-3.	Conceptual General Arrangement of the MFFF .....	3-27
Figure 3-4.	MOX Fuel Fabrication Production Process Flow.....	3-29
Figure 3-5.	Plutonium Polishing Block Diagram .....	3-31
Figure 3-6.	Aqueous Polishing Waste Streams .....	3-33
Figure 3-7.	MOX Fuel Fabrication Processes .....	3-35
Figure 3-8.	Ventilation Confinement for Aqueous Polishing.....	3-37
Figure 3-9.	Ventilation Confinement for Fuel Fabrication.....	3-39
Figure 3-10.	MFFF Airborne Waste Treatment Flowsheet.....	3-41
Figure 3-11.	MFFF Liquid Waste Management Flow Diagram.....	3-43
Figure 3-12.	Solid Waste Management Flow Diagram.....	3-45
Figure 4-1.	Location of the Savannah River Site .....	4-45
Figure 4-2.	Location of F Area and Controlled Area Boundary.....	4-47
Figure 4-3.	Location of MOX Fuel Fabrication Facility in the F Area .....	4-49
Figure 4-4.	Fifty-Mile (80-km) Radius with Towns and Roads.....	4-51
Figure 4-5.	MFFF Site Layout.....	4-53
Figure 4-6.	Generalized Land Use at SRS.....	4-55
Figure 4-7.	Relationship Between the Hydro- and Lithostratigraphic Units at SRS.....	4-57
Figure 4-8.	Crustal Geometry for Offshore South Carolina and North Carolina .....	4-59
Figure 4-9.	Elevation of Water Table in F Area.....	4-61
Figure 4-10.	Location of 100-Year Floodplain in the Vicinity of the MOX Fuel Fabrication Facility .....	4-63
Figure 4-11.	Generalized Hydrostratigraphic Cross Section of SRS.....	4-65
Figure 4-12.	Wind Rose Diagram for SRS.....	4-67
Figure 4-13.	Land Cover in F Area .....	4-69
Figure 4-14.	Surface Water and Wetlands in F Area.....	4-71
Figure 4-15.	Distribution of Minority Population Within 10 Miles (16 km) of the MOX Fuel Fabrication Facility.....	4-73

Figure 4-16.	Distribution of Population Living Below the Poverty Threshold within 10 Miles (16 km) of the MOX Fuel Fabrication Facility.....	4-75
Figure 5-1.	MFFF Water Balance.....	5-59
Figure 5-2.	Location of Potential MFFF Sites.....	5-61

**LIST OF TABLES**

Table 1-1.	Description of Variants Analyzed in the S&D PEIS .....	1-13
Table 1-2.	Summary of Alternatives Considered in the Surplus Plutonium Disposition Environmental Impact Statement.....	1-15
Table 3-1.	Key MFFF Design and Operation Parameters.....	3-49
Table 3-2.	MFFF Chemical Usage .....	3-50
Table 3-3.	Aqueous Polishing Waste Streams .....	3-51
Table 3-4.	Solid Waste Generated by MFFF Fuel Fabrication Processes.....	3-52
Table 4-1.	Annual Maximum Instantaneous Discharges of the Savannah River at Augusta, Georgia, for Water Years 1921 through 1995 (USGS Flow Data, 1922-1995).....	4-79
Table 4-2.	Annual Maximum Instantaneous Discharges of Upper Three Runs for Water Years 1967 through 1995 .....	4-80
Table 4-3.	Probable Maximum Precipitation for F Area.....	4-81
Table 4-4.	MFFF Site <sup>a</sup> Climatological Summary – Temperature (°F).....	4-82
Table 4-5.	MFFF Site <sup>a</sup> Climatological Summary – Precipitation (inches) .....	4-83
Table 4-6.	SRS Seasonal Mixing Heights.....	4-84
Table 4-7.	Percent Occurrence of Atmospheric Stability Class for SRS Meteorological Towers.....	4-85
Table 4-8.	Joint Frequency Distribution of Wind Speed, Wind Direction, and Atmospheric Stability Class for 1992-1996 SRS H-Area Meteorological Tower Data.....	4-86
Table 4-9.	Fujita Tornado Intensity Scale.....	4-93
Table 4-10.	Comparison of Ambient Air Concentrations from SRS Sources With Most Stringent Applicable Standards or Guidelines, 1994 .....	4-94
Table 4-11.	Threatened or Endangered Species Potentially Occurring in the Vicinity of F Area .....	4-96
Table 4-12.	Population Distribution – 1990.....	4-97
Table 4-13.	Projected Population Distribution – 2000.....	4-98
Table 4-14.	Projected Population Distribution – 2010.....	4-99
Table 4-15.	Projected Population Distribution – 2020.....	4-100
Table 4-16.	Projected Population Distribution – 2030.....	4-101
Table 4-17.	Racial and Ethnic Mix of Local Area Population, 1997 (Estimated) .....	4-102

Table 4-18.	Public School Population within 10 Miles (16 km) of the MFFF .....	4-103
Table 4-19.	Year 2000 SRS Employees (approximate) by County of Residence.....	4-104
Table 4-20.	Economic and Unemployment Data for Counties Within 50 Miles (80 km) of the MFFF .....	4-105
Table 4-21.	Income and Poverty Data for the Three-County Local Area .....	4-106
Table 4-22.	1997 Employment by Business Sector - Counties Within 50 Miles (80 km) of the MFFF .....	4-107
Table 4-23.	Sources of Radiation Exposure to Individuals in the SRS Vicinity Unrelated to SRS Operations .....	4-108
Table 4-24.	Radiation Doses to the Public from Normal SRS Operations in 1999 (Total Effective Dose Equivalent) .....	4-109
Table 4-25.	Radiation Doses to Workers from Normal SRS Operations (Total Effective Dose Equivalent) .....	4-110
Table 4-26.	Existing Infrastructure in the Vicinity of the MFFF Site.....	4-111
Table 4-27.	Waste Generation Rates and Inventories at SRS .....	4-112
Table 5-1.	Emissions (kg/yr) from MFFF Construction .....	5-65
Table 5-2.	Increments to Ambient Concentrations ( $\mu\text{g}/\text{m}^3$ ) at the SRS site boundary from MFFF Construction.....	5-66
Table 5-3.	Construction Employment Requirements for the MFFF .....	5-67
Table 5-4.	Estimate of Heavy Vehicles on Site for Each Year of Construction .....	5-68
Table 5-5.	Maximum Additional Site Infrastructure Requirements for MFFF Construction in F Area at SRS.....	5-69
Table 5-6.	Wastes Generated During Construction.....	5-70
Table 5-7.	Emissions (kg/yr) from MFFF Operation .....	5-71
Table 5-8.	Increments to Ambient Concentrations ( $\mu\text{g}/\text{m}^3$ ) from MFFF Operation <sup>a</sup> .....	5-72
Table 5-9.	Comparison of MFFF Impacts to PSD Class II Limits .....	5-73
Table 5-10.	Minority and Low Income Populations Along Transportation Corridors .....	5-74
Table 5-11.	Potential Radiological Impacts on the General Public and Site Workers Due to Normal Operations of the MFFF.....	5-75
Table 5-12.	Potential Waste Management Impacts from MFFF Operation.....	5-77
Table 5-13.	Summary of Bounding Consequences for MFFF Postulated Events.....	5-78
Table 5-14.	Potential Impacts from Construction of the PDCF and PIP Facilities in the SRS F Area .....	5-79
Table 5-15.	Summary of Cumulative Operational Impacts Within SRS .....	5-80

Table 5-16.	Summary of Impacts for the No Action Alternative.....	5-81
Table 5-17.	Accident Scenarios for Plutonium Storage Under the No Action Alternative <sup>a</sup> .....	5-85
Table 5-18.	Summary of Accident Dose (rem) for Plutonium Storage Under the No Accident Alternative <sup>a</sup> .....	5-86
Table 5-19.	F-Area Site Evaluation Matrix.....	5-87
Table 5-20.	Irreversible and Irretrievable Commitments of Construction Resources for the MOX Fuel Fabrication Facility.....	5-88
Table 5-21.	Irreversible and Irretrievable Commitments of Operations Resources for the MOX Fuel Fabrication Facility.....	5-89
Table 6-1.	Comparison of Environmental Impacts for the Proposed Action and the No Action Alternative.....	6-7
Table 7-1.	Status of Compliance with Federal and State Environmental Laws.....	7-11



**LIST OF APPENDICES**

- APPENDIX A. AGENCY CONSULTATIONS AND CORRESPONDENCE
- APPENDIX B. IMPACT ASSESSMENT METHODOLOGY
- APPENDIX C. ANALYSIS OF ENVIRONMENTAL JUSTICE
- APPENDIX D. RISK FROM IONIZING RADIATION
- APPENDIX E. TRANSPORTATION RISK ASSESSMENT
- APPENDIX F. FACILITY ACCIDENTS

**LIST OF ACRONYMS AND ABBREVIATIONS**

°C	degrees Celsius (Centigrade)
°F	degrees Fahrenheit
46°26'07"	46 degrees, 26 minutes, 7 seconds
ac	acre
ALARA	as low as reasonably achievable
ALOHA	Areal Locations of Hazardous Atmospheres
ANS	American Nuclear Society
ANSI	American National Standards Institute
APSF	Actinide Packaging and Storage Facility
ARF	airborne release fraction
ARR	airborne release rate
bgs	below ground surface
BMP	Best Management Practice
Bq	Becquerel
Btu	British thermal unit
CAA	Clean Air Act
CAR	Construction Authorization Request
CEQ	Council on Environmental Quality
CERCLA	Comprehensive Environmental Response, Compensation, and Liability Act
CFR	Code of Federal Regulations
cfs	cubic feet per second
Ci	Curie
CISAC	Committee on International Security and Arms Control
cm	centimeter
COE	U.S. Army Corps of Engineers
CPT	cone penetration test
CSWTF	Central Sanitary Waste Treatment Facility
CWA	Clean Water Act
D&D	decontamination and decommissioning
dB	decibel
dBA	decibels A-weighted
DCS	Duke Cogema Stone & Webster, LLC
DOE	U.S. Department of Energy
DOE-MD	U.S. Department of Energy Office of Fissile Materials Disposition
DOE-SR	U.S. Department of Energy Savannah River Operations Office
DOI	U.S. Department of Interior
DOT	U.S. Department of Transportation
DR	damage ratio
DWPF	Defense Waste Processing Facility
EF	efficiency factor
EIS	Environmental Impact Statement

---

EPA	U.S. Environmental Protection Agency
ER	Environmental Report
ETF	Effluent Treatment Facility
FFCA	Federal Facility Compliance Act
FR	Federal Register
ft	foot
ft <sup>2</sup>	square foot
ft <sup>3</sup>	cubic foot
g	acceleration due to gravity
g	gram
gal	gallon
GDP	Gaseous Diffusion Plant
GE	General Electric
GPG	Good Practice Guide
GSAR	Generic Safety Analysis Report
ha	hectare
HEPA	high-efficiency particulate air
HEU	highly enriched uranium
HLW	high-level radioactive waste
hr	hour
HVAC	heating, ventilation, and air conditioning
ICRP	International Commission on Radiological Protection
in	inch
INEEL	Idaho National Engineering and Environmental Laboratory
IROFS	items relied on for safety
ISCST	Industrial Source Complex Short-Term
kg	kilogram
km	kilometer
km <sup>2</sup>	square kilometer
kV	kilovolt
kW	kilowatt
L	liter
LANL	Los Alamos National Laboratory
lb	pound
LCF	latent cancer fatality
LDR	Land Disposal Restrictions
LLC	Limited Liability Company
LLNL	Lawrence Livermore National Laboratory
LLW	low-level radioactive waste
LPF	leak path factor
LWR	light water reactor
m	meter
M	molar
M&O	Management and Operating

---

---

m <sup>2</sup>	square meter
m <sup>3</sup>	cubic meter
MACCS2	MELCOR Accident Consequence Code System for the Calculation of the Health and Economic Consequences of Accidental Atmospheric Radiological Releases
MAR	material at risk
MARSSIM	Multi-Agency Radiation Survey and Site Investigation Manual NUREG-1575
MEI	maximally exposed individual
MEPA	moderate-efficiency particulate air
MFFF	Mixed Oxide Fuel Fabrication Facility
MFFP	MOX Fresh Fuel Package
mg	milligram
mi	mile
mi <sup>2</sup>	square mile
min	minute
MOX	mixed oxide
mph	miles per hour
mRad	milliRad
mrem	millirem
MSA	Metropolitan Statistical Area
msl	mean sea level
MW	megawatt
MWh	megawatt hour
MWMF	Mixed Waste Management Facility
N	normal
NAAQS	National Ambient Air Quality Standards
NAS	National Academy of Sciences
nCi	nanocurie
NEPA	National Environmental Policy Act
NESHAP	National Emissions Standards for Hazardous Air Pollutants
NMSS	Nuclear Materials Safety and Safeguards
NOI	Notice of Intent
NO <sub>x</sub>	Nitric Oxide
NPDES	National Pollutant Discharge Elimination System
NRC	U.S. Nuclear Regulatory Commission
NTS	Nevada Test Site
OML	Oxalic Mother Liquors
ORNL	Oak Ridge National Laboratory
ORR	Oak Ridge Reservation
OSHA	Occupational Safety and Health Administration
Pa	Pascal
pCi	picocurie
PCV	primary containment vessel
PDCF	Pit Disassembly and Conversion Facility

PEIS	Programmatic Environmental Impact Statement
pH	hydrogen ion concentration
PIDAS	Perimeter Intrusion Detection and Assessment System
PIP	Plutonium Immobilization Plant
PM <sub>10</sub>	particulate matter less than or equal to 10 µm in diameter
PMF	probable maximum flood
PMOA	Programmatic Memorandum of Agreement
PMP	probable maximum precipitation
ppm	parts per million
PSD	prevention of significant deterioration
psf	pounds per square foot
PuO <sub>2</sub>	plutonium dioxide
rad	radiation absorbed dose
RCRA	Resource Conservation and Recovery Act
rem	roentgen equivalent man
RF	respirable fraction
RFETS	Rocky Flats Environmental Technology Site
ROD	Record of Decision
ROI	region of influence
S&D	Storage and Disposition
SA	Safety Assessment
SAMS	secondary alarm monitoring station
SCAPA	Subcommittee on Consequence Assessment and Protective Action
SCDHEC	South Carolina Department of Health and Environmental Control
SCDNR	South Carolina Department of Natural Resources
SDWA	Safe Drinking Water Act
sec	second
SGT	SafeGuards Transporter
SHPO	State Historic Preservation Officer, State Historic Preservation Office
Sv	Sievert
SNM	special nuclear material
SPCC	Spill Prevention Control and Countermeasures
SPD	Surplus Plutonium Disposition
SRS	Savannah River Site
SSCs	structures, systems, and components
SST	safe secure transport
ST	source term
SWPPP	Stormwater Management Pollution Prevention Plan
TCE	trichloroethylene
TEEL	Temporary Emergency Exposure Limit
ton	short ton
TRU	transuranic
TSCA	Toxic Substances Control Act
UCNI	Unclassified Controlled Nuclear Information

UF <sub>6</sub>	uranium hexafluoride
UO <sub>2</sub>	uranium dioxide
UPS	uninterruptible power supply
USDA	U.S. Department of Agriculture
USFWS	U.S. Fish and Wildlife Services
USGS	United States Geological Service
USNRCS	U.S. Natural Resources Conservation Service
UST	underground storage tank
VOC	volatile organic compound
VRM	Visual Resource Management
WA	watt ampere
WAC	Waste Acceptance Criteria
WIPP	Waste Isolation Pilot Plant
WSI	Wackenhut Services Inc.
WSRC	Westinghouse Savannah River Company
wt %	weight percent
yd	yard
yr	year
μg	microgram
μm	micrometer (micron)
μSv	microsievert

**Metric Conversion Chart**

To Convert Into Metric			To Convert Out of Metric		
If You Know	Multiply By	To Get	If You Know	Multiply By	To Get
<b>Length</b>					
inches	2.54	centimeters	centimeters	0.3937	inches
feet	30.48	centimeters	centimeters	0.0328	feet
feet	0.3048	meters	meters	3.281	feet
yards	0.9144	meters	meters	1.0936	yards
miles	1.60934	kilometers	kilometers	0.6214	miles
<b>Area</b>					
sq. inches	6.4516	sq. centimeters	sq. centimeters	0.155	sq. inches
sq. feet	0.092903	sq. meters	sq. meters	10.7639	sq. feet
sq. yards	0.8361	sq. meters	sq. meters	1.196	sq. yards
acres	0.40469	hectares	hectares	2.471	acres
sq. miles	2.58999	sq. kilometers	sq. kilometers	0.3861	sq. miles
<b>Volume</b>					
fluid ounces	29.574	milliliters	milliliters	0.0338	fluid ounces
gallons	3.7854	liters	liters	0.26417	gallons
cubic feet	0.028317	cubic meters	cubic meters	35.315	cubic feet
cubic yards	0.76455	cubic meters	cubic meters	1.308	cubic yards
<b>Weight</b>					
ounces	28.3495	grams	grams	0.03527	ounces
pounds	0.45360	kilograms	kilograms	2.2046	pounds
short tons	0.90718	metric tons	metric tons	1.1023	short tons
<b>Temperature</b>					
Fahrenheit	Subtract 32 then multiply by 5/9ths	Celsius	Celsius	Multiply by 9/5ths, then add 32	Fahrenheit

## **1. PROPOSED ACTION AND ALTERNATIVES**

An Environmental Report (ER) has been prepared to comply with Title 10 of the U.S. Code of Federal Regulations (CFR) Part 51, in support of the implementation of the U.S. Nuclear Regulatory Commission (NRC) responsibilities under the National Environmental Policy Act (NEPA). This ER describes the proposed action and various alternatives (Chapter 1), discusses the need and purpose of the proposed action (Chapter 2), describes the Mixed Oxide (MOX) Fuel Fabrication Facility (MFFF) and its operations (Chapter 3), describes the affected environment (Chapter 4), and identifies possible impacts of the proposed action and alternatives (Chapter 5). The potential impacts of the proposed action and alternatives are summarized in Chapter 6, while the status of Federal, State, and local permits applicable to the proposed action is summarized in Chapter 7. Appendix A provides correspondence with federal and state agencies. Impact methodology is discussed in Appendix B. The remaining appendices provide supporting information for the analyses presented in the ER.

### **1.1 DESCRIPTION OF THE PROPOSED ACTION**

The action proposed in this ER is the issuance of an NRC license, under 10 CFR Part 70, to possess and use special nuclear material (SNM) in the MFFF at the U.S. Department of Energy's (DOE's) Savannah River Site (SRS) near Aiken, South Carolina.

DOE will own the MFFF. DOE has contracted with Duke Cogema Stone & Webster, LLC (DCS) to design, construct, operate, and deactivate the MFFF. DCS will be the license holder for the MFFF. DCS currently has a contract to convert up to 36.4 tons (33 metric tons) of surplus plutonium to MOX fuel. After the contractual amount of the surplus plutonium has been converted to MOX fuel, DCS will deactivate<sup>1</sup> the facility and turn the facility over to DOE, and the license will be terminated. DOE is responsible for the ultimate disposition (e.g., reutilization, decommissioning) of the MFFF. Decommissioning is not part of the DCS contract with DOE and is not part of the proposed action.

DCS is a Limited Liability Company (LLC) owned by Duke Engineering & Services, Inc., COGEMA, Inc. and Stone & Webster Inc. (a Shaw Group Company). These three companies are the equity owners of the LLC. The DCS corporate office is located in Charlotte, North Carolina, with a satellite office in Aiken, South Carolina, to serve the MFFF site.

The MFFF will be located on 41 ac (16.6 ha) in F Area of SRS. Other proposed surplus plutonium disposition facilities owned by DOE and to be operated by its Management and Operating (M&O) Contractor, but not licensed by the NRC, will be located nearby. The other

---

<sup>1</sup>Deactivation, rather than decommissioning, is required by the DOE contract with DCS. Deactivation is the process of removing a facility from operation and placing the facility in a safe-shutdown condition that is economical to monitor and maintain for an extended period until reuse or decommissioning.



proposed surplus plutonium disposition facilities are the Pit Disassembly and Conversion Facility (PDCF) and the Plutonium Immobilization Plant (PIP). Each of the three proposed surplus plutonium disposition facilities will use existing SRS sitewide infrastructure and services such as security, emergency management, radiation safety services, environmental monitoring, and waste management.

The MFFF consists of the MOX Fuel Fabrication Building (comprised of the aqueous polishing area, MOX processing area, and shipping and receiving area), and various support buildings.

The MFFF is designed to convert up to 36.4 tons (33 metric tons) of plutonium oxide, which will be supplied by the PDCF, to MOX fuel. The fabricated MOX fuel assemblies will be transported to, and subsequently irradiated in, four mission commercial nuclear power reactors: the Catawba Nuclear Station (Units 1 and 2) near York, South Carolina, and the McGuire Nuclear Station (Units 1 and 2) near Huntersville, North Carolina. The MFFF is designed to operate for 20 years (including deactivation activities) with an annual design throughput of 3.8 tons (3.5 metric tons). The term of the contract is expected to be met in less than the 20-year design life.

About 95% of the MOX fuel matrix is uranium dioxide. The MOX fuel fabrication process has many of the same process elements that are used to produce low-enriched uranium fuel for commercial nuclear power reactors. With respect to the MOX process, the plutonium oxide and uranium dioxide powders are blended together into a mixed oxide. The processing of feed materials begins with the plutonium polishing (i.e., aqueous polishing) process to chemically remove gallium from the weapons-grade feedstock. The process also removes other impurities, including americium, aluminum, and fluorides. This process includes three sub-processes: dissolution of the plutonium in nitric acid, removal of impurities by chemical separation (i.e., solvent extraction), and conversion of the plutonium back to an oxide powder by oxalate precipitation. Acid and solvent recovery steps, by which nearly all the nitric acid and extraction solvents would be recovered and reused in the process, are also included. This process is similar to the plutonium recovery and extraction process presently in use at the nearby F Canyon at SRS. The recovery steps are state-of-the-art due to the lessons learned from many years of European operating experience at COGEMA's La Hague Plutonium Finishing Facilities in northern France.

The polished plutonium dioxide, verified to meet fabrication requirements, is then transferred into reusable containers for storage until needed or transferred directly to the MOX fuel fabrication (i.e., MOX processing) process. MOX fuel fabrication begins with blending and milling of the plutonium dioxide powder to ensure general consistency in enrichment and isotopic concentration. The MOX powder is made into pellets by pressing the powder into shape, sintering (i.e., baking at high temperature) the formed pellets, and grinding the sintered pellets to the proper dimensions.

The finished pellets are moved to the fuel rod fabrication area where they are loaded into empty rods. The rods are sealed, inspected, decontaminated, and then bundled together to form fuel assemblies. Individual fuel assemblies can be stored for two years prior to shipment to the

designated domestic commercial reactor, although production is anticipated to closely follow product need.

## **1.2 RELATED ACTIONS**

### **1.2.1 F-Area Infrastructure Upgrades**

As part of the implementation of the surplus plutonium disposition facilities, the U.S. Department of Energy Savannah River Operations Office (DOE-SR) will provide integrated upgrades to F-Area infrastructure to support all three surplus plutonium disposition facilities. These upgrades include clearing and grading all three sites, developing integrated stormwater flow patterns for all three sites, providing utility services to all three sites, and providing any necessary access roads. Specific to the MFFF, the F-Area infrastructure upgrade will include augmenting deionized water supplies and constructing a liquid waste pipeline from the MFFF to the F-Area Outside Facility. The environmental impacts resulting from this infrastructure project were considered in the DOE *Surplus Plutonium Disposition Final Environmental Impact Statement* (SPD EIS) issued November 1999 (DOE 1999c). Any actions that are not included in the SPD EIS assumptions may subsequently be evaluated by DOE through the appropriate site-specific NEPA documents.

### **1.2.2 Irradiation of MOX Fuel**

The MOX fuel will be irradiated in four mission commercial nuclear power reactors: two units at the Catawba Nuclear Station near York, South Carolina, and two units at the McGuire Nuclear Station near Huntersville, North Carolina. The environmental impacts associated with irradiating the MOX fuel in these reactors were evaluated as part of the SPD EIS (DOE 1999c, 2000b). Fuel irradiation will require separate NRC licensing action. The NRC licensees for these commercial nuclear reactors will submit license amendment requests to gain NRC approval to irradiate MOX fuel. Any appropriate environmental impacts of irradiation will be considered at that time. Accordingly, the irradiation of the MOX fuel is not part of the proposed licensing action described in this ER.

Although the irradiation of the MOX fuel is not part of this proposed licensing action and the environmental impacts of irradiation will not be reanalyzed in this ER, the conclusions presented in the SPD EIS regarding irradiation impacts are summarized in Section 5.6 of this ER as part of the cumulative impacts discussion. Refer to the SPD EIS and SPD EIS Record of Decision (ROD) for detailed discussion of the environmental impacts related to the irradiation of the MOX fuel.

### **1.2.3 Pit Disassembly and Conversion**

DOE will construct, operate, and ultimately decommission a facility (i.e., PDCF) for disassembling pits (a weapons component) and converting the recovered plutonium, as well as plutonium from other sources, into plutonium dioxide for ultimate disposition. The PDCF will

be located near the MFFF and will provide the plutonium dioxide feedstock for both the MFFF and the PIP.

The PDCF is not part of this proposed action since the PDCF will not be licensed by the NRC. Accordingly, the discussion of the environmental impacts of the PDCF will not be reanalyzed in this ER; however, PDCF impacts are included in the cumulative impacts discussion in Section 5.6 of this ER. Refer to the SPD EIS and SPD EIS ROD (DOE 1999c, 2000b) for detailed discussion of the environmental impacts related to the PDCF.

#### **1.2.4 Plutonium Immobilization**

As the second part of the DOE plutonium disposition strategy, DOE will also immobilize some of the surplus plutonium into ceramic pucks for insertion into canisters at the SRS Defense Waste Processing Facility (DWPF) as part of high-level radioactive waste (HLW) packages for subsequent disposal. This process is known as can-in-canister disposal. The PIP will also be located at SRS near the MFFF and PDCF.

The PIP is not part of this proposed licensing action; therefore, any discussion of its environmental impacts will not be reanalyzed in this ER. Similar to the PDCF, PIP impacts are combined with the MFFF impacts as part of the cumulative impacts discussion in Section 5.6 of this ER. Refer to the SPD EIS and SPD EIS ROD (DOE 1999c, 2000b) for detailed discussion of the environmental impacts related to the PIP.

#### **1.2.5 Lead Assemblies**

The environmental impacts resulting from the fabrication, irradiation, and examination of lead assemblies were discussed in the SPD EIS (DOE 1999c). In that EIS, five DOE sites were evaluated for the fabrication of lead assemblies: SRS, Los Alamos National Laboratory (LANL), Lawrence Livermore National Laboratory (LLNL), Hanford, and Idaho National Engineering and Environmental Laboratory (INEEL). Two DOE sites were evaluated for post-irradiation examination: INEEL and Oak Ridge National Laboratory (ORNL). In the ROD associated with this EIS, DOE selected LANL as the site to fabricate lead assemblies and ORNL as the site to conduct post-irradiation examination. Subsequent to the issuance of the ROD, DOE has decided to revisit the decision regarding the fabrication of lead assemblies. The first option involves the fabrication occurring in Europe, while the second option involves fabrication at the MFFF.

Should DOE pursue the first option (European fabrication) it should be noted that the environmental impacts associated with the European fabrication option are outside the scope of NEPA. In addition, the environmental impacts associated with transport of MOX fuel across the global commons were evaluated in the *Storage and Disposition of Weapons-Usable Fissile Materials Final Programmatic Environmental Impact Statement (S&D PEIS)* (DOE 1996b). The environmental impacts of the second option (fabrication at the MFFF) are bounded by the impacts discussed for full production of MOX fuel discussed in this ER.

### **1.2.6 Transportation**

The environmental impacts associated with transportation of SNM to the plutonium disposition facilities, transportation of MOX fuel to the mission reactors, and transportation of wastes for ultimate disposal were discussed in the SPD EIS (DOE 1999c).

Because one mission reactor site was eliminated since the publication of the SPD EIS, the environmental impacts of MOX fuel transport to the mission reactors are reevaluated in this ER.

### **1.2.7 Transport and Disposal of Spent MOX Fuel**

The transportation and disposal of spent MOX fuel at a geologic repository are not part of this proposed licensing action. The environmental impacts associated with transport and disposal of spent MOX fuel were discussed in the S&D PEIS (DOE 1996b) and the *Draft Environmental Impact Statement for a Geologic Repository for the Disposal of Spent Nuclear Fuel and High-Level Radioactive Waste at Yucca Mountain, Nye County, Nevada* (DOE 1999a). These impacts will not be addressed in this ER.

### **1.2.8 Decommissioning the Surplus Plutonium Disposition Facilities**

As stated in Section 4.31.2 of the SPD EIS (DOE 1999c):

The nature, extent and timing of future D&D [decontamination and decommissioning] activities are not known at this time. Although some choices currently exist, both technically and under environmental regulations for performing final D&D, DOE expects that there will be additional options available in the future.

No meaningful alternatives or analysis of impacts can be formulated at this time. D&D is so remote in time that neither the means to conduct D&D, nor the impacts of the actions, are foreseeable in the sense of being susceptible to meaningful analysis now.

By contract, DCS is required to deactivate the MFFF, terminate the license, and turn the facility over to DOE. The impacts associated with deactivation are discussed in this ER.

## **1.3 ALTERNATIVES PREVIOUSLY EVALUATED BY DOE**

To develop an appropriate range of alternatives to be considered and compared to the proposed action, it was necessary to consider the scope of the environmental determinations previously made by DOE. Sections 1.3.1 and 1.3.2 summarize DOE's prior environmental determinations related to the overall surplus plutonium disposition program.

In 1992, General Brent Scowcroft, then National Security Advisor to President Bush, requested the National Academy of Sciences (NAS) Committee on International Security and Arms

Control (CISAC) to perform a study of the management and disposition options for surplus weapons-usable plutonium. The results of the CISAC study were published in *Management and Disposition of Excess Weapons Plutonium* (NAS 1994). This study was followed by a series of agreements between the governments of the United States and the Russian Federation culminating in the most recent *Agreement Between the Government of the United States of America and the Government of the Russian Federation Concerning the Management and Disposition of Plutonium Designated as No Longer Required for Defense Purposes and Related Cooperation* (White House 2000). The agreement commits the United States to disposal of 28.2 tons (25.57 metric tons) of plutonium through conversion to MOX fuel and irradiation in power reactors. As the agency responsible for the management of surplus plutonium, DOE is charged with implementing these agreements.

The disposition of surplus weapons-usable plutonium was evaluated by DOE in two previous NEPA actions: the S&D PEIS (DOE 1996b) and the SPD EIS (DOE 1999c). Together, these comprehensive evaluations considered over 100 alternatives for storage and disposition of surplus plutonium and highly enriched uranium (HEU). DOE has issued a ROD for each of these NEPA actions (DOE 1997c, 2000b), which supported the decision to construct the MFFF at SRS in F Area. In addition, the United States and the Russian Federation have entered into agreements based on the decisions in these RODs. The alternatives previously evaluated in the S&D PEIS and SPD EIS are briefly discussed in the following sections.

### **1.3.1 Storage and Disposition of Weapons-Usable Fissile Materials Final Programmatic Environmental Impact Statement (S&D PEIS)**

In the S&D PEIS (DOE 1996b), DOE initially evaluated 37 potential disposition alternatives, as shown in Table 1-1. In addition to the 37 disposition alternatives, the S&D PEIS analyzed a No Action Alternative (i.e., all weapons-usable fissile materials would remain in storage at existing sites using proven nuclear material safeguards and security procedures) and the No Disposition Action Alternative (all weapons-usable fissile materials would remain in centralized storage).

Each of the alternatives was analyzed for the full range of natural resource, human resource, and issue areas pertinent to the sites considered for the long-term storage and disposition alternatives. The resource/issue areas are land resources, site infrastructure, air quality and noise, water resources, geology and soils, biological resources, cultural and paleontological resources, socioeconomics, public and occupational health and safety, waste management, intersite transportation, and environmental justice.

The S&D PEIS also analyzed six candidate sites for the long-term storage of weapons-usable fissile materials: Hanford, Nevada Test Site (NTS), INEEL, Pantex, Oak Ridge Reservation (ORR), and SRS. These same sites were also used to evaluate the construction and operation of various facilities required for the disposition alternatives. These facilities include the pit disassembly/conversion and the plutonium conversion facilities common to all disposition alternatives, the MOX fuel fabrication facility common to all reactor alternatives, the ceramic

immobilization facility for the deep borehole alternative, the glass vitrification and ceramic immobilization facilities, and the Evolutionary Light Water Reactor (LWR) Alternative.

In the S&D PEIS ROD (DOE 1997c), issued in January 1997, DOE concluded the following:

The fundamental purpose of the program is to maintain a high standard of security and accounting for these materials while in storage, and to ensure that plutonium produced for nuclear weapons and declared excess to national security needs (now, or in the future) is never again used for nuclear weapons.

DOE's strategy for disposition of surplus plutonium is to pursue an approach that allows immobilization of surplus plutonium in glass or ceramic material for disposal in a geologic repository pursuant to the Nuclear Waste Policy Act, and burning of some of the surplus plutonium as MOX fuel in existing, domestic, commercial reactors, with subsequent disposal of the spent fuel in a geologic repository pursuant to the Nuclear Waste Policy Act. ... The timing and extent to which either or both of these disposition approaches (immobilization or MOX) are ultimately deployed will depend upon the results of future technology development and demonstrations, follow-on (tiered) site-specific environmental review, contract negotiations, and detailed cost reviews, as well as nonproliferation considerations, and agreements with Russia and other nations. [Emphasis added]

In explaining the DOE decision, the S&D PEIS ROD noted the following:

DOE has decided to pursue a strategy for plutonium disposition that allows for immobilization of surplus weapons plutonium in glass or ceramic forms and burning of the surplus plutonium as MOX in existing reactors. The decision to pursue disposition of the surplus plutonium using these approaches is supported by the analyses in the Disposition Technical Summary Report and the Nonproliferation Assessment, as well as the S&D Final PEIS. The results of additional technology development and demonstrations, site-specific environmental review, detailed cost proposals, nonproliferation considerations, and negotiations with Russia and other nations will ultimately determine the timing and extent to which MOX as well as immobilization is deployed. These efforts will provide the basis and flexibility for the United States to initiate disposition efforts either multilaterally or bilaterally through negotiations with other nations, or unilaterally as an example to Russia and other nations.

Therefore, in the S&D PEIS, DOE conducted the requisite environmental analyses and determined that MOX irradiation would be part of an overall hybrid strategy for surplus plutonium disposition.

### 1.3.2 Surplus Plutonium Disposition Environmental Impact Statement (SPD EIS)

Having determined that MOX irradiation should be part of the overall surplus plutonium disposition strategy, DOE next considered how best to implement that strategy, including how best to provide for MOX irradiation.

The SPD EIS (DOE 1999c) considered 14 alternatives including a No Action Alternative (i.e., all weapons-usable fissile materials would remain in storage at existing sites using proven nuclear material safeguards and security procedures) and several host sites. These alternatives are summarized in Table 1-2. The SPD EIS provided a general description of the MFFF facility and process, including the fact that the design would "... process up to 3.5 t [metric tons] (3.8 tons) of surplus plutonium ... annually." For each potential host site, the SPD EIS considered specific locations at the host site.

The SPD EIS ROD (DOE 2000b), issued in January 2000, provided the DOE rationale for deciding to construct and operate the MFFF at SRS:

The fundamental purpose of the program is to ensure that plutonium produced for nuclear weapons and declared excess to national security needs (now and in the future) is never again used for nuclear weapons. Specifically, the Department has decided to use a hybrid approach for the disposition of surplus plutonium. This approach allows for the immobilization of approximately 17 metric tons of surplus plutonium and the use of up to 33 metric tons of surplus plutonium as MOX fuel. The Department has selected the Savannah River Site in South Carolina as the location for all three disposition facilities. ... SRS is preferred for the MOX facility because this activity would complement existing missions and take advantage of existing infrastructure and staff expertise.

In discussing the advantages and disadvantages of the hybrid approach, the SPD EIS ROD noted the following:

Reactor technology will meet the *Spent Fuel Standard*. Reactor technology has some advantage over the immobilization technology with respect to perceived irreversibility, in that the plutonium would be converted from weapons-grade to reactor-grade, even though it is possible to produce nuclear weapons with both weapons and reactor-grade plutonium. However, the immobilization technology has some advantage over the reactor technology in avoiding the perception that the latter approach could potentially encourage additional separation and civilian use of plutonium, which itself poses proliferation risks.

Pursuing this hybrid approach provides the best opportunity for U.S. leadership in working with Russia to implement similar options for reducing Russia's excess plutonium in parallel. Further, it sends the strongest possible signal to the world of U.S. determination to reduce stockpiles of surplus weapons-usable plutonium as quickly as possible and in an irreversible manner. Pursuing both immobilization

and MOX fuel fabrication also provides important insurance against uncertainties of implementing either approach by itself.

In response to the foreign policy commitments in the *Agreement Between the Government of the United States of America and the Government of the Russian Federation Concerning the Management and Disposition of Plutonium Designated as No Longer Required for Defense Purposes and Related Cooperation* (White House 2000), DOE believes that only the hybrid approach can meet the need for the action to reduce the threat of nuclear weapons proliferation worldwide by disposing of surplus plutonium.

#### **1.4 ALTERNATIVES CONSIDERED IN THIS ENVIRONMENTAL REPORT**

Taking into consideration the above framework of determinations previously made by DOE and the nature of the proposed action before the NRC (see Section 1.1 above), DCS has developed the following range of alternatives for consideration in this ER.

This ER includes a No Action Alternative that is relevant to the proposed action. The No Action Alternative for this ER is a decision by the NRC to not grant a license to DCS to possess and use SNM at the MFFF. Because of previous DOE decisions, the consequences of the No Action Alternative are the same as those discussed in the SPD EIS (DOE 1999c); all weapons-usable fissile materials would remain in storage at existing sites using proven nuclear material safeguards and security procedures. The No Action Alternative consequences, evaluated and discussed in the SPD EIS, are summarized in Section 5.7.1 of this ER but were not reanalyzed in this ER. The consequences of the No Action Alternative are discussed in more detail in the SPD EIS.

Within F Area at SRS, DCS considered various locations for the MFFF. This evaluation is discussed in Section 5.7.2 of this ER. Design alternatives that may impact the environment are addressed in Section 5.7.3 of this ER.

#### **1.5 PROJECT SCHEDULE**

The following timetable represents the anticipated schedule for licensing, construction, and operation of the MFFF.

Submit Application for Construction Authorization	Early 2001
Submit License Application	June 2002
Initiate Facility Construction	March 2003
Receive SNM	November 2005
Commence Production of MOX Fuel	January 2007

Any significant delay in the schedule of the MFFF could adversely affect the overall MFFF plutonium disposition mission.



**This page intentionally left blank.**

## **Tables**

**This page intentionally left blank.**

**Table 1-1. Description of Variants Analyzed in the S&D PEIS**

Alternatives Analyzed	Possible Variants
Deep Borehole Direct Disposition	<ul style="list-style-type: none"> <li>• Arrangement of plutonium in different types of emplacement</li> </ul>
Deep Borehole Immobilized Disposition	<ul style="list-style-type: none"> <li>• Emplacement of pellet-grout mix</li> <li>• Pumped emplacement of pellet-grout mix</li> <li>• Plutonium concentration loading; size and shape of ceramic pellets</li> </ul>
New Vitrification Facilities	<ul style="list-style-type: none"> <li>• Collocated pit disassembly/conversion, plutonium conversion, and immobilization facilities</li> <li>• Use of either Cs-137 from capsules or high-level waste (HLW) as a radiation barrier</li> <li>• Wet or dry feed preparation technologies</li> <li>• An adjunct melter adjacent to the DWPF at SRS, in which borosilicate glass frit with plutonium (without highly radioactive radionuclides) is added to borosilicate glass containing HLW from the DWPF</li> <li>• A can-in-canister approach at SRS in which cans of plutonium glass (without highly radioactive radionuclides) are placed in DWPF canisters, which are then filled with borosilicate glass containing HLW in the DWPF</li> <li>• A can-in-canister approach similar to the above but using new facilities at sites other than SRS</li> </ul>
New Ceramic Immobilization Facilities	<ul style="list-style-type: none"> <li>• Collocated pit disassembly/plutonium conversion, and immobilization facilities</li> <li>• Use of either Cs-137 from capsules or HLW as a radiation barrier</li> <li>• Wet or dry feed preparation technologies</li> <li>• A can-in-canister approach at SRS in which plutonium is immobilized, without highly radioactive radionuclides, in a ceramic matrix and then placed in the DWPF canisters that are then filled with borosilicate glass containing HLW</li> <li>• A can-in-canister approach similar to the above but using facilities at sites other than SRS</li> </ul>
Electrometallurgical Treatment	<ul style="list-style-type: none"> <li>• Immobilize plutonium into metal ingot form</li> <li>• Locate at DOE sites other than Argonne National Laboratory-West at INEEL</li> </ul>
Existing LWR With New MOX Facilities	<ul style="list-style-type: none"> <li>• Pressurized or boiling water reactors</li> <li>• Different numbers of reactors</li> <li>• European MOX fuel fabrication</li> <li>• Modification/completion of existing facilities for MOX fabrication</li> <li>• Collocated pit disassembly/conversion, plutonium conversion, and MOX facilities</li> <li>• Reactors with different core management schemes</li> </ul>

**Table 1-1. Description of Variants Analyzed in the S&D PEIS (continued)**

<b>Alternatives Analyzed</b>	<b>Possible Variants</b>
Partially Completed LWR With New MOX Facilities	<ul style="list-style-type: none"> <li>• Pressurized or boiling water reactors</li> <li>• Different numbers of reactors</li> <li>• Modification/completion of existing facilities for MOX fabrication</li> <li>• Collocated pit disassembly/conversion, plutonium conversion, and MOX facilities</li> <li>• Reactors with different core management schemes</li> </ul>
New Evolutionary LWR With New MOX Facilities	<ul style="list-style-type: none"> <li>• Pressurized or boiling water reactors</li> <li>• Different numbers of reactors</li> <li>• Modification/completion of existing facilities for MOX fabrication</li> <li>• Collocated pit disassembly/conversion, plutonium conversion, and MOX facilities</li> <li>• Reactors with different core management schemes</li> </ul>
Existing CANDU Reactor With New MOX Facilities	<ul style="list-style-type: none"> <li>• Different numbers of reactors</li> <li>• Modification/completion of existing facilities for MOX fabrication</li> <li>• Collocated pit disassembly/conversion, plutonium conversion, and MOX facilities</li> <li>• Reactors with different core management schemes</li> </ul>

**Table 1-2. Summary of Alternatives Considered in the Surplus Plutonium Disposition Environmental Impact Statement**

Alternative	Pit Disassembly and Conversion (PDCF)	Plutonium Conversion and Immobilization (PIP)	MOX Fuel Fabrication (MFFF)	Disposition Amounts (metric tons of MOX)
1	No Action			
2	Hanford	Hanford	Hanford	33
3	SRS	SRS	SRS	33
4	Pantex	Hanford	Hanford	33
5	Pantex	SRS	SRS	33
6	Hanford	SRS	Hanford	33
7	INEEL	SRS	INEEL	33
8	INEEL	Hanford	INEEL	33
9	Pantex	SRS	Pantex	33
10	Pantex	Hanford	Pantex	33
11A	Hanford	Hanford	None	0
11B	Pantex	Hanford	None	0
12A	SRS	SRS	None	0
12B	Pantex	SRS	None	0

Note: This ER addresses the MFFF portion of Alternative 3. Section 5.6 discusses the cumulative impacts of all three SPD missions identified in Alternative 3.

**This page intentionally left blank.**

## **2. PURPOSE OF THE PROPOSED ACTION**

This section provides background information (Section 2.1) and discusses the need for the MFFF (Section 2.2).

### **2.1 BACKGROUND INFORMATION**

On September 27, 1991, President George Bush announced the end of the 42-year Cold War with the Soviet Union, soon after the Russian nation suffered great political upheaval. This event led to a determination that our nuclear weapons stockpile needed to be reduced, resulting in surplus plutonium and surplus HEU. In 1992, General Brent Scowcroft, then National Security Advisor to President Bush, requested the NAS CISAC to perform a study of the management and disposition options for surplus weapons-usable plutonium. The request was later confirmed by President Clinton when he assumed office in January 1993. The results of the CISAC study were published in *Management and Disposition of Excess Weapons Plutonium* (NAS 1994).

The CISAC recommended, among other actions, that the United States and Russia pursue a long-term plutonium disposition option that results in a form from which the plutonium would be as difficult to recover for weapons use as the larger and growing quantity of plutonium in commercial spent fuel. This recommendation became known as the Spent Fuel Standard. The CISAC report noted that two approaches could be used to achieve the Spent Fuel Standard. One approach is fabrication and use of MOX fuel in nuclear reactors. The plutonium in the MOX fuel would be irradiated and become part of the spent fuel that will be disposed in a geologic repository. The second approach is incorporation of plutonium in a vitrified HLW matrix (i.e., immobilization) with disposition in the same geologic repository. The study noted that there may be some public opposition to the proven MOX fuel option. The study also noted the existence of technical difficulties and longer implementation time with the immobilization option. Finally, the study noted that the immobilization option was not acceptable to Russian officials who view their surplus plutonium as a resource.

In December 1996, DOE published the S&D PEIS (DOE 1996b). The S&D PEIS analyzed the potential environmental consequences of alternative strategies for the long-term storage of weapons-usable plutonium and HEU and the disposition of weapons-usable plutonium that has been or may be declared surplus to national security needs. The ROD for the S&D PEIS, issued on January 21, 1997 (DOE 1997c), outlined DOE's decision to pursue a hybrid approach to plutonium disposition that would make surplus weapons-usable plutonium inaccessible and unattractive for weapons use. DOE's disposition strategy, consistent with the Preferred Alternative analyzed in the S&D PEIS, allowed for both the immobilization of some (and potentially all) of the surplus plutonium and use of some of the surplus plutonium as MOX fuel in existing domestic, commercial reactors.

The ROD also noted, "The timing and extent to which either or both of these disposition approaches (i.e., immobilization or MOX fuel fabrication and irradiation) are ultimately deployed will depend upon the results of future technology development and demonstrations,



follow-on (i.e., tiered) site-specific environmental review, contract negotiations, and detailed cost reviews, as well as non-proliferation considerations, and agreements with Russia and other nations.” [Emphasis added]

The MOX decision is reinforced by the language in the *Joint Statement of Principles for Management and Disposition of Plutonium Designated as No Longer Required for Defense Purposes* (White House 1998), signed by Presidents Clinton and Yeltsen in September 1998, “In cooperation with others, the U.S. and Russia will, as soon as practically feasible, and according to a time frame to be negotiated by the two governments, develop and operate an initial set of industrial-scale facilities for the conversion of plutonium to fuel for the above-mentioned existing reactors.” [Emphasis added]

In September 2000, the governments of the United States and the Russian Federation signed the *Agreement Between the Government of the United States of America and the Government of the Russian Federation Concerning the Management and Disposition of Plutonium Designated as No Longer Required for Defense Purposes and Related Cooperation* (White House 2000). The agreement commits the United States to disposal of 28.2 tons (25.57 metric tons) of plutonium through conversion to MOX fuel and irradiation in power reactors.

On May 22, 1997, DOE published a Notice of Intent (NOI) in the Federal Register (DOE 1997d) announcing its decision to prepare an EIS that would tier from the analysis and decisions reached in connection with the S&D PEIS. The SPD EIS (DOE 1999c) addressed the extent to which each of the two plutonium disposition approaches (i.e., immobilization and MOX) would be implemented and analyzed candidate sites for plutonium disposition facilities and activities.

In January 2000, DOE issued the SPD EIS ROD (DOE 2000b), which contained the following decision:

The fundamental purpose of the program is to ensure that plutonium produced for nuclear weapons and declared excess to national security needs (now and in the future) is never again used for nuclear weapons. Specifically, the Department has decided to use a hybrid approach for the disposition of surplus plutonium. This approach allows for the immobilization of approximately 17 metric tons of surplus plutonium and the use of up to 33 metric tons of surplus plutonium as MOX fuel. The Department has selected the Savannah River Site in South Carolina as the location for all three disposition facilities. ... SRS is preferred for the MOX facility because this activity would complement existing missions and take advantage of existing infrastructure and staff expertise.

## **2.2 NEED FOR THE FACILITY**

The proposed action, issuing a license to possess and use SNM in an MFFF, is essential to the successful implementation of the joint United States-Russian nuclear disarmament policy.

DOE has previously determined that there is a clear need for the development of an MFFF at SRS. As stated in the SPD EIS (DOE 1999c):

The purpose of and need for the proposed action [construction of a PDCF, MFFF, and PIP] is to reduce the threat of nuclear weapons proliferation worldwide by conducting disposition of surplus plutonium in the United States in an environmentally safe and timely manner. Comprehensive disposition actions are needed to ensure that surplus plutonium is converted to proliferation-resistant forms. In September 1993, President Clinton issued the *Nonproliferation and Export Control Policy* (White House 1993) in response to the growing threat of nuclear proliferation. Further, in January 1994, President Clinton and Russia's President Yeltsin issued a *Joint Statement Between the United States and Russia on Non-Proliferation of Weapons of Mass Destruction and the Means of Their Delivery* (White House 1994). In accordance with these policies, the focus of the U.S. nonproliferation efforts includes ensuring the safe, secure, long-term storage and disposition of surplus weapons-usable fissile plutonium. The United States and Russia signed a 5-year agreement to provide the scientific and technical basis for decisions concerning how surplus plutonium will be managed and a statement of principles with the intention of removing approximately 50 t [metric tons] (55 tons) of plutonium from each country's stockpile.

In the SPD EIS ROD (DOE 2000b), DOE decided to convert up to 36.4 tons (33 metric tons) of surplus plutonium to MOX fuel:

The Department has decided to implement a program to provide for the safe and secure disposition of up to 50 metric tons of surplus plutonium as specified in the Preferred Alternative in the *Surplus Plutonium Disposition Final Environmental Impact Statement*. The fundamental purpose of the program is to ensure that plutonium produced for nuclear weapons and declared excess to national security needs (now and in the future) is never again used for nuclear weapons. Specifically, the Department has decided to use a hybrid approach for the disposition of surplus plutonium. This approach allows for the immobilization of approximately 17 metric tons of surplus plutonium and the use of up to 33 metric tons of surplus plutonium as MOX fuel. The Department has selected the Savannah River Site in South Carolina as the location for all three disposition facilities.

The DOE decision to construct and operate the MFFF is an essential component of the United States foreign policy as stipulated in the September 2000 agreement between the United States and Russian Federation (White House 2000). Accordingly, all of the aforementioned NEPA actions and foreign policy agreements strongly support the need for the MFFF.

**This page intentionally left blank.**

### **3. DESCRIPTION OF THE MOX FUEL FABRICATION FACILITY**

This chapter describes the MFFF buildings and the major MFFF design and operating parameters. An overview of the buildings is provided in Section 3.1, including the general facility arrangements. The layout of the MFFF site is provided in Figure 3-1, and key design and operation parameters are listed in Table 3-1. A summary of facility processes and operations in sufficient detail to identify waste streams and effluent releases is provided in Section 3.2. The waste management systems and waste disposition are discussed in Section 3.3. The facility and process descriptions are based on the preliminary design and may be subject to change.

The MOX aqueous polishing and fuel fabrication processes and the basic plant design are based on the operational COGEMA MELOX Plant and La Hague Plutonium Finishing Facilities, located in Marcoule and La Hague, France, respectively. The proven COGEMA plant design is being adapted to meet appropriate United States codes and standards.

#### **3.1 GENERAL FACILITY ARRANGEMENT**

The MFFF site is located on the north-northwest side of F Area at SRS. Approximately 17 ac (6.9 ha) of the 41-ac (16.6-ha) MFFF site will be developed with buildings, facilities, or pavement. The remaining 24 ac (9.7 ha) of the MFFF site will be landscaped in either grass or gravel.

The buildings and facilities of the MFFF are arranged and oriented to ensure safe, secure, and efficient performance of all MFFF functions. The site layout provides the desired arrangement and physical site characteristics necessary to satisfy the very stringent security criteria for safeguarding SNM. The site layout also supports safe and efficient MFFF operations (e.g., receiving, handling, storing, and shipping feedstocks and product).

The protected area inside the double fence Perimeter Intrusion Detection and Assessment System (PIDAS) occupies approximately 14 ac (5.7 ha) and is roughly square in shape, as indicated on Figure 3-1. All deliveries are made to the MFFF protected area by truck shipment or pipeline from offsite. The plutonium oxide is transferred from the PDCF by truck. The Administration Building, Diesel Fuel Fill Station, and Gas Storage Facility are all located outside the PIDAS.

The MFFF consists of the following buildings:

- MOX Fuel Fabrication Building
- Reagent Process Building
- Emergency Diesel Generator Building
- Standby Diesel Generator Building
- Secured Warehouse Building
- Administration Building
- Technical Support Building.

These buildings and their operations are described in the following subsections.

### **3.1.1 MOX Fuel Fabrication Building**

The MOX Fuel Fabrication Building is a multi-functional complex containing all of the plutonium handling, fuel processing, and fuel fabrication operations of the MFFF. The MOX Fuel Fabrication Building is located within the protected area and has the requisite security measures in place to adequately safeguard the facility and prevent any attempts to illicitly remove SNM from the facility. The MOX Fuel Fabrication Building is comprised of three major functional interrelated areas: the aqueous polishing area, the fuel fabrication area, and the shipping and receiving area. Figures 3-2 and 3-3 provide a conceptual general arrangement of the aqueous polishing area and fuel fabrication area, respectively. Detailed general arrangement drawings contain Unclassified Controlled Nuclear Information (UCNI). The primary thrust of UCNI is the protection of information about security-related items. To protect the integrity of this security-sensitive information, general arrangement drawings are not provided in the ER.

The MOX Fuel Fabrication Building (i.e., aqueous polishing area, fuel fabrication area, and shipping and receiving area) is a multi-story, hardened, reinforced-concrete structure with a partial below-grade basement and an at-grade first floor. The MOX Fuel Fabrication Building has an overall height above grade of 73 ft (22.3 m). The 20-ft (6-m) tall vent stack, mounted on top of the MOX Fuel Fabrication Building, has a top elevation of approximately 93 ft (28 m) above grade. This facility meets all applicable requirements for processing SNM, as discussed in the Construction Authorization Request (CAR) and Safety Assessment (SA). The entire MOX Fuel Fabrication Building structure and the three component building areas are designed to withstand extreme natural phenomena, including design basis earthquakes, floods, and tornadoes, as well as a spectrum of potential industrial accidents that could impact the fissile process materials. The lowest floor level of the MOX Fuel Fabrication Building, approximate elevation 256 ft (78 m) above mean sea level (msl), is well above the F-Area calculated design basis flood level with a 100,000-year return period (WSRC 1999a). Stormwater runoff from the MFFF site is directed to retention basins where it is released at rates equivalent to pre-construction stormwater runoff rates. Additional information on the MFFF design basis is provided in the CAR.

Functional areas and processes in the MOX Fuel Fabrication Building complex include the following:

- Shipping and receiving (i.e., truck bay) area
- Aqueous polishing area
- Blending and milling area
- Pelletizing area
- Sintering area
- Grinding area
- Fuel rod fabrication area
- Fuel bundle assembly area
- Storage areas for feed material, pellets, rods, and fuel assemblies
- A laboratory area

- Space for use by the International Atomic Energy Agency.

Support equipment (e.g., heating, ventilation, and air conditioning [HVAC] components; high-efficiency particulate air [HEPA] filter plenums; inverters; switchgear; pumps) is also present within the building complex. Adequate space for waste packaging and its temporary storage is provided. The MFFF processes (i.e., plutonium polishing, powder processing, pellet processing, rod processing, building and glovebox ventilation systems, and offgas treatment) are described in Section 3.2.

The MOX Fuel Fabrication Building contains the SNM processing areas. This building complex is the source of any anticipated radiological releases to the environment. The MOX Fuel Fabrication Building produces solid and liquid wastes and airborne effluents. Solid wastes and liquid waste streams are transferred to the appropriate SRS waste management facilities in accordance with the applicable SRS Waste Acceptance Criteria (WAC) (WSRC 2000b). Anticipated airborne effluents are treated, as described in Sections 3.2 and 3.3, and monitored before being released to the environment. The management of the MFFF waste streams is described in Section 3.3.

### **3.1.2 Reagent Process Building**

The Reagent Process Building, located inside the protected area adjacent to the aqueous polishing area of the MOX Fuel Fabrication Building, provides space for storage and mixing of the chemical reagents used in the aqueous polishing process. The Reagent Process Building consists of a number of separate rooms/areas for the various chemicals. Liquid chemical containers are located inside curbed areas for containment of accidental spills. Safety showers and eyewash stations are located in each of the chemical rooms/areas. One end of the Reagent Process Building has a loading dock for transfer of chemical drums in and out of the building. The Reagent Process Building floor level is slightly above grade with a below-grade collection tank room that receives waste chemicals from the aqueous polishing area and the Reagent Process Building. The Reagent Process Building contains shower, restroom, and locker facilities. Chemicals are transferred to the aqueous polishing area from the Reagent Process Building via piping located in a concrete, below-grade trench between the two buildings.

Table 3-2 summarizes the chemicals used at the MFFF site, many of which are stored in the Reagent Process Building. The Reagent Process Building has roof vents to allow for venting in emergency situations. No measurable gaseous emissions are expected from activities within this building.

### **3.1.3 Emergency Diesel Generator Building**

The Emergency Diesel Generator Building, located inside the protected area adjacent to the MOX Fuel Fabrication Building, contains the diesel generators that provide the emergency power for items relied on for safety (IROFS) in the MFFF. The building is a single-story, slab-on-grade, reinforced-concrete building. The roof and walls of the building are of sufficient

strength and thickness to protect against the effects of extreme natural phenomena (e.g., severe wind and tornado) and associated generated missiles, as well as to resist the design basis earthquake. Natural disasters considered in the design of the Emergency Diesel Generator Building are the same as those considered for the MOX Fuel Fabrication Building.

The emergency onsite power is provided by two 1,000-kW seismically-mounted diesel generators. Located adjacent to the diesel generator rooms, but separated from them by firewalls, are the switchgear, motor control centers, and uninterruptible power supplies (UPSs). The UPS equipment uses sealed, maintenance-free batteries.

Associated with the Emergency Diesel Generator Building is an 18,000-gal (68,130-L) fuel tank sited in a concrete bunker adjacent to the building. The top of this bunker is slightly above plant grade. This tank within a vault meets the design requirements of 40 CFR Part 280 for underground storage tanks. The diesel generator rooms contain a day tank that stores a maximum of 660 gal (2,498 L) of fuel oil. Each day tank is enclosed with a dike that can accommodate the full contents of the associated tank.

When operating, the diesel generators emit criteria pollutants as combustion products. Unless there is a leak associated with the diesel fuel storage tanks, these tanks only provide fugitive emissions due to a very small evaporation (i.e., approximately 0.5 lb/yr [0.23 kg/yr]) of volatile organic compounds (VOCs).

### **3.1.4 Standby Diesel Generator Building**

The Standby Diesel Generator Building is located inside the protected area and contains the normal operation electrical generators that provide the onsite power source for the major loads in the event of a loss of offsite power. The building is a single-story, slab-on-grade structure with pre-engineered steel framing and insulated metal siding and roof.

The building contains two 2,000-kW standby diesel generators. The normal switchgear, load centers, motor control centers, power panels, and dry type transformers are located adjacent to the diesel generator rooms and are separated from them by firewalls.

Fuel for the standby diesel generators is provided by a 5,000-gal (18,925-L), double-walled tank buried adjacent to the building. This double-walled tank meets the design requirements of 40 CFR Part 280 for underground storage tanks. The diesel generator rooms contain a day tank that stores a maximum of 660 gal (2,498 L) of fuel oil. Each day tank is enclosed with a dike that can accommodate the full contents of the associated tank. These diesel generators also emit criteria pollutants during operation, and the diesel fuel tank emits a very small amount of VOCs due to evaporative losses.

### **3.1.5 Secured Warehouse Building**

The Secured Warehouse Building is a single-story, slab-on-grade, pre-engineered, metal building. The exterior walls and roof consist of insulated metal panels. The office area is

constructed of light-gauge steel framing. Two receiving bays with roll-up doors and a canopy roof are provided on the front of the building.

The Secured Warehouse Building, located near the MOX Fuel Fabrication Building, supports the MFFF operations by receiving and storing materials, equipment, and supplies inside the protected area near the MOX Fuel Fabrication Building, making them readily available when needed. All materials entering the secured area pass through the Material Access Portal inside the Secured Warehouse Building. The Material Access Portal is equipped with screening equipment that allows identification of all materials prior to passing through the portal. Security personnel occupy the office area adjacent to the Material Access Portal. The Secured Warehouse Building is not a personnel access through the PIDAS, but the Vehicle Gatehouse is equipped for Safe Secure Transport (SST) driver/escort admittance into the protected area. Depleted uranium dioxide (UO<sub>2</sub>), a MOX feedstock, is stored in drums in the Secured Warehouse Building.

The Secured Warehouse Building also provides storage locations for 16 new-fuel shipping packages and space for incidental periodic maintenance of these shipping packages.

The two-story Parts Washing Facility is located in the Secured Warehouse Building. Maintenance/service personnel utilize the Parts Washing Facility, and inventory control personnel occupy an office area located in the Secured Warehouse Building. The Parts Washing Facility is where new fuel rod assembly parts are cleaned prior to use in the MOX Fuel Fabrication Building. This facility has a separate ventilation/exhaust system and is equipped with a hood for worker protection. Wastes from parts washing are nonradioactive and will be managed as hazardous wastes and disposed of through the SRS waste management infrastructure<sup>1</sup>.

### **3.1.6 Administration Building**

The Administration Building, located outside of the protected area of the MFFF complex, provides space for administrative support functions to the MFFF and its operations. The Administration Building is accessed from the main project personnel and public parking area. The Administration Building is a two-story, slab-on-grade, steel-framed structure. The following functions are performed within the Administration Building:

- Facility management
- Facility operations
- Facilities engineering
- Material accountability administration
- Finance and administration
- Health and safety evaluations

---

<sup>1</sup> The design of the Parts Washing Facility is not sufficiently developed to project waste quantities or emissions.



- Quality assurance
- Personnel management.

Also located in the Administration Building is the Programmable Logic Controller Software Simulation Laboratory where operations computer software maintenance and development are conducted.

The Administration Building does not emit any gaseous or liquid effluents, with the exception of sanitary waste that is routed to the Central Sanitary Waste Treatment Facility (CSWTF).

### **3.1.7 Technical Support Building**

The Technical Support Building, located adjacent to the MOX Fuel Fabrication Building, provides personnel access control to the MOX Fuel Fabrication Building and support facilities for MOX Fuel Fabrication Building personnel. The Technical Support Building is a slab-on-grade, steel-framed structure. The two-story portion of the building contains the service-oriented facilities, such as the electronic maintenance lab, mechanical maintenance shop, and building mechanical equipment room. The one-story portion contains the personnel-oriented facilities, such as the locker and change rooms, toilet facilities, work and anti-contamination protective clothing storage and access, dosimeter and respirator issue, first aid station, and lunch/break room.

Such activities as badging, photo identification, search, and pass-through take place in the Personnel Access Portal. Security monitoring at the Personnel Access Portal includes metal detectors, explosive detectors, and radiation monitors. Also included in the Technical Support Building are the following:

- Security operations center and support facilities
- Secondary alarm monitoring station
- Safeguards vault
- Security response ready room
- Armory
- Emergency power room
- Computer and telecommunications room
- Building mechanical equipment room.

The secondary alarm monitoring station is considered a vital area and is designed and constructed as a hardened bulletproof area with its own support systems. Additional security identification is required for entrance into this area.

The Technical Support Building is not directly involved in the principal processing functions of the MFFF.

### **3.2 MOX FUEL FABRICATION PROCESS**

The following process description is intended to support the discussion of environmental impacts from MFFF operations in Chapter 5. The SA and the CAR contain more detailed descriptions of the MOX fuel fabrication process.

The plutonium polishing (i.e., aqueous polishing) and fuel fabrication processes are based on similar processes used at the COGEMA MELOX Plant and La Hague Plutonium Finishing Facilities in France. The flow of plutonium compounds through the MOX fuel fabrication process is illustrated in Figure 3-4. The following brief discussion of the process focuses on process aspects of concern when addressing environmental impacts.

The MOX fuel fabrication process is divided into two major subprocesses:

- Aqueous polishing – Removes impurities (i.e., gallium, americium, and uranium) from the weapons-grade plutonium oxide
- Fuel fabrication – Blends plutonium and uranium oxides and recycled scraps to a mixed oxide, converts the MOX powder to a fuel pellet, loads the MOX fuel pellets into fuel rods, and bundles the rods into fuel assemblies.

The aqueous polishing subprocess produces most of the liquid waste streams and employs extensive reuse of reagents to minimize plutonium losses and waste. The fuel fabrication subprocess produces solid scrap material, which is reused in the overall process. Both subprocesses generate small amounts of contaminated solid wastes related to maintenance activities. The building and glovebox ventilation systems are essential for contamination control. The associated airborne emissions are collected from the process ventilation (i.e., gloveboxes and equipment) and building ventilation in the controlled area.

#### **3.2.1 Plutonium Polishing**

Plutonium polishing is schematically represented in Figure 3-5. The polishing process can be divided into five discrete steps:

1. Plutonium oxide ( $\text{PuO}_2$ ) is first electrochemically dissolved with silver ( $\text{Ag}^{2+}$ ) in nitric acid.
2. The plutonium nitrate solution is solvent extracted using tributyl phosphate in an aliphatic diluent (dodecane) to remove impurities. The solution containing plutonium nitrate is washed with nitric acid. The plutonium is removed from the solvent by an aqueous solution of hydroxylamine nitrate, hydrazine, and nitric acid.
3. The plutonium valence is oxidized back to Pu(IV) by driving nitrous fumes ( $\text{NO}_x$ ) through the plutonium solution.

4. The plutonium is then precipitated with excess oxalic acid as plutonium oxalate that is collected on a filter.
5. The moist oxalate is dried and calcined to  $\text{PuO}_2$  that is packaged in cans for use in the MOX fuel fabrication process.

The plutonium losses and liquid waste generation are maintained as low as technically and economically possible by specific solvent treatment and by reuse of nitric acid and silver in the polishing process. The MFFF design has a very stringent requirement imposed for plutonium loss in accordance with the DOE contract. The various liquid waste streams from the aqueous polishing process are illustrated in Figure 3-6, listed in Table 3-3, and described in the following paragraphs.

Plutonium oxide ( $\text{PuO}_2$ ) is electrochemically dissolved with silver ( $\text{Ag}^{2+}$ ) in nitric acid. A solvent (tributyl phosphate) in an aliphatic diluent (dodecane) then extracts the plutonium nitrate from the nitrate solution. Nitrate impurities (i.e., americium, gallium, and silver) remain in the aqueous (i.e., raffinate) phase. After diluent washing, the raffinate stream is routed to an acid recovery unit (see Section 3.2.2.1).

The extracted plutonium is washed with nitric acid. The plutonium is then reduced to trivalent plutonium by the introduction of hydroxylamine nitrate. The plutonium is removed from the solvent using a solution of nitric acid, hydrazine, and hydroxylamine nitrate. A silver recovery unit (see Section 3.2.2.2), based on electrolytic separation, recovers a large portion of the silver. The organic solvent that has had the plutonium removed is mixed with an additional stripping solution in a plutonium barrier before being routed to the uranium removal process. Uranium impurities are removed from the organic solvent with dilute nitric acid (see Section 3.2.2.3). Criticality is an issue because of the high uranium-235 content of the stream. It is therefore necessary to perform an isotopic dilution through the addition of depleted uranium to reduce the uranium-235 concentration to below 30%. The solvent that has had the plutonium and uranium removed is routed to solvent recovery mixer-settlers to be recycled back into the process (see Section 3.2.2.4).

After the extraction steps, the plutonium is oxidized back to quadravalent plutonium by driving nitrous fumes ( $\text{NO}_x$ ) through the plutonium solution. Nitrous acid is removed in an air-stripping column. The  $\text{NO}_x$ -containing gas stream is demisted to limit plutonium loss, then treated through an  $\text{NO}_x$  scrubbing column, before being released to the process offgas treatment unit. Recombined acid is routed to acid recovery (see Section 3.2.2.1).

The oxidized plutonium is reacted with excess oxalic acid ( $\text{H}_2\text{C}_2\text{O}_4$ ) to precipitate plutonium oxalate, which is collected on a filter, then dried in a screw calciner, to produce purified plutonium oxide powder ( $\text{PuO}_2$ ), which is stored in cans. Offgas from the screw calciner is treated before discharge to the downstream Very High Negative Pressure main filters. The filtered oxalic mother liquors are concentrated, reacted with manganese to destroy the oxalic acid, and recycled to the beginning of the extraction cycle to minimize plutonium loss from the process.

## **3.2.2 Material Recovery and Recycling**

### **3.2.2.1 Acid Recovery**

Spent acid, consisting of oxalic mother liquor distillates, raffinates, calcination concentrates, and recombined acid, is mixed in a buffering tank and injected into an evaporator. The first evaporator of the acid recovery unit is a concentration step before treatment of the concentrates in the silver recovery unit. The evaporator bottom concentrates, which contain significant amounts of silver, are routed to the silver recovery unit. After an additional evaporation step, the vapor is injected into a distillation column dedicated to acid rectification. Nitric acid is recovered from the rectification evaporator bottoms and partly reused as reagent feedstock for the plutonium dissolution subprocess. Distillates from the rectification evaporator are collected and partly reused in the process. The offgas is routed to a cooler and a demister before treatment. Process ventilation offgas treatment is described in Section 3.2.4.

### **3.2.2.2 Silver Recovery**

The concentrates from the first evaporator of the acid recovery unit are treated in the silver recovery unit. Silver recovery is a batch process that is based on electrolytic separation. After treatment, recovered silver is transferred back to the dissolution unit.

### **3.2.2.3 Stripped Uranium Collection**

Before the commencement of the purification cycle, HEU impurities are present, which are diluted to approximately 30% with depleted uranium. After the uranium stripping process, uranium removed from the plutonium stream is diluted with depleted uranium to approximately 1%. The diluted uranium is collected in storage vessels prior to subsequent processing within the SRS waste management infrastructure.

### **3.2.2.4 Solvent Regeneration**

The regeneration of spent solvent from the plutonium separation step is accomplished by washing with sodium carbonate, sodium hydroxide, and nitric acid to remove degradation products from organic compounds, including trace amounts of plutonium and uranium. The regenerated solvent is adjusted with the addition of tributyl phosphate and reused in the purification process.

## **3.2.3 MOX Fuel Fabrication**

The remaining steps in the MOX fuel fabrication process (i.e., powder, pellet, and rod processing) are dry subprocesses and are illustrated in Figure 3-7. The solid wastes produced from these steps are listed in Table 3-4.

Polished plutonium oxide is mixed with uranium oxide and recycled scraps to produce an initial MOX mixture that is 20% plutonium. This mixture is subjected to a micronized homogenization process in a ball mill and mixed with additional uranium oxide and recycled scraps to produce a final blend with the required plutonium content of 2.3% to 4.8%. The MFFF design is capable of producing MOX with a plutonium content of 6%. This final blend is further homogenized to meet the stringent plutonium distribution requirements. During the final homogenization process, lubricants and poreformers are added to control specific gravity.

Powder processing is performed in closed containers located in gloveboxes to contain any contamination. Gaseous exhaust points from the gloveboxes are equipped with HEPA filters to contain particulate emissions.

The homogenized powder is pneumatically transferred from the homogenizer to the press feeding hopper under negative pressure. The powder is then transferred by gravity to the press shoe.

The sintering process is performed in a furnace by heating the fuel pellets to a temperature of 3,092°F (1,700°C) under gas scavenging, using a nonexplosive mixture of argon and hydrogen. This specific furnace atmosphere controls sintering and pellet stoichiometry and is not subject to inadvertent detonations and deflagrations due to low hydrogen content. The pellet boats, which contain 22 lb (10 kg) of pellets each, are positioned on a molybdenum plate and then transferred to the furnace. An inlet and outlet furnace airlock is required for changes in atmospheric pressure. A pusher system provides continuous motion of the sets (i.e., boat on shoe) through the furnace. The last set introduced in the furnace pushes the preceding ones.

The sintered pellets are dry ground to meet the size and roughness of the fuel specifications for the specific reactor. The grinding process is performed in four dedicated gloveboxes. A dust removal system, composed of an extractor and a decloggable filter, is installed in the unit to minimize the spread of powder in the gloveboxes. This dust abatement technique minimizes waste production in the form of disposable filters and allows recovery and recycle of the captured dust. Grinding dust and pellet chips are routed back as feedstock to the scrap recycling process.

Pellet processing is performed in gloveboxes with HEPA filters on the vents to contain any dust. Glovebox exhausts are equipped with HEPA filters to contain any particulate emissions.

After the pellets are ground, they are automatically and visually inspected and sorted. Pellets that meet specifications are lined up and loaded into rods. Discarded pellets are routed to scrap processing and reintroduced to the blending feedstock (see Figure 3-7).

Within a glovebox environment, the rods are capped, welded, pressurized with helium, sealed, and then decontaminated. The decontaminated rods are removed from the gloveboxes and placed on trays for inspection and assembly.

Rods are inspected by testing for leaks and performing x-ray analysis of welds. The rods are then gamma-scanned to ensure that the plutonium content and length of the pellet column are

correct. Bundles of three different plutonium content rods are assembled into the fuel assembly skeleton. The fuel assembly is subjected to a final inspection prior to shipment.

Rod processing, until the decontamination step, is performed in gloveboxes with HEPA filters on the vents to contain the minute amounts of particulates. Any air exhaust from the gloveboxes is equipped with HEPA filters to contain particulate emissions.

### **3.2.4 Process Ventilation Offgas Treatment System**

The aqueous polishing process ventilation system, which is part of the process ventilation offgas treatment system, is used to:

- Remove plutonium from offgases released during dissolution and from the oxidation and degassing columns of the purification cycle
- Decontaminate the offgas effluents from all of the aqueous polishing units
- Maintain negative pressure in the tanks and equipment connected to the process ventilation system (i.e., more than 500 Pa with respect to the cell or glovebox in which equipment is placed)
- Provide continuity of the first confinement barrier.

NO<sub>x</sub> and air scrubbing columns generate most of the plutonium released to the ventilation. NO<sub>x</sub>-containing exhausts are demisted through a cap impactor to maximize plutonium recycling to the process. The NO<sub>x</sub> offgases are subsequently routed through a specific NO<sub>x</sub> scrubbing column after demisting through a can impactor to maximize plutonium recycling to the process. Finally, the scrubbed exhaust gas is diluted with process ventilation air and cleaned through a final scrubbing column. The exhaust is filtered through two final HEPA filter stages prior to being released through the MFFF stack.

The exhaust from the air pulsation columns is passed through two final HEPA filters before being released through the MFFF stack. A continuous air monitor is used to monitor stack releases to the environment.

There is a separate ventilation system for the calcination furnace exhaust. Exhaust gas from the calcination furnace is filtered through a metallic filter to remove most of the dust, cooled, and filtered through two HEPA filter stages before extraction by the very high negative pressure duct.

### **3.2.5 Building and Glovebox Ventilation Systems**

Areas within the facility with the highest potential for contamination are maintained at the lowest, or most negative, pressure compared to the adjacent room. Airflow cascades progressively from the areas of least potential contamination to the areas of highest potential contamination.

### 3.2.5.1 Confinement Zones

The MFFF ventilation systems maintain pressure gradients between the different confinement zones to ensure that leakage air flows from the zones of lowest contamination potential to zones of increasing contamination potential. Confinement zone classification is based on the fuel fabrication process, material handling, and the level of potential airborne and transferable contaminants generated in the various process areas. The confinement zone classification scheme is summarized as follows:

- Class Level C4 – gloveboxes, and process equipment located in process cells after gloveboxes, that contain dispersible radioactive material in the fuel fabrication and aqueous polishing areas.
- Class Level Process Cells – rooms in the aqueous polishing areas containing all welded process vessels and piping with no discontinuities where there is very low likelihood of contamination, but if contamination occurred it could be moderate to large.
- Class Level C3 zones are subdivided into two sublevels:
  - Class Level C3b – fuel fabrication and aqueous polishing areas, such as laboratories, waste drum storage, hoods, and areas enclosing gloveboxes, where there is a moderate occasional contamination risk.
  - Class Level C3a – fuel fabrication and aqueous polishing areas, such as airlocks and intermediate filter rooms, where there is a low occasional contamination risk.
- Class Level C2 – fuel fabrication and aqueous polishing areas, such as process rooms containing rods or assemblies and corridors around C3 areas, where there is a very low occasional contamination risk.
- Class Level C1 – areas with zero occasional contamination risk located within the shipping and receiving area and areas with an opening to the outside.

The MFFF has multiple static and dynamic confinement systems as shown in Figures 3-8 and 3-9. Figure 3-8 shows the ventilation confinement for the aqueous polishing process, while Figure 3-9 shows the ventilation confinement for the fuel fabrication process. Confinement systems are used to confine dispersible radioactive contamination within specific controlled areas under all normal, abnormal, and accident conditions. The dynamic confinement systems maintain pressure gradients between the different confinement zones.

Three confinement systems (primary, secondary, and tertiary) are used in the MFFF. Each confinement system consists of a static confinement subsystem and a dynamic confinement subsystem. The static confinement systems include building walls, barriers, equipment gloveboxes, cells, enclosures, filters, piping, tanks, portions of supply and exhaust ductwork, plenums, and vessels. The dynamic confinement systems consist of the static confinement

systems and the HVAC exhaust subsystems and equipment out through and including the stack. These subsystems and equipment are designed as primarily IROFS systems so that the failure of any one component (i.e., equipment or control device) does not affect the continuous operation of the system.

Ventilation systems and components have features that provide for alarm indication. HVAC and dynamic confinement systems are designed to withstand any credible fire and continue to function without the loss of confinement. The HVAC and dynamic confinement systems operate continuously to protect personnel from exposure to airborne and transferable contamination. Redundancy and defense-in-depth features ensure continuous operation of an HVAC system in the event of the failure of an active component, such as a fan, during normal or off-normal conditions.

#### **3.2.5.2 Very High Negative Pressure Ventilation System**

The primary confinement system consists of gloveboxes constituting the C4 confinement zones and their associated ventilation systems. The dynamic confinement of class C4 enclosures is ensured by a Very High Negative Pressure Ventilation System, which maintains a negative pressure of 300 to 500 Pa in C4 enclosures relative to the C3b rooms in which they are installed. Each process glovebox supply and exhaust is fitted with two HEPA filter stages within the process rooms. Inside the grinding gloveboxes, contamination is collected with an additional decloggable pre-filter to reduce the airborne concentration. The exhaust from the C4 enclosures prior to exhausting through the MFFF stack is routed through two additional final HEPA filters.

#### **3.2.5.3 High Negative Pressure Ventilation System**

The secondary confinement system consists of walls, floors, and roofs surrounding gloveboxes, process cells, C3 confinement zones, and their associated ventilation systems. The process cell confinements in the aqueous polishing area are served by the aqueous polishing area exhaust system. The secondary confinement C3 areas are served by the High Negative Pressure Ventilation System.

Dynamic confinement of C3a and C3b rooms within the secondary confinement system is provided by the High Negative Pressure Ventilation System, which maintains a negative pressure of 120 to 160 Pa in C3a rooms and 160 to 180 Pa in C3b rooms relative to the atmosphere. This room ventilation air is normally not contaminated. The exhaust from the C3 rooms is routed through a HEPA filter at the boundary between the C3 and C2 areas, and then through two final HEPA filters before exhausting through the MFFF stack.

#### **3.2.5.4 Medium Negative Pressure Ventilation System**

Dynamic confinement of class C2 rooms within the tertiary confinement system is provided by the Medium Negative Pressure Ventilation System, which maintains a negative pressure of 60 to



100 Pa in C2 rooms relative to the atmosphere. The exhaust from the Class C2 areas is passed through two final HEPA filter stages before being released through the MFFF stack.

### **3.3 WASTE MANAGEMENT SYSTEMS**

MFFF waste management is guided by the principles of as low as reasonably achievable (ALARA), waste minimization, and pollution prevention. Liquid and solid wastes produced in the MFFF will be transferred to the appropriate SRS facility for waste processing. Consequently, there are no process liquid effluents from the MFFF. The MFFF site does discharge stormwater to an NPDES permitted outfall. All wastes transferred to SRS meet the WAC for the respective waste management facility. Processes related to waste management are discussed in the following subsections. Tables 3-3 and 3-4 summarize waste volumes and characteristics for the MFFF. Figure 3-6 illustrates the primary sources of liquid wastes generated by the aqueous polishing process. Treatment of airborne wastes is illustrated in Figure 3-10. Figures 3-11 and 3-12 provide the waste management flow diagrams for liquid and solid wastes, respectively.

The MOX fuel fabrication process employs reuse of reagent feedstocks and plutonium to the maximum extent possible. This approach results in a very small amount of generated waste that is transferred from the facility. The various waste streams are discussed in the following sections. No HLW will be generated by any of the facility operations.

#### **3.3.1 Airborne Emissions Management**

Airborne emissions are controlled by the building and glovebox ventilation systems, the process ventilation offgas system, and MFFF stack HEPA filters. The expected plutonium, americium, and uranium emissions are projected to be significantly smaller than those reported in the SPD EIS (DOE 1999c). Accordingly, the SPD EIS values may be considered conservative bounding limits for airborne emissions from the MFFF.

#### **3.3.2 Liquid Waste Management**

The aqueous polishing process is the primary source of liquid waste, although it is not the only source. Liquid feedstocks are recycled in the process to the maximum extent practical to minimize waste generation and plutonium losses. The various steps in the aqueous polishing process generating liquid waste streams are described below. Additional liquid wastes are also discussed. Figure 3-6 provides a flow diagram of the aqueous polishing waste streams, while Table 3-3 presents the annual volume and concentrations of stream isotopes.

##### **3.3.2.1 Silver Recovery**

The regenerated concentrates stream from the silver recovery process contains unwanted impurities (i.e., gallium, americium), trace amounts of silver, plutonium and uranium, and

possibly some excess acid. This stream is a potentially liquid high alpha activity waste<sup>2</sup>. The stream is collected in a storage tank, and the contents of the tank are sampled and analyzed. The waste pH is then adjusted to a level specified in the WAC for the transfer of this waste to an appropriate SRS facility.

Liquid high alpha activity waste (i.e., americium) will be transferred through a dedicated pipeline to the SRS F-Area Outside Facility. At the F-Area Outside Facility, the pH and the waste chemistry of the waste will be adjusted to conform to the WAC requirements for the F-Area Tank Farm. The F-Area Outside Facility is being upgraded through the addition of new tankage to be used for pretreatment of MOX process streams. The liquid high alpha activity waste will be transferred to the F-Area Tank Farm and managed by SRS accordingly.

### **3.3.2.2 Acid Recovery**

The acid recovery process produces a condensate stream and excess acid or evaporator bottoms. The acid recovery distillates stream also will be collected in buffer storage tanks and subsequently sampled and analyzed. Depending on the process requirements, the distillate stream may be either recycled into the process through rinsing and scrubbing of the columns or discharged to the SRS process sewer. The evaporator bottoms are expected to contain significant levels of alpha-emitting isotopes and will be managed with the liquid high alpha activity waste. The waste will be transferred to the F-Area Outside Facility for processing and transfer to the F-Area Tank Farm.

### **3.3.2.3 Solvent Regeneration**

The alkaline treatment process generates a small excess solvent stream and an alkaline waste stream. After these washings, the alkaline liquid waste stream is transferred to the liquid high alpha activity waste storage tanks and managed with the liquid alpha waste stream. The tanks are sampled and analyzed before the liquid is pumped to the F-Area Outside Facility for processing.

The slightly contaminated excess solvent is a LLW. It is collected and, when a sufficient quantity of solvent has been accumulated, packaged in a container. The container of spent solvent is transferred by truck to an appropriate SRS facility.

---

<sup>2</sup> Liquid high alpha activity waste contains alpha-emitting isotopes in excess of the low-level radioactive waste (LLW) limit (>100 nCi/g). Classification of the waste is deferred until further processing by SRS.

#### **3.3.2.4 Stripped Uranium Stream**

After the uranium stripping process, the diluted uranium (uranium-235 < 1%) is collected in a storage vessel. The uranium stream will be transferred to the F-Area Outside Facility with the liquid high alpha activity waste for management by SRS.

#### **3.3.2.5 Rinse Water**

Potentially contaminated wastewater is collected in the controlled area. This wastewater consists of laboratory rinse water, mop water from washing, and condensate from room air conditioners. These rinse waters are collected, sampled, and analyzed. After analysis, water with acceptable levels of radioactivity is discharged to the local SRS sanitary sewer line for transfer to the SRS CSWTF. If the levels of radioactivity are above what is permitted for CSWTF disposal, the rinse water stream is discharged to the process sewer for treatment at the SRS Effluent Treatment Facility (ETF).

#### **3.3.2.6 Contaminated Drains**

The MFFF building contaminated drains system consists of drains, piping, and necessary tanks, which collect all contaminated and potentially contaminated fluids from within the process areas and other potentially contaminated areas. All drains lead to central collection tanks in the MFFF building radioactive waste area for monitoring and discharge to the appropriate SRS facility for processing. Drains from rooms that contain criticality-safe equipment and collection tanks must have a critically-safe geometry aligned to criticality-safe tanks. Drains in rooms that contain conventional equipment will be aligned to conventional tanks. The design of the contaminated drains system considers the collection system guidelines in Regulatory Guide 3.10 (NRC 1973).

Additional liquid containment features include the following engineered systems:

- Tanks containing contaminated liquids are located in diked rooms/areas that are of sufficient size to contain the contents of a single tank.
- Concrete vaults and dikes are used for spill protection of diesel fuel oil storage tanks.
- Stainless steel-lined floors and portions of walls creating containment basins in tank rooms of the aqueous polishing building are used.
- Double-walled pipes are used for transport of contaminated liquids between or outside of the buildings.
- Stormwater collection and monitoring basins and oil separators are employed.

### **3.3.2.7 Nonhazardous Liquid Waste**

Nonhazardous liquid waste includes HVAC condensate, rinse water, and the sanitary waste from sinks, showers, urinals, and water closets from the inactive area. Nonhazardous wastewater, exclusive of the potentially radioactive LLW rinse water, is discharged to the SRS F-Area sanitary sewer system that connects to the CSWTF.

### **3.3.3 Facility Solid Waste Management**

The management of solid waste for the MFFF is discussed in the SPD EIS, Appendix H, Section H.4.2.3.2 (DOE 1999c). No HLW will be generated by the facility. Solid waste is classified as transuranic (TRU) waste, mixed TRU waste, LLW, mixed LLW, hazardous waste, and nonhazardous solid waste. Waste that is potentially contaminated with plutonium is collected, drummed, and then analyzed to determine the waste category. The drums are then separated by waste category and stored as TRU waste, mixed TRU waste, LLW, and mixed LLW. All solid waste will comply with SRS WAC and certification requirements. The methods and materials used in the management of these various waste streams are often similar and are noted in the following discussion.

#### **3.3.3.1 Solid Transuranic Waste**

TRU waste is radioactive waste containing more than 100 nCi (3,700 Bq) of alpha-emitting TRU isotopes per gram of waste, with half-lives greater than 20 years. Contact-handled TRU waste is TRU waste with a surface dose rate not greater than 200 mrem/hr. The container itself provides sufficient protection, and no extra shielding is required.

TRU solid waste generation is related to the normal process operations, maintenance operations, and replacement of faulty equipment. TRU solid waste includes disposable materials and replaced equipment. TRU solid waste may be both compactible and non-compactible.

TRU solid waste streams are separated at the source of generation and packaged in standard metallic 55-gal (208-L) drums.

Waste containers are marked at the point of generation. The containers are processed sequentially. Each drum is checked for plutonium mass, labeled, and registered, if within the plutonium mass limits. The drums are uniquely labeled, and the drums are tracked through the storage and shipping cycles in the waste management computer system.

#### **3.3.3.2 Solid Mixed Transuranic Waste**

The only solid mixed TRU waste produced at the MFFF may consist of the lead-lined gloves that may be used in the gloveboxes. Removal of this potential waste source is under consideration.

### **3.3.3.3 Solid Low-Level Waste**

LLW is defined as radioactive waste that is not HLW, spent nuclear fuel, TRU waste, uranium or thorium mill tailing, byproduct material, or naturally occurring radioactive material.

LLW will be generated as a result of normal MFFF process operations and maintenance activities. LLW is waste contaminated with radioactivity. It includes alpha-emitting radionuclides with half-lives greater than 20 years but in concentrations less than 100 nCi/g of the waste matrix without regard to source or form. Solid LLW will include both disposable materials and replaced equipment. Solid LLW will be compactible and non-compactible.

Acceptable containers for LLW are Department of Transportation (DOT) Type A Spec 7A drums or containers specified in the SRS WAC.

### **3.3.3.4 Solid Mixed Low-Level Radioactive Waste**

Mixed LLW is LLW determined to contain both a hazardous component subject to the Resource Conservation and Recovery Act (RCRA), as amended, and source, special nuclear, or byproduct material subject to the Atomic Energy Act of 1954, as amended.

Mixed LLW includes solidified solvents contaminated with plutonium, and scintillation vials from the laboratory.

Mixed LLW is packaged and stored onsite for processing in a manner consistent with the Site Treatment Plan for SRS. To the extent possible, commingling of waste from streams requiring different treatment technologies will be prevented. Packaging of mixed LLW will meet SRS requirements. For mixed LLW destined for an offsite facility, packaging, labeling, and marking will comply with DOT transportation regulations.

### **3.3.3.5 Potentially Contaminated Waste**

Wastes that are believed to be non-contaminated or potentially contaminated, as well as drums contaminated with plutonium, are collected, drummed, and then analyzed to determine the waste category. Drums may be categorized as LLW or nonradioactive waste.

### **3.3.3.6 Hazardous Solid Waste**

Hazardous solid waste is waste that is, or contains, listed hazardous waste or that exhibits one of the four EPA hazardous waste characteristics (i.e., ignitability, corrosivity, reactivity, and toxicity).

Hazardous waste includes spent solvents and reagents from the analytical laboratory that are not contaminated with radioactive material. Hazardous waste is packaged and stored onsite for treatment and/or offsite disposal in a manner consistent with the SRS WAC. Hazardous waste from the MFFF will be managed at SRS facilities, at other DOE sites, or by commercial services.

Hazardous wastes will be certified as meeting the WSRC WAC before being transferred. Hazardous waste that has been certified as meeting the WAC for transfer will be managed in a manner that maintains the certification status.

#### **3.3.3.7 Nonhazardous Solid Waste**

Nonhazardous waste is waste that is not or does not contain listed hazardous waste, that does not exhibit one of the four EPA hazardous waste characteristics (i.e., ignitability, corrosivity, reactivity, and toxicity), and that does not contain radioactive material.

Nonhazardous solid waste includes office garbage, machine shop waste, and other industrial wastes from utility and maintenance operations. Nonhazardous solid waste is packaged in conformance with standard industrial practice. Recyclable solid wastes (e.g., office paper, metal cans, and plastic and glass bottles) are sent offsite for recycling. The remaining solid sanitary waste is sent to the Three Rivers Landfill, which is located at SRS just southwest of B Area.

**This page intentionally left blank.**

## Figures



**This page intentionally left blank.**

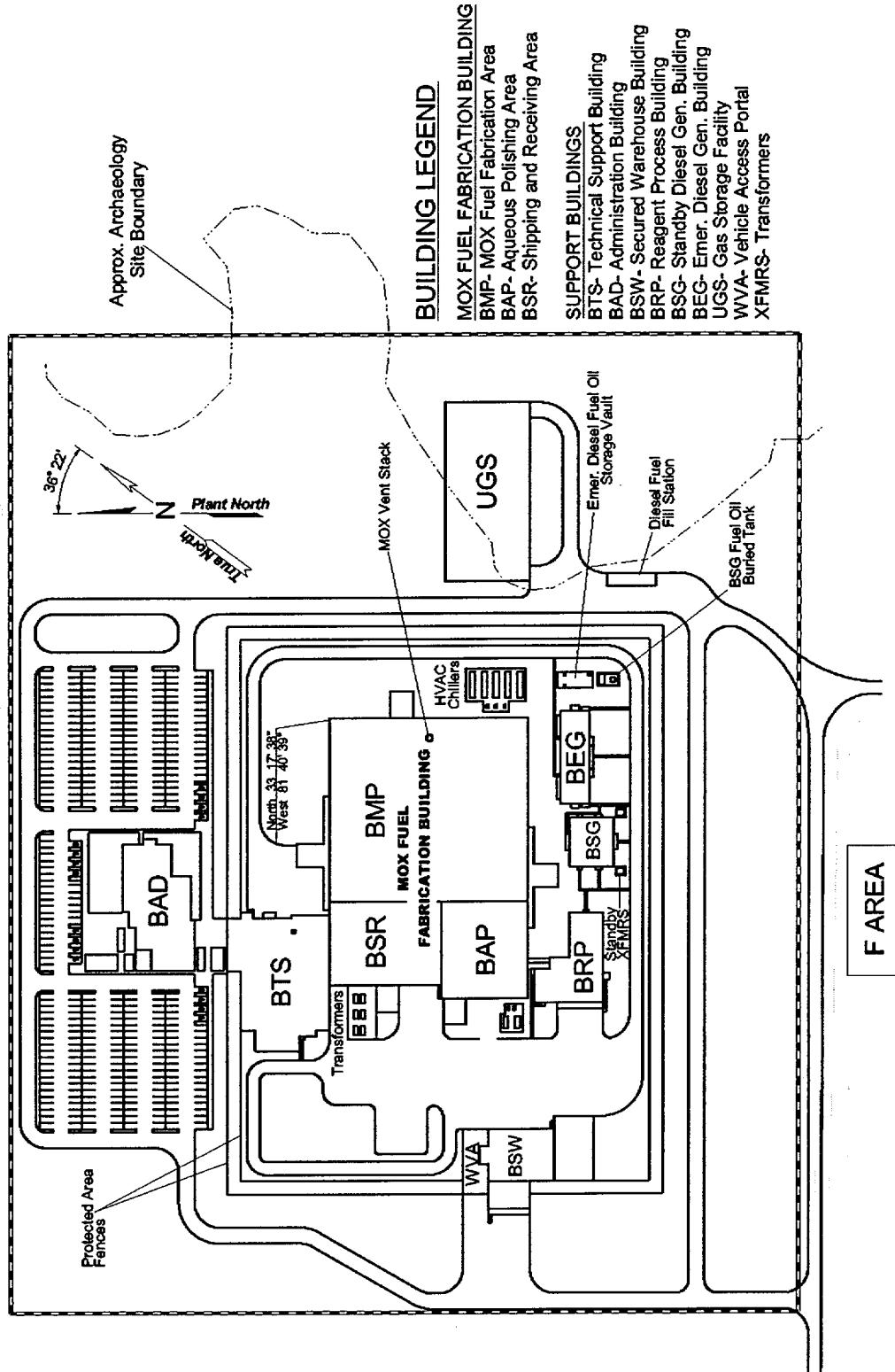

**BUILDING LEGEND**

- MOX FUEL FABRICATION BUILDING
- BMP- MOX Fuel Fabrication Area
- BAP- Aqueous Polishing Area
- BSR- Shipping and Receiving Area

**SUPPORT BUILDINGS**

- BTS- Technical Support Building
- BAD- Administration Building
- BSW- Secured Warehouse Building
- BRP- Reagent Process Building
- BSG- Standby Diesel Gen. Building
- BEG- Emer. Diesel Gen. Building
- UGS- Gas Storage Facility
- WVA- Vehicle Access Portal
- XFMRS- Transformers

Figure 3-1. Site Layout

**This page intentionally left blank.**

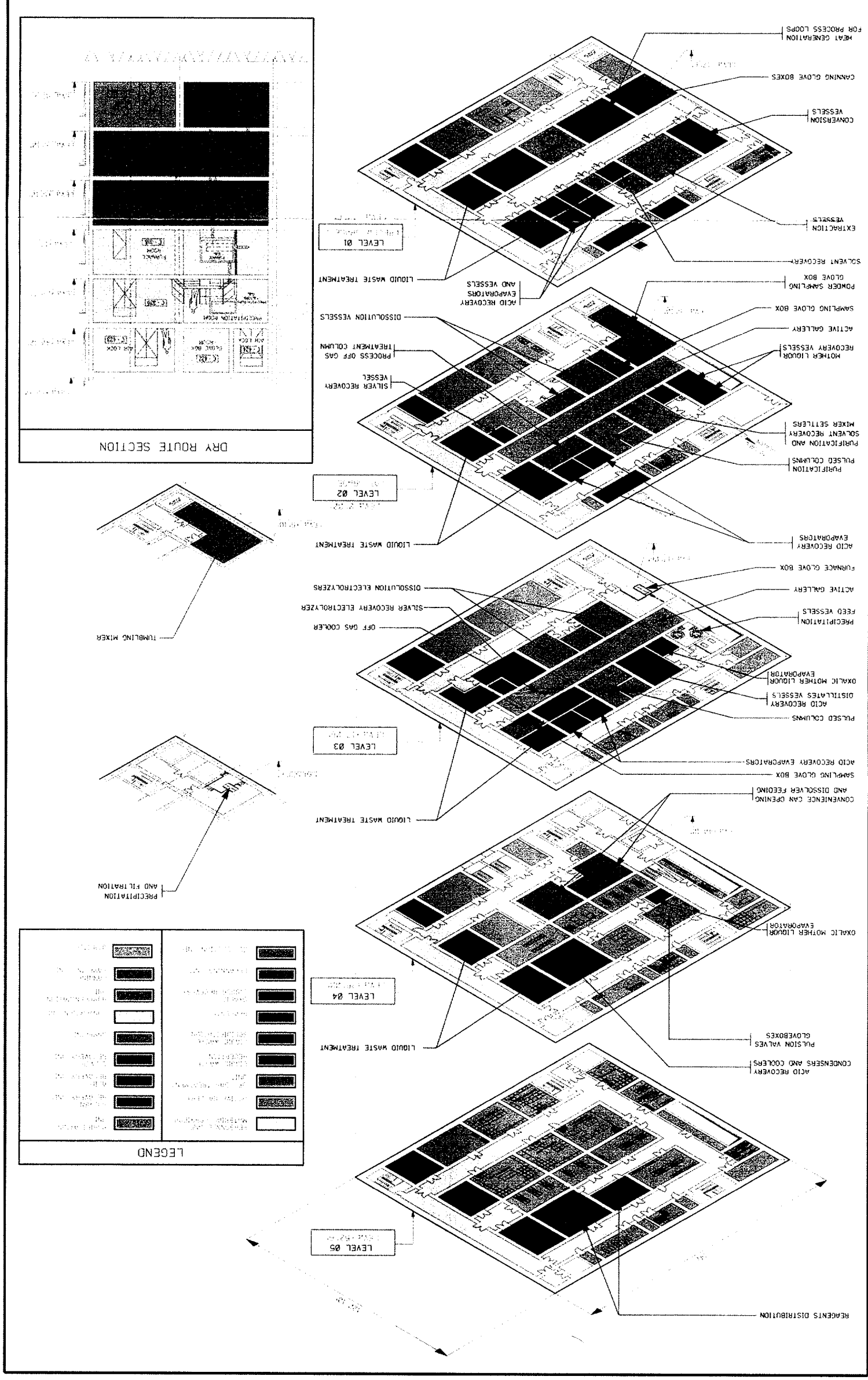

Figure 3-2. Conceptual General Arrangement of the Aqueous Polishing Area

**This page intentionally left blank.**



This page intentionally left blank.

# Aqueous Polishing (AP) Process

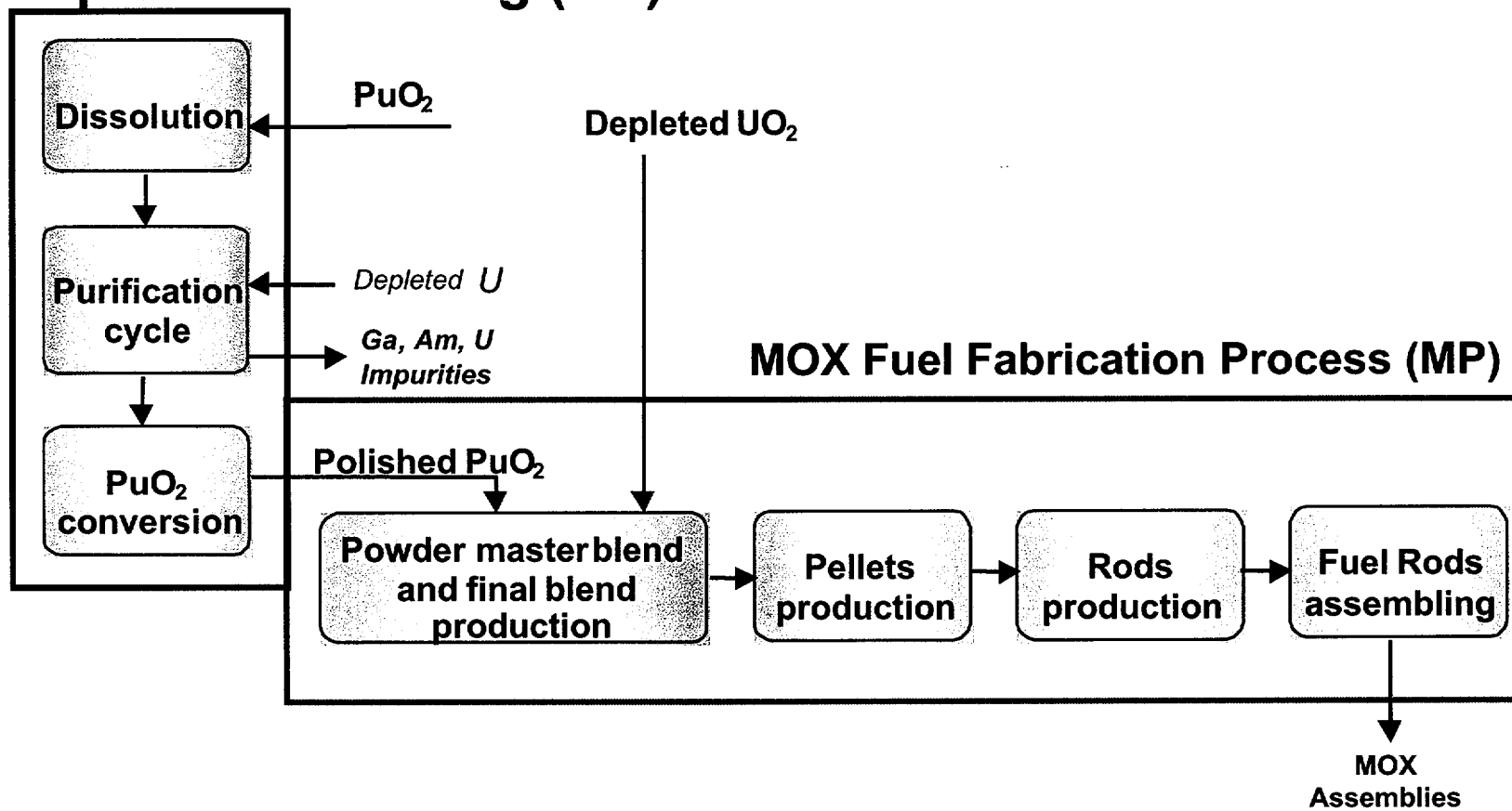

3-29

Figure 3-4. MOX Fuel Fabrication Production Process Flow



**This page intentionally left blank.**

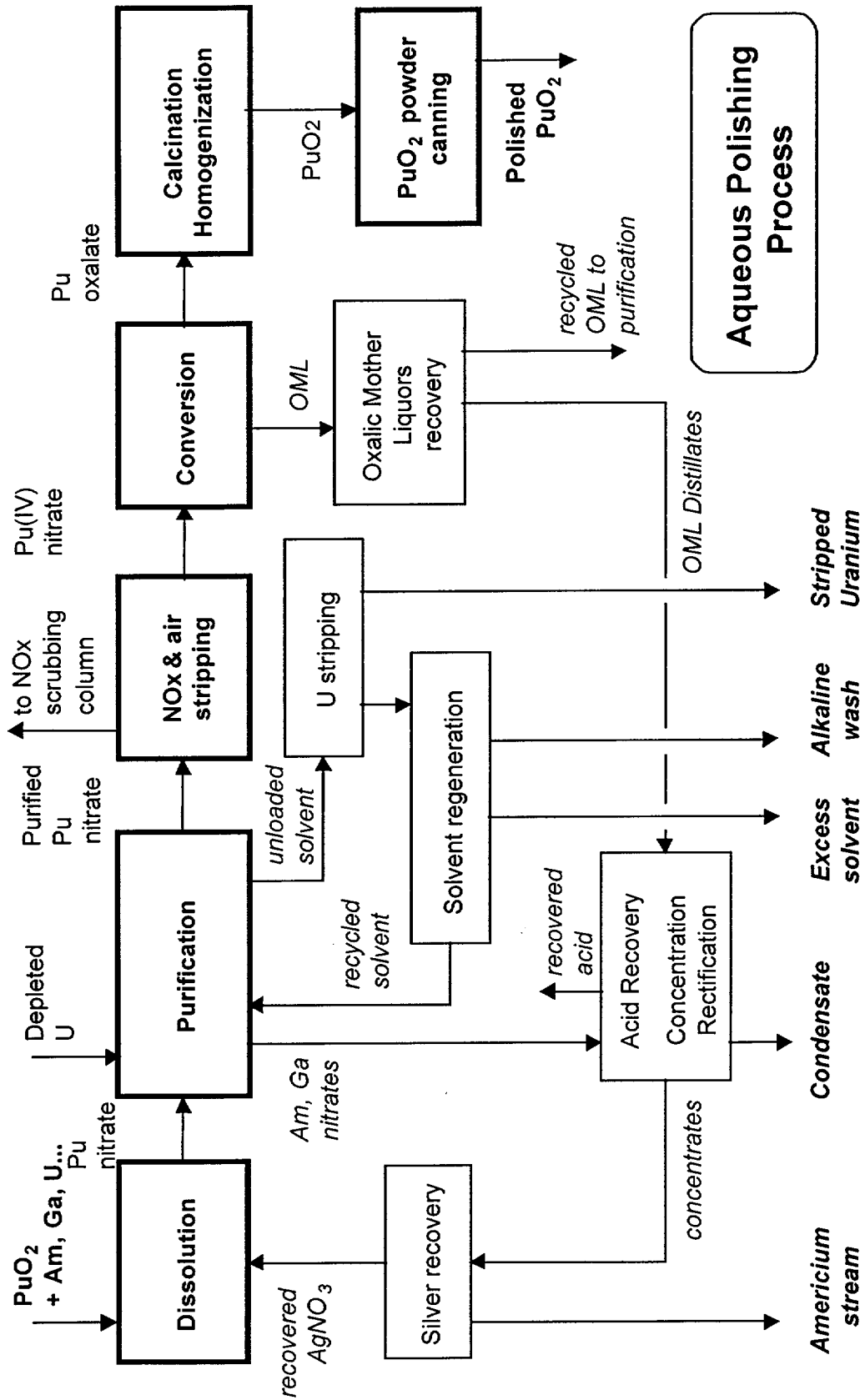

Figure 3-5. Plutonium Polishing Block Diagram

**This page intentionally left blank.**

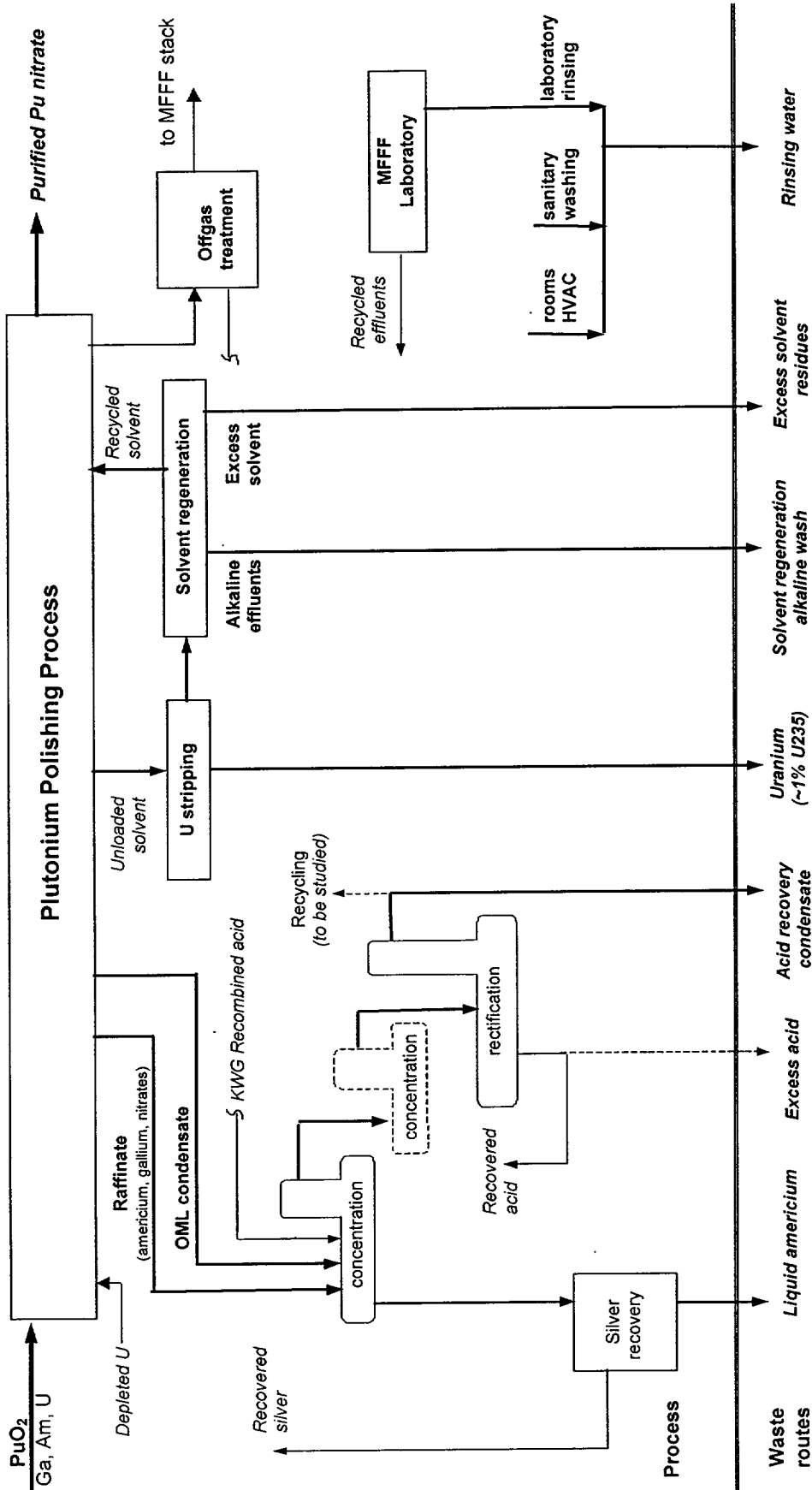

Figure 3-6. Aqueous Polishing Waste Streams

**This page intentionally left blank.**

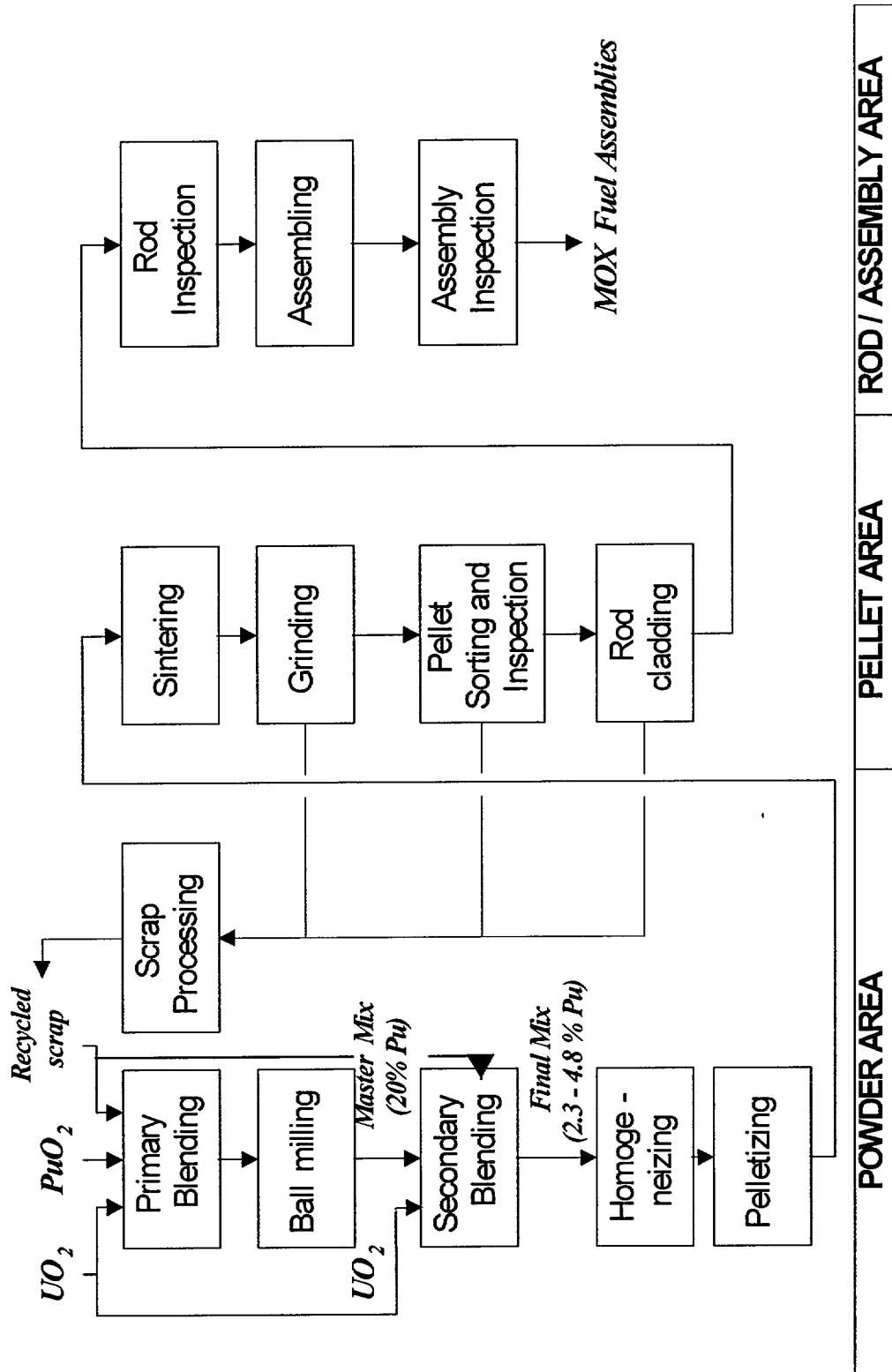

Figure 3-7. MOX Fuel Fabrication Processes

**This page intentionally left blank.**

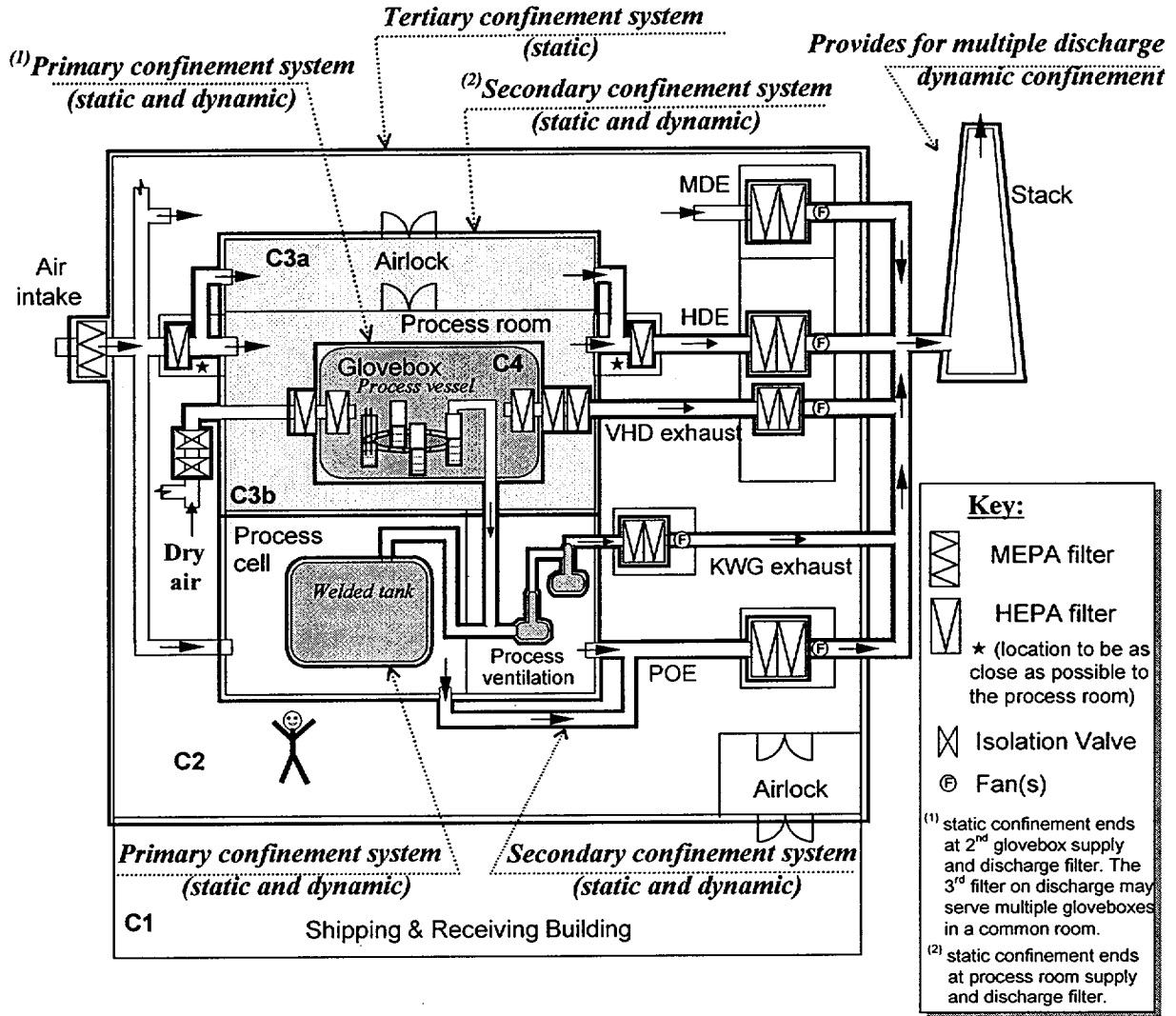

Figure 3-8. Ventilation Confinement for Aqueous Polishing



**This page intentionally left blank.**

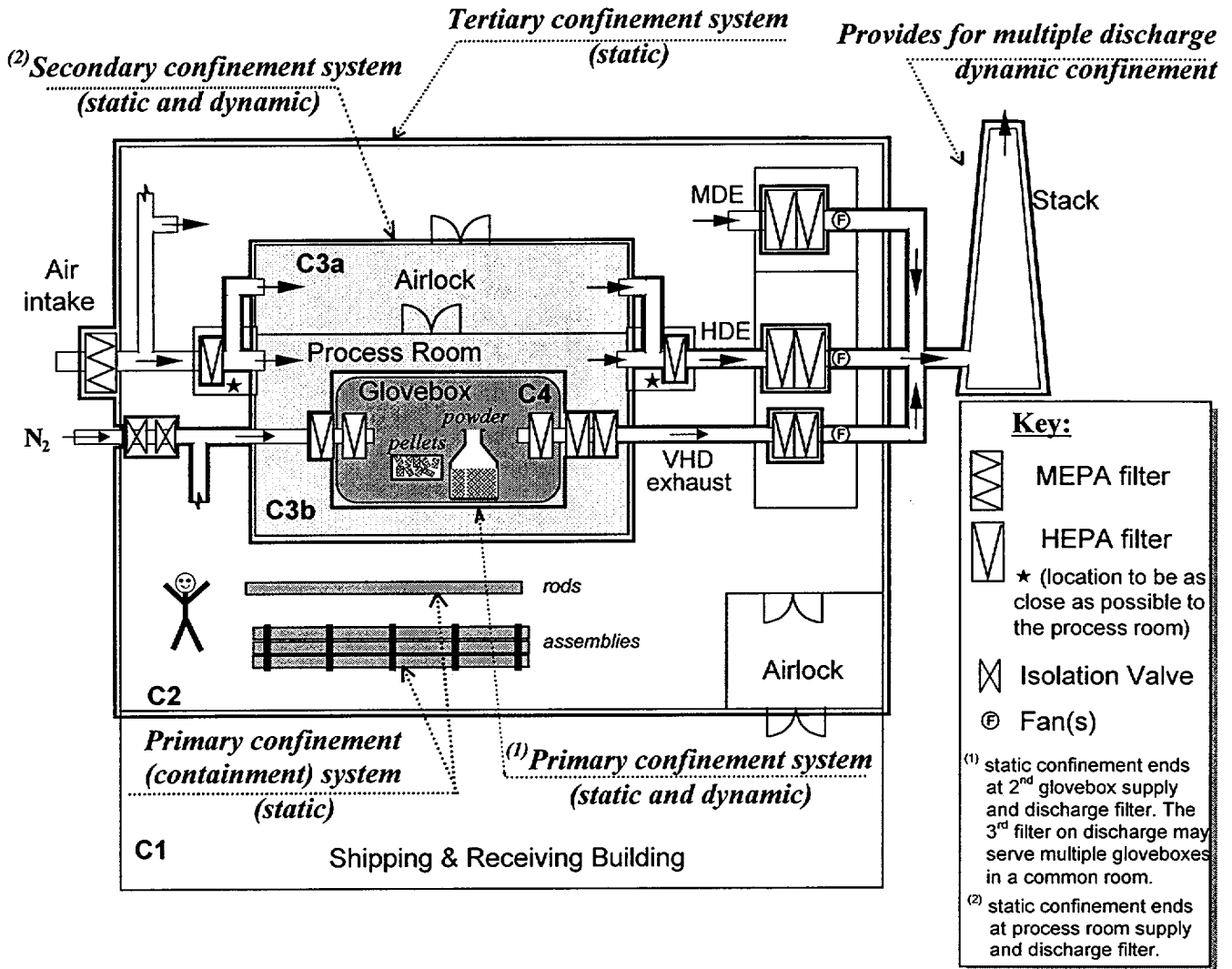

Figure 3-9. Ventilation Confinement for Fuel Fabrication

**This page intentionally left blank.**

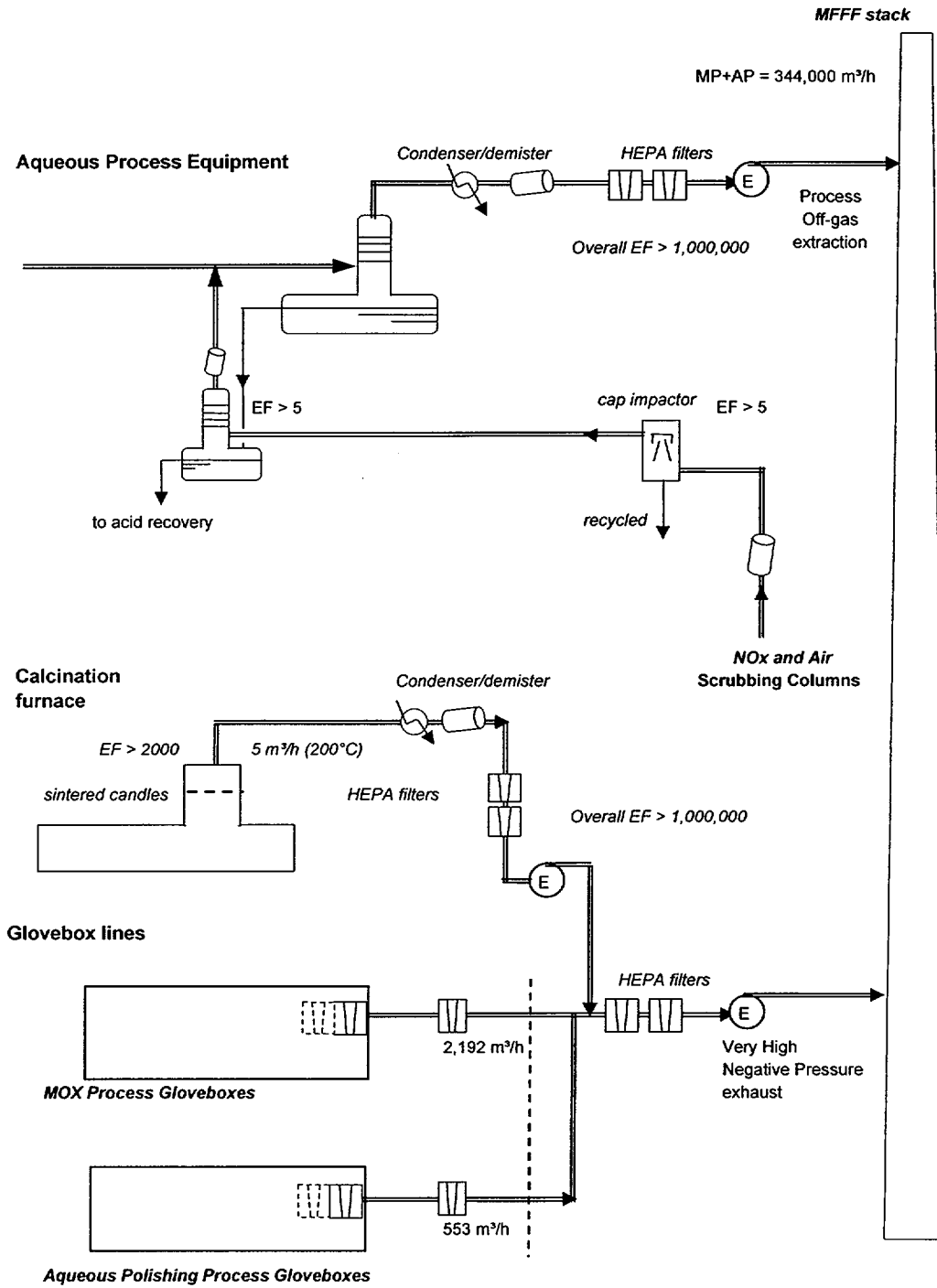
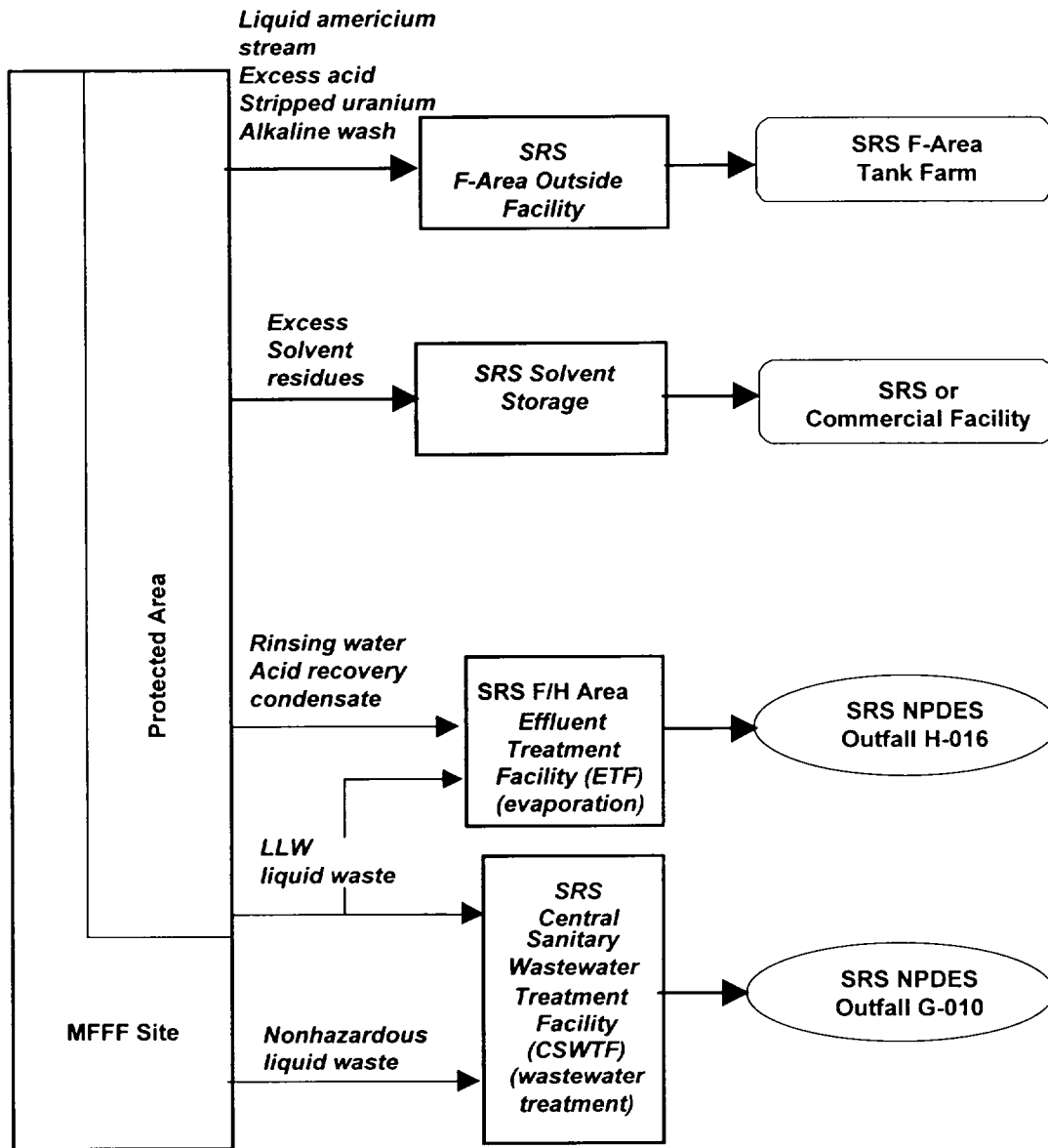

Figure 3-10. MFFF Airborne Waste Treatment Flowsheet

**This page intentionally left blank.**



**Figure 3-11. MFFF Liquid Waste Management Flow Diagram**

**This page intentionally left blank.**

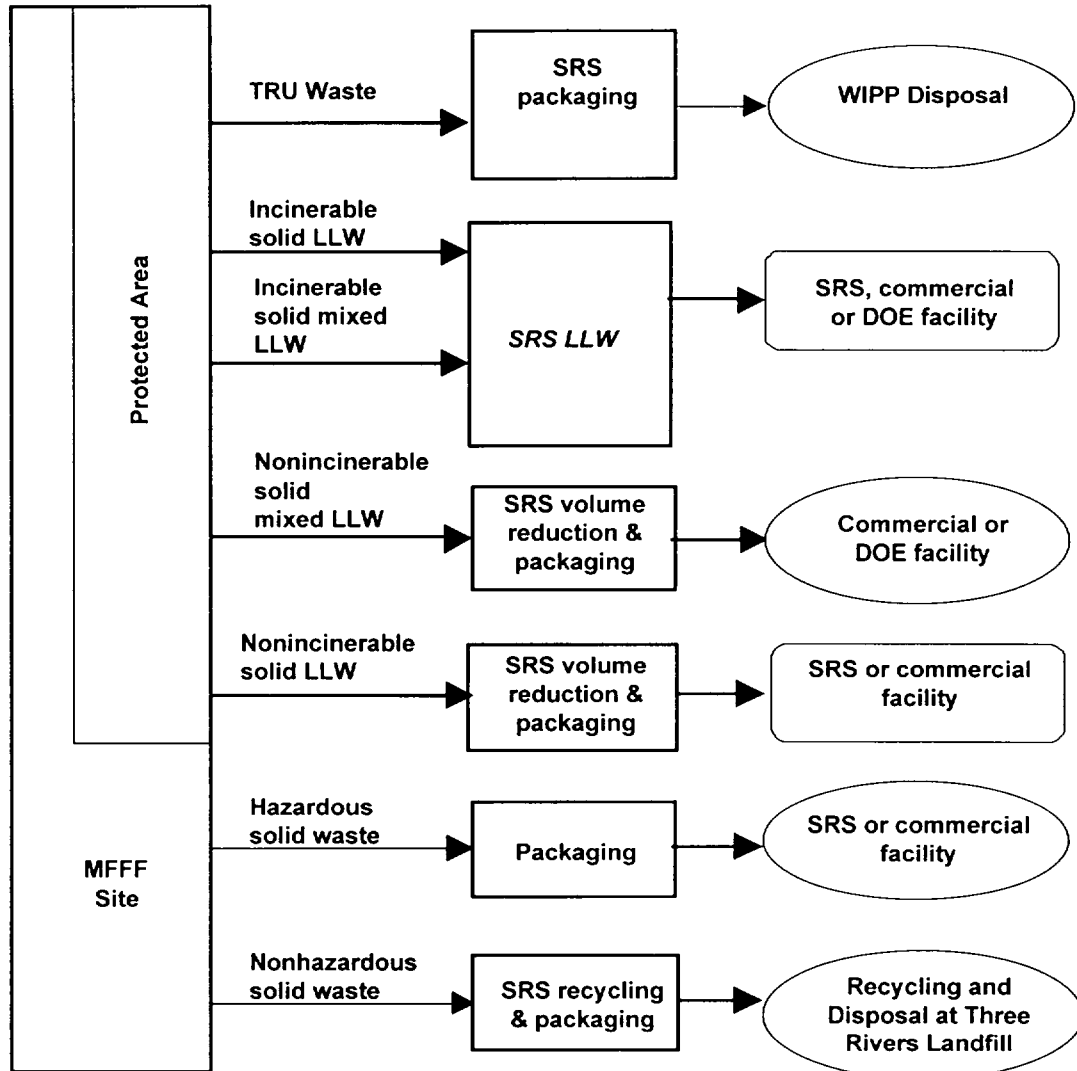

Figure 3-12. Solid Waste Management Flow Diagram



**This page intentionally left blank.**

## **Tables**

**This page intentionally left blank.**

**Table 3-1. Key MFFF Design and Operation Parameters**

<b>Parameter</b>	<b>Projected Value</b>
Site area (ac)	41
Building total floor area (ft <sup>2</sup> )	350,000
Building footprint (ft <sup>2</sup> )	113,000
Stack height (ft)	93
Electricity (MWh/yr)	80,000
Fuel oil (gal /yr)	22,500
Water consumption (gal /yr)	5,300,000
Total employees	400

Table 3-2. MFFF Chemical Usage

Chemical	Annual Consumption	Anticipated Onsite Inventory*
Argon	12,900,000 ft <sup>3</sup>	not available
Argon-Methane	367,000 ft <sup>3</sup>	not available
Dodecane	770 gal	400 gal
Helium	341,000 ft <sup>3</sup>	not available
Hydrazine (35%)	400 gal	160 gal
Hydrogen	371,000 ft <sup>3</sup>	not available
Hydrogen peroxide (35%)	530 gal	115 gal
Hydroxylamine nitrate	9,200 lb	1,220 lb
Manganese nitrate	10 lb	1 lb
Nitric acid (4.5N)	Included in 13.6N consumption	9,250 gal
Nitric acid (13.6N)	1,300 gal	925 gal
Nitrogen	160,000,000 ft <sup>3</sup>	not available
Nitrogen tetroxide	132,000 ft <sup>3</sup>	not available
Oxalic acid	8,900 lb	1,050 lb
Oxygen	71,000 ft <sup>3</sup>	not available
Porogen	660 lb	not available
Silver nitrate	240 lb	240 lb
Sodium carbonate	440 lb	66 lb
Sodium hydroxide (10M)	5gal	15 gal
Tributyl phosphate	740 gal	320 gal
Zinc stearate	617 lb	not available

\* Onsite inventory of pressurized gases is not finalized.

**Table 3-3. Aqueous Polishing Waste Streams**

Waste Stream	Annual Volume (gal)	Main Chemical or Isotope Concentration or Annual Quantity
<b>Liquid americium stream</b> Concentrated stream from acid recovery after silver recovery	8,900	Am-241: < 24.5 kg (0.7% maximum Pu content) Pu: < 150 g/yr Hydrogen ions: 3 N Nitrate salts: 200 kg Silver: < 8 kg/yr
<b>Excess acid</b>	1,400	Am: < 14 mg/y (rectification step after two evaporation steps) Hydrogen ions: 13.6 N
<b>Stripped uranium</b>	68,000	Plutonium: < 16 g/yr Stripped U quantity: < 2150 kg [~1% U-235]  Hydrogen ions: 0.11 N
<b>Solvent regeneration alkaline wash</b>	3,000	Pu: < 13 g/yr U: < 13 g/yr Na: < 115 kg
<b>Excess solvent residues</b>	2,800	Solvent: 30% tributyl phosphate in branched-dodecane Hydrogen ions: 0.007 N Pu: < 17 mg
<b>Acid recovery condensate</b>	82,000	Pu: < 4E-03 mg/yr Am-241: < 0.8 mg/yr Activity 10 <sup>8</sup> Bq/yr (after two rectification and evaporation steps)
<b>Rinsing water</b>	132,000	Alpha activity: < 5 Bq α/L

**Table 3-4. Solid Waste Generated by MFFF Fuel Fabrication Processes**

Waste Stream	Annual Volume (Mass) <sup>a</sup>	Contamination <sup>b</sup> (mg Pu/kg)
Potentially contaminated solid waste <sup>c</sup>	600 yd <sup>3</sup> (78 tons)	Under detection limit Free of contamination waste collected in controlled area
UO <sub>2</sub> area LLW	18 yd <sup>3</sup> (1.6 tons)	Uranium contamination
Cladding area organic waste	20 yd <sup>3</sup> (1.8 tons)	< 1
Zirconium swarfs and samples	3 yd <sup>3</sup> (0.4 tons)	< 0.2
Inner cans	< 9 yd <sup>3</sup> (2 tons)	< 0.2
Building and U area ventilation filters	< 52 yd <sup>3</sup> (5.6 tons)	< 0.3
Nonroutine Low-Level Waste (LLW)	< 1 yd <sup>3</sup> (0.2 tons)	< 0.2
Low contamination TRU waste	106 yd <sup>3</sup> (16 tons)	approximately 5
High contamination TRU waste	80 yd <sup>3</sup> (12 tons)	approximately 250
PuO <sub>2</sub> convenience cans	6.5 yd <sup>3</sup> (1 tons)	approximately 200
Filters	14 yd <sup>3</sup> (1 tons)	approximately 1,000
Nonroutine TRU waste	1.6 yd <sup>3</sup> (0.5 tons)	approximately 200

<sup>a</sup> Values are approximate based on preliminary design

<sup>b</sup> Estimates for plutonium mass collected in solid waste is about 4 kg.

<sup>c</sup> Potentially contaminated waste will be surveyed and released as nonradioactive if determined to be below NRC release limits.

## 4. DESCRIPTION OF THE AFFECTED ENVIRONMENT

The SPD EIS (DOE 1999c) provided an extensive discussion of the affected environment for SRS, including F Area. That discussion is included in this chapter with appropriate updated information. SRS developed the *Generic Safety Analysis Report* (GSAR) (WSRC 1999a) for all facilities located at SRS. The GSAR provides key site information including (but not limited to) geology, hydrology, meteorology, land use, and demographics for SRS. The GSAR is updated on a periodic basis. The GSAR is used in this ER to supplement the information provided in the SPD EIS. This ER also uses the SRS Environmental Reports for 1998 and 1999 (Arnett and Mamatey 1999, 2000a) to update information provided in the SPD EIS. Where more recent information is not available, the data provided in the SPD EIS were used. In some instances, more recent data were investigated, and it was determined that data presented in the SPD EIS provided a more conservative basis for projecting impacts on the affected environment.

### 4.1 SITE LOCATION AND LAYOUT

The site location is summarized in Section 4.1.1, and the site layout is described in Section 4.1.2.

#### 4.1.1 Site Location

The MFFF is located in the Separations Area (F Area) of SRS in South Carolina (Figure 4-1). SRS, which is owned by the U.S. Government, was set aside in 1950 for the production of nuclear materials for national defense. SRS, as shown in Figure 4-1, is an approximately circular tract of land occupying 310 mi<sup>2</sup> (803 km<sup>2</sup>) or 198,400 ac (80,292 ha) within Aiken, Barnwell, and Allendale Counties in southwestern South Carolina. Because public access to the SRS area is limited by DOE security regulations, DCS plans to use the DOE site boundary as the controlled area boundary for the MFFF (Figure 4-2). F Area and the MFFF are located in Aiken County near the center of SRS, east of SRS Road C and north of SRS Road E. F Area comprises approximately 395 ac (160 ha) of SRS. The nearest site boundary to F Area is approximately 5.8 mi (9.3 km) to the west. The location of the MFFF is N33°17'38", E81°40'39". The center of F Area is approximately 25 mi (40 km) southeast of the city limits of Augusta, Georgia; 100 mi (161 km) from the Atlantic Coast; 6 mi (9.7 km) east of the Georgia border; and about 110 mi (177 km) south-southwest of the North Carolina border. The MFFF site is located adjacent to the north-northwest corner of F Area (Figure 4-3).

The location of SRS and F Area relative to towns, cities, and other political subdivisions within a 50-mi (80-km) radius is shown in Figure 4-4. The largest nearby population centers are Aiken, South Carolina, and Augusta, Georgia. The only towns within 15 mi (24 km) of the center of F Area are New Ellenton, Jackson, Barnwell, Snelling, and Williston, South Carolina.

Prominent geographical features within 50 mi (80 km) of SRS are Thurmond Lake (formerly called Clarks Hill Reservoir) and the Savannah River. Thurmond Lake is an impoundment of the Savannah River approximately 40 mi (64 km) northwest of the center of SRS. The Savannah River bounds 17 mi (27 km) of the southwest border of SRS.



Six principal tributaries to the Savannah River are located on SRS: Upper Three Runs, Beaver Dam Creek, Fourmile Branch, Pen Branch, Steel Creek, and Lower Three Runs. F Area is drained by several tributaries of Upper Three Runs and by Fourmile Branch.

The PDCF and PIP are part of the DOE's surplus plutonium disposition program in addition to the MFFF. The PDCF and PIP will be located in F Area at SRS near the MFFF. The PDCF will supply plutonium feedstock to both the MFFF and the PIP.

The main processing facility in F Area is F Canyon, which is composed of a chemical separations plant and associated waste storage facilities. During the SRS production years, F Canyon was used to chemically separate uranium, plutonium, and fission products from irradiated fuel and target assemblies. The separated uranium and plutonium were transferred to other DOE facilities for further processing and final use. F Canyon is presently used to process the remaining transplutonium solutions and other material onsite for eventual disposal in a geologic repository. F-Canyon waste is transferred to HLW tanks in the area for storage. The F-Area Tank Farm consists of 22 underground storage tanks that store aqueous radioactive HLW and saltcake.

Five reactor facilities are located within a 10-mi (16-km) radius of F Area; however, all five of these reactors have been placed in cold shutdown with no plans for restart.

Facilities in Z Area, which is located about 2.5 mi (4 km) from F Area, are used to process and dispose of decontaminated salt solution supernatants from waste tanks. The DWPF in nearby S Area vitrifies the F-Area waste tank HLW into borosilicate glass for disposal offsite.

H Area is located 2 mi (3.2 km) to the east of F Area. The H-Canyon Facility in H Area is used to convert highly enriched weapons-grade uranium to a low enriched form not usable for weapons production and to stabilize plutonium-242 solutions. In July 2000, work commenced on the Replacement Tritium Facility, which will extract tritium from irradiated fuel rods from the Tennessee Valley Authority Sequoyah and Watts Bar nuclear plants.

Reactor material fabrication facilities in M Area are located approximately 5 mi (8 km) from F Area.

#### **4.1.2 Site Layout**

The MFFF is located adjacent to the north-northwest corner of F Area, as shown in Figure 4-3. The buildings and facilities of the MFFF, shown in Figure 4-5, are arranged to ensure safe, secure, and efficient performance of all MFFF functions. The site layout provides the characteristics necessary to satisfy the stringent security criteria for safeguarding the SNM and to support safe and efficient MFFF operations. The entire facility comprises an area of approximately 41 ac (16.6 ha). No highways, railroads, or waterways traverse the MFFF site, and the movement of material and personnel to and from the MFFF site takes place via the SRS internal road system.

A conventional PIDAS fence surrounds the protected area of the MFFF. The specific functions of the MFFF buildings and facilities are described in Section 3.1. The MOX Fuel Fabrication Building is located within the protected area and is comprised of three major functional areas: the MOX Processing Area, the Aqueous Polishing Area, and the Shipping and Receiving Area. The Diesel Generator Buildings, the Technical Support Building, and the Secured Warehouse Building are also located inside the protected area. The Administration Building and the Gas Storage Facility are located outside the PIDAS. The Secured Warehouse Building, which is located adjacent to the site access road, is an integral part of the outer PIDAS security barrier. The Technical Support Building, which serves as the sole personnel access point to the protected area, is located near the Administration Building and is accessed by a walkway between the two buildings.

## **4.2 LAND USE**

Information in this section was previously discussed in Section 3.5.10.1 of the SPD EIS (DOE 1999c). Land may be characterized by its potential for the location of human activities (i.e., land use). Natural resource attributes and other environmental characteristics could make a site more suitable for some land uses than for others. Changes in land use may have both beneficial and adverse effects on other resources (i.e., biological, cultural, geological, aquatic, and atmospheric).

### **4.2.1 General Site Description**

The general site description was provided previously in Section 3.5.10.1.1 of the SPD EIS (DOE 1999c). Forest and agricultural land predominate in the areas bordering SRS. There are also significant open water and nonforested wetlands along the Savannah River Valley. Incorporated and industrial areas are the only other significant land uses. There is limited urban and residential development bordering SRS. The three counties in which SRS is located have not zoned any of the site land. The only adjacent area with any zoning is the town of New Ellenton, which has lands bordering SRS in two zoning categories: urban development and residential development. The closest residences are to the west, north, and northeast, within 200 ft (61 m) of the SRS boundary (DOE 1996b).

Various industrial, manufacturing, medical, and farming operations are conducted in areas around the site. Major industrial and manufacturing facilities in the area include textile mills, plants producing polystyrene foam and paper products, chemical processing plants, and a commercial nuclear power plant. Farming is diversified in the region; it includes such crops as peaches, watermelon, cotton, soybeans, corn, and small grains (DOE 1995a).

Outdoor public recreation facilities are plentiful and varied in the SRS region. Included are the Sumter National Forest, 47 mi (76 km) to the northwest; Santee National Wildlife Refuge, 50 mi (80 km) to the east; and Clarks Hill/Strom Thurmond Reservoir, 43 mi (69 km) to the northwest. There are also a number of state, county, and local parks in the region, most notably Redcliffe Plantation, Rivers Bridge, Barnwell and Aiken County State Parks in South Carolina, and

Mistletoe State Park in Georgia (DOE 1995a). The Crackneck Wildlife Management Area, which extends over 4,770 ac (1,930 ha) of SRS adjacent to the Savannah River, is open to the public for hunting and fishing. Public hunts are allowed under DOE Order 4300.1C, which states that "all installations having suitable land and water areas will have programs for the harvesting of fish and wildlife by the public" (Noah 1995). SRS is a controlled area with public access limited to through traffic on South Carolina Highway 125 (SRS Road A), U.S. Highway 278, SRS Road 1, and the CSX railway line (DOE 1995a).

Land use at SRS can be classified into three major categories: forest/undeveloped, water/wetlands, and developed facilities. General land use at SRS and its vicinity is shown on Figure 4-6. Approximately 226 mi<sup>2</sup> (585 km<sup>2</sup>) of SRS (i.e., 73% of the area) is undeveloped (DOE 1996b). Wetlands, streams, and lakes account for 70 mi<sup>2</sup> (181 km<sup>2</sup>) or 22% of the site, while developed facilities including production and support areas, roads, and utility corridors only make up approximately 5% or 15 mi<sup>2</sup> (38.9 km<sup>2</sup>) of SRS (DOE 1996b). The woodlands area is primarily in revenue-producing, managed timber production. The U.S. Forest Service, under an interagency agreement with DOE, harvests about 2.8 mi<sup>2</sup> (7.3 km<sup>2</sup>) of timber from SRS each year (DOE 1997b). Soil map units that meet the requirements for prime farmland soils exist onsite. However, the U.S. Department of Agriculture, Natural Resources Conservation Service, does not identify these as prime farmlands because the land is not available for agricultural production (DOE 1996b).

In 1972, DOE designated all of SRS as a National Environmental Research Park. The National Environmental Research Park is used by the national scientific community to study the impacts of human activities on the cypress swamp and hardwood forest ecosystems (DOE 1996b). DOE has set aside approximately 22 mi<sup>2</sup> (57 km<sup>2</sup>) of SRS exclusively for nondestructive environmental research (DOE 1997b).

Decisions on future land uses at SRS are made by DOE through the site development, land use, and future planning processes. SRS has established a Land Use Technical Committee composed of representatives from DOE, WSRC, and other SRS organizations. The draft *SRS Long Range Comprehensive Plan* (DOE 2000a), issued in September 2000, includes the operation of the MFFF as part of the plan. DOE also issued a draft *Savannah River Site Strategic Plan* (DOE 1999b) on December 13, 1999. Under the Nuclear Materials Stewardship Program, the NMS-1 Goal is to reduce the global nuclear danger by providing safe and secure storage, stabilization, and disposition of nuclear materials and spent nuclear fuel. The design, construction, and operation of the MFFF in F Area is one of the strategies that DOE plans to use to achieve this strategic goal.

In addition to DOE planning, the state of South Carolina also conducts land use planning in the vicinity of SRS as discussed in Section 3.5.10.1.1 of the SPD EIS (DOE 1999c). The state of South Carolina requires local jurisdictions to undertake comprehensive planning. Regional-level planning also occurs within the state, which is divided into 10 planning districts guided by regional advisory councils (DOE 1996b). The counties of Aiken, Allendale, and Barnwell

together constitute part of the Lower Savannah River Council of Governments. Private lands bordering SRS are subject to the planning regulations of these three counties.

No onsite areas are subject to Native American Treaty Rights. However, five Native American groups (the Yuchi Tribal Organization, the National Council of Muskogee Creek, the Indian Peoples Muskogee Tribal Town Confederacy, the Pee Dee Indian Association, and the Ma Chis Lower Alabama Creek Indian Tribe) have expressed concern over sites and items of religious significance on SRS. DOE routinely notifies these organizations about major planned actions at SRS and asks them to comment on SRS documents prepared in accordance with NEPA.

#### **4.2.2 Proposed Facility Location**

Land use in F Area is industrial, as described previously in Section 3.5.10.1.2 of the SPD EIS (DOE 1999c). Many buildings are situated within F Area. Included is Building 221-F, one of the canyons where plutonium was recovered from targets during DOE's plutonium production phase. Land use at Building 221-F in F Area is classified as heavy industrial.

F Area occupies approximately 395 ac (160 ha) of SRS. The proposed MFFF will occupy a 41-ac (16.6-ha) area just north of the planned Actinide Packaging and Storage Facility.

### **4.3 GEOLOGY**

Section 3.5.6 of the SPD EIS (DOE 1999c) describes the geology of the MFFF site. Section 1.4.3 of the SRS GSAR (WSRC 1999a) provides a comprehensive presentation of the regional and SRS site geology. This section presents an overview of the site geology as presented in these two references and based on a detailed geotechnical program conducted in calendar year 2000 to provide site-specific design information for the MFFF site.

#### **4.3.1 Regional Geology**

The southeastern continental margin, within a 200-mi (322-km) radius of SRS, contains portions of all the major divisions of the Appalachian orogen (mountain belt) in addition to the elements that represent the evolution to a passive margin.

Within the Appalachian orogen, several lithotectonic terranes that have been extensively documented include the foreland fold belt (Valley and Ridge) and western Blue Ridge Precambrian-Paleozoic continental margin; the eastern Blue Ridge-Chauga Belt-Inner Piedmont terrane; the volcanic-plutonic Carolina Terrane; and the geophysically defined basement terrane beneath the Atlantic Coastal Plain. These geological divisions record a series of compressional and extensional events that span the Paleozoic. The modern continental margin includes the Triassic-Jurassic rift basins that record the beginning of extension and continental rifting during the early to middle Mesozoic. The offshore Jurassic-Cretaceous clastic-carbonate bank sequence covered by younger Cretaceous and Tertiary marine sediments, and the onshore Cenozoic sediments represent a prograding shelf-slope and the final evolution to a passive margin. Other

offshore continental margin elements include the Florida-Hatteras shelf and slope and the unusual Blake Plateau basin and escarpment.

The two predominant processes sculpting the landscape during this tectonically quiet period included erosion of the newly formed highlands and subsequent deposition of the sediments on the coastal plain to the east. The passive margin region consists of a wedge of Cretaceous and Cenozoic sediments that thickens from near zero at the Fall Line to about 1,100 ft (335 m) in the center of SRS, and to approximately 4,000 ft (1,219 m) at the South Carolina coast. The fluvial to marine sedimentary wedge consists of alternating sand and clay with tidal and shelf carbonates common in the downdip Tertiary section.

#### **4.3.1.1 Coastal Plain Stratigraphy**

The sediments of the Atlantic Coastal Plain in South Carolina are stratified sand, clay, limestone, and gravel that dip gently seaward and range in age from Late Cretaceous to Recent. The sedimentary sequence thickens from essentially zero at the Fall Line to more than 4,000 ft (1,219 m) at the coast. Regional dip is to the southeast, although beds dip and thicken locally in other directions because of locally variable depositional regimes and differential subsidence of basement features such as the Cape Fear Arch and the South Georgia Embayment.

The Coastal Plain sedimentary sequence near the center of the region (i.e., SRS) consists of about 700 ft (213 m) of Upper Cretaceous quartz sand, pebbly sand, and kaolinitic clay, overlain by about 60 ft (18 m) of Paleocene clayey and silty quartz sand, glauconitic sand, and silt. The Paleocene beds are in turn overlain by about 350 ft (107 m) of Eocene quartz sand, glauconitic quartz sand, clay, and limestone grading into calcareous sand, silt, and clay. The calcareous strata are common in the upper part of the Eocene section in downdip parts of the study area. In places, especially at higher elevations, the sequence is capped by deposits of pebbly, clayey sand, conglomerate, and clay of Miocene or Oligocene age. Lateral and vertical facies changes are characteristic of most of the Coastal Plain sequence.

#### **4.3.1.2 Coastal Plain Sediments**

Upper Cretaceous sediments overlie Paleozoic crystalline rocks or lower Mesozoic sedimentary rocks throughout most of the study area. The Upper Cretaceous sequence includes the basal Cape Fear Formation and the overlying Lumbee Group, which is divided into three formations (see Figure 4-7). The sediments in this region consist predominantly of poorly consolidated, clay-rich, fine- to medium-grained, micaceous sand, sandy clay, and gravel and are about 700 ft (213 m) thick near the center of the study area. Thin clay layers are common. In parts of the section, clay beds and lenses up to 70 ft (21 m) thick are present.

Tertiary sediments range in age from Early Paleocene to Miocene and were deposited in fluvial to marine shelf environments. The Tertiary sequence of sand, silt, and clay generally grades into highly permeable platform carbonates in the southern part of the study area and these continue southward to the coast. The Tertiary sequence is divided into three groups, the Black Mingo

Group, Orangeburg Group, and Barnwell Group, which are further subdivided into formations and members (see Figure 4-7). These groups are overlain by the ubiquitous Upland unit.

The Orangeburg Group underlies SRS and the MFFF site and consists of the lower middle Eocene Congaree Formation (Tallahatta equivalent) and the upper middle Eocene Warley Hill Formation and Tinker/Santee Formation (Lisbon equivalent) (see Figure 4-7). Over most of the study area, these post-Paleocene sediments are more marine in character than the underlying Cretaceous and Paleocene sediments of the Black Mingo group; they consist of alternating layers of sand, limestone, marl, and clay.

The group crops out at lower elevations in many places within and near SRS. The sediments thicken from about 85 ft (26 m) at well P-30 near the northwestern SRS boundary to 200 ft (61 m) at well C-10 in the south. Dip of the upper surface is 12 ft/mi (2 m/km) to the southeast.

In the central part of the study area, the Orangeburg group includes, in ascending order, the Congaree, Warley Hill, and Tinker/Santee Formations (see Figure 4-7). The units consist of alternating layers of sand, limestone, marl, and clay that are indicative of deposition in shoreline to shallow shelf environments. From the base upward, the Orangeburg Group passes from clean shoreline sand, characteristic of the Congaree Formation, to shelf marl, clay, sand, and limestone, typical of the Warley Hill and Tinker/Santee Formations. Near the center of the study area, the Santee sediments consist of up to 30% carbonate by volume. The sequence is transgressive, with the middle Eocene Sea reaching its most northerly position during Tinker/Santee deposition.

The late middle Eocene deposits overlying the Warley Hill Formation consist of moderately sorted yellow and tan sand, calcareous sand and clay, limestone, and marl. Calcareous sediments dominate downdip, are sporadic in the middle of the study area, and are missing in the northwest portion of SRS. The limestone represents the farthest advance to the northwest of the transgressing carbonate platform first developed in early Paleocene time near the South Carolina and Georgia coasts.

The Tinker/Santee interval is about 70 ft (21 m) thick near the center of SRS, and the sediments indicate deposition in shallow marine environments. Often found within the Tinker/Santee sediments, particularly in the upper third of the interval, are weak zones interspersed in stronger carbonate-rich matrix materials. The weak zones, which vary in apparent thickness and lateral extent, were noted where rod drops and/or lost circulation occurred during drilling, low blow counts occurred during soil penetration test pushes, etc. These weak zones have variously been termed in SRS reference documents as “soft zones,” the “critical layer,” “underconsolidated zones,” “bad ground,” and “void.” The preferred term used to describe these zones is “soft zones.” The soft zones can be in the form of irregular isolated pods, extended thin ribbons, or stacked thin ribbons separated by intervening unsilicified parent sediment. Soft zones encountered in one location could be absent at a location only a few feet away.

Upper Eocene sediments of the Barnwell Group (see Figure 4-7) represent the Upper Coastal Plain of western South Carolina and eastern Georgia. Sediments of the Barnwell Group are present at the MFFF site and overlie the Tinker/Santee Formation and consist mostly of shallow

marine quartz sand containing sporadic clay layers. The group is about 70 ft (21 m) thick near the northwestern boundary of SRS and 170 ft (52 m) near its southeastern boundary. The regionally significant Santee Unconformity separates the Clinchfield Formation from the overlying Dry Branch Formation. The Santee Unconformity is a pronounced erosional surface observable throughout the SRS region.

In the northern part of the study area, the Barnwell Group consists of red or brown, fine to coarse-grained, well-sorted, massive sandy clay and clayey sand, calcareous sand and clay, as well as scattered thin layers of silicified fossiliferous limestone. All are suggestive of lower delta plain and/or shallow shelf environments.

#### **4.3.1.3 Crustal Thickness**

In general, the thickness of continental crust thins from west to east across the eastern United States continental margin. The zone of transition from continental crust to oceanic crust is thought to underlie the offshore Carolina Trough and the Blake Plateau basin. A cross-section through the continental margin offshore at South Carolina and North Carolina shows a geometry of thinning crust (see Figure 4-8). This is a typical Atlantic-type margin showing the geometry of oceanic crust to the east and continental crust to the west. The Moho deepens from east to west from about 9 mi (15 km) to about 25 mi (40 km), respectively. The continental crust along the margin has been extended and intruded during Mesozoic rifting and is described as rift stage crust. The data that support this interpretive model come largely from seismic reflection and refraction surveys and potential field surveys.

Further inland, the base of crust is discerned by following the configuration of the Moho on seismic refraction or reflection lines. From seismic reflection data collected at SRS, the Moho is interpreted at about 18.6 to 19.6 mi (30.0 to 31.5 km) depth. On the deep seismic profiles, a wide band of reflections (200 to 300 milliseconds wide) at 10.5 to 11.05 seconds are interpreted to be the Moho. Luetgert et al. (1994) reports crustal thickness changes along a survey from SRS southeast to Walterboro, South Carolina.

#### **4.3.1.4 Faulting**

The most definitive evidence of crustal deformation in the Late Cretaceous through Cenozoic is the reverse sense faulting found in the Coastal Plain section of the eastern United States. Under the auspices of the Reactor Hazards Program of the late 1970s and early 1980s, the United States Geological Survey (USGS) conducted a field mapping effort to identify and compile data on all young tectonic faults in the Atlantic Coastal Plain. Consequently, many large, previously unrecognized Cretaceous and Cenozoic fault zones were found. Of 131 fault localities cited, 26 were within North Carolina and South Carolina. The identification of Cretaceous and younger faults in the eastern United States is greatly affected by distribution of geologic units of that age.

Prowell and Obermeier (1991) characterized the faults as mostly northeast trending reverse slip fault zones with up to 62 mi (100 km) lateral extent and up to 250 ft (76 m) vertical displacement

in the Cretaceous. The faults dip 40° to 85°. Offsets were observed to be progressively smaller in younger sediments. This may be due to an extended movement history from Cretaceous through Cenozoic. Based on their similar characteristics, Prowell (1988) was able to associate Cretaceous and younger faulting in the Coastal Plain into several Fault Provinces. SRS falls into Prowell's (1988) Atlantic Coast Fault Province. A comparison of Cretaceous and younger faulting in SRS found that faulting on SRS shared similar characteristics with the faults in the Atlantic Coastal Fault Province including orientation and offset history. This comparison concluded that Cretaceous and younger faulting on SRS was not unique in comparison to the Atlantic Coast Fault Province in general and as a result shared the same seismic hazard.

Offset of Coastal Plain sediments at SRS includes all four Tertiary unconformities. Following deposition of the Late Paleocene Snapp Formation, some evidence indicates oblique-slip movement on the existing faults.

This faulting was followed by erosion and truncation of the Paleocene section at the Lang Syne/Sawdust Landing unconformity. Subsequent sediments were normal faulted following deposition of the Tinker/Santee Formation. Locally, however, offset of the overlying section indicates renewed movement on new or existing faults after deposition of Tobacco Road/Dry Branch sediments.

In conjunction with these observations of Coastal Plain faults, modern stress measurements provide an indication of the likelihood of Holocene movement. Moos and Zoback (1992, 1993) report a consistent northeast-southwest direction of maximum horizontal compressive stress (N 55-70°E) in the southeast United States. Their determination is based on direct in situ stress measurements, focal mechanisms of recent earthquakes, and young geologic indicators. Moos and Zoback (1992) conclude that the northeast directed stress would not induce damaging reverse and strike-slip faulting earthquakes on the Pen Branch fault, a northeast-striking Tertiary fault in the area. These same conclusions may be implied for the other northeast-trending faults.

#### **4.3.1.5 SRS Geological Conditions**

As discussed in this section, many SRS investigations and an extensive literature review support the conclusion that there are no geologic threats affecting the MFFF site, except the Charleston Seismic Zone and minor random Piedmont earthquakes. In the immediate region of SRS, there are no known capable faults. A capable fault is one that has had movement at or near the ground surface at least once within the past 35,000 years or recurrent movement within the past 500,000 years. Several faults have been identified from subsurface mapping and seismic surveys within the Paleozoic and Triassic basement beneath SRS. The largest of these is the Pen Branch Fault. There is no evidence of movement within the last 38 million years along this fault (DOE 1996b).

Three earthquakes of Intensity III or less occurred during recent years with epicenters inside the SRS boundary. On June 9, 1985, an earthquake with a local magnitude of III and a focal depth of about 0.6 mi (1 km) occurred at SRS. Its epicenter was west of C and K Areas. The acceleration produced by the earthquake did not activate seismic monitoring instruments in the



reactor areas. (These instruments have detection limits of 0.002g.) On August 5, 1988, another earthquake with a local magnitude of I-II, a local duration magnitude of 2.0, and a focal depth of about 1.7 mi (2.7 km) occurred at SRS. Its epicenter was northwest of K Area. The seismic alarms in SRS facilities were not triggered. Existing information does not conclusively correlate the two earthquakes with any of the known faults on the site. Earthquakes capable of producing structural damage are not likely to occur in the vicinity of SRS (WSRC 2000c).

On May 17, 1997, an earthquake with a duration magnitude of 2.3 occurred. It was felt by workers in K Area and by nearby guards. An accelerograph, located 3 mi (4.8 km) east of the epicenter, was not triggered. Another more sensitive machine, located about 10 mi (16 km) away, was also not triggered. These events are small and appear to be shallow events associated with strain release near small-scale faults, intrusions, or edges of metamorphic belts. No damage has been reported (WSRC 2000c).

Historically, two large earthquakes have occurred within 186 mi (300 km) of SRS. The largest of these, the Charleston earthquake of 1886, had an estimated Richter scale magnitude ranging from 6.5 to 7.5. The SRS area experienced an estimated peak horizontal acceleration of 0.10g during this earthquake.

There are no volcanic hazards at SRS. The area has not experienced volcanic activity within the last 230 million years. Future volcanism is not expected because SRS is along the passive continental margin of North America.

The soils at SRS are primarily sands and sandy loams. The somewhat excessively drained soils have a thick, sandy surface layer that extends to a depth of 6.6 ft (2 m) or more in some areas. Soil units that meet the soil requirements for prime farmland soils exist on SRS. However, the U.S. Department of Agriculture, Natural Resources Conservation Service, does not identify these lands as prime farmland due to the nature of site use; that is, the lands are not available for the production of food or fiber. The soils at SRS are considered acceptable for standard construction techniques. Detailed descriptions of the geology and the soil conditions at SRS are included in the S&D PEIS and the *Savannah River Site Waste Management Final Environmental Impact Statement* (DOE 1995b).

#### **4.3.2 MFFF Site-Specific Geology**

Soils in F Area are predominantly of the Fuquay-Blanton-Dothan association, consisting of nearly level to sloping, well-drained soils. Other soils include the Troup-Pickney-Lucy association, consisting of nearly level soils formed along, and parallel to, the floodplains of streams.

In 2000, 13 exploration borings and 63 cone penetration test (CPT) holes were used to define subsurface conditions at the MFFF site. Additional site geotechnical programs previously performed by others adjacent to and on this site were also used to evaluate site subsurface geologic and groundwater conditions. Actual conditions encountered at the MFFF site were

evaluated with known geologic and groundwater hydrology conditions (described in Section 4.4.3), and no unusual conditions were encountered.

The CPT holes extended from approximately 64 ft (19.5 m) to 140 ft (42.7 m) below existing site grade. Each CPT hole provided a continuous profile of the soil conditions encountered at each test location. Seismic, resistivity, and piezometric measurements were obtained in many of the CPT holes. Some soft soil zones related to past solution and deposition activity were identified at depth on the MFFF site. The soft zones encountered were typical of those that have been described in previous F-Area investigations. The CPT holes were used to define limits of the soft zones. The planned locations of heavily loaded structures, such as the MOX Building and Diesel Generator Building, were adjusted on the MFFF site to minimize the potential impact of the underlying soft zones. This adjustment was necessitated by the potential of the soil to liquefy under certain conditions, forcing foundations to fail.

The soil exploration borings extended from approximately 131 ft (40 m) to 181 ft (55.2 m) below existing site grade. The exploration borings were used to correlate with the CPT holes and to obtain soil samples for laboratory testing. Three cased holes for the exploration program were used for downhole seismic testing.

A comprehensive laboratory testing program was conducted to establish both static and dynamic design parameters for use in analysis. Laboratory results indicate that conditions at the MFFF site are consistent with those encountered in previous investigations in F Area and other studies in the same geologic units described at SRS.

The upper geologic units at the MFFF site are composed of the Barnwell Group described in Section 4.3.1.2. The exploration borings also extended through the Tinker/Santee Formation, Warley Hill Formation, and into the Congaree Formation of the Orangeburg Group.

The unconfined water table is within the Upper Three Runs aquifer, as described in Section 4.4.3.1. Based on the results of pore water pressure dissipation testing, the groundwater level at the MFFF site was generally encountered at a depth of 60 ft (18.3 m) or more below grade, at the time of site exploration. This water table is expected to fluctuate seasonally. The water table and gradient at the MFFF site are consistent with Figure 4-9.

The subsurface conditions encountered at the MFFF site are considered suitable to support the proposed structures for the MFFF.

#### **4.4 HYDROLOGY**

This section addresses the baseline hydrology in the vicinity of the MFFF site. Hydrology was discussed in Section 3.5.7 of the SPD EIS (DOE 1999c). Some updated information is provided in the following sections. Section 4.4.1 discusses water use in the region, Section 4.4.2 discusses the surface water hydrology, and Section 4.4.3 discusses the groundwater hydrology.

#### **4.4.1 Water Use**

Water has historically been withdrawn from the Savannah River for use mainly as cooling water; however, some has been used for domestic purposes (DOE 1996b). SRS currently withdraws about 37 billion gal/yr (140 billion L/yr) from the river. Most of this water is returned to the river through discharges to various tributaries (DOE 1996b).

The average flow of the Savannah River is 10,000 ft<sup>3</sup>/sec (283 m<sup>3</sup>/sec). Three large upstream reservoirs (Hartwell, Richard B. Russell, and Strom Thurmond/Clarks Hill) regulate the flow in the Savannah River, thereby lessening the impacts of drought and flooding on users downstream (DOE 1995b).

Several communities in the area use the Savannah River as a source of domestic water. The nearest downstream water intake is the Beaufort-Jasper Water Authority in South Carolina, which withdraws about 8.1 ft<sup>3</sup>/sec (0.23 m<sup>3</sup>/sec) to service about 51,000 people. Treated effluent is discharged to the Savannah River from upstream communities and from treatment facilities at SRS. The average annual volume of flow discharged by the sewage treatment facilities at SRS is about 185 million gal (700 million L) (DOE 1996b).

Groundwater aquifers are classified by federal and state authorities according to use and quality. The federal classifications include Class I, II, and III groundwater. Class I groundwater either is the sole source of drinking water or is ecologically vital. Class IIA and IIB are current or potential sources of drinking water (or other beneficial use), respectively. Class III is not considered a potential source of drinking water and is of limited beneficial use. The state of South Carolina classifies groundwater as "GA" (exceptional quality), "GB" (suitable for domestic drinking water), or "GC" (little potential as an underground source of drinking water). All groundwater in the vicinity of SRS is classified as GB by South Carolina and as Class IIA by EPA.

Groundwater in the area is used extensively for domestic and industrial purposes. Most municipal and industrial water supplies are withdrawn from the Crouch Branch and McQueen Branch aquifers, while small domestic supplies are withdrawn from the Gordon aquifer. It is estimated that about 3.4 billion gal/yr (13 billion L/yr) are withdrawn from the aquifers within a 10-mi (16-km) radius of the site, which is similar to the volume used by SRS (DOE 1996b). The Crouch Branch and McQueen Branch aquifers are an important water resource for the SRS region. The water is generally soft, slightly acidic, and low in dissolved and suspended solids (DOE 1995b).

Groundwater is the only source of domestic water at SRS (DOE 1995b). Depth to groundwater ranges from near the surface to about 150 ft (46 m) below ground surface (bgs). In 1993, SRS withdrew about 3.4 billion gal/yr (13 billion L/yr) of groundwater to support site operations (DOE 1996b). There are no designated sole source aquifers in the area (DOE 1999b).

Groundwater ranges in quality across the site; in some areas it meets drinking water quality standards, while in areas near some waste sites it does not. The Crouch Branch and McQueen

Branch aquifers are generally unaffected except for an area near A Area, where trichloroethylene (TCE) has been reported. TCE has also been reported in A and M Areas in the Crouch Branch and McQueen Branch aquifers. Tritium has been reported in the Gordon aquifer in the Separations Area. The water table aquifer is contaminated with solvents, metals, and low levels of radionuclides at several SRS sites and facilities. Groundwater eventually discharges into onsite streams or the Savannah River (DOE 1996b), but groundwater contamination has not been detected beyond SRS boundaries (DOE 1995b).

Groundwater rights in South Carolina are associated with the absolute ownership rule. Owners of land overlying a groundwater source are allowed to withdraw as much water as they desire; however, the state requires users who withdraw more than 100,000 gal/day (379,000 L/day) to report their withdrawals. DOE is required to report because its usage is above the reporting level (DOE 1996b).

#### **4.4.2 Surface Water Hydrology**

Surface water includes marine or freshwater bodies that occur above the ground surface, including rivers, streams, lakes, ponds, rainwater catchments, embayments, and oceans.

##### **4.4.2.1 General Site Description**

The largest river in the area of SRS is the Savannah River, which borders the site on the southwest. Six streams flow through SRS and discharge into the Savannah River: Upper Three Runs, Beaver Dam Creek, Fourmile Branch, Pen Branch, Steel Creek, and Lower Three Runs. Upper Three Runs has two tributaries, Tims Branch and Tinker Creek; Pen Branch has one tributary, Indian Grave Branch; and Steel Creek has one tributary, Meyers Branch (DOE 1996b).

There are two manmade lakes at SRS: L Lake, which discharges to Steel Creek, and Par Pond, which discharges to Lower Three Runs. Also, about 299 Carolina bays (i.e., closed depressions capable of holding water) occur throughout the site. While these bays receive no direct effluent discharges, they do receive stormwater runoff (DOE 1996b; WSRC 1997a).

It is clear that the surplus plutonium disposition facilities would not be located within a 100-year floodplain, but there is no information concerning 500-year floodplains (DOE 1996b). No federally designated Wild and Scenic Rivers occur within the site (DOE 1996b). A map showing the 100-year floodplain is presented as Figure 4-10.

The Savannah River is classified as a freshwater source that is suitable for primary and secondary contact recreation; drinking, after appropriate treatment; fishing; balanced indigenous aquatic community development and propagation; and industrial and agricultural uses. A comparison of Savannah River water quality upstream (river-mi 160 [river-km 257]) and downstream (river-mi 120 [river-km 193]) of SRS showed no significant differences for nonradiological parameters (Arnett and Mamatey 1996). A comparison of current and historical data shows that the coliform data are within normal fluctuations for river water in this area. For the different river locations, however, there has been an increase in the number of analyses in which standards were not met.

The data for the river's monitoring locations generally met the freshwater standards set by the state; a comparison of the 1995 and earlier measurements for river samples showed no abnormal deviations. As for radiological constituents, tritium is the only radionuclide detected above background levels in the Savannah River (Arnett and Mamatey 1996).

Surface water rights for SRS are determined by the Doctrine of Riparian Rights, which allows owners of land adjacent to or under the water to use the water beneficially (DOE 1996b). SRS has five NPDES permits, two (SC0000175 and SC0044903) for industrial wastewater discharges, two (SCR000000 and SCR100000) for general stormwater discharges, and one (ND0072125) for land application. Permit SC0000175 regulates 76 outfalls; Permit SC0044903, another 7. The 1995 compliance rate for these outfalls was 99.8%. The 48 stormwater-only outfalls regulated by the stormwater permits are monitored as required. A pollution prevention plan has been developed to identify where best available technology and best management practices must be used. For stormwater runoff from construction activities extending over 5 ac (2 ha), a sediment reduction and erosion plan is required (Arnett and Mamatey 1996). Presently, only Permit SC0000175 is active at SRS for industrial wastewater discharges. The other active permits are related to stormwater discharges.

#### **4.4.2.2 Proposed Facility Location**

The land around F Area drains to Upper Three Runs and Fourmile Branch. Upper Three Runs is a large, cool blackwater stream that flows into the Savannah River. It drains about 210 mi<sup>2</sup> (544 km<sup>2</sup>) and, during water year 1995, had a mean discharge of 245 ft<sup>3</sup>/sec (6.9 m<sup>3</sup>/sec) near its mouth. The 7-day, 10-year low flow over the period of record (water years 1974 to 1995) at SRS Road A is about 100 ft<sup>3</sup>/sec (2.8 m<sup>3</sup>/sec). The stream is about 25 mi (40 km) long, and only its lower reaches extend through SRS. It receives more water from underground sources (Dublin-Midville aquifer system) than any other SRS stream and therefore has lower dissolved solids, hardness, and pH values. It is the only major stream onsite that has not received thermal discharges. It receives permitted discharges from several areas at SRS, including F Area, S Area, the S-Area sewage treatment plant, and treated industrial wastewater from the Chemical Waste Treatment Facility steam condensate. Flow from the sanitary wastewater discharge averages less than 0.035 ft<sup>3</sup>/sec (0.001 m<sup>3</sup>/sec) or 16 gal/min (61 L/min). A comparison with the 7-day, 10-year low flow of 100 ft<sup>3</sup>/sec (2.8 m<sup>3</sup>/sec) in Upper Three Runs shows that the present discharges are very small. The analytical results for the active outfalls show the constituents of concern are maintained within permit limitations (Arnett and Mamatey 2000a, 2000b).

Fourmile Branch is a blackwater stream (freshwater, dark color resulting from organic debris) affected by past operational practices at SRS. Its headwaters are near the center of the site, and it flows southwesterly before discharging into the Savannah River. The watershed is about 21 mi<sup>2</sup> (54 km<sup>2</sup>) and receives permitted effluent discharges from F and H Areas. This stream received cooling water discharges from C Reactor while it was operating. Since those discharges ceased in 1985, the maximum recorded temperature in the stream has been 90°F (32°C). The average flow in the stream since 1985 is about 64 ft<sup>3</sup>/sec (1.8 m<sup>3</sup>/sec) (DOE 1995b). In water year 1995, the mean flow of Fourmile Branch at SRS Road A-13.2 was 37.3 ft<sup>3</sup>/sec (1.1 m<sup>3</sup>/sec). The 7-day,

10-year low flow over the period of record (water years 1977 to 1995) at SRS Road A-13.2 was 8.2 ft<sup>3</sup>/sec (0.23 m<sup>3</sup>/sec) (WSRC 1997a). In its lower reaches, this stream widens and flows via braided channels through a delta. Downstream of this delta area, it re-forms into one main channel, and most of the flow discharges into the Savannah River at river-mi 152.1 (river-km 245). When the Savannah River floods, water from Fourmile Branch flows along the northern boundary of the floodplain and joins with other site streams to exit the swamp via Steel Creek instead of flowing directly into the Savannah River (DOE 1995b).

Prior to 1996, Fourmile Branch received effluents from 16 National Pollutant Discharge Elimination System (NPDES) outfalls in C, F, and H Areas, and Central Shops, as well as groundwater from beneath F and H Areas due to outcropping. With the new NPDES permit (SC0000175) issued in 1996, outfalls were reduced from 16 to 5 due to deletions of waste streams and the consolidation of the outfalls. Effluent from the new 1.05 million gal/day (4.0 million L/day) CSWTF began discharging to Fourmile Branch in 1995 (WSRC 1997a).

Fourmile Branch, either directly or via tributaries, receives the following NPDES-permitted discharges: 186 basin overflows, cooling water, floor drains, steam condensate, process wastewater, laundry effluent, stormwater, sanitary treatment wastewater, ash basin runoff, and lab drains (WSRC 1997a).

Table 4-1 (WSRC 1999a) presents the annual instantaneous discharges of the Savannah River at Augusta, Georgia.

#### **4.4.2.3 Summary of Potential for Flooding**

There is no evidence that the selected site has experienced flooding in the past. Storm-induced runoff will provide sheet flow toward the site, which will be controlled by construction of short diversion berms near the site. The potential for flooding is discussed in the SRS GSAR (WSRC 1999a) and presented in this section.

The annual instantaneous maximum flows for Upper Three Runs gauging stations at Highway 278 near SRS Road C and at SRS Road A are listed in Table 4-2 (WSRC 1999a). The station at Highway 278 has the longest historical record.

For Upper Three Runs at Highway 278, the maximum flood recorded was 820 ft<sup>3</sup>/sec (23 m<sup>3</sup>/sec) on October 23, 1991, and the corresponding flood stage elevation was 174 ft (53 m) above msl. Similarly, the maximum flow at SRS Road C was 2,040 ft<sup>3</sup>/sec (58 m<sup>3</sup>/sec) (132.9 ft [40.5 m] above msl) on October 12, 1991, and at SRS Road A was more than 2,000 ft<sup>3</sup>/sec (57 m<sup>3</sup>/sec) (98 ft [29.9 m] above msl) on October 12, 1990. No dams are located in Upper Three Runs.

The site grade will be set at a mean elevation of 272 ft (83 m) above msl to ensure that there will be no flooding at the site due to the hydrological activity of these two streams.

The calculated probable maximum flood (PMF) for Upper Three Runs, downstream from the point where it is joined by Tinker Creek, is 150,000 ft<sup>3</sup>/sec (4,248 m<sup>3</sup>/sec). The watershed area at

this point is 163 mi<sup>2</sup> (422 km<sup>2</sup>), based on the drainage area at the nearest upstream gauging station (Station 02197300) and the planimetered additional drainage area. The maximum stage corresponding to this flow is 173.5 ft (52.9 m) above msl.

The estimated PMF for Upper Three Runs results in a water level of about 175 ft (53 m) above msl near F, H, and S Areas. The PMF for a small unnamed tributary of Upper Three Runs, located about 0.4 mi (0.6 km) northwest of F Canyon, corresponds to a peak stage of approximately 225 ft (69 m) above msl.

In F and E Areas, the 6-hr, 10-mi<sup>2</sup> (26-km<sup>2</sup>) probable maximum precipitation (PMP) is 31 in (78.7 cm), as indicated in *Probable Maximum Precipitation Estimates, United States East of the 105th Meridian* (Schreiner and Reidel 1978), with a maximum intensity of 15.1 in (38.4 cm) in 1 hr. This rainfall was adjusted to a point PMP of 19 in (48.3 cm) in 1 hr, as shown by Hanson et al. (1993) and used to generate the PMF for the small watershed of the unnamed tributary near SRS. Incremental rainfall for 1-hr periods adjacent to the PMP was also determined as shown in Table 4-3 (WSRC 1999a). A synthetic hydrograph was used to determine peak flow. The peak stage corresponding to the PMF is 224.5 ft (68.4 m) above msl. Because F Area lies near a watershed divide, incident rainfall naturally drains away from the facilities.

The PMF flood peak for Upper Three Runs was calculated using the simplified method in Regulatory Guide 1.59. The PMF was plotted using the figures in Appendix B of Regulatory Guide 1.59 (NRC 1977b) for drainage areas ranging from 100 to 20,000 mi<sup>2</sup> (260 to 52,000 km<sup>2</sup>); then interpolation of the logarithmic plot provided the PMF for the 163-mi<sup>2</sup> (423.8-km<sup>2</sup>) watershed of Upper Three Runs (WSRC 1999a).

Unusual short-duration heavy rainfall occurred in F and E Areas in August 1990 and October 1990. Total rainfall measured in F Area was reported in the GSAR (WSRC 1999a) as follows:

- On August 22, 1990, 6.1 in (15.5 cm) of rainwater was collected.
- On October 11 and 12, 1990, about 10 in (25.4 cm) of rainfall was collected.

#### 4.4.3 Groundwater Hydrology

Groundwater in the vicinity of the MFFF site is discussed in Section 3.5.7.2 of the SPD EIS (DOE 1999c). The following sections update that discussion using additional information from the SRS GSAR (WSRC 1999a).

##### 4.4.3.1 General Site Description

The Southeastern Coastal Plain hydrogeologic province underlies 120,000 mi<sup>2</sup> (312,000 km<sup>2</sup>) of the Coastal Plain of South Carolina, Georgia, Alabama, Mississippi, and Florida and a small contiguous area of southeastern North Carolina. This hydrogeologic province comprises a multi-layered hydraulic complex in which retarding beds composed of clay and marl are interspersed with beds of sand and limestone that transmit water more readily. Groundwater flow paths and flow velocity for each of these units are governed by the unit's hydraulic properties, the

geometry of the particular unit, and the distribution of recharge and discharge areas. Miller and Renken (1988) divided the Southeastern Coastal Plain hydrogeologic province into seven regional hydrologic units: four regional aquifer units separated by three regional confining units. Six of the seven hydrologic units are recognized in the SRS area and are referred to as hydrogeologic systems. These systems have been grouped into three aquifer systems divided by two confining systems, all of which are underlain by the Appleton confining system. The Appleton confining system separates the Southeastern Coastal Plain hydrogeologic province from the underlying Piedmont hydrogeologic province. The regional aquifer/confining systems at SRS are presented in Figures 4-7 and 4-11 (WSRC 1999a).

In descending order, the aquifer systems beneath SRS are the Floridan aquifer system, the Dublin aquifer system, and the Midville aquifer system (see Figure 4-7). In descending order, the confining systems are the Meyers Branch confining system, the Allendale confining system, and the Appleton confining system. Beneath SRS, the Midville and Dublin aquifer systems each consists of a single aquifer, the McQueen Branch aquifer and Crouch Branch aquifer, respectively. Down dip, beyond SRS, aquifer systems are subdivided into several aquifers and confining units.

The Floridan aquifer system consists of two aquifers in the study area, the Upper Three Runs aquifer unit, and the underlying Gordon aquifer unit, which are separated by the Gordon confining unit. Northward, the Gordon and Upper Three Runs aquifer units coalesce to form the Steed Pond aquifer.

#### **4.4.3.2 Proposed Facility Location**

Groundwater in the shallow, intermediate, and deep aquifers flows in different directions, depending on the depths of the streams that cut the aquifers. The shallow aquifer discharges to Upper Three Runs and Fourmile Branch. Groundwater in the intermediate and deep aquifers flows horizontally toward the Savannah River and southeast toward the coast (DOE 1994a).

Groundwater also moves vertically. In the shallow aquifer, it moves downward until its movement is obstructed by impermeable material. Operating under a different set of physical conditions, groundwater in the intermediate and deep aquifers flows mostly horizontally. Near F Area it moves upward due to higher water pressure below the confining unit between the upper and lower aquifers. This upward movement helps to protect the lower aquifers from contaminants found in the shallow aquifer. The elevation of groundwater in F Area varies from about 190 ft (57.9 m) to over 220 ft (67.1 m) (Figure 4-9).

Groundwater quality in F Area is not significantly different from that for the site as a whole. It is abundant, usually soft, slightly acidic, and low in dissolved solids. High dissolved iron concentrations occur in some aquifers. Where needed, groundwater is treated to raise the pH and remove iron. Recent sampling onsite showed no existing contamination and gradients that are not conducive to development of contaminated plumes.



F-Area groundwater quality can exceed drinking water standards for several contaminants. Near the F-Area seepage basins and inactive process sewer line, radionuclide contamination is widespread. Most of these wells contain tritium above drinking water standards. Other wells exhibit gross alpha, gross beta, iodine-129, and strontium-90 above their standards. Other radionuclides found above proposed standards in several wells include americium-241; curium-243 and -244; radium-226 and -228; strontium-90; total alpha-emitting radium; and uranium-233, -234, -235, and -238. Cesium-137, curium-245 and -246, and plutonium-238 were also found (Arnett and Mamatey 1996).

Near the F-Area Tank Farm, cadmium, gross alpha, lead, mercury, nitrate-nitrite as nitrogen, and tritium were detected above drinking water standards in one or more wells. The pH exceeded the basic standard, and trichlorofluoromethane (Freon 11), which has no drinking water standard, was present in elevated levels (Arnett and Mamatey 1996).

At the F-Area Sanitary Sludge Land Application Site, tritium, specific conductance, lead, and copper were found to exceed their drinking water standards in one or more wells (Arnett and Mamatey 1996). Groundwater near the F-Area Acid/Caustic Basin consistently exceeded drinking water standards for gross alpha. Alkalinity, gross beta, nitrate as nitrogen, pH, and total alpha-emitting radium were above their respective standards in one or more wells (Arnett and Mamatey 1996). The groundwater near the F-Area Coal Pile Runoff Containment Basin did not exceed any chemical or radiological standard during 1995 (Arnett and Mamatey 1996).

#### **4.4.3.3 Potential Sources of Groundwater Contamination**

Groundwater resources are affected by many physical factors, including aquifer leakage, natural variations over distance, and differences in behavior caused by natural and pumping cycles. Groundwater use and quality at SRS are related to each other, as well as to surface water use and quality. Groundwater provides the base flow for streams and for discharges to the Savannah River.

At SRS, groundwater monitoring for radioactive constituents began in the 1950s, while monitoring for nonradioactive constituents began in 1975. The SRS environmental monitoring program now encompasses more than 100 locations, including waste disposal sites, chemical storage areas, tanks, sewers, spill areas, buildings, and proposed construction areas (Noah 1995).

Groundwater beneath an estimated 5% to 10% of SRS has been contaminated by industrial solvents, tritium, metals, or other constituents used or generated by operations. Groundwater in the area contains one or more of these constituents at or above primary drinking water standards (Noah 1995). In most instances, the contamination is confined to the uppermost aquifer system (water table).

The 2000 RCRA Part B Permit Renewal Application, Volume VII, Mixed Waste Management Facility (MWMF) at SRS (WSRC 2000a) provides a comprehensive description of groundwater contamination plumes in F Area. Also, the RCRA Facility Investigation/Remedial Investigation Report for the Old F-Area Seepage Basin (WSRC 1995) defines the soil and groundwater

contamination from past disposal practices into the seepage basin. The Old F-Area Seepage Basin is located just northwest of the MFFF site. The contaminated soil zone was just remediated in 2000. These two reports indicate that there is no known soil or groundwater contamination on the MFFF site. This information was confirmed with the recent comprehensive geotechnical investigations conducted during summer 2000 at the MFFF site. Radiological testing was performed for drill cuttings and all samples. No radioactive contamination was encountered during this program in the Upper Three Runs or Gordon aquifers, which are the upper aquifers at the MFFF site.

#### **4.4.3.4 Potential Changes in Baseline Hydrology as a Result of Recent Activities**

At SRS, the Atlantic Coastal Plain sediments are divided into two major aquifer systems (Floridan and Dublin-Midville) and two confining systems (Appleton and Meyers Branch). These systems are subdivided further into additional aquifer and confining units. The Dublin-Midville aquifer system is known to sustain single-well yields of 2.7 million gal/day (10.2 million L/day). This system is being utilized well below its capacity.

At SRS, most groundwater production is from the Dublin-Midville aquifer system (i.e., about 9 to 12 million gal/day [34 to 45 million L/day]), with a few lower-capacity wells pumping from the Floridan aquifer system, the uppermost aquifer system. Every major operating area at SRS has groundwater production wells.

SRS uses groundwater as a main water supply source because of (1) the convenience afforded by the availability of a prolific source, (2) the transmissivity of the Dublin-Midville aquifer system, and (3) the high quality of the water. Groundwater withdrawals are used primarily for process water, while other uses include domestic water and fire protection. Further withdrawals could potentially impact the productivity and stability of the aquifer system.

## **4.5 METEOROLOGY AND AIR QUALITY**

This section describes the meteorology and air quality in the locale of the MFFF. The local meteorology is characterized in Section 4.5.1 in terms of temperature, precipitation, humidity, wind patterns, atmospheric transport and dispersion climatology, and storm characteristics. The sources of the meteorological data are also provided in Section 4.5.1. Existing levels of air pollution and the local air quality are discussed in Section 4.5.2. Lastly, the impact of local terrain and large bodies of water on meteorological conditions is discussed in Section 4.5.3.

### **4.5.1 Onsite Meteorological Conditions**

The climate in the region around and the area near the MFFF is summarized and discussed in the following sections.

#### **4.5.1.1 Data Sources**

The description of the regional climatology of SRS is based on *Climatology of the United States No. 60, Climate of South Carolina* published by the National Climatic Data Center (DOC 1977) and the discussion in Section 1.4.1 of the SRS GSAR (WSRC 1999a). It is also based on long-term meteorological data collected by the National Weather Service at Bush Field in Augusta, Georgia, as summarized by the National Climatic Data Center (DOC 1999a). Bush Field is located approximately 12 mi (19.3 km) northwest of SRS. Normals, means, and extremes of temperature, precipitation, and wind speed are taken from DOC (1999a). Data on tornado occurrences and hurricanes are derived from Grazulis (1993) and the SRS GSAR (WSRC 1999a).

#### **4.5.1.2 General Climate**

The general climate was described in Section 3.5.1.1 of the SPD EIS (DOE 1999c) and has been modified and updated.

The SRS region has a temperate climate with short, mild winters and long, humid summers. Throughout the year, the climate is frequently affected by warm, moist maritime air masses. Summer weather usually lasts from May through September, when the area is subject to the influence of the western extension of the semi-permanent Atlantic subtropical anticyclone, or the "Bermuda high" pressure system. As a result, winds are generally light and weather associated with low-pressure systems and fronts usually remains well to the north of the area. Because the Bermuda high is a persistent feature, there are few breaks in the summer heat. High temperatures during the summer months are greater than 90°F (32.2°C) on more than half of all days (DOC 1999a). The relatively high heat and humidity often result in scattered afternoon and evening thunderstorms.

The influence of the Bermuda high begins to diminish during the fall, resulting in drier weather and temperatures that are more moderate. During the month of October, a semi-permanent Appalachian anticyclone results in mild dry weather. Average rainfall for the fall months is lower than average for the other months of the year. Frequently, fall days are characterized by cool, clear mornings and warm, sunny afternoons. Average daily temperatures in the fall range from a high of 76°F (24.4°C) to a low of 50°F (10°C). During the winter, migratory low-pressure systems and associated fronts influence the weather of SRS. Conditions frequently alternate between warm, moist, subtropical air from the Gulf of Mexico region and cool, dry, polar air. Occasionally, an arctic air mass will influence the area; however, the Appalachian Mountains to the north and northwest of SRS moderate the cold temperatures associated with the polar or arctic air. Consequently, less than one-third of the winter days have minimum temperatures below freezing, and temperatures below 20°F (-6.7°C) are infrequent.

Spring is characterized by a higher frequency of occurrence of tornadoes and severe thunderstorms than the other seasons of the year. This weather is often associated with the

passage of cold fronts. Although weather during the spring is variable and relatively windy, temperatures are usually mild.

The average annual temperature at SRS is 63.2°F (17.3°C). A second data set from SRS yields an annual average temperature of 64.7°F (18.2°C) (WSRC 2000c). Temperatures vary from an average daily minimum of 32°F (0°C) in January to an average daily maximum of 91.7°F (33.2°C) in July. Long-term monthly and annual temperature data for Bush Field in Augusta, Georgia are summarized in Table 4-4. The average annual precipitation at SRS is about 45 in (114 cm). Data from 1967 to 1996 at SRS show an annual average precipitation of 49.5 in (126 cm). Precipitation is distributed fairly evenly throughout the year, with the highest in summer and the lowest in autumn. The summer precipitation amounts are mainly due to afternoon thunderstorms or the influence of tropical storms. Long-term monthly and annual precipitation data for Bush Field are summarized in Table 4-5.

On an annual average basis, relative humidities at Bush Field range from a high of 83% in the early morning hours to 51% in the afternoon. Comparable August values at SRS are 97% in the early morning hours to 50% in the afternoon. On a seasonal basis, the highest relative humidities occur in late summer during the months of August and September while spring (i.e., March and April) relative humidities are generally the lowest. The highest early morning relative humidity in August and September is 91% while the lowest afternoon values are 55% and 56% for August and September, respectively. In April, the early morning relative humidity averages 85% and the afternoon value is 45%.

A better measure of atmospheric moisture is the dew point temperature, which indicates the actual amount of moisture in the air because it is the temperature at which saturation occurs. Monthly average dew point temperatures in this area range from a high of approximately 69°F (20.6°C) in July and August to lows of approximately 34°F (1.1°C) in January. Heavy fog with visibility below 0.25 mi (0.4 km) occurs at Bush Field with an average annual frequency of 31.6 days per year.

Based on a short record of measurements from the SRS Central Climatology Station (i.e., 1995 to 1996), the annual average absolute humidity is 11.1 g/m<sup>3</sup>, ranging from 18.4 g/m<sup>3</sup> in July to 6.0 g/m<sup>3</sup> in December and January (WSRC 2000c).

The mixing height is the level of the atmosphere below which pollutants are easily mixed; it is often used to approximate the base of an elevated inversion. Estimates of seasonally averaged morning mixing heights for SRS were interpolated from data presented in *Mixing Heights, Wind Speeds, and Potential for Urban Air Pollution Throughout the Contiguous United States* (Holzworth 1972) and are presented in Table 4-6. The Holzworth data<sup>1</sup> are derived from radiosonde observations during the five-year period 1960 to 1964.

---

<sup>1</sup>Although the source of data is for a 40-year old period, this is the only available data source supplying this type of information and the age of the data should not be relevant to seasonally averaged mixing heights.

### **4.5.1.3 Wind Patterns and Dispersion Climatology**

Winds in the SRS region are generally light to moderate with the highest speeds occurring during spring with an average of approximately 7 mph (11.3 km/hr) for those months at Bush Field. The lightest winds occur in the summer and fall with the lowest monthly average wind speed of 5.1 mph (8.2 km/hr) occurring in August. The highest monthly wind speed of 7.7 mph (12.4 km/hr) occurs in March, and the long-term mean wind speed for the year is 6.2 mph (10 km/hr) at Bush Field. The prevailing wind direction at Augusta is generally from the northwest during the winter months, from the southeast during the late spring and early autumn, and from the southwest in the summer. There is no overall prevailing wind direction because it is variable throughout the year.

The highest observed 1-minute wind speed at Augusta is 62 mph (100 km/hr) from the east (June 1965) based on 42 years of observations, while the peak gust is 60 mph (96.5 km/hr) from the northwest (June 1988) based on 10 years of observations. The peak gust should be higher than the fastest mile wind speed due to its shorter duration, but in this case, the difference in the period of record (42 years vs. 10 years) results in a smaller peak gust. Higher localized wind speeds have occurred during storms (see Section 4.5.1.4).

A meteorological database for the 5-year period 1992 to 1996 is currently used for safety analysis at SRS. An averaged wind rose plot for the H-Area tower for this period of record is shown in Figure 4-12. As indicated by this plot, there is no strong prevailing wind direction at the site. Northeasterly winds occurred approximately 10% of the time (mostly during late summer, fall, and early winter), and west to southwest winds occurred about 8% of the time (mostly late winter, spring, and early summer). Annual average wind speeds ranged from 9.4 to 8.0 mph (15.1 to 12.9 km/hr).

The relative ability of the atmosphere to disperse air pollutants is commonly characterized in terms of Pasquill stability class. The Pasquill stability classes range from class A (very unstable conditions characterized by considerable turbulence producing rapid dispersion) to class G (extremely stable conditions with little turbulence and very weak dispersion). The percent occurrence of Pasquill stability class for each of the eight SRS area towers is summarized in Table 4-7. Stable conditions were observed between 20% and 30% of the time during the five-year report.

A joint frequency distribution of windspeed, wind direction, and stability class for the 1992 to 1996 period of observations from the 200-ft (61.0-m) elevation of the SRS H-Area meteorological tower are presented in Table 4-8.

### **4.5.1.4 Storms**

The SRS region occasionally experiences severe weather in the form of violent thunderstorms, tornadoes, and hurricanes. Although thunderstorms are common in the summer months, the more violent storms are commonly associated with squall lines and active cold fronts in the spring. Augusta averages 52.9 thunderstorm days per year with the highest number of days (9 to

12 days per month) occurring in June, July, and August (DOC 1999a). The occurrence of hail with thunderstorms is infrequent. Based on observations in a 1-degree square of latitude and longitude that includes SRS, hail occurs once every two years on the average (Pautz 1969).

A total of 17 “significant” tornadoes occurring in Aiken or Barnwell Counties in South Carolina or in Burke County, Georgia, has been documented (Grazulis 1993) for the period 1880 to 1995. This reference defines a “significant” tornado as one causing confirmable Fujita Scale classification F2 damage or one that has killed a person. The Fujita Scale classification system is explained in Table 4-9. In addition, there have been nine confirmed tornadoes passing through or close to SRS since operations began. A tornado that occurred on October 1, 1989, knocked down several thousand trees over a 16-mi (25.7-km) path across the southern and eastern portions of the site. Wind speeds produced by this F-2 tornado were estimated to be as high as 150 mph (241 km/hr). Four F-2 tornadoes struck forested areas of SRS on three separate days during March 1991 (Parker 1991). Considerable damage to trees was observed in the affected area. The other four confirmed tornadoes were classified as F-1 and produced relatively minor damage. None of the nine tornadoes caused damage to buildings.

Tropical storms or hurricanes affect the state about every other year. A total of 36 hurricanes have caused damage in South Carolina between 1700 and 1989. Most hurricanes only affect the Outer Coastal Plain and rapidly decrease in intensity as they move inland. However, considerable flooding can occur from hurricanes that come far inland. The average frequency of occurrence of a hurricane in the state is once every eight years. However, the observed interval between hurricane occurrences has ranged from two months to 27 years. Approximately 80% have occurred in August and September when hurricane activity in the Atlantic Ocean reaches its maximum.

Because SRS is approximately 100 mi (161 km) inland, winds associated with tropical weather systems usually diminish below hurricane force (sustained speeds of 75 mph [120 km/hr] or greater). However, winds associated with Hurricane Gracie, which passed to the north of SRS on September 29, 1959, were measured as high as 75 mph (121 km/hr) on an anemometer located in F Area. No other hurricane force wind has been measured onsite. On September 22, 1989, the center of Hurricane Hugo passed about 100 mi (161 km) northeast of SRS. The maximum 15-minute average wind speed observed onsite during this hurricane was 38 mph (61 km/hr). The highest observed instantaneous wind speed was 62 mph (100 km/hr). The data were collected from the onsite tower network (measurements taken at 200 ft [60 m] above ground). Extreme rainfall and tornadoes, which frequently accompany tropical weather systems, usually have the most significant hurricane-related impact on SRS operations (Hunter 1990).

#### **4.5.2 Existing Levels of Air Pollution**

Existing air quality was discussed in Section 3.5.1.1.1 of the SPD EIS (DOE 1999c) and has been updated. Air pollution refers to any substance in the air that could harm human or animal populations, vegetation, or structures, or that unreasonably interferes with the comfortable enjoyment of life and property. Air pollutants are transported, dispersed, or concentrated by

meteorological and topographical conditions. Air quality is affected by air pollutant emission characteristics, meteorology, and topography.

SRS is near the center of the Augusta-Aiken Interstate Air Quality Control Region #53. None of the areas within SRS and its surrounding counties are designated as nonattainment areas with respect to the National Ambient Air Quality Standards (NAAQS) for criteria air pollutants (40 CFR §81.311 and §81.341). Existing ambient concentrations are compared to applicable NAAQS and the ambient air quality standards for the states of South Carolina and Georgia in Table 4-10.

There are no prevention of significant deterioration (PSD) Class I areas within 62 mi (100 km) of SRS. None of the facilities at SRS have been required to obtain a PSD permit (DOE 1996b).

The primary emission sources of criteria air pollutants and/or air toxics at SRS are the nine coal-burning boilers and four fuel-oil-burning package boilers (when operating) that produce steam and electricity, diesel engine-powered equipment, the DWPF, groundwater air strippers, and various other process facilities. Other emissions and sources include fugitive particulates from coal piles and coal-processing facilities, vehicles, controlled burning of forestry areas, and temporary emissions from various construction-related activities (DOE 1996b).

Table 4-10 presents the ambient air concentrations attributable to sources at SRS. These concentrations are based on emissions for the year 1994 (DOE 1998a; DOE 1998b). Only those hazardous pollutants that would be emitted for the MFFF alternatives are presented. Additional information on ambient air quality at SRS is in the *SRS Environmental Report for 1999* (Arnett and Mamatey 2000a). Concentrations shown in Table 4-10 attributable to SRS are in compliance with applicable guidelines and regulations. Data for 1997 from nearby South Carolina monitors at Beech Island, Jackson, and Barnwell indicate that the NAAQS for particulate matter, lead, ozone, sulfur dioxide, and nitrogen dioxide are not exceeded in the area around SRS (SCDHEC 2000a). Air pollutant measurements at these monitoring locations during 1997 showed for nitrogen dioxide an annual average concentration of  $9.4 \mu\text{g}/\text{m}^3$ ; for sulfur dioxide, concentrations of  $71 \mu\text{g}/\text{m}^3$  for 3-hr averaging,  $23 \mu\text{g}/\text{m}^3$  for 24-hr averaging, and  $5 \mu\text{g}/\text{m}^3$  for the annual average; for total suspended particulates, an annual average concentration of  $36 \mu\text{g}/\text{m}^3$ ; and for particulate matter, concentrations of  $62 \mu\text{g}/\text{m}^3$  for 24-hr averaging and  $19 \text{g}/\text{m}^3$  for the annual average.

#### **4.5.3 Impact of Local Terrain and Large Bodies of Water on Meteorological Conditions**

Local terrain in the form of hills, valleys, and large water bodies can have a significant impact on the meteorological conditions. In the vicinity of the facility, the terrain can be described as gently rolling, forested hills. In general, terrain elevations decrease gradually from the Appalachian foothills northwest of the site toward the Atlantic coastal plain to the southeast. The local SRS terrain elevations also generally decrease gradually toward the Savannah River, which runs along the southwestern boundary of the site. Site elevations range from 100 ft (30.5 m) to about 400 ft (122 m) above msl.

The closest pronounced topographic feature (e.g., hill, large lake) is approximately 20 mi (32.2 km) from the site; the local terrain has little effect on wind and stability climatology at SRS. During stable atmospheric conditions, some channeling or airflow stagnation could occur in some of the more pronounced valleys. However, any terrain-induced increase in pollutant concentrations would be much localized and short-lived. SRS is too far from the Atlantic Ocean to experience any meaningful seabreeze activity.

## **4.6 ECOLOGY**

Section 3.5.8 of the SPD EIS (DOE 1999c) discusses the ecological resources in the vicinity of the MFFF site. This discussion has been updated.

Ecological resources are defined as terrestrial (predominantly land) and aquatic (predominantly water) ecosystems characterized by the presence of native and naturalized plants and animals. For the purposes of this ER, those ecosystems are differentiated in terms of habitat support of threatened, endangered, and other special-status species (i.e., “nonsensitive” versus “sensitive” habitat).

### **4.6.1 Nonsensitive Habitat**

Nonsensitive habitat comprises those terrestrial and aquatic areas of the site that typically support the region’s major plant and animal species.

#### **4.6.1.1 General Site Description**

At least 90% of the SRS land cover is composed of upland pine and bottomland hardwood forests (DOE 1997a). Five major plant communities have been identified at SRS: bottomland hardwood (most commonly sweetgum and yellow poplar); upland hardwood-scrub oak (predominantly oaks and hickories); pine/hardwood; loblolly, longleaf, and slash pine; and swamp. The loblolly, longleaf, and slash pine community covers about 65% of the upland areas of SRS. Swamp forests and bottomland hardwood forests occur along the Savannah River and the numerous streams found on SRS.

The biodiversity of the region is extensive due to the variety of plant communities and the mild climate. Animal species known to inhabit SRS include 44 species of amphibians, 255 species of birds, 54 species of mammals, and 59 species of reptiles. Common species include the eastern box turtle, Carolina chickadee, common crow, eastern cottontail, and gray fox (DOE 1996b; WSRC 1997a). Game animals include a number of species, two of which, the white-tailed deer and feral hogs, are hunted onsite (DOE 1996b). Raptors, such as the Cooper’s hawk and black vulture, and carnivores, such as the raccoon, are ecologically important groups at SRS (DOE 1996b).

Aquatic habitat within SRS includes manmade ponds, Carolina bays, reservoirs, and the Savannah River and its tributaries.



There are more than 50 manmade impoundments throughout the SRS site that support populations of bass and sunfish. Carolina bays, a type of wetland unique to the southeastern United States, are natural shallow depressions that occur in interstream areas. These bays can range from lakes to shallow marshes, herbaceous bogs, shrub bogs, or swamp forests. Among the 299 Carolina bays found throughout SRS, fewer than 20 have permanent fish populations. Redfin pickerel, mud sunfish, lake chubsucker, and mosquito fish are present in these bays.

Although sport and commercial fishing is only permitted on portions of SRS (Crackerneck Wildlife Management Area), the Savannah River is used extensively for both. Important commercial species are the American shad, hickory shad, and striped bass, all of which are anadromous. The most important warm-water game fish are bass, pickerel, crappie, bream, and catfish (DOE 1996b; WSRC 1997a).

#### **4.6.1.2 Proposed Facility Location**

F Area is situated on an upland plateau between the drainage areas of Upper Three Runs and Fourmile Branch. This heavily industrialized area is dominated by buildings, paved parking lots, graveled construction areas, and laydown yards (Figure 4-13); little natural vegetation remains inside the fenced areas. Grassed areas occur around the administration buildings, and some vegetation is present along drainage ditches, but most of the developed areas have no vegetation (DOE 1994a; 1995a). The most common plant communities in the vicinity of F Area include loblolly, longleaf, and slash pine; upland hardwood-scrub oak; pine/hardwood; and bottomland hardwood (DOE 1995b; DOE 1996b). Cleared fields are also common in F Area, and a roughly 15-ac (6.1-ha) oak-hickory forest area designated as a National Environmental Research Park set aside is northwest of F Area (DOE 1996b). The MFFF site is composed primarily (68%) of mixed evergreen and evergreen forest in its undeveloped areas (Figure 4-13) (DOE 1995b).

A recent (1994 to 1997) study was conducted to document the composition and diversity of urban wildlife, those species of amphibians, birds, mammals, and reptiles that inhabit or temporarily use the developed areas on SRS. Results indicate that the use of the developed areas by wildlife species is more common than has been previously reported (Mayer and Wike 1997). A total of 41 wildlife species were observed in and around F Area, including 18 species of birds, 11 species of mammals, and 12 species of reptiles.

Bird species commonly seen include the bufflehead, turkey vulture, black vulture, killdeer, rock dove, mourning dove, chimney swift, great crested flycatcher, barn swallow, common crow, fish crow, northern mockingbird, American robin, European starling, and common grackle. Frequently sighted mammals include the Virginia opossum, eastern cottontail, house mouse, feral cat, striped skunk, and raccoon. The only reptile commonly observed is the banded water snake (Mayer and Wike 1997).

Upper Three Runs and its tributaries and three Carolina bays constitute the aquatic habitat in the vicinity of F Area. Streams support largemouth bass, black crappie, and various species of pan fish. Upper Three Runs has a rich fauna; more than 551 species of aquatic insects have been

collected (DOE 1996b; WSRC 1997a). It is important as a spawning area for blueback herring, and as a seasonal nursery habitat for American shad, striped bass, and other Savannah River species. Aquatic resources information on the three Carolina bays is unavailable (DOE 1996b).

#### **4.6.2 Sensitive Habitat**

Sensitive habitat comprises those terrestrial and aquatic (including wetlands) areas of the site that support threatened and endangered, state-protected, and other special-status plant and animal species.

##### **4.6.2.1 General Site Description**

SRS wetlands, most of which are associated with floodplains, streams, and impoundments, include bottomland hardwood, cypress-tupelo, scrub-shrub, and emergent vegetation, as well as open water. Swamp forest along the Savannah River is the most extensive wetlands vegetation type (DOE 1996b).

Sixty-one threatened, endangered, and other special-status species listed by the federal government or the state of South Carolina may be found in the vicinity of SRS. Table 4-11 identifies those potentially occurring in the vicinity of F Area. No critical habitat for threatened or endangered species exists on SRS (DOE 1996b).

##### **4.6.2.2 Proposed Facility Location**

Figures 4-13 and 4-14 identify the land cover characteristics and show the location of wetlands in the general vicinity of F Area. No wetlands are located in the MFFF site area.

No federally listed threatened or endangered species are known to occur in F Area. The American alligator, although listed as threatened (by virtue of similarity in appearance to the endangered crocodile) is fairly abundant on SRS. It was recently observed near F Area, but its occurrence there is seen as uncommon. Furthermore, no state-listed protected species have been found in any developed area on SRS, and of the state-listed organisms known to occur, none would be expected to use any of the disturbed areas for extended periods (Mayer and Wike 1997).

The Pen Branch area, about 8.7 mi (14 km) southwest of the proposed sites, and an area south of Par Pond, about 7.5 mi (12 km) to the southeast, support active bald eagle nests. Wood storks have been observed about 13 mi (21 km) from the proposed site, near the Fourmile Branch delta. The closest colony of red-cockaded woodpeckers is about 3.1 mi (5 km) away, but suitable forage habitat exists on the proposed sites. The smooth purple coneflower, the only endangered plant species found on SRS, could be found on the proposed sites (DOE 1996b). Botanical surveys conducted by the Savannah River Forest Station in 1992 and 1994 identified three populations of Oconee azalea in the area northwest of F Area. This state-listed rare plant species was found on the steep slopes adjacent to the Upper Three Runs floodplain (DOE 1995b).

Surveys conducted in 1998 and 2000 in the area north of F Area and east of Upper Three Runs did not find any federally listed threatened, endangered, proposed, or sensitive plant or animal species (DOA 2000). Of the listed species, appropriate habitat was found only for the red-cockaded woodpecker, although there were no sightings during the survey. Appropriate habitat is lacking in the survey area for the bald eagle, wood stork, American alligator, and shortnosed sturgeon.

## **4.7 NOISE**

Noise is unwanted sound that interferes or interacts negatively with the human or natural environment. Noise may disrupt normal activities or diminish the quality of the environment. The existing sources of noise were described in Section 3.5.1.2 of the SPD EIS (DOE 1999c).

### **4.7.1 General Site Description**

Major noise sources at SRS are primarily in developed or active areas and include various industrial facilities, equipment, and machines (e.g., cooling systems, transformers, engines, pumps, boilers, steam vents, paging systems, construction and materials-handling equipment, and vehicles). Major noise emission sources outside of these active areas consist primarily of vehicles and rail operations. Existing SRS-related noise sources of importance to the public are those related to transportation of people and materials to and from the site, including trucks, private vehicles, helicopters, and trains (DOE 1996b).

Another important contributor to noise levels is traffic to and from SRS operations along access highways through the nearby towns of New Ellenton, Jackson, and Aiken. Noise measurements recorded during 1989 and 1990 along South Carolina Highway 125 in the town of Jackson at a point about 50 ft (15 m) from the roadway indicate that the 1-hr equivalent sound level from traffic ranged from 48 to 72 dBA. The estimated day-night average sound levels along this route were 66 dBA for summer and 69 dBA for winter. Similarly, noise measurements along South Carolina Highway 19 in the town of New Ellenton at a point about 50 ft (15 m) from the roadway indicate that the 1-hr equivalent sound level from traffic ranged from 53 to 71 dBA. The estimated average day-night average sound levels along this route were 68 dBA for summer and 67 dBA for winter (NUS 1990).

Most industrial facilities at SRS are far enough from the site boundary that noise levels from these sources at the boundary would not be measurable or would be barely distinguishable from background levels.

The states of Georgia and South Carolina, and the counties in which SRS is located, have not established any noise regulations that specify acceptable community noise levels, with the exception of a provision in the Aiken County Zoning and Development Standards Ordinance that limits daytime and nighttime noise by frequency band (DOE 1996b).

The EPA guidelines for environmental noise protection recommend an average day-night average sound level of 55 dBA as sufficient to protect the public from the effects of broadband

environmental noise in typically quiet outdoor and residential areas (EPA 1974). Land-use compatibility guidelines adopted by the Federal Aviation Administration and the Federal Interagency Committee on Urban Noise indicate that yearly day-night average sound levels less than 65 dBA are compatible with residential land uses and levels up to 75 dBA are compatible with residential uses if suitable noise reduction features are incorporated into structures (14 CFR Part 150). It is expected that for most residences near SRS, the day-night average sound level is less than 65 dBA and is compatible with the residential land use, although for some residences along major roadways noise levels may be higher.

#### **4.7.2 Proposed Facility Location**

No distinguishing noise characteristics at F Area have been identified. F Area is far enough (5.8 mi [9.3 km]) from the site boundary that noise levels from the facilities are not measurable or are barely distinguishable from background levels.

### **4.8 REGIONAL HISTORIC, SCENIC, AND CULTURAL RESOURCES**

Field studies conducted over the past two decades by the South Carolina Institute of Archaeology and Anthropology of the University of South Carolina have provided considerable information about the distribution and content of cultural resources at SRS. About 60% of SRS has been surveyed, and 858 historic and prehistoric archaeological sites have been identified. Although final eligibility determinations have not yet been made on a majority of the sites, 67 are considered potentially eligible for listing on the National Register of Historic Places (DOE 1999c).

Cultural resources at SRS are managed under the terms of a Programmatic Memorandum of Agreement (PMOA) executed between DOE-SR, the South Carolina State Historic Preservation Officer, and the Advisory Council on Historic Preservation, on August 24, 1990. Guidance on the management of cultural resources at SRS is included in the *Archaeological Resource Management Plan of the Savannah River Archaeological Research Program* (SRARP 1989).

Historic, prehistoric, visual, and Native American resources are discussed in Sections 4.8.1 through 4.8.4, respectively.

#### **4.8.1 Historic Resources**

About 400 historic sites or sites with historic components have been identified within SRS property. None of the identified historic sites fall within the location of the proposed MFFF facility.

#### **4.8.2 Prehistoric Resources**

Prehistoric sites at SRS consist of the remains of villages, base camps, limited-activity sites, quarries, and workshops. An extensive archaeological survey program, begun at SRS in 1974,

includes numerous field studies that include reconnaissance surveys, shovel testing, and intensive site testing and excavation. There is prehistoric evidence in more than 800 sites, some of which fall in the vicinity of the proposed facility. Fewer than 8% of the 800 sites have been evaluated for National Register eligibility (DOE 1999c); many of the sites are away from development and are in little danger of serious loss.

Archaeological surveys of F Area in the vicinity of the proposed MFFF site identified four prehistoric sites (38AK330, 38AK548, 38AK546/547, and 38AK757) that could be affected by construction of the proposed facilities<sup>2</sup>. Sites 38AK330, 38AK548, and 38AK546/547 were identified during 1993 to 1994 surveys. Site 38AK757 was identified during surveys conducted between December 11, 1998, and February 9, 2000, and also in mid-November 1999. Of these sites, 38AK546/547 and 38AK757 have been found eligible for listing in the National Register of Historic Places under Criterion D<sup>3</sup> (Green 2000). The State Historic Preservation Office also concurred with the finding that sites 38AK330 and 38AK548 were not eligible and that no further work was required concerning those two sites (Green 2000).

#### **4.8.3 Visual Resources**

Visual resources at SRS were discussed in Section 3.5.10.2 of the SPD EIS (DOE 1999c).

The dominant viewshed in the vicinity of SRS consists mainly of agricultural land and forest, with some limited residential and industrial areas. The SRS landscape is characterized by wetlands and upland hills. Vegetation is composed of bottomland hardwood forests, scrub oak and pine woodlands, and wetland forests. DOE facilities are scattered throughout SRS and are brightly lit at night. These facilities are generally not visible offsite because views are limited by rolling terrain, frequent hazy atmospheric conditions, and heavy forests and vegetation. The only areas visually impacted by the DOE facilities are those within the view corridors of South Carolina Highway 125 and SRS Road 1.

The developed areas and utility corridors (i.e., transmission lines and aboveground pipelines) of SRS are consistent with a Visual Resources Management (VRM) Class IV designation. The remainder of SRS is consistent with VRM Class III or IV (DOE 1996b; DOI 1986a, 1986b).

Industrial facilities within F Area consist of large concrete structures, smaller administrative and support buildings, and parking lots (DOE 1994a). The structures range in height from 10 to 100 ft (3 to 30 m), with a few stacks and towers that reach 200 ft (61 m). The facilities in this area are brightly lit at night and visible when approached via SRS access roads. Visual resource

---

<sup>2</sup>Although the SPD EIS ROD (DOE 2000b) identified five sites that were potentially affected by MFFF construction, subsequent shifting of the facility site left one site outside the potential impact area.

<sup>3</sup>Criterion D – “Property has yielded, or is likely to yield, information important in prehistory or history.” (DOI 1991).

conditions in F Area are consistent with VRM Class IV (DOI 1986a, 1986b; Sessions 1997a). F Area is about 4.3 mi (7 km) from South Carolina Highway 125 and 5.3 mi (8.5 km) from SRS Road 1. Public view of F-Area facilities is restricted by heavily wooded areas bordering segments of the SRS Road 1 system and site-crossing South Carolina Highway 125. Moreover, those facilities are not visible from the Savannah River, which is about 6.2 mi (10 km) to the west.

#### **4.8.4 Native American Resources**

Less than 1% of the population of counties within a 10-mi (16-km) radius of the proposed MFFF site are of American Indian decent. Native American groups with traditional ties to the area include the Apalachee, Cherokee, Chickasaw, Creek, Shawnee, Westo, and Yuchi. At different times, each of these groups was encouraged by the English to settle in the area to provide protection from the French, Spanish, or other Native American groups. Main villages of both the Cherokee and Creek were located southwest and northwest of SRS, respectively, but both groups may have used the area for hunting and gathering activities. During the early 1800s, most of the remaining Native Americans residing in the region were relocated to the Oklahoma Territory (DOE 1999c).

Native American resources in the region include remains of villages or town sites, ceremonial lodges, burials, cemeteries, and natural areas containing traditional plants used in religious ceremonies. Literature reviews and consultations with Native American representatives have revealed concerns related to the American Indian Religious Freedom Act within the central Savannah River valley, including some sensitive Native American resources and several plants traditionally used in ceremonies.

In 1991, DOE conducted a survey of Native American concerns about religious rights in the central Savannah River valley. During this study, three Native American groups, the Yuchi Tribal Organization, the National Council of Muskogee Creek, and the Indian People's Muskogee Tribal Town Confederacy, expressed continuing interest in the SRS region with regard to the practice of their traditional religious beliefs. The Yuchi Tribal Organization and the National Council of Muskogee Creek have expressed concerns that several plant species (e.g., redroot [*Lachnanthese carolinianum*], button snakeroot [*Erynglum yuccifolium*], and American ginseng [*Panax quinquefolium*]) traditionally used in tribal ceremonies could exist on SRS. Redroot and button snakeroot are known to occur on SRS but are typically found in wet, sandy areas such as evergreen shrub bogs and savannas. Neither species is likely to be found in F Area due to clearing prior to the establishment of SRS in the 1950s (DOE 1994a). Consultations were initiated with appropriate Native American groups to determine any concerns associated with the actions evaluated in the SPD EIS (DOE 1999c).

#### **4.9 REGIONAL DEMOGRAPHY**

A demographic evaluation was conducted to identify population distribution and anticipated growth within a 50-mi (80-km) radius of the proposed MFFF site. The analysis also reviewed

detailed characteristics of the population within a more local, 10-mi (16-km) radius. All land within a 5-mi (8-km) radius of the MFFF is within SRS and contains no residential population.

#### **4.9.1 Permanent Population**

A total of about 621,527 people resided within 50 mi (80 km) of the MFFF site in 1990. That population is projected to grow by about 92% to a total of 1,042,483 by the year 2030. Tables 4-12 through 4-16 present population distribution for 1990, 2000, 2010, 2020, and 2030, respectively. The 1990 numbers are based on 1990 U.S. Census counts, while years 2000 through 2030 are projections compiled for the SRS GSAR (WSRC 1999a) and are based on growth projections provided by the University of Georgia (WSRC 1993). The analysis included spatial distribution of the population based on a circular grid comprised of 22 ½ degree sectors centered on the 16 cardinal compass point directions and six radial distances of 0 to 5, 5 to 10, 10 to 20, 20 to 30, 30 to 40, and 40 to 50 miles (0 to 8, 8 to 16, 16 to 32.2, 32.2 to 48.3, 48.3 to 64.4, and 64.4 to 80 km). Since all land within a 5-mi (8-km) radius of the MFFF site is within SRS and contains no residential population, the usual 1 mi (1.6 km) increment analysis for the area within 5 mi (8 km) of the site is not shown.

Of the combined population of counties that are partially or entirely within the 50-mi (80-km) radius of the MFFF, about 48% is male and 52% is female. Racially, the population is predominantly white, with 34% black and about 1% Asian or Pacific Islander. Less than 0.1% of the population is of Hispanic decent (DOC 1998a, 1998b).

The area within 50 mi (80 km) includes all, or portions of, two major metropolitan areas where large concentrations of population may be found. The Augusta-Aiken Metropolitan Statistical Area<sup>4</sup> (MSA), which includes Columbia, Richmond, and McDuffie Counties in Georgia, and Edgefield and Aiken Counties in South Carolina, is anchored by the city of Augusta, which is over 20 mi (32.2 km) west-northwest of the site. The Augusta MSA contained 415,220 people in 1990, and an estimated 458,271 people in 1998, primarily in the cities of Augusta, Aiken, and North Augusta (DOC 1999b). The closest boundary of the Columbia City MSA, which includes Lexington and Richland Counties (South Carolina), is located over 30 mi (48.3 km) northeast of the MFFF site: Columbia City, the core of this MSA, is located outside of the 50-mi (80-km) radius. The Columbia City MSA contained 453,932 people in 1990 and an estimated 512,316 people in 1998 (DOC 1999c). Greater than 50% of the population in the Columbia City MSA live over 50 mi (80 km) from the MFFF site.

---

<sup>4</sup>The U.S. Census Bureau defines a Metropolitan Statistical Area (MSA) as a large population nucleus, together with adjacent communities that have a high degree of economic and social integration with that nucleus. Each MSA contains one or more central counties containing the area's main population concentration, an urbanized area with at least 50,000 inhabitants. An MSA may also include outlying counties that have close economic and social relationships with the central counties.

The local area within a 10-mi (16-km) radius around the MFFF site is comprised of portions of three counties, Aiken and Barnwell, South Carolina, and Burke County, Georgia. The MFFF is located on SRS in Aiken County. Only SRS facilities, and no residential population, are located within 5 mi (8 km) of the proposed site.

The area between 5 and 10 mi (8 and 16 km) from the MFFF site contained about 6,500 people in 1990 (WSRC 1999a). That population is projected to grow to a total of approximately 12,000 by the year 2040 (WSRC 1999a). A majority of this local population resides to the north and northwest of the site in the towns of New Ellenton and Jackson, which contained estimated populations of 7,197 and 2,843 people in 1998, respectively (DOC 2000a). Existing and projected population between 5 and 10 mi (8 and 16 km) of the MFFF site are included in Tables 4-12 through 4-16.

As shown in Table 4-17, the racial and ethnic mix of the local counties' populations, as well as the states of South Carolina and Georgia, is predominantly white or black. Less than 2% of the population is comprised of individuals of Hispanic, Native American, or other non-white or black racial or ethnic background.

The U.S. Census Bureau estimated that 1,765 people resided in group quarters<sup>5</sup> in Aiken County, 297 in Barnwell County, and 216 in Burke County in 1997 (DOC 1998b). The only residential institutions classified as "group quarters" within 10 mi (16 km) of the site are three residential care facilities located in New Ellenton: the New Ellenton Nursing Center (26 beds), Coleman's Residential Care (10 beds), and Parker's Residential Care Home (nine beds) (SCDHEC 1999b). The closest of these three facilities, Parker's Residential Care Home on Pine View Drive, is over 6 mi (9.6 km) northwest of the proposed MFFF site.

A minimal number of facilities, mostly schools, containing transient populations are located within the 10-mi (16-km) area surrounding the proposed MFFF site. Five public schools are located within the area to the northwest and west, with the closest being over 6 mi (9.6 km) away from the site. Table 4-18 lists local public schools within 10 mi (16 km) of the MFFF site and recent enrollments (1998 to 1999). The students in these schools are assumed to be part of the resident population within 50 mi (80 km) of the MFFF.

#### **4.9.2 Transient Population**

The proposed MFFF site is located in F Area of SRS. There are no facilities or population within 5 mi (8 km) of the MFFF site that are not part of the SRS complex. In December 1998, the total onsite employment at SRS during the day shift of a weekday was 14,177, including 12,622 WSRC employees; 520 DOE employees; and 742 Wackenhut Services Inc. (WSI) employees (the balance included United States Forest Service, Savannah River Ecology Lab, and other contractors to DOE-SR). The population of workers at SRS has decreased to approximately

---

<sup>5</sup>Group quarters include prisons, nursing homes, psychiatric hospitals, juvenile institutions, college dormitories, military quarters, and homeless shelters.



13,616 in 2000, including 11,969 employed by WSRC (M&O Contractor); 792 employed by WSI; 492 employees under DOE-SR; and 363 other SRS contract employees (Blackmon 2000). Table 4-19 identifies the distribution of SRS employees by county of residence within the region of influence (ROI).

The local area surrounding the proposed facility is not a destination for tourism. As a result, seasonal variations in population resulting from tourist activities are negligible.

## **4.10 SOCIOECONOMIC CHARACTERISTICS AND COMMUNITY SERVICES**

### **4.10.1 Local Socioeconomic Characteristics**

In 2000, SRS employed approximately 13,616 persons. As shown in Table 4-19, approximately 90% of that workforce resides within five counties: Aiken, Barnwell, and Edgefield, South Carolina, and Columbia and Richmond, Georgia. This information was used to determine the residential preference of people currently employed at SRS and to estimate where new workers might reside if they must relocate into the area. The five-county area is referred to as the ROI.

As shown on Table 4-20, over 20% of the population of a majority of the counties in the 50-mi (80-km) region (i.e., 14 out of 21) had income levels below the federal poverty threshold; only Aiken and Lexington Counties in South Carolina, and Columbia and Glascock Counties in Georgia had lower percentages of population below the poverty threshold than their respective state averages. Only Aiken and Lexington Counties exceeded state averages for per capita income in 1994 (DOC 1998a, 1998b).

Within the three counties that make up the local 10-mi (16-km) area, Burke County, Georgia, contains the least affluent population, with a 1990 per capita income of \$11,172 and about 30.3% of its population living below the poverty level in 1989 (Table 4-21). In the same years, the per capita income for the state of Georgia was \$17,123 with approximately 14.7% of its population living below the poverty level. Within South Carolina, Aiken County had per capita income and poverty levels superior to the state average, but Barnwell County was considerably below in income (i.e., about 20% below the state average) and contained a higher percentage of individuals below poverty level. As shown in Table 4-21, while income levels have grown slightly since 1989, the percentage of the population with incomes below the poverty level in each of the three local counties has remained consistent. Unemployment in the local area ranged from a high of 16% in Burke County to a low of 7% in Aiken County in 1996 (DOC 1996).

### **4.10.2 Regional Economic Characteristics**

#### **4.10.2.1 Employment**

Selected unemployment and regional economic statistics for counties located partially or entirely within 50 mi (80 km) of the MFFF site are summarized in Table 4-20. In 1996, unemployment in the region ranged from a high of 16% in Burke County, Georgia, to a low of 3.1% in Bulloch

County, Georgia. With the exception of Bulloch and Columbia Counties in Georgia and Lexington County in South Carolina, the county rates of unemployment were consistently higher than the respective state averages of 6% and 4.6%, respectively, for South Carolina and Georgia. In May 2000, the average unemployment rates for the Augusta-Aiken and Columbia City MSAs were 4.5% and 2.7%, respectively.

Within the counties that are entirely or partially within a 50-mi (80-km) radius of the MFFF site, over 90,000 workers, or about 29%, were employed in the services sector of the workforce in 1997. Construction workers comprised about 6% of that workforce, or 18,290 workers, in that same year. Table 4-22 lists 1997 employment by business sector for the counties that are within 50 mi (80 km) of the MFFF site.

#### **4.10.2.2 Housing**

The six-county ROI contained over 165,000 housing units in 1990, approximately 10% of which were vacant. Richmond County in Georgia contained the largest number of units (77,288) in this region, followed by Aiken County in South Carolina (49,266) and Columbia County in Georgia (23,745). Barnwell County and Edgefield County in South Carolina each contained less than 8,000 units.

Of the six counties, Columbia County has seen the fastest growth in housing over the past 30 years with increases of 109.2% from 1970 to 1980, and 68.4% from 1980 to 1990. This trend is in line with that county's rapid population growth and appears to be continuing. From 1970 to 1980 and from 1980 to 1990, Columbia County's population grew approximately 80% and 47%, respectively. The state of Georgia estimates that the population of Columbia County grew by an additional 50% to a total of 88,812 people between 1990 and 1997. In 1997, Columbia County issued the largest number of construction permits for new housing (i.e., 868 permits) when compared to the other six ROI counties.

#### **4.10.3 Community Services**

##### **4.10.3.1 Education**

Five public schools are located within a 10-mi (16-km) radius of the MFFF site, all over 6 mi (9.6 km) from the site. These schools, and their 1999-2000 enrollments, are listed in Table 4-18. The schools operate for 180 days each year, from late-August through late-May. There are no private schools or colleges in the 10-mi (16-km) area.

##### **4.10.3.2 Public Safety**

The five-county ROI (excluding Bamberg County) was served by a total of 973 sworn police officers in 1997, with an average officer-to-population ratio of 2.1 officers per 1,000 persons (DOE 1999c). In 1990, Georgia averaged 2.0 officers per 1,000 persons and South Carolina averaged 1.8 officers per 1,000 persons (DOE 1999c).

Firefighting services in the SRS ROI (excluding Bamberg County) were provided by 1,712 paid and volunteer firefighters in 1997. The average firefighter-to-population ratio in the ROI was 3.8 firefighters per 1,000 persons (DOE 1999c). The average 1990 firefighter-to-population ratios for Georgia and South Carolina were 1.0 firefighter per 1,000 persons, and 0.8 firefighter per 1,000 persons, respectively (DOE 1999c).

#### **4.10.3.3 Health Care**

No hospitals are located within a 10-mi (16-km) radius of the MFFF site. The nearest hospital, the Aiken Regional Medical Center, is located about 20 mi (32.2 km) from the MFFF site in the city of Aiken. In 1996, a total of 1,722 physicians served the ROI (excluding Bamberg County). The average physician-to-population ratio in the ROI was 3.8 physicians per 1,000 persons. This ratio compares with a 1996 state average of 2.3 physicians per 1,000 persons for Georgia and 2.2 physicians per 1,000 persons for South Carolina. In 1997, there were 10 hospitals serving the ROI (excluding Bamberg County). The hospital bed-to-population ratio averaged 7.7 beds per 1,000 persons. This ratio compares with a 1990 state average of 4.1 beds per 1,000 persons for Georgia and 3.3 beds per 1,000 persons for South Carolina (DOE 1999c).

#### **4.10.3.4 Local Transportation**

Vehicular access to SRS is provided by South Carolina Highways 19, 64, 78, 125, and 278. Two road segments in the ROI could be affected by the disposition alternatives: South Carolina Highway 19 from U.S. Route 78 at Aiken to U.S. Route 278 and South Carolina Highway 230 from U.S. 25 Business at North Augusta to U.S. Routes 25, 78, and 278. Three road improvement projects are planned that are independent of the proposed action but would alleviate traffic congestion leading into SRS.

The first improvement project is the widening of South Carolina Highway 302 (Pine Log Road) from U.S. Route 78 and the construction of new segments to extend the route to South Carolina Highway 19. U.S. Route 25 is also being widened for one-half mile south of I-20. The widening project will be in conjunction with the second improvement project, the new construction of the Bobby Jones Expressway (I-520). The expressway will head in a southwest direction crossing South Carolina Highways 126 and 125 and U.S. Route 1 and continue over the Savannah River to connect with the Georgia portion of the Bobby Jones Expressway, which is already constructed. The third improvement project is the completion of South Carolina Highway 118 around Aiken. South Carolina Highway 118 will be widened with the construction of new segments to complete the by-pass (DOE 1999c). With the exception of the U.S. Route 25 project, which is expected to be completed the year MFFF construction begins, these projects will be completed prior to MFFF construction (SCDOT 2000).

There is no public transportation to SRS. Rail service in the ROI is provided by the Norfolk Southern Corporation and CSX Transportation. SRS is provided rail access via Robbins Station on the CSX Transportation line.

Waterborne transportation is available via the Savannah River. Currently, the Savannah River is used primarily for recreation. SRS has no commercial docking facilities, but it has a boat ramp that has accepted large transport barge shipments.

Columbia Metropolitan Airport in the city of Columbia, South Carolina, and Augusta Regional Airport (Bush Field) in the city of Augusta, Georgia, receive jet air passenger and cargo service from both national and local carriers. Numerous smaller private airports are located in the ROI (DOE 1999c).

#### **4.10.4 Environmental Justice**

“Environmental Justice” refers to a federal policy under which federal actions should not result in disproportionately high and adverse environmental impacts on low-income or minority populations. As a general matter, a minority population is defined to exist if the percentage of minorities within a specified area exceeds the percentage of minorities in an entire state by 20%, or if the percentage of minorities within the area is at least 50%. Executive Order 12898 directs federal executive agencies to consider environmental justice under NEPA. Although it is not subject to the executive order, the NRC has voluntarily committed to undertake environmental justice reviews. The scope of DCS’ review includes an analysis of impacts on low-income and minority populations.

In determining the area to review for environmental justice, guidance provided by the NRC specifies that “If a facility is located outside the city limits or in a rural area, a 4-mi (6.4-km) radius (50 mi<sup>2</sup> [130 km<sup>2</sup>]) should be used. ... The goal is to evaluate the “communities,” neighborhoods, or areas that may be disproportionately impacted” (NRC 1999a). The MFFF site within SRS is extremely rural, is entirely within the boundaries of the SRS property, and contains no communities, neighborhoods, or other areas that may be impacted by MOX operations. The nearest population is located more than 5 mi (8 km) from the MFFF site.

A majority of the population within a 10-mi (16-km) radius of the proposed MFFF site resides within Aiken County. Figure 4-15 shows the distribution of minority populations within a 10-mi (16-km) radius of the MFFF site. The figure is based on U.S. Census 1990 block group data. Ethnic and racial characteristics of the total population of each county that is partially located within a 10-mi (16-km) radius of the MFFF site and for the states of Georgia and South Carolina are listed in Table 4-17. Only the racial mix of Burke County is significantly different<sup>6</sup> from that of the state, with the black portion of the county population 29 percentage points higher than the overall black portion of Georgia’s population. The portion of Burke County’s population within 10 mi (16 km) of the MFFF site, however, is extremely small and over 7 mi (11.3 km) away at its closest point. The racial mix of South Carolina counties within the local area is not significantly different from that of the state as a whole.

---

<sup>6</sup>The Nuclear Materials Safety and Safeguards guidance states that “As a general matter (and where appropriate), staff may consider differences greater than 20 percent to be significant.”

Economically, Aiken County exceeds the state averages for per capita income and has a lower percentage of persons with incomes below the poverty threshold (e.g., \$9,981 for a family of three with one related child under 18 in 1990). As shown in Table 4-20, both Barnwell and Burke Counties are somewhat below their respective state averages in per capita income and have significantly higher portions of their population with income levels below the poverty threshold. As noted above, however, the portion of Burke County's population within 10 mi (16 km) of the MFFF site is extremely small as is the case for Barnwell County and no population is located within 5 mi (8 km) of the MFFF site. Figure 4-16, based on 1990 U.S. Census block group data, shows the distribution of the population living below the poverty threshold within a 10-mi (16-km) radius of the proposed MFFF site. Additional details of the environmental justice analysis are provided in Appendix C.

#### **4.11 CURRENT RISK FROM IONIZING RADIATION**

Major sources and levels of background radiation exposure to individuals in the vicinity of SRS are shown in Table 4-23. Annual background radiation doses to individuals are expected to remain constant over time. The total dose to the population, in terms of person-rem, changes as the population size changes. Background radiation doses are unrelated to SRS operations.

Releases of radionuclides to the environment from SRS operations provide another source of radiation exposure to individuals in the vicinity of SRS. Types and quantities of radionuclides released from SRS operations in 1999 are listed in the *Savannah River Site Environmental Report for 1999* (Arnett and Mamatey 2000a).

Doses to the public resulting from these releases are presented in Table 4-24. These doses fall within radiological limits prescribed by 10 CFR Part 20 (DOE 1993), and are much lower than those of background radiation.

SRS workers receive the same dose as the general public from background radiation but may also receive an additional dose from working in facilities with nuclear materials. Table 4-25 presents the average worker and cumulative worker dose to SRS workers based on the most recent published data. These doses fall within the radiological regulatory limits of 10 CFR Part 20.

#### **4.12 EXISTING SRS INFRASTRUCTURE**

Site infrastructure includes utilities and other resources to support construction and operation of the MFFF. As discussed elsewhere in the ER, one of the reasons that DOE selected the SRS F Area as the site for the surplus plutonium disposition facilities was the availability of infrastructure to support the facilities. Section 3.5.11 of the SPD EIS (DOE 1999c) discusses the current infrastructure at SRS and in F Area.

SRS uses a 115-kV system in a ring arrangement to supply power to the operations areas. Power is supplied by three transmission lines from the South Carolina Electric & Gas Company. Power for F Area is provided by the 200-F power loop, supplied by the 251-F electrical substation. This

substation consists of two 115/13.8-kV, 24/32-WA transformers and associated switchgear. F-Area consumption is about 78,300 MWh/yr. The F-Area capacity is about 561,000 MWh/yr (Table 4-26).

SRS uses a new central domestic water system consisting of several wells and water treatment plants. System capacity is 3,450 gal/min (13,058 L/min). Current usage in F Area is 100 million gal/yr (378 million L/yr) compared to a capacity of 420 million gal/yr (1,590 million L/yr). Additional process and service water can be provided through deep-well systems in F Area. F Area is served by two wells, each with a capacity of 525 million gal/yr (1,987 million L/yr). Current usage in F Area is 127 million gal/yr (481 million L/yr).

SRS does not use natural gas.

SRS also provides a fire department through three fire stations using a 12-hr rotational shift. Part of the fire department is the SRS Hazardous Materials Response Team and Rescue Team. The fire department is supported by a fleet of 20 vehicles, including six pumpers, one pumper-tanker, one tanker, and one aerial platform ladder truck.

SRS provides an integrated-site emergency response organization. The site emergency response organization provides infrastructure to support all SRS operations, South Carolina and Georgia emergency response teams, and national and international emergency response teams as necessary.

#### **4.13 EXISTING SRS WASTE MANAGEMENT INFRASTRUCTURE**

Waste management includes minimization, characterization, treatment, storage, transportation, and disposal of waste generated from ongoing DOE activities. The waste at SRS is managed according to appropriate treatment, storage, and disposal technologies and in compliance with applicable federal and state statutes and DOE Orders. SRS waste management is described in Section 3.5.2 of the SPD EIS (DOE 1999c) and presented below.

##### **4.13.1 Overview of Waste Inventories and Activities**

SRS manages the following types of waste: HLW, TRU, mixed TRU, LLW, mixed LLW, hazardous, and nonhazardous. HLW would not be generated by surplus plutonium disposition activities at SRS, and therefore, will not be discussed further. Waste generation rates and the inventory of stored waste from activities at SRS are provided in Table 4-27. More detailed descriptions of the waste management system capabilities at SRS are included in the S&D PEIS (DOE 1996b) and the *Savannah River Site Waste Management Final Environmental Impact Statement* (DOE 1995b).

EPA placed SRS on the National Priorities List in December 1989. In accordance with the Comprehensive Environmental Response, Compensation, and Liability Act (CERCLA), DOE entered into a Federal Facility Compliance Agreement with EPA and the state of South Carolina to coordinate cleanup activities at SRS under one comprehensive strategy. The agreement

combines the RCRA Facility Investigation Program Plan with a CERCLA cleanup program titled the RCRA Facility Investigation/Remedial Investigation Program Plan (DOE 1996b).

#### **4.13.2 Transuranic and Mixed Transuranic Waste**

TRU waste generated between 1974 and 1986 is stored on five concrete pads and one asphalt pad that have been covered with approximately 4 ft (1.2 m) of soil. TRU waste generated since 1986 is stored on 13 concrete pads that are not covered with soil. The TRU waste storage pads are in the Low-Level Radioactive Waste Disposal Facility (DOE 1995b).

A TRU Waste Characterization and Certification Facility is planned and would provide extensive containerized waste certification capabilities. The facility is needed to prepare TRU waste for treatment and to certify TRU waste for disposal at the Waste Isolation Pilot Plant (WIPP). Drums that are certified for shipment to WIPP will be placed in interim storage on concrete pads in E Area (DOE 1996b). LLW containing concentrations of TRU nuclides between 10 and 100 nCi (referred to as alpha-contaminated LLW) is managed like TRU waste because its physical and chemical properties are similar and similar procedures will be used to determine its final disposition (DOE 1996b). WIPP was scheduled to begin receiving waste from SRS in 2000 (Aragon 1999).

#### **4.13.3 Low-Level Radioactive Waste**

Both liquid and solid LLW are treated at SRS. Most aqueous LLW streams are sent to the F- and H-Area Effluent Treatment Facility and treated by filtration, reverse osmosis, and ion exchange to remove the radionuclide contaminants. After treatment, the effluent is discharged to Upper Three Runs within the NPDES Permit discharge limitations.

After completion of a series of extensive readiness tests, the Consolidated Incineration Facility began radioactive operations in 1997. The Consolidated Incineration Facility is designed to incinerate both solid and liquid LLW, mixed LLW, and hazardous waste (WSRC 1997b). The Consolidated Incineration Facility went into temporary shutdown on September 30, 2000.

Solid LLW is segregated into several categories to facilitate proper treatment, storage, and disposal. Solid LLW that radiates less than 200 mrem/hr at 2 in (5.1 cm) from the unshielded container is considered low-activity waste. If it radiates greater than 200 mrem/hr at 2 in (5.1 cm), it is considered intermediate-activity waste. Intermediate-activity tritium waste is intermediate-activity waste with more than 10 Ci of tritium per container. Long-lived waste is contaminated with long-lived isotopes that exceed the WAC for onsite disposal (DOE 1996b).

Four basic types of vaults and buildings are used for storing the different waste categories: low-activity waste vaults, intermediate-level nontritium vaults, intermediate-level tritium vaults, and the long-lived waste storage building. The vaults are below-grade concrete structures, and the storage building is a metal building on a concrete pad (DOE 1996b).

Currently, DOE places low-activity LLW in carbon steel boxes and deposits them in the low-activity waste vaults in E Area. Intermediate-activity LLW is packaged according to waste form and disposed of in the intermediate-level waste vaults in E Area. Long-lived wastes are stored in the Long-Lived Waste Storage Building in E Area until treatment and disposal technologies are developed (DOE 1995b).

Saltstone generated in the solidification of LLW salts extracted from HLW is disposed of in the Z-Area Saltstone Vaults. Saltstone is solidified grout formed by mixing the LLW salt with cement, flyash, and furnace slag. Saltstone is the highest volume of solid LLW disposed of at SRS. SRS disposal facilities are projected to meet solid LLW disposal requirements, including LLW from offsite, for the next 20 years (DOE 1996b).

#### **4.13.4 Mixed Low-Level Radioactive Waste**

The FFCA of October 6, 1992, addresses SRS compliance with RCRA Land Disposal Restrictions (LDR). The FFCA requires DOE facilities storing mixed waste to develop site-specific treatment plans and to submit them for approval (DOE 1996b). The site treatment plan for mixed waste specifies treatment technologies or technology development schedules for SRS mixed waste (Arnett and Mamatey 1996). SRS is allowed to continue to generate and store mixed waste, subject to LDR. Schedules to provide compliance through treatment in the Consolidated Incineration Facility are included in the Federal Facility Compliance Agreement (DOE 1996b).

The SRS mixed waste program consists primarily of safely storing waste until treatment and disposal facilities are available. Mixed LLW is stored in A, E, M, N, and S Areas in various tanks and buildings. These facilities include burial ground solvent tanks, the M-Area Process Waste Interim Treatment/Storage Facility, the Savannah River Technology Center Mixed Waste Storage Tanks, and the DWPF Organic Waste Storage Tank (DOE 1995b). These South Carolina Department of Health and Environmental Control permitted facilities will remain in use until appropriate treatment and disposal is performed on the waste (DOE 1996b).

In addition to SRS onsite treatment and disposal capability, SRS has begun to use permitted commercial sites.

#### **4.13.5 Hazardous Waste**

Hazardous waste is accumulated at the generating facility for a maximum of 90 days, or stored in DOT-approved containers in three RCRA-permitted hazardous waste storage buildings and on three interim status storage pads in B and N Areas. Most of the waste is shipped offsite to commercial RCRA-permitted treatment and disposal facilities using DOT-certified transporters. In 1995, 2,538 ft<sup>3</sup> (72 m<sup>3</sup>) of hazardous waste were sent to onsite storage. Of this amount, 712 ft<sup>3</sup> (20 m<sup>3</sup>) were shipped offsite for commercial treatment or disposal (Arnett and Mamatey 1996).



#### **4.13.6 Nonhazardous Waste**

In 1994, the centralization and upgrading of the sanitary wastewater collection and treatment systems at SRS were completed. The program included the replacement of 14 of 20 aging treatment facilities scattered across the site with a new 1.1 million gal/day (4.1 million L/day) central treatment facility and connecting them with a new 18-mi (29-km) sanitary sewer system. The central treatment facility treats sanitary wastewater by the extended aeration activated sludge process. The treatment facility separates the wastewater into two forms: clarified effluent and sludge. The liquid effluent is further treated by the nonchemical method of ultraviolet light disinfection to meet NPDES discharge limitations for the outfall to Fourmile Branch. The sludge is further treated to reduce pathogen levels to meet proposed land application criteria. The remaining sanitary wastewater treatment facilities are being upgraded as necessary by replacing existing chlorination treatment systems with nonchemical ultraviolet light disinfection systems to meet NPDES limitations (DOE 1996b).

SRS has privatized the collection, hauling, and disposal of its sanitary waste (Arnett and Mamatey 1996). SRS-generated solid sanitary waste is sent to the Three Rivers Landfill, which is located just southwest of B Area (DOE 1998b). SRS conducts a recycling program using the City of North Augusta Regional Material Recovery Facility. In 1999, in excess of 35% of the compactible sanitary waste stream was recycled (WSRC 1999b). SRS disposes of other nonhazardous waste that consists of scrap metal, powerhouse ash, domestic sewage, scrap wood, construction debris, and used railroad ties in a variety of ways. Scrap metal is sold to salvage vendors for reclamation. Powerhouse ash and domestic sewage sludge are used for land reclamation. Scrap wood is burned onsite or chipped for mulch. Construction debris is used for erosion control. Railroad ties are shipped offsite for disposal (DOE 1996b).

#### **4.13.7 Waste Minimization**

The total amount of waste generated and disposed of at SRS has been and continues to be reduced through the efforts of the pollution prevention and waste minimization program at the site. This program is designed to achieve continuous reduction of waste and pollutant releases to the maximum extent feasible and in accordance with regulatory requirements while fulfilling national security missions (DOE 1996b). The program focuses mainly on source reduction, recycling, and increasing employee participation in pollution prevention. For example, 1995 nonhazardous solid waste generation was 32% below that of 1994, and the disposal volume of other solid waste, including radioactive and hazardous wastes, was 38% below 1994 levels. In 1995, SRS achieved a 9% reduction in its radioactive waste generation volume compared with 1994. Total solid waste volumes have declined by more than 70% since 1991. Radioactive solid waste volumes have declined by about 63%, or more than 600,000 ft<sup>3</sup> (182,880 m<sup>3</sup>) from 1991 through 1995. In 1995, more than 3,300 tons (2,990 metric tons) of nonradioactive materials were recycled at SRS, including 1,062 tons (963 metric tons) of paper and cardboard (Arnett and Mamatey 1996). During 1999, over 90 projects were implemented by waste generators that resulted in an avoidance of approximately 88,000 ft<sup>3</sup> (2,492 m<sup>3</sup>) of radioactive and hazardous waste (WSRC 1999b).

## Figures

**This page intentionally left blank.**

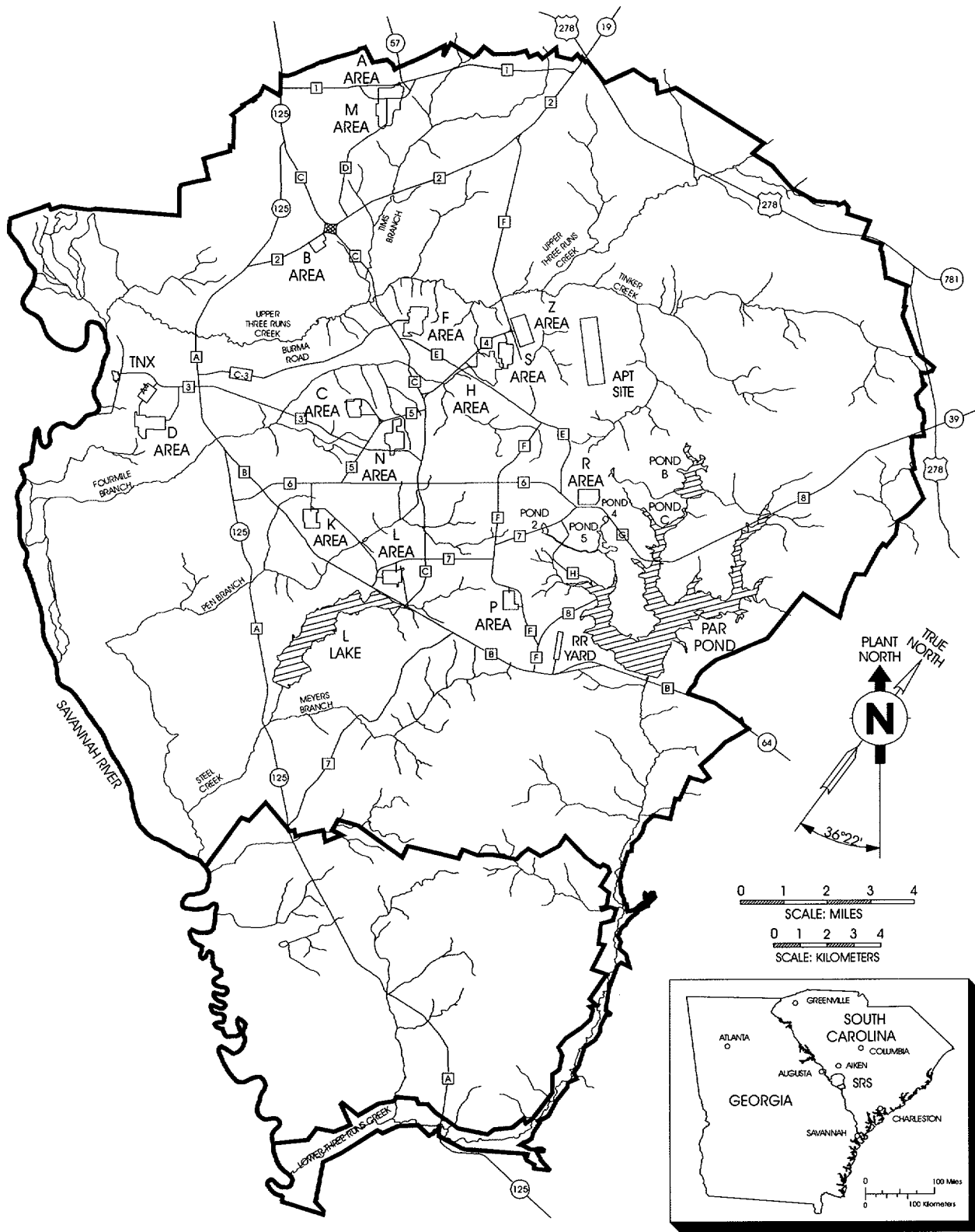

**Figure 4-1. Location of the Savannah River Site**

**This page intentionally left blank.**

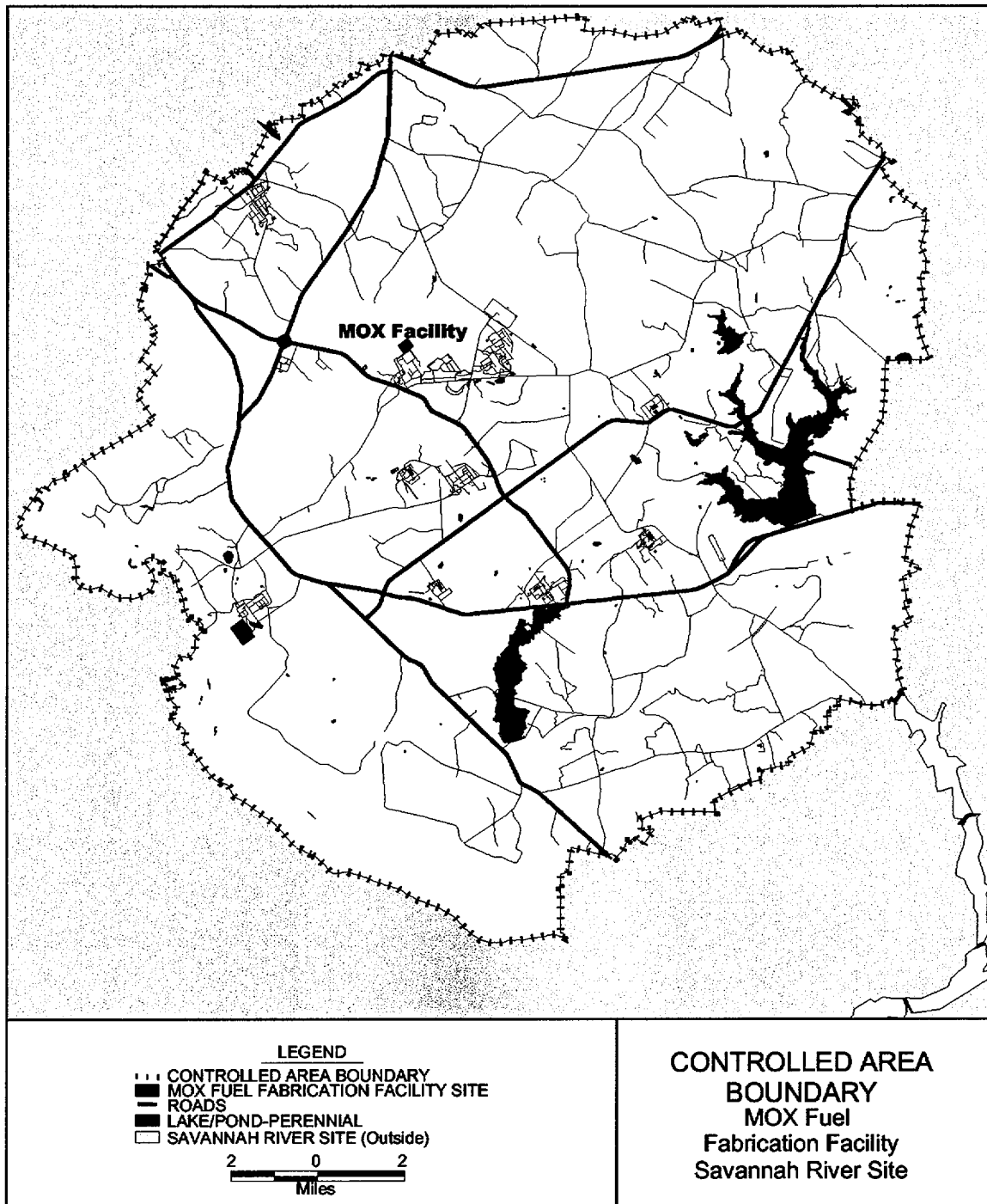

Figure 4-2. Location of F Area and Controlled Area Boundary

**This page intentionally left blank.**

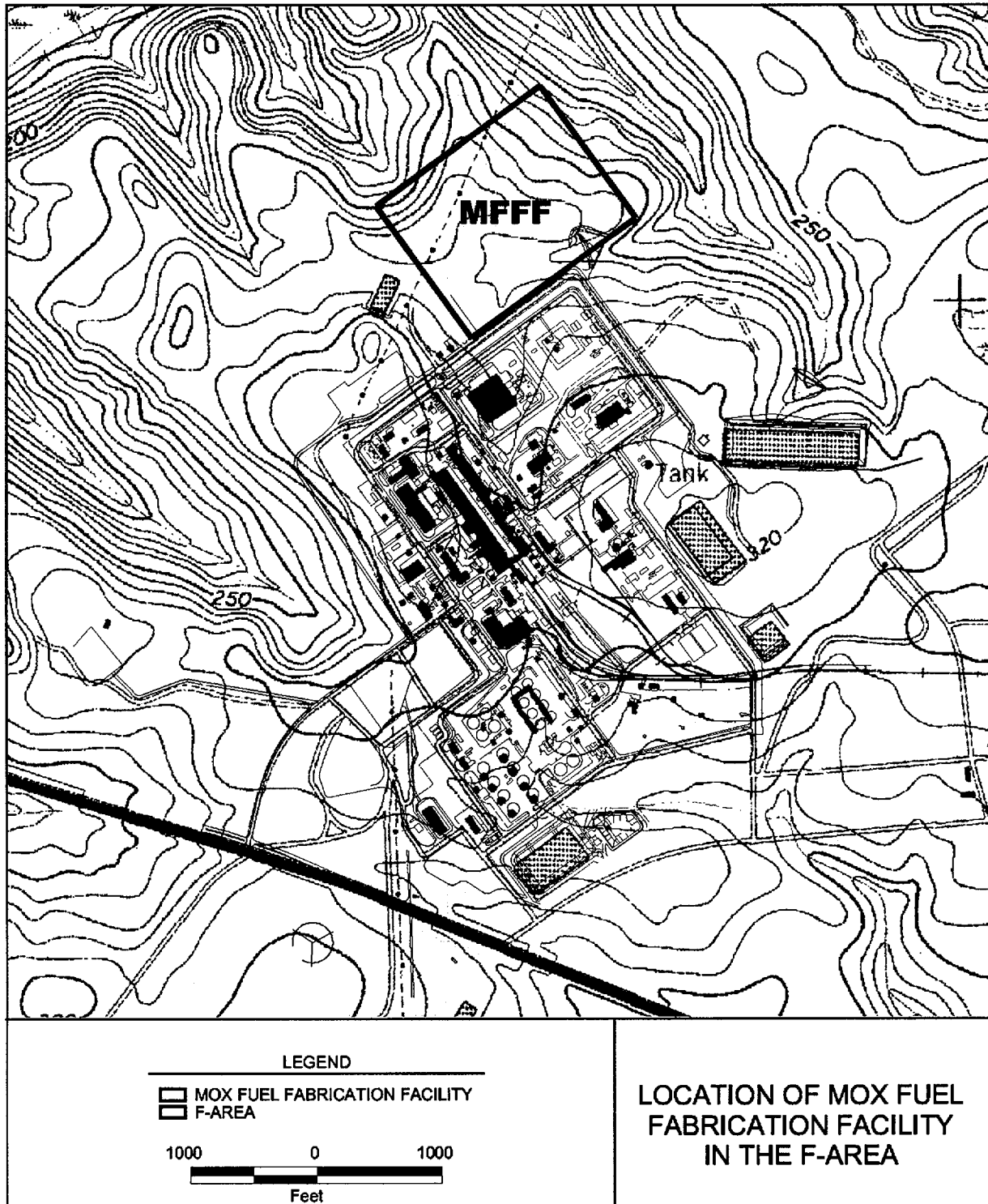
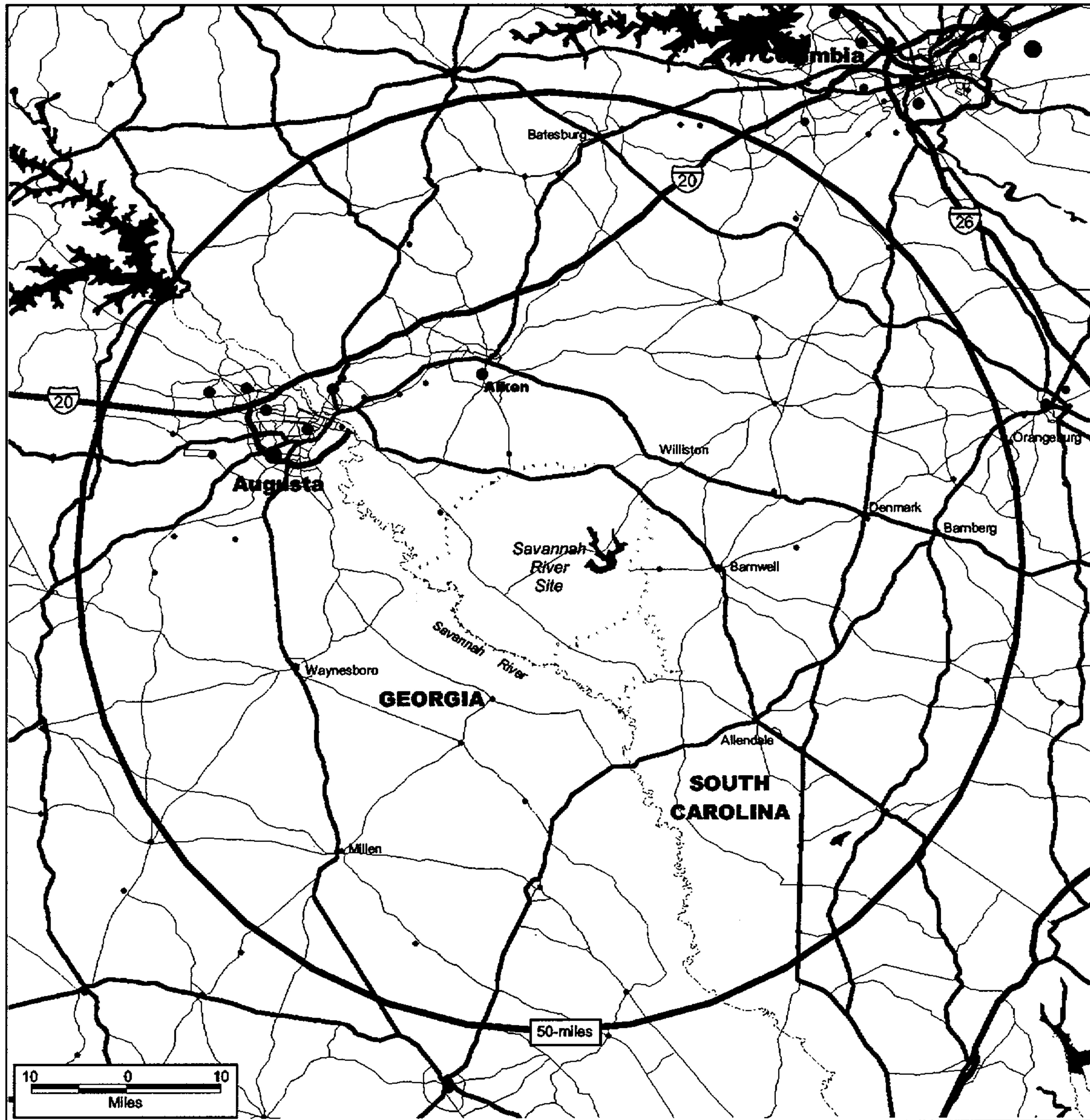

Figure 4-3. Location of MOX Fuel Fabrication Facility in the F Area







**Figure 4-4. Fifty-Mile (80-km) Radius with Towns and Roads**

**This page intentionally left blank.**

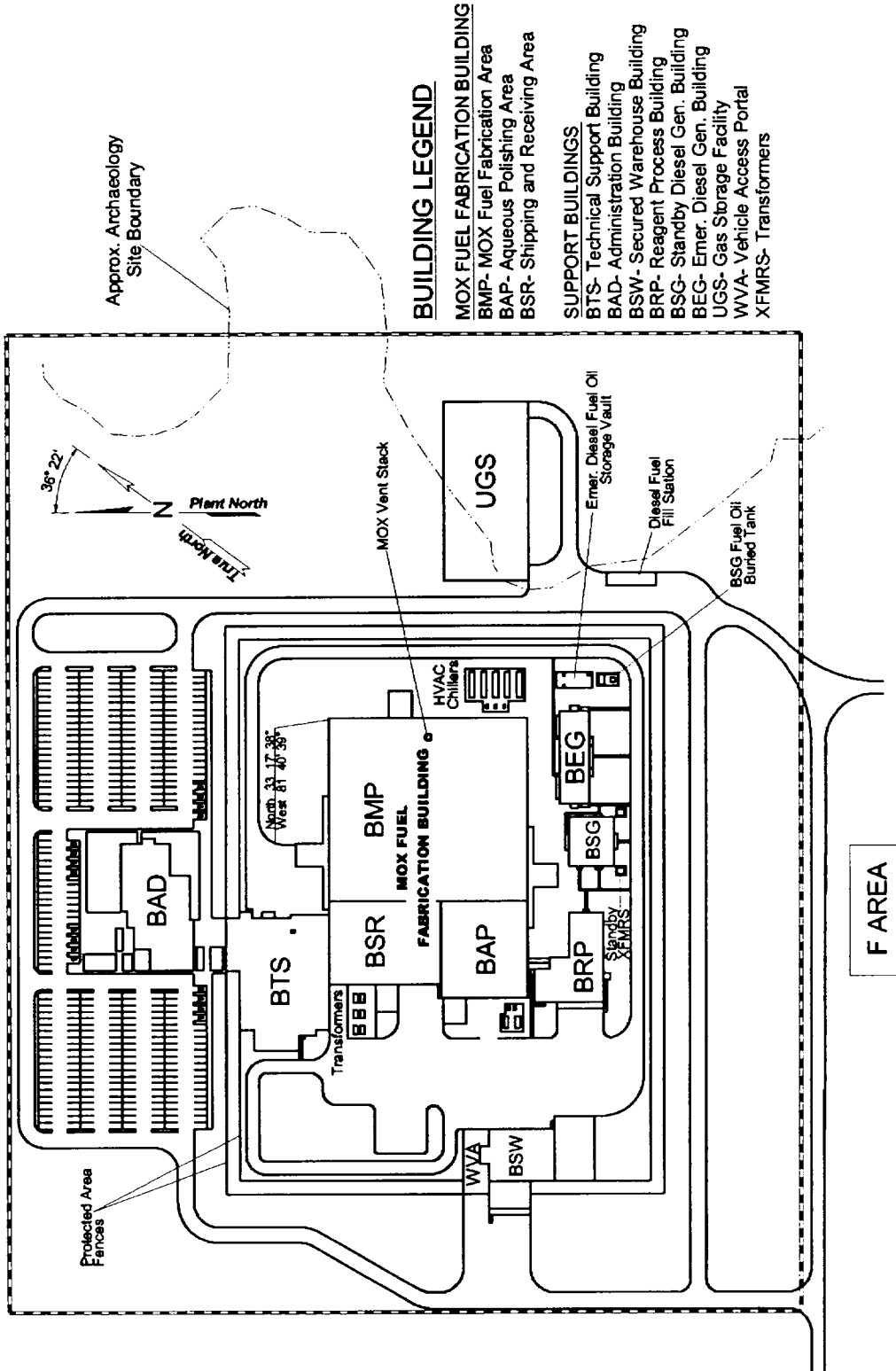

Figure 4-5. MFFF Site Layout

**This page intentionally left blank.**

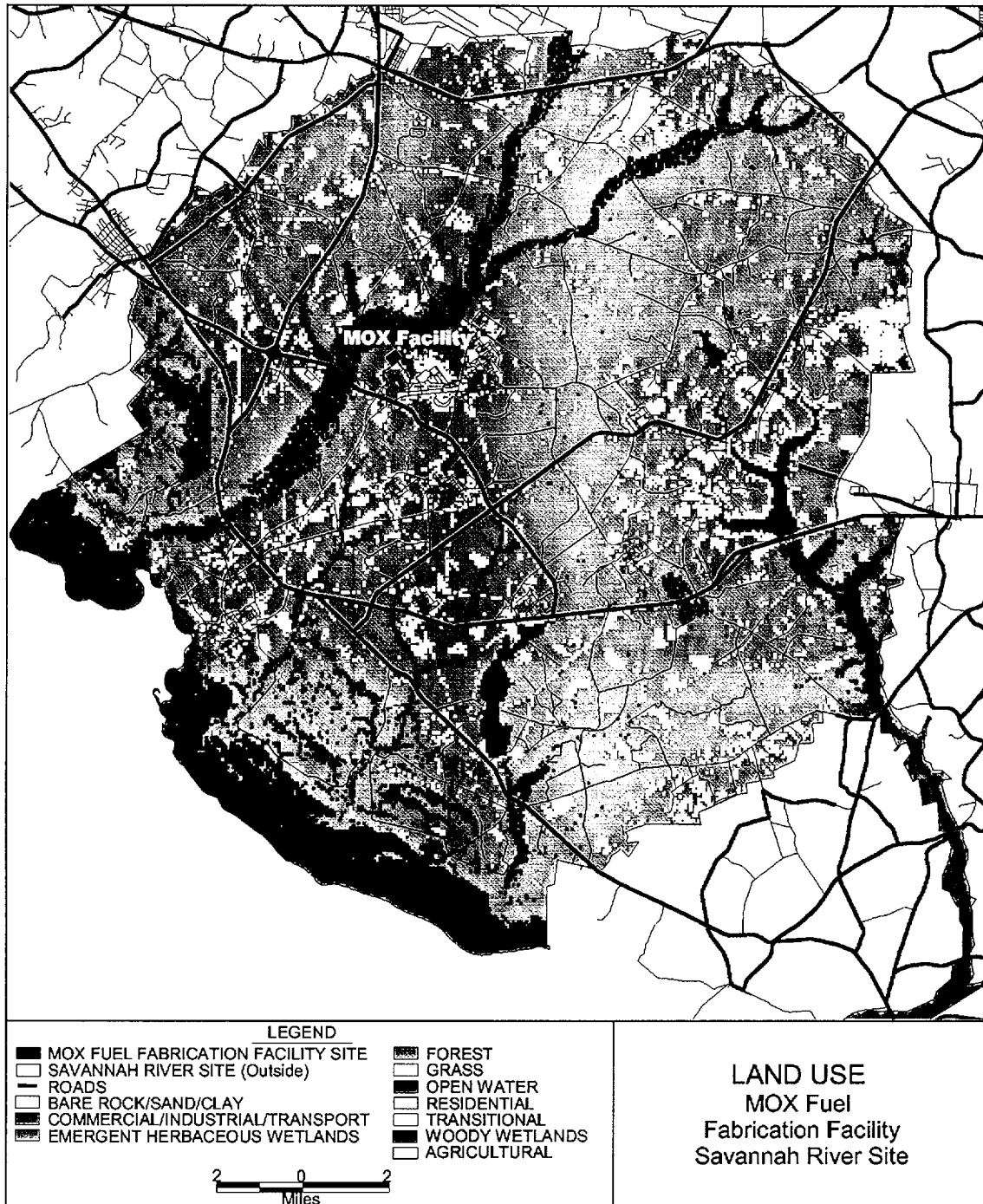
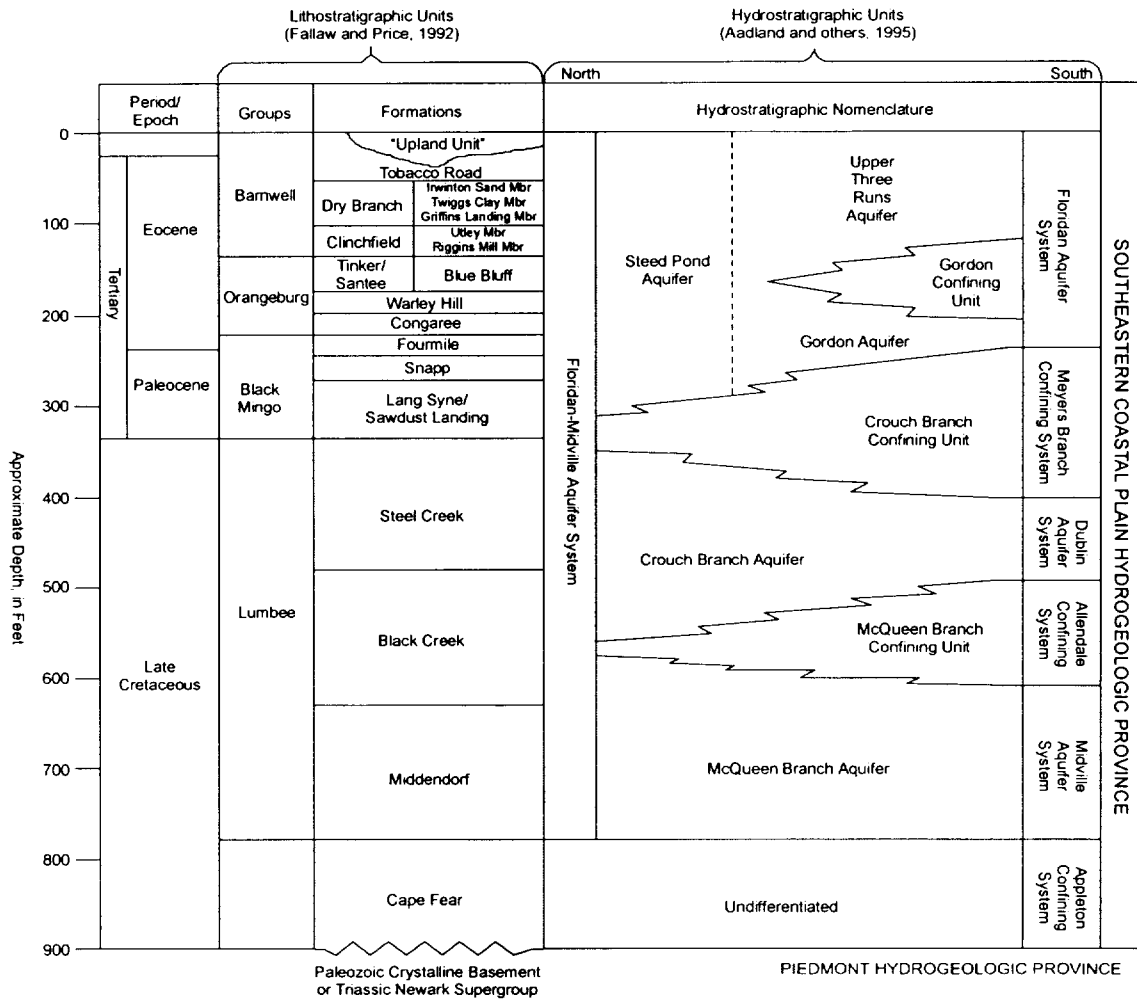

Figure 4-6. Generalized Land Use at SRS

**This page intentionally left blank.**



Source: SRS GSAR (WSRC 1999a)

**Figure 4-7. Relationship Between the Hydro- and Lithostratigraphic Units at SRS**



**This page intentionally left blank.**

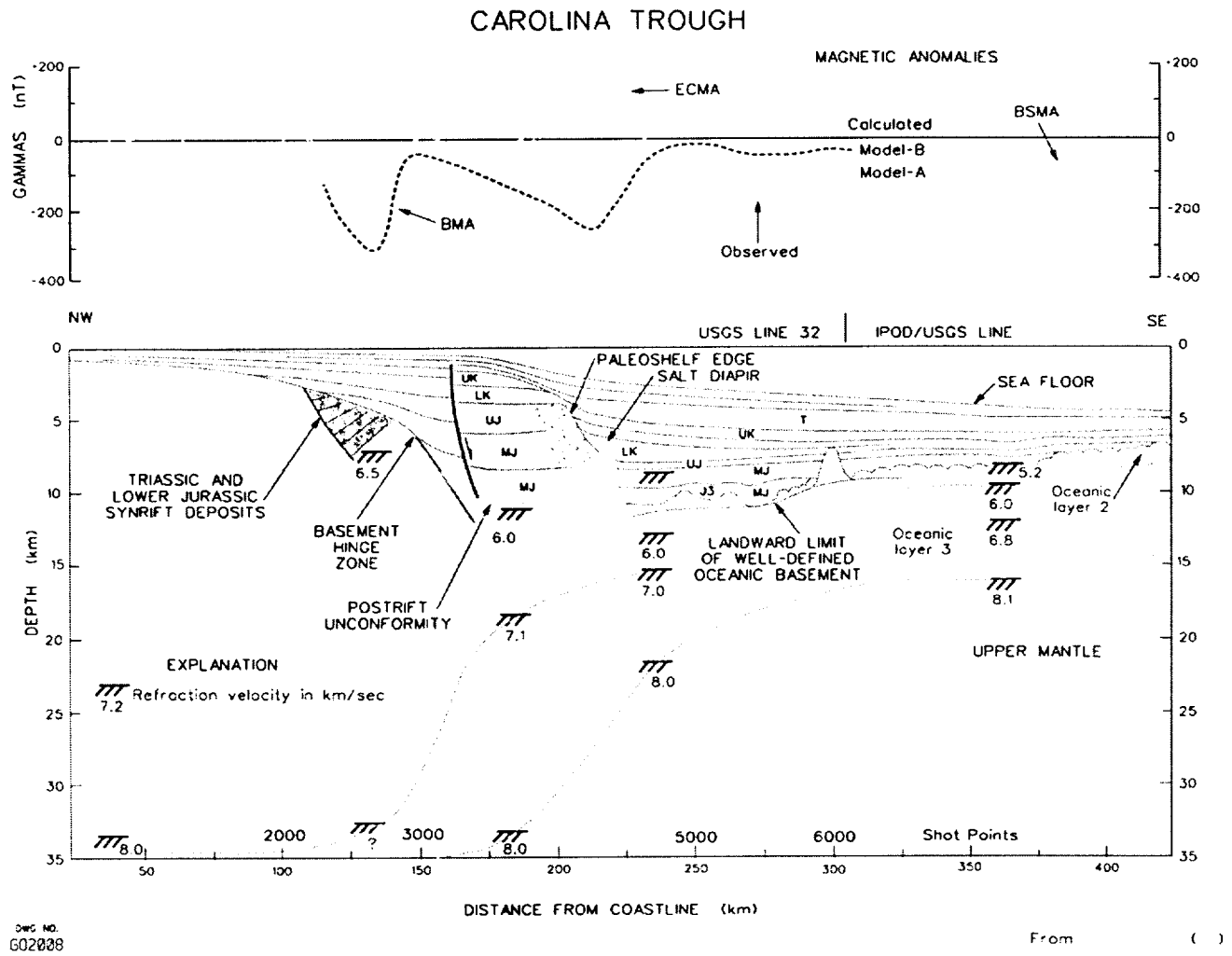

Source: SRS GSAR (WSRC 1999a)

**Figure 4-8. Crustal Geometry for Offshore South Carolina and North Carolina**

**This page intentionally left blank.**

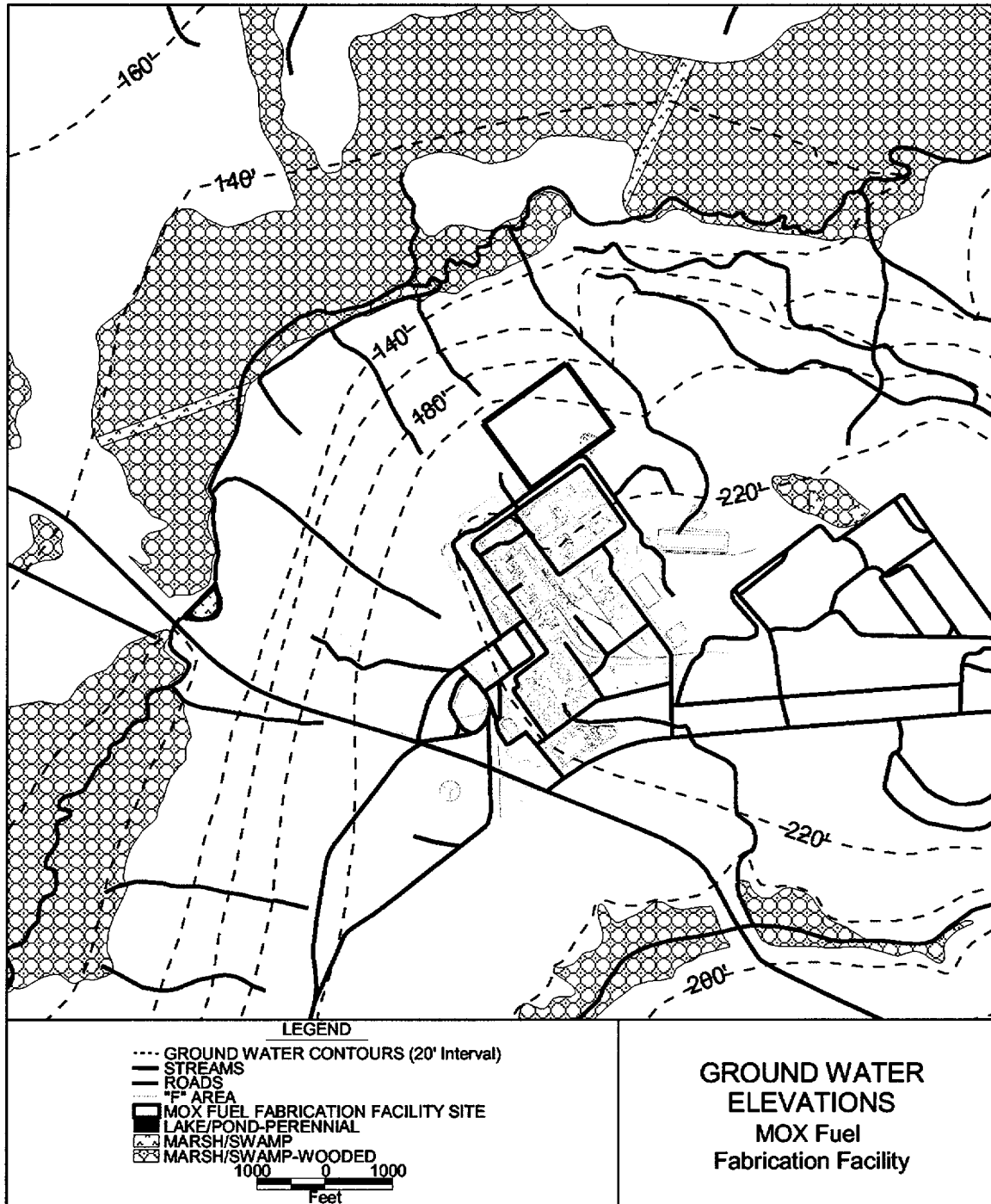

Figure 4-9. Elevation of Water Table in F Area

**This page intentionally left blank.**

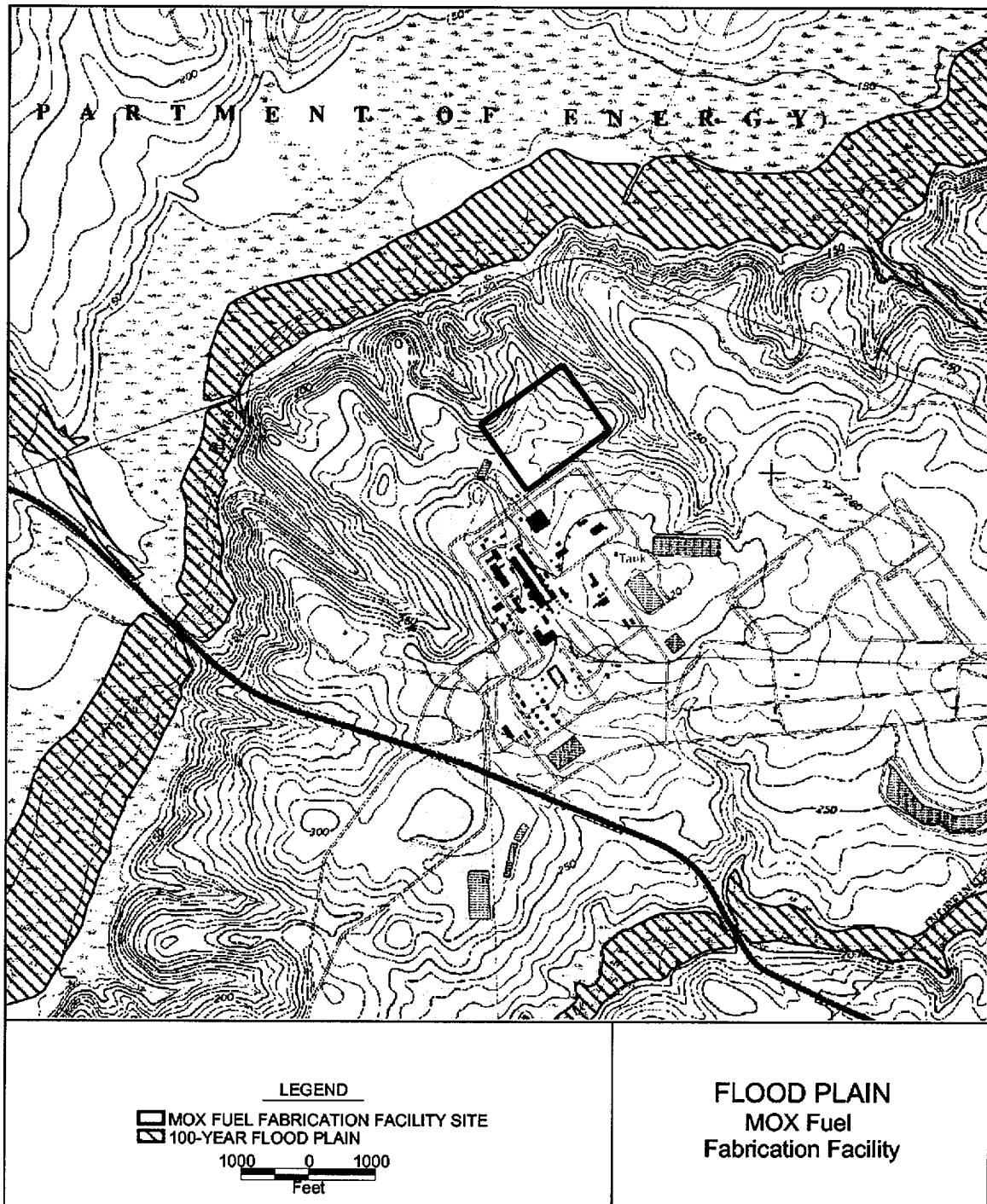
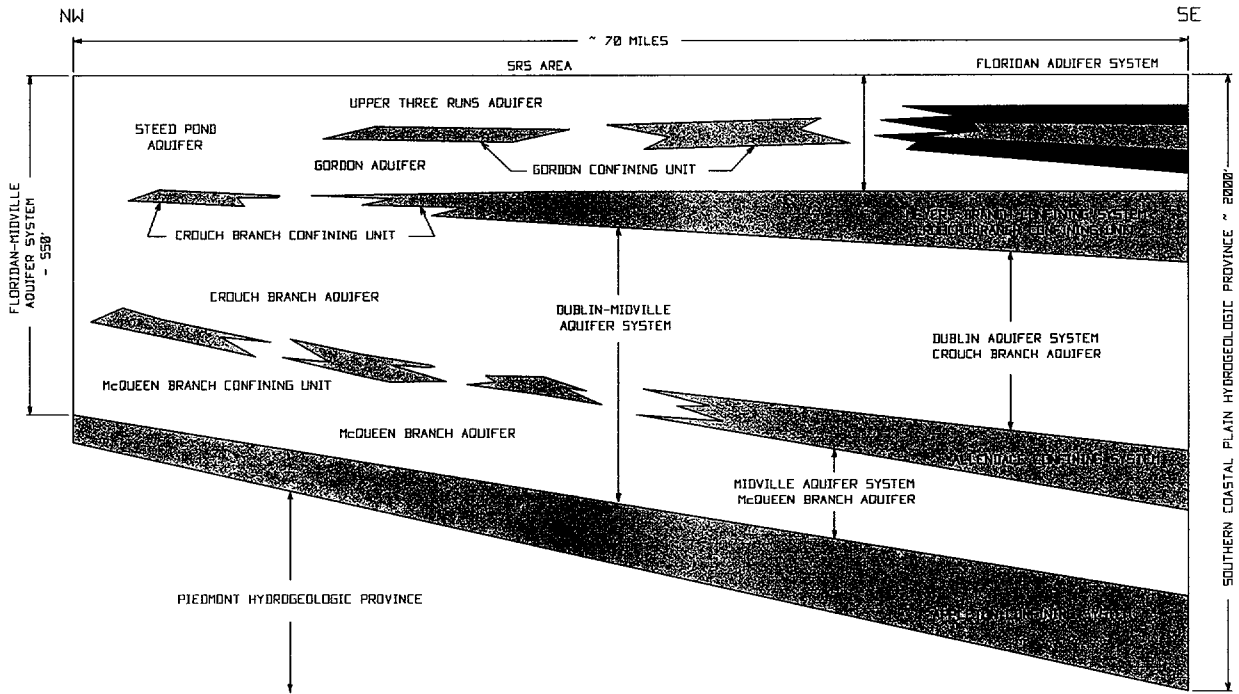

Figure 4-10. Location of 100-Year Floodplain in the Vicinity of the MOX Fuel Fabrication Facility

**This page intentionally left blank.**



Source: SRS GSAR (WSRC 1999a)

Figure 4-11. Generalized Hydrostratigraphic Cross Section of SRS



**This page intentionally left blank.**

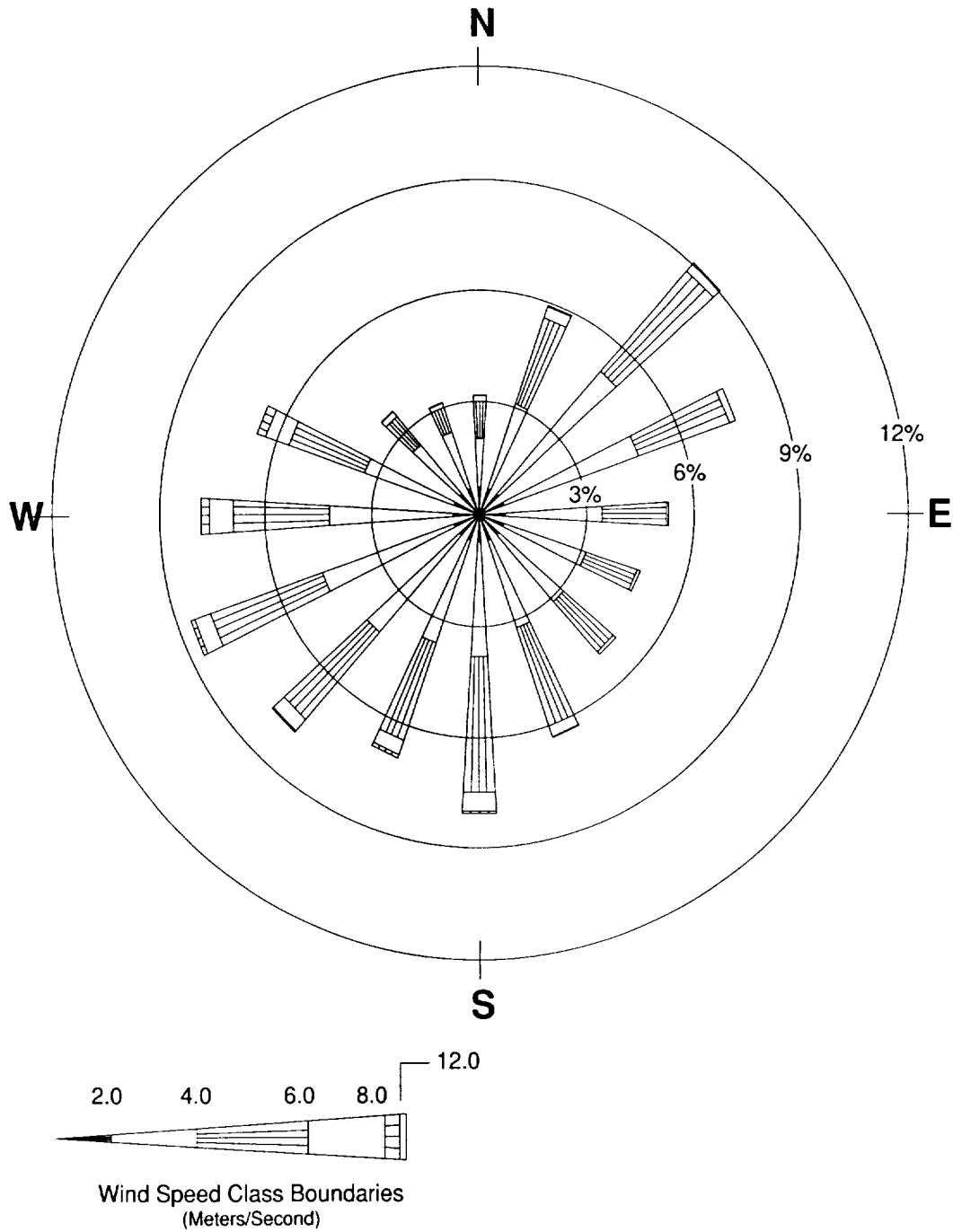

Source: SRS GSAR (WSRC 1999a)

Figure 4-12. Wind Rose Diagram for SRS

**This page intentionally left blank.**

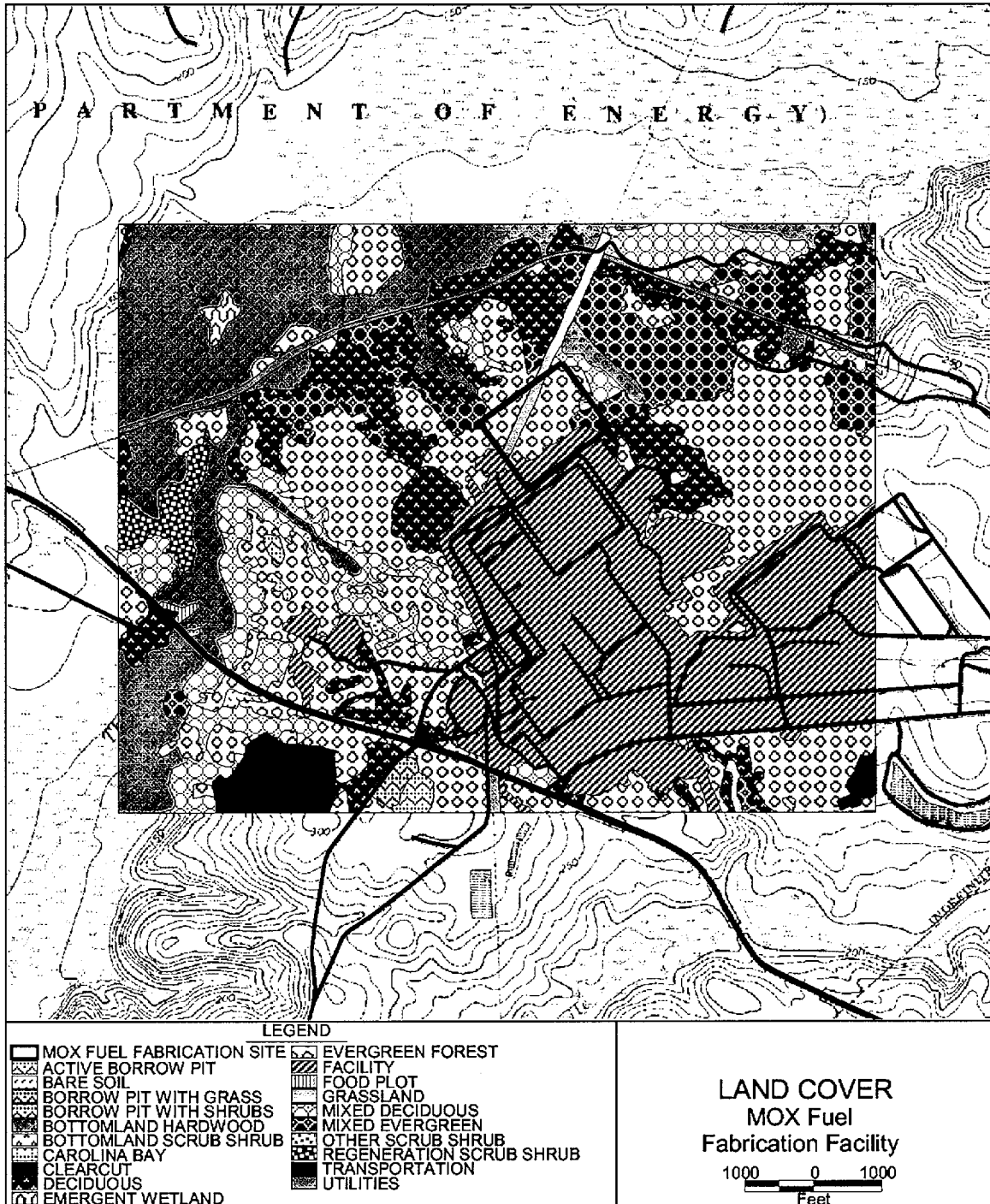

Figure 4-13. Land Cover in F Area

**This page intentionally left blank.**

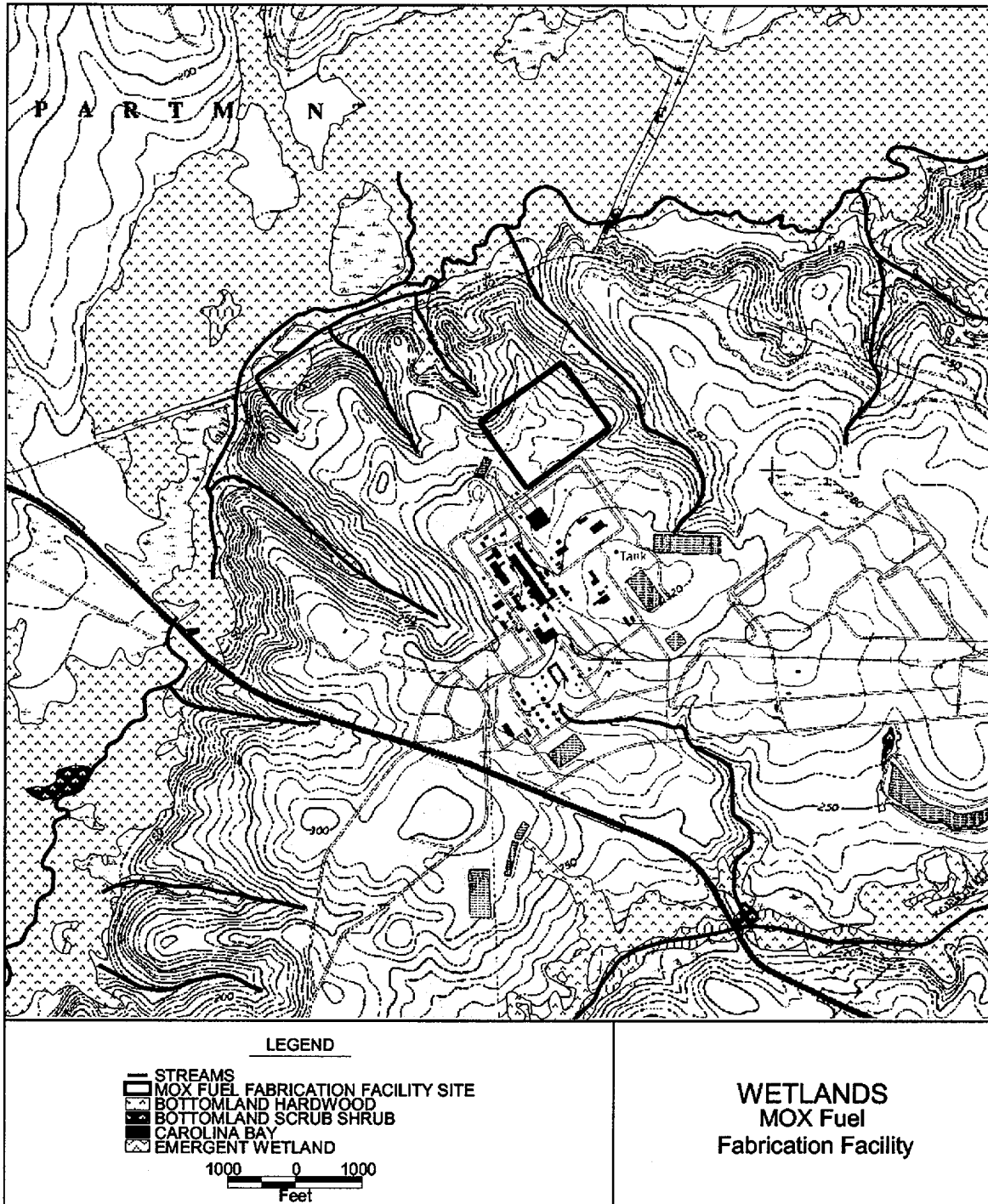
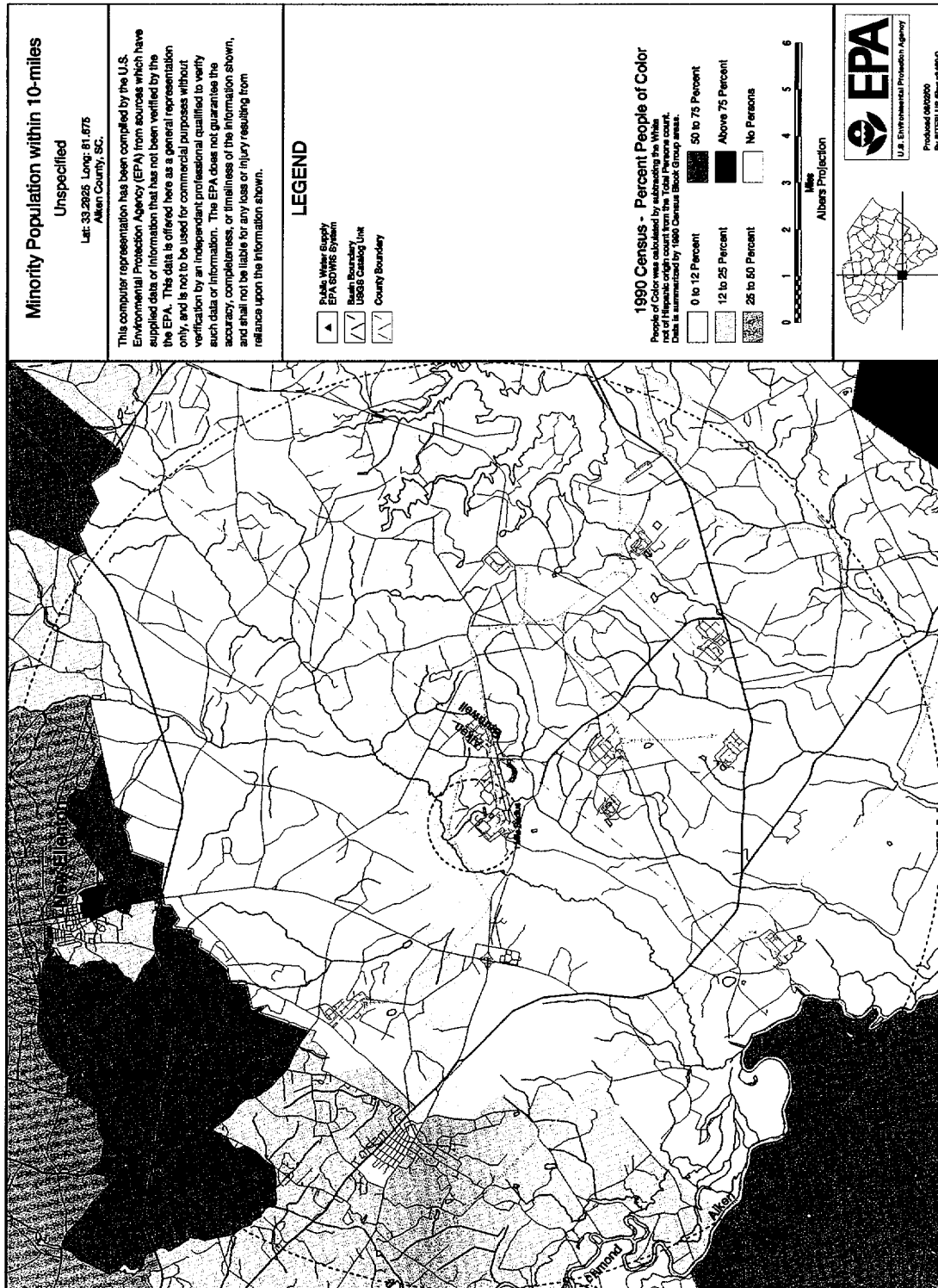

Figure 4-14. Surface Water and Wetlands in F Area

**This page intentionally left blank.**



**Figure 4-15. Distribution of Minority Population Within 10 Miles (16 km) of the MOX Fuel Fabrication Facility**



**This page intentionally left blank.**

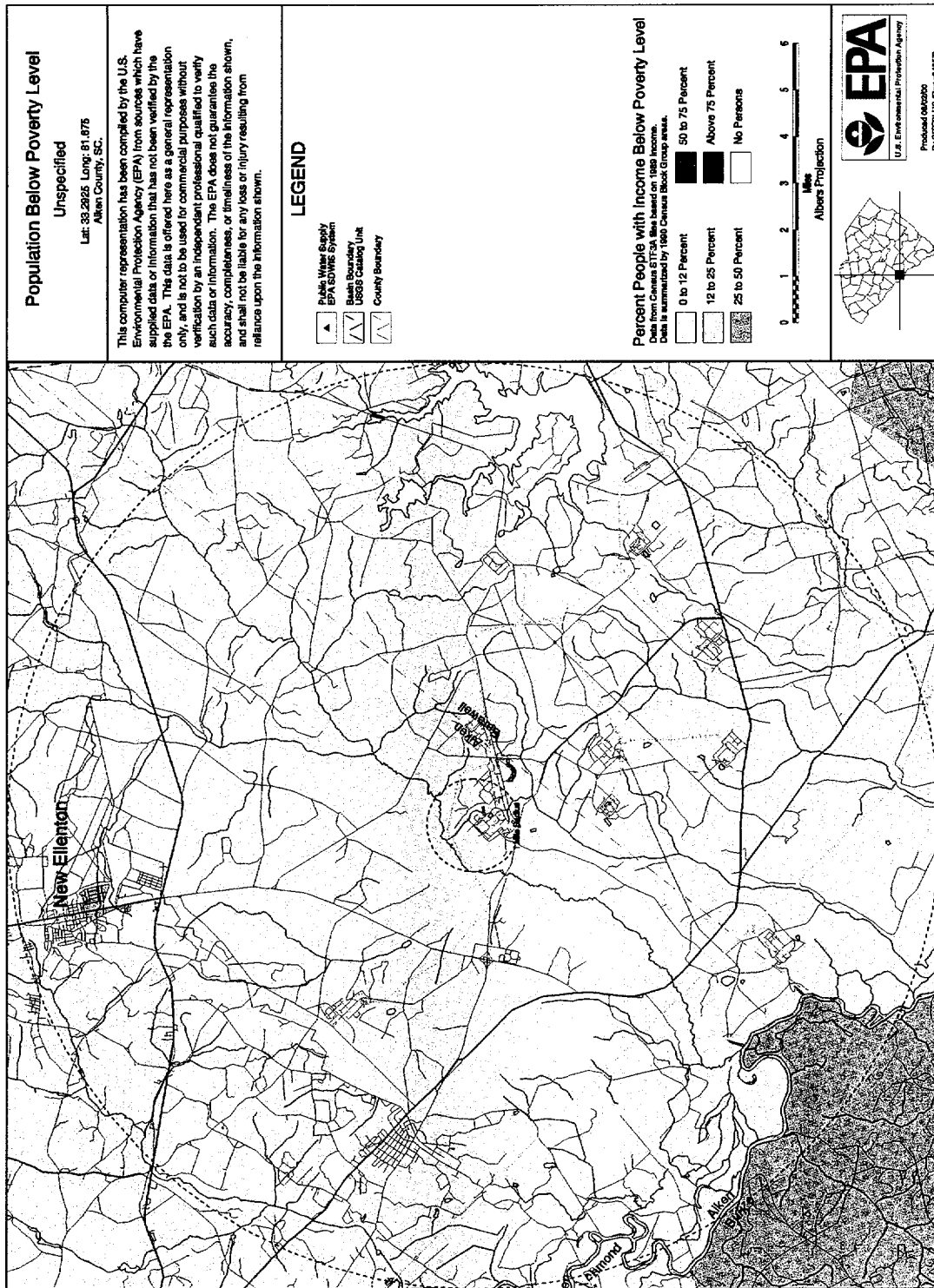

Figure 4-16. Distribution of Population Living Below the Poverty Threshold within 10 Miles (16 km) of the MOX Fuel Fabrication Facility

**This page intentionally left blank.**

## Tables

**This page intentionally left blank.**

**Table 4-1. Annual Maximum Instantaneous Discharges of the Savannah River at Augusta, Georgia, for Water Years 1921 through 1995 (USGS Flow Data, 1922-1995)**

Year	Discharges (cfs)	Year	Discharge (cfs)
1921	129,000	1959	28,500
1922	92,000	1960	34,900
1923	59,700	1961	34,800
1924	56,400	1962	32,500
1925	150,000	1963	31,300
1926	55,300	1964	87,100
1927	39,000	1965	34,600
1928	226,000	1966	39,300
1929	191,000	1967	35,900
1930	350,000	1968	35,900
1931	26,100	1969	45,600
1932	93,800	1970	25,200
1933	48,200	1971	63,900
1934	73,200	1972	33,700
1935	63,700	1973	40,200
1936	258,000	1974	32,900
1937	90,200	1975	45,600
1938	65,300	1976	33,300
1939	82,400	1977	34,200
1940	252,000	1978	43,100
1941	52,200	1979	37,300
1942	115,000	1980	47,200
1943	132,000	1981	17,300
1944	141,000	1982	30,700
1945	62,100	1983	66,100
1946	109,000	1984	34,000
1947	90,200	1985	25,700
1948	76,100	1986	21,000
1949	172,000	1987	29,200
1950	32,500	1988	13,600
1951	41,400	1989	20,200
1952	39,300	1990	35,300
1953	35,200	1991	59,200
1954	25,500	1992	22,100
1955	23,900	1993	45,100
1956	18,600	1994	40,700
1957	18,000	1995	33,600
1958	66,300		

Source: *Water Resources Data for South Carolina USGS Annual Data Reports for Water Years 1967 – 1995* (USGS 1995)

**Table 4-2. Annual Maximum Instantaneous Discharges of Upper Three Runs for Water Years 1967 through 1995**

Water Year	Discharge at Highway 278 <sup>a</sup> (cfs)	Discharge at SRS Road C <sup>b</sup> (cfs)	Discharge at SRS Road A <sup>c</sup> (cfs)
1967	320	- <sup>d</sup>	
1968	237	-	-
1969	301	-	-
1970	303	-	-
1971	420	-	-
1972	382	-	-
1973	472	-	-
1974	260	-	-
1975	341	586	-
1976	429	732	1,230
1977	304	540	717
1978	344	646	Not gauged
1979	341	680	996
1980	420	880	951
1981	308	582	620
1982	364	696	793
1983	472	880	1,010
1984	466	840	861
1985	400	962	893
1986	360	802	780
1987	370	819	869
1988	278	460	428
1989	304	613	592
1990	202	869	572
1991	820	2,040	Unknown
1992	742	1,010	926
1993	421	1,280	1,100
1994	302	826	
1995	412	1,240	1,010

Source: *Water Resources Data for South Carolina USGS Annual Data Reports for Water Years 1967 – 1995* (USGS 1995).

<sup>a</sup> Station 02197300; drainage area 87 mi<sup>2</sup> (225 km<sup>2</sup>).

<sup>b</sup> Station 02197310; drainage area 176 mi<sup>2</sup> (456 km<sup>2</sup>).

<sup>c</sup> Station 02197315; drainage area 203 mi<sup>2</sup> (526 km<sup>2</sup>).

<sup>d</sup> Indicates discharge point that was not monitored.

**Table 4-3. Probable Maximum Precipitation for F Area**

<b>Time (hr)</b>	<b>Incremental Rainfall (in)</b>	<b>Total Rainfall (in)</b>
0	--	0
1	2.2	2.2
2	2.8	5.0
3	3.1	8.1
4	15.1	23.2
5	4.9	28.1
6	2.7	30.8

Source: *Probable Maximum Precipitation Estimates, United States East of the 105th Meridian*, Hydrometeorological Report No. 51 (Schreiner and Reidel 1978)



**Table 4-4. MFFF Site <sup>a</sup> Climatological Summary – Temperature (°F)**

<b>Month</b>	<b>Daily Maximum</b>	<b>Daily Minimum</b>	<b>Monthly</b>	<b>Record Highest</b>	<b>Year Occurred</b>	<b>Record Lowest</b>	<b>Year Occurred</b>
January	55.7	32.0	43.9	84	1985	-1	1985
February	60.1	34.7	47.4	86	1962	3	1998
March	68.6	42.2	55.5	93	1995	12	1998
April	76.6	48.6	62.7	96	1986	26	1982
May	83.7	57.5	70.7	100	1964	35	1971
June	89.3	65.6	77.5	105	1952	47	1984
July	91.7	69.9	80.8	107	1980	55	1951
August	90.3	69.1	79.7	108	1983	54	1968
September	85.7	63.1	74.5	105	1999	36	1967
October	77.2	50.3	63.8	97	1954	22	1952
November	68.3	41.6	55.0	90	1961	15	1970
December	59.5	34.8	47.2	82	1998	5	1981
Year	75.6	50.8	63.2	108	1983	-1	1985

Source: *Local Climatological Data, Annual Summary with Comparative Data, 1991, Augusta, GA* (DOC 1992b)

<sup>a</sup> Taken at Bush Field, Augusta, Georgia, national weather station

**Table 4-5. MFFF Site <sup>a</sup> Climatological Summary – Precipitation (inches)**

Month	Normal Monthly	Maximum Monthly	Year Occurred	Minimum Monthly	Year Occurred	24-Hour Maximum	Year Occurred
January	4.05	8.91	1987	0.75	1981	3.61	1960
February	4.27	7.67	1961	0.69	1968	3.69	1985
March	4.65	11.92	1980	0.88	1968	5.31	1967
April	3.31	8.43	1961	0.60	1970	3.96	1955
May	3.77	9.61	1979	0.48	1951	4.44	1981
June	4.13	8.84	1989	0.68	1984	5.08	1981
July	4.24	11.43	1967	1.02	1987	3.71	1979
August	4.50	11.34	1986	0.65	1980	5.98	1964
September	3.02	9.51	1975	0.31	1984	7.30	1998
October	2.84	14.82	1990	T	1953	8.57	1990
November	2.48	7.76	1985	0.09	1960	3.82	1985
December	3.40	8.65	1981	0.32	1955	3.12	1970
Year	44.66	14.82	1990	T	1953	8.57	1990

Source: *Local Climatological Data, Annual Summary with Comparative Data, 1991, Augusta, GA* (DOC 1992b)

T – Trace

<sup>a</sup> Taken at Bush Field, Augusta, Georgia, national weather station

**Table 4-6. SRS Seasonal Mixing Heights**

Season	Mixing Height (meters)	
	Morning	Afternoon
Winter	1,148	3,362
Spring	1,230	5,576
Summer	1,312	5,904
Fall	984	4,592
Annual	1,230	4,756

Source: *Mixing Heights, Wind Speeds, and Potential for Urban Air Pollution Throughout the Contiguous United States* (Holzworth 1972)

**Table 4-7. Percent Occurrence of Atmospheric Stability Class for SRS Meteorological Towers**

Stability Class	Percent Occurrence Per Year							
	A Area	C Area	D Area	F Area	H Area	K Area	L Area	P Area
A	17.5	15.6	20.5	13.3	25.9	15.4	16.8	14.9
B	10.6	8.8	11.9	8.3	13.2	9.8	10.2	9.4
C	17.6	15.7	19.4	15.2	20.1	17.0	18.0	16.4
D	26.6	27.1	24.9	28.6	22.1	25.4	25.1	26.5
E	19.6	20.6	17.4	24.9	15.5	21.2	18.7	21.1
F/G	8.0	12.1	6.0	10.6	3.2	11.1	11.1	11.8

Period of record: 1992-1996.

Source: "Updated Meteorological Data for Revision 4 of the SRS Generic Safety Analysis Report" (Hunter 1999).

**Table 4-8. Joint Frequency Distribution of Wind Speed, Wind Direction, and Atmospheric Stability Class for 1992-1996 SRS H-Area Meteorological Tower Data**

Stability Class A Number of Hourly Observations							
Winds From	Wind Speed (mph)						Total
	1-3	4-7	8-12	13-18	19-24	25+	
N	109	385	452	91	5	0	1,042
NNE	86	320	290	79	2	0	777
NE	105	404	231	15	0	0	755
ENE	106	454	220	14	0	0	794
E	93	463	195	5	0	0	756
ESE	78	345	130	9	1	0	563
SE	65	306	113	10	0	0	494
SSE	80	242	87	4	0	0	413
S	74	324	163	10	0	0	571
SSW	76	341	189	16	1	0	623
SW	94	493	263	24	0	0	874
WSW	96	599	305	43	3	0	1,046
W	78	521	310	38	7	1	955
WNW	80	361	210	50	7	0	708
NW	68	246	105	15	0	0	434
NNW	92	251	160	40	3	1	547
TOTAL	1,380	6,055	3,423	463	29	2	11,352

Note: Total number of observations used for the 1992 to 1996 period = 43,848

**Table 4-8. Joint Frequency Distribution of Wind Speed, Wind Direction, and Atmospheric Stability Class for 1992-1996 SRS H-Area Meteorological Tower Data (continued)**

Stability Class B Number of Hourly Observations							
Winds From	Wind Speed (mph)						Total
	1-3	4-7	8-12	13-18	19-24	25+	
N	9	104	94	7	0	0	214
NNE	13	160	251	75	4	0	503
NE	13	187	283	54	0	0	537
ENE	12	191	292	19	0	0	514
E	5	154	142	18	0	0	319
ESE	2	111	103	11	0	0	227
SE	1	82	71	20	0	0	174
SSE	5	92	82	19	1	0	199
S	5	114	137	16	0	0	272
SSW	6	107	145	39	1	0	298
SW	11	147	242	78	7	0	485
WSW	15	165	331	137	14	1	663
W	2	127	240	202	34	0	605
WNW	12	109	159	151	28	2	461
NW	13	69	68	40	6	0	196
NNW	8	72	77	13	1	0	171
<b>TOTAL</b>	<b>132</b>	<b>1,991</b>	<b>2,717</b>	<b>899</b>	<b>96</b>	<b>3</b>	<b>5,838</b>

Note: Total number of observations used for the 1992 to 1996 period = 43,848

**Table 4-8. Joint Frequency Distribution of Wind Speed, Wind Direction, and Atmospheric Stability Class for 1992-1996 SRS H-Area Meteorological Tower Data (continued)**

Stability Class C Number of Hourly Observations							
Winds From	Wind Speed (mph)						Total
	1-3	4-7	8-12	13-18	19-24	25+	
N	8	66	70	1	0	0	145
NNE	5	172	301	81	3	0	562
NE	4	322	655	203	1	0	1,185
ENE	8	218	376	90	2	0	694
E	5	173	292	37	3	0	510
ESE	4	104	194	38	0	0	340
SE	9	105	184	72	5	0	375
SSE	11	129	184	98	16	1	439
S	13	145	229	86	17	1	491
SSW	4	157	254	126	23	1	565
SW	6	187	326	179	23	0	721
WSW	5	213	341	203	35	1	798
W	4	148	340	321	78	3	894
WNW	7	124	248	270	45	3	697
NW	6	99	119	59	7	0	290
NNW	6	77	62	4	1	0	150
TOTAL	105	2,439	4,175	1,868	259	10	8,856

Note: Total number of observations used for the 1992 to 1996 period = 43,848

**Table 4-8. Joint Frequency Distribution of Wind Speed, Wind Direction, and Atmospheric Stability Class for 1992-1996 SRS H-Area Meteorological Tower Data (continued)**

Stability Class D Number of Hourly Observations							
Winds From	Wind Speed (mph)						Total
	1-3	4-7	8-12	13-18	19-24	25+	
N	4	38	54	0	1	0	97
NNE	10	109	228	40	0	0	387
NE	0	257	718	82	2	0	1,059
ENE	7	151	417	36	0	0	611
E	9	136	354	24	0	0	523
ESE	5	118	307	25	0	0	455
SE	6	147	368	55	1	0	577
SSE	7	163	491	203	14	0	878
S	7	182	648	190	10	0	1,037
SSW	10	170	459	106	9	0	754
SW	7	166	554	105	6	0	838
WSW	6	146	558	53	1	0	764
W	3	133	444	55	10	12	657
WNW	3	98	384	48	2	2	537
NW	5	114	218	31	0	0	368
NNW	11	92	86	2	0	0	191
TOTAL	100	2,220	6,288	1,055	56	14	9,733

Note: Total number of observations used for the 1992 to 1996 period = 43,848



**Table 4-8. Joint Frequency Distribution of Wind Speed, Wind Direction, and Atmospheric Stability Class for 1992-1996 SRS H-Area Meteorological Tower Data (continued)**

Stability Class E Number of Hourly Observations							
Winds From	Wind Speed (mph)						Total
	1-3	4-7	8-12	13-18	19-24	25+	
N	0	4	28	2	0	0	34
NNE	0	40	281	40	0	0	361
NE	2	123	474	27	0	0	626
ENE	0	48	355	40	1	0	444
E	0	34	274	29	0	0	337
ESE	0	70	272	24	0	0	366
SE	2	75	358	20	0	0	455
SSE	2	80	431	41	0	0	554
S	3	112	525	57	0	0	697
SSW	3	98	481	42	0	0	624
SW	1	84	466	85	0	0	636
WSW	0	88	489	30	2	0	609
W	2	58	276	8	6	0	350
WNW	0	59	205	7	1	0	272
NW	0	50	183	3	0	0	236
NNW	0	59	106	0	0	0	165
TOTAL	15	1,082	5,204	455	10	0	6,766

Note: Total number of observations used for the 1992 to 1996 period = 43,848

**Table 4-8. Joint Frequency Distribution of Wind Speed, Wind Direction, and Atmospheric Stability Class for 1992-1996 SRS H-Area Meteorological Tower Data (continued)**

Stability Class F Number of Hourly Observations							
Winds From	Wind Speed (mph)						Total
	1-3	4-7	8-12	13-18	19-24	25+	
N	0	3	10	0	0	0	13
NNE	0	8	98	16	0	0	122
NE	0	10	82	10	0	0	102
ENE	0	5	32	12	0	0	49
E	0	2	44	5	0	0	51
ESE	0	12	68	14	0	0	94
SE	0	9	80	7	0	0	96
SSE	0	11	74	6	0	0	91
S	0	15	96	6	0	0	117
SSW	0	14	71	5	0	0	90
SW	0	10	93	11	0	0	114
WSW	1	21	120	10	0	0	152
W	0	1	29	6	0	0	36
WNW	0	5	28	0	0	0	33
NW	0	8	20	2	0	0	30
NNW	0	16	26	1	0	0	43
TOTAL	1	150	971	111	0	0	1,233

Note: Total number of observations used for the 1992 to 1996 period = 43,848

**Table 4-8. Joint Frequency Distribution of Wind Speed, Wind Direction, and Atmospheric Stability Class for 1992-1996 SRS H-Area Meteorological Tower Data (continued)**

Stability Class G Number of Hourly Observations							
Winds From	Wind Speed (mph)						Total
	1-3	4-7	8-12	13-18	19-24	25+	
N	0	0	1	0	0	0	1
NNE	0	2	7	0	0	0	9
NE	0	0	5	0	0	0	5
ENE	0	0	0	1	0	0	1
E	0	0	1	0	0	0	1
ESE	0	0	6	1	0	0	7
SE	0	0	5	2	0	0	7
SSE	0	0	5	0	0	0	5
S	0	0	8	0	0	0	8
SSW	0	0	5	2	0	0	7
SW	0	1	3	0	0	0	4
WSW	0	0	8	0	0	0	8
W	0	1	0	1	0	0	2
WNW	0	0	1	0	0	0	1
NW	0	0	1	0	0	0	1
NNW	0	2	1	0	0	0	3
TOTAL	0	6	57	7	0	0	70

Note: Total number of observations used for the 1992 to 1996 period = 43,848

**Table 4-9. Fujita Tornado Intensity Scale**

	<b>Classification</b>	<b>Wind Speed (Mph)</b>	<b>Description of Damage</b>
F0	Gale Tornado	40 - 72	Light damage. Some damage to chimneys; breaks branches off trees; pushes over shallow-rooted trees; damages sign boards.
F1	Moderate Tornado	73 - 112	Moderate damage. The lower limit is the beginning of hurricane wind speed; peels surface off roofs; mobile homes pushed off foundations or overturned; moving autos pushed off the roads; attached garages may be destroyed.
F2	Significant Tornado	113 - 157	Considerable damage. Roofs torn off frame houses; mobile homes demolished; boxcars pushed over; large trees snapped or uprooted; light-object missiles generated.
F3	Severe Tornado	158 - 206	Severe damage. Roof and some walls torn off well-constructed houses; trains overturned; most trees in forest uprooted; heavy cars lifted off ground and thrown.
F4	Devastating Tornado	207 - 260	Devastating damage. Well-constructed houses leveled; structures with weak foundations blown off some distance; cars thrown and large missiles generated.
F5	Incredible Tornado	261 - 318	Incredible damage. Strong frame houses lifted off foundation and carried considerable distances to disintegrate; automobile-sized missiles fly through the air in excess of 100 meters; trees debarked; steel-reinforced concrete structures badly damaged.
F6	Inconceivable Tornado	319 - 379	These winds are very unlikely. The small area of damage they might produce would probably not be recognizable along with the mess produced by the F4 and F5 wind that would surround the F6 winds. Missiles, such as cars and refrigerators, would do serious secondary damage that could not be directly identified as F6 damage. If this level is ever achieved, evidence for it might only be found in some manner of ground swirl pattern, for it may never be identifiable through engineering studies.

**Table 4-10. Comparison of Ambient Air Concentrations from SRS Sources With Most Stringent Applicable Standards or Guidelines, 1994**

Pollutant	Averaging Period	Most Stringent Standard or Guideline <sup>a</sup> (µg/m <sup>3</sup> )	Concentration (µg/m <sup>3</sup> )
<b>Criteria pollutants</b>			
Carbon monoxide	8 hours	10,000 <sup>b</sup>	632
	1 hour	40,000 <sup>b</sup>	5,010
Nitrogen dioxide	Annual	100 <sup>b</sup>	8.8
Ozone	8 hours	157 <sup>c</sup>	(d)
PM <sub>10</sub>	Annual	50 <sup>b</sup>	4.8
	24 hours	150 <sup>b</sup>	80.6
PM <sub>2.5</sub>	3-year annual	15 <sup>c</sup>	(e)
	24 hours	65 <sup>c</sup>	(e)
	(98 <sup>th</sup> percentile over 3 years)		
Sulfur dioxide	Annual	80 <sup>b</sup>	16.3
	24 hours	365 <sup>b</sup>	215
	3 hours	1,300 <sup>b</sup>	690
Lead	Calendar quarter	1.5 <sup>b</sup>	<0.01
<b>Other regulated pollutants</b>			
Gaseous fluoride	30 days	0.8 <sup>f</sup>	(g)
	7 days	1.6 <sup>f</sup>	0.11
	24 hours	2.9 <sup>f</sup>	0.60
	12 hours	3.7 <sup>f</sup>	241
Total suspended particulates	Annual	75 <sup>f</sup>	43.3

PM – particulate matter

**Table 4-10. Comparison of Ambient Air Concentrations from SRS Sources With Most Stringent Applicable Standards or Guidelines, 1994 (continued)**

Notes:

- <sup>a</sup> The more stringent of the federal and state standards is presented if both exist for the averaging period. The National Ambient Air Quality Standards (NAAQS) (40 CFR Part 50), other than those for ozone, particulate matter, and lead, and those based on annual averages, are not to be exceeded more than once per year. The 1-hr ozone standard is attained when the expected number of days per year with maximum hourly average concentrations above the standard is 1. The 1-hr ozone standard applies only to nonattainment areas. The 8-hr ozone standard is attained when the 3-year average of the annual fourth-highest daily maximum 8-hr average concentration is less than or equal to  $157 \mu\text{g}/\text{m}^3$ . The 24-hr particulate matter standard is attained when the expected number of days with a 24-hr average concentration above the standards is 1. The annual arithmetic mean particulate matter standard is attained when the expected annual arithmetic mean concentration is less than or equal to the standard.
- <sup>b</sup> Federal and state standard.
- <sup>c</sup> Federal standard.
- <sup>d</sup> Not directly emitted or monitored by the site.
- <sup>e</sup> No data are available with which to assess  $\text{PM}_{2.5}$  concentrations.
- <sup>f</sup> State standard.
- <sup>g</sup> No concentration reported.

Note: The NAAQS also includes standards for lead. No sources of lead emissions have been identified for any of the alternatives presented in Chapter 4. Emissions of other air pollutants not listed here have been identified at SRS but are not associated with any of the alternatives evaluated. These other air pollutants are quantified in the S&D PEIS (DOE 1996b). EPA recently revised the ambient air quality standards for particulate matter and ozone. The new standards, finalized on July 18, 1997, changed the ozone primary and secondary standards from a 1-hr concentration of  $235 \mu\text{g}/\text{m}^3$  (0.12 ppm) to an 8-hr concentration of  $157 \mu\text{g}/\text{m}^3$  (0.08 ppm). During a transition period while states are developing state implementation plan revisions for attaining and maintaining these standards, the 1-hr ozone standard will continue to apply in nonattainment areas (EPA 1997a). The 8-hr standard cannot be enforced at this time due to legal challenges. For particulate matter, the current annual standard is retained, and two PM standards are added. These standards are set at a  $15\text{-}\mu\text{g}/\text{m}^3$  3-year annual arithmetic mean based on community-oriented monitors and a  $65\text{-}\mu\text{g}/\text{m}^3$  3-year average of the 98th percentile of 24-hr concentrations at population-oriented monitors. The revised 24-hr standard is based on the 99th percentile of 24-hr concentrations. The existing standards will continue to apply in the interim period (EPA 1997b). Values may differ from those of the source document due to rounding.

Source: DOE 1998a, 1998b; 40 CFR Part 50; SCDHEC 1999a.

**Table 4-11. Threatened or Endangered Species Potentially Occurring in the Vicinity of F Area**

Common Name	Scientific Name	Federal Status	State Status
<b>Birds</b>			
Bald eagle	<i>Haliaeetus leucocephalus</i>	Threatened	Endangered
Red-cockaded woodpecker	<i>Picoides borealis</i>	Endangered	Endangered
Wood stork	<i>Mycteria americana</i>	Endangered	Endangered
<b>Plants</b>			
Oconee azalea	<i>Rhododendron flammeum</i>	Not listed	Species of Concern
Smooth purple coneflower	<i>Echinacea laevigata</i>	Endangered	Endangered
<b>Reptiles</b>			
American alligator	<i>Alligator mississippiensis</i>	Considered Threatened (S/A) <sup>a</sup>	Not listed

<sup>a</sup> Protected under the Similarity of Appearance Provision of the Endangered Species Act.

Source: "Threatened and Endangered Species at SRS" (Osteen 2000)

**Table 4-12. Population Distribution – 1990**

	5 to 10 mi (3 to 16 km)	10 to 20 mi (16 to 32 km)	20 to 30 mi (32 to 48 km)	30 to 40 mi (48 to 64 km)	40 to 50 mi (64 to 80 km)	TOTAL
<b>N</b>	2,072	21,439	9,195	6,687	10,462	49,855
<b>NNE</b>	235	1,782	2,081	4,100	17,085	25,283
<b>NE</b>	8	1,545	2,730	5,240	11,442	20,965
<b>ENE</b>	0	3,277	4,657	5,189	31,845	44,968
<b>E</b>	1	4,773	5,086	10,908	5,512	26,280
<b>ESE</b>	8	2,166	2,577	2,839	2,891	10,481
<b>SE</b>	0	563	4,543	6,387	10,432	21,925
<b>SSE</b>	0	364	683	1,046	2,507	4,600
<b>S</b>	0	545	1,596	6,730	3,560	12,431
<b>SSW</b>	99	780	2,186	4,805	2,591	10,461
<b>SW</b>	110	1,171	4,578	2,093	2,711	10,663
<b>WSW</b>	101	1,523	4,472	2,586	6,149	14,831
<b>W</b>	241	6,031	10,519	8,946	6,959	32,696
<b>WNW</b>	1,380	5,066	129,791	32,475	14,790	183,502
<b>NW</b>	1,102	15,212	81,259	9,385	3,296	110,254
<b>NNW</b>	1,171	19,728	11,205	6,884	3,344	42,332
<b>TOTAL</b>	6,528	85,965	277,158	116,300	135,576	621,527

Source: SRS GSAR (WSRC 1999a)



**Table 4-13. Projected Population Distribution – 2000**

	<b>5 to 10 mi (3 to 16 km)</b>	<b>10 to 20 mi (16 to 32 km)</b>	<b>20 to 30 mi (32 to 48 km)</b>	<b>30 to 40 mi (48 to 64 km)</b>	<b>40 to 50 mi (64 to 80 km)</b>	<b>TOTAL</b>
<b>N</b>	2,362	24,440	10,482	7,623	11,927	56,834
<b>NNE</b>	268	2,031	2,372	4,674	19,477	28,822
<b>NE</b>	9	1,761	3,112	5,974	13,044	23,900
<b>ENE</b>	0	3,736	5,309	5,915	36,303	51,263
<b>E</b>	1	5,441	5,798	12,435	6,284	29,959
<b>ESE</b>	9	2,469	2,938	3,236	3,296	11,948
<b>SE</b>	0	642	5,179	7,281	11,892	24,994
<b>SSE</b>	0	415	779	1,192	2,858	5,244
<b>S</b>	0	621	1,819	7,672	4,058	14,170
<b>SSW</b>	10	889	2,492	5,478	2,954	11,823
<b>SW</b>	125	1,335	5,219	2,386	3,091	12,156
<b>WSW</b>	115	1,736	5,098	2,948	7,010	16,907
<b>W</b>	275	6,875	11,992	10,198	7,933	37,273
<b>WNW</b>	1,573	5,775	147,962	37,022	16,861	209,193
<b>NW</b>	1,256	17,342	92,635	10,699	3,757	125,689
<b>NNW</b>	1,335	22,490	12,774	7,848	3,812	48,259
<b>TOTAL</b>	7,338	97,998	315,960	132,581	154,557	708,434

Source: SRS GSAR (WSRC 1999a)

**Table 4-14. Projected Population Distribution – 2010**

	5 to 10 mi (3 to 16 km)	10 to 20 mi (16 to 32 km)	20 to 30 mi (32 to 48 km)	30 to 40 mi (48 to 64 km)	40 to 50 mi (64 to 80 km)	TOTAL
<b>N</b>	2,693	27,862	11,950	8,690	13,596	64,791
<b>NNE</b>	305	2,316	2,704	5,328	22,204	32,857
<b>NE</b>	10	2,008	3,548	6,810	14,870	27,246
<b>ENE</b>	0	4,259	6,052	6,744	41,386	58,441
<b>E</b>	1	6,203	6,610	14,176	7,163	34,153
<b>ESE</b>	10	2,815	3,349	3,690	3,757	13,621
<b>SE</b>	0	732	5,904	8,301	13,557	28,494
<b>SSE</b>	0	473	888	1,359	3,258	5,978
<b>S</b>	0	708	2,074	8,746	4,627	16,155
<b>SSW</b>	12	1,014	2,841	6,245	3,367	13,479
<b>SW</b>	143	1,522	5,950	2,720	3,523	13,858
<b>WSW</b>	131	1,979	5,812	3,361	7,991	19,274
<b>W</b>	313	7,838	13,670	11,626	9,044	42,491
<b>WNW</b>	1,793	6,584	168,676	42,205	19,221	238,479
<b>NW</b>	1,432	19,770	105,604	12,197	4,283	143,286
<b>NNW</b>	1,522	25,639	14,562	8,946	4,346	55,015
<b>TOTAL</b>	8,365	111,722	360,194	151,144	176,193	807,618

Source: SRS GSAR (WSRC 1999a)

**Table 4-15. Projected Population Distribution – 2020**

	5 to 10 mi (3 to 16 km)	10 to 20 mi (16 to 32 km)	20 to 30 mi (32 to 48 km)	30 to 40 mi (48 to 64 km)	40 to 50 mi (64 to 80 km)	TOTAL
<b>N</b>	3,070	31,763	13,623	9,907	15,500	73,863
<b>NNE</b>	348	3,640	3,083	6,074	25,312	38,457
<b>NE</b>	12	2,289	4,045	7,763	16,952	31,061
<b>ENE</b>	0	4,855	6,900	7,688	47,180	66,623
<b>E</b>	1	7,071	7,535	16,161	8,166	38,934
<b>ESE</b>	12	3,209	3,818	4,206	4,283	15,528
<b>SE</b>	0	834	6,731	9,463	15,455	32,483
<b>SSE</b>	0	539	1,012	1,550	3,714	6,815
<b>S</b>	0	807	2,365	9,971	5,274	18,417
<b>SSW</b>	13	1,156	3,239	7,119	3,839	15,366
<b>SW</b>	163	1,735	6,783	3,101	4,016	15,798
<b>WSW</b>	150	2,256	6,625	3,831	9,110	21,972
<b>W</b>	357	8,935	15,584	13,254	10,310	48,440
<b>WNW</b>	2,045	7,506	192,291	48,113	21,912	271,867
<b>NW</b>	1,633	22,537	120,389	13,904	4,883	163,346
<b>NNW</b>	1,735	29,228	16,601	10,199	4,954	62,717
<b>TOTAL</b>	9,539	128,360	410,624	172,304	200,860	921,687

Source: SRS GSAR (WSRC 1999a)

**Table 4-16. Projected Population Distribution – 2030**

	5 to 10 mi (3 to 16 km)	10 to 20 mi (16 to 32 km)	20 to 30 mi (32 to 48 km)	30 to 40 mi (48 to 64 km)	40 to 50 mi (64 to 80 km)	TOTAL
<b>N</b>	3,500	36,210	15,530	11,294	17,670	84,204
<b>NNE</b>	397	3,010	3,515	6,925	28,857	42,704
<b>NE</b>	14	2,609	4,611	8,850	19,325	35,409
<b>ENE</b>	0	5,535	7,865	8,764	53,785	75,949
<b>E</b>	2	8,061	8,590	18,423	9,310	44,386
<b>ESE</b>	14	3,658	4,352	5,466	488	13,978
<b>SE</b>	0	951	7,673	7,409	17,619	33,652
<b>SSE</b>	0	615	1,154	1,767	4,234	7,770
<b>S</b>	0	920	2,696	11,367	6,013	20,996
<b>SSW</b>	15	1,317	3,692	8,115	4,376	17,515
<b>SW</b>	186	1,978	7,732	3,535	4,579	18,010
<b>WSW</b>	171	2,572	7,553	4,368	10,385	25,049
<b>W</b>	407	10,186	17,766	15,109	11,753	55,221
<b>WNW</b>	2,331	8,556	219,212	54,849	24,980	309,928
<b>NW</b>	1,861	25,692	137,243	15,851	5,567	186,214
<b>NNW</b>	1,978	33,320	18,925	11,627	5,648	71,498
<b>TOTAL</b>	10,876	145,190	468,109	193,719	224,589	1,042,483

Source: SRS GSAR (WSRC 1999a)

**Table 4-17. Racial and Ethnic Mix of Local Area Population, 1997 (Estimated)**

	<b>Aiken County, SC</b>	<b>Barnwell County, SC</b>	<b>Burke County, GA</b>	<b>Georgia</b>	<b>South Carolina</b>
Total Population	133,980	21,830	22,725	6,478,216	3,486,703
White	74.3%	56.0%	43.8%	71.0%	69.0%
Black	24.9%	43.7%	56.0%	26.9%	29.8%
American Indian, Eskimo or Aleut	0.2%	0.2%	0.1%	0.2%	0.3%
Asian or Pacific Islander	0.6%	0.1%	0.2%	1.1%	0.6%
Hispanic (any race)	1.0%	0.8%	0.5%	0.6%	0.3%

Source: *USA Counties<sup>TM</sup> 1998, General Profile (DOC 1998a)*

**Table 4-18. Public School Population within 10 Miles (16 km) of the MFFF**

<b>School</b>	<b>Location</b>	<b>Grades</b>	<b>1998 - 1999 Enrollment</b>
Greendale Elementary	New Ellenton, SC	Pre-K through 5	426
Jackson Middle	Jackson, SC	6 through 8	517
New Ellenton Middle	New Ellenton, SC	6 through 8	263
Redcliff Elementary	Jackson, SC	Pre-K through 5	967
Silver Bluff High	Aiken, SC	9 through 12	914

Source: *South Carolina Education Profiles* (SCDE 1999)

**Table 4-19. Year 2000 SRS Employees (approximate) by County of Residence**

County	WSRC/ M&O	DOE-SR Operations	Savannah River Ecology Lab	WSI	Total	Percent
Aiken, SC	6,353	318	122	326	7,119	53.0
Columbia, GA	1,835	49	5	62	1,951	14.5
Richmond, GA	1,571	93	20	239	1,923	14.3
Barnwell, SC	862	10	3	47	923	6.9
Edgefield, SC	212	NA	1	NA	213	1.6
Other Counties	1,136	22	NA	117	1,487	9.7
<b>TOTAL</b>	11,969	492	151	792	13,616	100

Source: Personal Communication (Blackmon 2000)  
NA – Not Available

**Table 4-20. Economic and Unemployment Data for Counties  
Within 50 Miles (80 km) of the MFFF**

County	1994 Per Capita Income	1993 Percent of Pop. Below Poverty	Unemployment Rate – 1996 (%)
<i>South Carolina</i>	\$17,710	16.6	6.0
Aiken	\$19,468	13.8	7.0
Allendale	\$12,175	34.3	9.1
Bamberg	\$13,253	27.9	9.9
Barnwell	\$16,736	21.9	10.9
Colleton	\$13,988	24.1	6.8
Edgefield	\$15,076	17.4	7.4
Hampton	\$14,595	24.4	7.3
Lexington	\$20,111	9.8	3.3
McCormick	\$12,500	21.1	10.2
Orangeburg	\$14,932	25.6	10.4
Saluda	\$15,316	17.7	6.6
<i>Georgia</i>	\$20,212	16.8	4.6
Bulloch	\$14,319	22.4	3.1
Burke	\$14,270	29.2	16.0
Columbia	\$17,810	7.7	4.1
Glascocock	\$16,417	16.1	9.0
Jefferson	\$15,303	27.7	13.4
Jenkins	\$14,098	25.2	4.7
Lincoln	\$15,358	17.5	6.4
McDuffie	\$16,422	20.7	9.3
Richmond	\$19,251	21.9	7.3
Warren	\$13,747	27.1	9.8

Source: *USA Counties™ 1998, General Profile* (DOC 1998a)



**Table 4-21. Income and Poverty Data for the Three-County Local Area**

County	1990 Population	1990 Per Capita Income	1989 % Population Below Poverty	1994 Per Capita Income	1993 % Below Poverty
Aiken, SC	120,940	\$17,156	14.0	\$19,468	13.8
Barnwell, SC	20,293	\$13,397	21.8	\$16,736	21.9
Burke, GA	20,579	\$11,172	30.3	\$14,270	29.2
Georgia	6,478,216	\$17,123	14.7	\$20,212	16.8
So. Carolina	3,487,714	\$15,106	15.4	\$17,710	16.6

Source: U.S. Census Bureau, 1990 US Census Data; Database: C90STF3C1.

*USA Counties<sup>TM</sup> 1998, General Profile (DOC 1998a)*

Table 4-22. 1997 Employment by Business Sector - Counties Within 50 Miles (80 km) of the MFFF

County	Agr., Forestry & Fishing	Mining	Construct.	Manuf.	Transp. & P.U.	Wholesale Trade	Retail Trade	Finance Ins. & RE	Services	Unclass.	Total
Aiken, SC	252 (A)	1,832	1,832	20,843	1,840 (B)	643 (B)	9,537	1,261	13,066	31 (A)	51,137
Allendale, SC	35 (A)	0	153	1,563	169 (B)	57 (B)	351	58	318	0 (A)	2,443
Bamberg, SC	35 (A)	0	70	1,281	396 (C)	823 (C)	1,290	118	1,041	0 (A)	3,594
Barnwell, SC	86 (A)	0	300	3,403	349 (A)	496 (A)	2,408	486	2,002	2 (A)	8,323
Colleton, SC	125 (A)	0	213	2,185	89 (A)	84 (A)	634	98	881	2 (A)	4,311
Edgefield, SC	51 (A)	0	254	1,523	268 (A)	281 (A)	1,316	136	797	6 (A)	4,632
Hampton, SC	452 (A)	142 (A)	5,534	10,513	4,525 (A)	5,376 (B)	15,291 (E)	2,591	17,003 (E)	14 (A)	61,441
McCormick, SC	131 (A)	0	875	9,467	631 (A)	1,022 (B)	6,892 (E)	104	7,274	1 (A)	27,440
Orangeburg, SC	95 (A)	0	160	2,501	106 (A)	105 (A)	539	61	597	1 (A)	4,165
Saluda, SC	100 (B)	0	1,082	3,270	381 (A)	718 (A)	5,231	615	3,414	16 (A)	14,827
Burke, GA	207 (A)	0	113	1,355	1,750 (A)	268 (A)	927	125	900	0 (A)	5,438
Columbia, GA	207 (A)	0	2,287	6,315	640 (A)	954 (A)	5,364	946	9,242	0 (A)	25,955
Emmanuel, GA	86 (A)	0	157 (A)	2,326	146 (A)	281 (A)	1,195	234 (A)	1,132 (C)	1 (A)	5,471
Glascok, GA	86 (A)	382 (A)	160 (A)	2,198	176 (A)	203 (A)	832	182 (A)	602 (C)	1 (A)	4,822
Jefferson, GA	12 (B)	0	45 (A)	1,295	87 (A)	71 (A)	319	59 (B)	329 (B)	0 (A)	2,217
Jenkins, GA	12 (B)	0	83 (A)	847	73 (A)	40 (A)	251	283 (B)	183 (B)	0 (A)	1,477
Lincoln, GA	261 (A)	0	370 (B)	1,806	182 (A)	134 (A)	2,028	283 (A)	1,660 (A)	0 (A)	6,463
McDuffie, GA	261 (A)	0	3,884 (B)	12,435	3,255 (B)	2,827 (B)	19,481	3,752 (B)	30,433 (B)	0 (A)	76,328
Richmond, GA	25 (A)	0	103 (A)	1,340	54 (A)	89 (A)	516	101 (A)	584 (A)	0 (A)	2,787
Screven, GA	25 (A)	0	1 (A)	879	25 (A)	11 (A)	144	333 (A)	333 (A)	0 (A)	1,418

Notes to table: (A) - 0 to 19; (B) - 20 to 99; (C) - 100 to 249; (E) - 250 to 499.

Source: 1997 County Business Patterns (DOC 1997)

**Table 4-23. Sources of Radiation Exposure to Individuals in the SRS Vicinity Unrelated to SRS Operations**

Source	Effective Dose Equivalent (mrem/yr)
<b>Natural background radiation <sup>a</sup></b>	
Cosmic radiation	27
External radiation	28
Internal terrestrial radiation	40
Radon in homes (inhaled)	200 <sup>b</sup>
<b>Total</b>	295
<b>Anthropogenic background radiation <sup>c</sup></b>	
Diagnostic x rays and nuclear medicine	53
Weapons test fallout	<1
Air travel	1
Consumer and industrial products	10
<b>Total</b>	65
<b>Total</b>	360

<sup>a</sup> Source: *Savannah River Site Environmental Report for 1998* (Arnett and Mamatey 1999)

<sup>b</sup> An average for the United States.

<sup>c</sup> Source: *Ionizing Radiation Exposure of the Population of the United States* (NCRP 1987).

**Table 4-24. Radiation Doses to the Public from Normal SRS Operations in 1999 (Total Effective Dose Equivalent)**

Members of the Public	Atmospheric Releases		Liquid Releases		Total	
	Standard <sup>a</sup>	Actual	Standard <sup>a</sup>	Actual <sup>b</sup>	Standard <sup>c</sup>	Actual
Maximally exposed individual (mrem/yr)	10	0.06 <sup>d</sup>	4	0.22 <sup>d</sup>	100	0.28 <sup>e</sup>
Population within 50 mi (80 km) (person-rem/yr) <sup>f</sup>	None	2.6 <sup>d</sup>	None	4.0 <sup>d</sup>	None	6.6 <sup>e</sup>
Average individual within 50 mi (80 km) (mrem/yr) <sup>g</sup>	None	3.7E-03	None	5.6E-03	None	9.3E-03

<sup>a</sup> The 10-mrem/yr limit from airborne emissions is required by the Clean Air Act and Regulatory Guide 4.20, and the 4-mrem/yr limit is required by the Safe Drinking Water Act; for this ER document, the 4-mrem/yr value is conservatively assumed to be the limit for the sum of doses from all liquid pathways.

<sup>b</sup> Conservatively includes all water pathways, not just the drinking water pathway. The population dose includes contributions to Savannah River users downstream of SRS to the Atlantic Ocean.

<sup>c</sup> The total dose of 100 mrem/yr is the limit for all pathways combined (10 CFR Part 20, Subpart D).

<sup>d</sup> Source: SRS GSAR (WSRC 1999a).

<sup>e</sup> Calculated as the sum of the dose due to atmospheric releases and the dose due to liquid releases.

<sup>f</sup> About 708,450 (see Table 4-2) in 2000. For liquid releases, an additional 85,000 water users in Port Wentworth, Georgia, and Beaufort, South Carolina (about 98 mi [160 km] downstream), are included in the assessment.

<sup>g</sup> Obtained by dividing the population dose by the number of people living within 50 mi (80 km) of the site for atmospheric releases; for liquid releases the number of people includes water users who live more than 50 mi (80 km) downstream of the site.

Source: *Savannah River Site Environmental Report for 1998* (Arnett and Mamatey 1999).

**Table 4-25. Radiation Doses to Workers from Normal SRS Operations  
(Total Effective Dose Equivalent)**

Occupational Personnel	Onsite Releases and Direct Radiation	
	Standard <sup>a</sup>	Actual
Average radiation worker (mrem/yr)	5,000	156 <sup>b</sup>
Total workers (person-rem/yr) <sup>c</sup>	None	2,124 <sup>d</sup>

<sup>a</sup> The radiological limit for an individual worker is 5,000 mrem/yr (10 CFR Part 20, Subpart C). However, DOE's goal is to maintain radiological exposure as low as reasonably achievable. It has therefore established an administrative control level of 2,000 mrem/yr (DOE 1994b); DOE must make reasonable attempts to maintain worker doses below this level.

<sup>b</sup> Source: *SRS External Dosimetry Technical Basis Manual (U)* (WSRC 1999c). Dose due to normal SRS operations ranges from a low of 2 mrem/month to a high of 13 mrem/month. The mean dose is 6.6 mrem/month. The maximum dose was used to calculate the average worker dose.

<sup>c</sup> About 13,616 in 2000.

<sup>d</sup> Calculated as average worker dose times total number of workers.

**Table 4-26. Existing Infrastructure in the Vicinity of the MFFF Site**

<b>Resource</b>	<b>F-Area Usage</b>	<b>F-Area Capacity</b>	<b>SRS Usage</b>	<b>SRS Capacity</b>
Electricity Consumption (MWh/yr)	78,300	561,000	420,000	5,200,000
Electricity peak load (MW)	14.5	64	70	330
Water (mill L/yr)	374	1,590	1,780	3,870
Natural gas (m <sup>3</sup> /yr)	0	0	0	0

Source: SPD EIS (DOE 1999c), Tables 3-48 and 3-49

Table 4-27. Waste Generation Rates and Inventories at SRS

Waste Type	Generation Rate (yd <sup>3</sup> /yr)	Inventory (yd <sup>3</sup> )	Projected 2001 Generation Rate (yd <sup>3</sup> /yr)
<b>TRU<sup>a</sup></b>			144
Contact handled	558	9,125	
Remotely handled	5.2	0	
<b>LLW</b>	13,136	3,113	10,208
<b>Mixed LLW</b>			105
RCRA	1,484	9,077	
TSCA	0	144	
<b>Hazardous</b>	97	1,,852 <sup>b</sup>	4,483
<b>Nonhazardous</b>			
Liquid (gal/yr)	109,921,990	NA <sup>c</sup>	Not available
Solid	8,724	NA <sup>c</sup>	Not available

<sup>a</sup> Includes mixed TRU wastes.

<sup>b</sup> Sessions 1997b.

<sup>c</sup> Generally, nonhazardous wastes are not held in long-term storage.

Key: LLW, low-level radioactive waste; NA, not applicable; RCRA, Resource Conservation and Recovery Act; TRU, transuranic; TSCA, Toxic Substances Control Act.

Source: *Integrated Data Base Report - 1995: U.S. Spent Nuclear Fuel and Radioactive Waste Inventories, Projections, and Characteristics* (DOE 1996a), except for hazardous and nonhazardous solid waste (DOE 1996b) and nonhazardous liquid waste (Sessions 1997b), 2001 projections (Mottel 2000).

## 5. ENVIRONMENTAL CONSIDERATIONS

This chapter discusses potential environmental impacts resulting from site preparation and facility construction (Section 5.1), facility operation (Section 5.2), deactivation (Section 5.3), radioactive material transportation (Section 5.4), and potential facility accidents (Section 5.5). Also presented is a discussion of cumulative impacts (Section 5.6), impacts from alternatives to the proposed action (Section 5.7), impacts on short-term uses and long-term environmental productivity (Section 5.8), and commitment of resources (Section 5.9). Finally, an overview of environmental monitoring is discussed in Section 5.10. Environmental impacts that were projected in the SPD EIS (DOE 1999c) and remain valid in this ER are incorporated by reference but not discussed extensively.

The MFFF facility will be located on SRS land adjacent to F Area. F Area will be expanded to include the material disposition facilities. F Area has been used for over 40 years for the separation of plutonium. The area is highly industrialized and has undergone numerous land disturbances. The MFFF will be located on 41 ac (16.6 ha) of land, some of which most recently was used as the spoils area from the excavation of the Actinide Packaging and Storage Facility (APSF). F Area, near the geographic center of SRS, is at least 5 mi (8 km) away from public access. The public will be relatively insulated from any near-field impact of the MFFF. The previous use of the land in and adjacent to F Area and the relative isolation from the public are important factors in evaluating the environmental impacts of the construction and operation of the MFFF.

### 5.1 IMPACT OF SITE PREPARATION AND FACILITY CONSTRUCTION

This section discusses the effects of site preparation and construction activities on various environmental resources.

#### 5.1.1 Land Use

Construction of the MFFF will require approximately 41 ac (16.6 ha) of land. A number of construction areas exist within F Area but are currently inactive. F Area has ample space available for construction (UC 1998). Land area requirements for the MFFF are relatively small. Because the land is used for industrial activities and could continue to be used for industrial activities after the MFFF deactivation, no permanent loss of land use would result from construction and operation of the facility at SRS.

Construction on the site is consistent with other SRS uses and with the industrial land use activity in the surrounding area. It is also consistent with the SRS Land Use Technical Committee's *Draft SRS Long Range Comprehensive Plan* (DOE 2000a) for land use in the area.

Part of the land within F Area has been previously disturbed and is partially developed. The area where the MFFF will be located is mostly evergreen plantation. Some changes in topography



have already taken place. The MFFF site will be graded to a mean elevation of 272 ft (83 m) above msl.

Based on soil type, some areas of SRS could be considered prime farmlands; however, they are not designated as such because they are not available for agricultural purposes.

To support the MFFF activities, DOE will construct the F-Area Outside Facility for the processing of liquid high alpha activity waste. This facility, to be located near the F-Area waste treatment facilities, will be connected to the MFFF by a dedicated double-walled pipeline. The pipeline will be used to convey the liquid high alpha activity waste to the F-Area Outside Facility. Because the facility and pipeline have not been designed by the SRS M&O contractor, environmental impacts of construction of this facility cannot be evaluated.

During construction, utilities and waste pipelines will be put in place. While routes have not yet been selected, the industrial nature of the site and absence of critical habitat suggests that sensitive vegetated areas can be avoided in selecting routes, thus minimizing impacts of construction.

### **5.1.2 Geology**

The following discussion of construction impacts to geology and soils is taken from Section 4.26.4.1.1 of the SPD EIS (DOE 1999c). In general, construction results in disturbance of about 41 ac (16.6 ha) of soils for the MFFF site plus an additional 8 ac (3.2 ha) in slope and grade surrounding the MFFF site, some of which have already been disturbed by construction of the APSF. Soils on the site will be moved, as appropriate, to achieve a uniform elevation. To date, no offsite borrow pits or spoil piles have been identified.

Actual creation of foundations and building of structures on the site will be limited to upper geological layers, minimizing impacts to geology and groundwater.

The soils at SRS are considered suitable for standard construction techniques. No economically viable geologic resources have been identified at SRS. While soils at SRS could be classified as prime farmlands, the U.S. Department of Agriculture does not classify them as prime farmlands because all of SRS is removed from public access.

Construction of the MFFF in the SRS F Area would have a negligible impact on the geologic and soil resources.

### **5.1.3 Water Use and Quality**

Environmental impacts resulting from water use during MFFF construction were discussed in Section 4.26.4.2.1 of the SPD EIS (DOE 1999c) and are addressed in the following paragraphs.

All water for construction activities will be provided from existing SRS utilities. Local surface water would not be used in the construction of proposed facilities at SRS. Thus, there would be

no impact on the local surface water availability to downstream users. Sanitary waste will be collected using a combination of portable toilets and semi-permanent facilities connected to the SRS CSWTF. All wastewater would be treated in the sitewide treatment system, which has sufficient hydraulic and organic capacity to treat the flows expected from these activities. No impacts on surface water quality would be expected from the discharge of these flows to the treatment system and, subsequently, to the receiving stream (Sessions 1997a).

The estimated annual average water usage for constructing all the proposed facilities at the MFFF site is 30.0 million gal (114 million L). Current water usage in F Area is 98.8 million gal/yr (374 million L/yr) (DOE 1999c). The total construction requirement represents approximately 7% of the F-Area groundwater capacity of about 423 million gal/yr (1.6 billion L/yr) (DOE 1999c). Therefore, no impact on water availability is anticipated.

Proven construction techniques will be used to mitigate the impact of soil erosion on receiving streams. The MFFF construction stormwater pollution prevention plan will be consistent with the existing SRS stormwater and erosion management practices. Because of the effectiveness of these techniques, no long-term impacts from soil erosion due to construction activities would be expected.

Because the construction of the MFFF will involve building structures, parking lots, and roadways, which will increase the impervious surface area, the stormwater runoff quantity at peak discharge would increase accordingly. The area within the boundary of the selected site is estimated to be 41 ac (16.6 ha). The total area of the impervious surfaces (e.g., roofs, roadways, paved parking lots) as a result of construction of the MFFF is estimated to be 17 ac (6.9 ha) or 41.4% of the site area.

To comply with *South Carolina State Standards for Stormwater Management and Sediment Reduction* (SCDHEC 2000b), detention ponds designed to control the release of the stormwater runoff at a rate equal to or less than that of the pre-development stage will be built at strategic locations as part of the SRS infrastructure program.

Because of the proximity of the three components of the plutonium disposition project (i.e., MFFF, PDCF, and PIP), SRS is developing a comprehensive and coordinated approach to infrastructure management. Stormwater management is part of this infrastructure management.

SRS will grade all three sites to create a comprehensive stormwater collection and routing system. The stormwater runoff flow from all three sites will discharge through the existing SRS stormwater NPDES outfall or new outfalls. If the existing stormwater outfalls are impacted by construction of the surplus plutonium disposition facilities, they will be relocated and/or new outfalls will be constructed.

#### **5.1.4 Air Quality**

Potential impacts to local air quality during construction of the MFFF are presented in Section 4.4.1.1 of the SPD EIS (DOE 1999c).

Potential air quality impacts from construction of new MOX and support facilities at SRS were analyzed using ISCST3 as described in Appendix B. Construction impacts result from diesel fuel emissions from construction equipment, particulate matter emissions from disturbance of soil by construction equipment and other vehicles (i.e., construction fugitive emissions), operation of a potential concrete batch plant, construction worker vehicles, and trucks moving materials and wastes. Emissions from these sources are summarized in Table 5-1. Maximum air pollutant concentrations from construction activities are summarized in Table 5-2.

The incremental MFFF construction impacts shown in Table 5-2 are trivial compared to the existing ambient concentrations, and the total impacts are well below the most stringent air quality standard or guideline.

### **5.1.5 Ecology**

Construction impacts to ecological systems were discussed in Section 4.26.4.3.1 of the SPD EIS (DOE 1999c). Impacts to the local ecology are not expected to be significantly different from those described in the SPD EIS. The following discussion of construction impacts is derived from the SPD EIS with updated data reflecting the present MFFF design and specific location adjacent to F Area.

#### **5.1.5.1 Non-Sensitive Habitat**

Siting the MFFF at SRS would disturb a total of about 41 ac (16.6 ha). There should be no direct impacts on non-sensitive aquatic habitats because best-management practices for soil erosion and sediment control will be used to prevent construction runoff to these habitats, and direct construction disturbance would be avoided. It is estimated that slightly less than 28 ac (11.3 ha) of evergreen woodlands and other vegetation in the construction area would be lost as terrestrial habitat (Figure 4-13). The associated animal populations would be affected. Some of the less-mobile or established animals within the construction zone could perish during land-clearing activities and from increased vehicular traffic. Furthermore, activities and noise associated with construction could cause larger mammals and birds to relocate to similar habitat in the area. Also, animal species inhabiting areas surrounding F Area could be disturbed by the increased noise associated with construction activities, and the additional vehicular traffic could result in higher mortality for individual members of local animal populations. The recent survey of the site (DOA 2000) did not reveal any migratory bird nests. Prior to construction, the proposed site will be surveyed for nests of migratory birds. There would be no impacts on aquatic habitat from surface water consumption because water required for construction will be drawn from groundwater by the SRS utilities.

#### **5.1.5.2 Sensitive Habitat**

Wetlands associated with floodplains, streams, and impoundments should not be directly impacted by construction activities. No runoff or sediments are expected to be deposited in these areas because appropriate erosion and sedimentation controls will be used during construction.

No critical habitat for any threatened or endangered species exists on SRS. However, as discussed in Section 4.6.2.1, the bald eagle, red-cockaded woodpecker, wood stork, American alligator, smooth purple coneflower, and Oconee azalea might occur near F Area (DOE 1995b). Surveys conducted in 1998 and 2000 did not find any federally listed threatened, endangered, proposed, or sensitive plant or animal species (DOA 2000). Consultations were initiated by DOE with the U.S. Fish and Wildlife Service (USFWS) and the South Carolina Department of Natural Resources (SCDNR) to request comments on potential impacts on animal and plant species and to request any additional sensitive species information. The USFWS field office in Charleston, South Carolina, provided a written response indicating that the proposed facilities at SRS do not appear to present a substantial risk to federally listed species or other species of concern. That office also provided additional information concerning listed species and species of concern occurring in the vicinity of SRS (EuDaly 1998).

### **5.1.6 Noise**

MFFF construction impacts on local noise levels were evaluated in Section 4.4.1.1 of the SPD EIS (DOE 1999c).

The location of the MFFF relative to the site boundary and sensitive receptors was examined to evaluate the potential for onsite and offsite noise impacts. Noise sources during construction would include heavy construction equipment, employee vehicles, and truck traffic. Traffic noise associated with the construction of the MFFF would occur on the site and along offsite local and regional transportation routes used to bring construction materials and workers to the site.

Given the distance to the site boundary (about 5.4 mi [8.7 km]), noise emissions from construction equipment would not be expected to annoy the public. These noise sources would be far enough away from offsite areas that the contribution to offsite noise levels would be small. Some noise sources could have onsite impacts, such as the disturbance of wildlife. However, noise would be unlikely to affect federally-listed threatened or endangered species or their critical habitats because none are known to occur in F Area (see Section 4.6.2.2). Noise from traffic associated with the construction of the MFFF would likely produce less than a 1-dB increase in traffic noise levels along roads used to access the site, and thus would not result in any increased annoyance of the public.

Construction workers could be exposed to noise levels higher than the acceptable limits specified by the Occupational Safety and Health Administration (OSHA) in its noise regulations (29 CFR §1926.52). However, DOE has implemented appropriate hearing protection programs to minimize noise impacts on workers. These programs include the use of standard silencing packages on construction equipment, administrative controls, engineering controls, and personal hearing protection equipment.

### **5.1.7 Regional Historic, Scenic, and Cultural Resources**

MFFF construction will not affect historic resources, including those associated with the Cold War Era, nor will construction affect resources of value to Native Americans. Preliminary consultations with appropriate American Indian Tribal Governments and the State Historic Preservation Office have been performed by DOE. Consultations with Native American groups indicate that it is unlikely that significant Native American resources would be impacted.

Archaeological surveys of F Area in the vicinity of the MFFF site identified four prehistoric sites that could be affected by MFFF construction. As noted in Section 4.8.2, two of the sites, 38AK546/547 and 38AK757, have the potential to yield significant information about prehistoric periods in the Aiken Plateau and have been determined to be eligible for inclusion in the National Register of Historic Places (Green 2000). A data recovery plan for impact mitigation is being developed for the two eligible sites and will be submitted to the South Carolina State Historic Preservation Office for review and comment in compliance with the SRS PMOA prior to execution<sup>1</sup>. Although it is usually preferable to leave sites intact and undisturbed, the mitigation actions should serve to minimize project impacts by recovering sufficient resources and data from the sites to gain whatever information they may contain concerning site use and age. Figure 4-5 illustrates the boundary of the archaeological sites in relation to the proposed MFFF facilities.

Inadvertent discoveries of cultural resources will be handled in accordance with 36 CFR §800.11 (historic properties) or 43 CFR §10.4 (Native American human remains, funerary objects, objects of cultural patrimony, and sacred objects) as well as with the terms of the SRS PMOA.

The MFFF buildings will have a minimal effect on the scenic character of the surrounding area and are consistent with the VRM Class IV designation for the area. The buildings are low-rise structures of varying heights less than 100 ft (30 m). This height is consistent with, and does not exceed, the other building heights in the area, which range from 10 to 100 ft (3 to 30 m). The tallest new structure is an exhaust stack, which is located on top of the MFFF building. The stack is less than 100 ft (30 m) above the existing grade, and its distance from sensitive receptors and screening by trees will minimize its impact as a visual intrusion to the scenic character of the area.

The appearance of MFFF facilities in and adjacent to F Area would remain consistent with the area's industrialized landscape character. In height and size, the proposed facilities will be similar to existing buildings in F Area. Facilities are generally not visible offsite because views are limited by rolling terrain and heavy vegetation. Construction and operation of the MFFF would not effect a major change in any natural features of visual interest in the area. The nearest

---

<sup>1</sup>The SPD EIS ROD (DOE 2000b) anticipated mitigation through avoidance. Subsequent shifts in the MFFF site boundaries made it impossible to avoid impacting the sites, hence the plan for mitigation through data recovery.

sensitive viewpoints are those on South Carolina Highway 125 and SRS Road 1, 4.3 mi (6.9 km) and 5.3 mi (8.5 km) away, respectively.

### **5.1.8 Socioeconomics**

Construction of the MFFF at SRS would have minor beneficial socioeconomic impacts on the region. Construction employment requirements are listed in Table 5-3.

According to the U.S. Census Bureau (DOC 1997), over 18,000 residents of counties that comprise the 50-mi (80-km) region surrounding the MFFF site were employed in the construction trades in 1997. During a majority of the construction period, labor needs at the site should easily be met within the existing regional construction labor pool. At its peak, MFFF construction activities are expected to employ about 1,050 craft workers. Although the region should directly benefit from MFFF construction employment, the peak employment estimate represents approximately 8% of the total 1997 regional construction workforce and could adversely affect other construction activities in the region as a result of direct competition for labor. Since the 1,050-person peak need for labor is not expected to last for more than a few months, any adverse effects will be temporary and short-lived and should have no long-term impact on the overall economy of the area.

It is anticipated that some construction labor may be hired from counties that are outside of the 50-mi (80-km) region. The Columbia MSA, consisting of Lexington and Richland Counties in South Carolina, contained a total of 12,912 construction workers in 1997 and is a likely source of some of the construction labor. If workers from Richland County are included with those in the region (note that Lexington is partially within the 50-mi [80-km] region and already included as part of the labor pool), a total construction labor pool available to the project will be over 25,000 workers. This total drops the 1,050-person peak employment requirements for the MFFF to less than 4% of the combined regional total construction workforce. Since construction workers often commute considerable distances for short-term work and since a majority of Richland County is within about 65 mi (105 km) of the MFFF site, the inclusion of Richland County's construction labor force in this analysis is reasonable. Given that a majority of MFFF construction workers will be hired from within the existing regional labor pool, no significant relocation of workers is expected and secondary impacts to area businesses, public services, and facilities will be negligible.

Transportation impacts during construction of the MFFF will primarily be associated with construction labor. Currently, one 10-hour shift is planned per day. To minimize conflicts with other SRS activities, the work schedule (i.e., start and stop times) will be coordinated and staggered with other SRS schedules to minimize the number of vehicles entering and exiting the site during peak commuting periods. Table 5-3 lists the anticipated average number of workers that will be onsite each year of construction. Since some workers typically carpool, the number of worker vehicles anticipated each year during construction is assumed to be equivalent to about 60% of the average number of workers. As a result, during the third and fourth years of construction, an average of between 420 and 480 vehicles carrying construction workers will

make daily round trips to the site; during the peak construction period, an estimated 630 vehicles are anticipated.

As noted in Section 4.10.3.4, state road improvements, independent of the proposed action, are planned for three of the major roads in the local area, which will increase roadway capacity and help minimize the effect of worker traffic associated with MFFF construction. The widening of South Carolina Highway 302 to South Carolina Highway 19, and the completion of South Carolina Highway 118 around Aiken are scheduled to be completed prior to commencement of MFFF construction. The widening of U.S. Route 25 is scheduled for completion during the first year of MFFF construction.

Construction activities will also require the delivery of materials and equipment. Table 5-4 lists the estimated number of heavy vehicles per year that will be associated with MFFF construction. The largest number is anticipated during the first few years of construction with about 24 heavy vehicles anticipated during the first year and 20 anticipated in the two subsequent years. These heavy vehicles will be scheduled to arrive at the site during “off” hours that do not correspond with SRS commuting times. As a result, delivery of the heavy vehicles, even during the first year, is insufficient to create any significant impacts to traffic flow in the local area.

#### **5.1.9 Environmental Justice**

The MFFF is located within SRS and is over 5 mi (8 km) from the nearest minority or low-income community. Impacts from construction activities that could affect public health, such as the generation of noise and dust, will be limited to the construction site area. As presented in Section 4.4.1.6 of the SPD EIS (DOE 1999c), there are no anticipated environmental justice issues associated with construction of the MFFF at SRS. Construction would pose no significant health risks to the public regardless of racial or ethnic composition, or economic status.

Increased traffic during peak commuting hours could cause some slowing of traffic on South Carolina Highways 125 and 19 through the towns of Jackson and New Ellenton, respectively. The effects associated with commuting will be limited to peak periods in the morning and evening and will last only for the duration of the construction period. In addition, staggering of work hours and scheduled roadway improvements should help minimize any adverse impacts. Because construction vendors and delivery routes are not known yet, the exact effect on traffic congestion is unknown. Given the limited nature of transportation changes that will result from MFFF construction, there should be no environmental justice issues associated with construction traffic.

#### **5.1.10 Impacts from Ionizing Radiation**

The human health risk from construction is discussed in Section 4.4.1.4 of the SPD EIS (DOE 1999c). No radiological risk would be incurred by members of the public from construction activities. The public is far enough from the MFFF site to be relatively unaffected by any construction emissions.

Construction workers are exposed to radiation as a result of existing F-Area operations and from radiography during construction. The SPD EIS presented a projected dose to construction workers in F Area of 4 mrem/yr. More recent monitoring data indicate a 0.2 mRad/day exposure in F Area (Arnett and Mamatey 1999). Construction worker exposures to radiation will be kept ALARA through a construction ALARA program. To this end, construction workers will be monitored and badged as appropriate.

### **5.1.11 Infrastructure**

As discussed in the Section 4.26.4.6.1 of the SPD EIS (DOE 1999c), MFFF construction would have negligible impacts on infrastructure resources at SRS.

Construction would require only a fraction of the available resources and thus would not jeopardize the resources required to operate the site. Total construction requirements for diesel fuel might be higher than currently available storage, but the majority of fuel usage would be connected to construction vehicle usage. Therefore, storage would not be limiting. Table 5-5 reflects estimates of the additional infrastructure requirements for construction of the proposed facilities. Site resource availability is also presented.

As part of the surplus plutonium disposition project, DOE-SR will be conducting a coordinated upgrade of the infrastructure necessary to support all three facilities (MFFF, PDCF, and PIP). These upgrades include clearing and grading all three sites, developing integrated stormwater flow patterns for all three sites, providing utility services to all three sites, and providing any necessary access roads. The environmental impacts of these activities were considered in the SPD EIS or will be considered in SRS-specific NEPA documents. Consequently, these activities and impacts are not considered in this ER.

### **5.1.12 Construction Waste**

The SPD EIS (DOE 1999c) discusses the impacts of construction waste on SRS waste management resources.

Table 5-6 compares the wastes generated during the construction of the MFFF at SRS with the existing treatment, storage, and disposal capacity for the various waste types. It is anticipated that no TRU waste, LLW, or mixed LLW would be generated during the construction period. In addition, no soil contaminated with hazardous or radioactive constituents should be generated during construction. However, if any were generated, the waste would be managed in accordance with site practice and applicable federal and state regulations.

Hazardous wastes generated during construction would be typical of those generated during the construction of an industrial facility. Any hazardous wastes generated during construction would be packaged in DOT-approved containers and shipped offsite to permitted commercial recycling, treatment, and disposal facilities.



Nonhazardous solid wastes generated during the construction of the MFFF would be packaged in conformance with standard industrial practice and shipped to commercial or municipal facilities for recycling or disposal. The City of North Augusta Regional Material Recovery Facility is available for recycling waste generated during construction. The Three Rivers Landfill is available for wastes that cannot be recycled or recovered. Sanitary waste will be collected using a combination of portable toilets and semi-permanent facilities connected to the SRS CSWTF.

Several areas of SRS were considered as the site for the MFFF before F Area was selected (see Section 5.7.2.3). Indications of contamination on the surface or associated with groundwater were included in considering potential sites, and at least one other possible site was abandoned. In contrast, the area selected does not appear to have contamination to remediate prior to construction, thereby easing construction, speeding up approvals, and limiting potential liability.

### **5.1.13 Facility Accidents**

The impacts of construction accidents were discussed in Section 4.4.1.5 of the SPD EIS (DOE 1999c) but are expected to be less than the projection in the SPD EIS. Recent construction labor projections are for 2,450 person-years. Applying standard U.S. Department of Labor accident rates for construction sites to this projection reduces the potential nonfatal occupational injury or illness to 242 potential cases and only 0.34 potential fatality.

Because construction would be in nonradiological areas, no radiological accidents are anticipated.

## **5.2 EFFECTS OF FACILITY OPERATION**

This section describes the effects of facility operation on the environment surrounding the MFFF.

### **5.2.1 Impacts on Land Use and Site Geology**

Operation of the MFFF is not projected to have any impact on land use other than the continued removal of the 41-ac (16.6-ha) site from other uses. The operation of the MFFF should not impact site geology.

### **5.2.2 Impacts on Surface Water Use and Quality**

The MFFF does not discharge any process liquid directly to the environment except stormwater runoff. All liquid wastes are transferred to SRS for treatment, storage, and ultimate disposal. A description of these wastes is provided in Section 3.3.

Nonhazardous wastewater will be treated, if necessary, before being discharged to the F-Area process sewer system that connects to the SRS Effluent Treatment Facility (ETF). Nonhazardous wastewater is estimated to be less than 10% of the capacity of the ETF. Therefore, impacts on

the system should not be major. Because the ETF is able to treat these flows adequately to meet SRS NPDES permit limitations, negligible impacts on surface water quality are expected.

### **5.2.3 Impacts on Groundwater Quality**

The MFFF does not employ settling or holding basins as part of the wastewater treatment system. There will be no direct discharge of wastewater to the groundwater. Therefore, no impacts on groundwater quality are expected.

### **5.2.4 Impacts on Ambient Air Quality**

There are four sources of air emissions from the MFFF operations:

- NO<sub>x</sub> emissions from the MFFF stack derived from the aqueous polishing process
- Criteria pollutant emissions from routine testing of the emergency and standby diesel generators
- Fugitive emissions from chemical and fuel storage tanks
- Emissions from employee and site vehicles.

Impacts of the chemical air emissions from the MFFF are presented in Section 4.4.2.1 and Appendix G, Section G.4.2.4.2 of the SPD EIS (DOE 1999c), and are updated in the following discussion.

Potential air quality impacts from operation of the new MOX and support facilities at SRS were analyzed using ISCST3 as described in Appendix B. Emissions from these sources are summarized in Table 5-7. Emergency and standby generators were modeled as a volume source.

Maximum air pollutant concentrations resulting from the emergency and standby diesel generators and process sources, plus the SRS baseline concentrations, are summarized in Table 5-8.

The increased concentrations of nitrogen dioxide, PM<sub>10</sub>, and sulfur dioxide from the operation of the MFFF would be a small fraction of the PSD Class II area increments, as summarized in Table 5-9.

Total vehicle emissions associated with activities at SRS would likely decrease somewhat from current emissions because of a decrease in overall site employment during this time frame.

The combustion of fossil fuels associated with MFFF operations would result in the emission of carbon dioxide, one of the atmospheric gases that are believed to influence the global climate. Annual carbon dioxide emissions from operations would represent less than 0.0002% of the

annual United States emissions of carbon dioxide from fossil fuel combustion and industrial processes, and therefore would not appreciably affect global concentrations of this pollutant.

### **5.2.5 Ecological Impacts**

The environmental impacts of MFFF operations on local ecology are discussed in Section 4.26.4.3.2 of the SPD EIS (DOE 1999c), and updated in the following discussion.

#### **5.2.5.1 Nonsensitive Habitat**

Noise disturbance would probably be the most significant impact of routine operation of the MFFF on local wildlife populations. Disturbed individual members of local populations could migrate to adjacent areas of similar habitat. However, impacts associated with airborne releases of criteria pollutants, hazardous and toxic air pollutants, and radionuclides would be unlikely because scrubbers and filters will be used. Impacts on aquatic habitats should be limited because all liquid will be transferred to SRS for disposal in accordance with approved permits and procedures (see Section 7.2).

#### **5.2.5.2 Sensitive Habitat**

Operational impacts on wetlands or other sensitive habitats would be unlikely because airborne and aqueous effluents would be controlled through state permits (see Section 7.2).

It is also unlikely that any federally listed threatened or endangered species would be affected, although South Carolina state-classified special-status species (American alligator) could be affected by noise or human activity during operations, as discussed for construction (Section 5.1.5.2).

### **5.2.6 Impacts from Facility Noise**

The location of the MFFF relative to the site boundary and sensitive receptors was examined to evaluate the potential for onsite and offsite noise impacts. Noise sources during operations would include new or existing sources (e.g., cooling systems, vents, motors, material-handling equipment, emergency and standby diesel generators), employee vehicles, and truck traffic. Given the distance to the site boundary (about 5.4 mi [8.7 km]), noise emissions from equipment would not be expected to annoy the public.

Some noise sources could have onsite impacts, such as the disturbance of wildlife. However, noise would be unlikely to affect federally-listed threatened or endangered species or their critical habitats because none are known to occur in F Area. Traffic noise associated with operation of the MFFF would occur on the site and along offsite local and regional transportation routes used to bring materials and workers to the site. Noise from traffic associated with operation of the MFFF would likely produce less than a 1-dB increase in traffic noise levels

along roads used to access the site, and thus would not result in any increased annoyance of the public.

Operations workers could be exposed to noise levels higher than the acceptable limits specified by OSHA in its noise regulation (29 CFR §1926.52). However, DCS will implement appropriate hearing protection programs to minimize noise impacts on workers. These programs include the use of administrative controls, engineering controls, and personal hearing protection equipment.

### **5.2.7 Impacts on Historic, Scenic, and Cultural Resources**

Once the construction impacts to the archaeological site have been mitigated, operation of the MFFF is not projected to have any impact on site or regional historic or cultural resources.

The MFFF buildings will have a minimal effect on the scenic character of the surrounding area and is consistent with the VRM Class IV designation for the area. The buildings are low-rise structures of varying heights less than 100 ft (30 m). This height is consistent with, and does not exceed, the other building heights in the area, which range from 10 to 100 ft (3 to 30 m). The tallest new structure is an exhaust stack, which is located on top of the MFFF building. The stack is less than 100 ft (30 m) above the existing grade, and its distance from sensitive receptors and screening by trees will minimize its impact as a visual intrusion to the scenic character of the area.

The appearance of MFFF facilities in and adjacent to F Area would remain consistent with the area's industrialized landscape character. In height and size, the proposed facilities will be similar to existing buildings in F Area. Facilities generally are not visible offsite because views are limited by rolling terrain and heavy vegetation. Construction and operation of the surplus plutonium disposition facilities would not effect a major change in any natural features of visual interest in the area. The nearest sensitive viewpoints are those on South Carolina Highway 125 and SRS Road 1, 4.3 mi (6.9 km) and 5.3 mi (8.5 km) away, respectively.

### **5.2.8 Socioeconomic Impacts**

Approximately 400 new permanent jobs will be created in 2006 for MFFF operation. To fill these jobs, some employees may be hired from other regions of the state or country. Over 400,000 people resided within the five-county ROI in 1990. Assuming that any MFFF employees and their families that may move into the area as a direct result of MFFF employment choose to live in one of the five ROI counties, their numbers would represent less than 1% of the total 1990 ROI population. Given the size of the population of the region, and the rate of growth it is already experiencing, no significant socioeconomic impacts are anticipated.

### 5.2.9 Environmental Justice Impacts

Nuclear Materials Safety and Safeguards policy and procedures<sup>2</sup> specify that a 4-mi (6.4-km) radius should be used as the area of consideration in rural areas or areas that are outside of city limits. The MFFF is located on SRS. There is no resident population within a 5-mi (8-km) radius of the MFFF site, and the nearest minority or low-income community is over 5 mi (8 km) away. As noted in Section 4.9 and shown on Figures 4-15 and 4-16, a disproportionate minority or low-income population does not exist even within a 10-mi (16-km) radius of the MFFF site. As a result, MFFF operation will pose no significant health risks to the public regardless of the racial or ethnic composition or economic status.

MOX fuel fabrication requires uranium dioxide that will be transported to SRS from another location in the United States. The ER evaluates the impacts on environmental justice resulting from this transportation. The SPD EIS (DOE 1999c) identified a DOE enrichment facility near Portsmouth, Ohio, as a representative site for the source of the depleted uranium hexafluoride (UF<sub>6</sub>) and a nuclear fuel fabrication facility in Wilmington, North Carolina, as a potential uranium conversion facility. Although the source of depleted uranium hexafluoride has not been selected for the MFFF, this ER analysis assumes transportation of uranium hexafluoride from Portsmouth, Ohio, to Wilmington, North Carolina, and then transport of converted uranium dioxide to the MFFF site. Minority and low-income populations residing along 1-mi (1.6-km) corridors centered on routes that are representative of those that could be used for the transportation of nuclear materials under the proposed action were identified in the SPD EIS (DOE 1999c) and are listed in Table 5-10. Population was calculated using U.S. Census block group data.

Once the MOX fuel is fabricated, it will be transported to one of four operating nuclear power plants: the McGuire Nuclear Station Units 1 & 2 near Huntersville, North Carolina, or the Catawba Nuclear Station Units 1 & 2 near York, South Carolina. Travel from the MFFF to the Catawba Nuclear Station will be through South Carolina and Georgia and to the McGuire Nuclear Station will be through South Carolina, Georgia, and North Carolina. Minority populations (1990) along the corridors between the MFFF and the McGuire and Catawba Nuclear Stations are listed in Table 5-10. The populations were calculated using updated U.S. Census block group data and assume a 0.5-mi (0.8-km) corridor on either side of the roadways.

Potential transportation accidents are discussed in Section 5.4. As noted in that section, the NRC evaluated the environmental impacts of cargo-related accidents resulting from the transport of nuclear materials in NUREG-0170 (NRC 1977c) and concluded the potential impacts to be small. No radiological or nonradiological fatalities would be expected to result from accident-free transportation associated with the MFFF, nor would radiological or nonradiological fatalities be expected to result from transportation accidents. Consequently, transportation of

---

<sup>2</sup>*Environmental Justice in NEPA Documents* (NRC 1999) specifies the guidelines for determining the area for assessment, "If the facility is located outside the city limits or in a rural area, a 4 mile radius (50 square miles) should be used."

materials associated with the operation of the MFFF would pose no significant risks to the public, including minority and low-income populations.

### **5.2.10 Impacts from Ionizing Radiation**

Normal operations of the MFFF will result in radiological releases to the environment and direct in-plant exposures. Radiation doses to the general public, site workers (i.e., SRS workers not involved with the MFFF), and facility workers due to normal operations of the MFFF are presented below.

#### **5.2.10.1 Radiation Doses to the Public**

The estimation of radiological impacts to the public due to incident-free operations of the MFFF is summarized here and described in detail in Appendix D. The dose calculations used the GENII system (the Hanford Environmental Radiation Dosimetry Software System) (Pacific Northwest Laboratory 1988a, 1988b). The GENII model was selected to maintain a consistency with the SPD EIS analysis. The GENII model is also appropriate because it includes isotopes not included in traditional models for power plants and it provides dose estimates consistent with the most recent 10 CFR Part 20 guidance.

The calculated dose is the 50-year committed effective dose equivalent due to internal exposure and the effective dose equivalent due to external exposure resulting from one year of release and one year of uptake. Determination of dose to the maximally exposed individual (MEI) and the general public as a result of normal operations of the MFFF assumed the following:

- Chronic atmospheric releases.
- Exposure pathways of inhalation uptake, external exposure to the airborne plume, ingestion of terrestrial foods and animal products, and inadvertent soil ingestion.
- The entire population within the 50-mi (80-km) assessment area consists of adults (DOE 1988).
- The MEI resides 5 mi (8 km) from the facility in the southwest direction.
- No previous contamination of the ground surface and no previous irrigation with contaminated water.
- A finite plume model (i.e., center of the plume located at ground level) for the calculation of dose.
- The annual external exposure time to the plume and to soil contamination is 0.7 year for the MEI (NRC 1977a).

- The annual external exposure time to the plume and to soil contamination is 0.5 year for the general population (NRC 1977a).
- The annual inhalation exposure time to the plume is 1 year for the MEI and general population (NRC 1977a).
- A stack height equal to the actual stack height rather than the effective stack height to negate plume rise.
- Airborne releases used in the SPD EIS (DOE 1999c), which are about one order of magnitude higher than the releases expected during normal MFFF operations.
- The MEI and the general population consume only food grown within the assessment area and only animal products produced within the assessment area.
- Terrestrial food is irrigated with uncontaminated water.
- All water consumed by animals within the assessment area comes from an uncontaminated source.
- Animal food sources are not irrigated.
- No resuspension of soil particles into the air.
- A general population equal to the estimated population for 2030.

Dose for the MEI and the general population was calculated for a release from the top of the vent stack (nominally 93 ft [28 m] above grade; see Section 3.1.1). To bound the dose calculations and to provide a buffer in the event that the designed building and/or vent stack heights are modified in the future, a groundlevel release (1 ft [0.3 m] above grade) was also modeled. As a conservative measure, the airborne release used was identical to that used in the SPD EIS (DOE 1999c). Actual releases are estimated to be an order of magnitude less than those used for this calculation. Because the MFFF does not discharge any liquid directly to the environment, the liquid/aquatic pathway was not considered in the dose calculations.

Table 5-11 summarizes the potential radiological impacts on three individual receptor groups: the population living within 50 mi (80 km) of SRS, the maximally exposed member of the public, and the average exposed member of the public. This table also shows a comparison of the calculated potential doses due to normal operations to the all-pathway standard given in 10 CFR Part 20, Subpart D and the doses from natural background radiation.

Given incident-free operation of the MFFF, the total population dose would be 0.035 person-rem/yr. Lowering the release elevation would increase the population dose to only 0.12 person-rem/yr. The annual dose to the maximally exposed member of the public from operation of the MFFF would be 4.1E-04 mrem/yr. Lowering the release elevation would increase the annual

dose to the maximally exposed member of the public to 1.5E-03 mrem/yr. The dose to the average individual in the population would be 3.9E-05 mrem/yr increasing to 1.2E-04 mrem/yr if the stack were lowered to ground level. Details regarding calculation of the radiological impact of normal operations of the MFFF on the general public are presented in Appendix D.

#### **5.2.10.2 Radiation Doses to Site Workers**

Site workers are defined as those that work within the SRS boundaries but are not directly involved in process activities at the MFFF. The doses to site workers presented here were determined using the GENII system (Pacific Northwest Laboratory 1988a, 1988b). The calculated dose is the 50-year committed effective dose equivalent due to internal exposure and the effective dose equivalent due to external exposure resulting from one year of release and one year of uptake. Details related to the dose calculations for site workers can be found in Appendix D.

The current spatial distribution of site workers within the SRS boundary is not readily available. Therefore, a population dose for site workers could not be directly determined. Rather, a dose to a site worker located on the MFFF boundary (328 ft [100 m] from the release point) and a dose to a site worker located on the SRS boundary (5 mi [8 km] from the release point) were calculated. Those doses were then multiplied by the total number of site workers to obtain a maximum population dose at the boundary of the MFFF and at the boundary of SRS. These two values provide the maximum and minimum, respectively, estimated population dose for the site workers. Actual dose to SRS site workers is projected to be between these two extremes.

Calculation of the dose due to normal operations of the MFFF for the MEI representing site workers assumed the following:

- Chronic atmospheric releases.
- Exposure pathways of inhalation uptake, external exposure to the airborne plume, and inadvertent soil ingestion.
- All site workers are adults.
- There are no food products grown within the SRS boundary.
- The MEI is located at a distance of 328 ft (100 m) from the release point, which corresponds to the fence of the MFFF.
- The MEI is located in the direction from the release point that gives the maximum dose based on dose calculations for the 16 directions considered by GENII (in the east-northeast direction for the elevated release and in the southwest direction for the groundlevel release).



- The population dose can be bounded by a maximum dose calculated as the MEI dose at the MFFF boundary times the total number of site workers and a minimum dose calculated as the MEI dose at the SRS boundary times the total number of workers.
- A total number of site workers equal to the number of site workers in 2000 (approximately 13,616 workers).
- No previous contamination of the ground surface.
- A finite plume model (i.e., center of the plume located at ground level) for the calculation of dose.
- The annual external exposure time to the plume and to soil contamination is 0.7 year for the MEI (NRC 1977a).
- The annual inhalation exposure time to the plume is 1 year for the MEI (NRC 1977a).
- A stack height equal to the actual stack height rather than the effective stack height to negate plume rise.
- Airborne releases used in the SPD EIS (DOE 1999c), which are about one order of magnitude higher than the releases expected during normal MFFF operations.
- No resuspension of soil particles into the air.
- The meteorological data used to determine dose to the public (see Appendix D) were also used to determine dose to the site workers.

The calculation of dose to the site workers was essentially identical to that for the general public with the following exceptions:

1. The distance from the release point.
2. The number of persons exposed.
3. The spatial distribution of persons exposed.

Radiation dose due to the ingestion of food products was not included for the calculation of dose to the site workers because no agriculture occurs within the SRS boundary and, therefore, consumption of food grown within the SRS boundary is impossible. Workers are also assumed to be members of the public (see Section 5.2.10.1).

The designed vent stack height is 93 ft (28 m) above grade (see Section 3.1.1). Doses were calculated for an elevated release at this height as well as for a groundlevel release (1 ft [0.3 m] above grade). The reason for providing dose calculations using both the designed release height and a groundlevel release is to bound the calculated dose and provide a buffer in the event that the designed building and/or vent stack heights are modified in the future.

Although the construction and operation of the MFFF will disturb 49 ac (19.8 ha) of SRS land, some of this land is already the site of a spoils pile from other F-Area construction, and there will be no impacts to sensitive ecological areas because no such areas were identified on the MFFF site. The construction of the MFFF will require the excavation and recovery of an archaeological site. The archaeological site is not expected to contain any human or sacred artifacts and so the excavation and recovery of the artifacts may represent a benefit through the preservation of the artifacts.

The most significant impact of MFFF operations will be the amount of waste generated. With the exception of the liquid high alpha activity waste, the amounts generated are a small fraction of annual SRS waste generation. The liquid high alpha activity waste generated by the MFFF will be processed in the F-Area Tank Farm. The MFFF liquid high alpha activity waste represents a small increase in the amount of waste currently stored in the F-Area Tank Farm.

Cumulative impacts in the geographic vicinity of the MFFF and SRS are dominated by the impacts of existing SRS activities. SRS is currently in substantial compliance with applicable federal, state, and local air quality regulations, and compliance would be maintained even with the cumulative effects of all surplus plutonium disposition activities. Dose to the public from all activities would increase by 1.2 person-rem per year or about 2.6% over the current SRS dose of 44.8 person-rem per year. With the exception of the liquid high alpha activity waste, which is a new waste stream, all other MFFF wastes represent very small additions to the current SRS waste generation rates and should not represent any significant cumulative impact.

The total dose to transportation workers associated with the  $UF_6$  shipments is estimated to be 0.94 person-rem, corresponding to  $3.76E-04$  LCFs. The total dose to transportation workers associated with the  $UO_2$  shipments is estimated to be 0.69 person-rem, corresponding to  $2.76E-04$  LCFs.

The dose to the public associated with the  $UF_6$  shipments is estimated to be 0.17 person-rem, corresponding to  $8.60E-05$  LCFs. For the  $UO_2$  shipments, the total dose to the public is estimated to be 0.11 person-rem, corresponding to  $5.40E-05$  LCFs.

The cumulative dose to the transportation workers associated with the MOX fuel shipments to the mission reactors is estimated to be 9.8 person-rem, corresponding to  $3.92E-03$  LCFs. The dose to the public associated with these shipments is estimated to be 2.12 person-rem, corresponding to  $1.06E-03$  LCFs.

The incident-free dose per shipment (in person-rem) for the plutonium recycle shipments in NUREG-0170 (NRC 1977c) was calculated to be 0.17, versus a maximum of 0.03 person-rem per shipment for the MOX shipments from the SRS MFFF to the mission reactor sites. The dose to the MEI for the person in traffic next to a shipment of MOX fuel is 2.0 mrem. This dose is a small fraction of the dose received from natural background radiation and is consistent with the conclusions of NUREG-0170 (NRC 1977c).

gal/yr (1.6 billion L/yr) (DOE 1999c). The water treatment system has an approved capacity to service this volume of water. Therefore, no impacts on water availability would be expected.

### **5.2.12 Waste Management Impacts**

MFFF operational impacts on SRS waste management activities are discussed in Section 4.4.2.2 of the SPD EIS (DOE 1999c).

The waste management facilities within the MFFF will transfer all wastes generated to SRS. Table 5-12 compares the expected waste generation rates from operating the MFFF with the existing site waste generation rates.

As described in Section 3.3, the MFFF will not generate any HLW. The aqueous polishing process produces a liquid high alpha activity waste that will be transferred through a double-walled pipe to the F-Area Outside Facility. The aqueous polishing process also produces a uranium waste stream that is transferred to the F-Area Outside Facility with the liquid high alpha activity waste. Unrecyclable solvent will be collected as a liquid hazardous waste at a satellite collection point and transferred to SRS for disposal as a hazardous waste. Potentially contaminated wastewater will be tested for radiological contaminant levels. If levels are acceptable for discharge, the waste will be discharged to the SRS CSWTF. If contaminant levels are not suitable for discharge, the liquid waste will be discharged to the ETF for processing.

Solid wastes will be packaged and certified to meet WSRC WAC, as appropriate, and transferred to SRS for treatment and disposal. All waste will be stored, treated, and disposed by SRS in accordance with the SRS Waste Management Plan. The environmental impacts of SRS waste management were previously evaluated in two DOE EISs (DOE 1995a, 1995b).

Table 5-12 illustrates that the MFFF waste generation rates are generally less than 10% of the SRS generation rates, except for solid TRU waste, which is projected to be about 37% of the SRS annual generation rate. Because MFFF waste generation is small compared to SRS waste generation, any impacts to the environment should be bounded by those evaluated in the previous DOE EISs (DOE 1995a, 1995b). The MFFF will generate a liquid high alpha activity waste. This liquid high alpha activity waste is a new waste stream, and the F-Area Outside Facility is being developed to process this waste appropriately. The MFFF liquid high alpha activity waste is predominately a remotely handled liquid americium stream generated by the aqueous polishing process. This stream will be processed to conform to the WAC requirements for the F-Area Tank Farm in the F-Area Outside Facility and combined with the F-Area liquid HLW.

## **5.3 DEACTIVATION**

### **5.3.1 Introduction**

The MFFF is owned by DOE and operated by DCS under the terms of the DOE-DCS contract and scope of work. After all of the MOX fuel is fabricated, DCS is required to deactivate the

MFFF, terminate the NRC license, and return the facility in its deactivated state back to the DOE. Future use of the facility, including any decision by DOE to decommission or reutilize the facility, will be made after the NRC license is terminated and DCS is no longer involved in this venture. DOE has not determined when and under what circumstances the facility will be decontaminated and either reused or decommissioned (DOE 1999c). As a result, no meaningful alternatives or reasonably foreseeable future impacts of decommissioning can be assessed.

Deactivation is the process of removing a facility from operation and placing the facility in a safe-shutdown condition that is economical to monitor and maintain for an extended period until reuse or decommissioning (DOE 1999d). There are no explicit NRC regulations governing this process other than the requirement to continue compliance with the applicable provisions of 10 CFR Part 20 and 10 CFR Part 70 and any other facility-specific conditions imposed by NRC during MFFF operations. In SECY 99-177 (NRC 1999b), the NRC staff indicated that

... DOE intends to assume responsibility for decommissioning the MOX fuel fabrication facility and has included in its contract with the consortium a requirement that, following completion of its mission for disposition of excess plutonium by conversion to MOX fuel, the facility will be deactivated and returned to DOE for decommissioning.... NRC licensing and regulatory authority applies to "...any facility under a contract with and for the account of the Department of Energy that is utilized for the express purpose of fabrication of mixed plutonium-uranium oxide nuclear reactor fuel for use in a commercial nuclear reactor...", NRC may interpret that authority to apply only when the facility is being operated under contract with DOE. Therefore the regulatory authority would end and the license could be terminated to return the facility to DOE regulatory oversight when the facility is no longer operated for this purpose.

Deactivation is similar to the restricted release of property allowed by 10 CFR §70.38 for decommissioning of facilities. NRC defines decommissioning as removing a facility or site safely from service and reducing residual radioactivity to a level that permits (1) release of the property for unrestricted use and termination of the license; or (2) release of the property under restricted conditions and termination of the license (10 CFR §70.4). The DOE-DCS contract statement of work describes the state of deactivation as having the following characteristics:

1. All loose surface contamination is removed.
2. The facility is accessible without protective clothing.
3. All gloveboxes and associated ventilation systems are sealed in accordance with applicable standards to enable removal from the facility.
4. All systems are depressurized and/or disabled, as applicable, except as required to enable accessibility as stated in (2) above.

5. All remaining unused plutonium and uranium feed materials are packaged in appropriate containers and provided to DOE for disposition. All nuclear waste products are packaged as required in Option 2 of the contract and provided to DOE for disposition.
6. All processing chemical substances are removed and disposed of in accordance with applicable regulations.

Deactivation of the MFFF must be accomplished in a manner that will support the ultimate decommissioning or reutilization of the facility in compliance with the applicable DOE regulations. 10 CFR §20.1101(b) requires that a licensee shall use, to the extent practicable, procedures and engineering controls based upon sound radiation principles to achieve occupational doses and doses to members of the public that are ALARA. Compliance with the ALARA requirement will be required throughout MFFF operations and will continue throughout the deactivation process by minimizing waste volumes and the spread of radioactive contamination. Upon completion of MFFF deactivation, the following conditions shall apply:

- The whole-body dose (internal and external) shall be less than 100 mrem/yr (less than 0.05 mrem/hr for continuous occupancy) for minors, students, visitors, and the public, resulting in a lower limit than specified in 10 CFR §20.1207 and 10 CFR §20.1301(a)(1).
- The external dose from the deactivated facility in any restricted area shall not exceed 2 mrem in any one hour, as specified in 10 CFR §20.1301(a)(2).

Upon completion of MFFF fuel fabrication activities, a preliminary characterization will be performed to establish a baseline of information concerning the physical, chemical, and radiological condition of the facility. These results will serve as the technical basis for selected preferred deactivation techniques and developing the detailed scope of work for the deactivation.

The following subsections discuss the design and administrative features that will facilitate the deactivation of the MFFF to a state where a fuel fabrication license from the NRC is no longer required. This section also discusses the potential environmental impacts associated with these deactivation activities and the availability of the MFFF and its site for reutilization after deactivation is completed.

### **5.3.2 Design Features to Facilitate Deactivation**

Specific features are incorporated into the MFFF design that will facilitate both deactivation and the eventual decommissioning or reutilization of the facility. Facility design features that result in waste minimization, minimization of the spread of radioactive contamination, and maintenance of occupational and public doses at ALARA levels during MFFF operations will also serve to facilitate deactivation.

Design features that will minimize waste generation include placing only essential process equipment in gloveboxes, using materials that are easily cleaned, and isolating utility systems

from plutonium processing equipment to prevent its contamination. These design features will simplify the deactivation approach and result in life-cycle cost reductions.

Six different types of design features are incorporated into the MFFF that will minimize the spread of radioactive contamination and maintain occupational and public doses ALARA:

1. **Plant layout:** All areas of the MFFF are sectioned off into clean areas and potentially contaminated areas with appropriate radiation zone designations to meet 10 CFR Part 20 criteria. Process equipment and systems are situated according to radiation zone designations and have adequate space to facilitate access for required maintenance to permit easy installation of shielding. The plant layout provides for ready removal of equipment and appropriate space for equipment decontamination. Thus, human factors in the design will result in minimal doses during deactivation. In addition, a comprehensive ALARA Report, documenting room-by-room ALARA reviews performed at various stages in the design process, will provide significant input into the deactivation process.
2. **Access control:** In accordance with ALARA design considerations in 10 CFR Part 20, an appropriate entry control program for MFFF radiological areas has been established with associated ingress and egress monitoring. The Access Control Point provides for removal of protective clothing and verification that personnel contamination has not occurred. Step-off pads and locked doors and barriers complete the access control design features, which will be actively used during the deactivation process.
3. **Radiation shielding:** The radiation shielding design is based on conservative estimates of quantity and isotopic materials anticipated during operations. The analyses address both gamma and neutron radiation and include exposures due to scatter and streaming radiation. Therefore, the shielding design will minimize the occupational doses during deactivation.
4. **Ventilation:** The MFFF ventilation system has been designed with the capability of capturing and filtering airborne particulate activity and is continuously maintained under a slight negative pressure. Lastly, gloveboxes and hoods are installed in various rooms to contain and/or move airborne contaminants away from the worker's breathing zone. Each of these design features contributes to meeting ALARA criteria during operations and deactivation.
5. **Structural, mechanical, instrumentation, and electrical components:** Numerous design features of the MFFF (e.g., use of washable epoxy coatings, segregation of waste streams, remote readout for instrumentation, and location of breaker boxes and electrical cabinets in low-dose-rate areas) facilitate decontamination, minimize the spread of contamination, and maintain doses to facility personnel ALARA.
6. **Radiation monitoring:** The MFFF is designed with a comprehensive array of radiation monitoring systems to monitor working spaces and potential releases to the environment for the purpose of protecting the health and safety of the workforce, the public, and the

environment. These systems include area radiation monitoring, airborne radiation monitoring, airborne radioactive effluent monitoring, and alarm monitoring. This protection will be afforded throughout operations and deactivation.

### **5.3.3 Administrative Features to Facilitate Deactivation**

The MFFF design utilizes lessons learned from the operation of the MELOX and La Hague facilities in France to minimize contamination during operations, thereby reducing the effects of contamination on deactivation. Good housekeeping practices are essential in keeping plant surfaces clean. Periodic housekeeping is performed within contaminated areas to minimize the buildup of contamination and contaminated waste. Contaminated gloveboxes and the general work area are decontaminated periodically to minimize removable contamination. Appropriate control zones with limits and action levels to control contamination for those zones will be established. Contamination control will be accomplished through implementation of the many operational programs and practices that will significantly facilitate the eventual deactivation of the facility. These operational programs and practices will continue to be employed throughout facility deactivation and will complement the design features to ensure that the deactivation activities will result in minimal doses.

### **5.3.4 Projected Environmental Impacts of Deactivation**

The design and administrative controls associated with the comprehensive deactivation activities, should maintain occupational and public doses within the ALARA criteria. Therefore, these controls will be well within applicable 10 CFR §20.1207, 10 CFR §20.1301(a)(1) and 10 CFR §20.1301(a)(2) levels. These levels are as follows:

- The whole-body dose (internal and external) shall be less than 100 mrem/yr (less than 0.05 mrem/hr for continuous occupancy) for minors, students, visitors, and the public, resulting in a lower limit than specified in 10 CFR §20.1207 and 10 CFR §20.1301(a)(1).
- The external dose from the deactivated facility in any restricted area shall not exceed 2 mrem in any one hour, as specified in 10 CFR §20.1301(a)(2).

Deactivation will not involve demolition or removal of the buildings. Physical barriers to the release of contamination will continue in place during deactivation. Contaminant releases should be within the levels experienced during operations. Waste generated during deactivation should approximate that generated from routine maintenance activities during the operational phase. All deactivation waste will be processed through the SRS waste treatment systems used during the operational phase of the MFFF. Since the ALARA criteria will be met, there will be no meaningful environmental impacts to the workers and the general public.

### **5.3.5 Accessibility of Land After Deactivation**

Once the MFFF is deactivated and its NRC license terminated, accessibility to the land surrounding the facility will be controlled by DOE and subject to its applicable security requirements. A final radiological survey will verify that the radiological endpoint conditions have been satisfied. This survey will be designed and implemented with the Multi-Agency Radiation Survey and Site Investigation Manual (MARSSIM) methodology that will demonstrate compliance with dose- or risk-based regulation (NRC 2000b). Due to these comprehensive deactivation activities, no accessibility limitations resulting from radioactive contamination are expected.

## **5.4 TRANSPORTATION**

An assessment of the human health risks of the overland transport of radioactive materials is crucial to a complete appraisal of the environment impacts of the MFFF. Operational transportation impacts may be divided into two parts: impacts due to incident-free transportation and those due to transportation accidents. They may be further subdivided into nonradiological and radiological impacts. Nonradiological impacts are specifically vehicular, such as vehicular emissions and traffic accidents. Radiological impacts are those related to the dose received by transportation workers (e.g., truck crew, inspectors) and the public during normal operations and in the case of accidents in which the radioactive material being shipped may be released. See Appendix E for more detailed information on the transportation analysis performed. The following discussion summarizes the transportation risk results for each of the types of material shipments.

### **5.4.1 Plutonium Oxide Feedstock**

Plutonium oxide feedstock will be moved by an appropriate truck from the adjacent PDCF to the MFFF. Because the facilities are adjacent to one another and located on SRS, there will be no need to consider additional environmental impacts associated with plutonium feedstock movement to the MFFF.

### **5.4.2 Uranium Dioxide Feedstock**

A specific supplier of uranium dioxide feedstock has not been selected at this time. For purposes of this ER, the assumptions employed in Section 4.4.2.6 of the SPD EIS (DOE 1999c) were used. A DOE enrichment facility near Portsmouth, Ohio<sup>3</sup>, was chosen as a representative site for the source of the depleted uranium hexafluoride (UF<sub>6</sub>), and a nuclear fuel fabrication facility in Wilmington, North Carolina, was chosen as representative of a uranium conversion facility. A total of 110 shipments of up to five 30-in (76-cm) diameter UF<sub>6</sub> cylinders needed for the MOX fuel would be sent via commercial truck to the uranium conversion facility at Wilmington, North

---

<sup>3</sup>There is a large stockpile of depleted UF<sub>6</sub> from historical operations that will continue to be stored onsite and should be available for use in the fabrication of MOX fuel.



Carolina. After conversion into uranium dioxide, the depleted feed material would be shipped in 55-gal (208-L) drum containers via commercial truck from the conversion facility to the MFFF at SRS. A total of 60 shipments of depleted uranium dioxide would be required to supply sufficient feed material to satisfy the mission requirements for the disposition of 36.4 tons (33 metric tons) of plutonium.

#### **5.4.2.1 Impacts of Incident-Free Transportation**

The total dose for the entire shipping campaign to the transportation workers associated with the  $UF_6$  shipments is estimated to be 0.94 person-rem, corresponding to  $3.76E-04$  LCFs. The total dose to transportation workers associated with the  $UO_2$  shipments is estimated to be 0.69 person-rem, corresponding to  $2.76E-04$  LCFs.

The dose to the public for the entire shipping campaign associated with the  $UF_6$  shipments is estimated to be 0.17 person-rem, corresponding to  $8.60E-05$  LCFs. For the  $UO_2$  shipments, the total dose to the public is estimated to be 0.11 person-rem, corresponding to  $5.40E-05$  LCFs.

The estimated number of nonradiological fatalities due to exhaust emissions exceeds the radiological fatalities. The number of nonradiological fatalities associated with the  $UF_6$  shipments is estimated to be  $1.01E-02$ ; the corresponding value for the  $UO_2$  shipments is  $2.68E-03$ . See Table E-3 for all incident-free transportation impacts.

#### **5.4.2.2 Impacts of Transportation Accidents**

The total transportation accident risks were estimated by summing the risks to the affected population from all hypothetical accidents. For the  $UF_6$  shipments, this process resulted in an estimated number of LCFs of  $2.17E-06$ , well below the nonradiological value of  $2.24E-03$  calculated by applying the historical accident rate by the number of miles shipped for this material. Similarly, for the  $UO_2$  shipments, the estimated number of LCFs is  $1.81E-09$ , well below the nonradiological value of  $6.06E-04$  calculated by applying the historical accident rate by the number of miles shipped for this material. See Table E-3 for all transportation accident impacts.

#### **5.4.2.3 Maximally Exposed Individuals**

The risk to MEIs under incident-free transportation conditions was estimated for four different hypothetical exposure scenarios: (1) an inspector receiving a dose while the vehicle is at a stop, (2) a person stuck in traffic for 30 minutes next to the vehicle, (3) a gas station worker receiving a dose while refueling the truck, and (4) a resident at his or her home located 98 ft (30 m) from the shipment route who is present for all shipments on this route. The maximum dose resulting from these scenarios was obtained for the person stuck in traffic next to a shipment of  $UO_2$ , with an estimated dose of 0.33 mrem (see Table E-8). If the exposure duration was longer, the dose would rise proportionately. This dose is minimal and indistinguishable from background radiation levels.

### **5.4.3 MOX Fuel**

After fabrication, the unirradiated MOX fuel assemblies will be shipped via SafeGuards Transporter (SGT) truck (see Appendix E, Section E.3.3) to the selected commercial reactor sites: McGuire Nuclear Station and Catawba Nuclear Station. Much of the routes to both McGuire and Catawba are similar because of the close proximity of the two sites. These two sites, housing four reactors, represent the current contracts for irradiation of MOX fuel. Any additional MOX fuel irradiation in unspecified reactors (up to the 36.4 tons [33 metric tons] of plutonium specified in the contract) would be addressed in a supplement to the ER at the time additional reactors are selected. Between 2007 and 2021, a total of about 1,316 MOX fuel assemblies will be shipped from the MFFF at SRS to the mission reactors, with 238 shipments to the Catawba Nuclear Station and 212 shipments to the McGuire Nuclear Station. Although the plutonium content will average about 4.3% of the total heavy metal per assembly, a maximum value of 6.0% plutonium content was used for the source term in the analysis for conservatism.

#### **5.4.3.1 Impacts of Incident-Free Transportation**

For all fuel shipments, the total dose to transportation workers, during the entire campaign, is estimated to be 9.8 person-rem, corresponding to 3.92E-03 LCFs (see Table E-3). The dose to the public associated with these shipments is estimated to be 2.12 person-rem, corresponding to 1.06E-03 LCFs (see Table E-3).

The estimated number of nonradiological fatalities (1.48E-02) due to exhaust emissions exceeds the radiological fatalities (1.06E-03). The number of nonradiological fatalities associated with the MOX shipments is very similar for each of the reactor sites since it is a function only of the total distance traveled.

#### **5.4.3.2 Impacts of Transportation Accidents**

The total transportation accident risks were estimated by summing the risks to the affected population from all hypothetical accidents for each of the individual routes and multiplying by the number of shipments to each site. For all MOX shipment routes, the nonradiological risks greatly exceed the radiological risks. The total number of LCFs due to radiological causes for the MOX fuel shipments is estimated to be 1.69E-15. The maximum nonradiological estimate yielded 3.29E-03 fatalities, calculated by applying the historical accident rate by the number of miles shipped for this material.

#### **5.4.3.3 Maximally Exposed Individuals**

The risk to MEIs under incident-free transportation conditions was estimated for four different hypothetical exposure scenarios: (1) an inspector receiving a dose while the vehicle is at a stop, (2) a person stuck in traffic for 30 minutes next to the vehicle, (3) a gas station worker receiving a dose while refueling the truck, and (4) a resident at his or her home located 98 ft (30 m) from the shipment route who is present for all shipments on this route. However, the dose to the

inspector and the gas station worker for the MOX shipments is not considered since these duties are performed by the SGT crew (who are subject to a radiation monitoring program). The maximum dose resulting from these scenarios was obtained for the person stuck in traffic next to a shipment of MOX fuel, with an estimated dose of 2.0 mrem (see Table E-8). If the exposure duration was longer, the dose would rise proportionately. This dose is minimal and indistinguishable from background radiation levels.

#### **5.4.4 Radioactive Wastes**

All radioactive wastes will be moved from the MFFF to the SRS centralized facilities for radioactive waste treatment, storage, and disposal. These wastes will be handled in the same manner as other SRS site waste shipments and would not represent a large increase in the amount of waste generated at the site. The environmental impacts of transportation of waste from the SRS centralized facilities to ultimate disposal sites are documented in the Waste Management PEIS (DOE 1997a) and the SRS Waste Management Final EIS (DOE 1995b).

#### **5.4.5 Comparison with NUREG-0170**

The NRC analyzed the environmental impacts of the normal routine transportation of radioactive material in NUREG-0170, *Final Environmental Statement on the Transportation of Radioactive Material by Air and Other Modes* (NRC 1977c). This EIS included an evaluation of the impact of fuel cycle shipments in 1975 and a projected estimate of shipments in 1985. The 1985 projections reflected the potential development of plutonium recycle and included an estimate of 41 shipments of MOX fuel assemblies via truck. A total of 450 MOX shipments will be required for the MFFF over a period of 13 1/2 years, an average of about 33 shipments per year.

The NRC determined that the environmental impacts of normal transportation of radioactive material and the risk attendant to accidents involving these materials (which includes those fuel cycle activities associated with power production) were sufficiently small to allow continued shipments via the existing federal regulations. The analysis concluded that "The average radiation dose to the population at risk from normal transportation is a small fraction of the limits recommended for members of the general public from all sources of radiation other than natural and medical sources and is a small fraction of natural background dose." This conclusion has been confirmed for the MOX fuel shipments by comparing the dose determined by the NRC in its 1985 projections with a calculated dose from the SRS MFFF to the reactor sites at McGuire and Catawba Nuclear Stations. The incident-free dose per shipment (in person-rem) for the plutonium recycle shipments in NUREG-0170 was calculated to be 0.17, versus a maximum of 0.03 person-rem per shipment for the MOX shipments from the SRS MFFF to the mission reactor sites. The dose to the MEI for the person in traffic next to a shipment of MOX fuel is 2.0 mrem. This dose is a small fraction of the dose received from natural background radiation and is consistent with the conclusions of NUREG-0170.

## **5.5 FACILITY ACCIDENTS**

This section summarizes the evaluation of potential facility accidents at the MFFF. The evaluation includes internal process-related events, external man-made events, and events associated with natural phenomena. The evaluations of these events show that the environmental risk from a facility accident is low.

The information presented in this section is based on the MFFF Integrated Safety Analysis, Safety Assessment of the Design Basis. The analysis method uses conservative assumptions and produces a comprehensive, bounding analysis. Appendix F provides additional analysis details.

### **5.5.1 Environmental Risk Assessment Method**

Accidents that could occur as a result of MFFF operations are identified and evaluated in a systematic, comprehensive manner. The general approach includes the following evaluations:

- Internal Hazard Identification – A systematic and comprehensive identification of radioactive, hazardous material, and energy sources throughout the MFFF
- External Hazard Identification – A systematic and comprehensive identification of applicable natural phenomena and events originating from nearby facilities
- Hazard Evaluation – A systematic and comprehensive evaluation to postulate event scenarios involving the information developed in the Hazard Identification
- Accident Analysis – A detailed evaluation of postulated events to determine consequences and frequencies and to identify appropriate prevention and mitigation features. The accident analysis evaluates all credible events as defined in Appendix F. Thus, all internally initiated accidents are evaluated without regard to their initiating frequency, and all natural phenomena hazard and external man-made hazard generated events are evaluated unless their probability of impacting the MFFF is extremely low. The results of the evaluation include events with no or low consequences, design basis events, and severe accidents.

### **5.5.2 Environmental Risk Assessment Summary**

Potential accidents that could occur as a result of MFFF operations have been grouped into one of the following event types:

- Natural phenomena
- Loss of confinement
- Internal fire
- Explosion
- Load handling
- External man-made events

- Criticality
- Direct radiation exposure
- Chemical releases.

The environmental risk assessment addresses the consequences associated with accidents in each event type up to and including design basis accidents. The environmental impacts of beyond design basis events are remote and speculative and do not warrant consideration under NEPA. While beyond design basis events are theoretically possible, their likelihood of occurrence is so low as to not result in any significant, additional risk from MFFF operations.

Design basis events for each event type are discussed in the following sections.

#### **5.5.2.1 Natural Phenomena**

A screening process was performed on a comprehensive list of natural phenomena to identify those credible natural phenomena that have the potential to affect the MFFF during the period of facility operation. Credible natural phenomena that could have an impact on MFFF operations include the following:

- Extreme winds
- External flooding
- Earthquakes
- Tornadoes
- External fires
- Rain, snow, and ice
- Lightning.

Natural phenomena could result in either the dispersion of radioactive material and hazardous chemicals or a loss of subcritical conditions. Natural phenomena events are discussed in the following sections.

##### **5.5.2.1.1 Extreme Winds**

Extreme winds are straight-line winds associated with thunderstorms or hurricanes. The design basis extreme wind has an annual exceedance probability of 1E-04. Extreme wind loads include loads from wind pressure and wind-driven missiles.

The associated wind load criteria are based on a basic wind speed of 130 mph. The wind-driven missile considered in the design is a 2- by 4-in (5.1- by 10.2-cm) timber plank, 15 lb (6.8 kg), at 50 mph (horizontal), at a maximum height of 50 ft (15.2 m).

The MFFF is designed to withstand the effects of the design basis extreme wind and the associated missiles. The design and associated margin reduce the likelihood of significant damage to the MFFF to Highly Unlikely. The likelihood definition is provided in Appendix F.

Thus, no significant radioactive or hazardous material release or loss of subcritical conditions at the MFFF is postulated to occur for extreme wind events.

#### 5.5.2.1.2 External Flooding

External flooding includes floods associated with rising rivers or lakes. The design basis flood has an annual exceedance probability of 1E-05 and would be expected to reach an elevation of less than 210 ft (64 m) above msl at SRS.

The MFFF site elevation is greater than 260 ft (79 m) above msl. Thus, no radioactive or hazardous material release or loss of subcritical conditions at the MFFF is postulated to occur for external floods.

#### 5.5.2.1.3 Earthquakes

Earthquakes may result from movement of the earth's tectonic plates or volcanic activity. The design basis earthquake for the MFFF site is selected to have a 0.20g maximum horizontal ground acceleration and a maximum vertical ground acceleration of 0.13g applied at grade. This represents an event with an annual exceedance probability of approximately 1E-04. The possibility of soil liquefaction during an earthquake is also evaluated.

The MFFF is designed to withstand the effects of the design basis earthquake. The design and the associated design margin reduce the likelihood of significant damage to the MFFF to Highly Unlikely. Thus, no significant radioactive or hazardous material release or loss of subcritical conditions at the MFFF is postulated to occur for earthquakes.

#### 5.5.2.1.4 Tornadoes

Tornadoes may occur in extreme weather such as thunderstorms or hurricanes. The design basis tornado has an annual exceedance probability of 2E-06. Tornado loads include loads due to tornado wind pressure, loads created by the tornado-created differential pressure, and loads resulting from tornado-generated missiles.

The associated wind load criteria and differential pressure load criteria for the MFFF site are based on the following:

- Maximum tornado wind speed: 240 mph
- Pressure drop across tornado: 150 psf
- Rate of pressure drop: 55 psf/sec.

The associated tornado-generated missile load criteria are based on the following:

Missile Description	Mass (lb)	Size (in)	Horizontal Impact Speed (mph)	Maximum Height (ft)	Vertical Impact Speed (mph)
Penetrating missile – 3-in (7.6-cm) diameter steel pipe	75	3 ½ (outside diameter)	75	100	50
Small missile – 2- by 4-in (5.1- by 10.2-cm) timber plank	15	1 ½ by 3 ½	150	200	100
Automobile	3,000	not applicable	25	rolls and tumbles	not applicable

The MFFF is designed to withstand the effects of the design basis tornado, and missile barriers are provided at building openings as necessary. The design and the associated design margin reduce the likelihood of significant damage to the MFFF to Highly Unlikely. Thus, no significant radioactive or hazardous material release or loss of subcritical conditions at the MFFF is postulated to occur for tornadoes.

#### 5.5.2.1.5 External Fires

External fires are those fires associated with nearby forests or vegetation. Fires associated with nearby facilities are discussed in Section 5.5.2.6. The design basis external fire assumes a forest fire occurs in the forest nearby the MFFF site.

The MFFF is designed to withstand the design basis external fire. Thus, no radioactive or hazardous material release or loss of subcritical conditions at the MFFF is postulated to occur for external fires.

#### 5.5.2.1.6 Rain, Snow, and Ice

Rain, snow, and ice are postulated to occur at the MFFF site several times during operation of the facility. The design basis rainfall has an annual exceedance probability of 1E-05, which corresponds to a peak rainfall of 7.4 in (18.8 cm) in one hour, or 3.9 in (9.9 cm) in 15 minutes. The design basis snow and ice events have an annual exceedance probability of 1E-02. The loads associated with these events are less than 10 psf. The effects of snow and ice loads associated with events that have a lower annual exceedance probability are bounded by the design for other live loads.

The MFFF is designed to withstand the effects of rain, snow, and ice. Thus, no radioactive or hazardous material release or loss of subcritical conditions at the MFFF is postulated to occur during or following these conditions.

#### 5.5.2.1.7 Lightning

Lightning occurs during extreme weather (e.g., thunderstorms) and is postulated to occur on or near the MFFF site several times per year. Protection is provided in accordance with NFPA 780 (NFPA 1997). Thus, no radioactive or hazardous material release or loss of subcritical conditions at the MFFF is postulated to occur during or following these conditions.

#### 5.5.2.2 Loss of Confinement

Within the MFFF, radioactive material is confined within one or more confinement barriers. Primary confinement barriers include gloveboxes and the associated ventilation systems; welded vessels, tanks, and piping; plutonium storage (inner can) containers; fuel rod cladding; ventilation system ducts and filters; and some process equipment. Secondary confinement barriers include plutonium storage containers (outer can), process rooms and the associated ventilation systems, and process cells and the associated ventilation systems. Tertiary confinement systems include the MFFF building and the associated ventilation systems.

The loss or damage of the primary confinement barrier may result in either the dispersion of radioactive materials and hazardous chemicals or a loss of subcritical conditions. Criticality events and the effects of hazardous chemicals are discussed in Sections 5.5.2.7 and 5.5.2.9, respectively. The loss at each level of confinement is necessary for a non-negligible release from the MFFF site to occur.

Damage to or failure of the confinement barriers can be caused by human error or equipment failure resulting in the following:

- Failure of negative pressure or a flow perturbation causing flow reversals between some confinement zones
- Breaches of container or rod confinement boundaries due to crushing, shearing, grinding, cutting, and handling errors
- Backflow into lines that penetrate primary and secondary confinement boundaries
- Corrosion-induced confinement failures
- Pipe or vessel breaks or leaks
- Clogging of filters
- Failure of filters
- Glove or seal failures during normal or maintenance operations
- Thermal excursions leading to failure of gloves, seals, and/or cladding.



Loss-of-confinement events caused by fires, explosions, load-handling events, natural phenomena, and external events are covered in their respective event discussions. Loss-of-confinement events are postulated to occur and are evaluated for each primary confinement within the MFFF without regard to the probability of the initiating event. Postulated loss-of-confinement events include the following:

- Loss of confinement from a glovebox containing powders, pellets, or fuel rods
- Loss of confinement from aqueous polishing process equipment containing plutonium in solution form
- Loss of confinement from canisters, fuel rods, fuel assemblies, HEPA filters, or waste drums
- Loss of confinement from transportation packages or UO<sub>2</sub> drums.

The loss-of-confinement event postulated to produce the largest radiological consequences is an event caused by an internal fire involving the PuO<sub>2</sub> Buffer Storage Unit. See Section 5.5.2.3 for a description of this event. The bounding radiological consequences associated with this event are provided in Table 5-13. The frequency associated with this event is estimated to be unlikely or lower since multiple failures are required for this event to occur.

The MFFF utilizes many features to reduce the likelihood and consequences of this event as well as other loss-of-confinement events. Key features include reliable and redundant confinement systems; process temperature, pressure, and flow controls; radiation monitoring systems; redundant control systems; emergency procedures; and worker training.

As shown in Table 5-13, the radiological consequences at the site boundary are low. Such impacts would not be sufficient to warrant evacuation of the public or interdiction or decontamination of land or food supplies. Table 5-13 also shows that the radiological consequences to the nearest SRS worker are low.

Given the low consequences and/or small likelihood of this type of accident, the radiological risk from the loss-of-confinement events is low.

### **5.5.2.3 Internal Fire**

A fire hazard arises from the simultaneous presence of combustible materials, an oxygen source, and a sufficient ignition source. A fire can spread from one point to another by conduction, convection, or radiation. The immediate consequence of a fire is the destruction, by combustion or by thermal damage, of elements in contact with the fire. A fire can lead to either the dispersion of radioactive materials and hazardous chemicals or a loss of subcritical conditions. Criticality events and the effects of hazardous chemicals are discussed in Sections 5.5.2.7 and 5.5.2.9, respectively.

Fires can be caused by human error, electrical equipment failures, equipment that operates at high temperatures, uncontrolled chemical reactions, or static electricity.

Fires are postulated to occur and are evaluated for each fire area within the MFFF without regard to the probability of the fire occurring. Fire areas and the associated fire boundary limit the size of the fire and contain the fire within the fire area. MFFF fire areas are relatively small and generally correspond to room boundaries. Thus, a facility-wide fire or a fire involving two or more fire areas simultaneously is a remote and speculative event. Postulated fires include the following:

- Fires within a fire area involving gloveboxes containing plutonium powder, pellets, or fuel rods
- Fires within a fire area involving aqueous polishing process equipment containing plutonium in solution form
- Fires within a fire area involving fuel rods, fuel assemblies, canisters of plutonium, HEPA filters, or waste drums
- Fires within a fire area involving plutonium in transportation packages or uranium in drums.

The fire event postulated to produce the largest radiological consequences is a fire in the fire area containing the PuO<sub>2</sub> Buffer Storage Unit. This unit is the storage location for “pots” of polished plutonium powder. The evaluation conservatively assumes that a fire occurs in this fire area and impacts the powder stored in this area, resulting in a release of radioactive material. The bounding radiological consequences associated with this event are provided in Table 5-13. The frequency associated with this event is estimated to be unlikely or lower since multiple failures are required for this event to occur. Appendix F provides assumptions associated with this event and the other bounding events.

The MFFF utilizes many features to reduce the likelihood and consequences of this event as well as other fire-related events. Key features include fire barriers, minimization of combustibles and ignition sources, ventilation systems with fire dampers and HEPA filters, nitrogen blanket systems, qualified canisters and containers, fire suppression and detection systems, emergency procedures, worker training, and local fire brigades.

As shown in Table 5-13, the radiological consequences at the site boundary are low. Such impacts would not be sufficient to warrant evacuation of the public or interdiction or decontamination of land or food supplies. Table 5-13 also shows that the radiological consequences to the nearest SRS worker are low.

Given the low consequences and/or small likelihood of this type of accident, the radiological risk from fire events is low.

#### **5.5.2.4 Explosion**

Internal explosion events within the MFFF result from the presence of potentially explosive mixtures and potential overpressurization events. These events may result in either the dispersion of radioactive materials and hazardous chemicals or a loss of subcritical conditions. Criticality events and the effects of hazardous chemicals are discussed in Sections 5.5.2.7 and 5.5.2.9, respectively. Explosions may be caused by human error or equipment failure and include the following:

- Loss of instrument air or offgas exhaust flow in units where radiolysis is possible
- High flow of fluids into tanks or vessels
- Pressurizing chemical reactions in vessels or tanks
- Increase in temperature beyond the safety limit in tanks and vessels
- Incorrect chemical addition/reagent preparation
- Excessive introduction of hydrogen into furnace
- Hydrogen accumulation
- Oxygen leaks
- Organic liquid vapor/methane reactions.

Postulated explosions include explosions involving flammable gases, chemical interactions, and overpressurization events.

The MFFF processes are designed to preclude explosions through the use of reliable engineering features and administrative controls. Key features include scavenging air systems, hydrogen monitoring systems, temperature control systems, chemical addition and concentration control systems, sampling systems, process shutdown controls, operator training, and operations and maintenance procedures. Simultaneous failure of the design features and administrative controls resulting in an explosion and the subsequent release of radioactive materials is highly unlikely. Thus, explosions at the MFFF resulting in a radioactive material release are remote and speculative and need not be considered under NEPA.

Although explosion events resulting in a radioactive material release at the MFFF are remote and speculative events, a hypothetical explosion event is evaluated. The evaluation conservatively assumes that an explosion occurs in an aqueous polishing process cell and involves the maximum material at risk in any process cell. The radiological consequences of this hypothetical event are presented in Table 5-13. As shown, the impacts to the public and the SRS workers are low.

Given the low consequences and/or small likelihood of this type of accident, the radiological risk from explosion events is low.

#### **5.5.2.5 Load Handling**

A load-handling hazard arises from the presence of lifting or hoisting equipment used during either normal operations or maintenance activities. A load-handling event occurs when either the

lifted load is dropped or the lifted load or the lifting equipment impacts other nearby items. A load-handling event may result in either the dispersion of radioactive materials and hazardous chemicals or a loss of subcritical conditions. Criticality events and the effects of hazardous chemicals are discussed in Sections 5.5.2.7 and 5.5.2.9, respectively.

Load-handling events can be caused by equipment failure or human error.

Load-handling events are postulated to occur and are evaluated for all primary confinements throughout the MFFF without regard to the probability of the initiating event. Postulated load-handling events include the following:

- Drops impacting a glovebox containing powders, pellets, or fuel rods
- Drops impacting aqueous polishing process equipment containing plutonium in solution form
- Drops involving plutonium in canisters, fuel rods, fuel assemblies, HEPA filters, or waste drums
- Drops involving plutonium in transportation packages or uranium in drums.

The load-handling event postulated to produce the largest radiological consequences is a drop event involving the glovebox in the Jar Storage and Handling Unit. This glovebox contains jars of plutonium powder. The glovebox is postulated to be impacted during maintenance operations by either a lifting device or a lifted load outside of the glovebox, damaging a portion of the glovebox causing some of its contents to drop to the floor, resulting in a release of radioactive material. The bounding radiological consequences associated with this event are provided in Table 5-13. The frequency associated with this event is estimated to be unlikely or lower since multiple failures are required for this event to occur.

The MFFF utilizes many features to reduce the likelihood and consequences of this event as well as other load-handling events. Key features include loadpath restrictions, crane-operating procedures, maintenance procedures, operator training, qualified canisters, reliable load-handling equipment, and ventilation systems with HEPA filters.

As shown in Table 5-13, the radiological consequences at the site boundary are low. Such impacts would not be sufficient to warrant evacuation of the public or interdiction or decontamination of land or food supplies. Table 5-13 also shows that the radiological consequences to the nearest SRS worker are low.

Given the low consequences and small likelihood of this type of accident, the radiological risk from load-handling events is low.

### **5.5.2.6 External Man-Made Events**

External man-made events originate from the operations of facilities or vehicles nearby the MFFF site. These events could then initiate events at the MFFF. The categories of nearby facilities and vehicles considered include the following: industrial facilities, military facilities, chemical facilities, SRS facilities, pipelines, automobiles, trucks, aircraft, helicopters, trains, and ships/barges. Events from these facilities and vehicles that could impact the MFFF are radiological releases, chemical releases, explosions, fires, and direct impact on the MFFF (i.e., airplane crash).

A screening evaluation was performed to determine if any credible external man-made events could impact MFFF operations. The screening evaluation determined that credible external man-made events will not significantly impact MFFF operations. The effects on the MFFF or the consequences from any potential MFFF event initiated by a credible external man-made event are bounded by the effects and consequences of events initiated by natural phenomena or MFFF internal hazards.

The screening evaluation did not include the effects of two nearby SRS facilities, PDCF and the PIP, due to their early design stage. These facilities will be evaluated as their safety analyses become available. It is expected that the effects on the MFFF from credible events at these facilities are bounded by the effects of the natural phenomenon hazards and internal events currently evaluated. If necessary, additional features will be incorporated into the MFFF design and operations to account for potential accidents at these facilities.

Given the low consequences and small likelihood of this type of accident, the radiological risk from external man made events is low.

### **5.5.2.7 Criticality**

Criticality is a physical phenomenon characterized by the attainment of a self-sustaining fission chain reaction. Criticality accidents can potentially release a large amount of energy over a short period of time. A criticality hazard arises whenever fissionable materials (e.g., uranium-235 or plutonium-239) are present in sufficient quantities to attain a self-sustaining fission chain reaction under optimal conditions.

The immediate consequence of a criticality accident is a rapid increase in system thermal power and radiation as a “fission spike” that is generally terminated by heating and thermal expansion of the system. Subsequent spikes of less intensity may be expected. Direct radiation and dispersion of radioactive materials occur during and following a criticality accident. However, the direct radiation hazard to the public and the site worker is negligible since the radiation shielding afforded by facility structural features and the distances to these receptors inherently mitigate the direct radiation.

Criticality events can be caused by human error or equipment failure.

The MFFF processes are evaluated to determine where criticality events are possible. Further evaluations are performed, and prevention controls and measures are identified. Key controls include Geometry, Mass, and Moderation. These controls provide the primary means of protection against nuclear criticality events at the MFFF. Adherence to the double contingency principle, as specified in ANSI/ANS-8.1 (ANSI/ANS 1983b), ensures that a criticality event is Highly Unlikely. Thus, a criticality event at the MFFF is a remote and speculative event.

Although criticality events at the MFFF are remote and speculative, a generic hypothetical criticality event is evaluated. Regulatory Guides 3.71 (NRC 1998c) and 3.35 (NRC 1979) provide guidance for developing source terms for direct radiation and airborne releases resulting from a criticality accident. The radiological consequences of this hypothetical event are presented in Table 5-13. In addition to the consequences shown in Table 5-13, the radiological consequences to a nearby MFFF worker (within meters of the event) could be severe.

Given the low likelihood of a criticality event occurring, and the low potential consequences to the site worker and public, the overall radiological risk from a criticality event is low.

#### **5.5.2.8 Direct Radiation Exposure**

A direct radiation hazard arises from the presence of radioactive material within the MFFF. Direct radiation exposure events include those events that result in a radiation dose from radiation sources external to the body. Due to the nature of the radioactive material present in the MFFF and the distance to the site boundary, there are no accidents at the MFFF that produce a direct radiation exposure hazard to the public from MFFF operations. Furthermore, there are no accidents (other than criticality) that produce a significant direct radiation hazard to the SRS workers.

#### **5.5.2.9 Chemical Releases**

A chemical hazard arises mainly from the use of chemicals in the aqueous polishing process and, to a much lesser extent, from chemicals used in the fuel fabrication process. Chemicals evaluated include those used during all modes of operation, those produced as a byproduct of operations, and those potentially produced by inadvertent chemical mixing and interactions. Chemical releases are postulated to occur from human error and equipment failures.

Consequences of chemical releases were determined for a potential release of each chemical. The results indicate that the concentration of all chemicals at the site boundary following a release from the MFFF is low. The results also indicate that the maximum chemical concentration for an SRS worker is low. The frequency of significant chemical releases at the MFFF is conservatively estimated to be unlikely. Appendix F provides additional information related to the chemical evaluation.

MFFF features to reduce the frequency and magnitude of a chemical release include the following: reagent preparation controls, separation and segregation of incompatible reagents,

process temperature controls, ventilation controls, vessel level indications, drip trays, leak detection, sumps, drains, operating procedures, emergency procedures, operator training, hazardous material control, toxic gas exhaust systems, and an emergency control room.

Given the low consequences and/or small likelihood of this type of accident, the risk from chemical releases is low.

### **5.5.3 Evaluation of Facility Workers**

The risk to workers is qualitatively evaluated for all MFFF events. Sufficient engineering design features and administrative controls have been incorporated into the MFFF design to ensure that any unacceptable consequence is highly unlikely.

Key design features include shielding, confinement systems, criticality and explosion prevention structures, systems, and components (SSCs), radiation monitoring systems, and fire protection systems. Key administrative controls include operator training, criticality safety, radiation protection, fire safety, and industrial hygiene programs. In addition, workers are trained and qualified and perform their work in accordance with approved procedures.

Given the low consequences and/or low likelihood of events, the overall radiological risk to the MFFF worker is low.

### **5.5.4 Conclusions**

The environmental impacts that have been considered include potential radiation and chemical exposures to individuals and to the population as a whole, the risk of near- and long-term adverse health effects that such exposures could entail. The evaluation demonstrates that the environmental risk is low.

## **5.6 CUMULATIVE IMPACTS**

Cumulative impacts are the impacts on the environment which result from the incremental impact of the proposed action when added to other past, present, and reasonably foreseeable future actions regardless of what agency or person undertakes those other actions. In the case of the MFFF, the cumulative impacts are divided into the following groupings:

1. **Impacts from SRS activities:** These are other activities in geographic proximity to the MFFF that combine with the MFFF to produce a larger impact to the environment than the MFFF alone. Included in these impacts are those related to construction, operation, and deactivation of the PDCF and PIP.
2. **Impacts of other actions near the MFFF and SRS:** These are impacts from activities of other federal or state agencies or private industry that may combine with the MFFF and SRS impacts to produce a larger impact to the environment than the MFFF alone.

3. **Transportation impacts:** These are impacts that the proposed action causes to the environment beyond the geographic bounds of the MFFF or SRS.
4. **Impacts at mission reactors:** These are impacts related to the proposed MFFF but not directly connected to MFFF operations.

Each of these impacts is discussed in the following sections.

### 5.6.1 Impacts from SRS Activities

The SPD EIS (DOE 1999c) discussed the impacts from constructing the PDCF and PIP. Data presented in Appendices G, H, and J of the SPD EIS are summarized in Table 5-14.

In Section 4.32.4 and Appendix F of the SPD EIS, DOE provided an extensive discussion on the cumulative impacts of the three plutonium disposition facilities at SRS. Their discussion, with only minor clarifications, as appropriate, is incorporated in this section.

In the SPD EIS, Alternative 3 represented all three plutonium disposition facilities located at SRS. In the following discussion, the various activities at SRS are summed as “other site activities” to distinguish their impacts from the plutonium disposition activities. Design changes to the MFFF, subsequent to the analyses of cumulative impacts, are not expected to significantly alter the magnitude of the cumulative impacts presented in the SPD EIS. Cumulative impacts from the plutonium disposition facilities are dominated by impacts from the PDCF and PIP.

Cumulative impact on land use is dominated by existing SRS land use activities. All three surplus plutonium disposition facilities are minor contributors to this impact. Because SRS already represents a large amount of developed land, the MFFF does not significantly contribute to this cumulative impact.

SRS is currently in substantial compliance with applicable federal, state, and local air quality regulations and compliance would be maintained even with the consideration of the cumulative effects of all surplus plutonium disposition activities. As shown in Table 5-15, the projected air quality contributions of the surplus plutonium disposition facilities to overall site concentrations are extremely small.

Cumulative impacts, in terms of radiation exposure on the public and workers at SRS, are also dominated by the other SRS activities. Dose to the public from all SRS activities would increase by about 2.6%. Therefore, the human health impacts from the operation of the surplus plutonium disposition facilities are *de minimus*.

Cumulative impacts of plutonium disposition on SRS waste management infrastructure are presented in Table 5-15. The MFFF generates a new waste stream, a liquid high alpha activity waste. The MFFF liquid high alpha activity waste is largely a liquid americium stream produced by the aqueous polishing process. This stream will be transferred by double-walled pipe to the treatment facility at the F-Area Outside Facility. The volume of the stream should be reduced



significantly through processing before the waste is released from the SRS treatment facility. Waste classification will be determined by SRS. All other MFFF wastes represent very small additions to the current SRS waste generation rates and should not represent any significant cumulative impact.

In the SPD EIS, DOE concluded that decommissioning of the PDCF and PIP was too far into the future to allow any meaningful evaluation of impacts.

### **5.6.2 Impacts from Other Nearby Actions**

Nuclear facilities within a 50-mi (80-km) radius of SRS include the following:

- Georgia Power Company's Vogtle Electric Generating Plant in Sardis, Georgia, across the river from D Area of SRS
- Chem-Nuclear Services LLW disposal facility, several miles east of SRS
- Starmet CMI, Inc., located southeast of SRS, which processes uranium-contaminated metals.

Radiological impacts from operation of Vogtle Electric Generating Plant, a two-unit commercial nuclear power plant, are minimal. However, DOE factored them into the human health risk analysis for the SRS activities. The SCDHEC Annual Report (SCDHEC 1996) indicated that operation of the Chem-Nuclear Services facility and the Starmet CMI facility does not noticeably impact radiation levels in air or liquid pathways in the vicinity of SRS. Therefore, they are not included in this assessment.

The counties surrounding SRS have numerous existing and planned industrial facilities with permitted air emissions and discharges to surface water. Because of the large distances between SRS and the private industrial facilities (e.g., more than 20 mi [32.2 km] from Augusta-Richmond County industrial complex), there is little opportunity for interactions of facility emissions, and no major cumulative impact on air or water quality.

The planned federal and state highway projects in the vicinity of SRS, discussed in Section 4.10.3, are all expected to be completed before construction of the MFFF and do not represent a cumulative impact.

### **5.6.3 Transportation Impacts**

Transportation impacts are discussed in Section 5.4.

### **5.6.4 Impacts Related to Fuel Irradiation at Mission Reactor Sites**

The irradiation of MOX fuel is a related action that was evaluated in the SPD EIS (DOE 1999c). In the SPD EIS, DOE reported information about the mission reactors concerning the projected

irradiation of MOX fuel. DOE used this information to project the impacts that might be expected from irradiating MOX fuel.

As discussed in Section 4.28 of the SPD EIS, there are no anticipated construction impacts because the irradiation of MOX fuel will not require any construction at the mission reactors. The SPD EIS discussed impacts to air quality, water quality, waste management, socioeconomics, human health, ecological resources, cultural resources, land use, and infrastructure. The SPD EIS determined that there should be no change in impacts to the environment during normal operations at the mission reactors resulting from the irradiation of MOX fuel. This conclusion is reinforced by a communication from Electricite de France, which operates several MOX fuel power plants in France. Electricite de France (Provost 1998) noted that average dose to the public at operating MOX fueled plants was not sensitive to low enriched uranium or MOX fuel and approximated 1  $\mu\text{Sv}/\text{yr}$  (0.1 mrem/yr), compared to natural exposure of 2,500  $\mu\text{Sv}/\text{yr}$  (250 mrem/yr).

The SPD EIS (Section 4.28.2.5) also determined that the impacts on the public of the design basis and beyond design basis accidents for the mission reactors involving MOX fuel were not significantly different from the impact of accidents involving low enriched uranium fuel. The analysis results reported by DOE were obtained using somewhat different methodology than would be used for NRC safety analyses. However, the results still support the conclusion that the environmental impacts related to the use of MOX fuel at the mission reactors are not significantly different from the impacts related to using uranium fuel. Safety and environmental impacts of design basis and beyond-design basis accidents will be analyzed by the mission reactor licensee as part of the 10 CFR Part 50 reactor license amendment process.

#### **5.6.5 Impacts to Commercial Fuel Fabrication**

The amount of MOX fuel that will be produced by the MFFF represents less than 1% of the domestic commercial fuel used (Clark 2000). Consequently, financial impacts to commercial fuel fabrication should be minimal.

### **5.7 ALTERNATIVES TO THE PROPOSED ACTION**

Alternatives to the MFFF facility were evaluated as part of the SPD EIS (DOE 1999c). The SPD EIS ROD (DOE 2000b) announced the decisions regarding alternatives. It should be emphasized that the alternatives considered in the SPD EIS are not alternatives to the proposed action in this ER and therefore will not be presented in this ER. The No Action Alternative for this ER is denial of a license to possess and use SNM. This No Action Alternative, however, does not meet the "need" for the facility as described in the SPD EIS ROD or the joint U.S.-Russian Federation Agreement signed in September 2000 (White House 2000). The consequences of the No Action Alternative, continued long-term storage of surplus plutonium, are identical to the consequences for the No Action Alternative described in the SPD EIS. The impacts of this alternative are described in Section 5.7.1. The Preferred Alternative presented in the SPD EIS, and chosen in the SPD EIS ROD, included the location of the MFFF in F Area at SRS. Accordingly, the

guidance in Appendix F of NUREG-1718 (NRC 2000a) regarding siting alternatives are not deemed relevant, and only siting alternatives for the MFFF within F Area are considered in this ER. This evaluation is discussed in Section 5.7.2. Design alternatives that may impact the environment are discussed in Section 5.7.3.

### **5.7.1 No Action Alternative**

As discussed in Section 1.3, the No Action Alternative is denial of a license to possess and use SNM. This No Action Alternative, however, does not meet the “need” for the facility as described in the SPD EIS ROD (DOE 2000b) or the joint United States-Russian Federation Agreement signed in September 2000 (White House 2000). The consequences of the No Action Alternative are continued storage of surplus plutonium at existing facilities. Surplus plutonium is currently stored at (1) the Hanford Reservation in Washington, (2) INEEL in Idaho, (3) the Pantex Site in Texas, (4) SRS in South Carolina, (5) Rocky Flats Environmental Technology Site (RFETS) in Colorado, (6) LANL in New Mexico, and (7) LLNL in California. The environmental impacts of continued surplus plutonium storage at these sites were discussed in the S&D PEIS (DOE 1996b) and the SPD EIS (DOE 1999c). The information presented in this section is a summary of the information from these two DOE NEPA documents.

The environmental impacts of continued plutonium storage at each of these sites are summarized in Table 5-16 and discussed in the following sections.

#### **5.7.1.1 Air Quality**

Continued storage of surplus plutonium would generate air pollutants associated with operation of boilers, diesel generators, vehicles, and other emission sources required to maintain the storage facilities in a stable configuration. The estimates of air pollutant impacts presented in Table 5-16 were extracted from Tables 4-1 through 4-7 of the SPD EIS (DOE 1999c). These estimates are based on emission rates reported in the S&D PEIS (DOE 1996b). The emission rates were based on actual air quality records for the various sites. For the No Action Alternative, the emissions data were converted to ambient concentrations using the EPA-recommended Industrial Source Complex Short-Term Model Version 2 (EPA 1992). A full discussion of the process used to generate these air quality impact estimates is provided in Appendix F of the S&D PEIS.

For most storage sites, with the exception of LLNL, the impact of continued surplus plutonium storage on ambient air quality concentrations is projected to be below the most stringent federal or state standard. At LLNL, continued storage of surplus plutonium is expected to result in an exceedance of the one-hour standard for nitrogen dioxide.

#### **5.7.1.2 Human Health**

For all sites, continued surplus plutonium storage would result in population doses within 50 mi (80 km) ranging from 6.3E-06 person-rem at Pantex to 2.7 person-rem at LANL. Dose to the

MEI (public) would range from 1.8E-08 mrem at Pantex to 6.5 mrem at LANL. Potential LCFs, over the 50-year period examined in the SPD EIS (DOE 1999c), resulting from these doses to the population ranged from 0.36 at INEEL to 1.3 at SRS.

Health impacts to the public from exposure to hazardous chemicals would not change appreciably from existing impacts.

#### **5.7.1.3 Facility Accidents**

Facility accidents associated with continued surplus plutonium storage were evaluated in the S&D PEIS (DOE 1996b). The accident scenarios evaluated in the S&D PEIS are summarized in Table 5-17. The accident consequences evaluated are summarized in Table 5-18. Based on the analyses, for the sites evaluated, the beyond evaluation basis earthquake was the facility accident of greatest consequence. The population dose and associated potential LCFs for the beyond evaluation basis earthquake are summarized in Table 5-16.

#### **5.7.1.4 Radioactive Waste Generation**

Wastes generated by activities associated with the storage of surplus plutonium at each of the existing sites are a portion of the existing site generation rates. Waste generation rates should not appreciably change at these sites; therefore, impacts are not expected to change from those currently experienced from other site activities at each of these sites.

#### **5.7.1.5 Transportation**

Continued storage of surplus plutonium at existing sites would not involve intersite transportation of radioactive materials.

#### **5.7.1.6 Ecological Resources**

The No Action Alternative involves continued surplus plutonium storage in existing facilities. Under this alternative, there would not be any construction of new buildings or demolition of existing buildings. Consequently, there are no expected impacts to ecological resources.

#### **5.7.2 Site Selection**

The selection of a site for the MFFF involved evaluations included in the S&D PEIS (DOE 1996b), the SPD EIS (DOE 1999c), and the MFFF ER. At each stage of the selection process, the range of site alternatives was narrowed by using increasing detail in the evaluation of environmental and engineering impacts. The following is a summary of the processes used to select the final location of the MFFF.

### **5.7.2.1 Storage and Disposition Programmatic Environmental Impact Statement**

In the S&D PEIS (DOE 1996b), DOE considered only sites that already possessed weapons-usable fissile material as candidate sites for the surplus plutonium disposition facilities. This criterion allowed for the utilization of existing security and facilities that were already adapted to weapons-usable fissile material. The Summary for the S&D PEIS notes the following:

The Storage and Disposition PEIS analyzes six candidate sites for long-term storage of weapons-usable fissile material. These sites are Hanford, NTS [Nevada Test Site], INEL [Idaho National Engineering Laboratory now named the Idaho National Engineering and Environmental Laboratory], Pantex, ORR [Oak Ridge Reservation], and SRS. These same sites were also used to evaluate the construction and operation of various facilities required for the disposition alternatives.

The S&D PEIS did not select a site for the disposition facilities. The impacts of the surplus plutonium disposition facilities were considered for all the candidate sites as part of the evaluation of the generic impacts of the alternatives. Consequently, DOE did not conduct a separate siting study. As a result of the S&D PEIS evaluation, DOE issued a ROD. The following decision concerning the siting of the MFFF is found in the S&D PEIS ROD (DOE 1997c):

The exact locations for disposition facilities will be determined pursuant to a follow-on, site-specific disposition environmental impact statement (EIS) as well as cost, technical and nonproliferation studies. However, DOE has decided to narrow the field of candidate disposition sites. DOE has decided that a vitrification or immobilization facility (collocated with a plutonium conversion facility) will be located at either Hanford or SRS, that a potential MOX fuel fabrication facility will be located at Hanford, INEL, Pantex, or SRS (only one site), and that a "pit" disassembly and conversion facility will be located at Hanford, INEL, Pantex, or SRS (only one site).

This decision is further discussed in Section V.B (p. 21) of the ROD:

[DOE will] construct and operate a domestic, government-owned, limited-purpose MOX fuel fabrication facility at Hanford, INEL, Pantex, or SRS (only one site). As noted above, NTS and ORR will not be considered further for plutonium disposition activities. In follow-on NEPA review, DOE will analyze alternative locations at Hanford, INEL, Pantex, and SRS, for constructing new buildings or using modified existing buildings. The MOX fuel fabrication facility will serve only the limited mission of fabricating MOX fuel from plutonium declared surplus to U.S. defense needs, with shut-down and decontamination and decommissioning of the facility upon completion of this mission. [DCS is contractually responsible for deactivation of the MFFF. DOE will perform any required decommissioning after the license is terminated and the MFFF is turned over to DOE.]

### **5.7.2.2 Surplus Plutonium Disposition Environmental Impact Statement**

In the SPD EIS (DOE 1999c), the selection of a site for the MFFF was integral to the selection of a preferred alternative. Consequently, DOE did not conduct a site selection separate from the environmental evaluation of the various alternatives.

The four potential sites selected in the S&D PEIS ROD (DOE 1997c) were combined with the three facilities (PDCF, MFFF, and PIP) to yield 64 possible alternatives. These alternatives were narrowed, as described in Section S.4 of the SPD EIS (DOE 1999c).

In the Record of Decision (ROD) for the Storage and Disposition PEIS, DOE identified a large number of possible options to locate three surplus plutonium disposition facilities at four sites, and limited the immobilization options to Hanford and SRS. In addition to the four different sites for potential facility locations, the options were further increased by considering the use of either existing or new facilities at the sites, and by considering whether disposition would occur by the hybrid approach (MOX fuel fabrication and immobilization) or only through immobilization.

The following equally weighted screening criteria were used to reduce the large number of possible facility and site combinations to a range of reasonable alternatives:

- Worker and public exposure to radiation
- Proliferation concerns due to transportation of materials
- Infrastructure.

Over 64 options were evaluated, yielding a range of 20 reasonable alternatives that met all of the criteria. Examples of options that were eliminated include all those options placing three facilities at three different sites. In its NOI, DOE proposed to collocate the pit conversion and immobilization facilities for the immobilization-only alternatives. However, during the public scoping process, the comment was made that, under all situations, Pantex should be considered as a candidate site for the pit conversion facility because most of the surplus pits are currently stored there. After confirming that they met all of the screening criteria, three additional immobilization-only alternatives, which place the pit conversion facility at Pantex, were included in the range of reasonable alternatives evaluated in the draft SPD EIS. The number of reasonable alternatives was reduced to 15 in the Supplement when DOE determined that Building 221-F at SRS was no longer a reasonable location for the immobilization facility.

Using the data provided in the SPD EIS, DOE issued the following decision in the SPD EIS ROD (DOE 2000b).

The Department has decided to implement a program to provide for the safe and secure disposition of up to 50 metric tons of surplus plutonium as specified in the Preferred Alternative in the *Surplus Plutonium Disposition Final Environmental Impact Statement*. The fundamental purpose of the program is to ensure that

plutonium produced for nuclear weapons and declared excess to national security needs (now and in the future) is never again used for nuclear weapons. Specifically, the Department has decided to use a hybrid approach for the disposition of surplus plutonium. This approach allows for the immobilization of approximately 17 metric tons of surplus plutonium and the use of up to 33 metric tons of surplus plutonium as MOX fuel. The Department has selected the Savannah River Site in South Carolina as the location for all three disposition facilities. Based upon this selection, the Department will authorize DCS to fully implement the base contract.

The Preferred Alternative presented in the SPD EIS (DOE 1999c), and chosen in the SPD EIS ROD (DOE 2000b), included the location of the MFFF in F Area at SRS. Accordingly, only siting alternatives for the MFFF within F Area are considered in this ER. There are five potential plots within F Area that could be used for the MFFF. DOE determined the exact location of the MFFF subsequent to the SPD EIS ROD. The following section describes how the exact plot for the MFFF was selected.

#### **5.7.2.3 Site Selection within SRS F Area**

The site selection process considered the guidance in DOE Good Practice Guide GPG-FM-024, *Site Selection Process* (DOE 1996c), and NRC Regulatory Guide 4.7, *General Site Suitability Criteria for Nuclear Power Stations* (NRC 1998b). Figure 5-2 illustrates the location of the five potential plots (labeled 1 through 5) for the MFFF. The plot between locations 2 and 5 was previously selected by DOE for the PDCF. Area 1 was also designated for another use. After a preliminary evaluation, DOE identified four options:

- Option 1 – Locate the MFFF in Area 2
- Option 2 – Reconfigure and re-orient the PDCF and MFFF as far north as possible in Areas 4 and 5
- Option 3 – Locate the MFFF in Area 3 or some combination of Areas 3 and 4
- Option 4 – Locate the MFFF in Area 5.

#### **5.7.2.4 Siting Qualification Criteria**

The following criteria were chosen as the most significant challenges to successful licensing of the MFFF and represent the selection criteria that the site must meet:

- **Free from subsurface contamination:** There are no plumes of substances possibly requiring remediation or resulting in increased costs, delays, licensing difficulties, or health hazards.

- **Adequate terrain and area:** The site option provides sufficient level terrain and is generally suitable for the footprint of the MFFF without adverse impact to the facility function.
- **Free from RCRA/CERCLA features:** No features governed by RCRA or CERCLA are known to be present. The presence of such features poses an issue with as yet indeterminate and potentially significant liabilities for removal/remediation.

#### 5.7.2.5 Siting Evaluation Criteria

Evaluation criteria are more qualitative in nature and are based on technical, environmental, and economic factors. The perceived relative importance of each of these criteria is determined and assigned a weight from 1 (least important) to 3 (most important). The ability of each site to meet each criterion is assessed, and a rating is assigned from 1 (marginal) to 3 (more than adequate). The product of the weights and ratings for each site criterion is determined and added for each site. The qualitative evaluation criteria chosen are as follows:

- **Protected species:** No known protected flora or fauna species.
- **Water table:** The water table must lie significantly below the MFFF substructure to ensure economical design and construction and to avoid nuclear design issues.
- **Topography:** Balancing of cut and fill, with a high site option being preferred for security purposes. Relatively level with a minimum of steep grades. It is impractical for an MFFF site to block natural drainage.
- **Accessibility:** Proximity to existing roads and to the planned PDCF site.
- **Soft zones:** Site differences in potential for subsurface soft zones.
- **Utilities/infrastructure:** A measure of availability of water, sewer, electricity, waste disposal, and related services.
- **Wetlands:** Low-lying areas where compensatory measures are required if the wetlands are altered or destroyed.
- **Archaeological features:** Indicates that historical artifacts requiring further investigation have been found.
- **Interference with existing SSCs:** Existing SSCs would have to be relocated or removed.



### 5.7.2.6 Summary of Siting Evaluation

Table 5-19 summarizes the evaluation scores for the four options considered by DOE to locate the MFFF within the SRS F Area.

Only Area F-2 (Option 1) actually met all the qualification criteria. Additionally, Area F-2 also had the best score among the evaluation criteria. Therefore, Area F-2 was selected as the plot for the MFFF.

### 5.7.3 Design Alternatives

As part of the consideration of reasonable alternatives to the proposed action, DCS considered several design alternatives for the MFFF in addition to the No Action and siting alternatives discussed earlier. In selecting design alternatives for review, DCS focused on possible alternatives that could have some potential impact or significance from an environmental perspective. Changes in the MFFF design that would not have any significant environmental impact (e.g., modifications to the size or construction of administrative buildings) were not considered in detail.

In 1999, while the SPD EIS (DOE 1999c) was in preparation, DOE selected DCS to execute the design, construction, operation, and deactivation of the MFFF. The Request for Proposals required the submission of a general facility and process design to accomplish the fabrication of MOX fuel. One of the bases for selection of DCS as the contractor was the DCS proposal to use a proven design (the COGEMA process) based on actual operations of similar facilities (MELOX and La Hague) in France. The COGEMA design represents the results of several iterations of process design and operating experience over several years of MOX fuel production in France. This design optimizes both production and safety. The selection of DCS and the contractual arrangements with DOE established the basic design of the facility and process.

In particular, the SPD EIS covered the throughput and support facilities for the MFFF. The MFFF maximum throughput was established at 3.9 tons (3.5 metric tons) of plutonium (DOE 1999c). The general design of the MFFF building is provided in the SPD EIS. The MFFF would be a hardened, reinforced-concrete structure. Areas of the facility in which plutonium would be processed or stored would be designed to survive natural phenomena and potential accidents. Ancillary buildings would be required for support activities. Facility operations would require a staff of about 385 personnel<sup>4</sup>.

The SPD EIS identified the fuel fabrication areas as two parallel process lines with room for a third line to accommodate the potential for fabricating a different type of fuel. The process would be in batch operations conducted in continually monitored, negative-pressure, inert atmosphere gloveboxes. The building ventilation system would be designed to maintain

---

<sup>4</sup>Although the SPD EIS projected a staff level of 385, current projections are for a staff level of about 400 personnel.

confinement and include HEPA filters for both internal systems and building exhausts. Both intake and exhaust air would be filtered, and exhaust gases would be monitored for radioactivity. Power would be supplied to the MFFF by two independent offsite power supplies and backed up by an onsite uninterruptible power supply and standby generators.

The SPD EIS also indicated that the MFFF would contain areas for support activities including SNM vault areas, shipping and receiving, emergency generators, and process gas waste treatment. Support areas for access control, office space, and some warehouse space would be located outside the protective fence.

In selecting the SRS F Area as the location for the MFFF, DOE took advantage of the existing SRS infrastructure for providing security, emergency, and utility support services including existing waste management facilities. This decision, contained in the SPD EIS, eliminated the need for a new waste treatment system for the MFFF wastes. This decision reduces the environmental impacts associated with the construction and operation of a waste treatment system for the MFFF.

In the process of converting the COGEMA design, based on the MELOX and La Hague facilities, to meet United States regulations, codes, and standards, DCS considered the design alternatives discussed in the following sections.

The basic design of the MOX fuel fabrication building consists of an aqueous polishing process area, a MOX fuel fabrication process area, and a shipping and receiving area. The MOX fuel fabrication process area utilizes essentially two parallel process lines that maximize automation while performing batch operations in continually monitored, negative-pressure, and in many cases, inert atmosphere gloveboxes. The building ventilation system is designed to maintain dynamic confinement and includes two HEPA filters at the supply and exhaust of all gloveboxes, an intermediate supply and exhaust room filter in rooms that contain gloveboxes, and two final HEPA filters in all ductwork prior to discharge into a common stack. Exhaust gases are monitored for radioactivity. Power to the MFFF is supplied by two independent offsite power supplies and backed up for selective operations by redundant emergency and standby diesel generators and an onsite redundant emergency uninterruptible power supply. Support areas include office space, gas storage, portions of access control, and warehouse space.

This design is consistent with the design described in the SPD EIS and implements the COGEMA design, based on the MELOX and La Hague facilities. In implementing the COGEMA design, DCS also considered lessons learned based on past operating experience and Americanization to meet United States regulations, codes, and standards. During design development for the MFFF, DCS considered various design alternatives that involved auxiliary processes, support systems, and services that could potentially impact or have significance from an environmental perspective. Nine design alternatives are discussed in the following sections.

### **5.7.3.1 Reagent Process Building**

DCS considered two options for locating the aqueous polishing reagent process. One option was to locate the preparation of reagents within the same area as the aqueous polishing area. The second option was to locate the reagent process in a separate building and pump mixed reagents to the aqueous polishing area.

The reagent preparation process involves an exothermic reaction that presents a potential explosion hazard. DCS decided to separate the preparation of material presenting the potential chemical explosion hazard from the SNM. The reagent preparation process was moved to a separate building adjacent to the aqueous polishing area. The mixed reagents will be pumped to the aqueous polishing area on an as-needed basis. The relocation of these processes reduces the potential of a chemical accident resulting in a release of radioactivity to the environment.

In the design of the Reagent Process Building, DCS considered the use of underground storage tanks to contain any overflows and spills from the reagent storage and mixing tanks. Because of the environmental risk associated with underground waste storage tanks, DCS decided to eliminate the underground tanks. Any overflows and spills from the reagent storage and mixing tanks will be contained in a curbed area and will be manually pumped to an above-ground waste collection vessel within the Reagent Process Building.

### **5.7.3.2 Recycling of Acid Recovery Distillates in the Aqueous Polishing Process**

DCS selected a design alternative for the acid recovery process that consists of adding an evaporation step to lower the activity of these distillates and to recycle half of the volume of the distillates in place of fresh demineralized water. The reduced volume of evaporator concentrates is transferred to the F-Area Outside Facility as a liquid high alpha activity waste. The addition of this evaporator reduces the volume of liquid for processing at the F-Area Outside Facility and reduces the volume of demineralized water required for the process.

### **5.7.3.3 Reduction in TRU Waste Volume Due to Lower Glovebox Cooling Flow Rates**

Glovebox internal cooling flow rates at MELOX are dependent on the heat release of reactor-grade plutonium. The heat release of weapons-grade plutonium is significantly lower than that of reactor-grade plutonium. Because of the lower heat release, the glovebox internals can be cooled by natural convective cooling, which results in a reduced airflow, filter size, and TRU solid waste volume during periodic filter replacement.

### **5.7.3.4 Recycling of Laboratory Effluents Using Aqueous Polishing Capability**

Aqueous laboratory wastes at MELOX are precipitated and solidified, resulting in TRU wastes. In the MFFF, the plutonium is removed from the laboratory waste and recycled into the aqueous polishing process. The resulting laboratory wastes are LLW.

#### **5.7.3.5 Decloggable Metallic Pre-filter in Powder Grinding Glovebox**

Based on operating experience, DCS replaced a two-stage cyclone separator in the MOX powder processing with a decloggable metallic filter. This design results in an overall reduction of TRU waste volume during periodic filter replacement downstream of these components.

#### **5.7.3.6 Sand Filters Versus Multiple Fire Areas**

DCS has selected a design that limits the propagation of fires to small fire areas within the facility, eliminating the possibility of a facilitywide fire. This design maintains dynamic confinement during postulated fire events with the normal HEPA filters. The design eliminates the need for additional filtration such as sand filters. Environmental impacts from the additional land requirements for the sand filters are eliminated.

#### **5.7.3.7 Facility Heat Exchangers**

Because the MFFF has a relatively small heat load, DCS evaluated both water-cooled (cooling tower) and air-cooled heat exchangers to dissipate the building and process heat loads. The engineering evaluation recommended the use of air-cooled heat exchangers for the MFFF. This decision eliminated any potential environmental impacts normally associated with water-cooled heat exchangers such as impacts from cooling tower drift or blowdown.

#### **5.7.3.8 Physical Security Barriers**

DCS evaluated a number of options for the creation of security barriers for the facility. One option included the construction of an engineered berm around the facility. This option, which would have required a larger site and impacted land resources, was eliminated in favor of other security barrier options, which resulted in less land disturbance.

#### **5.7.3.9 Material Transfer Between the PDCF and MFFF**

Plutonium that has been converted to plutonium oxide must be transferred from the PDCF to the MFFF. DCS evaluated several different options for this transfer including a tunnel and a closed transfer trench. The engineering evaluation discarded both of these options in favor of transfer using an overland vehicle. Both the tunnel and trench options would have had minor impacts to land resources. The vehicle option requires no additional land and moves the material over relatively short distances within F Area.

### **5.8 SHORT-TERM USES AND LONG-TERM ENVIRONMENTAL PRODUCTIVITY**

The use of land on SRS for the MFFF would be a short-term use of the environment; on completion of the disposition activities, such land could be returned to other uses, including long-term productive uses.

Losses of the natural productivity of terrestrial and aquatic habitats due to construction and operation of the MFFF are possible. Land clearing and construction and operational activities

could disperse wildlife and eliminate habitat. Because this land is managed by the U.S. Forest Service, periodic habitat loss would normally occur. Although some destruction would occur during and after construction, losses will be minimized by careful siting of facilities and incorporation of mitigation measures into all construction activities. In addition, consultation and coordination with state and federal natural resource and wildlife agencies prior to any site disturbances will ensure that all potential sensitive species, candidate or listed, are protected to the maximum extent possible.

There are no other activities that would affect long-term productivity of environmental resources.

## **5.9 RESOURCES COMMITTED**

Site preparation, construction, and operation of the MFFF commit both onsite and offsite resources, some of which are irreversibly committed and irretrievably lost. Irreversible and irretrievable commitments of resources include those resources consumed during facility operation and those that are not expected to revert to a natural state if the structures are removed at the end of the station life. Section 5.9.1 discusses the commitment of resources during construction, while Section 5.9.2 discusses the commitment of resources during operation.

### **5.9.1 Resources Committed During Construction**

Construction of the MFFF will consume 41 ac (16.6 ha) of land as shown in Table 5-20. Approximately 28 ac (11.3 ha) of this land is currently managed as a timber crop by the U.S. Forest Service that could be harvested independent of the MFFF's construction. Although removal of this timber represents a resource loss, as part of a managed forest, the resource is normally considered replaceable. Part of the land is also currently used as a spoils area for soil excavated for the APSF. This soil will be relocated to an SRS landfill prior to construction of the MFFF. Because the area is utilized by DOE as an industrial site, continued industrial use after completion of the MFFF mission is possible.

Water consumed during construction will be treated in the SRS waste treatment system and returned to the environment. Waste disposal capacity will be provided by the current SRS infrastructure. Use of the existing SRS infrastructure eliminates the need to construct new waste treatment infrastructure and avoids the associated environmental impacts.

During construction, the heavy equipment onsite will consume diesel fuel and electricity. Major materials required during facility construction include concrete aggregate and cement, reinforcing steel, aluminum, lumber, piping materials, and electric wire and cable.

Concrete and steel constitute the bulk of construction materials; however, there are numerous other minor resources incorporated into the physical plant. Some materials (e.g., copper wire and cable and aluminum) are valuable enough to be recycled, whereas the value of others does not encourage recycling.

### **5.9.2 Resources Committed During Operation**

Water consumed during operation will be treated in the SRS waste treatment system and returned to the environment.

During operations, the MFFF will nominally consume 3.9 tons (3.5 metric tons) of surplus plutonium and 73.3 tons (66.5 metric tons) of surplus depleted uranium annually. The MFFF will also consume various chemicals as reagents. Consumption of chemicals is kept at a minimum through extensive recovery and recycling as feedstock. Estimated consumption of resources during MFFF operation is provided in Table 5-21.

### **5.10 ENVIRONMENTAL MONITORING PROGRAM**

As provided in guidance for the ER (NRC 2000a), details of the preoperational and operational environmental monitoring programs are provided in the *Construction Authorization Request* and will be updated in the *License Application*. This section of the ER provides an overview of the environmental monitoring program and its objectives.

An environmental monitoring program is established to evaluate the impacts of facility construction, operation, and deactivation on the facility environs for chemical and radiological releases during normal operations, anticipated operational occurrences, and from postulated accidents. The environmental monitoring program will be established prior to construction and continue through deactivation. Since the MFFF will be located adjacent to other F-Area facilities, there may be areas of historical contamination that should be characterized prior to operation. Chemicals released from F-Area facilities include ammonia, nitrate, cadmium, chromium, hydrazine, mercury, manganese, nitric acid, and oxides of nitrogen. Major radiological contaminants released from F-Area facilities include moderate- to long-lived fission products such as Cs-137, Sr-89 and Sr-90; isotopes of uranium and plutonium, and other actinides (Fledderman 2000). The objectives of the preoperational environmental monitoring program are to:

- Establish a baseline of existing radiological, chemical, physical, and biological conditions in the area of the site and develop an understanding of the critical pathways that could transport contaminants to human and other receptors.
- Determine the presence of any contaminants that could be a safety concern for construction personnel.
- Evaluate procedures, equipment, and techniques used in the collection and analysis of environmental data and train personnel in their use.

The objective of the operational environmental monitoring program is to determine whether or not there are adverse impacts from operations that result in radiological, chemical, physical, and biological effects to the facility site and environs.

The SRS maintains an extensive environmental monitoring program for all activities conducted on the SRS including in the F Area (Fledderman 2000). DCS plans to make full use of the data provided from this monitoring to measure any construction or operational impacts of the MFFF in the vicinity of the SRS. DCS will augment the SRS environmental studies with additional sample collections as necessary based on the evaluations in this ER and operating experience.

As discussed in this chapter and summarized in Chapter 6, non-radiological impacts to the environment from the construction and operation of the MFFF are expected to be minimal. Consequently, non-radiological environmental monitoring prescribed through the various environmental permits for the construction and operation of the MFFF are expected to be sufficient to evaluate any non-radiological environmental impacts.

As discussed in this chapter and summarized in Chapter 6, radiological impacts to the environment from construction and operation of the MFFF are expected to be minimal. The radiological environmental monitoring program measures radiation levels and radioactivity in the facility environs due to radioactive effluent releases to the environment. Routine radioactive releases from the MFFF are limited to a single radioactive airborne release through a stack located on the roof of the MOX Fuel Fabrication Building. The transport of contaminants from the stack to the receptor can result in exposure by immersion, inhalation, and ingestion of foodstuffs on which contaminants have been deposited by either wet or dry deposition processes. Direction radiation measurements, air sampling, soil sampling, and vegetation sampling will be performed with analyses for uranium and plutonium, MFFF radionuclides of interest.

The MFFF does not routinely discharge any radioactive liquid directly to the environment. Process liquids are transferred to appropriate SRS treatment facilities. The non-radioactive liquid effluent is stormwater runoff. Therefore, the radiological monitoring program will focus on the environmental media impacted by the airborne pathway for the anticipated types and quantities of radionuclides release from the facility. Although stormwater runoff is not expected to be contaminated, confirmatory measurements will be performed. Stormwater runoff drains to an unnamed tributary of Upper Three Runs (Fledderman 2000). Surface water sampling and sediment sampling will be performed with analyses for uranium and plutonium.

Data obtained from the radiological environmental monitoring program will be used to show that levels of radiation and radioactivity in the environment are consistent with those determined by the radioactive effluent monitoring and sampling program.

## Figures



**This page intentionally left blank.**

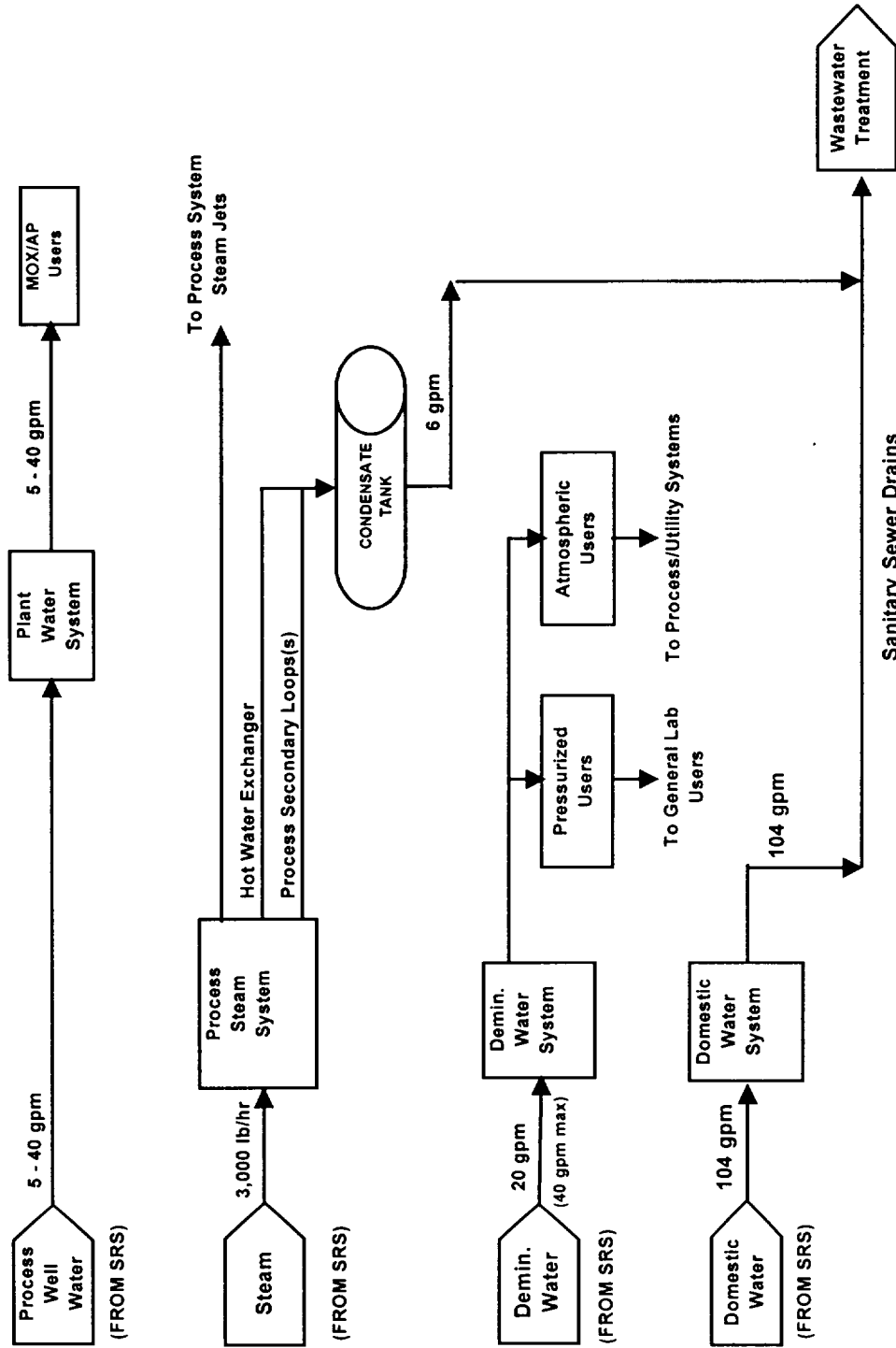
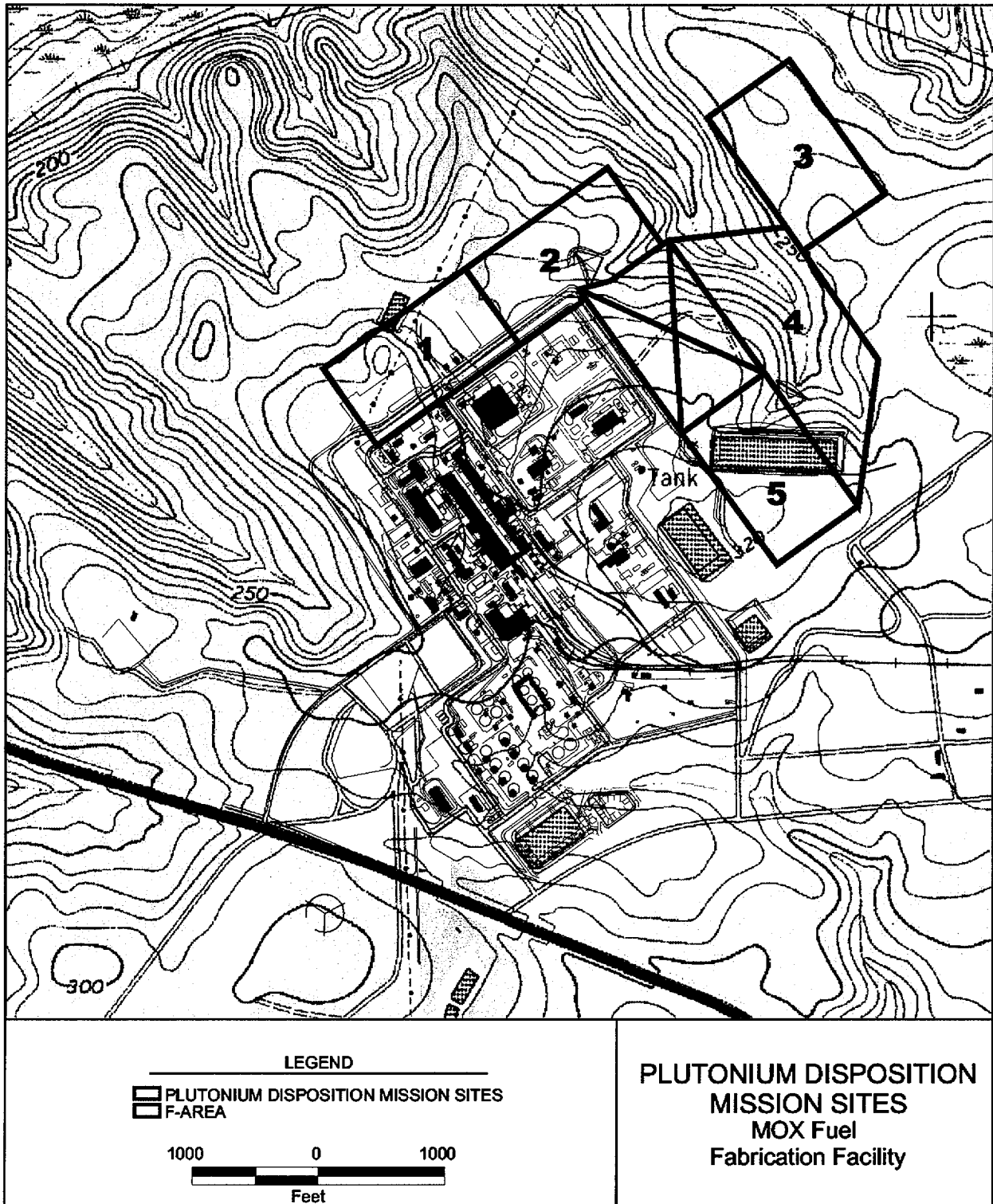

Figure 5-1. MFFF Water Balance

**This page intentionally left blank.**



**Figure 5-2. Location of Potential MFFF Sites**

**This page intentionally left blank.**

## Tables

**This page intentionally left blank.**

**Table 5-1. Emissions (kg/yr) from MFFF Construction**  
(update of Table G-65 of the SPD EIS, p. G-40)

Pollutant	Diesel Equipment	Construction Fugitive Emissions <sup>a</sup>	Concrete Batch Plant	Vehicles <sup>d</sup>
Carbon monoxide	8,400	0	0	33,600
Nitrogen dioxide	22,110	0	0	9,740
PM <sub>10</sub>	1,680 <sup>b</sup>	6,920	9,980 <sup>b</sup>	34,400
Sulfur dioxide	2,230	0	0	0
Volatile organic compounds	1,730	0	0	4,490
Total suspended particulates	1,680	13,700	9,980	34,400
Air toxics <sup>c</sup>	0	<1	0	0

<sup>a</sup> Does not include fugitive emissions from potential concrete batch plant.

<sup>b</sup> PM<sub>10</sub> emissions were assumed to be the same as total suspended particulate emissions for this analysis resulting in some overestimate of PM<sub>10</sub> concentrations.

<sup>c</sup> Various toxic air pollutants (e.g., lead, benzene, hexane) could be emitted during construction.

<sup>d</sup> Vehicle emissions based on construction worker, construction material, and waste shipment mileage.



**Table 5-2. Increments to Ambient Concentrations ( $\mu\text{g}/\text{m}^3$ ) at the SRS Site Boundary from MFFF Construction**

(update of Table G-66 of the SPD EIS, p. G-40)

Pollutant	Averaging Period	Most Stringent Standard or Guideline <sup>a</sup>	Current Concentration	MFFF Contribution	Total
Carbon monoxide	8 hours	10,000	671	1.20	672
	1 hour	40,000	5,100	5.43	5,105
Nitrogen dioxide	Annual	100	11.4	0.045	11.4
PM <sub>10</sub>	Annual	50	4.94	0.020	4.96
	24 hours	150	85.7	1.9	87.6
Sulfur dioxide	Annual	80	16.7	0.0046	16.7
	24 hours	365	222	0.113	222
	3 hours	1,300	725	0.68	726
Total suspended particulates	Annual	75	45.4	0.034	45.4
Air toxics <sup>b</sup>	24 hours	150	20.7	0.000224	20.7

<sup>a</sup> The more stringent of the federal and state standards is presented if both exist for the averaging period.

<sup>b</sup> Various toxic air pollutants (e.g., lead, benzene, hexane) could be emitted during construction.

**Table 5-3. Construction Employment Requirements for the MFFF**

<b>Year</b>	<b>Average Number of Workers</b>
2002	50
2003	400
2004	700
2005	800
2006	500

**Table 5-4. Estimate of Heavy Vehicles on Site for Each Year of Construction**

<b>Year</b>	<b>Number of Vehicles</b>
2002	24
2003	20
2004	20
2005	10
2006	10

**Table 5-5. Maximum Additional Site Infrastructure Requirements for MFFF Construction in F Area at SRS**

<b>Resource</b>	<b>MFFF</b>	<b>Availability<sup>a</sup></b>
<b>Transportation</b>		
Roads (mi)	2.0	142
<b>Electricity (MWh/yr)</b>	12	482,700
<b>Diesel Fuel (gal/yr)</b>	300,000	NA <sup>b</sup>
<b>Water (gal/yr)</b>	30,000,000	321,000,000

<sup>a</sup> Capacity minus current usage

<sup>b</sup> Not applicable due to the ability to procure additional resources.

**Table 5-6. Wastes Generated During Construction**

<b>Waste Type</b>	<b>Estimated Additional Waste Generation (yd<sup>3</sup>/yr)</b>	<b>Disposal Capacity (yd<sup>3</sup>/yr)</b>
Hazardous	100	NA <sup>a</sup>
Nonhazardous		
Liquid	47,000	1,352,000 <sup>b</sup>
Solid	11,000	NA <sup>a</sup>

<sup>a</sup> Not Applicable; shipped offsite.

<sup>b</sup> Capacity of CSWTF.

**Table 5-7. Emissions (kg/yr) from MFFF Operation**  
(update of Table G-67 of the SPD EIS, p. G-41)

<b>Pollutant</b>	<b>Emergency/ Standby Generators</b>	<b>Process <sup>c</sup></b>	<b>Vehicles</b>
Carbon monoxide	1,326	0	32,700
Nitrogen dioxide	6,154	500	9,470
PM <sub>10</sub>	433	0	33,400
Sulfur dioxide	405	0	0
Volatile organic compounds <sup>a</sup>	502	0.27	4,370
Total suspended particulates	433	0	33,400
Nitric acid <sup>b</sup>	0	6.4	0

<sup>a</sup> Process VOC emissions are evaporative emissions from diesel fuel storage tanks.

<sup>b</sup> Emissions are from dilute nitric acid storage tanks vented outside the building.

<sup>c</sup> NO<sub>x</sub> emissions are from the MFFF stack resulting from the aqueous polishing process.

**Table 5-8. Increments to Ambient Concentrations ( $\mu\text{g}/\text{m}^3$ ) from MFFF Operation <sup>a</sup>**  
(update of Table G-68 of the SPD EIS, p. G-41)

<b>Pollutant</b>	<b>Averaging Period</b>	<b>Most Stringent Standard or Guideline <sup>b</sup></b>	<b>Current Concentration</b>	<b>MFFF Contribution</b>	<b>Total</b>
Carbon monoxide	8 hours	10,000	671	0.189	671
	1 hour	40,000	5,100	0.857	5,101
Nitrogen dioxide	Annual	100	11.4	0.0127	11.4
PM <sub>10</sub>	Annual	50	4.94	0.00089	4.94
	24 hours	150	85.7	0.0220	85.7
Sulfur dioxide	Annual	80	16.7	0.00083	16.7
	24 hours	365	222	0.0205	222
	3 hours	1,300	725	0.123	725
Total suspended particulates	Annual	75	45.4	0.00089	45.4

<sup>a</sup> Concentrations are the maximum occurring at or beyond the site boundary or a public access road.

<sup>b</sup> The more stringent of the federal and state standards is presented if both exists for the averaging period.

**Table 5-9. Comparison of MFFF Impacts to PSD Class II Limits**

<b>Pollutant</b>	<b>Averaging Period</b>	<b>Increase in Concentration (<math>\mu\text{g}/\text{m}^3</math>)</b>	<b>PSD Class II Area Allowable Increment (<math>\mu\text{g}/\text{m}^3</math>)</b>	<b>Percent of Increment</b>
Nitrogen dioxide	Annual	0.0127	25	0.051
PM <sub>10</sub>	Annual	0.00089	17	0.0052
	24 hours	0.0220	30	0.0073
Sulfur dioxide	Annual	0.00083	20	0.0042
	24 hours	0.0205	91	0.023
	3 hours	0.123	512	0.024



**Table 5-10. Minority and Low Income Populations Along Transportation Corridors**

	<b>Portsmouth, OH to Fuel Fabrication</b>	<b>Fuel Fabrication to MFFF</b>	<b>MFFF to Catawba Nuclear Station</b>	<b>MFFF to McGuire Nuclear Station</b>
Distance (km)	977	578	298	339
Estimated total population along route	239,221	75,050	74,531	102,182
Estimated minority population along route	40,636	30,702	29,010	53,094
% minority population along route	17.0	40.9	38.9	51.9
Estimated low income population along route	33,268	10,673	Not available	Not available
% low income population along route	13.9	14.2	Not available	Not available

**Table 5-11. Potential Radiological Impacts on the General Public and Site Workers Due to Normal Operations of the MFFF**

<b>RADIATION DOSE TO THE GENERAL PUBLIC</b>	<b>Impact</b>
<b>Maximally Exposed Individual</b>	
Annual Dose (mrem/yr) <sup>a</sup>	4.1E-04
Percentage of 10 CFR Part 20, Subpart D Standard <sup>b</sup>	4.1E-04
Percentage of Natural Background Radiation <sup>c</sup>	1.4E-04
Annual LCF Risk <sup>d</sup>	2.1E-10
<b>General Population Within 50 mi (80 km)</b>	
Annual Dose (person-rem/yr) <sup>a</sup>	0.035
Percentage of Natural Background Radiation <sup>c</sup>	1.1E-05
Annual LCF Risk <sup>d</sup>	1.8E-05
<b>Average Exposed Individual Within 50 mi (80 km)</b>	
Annual Dose (mrem/yr) <sup>f</sup>	3.4E-05
Percentage of 10 CFR Part 20, Subpart D Standard <sup>b</sup>	3.4E-05
Percentage of Natural Background Radiation <sup>c</sup>	1.2E-05
Annual LCF Risk <sup>d</sup>	1.7E-11

<b>RADIATION DOSE TO SITE WORKERS</b>	<b>Impact</b>	
<b>Maximally Exposed Site Worker</b>		
Annual Dose (mrem/yr) <sup>g</sup>	0.022	
Percentage of 10 CFR Part 20, Subpart C Standard <sup>h</sup>	4.4E-04	
Percentage of Natural Background Radiation <sup>c</sup>	7.5E-03	
Annual LCF Risk <sup>i</sup>	8.8E-09	
<b>General Site Worker Population</b>	<b>Minimum<sup>j</sup></b>	<b>Maximum<sup>k</sup></b>
Maximum Annual Dose (person-rem/yr) <sup>l</sup>	5.3E-03	0.3
Percentage of Natural Background Radiation <sup>m</sup>	1.3E-04	7.5E-03
Annual LCF Risk <sup>i</sup>	2.1E-06	1.2E-04
<b>RADIATION DOSE TO FACILITY WORKERS</b>		
<b>Impact</b>		
Average Worker Dose (mrem/yr) <sup>n</sup>	50	
Percentage of 10 CFR Part 20, Subpart C Standard <sup>h</sup>	1	
Percentage of Natural Background Radiation <sup>c</sup>	17	
Annual LCF Risk <sup>i</sup>	2.0E-05	

**Table 5-11. Potential Radiological Impacts on the General Public and Site Workers Due to Normal Operations of the MFFF (continued)**

- <sup>a</sup> Source is GENII model results for general public (see Appendix D).
- <sup>b</sup> 10 CFR Part 20, Subpart D standard is an annual dose of 100 mrem.
- <sup>c</sup> Natural background radiation is 295 mrem/yr (see Table 4-23).
- <sup>d</sup> Calculated using a cancer risk factor of 0.0005 per rem (500 cancers/10<sup>6</sup> person-rem).
- <sup>e</sup> Natural background radiation for the public was calculated as the individual background radiation (295 mrem/yr) times the number of people projected to live in the 50-mi (80-km) assessment area in 2030 (1,042,483 people). The calculated value is 307,532 person-rem/yr.
- <sup>f</sup> Calculated as the population dose divided by the number of people projected to live in the 50-mi (80-km) assessment area in 2030 (1,042,483 people).
- <sup>g</sup> Source is GENII model results for site workers (see Appendix D).
- <sup>h</sup> 10 CFR Part 20, Subpart C standard is an annual dose of 5,000 mrem.
- <sup>i</sup> Calculated using a cancer risk factor of 0.0004 per rem (400 cancers/10<sup>6</sup> person-rem).
- <sup>j</sup> Minimum values based on a distance of 5 mi (8 km) from the release point (i.e., at the SRS boundary).
- <sup>k</sup> Maximum values based on a distance of 328 ft (100 m) from the release point (i.e., at the MFFF boundary).
- <sup>l</sup> Dose for the site worker population was determined by multiplying the MEI dose at the respective distance from the release point by the total number of site workers (13,616 workers). The MEI doses are as follows:
  - MEI dose at the MFFF boundary for an elevated release = 2.2E-02 mrem/yr
  - MEI dose at the SRS boundary for an elevated release = 3.9E-04 mrem/yr
  - MEI dose at the MFFF boundary for a groundlevel release = 3.0 mrem/yr
  - MEI dose at the SRS boundary for a groundlevel release = 1.4E-03 mrem/yr
- <sup>m</sup> Natural background radiation for the site workers was calculated as the individual background radiation (295 mrem/yr) times the number of site workers in 2000 (13,616 workers). The calculated value is 4,017 person-rem/yr.
- <sup>n</sup> Based on preliminary dose analyses for the MFFF.

**Table 5-12. Potential Waste Management Impacts from MFFF Operation**

Waste Type	Estimated Waste Generation <sup>a</sup>	Site Waste Generation <sup>b</sup>	Percent of Site Waste Generation
Liquid LLW (gal/yr)	214,000	Not available	Not available
Solid LLW (yd <sup>3</sup> /yr)	103	13,136	< 1
Liquid High Alpha Activity Waste (gal/yr)	81,300	Not available <sup>d</sup>	Not available <sup>d</sup>
Solid TRU Waste <sup>c</sup> (yd <sup>3</sup> /yr)	210	564	37
Hazardous Waste (yd <sup>3</sup> /yr)	11	97	11
Liquid Nonhazardous Waste (gal/yr)	1,700,000	109,921,990	1.5
Solid Nonhazardous Waste (yd <sup>3</sup> /yr)	600	8,724	6.8

<sup>a</sup> From Tables 3-3 and 3-4.

<sup>b</sup> From Table 4-27.

<sup>c</sup> Includes mixed TRU waste.

<sup>d</sup> Pending classification of high alpha activity waste.

Table 5-13. Summary of Bounding Consequences for MFFF Postulated Events

Bounding Accident	Meteorology <sup>a</sup>	Maximum Impact to Worker (mrem)	Maximum Impact to SRS Worker (probability of cancer deaths)	Maximum Impact to Person at Site Boundary (mrem)	Maximum Impact at Site Boundary (probability of cancer deaths)	Impact on Population within 80 km (person-rem)	Impact on Population within 80 km (LCFs)
Loss of Confinement	bounding – 95% percentile	<90	<4E-5	<0.8	<4E-7	<3E-2	<2E-5
Internal Fire	bounding – 95% percentile	<90	<4E-5	<0.8	<4E-7	<3E-2	<2E-5
Load Handling	bounding – 95% percentile	<80	<3E-5	<0.7	<4E-7	<2E-2	<1E-5
Hypothetical Explosion Event	bounding – 95% percentile	<300	<2E-4	<3.0	<2E-6	<9E-2	<5E-5
Hypothetical Criticality Event	bounding – 95% percentile	<1550	<6E-4	<12	<6E-6	<6	<3E-3

<sup>a</sup> Values calculated for 50<sup>th</sup> percentile indicate that median meteorology is at least three times lower than the bounding values.

**Table 5-14. Potential Impacts from Construction of the PDCF and PIP Facilities in the SRS F Area**

Pollutant	Impact from PDCF and PIP Construction <sup>a</sup>
8-hr Carbon Monoxide Increase ( $\mu\text{g}/\text{m}^3$ ) <sup>b</sup>	675
Annual Nitrogen Dioxide Increase ( $\mu\text{g}/\text{m}^3$ ) <sup>b</sup>	11.5
Annual $\text{PM}_{10}$ Increase ( $\mu\text{g}/\text{m}^3$ ) <sup>b</sup>	5.02
Annual Sulfur Dioxide Increase ( $\mu\text{g}/\text{m}^3$ ) <sup>b</sup>	16.7
Annual Total Suspended Particulate Increase ( $\mu\text{g}/\text{m}^3$ ) <sup>b</sup>	45.5
Dose to Workers <sup>c</sup> (person-rem/yr)	2.8
Average Worker Dose <sup>c</sup> (mrem/yr)	4
Hazardous waste <sup>d</sup> ( $\text{m}^3/\text{yr}$ )	85
Nonhazardous Waste <sup>d</sup>	
Liquid <sup>d</sup> ( $\text{m}^3/\text{yr}$ )	26,300
Solid <sup>d</sup> ( $\text{m}^3/\text{yr}$ )	2,320

<sup>a</sup> Source: SPD EIS (DOE 1999c)

<sup>b</sup> Table G-70 of the SPD EIS (DOE 1999c)

<sup>c</sup> Table J-55 of the SPD EIS (DOE 1999c)

<sup>d</sup> Table H-33 of the SPD EIS (DOE 1999c)

**Table 5-15. Summary of Cumulative Operational Impacts Within SRS**

Impact	MOX Fuel Fabrication Facility	Surplus Plutonium Disposition Facilities <sup>a</sup>	Other Savannah River Site Activities <sup>a</sup>
Developed Land (acres)	41	79	17,000
Water Use (Million Gallons/yr)	5.3	57	2,068
8-hr Carbon Monoxide Increase ( $\mu\text{g}/\text{m}^3$ ) <sup>b</sup>	0.189	0.37	673
Annual Nitrogen Dioxide Increase ( $\mu\text{g}/\text{m}^3$ ) <sup>b</sup>	0.0127	0.063	14.8
Annual PM <sub>10</sub> Increase ( $\mu\text{g}/\text{m}^3$ ) <sup>b</sup>	0.00089	0.0042	4.96
Annual Sulfur Dioxide Increase ( $\mu\text{g}/\text{m}^3$ ) <sup>b</sup>	0.00083	0.12	16.8
Annual Total Suspended Particulate Increase ( $\mu\text{g}/\text{m}^3$ ) <sup>b</sup>	0.00089	0.0042	45.4
Population Dose within 50 miles (person-rem/yr)	0.035	1.2	44.8
Workers	400	1,120	13,616
Critical Habitat Disturbance (acres)	0	0	0
Cultural Resources Disturbed	Excavate prehistoric site	Excavate prehistoric site	None identified
Liquid Low-Level Radioactive Waste (gal/yr)	214,000	Not Reported	Not Reported
Solid Low-Level Radioactive Waste (yd <sup>3</sup> /yr)	103	314	13,136
Liquid High Alpha Activity Waste (gal/yr)	81,300	Not Reported	Not Reported
Solid TRU Waste (yd <sup>3</sup> /yr)	210	235	564
Hazardous Waste (yd <sup>3</sup> /yr)	11	123	97
Liquid Nonhazardous Waste (gal/yr)	1,700,000	29,058,925	109,921,990
Solid Nonhazardous Waste (yd <sup>3</sup> /yr)	600	4,055	8,724

<sup>a</sup> Source: SPD EIS (DOE 1999c)

<sup>b</sup> Contribution to ambient concentrations

Table 5-16. Summary of Impacts for the No Action Alternative

Impact	Hanford	INEEL	Pantex	SRS	LLNL	LANL	RFETS
<b>Air Quality</b>							
Carbon Monoxide Emissions ( $\mu\text{g}/\text{m}^3$ )	8 hrs: 34.1 1 hr: 48.3	8 hrs: 302 1 hr: 1220	8 hrs: 620 1 hr: 2990	8 hrs: 671 1 hr: 5100	8 hrs: 69.69 1 hr: 235.5	8 hrs: 3000 1 hr: 5060	8 hrs: 145 1 hr: 534
Percent of State or Federal Standard (%)	8 hrs: 0.34 1 hr: 0.12	8 hrs: 3.0 1 hr: 3.1	8 hrs: 6.2 1 hr: 7.5	8 hrs: 6.7 1 hr: 13	8 hrs: 0.7 1 hr: 1	8 hrs: 38 1 hr: 43	8 hrs: 1.5 1 hr: 1.3
Nitrogen Dioxide ( $\mu\text{g}/\text{m}^3$ )	Annual: 0.25	Annual: 11	Annual: 1.94	Annual: 11.4	Annual: 6.08	Annual: 24 24 hrs: 119	Annual: 4.14
Percent of State or Federal Standard (%)	Annual: 0.25	Annual: 11	Annual: 1.9	Annual: 11	Annual: 6.1 1 hr: 1205.75	Annual: 32 24 hrs: 81	Annual: 4.1
Particulate Matter (10 $\mu\text{m}$ ) ( $\mu\text{g}/\text{m}^3$ )	Annual: 0.0179 24 hrs: 0.77	Annual: 3 24 hrs: 39	Annual: 8.79 24 hrs: 89.4	Annual: 4.94 24 hrs: 85.7	Annual: 0.83 24 hrs: 16.18	Annual: 11 24 hrs: 39	Annual: 0.235 24 hrs: 17.4
Percent of State or Federal Standard (%)	Annual: 0.036 24 hrs: 0.51	Annual: 6 24 hrs: 26	Annual: 18 24 hrs: 60	Annual: 9.9 24 hrs: 57	Annual: 2.8 24 hrs: 32	Annual: 22 24 hrs: 26	Annual: 0.5 24 hrs: 12



Table 5-16. Summary of Impacts for the No Action Alternative (continued)

Impact	Hanford	INEEL	Pantex	SRS	LLNL	LANL	RFETS
Sulfur Dioxide ( $\mu\text{g}/\text{m}^3$ )	Annual: 1.63 24 hrs: 8.91 3 hrs: 29.6 1 hr: 32.9	Annual: 6 24 hrs: 137 3 hrs: 591	Annual: 0 24 hrs: 2.0E-05 3 hrs: 8.0E-05 0.5 hr: 1.6E-04	Annual: 16.7 24 hrs: 222 3 hrs: 725	Annual: 0.08 24 hrs: 1.59 3 hrs: 10.44 1 hr: 16.01	Annual: 26 24 hrs: 171 3 hrs: 459	Annual: 0.295 24 hrs: 21.8 3 hrs: 64.6
Percent of State or Federal Standard (%)	Annual: 3.1 24 hrs: 3.4 3 hrs: 2.3 1 hrs: 5.0	Annual: 7.5 24 hrs: 38 3 hrs: 45	Annual: 0 24 hrs: <.001 3 hrs: <.001 0.5 hr: <.001	Annual: 21 24 hrs: 61 3 hrs: 56	Annual: 0.1 24 hrs: 1.5 3 hrs: 0.8 1 hrs: 2.4	Annual: 63 24 hrs: 83 3 hrs: 45	Annual: 0.37 24 hrs: 6 3 hrs: 9.2
Total Suspended Particulates ( $\mu\text{g}/\text{m}^3$ )	Annual: 0.0179 24 hrs: 0.77	(a)	(b)	Annual: 45.4	(a)	Annual: 14 24 hrs: 48	Annual: 0.284 24 hrs: 21
Percent of State or Federal Standard (%)	Annual: 0.036 24 hrs: 0.51	(a)	(b)	Annual: 61	(a)	Annual: 23 24 hrs: 32	Annual: 0.38 24 hrs: 14
Benzene ( $\mu\text{g}/\text{m}^3$ )	Annual: 6.0E-06	Annual: 2.9E-02	Annual: 5.47E-02 1 hr: 19.4	24 hrs: 20.7	(a)	(a)	(a)
Percent of State or Federal Standard (%)	Annual: 0.01	Annual: 24	Annual: 1.8 1 hr: 26	24 hrs: 14	(a)	(a)	(a)

Table 5-16. Summary of Impacts for the No Action Alternative (continued)

Impact	Hanford	INEEL	Pantex	SRS	LLNL	LANL	RFETS
<b>Human Health</b>							
Public Population Dose 50 mi (80 km) in 2030 (person-rem)	4.7 E-02	7.6E-05	6.3E-06	2.9E-04	6.7E-03	2.7	1.0E-01
50-year Fatal Cancers	1.2E-03	1.9E-06	1.6E-07	7.2E-06	1.7E-04	6.8E-02	2.5E-03
Maximally Exposed Public Individual in 2030 (mrem)	4.1E-04	1.4E-05	1.8E-08	6.8E-06	3.1E-04	6.5	4.8E-01
50-year Fatal Cancer Risk	1.0E-08	3.5E-10	4.5E-13	1.7E-10	7.8E-09	1.6E-04	1.2E-05
<b>Facility Accident Type<sup>c</sup></b>							
Beyond Evaluation Basis Earthquake	Beyond Evaluation Basis Earthquake	Beyond Evaluation Basis Earthquake	Beyond Evaluation Basis Earthquake	Beyond Evaluation Basis Earthquake	(b)	(b)	(b)
Frequency Estimate <sup>c</sup>	1.0E-07	1.0E-07	1.0E-07	1.0E-07	(b)	(b)	(b)
Public Population Dose Within 50 mi (80 km) <sup>c</sup> (person-rem)	2,410	723	821	2,590	(b)	(b)	(b)
LCFs <sup>c</sup>	1.2	0.36	0.41	1.3	(b)	(b)	(b)
<b>Ecological Resource</b>							
Surface Water	None	None	None	None	None	None	None
Surface Water Quality	None	None	None	None	None	None	None
Groundwater	None	None	None	None	None	None	None

Table 5-16. Summary of Impacts for the No Action Alternative (continued)

Impact	Hanford	INEEL	Pantex	SRS	LLNL	LANL	RFETS
Groundwater Quality	None	None	None	None	None	None	None
Endangered Species	None	None	None	None	None	None	None
Wetlands	None	None	None	None	None	None	None
Cultural, Historic and Archaeological	None	None	None	None	None	None	None
Land Use	None	None	None	None	None	None	None

Key: INEEL – Idaho National Engineering & Environmental Laboratory; SRS – Savannah River Site; LLNL – Lawrence Livermore National Laboratory; LANL – Los Alamos National Laboratory; RFETS – Rocky Flats Environmental Technology Site

<sup>a</sup> No state standards were presented in the SPD EIS (DOE 1999c) for the location.

<sup>b</sup> Information was not included in the SPD EIS (DOE 1999c)

<sup>c</sup> Information on facility accidents obtained from the S&D PEIS (DOE 1996b)

**Table 5-17. Accident Scenarios for Plutonium Storage Under the No Action Alternative<sup>a</sup>**

Accident Scenario	Accident Frequency	Source Term at Risk <sup>b</sup> (No. of PCV)	Source Term Related to the Environment (g Pu)
PCV puncture by forklift	6.0E-04	2	0.0387
PCV breach by firearms discharge	3.5E-04	1	3.87E-03
PCV penetration by corrosion	0.064	1	0.158
Vault fire	1.0E-07	120	81.3
Truck bay fire	1.0E-07	12	5.40
Spontaneous combustion	7.0E-07	2	7.75E-03
Explosion in vault	1.0E-07	45	12.7
Explosion outside vault	1.0E-07	1	0.058
Nuclear criticality	1.0E-07	Not Applicable	1.0E+19 fissions
Beyond evaluation basis earthquake	1.0E-07	194	146

<sup>a</sup> Source: S&D PEIS (DOE 1996b)

<sup>b</sup> Primary Containment Vessel (PCV) is assumed to contain up to 4,500 g of weapons-grade plutonium as a bounding case.

Table 5-18. Summary of Accident Dose (rem) for Plutonium Storage Under the No Action Alternative<sup>a</sup>

Accident Scenario	Hanford		INEEL		Pantex		SRS	
	MEI Dose	Population Dose	MEI Dose	Population Dose	MEI Dose	Population Dose	MEI Dose	Population Dose
PCV puncture by forklift	8.8E-05	0.64	8.8E-05	0.19	1.4E-03	0.22	1.4E-04	0.068
PCV breach by firearms discharge	8.8E-06	0.064	8.8E-06	0.19	1.4E-03	0.022	1.4E-05	0.068
PCV penetration by corrosion	3.6E-04	2.6	3.6E-04	0.78	5.8E-03	0.89	5.8E-04	2.8
Vault fire	0.18	1,340	0.19	402	3.0	456	0.3	1,440
Truck bay fire	0.012	89	0.012	26.7	0.20	303	0.020	95.5
Spontaneous combustion	1.8E-05	0.13	1.8E-05	0.038	2.8E-04	0.044	2.8E-05	0.14
Explosion in vault	0.029	209	0.029	62.7	0.46	71.2	0.046	224
Explosion outside vault	1.3E-04	0.96	1.3E-04	0.29	2.1E-03	0.33	2.1E-04	1.0
Nuclear criticality	6.5E-05	0.07	7.7E-05	0.018	1.9E-03	0.046	1.1E-04	0.094
Beyond evaluation basis earthquake	0.33	2,410	0.34	723	5.34	821	0.53	2,590

<sup>a</sup> Source: S&D PEIS (DOE 1996b).

PCV – Primary Containment Vessel

**Table 5-19. F-Area Site Evaluation Matrix**

Qualification Criteria	Area			
	3	2	4	5
Free from Subsurface Contamination	No		No	No
Adequate Terrain and Area			No	
Free from RCRA / CERCLA Features				No

Evaluation Criteria	Weight	Rating			
		3	2	1	0
Protected Species	3	2	2	2	2
Water Table	3	2	2	1	3
Topography	3	3	3	1	2
Accessibility	2	1	3	2	3
Soft Zones	2	2	2	2	2
Utilities / Infrastructure	2	1	3	2	2
Wetlands	1	2	2	1	2
Archaeological Features	1	1	1	2	2
Interference with Existing SSCs	1	1	2	2	1
<b>Sum of the (weights) x (ratings)</b>		<b>33</b>	<b>42</b>	<b>29</b>	<b>40</b>

Rating:

3 = More than Adequate

2 = Adequate

1 = Marginal

**Table 5-20. Irreversible and Irretrievable Commitments of Construction Resources for the MOX Fuel Fabrication Facility**

<b>Resource</b>	<b>Consumption</b>	<b>Comments</b>
Land	41 acres	Land will be returned to industrial use after completion of the MFFF mission
Electricity (MWh)	12	
Fuel (gal)	300,000	
Water (gal)	30,000,000	Water will be treated and returned to the environment
Concrete (yd <sup>3</sup> )	103,000	
Steel (tons)	2,000	

**Table 5-21. Irreversible and Irretrievable Commitments of Operations Resources for the MOX Fuel Fabrication Facility**

Resource	Annual Consumption	Comments
Electricity	80,000 MWh	
Water	5,300,000 gal	Water will be treated and returned to the environment
Fuel Oil	22,500 gal	Used for emergency and standby diesels
Plutonium	3.5 metric tons (Pu)	
Depleted Uranium	66.5 metric tons (U)	
Argon	12,900,000 ft <sup>3</sup>	
Argon-Methane	367,000 ft <sup>3</sup>	
Dodecane	770 gal	
Helium	341,000 ft <sup>3</sup>	
Hydrazine (35%)	400 gal	
Hydrogen	371,000 ft <sup>3</sup>	
Hydrogen Peroxide (35%)	530 gal	
Hydroxylamine Nitrate	9,200 gal	
Manganese Nitrate	10 lb	
Nitric Acid	1,300 gal	95% of acid is recovered and recycled
Nitrogen	160,000,000 ft <sup>3</sup>	
Nitrogen Tetroxide	132,000 ft <sup>3</sup>	
Oxalic Acid Dehydrate	8,900 lb	
Oxygen	71,000 ft <sup>3</sup>	
Porogen	660 lb	
Silver Nitrate	240 lb	96% of silver is recovered and recycled
Sodium Carbonate	440 lb	
Sodium Hydroxide (10M)	5 gal	
Tri-Butyl Phosphate	740 gal	
Zinc Stearate	617 lb	



**This page intentionally left blank.**

## **6. ANALYSIS OF ENVIRONMENTAL IMPACTS OF PROPOSED ACTION AND ALTERNATIVES**

This chapter summarizes each alternative examined in this ER, considering both the benefits and environmental costs of each alternative. The conclusion of the environmental analysis conducted in this ER is that the proposed action is the appropriate course of action.

### **6.1 PROPOSED ACTION**

As discussed previously, the proposed action is the issuance of an NRC license to possess and use SNM in an MFFF at SRS. The primary benefit of the proposed action is that it meets the purpose and need for action discussed in Chapter 2. The proposed action provides the mechanism to implement the joint United States and Russian Federation Agreement (White House 2000) to convert 28.2 tons (25.57 metric tons) of surplus plutonium to MOX fuel.

In addition to the significant national security benefit of implementing the joint United States and Russian Federation Agreement, the proposed action also results in additional benefits to the local community around SRS by providing approximately 400 to 800 construction jobs and 400 full-time jobs over the lifetime of the project. This increase in jobs will partially offset the planned job reductions as the SRS mission changes. The process of converting the surplus plutonium to MOX fuel will also consume up to 728 tons (660 metric tons) of surplus depleted uranium currently in the DOE stockpile. The use of this depleted uranium reduces the amount of depleted uranium that DOE will have to dispose.

The direct environmental impacts of the proposed action are summarized in Table 6-1. The proposed action will require 41 ac (16.6 ha) of land in the SRS F Area. All liquid and solid wastes will be transferred to the appropriate SRS waste treatment facility. Because the MFFF does not have any process liquid effluent, there are no expected impacts on surface water or groundwater. The MFFF site will have a stormwater collection and routing system that will discharge through the existing SRS stormwater NPDES outfall or new outfalls. There may be slight temporary impacts from construction runoff, but these should disappear once construction is completed.

The MFFF will have emergency and standby diesel generators that will be tested periodically, resulting in criteria pollutant emissions during the testing periods. Incremental increases in ambient concentrations of these criteria pollutants will be well below the ambient air quality standards for southwestern South Carolina. The MOX fuel fabrication process also will release small quantities of NO<sub>x</sub>. The annual releases are accounted for in the nitrogen dioxide projections for the facility.

Dose to the public from normal MFFF operations (0.035 person-rem/yr; 4.1E-04 mrem/yr for the MEI) will be well below NRC and EPA criteria and also below background radiation levels.

Although the construction and operation of the MFFF will disturb 49 ac (19.8 ha) of SRS land, some of this land is already the site of a spoils pile from other F-Area construction, and there will be no impacts to sensitive ecological areas because no such areas were identified on the MFFF site. The construction of the MFFF will require the excavation and recovery of an archaeological site. The archaeological site is not expected to contain any human or sacred artifacts and so the excavation and recovery of the artifacts may represent a benefit through the preservation of the artifacts.

The most significant impact of MFFF operations will be the amount of waste generated. With the exception of the liquid high alpha activity waste, the amounts generated are a small fraction of annual SRS waste generation. The liquid high alpha activity waste generated by the MFFF will be processed in the F-Area Tank Farm. The MFFF liquid high alpha activity waste represents a small increase in the amount of waste currently stored in the F-Area Tank Farm.

Cumulative impacts in the geographic vicinity of the MFFF and SRS are dominated by the impacts of existing SRS activities. SRS is currently in substantial compliance with applicable federal, state, and local air quality regulations, and compliance would be maintained even with the cumulative effects of all surplus plutonium disposition activities. Dose to the public from all activities would increase by 1.2 person-rem per year or about 2.6% over the current SRS dose of 44.8 person-rem per year. With the exception of the liquid high alpha activity waste, which is a new waste stream, all other MFFF wastes represent very small additions to the current SRS waste generation rates and should not represent any significant cumulative impact.

The total dose to transportation workers associated with the  $UF_6$  shipments is estimated to be 0.94 person-rem, corresponding to  $3.76E-04$  LCFs. The total dose to transportation workers associated with the  $UO_2$  shipments is estimated to be 0.69 person-rem, corresponding to  $2.76E-04$  LCFs.

The dose to the public associated with the  $UF_6$  shipments is estimated to be 0.17 person-rem, corresponding to  $8.60E-05$  LCFs. For the  $UO_2$  shipments, the total dose to the public is estimated to be 0.11 person-rem, corresponding to  $5.40E-05$  LCFs.

The cumulative dose to the transportation workers associated with the MOX fuel shipments to the mission reactors is estimated to be 9.8 person-rem, corresponding to  $3.92E-03$  LCFs. The dose to the public associated with these shipments is estimated to be 2.12 person-rem, corresponding to  $1.06E-03$  LCFs.

The incident-free dose per shipment (in person-rem) for the plutonium recycle shipments in NUREG-0170 (NRC 1977c) was calculated to be 0.17, versus a maximum of 0.03 person-rem per shipment for the MOX shipments from the SRS MFFF to the mission reactor sites. The dose to the MEI for the person in traffic next to a shipment of MOX fuel is 2.0 mrem. This dose is a small fraction of the dose received from natural background radiation and is consistent with the conclusions of NUREG-0170 (NRC 1977c).

This ER relied on the mission reactor impacts analysis provided in the SPD EIS (DOE 1999c). The SPD EIS determined that there should be no change in impacts to the environment during normal operations at the mission reactors resulting from the irradiation of MOX fuel. This conclusion is reinforced by operating experience from Electricite de France, which operates MOX fuel power plants in France.

Because the MOX fuel that will be produced by the MFFF represents less than 1% of the domestic commercial nuclear fuel use, financial impacts to commercial fuel facilities should be minimal.

Although the proposed action does have environmental impacts, the impacts are small and consequently acceptable. The environmental impacts are outweighed by the benefit of enhancing nuclear weapons reductions both in the United States and in Russia.

## **6.2 NO ACTION ALTERNATIVE**

The No Action Alternative is the denial of a license to possess and use SNM in an MFFF at SRS. Because of previous DOE decisions in the SPD EIS ROD (DOE 2000b), the consequence of the No Action Alternative is continued storage of surplus plutonium at existing sites. The No Action Alternative does not meet the need for implementing the joint United States and Russian Federation Agreement (White House 2000) to convert 28.2 tons (25.57 metric tons) of surplus plutonium to MOX fuel.

The primary benefit of the No Action Alternative is the avoidance of impacts associated with the proposed action. This avoidance is generally in the area of waste generation. Because the impacts of the No Action Alternative are spread over seven different locations, as reported in the SPD EIS (DOE 1999c), the range of impacts is reported in Table 6-1. Because the No Action Alternative uses existing storage facilities, there is minimal impact on land or water use.

For the No Action Alternative, emissions include not only emergency generators but also emissions from vehicles and maintenance activities. As with the proposed action, the impacts to ambient air quality under the No Action Alternative represent a small percentage of the state or federal standard. However, the emissions under the No Action Alternative would occur indefinitely, since storage would be required indefinitely.

For the No Action Alternative, all storage occurs in existing facilities with no ecological impacts for continued use of these facilities. Storage activities do not generate significant amounts of waste.

## **6.3 SITING ALTERNATIVES**

In the SPD EIS (DOE 1999c), DOE evaluated several combinations of facilities and sites and chose as its Preferred Alternative to site the MFFF (along with the PDCF and PIP) in F Area at SRS. In the subsequent ROD (DOE 2000b), DOE confirmed the SPD EIS Preferred Alternative. Subsequent to the ROD, DOE investigated several sites within F Area for the MFFF and other

surplus plutonium disposition facilities. The results of this investigation are summarized in Section 5.7.2.

Environmental impacts associated with facility operations (i.e., land use, water use, radiological and nonradiological emissions, and waste generation) are unaffected by the selection of any site within F Area. The selected site does not have wetlands or critical habitat; some alternative sites included wetlands. The selected site does not exhibit any groundwater plumes or significant contamination; some alternative sites do exhibit significant groundwater contamination. The selected site, however, will require mitigation of an archaeological site; most of the alternative sites would have avoided the archaeological site. In the final evaluation, none of the alternative sites were obviously superior to the selected site.

#### **6.4 DESIGN ALTERNATIVES**

One of the bases for selection of DCS as the contractor for the MFFF was the DCS proposal to use a proven design (the COGEMA process) based on actual operations of similar facilities (MELOX and La Hague) in France. The COGEMA design represents the results of several iterations of process design and operating experience over several years of MOX fuel production in France. This design optimizes both production and safety. The selection of DCS and the contractual arrangements with DOE established the basic design of the facility and process. In the process of converting the COGEMA design, based on the MELOX and La Hague facilities, to meet United States regulations, codes, and standards, DCS considered several design alternatives (see Section 5.7.3). In each case, the design alternatives selected resulted in a lower environmental impact.

## **Tables**

**This page intentionally left blank.**

**Table 6-1. Comparison of Environmental Impacts for the Proposed Action and the No Action Alternative**

Environmental Impact	Proposed Action <sup>a</sup>	No Action Alternative <sup>b</sup>
Land Use (acres)	41	0
Surface Water Quality	No Impact	No Impact
Groundwater Quality	No Impact	No Impact
Ambient Carbon Monoxide Increment ( $\mu\text{g}/\text{m}^3$ ) 8-hour average	0.189	34.1 – 3000
Ambient Nitrogen Dioxide Increment ( $\mu\text{g}/\text{m}^3$ ) Annual average	0.0127	0.25 – 24
Ambient Particulate Matter – $\text{PM}_{10}$ Increment ( $\mu\text{g}/\text{m}^3$ ) 24-hour average	0.0220	0.77 – 89
Ambient Sulfur Dioxide Increment ( $\mu\text{g}/\text{m}^3$ ) 24-hour average	0.0205	2.0E-05 – 171
Public Population Dose – 50 mi (80 km) in 2030 (person-rem)	0.035	6.3E-06 – 2.9E-04
Maximally Exposed Public Individual (mrem)	4.1E-04	6.8E-06 – 6.5
Limiting Accident Public Population Dose Within 50 mi (80 km) (person-rem)	< 6	723 – 2,590
Wetlands Affected (acres)	None	None
Critical Habitat Lost (acres)	None	None
Cultural Resources Disturbed	Excavation of archaeological site <sup>c</sup>	None
Liquid LLW (gal/yr)	214,000	No change
Solid LLW ( $\text{yd}^3/\text{yr}$ )	103	No change
Liquid High Alpha Activity Waste (gal/yr)	81,300	No change
Solid TRU Waste ( $\text{yd}^3/\text{yr}$ )	210	No change
Hazardous Waste ( $\text{yd}^3/\text{yr}$ )	11	No change
Liquid Nonhazardous Waste (gal/yr)	1,700,000	No change
Solid Nonhazardous Waste ( $\text{yd}^3/\text{yr}$ )	600	No change

Source for No Action Impacts: S&D PEIS (DOE 1996b) and SPD EIS (DOE 1999c); Source for Mission Reactor Impacts: SPD EIS (DOE 1999c)

<sup>a</sup> Projected impacts are based on preliminary design and assumed to be bounding. Impacts of the proposed action are expected to occur for a 20-year period.

<sup>b</sup> Impacts for the No Action Alternative are expected to occur indefinitely.

<sup>c</sup> Mitigation of the archaeological site may result in a positive environmental impact due to recovery of archaeological artifacts.



**This page intentionally left blank.**

## **7. STATUS OF COMPLIANCE WITH FEDERAL AND STATE ENVIRONMENTAL REGULATIONS**

Several environmental permits and plans required by federal and state agencies need to be developed and approved in order to construct and operate the MFFF. In addition, under NEPA rules and the enabling regulations of the NRC (10 CFR Part 51), consultations may be required with other federal agencies, as appropriate. Comments and recommendations made by these agencies are part of the review process for NRC project approvals. Permits and approvals are summarized in Table 7-1.

### **7.1 UNITED STATES GOVERNMENT**

The following is a summary of federal agencies that will be involved in the environmental permit and plan approvals and the consultation process for MFFF project construction and operations activities.

#### **7.1.1 U.S. Nuclear Regulatory Commission (NRC)**

The NRC is responsible for the review and licensing of fuel fabrication facilities. The federal guidelines for licensing a fuel fabrication facility are identified in 10 CFR Part 70. Under 10 CFR Part 70, a comprehensive License Application and a Safety Assessment Summary must be submitted to NRC. An ER is submitted to meet the requirements of 10 CFR Part 51. NRC is responsible for establishing limits on radiological releases from the MFFF.

#### **7.1.2 U.S. Environmental Protection Agency (EPA)**

Permitting of the MFFF is governed by federal and state environmental laws and enabling regulations. SRS F Area has been an established industrial area for approximately 50 years. The area surrounding F Area has been impacted previously by F-Area construction and operations activities and is presently undergoing environmental restoration activities.

EPA Region IV in Atlanta, Georgia, has delegated regulatory jurisdiction to SCDHEC for virtually all aspects of permitting, monitoring, and reporting activities. Therefore, all activities associated with compliance to the Clean Air Act (CAA), Clean Water Act (CWA), Safe Drinking Water Act (SDWA), and Resource Conservation and Recovery Act (RCRA) will be undertaken with SCDHEC (addressed in Section 7.2.1).

The projected quantities of chemicals will not be greater than the threshold level in 40 CFR §68.130. Accordingly, compliance with 40 CFR Part 68, the Risk Management Rule, is not invoked, and a Risk Management Plan does not have to be developed.

### **7.1.3 U.S. Army Corps of Engineers (COE)**

An Individual or General 404 Permit is not required from the COE since there are no plans to dredge and fill jurisdictional wetlands during the construction of the MFFF.

A Floodplain Assessment (WSRC 1999a) that addresses the flood history of the Savannah River and Upper Three Runs, and the effects of local intense precipitation at F Area, indicates that the MFFF site is situated well above the design basis flood. The MFFF site is not located in a floodplain, nor are there any wetlands present within the MFFF site.

### **7.1.4 U.S. Department of Energy (DOE)**

The MFFF will be a DOE-owned, NRC-licensed facility located at SRS. DOE Materials Disposition (DOE-MD) is the owner, while DOE-SR is providing the host site. Accordingly, environmental and site utility permits and plans are needed from DOE-SR for MFFF construction and operation. In addition, several SRS sitewide permits will serve as a platform for a majority of the MFFF environmental permits.

### **7.1.5 U.S. Department of Transportation (DOT)**

Transport of the MFFF fuel to the mission reactors requires compliance with the following DOT enabling regulations:

- 49 CFR Part 107, "Hazardous Materials Program Procedures," Subpart G: Registration and fee to DOT as a person who offers or transports hazardous materials
- 49 CFR Part 171, "General Information, Regulations, and Definitions"
- 49 CFR Part 173, "Shippers – General Requirements for Shipments and Packages," Subpart I: Radioactive materials
- 49 CFR Part 177, "Carriage by Public Highway"
- 49 CFR Part 178, "Specification for Packagings."

All provisions of these enabling regulations will be met prior to the transport of MFFF fuel assemblies from the MFFF to the mission reactors.

### **7.1.6 U.S. Department of Interior (DOI)**

The U.S. Fish and Wildlife Services (USFWS) branch of DOI is responsible for the protection of threatened and endangered species. Since there are no threatened or endangered species on the MFFF site, a negative declaration on endangered species has been requested from the USFWS.

### **7.1.7 U.S. Department of Agriculture (USDA)**

The U.S. Natural Resources Conservation Service (USNRCS) branch of the USDA is responsible for the preservation of prime or unique farmlands. However, the USNRCS does not identify SRS land as prime farmlands because the land is not available for agricultural production (DOE 1996b:3-230).

## **7.2 STATE OF SOUTH CAROLINA**

With the exception of the NRC license, MFFF permitting is under the jurisdiction of South Carolina state agencies. The following is a summary of environmental permitting activities to be undertaken with the appropriate state agencies.

### **7.2.1 South Carolina Department of Health and Environmental Control (SCDHEC)**

#### **7.2.1.1 Preservation of Air Quality**

MFFF construction and operations activities are not expected to have any measurable impact on the local air quality since no significant criteria or hazardous air pollutant emissions will result.

Any potential air quality-related impacts associated with the construction of the MFFF result from diesel fuel emissions from construction equipment, particulate matter emissions from disturbance of soil by construction equipment, if used, and other vehicles (construction fugitive emissions), operation of a concrete batch plant, employee vehicles, and trucks moving materials and wastes. There are no SCDHEC regulations governing the generation of fugitive dust resulting from construction activities. However, for a project of this size, steps need to be taken to minimize fugitive dust emissions. Accordingly, a Construction Emissions Control Plan will be developed to provide assurance that fugitive dust emissions will be effectively managed and minimized throughout MFFF construction. This plan will include dust control techniques, such as watering of unpaved surfaces, chemical stabilization of potential dust sources, the use of portable wind screens and fences, and other equivalent mitigation measures.

During operations, MFFF gaseous emissions are limited to criteria pollutants from aqueous polishing process offgas through the MFFF stack from intermittent usage of standby and emergency diesel generators and from the evaporation of a very small amount of VOCs from the ventilation stack on the diesel fuel storage tanks. These minor sources will not trigger 40 CFR Part 60 New Source Performance Standards or 40 CFR Part 52 Prevention of Significant Deterioration permitting requirements. In addition, small space heating sources of air pollutants (less than 1 million Btu/hr heat input) are exempt from applicable SCDHEC air quality regulations. Moreover, the diesel generators are nonconstruction stationary sources of air pollutants greater than 150 kW in size but are not expected to operate more than 250 hours per year. As long as diesel generator usage is appropriately documented, the diesel generators are exempted from permitting requirements in accordance with South Carolina Regulation 61-61.2, Section II.F.(2).(e). Finally, the quantity of criteria and hazardous air pollutants expected to be

emitted during MFFF operations is not of sufficient magnitude to trigger any CAA Title V (40 CFR Part 71) permitting requirements. The MFFF sintering furnace and aqueous polishing screw calciner are electrically fired and therefore will not generate any criteria emissions.

Extremely small quantities of gaseous and particulate radionuclides are expected under normal MFFF operations. NRC-licensed fuel fabrication facilities are exempted from National Emissions Standards for Hazardous Air Pollutants (NESHAP) requirements governing radiological releases. Compliance with applicable enabling regulations and other guidance on radiological releases is addressed in the *Construction Authorization Request and License Application*.

Emissions of hazardous air pollutants from the Reagent Process Building will be under the triggers of 10 tons (9.1 metric tons) per year for a single hazardous air pollutant and 25 tons (22.7 metric tons) per year for all hazardous air pollutants. Refrigerants used for air conditioning at the MFFF will consist of Class II refrigerants (i.e., non-ozone-depleting substances). Therefore, permitting for CAA Title VI, "Stratospheric Ozone Protection" (40 CFR Part 82), relative to the usage and storage of refrigerants, will not be required.

Although the criteria and hazardous air pollutant emissions during MFFF operation are minimal, SCDHEC does require the development of Bureau of Air Quality permit forms (i.e., Permit Forms I and IIB) to obtain exemptions. Moreover, permit forms need to be submitted to augment the SRS Title V Operating Permit. The appropriate forms for emissions from the MFFF stack, diesel generators, and diesel fuel storage vault will be prepared, and the SRS Title V Permit will be augmented appropriately.

#### **7.2.1.2 Surface Water Protection**

To protect jurisdictional waters from pollutants that could be conveyed in construction-related stormwater runoff, EPA enabling regulations require construction projects disturbing 5 ac (2 ha) or more of soil to secure coverage under an NPDES permit authorizing the construction-related stormwater discharges. If a concrete batch plant is part of the construction activities, its runoff would also need to be addressed within this permitting structure (i.e., filing an NPDES Permit for no discharge basin). EPA regulates the proper disposition of stormwater from these larger construction sites through an NPDES permit program (i.e., 40 CFR §122.26(b)(14)) pursuant to Section 402 of the CWA. With respect to MFFF construction activities at SRS, a sitewide Construction NPDES General Permit (SCR100000) is available to cover construction projects disturbing 5 ac (2 ha) or more of soil.

Coverage under the SRS General Permit will be secured by filing an application form with SCDHEC (i.e., NOI) at least 48 hours prior to initiating any construction activities. The scope of construction will need to comply with applicable terms and conditions identified in the Storm Water General Permit.

Soil-disturbing activities associated with construction of the MFFF include the following:

- Site grading
- Berms that will function as diversion ditches
- Stormwater detention basin
- Construction of the site access road
- Construction laydown area.

Approximately 49 ac ( 19.8 ha) of soil will be disturbed during MFFF construction.

Once the NOI is filed with SCDHEC, coverage under the SRS General Permit is received by default 48 hours after filing. However, several activities must be conducted prior to filing an NOI. These activities include the preparation and approval of a Stormwater Management Pollution Prevention Plan (SWPPP).

The NOI will provide general information about the site, such as name, location, dates, and other general information relevant to the nature of the construction activities. Within the SWPPP, there will be provisions outlining erosion and sediment controls, soil stabilization practices, structural controls, and other Best Management Practices (BMPs) that will be employed during construction to protect offsite waters from adverse impacts from construction-related stormwater runoff. The SWPPP will also outline maintenance and inspection requirements and identify BMPs for the effective management of stormwater runoff from a concrete batch plant, if one is employed. If a detention basin is required, it will also be appropriately sized to meet the applicable criteria in the General Permit. BMPs include schedules of activities, prohibition of practices, maintenance procedures, and other management practices designed to prevent or reduce the pollution of waters of the United States. BMPs also include treatment requirements, operating procedures, and practices to control plant site runoff, spillage or leaks, sludge or waste disposal, or drainage from raw material storage.

The SWPPP will be maintained onsite throughout the construction process and will be updated as appropriate. The SWPPP will also be made available for review, upon request, by the cognizant regulators.

Grading Permits, which are required by SRS, will be developed and filed, as appropriate.

Once construction has been completed, the existing SRS Industrial NPDES General Permit for stormwater that is exposed to pollutants in an industrial activity will be modified to accommodate the MFFF. The existing SRS (SC0000175) NPDES Permit for process water discharges will not require modification since there are no expected MFFF process water discharges.

A Spill Prevention Control and Countermeasures (SPCC) Plan does not need to be developed since the 40 CFR Part 112 threshold will not be exceeded because the MFFF diesel fuel storage tanks will be underground.

### **7.2.1.3 Drinking Water and Groundwater Protection**

Drinking water requirements for construction and operation of the MFFF will be satisfied by a tie-in to the available drinking water from the SRS domestic water system. This system complies with applicable SDWA enabling regulations associated with the delivery of safe and reliable drinking water for SRS employees. A Domestic Water Distribution Construction Permit will be obtained prior to construction. Approval from the SRS Water Services Department and Environmental Protection Department will be sought by providing static and residual pressure at the tie-in and design calculations of head loss, interior flows, and fire fighting flow requirements. SCDHEC has delegated permitting authority for domestic water permits to the Environmental Protection Department. Prior to operations, a Domestic Water Distribution Operating Permit will be obtained following the same protocol.

Sanitary wastewater from MFFF construction and operations activities will be disposed of through a tie-in with the CSWTF. Influent quality requirements have to be met by each CSWTF contributor. The amount of sanitary waste generated during MFFF operations will result in a trivial increase to the CSWTF. Prior to MFFF construction, an Engineering Report that identifies all liquid waste streams, influent quality parameters (i.e., pre-treatment requirements), facilities, and lift stations will be developed, and a SCDHEC Sanitary Wastewater Construction Permit will be obtained prior to the tie-in. Prior to operations, a SCDHEC Sanitary Wastewater Operating Permit will be obtained following the same protocol.

Contaminated wastewater will be collected in a series of wastewater tanks to ensure zero liquid radioactive liquid discharges from MFFF operation. The wastewater will be transported periodically to a disposal facility in F Area for disposition.

There is a possibility that the soft zones beneath the MFFF will require grouting. If a decision is made to grout, an Underground Injection Control Permit will be acquired.

### **7.2.1.4 Pollution Prevention and Waste Management**

The MFFF project is committed to pollution prevention and waste minimization practices and will incorporate RCRA pollution prevention goals, as identified in 40 CFR Part 261. A Waste Minimization Plan will be developed to meet the waste minimization criteria of both NRC and EPA regulations. The Waste Minimization Plan will describe how the MFFF design procedures for operation will minimize (to the extent practicable) contamination of the facility and the environment and minimize (to the extent practicable) the generation of radioactive, mixed, hazardous, and nonhazardous solid waste.

Nonhazardous RCRA wastes from construction activities will be appropriately disposed at an offsite permitted landfill.

Throughout operations, the small quantities of waste generated will be appropriately handled and disposed. The small quantities of hazardous wastes that would be generated are expected to be much less than 100 kg/month. Thus, the MFFF should qualify as a Small Quantity Hazardous

Waste Generator. The MFFF-generated wastes will be transported to a satellite accumulation area and later relocated to a staging area or existing SRS-permitted RCRA storage area. Since there will be no treatment or long-term storage of MFFF RCRA wastes in MFFF facilities, there will be no need for an MFFF RCRA Part B Permit.

The MFFF design includes a 5,000-gal (18,925-L) double-walled tank and an 18,000-gal (68,130-L) tank within a vault. Both tanks meet the design requirements of 40 CFR Part 280 and SCDHEC Regulation 61-92 Part 280 for underground storage tanks (USTs). Therefore, registrations for both USTs will be required.

MFFF-generated wastes will be treated, stored, and disposed through the existing SRS waste management infrastructure.

### **7.2.2 South Carolina Department of History and Archives**

Construction activities that take place at SRS require compliance with applicable federal historic preservation requirements administered through the state of South Carolina.

The SPD EIS (DOE 1999c) documented that there are no cultural resources located on the MFFF site. However, there is an archaeological resource area on the MFFF. Discussions have been initiated with the state historic preservation officer and mitigation measures have been identified. These mitigation measures will precede any construction activities and are part of the SRS Infrastructure Project.

### **7.2.3 South Carolina Department of Natural Resources (SCDNR)**

SCDNR is responsible for the protection of threatened and endangered species listed by the State of South Carolina. Since there are no threatened or endangered species on the MFFF site, a negative declaration on endangered species has been requested of the SCDNR.

## **7.3 AIKEN COUNTY**

Aiken County does not have any applicable environmental permitting requirements.

As part of the notification requirements associated with 40 CFR Part 355 (implementing regulation for the Emergency Planning and Community Right-to-Know Act), any necessary notifications will be established with the Local Emergency Planning Committee, at the appropriate time, to identify hazardous materials that will be used once the MFFF is operational.

## **7.4 PERMIT AND APPROVAL STATUS AND CONSULTATIONS**

### **7.4.1 Permit and Approval Status**

Several permits and plans associated with construction activities are in the early stages of preparation and will be formally filed with the appropriate agency prior to the commencement of



construction. Construction and operational permit applications will be prepared and filed, and regulator approval and/or permits will be received prior to applicable construction or facility operation.

Table 7-1 provides the status of compliance with federal and state environmental laws.

#### **7.4.2 Agency Consultations**

Initial consultations have been made with the cognizant agencies. More specific discussions will be held, as appropriate, as the project progresses.

## Tables

**This page intentionally left blank.**

**Table 7-1. Status of Compliance with Federal and State Environmental Laws**

<b>Requirement</b>	<b>Status</b>	<b>Comments</b>
<b>Federal</b>		
Negative declaration on cultural resources from State Historic Preservation Officer (SHPO)  43 CFR Part 7; 36 CFR Parts 60, 61, 63, 65, 67, 68	Pending	Discussions with the SHPO have been initiated. See Appendix A.
Negative declaration on endangered species from the U.S. Fish and Wildlife Services (USFWS)  50 CFR Parts 13, 17, 222, 226, 227, 402, 424, 450-453	Pending	Discussions with the USFWS have been initiated. See Appendix A.
Negative declaration on prime or unique farmlands from U.S. Natural Resources Conservation Service (USNRCS)  7 CFR Part 658	Not required	USNRCS does not identify SRS as prime farmlands because the land is not available for agricultural production (DOE 1996b:3-230).
Negative declaration on 404 Permit from U.S. Army Corps of Engineers (COE)	Not required	No jurisdictional wetlands on MFFF site.
Risk Management Plan	Not required	No federal or state interfaces are necessary.
Floodplain Assessment	Completed	Floodplain Assessment incorporated into the design basis.
<b>State of South Carolina</b>		
Negative declaration on endangered species from SCDNR	Pending	Discussions with SCDNR have been initiated. See Appendix A.
Construction Emissions Control Plan	Scoped	Consultation with SCDHEC initiated.
Bureau of Air Quality Construction Permit	Scoped	Consultation with SCDHEC initiated.
Construction NPDES General Permit	Scoped	Consultation with SCDHEC initiated.
Notice of Intent (supports SWPPP)	Scoped	Consultation with SCDHEC initiated.

**Table 7-1. Status of Compliance with Federal and State Environmental Laws (continued)**

<b>Requirement</b>	<b>Status</b>	<b>Comments</b>
Construction Stormwater Management Pollution Prevention Plan (SWPPP)	Scoped	Consultation with SCDHEC initiated.
Domestic Water Distribution Construction Permit	Scoped	Consultation with SCDHEC initiated.
Backflow Preventer Test Form (accompanies Domestic Water Distribution Construction Permit)	Scoped	Consultation with SCDHEC initiated.
SCDHEC Sanitary Wastewater Construction Permit	Scoped	Consultation with SCDHEC initiated.
Title V Operating Permit	Scoped	Consultation with SCDHEC initiated.
Industrial NPDES General Permit	Scoped	Consultation with SCDHEC initiated.
Waste Minimization Plan	Scoped	Consultation with SCDHEC initiated.
Emergency Planning and Community Right-to-Know notifications	Scoped	Consultation with SCDHEC initiated.
Grading Permit	Scoped	Consultation with SCDHEC initiated.
Underground Injection Control Permit	Scoped	Consultation with SCDHEC initiated.
SCDHEC Sanitary Wastewater Operation Permit	Scoped	Consultation with SCDHEC initiated.
Industrial SWPPP	Scoped	Consultation with SCDHEC initiated.
Domestic Water Distribution Operating Permit	Scoped	Consultation with SCDHEC initiated.
SWPPP BMP	Scoped	Consultation with SCDHEC initiated.
UST Registrations	Scoped	Consultation with SCDHEC initiated.

## 8.0 REFERENCES

- ANSI/ANS (American National Standards Institute/American Nuclear Society), 1983a. *Criteria for Nuclear Criticality Safety Controls in Operations with Shielding and Confinement*, ANSI/ANS-8.10
- ANSI/ANS, 1983b. *Nuclear Criticality Safety in Operations with Fissionable Materials Outside Reactors*, ANSI/ANS-8.1
- Aragon, K., 1999. U.S. Department of Energy, Carlsbad Area Office, Carlsbad, NM, personal communication (facsimile) to J. DiMarzio, Science Applications International Corporation, Germantown, MD, "Schedule for TRU Waste Shipments Sent from Generator Sites," February 4
- Arnett, M.W. and A.R. Mamatey (eds.), 1996. *Savannah River Site Environmental Report for 1995*, WSRC-TR-96-0075, Westinghouse Savannah River Company, Savannah River Site, Aiken, SC
- Arnett, M.W. and A.R. Mamatey (eds.), 1999. *Savannah River Site Environmental Report for 1998*, WSRC-TR-98-00312, Environmental Monitoring Section, Environmental Protection Department, Westinghouse Savannah River Company, Savannah River Site, Aiken, SC
- Arnett, M.W. and A.R. Mamatey (eds.), 2000a. *Savannah River Site Environmental Report for 1999*, WSRC-TR-99-00299, Environmental Monitoring Section, Environmental Protection Department, Westinghouse Savannah River Company, Savannah River Site, Aiken, SC
- Arnett, M.W. and A.R. Mamatey (eds.), 2000b. *Savannah River Site Environmental Data for 1999*, WSRC-TR-99-00310, Environmental Monitoring Section, Environmental Protection Department, Westinghouse Savannah River Company, Savannah River Site, Aiken, SC
- Biwer, B.M., J. Arnish, Y.S. Chang, D. Brown, D. Maloney, and A.J. Policastro, 1997. *Transportation Impact Analyses in Support of the Depleted UF<sub>6</sub> Programmatic Environmental Impact Statement*, July
- Blackmon, A. (SRS), 2000. Personal communication with C. Mazzola (DCS), "SRS Employee Residence Data," July 5
- Chapman, W.L. and M.P. DiStefano, 1989. *Savannah River Plant Seismic Survey, 1987-88*, Research Report 1809-005-006-1-89, Conoco, Inc., Seismic Acquisition Section
- Clark, R.H. (DCS), 2000. Personal communication with T. Bowling (DCS), "MOX Fuel as Percent of Commercial Fuel Fabrication," May
- Croff, A.G., 1980. *ORIGEN2 - A Revised and Updated Version of the Oak Ridge Isotope Generation and Depletion Code*, ORNL-5621, July

- DOA (U.S. Department of Agriculture), 2000. *Threatened, Endangered, and Sensitive Species Survey and Evaluation of F-Area Plutonium Disposition Mission Area at the Savannah River Site*, U.S. Forest Service, Savannah River Institute, Savannah River Site, Natural Resource Management Program, March 29
- DOC (U.S. Department of Commerce), 1977. *Climatology of the United States No. 60, Climate of South Carolina*, National Oceanic and Atmospheric Administration, National Environmental Satellite, Data, and Information Service, National Climatic Data Center
- DOC, 1990. *1990 U.S. Census Data; Database C90STF3C1*, U.S. Census Bureau, Washington, DC
- DOC, 1992a. *Census of Population and Housing, 1990; Summary Tape File 3 on CD-ROM*, U.S. Census Bureau, Washington, DC
- DOC, 1992b. *Local Climatological Data, Annual Summary with Comparative Data, 1991, Augusta, GA*, NOAA, National Climate Data Center, Asheville, NC
- DOC, 1996. *Statistical Abstract of the United States: 1996*, 116th Edition, U.S. Census Bureau, Washington, DC, October
- DOC, 1997. *1997 County Business Pattern*, U.S. Census Bureau, Washington, DC
- DOC, 1998a. *USA Counties<sup>TM</sup> 1998, General Profile*, U.S. Census Bureau, Washington, DC
- DOC, 1998b. *USA Counties<sup>TM</sup> 1998, Population, Group Quarters*, U.S. Census Bureau, Washington, DC
- DOC, 1999a. *Local Climatological Data, Annual Summary with Comparative Data for 1999: Augusta, Georgia*, National Oceanic and Atmospheric Administration, National Environmental Satellite, Data, and Information Service, National Climatic Data Center
- DOC, 1999b. *Population Estimates for Cities with Populations of 100,000 and Greater (Sorted by 1990-98 Percent Population Change Rank in U.S.): July 1, 1998*, Population Estimates Program, Population Division, U.S. Census Bureau, Washington, DC, June 30
- DOC, 1999c. *Population Estimates for States, Counties, Places and Minor Civil Divisions: Annual Time Series, July 1, 1990 to July 1, 1998*, Population Estimates Program, Population Division, U.S. Census Bureau, Washington, DC, June 30
- DOC, 2000a. *County Population Estimates for July 1, 1999 and Population Change for July 1, 1998 to July 1, 1999*, Population Estimates Program, Population Division, U.S. Census Bureau, Washington, DC, March 9
- DOC, 2000b. *U.S. Census, Projected State Populations, by Sex, Race, and Hispanic Origin: 1995-2025*, U.S. Census web site:<http://www.census.gov/population/projections/state/stpjrace.txt>

- DOE (U.S. Department of Energy), 1988. *External and Internal Dose Conversion Factors for Calculation of Dose to the Public*, DOE/EH-0070&71, U.S. Department of Energy, Washington, DC
- DOE, 1993. *Radiation Protection of the Public and the Environment*, DOE Order 5400.5, Office of Environment, Safety and Health, January 7
- DOE, 1994a. *Final Supplemental Environmental Impact Statement, Defense Waste Processing Facility*, DOE/EIS-0082-S, Savannah River Operations Office, Aiken, SC, November
- DOE, 1994b. *Radiological Control Manual*, DOE/EH-02567, Rev. 1, Office of Environment, Safety, and Health, Washington, DC, April
- DOE, 1995a. *Department of Energy Programmatic Spent Nuclear Fuel Management and Idaho National Engineering Laboratory Environmental Restoration and Waste Management Programs Final Environmental Impact Statement*, DOE/EIS-0203-F, Office of Environmental Management, Idaho Operations Office, Idaho Falls, ID, April
- DOE, 1995b. *Savannah River Site Waste Management Final Environmental Impact Statement*, DOE/EIS-0217, Savannah River Operations Office, Aiken, SC, July
- DOE, 1996a. *Integrated Data Base Report - 1995: U.S. Spent Nuclear Fuel and Radioactive Waste Inventories, Projections, and Characteristics*, DOE/RW-0006, Rev. 12, Office of Environmental Management, Germantown, MD, December
- DOE, 1996b. *Storage and Disposition of Weapons-Usable Fissile Materials Final Programmatic Environmental Impact Statement*, DOE/EIS-0229, Office of Fissile Materials Disposition, Washington, DC, December
- DOE, 1996c. *Site Selection Process*, DOE Good Practice Guide GPG-FM-024, Office of Project and Fixed Asset Management, Washington, DC
- DOE, 1997a. *Final Waste Management Programmatic Environmental Impact Statement for Managing Treatment, Storage, and Disposal of Radioactive and Hazardous Waste*, DOE/EIS-0200-F, Office of Environmental Management, Washington, DC, May
- DOE, 1997b. *Shutdown of the River Water System at the Savannah River Site Final Environmental Impact Statement*, DOE/EIS-0268, Savannah River Operations Office, Aiken, SC, May
- DOE, 1997c. *Storage and Disposition of Weapons-Usable Fissile Materials Final Programmatic Environmental Impact Statement Record of Decision*, 62 FR 3014, January 21
- DOE, 1997d. *Surplus Plutonium Disposition Environmental Impact Statement – Notice of Intent*, 62 FR 28009, May 22



- DOE, 1997e. *Waste Isolation Pilot Plant Disposal Phase Final Supplemental Environmental Impact Statement*, DOE/EIS-0026-S-2, Carlsbad Area Office, Carlsbad, NM, September
- DOE, 1998a. *Draft Environmental Impact Statement for the Construction and Operation of a Tritium Extraction Facility at the Savannah River Site*, DOE/EIS-0271D, Savannah River Operations Office, Aiken, SC, May
- DOE, 1998b. *Savannah River Site Spent Nuclear Fuel Management Draft Environmental Impact Statement*, DOE/EIS-0279D, Savannah River Operations Office, Aiken, SC, December
- DOE, 1998c. *Record of Decision for the Department of Energy's Waste Management Program Treatment of Nonhazardous Wastewater Hazardous Waste*, 63 FR 41810, August 5
- DOE, 1998d. *Record of Decision for the Department of Energy's Waste Isolation Pilot Plant Disposal Phase; Notice Record of Decision for the Department of Energy's Waste Management Program: Treatment and Storage of Transuranic Waste; Notice*, 63 FR 3624, January 23
- DOE, 1999a. *Draft Environmental Impact Statement for a Geologic Repository for the Disposal of Spent Nuclear Fuel and High-Level Radioactive Waste at Yucca Mountain, Nye County, Nevada*, DOE-EIS-0250D, Office of Civilian Radioactive Waste Management, Las Vegas, NV
- DOE, 1999b. *Savannah River Site Strategic Plan, 21<sup>st</sup> Century Stewards for the Nation*, draft, U.S. Department of Energy, Savannah River Operations Office, Aiken, SC, December 13
- DOE, 1999c. *Surplus Plutonium Disposition Final Environmental Impact Statement*, DOE/EIS-0283, November
- DOE, 1999d. *Deactivation Implementation Guide*, DOE G 430.1-3, Office of Field Integration, Washington, DC
- DOE, 2000a. *SRS Long Range Comprehensive Plan*, draft, U.S. Department of Energy, Savannah River Operations Office, Aiken, SC, September
- DOE, 2000b. *Surplus Plutonium Disposition Final Environmental Impact Statement Record of Decision*, 65 FR 1608, January 11
- DOI (U.S. Department of the Interior), 1986a. *Visual Resource Contrast Rating, BLM Manual Handbook H-8431-1*, Bureau of Land Management, Washington, DC, January 17
- DOI, 1986b. *Visual Resource Inventory, BLM Manual Handbook H-8410-1*, Bureau of Land Management, Washington, DC, January 17

- DOI, 1991. *Guidelines for Completing National Register of Historic Places Forms, Part A, How to Complete the National Register Registration Form*, National Register Bulletin 16, National Register Branch, Interagency Resources Division, National Park Service
- EPA (U.S. Environmental Protection Agency), 1974. *Information on Levels of Environmental Noise Requisite to Protect Public Health and Welfare With an Adequate Margin of Safety*, EPA/550/9-74-004, Office of Noise Abatement and Control, Washington, DC, March
- EPA, 1988. *Limiting Values of Radionuclide Intake and Air Concentration and Dose Conversion Factors for Inhalation, Submersion, and Ingestion*, Federal Guidance Report No. 11, EPA-520/1-88-020, September
- EPA, 1991. *Compilation of Air Pollutant Emission Factors: Mobile Sources*, 4<sup>th</sup> ed., Vol. II, AP-42, Supp. A, Office of Mobile Source Air Pollution Control, Ann Arbor, MI, January
- EPA, 1992. *User's Guide for the Industrial Source Complex (ISC2) Dispersion Models*, EPA-450/4-92-008a, Office of Air Quality Planning and Standards, Technical Support Division, March
- EPA, 1993. *Determining Conformity of General Federal Actions to State or Federal Implementation Plans*, 58 FR 63214, Office of the Federal Register, Washington, DC, November 30
- EPA, 1996. *Compilation of Air Pollutant Emission Factors: Stationary Point and Area Sources*, 5<sup>th</sup> ed., Vol. I, AP-42, Supp. B, Office of Air Quality Planning and Standards, Office of Air and Radiation, Research Triangle Park, NC, November
- EPA, 1997a. *National Ambient Air Quality Standards for Ozone*, 62 FR 38855, July 18
- EPA, 1997b. *National Ambient Air Quality Standards for Particulate Matter*, 62 FR 38855, July 18
- EPA, 1999. *ALOHA – Area Locations of Hazardous Atmospheres*, User's Manual, Computer-Aided Management of Emergency Operations, August
- EuDaly, E.M., 1998. U.S. Department of the Interior, Fish and Wildlife Service, Charleston, SC, personal communication to M. Jones, U.S. Department of Energy, Office of Fissile Materials Disposition, Washington, DC, "FWS Log No. 4-6-98-364, Surplus Plutonium Disposition, Savannah River Site (SRS), Aiken County, South Carolina," September 8
- Fledderman, P.D., 2000. *Surplus Plutonium Disposition (PDP) Preconstruction and Preoperational Monitoring Plan*, ESH-EMS-2000-897, Rev. b, Savannah River Site Operations Office, Aiken, SC, August 30
- Grazulis, T.P., 1993. *Significant Tornadoes 1680 – 1991*, Tornado Project of Environmental Films, St. Johnsbury, VT

- Green, W., 2000. South Carolina Archives and History Center, Letter to Mr. A.B. Gould, Department of Energy, Savannah River Operations Office, "Draft Report: Archaeological Survey and Testing of the Surplus Plutonium Disposition Facilities," Technical Report Series Number 24, prepared by Adam King and Keith Stephenson of the Savannah River Archaeological Research Program, May 19
- Halliburton NUS Corporation, 1996. *Storage and Disposition of Weapons-Usable Fissile Materials Final Programmatic Environmental Impact Statement Volume 2: Health Risk Data Reading Room Material*, DOE/EIS-0229, U.S. Department of Energy, Washington, DC
- Hanson, K.L., et al., 1993. "Applications of Quaternary Stratigraphic, Soil-Geomorphic, and Quantitative Geomorphic Analyses to the Evaluation of Tectonic Activity and Landscape Evolution in the Upper Coastal Plain, South Carolina," *Proceedings, 4<sup>th</sup> DOE Natural Phenomena Hazards Mitigation Conference*, Vol. 2, Atlanta, GA
- Holzworth, G.C., 1972. *Mixing Heights, Wind Speeds, and Potential for Urban Air Pollution Throughout the Contiguous United States*, AP-101, U.S. Environmental Protection Agency, Washington, DC, January
- Huang, J.C., 1993. Memorandum entitled "New Onsite and Offsite Population Databases," NPSR Section, Westinghouse Savannah River Company, Aiken, SC, July
- Hunter, C.H., 1990. *A Climatological Description of the Savannah River Site*, WSRC-RP-89-313, Westinghouse Savannah River Company, Savannah River Site, Aiken, SC, May
- Hunter, C.H., 1999. Memorandum to J. Howley, "Updated Meteorological Data for Revision 4 of the SRS Generic Safety Analysis Report," SRT-NTS-990043, Westinghouse Savannah River Company, Aiken, SC, March 1
- ICRP (International Commission on Radiological Protection), 1991. *1990 Recommendations of the International Commission on Radiological Protection*, Publication 60, Elmsford, NY
- Johnson, P.E., D.S. Joy, D.B. Clarke, and J.M. Jacobi, 1993. *HIGHWAY 3.1 — An Enhanced Highway Routing Model: Program Description, Methodology, and Revised User's Manual*, ORNL/TM-12124, March
- Leutgert, et al., 1994. "Crystal Structure Beneath the Atlantic Coast Plain of South Carolina," *Seismological Research Letters*, Vol. 65, No. 2 (as cited in WSRC 2000c)
- Ludwig, S.B., 1992. *An ORIGEN2 Update for PCs and Mainframes*, Proceedings of the Third International Conference on High Level Radioactive Waste Management, Las Vegas, NV, April 12-16, 1992, p. 93-98

- Mayer, J.J., and L.D. Wike, 1997. *SRS Urban Wildlife: Environmental Information Document*, WSRC-TR-97-0093, Westinghouse Savannah River Company, Savannah River Site, Aiken, SC, May
- Miller, J.A. and R.A. Renkin, 1988. *Nomenclature of Regional Hydrogeologic Units of the Southeastern Coastal Plane Aquifer System*, U.S. Geological Survey Water Resources Investigations Report 874202
- Moos, D. and M.D. Zoback, 1992. *In Situ Stress Measurements in the NPR Hole, Savannah River Site, South Carolina: Final Report to Westinghouse Savannah River Co., Vol. 1, Results and Interpretations*, Subcontract AA00925P, Science Applications International Corporation, Augusta, GA (as cited in WSRC 2000c)
- Moos, D. and M.D. Zoback, 1993. *Near Surface "Thin Skin" Reverse Faulting Stresses in the Southeastern United States*, Vol. 30, No. 7 (as cited in WSRC 2000c)
- Mottel, P., 2000. "SRS Waste Generation Numbers for FY01," personal communication to P. LeClare, DCS
- NAS (National Academy of Sciences), 1994. *Management and Disposition of Excess Weapons Plutonium*, National Academy Press, Washington, DC
- NCRP (National Council on Radiation Protection and Measurements), 1987. *Ionizing Radiation Exposure of the Population of the United States*, NCRP Report No. 93, Bethesda, MD
- Neuhauser, K.S. and F.L. Kanipe, 1992. *RADTRAN 4: Volume III, User Guide*, SAND89-2370, TTC-0943, January
- Neuhauser, K.S. and F.L. Kanipe, 1995. *RADTRAN 4: Volume II, Technical Manual*, SAND89-2370, TTC-0943, March
- NFPA (National Fire Protection Association), 1997. *Standard for the Installation of Lightning Protection Systems*, NFPA 780, 1997 edition
- Noah, J.C. (compiler), 1995. *Land-Use Baseline Report, Savannah River Site*, WSRC-TR-95-0276, Westinghouse Savannah River Company, Savannah River Site, Aiken, SC, June
- NRC (U.S. Nuclear Regulatory Commission), 1972. *Assumptions Used for Evaluating the Potential Radiological Consequences of a Fuel Handling Accident in the Fuel Handling and Storage Facility for Boiling and Pressurized Water Reactors*, Regulatory Guide 1.25, U.S. Nuclear Regulatory Commission, Washington, DC
- NRC, 1973. *Liquid Waste Treatment System Design Guide for Plutonium Processing and Fuel Fabrication Plants*, Regulatory Guide 3.10, U.S. Nuclear Regulatory Commission, June

- NRC, 1977a. *Calculation of Annual Doses to Man from Routine Releases of Reactor Effluents for the Purpose of Evaluating Compliance With 10 CFR 50*, Appendix I, Regulatory Guide 1.109, Office of Standards Development, Washington, DC
- NRC, 1977b. *Design Basis Floods for Nuclear Power Plants*, Regulatory Guide 1.59, Rev. 2, Washington, DC
- NRC, 1977c. *Final Environmental Statement on the Transportation of Radioactive Material by Air and Other Modes*, NUREG-0170, Office of Standards and Development, Washington, DC
- NRC, 1979. *Assumptions Used for Evaluating the Potential Radiological Consequences of Accidental Nuclear Criticality in a Plutonium Processing and Fuel Fabrication Plant*, Regulatory Guide 3.35, Office of Nuclear Regulatory Research, Washington, DC, July
- NRC, 1997. *Atmospheric Relative Concentrations in Building Wakes*, NUREG/CR-6331, PNNL-10521, May
- NRC, 1998a. *Code Manual for MACCS2: Volume 1, User's Guide*, NUREG/CR-6613, SAND97-0594, Vol. 1, May
- NRC, 1998b. *General Site Suitability Criteria for Nuclear Power Stations*, Regulatory Guide 4.7, Rev. 2, Office of Nuclear Regulatory Research, Washington, DC
- NRC, 1998c. *Nuclear Criticality Safety Standards for Fuels and Material Facilities*, Regulatory Guide 3.71, Office of Nuclear Regulatory Research, Washington, DC, August
- NRC, 1998d. *Nuclear Fuel Cycle Facility Handbook*, NUREG/CR 6410, Office of Nuclear Material Safety and Safeguards: Division of Fuel Cycle Safety and Safeguards, Washington, DC
- NRC, 1999a. *Environmental Justice in NEPA Documents*, Nuclear Materials Safety Safeguards (NMSS) Policy and Procedures Letter 1-50, Rev. 2, September
- NRC, 1999b. *Current Status of Legislative Issues Related to NRC Licensing a Mixed Oxide Fuel Fabrication Facility*, SECY99-177, July
- NRC, 2000a. *Standard Review Plan for a License Application for a Mixed Oxide Fuel Fabrication Facility*, NUREG-1718, Nuclear Materials Safety Safeguards, Washington, DC
- NRC, 2000b. *Multi-Agency Radiation Site Survey and Investigation Manual (MARSSIM)*, NUREG-1575, Revision 1, August
- NUS (NUS Corporation), 1990. *Sound-Level Characterization of the Savannah River Site*, NUS-5251, Aiken, SC, August
- Osteen, V., 2000. "Threatened and Endangered Species at SRS," personal communication to K. Dyer (WSRC) March 6

- Pacific Northwest Laboratory, 1988a. *GENII – The Hanford Environmental Radiation Dosimetry Software System Volume 1: Conceptual Representation*, PNL-6584 Vol. 1, Richland, WA
- Pacific Northwest Laboratory, 1988b. *GENII – The Hanford Environmental Radiation Dosimetry Software System Volume 2: Users' Manual*, PNL-6584 Vol. 2, Richland, WA
- Parker, M.J., 1991. *Savannah River Site Tornado Damage of March 1991*, WSRC-RP-91-439, Westinghouse Savannah River Company, Savannah River Site, Aiken, SC
- Pautz, M.E., 1969. "Severe Local Storm Occurrences, 1955-1967," Weather Bureau Technical Memorandum, No. 12, U.S. Department of Commerce, Washington, DC
- Provost, J.L., 1998. Personal communication to G. David (COGEMA) "Requested Information for Duke Power," June 17
- Prowell, D.C., 1988. *Cretaceous and Cenozoic Tectonism on the Atlantic Coast Margin, The Geology of North America, The Atlantic Continental Margin*, Geological Society of America, Vol. 1-2 (as cited in WSRC 2000c)
- Prowell, D.C. and S.F. Obermeier, 1991. "Evidence of Cenozoic Tectonism," *The Geology of the Carolinas*, University of Tennessee Press, Knoxville, TN (as cited in WSRC 2000c)
- Rao, et al., 1982. *Nonradiological Impacts of Transporting Radioactive Materials*, SAND81-1703, TTC-0236, Sandia National Laboratories, Albuquerque, NM
- Saricks, C. and T. Kvitek, 1994. *Longitudinal Review of State-level Accident Statistics for Carriers of Interstate Freight*, ANL/ESD/TM-68, March
- Saricks, C.L. and M.M. Tompkins, 1999. *State-Level Accident Rates of Surface Freight Transportation: A Reexamination*, ANL/ESD/TM-150, April
- SCDE (South Carolina Department of Education), 1999. *South Carolina Education Profiles*, South Carolina Department of Education, Columbia, SC, October
- SCDHEC (South Carolina Department of Health and Environmental Control), 1996. *1996 Nuclear Facility Environmental Radiation Monitoring Annual Report*, Radiological Environmental Monitoring Division, Columbia, SC
- SCDHEC, 1999a. "Ambient Air Quality Standards," *Air Pollution Control Regulations and Standards*, Chapter 61-62, Subchapter 62.5, Standard No. 2
- SCDHEC, 1999b. *Mailing Labels for Licensed Health Care Facilities*, South Carolina Department of Health and Environmental Control, August 5
- SCDHEC, 2000a. South Carolina Department of Health and Environmental Control, Bureau of Air Quality Web Site <http://www.state.sc.us/dhec/eqc/baq/>

- SCDHEC, 2000b. *South Carolina State Standards for Stormwater Management and Sediment Reduction*, South Carolina Regulation
- SCDOT (South Carolina Department of Transportation), 2000. *State Improvement Plan 2000-2005*, SCDOT website
- Schreiner, L.C. and J.T. Reidel, 1978. *Probable Maximum Precipitation Estimates, United States East of the 105th Meridian*, NOAA Hydrometeorological Report No. 51, U.S. Department of Commerce, Washington, DC
- Sessions, J., 1997a. Westinghouse Savannah River Company, Aiken, SC, personal communication to K. Gandee, U.S. Department of Energy, Office of Fissile Materials Disposition, Washington, DC, "Surplus Pu Disposition EIS Savannah River Site Affected Environmental Data Call," ESH-EAP-97-0057, June 9
- Sessions, J., 1997b. "Request for Waste Management Information," Westinghouse Savannah River Company, Aiken, SC, personal communication to J.DiMarzio, SAIC, October 1
- SRARP (Savannah River Archaeological Research Program), 1989. *Archaeological Resource Management Plan of the Savannah River Archaeological Research Program*, South Carolina Institute of Archaeology and Anthropology, University of South Carolina, Columbia, SC, December
- UC (Regents of the University of California), 1998. *Response to the Surplus Plutonium Disposition Environmental Impact Statement Data Call for a Mixed Oxide Fuel Fabrication Facility Located at the Savannah River Site*, LA-UR-97-2066, Rev. 3, Los Alamos National Laboratory, Los Alamos, NM, June 22
- UC, 1999. *Fissile Materials Disposition Program, EIS Data Call Report: Plutonium Immobilization Plant Using Glass in New Facilities at the Savannah River Site*, UCRL-ID-128271, Rev. 1, Lawrence Livermore National Laboratory, Livermore, CA, September
- USEC (United States Enrichment Corporation), 1999. *The UF<sub>6</sub> Manual, Good Handling Practices for Uranium Hexafluoride*, USEC-651, Rev. 8, January
- USGS (U.S. Geological Survey), 1995. *Water Resources Data for South Carolina USGS Annual Data Reports for Water Years 1967 – 1995*, U.S. Geological Survey
- White, V.S., 1997. *Initial Data Report in Response to the Surplus Plutonium Disposition Environmental Impact Statement Data Call for the UO<sub>2</sub> Supply*, ORNL/TM-13466, Rev. 1, November
- White House, 1993. *Nonproliferation and Export Control Policy*, Washington, DC, September 27

- White House, 1994. *Joint Statement by the President of the Russian Federation and the President of the United States on the Non-Proliferation of Weapons of Mass Destruction and the Means of Their Delivery*, Washington, DC, January 14
- White House, 1998. *Joint Statement of Principles for Management and Disposition of Plutonium Designated as No Longer Required for Defense Purposes*, September
- White House, 2000. *Agreement Between the Government of the United States of America and the Government of the Russian Federation Concerning the Management and Disposition of Plutonium Designated as No Longer Required for Defense Purposes and Related Cooperation*, September
- WSRC (Westinghouse Savannah River Company), 1993. *Development of Onsite and Offsite Population Distribution for Use in Dose Summary Codes*, SRT-ETS-930635, Westinghouse Savannah River Company, Aiken, SC
- WSRC, 1995. *RCRA Facility Investigation/Remedial Investigation Report for the Old F-Area Seepage Basin*, Westinghouse Savannah River Company, Savannah River Site, Aiken, SC
- WSRC, 1997a. *SRS Ecology Environmental Information Document*, WSRC-TR-97-0223, Aiken, SC
- WSRC, 1997b. *SRS News Highlights, This Month's Top Stories, CIF: Starting a New Era of Waste Management at SRS*, from [www.srs.gov/general/aboutsrs/pub\\_rel/srsnews.html#STORYONE](http://www.srs.gov/general/aboutsrs/pub_rel/srsnews.html#STORYONE), Public Relations Department, Aiken, SC, September 2
- WSRC, 1998. *Methodology for Deriving TEELs*, WSRC-TR-98-0080, Table 3, WSMS-SAE-00-0001, Westinghouse Savannah River Company, Savannah River Site, Aiken, SC
- WSRC, 1999a. *Generic Safety Analysis Report*, WSRC-TR-99-0369, Westinghouse Savannah River Company, Savannah River Site, Aiken, SC
- WSRC, 1999b. *Savannah River Site Annual Report for 1999*, Solid Waste Division, Westinghouse Savannah River Company, Savannah River Site, Aiken, SC
- WSRC, 1999c. *SRS External Dosimetry Technical Basis Manual (U)*, WSRC-IM-92-101, Westinghouse Savannah River Company, Savannah River Site, Aiken, SC, December 15
- WSRC, 2000a. *2000 RCRA Part B Permit Renewal Application, Volume VII, Mixed Waste Management Facility (MWMF)*, Westinghouse Savannah River Company, Savannah River Site, Aiken, SC
- WSRC, 2000b. *Savannah River Site Waste Acceptance Criteria Manual, Procedure Manual 1S*, Westinghouse Savannah River Company, Savannah River Site, Aiken, SC



WSRC, 2000c. *Natural Phenomena Hazards (NPH) Design Criteria and Other Characterization Information for the Mixed Oxide (MOX) Fuel Fabrication Facility at Savannah River Site (U)*, WSRC-TR-2000-00454, Rev. 0, Westinghouse Savannah River Company, Savannah River Site, Aiken, SC, November

Yuan, Y.C., S.Y. Chen, B.M. Biwer, and D.J. LePoire, 1995. *RISKIND — A Computer Program for Calculating Consequences and Health Risks from the Transportation of Spent Nuclear Fuel*, ANL/EAD-1, November

**APPENDIX A. AGENCY CONSULTATIONS AND CORRESPONDENCE**

---

**This page intentionally left blank.**

---



**Department of Energy**  
Washington, DC 20585

October 30, 1998

Dr. Rodger Stroup  
State Historic Preservation Officer  
8301 Parklane Road  
Columbia, South Carolina 29223

*Subject: Consultation for Surplus Plutonium Disposition Environmental Impact Analysis Process*

Dear Dr. Stroup:

The purpose of this letter is to notify you that the United States Department of Energy (DOE) is in the process of conducting an Environmental Impact Analysis concerning the disposition of surplus plutonium.

With this letter we are soliciting specific concerns the South Carolina State Historic Preservation Office may have about the proposal. This consultation is in accordance with National Environmental Policy Act and Section 106 of the National Historic Preservation Act.

The *Surplus Plutonium Disposition Environmental Impact Statement (SPD EIS)* is tiered from the *Storage and Disposition of Weapons-Usable Fissile Materials Final Programmatic EIS (DOE/EIS-0229)*, issued in December 1996, and the associated Record of Decision [62 FR 3014], issued on January 14, 1997. DOE is producing the SPD EIS in compliance with the National Environmental Policy Act (NEPA) and Council on Environmental Quality regulations implementing NEPA, DOE's NEPA Implementing Regulations (10 CFR 1021), and other applicable federal and state environmental legislation.

The purpose and need for the proposed action is to reduce the threat of nuclear weapons proliferation worldwide by disposing of surplus plutonium in the United States in an environmentally safe and timely manner. The SPD Draft EIS, a copy of which is attached for your review, examines the potential environmental impacts for 24 alternatives for the proposed siting, construction, and operation of three types of facilities: pit disassembly and conversion; mixed oxide (MOX) fuel fabrication; and plutonium conversion and immobilization.

If an alternative is selected that includes siting of surplus plutonium disposition facilities at the Savannah River site (e.g., Alternatives 3A or 3B), a maximum of about 31 hectares (77 acres) of land adjacent to the Actinide Packaging and Storage Facility (APSF) in F-Area, would be impacted. Not all areas within the proposed construction

Mr. Rodger Stroup  
State Historic Preservation Officer  
10/30/98  
Page 2

area have been completely surveyed for cultural resources, and this area has a high potential to yield subsurface deposits with cultural material. Based on previous archaeological investigations, four archaeological sites have been recorded in or near the proposed construction areas. One of these sites (38AK546) has been recommended as eligible for nomination to the National Register. All compliance activities, including survey, testing, and impact mitigation would be conducted in accordance with *Programmatic Memorandum of Agreement for the Savannah River Site* (1989).

If you have any specific concerns about the SPD EIS proposal, we would like to hear from you. Please contact me with your concerns or questions at:

Marcus Jones  
SPD EIS Document Manager  
U.S. Department of Energy  
Office of Fissile Materials Disposition  
P.O. Box 23786  
Washington, DC 20026-3786  
(202) 586-0149.

You may also contact Mark Brooks, the Cultural Resources Manager at Savannah River Site, at (803) 725-3724.

Sincerely,

Marcus Jones  
SPD EIS Document Manager

cc: Mark Brooks, Archaeological Program Manager, SRS  
Lois Thompson, Federal Preservation Officer, DOE HQ

SPD EIS enclosure



November 12, 1998

Mr. Marcus Jones  
SPD EIS Document Manager  
Department of Energy  
Washington, DC 20585

Re: Consultation for Surplus Plutonium Disposition Environmental Impact  
Analysis Process  
Savannah River Site, Aiken County

Dear Mr. Jones:

Thank you for providing the draft Environmental Impact Statement for the disposition of surplus plutonium.

We note that Alternatives 3A and 3B, if selected, will affect the Savannah River Site. If these alternatives are selected, we further note that cultural resources survey, testing, and impact mitigation will be conducted. These measures will be conducted in accordance with the stipulations of the existing Programmatic Memorandum of Agreement for the Savannah River Site.

We look forward to further consultation if Alternatives 3A and 3B are selected. If you have questions, please don't hesitate to call me (803-896-6169) or Staff Archaeologist Bill Green (803/896-6181).

Sincerely,

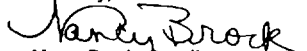
  
Nancy Brock, Coordinator  
Review and Compliance Programs  
State Historic Preservation Office

Cc: Mr. Mark Brooks, Archaeological Program Manager, SRS



RECEIVED  
09 MAY 23 PM 12:00

May 19, 2000 MAIL CONTROL

002181

CRIC-EGM

Mr. A. B. Gould, Director  
Environmental Quality Management Division  
Department of Energy, Savannah River Operations Office  
P.O. Box A  
Aiken, South Carolina 29802

RE: Draft report: *Archaeological Survey and Testing of the Surplus Plutonium Disposition Facilities* (Technical Report Series Number 24) prepared by Adam King and Keith Stephenson of the Savannah River Archaeological Research Program.

Dear Mr. Gould:

Thank you for providing us with one copy of the above-referenced draft report. We have reviewed the report and found that it is well written and informative and meets the standards and guidelines established by the Secretary of the Interior and this office.

We concur with the authors' recommendation that archaeological sites 38AK155, 38AK546/547, and 38AK757 are eligible for inclusion in the National Register of Historic Places (NRHP) and that these sites should be avoided by the SPDF. If these sites cannot be avoided, we should begin consultation on ways to mitigate the adverse effects to these important sites.

In regard to sites 38AK154, 38AK330, and 38AK548, we also concur with the authors' recommendation that these sites are not eligible for inclusion in the NRHP and that no additional work is required. I have attached some additional technical comments that should be addressed prior to submitting three copies of the final report to this office. These comments are provided to assist you with your responsibilities under Sections 106 and 110 of the National Historic Preservation Act, as amended, and the regulations codified at 36 CFR Part 800. I can be contacted at 803-216-9330 if you have any questions or comments about this matter.

Sincerely,

  
William Green  
Staff Archaeologist  
State Historic Preservation Office

Attachment

cc: Mark Brooks, Savannah River Archaeological Research Program  
Don Klima, Advisory Council on Historic Preservation (w/o attachment)  
Keith Derting, South Carolina Institute of Archaeology and Anthropology (w/o attachment)

S. C. Department of Archives & History • 8301 Parklane Road • Columbia • South Carolina • 29223-4905 • (803) 896-6100 • www.state.sc.us/scdah



Department of Energy  
Savannah River Operations Office  
P.O. Box A  
Aiken, South Carolina 29802

DEC 08 2000

Ms. Nancy Brock, Coordinator  
Review and Compliance Program  
South Carolina Department of Archives and History  
8301 Parklane Road  
Columbia, SC 29223-4905

Dear Ms. Brock:

Re: Department of Energy, Surplus Plutonium Disposition Facilities  
Mixed Oxide Fuel Fabrication Facility

Report: *Archaeological Survey and testing of the Surplus Plutonium Disposition  
Facilities* (Technical Report Series Number 24)

In October, 1998 the Department of Energy notified the South Carolina State Historic Preservation Office concerning plans to locate the Surplus Plutonium Disposition Facilities at the Savannah River Site and solicited comments on the Surplus Plutonium Disposition Environmental Impact Statement (letter from Mr. Marcus Jones to Dr. Rodger Stroup, October 30, 1998). Subsequently, the Savannah River Archaeological Research Program provided the South Carolina State Historic Preservation Office with a copy of *Archaeological Survey and testing of the Surplus Plutonium Disposition Facilities* (Technical Report Series Number 24) for your review. In response, the South Carolina State Historic Preservation Office concurred that sites 38AK155, 38AK546/547, and 38AK757 were eligible for inclusion in the National Register of Historic Places. Your office also requested that if the sites could not be avoided, the Department of Energy should begin consultations with your office on ways to mitigate any adverse impacts.

The Department of Energy pursued site investigations including soil testing for the site of the Mixed Oxide Fuel Fabrication Facility (one of the three surplus plutonium disposition facilities). This testing included core borings west of 38AK546/547.

The Department of Energy has prepared a preliminary site layout for the Mixed Oxide Fuel Fabrication Facility (one of the three surplus plutonium disposition facilities) which is illustrated on the enclosed map as site "2M". We have located the facility as far to the west as possible without infringing on other surplus plutonium facilities. However we anticipate that construction activities will impact 38AK546/547. The Department of Energy is committed to mitigate any impact to 38AK546/547 by recovering artifacts in the affected area before any site preparation. A proposed mitigation plan for this area is currently being prepared and will be transmitted to you in January 2001 for your review and concurrence.

Sincerely,

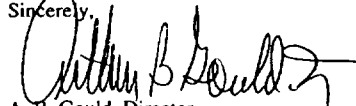

A. B. Gould, Director  
Environmental Quality and Management Division

kwd/aeo  
Att.





**Department of Energy**  
Washington, DC 20585

October 30, 1998

Mr. Tom Berryhill, Council Member  
National Council of the Muskogee Creek  
P.O. Box 158  
Okmulgee, OK 74447

**Subject:** *Consultation for Surplus Plutonium Disposition Environmental Impact Analysis Process, Under Executive Memorandum Concerning Government-to-Government Relations with Native American Tribal Governments*

Dear Mr. Berryhill:

The purpose of this letter is to notify you that the United States Department of Energy (DOE) is in the process of conducting an Environmental Impact Analysis concerning the disposition of surplus plutonium.

With this letter we are soliciting specific concerns the National Council of the Muskogee Creek may have about the proposal. This consultation is in accordance with the Executive Memorandum (29 April 1994) entitled, "Government-to-Government Relations with Native American Tribal Governments", and DOE Order 1230.2. It also follows prior consultation initiated for compliance with the American Indian Religious Freedom Act (AIRFA) (PL 95-341) and the Native American Graves Protection and Repatriation Act (NAGPRA) (PL 101-601).

The *Surplus Plutonium Disposition Environmental Impact Statement (SPD EIS)* is tiered from the *Storage and Disposition of Weapons-Usable Fissile Materials Final Programmatic EIS (DOE/EIS-0229)*, issued in December 1996, and the associated Record of Decision (62 FR 3014), issued on January 14, 1997. DOE is producing the SPD EIS in compliance with the National Environmental Policy Act (NEPA) and Council on Environmental Quality regulations implementing NEPA, DOE's NEPA Implementing Regulations (10 CFR 1021), and other applicable federal and state environmental legislation.

The purpose and need for the proposed action is to reduce the threat of nuclear weapons proliferation worldwide by disposing of surplus plutonium in the United States in an environmentally safe and timely manner. The SPD Draft EIS, a copy of which is attached for your review, examines the potential environmental impacts for 24 alternatives for the proposed siting, construction, and operation of three types of facilities: pit disassembly and conversion; mixed oxide (MOX) fuel fabrication; and plutonium conversion and immobilization.

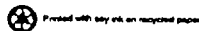

Mr. Tom Berryhill, Council Member  
National Council of the Muskogee Creek  
10/30/98  
Page 2

If an alternative is selected that includes siting of surplus plutonium disposition facilities at the Savannah River Site (e.g., Alternatives 3A or 3B), a maximum of about 31 hectares (77 acres) of land adjacent to the Actinide Packaging and Storage Facility (APSF) in F-Area, would be impacted. No Native American cultural sites are known to exist within the proposed construction area.

If you have any specific concerns about the SPD EIS proposal, we would like to hear from you. Please contact me with your concerns or questions at:

Marcus Jones  
SPD EIS Document Manager  
U.S. Department of Energy  
Office of Fissile Materials Disposition  
P.O. Box 23786  
Washington, DC 20026-3786  
(202) 586-0149

You may also contact A. Ben Gould, Savannah River Site Indian Liaison Officer, at:  
(803) 725-3969.

Sincerely,

Marcus Jones  
SPD EIS Document Manager

cc: A. Ben Gould, SRS  
Brandt Petrasck, EM-20, DOE HQ

SPD EIS enclosure



Department of Energy  
Washington, DC 20585

October 30, 1998

Ms. Nancy Carnley, Secretary  
Ma Chis Lower Alabama Creek Indian Tribe  
Route 1  
708 S. John Street  
New Brockton, Alabama 36351

**Subject:** *Consultation for Surplus Plutonium Disposition Environmental Impact Analysis Process, Under Executive Memorandum Concerning Government-to-Government Relations with Native American Tribal Governments*

Dear Ms. Carnley:

The purpose of this letter is to notify you that the United States Department of Energy (DOE) is in the process of conducting an Environmental Impact Analysis concerning the disposition of surplus plutonium.

With this letter we are soliciting specific concerns the Ma Chis Lower Alabama Creek Indian Tribe may have about the proposal. This consultation is in accordance with the Executive Memorandum (29 April 1994) entitled, "Government-to-Government Relations with Native American Tribal Governments", and DOE Order 1230.2. It also follows prior consultation initiated for compliance with the American Indian Religious Freedom Act (AIRFA) (PL 95-341) and the Native American Graves Protection and Repatriation Act (NAGPRA) (PL 101-601).

The *Surplus Plutonium Disposition Environmental Impact Statement* (SPD EIS) is tiered from the *Storage and Disposition of Weapons-Usable Fissile Materials Final Programmatic EIS* (DOE/EIS-0229), issued in December 1996, and the associated Record of Decision (62 FR 3014), issued on January 14, 1997. DOE is producing the SPD EIS in compliance with the National Environmental Policy Act (NEPA) and Council on Environmental Quality regulations implementing NEPA, DOE's NEPA Implementing Regulations (10 CFR 1021), and other applicable federal and state environmental legislation.

The purpose and need for the proposed action is to reduce the threat of nuclear weapons proliferation worldwide by disposing of surplus plutonium in the United States in an environmentally safe and timely manner. The SPD Draft EIS, a copy of which is attached for your review, examines the potential environmental impacts for 24 alternatives for the proposed siting, construction, and operation of three types of facilities: pit disassembly and conversion; mixed oxide (MOX) fuel fabrication; and plutonium conversion and immobilization.

Ms. Nancy Carnley, Secretary  
Ma Chis Lower Alabama Creek Indian Tribe  
10/30/98  
Page 2

If an alternative is selected that includes siting of surplus plutonium disposition facilities at the Savannah River Site (e.g., Alternatives 3A or 3B), a maximum of about 31 hectares (77 acres) of land adjacent to the Actinide Packaging and Storage Facility (APSF) in F-Area, would be impacted. No Native American cultural sites are known to exist within the proposed construction area.

If you have any specific concerns about the SPD EIS proposal, we would like to hear from you. Please contact me with your concerns or questions at:

Marcus Jones  
SPD EIS Document Manager  
U.S. Department of Energy  
Office of Fissile Materials Disposition  
P.O. Box 23786  
Washington, DC 20026-3786  
(202) 586-0149

You may also contact A. Ben Gould, Savannah River Site Indian Liaison Officer, at:  
(803) 725-3969.

Sincerely,

Marcus Jones  
SPD EIS Document Manager

cc: A. Ben Gould, SRS  
Brandt Petrasek, EM-20, DOE HQ

SPD EIS enclosure



**Department of Energy**  
Washington, DC 20585

October 30, 1998

Miko Tony Hill  
Indian People's Muskogee Tribal Town Confederacy  
P.O. Box 14  
Okemah, OK 74859

**Subject:** *Consultation for Surplus Plutonium Disposition Environmental Impact Analysis Process, Under Executive Memorandum Concerning Government-to-Government Relations with Native American Tribal Governments*

Dear Miko Hill:

The purpose of this letter is to notify you that the United States Department of Energy (DOE) is in the process of conducting an Environmental Impact Analysis concerning the disposition of surplus plutonium.

With this letter we are soliciting specific concerns the Indian People's Muskogee Tribal Town Confederacy may have about the proposal. This consultation is in accordance with the Executive Memorandum (29 April 1994) entitled, "Government-to-Government Relations with Native American Tribal Governments", and DOE Order 1230.2. It also follows prior consultation initiated for compliance with the American Indian Religious Freedom Act (AIRFA) (PL 95-341) and the Native American Graves Protection and Repatriation Act (NAGPRA) (PL 101-601).

The *Surplus Plutonium Disposition Environmental Impact Statement* (SPD EIS) is tiered from the *Storage and Disposition of Weapons-Usable Fissile Materials Final Programmatic EIS* (DOE/EIS-0229), issued in December 1996, and the associated Record of Decision (62 FR 3014), issued on January 14, 1997. DOE is producing the SPD EIS in compliance with the National Environmental Policy Act (NEPA) and Council on Environmental Quality regulations implementing NEPA, DOE's NEPA Implementing Regulations (10 CFR 1021), and other applicable federal and state environmental legislation.

The purpose and need for the proposed action is to reduce the threat of nuclear weapons proliferation worldwide by disposing of surplus plutonium in the United States in an environmentally safe and timely manner. The SPD Draft EIS, a copy of which is attached for your review, examines the potential environmental impacts for 24 alternatives for the proposed siting, construction, and operation of three types of facilities: pit disassembly and conversion; mixed oxide (MOX) fuel fabrication; and plutonium conversion and immobilization.

Miko Tony Hill  
Indian People's Muskogee Tribal Town Confederacy  
10/30/98  
Page 2

If an alternative is selected that includes siting of surplus plutonium disposition facilities at the Savannah River Site (e.g., Alternatives 3A or 3B), a maximum of about 31 hectares (77 acres) of land adjacent to the Actinide Packaging and Storage Facility (APSF) in F-Area, would be impacted. No Native American cultural sites are known to exist within the proposed construction area.

If you have any specific concerns about the SPD EIS proposal, we would like to hear from you. Please contact me with your concerns or questions at:

Marcus Jones  
SPD EIS Document Manager  
U.S. Department of Energy  
Office of Fissile Materials Disposition  
P.O. Box 23786  
Washington, DC 20026-3786  
(202) 586-0149

You may also contact A. Ben Gould, Savannah River Site Indian Liaison Officer, at: (803) 725-3969.

Sincerely,

Marcus Jones  
SPD EIS Document Manager

cc: A. Ben Gould, SRS  
Brandt Petrusek, EM-20, DOE HQ

SPD EIS enclosure



Department of Energy  
Washington, DC 20585

October 30, 1998

Ms. Virginia Montoya  
Pee Dee Indian Association  
101 E. Tatum Avenue  
McColl, South Carolina 29570

*Subject: Consultation for Surplus Plutonium Disposition Environmental Impact Analysis Process, Under Executive Memorandum Concerning Government-to-Government Relations with Native American Tribal Governments*

Dear Ms. Montoya:

The purpose of this letter is to notify you that the United States Department of Energy (DOE) is in the process of conducting an Environmental Impact Analysis concerning the disposition of surplus plutonium.

With this letter we are soliciting specific concerns the Pee Dee Indian Association may have about the proposal. This consultation is in accordance with the Executive Memorandum (29 April 1994) entitled, "Government-to-Government Relations with Native American Tribal Governments", and DOE Order 1230.2. It also follows prior consultation initiated for compliance with the American Indian Religious Freedom Act (AIRFA) (PL 95-341) and the Native American Graves Protection and Repatriation Act (NAGPRA) (PL 101-601).

The *Surplus Plutonium Disposition Environmental Impact Statement* (SPD EIS) is tiered from the *Storage and Disposition of Weapons-Usable Fissile Materials Final Programmatic EIS* (DOE/EIS-0229), issued in December 1996, and the associated Record of Decision (62 FR 3014), issued on January 14, 1997. DOE is producing the SPD EIS in compliance with the National Environmental Policy Act (NEPA) and Council on Environmental Quality regulations implementing NEPA, DOE's NEPA Implementing Regulations (10 CFR 1021), and other applicable federal and state environmental legislation.

The purpose and need for the proposed action is to reduce the threat of nuclear weapons proliferation worldwide by disposing of surplus plutonium in the United States in an environmentally safe and timely manner. The SPD Draft EIS, a copy of which is attached for your review, examines the potential environmental impacts for 24 alternatives for the proposed siting, construction, and operation of three types of facilities: pit disassembly and conversion; mixed oxide (MOX) fuel fabrication; and plutonium conversion and immobilization.

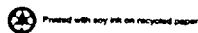

Ms. Virginia Montoya  
Pee Dee Indian Association  
10/30/98  
Page 2

If an alternative is selected that includes siting of surplus plutonium disposition facilities at the Savannah River Site (e.g., Alternatives 3A or 3B), a maximum of about 31 hectares (77 acres) of land adjacent to the Actinide Packaging and Storage Facility (APSF) in F-Area, would be impacted. No Native American cultural sites are known to exist within the proposed construction area.

If you have any specific concerns about the SPD EIS proposal, we would like to hear from you. Please contact me with your concerns or questions at:

Marcus Jones  
SPD EIS Document Manager  
U.S. Department of Energy  
Office of Fissile Materials Disposition  
P.O. Box 23786  
Washington, DC 20026-3786  
(202) 586-0149

You may also contact A. Ben Gould, Savannah River Site Indian Liaison Officer, at: (803) 725-3969.

Sincerely,

Marcus Jones  
SPD EIS Document Manager

cc: A. Ben Gould, SRS  
Brandt Petrusek, EM-20, DOE HQ

SPD EIS enclosure





Department of Energy  
Washington, DC 20585

October 30, 1998

Mr. Al Rolland, Project Director  
Yuchi Tribal Organization, Inc.  
P.O. Box 1990  
Sapulpa, OK 74067

*Subject: Consultation for Surplus Plutonium Disposition Environmental Impact  
Analysis Process, Under Executive Memorandum Concerning Govern-  
ment-to-Government Relations with Native American Tribal Governments*

Dear Mr. Rolland:

The purpose of this letter is to notify you that the United States Department of Energy (DOE) is in the process of conducting an Environmental Impact Analysis concerning the disposition of surplus plutonium.

With this letter we are soliciting specific concerns the Yuchi Tribal Organization may have about the proposal. This consultation is in accordance with the Executive Memorandum (29 April 1994) entitled, "Government-to-Government Relations with Native American Tribal Governments", and DOE Order 1230.2. It also follows prior consultation initiated for compliance with the American Indian Religious Freedom Act (AIRFA) (PL 95-341) and the Native American Graves Protection and Repatriation Act (NAGPRA) (PL 101-601).

The *Surplus Plutonium Disposition Environmental Impact Statement* (SPD EIS) is tiered from the *Storage and Disposition of Weapons-Usable Fissile Materials Final Programmatic EIS* (DOE/EIS-0229), issued in December 1996, and the associated Record of Decision (62 FR 3014), issued on January 14, 1997. DOE is producing the SPD EIS in compliance with the National Environmental Policy Act (NEPA) and Council on Environmental Quality regulations implementing NEPA, DOE's NEPA Implementing Regulations (10 CFR 1021), and other applicable federal and state environmental legislation.

The purpose and need for the proposed action is to reduce the threat of nuclear weapons proliferation worldwide by disposing of surplus plutonium in the United States in an environmentally safe and timely manner. The SPD Draft EIS, a copy of which is attached for your review, examines the potential environmental impacts for 24 alternatives for the proposed siting, construction, and operation of three types of facilities: pit disassembly and conversion; mixed oxide (MOX) fuel fabrication; and plutonium conversion and immobilization.

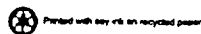

Mr. Al Rolland, Project Director  
Yuchi Tribal Organization, Inc.  
10/30/98  
Page 2

If an alternative is selected that includes siting of surplus plutonium disposition facilities at the Savannah River Site (e.g., Alternatives 3A or 3B), a maximum of about 31 hectares (77 acres) of land adjacent to the Actinide Packaging and Storage Facility (APSF) in F-Area, would be impacted. No Native American cultural sites are known to exist within the proposed construction area.

If you have any specific concerns about the SPD EIS proposal, we would like to hear from you. Please contact me with your concerns or questions at:

Marcus Jones  
SPD EIS Document Manager  
U.S. Department of Energy  
Office of Fissile Materials Disposition  
P.O. Box 23786  
Washington, DC 20026-3786  
(202) 586-0149.

You may also contact A. Ben Gould, Savannah River Site Indian Liaison Officer, at (803) 725-3969.

Sincerely,

Marcus Jones  
SPD EIS Document Manager

cc: A. Ben Gould, SRS  
Brandt Petrusek, EM-20, DOE HQ

SPD EIS enclosure



Department of Energy  
Washington, DC 20585

October 30, 1998

Mr. John Ross, Chief Elect  
United Keetoowah Band  
2450 S. Muskogee  
Tahlequah, Oklahoma 74464

*Subject: Consultation for Surplus Plutonium Disposition Environmental Impact Analysis Process, Under Executive Memorandum Concerning Government-to-Government Relations with Native American Tribal Governments*

Dear Mr. Ross:

The purpose of this letter is to notify you that the United States Department of Energy (DOE) is in the process of conducting an Environmental Impact Analysis concerning the disposition of surplus plutonium.

With this letter we are soliciting specific concerns the United Keetoowah Band may have about the proposal. This consultation is in accordance with the Executive Memorandum (29 April 1994) entitled, "Government-to-Government Relations with Native American Tribal Governments", and DOE Order 1230.2. It also follows prior consultation initiated for compliance with the American Indian Religious Freedom Act (AIRFA) (PL 95-341) and the Native American Graves Protection and Repatriation Act (NAGPRA) (PL 101-601).

The *Surplus Plutonium Disposition Environmental Impact Statement* (SPD EIS) is tiered from the *Storage and Disposition of Weapons-Usable Fissile Materials Final Programmatic EIS* (DOE/EIS-0229), issued in December 1996, and the associated Record of Decision (62 FR 3014), issued on January 14, 1997. DOE is producing the SPD EIS in compliance with the National Environmental Policy Act (NEPA) and Council on Environmental Quality regulations implementing NEPA, DOE's NEPA Implementing Regulations (10 CFR 1021), and other applicable federal and state environmental legislation.

The purpose and need for the proposed action is to reduce the threat of nuclear weapons proliferation worldwide by disposing of surplus plutonium in the United States in an environmentally safe and timely manner. The SPD Draft EIS, a copy of which is attached for your review, examines the potential environmental impacts for 24 alternatives for the proposed siting, construction, and operation of three types of facilities: pit disassembly and conversion; mixed oxide (MOX) fuel fabrication; and plutonium conversion and immobilization.

Mr. John Ross, Chief Elect  
United Keetoowah Band  
10/30/98  
Page 2

If an alternative is selected that includes siting of surplus plutonium disposition facilities at the Savannah River Site (e.g., Alternatives 3A or 3B), a maximum of about 31 hectares (77 acres) of land adjacent to the Actinide Packaging and Storage Facility (APSF) in F-Area, would be impacted. No Native American cultural sites are known to exist within the proposed construction area.

If you have any specific concerns about the SPD EIS proposal, we would like to hear from you. Please contact me with your concerns or questions at:

Marcus Jones  
SPD EIS Document Manager  
U.S. Department of Energy  
Office of Fissile Materials Disposition  
P.O. Box 23786  
Washington, DC 20026-3786  
(202) 586-0149

You may also contact A. Ben Gould, Savannah River Site Indian Liaison Officer, at: (803) 725-3969.

Sincerely,

Marcus Jones  
SPD EIS Document Manager

cc: A. Ben Gould, SRS  
Brandt Petrasek, EM-20, DOE HQ

SPD EIS enclosure



**Department of Energy**

Washington, DC 20585  
July 28, 1998

Mr. Roger Banks  
Field Supervisor  
U.S. Department of the Interior  
Fish and Wildlife Service  
Post Office Box 12559  
217 Fort Johnson Road  
Charleston, SC 29422-2559

Dear Mr. Banks:

**INFORMAL CONSULTATION UNDER SECTION 7 OF THE ENDANGERED SPECIES  
ACT FOR SURPLUS PLUTONIUM DISPOSITION**

The Department of Energy (DOE) published its Notice of Intent to prepare the *Surplus Plutonium Disposition Environmental Impact Statement* (SPD EIS) in the Federal Register (Vol. 92, No. 99) on May 22, 1997. This SPD EIS is tiered from the *Storage and Disposition of Weapons-Usable Fissile Materials Programmatic EIS* (DOE/EIS-0229), issued in December 1996, and the associated Record of Decision (62 FR 3014), issued on January 14, 1997. To summarize, the purpose of the proposed action is to reduce the threat of nuclear weapons proliferation worldwide in an environmentally safe and timely manner by conducting disposition of surplus plutonium in the United States, thus setting a nonproliferation example for other nations.

The SPD Draft EIS, a copy of which is attached for your review, examines twenty-four alternatives and analyzes the potential environmental impacts for the proposed siting, construction, and operation of three types of facilities: pit disassembly and conversion, mixed oxide (MOX) fuel fabrication, and plutonium conversion and immobilization. The Savannah River Site (SRS) near Aiken, South Carolina is a candidate site for all three facilities. The candidate sites and alternatives are shown in Table 2-1 of the SPD Draft EIS. Please note that where practical, the modification of existing buildings is being considered.

Alternative 3A proposes locating the three surplus plutonium disposition facilities in new construction adjacent to the Actinide Packaging and Storage Facility in F-Area at SRS. In addition, the canister receipt area at the Defense Waste Processing Facility in S-Area would be modified to accommodate the receipt and processing of the canisters from the plutonium conversion and immobilization facility. Although several alternatives include locating facilities at SRS, Alternative 3A has the greatest potential for impacts on ecological resources.

Preliminary analyses suggest that overall impacts on ecological resources from constructing and operating the proposed surplus plutonium disposition facilities would be limited because the land area required (31 hectares [77 acres]) is relatively small in comparison to regionally available habitat. Habitat disturbance would be minimized because construction would take place in



previously disturbed or developed areas; and operational impacts would be minimized because facility releases of airborne and aqueous effluents would be controlled and permitted. Section 4.26 4.3 of the SPD Draft EIS presents the ecological resources analysis for SRS.

Although sources indicate that no critical habitat for any threatened and endangered species exists at SRS, there may be Federal or State-classified special status species in the environs surrounding F-Area. These species include American alligator, bald eagle, Oconee azalea, red-cockaded woodpecker, smooth purple coneflower, and wood stork. Noise disturbance is probably the most important impact affecting local wildlife populations.

Consistent with the Endangered Species Act, DOE requests that the Fish and Wildlife Service provide any additional information on the presence of threatened and endangered animal and plant species, both listed and proposed, in the vicinity of F- and S-Areas at SRS. Information on the habitats of these species would also be appreciated. DOE also requests information on any other species of concern that are known to occur or potentially occur in the vicinity of F- and S-Areas.

As part of DOE's National Environmental Policy Act process, DOE encourages the Fish and Wildlife Service to identify any concerns or issues it believes should be addressed in the SPD EIS. To facilitate incorporation of your input into the SPD Final EIS, please provide a written response by September 16, 1998.

Please mail your response to:

Marcus Jones  
SPD EIS Document Manager  
U.S. Department of Energy  
Office of Fissile Materials Disposition  
1000 Independence Avenue, SW  
Washington, DC 20585

If you have any questions, please contact me at (202) 586-0149.

Sincerely,



Marcus Jones  
SPD EIS Document Manager

cc: John B. Gladden, WSRC  
David P. Roberts, DOE



United States Department of the Interior

FISH AND WILDLIFE SERVICE  
P.O. Box 12559  
217 Fort Johnson Road  
Charleston, South Carolina 29422-2559

September 8, 1998

Mr. Marcus Jones  
SPD EIS Document Manager  
U.S. Department of Energy  
Office of Fissile Materials Disposition  
1000 Independence Avenue, SW  
Washington, DC 20585

Re: FWS Log No. 4-6-98-364, Surplus Plutonium Disposition, Savannah River Site (SRS),  
Aiken County, South Carolina

Dear Mr. Jones:

We have reviewed the information received August 4, 1998 concerning the above-referenced project in Aiken County, South Carolina. The following comments are provided in accordance with the Fish and Wildlife Coordination Act, as amended (16 U.S.C. 661-667e), and Section 7 of the Endangered Species Act, as amended (16 U.S.C. 1531-1543), as well as, general comments from the review of the Draft Environmental Impact Statement (DEIS).

As indicated in your August 4 letter there is potential habitat for federally protected species within the action area of your proposed project. Therefore, we are providing you with the list of the federally endangered (E) and threatened (T) species which potentially occur in Aiken South Carolina (Table 1) and the habitat information you requested (Table 2). The list also includes species of concern under review by the Service. Species of concern (SC) are not legally protected under the Endangered Species Act, and are not subject to any of its provisions, including Section 7, until they are formally proposed or listed as endangered/threatened. We are including these species in our response for the purpose of giving you advance notification. These species may be listed in the future, at which time they will be protected under the Endangered Species Act. Therefore, it would be prudent for you to consider these species early in project planning to avoid any adverse effects.

**TABLE 1. SOUTH CAROLINA COUNTY DISTRIBUTION RECORDS OF ENDANGERED, THREATENED AND CANDIDATE SPECIES FOR AIKEN COUNTY**

These lists should be used only as a guideline. The lists include known occurrences and areas where the species has a high possibility of occurring. Records are updated continually and may be different from the following.

Aiken County		
Bald eagle ( <i>Haliaeetus leucocephalus</i> )	T	Known
Wood stork ( <i>Mycteria americana</i> )	E	Known
Red-cockaded woodpecker ( <i>Picoides borealis</i> )	E	Known
Shortnose sturgeon ( <i>Acipenser brevirostrum</i> )*	O	Known
Relict trillium ( <i>Trillium reliquum</i> )	E	Known
Piedmont bishop-weed ( <i>Ptilimnium nodosum</i> )	E	Known
Smooth coneflower ( <i>Echinacea laevigata</i> )	E	Known
Rafinesque's big-eared bat ( <i>Corynomorhinus rafinesquii</i> )	SC	Possible
Southeastern myotis ( <i>Myotis austroriparius</i> )	SC	Possible
Loggerhead shrike ( <i>Lanius ludovicianus</i> )	SC	Possible
Painted bunting ( <i>Passerina ciris</i> )	SC	Known
Gopher tortoise ( <i>Gopherus polyphemus</i> )	SC	Known
Gopher frog ( <i>Rana areolata capito</i> )	SC	Known
Aphodius tortoise commensal scarab ( <i>Aphodius troglodytes</i> )	SC	Possible
Onthophagus tortoise commensal scarab ( <i>Onthophagus polyphemii</i> )	SC	Possible
Georgia aster ( <i>Aster georgianus</i> )	SC	Possible
Sandhills milk-vetch ( <i>Astragalus michauxii</i> )	SC	Possible
Chapman's sedge ( <i>Carex chapmanii</i> )	SC	Possible
Burhead ( <i>Echinodorus tenellus</i> , var. <i>parvulus</i> )	SC	Known
Stream-bank spider-lily ( <i>Hymenocallis coronaria</i> )	SC	Known
Bog spicebush ( <i>Lindera subcoriacea</i> )	SC	Known
Boykin's lobelia ( <i>Lobelia boykinii</i> )	SC	Possible
Carolina birds-in-a nest ( <i>Macbridea caroliniana</i> )	SC	Known
Loose watermilfoil ( <i>Myriophyllum laxum</i> )	SC	Known
Pickering's morning-glory ( <i>Stylisma pickeringii</i> )	SC	Known
Meadow rue ( <i>Thalictrum subrotundum</i> )	SC	Known
American sandfiltering mayfly ( <i>Dolania americana</i> )		SC
Arogos Skipper ( <i>Atrytone Arogos Arogos</i> )	SC	Known

E=Endangered, T=Threatened, SC=Service has on file limited evidence to support proposals for listing these species; O=Contact National Marine Fisheries Service.



**TABLE 2. HABITAT, FRUITING/LOWERING PERIOD & COUNTY OCCURRENCES**

Scientific Name	Common Name	Federal Status
<i>Haliaeetus leucocephalus</i>	Bald eagle	E
Associated with coasts, rivers, lakes, usually nesting near bodies of water where it feeds. Aiken, Barnwell, Beaufort, Berkeley, Calhoun, Charleston, Chesterfield, Clarendon, Colleton, Dorchester, Fairfield, Georgetown, Jasper, Kershaw, Lexington, Marion, McCormick, Newberry, Oconee, Orangeburg, Pickens, Richland, Sumter, Williamsburg.		
<i>Mycteria americana</i>	Wood stork	E
Freshwater and brackish wetlands, primarily nesting in cypress or mangrove swamps. Feeding in freshwater marshes, flooded pastures, flooded ditches. Aiken, Allendale, Barnwell, Beaufort, Berkeley, Charleston, Colleton, Dorchester, Georgetown, Hampton, Horry, Jasper, Marion, Williamsburg.		
<i>Picoides borealis</i>	Red-cockaded woodpecker	E
Open stands of pines 60+ years old provide roosting/nesting habitat. Foraging habitat is pine and pine/hardwood stands 30+ year old. Aiken, Allendale, Bamberg, Barnwell, Beaufort, Berkeley, Calhoun, Charleston, Chesterfield, Clarendon, Colleton, Darlington, Dillon, Dorchester, Edgefield, Florence, Georgetown, Hampton, Horry, Jasper, Kershaw, Laurens, Lee, Lexington, Marion, Marlboro, McCormick, Orangeburg, Richland, Saluda, Sumter, Williamsburg.		
<i>Alligator mississippiensis</i>	American alligator	T(S/A)
Rivers systems, canals, lakes, swamps.		
<i>Echinacea laevigata</i>	Smooth coneflower	E
Piedmont- mountains. Basic or circumneutral soils (Hayesville, Cecil, Porter, Madison) of meadows and woodlands. Successful colonies are almost always at sites featuring open, bare soil, a fairly high soil pH, and exposures allowing optimal sunshines. Late May-July. Aiken, Allendale, Anderson, Barnwell, Lancaster, Lexington, Oconee, Pickens, Richland.		

From review of the DEIS for this project, it does not appear that the proposed siting or construction of the proposed facilities represent a substantial risk to federally listed or proposed endangered or threatened plant or animal species. In view of this, we believe that the requirements of Section 7 of the Endangered Species Act have been satisfied. However, obligations under Section 7 of the Act must be reconsidered if (1) new information reveals

impacts of this identified action that may affect listed species or critical habitat in a manner not previously considered, (2) this action is subsequently modified in a manner which was not considered in this assessment, or (3) a new species is listed or critical habitat determined that may be affected by the identified action.

In addition, the operation of these facilities and the subsequent disposition of large quantities of immobilized plutonium in geologic repositories at the SRS, may impact the future quality of the environment at the site. The DEIS does not fully address the issues associated with geological disposition and therefore they are not a part of this consultation. Once the issue of disposition in geologic repositories is addressed we would be glad to consult with DOE and provide any information necessary for the assessment of potential impacts to the environment.

Also, the DEIS does not present an adequate analysis of potential environmental impacts to the non-human environment. While human health is considered throughout the document, ecological health is rarely discussed. This presumably occurred due to the assumption that environmental receptors are not present within the action area. This assumption does suggest that substantial environmental impacts are improbable in the action area, but does not justify the exclusion of this analysis as a part of the environmental impact assessment. We suggest that the final Environmental Impact Statement (EIS) reflect that appropriate consideration was given not only to the human environment, but the ecological environment as well.

Your interest in ensuring the protection of endangered and threatened species and our nation's valuable wetland resources is appreciated. We hope this letter and the accompanying information on endangered and threatened species will be useful in project development. If you require further assistance please contact Mr. Rusty Jeffers of my staff at (803) 727-4707 ext. 20. In future correspondence concerning the project, please reference FWS Log No. 4-6-98-364.

Sincerely yours,

  
Edwin M. EuDaly  
Acting Field Supervisor

EME/RDJ/km



Department of Energy  
Savannah River Operations Office  
P.O. Box A  
Aiken, South Carolina 29802

DEC 04 2009

Mr. Roger Banks  
U. S. Department of the Interior  
Fish and Wildlife Service  
P. O. Box 12559  
Charleston, SC 29422-2559

Dear Mr. Banks:

Re: Informal Consultation Under Section 7 of the Endangered Species Act for the  
Surplus Plutonium Disposition - Mixed Oxide Fuel Fabrication Facility

In July 1998, the Department of Energy notified the U.S. Fish and Wildlife Service of plans to locate the Surplus Plutonium Disposition Facilities at the Savannah River Site and solicited comment on the Surplus Plutonium Disposition Environmental Impact Statement. In your response (letter from Mr. R. Banks to Mr. M. Jones, September 8, 1998) you provided a listing of several species that are currently listed as endangered or threatened along with several species of concern that are known to exist in the Aiken, South Carolina area.

The Department of Energy has determined a preliminary site layout for the Mixed Oxide Fuel Fabrication Facility (one of the three surplus plutonium disposition facilities) which is illustrated on the enclosed map as site "2M". The Department of Energy also performed a survey of the Mixed Oxide Fuel Fabrication Facility site for wetlands, and endangered and threatened species or critical habitat. Enclosed is the survey report. We request your review and concurrence with the results of our survey.

Sincerely,



A. B. Gould, Director  
Environmental Quality and Management Division

kwd/aec  
Att.



**Department of Energy**

Washington, DC 20585  
July 28, 1998

Mr. Tom Murphy  
South Carolina Department of Natural Resources  
Lower Coastal Wildlife Diversity  
585 Donnelley Drive  
Green Pond, SC 29446

Dear Mr. Murphy:

The Department of Energy (DOE) published its Notice of Intent to prepare the *Surplus Plutonium Disposition Environmental Impact Statement* (SPD EIS) in the Federal Register (Vol. 92, No. 99) on May 22, 1997. This SPD EIS is tiered from the *Storage and Disposition of Weapons-Usable Fissile Materials Programmatic EIS* (DOE/EIS-0229), issued in December 1996, and the associated Record of Decision (62 FR 3014), issued on January 14, 1997. To summarize, the purpose of the proposed action is to reduce the threat of nuclear weapons proliferation worldwide in an environmentally safe and timely manner by conducting disposition of surplus plutonium in the United States, thus setting a nonproliferation example for other nations.

The SPD Draft EIS, a copy of which is attached for your review, examines twenty-four alternatives and analyzes the potential environmental impacts for the proposed siting, construction, and operation of three types of facilities: pit disassembly and conversion, mixed oxide (MOX) fuel fabrication, and plutonium conversion and immobilization. The Savannah River Site (SRS) near Aiken, South Carolina is a candidate site for all three facilities. The candidate sites and alternatives are shown in Table 2-1 of the SPD Draft EIS. Please note that where practical, the modification of existing buildings is being considered.

Alternative 3A proposes locating the three surplus plutonium disposition facilities in new construction adjacent to the Actinide Packaging and Storage Facility in F-Area at SRS. In addition, the canister receipt area at the Defense Waste Processing Facility in S-Area would be modified to accommodate the receipt and processing of the canisters from the plutonium conversion and immobilization facility. Although several alternatives include locating facilities at SRS, Alternative 3A has the greatest potential for impacts on ecological resources.

Preliminary analyses suggest that overall impacts on ecological resources from constructing and operating the proposed surplus plutonium disposition facilities would be limited because the land area required (31 hectares [77 acres]) is relatively small in comparison to regionally available habitat, habitat disturbance would be minimized because construction would take place in previously disturbed or developed areas; and operational impacts would be minimized because facility releases of airborne and aqueous effluents would be controlled and permitted. Section 4.26.4.3 of the SPD Draft EIS presents the ecological resources analysis for SRS.

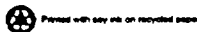

Although sources indicate that no critical habitat for any threatened and endangered species exists at SRS, there may be Federal or State-classified special status species in the environs surrounding F-Area. These species include American alligator, bald eagle, Oconee azalea, red-cockaded woodpecker, smooth purple coneflower, and wood stork. Noise disturbance is probably the most important impact affecting local wildlife populations.

As part of DOE's National Environmental Policy Act process, DOE encourages the South Carolina Department of Natural Resources to identify any concerns or issues it believes should be addressed in the SPD EIS. To facilitate incorporation of your input into the SPD Final EIS, please provide a written response by September 16, 1998.

Please mail your response to:

Marcus Jones  
SPD EIS Document Manager  
U.S. Department of Energy  
Office of Fissile Materials Disposition  
1000 Independence Avenue, SW  
Washington, DC 20585

If you have any questions, please contact me at (202) 586-0149.

Sincerely,



Marcus Jones  
SPD EIS Document Manager

cc: John B. Gladden, WSRC  
David P. Roberts, DOE



**Department of Energy**  
Savannah River Operations Office  
P.O. Box A  
Aiken, South Carolina 29802

DEF 0 8 2mm

Mr. D. L. Johnson  
South Carolina Department of Natural Resources  
1201 Main Street  
Suite 1100  
Columbia, SC 29201

Dear Mr. Johnson:

Re: U.S. Department of Energy, Savannah River Site  
Surplus Plutonium Disposition - Mixed Oxide Fuel Fabrication Facility

In July 1998, the Department of Energy notified the South Carolina Department of Natural Resources, Lower Coastal Wildlife Diversity, of plans to locate the Surplus Plutonium Disposition Facilities at the Savannah River Site and solicited comment on the Surplus Plutonium Disposition Environmental Impact Statement (letter from Mr. M. Jones to Mr. T. Murphy July 28, 1998).

The Department of Energy has determined a preliminary site layout for the Mixed Oxide Fuel Fabrication Facility (one of the three surplus plutonium disposition facilities) which is illustrated on the enclosed map as site "2M". The Department of Energy also performed a survey of the Mixed Oxide Fuel Fabrication Facility site for wetlands, and endangered and threatened species or critical habitat. Enclosed is the survey report. We request your review and concurrence with the results of our survey.

Sincerely,



A. B. Gould, Director  
Environmental Quality and Management Division

kwd/aec  
Enc.

**This page intentionally left blank.**

**APPENDIX B. IMPACT ASSESSMENT METHODOLOGY**

---



**This page intentionally left blank.**

---

This appendix briefly describes the methods used to evaluate the potential direct, indirect, and cumulative effects of the MFFF. Included are impact assessment methods for the following:

- Land resources
- Geology and soils
- Water resources
- Air quality
- Ecological resources
- Noise
- Historic, scenic, and cultural resources
- Socioeconomics
- Environmental justice
- Human health risk during normal operations
- Infrastructure
- Waste management
- Facility accidents
- Transportation
- Cumulative impacts.

Each section is organized so that the affected resource is first described and then the impact assessment method is presented.

Although impacts were generally described as either major or minor, this assignment was made in different ways, depending on the resource. For air quality, for example, estimated pollutant emissions from the proposed MFFF were compared with the appropriate regulatory standards or guidelines. For human health risk, estimated human exposure to radionuclides from the proposed facility was compared with applicable dose limits. Comparison with regulatory standards is a commonly used method for benchmarking environmental impact and is done here to provide perspective on the magnitude of identified impacts.

Other indicators of impact were also established to focus the analysis on impacts that could be major. The analysis of waste management impacts, for example, focused on where additional waste generation would be a large percentage of current site waste generation, although a major impact was suggested only where waste generation would exceed the capacity of existing waste management facilities. Cumulative impacts were also evaluated with a view to ensuring that actions with minor impacts individually could not have major impacts collectively.

Impacts in all resource areas were analyzed consistently; that is, the impact values were estimated using a consistent set of input variables and computations. Moreover, efforts were made to ensure that calculations in all areas used accepted protocols and up-to-date models. Finally, like presentations were developed to facilitate the comparison of alternatives.

## **B.1 LAND RESOURCES**

### **B.1.1 Description of Affected Resources**

Land resources include the following:

- Land on and contiguous to the MFFF
- Physical features that influence current or proposed uses
- Local urban and rural population density
- Pertinent state, county, and municipal land use plans and regulations
- Land ownership and availability
- Aesthetic characteristics of the site and surrounding areas.

Land resource analysis for the MFFF determined the potential beneficial or adverse impacts on land use and visual resources. The ROI for visual resources includes those lands within the viewshed of the proposed action and alternatives.

### **B.1.2 Description of Impact Assessment**

#### **B.1.2.1 Land Use Analysis**

The MFFF ER estimates the impacts on land use within the site, adjacent federal or state lands, adjacent communities, and wildlife or resource areas. At issue is the net land area affected and its relationship to conforming and nonconforming land uses; current growth trends, land values, and other socioeconomic factors pertaining to land use; and the projected modifications to other facility activities and missions consistent with the proposed action (see Table B-1).

Evaluation of existing land uses required review of existing and future facility land use plans. Total land area requirements include those areas to be occupied by the footprint of each building and nonbuilding support area, in conjunction with all paved roads, parking areas, graveled areas, construction laydown areas, and any land graded and cleared of vegetation. Land area requirements were identified using proposed facility designs.

#### **B.1.2.2 Visual Resources Analysis**

Visual resource impacts are changes in the physical features of the landscape attributable to the proposed action. Visual resource assessment was based on the Bureau of Land Management VRM classification scheme (DOI 1986a, 1986b). Impacts on scenic or visual resources were analyzed by identifying existing VRM classifications and documenting any potential reductions as a result of the proposed action (see Table B-1). Existing class designation was derived from an inventory of scenic qualities, sensitivity levels, and distance zones for particular areas. The elements of scenic quality are landforms, vegetation, water, color, adjacent scenery, scarcity, and cultural modification. Scenic value is determined by the variety of the elements of scenic

quality. Sensitivity levels are determined by user volumes and user attention. Distance zones concern the visibility from travel routes or observation points.

Important concerns of the visual resources analysis are the degree of contrast between the MFFF and the surrounding landscape, the location and sensitivity levels of public vantage points, and the visibility of the proposed action from the vantage points. The distance from a vantage point to the affected area and atmospheric conditions were also taken into consideration because distance and haze can diminish the degree of contrast and visibility. A qualitative assessment of the degree of contrast between the MFFF and the existing visual landscape was also considered. Reduction of an assigned VRM classification could result if the affected area could be seen from the vantage point with a high sensitivity level.

## **B.2 GEOLOGY AND SOILS**

### **B.2.1 Description of Affected Resources**

Geologic resources include consolidated and unconsolidated earth materials, including mineral assets such as ore and aggregate materials, and fossil fuels such as coal, oil, and natural gas. Geologic conditions include hazards such as earthquakes, faults, volcanoes, landslides, and land subsidence. Soil resources include the loose surface materials of the earth in which plants grow, usually consisting of mineral particles from disintegrating rock, organic matter, and soluble salts.

The ROI for geology and soils included the 41 ac (16.6 ha) subject to disturbance by construction and operation of the MFFF.

Geology and soils were considered with respect to natural conditions that could affect the MFFF, as well as those portions of the resource that could be affected by the MFFF. Geologic and soil conditions that could affect the integrity and safety of the MFFF include large-scale geologic hazards and attributes of the soil beneath the proposed facility. Geology and soil resources that could be affected by the MFFF include economically valuable mineral resources and prime farmland soils.

### **B.2.2 Description of Impact Assessment**

Facility construction and operations for the MFFF were considered from the perspective of impacts on specific geologic resources and soil attributes. Construction impacts would predominate in effects on geologic and soil resources; hence, key factors in the analysis were the land area to be disturbed during construction and occupied during operations (see Table B-2). The main objective was to avoid siting facilities over unstable soils (i.e., soils prone to liquefaction, shrink-swell, or erosion).

Included in the geology and soil impact analysis was consideration of the risks to the proposed facilities of large-scale geologic hazards such as faulting and earthquakes, lava extrusions and other volcanic activity, landslides, sinkholes, and salt dissolution (i.e., conditions that tend to

affect broad expanses of land). Efforts were also made to determine if locating the MFFF at a specific site could destroy, or preclude the use of, valuable mineral or energy resources.

Pursuant to the Farmland Protection Policy Act (7 USC 4201 et seq.), and the regulations (7 CFR Part 658) promulgated as a result thereof, the presence of prime farmlands was also evaluated.

## **B.3 WATER RESOURCES**

### **B.3.1 Description of Affected Resources**

Water resources are the surface and subsurface waters that are suitable for human consumption, agricultural purposes, or irrigation or industrial/commercial purposes, and that could be impacted by the proposed action. This analysis involved the review of engineering estimates of expected water use and effluent discharges from proposed construction, operation, and maintenance of the MFFF, and ultimately the impacts of the activities on the local surface water and groundwater.

### **B.3.2 Description of Impact Assessment**

Determination of the impacts of the MFFF on water resources (see Table B-3) consisted of a comparison of design specifications, regulatory standards, design parameters commonly used in the water and wastewater design industry, and accepted industry standards.

Certain assumptions were integral to this analysis: (1) all water and sewage treatment facilities would be approved by the appropriate permitting authority; thus, the impacts of project-specific withdrawals from the water treatment plants and effluent discharges from the sewage treatment plant would be in accordance with established standards; (2) the sewage treatment facilities would meet the effluent limitations imposed by their respective NPDES permits; and (3) any stormwater runoff from construction or operation activities would be handled in accordance with the regulations of the appropriate permitting authority. It was also assumed that, during construction, siltation fencing or other erosion control devices would be used to mitigate short-term adverse impacts from siltation, and that, as appropriate, stormwater holding ponds would be constructed to lessen the impacts of rainfall events on the receiving streams.

The first step in the analysis was to determine whether the design capacity of the water and wastewater treatment facilities would be exceeded by the additional flows. If the combined flow (i.e., the existing flow plus that from the MFFF) was less than the design capacity of the water and sewage treatment plants, then it was assumed that there would be no impact on water availability for local users or on the receiving stream from sewage treatment plant effluent discharges. If the flows from the MFFF were found to exceed the design capacity of the existing water or sewage treatment facilities, more extensive analyses would be required.

## **B.4 AIR QUALITY**

### **B.4.1 Description of Affected Resources**

Air pollution refers to any substance in the air that could harm human or animal populations, vegetation, or structures, or that unreasonably interferes with the comfortable enjoyment of life and property. For purposes of the MFFF ER, only outdoor air pollutants were addressed. They may be in the form of solid particles, liquid droplets, gases, or a combination of these forms. Generally, they can be categorized as primary pollutants (i.e., those emitted directly from identifiable sources) and secondary pollutants (i.e., those produced in the air by interaction between two or more primary pollutants or by reaction with normal atmospheric constituents, which may be influenced by sunlight). Air pollutants are transported and dispersed by the atmosphere and influenced by topographical conditions. Thus, air quality is affected by air pollutant emission characteristics and atmospheric transport and dispersion.

Ambient air quality in a given location can be described by comparing the concentrations of various pollutants in the atmosphere with the appropriate standards. Ambient air quality standards have been established by federal and state agencies, allowing an adequate margin of safety for protection of public health and welfare from the adverse effects of pollutants in the ambient air. Pollutant concentrations higher than the corresponding standards are considered unhealthy; those below such standards, acceptable.

The pollutants of concern are primarily those for which federal and state ambient air quality standards have been established, including criteria air pollutants, hazardous air pollutants, and other toxic air compounds. Criteria air pollutants are those listed in 40 CFR Part 50, "National Primary and Secondary Ambient Air Quality Standards." Hazardous air pollutants and other toxic compounds (i.e., air toxics) are listed in Title I of the 1990 CAA, as amended, and include those regulated by NESHAP. In addition, air pollutants that have been proposed or adopted for regulation by the respective state or listed in state guidelines are also considered. Also of concern are air pollutant emissions that may contribute to the depletion of stratospheric ozone or to global warming.

Areas with air quality better than the NAAQS for criteria air pollutants are designated as being in attainment; areas with air quality worse than the NAAQS for such pollutants are nonattainment areas. Areas may be designated as unclassified when sufficient data for attainment status designation are lacking. Attainment status designations are assigned by county, MSA, consolidated MSA, or portions thereof. Air Quality Control Regions designated by EPA are listed in 40 CFR Part 81, "Designation of Areas for Air Quality Planning Purposes."

For locations that are in an attainment area for criteria air pollutants, PSD regulations limit pollutant emissions from new sources and establish allowable increments of pollutant concentrations. Three PSD classifications are specified with the criteria established in the CAA amendments. Class I areas include national wilderness areas, memorial parks larger than 5,000 ac (2,020 ha), national parks larger than 6,000 ac (2,430 ha), and areas that have been

redesignated as Class I. Class II areas are all areas not designated as Class I; no Class III areas have been designated.

Designation as a nonattainment area for criteria air pollutants triggers control requirements designed to achieve attainment status by specified dates. In addition, facilities that constitute major new emission sources cannot be constructed in a nonattainment area without permits that impose stringent pollution control requirements to ensure progress toward compliance.

The ROI for air quality is that area around SRS potentially affected by air pollutant emissions caused by the MFFF. The air quality impact area normally evaluated is the area in which concentrations of criteria air pollutants would increase more than a significant amount in a Class II area. Significance varies according to the averaging period: 2,000  $\mu\text{g}/\text{m}^3$  for 1 hour for carbon monoxide; 25  $\mu\text{g}/\text{m}^3$  for 3 hours for sulfur dioxide; 5  $\mu\text{g}/\text{m}^3$  for 24 hours for sulfur dioxide and particulate matter with an aerodynamic diameter less than or equal to 10 microns ( $\text{PM}_{10}$ ); and 1  $\mu\text{g}/\text{m}^3$  annually for sulfur dioxide,  $\text{PM}_{10}$ , and nitrogen dioxide. Generally, the ROI covers a few kilometers downwind from the source. The size of the ROI depends on emission source characteristics, pollutant types, emission rates, and meteorological and topographical conditions. For purposes of this analysis, impacts were evaluated at the SRS boundary.

Baseline air quality is typically described in terms of pollutant concentrations modeled for existing sources at SRS and background air pollutant concentrations measured near SRS. For this analysis, concentrations for existing sources were obtained from the SPD EIS (DOE 1999c) and the S&D PEIS (DOE 1996b) where appropriate. The maximum concentrations of toxic air pollutants at or beyond the site boundary were compared with federal and state regulations or limits.

#### **B.4.2 Description of Impact Assessment**

Potential air quality impacts of pollutant emissions from construction and normal operations were evaluated for the MFFF (see Table B-4). The assessment included a comparison of effects of the MFFF with applicable federal and state ambient air quality standards and concentration limits. The more stringent standards, EPA or state, served as the assessment criteria. Criteria for hazardous and toxic air pollutants include those listed in Title III of the 1990 CAA Amendments, NESHAP, and standards and guidelines adopted by the state of South Carolina. The state ambient standards are the same as or more stringent than the federal ambient standards. The federal primary ambient standards define levels of air quality that EPA “judges are necessary with an adequate margin of safety, to protect the public health” (40 CFR Part 50). The federal secondary ambient standards define levels of air quality that EPA “judges are necessary to protect the public welfare from any known or anticipated adverse effects of a pollutant” (40 CFR Part 50). The MFFF incremental change in concentrations of pollutants was compared with the PSD Class II allowable increments.

Operational air pollutant emissions data for the MFFF were based on engineering design reports. Construction emissions were based on engineering design reports, emission factors for

**Table D-3. Agricultural Food Production Within 50 miles (80 km) Surrounding SRS  
Used for Determination of Population Dose to the Offsite Public (continued)**

**Eggs (kg/yr)**

Direction	Distance (miles)					
	0 to 5	5 to 10	10 to 20	20 to 30	30 to 40	40 to 50
S	0	0	6.3E+02	0	0	8.3E+04
SSW	0	0	0	0	0	1.0E+05
SW	0	6.2E+05	0	0	0	91
WSW	0	0	0	0	1.2E+02	7.0E+02
W	0	0	0	0	2.2E+02	3.3E+02
WNW	0	0	0	0	0	1.0E+05
NW	0	0	0	1.2E+05	3.2E+05	1.1E+05
NNW	0	0	0	1.0E+05	5.9E+05	6.4E+05
N	0	0	0	0	1.7E+05	29
NNE	0	0	0	0	0	1.0E+05
NE	0	0	4.1E+03	4.0E+03	1.6E+02	1.2E+02
ENE	0	0	4.3E+04	5.5E+04	5.0E+02	6.3E+02
E	0	0	4.5E+04	5.6E+04	71	4.0E+02
ESE	0	0	4.2E+04	5.8E+04	1.2E+02	0
SE	0	0	6.3E+05	1.2E+03	0	0
SSE	0	0	3.1E+05	0	0	0

Source: *Storage and Disposition of Weapons-Usable Fissile Materials Final Programmatic Environmental Impact Statement Volume 2: Health Risk Data Reading Room Material* (Halliburton NUS Corp. 1996)



Ozone is typically formed as a secondary pollutant in the ambient air (troposphere). It is formed from such primary pollutants as nitrogen oxides and VOCs, which emanate from vehicular (mobile), natural, and other stationary sources. It is not emitted directly as a pollutant from the site. Although ozone may thus be regarded appropriately as a regional issue, specific ozone precursors, notably nitrogen dioxide and VOCs, were analyzed as applicable to the MFFF.

The CAA, as amended, required that federal actions conform to the host state's "State Implementation Plan." A State Implementation Plan provides for the implementation, maintenance, and enforcement of NAAQS for the six criteria pollutants: sulfur dioxide, PM<sub>10</sub>, carbon monoxide, ozone, nitrogen dioxide, and lead. Its purpose is to eliminate or reduce the severity and number of violations of NAAQS and to expedite the attainment of these standards. No department, agency, or instrumentality of the federal government shall engage in or support in any way (i.e., provide financial assistance for, license or permit, or approve) any activity that does not conform to an applicable implementation plan. The final rule for *Determining Conformity of General Federal Actions to State or Federal Implementation Plans* (EPA 1993) took effect on January 31, 1994. SRS is within an area currently designated as attainment for criteria air pollutants. Therefore, the MFFF at this site is not affected by the provisions of the conformity rule.

Emissions of potential stratospheric ozone-depleting compounds (e.g., chlorofluorocarbons) were not evaluated because no emissions of these pollutants were identified in the engineering design reports.

## **B.5 ECOLOGICAL RESOURCES**

### **B.5.1 Description of Affected Resources**

Ecological resources include terrestrial and aquatic resources (plants and animals), wetlands, and threatened and endangered species that could be affected by proposed construction and operations at the MFFF. The ROI for habitat impacts from facility construction and operations is the 41 ac (16.6 ha) used by the proposed facility. Because the MFFF is located in an industrialized area, a wider ROI is not appropriate.

### **B.5.2 Description of Impact Assessment**

The proposed action would involve, at a minimum, land disturbance during site clearing for construction of new facilities (see Table B-5). Accordingly, ecological impacts were assessed in terms of potential disturbances or loss of nonsensitive terrestrial and aquatic habitats and the potential effects on nearby sensitive habitats. For purposes of the ER, sensitive habitats include those areas occupied by threatened and endangered species, state-protected species, and wetlands.

### **B.5.2.1 Nonsensitive Habitat Impacts**

During the construction phase, ecological resources could be affected through disturbance or loss of habitat resulting from site clearing, land disturbance, human intrusion, and noise. Terrestrial resources could be directly affected through changes in vegetative cover important to individual animals of certain species with limited home ranges, such as small mammals and songbirds. Likely impacts include increased direct mortality and susceptibility to predation. Activities associated with the construction and operation of facilities (e.g., human intrusion and noise) could also compel the migration of the wildlife to adjacent areas with similar habitat. If the receiving areas were already supporting the maximum sustainable wildlife, competition for limited resources and habitat degradation could be fatal to some species. Therefore, the analysis of impacts on terrestrial wildlife was based largely on the extent of plant community loss or modification.

Construction or modification of facilities, and the operation thereof, could directly affect aquatic resources through increased runoff and sedimentation, increased flows, and the introduction of thermal and chemical changes to the water. However, various mitigation techniques should minimize construction impacts, and discharges of contaminants to surface waters from routine operations are expected to be limited by engineering control practices. Therefore, impacts are expected to be minimal.

### **B.5.2.2 Sensitive Habitat Impacts**

Impacts on threatened and endangered species, state-protected species, and their habitats during construction of the MFFF were determined in a manner similar to those for nonsensitive habitats. A list of sensitive species that could be present at F Area was compiled. Informal consultations were initiated, as part of the SPD EIS (DOE 1999c), with the appropriate USFWS offices and SCDNR, as part of the impacts assessment for sensitive species. Surveys were conducted to determine the presence of any federal- or state-listed species within the 41-ac (16.6-ha) site.

Most construction impacts on wetlands are related to the displacement of wetlands by filling, draining, or dredging activities. Operational impacts thereon could result from effluents, surface water or groundwater withdrawals, or the creation of new wetlands. Loss of wetlands resulting from construction and operation of the MFFF was addressed by comparing data on the location and areal extent of wetlands in the ROI with the land area requirements for the proposed facilities.

## **B.6 NOISE**

### **B.6.1 Description of Affected Resources**

Noise is undesirable sound that interferes with the human or natural environment. Noise may disrupt normal activities (e.g., hearing, sleep), damage hearing, or diminish the quality of the environment.

Sound-level measurements used to evaluate the effects of sound on humans are taken using an A-weighting scale that accounts for the hearing response characteristics (i.e., frequency) of the human ear. Sound levels are expressed in decibels, or in the case of A-weighted measurements, decibels A-weighted, or dBA. EPA has developed noise-level guidelines for different land use classifications. Some states and localities have established noise control regulations or zoning ordinances that specify acceptable noise levels by land use category.

Noise from facility operations and associated traffic could potentially affect human and animal populations. However, because most nontraffic noise associated with construction and operation of the proposed facilities would be distant from offsite noise-sensitive receptors, the contribution to offsite noise levels should be small. Impacts associated with transportation access routes, including noise from increased traffic, could result in small increases in noise along these routes. The ROI includes SRS and surrounding areas, including transportation corridors, where proposed activities might increase noise levels. Transportation corridors most likely to experience increased noise levels are those roads within a few miles of the site boundary that carry most of the site's employee and shipping traffic.

Sound-level data representative of site environs were obtained from existing reports and from calculations of the sound levels typical of prevailing traffic volumes along the transportation corridors. The acoustic environment was further described in terms of existing noise sources for the site.

## **B.6.2 Description of Impact Assessment**

Also addressed in the MFFF assessment were the onsite and offsite acoustic impacts of construction and operation of the proposed facilities (see Table B-4). That analysis drew from available information (e.g., engineering design reports) on the types of noise sources and the locations of the proposed facilities relative to the site boundary and noise-sensitive locations. Its focus was the degree of change in noise levels at sensitive receptors (e.g., residences near the site boundary and along access routes, and schools along access routes) with respect to ambient conditions. (A change in noise level of less than 3 dB is generally not detectable by the human ear. An increase of 10 dB is roughly equivalent to a doubling of the perceived sound.) Most nontraffic noise sources associated with construction and operation of the surplus plutonium disposition facilities are far enough from offsite noise-sensitive receptors that the contribution to offsite noise levels should be small. Projections of traffic noise during construction and operations were based on the employment and shipment projections provided in the engineering design reports.

## **B.7 HISTORIC, SCENIC, AND CULTURAL RESOURCES**

### **B.7.1 Description of Affected Resources**

Cultural resources are the indications of human occupation and use of land as defined and protected by a series of federal laws, regulations, and guidelines. The potential impacts of MFFF

facilities were assessed separately for each of three general categories of cultural resources: prehistoric, historic, and traditional cultural resources.

The area assessed for the cultural and paleontological resource analyses encompasses the land areas that will be directly disturbed by construction and operation of the proposed MFFF. The natural setting of those resources was considered a contextual component thereof.

### **B.7.2 Description of Impact Assessment**

The assessment of direct impacts focused on ground-disturbing activities and alterations to existing resources, particularly those listed or eligible for listing on the National Register of Historic Places, and those considered important to Native Americans or other local ethnic groups.

The State Historic Preservation Officer was consulted and site cultural resource surveys and management plans were reviewed to determine the importance of the identified sites and their eligibility for listing in the National Register of Historic Places, and to identify and assess measures to mitigate potential impacts of the proposed action. Additional archaeological surveys were conducted in late 1999 in formerly unsurveyed areas of the property proposed for development of MFFF facilities. All cultural resource work at SRS is done in compliance with the *Archaeological Resource Management Plan of the Savannah River Archaeological Research Program* (SRARP 1989).

## **B.8 SOCIOECONOMICS**

### **B.8.1 Description of Affected Resources**

Socioeconomic impacts may be defined as the environmental consequences of a proposed action in terms of demographic and economic changes. Two types of jobs will be created by the development of the MOX project: (1) construction-related jobs, transient in nature and short-term in duration; and (2) jobs related to plant operations, required for a decade or more.

### **B.8.2 Description of Impact Assessment**

Statistics were compiled for two geographic areas: (1) counties within a 50-mi (80-km) radius of the MFFF site; and (2) a more local area within about 10 mi (16 mi) of the site. Data, including statistics on labor, housing, population, and community services, were used to help determine the potential extent of impact the proposed project would have on the areas of interest.

SRS's overall workforce is projected to decrease during the time that additional workers will be needed to support project development. As a result, there will be little change in the site's overall workforce from current levels, and thus very little change in requirements for community services.

## **B.9 ENVIRONMENTAL JUSTICE**

### **B.9.1 Description of Affected Resources**

Local minority populations are divided between four groupings counted by the 1990 federal census: Asian or Pacific Islanders, Blacks, Hispanics, and Native Americans. Information on minority populations was reviewed at the town, division, and block group level for communities within a 10-mi (16-km) radius of the MFFF site.

### **B.9.2 Description of Impact Assessment**

NRC Nuclear Materials Safeguards and Security guidance on performing environmental justice reviews was consulted in performing this analysis (NRC 1999). Since no residential population exists within the 4-mi (6-km) radial area suggested by the guidance as the area of interest, the analysis for this project also considered general population characteristics of communities within 10 mi (16 km) of the site.

Given the distance of the nearest residential populations from the MFFF site, data at the town and division level were generally considered sufficient for the analysis. Maps showing the geographic distribution of minority populations and low-income populations within a 10-mi (16-km) radius of the site were obtained from the EPA "Maps on Demand" website, which uses Landview III software and 1990 U.S. Census block group data as its database. Additional data from the U.S. Census provided detailed breakdowns of racial and economic components of the local area populations.

Uniform population distribution in communities was assumed for purposes of this analysis. In addition, given the lack of published projections by race for local areas, state-level growth rates by race were assumed to be reasonable for use in determining the potential growth of local, smaller component area populations (e.g., towns, divisions, counties).

The following definitions were used in the evaluation:

- **Minority individuals:** Persons who are members of any of the following population groups: Asian or Pacific Islander, Black, Hispanic, or Native Americans (American Indian, Eskimo, or Aleut). This definition includes all persons except those self-designated as not of Hispanic origin and as either White or "Other Race" (one of the classifications used by the Census Bureau in the 1990 census).
- **Minority population:** The total number of minority individuals residing within a potentially affected area.
- **Low-income individuals:** All persons whose self-reported income is below the poverty threshold as adopted by the Census Bureau.

- **Low-income population:** The total number of low-income individuals residing within a potentially affected area.

## **B.10 HUMAN HEALTH RISK DURING NORMAL OPERATIONS**

The methodology for the estimation of human health risks is discussed in Appendix D.

## **B.11 INFRASTRUCTURE**

### **B.11.1 Description of Affected Resources**

Site infrastructure includes physical resources required to support the construction and operation of facilities. It includes the capacities of the onsite road and rail transportation networks; electric power and electrical load capacities; natural gas, coal, and fuel oil capacities; and water supply system capacities. The ROI is limited to the boundaries of SRS.

### **B.11.2 Description of Impact Assessment**

In general, the impacts to the site infrastructure were assessed by evaluating the MFFF requirements against the SRS capacities. An impact assessment was made for each resource (road networks, electricity, fuel, and water) (see Table B-6). Tables reflecting site availability and infrastructure requirements were developed for each alternative. Data for these tables were obtained from reports describing the existing infrastructure at the sites and from the data reports for each facility. If necessary, design mitigation considerations conducive to reduction of the infrastructure demand were also identified.

Any projected demand for infrastructure resources exceeding site availability was regarded as an indicator of environmental impact. Whenever projected demand approaches or exceeds capacity, further analysis for that resource is warranted. Often, design changes can mitigate the impact of additional demand for a given resource. For example, substituting fuel oil for natural gas (or vice versa) for heating or industrial processes can be accomplished at little cost during the design of a facility, provided the potential for impact is identified early. Similarly, a dramatic “spike” in peak demand for electricity can sometimes be mitigated by changes to operational procedures or parameters.

## **B.12 WASTE MANAGEMENT**

### **B.12.1 Description of Affected Resources**

The operation of the MFFF will generate several types of waste, including the following:

- **Liquid high alpha activity waste:** Waste containing more than 100 nCi of alpha-emitting isotopes with half-lives greater than 20 years per gram of waste. Classification of liquid high alpha activity waste is deferred until after SRS processing.

- **Transuranic waste:** Waste containing more than 100 nCi per gram of waste of alpha-emitting TRU isotopes with half-lives greater than 20 years, except for the following:
  - High-level radioactive waste
  - Waste that DOE has determined, with the concurrence of EPA, does not need the degree of isolation required by 40 CFR Part 191
  - Waste that the NRC has approved for disposal, on a case-by-case basis, in accordance with 10 CFR Part 61.
- **Mixed transuranic waste:** TRU waste that also contains hazardous components regulated under RCRA.
- **Low-level radioactive waste:** Waste that contains radioactive material and is not classified as HLW, TRU waste, or spent nuclear fuel,<sup>1</sup> or the tailings or wastes produced by the extraction or concentration of uranium or thorium from any ore processed primarily for its source material. Test specimens of fissionable material irradiated for research and development only, and not for the production of power or plutonium, may be classified as LLW, provided the TRU concentration is less than 100 nCi/g of waste.
- **Mixed low-level radioactive waste:** LLW that also contains hazardous components regulated under RCRA.
- **Hazardous waste:** Under RCRA, a solid waste that, because of its characteristics, may
  - Cause or significantly contribute to an increase in mortality or an increase in serious irreversible, or incapacitating reversible illness, or
  - Pose a substantial present or potential hazard to human health or the environment when improperly treated, stored, transported, disposed of, or otherwise managed.

Hazardous wastes appear on special EPA lists or possess at least one of the following characteristics: ignitability, corrosivity, reactivity, or toxicity. This category does not include source, special nuclear, or byproduct material as defined by the Atomic Energy Act.

- **Nonhazardous waste:** Discarded material, including solid, liquid, semisolid, or contained gaseous material, resulting from industrial, commercial, mining, and agricultural operations and from community activities. This category does not include source, special nuclear, or byproduct material as defined by the Atomic Energy Act.

Construction wastes would be similar to those generated by any construction project of comparable scale.

---

<sup>1</sup>Fuel withdrawn from a nuclear reactor following irradiation, the constituent elements of which have not been separated by reprocessing.

SRS waste management activities in support of the MFFF are evaluated in the *Final Waste Management Programmatic Environmental Impact Statement for Managing Treatment, Storage, and Disposal of Radioactive and Hazardous Waste* (DOE 1997a). Depending on future waste-type-specific RODs, in accordance with that EIS, wastes could be treated and disposed at SRS or at regionally or centrally located waste management centers. The ROD for hazardous waste issued on August 5, 1998 (DOE 1998c) states that SRS will continue to treat some of their own hazardous waste on the site in existing facilities, where economically favorable. According to the TRU Waste ROD issued on January 23, 1998 (DOE 1998d), TRU and TRU mixed waste would be treated by SRS on the site according to the current planning-basis WIPP WAC and shipped to WIPP for disposal. The impacts of disposing TRU waste at WIPP are described in the *Waste Isolation Pilot Plant Disposal Phase Final Supplemental Environmental Impact Statement* (DOE 1997e). Current schedules for shipment of TRU waste to WIPP would accommodate shipment of contact-handled TRU waste from SRS beginning in 2016 (DOE 1997c). Therefore, it is assumed that TRU waste would be stored by SRS onsite until 2016.

### **B.12.2 Description of Impact Assessment**

As shown in Table B-7, impacts were assessed by comparing the projected waste stream volumes generated from the MFFF with SRS waste generation rates and storage volumes. Most likely, each waste type would be managed at many different facilities on SRS; for simplicity, however, it was assumed that the entire waste volume would be managed at one treatment facility, one storage facility, and one disposal facility.

## **B.13 FACILITY ACCIDENTS**

The methodology for the estimation of facility accidents is discussed in Appendix F.

## **B.14 TRANSPORTATION**

### **B.14.1 Description of Affected Resources**

Overland transportation of any commodity involves a risk to both transportation crew members and members of the public. This risk results directly from transportation-related accidents and indirectly from the increased levels of pollution from vehicle emissions, regardless of cargo. The transportation of plutonium, radioactive waste, or other nuclear materials can pose additional risks owing to the unique properties of the material.

Accordingly, DOE, NRC, and DOT have instituted strict policies and regulations governing the transport of such materials. The requirements are applicable throughout a shipment's ROI, which encompasses the onsite roadways, as well as the public roads between DOE sites and between DOE sites and commercial sites. For site-to-site transport, for example, shippers are required to use interstate highways predominantly.



For the MFFF, the persons affected by the transport of the UF<sub>6</sub>, UO<sub>2</sub>, and MOX fuel shipments include the truck crew members involved in the actual shipments and any members of the general public that could be exposed to a shipment while it is either moving or stopped enroute.

#### **B.14.2 Description of Impact Assessment**

An assessment of the human health risks of truck transport of radioactive materials is crucial to a complete appraisal of the environmental impacts of the MFFF located at SRS. An overview of the approach used is presented in Appendix E, "Transportation Risk Assessment." It includes a discussion of the scope of the assessment, the analytical methods used (i.e., computer models), and important assumptions. The analysis summary provided in Appendix E is an update of the transportation risk assessment presented in the SPD EIS (DOE 1999c), specifically for the transportation activities associated with the MFFF located at SRS. The update includes more recently developed information about the numbers and destinations of MOX fresh fuel shipments and revised external dose rates for the MOX fresh fuel package.

The first analytical step in the transportation analysis is to determine the incident-free and accident risk factors per shipment for transportation of the various types of hazardous materials. As with any risk estimate, the risk factors are calculated as the product of the probability and the magnitude of the exposure. Accident risk factors are calculated for both radiological and nonradiological traffic accidents. The probabilities (much lower than unity) and the magnitudes of exposure are multiplied, yielding risk numbers. Incident-free risk factors are calculated for crew and public exposure to radiation emanating from the package and for public exposure to the chemical toxicity of the transportation vehicle exhaust. The probability of incident-free exposure is unity.

Radiological doses, expressed in units of rem, are multiplied by the International Commission on Radiological Protection (ICRP) Publication 60 (ICRP 1991) conversion factors and the estimated numbers of shipments to produce risk estimates in units of LCFs. The nonradiological risk factors are multiplied by the number of shipments. The vehicle emission risk factors are calculated in terms of latent fatalities; the vehicle accident risk factors are calculated in terms of fatalities.

For the incident-free assessment, risks are calculated for "collective populations" of potentially exposed individuals and for the hypothetical MEI. The collective population risk is a measure of the radiological risk posed to society as a whole. The risk from incident-free transportation is assessed for persons living within 0.5 mi (0.8 km) of the route.

The risk from hypothetical accidents is assessed for persons living within 50 mi (80 km) of the route. The accident assessment addresses the probabilities and consequences of a range of possible transportation accident environments, including low-probability accidents with high consequences and high-probability accidents with low consequences.

## **B.15 CUMULATIVE IMPACTS**

Cumulative impacts can result from individually minor but collectively significant actions taking place over a period of time (40 CFR §1508.7). The cumulative impact analysis for the ER involved combining the impacts of the MFFF and the other surplus plutonium disposition facilities with the impacts of other past, present, and reasonably foreseeable activities.

In general, cumulative impacts were calculated by adding the values for the baseline<sup>2</sup>, the maximum impacts from the MFFF and other surplus plutonium disposition activities<sup>3</sup>, and other future actions. This cumulative value was then weighed against the appropriate impact indicators to determine the potential for impact. Non-DOE actions were also considered where information was readily available. Public documents prepared by agencies of federal, state, and local government were the primary sources of information for the non-DOE actions.

It is assumed that construction impacts would not be cumulative because such construction is typically of short duration and construction impacts are generally temporary. Decontamination and decommissioning of the proposed facilities were not addressed in the cumulative impact estimates. As indicated in Chapter 5, the MFFF will be deactivated and then turned over to DOE for final disposition.

---

<sup>2</sup>The conditions attributable to actions, past and present, by DOE and other public and private entities.

<sup>3</sup>As reported in the SPD EIS (DOE 1999c).

**This page intentionally left blank.**

## **Tables**

**This page intentionally left blank.**

**Table B-1. Impact Assessment Protocol for Land Resources**

Resource	Required Data		Measure of Impact
	Affected Environment	Facility Design	
Land use; area used	Total site acreage; available acreage.	Location of proposed facility on the site; total land area requirements.	Facility land requirements within 30% of available acreage.
Compatibility with existing or future land use plans, policies, or regulations	Existing SRS land use configurations; applicable plans, policies, or regulations.	Location of proposed facility on the site.	Compatibility with existing facility or adjacent land use; long-term land use resulting from facility construction, operation, or decontamination and decommissioning.
Visual resources	Delineation of nearby visual resources and viewsheds, including Class I areas.	Location of proposed facility on the site; facility dimensions and appearance.	Significant reduction of assigned VRM classification for a notable viewshed.

Source: SPD EIS (DOE 1999c)

**Table B-2. Impact Assessment Protocol for Geology and Soils**

Resource	Required Data		Measure of Impact
	Affected Environment	Facility Design	
Soil attributes	Presence of any unstable soils at proposed facility location	Location of proposed facility on the site	Location of facility on unstable soils
Valuable mineral and energy resources	Presence of any valuable mineral or energy resources at proposed facility location	Location of proposed facility on the site	Destruction or rendering inaccessible of valuable mineral or energy resources

Source: SPD EIS (DOE 1999c)

**Table B-3. Impact Assessment Protocol for Water Resources**

Resource	Required Data		Measure of Impact
	Affected Environment	Facility Design	
Surface water quality	Surface waters near the facilities in terms of stream classifications and change in water quality	Anticipated effluent quantity and quality	Compliance of surface water quality with relevant standards of CAA or with state regulations
Groundwater quality	Groundwater near the facilities in terms of classification, presence of designated sole source aquifers, and changes in quality of groundwater	Quantity and quality of anticipated withdrawals from, or discharges to, groundwater	Concentrations of contaminants in groundwater exceeding standards established in accordance with Safe Drinking Water Act or state regulations
Surface water availability	Surface waters near the facilities, including average flow, 7-day, 10-year low flow; and numbers of downstream users	Volume of withdrawals from, and discharges to, surface waters	Changes in availability to downstream users of water for drinking, irrigation, or animal feeding <sup>a</sup>
Groundwater availability	Groundwater near the facilities, including numbers of all groundwater users, existing water rights for major water users, and contractual agreements for water supply use within impacted area	Volume of withdrawals from, and discharges to, groundwater	Changes in availability of groundwater for human consumption, irrigation, or animal feeding
Flooding impacts	Location of 100- and 500-year floodplains	Facility location on the site	Construction of facilities in a floodplain

Source: SPD EIS (DOE 1999c)

<sup>a</sup> An impact is assumed if withdrawals exceed 10% of the 7-day, 10-year low flow of the receiving stream.



**Table B-4. Impact Assessment Protocol for Air Quality and Noise**

Resource	Required Data		Measure of Impact
	Affected Environment	Facility Design	
Air quality Criteria air pollutants and other regulated pollutants <sup>a</sup>	Ambient concentration ( $\mu\text{g}/\text{m}^3$ ) of air pollutants and concentrations of pollutants from existing sources at SRS	Emission (kg/yr) of air pollutants from facility and facility construction or modification; source characteristics (e.g., stack height and diameter, exit temperature and velocity); shipments and workforce estimates	Contribution of MFFF to concentrations of each pollutant at or beyond SRS boundary; total concentration of each pollutant at or beyond SRS boundary; percent of applicable standard
Noise	Sound levels at sensitive offsite receptors (e.g., at nearby residences, along major access routes); sound levels at noise-sensitive wildlife habitat (nearby threatened and endangered wildlife habitat)	Descriptions of major construction and operation sources; shipment and workforce estimates	Increases in day/night average sound level at sensitive receptors

Source: SPD EIS (DOE 1999c)

<sup>a</sup> Carbon monoxide; nitrogen oxides; particulate matter with an aerodynamic diameter less than or equal to 10  $\mu\text{g}$ ; sulfur dioxide; total suspended particulates.

**Table B-5. Impact Assessment Protocol for Ecological Resources**

Resource	Required Data		Measure of Impact
	Affected Environment	Facility Design	
Nonsensitive terrestrial and aquatic habitats	Vegetation and wildlife within proposed facility location.	Area disturbed by construction of proposed facility.	Decrease in acreage of undisturbed local and regional nonsensitive habitats.
Sensitive terrestrial and aquatic habitats, including wetlands	Sensitive species habitats within proposed facility location.	Area disturbed by construction of proposed facility.	Decrease in extent of sensitive habitats site.  Determination by USFWS and state agencies that facility construction could disturb sensitive habitats.

Source: SPD EIS (DOE 1999c)

**Table B-6. Impact Assessment Protocol for Infrastructure**

Resource	Required Data		Measure of Impact
	Affected Environment	Facility Design	
<b>Transportation</b> Roads (mi)	SRS capacity and current usage	Facility requirements	Relation of requirement to SRS capacity
<b>Electricity</b> Energy consumption (MWh/yr)	SRS capacity and current usage	Facility requirements	Relation of requirement to SRS capacity
<b>Fuel</b> Oil (gal/yr)	SRS capacity and current usage	Facility requirements	Relation of requirement to SRS capacity
<b>Water</b> (gal/yr)	SRS capacity and current usage	Facility requirements	Relation of requirement to SRS capacity

Source: SPD EIS (DOE 1999c)

**Table B-7. Impact Assessment Protocol for Waste Management**

Resource	Required Data		Measure of Impact
	Affected Environment	Facility Design	
Waste management capacity	Site generation rates (yd <sup>3</sup> /yr or gal/yr) for each waste type. Site management capacities (yd <sup>3</sup> or gal) for potentially affected treatment, storage, and disposal facilities.	Operation generation rates (yd <sup>3</sup> /yr or gal/yr).	MFFF waste generation rates as a percentage of existing site generation rates.

Source: SPD EIS (DOE 1999c)

**This page intentionally left blank.**

**APPENDIX C. ANALYSIS OF ENVIRONMENTAL JUSTICE**

**This page intentionally left blank.**

---

## **C.1 INTRODUCTION**

Executive Order 12898, *Federal Actions to Address Environmental Justice in Minority Populations and Low-Income Populations*, directs federal agencies to identify and address, as appropriate, disproportionately high and adverse health or environmental effects of their programs, policies, and activities on minority and low-income populations.

The Council on Environmental Quality (CEQ) released guidance on environmental justice in December 1997. As an independent agency, the Council's guidance is not binding on the NRC; however, the NRC considered the CEQ's guidance when establishing its policies and procedures. The analysis of environmental justice in this ER is based on the guidance document *Environmental Justice in NEPA Documents*, developed as part of the NMSS Policy and Procedures Letter 1-50 (NRC 1999a) and provided by the NRC as guidance.

## **C.2 APPROACH**

The NMSS document provides guidelines for identifying the geographical area for assessment of environmental justice as follows:

If the facility is located within the city limits, a 0.56 mile radius (1 square mile) from the center of the site is probably sufficient for evaluation purposes; however, if the facility itself covers this much area, use a radius that would be equivalent to 0.5 miles from the site. If the facility is located outside the city limits or in a rural area, a 4-mile radius (50 square miles) should be used.

The MFFF site is located in a rural part of South Carolina, within the SRS property. The nearest SRS property boundary is over 4 mi (6.4 km) from the site, and there is no population except for a daily transient population associated with SRS activities within the 4-mi (6.4-km) distance suggested in the NMSS guidance.

Looking further beyond the suggested 4-mi (6.4-km) radius, the nearest residential population is located over 5 mi (8 km) northwest of the MFFF site. To be conservative, the distribution of the population below the federal poverty level and the minority population was reviewed within a 10-mi (16-km) radius using maps developed from 1990 census data at the block group level (Figures 4-15 and 4-16). Detailed population characteristics of the counties and towns that comprise the 10-mi (16-km) area were also reviewed.

## **C.3 POPULATION PROJECTIONS**

Projections of population growth for the 50-mi (80-km) area surrounding the MFFF site were compiled by SRS as part of their regular GSAR update (Tables 4-12 through 4-16). The population is not projected to grow any closer to the MFFF.



#### **C.4 GEOGRAPHICAL DISPERSION OF MINORITY AND LOW-INCOME POPULATIONS**

Figures 4-15 and 4-16 show the geographical distribution of minority and low-income populations in the vicinity (within 10 mi [16 km]) of the MFFF site. Distributions shown on these figures are based on baseline U.S. Census 1990 block group data. Figure 4-15 shows the geographical distribution of minority populations in areas within a distance of 10 mi (16 km) of the MFFF site. Block groups are shaded to indicate the percentage of minorities within the total population (calculated by subtracting the white, not of Hispanic origin, count from the total persons count). The highest concentration of minorities is located in the town of New Ellenton, over 7 mi (11.3 km) north of the MFFF site.

The incorporated boundaries of the towns of New Ellenton and Jackson are situated entirely within a 10-mi (16-km) radius of the MFFF site. The combined populations of New Ellenton and Jackson represent about 66% of the population within a 10-mi (16-km) radius of the MFFF site. Growth rates obtained by race for South Carolina were applied to the populations of the towns to determine future potential shifts in the racial balance of the area (DOC 2000b). Within the town of New Ellenton, the population is expected to shift slightly from about 34% black and 66% non-Hispanic white in 1990 to about 41% black and 58% non-Hispanic white in 2025. The town of Jackson shows even less change. In 1990, Jackson's population was about 4% black and about 94% non-Hispanic white. The population is projected to change only slightly to about 5% black and 92% non-Hispanic white by 2025. Population projections by race for places entirely or partially within a 10-mi (16-km) radius of the MFFF site are listed in Table C-1.

Figure 4-16 shows the geographical distribution of low-income populations within the local, 10-mi (16-km) radial area. According to the decennial census of 1990, about 16.8% and 16.6% of the respective populations of Georgia and South Carolina were living below the federal poverty limit. Within the three-county local area, Aiken County was below the state average with only about 14% of its population living below the poverty threshold, while Barnwell County and Burke County were above their state averages with 21.9% and 29.2% below the poverty thresholds, respectively. As shown on Figure 4-16, the population within about a 7-mi (11.3-km) radius of the MFFF site is above the state average with only 0% to 12% living on less than the poverty limit. In total, a minimal portion, less than 25%, of the 10-mi (16-km) area contains high numbers of people living below the poverty threshold.

#### **C.5 ENVIRONMENTAL EFFECTS ON MINORITY AND LOW-INCOME POPULATIONS**

The analysis of environmental effects on populations residing within 10 mi (16 km) of proposed facilities is presented in Chapter 5. This analysis shows that no radiological fatalities are likely to result from implementation of the proposed action. Radiological risks to the public are small regardless of the racial and ethnic composition or the economic status of individuals comprising the population. Nonradiological risks to the general population are also small regardless of the racial and ethnic composition or economic status of the population. Thus, disproportionately

high and adverse impacts on minority and low-income populations residing near the various facilities are not likely to result from implementation of the proposed action or alternatives.

**This page intentionally left blank.**

## **Tables**

**This page intentionally left blank.**

**Table C-1. Population Projections by Race and Ethnicity**

	1990	1995	2000	2005	2015	2025
<b><i>New Ellenton Division*</i></b>	<b>4,603</b>	<b>4,095</b>	<b>4,515</b>	<b>4,866</b>	<b>5,421</b>	<b>5,922</b>
Black	1,849	2,031	2,293	2,529	2,946	3,341
Am. Indian, Eskimo, Aleut	31	34	36	38	40	44
Asian or Pacific Islander	18	20	25	29	35	42
Hispanic	50	55	69	82	101	125
Non-Hispanic White	2,655	1,955	2,092	2,188	2,299	2,370
<b><i>New Ellenton Town</i></b>	<b>2,630</b>	<b>2,890</b>	<b>3,151</b>	<b>3,360</b>	<b>3,673</b>	<b>3,936</b>
Black	898	987	1,114	1,229	1,432	1,624
Am. Indian, Eskimo, Aleut	0	0	0	0	0	0
Asian or Pacific Islander	0	0	0	0	0	0
Hispanic	5	5	6	7	9	11
Non-Hispanic White	1,727	1,898	2,031	2,124	2,232	2,301
<b><i>Jackson Division*</i></b>	<b>1,126</b>	<b>1,237</b>	<b>1,345</b>	<b>1,396</b>	<b>1,512</b>	<b>1,605</b>
Black	295	324	366	371	432	489
Am. Indian, Eskimo, Aleut	0	0	0	0	0	0
Asian or Pacific Islander	9	10	13	15	18	22
Hispanic	0	0	0	0	0	0
Non-Hispanic White	822	903	966	1,010	1,062	1,094
<b><i>Jackson Town</i></b>	<b>1,681</b>	<b>1,847</b>	<b>1,981</b>	<b>2,078</b>	<b>2,197</b>	<b>2,281</b>
Black	66	73	82	90	105	119
Am. Indian, Eskimo, Aleut	25	27	29	31	33	36
Asian or Pacific Islander	2	2	2	2	2	2
Hispanic	8	9	11	13	16	20
Non-Hispanic White	1,580	1,736	1,857	1,942	2,041	2,104
<b><i>Barnwell Division</i></b>	<b>8,371</b>	<b>9,200</b>	<b>10,015</b>	<b>10,354</b>	<b>11,246</b>	<b>11,983</b>
Black	2,460	2,704	3,053	3,061	3,566	4,044
Am. Indian, Eskimo, Aleut	0	0	0	0	0	0
Asian or Pacific Islander	41	45	57	67	82	99
Hispanic	14	15	19	23	28	35
Non-Hispanic White	5,856	6,436	6,886	7,203	7,570	7,805
<b><i>Burke County</i></b>	<b>20,534</b>	<b>21,649</b>	<b>22,693</b>	<b>23,664</b>	<b>25,585</b>	<b>27,217</b>
Black	10,741	11,325	11,867	12,365	13,391	14,368
Am. Indian, Eskimo, Aleut	26	27	27	27	34	34
Asian or Pacific Islander	5	5	6	7	9	11
Hispanic	58	61	71	82	107	133
Non-Hispanic White	9,702	10,229	10,720	11,181	12,042	12,668

\* The populations of New Ellenton and Jackson towns are not included in their respective division's population to give a more reliable estimate of the divisions' racial mix in areas outside the incorporated boundaries of the towns.

**This page intentionally left blank.**

**APPENDIX D. RISK FROM IONIZING RADIATION**



**This page intentionally left blank.**

---

This appendix presents the assessment of potential dose to offsite individuals, the offsite general population, site workers, and MFFF facility workers due to normal operations of the MFFF. Site workers are defined as those who work within the SRS boundaries but are not involved with process activities at the MFFF. Facility workers are defined as those individuals who are engaged in MFFF activities within the MFFF fence. The term “dose” is used here to reflect the committed effective dose equivalent (i.e., 50-year committed dose) due to internal exposure to radionuclides and the effective dose equivalent due to external exposure to radionuclides. The dose assessment considers chronic atmospheric releases from both an elevated release point and a release point at ground level. Exposure pathways for the offsite public are inhalation uptake, external exposure to the airborne plume, ingestion of terrestrial foods and animal products, and inadvertent soil ingestion. Exposure pathways for the site workers are inhalation uptake, external exposure to the airborne plume, and inadvertent soil ingestion. The MFFF does not have a liquid release to the environment as a result of normal operations and, therefore, the liquid/aquatic pathway was not considered in the dose calculations.

Potential offsite doses to the public were determined for the MEI and the general population residing within an assessment area defined by a 50-mi (80-km) radius around the facility. The entire population within the 50-mi (80-km) assessment area was assumed to consist of adults (DOE 1988). The MEI was assumed to reside 5 mi (8 km) from the facility (i.e., at the SRS boundary) in the southwest direction.

Potential doses to site workers (SRS workers not assigned to the MFFF) were determined for the MEI and the worker population within the SRS boundary but outside the boundary of the MFFF. All workers were assumed to be adults. The MEI was assumed to be located at the MFFF boundary, which is 328 ft (100 m) from the release point.

Potential doses to facility workers (MFFF workers) were determined from preliminary dose analyses for the MFFF. The historical measurements from similar facilities were adjusted to reflect the expected source term in the MFFF.

Fifty-year committed doses were calculated for both the offsite public and site workers based on one year of release and one year of intake. All dose calculations assumed no previous contamination of the ground surface, no previous irrigation with contaminated water, and a finite plume model, which assumes that the center of the plume is located at ground level.

Determination of the potential annual doses utilized the GENII system (the Hanford Environmental Radiation Dosimetry Software System) (Pacific Northwest Laboratory 1988a). GENII is a system of codes and associated data libraries designed to calculate radiation doses to populations and individuals resulting from environmental contamination. The GENII system calculates the transport of radionuclides in the environment due to contamination of air, water, and soil. Calculated radionuclide concentrations are combined with external exposure rates and intake to determine external and internal radiation doses. A complete discussion of the theory and implementation of the GENII system is provided in *GENII – The Hanford Environmental Radiation Dosimetry Software System Volume 1: Conceptual Representation* (Pacific Northwest

Laboratory 1988a). The GENII user's manual is given in *GENII – The Hanford Environmental Radiation Dosimetry Software System Volume 2: Users' Manual* (Pacific Northwest Laboratory 1988b).

## **D.1 GENII INPUT**

The following sections summarize the GENII input parameters and values used for the assessment of potential doses to the offsite public and to site workers due to normal operations of the MFFF.

### **D.1.1 Meteorological Data**

GENII requires meteorological data in the form of a joint frequency distribution for the calculations of dose to the offsite public and to site workers due to airborne releases. This distribution contains wind data specifying the time (in percentage) that the wind blows in each of 16 sectors for user-specified wind speeds and atmospheric stability classes. The joint frequency distribution used in the dose calculations is presented in Table D-1. This distribution was developed using meteorological data collected from the 197-ft (60-m) tower level in H Area from 1992 to 1996. Data from the H-Area meteorological tower were used because the tower is located near F Area and the geographical center of SRS.

The GENII calculations of dose also use the absolute humidity when considering airborne releases. During the period from January 1995 to December 1996, the average monthly absolute humidity ranged from 6.0 to 18.4 g/m<sup>3</sup> (WSRC 1999a). The overall average absolute humidity for this same time period was 11.1 g/m<sup>3</sup>, which is the value used in the GENII analyses.

### **D.1.2 Population Data for the Offsite Public**

The population data used in the population dose calculations were taken from the GSAR (WSRC 1999a) and are presented in Table D-2. The 1990 Census of Population and Housing Data (DOC 1992a) were used to project the population distribution within a 50-mi (80-km) radius of the SRS F Area at 10-year intervals through 2030 (WSRC 1993). Population growth was determined using growth ratios relative to the 1990 population of 1.140 for the year 2000, 1.299 for the year 2010, 1.481 for the year 2020, and 1.688 for the year 2030. These ratios were determined assuming that the growth rate for the total population in the west-northwest sector can be applied to all other sectors (Huang 1993). The population was distributed into 16 radial sectors and six radial distances of 0 to 5, 5 to 10, 10 to 20, 20 to 30, 30 to 40, and 40 to 50 mi (0 to 8, 8 to 16, 16 to 32, 32 to 64, and 64 to 80 km). All property within 5 mi (8 km) of F Area is owned by DOE and has zero permanent population.

Calculation of the population dose for the offsite public used the projected population for 2030. Operation of the MFFF is expected to end in 2026 based on a 20-year license and startup in 2006. Use of a population distribution projected for a time later than the end of operational life ensures conservative dose calculations and provides a buffer if the start of the project is delayed.

Dose calculations for the MEI assumed that the individual resides 5 mi (8 km) from the MFFF in the southwest direction. The nearest SRS boundary is actually located 5.1 mi (8.2 km) from the facility in the northwest direction. This distance was reduced to 5 mi (8 km) for the analysis. Examination of the joint frequency distribution data indicates that the wind blows in the southwest direction the majority of the time (see Table D-1). Therefore, an individual located southwest of the facility should receive the highest dose due to airborne releases. This assumption was confirmed by conducting GENII simulations with the MEI located in each of the 16 wind directions. Results from those simulations yielded the highest dose due to airborne releases when the MEI was assumed to be located in the southwest direction.

### **D.1.3 Population Data for Site Workers**

Approximately 13,616 site workers were employed at SRS in 2000. The current spatial distribution of those workers is not readily available. Therefore, a population dose for the site workers could not be directly determined. The methodology used to estimate the population dose for the site workers is discussed in Section D.2.

The MEI dose calculations for the maximally exposed site worker assumed that the worker was located at the edge of the MFFF boundary, which is 328 ft (100 m) from the release point. The maximally exposed site worker was assumed to be located in the direction from the release point that gives the maximum dose based on dose calculations for the 16 wind directions considered by GENII. These directions are east-northeast for the elevated release and southwest for the groundlevel release.

### **D.1.4 Food Production Data**

The dose due to ingestion of terrestrial food and animal products, calculated for the offsite population only, requires information regarding food production. Production data for the 50-mi (80-km) assessment area surrounding SRS were taken from the 1987 Census of Agriculture (Halliburton NUS Corp. 1996). The food production data were organized into a food grid, or wheel, consistent with the grid developed for the population distribution. The fraction of each county located within the grid sectors was combined with the food production in each sector to generate the food grid. Food production in each county was assumed to occur uniformly across the entire county. The grid consists of data for the eight food categories included in the analysis (i.e., leafy vegetables, root vegetables, fruits, grains, beef, poultry, milk, and eggs) at 10 radial distances from the facility for 16 wind directions. The food grid used in the GENII analysis was taken from the data for an F-Area release location given in Table 3.6-5 of *Storage and Disposition of Weapons-Usable Fissile Materials Final Programmatic Environmental Impact Statement Volume 2: Health Risk Data Reading Room Material* (Halliburton NUS Corp. 1996). These data are reproduced in Table D-3.

The radiation dose from ingestion of food products was not included in the calculation of dose to the site workers because no food is produced within the SRS boundary and, therefore, consumption of food grown within the SRS boundary is impossible.

### **D.1.5 Food Ingestion Data (applicable for calculations of dose to the offsite public only)**

This section summarizes the input parameters required for the calculation of dose to the offsite public due to food ingestion. The two types of food considered in the analysis were terrestrial food and animal products.

#### **D.1.5.1 Terrestrial Food**

Determination of dose due to the ingestion of terrestrial food requires input of (1) consumption rate, (2) the length of the growing season (used only for analyses with acute releases), (3) data related to irrigation with contaminated water, (4) crop yield, (5) the food production rate, and (6) holdup time between harvest and storage. Although the growing season lengths are input, they are not used by GENII for this analysis, which considers a chronic release rather than an acute release. Irrigation of the terrestrial food with contaminated water was not incorporated into the dose calculations. The dose calculations assumed that the MEI and the general population consume only food grown within the assessment area. The input parameters related to the ingestion of terrestrial foods are summarized in Table D-4. The source for the consumption rates is *Savannah River Site Environmental Data for 1999* (Arnett and Mamatey 2000b). For the remaining parameters, the GENII default values were used.

#### **D.1.5.2 Animal Products**

Calculation of dose due to the ingestion of animal products requires input of (1) consumption rates, (2) holdup times, (3) production rates, (4) the fraction of drinking water consumed by the animals that comes from a contaminated source, and (5) parameters related to the diet and food sources for the animals. GENII considers two food sources for beef (stored feed and fresh forage), and a single food source for poultry (stored feed). The dose calculations assume that (1) all water consumed by the animals comes from an uncontaminated source, (2) animal food sources are not irrigated, and (3) all animal products consumed by the MEI and general population are produced within the assessment area. The input parameters related to the ingestion of animal products are summarized in Table D-5 along with their sources.

### **D.1.6 External Exposure Data**

The calculation of dose to the offsite public and to site workers due to external and inhalation exposure to contaminated air requires input of (1) external exposure time to chronic atmospheric plumes, (2) external exposure time to soil contamination, (3) inhalation exposure time to contaminated air from either chronic plumes or from resuspension, (4) the resuspension model to be used, and (5) stack height for elevated releases. Values for these parameters are needed for calculation of the dose for the MEI in the offsite public, the general public population, and the maximally exposed site worker. The parameter values used are given in Table D-6.

NRC Regulatory Guide 1.109 (NRC 1977a) states the following:

- The annual external exposure time to the plume and to soil contamination should be 0.7 year for the MEI.
- The annual external exposure time to the plume and to soil contamination should be 0.5 year for the population.
- The annual inhalation exposure time to the plume should be 1 year for the MEI and the population.

These guidelines were used for the GENII analyses.

All dose calculations assumed no resuspension of soil particles into the air. Based on the design heights for the MFFF building and the vent stack, airborne emissions will exit the facility at a height of 93 ft (28 m) above grade (see Section 3.1.1). Calculations of dose to the offsite public and to site workers considered both an elevated release at this height as well as a groundlevel release. Both release locations were considered in order to bound the dose calculations and to provide a buffer in the event that the designed building and/or vent stack heights are modified in the future. For both releases, plume rise was conservatively ignored since calculated dose decreases as release height increases.

#### **D.1.7 Release Data**

Airborne releases due to normal operations of the MFFF were taken from the SPD EIS (DOE 1999c) and are given in Table D-7. These releases are about an order of magnitude higher than the releases expected during normal MFFF operations. Therefore, these source terms are conservative and bounding based on the latest design information.

#### **D.2 CALCULATED DOSES**

Recall that the spatial distribution of site workers within the SRS boundary is not readily available and, therefore, a population dose for site workers could not be directly determined. In order to estimate a site worker population dose, the MEI dose was multiplied by the estimated number of site workers for the year 2000 (13,616 workers). Calculation of the dose in this manner overestimated the site worker population dose because it used the dose for the maximally exposed site worker rather than the dose for an average exposed worker. As previously stated, the MEI dose for the maximally exposed site worker assumed that the worker is located at the MFFF boundary 328 ft (100 m) from the release point. Not all site workers will work this close to the MFFF. In order to take into account the fact that site workers are distributed between the MFFF boundary and the SRS boundary located 5 mi (8 km) from the release point, a range in the population dose for the site workers was determined. The maximum value for the range was estimated using an MEI dose calculated for a worker located at the MFFF boundary, and the minimum value for the range was estimated using an MEI dose calculated for a worker located at the SRS boundary. For both locations and release heights, GENII simulations were performed to determine the direction from the release point to the maximally exposed worker that yielded the highest dose. Those maximum doses were then used to calculate the worker population dose. The directions giving the highest dose were (1) east-northeast for an elevated release and the

maximally exposed worker located at the MFFF boundary, and (2) southwest for an elevated release, the maximally exposed worker located at the SRS boundary, and both groundlevel releases.

Table D-8 gives the doses calculated for the offsite public and for site workers due to airborne releases resulting from normal operations of the MFFF. This table also shows a comparison of the calculated potential doses due to normal operations to the all-pathway standard given in 10 CFR Part 20, Subpart D for the offsite public and in 10 CFR Part 20, Subpart C for site workers, and the doses from natural background radiation. Annual LCFs were calculated based on a cancer risk factor of 0.0005 per rem (500 cancers per  $10^6$  person-rem) for the offsite public and 0.0004 per rem (400 cancers per  $10^6$  person-rem) for site workers (see Table D-8). The annual dose to an average member of the offsite population within the 50-mi (80-km) assessment area is also presented in Table D-8. This dose was calculated as the annual offsite population dose divided by the total population projected to live in the assessment area in the year 2030.

As can be seen from Table D-8, the MEI doses for both the offsite public and site workers fall below the 10 CFR Part 20 standards and the natural background radiation. In addition, the population doses for both the offsite public and site workers, as well as the dose for an average individual in the offsite public, also fall below natural background radiation levels. These results indicate that normal operation of the MFFF should have no adverse health effect on the offsite public or site workers.

## **Tables**



**This page intentionally left blank.**

**Table D-1. Joint Frequency Distribution Used for Calculation of Dose to the Offsite Public and to Site Workers Due to Airborne Releases Resulting from Normal Operations of the MFFF**

Wind Speed (m/s)	Stability Class	Wind Direction															
		S	SSW	SW	WSW	W	WNW	NW	NNW	N	NNE	NE	ENE	E	ESE	SE	SSE
2.0	A	0.25	0.20	0.24	0.24	0.21	0.18	0.15	0.18	0.17	0.17	0.21	0.22	0.18	0.18	0.16	0.21
	B	0.02	0.03	0.03	0.03	0.01	0	0	0.01	0.01	0.01	0.03	0.03	0	0.03	0.03	0.02
	C	0.02	0.01	0.01	0.02	0.01	0.01	0.02	0.03	0.03	0.03	0.01	0.01	0.01	0.01	0.01	0.01
	D	0.01	0.02	0	0.02	0.02	0.01	0.01	0.01	0.02	0.02	0.02	0.01	0.01	0.01	0.01	0.03
	E	0	0	0	0	0	0	0	0.01	0.01	0.01	0	0	0	0	0	0
	F	0	0	0	0	0	0	0	0	0	0	0	0	0	0	0	0
	G	0	0	0	0	0	0	0	0	0	0	0	0	0	0	0	0
5.5	A	0.88	0.73	0.92	1.04	1.06	0.79	0.70	0.55	0.74	0.78	1.12	1.37	1.19	0.82	0.56	0.57
	B	0.24	0.36	0.43	0.44	0.35	0.25	0.19	0.21	0.26	0.24	0.34	0.38	0.29	0.25	0.16	0.16
	C	0.15	0.39	0.73	0.50	0.39	0.24	0.24	0.29	0.33	0.33	0.36	0.43	0.34	0.28	0.23	0.18
	D	0.09	0.25	0.59	0.34	0.31	0.27	0.34	0.37	0.42	0.42	0.39	0.38	0.30	0.22	0.26	0.21
	E	0.01	0.09	0.28	0.11	0.08	0.16	0.17	0.18	0.26	0.26	0.22	0.19	0.20	0.13	0.11	0.13
	F	0.01	0.02	0.02	0.01	0	0.03	0.02	0.03	0.03	0.03	0.03	0.02	0.05	0	0.02	0.04
	G	0	0	0	0	0	0	0	0	0	0	0	0	0	0	0	0
10.0	A	1.03	0.66	0.53	0.50	0.44	0.30	0.26	0.20	0.37	0.43	0.60	0.70	0.71	0.48	0.24	0.36
	B	0.21	0.57	0.65	0.67	0.32	0.23	0.16	0.19	0.31	0.33	0.55	0.75	0.55	0.36	0.16	0.18
	C	0.16	0.69	1.49	0.86	0.67	0.44	0.42	0.42	0.52	0.58	0.74	0.78	0.78	0.57	0.27	0.14
	D	0.12	0.52	1.64	0.95	0.81	0.70	0.84	1.12	1.48	1.05	1.26	1.27	1.01	0.88	0.50	0.20
	E	0.06	0.64	1.08	0.81	0.62	0.62	0.82	0.98	1.20	1.10	1.06	1.12	0.63	0.47	0.42	0.24
	F	0.02	0.22	0.19	0.07	0.10	0.16	0.18	0.17	0.22	0.22	0.16	0.21	0.27	0.07	0.06	0.06
	G	0	0.02	0.01	0	0	0.01	0.01	0.01	0.02	0.01	0.01	0.01	0.02	0	0	0
15.5	A	0.21	0.18	0.03	0.03	0.01	0.02	0.02	0.01	0.02	0.04	0.05	0.10	0.09	0.11	0.03	0.09
	B	0.02	0.17	0.12	0.04	0.04	0.03	0.05	0.04	0.04	0.09	0.18	0.31	0.46	0.34	0.09	0.03
	C	0	0.18	0.46	0.21	0.08	0.09	0.16	0.22	0.20	0.29	0.41	0.46	0.73	0.62	0.13	0.01
	D	0	0.09	0.19	0.08	0.05	0.06	0.13	0.46	0.43	0.24	0.24	0.12	0.13	0.11	0.07	0
	E	0	0.09	0.06	0.09	0.07	0.05	0.05	0.09	0.13	0.10	0.19	0.07	0.02	0.02	0.01	0
	F	0	0.04	0.02	0.03	0.01	0.03	0.02	0.01	0.01	0.01	0.03	0.02	0.02	0.01	0	0
	G	0	0	0	0	0	0	0	0	0	0	0	0	0	0	0	0

Table D-1. Joint Frequency Distribution Used for Calculation of Dose to the Offsite Public and to Site Workers Due to Airborne Releases Resulting from Normal Operations of the MFFF (continued)

Wind Speed (m/s)	Stability Class	Wind Direction																
		S	SSW	SW	WSW	W	WNW	NW	NNW	N	NNE	NE	ENE	E	ESE	SE	SSE	
21.5	A	0.01	0	0	0	0	0	0	0	0	0	0	0	0	0.01	0.02	0	0.01
	B	0	0.01	0	0	0	0	0	0	0	0	0	0	0	0.03	0.08	0	0.01
	C	0	0.01	0	0	0.01	0	0.04	0.04	0.05	0.05	0.05	0.08	0.18	0.10	0.02	0	0.02
	D	0	0	0	0	0	0	0.03	0.02	0.02	0.02	0.01	0	0	0	0	0	0
	E	0	0	0	0	0	0	0	0	0	0	0	0	0.01	0	0	0	0
	F	0	0	0	0	0	0	0	0	0	0	0	0	0	0	0	0	0
	G	0	0	0	0	0	0	0	0	0	0	0	0	0	0	0	0	0
25.0	A	0	0	0	0	0	0	0	0	0	0	0	0	0	0	0	0	0
	B	0	0	0	0	0	0	0	0	0	0	0	0	0	0	0	0	0
	C	0	0	0	0	0	0	0	0	0	0	0	0	0	0	0	0	0
	D	0	0	0	0	0	0	0	0	0	0	0	0	0	0	0	0	0
	E	0	0	0	0	0	0	0	0	0	0	0	0	0	0	0	0	0
	F	0	0	0	0	0	0	0	0	0	0	0	0	0	0	0	0	0
	G	0	0	0	0	0	0	0	0	0	0	0	0	0	0	0	0	0

**Table D-2. Projected Population Distribution for the Offsite Public Within 50 miles (80 km) of SRS F Area for the Year 2030<sup>a</sup>**

Direction	Distance (miles)						Total
	0 to 5	5 to 10	10 to 20	20 to 30	30 to 40	40 to 50	
S	0	0	920	2,696	11,367	6,013	20,996
SSW	0	15	1,317	3,692	8,115	4,376	17,515
SW	0	186	1,978	7,732	3,535	4,579	18,010
WSW	0	171	2,572	7,553	4,368	10,385	25,049
W	0	407	10,186	17,766	15,109	11,753	55,221
WNW	0	2,331	8,556	219,212	54,849	24,980	309,928
NW	0	1,861	25,692	137,243	15,851	5,567	186,214
NNW	0	1,978	33,320	18,925	11,627	5,648	71,498
N	0	3,500	36,210	15,530	11,294	17,670	84,204
NNE	0	397	3,010	3,515	6,925	28,857	42,704
NE	0	14	2,609	4,611	8,850	19,325	35,409
ENE	0	0	5,535	7,865	8,764	53,785	75,949
E	0	2	8,061	8,590	18,423	9,310	44,386
ESE	0	14	3,658	4,352	5,466	488	13,978
SE	0	0	951	7,673	7,409	17,619	33,652
SSE	0	0	615	1,154	1,767	4,234	7,770
<b>Total</b>	<b>0</b>	<b>10,876</b>	<b>145,190</b>	<b>468,109</b>	<b>193,719</b>	<b>224,589</b>	<b>1,042,483</b>

<sup>a</sup> Source: Figure 1.3-39 of the GSAR (WSRC 1999a).

**Table D-3. Agricultural Food Production Within 50 miles (80 km) Surrounding SRS  
Used for Determination of Population Dose to the Offsite Public**

**Leafy Vegetables (kg/yr)**

Direction	Distance (miles)					
	0 to 5	5 to 10	10 to 20	20 to 30	30 to 40	40 to 50
S	0	0	0	0	0	1.0E+05
SSW	0	0	0	0	0	1.0E+05
SW	0	3.4E+05	0	0	0	1.1E+03
WSW	0	3.7E+02	33	0	1.6E+03	8.8E+03
W	0	1.3E+03	1.3E+02	0	2.8E+03	4.1E+03
WNW	0	1.4E+03	3.4E+03	0	0	0
NW	0	1.4E+03	6.3E+03	4.7E+03	0	0
NNW	0	1.3E+03	6.9E+03	8.7E+03	8.6	2.4E+03
N	0	1.1E+03	6.9E+03	1.2E+04	1.1E+04	4.8E+04
NNE	0	5.9E+02	6.9E+03	1.2E+04	3.1E+05	9.6E+05
NE	0	46	6.0E+03	3.1E+04	2.5E+05	7.7E+05
ENE	0	0	7.6	3.2E+04	1.6E+05	2.1E+05
E	0	0	0	0	2.3E+04	1.3E+05
ESE	0	0	0	0	0	1.0E+05
SE	0	0	0	0	0	1.0E+05
SSE	0	0	0	0	0	1.0E+05

**Table D-3. Agricultural Food Production Within 50 miles (80 km) Surrounding SRS  
Used for Determination of Population Dose to the Offsite Public (continued)**

**Root Vegetables (kg/yr)**

Direction	Distance (miles)					
	0 to 5	5 to 10	10 to 20	20 to 30	30 to 40	40 to 50
S	0	0	1.8E+06	3.1E+06	4.1E+06	6.3E+06
SSW	0	3.1E+03	2.1E+06	3.4E+06	4.3E+06	6.7E+06
SW	0	9.7E+07	2.2E+06	3.6E+06	4.8E+06	5.8E+06
WSW	0	1.1E+05	2.1E+06	3.6E+06	5.3E+06	8.0E+06
W	0	1.8E+05	2.3E+05	1.3E+06	3.4E+06	4.4E+06
WNW	0	1.9E+05	5.0E+05	1.1E+05	5.4E+04	3.2E+05
NW	0	2.0E+05	8.8E+05	8.2E+05	4.0E+05	1.4E+05
NNW	0	1.9E+05	9.6E+05	1.3E+06	7.3E+05	1.2E+06
N	0	1.5E+05	9.6E+05	1.6E+06	1.7E+06	2.4E+06
NNE	0	8.1E+04	9.6E+05	1.6E+06	2.5E+06	3.8E+06
NE	0	6.3E+03	1.2E+06	2.6E+06	4.2E+06	5.1E+06
ENE	0	0	3.4E+06	6.3E+06	7.8E+06	9.9E+06
E	0	0	3.6E+06	6.3E+06	7.9E+06	1.0E+07
ESE	0	0	3.3E+06	6.6E+06	8.4E+06	5.3E+06
SE	0	0	6.4E+07	6.8E+06	8.8E+06	9.2E+06
SSE	0	0	3.8E+07	3.0E+07	6.7E+06	7.8E+06

**Table D-3. Agricultural Food Production Within 50 miles (80 km) Surrounding SRS Used for Determination of Population Dose to the Offsite Public (continued)**

Fruit (kg/yr)

Direction	Distance (miles)					
	0 to 5	5 to 10	10 to 20	20 to 30	30 to 40	40 to 50
S	0	0	3.9E+05	1.1E+06	1.7E+06	2.5E+06
SSW	0	6.9E+02	4.5E+05	8.7E+05	1.4E+06	2.3E+06
SW	0	3.3E+07	4.8E+05	7.9E+05	1.2E+06	1.2E+06
WSW	0	4.4E+04	4.7E+05	7.9E+05	1.0E+06	8.8E+05
W	0	1.1E+05	4.5E+04	2.7E+05	4.4E+05	3.9E+05
WNW	0	1.2E+05	2.8E+05	1.1E+03	2.3E+02	1.3E+03
NW	0	1.2E+05	5.3E+05	2.8E+06	6.6E+06	2.2E+06
NNW	0	1.1E+05	5.8E+05	2.8E+06	1.2E+07	1.4E+07
N	0	9.0E+04	5.8E+05	9.7E+05	5.1E+06	4.8E+06
NNE	0	4.9E+04	5.8E+05	9.7E+05	1.0E+06	7.4E+05
NE	0	3.9E+03	5.3E+05	8.9E+05	1.0E+06	7.5E+05
ENE	0	0	2.5E+05	4.9E+05	8.5E+05	1.1E+06
E	0	0	2.6E+05	3.4E+05	1.6E+05	7.0E+05
ESE	0	0	2.4E+05	4.0E+05	1.8E+05	5.6E+04
SE	0	0	4.3E+06	3.1E+05	3.7E+05	3.1E+05
SSE	0	0	2.6E+06	2.0E+06	1.1E+06	1.0E+06

**Table D-3. Agricultural Food Production Within 50 miles (80 km) Surrounding SRS  
Used for Determination of Population Dose to the Offsite Public (continued)**

Grains (kg/yr)

Direction	Distance (miles)					
	0 to 5	5 to 10	10 to 20	20 to 30	30 to 40	40 to 50
S	0	0	2.6E+06	7.4E+06	1.1E+07	1.5E+07
SSW	0	4.5E+03	2.9E+06	6.0E+06	1.1E+07	1.4E+07
SW	0	1.1E+08	3.1E+06	5.1E+06	8.2E+06	1.0E+07
WSW	0	1.4E+05	3.0E+06	5.1E+06	8.1E+06	1.5E+07
W	0	2.1E+05	6.4E+05	2.2E+06	6.1E+06	7.9E+06
WNW	0	2.2E+05	7.6E+05	7.2E+05	2.6E+05	6.5E+05
NW	0	2.2E+05	1.0E+06	1.2E+06	7.5E+05	3.3E+05
NNW	0	2.1E+05	1.1E+06	1.6E+06	1.3E+06	2.0E+06
N	0	1.7E+05	1.1E+06	1.8E+06	2.3E+06	4.1E+06
NNE	0	9.3E+04	1.1E+06	1.8E+06	2.7E+06	3.6E+06
NE	0	7.3E+03	1.3E+06	3.6E+06	6.1E+06	6.9E+06
ENE	0	0	4.0E+06	8.7E+06	1.4E+07	1.8E+07
E	0	0	4.2E+06	9.0E+06	1.6E+07	1.9E+07
ESE	0	0	3.9E+06	8.9E+06	1.6E+07	1.2E+07
SE	0	0	8.2E+07	1.1E+07	1.5E+07	1.7E+07
SSE	0	0	5.2E+07	5.2E+07	1.3E+07	1.6E+07



**Table D-3. Agricultural Food Production Within 50 miles (80 km) Surrounding SRS Used for Determination of Population Dose to the Offsite Public (continued)**

**Beef (kg/yr)**

Direction	Distance (miles)					
	0 to 5	5 to 10	10 to 20	20 to 30	30 to 40	40 to 50
S	0	0	1.2E+05	4.6E+05	7.3E+05	9.9E+05
SSW	0	2.2E+02	1.5E+05	3.4E+05	6.9E+05	9.3E+05
SW	0	6.0E+04	1.5E+05	2.5E+05	4.6E+05	6.1E+05
WSW	0	1.0E+04	1.5E+05	2.5E+05	4.1E+05	7.9E+05
W	0	2.1E+04	4.0E+04	1.2E+05	3.4E+05	5.1E+05
WNW	0	2.2E+04	7.0E+04	5.0E+04	9.5E+04	1.8E+05
NW	0	2.3E+04	1.1E+05	1.4E+05	1.6E+05	2.1E+05
NNW	0	2.2E+04	1.1E+05	1.8E+05	2.3E+05	3.5E+05
N	0	1.7E+04	1.1E+05	1.9E+05	3.1E+05	6.5E+05
NNE	0	9.6E+03	1.1E+05	1.9E+05	2.5E+05	2.9E+05
NE	0	7.5E+02	1.0E+05	2.6E+05	4.3E+05	5.0E+05
ENE	0	0	2.4E+04	2.2E+05	8.2E+05	1.1E+06
E	0	0	2.6E+04	1.4E+05	5.2E+05	8.8E+05
ESE	0	0	2.4E+04	8.2E+04	3.4E+05	4.5E+05
SE	0	0	4.8E+05	6.4E+04	2.0E+05	5.2E+05
SSE	0	0	3.6E+05	5.8E+05	4.3E+05	6.7E+05

**Table D-3. Agricultural Food Production Within 50 miles (80 km) Surrounding SRS  
Used for Determination of Population Dose to the Offsite Public (continued)**

**Poultry (kg/yr)**

Direction	Distance (miles)					
	0 to 5	5 to 10	10 to 20	20 to 30	30 to 40	40 to 50
S	0	0	0	0	0	5.4E+04
SSW	0	0	0	0	0	6.7E+04
SW	0	4.7E+07	0	0	0	45
WSW	0	5.1E+04	4.5E+03	0	61	3.5E+02
W	0	1.7E+05	1.8E+04	0	1.1E+02	1.6E+02
WNW	0	1.9E+05	4.6E+05	0	0	5.1E+03
NW	0	1.9E+05	8.6E+05	6.4E+05	0	3.0E+05
NNW	0	1.8E+05	9.4E+05	1.2E+06	1.2E+03	5.4E+05
N	0	1.5E+05	9.4E+05	1.6E+06	1.7E+06	3.6E+06
NNE	0	8.0E+04	9.4E+05	1.6E+06	1.3E+06	5.4E+03
NE	0	6.3E+03	8.2E+05	1.2E+06	9.7E+05	0
ENE	0	0	1.1E+03	0	0	0
E	0	0	0	0	0	1.0E+05
ESE	0	0	0	0	0	1.0E+05
SE	0	0	0	0	0	1.0E+05
SSE	0	0	0	0	0	1.0E+05

**Table D-3. Agricultural Food Production Within 50 miles (80 km) Surrounding SRS Used for Determination of Population Dose to the Offsite Public (continued)**

Milk (kg/yr)

Direction	Distance (miles)					
	0 to 5	5 to 10	10 to 20	20 to 30	30 to 40	40 to 50
S	0	0	5.5E+05	6.2E+05	6.5E+05	7.6E+05
SSW	0	9.7E+02	6.4E+05	2.9E+06	7.9E+06	8.1E+06
SW	0	3.2E+06	6.7E+05	1.1E+06	3.8E+06	2.9E+06
WSW	0	2.2E+04	6.6E+05	1.1E+06	2.0E+06	4.4E+06
W	0	1.2E+04	4.9E+04	3.8E+05	1.8E+06	3.5E+06
WNW	0	1.3E+04	3.1E+04	0	4.7E+04	1.2E+06
NW	0	1.3E+04	5.8E+04	4.4E+05	1.1E+06	7.9E+05
NNW	0	1.2E+04	6.4E+04	4.3E+05	2.0E+06	3.3E+06
N	0	9.9E+03	6.4E+04	1.1E+05	1.9E+06	7.4E+06
NNE	0	5.4E+03	6.4E+04	1.1E+05	3.9E+05	9.7E+06
NE	0	4.2E+02	5.5E+04	6.9E+05	1.7E+06	1.8E+06
ENE	0	0	70	1.1E+06	4.6E+06	5.6E+06
E	0	0	0	9.6E+05	4.2E+06	5.7E+06
ESE	0	0	0	3.2E+05	2.6E+06	1.6E+06
SE	0	0	2.4E+04	1.2E+04	4.2E+04	1.2E+05
SSE	0	0	2.0E+05	3.2E+05	3.5E+05	3.9E+05

**Table D-3. Agricultural Food Production Within 50 miles (80 km) Surrounding SRS  
Used for Determination of Population Dose to the Offsite Public (continued)**

**Eggs (kg/yr)**

Direction	Distance (miles)					
	0 to 5	5 to 10	10 to 20	20 to 30	30 to 40	40 to 50
S	0	0	6.3E+02	0	0	8.3E+04
SSW	0	0	0	0	0	1.0E+05
SW	0	6.2E+05	0	0	0	91
WSW	0	0	0	0	1.2E+02	7.0E+02
W	0	0	0	0	2.2E+02	3.3E+02
WNW	0	0	0	0	0	1.0E+05
NW	0	0	0	1.2E+05	3.2E+05	1.1E+05
NNW	0	0	0	1.0E+05	5.9E+05	6.4E+05
N	0	0	0	0	1.7E+05	29
NNE	0	0	0	0	0	1.0E+05
NE	0	0	4.1E+03	4.0E+03	1.6E+02	1.2E+02
ENE	0	0	4.3E+04	5.5E+04	5.0E+02	6.3E+02
E	0	0	4.5E+04	5.6E+04	71	4.0E+02
ESE	0	0	4.2E+04	5.8E+04	1.2E+02	0
SE	0	0	6.3E+05	1.2E+03	0	0
SSE	0	0	3.1E+05	0	0	0

Source: *Storage and Disposition of Weapons-Usable Fissile Materials Final Programmatic Environmental Impact Statement Volume 2: Health Risk Data Reading Room Material* (Halliburton NUS Corp. 1996)

**Table D-4. Input Parameters and Values for Calculation of Dose to the Offsite Public Due to Ingestion of Terrestrial Food**

Parameter	Value	
	Maximally Exposed Individual	Population
Consumption rate (kg/yr) <sup>a</sup>		
leafy vegetables	43	21
root vegetables	276	163
fruit	276	163
grain	276	163
Length of growing season <sup>b</sup>	N/A	N/A
Crop yield (kg/m <sup>2</sup> ) <sup>c</sup>		
leafy vegetables	1.5	1.5
root vegetables	4.0	4.0
fruit	2.0	2.0
grain	0.8	0.8
Production rates (kg/yr)	N/A	<sup>d</sup>
Hold time between harvest and storage (days) <sup>c</sup>		
leafy vegetables	1	14
root vegetables	5	14
fruit	5	14
grain	180	180

<sup>a</sup> Source: *Savannah River Site Environmental Data for 1999* (Arnett and Mamatey 2000b).

<sup>b</sup> Growing season length, which is used only for acute releases, is not applicable for this analysis, which considers chronic releases.

<sup>c</sup> GENII default values.

<sup>d</sup> See Section D.1.4 and Table D-3.

N/A = Not applicable

**Table D-5. Input Parameters and Values for Calculation of Dose to the Offsite Public Due to Ingestion of Animal Products**

Parameter	Value	
	Maximally Exposed Individual	Population
Consumption rate (kg/yr)		
beef <sup>a</sup>	81	43
milk <sup>a</sup>	230	120
poultry <sup>b</sup>	18	8.5
eggs <sup>b</sup>	30	20
Holdup time (days) <sup>b</sup>		
beef	15	34
milk	1	3
poultry	1	34
eggs	1	18
Production rate (kg/yr)	N/A	<sup>c</sup>
Diet fraction for animal food sources <sup>b</sup>		
stored feed		
beef	0.25	0.25
milk	0.25	0.25
poultry	1.00	1.00
eggs	1.00	1.00
fresh forage		
beef	0.75	0.75
milk	0.75	0.75
Growing time for animal food sources (days) <sup>b</sup>		
stored feed		
beef	90	90
milk	45	45
poultry	90	90
eggs	90	90
fresh forage		
beef	45	45
milk	30	30
Yield of animal food sources (kg/m <sup>3</sup> ) <sup>b</sup>		
stored feed		
beef	0.8	0.8
milk	2.0	2.0
poultry	0.8	0.8
eggs	0.8	0.8
fresh forage		
beef	2.0	2.0
milk	1.5	1.5

**Table D-5. Input Parameters and Values for Calculation of Dose to the Offsite Public Due to Ingestion of Animal Products (continued)**

Parameter	Value	
	Maximally Exposed Individual	Population
Storage time for animal food sources (days) <sup>b</sup>		
stored feed		
beef	180	180
milk	100	100
poultry	180	180
eggs	180	180
fresh forage		
beef	100	100
milk	0	0

<sup>a</sup> Source: *Savannah River Site Environmental Data for 1999* (Arnett and Mamatey 2000b).

<sup>b</sup> GENII default values.

<sup>c</sup> See Section D.1.4 and Table D-3.

N/A = Not applicable

**Table D-6. Input Parameters and Values for Calculation of Dose to the Offsite Public and Site Workers Due to External Exposure and Inhalation**

Parameter	Value	
	Maximally Exposed Individual <sup>a</sup>	Population <sup>b</sup>
External exposure time to chronic atmospheric plume (hr/yr) <sup>c</sup>	6,136.2	4,383
External exposure time to soil contamination (hr/yr) <sup>c</sup>	6,136.2	4,383
Inhalation exposure time to chronic plume (hr/yr) <sup>c</sup>	8,766	8,766
Stack height (m)	28 and 0.3 <sup>d</sup>	28 and 0.3 <sup>d</sup>

<sup>a</sup> Applicable for calculation of radiological impact on both the offsite public and site workers.

<sup>b</sup> Applicable for calculation of radiological impact to the offsite public only.

<sup>c</sup> Source: *Calculation of Annual Doses to Man From Routine Releases of Reactor Effluents for the Purpose of Evaluating Compliance with 10 CFR 50, Appendix I* (NRC 1977a).

<sup>d</sup> Doses were calculated for both an elevated release (93 ft [28 m] above grade; see Section 3.1.1) and an essentially groundlevel release (1 ft [0.3 m] above grade) to bound the dose calculations.



**Table D-7. Estimated Radiological Releases from the MFFF during Normal Operations<sup>a</sup> and Radionuclide Half-lives<sup>b</sup>**

Isotope	Airborne Radiological Releases ( $\mu\text{Ci}/\text{yr}$ )	Half-Life (days)
Plutonium-236	1.3E-08	1,041.33
Plutonium-238	8.5	32,050.7
Plutonium-239	91	8.814E+06
Plutonium-240	23	2.388E+06
Plutonium-241	101	5,259.6
Plutonium-242	6.1E-03	1.373E+08
Americium-241	48	157,861
Uranium-234	5.1E-03	8.93E+07
Uranium-235	2.1E-04	257.1E+09
Uranium-238	0.012	1.63E+12

<sup>a</sup> Source terms taken from the SPD EIS (DOE 1999c); these source terms are about an order of magnitude higher than the source terms expected for normal MFFF operations.

<sup>b</sup> Values for radionuclide half-lives used by GENII.

Table D-8. Potential Radiological Impacts on the General Public and Site Workers Due to Normal Operations of the MFFF

RADIATION DOSE TO THE GENERAL PUBLIC		Elevated Release <sup>a</sup>	Groundlevel Release <sup>b</sup>
<b>Maximally Exposed Individual</b>			
Annual Dose (mrem/yr) <sup>e</sup>		4.1E-04	1.5E-03
Percentage of 10 CFR Part 20, Subpart D Standard <sup>d</sup>		4.1E-04	1.5E-03
Percentage of Natural Background Radiation <sup>e</sup>		1.4E-04	5.1E-04
Annual LCF Risk <sup>f</sup>		2.1E-10	7.5E-10
<b>General Population Within 50 mi (80 km)</b>			
Annual Dose (person-rem/yr) <sup>e</sup>		0.035	0.12
Percentage of Natural Background Radiation <sup>e</sup>		1.1E-05	3.9E-05
Annual LCF Risk <sup>f</sup>		1.8E-05	6.0E-05
<b>Average Exposed Individual Within 50 mi (80 km)</b>			
Annual Dose (mrem/yr) <sup>h</sup>		3.4E-05	1.2E-04
Percentage of 10 CFR Part 20, Subpart D Standard <sup>d</sup>		3.4E-05	1.2E-04
Percentage of Natural Background Radiation <sup>e</sup>		1.2E-05	4.1E-05
Annual LCF Risk <sup>f</sup>		1.7E-11	6.0E-11
<b>RADIATION DOSE TO SITE WORKERS</b>			
<b>Maximally Exposed Site Worker</b>			
Annual Dose (mrem/yr) <sup>i</sup>		0.022	3.0
Percentage of 10 CFR Part 20, Subpart C Standard <sup>d</sup>		4.4E-04	6.0E-02
Percentage of Natural Background Radiation <sup>e</sup>		7.5E-03	1.0
Annual LCF Risk <sup>k</sup>		8.8E-09	1.2E-06
<b>General Site Worker Population</b>			
Maximum Annual Dose (person-rem/yr) <sup>n</sup>	<b>Minimum<sup>l</sup></b>	<b>Maximum<sup>m</sup></b>	<b>Minimum<sup>l</sup></b>
	5.3E-03	0.3	0.019
Percentage of Natural Background Radiation <sup>e</sup>	1.3E-04	7.5E-03	4.7E-04
Annual LCF Risk <sup>k</sup>	2.1E-06	1.2E-04	7.6E-06
			1.6E-02

**Table D-8. Potential Radiological Impacts on the General Public and Site Workers Due to Normal Operations of the MFFF (continued)**

- <sup>a</sup> Height of elevated release corresponds to the design height of the vent stack (93 ft [28 m] above grade).
- <sup>b</sup> Height of groundlevel release is 1 ft (0.3 m) above grade.
- <sup>c</sup> Source is GENII model results for the offsite public.
- <sup>d</sup> 10 CFR Part 20, Subpart D standard is an annual dose of 100 mrem.
- <sup>e</sup> Natural background radiation is 295 mrem/yr (see Table 4-23).
- <sup>f</sup> Calculated using a cancer risk factor of 0.0005 per rem (500 cancers/10<sup>6</sup> person-rem).
- <sup>g</sup> Natural background radiation for the offsite public was calculated as the individual background radiation (295 mrem/yr) times the number of people projected to live in the 50-mi (80-km) assessment area in the year 2030 (1,042,483 people). The calculated value is 307,532 person-rem/yr.
- <sup>h</sup> Calculated as the population dose divided by the number of people projected to live in the 50-mi (80-km) assessment area in the year 2030 (1,042,483 people).
- <sup>i</sup> Source is GENII model results for site workers.
- <sup>j</sup> 10 CFR Part 20, Subpart C standard is an annual dose of 5,000 mrem.
- <sup>k</sup> Calculated using a cancer risk factor of 0.0004 per rem (400 cancers/10<sup>6</sup> person-rem).
- <sup>l</sup> Minimum values based on a distance of 5 mi (8 km) from the release point (i.e., at the SRS boundary).
- <sup>m</sup> Maximum values based on a distance of 328 ft (100 m) from the release point (i.e., at the MFFF boundary).
- <sup>n</sup> Dose for the site worker population was determined by multiplying the MEI dose at the respective distance from the release point by the total number of site workers (13,616 workers). The MEI doses are as follows:
  - MEI dose at the MFFF boundary for an elevated release = 2.2E-02 mrem/yr
  - MEI dose at the SRS boundary for an elevated release = 3.9E-04 mrem/yr
  - MEI dose at the MFFF boundary for a groundlevel release = 3.0 mrem/yr
  - MEI dose at the SRS boundary for a groundlevel release = 1.4E-03 mrem/yr
- <sup>o</sup> Natural background radiation for the site workers was calculated as the individual background radiation (295 mrem/yr) times the estimated number of site workers in 2000 (13,616 workers). The calculated value is 4,017 person-rem/yr.

**APPENDIX E. TRANSPORTATION RISK ASSESSMENT**

---

**This page intentionally left blank.**

---

## **E.1 INTRODUCTION**

The overland transportation of any commodity involves a risk to both transportation crew members and members of the public. This risk results directly from transportation-related accidents and indirectly from the increased levels of pollution from vehicle emissions, regardless of the cargo. The transportation of certain materials, such as radioactive materials, can pose additional risk due to the hazardous nature of the material.

This appendix provides an overview of the approach used to assess the health risks that may result from overland transportation activities. This appendix discusses the scope of the assessment, the analytical methods used in transportation risk assessment (i.e., computer models), and important assessment assumptions, and it determines potential transportation routes.

The risk assessment results are presented in terms of “per-shipment” risk factors, as well as for total risks associated with each type of material that will be transported. Per-shipment risk factors provide an estimate of the risk from a single hazardous material shipment between a specific origin and destination. Total risks for a given hazardous material are then presented based on an assumed number of total shipments.

This appendix updates the transportation risk assessment results presented in Appendix L of the SPD EIS (DOE 1999c), specifically for the transportation activities associated with the MFFF located at SRS. The update includes more recently developed information about the numbers and destinations of MOX fresh fuel shipments based on the SNM Transportation Integration Management Plan, which is derived from the Mission Reactors Irradiation Plan. External dose rate information about the MOX fresh fuel package is derived from the MOX Fresh Fuel Package Concept Design Report. Information about UF<sub>6</sub> shipments has been assembled from *Transportation Impact Analyses in Support of the Depleted UF<sub>6</sub> Programmatic Environmental Impact Statement* (Biwer et al. 1997). UO<sub>2</sub> shipment data have been assembled from the *Initial Data Report in Response to the Surplus Plutonium Disposition Environmental Impact Statement Data Call for the UO<sub>2</sub> Supply* (White 1997).

## **E.2 SCOPE**

The scope of the overland transportation risk assessment, including a description of the transportation activities, potential radiological and nonradiological impacts, transportation modes and packages, and receptors, is described below.

### **E.2.1 Radiological Impacts**

For each shipment, radiological risks (i.e., those risks that result from the radioactive nature of the hazardous materials) are assessed for both incident-free (i.e., normal) and accident transportation conditions. The radiological risk associated with incident-free transportation conditions would result from the potential exposure of people to external radiation in the vicinity of a loaded shipment. The radiological risk from transportation accidents would come from the

potential release and dispersal of the radioactive material into the environment during an accident and the subsequent exposure of people through multiple exposure pathways (i.e., exposure to contaminated ground or air, or ingestion of contaminated food).

All radiological impacts are calculated in terms of effective dose and associated health effects in the exposed populations. The radiation dose calculated is the total effective dose equivalent, which is the sum of the effective dose equivalent from external radiation exposure and the 50-year committed effective dose equivalent from internal radiation exposure (10 CFR Part 20). Radiation doses are presented in units of rem for individuals and person-rem for collective populations. The impacts are further expressed as health risks in terms of LCFs and cancer incidence in exposed populations. The health risk conversion factors (expected health effects per dose absorbed) were taken from the *1990 Recommendations of the International Commission on Radiological Protection* (ICRP 1991).

## **E.2.2 Nonradiological Impacts**

In addition to the radiological risks posed by overland transportation activities, vehicle-related risks are also assessed for nonradiological causes (i.e., related to the transport vehicles and not the radioactive cargo) for the same transportation routes. The nonradiological transportation risks are independent of the radioactive nature of the cargo and would be incurred for similar shipments of any commodity. The nonradiological risks are assessed for both incident-free and accident conditions. Nonradiological risks during incident-free transportation conditions would be caused by potential exposure to increased vehicle emissions. The nonradiological accident risk refers to the potential occurrence of transportation accidents that directly result in fatalities unrelated to the cargo. Nonradiological risks are presented in terms of estimated fatalities.

## **E.2.3 Transportation Modes and Receptors**

### **E.2.3.1 Transportation Modes**

All overland shipments were assumed to take place by truck.

### **E.2.3.2 Receptors**

Transportation-related risks are calculated and presented separately for workers and members of the general public. The workers considered are truck crew members involved in the actual overland transportation. The general public includes all persons who could be exposed to a shipment while it is moving or stopped enroute. Potential risks are estimated for the collective populations of exposed people, as well as the hypothetical MEI. The collective population risk is a measure of the radiological risk posed to society as a whole.

## **E.3 PACKAGING AND REPRESENTATIVE SHIPMENT CONFIGURATIONS**

Regulations that govern the transportation of radioactive materials (10 CFR Part 71) are designed to protect the public from the potential loss or dispersal of radioactive materials, as well as from routine radiation doses during transit. The primary regulatory approach to promote safety is

through the specification of performance standards for the packaging of radioactive materials. Because packaging represents the primary barrier between the radioactive material being transported and the radiation exposure to the public and the environment, packaging requirements are an important consideration for the transportation risk assessment. Representative packaging and shipment configurations for the materials associated with the MFFF that will need to be transported are described below.

### **E.3.1 Uranium Hexafluoride Packaging**

Uranium hexafluoride (UF<sub>6</sub>) would be shipped using a commercial vehicle from one of the United States Enrichment Corporation's gaseous diffusion plants to a commercial fuel fabrication facility for conversion to uranium dioxide (UO<sub>2</sub>). For the purpose of this risk assessment (and consistent with the assumptions used in the SPD EIS [DOE 1999c]), the gaseous diffusion plant in Portsmouth, Ohio<sup>1</sup>, and the General Electric (GE) Fuel Fabrication Facility in Wilmington, North Carolina, were chosen as representative sites for these activities. The UF<sub>6</sub> would be shipped in Model 30B cylinders, which are Type A packages. Examples of such cylinders are shown in Figures E-1 and E-2, which also show examples of two different overpack containers that could be used. Five overpacked cylinders would be transported per commercial truck, as shown in Figure E-3.

### **E.3.2 Uranium Dioxide Packaging**

UO<sub>2</sub> would be shipped by commercial vehicle from the commercial fuel fabrication facility, assumed for analysis purposes to be the GE Fuel Fabrication Facility in Wilmington, North Carolina, to the MFFF in gasketed, open-head, 55-gal (208-L) drums with heavy plastic liners, which are Industrial Package Type 1 packages. An example of such drums is shown in Figure E-4. A total of 24 drums, each containing 1,470 lb (667 kg) of UO<sub>2</sub> per package, would be transported using a standard covered commercial trailer. An example of a trailer for shipment of UO<sub>2</sub> drums is shown in Figure E-5.

### **E.3.3 MOX Fuel Packaging**

DCS is designing a container for the transport of fresh MOX fuel assemblies, a Type B (U)F-85 package, which will be certified for this use by the NRC. Each package will hold three MOX fresh fuel assemblies from a pressurized water reactor. Figure E-6 shows a schematic of the MOX fresh fuel package. One package will be transported by SafeGuards Transporter (SGT). The SGT is a fundamental component of the DOE Transportation Safeguards System that is operated by the Transportation Safeguards Division of the Albuquerque Operations Office for the DOE Headquarters Office of Defense Programs. Since its establishment in 1975, the Office of Transportation Safeguards has accumulated more than 94 million mi (151 million km) of over-the-road experience transporting DOE-owned cargo with no accidents resulting in a fatality or release of radioactive material. The SGT is a specially designed component of an 18-wheel

---

<sup>1</sup>There is a large stockpile of depleted UF<sub>6</sub> from historical operations that will continue to be stored onsite and should be available for use in the fabrication of MOX fuel.



tractor-trailer vehicle. Although details of vehicle enhancements and some operational aspects are classified information, key characteristics include the following:

- Enhanced structural characteristics and a highly reliable tie-down system to protect the cargo from impact
- Heightened thermal resistance to protect the cargo in case of fire
- Established operational and emergency plans and procedures governing the shipment of nuclear materials
- An armored tractor component that provides courier protection against attack and contains advanced communication equipment
- Specially designed escort vehicles containing advanced communications and additional couriers
- 24-hour-a-day real-time communications to monitor the location and status of all SGT shipments
- Couriers who are armed federal officers and who have received vigorous specialized training
- Significantly more stringent maintenance standards than those for commercial transport equipment.

Figure E-7 shows an example of how the MOX fresh fuel package would be transported within the SGT.

#### **E.4 METHODS FOR CALCULATING TRANSPORTATION RISKS**

Overland transportation of any commodity involves a risk to both transportation crew members and members of the public. This risk results directly from transportation-related accidents and indirectly from the increased levels of pollution from vehicle emissions, regardless of cargo. The transportation of radioactive materials can pose additional risks owing to the unique properties of the material.

Accordingly, DOE, NRC, and DOT have instituted strict policies and regulations governing the transport of such materials. The requirements are applicable throughout the entire shipment, which encompasses the onsite roadways, as well as the public roads near DOE and commercial sites. Between sites, shipments are predominately routed over the interstate highway system.

The overland transportation risk assessment methodology is summarized in Figure E-8. After the materials to be transported were identified and a shipping campaign was specified, the next step in determining the transportation risks was to collect data on material characteristics and accident parameters. Physical, radiological, and packaging data were assembled from the SPD EIS (DOE 1999c) or from more recent reports. Accident parameters are largely based on

*Longitudinal Review of State-level Accident Statistics for Carriers of Interstate Freight* (Saricks and Kvitck 1994). A more recent report, *State-Level Accident Rates of Surface Freight Transportation: A Reexamination* (Saricks and Tompkins 1999), was not used because this more recent report did not contain state-specific data for two states (South Carolina and Georgia) and because this information was summarized differently from the previous assessment, making it difficult to evaluate.

The HIGHWAY computer code (Johnson et al. 1993), developed by the Oak Ridge National Laboratory (ORNL), was used for selecting representative highway routes. The HIGHWAY code contains a database that is a computerized road atlas that currently describes about 240,000 mi (386,300 km) of roads, including all interstates and United States-designated highways. The code is updated periodically to reflect current road conditions and has been benchmarked against reported mileages and observations of commercial truck firms. Results from the HIGHWAY code include the distances and population densities along each route.

The ORIGEN2 computer code (Croff 1980; Ludwig 1992), developed by ORNL, was used to determine the radioactive source terms of the various materials.

The RADTRAN4 computer code (Neuhauser and Kanipe 1992, 1995) was used for the incident-free and accident risk assessments to estimate the impacts on collective populations. Calculations are in terms of probabilities and consequences of potential exposure events. Release fractions under accident conditions were based on those values used in the SPD EIS (DOE 1999c) and were derived, in part, from work conducted by the NRC (NRC 1977c).

The RISKIND computer code (Yuan et al. 1995) was used to estimate the incident-free dose to MEIs for a series of specific exposure scenarios. RISKIND calculations supplement the collective risk results achieved with RADTRAN4; they address areas of specific concern to individuals and population subgroups. Essentially, the RISKIND analyses answered the “what-if” questions such as, “What if I live next to the site access road during every shipment?” or “What if I’m stuck in traffic next to the shipment for a period of time?”

Radiation doses to populations, expressed in units of person-rem, were multiplied by the ICRP-60 (ICRP 1991) conversion factors and the estimated numbers of shipments to produce risk estimates in units of LCFs. The ICRP-60 health risk conversion factors are 0.0005 and 0.0004 fatal cancer cases per person-rem for members of the public and workers, respectively. The vehicle emission risk factor of 1.0E-07 LCFs/km was used to report the LCFs associated with exposure to vehicle emissions. The national average accident fatality rates were used to estimate the fatalities resulting from the physical trauma of traffic accidents. These per-shipment nonradiological risk factors were multiplied by the number of shipments to determine the total risk.

For each material shipment, risks for both the incident-free and accident conditions were assessed. For incident-free assessment, risks were calculated for “collective populations” of potentially exposed individuals and for MEIs. The collective population risk is a measure of the radiological risk posed to society as a whole by each shipment.

## E.5 REPRESENTATIVE ROUTES, PARAMETERS, AND ASSUMPTIONS

Shipments of UF<sub>6</sub> and UO<sub>2</sub> were assumed to use the most direct commercial routes. Shipments of MOX fuel assemblies, which are shipped using the DOE Transportation Safeguards System, were assumed to follow “highway route controlled quantity” routes, which preferentially utilize the interstate highway system, including interstate system bypasses around cities. Because of the classified nature of SGT shipments, the actual routes used and shipment schedule will not be publicly available.

Table E-1 summarizes the material shipments that are expected. This table lists the assumed origin and destination pairs; the material form, container, and transport vehicle; and the estimated number of shipments that will be required.

Four routes were analyzed:

- Portsmouth, Ohio to Wilmington, North Carolina      UF<sub>6</sub>
- Wilmington, North Carolina to Savannah River Site      UO<sub>2</sub>
- Savannah River Site to Catawba Nuclear Station      MOX
- Savannah River Site to McGuire Nuclear Station      MOX

Sufficient quantities of UF<sub>6</sub> and UO<sub>2</sub> are assumed to be shipped so that a total of 36.4 tons (33 metric tons) of plutonium can be fabricated into MOX fuel assemblies for irradiation as reactor fuel. However, the transportation analyses considers only MOX fuel assembly shipments to two selected commercial reactor sites: McGuire Nuclear Station and Catawba Nuclear Station. These two sites, housing four reactors, can accommodate 28.1 tons (25.5 metric tons) of surplus plutonium as fuel over a 13-1/2-year timeframe that is planned for operations of the MFFF. Any additional MOX fuel irradiation in unspecified reactors (up to the 36.4 tons [33 metric tons] of plutonium specified in the ER) will be addressed in a supplement to the ER if necessary. Between 2007 and 2021, a total of about 1,316 MOX fuel assemblies will be shipped from the MFFF at SRS to the mission reactors, with 238 shipments to the Catawba Nuclear Station and 212 shipments to the McGuire Nuclear Station. As previously indicated, each SGT carries one package containing three MOX fuel assemblies.

The HIGHWAY (Johnson et al. 1993) results listed in Table E-2 summarize the key parameters required by the RADTRAN4 code (i.e., shipment distance and population density). The “affected population” value is calculated by multiplying the total distance by 1.6, then multiplying it by the sum of the population density times the percentage in the zone for the different population zones (i.e., rural, suburban, and urban). This result represents the population within 0.5 mi (0.8 km) of either side of the route.

For consistency, the MFFF ER has relied upon many of the same assumptions used in the SPD EIS (DOE 1999c). Parameters such as accident rates, severity fractions, and release fractions are identical to those used in the SPD EIS. Other parameters, such as the nuclide inventories, population densities, and shipment distances, are unique for each of the cases shown below. Nuclide inventories were developed using the ORIGEN2 code (Croff 1980; Ludwig 1992).

## **E.6 RISK ASSESSMENT RESULTS**

Table E-3 summarizes the radiological and nonradiological health risks (in terms of either LCF or fatalities, as noted) for all the shipments associated with the MFFF, for both the incident-free (normal) transportation and as a result of potential accidents. These results indicate that the nonradiological human health risks resulting from exhaust emissions and vehicular traffic accidents exceed those resulting from the radiological nature of the cargo.

Table E-4 summarizes the incident-free radiological dose (in person-rem) to the public and truck on a per-shipment basis. This table provides a detailed breakdown of the source of the incident-free dose to the public: off-link, on-link, and stops.

Table E-5 shows the radiological accident dose to the public on a per-shipment basis, broken down by categories of groundshine, inhalation, resuspension, and cloudshine.

Table E-6 summarizes the accident-related risks per shipment. It is important to note that the estimated nonradiological accident fatalities greatly overshadow the radiological risks.

Table E-7 summarizes the nonradiological risk factors on a per-shipment basis.

Using RISKIND, MEI doses for the shipments of UF<sub>6</sub> and UO<sub>2</sub> were calculated for four different hypothetical exposure scenarios:

1. Inspector – dose to a person located an average of 9.8 ft (3 m) from the shipment for 1 hour while shipment is stopped
2. Person stuck in traffic – dose to a person located 4 ft (1.2 m) from the shipment for 0.5 hour while stuck in traffic
3. Gas station worker – dose to a person located 6.5 ft (2 m) from the shipment for 0.5 hour while filling up the truck
4. Resident nearby as each shipment passes – dose to a person located 98 ft (30 m) from every shipment as the shipment passes by at 15 mph (24 km/hr). Note that this result must be multiplied by the number of shipments.

For MOX shipments, only two of the MEI cases listed above are valid: the “person stuck in traffic” and “resident nearby as each shipment passes” cases. The “inspector” and “gas station worker” cases were ignored since the SGT crew (who are subject to a radiation monitoring program) perform these duties. Therefore, for the MOX shipments, the following MEI cases were evaluated:

1. Person stuck in traffic – dose to a person located 4 ft (1.2 m) from the shipment for 0.5 hour while stuck in traffic

2. Resident nearby as each shipment passes – dose to a person located 98 ft (30 m) from every shipment as the shipment passes by at 15 mph (24 km/hr). Note that this result must be multiplied by the number of shipments.

The doses to the MEI for each of these hypothetical exposure scenarios are summarized in Table E-8. The maximum dose of 2 mrem occurs for the person stuck in traffic next to a MOX shipment for 30 minutes. If the exposure duration was longer, the dose would rise proportionately.

## Figures

**This page intentionally left blank.**

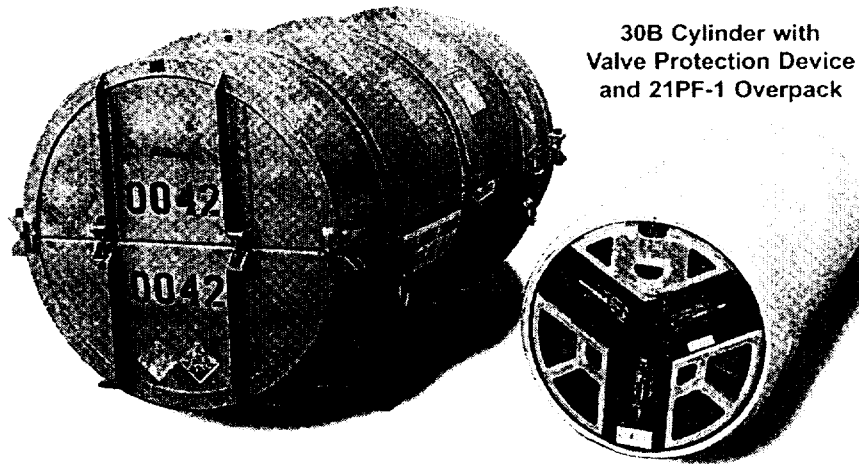

**Figure E-1. 30B Cylinder with Valve Protection Device and 21PF-1 Overpack**  
Photo courtesy of United States Enrichment Corporation (USEC 1999).

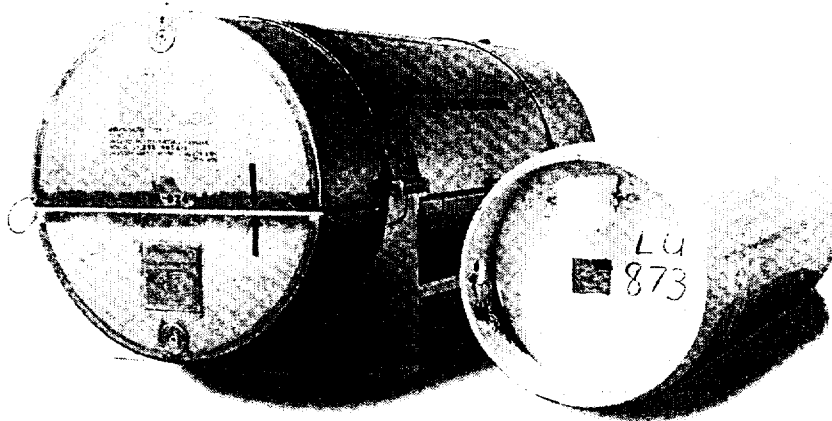

**Figure E-2. 30B Cylinder with UX-30 Overpack**  
Photo courtesy of United States Enrichment Corporation (USEC 1999).



**This page intentionally left blank.**

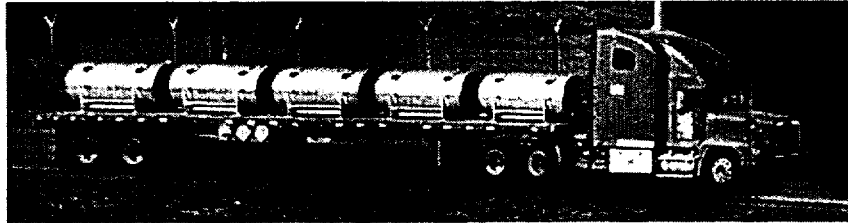

**Figure E-3. Trailer Carrying Five UF<sub>6</sub> Cylinders in Overpacks**  
Photo courtesy of United States Enrichment Corporation (USEC 1999).

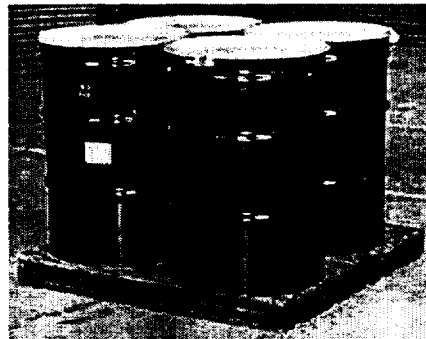

**Figure E-4. 55-Gallon Drums of UO<sub>2</sub>**

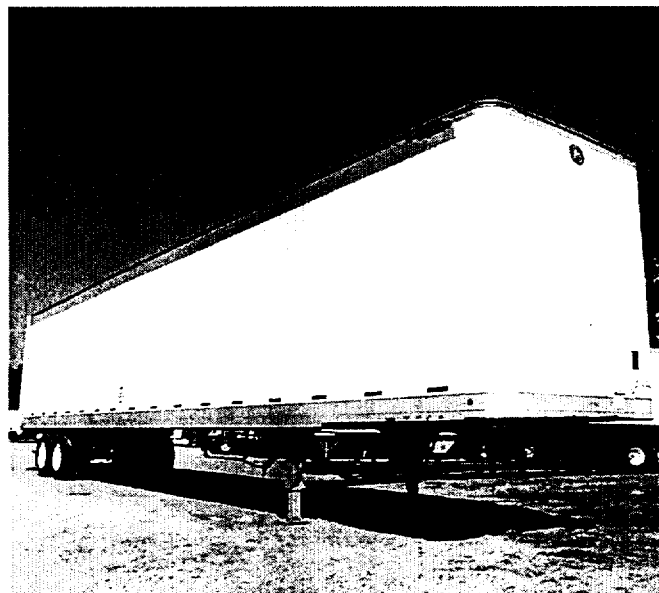

**Figure E-5. Trailer for Shipment of UO<sub>2</sub> Drums**

**This page intentionally left blank.**

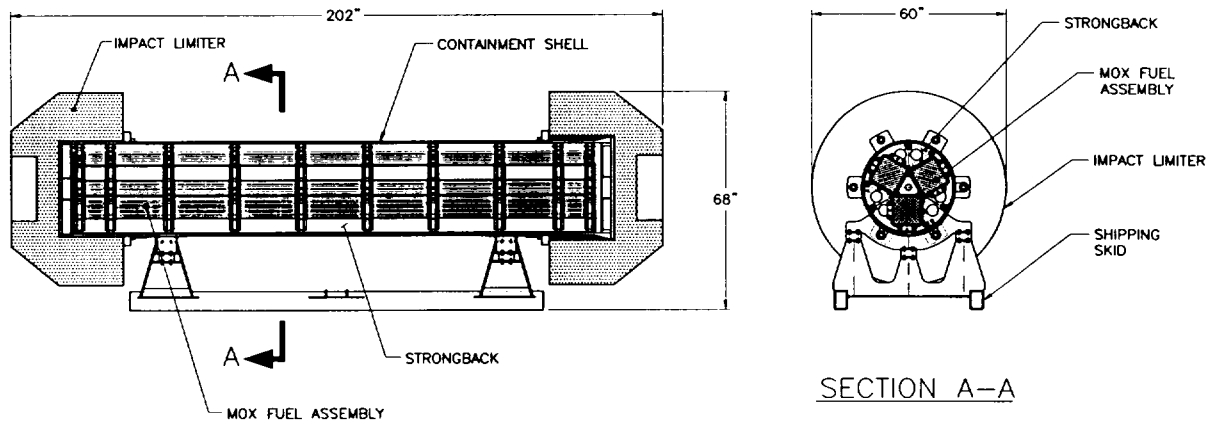

Figure E-6. MOX Fresh Fuel Package Schematic

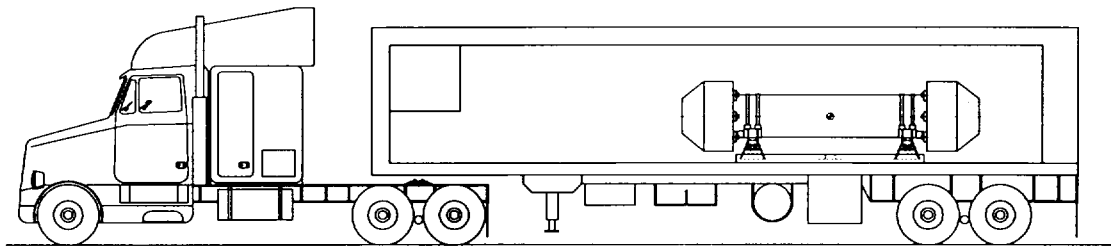

Figure E-7. MOX Fresh Fuel Package Loaded in SGT

**This page intentionally left blank.**

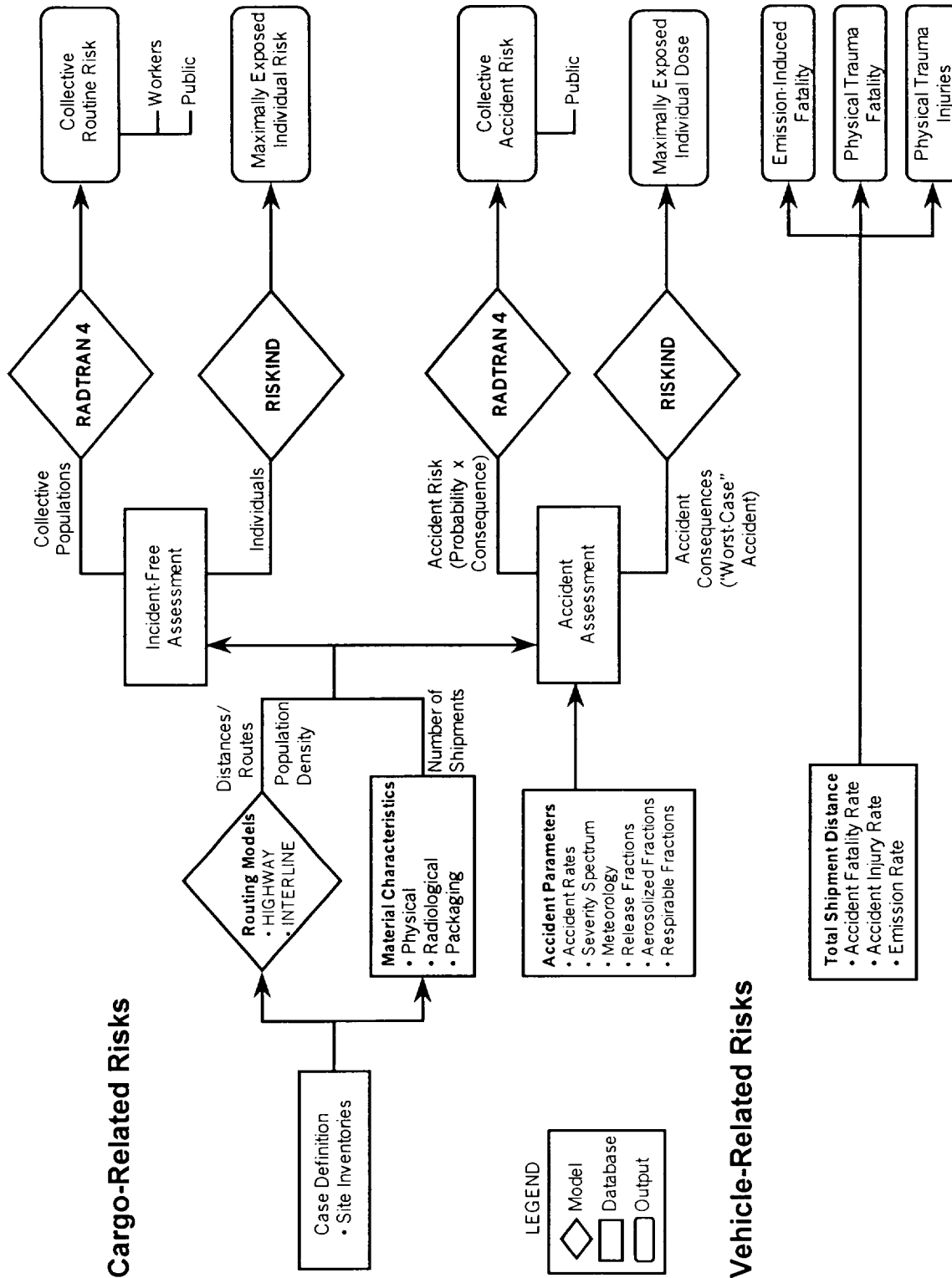

Figure E-8. Overland Transportation Risk Assessment Methodology

**This page intentionally left blank.**

## **Tables**



**This page intentionally left blank.**

**Table E-1. Summary of Material Shipments**

<b>Origin</b>	<b>Destination</b>	<b>Material Form</b>	<b>Container</b>	<b>Vehicle</b>	<b>No. of Shipments</b>
<b>MOX Fuel Fabrication Facility</b>					
Portsmouth GDP, Portsmouth, OH	GE Nuclear, Wilmington, NC	UF <sub>6</sub>	30B cylinder in overpack	Commercial	110
GE Nuclear, Wilmington, NC	MFFF, Savannah River Site F Area	UO <sub>2</sub>	55-gal drum	Commercial	60
MFFF, Savannah River Site F Area	Catawba NS, York, SC	MOX fuel assemblies	MFFP	SGT	238
MFFF, Savannah River Site F Area	McGuire NS, Huntersville, NC	MOX fuel assemblies	MFFP	SGT	212

Key: GDP - gaseous diffusion plant; MFFF - MOX fuel fabrication facility; MFFP - MOX fresh fuel package; NS - nuclear station; SGT - SafeGuards Transporter; UF<sub>6</sub> - uranium hexafluoride; UO<sub>2</sub> - uranium oxide.

**Table E-2. Key Parameters Required by the RADTRAN4 Code**

From	To	Distance (mi)	Percentage in Zones			Population Density (persons/km <sup>2</sup> )			Affected Population <sup>a</sup>
			Rural	Suburban	Urban	Rural	Suburban	Urban	
Portsmouth GDP	GE Nuclear	572	66.0	31.5	2.4	16.6	329.6	2,078.4	243,000
GE Nuclear	MFFF, F Area, SRS	278	73.7	25.1	1.2	17.6	273.7	2,115.8	77,000
MFFF, F Area, SRS	Catawba NS	191	66.2	32.1	1.7	14.7	341.4	1,884.5	74,000
MFFF, F Area, SRS	McGuire NS	219	64.4	33.3	2.3	12.9	353.6	1,936.6	96,000

<sup>a</sup> The affected population is the population within 0.5 mi (0.8 km) of either side of the route. This value is calculated by multiplying the distance (mi) by 1.6, then multiplying it by the sum of the population density times the percentage in the zone for the different population zones (i.e., rural, suburban, and urban), rounded to the nearest 1,000 people.

Table E-3. Total Transportation Risks Associated with the MFFF

From	To	Incident-Free				Accident	
		Radiological (LCFs)		Nonradiological (Fatalities) Exhaust Emission	Radiological (LCFs)	Traffic	Radiological (LCFs)
		Crew	Public				
Portsmouth GDP, Portsmouth, OH	GE Nuclear, Wilmington, NC	3.76E-04	8.60E-05	1.01E-02	2.24E-03	2.17E-06	
GE Nuclear, Wilmington, NC	MFFF, Savannah River Site F Area	2.76E-04	5.40E-05	2.68E-03	6.06E-04	1.81E-09	
MFFF, Savannah River Site F Area	Catawba NS, York, SC	1.92E-03	4.88E-04	7.31E-03	1.85E-03	8.59E-15	
MFFF, Savannah River Site F Area	McGuire NS, Huntersville, NC	2.00E-03	5.70E-04	7.46E-03	1.44E-03	8.35E-15	
<b>TOTAL (LCFs/fatalities) (person-rem)</b>		4.57E-03 11.4	1.20E-03 2.40	2.76E-02	6.14E-03	2.17E-06 4.34E-03	

Table E-4. Radiological Incident-Free Dose (in person-rem) to the Public and Truck Crew Per Shipment

From	To	Incident-Free Dose (person-rem)				
		Crew	Off-link	On-link	Stops	Total
Portsmouth GDP, Portsmouth, OH	GE Nuclear, Wilmington, NC	8.54E-03	1.25E-04	7.93E-04	6.20E-04	1.01E-02
GE Nuclear, Wilmington, NC	MFFF, Savannah River Site F Area	1.15E-02	1.24E-04	8.23E-04	9.01E-04	1.33E-02
MFFF, Savannah River Site F Area	Catawba NS, York, SC	2.02E-02	4.04E-04	3.76E-03	0	2.43E-02
MFFF, Savannah River Site F Area	McGuire NS, Huntersville, NC	2.36E-02	4.95E-04	4.90E-03	0	2.90E-02

Note: It has been assumed that no stops would be required for MOX fresh fuel shipments by SGT.

**Table E-5. Public Radiological Accident Dose (in person-rem) Per Shipment**

<b>From</b>	<b>To</b>	<b>Groundshine</b>	<b>Inhalation</b>	<b>Resuspension</b>	<b>Cloudshine</b>	<b>Total</b>
Portsmouth GDP, Portsmouth, OH	GE Nuclear, Wilmington, NC	4.90E-09	7.08E-06	3.22E-05	3.93E-14	3.93E-05
GE Nuclear, Wilmington, NC	MFFF, Savannah River Site F Area	1.50E-10	1.08E-08	4.92E-08	1.20E-15	6.02E-08
MFFF, Savannah River Site F Area	Catawba NS, York, SC	1.67E-17	1.30E-14	5.91E-14	1.65E-23	7.21E-14
MFFF, Savannah River Site F Area	McGuire NS, Huntersville, NC	1.83E-17	1.42E-14	6.45E-14	1.80E-23	7.88E-14

**Table E-6. Total Accident-related Risks Per Shipment**

<b>From</b>	<b>To</b>	<b>Radiological Accident LCFs</b>	<b>Non-Radiological Accident Fatalities <sup>a</sup></b>
Portsmouth GDP, Portsmouth, OH	GE Nuclear, Wilmington, NC	1.97E-08	2.04E-05
GE Nuclear, Wilmington, NC	MFFF, Savannah River Site F Area	3.01E-11	1.01E-05
MFFF, Savannah River Site F Area	Catawba NS, York, SC	3.61E-17	7.79E-06
MFFF, Savannah River Site F Area	McGuire NS, Huntersville, NC	3.94E-17	6.81E-06

<sup>a</sup> Nonradiological accident fatalities are the fatalities due to the physical trauma that result from an accident. Results are calculated by multiplying shipment distance by fatality rate.

**Table E-7. Summary of Nonradiological Risk Factors Per Shipment**

<b>Nonradiological Risk Estimates (Fatalities/Shipment)</b>			
<b>From</b>	<b>To</b>	<b>Exhaust Emission</b>	<b>Accident</b>
Portsmouth GDP, Portsmouth, OH	GE Nuclear, Wilmington, NC	9.21E-05	2.04E-05
GE Nuclear, Wilmington, NC	MFFF, Savannah River Site F Area	4.47E-05	1.01E-05
MFFF, Savannah River Site F Area	Catawba NS, York, SC	3.07E-05	7.79E-06
MFFF, Savannah River Site F Area	McGuire NS, Huntersville, NC	3.52E-05	6.81E-06

Note: Risks from exhaust emissions are calculated by multiplying 1.0E-07 fatalities/km (Rao et al. 1982) by the shipment distance. Nonradiological accident risks are calculated by multiplying the U.S. average accident-fatality rates (Saricks 1994) by the shipment distance, based on the shipment fractions within each population zone.



**Table E-8. Maximum Exposed Individual (MEI) Doses (in rem)**

From	To	Inspector	Person Stuck in Traffic	Service Station Worker	Resident - nearby as each shipment passes
Portsmouth GDP, Portsmouth, OH	GE Nuclear, Wilmington, NC	7.1E-05	9.9E-05	5.9E-05	4.6E-07
GE Nuclear, Wilmington, NC	MFFF, Savannah River Site F Area	2.3E-04	3.3E-04	1.9E-04	7.8E-07
MFFF, Savannah River Site F Area	Catawba NS, York, SC	1.3E-03	2.0E-03	1.1E-03	1.7E-05
MFFF, Savannah River Site F Area	McGuire NS, Huntersville, NC	1.3E-03	2.0E-03	1.1E-03	1.5E-05

**APPENDIX F. FACILITY ACCIDENTS**

---

**This page intentionally left blank.**

---

This appendix summarizes the assessment methods and important analysis assumptions used to support the accident analysis presented in Section 5.5. This information is based on the MFFF Integrated Safety Analysis and Safety Assessment of the Design Basis.

## F.1 GENERAL CONSEQUENCE ANALYSIS METHODS AND ASSUMPTIONS

### F.1.1 Total Effective Dose Equivalent

The Total Effective Dose Equivalent (TEDE) to the receptors of interest is equal to the Inhalation Dose. Air submersion, ingestion, water immersion, and contaminated soil dose pathways are assumed negligible contributors to the TEDE. The Inhalation Dose is calculated as follows:

$$[\text{Inhalation Dose}]_{\text{effective}} = [\text{ST}] \cdot [\chi / \text{Q}] \cdot [\text{BR}] \cdot [\text{C}] \cdot \sum_{\text{X}=1}^{\text{N}} f_{\text{X}} \cdot [\text{DCF}]_{\text{effective}, \text{X}} \quad (\text{F-1})$$

where:

ST = source term

$\chi/\text{Q}$  = atmospheric dispersion factor

BR = breathing rate

C = unit's conversion constant

$f$  = specific activity of nuclide x

DCF = dose conversion factor of nuclide x

N = total number of dose-contributing radionuclides

### F.1.2 Source Term

The source term (ST) is the amount of respirable radioactive material released to the air. The initial source term is the amount of radioactive material driven airborne at the accident source. The initial respirable source term, a subset of the initial source term, is the amount of radioactive material driven airborne at the accident source that is effectively inhalable. Lesser source terms are determined by applying filtration or deposition factors to the initial source term. The MFFF Safety Assessment uses the following equation to determine the quantity of respirable material released by an event to the environs:

$$[\text{ST}] = [\text{MAR}] \times [\text{DR}] \times [\text{ARF}] \times [\text{RF}] \times [\text{LPF}] \quad (\text{NRC 1998d}) \quad (\text{F-2})$$

The material at risk (MAR) is the amount of radioactive material (in grams or curies of activity) available to be acted on by a given physical stress. For facilities, processes, and activities, the MAR is a value representing some maximum quantity of radionuclide present or reasonably anticipated for the process or structure being analyzed. Different MARs may be assigned for different accidents since it is only necessary to define the material in those discrete physical locations that are exposed to a given stress.

The damage ratio (DR) is the fraction of the MAR actually impacted by the accident-generated conditions. The DR is estimated based upon engineering analysis of the response of structural materials for containment to the type and level of stress or force generated by the event. Conservative engineering approximations are typically used. These approximations often include a degree of conservatism due to simplification of phenomena to obtain a usable model, but the purpose of the approximation is to obtain, to the degree possible, a realistic understanding of potential effects.

The airborne release fraction (ARF) is the coefficient used to estimate the amount of a radioactive material suspended in air as an aerosol and thus available for transport due to physical stresses from a specific accident. For discrete events, the ARF is a fraction of the material affected. An entrainment event is treated in the same manner, with the exception that its release mechanism is a function of time. Thus, to use the five-factor formula, the airborne release rate (ARR) of an entrainment event must be multiplied by the duration of the entrainment and then equated to the ARF (i.e.,  $ARF = ARR \times \text{duration}$ ). Entrainment is not considered for materials in the form of a pellet or for materials contained in rods or filters.

The respirable fraction (RF) is the fraction of airborne radionuclides as particles that can be transported through air and inhaled into the human respiratory system.

Values for the RF and ARF are based on bounding values from the NRC (NRC 1998d).

The leak path factor (LPF) is the fraction of the radionuclides in the aerosol transported through some confinement deposition or filtration mechanism. There can be many LPFs for some hazard events, and their cumulative effect is often expressed as one value that is the product of all leak-path multiples. Inclusion of these multiples in a single LPF is done to clearly differentiate between calculations of doses without controls (where the LPF is assumed equal to 1) and calculations of doses with controls (where the LPF reflects the dose credit provided to the controls). In this manner, the LPF represents the credit taken for the control features at the MFFF.

Specific values for these parameters used in the bounding analysis are provided in Section F.6.

### **F.1.3 Potential Receptors**

For each potential accident, information is provided on accident consequences and frequencies to three types of receptors: (1) a site worker, (2) the maximally exposed member of the public, and (3) the offsite population. The first receptor, a site worker or SRS worker, is a hypothetical

individual working on the site but not involved in the proposed activity. The worker is conservatively evaluated downwind at a point 328 ft (100 m) from the accident. The second receptor, a maximally exposed member of the public, is a hypothetical individual assumed to be downwind at the site boundary. The MFFF site boundary is conservatively evaluated at a distance of 5 mi (8 km). Exposures received by this individual are intended to represent the highest doses to a member of the public. The third receptor, the offsite population, is all members of the public within 50 mi (80 km) of the accident location.

#### **F.1.4 Dispersion Modeling**

The MACCS2 (MELCOR Accident Consequence Code System for the Calculation of the Health and Economic Consequences of Accidental Atmospheric Radiological Releases) computer code was used to compute the downwind relative air concentrations ( $\chi/Q$ ) for a groundlevel release from the MFFF (NRC 1998a). The relative concentration (atmospheric dispersion factors) ( $\chi/Q$ ) is the dilution provided relative to site meteorology and distance to the receptor(s). MACCS2 simulates the impact of accidental atmospheric releases of radiological materials on the surrounding environment. MACCS2 was developed as a general-purpose application to diverse reactor and nonreactor facilities licensed by the NRC or operated by DOE or the Department of Defense.

The receptor of interest includes the maximally exposed individual (MEI) at 5 mi (8 km). The input into the MACCS2 code included a meteorological data file, which contains one year of hourly meteorological conditions for SRS. No credit is taken for building wake effects. The SRS meteorological data files are composed of hourly data for each calendar year from 1987 through 1996. Test runs demonstrated that 1987 and 1988 yield the most conservative  $\chi/Q$  values; therefore, calculations were performed using the 1987 and 1988 meteorological data files.

The dose incurred by the MEI is reported at the 95th percentile level, without regard to sector, from a ground release. The associated atmospheric dispersion factor ( $\chi/Q$ ) is  $3.69E-06 \text{ sec/m}^3$ .

The ARCON96 computer code was used to compute the downwind relative air concentrations ( $\chi/Q$ ) for the onsite receptor located within 328 ft (100 m) of a groundlevel release from the MFFF to account for low wind meander and building wake effects (NRC 1997). ARCON96 implements a straight-line Gaussian dispersion model with dispersion coefficients that are modified to account for low wind meander and building wake effects. A constant release rate is assumed for the entire period of release. Building wake effects are considered in the evaluation of relative concentration from groundlevel releases. ARCON96 calculates relative concentration using hourly meteorological data. It then combines the hourly averages to estimate concentrations for periods ranging in duration from 2 hours to 30 days. Wind direction is considered as the averages are formed. As a result, the averages account for persistence in both diffusion conditions and wind direction. Cumulative frequency distributions are prepared from the average relative concentrations. Relative concentrations that are exceeded no more than 5% of the time (95th percentile relative concentrations) are determined from the cumulative

frequency distributions for each averaging period. The associated  $\chi/Q$  for the site worker is  $4.1E-04 \text{ sec/m}^3$ .

The breathing rate is conservatively assumed to be  $3.47E-04 \text{ m}^3/\text{sec}$ . This value is from Regulatory Guide 1.25 (NRC 1972) and is equivalent to the uptake volume ( $353 \text{ ft}^3 [10 \text{ m}^3]$ ) of a worker in an eight-hour workday.

The inhalation dose conversion factors are taken from Federal Guidance Report 11 (EPA 1988). While some events involve radionuclides such as americium, the bounding releases from potential events at the MFFF involve plutonium particulate in the form of an oxide. The dose conversion factors corresponding to the yearly lung clearance class are applied to the released radionuclides accounting for this chemical form.

### **F.1.5 Source Term Composition**

Source term composition for the plutonium involved in the bounding events is provided in Table F-1. Plutonium is designated as unpolished prior to being processed through the aqueous polishing process. Plutonium is designated as polished after it has been processed through the aqueous polishing process.

### **F.1.6 Likelihood Of Fatal Cancer**

The probability coefficients for determining the likelihood of fatal cancer, given a dose, is taken from the *1990 Recommendations of the International Commission on Radiological Protection* (ICRP 1991). For low doses or low dose rates, respective probability coefficients of  $4.0E-04$  and  $5.0E-04$  fatal cancers per rem are applied for workers and the general public.<sup>1</sup> For high doses received at a high rate, respective probability coefficients of  $8.0E-04$  and  $1.0E-03$  fatal cancers per rem are applied for noninvolved workers and the public. These higher probability coefficients apply where doses are above 20 rem and dose rates are above 10 rem/hr.

## **F.2 FREQUENCY CATEGORIES**

Frequency categories in the MFFF Safety Assessment are based on qualitative estimates. The frequency categories are defined as follows:

- Not Unlikely – Event may occur during the facility’s lifetime.
- Unlikely – Event is not expected to occur during the facility’s lifetime.

---

<sup>1</sup>The SPD EIS ROD (DOE 2000b) anticipated mitigation through avoidance. Subsequent shifts in the MFFF site boundaries made it impossible to avoid impacting the sites, hence the plan for mitigation through data recovery.

- Highly Unlikely – The use of sufficient principal SSCs (or IROFS) applied to unmitigated events classified as Not Unlikely or Unlikely to further reduce their frequency to an acceptable level.
- Credible – Events that are not “Not Credible.”
- Not Credible – Natural phenomena or external man-made events with an extremely low initiating frequency, or process events that are not possible.

Note that the Highly Unlikely category is not used in the unmitigated analysis. Only through the application of MFFF engineered features are events placed into this category. Also note that events deemed Not Credible are not considered in the MFFF design.

### **F.3 CONSEQUENCE CATEGORIES**

Consequences are categorized according to three severity levels: High, Intermediate, and Low. The consequence severity levels are based on 10 CFR §70.61 and are shown in Table F-2.

### **F.4 RISK CATEGORIES**

Risk is represented by the frequency and the consequence. Based on 10 CFR §70.61, the risk categories are shown in Table F-3. This matrix is applicable to all receptors.

In accordance with 10 CFR §70.61, the risk posed by those events falling in risk categories 6 and 9 must be addressed with engineered controls, administrative controls, or both to reduce the risk to an acceptable level.

Note that 10 CFR §70.61 places no consequence criteria for events considered Highly Unlikely. Thus, the environmental assessment does not report consequences for events deemed Highly Unlikely.

### **F.5 UNCERTAINTIES AND CONSERVATISM**

The determination of risk is based on calculations associated with hypothetical sequences of events and models of their effects. The models provide estimates of the frequencies, source terms, pathways for dispersion, exposures, and the effects on human health and the environment that are as realistic as possible within the scope of the analysis. The uncertainty in the calculation of consequences and event frequency requires the use of models or input values that yield conservative consequence and frequency estimates. All events have been evaluated using uniform methods and data, allowing a fair comparison of all events.

The bounding consequence calculations are based on extremely conservative assumptions. The actual source term involved in the event would be far lower than the source term considered in the calculation due to the actual MFFF design. Specific conservative assumptions include 95%



meteorology; an LPF of 1E-04 for more than two sets of HEPA filters; and bounding source terms, release fractions, and respirable fractions as described in Section F.6.

The estimation of event frequency is especially subject to considerable uncertainty. The uncertainty in estimates of the frequency of Highly Unlikely events can be several orders of magnitude. For this reason, event frequency is reported qualitatively, in terms of broad frequency bins, as opposed to numerically.

The analysis uses an extremely conservative approach with respect to frequency. All natural phenomena hazards and external man-made hazards are considered unless their probability of impacting the MFFF is extremely low, and all internal hazards generated by the MFFF design and operations are considered. For these hazards, unmitigated events are evaluated without regard to the frequency of the initiating event. In most cases, the failure of many features is required for the bounding event to occur.

## **F.6 ADDITIONAL INTERNAL EVENT DESCRIPTIONS**

This section provides supporting details for the bounding events described in Section 5.5.

### **F.6.1 Internal Fire**

The internal fire event postulated to produce the largest radiological consequences is a fire in the fire area containing the PuO<sub>2</sub> Buffer Storage Unit. This unit is the storage location for “pots” of polished plutonium powder. This fire area is postulated to contain the largest source term for this event, thus producing the largest consequences. Fire areas with a larger material at risk have a lower damage ratio for this event resulting in a lower overall source term.

The evaluation conservatively assumes that a fire occurs in this fire area and impacts the powder stored in this area, resulting in a release of radioactive material. The maximum amount of plutonium in this fire area is 860 lb (390 kg) of polished powder. Due to the low combustible loading in this fire area, just a small fraction of this material would be expected to be involved in the fire. However, the evaluation conservatively uses the entire fire area inventory in the consequence analysis. The damage ratio is assumed to be one, the bounding respirable release fraction is 6E-04, and the bounding leak path factor is 1E-04. The bounding radiological consequences associated with this event are provided in Table 5-13.

The MFFF utilizes many features to reduce the likelihood and consequences of this event as well as other fire-related events. Key features include fire barriers, minimization of combustibles and ignition sources, ventilation systems with fire dampers and HEPA filters, nitrogen blanket systems, qualified canisters and containers, fire suppression and detection systems, emergency procedures, worker training, and local fire brigades.

The frequency associated with this event is estimated to be Unlikely or lower because multiple failures are required for this event to occur.

### **F.6.2 Load Handling**

The load-handling event postulated to produce the largest radiological consequences is a drop event involving the glovebox in the Jar Storage and Handling Unit. This glovebox contains jars of plutonium powder. This glovebox is postulated to contain the largest source term for this event, thus producing the largest consequences. Gloveboxes that contain a larger material at risk have a lower damage ratio for this event resulting in a lower overall source term.

The glovebox is postulated to be impacted during maintenance operations by either a lifting device or a lifted load outside of the glovebox, damaging a portion of the glovebox causing some of its contents to drop to the floor, resulting in a release of radioactive material. The maximum amount of plutonium in this glovebox is approximately 743 lb (337 kg) of polished powder. Due to the large glovebox size, it is expected that just a small fraction of this amount would be involved in the event. However, the evaluation conservatively uses the entire glovebox inventory in the consequence calculations. The damage ratio is assumed to be one, the bounding respirable release fraction is 6E-04, and the bounding leak path factor is 1E-04. The bounding radiological consequences associated with this event are provided in Table 5-13.

The MFFF utilizes many features to reduce the likelihood and consequences of this event as well as other load-handling events. Key features include loadpath restrictions, crane-operating procedures, maintenance procedures, operator training, qualified canisters, reliable load-handling equipment, and ventilation systems with HEPA filters.

The frequency associated with this event is estimated to be Unlikely or lower because multiple failures are required for this event to occur.

### **F.6.3 Hypothetical Criticality Event**

The MFFF processes are designed to preclude a criticality event through the use of reliable engineered features and administrative controls. Adherence to the double contingency principle, as specified in ANSI/ANS-8.1 (ANSI/ANS 1983b), is employed. Simultaneous failure of the criticality controls is Highly Unlikely.

Although criticality events at the MFFF are prevented, a generic hypothetical criticality event is evaluated. A bounding source term of  $10^{19}$  fissions in solution is evaluated consistent with guidance provided in Regulatory Guide 3.71 (NRC 1998c). Airborne releases and direct radiation result from the criticality. The direct radiation contribution is negligible due to the shielding provided by the building and the distance to the site worker and the offsite public. Airborne releases are calculated consistent with the guidance of Regulatory Guide 3.35 (NRC 1979). The leak path factor for gases and particulates is 1.0 and 1E-04, respectively. The evaluation is based on 88 lb (40 kg) of unpolished plutonium, the maximum tank inventory of plutonium in solution. The radiological consequences associated with this event are shown in Table 5-13.

#### F.6.4 Hypothetical Explosion Event

The MFFF processes are designed to preclude explosions through the use of reliable engineered features and administrative controls, the simultaneous failure of which is Highly Unlikely.

Although explosion events at the MFFF are Highly Unlikely, a generic hypothetical explosion event is evaluated. The evaluation conservatively assumes that an explosion occurs and involves the entire material at risk within a process cell. The maximum amount of plutonium in any process cell is approximately 132 lb (60 kg) of unpolished plutonium. Because the material at risk is in three separate tanks within this cell, only a fraction of this amount would be involved in the event. However, the evaluation conservatively uses the entire process cell inventory in the consequence calculation. The damage ratio is assumed to be one, the bounding respirable release fraction is 0.01, and the bounding leak path factor is 1E-04. The radiological consequences of this hypothetical event are presented in Table 5-13.

#### F.6.5 Chemical Releases

Chemicals that interact with or that could affect nuclear material were evaluated separately for their impact. Chemical concentrations associated with potential chemical releases were calculated using the ALOHA (Areal Locations of Hazardous Atmospheres) computer code (EPA 1999).

ALOHA is an atmospheric dispersion model used for evaluating releases of hazardous chemical vapors. ALOHA allows the user to estimate the downwind dispersion of a chemical cloud based on the toxicological/physical characteristics of the released chemical, atmospheric conditions, and specific circumstances of the release. ALOHA also accounts for some of the physical characteristics of the release site, weather conditions, and the circumstances of the release.

Two separate dispersion models are included in ALOHA: *Gaussian* and *heavy gas*.

ALOHA uses the Gaussian model to predict atmospheric dispersal of neutrally buoyant gases. Such neutrally buoyant gases have about the same density as air. According to this model, wind and atmospheric turbulence are the forces that move the molecules of a released gas through the air. Therefore, as an escaped cloud is blown downwind, "turbulent mixing" causes it to spread out in the crosswind and upward directions. According to the Gaussian model, a graph of gas concentration within any crosswind slice of a moving pollutant cloud looks like a bell-shaped curve, high in the center (where concentration is highest) and lower on the sides (where concentration is lower). Right at the point of a release, the pollutant gas concentration is very high, and the gas has not diffused very far in the crosswind and upward directions, so a graph of concentration in a crosswind slice of the cloud close to the source looks like a spike. As the pollutant cloud drifts farther downwind, it spreads out and the "bell shape" becomes wider and flatter.

A gas heavier than air initially behaves very differently from a neutrally buoyant gas at the source. The heavy gas first "slumps," or sinks, because it is heavier than the surrounding air. As

the gas cloud moves downwind, gravity causes it to spread, which can cause some of the vapor to travel upwind of its release point. Farther downwind, as the cloud becomes more diluted and its density approaches that of air, it begins behaving like a neutrally buoyant gas. This phenomenon occurs when the concentration of heavy gas in the surrounding air drops below about 1%, which for many small releases will occur in the first few yards and for large releases may occur much further downwind.

Calculated concentrations were compared to Temporary Emergency Exposure Limits (TEELs). TEELs describe temporary or equivalent exposure limits for chemicals for which official Emergency Response Planning Guidelines have not yet been developed. This method was adopted by DOE's Subcommittee on Consequence Assessment and Protective Action (SCAPA). The SCAPA-approved methodology published in the American Industrial Hygiene Association Journal was used to obtain hierarchy-derived TEELs (WSRC 1998). TEELs are provided for nearly 1,200 additional chemicals. TEELs are equal to the Acute Exposure Guideline Level and Emergency Response Planning Guidelines, where these values are available.

The definitions of TEEL levels consistent with 10 CFR §70.61 are as follows:

- TEEL-1 – The maximum concentration in air below which it is believed nearly all individuals could be exposed without experiencing other than mild transient adverse health effects or perceiving a clearly defined objectionable odor.
- TEEL-2 – The maximum concentration in air below which it is believed nearly all individuals could be exposed without experiencing or developing irreversible or other serious health effects or symptoms that could impair their abilities to take protective action.
- TEEL-3 – The maximum concentration in air below which it is believed nearly all individuals could be exposed without experiencing or developing life-threatening health effects.

Three severity consequence levels identified are Low, Intermediate, and High. The consequence severity level defined in Table F-4 is based on 10 CFR §70.61.

The results of the preliminary chemical evaluation indicate that the chemical consequences at the site boundary and to the SRS worker are low.

**This page intentionally left blank.**

## Tables

**This page intentionally left blank.**

**Table F-1. Source Term Composition for Bounding Accidents**

<b>Isotope</b>	<b>Unpolished Pu Isotopic Fraction</b>	<b>Polished Pu Isotopic Fraction</b>
Pu-236	0.00%	0.00%
Pu-238	0.04%	0.04%
Pu-239	92.02%	92.67%
Pu-240	6.14%	6.18%
Pu-241	1.00%	1.01%
Pu-242	0.10%	0.10%
Am-241	0.70%	0.00%



**Table F-2. Consequence Severity Categories Based on 10 CFR §70.61**

<b>Consequence Category</b>	<b>Worker TEDE</b>	<b>Offsite Public TEDE/Uranium Intake</b>	<b>Environmental Release</b>
3: High	> 1 Sv (> 100 rem)	> 0.25 Sv (> 25 rem)  >30 mg soluble uranium intake	Not applicable
2: Intermediate	0.25 Sv to ≤ 1 Sv (25 rem to ≤ 100 rem)	0.05 Sv to ≤ 0.25 Sv (5 rem to ≤ 25 rem)	> 5,000 times the concentrations in Table 2, Attachment B of 10 CFR Part 20
1: Low	Events of lesser radiological exposures to workers than those above in this column	Events of lesser radiological exposures to the public than those above in this column	Radioactive releases producing effects less than those specified above in this column

TEDE – Total Effective Dose Equivalent

**Table F-3. Event Risk Matrix**

<b>CONSEQUENCE</b>	<b>High</b>	3 <b>acceptable risk</b>	6 <b>unacceptable risk</b>	9 <b>unacceptable risk</b>
	<b>Intermediate</b>	2 <b>acceptable risk</b>	4 <b>acceptable risk</b>	6 <b>unacceptable risk</b>
	<b>Low</b>	1 <b>acceptable risk</b>	2 <b>acceptable risk</b>	3 <b>acceptable risk</b>
		<b>Highly Unlikely</b>	<b>Unlikely</b>	<b>Not Unlikely</b>
		<b>LIKELIHOOD</b>		

**Table F-4. Consequence Severity Categories Based on TEEL**

<b>Consequence Category</b>	<b>Workers</b>	<b>Offsite Public</b>
High	> TEEL-3	> TEEL-2
Intermediate	TEEL-2 < x < TEEL-3	TEEL-1 < x < TEEL-2
Low	< TEEL-2	< TEEL-1