

**COMPUTER TESTING
SUPPLEMENT
FOR
RECREATIONAL PILOT
AND
PRIVATE PILOT**



DO NOT MARK IN THIS BOOK



**COMPUTER TESTING
SUPPLEMENT
FOR
RECREATIONAL PILOT
AND
PRIVATE PILOT**

2004

PREFACE

This computer testing supplement is designed by the Flight Standards Service of the Federal Aviation Administration (FAA) for use by computer testing designees (CTDs) in the administration of computer-assisted airman knowledge tests in the following knowledge areas:

Recreational Pilot—Airplane (RPA)
Recreational Pilot—Rotorcraft/Helicopter (RPH)
Recreational Pilot—Rotorcraft/Gyroplane (RPG)
Private Pilot—Airplane/Recreational Pilot—Transition (PAT)
Private Pilot—Helicopter/Recreational Pilot—Transition (PHT)
Private Pilot—Gyroplane/Recreational Pilot—Transition (PGT)
Private Pilot—Airplane (PAR)
Private Pilot—Rotorcraft/Helicopter (PRH)
Private Pilot—Rotorcraft/Gyroplane (PRG)
Private Pilot—Glider (PGL)
Private Pilot—Free Balloon – Hot Air (PBH)
Private Pilot—Free Balloon – Gas (PBG)
Private Pilot—Lighter-Than-Air – Airship (PLA)
Private Pilot—Powered-Parachute (PPP)
Private Pilot—Weight-shift Control (PWS)

FAA-CT-8080-2E supersedes FAA-CT-8080-2D, Computer Testing Supplement for Recreational Pilot and Private Pilot.

Comments regarding this supplement should be sent to:

U.S. Department of Transportation
Federal Aviation Administration
Flight Standards Service
Airman Testing Standards Branch, AFS-630
P.O. Box 25082
Oklahoma City, OK 73125

CONTENTS

Preface	iii
Contents	v

APPENDIX 1

LEGEND 1.—Sectional Aeronautical Chart	1
LEGEND 2.—Airport/Facility Directory	2
LEGEND 3.—Airport/Facility Directory	3
LEGEND 4.—Airport/Facility Directory	4
LEGEND 5.—Airport/Facility Directory	5
LEGEND 6.—Airport/Facility Directory	6
LEGEND 7.—Airport/Facility Directory	7
LEGEND 8.—Airport/Facility Directory	8
LEGEND 9.—Airport/Facility Directory	9

APPENDIX 2

FIGURE 1.—Lift Vector	1
FIGURE 2.—Load Factor Chart	1
FIGURE 3.—Altimeter	1
FIGURE 4.—Airspeed Indicator	2
FIGURE 5.—Turn Coordinator	2
FIGURE 6.—Heading Indicator	2
FIGURE 7.—Attitude Indicator	2
FIGURE 8.—Density Altitude Chart	3
FIGURE 9.—Control Position for Taxi	4
FIGURE 10.—Gyroplane Rotor Blade Position	4
FIGURE 11.—Glider Yaw String	4
FIGURE 12.—Aviation Routine Weather Reports (METAR)	5
FIGURE 13.—Telephone Weather Briefing	5
FIGURE 14.—Pilot Weather Report	6
FIGURE 15.—Terminal Aerodrome Forecasts (TAF)	6
FIGURE 16.—Area Forecast	7
FIGURE 17.—Winds and Temperatures Aloft Forecast	8
FIGURE 18.—Weather Depiction Chart	9
FIGURE 19.—Radar Summary Chart	10
FIGURE 20.—Significant Weather Prognostic Chart	11
FIGURE 21.—Sectional Chart Excerpt	12
FIGURE 22.—Sectional Chart Excerpt	13
FIGURE 23.—Sectional Chart Excerpt	14
FIGURE 24.—Sectional Chart Excerpt	15
FIGURE 25.—Sectional Chart Excerpt	16
FIGURE 26.—Sectional Chart Excerpt	17
FIGURE 27.—Sectional Chart Excerpt	18
FIGURE 28.—Time Conversion Table	19
FIGURE 29.—VOR	20

CONTENTS—Continued

FIGURE 30.—ADF (Movable Card)	21
FIGURE 31.—ADF (Fixed Card)	21
FIGURE 32.—Airport/Facility Directory Excerpt	22
FIGURE 33.—Airplane Weight and Balance Tables	23
FIGURE 34.—Airplane Weight and Balance Tables	24
FIGURE 35.—Airplane Weight and Balance Graphs	25
FIGURE 36.—Airplane Power Setting Table	26
FIGURE 37.—Crosswind Component Graph	26
FIGURE 38.—Airplane Landing Distance Graph	27
FIGURE 39.—Airplane Landing Distance Table	27
FIGURE 40.—Gyroplane Takeoff and Landing Graphs	28
FIGURE 41.—Airplane Takeoff Distance Graph	29
FIGURE 42.—Helicopter Weight and Balance Graph	30
FIGURE 43.—Helicopter Weight and Balance Graphs	31
FIGURE 44.—Helicopter CG Envelopes	32
FIGURE 45.—Gyroplane Weight and Balance Graph	33
FIGURE 46.—Gyroplane Weight and Balance Graph	34
FIGURE 47.—Helicopter Height Velocity Diagram	35
FIGURE 48.—VASI Illustrations	36
FIGURE 49.—Airport Diagram	36
FIGURE 50.—Airport Diagram	37
FIGURE 51.—Airport Landing Indicator	37
FIGURE 52.—Flight Plan Form	37
FIGURE 53.—Airport/Facility Directory Excerpt	38
FIGURE 54.—Glider Weight and Balance Diagram	39
FIGURE 55.—Glider Performance Graph	40
FIGURE 56.—Standard Soaring Signals	41
FIGURE 57.—Hot Air Balloon Performance Graph	42
FIGURE 58.—Hot Air Balloon Performance Graph	43
FIGURE 59.—Compass Card	43
FIGURE 60.—Sectional Chart Excerpt	44
FIGURE 61.—Weight and Balance Diagram	45
FIGURE 62.—Weight and Balance Diagram	45
FIGURE 63.—Rectangular Course	45
FIGURE 64.—Airport/Facility Directory Excerpt	46
FIGURE 65.—Airport Markings	47
FIGURE 66.—U.S. Airport Signs	48
FIGURE 67.—S-Turn Diagram	49

APPENDIX 1

SECTIONAL AERONAUTICAL CHART SCALE 1:500,000

LEGEND

Airports having **Control Towers** are shown in blue, all others in magenta. Consult Airport/Facility Directory (AFD) for details involving airport lighting, navigation aids, and services. For additional symbol information refer to the Chart User's Guide.

AIRPORTS

- Other than hard-surfaced runways
- Hard-surfaced runways 1500 ft. to 8069 ft. in length
- Hard-surfaced runways greater than 8069 ft., or some multiple runways less than 8069 ft.
- Open dot within hard-surfaced runway configuration indicates approximate VOR, VOR-DME, or VORTAC location
- All recognizable hard-surfaced runways, including those closed, are shown for visual identification. Airports may be public or private.

ADDITIONAL AIRPORT INFORMATION

- Private "IP-41" - Non-public use having emergency or landmark value.
- Military - Other than hard-surfaced. All military airports are identified by abbreviations: AFB, NAS, AAF, etc. For complete airport information consult DOD FLIP.
- Unverified
- Abandoned - paved, having landmark value, 3000 ft. or greater
- Unlighted Flight Park
- Selected

Services not available and field tended during normal working hours depicted by use of enhanced airport symbol. [Normal working hours are Mon thru Fri 10:00 A.M. to 4:30 P.M., local time.] Consult AFD for service availability at airports with hard-surfaced runways greater than 8069 ft.

★ Rotating airport beacon in operation Sunset to Sunrise.

RADIO AIDS TO NAVIGATION AND COMMUNICATION BOXES

- VHF OMNI RANGE (VOR)
- VORTAC
- VOR-DME
- Non-Directional Radio beacon (NDB)
- NDB-DME
- Other facilities, i.e., Commercial Broadcast Stations, FSS Outlets, RCO, etc.

Box indicates F.A.R. 93 Airport Surveillance Radar. Consult Airport/Facility Directory (AFD) for details involving Airport Air Traffic Rules & Airport Traffic Patterns.

AIRPORT DATA

NO. FSS VFR Location Identifier
NAME (N/A/M) Identifier
CT - 118.3 * ATIS 123.8
285 U 72 122.95 UNICOM
VFR Advty 123.0
Airport of Entry

FSS - Flight Service Station
NO SVFR - Fixed-wing special VFR flight is prohibited.
CT - 118.3 - Control tower (CT) - primary frequency
NFACT - Non-Federal Control Tower
* - 31st indicates operation part-time (see lower frequencies regulation for hours of operation).
@ - Indicates Common Traffic Advisory Frequencies (CTAF)
ATIS 123.8 - Automatic Terminal Information Service
ASOS/AWOS 135.42 - Automated Surface Weather Observing System, NDBs broadcasting ASOS/AWOS data may not be located at the airport.
UNICOM - Aeronautical advisory station
VFR Advty - VFR Advisory Service shown where ATIS not available and frequency is other than primary CT frequency
285 - Elevation in feet
* L - Lighting limitations exist, refer to Airport/Facility Directory.
72 - Length of longest runway in hundreds of feet; usable length may be less.
When facility or information is lacking, the respective character is replaced by a dash. All lighting codes refer to runway light. Lighted runway may not be the longest or lighted full length. All times are local.

CHICAGO CHI
122.1R 122.8 123.8
OAKDALE
118.8 OAK
382 * 118.8 OAK
Heavy line box indicates Flight Service Station (FSS). Freqs. 121.5, 122.2, 243.0, and 255.4 (Canada - 121.5, 126.7 and 243.0) are normally available at all FSSs and are not shown above boxes. All other freqs. are shown.
For Local Airport Advisory use FSS freq. 123.6.

Frequencies above thin line box are omitted to NAVDAD site. Other frequencies of FSS providing voice communication may be available as determined by altitude and terrain. Consult Airport/Facility Directory for complete information.

CONTOUR INTERVAL 500 feet
500

HIGHEST TERRAIN elevation is 3818 feet
located at 34°52'N - 101°59'W

Spot elevation..... • 4254
Approximate elevation x 3200
Doubtful locations are indicated by omission of the point locator (dot or "x")

Only the controlled and reserved airspace effective below 18,000 ft. MSL are shown on this chart. All times are local.

Class B Airspace
Class C Airspace (Mode C)
See F.A.R. 91.215/AMJ

OBSTRUCTIONS

1000 ft and higher AGL below 1000 ft. AGL

Group Obstruction
Obstruction with high-intensity lights. May operate part-time
2049 - Elevation of the top above mean sea level (1149)
UC - Height above ground
Under construction or reported position and elevation unverified
NOTICE: Guy wires may extend outward from structures.

MISCELLANEOUS

10 E - Isogonic Line (1995 VALUE)
Ultraviolet Light
Flashing Light
Marine Light
Hanging Obstruction
Activity
Climax Operations
NAME (Magenta, Blue, or Black)
Visual Check Point
Parachute Jumping Area
[See Airport/Facility Directory]

10 E - Isogonic Line (1995 VALUE)
Ultraviolet Light
Flashing Light
Marine Light
Hanging Obstruction
Activity
Climax Operations
NAME (Magenta, Blue, or Black)
Visual Check Point
Parachute Jumping Area
[See Airport/Facility Directory]

TOPOGRAPHIC INFORMATION

Roads
Road Markers
Railroad
Bridges And Viaducts
Power Transmission Lines
Aerial Cable
Landmark Feature - stadium, factory, school, golf course, etc.
Outdoor Theatre
Lookout Tower P-17 (Site Number) 618 (Elevation Base of Tower)
US Coast Guard Station
Race Track
Tank-water, oil or gas
Oil Well • Water Well
Mines And Quarries
Mountain Pass
11823 (Elevation of Pass)
Rocks
Dams
Perennial Lake
Non-Perennial Lake

AIRPORT TRAFFIC SERVICE AND AIRSPACE INFORMATION

Mode C (See F.A.R. 91.215/AMJ)
National Security Area
Terminal Radar Service Area (TRSA)
MTR - Military Training Routes

MILITARY TRAINING ROUTES (MTRs)

All IR and VR (MTRs) are shown, and may extend from the surface upwards. Only the route centerline, direction of flight along the route and the route designator are depicted - route widths and altitudes are not shown.
Since these routes are subject to change every 56 days, and the charts are reissued every 6 months, you are cautioned and advised to contact the nearest FSS for route dimensions and current status for those routes affecting your flight. Routes with a change in the alignment of the charted route centerline will be indicated in the Aeronautical Chart Bulletin of the Airport/Facility Directory.
Military Pilots refer to Area Planning AP/18 Military Training Route North and South America for current routes.

ATTENTION

THIS CHART CONTAINS MAXIMUM ELEVATION FIGURES (MEF). The Maximum Elevation Figures shown in quadrangles bounded by ticked lines of latitude and longitude are represented in THOUSANDS and HUNDREDS of feet above mean sea level. The MEF is based on information available concerning the highest known feature in each quadrangle, including terrain and obstructions (trees, towers, antennas, etc.).

Example: 12,500 feet **125**

LEGEND 1.—SECTIONAL AERONAUTICAL CHART.

2

**DIRECTORY LEGEND
SAMPLE**

1 3 4 5 6 7

CITY NAME
AIRPORT NAME (ORL) 4 E UTC-5(-4DT) N28°32.72' W81°21.17' JACKSONVILLE
 200 B S4 FUEL 100. JET A OX 1. 2.3 TPA-1000(800) AOE ARFF Index A Not insp. COPTER
 H-4G, L-19C
 IAP

9 10 11 12 13 14 15 16 17 8

18 → RWY 07-25: H6000X150 (ASPH-PFC) S-90, D-160, DT-300-PCN 80 R/B/W/T HIRL CL 0.4% up E
 RWY 07: ALSF1. Trees. RWY 25: REIL. Rgt tfc.
 RWY 13-31: H4620X100 (ASPH) HIRL
 RWY 13: SAVASI(S2L)—GA 3.3° TCH 89'. Pole. RWY 31: PAPI(P2L)—GA 3.1° TCH 36'. Tree. Rgt tfc.
RUNWAY DECLARED DISTANCE INFORMATION
 RWY 07: TORA-6000 TODA-6700 ASDA-5700 LDA-5500
 RWY 25: TORA-6000 TODA-6000 ASDA-6000 LDA-5700

19 → **AIRPORT REMARKS:** Special Air Traffic Rules—Part 93, see Regulatory Notices. Attended 1200-0300Z†. Parachute
 Jumping. CAUTION cattle and deer on arpt. Acft 100,000 lbs or over ctc Director of Aviation for approval
 305-894-9831. Fee for all airline charters, travel clubs and certain revenue producing acft. Flight Notification
 Service (ADCUS) available.

20 → **WEATHER DATA SOURCES:** AWOS-1 120.3 (202) 426-8000. LLWAS.

21 → **COMMUNICATIONS:** ATIS 127.25 UNICOM 122.95
 NAME FSS (ORL) on arpt. 123.65 122.65 122.2. TF 1-800-WX-BRIEF. NOTAM FILE ORL. ← 2
 NAME APP/DEP CON 128.35 (1200-0400Z†)

22 → TOWER 118.7 GND CON 121.7 CLNC DEL 125.55 PRE TAXI CLNC 125.5

23 → **AIRSPACE:** CLASS B See VFR Terminal Area Chart.
RADIO AIDS TO NAVIGATION: NOTAM FILE MCO. VHF/DF ctc FSS.
 (H) ABVORTAC 112.2 MCO Chan 59 N28°32.55' W81°20.12' at fld. 1110/8E.
 TWEB avbl 1300-0100Z†. VOR unusable 050°-060° beyond 15 NM below 5000'.
 HERNY NDB (LOM) 221 OR N28°30.40' W81°26.05' 067° 5.4 NM to fld.
 ILS 109.9 I-ORL Rwy 07. LOM HERNY NDB.
 ASR/PAR (1200-0400Z†)

24 → **COMM/NAVAID REMARKS:** Emerg frequency 121.5 not available at tower.
 HELIPAD H1: H100X75 (ASPH)
 HELIPAD H2: H60X60 (ASPH)
 HELIPORT REMARKS: Helipad H1 lctd on general aviation side and H2 lctd on air carrier side of arpt.
 187 TPA 1000(813)
 WATERWAY 13-31: 5000X300 (WATER)
SEAPLANE REMARKS: Birds roosting and feeding areas along river banks. Seaplanes operating adjacent to NE side of
 arpt not visible from twr and are required to ctc twr.

D AIRPORT NAME (MCO) 6 SE UTC-5(-4DT) N28°25.88' W81°19.48' JACKSONVILLE
 96 B FUEL 100. JET A. MOGAS LRA H-4G, L-19C
 RWY 18R-36L: H12004X300 (CONC-GRVD) S-100, D-200, DT-400 HIRL IAP
 RWY 18R: ALSF1. REIL. Rgt tfc. 0.3% up. RWY 36L: ALSF1. 0.4% down.
 RWY 18L-36R: H12004X200 (ASPH) S-165, D-200, DT-400 HIRL
 RWY 18L: LDIN. ALSF1. TDZL. REIL. VASI(V4L)—GA 3.5° TCH 36'. Thld dspldc 300'. Trees. Rgt tfc. Arresting device.
AIRPORT REMARKS: Attended 1200-0300Z†. ACTIVE HIRL Rwy 18L-36R—CTAF.
COMMUNICATIONS: CTAF 124.3 ATIS 127.75 UNICOM 122.8
 NAME FSS (MCO) TF 1-800-WX-BRIEF. LC 894-0869. NOTAM FILE MCO.
 NAME RCD 122.4 112.2T 122.1R (NAME FSS)
 APP CON 124.8 (337°-179°) 120.1 (180°-336°) DEP CON 120.15
 TOWER 124.3 NFCT (1200-0400Z†) GND CON 121.85 CLNC DEL 134.7
AIRSPACE: CLASS D svc 1200-0400Z† other times CLASS E.
RADIO AIDS TO NAVIGATION: NOTAM FILE MCO.
 (H) VORTAC 112.2 MCO Chan 59 N28°32.55' W81°20.12' 173° 5.7 NM to fld. 1110/8E. HIWAS.
 MLS Chan 514 Rwy 36R.

All Bearings and Radials are Magnetic unless otherwise specified.
 All mileages are nautical unless otherwise noted.
 All times are UTC except as noted.
 The horizontal reference datum of this publication is North American Datum of 1983 (NAD83), which for charting purposes
 is considered equivalent to World Geodetic System 1984 (WGS 84).

LEGEND 2.—Airport/Facility Directory.

DIRECTORY LEGEND

3

LEGEND

This Directory is an alphabetical listing of data on record with the FAA on all airports that are open to the public, associated terminal control facilities, air route traffic control centers and radio aids to navigation within the conterminous United States, Puerto Rico and the Virgin Islands. Airports are listed alphabetically by associated city name and cross referenced by airport name. Facilities associated with an airport, but with a different name, are listed individually under their own name, as well as under the airport with which they are associated.

The listing of an airport in this directory merely indicates the airport operator's willingness to accommodate transient aircraft, and does not represent that the facility conforms with any Federal or local standards, or that it has been approved for use on the part of the general public.

The information on obstructions is taken from reports submitted to the FAA. It has not been verified in all cases. Pilots are cautioned that objects not indicated in this tabulation (or on charts) may exist which can create a hazard to flight operation.

Detailed specifics concerning services and facilities tabulated within this directory are contained in Aeronautical Information Manual, Basic Flight Information and ATC Procedures.

The legend items that follow explain in detail the contents of this Directory and are keyed to the circled numbers on the sample on the preceding page.

① CITY/AIRPORT NAME

Airports and facilities in this directory are listed alphabetically by associated city and state. Where the city name is different from the airport name the city name will appear on the line above the airport name. Airports with the same associated city name will be listed alphabetically by airport name and will be separated by a dashed rule line. All others will be separated by a solid rule line. (Designated Helipads and Seaplane Landing Areas (Water) associated with a land airport will be separated by a dotted line.)

② NOTAM SERVICE

All public use landing areas are provided NOTAM "D" (distant dissemination) and NOTAM "L" (local dissemination) service. Airport NOTAM file identifier is shown following the associated FSS data for individual airports, e.g. "NOTAM FILE IAD". See AIM, Basic Flight Information and ATC Procedures for detailed description of NOTAM's.

③ LOCATION IDENTIFIER

A three or four character code assigned to airports. These identifiers are used by ATC in lieu of the airport name in flight plans, flight strips and other written records and computer operations.

④ AIRPORT LOCATION

Airport location is expressed as distance and direction from the center of the associated city in nautical miles and cardinal points, i.e., 4 NE.

⑤ TIME CONVERSION

Hours of operation of all facilities are expressed in Coordinated Universal Time (UTC) and shown as "Z" time. The directory indicates the number of hours to be subtracted from UTC to obtain local standard time and local daylight saving time UTC-5(-4DT). The symbol ‡ indicates that during periods of Daylight Saving Time effective hours will be one hour earlier than shown. In those areas where daylight saving time is not observed that (-4DT) and ‡ will not be shown. All states observe daylight savings time except Arizona, Hawaii and that portion of Indiana in the Eastern Time Zone and Puerto Rico and the Virgin Islands.

⑥ GEOGRAPHIC POSITION OF AIRPORT

Positions are shown in degrees, minutes and hundredths of a minute and represent the approximate center of mass of all usable runways.

⑦ CHARTS

The Sectional Chart and Low and High Altitude Enroute Chart and panel on which the airport or facility is located. Helicopter Chart locations will be indicated as, i.e., COPTER.

⑧ INSTRUMENT APPROACH PROCEDURES

IAP indicates an airport for which a prescribed (Public Use) FAA Instrument Approach Procedure has been published.

⑨ ELEVATION

The highest point of an airport's usable runways measured in feet from mean sea level. When elevation is sea level it will be indicated as (00). When elevation is below sea level a minus (-) sign will precede the figure.

⑩ ROTATING LIGHT BEACON

R indicates rotating beacon is available. Rotating beacons operate dusk to dawn unless otherwise indicated in AIRPORT REMARKS.

⑪ SERVICING

S1: Minor airframe repairs.

S3: Major airframe and minor powerplant repairs.

S2: Minor airframe and minor powerplant repairs.

S4: Major airframe and major powerplant repairs.

LEGEND 3.—Airport/Facility Directory.

4

DIRECTORY LEGEND

12 FUEL

CODE	FUEL	CODE	FUEL
80	Grade 80 gasoline (Red)	B	Jet B—Wide-cut turbine fuel. freeze point-50° C.
100	Grade 100 gasoline (Green)	B+	Jet B—Wide-cut turbine fuel with icing inhibitor. freeze point-50° C.
100LL	100LL gasoline (low lead) (Blue)	MOGAS	Automobile gasoline which is to be used as aircraft fuel.
115	Grade 115 gasoline		
A	Jet A—Kerosene freeze point-40° C.		
A1	Jet A-1—Kerosene freeze point-50° C.		
A1+	Jet A-1—Kerosene with icing inhibitor. freeze point-50° C.		

NOTE: Automobile Gasoline. Certain automobile gasoline may be used in specific aircraft engines if a FAA supplemental type certificate has been obtained. Automobile gasoline which is to be used in aircraft engines will be identified as "MOGAS", however, the grade/type and other octane rating will not be published.

Data shown on fuel availability represents the most recent information the publisher has been able to acquire. Because of a variety of factors, the fuel listed may not always be obtainable by transient civil pilots. Confirmation of availability of fuel should be made directly with fuel dispensers at locations where refueling is planned.

13 OXYGEN

OX 1	High Pressure	OX 3	High Pressure—Replacement Bottles
OX 2	Low Pressure	OX 4	Low Pressure—Replacement Bottles

14 TRAFFIC PATTERN ALTITUDE

Traffic Pattern Altitude (TPA)—The first figure shown is TPA above mean sea level. The second figure in parentheses is TPA above airport elevation.

15 AIRPORT OF ENTRY, LANDING RIGHTS, AND CUSTOMS USER FEE AIRPORTS

U.S. CUSTOMS USER FEE AIRPORT—Private Aircraft operators are frequently required to pay the costs associated with customs processing.

AOE—Airport of Entry—A customs Airport of Entry where permission from U.S. Customs is not required, however, at least one hour advance notice of arrival must be furnished.

LRA—Landing Rights Airport—Application for permission to land must be submitted in advance to U.S. Customs. At least one hour advance notice of arrival must be furnished.

NOTE: Advance notice of arrival at both an AOE and LRA airport may be included in the flight plan when filed in Canada or Mexico, where Flight Notification Service (ADCUS) is available the airport remark will indicate this service. This notice will also be treated as an application for permission to land in the case of an LRA. Although advance notice of arrival may be relayed to Customs through Mexico, Canadian, and U.S. Communications facilities by flight plan, the aircraft operator is solely responsible for insuring that Customs receives the notification. (See Customs, Immigration and Naturalization, Public Health and Agriculture Department requirements in the International Flight Information Manual for further details.)

16 CERTIFICATED AIRPORT (FAR 139)

Airports serving Department of Transportation certified carriers and certified under FAR, Part 139, are indicated by the ARFF index; i.e., ARFF Index A, which relates to the availability of crash, fire, rescue equipment.

FAR-PART 139 CERTIFICATED AIRPORTS

INDICES AND AIRCRAFT RESCUE AND FIRE FIGHTING EQUIPMENT REQUIREMENTS

Airport Index	Required No. Vehicles	Aircraft Length	Scheduled Departures	Agent + Water for Foam
A	1	<90'	≥1	500#DC or HALON 1211 or 450#DC + 100 gal H ₂ O
B	1 or 2	≥90', <126' ----- ≥126', <159'	≥5 ----- <5	Index A + 1500 gal H ₂ O
C	2 or 3	≥126', <159' ----- ≥159', <200'	≥5 ----- <5	Index A + 3000 gal H ₂ O
D	3	≥159', <200' >200'	≥5 <5	Index A + 4000 gal H ₂ O
E	3	≥200'	≥5	Index A + 6000 gal H ₂ O

> Greater Than; < Less Than; ≥ Equal or Greater Than; ≤ Equal or Less Than; H₂O—Water; DC—Dry Chemical.

NOTE: The listing of ARFF index does not necessarily assure coverage for non-air carrier operations or at other than prescribed times for air carrier. ARFF Index Ltd.—indicates ARFF coverage may or may not be available, for information contact airport manager prior to flight.

LEGEND 4.—Airport/Facility Directory.

DIRECTORY LEGEND

5

17 FAA INSPECTION

All airports not inspected by FAA will be identified by the note: Not insp. This indicates that the airport information has been provided by the owner or operator of the field.

18 RUNWAY DATA

Runway information is shown on two lines. That information common to the entire runway is shown on the first line while information concerning the runway ends are shown on the second or following line. Lengthy information will be placed in the Airport Remarks.

Runway direction, surface, length, width, weight bearing capacity, lighting, slope and appropriate remarks are shown for each runway. Direction, length, width, lighting and remarks are shown for sealanes. The full dimensions of helipads are shown. i.e., 50X150.

RUNWAY SURFACE AND LENGTH

Runway lengths prefixed by the letter "H" indicate that the runways are hard surfaced (concrete, asphalt). If the runway length is not prefixed, the surface is sod, clay, etc. The runway surface composition is indicated in parentheses after runway length as follows:

(AFSC)—Aggregate friction seal coat	(GRVD)—Grooved	(RFSC)—Rubberized friction seal coat
(ASPH)—Asphalt	(GRVL)—Gravel, or cinders	(TURF)—Turf
(CONC)—Concrete	(PFC)—Porous friction courses	(TRTD)—Treated
(DIRT)—Dirt	(PSP)—Pierced steel plank	(WC)—Wire combed

RUNWAY WEIGHT BEARING CAPACITY

Runway strength data shown in this publication is derived from available information and is a realistic estimate of capability at an average level of activity. It is not intended as a maximum allowable weight or as an operating limitation. Many airport pavements are capable of supporting limited operations with gross weights of 25-50% in excess of the published figures. Permissible operating weights, insofar as runway strengths are concerned, are a matter of agreement between the owner and user. When desiring to operate into any airport at weights in excess of those published in the publication, users should contact the airport management for permission. Add 000 to figure following S, D, DT, DDT, AUW, etc., for gross weight capacity:

- S—Single-wheel type landing gear. (DC-3), (C-47), (F-15), etc.
- D—Dual-wheel type landing gear. (DC-6), etc.
- T—Twin-wheel type landing gear. (DC-6), (C-9A), etc.
- ST—Single-tandem type landing gear. (C-130).
- SBTT—Single-belly twin tandem landing gear (KC-10).
- DT—Dual-tandem type landing gear. (707), etc.
- TT—Twin-tandem type (includes quadricycle) landing gear (707), (B-52), (C-135), etc.
- TRT—Triple-tandem landing gear. (C-17)
- DDT—Double dual-tandem landing gear. (E4A/747).
- TDT—Twin delta-tandem landing gear. (C-5, Concorde).
- AUW—All up weight. Maximum weight bearing capacity for any aircraft irrespective of landing gear configuration.
- SWL—Single Wheel Loading. (This includes information submitted in terms of Equivalent Single Wheel Loading (ESWL) and Single Isolated Wheel Loading). SWL figures are shown in thousands of pounds with the last three figures being omitted.
- PSI—Pounds per square inch. PSI is the actual figure expressing maximum pounds per square inch runway will support. e.g., (SWL 000/PSI 535).

Quadricycle and dual-tandem are considered virtually equal for runway weight bearing consideration, as are single-tandem and dual-wheel. Omission of weight bearing capacity indicates information unknown.

The ACN/PCN System is the ICAO method of reporting pavement strength for pavements with bearing strengths greater than 12,500 pounds. The Pavement Classification Number (PCN) is established by an engineering assessment of the runway. The PCN is for use in conjunction with an Aircraft Classification Number (ACN). Consult the Aircraft Flight Manual or other appropriate source for ACN tables or charts. Currently, ACN data may not be available for all aircraft. If an ACN table or chart is available, the ACN can be calculated by taking into account the aircraft weight, the pavement type, and the subgrade category. For runways that have been evaluated under the ACN/PCN system, the PCN will be shown as a five part code (e.g. PCN 80 R/B/W/T). Details of the coded format are as follows:

- (1) The PCN NUMBER—The reported PCN indicates that an aircraft with an ACN equal or less than the reported PCN can operate on the pavement subject to any limitation on the tire pressure.
- (2) The type of pavement:
 - R — Rigid
 - F — Flexible
- (3) The pavement subgrade category:
 - A — High
 - B — Medium
 - C — Low
 - D — Ultra-low
- (4) The maximum tire pressure authorized for the pavement:
 - W — High, no limit
 - X — Medium, limited to 217 psi
 - Y — Low, limited to 145 psi
 - Z — Very low, limited to 73 psi
- (5) Pavement evaluation method:
 - T — Technical evaluation
 - U — By experience of aircraft using the pavement

NOTE: Prior permission from the airport controlling authority is required when the ACN of the aircraft exceeds the published PCN or aircraft tire pressure exceeds the published limits.

LEGEND 5.—Airport/Facility Directory.

6

DIRECTORY LEGEND

RUNWAY LIGHTING

Lights are in operation sunset to sunrise. Lighting available by prior arrangement only or operating part of the night only and/or pilot controlled and with specific operating hours are indicated under airport remarks. Since obstructions are usually lighted, obstruction lighting is not included in this code. Unlighted obstructions on or surrounding an airport will be noted in airport remarks. Runway lights nonstandard (NSTD) are systems for which the light fixtures are not FAA approved L-800 series; color, intensity, or spacing does not meet FAA standards. Nonstandard runway lights, VASI, or any other system not listed below will be shown in airport remarks.

Temporary, emergency or limited runway edge lighting such as flares, smudge pots, lanterns or portable runway lights will also be shown in airport remarks. Types of lighting are shown with the runway or runway end they serve.

NSTD—Light system fails to meet FAA standards.

LIRL—Low Intensity Runway Lights

MIRL—Medium Intensity Runway Lights

HIRL—High Intensity Runway Lights

RAIL—Runway Alignment Indicator Lights

REIL—Runway End Identifier Lights

CL—Centerline Lights

TDZL—Touchdown Zone Lights

ODALS—Omni Directional Approach Lighting System.

AF OVRN—Air Force Overrun 1000' Standard

Approach Lighting System.

LDIN—Lead-In Lighting System.

MALS—Medium Intensity Approach Lighting System.

MALSF—Medium Intensity Approach Lighting System with Sequenced Flashing Lights.

MALSR—Medium Intensity Approach Lighting System with Runway Alignment Indicator Lights.

NOTE: Civil ALSF 2 may be operated as SSALR during favorable weather conditions.

SALS—Short Approach Lighting System.

SALSF—Short Approach Lighting System with Sequenced Flashing Lights.

SSALS—Simplified Short Approach Lighting System.

SSALF—Simplified Short Approach Lighting System with Sequenced Flashing Lights.

SSALR—Simplified Short Approach Lighting System with Runway Alignment Indicator Lights.

ALSAF—High Intensity Approach Lighting System with Sequenced Flashing Lights

ALSF1—High Intensity Approach Lighting System with Sequenced Flashing Lights, Category I, Configuration.

ALSF2—High Intensity Approach Lighting System with Sequenced Flashing Lights, Category II, Configuration.

VASI—Visual Approach Slope Indicator System.

VISUAL GLIDESLOPE INDICATORS

APAP—A system of panels, which may or may not be lighted, used for alignment of approach path.

PNIL APAP on left side of runway

PNIR APAP on right side of runway

PAPI—Precision Approach Path Indicator

P2L 2-identical light units placed on left side of runway

P4L 4-identical light units placed on left side of runway

P2R 2-identical light units placed on right side of runway

P4R 4-identical light units placed on right side of runway

PVASI—Pulsating/steady burning visual approach slope indicator, normally a single light unit projecting two colors.

PSIL PVASI on left side of runway

PSIR PVASI on right side of runway

SAVASI—Simplified Abbreviated Visual Approach Slope Indicator

S2L 2-box SAVASI on left side of runway

S2R 2-box SAVASI on right side of runway

TRCV—Tri-color visual approach slope indicator, normally a single light unit projecting three colors.

TRIL TRCV on left side of runway

TRIR TRCV on right side of runway

VASI—Visual Approach Slope Indicator

V2L 2-box VASI on left side of runway

V6L 6-box VASI on left side of runway

V2R 2-box VASI on right side of runway

V6R 6-box VASI on right side of runway

V4L 4-box VASI on left side of runway

V12 12-box VASI on both sides of runway

V4R 4-box VASI on right side of runway

V16 16-box VASI on both sides of runway

NOTE: Approach slope angle and threshold crossing height will be shown when available; i.e., -GA 3.5° TCH 37'.

PILOT CONTROL OF AIRPORT LIGHTING

Key Mike

7 times within 5 seconds

5 times within 5 seconds

3 times within 5 seconds

Function

Highest intensity available

Medium or lower intensity (Lower REIL or REIL-Off)

Lowest intensity available (Lower REIL or REIL-Off)

Available systems will be indicated in the Airport Remarks, as follows:

ACTIVATE MALSR Rwy 07, HIRL Rwy 07-25-122.8 (or CTAF).

or

ACTIVATE MIRL Rwy 18-36-122.8 (or CTAF).

or

ACTIVATE VASI and REIL, Rwy 07-122.8 (or CTAF).

Where the airport is not served by an instrument approach procedure and/or has an independent type system of different specification installed by the airport sponsor, descriptions of the type lights, method of control, and operating frequency will be explained in clear text. See AIM, "Basic Flight Information and ATC Procedures," for detailed description of pilot control of airport lighting.

RUNWAY SLOPE

Runway slope will be shown only when it is 0.3 percent or more. On runways less than 8000 feet: When available the direction of the slope upward will be indicated, i.e., 0.3% up NW. On runways 8000 feet or greater: When available the slope will be shown on the runway end line, i.e., RWY 13: 0.3% up., RWY 21: Pole. Rgt t/c. 0.4% down.

RUNWAY END DATA

Lighting systems such as VASI, MALSR, REIL; obstructions; displaced thresholds will be shown on the specific runway end. "Rgt t/c"—Right traffic indicates right turns should be made on landing and takeoff for specified runway end.

LEGEND 6.—Airport/Facility Directory.

DIRECTORY LEGEND

7

RUNWAY DECLARED DISTANCE INFORMATION

TORA—Take-off Run Available
 TODA—Take-off Distance Available
 ASDA—Accelerate-Stop Distance Available
 LDA—Landing Distance Available

19 AIRPORT REMARKS

Landing Fee indicates landing charges for private or non-revenue producing aircraft, in addition, fees may be charged for planes that remain over a couple of hours and buy no services, or at major airline terminals for all aircraft.

Remarks—Data is confined to operational items affecting the status and usability of the airport.

Parachute Jumping.—See "PARACHUTE" tabulation for details.

Unless otherwise stated, remarks including runway ends refer to the runway's approach end.

20 WEATHER DATA SOURCES

ASOS—Automated Surface Observing System. Reports the same as an AWOS-3 plus precipitation identification and intensity, and freezing rain occurrence (future enhancement).

AWOS—Automated Weather Observing System

AWOS A—reports altimeter setting.

AWOS-1—reports altimeter setting, wind data and usually temperature, dewpoint and density altitude.

AWOS-2—reports the same as AWOS-1 plus visibility.

AWOS-3—reports the same as AWOS-1 plus visibility and cloud/ceiling data.

See AIM, Basic Flight Information and ATC Procedures for detailed description of AWOS.

HIWAS—See RADIO AIDS TO NAVIGATION

LAWRS—Limited Aviation Weather Reporting Station where observers report cloud height, weather, obstructions to vision, temperature and dewpoint (in most cases), surface wind, altimeter and pertinent remarks.

LLWAS—indicates a Low Level Wind Shear Alert System consisting of a center field and several field perimeter anemometers.

SAWRS—identifies airports that have a Supplemental Aviation Weather Reporting Station available to pilots for current weather information.

SWSL—Supplemental Weather Service Location providing current local weather information via radio and telephone.

21 COMMUNICATIONS

Communications will be listed in sequence in the order shown below:

Common Traffic Advisory Frequency (CTAF), Automatic Terminal Information Service (ATIS) and Aeronautical Advisory Stations (UNICOM) along with their frequency is shown, where available, on the line following the heading "COMMUNICATIONS." When the CTAF and UNICOM is the same frequency, the frequency will be shown as CTAF/UNICOM freq.

Flight Service Station (FSS) information. The associated FSS will be shown followed by the identifier and information concerning availability of telephone service, e.g., Direct Line (DL), Local Call (LC-384-2341), Toll free call, dial (TF 800-852-7036 or TF 1-800-227-7160), Long Distance (LD 202-426-8800 or LD 1-202-555-1212) etc. The airport NOTAM file identifier will be shown as "NOTAM FILE IAD." Where the FSS is located on the field it will be indicated as "on arpt" following the identifier. Frequencies available will follow. The FSS telephone number will follow along with any significant operational information. FSS's whose name is not the same as the airport on which located will also be listed in the normal alphabetical name listing for the state in which located. Remote Communications Outlet (RCO) providing service to the airport followed by the frequency and name of the Controlling FSS.

FSS's provide information on airport conditions, radio aids and other facilities, and process flight plans. Local Airport Advisory Service is provided on the CTAF by FSS's located at non-tower airports or airports where the tower is not in operation.

(See AIM, Par. 157/158 Traffic Advisory Practices at airports where a tower is not in operation or AC 90-42C.)

Aviation weather briefing service is provided by FSS specialists. Flight and weather briefing services are also available by calling the telephone numbers listed.

Remote Communications Outlet (RCO)—An unmanned air/ground communications facility, remotely controlled and providing UHF or VHF communications capability to extend the service range of an FSS.

Civil Communications Frequencies—Civil communications frequencies used in the FSS air/ground system are now operated simplex on 122.0, 122.2, 122.3, 122.4, 122.6, 123.6; emergency 121.5; plus receive-only on 122.05, 122.1, 122.15, and 123.6.

- a. 122.0 is assigned as the Enroute Flight Advisory Service channel at selected FSS's.
- b. 122.2 is assigned to most FSS's as a common enroute simplex service.
- c. 123.6 is assigned as the airport advisory channel at non-tower FSS locations, however, it is still in commission at some FSS's collocated with towers to provide part time Local Airport Advisory Service.
- d. 122.1 is the primary receive-only frequency at VOR's. 122.05, 122.15 and 123.6 are assigned at selected VOR's meeting certain criteria.
- e. Some FSS's are assigned 50 kHz channels for simplex operation in the 122-123 MHz band (e.g. 122.35). Pilots using the FSS A/G system should refer to this directory or appropriate charts to determine frequencies available at the FSS or remotd facility through which they wish to communicate.

Part time FSS hours of operation are shown in remarks under facility name.

Emergency frequency 121.5 is available at all Flight Service Stations, Towers, Approach Control and RADAR facilities, unless indicated as not available.

Frequencies published followed by the letter "T" or "R", indicate that the facility will only transmit or receive respectively on that frequency. All radio aids to navigation frequencies are transmit only.

LEGEND 7.—Airport/Facility Directory.

DIRECTORY LEGEND

TERMINAL SERVICES

CTAF—A program designed to get all vehicles and aircraft at uncontrolled airports on a common frequency.
 ATIS—A continuous broadcast of recorded non-control information in selected areas of high activity.
 UNICOM—A non-government air/ground radio communications facility utilized to provide general airport advisory service.
 APP CON —Approach Control. The symbol **(R)** indicates radar approach control.
 TOWER—Control tower
 GND CON—Ground Control
 DEP CON—Departure Control. The symbol **(R)** indicates radar departure control.
 CLNC DEL—Clearance Delivery.
 PRE TAXI CLNC—Pre taxi clearance
 VFR ADVSY SVC—VFR Advisory Service. Service provided by Non-Radar Approach Control.
 Advisory Service for VFR aircraft (upon a workload basis) ctc APP CON.
 TOWER, APP CON and DEP CON RADIO CALL will be the same as the airport name unless indicated otherwise.

(22) AIRSPACE

CLASS B—Radar Sequencing and Separation Service for all aircraft in CLASS B airspace
 TRSA—Radar Sequencing and Separation Service for participating VFR Aircraft within a Terminal Radar Service Area
 Class C, D, and E airspace described in this publication is that airspace usually consisting of a 5 NM radius core surface area that begins at the surface and extends upward to an altitude above the airport elevation (charted in MSL for Class C and Class D).
 When CLASS C airspace defaults to CLASS E, the core surface area becomes CLASS E. This will be formatted as: **AIRSPACE: CLASS C** svc "times" ctc **APP CON** other times CLASS E.
 When Class C airspace defaults to Class G, the core surface area becomes Class G up to but not including the overlying controlled airspace. There are Class E airspace areas beginning at either 700' or 1200' AGL used to transition to/from the terminal or enroute environment. This will be formatted as: **AIRSPACE: CLASS C** svc "times" ctc **APP CON** other times CLASS G, CLASS E 700' (or 1200') AGL & abv.
NOTE: AIRSPACE SVC EFF "TIMES" INCLUDE ALL ASSOCIATED EXTENSIONS. Arrival extensions for instrument approach procedures become part of the primary core surface area. These extensions may be either Class D or Class E airspace and are effective concurrent with the times of the primary core surface area.

(See CLASS AIRSPACE in the Aeronautical Information Manual for further details)

(23) RADIO AIDS TO NAVIGATION

The Airport Facility Directory lists by facility name all Radio Aids to Navigation, except Military TACANS, that appear on National Ocean Service Visual or IFR Aeronautical Charts and those upon which the FAA has approved an Instrument Approach Procedure. All VOR, VORTAC ILS and MLS equipment in the National Airspace System has an automatic monitoring and shutdown feature in the event of malfunction. Unmonitored, as used in this publication for any navigational aid, means that FSS or tower personnel cannot observe the malfunction or shutdown signal. The NAVAID NOTAM file identifier will be shown as "NOTAM FILE IAD" and will be listed on the Radio Aids to Navigation line. When two or more NAVAIDS are listed and the NOTAM file identifier is different than shown on the Radio Aids to Navigation line, then it will be shown with the NAVAID listing. NOTAM file identifiers for ILS's and their components (e.g., NDB (LOM) are the same as the identifiers for the associated airports and are not repeated. Hazardous Inflight Weather Advisory Service (HIWAS) will be shown where this service is broadcast over selected VOR's.
 NAVAID information is tabulated as indicated in the following sample:

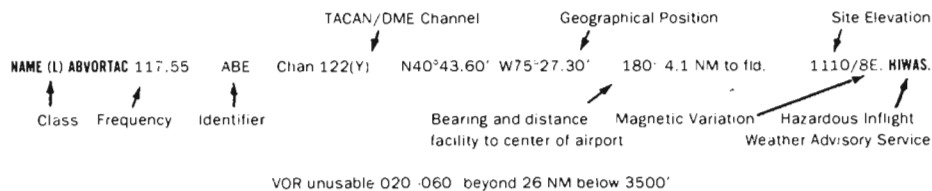

Restriction within the normal altitude/range of the navigational aid (See primary alphabetical listing for restrictions on VORTAC and VOR/DME).

Note: Those DME channel numbers with a (Y) suffix require TACAN to be placed in the "Y" mode to receive distance information.

HIWAS—Hazardous Inflight Weather Advisory Service is a continuous broadcast of inflight weather advisories including summarized SIGMETs, convective SIGMETs, AIRMETs and urgent PIREPs. HIWAS is presently broadcast over selected VOR's and will be implemented throughout the conterminous U.S.

ASR/PAR—Indicates that Surveillance (ASR) or Precision (PAR) radar instrument approach minimums are published in the U.S. Terminal Procedures. Only part-time hours of operation will be shown.

LEGEND 8.—Airport/Facility Directory.

DIRECTORY LEGEND

9

RADIO CLASS DESIGNATIONS

VOR/DME/TACAN Standard Service Volume (SSV) Classifications

<u>SSV Class</u>	<u>Altitudes</u>	<u>Distance (NM)</u>
(T) Terminal	1000' to 12,000'	25
(L) Low Altitude	1000' to 18,000'	40
(H) High Altitude	1000' to 14,500'	40
	14,500' to 18,000'	100
	18,000' to 45,000'	130
	45,000' to 60,000'	100

NOTE: Additionally, (H) facilities provide (L) and (T) service volume and (L) facilities provide (T) service. Altitudes are with respect to the station's site elevation. Coverage is not available in a cone of airspace directly above the facility.

The term VOR is, operationally, a general term covering the VHF omnidirectional bearing type of facility without regard to the fact that the power, the frequency protected service volume, the equipment configuration, and operational requirements may vary between facilities at different locations.

AB _____	Automatic Weather Broadcast
DF _____	Direction Finding Service.
DME _____	UHF standard (TACAN compatible) distance measuring equipment.
DME(Y) _____	UHF standard (TACAN compatible) distance measuring equipment that require TACAN to be placed in the "Y" mode to receive DME.
H _____	Non-directional radio beacon (homing), power 50 watts to less than 2,000 watts (50 NM at all altitudes).
HH _____	Non-directional radio beacon (homing), power 2,000 watts or more (75 NM at all altitudes).
H-SAB _____	Non-directional radio beacons providing automatic transcribed weather service.
ILS _____	Instrument Landing System (voice, where available, on localizer channel).
ISMLS _____	Interim Standard Microwave Landing System.
LDA _____	Localizer Directional Aid.
LMM _____	Compass locator station when installed at middle marker site (15 NM at all altitudes).
LOM _____	Compass locator station when installed at outer marker site (15 NM at all altitudes).
MH _____	Non-directional radio beacon (homing) power less than 50 watts (25 NM at all altitudes).
MLS _____	Microwave Landing System
S _____	Simultaneous range homing signal and/or voice.
SABH _____	Non-directional radio beacon not authorized for IFR or ATC. Provides automatic weather broadcasts.
SDF _____	Simplified Direction Facility.
TACAN _____	UHF navigational facility-omnidirectional course and distance information.
VOR _____	VHF navigational facility-omnidirectional course only.
VOR/DME _____	Collocated VOR navigational facility and UHF standard distance measuring equipment.
VORTAC _____	Collocated VOR and TACAN navigational facilities.
W _____	Without voice on radio facility frequency.
Z _____	VHF station location marker at a LF radio facility.

LEGEND 9.—Airport/Facility Directory.

APPENDIX 2

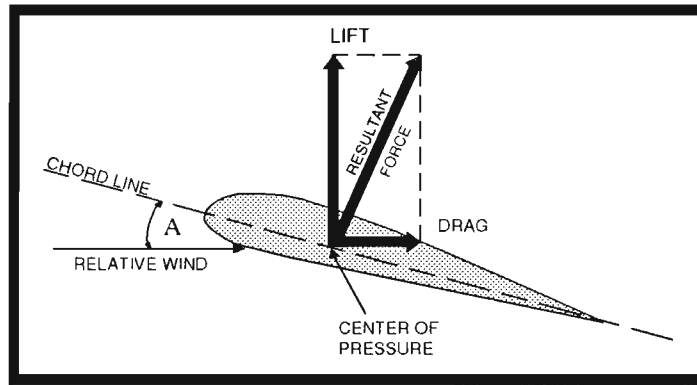

FIGURE 1.—Lift Vector.

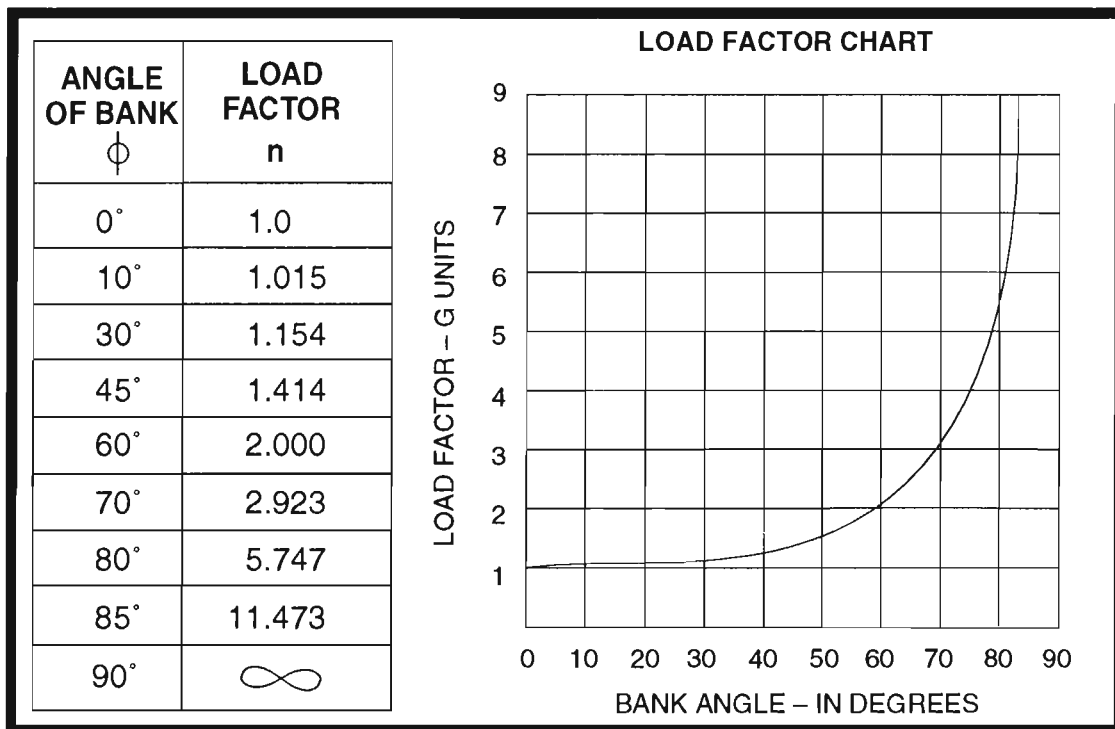

FIGURE 2.—Load Factor Chart.

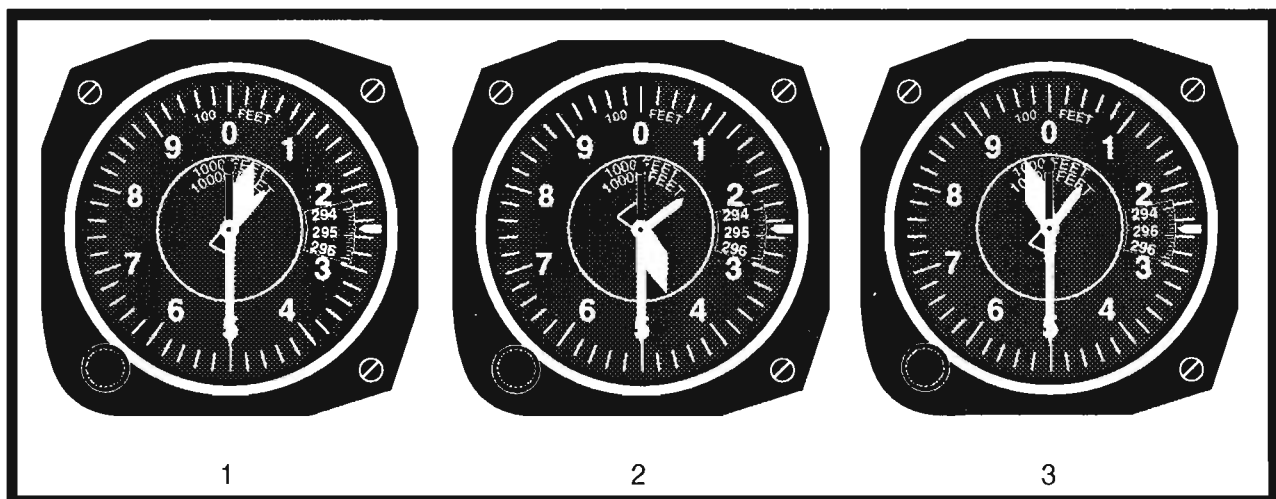

FIGURE 3.—Altimeter.



FIGURE 4.—Airspeed Indicator.

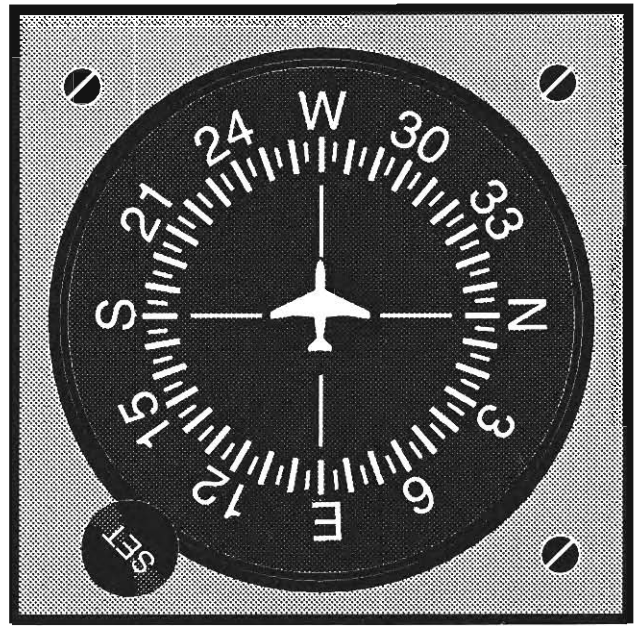

FIGURE 6.—Heading Indicator.



FIGURE 5.—Turn Coordinator.

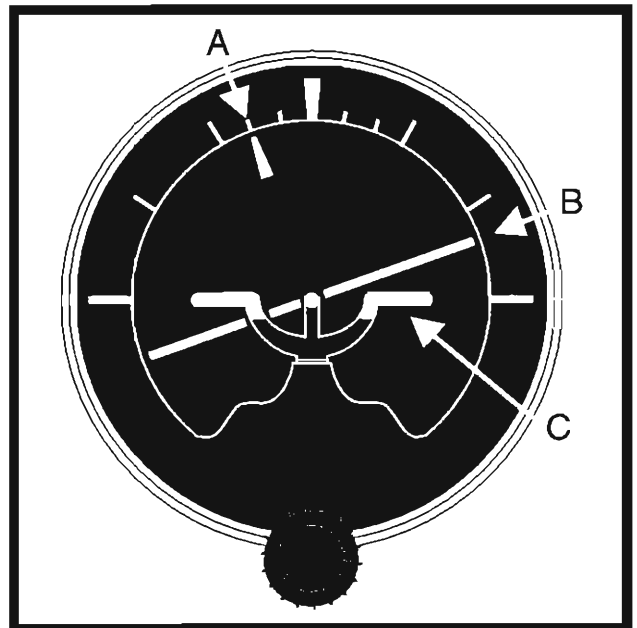

FIGURE 7.—Attitude Indicator.

DENSITY ALTITUDE CHART

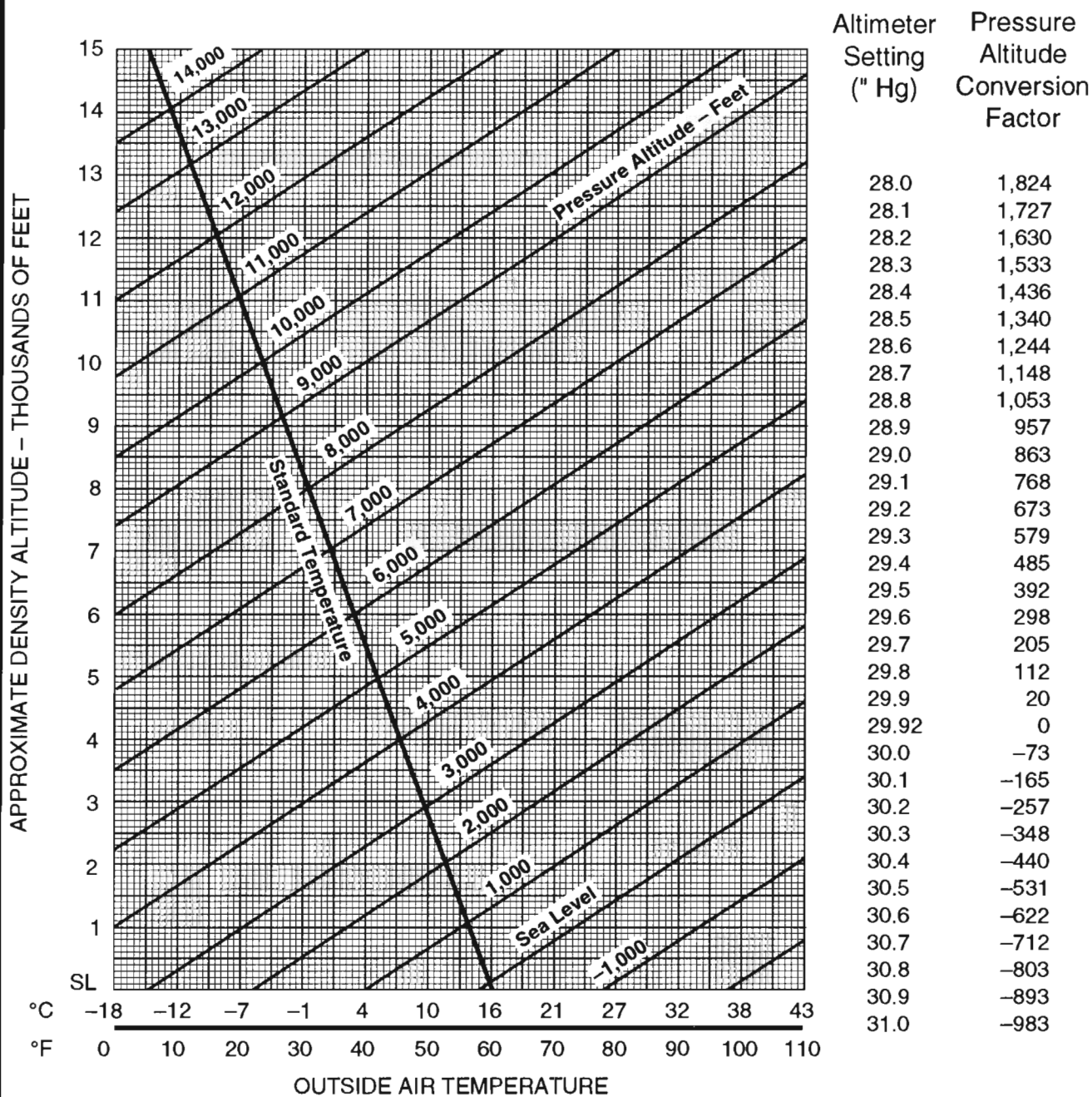

FIGURE 8.—Density Altitude Chart.

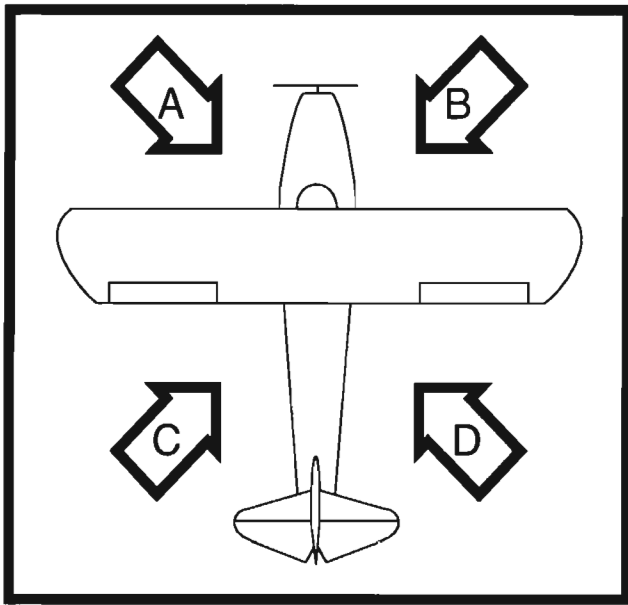

FIGURE 9.—Control Position for Taxi.

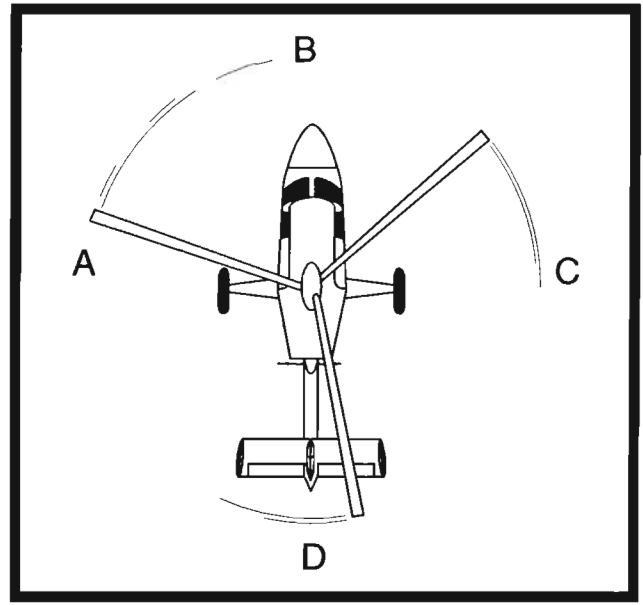

FIGURE 10.—Gyroplane Rotor Blade Position.

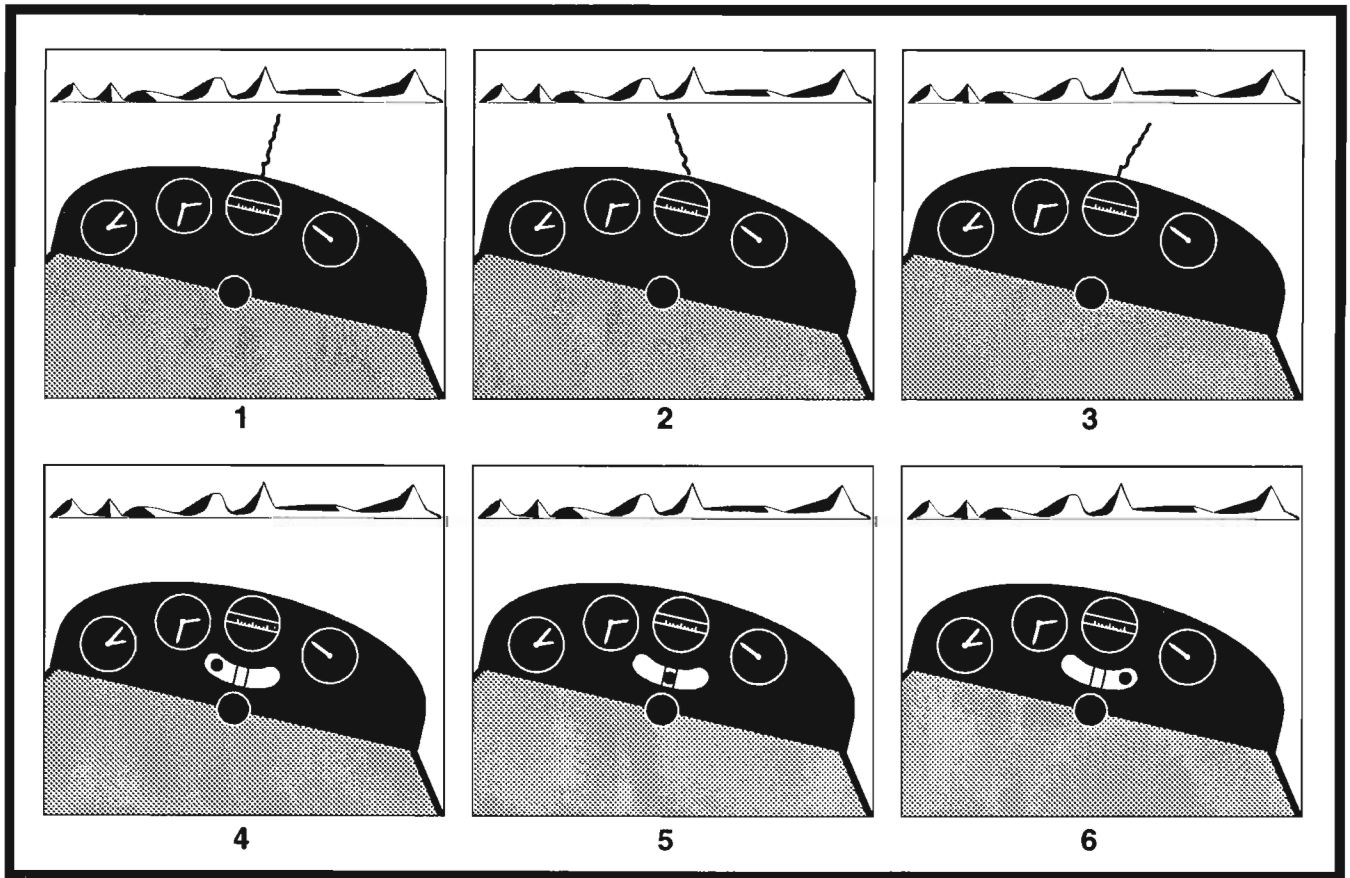

FIGURE 11.—Glider Yaw String.

```

METAR KINK 121845Z 11012G18KT 15SM SKC 25/17 A3000

METAR KBOI 121854Z 13004KT 30SM SCT150 17/6 A3015

METAR KLAX 121852Z 25004KT 6SM BR SCT007 SCT250 16/15 A2991

SPECI KMDW 121856Z 32005KT 1 1/2SM RA OVC007 17/16 A2980 RMK
RAB35

SPECI KJFK 121853Z 18004KT 1/2SM FG R04/2200 OVC005 20/18 A3006

```

FIGURE 12.—Aviation Routine Weather Reports (METAR).

This is a telephone weather briefing from the Dallas FSS for a local operation of gliders and lighter-than-air at Caddo Mills, Texas (about 30 miles east of Dallas). The briefing is at 13Z.

"There are no adverse conditions reported or forecast for today."

"A weak low pressure over the Texas Panhandle and eastern New Mexico is causing a weak southerly flow over the area."

"Current weather here at Dallas is wind south 5 knots, visibility 12 miles, clear, temperature 21, dewpoint 9, altimeter 29 point 78."

"By 15Z we should have a few scattered cumuliform clouds at 5 thousand AGL, with higher scattered cirrus at 25 thousand MSL. After 20Z the wind should pick up to about 15 knots from the south."

"The winds aloft are: 3 thousand 170 at 7, temperature 20; 6 thousand 200 at 18, temperature 14; 9 thousand 210 at 22, temperature 8; 12 thousand 225 at 27, temperature 0; 18 thousand 240 at 30, temperature -7."

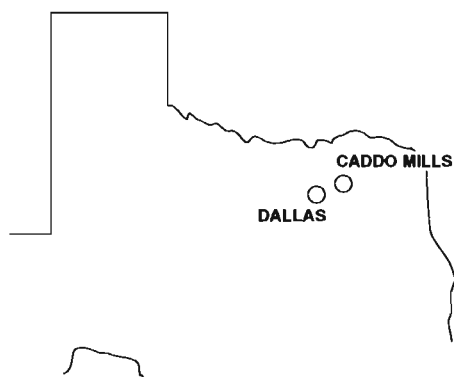

FIGURE 13.—Telephone Weather Briefing.

UA/OV KOKC-KTUL/TM 1800/FL120/TP BE90//SK BKN018-TOP055/OVC072-
TOP089/CLR ABV/TA M7/WV 08021/TB LGT 055-072/IC LGT-MOD RIME 072-089

FIGURE 14.—Pilot Weather Report.

TAF

KMEM 121720Z 121818 20012KT 5SM HZ BKN030 PROB40 2022 1SM TSRA OVC008CB
FM2200 33015G20KT P6SM BKN015 OVC025 PROB40 2202 3SM SHRA
FM0200 35012KT OVC008 PROB40 0205 2SM -RASN BECMG 0608 02008KT BKN012
BECMG 1012 00000KT 3SM BR SKC TEMPO 1214 1/2SM FG
FM1600 VRB06KT P6SM SKC=

KOKC 051130Z 051212 14008KT 5SM BR BKN030 TEMPO 1316 1 1/2SM BR
FM1600 18010KT P6SM SKC BECMG 2224 20013G20KT 4SM SHRA OVC020
PROB40 0006 2SM TSRA OVC008CB BECMG 0608 21015KT P6SM SCT040=

FIGURE 15.—Terminal Aerodrome Forecasts (TAF).

BOSC FA 241845
 SYNOPSIS AND VFR CLDS/WX
 SYNOPSIS VALID UNTIL 251300
 CLDS/WX VALID UNTIL 250700...OTLK VALID 250700-251300
 ME NH VT MA RI CT NY LO NJ PA OH LE WV MD DC DE VA AND CSTL WTRS

SEE AIRMET SIERRA FOR IFR CONDS AND MTN OBSCN.
 TS IMPLY SEV OR GTR TURB SEV ICE LLWS AND IFR CONDS.
 NON MSL HGTS DENOTED BY AGL OR CIG.

SYNOPSIS...19Z CDFNT ALG A 160NE ACK-ENE LN...CONTG AS A QSTNRY
 FNT ALG AN END-50SW MSS LN. BY 13Z...CDFNT ALG A 140ESE ACK-HTO
 LN...CONTG AS A QSTNRY FNT ALG A HTO-SYR-YYZ LN. TROF ACRS CNTRL
 PA INTO NRN VA. ...REYNOLDS...

OH LE
 NRN HLF OH LE...SCT-BKN025 OVC045. CLDS LYRD 150. SCT SHRA. WDLY
 SCT TSRA. CB TOPS FL350. 23-01Z OVC020-030. VIS 3SM BR. OCNL -
 RA. OTLK...IFR CIG BR FG.
 SWRN QTR OH...BKN050-060 TOPS 100. OTLK...MVFR BR.
 SERN QTR OH...SCT-BKN040 BKN070 TOPS 120. WDLY SCT -TSRA. 00Z
 SCT-BKN030 OVC050. WDLY SCT -TSRA. CB TOPS FL350. OTLK...VFR
 SHRA.

CHIC FA 241945
 SYNOPSIS AND VFR CLDS/WX
 SYNOPSIS VALID UNTIL 251400
 CLDS/WX VALID UNTIL 250800...OTLK VALID 250800-251400
 ND SD NE KS MN IA MO WI LM LS MI LH IL IN KY

SEE AIRMET SIERRA FOR IFR CONDS AND MTN OBSCN.
 TS IMPLY SEV OR GTR TURB SEV ICE LLWS AND IFR CONDS.
 NON MSL HGTS DENOTED BY AGL OR CIG.

SYNOPSIS...LOW PRES AREA 20Z CNTRD OVR SERN WI FCST MOV NEWD INTO
 LH BY 12Z AND WKN. LOW PRES FCST DEEPEN OVR ERN CO DURG PD AND
 MOV NR WRN KS BORDER BY 14Z. DVLPG CDFNT WL MOV EWD INTO S CNTRL
 NE-CNTRL KS BY 14Z. ..SMITH..

UPR MI LS
 WRN PTNS...AGL SCT030 SCT-BKN050. TOPS 080. 02-05Z BECMG CIG
 OVC010 VIS 3-5SM BR. OTLK...IFR CIG BR.
 ERN PTNS...CIG BKN020 OVC040. OCNL VIS 3-5SM -RA BR. TOPS FL200.
 23Z CIG OVC010 VIS 3-5SM -RA BR. OTLK...IFR CIG BR.

LWR MI LM LH
 CNTRL/NRN PTNS...CIG OVC010 VIS 3-5SM -RA BR. TOPS FL200.
 OTLK...IFR CIG BR.

SRN THIRD...CIG OVC015-025. SCT -SHRA. TOPS 150. 00-02Z BECMG CIG
 OVC010 VIS 3-5SM BR. TOPS 060. OTLK...IFR CIG BR.

IN
 NRN HALF...CIG BKN035 BKN080. TOPS FL200. SCT -SHRA. 00Z CIG
 BKN-SCT040 BKN-SCT080. TOPS 120. 06Z AGL SCT-BKN030. TOPS 080.
 OCNL VIS 3-5SM BR. OTLK...MVFR CIG BR.
 SRN HALF...AGL SCT050 SCT-BKN100. TOPS 120. 07Z AGL SCT 030
 SCT100. OTLK...VFR.

FIGURE 16.—Area Forecast.

Appendix 2

FD WBC 151745
DATA BASED ON 151200Z
VALID 1600Z FOR USE 1800-0300Z. TEMPS NEG ABV 24000

	3000	6000	9000	12000	18000	24000	30000	34000	39000
FT									
ALS			2420	2635-08	2535-18	2444-30	245945	246755	246862
AMA		2714	2725+00	2625-04	2531-15	2542-27	265842	256352	256762
DEN			2321-04	2532-08	2434-19	2441-31	235347	236056	236262
HLC		1707-01	2113-03	2219-07	2330-17	2435-30	244145	244854	245561
MKC	0507	2006+03	2215-01	2322-06	2338-17	2348-29	236143	237252	238160
STL	2113	2325+07	2332+02	2339-04	2356-16	2373-27	239440	730649	731960

FIGURE 17.—Winds and Temperatures Aloft Forecast.

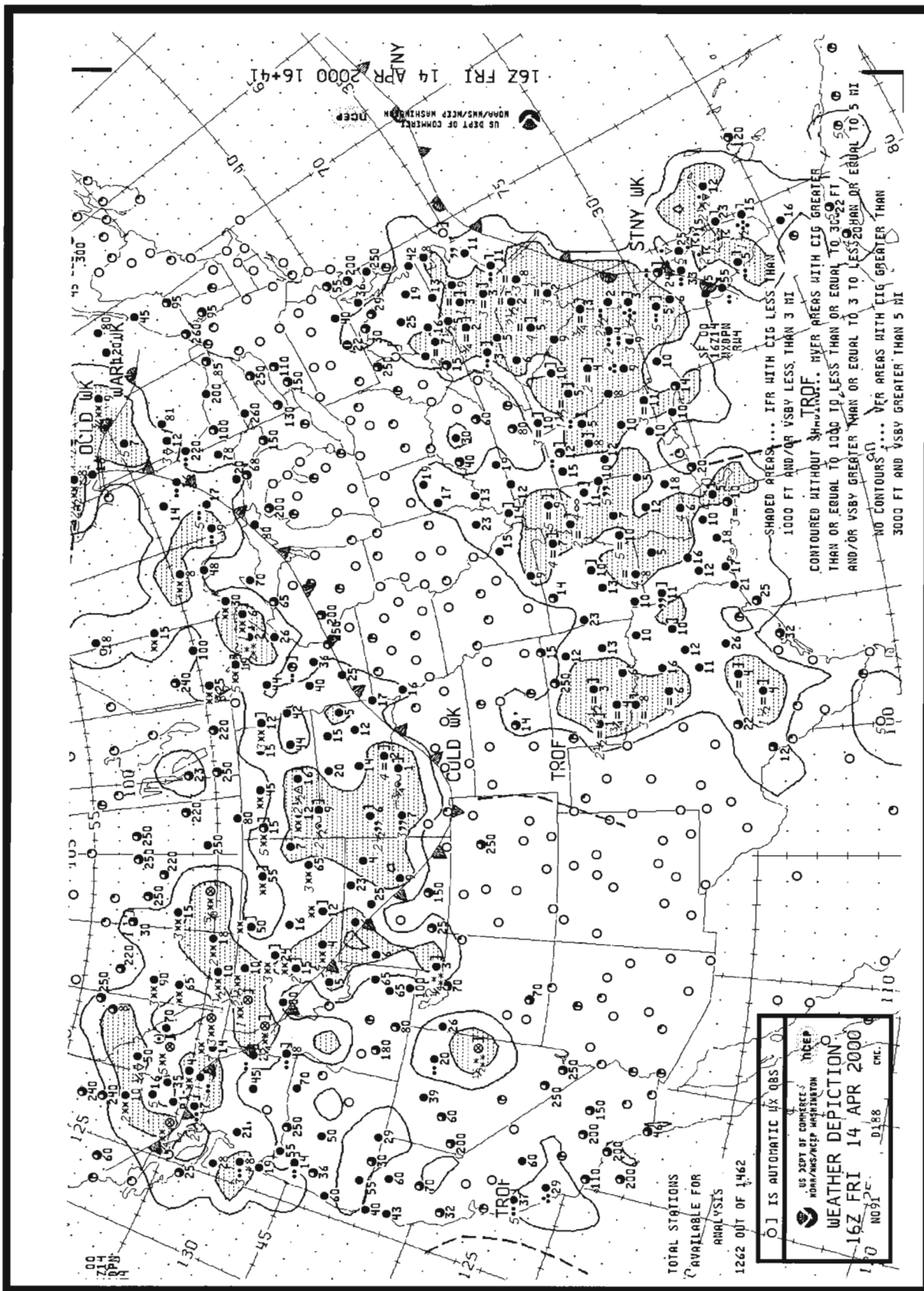

FIGURE 18.—Weather Depiction Chart.

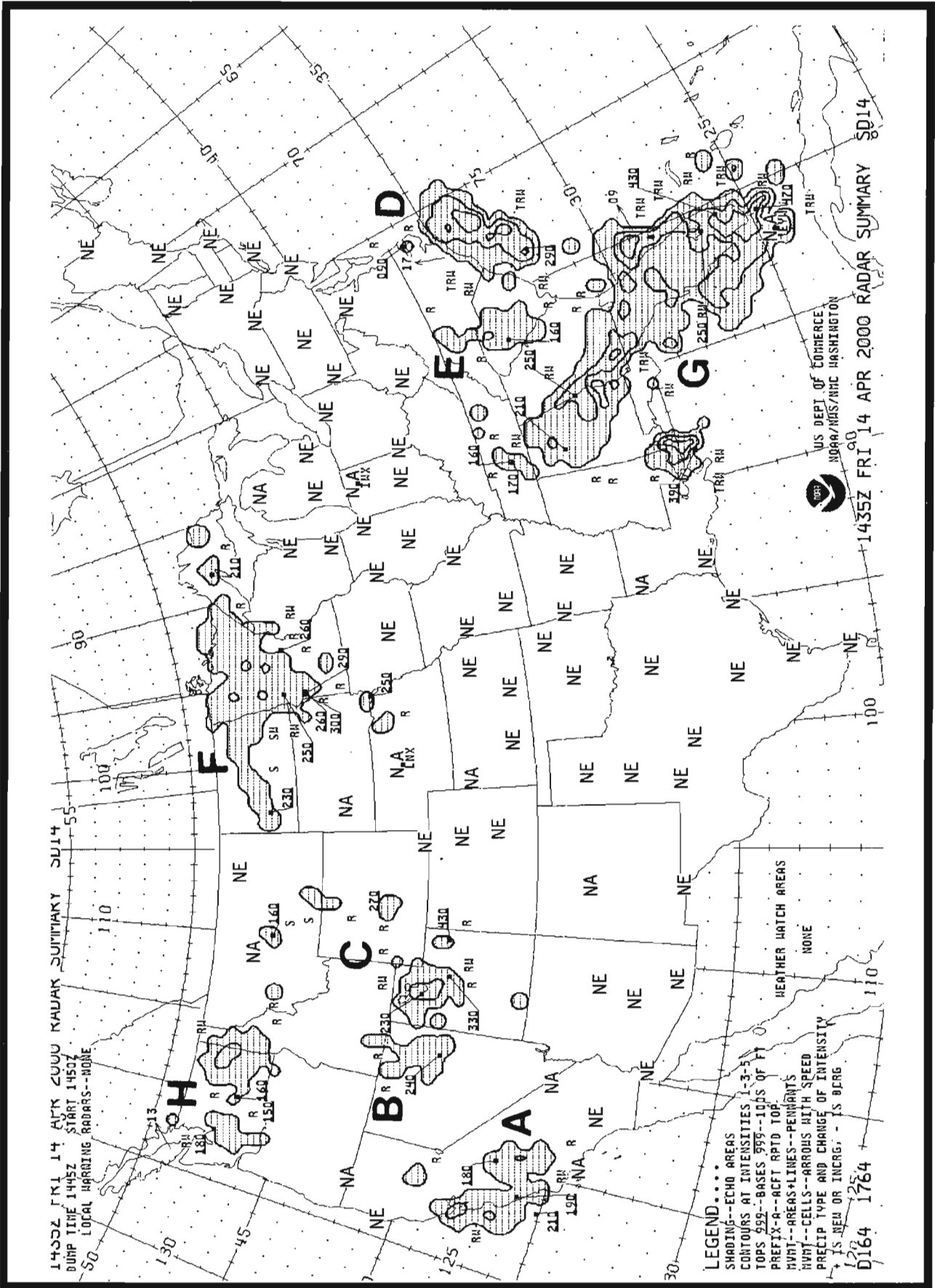

FIGURE 19.—Radar Summary Chart.

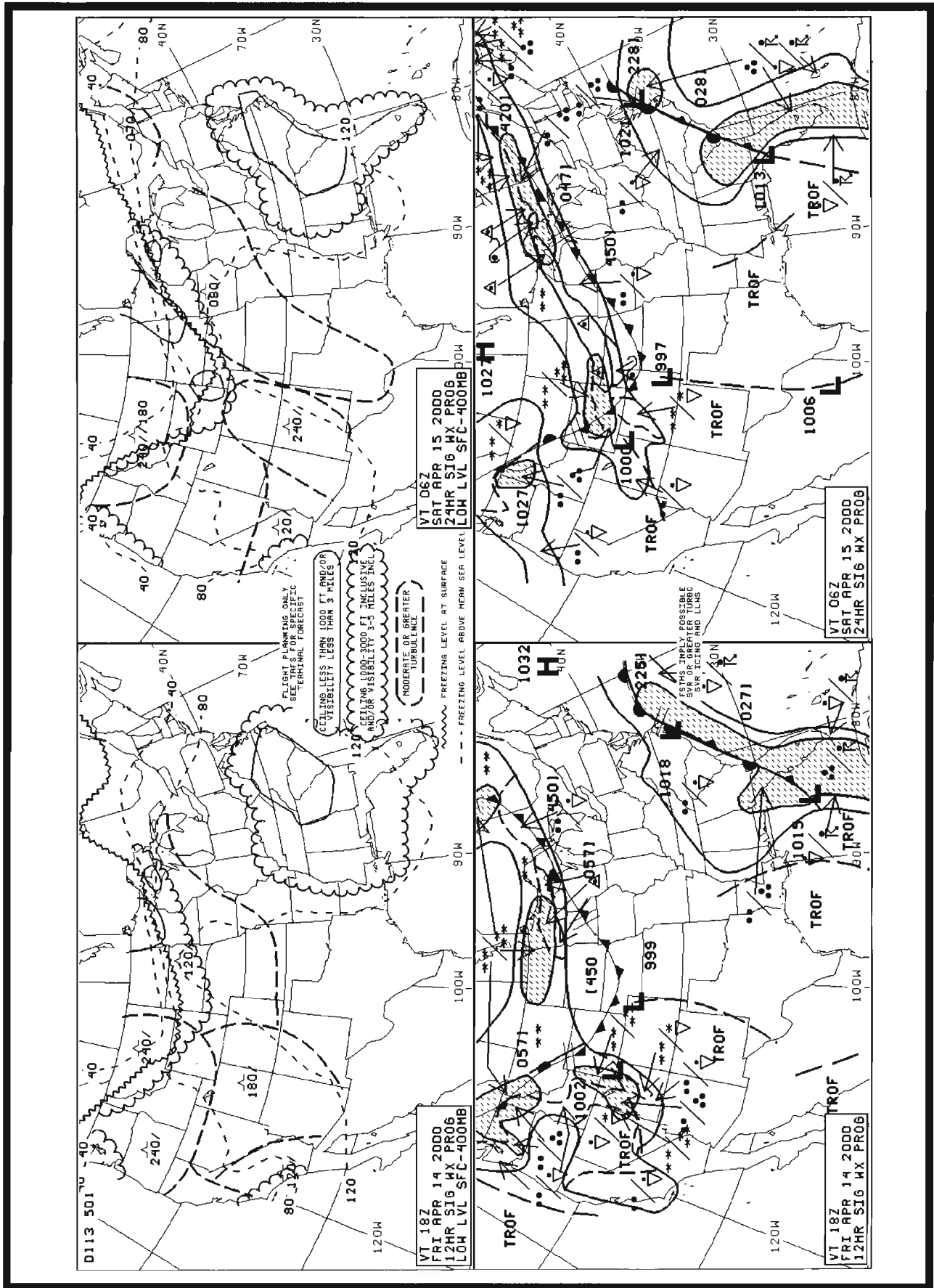

FIGURE 20.—Significant Weather Prognostic Chart.

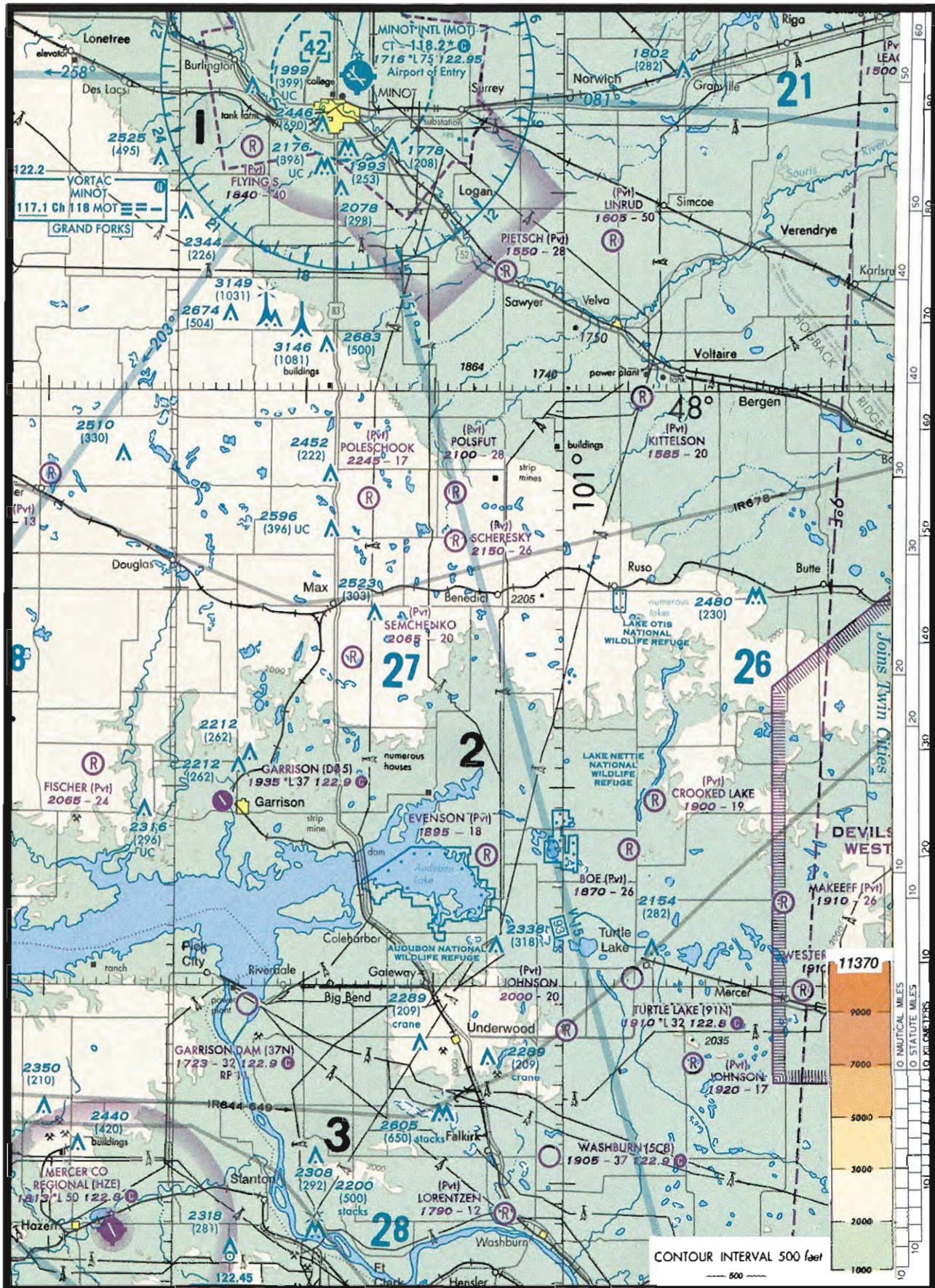

FIGURE 22.—Sectional Chart Excerpt.

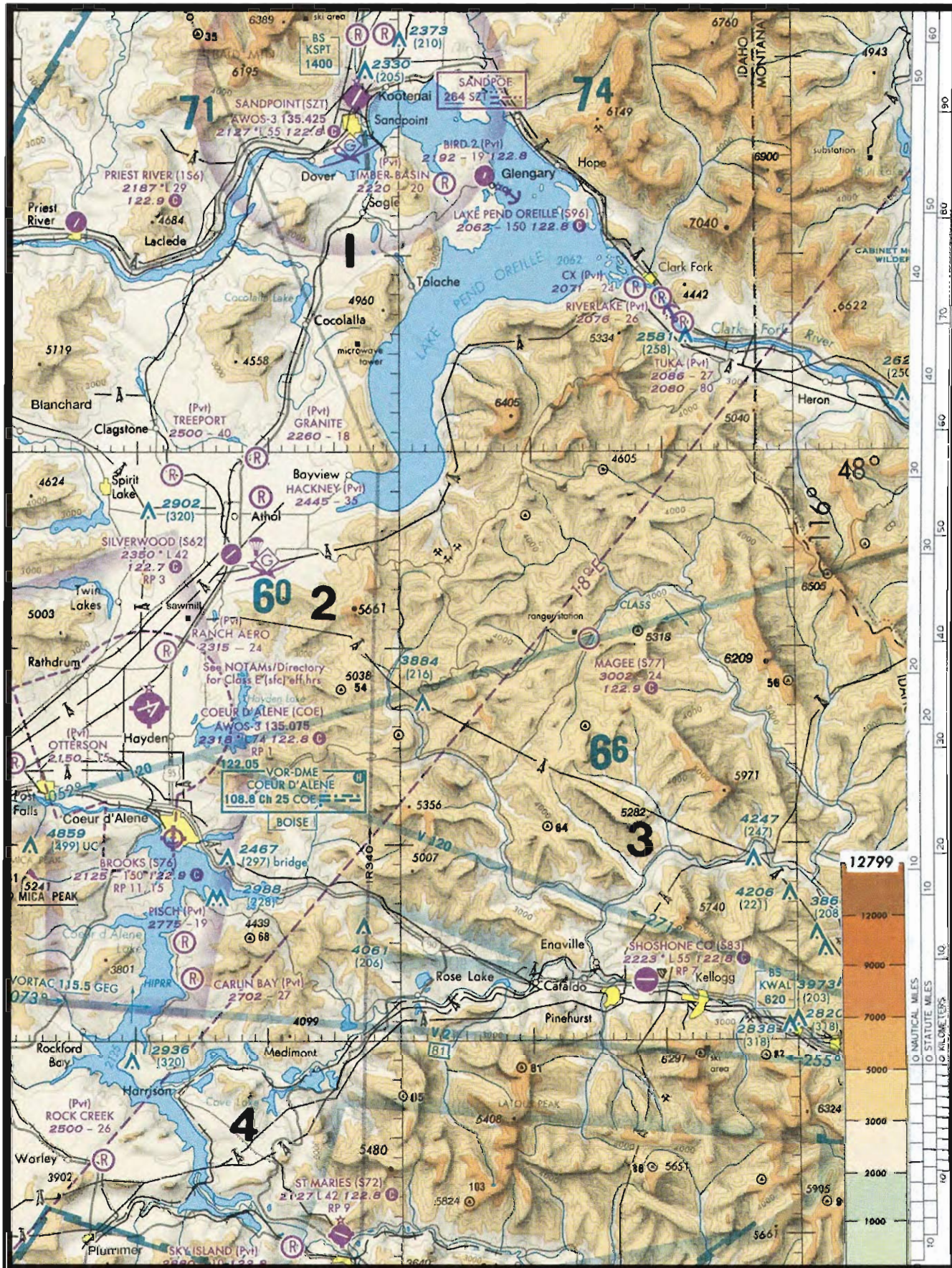

FIGURE 23.—Sectional Chart Excerpt.

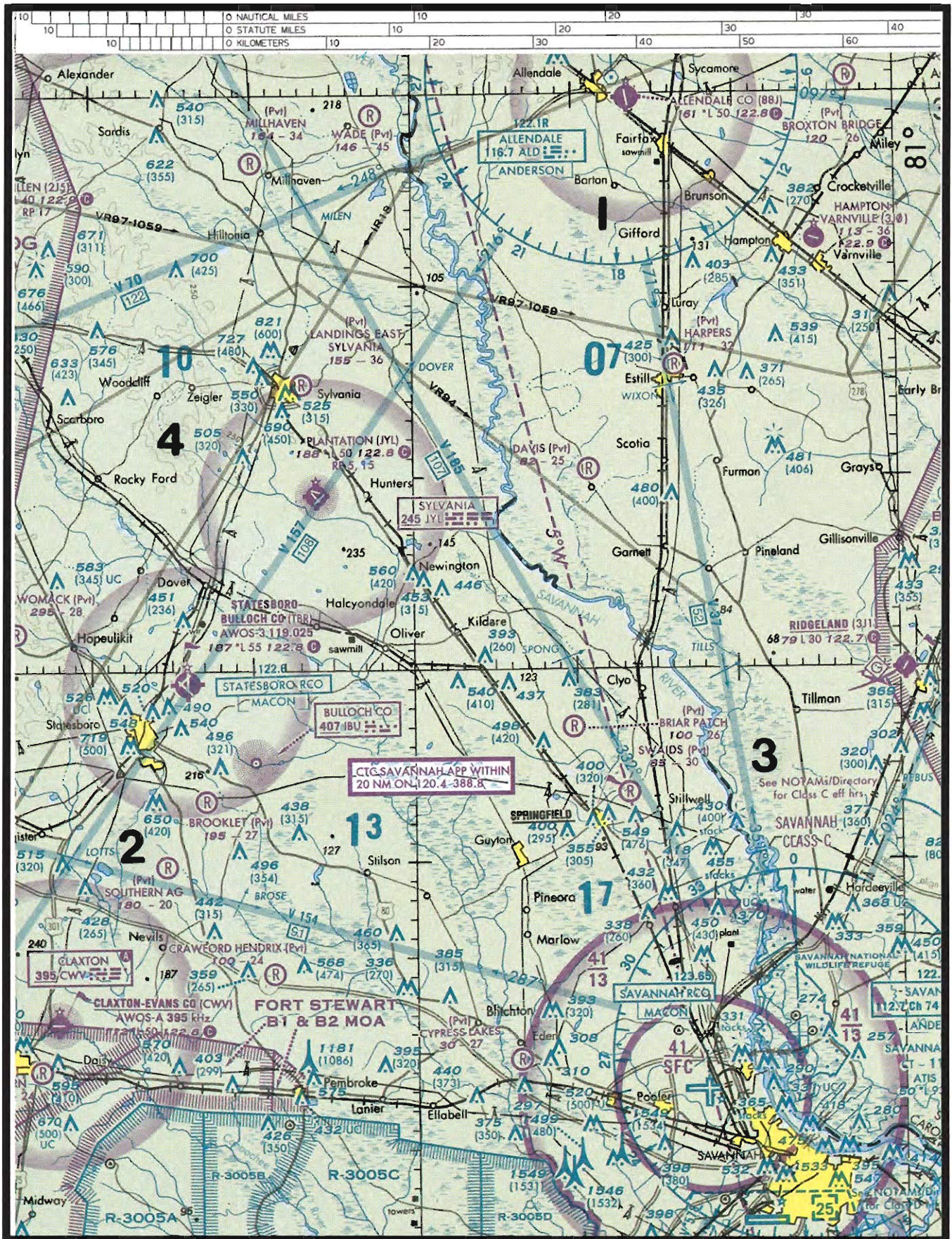

FIGURE 24.—Sectional Chart Excerpt.

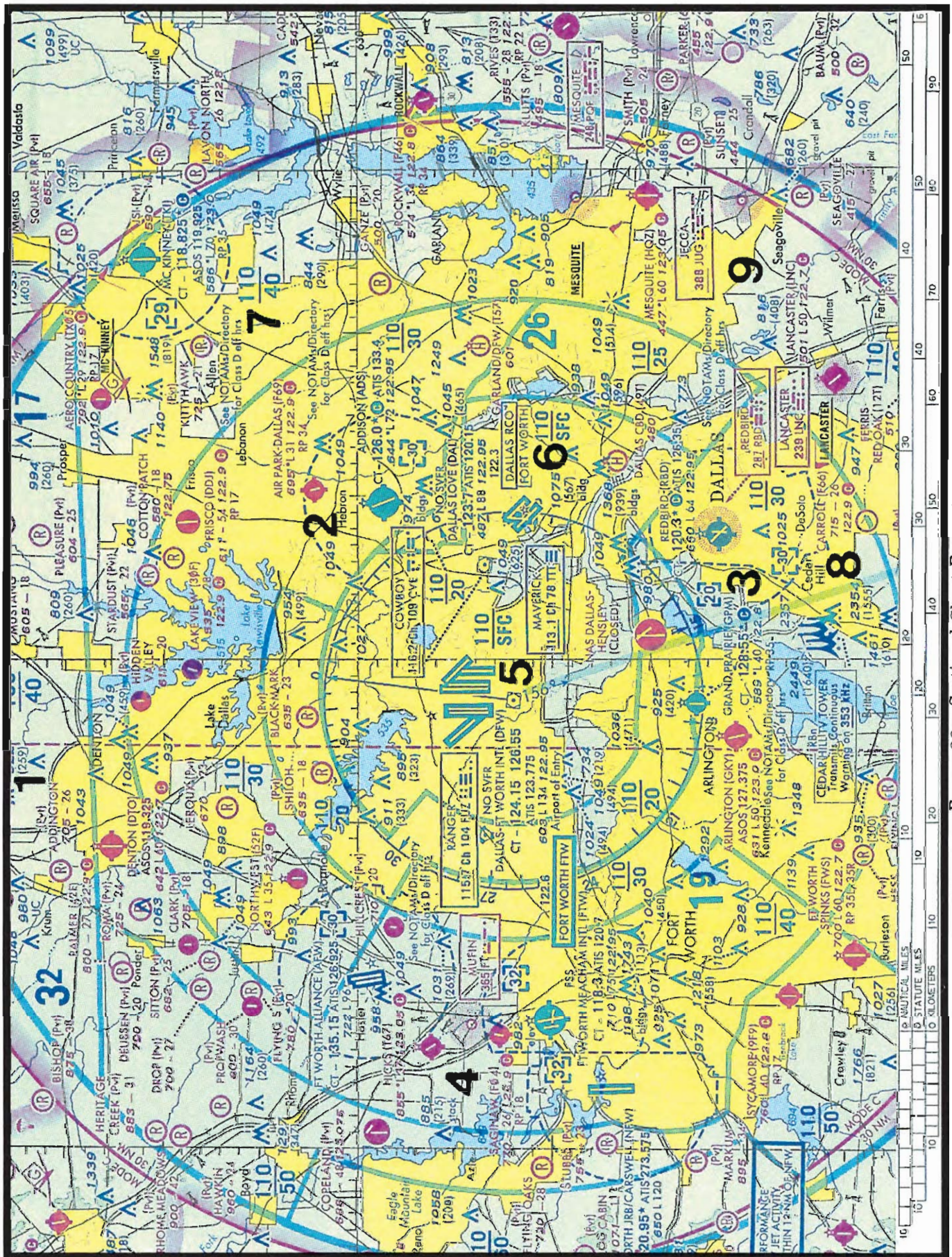

FIGURE 26.—Sectional Chart Excerpt.

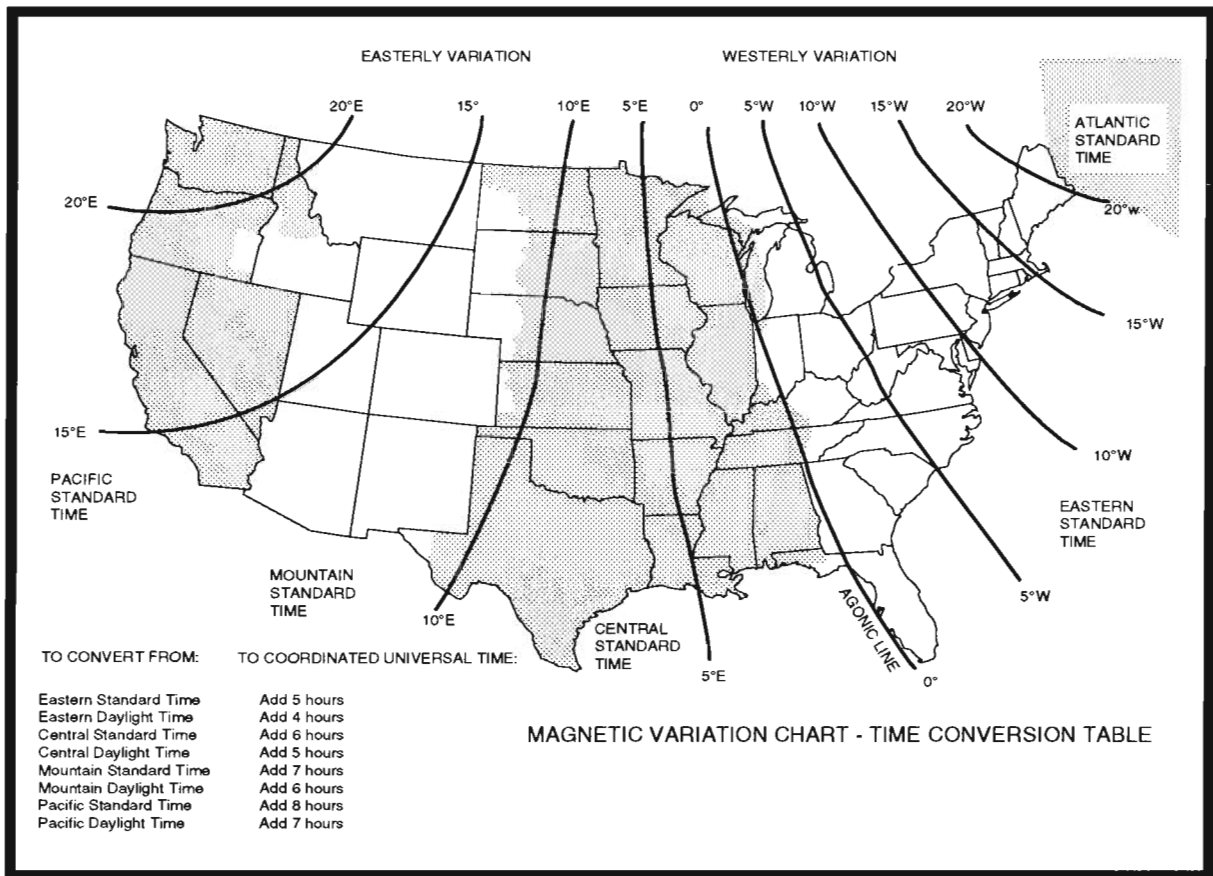

FIGURE 28.—Time Conversion Table.

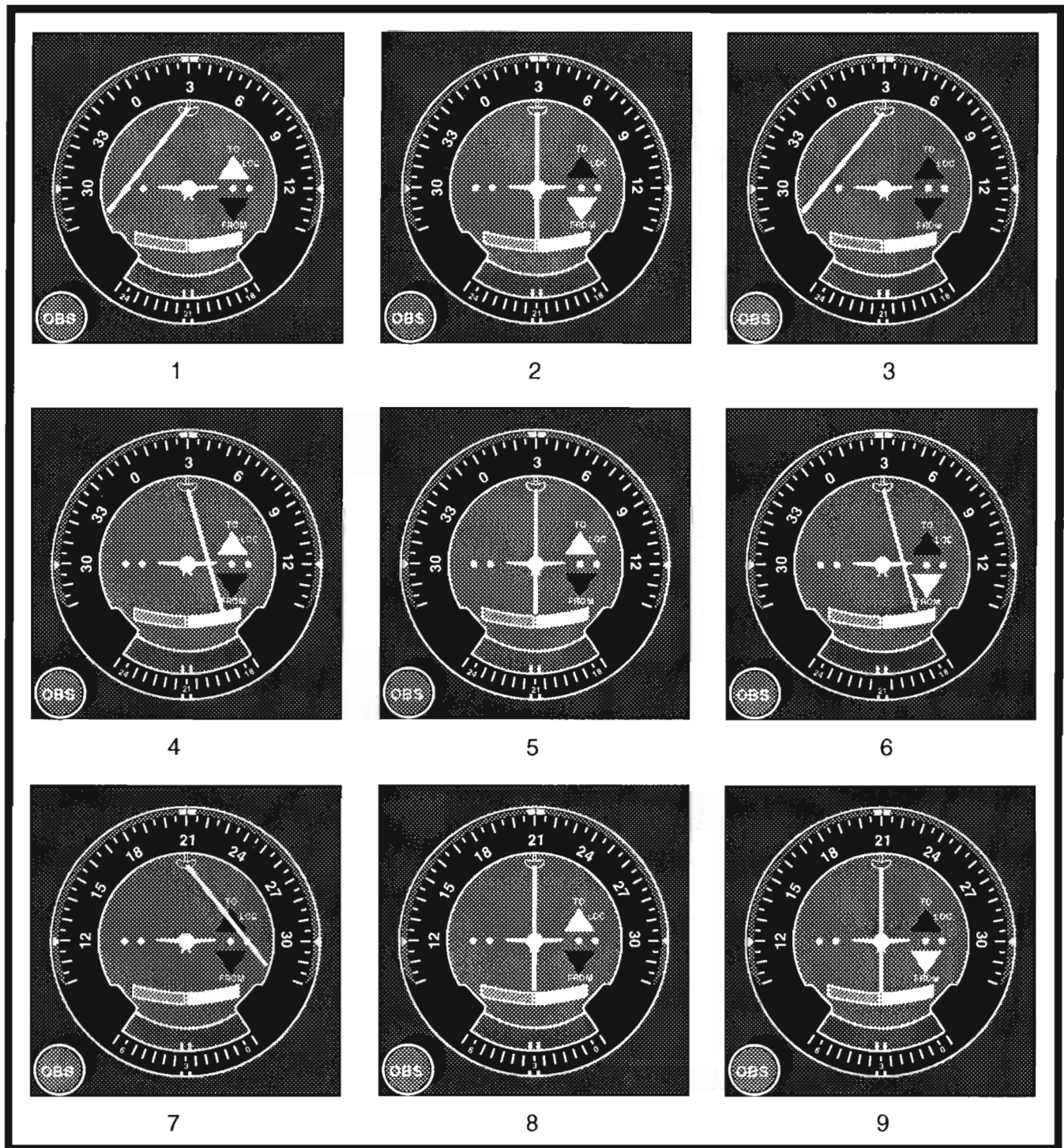

FIGURE 29.—VOR.

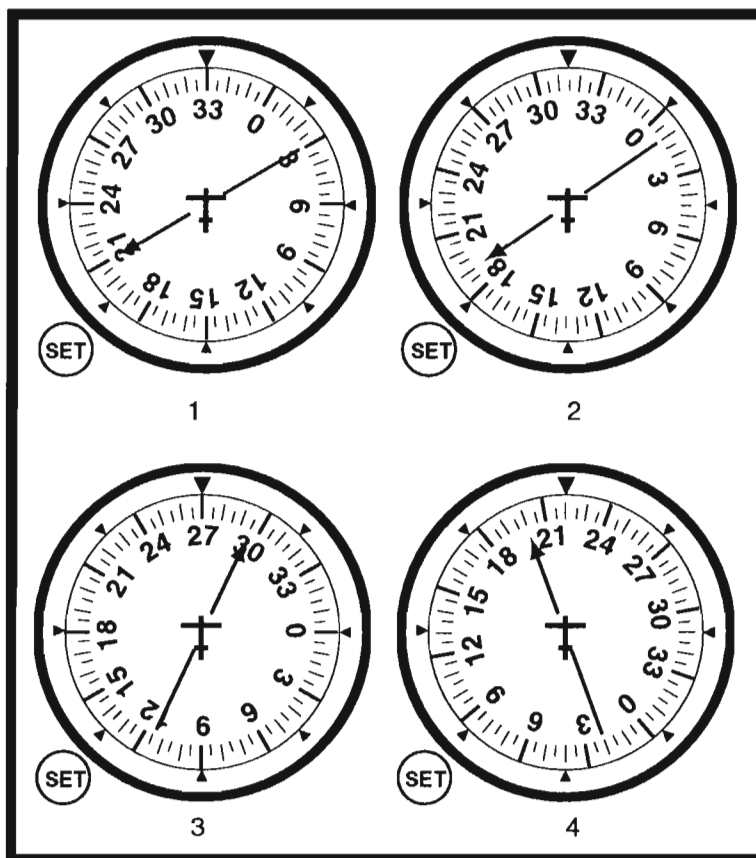

FIGURE 30.—ADF (Movable Card).

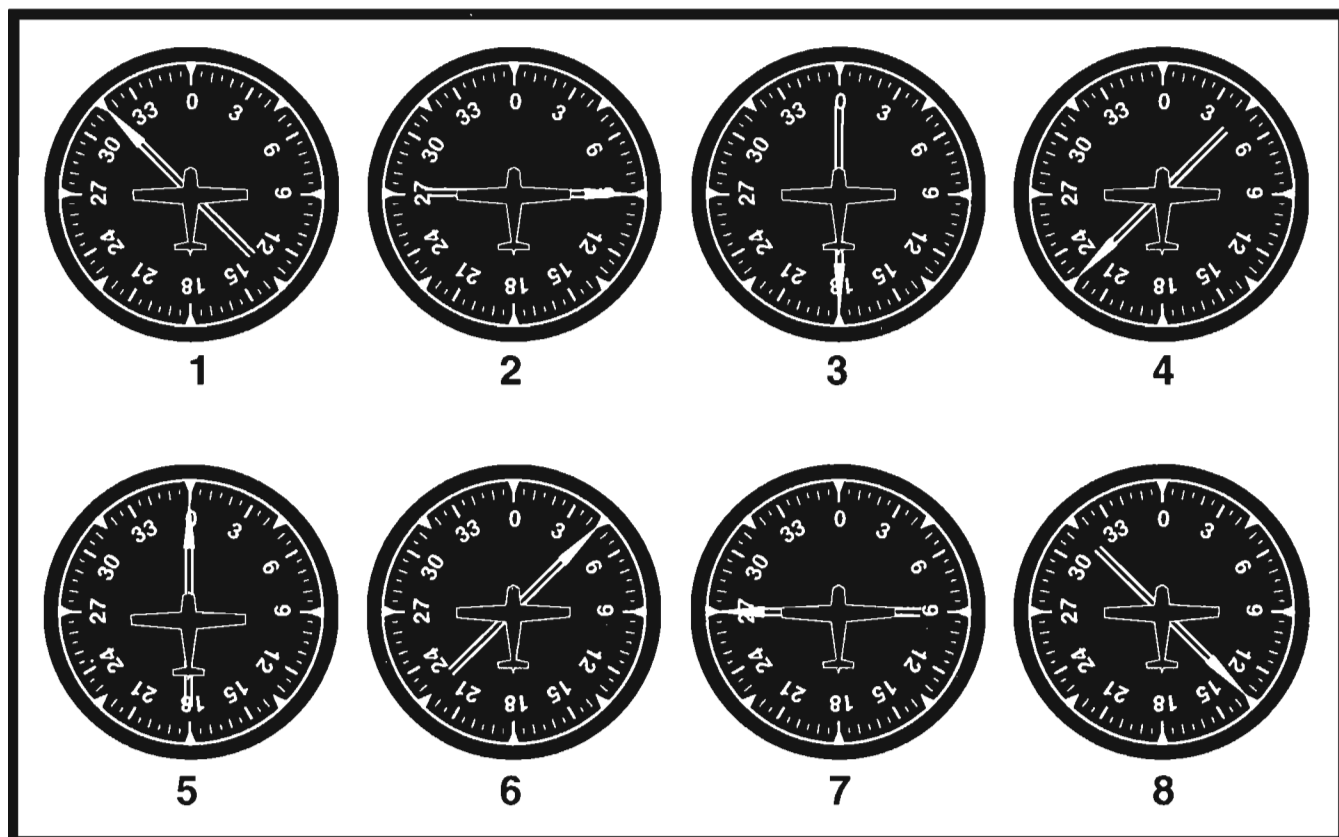

FIGURE 31.—ADF (Fixed Card).

18	IDAHO	

COEUR D'ALENE AIR TERMINAL	(COE) 9 NW UTC-8(-7DT) N47°46.46' W116°49.17'	GREAT FALLS
2318 B S4 FUEL 80.100. JET A OX 1.2		H-1B. L-9A
RWY 05-23: H7400X140 (ASPH-GRVD) S-57. D-95. DT-165 HIRL 0.7%up NE		IAP
RWY 05: MALSR. RWY 23: REIL. VASI(V4L)-GA 3.0° TCH 39'.		
RWY 01-19: H5400X75 (ASPH) S-50. D-83. DT-150 MIRL		
RWY 01: REIL. Rgt lfc.		
AIRPORT REMARKS: Attended Mon-Fri 1500-0100Z. Rwy 05-23 potential standing water and/or ice on center 3000' of rwy. Arpt conditions avbl on UNICOM. Rwy 19 is designated calm wind rwy. ACTIVATE MIRL Rwy 01-19. HIRL Rwy 05-23 and MALSR Rwy 05-CTAF. REIL Rwy 23 opr only when HIRL on high ints.		
WEATHER DATA SOURCES: AWOS-3 135.075 (208) 772-8215.		
COMMUNICATIONS: CTAF/UNICOM 122.8		
BOISE FSS (BOI) TF 1-800-WX-BRIEF. NOTAM FILE COE.		
RCO 122.05 (BOISE FSS)		
Ⓡ SPOKANE APP/DEP CON 132.1		
RADIO AIDS TO NAVIGATION: NOTAM FILE COE.		
(T) VOR/DME 108.8 COE Chan 25 N47°46.42' W116°49.24' at fld. 2290/19E.		
DME portion unusable 280°-350° byd 15 NM bto 11000' 220°-240° byd 15 NM.		
LEENY NDB (LOM) 347 CO N47°44.57' W116°57.66' 053° 6.0 NM to fld.		
ILS 110.7 I-COE Rwy 05 LOM LEENY NDB. ILS localizer/glide slope unmonitored.		

FIGURE 32.—Airport/Facility Directory Excerpt.

USEFUL LOAD WEIGHTS AND MOMENTS

OCCUPANTS

FRONT SEATS ARM 85		REAR SEATS ARM 121	
Weight	<u>Moment</u> 100	Weight	<u>Moment</u> 100
120	102	120	145
130	110	130	157
140	119	140	169
150	128	150	182
160	136	160	194
170	144	170	206
180	153	180	218
190	162	190	230
200	170	200	242

USABLE FUEL

MAIN WING TANKS ARM 75		
Gallons	Weight	<u>Moment</u> 100
5	30	22
10	60	45
15	90	68
20	120	90
25	150	112
30	180	135
35	210	158
40	240	180
44	264	198

BAGGAGE OR 5TH SEAT OCCUPANT
ARM 140

Weight	<u>Moment</u> 100
10	14
20	28
30	42
40	56
50	70
60	84
70	98
80	112
90	126
100	140
110	154
120	168
130	182
140	196
150	210
160	224
170	238
180	252
190	266
200	280
210	294
220	308
230	322
240	336
250	350
260	364
270	378

AUXILIARY WING TANKS
ARM 94

Gallons	Weight	<u>Moment</u> 100
5	30	28
10	60	56
15	90	85
19	114	107

*OIL

Quarts	Weight	<u>Moment</u> 100
10	19	5

*Included in basic Empty Weight

Empty Weight ~ 2015

MOM / 100 ~ 1554

MOMENT LIMITS vs WEIGHT

Moment limits are based on the following weight and center of gravity limit data (landing gear down).

WEIGHT CONDITION	FORWARD CG LIMIT	AFT CG LIMIT
2950 lb (takeoff or landing)	82.1	84.7
2525 lb	77.5	85.7
2475 lb or less	77.0	85.7

FIGURE 33.—Airplane Weight and Balance Tables.

MOMENT LIMITS vs WEIGHT (Continued)

Weight	Minimum Moment 100	Maximum Moment 100	Weight	Minimum Moment 100	Maximum Moment 100
2100	1617	1800	2600	2037	2224
2110	1625	1808	2610	2048	2232
2120	1632	1817	2620	2058	2239
2130	1640	1825	2630	2069	2247
2140	1648	1834	2640	2080	2255
2150	1656	1843	2650	2090	2263
2160	1663	1851	2660	2101	2271
2170	1671	1860	2670	2112	2279
2180	1679	1868	2680	2123	2287
2190	1686	1877	2690	2133	2295
2200	1694	1885	2700	2144	2303
2210	1702	1894	2710	2155	2311
2220	1709	1903	2720	2166	2319
2230	1717	1911	2730	2177	2326
2240	1725	1920	2740	2188	2334
2250	1733	1928	2750	2199	2342
2260	1740	1937	2760	2210	2350
2270	1748	1945	2770	2221	2358
2280	1756	1954	2780	2232	2366
2290	1763	1963	2790	2243	2374
2300	1771	1971	2800	2254	2381
2310	1779	1980	2810	2265	2389
2320	1786	1988	2820	2276	2397
2330	1794	1997	2830	2287	2405
2340	1802	2005	2840	2298	2413
2350	1810	2014	2850	2309	2421
2360	1817	2023	2860	2320	2428
2370	1825	2031	2870	2332	2436
2380	1833	2040	2880	2343	2444
2390	1840	2048	2890	2354	2452
2400	1848	2057	2900	2365	2460
2410	1856	2065	2910	2377	2468
2420	1863	2074	2920	2388	2475
2430	1871	2083	2930	2399	2483
2440	1879	2091	2940	2411	2491
2450	1887	2100	2950	2422	2499
2460	1894	2108			
2470	1902	2117			
2480	1911	2125			
2490	1921	2134			
2500	1932	2143			
2510	1942	2151			
2520	1953	2160			
2530	1963	2168			
2540	1974	2176			
2550	1984	2184			
2560	1995	2192			
2570	2005	2200			
2580	2016	2208			
2590	2026	2216			

FIGURE 34.—Airplane Weight and Balance Tables.

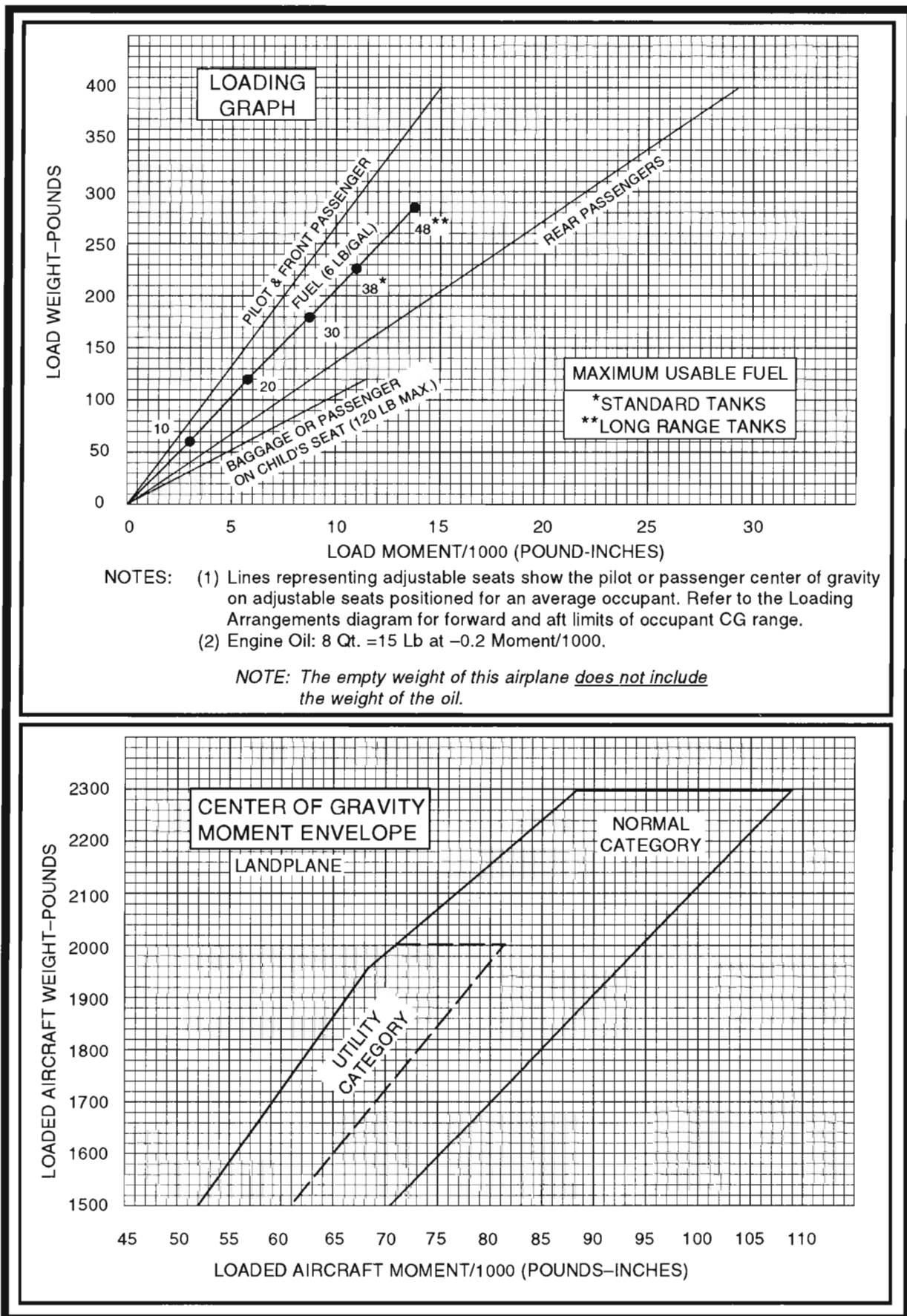

FIGURE 35.—Airplane Weight and Balance Graphs.

CRUISE POWER SETTINGS

65% MAXIMUM CONTINUOUS POWER (OR FULL THROTTLE)
2800 POUNDS

PRESS ALT.	ISA -20 °C (-36 °F)								STANDARD DAY (ISA)								ISA +20 °C (+36 °F)							
	IOAT		ENGINE SPEED	MAN. PRESS	FUEL FLOW PER ENGINE		TAS		IOAT		ENGINE SPEED	MAN. PRESS	FUEL FLOW PER ENGINE		TAS		IOAT		ENGINE SPEED	MAN. PRESS	FUEL FLOW PER ENGINE		TAS	
	FEET	°F	°C	RPM	IN HG	PSI	GPH	KTS	MPH	°F	°C	RPM	IN HG	PSI	GPH	KTS	MPH	°F	°C	RPM	IN HG	PSI	GPH	KTS
SL	27	-3	2450	20.7	6.6	11.5	147	169	63	17	2450	21.2	6.6	11.5	150	173	99	37	2450	21.8	6.6	11.5	153	176
2000	19	-7	2450	20.4	6.6	11.5	149	171	55	13	2450	21.0	6.6	11.5	153	176	91	33	2450	21.5	6.6	11.5	156	180
4000	12	-11	2450	20.1	6.6	11.5	152	175	48	9	2450	20.7	6.6	11.5	156	180	84	29	2450	21.3	6.6	11.5	159	183
6000	5	-15	2450	19.8	6.6	11.5	155	178	41	5	2450	20.4	6.6	11.5	158	182	79	26	2450	21.0	6.6	11.5	161	185
8000	-2	-19	2450	19.5	6.6	11.5	157	181	36	2	2450	20.2	6.6	11.5	161	185	72	22	2450	20.8	6.6	11.5	164	189
10000	-8	-22	2450	19.2	6.6	11.5	160	184	28	-2	2450	19.9	6.6	11.5	163	188	64	18	2450	20.3	6.5	11.4	166	191
12000	-15	-26	2450	18.8	6.4	11.3	162	186	21	-6	2450	18.8	6.1	10.9	163	188	57	14	2450	18.8	5.9	10.8	163	188
14000	-22	-30	2450	17.4	5.8	10.5	159	183	14	-10	2450	17.4	5.6	10.1	160	184	50	10	2450	17.4	5.4	9.8	160	184
16000	-29	-34	2450	16.1	5.3	9.7	156	180	7	-14	2450	16.1	5.1	9.4	156	180	43	6	2450	16.1	4.9	9.1	155	178

NOTES: 1. Full throttle manifold pressure settings are approximate.
2. Shaded area represents operation with full throttle.

FIGURE 36.—Airplane Power Setting Table.

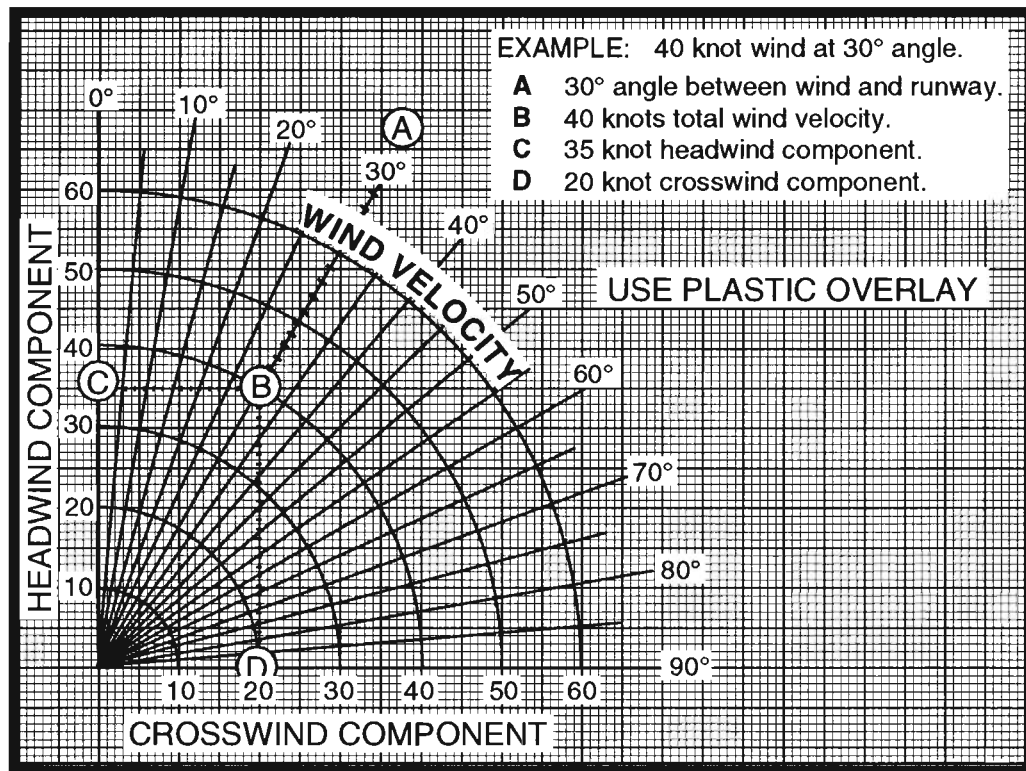

FIGURE 37.—Crosswind Component Graph.

LANDING DISTANCE

ASSOCIATED CONDITIONS:

POWER	RETARDED TO MAINTAIN 900 FT/on FINAL APPROACH
FLAPS	DOWN
LANDING GEAR	DOWN
RUNWAY	PAVED, LEVEL, DRY SURFACE
APPROACH SPEED	IAS AS TABULATED
BRAKING	MAXIMUM

WEIGHT ~ POUNDS	SPEED AT 50 FT	
	KNOTS	MPH
2950	70	80
2800	68	78
2600	65	75
2400	63	72
2200	60	69

EXAMPLE:

OAT	25 °C (77 °F)
PRESSURE ALTITUDE	3965 FT
WEIGHT	2814 LB
WIND COMPONENT	9.0 KNOTS (HEADWIND)
GROUND ROLL	1080 FT
TOTAL OVER 50 FT OBSTACLE	1700 FT
APPROACH SPEED	68 KNOTS (78 MPH)

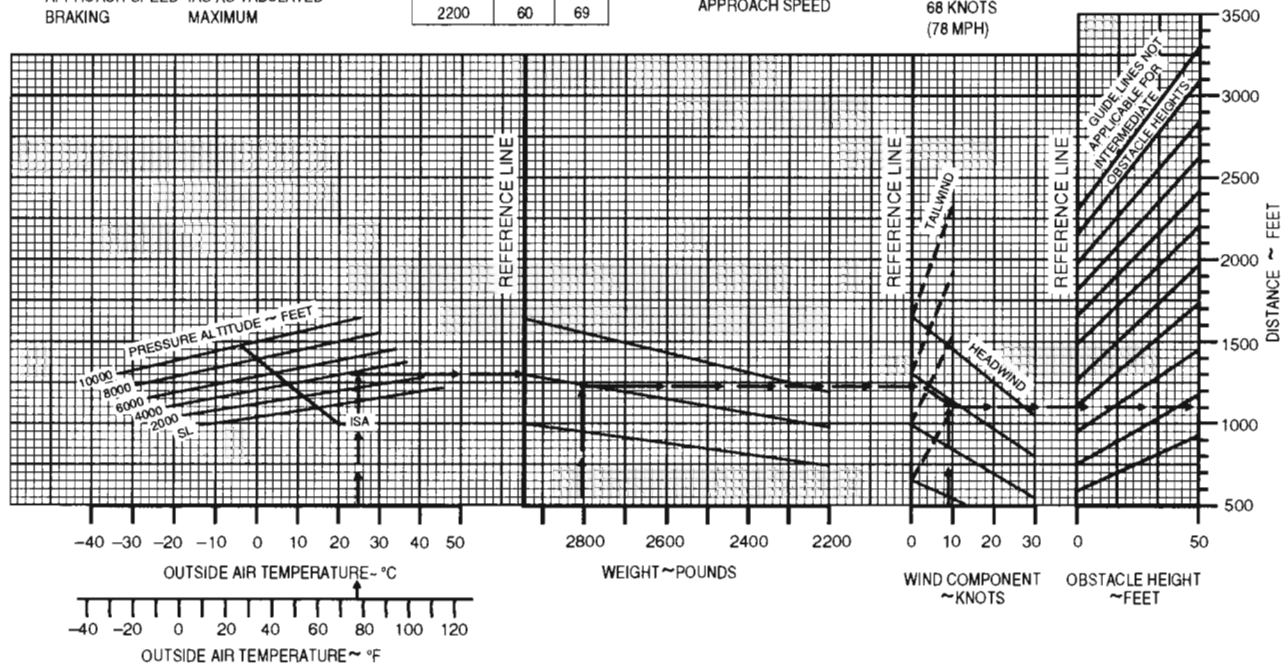

FIGURE 38.—Airplane Landing Distance Graph.

LANDING DISTANCE

FLAPS LOWERED TO 40° - POWER OFF
HARD SURFACE RUNWAY - ZERO WIND

GROSS WEIGHT LB	APPROACH SPEED, IAS, MPH	AT SEA LEVEL & 59 °F		AT 2500 FT & 50 °F		AT 5000 FT & 41 °F		AT 7500 FT & 32 °F	
		GROUND ROLL	TOTAL TO CLEAR 50 FT OBS	GROUND ROLL	TOTAL TO CLEAR 50 FT OBS	GROUND ROLL	TOTAL TO CLEAR 50 FT OBS	GROUND ROLL	TOTAL TO CLEAR 50 FT OBS
1600	60	445	1075	470	1135	495	1195	520	1255

- NOTES: 1. Decrease the distances shown by 10% for each 4 knots of headwind.
2. Increase the distance by 10% for each 60 °F temperature increase above standard.
3. For operation on a dry, grass runway, increase distances (both "ground roll" and "total to clear 50 ft obstacle") by 20% of the "total to clear 50 ft obstacle" figure.

FIGURE 39.—Airplane Landing Distance Table.

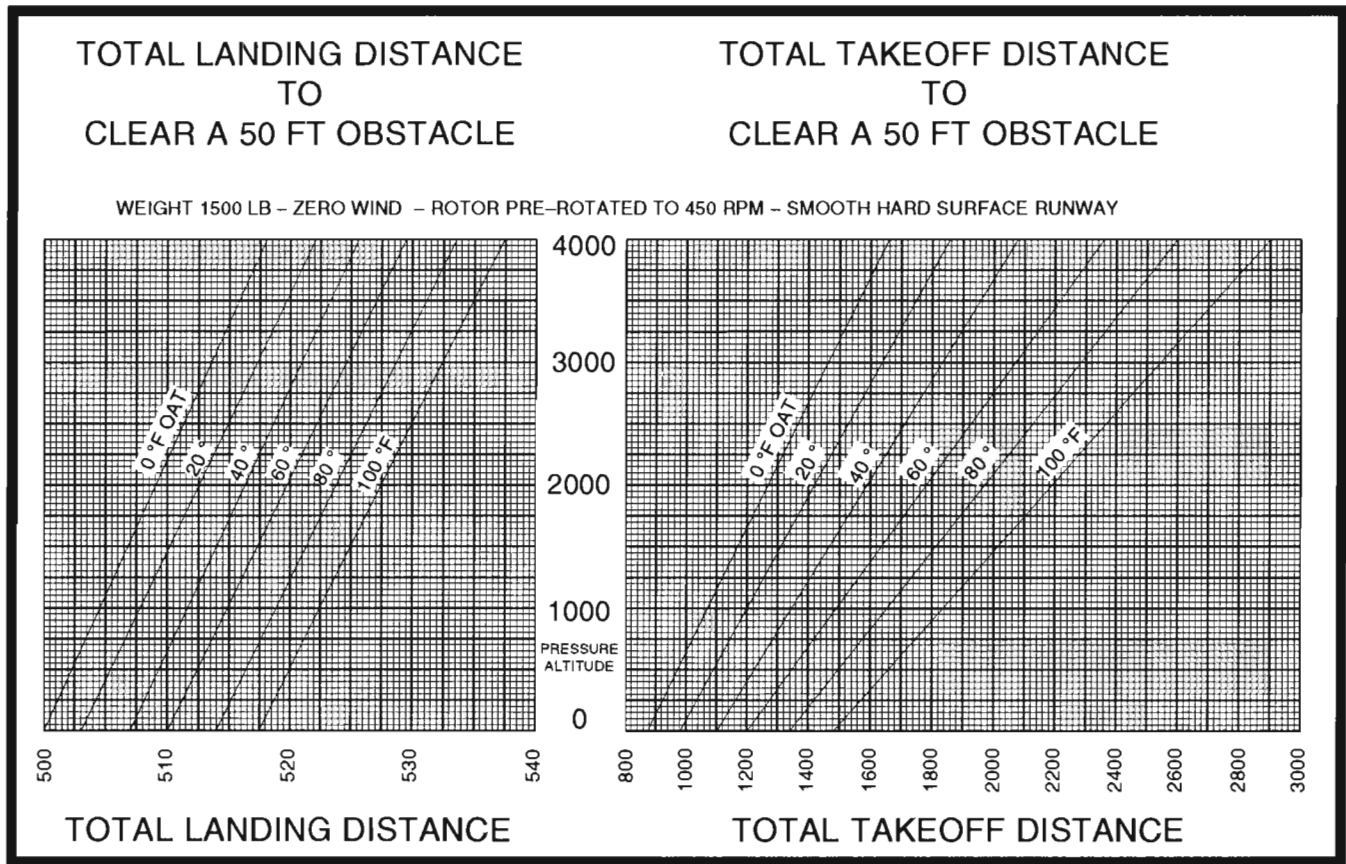

FIGURE 40.—Gyroplane Takeoff and Landing Graphs.

TAKEOFF DISTANCE

ASSOCIATED CONDITIONS:

- POWER FULL THROTTLE
2600 RPM
- MIXTURE LEAN TO APPROPRIATE
FUEL PRESSURE
- FLAPS UP
- LANDING GEAR RETRACT AFTER POSITIVE
CLIMB ESTABLISHED
- COWL FLAPS OPEN

WEIGHT ~ POUNDS	TAKEOFF SPEED			
	LIFT-OFF		50 FT	
	KNOTS	MPH	KNOTS	MPH
2950	66	76	72	83
2800	64	74	70	81
2600	63	72	68	78
2400	61	70	66	76
2200	58	67	63	73

EXAMPLE:

- OAT 15 °C (59 °F)
- PRESSURE ALTITUDE 5650 FT
- TAKEOFF WEIGHT 2950 LB
- HEADWIND COMP. 9.0 KNOTS

- GROUND ROLL 1375 FT
- TOTAL DISTANCE OVER
A 50 FT OBSTACLE 2300 FT
- TAKEOFF SPEED AT
LIFT-OFF 66 KNOTS (76 MPH)
- 50 FT 72 KNOTS (83 MPH)

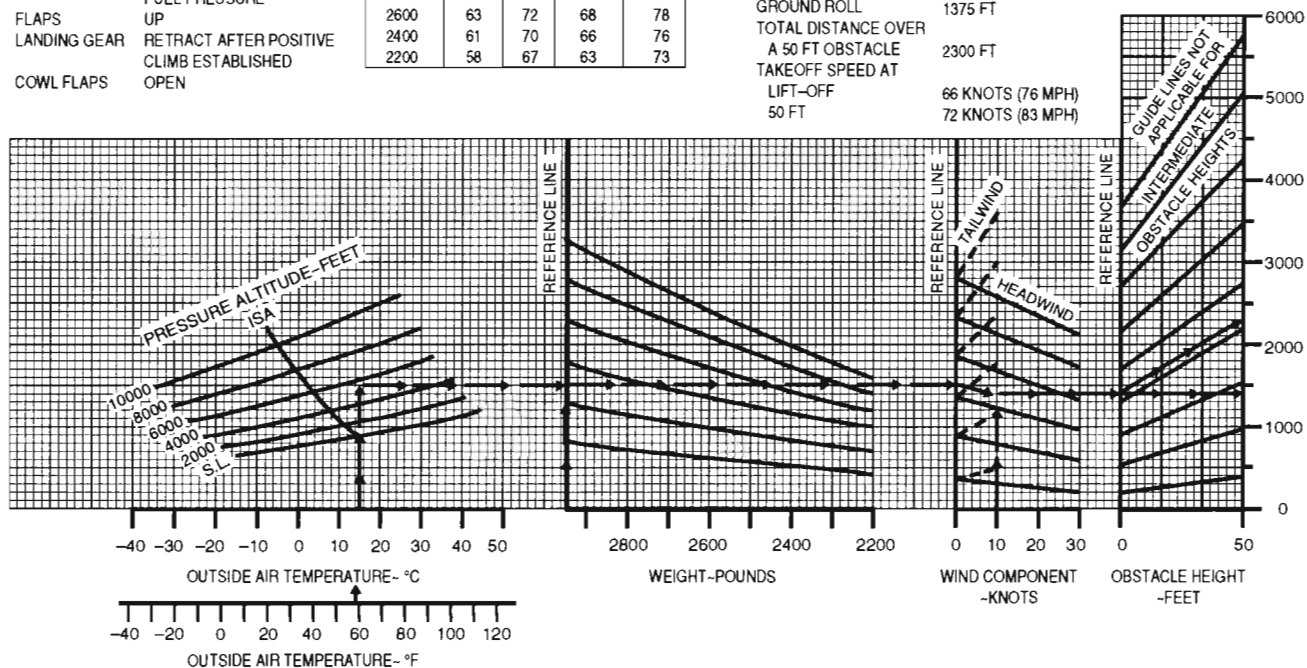

FIGURE 41.—Airplane Takeoff Distance Graph.

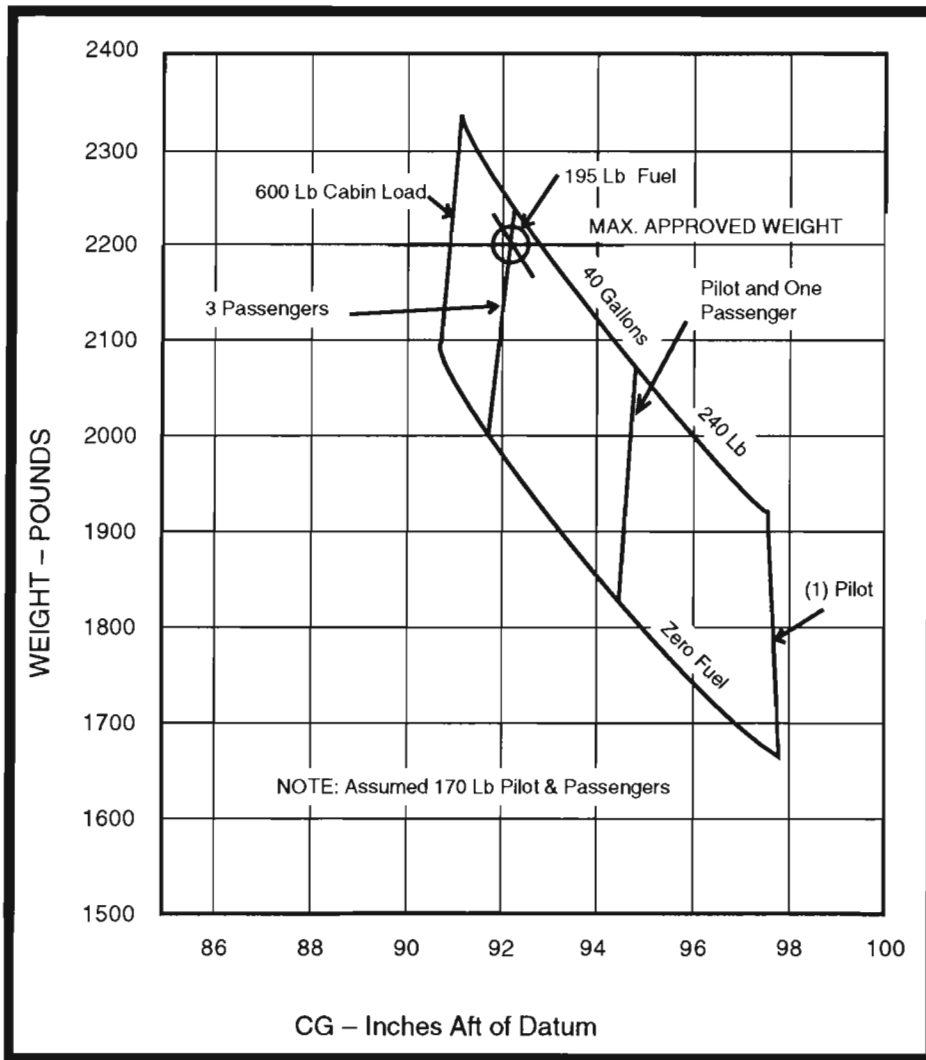

FIGURE 42.—Helicopter Weight and Balance Graph.

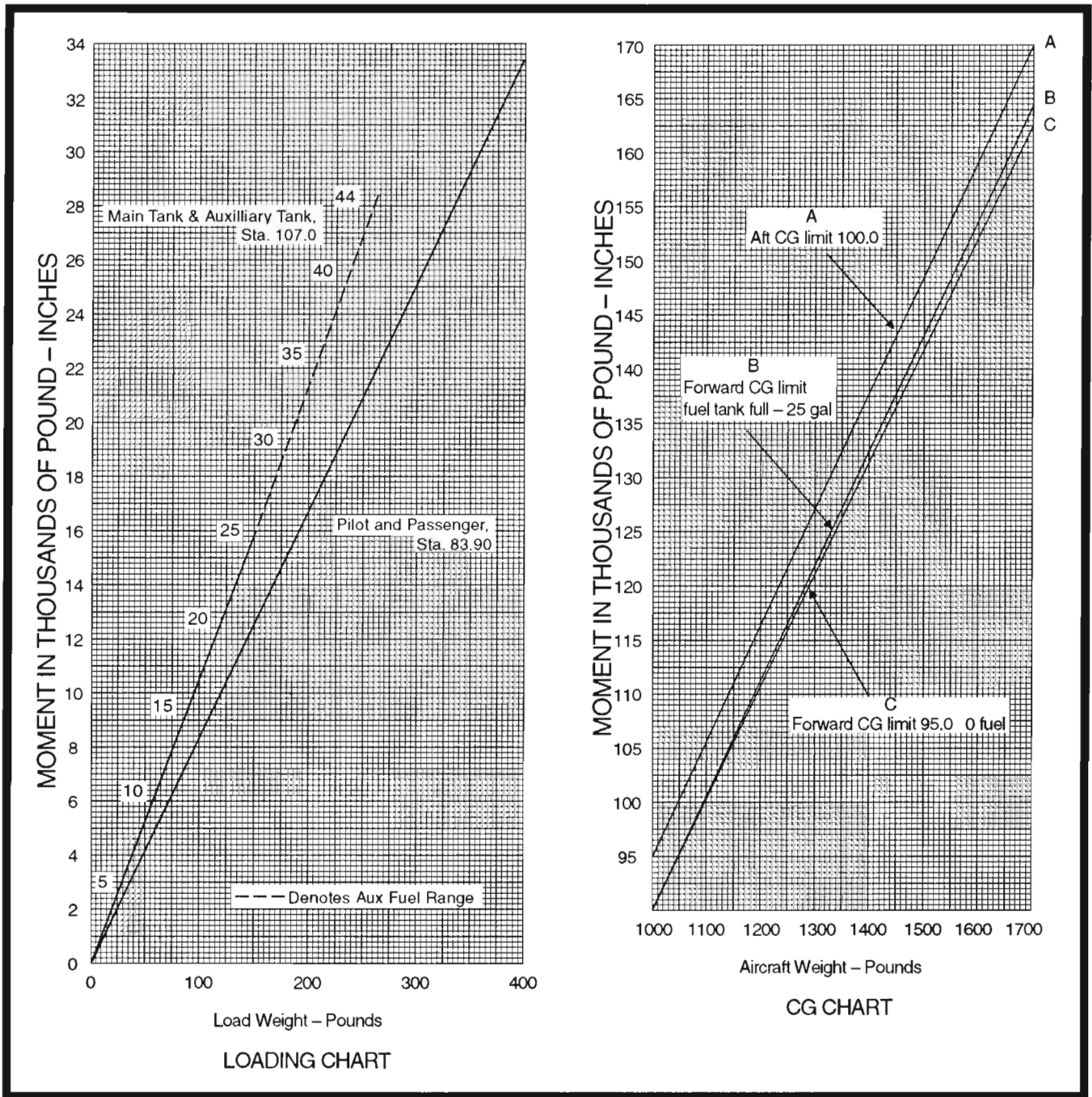

FIGURE 43.—Helicopter Weight and Balance Graphs.

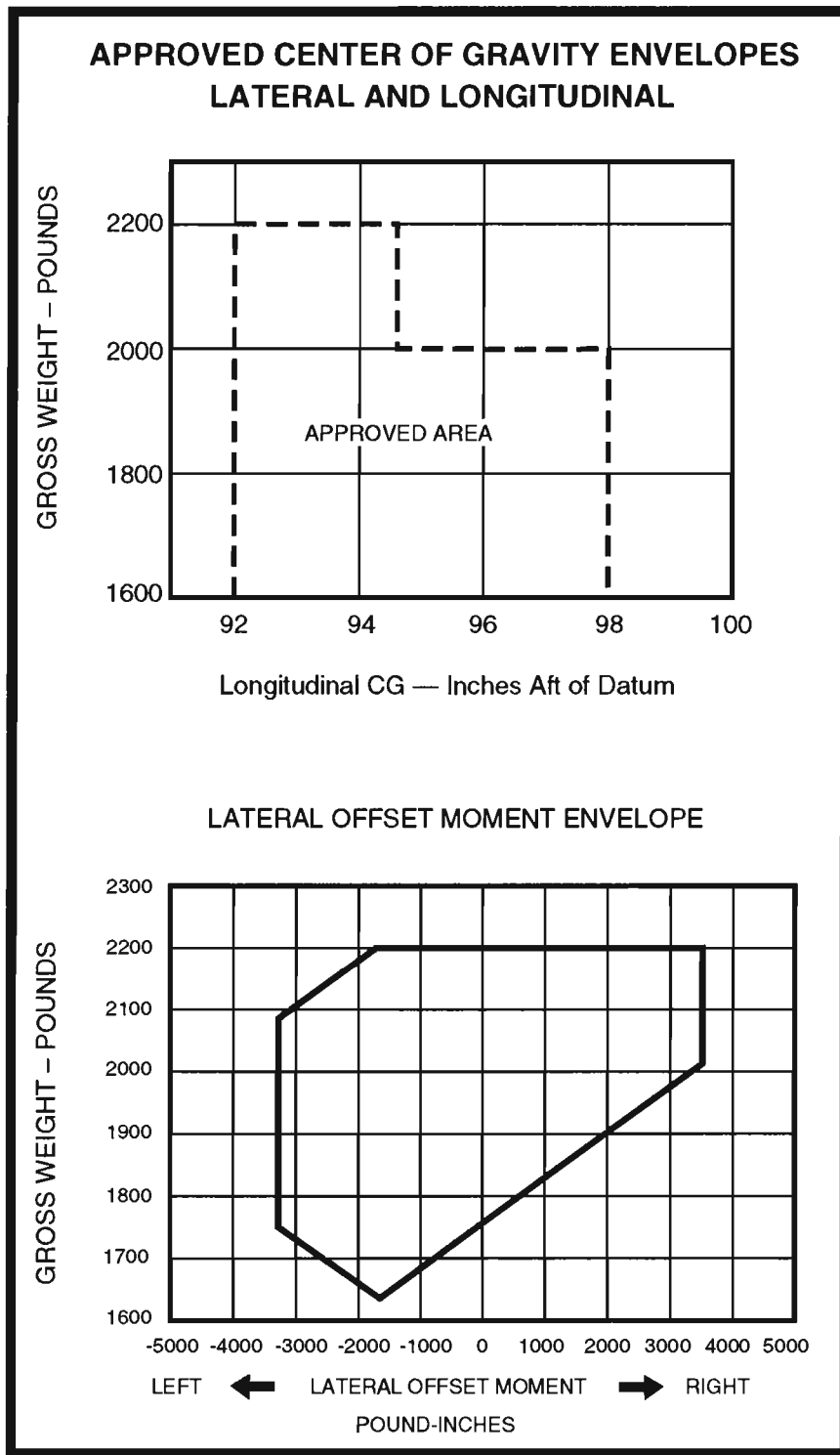

FIGURE 44.—Helicopter CG Envelopes.

CENTER OF GRAVITY MOMENT ENVELOPE

NORMAL CATEGORY

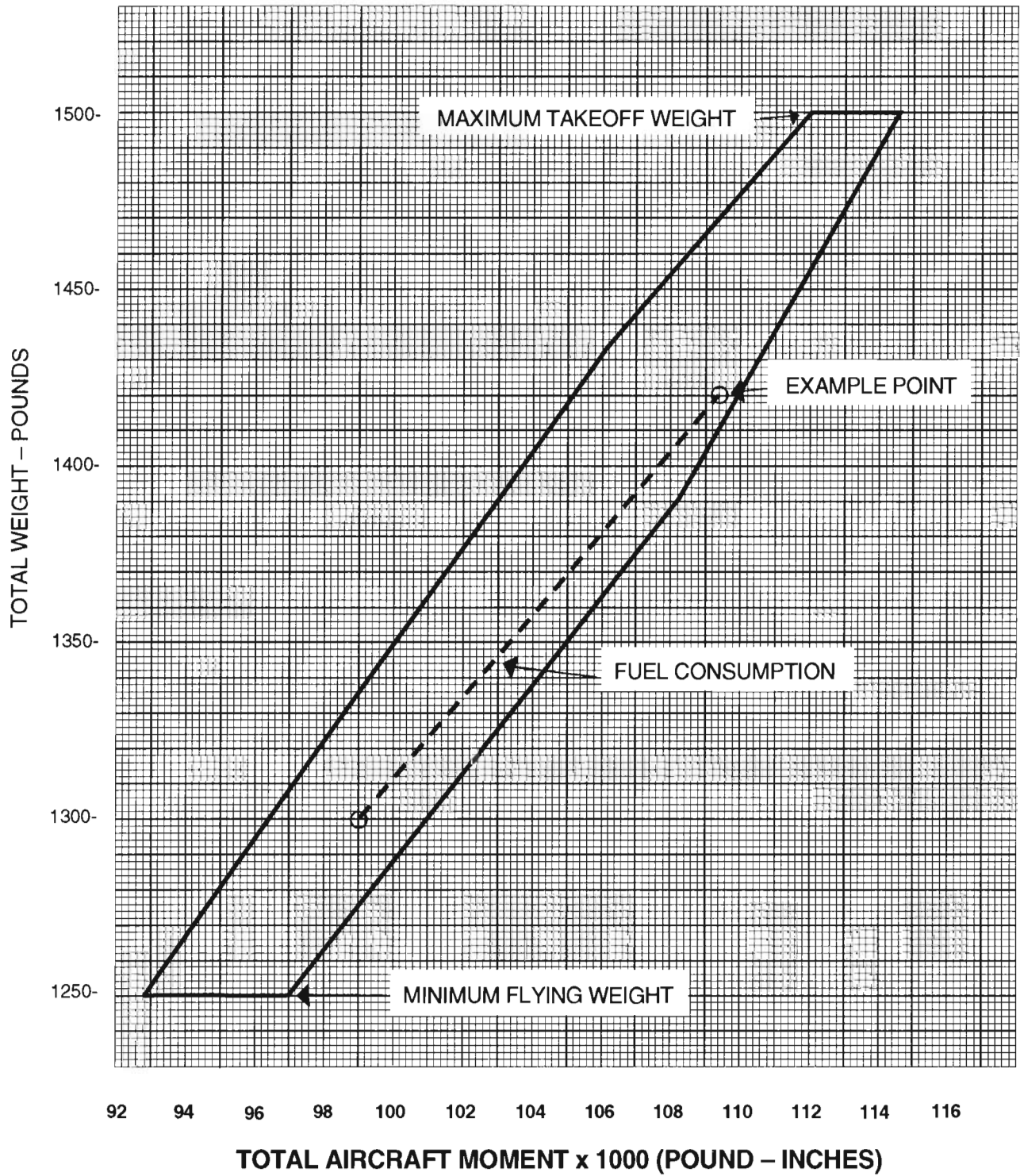

FIGURE 45.—Gyroplane Weight and Balance Graph.

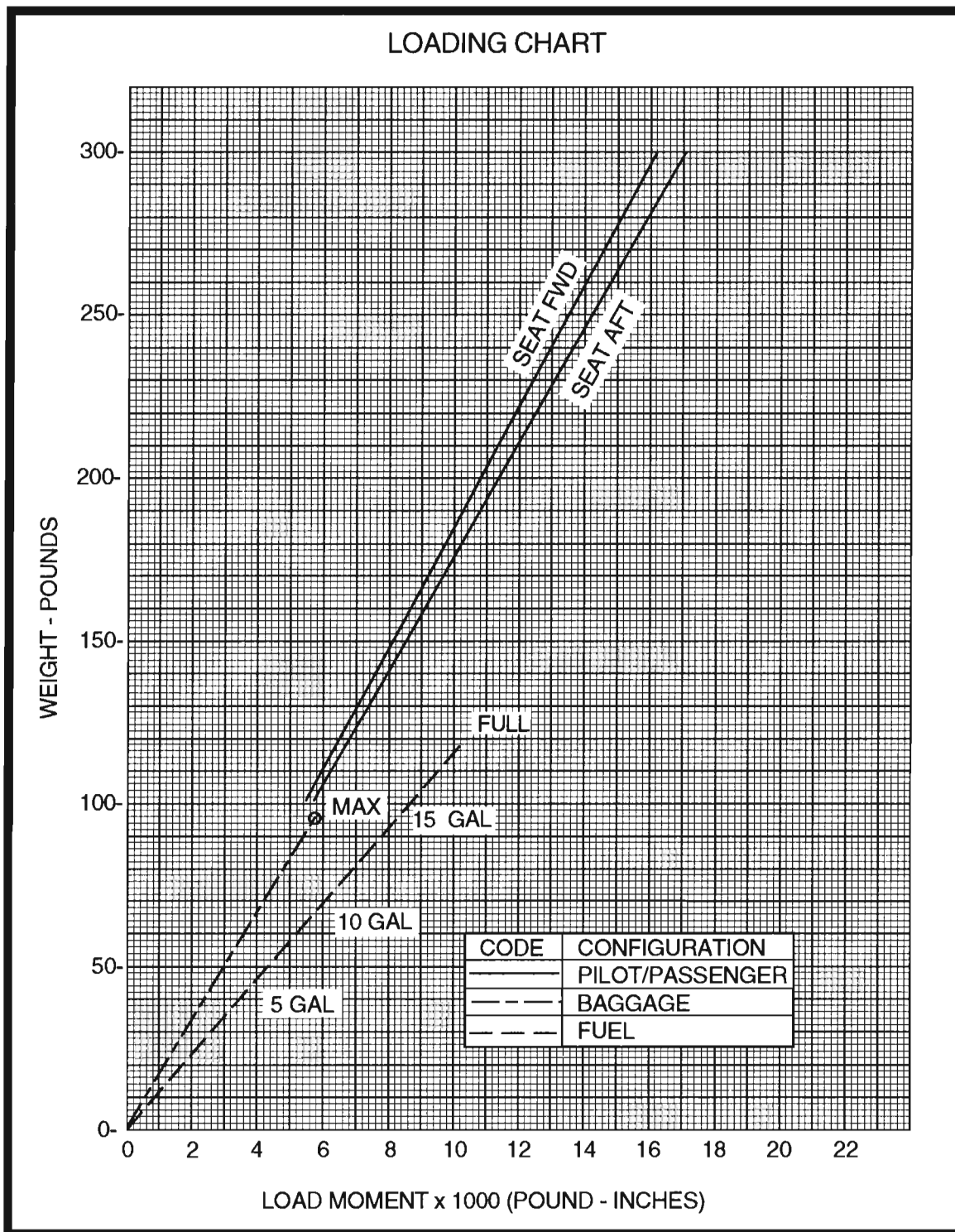

FIGURE 46.—Gyroplane Weight and Balance Graph.

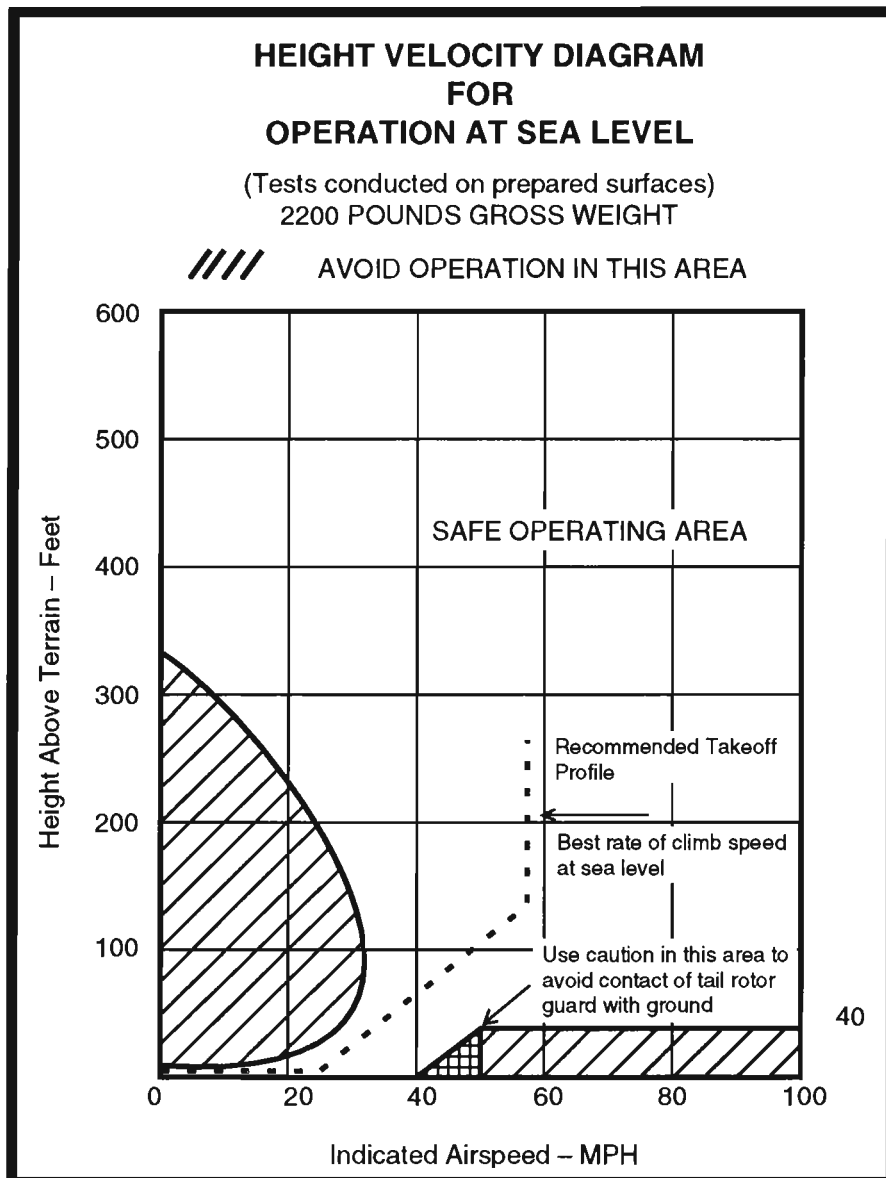

FIGURE 47.—Helicopter Height Velocity Diagram.

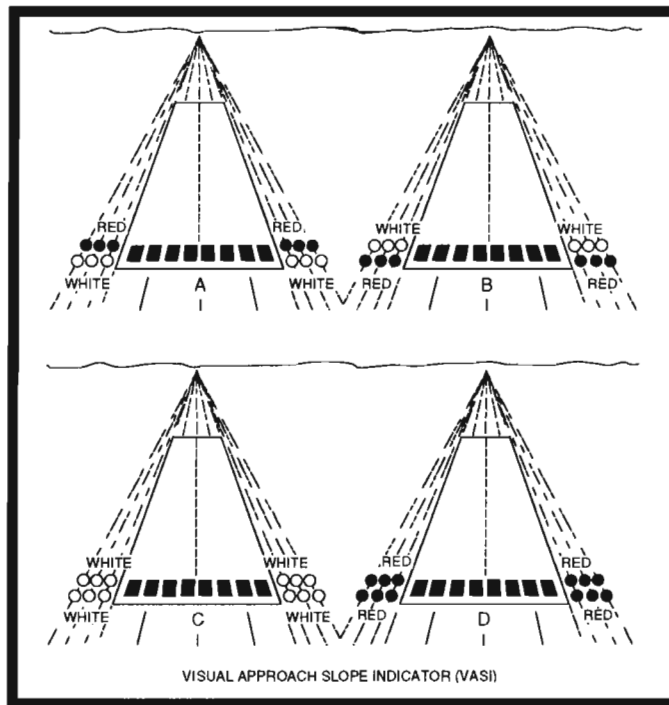

FIGURE 48.—VASI Illustrations.

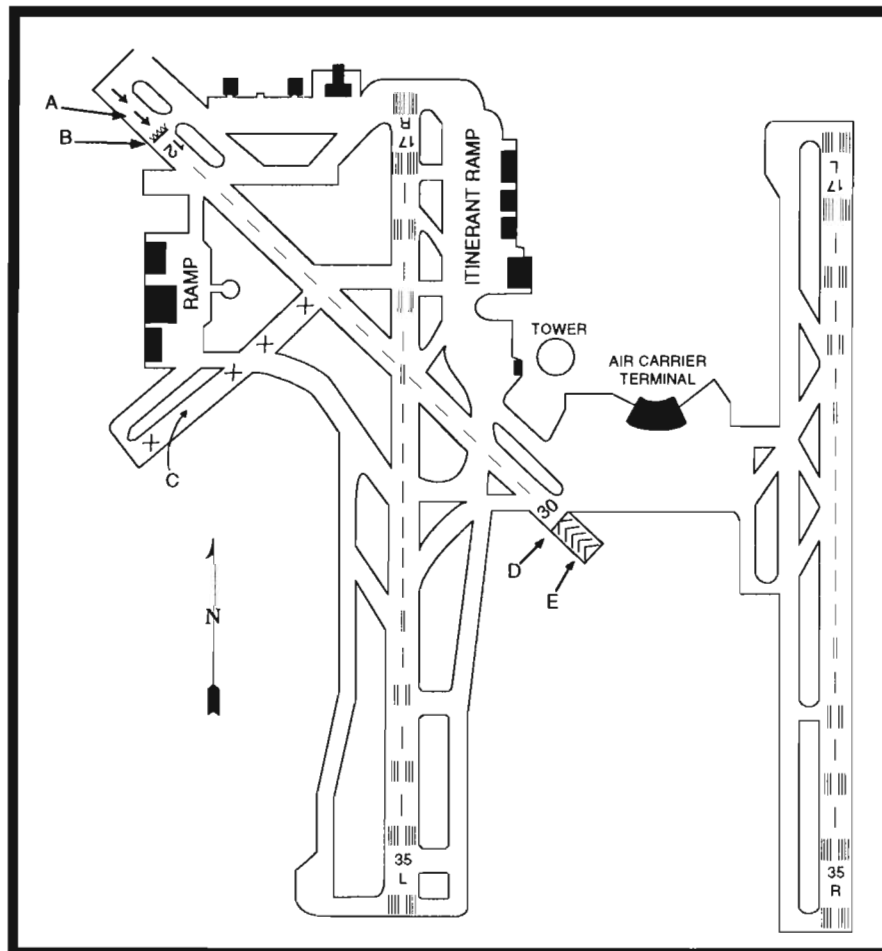

FIGURE 49.—Airport Diagram.

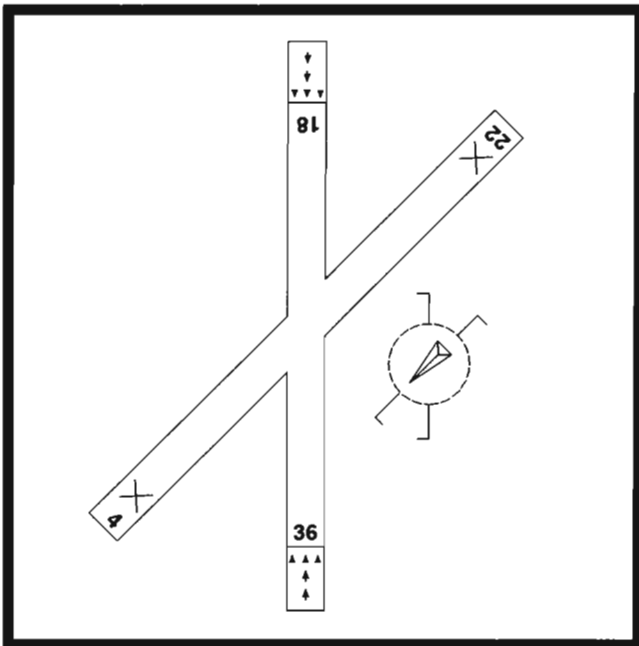

FIGURE 50.—Airport Diagram.

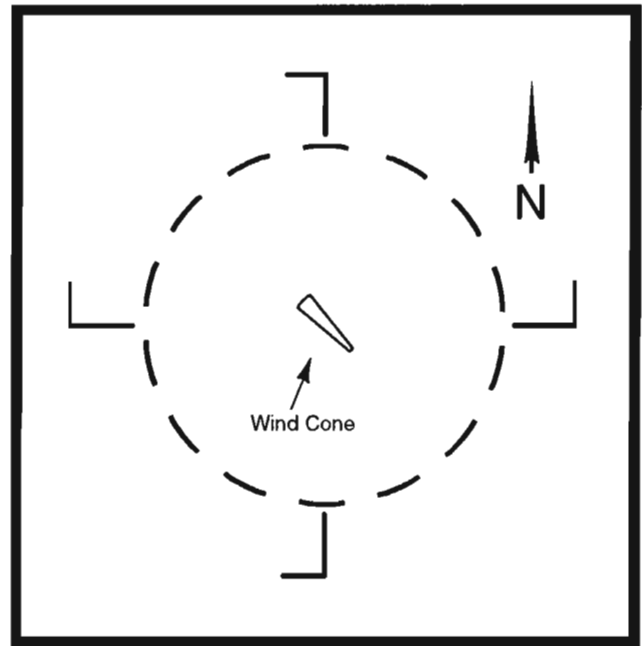

FIGURE 51.—Airport Landing Indicator.

1 TYPE		2 AIRCRAFT IDENTIFICATION		3 AIRCRAFT TYPE/SPECIAL EQUIPMENT		4 TRUE AIRSPEED		5 DEPARTURE POINT		6 DEPARTURE TIME		7 CRUISING ALTITUDE	
<input type="checkbox"/> VFR <input type="checkbox"/> IFR <input type="checkbox"/> DVFR						KTS				PROPOSED (Z) ACTUAL (Z)			
8 ROUTE OF FLIGHT													
9 DESTINATION (Name of airport and city)				10 EST. TIME ENROUTE		11 REMARKS							
				HOURS MINUTES									
12 FUEL ON BOARD			13 ALTERNATE AIRPORT(S)			14 PILOT'S NAME, ADDRESS & TELEPHONE NUMBER & AIRCRAFT HOME BASE					15 NUMBER ABOARD		
HOURS MINUTES													
16 COLOR OF AIRCRAFT						17 DESTINATION CONTACT/TELEPHONE (OPTIONAL)							
						CIVIL AIRCRAFT PILOTS. FAR Part 91 requires you file an IFR flight plan to operate under instrument flight rules in controlled airspace. Failure to file could result in a civil penalty not to exceed \$1,000 for each violation (Section 901 of the Federal Aviation Act of 1958, as amended). Filing of a VFR flight plan is recommended as a good operating practice. See also Part 99 for requirements concerning DVFR flight plans.							

Form Approved: OMB No. 2120-0026

U.S. DEPARTMENT OF TRANSPORTATION
FEDERAL AVIATION ADMINISTRATION

(FAA USE ONLY) PILOT BRIEFING VNR

FLIGHT PLAN STOPOVER

TIME STARTED SPECIALIST INITIALS

FAA Form 7233-1 (8-82) CLOSE VFR FLIGHT PLAN WITH _____ FSS ON ARRIVAL

FIGURE 52.—Flight Plan Form.

180

NEBRASKA

LINCOLN MUNI (LNK) 4 NW UTC-6(-5DT) N40°51.05' W96°45.55' OMAHA
 1218 B S4 FUEL 100LL JET A TPA--2218(1000) ARFF Index B H-1E, 3F, 4F, L-11B
 RWY 17R-35L: H12901X200 (ASPH-CONC-GRVD) S-100, D-200, DT-400 HIRL IAP
 RWY 17R: MALS R. VASI(V4L)—GA 3.0° TCH 55'. Rgt ttc. 0.4% down.
 RWY 35L: MALS R. VASI(V4L)—GA 3.0° TCH 55'.
 RWY 14-32: H8620X150 (ASPH-CONC-GRVD) S-80, D-170, DT-280 MIRL
 RWY 14: REIL. VASI(V4L)—GA 3.0° TCH 48'.
 RWY 32: VASI(V4L)—GA 3.0° TCH 53'. Thld dspcd 431'. Pole. 0.3% up.
 RWY 17L-35R: H5400X100 (ASPH-CONC-AFSC) S-49, D-60 HIRL 0.8% up N
 RWY 17L: PAPI(P4L)—GA 3.0° TCH 33'. RWY 35R: PAPI(P4L)—GA 3.0° TCH 40'. Pole. Rgt ttc.
AIRPORT REMARKS: Attended continuously. Birds in vicinity of arpt. Twy D clsd between taxiways S and H indef. For
 MALS Rwy 17R and Rwy 35L ctc twr. When twr clsd MALS Rwy 17R and Rwy 35L preset on med ints, and REIL
 Rwy 14 left on when wind favor. NOTE: See Land and Hold Short Operations Section.
WEATHER DATA SOURCES: ASOS (402) 474-9214, LLWAS
COMMUNICATIONS: CTAF 118.5 ATIS 118.05 UNICOM 122.95
 COLUMBUS FSS (OLU) TF 1-800-WX-BRIEF, NOTAM FILE LNK.
 RCD 122.65 (COLUMBUS FSS)
 (R) APP/DEP CON 124.0 (170°-349°) 124.8 (350°-169°) (1130-0630Z†)
 (R) MINNEAPOLIS CENTER APP/DEP CON 128.75 (0630-1130Z†)
 TOWER 118.5 125.7 (1130-0630Z†) GND CON 121.9 CLNC DEL 120.7
AIRSPACE: CLASS C svc 1130-0630Z† ctc APP CON other times CLASS E.
RADIO AIDS TO NAVIGATION: NOTAM FILE LNK, VHF/DF ctc FSS.
 (H) VORTACW 116.1 LNK Chan 108 N40°55.43' W96°44.52' 181° 4.5 NM to fld, 1370/9E
 POTTS NDB (MHW/LOM) 385 LN N40°44.83' W96°45.75' 355° 6.2 NM to fld. Unmonitored when twr clsd.
 ILS 111.1 I-OCZ Rwy 17R. MM and OM unmonitored.
 ILS 109.9 I-LNK Rwy 35L LOM POTTS NDB. MM unmonitored. LOM unmonitored when twr clsd.
COMM/NAVAID REMARKS: Emerg frequency 121.5 not available at tower.

LOUP CITY MUNI (NE03) 1 NW UTC-6(-5DT) N41°17.42' W98°59.44' OMAHA
 2070 B FUEL 100LL L-11B
 RWY 15-33: H3200X50 (ASPH) S-8 LIRL
 RWY 33: Trees.
 RWY 04-22: 2100X100 (TURF)
 RWY 04: Tree. RWY 22: Road.
AIRPORT REMARKS: Unattended. For svc call 308-745-0328/1244/0664.
COMMUNICATIONS: CTAF 122.9
 COLUMBUS FSS (OLU) TF 1-800-WX-BRIEF, NOTAM FILE OLU.
RADIO AIDS TO NAVIGATION: NOTAM FILE OLU.
 WOLBACH (H) VORTAC 114.8 OBH Chan 95 N41°22.54' W98°21.22' 253° 29.3 NM to fld, 2010/7E.

MARTIN FLD (See SO SIOUX CITY)

MC COOK MUNI (MCK) 2 E UTC-6(-5DT) N40°12.36' W100°35.51' OMAHA
 2579 B S4 FUEL 100LL JET A ARFF Index Ltd. H-2D, L-11A
 RWY 12-30: H5999X100 (CONC) S-30, D-38 MIRL 0.6% up NW IAP
 RWY 12: MALS. VASI(V4L)—GA 3.0° TCH 33'. Tree. RWY 30: REIL. VASI(V4L)—GA 3.0° TCH 42'.
 RWY 03-21: H3999X75 (CONC) S-30, D-38 MIRL
 RWY 03: VASI(V2L)—GA 3.0° TCH 26'. Rgt ttc. RWY 21: VASI(V2L)—GA 3.0° TCH 26'.
 RWY 17-35: 1350X200 (TURF)
AIRPORT REMARKS: Attended daylight hours. Parachute Jumping. Deer on and in vicinity of arpt. Numerous
 waterfowl/migratory birds invof arpt. Arpt closed to air carrier operations with more than 30 passengers except
 24 hour PPR, call arpt manager 308-345-2022. Avoid McCook State (abandoned) arpt 7 miles NW on the MCK
 VOR/DME 313° radial at 8.3 DME. ACTIVATE VASI Rwy 12 and 30 and MALS Rwy 12—CTAF.
COMMUNICATIONS: CTAF/UNICOM 122.8
 COLUMBUS FSS (OLU) TF 1-800-WX-BRIEF, NOTAM FILE MCK.
 RCD 122.6 (COLUMBUS FSS)
 DENVER CENTER APP/DEP CON 132.7
AIRSPACE: CLASS E svc effective 1100-0500Z† except holidays other times CLASS G.
RADIO AIDS TO NAVIGATION: NOTAM FILE MCK.
 (H) VOR/DME 115.3 MCK Chan 100 N40°12.23' W100°35.65' at fld, 2570/8E.

FIGURE 53.—Airport/Facility Directory Excerpt.

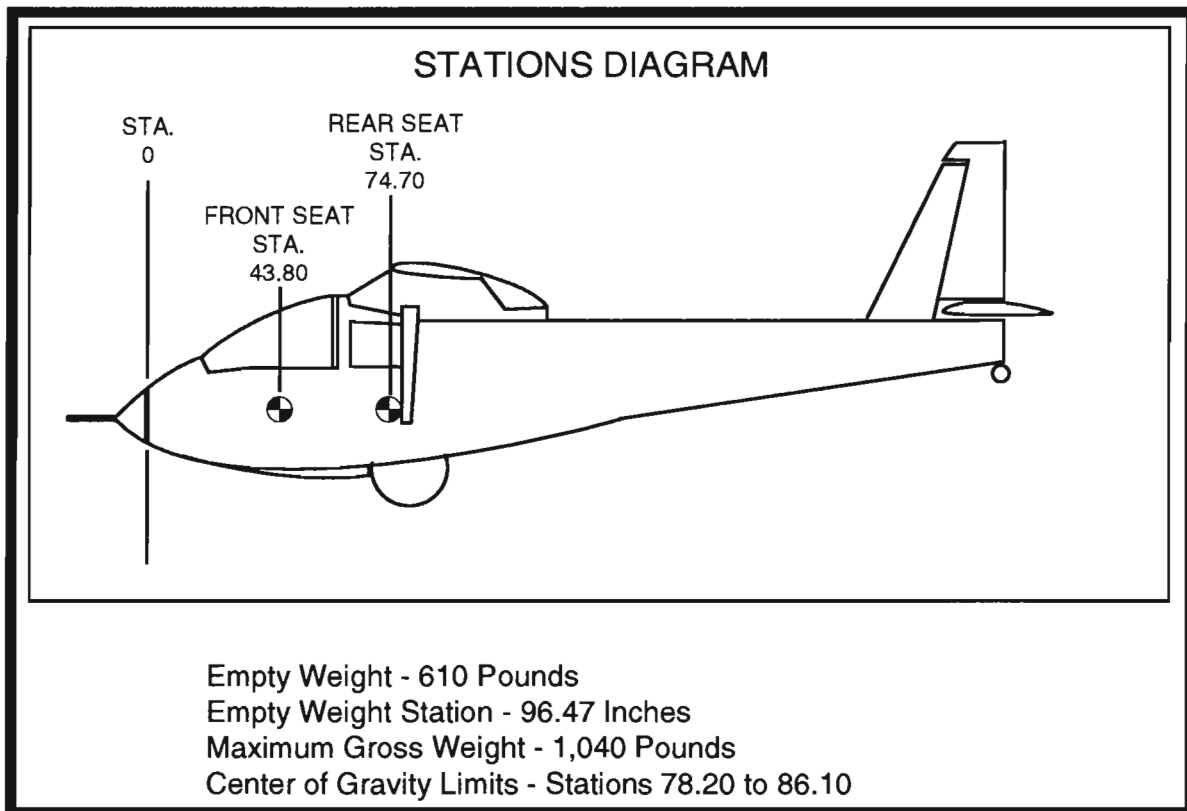

FIGURE 54.—Glider Weight and Balance Diagram.

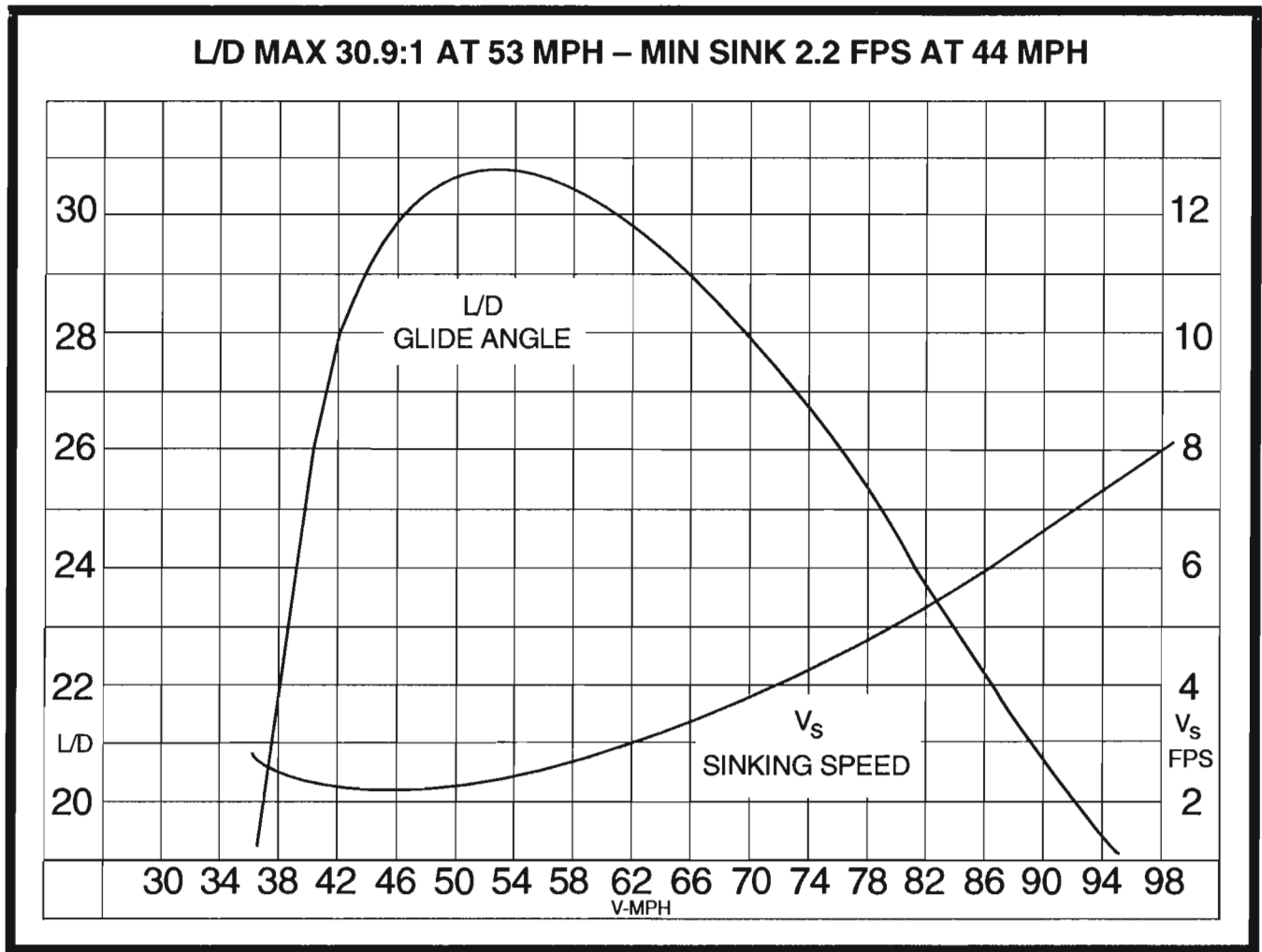

FIGURE 55.—Glider Performance Graph.

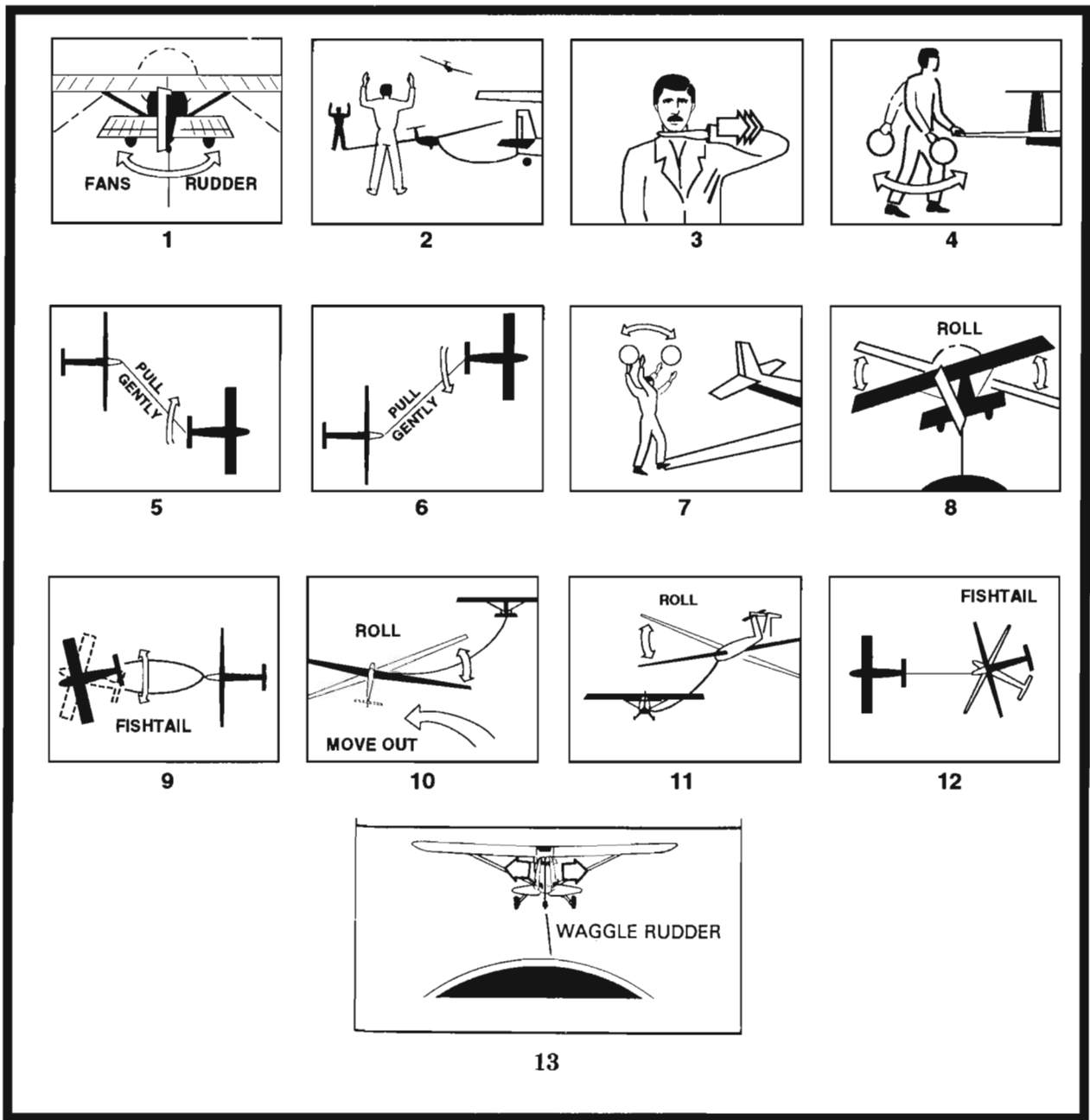

FIGURE 56.—Standard Soaring Signals.

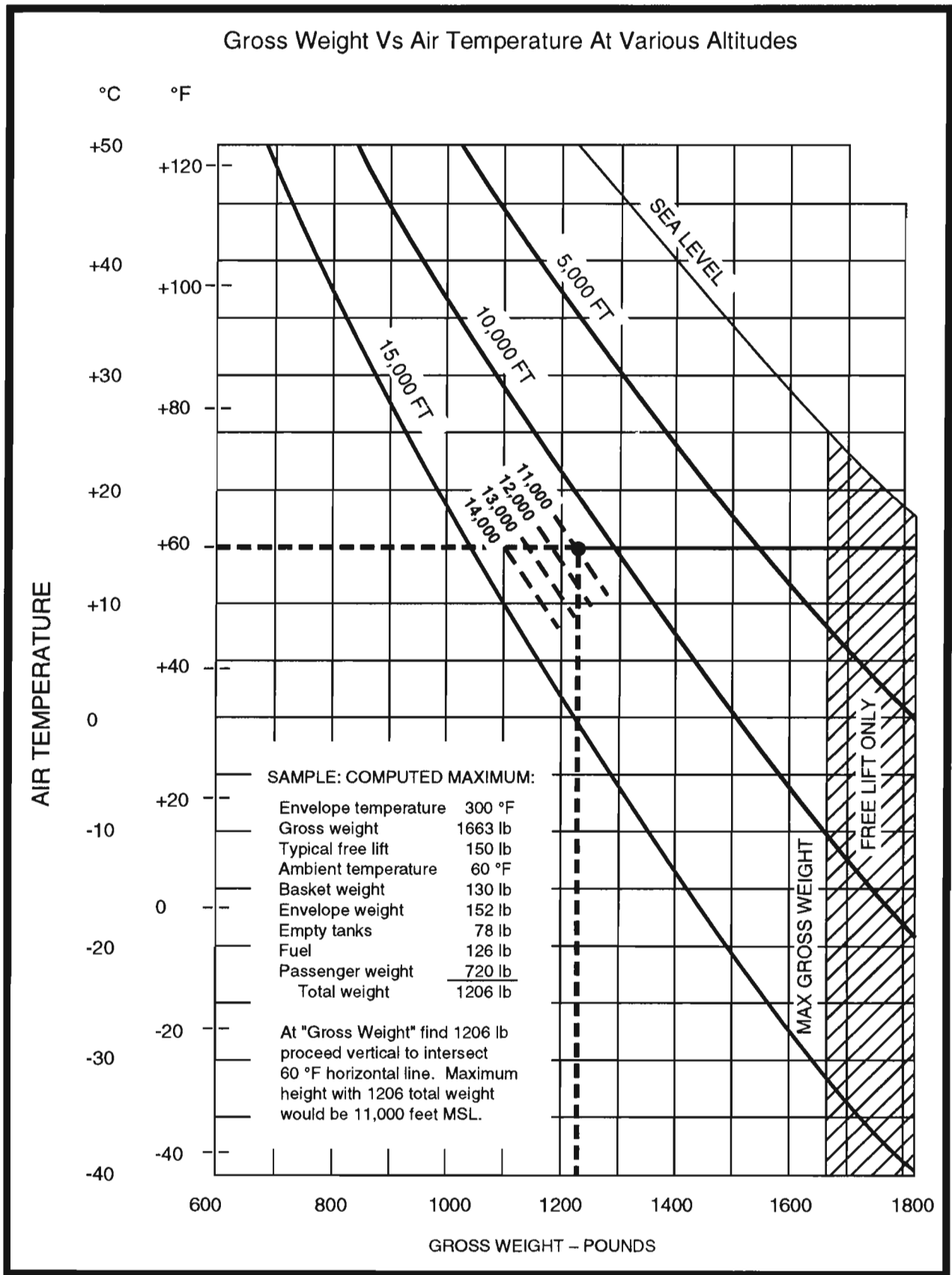

FIGURE 57.—Hot Air Balloon Performance Graph.

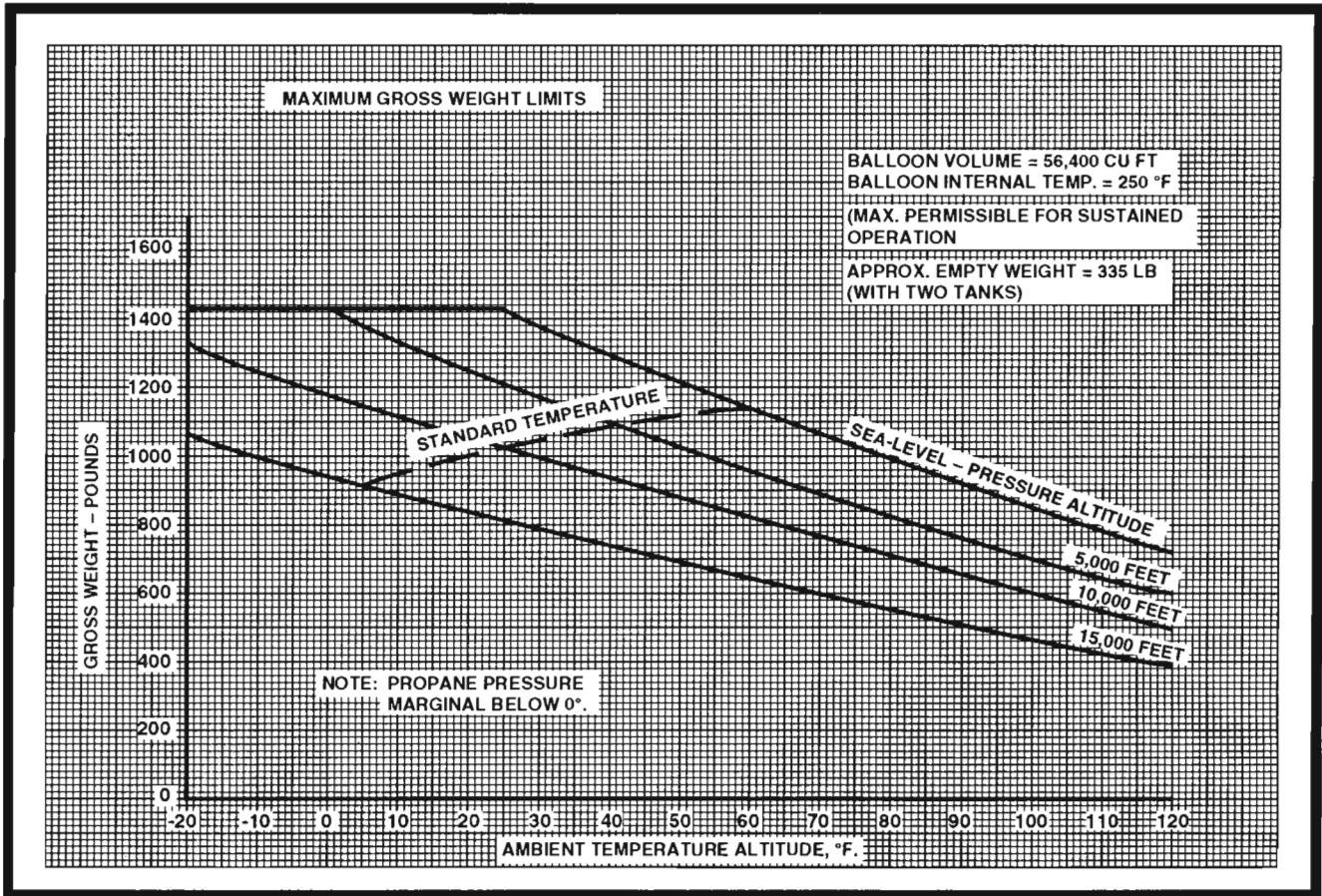

FIGURE 58.—Hot Air Balloon Performance Graph.

For	N	30	60	E	120	150
Steer	0	27	56	85	116	148
For	S	210	240	W	300	330
Steer	181	214	244	274	303	332

FIGURE 59.—Compass card.

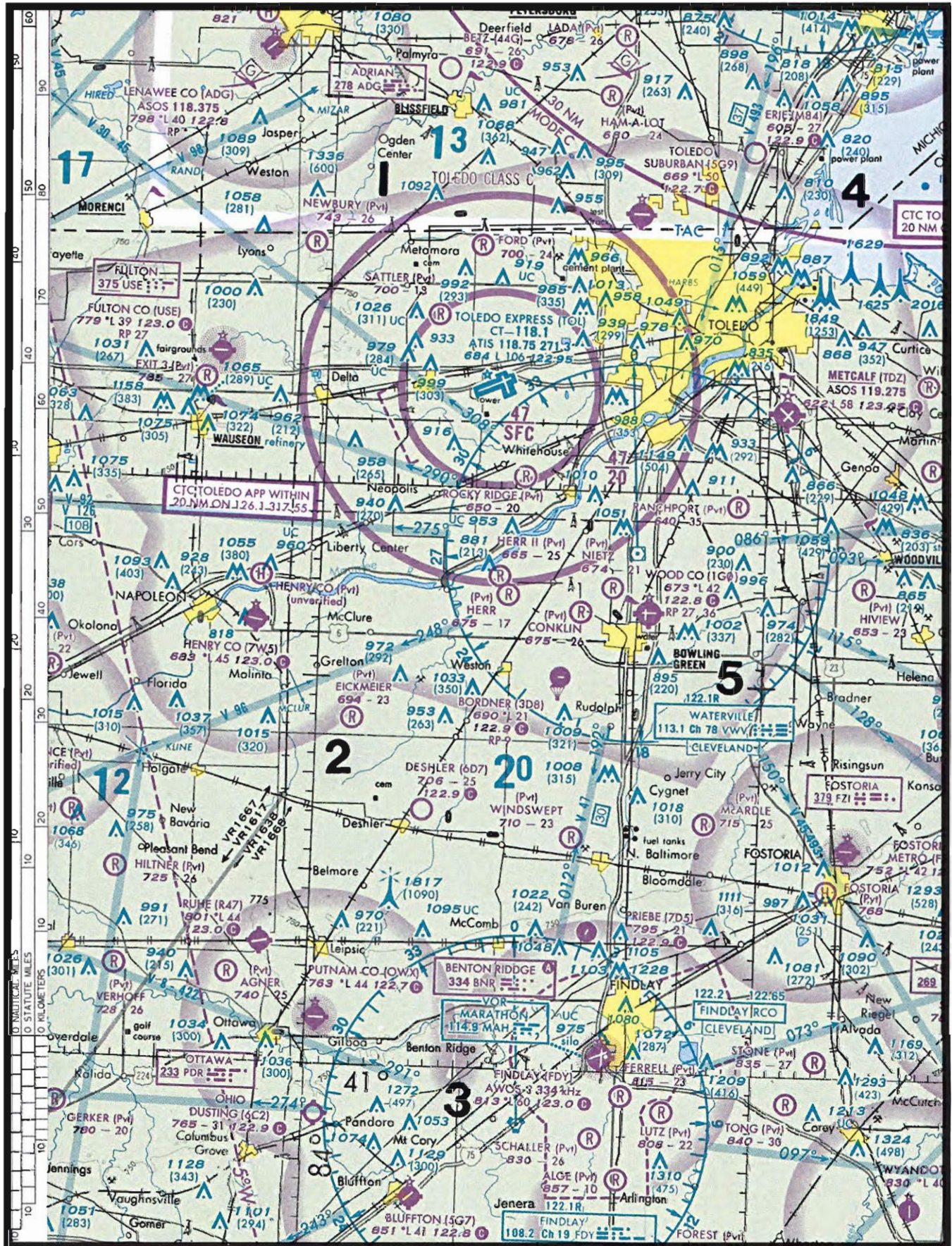

FIGURE 60.—Sectional Chart Excerpt.

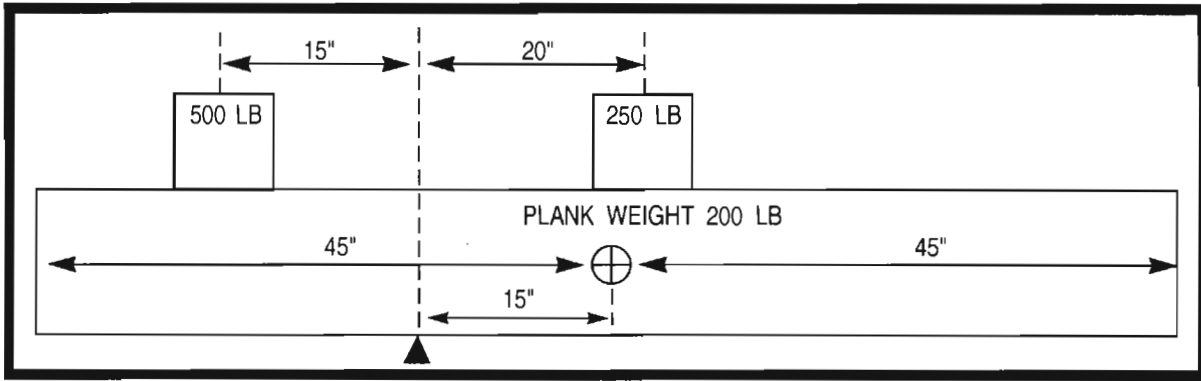

FIGURE 61.—Weight and Balance Diagram.

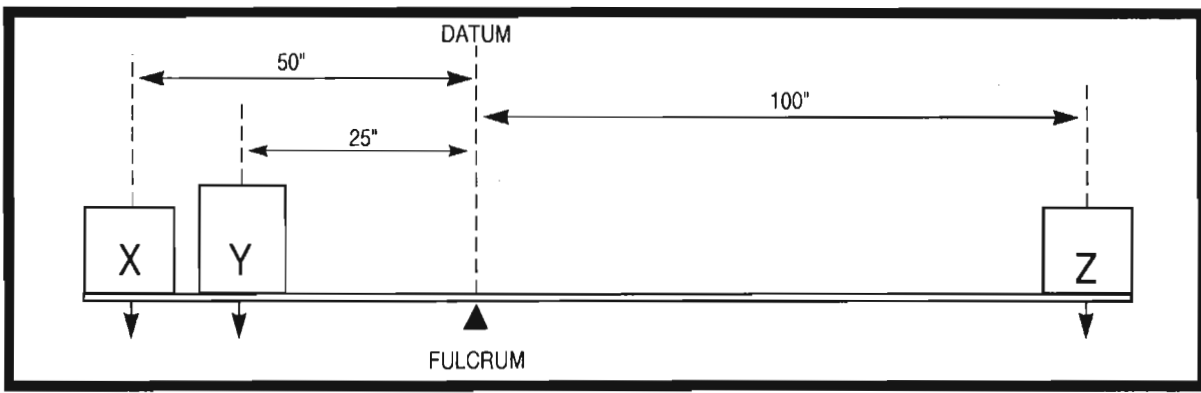

FIGURE 62.—Weight and Balance Diagram.

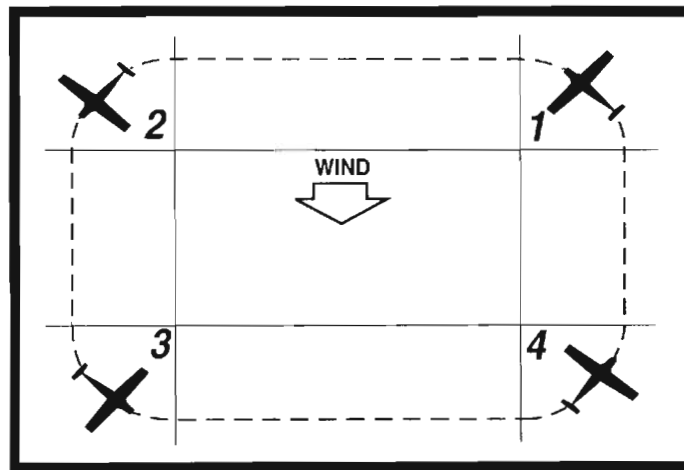

FIGURE 63.—Rectangular Course.

OHIO

TOLEDO

METCALF FLD (TDZ) 6 SE UTC-5(-4DT) N41°33.89' W83°28.94'

DETROIT
H-3H, L-23C
IAP

622 B S4 FUEL 100LL, JET A OX 1, 3

RWY 14-32: H5830X100 (ASPH) S-63, D-85 MIRL

RWY 14: REIL. Tower. RWY 32: VASI(V4L)—GA 3.0° TCH 43'.
Road.

RWY 04-22: H3664X150 (ASPH) S-63, D-85 MIRL

RWY 04: REIL. VASI(V4L)—GA 3.0° TCH 45'. Trees.

RWY 22: REIL. VASI(V4R)—GA 3.0° TCH 39'. Thld dsplcd 90'. Tree.

RUNWAY DECLARED DISTANCE INFORMATION

RWY 14: TORA 4600 TODA 4600 ASDA 5242 LDA 4680

RWY 32: TORA 5268 TODA 5268 ASDA 5268 LDA 4680

AIRPORT REMARKS: Attended Mon-Fri all hrs; Sat-Sun 1200-0100Z.

Parallel twy Rwy 04-22 and Rwy 14-32 25' wide. Seagulls on and

invol aprt. Ldg fee. ACTIVATE REILs Rwy 04 and Rwy 22—CTAF.

Rwy 32 VASI OTS indef. REIL Rwy 14 OTS indef.

WEATHER DATA SOURCES: ASOS 119.275 (419) 838-5034.

COMMUNICATIONS: CTAF/UNICOM 123.05

CLEVELAND FSS (CLE) TF 1-800-WX-BRIEF. NOTAM FILE TDZ.

Ⓡ TOLEDO APP/DEP CON 134.35 CLNC DEL 125.6 OTS indef.

RADIO AIDS TO NAVIGATION: NOTAM FILE CLE.

WATERVILLE (L) VOR/DME 113.1 VVW Chan 78 N41°27.09'

W83°38.32' 048° 9.8 NM to fld. 660/2W.

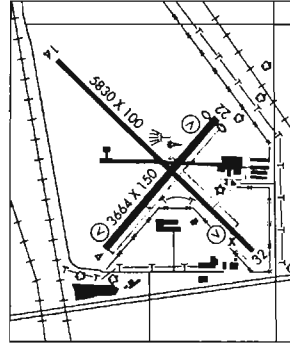

TOLEDD EXPRESS (TOL) 10 W UTC-5(-4DT) N41°35.21' W83°48.47'

DETROIT
H-3H, L-23C
IAP

684 B S4 FUEL 100LL, JET A OX 3 LRA ARFF Index B

RWY 07-25: H10600X150 (ASPH-GRVD) S-100, D-174, DT-300, DDT-550 HIRL CL

RWY 07: ALSF2. TDZL. Tree. Arresting device.

RWY 25: MALSR. VASI(V4L)—GA 3.0° TCH 51'. Tree. Arresting device. 0.3% up.

RWY 16-34: H5599X150 (ASPH-GRVD) S-100, D-174, DT-300 MIRL

RWY 16: REIL. Trees. RWY 34: REIL. VASI(V4L)—GA 3.0° TCH 35'. Trees.

AIRPORT REMARKS: Attended continuously. Fuel and svc avbl 1300-0500Z. Birds and deer on and invol aprt.

Customs: Sat-Sun req must be made prior to 2200Z on Frn, phone 419-259-6424. Twy C restricted to B-727

act or smaller. Rwy 34 REIL OTS indef. NOTE: See Land and Hold Short Operations Section.

WEATHER DATA SOURCES: ASOS (419) 865-8351.

COMMUNICATIONS: ATIS 118.75 UNICOM 122.95

CLEVELAND FSS (CLE) TF 1-800-WX-BRIEF. NOTAM FILE TOL.

Ⓡ APP/DEP CON 126.1 (180°-359°) 134.35 (360°-179°) 123.975

TOWER 118.1 GND CON 121.9 CLNC DEL 121.75

AIRSPACE: CLASS C svc continuous ctc APP CON

RADIO AIDS TO NAVIGATION: NOTAM FILE CLE.

WATERVILLE (L) VOR/DME 113.1 VVW Chan 78 N41°27.09' W83°38.32' 319° 11.1 NM to fld. 660/2W.

TOPHR NDB (LOM) 219 TO N41°33.21' W83°55.27' 074° 5.5 NM to fld. Unmonitored. NOTAM FILE TOL.

ILS 109.7. I-TOL Rwy 07. LOM TOPHR NDB.

ILS 108.7. I-BQE Rwy 25.

ASR

SEAGATE HELISTOP (6T2) 00 N UTC-5(-4DT) N41°39.25' W83°31.88'

DETROIT

650

HELIPAD HI: 50X50 (CONC)

HELIPAD REMARKS: Unattended. Ldg fee. ACTIVATE orange perimeter lgts—CTAF. Helipad H1 NSTD 1-box (2 VASIS).

For helipad access to street phone 419-247-2172; 2 days in advance. Helipad H1 not marked with "H."

Helipad H1 perimeter lgts.

COMMUNICATIONS: CTAF/UNICOM 123.05

CLEVELAND FSS (FDY) TF 800-WX-BRIEF. NOTAM FILE CLE.

MICHIGAN

ADRIAN

LENAWEE CO (ADG) 3 SW UTC-5(-4DT) N41°52.17' W84°04.49'

DETROIT
L-23C
IAP

798 B S4 FUEL 100LL, JET A

RWY 05-23: H3994X75 (ASPH) S-20 MIRL

RWY 05: REIL. VASI(V4L)—GA 3.0° TCH 40'. Road. RWY 23: PAPI(P4R)—GA 3.2° TCH 30'. Tree.

RWY 11-29: 2400X270 (TURF)

RWY 11: Trees. RWY 29: Trees.

AIRPORT REMARKS: Attended 1300Z-dusk. Arpt unattended major holidays except by prior arrangement; call arpt

manager 517-263-0045. Rwy 11-29 CLOSED Dec-Apr and when snow covered. Snow removal Rwy 05-23 only.

Extensive glider ops weekends. Rgt tfc Rwy 05 for glider ops. Perimeters twy marked with reflectors. Taxi on

hard surfaces only during spring thaw and wet conditions. Rwy 11-29 marked with 3' yellow cones. MIRL Rwy

05-23, preset low inst; to increase ints and ACTIVATE REIL Rwy 05; VASI Rwy 05 and PAPI Rwy 23—CTAF.

WEATHER DATA SOURCES: ASOS 118.375 (517) 265-9089.

COMMUNICATIONS: CTAF/UNICOM 122.8

LANSING FSS (LAN) TF 1-800-WX-BRIEF. NOTAM FILE ADG.

Ⓡ TOLEDO APP/DEP CON 126.1

RADIO AIDS TO NAVIGATION: NOTAM FILE JXN.

JACKSON (L) VOR/DME 109.6 JXN Chan 33 N42°15.55' W84°27.52' 149° 29 NM to fld. 1000/5W.

ADRIAN NDB (MHW) 278 ADG N41°52.20' W84°04.66' at fld. NOTAM FILE ADG. Unmonitored.

FIGURE 64.—Airport/Facility Directory Excerpt.

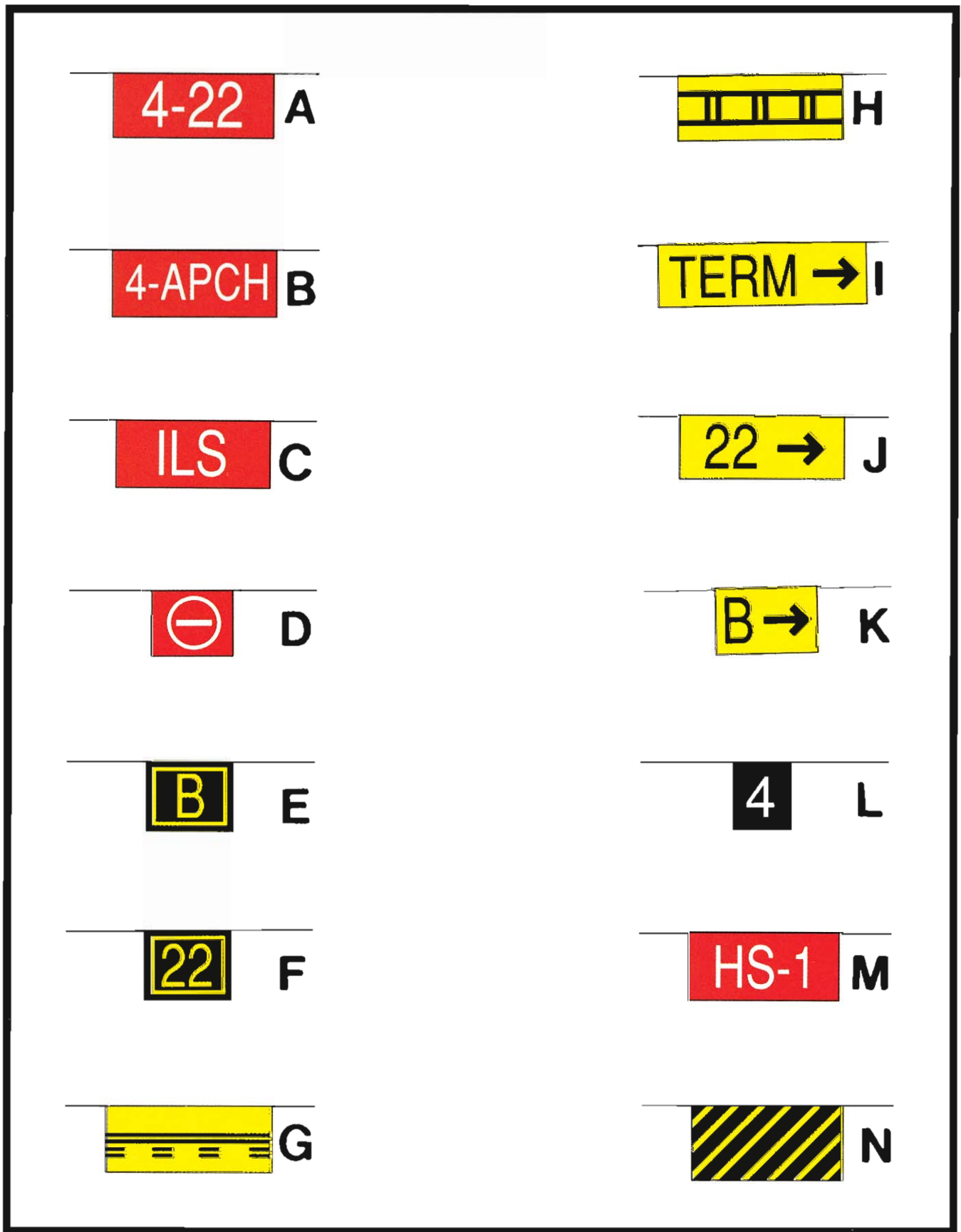

FIGURE 66.—U.S. Airport Signs.

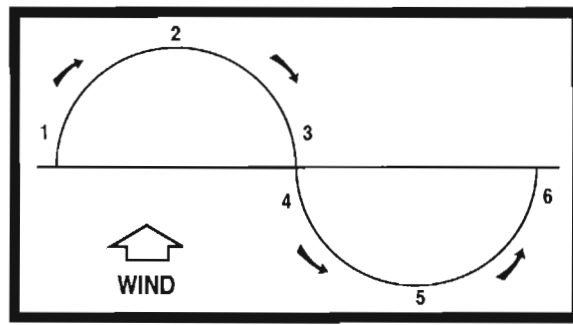

FIGURE 67.—S-Turn Diagram.

