



# International Agreement Report

## Simulation of the Experimental Series F2.2 at PKL Facility Using RELAP5/Mod 3.3

Prepared by:

S. Carlos, J. F. Villanueva, S. Martorell, V. Serradell

Universidad Politécnica de Valencia  
Departamento de Ingeniería Química y Nuclear  
Camino Vera s/n  
46022 Valencia, SPAIN

A. Calvo, NRC Project Manager

**Office of Nuclear Regulatory Research  
U.S. Nuclear Regulatory Commission  
Washington, DC 20555-0001**

**Manuscript Completed:** November 2011

**Date Published:** February 2012

Prepared as part of  
The Agreement on Research Participation and Technical Exchange  
Under the Thermal-Hydraulic Code Applications and Maintenance Program (CAMP)

**Published by  
U.S. Nuclear Regulatory Commission**

**AVAILABILITY OF REFERENCE MATERIALS  
IN NRC PUBLICATIONS**

**NRC Reference Material**

As of November 1999, you may electronically access NUREG-series publications and other NRC records at NRC's Public Electronic Reading Room at <http://www.nrc.gov/reading-rm.html>. Publicly released records include, to name a few, NUREG-series publications; *Federal Register* notices; applicant, licensee, and vendor documents and correspondence; NRC correspondence and internal memoranda; bulletins and information notices; inspection and investigative reports; licensee event reports; and Commission papers and their attachments.

NRC publications in the NUREG series, NRC regulations, and *Title 10, Energy*, in the Code of *Federal Regulations* may also be purchased from one of these two sources.

1. The Superintendent of Documents  
U.S. Government Printing Office  
Mail Stop SSOP  
Washington, DC 20402-0001  
Internet: [bookstore.gpo.gov](http://bookstore.gpo.gov)  
Telephone: 202-512-1800  
Fax: 202-512-2250
2. The National Technical Information Service  
Springfield, VA 22161-0002  
[www.ntis.gov](http://www.ntis.gov)  
1-800-553-6847 or, locally, 703-605-6000

A single copy of each NRC draft report for comment is available free, to the extent of supply, upon written request as follows:

Address: U.S. Nuclear Regulatory Commission  
Office of Administration  
Publications Branch  
Washington, DC 20555-0001  
E-mail: [DISTRIBUTION.RESOURCE@NRC.GOV](mailto:DISTRIBUTION.RESOURCE@NRC.GOV)  
Facsimile: 301-415-2289

Some publications in the NUREG series that are posted at NRC's Web site address <http://www.nrc.gov/reading-rm/doc-collections/nuregs> are updated periodically and may differ from the last printed version. Although references to material found on a Web site bear the date the material was accessed, the material available on the date cited may subsequently be removed from the site.

**Non-NRC Reference Material**

Documents available from public and special technical libraries include all open literature items, such as books, journal articles, and transactions, *Federal Register* notices, Federal and State legislation, and congressional reports. Such documents as theses, dissertations, foreign reports and translations, and non-NRC conference proceedings may be purchased from their sponsoring organization.

Copies of industry codes and standards used in a substantive manner in the NRC regulatory process are maintained at—

The NRC Technical Library  
Two White Flint North  
11545 Rockville Pike  
Rockville, MD 20852-2738

These standards are available in the library for reference use by the public. Codes and standards are usually copyrighted and may be purchased from the originating organization or, if they are American National Standards, from—

American National Standards Institute  
11 West 42<sup>nd</sup> Street  
New York, NY 10036-8002  
[www.ansi.org](http://www.ansi.org)  
212-642-4900

Legally binding regulatory requirements are stated only in laws; NRC regulations; licenses, including technical specifications; or orders, not in NUREG-series publications. The views expressed in contractor-prepared publications in this series are not necessarily those of the NRC.

The NUREG series comprises (1) technical and administrative reports and books prepared by the staff (NUREG-XXXX) or agency contractors (NUREG/CR-XXXX), (2) proceedings of conferences (NUREG/CP-XXXX), (3) reports resulting from international agreements (NUREG/IA-XXXX), (4) brochures (NUREG/BR-XXXX), and (5) compilations of legal decisions and orders of the Commission and Atomic and Safety Licensing Boards and of Directors' decisions under Section 2.206 of NRC's regulations (NUREG-0750).

**DISCLAIMER:** This report was prepared under an international cooperative agreement for the exchange of technical information. Neither the U.S. Government nor any agency thereof, nor any employee, makes any warranty, expressed or implied, or assumes any legal liability or responsibility for any third party's use, or the results of such use, of any information, apparatus, product or process disclosed in this publication, or represents that its use by such third party would not infringe privately owned rights.



# International Agreement Report

## Simulation of the Experimental Series F2.2 at PKL Facility Using RELAP5/Mod 3.3

Prepared by:

S. Carlos, J. F. Villanueva, S. Martorell, V. Serradell

Universidad Politécnica de Valencia  
Departamento de Ingeniería Química y Nuclear  
Camino Vera s/n  
46022 Valencia, SPAIN

A. Calvo, NRC Project Manager

**Office of Nuclear Regulatory Research  
U.S. Nuclear Regulatory Commission  
Washington, DC 20555-0001**

**Manuscript Completed:** November 2011

**Date Published:** February 2012

Prepared as part of  
The Agreement on Research Participation and Technical Exchange  
Under the Thermal-Hydraulic Code Applications and Maintenance Program (CAMP)

**Published by  
U.S. Nuclear Regulatory Commission**



## ABSTRACT

The reactor coolant system water level is reduced when a nuclear power plant is in shutdown conditions for refuelling. This situation is known as mid-loop operation, and the residual heat removal (RHR) system is used to remove the decay power heat generated in the reactor core.

In mid-loop conditions, some accidental situations may occur with a nonnegligible contribution to the plant risk, and all involve the loss of the RHR system. Thus, to better understand the thermal-hydraulic processes following the loss of the RHR during shutdown, transients of this kind have been simulated using best-estimate codes in different integral test facilities. In PKL facility different series of experiments have been undertaken to analyse the plant response in shutdown. In this context, the F2 series consists of analyzing the loss of residual heat removal under  $\frac{3}{4}$  loop operation with closed primary circuit. In particular test F2.2 has been developed to investigate the influence of the configuration of the secondary side (i.e. number of SGs filled with water and ready for activation) on the heat transfer mechanisms in the U-tubes of the SGs and study the boron dilution process in critical parts of the primary circuit. Two experiments belonging to this experimental series have been performed, F2.2 RUN1 and F2.2 RUN2. The simulations present differences in number of steam generators filled and ready for operation. Thus for RUN1 there is one steam generator filled with water and controlled at 2 bar and in RUN2 there are two steam generators SGs filled with water and controlled at 2 bar.

This work focuses on the simulation, using the best estimate code RELAP5/Mod 3.3, of both of the Runs of the experiment F2.2 conducted at the PKL facility.



## FOREWORD

Extensive knowledge and techniques have been produced and made available in the field of thermal-hydraulic responses during reactor transients and accidents, and major system computer codes have achieved a high degree of maturity through extensive qualification, assessment and validation processes. Best-estimate analysis methods are increasingly used in licensing, replacing the traditional conservative approaches. Such methods include an assessment of the uncertainty of their results that must be taken into account when the safety acceptance criteria for the licensing analysis are verified.

Traditional agreements between the Nuclear Regulatory Commission of the United States of America (USNRC) and the Consejo de Seguridad Nuclear of Spain (CSN) in the area of nuclear safety research have given access to CSN to the NRC-developed best estimate thermalhydraulic codes RELAP5, TRAC-P, TRAC-B, and currently TRACE. These complex tools, suitable state-of-the-art application of current two-phase flow fluid mechanics techniques to light water nuclear power plants, allow a realistic representation and simulation of thermalhydraulic phenomena at normal and incidental operation of NPP. Owe to the huge required resources, qualification of these codes have been performed through international cooperation programs. USNRC CAMP program (Code Applications and Maintenance Program) represents the international framework for verification and validation of NRC TH codes, allowing to:

- Share experience on code errors and inadequacies, cooperating in resolution of deficiencies and maintaining a single, internationally recognized code version.
- Share user experience on code scaling, applicability, and uncertainty studies.
- Share a well documented code assessment data base.
- Share experience on full scale power plant safety-related analyses performed with codes (analyses of operating reactors, advanced light water reactors, transients, risk-dominant sequences, and accident management and operator procedures-related studies).
- Maintain and improve user expertise and guidelines for code applications.

Since 1984, when the first LOFT agreement was settled down, CSN has been promoting coordinated joint efforts with Spanish organizations, such as UNESA (the association of Spanish electric energy industry) as well as universities and engineering companies, in the aim of assimilating, applying, improving and helping the international community in the validation of these TH simulation codes<sup>1</sup>, within different periods of the associated national programs (e.g., CAMP-España). As a result of these actions, there is currently in Spain a good collection of productive plant models as well as a good selection of national experts in the application of TH simulation tools, with adequate TH knowledge and suitable experience on their use.

Many experimental facilities have contributed to the today's availability of a large thermal-hydraulic database (both separated and integral effect tests). However there is continued need for additional experimental work and code development and verification, in areas where no emphasis have been made along the past. On the basis of the SESAR/FAP<sup>2</sup> reports "Nuclear Safety Research in OECD Countries:Major Facilities and Programmes at Risk" (SESAR/FAP, 2001) and its 2007 updated version "Support Facilities for Existing and Advanced Reactors (SFEAR) NEA/CSNI/R(2007)6", CSNI is promoting since 2001 several collaborative international actions in the area of experimental TH research. These reports presented some findings and recommendations to the CSNI, to sustain an adequate level of research, identifying a number of experimental facilities and programmes of potential interest for present or future international collaboration within the safety community during the coming decade.

CSN, as Spanish representative in CSNI, is involved in some of these research activities, helping in this international support of facilities and in the establishment of a large network of international collaborations. In

---

<sup>1</sup> It's worth to note the emphasis made in the application to actual NPP incidents.

<sup>2</sup> SESAR/FAP is the Senior Group of Experts on Nuclear Safety Research Facilities and Programmes of NEA Committee on the Safety of Nuclear Installations (CSNI).

the TH framework, most of these actions are either covering not enough investigated safety issues and phenomena (e.g., boron dilution, low power and shutdown conditions), or enlarging code validation and qualification data bases incorporating new information (e.g., multi-dimensional aspects, non-condensable gas effects). In particular, CSN is currently participating in the PKL and ROSA programmes.

The PKL is an important integral test facility operated by of AREVA-NP in Erlangen (Germany), and designed to investigate thermal-hydraulic response of a four-loop Siemens designed PWR. Experiments performed during the PKL/OECD program have been focused on the issues:

- Boron dilution events after small-break loss of coolant accidents.
- Loss of residual heat removal during mid-loop operation (both with closed and open reactor coolant system).

ROSA/LSTF of Japan Atomic Energy Research Institute (JAERI) is an integral test facility designed to simulate a 1100 MWe four-loop Westinghouse-type PWR, by two loops at full-height and 1/48 volumetric scaling to better simulate thermal-hydraulic responses in large-scale components. The ROSA/OECD project has investigated issues in thermal-hydraulics analyses relevant to water reactor safety, focusing on the verification of models and simulation methods for complex phenomena that can occur during reactor transients and accidents such as:

- Temperature stratification and coolant mixing during ECCS coolant injection
- Water hammer-like phenomena
- ATWS
- Natural circulation with super-heated steam
- Primary cooling through SG depressurization
- Pressure vessel upper-head and bottom break LOCA

This overall CSN involvement in different international TH programmes has outlined the scope of the new period of CAMP-España activities focused on:

- Analysis, simulation and investigation of specific safety aspects of PKL/OECD and ROSA/OECD experiments.
- Analysis of applicability and/or extension of the results and knowledge acquired in these projects to the safety, operation or availability of the Spanish nuclear power plants.

Both objectives are carried out by simulating experiments and plant application with the last available versions of NRC TH codes (RELAP5 and TRACE). A CAMP in-kind contribution is aimed as end result of both types of studies.

Development of these activities, technically and financially supported by CSN, is being carried out by 5 different national research groups (Technical Universities of Madrid, Valencia and Cataluña). On the whole, CSN is seeking to assure and to maintain the capability of the national groups with experience in the thermal hydraulics analysis of accidents of the Spanish nuclear power plants.

---

Francisco Fernández Moreno, Commissioner  
Consejo de Seguridad Nuclear (CSN)



# CONTENTS

ABSTRACT .....	iii
FOREWORD.....	v
EXECUTIVE SUMMARY .....	xiii
ACKNOWLEDGEMENTS.....	xv
ABBREVIATIONS .....	xvii
1 INTRODUCTION .....	1
2 PKL FACILITY DESCRIPTION .....	2-1
3 F2.2 TRANSIENT DESCRIPTION.....	3-1
4 RELAP5 MODEL OF PKL FACILITY .....	4-1
5 F2.2 SIMULATION RESULTS.....	5-1
5.1 F2.2 Run 1 simulation results.....	5-1
5.2 F2.2 Run 2 simulation results.....	5-6
5.3 Comparison of F2.2 Run 1 and Run 2 plant evolution simulation. ....	5-12
6 RUN STATISTICS .....	6-1
7 CONCLUSIONS .....	7-1
8 REFERENCES .....	8-1



# FIGURES

Figure 1: PKL facility .....	2-1
Figure 2: Primary and Secondary Pressure in F2.2 Run 1 .....	3-2
Figure 3: Primary and Secondary Pressure in F2.2 Run 2 .....	3-2
Figure 4: RELAP5 nodalization of PKL facility .....	4-2
Figure 5: Pressure in the primary circuit .....	5-2
Figure 6: Water level inlet side of SG1 U-tubes .....	5-3
Figure 7: Secondary side pressure in steam generator one .....	5-3
Figure 8: Reactor Vessel Level .....	5-4
Figure 9: Pressurizer Level .....	5-5
Figure 10: Boron concentration in loop seal one .....	5-5
Figure 11: Water level in the inlet side of SG1 U-tubes .....	5-7
Figure 12: Water level in the inlet side of SG2 U-tubes .....	5-7
Figure 13: Pressure in the SG1 Secondary Side .....	5-8
Figure 14: Pressure in the SG2 Secondary Side .....	5-8
Figure 15: Primary Pressure Evolution .....	5-9
Figure 16: Pressurizer Level .....	5-10
Figure 17: Reactor Vessel Level .....	5-11
Figure 18: Boron concentration at the core inlet .....	5-11
Figure 19: F2.2 Run 1 and Run2 Primary Pressure Calculation .....	5-12
Figure 20: F2.2 Run 1 and Run2 pressurizer level calculation .....	5-13
Figure 21: F2.2 Run1 and Run2 vessel level calculation .....	5-13
Figure 22: F2.2 Run1 and Run2 SG1 U-Tubes level calculation .....	5-14
Figure 23: F2.2 Run1 and Run2 SG2 U-Tubes level calculation .....	5-14
Figure 24: F2.2 Run 1 and 2 boron concentration calculation .....	5-15



## TABLES

Table 1: F2.2 Initial Conditions .....	3-1
Table 2: Experimental and calculated initial conditions for F2.2 Run 1 .....	5-1
Table 3: Experimental and calculated initial conditions for F2.2 Run 2 .....	5-6
Table 4: Run Statistics F2.2 Run 1 .....	6-1
Table 5: Run Statistics F2.2 Run 2 .....	6-1



## EXECUTIVE SUMMARY

When a Pressurized Water Reactor is in shutdown conditions for refuelling, and to perform steam generator U-tubes and reactor coolant pump maintenance activities, the reactor coolant system water level is reduced to a height lower than the top of the hot leg pipe. Under these conditions, it is said that the plant is in mid-loop operation. In this mode of operation, the residual heat removal system is used to remove the decay power heat generated in the reactor core. Some accidental situations may occur in mid-loop conditions that have a significant contribution to the plant risk, and all involve the loss of the RHR system. In fact, the loss of RHR has been experienced several times in pressurized water reactor plants. For these reasons, the study of transients in mid-loop operation is of great interest to analyze the plant safety.

To better understand the thermal-hydraulic processes following the loss of the RHR during shutdown, transients of this kind have been simulated using best-estimate codes such as RELAP5, TRACE, CATHARE etc. Such codes have initially been developed to simulate full power operation conditions, which are different physical conditions from the ones faced in mid-loop operation mode. Thus, to assess the capability of best estimate codes in simulating the physical phenomena under mid-loop conditions it is necessary to compare the code calculation with data obtained from experiments reproducing such type of conditions.

The work presented in this report is focused on the simulation, using the best estimate code RELAP5/Mod 3.3, of the experiment F2.2 conducted at the PKL facility. The experiment F2.2 belongs to an experimental series established in the OECD/PKL program devoted to the study of boron dilution sequences and the effect of the primary coolant inventory in shutdown conditions, when the RHR system is lost and the plant is in mid-loop conditions for refuelling and with the primary circuit closed. F2.2 experiment is composed by two runs with differences in the number of SG filled and ready for operation. Thus, in experiment F2.2 Run1 only SG 1 is filled and ready for operation, while in experiment F2.2 Run2, SG 1 and 2 are ready.

From the results obtained in both simulations it can be concluded that, in general, the calculations reproduce the physical phenomena observed in the experimental data, but some differences, especially in the reactor coolant circuit mass distribution, are observed. In addition, when comparing the calculations obtained in F2.2 Run1 and F2.2 Run2, it is observed that the number of steam generators influences the plant behaviour after the RHR is lost, in fact for both cases the plant reaches a stable situation but, as it happens in the experiment, the plant stabilization values are different in each case.





## **ACKNOWLEDGEMENTS**

This work contains findings that were produced within the OECD-NEA/PKL Project. The authors are grateful to the Management Board of the PKL Project for their consent to this publication, and thank the Spanish Nuclear Regulatory Body (CSN) for the technical and financial support under the agreement STN/1388/05/748.



## ABBREVIATIONS

ACC	Accumulator
ATWS	Anticipated transient without scram
C	Total number of volumes
CAMP	Code Applications and Maintenance Program
CL	Cold Leg
CPU	Execution time (s)
CSN	Consejo de Seguridad Nuclear (Nuclear Safety Council)
DT	Total number of time steps
ECCS	Emergency Core Cooling System
HL	Hot Leg
HPIS	High Pressure injection system
JAEA	Japan Atomic Energy Agency
kg	kilogram(s)
kg/s	kilograms per second
LBLOCA	Large Break Loss-of-Coolant Accident
LPIS	Low Pressure injection system
m	meter(s)
Pa	Pascal
MWe	megawatt(s) electric
MWt	megawatt(s) thermal
NEA	Nuclear Energy Agency
NPP	nuclear power plant
NRC	U.S. Nuclear Regulatory Commission
OECD	Organisation for Economic Cooperation and Development
PKL	Primärkreislanf-Versuchsanlage (primary coolant loop test facility)
PWR	Pressurized Water Reactor
RCL	Reactor Coolant Line
RCS	Reactor Coolant System
RHR	Residual Heat Removal
RT	Transient time (s)
SBLOCA	Small Break Loss of Coolant Accident
SG	Steam Generator
TH	Thermal-hydraulics
TS	Maximum time step (s)
UNESA	Asociación Española de la Industria Eléctrica (Spanish Electricity Industry Association)



# 1 INTRODUCTION

When a Pressurized Water Reactor (PWR) is in shutdown conditions for refuelling, and to perform steam generator (SG) U-tubes and reactor coolant pump maintenance activities, the reactor coolant system water level is reduced to a value lower than the top of the hot leg pipe [1]. Under these conditions, it is said that the plant is in mid-loop operation. In this mode of operation, the residual heat removal (RHR) system is used to remove the decay power heat generated in the reactor core.

Some accidental situations may occur in mid-loop conditions that have a significant contribution to the plant risk, and all involve the loss of the RHR system. The three major causes of a loss of the RHR system are: A loss of reactor coolant system (RCS) inventory, a loss of RHR flow and a loss of support systems [2]. Moreover, the loss of RHR has been experienced several times in pressurized water reactor (PWR) plants as, for example, in Diablo Canyon Unit 2 [3] and in Voltge Unit 1 [4]. The causes of the loss of the RHR in those plants were a failure in the RHR pump and a loss of off-site power, respectively. For the reasons above exposed, the study of transients in mid-loop operation has become of great interest during the last decades [1, 5, 6, 7, 8, 9, 10, 11].

To better understand the thermal-hydraulic processes following the loss of the RHR during shutdown, transients of this kind have been simulated using best-estimate codes such as RELAP5 [5, 6; 9; 10] or CATHARE [7] etc. Such codes have initially been developed to simulate full power operation conditions, which are different from mid-loop conditions. Thus, to assess the capability of best estimate codes in simulating the physical phenomena under mid-loop conditions it is necessary to compare the code calculation with data obtained from an experiment simulating such type of conditions.

This report focuses on the simulation, using the best estimate code RELAP5/Mod 3.3 [12], of the experimental series F2.2 conducted at the PKL facility. This test has been used to investigate the effect on the heat transfer mechanisms in the U-tubes depending on the number of steam generators available, and to analyse the boron dilution process in the reactor coolant circuit. Two experiments were performed in this experimental series, in Run1 only one steam generator filled with water and controlled at 2 bar was considered, while in Run2 two steam generators are initially filled with water and controlled at 2 bar.

The rest of the report is organized as follows: The PKL facility is briefly described in Section 2. Section 3 is devoted to introduce both experiments F2.2 RUN1 and F2.2 RUN2, section 4 is devoted to describe the RELAP5/Mod 3.3 model for the PKL facility used to simulate the experiment. In section 5, the main results obtained from both simulations are presented and compared with the experimental data. Finally, the main conclusions of this analysis are summarized in section 6.



## 2 PKL FACILITY DESCRIPTION

The PKL test facility represents a typical 1300MWe PWR Siemens/KWU designed with a volume and power scale of 1:145, while all the components height on the primary and secondary side correspond to real plant dimensions. It models the entire primary system and the relevant parts of the secondary side. In order to investigate the influence of non symmetrical boundary conditions on the system behaviour, PKL facility is equipped with four primary loops symmetrically arranged around the reactor pressurized vessel. Each loop contains a reactor coolant pump and a steam generator [11].

The facility also models all the important safety and auxiliary systems as eight accumulators, one in each of the hot legs and one in each of the cold legs, four independent injections from the high and low pressure injection system, the residual heat removal system and the pressure control in the pressurizer. Figure 1 shows an overview of PKL test facility.

Three experimental programs have been conducted at PKL facility. Programs PKL I and PKL II, focused on the study of Large Break Loss of Coolant Accidents (LBLOCAs) and Small Break Loss of Coolant Accidents (SBLOCAs) with the objective of best estimate codes test and validation. PKL III program started in 1986 [11], with the objective of studying different transients with and without LOCAs. The PKL tests results have also been used for preparation and verification of procedures described in the operating manuals and for answering questions from the regulatory bodies.

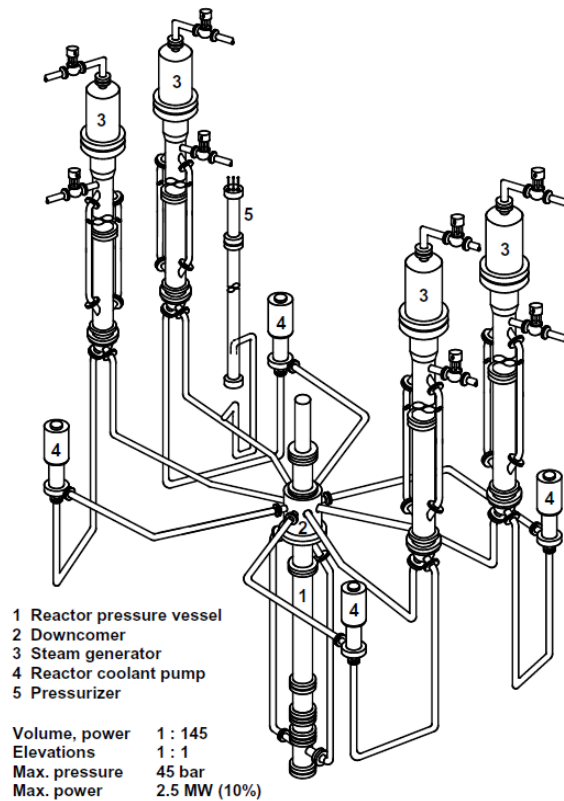


Figure 1: PKL facility

In particular, PKL III F series include researches on the inadvertent boron dilution events and on the effect of the primary coolant inventory in transients under shutdown conditions. The importance of the boron dilution events lies on the possibility that low borated water may enter the reactor vessel, and this may lead to a local reactivity insertion event in the reactor core.

Moreover, the size of the secondary side (number of SGs filled with water and ready for activation) may affect the plant evolution and heat transfer mechanisms in the U-tubes of the SGs. Thus, series F2.2 consist of two experiments with different number of SGs available.



### 3 F2.2 TRANSIENT DESCRIPTION

The experimental series F2.2 conducted in the PKL facility consists of the loss of the RHR system when the plant has been shut down for refuelling, with the primary circuit closed and filled up to  $\frac{3}{4}$  loop. In this experimental series two runs were performed just changing the configuration of the steam generators secondary side. The main objective of this series is to observe the influence of the secondary side in the heat exchanged through the U-tubes and in the boron dilution process in the reactor coolant circuit. Table 1 presents the values for the main parameters in the initial conditions for both runs.

**Table 1: F2.2 Initial Conditions**

Test (RUN)	PKL III F OECD-PKL	
	F2.2 RUN1	F2.2 RUN 2
Secondary side boundary conditions	One SG filled with water and controlled at 2 bar	Two SGs filled with water and controlled at 2 bar
Primary side:		
Coolant inventory (kg)	1280 kg	1280 kg
Level (hot legs)	$\frac{3}{4}$ loop	$\frac{3}{4}$ loop
Temperature at core outlet (°C)	63.4	61.5
Pressure (bar)	1	1
Power (kW)	220	220

Under the conditions exposed in table 1, both experiments start when the RHR fails. Both transients can be divided in two separated phases:

Phase one:

- 1.- Due to the residual heat generated in the core there is a rise in the core temperature and the void formation in the core starts, with an associated increase in the primary pressure.
- 2.- Primary coolant comes out from the vessel towards the steam generator U-tubes, which act as heat sink.

In this phase the physical processes of interest to be studied are:

- 1.- The heat removal from the core towards the steam generators and,
- 2.- The transfer mechanisms in presence of nitrogen, the primary level pressure at which the plant is stabilized and the boron dilution process in the cold legs.

In phase two, different actions are taken depending on the test run:

RUN1:

- 1.- Four injections from accumulators one in each of the hot legs.
- 2.- Continuous injection from the High Pressure Injection System (HPIS) is produced

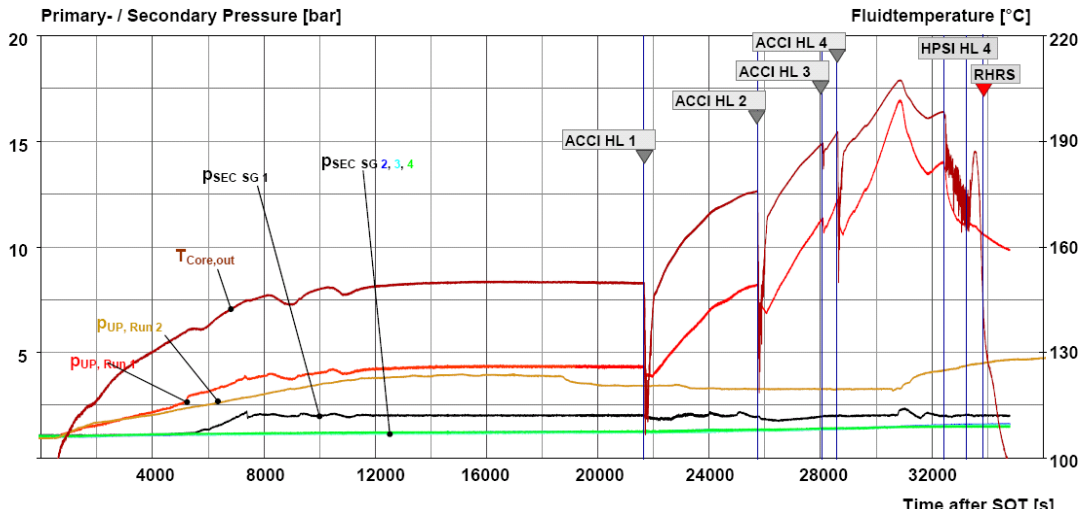
RUN 2:

- 1.- The two remaining steam generators initially empty are filled.
- 2.- Emergency Core Cooling (ECC) injection

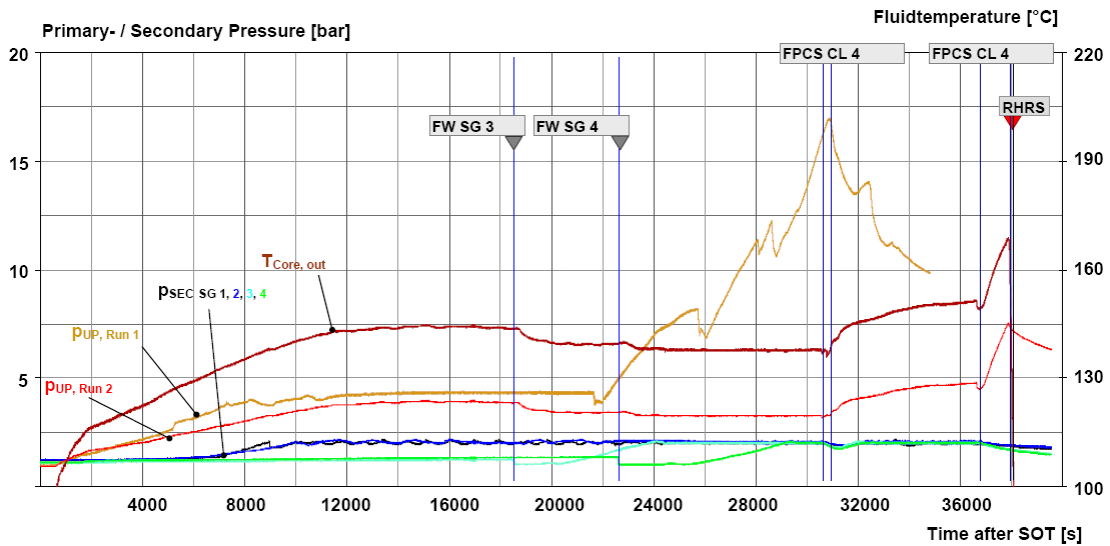
The objective of this phase is focused on studying the influence of emergency core cooling (ECC)

injection on the heat transfer and if the conditions to restore the RHR system are achieved.

Figure 2 and 3 present the evolutions of the pressures in the primary and secondary sides and the different actuations of F2.2 Run1 and F2.2 Run2 test, respectively.



**Figure 2: Primary and Secondary Pressure in F2.2 Run 1**



**Figure 3: Primary and Secondary Pressure in F2.2 Run 2**

## 4 RELAP5 MODEL OF PKL FACILITY

The transient simulation has been performed using RELAP5-Mod 3.3 code [12]. The RELAP5 model used consists of 600 hydraulic volumes, 622 junctions and 512 heat structures. This model has been adapted to simulate shutdown conditions, from the PKL model provided by the facility [13]. Figure 4 outlines the nodalization used in the simulation.

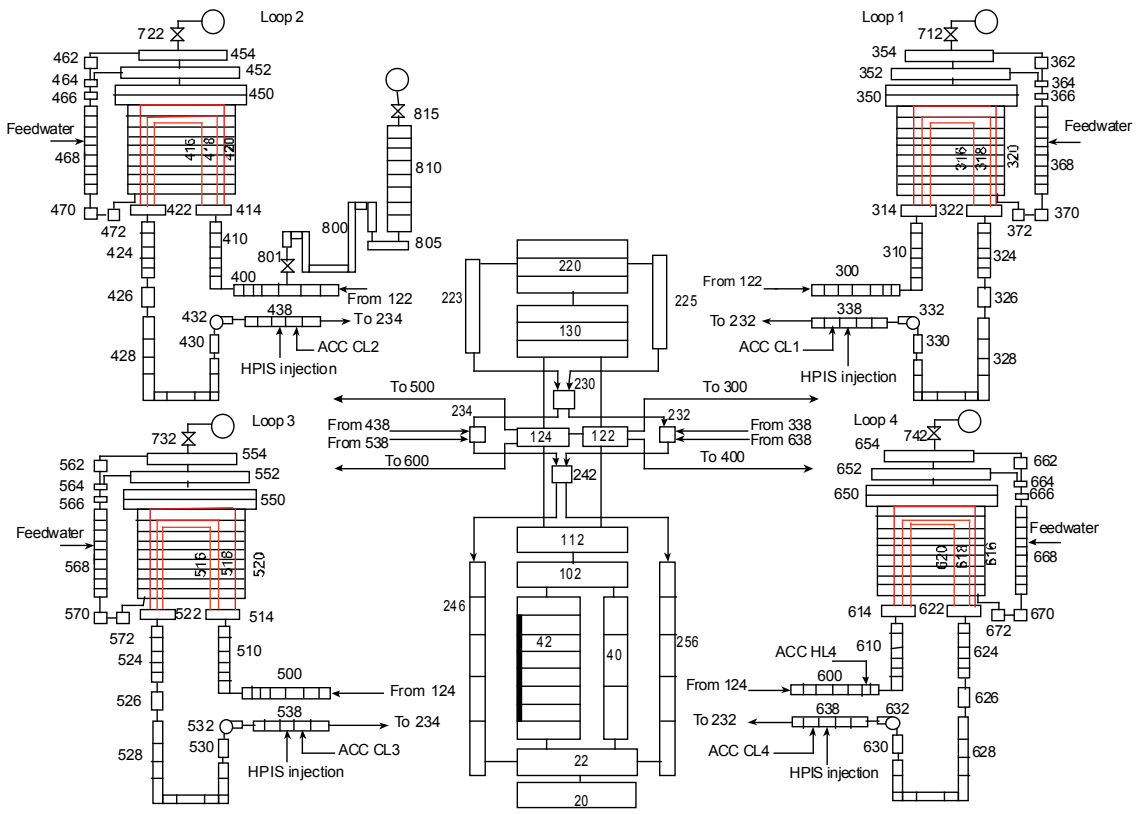
The core is simulated using a pipe component of eight volumes. Six of these volumes contain the fuel rods, which are simulated using a heat structure component that generates the residual power established in Table 1. The vessel of the PKL facility has two external downcomers (see Figure 1) simulated in the RELAP model by means of two external pipes. The cold legs of all four loops are nodalized using pipe and branch components, which are connected to two branches, volumes 232 and 234, which in turn are connected to the downcomer vessel. The facility has four by-passes in the vessel upper head which have been collapsed in this model into two branch components, 223 and 225.

The four primary loops are modelled with a pump and a steam generator in each loop using pipe, pump and branch components. The U-tubes of the steam generators are lumped into three pipe components of different heights. The heat transfer between the primary and secondary systems is simulated using three heat structures one for each of the three pipes that simulate the steam generators U-tubes.

The different injections from the accumulators performed at the end of the transient (see Figure 2 and 3) have been simulated using an accum component connected to the loop by a valve. The locations of the injections from the accumulators are shown in Figure 4.

As the RHR, LPIS and HPIS inject in the same location of the facility, one injection in each cold leg (see figure 4), the model of these injections has been simplified by using time dependent volumes connected with time dependent junctions which establish the amount of water to be injected.

The failure of the RHR system is simulated, in this model, by the onset of the power in the core heat structure, which generates the residual heat power included in Table 1. In the same way, the restoration of the RHR system at the end of the transient is simulated by disconnecting the power in the core heat structure. A sensitivity analysis has been performed using TMDPJUN and TMPDVOL to simulate the RHR system operation, but no difference was observed in the results.



**Figure 4: RELAP5 nodalization of PKL facility**

## 5 F2.2 SIMULATION RESULTS

This section is divided into two subsections, each one devoted to present the results obtained from the simulation using RELAP5 of experiment F2.2 Run1 and Run2, respectively.

### 5.1 F2.2 Run 1 simulation results

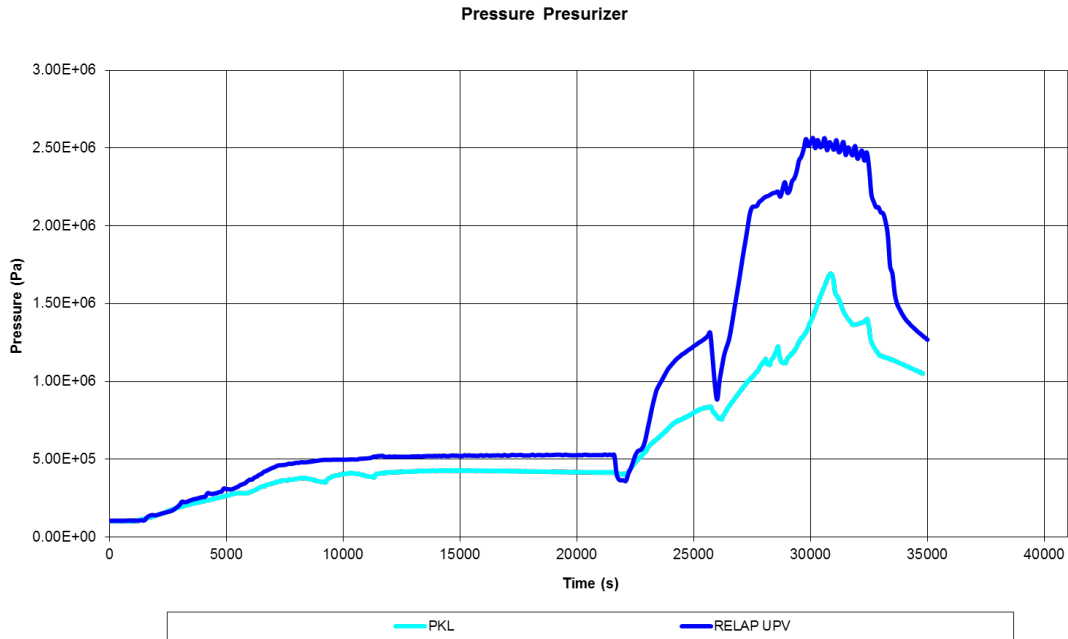
The first step in the simulation of F2.2 Run1 experiment is the calculation of the transient initial conditions shown in Table 1. The amount of water required in the primary circuit has been obtained by controlling the water level in the primary loops to  $\frac{3}{4}$  of hot leg. In this phase, the RHR injections have been used to extract or supply the amount of water necessary to reach this level. The rest of the primary circuit is initialized as full of nitrogen.

The secondary side water level of steam generator in loop is achieved using the secondary side feedwater injection (see Figure 4) to reach the value established in Table 1. Steam generators 2, 3 and 4 secondary sides are initialized full of nitrogen, as in the transient specification they are empty. Table 2 shows the values for the initial conditions obtained in the RELAP5 calculations as compared with experimental data.

**Table 2: Experimental and calculated initial conditions for F2.2 Run 1**

	Experiment specification	RELAP5 initial condition RUN1
<b>Primary:</b> closed and filled with borated water up to $\frac{3}{4}$ -loop, above filled with N <sub>2</sub>		
Coolant inventory	$\frac{3}{4}$ loop	7.71 m in vessel ( $\frac{3}{4}$ loop)
Boron concentration	2200 ppm	2200 ppm
Pressure	0.93 bar	0.93 bar
Fluid temperature at core outlet	63,4°C	64°C
Pressurizer wall temperature	32-52°C	56°C
Flow conditions	No flow	0.0 kg/s
Pressurizer level	1.18 m.	1.0 m
<b>Secondary:</b> SG1 full of water and ready for operation, SG2, SG3 and SG4 full of air and isolated		
Steam generators secondary pressure	aprox. 1 bar	1.14 / 1.12 / 1.05 / 0.99
SG1 secondary temperature	60°C	58°C
SG1 level	12.1 m.	12.1 m

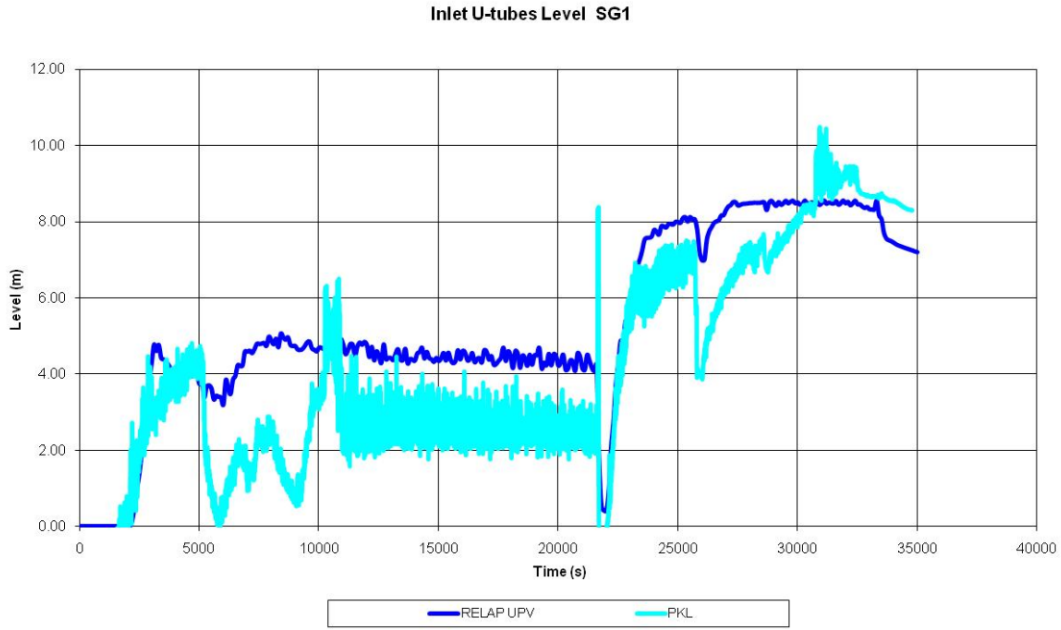
Once the initial conditions are reached, the transient is initiated by the failure of the RHR system. Thus, when the RHR system fails the primary circuit starts to heat up until it reaches saturation conditions and void formation in the core begins. The void formation in the core produces a rise in the primary circuit pressure, as shown in figure 5, until the plant reaches a stabilization pressure, around 10000 s after the start of the transient. As observed in this figure, RELAP5 predicts a stabilization pressure slightly higher than the experimental data. This situation is maintained until the first injection from the accumulators is produced. The start of the injections from the hot leg accumulators, produces a sharp rise in the primary pressure; the maximum value predicted by RELAP5 is considerably higher compared with the value obtained in the experiment. Finally, at 34000 s pressure decreases due to the start of the injection from the HPIS.



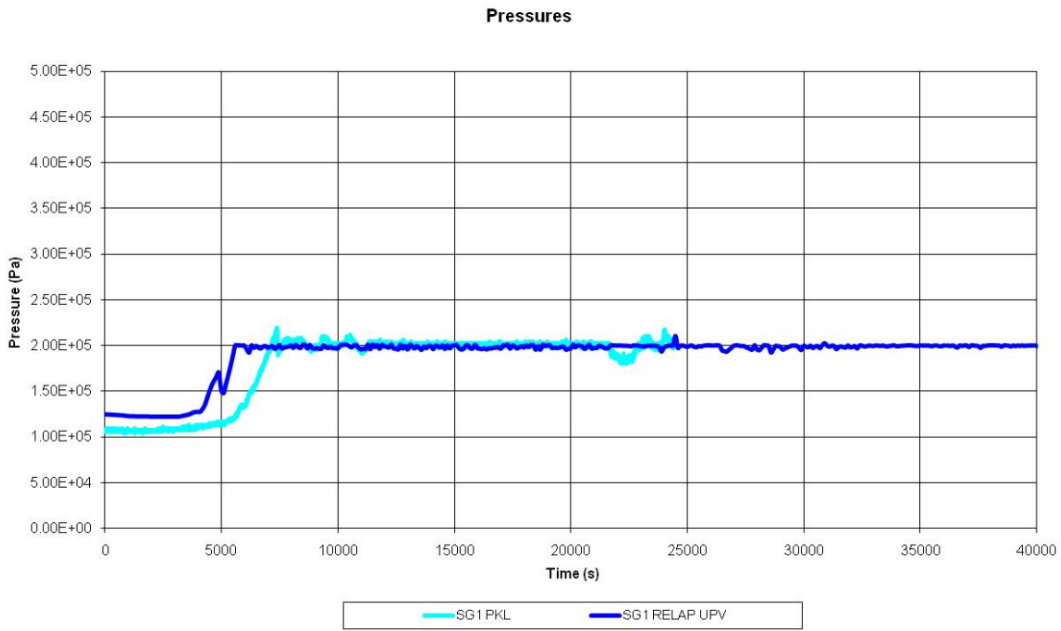
**Figure 5: Pressure in the primary circuit**

The rise of the pressure in the core produces a displacement of the coolant towards the steam generators U-tubes of the steam generator initially filled with water, SG1, which act as heat sink. Figure 6 shows the comparison between experimental data and RELAP5 calculations of the water level in inlet side of SG1 U-tubes. The calculations performed by RELAP5 provide a good prediction of the time at which water starts entering the U-tubes, although, in some periods of the transient the level calculated differs from the experimental data, e.g. in the period between 5000 and 10000 seconds where RELAP5 predicts a higher level of water in the inlet side of the SG1 U-Tubes. When stabilization is achieved, the level in the inlet side of SG1 predicted by RELAP5 is above 4 m and the experimental data is always maintained below 4 m, shown in figure 6.

The heat transferred through the SG1, produces an increase in the temperature and pressure of the secondary side of SG1. The pressure rises until 2 bar and is maintained at this value during the rest of the transient. Figure 7 shows the evolution of the secondary side pressure in SG1. As observed in this figure, RELAP5 predicts an advancement of the opening of the valve, as the pressure rises faster than in the experimental data. This evolution agrees with the level calculated (see figure 6) as the water level is higher in the calculations, the heat transferred will be higher, and so, the secondary side pressure rises faster, which triggers an earlier activation of pressure control.

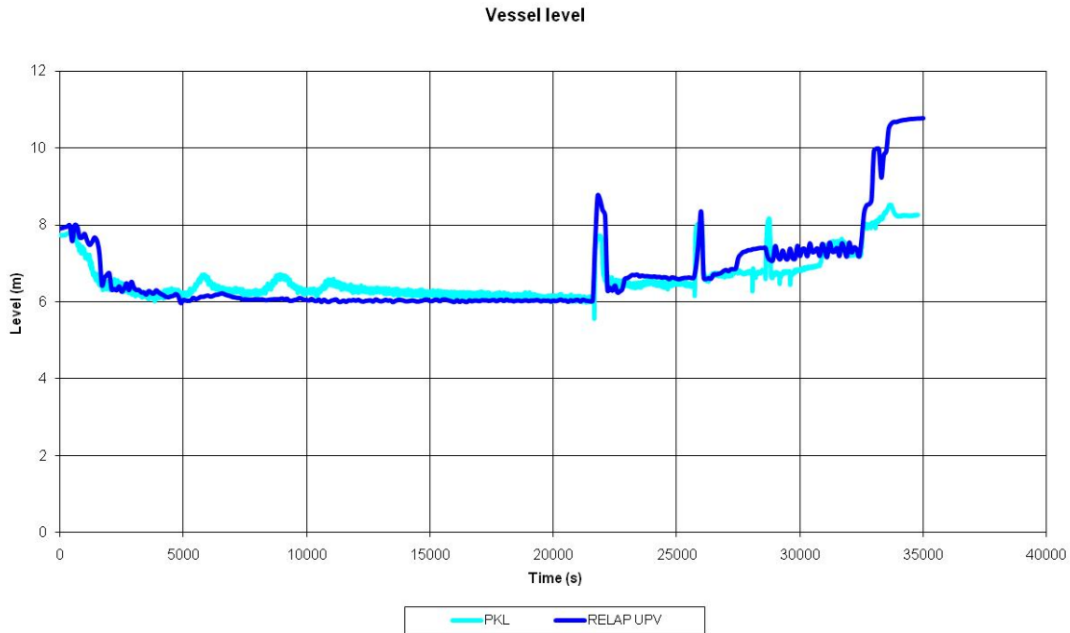


**Figure 6: Water level inlet side of SG1 U-tubes**



**Figure 7: Secondary side pressure in steam generator one**

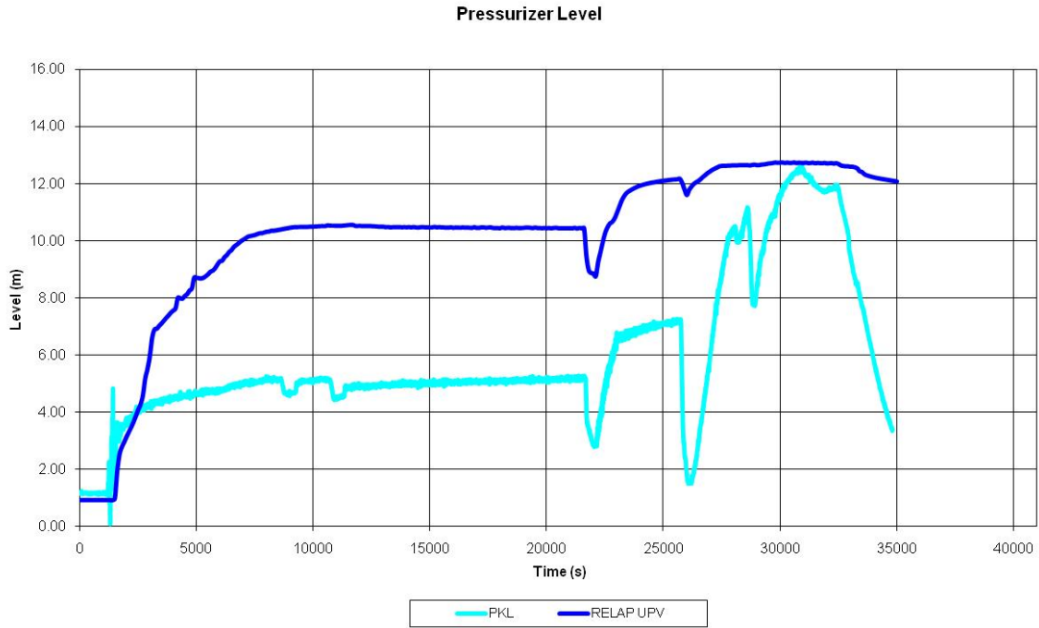
Regarding other important variables in the primary circuit, a difference between the mass inventory distribution calculated by RELAP5 and the experiment data is observed. Figure 8 shows the reactor vessel level, and indicates that the mass inside the reactor vessel is similar for experimental and calculated data, although the calculations predict a lower level inside the reactor level in some intervals of time, for example between 5000 and 15000 seconds, meaning that more water is displaced from the core towards the reactor coolant circuit.



**Figure 8: Reactor Vessel Level**

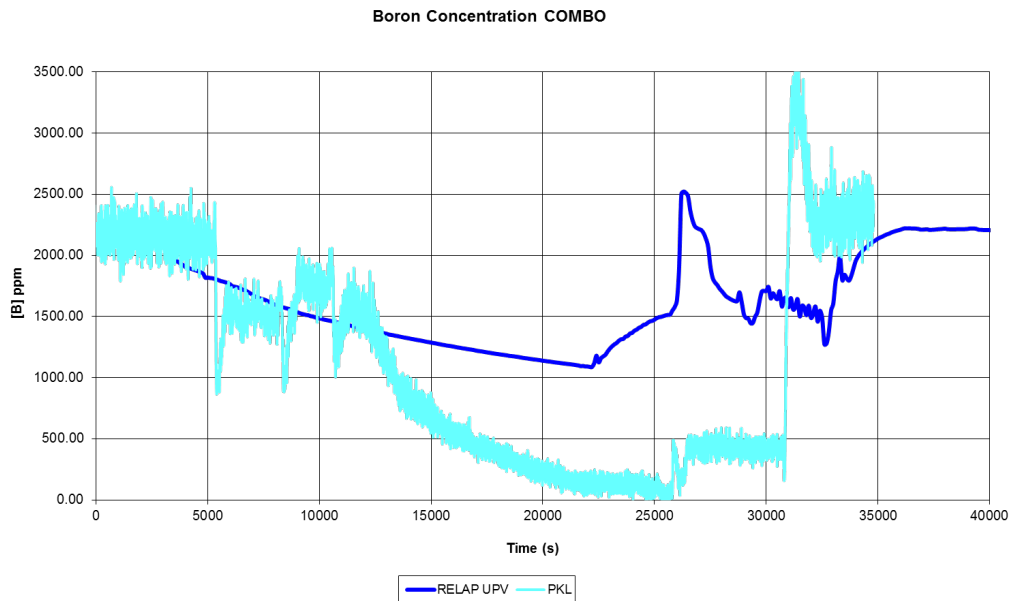
In fact, the water comes out from the vessel towards the SG1 U-tubes, as shown in figure 6, and towards the pressurizer. Figure 9 shows the water level inside the pressurizer, where great differences between the experimental data and RELAP5 calculation can be observed. In both cases, water starts entering the pressurizer at the same time and with the same water flow, however, after about 2500 seconds the level in the pressurizer calculated by RELAP5 continues to rise up to 10 m, being, quite different from the experimental value.





**Figure 9: Pressurizer Level**

Boron dilution process during this transient is analysed by monitoring the boron concentration in the loop seal one (see Figure 10) (i.e., in the lowest part of the loop 1), as this loop is the one with the active steam generator. As shown in this figure, calculation predicts a lower decrease of the boron concentration. This drop in the boron concentration is due to the mass flow coming from the inlet to the outlet of the steam generators U-tubes. The vapour that reaches the top of the U-tubes condenses in the downcomer side of the tubes. As this condensate is boron free, it causes the drop in the boron concentration when it reaches the loop seal. This phenomenon is not well reproduced by RELAP5 calculations.



**Figure 10: Boron concentration in loop seal one**

## 5.2 F2.2 Run 2 simulation results

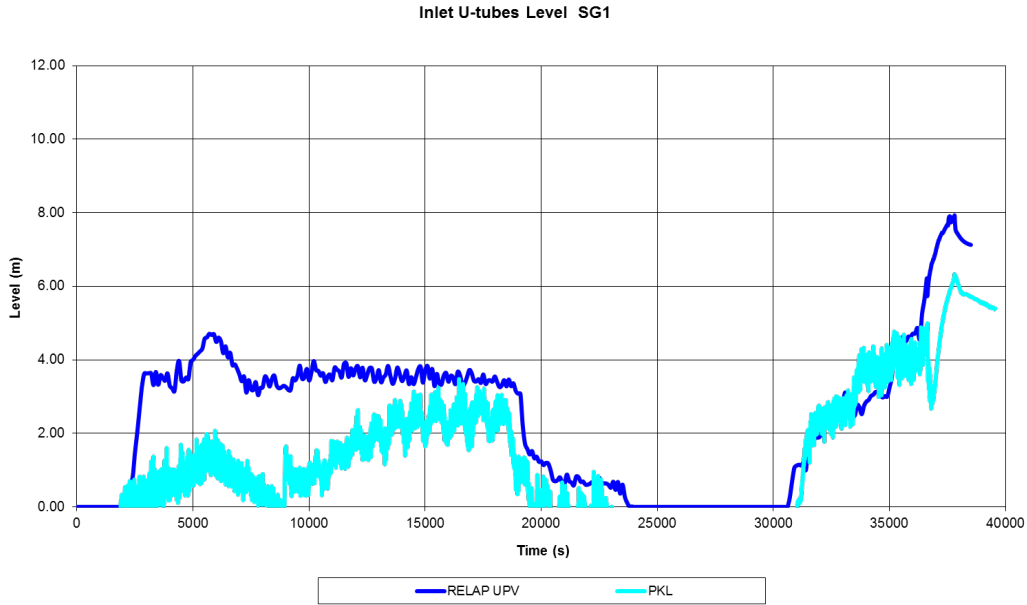
As in the previous case, the first step in the F2.2 RUN 2 simulation is the calculation of the transient initial conditions. In this case the primary circuit is full of water up to the lower edge of the reactor coolant line (RCL), and the wall temperature in the pressurizer ranges in the interval 35-51°C. Table 3 shows the initial conditions for F2.2 Run 2 transient obtained with RELAP5 calculation as compared with experimental data.

**Table 3: Experimental and calculated initial conditions for F2.2 Run 2**

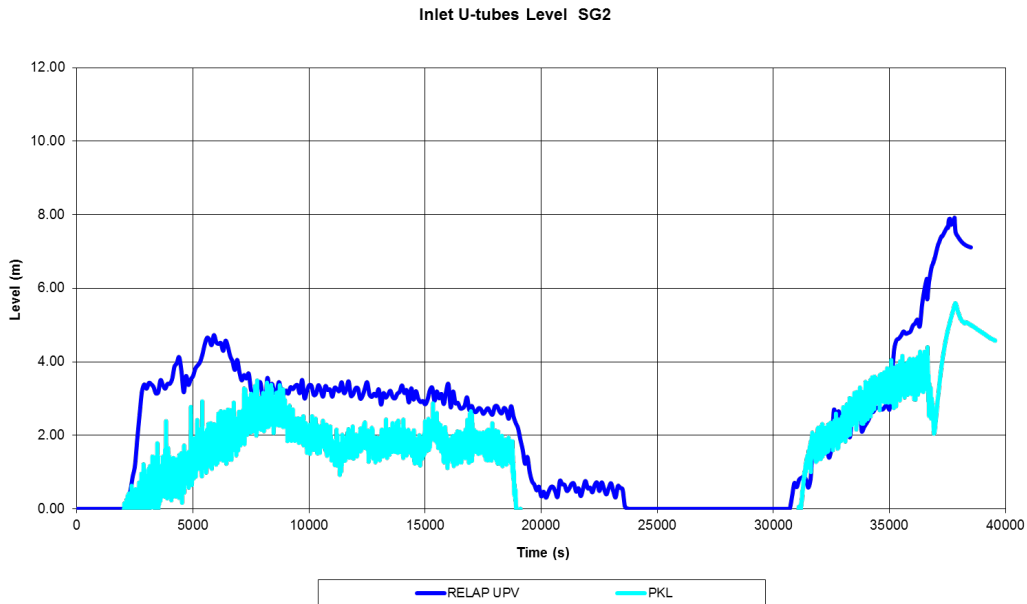
	<b>Experiment specification</b>	<b>RELAP5 initial condition RUN 2</b>
<b>Primary</b> closed and filled with borated water up to lower edge of RCL, above filled with N <sub>2</sub>		
Coolant inventory	Lower edge of hot legs	7.73 m in vessel (3/4 loop).
Boron concentration	2200 ppm	2200 ppm
Pressure	0.93 bar	0.88 bar
Fluid temperature at core outlet	61.5°C	61 °C
Pressurizer wall temperature	35-51°C	56 °C
Flow conditions	No flow	0.0 kg/s
Pressurizer level	1.01 m.	0.94 m
<b>Secondary:</b> SG1 and SG2 full of water and ready for operation, SG3-4 full of air		
Steam generators secondary pressure	aprox. 1 bar	1.25/1.25/1.05/0.9 bar
SG1 and SG2 secondary temperature	60°C	66°C
SG1 and SG2 level	12.2 m.	12.1 m

Once the initial conditions are reached, the transient is initiated by the failure of the RHR system. Thus, when the RHR system fails the primary circuit starts to heat up until it reaches saturation conditions and void formation in the core begins. The two steam generators with the secondary filled with water, SG1 and SG2, act as heat sink.

Figure 11 and figure 12 show the comparison between experimental data and RELAP5 calculations of the water level in the inlet side of SG1 and SG2 U-tubes, respectively.



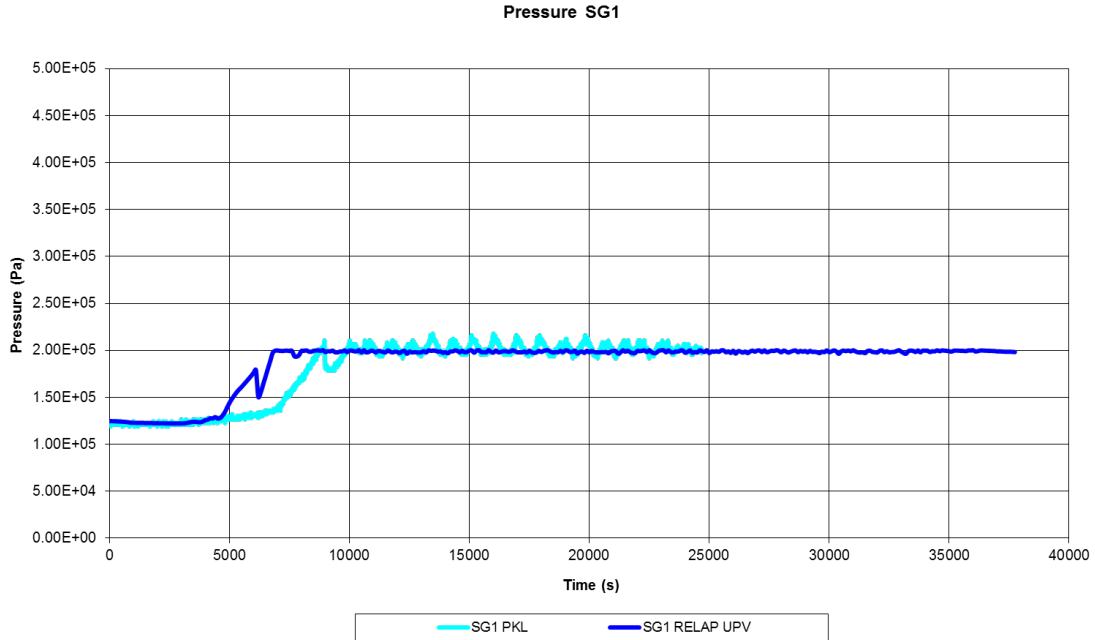
**Figure 11: Water level in the inlet side of SG1 U-tubes**



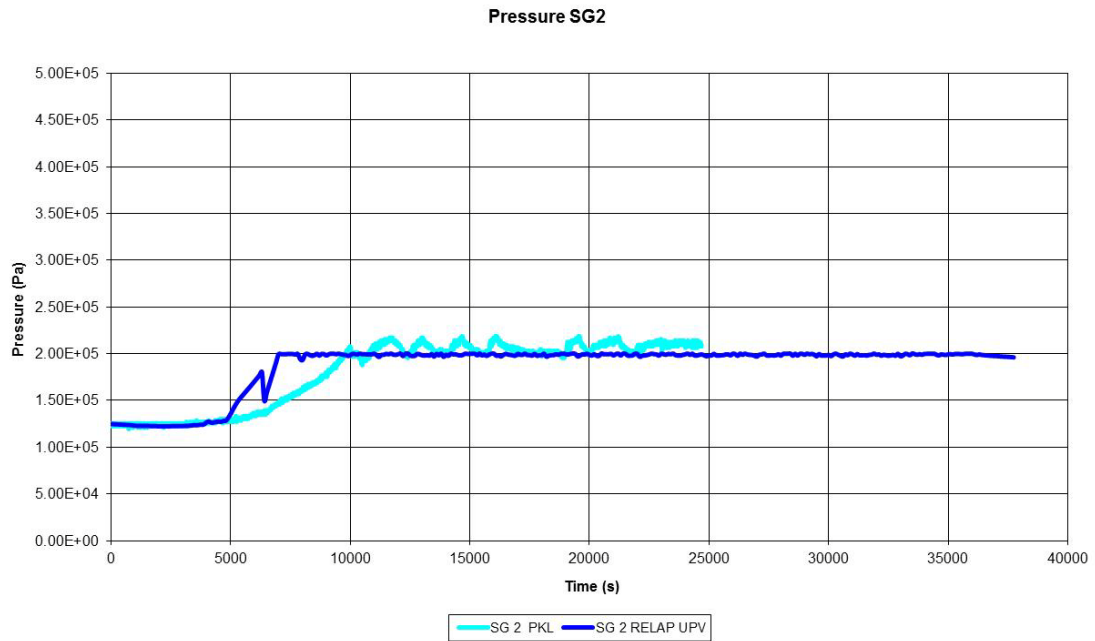
**Figure 12: Water level in the inlet side of SG2 U-tubes**

The behaviour predicted by RELAP5 for both steam generators is the same, as can be observed in figure 11 and 12, but it is slightly different in the experiment. In SG1 the liquid level in the inlet side of the steam generator U-tubes is, until 10000 seconds, higher than the experimental data. However, when stabilization is achieved, the level calculated by RELAP5 drops below 2m, a value lower than the measured. The level in the inlet U-tubes of SG2 is also higher than the experimental data, but when it reaches a quasi-steady situation, the calculated and the measured levels are quite similar. In both cases, when the feedwater injection of SG3 starts, the level of water in the inlet side of SG1 and SG2 U-tubes fall until they become empty.

The larger amount of water inside the steam generators U-tubes predicted by RELAP5 advances activation of the pressure control in SG1 and SG2, as shown namely in figures 13 and 14. The more water is present inside the U-tubes the more heat is exchanged, and so earlier than in the experiment, the secondary side temperature and pressure start to rise. This triggers the pressure control in both steam generators.

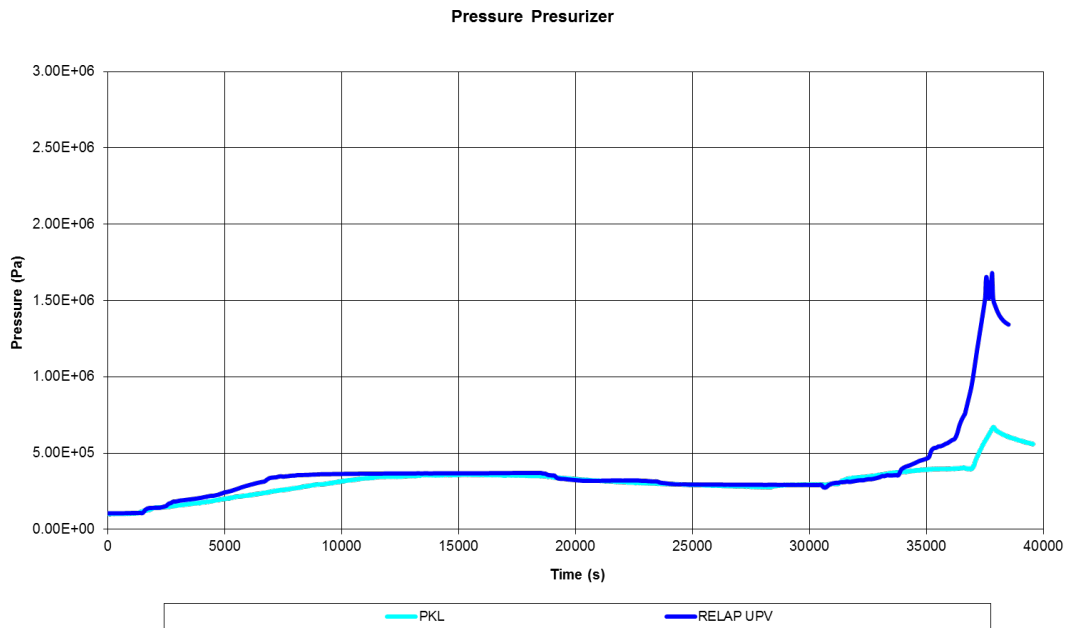


**Figure 13: Pressure in the SG1 Secondary Side**



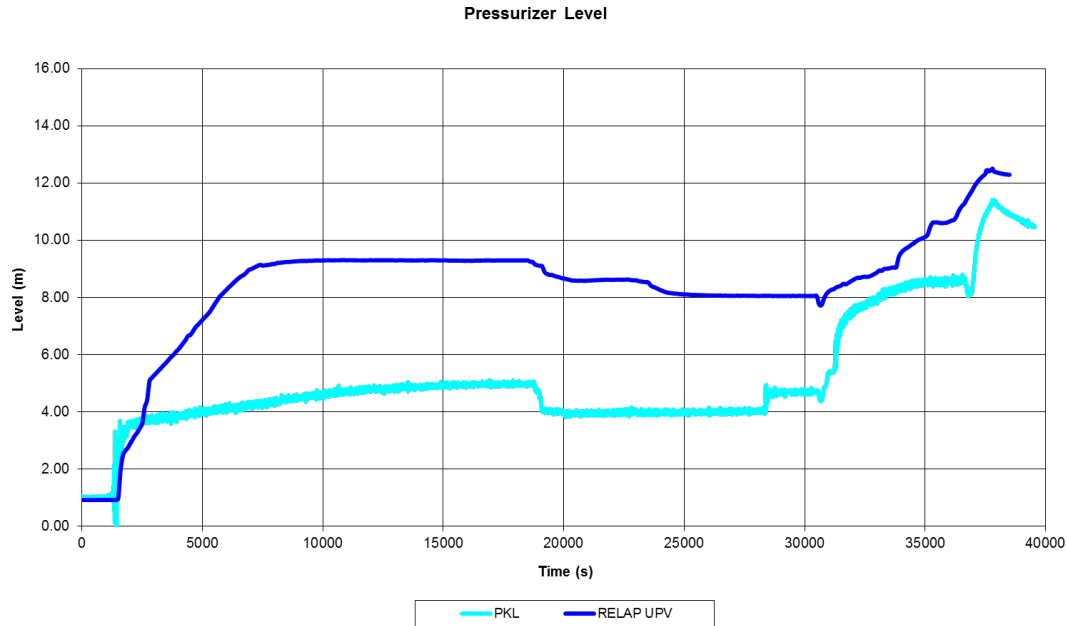
**Figure 14: Pressure in the SG2 Secondary Side**

When the RHR is lost, primary pressure rises until the plant reaches a steady situation around  $3.08 \times 10^5$  Pa, as shown in figure 15. This situation is maintained until the injection from the feedwater of SG3 at 18540 seconds and of SG4 at 22780 seconds. The actuation of those injections produce a slight decrease in the primary pressure, that reaches 2.5 bar around 20000 seconds, as more heat is removed through the steam generators.



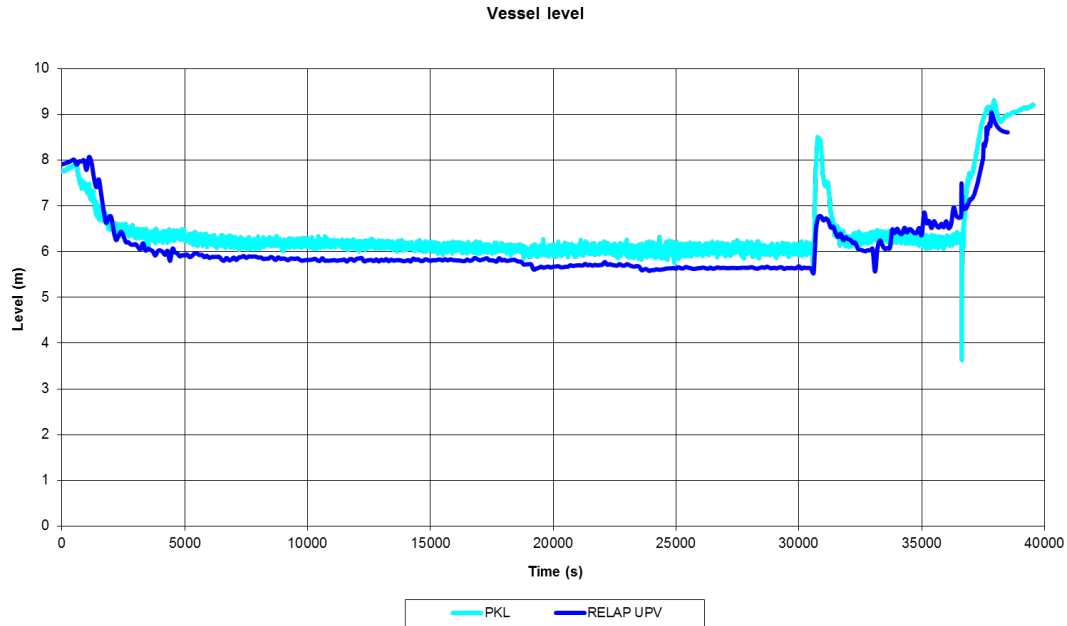
**Figure 15: Primary Pressure Evolution**

Figure 15 shows a sharp increase in the primary pressure predicted by RELAP5 at the end of the transient, but not observed in the experimental data. The pressure increase is due to the actuation of the safety injection in the cold leg of loop four (see Figure 3). The entrance of water in the primary circuit makes the pressure to rise, but in the experiment this increase is not as high as the one observed in RELAP5 calculations. This is due to the difference in the amount of water inside the pressurizer, as shown in figure 16. The calculation predicts more water entering the pressurizer reaching 10 m, while the experiment only measure about 5 m inside the pressurizer. When the injection in cold leg starts, more water enters the pressurizer, and so the pressurizer fills up earlier in the calculations originating a fast pressure rise. In the experimental data, this pressure increase is not so high because more water can into the pressurizer to be completely full.



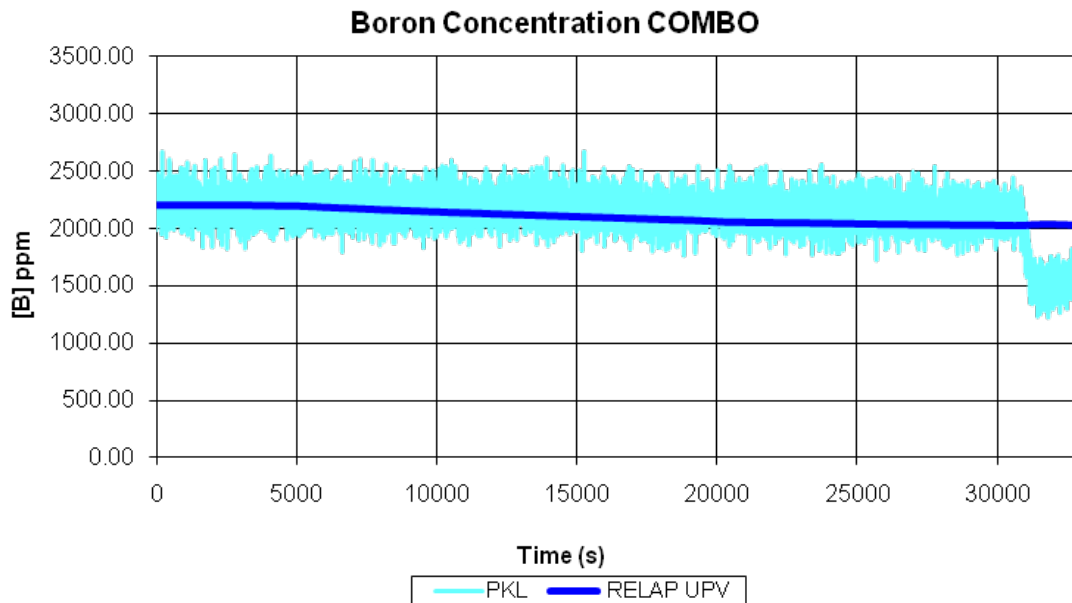
**Figure 16: Pressurizer Level**

The excess of water in the pressurizer and in the steam generators U-tubes is due to displacement of water from the reactor vessel. Figure 17 shows the evolution of the level in the reactor vessel. In this figure it is observed that around 1900 seconds there is a displacement of water outside the vessel in both experimental data and RELAP5 calculations. However, RELAP5 predicts more water coming out from the vessel, and that results in an excess of water inside the pressurizer and inside the U-Tubes.



**Figure 17: Reactor Vessel Level**

Figure 18 shows the evolution of the boron concentration at the loop seal of loop one. In this figure it can be observed that, RELAP5 calculations predict very well the behaviour of boron concentration but not reproduce the decrease when injections start.



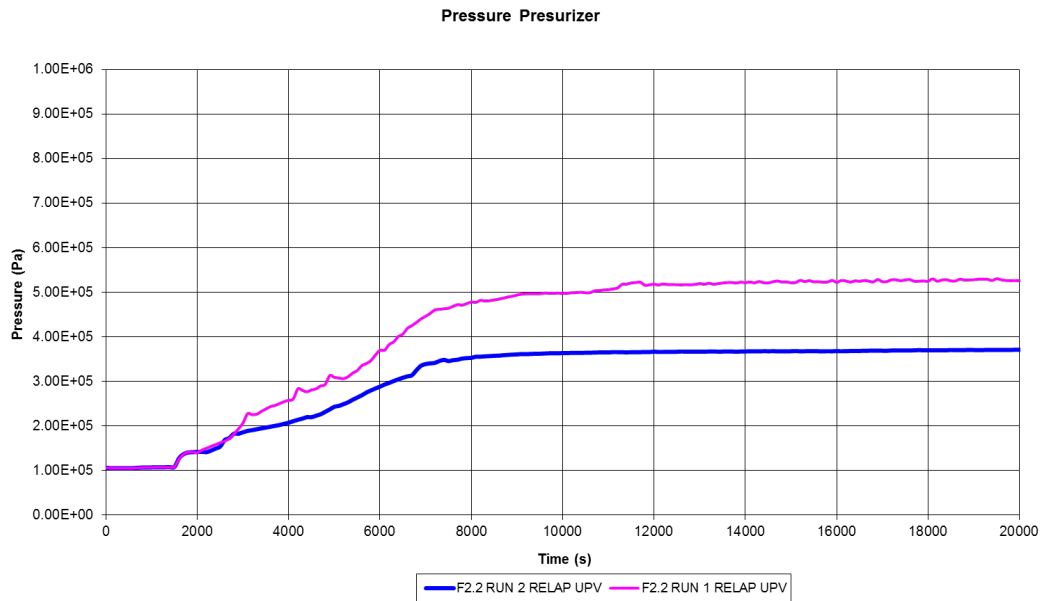
**Figure 18: Boron concentration at the core inlet**

### 5.3 Comparison of F2.2 Run 1 and Run 2 plant evolution simulation.

One of the objectives of this work is focused on analyzing the influence on the heat transfer mechanisms in the U-tubes of the number of steam generators available, and to analyze the boron dilution process in the reactor coolant circuit once the RHR is lost. In this case, the two runs simulated differ in the number of steam generators available. The effect of the variation in the number of SG available can only be analyzed during the first part of the transient, until the plant reaches a quasi-steady situation, as after this time, different actions are taken in each case to mitigate the transient consequences.

In this section, the evolutions along the first part of the transient of some important variables, which show the difference in the plant behaviour, are presented. The following figures compare the evolutions of the calculations performed using RELAP5 for F2.2 Run 1 and F2.2 Run 2.

Figure 19 shows the evolution of the primary pressure for F2.2 Run1 and F2.2 Run 2. For both cases the plant reaches a quasi-steady condition, but with different value of the primary pressure depending on the number of steam generators considered available as heat sink. For the case with one SG the stabilization pressure is higher than for the case with two SG available.

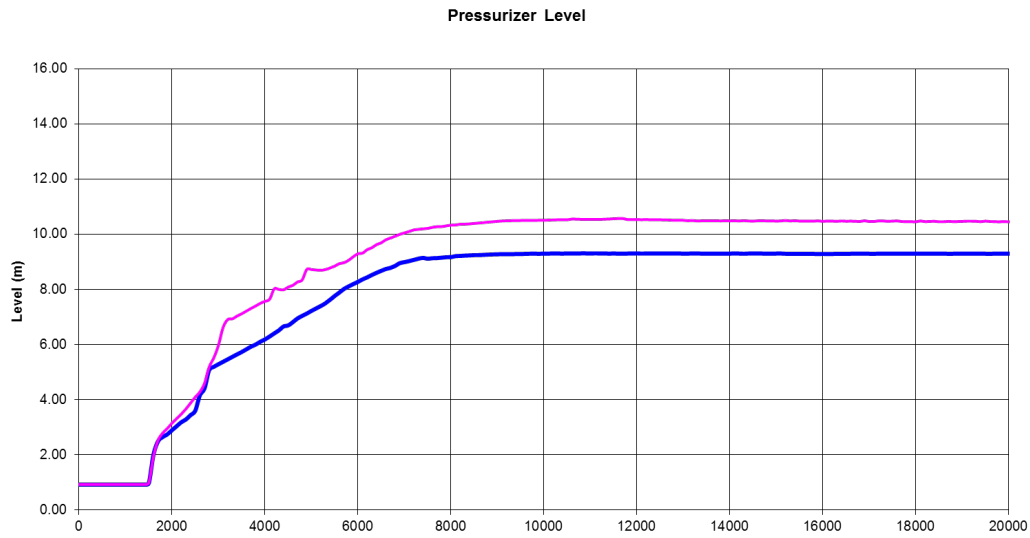


**Figure 19: F2.2 Run 1 and Run2 Primary Pressure Calculation**

Regarding the mass distribution inside the primary circuit, in both cases RELAP5 predicts a different behaviour than in the experiments as explained in previous sections. In fact, the same behaviour is observed in both Runs, for which RELAP5 calculations predict a higher level of water in the pressurizer (see figures 9 and 16). Figure 20, shows the water level inside the pressurizer that reaches 10m for Run1 and Run2, which corresponds to the pressurizer full of water. The only

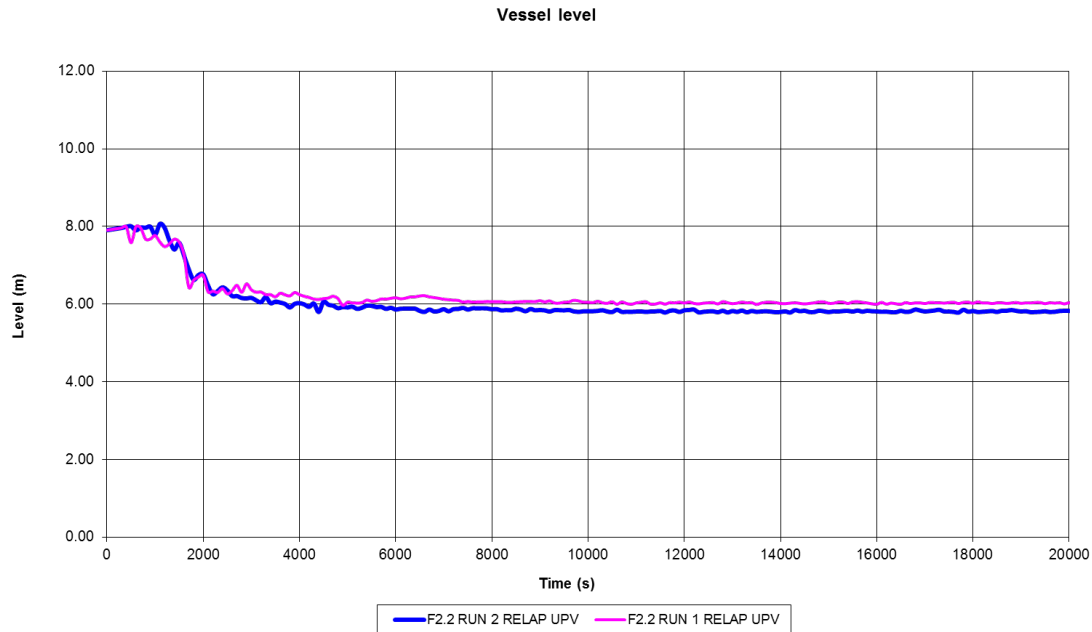


difference observed in the evolution of the water level inside the pressurizer is that for F2.2 Run2, the water into the pressurizer is lower than in F2.2 Run1.



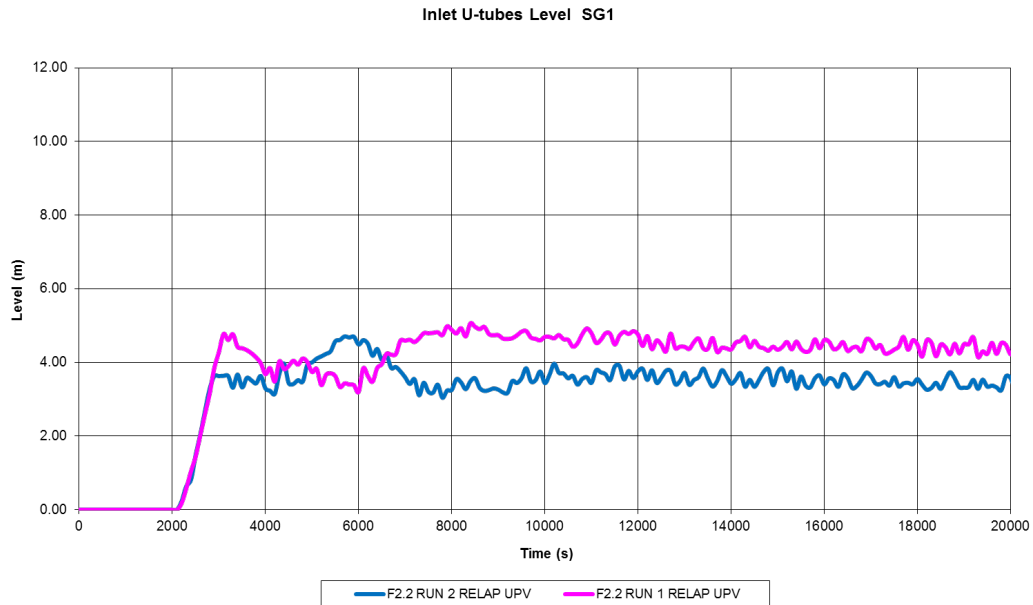
**Figure 20: F2.2 Run 1 and Run2 pressurizer level calculation**

The evolution of the water level in the pressurizer agrees with the behaviour of the water inside the reactor vessel in each case. Thus, figure 21 show the evolution of the level of water inside the vessel for F2.2 Run1 and F2.2 Run2 calculations.

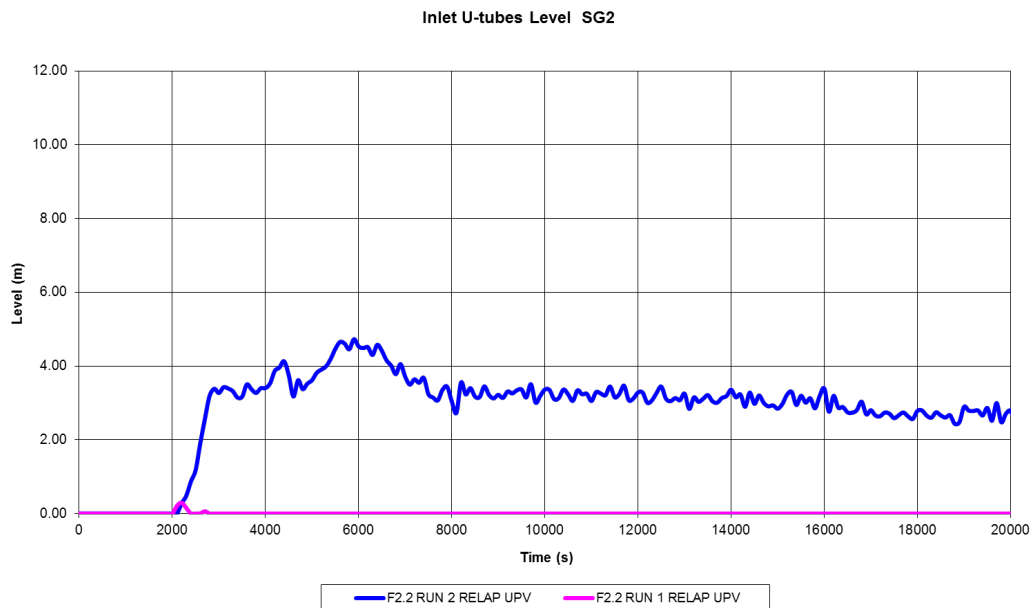


**Figure 21: F2.2 Run1 and Run2 vessel level calculation**

The difference in the water levels observed in figure 20 and 21 between RUN1 and RUN 2 is explained by the coolant distribution inside the steam generators u-Tubes. Thus, figure 22 and 23 show the water level inside the U-tubes of steam generator 1 and 2, respectively. In steam generator 1 the water level is similar for both runs, but the level is considerably different in steam generator 2, see figure 23. As in RUN2 steam generator 2 is available, it acts as heat sink and a certain level of water is observed inside the U-tubes. So as more water is moved toward the steam generator, less coolant enters into the pressurizer, see figures 20 and 23.



**Figure 22: F2.2 Run1 and Run2 SG1 U-Tubes level calculation**



**Figure 23: F2.2 Run1 and Run2 SG2 U-Tubes level calculation**

Finally, figure 24 presents the results obtained with RELAP5 for the boron concentration evolution in the loop seal one. In this case, there is a significant influence of the number of steam generators, with lower deboration when there are two steam generators available, than when there is only one.

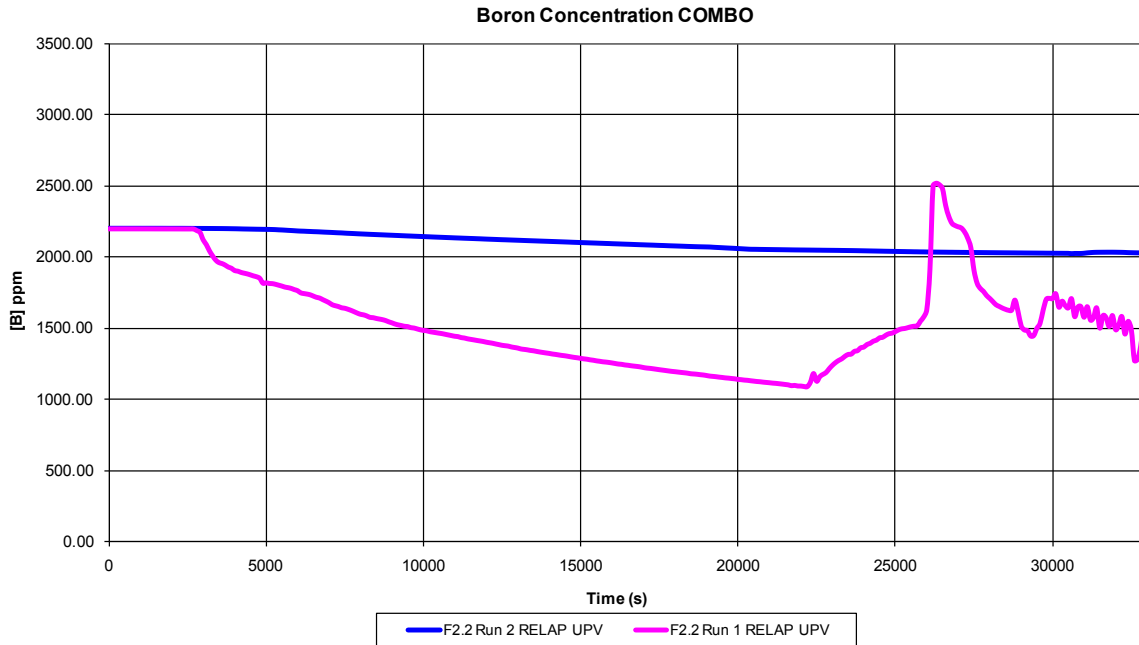


Figure 24: F2.2 Run 1 and 2 boron concentration calculation



## 6 RUN STATISTICS

The calculations of F2.2 Run 1 and 2 have been performed using a server of Cluster IBM 1350 with a biprocessor Intel Xeon with the following characteristics:

- x335 2.40GHz/100MHz/512KB L2, 512MB Memory, 331W, HS Open bay.
- x335 Processor 2.4GHz/512KB Upgrade.
- 1GB PC2100 CL2.5 ECC DDR SDRAM RDIMM.
- 18.2GB 10K-RPM ULTRA 160 SCSI Hot-Swap SL HDD
- Remote Supervisor Adaptor

In, tables 4 and 5 there are exposed the relevant parameters of the run statistics of the simulation of experiment F2.2 RUN1 and RUN2, respectively.

**Table 4: Run Statistics F2.2 Run 1**

	RT	CPU	TS	CPU/RT	C	DT	GT
Steady-state	2800	8514.48	0.09	3.0409	600	104768	0.1354
Pressure control	5600	73687.47	0.01	13.1585	600	835641	0.1470
Primary stabilization	10000	120626.38	0.01	12.0626	600	1349621	0.1490
First injection	21660	224533.27	0.01	10.3663	600	2519785	0.1485
End of transient	34770	908540.71	0.005	26.1300	600	12520282	0.1209

**Table 5: Run Statistics F2.2 Run 2**

	RT	CPU	TS	CPU/RT	C	DT	GT
Steady-state	2800	8300.35	0.1	2.9644	600	100747	0.1373
Pressure control	6400	99001.57	0.01	15.4690	600	1130993	0.1460
Primary stabilization	10000	129467.94	0.01	12.9468	600	1491097	0.1447
Filling up SG3-SG4	18540	199236.86	0.01	10.7463	600	2341097	0.1418
Primary stabilization	25000	255716.68	0.01	10.2287	600	3020295	0.1411
First injection	30560	303260.33	0.01	9.9234	600	3579701	0.1412
End of transient	37880	385494.32	0.01	10.1767	600	4505028	0.1426

RT: Transient time (s)

CPU: Execution time (s)

TS: Maximum time step (s)

C: Total number of volumes

DT: Total number of time steps

GT:  $GT = (CPU \cdot 10^3 / (C \cdot DT))$



## 7 CONCLUSIONS

This work focuses on the simulation of a RHR failure with the plant in shutdown conditions and the primary circuit closed. In these conditions two experiments have been performed to assess the effect of amount of water in the secondary circuit.

From the results reported in the previous sections it can be concluded that in any case the plant reaches a stable situation when the residual heat is evacuated through the steam generators. The new situations reached maintain the plant integrity and the injections produced at the end of the transient assure the plant safety during the entire transient.

The results obtained in F2.2 Run1 simulation agree with the experimental data although a significant difference in the mass distribution in the primary circuit is found, as for example in the pressurizer, U-tubes and vessel levels. Regarding the boron, the simulation predicts a lower decrease of the boron concentration in the loop seal. A similar result is obtained from the F2.2 Run2 simulation when comparing the levels inside the primary, what implies that again in this calculation the mass distribution inside the primary circuit is different from the experimental data. In this case water fills the pressurizer as well as the U-tubes of SG1 and 2. Boron concentration in the loop seal calculated by RELAP is more similar to the experiment in F2.2 Run2 than in Run1, but only until the injections from the accumulators are actuated.

Comparison among the obtained results shows that the number of steam generators affects the plant behaviour. In any case a quasi-steady plant situation is reached, and it is always maintained under safe conditions, but with different stabilization values.





## 8 REFERENCES

1. Seo J.K. and Park G.C. 2000. Return momentum effect on water level distribution during mid-loop operations. Nucl. Eng. Des., 202, 97-108.
2. Seul K.W., Bang Y.S., Kim H.J. 2000. Mitigation measures following a loss-of-residual-heat-removal event during shutdown. Nuclear Technology, 132, 152-165.
3. NUREG-1269, 1987. Loss of residual heat removal system, Diablo Canyon Unit 2, April 10, 1987. U.S. Nuclear Regulatory Commission.
4. NUREG-1410, 1990. Loss of vital AC power and the residual heat removal system during midloop operations at Vogtle Unit 1 on March 20,1990. U.S. Nuclear Regulatory Commission.
5. Hassan Y.A., RAJA L.L. 1993. Simulation of loss of RHR during midloop operations and the role of steam generators in decay heat removal using the RELAP5/Mod3 code. Nuclear Technology, 103, 310- 318.
6. Hassan Y.A., Banerjee S.S. 1994. RELAP5/Mod3 simulation of the loss of the residual heat removal system during a midloop operation experiment conducted at the ROSA-IV large scale test facility. Nuclear Technology, 118, 191-206.
7. Hassan YA, Troshko AA. 1997. Simulation of loss of the residual heat removal system of BETHSY integral test facility using CATHARE thermal-hydraulic code. Nuclear Technology, 119,1, 29-37.
8. Seul K.W. Bang Y.S. Kim H.J. 1998. Plant behaviour following a loss-of-residual-heat-removal event during shutdown conditions. Nuclear Technology, 126, 265-277.
9. Choi C.J., Nakamura H. 1997. RELAP5/Mod3 analysis of a ROSA –IV/LSTF loss of RHR experiment with a 5% cold leg break. Ann. Nucl. Energy, 24, 4, 275-285.
10. Ferng Y. Ma S. 1996. Investigation of system responses of the Maanshan nuclear power plant to the loss of the heat removal during midloop operation using RELAP5/Mod3 simulation. Nuclear Technology, 116, 160-172.
11. Umminger, K., Mandl, R. and Wegner, R. 2002. Restart of Natural circulation in a PWR-PKL test results and s-RELAP5 calculations. Nucl. Eng. Des., 39-50.
12. NUREG-5535, 2001. RELAP5/MOD3.3 code manual. Volume II: User's guide and input requirements. December 2001. U.S. Nuclear Regulatory Commission.
13. FRAMATOME ANP, 2002. PKL III: RELAP5/Mod3 Input-Model. NGES1/2002/en/0059



<p><b>NRC FORM 335</b> (9-2004) NRCMD 3.7</p> <p style="text-align: center;"><b>U.S. NUCLEAR REGULATORY COMMISSION</b></p> <p style="text-align: center;"><b>BIBLIOGRAPHIC DATA SHEET</b> <i>(See instructions on the reverse)</i></p>	<p>1. REPORT NUMBER (Assigned by NRC, Add Vol., Supp., Rev., and Addendum Numbers, if any.)</p> <p style="text-align: center;">NUREG/IA-0411</p>				
<p>2. TITLE AND SUBTITLE Simulation of the experimental series F2.2 at PKL facility using RELAP5/Mod3.3</p>	<p>3. DATE REPORT PUBLISHED</p> <table border="1" style="width: 100%;"> <tr> <td style="width: 50%;">MONTH</td> <td style="width: 50%;">YEAR</td> </tr> <tr> <td>February</td> <td>2012</td> </tr> </table> <p>4. FIN OR GRANT NUMBER</p>	MONTH	YEAR	February	2012
MONTH	YEAR				
February	2012				
<p>5. AUTHOR(S) S. Carlos, J.F. Villanueva, S. Martorell, V. Serradell</p>	<p>6. TYPE OF REPORT Technical</p> <p>7. PERIOD COVERED <i>(Inclusive Dates)</i></p>				
<p>8. PERFORMING ORGANIZATION - NAME AND ADDRESS <i>(If NRC, provide Division, Office or Region, U.S. Nuclear Regulatory Commission, and mailing address; if contractor, provide name and mailing address.)</i>          Universidad Politécnica de Valencia          Departamento de Ingeniería Química y Nuclear          Camino Vera s/n          46022 Valencia, SPAIN</p>					
<p>9. SPONSORING ORGANIZATION - NAME AND ADDRESS <i>(If NRC, type "Same as above"; if contractor, provide NRC Division, Office or Region, U.S. Nuclear Regulatory Commission, and mailing address.)</i>          Division of Systems Analysis          Office of Nuclear Regulatory Research          U.S. Nuclear Regulatory Commission          Washington, DC 20555-0001</p>					
<p>10. SUPPLEMENTARY NOTES A. Calvo, NRC Project Manager</p>					
<p>11. ABSTRACT <i>(200 words or less)</i></p> <p>The reactor coolant system water level is reduced when a nuclear power plant is in shutdown conditions for refuelling. This situation is known as mid-loop operation, and the residual heat removal (RHR) system is used to remove the decay power heat generated in the reactor core.</p> <p>In mid-loop conditions, some accidental situations may occur with a nonnegligible contribution to the plant risk, and all involve the loss of the RHR system. Thus, to better understand the thermal-hydraulic processes following the loss of the RHR during shutdown, transients of this kind have been simulated using best-estimate codes in different integral test facilities. In PKL facility different series of experiments have been undertaken to analyse the plant response in shutdown. In this context, the F2 series consists of analyzing the loss of residual heat removal under ¾ loop operation with closed primary circuit. In particular test F2.2 has been developed to investigate the influence of the configuration of the secondary side (i.e. number of SGs filled with water and ready for activation) on the heat transfer mechanisms in the U-tubes of the SGs and study the boron dilution process in critical parts of the primary circuit. Two experiments belonging to this experimental series have been performed, F2.2 RUN1 and F2.2 RUN2. The simulations present differences in number of steam generators filled and ready for operation. Thus for RUN1 there is one steam generator filled with water and controlled at 2 bar and in RUN2 there are two steam generators SGs filled with water and controlled at 2 bar.</p>					
<p>12. KEY WORDS/DESCRIPTORS <i>(List words or phrases that will assist researchers in locating the report.)</i>          Consejo de Seguridad Nuclear (CSN)          Thermal-hydraulic          CAMP-Spain program          RELAP5/Mod 3.3,          Residual heat removal (RHR)          ROSA/LSTF of Japan Atomic Energy Research Institute (JAERI)          ROSA/OECD          ATWS          TRACE</p>	<p>13. AVAILABILITY STATEMENT unlimited</p> <p>14. SECURITY CLASSIFICATION</p> <p><i>(This Page)</i> unclassified</p> <p><i>(This Report)</i> unclassified</p> <p>15. NUMBER OF PAGES</p> <p>16. PRICE</p>				







Federal Recycling Program





**UNITED STATES  
NUCLEAR REGULATORY COMMISSION**  
WASHINGTON, DC 20555-0001  
-----  
OFFICIAL BUSINESS



**NUREG/IA-0411**

**Simulation of the Experimental Series F2.2 at  
PKL Facility Using RELAP5/Mod 3.3**

**February 2012**