



NIST Response to the World Trade Center Disaster

**Federal Building and Fire Safety Investigation
of
the World Trade Center Disaster**

Part IIA – Collapse Analysis

April 5, 2005

**National Institute of Standards and Technology
Technology Administration
U.S. Department of Commerce**

Analysis of Probable Collapse Sequence

NIST developed and used a series of rigorous and comprehensive models to determine the probable collapse sequence for the WTC towers, from aircraft impact to collapse initiation. The approach:

- ❑ Combined mathematical modeling, well-established statistical and probability-based analysis methods, laboratory experiments, and analysis of visual and physical evidence—**significantly advancing the current state-of-the-art and testing the limits of current computational capabilities.**
- ❑ Analyzed the complete sequence of events from aircraft impact to the spread of jet-fuel-ignited multi-floor fires, thermal weakening of structural components, and the progression of local structural failures that ultimately initiated collapse of the buildings.
- ❑ Allowed for evaluation and comparison of possible collapse sequences based on different damage states, fire paths, and structural load redistribution paths.
- ❑ Accounted for variations in models, input parameters, analyses, and observed events.
- ❑ Required use of **advanced strategies for managing computational demands due to unprecedented analysis complexity and sophistication; adequately captured the physics of phenomena essential to determining the probable collapse sequence.**

Critical Analysis Inter-Dependencies

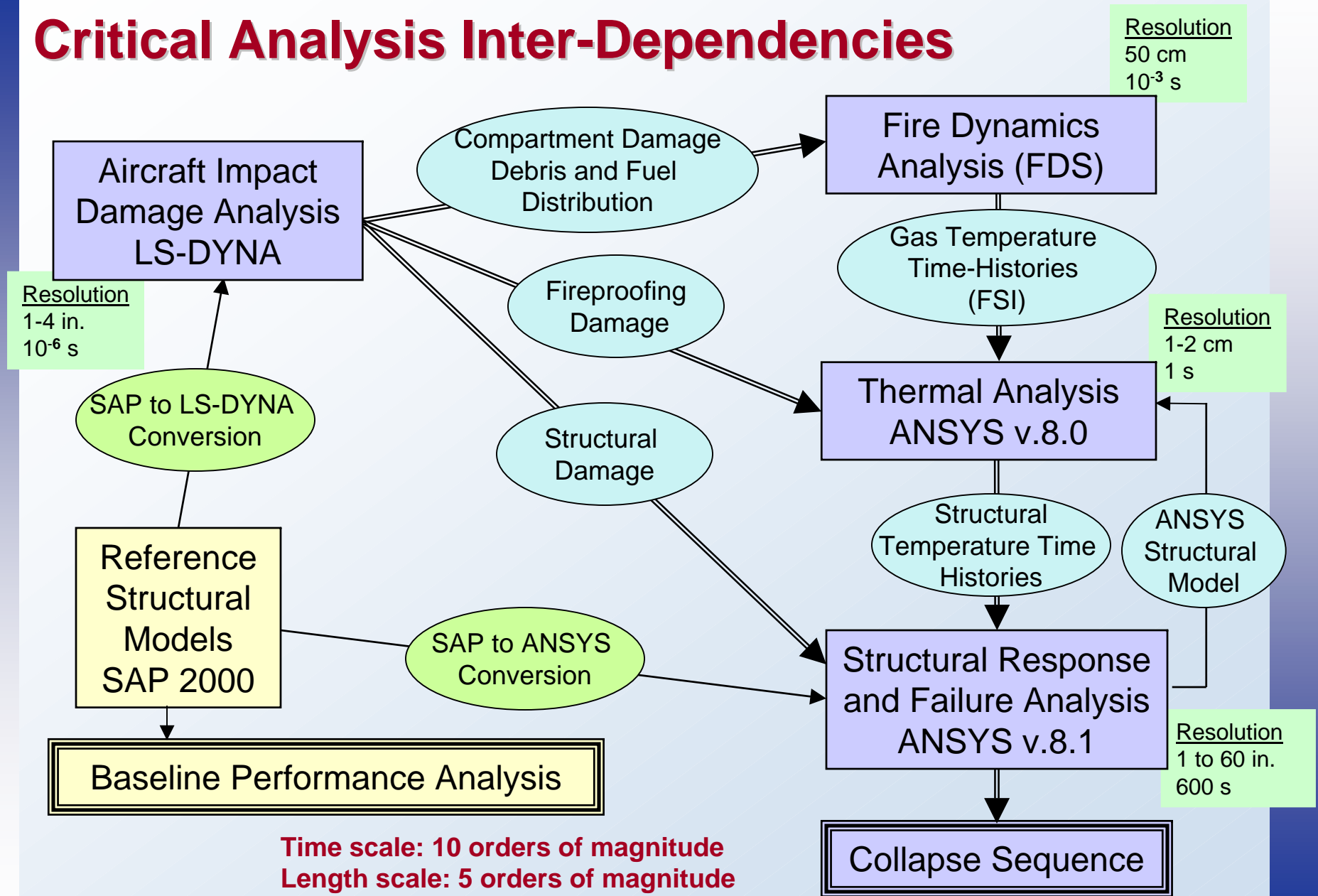

Structural, Fire, and Thermal Analysis Models

- NIST simulated highly-complex structural failures and fires at the **component, subsystem, and system levels** to determine the probable collapse sequences. The models include:
 - Reference structural model of a typical **truss-framed floor** of the WTC towers with over 40,000 elements and 166,000 degrees of freedom.
 - Reference structural model of a typical **beam-framed floor** of WTC towers with over 12,000 elements and 35,000 degrees of freedom.
 - Reference global model of **WTC 1 structure** with over 80,000 elements and 218,000 degrees of freedom (with 17 flexible and other rigid diaphragm floors).
 - Reference global model of **WTC 2 structure** with over 78,000 elements and 200,000 degrees of freedom.
 - Structural model of a typical **turbofan engine** of the Boeing 767-200ER aircraft with over 60,000 elements and 100,000 nodes.
 - Structural model of the **Boeing 767-200ER aircraft**, including engines, airframe, landing gear, fuel tanks, passenger cabin, and cargo bay, with over 700,000 elements and 740,000 nodes.
 - Structural model of the **WTC structure for the aircraft impact damage analysis** with over 1,200,000 elements and 1,300,000 nodes.
 - Computational fluid dynamics model of the **fires and thermal environments** that encompasses 8 floors and 1,200,000 cells in WTC 1 and 6 floors and 900,000 cells in WTC 2.
 - **Fire-structure interface** model that maps the thermal environment onto and within the structural model, comprising 500,000 floor elements and 300,000 column nodes per building floor.
- The first four models described above were used to evaluate the baseline performance of the WTC towers under design gravity and wind loads. They also served as **reference** models for analyses of aircraft impact damage and response of the thermally-insulated WTC structures to subsequent fires.

High Fidelity Aircraft Model

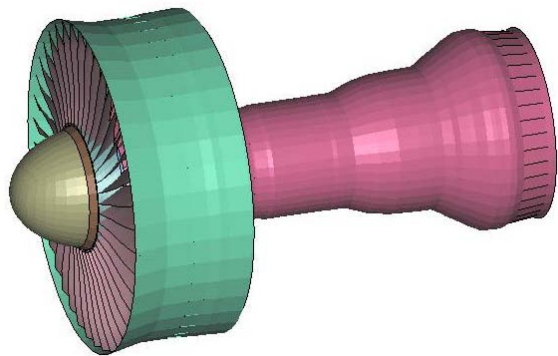
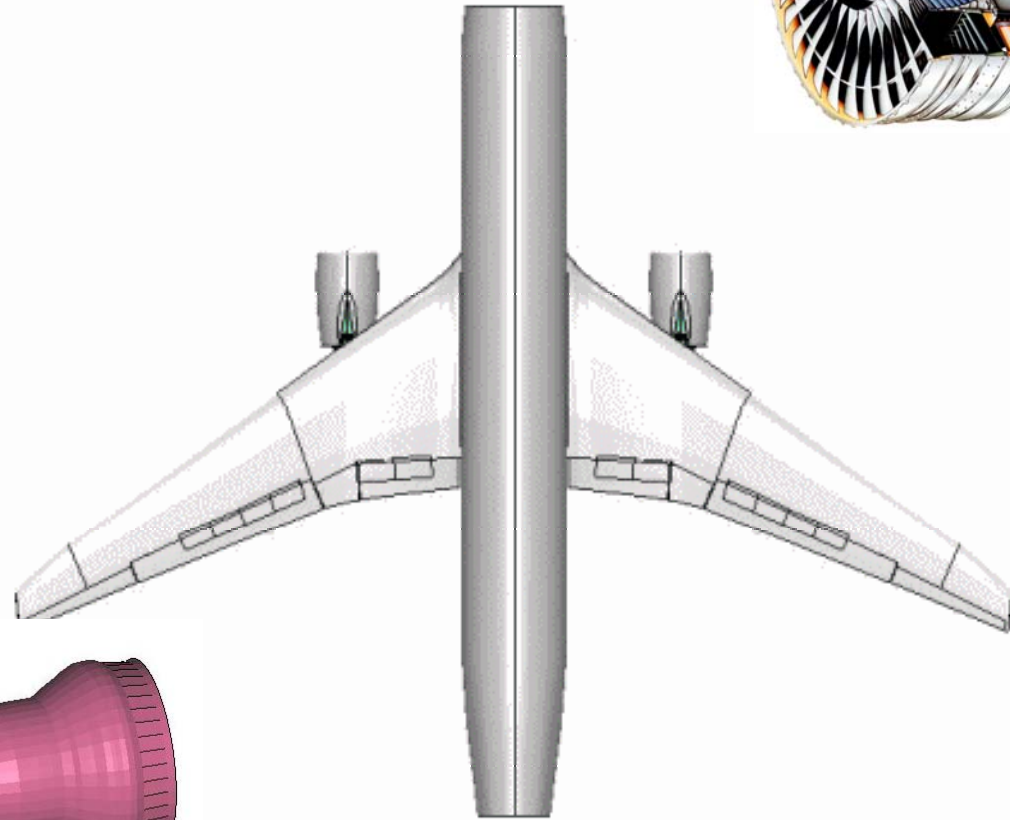
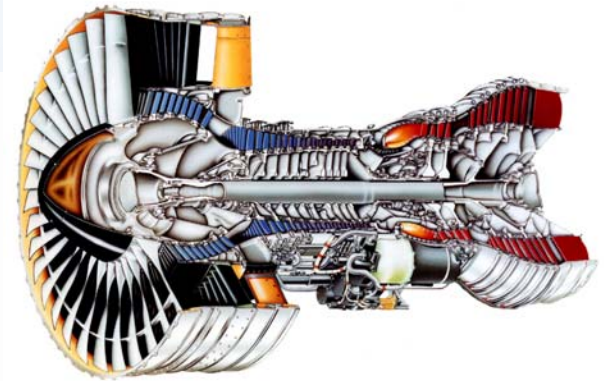

High Fidelity Aircraft Models

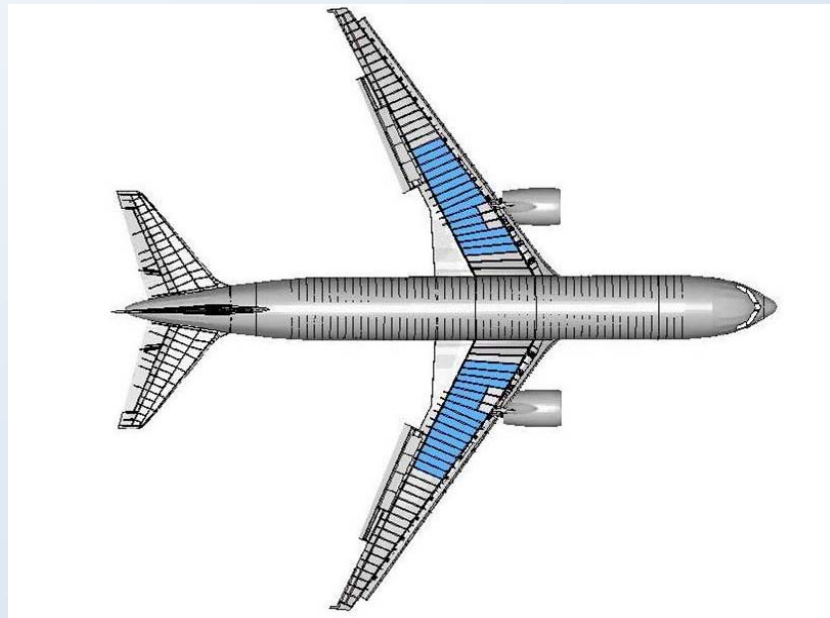
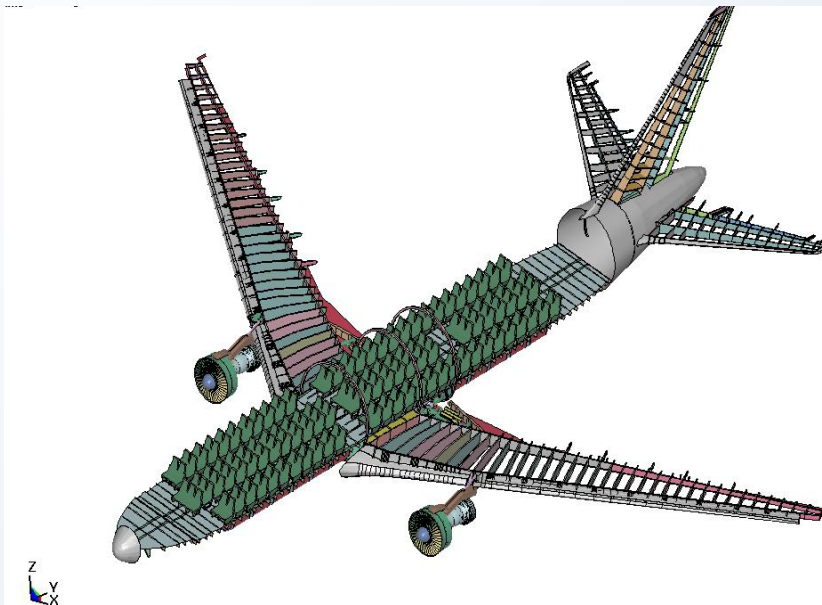

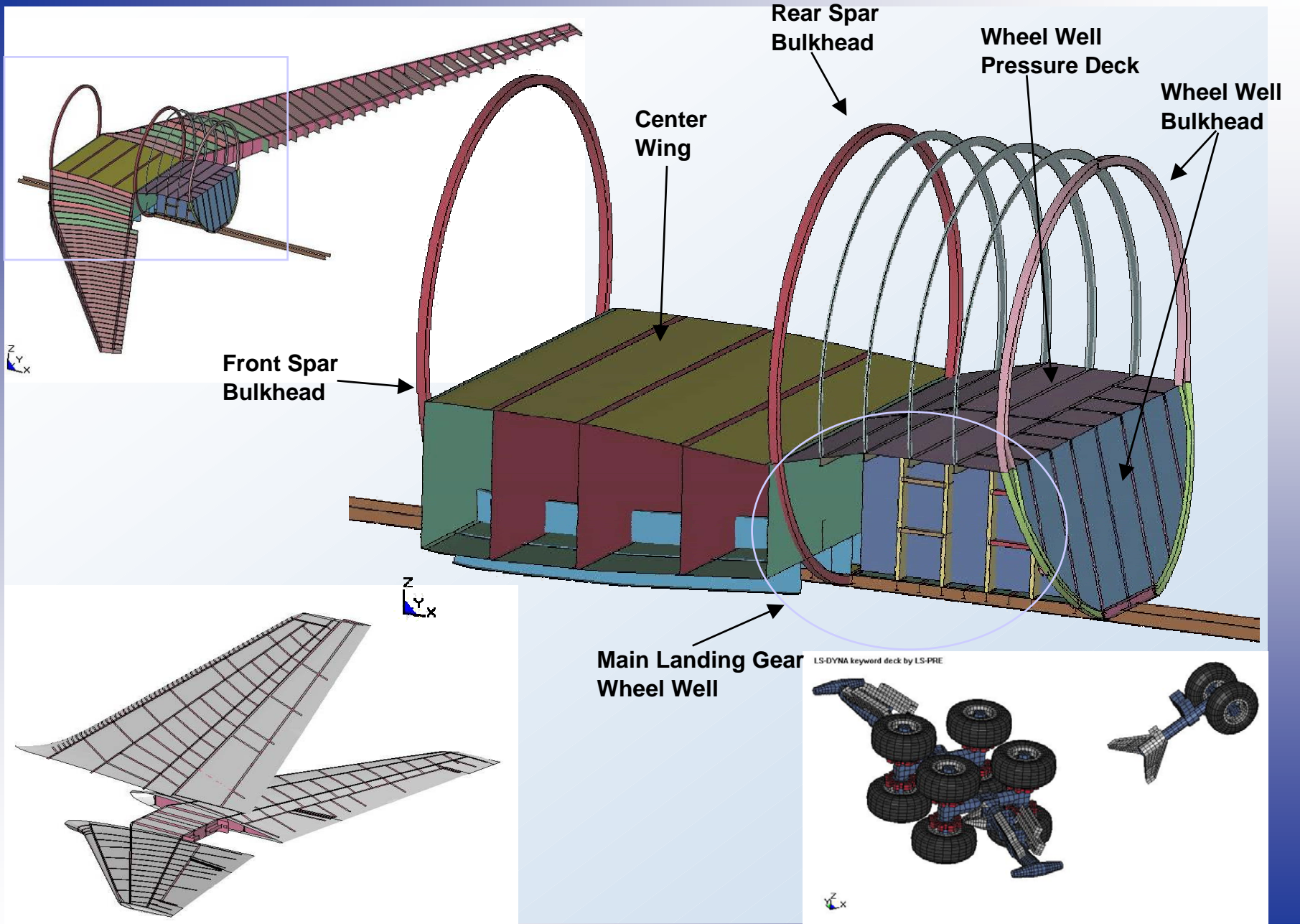

Preliminary Aircraft Impact Damage Analysis

- ❑ The impact of the exterior wall by an empty wing segment produces significant damage to the perimeter columns, not necessarily complete failure.
- ❑ The impact of a fuel-filled wing section results in extensive damage to the exterior wall panel, including complete failure of the perimeter columns.

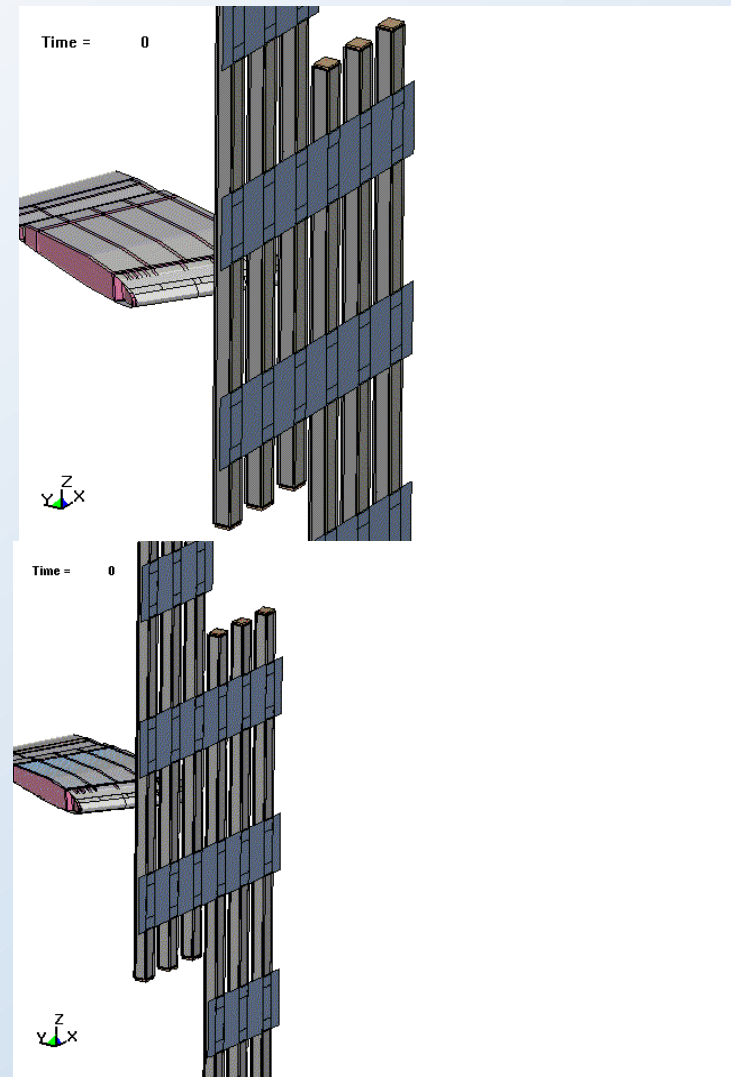

Preliminary Aircraft Impact Damage Analysis

- ❑ Engine impact against an exterior wall panel results in a penetration of the exterior wall and failure of impacted perimeter columns.
- ❑ The residual velocity and mass of the engine after penetration is sufficient to fail a core column in the event of a direct impact

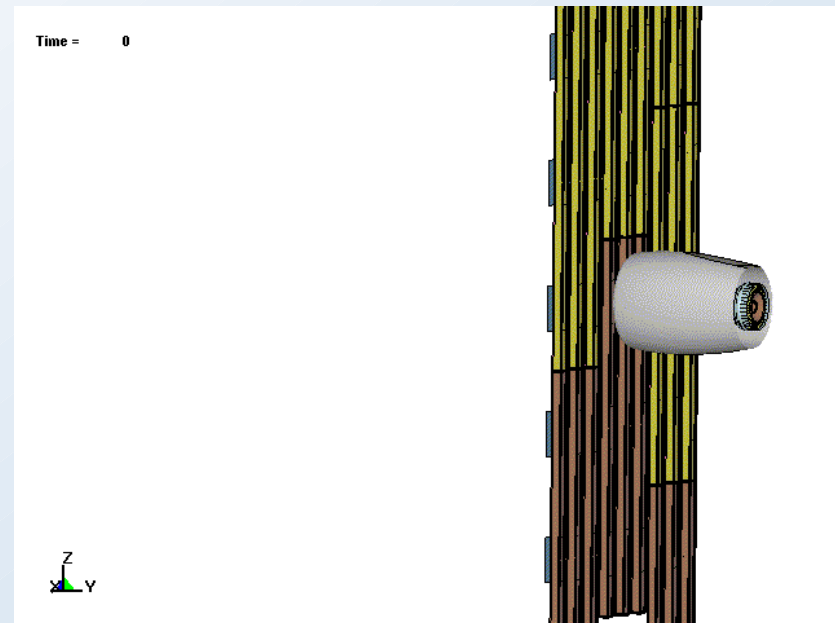

Aircraft Engine Impacting Column Floor Subsystem

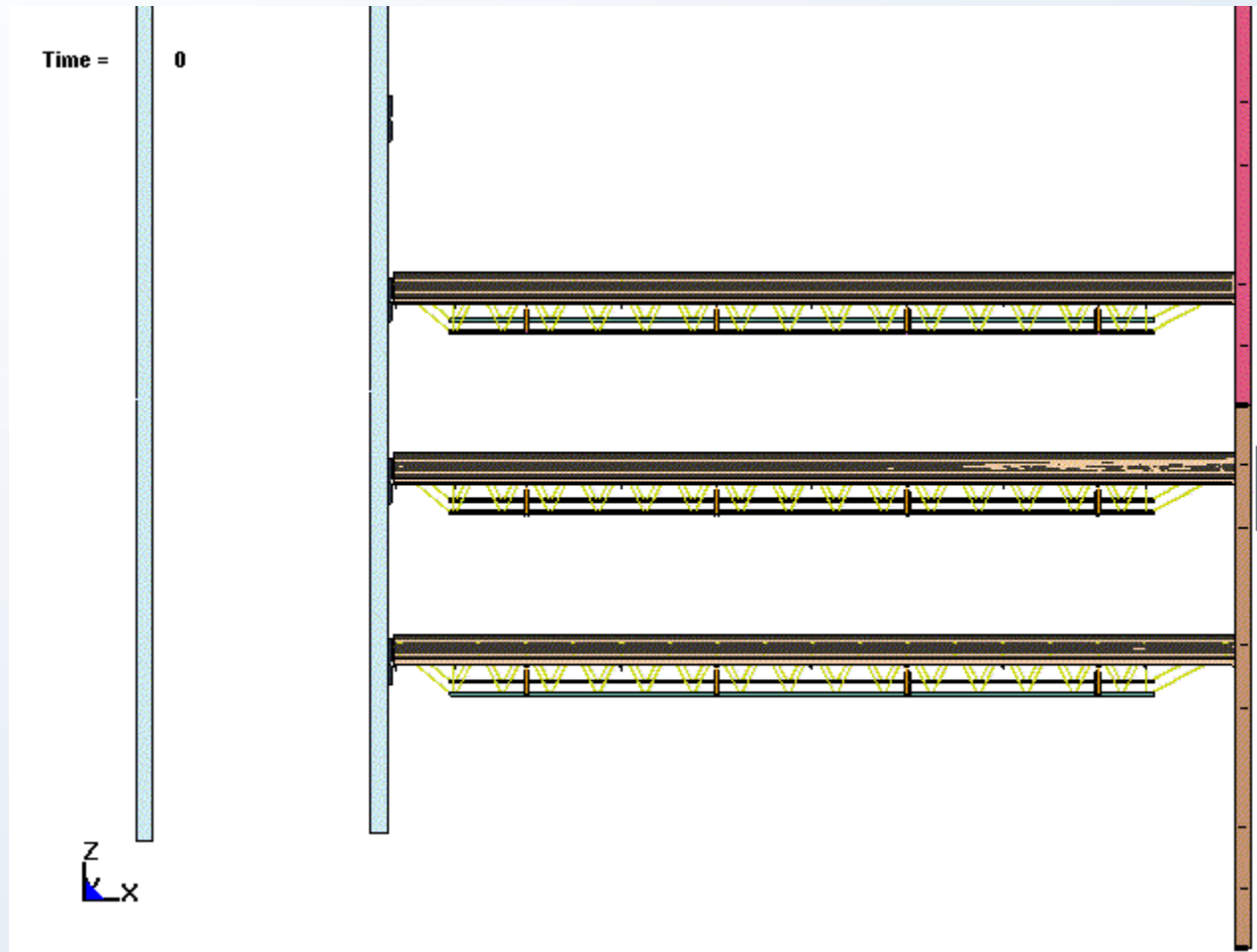

Engine Impact on WTC Tower Subsystem

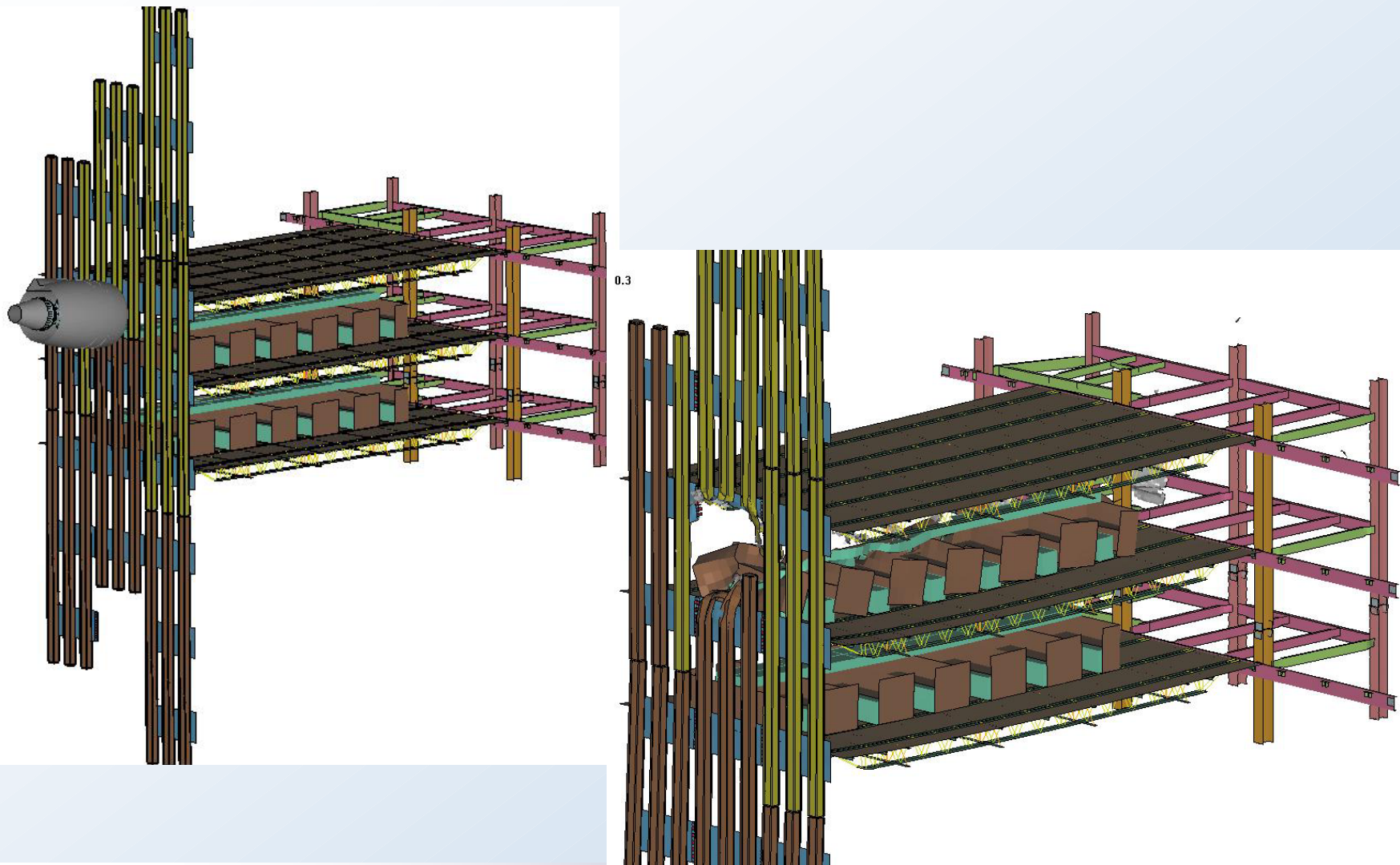

Effect of Engine Impact Location

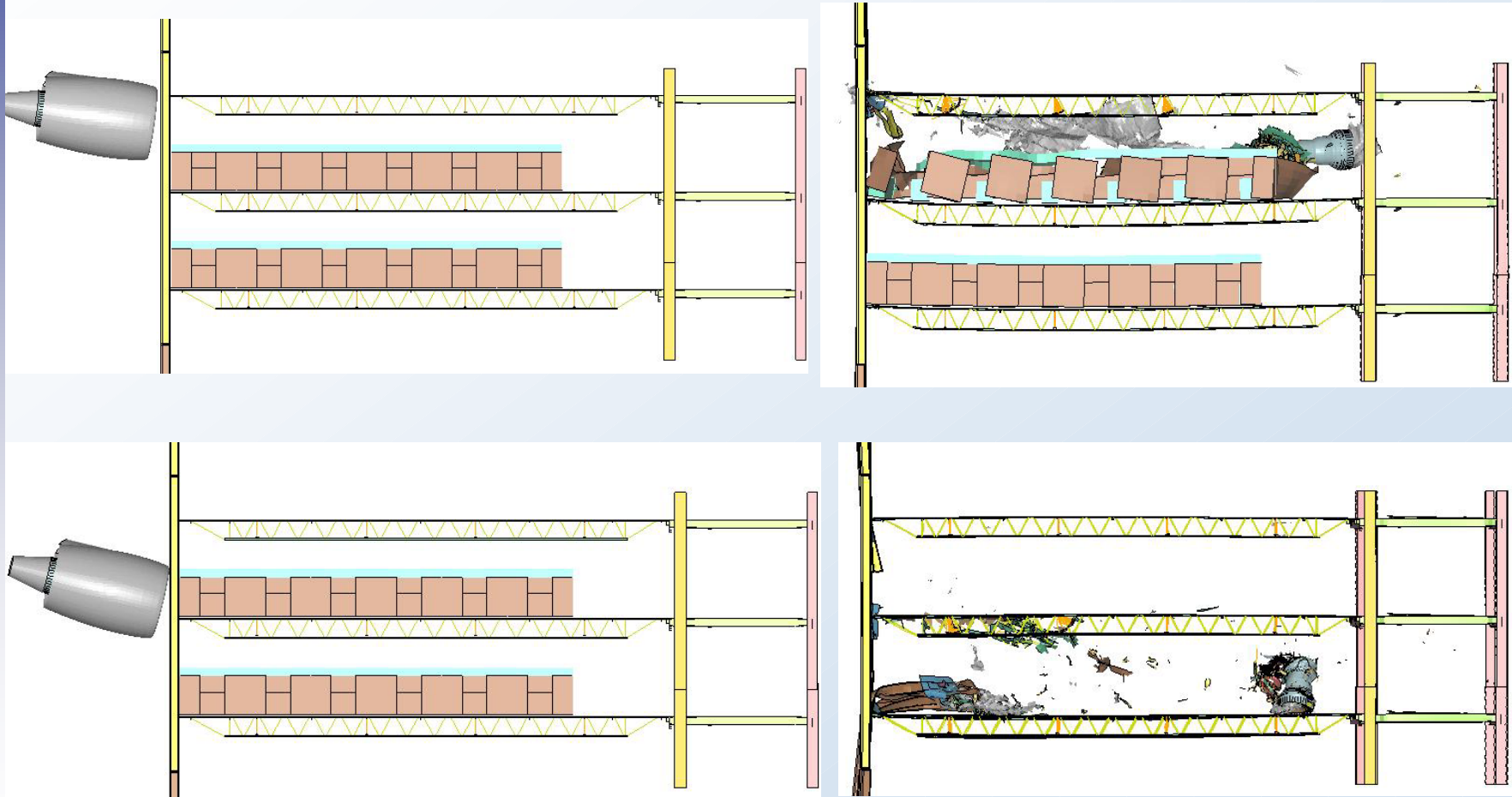

WTC 1 Tower Model for Aircraft Impact Analysis

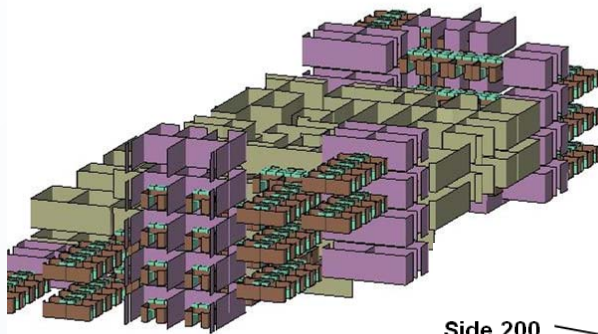

Side 200

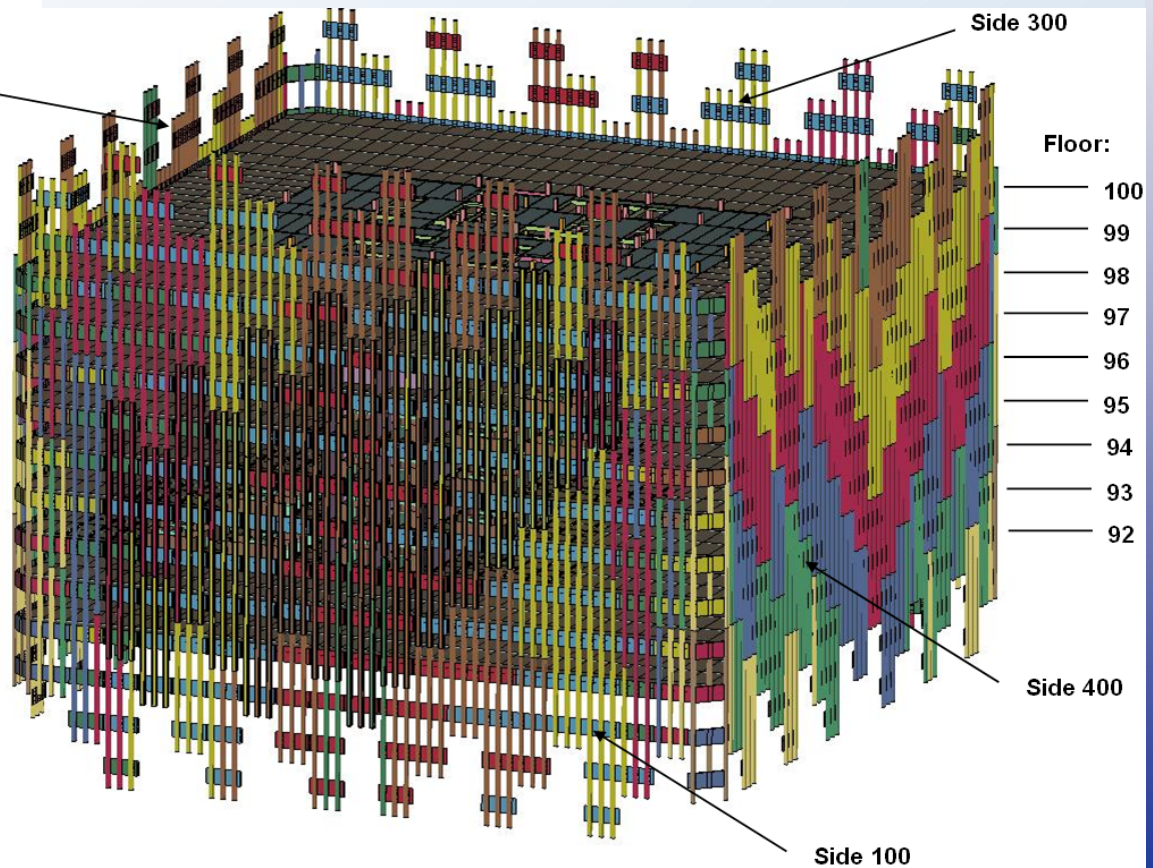

Side 300

Floor:

100

99

98

97

96

95

94

93

92

Side 400

Side 100

WTC 2 Tower Model for Aircraft Impact Analysis

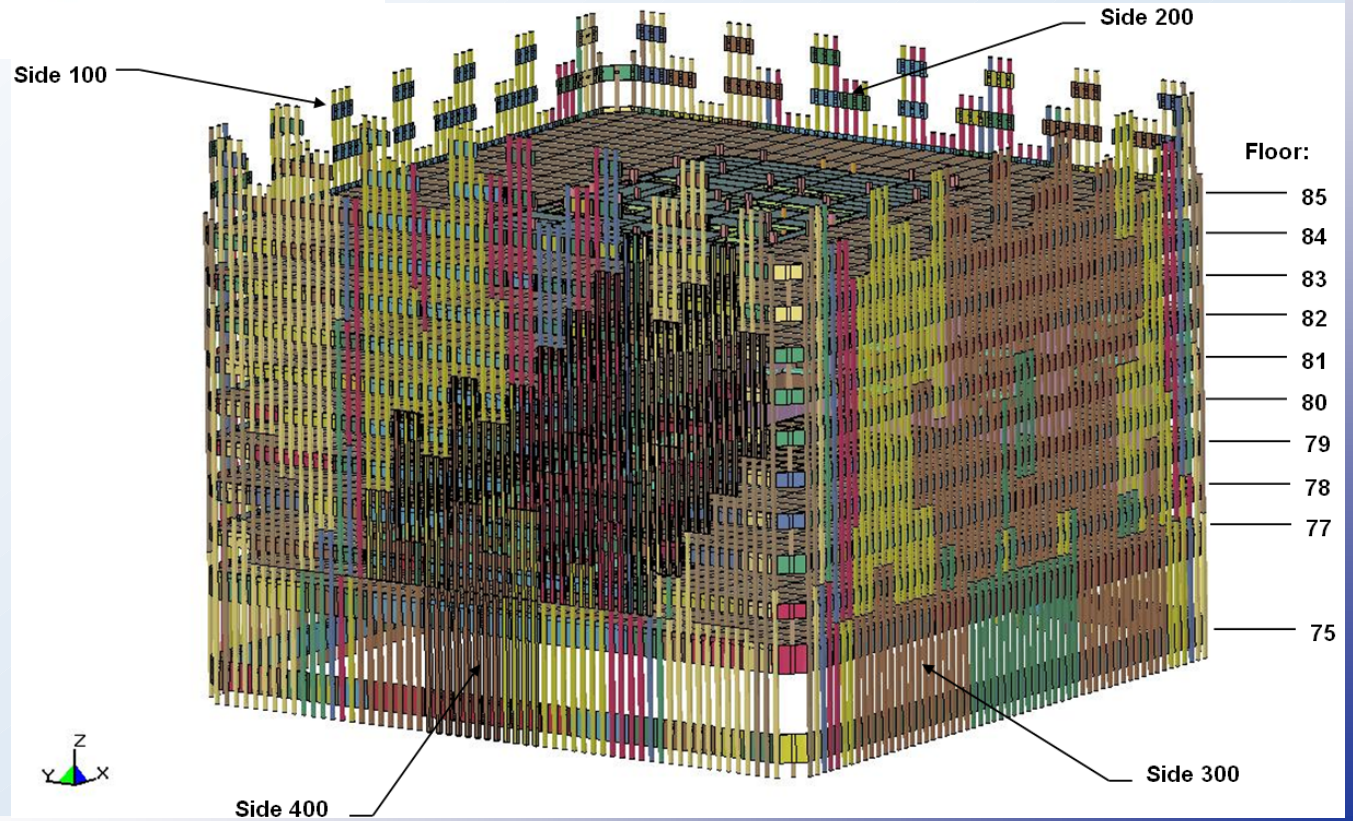
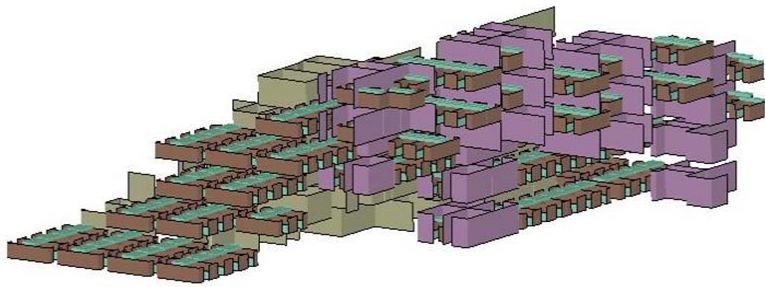

AA 11 (WTC 1) Aircraft Impact Initial Conditions

	FEMA	Hart-Weidlinger	MIT	NIST Simplified Analysis	NIST
Best Estimate Speed (mph)	470	500	429	466	443
Speed Error Estimate (mph)		+ 30 / - 50	± 51	± 34	± 30
Lateral Approach Angle (clockwise)		4.3°			0.3° ± 4°
Vertical Approach Angle (downward)		6.2°			10.6° ± 3°
Aircraft Roll (left wing down)		20.7°			25° ± 2°

UAL 175 (WTC 2) Aircraft Impact Initial Conditions

	FEMA	Hart-Weidlinger	MIT	NIST Simplified Analysis	NIST
Best Estimate Speed (mph)	590	550	503	545	542
Speed Error Estimate (mph)			± 38	± 18	± 24
Lateral Approach Angle (clockwise)		11.7°	15°		13° ± 2°
Vertical Approach Angle (downward)		2.7°	0°		6° ± 2°
Aircraft Roll (left wing down)		30.1°			38° ± 2°

WTC 1 Severe Case

Time = 0

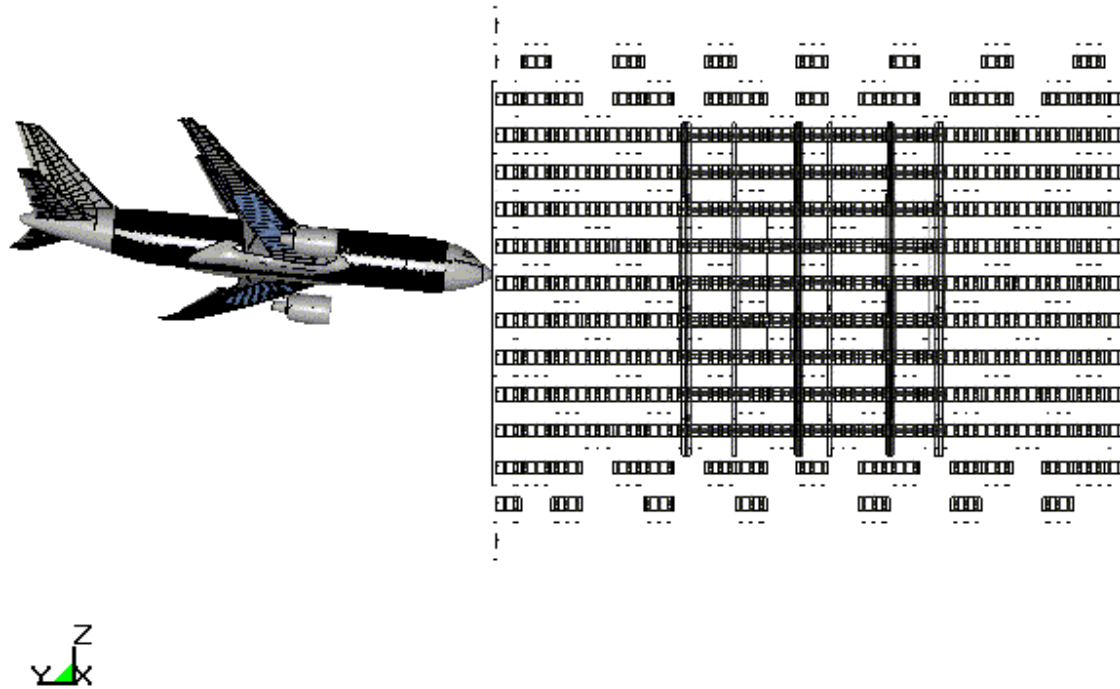

WTC 1 Severe Case

Time = 0

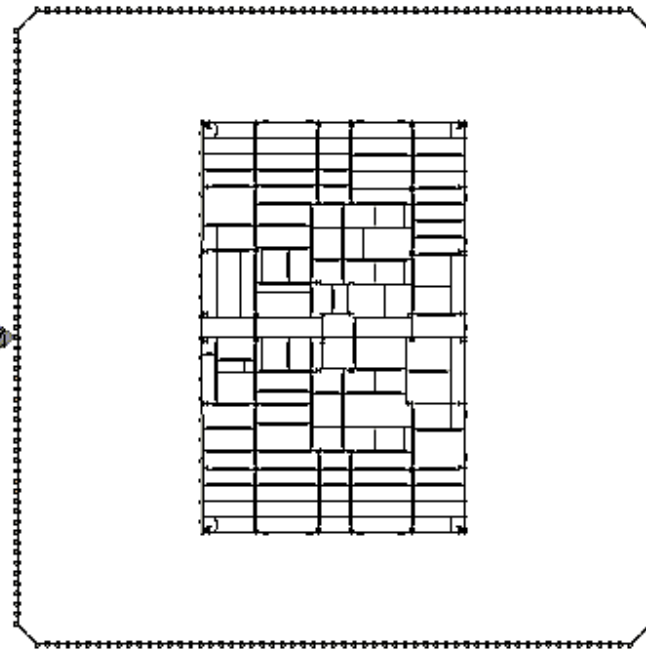
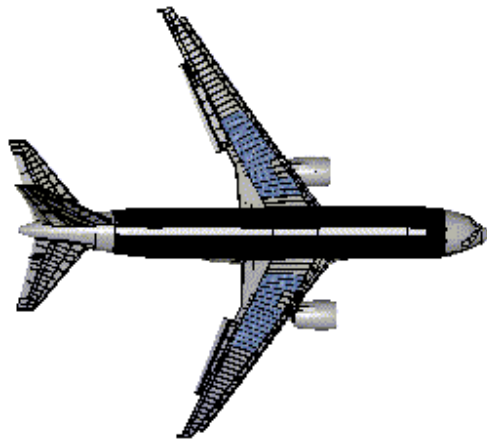

WTC 1 Aircraft Impact

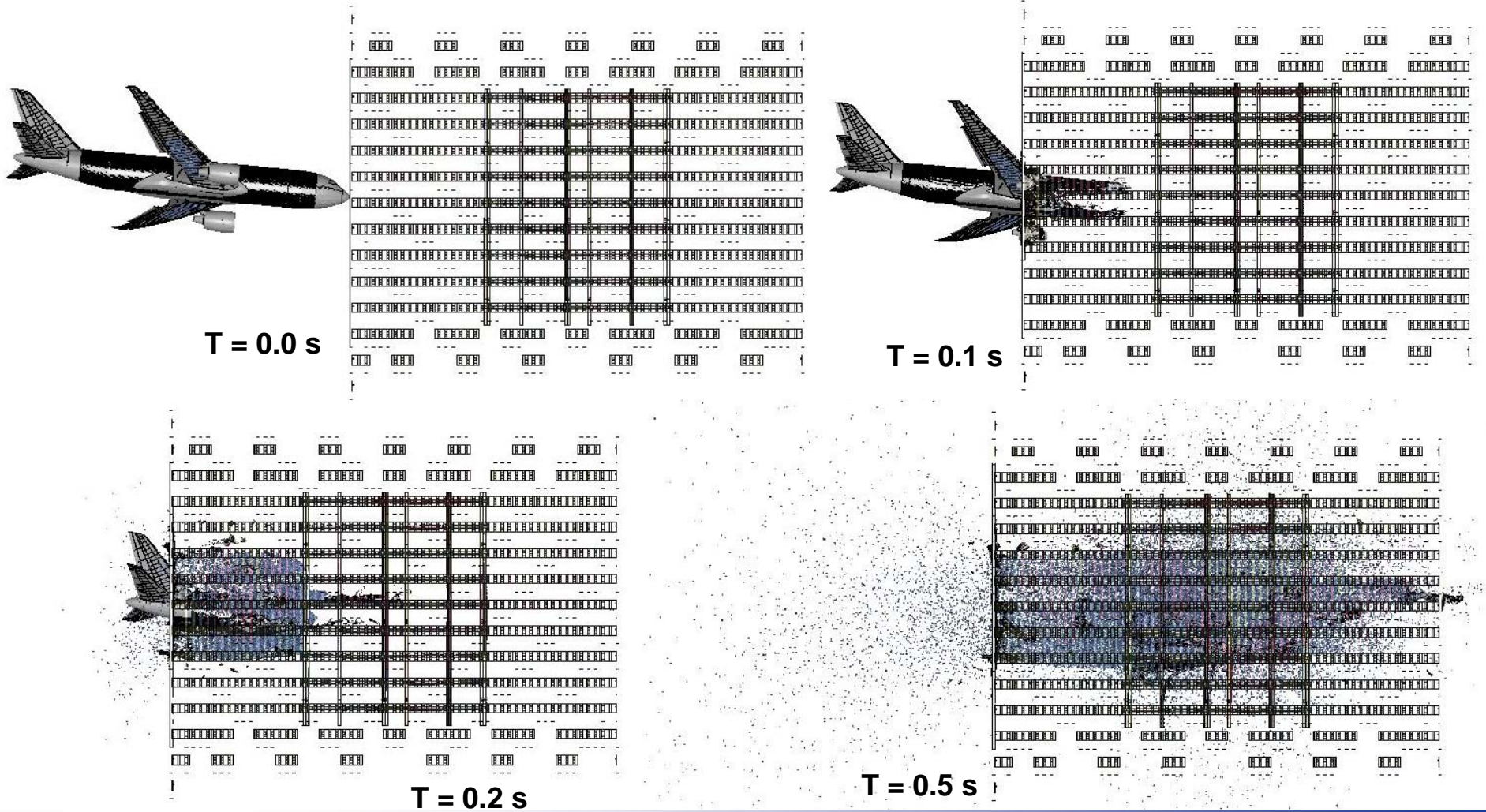

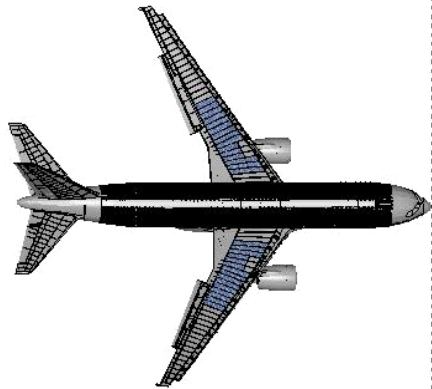

$T = 0.0 \text{ s}$

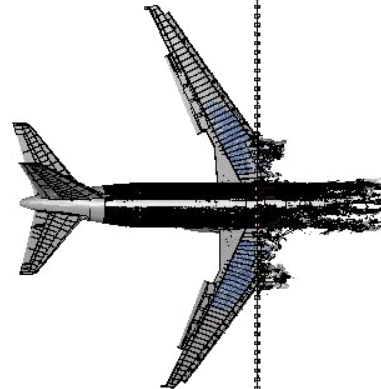

$T = 0.1 \text{ s}$

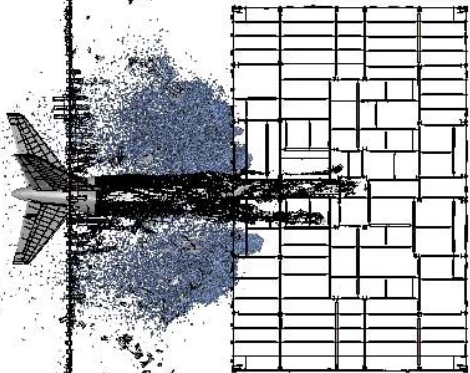

$T = 0.2 \text{ s}$

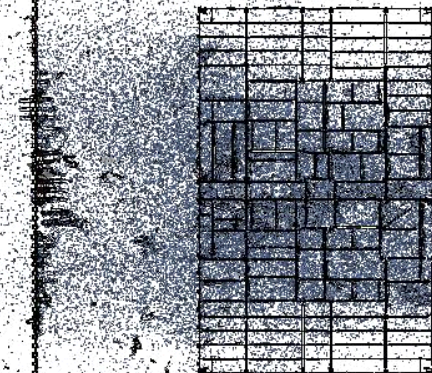

$T = 0.5 \text{ s}$

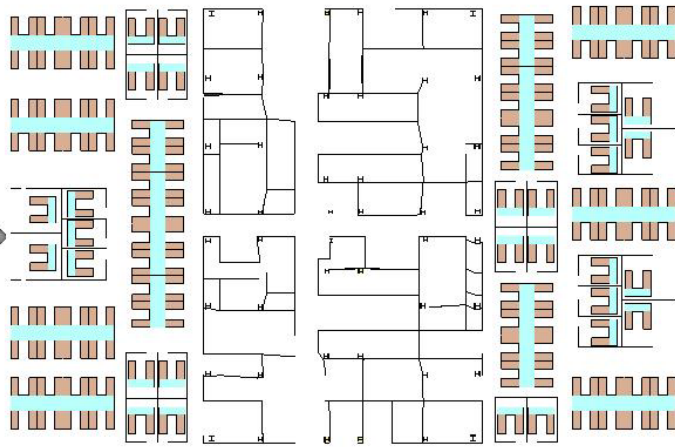
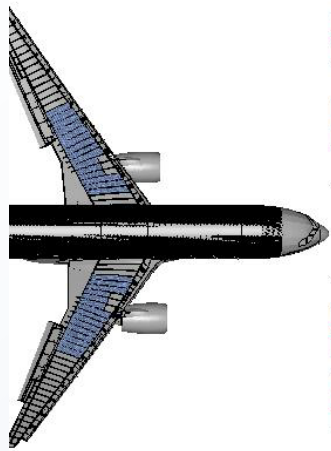

Time = 0.685



WTC 2 Severe Case

Time = 0

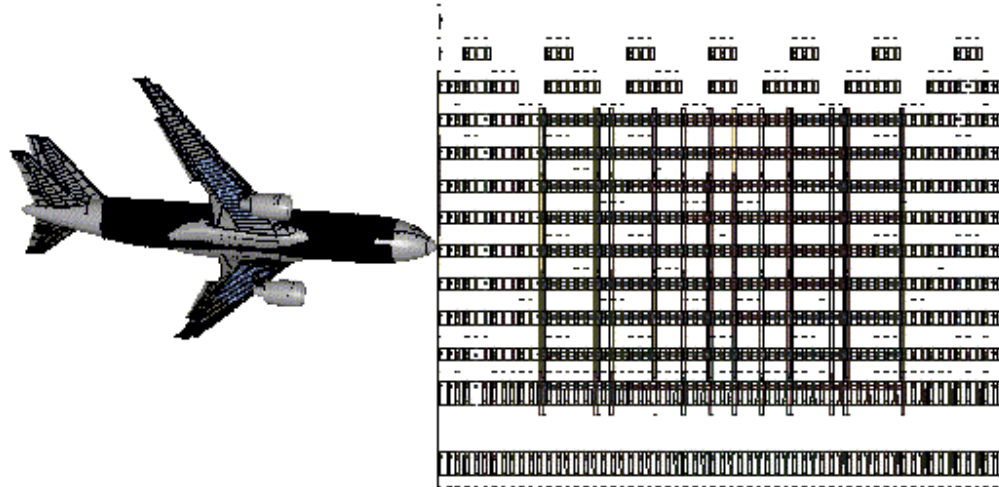

WTC 2 Severe Case

Time = 0

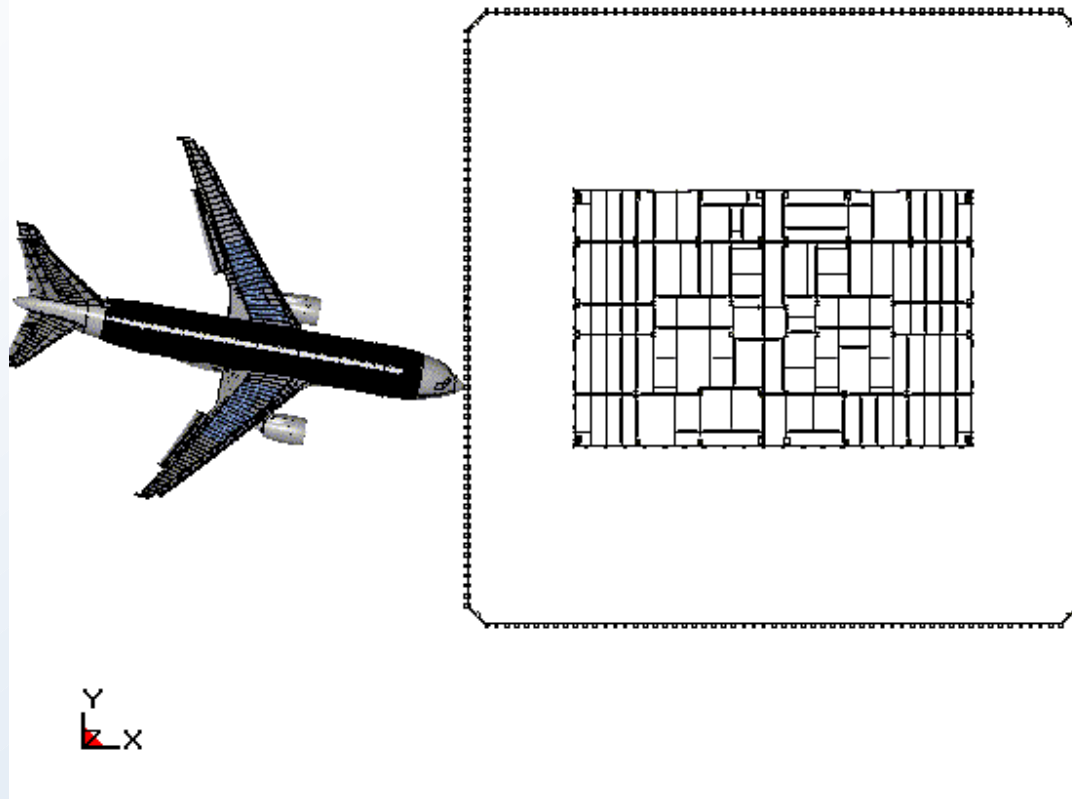

WTC 2 Aircraft Impact



T = 0.0 s

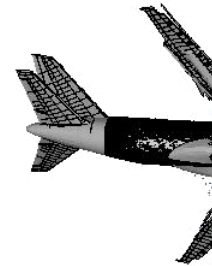
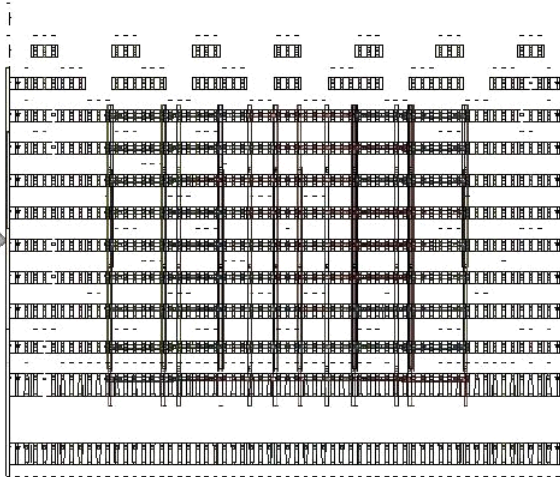

T = 0.1 s

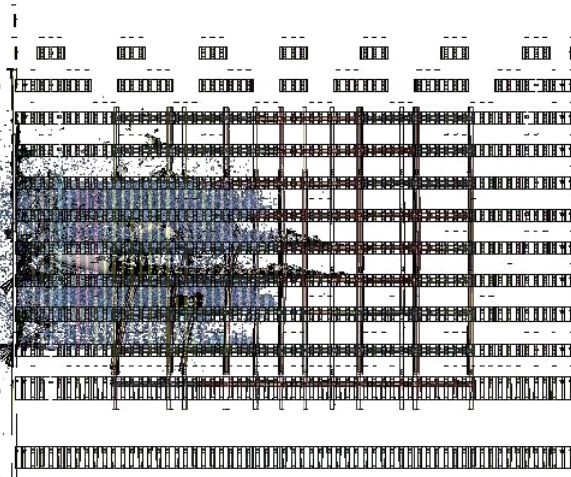
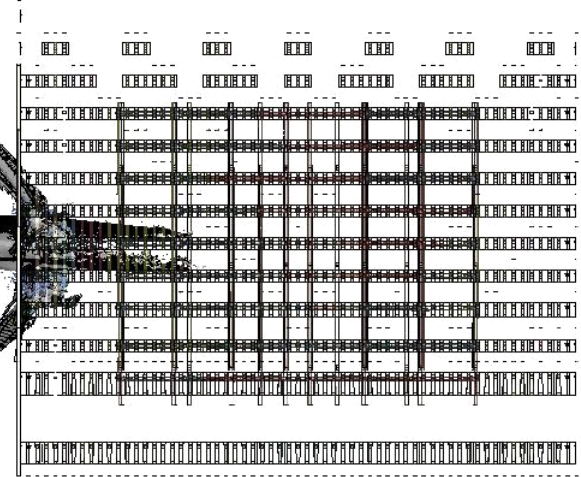

T = 0.2 s

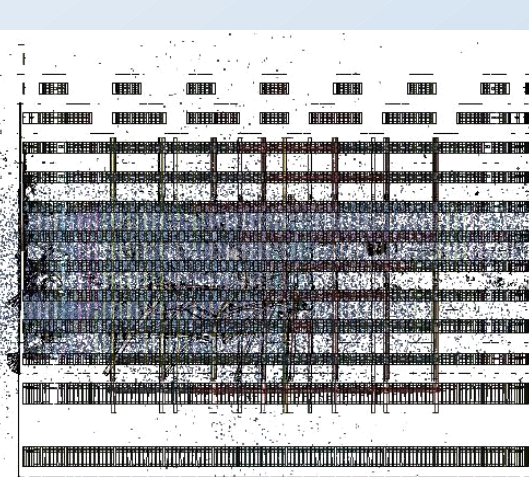

T = 0.5 s

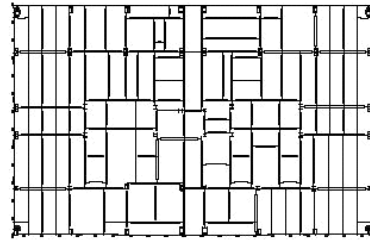
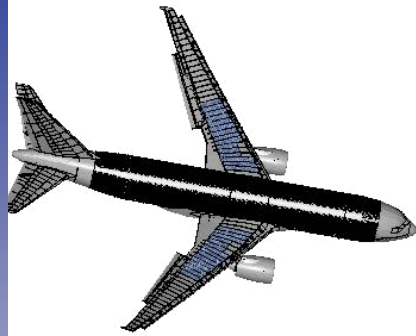

$T = 0.0 \text{ s}$

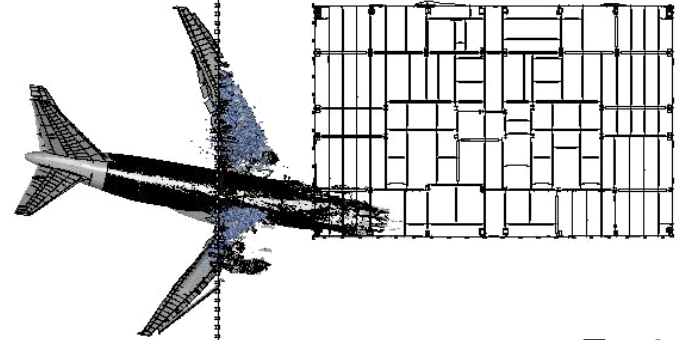

$T = 0.1 \text{ s}$

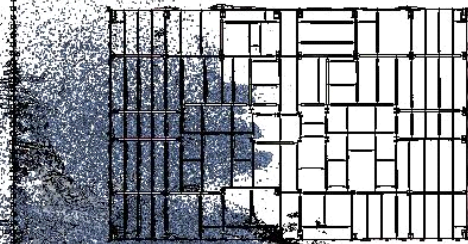

$T = 0.2 \text{ s}$

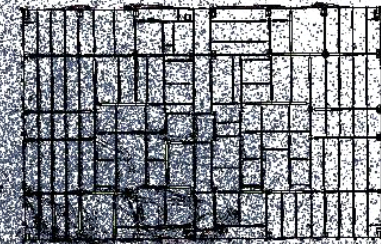

$T = 0.5 \text{ s}$

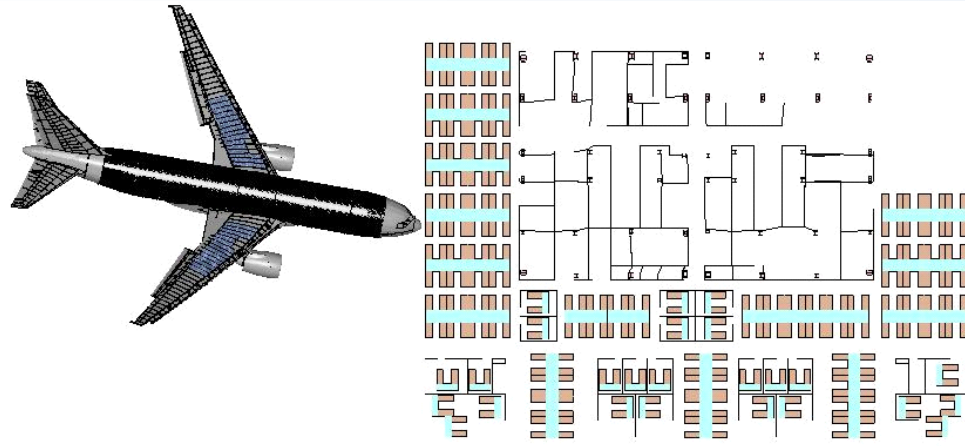

Time = 0.58



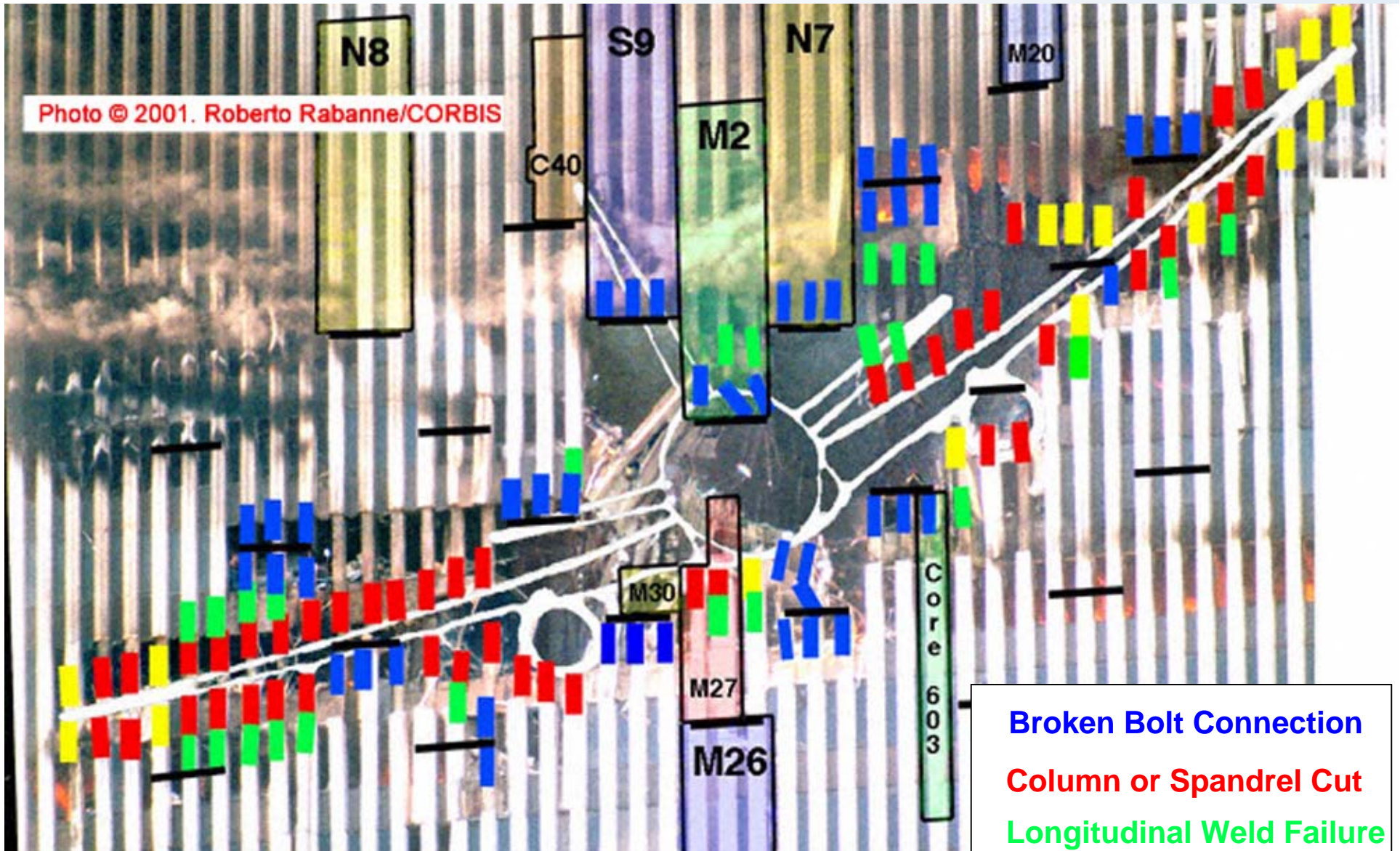

Enhancements added by NIST.

- Broken Bolt Connection
- Column or Spandrel Cut
- Longitudinal Weld Failure
- Obscured
- Panel Junction

Validation of Aircraft Impact Model Prediction With Observations for WTC 1

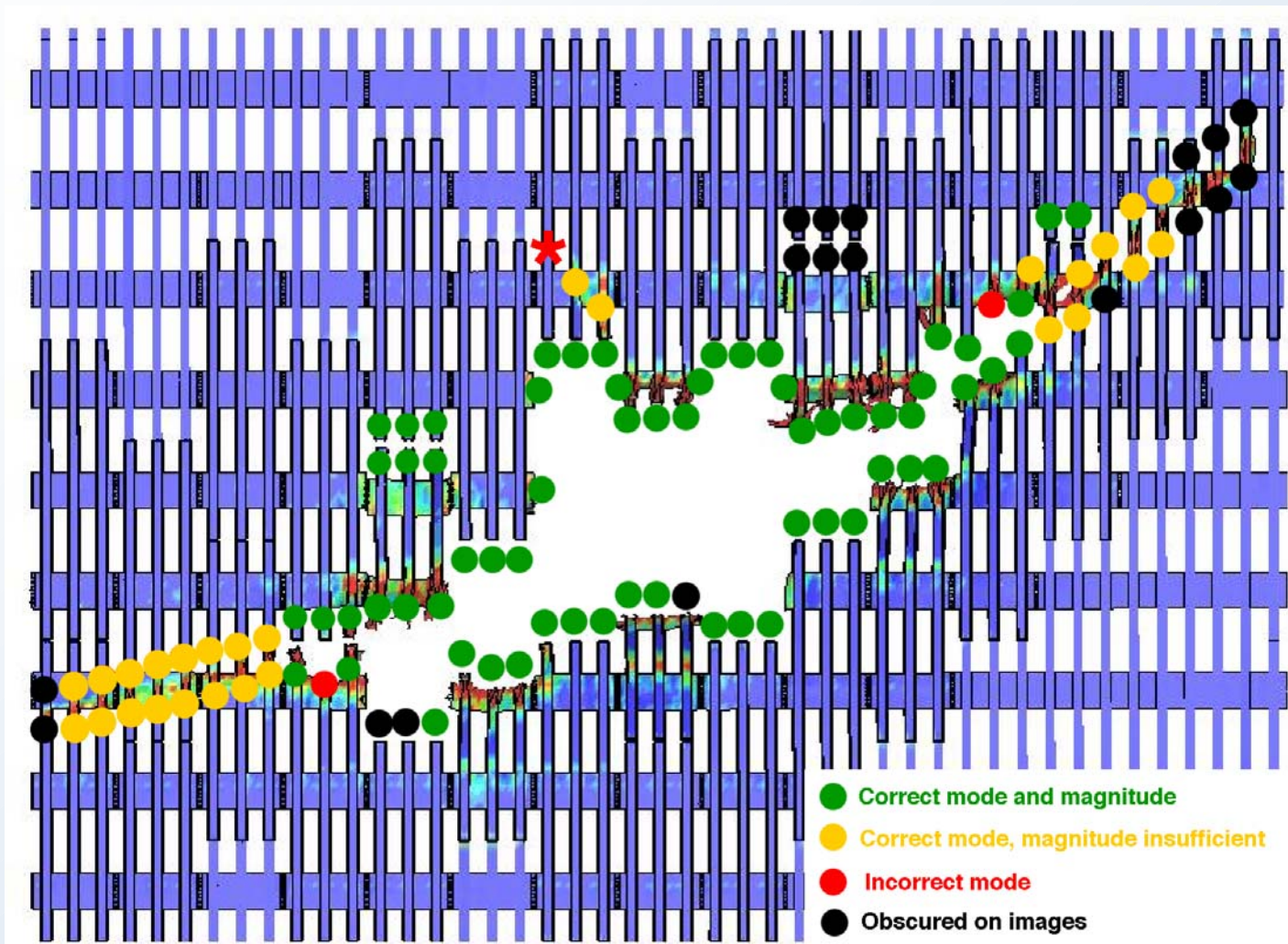

Validation of Aircraft Impact Model Prediction With Observations for WTC 2

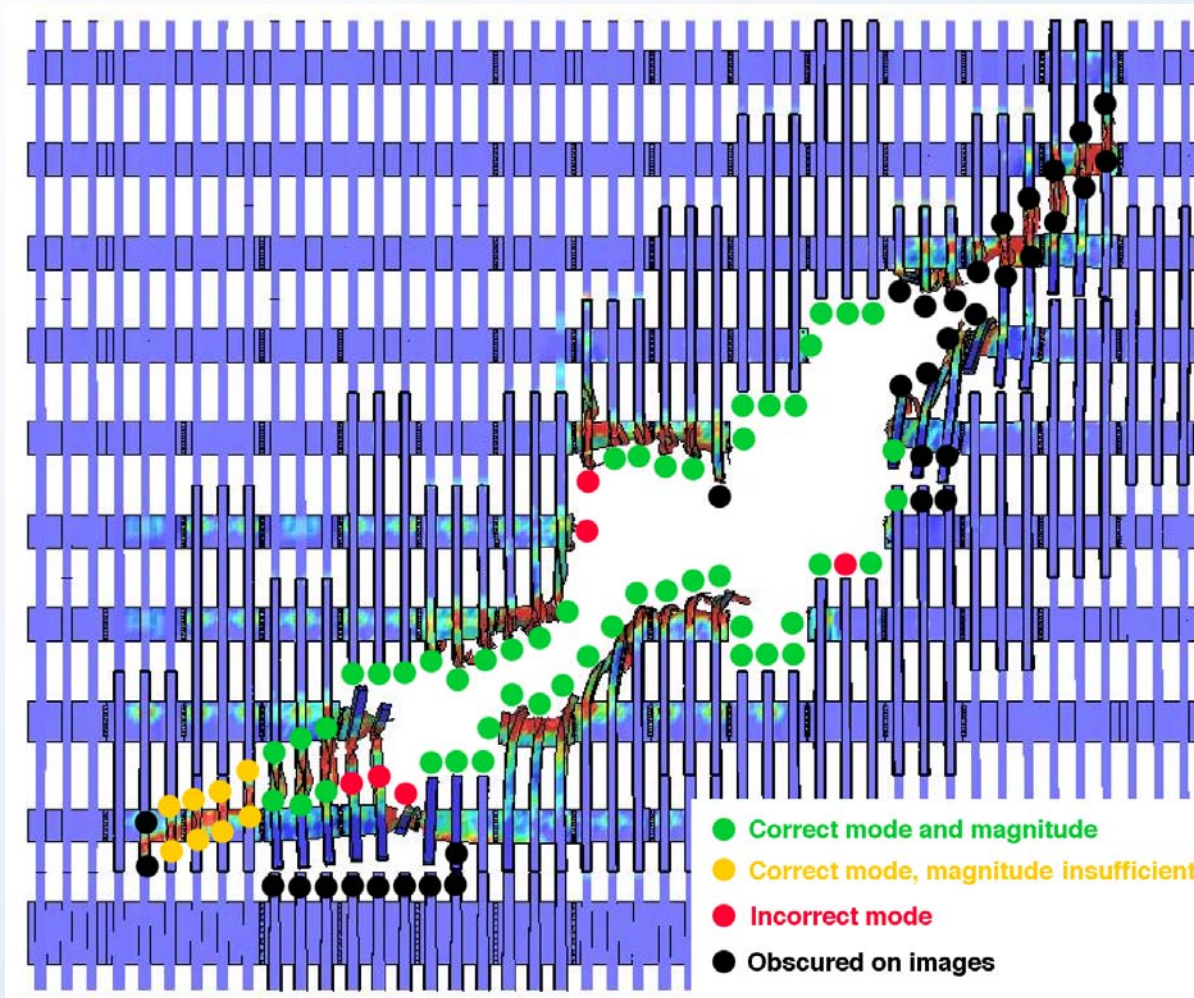

Initial Fire and Smoke Simulations: Fall 2001

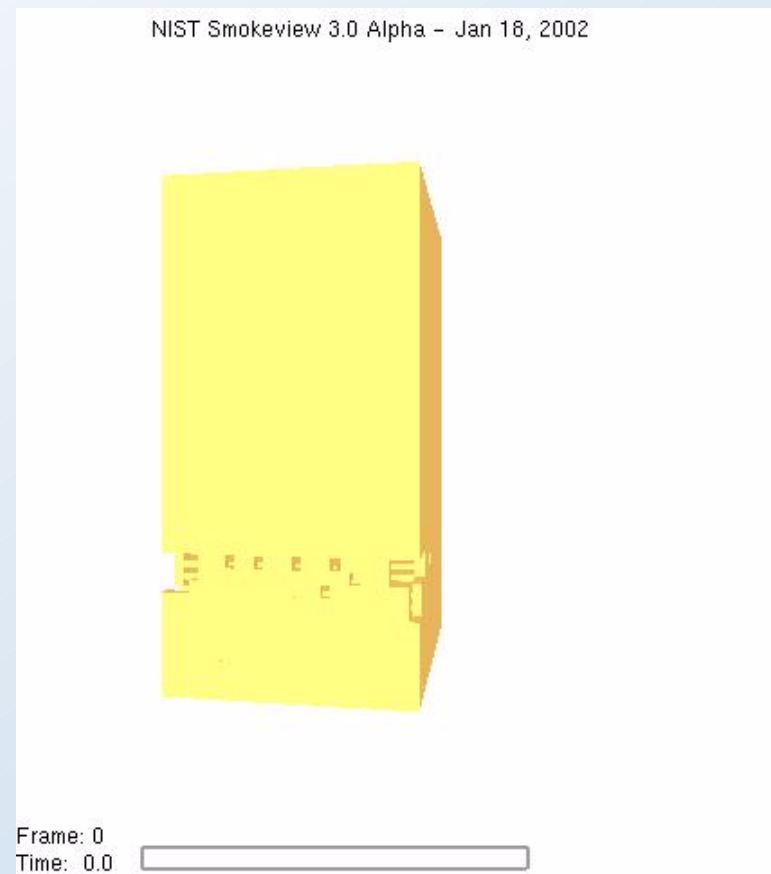
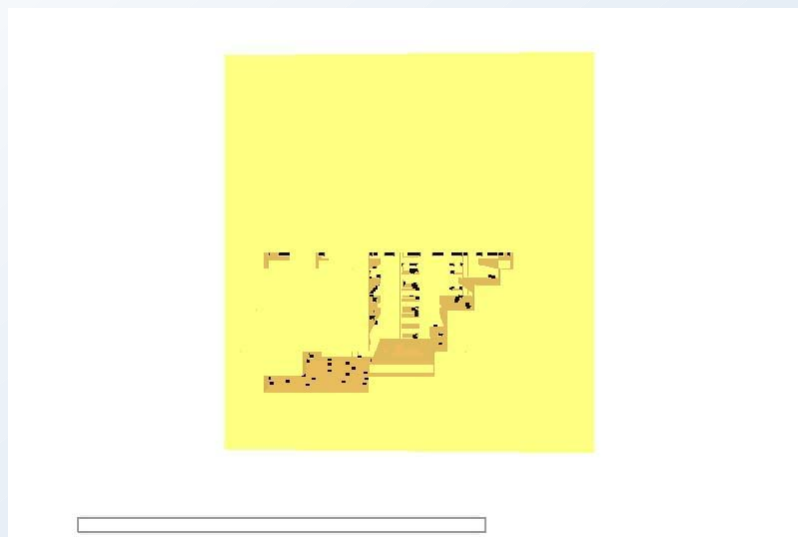
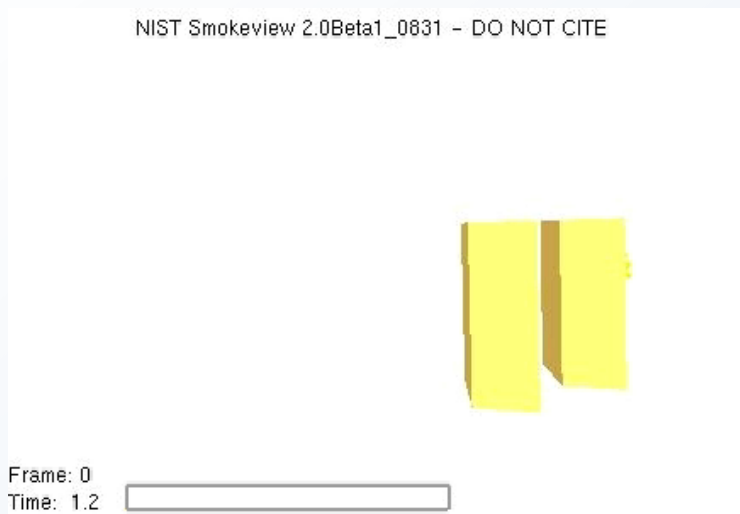

WTC Fire Model Validation Experiments



Prediction of steel temperatures through fireproofing



Assess the effect of impact on damage to ceiling tile systems



Single workstation burn tests for input to fire dynamics simulator



Multiple workstation burn tests for validation of fire model predictions



No Picture

WTC fire test1

NIST Smokeview 4.0 Alpha - Apr 17 2003

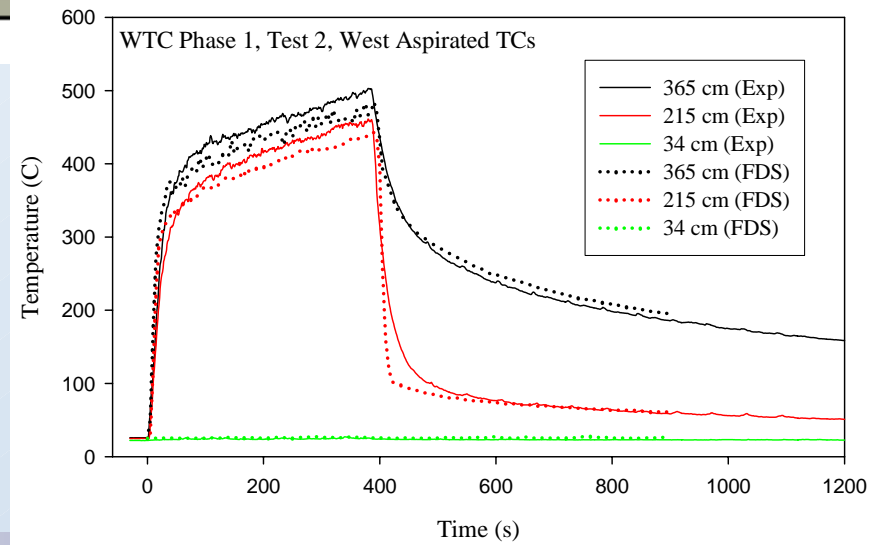
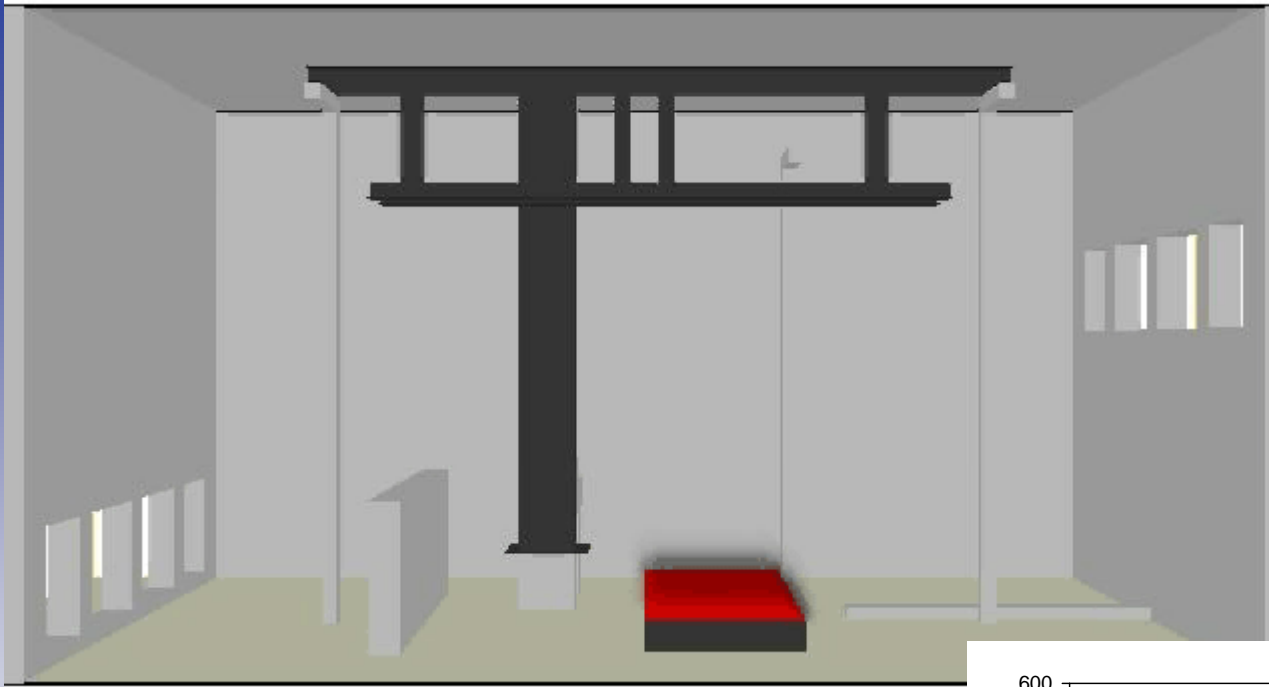

Multiple Workstation Burn

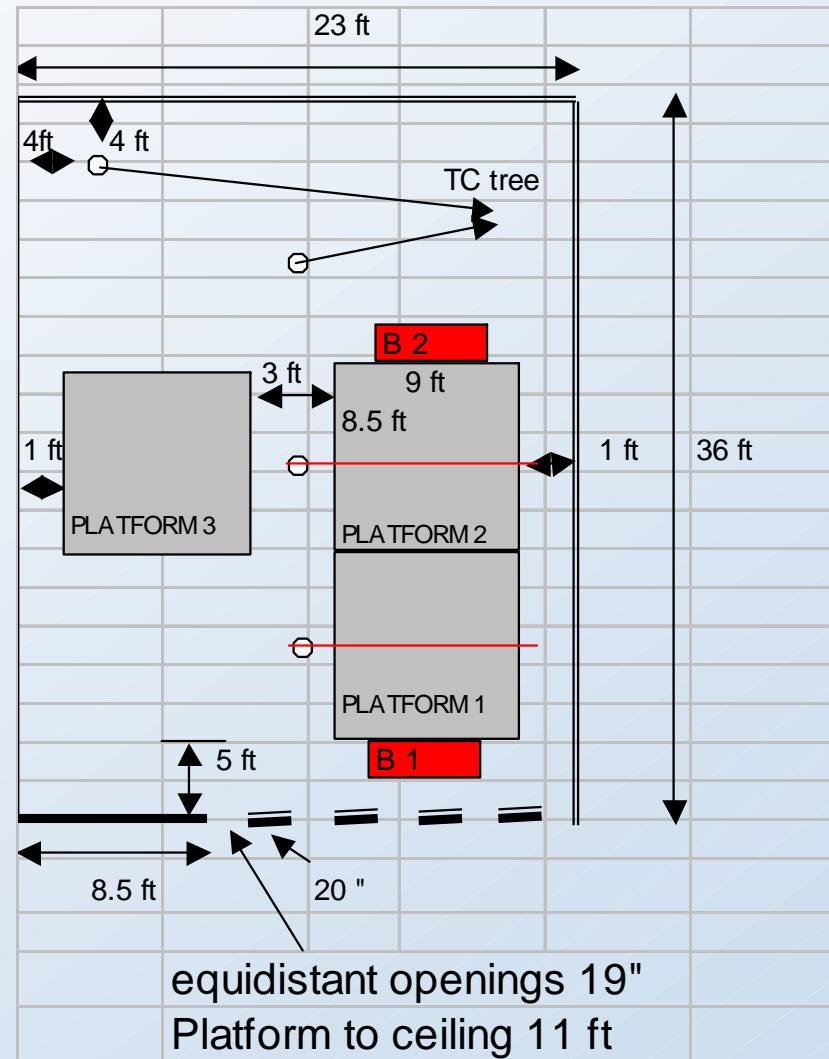

Multiple Workstation Burn and Simulation

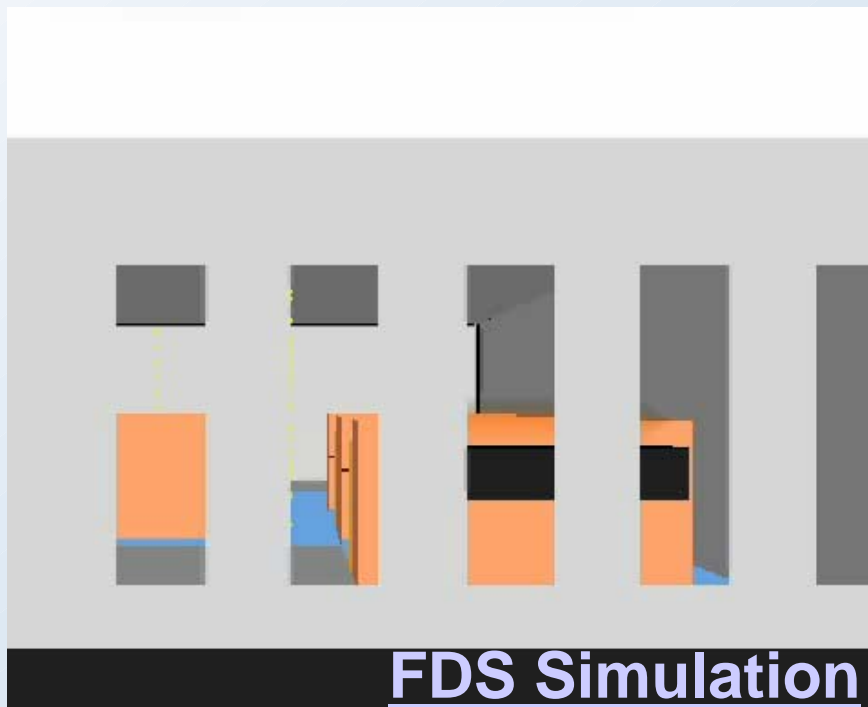

Multiple Workstation Burn Results

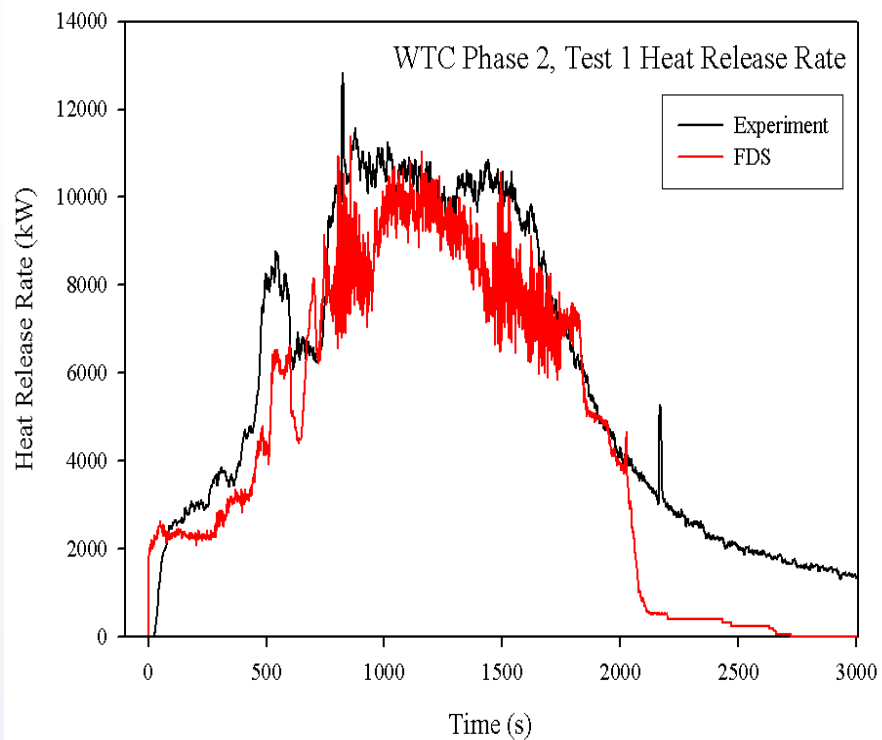

Excellent agreement

Noise is from turbulence, both in the model and the experiment

Early HRR falloff in prediction due to small underestimate of combustible mass

Provisional finding: FDS can be used with confidence to recreate a given WTC fire event

Reconstruction of the WTC Fires

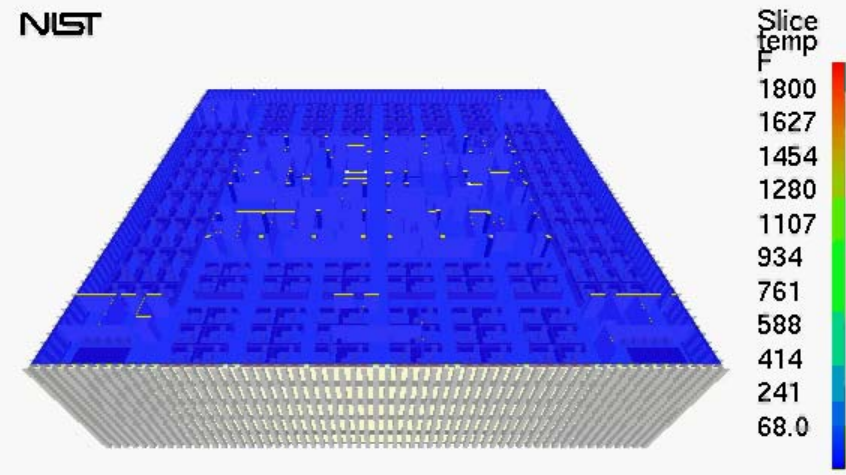
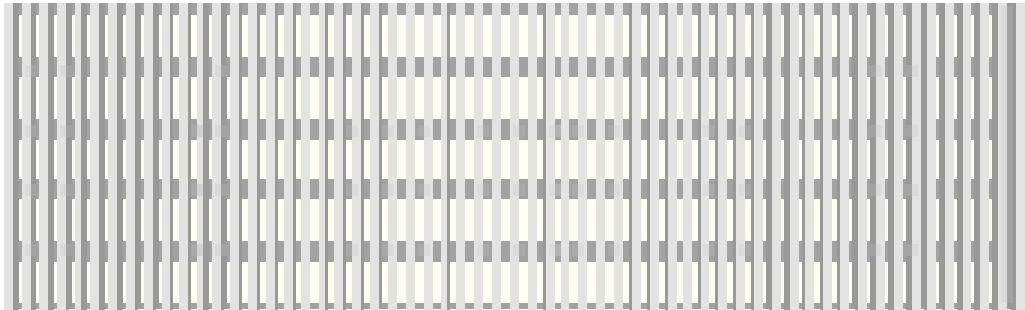

0:00:00.0

Upper Layer Temperatures (WTC 1, Floor 97)

Severe Case

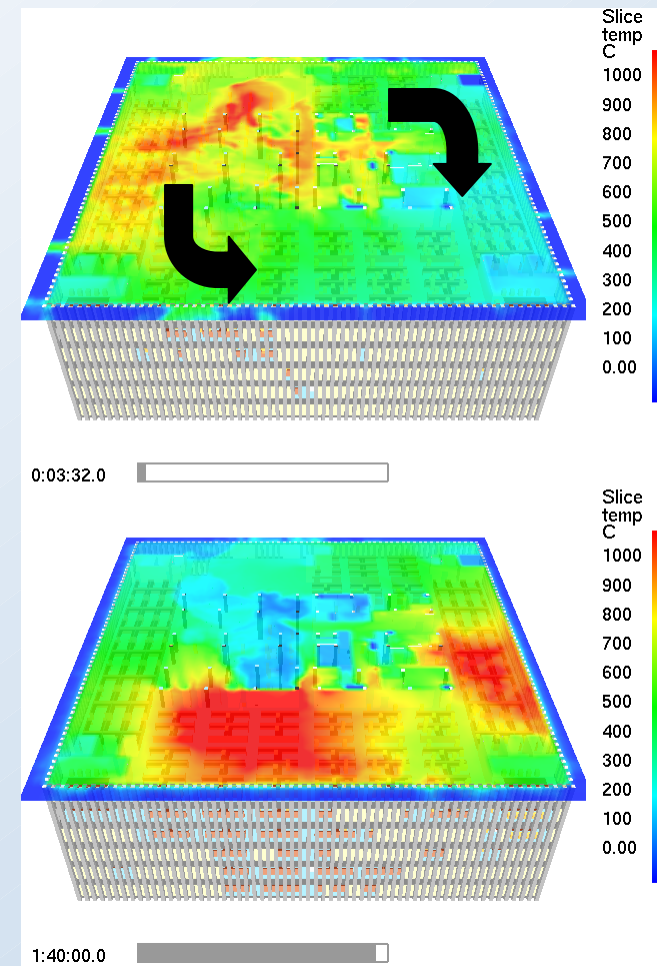
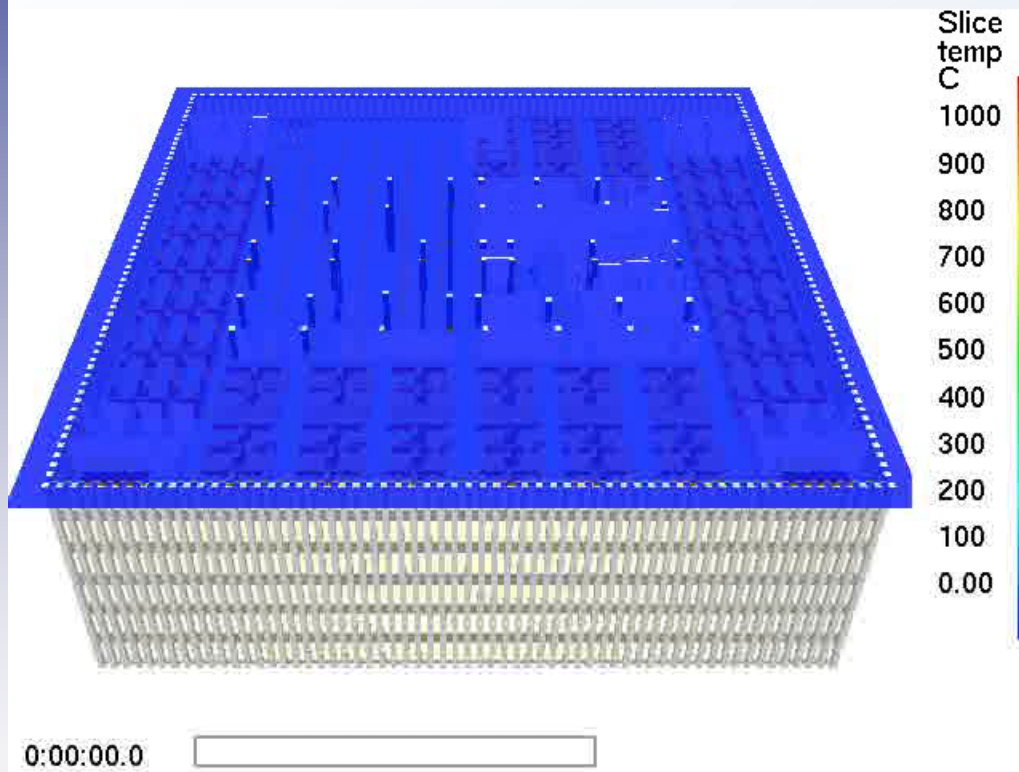

Collection and Analysis of Photographic and Video Images

- Visual database contains:
 - Well in excess of 7,000 photographs taken by more than 185 photographers
 - 150 hours of videotape from major media outlets and more than 20 individuals
- From the analysis of the visual images to date, NIST has identified significant events for WTC 1 and 2 related to aircraft impact, fire development, and building damage
- **NIST has developed detailed mappings for the fire, smoke, and the condition of windows at several specific times for each WTC tower; work is nearing completion for WTC 7**



Structural Analysis: Aircraft Damage, Thermal Response, Local Failures, Collapse Initiation

- Structural response analysis posed unprecedented challenges:
 - Captured complex physical mechanisms and structural states determined from prior analyses.
 - Captured additional physical complexities and structural states resulting from progression of local failures at component, connection, and sub-system levels that ultimately initiated global building collapse.
 - Overcame computational demands associated with integration of physical complexities, analysis of highly nonlinear temperature-dependent and unstable mechanisms, and model size limitations.
- Adopted rigorous approach with cascading complexity to adequately capture physics of phenomena essential to determining the probable collapse sequence with advanced strategies for managing computational demand.
- **Conducted extensive and methodical sensitivity analyses at component, connection, sub-system, and system levels to identify and model the most influential physical mechanisms and associated failure criteria.**

Structural Analysis Progression

Component Analyses

- Knuckle
- Truss seat connections
- Single truss and concrete slab
- Full floor
- Column splice connection
- Single story column
- Nine story column
- Nine story-nine column exterior wall panel

Detailed nonlinear analyses to determine component behaviors and failure mechanisms



Subsystem Analyses

- WTC 1
 - Isolated Core
 - South Exterior Face
 - Floors 93 to 99
- WTC 2
 - Isolated Core
 - East Exterior Face
 - Floors 79 to 83

Nonlinear analyses with component simplifications and failure mechanism simplifications to determine major subsystem behavior and sequential failure mechanisms.



Global Analyses

- WTC 1
- WTC 2

Nonlinear analyses to determine global behavior and sequential failure mechanisms.

Structural Analysis: Connection Models

- **Knuckle shear connector**

- ❑ Truss web members protruded above the top chord in the form of a “knuckle” which was embedded in the concrete slab to develop composite action
- ❑ Failure modes between the concrete slab and steel knuckle for longitudinal and transverse shear transfer capacity were evaluated:
 - Knuckle to concrete interface was modeled as unbonded and fully bonded
 - Nonlinear concrete behavior included concrete crushing
- ❑ Analysis results were validated against test results
- ❑ Knuckle capacity based on steel and concrete properties at elevated temperatures

- **Perimeter column splice**

- ❑ Perimeter columns were connected with a four bolt splice in the upper stories
 - Bolt pretension was found to play a minor role in bolt stiffness and was not modeled
- ❑ Failure modes of the bolts were evaluated:
 - Tensile failure due to rotation or tension at column splices
 - Shear failure was not modeled as it was not a likely failure mode in the exterior wall

Shear Knuckle Analysis

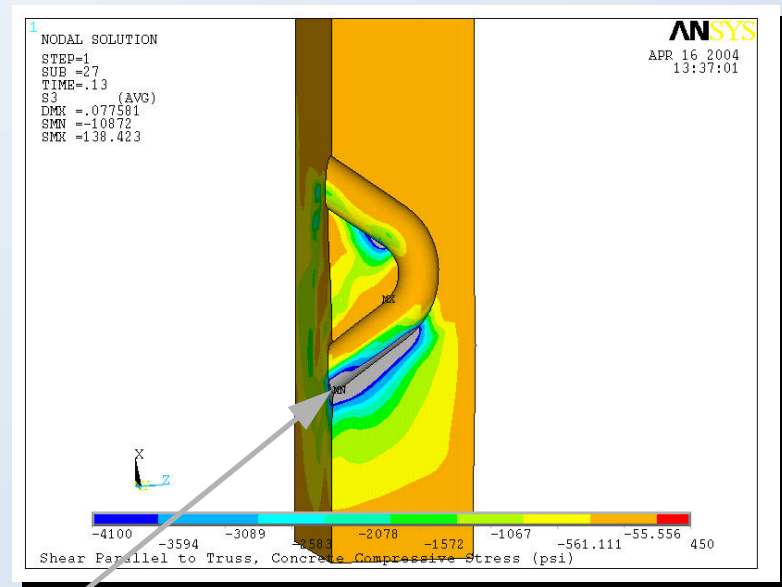
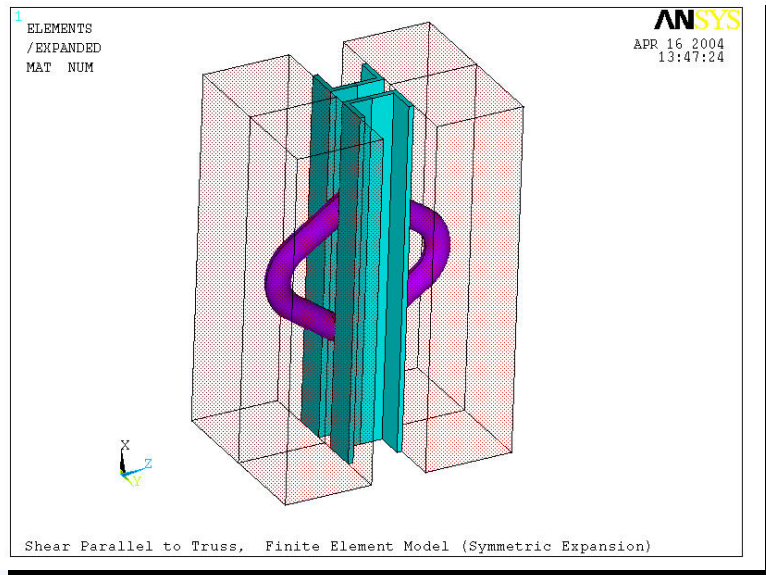

Column Splice Analysis

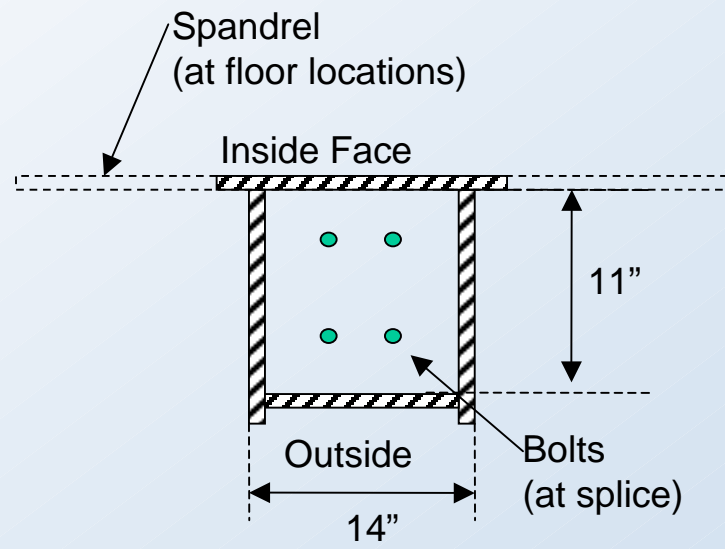
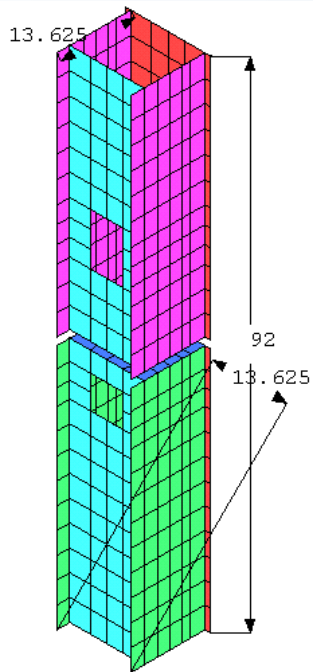

Column Cross Section
Not to Scale

Structural Analysis: Connection Models (2)

- **Truss-to-column connections (interior and exterior)**
 - ❑ Connection capacities were designed for at least 2 percent of column design load.
 - ❑ Exterior truss connections had a welded gusset plate at the top chord and two bolts at the truss seat, with the gusset plate and truss seat welded to the spandrel.
 - ❑ Interior truss connections had two bolts at the truss seat, with the truss seat welded to a floor support beam at the edge of the core.
 - ❑ Horizontal and vertical temperature-dependent capacities and failure sequences were computed for 12 truss seat configurations.
 - ❑ Failure modes included:
 - Failure of groove weld between the gusset plate and the spandrel
 - Failure of fillet weld between the gusset plate and truss top chord
 - Failure of fillet weld at the truss seat-to-spandrel connection
 - Tensile failure of the gusset plate
 - Bolt shear, bearing and tear-out failures
 - Truss walking off the seat support

Truss Seat Connections

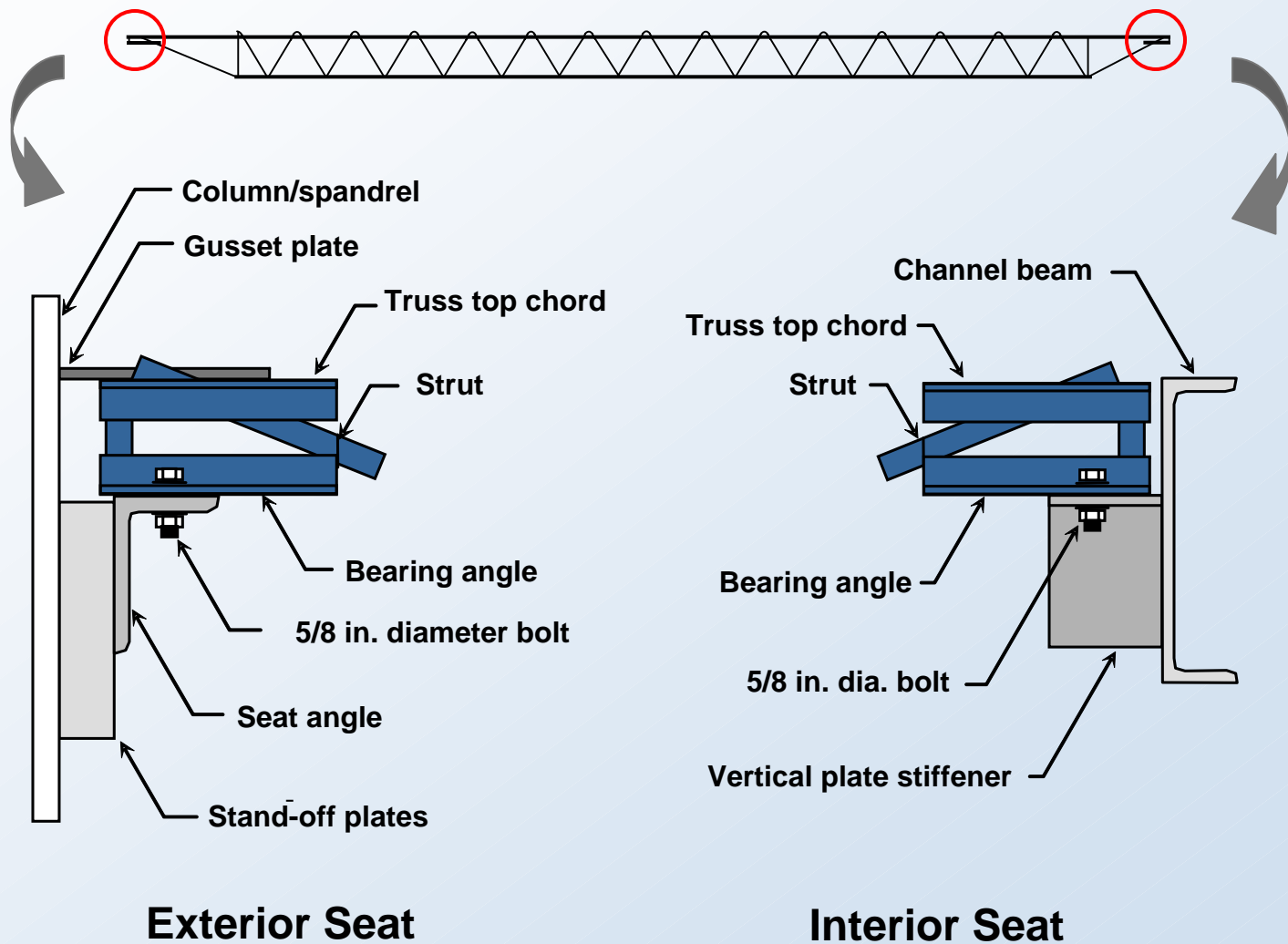

Horizontal Tensile Force Resistance of Exterior Seats

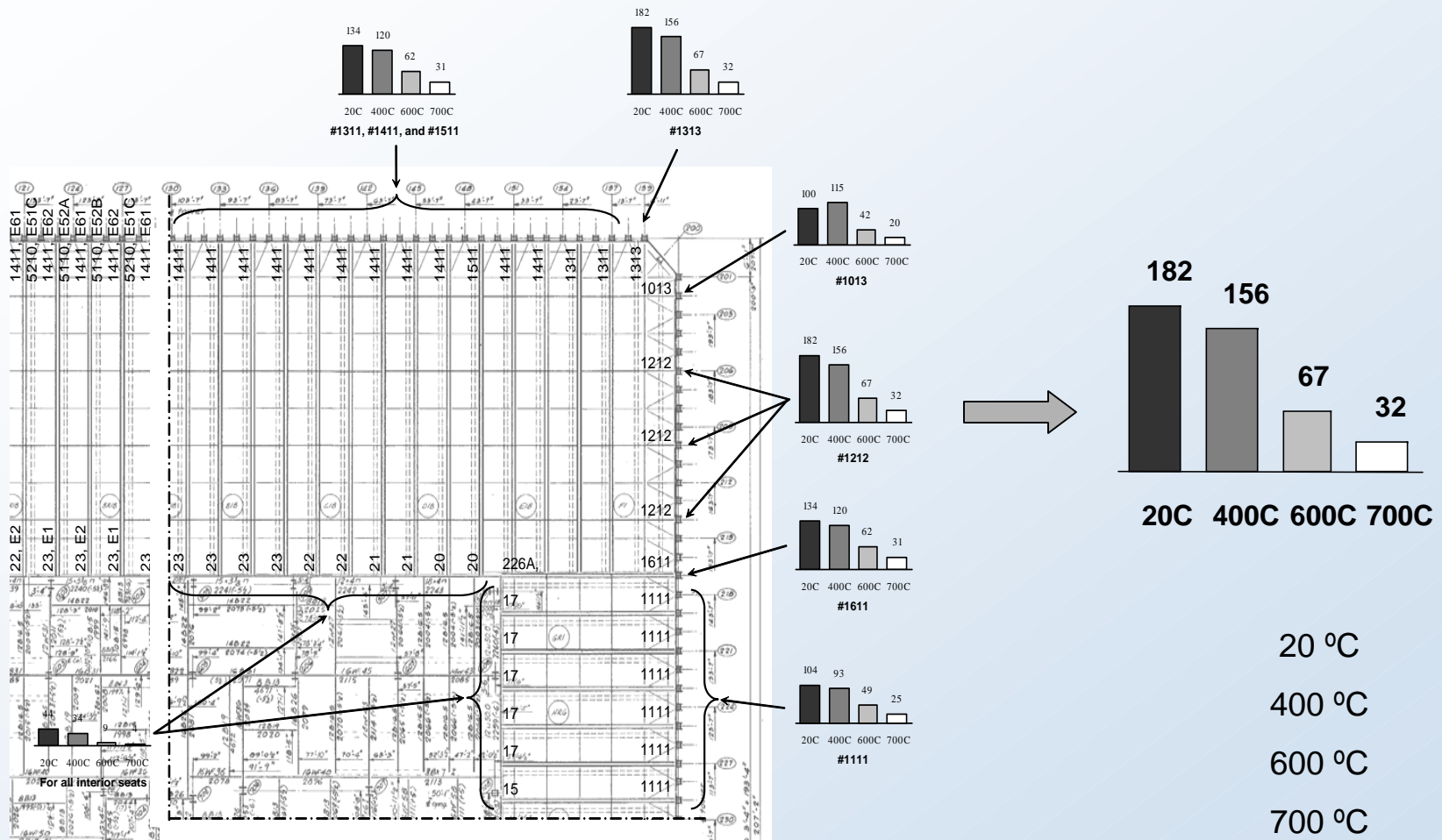

Original drawing used with permission of PANYNJ

Vertical Force Resistance of Exterior Seats

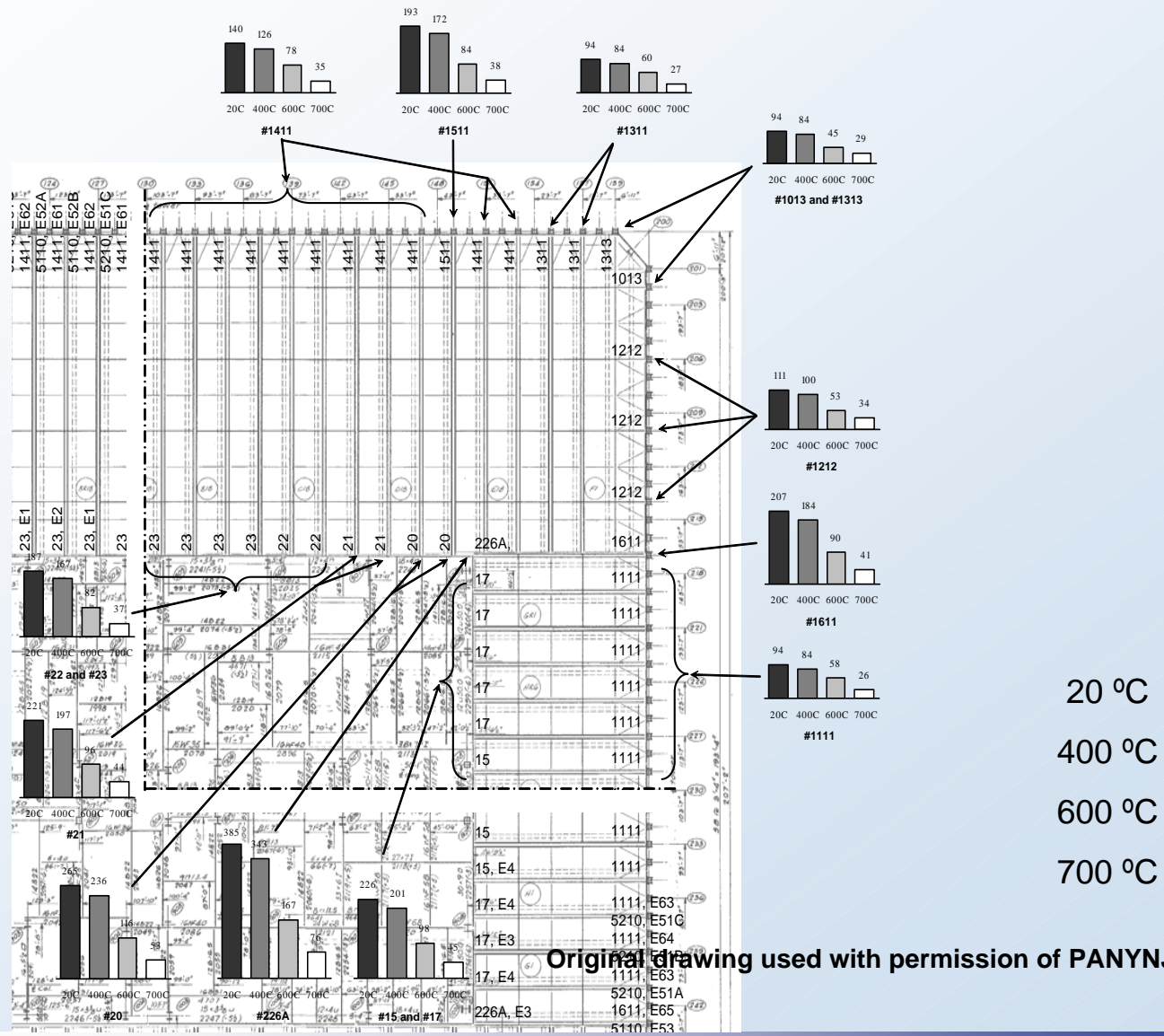

20 °C
 400 °C
 600 °C
 700 °C

Structural Analysis: Floor Sub-System Models

- **Single truss with tributary slab section**

- Detailed model to determine the response of a truss section to uniformly increasing temperatures; included:

- Large deflections and inelastic buckling
 - Temperature-dependent steel material properties – thermal expansion, plasticity, creep, modulus, and yield strength
 - Temperature-dependent concrete material properties – thermal expansion, nonlinear tensile and compressive strengths, and modulus
 - Failure of welds, knuckles, truss seat connections, and studs on the steel straps and on the spandrel

- **Composite floor sub-system**

- Detailed model to determine the response of a full floor to representative thermal loads in each of the WTC towers; included:

- Simplified truss model, validated against the single truss model results
 - Primary and bridging trusses, deck support angles, spandrels, moment-connected core floor beams, and concrete floor slab
 - Restraint was provided by exterior and core columns which extended one floor above and below modeled floor
 - Large deflections and inelastic buckling
 - Temperature-dependent steel material properties – creep was not included
 - Temperature-dependent concrete material properties – bilinear tensile and compressive strengths
 - Failure of connection between primary and bridging trusses; connection between long-span and transfer trusses

Truss Section Model

Exterior End of Truss

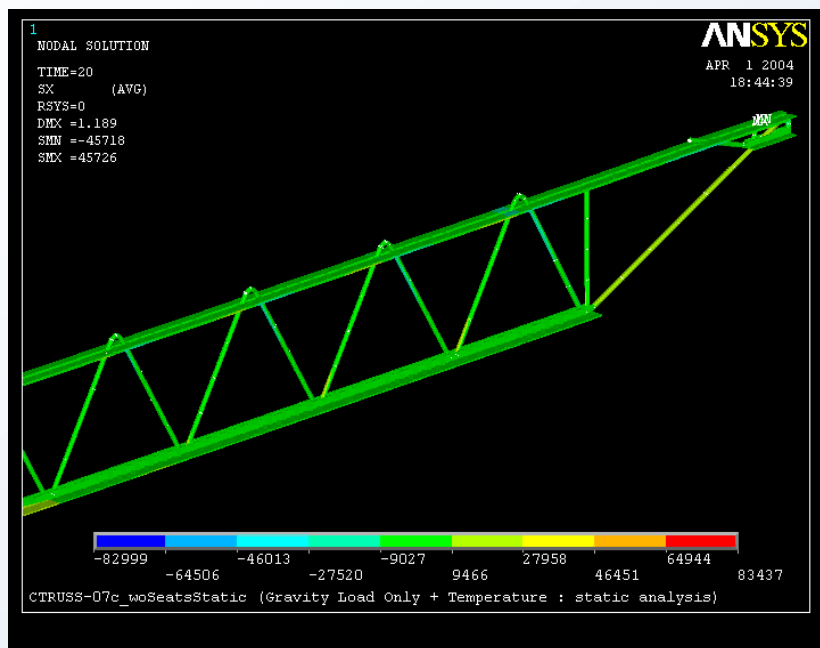

Core End of Truss

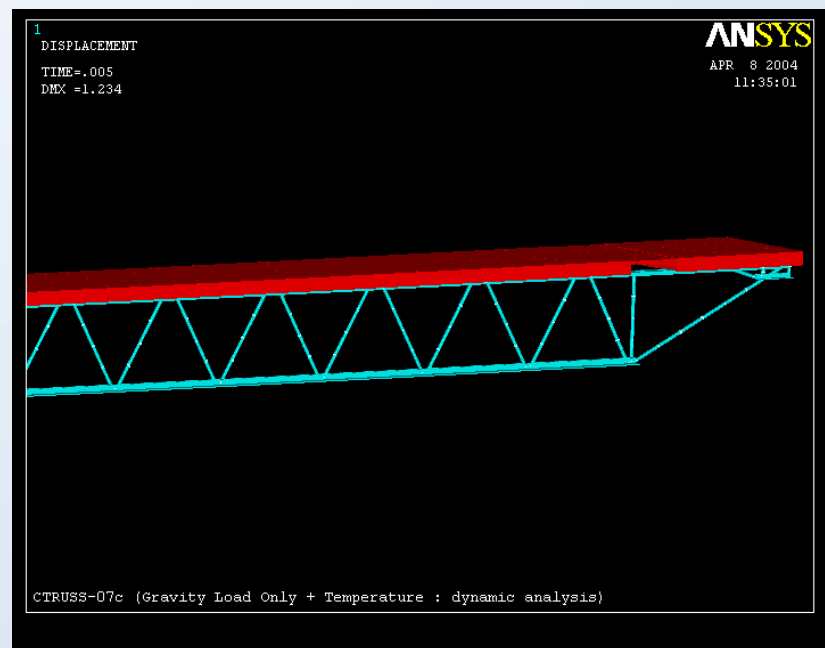

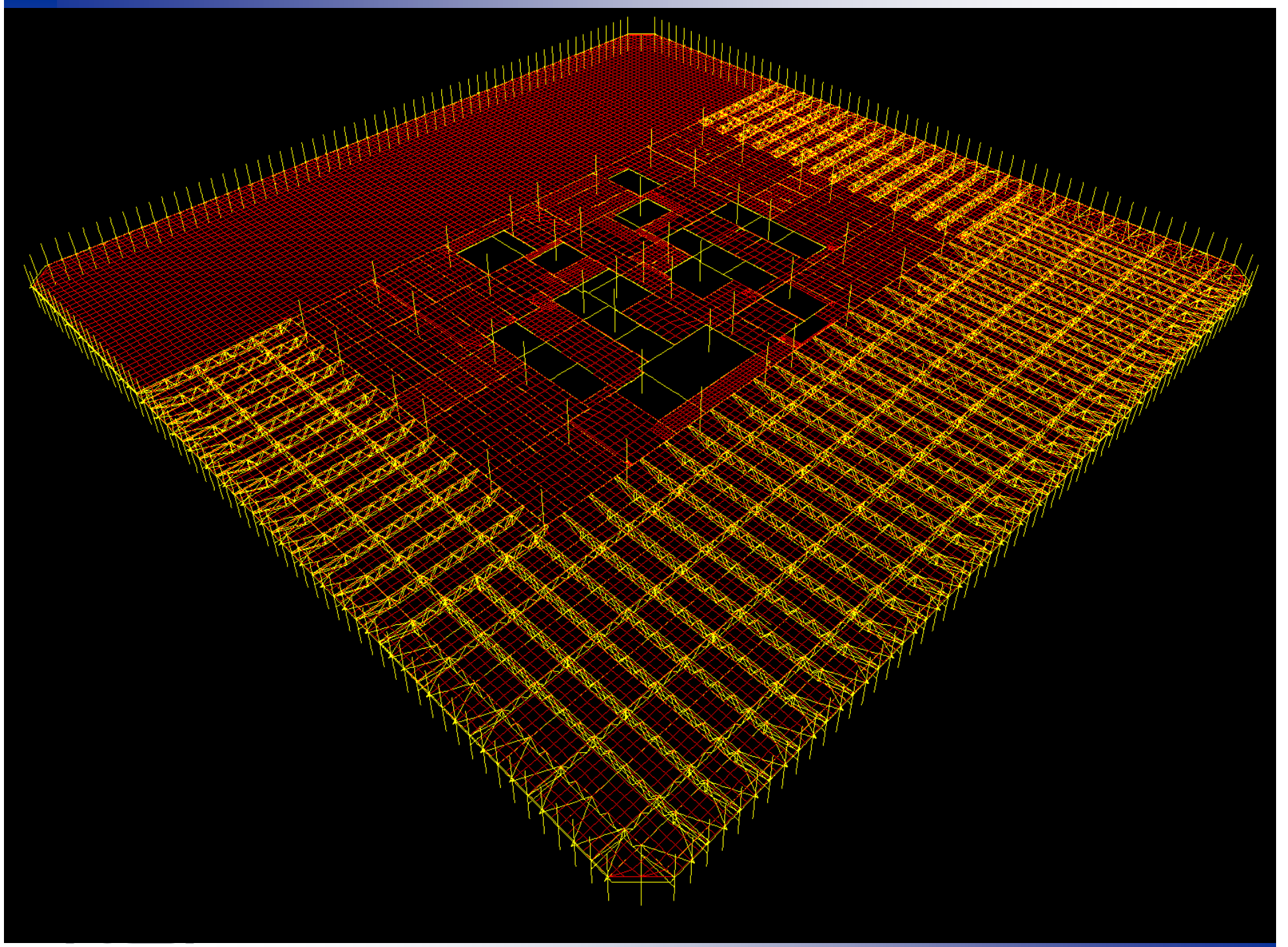

Structural Analysis: Floor Sub-System Models (2)

- **Impact of floor dropping onto the floor below**
 - ❑ Analysis examined whether the impact of falling floor sections would severely damage floors below.
 - ❑ Conditions modeled included
 - full truss section dropping to the floor below
 - one end of a truss section dropping to the floor below
 - ❑ Dynamic response was calculated using conservation of energy and momentum principles including loss of kinetic energy during truss deformation
 - ❑ Estimated floor response at room and elevated temperatures (truss seat capacity as a function of temperature was included):
 - All truss seats have sufficient capacity to support the weight of two floors for temperatures up to 700 °C
 - No truss seat failures expected for gravity plus impact loads for temperatures up to 400 °C
 - At 400 °C, the interior side of the truss may walk off the interior seat after impact
 - At 700 °C, the failure of impacted interior or exterior seats is expected
 - If the impacted truss deforms to an extent that it loses composite action with large sagging deformation, it will not restrain the exterior column against transverse movement or instability

Schematic of Full Truss or Partial Truss Drop and Diagonal Crushing at Impact

Schematic of full truss drop

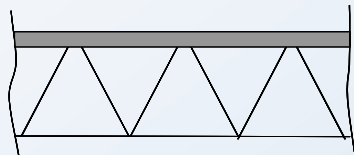
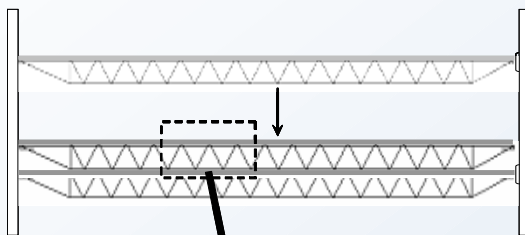

Before impact

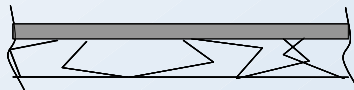

After impact

Schematic of partial truss drop

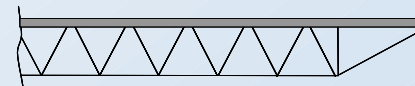
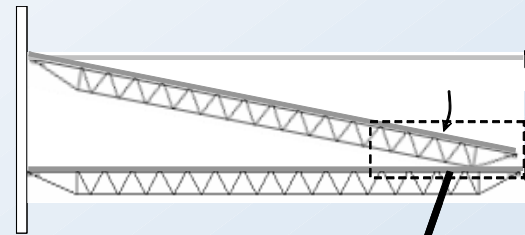

Before impact

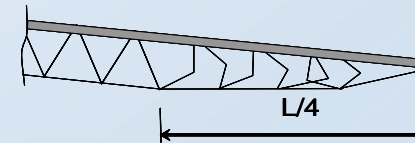

After impact

Structural Analysis: Column Sub-System Models

- Single-story exterior column

- Model was evaluated for:

- Temperature-dependent steel material properties – thermal expansion, plasticity, creep, modulus and yield strength
 - Local buckling and plastic hinge formation under axial load
 - Post buckling strength

- Single 9-story exterior column

- Model integrated behavior of single-story column and added column and spandrel splices; included:

- Temperature dependent steel material properties - creep not included
 - Column splices (bolt shear and tensile failures and friction between butt plates)
 - Thermal gradients (linear through column cross section)
 - Column stability (effect of floor disconnection or inward pull)

- Pushdown analysis was used to determine reserve capacity

- Exterior wall sub-system (3x3 panel section; 9 columns wide, 9 stories high)

- Model integrated behavior of 9-story column to evaluate column panel behavior; included:

- Spandrel temperature gradients over their depth
 - Spandrel splice failure

- Analysis results include:

- Spandrel splices may partially separate or spandrels may buckle at elevated temperatures but these behaviors do not affect column stability
 - Instability of exterior wall columns may occur when at least three adjacent floors are disconnected or do not restrain the columns

Exterior Wall Model

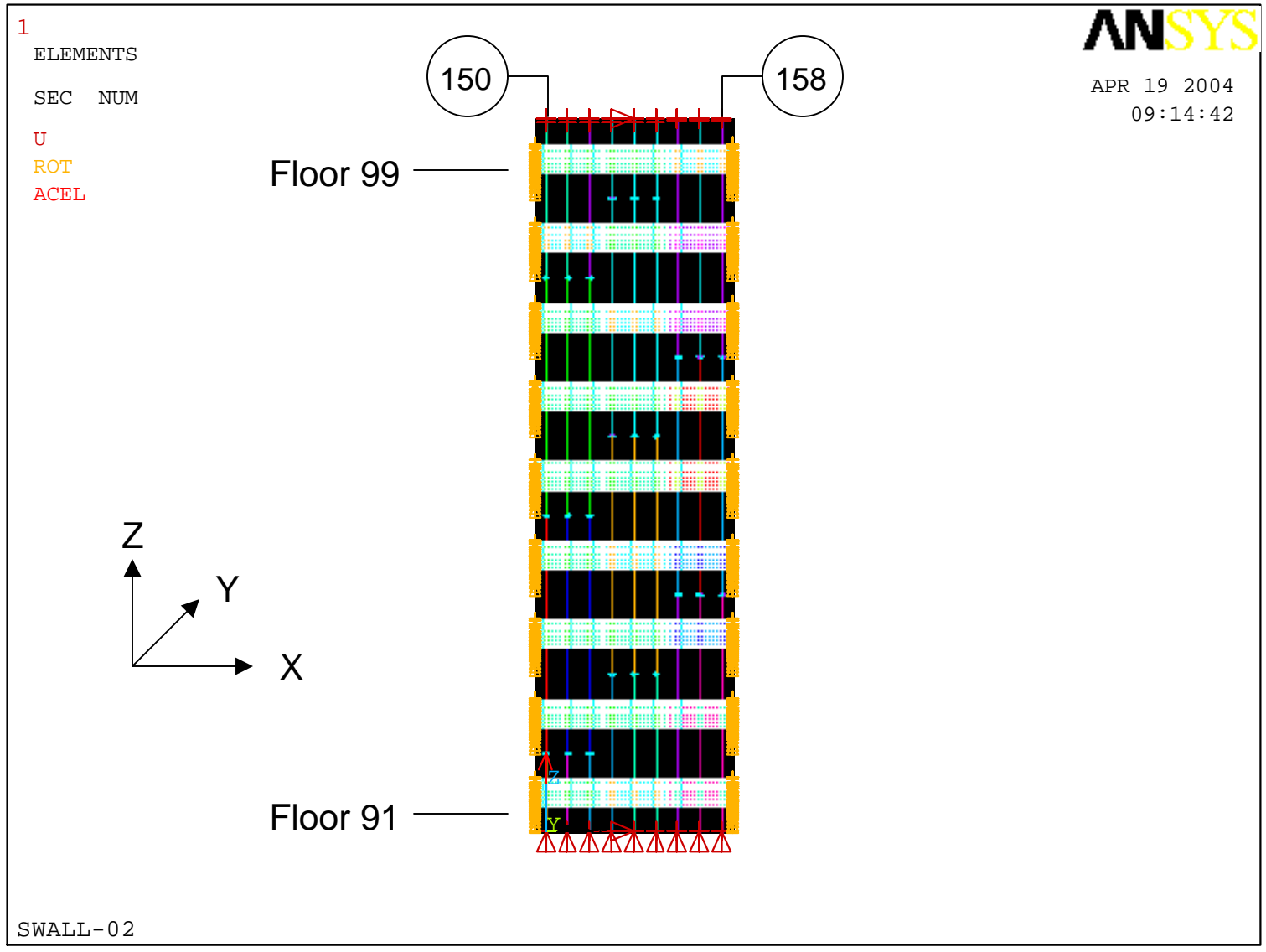

Structural Analysis: Exterior Wall Sub-System Model

- ❑ Models included: South face of WTC 1 (floors 89 to 106) and East face of WTC 2 (floors 73 to 90) based on photographic evidence of column bowing

- ❑ Model features included:
 - Equivalent springs at the base of the wall model to represent the floors below
 - Removal of aircraft-damaged components
 - Post-impact column axial forces from global model
 - Gravity (dead/service) loads at each floor level from global model
 - Temperature histories applied at 10 min intervals with linear ramping between time intervals
 - Failed truss seat connections removed at start of time interval during which failure occurred

- ❑ Floor disconnections were applied at wall-to-floor connections; they were based upon the floor subsystem analysis and observations.

- ❑ Inward pull forces were applied at wall-to-floor connections; they were based upon the floor subsystem analysis and adjusted (in magnitude and extent) such that the wall subsystem results matched the observed inward bowing.

- ❑ At the end of the thermal loading (6000 s for WTC 1, 3600 s for WTC 2), the gravity loads were updated from the global model
 - Axial column forces were corrected for load redistribution from the core and other exterior faces
 - Corrective forces were applied at columns on the floors immediately above the fire region (WTC 1 floor 99 and WTC 2 floor 84)

- ❑ A pushdown analysis at the end of the thermal loading was conducted to determine reserve capacity

Structural Analysis: Core Sub-System Model

- ❑ Models extended from below the impact and fire zones to the highest floor below the hat truss structure
 - WTC 1: floors 89 to 106
 - WTC 2: floors 73 to 106

- ❑ Model features included:
 - Core columns, moment-connected floor beams, and concrete slab
 - Equivalent springs at the base of the core columns represented the structure below the model
 - Removal of aircraft damaged components
 - Large deflections and inelastic buckling
 - Temperature-dependent steel material properties – thermal expansion, plasticity, creep, modulus and yield strength
 - Temperature-dependent concrete material properties – thermal expansion, bilinear tensile and compressive strengths and modulus
 - Post-impact column axial forces from global model were applied at floor 106
 - Gravity (dead/service live) loads from global model applied at each floor level
 - Temperature histories applied at 10 min intervals with linear ramping between time intervals

- ❑ Analyses determined core stability and deformations under impact conditions and thermal loads
 - WTC 1 core was stable under base case impact damage with severe thermal loads
 - WTC 1 core was not stable under base case impact damage and base case thermal loads and tilted to the northeast; the core model was restrained in horizontal directions at floors above the impact zone half way through the thermal loads
 - WTC 2 core was not stable for either base case or severe impact damage conditions and tilted to the southeast in both cases; the core model was restrained in horizontal directions at all floors to represent the restraint provided by the perimeter wall
 - WTC 1 and WTC 2 cores did not converge under severe impact damage; no thermal loads were applied.

- ❑ A pushdown analysis at the end of the thermal loading determined reserve capacity

Structural Analysis: Global System Model

- Global analysis *without* creep and plastic buckling of columns
 - ❑ These models provided analysis results more quickly than the global models with creep and plastic buckling and provided initial insight into sub-system interactions under impact damage and thermal loads.
 - ❑ Models extended from below the impact and fire zones to the roof level at floor 110 for WTC 1 (floors 89 to 110) and WTC 2 (floors 73 to 110).
 - ❑ Model features included:
 - Equivalent springs at the base of the core columns to represent the structure below the model
 - Removal of aircraft damaged components
 - Large deflection and temperature-dependent column properties – thermal expansion, plasticity, modulus and yield strength
 - Equivalent linear-elastic floor slabs that model composite floor systems in tenant areas
 - Equivalent linear-elastic core floor slabs and moment connected core beams
 - Hat truss members
 - WTC time temperature histories applied at 10 min intervals with linear ramping between time intervals
 - ❑ Staged analysis simulated the effects of construction sequence as follow:
 - Stage 1: apply dead loads up to and including floor 106
 - Stage 2: add members above floor 106 (including hat truss) and additional dead loads
 - Stage 3: add 25% service live loads
 - Stage 4: remove components severed by aircraft impact
 - Stage 5 onwards: thermal loads at 10 minute intervals with linear temperature ramp during interval

Structural Analysis: Global System Model (2)

- **Global analysis *with* creep and plastic buckling of columns**
 - ❑ These models provided complete analysis results and insight into sub-system interactions leading to the probable collapse sequence.
 - ❑ Models extended from below the impact and fire zones (floor 91 for WTC 1 and floor 77 for WTC 2) to the roof level
 - ❑ Additional model features included:
 - Plastic buckling and temperature dependent plasticity and creep
 - Use of super-elements in WTC 2 for the section of the building above Floor 86 that remained essentially elastic in previous analyses; any hat truss nonlinear behavior was not captured
 - 3D thin-walled beam (BEAM24) was substituted for 3D linear finite strain beam (BEAM188) to improve column buckling behavior under thermal loads
 - Effects of construction sequence not included
 - 7 % to 15% increase in axial forces for exterior columns
 - 10% decrease in axial forces for core columns
 - Hat truss outriggers yield strength was increased to compensate for increased loads with construction sequencing
 - Gravity loads were applied following removal of aircraft damaged components and prior to thermal loading

Structural Analysis: Global System Model (3)

□ Additional model features included (contd.):

- Equivalent linear-elastic floor slabs that model composite floor systems in tenant areas
- Removal of thermal expansion from the spandrels and equivalent slabs in the tenant area to avoid local buckling that affected convergence but had little influence on global collapse initiation.
- Floor thermal *forces* estimated from single truss with slab section model and adjusted to match observations using wall subsystem model; imposed as forces at columns.
- Floor thermally-induced *disconnections* estimated from full floor model; disconnections due to aircraft impact damage (adjusted to match observed damage) and thermal effects imposed at failed connections.

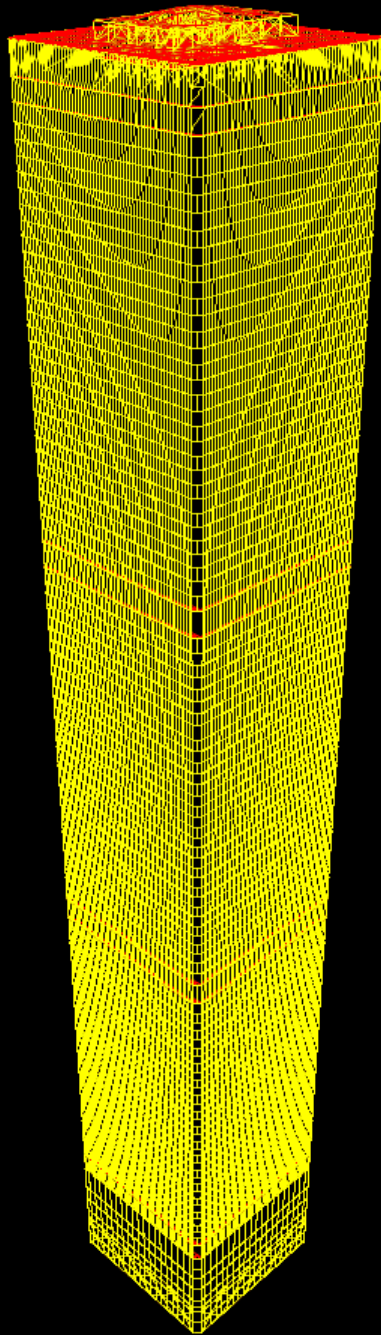

Web site <http://wtc.nist.gov>

Email to wtc@nist.gov

Facsimile to (301) 975-6122

Regular mail:

**WTC Technical Information Repository, Stop 8610,
100 Bureau Drive, Gaithersburg, MD 20899-8610.**

Background Slides

WTC 1 Severe Case

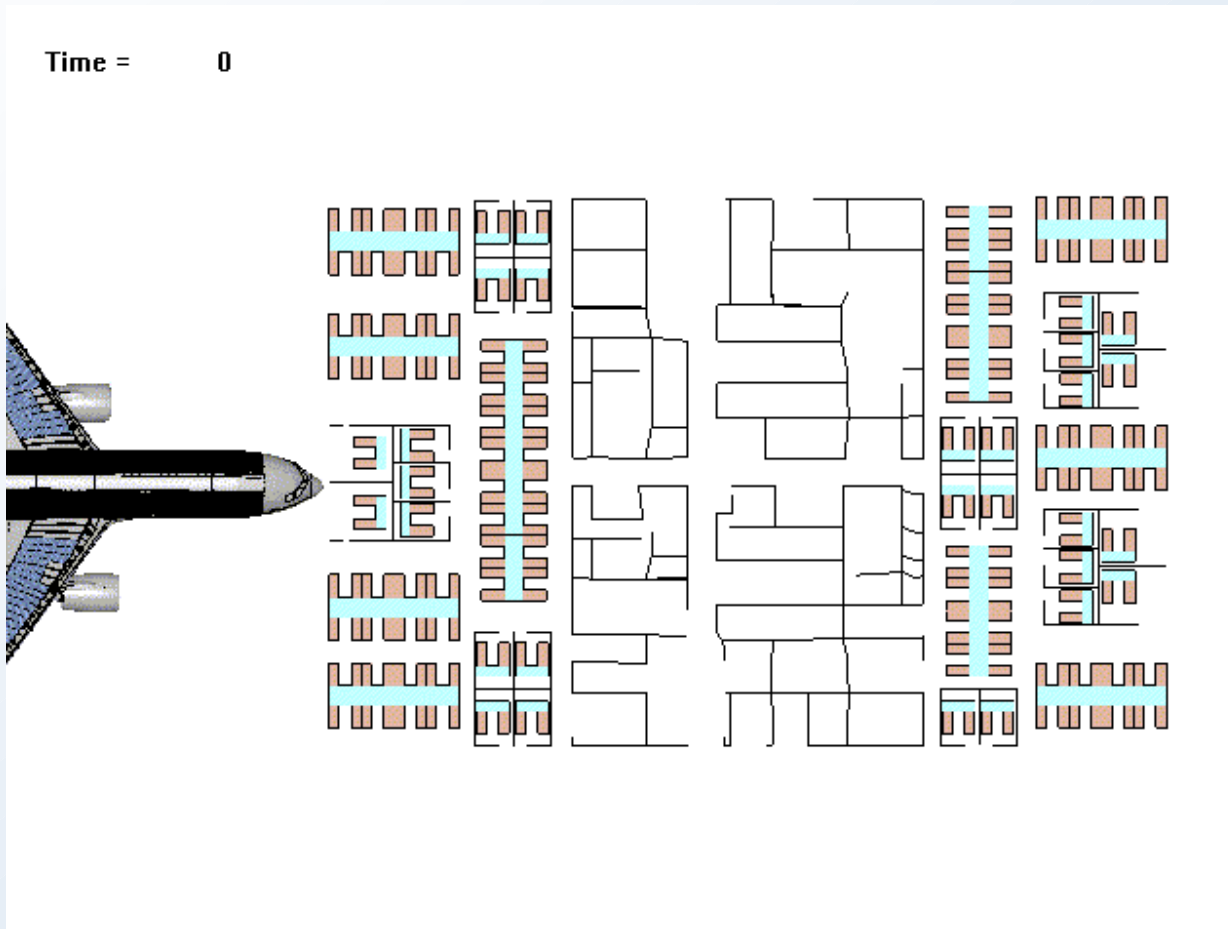

WTC 2 Severe Case

