



LEARN MORE AT  
[energystar.gov](http://energystar.gov)

ENERGY STAR® is a U.S. Environmental Protection Agency program helping businesses and individuals fight global warming through superior energy efficiency.

# ENERGY STAR® Building Upgrade Manual



United States  
Environmental Protection  
Agency

Office of Air and Radiation  
2008 Edition



# ENERGY STAR®

# Building Upgrade

# Manual

## Contents

### **1. Introduction**

---

- 1.1 Overview
- 1.2 Technical Advice
- 1.3 Getting Started Now
- Bibliography

### **2. Benchmarking**

---

- 2.1 Overview
- 2.2 Develop a Benchmarking Plan
- 2.3 Implement the Benchmarking Plan
- 2.4 Summary
- Bibliography

### **3. Investment Analysis**

---

- 3.1 Overview
- 3.2 Analytic Conventions
- 3.3 Cash-Flow Analysis Tools
- 3.4 Selecting an Analysis Tool
- 3.5 The Investment Analysis Process
- 3.6 Other Considerations
- 3.7 Summary
- Bibliography

### **4. Financing**

---

- 4.1 Overview
- 4.2 Purchasing Equipment and Services
- 4.3 Leasing
- 4.4 Performance Contracting

4.5 Unconventional Opportunities

4.6 Summary

Bibliography

## **5. Retrocommissioning**

---

5.1 Overview

5.2 Project Planning

5.3 Project Execution

5.4 Tune-up Opportunities

5.5 Summary

Bibliography

## **6. Lighting**

---

6.1 Overview

6.2 The Importance of Lighting

6.3 A Whole-System Approach

6.4 Lighting Design

6.5 Use Efficient Light Sources

6.6 Use Efficient Luminaires

6.7 Automatically Control Lighting

6.8 Build In an Operations and Maintenance Plan

6.9 Summary

Bibliography

## **7. Supplemental Loads**

---

7.1 Overview

7.2 Reducing Equipment Energy Use

7.3 Upgrading the Building Envelope

7.4 Summary

Bibliography

## **8. Air Distribution Systems**

---

8.1 Overview

8.2 Air-Handling System Types

8.3 Air-Handling Components

8.4 Best Opportunities

8.5 Summary

Bibliography

## **9. Heating and Cooling**

---

- 9.1 Overview
- 9.2 Central Cooling Systems
- 9.3 Central Heating Systems
- 9.4 Unitary Systems
- 9.5 Additional Strategies
- 9.6 Summary
- Bibliography

## **10. Facility Type: K–12 Schools**

---

- 10.1 Challenges and Opportunities
- 10.2 Energy Use Profile
- 10.3 Technical Recommendations
- 10.4 Financial and Implementation Issues
- Bibliography

## **11. Facility Type: Supermarkets and Grocery Stores**

---

- 11.1 Challenges and Opportunities
- 11.2 Energy Use Profiles
- 11.3 Technical Recommendations
- 11.4 Financial and Implementation Issues
- Bibliography

## **12. Facility Type: Hotels and Motels**

---

- 12.1 Challenges and Opportunities
- 12.2 Energy Use Profile
- 12.3 Technical Recommendations
- 12.4 Financial and Implementation Issues
- Bibliography

## **13. Facility Type: Retail Stores**

---

- 13.1 Challenges and Opportunities
- 13.2 Energy Use Profile
- 13.3 Technical Recommendations
- 13.4 Financial and Implementation Issues
- Bibliography



LEARN MORE AT  
[energystar.gov](http://energystar.gov)

ENERGY STAR® is a U.S. Environmental Protection Agency program helping businesses and individuals fight global warming through superior energy efficiency.

# Chapter 1

## Introduction





# 1. Introduction

Revised October 2007

<b>1.1 Overview</b>	<b>2</b>
<b>1.2 Technical Advice</b>	<b>3</b>
Managing an Upgrade Project	3
Staged Approach to Building Upgrades	4
Unique Building Challenges	5
<b>1.3 Getting Started Now</b>	<b>5</b>
<b>Bibliography</b>	<b>6</b>
<b>Glossary</b>	<b>G-1</b>

## 1.1 Overview

ENERGY STAR® is a voluntary government and industry partnership that makes it easy for businesses and consumers to save money and protect the environment. The current program began in 1991 as the U.S. Environmental Protection Agency (EPA) Green Lights program, followed shortly by the introduction of the ENERGY STAR label. In 1996, the EPA partnered with the U.S. Department of Energy to increase the range of ENERGY STAR product offerings. The label now covers new homes, commercial and institutional buildings, residential heating and cooling equipment, major appliances, office equipment, lighting, and consumer electronics. The ENERGY STAR logo is the most recognizable symbol of exemplary energy performance in the U.S., with labeled buildings, homes, and products providing cost-effective solutions to the challenges of energy management and pollution prevention.

Because commercial buildings are major energy consumers, representing 18 percent of the total energy used in the U.S., the EPA developed the Guidelines for Energy Management to help building owners and operators identify and implement cost-effective strategies and technologies to reduce energy use (see [www.energystar.gov/guidelines](http://www.energystar.gov/guidelines)). The guidelines are based on the successful practices of ENERGY STAR partners and offer a proven strategy for superior energy management. With tools and resources available for each step of the way, the guidelines can help an organization improve its energy and financial performance and distinguish itself as an environmental leader.

Energy management begins with a senior-level commitment to continuous improvement in energy efficiency. Executive leadership demonstrates this commitment by issuing a formal energy policy for the organization and by supporting the energy objectives with adequate financial and staffing resources. Every organization should form an energy team that is responsible for overseeing the stated energy objectives and for performing periodic evaluations of energy use for all of the organization's major facilities and functions. The first time this evaluation is performed, the information can be used to establish a baseline against which progress can be measured. Energy goals should be established relative to that baseline to guide decision-making and to form the basis for tracking and measuring progress. Communicating the goals engages the entire organization in the process and can motivate staff to support energy-management efforts.

Clear performance goals also inform the development of an energy action plan. Effective plans should include company policies, financial strategies, and technical building upgrades aimed at achieving continuous improvement in energy efficiency. A detailed action plan identifies specific activities, responsible parties, and measures of success. The plan should be reviewed regularly and updated to reflect recent achievements, changes in performance, and shifting priorities.

As an organization proceeds with its energy action plan, it is important to evaluate progress through a formal comparison of actual energy consumption data and stated performance goals. This comparison will determine whether goals have been achieved, will identify the organization's best practices, and will inform decisions about how to achieve future goals. Those individuals and groups that helped achieve significant results should be recognized for their accomplishments based on this review, and the organization should seek opportunities for external recognition of those achievements. Formal recognition encourages further efforts and builds support for the plan.

Given the cost-savings potential of improving energy efficiency in existing buildings, the EPA has developed this Building Upgrade Manual to assist organizations in planning and implementing profitable upgrades. This manual outlines a process for developing a comprehensive energy-management strategy and an integrated approach to upgrading existing buildings. It also provides information on proven energy-efficient technologies that can produce energy savings of 35 percent or more. The EPA estimates that if the energy efficiency of commercial and industrial buildings improved by just 10 percent, Americans would save about \$20 billion annually and reduce greenhouse gas emissions equal to the emissions from almost 30 million vehicles. As part of its efforts to encourage energy efficiency in buildings, the EPA has awarded the ENERGY STAR to thousands of facilities for their superior performance. (For more on the ENERGY STAR Buildings Program, visit [www.energystar.gov/buildings](http://www.energystar.gov/buildings).)

## 1.2 Technical Advice

The building upgrade effort, like most business projects, will be most successful if it involves a commitment from senior-level management to energy performance and pollution prevention. The recommended upgrade process follows a five-stage approach and emphasizes continuous improvement. The five stages are appropriate for any type of facility, but different types of facilities have different needs and characteristics that will influence just how the stages are implemented.

### Managing an Upgrade Project

The process recommended in this manual begins with management and planning advice. Strategies that contribute to the success of any major business undertaking should be applied to building upgrades:

- *Benchmarking (Chapter 2)*. Comparing the energy use of facilities with others nationwide helps to identify opportunities for savings. The EPA's Portfolio Manager is an interactive energy management tool available in a secure online environment. It allows organizations to effectively benchmark by tracking and assessing energy and water consumption across an entire portfolio of buildings. Certain types of buildings can use the tool to go a step further and compare building energy performance relative to the national population of buildings with similar characteristics and receive a score on a scale of 1 to 100. A score of 75, for example, indicates that the building performs better than 75 percent of all similar buildings nationwide and may qualify that facility for an ENERGY STAR label ([www.energystar.gov/benchmark](http://www.energystar.gov/benchmark)).
- *Investment Analysis (Chapter 3)*. As with any other investment, potential building upgrade projects should be analyzed based on their expected cash flows. Organizations typically employ one or more financial-analysis tools rooted in cash flow to study, rank, and choose among investment opportunities. To compete successfully for capital against other investments, building upgrades should be evaluated using the same tools.
- *Financing (Chapter 4)*. Many opportunities exist for financing efficiency projects, and new opportunities are being created all the time. In addition to traditional sources of funding such as financial institutions and capital markets, many utilities, governments, and nonprofit organizations offer financial support through grants, rebates, and loans. Well-designed efficiency projects are almost always fundable.



## Staged Approach to Building Upgrades

A staged approach to building upgrades will help to increase the financial and environmental benefits realized. The stages recommended by the EPA account for the interactions among all the energy flows in a building (**Figure 1.1**) and produce a systematic method for planning upgrades. Each stage includes changes that will affect the upgrades performed in subsequent stages, so when they are performed sequentially they set up the overall process for the greatest energy and cost savings.

The five stages recommended by the EPA are:

- *Retrocommissioning (Chapter 5)*. Retrocommissioning is the first stage because it provides an understanding of how a facility is operating and how closely it comes to operating as intended. Specifically, it helps to identify improper equipment performance, equipment or systems that need to be replaced, and operational strategies for improving the performance of the various building systems.
- *Lighting (Chapter 6)*. Lighting upgrades, which may include new light sources, fixtures, and controls, come early in the process because the lighting system has a significant impact on other building systems. Lighting affects heating and cooling loads and power quality.
- *Supplemental Load Reductions (Chapter 7)*. Supplemental load sources, such as building occupants and electronic equipment, are secondary contributors to energy consumption in buildings. They can affect heating, cooling, and electric loads. With careful analysis of these sources and their interactions with HVAC systems, equipment size and upgrade costs can be reduced.
- *Air Distribution Systems (Chapter 8)*. Air distribution systems bring conditioned air for heating or cooling to building occupants, and therefore directly affect both energy consumption and occupant comfort. Fan systems can be upgraded and adjusted to optimize the delivery of air in the most energy-efficient way.

**Figure 1.1: The staged approach to building upgrades**

The staged approach recommended by ENERGY STAR accounts for the interactions among all the energy flows in a building. Each stage includes changes that will affect the upgrades performed in subsequent stages, thus setting the overall process up for the greatest energy and cost savings possible.

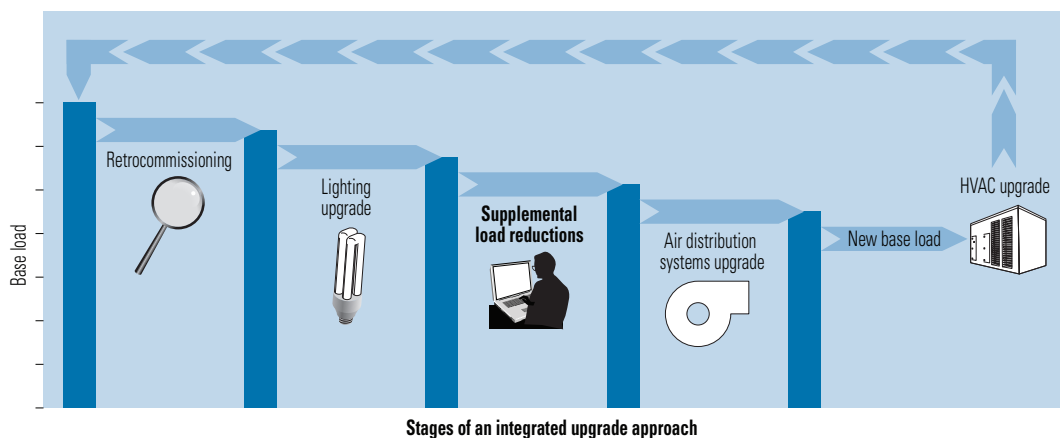

Courtesy: E SOURCE

- *Heating and Cooling Systems (Chapter 9)*. If the steps outlined in the first four stages have been followed, cooling and heating loads are likely to have been reduced. That reduction, coupled with the fact that many existing HVAC systems are oversized to begin with, means that it may be possible to justify replacing an existing system with one that is properly sized or retrofitting a system so that it operates more efficiently. In addition to saving energy, proper sizing will likely reduce noise, lower the first costs for equipment, and optimize equipment operation, often leading to less required maintenance and longer equipment lifetimes.

Energy management should also be viewed as a path of continuous improvement. As illustrated in Figure 1.1, after completion of the fifth stage, the process can begin again with a recommissioning effort to determine where further savings can be found.

## Unique Building Challenges

The overall strategy described in this manual is appropriate for all types of facilities, and many of the specific measures described can be used no matter what type of building is under consideration. However there are also many strategies, priorities, and opportunities that are unique to, or most effective in, specific facility types. To address these unique challenges and opportunities, the manual includes chapters on the following types of facilities:

- *K–12 Schools (Chapter 10)*. Because of the need to ensure a good educational environment, important considerations when upgrading schools include security and safety, indoor air quality, thermal comfort, visual comfort, and acoustic comfort.
- *Supermarkets (Chapter 11)*. A major opportunity for energy savings unique to supermarkets lies with the refrigeration equipment that keeps food from spoiling. Careful attention should be paid to the interactions among refrigeration and other building systems, such as lighting and space conditioning.
- *Hotels and Motels (Chapter 12)*. The major challenge in upgrading hotels and motels is to maintain guest comfort in a wide variety of spaces, including guest rooms, public lobbies, banquet facilities and restaurants, lounges, offices, retail outlets, and swimming pools. The opportunities for improved guest comfort, longer equipment life, lower operating costs, and an improved corporate image make the challenge worthwhile.
- *Retail Establishments (Chapter 13)*. Energy is one of the few expenses that can be reduced without negatively affecting a retailer's operation. In fact, a building upgrade can provide a number of benefits, including increased profitability, reduced vulnerability to energy price fluctuations, increased sales, and improved public image.

## 1.3 Getting Started Now

Energy consumption represents a significant portion of any building's operating cost, whether that building is used to educate students, host weary travelers, or provide any other function. For many facilities, energy costs are the single largest controllable cost of operations, so improved energy efficiency has a direct and substantial payback for investors. Each day of delay in boosting efficiency means lost potential savings. The first step in starting the upgrade process and beginning to reap the benefits is to become an ENERGY STAR partner. When a senior executive signs a Partnership Letter, it means that the organization is committed to improving energy performance by:

- Measuring and tracking the energy performance of the organization's facilities where possible by using tools such as those offered through ENERGY STAR
- Developing and implementing a plan consistent with the ENERGY STAR Guidelines for Energy Management to achieve energy savings
- Helping to spread the word about the importance of energy efficiency to its staff and the surrounding communities
- Supporting the ENERGY STAR Challenge, a national call to action intended to help improve the energy efficiency of America's commercial and industrial buildings by 10 percent or more
- Highlighting their achievements with recognition offered through ENERGY STAR

The EPA provides resources and assistance that can help an organization achieve exemplary energy-performance goals. That assistance takes the form of analytical software tools, publications, technical guidance, and visible recognition of achievements. To learn more, visit the ENERGY STAR web site ([www.energystar.gov](http://www.energystar.gov)) or call the ENERGY STAR Hotline at 1-888-STAR-YES (1-888-782-7937).

### Bibliography

U.S. Department of Energy, Energy Efficiency and Renewable Energy, "2006 Buildings Energy Data Book" (September 2006), <http://buildingsdatabook.eere.energy.gov>.

U.S. Environmental Protection Agency, "The ENERGY STAR for Buildings," [www.energystar.gov/index.cfm?c=business.bus\\_bldgs](http://www.energystar.gov/index.cfm?c=business.bus_bldgs).



LEARN MORE AT  
[energystar.gov](http://energystar.gov)

ENERGY STAR® is a U.S. Environmental Protection Agency program helping businesses and individuals fight global warming through superior energy efficiency.

## Chapter 2 Benchmarking





# 2. Benchmarking

Revised April 2008

<b>2.1</b>	<b>Overview</b>	<b>2</b>
	Successful Benchmarking	2
	Types of Benchmarking	3
<b>2.2</b>	<b>Develop a Benchmarking Plan</b>	<b>4</b>
	Set Goals	4
	Define the Scope and Identify a Benchmark	5
	Develop Data Requirements	7
	Engage Partners	9
<b>2.3</b>	<b>Implement the Benchmarking Plan</b>	<b>9</b>
	Collect Data	9
	Evaluate Benchmarks and Apply the Results	9
<b>2.4</b>	<b>Summary</b>	<b>12</b>
	<b>Bibliography</b>	<b>12</b>
	<b>Glossary</b>	<b>G-1</b>

## 2.1 Overview

Businesses are reducing their energy use by 30 percent or more through effective energy management practices that involve assessing energy performance, setting energy savings goals, and regularly evaluating progress. Building-level energy performance benchmarking is an integral part of this effort. It provides the reference points necessary for developing sound energy management practices and strategies and for gauging their effectiveness.

Energy use benchmarking is a process that either compares the energy use of a building or group of buildings with other similar structures or looks at how energy use varies from a baseline. It is a critical step in any building upgrade project, because it informs organizations about how and where they use energy and what factors drive their energy use. Benchmarking enables energy managers to determine the key metrics for assessing performance, to establish baselines, and to set goals for energy performance. It also helps them identify building upgrade opportunities that can increase profitability by lowering energy and operating costs, and it facilitates continuous improvement by providing diagnostic measures to evaluate performance over time.

Benchmarking energy performance helps energy managers to identify best practices that can be replicated, either within a building or across a portfolio of buildings. Benchmarks can be reference points for measuring and rewarding good performance. They allow an organization to identify top-performing facilities for recognition and to prioritize poorly performing facilities for immediate improvement.

The experiences of USAA Real Estate Co., an organization with buildings across the country, illustrate how benchmarking can inform the whole energy management process: Until USAA Real Estate benchmarked its holdings, the company's management believed its portfolio of buildings to be highly energy-efficient. However, initial results indicated that there was room for improvement. The company went on to benchmark 100 percent of its space. That effort, in turn, led to changes in energy management practices and building upgrades that resulted in more than \$10 million in energy savings over a five-year period through 2007. USAA Real Estate was named an ENERGY STAR Partner of the Year every year from 2003 through 2007.

Any type of building can benefit from benchmarking. The Marriott hotel chain relied on benchmarking as part of its full-circle approach to observing energy performance and improving energy management systems and procedures. As a result, Marriott's hotels save \$4.5 million annually in energy costs. In a totally different environment, energy benchmarking has become a staple of the Seaford (Delaware) School District's Energy Management Program. Building improvements flowed from the critical first step of benchmarking to find and eliminate energy waste within the schools.

### Successful Benchmarking

To increase the effectiveness of benchmarking efforts, the U.S. Environmental Protection Agency (EPA) provides guidance and benchmarking tools that simplify the process and help organizations successfully save energy. These resources enable energy managers to determine the energy efficiency of their operations and to make informed management and investment decisions. They also help managers set appropriate goals, determine the data that are needed for a whole-building assessment, and evaluate and measure progress.

Benchmarking starts with a plan that identifies goals, defines the scope of the project, suggests appropriate metrics of performance, and recommends potential partners. As the project proceeds, managers collect data about their facilities, normalize the data, and ensure that the data and any assumptions made are valid. Energy use is influenced by a variety of factors, each of which should be accounted for to provide valid comparisons. At a specific building, for example, the data can be normalized for weather, occupancy levels, or tasks that affect energy use. Normalizing creates a level playing field that avoids an apples-to-oranges type of comparison. Although this sounds like a complicated task, the ENERGY STAR tools make normalizing the data straightforward.

Benchmarking results provide pointers to follow-on efforts to improve energy performance and energy management. Energy managers can use the results to screen their portfolio of facilities regularly to decide where to do on-site energy audits, to identify which sites would provide the greatest return from tune-ups and retrofits, and to remind local managers about energy-efficient behaviors. Benchmarking also enables managers to compare performance to external data. In addition, energy managers can use benchmarking data to motivate action in employee energy-awareness campaigns and to communicate good results to the general public.

## Types of Benchmarking

Energy benchmarking can be categorized in two ways: internal or external. Internal benchmarking allows an organization to compare the energy use at a building or group of buildings to that of others in that organization. The results can be used within an organization to compare energy performance among buildings, to identify buildings with the greatest potential for improvement, to track performance over time, to identify best practices at individual sites that can be replicated, and to increase management's understanding of how to analyze and interpret energy data.

In external benchmarking, buildings are compared to other, similar buildings. The results can be used to assess performance relative to peers in the same sector or industry and across other sectors and industries, to compare the energy performance of facilities against a national performance rating, to track performance against industry or sector performance levels, to identify new best practices for improving building performance, to increase understanding of how to analyze and evaluate energy performance, and to identify high-performing buildings for recognition opportunities such as the ENERGY STAR label.

Whether internal or external, benchmarking may be either quantitative or qualitative. In a quantitative benchmarking process, numerical measures of performance are compared. These numbers may be looked at in a historical context (How has the building's performance changed over time?) or in an industrial context (How does the building compare to a peer group of buildings?). In a qualitative process, management and operational practices across a portfolio of buildings are examined to identify best practices or areas for improvement. Many benchmarking projects combine quantitative and qualitative measures.

Food Lion, one of the largest supermarket chains in the United States and an ENERGY STAR Partner, uses both internal and external benchmarking to guide its efforts. Internally, the company uses normalized quarterly reports created by a utility bill-handling service to rank the efficiency of its stores by region. Its energy team distributes these rankings to associates across the chain through individualized Performance Scorecards and Maintenance Scorecards, which detail each store's energy use and provide a summary of quarterly energy and year-to-date capital and refrigeration costs. Food Lion posts the scorecards on bulletin boards and on its intranet; it also sends e-mail notifications to upper management.

Externally, the company compares its stores to similar stores in the country by using the EPA's energy performance rating system (see Section 2.2) to generate ratings for each store. In 2004, Food Lion expanded its use of the rating system for supermarkets by partnering with its outside billing service and the EPA to generate automated monthly ratings. This process, known as *automated benchmarking* (see Section 2.3), makes it easier for companies with large portfolios of buildings to gather and update their energy data. With this system, the energy team can easily view trends on a monthly, quarterly, and yearly basis, both internally and against competitors. Using this automated system has allowed Food Lion to identify energy-wasting problems quickly and see the results of energy-saving initiatives on a much broader scale than in the past.

## 2.2 Develop a Benchmarking Plan

An effective benchmarking process includes setting goals, defining the scope of the benchmarking effort, identifying the data needed, and engaging partners who will take part in the project.

### Set Goals

The EPA's *Guidelines for Energy Management* ([www.energystar.gov/guidelines](http://www.energystar.gov/guidelines)) explains that benchmarking goals should be consistent with and support corporate goals. In fact, initial benchmarking results can be used to help establish new or modify existing corporate goals. The ENERGY STAR guidelines call for evaluating energy use across the organization's major facilities and functions. This information can be used to establish a baseline against which progress can be measured. Energy goals can then be established relative to that baseline to guide decision-making and to form the basis for tracking and measuring progress. Benchmarking is a best practice consistently applied by ENERGY STAR Partner of the Year winners.

Setting a goal for the project will help to determine what type of benchmark will be most useful. For example, if the goal is to improve performance over time, the benchmark might be the baseline energy consumption of a building or portfolio of buildings. Alternatively, a project with an external focus may seek to benchmark a facility relative to a measure of the best in class. Examples of the types of benchmarks commonly used are summarized in **Table 2.1**.

**Table 2.1: Common benchmarks**

The type of benchmark chosen by a company depends on its goals. This table lists some of the most commonly used benchmarks.

Benchmark type	Description
Best in class	The performance level of the top performer sets the bar when comparing similar buildings.
Performance goal	A specific performance level can be established as a target against which progress can be measured.
Baseline	An initial performance baseline of the building that is established before any commissioning or other measures are taken can be used to track improvements over time.
Above average	Percentages above an average can be used to establish a benchmark.
Commissioned performance level	The performance level of a commissioned building can be used as a benchmark.
National ratings	National performance ratings, such as those established by ENERGY STAR, can be used as performance targets for specific buildings.

Courtesy: E SOURCE



## Define the Scope and Identify a Benchmark

Once goals have been set, the scope of the benchmarking effort can be defined in terms of scale, organizational focus, and time frame. The scale of the effort may cover whole buildings, a portfolio of buildings, or the entire organization. The focus may be internal to the company or it may be external, comparing performance to that of competitors or peers. The time frame may be annual, monthly, weekly, or even continuously, depending on the goals.

Based on the defined goals and scope, it is possible to identify a specific benchmark. Companies may find it possible to use established benchmarks, such as the EPA's energy performance ratings, or it may be necessary to develop unique benchmarks.

**EPA benchmarks.** The EPA provides a set of benchmarks that can be used to assess energy performance for many building types. These benchmarks are developed from a national survey conducted every four years by the U.S. Department of Energy's Energy Information Administration. The Commercial Building Energy Consumption Survey (CBECS) gathers data on building characteristics and energy use from thousands of buildings across the United States. Using those data, the EPA has created a list of energy performance targets that are based on average energy use as calculated across different types of buildings (see [www.energystar.gov/ia/business/tools\\_resources/new\\_bldg\\_design/2003\\_CBECSPerformanceTargetsTable.pdf](http://www.energystar.gov/ia/business/tools_resources/new_bldg_design/2003_CBECSPerformanceTargetsTable.pdf)). These energy performance targets are expressed in terms of energy use intensity; they are not normalized for climate or adjusted for activities that may affect energy use. They can serve as a starting point for a company's benchmarking effort and can be supplemented with other data, as described below, to develop new benchmarks.

Where enough data are available, the EPA has gone further and developed energy performance ratings. The energy performance ratings are developed by applying statistical algorithms to CBECS data and are normalized for weather and important building characteristics such as operating hours, building size, occupancy, and number of computers. Most of the EPA energy performance ratings are based on CBECS data, but due to data limitations, some energy performance ratings are based on other data sets. For more information on the reference data used for each model, please refer to the technical descriptions for each building type ([www.energystar.gov/index.cfm?c=evaluate\\_performance.bus\\_portfoliomanager\\_model\\_tech\\_desc](http://www.energystar.gov/index.cfm?c=evaluate_performance.bus_portfoliomanager_model_tech_desc)).

The EPA currently maintains performance ratings for all major commercial building types, including banks and financial institutions, courthouses, hospitals (acute care and children's), hotels and motels, K–12 schools, medical offices, offices, residence halls and dormitories, retail stores, supermarkets, warehouses (refrigerated and nonrefrigerated), and wastewater treatment plants. The benchmarks and ratings are made available through a free online tool, Portfolio Manager (<https://www.energystar.gov/istar/pmpam/>), which allows users to set up private accounts to track building portfolios, set baselines, share information, and document the results of their efforts to improve energy performance.

It is important to reiterate that the energy performance ratings are based on the national CBECS survey; they are not developed based on the other buildings that people have entered into Portfolio Manager. The energy bill data and the operating characteristics that have been entered into the tool are used to compare the user's building with other buildings within CBECS. The energy performance ratings account for key factors that impact energy use but that are not the result of inefficiency, such as climate, occupancy level, and hours of operation.

Ultimately, the energy performance rating is expressed on a scale of 1 to 100, which denotes the percentile of performance relative to the other buildings in the national CBECS data set. A rating of 75 means a particular building outperforms approximately 75 percent of its

peers; these buildings are in the top quartile for their building type and are eligible to earn an ENERGY STAR label. In general, buildings with lower ratings have a greater opportunity to improve their energy performance levels.

In addition, the EPA provides ratings known as Energy Performance Indicators (EPIs) for certain manufacturing plants. These indicators are not located within Portfolio Manager, but are available as specific Excel-based spreadsheet tools. These are industry-specific tools that enable energy managers and corporate executives to evaluate the energy efficiency of their plants relative to similar facilities ([www.energystar.gov/index.cfm?c=in\\_focus.bus\\_industries\\_focus](http://www.energystar.gov/index.cfm?c=in_focus.bus_industries_focus)). EPIs are derived from facility-level production and energy data. They normalize for key factors that drive energy use, including plant utilization, weather, product mix, and facility and product characteristics.

**Common industry benchmarks.** In addition to the ENERGY STAR ratings, there are other industry benchmarks that can facilitate energy management. These include benchmarking methodologies established by industry trade organizations, as well as national data sets (see sidebar).

**Develop new benchmarks.** If there is neither an EPA benchmark nor a commonly accepted industry benchmark for a specific building type, the EPA provides technical guidance to help energy managers develop their own benchmarks. The ENERGY STAR *Guidelines for Energy Management* helps managers plan their efforts, develop metrics, normalize data, and use the results. Successful benchmarking programs are tailored to the structure and culture of each specific organization.

---

---

## RESOURCES: Industry Benchmarking Tools

A number of tools are available to help companies with their benchmarking programs in addition to those available from the ENERGY STAR Program. These include:

**Healthcare Energy Guidebook.** The American Society for Healthcare Engineering collaborated with the ENERGY STAR Program in the Healthcare Energy Project (HEP) to produce the *Healthcare Energy Guidebook*. The guidebook profiles the U.S. healthcare market on size- and energy-related characteristics and provides energy benchmarking data that can be used to make meaningful comparisons among healthcare facilities ([www.ashe.org/ashe/facilities/e2c/resources.html](http://www.ashe.org/ashe/facilities/e2c/resources.html)).

**The Exchange Report.** This annual report and CD from the Building Owners and Managers Association provides data for office buildings on building type, occupancy, and operating expenditures, including energy.

**Benchmarking services.** There are also many software products and consulting services available to help benchmark multiple facilities. For example, the consulting firm Jackson Associates maintains the Market Analysis and Information System ([www.maisy.com](http://www.maisy.com)), which includes a state-level database. This system has building energy use, building structure, and end-use equipment data.

Automated benchmarking tools that help in the data-collection process are described in Section 2.3.

---

---

In these unique programs, the benchmarking plan should include a larger data-collection effort to capture information on potentially important factors. These data can be analyzed to develop the most appropriate benchmark. Often it is instructive to begin with simple energy-intensity benchmarks. Energy-intensity metrics (**Table 2.2**) normalize energy consumption relative to a single, primary measure of business or operation. These metrics are most useful when expressed in terms commonly used by an organization. For example, number of employees may be a good indicator of energy use for an office building, but it could be a poor one for a data center.

In some cases, it may be necessary to develop a benchmark that adjusts for multiple factors. Multi-factor normalization can be accomplished through statistical techniques such as regression analysis. Various factors can be analyzed to determine their correlation with energy consumption, and statistical models can be made to adjust for multiple factors at once. This type of analysis will require consultation with statisticians or engineers who are familiar with the energy characteristics of the buildings under evaluation.

## Develop Data Requirements

The specific benchmarking metrics selected will determine the data-collection requirements. For example, to receive an energy performance rating for a building through Portfolio Manager, it is necessary to collect data on specific building characteristics, which are used to normalize energy use and compute the rating. Based on the scope of the benchmarking analysis, managers can identify required data elements and the sources for those data. In some cases, much of the data may already be tracked, such as energy purchases, hours of operation, or production outputs. Other data may require more investigation and new measurements may need to be made. There are several common types of data used for benchmarking.

**Energy use.** The quantities of electricity, natural gas, steam, chilled water, and other delivered energy sources may be gathered at the corporate, campus, building, process, or equipment level. These data may come from accounting systems or bill-handling services. Depending on the types of energy used, more-detailed consumption data may be available from process or equipment submeters (see sidebar). All energy sources must be accounted for.

**Table 2.2: Common energy-intensity metrics**

Energy-intensity metrics can be used to compare performance across multiple buildings, but the metric to use depends on the benchmarking goals and the type of building being measured.

Metric	Application
Btu per square foot	Any building
Btu per employee	Office building
Btu per unit of product	Assembly plant
Btu per pound of product	Manufacturer
Btu per pound of product processed	Refinery
Btu per number of beds occupied	Hotel or hospital
Kilowatt-hours per square foot	Lighting
Kilowatts per ton	Chilled water efficiency
Watts per cubic foot of airflow per minute	HVAC systems

Courtesy: E SOURCE

**Energy cost information.** The purchase cost of electricity, fuels, steam, compressed air, chilled water, and other energy sources is usually available from accounting systems or bill-handling services.

**Physical and design attributes.** Key building characteristics, such as floor area, equipment used, plug loads, special activities, and space types can be found from a variety of sources, including building records that are available from the facility manager or office of the physical plant. Dynamic organizations that often change equipment or alter space configurations and uses may have to take manual floor-area measurements and counts of various types of equipment (including boilers, motors, lighting fixtures, HVAC units, and plug loads).

**Output or utilization data.** Data that offer insights into the utilization of space, including labor hours, occupancy levels, operating hours, and number of shifts, can assist in revealing energy-use patterns. Labor data is typically collected for Occupational Safety and Health Administration (OSHA) reports, so it may already be available from the health and safety department.

**Production data.** Data that captures differences in product characteristics or production inputs or processes can usually be found in production records, including inventory data, invoices for all inputs in the supply chain, and shipping records for intermediate and final goods produced. Quantities may be expressed in the number of units produced or some measure of weight or volume.

**Financial data.** These data can include revenue and sales data, value of shipments, and value added, things that are usually tracked for accounting purposes.

**Climate variables.** Variables such as heating and cooling degree-days, altitude, and barometric pressure data are available from local weather stations or may be tracked on site.

**Economic variables.** Various economic metrics, such as the implicit price deflator for gross domestic product, are often used to adjust sales data for inflation and are available from the federal government.

---

---

### **BEST PRACTICES: Submetering Helps Food Lion Find Energy Drains**

Food Lion, one of the largest supermarket chains in the United States with more than 1,220 stores in 11 Southeastern and Mid-Atlantic states, uses a special submetering system to monitor and analyze 17 different loads for each of its stores that have submetering in place. The meters track energy consumption in such areas as HVAC, lighting, deli, and refrigeration. Without submetering, a quick look at Food Lion's utility bill could flag a problem store, but further investigation would be required to pinpoint the problem. With submetering, Food Lion can quickly tell, for example, the specific area of the store that was involved in an energy spike. The company's maintenance crews can then immediately correct the problems and, using the submetering system, know within 15 minutes whether the entire problem has been corrected.

---

---

## Engage Partners

A successful benchmarking study often requires the help of other parties, who should be identified and engaged at the beginning of the process. Primary candidates for participation include departments or organizations that own the data that are needed for the benchmarking effort. For external benchmarking, look for partners in the same industry or sector. An effective partnership requires that the partners understand the objectives, expected outcomes, and schedule of the project, and know their role and the costs and benefits of their participation.

For internal benchmarking projects, some participants may feel threatened by a focus on energy consumption and operations, fearing results that may reflect poorly on them. Therefore it is important to be open and clear about the purpose of the project. Focusing on the contribution that benchmarking makes to competitiveness and profitability objectives can be helpful. USAA Real Estate displays its Strategic Energy Management plan and corporate commitment on its intranet site. Expanded access to such documents and to ENERGY STAR information helps raise awareness of the impact that energy efficiency can have on an organization's performance and its positive contribution to the community in the form of environmental benefits.

### 2.3 Implement the Benchmarking Plan

Once a plan has been developed, the benchmarking team will collect data, evaluate benchmark metrics, and apply the results. There are many tools available to aid in this process. Results can also be achieved using homemade spreadsheets for quick comparisons to national or regional data.

#### Collect Data

The success of a data-collection effort will depend on the ability of participants to share data in a common platform. Portfolio Manager (<https://www.energystar.gov/istar/pmpam/>) is one widely used online tool for tracking energy consumption. It enables users to track multiple energy and water meters, benchmark facilities relative to past performance, view percent improvement in normalized source energy, monitor energy and water costs, verify building energy performance, and determine energy performance ratings.

The software requires that the user specify the type of building, its operating characteristics (such as floor area and hours of operation), and its actual energy-bill data. To get started, there must be at least 11 full consecutive calendar months of energy data available for all active meters at the site. The billing data are updated as new bills come in. The data may be entered manually, and automated benchmarking tools are available to simplify the data-collection process for companies with large portfolios of buildings to manage (see sidebar).

A variety of other tools are also available. For a quick check to prioritize further in-depth analysis, some companies build their own spreadsheets and then compare results to regional or national averages, such as those provided through the ENERGY STAR Program. For more accurate results, free benchmarking software is available online and software that analyzes billing or meter data is available for purchase (see Industry Benchmarking Tools sidebar).

#### Evaluate Benchmarks and Apply the Results

Once data have been collected, the specific benchmarks can be computed for the building or across a set of buildings under investigation. Benchmarking results can be put to use in a variety of ways.

**Rank facilities.** The first step is to use the data gathered to compare or rank the buildings. Buildings may be ranked according to the benchmark to identify the top performers and prioritize investment opportunities.

**Set goals.** It is possible to set new goals based on the initial benchmarking results. For example, a goal may be set to bring buildings that are performing below average up to the average performance. Another goal might be to pursue a 10 percent energy improvement across the board. Goals may be established at the building or organizational level; the exact goal will depend on the objectives of the benchmarking project that were identified at the outset. The actual benchmarking data will transform these broader objectives into quantifiable goals.

Based on benchmarking results, USAA Real Estate managers create an ENERGY STAR Energy Performance Plan for each building in their portfolios. The plan describes an overview of the property, establishes a baseline of energy management performance and achievements, and sets goals for the following year. Specifying portfolio-wide and building-wide energy management goals has resulted in an increased average energy performance and significant annual energy cost savings. Similarly, Marriott collects information at each of its properties and, at the end of each quarter, the property's general manager and energy conservation committee meet to review audit forms and inspection reports that have been filed over the previous three months. This review is the foundation for setting goals for the next quarter.

**Identify and share best practices.** Top-performing buildings can be examined to identify successful management and operational practices. These procedures can be extended and applied to improve lower-performing facilities.

---

---

## RESOURCES: Automated Benchmarking

The EPA has partnered with companies that offer invoice and energy management services in which the companies host the EPA's energy performance rating system within their web-based products. For organizations with large portfolios of buildings, obtaining and managing the data necessary to benchmark can be difficult. Invoice and energy management service vendors typically already collect most of the data required to benchmark buildings in the EPA's energy performance rating system. Integrating the ENERGY STAR rating with existing services gives customers the convenience of receiving ratings within the same energy information environment that they use for planning, tracking, and managing energy use and costs. Advantage IQ, Cadence Network, Energard, Johnson Controls, EnergySolve, ei3, UtilityAccounts.com, and Poco Energy have all partnered with ENERGY STAR to offer the automated benchmarking service.

The Gresham-Barlow school district in Gresham, Oregon, used automated benchmarking services to help reduce its energy use by 46 percent over a seven-year period. The school district, which has been named an ENERGY STAR Partner of the Year several times and has been recognized as an ENERGY STAR Leader for improvements across its portfolio of facilities, has earned the ENERGY STAR label for most of its individual schools with the help of software that automates the transfer of its utility data to the EPA's rating system. The software also helped the district identify billing errors and consumption anomalies, track real-time energy use, identify trends, make accurate projections, and create sophisticated forecasts, budgets, and customized reports.

---

---

**Take action.** Energy managers can use benchmarking data to screen their portfolio of facilities. The information will help them decide where to do on-site audits, identify which sites would get the best return from tune-ups and retrofits, or even just know when to remind local managers about energy-efficient behaviors. With this data, they can also calculate what is needed to meet an internal or external goal across the organization.

**Track progress.** Based on the scope of the project, benchmarking can be repeated over time to assess progress relative to the defined goals and to encourage continuous improvement. It is important to track progress and compare actual energy consumption data with stated goals. This comparison will show whether or not goals have been achieved and how much money energy savings have contributed to the organization's bottom line. The comparison will also help to identify the organization's best practices and will inform decisions about how to achieve future goals. Setting new goals on a regular basis will help foster an environment of continuous improvement.

**Recognize achievements.** Data from the benchmarking project can be used to award internal recognition and to seek external recognition opportunities. Formal recognition encourages further efforts and builds support for an organization's energy management plan. For example, internal recognition may be structured to recognize the energy manager who has achieved the greatest reductions across his or her facilities over the past quarter. Retailer JC Penney developed an energy contest to encourage its employees to reduce energy use in each store. To make energy efficiency fun and rewarding, the company designated a volunteer "energy captain" for each store. The captains give employees incentives and ideas for reducing energy use along with the latest data about the energy use in their store, and it has led to significant savings: The program saved more than \$500,000 in the first month and has since been expanded from a single event to an ongoing incentive.

The EPA provides a variety of opportunities for external recognition. Individual buildings that perform in the top quartile are eligible for the ENERGY STAR label ([www.energystar.gov/index.cfm?c=business.bus\\_bldgs](http://www.energystar.gov/index.cfm?c=business.bus_bldgs)). Organizations that partner with ENERGY STAR and achieve a 10 percent energy reduction across their portfolio can earn recognition as ENERGY STAR Leaders ([www.energystar.gov/index.cfm?c=leaders.bus\\_leaders](http://www.energystar.gov/index.cfm?c=leaders.bus_leaders)). In addition, ENERGY STAR Partners may apply to be recognized as an ENERGY STAR Partner of the Year based on their accomplishments across an entire organization ([www.energystar.gov/index.cfm?c=pt\\_awards.pt\\_es\\_awards](http://www.energystar.gov/index.cfm?c=pt_awards.pt_es_awards)).

External opportunities for recognition are also available through a variety of associations. For example, the American Society of Healthcare Engineering (ASHE) has developed an E2C campaign that offers free Professional Engineer verification for hospitals that qualify for the ENERGY STAR label. Additionally, the Building Owners and Managers Association (BOMA) and its local chapters, such as BOMA Austin and BOMA Seattle–King County, have developed contests and offered incentives to challenge the commercial real estate industry to pursue energy efficiency. Participants in these campaigns receive a variety of benefits, including free advertisements and recognition, energy engineering certification, and private reports detailing the energy performance of their buildings.

## 2.4 Summary

Benchmarking serves to inform organizations about how they use energy, where they use it, and what factors drive its use. It helps companies identify the key metrics for assessing performance, establish baselines, and set goals for energy performance. Benchmarking, which may be internal, external, or a combination of the two, helps companies identify and prioritize building upgrade opportunities that will lower energy and operating costs, and it provides a means for tracking and improving performance over time. The benchmarking process requires managers to:

- Define goals
- Set the scope of the project
- Identify data requirements
- Engage partners who will participate in the project

Once the benchmarking data has been gathered and processed, it can be used, first to rank buildings and then to:

- Identify buildings with subpar performance
- Define best practices
- Compare current performance to goals
- Recognize achievements

To get started, visit the Portfolio Manager web site (<https://www.energystar.gov/benchmark>) to make use of the ENERGY STAR Program's various tools and links.

## Bibliography

U.S. Department of Energy, Energy Information Administration, "Public Use Microdata Files" (2003 data; published 2006), Commercial Building Energy Consumption Survey (CBECS), [www.eia.doe.gov/emeu/cbecs/cbecs2003/public\\_use\\_2003/cbecs\\_pudata2003.html](http://www.eia.doe.gov/emeu/cbecs/cbecs2003/public_use_2003/cbecs_pudata2003.html).

U.S. Environmental Protection Agency (EPA), ENERGY STAR Program, "Portfolio Manager," [www.energystar.gov/index.cfm?c=evaluate\\_performance.bus\\_portfoliomanager](http://www.energystar.gov/index.cfm?c=evaluate_performance.bus_portfoliomanager).

U.S. EPA, "Guidelines for Energy Management," [www.energystar.gov/index.cfm?c=guidelines.guidelines\\_index](http://www.energystar.gov/index.cfm?c=guidelines.guidelines_index).

U.S. EPA, "Service and Product Provider Success Story," [www.energystar.gov/ia/partners/downloads/Success\\_Story\\_SMR-GreshamBarlow.pdf](http://www.energystar.gov/ia/partners/downloads/Success_Story_SMR-GreshamBarlow.pdf).





LEARN MORE AT  
[energystar.gov](http://energystar.gov)

ENERGY STAR® is a U.S. Environmental Protection Agency program helping businesses and individuals fight global warming through superior energy efficiency.

## Chapter 3 Investment Analysis





# 3. Investment Analysis

Revised July 2007

<b>3.1 Overview</b>	<b>2</b>
<b>3.2 Analytic Conventions</b>	<b>2</b>
<b>3.3 Cash-Flow Analysis Tools</b>	<b>2</b>
Payback Period	3
Net Present Value	4
Internal Rate of Return	6
<b>3.4 Selecting an Analysis Tool</b>	<b>7</b>
<b>3.5 The Investment Analysis Process</b>	<b>8</b>
Choose the Right Time Frame	8
Consider All of the Impacts on Cash Flow	8
Account for Interactions Among Measures	9
Include Anticipated Price Changes	10
Adjust for Taxes	10
Consider Sensitivity Analysis	10
<b>3.6 Other Considerations</b>	<b>11</b>
Qualitative Assessments	11
Effect of Energy Performance on Shareholder Value	11
<b>3.7 Summary</b>	<b>11</b>
<b>Bibliography</b>	<b>12</b>
<b>Glossary</b>	<b>G-1</b>

### 3.1 Overview

All types of organizations, for-profit and not-for-profit alike, should analyze prospective investments based on their expected cash flows. If a business is contemplating an investment to support a higher level of sales, it should weigh the cost of the investment and any related operating expenses against the additional cash benefits to the business from the projected incremental sales. Only if the expected cash inflow is more valuable than the expected outflow should the investment move forward.

Building upgrades for energy performance also generate cash flow, but not through sales; instead, they reduce the cash flowing out to pay for energy. In some circumstances, energy-efficiency investments can also produce non-energy cash benefits, such as maintenance savings. From the standpoint of the organization's financial health, reduced cash outflow—such as savings in energy and maintenance costs—is just as valuable as increased cash inflow from sales.

Organizations typically employ one or more financial analysis tools rooted in cash flow to study, rank, and choose among investment opportunities. To successfully compete for capital against other investments, building upgrades should be evaluated using the same tools.

### 3.2 Analytic Conventions

All of the analysis tools explained in this chapter share some conventions and simplifying assumptions. An investment is measured by its impact over time—positive or negative—on the organization's cash position. Positive cash flow indicates an inflow of cash or the equivalent reduction in cash expenditures. Negative cash flow designates an investment of cash or a reduction in cash receipts.

For straightforward energy-efficiency investments, an initial outlay, or *first cost* (a negative cash flow), is followed by energy savings (a positive cash flow). The savings can continue for several years.

Normally, savings from energy-efficiency investments occur more or less continually. For simplicity, however, it is customary to assume that all cash flows occur at one-year intervals, and that the first year's worth of positive cash flows is not received until one year after the initial investment. By convention, the time of the initial outlay is designated *Year 0*. Savings from the investment are then recorded as occurring in Year 1, Year 2, and so on.

Because corporate income taxes add significant complexity to investment analysis, taxes are omitted from the initial explanations of the analysis tools and taken up later in the chapter. Only for-profit businesses need concern themselves with including taxes in the analysis.

### 3.3 Cash-Flow Analysis Tools

Three cash-flow analysis tools—payback period, net present value, and internal rate of return—are commonly used to evaluate building upgrade investments that improve energy performance.

## Payback Period

The most basic, and probably most common, financial gauge of a building upgrade investment is its payback period. It is defined as the time, in years, required for an investment's cumulative cash flow (including the initial outlay) to reach zero.

Suppose you are presented with a proposal to upgrade a building's shell for greater energy efficiency. The contractor says that the installed cost will be \$20,000 and that you can expect annual energy savings of \$4,000. Assume that your organization plans to occupy the building for at least another 10 years.

**Table 3.1** shows the expected cash flow from this investment over 10 years. On a cumulative basis, cash flow is negative until reaching zero in Year 5, so this investment has a five-year payback.

Of course, the same result could be obtained by dividing the initial outlay of \$20,000 by the annual savings of \$4,000. Suppose, however, that savings were expected to increase after Year 1 due to rising energy prices. In that case, an accurate estimate of payback would require accumulating the yearly cash flows, as in Table 3.1, rather than simply dividing the outlay by the first year's savings.

Even with fluctuating cash flows, the payback period is easy to understand and calculate. Payback can also serve as a rough measure of investment risk: The shorter the payback, the lower the chances that something will interfere with the productivity of an investment before the initial outlay has been recovered.

As an investment analysis tool, however, payback has its shortcomings. It does not account for the cash flows that occur after payback has been achieved and thus does not measure the long-term value of an investment. Also, it treats all cash flows the same, whether they occur in Year 1 or in Year 5. In financial terms, payback ignores the *time value of money*: the principle that money received in the future is not as valuable as money received today.

**Table 3.1: Calculation of payback period**

Payback is achieved when the cumulative cash flow reaches zero. In this example, payback occurs in Year 5.

Year	Initial investment (\$)	Energy savings (\$)	Cumulative cash flow (\$)
0	-20,000	—	-20,000
1	—	4,000	-16,000
2	—	4,000	-12,000
3	—	4,000	-8,000
4	—	4,000	-4,000
<b>5</b>	<b>—</b>	<b>4,000</b>	<b>0</b>
6	—	4,000	4,000
7	—	4,000	8,000
8	—	4,000	12,000
9	—	4,000	16,000
10	—	4,000	20,000

Courtesy: E SOURCE

## Net Present Value

*Net present value* (NPV) is a measure of investment worth that explicitly accounts for the time value of money. Like payback period, NPV is computed from the stream of cash flows resulting from the investment. Unlike payback period, those cash flows are adjusted (or “discounted”) so as to place relatively greater value on near-term cash flows and relatively lesser value on cash flows that are more distant in the future.

The *discount rate* is an interest rate used to adjust a future cash flow to its *present value*: its value to the organization today, which normally corresponds to Year 0. The discount rate is expressed either as a percentage or as its decimal equivalent—for example, 10 percent or 0.1.

Mathematically, if  $r$  is the discount rate, then the present value (PV) of a single cash flow (CF) received one year from now—that is, in Year 1—is defined by this equation:

$$PV = CF \times 1/(1 + r)$$

For example, if the discount rate is 10 percent, then the present value of a \$4,000 cash flow expected one year from now is:

$$PV = \$4,000 \times 1/(1 + 0.1) = \$3,636$$

More generally, for any cash flow received in Year  $t$  (where  $t$  represents the elapsed time in years), the present value is the product of the future cash flow and the *present value factor*,  $1/(1 + r)^t$ :

$$PV = CF \times 1/(1 + r)^t$$

For example, if the discount rate is 10 percent, the present value of \$4,000 received five years from now is:

$$PV = \$4,000 \times 1/(1 + 0.1)^5 = \$4,000 \times 0.621 = \$2,484$$

You might find it useful to think of discounting as the inverse of earning interest. In fact, if you invested \$2,484 today in a certificate of deposit (CD) that paid 10 percent interest annually, then in five years the CD would be worth \$4,000.

The NPV of an investment is the sum of the present values of all the cash flows, including the initial outlay (expressed as a negative number). Refer to **Table 3.2**, which shows the calculation of NPV for the same investment example used in Table 3.1. The sum of the present values is \$4,578.

**Interpreting and applying net present value.** NPV is a measure of the investment’s financial worth to the organization, taking into account the preference for receiving cash flows sooner rather than later. An investment is financially worthwhile if its NPV is greater than zero, because the present value of future cash flows is greater than the outlay. In the rare case of an opportunity with a zero NPV, the organization should theoretically be indifferent between making or not making the investment. A positive NPV is the net gain to the organization from making the investment—assuming that the discount rate properly adjusts for the timing of the cash flows.

Besides helping to decide whether an investment is worthwhile, the NPV can be used to choose among alternative investments. If an organization has two or more investment opportunities but can only pick one, the financially sound decision is to pick the one with the greatest NPV.

**Selecting the discount rate.** The discount rate has a strong direct effect on the NPV. To illustrate this, **Figure 3.1** shows how the NPV for the example project in Table 3.2 varies for

discount rates ranging from 0 to 20 percent. If the discount rate is high enough—in the example, just over 15 percent—the NPV turns negative and the investment flips from being financially attractive to unattractive. Obviously, the choice of a discount rate is an important matter.

**Table 3.2: Calculation of net present value**

The project laid out here is the same as in Table 3.1, with the additional assumption that the discount rate is 10 percent (0.1). The net present value (NPV) is the sum of the present values of all of the cash flows—in this case, \$4,578.

Year	Initial investment (\$)	Energy savings (\$)	Present value factor $(1/(1+r)^t)$	Present value of cash flow (\$)
0	-20,000	—	1	-20,000
1	—	4,000	0.909	3,636
2	—	4,000	0.826	3,306
3	—	4,000	0.751	3,005
4	—	4,000	0.683	2,732
5	—	4,000	0.621	2,484
6	—	4,000	0.564	2,258
7	—	4,000	0.513	2,053
8	—	4,000	0.467	1,866
9	—	4,000	0.424	1,696
10	—	4,000	0.386	1,542
<b>NPV</b>				<b>4,578</b>

Note: r = the discount rate; t = the elapsed time in years.

Courtesy: E SOURCE

**Figure 3.1: How the discount rate affects net present value**

The project in Table 3.2 is shown here with varying discount rates. With no discounting—a discount rate of zero—the net present value of a project is the simple sum of all of its cash flows, including the initial outlay as a negative cash flow. As the discount rate is increased, the NPV declines and eventually turns negative.

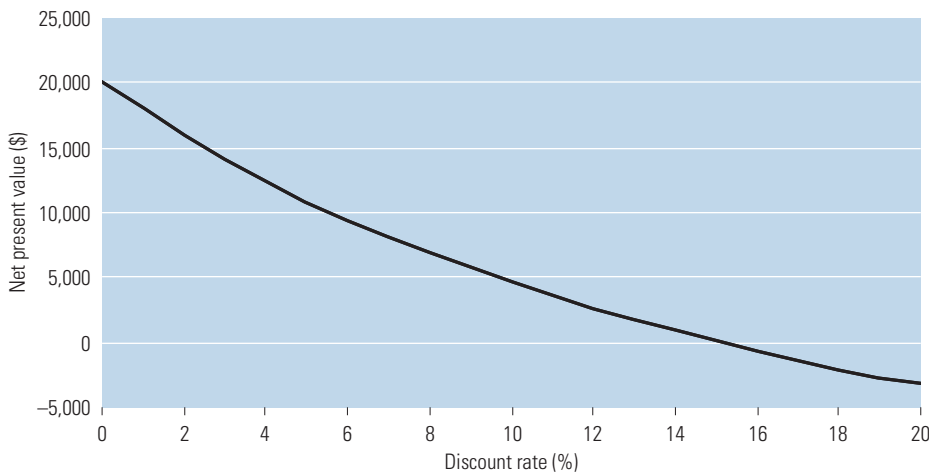

Courtesy: E SOURCE

As the starting point for the discount rate, most organizations use their *cost of capital*—the rate of return that must be earned in order to pay interest on debt (loans and/or bonds) used to finance investments and, where applicable, to attract equity (stock) investors.

Suppose an organization could obtain a loan to finance the entire cost of an energy-saving building upgrade and that the loan carried an interest rate of 8 percent. The cost of capital for this project would be 8 percent. If, using an 8 percent discount rate, the NPV were greater than zero, the project would be financially worthwhile, because the cash flows would be sufficient to pay off the loan and have some money left over.

Some organizations use discount rates slightly higher than their cost of capital in order to lend a conservative bias to investment analyses. A higher discount rate serves to make risky projects less attractive and to screen out investments that are only marginally profitable. On the other hand, a lower discount rate might be used for investments that are perceived as less risky than the organization's normal business activities. A *risk-adjusted discount rate* is one that has been tailored to the risk characteristics of the project being analyzed.

Building upgrades typically involve proven technologies and generate predictable savings. This makes them, in most cases, fairly low-risk investments. Where an organization's overall business activities are riskier than its energy-efficiency opportunities, a discount rate below the organizational cost of capital would be appropriate.

When multiple capital sources—loans, bonds, internally generated funds, and stock—and varying levels of project risk are involved, determining the cost of capital and the appropriate discount rate can get quite complicated. Rather than trying to select the discount rate yourself, you should consult financial experts within your organization to determine if there is a standard discount rate or a standard methodology for selecting the discount rate.

**Computing NPV.** With spreadsheet software, computing NPV is not difficult. Following Table 3.2, it can be done using year-by-year present value factors. Built-in NPV calculators in some spreadsheet software (including Microsoft Excel) can make the evaluation even easier.

Alternatively, NPV can be computed using certain handheld calculators. Both Hewlett-Packard and Texas Instruments make several models of financial calculators that can store a series of cash flows and compute the NPV.

## Internal Rate of Return

The *internal rate of return* (IRR) is an alternative cash-flow analysis tool closely related to NPV. IRR is a percentage figure that describes the yield or return on an investment over a multiyear period. For a given series of cash flows, the IRR is the discount rate that results in an NPV of zero.

In Figure 3.1, the IRR is the point where the curve crosses the horizontal axis: slightly above 15 percent. It would be possible—though extremely tedious—to determine the exact IRR (15.1 percent, in this case) through a trial-and-error procedure, testing different discount rates until homing in on the one at which NPV equals zero. Fortunately, this task can be automated using spreadsheet software or a financial calculator.

Once a potential project's IRR is in hand, the question becomes, is it high enough to justify the investment? The answer, unsurprisingly, is that it depends on the organization's discount rate: If the IRR is greater than the discount rate, the investment is financially worthwhile. If no formal discount rate has been established, try comparing the IRR for the project in question to the IRRs for other projects that the organization has recently funded. Or if project-specific financing will be used, compare the IRR to the interest rate on the financing.

When used as the threshold for an acceptable IRR, the discount rate is often called the *hurdle rate*. As with NPV, it may be appropriate to apply a hurdle rate greater than the cost of capital to prospective investments that are especially risky—or one below the cost of capital to investments of low risk. Energy-efficiency projects that rely on proven technologies are often in the latter category. As with the selection of a discount rate, it is important to consult with financial experts within the organization in order to determine an appropriate hurdle rate.

### 3.4 Selecting an Analysis Tool

Which financial analysis tool should you use to evaluate energy-saving building upgrades: payback period, net present value, or internal rate of return? The short answer is to use whichever tool your organization normally applies to evaluate investments. For instance, if all investment decisions in your organization are evaluated using payback period, then you should at least include the payback period in any proposal to fund a building upgrade.

Be aware, however, that relying solely on payback may result in forgoing building upgrades that will more than pay for themselves if given enough time. It is not uncommon for organizations to have informal rules that restrict discretionary investments to projects with two-year or better payback. That means a building upgrade costing \$7,500 and yielding \$2,500 in savings for 10 years would be rejected—even though the cash-flow stream provides an impressive 31.1 percent IRR.

If there is leeway to choose the evaluation tool or to present more than one result, either NPV or IRR is a better choice than payback period. Both measures are rooted in time value of money concepts and account for the benefit stream over the entire useful life of an investment. There are some circumstances, however, in which IRR analysis might yield misleading or confusing results. One such situation involves choosing between mutually exclusive investments—that is, when faced with an either/or decision. The option with the higher IRR is not necessarily the better choice, because the other option might provide greater total worth.

**Table 3.3** illustrates this situation. Suppose an organization is considering two ways to turn off unneeded lights. Option A, using occupancy sensors, costs \$42,000 and will save \$12,200 annually in energy. Option B, using a central time clock, costs less up front (\$9,000) but also saves less (\$3,550 annually). Considering only the IRRs, option B looks better: It provides a 37.9 percent return, well above the 26.2 percent return from option A. The NPVs, however, show that option A is worth over twice as much in present value terms as option B.

Another issue with IRR is that some cash-flow streams may have indeterminate IRRs, or even two or more IRRs. These anomalous results can occur when one or more negative cash flows occur following some years of positive cash flows. Because of these and other issues with IRR, NPV is generally considered the superior analysis tool. Although the circumstances in which IRR might yield misleading results are fairly uncommon, NPV will always point to the financially correct decision.

ENERGY STAR, in partnership with Building Owners and Managers Association (BOMA) International and the BOMA Foundation, developed the Building Upgrade Value Calculator, a Microsoft Excel-based tool designed specifically for analyzing the financial impact of energy-efficiency investments in commercial office buildings. It projects cash flows and computes IRR, NPV, and other investment measures commonly used in the real estate industry. The Building Upgrade Value Calculator is available as a free download from the ENERGY STAR web site ([www.energystar.gov/index.cfm?c=comm\\_real\\_estate.building\\_upgrade\\_value\\_calculator](http://www.energystar.gov/index.cfm?c=comm_real_estate.building_upgrade_value_calculator)).



**Table 3.3: Use NPV to choose between mutually exclusive investments**

Faced with a choice between two upgrades, use net present value (NPV) rather than internal rate of return (IRR) to guide the decision, because NPV measures the total value of the investment to the organization.

Year	Option A: occupancy sensors		Option B: central time clock	
	Initial investment (\$)	Energy savings (\$)	Initial investment (\$)	Energy savings (\$)
0	-42,000	—	-9,000	—
1	—	12,200	—	3,550
2	—	12,200	—	3,550
3	—	12,200	—	3,550
4	—	12,200	—	3,550
5	—	12,200	—	3,550
6	—	12,200	—	3,550
7	—	12,200	—	3,550
8	—	12,200	—	3,550
9	—	12,200	—	3,550
10	—	12,200	—	3,550
<b>IRR</b>		<b>26.2%</b>		<b>37.9%</b>
<b>NPV (10% discount rate)</b>		<b>80,000</b>		<b>26,500</b>

Courtesy: E SOURCE

### 3.5 The Investment Analysis Process

Whether IRR or NPV is the basis for making investment decisions, several principles should be followed in constructing a cash-flow analysis.

#### Choose the Right Time Frame

The analysis should cover as many years as an organization can reasonably expect to receive the benefits of the investment. That period often corresponds to the useful life of the equipment involved, but it might be shorter, depending on the certainty of plans for future use of the building. If, for example, the organization has a 10-year lease on a building in which upgrades are to be installed, it should probably limit its analysis to 10 years, even if the equipment is capable of generating savings beyond that point.

Do not shortchange a project by cutting the analysis short when a longer time frame can be justified. Consider, for example, that the cash-flow stream shown in Table 3.1, which has a 15.1 percent IRR, would have an 18.4 percent IRR if the benefits continued for another five years. If the organization’s hurdle rate were 16 percent, those additional years could be decisive.

#### Consider All of the Impacts on Cash Flow

The cash-flow examples used so far in this chapter follow a very simple pattern: A single investment is followed by several years of steady cash flows from energy savings. In the real world, building upgrades are not always so simple, and there are additional impacts on cash flow that must be taken into account.

Suppose, for example, that an organization is considering replacing conventional light fixtures that use incandescent bulbs with hard-wired compact fluorescent lamp (CFL) fixtures throughout a building. There will be an initial outlay for the fixtures and the CFLs themselves, followed by multiple years of energy savings, because the wattage used for lighting will be cut by roughly two-thirds. But there will be additional impacts on cash flow. If the analysis applies a 10-year time frame (because the new fixtures will last at least that long), it will also need to take into account:

- *The avoided cost of incandescent bulbs.* Because such bulbs normally last only about 1,000 hours, over a 10-year period quite a few replacement bulbs would have been purchased. Money not spent on these bulbs should be recognized as a positive cash flow.
- *The cost of replacement CFLs.* CFLs typically last 8,000 to 10,000 hours, so several replacement lamps might be needed over 10 years (depending, of course, on the hours the lights are in operation). The cost of those replacements would be a negative cash flow.
- *Labor savings from fewer changes.* Although either type of bulb needs periodic replacement, the CFLs would be changed much less often. If an organization pays \$20 per hour for maintenance tasks and a worker can change, on average, 12 bulbs per hour, then the average change-out is costing \$1.67 per bulb. The difference between the costs of two change-out schedules—that is, the value of the changes avoided each year by the switch to CFL—should be counted as a positive cash flow attributable to the upgrade.

The additional components of the cash-flow analysis are merely illustrative. For any measures added or removed through the upgrade, you need to think through all the ways in which expenditures could be increased or reduced and then quantify and include those cash flows in the analysis. For example, if the performance of an energy-saving upgrade is expected to degrade over time, the value of the savings should be reduced accordingly.

### Account for Interactions Among Measures

As explained in Chapter 1, this manual recommends looking at the building as a whole and pursuing upgrades in a way that considers interactions among measures. Interactions can have a material effect on energy savings and consequently on the projected cash flows for a package of measures.

Take, for example, a lighting retrofit. More-efficient lighting produces less heat, thereby lowering the building's HVAC load. If that factor is ignored, the actual savings will not match the estimate: If cooling is the dominant HVAC load, the actual savings will be higher; if heating is the dominant HVAC load, the actual savings will be lower.

Interactions can also have important consequences for equipment selection. The reduction in cooling load resulting from an energy-efficient lighting system, for example, may be sufficient to justify a reduction in the size of the ducts, pipes, pumps, chillers, and cooling towers that serve that load. "Rightsizing" equipment in this way can produce additional savings, because smaller equipment is generally less expensive. The stages presented in the ENERGY STAR Building Upgrade Manual are designed to maximize savings by accounting for interactions among building systems. Each stage identifies changes that will affect the upgrades performed in subsequent stages, in an overall process that will yield the greatest energy and cost savings.

When considering multiple measures, building simulation software is the recommended approach. Simulation modeling will produce more-accurate estimates of the combined savings of a package of measures than merely summing up individual measure-by-measure analyses, and it can facilitate optimal sizing of the components of the package.

## Include Anticipated Price Changes

Even if the physical energy savings attributable to an upgrade are expected to remain constant over the period of analysis, the value of those savings may vary due to changing energy prices. Rising energy prices will, of course, increase the cash flow from energy-efficiency investments. If an organization has access to price forecasts that are specific to its energy suppliers, it makes sense to factor those price changes into the analysis. Long-run national and regional price trends are forecast by the Department of Energy in its *Annual Energy Outlook* and are available online from the Energy Information Administration ([www.eia.doe.gov](http://www.eia.doe.gov)). Price forecasts can also be purchased from a variety of business-information and specialty consulting firms.

## Adjust for Taxes

Organizations that are required to pay corporate income taxes should analyze investment opportunities on an after-tax basis. Including the effects of taxes, unfortunately, requires several adjustments to cash-flow analyses.

First, the savings in energy expenses resulting from building upgrades count as taxable income. Paying taxes on that income reduces the net cash benefit to the business. When the effects of federal and state taxes are combined, many businesses' income tax rates are in the range of 30 to 40 percent or higher. This means, for example, that \$100 in energy savings might be worth only \$60 to the company after taxes have been paid. In general, pretax cash flows resulting from changes in operating and maintenance expenses (including energy expenses) must be reduced by an amount equal to the tax rate times the pretax cash flow.

Second, many building upgrades are subject to depreciation for tax purposes. In calculating income taxes, businesses are allowed to deduct depreciation charges for eligible investments from their taxable income. Those depreciation charges are governed by a complex set of rules and schedules that allocate the deductions over a period ranging from 3 to 39 years, depending upon the nature of the equipment or building.

Depreciation is not a cash expense—no money changes hands when an investment is depreciated—but it reduces the amount of taxes due and therefore increases cash flow. Specifically, the tax-related cash benefit from depreciation in any year (sometimes called the *depreciation tax shield*) is equal to the depreciation deduction times the tax rate.

Third, income taxes affect the cost of some types of capital and thus affect the discount rate. Interest paid on debt, including loans or bonds, is deductible from a firm's taxable income; as a result, the true cost to the firm, after taxes, is less than the stated interest rate. For example, a loan at a 10 percent interest rate has an after-tax cost of only 6 percent if the firm pays income tax at a 40 percent rate.

Fourth, tax deductions or credits may be available for certain types of energy-efficiency investments. A useful resource for investigating tax benefits is the Database of State Incentives for Renewables & Efficiency ([www.dsireusa.org](http://www.dsireusa.org)), which despite its name covers incentives at both the state and federal levels. It is beyond the scope of this manual to provide details on all of the tax implications of building upgrade investments. Organizations subject to corporate income taxes should consult a tax specialist for assistance in capturing all of the tax-related effects in the cash-flow analysis of investment opportunities.

## Consider Sensitivity Analysis

Consider conducting *sensitivity analysis* around critical assumptions, especially ones that are highly uncertain. Suppose, for example, that you are considering an investment in an

energy-saving measure that the manufacturer projects to have a useful life of 20,000 operating hours. If you do not have a high level of confidence in that projection, you might explore whether the investment would still be worthwhile if the useful life were only 10,000 hours. This type of analysis can shed light on the riskiness of the investment. It can also help pinpoint assumptions that merit further research before committing to an investment.

### 3.6 Other Considerations

Although this chapter strongly advocates analyzing building upgrades based on their cash flows, other considerations may be brought into the picture and might help sway decision-makers who are on the fence about building upgrades.

#### Qualitative Assessments

Frequently, the benefits of building upgrades extend beyond energy savings to other areas such as improvements in employee comfort and productivity or corporate image. If these benefits can be projected and expressed in monetary values, it is best to factor them into the cash flows. Often, however, they are difficult to quantify. In such cases it is advisable to describe the benefits in words and include that information as a supplement to the financial analysis.

Similarly, it may be worthwhile to present qualitative information on the relative investment risk of the proposed building upgrades. Most energy equipment is dependable; the savings can be predicted accurately through careful engineering analysis and the value of savings will remain constant or increase, except in the unlikely event of a downturn in energy prices. This is not to say that building upgrades are totally risk-free: A decision to close down a facility prematurely may zero out several years of expected benefits. But in contrast to other investment opportunities that often hinge on highly unpredictable market forces, building upgrades generally carry low risk. Applying a lower discount rate is one way to adjust for risk; qualitatively highlighting the investment's low-risk profile may be used instead of, or in addition to, a risk-adjusted discount rate.

#### Effect of Energy Performance on Shareholder Value

A large-scale organizational commitment to building upgrades for energy performance can have a favorable impact on profits, earnings per share, and—ultimately—shareholder value. The U.S. Environmental Protection Agency (EPA) has developed a spreadsheet tool, the Financial Value Calculator, which uses a company's price-to-earnings ratio to project the market value of increased earnings from energy efficiency. The output from the Financial Value Calculator can be presented to senior management as further support for a proposed building upgrade strategy. The calculator is available as a free download from the ENERGY STAR web site ([http://www.energystar.gov/index.cfm?c=tools\\_resources.bus\\_energy\\_management\\_tools\\_resources](http://www.energystar.gov/index.cfm?c=tools_resources.bus_energy_management_tools_resources), under Financial Evaluation).

### 3.7 Summary

To compete for investment capital, building upgrade projects should be evaluated using standard financial analysis tools that evaluate cash flow. Although reliance on payback period is widespread, other tools such as NPV and IRR are better choices, because they take into account the time value of money and the full stream of benefits over the life of the project.

Constructing a valid building upgrade investment analysis requires careful attention to several steps:

- Choosing an appropriate time frame
- Identifying and quantifying all of the contributing elements to cash flow, both positive and negative
- Considering interactions among measures
- Accounting for future energy price changes
- Adjusting for taxes, where applicable
- Examining the sensitivity of results to changes in key assumptions

The EPA's ENERGY STAR program provides several downloadable spreadsheet tools that can assist in analyzing upgrade opportunities and demonstrating their value to the organization.

## Bibliography

A.A. Groppelli and Ehsan Nikbakht, *Finance*, 5th ed. (Barrons, 2006).

John Leslie Livingstone and Theodore Gross, *The Portable MBA in Finance and Accounting*, 3rd ed. (Wiley, 2001).



LEARN MORE AT  
[energystar.gov](http://energystar.gov)

ENERGY STAR® is a U.S. Environmental Protection Agency program helping businesses and individuals fight global warming through superior energy efficiency.

## Chapter 4 Financing





# 4. Financing

Revised July 2007

<b>4.1</b>	<b>Overview</b>	<b>2</b>
<b>4.2</b>	<b>Purchasing Equipment and Services</b>	<b>3</b>
	Cash	3
	Loans	3
	Bonds	4
<b>4.3</b>	<b>Leasing</b>	<b>4</b>
	Operating Leases	4
	Capital Leases	4
	Municipal Leases	5
<b>4.4</b>	<b>Performance Contracting</b>	<b>6</b>
<b>4.5</b>	<b>Unconventional Opportunities</b>	<b>8</b>
<b>4.6</b>	<b>Summary</b>	<b>8</b>
	<b>Bibliography</b>	<b>9</b>
	<b>Glossary</b>	<b>G-1</b>

## 4.1 Overview

Chapter 3 described how to evaluate projects to determine which are sufficiently profitable to move forward. This chapter looks at the various ways to pay for those projects. Energy-efficiency projects reduce or eliminate expenses that would otherwise be incurred, typically by using proven technologies and time-tested methods. This often makes them relatively low-risk investments that are easier to finance than other projects that carry greater risk.

Today there are many opportunities for financing efficiency projects, and new opportunities are being created regularly. In addition to traditional sources of funding—financial institutions and capital markets—many utilities, governments, and nonprofit organizations offer financial support through grants, rebates, and loans. Well-designed efficiency projects are almost always fundable. With some dedicated research, a diligent organization may find special deals that save a significant amount of money.

This chapter gives an overview of financing methods and suggests criteria for selecting the best method for a given organization and project. Financing categories include purchasing, leasing, performance contracting, and unconventional opportunities, and each affords choices appropriate for private-sector projects, public-sector projects, or both (**Table 4.1**). Although the right financing option depends on many factors—such as debt capacity, in-house expertise, and risk tolerance—there are viable options for virtually any type of organization to implement a well-designed project.

**Table 4.1: Financing options**

There are a number of financing options for a building upgrade, whether the project is pursued by a public or private organization.

	Public	Private
<b>Purchasing</b>		
Cash	X	X
Loans		X
Bonds	X	X <sup>a</sup>
<b>Leasing</b>		
Operating lease	X	X
Municipal lease	X	
Capital lease		X
<b>Performance contracting</b>		
Guaranteed savings	X	X
Shared savings	X	X
Paid-from savings	X	X
<b>Other</b>		
Utility incentives	X	X
State incentives	X	X
Foundations and nonprofits	X	X

Note: a. In rare situations.

Courtesy: E SOURCE; adapted from EPA



As a first step, consider spending some time with the ENERGY STAR Cash Flow Opportunity Calculator available at [www.energystar.gov/index.cfm?c=business.bus\\_financing](http://www.energystar.gov/index.cfm?c=business.bus_financing). This financial spreadsheet helps organizations answer three critical questions about energy-efficiency investments:

- How much new energy-efficiency equipment can be purchased from the anticipated savings?
- Should this equipment purchase be financed now, or is it better to wait and use cash from a future budget?
- Is money being lost by waiting for a lower interest rate?

Understanding these basic considerations will help provide context when choosing a financing strategy.

## 4.2 Purchasing Equipment and Services

One way to finance an efficiency project is to buy the equipment and services. Organizations can use cash, a loan from a financial institution, or the proceeds of a bond issuance to make the purchases. In this scenario the organization receives title to any purchased equipment and will add fixed assets and debt to its balance sheet (cash purchases will not add debt, but will reduce cash). Equipment depreciation and any other costs capitalized into the project are tax deductible, as is interest expense (if borrowing to purchase). There may also be other incentives that accrue to the owner, such as tax credits and rebates from utilities.

### Cash

A cash purchase is the simplest method for financing efficiency projects. Cash makes sense for organizations with cash reserves and a strong balance sheet. The disadvantages are reduced liquidity and a potential for lost investment opportunities that require cash.

Generally cash is most appropriate for relatively inexpensive, simple efficiency measures that are likely to pay for themselves quickly. Large and complex projects are best funded with debt or off-balance-sheet financing, as discussed below.

### Loans

Banks often make loans for equipment purchases. This can be an ideal way for an organization to avoid expending cash on the “hard costs” of the project. However, it is more difficult to borrow money to fund the “soft costs”—such as consultants or the time people spend on the project—because there are no tangible assets to secure that portion of the loan. But with strong credit it may be possible to find lenders who will cover some or all of a project’s soft costs.

Equipment loans normally require a down payment of 20 to 25 percent and are secured by a lien on the items purchased. Lenders will also look at the organization’s financial strength—credit history, cash flow, and current debt—to determine if additional security is required, such as liens on other assets or a personal guarantee. A borrower’s ability to negotiate favorable terms (down payment, soft costs, interest rate, payment structure) depends largely on the lender’s perception of the risk.

A credit-worthy organization funding a solid efficiency project should be able to negotiate a loan in which the payments are less than the cash savings from the project. This allows the organization to bear all the risk of the project as well as receive all the benefits.

## Bonds

Bonds are debt instruments sold by public- and private-sector organizations to borrow money from capital markets. They are complex agreements that often require attorneys, accountants, and investment bankers—and therefore have high transaction costs. Issuing municipal bonds requires approval by legislative bodies and voter referenda, so these are only issued to raise large amounts of money, generally in the millions of dollars.

Although it is rare for private-sector organizations to finance efficiency projects with bonds, it is common in the public sector. Some state energy programs raise money with bonds to create pools of money for funding smaller projects sponsored by local governments and school districts. Public-sector organizations should check with their state government to see if their projects are eligible for such a program.

### 4.3 Leasing

An alternative to purchasing is leasing. A lease is essentially a loan in which the lessor (the lender) retains legal title to the property being leased. A lease in which the clear intent is to return the equipment to the lessor at the end of the lease term is called an *operating lease*. Some leases are structured so that the lessee receives most or all of the economic value of the equipment—such a lease is essentially a purchase and is called a *capital lease*. The financial accounting and tax rules for operating and capital leases differ significantly and can play an important role in the financing decision.

Compared to most other forms of financing, leases are quick and easy to set up and administer. Equipment manufacturers or their affiliates will often set up the lease and arrange for equipment purchase and delivery. It is often possible to obtain a line of credit under a master lease to cover the entire project; each equipment purchase for the project would create a new schedule under the master lease, with interest starting to accrue at the time of purchase.

#### Operating Leases

Under an operating lease, the lessor owns the equipment and rents it to the lessee for a fixed monthly fee. At the end of the lease term the lessee may be able to purchase the equipment (usually for fair market value), extend the lease, negotiate a new lease, or return the equipment.

Operating leases are simple, funded out of operating budgets, and may be ideal for shorter-term projects or projects where owning the equipment is not desirable. Payments are usually lower than for capital leases and are 100 percent tax deductible (with a capital lease only the interest portion of the payment is deductible).

#### Capital Leases

Capital leases are essentially installment purchases of equipment, although legal title to the equipment remains with the lessor during the lease term. Title will often pass automatically to the lessee at the end of the lease term, or for a small charge (often \$1). Little or no initial capital outlay is required. Because the economics of a capital lease are so similar to those of a purchase, both financial accounting and tax rules treat these transactions as purchases. Therefore, leased assets are depreciated, and this depreciation is a tax deduction along with the interest portion of the lease payments. Fixed assets and debt are added to the balance sheet.

The Financial Accounting Standards Board, the designated private-sector organization in the U.S. that establishes financial accounting and reporting standards, created rules for lease

classification in its Statement No. 13. A lease meeting any one of the following criteria must be treated as a capital lease:

- Ownership of the property is transferred at the end of the lease term.
- The lease includes a bargain purchase option (usually \$1).
- The lease term covers 75 percent or more of the economic life of the property.
- The present value of the future lease payments equals or exceeds 90 percent of the fair market value of the property at the beginning of the lease.

Capital leases can offer advantages over bank loans. Because leasing companies are not subject to the regulations that govern banks, they have much more flexibility in setting their terms. Capital leases typically require little or no down payment, have significantly less paperwork, and are approved faster. Capital leases may also finance soft costs. Credit-worthy organizations may obtain capital leases for as much as 140 percent of the value of the equipment purchased (hard costs). In such a case, a project requiring \$500,000 in equipment may also fund another \$200,000 of installation and other soft costs.

## Municipal Leases

A tax-exempt municipal lease purchase agreement is simply a conditional sales or installment sales agreement. It is the market alternative to a cash purchase or tax-exempt municipal bond issue. The interest portion of the lease payment (income to the lessor) is exempt from federal taxation, allowing rates to be set lower than for bonds that generate taxable interest income and therefore providing the lessee (the municipality) with significant cost savings.

A distinct advantage of municipal leases is that the lessee's payment obligation usually terminates if the lessee fails to appropriate funds to make lease payments. This allows the lease to be kept off the balance sheet. Of course, because these assets are saving money it would not make sense for the municipality to fail to appropriate these funds, so the risk to the lessor is minimal.

During the term of a municipal lease, the municipality holds title to the leased equipment while the lessor retains a security interest. With each payment the municipality establishes an equity interest in the equipment. At the end of the original lease term, the security interest is removed and the municipality has clear title to the equipment.

Municipal leases offer a number of advantages that lenders often highlight:

- *Fast, simple approval process.* Compared to issuing a bond referendum, a municipal lease purchase is fast and flexible—the time required to close financing is typically weeks instead of months.
- *Reduced transaction costs.* Most costs associated with bond financing are eliminated. With a municipal lease, the municipality borrows only the cost of the assets. With bond financing, the municipality borrows both the cost of the assets and the fees associated with issuing the bonds.
- *Lower interest rates.* The interest income on a municipal lease is tax exempt to the lessor. The municipality benefits when the lessor passes these savings to the municipality in the form of a lower interest rate.
- *Full financing.* All of the project costs can be financed with a municipal lease. No down payments are required and vendors are paid promptly upon funding the lease. Funding

into an escrow account for projects requiring progress payments ensures that the municipality can take advantage of the deepest discounts afforded by the vendor.

- *Practical terms.* The lease term matches the useful life of the asset.
- *No large capital outlay.* Current taxpayers pay for project costs as they are incurred. This process also helps local governments and school districts manage their capital reserve fund balances.
- *Ultimate ownership.* Each lease payment builds equity in the future unencumbered ownership of the asset. At the end of the original lease term there are no residual values, balloon payments, or purchase options to consider. Municipal leases do not involve return provisions, run-on rent, stipulated loss values, and asset management, thus avoiding hidden liability issues.

## 4.4 Performance Contracting

A performance contract is an agreement with a private energy service company (ESCO) to manage a group of efficiency projects from beginning to end. The savings that the projects generate are used to cover the entire cost of the projects, and any surplus savings are allocated between the contracting organization and the ESCO as stipulated in the contract. **Figure 4.1** illustrates this distribution of dollar savings. Performance contracts are especially well suited for financing large and complex projects.

An ESCO is a business that develops, installs, and finances projects designed to improve the energy efficiency of buildings. The ESCO becomes a business partner for the life of the project, acting as the general contractor responsible for all aspects of the project and assuming the associated technical and performance risks.

**Figure 4.1: Performance contract economics**

In a performance contract, the dollar savings generated by the project is allocated between the organization and the contractor.

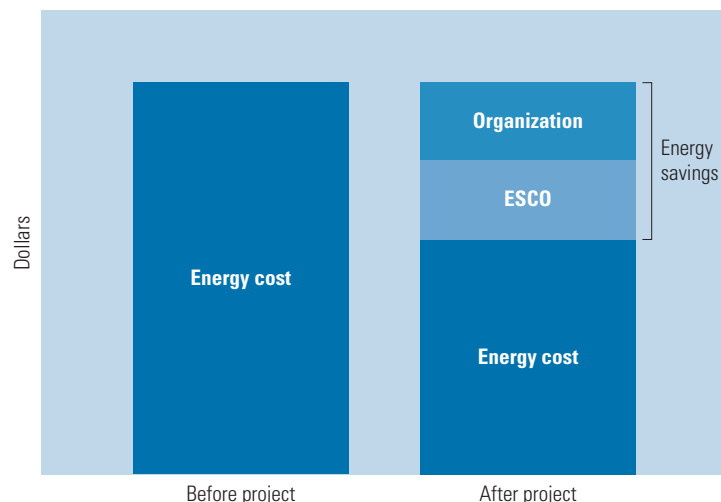

Source: EPA

The ESCO typically conducts an energy audit, designs the project, obtains bids from subcontractors, manages the construction, guarantees energy savings, obtains financing, and may even operate and maintain the energy-saving equipment. The ESCO bills the contracting organization for a share of the energy-cost savings such that the savings pay for the project and all of the ESCO's services.

There must be a large savings potential before an ESCO and financier will make a commitment to an energy-efficiency project, so performance contracts are generally arranged for facilities with annual energy costs above \$150,000. ESCOs often show little interest in projects costing less than \$1 million, although some ESCOs welcome smaller projects depending on the specifics.

There are substantial advantages to performance contracting. Because the ESCO takes responsibility for funding, there are no up-front costs and no debt is added to the balance sheet. ESCOs have great depth of expertise and experience that enables them to design and implement high-quality projects relatively quickly and guarantee savings from the projects. This minimizes the burden on the contracting organization.

The main disadvantage of performance contracting is that a significant portion of the dollar savings generated by the efficiency project goes to the ESCO. But given the benefits, this may be a reasonable cost.

Performance contracts can be complex and take a long time to negotiate. These contracts usually:

- Specify detailed work for individual facilities.
- Involve large sums of capital.
- Cover a wide range of contingencies.
- Require significant expertise in law, engineering, and finance.

How the cost savings get distributed is an important part of negotiating a performance contract. The savings always go first to servicing the debt incurred in financing the project. Additional savings then get distributed according to contract stipulations. Three common distribution methods in performance contracting include:

- *Guaranteed savings.* The contracting organization receives a guaranteed amount and the ESCO gets the rest.
- *Shared savings.* The contracting organization and the ESCO split the savings according to a percentage, such as 60/40.
- *Paid-from savings.* The ESCO receives a guaranteed amount and the contracting organization gets the rest.

In shared-savings contracts, it is critical to determine the value of the energy saved, and this can be a significant challenge. This issue—called measurement and verification (M&V)—is the subject of much attention in the energy-efficiency world.

The M&V associated with some project components can be simple, such as determining the savings from installing energy-efficient light bulbs. But other calculations can be very complex: Did the natural gas bill go down because of the new insulation, or because of the warm winter? Shared-savings performance contracts include a detailed description of M&V calculation

methods and it is crucial that contracting organizations understand and agree with these methods. M&V determines the amount of money paid to the ESCO over the life of the project, and the amount of savings realized by the contracting organization.

When planning to execute a performance contract, consider implementing simple upgrades, behavioral changes, and operational improvements to save energy prior to setting the baseline energy demand that will be used to measure dollar savings under a performance contract. This way all the savings from these easier changes will accrue to the contracting organization rather than being shared with the ESCO.

Find more information on performance contracting and ESCOs at:

- Federal Energy Management Program, [www1.eere.energy.gov/femp](http://www1.eere.energy.gov/femp)
- Energy Services Coalition, [www.energyservicescoalition.org](http://www.energyservicescoalition.org)
- National Association of Energy Service Companies, [www.naesco.org](http://www.naesco.org)

## 4.5 Unconventional Opportunities

When searching for project capital, begin by bargain hunting for special programs that support energy performance. Every organization planning an energy performance upgrade should investigate utility incentives, state assistance, and other funding opportunities. A good place to start is the Database of State Incentives for Renewables & Efficiency, at [www.dsireusa.org](http://www.dsireusa.org).

**Utility incentives.** Utilities often provide financial incentives for energy-performance upgrades through grants, rebates, fuel-switching incentives, low-interest loans, and energy audits. Check with the local utility to learn what programs are available.

**State assistance.** Many states offer financial assistance to local governments, nonprofit organizations, small businesses, and other targeted organizations for energy-efficiency upgrades. Contact the state agency that manages energy programs to see what is available and to determine who is eligible.

**Foundations and nonprofit organizations.** Many foundations and nonprofit organizations sponsor programs that fund energy-efficiency projects. Examples include the Northeast Energy Efficiency Partnerships and the Illinois Clean Energy Community Foundation.

## 4.6 Summary

Whether an efficiency project involves small improvements or a complete system upgrade, there is a suitable financing option available. A simple cash purchase yields immediate benefits to the customer and is a straightforward transaction well suited for small or low-risk projects. Performance contracting, the most complex type of arrangement, offers the customer the benefit of turnkey implementation and risk protection. It is also the most costly financing option because the ESCO does all the work and accepts all the risk. However, even this more expensive alternative yields a positive cash flow for the customer.

**Table 4.2** lays out ten evaluation factors across the seven financing tools discussed in this chapter. These factors must be balanced against the characteristics of the organization and the specifics of the project to find the best financing method. The financing decision will hinge

on the organization's financial and operational flexibility, its tolerance for risk, and any savings requirements. Well-designed efficiency projects will almost always qualify for one or more of these financing tools and generate a positive return.

**Table 4.2: Comparing financing options**

The importance of these factors will vary depending upon the unique circumstances of the organization and the efficiency projects being considered.

Evaluation factor	Purchase			Lease			Performance contract
	Cash	Loan	Bond	Operating	Capital	Municipal	
Down payment (%)	100	20 to 25	0	0	0	0	0
Transaction cost <sup>a</sup>	—	Medium	High	—	Low	Low	Medium
Balance sheet	Asset	Asset and liability	Asset and liability	—	Asset and liability	—	—
Tax deductions	Depreciation	Depreciation and interest	Depreciation	Lease payments	Depreciation	—	—
Interest rate	—	Medium	Low	—	High	Low	—
Financing term	—	3 years	10 to 20 years	—	3 to 5 years	Project life	Project life
Approval process	Internal	Bank	Referendum	Internal	Lessor	Lessor	Internal
Approval time	Short	Medium	Very long	Short	Short	Short	Long
Flexibility	Usually small projects	Limited to equipment value	Large projects only	Usually small projects	Equipment cost + 20 to 40 percent	100 percent of project cost	100 percent of project cost
Capital or operating budget	Either	Capital	Capital	Operating	Capital	Operating	Operating

Notes: a. Transaction costs include professional services and staff time devoted to the transaction.

Courtesy: E SOURCE; adapted from EPA

## Bibliography

M&T Bank Corp., “Tax Exempt Municipal Lease Financing” (2006), [www.mandtbank.com/government](http://www.mandtbank.com/government).



LEARN MORE AT  
[energystar.gov](http://energystar.gov)

ENERGY STAR® is a U.S. Environmental Protection Agency program helping businesses and individuals fight global warming through superior energy efficiency.

## Chapter 5 Retrocommissioning







# 5. Retrocommissioning

Revised October 2007

<b>5.1</b>	<b>Overview</b>	<b>2</b>
	Energy and Non-energy Benefits	3
<b>5.2</b>	<b>Project Planning</b>	<b>5</b>
	Selecting a Project	5
	Benchmarking	5
	Selecting a Provider and Team	6
	Developing a Scope of Work	7
<b>5.3</b>	<b>Project Execution</b>	<b>7</b>
	Implementing the Recommendations	8
	Maintaining the Benefits	9
	Planning for Recommissioning	10
<b>5.4</b>	<b>Tune-up Opportunities</b>	<b>11</b>
	Lighting	11
	Supplemental Loads	12
	Distribution Systems	13
	Heating and Cooling Systems	14
<b>5.5</b>	<b>Summary</b>	<b>16</b>
	<b>Bibliography</b>	<b>17</b>
	<b>Glossary</b>	<b>G-1</b>

## 5.1 Overview

Retrocommissioning is the first stage in the building upgrade process. The staged approach accounts for the interactions among all the energy flows in a building (**Figure 5.1**) and produces a systematic method for planning upgrades that increases energy savings. When the staged approach is adopted and performed sequentially, each stage includes changes that will affect the upgrades performed in subsequent stages, thus setting up the overall process for the greatest possible energy and cost savings. In this staged approach, retrocommissioning comes first because it provides an understanding of how closely the building comes to operating as intended. It also helps to identify improper equipment performance, what equipment or systems need to be replaced, opportunities for saving energy and money, and strategies for improving performance of the various building systems.

Specifically, retrocommissioning is a form of commissioning. Commissioning is the process of ensuring that systems are designed, installed, functionally tested, and capable of being operated and maintained according to the owner's operational needs. *Retrocommissioning* is the same systematic process applied to existing buildings that have never been commissioned to ensure that their systems can be operated and maintained according to the owner's needs. For buildings that have already been commissioned or retrocommissioned, it is recommended that the practices of recommissioning or ongoing commissioning be applied.

*Recommissioning* (see Section 5.3) is the term for applying the commissioning process to a building that has been commissioned previously (either during construction or as an existing building); it is normally done every three to five years to maintain top levels of building performance and/or after other stages of the upgrade process to identify new opportunities for improvement.

In *ongoing commissioning*, monitoring equipment is left in place to allow for ongoing diagnostics. Ongoing commissioning is effective when building staff have the time and budget

**Figure 5.1: The staged approach to building upgrades**

The staged approach to building upgrades accounts for the interactions among all the energy flows in a building. Each stage includes changes that will affect the upgrades performed in subsequent stages, thus setting up the overall process for the greatest possible energy and cost savings. Retrocommissioning begins the process because it provides an understanding of how a facility is currently operating and helps to identify specific opportunities for improvement.

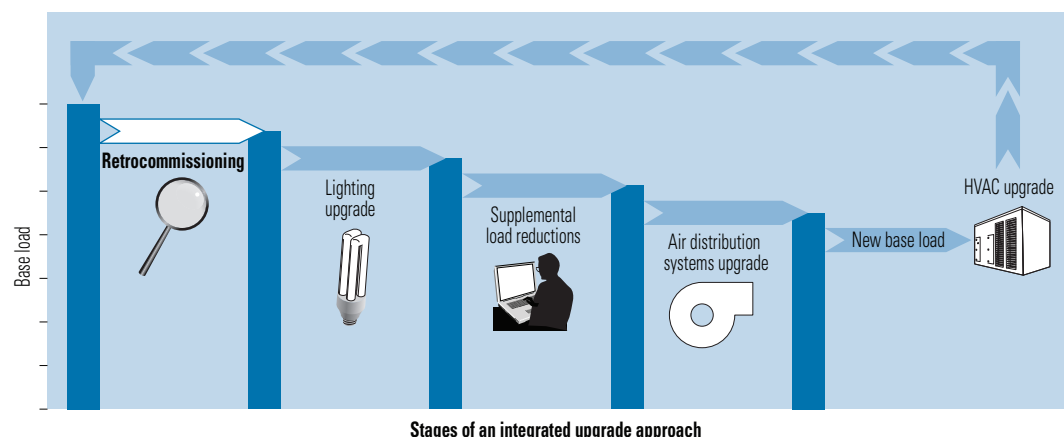

Courtesy: E SOURCE

not only to gather and analyze the data but also to implement the solutions that come out of the analysis.

Building owners, managers, staff, and tenants all stand to gain from the retrocommissioning process. It can lower building operating costs by reducing demand, energy consumption, and time spent by management or staff responding to complaints. It can also increase equipment life and improve tenant satisfaction by increasing the comfort and safety of occupants.

### Energy and Non-energy Benefits

Researchers at three of the foremost building-commissioning think tanks in the U.S.—Lawrence Berkeley National Laboratory (LBNL), Portland Energy Conservation Inc., and the Energy Systems Laboratory at Texas A&M University—concluded in a study published in December 2004 that retrocommissioning is one of the most cost-effective means of improving energy efficiency in commercial buildings. The researchers statistically analyzed more than 224 new and existing buildings that had been commissioned, totaling over 30 million square feet (ft<sup>2</sup>) of commissioned floorspace (73 percent existing buildings and 27 percent new construction). The results revealed the most common problem areas and showed that both energy and non-energy benefits were achieved (**Figure 5.2**). Analysis of commissioning projects for existing buildings showed a median commissioning cost of US\$0.27 per ft<sup>2</sup>, energy savings of 15 percent, and a simple payback period of 0.7 years. The most cost-effective commissioning projects are typically in energy-intensive buildings such as hospitals and laboratories, whereas the least cost-effective projects are in buildings that are small in comparison with the size of the average commercial building.

**Figure 5.2: Retrocommissioning results**

Building energy system deficiencies: A recent study of retrocommissioning revealed a wide variety of problems—those related to the overall HVAC system were the most common type (A). Energy and non-energy benefits: Retrocommissioning provided both energy and non-energy benefits—the most common of these, noted in one-third of the buildings surveyed, was the extension of equipment life (B).

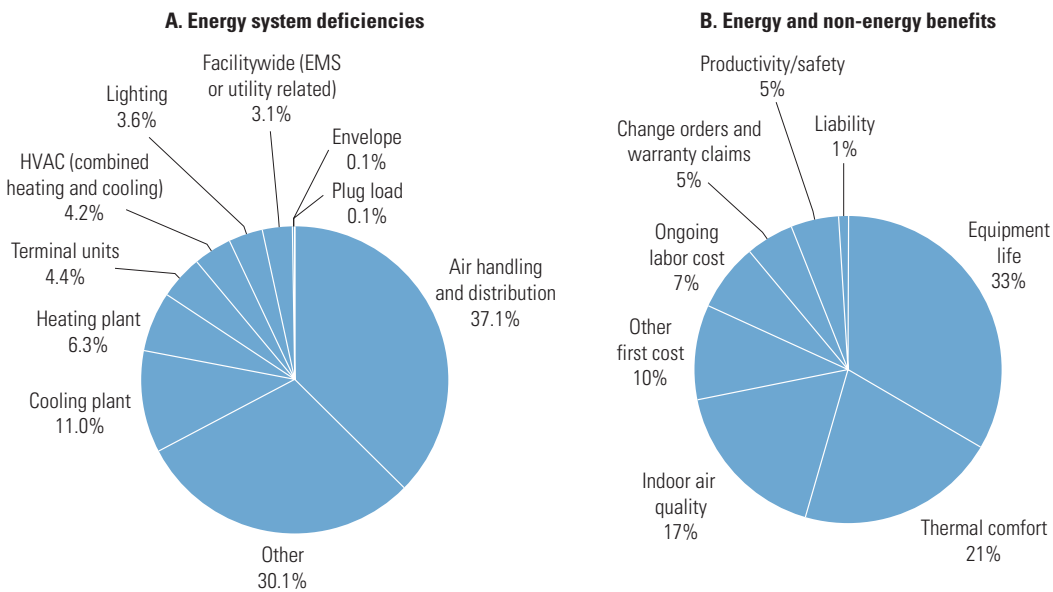

Note: EMS = energy management system.

Courtesy: E SOURCE; data from Lawrence Berkeley National Laboratory, Portland Energy Conservation Inc., and Energy Systems Laboratory, Texas A&M University

Target Stores underwent a retrocommissioning project that realized both energy and non-energy benefits. The project was conducted in several SuperTarget® stores where the company identified adjustments to its refrigeration systems, leading to \$5,000 to \$10,000 in annual energy savings. In addition, according to a study titled “Owner’s Strategies for in-House Commissioning,” presented at the 2005 National Conference on Building Commissioning, Target funded this effort not only as an energy savings measure but also as a risk-minimization strategy. Optimization of refrigeration equipment reduces risks associated with food quality, which is sensitive to temperature and storage conditions.

Dozens of companies have retrocommissioned their buildings to start their building energy-efficiency upgrade efforts as part of their efforts to earn the ENERGY STAR® Building label (see sidebar). To see descriptions of buildings that have taken this step as part of an ongoing building upgrade process, visit [www.energystar.gov/index.cfm?fuseaction=labeled\\_buildings.showUpgradeSearch&building\\_type\\_id=ALL&s\\_code=ALL&profiles=0&also\\_search\\_id=UPGRADE](http://www.energystar.gov/index.cfm?fuseaction=labeled_buildings.showUpgradeSearch&building_type_id=ALL&s_code=ALL&profiles=0&also_search_id=UPGRADE), click on Stage 1, and submit.

The retrocommissioning process described in Sections 5.2 and 5.3 of this chapter follows the recommendations of the “Advanced Retrocommissioning Workbook: A Guide for Building Owners,” developed by Portland Energy Conservation Inc. with funding from the U.S. Environmental Protection Agency ENERGY STAR Program. A number of tune-up opportunities may be discovered through this process, as discussed in Section 5.4.

---

---

### CASE STUDY: The Hatfield Courthouse

Most of the retrocommissioning steps recommended here were carried out when the U.S. General Services Administration (GSA) initiated a full retrocommissioning study of the Hatfield Courthouse, a U.S. federal courthouse located in Portland, Oregon. Built in 1997, the Hatfield Courthouse features 21 floors and a gross square footage of 589,000. The GSA’s retrocommissioning goals, as reported by Portland Energy Conservation Inc., were to:

- Improve occupant comfort
- Identify operations and maintenance and energy-efficiency improvements
- Train the building operators on how to help improvements persist
- Review and enhance building documentation

Investigation involved reviewing the building’s documentation and utility bills, inspecting building equipment, interviewing building operators, testing selected equipment and systems, and extensive trending of the HVAC control system. The investigation process identified 29 findings that addressed GSA’s retrocommissioning goals.

The implementation process involved coordinating efforts among the commissioning provider, facility staff, and building services contractors. The retrocommissioning process resulted in a 10 percent reduction in energy use and significant improvements in building comfort and system operations. Retrocommissioning also increased the building’s ENERGY STAR rating from 65 to 75, allowing the building to receive an ENERGY STAR label.

Overall, the project cut annual utility costs by about 10 percent, or \$56,000. The project cost (including investigation and implementation, and project oversight costs) was \$180,554. Incentives and tax credits brought that number down to \$154,772, or about \$0.29 per square foot.

---

---

## 5.2 Project Planning

Initial planning activities are critical to the success of any retrocommissioning project because they set the objectives and lay the foundation for the effort. The planning phase begins with the selection of a project, based in part on the generation of an initial benchmark score using the ENERGY STAR national energy performance rating system; selecting and hiring a retrocommissioning service provider and assembling the team that will see the project through to completion; and developing a scope of work.

### Selecting a Project

Retrocommissioning is appropriate for most buildings, but there are indicators that can help determine the buildings for which it will be most cost-effective. Owners and property management firms that have building portfolios can look across their holdings to find those properties that should be prioritized for retrocommissioning. Factors to consider are the age and condition of a building and its equipment, existing comfort problems, utility costs, opportunities to share costs with tenants, and the availability of utility and state incentive programs.

The top candidates for retrocommissioning are those buildings with:

- A low ENERGY STAR performance rating or a high energy use index (Btu per ft<sup>2</sup>, Btu per patient, and so forth) that cannot be explained, or unexplained increases in energy consumption
- Persistent failure of building equipment, control systems, or both
- Excessive occupant complaints about temperature, airflow, and comfort

### Benchmarking

Owners of multiple buildings (private building owners, investment trusts, and property management firms) can evaluate the potential for energy improvement across a portfolio of buildings and select those with the most potential benefit. Owners may choose to have a commissioning provider conduct a study of all their facilities to support development of a multiyear retrocommissioning plan. At a minimum, owners considering retrocommissioning should develop a spreadsheet to understand, compare, and prioritize their building stock to determine which sites present the most opportunity for retrocommissioning. The ENERGY STAR Portfolio Manager benchmarking tool is an effective resource that owners can use for building selection. This tool, including a detailed description of its capabilities, can be accessed by visiting [www.energystar.gov/index.cfm?c=evaluate\\_performance.bus\\_portfoliomanager](http://www.energystar.gov/index.cfm?c=evaluate_performance.bus_portfoliomanager).

Portfolio Manager is the most widely used building benchmarking tool in the United States—roughly 17 percent of the eligible commercial space (on a square-footage basis) in the U.S. has been benchmarked using this tool. The building information needed is minimal and can be easily entered online in a private account that owners can create and manage for their buildings.

The tool uses the national energy performance rating system, which was built using statistical algorithms based on an analysis of national survey data conducted by the Department of Energy's Energy Information Administration. This national survey, known as the Commercial Building Energy Consumption Survey (CBECS), is conducted every four years and gathers data on building characteristics and energy use from thousands of buildings across the United States. A specific building's peer group of comparison is defined by those buildings in the CBECS survey that have similar building and operating characteristics. A building is not compared to the other buildings

entered into Portfolio Manager to determine the ENERGY STAR rating. For a given building, energy bill data and building characteristics are used to rank the facility on a scale of 1 to 100. The tool accounts for factors that affect energy use but are not the result of inefficient energy use, including climate, occupancy level, hours of operation, and hours of space use. The ranking received by a building reflects how its performance compares to that of similar buildings. A score of 75, for example, means a particular building outperforms approximately 75 percent of its peers. Buildings with a rating of 75 or higher are eligible to receive the ENERGY STAR label, signifying their outstanding level of performance. In general, the lower the rating, the greater the opportunity to improve energy performance levels.

## Selecting a Provider and Team

Retrocommissioning projects are often led by a third-party commissioning provider, with varying degrees of involvement by the building owner and staff. When reviewing a commissioning provider's qualifications, it is important to consider the provider's certification (see sidebar), technical knowledge, relevant experience, availability, and communication skills. The building owner should ask if the agent has been involved with ENERGY STAR buildings and benchmarking through Portfolio Manager. If the building does not currently have a rating, this would be a good opportunity to benchmark and get one.

The selection of the commissioning provider is done either by competitive bid or by selection by qualification. A competitive bid requires the owner to issue a request for proposal (RFP). This can be time consuming and expensive but may be the most appropriate method if the project is complex. One word of caution—when comparing bids, be sure to account for any differences in the proposed scope of work from different bidders. Not every bidder responds to the full scope of the RFP.

Many public agencies are required to go with the lowest qualified bidder and should, if using an RFP process, carefully define the minimum qualifications. Selection by qualification is

---

---

## RESOURCES: Commissioning Certification

The following five organizations currently certify commissioning providers. Visit the organizations' web sites for more information on their certification programs and to obtain lists of certified commissioning providers:

- "Certified Commissioning Professional (CCP)": Building Commissioning Association (BCA), [www.bcx.org/certification/index.htm](http://www.bcx.org/certification/index.htm)
  - "Certified Commissioning Provider": Associated Air Balancing Council Commissioning Group (ACG), [www.acgcommissioning.com/membershipcertification](http://www.acgcommissioning.com/membershipcertification)
  - "Accredited Commissioning Process Provider": University of Wisconsin at Madison (UWM), <http://epdweb.engr.wisc.edu/courses/index.lasso> (use link to Building Systems and Construction to find certification training)
  - "Systems Commissioning Administrator": National Environmental Balancing Bureau (NEBB), [www.nebb.org/bsccertif.htm](http://www.nebb.org/bsccertif.htm)
  - "Certified Building Commissioning Professional (CBCP®)": Association of Energy Engineers (AEE), [www.aeecenter.org/certification](http://www.aeecenter.org/certification)
- 
-

often simpler but requires that the owner carefully evaluate the providers' qualifications and interview past clients and references. The process also allows the owner to select the most qualified provider regardless of cost. A sample template and a checklist of factors is included in the "Advanced Retrocommissioning Workbook: A Guide for Building Owners."

## Developing a Scope of Work

To develop a scope of work, the commissioning provider visits the site, talks with operations and maintenance staff, and reviews current operating conditions. The commissioning provider then identifies areas of opportunity in the building for energy savings. The following items are indicators of retrocommissioning opportunities commonly found during a building walk-through. Their presence indicates potential problems that can be identified and fixed through a retrocommissioning project:

- Systems that simultaneously heat and cool, such as constant and variable air volume reheat
- Economizers, which often need repair or adjustment—potential problems include frozen dampers, broken or disconnected linkages, malfunctioning actuators and sensors, and improper control settings
- Pumps with throttled discharges
- Equipment or lighting that is on when it may not need to be
- Improper building pressurization (either negative or positive), that is, doors that stand open or are difficult to get open
- Equipment or piping that is hot or cold when it should not be; unusual flow noises at valves or mechanical noises
- Short cycling of equipment
- Variable-frequency drives that operate at unnecessarily high speeds
- Variable-frequency drives that operate at a constant speed even though the load being served should vary

The next step is to define the scope of work—a proposal for work negotiated between the commissioning provider and the owner that outlines the processes and procedures to be undertaken, provides a schedule of activities, identifies the roles of team members, and includes sample forms and templates that the commissioning provider will use to document the retrocommissioning activities.

### 5.3 Project Execution

The execution phase of retrocommissioning begins with an investigation phase that leads to an understanding of how and why building systems are currently operated and maintained, the identification of issues and potential improvements, and the selection of the most cost-effective measures for implementation. The tasks required to fulfill these goals include:

- A review of facility documentation, which covers operating requirements; original design documents; equipment lists; drawings of the building's main energy-using systems; controls documentation; operations and maintenance manuals; and testing, adjusting, and balancing reports.

- Diagnostic monitoring of energy systems, which can help determine where particular problems lie. Data are typically gathered using a building's existing energy management system (EMS) along with portable data loggers to obtain any data not available through the EMS. Variables typically monitored include whole-building energy consumption (including electricity, gas, steam, or chilled water), end-use energy consumption, operating parameters (such as temperatures, flow rates, and pressures), weather data, equipment status and run times, actuator positions, and setpoints.
- Functional testing, which takes a system or piece of equipment through its paces while personnel observe, measure, and record its performance in all key operating modes. Functional testing also may be used to help verify whether a particular improvement is really needed and is cost-effective. For example, the commissioning provider may observe that the throttling valve on a pump is not fully open. This may indicate that energy savings could be achieved by trimming the impeller so the valve can be fully open. A functional pump test will determine the value of this possible improvement.

## Implementing the Recommendations

The recommendations from the investigation are typically implemented according to one of three basic approaches:

- Turnkey implementation is usually applied to projects in which the retrocommissioning provider is capable of providing the service and the in-house staff is either not available to implement any of the measures or does not have the necessary skills. The main advantage of this approach is that only one contract is held by the owner, and any subcontracts are held and managed by the commissioning provider.
- Recommendations can be implemented with the assistance of the retrocommissioning provider, in which case the provider oversees the implementation process but does not directly complete the majority of the work. This strategy works best when a highly skilled in-house staff is available and can carry out much of the work or when the specialized skills of contractors (controls contractors, design professionals, and testing specialists) are required. Working with a commissioning provider to implement the retrocommissioning findings can build in-house skills among facility staff so that they are better able to maintain performance of systems over time.
- Owner-led implementation may be attractive to owners who have strong, established relationships with a service contractor or a highly capable in-house engineer who can implement and verify the retrocommissioning measures.

Whichever approach is used, the recommendations of the investigation phase can be adopted in a staged fashion to accommodate budgeting constraints or implemented in one overall project. Implementing all or most of the measures immediately maintains project momentum and staff involvement and maximizes cost savings. Another key factor is the continued involvement of the commissioning provider, which can be more difficult to maintain if too much time passes without the project moving forward.

As measures are implemented, it is important to verify the results. This verification ensures that the work is completed correctly; it also establishes a new baseline for performance and updates cost savings estimates. The new baseline can be used to establish criteria or parameters for tracking whether or not the improvements are performing properly throughout the life of the equipment or systems and can serve as the baseline for the next round of upgrades on the road of continuous improvement.



---

---

## RESOURCES: Operator Training

An example of training that is available in many locations across the country is Building Operator Certification (BOC) courses. This series is designed specifically for building operators to improve their ability to operate and maintain comfortable, efficient facilities. There are two skill levels for the courses, and both address multiple topics, including electrical, HVAC, and lighting systems; indoor air quality; environmental health and safety; and energy conservation. More information on locations, schedules, and descriptions is available on the BOC web site at [www.theboc.info](http://www.theboc.info).

---

---

## Maintaining the Benefits

Implementation is not the end of the project. Without training for facility staff and an operations and maintenance program, the benefits that accrue will not last. The building owner should request that the commissioning provider develop and conduct additional training for facility staff at the end of the project (see sidebar). A training session usually involves a classroom workshop with some hands-on demonstrations on the building equipment. Owners should consider videotaping the training session for later use and as a resource for training new facility staff. Suggested topics for training sessions include:

- Energy usage analysis
- Operating schedules and requirements
- Methods for identifying problems and deficiencies
- A description of project findings and measures that were implemented
- Improvements expected as a result of the project (show before and after trends if available)
- Operations and maintenance procedures needed to ensure that benefits are maintained
- Staff role in helping to maintain the persistence of savings

A typical preventive maintenance plan consists of a checklist of maintenance tasks and a schedule for performing them. The checklists are kept for each piece of equipment and are updated after maintenance tasks are performed. Incorporating operations into the current maintenance plan entails similar rigor for recording setpoints, settings, and parameters for the control strategies. It also means that operators regularly review and update the owner's operating requirements as occupancy or operational changes are made. A good preventive operation and maintenance plan encourages building operators to continuously ask questions such as:

- Have occupancy patterns or space layouts changed?
- Have temporary occupancy schedules been returned to original settings?
- Have altered equipment schedules or lockouts been returned to original settings?
- Is equipment short-cycling?
- Are time-clocks checked monthly to ensure proper operation?
- Have any changes in room furniture or equipment adversely affected thermostat functions?

- Have occupancy patterns or space layouts changed?
- Are new tenants educated in the proper use and function of thermostats and lighting controls?
- Are the building's sequences of operation performing as intended?

## Planning for Recommissioning

From the start, the retrocommissioning project includes steps that ensure that the benefits gained will persist and even be improved upon. That is one reason why good documentation, ongoing training, and the performance of preventive operations and maintenance should be included. In addition, planning for recommissioning or ongoing commissioning will help keep a building operating at optimal levels.

The timing of a recommissioning effort will vary depending on the timing of changes in the facility's use, the quality and schedule of preventive maintenance activities, and the frequency of operational problems (see sidebar). Factors that indicate the need for recommissioning include:

- An unjustified increase in energy use or a lower ENERGY STAR score
- An increase in the number of comfort complaints
- An increase in nighttime energy use

---

---

### CASE STUDY: Recommissioning Provides Rapid Payback

The University of Montana in Missoula, Montana, found that even for a relatively new building, the recommissioning process can be cost-effective. The Gallagher School of Business Administration building was partially commissioned after it was built in 1997. After several years of operation, however, performance problems and complaints began to appear. To address the problems, the university decided to recommission the building.

Working with the Montana Department of Environmental Quality (MDEQ), with funding from the Northwest Energy Efficiency Alliance and support from the U.S. Department of Energy's Rebuild America Program, the university hired a commissioning provider who completed the process by the fall of 2002. The analysis revealed and suggested fixes for 346 problems in the building, including dampers that could not fully open or close, valves that leaked or could not close, and equipment controls that were out of calibration. Implementing many of these measures produced an estimated annual energy cost savings of approximately \$19,500. The simple payback for the commissioning provider fee of \$24,380 was 1.25 years (the university used its own building staff to implement the corrective measures).

The recommissioning effort delivered several lessons. A big factor in the building's declining performance was that its occupancy load had changed. As enrollment in the business school increased, the number of new people and computers added loads that the heating and cooling systems had not been designed to handle. Periodic recommissioning can help a building to meet such changing needs. In addition, periodic recommissioning is required for complex HVAC control systems to maintain their efficiency and performance. Based on the commissioning findings and a payback analysis, the MDEQ recommended that the university recommission the Gallagher building every three to five years to keep it operating efficiently.

---

---

- An awareness of problems but lack of time or expertise to fix them
- Overriding of control logic or setpoints by staff or occupants to quickly “fix” problems
- Frequent equipment or component failures
- Significant tenant build-out projects
- Replacement of major systems or controls since the last commissioning or retrocommissioning effort

The recommissioning process is similar to that followed for retrocommissioning, although it can be less expensive because it can build on the data collection and documentation that will have already been completed. Recommissioning typically involves minor system improvements but in some projects may require more significant design, scheduling, and budgeting issues.

In some cases, ongoing commissioning can be cost-effective. In these cases, monitoring equipment is installed or left in place to allow for ongoing diagnostics and corrective actions. This approach works best in buildings with modern EMSs, Class A buildings (the most prestigious buildings in a particular market), and any site where there is an individual or champion committed to the process. A modern EMS makes more control strategies available and typically has most of the data needed to do diagnostics. Class A buildings often have dedicated energy managers concerned with both saving energy and keeping occupants comfortable.

## 5.4 Tune-up Opportunities

As part of the retrocommissioning process, all elements of a building and its energy-using equipment and systems will be examined. Specifically, the commissioning agents will look at lighting, supplemental loads, HVAC distribution systems, and heating and cooling plants to identify tune-up opportunities. The order in which the various measures will be implemented is determined after all the potential improvements have been identified and the most cost-effective measures have been selected for implementation. However, making simple repairs as the need is identified is usually the most effective strategy. Small adjustments, such as a sensor calibration, not only improve current operations but also increase the effectiveness of diagnostic monitoring and testing.

### Lighting

The lighting systems within a building are an integral part of a comfortable working environment (see Chapter 6). Over time, all lighting systems become gradually less efficient. Certain efficiency losses are unavoidable, such as reductions in light output due to the aging of lighting equipment. However, other efficiency losses, such as improperly functioning controls, dirt accumulation on fixture lenses and housings, and lumen depreciation can be avoided by regularly scheduled lighting maintenance.

A lighting system tune-up should be performed in the following order:

- Follow a strategic lighting maintenance plan of scheduled group relamping and fixture cleaning
- Measure and ensure proper light levels
- Calibrate lighting controls

Periodically cleaning the existing fixtures and replacing burned-out lamps and ballasts can considerably increase fixture light output (see the section on building in an operations and maintenance plan in Chapter 6, “Lighting”). This simple and cost-effective tune-up item can often restore light levels in a building to close to their initial design specifications.

After cleaning and relamping have been accomplished, measure existing light levels to determine whether or not illuminance levels are appropriate for the tasks being performed in the space (see Chapter 6, “Lighting”). Because space use and furnishings may change over time, it is important to match the lighting level to the current occupant requirements. The Illuminating Engineering Society of North America issues recommended illuminance levels depending on the job or activity performed. Overlit or underlit areas should be corrected. Lighting uniformity should also be assessed, as relocation of furniture and even walls may have altered lighting distribution.

Once the proper light levels and uniformity have been achieved in the space, examine the automatic lighting controls. Many buildings use a variety of automatic controls for time-based, occupancy-based, and lighting level-based strategies (see the section on automatically controlling lighting in Chapter 6, “Lighting”). These controls may have never been properly calibrated during installation, or occupants may have tampered with them. Adjusting these controls and associated sensors will reduce occupant complaints, maintain safety, and ensure maximum energy savings.

Many buildings use EMSs, time-clocks, and electronic wall-box timers to control lighting automatically based on a predictable time schedule. These systems need to be programmed correctly to ensure that lights are operating only when the building is occupied and that overrides are operational where required. Exterior lighting schedules must also be changed throughout the year according to the season.

The performance of occupancy or motion sensors depends on customizing the sensitivity and time-delay settings to the requirements of each individual space. The sensor’s installed position should also be checked to ensure adequate coverage of the occupied area. Also, keep furnishings from obstructing the sensor’s line of sight. Any indoor and outdoor photocell controls should also be checked to ensure the desired daylight dimming or daylight switching response. Setpoints should be adjusted so that the desired light levels are maintained.

The savings associated with performing a lighting tune-up will vary depending on the quality and performance of the current lighting system. For example, cleaning alone may boost fixture light output from 10 percent in enclosed fixtures in clean environments to more than 60 percent in open fixtures located in dirty areas. Simple calibration of occupancy sensors and photocells can restore correct operation, reducing the energy used by the lighting system in those areas by 50 percent or more.

## Supplemental Loads

Supplemental load sources are secondary load contributors to energy consumption in buildings. In the retrocommissioning process, loads can be cut by reducing equipment energy use and sealing the building envelope.

In many facilities, energy is wasted running office equipment that is left on when not in use throughout the workday, at night, and on weekends. Electrical loads from office equipment can be reduced by encouraging occupants to shut off equipment when it is not in use, using ENERGY STAR–labeled office equipment, and enabling power management features (see Chapter 7). Energy-efficient equipment not only uses energy efficiently but typically features

a low-power sleep mode for inactive equipment. ENERGY STAR–labeled equipment often costs the same as comparable nonlabeled equipment, but these products typically use about half as much electricity as conventional equipment.

For the building envelope, air infiltration is often a major energy drain that can be addressed during retrocommissioning. Outside air can penetrate a building through a variety of places, most commonly the windows, doors, walls, and roof. In general, a building envelope should meet recommended infiltration standards. A frequent result of infiltration problems is an increase in building heating, cooling, and/or electrical loads (when, for example, occupants may bring in space heaters or fans). In addition, the escape of conditioned air forces the air-handling system to work longer and harder to provide the required space temperature.

To reduce air infiltration, take the following steps:

- Tighten the existing building by locating all air leaks in the windows, doors, walls, and roofs.
- Seal with appropriate materials and techniques such as weather stripping on doors; sealing and caulking on windows; and proper insulation distribution in walls, ceilings, and roofing.
- Encourage the use of revolving doors in buildings so equipped. Revolving doors significantly reduce drafts and the loss of conditioned air.
- Calibrate automatic doors to minimize air loss from the building envelope.

Reducing infiltration will result in a reduction in heating and cooling loads. Typical savings for a large office building range up to 5 percent of heating and cooling costs.

## Distribution Systems

The systems that distribute air and water for space conditioning throughout a facility may need to be balanced and cleaned as part of the retrocommissioning effort. In a process known as testing, adjusting, and balancing (TAB), HVAC system components are adjusted so that air and water flows match load requirements. The process begins with testing to evaluate the performance of the equipment in its current state and making recommendations for improvements. Adjustments to flow rates of air or water are then made for the purpose of balancing the system and matching the loads throughout a building. Indications that TAB is needed include frequent complaints from occupants about hot or cold spots in a building, the renovation of spaces for different uses and occupancy, and the need for frequent adjustments of HVAC components to maintain comfort.

A TAB analysis usually includes a complete review of a building's design documentation. Typical HVAC system components and parameters to investigate include:

- Air system flow rates, including supply, return, exhaust, and outside airflow (flows go through main ducts, branches, and supply diffusers that lead to specific spaces in a building)
- Water system flow rates for chillers, condensers, boilers, and primary and secondary heating and cooling coils
- Temperatures of heating and cooling delivery systems (air side and water side)
- Positions and functioning of flow-control devices for air and water delivery systems

- Control settings and operation
- Fan and pump speeds and pressures

The savings associated with TAB come from the reductions in the energy used by the heating and cooling system and can range up to 10 percent of heating and cooling costs.

The heat exchange equipment that cools and heats the air that ultimately reaches building spaces should also be inspected and cleaned if necessary. This equipment usually consists of heating and cooling coils installed in air handlers, fan coil terminal units, or baseboard radiators. These units are typically supplied with chilled water and hot water from a central plant. The heating and cooling coils can also be part of a packaged unit such as a rooftop air-conditioning unit or central station air-handling unit.

All surfaces and filters should be clean—dirty surfaces reduce heat transfer and increase pressure loss, which serves to increase energy use. The cleaning technique depends on the type of equipment:

- For air-side heating and cooling coils, whether in an air handler or in a rooftop unit, the methods for cleaning include compressed air, dust rags or brushes, and power washes. Any of these techniques will reduce deposit buildup. In addition, check baseboard heating systems for dust buildup, and clean them if necessary.
- The water side of heating and cooling systems is generally inaccessible for mechanical cleaning. Chemical treatments are often the best solution for cleaning these surfaces. Ongoing water treatment and filtering of the water side are recommended to reduce dirt, biological, and mineral-scale buildup. Filters for both air-side and water-side systems should be cleaned and replaced as necessary.

In addition, make sure that terminal fan coil units and baseboards are not blocked or covered with books, boxes, or file cabinets. Besides creating a fire hazard (in the case of radiators), blocking the units prevents proper air circulation and renders heating and cooling inefficient.

In general, the cleaner the heat transfer surfaces, the greater the savings. In addition, cleaning coils and filters may reduce the pressure drop across the coil and reduce fan or pump energy consumption. Savings can range up to 10 percent.

## Heating and Cooling Systems

Both controls and components of the heating and cooling systems present savings opportunities during the retrocommissioning process. The EMS and controls within a building play a crucial role in providing a comfortable building environment. Over time, temperature sensors or thermostats may drift out of tune. Wall thermostats are frequently adjusted by occupants, throwing off controls and causing unintended energy consumption within a building. Poorly calibrated sensors can increase heating and cooling loads and lead to occupant discomfort. Occupants are likely to take matters into their own hands if they consistently experience heating or cooling problems. To tune up the heating and cooling controls, take the following steps:

- *Calibrate the indoor and outdoor building sensors.* Calibration of room thermostats, duct thermostats, humidistats, and pressure and temperature sensors should be in accordance with the original design specifications. Calibrating these controls may require specialized skills or equipment and may call for outside expertise.

- *Inspect damper and valve controls to make sure they are functioning properly.* Check pneumatically controlled dampers for leaks in the compressed-air hoses. Also examine dampers to ensure that they open and close properly. Stiff dampers can cause improper modulation of the amount of outside air being used in the supply airstream. In some cases, dampers may actually be wired in a single position or disconnected, violating minimum outside air requirements.
- *Review building operating schedules.* HVAC controls must be adjusted to heat and cool the building properly during occupied hours. Occupancy schedules can change frequently over the life of a building, and control schedules should be adjusted accordingly. Operating schedules should also be adjusted to reflect daylight saving time. When the building is unoccupied, set the temperature back to save some heating or cooling energy, but keep in mind that some minimum heating and cooling may be required when the building is unoccupied. In cold climates, for example, heating may be needed to keep water pipes from freezing.
- *Review the utility rate schedule.* Utilities typically charge on-peak and off-peak times within a rate, which can dramatically affect the amount of electric bills. If possible, equipment should run during the less expensive off-peak hours. For certain buildings, precooling and/or preheating strategies may be called for (see Chapter 9, Additional Strategies).

Savings from these control tune-up measures can range up to 30 percent of annual heating and cooling costs. The elements of both heating and cooling systems can also benefit from a tune-up as part of the retrocommissioning process. On the cooling side, the following measures can be effective:

- *Chilled-water and condenser-water reset.* In facilities with a central chiller system, the operating efficiency can be increased through a practice known as chilled-water reset—modifying the chilled-water temperature and/or condenser-water temperature in order to reduce chiller energy consumption. (For more information on chilled water reset and specific types of chiller equipment, see Chapter 9.)
- *Chiller tube cleaning and water treatment.* Cleaning chiller tubes and improving water treatment can also improve performance of a chiller system by providing cleaner surfaces for heat transfer on both the refrigerant and water sides of the chiller tubes (see Chapter 9).
- *Reciprocating compressor unloading.* For smaller chiller systems that use reciprocating compressors with multiple pistons, part-load performance can be improved by making sure that the control system properly unloads pistons as the load decreases. If the controls fail to unload, then the system may cycle unnecessarily during low cooling loads. Because starting and stopping are inherently inefficient, cycling decreases the efficiency of the cooling system. Additionally, increased cycling can lead to compressor and/or electrical failures. Unloading is typically controlled by a pressure sensor that is set for a specific evaporator pressure. This sensor, and the controls dependent upon it, can fall out of calibration or fail.
- *Chiller tube cleaning and water treatment.* Cleaning chiller tubes and improving water treatment can also improve performance of a chiller system by providing cleaner surfaces for heat transfer on both the refrigerant and water sides of the chiller tubes (see Chapter 9).

On the heating side, boiler performance can often be improved by a tune-up. For safety reasons, it is a good idea to obtain specialized expertise for boiler tune-up items. The following measures can be effective:

- *Maintaining boiler steam traps.* Boiler system steam traps, which remove condensate and air from the system, commonly need maintenance. They frequently become stuck in the open or closed position. When a trap is stuck open, steam can escape through the condensate return lines to the atmosphere, and the resulting energy loss can be significant. Check steam traps frequently for leaks, and make repairs as needed.
- *Adjusting combustion airflow.* For fossil-fuel-powered boilers, adjusting the combustion airflow usually improves system performance. More air is typically supplied for combustion than is needed. Excess air helps prevent incomplete combustion, and that action helps eliminate hazards such as smoke and carbon monoxide buildup. However, if too much air is introduced, some of the fuel is wasted in heating this excess air. A tune-up of combustion air consists of adjusting combustion air intake until measured oxygen levels in the flue gas reach a safe minimum.
- *Boiler tube cleaning and water treatment.* As with chillers, these measures improve heat transfer in the system. Both the fire side and water side of the boiler tubes can be cleaned by physically scrubbing the surfaces and sometimes by applying a chemical treatment. Treating the heating water may also be a good option to improve efficiency.

When all retrocommissioning steps are taken together, heating and cooling cost savings can reach upwards of 15 percent.

## 5.5 Summary

The goal of the retrocommissioning stage in a building upgrade effort is to ensure that the building operates as intended and meets current operational needs. Doing so can be very cost-effective, with field experience showing typical costs of about US\$0.27/ ft<sup>2</sup>, energy savings of about 15 percent, and a simple payback period of 0.7 years.

A well-planned and -executed retrocommissioning project generally consists of planning and execution phases. In addition, the effort includes plans to ensure that benefits persist and can be added to through such measures as training, preventive operations and maintenance, and performance tracking. Plans should also be made for periodic recommissioning or ongoing commissioning of the building. Recommissioning follows the same process as retrocommissioning, but where *retrocommissioning* applies to buildings that have never been commissioned, *recommissioning* is the term used for buildings that have already been commissioned at least once. In *ongoing commissioning*, monitoring equipment is left in place to allow for ongoing diagnostics.

As part of the retrocommissioning effort, adjustments and fine-tuning may be made to all building systems, including lighting, supplemental loads, building envelope, controls, and all aspects of heating and cooling systems.



## Bibliography

California Commissioning Collaborative, [www.cacx.org](http://www.cacx.org).

California Energy Commission, *California Commissioning Guide: Existing Buildings* (2006), prepared by Portland Energy Conservation Inc. (PECI), [http://resources.cacx.org/library/holdings/CA\\_Commissioning\\_Guide\\_existing.pdf](http://resources.cacx.org/library/holdings/CA_Commissioning_Guide_existing.pdf).

Haasl, Tudi, Robert Bahl, E.J. Hilts, and David Sellers, “Appropriate Use of Third Parties in the Existing Building Commissioning Process—an in-House Approach to Retrocommissioning,” presented at the World Energy Engineering Congress (2004).

Jewell, Mark, RealWinWin Inc., “Understanding the Value of Commissioning in Income-Producing Office Buildings,” *Proceedings of 12th National Conference on Building Commissioning*, PECI, 2004.

Mills, E., H. Friedman, T. Powell, N. Bourassa, D. Claridge, T. Haasl, and M.A. Piette, “The Cost-Effectiveness of Commercial-Buildings Commissioning” (2004), Lawrence Berkeley National Laboratory, <http://eetd.lbl.gov/EMills/PUBS/Cx-Costs-Benefits.html>.

New York State Energy Research and Development Authority, *Guideline to the Building Commissioning Process for Existing Buildings, or “Retrocommissioning”* (2003), prepared by PECI.

Oregon Department of Energy, *Retrocommissioning Handbook for Facility Managers* (2001), prepared by PECI.

Portland Energy Conservation Inc., [www.peci.org/commissioning.htm](http://www.peci.org/commissioning.htm).

Texas A&M Energy Systems Laboratory, <http://esl.eslwin.tamu.edu/continuous-commissioning-.html>.

U.S. Department of Energy, *A Practical Guide for Commissioning Existing Buildings* (1999), prepared by Oak Ridge National Laboratory and PECI, <http://eber.ed.ornl.gov/commercialproducts/RetroCommissioningGuide-w-cover.pdf>.

U.S. Department of Energy, Federal Energy Management Program, *Continuous Commissioning Guidebook: Maximizing Building Energy Efficiency and Comfort* (2002), prepared by Energy System Laboratories of Texas A&M University and University of Nebraska.

U.S. Department of Energy, Public Interest Energy Research, *Strategies for Improving Persistence of Commissioning Benefits* (2003).

U.S. Department of Energy, Rebuild America Program, *Building Commissioning: The Key to Quality Assurance* (1998), prepared by PECI.

U.S. Environmental Protection Agency, ENERGY STAR Program, “Advanced Retrocommissioning Workbook: A Guide for Building Owners” (forthcoming), prepared by PECI.

U.S. Environmental Protection Agency and U.S. Department of Energy, *Operations and Maintenance Assessments: A Best Practice for Energy-Efficient Building Operation* (1999), prepared by Portland Energy Conservation Inc.

Williams, Scott D., “Owner’s Strategies for in-House Commissioning,” presented at the National Conference on Building Commissioning (2005), [www.peci.org/ncbc/proceedings/2005/02\\_Williams\\_NCBC2005.pdf](http://www.peci.org/ncbc/proceedings/2005/02_Williams_NCBC2005.pdf).



LEARN MORE AT  
[energystar.gov](http://energystar.gov)

ENERGY STAR® is a U.S. Environmental Protection Agency program helping businesses and individuals fight global warming through superior energy efficiency.

## Chapter 6 Lighting





# 6. Lighting

Revised November 2006

<b>6.1</b>	<b>Overview</b>	<b>3</b>
<b>6.2</b>	<b>The Importance of Lighting</b>	<b>4</b>
	Lighting and Your Building	4
	Lighting and People	6
<b>6.3</b>	<b>A Whole-System Approach</b>	<b>7</b>
<b>6.4</b>	<b>Lighting Design</b>	<b>9</b>
	The Right Quantity of Light	9
	The Right Quality of Light	10
	Outdoor Lighting	11
<b>6.5</b>	<b>Use Efficient Light Sources</b>	<b>12</b>
	Make Use of Daylight	13
	Linear Fluorescent Lamps	15
	Compact Fluorescent Lamps	18
	High-Intensity Discharge Lamps	18
	Other Light Sources	20
<b>6.6</b>	<b>Use Efficient Luminaires</b>	<b>22</b>
	Direct Lighting	22
	Indirect Lighting	23
<b>6.7</b>	<b>Automatically Control Lighting</b>	<b>24</b>
	On-Off Controls	24
	Dimming Controls	27
	Commissioning Ensures the Benefits of Lighting Controls	30
<b>6.8</b>	<b>Build In an Operations and Maintenance Plan</b>	<b>31</b>
	Plan for Group Relamping	32
	Retrocommission Lighting Controls	34
	Develop an O&M Manual	34
	Dispose of Lamps Properly	35

<b>6.9 Summary</b>	<b>36</b>
<b>Bibliography</b>	<b>36</b>
<b>Glossary</b>	<b>G-1</b>

## 6.1 Overview

A lighting upgrade is the second stage in the building upgrade process. The staged approach accounts for the interactions among all the energy flows in a building (**Figure 6.1**) and produces a systematic method for planning upgrades that maximize energy savings. When the staged approach is performed sequentially, each stage includes changes that will affect the upgrades performed in subsequent stages, thus setting the overall process up for the greatest energy and cost savings possible. In the staged approach to building upgrades, lighting upgrades come early in the process because the lighting system has a significant impact on other building systems, affecting heating and cooling loads and power quality.

Lighting consumes close to 35 percent of the electricity used in commercial buildings in the United States and affects other building systems through its electrical requirements and the waste heat that it produces. Upgrading lighting systems with efficient light sources, fixtures, and controls can reduce lighting energy use, improve the visual environment, and affect the sizing of HVAC and electrical systems.

Any goals for a lighting upgrade should be consistent with overall company goals and energy policies. They should also include provisions for commissioning—to make sure that the installed systems work as intended—and retrocommissioning, to make sure that the installed systems continue to provide the intended benefits throughout their useful life (see U.S. Environmental Protection Agency [EPA], “Guidelines for Energy Management Overview,” [www.energystar.gov/index.cfm?c=guidelines.guidelines\\_index](http://www.energystar.gov/index.cfm?c=guidelines.guidelines_index)). It is also important to remember that, as the EPA’s guidelines point out, the upgrade is not an end point but a step along a path of continuous improvement. To ensure that a lighting upgrade leads to an effective and efficient system, follow these key guidelines:

- Design the system to get the appropriate amount of light for the tasks to be performed in the space in question.

**Figure 6.1: The staged approach to building upgrades**

The staged approach to building upgrades accounts for the interactions among all the energy flows in a building. Each stage includes changes that will affect the upgrades performed in subsequent stages, thus setting the overall process up for the greatest energy and cost savings possible. Lighting upgrades come early in the process, because the lighting system affects heating and cooling loads and power quality.

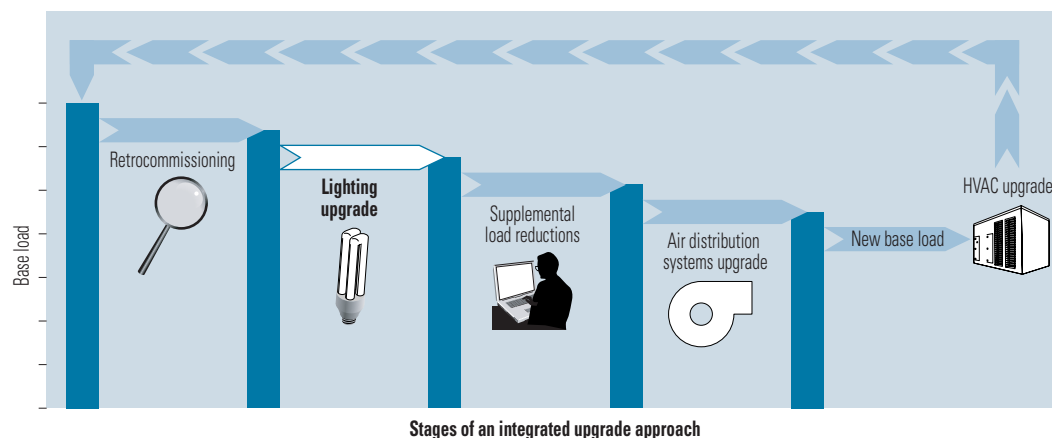

Courtesy: E SOURCE

- Distribute that light to prevent glare.
- Use daylight whenever possible but avoid direct sunlight, and install controls to reduce the use of electric lights in response to daylight.
- Use the most efficient light source for the application: high-performance fluorescent systems as the primary light source for most commercial spaces; compact fluorescent lamps in place of incandescent bulbs in most cases; and high-intensity discharge lamps where appropriate.
- Use automatic controls to turn lights off or dim lights as appropriate.
- Plan for and carry out the commissioning of all lighting systems to ensure that they are performing as required, and create a schedule to retrocommission systems periodically.
- Design lighting systems with ongoing maintenance in mind, and include a comprehensive plan for group relamping, fixture cleaning, and proper disposal of old lamps and ballasts.

Dozens of companies have followed these steps to improve their lighting systems. To see descriptions of buildings that have upgraded their lighting systems as part of an ongoing building upgrade process, visit [www.energystar.gov/index.cfm?fuseaction=labeled\\_buildings.showUpgradeSearch&building\\_type\\_id=ALL&s\\_code=ALL&profiles=0&also\\_search\\_id=UPGRADE](http://www.energystar.gov/index.cfm?fuseaction=labeled_buildings.showUpgradeSearch&building_type_id=ALL&s_code=ALL&profiles=0&also_search_id=UPGRADE), click on Stage 2, and submit.

## 6.2 The Importance of Lighting

Lighting uses about 18 percent of the electricity generated in the U.S., and another 4 to 5 percent goes to remove the waste heat generated by those lights. Lighting in commercial buildings accounts for close to 71 percent of overall lighting electricity use in the U.S. With good design, lighting energy use in most buildings can be cut at least in half while maintaining or improving lighting quality. Such designs typically pay for themselves in energy savings alone within a few years, and they offer more benefits in terms of the potential for smaller and less costly cooling systems and more-productive work environments.

### Lighting and Your Building

Lighting is a significant expense in operating a building. It is the largest cost component of a commercial building's electricity bill (**Figure 6.2**) and a significant portion of the total energy bill. When planning full-building upgrades, a lighting upgrade should come early in the process, because it can affect heating and cooling loads and power quality, which can make a significant difference in the specifications for other building systems.

**Heating and cooling loads.** Lighting systems produce large amounts of heat as well as light. Lighting is typically the largest source of waste heat, often called “heat gain,” inside commercial buildings. This internal heat gain may be useful when the building requires heating, but it is counterproductive when the building requires cooling. Energy-efficient lighting adds less heat to a space per unit of light output than inefficient lighting.

By reducing internal heat gain, efficient lighting also reduces a building's cooling requirements. Consequently, the existing cooling system may be able to serve future added loads. In addition, when it comes time to replace a building's cooling systems, the use of efficient lighting leads to reduced cooling loads, which can allow replacement chillers to be smaller and hence less costly to buy and operate.

**Figure 6.2: Lighting share of commercial building electricity use**

Lighting takes a larger share of a building's electricity use than any other single end use—more than 35 percent.

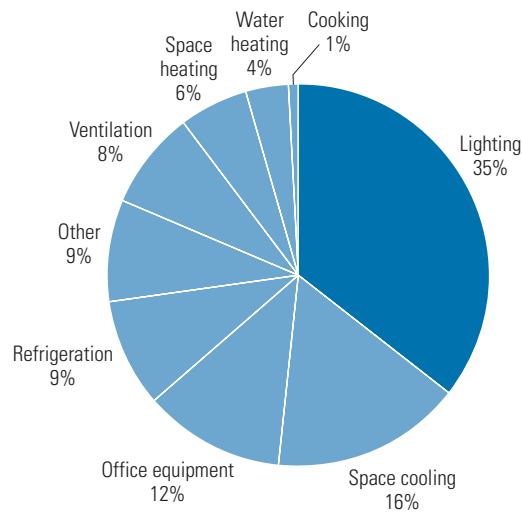

Courtesy: E SOURCE; data from 2005 Buildings Energy Data Book

The net annual effect on HVAC energy use at a site depends on the type of building, the climate, the efficiency of heating and cooling systems, and the relative size of the heating and air-conditioning loads. Large buildings that are dominated by internal loads and use far more air conditioning than heating can experience a site energy HVAC bonus of 40 percent or more. This means that each kilowatt-hour (kWh) of reduction in annual lighting energy use yields an additional 0.4 kWh of annual reduction in HVAC energy by reducing cooling energy more than it increases required heating energy.

For small, envelope-dominated buildings—especially those in cold climates—the net impact may be an HVAC penalty, meaning that each kWh in lighting energy use increases HVAC energy by increasing the annual heating energy use more than it reduces cooling energy.

Lighting upgrades in most commercial buildings are likely to reduce cooling costs more than they increase heating costs, but the precise effect on any given building can be determined by computer simulation. Some simplified methods for approximating the effect are also available. For example, see Lawrence Berkeley National Laboratory (LBNL), *Interactions Between Lighting and Space Conditioning Energy Use in U.S. Commercial Buildings*, LBNL 39795, <http://enduse.lbl.gov/info/LBNL-39795.pdf>.

**Improve power quality.** Lighting also affects the power quality of a building's electrical distribution system. Poor power quality is a concern because it wastes energy, reduces electrical capacity, and can harm equipment and the electrical distribution system itself. Upgrading to lighting equipment with clean power quality (high power factor and low harmonic distortion) can improve the power quality in a building's electrical system. Furthermore, upgrading with higher-efficiency and higher-power-factor lighting equipment can also free up valuable electrical capacity. This benefit alone may justify the cost of a lighting upgrade (see sidebar).

---

---

## CASE STUDY: Lighting Upgrade Improves Electric Load

Columbia University found that upgrading lighting in two adjacent buildings on its campus freed up enough electrical capacity to allow the wiring of all the lighting circuits into one building's electric service. Purchasing the transformers for that one system then became a cost-effective way to place both structures on high-tension service, saving another 29 percent on the two buildings' electric bills. When the costs and savings of this option were combined with those of the lighting upgrades, overall payback remained at about 2.5 years, but total savings nearly doubled, demonstrating the synergistic effects that can result by using lighting upgrades for electric load management. This option was previously unavailable because purchasing the transformers for both buildings yielded an unacceptably high payback.

---

---

## Lighting and People

A lighting upgrade is an investment not only in reducing electricity consumption but also in improving the way a building supports its occupants. A building's lighting directly affects the comfort, mood, productivity, health, and safety of its occupants. Moreover, as the most visible building system, it also directly affects the aesthetics and image of the building. Successful lighting upgrades take into account the impact of energy-performance choices on building occupants and seek to marry efficiency with improved lighting quality and architectural aesthetics wherever possible. Although such effects are difficult to quantify, comfort, mood, productivity, health, safety, and other effects lighting has on people should be considered as part of every lighting upgrade.

**Productivity.** Improved lighting enhances visual comfort, reduces eye fatigue, and improves performance on visual tasks. Well-designed lighting may also increase productivity and reduce absenteeism. For example, one lighting upgrade—at a mail-processing center in Reno, Nevada—led to a 6 percent increase in worker output and a reduction in sorting errors. Most lighting upgrades are cost-effective based on energy savings alone, but because costs associated with a building's occupants greatly outweigh other building costs (**Figure 6.3**), any lighting change that improves the interior environment is worth investigating. Those effects are hard to quantify, but research efforts are helping to pin down the benefits (see, for example, the work of the Light Right Consortium, [www.lightright.org](http://www.lightright.org)).

**Safety.** Lighting also contributes to the safety of occupants and the security of buildings. Emergency lighting must be available during power outages, and minimum levels of light must be available at night when most lighting is turned off. In addition, safety codes require exit signs to highlight escape routes during fires or other emergencies. Outside lighting and indoor night lighting deter crime by exposing intruders' movements and permitting occupants to move safely through the building or to cars. A visually safe environment will not expose people to excessive levels of glare or large differences in luminance levels. Outdoor light levels may depend on local ordinances, but can generally be fairly low—the guidelines laid out by the Illuminating Engineering Society of North America (IESNA, [www.iesna.org](http://www.iesna.org)) suggest 0.5 to 5.0 foot-candles, depending on the level of activity and the potential hazards.



### Figure 6.3: Annual operating costs per square foot in a typical office space

Salary costs far outweigh the costs for lighting in a typical office building, so even small improvements in worker productivity, absenteeism, or staff retention will quickly offset the costs of a well-executed lighting upgrade.

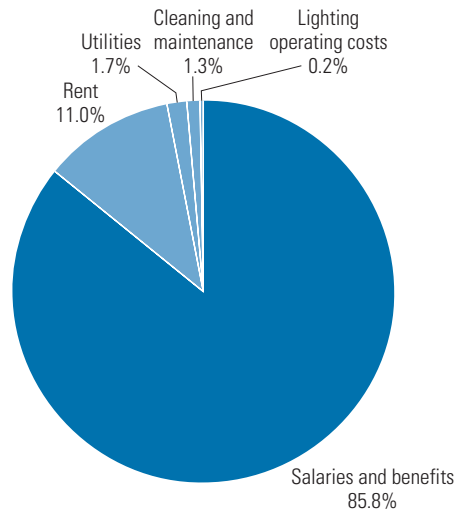

Courtesy: E SOURCE; data from Right Light Consortium

## 6.3 A Whole-System Approach

A comprehensive lighting upgrade achieves qualitative lighting objectives while maximizing efficiency and profitability. The process begins with the identification of the appropriate quality and quantity of light for various areas of a facility; proceeds through the selection of the best combination of light sources, luminaires, and controls; and includes provisions for maintenance and periodic reviews to ensure that goals for efficiency and quality continue to be met. This whole-system approach takes what is frequently regarded as a complex system of individual decisions and unites them into a strategic plan that ensures that each opportunity is addressed and balanced with other objectives (**Figure 6.4**).

Many lighting-efficiency efforts are oriented toward the installation of specific pieces of equipment, such as electronic ballasts or compact fluorescent downlights. But as with many other types of complex systems, the interactions among system elements in lighting equipment create energy and power savings that can be greater than the sum of their parts. **Table 6.1** illustrates the effects of pursuing incrementally more-aggressive upgrades while maintaining profitability and lighting quality and quantity. Starting with a system of fixtures containing four energy-saver T12 lamps, an upgrade to standard T8 lamps and electronic ballasts can produce energy savings of more than 25 percent; using high-performance T8 lamps boosts savings to more than 40 percent.

The next option begins to capture some system interactions. Each fixture is equipped with a specular reflector and a new acrylic flat prismatic lens. Because these are significantly better at getting light out of the fixture than the old white-painted luminaire and aged diffuser, the fixture can be delamped by 50 percent—to two high-performance T8 lamps—and still provide virtually the same amount of light for the task. Adding reflectors and new lenses to the fixtures enables

**Figure 6.4: Comprehensive lighting upgrade strategy**

A whole-system approach takes a complex system of individual decisions and unites them into a strategic approach that ensures that each opportunity is addressed and balanced with other objectives. The approach also includes provisions for monitoring and maintenance so that efficiency is maintained and the lighting system accommodates any changes in the use or configuration of the space.

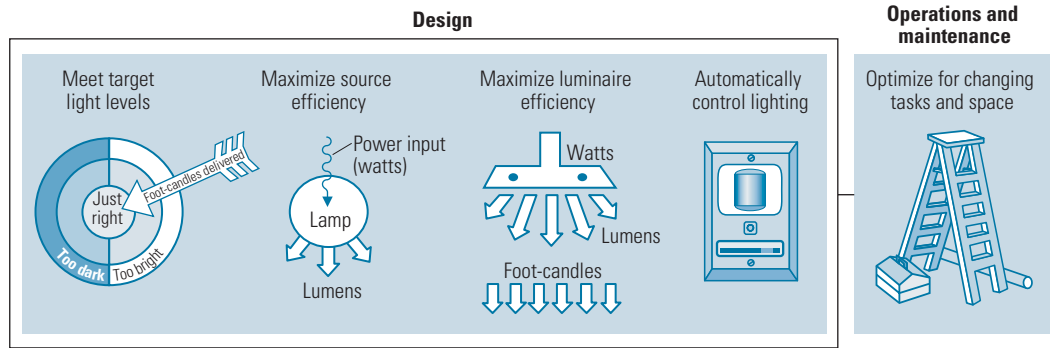

Source: EPA

**Table 6.1: Performance comparison of fluorescent retrofit options**

Packages of lighting-efficiency measures such as high-performance lamps and ballasts, delamping, and controls achieve deep savings with attractive economics. In each case, it is assumed that a minimum illumination level of 25 foot-candles is maintained and that lamps are replaced at burnout.

Retrofit option	Base case: Energy-saving T12 lamps with magnetic ballasts	Case 1: T8 lamps with electronic ballasts	Case 2: High-performance T8s with electronic ballasts	Case 3: Case 2 + specular reflector + lens + 50% delamping	Case 4: Case 3 + occupancy sensing and daylight dimming
Average maintained foot-candles	25	30	28	25	26
Power per fixture (W)	156	116	90	45	49
Annual energy use (kWh)	7,507	5,568	4,320	2,160	1,275
Energy savings (%)	NA	26	42	71	83
Annual operating cost (\$)	826	612	475	238	175
Upgrade cost (\$)	NA	1,165	1,320	1,560	2,150
Simple payback (years)	NA	5.5	3.8	2.7	3.3

Notes: kWh = kilowatt-hour; NA = not applicable; W = watt.

Courtesy: *E SOURCE Lighting Technology Atlas* (2005)

Assumptions:

1. Fixture cleaning occurs at end of the rated life, base case. Assuming burn hours of 4,000 hours per year and a 20,000-hour rated life, that works out to five years between cleanings and a total dirt loss of 30 percent.
2. The specular reflector retrofit kit is designed to maintain the same spacing ratio.
3. The existing diffuser has yellowed and gathered sufficient adhesive dirt (which isn't easily removed during routine cleaning) to reduce transmittance by another 10 percent.
4. Energy costs: demand = \$10 per kilowatt per month (all 12 months of the year); consumption = 7¢ per kWh (all times of day).

delamping—a reduction in the number of lamps required per fixture—with little loss in light levels, for a savings of 71 percent compared to the base case. Adding occupancy sensors and daylighting controls can boost savings to more than 80 percent compared to the base case, and more than 50 percent compared to a system with standard-grade T8 lamps and electronic ballasts.

Another option is to replace existing fixtures with new fixtures, rather than upgrading the various elements. Upgrading the elements can be less costly and less disruptive to ongoing operations, but new fixtures are a good approach if you want to convert from direct to indirect lighting, use a different type of light source (for example, replace high-intensity discharge lighting with fluorescent lighting), incorporate some of the advanced lighting control technologies, or provide lower levels of ambient lighting while increasing task lighting levels.

## 6.4 Lighting Design

Successful lighting design begins with an assessment of occupants' lighting needs, which depend on the tasks performed in the workspace. The lighting system should be designed to provide the quantity and quality of light responsive to those requirements. Chapter 10 of the *IESNA Lighting Handbook* (9th edition), "Quality of the Visual Environment," identifies several issues that should be considered, including color, daylight availability, glare, and light distribution. Retrofits that skip this assessment may perpetuate designs that have become inadequate because of workspace rearrangements or changing tasks (for example, moving from paper-based to computer-based tasks). The principles and guidance that apply to interior lighting are applicable to exterior lighting as well. Outdoor lighting that is designed and implemented properly should be cost-effective, should control light by directing it where it is needed, should reduce glare and distribute illumination evenly, and should reduce light trespass.

### The Right Quantity of Light

The quantity of light, or foot-candle illuminance level, that makes up an acceptable design depends on the tasks being performed in the space. Chapter 10 of the *IESNA Lighting Handbook* includes a "Lighting Design Guide" that provides recommended illuminances for seven general application categories, divided into three sets of visual tasks (**Table 6.2**). The guide provides a methodology for combining these seven recommended illuminance levels with 22 other criteria to develop high-quality lighting for hundreds of different applications. IESNA also provides specific luminance recommendations for hundreds of indoor and outdoor activities in 17 recommended practices for various lighting applications.

Keep in mind that the lighting level targets should be considered average maintained levels for the task; they should not necessarily be applied uniformly as the ambient light level for the entire space. Lighting levels should be customized through the use of supplemental task lighting in areas requiring higher localized levels. Target lighting levels should be the sum of the ambient and task lighting levels. This task-ambient lighting design approach creates flexibility to accommodate individual tasks or worker requirements, creates visual interest, and can save considerable energy in comparison to a uniform ambient-level approach.

Room dimensions and finishes also affect the required light output and thus the energy consumption of all interior lighting systems. As much as one-third of the energy used by a lighting system depends on the surrounding interior features, including the ceiling height, number and location of windows, and color and reflectivity of room surfaces and furnishings. Lighting designers can work with architects and interior designers to ensure that features that enhance

**Table 6.2: Recommended light levels**

The 9th edition of the *IESNA Lighting Handbook* includes a “Lighting Design Guide” that provides recommended illuminances for seven general application categories divided into three sets of visual tasks. The guide also provides a methodology for combining these illuminance levels with 22 other criteria to develop high-quality lighting for hundreds of different applications.

Category	Description	Illuminance (foot-candles)
<b>Orientation and simple visual tasks</b> in public spaces where reading and visual inspection rarely take place and visual performance is not crucial. Higher levels recommended for tasks where visual performance might be required.		
A	Public spaces	3
B	Simple orientation for short visits	5
C	Working spaces where simple visual tasks are performed	10
<b>Common visual tasks</b> in commercial, industrial, and residential applications—where visual performance is important. Recommended illuminance levels differ based on the visual tasks being illuminated. Higher levels recommended for visual tasks with critical elements of low contrast or small size.		
D	Performance of visual tasks of high contrast and large size	30
E	Performance of visual tasks of high contrast and small size or low contrast and large size	50
F	Performance of visual tasks of low contrast and small size	100
<b>Special visual tasks</b> including tasks with critical elements of very small or very low contrast. Visual performance is critical. Recommended illuminance levels should be achieved with supplementary task lighting. Higher recommended levels are often achieved by moving the light source closer to the task.		
G	Performance of visual tasks near threshold	300–1,000

Courtesy: *E SOURCE Lighting Technology Atlas* (2005); adapted from *IESNA Lighting Handbook*, 9th edition

lighting levels, such as light-colored finishes, are used wherever possible. This helps minimize the required light output and therefore the energy consumption of the lighting system.

## The Right Quality of Light

Lighting quality is the cornerstone of efficient lighting. The most efficient light sources mounted in the best luminaires may save energy, but they will not produce much value for building owners and occupants if they are applied improperly. Lighting designers can ensure high quality by considering such classic elements of lighting design as luminance ratios and color qualities.

**Luminance ratios and glare.** The eye does not see absolute levels of *illuminance* (the amount of light shining on a surface); it sees differences in *luminance* (the amount of light reflected back from a surface). Eyestrain and fatigue are caused when the eye is forced to adapt continually to different luminances. Therefore, it is important not only to provide the right level of light but also to ensure that light is evenly distributed across the task area. Balancing light levels also ensures that task lighting levels will be adequate throughout the space. Uniformity on vertical surfaces should also be maintained to avoid a gloomy, cave-like atmosphere.

IESNA recommends as good design practice an average luminance ratio of no more than 3 to 1 for close objects and 10 to 1 for distant objects and outdoor applications. In other words, the difference in light level between the task area and the background should be less than a factor of three. Although some designers use variation in illuminance as an organizing theme (for example, to define hallways leading to open offices or as a highlighting strategy in retail areas), large foot-candle variations within a workspace should be avoided.

*Glare* is the most important quality factor. Glare results when luminance levels—or the differences in luminance levels—are too high and objects appear too bright. Because glare creates discomfort, loss of visual performance, and impaired visibility, it should be minimized wherever possible.

*Direct glare* is the presence of a bright surface (such as a bare lamp or the sun) in the field of view that causes discomfort or loss in visual performance. This type of glare can be addressed with “cutoff reflectors,” which prevent light from shining directly into an occupant’s eyes, or with window shades that block direct sunlight.

A specific type of reflected glare called *veiling reflection* is a more challenging issue for the lighting designer. A veiling reflection occurs when light strikes a task and produces shiny spots that overwhelm the task. The decrease in contrast reduces visibility and can cause eyestrain. To combat glare from veiling reflections, imagine that the occupant’s visual task is a mirror, and then do not place bright fixtures such that they would appear in that mirror. Because it is difficult to predict exactly where workstations and tasks will be placed, one solution is to avoid direct lighting fixtures entirely. This is partly why indirect lighting fixtures have become popular—they create large areas of moderate brightness rather than small areas of high brightness that may be reflected in such a way as to obscure visual tasks.

**Color and spectral content of light sources.** There are two common ways to describe the color of light from a source: correlated color temperature (CCT) and color rendering index (CRI). Both metrics should be considered when evaluating light sources.

*Correlated color temperature*, measured in degrees kelvin (K), refers to the temperature of a black-body radiator emitting light of comparable color. The scale may seem intuitively backward: The higher the color temperature, the “cooler” or bluer the light. The “right” color temperature for an application may depend on the foot-candle level being maintained. Using lamps with high color temperature at low light levels makes spaces appear cold and dim. Conversely, using lamps with low color temperature at high levels of illumination will make a space look overly colorful. It is particularly important to consider this in dimming applications, because a light source that looks good at 50 foot-candles may not look as good at higher or lower illuminances. This issue is especially important in retail stores and restaurants, where the appearance of objects, people, and food is very important. Another important consideration in selecting an appropriate color temperature is the presence of daylight. For spaces that are daylit, 5,000 K may be the most appropriate CCT.

*Color rendering index*, measured on a scale of 0 to 100, describes the ability of a light source to render a sample of eight standard colors relative to a reference source. A CRI of 100 means that the source renders the eight standard colors in exactly the same way that the reference light source renders the same colors. CRI is an average value, so it will not describe how a light source renders a specific color. However, in general, high-CRI light sources render colors better than low-CRI sources (**Table 6.3**). A CRI of 80 or greater is considered by the industry to provide excellent color rendering.

## Outdoor Lighting

Well-designed outdoor lighting is cost-effective, controls light by directing it where it is needed, reduces glare, distributes illumination evenly, and reduces light trespass. The most common lamps used for outdoor lighting are high-intensity discharge (HID) sources—metal halide and high-pressure sodium. In recent years, compact fluorescent lamps (CFLs) and induction lamps have become viable sources for outdoor lighting as well, offering good color quality and better control options than HID sources. As costs come down and performance improves, light-emitting diodes (LEDs) could become a good choice for outdoor lighting as well. Regardless of the light source, however, the following points are important in the design of exterior lighting:

**Table 6.3: Typical CRI values for selected light sources**

Light sources with a color rendering index (CRI) of 80 or higher are considered to provide excellent color rendering.

Light source	CRI range
Incandescent	100
Ceramic metal halide	85 to 94
T5 fluorescents	80s
T8 fluorescents	75 to 98 <sup>a</sup>
Quartz metal halide	65 to 70
T12 fluorescents	58 to 62
High-pressure sodium	22

Note: a. T8 lamps with CRIs in the 90s offer lower efficacy than other T8 lamps.

Courtesy: E SOURCE

- *Pick the appropriate design illumination level.* An average of 1 foot-candle (or less) is usually sufficient. For more information, refer to the *IESNA Lighting Handbook* and several of its recommended practices.
- *Use IESNA-cutoff luminaires or full-cutoff luminaires.* These types of fixtures do not spread light into the sky above the horizontal.
- *Use whiter light sources.* Recent research, although not yet codified, shows that the whiter light produced by metal halide and fluorescent lamps provides better “seeability” than an equivalent amount of yellowish light from sodium lamps.
- *Provide controls.* Use time clocks, photo cells, motion detectors, or pager controls to run the lights only when needed or to dim them as appropriate.

Light pollution is a major concern in designing exterior lighting. Outdoor lighting ordinances and codes encourage better-quality lighting that reduces glare, light trespass, and energy waste. Many codes are now including the concept of e-zones to distinguish between different types of lighting areas. For example, near national or state parks, wildlife refuges, or astronomical observatories, lighting levels should be much lower than in city centers. The ordinances and community standards vary, and local zoning departments should be contacted before implementing an outdoor lighting project. (For more information, visit the web site of the International Dark Sky Association, [www.darksky.org](http://www.darksky.org).)

## 6.5 Use Efficient Light Sources

Efficient lighting begins with the use of as much daylight as possible. After that, choose the lamp/ballast/fixture combination that will maximize efficiency while balancing the considerations of lighting quality and quantity described above. There is a wide variety of light sources to choose from including fluorescent (linear and compact), high-intensity discharge (HID), and newer sources such as induction lamps and light-emitting diodes (LEDs). These sources vary widely in their efficacy, color quality, service life, and the applications for which they are best suited (**Table 6.4**). Historically, fluorescent lighting has been used for high-quality, general-purpose indoor diffuse lighting. HID lighting has been used for industrial and outside lighting. However, technical advances and a flood of new products have led to some crossover in the way

**Table 6.4: Typical properties of light-source upgrade alternatives**

A variety of lamps are available for energy-efficient upgrades. Linear fluorescent lamps are the most widely used, but each type has applications in which it can be an effective choice. The data listed do not represent the full range of variations for each lamp type, but only the ranges for the most effective choices.

Lamp type	Lamp property					Typical applications
	Mean efficacy, including ballast (mean lm/W)	Lumen maintenance (%)	Rated life (hours)	Color rendering index	Correlated color temperature (K)	
Full-size fluorescent (T5, high-performance T8)	80 to 97	92 to 93	20,000 to 30,000	80 to 85	2,700 to 6,500	General area lighting of all kinds, including open and closed offices, classrooms, and high-bay areas
Compact fluorescent	43 to 71 <sup>a</sup>	86	6,000 to 12,000	80 to 85	2,700 to 6,500	Incandescent replacements in table and floor lamps, cans, wall washers, and sconces
Quartz pulse-start metal halide	60 to 80 <sup>a</sup>	65 to 75	20,000	65 to 70	2,900 to 4,200	Outdoor lighting, high-bay lighting, and remote-source lighting
Ceramic pulse-start metal halide	60 to 80 <sup>a</sup>	80	20,000	85 to 94	2,900 to 4,200	Where color is critical, including high-bay and retail applications
High-pressure sodium	60 to 110 <sup>a</sup>	85 to 90	24,000	22	1,900 to 2,200	Outdoor lighting and in high-bay applications where color is not critical
Induction	50 to 60 <sup>a</sup>	70 at 60,000 hours; 55 at 100,000 hours	100,000	80	2,700 to 4,100	Where maintenance costs are high, including roadways and tunnels, parking garages, escalator wells, warehouses, and malls
LED	15 to 30	70	50,000 <sup>b</sup>	80 to 90	2,700 to 10,000	In color-based applications such as exit signs, niche applications such as outdoor signage, task lamps, and accent lighting

Notes: K = kelvin; LED = light-emitting diode; lm/W = lumen per watt.

a. Higher efficacies for higher-wattage lamps.

b. Time at which output has degraded to 70 percent of initial output.

Courtesy: E SOURCE

these lamps are applied—fluorescent lighting is now the most effective choice for many industrial and exterior lighting applications, while HID lighting (specifically metal halide) is now a good choice for some interior uses.

## Make Use of Daylight

The most efficient source of light is the sun, effectively providing up to 140 lumens (lm) of light for each watt (W) of heat energy, which compares favorably with the 90 lm/W from an efficient electric lighting system. Systems that use daylight to supplement electric lighting offer the potential to cut energy use, reduce peak demand, and create a more desirable indoor environment. However, it takes careful planning to achieve all the possible benefits from a daylighting system, and a number of resources are available on the web to help in the effort (see sidebar). As an overall guide, follow these four basic principles to produce an effective daylighting system:

- *Bring in the light.* Light can be brought into a building via conventional glazing, light shelves, skylights, and clerestory windows (**Figure 6.5**) or with more advanced approaches such as light pipes or specialized reflective materials.

- *Eliminate glare.* Glare is the number-one killer of daylighting systems—direct sunlight can cause very uneven luminance ratios that are distracting or even painful to occupants. Means for combating glare include using translucent materials and bouncing direct light off surfaces such as painted walls, perforated metal, or fabrics.
- *Adjust electric lights as appropriate.* Without lighting controls, daylighting will not save any energy. Automatic controls that sense ambient daylight are the best approach, because they ensure that electric lighting will be reduced when enough daylight is available. **Figure 6.6** shows how an automatic daylight control system installed at a grocery store cut energy use by 30 percent and decreased demand during peak hours.
- *Commission the system.* Many daylighting systems fail to deliver the expected benefit because they are not commissioned. Commissioning consists of adjusting photosensors and ensuring proper sensor placement so that the electric lighting system responds properly to the presence of daylight.

### Figure 6.5: Simple daylighting techniques

A mix of top- and side-lighting, light shelves, high-reflectance ceilings, and wall diffusion provides fairly uniform deep-plan daylighting without the glare of direct sun.

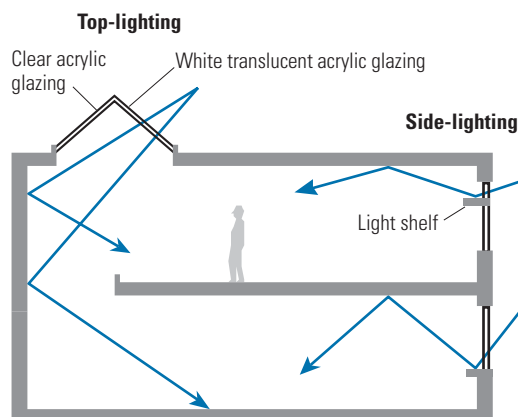

Courtesy: E SOURCE Lighting Technology Atlas (2005)

### Figure 6.6: Skylights cut lighting energy use

A grocery store in Valencia, California, used skylights and photocells to reduce lighting energy use by 30 percent during a monitored two-week period.

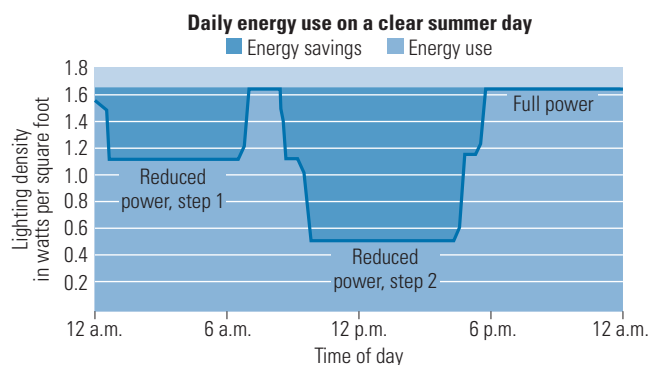

Source: California Energy Commission, PIER program



Properly planning and implementing a lighting control system will reduce the chances of over-dimming, under-dimming, and rapid cycling—problems that frequently occur in daylighting systems. These problems can often lead to users overriding the control system and eliminating any savings that may have accrued.

## Linear Fluorescent Lamps

Fluorescent lighting systems offer high efficacy, long life, and good light quality, and they generally have few operational limitations for most indoor lighting applications. They are the best choice for general lighting in commercial, institutional, and industrial spaces with low to medium ceiling height. In addition, the introduction of high-intensity fluorescent lamps and fixtures makes fluorescent systems a leading choice for areas with high ceilings (more than 15

---

---

### RESOURCES: Daylighting

A number of daylighting resources, including reference guides, case histories, and software, are available free of charge on the web:

#### *Daylight in Buildings: Source Book on Daylighting Systems and Components*

<http://gaia.lbl.gov/iea21>

This comprehensive reference book, published by Lawrence Berkeley National Laboratory's Building Technologies Department, describes and evaluates new and innovative technologies for using daylight in buildings.

#### **Daylight Dividends** [www.daylightdividends.org](http://www.daylightdividends.org)

The Lighting Research Center maintains a web site that provides information, including case studies, aimed at building owners, architects, and engineers interested in the benefits of natural light.

#### **BetterBricks** [www.betterbricks.com/default.aspx?pid=lightinglabs](http://www.betterbricks.com/default.aspx?pid=lightinglabs)

This organization sponsors a network of university-associated laboratories throughout the northwest region of the United States. Its labs offer free analysis and consultation.

#### **DesignLights Consortium** [www.designlights.org](http://www.designlights.org)

This group offers guidelines on skylighting for warehouses and retail outlets and also provides case studies and software for skylight system design.

#### **Wisconsin Daylighting Collaborative/Energy Center of Wisconsin** [www.daylighting.org](http://www.daylighting.org)

The collaborative provides case studies, training programs, demonstrations, and design assistance.

#### **Skycalc** [www.energydesignresources.com/resource/129](http://www.energydesignresources.com/resource/129)

Skycalc is a Microsoft Excel-based software tool that assists designers in developing daylighting strategies that use skylights.

#### **SPOT** [www.archenergy.com/SPOT/index.html](http://www.archenergy.com/SPOT/index.html)

The Sensor Placement and Orientation Tool (SPOT) helps designers establish correct photosensor placement relative to a proposed daylighting electric lighting design. It also analyzes and predicts overall system performance prior to field installation and commissioning.

---

---

feet)—the type of application that used to be the exclusive domain of HID light sources (see sidebar). A successful upgrade using fluorescent lamps requires careful consideration of options for lamps (diameter, length, intensity, and phosphor blend) and ballasts (electronic versus magnetic, rapid-start or programmed rapid-start versus instant-start).

**Picking the right fluorescent lamp.** Manufacturers have introduced a wide array of linear fluorescent lamp choices, including reduced-wattage, premium, and high-performance versions. There are also choices of CCT, CRI, lamp diameter, light output level (standard, high-output, or very high output), and starting method (rapid-start, programmed rapid-start, or instant-start). For most general lighting upgrades, the best choices are:

- *T8 (eight-eighths of an inch in diameter) or T5 (five-eighths of an inch in diameter) lamps.* The most efficient T8s are the high-performance type, also commonly called “super T8s” (Table 6.5). High-performance T8 lamps can be installed to replace T12 lamps and even cost-effectively upgrade lower-quality T8s. An office building in Minneapolis owned and managed by Hines upgraded more than 15,000 fixtures from T12 to T8 technology on its way to achieving and maintaining ENERGY STAR status. A retrofit from standard T8 lamps to high-performance T8s in modular classrooms in California cut lighting power from 116 W to 74 W and decreased air-conditioning loads in the confined classroom spaces. High-performance T8 lamps provide their biggest boost in efficiency when they are combined with high-performance ballasts. Reduced-wattage T8s, sometimes called “energy-saver” lamps, can also provide energy savings, but they have several shortcomings: They can only operate in spaces where temperatures are kept at a minimum of 60° Fahrenheit (F), they produce less light than full-wattage lamps, and they are not dimmable with current ballast technology.

T5 lamps, on the other hand, come only in metric lengths, which means that they are not a good retrofit option, unless fixtures are being replaced as well as lamps and ballasts. The efficacy of T5s is similar to that of T8 lamps, but because they are smaller they provide better optical control. T5 lamps also offer high lumen maintenance, putting out as much as 97 percent of their original light output at 40 percent of rated life. T5 lamps also offer better performance than T8s in enclosed fixtures and warm spaces because they are designed for a higher operating temperature.

- *Four-foot lamps.* The most common length for T8 lamps is four feet, which makes it the cheapest and easiest length to buy and stock. Eight-foot lamps are slightly more efficient, but they break more easily and can be difficult to transport.

---

---

### **CASE STUDY: Upgrade to Fluorescents Improves Distribution Center Lighting**

Demoula’s Market Basket supermarket chain converted the lighting in its main warehouse distribution center in New England from high-intensity discharge to fluorescent equipment. The new fixtures, each of which houses six high-output T5 lamps, replaced 400-watt mercury vapor or high-pressure sodium fixtures on a one-for-one basis. The connected load was reduced from 460 to 351 watts per fixture. When aisles are vacant, occupancy sensors now turn off four of the lamps to drop the lighting energy by two-thirds (to 117 watts per fixture). In addition to achieving over 50 percent energy savings, the new lighting is much brighter, has better color, and offers instant-on and instant-restrike capabilities.

---

---

**Table 6.5: The T8 family tree**

Linear T8 fluorescent lamps are available with a wide variety of characteristics. The high-performance T8 lamps offer the highest output and the best color quality.

Lamp type	Nominal power (W)	CRI	Efficacy (lm/W)
700 series	32	70s	<85
800 series	32	Low 80s	87 to 94
High performance (super T8)	32	High 80s	94 to 100
Energy saver	30	High 80s	94 to 100
Reduced wattage	28	High 80s	94 to 100
Reduced wattage	25	High 80s	94 to 100

Notes: CRI = color rendering index; lm/W = lumens per watt; W = watt.

Courtesy: E SOURCE; data from Consortium for Energy Efficiency

- *Standard light output.* Standard-output lamps are more efficient and less costly than high-output (HO) and very high output (VHO) systems, and they are available with a wider range of color temperatures. T5HO lamps are often used for high-bay applications because their high-intensity light is useful in large spaces.
- *CRI in the 80s.* Light sources with a CRI in the 80s provide good color rendering—far better than the old “cool-white” T12 lamps that provided a CRI in the 60s. Fluorescent lamps with CRIs in the 90s are available, but they carry a substantial penalty in efficacy.
- *CCT of 3,500 K to 4,100 K.* A CCT of 3,500 K is a good middle ground that can blend acceptably with warmer incandescent lights or earth-tone color schemes; 4,100-K lamps may blend better with cooler daylight, HID sources, or blue-gray color schemes.

**Picking the right fluorescent ballast.** Ballast choices can be equally bewildering. The best choices for ballasts are:

- *Electronic (high-frequency).* Electronic ballasts are about 12 percent more efficient than conventional magnetic ballasts. They eliminate flicker and hum and are extremely cost-effective. The most efficient units are high-performance ballasts as defined by the Consortium for Energy Efficiency ([www.cee1.org/com-lt/com-lt-specs.pdf](http://www.cee1.org/com-lt/com-lt-specs.pdf)).
- *Instant-start.* This is the most efficient type of ballast, but it yields the shortest lamp life in applications with frequent on/off cycling. Instant-start ballasts are a good choice for lamps that burn six hours or more per start.
- *Programmed-start.* Programmed-start ballasts, also called programmed rapid-start ballasts, represent the next step in the evolution of rapid-start technology. Their use increases lamp life but carries some penalty in efficiency. They are the best choice in applications where lights will frequently be turned on and off, as often happens when occupancy sensors are used.
- *Universal-input.* Universal-input ballasts typically accept any input voltage between 120 and 277 volts. They make retrofitting easier and reduce stocking requirements, but provide slightly lower efficiency than dedicated-voltage ballasts.

Finally, make sure that lamps and ballasts are compatible. Most lamps are only compatible with one starting method; the major exception is high-performance T8s, which can use either rapid- or instant-start ballasts.

## Compact Fluorescent Lamps

Use compact fluorescent lamps (CFLs) to replace incandescent lamps in downlights, sconces, table lamps, task lights, and wall washers. They cost more initially than incandescent lamps do, but quickly pay for themselves through energy and maintenance savings. The longer the annual operating hours, the more attractive the economics of CFLs become, because more incandescent relamping costs are being avoided per year.

CFLs come in two general forms—self-ballasted or pin-base. Self-ballasted CFLs—also known as screw-base, screw-in, or integrally ballasted CFLs—can replace incandescent lamps without modifications to the existing fixtures. They combine a lamp, ballast, and base in a single sealed assembly that is discarded when the lamp or ballast burns out.

Pin-base CFLs, the type most commonly employed in commercial buildings, are used with a separate ballast. They are available in lower-power versions, which can replace incandescent lamps, and in higher-power versions, which can replace linear fluorescent lamps or HID lamps. Pin-base systems feature a ballast and pin-base fluorescent lamp socket that is wired into a fixture by the fixture manufacturer or as part of a retrofit kit. Because they are hardwired, dedicated systems, they eliminate the possibility that a user will return to using an inefficient incandescent bulb.

One of the most common uses of CFLs in commercial buildings is in recessed downlight cans. A wide range of fixtures is now available for this fixture class, some with very good reflector designs, good optical control, and dimming capabilities. Care must be taken in this application to ensure that excess heat buildup does not shorten the lamp life.

When using CFLs, remember these key points:

- *Go for a 3:1 ratio.* Lamp manufacturers often publish a 4:1 ratio for replacing incandescent bulbs with CFLs (that is, a 25-W CFL can replace a 100-W incandescent lamp). A 3:1 ratio is more appropriate (a 25-W CFL can replace a 75-W incandescent lamp)—in practice, CFL output is lower than the nominal rating because of lumen degradation and the effects of temperature and position on lamp output.
- *Limit the number of CFL types.* CFLs are available in a wide variety of sizes and shapes—it is useful to standardize on just a few types to reduce stocking requirements and confusion at relamping time.
- *Use dedicated fixtures.* To prevent the replacement of CFLs with incandescent bulbs when it is time to relamp, use dedicated fixtures that will only accept pin-based CFLs.
- *Choose CFLs that have earned the ENERGY STAR.* This rating from the EPA ensures reliability as well as efficiency in self-ballasted CFLs (visit [www.energystar.gov/index.cfm?c=cfls.pr\\_cfls](http://www.energystar.gov/index.cfm?c=cfls.pr_cfls) for more information).

## High-Intensity Discharge Lamps

Wherever an intense point source of light is required, HID light sources are the primary alternative to high-wattage incandescent lamps. Although HID lamps can provide high efficacy in a wide range of sizes, they have special requirements for start-up time, restrike time, safety, and mounting position. The basic types of HID lamps include mercury vapor, metal halide, and sodium, but mercury vapor lamps are an old, inefficient technology and should not be part of any upgrade plans. The primary uses for HID lighting are outdoor lighting, high-bay lighting, retail lighting, and remote-source lighting (**Table 6.6**).

**Metal halide lamps.** Metal halide lamps offer good color quality and efficacies of up to 100 lm/W. Were it not for several limitations, metal halide lamps might be considered the ideal light source. The limitations include:

- *Long start-up times.* Starting the lamps initially takes three to five minutes, and restarting after a shutdown or power outage takes 10 to 20 minutes. The introduction of electronic ballasts has reduced but not eliminated these delays (**Table 6.7**).
- *High UV output.* Metal halide lamps produce relatively high levels of ultraviolet (UV) radiation that must be controlled with shielding glass in the lamp or fixture. Protection from possible explosion is also required.
- *Color shifting.* The color of the light output from a metal halide lamp can shift, sometimes dramatically and randomly. The use of electronic ballasts and ceramic metal halide lamps reduces this effect.
- *Lamp position.* The light output of metal halide lamps is sensitive to the position of the lamp. (Sodium lamps are not position-sensitive.)

**Table 6.6: Applications for HID light sources**

Good color properties and a wide range of sizes make metal halide lamps the most versatile high-intensity discharge (HID) light source.

Application	Metal halide	Ceramic metal halide	High-pressure sodium	Low-pressure sodium
Interior, decorative	x	x		
Downlights	x	x		
Parking areas	x		x	x
General outdoor	x		x	x
Roadways or tunnels	x		x	x
Sports arenas	x	x		
High-bay spaces (including hangars and warehouses)	x	x	x	
Low-bay spaces (including supermarkets, light industrial, or retail shops)	x	x	x	
Outdoor signage	x			

Courtesy: E SOURCE

**Table 6.7: Metal halide warm-up and restrike times**

Electronic ballasts have shortened warm-up and restrike times for pulse-start metal halide lamps but have not eliminated them entirely.

Lamp/ballast type	Warm-up time (minutes)	Restrike time (minutes)
Probe-start/magnetic	4 to 5	10 to 20
Pulse-start/magnetic	2 to 3	3 to 5
Ceramic/magnetic	2 to 3	10 to 20+
Quartz pulse-start/electronic	1 to 3	2 to 4
Ceramic/electronic	1 to 3	10 to 20+

Courtesy: E SOURCE; data from Stan Walerczyk

Several developments in technology have made metal halide systems more effective. Manufacturers introduced pulse-start technology in the late 1980s and early 1990s to improve on the performance of older probe-start technology. More recently, electronic ballasts and ceramic metal halide lamps have improved performance even further. Ceramic metal halide lamps offer better CRI and lower lumen depreciation rates than the conventional quartz version. Electronic ballasts improve efficiency and color stability, reduce lumen depreciation rates, and cut warm-up and restrike times (**Table 6.8**). Many electronic ballasts are also dimmable.

Despite their limitations, metal halide lamps can be a good option in a number of applications, including outdoor and high-bay lighting. Ceramic metal halide lamps are also a good choice wherever color quality is critical, including retail lighting and some manufacturing operations. For example, a retrofit of ceramic metal halide lamps with a CRI of 92 is helping maintenance workers do their jobs better in the Alaska Airlines maintenance hangar at Seattle-Tacoma airport.

**Sodium lamps.** There are two types of sodium lamps: high-pressure sodium (HPS) and low-pressure sodium (LPS). HPS lamps, which produce a yellowish light, vary widely in their efficacy and color quality. Three basic grades are available, based on CRI: The lowest, with a CRI of about 21, is typically used for outdoor lighting; general-purpose indoor units have a CRI of around 60; and the less-common “white” versions boast a CRI up to 80 or higher. For this last type of lamp, better color comes at the cost of lower efficacy and shorter lamp life. The most common application of HPS lamps is for roadway and parking-lot lighting. The applications of LPS lighting are extremely limited by the nearly monochromatic yellow light they produce. One of the few applications for LPS lamps is outdoor lighting near observatories, where the narrow wavelength band can more easily be filtered from the view of the telescope.

## Other Light Sources

Two other light sources bear consideration for some lighting upgrade applications: LEDs and induction lamps.

**LEDs.** light-emitting diodes are solid-state electronic devices that create light. They offer several advantages over conventional light sources, including long life and vibration resistance. Their small size and the directional nature of their light output are also beneficial in some cases. These characteristics have enabled LEDs to displace incandescent lamps in some applications, but efficiency still needs to improve significantly and costs need to decrease before LEDs are a cost-effective replacement for higher-efficiency sources such as fluorescent lamps.

**Table 6.8: Ceramics boost metal halide performance**

Ceramic arc tubes boost the color quality and lumen maintenance of pulse-start metal halide lamps.

Property	Quartz metal halide	Ceramic metal halide
CRI	65 to 70	90 to 95
End-of-life lumen maintenance with electronic ballast (%)	70	80

Notes: CRI = color rendering index.  
Data are for 250- to 400-watt lamps.

Courtesy: E SOURCE

The most successful early applications for LEDs have been those where they replace filtered incandescent bulbs, such as in traffic signals and exit signs, because the filtering of the emitted incandescent light makes an already inefficient source even less efficient. The efficacy of incandescent lamps is relatively low: about 17 lumens per watt for a conventional 100-watt bulb. When incandescent lamps are used to produce colored light, an absorptive filter is placed in front of the white light source to absorb all colors except those that are required for the application. When red light is needed for, say, an exit sign, this absorptive filter reduces the efficacy of the incandescent lamp-plus-filter combination to less than 5 lm/W. With LEDs, the color of the light they generate depends on the materials used to construct the LED, not on a filter. Modern, high-brightness red LEDs operate with an efficacy of 20 to 30 lumens per watt, which makes them much more efficient sources of red light than filtered incandescent lamps.

The other area where high-brightness LEDs have displaced other light sources is large outdoor displays. And retail accent lighting is a growing area for LEDs, because LEDs provide the ability to vary color, create sparkle, and aim the light precisely. Many facilities have already replaced incandescent exit signs with LED signs, cutting the energy used by the signs by 80 percent or more in the process. For information on ENERGY STAR–qualified exit signs, most of which use LEDs, visit [www.energystar.gov/index.cfm?c=exit\\_signs.pr\\_exit\\_signs](http://www.energystar.gov/index.cfm?c=exit_signs.pr_exit_signs).

For general illumination, LEDs have great potential but are still under development. As of 2006 the most efficient white LEDs available offered an efficacy of about 30 lumens per watt in real-world conditions—and producing white light with LEDs still costs far more than it does with other light sources. (For updates on the status of LED lighting, visit the U.S. Department of Energy’s “Solid State Lighting” web site, [www.netl.doe.gov/ssl](http://www.netl.doe.gov/ssl).)

**Induction lamps.** Induction lamps, also called electrodeless lamps, consist of a high-frequency power generator, a coupling device that generates a magnetic field (essentially an antenna), and a glass housing that contains the gases and phosphor coating—no electrodes required. The main advantages of induction lighting are the ability to produce a substantial amount of light in a relatively compact package and a long lamp life due to the elimination of the electrodes. The major drawback of induction lighting is high installed cost. In applications where maintenance costs are high, though, induction lighting systems can be cost-effective.

Existing induction-lamp products are aimed at two distinct market niches. The higher-wattage versions available (55 to 165 W) offer very long life (up to 100,000 hours) and can be a good choice anywhere that relamping and maintenance are difficult or hazardous. These lamps have been used in all of the following locations:

- Escalator wells
- High-ceilinged spaces, including atriums (such as over open mall areas) and in warehouses and factories
- Parking garages
- Roadways, including bridges, tunnels, underpasses, and signs
- Exterior pedestrian lighting

Lower-wattage induction lamps (20 and 23 watts) are also available as direct replacements for medium-base incandescent and compact fluorescent lamps. They offer efficacies of about 50 lumens per watt, CRIs of 82, and an expected life of 15,000 hours.

## 6.6 Use Efficient Luminaires

Many lighting projects use efficient lighting sources but fail to deliver the light in an efficient manner. To make the best use of an efficient source, it is essential to consider the efficiency and light distribution of the fixture that will deliver the light from the source. The fixture efficiency is a measure of how much of the light produced by the light source actually gets out of the fixture. It can vary from a low of about 50 percent to a high near 100 percent. In practice, fixture efficiency can make a big difference in a lighting system's overall efficiency—a fixture with an efficiency of 90 percent will deliver 50 percent more of its light than one with an efficiency of only 60 percent. To illustrate the impact improved efficiency can have, a designer who uses a fixture with a 90 percent efficiency and needs 100 fixtures to provide adequate lighting would have needed 150 fixtures to provide the same amount of light with the less-efficient fixture, all else being equal. Lighting fixtures for commercial installations are classified as direct, indirect, or indirect/direct (Figure 6.7).

### Direct Lighting

The most common and lowest first-cost approach for general commercial lighting is direct downlighting with 2-by-4 or 2-by-2 fluorescent fixtures. This design provides good illumination for horizontal tasks, but it leaves ceilings and wall surfaces dark, creating a cave effect. It also may cause glare for computer-based work, because the fixtures may use bright lamps or lenses that can be reflected in computer screens. These fixtures may also be a source of direct glare into an occupant's eyes. The pattern of light distribution from a direct fixture is determined by the reflectors and lenses or diffusers it uses.

**Reflectors.** Reflectors are inserts designed to reduce the internal light loss in fixtures by using highly reflective surfaces to redirect light out of the fixture. They can be used in new fixtures or installed in existing fixtures as part of an energy-savings retrofit strategy.

**Figure 6.7: Fixtures have their ups and downs**

Lighting fixtures may send all or most of their light downward (A), upward (B), or a mixture of the two (C).

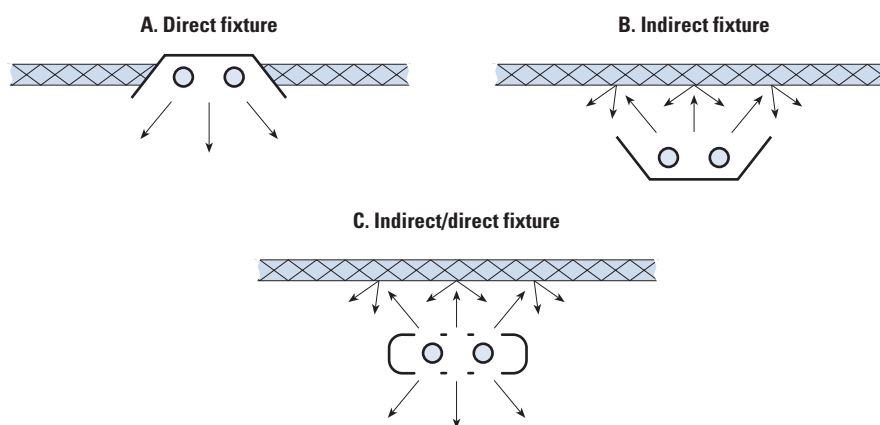

Courtesy: *E SOURCE Lighting Technology Atlas* (2005)



Most high-efficiency fixtures use specular reflectors, which perform like mirrors to aim light in particular directions. The same fixture with a different reflector design can produce a very different distribution pattern. Light distribution also varies according to the horizontal orientation of the fixture. Although a spherical HID fixture usually distributes its light in a uniform, circular pattern, many of the more efficient fluorescent fixtures emit light differently along their length than they do at the ends. This pattern can be used to improve system efficiency in applications such as narrow warehouse aisles.

Specular reflectors can also be retrofitted into existing fixtures, providing a 12 to 16 percent efficacy improvement over new white-enamel diffuse reflectors. These retrofitted reflectors provide more directional control than the white paint that is often employed, and they can be used to widen or narrow the light distribution from the fixtures. In some cases, the use of reflectors and high-efficiency sources enables delamping.

**Lenses and diffusers.** Most indoor commercial fixtures use some type of diffuser, lens, or louver over the face of the fixture to block direct view of the lamp or to diffuse or redirect light. Diffusers are simply semitranslucent plastic sheets that hide lamp images and diffuse light evenly across the face of the fixture. Because they spread light in all directions and absorb a large amount of light, diffusers are not only inefficient but also ineffective at controlling glare. Using clear plastic lenses with small prismatic surface patterns instead of diffusers improves efficiency and the distribution of light.

**Louvers.** Specular parabolic cube (or “paracube”) louvers can reduce the light loss that occurs with translucent lenses. By employing highly reflective surfaces shaped to send light down to a task (instead of bouncing it back and forth between parallel surfaces, as occurs with “eggcrate”-style louvers), these devices block lamp images, reducing the potential for reflected glare in computer screens or other shiny materials. Paracube louvers with openings smaller than 1 inch are effective at reducing glare, but they absorb a great deal of light and dramatically reduce fixture efficiency. Appropriate louver cube sizing (over 1.5 inches) typically requires a deeper fixture and a different method of attachment than conventional shallow fixtures can provide. Large-cell parabolic louvers can create an acceptable appearance and distribution, adding value to a lighting upgrade.

## Indirect Lighting

The best type of lighting system for glare control and visual comfort is an indirect or indirect/direct system. Indirect lighting can make a space feel brighter with less light because it illuminates the ceiling and top portions of walls. If the ceiling and walls are made of a light-colored material, little light is lost with this approach. Indirect light works well within a task-ambient lighting scheme and is also very appropriate for work areas that use computer terminals. Indirect lighting is most useful in rooms with ceilings that are a bit higher than normal (10 feet or higher would be ideal, but 9 feet is acceptable). For lower ceiling heights, recessed direct/indirect fixtures—which provide a mixture of direct and indirect illumination—can be considered, or indirect fixtures can be integrated into or mounted onto office furniture.

The introduction of T5 fluorescent lamps, which are thinner and provide a higher intensity of light output than T8 lamps, has widened the applicability of indirect lighting. The high light output of T5 lamps means that rows of indirect fixtures can be placed as much as 12 to 15 feet apart on ceilings as low as 9 feet (some manufacturers claim that the fixtures can be used on ceilings 8 feet 6 inches or lower) and still provide uniform ceiling illumination levels. Wider spacing means that fewer fixtures need to be used in a given space and the overall cost for an installation can be reduced accordingly.

Indirect lighting can also provide another benefit: The even illumination that it provides means that a lower ambient lighting level may work for a given space. For example, 30 foot-candles of indirect illumination may be sufficient in a location where 40 or 50 foot-candles of direct lighting would be required to provide a similar work environment.

## 6.7 Automatically Control Lighting

Reducing the connected load of the lighting system represents only one part of the potential for maximizing energy savings. The other part is minimizing the use of that load through automatic controls. Automatic controls switch or dim lighting based on time, occupancy, lighting-level strategies, or a combination of all three. In situations where lighting may be on longer than needed, left on in unoccupied areas, or used when sufficient daylight exists, consider installing automatic controls as a supplement or replacement for manual controls.

The general control strategies used by lighting designers include:

- *Occupancy sensing*, in which lights are turned on and off or dimmed according to occupancy;
- *Scheduling*, in which lights are turned on and off according to a schedule;
- *Tuning*, in which light output is reduced to meet current user needs;
- *Daylight harvesting*, in which electric lights are dimmed or turned off in response to the presence of daylight;
- *Demand response*, in which power to electric lights is reduced in response to utility curtailment signals or to reduce peak power charges at a facility; and
- *Adaptive compensation*, in which light levels are lowered at night to take advantage of the fact that people need and prefer less light at night than they do during the day.

These strategies can be accomplished by means of various control devices, including on-off controls, dimming controls, and systems that combine the use of both types of equipment (**Table 6.9**). These controls can be quite sophisticated, but in general they perform two basic functions: They turn lights off when not needed, and they modulate light output so that no more light than necessary is produced. The equipment required to achieve these functions varies in complexity from simple timers to intricate electronic dimming circuits. Each of these technologies can be applied individually to great effect or combined for even greater benefit. Whatever control strategy is employed, steps must also be taken to commission the system to make sure that it performs as expected, and plans must be made for retrocommissioning the system over time so that it continues to perform that way.

### On-Off Controls

The simplest way to reduce the amount of energy consumed by lighting systems is to turn lights off when they are not needed. All electric lights come with a manual switch for that purpose, but these switches are not used as often as they could be. As a result, the lighting industry offers several automatic switches that either mark time or sense the presence of occupants.

**Occupancy sensors.** Occupancy sensors are most effective in spaces where people move in and out frequently in unpredictable patterns: for example, private offices, lecture halls, auditoriums, warehouses, restrooms, and conference rooms. Occupancy sensors are less likely to be effective in open-plan offices, where one or more people may be present throughout the day, or

in reception areas, lobbies, retail spaces, or hospital rooms. The savings achievable with occupancy sensors, even in the most appropriate spaces, varies widely, depending on local conditions.

The three most common types of occupancy sensors are passive infrared (PIR), ultrasonic, and those that combine the two technologies. PIR devices are the least expensive and most commonly used type of occupancy sensor. They detect the heat emitted by occupants and are triggered by changes in infrared signals when, for example, a person moves in or out of the sensor’s field of view. PIR sensors are quite resistant to false triggering and are best used within a 15-foot radius (**Figure 6.8**).

Ultrasonic devices emit a sound at high frequency—above the levels audible to humans and animals. The sensors are programmed to detect a change in the frequency of the reflected sound. They cover a larger area than PIR sensors and are more sensitive. They are also more prone to

**Table 6.9: Lighting control strategies and equipment**

A number of different control strategies and a variety of equipment options are available to the lighting designer.

Strategy	Equipment
Occupancy sensing	Occupancy sensors—infrared, ultrasonic, dual technology
Scheduling	Timed switches, energy management systems
Tuning	Continuous dimming, bilevel switching
Daylight harvesting	Continuous dimming, bilevel switching, photosensors
Demand response	Voluntary or automatic curtailment via utility signals, dimmers, switches, energy management systems
Adaptive compensation	Dimming, switching, timers, photocells

Courtesy: E SOURCE; data from *Advanced Lighting Guidelines*

**Figure 6.8: Occupancy sensor coverage patterns**

Ultrasonic sensors can detect motion at any point within the contour lines. Infrared sensors “see” only in the wedge-shaped zones, and they do not generally see as far as ultrasonic units. Some sensors see farther straight ahead than to the side. The ranges shown here are representative; some sensors may be more or less sensitive.

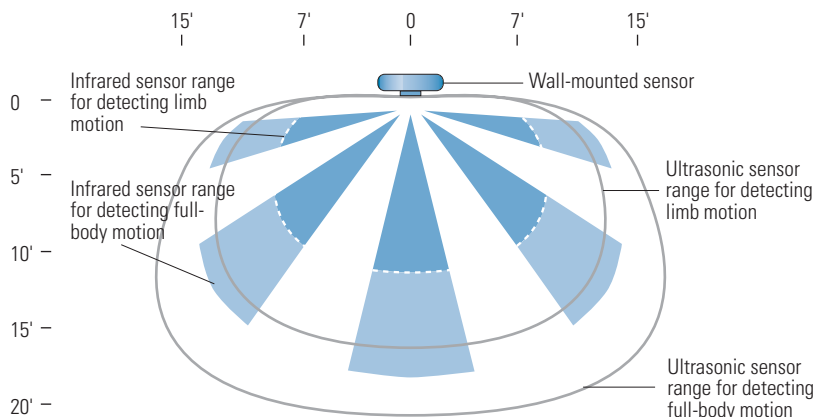

Courtesy: E SOURCE *Lighting Technology Atlas* (2005)

false triggering. For example, ultrasonic sensors can be fooled by the air currents produced by a person running past a door, moving curtains, or the on-off cycling of an HVAC system.

Hybrid devices that incorporate both PIR and ultrasonic sensors are also available. These take advantage of the PIR device's resistance to false triggering and the higher sensitivity of the ultrasonic sensor. Some hybrid sensors combine PIR with sensors for audible sound. That design has proved useful in cases where the frequencies used in ultrasonic sensors interfere with equipment such as hearing aids—a problem that is less frequent than it used to be because sensor manufacturers have learned to use frequencies that minimize the issue.

Evaluating the economic feasibility of an installation is best done by monitoring lighting and occupancy patterns. The use of inexpensive automatic datalogging systems will indicate the total amount of time the lights are on when the space is vacant, the time of day the savings take place, and the frequency of lamp cycling. Data can also be gathered through the use of recording ammeters connected at lighting breaker panels; through random surveys, such as observing a building's exterior at night or interviewing custodial and security personnel; and through existing timers, scheduling controllers, and energy management systems. Whatever way the data is gathered, it is important to account for seasonal variations in operation in order to avoid incorrectly extrapolating short-duration data to a full year. This information will help lead to an informed decision on the economic feasibility of potential occupancy-control opportunities.

Sensor placement is also crucial to success (see sidebar). Wall-mounted sensors are suitable in smaller rooms—offices, bathrooms, and equipment rooms that are only intermittently occupied. In larger spaces or wherever the lighting load is higher, it is better to mount the sensor in the ceiling. Some units can be mounted in the corner or on the wall near the ceiling (**Table 6.10**).

**Timed switches.** Timed switches operate based on either elapsed time after triggering or on programmed schedules using clock time. Elapsed-time switches, also called timer switches, typically fit into or over a standard wall-switch box and allow occupants to turn lights on for a period that is determined either by the occupant or by the installer. Lights go off at the end of that interval unless the cycle has been restarted by the occupant or manually turned off sooner. Time intervals typically range from 10 minutes to 12 hours. Elapsed-time switches are much simpler to specify than occupancy sensors, are less prone to faulty user adjustment, and cost less.

---

---

### **CASE STUDY: Saving Energy with Occupancy Sensors**

As part of a lighting upgrade at one of its facilities in Beverly Hills, California, Arden Realty installed a variety of occupancy sensors. These included ceiling sensors in larger areas and wall sensors in smaller offices. The wall sensors used infrared technology and the ceiling sensors used the ultrasonic approach. Savings amounted to an estimated 3,920 kWh/year in lighting electricity use and another 1,253 kWh/year in reduced cooling energy. Energy use at the facility was also cut by more than 140,000 kWh/year by replacing T12 lamps with T8 lamps, retrofitting reflectors in some fixtures, and replacing incandescent bulbs with compact fluorescents. These lighting measures are part of a building upgrade that includes a new energy management system and the use of variable-frequency drives on various pumps and fans. Overall, Arden, the largest landlord of office buildings in Southern California, has performed more than 100 lighting retrofits, covering over 12 million square feet. The efficiency improvements of these lighting upgrades have been a key element for many Arden properties in earning the ENERGY STAR.

---

---

**Table 6.10: Occupancy sensor applications**

When using occupancy sensors, it is essential to place them correctly.

Type of sensor	Applications
Ceiling mount	Open partitioned areas, small open offices, file rooms, copy rooms, conference rooms, restrooms, garages
Corner mount/wide view	Large office spaces, conference rooms
Wall switch	Private offices, copy rooms, closets
Narrow view	Hallways, corridors, aisles
High mount/narrow view	Warehouse aisles

Courtesy: E SOURCE

Elapsed-time switches may be mechanical or electronic. Mechanical units, typically set by the user, are basically spring-wound kitchen timers connected to a relay, and so are subject to mechanical failures if used in high-traffic areas. Time intervals on electronic switches are typically set by the installer using a hidden setscrew. These electronic devices look like conventional toggle switches, so occupants are usually unaware of the presence of the device, which reduces vandalism and theft. Elapsed-time switches are also an easy, economical means of complying with energy codes that call for automatic lighting controls.

Clock switches control lights by turning them on and off at prearranged times, regardless of occupancy. They are most useful in locations where occupancy follows a well-defined pattern, such as a retail outlet. They are typically placed in electric closets that house lighting power panels. These devices cost relatively little to install and can control large loads with a single set of contactors. Equipment may consist of mechanical devices—motors, springs, and relays—or sophisticated electronic systems that handle several schedules simultaneously. Mechanical switches may require correction for daylight savings time or after a power failure unless battery backup is available, but battery backup can triple the device's price. Electronic devices routinely include battery backup and can be easily programmed to adjust for shifts to and from daylight savings time or for holiday schedules.

One thing to note: If a space has fluorescent lighting, make sure that electronic switches do not use a triac relay. Triacs may trickle a small amount of current to ballasts and lamps, even when they are off, which may damage the lamps as well as waste energy.

**Energy management systems (EMSs).** An EMS performs the same function for lighting as a clock switch, but with more sophistication and additional features. A typical EMS is designed to handle a variety of loads, including HVAC, but pure lighting-management systems are also available. Systems are now becoming available that combine on-off and dimming capabilities in an EMS. A common EMS feature is a sweep mode that automatically cycles lights on or off, one section or floor at a time, signaling occupants that lights will soon be shut off. Occupants can then override the shutdown in their area by pressing a local switch or by phoning in a code to the EMS (see sidebar).

## Dimming Controls

Dimming controls are usually used to match lighting levels with human needs and to save energy. When combined with photosensors that measure local light levels, dimming controls can correct for dirt buildup in fixtures and lamp lumen depreciation. Dimming controls are also used to modulate lamp output to account for incoming daylight. Dimming may be accomplished in either a

---

---

## CASE STUDY: Turning Off Lights with an EMS

A lighting control system linked to an energy management system at a 250,000-square-foot office building in Boston, Massachusetts, produced 112,500 kWh/year in energy savings. Most of the work at the site is done in a single shift, Monday through Friday. An audit at the start of an energy-efficiency upgrade found that the lights were frequently left on in some areas during times when the spaces were unoccupied. Cleaning crews and security guards were supposed to turn off the lights in unoccupied areas, but for various reasons that was often overlooked. Sometimes after-hours or weekend workers would turn on the lights but forget to turn them off when they left. The audit identified the general lighting in the facility as an opportunity for energy savings, but the layout of the facility was not deemed to be conducive to the use of occupancy sensors in all areas. Occupancy sensors were installed in private offices and restrooms, but high partitions and frequent rearranging of the space made them impractical for the large open areas. Instead, an automatic lighting control system was installed as part of a comprehensive EMS being installed at the site.

The building was divided into 47 lighting “zones,” and a time schedule was assigned to each zone. New electronic relays were installed on the lighting circuits and tied into the EMS. The system turns the lights on and off at the designated times and allows for overrides when necessary, ensuring that occupants are still in control when they need to be.

At each zone’s designated time, all the lights in that zone blink to alert any remaining occupants that all lights will go off in a few minutes. Anyone still working uses a phone to call a designated number (to the EMS computer) to get an additional hour of light. When that hour is up, if no further overrides are requested, the lights go out and stay out until the designated morning “lights on” time. Schedules for each zone can be changed easily if necessary. The system can also be accessed by facility managers from remote locations.

---

---

stepped or continuous fashion. Advanced dimming technologies, using individually addressable ballasts and wireless technology, are also available.

**Step dimming.** Two means of step dimming are available: banks of lamps may be put on different switching circuits or ballasts designed specifically for step dimming may be applied. The first method is often referred to as bilevel switching, even though more than two levels may actually be available. For example, in a system with three-lamp fluorescent fixtures, one switch may operate the center lamp in each fixture, while another operates the outer lamps. This arrangement makes three lighting levels possible (one lamp, two lamps, or three lamps lit), yet the term “bilevel” is still used to describe it.

Step-dimming ballasts offer more light control and energy savings than nondimming ballasts but cost less than the more versatile continuous-dimming ballasts. Step-dimming ballasts typically offer two or three lighting levels, and they can be used with occupancy sensors so that the sensors are able to dim the lamps rather than turn them off, which can reduce on-off cycling and extend lamp life. These units also offer a viable way to reduce lighting levels during non-critical hours and to shed peak demand in common areas such as corridors.

Step-dimming ballasts are especially useful for HID lamps. These lamps typically require long warm-up times, so they are not suited to being switched on and off by occupancy sensors. Better results can be obtained by switching the lamps between low power and full power.

**Continuous dimming.** Continuous-dimming controls adjust lighting levels over a wide range. They offer more flexibility than step dimming and are used in a wide variety of applications, including mood-setting and daylight dimming.

Fluorescent lamps may be dimmed for two purposes: energy savings and architectural effect. Energy-saving dimmers typically dim down to 20 percent, while architectural dimmers may reduce light levels to 1 percent or less. Dimming ballasts are often used to reduce electric light output whenever daylight is available. Dimming can also be used in load-shedding strategies—better to have employees work briefly under slightly lower light levels than be forced to send them home because of a power failure.

Dimming ballasts use either low-voltage or power-line control. Most ballasts are controlled by a separate, low-voltage circuit. This approach requires additional wiring, but the ballasts are compatible with a wide variety of dimming controls. For example, low-voltage-controlled ballasts can easily be connected to EMSs that offer 0- to 10-volt output channels. Power-line-controlled ballasts can dim fluorescent lamps with standard incandescent wall dimmers installed directly on the line-voltage switch leg—no extra wires necessary. The ballasts are not compatible with all dimmers, however, so ballast and dimmer should be checked for compatibility. Personal dimming controls, which allow individuals to control light levels in their own work areas, are also becoming more widely available. Such dimming controls have been shown to cut energy use and increase worker satisfaction levels.

In recent years, it has become easier to dim compact fluorescent lamps as well as full-size fluorescents. New screw-base, step-dimmable, and continuously dimmable CFLs provide dimming capabilities down to the range of 10 to 20 percent, and these products work well with most existing incandescent dimmers. These lamps cost two to three times more than standard CFLs. New pin-base CFL dimming products are on the market as well, providing opportunities to dim lights to 5 percent of maximum output or even lower levels.

HID dimming is more limited because it is accompanied by color shifting, reduced CRI, increased flicker, adverse impact on lamp life, and inadvertent lamp shutdown during line-voltage variations. New electronic dimming ballasts for metal halide lamps are reducing the severity of some of these effects, making HID dimming more feasible.

Building operators can achieve the highest levels of energy savings through a combination of dimming and on-off strategies. However, the total savings achieved by implementing both strategies will be less than the sum of the savings gained by implementation of each of the strategies alone. The reason for this is simple: Take, for example, a system that combines occupancy sensing and dimming. Dimming cannot save energy when occupancy sensors have already shut off a lamp, and the occupancy sensors save less energy when they turn off lights that otherwise would have been dimmed.

**Addressable ballasts.** Most dimming is accomplished by controlling banks of dimmable ballasts together. Digitally controlled ballasts that use control protocols such as DALI (digitally addressable lighting interface), LonWorks, BACnet, or other proprietary protocols provide more flexibility. Each ballast is assigned an identifier, or “address,” and can be controlled individually or in clusters that can easily be regrouped. With some systems, two-way communications are also possible. This capability not only gives users the ability to tailor local lighting conditions to their individual needs, but may also give energy managers a tool for tracking and controlling energy use and responding to load-shedding signals (see sidebar).

Some protocols, such as DALI, are designed for use over a dedicated low-voltage network, but DALI-to-Ethernet converters are available so that DALI can be used in buildings with existing

---

---

## CASE STUDY: System Controls and Tracks Lighting Use

A lighting control system based on the digitally addressable lighting interface (DALI) allows the energy manager at the Harvard School of Public Health to control any of the lights in the school's refurbished office space using a personal computer and the Internet. He can pinpoint the location of any failed lamps or ballasts and get up-to-the-minute reports on lighting energy consumption. The system has allowed him to better manage energy use and maintenance while keeping building occupants comfortable. All of the ballasts have been set to operate partially dimmed as the default mode, so if occupants say that they need more light, it takes just a few keystrokes to give it to them without having to add new fixtures. The system can also be used to dim lights in response to load-shedding signals from the local utility.

---

---

Ethernet networks without the need to run additional control wires. Some digital ballasts include a built-in DALI interface; others use another proprietary protocol. Conventional low-voltage controlled-dimming ballasts can be added to digital lighting control systems via special interfaces that connect to DALI systems and convert the DALI commands to standard 0- to 10-volt direct-current control signals.

Wireless lighting controls. One of the difficulties that comes up when adding controls as part of a lighting upgrade is the expense of running the wires. One promising solution is wireless lighting controls. A typical wireless lighting control system consists of a set of sensors, actuators, and controllers that communicate via radio waves rather than wires. Although wires are still required for the lighting equipment itself, using radio waves instead of wires to transmit control signals offers a number of potential advantages, both in terms of ease of installation and maintenance and in terms of flexibility. Wireless lighting controls have been available for a number of years, but their use has been limited to a few niche markets such as high-end homes, conference rooms, and classrooms that often need a large variety of lighting scenes. These systems are installed to provide amenities they're not aimed at energy savings and they lack the reliability and flexibility that would be needed in a commercial facility. Newer, more-capable wireless systems, some of which are available today, may broaden the wireless lighting controls market considerably if costs can be brought down. One promising technique uses a concept known as a mesh network, which is a decentralized set of wireless nodes that are linked to one another to form a self-organizing, self-healing network. Control is split up among the different nodes so that there are multiple, redundant paths throughout the network. Each device on the network is designed to transmit over short distances, which reduces power requirements and minimizes the potential for interference. Leading players in the mesh network field are the Zigbee Alliance ([www.zigbee.org](http://www.zigbee.org)) and the Z-Wave Alliance ([www.z-wavealliance.org/modules/start/](http://www.z-wavealliance.org/modules/start/)).

## Commissioning Ensures the Benefits of Lighting Controls

Most lighting controls require commissioning to ensure that they operate as intended and are properly adapted to local conditions. Specific steps depend on the types of controls installed:

- For all systems, verify that sensors are placed according to construction drawings and make adjustments for any unexpected obstructions.
- For daylighting systems, calibrate the system after all furnishings and interior surface finishes are in place. For help in commissioning daylighting systems, Architectural Energy Corp. has



created the Sensor Placement and Orientation Tool. This tool is available free of charge at [www.archenergy.com/SPOT/index.html](http://www.archenergy.com/SPOT/index.html).

- For systems with occupancy sensors, check placement and orientation against construction drawings and adjust the sensitivity and time delay of the sensor.
- For scheduling systems, put in appropriate start and stop times for weekday, weekend, and holiday operation and verify correct operation of overrides.
- For manual dimming, check that the dimmer is installed as specified and that the upper limits set are appropriate for the tasks being performed and the lower limits set do not cause the lamps to flicker.

In addition, to decrease the chances that occupants will sabotage the controls, occupants and maintenance personnel should be informed about the benefits of the systems and, where possible, involved in the design process. They should also be informed about how the controls work and trained in the use of the override controls so that they can use them when needed and not be tempted to override permanently. All control systems also need periodic maintenance to ensure that they continue to work properly.

## 6.8 Build In an Operations and Maintenance Plan

A lighting upgrade can cut energy bills, improve the look of a facility, and boost employee morale, but all those benefits can fade away if the new lighting systems are not well maintained. All lighting systems experience a decrease in light output and efficiency over time, because:

- Lamp light output decreases (lamp lumen depreciation) (**Figure 6.9**).
- Dirt accumulates on fixtures (luminaire dirt depreciation). The IESNA issued new guidelines in late 2003 for estimating the effect of dirt accumulation on luminaires. The document,

**Figure 6.9: Typical lamp lumen depreciation curves**

The slower rate of lumen depreciation of some lamps compared to others can translate to lower installed wattage for an equal amount of maintained foot-candles.

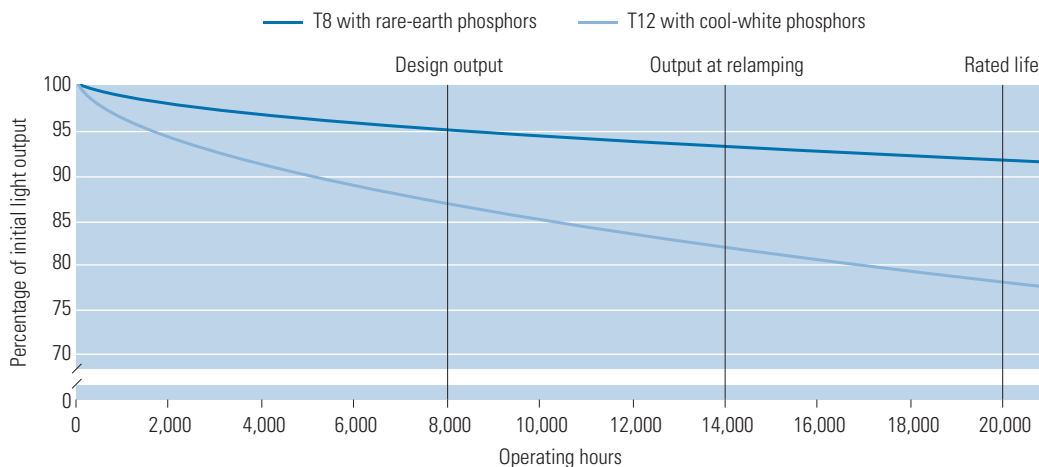

Courtesy: *E SOURCE Lighting Technology Atlas* (2005); data from Philips Lighting Co.

“IESNA/NALMCO RP-36-03,” may be purchased from <http://webstore.ansi.org/ansidocstore/product.asp?sku=IESNA%2FNALMCO+RP-36-03>.

- Lamps burn out.
- Control systems drift out of spec or are overridden by occupants.

For maximum effectiveness, maintenance should be addressed right from the start of the design process in the following ways.

- *Design lighting systems with components that minimize light loss over time, are easy to maintain, and use the fewest types of lamps.* The process begins with the choice of lamp. To account for lighting-system degradation, designers typically oversize initial light output by 35 percent or more to “maintain” minimum target illumination levels when lamps are changed and fixtures cleaned. Proper design and maintenance—using high-quality lighting components that suffer less degradation or degrade more slowly—can cut that excess nearly in half, saving almost 15 percent in connected load. Minimizing that 35 percent safety factor involves choosing lamps with minimum lumen depreciation. Maintenance costs can be further minimized by limiting the number of different types of lamps that must be stocked and by choosing lamps with maximum rated life to reduce burnout rate.
- *Train personnel in proper maintenance techniques, including cleaning and relamping.* Knowledge of the equipment; an understanding of the procedures; and an appreciation for the relative costs of energy, labor, and lamps are essential parts of instruction. Annual retraining is also necessary to remind staff of proper procedure and to account for changes in equipment and staff turnover. Retraining is especially important immediately after a lighting upgrade. Such training should include hands-on work with new devices and a quiz to indicate which employees may need further technical education. A variety of training and certification programs are offered by national organizations for the design and maintenance of efficient lighting systems (see sidebar). Many utilities also sponsor local training programs. Hiring a lighting-management company may simplify maintenance. Using an outside firm can eliminate the need to train employees in lamp maintenance practices and cut the necessity of maintaining large stocks of extra lamps. In addition, a firm familiar with new technologies can help a facility take advantage of the latest lighting-system improvements.
- *Control purchasing and inventory to ensure that only the right replacement components are available.* If the right ballast or lamp is not immediately available when an occupant complains about a burnout, the need to provide a quick replacement will almost guarantee that the wrong type is installed instead. Maintaining proper purchasing specifications and inventory eliminates the possibility of using the wrong equipment.

### Plan for Group Relamping

In many cases, the most cost-effective way to maintain a lighting system is a planned program of group relamping, in which all lamps are replaced in the same operation. This practice is in contrast to spot relamping, in which lamps are replaced only when they burn out.

- On a per-lamp basis, group relamping requires much less labor than spot relamping because the maintenance workers have all the required materials on hand and can move systematically from one fixture to the next. In addition, group relamping is normally done outside working hours, which reduces disruption of normal activities.
- It is an easy task to schedule and to delegate to outside contractors who have special equipment and training.

- Group relamping provides brighter and more-uniform lighting because it gets rid of lamps before they are at the end of their lumen depreciation curve.
- It offers increased control over the replacement lamps, reducing the probability of mixing incompatible lamps, such as those with different color temperatures.
- Other maintenance activities can be combined with group relamping, such as ballast and reflector inspection and lens cleaning. It also provides an opportunity for retrofitting reflectors, lamps, ballasts, or lenses as necessary.

---

---

## RESOURCES: Training and Certification Programs

A number of organizations offer training and certification programs for the design and maintenance of energy-efficient lighting systems.

### Association of Energy Engineers (AEE)

Contact Leslie Walcker, CLEP Certification Administrator  
Atlanta, Georgia  
Tel 770-447-5093 ext 223  
E-mail [leslie@aeecenter.org](mailto:leslie@aeecenter.org)  
Web [www.aeecenter.org/certification/clep](http://www.aeecenter.org/certification/clep)

The AEE Certified Lighting Efficiency Professional (CLEP) program includes a two-day seminar and a four-hour exam oriented toward design and specification of energy-efficient lighting systems.

### The interNational Association of Lighting Management Companies (NALMCO)

Des Moines, Iowa  
Tel 515-243-2360  
Fax 515-243-2049  
E-mail [director@nalmco.org](mailto:director@nalmco.org)  
Web [www.nalmco.org/](http://www.nalmco.org/)

The NALMCO Certified Lighting Management Consultant program is a preparatory course and one-day test focusing on lighting systems specification and management.

### National Council on Qualifications for the Lighting Professions (NCQLP)

Alexandria, Virginia  
Tel 703-518-4370  
Fax 703-706-9583  
Web [www.ncqlp.org](http://www.ncqlp.org)

The NCQLP Lighting Certification program consists of a four-hour exam that focuses on overall lighting knowledge as well as information-gathering and decision-making skills.

### Other Certifying Agencies

Contact information by state can be found at [www.boccentral.org](http://www.boccentral.org).

Various energy-efficiency groups around the country, such as the Midwest Energy Efficiency Alliance (MEEA) and Northeast Energy Efficiency Partnerships (NEEP), offer Building Operator Certification programs. Certification requires 56 hours of classroom training and approximately 16 hours of projects that encompass a wide variety of building elements, including energy-efficient lighting practices.

Group relamping is normally done at about 60 to 80 percent of rated lamp life, depending on variables such as labor costs, requirements for fixture cleaning, and the cost and mortality curves of the lamps.

Economic comparisons typically show that group relamping has higher lamp costs but lower labor costs than spot relamping. One such comparison shows a substantial overall savings from group relamping (**Table 6.11**).

## Retrocommission Lighting Controls

All lighting control systems need to go through periodic retrocommissioning where they are checked to ensure that they continue to work as expected—occupancy sensors may become obstructed by a new furniture arrangement, light sensors may require adjustment if interior surfaces are changed to materials with new reflectance values, or a new building may go up next door that changes incoming daylight patterns. Maintenance personnel should inspect the lighting controls at least annually to verify proper operation. Photoelectric controls need occasional cleaning of the photosensitive surface.

Scheduling controls that use relays need to be checked periodically to ensure that they are not permanently overridden. In cases where an override is found, determine the cause before simply clearing the override setting—the override may have been an attempt to solve a problem that has not yet been fixed.

## Develop an O&M Manual

To deal with these factors and sustain an efficient, high-performance lighting upgrade, assemble an operations and maintenance (O&M) manual. Use it as both the lighting-management policy and a central operating reference for building-management and maintenance staff. This manual should include the following information:

- Facility blueprints.
- Fixture and controls schedule.
- Equipment specifications, including product cut sheets.
- Equipment and service provider sources and contacts (include utility contacts).

**Table 6.11: Economics of group versus spot relamping**

Group relamping has higher lamp costs but much lower labor costs, providing, in this case, a 43 percent overall savings. Group relamping also provides additional benefits in lighting quality and facility management.

	Relamp cycle (hours)	Average lamps replaced per year	Average material cost per year	Average labor cost per year	Total average cost per year
Spot relamping on burnout <sup>a</sup>	20,000	525	\$945	\$3,938	\$4,883
Group relamping at 70 percent of rated life <sup>b</sup>	14,000	750	\$1,350	\$1,425	\$2,775
Difference	6,000	225	\$405	-\$2,513	-\$2,108

Notes: a. Assumes labor costs of \$7.50 for relamping and cleaning, material cost of \$1.80 per lamp, and 3,500 hours per year operation.

b. Assumes labor costs of \$1.90 for relamping and cleaning, material cost of \$1.80 per lamp, and 3,500 hours per year operation.

Courtesy: *E SOURCE Lighting Technology Atlas* (2005)

- Fixture cleaning and relamping schedule with service tracking log.
- Procedures for relamping, reballasting, and cleaning fixtures.
- Procedures for the adjustment of photosensors and occupancy sensors.
- Procedures for proper lamp and ballast disposal.

Review the O&M manual with the staff responsible for lighting maintenance. Make training mandatory for all new maintenance personnel. Correct operation and maintenance should be built into job descriptions and should become part of all annual performance reviews.

## Dispose of Lamps Properly

A lighting upgrade will most likely require the removal and disposal of lamps and ballasts. Group relamping every several years and occasional spot relamping as necessary will also create additional lamp waste. Some of this waste may be hazardous and must be managed according to applicable federal, state, and local requirements (see sidebar).

Many lamps contain mercury and are therefore considered hazardous waste under the Resource Conservation and Recovery Act (RCRA), including fluorescent, HID, neon, mercury vapor, HPS, and metal halide lamps. Visit the EPA's RCRA web site at [www.epa.gov/rcraonline](http://www.epa.gov/rcraonline) for more details. To help deal with the problem of lamp disposal, the EPA initiated an outreach program in 2002 to promote the recycling of mercury lamps by commercial and industrial end users. The outreach program aims to increase awareness of the proper disposal methods of these lamps in compliance with federal and state universal waste rules. The National Electrical Manufacturers Association (NEMA) supports the program and offers information on a web site designed specifically to address lamp recycling issues ([www.lamprecycle.org](http://www.lamprecycle.org)).

---

---

## RESOURCES: Disposal Contact and Resource Information

Lighting upgrades and ongoing maintenance will require the disposal of lamps and ballasts. Here are some sources of information on the proper disposal of these items, which may contain hazardous materials.

### Resource Conservation and Recovery Act (RCRA)

Hotline 800-424-9346 (Washington, D.C., metro area: 703-412-9810)

Web [www.epa.gov/rcraonline](http://www.epa.gov/rcraonline)

RCRA provides information on disposal of lamps that contain hazardous materials.

### National Electrical Manufacturers Association (NEMA)

Web [www.lamprecycle.org](http://www.lamprecycle.org)

NEMA maintains a web site with guidelines and detailed information on lamp recycling.

### Toxic Substances Control Act (TSCA)

Hotline 202-554-1401

E-mail [tsc-hotline@epa.gov](mailto:tsc-hotline@epa.gov)

Web [www.epa.gov/pcb](http://www.epa.gov/pcb)

The TSCA provides regulations and guidelines for disposal of ballasts that contain polychlorinated biphenyls (PCBs).

---

---

For ballasts, the proper method of disposal depends on the type and condition of the ballasts. Generally, ballasts manufactured after 1978 contain the statement “No PCBs,” meaning they have not been found to contain polychlorinated biphenyls (PCBs). The disposal of PCBs is regulated under the Toxic Substances Control Act (TSCA). Other factors controlling the disposal of ballasts will depend on the regulations and recommendations in effect in the state in which they are removed or discarded. Because disposal requirements vary from state to state, check with regional, state, or local authorities for all applicable regulations.

The costs of handling and disposal of lamps and ballasts vary, but the expense is rarely a deal-breaker in a lighting upgrade. Typically, disposal costs constitute a very small percentage of the overall life-cycle costs of operating a lighting system. Investigate and budget for these disposal costs, both as a first cost during the upgrade and as an ongoing O&M expense.

## 6.9 Summary

This chapter on the lighting stage of a building system upgrade has described opportunities for improving a building’s lighting system in a cost-effective manner. To ensure a successful upgrade, keep the following strategies in mind:

- Design light (quantity and quality) that is tailored to task and occupant needs.
- Specify equipment that maximizes system efficiency, not just component efficiency.
- Use automatic controls to turn lights off or down when not needed.
- Establish ongoing monitoring, maintenance, and disposal practices.

## Bibliography

American Society of Heating, Refrigerating and Air-Conditioning Engineers Inc. (ASHRAE), “Energy Standard for Buildings Except Low-Rise Residential Buildings,” ANSI/ASHRAE/IESNA Standard 90.1-2004, 404-636-8400, [www.ashrae.org](http://www.ashrae.org).

California Energy Commission, “Guide Illuminates Modular Skylight Well Design,” Public Interest Energy Research Buildings Program Technical Brief, CEC-500-2005-045-FS (2005), [www.esource.com/public/pdf/cec/CEC-TB-3.pdf](http://www.esource.com/public/pdf/cec/CEC-TB-3.pdf).

Consortium for Energy Efficiency, “High-Performance T8 Specification” (March 2006), [www.cee1.org/com/com-lt/com-lt-specs.pdf](http://www.cee1.org/com/com-lt/com-lt-specs.pdf).

EERE, *2005 Buildings Energy Data Book* (U.S. Department of Energy, 2005).

Illuminating Engineering Society of North America (IESNA), “Recommended Practice for Planned Indoor Lighting Maintenance,” IESNA/NALMCO RP-36-03 (2003).

Lawrence Berkeley National Laboratory (LBNL), *Interactions Between Lighting and Space Conditioning Energy Use in U.S. Commercial Buildings*, LBNL 39795 (April 1998), <http://enduse.lbl.gov/info/LBNL-39795.pdf>.

Lighting Research Center, Rensselaer Polytechnic Institute, “National Lighting Product Information Program,” [www.lrc.rpi.edu/programs/NLPIP/index.asp](http://www.lrc.rpi.edu/programs/NLPIP/index.asp) (accessed October 2006).

Light Right Consortium, “Lighting Quality & Office Worker Productivity,” brochure (November 2003).

Navigant Consulting Inc., “U.S. Lighting Market Characterization, Volume 1: National Lighting Inventory and Energy Consumption Estimate, Final Report” (September 2002), prepared for the U.S. Department of Energy’s Office of Energy Efficiency and Renewable Energy (EERE) Building Technologies Program, [www.eere.energy.gov/buildings/info/documents/pdfs/lmc\\_vol1\\_final.pdf](http://www.eere.energy.gov/buildings/info/documents/pdfs/lmc_vol1_final.pdf).

New Buildings Institute Inc., “Advanced Lighting Guidelines: 2003 Edition” (2003), [www.newbuildings.org/lighting.htm](http://www.newbuildings.org/lighting.htm).

Rea, Mark S., ed., *IESNA Lighting Handbook*, 9th edition (IESNA, 2000).

Roberts, Victor, and Ira Krepchin, *E Source Technology Atlas Series, Volume I: Lighting* (E SOURCE, 2005).

U.S. Environmental Protection Agency, “Guidelines for Energy Management Overview,” [www.energystar.gov/index.cfm?c=guidelines.guidelines\\_index](http://www.energystar.gov/index.cfm?c=guidelines.guidelines_index) (accessed October 2006).



LEARN MORE AT  
[energystar.gov](http://energystar.gov)

ENERGY STAR® is a U.S. Environmental Protection Agency program helping businesses and individuals fight global warming through superior energy efficiency.

## Chapter 7 Supplemental Loads







# 7. Reducing Supplemental Loads

Revised August 2007

<b>7.1</b>	<b>Overview</b>	<b>2</b>
<b>7.2</b>	<b>Reducing Equipment Energy Use</b>	<b>3</b>
	Corporate Purchasing Policies	3
	Office Equipment Efficiency Measures	4
	Kitchen Efficiency Measures	6
	Employee Energy Conservation Training	7
<b>7.3</b>	<b>Upgrading the Building Envelope</b>	<b>8</b>
	Windows	10
	Roofs	13
	Photovoltaic Panels	17
<b>7.4</b>	<b>Summary</b>	<b>18</b>
	<b>Bibliography</b>	<b>18</b>
	<b>Glossary</b>	<b>G-1</b>

## 7.1 Overview

Reducing supplemental loads is the third stage in the building upgrade process. The staged approach (**Figure 7.1**) accounts for interactions among all the energy flows in a building and produces a systematic method for planning upgrades that maximize energy savings. When the staged approach is performed sequentially, each stage includes changes that affect the upgrades performed in subsequent stages, thus setting up the overall process for the greatest energy and cost savings possible. In this upgrade sequence, supplemental load reductions are completed before heating and cooling loads can be determined.

Supplemental load sources are secondary load contributors to energy consumption in buildings—typically people, computers, lights, and the building itself. These loads can adversely affect heating, cooling, and electric loads. However, the effect of supplemental loads can be controlled and reduced through strategic planning and implementing energy-efficient upgrades. With careful analysis of these sources and their interactions with HVAC systems, equipment size and upgrade costs can be reduced. These upgrades can increase HVAC energy savings and reduce wasted energy.

This chapter helps identify these load sources and illustrates strategies that can mitigate their negative impact on energy performance: First assess the supplemental-load sources in a building to determine reduction opportunities. Then contact vendors, contractors, or engineering consultants to specify upgrades. Finally, install energy-efficient upgrades to reduce supplemental loads on heating, cooling, and electrical systems.

The best ways to reduce supplemental loads include:

- Reducing equipment energy use
- Upgrading the building envelope by improving insulation, fenestration, and roofing

**Figure 7.1: Staged approach to building upgrades**

The staged approach to building upgrades accounts for interactions among all the energy flows in a building. Each stage affects the upgrades performed in subsequent stages, thus ensuring the greatest energy and cost savings possible. Reducing supplemental loads affects heating, cooling, and electric loads.

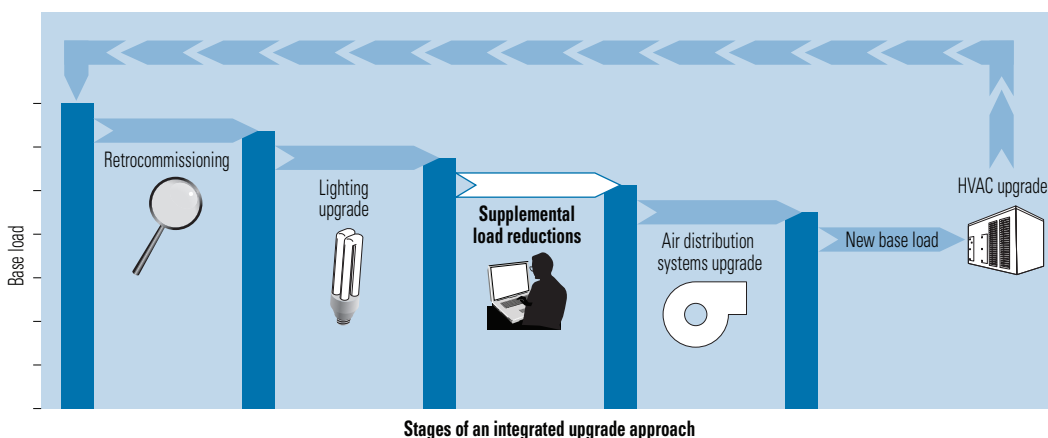

Courtesy: E SOURCE

Reducing heating, cooling, and electric loads through these measures, added to the reductions already achieved through the Retrocommissioning and Lighting Upgrade stages, allows installation of smaller, lower-first-cost HVAC equipment in the Air Distribution and Heating and Cooling Systems stages. If possible, do not install HVAC equipment until all loads have been reduced and the impacts on HVAC systems can be measured directly. If HVAC equipment installation cannot be delayed, take the time to predict the magnitude of load reductions from upgrade projects.

## 7.2 Reducing Equipment Energy Use

Electric-powered equipment obviously affects electric loads. It is also important to remember that for many types of equipment, much of the electricity used in a space will ultimately end up in that space as heat. Thus, reducing the energy use of electric equipment not only reduces electric loads but also reduces cooling loads and, as with lighting, provides an opportunity to replace that heat more efficiently, when needed, with gas heat or electric heat pumps. Office equipment and, in many facilities, kitchen equipment, can be cost-effectively upgraded with more efficient products and controls. The best way to ensure that this happens is with a corporate policy that encourages purchasing energy-efficient equipment. Employee training programs can also help ensure that equipment is used efficiently.

### Corporate Purchasing Policies

By purchasing and specifying energy-efficient products, organizations can cut energy use, achieve enormous cost savings, and help reduce pollution and greenhouse gas emissions. To ensure that new equipment purchases favor high-efficiency models, energy management programs should adopt a procurement policy as a key element for their overall strategy.

Instituting an effective policy can be as easy as asking procurement officials to specify ENERGY STAR–qualified products, such as office equipment, in their contracts or purchase orders. This can be made simple by inserting model procurement language (customized as necessary) into procurement contracts for energy-consuming products and systems. The language should specify the performance criteria used for ENERGY STAR–qualified and other high-efficiency products. For many products not covered under ENERGY STAR, such as ice machines, contracts can include recommendations that the Department of Energy provides to federal government procurement officials.

Procurement contracts typically specify the desired equipment along with other vendor requirements to ensure the equipment operates efficiently. For example, vendors may be required to properly configure energy-saving features and provide customer support for power-management features to ensure that they remain properly enabled and are repaired if a malfunction occurs.

EPA provides purchasing and procurement resources that can help organizations obtain energy-efficient ENERGY STAR products. These resources include lists of qualifying products, key product criteria, drop-in procurement language, and savings calculators. Visit the ENERGY STAR Purchasing & Procurement web site at [www.energystar.gov/purchasing](http://www.energystar.gov/purchasing) for more information. For products not covered under ENERGY STAR, the U.S. Department of Energy's Federal Energy Management Program (FEMP) offers its own recommendations. Both ENERGY STAR– and FEMP-recommended products use 25 to 50 percent less energy than their traditional counterparts, reduce fossil fuel use, and produce fewer greenhouse gas emissions. See the FEMP Energy-Efficient Products page at [www1.eere.energy.gov/femp/procurement/eep\\_modelang.html](http://www1.eere.energy.gov/femp/procurement/eep_modelang.html).

## Office Equipment Efficiency Measures

In the business world, office equipment is the fastest growing electric load. However, much of the energy used is wasted because equipment is left on when not in use throughout the workday, at night, and on weekends. Office equipment (whether mechanical, electrical, or electronic) also generates heat in the conditioned space which, although useful when space heating is needed, can generally be supplied more efficiently through gas-fired space heating or electric heat pumps.

A corporate procurement policy that mandates ENERGY STAR–labeled equipment can reduce electric loads from office equipment and space cooling loads. Virtually all office equipment manufacturers offer a wide range of ENERGY STAR models, including copiers, printers, mailing machines, fax machines, monitors, computers and workstations, scanners, and multifunction devices. Office equipment with the ENERGY STAR label saves energy and money by powering down and entering “sleep” mode or turning off when not in use and achieving higher efficiency when in use (see **Table 7.1**). Products that meet the ENERGY STAR specifications use about half as much electricity as conventional equipment. See the ENERGY STAR Office Equipment web site at [www.energystar.gov/index.cfm?fuseaction=find\\_a\\_product.showProductCategory&pcw\\_code=OEF](http://www.energystar.gov/index.cfm?fuseaction=find_a_product.showProductCategory&pcw_code=OEF).

Energy-efficient equipment with the ENERGY STAR label costs the same as comparable nonlabeled equipment and produces significant energy savings, as shown in **Table 7.2**. The estimated savings are per unit and can be multiplied to estimate savings for an office with hundreds of energy-efficient products.

**Table 7.1: Performance specifications for ENERGY STAR–labeled office equipment**

Office equipment labeled ENERGY STAR often must be more efficient than nonlabeled equipment when in active operation as well as during periods of inactivity. In some cases, there are additional requirements.

Equipment	ENERGY STAR specifications
Computers	Require improved efficiency over all operation modes due to use of highly efficient power supplies. Automatically enter a low-power sleep mode within 30 minutes of inactivity.
Copiers	Require improved efficiency when the product is in use. Also power down when not in use to a low energy consumption level. Depending on the speed, may be required to print double-sided pages, reducing both copying and paper costs.
Fax machines	Require improved efficiency when the product is in use. Automatically power down after 5 minutes of inactivity. Combination printer/fax machines consume half as much energy when idle as two stand-alone products.
Laptops	Require improved efficiency over all operation modes due to use of highly efficient internal and external power supplies. If left inactive, enter a low-power mode and may use 15 watts or less.
Monitors	Require improved efficiency when they are in active mode. Use 2 watts or less in sleep mode and 1 watt or less in off mode. Use up to 85 percent less electricity than standard models.
Multifunction devices	Offer copying as well as printing, faxing, scanning, and/or other capabilities. Automatically power down after 15 to 60 minutes of inactivity, depending on equipment speed. May require automated duplexing, depending on the speed.
Printers	Require improved efficiency when the product is in use. Automatically power down after 5 to 60 minutes of inactivity, depending on equipment speed. May require automated duplexing, depending on the speed.
Scanners	Require improved efficiency when the product is in use. Automatically power down after 15 minutes when not in use.

Source: EPA

**Table 7.2: ENERGY STAR office equipment estimated savings**

Office equipment labeled ENERGY STAR typically costs no more than nonlabeled equipment and produces significant energy savings when considering the many pieces of equipment in a typical office building.

Equipment	Annual energy savings per unit (kWh)	Annual cost savings per unit (\$)ª
Computers and monitors	200 to 370	20 to 37
Copiers	236	24
Fax machines	101	10
Printers	45	4

Note: a. Based on \$0.10/kWh electric rate; kWh = kilowatt-hours.

Source: EPA, Lawrence Berkely National Laboratory

In many offices, there is also a growing use of energy-consuming devices that are not covered by ENERGY STAR—such as personal coffee pots, cup warmers, fans, under-the-desk heaters, audio equipment, and computer peripherals. Although each device draws only a small amount of power, the total can be significant. Companies can have policies that ban such items or at least educate employees about wise use—turning devices off or unplugging them when not in use.

Besides purchasing energy-efficient equipment, it is also important to ensure people use the energy-saving settings. For computers and monitors this step can be accomplished using the power-management settings of networked work stations via three approaches.

**Have employees enable the existing power-management features on their computers and turn off computers at night.** Most computer equipment sold today can be set to enter a low-power sleep mode after a period of inactivity. Unfortunately, most users do not take advantage of this feature. Note that the power-management setting that puts the monitor to sleep is different from the screen saver—monitors still use full power while a screen saver is running.

This approach is inexpensive: Meet with information technology (IT) staff, energy-management staff, and executive management staff to explain the plan. Then send e-mails to employees explaining how to enable power management on their computers and urging them to do so. Unfortunately, it is difficult to ensure compliance with power-management policies or measure the energy savings. And given data indicating that only a small percentage of computers currently have power-management settings enabled, it is likely that this approach will only be marginally successful. Even within the fraction of employees who do comply with the policies, any savings will likely degrade over time as computers get replaced and users disable power-management settings.

**Have the IT department develop and deploy login scripts that control power-management settings.** Using login scripts to control power-management settings can help ensure compliance and sustained savings, but scripts pose their own problems. Perhaps the biggest hurdle is that the IT department will rarely be motivated solely by the prospect of energy savings to create a script flexible enough to accommodate the variety of hardware, operating systems, and users found on a company's network. Because scripts tend to be static one-size-fits-all solutions, they are likely to establish such lenient power-management settings (so that the settings will work for all equipment) that they capture little of the potential energy savings. Or more stringent scripts might alienate some employees if settings interfere with their work habits. Scripts also provide no information on the level of energy savings.

**Use third-party software to establish and implement a computer power-management policy across the company network.** Several software packages target energy savings in computer networks (see Sidebar). Each package has advantages and disadvantages, and any of them might be the best choice for a given organization. For example, if the company wants to control monitors only, the U.S. Environmental Protection Agency's free EZSave software may be the right choice. On the other hand, if a workforce has diverse schedules and computer usage patterns, one of the products that offer group-specific power-management settings may be the most appropriate. For help selecting a power management solution, visit the ENERGY STAR web site at [www.energystar.gov/index.cfm?c=power\\_mgt\\_pr\\_power\\_management](http://www.energystar.gov/index.cfm?c=power_mgt_pr_power_management).

## Kitchen Efficiency Measures

Most commercial buildings have small kitchen areas where occupants can prepare coffee, lunch, or snacks. Microwave ovens, coffee machines, and refrigerators are common in these areas. Microwave ovens and stoves generally consume energy in direct proportion to the need for warming foods, refrigerators run continuously, and coffee machines may be left on longer than necessary. Vending machines are typically lighted and often refrigerated continuously, consuming energy 24 hours per day. Because this equipment is located within conditioned space, its use of electricity also generates heat that contributes to cooling loads.

To reduce energy use and heat generation, purchase ENERGY STAR–labeled kitchen equipment such as refrigerators, water coolers, and vending machines. ENERGY STAR refrigerators contain high-efficiency compressors, improved insulation, and more precise temperature and defrost mechanisms to improve efficiency. They use at least 15 percent less energy than required by current federal standards and 40 percent less energy than conventional models sold in 2001.

A standard hot and cold bottled water cooler can use more energy than a large refrigerator. But an ENERGY STAR model requires about half as much energy as a standard unit, which can save building and business owners more than 1,600 kilowatt-hours (nearly \$130 annually) on utility bills per water cooler.

---

---

### CASE STUDY: Computer Power Management Cuts Costs at Queensborough Community College

Queensborough Community College in New York has about 12,000 students. College staff installed Verdiem Corp.'s SURVEYOR™ network energy manager software on about 850 computers. Most are “administrative” computers—used by instructors and administrative personnel. The rest are used in computer labs in some of the academic departments.

Before enforcing power-management settings at the Queensborough facilities, Verdiem had estimated annual energy savings of 111 kilowatt-hours (kWh) per administrative computer and almost 390 kWh per academic computer (due primarily to longer idle times) based on the time these two sets of equipment were spending in the on, low-power, and off states. About three months after a power-management policy was activated, Verdiem analyzed the usage data and verified savings of 129 kWh each for the administrative computers and 317 kWh for the academic units. If, as planned, another 1,050 computers were moved into a power-management group, weighted average savings would amount to about 240 kWh per computer annually. At \$0.10/kWh the annual savings were roughly \$46,000, which amounts to an estimated payback period of about one year for the software licenses and installation.

---

---

ENERGY STAR–qualified new and rebuilt vending machines incorporate more efficient compressors, fan motors, and lighting systems that can reduce energy use by 40 percent compared to standard models. They also come with onboard software that puts the machine into low-energy lighting and refrigeration modes during times of inactivity, which can cut energy use by another 20 percent.

Water heating for kitchen and bathroom sinks is another energy consumer and heat generator. On a lifecycle basis, gas-fired tank water heaters are likely the least expensive and most energy-efficient technologies to own and operate. They typically cost less to operate than electric versions because natural gas and propane are usually much cheaper (per Btu) than electricity, and gas units sized at 100 gallons or fewer are less expensive to buy than most other types of heaters because they are mass produced. In some circumstances, such as where gas is not available or there are no venting options, electric heaters are the only viable option.

## Employee Energy Conservation Training

Building occupants can do their part to minimize loads and costs by turning off equipment (including ENERGY STAR devices) at night and on weekends. Influencing employee behavior—energy related or otherwise—requires understanding some psychology. Simply issuing “thou shalt” memos or directives might alter behavior to a certain extent, but successful and sustainable awareness and behavior programs have all of these elements in common:

- *Effective communication.* Successful programs clearly communicate energy-management goals and the reasons why the change in behavior is desired (see sidebar). Program managers must develop or procure the materials to spread the word—such as posters, videos, or pamphlets—and decide how to distribute the information. Successful programs also have easy-to-use mechanisms for gathering employee input and returning feedback from management regarding how employee input is helping the organization accomplish its goals. Some companies use monthly e-mails to solicit ideas, others hold monthly or quarterly meetings with employees, and some do both.
- *Measurement.* Successful programs regularly measure and track energy use, and communicate this information to employees.
- *Reward and recognition.* Successful programs give credit where credit is due. Rewards and recognition give employees a true sense of accomplishment and help to build a personal sense of ownership in the program.
- *Leadership by example.* Successful programs recruit energy champions. Employees who see executives, upper management, and peers that they respect “walking the walk” are significantly more likely to adopt a change and sustain the effort.

The ENERGY STAR web site also offers ideas and examples to help companies build energy-awareness programs (see sidebar).

---

---

## CASE STUDY: State Farm Energy Awareness Program

At State Farm, an insurance provider, sharing information is a key part of the company's energy conservation efforts. Communication among regional offices is done both formally and informally. Formal sharing includes scheduled training classes, company triennial audits, and company maintenance manuals. Informal sharing is done in unit meetings, site visits, and consultations.

Weekly staff meetings held at the corporate office facilitate both formal and informal sharing of energy information. At these meetings, employees can share ideas and practices, provide support to each other in an informal setting, and solve problems that get raised. Meetings include open discussions, staff presentations, formal training, and vendor presentations. Staff members are often assigned to present information on specific energy-conservation topics. Meeting attendees include the engineers and technicians that service the 28 regional offices, three data support centers, three warehouses, 11 corporate buildings, and 600 field claim offices.

---

---

## RESOURCES: Employee Energy-Awareness Programs

The ENERGY STAR web site can help energy and facility managers develop successful employee energy-awareness programs. The ENERGY STAR Guidelines for Energy Management includes a step for creating a communications plan ([www.energystar.gov/index.cfm?c=implement\\_plan.communication\\_plan](http://www.energystar.gov/index.cfm?c=implement_plan.communication_plan)). To help with the plan, the ENERGY STAR Challenge Toolkit features ideas, examples, and templates that can be customized to help spread the word to employees, customers, and stakeholders.

---

---

### 7.3 Upgrading the Building Envelope

The building envelope includes windows, doors, walls, the roof, and the foundation. Heat always flows from the warmer side of the building shell to the colder side. The most commonly discussed parameters of heat flow through the building envelope, in or out, are conduction, infiltration, and solar radiation. Conduction is heat flow through a material from hot to cold. This phenomenon explains why the handle on a stove pot becomes hot, and why people insulate walls. Infiltration is a form of convection in which heat flows via air movement. This phenomenon explains why occupants feel cold when the door is open on a winter day, and why caulking small cracks around windows improves comfort. Radiation is heat flow over a distance from hot to cold, the way the Sun's heat reaches Earth. Building occupants use window shades in summer to block radiation.

Controlling these heat flows requires insulation, good sealing materials and techniques, and proper maintenance. Mechanical heating and cooling make up the heat lost (or gained) through conduction, infiltration, and solar radiation (see Chapter 9, "Heating and Cooling"), but these gains and losses can be controlled by various components of the building envelope.

**Conduction (roof, walls, windows).** Conductivity depends on the materials used in the building shell. Insulation slows, but does not stop, heat flow through walls and roofs. R-value indicates how well an insulation barrier impedes heat flow—the larger the R-value, the less heat flows through a wall or roof by conduction in a given amount of time. Windows typically have



a very low R-value, although storm windows or double-pane windows that feature an insulating air space between the panes can raise window's R-value (**Figure 7.2**). For more information see the Walls and Roofs page of the U.S. Department of Energy Building Technologies Program at [www1.eere.energy.gov/buildings/commercial/walls.html](http://www1.eere.energy.gov/buildings/commercial/walls.html).

**Infiltration.** In older buildings, heat often leaks through breaks in insulation or around windows. This infiltration can greatly reduce the insulation's effectiveness, so R-values alone do not fully describe the energy efficiency of a wall or roof.

All buildings allow some level of uncontrolled airflow through the building envelope. Infiltration paths include seals around operable windows, cracks or seams in exterior panels, door-jamb, and shell penetrations such as holes for wiring or roof curbs for HVAC equipment. Air flowing into or out of these leakage paths is driven by pressure differences caused by HVAC equipment between the inside and outside of the building, between windward and leeward sides

**Figure 7.2: Window heat flow**

Heat flows through a window via conduction, infiltration, and radiation. Convection also permits heat flow at the window surface.

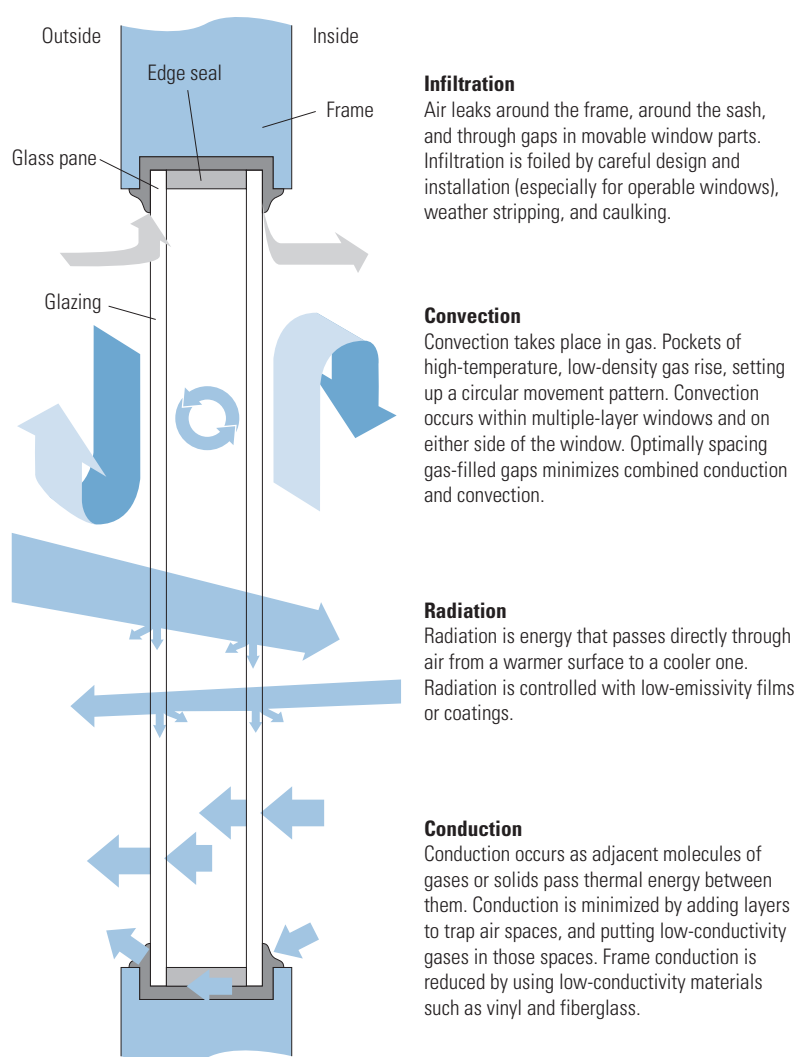

Courtesy: E SOURCE

of the building, and between upper and lower floors (natural convection, commonly called the chimney effect). As discussed in Chapter 5, “Retrocommissioning,” to reduce cooling loads in buildings with mechanical ventilation systems it is desirable to minimize uncontrolled air leakage through caulking and weather stripping. *Controlled leakage*, in which incoming outdoor air exchanges heat with exhaust air, is covered in Chapter 8, “Air Distribution Systems.”

**Solar Radiation.** Solar radiation can have an enormous influence on heating and cooling requirements. The sun often makes perimeter spaces uncomfortably hot, creates glare, and fades fabrics. Handled properly, however, this incoming solar radiation can reduce lighting loads (see the daylighting section Chapter 6, “Lighting”). Reducing solar gain (heating caused by solar radiation) without sacrificing all of the light available for daylighting offers very profitable opportunities for cooling-load reductions and energy savings.

Heat can also be radiated out of the building through the windows in winter if outdoor temperatures are much lower than room temperature. Yet, the amount of heat lost through radiation is far less significant than other types of heat gain or loss.

## Windows

Window films, window shading, and high-performance windows can reduce heat flow through a building’s windows.

### Window Films

Window films are thin layers of polyester, metallic coatings, and adhesives that save energy by limiting both the amount of solar radiation passing through the window and the amount of internal heat escaping. Window films can be retrofitted to existing windows to reduce heat gain from solar radiation and provide low-cost cooling load reduction (**Figure 7.3**). They can be applied directly to the interior surfaces of all types of glass and generally last 5 to 15 years.

**Figure 7.3: Window films**

Window films can be retrofitted to existing windows to reduce heat gain due to solar radiation and provide a low-cost cooling load reduction.

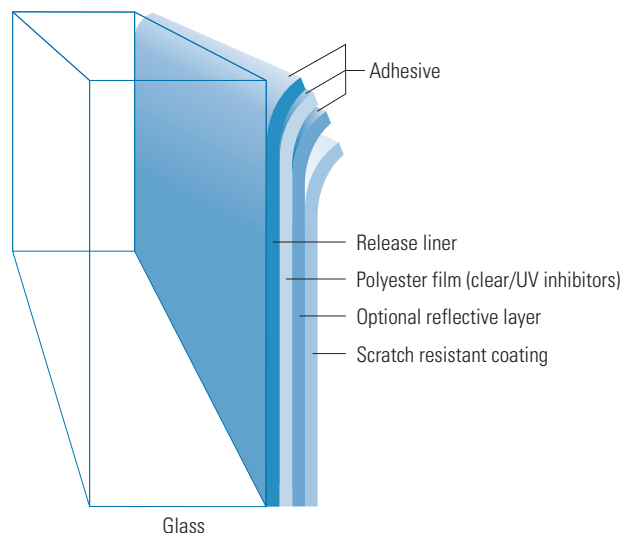

Courtesy: E SOURCE; adapted from EPA

During the heating season, in a typical 24-hour period more heat escapes through windows than comes in from the Sun; the extent depends on the local climate and the R-value of the window. Window films can help reduce this costly heat loss by reflecting indoor radiant heat back into the room. During the cooling season, even when drapes and blinds are closed, much of the Sun's heat passes through the glass into the room. Window films can address this problem by reducing solar heat gain at the window.

Window films save energy by generally improving the balance of heating and cooling systems and by allowing HVAC downsizing. They are likely to be cost-effective where:

- Windows account for greater than 25 percent of the building's outer surface area.
- The building is not well shaded.
- Windows on the south and west sides of the building receive direct sunlight.
- The building has single-pane windows (multiple-pane windows can also benefit from window films to a lesser extent).
- Windows are not tinted, colored, or imbued with reflective coatings.
- The building is located in a sunny climate.
- Fan systems and cooling equipment can be downsized following peak cooling load reductions.

It is not always economical to install window films everywhere. For old, drafty, single-pane windows, complete window replacement—although more expensive—might be more appropriate if the windows are in poor condition. It also can be most cost-effective to install window films only on the south and west sides of a building. Window films typically cost between \$1.35 and \$3 per square foot, installed. Proper installation is important to avoid bubbling, cracking, peeling, and even film-induced glass breakage, so buy films with a material and installation guarantee of 5 to 10 years. For more information, see *Glazing Types* from the Efficient Windows Collaborative at [www.efficientwindows.org/gtypes.cfm](http://www.efficientwindows.org/gtypes.cfm).

### Window Shading

Physical shading can also reduce the solar cooling load imposed by windows—exterior and interior shading are among the best ways to keep the Sun's heat out of buildings located in sunny climates (**Figure 7.4**). Properly placed shades also make daylighting systems more effective by eliminating glare.

Common shading techniques include:

**Interior shading.** Venetian blinds and other operable shades are low-cost and effective solutions for keeping out sunlight. More sophisticated systems, sometimes installed between two panes of window glazing, automatically open and close shades in response to the cooling load imposed by sunlight.

**Low-emissivity (low-e) coatings.** Available with many window systems, low-e coatings insulate better than bare windows, while allowing as much solar heat gain as possible.

**Exterior shading.** Overhangs, awnings, shade screens, roller blinds, and vegetation can provide exterior shading that also reduces the glare from direct sunlight striking glass. Overhangs and awnings can be particularly beneficial because they admit light from the low winter sun (when sunlight is beneficial for heating and lighting) and tend to block the higher summer sun when solar gain is less desirable. Awnings are popular on low-rise commercial buildings.

**Figure 7.4: Shading strategies**

Buildings in sunny areas can benefit from a variety of shading techniques.

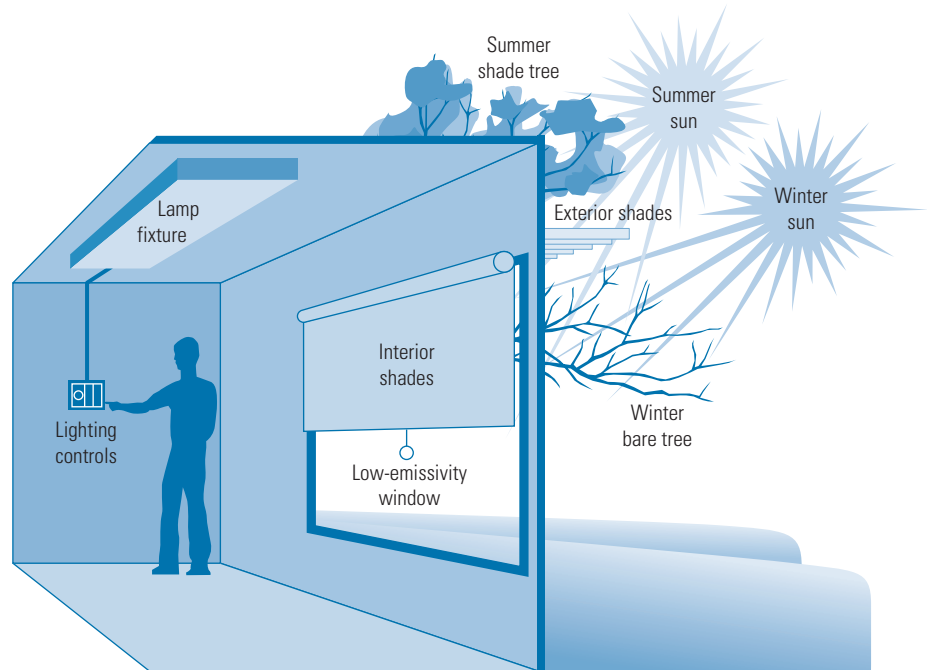

Courtesy: E source; adapted from EPA

Fiberglass or metal shade screens are often cost-effective for low-rise commercial applications and are capable of reducing solar heat gain up to 80 percent compared to unshaded clear glass. A shade screen is a specially fabricated screen of sheet material with narrow louvers formed in place to prevent solar radiation from striking a window—the louvers are so small that only extremely small insects can pass through. The air space between the exterior shade screen and the window helps carry away heat absorbed by the shade before it can be transferred through the window.

Exterior roller blinds offer another effective exterior shading method. These are a series of slats, typically horizontally oriented, made of wood, steel, aluminum, or vinyl. Like interior shades, they can be raised or lowered as needed to control the amount of sunlight entering a building space. In warm temperatures during sunny hours, they can be lowered to function as an insulating barrier, limiting incoming sunlight and reducing heat gain. In cold weather they can be raised to allow desirable heat gain. Partially rotating the blinds allows some daylight and air to enter between the slats. Studies indicate roller blinds can improve the R-value of the window area from the standard 0.88 for uncovered single-pane glass to 1.75 with a lowered blind. However, this shading technique can be expensive, and it alters the exterior appearance of a building.

When selecting shading system colors, remember that light colors are better at reflecting solar radiation. A dark awning, for example, may necessitate venting to allow heat dissipation.

Finally, deciduous trees are also very effective at providing shade. During the winter when they are bare, they allow sunlight to pass through; in summer they leaf out and provide shade. The best location for deciduous trees is due west of west-facing windows. East, southeast, and southwest sides of buildings are also good locations. Plant trees within 20 feet of windows and allow them to grow at least 10 feet higher than the window.

## High-Performance Windows

Windows almost always represent the largest source of unwanted heat loss and heat gain in buildings. This is because even the best windows provide less insulation (have lower R-values) than the worst walls or roofs, and because windows represent a common source of air leakage. Windows also admit solar radiation.

Although eliminating windows is generally impractical, replacing the complete window can be economically feasible in some situations, particularly as part of an extensive renovation. Window replacements can offer benefits superior to lesser improvements such as films, shading, and weather stripping.

Many window or glazing systems of buildings built in the 1960s and 1970s are beginning to fail. Often, these failing systems are single-pane glass. A building with windows that need replacement presents an excellent opportunity to use the latest in advanced window design, which can pay for itself in just a few years.

Options for new window products include:

- *Spectrally selective glass.* This type of glass can maximize or minimize solar gain and shading depending on the chosen selectivity.
- *Double-glazed, low-e systems.* Layers of low-e film are stretched across the interior air space between glass panes, and windows with this feature offer R-values as high as 8.
- *Gas filled windows.* Using argon or krypton gas between glass panes, this technology minimizes the convection currents and conduction through the gas-filled space, reducing overall heat transfer through the window.
- *Electrochromic windows.* When integrated with a daylighting control system, these windows can preserve the view outside while varying their tint to modulate transmitted light, glare, and solar heat gain. Sensors that adjust tint can automatically balance comfortable lighting with energy efficiency to reduce energy use and peak demand. Compared to efficient low-e windows with the same daylighting control system, electrochromic windows can reduce annual peak cooling load by 20 percent and lighting energy use by 50 percent when controlled for visual comfort. Occupants prefer electrochromic windows due to perceived reductions in glare. For more information on this technology see *Advancement of Electrochromic Windows* from the Lawrence Berkeley National Laboratory at [http://windows.lbl.gov/comm\\_perf/Electrochromic/electroSys-cec.htm](http://windows.lbl.gov/comm_perf/Electrochromic/electroSys-cec.htm).

Architects and facility planners now have a vast selection of new window types available that not only meet stringent energy performance requirements but also satisfy aesthetic concerns. For more information see the *Fenestration* page of the *Commercial Buildings* section of the U.S. Department of Energy Building Technologies Program at [www1.eere.energy.gov/buildings/commercial/fenestration.html](http://www1.eere.energy.gov/buildings/commercial/fenestration.html).

## Roofs

Measures that can be employed to reduce heat flow into and out of a building through the roof include roof insulation, cool roofs, and green roofs.

### Roof Insulation

Much of a building's heat losses and gains occur through the roof, so there are often significant energy-savings opportunities related to roof efficiency. **Figure 7.5** shows a typical

commercial-building roof consisting of insulation sandwiched between materials that provide support and weatherproofing. The best way to reduce heat transfer through the roof is to maximize R-value by adding thermal insulation.

When replacing a roof, it is always a good idea to incorporate insulation as part of the renovation. Rigid board insulation, typically two inches thick, can be applied to the outside surface of the roof before applying the new roof covering. This technique works well with roof replacement and new construction, but it is generally not cost effective to apply insulation to the outside surface of an existing roof.

Insulation can also go beneath a roof if it has an attic or crawlspace. Such applications use fiberglass blanket or “batt” insulation, blowing insulation such as spray-on urethane or fiberglass foam, or blown-in loose cellulose or fiberglass. In most cases, roof insulation for buildings with vented attic spaces is applied to the attic floor as fiberglass batts or blown-in loose insulation.

For buildings with unvented attics or no attic, or in buildings where foot traffic might damage attic floor insulation, apply insulation to the inside roof surface, using either rigid board or spray-on foam insulation. Also avoid using attic floor insulation when water pipes are present—sometimes heat flow from the occupied space below is needed to prevent attic pipes from freezing during the heating season.

#### Figure 7.5: Roofing composition

A roof system consists of a deck for support, insulation to slow the transfer of energy through the roof, and a roof covering and membrane for weather protection.

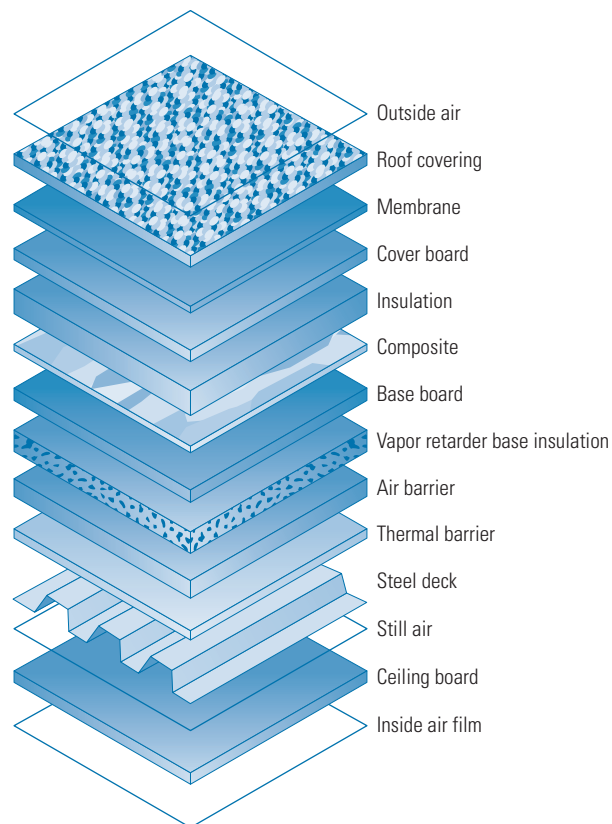

Courtesy: E SOURCE; adapted from EPA

Uninsulated structural members can reduce the effectiveness of building-envelope insulation by as much as 20 percent. It is important to insulate structural members of the roof—particularly those made of metal—to avoid significant heat loss in a building that is otherwise well insulated. However, in flat-roofed buildings with exterior roof insulation, this is not necessary. For more information see *Roof Insulation Guideline* from the New Buildings Institute at [www.newbuildings.org/guidelines.htm](http://www.newbuildings.org/guidelines.htm).

### Cool Roofs

Cool roofs feature a highly reflective outer surface that reduces the amount of heat conducted through the roof. On a sunny day, ENERGY STAR–labeled cool roof products typically lower the roof surface temperature by 50° to 70° Fahrenheit (F), thereby decreasing the amount of heat transferred into a building (see sidebar).

Benefits of cool roofs include:

- *Downsized air-conditioning equipment.* A cool roof can reduce peak cooling demand by up to 40 percent in warm climates, although in cold climates the heating load penalty may offset the cooling energy savings. Typical energy savings run around 20 percent, with simple payback periods of a few years.
- *Extended roof life.* Cool roofs tend to last longer because they are less susceptible to thermal expansion and contraction. Less heat absorption also helps the roof resist degradation by ultraviolet light and water.
- *Reduced heat island effect.* Nonreflective roofs can heat the air around them in a process known as the heat island effect. This phenomenon can raise the cooling demands of buildings and vehicles in a wide area, contributing to smog, elevated ambient temperatures, and associated health problems.

Energy savings from installing ENERGY STAR– or Cool Roofs Rating Council–labeled roof products (see sidebar) depend on the local climate, existing insulation levels, the type of roof replaced, the type of roof installed, and maintenance. In the best applications, cool roofs have no incremental cost and deliver a nearly instant payback. In the wrong applications, the payback may be unacceptably long. Generally cool roofs are most cost-effective when:

- A roof is being installed as part of new construction or needs to be replaced on an existing building.
- Older, inefficient HVAC equipment needs to be replaced.

---

---

### CASE STUDY: Texas Cool Roof Yields Big Savings at Target

Installing a reflective roof membrane on a 100,000-square-foot Target retail store in Austin, Texas, reduced the average summer daily maximum roof-surface temperature from 168° to 126° Fahrenheit. This temperature reduction cut the building's total air-conditioning energy use by 11 percent and peak air-conditioning demand by 14 percent. Researchers at Lawrence Berkeley National Laboratory estimate that this cool roof installation will save about \$65,000 over the course of its useful life. According to the building manager, the difference in labor and materials costs for installing a white thermoplastic roof instead of a black rubber roof was negligible, so that the payback for this system was immediate.

---

---

- The building is a flat-roofed, low-rise, air-conditioned commercial facility.
- There is little or no existing roof insulation.
- The climate is hot and sunny, at least in summer.

To help determine whether a cool roof is the right choice, see **Figure 7.6** or use the ENERGY STAR Roofing Comparison Calculator at [www.roofcalc.com/](http://www.roofcalc.com/).

---



---

## RESOURCES: Cool Roofs

Two complementary U.S. labeling programs can help people select cool roofing materials. Roofing products can qualify for the ENERGY STAR label in two categories: low-slope roofing products must have an initial solar reflectance of at least 0.65; and steep-slope roofs must have an initial reflectance of at least 0.25. After three years, these products must maintain a reflectance of at least 0.50 and 0.15, respectively. To see a list of qualifying products visit [www.energystar.gov/index.cfm?c=roof\\_prods.pr\\_roof\\_products](http://www.energystar.gov/index.cfm?c=roof_prods.pr_roof_products).

The Cool Roofs Rating Council (CRRC), an independent organization dedicated to providing credible energy-performance rating information about roof surfaces, also has a labeling program. The CRRC label is based on reflectance and emittance, and is verified through third-party testing. The label is used much like the yellow efficiency labels found on appliances that help consumers determine where the product falls in the range of available products. To see a directory of CRRC-rated products, visit [www.coolroofs.org/products/search.php](http://www.coolroofs.org/products/search.php).

---



---

### Figure 7.6: Energy savings from cool roofs on commercial buildings

Cool roofs perform differently in different climates: they save the most in warmer climates and at lower latitudes.

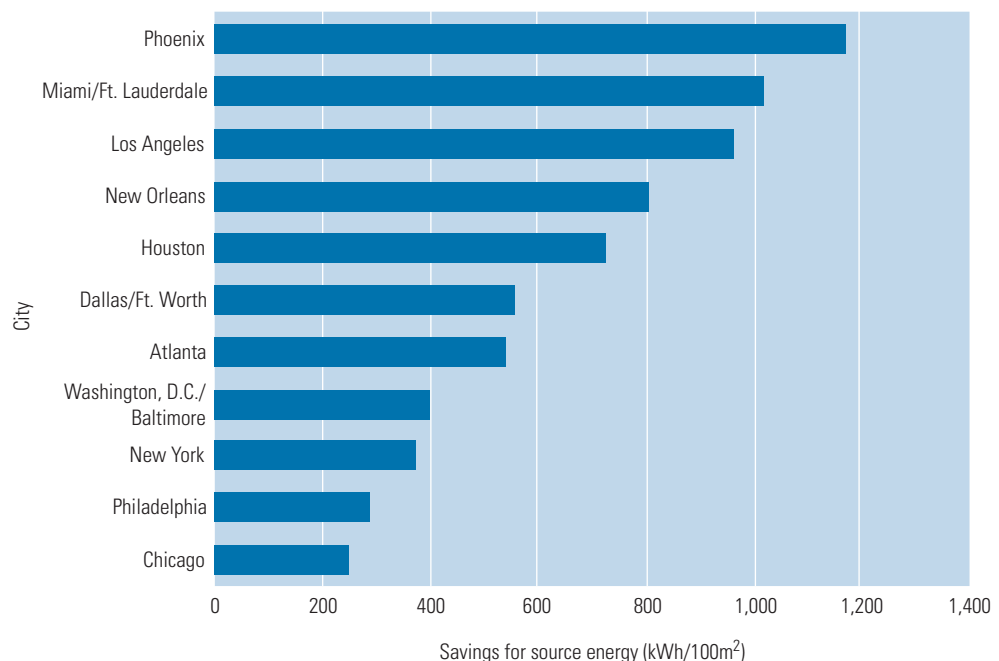

Notes: kWh/100m<sup>2</sup> = kilowatt-hours per 100 square meters.

Courtesy: E SOURCE; data from David Eijadi et al



## Green Roofs

Green roofs can be traced at least as far back as the hanging gardens of Babylon. More recently, they have been popular in Europe for the last few decades. In Germany an estimated 12 percent of all flat roofs are green, and the German green roof industry is growing 10 to 15 percent per year. In North America, however, green roofs are still rare.

Green roofs are a fairly simple concept: Take a flat roof, add some protective layers and soil, and create a system that allows rooftop vegetation to grow while protecting the underlying roof. Conventional roof gardens use pots and planters, but true green roofs allow for much more extensive cultivation of plant life across wide expanses of rooftop. Functionally, a green roof replaces the vegetated footprint that was destroyed when the building was constructed. In fact, several municipalities across North America are encouraging green roofs to mitigate storm-water overflow.

Green roofs and rooftop gardens save energy by mitigating the heat island effect. On warm summer days, urban heat islands are 6° to 8°F hotter than surrounding areas, and therefore have higher cooling loads.

Green roofs produce cooling in four ways:

- The soil provides a layer of insulation.
- Transpiration from the plants cools the rooftop just as sweating cools our bodies.
- The trees and other plants shade the roof.
- A green roof surface does not absorb much heat, so it emits less heat back into the surrounding air.

Much like cool roofs, green roofs save energy by mitigating the heat entering a building in summer and by reducing heat loss in winter. And like other types of cool roofs, green roofs last longer because they are more resistant to damage from sunlight and thermal stresses.

The cost-effectiveness of green roofs is still being evaluated through research. Green roofs save energy and have lower maintenance costs, but they also carry a cost premium ranging from \$5 to \$20 per square foot over conventional roofing and cool roofs.

For more information visit Green Roofs from the U.S. Environmental Protection Agency at [www.epa.gov/hiri/strategies/greenroofs.html](http://www.epa.gov/hiri/strategies/greenroofs.html) and Green Roofs for Healthy Cities, a green roof infrastructure industry association, at [www.greenroofs.net](http://www.greenroofs.net).

## Photovoltaic Panels

Photovoltaic (PV) panels generate electricity while absorbing solar radiation and, depending on their placement, reducing solar heat gain. PV panels can be mounted flush on the surface of a roof, supported at an angle off of the roof, or integrated into the building envelope as a structural or skin element. This latter approach is known as building-integrated PV and may take the form of traditional shingles, flat roof membranes, roof tiles, building facades, or glazing for skylights or atria.

Much of a building's exterior surface area has the potential to generate about 1 to 3 kilowatts of peak power for every 10 square meters, depending on building design. Besides reducing solar heat gain through the shell, PV technologies offer the advantage of providing the greatest power generation capacity in the afternoon, coincident with peak space-cooling needs. Because of their high cost—typically \$6 to \$10 per watt—photovoltaic systems are not yet widely used.

That situation could change if the industry achieves its 10-year goal of getting the cost down to \$3 per watt.

For more information see Photovoltaics from the U.S. Department of Energy Solar Energy Technologies Program at [www1.eere.energy.gov/solar/photovoltaics.html](http://www1.eere.energy.gov/solar/photovoltaics.html).

## 7.4 Summary

Many opportunities exist for reducing supplemental electric and heating loads in a building, thereby paving the way for smaller, lower-first-cost equipment in fan and HVAC systems. Here are the best savings strategies:

- Purchase ENERGY STAR–labeled equipment through a corporate purchasing policy.
- Develop a training program to encourage energy-conservation behavior among employees. Employees can make significant contributions to load reduction by turning off equipment when it is not in use and enabling energy-saving settings for computers and monitors.
- Upgrade the building envelope with high-performance windows, window films, shading, upgraded roof insulation, or a cool roof.

## Bibliography

Efficient Windows Collaborative, [www.efficientwindows.org](http://www.efficientwindows.org).

Eijadi, D., Vaidya, P., Reinertsen, J. and Kumar, S. “Introducing Comparative Analysis to the LEED System: A Case for Rational and Regional Application,” Proceedings of the ACEEE 2002 Summer Study on Energy Efficiency in Buildings.

Lawrence Berkeley National Laboratory, “Advancement of Electrochromic Windows,” [http://windows.lbl.gov/comm\\_perf/Electrochromic/electroSys-cec.htm](http://windows.lbl.gov/comm_perf/Electrochromic/electroSys-cec.htm).

Lawrence Berkeley National Laboratory, “Savings Estimates for the ENERGY STAR Voluntary Labeling Program 2001 Status Report,” [www-library.lbl.gov/docs/LBNL/484/96/PDF/LBNL-48496.pdf](http://www-library.lbl.gov/docs/LBNL/484/96/PDF/LBNL-48496.pdf).

New Buildings Institute, “Guideline—Roof Insulation,” [www.newbuildings.org/downloads/guidelines/InsulationGuideline.pdf](http://www.newbuildings.org/downloads/guidelines/InsulationGuideline.pdf).

U.S. Department of Energy, Building Technologies Program, Building Toolbox, [www.eere.energy.gov/buildings/info/components](http://www.eere.energy.gov/buildings/info/components).

U.S. Environmental Protection Agency, ENERGY STAR, [www.energystar.gov](http://www.energystar.gov).

U.S. Department of Energy, Solar Energy Technologies Program, [www1.eere.energy.gov/solar](http://www1.eere.energy.gov/solar).



LEARN MORE AT  
[energystar.gov](http://energystar.gov)

ENERGY STAR® is a U.S. Environmental Protection Agency program helping businesses and individuals fight global warming through superior energy efficiency.

## Chapter 8 Air Distribution Systems





# 8. Air Distribution Systems

Revised April 2008

<b>8.1</b>	<b>Overview</b>	<b>2</b>
<b>8.2</b>	<b>Air-Handling System Types</b>	<b>3</b>
	Constant-Volume Systems	3
	Variable Air Volume Systems	5
<b>8.3</b>	<b>Air-Handling Components</b>	<b>6</b>
	Fans	7
	Filters	7
	Ducts	9
	Dampers	10
<b>8.4</b>	<b>Best Opportunities</b>	<b>10</b>
	Optimize Zone-Level Performance	10
	Convert CV Systems to VAV	12
	Rightsize Fans	14
	Install Variable-Speed Drives	16
	Modify Controls	17
	Pick Premium-Efficiency Motors	23
	Use Energy-Efficient Belt Drives	25
	Consider a Testing, Adjusting, and Balancing Contractor	26
<b>8.5</b>	<b>Summary</b>	<b>26</b>
	<b>Bibliography</b>	<b>26</b>
	<b>Glossary</b>	<b>G-1</b>

## 8.1 Overview

Air distribution systems bring conditioned (heated and cooled) air to people occupying a building, and therefore directly affect occupant comfort. Over the last several decades, significant improvements have been made to the design of air distribution systems as well as to the way in which these systems are controlled. These improved designs and controls can result in dramatic energy savings, yet many buildings continue to rely on obsolete, inefficient systems for this critical function.

The energy savings achieved in the Retrocommissioning, Lighting, and Supplemental Load Reductions stages (**Figure 8.1**) are likely to have reduced the load on the building's HVAC system, sometimes considerably. But before evaluating the potential to replace the existing heating and/or cooling equipment with smaller and more-efficient equipment, optimize the efficiency of the air distribution system itself. Doing so may well enable even greater savings and a reduction in required heating and cooling equipment capacity.

On average, the fans that move conditioned air through commercial office buildings account for about 7 percent of the total energy consumed by these buildings (**Figure 8.2**), so reductions in fan consumption can result in significant energy savings. A U.S. Environmental Protection Agency (EPA) study found that almost 60 percent of building fan systems were oversized by at least 10 percent, with an average oversizing of 60 percent. “Rightsizing” a fan system, or better matching fan capacity to the requirements of the load, is an excellent way to save energy in air distribution systems. There are also opportunities for energy-saving improvements to the air distribution system in four other categories: adjusting ventilation to conform with code requirements or occupant needs, implementing energy-saving controls, taking advantage of free cooling where possible, and optimizing the efficiency of distribution system components. This chapter will describe the opportunities in each of these areas, but first, it is important to gain an understanding of the types of systems that are commonly encountered and the various components of air distribution systems.

**Figure 8.1 The staged approach to building upgrades**

The staged approach to building upgrades accounts for the interactions among all the energy flows in a building. Each stage includes changes that will affect the upgrades performed in subsequent stages, thus setting the overall process up for the greatest energy and cost savings possible. The air distribution systems stage takes advantage of the load reductions achieved in earlier stages.

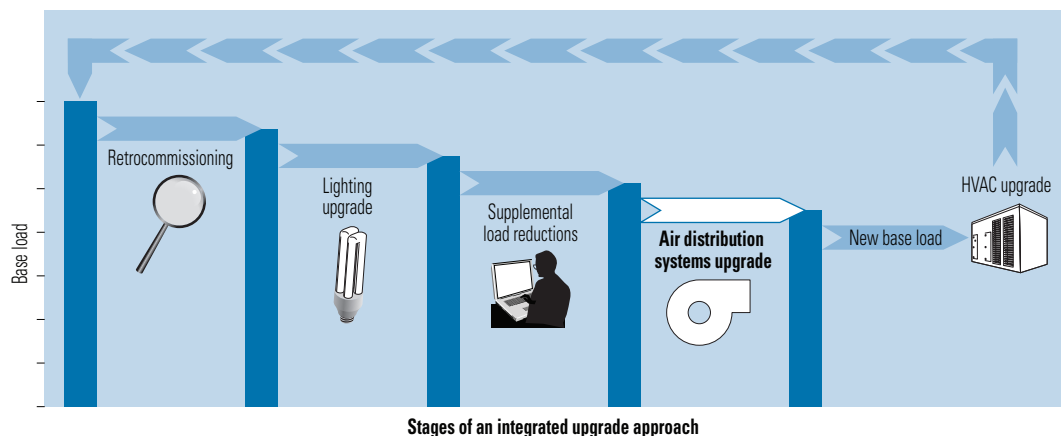

Courtesy: E SOURCE

## Figure 8.2: Typical electricity consumption in commercial office buildings

The power used to circulate conditioned air accounts for approximately 7 percent of commercial office building electricity consumption.

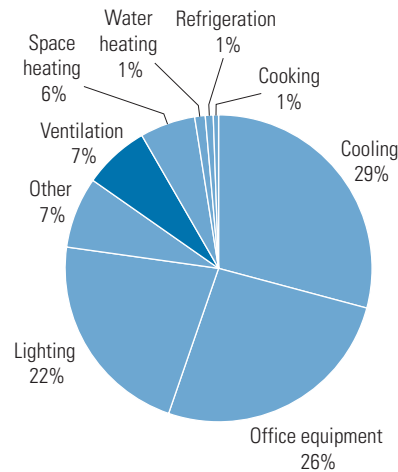

Source: U.S. Department of Energy

## 8.2 Air-Handling System Types

There are two types of air-handling systems: constant volume (CV) and variable air volume (VAV). In a CV system, a constant amount of air flows through the system whenever it is on. A VAV system changes the amount of airflow in response to changes in the heating and cooling load. VAV systems offer substantial energy savings and are becoming more widespread.

### Constant-Volume Systems

Constant-volume systems are the simplest type of air distribution system and are installed in a large percentage of existing commercial buildings. In a CV system, when the supply fan is on, a constant amount of air flows through; there is no modulation of the fan power, no discharge dampering at the fan, and no dampering at the terminal ends of the duct runs. In its simplest configuration, a CV system serves a single space (also called a zone). A thermostat is located in the zone that senses space temperature and sends signals to the air-handling unit to provide heating or cooling based on the thermostat setting.

**Reheat systems.** In larger buildings, CV systems serve multiple zones with varying heating or cooling requirements. For example, a perimeter office with a vast expanse of south-facing glass may require cooling in the middle of December when the rest of the building requires heating. Constant-volume systems that serve multiple zones are typically designed with some way to vary the temperature of air delivered to each zone. To meet differing cooling loads with a CV system, *terminal reheat* or *zone reheat* is frequently added: an electric resistance element, hot water coil, or other heat source that reheats the cooled air just before it enters the room. The system is sized to provide cooling to the zone with the peak load, and all zones with less cooling load have their air reheated as it enters the zone. In humid climates, reheat systems not only provide terminal control but also strip moisture out of the supply airstream by allowing deep cooling of the primary air.

Reheat systems are as inefficient as they sound: energy is used first to cool and then to reheat the air. The thermostat in a CV-supplied zone only controls the amount of reheat applied to that zone's air. If reheat is not applied, zones will be overcooled, possibly to uncomfortable levels. CV systems without temperature reset (thermostatic control of the supply-air temperature) are now prohibited by many energy codes.

**Constant-volume, variable-temperature (CVVT) systems.** A CV system that adjusts or resets the temperature of the supply air is a CVVT system. As cooling loads decrease, chilled water flow is reduced (or “reset” in control system parlance) to create warmer supply air. This reset can be controlled by monitoring either the outside air temperature (outside-air reset) or the cooling needs of the warmest zone (warmest-zone reset). Although outside-air reset has simpler controls and thus may be more reliable, it bases its strategy on the frequently incorrect assumption that cooling load varies linearly with the temperature of the outside air. Solar gain through the windows and internal heat gain from people, lights, and equipment all impact the cooling load independently of the outside temperature. Warmest-zone reset, which directly monitors the indoor air temperature of interest, is more accurate: the supply-air temperature is set just low enough to cool the zone with the highest cooling load.

Because CVVT systems respond to changes in cooling load by reducing the load on the chiller, they use less cooling energy than simple CV systems do. In reheat systems, less energy is used to reheat the air because the supply air is already warmer due to the temperature reset. However, the system only responds to the peak load in each zone; large load differences among zones can still cause substantial overcooling or reheating. This is why reduction of building-skin loads with shading or window films is important: it can reduce that peak load, raise the supply-air temperature, and enable all other zones served by that air handler to use warmer supply air, use less chiller energy, and require less reheat energy. Also, for hot water reheat systems, the temperature of the hot water can be reduced based on the outside air temperature or a “coldest-zone reset” to further reduce the energy waste associated with mixing heated and cooled air.

**Dual-duct systems.** Often found in buildings constructed during the 1960s and 1970s, dual-duct systems are a relatively effective means of maintaining comfort, yet an extremely inefficient method of conditioning air. Dual-duct systems consist of two independent systems, one warm and one cool, that circulate air through all sections of the building via a parallel sets of ducts. Hot and cold air are mixed in local mixing boxes (also called zone dampers or, sometimes, “pair of pants” dampers) in each zone and then fed into that area. Depending on the temperature needs of the zone, the mixture of hot and cold air is adjusted until the desired temperature is reached. Unfortunately, with a dual-duct system, a volume of air that is typically much larger than the actual volume required by the building must be cooled, heated, and circulated.

In addition, the dampers in dual-duct mixing boxes frequently leak, even when they are supposed to be fully closed. During cooling operation, warm duct leakage increases the energy necessary to condition the space. The leakage is a function of construction quality and of the static pressure in the duct. Leakage ratios vary from about 3 percent to about 20 percent, with 5 percent often used as an estimate for well-built systems.

**Multizone systems.** Multizone systems are similar to dual-duct systems in that two streams of air, hot and cold, are mixed to produce a desired temperature. But whereas dual-duct systems mix the air in individual boxes located at each area or room, multizone systems mix air with dampers near the fans. This conditioned air is then fed to each zone so that each zone receives air at a different temperature based on its load.

There are several advantages to the multizone design. These systems require less ductwork and dampering, and therefore occupy less space, than a dual-duct system. Furthermore, the location of the mixing dampers facilitates their inspection and repair. Also, these systems tend to be quieter because the noise and vibration associated with air passing over the mixing dampers is not directly above the conditioned space. On the other hand, the disadvantages of multizone systems are the wasted energy to supply simultaneous heating and cooling and the high capital cost for the multizone dampering unit. In addition, the placement of the mixing dampers directly downstream of the main supply fan means that the air velocity will be high as it passes through them, creating significant pressure loss. The supply fan must compensate for this pressure loss to ensure adequate airflow to each zone. Finally, the dampers on the hot and cold supply streams may leak, requiring additional energy to achieve the desired temperature setpoint.

## Variable Air Volume Systems

Currently available air distribution components, controls, and design strategies offer much more efficient designs than those installed and operating in many existing buildings. Today's VAV systems can handle changing load requirements by varying the amount of heated or cooled air circulated to the conditioned space in response to varying heating or cooling loads. This reduces fan power requirements, which saves energy and costs.

VAV systems work either by opening or closing dampers or by modulating the airflow through mixing boxes powered by VAV fans as loads in various zones of the building change (**Figure 8.3**). If, for example, more cooling in an area is required, the damper to that area is opened wider, increasing the flow of cold air until the desired temperature is reached. As the damper opens, static pressure in the duct drops, signaling the fan to increase air delivery. Conversely in this same example, if an area is too cool, the damper is slowly closed, reducing the flow of cold air. Used in combination with variable-speed drives (VSDs), this reduction in flow results in a reduction in the fan power needed, saving energy. Converting an existing constant-volume system to a VAV system is a popular option for many building owners, because it allows the system to turn itself down in response to changing demand.

**Figure 8.3: Variable air volume system**

In a VAV system, dampers control the flow of chilled air to respond to changes in cooling load.

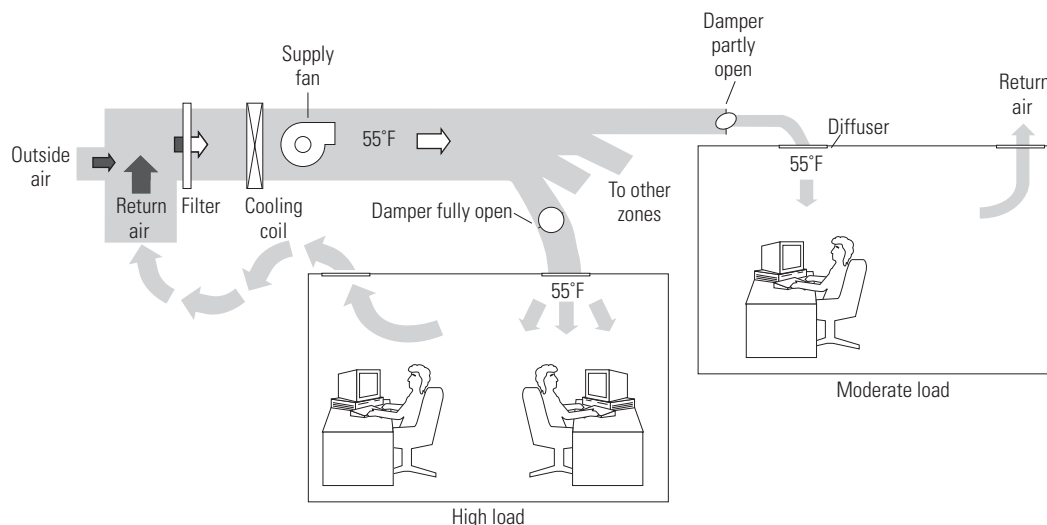

Note: F = Fahrenheit.

Courtesy: E SOURCE



A proper conversion to a VAV system includes changing constant-volume dampers to operate in variable-volume fashion, which typically reduces fan horsepower requirements by 40 to 60 percent. Conversion from constant to variable volume can be complicated in certain circumstances due to nonmechanical factors such as:

- If the existing zone dampers are located in difficult-to-access spaces;
- If the space has a hard ceiling (typically with undersized metal access panels used to reach the mixing dampers for service);
- If the spaces to be converted have a “concealed spline” ceiling tile system (where nearly the entire ceiling must be disassembled to get at one particular spot because all of the ceiling tiles interlock); or
- If asbestos is present in the ceiling space.

It is also possible to convert an existing constant-volume, single-zone system to variable volume without modifying the zone dampers, though careful planning and testing are required for a successful project. In this type of conversion, a VSD is installed to control supply-fan speed. The VSD is controlled by either the return air temperature or the outside air temperature. Typically, to maintain comfort, the airflow reduction range is limited in such systems to 30 to 40 percent of design flow. However, even this modest reduction in airflow can reduce fan power by more than 50 percent. An additional benefit is that, under mild temperature conditions, reheat energy will be reduced along with airflow.

As with constant-volume systems, VAV supply air temperature can be reset (raised) if loads drop enough, thus reducing chiller load as well as fan power. Such a variable-volume, variable-temperature (VVVT) system changes both the temperature and the volume of supply air as needed to achieve maximum load responsiveness while minimizing reheat. A fully loaded VVVT system moves fully chilled air, usually at 55° Fahrenheit (F), at maximum fan capacity with all terminal dampers wide open. As cooling loads drop, the terminal dampers close as necessary and the supply fan slows down. When dampers reach their minimum position, zone reheat is applied (if available). Finally, when all zones are at their minimum stops, the supply air temperature is reset (raised) so that the warmest zone will need no reheat. This has the double effect of reducing the load on the chiller and decreasing the reheat energy throughout the system. The trade-off between resetting supply-air temperature and lowering supply-air volume can be optimized for a given system, perhaps reversing the order of volume reduction and temperature reset. Due to the complexity of the control system, a high degree of expertise is required to successfully commission VVVT systems.

### 8.3 Air-Handling Components

The major components in an air-handling system are its fans, filters, ducts, and dampers. Each component performs a task critical to the proper operation of the system: Fans circulate the air and provide the pressure required to push it through filters, coils, ducts, transitions, fittings, dampers, and diffusers. Filters clean the air, protecting occupant health, inhibiting bacteria and mold growth, and keeping coil surfaces clean. Ducts convey the conditioned air throughout the building, distributing the air to occupants and then returning it to be conditioned and circulated again. Dampers control the flow and mix of returned and outside air through the ducts to the various parts of the building. All of these components must function well both individually and together to ensure efficient system operation and occupant comfort.

## Fans

Fans are the heart of a building's air-handling system. Like a heart that pumps blood through a body, they distribute the conditioned (heated or cooled) air throughout the building. There are two main types of fans: centrifugal and axial (**Figure 8.4**).

**Centrifugal fans.** Centrifugal fans are by far the most prevalent type of fan used in the HVAC industry today. They are usually cheaper than axial fans and simpler in construction, but they generally do not achieve the same efficiency. Centrifugal fans consist of a rotating wheel, or impeller, mounted inside a round housing. The impeller is driven by a motor, which is usually connected via a belt drive.

**Axial fans.** Axial fans consist of a cylindrical housing with the impeller mounted inside along the axis of the housing. In an axial fan, the impeller consists of blades mounted around a central hub similar to an airplane propeller. As with an airplane, the spinning blades force the air through the fan. Axial fans are typically used for higher-pressure applications (over 5 inches total static pressure) and are more efficient than centrifugal fans.

The motor of an axial fan can be mounted externally and connected to the fan by a belt. However, axial fans are often driven by a motor that is directly coupled to the impeller that is mounted within the central hub. As a result, all heat due to motor electrical losses is added to the airstream and must be removed by the cooling system.

## Filters

Air filtration occupies an increasingly important role in the building environment. The high profile of ASHRAE's (the American Society of Heating, Refrigerating, and Air-Conditioning Engineers') indoor air quality standard (Standard 62.1-2007) and recent actions by the Occupational Safety and Health Administration (OSHA) have combined to give air filtration new prominence. Filtration also has a substantial impact on energy efficiency. With static pressure drops of up to 0.072 pounds per square inch (psi), filters can consume an enormous amount of fan power. As with other air-handling components, the key to efficient filtration is to consider the details, especially face velocity (airflow per unit area of filter media).

**Figure 8.4: Centrifugal and axial fans**

Centrifugal fans (A) are the most common fans used in HVAC applications. They are often cheaper but usually less efficient than axial fans (B).

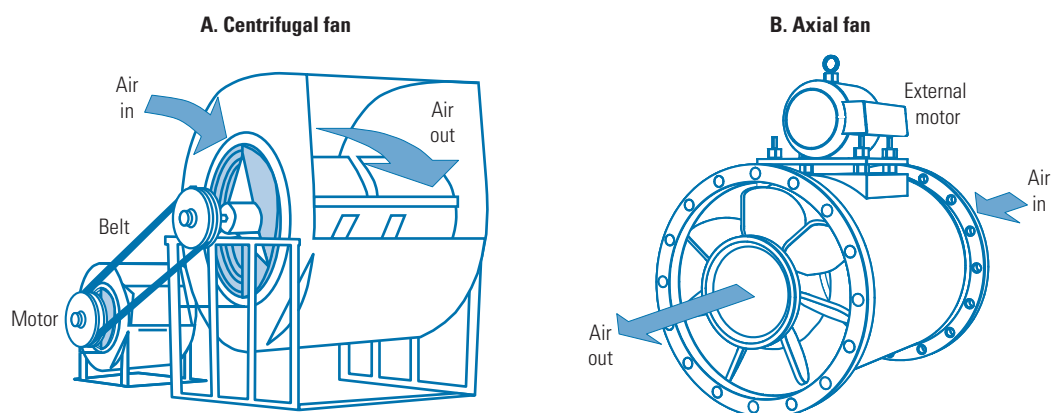

Courtesy: E SOURCE

Filters work by capturing particles through gravity or through centrifugal collection, screening, adhesion, impingement, and/or adsorption. The *efficiency* of a filter refers not to energy efficiency, but to how well it removes particles from the airstream. *Pressure drop* is the measure that determines how much fan power is required to move air through the filter, and it varies by the square of the air speed through it. For typical HVAC-duty filters (30 percent ASHRAE dust-spot efficiency) a reasonable target pressure drop is 0.0036 psi. Dirty, thick, or poorly designed filters can have pressure drops as high as 0.072 psi—as much as the entire frictional drag of the duct system. Higher pressure also increases fan noise and vibration, duct leakage, wear and tear on the fan and other mechanical components, and a host of other air-handling ills that add real costs to fan operation. Filter performance and longevity are improved with uniform airflow, which is found upstream of the supply fan rather than downstream. Upstream filter placement also cleans the air before it moves through the cooling coils and the fan, helping to maintain their efficiency as well.

Regular filter maintenance is essential to keeping ductwork and coils clean. Dirt accumulation in ductwork can facilitate the growth of bacteria and mold, particularly if condensation occurs within the ducts. Dirt accumulation on coils impedes heat transfer, reducing system efficiency and increasing HVAC costs. Dirty filters will also reduce airflow, and may therefore reduce occupant comfort.

Visual inspection is not always an adequate way to determine whether filter cleaning or replacement is necessary. A sure-fire way to determine when filter maintenance is necessary is to install a device that measures pressure drop across the filter bank. A signal from such a device can be an input to a building automation system to alert operators when filter maintenance is required.

Commonly found filter types in commercial buildings include dry filters, bag filters, high-efficiency particulate air (HEPA) filters, electrostatic precipitators, and carbon filters.

**Dry filters.** Dry filters have fine strands of fabric or fiber that intercept smaller particles of about 0.5 to 5.0 micrometers. The pleats in these filters give them greater surface area, but the additional surface also lowers their face velocity. The media is contained in a cardboard frame that is generally thrown away with the fabric when it becomes dirty. These are often used as pre-filters for bag or HEPA filters.

**Bag filters.** Bag filters use dry media that is arranged in a long stocking shape to extend their surface area or to allow recovery of the collected material. Although commonly used in HVAC systems, bag filters are generally being replaced by rigid dry filters.

**HEPA filters.** HEPA filters use thin, dry media (such as paper or glass-fiber mats) with very small pores that trap superfine particulates down to 0.01 micrometer in diameter. They are heavily pleated to reduce face velocity but still contribute pressure drops of up to 0.072 psi. HEPA filters are used mostly for the demanding applications of electronics and pharmaceutical production facilities, hospital operating rooms, and facilities that generate radioactive particles. HEPA filters should be coupled with a coarser pre-filter to extend their lifetime.

**Electrostatic precipitators.** Electrostatic precipitators use a high voltage to ionize particles suspended in the air, then pass the airstream between charged plates that attract and accrete the charged particles. Because there is no physical impediment to the air, these filters have very low pressure drops. However, the power equipment used to create the voltage differences continuously consumes about 20 to 40 watts per 1,000 cubic feet per minute (cfm) of airflow. An efficient fan uses about 140 watts per inch of pressure drop (water gauge) for each 1,000 cfm, so the precipitator energy is about the fan-energy equivalent of 0.004 to 0.007 psi of pressure

drop. Electrostatic precipitators are usually used together with low-efficiency dry media filters that capture the largest particles and minimize the need to clean the charged plates.

This dual filter use means that electrostatic precipitator systems typically require more energy consumption and maintenance than a system with conventional filters would. One engineer estimates that electronic filters “double or triple” filter maintenance costs. The effectiveness of electronic air cleaners decreases with heavily dust-laden plates, with high-speed air, and with nonuniform air velocity. The plates that collect the charged particles must periodically be taken out of the duct and washed off, adding a maintenance step more complex than simple filter replacement. However, they do decrease the use of nonrecyclable filter components, and avoid the increasingly difficult problem of filter disposal. For overall HVAC efficiency, electronic filters usually do not make sense unless they can fulfill a specific need, such as local air cleaning in a smoking lounge.

**Carbon filters.** Carbon filters clean the air of gases and vapors at the chemical or molecular level. The porosity of activated, granulated carbon media is such that large, odor-causing molecules become adsorbed as they seep through the filter. The carbon can adsorb up to half its own weight in gases, which can then be driven off by heating, allowing the carbon to be reused. Carbon filters are not common in typical commercial buildings, unless there is a need to remove persistent sources of odor, such as from local industry.

A common metric for filter performance is the minimum efficiency reporting value (MERV), a rating derived from a test method developed by ASHRAE. The MERV rating indicates a filter’s ability to capture particles between 0.3 and 10.0 microns in diameter. A higher MERV value translates to better filtration, so a MERV-13 filter works better than a MERV-8 filter.

## Ducts

Like the arteries and veins in the human body, ducts convey the conditioned air from the air-handling unit out through the building and return it back to be conditioned again (or exhausted from the building). They are usually constructed of sheet metal and are insulated.

Ductwork can either be round or rectangular. Rectangular duct material used to be cheaper and more common than round, but the trend these days is to use a spiral version that is fabricated at local manufacturing facilities to the sizes and lengths required for each job. Spiral duct construction is similar to that of a paper drinking straw; a long strip of metal is wrapped around itself in an overlapping, continuous pattern. Spiral ductwork can be fabricated in round or oval cross-section designs. Spiral ducts tend to be less expensive than rectangular and are characterized by lower pressure drop, reduced heat gain or loss (due to the reduced surface area), and reduced weight. Spiral ducts can be manufactured in long lengths, and the spiral-lock seams make the ductwork more rigid. From an architectural standpoint, more new buildings are leaving the ductwork exposed as opposed to concealing it behind a T-bar ceiling, and spiral ductwork has an attractive shape and surface pattern that lends itself to this sort of installation.

Rough-surfaced duct material makes a fan work harder than smooth duct materials do. In engineering terms, the pressure loss of a duct is proportional to the friction factor of its inside skin and to the square of the air speed. The friction factor depends on surface roughness (the average height of protrusions from the surface) and, to a much lesser extent, on duct diameter, air speed, and air density. Smooth sheet metal, usually steel or aluminum, is the best material for ductwork: Rigid fiberglass ductwork suffers nearly 30 percent more pressure drop than sheet metal. The acoustic fiber lining used in many supply ducts (especially just downstream of the fan) has 40 percent more frictional resistance than smooth sheet metal.

Ducts must be properly insulated to prevent excessive energy loss. Duct insulation helps prevent the warming of chilled air and the cooling of heated air as it passes through the ducts. ASHRAE standard 90.1, the energy code governing design of new commercial buildings in many jurisdictions in the U.S., specifies duct insulation with a heat flow resistance level of as much as R-8 in some locations for ducts carrying hot or cold air. This requirement varies by jurisdiction; local energy and/or mechanical codes must be consulted. Proper choice of insulation can also help reduce the transmission of fan and motor noise from the HVAC system to the working spaces inside buildings.

Proper installation of the duct insulation is important as well. Because soft insulation is frequently used, it must be kept from compressing under duct hangers, against the floor or roof structure above, or against the suspended ceiling below. This requires adequate vertical clearance. Some brands of ductwork come complete with an insulation layer.

## Dampers

Dampers modulate the flow of air through the ducts to the various parts of the building, reducing or increasing the airflow depending upon conditions. Dampers also regulate the quantity of outside air that is allowed to enter the air-handling unit and mix with return air for ventilation purposes. Dampers can be difficult to maintain and can affect occupant comfort as the space requirements change and as the air-handling system ages.

A typical commercial HVAC system has numerous dampers that alter the flow of outside air, return air, exhaust air, and supply air. An efficient air-handling system minimizes the number of dampers necessary overall and eliminates dampers or uses low-loss dampers at branch take-offs, reducing the fan power needed to blow air past them but maintaining the capability for minor balancing adjustments. Using variable-speed drives for fan regulation can eliminate the need for fan inlet or discharge dampers.

### 8.4 Best Opportunities

When considering options for improving the performance of an air distribution system, it is important to remember that the purpose of having an HVAC system in the first place is to regulate the temperature, humidity, freshness, and movement of air in buildings. Accordingly, energy-efficiency retrofit projects should not undermine the system's capability to provide thermal comfort and air quality. The goal of energy retrofit projects should be to improve system efficiency while maintaining or enhancing comfort.

Although there are different ways to address air-handling system efficiency opportunities, one effective approach is to start at the conditioned space and work back to the air-handling unit. Looking at the opportunities in this order enables building operators to take advantage of downstream savings when addressing upstream opportunities. For example, repairing corroded zone mixing dampers that are stuck in the full-cooling position in a dual-duct system will provide better comfort to the occupants while also reducing the amount of cool air that the air-handling unit must provide. Fixing the zone dampers may unearth upstream opportunities to take advantage of the reduced cooling load with system control reset strategies or the installation of rightsized equipment.

## Optimize Zone-Level Performance

The zone-level equipment consists of zone mixing dampers (such as dual-duct mixing dampers or VAV mixing boxes), reheat coils (hot water or electric), and the thermostats that control this

equipment in response to user preferences. As facilities age, zone-level equipment often falls out of calibration or into disrepair, impairing its ability to provide comfort and undermining overall system performance. Fixing zone-level problems can lead to more comfortable occupants as well as upstream energy savings.

Some of the most common opportunities to consider at the zone level are:

- *Recalibrate thermostats.* In systems with pneumatic controls, the thermostats periodically require recalibration (typically, every 6 to 12 months) in order to regulate space temperature more accurately. Though thermostat calibration should be checked if a comfort complaint exists, it is preferable to evaluate the thermostats on a regular basis as a proactive maintenance measure.
- *Inspect dampers.* For systems with zone dampers, periodically inspect the damper, linkage, and actuator for proper operation. In older buildings where maintenance has not been rigorous, it is likely that some of the zone dampers are frozen in position, rendering them ineffective at regulating comfort. Because evaluating and repairing nonfunctional zone dampers can be time-consuming and costly (especially in large buildings that may have hundreds or even thousands of zones), consider allocating a portion of the annual maintenance budget for this purpose to address a certain quantity or percentage of zones. For example, in a 100,000-square-foot, 10-story office building with 150 VAV zones, the maintenance budget might include time and money to evaluate 50 VAV zones per year.
- *Prevent overcooling.* In zone-level reheat systems, performance should be evaluated to keep cooling levels as low as possible. For hot water reheat systems, verify operation of the hot water reheat valve to ensure that it opens and closes in response to control system commands. Check the coil itself to confirm that water is flowing through when it is supposed to and that the coil is not clogged. Confirm the sequence of operation to make sure the reheat coil only operates when it is supposed to. For a single-duct VAV system, the reheat coil typically operates after the VAV damper has reached its minimum airflow position while the zone is calling for heat. If the reheat system is electric, verify proper operation of the coil in response to system commands. Verify the capacity of the electric coil by measuring its input power with an amp probe or true RMS (root-mean-square) power meter. Compare the calculated value with the nameplate value. If the calculated value is much lower than the nameplate value, the coil may have burned-out elements and may require replacement.
- *Disable reheat systems in summer months.* For CV reheat systems, consider whether the zone-level reheat systems can be disabled during the summer. Some facilities with electric reheat systems have successfully shut off the reheat coils at the breaker during the cooling season, leading to significant energy savings. In conjunction with this change, it may be necessary to adjust the supply-air temperature to avoid overcooling certain spaces, and it may be necessary to leave the reheat coil breakers active in certain spaces (such as interior zones) in order to maintain comfort.
- *Regulate static pressure.* Dual-duct systems typically include static balancing dampers for the hot and cold ducts (also called hot and cold “decks”). The purpose of static balancing dampers is to regulate the static pressure in the hot and cold decks in response to zone demands. Over time, these systems (consisting of a static pressure sensor, damper, actuator, and linkage) can fall into disrepair. Failure of the static balancing dampers can cause significant energy waste and discomfort. For example, if the static balancing damper for the cold deck is stuck in a nearly closed position, none of the zones will have an adequate source of cold air, leading to overheating.

## Convert CV Systems to VAV

Retrofits involving conversion from CV to VAV are perhaps the most widely employed energy-saving retrofit to commercial HVAC systems, because typical airflow requirements for VAV systems are only about 60 percent that of CV systems. VAV systems also cool only the air volume required to meet demand, rather than meeting demand by simultaneously heating and cooling large volumes of air. **Table 8.1** presents cost and savings data from several large VAV retrofits.

To determine whether the existing system is VAV or CV, review the original design drawings for the HVAC system. If there is a schedule of VAV terminals in the equipment list that includes a minimum and maximum airflow (cfm) for each zone, it is a VAV system.

The conversion of an older constant-volume reheat, multizone, or dual-duct system to a modern, energy-efficient variable air volume system is a task to be undertaken with serious consideration and expert analysis. Unless the facility's management possesses expertise in the

**Table 8.1: Installation cost and energy savings from variable air volume retrofits**

The cost and savings of VAV retrofits vary widely, though most retrofits cost between \$1 and \$4 per square foot.

	AT&T Bell Laboratories, Indian Hills Complex, Naperville, IL	Lamonts Apparel Inc. (Factoria Square), Bellevue, WA	One Bellevue Center, Bellevue, WA	Fanny Allen Hospital, Colchester, VT	General American Life Insurance Co., St. Louis, MO	St. Louis Children's Hospital, St. Louis, MO	100 Market Building, <sup>a</sup> Portland, OR
Building size (ft <sup>2</sup> )	1,200,000	50,000	344,715	114,000	450,000	560,000	120,000
Nominal fanpower (hp)	3,300	40	400	85	750	1,470	150
Peak flow (cfm)	600,000	44,000	n/a	58,800	n/a	n/a	132,000
<b>Project cost</b>							
VAV retrofit cost (\$)	3,500,000	33,620	965,104	810,838	1,013,000	405,000	575,000
Utility rebate (\$)	0	26,167	814,793	552,666	0	0	0
Net cost (\$)	3,500,000	7,453	150,311	258,172	1,013,000	405,000	575,000
Cost per square foot (\$/ft <sup>2</sup> )	2.90	0.67	2.80	7.10	2.30	0.70	4.80
Cost per nominal fan hp (\$/hp)	1,060	840	2,412	9,539	1,350	275	3,833
Cost per peak cfm (\$/cfm)	5.80	0.80	n/a	13.80	n/a	n/a	4.40
<b>Project savings</b>							
Fan energy savings (kWh/year)	15,000,000	97,456	2,052,391	1,336,592	7,146,974	2,416,160	2,000,000
Fan power savings (kW peak)	900	n/a	234	255	n/a	n/a	200
Energy savings (\$/year)	1,200,000	9,211	79,111	129,086	248,000	138,000	80,000
Payback with rebate (years)	2.9	0.8	1.9	2.0	4.1	2.9	7.2
Payback without rebate (years)	2.9	3.6	12.2	6.3	4.1	2.9	7.2

Note: cfm = cubic feet per minute; ft<sup>2</sup> = square foot; hp = horsepower; kWh = kilowatt-hour; n/a = not available; VAV = variable air volume.

Courtesy: E SOURCE

a: In this project, TRAV control logic by Microgrid/Hartman was utilized to control the VAV systems. The cost for this project includes fees for design, project management, contractor management, and commissioning.

conversion of CV systems, this would require the services of an engineering firm or an HVAC controls contractor. In some cases, the local energy utility may be able to provide technical assistance and incentives to help evaluate and implement the project.

The three factors that affect the feasibility of implementing a VAV retrofit are the implementation cost, the annual energy cost savings, and the building owner's minimum attractive rate of return. Surprisingly, in the case of VAV retrofit projects, the most volatile term in the cost-effectiveness equation is the implementation cost, because of the number of factors that influence the effort required to complete the retrofit. The difference between high and low energy cost savings, even when estimated using the simplest of methods, will not typically vary by more than a factor of two. On the other hand, the implementation cost can vary by a factor of ten or more depending on the characteristics of the HVAC system to be converted and the installation conditions. In certain circumstances, it will not be cost-effective to convert to a VAV system. The following factors provide an indication of whether a specific conversion project is likely to be straightforward (and therefore relatively low cost) or to present challenges that will make it more expensive.

### Building-level factors

- Consider what type of access the contractor will have to the zone dampers. For example, will the contractor have to work in cramped or inaccessible spaces to access a multizone system? Check the equipment accessibility of dual-duct systems where the zone dampers are located out in the conditioned space: Is the ceiling a T-bar system that facilitates access for equipment installed above the ceiling, or is it a “hard-lid” system that makes it more challenging to access the dampers?
- If the building includes asbestos-containing materials, they may either have to be removed or contained during the retrofit process, which can add significantly to project cost.

### System-level factors

- In an existing CV system, check the age and condition of the existing zone dampers and actuators. If they are in good condition, it will make the conversion easier than if the contractor also has to repair components along the way. It would not make sense to make costly changes to a system that has maintenance issues that would prevent it from functioning properly.
- For a dual-duct or multizone system, see whether the existing hot and cold dampers are controlled by one or two actuators. Converting these systems to VAV usually requires two actuators so that the hot and cold air supply can be regulated independently. Having two actuators already installed usually leads to a simpler, less expensive conversion. It is possible to add a second actuator if there is only one, but it will add cost and complexity to the project.
- If the existing system is in poor condition, a major portion of the total project cost for a VAV conversion can be attributed to system maintenance and replacement as opposed to an energy retrofit project. The energy savings are a benefit of such a conversion, but the focus ought to be how to make the HVAC system meet the occupants' thermal comfort requirements.

When soliciting bids from contractors, it can be helpful to look for nearby buildings that are similar in age and design to the building in question and determine whether VAV conversion has been implemented. Often, several similar buildings that used the same design and construction team would have been built in a city during the same era. As a result, the energy retrofit solutions that worked (or did not work) at one building might be applied to another. And a contractor who



has already converted similar HVAC systems in previous projects will likely be able to provide a more competitive price than ones who will need to figure it out as they go.

Once the conversion is complete, have the new system commissioned by an independent contractor as part of the retrofit project to ensure that everything operates according to plan.

## Rightsize Fans

If HVAC fans are oversized, replacing them with ones that are correctly sized—“rightsizing” them—can be cost-effective. Rightsizing can be implemented separately or in combination with the installation of premium-efficiency motors and VSDs. In general, rightsizing with a premium-efficiency motor, energy-efficient belts, and a VSD is the best alternative. A right-sized system saves energy costs, but there are other advantages as well:

- *Lower first costs.* Because the capacity required from the fan system is reduced, the system can be more accurately tailored to the new airflow requirements. By installing smaller, more energy-efficient equipment that meets these requirements, first costs are also reduced.
- *Comfort.* If the fan system supplies too much air to occupants, energy is wasted and comfort can be compromised. Too much air can result in disturbing drafts, increased humidity, and noise.
- *Longer equipment life.* Prolonged operation at very low speed of an oversized motor with a VSD can reduce the useful life of the motor and associated equipment. Properly sized equipment will be more suited to operation at reduced capacities.

As a first step, the opportunity for rightsizing an air distribution system can usually be determined by building maintenance staff. Once an opportunity has been identified, however, it is usually necessary to hire an HVAC engineer to verify it, to conduct a more detailed analysis, and to make recommendations for optimizing the system.

The approach to assessing the potential for rightsizing varies depending upon whether the existing system is constant or variable volume. Either way, though, it is critical that the proper amount of outside air is maintained to ensure occupant health and comfort. Consult local building codes for information about required outside-air quantities.

**Diagnosing oversized fans in VAV systems.** Although VAV systems are more energy efficient than CV systems, the potential for rightsizing may still exist. Building maintenance staff may be able to determine whether the VAV fans are oversized by using one of three methods: measuring fan-system static pressure, measuring the fan-motor current draw (amperage), or checking the fan-control vanes and dampers.

The first method is to measure the static pressure of the main supply fan system. It is best to get a baseline measurement on a hot, humid day. Make sure that all fan vanes and dampers and all VAV boxes are fully open. Compare the static pressure reading with the static pressure setpoint. If the reading is less than the setpoint and building occupants are comfortable, the setpoint can be adjusted to the lower static pressure.

Static pressure measurements must be taken at the same location in the distribution system as the pressure sensor that regulates system operation, usually about two-thirds of the way down the main supply duct. If such a measurement is not possible or practical, the desired setpoint can be found by gradually reducing the fan speed each day until the pressure is as low as possible but occupant space is still comfortable. This change will significantly reduce fan power requirements. Be sure to survey occupants periodically to assess comfort. It may also be necessary to restore the old setpoint

on extremely hot days. In those cases, consider having the control system programmed to automatically reset the static pressure setpoint (for more on pressure reset, see the Modify Controls section).

Next, measure the fan-motor power draw using a true RMS power meter. For a VAV system, make this measurement when the cooling system is operating under a peak load (for example, on a hot, humid day). Next, read the full-load power rating off the motor's nameplate or from the operating manual. Compare these two numbers. If the measured power is less than 75 percent of the motor's rating, the motor is oversized.

Comparisons of measured to rated current can be misleading because a motor's power factor drops when it is lightly loaded. Therefore, measuring only current does not provide an accurate estimate of motor loading. Better accuracy will be achieved by using an RMS power meter that measures voltage and current simultaneously and displays true power. Also, when comparing measured input power to nameplate power, keep in mind that 1 kilowatt = 0.746 horsepower (hp). Power meters typically display results in kilowatts, but motor nameplates in the U.S. are labeled in horsepower.

Last, check the position of the fan control vanes or dampers when the cooling system is operating under a peak load. If the vanes or dampers are closed more than 20 percent, the fan may be oversized.

**Diagnosing oversized fans in CV systems.** If it is not economically feasible to retrofit to a VAV system, rightsizing a CV system is generally a profitable choice. However, building maintenance staff is typically limited to just one method of determining the potential for rightsizing: measuring fan-system static pressure.

Measure the main supply fan system static pressure on a hot, humid day. Make sure that all fan vanes and dampers are fully open. If the measured static pressure is greater than the design pressure (found in building mechanical drawings), the fan is probably supplying too much air and is a good candidate for rightsizing.

**Three ways to rightsize.** If analysis indicates that a supply fan is oversized, considerable energy can be saved by rightsizing the fan in one of three ways:

- *Larger pulleys.* Replacing an existing belt-driven pulley with a larger one will reduce its speed, and since fan power is proportional to the cube of speed, even small speed reductions can reduce energy costs appreciably. The new pulley should operate the fan at a reduced speed that still matches peak load requirements.
- *Static pressure adjustment (VAV systems only).* Reducing static pressure in a VAV system reduces the fan horsepower consumption. By gradually reducing the static pressure setpoint to a level low enough to keep occupants comfortable, fan speed will be reduced, thereby reducing energy consumption.
- *Smaller, premium-efficiency motors.* Once the fan flow rate has been properly adjusted, the existing motor will probably be larger than necessary. Replace the existing, oversized motor with a smaller, premium-efficiency motor that matches the load. For example, rightsizing a 75-hp standard-efficiency motor to a 50-hp premium-efficiency motor could reduce motor energy consumption by about 33 percent. Some premium-efficiency motors operate at slightly higher speeds than the motors they replace. Because a fan's power consumption increases in proportion to the cube of its speed, it is important to compare the nameplate speed of the existing motor with its premium-efficiency replacement. See the Pick Premium-Efficiency Motors section.

**Estimating potential savings.** The expected benefits of rightsizing can be estimated using a commercially available fan analysis software program. The U.S. Department of Energy's (DOE's) Office of Energy Efficiency and Renewable Energy has collected information about several such packages ([www.eere.energy.gov/buildings/tools\\_directory/subjects.cfm/pagename=subjects/pagename\\_menu=materials\\_components/pagename\\_submenu=hvac\\_systems](http://www.eere.energy.gov/buildings/tools_directory/subjects.cfm/pagename=subjects/pagename_menu=materials_components/pagename_submenu=hvac_systems)). This software generally requires information about the existing fan system such as:

- Operating schedule
- Type of flow control
- Duty cycle
- Motor horsepower and efficiency
- Peak flow rate
- Peak cooling coil load

## Install Variable-Speed Drives

Variable-speed drives are an efficient and economical retrofit option that should be considered for all VAV systems. VSDs allow the motor speed to vary depending on actual operating conditions, rather than operating continuously at full speed. Varying a fan's speed allows it to match changing load requirements more closely, and because fan power draw is proportional to the cube of its speed, reducing speed can save a lot of energy. For example, reducing a fan's speed by 20 percent can reduce its energy requirements by nearly 50 percent (**Figure 8.5**). Installing a VSD on the fan motor allows the fan to automatically match this reduced capacity, slowing down in response to reduced demand, thereby saving energy.

---

---

### CASE STUDY: Big Savings from a VAV System Retrofit

A retrofit to the 12-story City Hall in Phoenix, Arizona, demonstrates the savings achievable by matching fan power to cooling and heating load. The building originally had a constant-volume, dual-duct system with cold deck temperature reset, supplied by four 60-hp supply-air fans and two 50-hp return-air fans. Pre-retrofit, the fan energy consumption was over 2.2 million kilowatt-hours per year. Analysis of the building's loads showed that the fans were considerably oversized, moving a constant 220,000 cubic feet per minute when the peak load actually called for only 130,000 cfm. On this basis, two of the supply fans and both return fans were disconnected, resulting in an immediate savings of over 50 percent. A bypass duct was installed around each of the disabled return fans, eliminating substantial friction losses.

The remaining two fans were converted to variable air volume by installing variable-speed drives controlled by static pressure sensors in the ducts. The interior zone dual-duct boxes were converted to VAV boxes by sealing off the connection from the hot deck and connecting a new pneumatic actuator to the cold deck damper that was operated by a zone thermostat. The new system registered average savings of 70 percent compared to constant-volume operation, with a maximum demand reduction of 78 percent. Complaints of discomfort also decreased. Based on a conservative estimate of 50 percent average annual VAV savings, the \$90,000 project saved 1.7 million kWh, worth over \$135,000 per year, resulting in a payback of about eight months.

---

---

**Figure 8.5: Fan power input versus speed**

The load on a fan motor increases as the cube of its speed. Therefore, using a variable-speed drive (VSD) to reduce speed to 80 percent of full speed reduces power consumption to just  $(0.8)^3$ , or 51.2 percent of its original load level. The VSD itself does consume some power, so careful assessment is necessary for any application where average fan speed will exceed 90 percent of full speed.

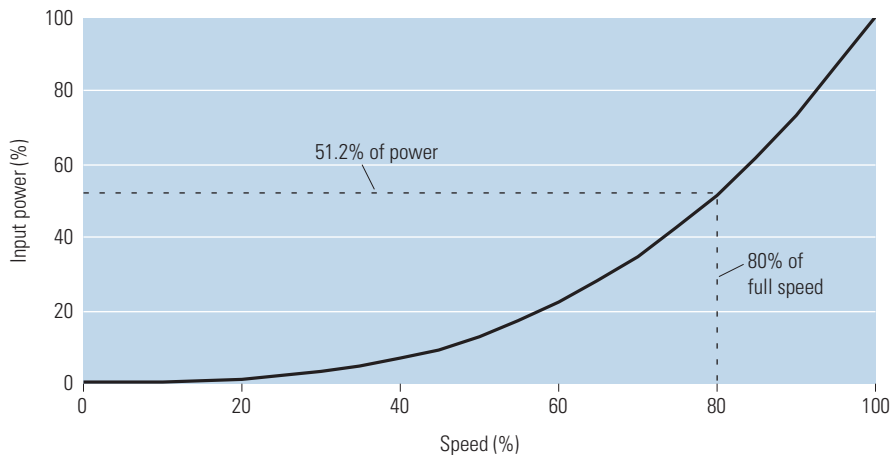

Courtesy: E SOURCE

A VSD is not a motor; it is an electronic device that varies the speed of a motor by changing the frequency of the electrical power between 0 and 60 Hertz. The EPA study “Variable Air Volume Systems Maximize Energy Efficiency and Profits” showed that VSDs can greatly reduce the energy used by the same fan operating under similar airflow volumes and static pressure conditions. Overall, the study indicated that VSDs provided an average energy savings of 52 percent.

VSDs make economic sense when installed on motors that operate many hours per year at fluctuating loads, and especially on larger motors. **Table 8.2** presents representative installed costs for VSDs of various sizes.

## Modify Controls

Modifying the way the distribution system operates, not just the system itself or its components, can also save energy.

**Optimized scheduling.** An optimum start-and-stop procedure is a common-sense control philosophy that can result in significant energy savings. Normally, a system is set to automatically turn itself on and off based upon the expected occupant working hours. For example, a building’s cooling system might come on at 6:00 a.m. and shut off at 7:00 p.m. Adjusting these times for varying seasons will reduce energy costs. In the spring and fall seasons, when cooling is required but the peak temperatures are typically lower than the summer peak temperatures, the system can be set to come on later in the morning and shut off earlier in the day. Of course, the system can also be shut down if the building is unoccupied.

**Supply-air temperature reset.** Most cooling coils are designed to deliver 53° to 55°F air to satisfy cooling requirements on the hottest day of the year. During periods of milder weather, this temperature can be automatically reset upward to improve system efficiency by reducing wasteful reheating of already cooled air. Supply-air temperature reset can be accomplished in a few different ways.

**Table 8.2: Installed costs of VSDs for various size motors**

Installed costs for variable-speed drives range from approximately \$2,500 for a 5-horsepower (hp) drive to \$16,000 for a 100-hp drive. Note that the price per horsepower declines dramatically as power capacity increases.

Motor hp	Installed cost (\$)	Price per hp (\$)
5.0	2,475	495
7.5	2,950	393
10.0	2,950	295
15.0	3,675	245
20.0	4,900	245
25.0	5,875	235
30.0	6,825	228
40.0	9,275	232
50.0	10,400	208
60.0	11,800	197
75.0	15,200	203
100.0	15,800	158

Courtesy: E SOURCE; data from R.S. Means Electrical Cost Data, 2007 edition

The most common reset strategy is to implement a simple proportional reset based on the outside air temperature; on a hot day, the supply-air temperature (SAT) is set to its design (or original) value, and when the weather is cooler, the SAT is increased. This is usually specified in a table that lists two outside temperatures and the corresponding SAT. For example, at 95°F outside temperature, the SAT is set to 53°F; at 65°F outside temperature the SAT is set at 68°F. The SAT is then reset proportionally between these two points. With a proportional reset system, building operating staff will often provide better comfort if they “tune” the reset parameters based on observed performance. Some buildings will require a colder SAT on mild days due to higher internal loads (people, lights, office equipment) or due to higher solar gain through windows. Conversely, buildings with efficient lighting systems and high-performance glazing may achieve good comfort with a warmer SAT at the same outside conditions.

For HVAC systems that include digital controls at the zone level, it is also possible to reset the SAT based on the “worst-case zone” approach. Under this scenario, the SAT setpoint is reset so that the zone with the greatest cooling requirement has its zone damper fully opened to provide 100 percent flow. All other zones, which have lower cooling requirements, will automatically adjust the VAV damper to maintain comfort.

For VAV systems, particularly those with VSDs installed, it is important to consider the impact of SAT reset on fan power; if the SAT is reset too high, then the energy saved due to reduced reheat will be overshadowed by increased fan power requirements.

**Pressure reset.** Pressure reset is a method that can yield additional energy savings in systems that have VSDs installed. Pressure and flow are related. Reducing the pressure supplied by fans also reduces the flow supplied, which in turn reduces the power required. By reducing the duct pressure by 30 percent when less air is required, almost instantaneous fan

energy savings of more than 50 percent can be achieved above and beyond the application of a VSD. The desired setpoint can be found by gradually reducing the fan speed each day until the pressure is as low as possible but occupant space is still comfortable. It is possible to have two or more pressure settings; for example, one for daytime and one for evening or one for summer and one for winter. With HVAC systems that include digital zone controls, it is also possible to implement a static pressure reset based on the worst-case zone approach described above for supply-air temperature reset. The strategy is the same: The static pressure setpoint is reset so that the zone damper in the worst-case zone is fully open. Keep in mind that, if both temperature and pressure resets are to be implemented simultaneously, some thought must be given to how these savings measures will interact.

---

---

### **CASE STUDY: Air Distribution System Upgrade Saves Energy, Boosts Comfort**

The building known as 600 B Street is a 24-story, 334,000-square-foot, Class A commercial office facility located in San Diego. The 25-year-old high-rise facility had unreliable cooling equipment, high operating and maintenance costs, and substantial numbers of tenant complaints.

Prior to the energy-efficiency implementation, the fan systems could not provide adequate comfort on hot, humid days. The variable air volume dampers would open fully in an attempt to satisfy the space-conditioning requirements. But as the chiller plant and air-handling systems reached their capacity limits, the supply-air temperature would climb too high and the system static pressure would be too low, blowing large quantities of air that was too warm and humid to provide the required cooling effect. As a result of these problems with static pressure control, the system was drafty on hot days and noisy on cold days. Variable-speed drives were installed on the supply fans to gain energy savings and quiet the system during low-load operation, reducing tenant complaints.

To allow faster resetting of the HVAC system variables and to maximize the potential for savings, 25 percent of the VAV terminal controllers in the building were switched from pneumatic control to digital (electronic) zone-terminal control and the information from the zones was used to reset the static pressure setpoint for the air-handling units and the supply-air temperature setpoint. Ideally, all of the VAV terminal controllers would have been replaced, but the cost of doing so would have been high. The digital system is configured to reset static pressure and supply-air temperature continually based on the loads being served.

After a two-year period of measurement and verification, it was determined that fan energy was reduced by 73 percent. The 800,000 kilowatt-hours per year in electrical savings equates to about \$120,000 per year in energy cost savings, resulting in a very cost-effective retrofit. Including the incentives offered by the local utility, the energy retrofit project (which included chiller plant measures in addition to the modifications to the air system) paid for itself within about three months. The indoor air quality has also improved dramatically, resulting in an 85 percent drop in tenant complaints.

As a result of the project's documented level of energy efficiency and its positive effect on occupant thermal comfort, the project was honored by ASHRAE for both the San Diego Chapter and the Western Region.

---

---

**Economizer cooling.** Air-side economizers consist of a collection of dampers, sensors, actuators, and logic devices on the supply-air side of the air-handling system (**Figure 8.6**). The outside-air damper is controlled so that when the outside air temperature is below a predefined setpoint, the outside-air damper opens, allowing more air to be drawn into the building. On hot days, the economizer damper closes to its lowest setting, which is the minimum amount of fresh air required by the local building code.

All economizers are not created equal. The simplest and most common type is the basic dry-bulb economizer that controls the outside-air damper based on a specified temperature setpoint. An enhancement to this approach is an enthalpy (or total energy content) economizer, which accounts for both the temperature and the humidity of the outside air and can improve the energy savings associated with the economizer by not cooling with outside air under high-humidity conditions. One of the most advanced economizer control strategies available today is a differential enthalpy system, in which two enthalpy sensors are installed (one for the outside air and the other for the return air). Under the differential control strategy, the system preferentially uses whichever air source (outside or return) has lower enthalpy when there is a need for cooling.

When the outside temperature and humidity are mild, economizers save energy by cooling buildings with outside air rather than using refrigeration equipment to cool recirculated air. A properly operating economizer can cut energy costs by as much as 10 percent of a building's

**Figure 8.6: The components of an economizer**

When the air outside is cooler than the return air and sufficiently dry, economizers cool buildings by bringing in outside air, thereby reducing the load on the compressor.

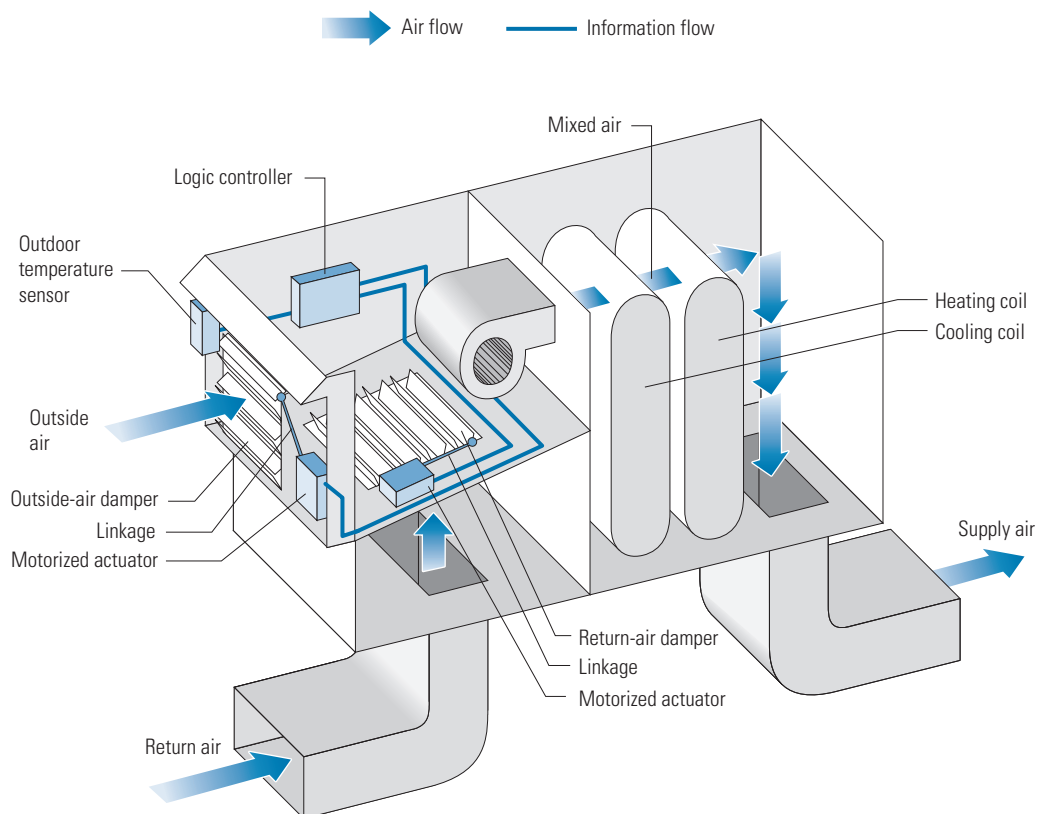

Courtesy: E SOURCE

total energy consumption (up to 20 percent in mild, coastal climates), depending mostly on local climate and internal cooling loads.

Economizer commissioning and maintenance are vital to proper operation and energy savings. A large number of newly installed economizers do not work properly, and their problems increase as they age. To make matters worse, malfunctioning economizers often waste much more energy than they were intended to save. If an economizer breaks down when its damper is wide open, peak loads can shoot up as cooling or heating systems try to compensate for the excess air entering the building. A computer simulation of an office building in arid Phoenix, Arizona, shows that a damper permanently stuck in the wide-open position could add as much as 80 percent to that building's summer peak load, assuming the building had enough cooling capacity to meet the much higher load resulting from cooling excessive outside air.

**Demand-controlled ventilation.** Many building codes in the United States base their ventilation requirements on a standard written by ASHRAE that requires that commercial buildings bring in a specified minimum amount of fresh air to ensure adequate indoor air quality. To adhere to this standard, the choice made in most buildings is to ventilate at the fixed minimum rate per person based on the building type and the assumed occupancy, which is usually the building's design occupancy. But because the number of people occupying the space at any given time can vary widely, the ASHRAE standard offers another way to ventilate based on actual occupancy numbers. This is called demand-controlled ventilation (DCV).

Because the average amount of carbon dioxide (CO<sub>2</sub>) exhaled by a person in a fixed time period at a given activity level is well known, the concentration of CO<sub>2</sub> in the air inside a building is a good indicator of the number of people in a space and the rate at which the air in the space is being diluted with outside air. The more occupants a building has at any given time, the higher the level of CO<sub>2</sub> in the air. The ASHRAE standard allows building operators to use DCV to bring in and condition only the air necessary for the actual occupancy. In a DCV system, sensors monitor the CO<sub>2</sub> levels inside and send a signal to the HVAC controls, which regulate the amount of outside ventilation air that is drawn into the building. Though ASHRAE does not set a maximum allowable CO<sub>2</sub> concentration, the most recent version of the standard recommends that the indoor CO<sub>2</sub> level be no more than 700 parts per million (ppm) above the outside level, which is typically about 350 ppm.

---

## CASE STUDY: Power Exhausts Cut Cooling Costs

The majority of conventional air-handling units are able to provide 100 percent outside air. However, at one 200,000-square-foot office building in a Boston suburb, it was noticed that air-conditioning compressors in the rooftop units operated on all sunny days, even when outside air temperature was as low as 35° Fahrenheit. The reason was that solar-heated interior air had no way to escape from the building, so even with outside air dampers wide open, the rooftop units could not provide enough outside air to cool the building without the aid of mechanical refrigeration.

The solution was to install power exhausts in the rooftop units that exhausted all indoor air when the building was in economizer cooling mode. Roughly 1,000 hours per year were found to have proper conditions for free cooling. After the installation of the power exhausts, cooling compressors only operated when the outside air temperature was above 55°F. The installation cost \$75,000 and paid for itself in under four years.

---



DCV systems save energy by reducing the need to heat or cool outside air. The only system change is the ratio of recirculated air to outside air; fan power is usually unaffected. DCV systems can save from \$0.05 to \$1.00 per square foot, depending on the occupancy schedule and climate (see sidebar).

The overall cost for implementing DCV has dropped substantially in recent years, opening up new opportunities for savings and spurring changes in some building codes. Also, several HVAC equipment manufacturers now offer DCV-ready rooftop units and variable air volume (VAV) boxes. This equipment is shipped with terminals for the CO<sub>2</sub> sensor wires and controls that are preprogrammed to implement a DCV strategy. By limiting installation costs to the cost of mounting the sensor and running wires to the rooftop unit or VAV box (wireless models are also available), DCV-ready HVAC equipment substantially reduces the cost of implementing DCV.

Facilities that would likely reap energy savings with the use of DCV tend to have long operating hours, widely varying and largely unpredictable occupancy levels, and at least moderate annual heating or cooling loads. A large number of facilities meet this description, including grocery stores, supermarkets, big-box stores, theaters and other performance spaces, lecture halls, places of worship, sports arenas, restaurants and bars of all types, and department stores. In fact, the majority of commercial facilities that are not now using DCV are at least potential targets for the technology.

Care must be applied when planning a DCV retrofit to ensure that adequate air quality is maintained. Of paramount concern are the location and quantity of CO<sub>2</sub> sensors. Although it might be tempting to install a single CO<sub>2</sub> sensor in the return-air duct for the entire building, this could lead to situations where the average CO<sub>2</sub> level is acceptable but the level in specific, highly occupied spaces (such as a packed conference room) is too high. For this reason, it is typically more effective to install CO<sub>2</sub> sensors in each high-occupant-density or high-diversity space and use them to command the minimum position of the VAV box.

Many energy codes that permit DCV also have required minimum ventilation and airflow rates (such as 0.15 cfm per square foot). Be sure to confirm local requirements before committing to a project.

A study conducted in 2003 at Purdue University shows favorable paybacks for DCV in a variety of buildings. The study investigated four types of buildings—a restaurant, a retail store, a

---

---

## RESOURCES: Demand-Controlled Ventilation Design Tools

Several free tools are available to evaluate potential energy savings from demand-controlled ventilation:

- Carrier provides the Hourly Analysis Program ([www.commercial.carrier.com/commercial/hvac/general/1,,CLI1\\_DIV12\\_ETI496,00.html?SMSESSION=NO](http://www.commercial.carrier.com/commercial/hvac/general/1,,CLI1_DIV12_ETI496,00.html?SMSESSION=NO)).
  - Honeywell has the Savings Estimator ([http://customer.honeywell.com/Business/Cultures/en-US/Products/Applications+and+Downloads/Economizer+Logic+Module+\(W7212\)+ Simulator+and+Demand+Control+Ventilation+Savings-Estimator.htm](http://customer.honeywell.com/Business/Cultures/en-US/Products/Applications+and+Downloads/Economizer+Logic+Module+(W7212)+ Simulator+and+Demand+Control+Ventilation+Savings-Estimator.htm)).
  - AirTest offers a spreadsheet-based demand-controlled ventilation savings analyzer (<https://www.airtesttechnologies.com/support/software/index.html>).
- 
-

school, and an office—in each of two cities in California and three cities outside the state. Total energy savings ranged from 6.4 to over 50 percent, and payback periods ranged from 0.25 to 6.8 years, though paybacks were well under two years for most of the modeled facilities.

Keep in mind that CO<sub>2</sub> concentration rates do not indicate the levels of other potential air contaminants contained within the space. If a facility contains significant nonhuman sources of contaminants (such as materials or products containing volatile organic compounds), additional ventilation may be required to provide acceptable indoor air quality. This makes warehouses, kitchens, dry cleaners, and many types of industrial facilities poor candidates for DCV. Consult local building codes for proper ventilation rates.

## Pick Premium-Efficiency Motors

All new motors installed in HVAC applications have been required to meet minimum federal energy-efficiency standards since October 1997. The motors that drive older HVAC systems are likely to be inefficient by today's standards, and even newer systems that meet the current federal motor efficiency standards can be made more efficient. Motors that perform to the National Electrical Manufacturers Association's NEMA Premium (NP) specification (see **Table 8.3**) can yield highly cost-effective energy savings in HVAC applications because these applications tend to have long running hours.

**Table 8.3: Premium versus standard efficiencies of totally enclosed, fan-cooled motors**

NEMA Premium motors often exceed the efficiencies of standard-efficiency motors by 1.5 to 2 percent. Although that may not seem like much, given their very long running hours in HVAC applications, it is often quite easy to justify the higher cost of premium-efficiency motors based on energy savings alone, particularly if the local utility offers a rebate.

Motor horsepower	Efficiency (%)					
	3,600 rpm		1,800 rpm		1,200 rpm	
	Standard	NEMA Premium	Standard	NEMA Premium	Standard	NEMA Premium
1.0	75.5	77.0	82.5	85.5	80.0	82.5
1.5	82.5	84.0	84.0	86.5	85.5	87.5
2.0	84.0	85.5	84.0	86.5	86.5	88.5
3.0	85.5	86.5	87.5	89.5	87.5	89.5
5.0	87.5	88.5	87.5	89.5	87.5	89.5
7.5	88.5	89.5	89.5	91.7	89.5	91.0
10.0	89.5	90.2	89.5	91.7	89.5	91.0
15.0	90.2	91.0	91.0	92.4	90.2	91.7
20.0	90.2	91.0	91.0	93.0	90.2	91.7
25.0	91.0	91.7	92.4	93.6	91.7	93.0
30.0	91.0	91.7	92.4	93.6	91.7	93.0
40.0	91.7	92.4	93.0	94.1	93.0	94.1
50.0	92.4	93.0	93.0	94.5	93.0	94.1
60.0	93.0	93.6	93.6	95.0	93.6	94.5
75.0	93.0	93.6	94.1	95.4	93.6	94.5
100.0	93.6	94.1	94.5	95.4	94.1	95.0

Courtesy: E SOURCE; data from NEMA and U.S. Department of Energy

After completing the building upgrade stages described earlier in this manual, building heating and cooling loads are likely to have been reduced, allowing for the installation of smaller motors that better match the reduced power requirements. Although NP motors also often come with a price premium, the cost of a smaller, premium-efficiency motor will often be less than that of a standard-efficiency motor of the same size as the existing motor, making the premium-efficiency motor an easy choice. Also, many utilities offer rebates on the purchase of NP motors that are designed to cover all or a portion of the price premium.

The DOE offers a free software application called MotorMaster that is an excellent tool for evaluating the economics of alternative motor choices. The software comes with a frequently updated database of commercially available motors and allows the user to compare the initial and lifecycle cost implications of replacing an existing motor with a standard- or premium-efficiency motor. MotorMaster can be downloaded from [www1.eere.energy.gov/industry/bestpractices/software.html#mm](http://www1.eere.energy.gov/industry/bestpractices/software.html#mm).

Here are a few additional issues to consider when evaluating HVAC motors.

**Motor speed.** Some premium-efficiency motors operate at higher speeds. All induction motors have a synchronous speed (the speed at which the magnetic field within the motor is rotating) and a full-load speed (the speed at which the motor shaft rotates when the motor is providing full-load torque or power). A motor's full-load speed will always be less than its synchronous speed by a few percent. The difference between synchronous and full-load speed is called slip.

The exact amount of slip a motor has depends on its design, construction, and loading. Be aware that premium-efficiency motors tend to have lower slip, which means that their full-load speed tends to be higher than that of less-efficient models. As noted earlier, the power a fan requires to move air varies by the cube of its speed, so power draw and energy consumption are very sensitive to motor speed. In air-circulation systems that are not controlled by a VSD, it is therefore conceivable that replacing an existing motor with a NP motor could actually result in greater energy consumption, even though the new motor operates at higher efficiency. Therefore, when selecting a premium-efficiency motor, it is important to compare its rated full-load speed to that of the motor it will replace. If necessary, the fan's speed can be reduced by increasing the diameter of its pulley.

**Voltage balance.** Three-phase induction motors (that is, motors that draw power from three phase conductors) are designed, specified, and rated by their manufacturers on the assumption that exactly the same voltage will be fed to each phase and that equal current will therefore flow through the coils connected to each phase, generating a uniform magnetic field from each pole pair. When this voltage is not balanced, however, significant harm can come to the motor, including reduced performance, increased heat, shortened life, and dramatically reduced efficiency. Phase unbalance dramatically increases the heat generated within a motor. That increase then feeds upon itself, because hotter windings have higher resistance, pushing up losses further. Just a 3.5 percent unbalance can increase total motor losses by 20 to 25 percent, which is equivalent to bringing the efficiency of a 90 percent efficient motor down to 87.5 to 88 percent.

Unbalance is defined by NEMA as 100 times the maximum deviation from the average of the voltages on the three phases, divided by that average voltage. For example, if the phase voltages measured at a motor's terminals are 465, 470, and 473 volts, the average voltage is 469.3 and

the maximum deviation is 4.3 volts. The unbalance, then, is  $4.3/469.3 = 0.9$  percent. A well-balanced system should have voltage unbalance of less than 1 percent. If voltage unbalance is greater than 1 percent, evaluate the loading on each phase. The unbalanced phase may be carrying significantly more or less load than the others, in which case rebalancing the loads across the phases will also rebalance phase voltages.

**Shaft alignment.** In typical fan-system configurations, the motor and the fan each have shafts that are connected with a belt or belts and two pulleys. If the pulley faces are not square with each other, then the belt and shafts are not in alignment. Improperly aligned shafts can not only result in poor efficiency and higher operating costs, but also can lead to premature failure and increased maintenance costs. Whenever a motor is replaced or rewound, be sure to pay close attention to the shaft alignment.

## Use Energy-Efficient Belt Drives

Belts are often used to transfer power from the motor to the fan system being driven. Standard V-belt drives can be found in the majority of belt applications. They are the lowest-cost option of the belt family. The trade-off, as usual, is reduced energy efficiency. New V-belts typically achieve efficiencies in the 90 to 95 percent range. A worn belt, however, can considerably reduce the efficiency by slippage caused by slackening and worn grip surfaces. Cogged V-belts are similar to standard V-belts, except that the normally flat underside has longitudinal grooves in it, allowing better grip and less slip than standard V-belts. They typically offer a 2 to 5 percent efficiency bonus.

Less commonly found synchronous belts combine toothed belts with grooved sprockets. The belts are called “synchronous” because both sprockets rotate in exact synchrony, eliminating losses from slippage and creep and significantly reducing maintenance because the nonstretch belt does not need retensioning. These belts transmit power by engaging teeth rather than tension-induced friction, so they operate much more efficiently than V-belts, achieving efficiencies in the range of 97 percent to 99 percent.

A potential downside to synchronous belts is that by reducing slippage, they will actually increase the speed of the fan, which will result in more airflow, but it will also require more power from the motor. For example, reducing belt slip on a constant-volume centrifugal fan by 3 percent will result in a corresponding 3 percent increase in rotational speed for the fan wheel and an increase in the volume of air that is delivered. Because such a fan has a cubic relationship between airflow and horsepower, however, the horsepower required to drive the fan will increase by  $(1.03)^3$ , or 1.093—a 9.3 percent increase from the previous requirements. So the building owner who wants energy savings may instead be getting increased airflow and increased energy use (and possibly an overheated fan motor) if the proper precautions are not taken. Retrofits from V-belts to synchronous belts should be coordinated with the replacement of standard-efficiency motors with properly sized premium-efficiency motors. Doing both retrofits together reduces total labor costs and offers an opportunity to correct for any changes in speed from the new motor or belts at zero marginal cost. Additionally, when selecting synchronous belts it is important to follow manufacturer guidelines for sizing and tensioning the belts to ensure quiet, trouble-free operation.

V-belts should be a standard replacement part in every building’s maintenance program, requiring replacement every few months. Energy-efficient synchronous belts can easily be incorporated into a standard maintenance program, and the savings generated greatly outweigh the slight increase in cost per belt.

## Consider a Testing, Adjusting, and Balancing Contractor

The modifications outlined above are likely to alter the operating characteristics of a building's HVAC system. Normally, the engineer or contractor who performed the work will be responsible for what is called the testing, adjusting, and balancing (TAB) of the modified or new system. TAB involves measuring and analyzing the various flows of air, chilled water, hot water, steam, etc., and ensuring that distribution of heating and cooling throughout the building meets the required specifications as outlined in the contract documents. Independent TAB contractors serve as an unbiased third party to ensure accuracy of the TAB measurements and are worth retaining if further oversight is desired. To find a qualified TAB firm, look for a firm that is certified by a recognized national professional society such as the Associated Air Balance Council. In addition, confirm that the TAB firm has experience with balancing systems in the type of facility in question (such as office, university building, or laboratory). Finally, ask for references.

### 8.5 Summary

This chapter illustrates the many options that are available to optimize constant-volume and variable air volume air distribution systems. Some of the strategies to remember are:

- Address zone-level opportunities first.
- Consider converting a CV system to VAV.
- Rightsize fan system to match actual loads.
- Install VSDs where practical.
- Consider improved controls to optimize scheduling and to implement temperature or pressure reset, economizer cooling, and demand-controlled ventilation.
- Install rightsized, premium-efficiency motors where possible.
- Install energy-efficient belts.

### Bibliography

ASHRAE (American Society of Heating, Refrigerating and Air-Conditioning Engineers), "Energy Standard for Buildings Except Low-Rise Residential Buildings," ANSI/ASHRAE/IESNA Standard 90.1-2004, [www.ashrae.org](http://www.ashrae.org).

ASHRAE, "Ventilation for Acceptable Indoor Air Quality," ASHRAE Standard 62.1-2004, [www.ashrae.org](http://www.ashrae.org).

California Energy Commission, "Advanced Variable Air Volume System Design Guide" (October 2003), [http://energy.ca.gov/reports/2003-11-17\\_500-03-082\\_A-11.PDF](http://energy.ca.gov/reports/2003-11-17_500-03-082_A-11.PDF).

California Energy Commission, *Guide to Preparing Feasibility Studies for Energy-Efficiency Projects*, P400-00-002 (California Energy Commission, 2000).

Englander, S.L. and L.K. Norford, "Saving Fan Energy in VAV Systems, Part 1: Analysis of a Variable Speed Retrofit," ASHRAE Transactions 1992a: 98.

NEMA, “Application Guide for AC Adjustable Speed Drive Systems” (2007), [www.nema.org/stds/acadjustable.cfm](http://www.nema.org/stds/acadjustable.cfm).

U.S. Department of Energy, Energy Information Administration, “End-Use Consumption by Principal Building Activity” (1999), [www.eia.doe.gov/emeu/cbecs/enduse\\_consumption/pba.html](http://www.eia.doe.gov/emeu/cbecs/enduse_consumption/pba.html).



LEARN MORE AT  
[energystar.gov](http://energystar.gov)

ENERGY STAR® is a U.S. Environmental Protection Agency program helping businesses and individuals fight global warming through superior energy efficiency.

## Chapter 9 Heating and Cooling





# 9. Heating and Cooling

Revised January 2008

<b>9.1</b>	<b>Overview</b>	<b>2</b>
<b>9.2</b>	<b>Central Cooling Systems</b>	<b>3</b>
	Chiller Plant Operations and Maintenance	4
	Chiller Plant Retrofits	6
<b>9.3</b>	<b>Central Heating Systems</b>	<b>10</b>
	Boiler System Operations and Maintenance	11
	Boiler System Retrofits	11
	Improving Furnace Efficiency	13
<b>9.4</b>	<b>Unitary Systems</b>	<b>14</b>
	Packaged Rooftop Units	16
	Split-System Packaged Units	18
	Air-Source Heat Pumps	18
	Ground-Source, Closed-Loop Heat Pumps	19
<b>9.5</b>	<b>Additional Strategies</b>	<b>20</b>
	Air-Side Economizer	20
	Energy Recovery	20
	Desiccant Dehumidification	20
	Night Precooling	21
	Cool Storage	22
	Evaporative Cooling	22
<b>9.6</b>	<b>Summary</b>	<b>22</b>
	<b>Bibliography</b>	<b>23</b>
	<b>Glossary</b>	<b>G-1</b>



## 9.1 Overview

Although heating and cooling systems provide a useful service by keeping occupants comfortable, they also account for a significant portion of a building's energy use—typically about a quarter. However, it is possible to lessen this impact in both central and unitary systems by increasing their efficiency.

This chapter identifies opportunities for improving the performance of heating and cooling systems. Cooling systems generally have higher space-conditioning capacities than heating systems because waste heat from people, lighting, and office equipment supplies a large portion of a building's heating requirement. Although their higher capacities often translate into more opportunities for savings from cooling systems, significant savings can still be had from heating systems.

Following the steps outlined in previous stages of this manual should have reduced cooling and heating loads (**Figure 9.1**). Many existing systems are oversized to begin with, so it may now be possible to justify replacing the current system with a properly sized one—or retrofitting it to operate more efficiently. When replacing system components, it is extremely important to size the equipment properly to meet current loads. Besides saving energy, proper sizing will likely reduce noise, lower first costs for equipment, and optimize equipment operation, which in turn reduces maintenance costs and extends equipment lifetime. For example, a 1 watt per square foot (W/ft<sup>2</sup>) reduction in lighting load in a 100,000-ft<sup>2</sup> building would allow a chiller capacity reduction of about 23 tons (assuming 80 percent of the waste heat reaches the conditioned space). If a typical chiller costs \$450 per ton, then a 23-ton reduction would reduce the first cost of a new chiller by more than \$10,000. Other load reductions would further reduce the required chiller size. To determine new heating and cooling loads accurately, it may be necessary consult an energy engineer or other expert.

**Figure 9.1: The staged approach to building upgrades**

The staged approach to building upgrades accounts for interactions among all the energy flows in a building. Each stage affects the upgrades performed in subsequent stages, thus ensuring the greatest energy and cost savings possible. The heating and cooling stage takes advantage of all the load reductions achieved in earlier stages.

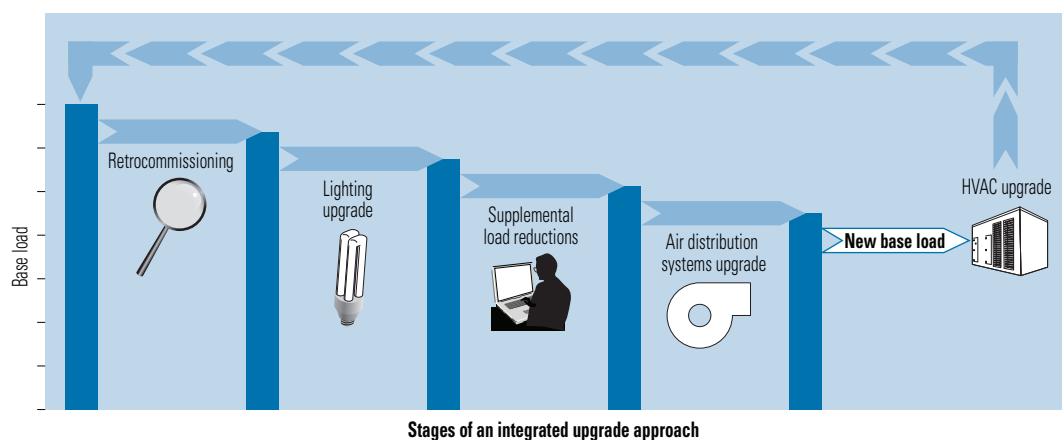

Courtesy: E SOURCE

The conventional approach to upgrading a heating and cooling system is to address each component of the system individually. However, addressing the interactions among components using an integrated-system approach ultimately results in superior efficiency, particularly with central systems.

An annual maintenance program is also essential for keeping any heating or cooling system operating efficiently. Clean or replace air filters regularly, verify proper refrigerant levels and airflow, and inspect equipment for obvious malfunctions like stuck dampers.

Although heating and cooling upgrades represent the last stage of building upgrades, they do not signal the end of the process. It is important to make sure the changes implemented continue to provide the intended benefits throughout their useful lifetimes—through periodic recommissioning and further upgrades as needed. See the EPA's Guidelines for Energy Management Overview at [www.energystar.gov/index.cfm?c=guidelines.guidelines\\_index](http://www.energystar.gov/index.cfm?c=guidelines.guidelines_index).

## 9.2 Central Cooling Systems

Chilled-water systems, found mainly in large buildings, feature separate central chillers and air handlers, with a network of pipes and pumps to connect them (**Figure 9.2**). Although only 18 percent of all U.S. commercial building floor space is cooled by chillers, about 39 percent of all buildings larger than 100,000 ft<sup>2</sup> contain chilled-water systems.

Chillers use one of four types of compressor: reciprocating, scroll, screw, and centrifugal. Reciprocating chillers are the least efficient. Screw and scroll compressors are typically used in applications needing up to 300 tons of cooling capacity. Centrifugal compressors traditionally provide larger capacities, although a new type of centrifugal compressor that employs magnetic bearings breaks this mold to serve the under-300-ton market.

There are no federal minimum efficiency standards for chillers. However, ASHRAE (the American Society of Heating, Refrigerating, and Air-Conditioning Engineers) does provide

**Figure 9.2: Typical water-cooled chiller system**

The air-handling unit captures heat inside the building and the cooling tower expels it.

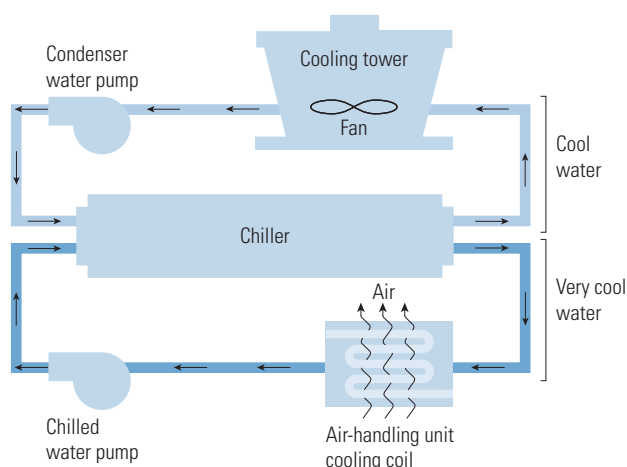

Courtesy: E source; adapted from EPA

efficiency specifications in its 90.1 standard, “Energy Standard for Buildings Except Low-Rise Residential Buildings,” which is used in many local building codes (**Table 9.1**).

As counterintuitive as it may sound, focusing on just the efficiency of the chiller will not necessarily lead to the most cost-effective savings. Chiller efficiencies do not account for pumps and fans in the cooling system and they apply only to single chillers (80 percent of plants use multiple chillers). Full-load efficiency data is also of little value because chillers rarely run at full load, and integrated part-load data is provided at too few operating points to give an accurate indication of performance. The best way to produce energy and demand savings is to consider the operation of the entire chiller plant using an integrated approach. Energy and demand savings are achievable through improved operation and maintenance of the plant as well as through efficiency retrofits. Note that many chillers that used the now-banned chlorofluorocarbon (CFC) refrigerants have already been either replaced or upgraded to use compliant refrigerants. When a remaining CFC system is finally replaced or upgraded, this presents an opportunity to evaluate other chiller plant modifications that could yield substantial energy savings.

## Chiller Plant Operations and Maintenance

The efficiency of a chiller plant can be improved through both operations and maintenance adjustments.

**Use controls to properly sequence chillers.** Monitor the capacity of all chillers in the plant and turn chillers on or off so that each one is loaded enough to keep it in its most efficient zone (see sidebar, “Sequencing Chillers Yields Savings”).

**Monitor outdoor conditions and reset the chilled-water temperature accordingly.**

This strategy can help match chiller output to the actual load. Note however that this strategy is often disabled by chiller plant operators trying to rectify unrelated plant problems. To help prevent this, show plant operators how to apply and maintain this strategy and explain why it is valuable.

**Monitor outdoor conditions and reset the condenser-water temperature accordingly.** Higher condenser-water temperatures decrease cooling tower fan power but increase chiller power. The optimum operating temperature occurs at the point where these two opposing trends combine to produce the lowest total power use. However, this point changes with outdoor conditions, so it needs to be adjusted periodically to maintain efficiency.

**Table 9.1: ASHRAE 90.1-2001 and 2004 minimum required efficiencies for water-cooled chillers**

Many local building codes directly reference ASHRAE 90.1 or require using the International Energy Conservation Code, which has adopted 90.1.

Chiller type	Capacity range					
	< 150 tons		150 to 300 tons		> 300 tons	
	Full load	IPLV	Full load	IPLV	Full load	IPLV
Centrifugal	0.703	0.670	0.634	0.596	0.576	0.549
Screw and scroll	0.790	0.676	0.718	0.628	0.639	0.572
Reciprocating	0.837	0.696	0.837	0.696	0.837	0.696

Note: IPLV = integrated part-load value.

Courtesy: E SOURCE; data from ASHRAE

---

---

## CASE STUDY: Sequencing Chillers Yields Savings

A chiller plant monitored in a loading and performance study by San Diego Gas & Electric demonstrates the savings potential of better chiller sequencing. The plant includes two 200-ton centrifugal chillers serving a 162,930-square-foot office building. The study revealed that many hours were spent with both chillers operating simultaneously at less than 45 percent capacity each. Calculations showed that savings of about 5 percent could be achieved by operating a single chiller at 90 percent load instead of both at 45 percent load. Annual energy savings would be about 34,500 kilowatt-hours (kWh), or about \$2,800 per year at \$0.08 per kWh.

Further study revealed additional savings. By shutting down one chiller, the auxiliary chilled-water and condenser-water pumps that served it could also be shut down. This would yield additional savings of about 14,100 kWh or \$1,100 annually, bringing the overall savings from improved chiller sequencing to about \$3,900 per year.

---

---

**Take full advantage of available cooling towers.** Most chilled-water plants have excess capacity, with one or more cooling towers not operating during low-load periods. To make the most of existing cooling towers, simply run condenser water over as many towers as possible, at the lowest possible fan speed, and as often as possible. This strategy is feasible only for chilled-water systems that include multiple chillers and towers plumbed in parallel—and the ability to vary the speed of the fans. For such systems, open all the condenser-water isolation valves at the cooling towers and leave them open. To avoid additional pumping power costs, run only enough condenser-water pumps to maintain adequate flow through the chillers. This retrofit strategy does have one drawback for two-speed fans: It causes additional fan cycling (between half speed and off, and between half speed and full speed). This in turn leads to additional wear and tear on motors and gears.

**Inspect tubes annually and clean as needed, or use automatic tube-cleaning equipment.** As a chiller runs, water may leave behind scale, algae, or slime on the inside of the condenser tubes (buildup is typically not a problem in the evaporator tubes because that is a closed system). These deposits can decrease both the efficiency and the capacity of the chiller by reducing heat-transfer efficiency. Periodic chemical or ozone treatments can help keep condenser tubes clear. Another option is automatic cleaning equipment that inserts thumb-sized nylon brushes into each condenser tube—catch baskets epoxied to the ends of the tubes collect the brushes. These brushes are slightly larger than the inside diameter of the tubes, so they brush the whole length of the tube as they are propelled by the water flow.

Energy and maintenance savings depend on the chemical or manual treatment that would otherwise have been used—the more deposits that would have built up, the greater the savings. A condenser fouled to the point that the temperature increases 5 degrees results in a 5 percent decrease in capacity and a 5 percent increase in power requirements. In some older machines, refrigerant tubes in the evaporator can become fouled by oil in the refrigerant—oil separators address this problem and are standard equipment on newer systems.

**Prevent scale formation in cooling towers.** Scaling, corrosion, and biological growth all impede tower efficiency and increase maintenance costs from the resultant condenser fouling and loss of heat transfer. Chemical treatments typically mitigate these problems, but nonchemical treatment technologies, such as ozone generators and ultraviolet irradiation, are also available.

## Chiller Plant Retrofits

Chilled-water plants are complex and thus present many retrofit efficiency opportunities. As a general approach, thinking upstream through possible retrofit opportunities—starting at the valves and ending at the cooling tower fan—can yield upstream capital cost savings and energy savings. For example, by reducing resistance in the piping system, a designer might be able to reduce capital costs by specifying a smaller pump and a smaller chiller. However, to improve the overall efficiency of a chiller plant, an integrated system approach must be used. This is important for two reasons. First, it is difficult to make generalizations about specific opportunities—creating the most cost-effective chiller plant for a particular building often requires a designer to consider energy and demand prices, building load characteristics, local climate, building design, operating schedules, and the part-load operating characteristics of the available chillers. Second, modifying the design or operation of one set of components often affects the performance of other components of the system. For example, increasing the chilled-water flow can improve chiller efficiency, but the extra pumping power required can result in an overall *reduction* in system efficiency.

To illustrate the challenge of improving a chiller plant’s overall efficiency, consider the case of a designer who switched a chiller condenser-tube bundle from two-pass flow to four-pass flow in order to improve chiller efficiency. That change indeed improved chiller efficiency from 0.62 kilowatts (kW) per ton to 0.60 kW per ton, but it also added 28 feet of pressure drop to the chilled-water flow stream—and thus increased the required pumping power. As shown in **Table 9.2**, this produced a net chiller plant energy savings at full load. However, because this particular building featured a constant-flow system, at the typical 75-percent load condition there was a net plant energy-use increase. The net effect was even worse at lower loads. Although the designer had intended to reduce energy consumption by improving chiller efficiency, the “improvement” wound up increasing overall building energy consumption.

Accounting for all the variables in a chiller plant can be a daunting task, so one of the best options for producing an optimal chilled-water system is to use a building energy performance simulation package. These computer programs (see sidebar, “Resources: Chillers”) perform the numerous and complex calculations needed to evaluate how buildings use energy. The most sophisticated programs can calculate building energy consumption hour by hour for an entire year. That allows designers to see how modifications to any of the building’s systems—including the chilled-water system—will affect the building’s annual energy consumption. These packages also account for interactions among building components, which allows building designers to experiment with a variety of combinations of efficiency strategies and determine which ones produce the most cost-effective building. Designers and their clients may seek to amortize the cost of

**Table 9.2: The perils of piecemeal chiller improvements**

By not considering the interaction of all chiller components, this conversion to a two-pass flow condenser-tube bundle resulted in a net energy use increase at the more typical load factor of 75 percent.

Component	Post-conversion power consumption	
	Full load (kW)	75% load (kW)
Chiller	-8.80	-6.60
Pumps	8.60	8.60
<b>Chiller + pumps</b>	<b>-0.20</b>	<b>2.00</b>

Note: kW = kilowatt.

Courtesy: E SOURCE

simulating building performance by using simulations after the building is occupied—to verify savings, optimize HVAC system control, and identify malfunctions in building systems. Several HVAC equipment manufacturers also offer energy simulation software.

The following list presents efficiency opportunities to consider for chilled-water systems.

**Replace standard valves with low-friction units to reduce flow resistance for the chilled water.** This measure reduces pump energy use and returns less heat to the chiller. Where valves control flow by inducing pressure drop, consider converting to variable-speed controls, trimming the impeller, or staging pumps instead. Then eliminate or completely open the valves.

**Insulate chilled-water pipes.** Insulation helps ensure that the chilled water only absorbs heat from the spaces where it is intended to do so.

**Replace standard-efficiency or oversized pumps with highly efficient units sized for the newly reduced loads.** Most induction motors that drive pumps reach peak efficiency when about 75 percent loaded, and are less efficient when fully loaded. Thus, wherever possible, size pumps so that much of their operating time is spent at or close to their most efficient part-load factor. If a pump is oversized, then it likely operates at an inefficient loading factor.

---

---

## RESOURCES: Chillers

### DOE-2

[www.doe2.com](http://www.doe2.com)

This hourly building energy performance simulation software was developed by the Simulation Research Group at Lawrence Berkeley National Laboratory. It takes some practice to become adept at this software and running a variety of scenarios can be quite time-consuming, so consider hiring consultants who specialize in performing these evaluations.

### eQUEST

[www.doe2.com/equest](http://www.doe2.com/equest)

Developed as part of the Saving by Design incentive program offered by California utilities, eQUEST is a free software package that provides a “window- and wizard-driven” front end to DOE-2. Although easier to use than DOE-2, it allows users to access DOE-2’s full capabilities to model many variables that affect a chiller’s performance. It can also be used to assess and help minimize building cooling loads. Savings achieved from proposed systems are compared with a modeled baseline chiller plant set to conform with local building codes.

### CoolTools Chilled Water Plant Design and Specification Guide

[www.taylor-engineering.com/publications/design\\_guides.shtml](http://www.taylor-engineering.com/publications/design_guides.shtml)

This free guide sponsored by Pacific Gas & Electric Co. is written for technical designers and offers direction on many of the options available in designing a chilled-water plant.

### Danfoss Turbocor

[www.turbocor.com](http://www.turbocor.com)

This is the only magnetic-bearing chiller compressor. Turbocor manufactures and supplies the compressor direct to end users for retrofits and to chiller manufacturers who incorporate the compressor into new chillers and offer them for retrofits.

---

---

**Control chilled-water pumps with variable-speed drives (VSDs).** VSDs can ensure that pumps are performing at maximum efficiency at part-load conditions. As with fan systems, the power required to operate a pump motor is proportional to the cube of its speed. For example, in a pump system with a VSD, a load reduction that results in a 10 percent reduction in motor speed reduces energy consumption by 27 percent:  $1 - (0.9)^3 = 0.27$ . However, it is necessary to ensure that flow rates through chillers are maintained at safe levels. With sophisticated controls, lower chilled-water flow rates enabled by VSD pumps can also be coordinated with a chilled-water temperature reset strategy to meet loads accurately and efficiently. For example, low loads might be most efficiently met by creating colder chilled water and reducing the flow rate to save pump energy.

**Upgrade the chiller compressor.** For a centrifugal compressor, install a VSD. This will allow the chiller to run at lower speeds under part-load conditions, thereby yielding a higher efficiency than is typically achieved by ordinary centrifugal chillers that control part-load operation with inlet vanes. However, a VSD may not be cost-effective in applications where there are extended periods with very low loads (10 percent of full load). In these cases, consider installing a separate small chiller just for these loads.

For reciprocating and screw chillers, replace the existing compressor with one that uses new magnetic bearing technology. These achieve much better efficiency than any other compressor type in the under-300-ton capacity range. Chillers using magnetic bearing compressors can achieve an integrated part-load value (IPLV) of 0.3699 kW/ton, as compared with an IPLV of 0.6000 kW/ton for standard screw- and scroll-based chillers, producing significant savings.

For example, at the San Diego East County Family Resource Center, a single 80-ton magnetic-bearing compressor replaced two reciprocating compressors on an existing 88-ton air-cooled chiller after one of the reciprocating compressors failed. Before-and-after monitoring showed an efficiency gain of 0.41 kW/ton. Because cooling loads were relatively low—1,347 equivalent full-load cooling hours (a metric used to estimate annual energy use for cooling in a building)—the chiller was oversized by about 30 tons. The compressor replacement produced an estimated payback period of 4.7 years (or 2.8 years with incentives from the San Diego Regional Energy Office) and an ongoing energy savings of about \$8,000 per year.

**For chillers without a VSD, use low-voltage soft starters.** The motor windings of constant-speed compressors experience great stress when the chiller is first started due to the high inrush of current. Over time this can lead to motor failure. Soft starting gradually raises the voltage and current to avoid the high inrush. Soft starting itself does not save energy, but it does enable shutting off chillers that are otherwise left running because operators are concerned about wear and tear from frequent starts.

**Replace an old or oversized standard-efficiency chiller with a properly sized high-efficiency water-cooled unit.** If the existing chiller is nearing the end of its life or is in need of substantial maintenance, consider retiring it early to capitalize on the savings that a new high-efficiency model can provide. The annual energy cost for operating a chiller can be as much as one-third of its purchase price, so even a modest improvement in efficiency can yield substantial savings and attractive paybacks. For example, paying an extra \$6 per ton for each 0.01 kW/ton improvement to raise the efficiency of a 500-ton chiller from 0.60 kW/ton to 0.56 kW/ton would increase that machine's first cost by \$12,000. But it would also reduce operating costs by \$3,000 per year, yielding a four-year simple payback. This can be particularly fruitful if the existing chiller is already oversized or if load reductions achieved through other stages in the building upgrade process allow the chiller to be downsized.

**When replacing an existing chiller, select one that will be most efficient under the conditions it is likely to experience.** Even though chiller performance can vary dramatically depending on loading and other conditions, designers frequently select chillers based on full-load, standard-condition efficiency. However, chillers spend most of their operating time at 40 to 70 percent load under conditions that are often considerably different from standard conditions. For example, when San Diego Gas & Electric reviewed the performance of 21 chiller plants, it found that at 11 of the sites more than one chiller was running at less than 50 percent of design load most of the time. To select the chiller that will have the lowest operating costs, determine what the actual operating conditions are likely to be and then consider how efficiently the unit will operate under those conditions. In many cases, VSD chillers along with VSD pumps and fans are highly cost-effective.

**Install plumbing to connect multiple cooling towers or multicell towers in parallel and VSDs to control cooling tower fans.** This step allows the chiller plant to use excess cooling tower capacity at part-load conditions and save on fan energy, as described in the Chiller Plant Operations and Maintenance section.

**Install water-side economizers to allow cooling towers to produce chilled water when weather conditions permit.** Under the right conditions, water-side economizers can save a lot of energy. In cool, dry climates, they can provide more than 75 percent of the cooling requirements; in warm climates they may provide only 20 percent. The most common type is an *indirect* economizer that uses a separate heat exchanger, typically of the plate-and-frame type (Figure 9.3). It allows for a total bypass of the chiller, transferring heat directly from the chilled-water circuit to the condenser-water loop. When the wet-bulb temperature is low enough, the chiller can be shut off and the cooling load may be served exclusively by the cooling tower.

Again, before pursuing any of the opportunities listed above, it is important to evaluate the performance of the chiller plant as an integrated system. Although an integrated approach requires more effort than simply picking measures independently, it can produce significant savings (see sidebar). Note that for the opportunities listed here that involve adding VSD

**Figure 9.3: Indirect water-side economizer**

Inserting a heat exchanger between the cooling tower and air-handling unit enables the controls to bypass the chiller when outdoor temperatures are low enough.

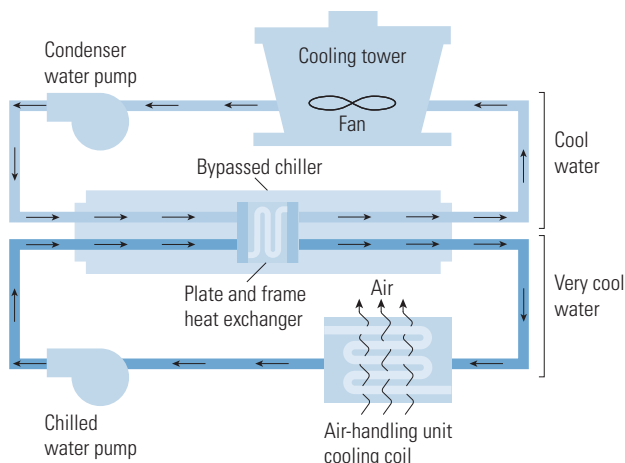

Courtesy: E SOURCE; adapted from EPA



---

---

## CASE STUDY: A Chiller Plant Overhaul

The cooling plant at the San Diego Crime Lab was in need of an upgrade. The chiller plant was 18 years old, used two outdated 130-ton air-cooled reciprocating chillers, and was wasting energy and increasing demand charges. On top of these problems, more cooling capacity was required for a planned laboratory expansion. One option was to replace the reciprocating compressors with air-cooled screw compressors. Based on a whole-plant analysis, this retrofit would supply the needed capacity—but with only moderate energy and demand savings. After further evaluation of the existing equipment and the facility's needs, the crime lab opted instead to install an all-variable-speed water-cooled chiller plant. This included variable-speed cooling tower fans and pumps on both the chilled- and condenser-water side, as well as a magnetic-bearing compressor that could operate at variable speeds.

The new chiller plant, including the pumps and fans, performed at an average efficiency of 0.538 kilowatts (kW) per ton. Traditionally, a plant efficiency of 0.7 to 0.8 kW/ton is considered good in the under-300-ton size range, and most plants operate at 1.0 kW/ton or above. The old air-cooled chiller plant was measured as using around 1.48 kW/ton. The incremental cost and savings between a new standard chiller plant (using air-cooled screw compressors without variable-speed equipment) and the all-variable plant produced a payback of five years based on energy and demand savings alone. Incentives provided by San Diego Gas & Electric further reduced the incremental payback to two years. The ongoing estimated annual energy and demand savings amount to about \$65,000.

---

---

components, control upgrades may also be required. VSD pumps, fans, and compressors provide greater operations flexibility and efficiency, but the control system must coordinate their operations with the rest of the system—existing controls may not be able to provide the advanced functions necessary for efficient operation.

### 9.3 Central Heating Systems

Two types of equipment are used to provide central heat for buildings: boilers and furnaces. Boilers, which produce hot water or steam that is then distributed throughout a building, heat about 32 percent of all U.S. commercial floor space (**Figure 9.4**). Typically there are more opportunities to improve the efficiency of boiler systems due to their more complicated nature, as compared to furnaces.

Furnaces heat air (instead of water) and distribute it to occupied spaces. Note that in commercial applications, the term “furnace” applies to several types of equipment, which together heat about 30 percent of the floor space in U.S. commercial buildings. Central furnaces, though they serve a relatively small percentage of heated commercial space, offer the greatest savings opportunities amongst furnaces because they are the only type that heats an entire building. Other types, such as duct furnaces and vertical-air-turnover furnaces, supply heat to only a limited area of the building.

Other heating systems, such as those contained in packaged rooftop units (see section 9.4), typically do not offer savings opportunities.

### Figure 9.4: A typical boiler

In this water-tube boiler, feedwater flows through tubes where hot gases from the combustion process heat the water. Exhaust gases leave through the flue.

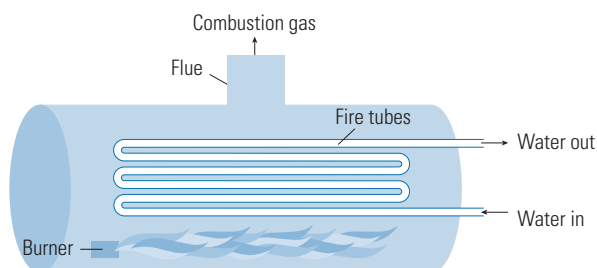

Courtesy: E source; adapted from EPA

## Boiler System Operations and Maintenance

The following list of operation and maintenance measures are important parts of the overall boiler system upgrade strategy and can provide significant energy savings:

- *Establish a total-system water treatment program.* This will help prevent the formation of deposits that degrade heat transfer and increase friction.
- *Periodically check the air-fuel ratio.* If it is not cost-effective to install a boiler combustion monitoring system, periodically check and calibrate the stack temperature, excess air, CO, CO<sub>2</sub>, opacity, and NO<sub>x</sub> using portable monitoring equipment. The data will reveal inefficiencies in the combustion process.
- *Periodically reset the boiler pressure.* If temperature/pressure reset controls are not used, periodically assess the temperatures required and reset boilers to the minimum necessary pressure.
- *Assess feedwater and blowdown rates.* Where it is not feasible or economical to install an automatic blowdown control system (see “Boiler System Retrofits”), establish the feedwater and blowdown rates described in the *Boiler and Pressure Vessel Code* developed by the American Society of Mechanical Engineers (see [www.asme.org](http://www.asme.org)). This will help remove dissolved solids that might otherwise damage equipment and waste energy.
- *Identify and repair steam leaks.* Leaks waste energy and can damage surrounding spaces.
- *Establish a program for systematically inspecting, testing, and repairing steam traps.* Leaking steam traps waste energy by allowing steam to escape into the condensate return line, thus preventing the steam from delivering heat where intended.
- *Remove scale from boiler heat-exchange surfaces.* Scale decreases the heat transfer capability of heat exchangers.

## Boiler System Retrofits

Consider replacing an existing boiler with a new, energy-efficient unit sized to reflect loads reduced through other stages of the building upgrade process. While the average gas boiler in the commercial stock has a combustion efficiency (100 percent minus flue losses) of 76 percent, new gas-fired commercial boilers have an average combustion efficiency of 80 percent, and high-efficiency boilers built with condensing heat exchangers have combustion efficiencies as high as 90 percent.

The current federal minimum efficiency standards for commercial boilers took effect on January 1, 1994. For boilers with a rated maximum input capacity of at least 300,000 Btu per hour, the combustion efficiency at the maximum rated capacity must be at least 80 percent for gas-fired equipment and 83 percent for oil-fired equipment.

Although the federal standards use combustion efficiency to measure the efficiency of boilers, the EPA qualifies boilers for the ENERGY STAR program based on their annual fuel utilization efficiency (AFUE). AFUE estimates energy use more accurately than combustion efficiency because it includes flue losses, off-cycle losses, and equipment-jacket losses. Qualified boilers must have an AFUE of at least 85 percent (see [www.energystar.gov/index.cfm?c=boilers.pr\\_boilers](http://www.energystar.gov/index.cfm?c=boilers.pr_boilers)).

Because efficient models require corrosion-resistant materials and sophisticated controls, they cost up to three times as much as conventional boilers. However, a properly sized condensing boiler system will generally beat out a less efficient boiler system in terms of life-cycle cost (boilers have an average life of 25 years). To determine whether to replace a boiler system, calculate the expected energy savings by comparing rated energy consumption at various loads for the old and new boiler systems. These calculations can be complicated, so it may be useful to consult an engineering firm or boiler manufacturer for assistance.

Several small boilers can also be grouped together in parallel to provide staged heating capacity. This approach is usually more economical and efficient than using a single large boiler because:

- The boilers can be staged to operate at or near their highest efficiency points.
- Small boilers are more efficient than large commercial boilers.
- Multiple boilers provide redundancy, which can reduce system downtime.
- Small boilers can reduce installation costs because each boiler is small enough to be handled without a crane.

The multiple-boiler approach can also be used as a retrofit measure to improve the seasonal efficiency of large, inefficient, aging boilers. A small high-efficiency “front-end” boiler can be installed in tandem with the old one—the small boiler serves the base heating load and the large boiler only fires up when needed to meet high demand.

Where boiler replacement is not feasible, there are many retrofit options that will improve the efficiency of an existing boiler system:

- *Insulate hot-water distribution lines.* Insulation reduces heat loss to unconditioned spaces, thereby optimizing the delivery of heat to the intended portions of the building.
- *Install VSD controls on hot-water distribution pump motors.* This measure is most effective in large buildings where pumping energy is significant and when used in conjunction with condensing boilers. Be careful with noncondensing boilers because low flow rates can cause flue gas condensation and corrosion in the boiler.
- *Install a combustion monitoring and control system.* Use the monitoring data to trim boiler excess air and/or install automatic oxygen trim controls. To learn more about flue gas monitoring and burning tuning, see the U.S. Department of Energy (DOE) Industrial Technologies Program Steam Tip Sheet #4 at [www1.eere.energy.gov/industry/bestpractices/pdfs/steam4\\_boiler\\_efficiency.pdf](http://www1.eere.energy.gov/industry/bestpractices/pdfs/steam4_boiler_efficiency.pdf).
- *Install temperature/pressure reset controls.* These provide significant energy savings by matching the supply of steam or hot water with the demand for heat—by resetting the system

temperature or pressure based on outdoor temperature. If outdoor temperature increases, the system water temperature or steam pressure is lowered.

- *Install controls to set back supply temperature during unoccupied hours.* This saves energy by reducing heating when maintaining occupant comfort is not required.
- *Install an automatic blowdown control system.* This helps remove dissolved solids that can damage equipment and lead to energy waste, depending on the concentrations present. See the DOE Steam Tip Sheet #23 at [www1.eere.energy.gov/industry/bestpractices/pdfs/steam23\\_control\\_system.pdf](http://www1.eere.energy.gov/industry/bestpractices/pdfs/steam23_control_system.pdf). When using continuous blowdown instead, install a heat exchanger to warm feedwater with heat recovered from blowdown.
- *Install a stack economizer.* A stack economizer captures waste heat in the exhaust flue gases and uses it to preheat the boiler feedwater. This measure is typically only cost-effective for very large (more than 2 million Btu per hour capacity) systems. When natural gas fuels the boiler, maintain the stack temperature at at least 250° Fahrenheit to avoid water condensation in the flue gases.
- *Install baffle inserts.* These induce combustion gases to flow in a turbulent spiral pattern, which increases heat-transfer efficiency.
- *Install outside-air intake vents for the boiler.* This reduces or eliminates building air infiltration caused by boiler operation.
- *For steam systems, use the DOE Steam System Scoping Tool.* This software, available at [www1.eere.energy.gov/industry/bestpractices/software.html](http://www1.eere.energy.gov/industry/bestpractices/software.html), quickly evaluates the entire steam system operation and suggests a range of ways to save steam energy and boost productivity. It also compares an existing system to identified best practices and evaluations of similar facilities. Also see the DOE's collection of Steam Tip Sheets at [www1.eere.energy.gov/industry/bestpractices/tip\\_sheets\\_steam.html](http://www1.eere.energy.gov/industry/bestpractices/tip_sheets_steam.html) for other improvement ideas.
- *Insulate steam distribution and condensate return lines.* Insulation will prevent heat loss through the system. The DOE provides the 3E Plus software tool at [www1.eere.energy.gov/industry/bestpractices/software.html](http://www1.eere.energy.gov/industry/bestpractices/software.html) to calculate how much insulation is needed to conserve energy and avoid the expense of overinsulation.
- *Install wide-deadband thermostats for unbalanced single-pipe steam systems.* Conventional thermostats with shorter deadbands may not cycle on the boiler long enough for steam to fill the entire distribution line, resulting in insufficient heating at the end. But increasing the thermostat setting to compensate causes overheating near the start of the line. Wide-deadband thermostats will produce longer on and off cycles and provide more even heating.

## Improving Furnace Efficiency

Furnaces are usually fueled by gas or oil; electric furnaces are rare and generally more expensive to operate. Although furnaces in the existing buildings stock have an average AFUE of only 76 percent, new gas-fired commercial furnaces have an average AFUE of 80 percent, and high-efficiency furnaces built with condensing heat exchangers have AFUEs as high as 92 percent.

The current federal minimum efficiency standards for commercial furnaces took effect on January 1, 1994. For furnaces of 225,000 Btu per hour capacity or greater, the standards specify a steady-state or thermal efficiency (100 percent minus flue losses) of at least 80 percent for gas-fired equipment and at least 81 percent for oil-fired equipment at their maximum rated input capacity. Note that these efficiency ratings do not account for cycling losses, losses through the

central heater's cabinet, or distribution losses. Although the standards only specify thermal efficiency, manufacturers can also include AFUE, which accounts for cycling and cabinet losses.

Residential warm-air gas furnaces are sometimes used in small commercial applications. The current federal standard for these units became effective on January 1, 1992, and establishes a minimum efficiency of 78 percent AFUE for units with an input rating of less than 225,000 Btu per hour. A new standard was set in November 2007—to become effective in 2015—raising the minimum efficiency to 80 percent AFUE. For more information on this change, see the DOE's Residential Furnaces and Boilers web page at [www.eere.energy.gov/buildings/appliance\\_standards/residential/furnaces\\_boilers.html](http://www.eere.energy.gov/buildings/appliance_standards/residential/furnaces_boilers.html).

To improve furnace system efficiency:

- *Consider replacing the existing furnace with a new, energy-efficient model.* It may be possible to downsize the furnace based on load reductions achieved through other stages of the building upgrade process.
- *Install controls to set back supply temperature during unoccupied hours.* This saves energy by reducing heating when maintaining occupant comfort is not required.
- *For electric furnaces, install two-stage setback controls.* In spaces where the temperature is reduced during unoccupied periods, the electric demand needed to bring the space back to its original temperature can be significant. In this case, if the local electric rate structure includes demand charges, install a two-stage setback thermostat with staged supplemental heat and a programmable demand limiter to prevent demand peaks in the morning. Also consider alternatives to resistance heating to reduce heating costs and environmental impact.

## 9.4 Unitary Systems

Unitary equipment cools about 70 percent of air-conditioned commercial buildings in the U.S. Unitary equipment is factory assembled, available as single-packaged or split-system units, and may take the form of a heat pump (providing both heating and cooling) or an air conditioner. Unitary systems include an evaporator, blower, compressor, and condenser. Some unitary air conditioners also include an electric resistance or gas heater section. The systems are typically cabinet- or skid-mounted for easy installation and range in cooling capacity from about 1.5 to 130 tons.

Compared to central chiller plants, unitary systems do not last as long (median lifetime of 15 years compared to 20 to 23 years for chillers) and are less efficient. Unitary systems are generally used in buildings up to three stories that have small cooling loads, such as retail spaces, small office buildings, and schools.

Generally speaking, it is not feasible to convert a building from a unitary to a central chilling system. However, it is not always necessary to replace an old unit with a new one of the same type. For example, a packaged rooftop air conditioner can be replaced with an air-to-air heat pump.

Commercial buildings typically have unitary systems with cooling capacities greater than 5 tons. These systems are rated by energy-efficiency ratio (EER), which is a measure of full-load efficiency at conditions specified by the Air-Conditioning and Refrigeration Institute. Some buildings use residential-sized unitary systems (under 5 tons, using single-phase power) because of space requirements, physical limitations, or for small additions. Residential-sized systems are rated by seasonal energy-efficiency ratio (SEER), a seasonally-adjusted value. For both EER and

SEER, a higher number indicates a higher efficiency. ENERGY STAR qualified residential air conditioners have a SEER of at least 14 (see [www.energystar.gov/index.cfm?c=cac.pr\\_central\\_ac](http://www.energystar.gov/index.cfm?c=cac.pr_central_ac) for more information).

Three-phase equipment under 5 tons falls into its own category in the federal standards—although designed for the commercial market, these units use the residential SEER rating. ENERGY STAR qualified three-phase equipment under 5 tons must have a SEER of at least 13 (see [www.energystar.gov/index.cfm?c=lchvac.pr\\_lchvac](http://www.energystar.gov/index.cfm?c=lchvac.pr_lchvac) for more information).

The current U.S. federal standard established in 1992 requires manufacturers to produce commercial air-cooled air conditioners and heat pumps at the minimum efficiencies specified in **Table 9.3**. The Energy Policy Act of 2005 set new federal standards for commercial packaged rooftop units with capacities greater than 65,000 Btu per hour that will take effect on January 1, 2010. For smaller three-phase equipment, a rule-making is in progress to determine whether new standards should be set for this size category. Note that federal standards do not cover geothermal heat pumps, although ASHRAE 90.1 requires that those with a cooling capacity below 135,000 Btu per hour have a minimum cooling efficiency of 13.4 EER and a minimum heating coefficient of performance (COP) of 3.1.

**Table 9.3: Federal efficiency standards for commercial packaged air-cooled air conditioners and heat pumps**

The U.S. Energy Policy Act of 2005 added a “very large” category as part of the update of the standards for commercial packaged air-cooled equipment, in addition to increasing the minimum efficiency levels for existing size categories. All equipment listed here uses three-phase power. ENERGY STAR criteria will likely change for <5-ton equipment when the new minimum standards become effective.

Federal size category	Equipment type	System design	Federal minimum standards			ENERGY STAR minimum criteria
			Effective January 1, 1994	Effective June 16, 2008	Effective January 1, 2010	
< 65 kBtu/h, < 5 tons	Air conditioner	Split system	SEER 10.0	SEER 13.0	—	SEER 13.0 <sup>a</sup>
		Single-packaged unit	SEER 9.7	SEER 13.0	—	SEER 13.0 <sup>a</sup>
	Heat pump	Split system	SEER 10.0 & HSPF 6.8	SEER 13.0 & HSPF 7.7	—	SEER 13.0 & HSPF 7.7 <sup>a</sup>
		Single-packaged unit	SEER 9.7 & HSPF 6.6	SEER 13.0 & HSPF 7.7	—	SEER 13.0 & HSPF 7.7 <sup>a</sup>
Small (65 to < 135 kBtu/h; 5 to 11.25 tons)	Air conditioner	Split system and single-packaged unit	EER 8.9	—	EER 11.2	EER 11.0 <sup>b</sup>
	Heat pump	Split system and single-packaged unit	EER 8.9 & COP 3.0	—	EER 11.0 & COP 3.3	EER 10.1 & COP 3.2 <sup>b</sup>
Large (135 to < 240 kBtu/h; 11.25 to 20 tons) <sup>c</sup>	Air conditioner	Split system and single-packaged unit	EER 8.5	—	EER 11.0	EER 10.80 <sup>b</sup>
	Heat pump	Split system and single-packaged unit	EER 8.5 & COP 2.9	—	EER 10.6 & COP 3.2	EER 9.3 & COP 3.2 <sup>b</sup>
Very large (240 to < 760 kBtu/h; 20 to 63 tons)	Air conditioner	Split system and single-packaged unit	—	—	EER 10.0	—
	Heat pump	Split system and single-packaged unit	—	—	EER 9.5 & COP 3.2	—

Notes: COP = coefficient of performance; EER = energy-efficiency ratio; HSPF = heating seasonal performance factor; kBtu/h = thousand Btu per hour; SEER = seasonal energy-efficiency ratio; ton = 12,000 Btu/h.  
a. Effective January 1, 2004; b. Effective January 1, 2002;  
c. Energy Star criteria apply to equipment of capacity up to 250 kBtu/h.

Courtesy: E SOURCE; data from U.S. Department of Energy and EPA

Regardless of the equipment chosen, it is important to commission the overall system to ensure its proper operation from the onset as well as to maintain it properly over time (see sidebar). Comprehensive testing, adjusting, and balancing the installed unit and its controls will maximize efficiency and comfort. Conducting regular tune-ups, correcting refrigerant charge, cleaning and adjusting the system to correct airflow and improve heat transfer, and verifying economizer operation can yield surprising energy savings at low cost. The Consortium for Energy Efficiency offers installation guidelines for commercial air-conditioning equipment at [www.cee1.org/com/hecac/hecac-spec.php3](http://www.cee1.org/com/hecac/hecac-spec.php3). Testing, adjusting, and balancing contractors; general HVAC service contractors; and those who use specialized diagnostic products to specifically measure refrigerant charge and airflow levels can perform commissioning and maintenance services.

## Packaged Rooftop Units

About half of all U.S. commercial floor space is cooled by self-contained, packaged air-conditioning units. Often called single-packaged units or rooftop units (RTUs), most sit on rooftops, but they can also be installed on a concrete pad at ground level. Typical units include a blower section, filter bank, evaporator coil, at least one compressor (larger units often have multiple compressors to improve load matching), and an air-cooled condenser section. Evaporatively cooled condensers are used to achieve higher efficiencies (**Figure 9.5**). They may also come equipped with a natural gas or electric heating section—gas models, depending on local energy prices, are generally more economical. When replacing a packaged unit that uses electric resistance heat, consider using a heat pump instead because it may be more cost-effective.

All newer packaged rooftop units are equipped with factory-installed microprocessor controls. These controls make maintaining equipment easier and improve the energy efficiency of both the unit and the overall HVAC system. Control features include temperature setback and on/off scheduling. Large systems have variable-air-volume capability (see Chapter 8, “Air Distribution”). Also, most units have an optional communication interface for connection to an energy management system or to a demand-controlled ventilation system.

**Selecting new high-efficiency models.** Efficiency levels for packaged rooftop units have gradually increased over the past 15 years. In the small size range, the number of units with an EER of at least 10.4 has grown from only 14 percent of available models in 1993 to at least 65 percent in 2007. Units in this size range now have EERs as high as 12.7—so upgrading older units to a new high-efficiency model can produce substantial long-term energy savings. For

---

---

### CASE STUDY: Diagnostic Service Proves Its Value

Air-conditioning tonnage and airflow-delivery systems are not always matched properly. A contractor certified to use a diagnostic tool that measures refrigerant charge and airflow levels received a report from the Poultry Palace and Deli in El Cajon, California, complaining that its air-conditioning system was not working. Two other companies had unsuccessfully attempted to repair the system. The certified contractor arrived on the site and determined that the refrigerant charge was correct, but the new 5-ton air conditioner had been coupled with a duct system capable of delivering only 3 tons of airflow. The service technician said he would not have found the problem had it not been for the diagnostic tool. The technician relayed the information to the customer, who authorized the repairs. Once repairs were made, the system was able to meet the cooling load.

---

---

**Figure 9.5: Components and features of efficient packaged rooftop unit design**

Manufacturers can incorporate several design features to produce high-efficiency units.

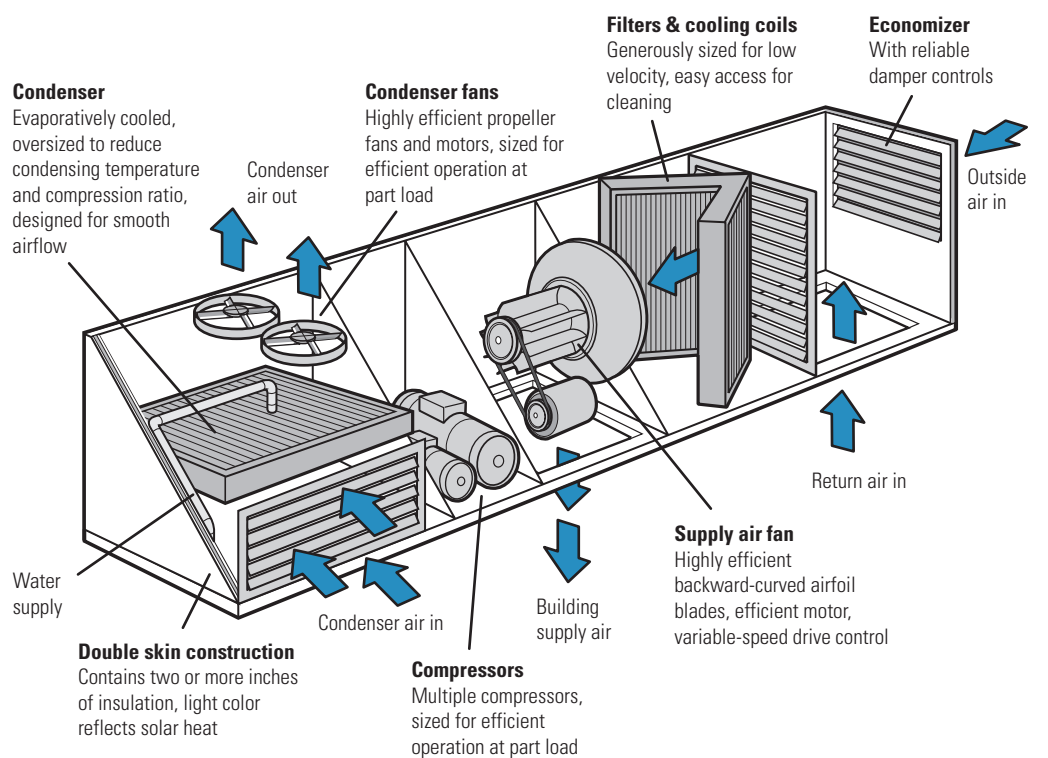

Courtesy: E SOURCE

example, a typical office building in Kansas City, Missouri, that has 10 standard 25-ton packaged units with EER ratings of 10 could save almost \$30,000 annually by upgrading to units with EERs of 12. Note that since packaged rooftop units are primarily used for cooling, those that also provide heating generally do not offer a high-efficiency option for the heating component.

When replacing broken equipment or evaluating early retirement of working equipment, use the free web-based life-cycle cost estimation tool from the Federal Energy Management Program ([www1.eere.energy.gov/femp/procurement/eep\\_unitary\\_ac\\_calc.html](http://www1.eere.energy.gov/femp/procurement/eep_unitary_ac_calc.html)) to see how much energy high-efficiency models will save. After entering data for a specific high-efficiency unit and location, the tool estimates life-cycle cost, simple payback, and other metrics as compared to a standard unit that the user selects. Equipment manufacturers or engineering consultants can provide more detailed assistance. The EPA also establishes ENERGY STAR program criteria for high-efficiency commercial air conditioners (Table 9.3) and provides a list of qualified units at [www.energystar.gov/index.cfm?c=lchvac.pr\\_lchvac](http://www.energystar.gov/index.cfm?c=lchvac.pr_lchvac).

**Upgrading existing rooftop units.** Upgrading existing packaged rooftop units is typically not feasible due to the cost and complexity of retrofitting components within a unit. However, there is one option that can be retrofitted onto the outside of a unit. Called the EER+, it is a heat-exchange module that can be retrofitted onto both existing air-cooled air conditioners and heat pumps to increase their efficiency. Made by Global Energy Group, a manufacturer of energy-efficient cooling equipment, it works by capturing waste condensate



water from the unit and routing it over evaporative cooling pads. Exhaust air or outdoor air is blown across the pads (Figure 9.6). The resulting evaporative cooling removes heat from the air conditioner’s refrigerant, increasing the efficiency and capacity of the system. When using exhaust air from the building, outdoor humidity does not significantly affect the heat exchangers. But when using outdoor air in humid climates, the efficiency increase may not be as great as it is in dry climates.

### Split-System Packaged Units

Split-system packaged units have an air-cooled condenser mounted on an outdoor pad or rooftop. Refrigerant piping connects the compressor section to an indoor air-handling unit and evaporator coil (Figure 9.7). Unless units include a heat pump, they cannot provide space heating. However, heating coils can be installed in the air-handling section, particularly if there is a central source of heat such as hot water or steam from a boiler. Split systems may be used in retrofit applications for architectural reasons (if a flat roof is not available, for example) or to provide cooling to a specific zone without having to cut a large hole in the roof, which would be required for the ductwork of a single-packaged unit. The same federal standards, ENERGY STAR criteria, and efficiency opportunities that apply to single packaged rooftop units also apply to split-system packaged units.

### Air-Source Heat Pumps

Air-source heat pump systems are typically mounted on the roof, packaged either complete or as split systems. In cooling mode, the unit operates like a typical air conditioner. In heating

**Figure 9.6: Rooftop unit efficiency upgrade**

With this retrofit product, an evaporative cooling pad uses condensate water to subcool and desuperheat the refrigerant.

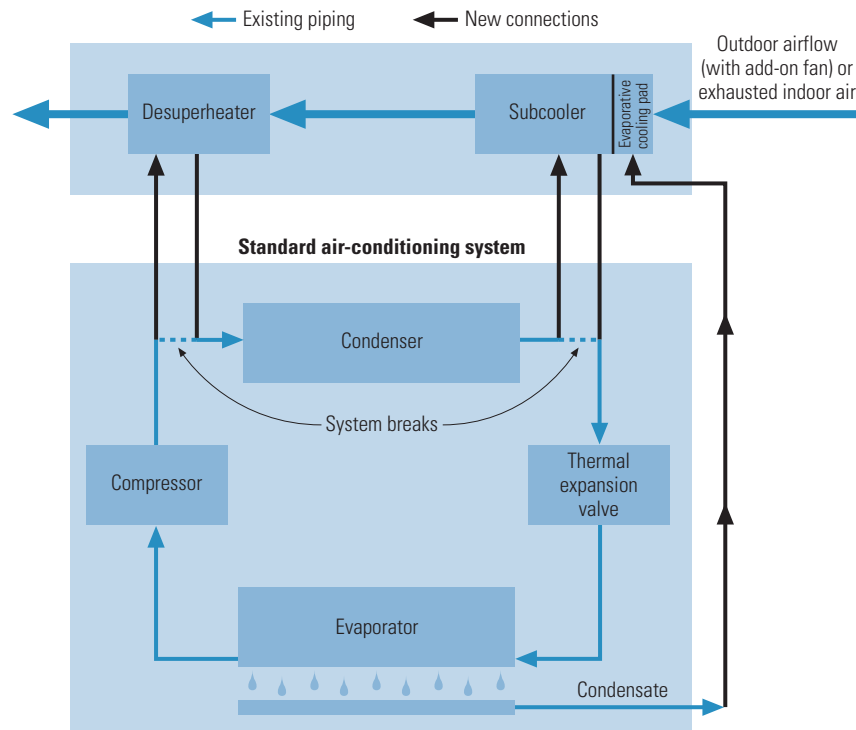

Courtesy: E SOURCE; adapted from Global Energy Group

**Figure 9.7: Location of split-system components**

The compressor and condenser are in one self-contained outdoor unit and the evaporator and air handler are in another unit inside the building.

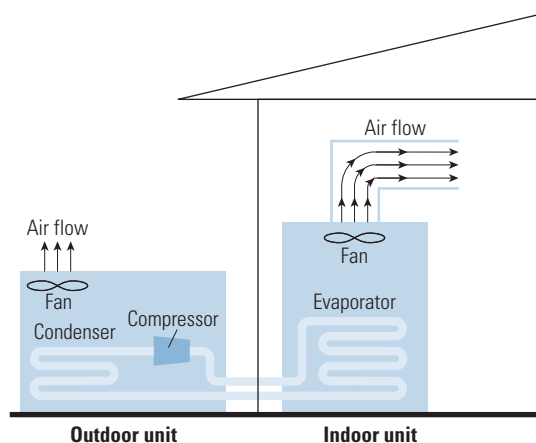

Courtesy: E SOURCE; adapted from EPA

mode, the cooling system operates in reverse, extracting heat from the outside air and using it to provide space heating. Air-source heat pump systems range in size from about 1.5 to 25 tons. High-efficiency air-source heat pumps have an EER as high as 11.5 and a COP for heating as high as 3.6.

Air-source heat pumps offer an attractive alternative to rooftop units in cases when one needs to be replaced or a new unit is needed. Compared to packaged rooftop air conditioners that incorporate electric resistance heating coils, heat pumps offer improved year-round energy efficiency; compared to air conditioners that incorporate gas heating, heat pumps can offer cheaper operation where gas prices are high and electric rates are low.

In either case, most heat pumps are best suited to relatively warm climates, such as the southeastern U.S. This is because when temperatures are low, a heat pump's COP falls dramatically: A 7.5-ton rooftop heat pump that has a high-temperature COP of 3.0 can have a low-temperature COP of 2.0 or lower. And at very low temperatures, a heat pump can require supplemental heat, typically in the form of electric resistance—so effective heating efficiencies become even lower. However, dual-fuel heat pumps are available in areas where natural gas can be used as the supplemental heating source.

### Ground-Source, Closed-Loop Heat Pumps

Ground-source (geothermal) heat pumps evolved from the family of water-to-air heat pumps used in commercial buildings. These devices pump water or antifreeze through a buried coil of pipe to absorb heat from or reject heat to the ground, depending on whether heating or cooling is needed. Unlike the less common open-loop systems, the heat-exchange fluid stays within a closed loop and does not come into contact with the environment. Ground-source systems offer higher efficiencies than air-source heat pumps—they have EERs as high as 30 and COPs as high as 5. However, these units are also more expensive due to the network of pipes that must be buried. They are most appropriate in cold climates where the ground temperature is significantly warmer and less variable than the air temperature, and where natural gas for heating is unavailable.

ENERGY STAR qualified ground-source closed-loop heat pumps must have at least an EER of 14.1 and a COP of 3.3. Both ENERGY STAR ([www.energystar.gov/index.cfm?c=geo\\_heat\\_pr\\_geo\\_heat\\_pumps](http://www.energystar.gov/index.cfm?c=geo_heat_pr_geo_heat_pumps)) and the Geothermal Heat Pump Consortium ([www.geoexchange.org](http://www.geoexchange.org)) offer more information on geothermal heat pump systems.

## 9.5 Additional Strategies

Depending on a building's size, location, business use, and local utility rate structures, it may be worthwhile to investigate a number of additional technological strategies for saving energy and reducing costs.

### Air-Side Economizer

There are times when increasing outside air beyond ASHRAE Standard 62.1, “Ventilation for Acceptable Indoor Air Quality,” will lower cooling loads. Economizers can often use outdoor air to partially or totally cool a space. An economizer consists of local controls and dampers capable of delivering up to 100 percent outdoor air. Air-side economizers come in two types: dry-bulb and wet-bulb. A dry-bulb economizer is activated by outdoor air temperature—as temperature varies, the air damper modulates to bring in sufficient outdoor air to satisfy cooling needs. A wet-bulb economizer operates in the same manner, except it also monitors relative humidity. However, wet-bulb economizers should only be used in appropriately humid climates because of their higher maintenance requirements—to maintain accuracy, they must be calibrated frequently.

Note that economizers offer excellent savings opportunities, but their operation is sensitive to temperature setpoints and the condition of system components. If operating incorrectly, they may not save energy. In some cases, if the dampers are stuck in the 100 percent outdoor air position all the time, for example, they could even waste energy. However, it is easy to avoid or minimize malfunctions. Using robust controls and a regular maintenance program can ensure that economizers function as intended. For guidance on proper economizer control, see the Eugene Water and Electric Board's Tech Brief, “Outside Air Economizers: Making Them Work Right for You,” available at [www.eweb.org/business/energy/energysmart/techbriefs](http://www.eweb.org/business/energy/energysmart/techbriefs).

### Energy Recovery

Heat recovery is one of the most effective ways to optimize energy efficiency during building operations. Exhaust air from HVAC systems is a primary source of useful waste heat. Transferring the energy from the exhaust air to the incoming outdoor air reduces the energy required to condition the incoming air.

Several heat-recovery technologies are available, including rotary heat wheels, plate-and-frame heat exchangers, runaround coils, and heat pipes—each suited to specific applications. Consult vendors and engineers to determine the best match for a given building. Depending on the application and technology type, these systems can recover 50 to 80 percent of the energy used to heat or cool incoming outdoor air.

### Desiccant Dehumidification

Desiccants dehumidify the air and can be regenerated through heating to drive out the absorbed moisture. The heat used for desiccant regeneration is generally derived from gas, steam, or waste heat from the building—and the cost of this heat is typically much lower than the cost of

electricity used for conventional dehumidification. Traditionally, desiccant systems have been targeted to humid climates or to applications that require tight control over humidity—like hospitals, museums, and supermarkets. But new hybrid air conditioning–desiccant systems are more efficient than previous desiccant technology. The higher efficiencies, coupled with changing building standards, are now making such systems appealing for applications where humidity control is still important but less critical, such as in schools, restaurants, and office buildings.

Changing building standards are making desiccant systems more appealing now for two reasons. First, to meet code, some buildings are admitting more outdoor air than their original design specified, leading to a larger need for humidity control. Second, where increasingly stringent energy-efficiency standards make the sensible (dry-air) cooling load lower than the humidity load, it is more challenging to handle humidity. For example, ASHRAE Standard 90.1, which is often adopted directly or indirectly in local building codes, has increased many efficiency requirements compared with the standards in place before the 1990s. Most of these changes have reduced the sensible cooling load (the portion of a building’s heat load unrelated to humidity) but not the latent cooling load (the portion of a building’s heat load contained in the moisture in the air). For instance, efficient lighting required by newer standards gives off less heat, but it does not reduce the moisture content of the air. A sensible load that is much lower than the latent load makes it more challenging for conventional air conditioners to condition the air properly without increasing energy use—desiccant systems offer another way to meet these challenges (see sidebar).

## Night Precooling

In many climates, night temperatures are cool even when daytime temperatures exceed economizer limits. Taking advantage of this resource, the air handler and economizer can flush the building with night air to cool down the building mass. The cool mass then acts as a heat sink the following day.

Setting controls for night precooling can save a significant amount of energy, depending on location. Studies indicate cost savings range from 5 percent in Phoenix, Arizona, to 18 percent in Denver, Colorado, for a typical office building. Night precooling also reduces peak demand. Simulation analyses show that precooling a 100,000-ft<sup>2</sup> three-story building in Sacramento, California, would reduce energy use by 12.6 percent and cause a peak demand reduction of 31.3 percent.

---

---

### CASE STUDY: Desiccants Save Energy While Dehumidifying

A November 2005 field study funded in part by the U.S. Department of Energy and conducted by the Georgia Tech Research Institute and Georgia State University showed that a hybrid air conditioner–desiccant system can dehumidify better than a conventional unit while saving energy. One elementary school in Atlanta, Georgia, was suffering from poor indoor air quality and occupant discomfort because the existing conventional packaged rooftop unit was not providing adequate dehumidification. The rooftop unit was replaced with a hybrid unit, which was able to maintain a relative humidity near 50 percent at an average thermostat setting 2.4° higher than the 70.4° Fahrenheit average setpoint the old system used. Based on energy simulations, this higher setpoint reduced cooling energy consumption by about 10 percent.

---

---

## Cool Storage

Cool storage uses cheaper off-peak power to supply cooling and is generally only cost-effective in retrofits where the local utility offers a critical peak pricing program. The technology cools a storage medium while chiller operating cost is low, and then the medium is discharged when chiller operating cost is high. Cool storage media include water, ice and water, or water circulating around chemical modules that freeze and thaw. Ice systems and freeze-thaw systems take up less space than chilled-water storage because the freezing process can naturally store much more “cold” in a given volume. Most cool storage is custom built for a particular application, but one manufacturer, Ice Energy, produces packaged cool storage equipment.

## Evaporative Cooling

Evaporative cooling typically uses less than a quarter the energy of vapor-compression air-conditioning systems. In its basic form, air is blown over a wet surface. Heat in the air evaporates moisture from the surface, thereby lowering the temperature of the air. There are several types of evaporative coolers:

- *Direct.* Also known as “swamp coolers,” these units evaporate moisture directly into the supply air stream, increasing its humidity. Although this effect may be desirable in dry climates, it is usually not so in humid ones.
- *Indirect.* These units cool the building supply air through a heat exchanger with a separate air stream cooled by a direct evaporative cooler. The supply air does not come into contact with the wet surface, so no moisture is added.
- *Indirect-direct.* Indirect-direct evaporative coolers, commonly called IDECs, first cool the supply air indirectly and then directly.

Although evaporative cooling systems are most effective in dry climates where the air has a large capacity to absorb evaporating water, they can also be used elsewhere to precool air to reduce the load on a mechanical refrigeration system. Mechanical refrigeration can also increase the evaporative cooling capacity by cooling the water used for evaporation.

## 9.6 Summary

Many opportunities exist for optimizing a building’s heating and cooling system efficiency. Load reductions achieved through other stages of the building upgrade process have likely made these opportunities more attractive than they were initially. When evaluating which heating and cooling upgrades to pursue, remember:

- Determine the building’s heating and cooling loads.
- Use current loads to calculate the proper capacity for equipment.
- Consider the interactions among all system components.
- Consider replacing old inefficient equipment with new high-efficiency equipment.
- Evaluate alternative strategies for meeting heating and cooling loads.
- Establish a regular maintenance program for all heating and cooling equipment.

Although heating and cooling improvements represent the final stage in the staged approach to building upgrades, they do not signal the end of the process. Building upgrades continue to provide the intended benefits throughout their useful life only through periodic recommissioning and further upgrades, as needed. An upgrade is not an endpoint but a step along a path of continuous improvement.

## Bibliography

American Society of Heating, Refrigerating and Air-Conditioning Engineers Inc., “Energy Standard for Buildings Except Low-Rise Residential Buildings,” ANSI/ASHRAE/IESNA Standard 90.1-2004, [www.ashrae.org](http://www.ashrae.org).

Criscione, P., “Big Problems for Chiller Specifiers,” *E Source Report*, ER-04-11 (2004).

Criscione, P., “Look! Up in the Chiller Room! It’s a Screw Compressor, It’s a Centrifugal... No, It’s Turbocor! New Technology Flies into Town with Superbenefits,” *E Source Report*, ER-06-8 (2006).

Criscione, P., “Packaged Rooftop Air Conditioners: Product and Market Update,” *E Source Report*, ER-03-17 (2003).

Energy Design Resources, “Design Brief: Air Conditioning and Ventilation,” [www.energydesignresources.com/resource/14](http://www.energydesignresources.com/resource/14) (accessed May 2007).

Fischer, J., Semco Inc., and Sand, J., “Field Test and Performance Verification: Integrated Active Desiccant Rooftop Hybrid System Installed in a School, Final Report: Phase 4a,” Oak Ridge National Laboratory, [www.ornl.gov/sci/engineering\\_science\\_technology/cooling\\_heating\\_power/pdf/Timber\\_Ridge\\_Report\\_Final\\_Nov2005.pdf](http://www.ornl.gov/sci/engineering_science_technology/cooling_heating_power/pdf/Timber_Ridge_Report_Final_Nov2005.pdf) (2005).

Krepchin, I. and Lunneberg, T., “Variable-Speed Chillers Hit the Big Time,” *E Source Report*, ER-03-6 (2003).

Leinweber, S., “Utilities Target HVAC Maintenance to Shave Peak Load,” *E Source Report*, ER-02-7 (2002).

National Archives and Record Administration, “Code of Federal Regulations, Title 10, Chapter II,” Part 430.32, Residential Unitary Equipment and Furnaces; Part 431.77, Commercial Furnaces; Part 431.87, Commercial Boilers; and Part 431.97, Commercial Unitary Equipment, [www.access.gpo.gov/nara/cfr/waisidx\\_07/10cfrv3\\_07.html](http://www.access.gpo.gov/nara/cfr/waisidx_07/10cfrv3_07.html) (accessed May 2007).

Stein, J., “Low-Cost/No-Cost Efficiency Retrofits for Chiller Water Systems,” *E Source Report*, TU-97-9 (1997).

U.S. Department of Energy, Energy Information Administration, “Commercial Building Energy Use Survey” (2003), Table B7: Building Size, Floorspace and Table B35: Percent of Floorspace Cooled, Number of Buildings and Floorspace, [www.eia.doe.gov/emeu/cbecs/cbecs2003/detailed\\_tables\\_2003/detailed\\_tables\\_2003.html](http://www.eia.doe.gov/emeu/cbecs/cbecs2003/detailed_tables_2003/detailed_tables_2003.html) (accessed May 2007).



LEARN MORE AT  
[energystar.gov](http://energystar.gov)

ENERGY STAR® is a U.S. Environmental Protection Agency program helping businesses and individuals fight global warming through superior energy efficiency.

## Chapter 10

# Facility Type: K-12 Schools





# 10. Facility Type: K–12 Schools

Revised November 2006

<b>10.1 Challenges and Opportunities</b>	<b>2</b>
<b>10.2 Energy-Use Profile</b>	<b>3</b>
<b>10.3 Technical Recommendations</b>	<b>4</b>
Retrocommissioning	5
Lighting	7
Load Reductions	9
Air Distribution Systems	11
Heating and Cooling Systems	13
<b>10.4 Financial and Implementation Issues</b>	<b>14</b>
<b>Bibliography</b>	<b>16</b>
<b>Glossary</b>	<b>G-1</b>



## 10.1 Challenges and Opportunities

America's schools spend more than \$7.5 billion annually on energy—more than they spend on textbooks and computers combined. Energy costs are the largest operating expense for school districts after salaries and benefits, and in recent years those costs have increasingly strained their budgets. The good news is that energy is one of the few expenses that can be decreased without negatively affecting classroom instruction.

As energy has become a larger and less predictable expense, it is imperative that school districts invest in retrofits and ongoing maintenance to assert control over their utility costs. Yet school districts perpetually struggle to budget appropriately for operations, maintenance, and capital projects. High-dollar capital projects are the first to go when budgets are cut, and trimming maintenance expenditures is more palatable to school boards than cutting instructional staff. It's also not unusual for school districts to build new schools or additions without making corresponding increases to maintenance spending and staff.

The result is an accumulation of deferred maintenance, which leads to higher energy costs and more equipment malfunctions. Lack of preventive maintenance reduces the operational life of building equipment, hastening the need to invest in costly capital retrofits.

Increasingly, facility condition is being recognized as an important factor for student learning. Lawsuits regarding inadequate funding for education in dozens of states have shifted the focus from spending per school or per student to the condition of school buildings. This trend is pushing school districts to better manage their facility assets.

Several aspects of building performance are fundamental in providing an environment that is conducive to learning. Research has shown a relationship between facility conditions and absenteeism, teacher turnover rates, and occupant health. The following factors should be considered integral to your energy-saving retrofit choices. Fortunately, many upgrade choices can improve these factors while cutting energy consumption.

- *Security and safety* can be enhanced with proper exterior lighting as well as adequate lighting in hallways and stairwells. Security of operable windows is another consideration.
- *Indoor air quality* can be improved with ventilation as well as by removing the source of pollutants. Indoor pollutants may include gases (such as radon), chemicals (for example, cleaning agents), mold, and particulates. Because children have higher breathing and metabolic rates than adults, they are more vulnerable to many environmental threats. High concentrations of carbon dioxide (CO<sub>2</sub>) have been correlated with sickness as well as poor academic test performance. Ventilation may be particularly important in factory-built relocatable classrooms that incorporate pressed-wood materials containing formaldehyde.
- *Thermal comfort* also has an impact on student performance. Warm temperatures reduce alertness, whereas cold temperatures reduce dexterity. Frequently and widely fluctuating temperatures can hinder children's ability to focus, although broader fluctuations tend to be more acceptable with natural ventilation.
- *Visual comfort* depends on having an adequate amount of evenly distributed illumination. "Daylighting in Schools: Reanalysis Report" ([www.newbuildings.org/downloads/FinalAttachments/A-3\\_Dayltg\\_Schools\\_2.2.5.pdf](http://www.newbuildings.org/downloads/FinalAttachments/A-3_Dayltg_Schools_2.2.5.pdf)), a major study conducted in 2003 by the Heschong Mahone Group, found that on average daylighting improves learning by 21 percent.

- *Acoustic comfort* is vital because up to 60 percent of classroom activities involve spoken communication. Noise from outside the building, interior hallways, and building systems (such as fans, boilers, and compressors) can be a significant distraction. Even the way sound reverberates within a classroom can cause levels of discomfort and stress that interfere with learning.

## 10.2 Energy-Use Profile

When planning your retrofit strategy, consider a school's largest energy loads. Typically, space heating, cooling, and lighting together account for nearly 70 percent of school energy use (see **Figure 10.1**). Plug loads—such as computers and copiers—constitute one of the top three electricity end uses, after lighting and cooling.

Energy intensity in schools varies widely and is influenced by both weather conditions and specific operating characteristics such as building size, classroom seating capacity, and the presence of an on-site cafeteria. On-site energy intensity in schools can range from under 10,000 Btu per square foot (ft<sup>2</sup>) to over 500,000 Btu/ft<sup>2</sup> (**Figure 10.2**). Given this large variation and skewed distribution, it can be misleading to assess a school building's performance by comparing its average energy intensity.

The EPA's national energy-performance rating system is designed to provide a meaningful benchmark for a school building. The rating system is accessible online as part of the EPA's free Portfolio Manager tool ([www.energystar.gov/index.cfm?c=evaluate\\_performance.bus\\_portfoliomanager](http://www.energystar.gov/index.cfm?c=evaluate_performance.bus_portfoliomanager)). It evaluates a school's energy intensity, normalizing for weather and operating characteristics. The rating is expressed as a score on a scale of 1 to 100, signifying the percentile of performance.

**Figure 10.1: Electric and natural gas end-use profiles for educational facilities**

Most of the electricity consumed by educational facilities is used for lighting, cooling, and plug loads such as computers and copiers; most of the natural gas is used for space heating. Each school's energy profile is different, so these charts are not representative of all schools. For example, school buildings in warmer climates will tend to show a larger share of electricity used for space cooling than those in cooler climates.

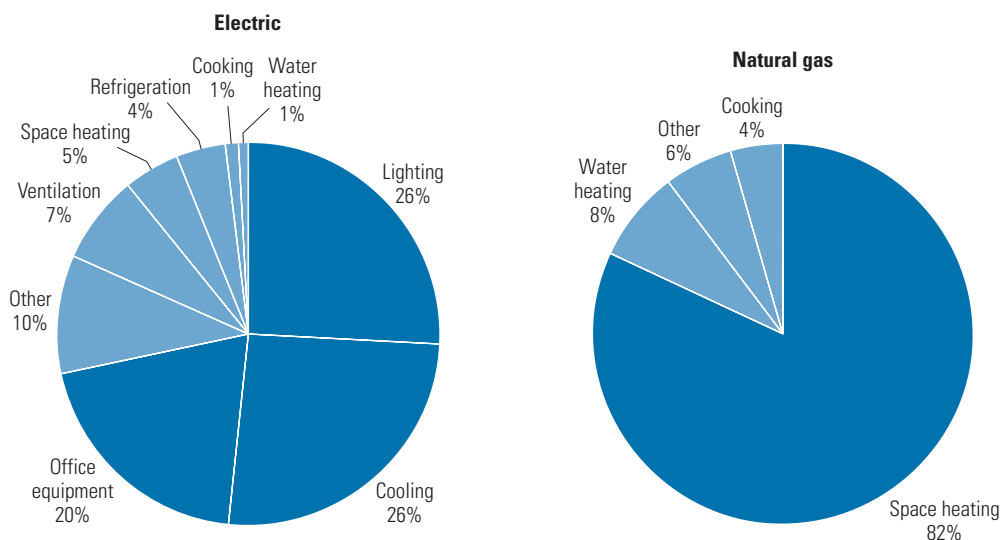

Courtesy: E SOURCE; from Commercial Building Energy Consumption Survey, 1999 data

### Figure 10.2: Distribution of energy intensity in school buildings

This curve shows the overall distribution of energy use intensity among a national sample of K–12 school buildings. By fitting a curve to the survey data, we can see that most schools tend to cluster around the median energy use intensity of approximately 68,700 Btu per square foot (ft<sup>2</sup>) from all energy sources. Many school buildings are significantly more energy-intensive than the median.

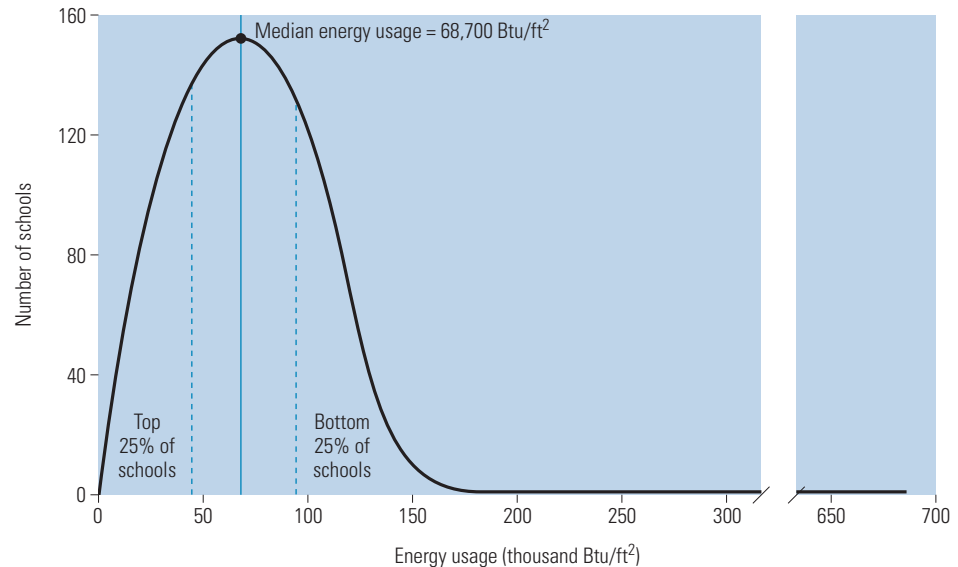

Courtesy: E SOURCE; from Commercial Building Energy Consumption Survey, 2003 data

Schools that earn a score of 75 or higher are performing in the top quartile and may be eligible to earn the ENERGY STAR label. The score serves as a standard of comparison against other schools and a way to evaluate performance after upgrades are implemented.

All upgrade projects should begin by establishing a benchmark. Use the ENERGY STAR rating system to identify your best- and worst-performing facilities. Although any school may benefit from retrocommissioning, operational improvements, and retrofits, you may choose to begin with low-scoring facilities.

## 10.3 Technical Recommendations

Considering that schools spent nearly \$75 per student on gas bills and \$130 per student for electricity in 2005—up 20 percent overall from 2003—it makes sense to invest some effort and capital to contain these mounting costs. Because maintenance resources are in short supply for school districts, it's also important to consider the maintenance implications of any systems a district plans to retrofit or replace.

Although school designs and systems vary, some common reasons for initiating energy-related school upgrades are:

- Frequent equipment malfunctions and shortened equipment lifetime due to years of deferred maintenance;
- Piecemeal additions to buildings and internal changes to existing spaces that haven't been accompanied by corresponding changes to heating and cooling systems;

- Previous attempts to reduce energy use by inappropriate measures, such as blacking out windows or covering vents;
- Portable classrooms with inadequate ventilation systems, high levels of indoor air pollutants, and poor acoustics;
- Multiple rooftop air-conditioning units that are hard to control and maintain properly as compared with a central cooling system; and
- Major capital equipment, such as a boiler or a roof, that is nearing the end of its useful life.

When the goal is energy savings, it may be tempting to focus on the lowest-cost retrofits with the quickest return on investment, such as lighting. But combining a mix of lower- and higher-cost measures will produce better results in the end. This approach allows you to use savings from the lower-cost fixes to help purchase big-ticket items—and get a bigger and longer-term return overall. For example, a boiler replacement can have a payback of less than 6 years when combined with other energy-saving retrofits; otherwise, a school district may not reach payback for that new boiler for as long as 60 years. And using the staged approach that is advocated throughout this manual can reveal opportunities for saving on capital costs by “right-sizing” major equipment. After lighting and load reduction measures have been implemented, it may be possible to specify smaller heating and cooling equipment.

Many of the following recommendations provide not only energy savings but also maintenance savings. Please note that this should not be considered an exhaustive list of measures appropriate for schools. School facility directors are encouraged to refer to the full guidelines presented throughout this manual when planning and managing a retrofit program.

## Retrocommissioning

**Energy savings and other benefits.** Problems uncovered during commissioning tend to have energy implications. Most concern HVAC systems—in particular, air distribution systems. At a typical 100,000-ft<sup>2</sup> school, retrocommissioning can uncover about \$10,000 to \$16,000 in annual energy savings, on average. The amount of savings will depend on the types of problems that are identified and the remedies that are implemented.

In addition to saving energy, retrocommissioning can reduce equipment downtime and keep maintenance expenditures in check. Because poorly performing ventilation systems can be a culprit in student sickness rates, retrocommissioning may also reduce absenteeism and improve learning.

Another reason to regularly perform retrocommissioning on schools is to create a body of documentation demonstrating that building systems are operating properly. Such information can be invaluable in the event that a related lawsuit is filed. Retrocommissioning is an important tool for ensuring that a school district’s indoor air quality standards are met. Safety is another consideration if the fire alarm and smoke-detection systems are integrated with other building systems. Problems with low-voltage electrical systems such as lighting, alarm, and building management systems are frequently identified during retrocommissioning.

**Best practices.** Some school districts are implementing guidelines and establishing standard contractual requirements to ensure that retrocommissioning is done properly and in a timely fashion. If district staff have sufficient expertise and familiarity with a building’s systems, they may carry out commissioning, but otherwise, it’s advisable to outsource the work.

The Collaborative for High Performance Schools ([www.chps.net](http://www.chps.net)) recommends that selected building systems undergo retrocommissioning every two to three years. Retrocommissioning should also be performed after major remodels or additions.

Even if a school was commissioned when it was first built, the building's use patterns may have changed over time, settings may have been altered, and equipment may no longer be functioning the way it should. If a school appears to be using more energy than expected when compared with past performance or with other schools, retrocommissioning is a great place to start looking for energy-savings opportunities. A simple, accurate way to benchmark energy performance is to enter energy consumption and building data for all schools in a district into the ENERGY STAR rating system and then compare scores. Other signs that it's time for retrocommissioning include inadequate ventilation (see sidebar) or a high volume of comfort-related calls from occupants.

**Training and documentation.** The benefits of retrocommissioning can be sustained through proper training of maintenance staff. A retrocommissioning contract should always specify that maintenance staff will receive initial training and manuals. Multiple copies of manuals that document system warranties, instructions for operations, and maintenance requirements should be kept on-site and by the district manager of facilities.

Training can cover topics such as equipment warranties and maintenance, operational schedules and setpoints, start-up and shutdown, emergency procedures, and an overview of air quality and comfort issues. Other staff—including regular and substitute teachers as well as office staff—should receive training and reminders on how to operate controls, window coverings, and computers properly. Such training could be repeated during the school year if there were significant staff turnover. Instruction can be provided at meetings, in special training sessions, or in printed manuals and videos of training sessions.

**Integration with facility planning.** School districts that establish multiyear maintenance plans that are approved at the board level are more likely to fund maintenance needs continuously. A multiyear plan can be used for prioritizing projects (depending on the funding available) while keeping the longer-term impact of those decisions in perspective. This type of plan can

---

---

### CASE STUDY: Retrocommissioning in Minnesota

A facility manager at Farmington Middle School West in Minnesota noticed some telltale signs that the building was not operating efficiently: Positive building pressure sometimes prevented the exterior doors from closing, and variable-frequency drives for air handlers were running at top speed almost continuously. A retrocommissioning study partially subsidized by the school's energy provider uncovered \$12,000 in possible annual electricity savings. The energy conservation measures implemented at the school yielded a payback period of just 2.4 years after additional utility rebates. (Payback would have taken 3.5 years without the rebate.)

At another school in Minnesota, outside air ventilation rates were insufficient and test-and-balance contractors had been unable to solve the problem. That was the primary reason retrocommissioning contractors were called in, but the school turned out to be an ideal candidate for retrocommissioning because it had been through several rounds of remodeling and additions. The result was a hodgepodge of HVAC systems, including 48 air handlers for a single-story, 220,000-ft<sup>2</sup> building. The retrocommissioning was implemented with other retrofits under a performance contract, and the resulting energy savings substantially exceeded the contractor's forecasts. The unexpected additional energy savings, which were attributed to the retrocommissioning work, were retained by the school district.

---

---

be structured around the results of a complete retrocommissioning of select facilities as well as an assessment of the condition of all buildings in the district. A typical facility condition assessment includes reviewing the age and condition of building components and then estimating their remaining expected lifetime and replacement costs. The “Guide for School Facility Appraisal,” one model for condition assessment, is available from the Council of Educational Facility Planners International ([www.cefpi.org/pubs.html](http://www.cefpi.org/pubs.html)).

School districts can use the EPA’s Healthy School Environments Assessment Tool (HealthySEAT, <http://epa.gov/schools/healthyseat/index.html>) to store and track data on facility conditions. The program is customizable for managing a variety of facility conditions, including nonenvironmental issues. The EPA recommends that an assessment be conducted at each school at least once a year.

## Lighting

**Energy savings.** Lighting represents about 26 percent of electricity consumption in a typical school, not including its impact on cooling loads. Lighting retrofits can save as much as 30 to 50 percent of lighting energy, plus 10 to 20 percent of cooling energy.

**Best practices.** Having enough light—but not too much—is the most important lighting criterion for classrooms (see **Table 10.1**). Students must be able to view the teacher and the work on their desktops comfortably, while quickly and frequently alternating between these positions. They should not have to strain their eyes to adjust to different types of tasks, as is the case with inadequate or high-contrast lighting.

The Illuminating Engineering Society of North America (IESNA) sets illumination standards by task. Keep in mind that the IESNA guidelines do not heavily emphasize energy savings or daylighting. When daylighting is incorporated into a classroom lighting strategy, the range of illumination levels can vary much more widely than with electric lighting alone.

Outdoor nighttime light levels may depend on local ordinances, but can generally be fairly low, depending on the level of activity and the potential hazards.

**Daylighting.** Natural daylight has been shown to enhance learning and so should be utilized wherever it is possible without negatively affecting other important aspects of lighting design. Energy savings is another major benefit of daylighting, and a significant portion of energy savings

**Table 10.1: Illumination recommendations for classrooms with daylighting**

The level of illumination in daylit classrooms can vary from 30 to 250 foot-candles and still be acceptable for most tasks. Usually, an average of 40 to 45 foot-candles is acceptable, which means that much of the room would have about 50 foot-candles of illumination.

Activity	Task light level (average at student desks)	Acceptable variation of task light level	Other considerations
Reading, artwork, social time	45 foot-candles (minimum 30)	30 to 250 foot-candles	Daylight glare should be controlled
Lecture with chalkboard or whiteboard	45 foot-candles (minimum 30)	30 to 250 foot-candles; may benefit from dimming to lower levels	May require additional vertical surface lighting for chalkboard or whiteboard
Multimedia lecture with screen projection (film, slides, or television)	15 foot-candles	Dimming to lower levels is acceptable; higher levels should be avoided	Maximum lighting on screen is 5 vertical foot-candles; use shades as required

Courtesy: Collaborative for High-Performance Schools

from a lighting retrofit can come from better utilizing natural light. In Johnston County, North Carolina, two daylit middle schools averaged energy bills that were more than 30 percent less than at similar schools, which school officials attribute to the schools' daylighting approach.

Daylighting is an excellent strategy not only for classrooms, but also for administrative offices, gymnasiums, and meeting rooms. Whenever possible, any lighting renovation should start by using daylighting as much as possible and reducing electric lighting accordingly. Good daylighting design will not introduce excessive heat gain, heat loss, glare, or uneven illumination. These problems can arise in cases where bright daylight streams through a bank of windows on one wall in a classroom. In its daylighting implementation, Bacon Elementary in the Poudre School District in Colorado alleviates these problems by using highly reflective paint on the ceiling and the upper portion of walls to distribute light more evenly. In addition, a system of dimmers and light sensors that uses photocell technology enables supplemental electric lighting to automatically adjust as needed.

Although a complete redesign of a lighting scheme to incorporate daylighting may be too costly for most renovation projects, some measures can be cost-effective. Light pipes, which deliver daylight from roof or exterior wall-mounted collectors through reflective tubes, can be a fairly low-cost retrofit for schools, particularly for meeting rooms or other staff rooms that lack windows. Newer light-pipe designs that make it possible to adjust the light flow can also be used in media centers.

Proper shading on existing windows can reduce heat gain and glare while still providing enough daylight to eliminate electric light usage for much of the school day. Check that blinds are in good condition. In rooms with high windows or transoms, try separate shades for the main (lower) and upper windows. This way, bright light can flow through the upper windows even when the lower shades are down to keep out glare and heat. This strategy would be particularly effective with dimmable lights and reflective ceilings. Then, when the teacher needs to darken the room for a video presentation, both the upper and lower shades can be closed. Additionally, consider applying window films that block solar heat and installing light shelves and exterior shades or overhangs.

**Electric lighting.** A mixture of light sources can create a pleasing and comfortable environment that is suitable for a variety of tasks. Electric lighting should be coordinated with a daylighting scheme or adjusted in response to it. A blend of direct and indirect electric lighting can provide soft and uniform illumination.

If a facility uses T12 fluorescent lamps, relamping with modern T8 lamps and electronic ballasts can reduce lighting energy consumption by 35 percent. Adding specular reflectors, new lenses, and occupancy sensors or timers can double the savings. Paybacks of one to three years are common. This retrofit is appropriate for most space types in a school, including classrooms, cafeterias, and offices.

Compact fluorescent lamps (CFLs) can replace incandescent lamps in many applications, reducing energy use by two-thirds and yielding savings of up to \$20 per lamp per year. Use CFLs in sconces and downlights in hallways and auditoriums, as well as in task lamps for teachers' desks and in the library. They are also appropriate for task lighting in computer labs and study areas.

High-intensity fluorescent lamps are a good alternative for gymnasiums, where high-intensity discharge (HID) lamps, such as metal halide and high-pressure sodium lamps, are often used. High-intensity fluorescents, either high-performance T8 lamps or high-output T5 lamps, feature virtually instant start-up and restrike times (making them candidates for occupancy

sensors), better dimming capability than HIDs, and lower heat output, which means reduced air-conditioning loads. At Bryant College in Smithfield, Rhode Island, school officials replaced HID fixtures in the gymnasium with fluorescent fixtures, partly so lights could be dimmed. This retrofit also improved the distribution of illumination throughout the facility and eradicated hot spots that made some areas in the bleachers uncomfortable for spectators. The combination of high-intensity fluorescents with occupancy sensors in gyms reduces both the risk of lights being left on unnecessarily and the inconvenience of waiting for lights to start up. High-intensity fluorescents may also be useful for auditoriums and libraries where ceilings are more than 15 feet high.

If you're not already using light-emitting diodes (LEDs) in exit signs, this is one retrofit that is usually a clear winner, not only for how much energy it can save but also for maintenance savings. An ENERGY STAR–rated LED exit sign can last 25 years without lamp replacement, compared with less than 1 year for an incandescent sign. LEDs are also excellent for gymnasium scoreboards. In this application, LEDs outperform incandescents in many ways: They withstand impacts better, typically feature lower maintenance costs, and their brightness and clarity provide better viewing from a wider range of vantage points and in a variety of ambient light levels. Full-matrix displays are also entirely flexible, so they can support multiple types of sporting events. LED scoreboards still cost more up front, but those costs have dropped significantly and the operational savings are substantial.

Often, school athletic fields are illuminated by incandescent and quartz lighting systems, but these are being replaced. Lighting professionals recommend metal halide lights that use less energy, last three times longer, and reduce glare. In 2003, Hillsborough County in Florida upgraded to metal halide lamps at 130 outdoor fields and courts and estimated savings in the first year of \$7.7 million in energy costs, plus maintenance savings.

**Controls.** Occupancy sensors save energy but also help to reduce maintenance costs by lengthening the relamping interval. Turning fluorescents off for 12 hours each day can extend the expected calendar life to nearly seven years—a 75 percent increase. Controls that provide continuous rather than stepped dimming will be less disruptive in classrooms. Wall switches should be available in classrooms so that teachers can override occupancy sensors if they need to. In large restrooms, ceiling-mounted ultrasonic occupancy sensors detect occupants around partitions and corners. For hallways, a recommended strategy is to use a combination of scheduled lighting and dimming plus occupancy sensor controls after hours. Occupancy sensors are also appropriate for storage and faculty rooms.

## Load Reductions

**Energy savings.** Load reduction measures that reduce the operational time or intensity of HVAC equipment while still maintaining a comfortable work environment can offer substantial savings. Plug loads from equipment such as computers and copiers represent about 20 percent of electricity used in education buildings. Cooking equipment represents a much smaller portion of total energy used by schools, but equipment purchases and operational measures for school kitchens can be very cost-effective. When purchasing these types of items, look for ENERGY STAR–qualified products ([www.energystar.gov/index.cfm?c=bulk\\_purchasing.bus\\_purchasing](http://www.energystar.gov/index.cfm?c=bulk_purchasing.bus_purchasing)), which use 10 to 50 percent less energy than conventional models without compromising quality or performance. Not only do they offer significant return on investment because of these savings, many also feature longer operating lifetimes and lower maintenance requirements.

**Best practices.** The quickest and easiest way to implement load reductions is to ensure that equipment is turned off when it's not needed. This can be accomplished by recruiting student



volunteers or custodial staff as monitors. Students are often eager to participate in initiatives like Michigan’s Green School program, which was enacted by the state legislature in 2006. For example, students can form teams to circulate through the school at the end of the day, leaving reminders where they discover lights and computers left on.

Even if computers are shut down at nights and on weekends, at least half the energy consumed by computers may be wasted because they are on continuously through the school day. A computer monitor can use two-thirds of the total energy of a desktop system, so it is important to power down monitors whenever they are not in use. The ENERGY STAR Power Management program provides free software that can automatically place active monitors and computers into a low-power sleep mode through a local area network ([www.energystar.gov/index.cfm?c=power\\_mgt.pr\\_power\\_management](http://www.energystar.gov/index.cfm?c=power_mgt.pr_power_management)). Whole-computer power management can save \$15 to \$45 annually per desktop computer; managing only monitors can save \$10 to \$30 per monitor annually.

As an example, though the North Thurston Public Schools in Washington State were already using monitor power management, the school district also installed ENERGY STAR’s free EZ GPO network software to apply computer power management. North Thurston has more than 4,000 computers and is now saving \$45,000 per year.

For schools with pools, simply using a cover on a heated pool can save 50 to 70 percent of the pool’s energy use, 30 to 50 percent of its makeup water, and 35 to 60 percent of its chemicals. In the kitchen, food preparation equipment shouldn’t be turned on for preheating more than 15 minutes before it is needed—simply reducing the operating time of kitchen appliances can cut cooking-related energy consumption by up to 60 percent. Hot water waste should be reduced in kitchens, bathrooms, and locker rooms; some measures to consider include automatic faucet shutoff, single-temperature fittings, and low-flow showerheads with pause control.

**Efficient equipment procurement.** A simple way to ensure that purchased equipment is energy efficient is to request that school district procurement officials specify ENERGY STAR-qualified products in their contracts or purchase orders. Additionally, the product recommendations for federal government procurement officials from the U.S. Department of Energy’s Federal Energy Management Program ([www.eere.energy.gov/femp/procurement](http://www.eere.energy.gov/femp/procurement)) may be appropriate for items not covered under the ENERGY STAR program. Some ENERGY STAR-qualified products that are relevant for schools include:

- Commercial refrigerators and freezers
- Commercial fryers
- Commercial steam cookers
- Televisions, DVD players, and audio equipment
- Computers and monitors
- Printers, fax machines, mailing machines, and scanners
- Copiers
- Vending machines
- Roof products

For example, one ENERGY STAR–qualified commercial refrigerator can save a school \$160 per year and reach simple payback in just 1.3 years. Replacing three conventional vending machines with ENERGY STAR–approved models would mean annual operational savings of \$460 because they are 40 percent more energy efficient. Purchasing 100 15-inch LCD (liquid crystal display) monitors that meet ENERGY STAR specifications could save a school \$700 annually compared with conventional models.

**Retrofits.** Several load-reducing retrofits are applicable to schools. For example, many schools have few floors yet a large footprint, which means they have a high ratio of roof area to total facility square footage. This makes them good candidates for cool-roof solutions. If a school’s roof needs recoating or painting, white or some other highly reflective color can minimize the amount of heat that the building absorbs. This change can often reduce peak cooling demand and cooling energy use by 15 to 20 percent, depending on the climate zone in which the school is located. When a roof requires replacement, adding insulation will reduce heat gain and loss.

Proper placement of deciduous trees not only offers energy savings (by providing cooling shade in summer without blocking sunlight in winter), but also enhances the school grounds.

Replacing purchased energy with on-site generation is an effective but capital-intensive load reduction strategy. Although photovoltaic (PV) systems are expensive, schools may be able to find utility or state rebates not available to private companies and may also have access to federal subsidies. The Clark County School District in Nevada received a \$250,000 rebate from Nevada Power to help purchase roof-mounted PV panels for four schools. The systems will have a combined generating capacity of 50,000 watts, and they will be connected to the school computer network, enabling students to monitor their operation for hands-on learning about renewable energy.

## Air Distribution Systems

**Energy savings.** On average, ventilation systems consume 7 percent of the electricity used in education buildings. Savings can be found by installing efficient fan motors and sizing the system to match your load (which may now be lower due to other measures you have already adopted). Even more savings are possible by using energy-recovery equipment and variable speed drives.

**Best practices.** A ventilation system must be designed, operated, and maintained to provide adequate fresh air intake and prevent mold growth from unwanted moisture accumulation. Ventilation rates at most schools are below recommended levels. Some schools have taken inadvisable measures to reduce fresh air intake in an attempt to reduce energy costs: In Brevard County, Florida, the ventilation sources in two junior high schools were covered, with the vents into classrooms sealed off. The result was an outdoor air volume that was substantially below recommended standards. Although the schools’ intent was apparently to reduce the need for additional mechanical cooling and combat humidity, the buildings suffered from high humidity and mold. With increased public awareness of the health issues relating to indoor air quality and mold, such careless methods to control costs can no longer stay under the radar.

It is also possible to supply insufficient volumes of fresh air inadvertently. This may occur with scheduled ventilation and variable air volume systems or may be caused by wind, stack effects, or unbalanced supply and return fans. Installing an outdoor air measuring station that modulates the outdoor air damper and return damper is relatively simple and ensures sufficient fresh air supply.

Increasing ventilation to safe and comfortable levels will likely increase energy consumption and so should be combined with other energy-saving measures. A study by Science Applications

International Corp. of four New York schools found that, in combination with energy conservation measures, it was possible to increase outside air ventilation rates to mitigate radon problems and achieve overall energy savings of 7.4 to 14.2 percent.

Often, insufficient ventilation air in classrooms is simply due to clogged intake screens that are difficult to access for inspection and cleaning. To prevent this problem, ensure that all HVAC system air supply diffusers, return registers, and outside air intakes are clean and unobstructed. Replace filters regularly. These measures to improve ventilation rates should not raise energy consumption. Similarly, economizers should be checked regularly to ensure that their dampers are functioning properly—dampers that are stuck open could be letting in too much outside air, and ones that are stuck closed won't provide the benefit of free cooling.

**Selecting a ventilation system.** Generally speaking, central air handling units that serve several rooms via ductwork tend to be a better choice for schools than unit ventilators that serve a single room. Individual room units have some advantages (such as reduced floorspace requirements), but it is more challenging to maintain multiple units than one central unit. Additionally, unit ventilator systems can create moisture problems. Central air handling units are quieter, less drafty, and less prone to inadvertently reducing fresh air flow; they also control humidity better.

For humid climates and high-occupancy buildings, dedicated outdoor air systems (DOASs) improve humidity control and may offer first-cost as well as operational savings. Preconditioning fresh air with a desiccant dehumidification system eliminates the need to use mechanical air conditioning systems for that purpose. The Willis Forman Elementary School in Augusta, Georgia, took this approach to generate energy savings and improve occupant comfort. Not only can the DOAS approach save energy—perhaps 8 to 20 percent—it also provides assurance, verifiable in a court of law, that a conditioned space is receiving the mandatory minimum ventilation air.

In some regions, natural ventilation through operable windows can provide fresh air and comfortable temperatures without introducing excessive humidity. Teachers generally appreciate the additional control over the classroom environment. Students and teachers in naturally ventilated schools tend to be comfortable in a wider range of thermal conditions than in schools with continuous mechanical cooling. Normally, the optimal temperature range for reading and mathematical tasks is between 68° and 74° Fahrenheit (F). With natural ventilation, the range of comfortable temperatures may extend from 62° to 86°F. Yet whether student performance is better in classrooms with operable windows or those that rely solely on mechanical HVAC has not been determined. Highly variable temperature as well as exposure to outside noise distractions and air pollutants can be negative factors in some areas. Uncontrolled outdoor air ventilation can allow contaminants to bypass filters, affect the balance of mechanical ventilation equipment, and introduce excess humidity.

**Add-on monitors and controls.** Economizers can be added as a retrofit to many systems. The energy savings will be most pronounced for low-occupancy spaces such as libraries or administration areas, but this retrofit will also be cost-effective in other space types, including classrooms and assembly rooms. Differential enthalpy controllers are appropriate for economizers in humid areas.

Demand-controlled ventilation is best used in spaces with occasionally high occupancy such as auditoriums, gyms, and cafeterias. It will be less cost-effective in classrooms. However, be careful not to reduce outdoor air below the recommended minimum.

**Design and program tools.** When designing a ventilation system that provides thermal comfort, proper humidity, and overall good indoor air quality without squandering your energy

budget, the EPA's School Advanced Ventilation Engineering Software (SAVES, [www.epa.gov/iaq/schooldesign/saves.html](http://www.epa.gov/iaq/schooldesign/saves.html)) can help to assess the payback and air quality benefits of various types of systems.

The Indoor Air Quality Tools for Schools Kit ([www.epa.gov/iaq/schools/index.html](http://www.epa.gov/iaq/schools/index.html)) provides guidance for establishing and implementing an effective indoor air quality management program. The school district's facility director is a logical choice to lead this type of program. The kit provides a variety of tools, including checklists and instructional videos, to help develop an indoor air quality management plan.

## Heating and Cooling Systems

**Energy savings.** Together, heating and cooling represent well over half of the energy used by schools. In most climates, the boiler is typically the largest single piece of energy-using equipment in a school. ENERGY STAR–qualified boilers use about 10 percent less energy than standard equipment. Alternative heating and cooling technologies offer as much as 50 percent energy savings.

**Best practices.** When replacing heating or cooling equipment, select a high-efficiency system. As energy prices escalate, payback calculations may adjust enough to enable early replacement. This is also an excellent opportunity to capitalize on the myriad other measures taken to reduce loads and losses throughout the facility. Optimize savings from all building improvements by right-sizing heating and cooling equipment to meet actual needs, rather than relying on rule-of-thumb sizing estimates. Too often this equipment is oversized, which means the systems rarely operate at peak efficiency. Right-sizing offers first-cost savings, as well.

**Selecting a heating or cooling system.** If a school is planning a comprehensive renovation of its heating and cooling system, then evaporative cooling, geothermal heat pumps, two-pipe systems, and thermal storage can be good options depending on the area's climate and energy rate structures. For example, evaporative cooling is especially effective in warm, dry climates. Thermal storage is appropriate where demand charges are high or time-based rates are used. The Energy Smart Schools program's Energy Design Guidelines for High Performance Schools provide a variety of technology recommendations by climate zone, many of which are applicable for existing buildings ([www1.eere.energy.gov/buildings/energysmartschools/](http://www1.eere.energy.gov/buildings/energysmartschools/)).

The latest two-pipe systems are ideal for retrofitting buildings that have never had central heating and cooling systems before or for upgrading existing systems when budgets are constrained. Digital sensors and controls coupled with creative mechanical design make it possible to circulate heated and chilled water to fan-coil units throughout a building using only two pipes, rather than the four pipes typically installed in schools. The new two-pipe design is not only simpler than its four-pipe counterparts, it is also far more energy-efficient, less expensive to install (typically by as much as 30 percent), and easier to maintain. The updated two-pipe design has seen a resurgence of popularity for school facilities (see sidebar).

Geothermal heat pumps, also known as ground-source heating and cooling, can use 25 to 50 percent less energy than traditional systems while also providing flexibility to distribute heating and cooling as needed to the individual zones of a building (see sidebar). Portable classrooms are good candidates for high-efficiency individual heat pumps (with enthalpy recovery ventilation) because they are independent structures that tend to rely on electric heating.

Schools that need to retrofit a chiller system can consider a relatively new compressor innovation that uses magnetic levitation instead of oil-lubricated bearings. Manufactured by Danfoss

---

---

### CASE STUDY: Evansville-Vanderburgh School District

When the Evansville-Vanderburgh School District in Indiana decided it needed to install air conditioning in its school buildings, an engineer at the architectural and engineering firm Veazey Parrott Durkin & Shoulders proposed a two-pipe HVAC system that came in at a significantly lower installation cost than comparable four-pipe versions. To boost operational savings, the schools' T12 lighting was replaced with T8s. Despite the addition of air conditioning, the schools' annual energy cost per square foot averaged \$0.54, compared with \$0.66 before the retrofits—a difference of \$0.12 per square foot. Districtwide, overall savings came to around 18.2 percent, with the highest savings for one school at \$0.28 per square foot per year.

---

---

---

---

### CASE STUDY: Daniel Boone High School

Daniel Boone High School in Tennessee opted to install a geothermal heating system even though it cost an additional \$197,000 compared with the next best two-pipe system it reviewed. This turned out to be a smart choice—the geothermal system saved \$62,000 during its first year of operation. That's a savings of \$0.39 per square foot compared with the school's original two-pipe system. Additionally, the new system also has the flexibility to vary temperature setpoints for individual zones using direct digital controls.

---

---

Turbocor, these compressors are available through major cooling equipment manufacturers. Although they can prove expensive for new installations, when used in a retrofit, the additional cost can be rapidly returned through energy savings. Other benefits make this chiller technology particularly well-suited to schools and could even outweigh the energy savings: The Turbocor compressor is quieter than conventional chillers; it is simpler to operate, so it requires less attention from maintenance staff; and maintenance costs are about 50 percent less.

## 10.4 Financial and Implementation Issues

Although capital budgets are tight, schools do have something working for them that can help make major retrofit projects possible: a long-term perspective. Most school districts can expect to be using their facilities for 50 years or more, giving them leeway to take full consideration of life-cycle costs when implementing upgrades. This makes it possible to minimize operating expenses and maximize energy efficiency. It can also open the door to a wider array of retrofit options than other commercial facilities are prepared to undertake because schools may accept payback periods of 5 years, 10 years, or even more.

Yet because capital budgets for school facilities are perpetually lacking, in practice it is a challenge for schools to adopt a long-term perspective. The ENERGY STAR Cash Flow Opportunity Calculator ([www.energystar.gov/index.cfm?c=assess\\_value.bus\\_financial\\_value\\_calculator](http://www.energystar.gov/index.cfm?c=assess_value.bus_financial_value_calculator)) can help school districts calculate how much they can afford to invest in retrofits from the anticipated savings and whether it would make sense to borrow funds to finance building upgrades.

Performance or shared-savings contracting provides a mechanism to fund not only energy-saving retrofits but also to cover deferred maintenance and capital renewal projects at the same time—all off-budget for the school district. Additionally, including ongoing maintenance in a performance contract can help to keep operating and maintenance costs under control and predictable (see sidebar). Although school district officials often prefer to keep facility operations in-house to preserve accountability and public approval, reducing the need to hire specialized expertise is one reason that schools privatize some functions. Additionally, having a long-term contract in place should ensure consistent funding for maintenance as well as provide an impetus for long-term strategic planning of equipment upkeep and replacement.

Apart from capital upgrades, many schools find that they can achieve energy savings of up to 25 percent through behavioral and operational measures alone. It is wise to implement these approaches first and track their impact on facility energy performance, particularly if you plan to invest in capital upgrades through a shared-savings contract. This way the school can demonstrate and claim energy savings from behavioral and simple operational changes. Shared-savings performance contracts can then be based on the new lower energy use baseline for the facility.

Another type of shared-savings program rewards schools within a district based on energy savings from behavioral and operational changes (see sidebar). The Alliance to Save Energy's Green Schools Program ([www.ase.org/section/program/greenschl](http://www.ase.org/section/program/greenschl)) provides guidelines and tools for school districts to create their own shared-savings initiatives.

---

---

### **CASE STUDY: Baltimore City Public School System**

The Baltimore City Public School System embarked on a performance contract that is typical in many ways. Its contract with Energy Systems Group includes facility improvements at 32 schools, including digital control system upgrades, energy-efficient lighting, new boilers in six schools, and complete HVAC overhauls in another three. The \$20 million contract features financial performance guarantees. An unusual element in the contract is an agreement that the contractor will perform on-site maintenance services at all 32 schools over 15 years.

---

---

### **BEST PRACTICE: Districtwide Shared-Savings Initiatives**

Schools in the Gresham-Barlow district in Oregon accumulate financial rewards based on a variety of metrics, including the savings achieved during particular periods of the year and whether the school created a resource committee. In Wake County, North Carolina, schools get to keep 10 percent of the annual savings achieved, which has been a primary factor in rounding up over \$600,000 per year in energy savings at the district's 100 campuses. Much of Wake County's savings are due to student and faculty activity as well as training. The school district of Philadelphia, Pennsylvania, discovered that a similar program brought in unexpected savings from demand-charge reductions. Those unanticipated funds were channeled into capital retrofits to capture even more savings.

---

---

Other benefits and savings from the types of retrofits recommended here are more difficult to quantify but may help in making a case for funding to a school board or community. The state of Washington determined that evidence of better teacher retention was sufficient to incorporate estimated dollar savings from lower teacher turnover in its cost/benefit analysis of sustainable building design. A case could also be made for the economic value of improved student performance, calculated based on the funds invested per student and a conservative estimate for performance improvement. So a conservative estimate of a 5 percent increase in student performance could translate to \$250 per student in additional educational value, based on a per-student cost of \$5,000 per year.

No less important is the benefit for students to have the opportunity to learn about energy savings with their own school as a laboratory. One study concluded that students at schools with systemic environmental education programs have higher test scores on state standardized tests over students at other comparable schools. Participating in energy-efficiency programs at their schools and witnessing the results of their efforts helps students to both learn practical skills and become actively engaged in improving their learning environment.

## Bibliography

Alliance to Save Energy, “School Operations and Maintenance: Best Practices for Controlling Energy Costs” (August 2004), prepared by Princeton Energy Resources International and HPowell Energy Associates, [www.ase.org/uploaded\\_files/greenschools/School%20Energy%20Guidebook\\_9-04.pdf](http://www.ase.org/uploaded_files/greenschools/School%20Energy%20Guidebook_9-04.pdf).

Associated Press, “Applications for Solar Projects Approved by Public Utilities Commission of Nevada” (March 17, 2006).

Bartosh, Oksana, “Environmental Education: Improving Student Achievement,” Thesis, Master of Environmental Studies, The Evergreen State College (June 2003), from [www.audubon.org/chapter/wa/wa/PDFs/Education-research-Oksana-1-3.pdf](http://www.audubon.org/chapter/wa/wa/PDFs/Education-research-Oksana-1-3.pdf).

Campaign for Fiscal Equity, “Public School Facilities: Providing Environments That Sustain Learning,” *Access Quarterly*, v. 4, no. 1 (Winter 2004).

Center for Energy and Environment, “Recommissioning of a Large Middle School,” from [www.mncee.org](http://www.mncee.org) (accessed August 2006).

Collaborative for High Performance Schools (CHPS), *Best Practices Manual, Volume I: Planning* (CHPS, 2006), [www.chps.net/manual/index.htm](http://www.chps.net/manual/index.htm).

CHPS, *Best Practices Manual, Volume II: Design* (CHPS, 2006), [www.chps.net/manual/index.htm](http://www.chps.net/manual/index.htm).

CHPS, *Best Practices Manual, Volume V: Commissioning* (CHPS, 2006), [www.chps.net/manual/index.htm](http://www.chps.net/manual/index.htm).

Criscione, Peter, “Look! Up in the Chiller Room! It’s a Screw Compressor, It’s a Centrifugal...No, It’s Turbocor! New Technology Flies into Town with Superbenefits,” *E SOURCE Technology Assessment Service, ER-06-08* (May 2006).

Earthman, Glen I., “Prioritization of 31 Criteria for School Building Adequacy,” white paper prepared for American Civil Liberties Union Foundation of Maryland (January 5, 2004), [www.aclu-md.org/aTop%20Issues/Education%20Reform/Earthman\\_Final\\_1\\_05\\_04.pdf](http://www.aclu-md.org/aTop%20Issues/Education%20Reform/Earthman_Final_1_05_04.pdf).

Earthman, Glen I., “School Facility Conditions and Student Academic Achievement,” white paper prepared for University of California at Los Angeles, Institute for Democracy, Education & Access (2002), [www.idea.gseis.ucla.edu/publications/williams/reports/pdfs/www08-Earthman.pdf](http://www.idea.gseis.ucla.edu/publications/williams/reports/pdfs/www08-Earthman.pdf).

Guckelberger, Dave, and B. Bradley, “A New Standard for Acoustics in the Classroom,” *Engineers Newsletter*, v. 32, no. 1 (2003).

Hawkins, Harold, and H. E. Lilley, *Guide for School Facility Appraisal* (Council of Educational Facility Planners International, 1998).

Heschong Mahone Group, “Daylighting in Schools: Reanalysis Report,” California Energy Commission Technical Report, 500-03-082-A-3 (October 2003).

Kinney, Larry, “Two-Pipe HVAC: It May Be Twice as Good as Four,” *E SOURCE Technology Assessment Service*, ER-01-13 (July 2001).

Klingensmith, Dawn, “Ready for Their Close-Up, Scoreboards That Steal the Spotlight,” *Recreation Magazine* (March 2006).

Maniccia, Dorine, “Green Light,” *American School & University* (August 1, 2003).

McMilin, Edward, “Maintenance Program,” *School Planning and Management* (June 2006).

Moglia, Dena, A. Smith, D. L. MacIntosh, and J. L. Somers, “Prevalence and Implementation of IAQ Programs in U.S. Schools,” *Environmental Health Perspectives*, v. 114, no. 1 (January 2006).

Oregon Department of Energy, “Case Study: Roof Top Units V. Central HVAC” (August 2004), [www.energy.state.or.us](http://www.energy.state.or.us).

Paladino and Co., “Washington High Performance School Buildings: Report to the Legislature,” prepared for Washington State Board of Education and Office of the Superintendent of Public Instruction (January 31, 2005), [www.k12.wa.us/SchFacilities/pubdocs/OSPIFinalReport.pdf](http://www.k12.wa.us/SchFacilities/pubdocs/OSPIFinalReport.pdf).

Sciarra, David G., K. L. Bell, and S. Kenyon, “Safe and Adequate: Using Litigation to Address Inadequate K-12 School Facilities,” Education Law Center (July 2006), [www.edlawcenter.org](http://www.edlawcenter.org).

Science Applications International Corp., “Evaluation of Increased Ventilation Rates and Energy Conservation Measures at Four New York State Schools,” report prepared for New York State Energy Research and Development Authority (1998), [www.nyserdera.org/publications/ventsum.pdf](http://www.nyserdera.org/publications/ventsum.pdf).

State of Maryland, “Task Force to Study Public School Facilities: Final Report” (February 2004), [http://mlis.state.md.us/other/education/public\\_school\\_facilities\\_2003/Final\\_Report.pdf](http://mlis.state.md.us/other/education/public_school_facilities_2003/Final_Report.pdf).

U.S. Department of Energy (DOE), “Energy Design Guidelines for High Performance Schools,” Office of Building Technology, State and Community Programs (August 1, 2002), from [www.rebuild.org](http://www.rebuild.org).

U.S. DOE, Energy Information Administration (EIA), Commercial Building Energy Consumption Survey (CBECS), “End-Use Consumption by Principal Building Activity” (1999 data; published 2003), [www.eia.doe.gov/emeu/cbecs/enduse\\_consumption/pba.html](http://www.eia.doe.gov/emeu/cbecs/enduse_consumption/pba.html).

U.S. DOE, EIA, “Public Use Microdata Files” (2003 data; published 2006), CBECS, [www.eia.doe.gov/emeu/cbecs/cbecs2003/public\\_use\\_2003/cbecs\\_pudata2003.html](http://www.eia.doe.gov/emeu/cbecs/cbecs2003/public_use_2003/cbecs_pudata2003.html).

U.S. DOE, Federal Energy Management Program, “Purchasing Specifications for Energy-Efficient Products” (May 2006), [www.eere.energy.gov/femp/procurement](http://www.eere.energy.gov/femp/procurement).



U.S. Environmental Protection Agency (EPA), “Effective Facility Maintenance for Healthy, High Performance Schools,” *Indoor Air Quality Tools for Schools Newsletter*, v. 4 (August 2006), [www.epa.gov/iaq/schools/pdf\\_files/facilities\\_bulletin.pdf](http://www.epa.gov/iaq/schools/pdf_files/facilities_bulletin.pdf).

U.S. EPA, “Energy Efficiency and Indoor Air Quality in Schools,” a joint EPA working paper from ENERGY STAR and Indoor Air Quality (September 2003), [www.energystar.gov/ia/business/k12\\_schools/Ee&iaq.pdf](http://www.energystar.gov/ia/business/k12_schools/Ee&iaq.pdf).

U.S. EPA, “Heating, Ventilation, and Air Conditioning (HVAC) Systems,” Indoor Air Quality Design Tools for Schools, [www.epa.gov/iaq/schooldesign/hvac.html](http://www.epa.gov/iaq/schooldesign/hvac.html).

U.S. EPA, “Indoor Air Quality and Student Performance,” Indoor Environments Division, 402-K-03-006 (revised August 2003), [www.epa.gov/iaq/schools/images/iaq\\_and\\_student\\_performance.pdf](http://www.epa.gov/iaq/schools/images/iaq_and_student_performance.pdf).

U.S. EPA, “North Thurston Public Schools Will Save \$45,000 by Putting Computers to Sleep,” ENERGY STAR case study, [www.energystar.gov/powermanagement](http://www.energystar.gov/powermanagement) (accessed August 2006).

Xcel Energy, “Recommissioning Nets Big Savings for School,” ConservationWise from Xcel Energy, [www.xcelenergy.com](http://www.xcelenergy.com) (accessed August 2006).



LEARN MORE AT  
[energystar.gov](http://energystar.gov)

ENERGY STAR® is a U.S. Environmental Protection Agency program helping businesses and individuals fight global warming through superior energy efficiency.

# Chapter 11

## Facility Type: Supermarkets and Grocery Stores





# 11. Facility Type: Supermarkets and Grocery Stores

Revised January 2008

<b>11.1 Challenges and Opportunities</b>	<b>2</b>
<b>11.2 Energy Use Profiles</b>	<b>3</b>
<b>11.3 Technical Recommendations</b>	<b>4</b>
Retrocommissioning	5
Lighting	8
Load Reductions	11
Air Distribution Systems	15
Heating and Cooling Systems	16
<b>11.4 Financial and Implementation Issues</b>	<b>17</b>
<b>Bibliography</b>	<b>17</b>
<b>Glossary</b>	<b>G-1</b>

## 11.1 Challenges and Opportunities

Energy is increasingly joining the ranks of top concerns for supermarket owners and facility managers. Supermarkets are the most electricity-intensive type of commercial building, using an average of about 50 kilowatt-hours (kWh) of electricity. They also use 50 cubic feet of natural gas per square foot (ft<sup>2</sup>) per year. At an average annual energy cost of more than \$4 per ft<sup>2</sup>, energy expenses represent the most significant portion of the annual operating budget after labor costs for the grocery retail sector. Because the profit margins of supermarkets are so thin, on the order of 1 percent, the U.S. Environmental Protection Agency (EPA) estimates that \$1 in energy savings is equivalent to increasing sales by \$59.

Merchandising trends are pushing grocery stores to become even more energy intensive as stores are carrying more fresh-food products, frozen-food aisles are expanding, food-safety temperature requirements are tightening, and demand for prepared food is growing. But this sector also offers some of the most cost-effective and rewarding opportunities for energy savings, not only by improving system efficiency and reducing unnecessary energy use but also by reducing loads at peak times during the day, when energy prices are highest. Here are the overall benefits that improved energy efficiency can provide:

- *Increased profitability.* Energy savings are reflected in a company's profit-and-loss statement as reduced operating costs, which directly increase profitability. Total annual energy costs to operate a supermarket are usually equivalent to net profit: Both are between 1 and 2 percent of sales. Therefore, a 10 percent reduction in energy costs can increase net profit by as much as 16 percent. For a major chain, efficiency improvements that cut energy costs by 10 percent could yield tens of millions of dollars in added profit.
- *Reduced vulnerability to energy price fluctuations.* Energy prices may be sensitive to numerous external factors, including major weather events and changes in national and state regulations. For some regions, the potential for utility deregulation also lends uncertainty to future energy costs. Reducing a facility's total energy consumption can soften the impact of energy price fluctuations.
- *Increased sales.* Improving the energy efficiency of a building usually involves upgrades to the lighting and HVAC systems. By creating a more pleasing shopping and working environment, these upgrades can also attract and retain more customers, leading to an increase in sales.
- *Reduced spoilage.* Upgrades to refrigeration and lighting systems can reduce spoilage of perishable goods while also saving on energy bills.
- *Enhanced public image.* With growing concerns over global warming and other environmental issues, many supermarket owners want to demonstrate to customers that they are responsible environmental stewards. Supermarket owners can upgrade their buildings to be more energy efficient as a way to achieve this goal.

The impact of rising energy costs and growing concerns about global warming are leading food sales organizations to take action. Hundreds of grocery stores, including national and regional chain stores as well as independent grocers, are participating in the EPA's ENERGY STAR buildings program. For example, Hannaford Bros. Co. received national recognition as an ENERGY STAR Leader in 2006 by achieving an average ENERGY STAR energy performance score of 75 or better across its portfolio of stores. Hannaford also earned ENERGY STAR

labels for 10 of its stores in Maine in 2007 by implementing upgrades and increasing energy awareness among staff; its annual energy savings is approximately \$452,000. Hannaford is able to use ENERGY STAR's rating system not only to earn public accolades but also to compare its stores' performance to that of similar stores nationwide and to track performance within the company's portfolio over time.

## 11.2 Energy Use Profiles

When planning a retrofit strategy, consider a supermarket's largest energy loads. Refrigeration is usually the largest electricity load in a supermarket, and space heating is by far the largest natural gas use (see **Figure 11.1**).

Energy intensity in supermarkets varies widely and is correlated to gross square footage, quantity of refrigeration, and number of workers, although other variables, such as total weekly operating hours and the presence of an on-site kitchen or cooking area, can affect it as well. Energy intensity in supermarkets ranges from less than 136,000 Btu/ft<sup>2</sup> to over 278,000 Btu/ft<sup>2</sup> (**Figure 11.2**, page 4). Given this wide range and skewed distribution, it can be misleading to assess a supermarket facility's performance by looking only at its average energy intensity.

The EPA's national energy-performance rating system is designed to provide a meaningful benchmark for supermarkets. The rating system is accessible online as part of the EPA's free Portfolio Manager tool ([www.energystar.gov/benchmark](http://www.energystar.gov/benchmark)). It evaluates a supermarket's energy intensity, normalizing for weather and operating characteristics. The rating is expressed as a score on a scale of 1 to 100, signifying the percentile of performance. Supermarkets that achieve a rating of 75 or higher are performing in the top quartile and may be eligible to earn

**Figure 11.1: Electric and natural gas end-use profile for supermarkets**

Most of the electricity consumed by supermarkets is used for refrigeration, and space heating typically represents the largest use of natural gas. Each facility's energy profile is different, however, so this chart is not representative of all supermarket buildings. Supermarket electricity use will vary depending on a store's gross square footage and total weekly operating hours, and supermarkets with on-site cooking facilities might see higher levels of gas consumption for cooking.

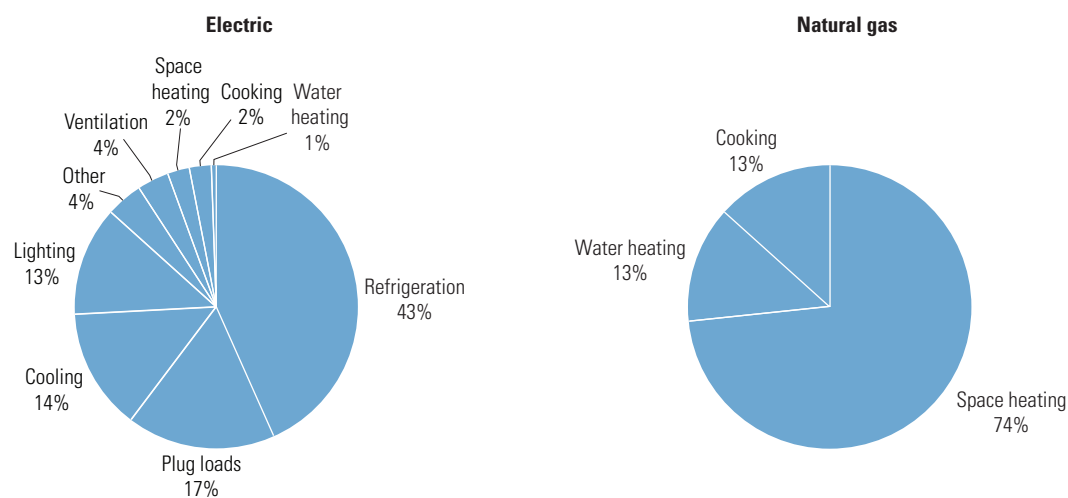

Courtesy: E SOURCE; from Commercial Building Energy Consumption Survey, 1999 data

**Figure 11.2: Distribution of energy intensity in supermarkets**

The median supermarket uses approximately 190,000 Btu per square foot (ft<sup>2</sup>) from all energy sources. However, many supermarkets are significantly more energy intensive than that.

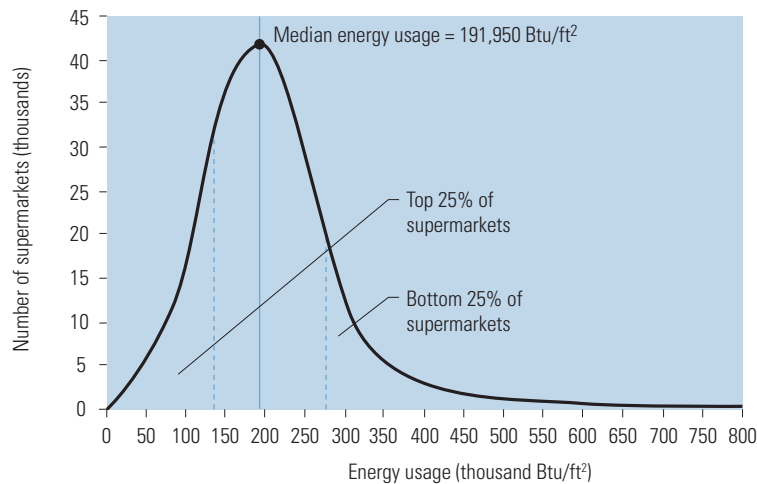

Courtesy: E SOURCE; from Commercial Building Energy Consumption Survey, 1999 data

the ENERGY STAR label. The rating serves as a standard of comparison against other supermarkets and provides a way to measure progress after upgrades are implemented.

All upgrade projects should begin by establishing a benchmark rating. Ranking stores by their ENERGY STAR performance ratings can help an organization to identify its best- and worst-performing supermarket facilities. Although any supermarket may benefit from retrocommissioning, operational improvements, and retrofits, it is usually most cost-effective to begin upgrade efforts with low-scoring facilities.

For more information, visit ENERGY STAR for Retail at [www.energystar.gov/retail](http://www.energystar.gov/retail); many of the success stories and press releases cover supermarket examples. For a listing of supermarkets that have earned the ENERGY STAR, visit [www.energystar.gov/index.cfm?fuseaction=labeled\\_buildings.showBuildingResults&building\\_type\\_id=352&s\\_code=ALL&profiles=0&also\\_search\\_id=NONE](http://www.energystar.gov/index.cfm?fuseaction=labeled_buildings.showBuildingResults&building_type_id=352&s_code=ALL&profiles=0&also_search_id=NONE).

### 11.3 Technical Recommendations

Although building systems in supermarkets vary, some common reasons for initiating upgrades of energy-related systems are

- Malfunctions and shortened lifetime of equipment due to improper maintenance and operations, such as excessive cycling of refrigeration compressors due to incorrect refrigerant charge;
- Poor equipment function due to incorrect settings, particularly if settings for refrigerated display cases are altered when the cases are upgraded or moved;
- Changes to interior spaces that have not been accompanied by corresponding changes to heating, cooling, and lighting systems and control regimes;

- Previous attempts to reduce energy use by inappropriate measures, such as covering vents or turning off antisweat heaters in display cases;
- Inadequate ventilation systems, high levels of indoor air contaminants from products or activities (such as cooking), and poor acoustics;
- Multiple rooftop air-conditioning units that are hard to control and maintain properly;
- Refrigerant leaks or phasing out of ozone-depleting refrigerants; and
- Major capital equipment, such as a boiler or a roof, that is nearing the end of its useful life.

Building managers frequently focus on the lowest-cost retrofits with the quickest return on investment, such as lighting. However, substantial energy-saving opportunities for grocery stores are typically available in refrigeration systems. In addition, using the staged approach that is advocated throughout this manual can reveal opportunities for saving on capital costs by “right-sizing” major equipment. After lighting and load-reduction measures (such as refrigeration fixes) have been implemented, it may be possible to specify smaller heating and cooling equipment while maintaining a comfortable ambient temperature.

Many of the following recommendations provide not only energy savings but also maintenance savings. Please note that this should not be considered an exhaustive list of measures appropriate for supermarkets. Supermarket facility directors are encouraged to refer to the full guidelines presented throughout this manual when planning and managing a retrofit program.

## Retrocommissioning

**Energy savings and other benefits.** The biggest savings opportunities uncovered through retrocommissioning of a grocery store typically are in the refrigeration and lighting control systems. As with all commissioning, the amount of savings will depend on the types of problems that are identified and the remedies that are implemented.

Retrocommissioning can produce other benefits. It can reduce equipment downtime and keep maintenance expenditures in check. When problems in lighting and ventilation systems are corrected, retrocommissioning may also create a more pleasing shopping environment. In addition, safety can be verified if the fire-alarm and smoke-detection systems are integrated with other building systems. Problems with low-voltage electrical systems such as lighting, alarm, and building management systems are frequently identified during retrocommissioning.

**Best practices.** Problems that are simple to fix but costly to ignore are often discovered in a retrocommissioning effort. Supermarkets in particular can reap substantial savings by recalibrating temperature setpoints that may be off by several degrees. Humidity sensors are frequently nonfunctional or inaccurate by several percentage points and may simply need to be cleaned so that air-cooling systems and anticondensate heaters in refrigerated cases are not operating more than necessary. Also, interior lighting controls may not be utilized to best advantage. For example, retrocommissioning may reveal that improperly wired lighting circuits prevent shedding light by zone at store closing and when restocking shelves.

Refrigeration is a major component of food sales, and this equipment should be examined regularly to ensure proper operation. Sometimes retrocommissioning is initiated because problems, such as condensation on refrigerated display case doors, are observed. In that case, commissioning of refrigerated cases can be expanded to encompass the entire building in order to take advantage of the full spectrum of savings opportunities. After a full commissioning, detailed on-site inspection every one to three years to check control settings and the condition

of gaskets, hinges, and motors is usually cost-effective because a few adjustments and minor upgrades can quickly produce significant savings.

Leaks and improper control regimes are typically big opportunities for savings in refrigeration systems. Refrigerant leaks are not just an emissions problem: Incorrect refrigerant levels can compromise efficiency by 5 to 20 percent and raise the risk of early component failure. Although many grocery chains and independent store owners have invested in refrigeration systems equipped with electronic controls, unexpected savings frequently can be found because the controls are not implemented to save energy. When refrigeration systems are installed, controls may be set to operate continuously for worst-case conditions in order to minimize the need for operator attention or to compensate for maintenance-related problems. Portland Energy Conservation Inc. (PECI) in San Diego, California, has found that floating suction pressure control (FSPC) and floating head pressure control (FHPC) strategies can save an annual average of 30,000 to 60,000 kWh from FSPC and 75,000 to 150,000 kWh from FHPC in a typical Southern California grocery store. In cooler climates, even more savings can be achieved through FHPC. Controls to implement FSPC and FHPC may be added as a retrofit and set to adapt automatically to variable conditions.

Internal supermarket operations and maintenance staff may not have sufficient expertise and familiarity with all of the building's systems, and particularly the refrigeration systems, to conduct a commissioning study. Therefore, it is advisable to seek outside experts, who are often able to reveal maintenance and operational problems that are not obvious to customers, sales-floor staff, or custodial crews.

**Tune-up opportunities.** A number of easy measures can reduce energy use in various areas of a supermarket.

For refrigerated equipment and cold-storage areas:

- Maintain appropriate temperature settings. Energy is wasted if temperature settings in refrigerated systems drift too low. The most commonly used settings for freezers are between  $-14^{\circ}$  Fahrenheit (F) and  $-8^{\circ}$ F. For refrigerators, they are between  $35^{\circ}$ F and  $38^{\circ}$ F.
- Clean evaporator coils. The buildup of dirt and ice on evaporator coils slows down the rate of heat transfer and causes the refrigeration system to use more energy to maintain the same temperature.
- Reduce air leakage in refrigerated cases. Replace worn seals and gaskets on refrigerator and freezer doors, install automatic door closers, and use night covers on both vertical and horizontal display cases. Add strip curtains to walk-in doors.

In hot-food preparation areas:

- Minimize preheating energy use by following the manufacturer's recommendations for preheat time and temperature setting. Longer times and higher settings waste energy with no cooking benefit.
- Set cooking schedules to use cooking equipment at full capacity. Fully loaded equipment uses energy most efficiently. Unused and backup equipment can be turned off during low production periods.
- Reduce air leakage in ovens by making sure doors fit tightly and gaskets are in good condition.



In offices and back rooms:

- Make sure HVAC settings in peripheral rooms are at minimum settings during hours of low use.
- Turn off all office equipment and lights during nonbusiness hours. If the computer cannot be turned off, turn off the monitor and the printer.

**Training and documentation.** The benefits of retrocommissioning can be sustained through proper training of maintenance staff. A retrocommissioning contract should specify that maintenance staff will receive initial training and operating instructions. BetterBricks, an energy-efficiency program operated by the Northwest Energy Efficiency Alliance (NEEA), recommends that grocery store maintenance staff and regular equipment service contractors be present during initial retrocommissioning and any subsequent recommissioning, so that they can receive hands-on instruction in how to maintain proper settings (see sidebar). Operational instructions such as setpoints and schedules should be clearly posted for on-site staff and service contractors. Contracts with equipment service providers can require proficiency in controls management and specify that performance objectives include energy savings in addition to comfort and product safety. Settings on lighting, HVAC, and refrigeration systems should be rechecked every six months, either on-site or remotely through wireless control and monitoring systems. Manuals that document system warranties, instructions for operations, and lists of maintenance requirements should be kept on-site and by the regional manager of facilities.

Training for store managers can cover topics such as equipment warranties and maintenance, operational schedules and setpoints, equipment start-up and shutdown, emergency procedures, and an overview of air-quality and comfort issues. Sales-floor and custodial staff may also benefit from training that includes a discussion of the significance of energy costs and their

---

---

### **CASE STUDY: Lamb's Markets Combines Refrigeration Commissioning with Service Training**

Lamb's Markets treats recommissioning of its refrigerated cases as a training opportunity for its regular service contractors. The training is intended to ensure that the savings achieved during recommissioning are retained over the long term. Each store's regular refrigeration service contractor is present during recommissioning and is given the task of taking readings from monitoring equipment and implementing adjustments. This helps to ensure that optimized settings are not changed and controls are not overridden. For example, at Lamb's Palisades Market in Lake Oswego, Oregon, their regular mechanical services contractor spent a day with a BetterBricks refrigeration technical advisor to review and optimize the store's refrigeration systems. (Assistance from BetterBricks, an energy-efficiency program operated by the Northwest Energy Efficiency Alliance, is funded by local energy utilities.) First they reset the holdback valves that determine the lowest allowable refrigerant pressure in the condenser, taking care to maintain system reliability. Next they measured the refrigerant superheat as it exited the evaporator coils and made adjustments to improve the effectiveness of heat transfer in the coil, which reduces compressor run time. After performing those first steps, they were able to raise the suction pressure setpoint on circuits that were operating at lower pressure than necessary. Datalogging before and after the adjustments showed a 9 percent reduction in electric energy use at the main panel. Annual electrical savings in this 27,000-square-foot store exceed \$9,000, and the store director reports fewer unanticipated service calls.

---

---

relationship to equipment operation, an explanation of lighting schedules, and instructions on covering open refrigerated cases after hours. Such training could be repeated during the year if there were significant staff turnover. Instruction can be provided at meetings, in special training sessions, or in printed manuals and videos of training sessions. The NEEA has created videos specifically to train nontechnical supermarket staff in energy-efficiency procedures.

**Integration with facility planning.** For supermarket owners with multiple stores, the complete retrocommissioning of selected facilities as well as an assessment of the condition of remaining buildings can be used to develop a multiyear facility management plan. The retrocommissioning efforts could provide a model to follow for planning and prioritizing projects at similar stores while keeping the longer-term impact of those decisions in perspective. A typical facility-condition assessment includes reviewing the age and condition of building components and then estimating their remaining expected lifetime and replacement costs.

**Building management systems.** Centralized building management systems can help keep supermarket energy systems operating efficiently. Centrally managed chains typically use these systems (also known as energy management systems) in stores larger than 30,000 ft<sup>2</sup> to control refrigeration, space conditioning, and water-heating equipment. By sending data and alarms to a central office, these systems can be used to limit the ability of in-store staff to make changes in settings that would result in inefficient operation.

## Lighting

**Energy savings.** Lighting represents about 13 percent of the electricity consumption in a food sales establishment, not including its impact on cooling loads. Lighting retrofits can save 30 to 50 percent of lighting energy as well as 10 to 20 percent of cooling energy.

**Best practices.** Competition is pushing stores to create an inviting and exciting shopping experience, which is greatly enhanced by good lighting design. Products need sufficient illumination to attract the attention of shoppers, though care is needed to protect some products from being overheated.

A mixture of light sources inside a grocery store can create an attractive and comfortable environment that accentuates and visually enhances products, thereby driving up sales revenues. A blend of direct and indirect electric lighting can provide soft and uniform illumination. Diffused daylight is particularly attractive lighting for fresh produce and also creates a pleasant background for focused lighting on packaged products. Electric lighting should be coordinated with a daylighting scheme or adjusted in response to it.

The Illuminating Engineering Society of North America (IESNA) sets illumination standards by task. These standards focus on requisite lighting levels; therefore, they do not emphasize daylighting or other energy-saving opportunities. It is also of note that with a good daylighting design, the range of illumination levels can vary more widely than the levels recommended for electric-only scenarios, without negative repercussions.

**Daylighting.** For many years, grocery stores were designed to let in as little natural light as possible because of concerns that strong glare from sunlight would not only increase the interior cooling load and damage product but also interfere with bar-code scanners. However, properly diffused daylighting has been shown to avoid both of these negative results and offer many benefits. Rather than clear windows and skylights that introduce heat and glare into a supermarket, tints and glazes can be used to diffuse the natural light, creating a pleasant ambience. Combined with appropriate supplemental artificial light, daylighting can provide

optimal illumination and color rendering for product displays. Products and people tend to look better under warm natural light, which has a higher color temperature than the artificial lighting usually used in supermarkets. Grocery store interior designers are changing their attitude about daylighting primarily to improve product appearance and customer experience, so energy savings is a welcome bonus.

Daylight offers two measurable benefits over electric lighting in grocery stores. First, it can save energy by reducing the need for electric lights. Of course, in order to reap those savings, artificial lights must be removed or turned off in response to daylight levels. For example, the supermarket chain Stop & Shop/Giant Food uses energy-efficient T5 fluorescent lighting that dims in response to daylight as one of its energy-saving strategies.

Second, there is some evidence that natural daylight can improve retail sales. A study published in 2003 and sponsored by the California Energy Commission looked at sales in 73 stores belonging to one retailer, 24 of which had a significant amount of daylighting. The study showed that the average effect of daylighting was to increase sales by up to 6 percent. It also found that stores with more hours of useful daylight per year are associated with a greater daylight effect on sales. Researchers concluded that daylighting could boost sales wherever color is among the key selection criteria for products.

Daylighting can be implemented as a retrofit with skylights and light pipes, a relatively low-cost solution that delivers light from roof- or exterior wall-mounted collectors through reflective tubes. Skylight fixtures and light pipes with diffusers can be designed to look like fluorescent fixtures. They can be laid out in a grid, similar to fluorescent lighting, to distribute illumination evenly. Giant Eagle, winner of an ENERGY STAR sustained excellence award, uses skylights for daylighting in its facilities.

**Electric lighting.** Because electric lights remain on for extended periods of time, substantial savings can be found by making improvements to lighting systems. Many supermarket owners have already upgraded their lighting systems at least once. But auditors continue to find new and overlooked lighting opportunities in supermarkets, even in regions where attention to energy savings has skyrocketed along with energy prices in recent years.

For storewide ambient lighting, efficient linear fluorescent lighting, either T5 lamps or high-performance T8 lamps, can reduce energy consumption by 35 percent or more compared to T12 lighting (as discussed in Chapter 6). In high-bay areas and big-box stores with ceiling heights greater than 15 feet, high-performance T8 and high-output T5 lamps are the most efficient approaches. However, some grocery store owners prefer the look of semispherical metal halide fixtures. In those cases, ceramic metal halide fixtures with electronic ballasts are a good choice. They combine high efficiency with superior color quality.

Supermarkets can also save energy by reducing ambient lighting levels and using spotlighting to attract customers to product displays. Spotlighting can be done with energy-efficient compact fluorescent lights and spot reflectors to direct the light.

For parking and outdoor applications, high-intensity fluorescent (HIF) lighting is often a more efficient choice than high-intensity discharge (HID) lighting. HIF fixtures can provide more even illumination with fewer fixtures than HID lights. To maintain their light output, HIF lamps should be enclosed when used outdoors in cold climates.

Induction lamp technology is a good choice in areas where relamping and maintenance are difficult or hazardous, such as in high-ceiling stores, parking garages, and exterior pedestrian

---

---

## CASE STUDY: Stater Bros. Retrofits with Light Pipes

Concerned about rolling blackouts caused by California’s energy crisis in 2001, Stater Bros. retrofitted six stores with tubular skylights from Solatube to provide backup lighting. Recognizing the energy-saving benefits, the company later installed 164 Solatube light pipes in a new 43,000-square-foot supermarket in Chino Hills, California. During most daylight hours, this free lighting source replaces nearly all of the artificial lighting in the store. Integrated photosensitive controls modulate supplementary artificial lighting in zones throughout the store relative to natural light from the light pipes. This daylighting system is estimated to cut the store’s lighting energy costs in half.

---

---

lighting. These products typically have long lifetimes (up to 100,000 hours, compared to 24,000 hours for HID lights), which means infrequent relamping. Moreover, they offer good lumen maintenance, compact construction, and vibration resistance. Induction lamps can start at temperatures as low as  $-40^{\circ}\text{F}$  with no delay and operate at those temperatures without significant loss of lumens.

Light-emitting diodes (LEDs) are a good light source for several supermarket applications. In addition to the common exit-sign retrofit, LEDs are also an efficient alternative to neon lighting for grocery department signs.

LEDs additionally offer some advantages over fluorescent lamps for refrigerated-display-case lighting. The most important feature is that they perform very well in cold temperatures, unlike fluorescent lamps, for which light output drops appreciably with temperature. LEDs are directional in nature, allowing light to be directed just where it is needed inside the case. Also, with fluorescent lighting most of the waste heat is dissipated inside the case, whereas the heat sink for an LED can be moved outside the case entirely, resulting in reduced refrigeration energy needs. In addition, a study conducted by the Lighting Research Center at the Rensselaer Polytechnic Institute found that customers perceived LED illumination in freezers to be “brighter, more even, more appealing, and more comfortable” than fluorescent lighting, even when the LEDs operated at a lower average light level than the fluorescent bulbs. Wal-Mart has announced plans to use LED lighting in the refrigerated display cases of 500 stores. The LEDs will be integrated with occupancy sensors and will automatically dim when no customers are nearby.

A good option for accent lighting of perishable goods is remote-source lighting, in which a single high-efficiency light source feeds multiple remotely placed fixtures via fiber-optic cables. The systems can be costly, but the ability to keep infrared radiation away from produce while still illuminating the goods in an efficient, attractive manner is a big plus.

**Controls.** Occupancy sensors save energy but also help to reduce maintenance costs by lengthening the relamping interval. In storage rooms, break rooms, offices, and restrooms, ceiling-mounted ultrasonic occupancy sensors can be used to detect occupants, even around partitions and corners. Food Lion installed occupancy sensors in break rooms and storage rooms as one of its first energy-saving measures (see sidebar, page 11). For areas that use daylighting, automatic dimming controls can be used to ensure that minimum light levels are met while saving energy. A photocell control can instruct outdoor lighting to turn on and off based on light levels, or an astronomical clock can be used like a timer and set to adjust automatically to daylight saving time.

---

---

## CASE STUDY: Food Lion's Major Lighting Overhaul

Since 2000, through lighting, refrigeration, and HVAC retrofits and companywide energy management efforts, Food Lion has reduced its energy use by 27 percent. This total savings is equivalent to eliminating energy use entirely at 457 of its 1,200 stores. Lighting is a big part of this grocery chain's energy-saving efforts. Food Lion completed a major lighting overhaul in 2003, swapping T-12 with T-8 fixtures and lamps across the chain. Energy efficiency was just one goal of the relamping effort. The new lighting systems also improve the quality of light, work environment, and safety, according to a regional maintenance manager at the company. They have also helped the company achieve ENERGY STAR status for over 700 stores. As the chain progresses toward its goal of earning the ENERGY STAR for every store, lighting upgrades will include T-5 and LED systems.

---

---

### Load Reductions

**Energy savings.** Load reduction measures that reduce the operational time or intensity of HVAC equipment while still maintaining a comfortable shopping and work environment can offer substantial savings. Refrigeration is by far the largest load in a grocery store, representing an average of 43 percent of supermarket electricity usage. Significant energy savings can be gained not only from regular refrigeration tune-ups and maintenance but also through retrofits and cost-effective replacements of older refrigeration equipment.

In addition to refrigeration, load-reduction strategies should include cooking equipment, which represents 13 percent of natural gas purchased by grocery stores. Many store owners have added or are expanding food service, either under their own brand or through partnerships with in-store tenants. For these establishments, consider purchasing ENERGY STAR qualified cooking equipment, which uses 10 to 50 percent less energy than conventional models. Often this equipment not only offers significant return on investment because of these savings but also features longer operating lifetimes and lower maintenance requirements, with no negative impact on cooking performance.

**Best practices.** The quickest and easiest way to implement load reductions is to ensure that equipment is turned off when it is not needed. Sales, custodial, or other staff can be recruited to accomplish this effort. For example, lights can be turned on by zone as needed in the morning, beginning with the bakery and meat departments. Staff should be informed of the automated schedules for lighting and other systems so that they understand the purpose of those schedules and do not override them unless necessary. Food Lion has cut utility costs per store by over 5 percent through such operational measures, motivating maintenance staff to save energy with quarterly bonuses.

For stores with food service, simply reducing the operating time of kitchen appliances when they are not needed can cut cooking-related energy consumption by up to 60 percent. If turning equipment on and off during store hours is inconvenient, choose equipment that uses less energy when idle. For example, rapid-cook ovens (which combine microwave with other heating technologies) have a very low power draw when idle.

Some maintenance procedures are widely known but are not regularly followed. Cleaning frost off refrigeration evaporator coils should be a top priority in every store's maintenance routine. The regular maintenance schedule should also include cleaning HVAC condenser coils and replacing filters. It is very important to keep rotisserie ovens clean because poor maintenance can dramatically interfere with cooking speed as well as their appearance to customers.

Equipment placement is also important. Do not install air-cooled refrigeration equipment in areas with poor air movement, such as a tight corner. Ice-making and refrigerated vending machines require good air circulation; poor air circulation reduces their operating efficiency.

The way goods are placed in refrigerated display cases can also affect display-case loads. Avoid overloading shelves and blocking air flows. Tests have shown that the common nonuniform loading arrangements used in supermarkets, including some overfilled shelves, gaps in other shelves, and partial blockage of return air, have a big effect on the cooling effectiveness of cases. Also, for cases that use air curtains, products should be placed so that they do not interfere with the curtain operation.

**Efficient-equipment procurement.** Manufacturers of refrigeration and cooking equipment are increasingly aware of their customers' concern regarding lifetime operational costs, including those for energy and maintenance. They are responding to customer demand by producing much-higher-efficiency equipment than was standard just a few years ago. For example, the latest medium-temperature cases feature higher evaporator temperatures, more-efficient compressors, better fan motors, less-frequent defrost cycles, and more-efficient lighting. Many grocery chains are opting for medium-temperature cases with doors, ignoring outdated assumptions about customer preferences and recognizing that customers regularly use such cases in convenience stores. In fact, the owner of Vic's Market in Sacramento, California, has found that customers tend to linger in freezer aisles longer since he installed closed refrigeration cases, which keep the aisles more comfortable for shoppers. By maintaining detailed cost records of existing equipment, managers may find that frequent repairs to a display case, ice maker, or food warmer cost more than replacement with a more efficient model.

Supermarket owners are also assessing the cost of retrofits compared with equipment replacement in light of the Clean Air Act's upcoming ban on the production and import of the popular refrigerant HCFC-22 for newly manufactured equipment. The ban will take effect January 1, 2010. Now may be an opportune time to purchase more-efficient equipment while proactively complying with Clean Air Act regulations. Some supermarkets are shifting from central-rack refrigeration systems to distributed systems with multiple smaller compressors located near the displays. Distributed systems require less refrigerant, piping, and energy to pump coolant throughout the store. Not only do they operate more efficiently at lower condensing temperatures, but this switch also offers product-display flexibility and better use of floorspace.

A simple way to ensure that purchased equipment is energy efficient is to request that procurement staff specify ENERGY STAR qualified products in their contracts or purchase orders ([www.energystar.gov/purchasing](http://www.energystar.gov/purchasing)). Some ENERGY STAR qualified products that are relevant for grocery stores include

- Commercial solid-door, reach-in refrigerators and freezers
- Commercial fryers, steam cookers, and hot-food holding cabinets
- Commercial dishwashers
- Commercial ice makers
- Computers and monitors
- Vending machines
- Roof products

For example, replacing three conventional refrigerated-beverage vending machines with ENERGY STAR qualified models would mean annual operational savings of \$390 because they are 40 percent more energy efficient. (Savings will vary depending on electricity rate.) Purchasing an ENERGY STAR qualified commercial ice machine can save about 1160 kWh annually, or an average of \$100 per year on utility bills compared with conventional models. Each individual ENERGY STAR qualified commercial refrigerator can save \$140 per year and reach simple payback in just 1.3 years. Companies such as Albertsons and Winn-Dixie are specifying energy-efficient coolers and freezers for their stores, including models with no-heat anticondensation glass doors and high-vacuum cases that can operate at a higher temperature, reducing defrost time.

Product recommendations from the U.S. Department of Energy's Federal Energy Management Program may be appropriate for items not covered under the ENERGY STAR program. In addition, useful data on food preparation equipment performance are available from test laboratories such as the Food Service Technology Center (see sidebar, page 14).

**Retrofits.** Many retrofit options for refrigeration systems promise significant savings and quick payback and are relatively simple to install. For example, the latest antisweat heater controls sense humidity in the store's ambient air and reduce operation of antisweat heaters in low-humidity conditions. Electronically commutated motors use about one-third the energy of the typical evaporator-fan motors in walk-in coolers. This upgrade can pay off within one year, depending on electricity rates.

---

### **CASE STUDY: EnergySmart Grocer Program Helps Grocery Chain Cut Refrigeration Loads**

The EnergySmart Grocer Program managed by Portland Energy Conservation Inc. (PECI) provides grocers with energy audits and information about efficient technology, operations, and management options that help to identify energy-saving opportunities and the financial benefits of increasing efficiency in their stores. For example, the program has helped a regional grocery chain in the San Francisco Bay area save over 350,000 kilowatt-hours (kWh) and \$53,000 per year by installing energy-saving measures in three of its stores. In one 25,000-square-foot (ft<sup>2</sup>) store, a PECI EnergySmart Grocer field energy analyst inspected the facility and recommended two phases of retrofits, beginning with simple measures for immediate results followed by retrofits for longer-term savings. The first phase involved adding 196 linear feet of night covers to open display cases to reduce the cooling load during off hours, cutting annual electricity use by 2,000 kWh. Strip curtains installed in walk-in freezers produced more-significant savings, reducing energy use by over 30,000 kWh for a 91-ft<sup>2</sup> doorway. Also as part of the first phase of retrofits, installation of antisweat heater controls is saving another 30,000 kWh per year for 120 linear feet of refrigerated-display-case doors.

The second phase of retrofits involved replacing low-temperature open refrigerated cases with new high-efficiency reach-in units that feature electronically commutated motor (ECM) fans and T8 lamps with electronic ballasts, saving 60,000 kWh per year with 62.5 linear feet of replacement cases. The store also installed 36 ECMs in place of existing shaded-pole evaporator-fan motors, providing approximately 20,000 kWh of annual savings. Another 234 feet of night covers were added for additional savings of nearly 2,400 kWh per year.

---

Another retrofit option is a “smart” defrost controller kit that monitors several variables and optimizes the number of daily defrost cycles for walk-in freezers. Smart defrost controllers can save hundreds of dollars each year, depending on the size of the freezer. Working with a store’s regular refrigeration service contractor when installing such a system will help discourage technicians from disabling the controllers to avoid possible service calls.

For stores that serve prepared food, prerinse spray valves, which remove food waste from dishes prior to cleaning in a dishwasher, are easy to install and reduce water consumption, water heating energy, and sewer charges. Look for models with a flow rate of 1.6 gallons per minute or less. In hot-food preparation areas, intelligent variable-speed hood controller systems can also significantly reduce energy costs. A photoelectric smoke or heat detector determines when and how much ventilation is needed and activates the exhaust fan at the proper speed. This

---

---

## RESOURCES: Load Reductions

The following organizations offer resources that help owners and operators of supermarkets to assess how effectively they currently use energy and to investigate efficient alternatives.

### Food Marketing Institute

[www.fmi.org/sustainability/](http://www.fmi.org/sustainability/)

The Food Marketing Institute is a nonprofit association that conducts programs in research, education, industry relations, and public affairs on behalf of its members and their subsidiaries, which include food retailers and wholesalers and their customers in the United States and around the world.

### Food Service Technology Center

[www.fishnick.com](http://www.fishnick.com)

The Food Service Technology Center is a fuel-neutral scientific testing facility for benchmarking the energy performance of equipment used in commercial kitchens.

### Northwest Energy Efficiency Alliance, Grocery Market Program

[www.betterbricks.com/subHomePage.aspx?ID=2](http://www.betterbricks.com/subHomePage.aspx?ID=2)

This program focuses on the efficient design and construction of new stores and improving energy use in existing stores. Information, tools, and training and support are provided with the aim of changing business practices related to energy management.

### Portland Energy Conservation Inc.

[www.peci.org/overview\\_cxtech.html](http://www.peci.org/overview_cxtech.html)

This organization provides assistance to governmental agencies and energy providers in implementation of energy-savings initiatives. It also hosts the annual National Conference on Building Commissioning and maintains free online reference material on commissioning.

### U.S. Department of Energy, Federal Energy Management Program

[www1.eere.energy.gov/femp/procurement](http://www1.eere.energy.gov/femp/procurement)

The Federal Energy Management Program maintains a database of energy-efficient products that is complementary to ENERGY STAR’s list of qualified products, plus guidelines for equipment procurement.

---

---



technology can yield a one- to two-year simple payback. However, makeup air to the cooking area may need to be adjusted to compensate for variable operation of the vent hoods.

Most supermarkets are single-story buildings with large footprints, which means they have a high ratio of roof area to total facility square footage. This makes them good candidates for cool-roof solutions. If a supermarket building's roof needs recoating or painting, white or some other highly reflective color can minimize the amount of heat that the building absorbs. This change can reduce peak cooling demand and cooling energy use by 15 to 20 percent, depending on the climate zone in which the store is located.

## Air Distribution Systems

**Energy savings.** Although ventilation systems consume only about 4 percent of the electricity used in grocery stores, there are opportunities for cost-effective efficiency measures. Savings can be found by installing efficient fan motors and sizing the system to match the load (which may now be lower due to measures adopted in earlier stages). Even more savings are possible by using variable-speed drives.

**Best practices.** A ventilation system must be designed, operated, and maintained to provide adequate fresh-air intake and prevent mold growth from unwanted moisture accumulation. ASHRAE (American Society of Heating, Refrigerating, and Air-Conditioning Engineers) Standard 62.1, "Ventilation for Acceptable Indoor Air Quality," establishes minimum ventilation levels for several types of retail spaces.

Insufficient ventilation air is often due simply to clogged intake screens that are difficult to access for inspection and cleaning. To prevent this problem, ensure that all HVAC system air-supply diffusers, return registers, and outside-air intakes are clean and unobstructed. Replace filters regularly. These measures to improve ventilation rates should not raise energy consumption.

Insufficient ventilation air may also occur with scheduled ventilation and variable-air-volume systems or may be caused by wind, stack effects, or unbalanced supply and return fans. Installing an outdoor-air-measuring station that modulates the outdoor-air damper and return damper is relatively simple and ensures a sufficient fresh-air supply. Increasing ventilation to safe and comfortable levels will likely increase energy consumption and so should be combined with other energy-saving measures.

It is also possible to bring in too much outside air, which many facilities do during warm and humid periods. In warm months, it can be effective to reduce outside-air intake, especially when humidity is high. If a facility is overventilating, then decreasing ventilation levels can produce energy savings in both the distribution system and the cooling and heating system.

**Retrofits.** For humid climates and high-occupancy buildings, dedicated outdoor air systems (DOASs) improve humidity control and can produce energy savings. In retrofit applications, the DOAS airstream can be brought into the building's ductwork through a mixing box or through the existing HVAC system. Either way, desiccant systems used as part of the DOAS can relieve mechanical air-conditioning systems of the duty of dehumidifying outdoor air.

Heat-recovery ventilators and energy-recovery ventilators have balanced exhaust and supply fans that meet all ventilation needs without creating drafts and air-pressure imbalances. Heat-recovery ventilators can feature efficiencies as high as 85 to 95 percent, with payback in roughly three and a half years. Consider these units wherever air is continuously exhausted and makeup or ventilation air is required, as in a food preparation area.

Outside-air intake can be reduced during known low-occupancy periods, such as late-night restocking or as determined automatically by carbon dioxide sensors. Declining costs for implementing demand-controlled ventilation (DCV) have made it attractive for use in supermarkets, which typically have high-variable occupancy. DCV provides the greatest savings if a store's occupancy is highly variable, it is open for long hours, it is located in a moderate to extreme heating or cooling climate, and its existing HVAC system does not use 100 percent outdoor air. Annual energy savings can amount to as much as \$1 per square foot. Since DCV reduces the amount of outdoor air brought in, groceries with food service should take care to provide enough ventilation to remove any related fumes.

## Heating and Cooling Systems

**Energy savings.** Cooling systems consume approximately 14 percent of the electricity used by grocery stores in the U.S., and space heating represents nearly 75 percent of natural gas used by the food-sales sector. High-efficiency rooftop units can save a significant amount of energy, particularly for cooling, and can reach payback within two years, depending on cooling loads and electricity prices.

**Best practices.** Heating, cooling, and refrigeration systems often compete with each other in grocery stores. If infiltration of cold air from freezer aisles is controlled (such as with doors, night covers, and air curtains in display cases), less space heating is required throughout the store.

Humidity control is particularly important in grocery stores because humidity can cause refrigeration systems to develop frost buildup and condensation on display-case doors. Desiccant dehumidification and/or energy recovery systems can be efficient and effective strategies for handling large humidity loads.

**Retrofits.** Commercial packaged rooftop units are the most common cooling system used in food-sales facilities, followed by residential-type central air conditioners. If packaged equipment is in need of replacement, using high-efficiency instead of standard-efficiency units can provide attractive savings. This is also an excellent opportunity to capitalize on the myriad other measures taken to reduce loads and losses throughout the facility. Take advantage of savings from all other building improvements by right-sizing heating and cooling equipment to meet actual needs rather than relying on rule-of-thumb sizing estimates. Too often this equipment is oversized, which means the systems rarely operate at peak efficiency. Right-sizing offers first-cost savings as well.

Economizers can be added to many systems to provide free cooling during spring and fall or on cool summer nights when the humidity level is not too high. In humid areas, they should be used with differential enthalpy controllers. Economizers must be checked regularly to ensure that their dampers are functioning properly. Dampers that are stuck open could be letting in too much outside air, and ones that are stuck closed will not provide the benefit of free cooling.

Central energy management systems can generate savings by effectively and automatically controlling multiple rooftop units to establish appropriate temperature setpoints, turning off equipment at night, and tracking energy use. Multisystem building management systems are available to monitor and control not only HVAC but also refrigeration and lighting, all from a remote location. In a two-year period, Wild Oats cut energy usage by 4.4 million kWh of electricity, which translated into an annual cost savings of \$512,369, mainly due to reprogramming of settings and controls via building management systems.

Heat recovery systems can be added to refrigeration equipment to capture heat in the form of hot water. A 7.5-horsepower compressor can provide nearly 100 percent of the hot water

needed in a medium-sized grocery store. The hot water can be used for kitchen cleanup areas or bathroom sinks, or it can be run through a heat exchanger for space heating in cold weather. Hannaford Bros. Co. stores in the Northeast and PCC Natural Markets in the Northwest both use heat reclamation to displace fossil fuels for space and water heating.

## 11.4 Financial and Implementation Issues

Recognizing the challenges and opportunities of saving energy in grocery stores, many energy utilities and governmental programs target this sector with rebates, financing, and informational assistance to promote energy-saving retrofits and operational fixes. By taking advantage of subsidies from its energy provider and considering other indirect benefits such as reduced losses of perishable goods, Albertsons has significantly improved its estimated rate of return on energy-efficiency projects.

Conducting upgrades in supermarkets located in multiuse buildings and leased space likely will need special consideration. The ability to upgrade some or all of the building systems in a particular space will depend on lease agreements, whether spaces are served by their own HVAC or other equipment, whether spaces are submetered, and the building owner's willingness to participate in the process. One way to enable a retrocommissioning or equipment upgrade is to share costs and savings between the building owner and tenants. Hines, one of the largest real estate organizations in the world, uses this model to implement building upgrades so that affected tenants do not pay extra during the payback period and after that reap pure savings.

The ENERGY STAR Cash Flow Opportunity Calculator ([www.energystar.gov/index.cfm?c=tools\\_resources.bus\\_energy\\_management\\_tools\\_resources](http://www.energystar.gov/index.cfm?c=tools_resources.bus_energy_management_tools_resources)) can help grocery store owners calculate how much they can afford to invest in retrofits from the anticipated savings and whether it would make sense to borrow funds to finance building upgrades.

Supermarket owners can also consider third-party performance or shared-savings contracting, which provides a mechanism to fund energy-saving retrofits and to cover deferred maintenance and capital renewal projects at the same time. The combination of refrigeration and lighting retrofits with the addition of an advanced building management system can be an excellent retrofit bundle for a performance contract, partly because continuous performance monitoring can be built in. In addition, including ongoing maintenance in a performance contract can help to keep operating and maintenance costs under control and predictable. This is particularly relevant for grocery store owners that would normally outsource system maintenance, because performance objectives would be built into the contract. Having a long-term contract in place should also provide an impetus for long-term strategic planning of equipment upkeep and replacement.

## Bibliography

BetterBricks, "PCC Natural Markets," [www.betterbricks.com/DetailPage.aspx?ID=270](http://www.betterbricks.com/DetailPage.aspx?ID=270) (accessed December 2007).

Cofer, Steve (August 2007), Program Manager, Portland Energy Conservation Inc., 503-595-4472, [scofer@peci.org](mailto:scofer@peci.org).

Coia, Anthony, "Energy Smart," *Supermarket News* (June 30, 2003).

Criscione, Peter, and Ira Krepchin, “Long Live Electrodeless Lamps,” *E Source Report, ER-02-6* (May 2002).

“Desiccant Dehumidification,” U.S. Department of Energy, [www.eere.energy.gov/buildings/info/components/hvac/cooling/desiccant.html](http://www.eere.energy.gov/buildings/info/components/hvac/cooling/desiccant.html) (accessed July 2007).

Ellis, George, “Let the Sun Shine In,” *Supermarket News* (June 25, 2007).

EnergyIdeas Clearinghouse, “Grocery Store Energy Conservation,” [www.energyideas.org/default.cfm?o=h,g,ds&c=z,z,4447](http://www.energyideas.org/default.cfm?o=h,g,ds&c=z,z,4447) (accessed November 2007).

Fedrizzi, Rick, and Jim Rogers, “Energy Efficiency Opportunities: Big Box Retail and Supermarkets,” report prepared for The Center for Energy and Climate Solutions (May 2002), <http://files.harc.edu/Sites/GulfCoastCHP/MarketAssessments/EnergyEfficiencyOpportunitiesBigBox.pdf>.

Food Marketing Institute, “Supermarket Facts, Industry Overview 2006,” [www.fmi.org/facts\\_figs/superfact.htm](http://www.fmi.org/facts_figs/superfact.htm) (accessed August 2007).

Heschong Mahone Group, “Daylight and Retail Sales” (October 2003), report prepared for the California Energy Commission, [www.h-m-g.com/projects/daylighting/projects-PIER.htm](http://www.h-m-g.com/projects/daylighting/projects-PIER.htm).

Innovest Strategic Value Advisors, “Energy Management and Investor Returns: The Retail Merchandising Sector” (February 2003), [www.energystar.gov/ia/business/guidelines/assess\\_value/merch.pdf](http://www.energystar.gov/ia/business/guidelines/assess_value/merch.pdf).

Krepchin, Ira, and Stan Walerczyk, “New Capabilities for High-Bay Metal Halide Technology,” *E Source Technology Assessment Service, ER-05-3* (January 2005).

Levin, Diane, and Lawrence Paulsen, “Supermarket Controls and Commissioning: Uncovering Hidden Opportunities,” 2006 American Council for an Energy-Efficient Economy Summer Study on Energy Efficiency in Buildings.

Litwak, David, “Bringing It All Together: Manufacturers Are Tying in Many Small Improvements to Generate Greater Energy Efficiency in Their Medium-Temperature Cases,” *Grocery Headquarters*, vol. 72, no. 2 (February 1, 2006), pp. 101–104.

Litwak, David, “Power Stretch: Reducing Stores’ Energy Consumption Has Become a Top Priority for Virtually Every Supermarket Operator,” *Grocery Headquarters*, vol. 72, no. 9 (September 1, 2006), pp. 109–112.

Pacific Power, “Albertsons,” Energy FinAnswer Case Study (February 2007), from [www.pacificpower.net/File/File72005.pdf](http://www.pacificpower.net/File/File72005.pdf) (accessed December 2007).

Romico, Michael, “Cool Running,” *Foodservice Equipment Reports*, vol. 11, no. 7 (July 2007), p. 53.

Sherer, Mike, “Figuring the Value of Equipment,” *Foodservice Equipment Reports*, vol. 11, no. 7 (July 2007), pp. 31–32.

Southern California Edison, “Supermarket Display Case Shields,” [www.sce.com/RebatesandSavings/LargeBusiness/Commercial/SupermarketDisplayCaseSheilds](http://www.sce.com/RebatesandSavings/LargeBusiness/Commercial/SupermarketDisplayCaseSheilds) (accessed November 2007).

Southern California Edison, “Testing Evaluates the Performance of a Refrigerated Display Case,” [www.sce.com/RebatesandSavings/LargeBusiness/Commercial/RefrigeratedDisplayCase](http://www.sce.com/RebatesandSavings/LargeBusiness/Commercial/RefrigeratedDisplayCase) (accessed November 2007).

Squazzo, Jessica, “Saving Energy, Cutting Costs,” *Grocery Headquarters* (August 2004).

U.S. Department of Energy (DOE), Energy Information Administration (EIA), Commercial Building Energy Consumption Survey (CBECS), “End-Use Consumption by Principal Building Activity” (1999 data; published 2003), [www.eia.doe.gov/emeu/cbeecs/enduse\\_consumption/pba.html](http://www.eia.doe.gov/emeu/cbeecs/enduse_consumption/pba.html).

U.S. DOE, EIA, “2003 Commercial Building Energy Consumption Survey (CBECS), Public Use Microdata Files” (published 2006).

U.S. Environmental Protection Agency, ENERGY STAR, “Food Lion, LLC, Partners in Practice,” case study, [www.energystar.gov](http://www.energystar.gov) (accessed August 2007).

Warila, Paul (August 2007), Project Manager, Northwest Energy Efficiency Alliance, 503-827-8416, [pwarila@nwalliance.org](mailto:pwarila@nwalliance.org).

Zimmerman, Kim Ann, “Putting a Chill on the Energy Bill,” *Grocery Headquarters* (August 2007).



LEARN MORE AT  
[energystar.gov](http://energystar.gov)

ENERGY STAR® is a U.S. Environmental Protection Agency program helping businesses and individuals fight global warming through superior energy efficiency.

## Chapter 12

# Facility Type: Hotels and Motels





# 12. Facility Type: Hotels and Motels

Revised December 2007

<b>12.1 Challenges and Opportunities</b>	<b>2</b>
<b>12.2 Energy-Use Profile</b>	<b>3</b>
<b>12.3 Technical Recommendations</b>	<b>4</b>
Retrocommissioning	5
Lighting	8
Load Reduction	11
Air Distribution Systems	13
Heating and Cooling Systems	15
<b>12.4 Financial and Implementation Issues</b>	<b>16</b>
<b>Bibliography</b>	<b>17</b>
<b>Glossary</b>	<b>G-1</b>

## 12.1 Challenges and Opportunities

The United States' 47,000 hotels and motels spend an average of \$2,196 per available room each year on energy, an amount that represents about 6 percent of all hotel operating costs. The varied nature of the physical facilities and the activities that they host can make energy management especially challenging, whether the facility is a large convention hotel, part of a large national chain, or a small inn or motel. However, the opportunities for improved guest comfort, longer equipment life, lower operating costs, and an improved corporate image make pursuing energy efficiency worthwhile. ENERGY STAR partners in the lodging industry have greatly reduced their expenditures on energy through measures such as lighting upgrades in guest rooms, lobbies, and hallways; occupancy-based guest-room energy controls; and the installation of energy-efficient water heating equipment, while still providing benefits for hotel guests, owners, operators, and shareholders.

Hotels and motels operate 24 hours a day, hosting guests and offering various services and amenities. Guest rooms, public lobbies, banquet facilities and restaurants, lounges, offices, retail outlets, and swimming pools fill the building or multiple buildings. Ice machines, vending machines, and game rooms may be scattered throughout. Laundries and kitchens are typically located on-site. The variety of services and amenities provided and the need to operate around the clock mean that lodging facilities present abundant opportunities for energy savings.

Building upgrades are especially demanding in hotels because there is never any downtime. Measures that are effective in other settings, such as occupancy sensing, time-clock control, and thermostat setbacks, must be implemented with great care in a hotel or motel so as not to detract from the experience of guests.

Nevertheless, the impact of rising energy costs (hotel utility costs increased an average of 12 percent each year from 2004 to 2006) and growing concerns about global warming are leading hotel operators to take action. Dozens of hotel operators are participating in the U.S. Environmental Protection Agency's (EPA's) ENERGY STAR buildings program. For example, Accor North America, one of the largest hotel chain owners and operators in North America, was recently recognized as an ENERGY STAR Leader by the EPA for achieving top energy performance, as signified by an average ENERGY STAR rating of 75 across its Red Roof Inn, Studio 6, and Motel 6 properties. Among the measures implemented by the participating hotels were the replacement of neon signs with light-emitting diode units, the swapping of compact fluorescent lamps for incandescent lamps, the installation of high-efficiency air-conditioning units, and the addition of attic insulation in older facilities. By introducing the energy performance rating to its portfolio, Accor is now better able to understand how its 900 properties stack up against each other and other similar hotels nationwide.

Hotels and motels throughout the U.S. are also recognizing that many of their guests are becoming more environmentally conscious and will support the hotels' efforts to cut energy use. For example, many hotels now offer guests the option of not having their sheets and towels laundered every night. Many hotels are also taking a proactive approach, realizing that a stay at an energy-efficient hotel can teach guests the principles of green and sustainable design from their lodging experience.

Keeping in mind the continual maintenance or improvement of guest comfort and satisfaction, which is the primary consideration in any hotel building project, the following items should be factored into energy-efficient upgrades:



- Thermal comfort has a big impact on guest satisfaction, and because individuals have different preferences, a responsive, controllable HVAC system is important.
- A sense of safety and security is important to the guest experience. Proper exterior lighting and adequate but not excessive lighting in hallways and stairways can enhance security. Efficient light sources, timers, and occupancy controls can make an efficient environment a secure one as well.
- Indoor air quality also affects the guest experience. Clean air free of mold, cleaning compounds, and smoke is not only healthier, it is more pleasant.
- The indoor acoustic environment should also be considered. Sounds from outside the building, interior hallways, and building equipment such as fans, boilers, and compressors can disrupt guests' sleep.

## 12.2 Energy Use Profile

Consider a hotel or motel's largest energy loads when planning a retrofit strategy. Typically, nearly 75 percent of a hotel's or motel's total energy use can be attributed to space heating, water heating, lighting, and cooling combined (see **Figure 12.1**). Cooling and lighting alone make up half of the building's electricity consumption.

Energy intensity in hotels and motels varies widely and is affected by climate, number of rooms, and types of on-site amenities. Energy intensity in hotels and motels can range from less than 15,000 Btu per square foot (ft<sup>2</sup>) to over 300,000 Btu/ft<sup>2</sup> (**Figure 12.2**, page 4). Given this wide range and skewed distribution, it can be misleading to assess a hotel or motel facility's performance by looking at its average energy intensity alone.

**Figure 12.1: Electric and natural gas end-use profile for hotels and motels**

Most of the electricity consumed by hotels and motels is used for space cooling and lighting. Typically, space heating represents the largest use of natural gas in hotels and motels. However, each facility's energy profile is different, so these charts are not representative of all lodging facilities. Hotel and motel energy use will also vary depending on the types of amenities available.

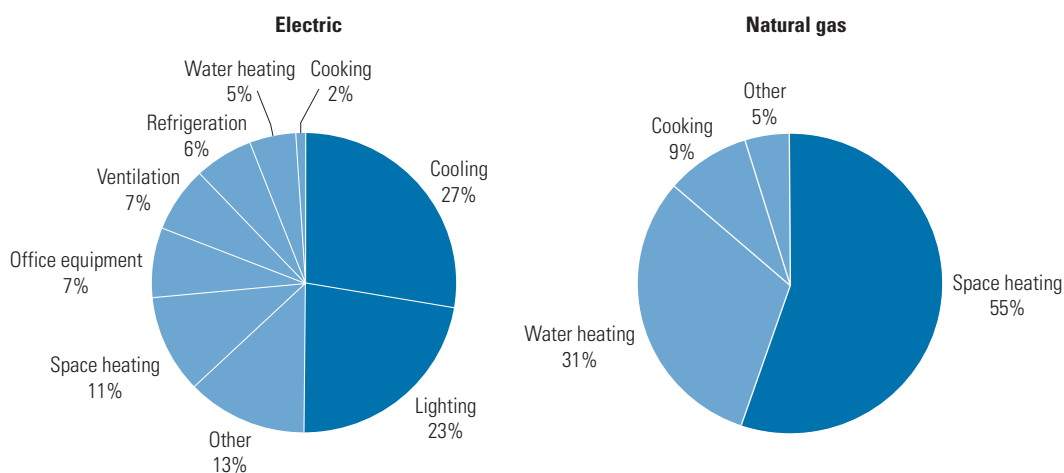

Courtesy: E SOURCE; from Commercial Building Energy Consumption Survey, 1999 data

**Figure 12.2: Distribution of energy intensity in hotels and motels**

The median hotel or motel uses approximately 70,000 Btu per square foot (ft<sup>2</sup>) from all energy sources. However, many lodging facilities are significantly more energy-intensive than that.

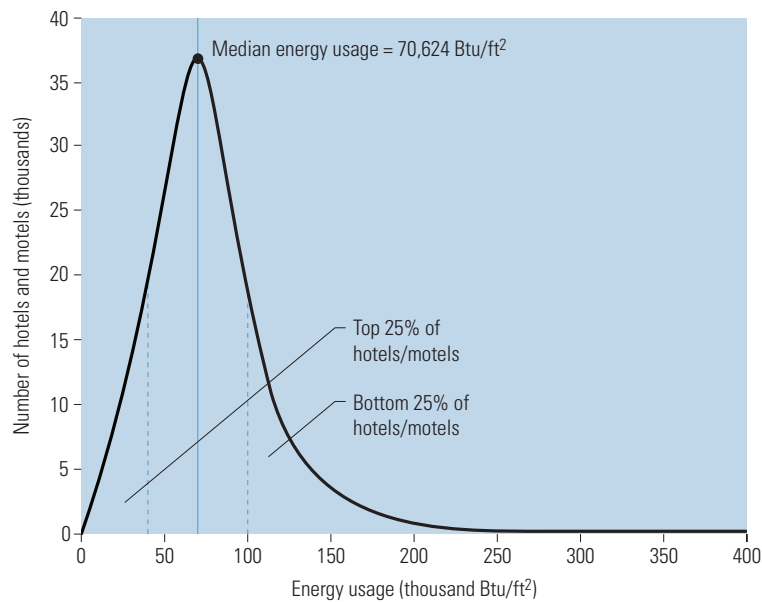

Courtesy: E SOURCE; from Commercial Building Energy Consumption Survey, 2003 data

The EPA's national energy performance rating system is designed to provide a meaningful benchmark for hotels and motels. The rating system is accessible online as part of the EPA's free Portfolio Manager tool ([www.energystar.gov/benchmark](http://www.energystar.gov/benchmark)). It evaluates a hotel's or motel's energy intensity, normalizing for weather and operating characteristics. The rating is expressed on a scale of 1 to 100, signifying the percentile of performance. Hotels or motels that achieve a rating of 75 or higher are performing in the top quartile and may be eligible to earn the ENERGY STAR label. The rating serves as a standard of comparison against other hotels and motels, and it provides a way to measure progress after upgrades are implemented.

All upgrade projects should begin by establishing a benchmark rating. The relative ENERGY STAR performance ratings can help an organization to identify its best- and worst-performing facilities. Although any hotel or motel may benefit from retrocommissioning, operation improvements, and retrofits, it is usually most cost-effective to begin upgrade efforts with low-scoring facilities.

For more information, visit ENERGY STAR for Hospitality at [www.energystar.gov/hospitality](http://www.energystar.gov/hospitality). For descriptions of hotels that have earned the ENERGY STAR, visit [www.energystar.gov/index.cfm?fuseaction=PARTNER\\_LIST.showPartnerResults&partner\\_type\\_id=CIO&s\\_code=ALL](http://www.energystar.gov/index.cfm?fuseaction=PARTNER_LIST.showPartnerResults&partner_type_id=CIO&s_code=ALL).

### 12.3 Technical Recommendations

In the highly competitive lodging industry, room rates cannot be raised easily, so reducing costs can be a significant means of increasing margins and profits. After labor costs, energy expenses represent the greatest portion of the annual operating budget for hotels and motels. With energy costs rising, it makes sense to invest in building upgrades that can help keep these

costs down. The EPA estimates that each 10 percent reduction in energy use is equivalent to improving average room rate by \$1.35 in full-service hotels (\$0.62 for limited-service hotels).

Common reasons for initiating energy-related upgrades in hotels and motels include:

- Customer complaints
- Corporate sustainability policies
- Frequent equipment malfunctions and shortened equipment lifetime due to years of deferred maintenance
- Piecemeal additions to buildings and internal changes to existing spaces that have not been accompanied by corresponding changes to heating and cooling systems
- Previous attempts to reduce energy use by inappropriate measures, such as covering vents
- Major pieces of capital equipment or building elements, such as a boiler or a roof, that are nearing the end of their useful life

Following the staged approach that is advocated throughout this manual can reveal opportunities for saving on capital costs by “right-sizing” major equipment. After lighting and load reduction measures have been implemented, it may be possible to specify smaller heating and cooling equipment.

Many of the recommendations provided here offer not only energy savings but also maintenance savings. Please note that this should not be considered an exhaustive list of measures appropriate for hotels and motels. Operators and owners are encouraged to refer to the full guidelines presented throughout this manual when planning and managing a retrofit program.

## Retrocommissioning

**Energy savings and other benefits.** Commissioning is a process during which engineers observe a building and perform a “tune-up” to ensure that its systems are operating efficiently and as intended. Commissioning typically takes place when a facility is first built; however, if a building has never been commissioned, then it is ripe for retrocommissioning, which entails a similar tune-up on an existing building. All buildings stand to benefit from regular recommissioning, which can then take place periodically throughout a building’s life. Studies have shown that commissioning can save a typical 100,000-ft<sup>2</sup> hotel 10 to 15 percent of its energy costs, or roughly \$20,000 per year. Savings typically result from resetting existing controls to reduce HVAC waste while maintaining or even increasing comfort levels for occupants.

In addition to saving energy, retrocommissioning can help hotels and motels reduce equipment downtime and keep maintenance expenditures in check. Another reason to retrocommission and regularly recommission lodging facilities is to create a body of documentation demonstrating that building systems are operating properly. Retrocommissioning is also an important tool for ensuring that a hotel’s indoor air quality standards are met. Safety is another consideration if the fire alarm and smoke-detection systems are integrated with other building systems. Problems with low-voltage electrical systems such as lighting, alarm, and building-management systems are frequently identified during retrocommissioning.

**Best practices.** Some hotel owners are implementing guidelines and establishing standard contractual requirements to ensure that retrocommissioning and recommissioning are done properly and in a timely fashion. If hotel staff has sufficient expertise and familiarity with a building’s systems, they may do these tune-ups, but otherwise, it may be advisable to outsource at least some of the work.

After initial commissioning or retrocommissioning, a hotel should be recommissioned every three to five years to maintain optimal performance. The precise timing will vary depending on the timing of changes in the facility's use, the quality and schedule of preventive maintenance activities, and the frequency of operational problems. Commissioning should also be performed after major remodels or additions.

Even if a hotel or motel was commissioned when it was first built, the building's use patterns may have changed over time, settings may have been altered, and equipment may no longer be functioning the way it should. If a facility appears to be using more energy than expected when compared with past performance or with other similar lodging facilities, recommissioning or retrocommissioning is a great place to start looking for energy-saving opportunities. Other signs that it is time for retrocommissioning include inadequate ventilation or a high volume of comfort-related calls from guests.

**Tune-up opportunities.** There are a number of easy measures that can reduce energy use in various areas of the hotel:

- *Peripheral and back rooms.* Make sure that HVAC settings in lobbies, offices, and other such peripheral rooms are at minimum settings during hours of low use.
- *Laundry.* Set laundry hot water to 120° Fahrenheit. This is a good temperature for all hot water uses outside of the kitchen, where codes are specific about water temperature.
- *Pools and hot tubs.* Make sure that all pools and hot tubs are covered after hours to diminish heat loss.
- *Housekeeping procedures.* Encourage housekeepers to turn off all lights and set temperatures to minimum levels after cleaning each room. Closing drapes when a room is unoccupied will reduce heat gain in the summer and heat loss in the winter.
- *Front desk.* Teach registration staff that they can help save energy costs by booking rooms in clusters, so that only occupied building areas or wings need to be heated or cooled to guest comfort levels. Rooms on top floors, at building corners, and facing west (in summer) or north (in winter) can be the most energy-intensive to heat or cool; therefore, consider renting them last.

---

### CASE STUDY: Retrocommissioning a Marriott

---

The Los Angeles Airport Marriott, a 1,000-room facility, conducted a retrocommissioning program at a cost of about 22 cents per square foot, or roughly \$125 per room. The project was conducted by a team of the company's own staff, including engineers and the regional vice president of engineering, with assistance as needed from an outside consultant. The project developed in-house expertise that will help maintain long-term benefits, which is a result that might not have been achieved if outside consultants had worked independently on the project. The project team developed 17 recommended measures for the hotel's air-handling units, chilled water plant, and other back-of-the-house systems. The average implementation cost for each of the 17 steps was slightly more than \$7,500, and the average payback period was less than one year. The hotel saved \$153,000 annually, and 30 percent of those savings came from a single adjustment to airflow from one air-handling unit.

---

**Training and documentation.** The benefits of retrocommissioning can be sustained through proper training of hotel maintenance staff. A retrocommissioning contract should always specify that maintenance staff will receive initial training and manuals. Multiple copies of manuals that document system warranties, instructions for operations, and maintenance requirements should be kept on-site and at corporate headquarters.

Training can cover topics such as equipment warranties and maintenance, operational schedules and setpoints, start-up and shutdown, emergency procedures, and an overview of air quality and comfort issues. Instruction can be provided at meetings, in special training sessions, or in printed manuals and videos of training sessions.

**Integration with facility planning.** Hotel owners who establish multiyear maintenance plans are more likely to fund maintenance needs continuously. A multiyear plan can be used for prioritizing projects (depending on the funding available) while keeping the longer-term impact of those decisions in perspective. This type of plan can be structured around the results of a complete retrocommissioning of select facilities as well as an assessment of the condition of all hotels in the chain. A typical facility condition assessment includes reviewing the age and condition of building components and then estimating their remaining expected lifetime and replacement costs. A number of resources are available to help hotels and motels assess their current operations and begin their investigation of energy-saving alternatives (see sidebar).

---

---

## RESOURCES: Retrocommissioning

The following resources are available to help hotel and motel owners and managers assess how effectively they use energy and to help them investigate efficient alternatives:

### American Hotel & Lodging Association

[www.ahla.com](http://www.ahla.com)

The American Hotel & Lodging Association (AH&LA) provides information on governmental and regulatory affairs, industry suppliers, media and public relations, and industry profile information. It has partnered with ENERGY STAR to launch an educational program called Good Earthkeeping, which helps hoteliers improve the energy and financial performance of their properties and demonstrate the environmental leadership of the hospitality industry.

### ENERGY STAR Hospitality Benchmarking Starter Kit

[www.energystar.gov/index.cfm?c=hospitality.bus\\_hospitality\\_bm\\_starter\\_kit](http://www.energystar.gov/index.cfm?c=hospitality.bus_hospitality_bm_starter_kit)

Hotels can assess energy performance with Portfolio Manager. This kit is intended to help users get started benchmarking, take the next steps, and assist in data collection.

### Green Globe

[www.ec3global.com/products-programs/green-globe/](http://www.ec3global.com/products-programs/green-globe/)

Green Globe is a worldwide certification program for sustainable travel and tourism.

### “Green” Hotels Association

[www.greenhotels.com](http://www.greenhotels.com)

The “Green” Hotels Association is committed to encouraging, promoting, and supporting ecological consciousness in the hospitality industry.

*continued on page 8*

*continued from page 7*

### Green Restaurant Association

[www.dinegreen.com](http://www.dinegreen.com)

The Green Restaurant Association, a national nonprofit organization, provides services in research, consulting, education, marketing, and community organizing on energy-related issues to hotel and motel operators and owners.

### Green Seal

[www.greenseal.org](http://www.greenseal.org)

Green Seal is dedicated to protecting the environment by promoting the purchase and use of environmentally responsible consumer products. It sets environmental standards and awards a “Green Seal of Approval” to products that cause less harm to the environment than other similar products.

### International Association of Assembly Managers Inc.

[www.iaam.org](http://www.iaam.org)

The International Association of Assembly Managers is made up of members who manage or provide products and services to convention centers.

### International Council on Hotel, Restaurant, and Institutional Education

<http://chrie.org/i4a/pages/index.cfm?pageid=1>

The International Council on Hotel, Restaurant, and Institutional Education was founded as a nonprofit association for schools, colleges, and universities that offer programs in hotel and restaurant management, food-service management, and culinary arts.

### Portland Energy Conservation Inc.

[www.peci.org](http://www.peci.org)

Portland Energy Conservation Inc. provides commissioning guidelines and services and promotes energy-efficient practices and technologies for businesses and individual consumers.

---

---

## Lighting

**Energy savings.** Lighting represents almost a quarter of all electricity consumed in a typical hotel, not including its effect on cooling loads. Lighting retrofits can reduce lighting electricity use by 50 percent or more, depending on the starting point, and cut cooling energy requirements by 10 to 20 percent as well.

**Best practices.** Illumination requirements vary throughout a hotel or motel, depending on the type of space. **Table 12.1** (page 9) describes some of the recommendations of the Illuminating Engineering Society of North America. Outdoor nighttime light levels may depend on local ordinances, but can generally be fairly low, depending on the level of activity and the potential hazards.

**Daylighting.** Natural daylight has been shown to improve a hotel’s indoor environment while reducing energy use and peak demand. Whenever possible, any lighting renovation should start by using daylighting as much as possible and reducing electric lighting accordingly. Good daylighting design will not introduce excessive heat gain, heat loss, glare, or uneven illumination. Midscale and upscale hotels can use daylighting controls in lobbies to improve lighting quality while reducing energy costs. For example, at the Mandarin Oriental

in New York, dimmers and daylight-harvesting sensors adjust the interior lighting levels in the restaurant, bar, and hotel suites in response to the intensity of natural light.

Daylighting is also an excellent strategy for other hotel areas. For example, at the Gaia Napa Valley Hotel in California, designers sought to maximize visual comfort while minimizing the use of electric lighting. In a corridor area they used a continuous clerestory (an upper portion of a wall containing windows for supplying natural light to a building) that wraps around all four wings of the hotel. Tubular skylights illuminate the lobby, hallways, and guest rooms. Trellises covered with vines shade the clerestory to protect corridors and rooms from excess solar radiation. The guest rooms feature windows of high-performance glass to reduce the contrast between outside and inside.

**Electric lighting.** A mixture of light sources can create a pleasing and comfortable environment that is suitable for a variety of tasks. Electric lighting should be coordinated with a daylighting scheme or adjusted in response to it. A blend of direct and indirect electric lighting can provide soft and uniform illumination.

In back-room areas such as kitchens and office space, incandescent and T12 fluorescent lamps can be replaced with compact fluorescent lamps (CFLs) or high-performance T8 lamps and electronic ballasts, a combination that can reduce lighting energy consumption by 35 percent. Adding specular reflectors, new lenses, and occupancy sensors or timers to a T8 fluorescent lighting system can double the savings. Paybacks of one to three years are common.

In guest rooms, CFLs are becoming the standard for table, floor, and reading lamps, and in recessed and vanity lighting in the bathroom. CFLs reduce energy use by two-thirds and yield savings of up to \$20 per lamp per year. When the Doubletree Hotel in Sacramento, California, replaced its 60-watt incandescent desk lamps in guestrooms with new CFL lamps, it not only saved money but also enhanced its guests' experience: Regular customers welcomed the

**Table 12.1: Illumination recommendations for hotels**

Light levels for hotels and motels depend on the type of space under consideration and the activities being performed in it. The values below come from the recommendations of the Illuminating Engineering Society of North America (IESNA). In addition to light levels, it is also important to consider lighting quality factors such as color appearance, luminances of room surfaces, glare, and shadows.

Space type	Illuminance level (foot-candles)
<b>Guest rooms</b>	
General lighting	10
Bathrooms	30
Desks	30
<b>Corridors, stairs</b>	
General lighting	5
<b>Front desk</b>	
General lighting	50
<b>Lobby</b>	
General lighting	10
Reading and work areas	30

Courtesy: E SOURCE; data from *IESNA Lighting Handbook*

change, and complaints about inadequate desk lighting declined. Moreover, guests are using the brighter, more-efficient desk lamps in lieu of other lamps in their rooms, compounding the Doubletree's energy savings. These changes also resulted in labor savings because CFLs last longer than incandescent lamps, saving relamping time.

Many hotel public areas, including corridors and hallways, can use CFLs in wall sconces and in recessed downlights. A Michigan Marriott replaced its public-space incandescent lamps with CFLs and saved more than \$40,000 in energy and maintenance costs. The historic Willard InterContinental in Washington, D.C., installed CFLs in common areas and guest rooms. The investment resulted in fewer complaints about lighting quality, and a six-month payback based on energy savings.

A number of hotel chains have implemented widespread CFL campaigns. One of the measures that helped Marriott International win the ENERGY STAR Sustained Excellence designation in 2007 was the installation of 450,000 CFLs. HG (InterContinental Hotels Group) announced that the Hotel Management Group, the company's American-operations division, will launch a new environmental initiative to replace more than 250,000 incandescent light bulbs with new energy-efficient CFLs in guest rooms at over 200 company-managed hotels across the Americas.

For parking lots and outdoor applications, high-intensity fluorescent (HIF) lighting is often the best choice rather than metal halide, mercury vapor, or high-pressure sodium lights. HIF lamps should be enclosed when used outdoors in cold climates. In parking garages, which often use inefficient high-intensity discharge fixtures, high-efficacy fluorescent fixtures can provide more even illumination with fewer fixtures.

In restaurants and lounges, LEDs (light-emitting diodes) are frequently used to create specialized lighting effects. Another measure that helped Marriott International achieve the award noted above was the conversion of all outdoor signage to LED and fiber-optic lighting. LEDs can also provide an accent to exterior arch elements and facades and can serve as nightlights in guest rooms. LEDs now illuminate the exterior of the Hard Rock Hotel & Casino in Las Vegas, providing more flexibility in creating lighting effects and cutting energy bills by \$41,000 compared to the previous metal halide fixtures. Using LED exit signs is also a proven energy- and labor-saving measure that can pay for itself in one year.

**Controls.** For hotels, lighting controls typically consist of occupancy sensors and scheduling systems. Occupancy sensors save energy and also help to reduce maintenance costs by lengthening the relamping interval. Turning fluorescents off for 12 hours each day can extend their expected calendar life by 75 percent, to nearly seven years. In large restrooms, ceiling-mounted ultrasonic occupancy sensors detect occupants around partitions and corners. For hallways, a recommended strategy is to use a combination of scheduled lighting and dimming plus occupancy-sensor controls after hours. Guests may not like a totally darkened hallway, but dimming lights in unoccupied hallways and stairwells and then turning them up to full brightness when someone enters is a sensible approach. Occupancy sensors are also appropriate for meeting rooms and back rooms.

Some modifications to controls can actually increase guest comfort. Saunders Hotels' Comfort Inn & Suites Boston/Airport has reduced the amount of overnight lighting used in the guest hallways by half. The results are not only energy savings but also the unforeseen benefit of fewer noise complaints from other guests. As guests step off of the elevators late at night, with the reduced lighting levels, they seem to instinctively understand that it is "after hours" and are quieter, therefore disturbing other guests much less frequently.



## Load Reduction

**Energy savings.** Load-reduction measures that reduce the operational time or intensity of hotel HVAC equipment while still maintaining a comfortable work environment can offer substantial savings. Plug loads from equipment such as computers and copiers represent about 7 percent of electricity used in hotels and motels. In addition, cooking accounts for about 9 percent of natural gas; water heating uses 5 percent of electricity and 31 percent of natural gas. Equipment purchases and operational measures for these uses can be very cost-effective. When purchasing these types of items, look for products that are labeled as “ENERGY STAR qualified” ([www.energystar.gov/purchasing](http://www.energystar.gov/purchasing))—they will use 25 to 50 percent less energy than conventional models without compromising quality or performance. Not only do they offer significant return on investment because of these savings, many also feature longer operating lifetimes and lower maintenance requirements.

**Best practices.** The quickest and easiest way to implement load reductions in a hotel or motel is to ensure that equipment is turned off when it is not needed. This can be accomplished by encouraging housekeepers to turn off all lights and set temperatures to minimum levels after cleaning each room.

For hotel office spaces, a computer monitor can use two-thirds of the total energy of a desktop system, so it is important to power down monitors whenever they are not in use. The ENERGY STAR Power Management program provides free software that can automatically place active monitors and computers into a low-power sleep mode through a local area network ([www.energystar.gov/index.cfm?c=power\\_mgt.pr\\_power\\_management](http://www.energystar.gov/index.cfm?c=power_mgt.pr_power_management)). Whole-computer power management can save \$15 to \$45 annually per desktop computer; managing only monitors can save \$10 to \$30 per monitor annually.

For hotel pools, simply using a cover on a heated pool can save 50 to 70 percent of the pool’s energy use, 30 to 50 percent of its makeup water, and 35 to 60 percent of its chemicals.

In the kitchen, food preparation equipment should not be turned on for preheating more than 15 minutes before it is needed; simply reducing the operating time of kitchen appliances can cut cooking-related energy consumption by up to 60 percent. Hot water waste should be reduced in kitchens, bathrooms, and fitness rooms; some measures to consider include automatic faucet shutoff, single-temperature fittings, and low-flow showerheads with pause control.

Equipment placement is also important. Do not install air-cooled refrigeration equipment in areas with poor air movement. For example, ice makers and cooled vending machines are often placed in rooms with little or no air for cooling, which reduces the operating efficiency of the units.

**Efficient equipment procurement.** A simple way to ensure that purchased equipment is energy efficient is for the corporate office to request that hotel purchasing departments or franchisees specify products that are ENERGY STAR qualified in their contracts or purchase orders. Additionally, the product recommendations for federal government procurement officials from the U.S. Department of Energy’s Federal Energy Management Program ([www.eere.energy.gov/femp/procurement](http://www.eere.energy.gov/femp/procurement)) may be appropriate for items not covered under the ENERGY STAR program. ENERGY STAR qualified products that are relevant for hotels and motels include:

- Commercial refrigerators and freezers
- Commercial fryers

- Commercial steam cookers
- Televisions, DVD players, and audio equipment
- Computers and monitors
- Printers, fax machines, mailing machines, and scanners
- Copiers
- Vending machines
- Roof products

In its energy-efficiency efforts, the Saunders Hotel Group purchased ENERGY STAR–qualified products such as refrigerators, clock radios, and televisions for guest rooms and computers and fax machines for offices. These purchases helped Saunders, which was an ENERGY STAR Partner of the Year in 2005, reduce energy use by 11 percent, even after a decade of other energy-savings successes.

In hotel kitchen areas, intelligent, variable-speed hood controller systems can also significantly reduce energy costs. In appropriate applications, this technology yields a one- to two-year simple payback. A photoelectric smoke or heat detector determines when and how much ventilation is needed and activates the exhaust fan at the proper speed.

**Water heating.** More than many other facility types, water heating is a major load for hotels and motels. It accounts for a third or more of a hotel facility’s energy consumption, some 40 percent of which is attributable to laundry and kitchen operations. Commercial heat pump water heaters (HPWHs) are two to four times more efficient than conventional water heaters, while also providing space-cooling capacity. In fact, they can cut water-heating costs up to 50 percent. However, before deciding to use HPWHs it is important to do a careful economic analysis—they are more expensive than conventional water-heating units, and their performance varies with climate. Direct-vent, sealed-combustion condensing water heaters and boilers with efficiencies higher than 90 percent are the next-most-efficient option. Condensing boilers operate very efficiently during periods of low water demand, unlike traditional hot water heaters, and they can also provide space heating. In general, installing multiple smaller water heaters provides better reliability, effectiveness, and efficiency compared to using one large hot water heater.

Hotels and motels can also use HVAC, shower, or laundry room heat-recovery systems to cut hot water expenditures. Hotels can obtain “free” hot water from their cooling and refrigeration equipment by using double-bundled heat exchangers in the chillers or a plate heat exchanger in the condenser-cooling loop. Gray water heat-recovery equipment used with showers saves 50 to 60 percent of water-heating energy with payback in two years. They also double or triple the first-hour capacity of water heaters. In addition, installing variable speed drive(s) on the hot water pumping systems will reduce pumping energy during periods of low hot water use.

In the hotel kitchen, prerinse spray valves are one of the easiest and most cost-effective energy-saving measures available. These devices use a spray of water to remove food waste from dishes prior to cleaning in a dishwasher. They reduce water consumption, water heating energy, and sewer charges. Look for models with a flow rate of 1.6 gallons per minute or less.

Several options are available for hotel laundry operations. New efficient tunnel washers can reduce costs through labor and utility savings. Ozone laundering systems offer big savings by

using cooler water and much less of it; they also use less energy and detergent. Jurys Doyle Hotel Group spent \$45,000 on an ozone system at its ENERGY STAR–labeled Boston facility. The system allows the use of cooler water, uses shorter washing cycles, and has cut detergent use by 30 percent, leading to a payback period of just 16 months.

For hotel swimming pools, indoor pool covers typically yield paybacks of one year; covers for heated outdoor pools and hot tubs may yield even better savings. Indoor pools require simultaneous heating and dehumidification. HPWHs can efficiently serve both of these needs: They heat water while producing cool, dehumidified air for the room housing the pool. Using an HPWH can reduce heating costs for gas- and electricity-heated pools as much as 40 and 80 percent, respectively. Low-temperature unglazed solar water heaters are an inexpensive approach that is well suited for swimming pools and spas in warmer climates. Glazed flat-plate collectors can provide higher-temperature water.

**Building envelope.** Outside the hotel, awnings, overhangs, light shelves, and windows with low solar heat gain coefficient (SHGC) help to reduce the amount of solar heat that comes in while still allowing daylight through. Light-colored roofing materials not only reduce cooling-energy consumption by 25 to 65 percent during the summer, they also extend roof life. Green roofs planted with grass and other vegetation provide excellent insulating properties, prolong roof life, reduce storm-water runoff, and offer an aesthetic appeal that could be valuable to a hotel or motel property. However, green roofs are expensive, and their cost-effectiveness is still being evaluated.

Retrofitting with new, high-performance windows can be prohibitively expensive, but installing reflective film inside existing windows can be a more cost-effective option. Energy savings from this film can be as high as 25 percent, and can result in paybacks of less than three years. Other window coverings such as shutters, shades, and draperies provide insulation benefits. This is especially true in summer months, when they reduce the amount of sunlight and heat entering rooms.

For lobby areas, revolving doors are the best choice for keeping wind and weather out. Check these doors periodically to ensure that there are no leaks along their edges or bottoms.

## Air Distribution Systems

**Energy savings.** On average, ventilation systems consume about 7 percent of the electricity used in hotels and motels. Savings can be found by installing efficient fan motors and sizing the system to match the load (which may now be lower due to retrocommissioning, improved lighting, and load reductions). Even more savings are possible by using energy-recovery equipment and variable-speed drives.

**Best practices.** A hotel ventilation system must be designed, operated, and maintained to provide adequate fresh-air intake and prevent mold growth from unwanted moisture accumulation. It is possible to inadvertently supply insufficient volumes of fresh air. This may occur with scheduled ventilation and variable air-volume systems or may be caused by wind, stack effects, or unbalanced supply and return fans. Installing an outdoor-air measuring station that modulates the outdoor-air damper and the return damper is relatively simple and ensures sufficient fresh-air supply. Increasing ventilation to safe and comfortable levels will likely increase energy consumption and so should be combined with other energy-saving measures.

In warm months, it can also be effective to reduce outside-air intake, especially when humidity is high. Many facilities bring in too much outside air during warm and humid periods.

Often, insufficient ventilation air results from clogged intake screens that are difficult to access for inspection and cleaning. To prevent this problem, ensure that all HVAC system air-supply diffusers, return registers, and outside-air intakes are clean and unobstructed. Replace filters regularly. These measures to improve ventilation rates should not raise hotel energy consumption.

Similarly, economizers should be checked regularly to ensure that their dampers are functioning properly. Dampers that are stuck open could be letting in too much outside air, and ones that are stuck closed will not provide the benefit of free cooling.

**Controlling mold.** Mold and mildew damage to wallpaper, carpet, and other materials caused by high humidity levels is estimated to cost the lodging industry \$68 million annually. Mold and mildew are caused by leaks in the building envelope in humid areas, oversized HVAC systems, poorly balanced air-handling systems, and insufficient moisture-removal capacity of vapor-compression HVAC systems. Desiccant HVAC and dehumidification systems excel at lowering humidity levels, improving indoor air quality, and increasing building occupant comfort. Two rooftop desiccant units handle the make-up air requirements for the lobby and hallways of the Park Hyatt Hotel in Washington, D.C., eliminating the need for a 100-ton rooftop chiller. Desiccant systems have low maintenance costs and can use a variety of fuels (waste heat, natural gas, or solar thermal energy) to lower peak electric demand, yet they may still be more expensive to operate than traditional HVAC systems, depending on local utility rates.

**Add-on monitors and controls.** Hotels can also use outdoor-air economizers with air-handling units, so that outdoor air can be used for free cooling during spring and fall or on cool summer nights when the humidity level is not too high.

In meeting rooms and other areas with variable occupancy, demand-controlled ventilation (DCV) systems can be used to reduce outdoor-air flows and the associated energy consumption during periods of low occupancy (see sidebar). DCV is most cost-effective for facilities located in a moderate to extreme heating or cooling climate and where existing HVAC systems do not use 100 percent outdoor air (such as those with evaporative cooling systems).

Large hotel casino facilities, which have very high ventilation demands, can use heat-recovery or energy-recovery ventilators that have balanced exhaust and supply fans and can meet all ventilation needs without creating drafts and air-pressure imbalances. Heat-recovery ventilators can feature efficiencies as high as 85 to 95 percent and can pay for themselves in roughly 3.5 years. Consider these units whenever air is continuously exhausted and make-up or ventilation air is required.

---

---

## RESOURCES: DCV Design Tools

Several free tools are available to evaluate potential energy savings from demand-controlled ventilation:

- Carrier provides the Hourly Analysis Program ([www.commercial.carrier.com/commercial/hvac/general/1,,CLI1\\_DIV12\\_ETI496,00.html?SMSESSION=NO](http://www.commercial.carrier.com/commercial/hvac/general/1,,CLI1_DIV12_ETI496,00.html?SMSESSION=NO))
  - Honeywell has the Savings Estimator ([http://customer.honeywell.com/Business/Cultures/en-US/Products/Applications+and+Downloads/Economizer+Logic+Module+\(W7212\)+Simulator+and+Demand+Control+Ventilation+Savings-Estimator.htm](http://customer.honeywell.com/Business/Cultures/en-US/Products/Applications+and+Downloads/Economizer+Logic+Module+(W7212)+Simulator+and+Demand+Control+Ventilation+Savings-Estimator.htm))
  - AirTest offers the CO<sub>2</sub> Ventilation Control and Energy Analysis tool ([www.airtesttechnologies.com/support/energy-analysis/](http://www.airtesttechnologies.com/support/energy-analysis/))
- 
-

A number of hotel systems can use variable-speed drives (VSDs), including variable air-volume systems, where they can adjust fan speeds according to operating requirements at different times of the day. VSDs should be installed on cooling-tower fans, continuously operating circulation pumps, and any constant-speed fans that only meet partial loads (for example, fans controlled with dampers). In kitchens, for example, fans can be linked to burners to reduce energy consumption during off-peak cooking periods. Be careful, however, not to cut exhaust to the point that kitchen odors permeate other areas of the facility.

## Heating and Cooling Systems

**Energy savings.** Heating and cooling represent almost 40 percent of the electricity and more than half of the natural gas used by hotels and motels. Many hotels heat and cool rooms regardless of whether they are occupied. Hotels tolerate this waste because their preeminent concern is guest comfort, not energy use. However, used correctly, controls and efficient technologies offer the potential for as much as 50 percent energy savings without compromising guest comfort.

**Best practices.** Smaller hotels tend to use distributed systems that often run entirely on electricity, most commonly stand-alone package terminal air conditioners (PTACs). Efficiency criteria for PTACs are currently being developed through ENERGY STAR. They will appear on the ENERGY STAR New Product Specifications in Development web page ([www.energystar.gov/index.cfm?c=new\\_specs.new\\_prod\\_specs](http://www.energystar.gov/index.cfm?c=new_specs.new_prod_specs)). Meanwhile, high-efficiency equipment can be ensured by purchasing equipment at the efficiency levels established by the ASHRAE (American Society of Heating, Refrigerating, and Air-Conditioning Engineers) Standard 90.1-2004, “The Energy Standard for Buildings Except Low-Rise Residential Buildings.” This standard provides minimum PTAC efficiency requirements that are higher than those in the federal standards.

For larger hotels, new chillers can be 25 to 50 percent more efficient than equipment 10 or more years old. Auxiliary condensers used to preheat makeup water for centrifugal chillers can pay for themselves in less than one year. For central heating, installing two or more smaller boilers will meet space-heating demands more effectively and efficiently than one large boiler. Geothermal heating and cooling can be a good choice, especially if there is a nearby body of water for a heat source or heat sink.

This is also an excellent opportunity for hotels to capitalize on the measures taken in earlier stages to reduce loads and losses throughout the facility. Optimize savings from all building improvements by right-sizing heating and cooling equipment to meet actual needs, rather than relying on rule-of-thumb sizing estimates. Too often this equipment is oversized, which means the systems rarely operate at peak efficiency. Right-sizing offers first-cost savings, as well.

**Controls.** Hotel studies have shown that sold rooms are unoccupied for 12 or more hours per day. Hotel operators can link their energy management system (EMS), reservation system, and automated check-out system together to keep an unsold room ventilated but with minimal heating or cooling. A sold room can then be heated or cooled to a comfortable temperature an hour before a guest’s scheduled arrival. Once the guests arrive in the room, they can then adjust the temperature as they like until they check out, when the HVAC system returns to the unsold mode. An EMS can enhance guest comfort while reducing energy costs by 35 to 45 percent, for a return on investment of 50 to 75 percent. New EMSs are so guest-friendly and effective that Cendant International, Starwood Hotels and Resorts, Hilton, and other chains are using them in their properties. Most EMSs can be used with central boiler/chiller systems or PTACs and are available with nightlights and wireless technology (requiring no additional electrical work).

Keycards that shut off all, or most, power-consuming devices when a guest leaves a room can also help reduce guest-room energy consumption. They have been used overseas for years, but have been slow to catch on in the U.S. However, with growing concerns about energy costs, that trend is starting to change. For example, the Westin Convention Center Pittsburgh installed a keycard system, which was consistent with the philosophy of the David L. Lawrence Convention Center complex of which the hotel is a part. (The Center has earned a gold Leadership in Energy and Environmental Design rating from the U.S. Green Building Council.) When a guest enters a room at the Westin, the keycard activates the entry light switch, the bathroom light, a pole light, and the HVAC system. When the card is removed from the room, power in the room automatically turns off. The hotel invested \$120,000 in the system and reportedly recovered its investment through energy savings in just 10 months. Energy consumption dropped more than 10 percent in the first year with the system, and engineers expect greater savings in the future as they improve communications with guests about the benefits of the system.

## 12.4 Financial and Implementation Issues

One of the challenges for implementing energy-efficiency upgrades in lodging facilities is the way that capital improvement projects are typically funded. Minor projects—room redecoration, for example—are often funded through a small portion of gross revenues that is saved to an escrow account. Major projects, such as chiller replacement, are paid for directly by the owners through line-item allocations. Historically, this type of arrangement has often favored minor cosmetic projects that are highly visible to guests over mechanical improvements. However, with energy costs rising, the balance may be starting to shift. In fact, a recent study of the prospects for installation of integrated energy systems in hotels found that larger properties expressed a strong interest in working with energy service companies for the purpose of stabilizing energy costs.

Another complicating factor in the lodging industry is the fact that there is often no central procurement authority for energy equipment—each project and property is bid out separately. In addition, priorities for owners may lie elsewhere. For example, in bringing newly acquired properties up to corporate standards, leaving less funding available to address energy-efficiency improvements.

For property-level hotel decision-makers, lack of financing is often cited as the main reason they are unable to take advantage of energy-efficiency opportunities. Hotels are more willing to take on capital improvement projects when third-party funds are available. The importance of financing is also evident in the very short paybacks demanded by the lodging industry. The typical payback period needed for hotel decision-makers to consider an efficiency measure is about two years. The ENERGY STAR Cash Flow Opportunity Calculator ([www.energystar.gov/index.cfm?c=tools\\_resources.bus\\_energy\\_management\\_tools\\_resources](http://www.energystar.gov/index.cfm?c=tools_resources.bus_energy_management_tools_resources)) can help hotel and motel managers calculate how much they can afford to invest in retrofits from the anticipated savings and whether it would make sense to borrow funds to finance building upgrades.

Hotel owners can also consider performance or shared-savings contracting, which provides a mechanism not only to fund energy-saving retrofits but also to cover deferred maintenance and capital renewal projects at the same time. Additionally, including ongoing maintenance in a performance contract can help to keep operating and maintenance costs under control and predictable. Having a long-term contract in place should ensure consistent funding for maintenance as well as providing an impetus for long-term strategic planning of equipment upkeep and replacement.

There are cases where the hotel ownership structure can be helpful in pursuing energy-efficiency upgrades. For example, many hotels and motels are franchise operations. On one hand, that structure can add layers of bureaucracy that make it harder to get approval for energy-efficiency measures that cost more than a certain amount. On the other hand, it enables projects to be designed centrally and rolled out to many locations, taking advantage of economies of scale. Franchisers may also have the ability to finance or arrange financing for the projects that they require franchisees to put in place. For example, Choice Hotels International has formed a strategic partnership with Panasonic to provide ENERGY STAR televisions designed specifically for the hotel market. Choice Hotels is the second-largest hotel franchise organization in the world; its family includes Comfort Inn, Quality Inn, Clarion, Sleep Inn, MainStay Suites, Econo Lodge, and Rodeway Inn. Choice Hotels expects its franchisees to purchase tens of thousands of these Panasonic televisions. The ENERGY STAR televisions draw only three watts of power or less when switched off, which results in an energy savings of up to 75 percent over conventional models. The TVs also feature energy-management circuitry that places the unit into a standby mode that helps reduce the energy wasted when guests fall asleep or leave the room unoccupied.

It is also crucial in developing an upgrade program to know how much energy is being used and where so that an economic analysis of efficiency measures can be performed. However, in many cases, hotel energy uses are ignored because the energy is not accounted for on an individual-operation basis. For example, hotel managers might not know how much it costs to maintain a pool facility or in-house laundry services, so they do not consider measures that could reduce energy costs in those operations. They believe it is an essential operation and must be maintained at any cost. As a result, they tend to overlook the potential savings from improving operational efficiency. For that reason, hoteliers are becoming more interested in energy information services, such as enhanced billing and consumption analysis.

## Bibliography

“A New Fixture Promotes CFLs’ Acceptance Based on Quality of Light” *E Source Tech News* (November 2001).

Campbell, Steven, “Reaping Untapped Energy Savings in Unoccupied Rooms,” *Hospitality Construction* (March/April 2007).

Dowling, Kevin, “LED Lighting Saves Energy and Helps Brave the Great Outdoors,” *Hospitality Construction* (March/April 2007).

Energy and Environmental Analysis Inc., “Market Potential for Advanced Thermally Activated BCHP in Five National Account Sectors” (May 2003), report prepared for Oak Ridge National Laboratory, [www.eere.energy.gov/de/pdfs/bchp\\_market\\_potential.pdf](http://www.eere.energy.gov/de/pdfs/bchp_market_potential.pdf).

Energy and Environmental Analysis Inc., “National Account Sector Energy Profiles,” report prepared for for Oak Ridge National Laboratory (April 2003), [www.eere.energy.gov/de/pdfs/national\\_account\\_energy\\_profiles.pdf](http://www.eere.energy.gov/de/pdfs/national_account_energy_profiles.pdf).

Fedrizzi, Rick, and Jim Rogers, “Energy Efficiency Opportunities: The Lodging Industry,” The Center for Energy and Climate Solutions (June 2002), <http://files.harc.edu/Sites/GulfCoastCHP/MarketAssessments/EnergyEfficiencyOpportunitiesLodging.pdf>.

Flex Your Power, “Boosting Restaurant Profits with Energy Efficiency: A Guide for Restaurant Owners and Managers” (August 2006), [http://fypower.org/pdf/BPG\\_RestaurantEnergyEfficiency.pdf](http://fypower.org/pdf/BPG_RestaurantEnergyEfficiency.pdf).

Hasek, Glenn, “Keycard-Based Energy Management Systems Gain Acceptance in U.S.,” *Green Lodging News* (August 2, 2007), [www.greenlodgingnews.com/Content.aspx?id=1270](http://www.greenlodgingnews.com/Content.aspx?id=1270).

Hospitality Net, “Accor North America Recognized by the EPA for Its Commitment to Energy Efficiency” (December 7, 2006), [www.hospitalitynet.org/news/4029644.html](http://www.hospitalitynet.org/news/4029644.html).

Kamm, Kristin, “Going Up? New Technologies Raise Elevator Efficiency,” *E Source Report, ER-06-02* (January 2006).

Krepchin, Ira, “Ozone Laundering: A Technology Ready to Clean Up?” *E Source Report, ER-99-4* (March 1999).

Loisos & Ubbelohde, “Gaia Napa Valley Hotel,” [www.coolshadow.com/ConsultingProj/CPrij\\_EcoHotel.html](http://www.coolshadow.com/ConsultingProj/CPrij_EcoHotel.html) (accessed July 2007).

National Action Plan for Energy Efficiency, Sector Collaborative on Energy Efficiency, “Hotel Energy Use Profile,” [www.epa.gov/solar/pdf/sector\\_meeting27Jun07/4bii\\_hotelenergy.pdf](http://www.epa.gov/solar/pdf/sector_meeting27Jun07/4bii_hotelenergy.pdf) (accessed August 2007).

National Renewable Energy Laboratory, “Solar Hot Water,” [www.nrel.gov/learning/re\\_solar\\_hot\\_water.html](http://www.nrel.gov/learning/re_solar_hot_water.html) (accessed July 2007).

Natural Resources Canada, “Saving Energy Dollars in Hotels, Motels and Restaurants,” [http://oee.nrcan.gc.ca/publications/infosource/pub/hospitality\\_sector/english/hosp\\_eng.pdf](http://oee.nrcan.gc.ca/publications/infosource/pub/hospitality_sector/english/hosp_eng.pdf) (accessed July 2007).

Paragon Consulting Services, “Technology Field Trials Program Final Report: Power Efficiency Corporation Performance Controller: Caesar’s Palace Hotel Escalator/Elevator Tests,” report prepared for Nevada Power (April 2006).

Rea, Mark S., ed., *IESNA Lighting Handbook*, 9th edition (Illuminating Engineering Society of North America, 2000).

Rogers, Jim, and Ira Krepchin, “Lighting Tips and Pointers,” *E Source Report, ER-02-02* (March 2002).

Tarricone, Paul, “Quiet and Under Control,” *Lighting Design & Application* (February 2007).

U.S. Department of Energy, “Desiccant Dehumidification,” [www.eere.energy.gov/buildings/info/components/hvac/cooling/desiccant.html](http://www.eere.energy.gov/buildings/info/components/hvac/cooling/desiccant.html) (accessed July 2007).

U.S. Department of Energy, Office of Energy Efficiency and Renewable Energy, “Energy Smart Management: Heat Pump Pool Heaters” [www.michigan.gov/documents/CIS\\_EO\\_Inside\\_heatpump\\_pool\\_39522\\_7.pdf](http://www.michigan.gov/documents/CIS_EO_Inside_heatpump_pool_39522_7.pdf) (accessed October 2007).

U.S. Environmental Protection Agency, “ENERGY STAR Qualified Televisions,” Hospitality Sector Fact Sheet, [www.energystar.gov/ia/business/hospitality/qualtvs.pdf](http://www.energystar.gov/ia/business/hospitality/qualtvs.pdf) (accessed August 2007).

U.S. Environmental Protection Agency, “Hotels: An Overview of Energy Use and Energy Efficiency Opportunities,” ENERGY STAR fact sheet, [www.energystar.gov/ia/business/challenge/learn\\_more/Hotel.pdf](http://www.energystar.gov/ia/business/challenge/learn_more/Hotel.pdf) (accessed October 2007).

“Wastewater Heat Recovery: An Overlooked Strategy for Long-Term Savings,” *E Source Tech News* (March 28, 2002).





LEARN MORE AT  
[energystar.gov](http://energystar.gov)

ENERGY STAR® is a U.S. Environmental Protection Agency program helping businesses and individuals fight global warming through superior energy efficiency.

## Chapter 13

# Facility Type: Retail Stores





# 13. Facility Type: Retail

Revised January 2008

<b>13.1 Challenges and Opportunities</b>	<b>2</b>
<b>13.2 Energy Use Profile</b>	<b>2</b>
<b>13.3 Technical Recommendations</b>	<b>4</b>
Retrocommissioning	5
Lighting	6
Load Reductions	9
Air Distribution Systems	10
Heating and Cooling Systems	11
<b>13.4 Financial and Implementation Issues</b>	<b>12</b>
<b>Bibliography</b>	<b>13</b>
<b>Glossary</b>	<b>G-1</b>

## 13.1 Challenges and Opportunities

There are approximately 657,000 retail buildings in the U.S., a number that represents about 13.5 percent of all U.S. commercial space. These buildings include stand-alone facilities, strip malls, and enclosed malls. Together, they consume approximately \$21 billion worth of energy annually. The good news is that energy is one of the few expenses that can be decreased without negatively affecting a retailer's operation.

Retailers stand to gain several benefits from building upgrades:

- *Increased profitability.* Energy savings are reflected on a company's profit-and-loss statement as reduced operating costs, which directly increase the profitability of a retail operation.
- *Reduced vulnerability to energy price fluctuations.* Energy prices may be sensitive to numerous external factors, including major weather events and changes in national policies. For some regions, the potential for utility deregulation also lends uncertainty to future energy costs. Reducing a retail facility's total energy consumption can soften the impact of energy price fluctuations from any of these factors.
- *Increased sales.* Improving the energy efficiency of a retail building usually involves upgrades to the lighting and HVAC systems. By creating a more pleasant shopping environment, these upgrades can also attract and retain more customers, leading to an increase in sales.
- *Enhanced public image.* With growing concerns over global warming and other environmental issues, many retailers want to demonstrate to potential customers that they are responsible environmental stewards. Retailers can upgrade their buildings to be more energy efficient as a way to achieve this goal.

## 13.2 Energy Use Profile

When planning a building upgrade, consider a retail establishment's largest energy loads. Typically, space heating and cooling, lighting, and plug loads such as computers and cash registers together account for nearly 70 percent of retail energy use (see **Figure 13.1**).

Energy intensity in retail establishments varies widely and is influenced by both weather conditions and the specific operations at the retail store, including the hours of operation, the number of workers, the number of cash registers, and the types of refrigeration required. On-site energy intensity in retail establishments can range from less than 10,000 Btu per square foot (ft<sup>2</sup>) to more than 200,000 Btu/ft<sup>2</sup> (**Figure 13.2**). Given this large variation and skewed distribution, it can be misleading to assess a retail building's performance just by looking at its average energy intensity.

The EPA's national energy performance rating system is designed to provide a meaningful benchmark for retail facilities. The rating system is accessible online as part of the EPA's free Portfolio Manager tool ([www.energystar.gov/benchmark](http://www.energystar.gov/benchmark)). It evaluates a retail facility's energy intensity, normalizing for weather and operating characteristics. The rating is expressed on a scale of 1 to 100, signifying the percentile of performance. Retail facilities that achieve a rating of 75 or higher are performing in the top quartile and may be eligible to earn the ENERGY STAR label. The rating serves as a standard of comparison against other retail sites, and it provides a way to measure progress after upgrades are implemented.

**Figure 13.1: Electric and natural gas end-use profiles for retail facilities**

Most of the electricity consumed by retail facilities is used for cooling, lighting, and plug loads such as cash registers, computers, and copiers; most of the natural gas is used for space heating. Each retail establishment's energy profile is different, so these charts are not representative of all retail spaces.

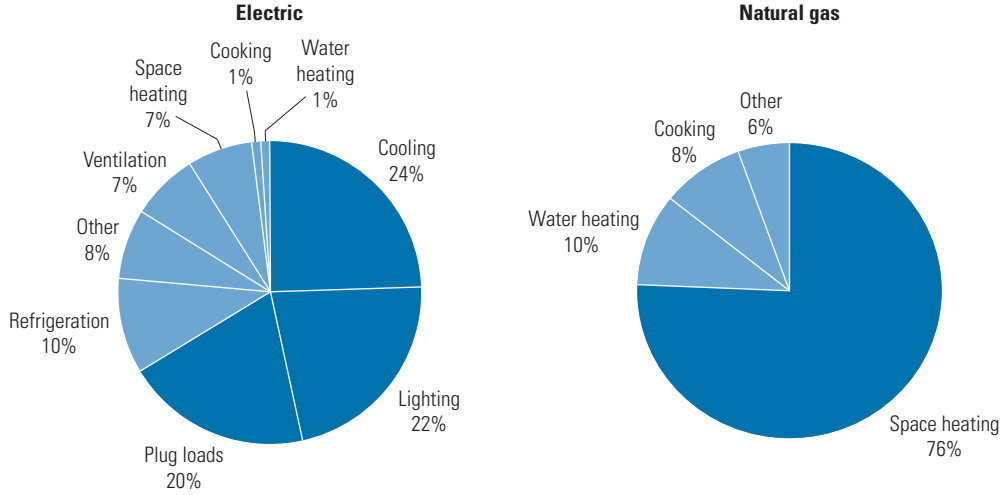

Courtesy: E SOURCE; from Commercial Building Energy Consumption Survey, 1999 data

**Figure 13.2: Distribution of energy intensity in retail facilities**

This curve shows the overall distribution of energy use intensity among a national sample of retail buildings. The median retail store uses approximately 70,000 Btu per square foot (ft<sup>2</sup>) from all energy sources. Many retail facilities, however, are significantly more energy-intensive than that.

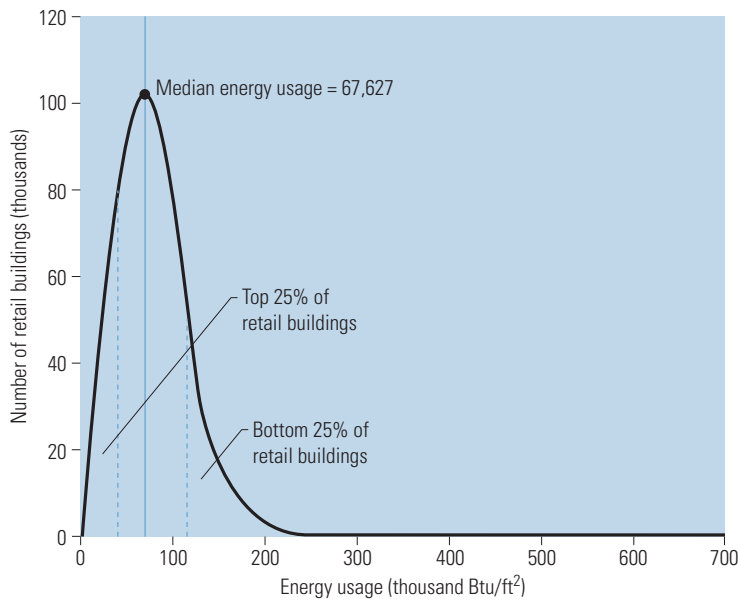

Courtesy: E SOURCE; from Commercial Building Energy Consumption Survey, 2003 data

Retail establishments should begin all upgrade projects by establishing a benchmark rating. The relative ENERGY STAR ratings can help an organization identify their best- and worst-performing facilities. Although any retail establishment may benefit from retrocommissioning, operational improvements, and retrofits, low-scoring facilities stand to benefit the most.

For more information, visit ENERGY STAR for Retail at [www.energystar.gov/retail](http://www.energystar.gov/retail). For descriptions of retail facilities that have earned the ENERGY STAR, visit [www.energystar.gov/index.cfm?fuseaction=PARTNER\\_LIST.showPartnerResults&leaders\\_yn=N&poy\\_yn=N&success\\_yn=N&partner\\_type\\_id=CIR&s\\_code=ALL](http://www.energystar.gov/index.cfm?fuseaction=PARTNER_LIST.showPartnerResults&leaders_yn=N&poy_yn=N&success_yn=N&partner_type_id=CIR&s_code=ALL).

### 13.3 Technical Recommendations

Although building systems in retail establishments vary, common reasons for initiating energy-related upgrades include:

- Equipment that malfunctions frequently or experiences shortened lifetimes due to years of deferred maintenance
- Piecemeal additions to buildings or internal changes to existing spaces made without corresponding changes to heating and cooling systems
- Previous attempts to reduce energy consumption that used inappropriate measures such as blacking out windows or covering vents
- Public spaces with inadequate ventilation systems, high levels of indoor air pollutants from products, or poor acoustics

---

---

#### RESOURCES: Retail organizations

The following organizations offer resources that can help owners and operators of retail facilities manage energy use.

##### National Association of Convenience Stores

[www.nacsonline.com](http://www.nacsonline.com)

The National Association of Convenience Stores is an international trade association representing 2,300 retail and 1,700 supplier company members.

##### National Association of Store Fixture Manufacturers

[www.nasfm.org](http://www.nasfm.org)

Member companies offer a full range of products and services for retail environments and include store fixture suppliers, retail design firms, suppliers of visual merchandising products, and suppliers of materials and equipment for the retail environment industry.

##### National Retail Federation

[www.nrf.com](http://www.nrf.com)

The National Retail Federation represents more than 100 state, national, and international trade organizations.

---

---

- Multiple rooftop air-conditioning units that are hard to control individually
- Major capital equipment or building infrastructure, such as a boiler or a roof, that is nearing the end of its useful life

In addition, following the staged approach that is advocated throughout this manual can reveal opportunities for saving on capital costs by “right-sizing” major equipment. After lighting and load-reduction measures have been implemented, it may be possible to specify smaller heating and cooling equipment.

Many of the following recommendations provide not only energy savings but also maintenance savings. Please note that this should not be considered an exhaustive list of measures appropriate for retail spaces. Facility directors for retail establishments are encouraged to refer to the full guidelines presented throughout this manual when planning and managing a building upgrade.

## Retrocommissioning

**Energy savings and other benefits.** Most of the opportunities that are identified during retrocommissioning concern HVAC systems and, in particular, air-distribution systems. The amount of savings achieved will depend on the types of problems that are identified and the remedies that are implemented.

Retrocommissioning can also produce non-energy benefits. It can reduce equipment downtime and keep maintenance expenditures in check. Retrocommissioning may also create a more pleasing shopping environment by identifying poorly performing ventilation systems, which can be a culprit in poor indoor air quality. Problems with low-voltage electrical systems such as lighting, alarm, and building management systems are frequently identified during retrocommissioning.

**Best practices.** If a retailer’s staff has sufficient expertise and familiarity with a building’s systems, they may carry out the retrocommissioning work. However, retail facilities are more likely than other building types to outsource this work. Regardless of who does the work, training and documentation are crucial to successful efforts, as described in Chapter 5, “Retrocommissioning.”

**Tune-up opportunities.** There are a number of easy measures that can reduce energy use in various store areas:

- *Storewide.* Turn HVAC temperature settings down in heating seasons and up in cooling seasons, while still maintaining comfortable conditions, and turn lights off when they are not in use. Occupancy sensors and timers can help with the latter, but a less-expensive alternative would be to develop a standard store-closing protocol for shutting off lights during closed hours.
- *Displays.* Many stores have electronic displays that remain on even when the store is closed. Consider shutting off the displays during closed hours either manually or with simple timers.
- *Peripheral rooms.* Make sure that HVAC settings in stockrooms, offices, and other peripheral rooms are at minimum settings.

**Integration with facility planning.** For retailers with multiple buildings, the complete retrocommissioning of select facilities as well as an assessment of the condition of their remaining buildings can be used to develop a multiyear facility management plan. The retrocommissioning programs could provide a model to follow for planning and prioritizing projects at other similar stores, while keeping the longer-term impact of those decisions in perspective. A typical facility assessment includes reviewing the age and condition of building components

---

---

## RESOURCES: Retrocommissioning

The following organizations offer resources that help owners and operators of retail facilities to assess how effectively they currently use energy and to investigate efficient alternatives.

### Building Commissioning Association

[www.bcxa.org](http://www.bcxa.org)

The Building Commissioning Association aims for diverse and creative approaches to building commissioning by focusing on identifying critical commissioning attributes and elements, rather than attempting to dictate a rigid process.

### California Commissioning Collaborative

[www.cacx.org](http://www.cacx.org)

The California Commissioning Collaborative is a non-profit organization made up of government, utility, and building services organizations and professionals, and provides commissioning information and resources for providers and building owners.

### Edison Electric Institute, National Accounts Program

[www.eei.org/industry\\_issues/retail\\_services\\_and\\_delivery/National\\_Accounts/about/index.htm](http://www.eei.org/industry_issues/retail_services_and_delivery/National_Accounts/about/index.htm)

The Edison Electric Institute's National Accounts Program focuses on the unique needs of those commercial customers with multiple sites or outlets, including chains and franchise operations.

### Food Marketing Institute

[www.fmi.org/energy/](http://www.fmi.org/energy/)

The Food Marketing Institute is a nonprofit association that conducts programs in research, education, industry relations, and public affairs on behalf of its members and their subsidiaries, which include food retailers and wholesalers and their customers in the United States and around the world.

### Portland Energy Conservation Inc.

[www.peci.org](http://www.peci.org)

Portland Energy Conservation Inc. provides commissioning guidelines and services and promotes energy-efficient practices and technologies for businesses and individual consumers.

### Professional Retail Store Maintenance

[www.prsm.com](http://www.prsm.com)

Professional Retail Store Maintenance is a member organization promoting the awareness of retail facilities management and its impact on the success of retailers.

---

---

and then estimating their remaining expected lifetime and replacement costs. A number of resources are available to help operators of retail facilities assess their current operations and begin their investigation of energy-saving alternatives (see sidebar).

## Lighting

**Energy savings.** Lighting represents about 22 percent of the electricity consumption in a typical retail establishment, not including its effect on cooling loads. Lighting retrofits can save 30 to 50 percent of lighting energy as well as 10 to 20 percent of cooling energy.

**Best practices.** Lighting is of critical importance to retailers because it can drive higher sales revenues. Products need sufficient illumination to attract attention from consumers, yet care is needed to protect some products from being overheated. Many retailers may not realize that contrasting light levels, not total light levels, make products stand out from their surroundings. Therefore, only key product areas should be highlighted—too much accent lighting not only uses more energy but negates contrast. Accent light levels can also be lowered when general illumination levels are kept lower. Although window display lighting levels may need to be high during the day to provide contrast in sunlit spaces, they can be lowered at night because contrast will be easier to achieve.

The Illuminating Engineering Society of North America (IESNA) sets illumination standards by task. Keep in mind that the IESNA guidelines do not heavily emphasize energy savings or daylighting. When daylighting is incorporated into a retail lighting strategy, the range of illumination levels can vary much more widely than with electric lighting alone.

**Daylighting.** Natural daylight offers two benefits over electric lighting in retail spaces. First, it can save energy by reducing the need for electric lights. For example, the Costco chain of discount stores began installing skylights and daylighting controls into its stores in the 1980s, and it now includes them as standard items in new stores. The payoff: projected annual energy savings of 1.5 kilowatt-hours/ft<sup>2</sup> per facility (approximately \$23,000).

Second, there is some evidence that natural daylight can improve retail sales. A study sponsored by the California Energy Commission, published in 2003, looked at sales in 73 of one retailer's stores, 24 of which had a significant amount of daylighting. It calculated that the average effect of daylighting was to increase sales by up to 6 percent. The study also found that stores in areas that had more hours of useful daylight per year showed a greater daylight effect on sales.

**Electric lighting.** A mixture of light sources can create a pleasing and comfortable environment that is energy efficient and suitable for a variety of tasks. Electric lighting should be coordinated with a daylighting scheme or adjusted in response to it. A blend of direct and indirect electric lighting can provide soft and uniform illumination.

For general illumination in retail establishments, fluorescent lighting provides an efficient option with good color quality. If a facility uses T12 fluorescent lamps and magnetic ballasts, relamping with high-performance T8 lamps and electronic ballasts can reduce lighting energy consumption by 35 percent. Adding specular reflectors and new lenses can create additional savings. For big-box stores with high ceilings, ceramic metal halide (CMH) lamps and high-output

---

## CASE STUDY: Hardware Store Cuts Costs with Lighting Upgrade

The owner of an Ace Hardware store in Martinez, California, sought to improve the quality of light in the store and reduce operating costs through a lighting upgrade. This was accomplished in part by using solar-tracking skylights instead of conventional ones. This technology uses multiple reflectors to track the sun and direct its light into the building through a diffuser, thereby achieving natural lighting of greater coverage, consistency, and duration than attainable with conventional skylights. In addition, the store's existing T12 fluorescent lamps and magnetic ballasts were replaced with T8 lamps and electronic ballasts. A light sensor in a skylight well turns on the electric lights when needed. Short-term monitoring revealed a 65 percent energy savings; for the 14,400-ft<sup>2</sup> facility, that worked out to be about 4.9 kilowatt-hours/ft<sup>2</sup>.

---



---

---

## CASE STUDY: Staples Store Lighting

Staples has made lighting efficiency a top priority throughout its national chain of retail office-supply stores. In 2003, it retrofitted 647 stores with single-lamp T8 fixtures, replacing two-lamp T8 fixtures except around the store perimeter. Though this change resulted in lower light levels, the stores appeared brighter because they used lamps with a higher color temperature (4,100 versus 3,500 kelvins) that gave off more blue light. The lighting upgrade resulted in a 6-million-watt annual reduction in energy use across all the stores.

Although some research has shown that visual acuity improves under light that emits more intensely in the blue part of the spectrum, the lighting community is not unanimous on the subject. However, Staples' experience seems to support the claim.

---

---

T5 fluorescent lamps are also good high-efficiency options. Office Depot replaced old metal halide lighting with T5 fluorescent lighting and not only cut energy use by about one-third, but increased light levels by 50 foot-candles as well.

For retail accent lighting, low-wattage CMH lamps with electronic ballasts are a good choice. They provide good color, long life, and high efficiency, and are now available in sizes as small as 20 watts to replace commonly used 75-watt halogen lamps. CMHs are available in popular MR16, PAR20, and PAR30 configurations.

For display cases and under-shelf illumination, T5 fluorescent lamps are a good choice. They are small in size and highly efficient, and they also have good color quality.

Another option for accent lighting is fiber optic lighting, in which a single high-efficiency light source feeds multiple remotely placed fixtures. Although installation can be costly, remote-source lighting offers a number of benefits important in retail applications, including minimizing the introduction of infrared and ultraviolet energy, allowing the use of more-powerful and more-efficient light sources, providing better targeting of the light, reducing maintenance requirements, and providing aesthetic appeal.

Light-emitting diodes (LEDs) also have a role to play in retail outlets. Retail accent lighting is a growing area for LEDs because they provide the ability to vary color, create sparkle, and aim the light precisely. The Alessi store in New York City uses LEDs to accent a line of stainless-steel products including coffee makers, containers, and flatware. For stores with refrigerated products, LEDs are a good solution for illumination inside refrigerated display cases because they do not create as much heat as fluorescent or incandescent lamps. If LED exit signs are not already in place, this is one retrofit that is usually a clear winner for any retailer, not only for how much energy it can save but also for maintenance savings. An ENERGY STAR qualified LED exit sign can go 25 years without lamp replacement, compared with less than 1 year for an incandescent sign.

Outdoor lighting is important for maintaining security and shopper comfort, though efficiency improvements can usually be made without impeding these functions. Two types of high-intensity discharge (HID) sources, metal halide and high-pressure sodium, offer efficient operation compared to mercury vapor or incandescent sources. Compact fluorescent lamps have also become viable for outdoor lighting, offering good color quality and better control options than HID sources.

For outdoor lighting and other areas where relamping and maintenance are difficult or hazardous, such as in escalator wells and high-ceilinged spaces (like those found over open mall

areas), induction lighting also offers an attractive alternative to HID lamps. Induction lamp products typically have long lifetimes (up to 100,000 hours, compared to 24,000 hours for HIDs), which means infrequent relamping. Moreover, they offer good lumen maintenance, compact construction, and vibration resistance. Finally, induction lamps can start at temperatures as low as  $-40^{\circ}$  Fahrenheit with no delay, and then operate at those temperatures without significant loss of lumens.

**Controls.** In the back-room areas of retail operations, occupancy sensors can save energy and also help to reduce maintenance costs by lengthening the relamping interval. In storage rooms, offices, and restrooms, ceiling-mounted ultrasonic occupancy sensors can be used to detect occupants around partitions and corners. For hallways, a recommended strategy is to use a combination of scheduled lighting and dimming plus occupancy sensor controls after hours.

For areas that use daylighting, automatic dimming controls can be used to ensure minimum light levels are met while still saving energy and to adjust light levels gradually so that those adjustments are not perceptible. Where dimming controls are not used, stepped controls that adjust lights over at least three levels can help to minimize noticeable light-level changes.

## Load Reductions

**Energy savings.** Load reduction measures that reduce the operational time or intensity of HVAC equipment in a retail setting while still maintaining a comfortable environment can offer substantial savings. In addition, plug loads present opportunities for savings. Equipment such as cash registers, computers, and copiers represent about 20 percent of the electricity used in retail establishments. Although cooking equipment traditionally has represented only about 1 percent of the total energy used by retail establishments, many retailers are now incorporating food service into their stores, either under their own brand or through partnerships, such as where a McDonald's restaurant operates inside of a Wal-Mart store. For these establishments, ENERGY STAR qualified cooking equipment, which uses 10 to 50 percent less energy than conventional models, can be a good choice.

**Best practices.** The quickest and easiest load reductions in a retail environment involve making sure that equipment is turned off when it is not needed. Retail, custodial, or other staff volunteers can be recruited for this effort. As an alternative, it may be possible to set some equipment, such as computers, to go into an idle or sleep mode when not in use. Low-power sleep modes can save \$10 to \$30 per monitor or \$15 to \$45 per desktop computer annually. Vending machines can also be shut off using occupancy sensors. Retailers that have multiple appliances on display may also benefit from using power strips to control phantom loads: Many power supplies still consume energy even when the appliance is off, particularly those with remote controls. For example, power to home electronics, such as televisions or stereo equipment, could be shut off completely at night using power strips. JC Penney launched a behavior modification campaign called Monthly Utility Mania in an attempt to get its employees to participate in energy reductions in each store. The program saved more than \$500,000 in the first month, and that success led to its expansion. By designating a volunteer Energy Captain in each store, JC Penney is making energy efficiency fun, easy, and rewarding. They give employees current information about the energy use in their stores, incentives, and ideas to reduce energy use, all of which has led to significant savings.

For retailers that provide food service, food-preparation equipment should not be turned on for preheating more than 15 minutes before it is needed. Simply reducing the operating time of kitchen appliances can cut cooking-related energy consumption by up to 60 percent. Also, rapid-cook ovens, which combine microwave with other heating technologies, have very low

power draw when idle and can eliminate the energy waste from idle conventional ovens. Hot water waste can be reduced in kitchens and bathrooms with low-flow prerinse spray valves, automatic faucet shutoffs, and single-temperature fittings.

**Efficient equipment procurement.** A simple way to ensure that purchased equipment is energy efficient is to request that procurement officials for retailers specify products that are ENERGY STAR qualified ([www.energystar.gov/purchasing](http://www.energystar.gov/purchasing)) in their contracts or purchase orders. Additionally, the product recommendations for federal government procurement officials from the U.S. Department of Energy's Federal Energy Management Program ([www1.eere.energy.gov/femp/procurement](http://www1.eere.energy.gov/femp/procurement)) may be appropriate for items that are not covered under the ENERGY STAR program. Some ENERGY STAR qualified products that are relevant for retailers include:

- Computers and monitors
- Printers, fax machines, mailing machines, and scanners
- Copiers
- Televisions, DVD players, and audio equipment
- Vending machines
- Roofing products
- Commercial refrigerators and freezers (for retailers that offer food service)

For example, replacing three conventional refrigerated beverage vending machines with ENERGY STAR qualified models, which are 40 percent more efficient, could mean annual operational savings of \$390. One ENERGY STAR qualified commercial refrigerator can save \$140 per year and reach simple payback in just 1.3 years. Purchasing ten 15-inch LCD (liquid crystal display) monitors for check-out stations that meet ENERGY STAR specifications could save \$70 annually compared with conventional models.

**Retrofits.** Many retail establishments have few floors but a large footprint, which means they have a high ratio of roof area to total facility square footage. This makes them good candidates for cool-roof solutions. If a retail building's roof needs recoating or painting, choosing white or some other highly reflective color can minimize the amount of heat that the building absorbs. This change can often reduce peak cooling demand and cooling energy use by 15 to 20 percent, depending on the climate zone in which the facility is located. When a roof requires replacement, adding insulation will reduce heat gain and loss. To see a list of qualifying ENERGY STAR roofing products, visit [www.energystar.gov/index.cfm?c=roof\\_prods.pr\\_roof\\_products](http://www.energystar.gov/index.cfm?c=roof_prods.pr_roof_products).

## Air Distribution Systems

**Energy savings.** Ventilation systems consume approximately 7 percent of the electricity used in retail buildings. Savings can be found by installing efficient fan motors and sizing the system to match the load (which may now be lower due to measures adopted in previous stages). Additional savings are possible through the use of energy-recovery equipment and variable-speed drives. If a facility is currently overventilated, then decreasing ventilation levels can produce energy savings both from the air distribution system and from the cooling and heating system. However, if ventilation needs to be increased to reach safe and comfortable levels, energy consumption will likely increase, so ventilation level changes should be combined with other energy-saving measures.

**Best practices.** A ventilation system must be designed, operated, and maintained to provide adequate fresh-air intake and prevent mold growth from unwanted moisture accumulation. ASHRAE (the American Society of Heating, Refrigerating, and Air-Conditioning Engineers) Standard 62.1, “Ventilation for Acceptable Indoor Air Quality,” establishes minimum ventilation levels for several types of retail spaces. Retailers with products that emit volatile organic compounds or other chemicals, such as hardware stores that sell paint or facilities that develop photographs on-site, may need to supply extra exhaust capacity and makeup air to sections of the store to remove these fumes.

**Retrofits.** Dehumidification is important for shopper and employee comfort. For retail stores in humid climates, dedicated outdoor air systems (DOASs) can improve humidity control and produce energy savings. In retrofit applications, the DOAS airstream can be brought into the building’s ductwork through a mixing box or through the existing HVAC system. Either way, desiccant systems used as part of the DOAS can relieve mechanical air-conditioning systems of the duty of dehumidifying outdoor air.

In retail outlets, which generally have an average occupancy that is low relative to their peak occupancy, demand-controlled ventilation (DCV) systems provide a cost-effective way to reduce outdoor air flows and the associated energy consumption during periods of low occupancy. Savings are highest where an establishment’s occupancy is highly variable, the store is open for long hours, the climate is characterized by extreme heating or cooling loads, and the existing HVAC system does not use 100 percent outdoor air (such as with evaporative cooling systems). Annual energy savings can amount to as much as \$1/ft<sup>2</sup>. Because DCV reduces the amount of outdoor air brought in only enough to satisfy maximum carbon-dioxide levels, retailers that carry products that give off chemical gases should take care to provide enough ventilation to remove these fumes.

## Heating and Cooling Systems

**Energy savings.** Together, heating and cooling systems consume approximately 38 percent of the energy used in retail establishments. Installing high-efficiency rooftop units (RTUs), which are frequently used on retail facilities, can save a significant amount of energy. For example, using a high-efficiency 10-ton unit with an energy-efficiency ratio (EER) of 12 versus a standard unit with an EER of 8.9 would generate about \$2,200 per year in energy savings in the climate of Boulder, Colorado, at an energy cost of \$0.08 per kilowatt-hour.

---

---

### CASE STUDY: Updating Yorkdale Mall

Starting in 2002, the Yorkdale Shopping Centre in Toronto implemented several building upgrades that have cut its C\$2 million energy bill in half. Following a building audit, an extensive lighting retrofit was undertaken that produced about 60 percent of the total savings achieved. The audit also revealed that the rooftop units cooling the mall were nearing the end of their life and that many of them were not properly maintained. In response, new RTUs were installed, along with a central energy management system, which generated the remaining 40 percent of the total savings achieved. The energy management system is used to turn the RTUs off at night and to control temperature setpoints. In addition, the mall implemented an automated electronic notification and tracking system for preventive maintenance. Service personnel automatically receive a notification on their personal digital assistants (PDAs) when it is time to perform regular equipment maintenance and, in turn, can send back to the system a report on what work is actually performed.

---

---

**Best practices.** Humidity control is particularly important for some types of retail establishments. In clothing stores, for example, if humid air inside makes customers feel sticky, they may be less likely to try on clothes. Also, humidity control in stores with refrigeration systems can help to prevent condensation and frost buildup. Desiccant dehumidification and heat-recovery systems can provide efficient and effective strategies for handling large humidity loads.

**Retrofits.** Commercial packaged RTUs and residential-type central air conditioners dominate the cooling of non-mall retail establishments, serving approximately 82 percent of the cooled floorspace. If packaged equipment is in need of replacement, using high-efficiency units rather than standard-efficiency models can provide attractive savings. Office Depot has adopted this strategy, retrofitting more than 500 RTUs throughout the chain with high-efficiency units.

Several other retrofits can also save energy. Economizers can be added to many systems, though in humid areas they should be used with differential enthalpy controllers. Ceiling fans can also be added to reduce the need for air conditioning. The Target retail chain, for example, uses them in several stores.

Central energy management systems can generate savings by enabling the easy control of multiple RTUs to establish appropriate temperature setpoints, by turning off equipment at night, and by tracking energy use. JC Penney is installing energy management systems in 800 stores to monitor each store's electrical and mechanical systems, to schedule the operation of HVAC and lighting equipment, to track store comfort levels, and to identify opportunities for saving energy.

### 13.4 Financial and Implementation Issues

For retail facilities, especially big-box stores, a big challenge is the fact that funds for building upgrades must compete with funds for new construction. Most energy equipment-related decisions for retail chain facilities are made at the corporate headquarters level. The same people are typically responsible for equipment decisions for all applications. Unlike other sectors, where engineering departments play a major role in decisions, in retail facilities, facility management, maintenance and construction departments, or senior management have the most influence. Decision-making guidelines often focus on both payback and life-cycle cost and can be project-specific for building upgrade projects. In general, big-box retailers look for rapid payback periods of two years or less on projects in existing buildings, largely because the funds needed for these projects compete with the capital required for opening new stores. However, payback periods of as long as five years may be acceptable for specific projects.

For retail spaces located in multiuse buildings, upgrades are likely to need special consideration. The ability to upgrade some or all of the building systems in a particular space will depend on lease agreements, whether spaces are served by their own HVAC or other equipment, whether spaces are submetered, and the building owner's willingness to participate in the process. One way to enable a retrocommissioning or equipment upgrade is to share both costs and savings between the building owner and the tenants. Hines, one of the largest real estate organizations in the world, uses this model to implement building upgrades so that affected tenants do not pay extra during the payback period and after that reap pure savings.

## Bibliography

Criscione, Peter, and Ira Krepchin, “Long Live Electroless Lamps,” *E Source Report, ER-02-6* (May 2002).

Designlights Consortium, “Retail Skylighting Know-how” and “Small Retail Lighting Know-how,” [www.designlights.org/guides.html](http://www.designlights.org/guides.html) (accessed August 2007).

Duff-Gray, Leslie, “Achieving Energy Efficiency,” Office Depot, [www.businessroundtable.org/pdf/ClimateRESOLVE/Event/38\\_Duff%20Gray\\_Presentation%2010.06.pdf](http://www.businessroundtable.org/pdf/ClimateRESOLVE/Event/38_Duff%20Gray_Presentation%2010.06.pdf) (accessed October 2007).

Energy and Environmental Analysis Inc., “National Account Sector Energy Profiles,” report prepared for Oak Ridge National Laboratory (April 2003), [www.eere.energy.gov/de/pdfs/national\\_account\\_energy\\_profiles.pdf](http://www.eere.energy.gov/de/pdfs/national_account_energy_profiles.pdf).

Fedrizzi, Rick, and Jim Rogers, “Energy Efficiency Opportunities: Big Box Retail and Supermarkets,” report prepared for the Center for Energy and Climate Solutions (May 2002), <http://files.harc.edu/Sites/GulfCoastCHP/MarketAssessments/EnergyEfficiencyOpportunitiesBigBox.pdf>.

Heschong Mahone Group, “Daylight and Retail Sales” (October 2003), report prepared for the California Energy Commission, [www.h-m-g.com/projects/daylighting/projects-PIER.htm](http://www.h-m-g.com/projects/daylighting/projects-PIER.htm).

Innovest Strategic Value Advisors, “Energy Management and Investor Returns: The Retail Merchandising Sector” (February 2003), [www.energystar.gov/ia/business/guidelines/assess\\_value/merch.pdf](http://www.energystar.gov/ia/business/guidelines/assess_value/merch.pdf).

Pacific Gas and Electric Co., “Daylighting Initiative, Retail Application: From Sunrise to Sunset—This Is a Well Lit Place” (1999), [www.pge.com/003\\_save\\_energy/003c\\_edu\\_train/pec/daylight/di\\_pubs/1487ACE\\_repaginated.pdf](http://www.pge.com/003_save_energy/003c_edu_train/pec/daylight/di_pubs/1487ACE_repaginated.pdf).

Pacific Gas and Electric Co., “Daylighting Initiative, Retail Application: A Cart Full of Energy Savings” (1999), [www.pge.com/003\\_save\\_energy/003c\\_edu\\_train/pec/daylight/di\\_pubs/1487Coco\\_repaginated.pdf](http://www.pge.com/003_save_energy/003c_edu_train/pec/daylight/di_pubs/1487Coco_repaginated.pdf).

U.S. Department of Energy (DOE), Energy Information Administration (EIA), Commercial Building Energy Consumption Survey (CBECS), “End-Use Consumption by Principal Building Activity” (1999 data; published 2003), [www.eia.doe.gov/emeu/cbecs/enduse\\_consumption/pba.html](http://www.eia.doe.gov/emeu/cbecs/enduse_consumption/pba.html).

U.S. DOE, EIA, “2003 CBECS (Commercial Building Energy Consumption Survey) Detailed Tables,” Tables A5 and B41, [www.eia.doe.gov/emeu/cbecs/cbecs2003/detailed\\_tables\\_2003/detailed\\_tables\\_2003.html](http://www.eia.doe.gov/emeu/cbecs/cbecs2003/detailed_tables_2003/detailed_tables_2003.html).

U.S. DOE, EIA, “1999 CBECS Detailed Tables,” Table C2, [www.eia.doe.gov/emeu/cbecs/detailed\\_tables\\_1999.html](http://www.eia.doe.gov/emeu/cbecs/detailed_tables_1999.html).

Wal-Mart, “Overview,” <http://walmartstores.com/GlobalWMStoresWeb/navigate.do?catg=217> (accessed June 2007).

Wilson, Marianne, “Green Light for Savings,” *Chain Store Age* (August 2004), [www.energystar.gov/ia/business/retail/Staples\\_energy\\_management\\_csa.pdf](http://www.energystar.gov/ia/business/retail/Staples_energy_management_csa.pdf).



LEARN MORE AT  
[energystar.gov](http://energystar.gov)

ENERGY STAR® is a U.S. Environmental Protection Agency program helping businesses and individuals fight global warming through superior energy efficiency.

## Glossary





# Glossary

Revised April 2008

<b>A</b>	<b>G-2</b>	<b>N</b>	<b>G-12</b>
<b>B</b>	<b>G-2</b>	<b>O</b>	<b>G-13</b>
<b>C</b>	<b>G-3</b>	<b>P</b>	<b>G-13</b>
<b>D</b>	<b>G-6</b>	<b>Q</b>	<b>G-14</b>
<b>E</b>	<b>G-7</b>	<b>R</b>	<b>G-14</b>
<b>F</b>	<b>G-8</b>	<b>S</b>	<b>G-16</b>
<b>G</b>	<b>G-8</b>	<b>T</b>	<b>G-16</b>
<b>H</b>	<b>G-9</b>	<b>U</b>	<b>G-17</b>
<b>I</b>	<b>G-9</b>	<b>V</b>	<b>G-17</b>
<b>K</b>	<b>G-10</b>	<b>W</b>	<b>G-18</b>
<b>L</b>	<b>G-10</b>	<b>Z</b>	<b>G-18</b>
<b>M</b>	<b>G-12</b>		



## A

**absorption** A general term for the process by which incident light is converted to another form of energy, usually heat.

**AC** *alternating current*

**accent lighting** Directional lighting used to emphasize or draw attention to an object or area.

**actuator** A device that converts an electrical control signal to the physical movement of a damper.

**AFUE** *annual fuel utilization efficiency*

**AHU** *air-handling unit*

**air-handling unit (AHU)** Equipment used to distribute conditioned air to a space. Includes heating and cooling coils, fans, ducts, and filters.

**air-side economizer** An opening in the supply-air ductwork with an operable damper, a filter, and a fan. It operates by substituting some outside air for building return air. The outside air is then used either directly, for cooling, or to supplement a conventional cooling system. Often just called an economizer when used with rooftop units.

**air-side systems** Equipment used to heat, cool, and transport air within building HVAC systems.

**ambient lighting** Lighting throughout an area that produces general illumination.

**annual fuel utilization efficiency (AFUE)** A measure of the efficiency of heating equipment that accounts for fuel-burning losses, flue losses, off-cycle losses, and equipment-jacket losses.

**ARI** *Air-Conditioning and Refrigeration Institute*

**ASHRAE** *American Society of Heating, Refrigerating, and Air-Conditioning Engineers*

**ASME** *American Society of Mechanical Engineers*

**axial fan** A type of fan that consists of a cylindrical housing with the impeller mounted inside along the axis. The impeller consists of blades mounted around a central hub similar to an airplane propeller.

## B

**balancing** Process of measuring and adjusting equipment to obtain desired flows. Applies to both air-side and water-side systems.

**ballast** An electrical device designed to control the current delivered to a fluorescent or HID lamp. Most ballasts also convert the line voltage into the proper voltage and waveform needed to start and operate the lamp.

**ballast efficacy factor (BEF)** The ratio of the ballast factor, specified as a percentage, to the ballast input power in watts. Ballast efficacy factor is only meaningful when used to compare ballasts operating the same type and number of lamps. Also called ballast efficiency factor.

**ballast factor (BF)** The luminous flux of a fluorescent or HID lamp (or lamps) operated on a ballast divided by the luminous flux of the same lamp when operated on the standard (reference) ballast specified for rating lamp lumens.

**base** The end of a lamp that contains electrical contacts.

**baseline** An initial performance level established to track improvements over time.

**BEF** *ballast efficacy factor* or *ballast efficiency factor*

**benchmarking** A process that compares the energy use of a building or group of buildings with similar structures or looks at how energy use varies from a baseline.

**BF** *ballast factor*

**bilevel switching** Refers to light-switching capabilities that enable two or more different light levels in a given area. For example, in a system with three-lamp fluorescent fixtures, one switch may operate the center lamp in each fixture while another operates the outer lamps. This arrangement makes three lighting levels possible (one, two, or all three lamps lit), yet the term “bilevel” is still used to describe it.

**blackbody** A body that absorbs all the light that hits it. At normal temperatures it would appear black, but as it heats up, it emits a distinct spectrum of thermal radiation based only on its temperature.

**blowdown** The discharge of water from a system to remove precipitated solids.

**boiler** A pressure vessel designed to transfer heat produced by combustion or electric resistance to a fluid. In most boilers, the fluid is water in the form of liquid or steam.

**Btu** *British thermal unit*. A unit of energy equal to the amount of heat required to raise the temperature of 1 pound of water 1° Fahrenheit.

**building envelope** The outer shell of a building, including walls, roof, windows, and doors.

**bulb** The glass envelope of a lamp.

## C

**C** *Celsius*

**calibration** The process of adjusting equipment to ensure that operation is within design parameters.

**capital lease** A lease that conveys some economic ownership of an asset, making it more similar to a purchase than to an operating lease. The Financial Accounting Standards Board offers a technical definition of a capital lease in pronouncement 13. Capital leases receive different accounting and tax treatment than operating leases.

**carbon dioxide (CO<sub>2</sub>)** Colorless, odorless, incombustible gas formed during respiration, combustion, and organic decomposition. Increasing levels of CO<sub>2</sub> in the atmosphere contribute to the global warming phenomenon.

**carbon monoxide (CO)** Colorless, odorless, poisonous gas formed during incomplete combustion of fuel.

**CBECS** *Commercial Building Energy Consumption Survey*

**CCT** *correlated color temperature*

**cd** *candela*

**central HVAC system** An entire HVAC system that serves a whole building, such as a chiller or boiler.

**central plant** Centrally located equipment that satisfies a building's cooling and heating loads.

**centrifugal fan** A type of fan consisting of a rotating wheel, or impeller, mounted inside a round housing. The impeller is driven by a motor, which is usually connected via a belt drive.

**CFL** *compact fluorescent lamp*

**chilled-water pump** A device that circulates chilled water.

**chilled-water reset** The practice of increasing chilled water temperature to raise chiller efficiency.

**chiller** Mechanical device that generates cold liquid that is circulated through cooling coils to cool the air supplied to a building.

**CIE** *Commission Internationale de l'Eclairage* (International Commission on Illumination), an international organization concerned with light and color.

**clerestory** That part of a building rising clear of the roofs or other parts and whose walls contain windows for lighting the interior.

**CO** *carbon monoxide*

**CO<sub>2</sub>** *carbon dioxide*

**coefficient of performance (COP)** A measure of either full- or part-load efficiency for heating or cooling equipment, where a higher value designates a more efficient system. For heating systems, it is the ratio of the rate of heat output to the energy input. For cooling systems, it is the ratio of the rate of heat removal to the energy input.

**coil** A heat exchanger element. See also *condenser coil*, *cooling coil*, *fan coil*, or *heating coil*.

**color rendering** A general expression for the effect of a light source on the color appearance of objects in comparison with their color appearance under a reference light source.

**color rendering index (CRI)** A measure of the degree of color shift objects undergo when illuminated by the light source as compared with those same objects when illuminated by a reference source of comparable color temperature.

**color temperature** The absolute temperature of a blackbody radiator having the same apparent color as the light source.

**combustion air** Air that supplies the oxygen required to burn fuel.

**Commercial Building Energy Consumption Survey (CBECS)** A survey that gathers data on building characteristics, energy cost information, and energy use from thousands of buildings across the United States. It is conducted by the U.S. Department of Energy's Energy Information Administration every four years.

**commissioning** The process of ensuring that systems are designed, installed, functionally tested, and capable of being operated and maintained according to the owner's operational needs.

**condenser** A heat exchanger used to expel building heat that is absorbed in the evaporator of a refrigeration system.

**condenser coil** A heat exchange element in the form of a pipe or tube that is used to condense refrigerant from a gas to a liquid.

**condenser-water pump** A device that circulates condenser water.

**condenser-water reset** The practice of decreasing condenser water temperature to obtain higher chiller efficiency.

**conditioned air** Air that serves a space and that has had its temperature and/or humidity altered to meet design specifications.

**conduction** Heat flow through a material from hot to cold.

**constant volume (CV)** A type of air-distribution system that circulates a constant volume of air to the conditioned space regardless of the demands of the space.

**constant-volume, variable-temperature (CVVT)** A type of air-handling system that adjusts or resets the temperature of the supply air.

**controls** An instrument or set of instructions for operating or regulating building systems.

**convection** Transferring heat by moving air or by means of the upward motion of particles of liquid or gas.

**cooling coil** A heat exchange element in the form of a pipe or tube with warm air on the outside and refrigerant on the inside that is used to cool air under forced convection with or without dehumidification. May consist of a single coil section or several coil sections assembled into a bank.

**cooling load** The amount of heat a cooling system must remove per unit of time to maintain the indoor design temperature and humidity level, typically measured in Btu/hour or tons.

**cooling tower** A device in water-cooled systems that transfers heat from warm water to the outside air through evaporation.

**cooling tower fan** A fan that is used to draw air through the cooling tower to carry away water vapor.

**cool white (CW)** The designation for a fluorescent lamp phosphor with a CCT of approximately 4,100 kelvin and a CRI of about 60.

**COP** *coefficient of performance*

**correlated color temperature (CCT)** Refers to the temperature of a blackbody radiator emitting light of comparable color to the light source in question. Measured in kelvins.

**cost of capital** The rate of return that must be earned in order to pay interest on debt (loans or bonds) that was used to finance investments and, where applicable, to attract equity (stock) investors.

**CRI** *color rendering index*

**CV** *constant volume.*

**CVVT** *constant-volume, variable-temperature. See constant-volume or constant volume, variable-temperature.*

**CW** *cool white*

**cycling** The noncontinuous operation of equipment.

## D

**DALI** *digitally addressable lighting interface*

**dampers** Single- or multiple-blade devices that open or close either manually or automatically to control the flow of air through an HVAC system.

**DC** *direct current*

**DCV** *demand-controlled ventilation*

**demand charges** Fees levied by a utility company for electric demand.

**demand-controlled ventilation (DCV)** An HVAC control system that varies the amount of outside air introduced to a building based on the internal concentration of CO<sub>2</sub> (an indication of building occupancy) to reduce the energy necessary to heat, cool, and dehumidify ventilation air.

**depreciation tax shield** The tax-related cash benefit from depreciation of an investment.

**desiccant** A material that absorbs moisture from another material. In HVAC systems, desiccants absorb moisture from the air.

**diffuser** A device that distributes light or conditioned air to a space.

**digitally addressable lighting interface (DALI)** A protocol that enables a computer to communicate with individual lighting fixtures that are equipped with DALI-compatible ballasts.

**dimmer** A device used to control the intensity of a lamp's emitted light by controlling the voltage or current available to power the lamp.

**direct lighting** Light from a luminaire that arrives at the work plane without being reflected by any room surfaces.

**discount rate** The interest rate used to adjust a future cash flow to its present value.

**downlight** A small direct-lighting unit that directs the light downward and can be recessed, surface-mounted, or suspended.

**dual-duct system** A constant-volume system that consists of two independent systems, one warm and one cool, which circulate air through all sections of the building via a parallel set of ducts.

## E

**EER** *energy-efficiency ratio*

**efficacy** The total luminous flux emitted by a lamp divided by the total lamp power input, expressed in lumens per watt.

**efficiency** The ratio of power output to power input.

**eggcrate** A type of louver used in a light fixture that has square cells oriented to allow light to pass through. Cell walls are typically parallel or perpendicular to each other (not curved) and may be opaque or translucent.

**electric demand** Electrical power delivered to a system at a given time or averaged over a designated period. Expressed in watts.

**electrodeless lamp** Also called *induction lamps*, these lamps use a varying magnetic field rather than a voltage across two electrodes to produce the electric field that ionizes the gases in a discharge lamp.

**electrodes** Electrically conductive elements inside a lamp that are used to provide the electric field that starts and operates the lamp.

**electronic ballast** Device using solid-state components to provide power to a discharge lamp at high frequency (typically 25,000 to 100,000 cycles per second, but sometimes as high as 2,500,000 cycles per second). Operation of fluorescent lamps at frequencies higher than 10,000 cycles per second produces more light using fewer watts than operation at power-line frequencies.

**EMS** *energy management system*

**energy-efficiency ratio (EER)** A measure of full-load efficiency at 95°F outside air temperature in units of Btu/watt-hour.

**energy management system (EMS)** The control system that monitors the environment and energy usage in a building and alters equipment operation to conserve energy while providing occupant comfort.

**Energy Performance Indicator (EPI)** Industry-specific rating developed by the EPA for manufacturing plants. EPIs are developed through statistical techniques. They normalize for key operational parameters.

**energy performance ratings** Ratings developed by the EPA through the application of statistical algorithms to CBECS data. The ratings are normalized for weather and important building characteristics such as operating hours, building size, occupancy, and number of computers.

**energy service company (ESCO)** A company that specializes in projects that improve the energy efficiency of existing buildings. These companies have technical, operational, and financial expertise that enable them to manage all aspects of energy-efficiency projects.

**ENERGY STAR label** Symbol of excellence in energy efficiency awarded to single buildings that have earned a rating of 75 or higher on the EPA rating scale.

**ENERGY STAR Leaders** ENERGY STAR partners who achieve significant energy-efficient improvements or a rating of 75 or better across their entire portfolio of buildings.

**EPA** *U.S. Environmental Protection Agency*

**EPI** *Energy Performance Indicator*

**equivalent full-load hours** A metric used to estimate annual energy use for heating or cooling a building. It translates the amount of time spent at varying loading factors experienced by equipment throughout the year into an equivalent amount of time at full-load conditions.

**ESCO** *energy service company*

**evaporator** Heat exchanger in a refrigeration system that absorbs heat from chilled water or building air, thus reducing the supply temperature.

**exhaust air** Air removed from a building and not reused.

**external benchmarking** A benchmarking approach in which buildings are compared to other, similar buildings not associated with the benchmarking organization.

## F

**F** *Fahrenheit*

**fan coil** A device that combines a heat exchanger and a fan in a single unit that conditions air by forced convection.

**fc** *foot-candle*

**fenestration** All areas in the building envelope that admit light, including windows, plastic panels, clerestories, skylights, glass doors, and glass-block walls.

**first cost** The initial financial outlay associated with an investment.

**flood** Type of lamp with a beam angle of 30 percent or more.

**fluorescent lamp** A low-pressure mercury electric-discharge lamp in which a fluorescent coating (phosphor) transforms some of the ultraviolet energy generated by the discharge into light.

**foot-candle (fc)** A unit of illuminance equal to 1 lumen per square foot, or 10.76 lux.

## G

**GDP** *gross domestic product*

**glare** The sensation produced by luminance within the visual field that is sufficiently greater than the luminance to which the eyes are adapted, causing annoyance, discomfort, or loss in visual performance and visibility.

**glazing** Glass set in or made to be set in frames.

**gpm** *gallons per minute*. A measure of water flow rate.

**greenhouse gas** A gas that traps the sun's heat in the atmosphere, contributing to the greenhouse effect. Greenhouse gases include water vapor, carbon dioxide, methane, ozone, chlorofluorocarbons, and nitrogen oxides.

**gross domestic product (GDP)** An estimate of the total money value of all the final goods and services produced in a given one-year period using the factors of production located within a particular country's borders.

## H

**hard costs** Expenditures for physical assets used in energy-efficiency projects. These assets can be attached as collateral for debt and are therefore easier to finance than soft costs.

**heat exchanger** A device that transfers heat from one fluid to another.

**heating coil** Heat exchanger that heats air under forced convection. May consist of a single coil section or several coil sections assembled into a bank.

**heating load** The amount of heat a heating system must provide per unit of time to maintain the indoor design temperature level, typically measured in Btu/hour.

**heat island effect** A phenomenon in which urban and suburban temperatures are 2° to 10°F (1° to 6°C) hotter than nearby rural areas due to the absorption of heat by paved areas, rooftops, and other urban structures.

**heat pump** A device that uses the vapor compression refrigeration cycle to move heat from one area to another. It can deliver cooling or heating to a space by reversing the flow of refrigerant.

**HID** *high-intensity discharge*

**high-bay lighting** Interior lighting where the roof truss or ceiling height is greater than approximately 7.6 meters (25 feet) above the floor.

**high-intensity discharge (HID)** A type of electric-discharge lamp in which the light-producing arc is stabilized by wall temperature and the arc tube has a bulb wall loading in excess of 3 watts per square centimeter. HID lamps include groups of lamps known as high-pressure mercury, metal halide, and high-pressure sodium.

**high-pressure sodium (HPS)** A high-intensity discharge lamp in which light is produced by radiation from sodium vapor operating at a partial pressure of about  $1.33 \times 10^4$  pascals (100 torr). Includes clear and diffuse-coated lamps.

**high output (HO)** Ballasts and fluorescent lamps designed to operate at higher power than standard products of the same size in order to provide greater light output.

**HO** *high output*

**HPS** *high-pressure sodium*

**hurdle rate** The minimum internal rate of return required for a project to be judged as an acceptable investment.

**HVAC** *heating, ventilating, and air-conditioning*

## I

**IEEE** *Institute of Electrical and Electronics Engineers*



**IESNA** *Illuminating Engineering Society of North America*

**illuminance** The amount of light shining on a surface.

**incandescence** The self-emission of radiant energy in the visible spectrum due to the thermal excitation of atoms or molecules.

**indirect lighting** Lighting by luminaires that distribute 90 to 100 percent of the emitted light in an upward direction.

**induction lamp** Also called electrodeless lamps, these lamps use a varying magnetic field rather than a voltage across two electrodes to produce the electric field that ionizes the gases in a discharge lamp.

**infiltration** Air that leaks into a building through the building shell.

**instant start (IS)** A lamp and ballast system designed to start a lamp without preheating the electrodes by providing a high open-circuit voltage. An instant-start fluorescent lamp is also known in some countries as a cold-start lamp.

**internal benchmarking** A benchmarking approach in which an organization compares the energy use at a building or group of buildings to others within that organization.

**internal rate of return (IRR)** A percentage figure that describes the yield or return on an investment over a multiyear period; the discount rate that results in an NPV of zero.

**International System of Units** A measurement system commonly referred to as the metric system.

**IRR** *internal rate of return*

**IS** *instant start*

**IT** *information technology*

## K

**K** *kelvin*

**kelvin (K)** A unit measuring temperature on the Kelvin scale. Each unit is equal to a Celsius degree, but 0 on the Kelvin scale is absolute zero, or  $-273.15^{\circ}$  Celsius.

**kilowatt (kW)** Unit of power equal to 1,000 watts.

**kilowatt-hour (kWh)** Unit of electric consumption equal to the work done by 1 kilowatt acting for 1 hour.

**kW** *kilowatt*

**kWh** *kilowatt-hour*

## L

**lamp** A device designed to convert electricity into light.

**lamp lumen depreciation (LLD)** The fractional loss of lamp lumens at rated operating conditions that progressively occurs during lamp operation.

**lamp socket** In fluorescent lamps, the tombstone-shaped component into which lamp contacts are inserted to make electrical contact with the ballast. In screw-base incandescent, compact fluorescent, or HID lamps, the component that receives the screw base and provides electrical connection to the power line or ballast.

**latent load** The portion of the cooling load necessitated by water vapor in the air.

**LDD** *luminaire dirt depreciation*

**LED** *light-emitting diode*

**lens** A glass or plastic element designed to change the direction and to control the distribution of light rays.

**light** Radiant energy that is capable of exciting the retina and producing a visual sensation. The visible portion of the electromagnetic spectrum covers wavelengths ranging from about 380 to 770 nanometers.

**light-emitting diode (LED)** A solid-state device that generates light by the recombination of electrons and holes in the junction between two different semiconductor materials.

**light shelf** A horizontal shelf positioned to direct daylight onto the ceiling and to shield occupants from direct glare.

**LLD** *lamp lumen depreciation*

**lm** *lumen*

**load** The demand upon the operating resources of a system. In the case of energy loads in buildings, it generally refers to heating, cooling, and electrical (or demand) loads. See also *cooling load* or *heating load*.

**louver** A series of baffles used to shield a light source from direct view, absorb unwanted light, or redirect light by reflection.

**low-pressure sodium (LPS)** A discharge lamp in which light is produced by radiation from sodium vapor operating at a partial pressure of 0.1 to 1.5 pascals (approximately  $10^{-3}$  to  $10^{-2}$  torr).

**LPS** *low-pressure sodium*

**lumen (lm)** The SI unit of luminous flux. Radiometrically, it is determined from the radiant power. Photometrically, it is the luminous flux emitted within a unit solid angle (1 steradian) by a point source having a uniform luminous intensity of 1 candela.

**luminaire** Generic term for a complete lighting unit consisting of one or more lamps with parts designed to distribute light from the lamps, ballasts to provide power to the lamps, and components to connect the lamps or ballasts to a power source.

**luminaire dirt depreciation (LDD)** The fractional loss of task illuminance due to the accumulation of dirt on a luminaire.

**luminaire efficiency** The ratio of luminous flux (lumens) emitted by a luminaire to that emitted by the lamps used therein.

**luminance** The amount of light reflected back from a surface.

**lux (lx)** The SI unit of illuminance. One lux is 1 lumen per square meter.

**lx** *lux*

## M

**M&V** *measurement and verification*

**magnetic ballast** Power circuit consisting of one or more magnetic coils and optional capacitors, designed to limit current and provide necessary starting voltage for discharge lamps.

**measurement and verification (M&V)** A formal documentation process that establishes the energy savings generated by an energy-efficiency project. Energy savings in a building can be very difficult to measure given the effects of weather, occupant behavior, and activity volume in addition to the performance efficiency of the building and its systems.

**mechanical heating and cooling** Heating and cooling provided by equipment such as compressors, chillers, and boilers.

**metal halide (MH)** A high-intensity discharge lamp in which the major portion of the light is produced by radiation of metals that are the product of dissociation of metal halides in the arc discharge. Includes clear and phosphor-coated lamps.

**MH** *metal halide*

**multizone systems** A type of air-distribution system that is similar to a dual-duct system in that two streams of air, hot and cold, are mixed to produce a desired temperature. But whereas dual-duct systems mix the air in individual boxes located at each area or room, multizone systems mix air with dampers near the fans, then feed the conditioned air to each zone based on its load.

**municipal bond** A debt security issued by a state or a state-authorized entity (municipality, county, state authority, or state agency) that pays interest that is exempt from federal taxation.

**municipal lease** A lease agreement specifically designed to support the borrowing requirements of municipal governments. It gives municipalities the ability to terminate the lease if funds are not appropriated for lease payments. Interest paid on municipal leases is exempt from federal income taxes.

## N

**net present value (NPV)** A measure of investment worth, computed as the sum of the present values of an investment's cash flows.

**normalize** A statistical method of massaging data to account for differences in circumstances, such as weather, occupancy levels, or tasks that affect energy use. Normalizing creates a level playing field that avoids apples-to-oranges comparisons.

**NPV** *net present value*

**O**

**off peak** A utility rate schedule designation of the time of day when energy and demand costs are typically less expensive.

**ongoing commissioning** Continuing the commissioning process by leaving monitoring equipment in place to allow for ongoing diagnostics.

**on peak** A utility rate schedule designation of the time of day when energy and demand costs are typically more expensive.

**operating lease** A lease that conveys limited control over an asset to the lessee. Operating leases are usually short term (weeks or months), with an expectation that the asset will be returned to the lessor at the end of the lease.

**P**

**packaged unit** A self-contained HVAC unit that provides heating and/or cooling to a building space.

**PAR** *parabolic aluminum reflector* or *parabolic aluminized reflector*

**parabolic cube (paracube)** A series of baffles arranged like an eggcrate except that the cross sections consist of segments of parabolas. Paracubes are designed to shield a light source while directing light through a narrowed angle, usually by specular reflection.

**parabolic louver (paralouver)** A series of parallel baffles where the cross sections consist of segments of parabolas. Paralouvers are designed to shield a light source while directing light through a narrowed angle, usually by specular reflection.

**paracube** *parabolic cube*

**paralouver** *parabolic louver*

**part load** Condition in which equipment operates at less than design load to meet the demand placed upon it; this is often the majority of the time the equipment is operating.

**part-load performance** Equipment efficiency at less than full capacity.

**payback period** The time required for an investment's cumulative cash flow (including the initial outlay) to reach zero. See also *simple payback*.

**PCB** *polychlorinated biphenyl*

**performance contract** An agreement in which the success of an energy-efficiency project plays a role in determining how the contractor is compensated for managing the project. Performance contracts generally shield the project owner from losses due to a failed project, thereby reducing or eliminating risk. A successful project may reward the contractor with above-market returns as compensation for taking on the risk of failure.

**phosphors** Substances that transform ultraviolet light generated by an electric arc into visible light. Phosphors can also be excited by electron impact, as in the cathode ray tubes used in televisions and computer monitors.

**pneumatic control** A control that utilizes air pressure to vary equipment operation.

**polychlorinated biphenyl (PCB)** A solvent used as dielectric fluid in wet capacitors in ballasts manufactured before 1980. Ballasts using PCBs cannot be discarded in sanitary landfills.

**Portfolio Manager** An online energy management tool, available through ENERGY STAR, for tracking and assessing energy and water consumption across a portfolio of buildings.

**power factor** The cosine of the phase angle between the current and voltage waveforms in an electrical system. Electrical loads such as motors have a property called inductance, which causes changes in the flow of current to be delayed relative to the changing AC voltage. Power factor is a measure of the degree to which current lags voltage.

**present value (PV)** The current value of a cash flow to be received in the future.

**present value factor** The number by which a future cash flow is multiplied to yield its present value.

**pressure drop** The loss in pressure experienced by flowing water or air due to friction and obstructions.

**pressure reset** A method that can yield additional energy savings in systems that have VSDs installed. Reducing the pressure supplied by fans also reduces the flow supplied, which in turn reduces the power required.

**prismatic** Adjective describing the shape of elements in a lens designed to redirect light over wider angles in all directions.

**pump** A device that circulates water or air. See also *chilled-water pump*, *condenser-water pump*, and *heat pump*.

**PV** *present value*

## Q

**qualitative benchmarking** A type of benchmarking in which management and operational practices across a portfolio of buildings are examined to identify best practices or areas for improvement.

**quantitative benchmarking** A benchmarking process in which numerical measures of performance are compared.

## R

**R-value** A measure of thermal resistance of insulation; higher R-values mean better insulation.

**radiator** Device that provides warmth to a space through radiant or convective heat provided by either steam or hot water.

**rapid start** A ballast and lamp system designed to start and operate a fluorescent lamp by simultaneous application of a low voltage to the lamp electrodes and a moderate voltage, higher than the lamp operating voltage, between one end of the lamp and the other. When the electrodes reach sufficient temperature, typically in about 1 second, the lamp starts without using high voltage.

**RCRA** *Resource Conservation and Recovery Act*

**recessed can** A cylindrical lighting fixture recessed into a ceiling (also called high hat).

**recommissioning** The commissioning process applied to a building that has been commissioned previously (either during construction or as an existing building).

**reference ballast** A ballast specially constructed to have certain prescribed characteristics. Used in measuring the performance of electric-discharge lamps under standard conditions in order to establish their rated performance.

**reflector** A device used to direct light from a source through reflection, either specular or diffuse.

**reflector lamp** An incandescent filament or electric-discharge lamp that uses a reflective surface to direct the light (including such lamp types as reflector, ellipsoidal-reflector, or parabolic). The light-transmitting region may be open, clear, frosted, patterned, or phosphor-coated.

**refrigerant** Substance used for heat transfer that picks up heat by evaporating at a low temperature and pressure and gives up heat when it condenses at a higher temperature and pressure.

**regression analysis** A statistical method for finding a mathematical relationship among two or more variables.

**reheat** The heating of air that has been previously cooled by cooling equipment or an economizer. A heating device, usually a hot water coil, is placed in the zone supply duct and is controlled via a zone thermostat.

**reset** The process of increasing or decreasing the temperature of an HVAC element to raise efficiency. See also *chilled-water reset*, *condenser-water reset*, and *temperature reset*.

**Resource Conservation and Recovery Act (RCRA)** An EPA regulation covering hazardous materials.

**retrocommissioning** The commissioning process applied to existing buildings that have never been commissioned before.

**rightsizing** The process of matching supply capacity with demand.

**risk-adjusted discount rate** A discount rate that has been tailored to the risk characteristics of the project being analyzed.

**roof curb** A raised and reinforced area on a roof for mounting equipment.

**rooftop unit** Self-contained packaged air-conditioning equipment that typically sits on the roof and can also include a heating section.

## S

**sconce** Wall-mounted fixture providing indirect light from a wall and ceiling as well as direct light through a lens.

**seasonal energy-efficiency ratio (SEER)** A seasonally adjusted measure of efficiency at 82°F outside air temperature in units of Btu/watt-hour.

**SEER** *seasonal energy-efficiency ratio*

**sensible load** The portion of the cooling load contributed by dry air. Sensible loads change the temperature of the air.

**sensitivity analysis** An analysis that examines the effects of changes in key assumptions (such as capital cost, discount rate, etc.) on outcomes (such as net present value or internal rate of return).

**setpoint** Desired temperature, humidity, or pressure in a space, duct, etc.

**shell, building** See *building envelope*.

**SI** *International System of Units*, abbreviated from the French *Système International d'Unités*.

**simple payback** Measurement of the elapsed time between an initial investment and the point at which accumulated savings are sufficient to offset the initial investment. See also *payback period*.

**soft costs** Expenditures not directly related to physical assets, such as costs for designing and implementing a project. Although soft costs are necessary to obtain physical assets, they do not directly create assets that can be used as collateral and are therefore more difficult to finance than hard costs.

**solar reflectance** A measure of a material's ability to reflect sunlight (including the visible, infrared, and ultraviolet wavelengths) on a scale of 0 to 1, where 0 indicates that the surface absorbs all solar radiation and 1 represents total reflectivity.

**space** The distinct area to which conditioned air is delivered.

**specular reflector** Reflector that directs light out at the same angle and in the same plane as it arrived at the reflector.

**steam trap** A device that separates air and condensed water from steam.

**submetering** Measuring the energy consumption of a piece of equipment or a portion of a building separately from the main electric meter.

## T

**T** A designation of lamp type, as in T8, T12, and so on. T stands for tubular; the number describes lamp diameter in one-eighth-inch increments. A T8 lamp is eight-eighths of an inch (or 1.0 inch) in diameter; a T12 is twelve-eighths of an inch (or 1.5 inches) in diameter.

**TAB** *testing, adjusting, and balancing*

**table lamp** A portable luminaire with a short stand, suitable for standing on furniture.

**task-ambient lighting** Task lighting and ambient lighting combined in an area in such a way that the general level of ambient lighting is lower than and complementary to the task lighting.

**task light** A fixture with limited beam spread, either mounted on office furniture or having its own base and electric cord, that is designed to illuminate a small area.

**temperature reset** Strategy for saving energy that adjusts the temperature of either the air or water supplied by an HVAC system based on measurements of the actual load or a proxy for the actual load, such as outdoor air temperature.

**testing, adjusting, and balancing (TAB)** The process of adjusting HVAC system components to supply air and water flows at desired values.

**thermostat** A device that maintains a temperature setpoint by controlling equipment in response to temperature changes.

**time value of money** The principle that money received in the future is not as valuable as money received today.

**ton** Unit of cooling capacity equal to 12,000 Btu per hour.

**torchiera** A portable light fixture, typically standing on the floor, that provides indirect lighting or a combination of direct and indirect lighting.

**transpiration** The process of water loss from plants through small openings on the underside of leaves, largely controlled by atmospheric humidity and soil moisture content.

**troffer** A recessed lighting unit having its opening flush with the ceiling in which it is installed. This term is a combination of “trough” and “coffer.”

**tungsten halogen** A type of incandescent lamp that uses a tungsten filament and a high-pressure halogen gas cycle to reduce tungsten evaporation and clean vaporized tungsten from the walls of the lamp.

## U

**unitary HVAC system** A heating, cooling, or ventilating system that only serves a limited part of a building or space, such as a packaged rooftop air conditioner or heat pump.

## V

**variable air volume (VAV)** A type of air-handling system that provides air at a constant temperature and varies the air quantity to each zone to match the variation in room load.

**variable-speed drive (VSD)** An electronic device that adjusts a motor's speed to match load requirements by changing the frequency of the voltage applied to motor terminals.

**variable volume, variable temperature (VVVT)** A type of air-handling system that can change supply air temperature in addition to air volume.

**VAV** *variable air volume*



**veiling reflection** Regular reflections that are superimposed upon diffuse reflections from an object and that partially or totally obscure the details to be seen by reducing the contrast. Sometimes called reflected glare.

**very high output (VHO)** Ballasts and T12 fluorescent lamps designed to operate using 1,500-milliamp current in order to provide greater light output.

**VHO** *very high output*

**VSD** *variable-speed drive*

**VVVT** *variable volume, variable temperature*

## W

**W** *watt*

**wall washer** Any fixture installed close to a wall and designed to project most of its light onto that wall.

**warm white (WW)** The designation for a phosphor with a CCT of approximately 3,000 kelvin.

**water-side economizer** A heat exchanger that transfers heat from an HVAC system's chilled water to its cooling-tower water.

**water-side systems** Equipment used to heat, cool, and transport water to building HVAC systems.

**WW** *warm white*

## Z

**zone** A space (or group of spaces) that has its heating and cooling controlled by a single thermostat.