

United States of America

United States Patent and Trademark Office

RAPID

Reg. No. 4,072,266

AUTOMSOFT INTERNATIONAL LIMITED (IRELAND COMPANY)

Registered Dec. 20, 2011

18 LANSDOWNE ROAD

DUBLIN 4, IRELAND

Int. Cl.: 9

FOR: COMPUTER HARDWARE, COMPUTER SOFTWARE, COMPUTER PROGRAMS, ALL OF THE ABOVE GOODS RELATING TO THE COLLECTION, STORAGE, AND ANALYSIS OF PRODUCTION DATA IN THE FIELD OF PRODUCTION AND MANUFACTURING MANAGEMENT FOR THE MANUFACTURING INDUSTRY, IN CLASS 9 (U.S. CLS. 21, 23, 26, 36 AND 38).

TRADEMARK

PRINCIPAL REGISTER

FIRST USE 8-9-2000; IN COMMERCE 8-9-2000.

SER. NO. 76-499,082, FILED 3-20-2003.

RUDY R. SINGLETON, EXAMINING ATTORNEY



David J. Kyffers

Director of the United States Patent and Trademark Office

United States of America

United States Patent and Trademark Office

TRANSACTION CENTRAL

Reg. No. 4,072,267

Registered Dec. 20, 2011

Int. Cl.: 36

SERVICE MARK

PRINCIPAL REGISTER

TRANSFIRST, LLC (DELAWARE LIMITED LIABILITY COMPANY)
5400 LBJ FREEWAY, SUITE 900
DALLAS, TX 75240

FOR: PAYMENT AND TRANSACTION PROCESSING, NAMELY, CREDIT CARD AND DEBIT CARD PROCESSING SERVICES FEATURING AN ONLINE AND BATCH PROCESSING SOFTWARE ENGINE FOR AUTHORIZING, PROCESSING, MAINTAINING AND CLEARING ONLINE REAL-TIME REPORTING, 24/7, INTERNET BASED, WIRELESS, AND POS TERMINAL BASED TRANSACTIONS, IN CLASS 36 (U.S. CLS. 100, 101 AND 102).

FIRST USE 3-1-2004; IN COMMERCE 3-1-2004.

THE MARK CONSISTS OF STANDARD CHARACTERS WITHOUT CLAIM TO ANY PARTICULAR FONT, STYLE, SIZE, OR COLOR.

NO CLAIM IS MADE TO THE EXCLUSIVE RIGHT TO USE "TRANSACTION", APART FROM THE MARK AS SHOWN.

SER. NO. 76-688,766, FILED 4-21-2008.

MEGHAN REINHART, EXAMINING ATTORNEY



David J. Kyros

Director of the United States Patent and Trademark Office

United States of America

United States Patent and Trademark Office

DESIGN FUSION

Reg. No. 4,072,268

Registered Dec. 20, 2011

Int. Cls.: 41, 42 and 44

SERVICE MARK

PRINCIPAL REGISTER

JDS INTERNATIONAL, INC. (NEW YORK CORPORATION)
164 WEST 25TH STREET
5TH FLOOR
NEW YORK, NY 10001

FOR: PARTY AND SPECIAL EVENT PLANNING, IN CLASS 41 (U.S. CLS. 100, 101 AND 107).

FIRST USE 6-30-1996; IN COMMERCE 6-30-1996.

FOR: INTERIOR DESIGN SERVICES, IN CLASS 42 (U.S. CLS. 100 AND 101).

FIRST USE 6-30-1996; IN COMMERCE 6-30-1996.

FOR: CREATION OF FLORAL ARRANGEMENTS AND CENTERPIECES, IN CLASS 44 (U.S. CLS. 100 AND 101).

FIRST USE 6-30-1996; IN COMMERCE 6-30-1996.

THE MARK CONSISTS OF STANDARD CHARACTERS WITHOUT CLAIM TO ANY PARTICULAR FONT, STYLE, SIZE, OR COLOR.

NO CLAIM IS MADE TO THE EXCLUSIVE RIGHT TO USE "DESIGN", APART FROM THE MARK AS SHOWN.

SER. NO. 76-690,313, FILED 6-6-2008.

TOBY BULLOFF, EXAMINING ATTORNEY



David J. Kyffers

Director of the United States Patent and Trademark Office

United States of America

United States Patent and Trademark Office



Seven Seas Gifts

Reg. No. 4,072,269

KIRBY, DARLENE (UNITED STATES INDIVIDUAL)
56 FAIRWOOD LANE
BRANDON, MS 39042

Registered Dec. 20, 2011

Int. Cl.: 35

FOR: ON-LINE RETAIL/WHOLESALE GIFT SHOP AND RETAIL/WHOLESALE STORE SERVICES FEATURING GIFT ITEMS, NAMELY, GIFT WARE, HOME DECOR/ACCENTS, ETHNIC-THEME DECOR, ART, GLASS SCULPTURES, VASES, MUSICAL ITEMS, JEWELRY AND TRINKET BOXES, KEY CHAINS/HOLDERS, ROOM FRAGRANCES, CANDLES AND HOLDERS/SCENTED OILS, HOUSEHOLD ITEMS, CURTAINS/RINGS, RUGS AND PILLOWS, KITCHEN ITEMS, BED-AND-BATH ITEMS, BABY ITEMS, LAMPS, CHANDELIERS, DOLLS, TOYS, GAMES, FRAMES, MINIATURE TEA SETS/OTHER COLLECTIBLES, STATIONERY ITEMS, OFFICE SUPPLIES, LUGGAGE, INDOOR/OUTDOOR SCULPTURES, INDOOR/OUTDOOR FOUNTAINS, SILK PLANTS AND FLORAL STANDS, GARDEN ITEMS/PLANTERS, BIRDBATHS/FEEDERS AND HOUSES, WIND CHIMES, TOOLS AND AUTO EMERGENCY KITS; ON-LINE RETAIL AND WHOLESALE GIFT SHOP SERVICES, IN CLASS 35 (U.S. CLS. 100, 101 AND 102).

SERVICE MARK

PRINCIPAL REGISTER

FIRST USE 2-1-1999; IN COMMERCE 0-0-2000.

NO CLAIM IS MADE TO THE EXCLUSIVE RIGHT TO USE "GIFTS", APART FROM THE MARK AS SHOWN.



THE MARK CONSISTS OF THE WORDING, "SEVEN SEAS GIFTS" WITH A SEAHORSE, EEL, DOLPHIN WITH WATER DROPLETS, SAND DOLLAR, SEA CREATURE, FISHING LINE & HOOK WITH RIPPLES, STARFISH, AND AN ANCHOR IN THE SHAPE OF, OR CONNECTED WITH, THE LETTERS. THE LETTER "S" IN THE WORD "GIFTS" IS IN THE SHAPE OF AN OLD-TIME-LOOK SAILING SHIP. AND AN OUTLINE OF THE SEA UNDERSCORES THE WORDING. THE ABOVE CONSISTS OF THE BUSINESS NAME AND LOGO, "SEVEN SEAS GIFTS".

SER. NO. 76-691,665, FILED 7-29-2008.

JUSTINE D. PARKER, EXAMINING ATTORNEY

David J. Kyffers

Director of the United States Patent and Trademark Office

United States of America

United States Patent and Trademark Office

COURAGE BEYOND THE BATTLEFIELD

Reg. No. 4,072,270

NA TECHNOLOGIES, LLC (TENNESSEE LIMITED LIABILITY COMPANY)
219 54TH AVENUE, N.
NASHVILLE, TN 37209

Registered Dec. 20, 2011

Int. Cls.: 44 and 45

FOR: PROVIDING A WEBSITE FEATURING INFORMATION CONCERNING PSYCHOLOGICAL COUNSELING, PSYCHOLOGICAL AND EMOTIONAL THERAPY AND PSYCHOLOGICAL SUPPORT FOR VETERANS AND MILITARY PERSONNEL, IN CLASS 44 (U.S. CLS. 100 AND 101).

SERVICE MARK

PRINCIPAL REGISTER

FIRST USE 9-1-2008; IN COMMERCE 9-1-2008.

FOR: PROVIDING A WEBSITE FEATURING INFORMATION CONCERNING EMOTIONAL COUNSELING AND EMOTIONAL SUPPORT FOR VETERANS AND MILITARY PERSONNEL; PROVIDING A SOCIAL NETWORKING WEB SITE FOR VETERANS AND MILITARY PERSONNEL, IN CLASS 45 (U.S. CLS. 100 AND 101).

FIRST USE 9-1-2008; IN COMMERCE 9-1-2008.

THE MARK CONSISTS OF STANDARD CHARACTERS WITHOUT CLAIM TO ANY PARTICULAR FONT, STYLE, SIZE, OR COLOR.

SER. NO. 76-701,819, FILED 2-26-2010.

KEVIN DINALLO, EXAMINING ATTORNEY



David J. Kybas

Director of the United States Patent and Trademark Office

United States of America

United States Patent and Trademark Office

ETERNAL YOUTH

Reg. No. 4,072,271

WHEELER, JACOB (UNITED STATES INDIVIDUAL)

Registered Dec. 20, 2011

PO BOX 654
CAPITOLA, CA 95010

Int. Cl.: 5

FOR: NUTRITIONAL SUPPLEMENTS, FOR SUPPORTING ENHANCED LIBIDO, IN CLASS 5 (U.S. CLS. 6, 18, 44, 46, 51 AND 52).

TRADEMARK

FIRST USE 10-27-2009; IN COMMERCE 10-27-2009.

PRINCIPAL REGISTER

THE MARK CONSISTS OF STANDARD CHARACTERS WITHOUT CLAIM TO ANY PARTICULAR FONT, STYLE, SIZE, OR COLOR.

SER. NO. 76-702,058, FILED 3-15-2010.

GRETCHEN ULRICH, EXAMINING ATTORNEY



David J. Kybas

Director of the United States Patent and Trademark Office

United States of America

United States Patent and Trademark Office



Reg. No. 4,072,272

Registered Dec. 20, 2011

Int. Cl.: 33

TRADEMARK

PRINCIPAL REGISTER

CONSORCIO NATLY, S.A DE C.V. (MEXICO PARTNERSHIP)
JAIME GOMEZ #1271
PASEOS DEL SOL.
ZAPOPAN, MEXICO 95079

FOR: ALCOHOLIC BEVERAGES, NAMELY, TEQUILA, IN CLASS 33 (U.S. CLS. 47 AND 49).

FIRST USE 2-9-2009; IN COMMERCE 2-9-2009.

THE MARK CONSISTS OF THE TERM "MULUK" CENTERED BETWEEN THE DESIGN ELEMENTS OF THE MARK. BELOW THE TERM IS A STYLIZED DESIGN CONSISTING OF HORIZONTAL LINES, DOTTED LINES AND STARBURST DESIGNS BELOW AN ABSTRACT DESIGN OF A PORTION OF AN AGAVE PLANT REACHING UPWARD. ABOVE THE TERM "MULUK" IS A STYLIZED DESIGN OF A QUARTER MOON REPRESENTING A HUMAN FACE. THE MOON DESIGN IS SURROUNDED BY A BLACK LINE REPRESENTING THE OUTLINE OF A FULL MOON. THE RIGHT PORTION OF THE MOON IS FILLED WITH STYLIZED FLOWERS AGAINST A BLACK BACKGROUND. TO THE RIGHT OF THE MOON DESIGN IS A SMALLER QUARTER MOON IN BLACK, FACING OUTWARD TO THE RIGHT. TO THE LEFT OF THE MOON DESIGN IS A SMALLER QUARTER MOON, FACING OUTWARD TO THE LEFT. AT THE TOP OF THE MARK IS A STYLIZED DESIGN CONSISTING OF HORIZONTAL LINES, DOTTED LINES AND STARBURST DESIGNS.

THE WORDING "MULUK" HAS NO MEANING IN A FOREIGN LANGUAGE.

SER. NO. 76-702,848, FILED 5-7-2010.

PAULA MAHONEY, EXAMINING ATTORNEY



David J. Kyffers

Director of the United States Patent and Trademark Office

United States of America

United States Patent and Trademark Office

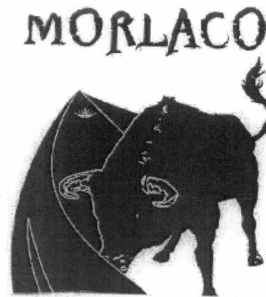

Reg. No. 4,072,273

Registered Dec. 20, 2011

Int. Cl.: 33

TRADEMARK

PRINCIPAL REGISTER

CORSORCIO NATLY SA DE CV (MEXICO PARTNERSHIP)
JAIME GOMEZ # 1271 PASCOS DOL SOL
JALISCO, MEXICO 45079

FOR: ALCOHOLIC BEVERAGES, NAMELY, TEQUILA, IN CLASS 33 (U.S. CLS. 47 AND 49).

FIRST USE 2-9-2009; IN COMMERCE 2-9-2009.

THE MARK CONSIST OF THE TERM "MORLACO", CENTERED AT THE TOP OF THE MARK. BELOW THE TERM IS A STYLIZED DESIGN OF A BULL CHARGING IN TO A CAPE. AT THE APEX OF THE CAPE IS A SMALL STYLIZED DESIGN OF AN AGAVE PLANT

THE WORDING "MORLACO" HAS NO MEANING IN A FOREIGN LANGUAGE.

SER. NO. 76-702,849, FILED 5-7-2010.

PAULA MAHONEY, EXAMINING ATTORNEY



David J. Kybas

Director of the United States Patent and Trademark Office

United States of America

United States Patent and Trademark Office

di PAZZO
cucina

Reg. No. 4,072,274

Registered Dec. 20, 2011

Int. Cl.: 43

SERVICE MARK

PRINCIPAL REGISTER

PFOODMAN HOLDINGS, L.L.C (MISSOURI LIMITED LIABILITY COMPANY)
15480 CLAYTON ROAD, SUITE 301
BALLWIN, MO 63011

FOR: RESTAURANT SERVICES, INCLUDING SIT-DOWN SERVICE OF FOOD AND TAKE-OUT RESTAURANT SERVICES IN A FOOD COURT; AND CATERING SERVICES , IN CLASS 43 (U.S. CLS. 100 AND 101).

FIRST USE 5-1-2009; IN COMMERCE 5-1-2009.

NO CLAIM IS MADE TO THE EXCLUSIVE RIGHT TO USE "CUCINA", APART FROM THE MARK AS SHOWN.

THE MARK CONSISTS OF THE WORDING "DI PAZZO" OVER THE WORDING "CUCINA" IN SCRIPT WRITING, WITH THE DESIGN OF A TOMATO AS THE "O" IN "PAZZO."

THE ENGLISH TRANSLATION OF "DI PAZZO CUCINA" IS "FROM THE CRAZY KITCHEN".

SER. NO. 76-703,054, FILED 5-21-2010.

ANN E. SAPPENFIELD, EXAMINING ATTORNEY



David J. Kybas

Director of the United States Patent and Trademark Office

United States of America

United States Patent and Trademark Office

GENERAL VENDING

Reg. No. 4,072,275

Registered Dec. 20, 2011

Int. Cl.: 41

SERVICE MARK

PRINCIPAL REGISTER

M&A GROUP, LLC (FLORIDA LIMITED LIABILITY COMPANY)
1112 WESTON RD.
NO. 190
WESTON, FL 33326

FOR: COIN OPERATED AMUSEMENT SERVICES, NAMELY, THE RENTAL OR LEASE OF COIN OPERATED AMUSEMENT MACHINES, IN CLASS 41 (U.S. CLS. 100, 101 AND 107).

FIRST USE 12-0-2005; IN COMMERCE 12-0-2005.

THE MARK CONSISTS OF STANDARD CHARACTERS WITHOUT CLAIM TO ANY PARTICULAR FONT, STYLE, SIZE, OR COLOR.

NO CLAIM IS MADE TO THE EXCLUSIVE RIGHT TO USE "VENDING", APART FROM THE MARK AS SHOWN.

SER. NO. 76-704,965, FILED 10-14-2010.

DEBRA LEE, EXAMINING ATTORNEY



David J. Kyffers

Director of the United States Patent and Trademark Office

United States of America

United States Patent and Trademark Office

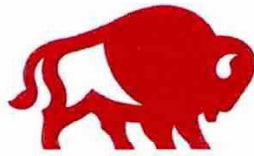

PrimeLending
A PlainsCapital Company

Reg. No. 4,072,276

Registered Dec. 20, 2011

Int. Cl.: 36

SERVICE MARK

PRINCIPAL REGISTER

PLAINSCAPITAL CORPORATION (TEXAS CORPORATION)
2323 VICTORY AVE.
SUITE 1400
DALLAS, TX 75219

FOR: MORTGAGE LENDING AND BROKERAGE SERVICES, IN CLASS 36 (U.S. CLS. 100, 101 AND 102).

FIRST USE 6-10-2010; IN COMMERCE 6-10-2010.

OWNER OF U.S. REG. NOS. 2,902,107 AND 2,971,881.

THE COLOR(S) RED AND BLACK ARE CLAIMED AS A FEATURE OF THE MARK.

NO CLAIM IS MADE TO THE EXCLUSIVE RIGHT TO USE "COMPANY", APART FROM THE MARK AS SHOWN.

THE MARK CONSISTS OF WORDING "PRIMELENDING" WITH "PRIME" APPEARING IN RED AND "LENDING" APPEARING IN BLACK, ALL ABOVE THE WORDING "A PLAINSCAPITAL COMPANY" IN BLACK, WITH A STYLIZED BUFFALO DESIGN IN RED ON TOP OF THE WORDING. THE WHITE IN THE MARK MERELY CONSTITUTES BACKGROUND.

SER. NO. 76-704,967, FILED 10-19-2010.

WARREN L. OLANDRIA, EXAMINING ATTORNEY



David J. Kyffers

Director of the United States Patent and Trademark Office

United States of America

United States Patent and Trademark Office



Reg. No. 4,072,277

Registered Dec. 20, 2011

Int. Cl.: 9

TRADEMARK

PRINCIPAL REGISTER

FOREVERLAST HUNTING PRODUCTS, INC. (TEXAS CORPORATION)
P.O. BOX 767
HALLETTSVILLE, TX 77964

FOR: PROTECTIVE GEAR, NAMELY, LEG GUARDS WORN OF THE LOWER LEG TO PROTECT FROM INJURY BY UNDERWATER STRUCTURES AND CREATURES, IN CLASS 9 (U.S. CLS. 21, 23, 26, 36 AND 38).

FIRST USE 4-0-2003; IN COMMERCE 5-0-2003.

NO CLAIM IS MADE TO THE EXCLUSIVE RIGHT TO USE "RAY-GUARD", APART FROM THE MARK AS SHOWN.

THE MARK CONSISTS OF THE WORDING "RAY-GUARD" ABOVE THE STYLIZED DESIGN OF A RAY.

SER. NO. 76-705,055, FILED 10-25-2010.

WILLIAM VERHOSEK, EXAMINING ATTORNEY



David J. Kybas

Director of the United States Patent and Trademark Office

United States of America
United States Patent and Trademark Office

KIRA'S KISS

Reg. No. 4,072,278

DAMSKER, ALEXANDRA (UNITED STATES INDIVIDUAL)
8033 WEST SHOSHONE
SPOKANE, WA 99203

Registered Dec. 20, 2011

Int. Cl.: 30

FOR: BREADS, PASTRIES AND BAKERY DESSERTS, IN CLASS 30 (U.S. CL. 46).

TRADEMARK

FIRST USE 2-15-2010; IN COMMERCE 2-15-2010.

PRINCIPAL REGISTER

THE MARK CONSISTS OF STANDARD CHARACTERS WITHOUT CLAIM TO ANY PARTICULAR FONT, STYLE, SIZE, OR COLOR.

SER. NO. 76-705,189, FILED 11-1-2010.

MARC LEIPZIG, EXAMINING ATTORNEY



David J. Kyfos

Director of the United States Patent and Trademark Office

United States of America

United States Patent and Trademark Office

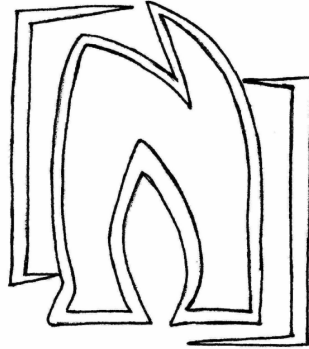

Reg. No. 4,072,279

ROGNER, CRAIG (UNITED STATES INDIVIDUAL)
1448 W. OLIVE
CHICAGO, IL 60660

Registered Dec. 20, 2011

Int. Cl.: 25

FOR: T-SHIRTS, HOODED JACKETS, HATS, WRISTBANDS, AND SHORTS, IN CLASS 25
(U.S. CLS. 22 AND 39).

TRADEMARK

FIRST USE 10-0-1999; IN COMMERCE 9-0-2010.

PRINCIPAL REGISTER

THE MARK CONSISTS OF A BACKWARDS LOWERCASE "N" WITH BROKEN LINES
AROUND IT.

SER. NO. 76-705,207, FILED 11-3-2010.

FRANK LATTUCA, EXAMINING ATTORNEY



David J. Kybas

Director of the United States Patent and Trademark Office

United States of America

United States Patent and Trademark Office



Reg. No. 4,072,280

Registered Dec. 20, 2011

Int. Cl.: 16

TRADEMARK

PRINCIPAL REGISTER

WOLFF, GAREN S. (UNITED STATES INDIVIDUAL)
49 VIRGINIA PARK
DETROIT, MI 48202

FOR: PRINTED MATTER AND PAPER GOODS, NAMELY, BOOKS FEATURING CHARACTERS FROM ANIMATED, ACTION ADVENTURE, COMEDY AND/OR DRAMA FEATURES, PICTURE BOOKS, CHILDREN'S BOOKS, COMIC BOOKS; PRINTED EDUCATIONAL AND TEACHING MATERIALS IN THE FIELDS OF READING, MATHEMATICS, MUSIC, BASIC LOGIC, GEOGRAPHY, AND THE ARTS; LITHOGRAPH PRINTS, SERIES OF FICTIONAL BOOKS AND MAGAZINES IN THE FIELD OF CHILDREN'S STORIES; PAPERWEIGHTS, MAGAZINES FEATURING CHARACTERS FROM ANIMATED, ACTION ADVENTURE, COMEDY AND/OR DRAMA FEATURES; COLORING BOOKS, STICKER BOOKS, CHILDREN'S ACTIVITY BOOKS; STATIONERY, WRITING PAPER, ENVELOPES, NOTEBOOKS, FOLDERS, DIARIES, NOTE PADS, NOTE CARDS; GREETING CARDS, TRADING CARDS; PENS, PENCILS, ERASERS, CRAYONS, HIGHLIGHTING MARKERS, COLORED PENCILS, PAINTING SETS FOR CHILDREN AND CASES THEREFOR; DECALS, STICKERS, PAPER HEAT TRANSFERS; POSTERS; MOUNTED AND UNMOUNTED PHOTOGRAPHS; BOOK COVERS, BOOK MARKS, CALENDARS, PAPER WALL CHARTS, GIFT WRAPPING PAPER; LETTER OPENERS, BOOKENDS, PAPER PARTY FAVORS AND PAPER PARTY DECORATIONS, NAMELY, PAPER NAPKINS, PAPER DOILIES, PAPER PLACE MATS, CREPE PAPER, PRINTED INVITATIONS, PAPER TABLE CLOTHS, PAPER CAKE DECORATIONS, IN CLASS 16 (U.S. CLS. 2, 5, 22, 23, 29, 37, 38 AND 50).

FIRST USE 9-9-2010; IN COMMERCE 9-9-2010.



David J. Kybas

Director of the United States Patent and Trademark Office

THE MARK CONSISTS OF FIVE GIRLS WITH FLESH TONE FACES, ARMS AND LEGS, EACH WEARING A PURPLE BLAZER HAVING PINK TRIM, ORANGE BUTTONS, AND A WHITE CURSIVE "G" ON A PINK BACKGROUND AS A LOGO; A VIOLET SKIRT WITH ORANGE AND PURPLE STRIPES, A WHITE SHIRT, AND A BLUE NECKTIE. THE FIRST GIRL HAS A RED HAT, BLACK HAIR, BROWN EYES, PINK LIPS, WHITE TEETH, AND BLACK SHOES; THE SECOND GIRL HAS A VIOLET HAT, BLACK HAIR, BROWN EYES, PINK LIPS, AND PINK BALLET SLIPPERS; THE THIRD GIRL HAS A RED HAT, BLACK HAIR, BROWN EYES, RED FRAME GLASSES, PINK LIPS, WHITE TEETH, AND BLACK AND WHITE SHOES; THE FOURTH GIRL HAS A VIOLET HAT, RED HAIR, BLUE EYES, PINK LIPS, AND DARK BROWN UPPER AND TAN LOWER COWBOY BOOTS; AND THE FIFTH GIRL HAS A RED HAT, BLACK HAIR, BROWN EYES, PINK LIPS, WHITE TEETH, AND BROWN SHOES WITH A WHITE BOW.

Reg. No. 4,072,280 THE COLOR(S) RED, PURPLE, PINK, BLUE, VIOLET, FLESH TONES, BROWN, TAN, BLACK, WHITE, AND ORANGE IS/ARE CLAIMED AS A FEATURE OF THE MARK.

SER. NO. 76-705,451, FILED 11-22-2010.

JOHN WILKE, EXAMINING ATTORNEY

United States of America

United States Patent and Trademark Office

FEAR THE BEARD

Reg. No. 4,072,281

Registered Dec. 20, 2011

Int. Cls.: 9, 16 and 25

TRADEMARK

PRINCIPAL REGISTER

DUCK COMMANDER, INC. (LOUISIANA CORPORATION)
117 KINGS LANE
WEST MONROE, LA 71292

FOR: PRERECORDED AUDIO AND VIDEO CASSETTES, AUDIO AND VIDEO TAPES, COMPACT DISKS, LASER DISKS AND DVDS FEATURING HUNTING ACTIVITIES , IN CLASS 9 (U.S. CLS. 21, 23, 26, 36 AND 38).

FIRST USE 6-10-2009; IN COMMERCE 6-10-2009.

FOR: DECALS AND POSTERS, IN CLASS 16 (U.S. CLS. 2, 5, 22, 23, 29, 37, 38 AND 50).

FIRST USE 11-11-2010; IN COMMERCE 11-11-2010.

FOR: APPAREL, NAMELY, SHIRTS AND CAPS, IN CLASS 25 (U.S. CLS. 22 AND 39).

FIRST USE 6-30-2009; IN COMMERCE 6-30-2009.

THE MARK CONSISTS OF STANDARD CHARACTERS WITHOUT CLAIM TO ANY PARTICULAR FONT, STYLE, SIZE, OR COLOR.

SER. NO. 76-705,466, FILED 11-24-2010.

DAVID YONTEF, EXAMINING ATTORNEY



David J. Kyfos

Director of the United States Patent and Trademark Office

United States of America

United States Patent and Trademark Office



Reg. No. 4,072,282

Registered Dec. 20, 2011

Int. Cl.: 1

TRADEMARK

PRINCIPAL REGISTER

HI-GEAR PRODUCTS, INC. (DELAWARE CORPORATION)
14 BRENT DRIVE
HUDSON, MA 07149

FOR: AUTOMOBILE SYSTEM LEAK SEALANTS, NAMELY, ENGINE BLOCK SEALANT, RADIATOR SEALANT, EXCLUDING FOAMACEOUS CAULKING MATERIAL, IN CLASS 1 (U.S. CLS. 1, 5, 6, 10, 26 AND 46).

FIRST USE 10-0-2001; IN COMMERCE 10-0-2001.

THE MARK CONSISTS OF THE WORDING "INSTA-SEAL" AGAINST A ROUNDED RECTANGULAR BACKGROUND WITH A PARTIAL INNER BORDER, FIFTEEN CIRCLES, FIVE RECTANGLES, AND A POLYGON.

SER. NO. 76-705,528, FILED 12-1-2010.

TINA MAI, EXAMINING ATTORNEY



David J. Kyffers

Director of the United States Patent and Trademark Office

United States of America

United States Patent and Trademark Office



Reg. No. 4,072,283

Registered Dec. 20, 2011

Int. Cl.: 9

TRADEMARK

PRINCIPAL REGISTER

NEWBORN CARE 101 LLC. (CALIFORNIA LIMITED LIABILITY COMPANY)
24307 MAGIC MOUNTAIN PARKWAY
VALENCIA, CA 91355

FOR: EDUCATIONAL KITS CONSISTING PRIMARILY OF A DVD AND A BOOKLET THAT ANSWER COMMON QUESTIONS ABOUT YOUNG CHILDREN, IN CLASS 9 (U.S. CLS. 21, 23, 26, 36 AND 38).

FIRST USE 10-0-2009; IN COMMERCE 12-0-2009.

NO CLAIM IS MADE TO THE EXCLUSIVE RIGHT TO USE "NEWBORN CARE", APART FROM THE MARK AS SHOWN.

THE MARK CONSISTS OF THE WORDING "NEWBORN CARE 101 WHAT PARENTS NEED TO KNOW" AND DESIGN. THE TERM "NEWBORN" APPEARS ABOVE THE TERM "CARE" AND THE NUMBER "101". THE NUMBER "101" IS SUPERIMPOSED ON A STAR. TO THE RIGHT IS THE DESIGN OF A PARTIAL CIRCLE AND SUPERIMPOSED ON THE CIRCLE IS THE DESIGN OF A BABY IN A BLANKET TIED WITH A BOW. A BANNER APPEARS BELOW CONTAINING THE WORDING "WHAT PARENTS NEED TO KNOW". A STAR APPEARS ABOVE THE LETTER "W" IN THE TERM "NEWBORN". A STAR APPEARS TO THE RIGHT AND AT THE BASE OF THE CIRCLE. A STAR APPEARS TO THE LEFT OF THE BANNER.

SER. NO. 76-705,707, FILED 12-17-2010.

MARLENE BELL, EXAMINING ATTORNEY



David J. Kybas

Director of the United States Patent and Trademark Office

United States of America

United States Patent and Trademark Office

CHANNELL

Reg. No. 4,072,284

Registered Dec. 20, 2011

Int. Cl.: 20

TRADEMARK

PRINCIPAL REGISTER

CHANNELL COMMERCIAL CORPORATION (DELAWARE CORPORATION)
76040 YNEZ ROAD
P.O. BOX 9022
TEMECULA, CA 925899022

FOR: POLYETHYLENE TANKS, NAMELY, RAINWATER STORAGE TANKS, MOLASSES TANKS, TRANSPORTER TANKS, BELLY TANKS; OTHER POLYETHYLENE PRODUCTS, NAMELY, GRADE LEVEL BOXES, VAULTS, AND HAND HOLES ALL IN THE NATURE OF PLASTIC STORAGE CONTAINERS FOR INDUSTRIAL OR COMMERCIAL USE, IN CLASS 20 (U.S. CLS. 2, 13, 22, 25, 32 AND 50).

FIRST USE 1-1-2006; IN COMMERCE 1-1-2006.

THE MARK CONSISTS OF STANDARD CHARACTERS WITHOUT CLAIM TO ANY PARTICULAR FONT, STYLE, SIZE, OR COLOR.

OWNER OF U.S. REG. NO. 2,548,576.

SEC. 2(F).

SER. NO. 76-706,235, FILED 2-1-2011.

TASNEEM HUSSAIN, EXAMINING ATTORNEY



David J. Kybas

Director of the United States Patent and Trademark Office

United States of America

United States Patent and Trademark Office

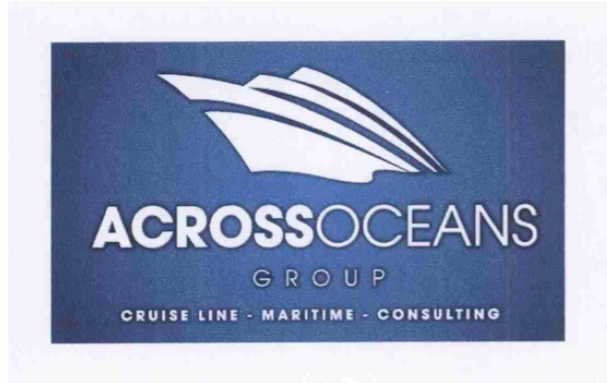

Reg. No. 4,072,285

Registered Dec. 20, 2011

Int. Cl.: 37

SERVICE MARK

PRINCIPAL REGISTER

ACROSS OCEANS GROUP, INC. (FLORIDA CORPORATION)
905 BRICKELL BAY DRIVE
TOWER II, SUITE 1431
MIAMI, FL 331312927

FOR: CONSULTING SERVICES RELATING TO THE REPAIR, CONSERVATION, RENOVATION AND REFIT OF MARITIME OBJECTS INCLUDING YACHTS, BOATS, VESSELS, CRUISE LINES, AND BARGES, IN CLASS 37 (U.S. CLS. 100, 103 AND 106).

FIRST USE 5-11-2010; IN COMMERCE 5-11-2010.

NO CLAIM IS MADE TO THE EXCLUSIVE RIGHT TO USE "GROUP CRUISE LINE MARITIME CONSULTING", APART FROM THE MARK AS SHOWN.

THE COLOR(S) WHITE, BLUE AND DARK OCEAN BLUE IS/ARE CLAIMED AS A FEATURE OF THE MARK.

THE LITERAL ELEMENT OF THE MARK CONSISTS OF "ACROSS OCEANS GROUP CRUISE LINE - MARITIME - CONSULTING". THE MARK CONSISTS OF THE WORDING "ACROSS OCEANS GROUP CRUISE LINE - MARITIME - CONSULTING" IN STYLIZED WHITE LETTERING WRITTEN ON THREE LINES. THE WORD "ACROSS" APPEARS IN BOLD LETTERING. A WHITE SHIP DESIGN WITH THREE DARK OCEAN BLUE LINES APPEARS ABOVE THE WORDING "ACROSS OCEANS GROUP CRUISE LINE - MARITIME - CONSULTING". A DARK OCEAN BLUE BACKGROUND APPEARS WITH A FADE OF BLUE TOWARDS THE CENTER.

SER. NO. 76-706,290, FILED 2-4-2011.

MARILYN IZZI, EXAMINING ATTORNEY



David J. Kybas

Director of the United States Patent and Trademark Office

United States of America
United States Patent and Trademark Office

fōnuts

Reg. No. 4,072,286

TRUMAN, NANCY (UNITED STATES INDIVIDUAL)
852 CALIFORNIA AVENUE
VENICE, CA 90291

Registered Dec. 20, 2011

Int. Cl.: 30

FOR: BAKED GOODS, NAMELY, BAKED DONUTS, IN CLASS 30 (U.S. CL. 46).

FIRST USE 2-14-2011; IN COMMERCE 2-14-2011.

TRADEMARK

THE MARK CONSISTS OF THE WORD "FONUTS" IN STYLIZED FONT, WITH A HORIZONTAL LINE OVER THE LETTER "O".

PRINCIPAL REGISTER

THE WORDING "FONUTS" HAS NO MEANING IN A FOREIGN LANGUAGE.

SER. NO. 76-706,483, FILED 2-22-2011.

ELISSA GARBER KON, EXAMINING ATTORNEY



David J. Kybas

Director of the United States Patent and Trademark Office

United States of America

United States Patent and Trademark Office



Reg. No. 4,072,287

Registered Dec. 20, 2011

Int. Cl.: 9

TRADEMARK

PRINCIPAL REGISTER

THOMAS, MARSHALL (UNITED STATES INDIVIDUAL)
320 23RD ST. SOUTH #426
ARLINGTON, VA 22202

FOR: MOTION PICTURE FILMS ABOUT TORTURE AND CRIMES AGAINST HUMANITY,
IN CLASS 9 (U.S. CLS. 21, 23, 26, 36 AND 38).

FIRST USE 8-1-2010; IN COMMERCE 8-1-2010.

THE MARK CONSISTS OF A MISCELLANEOUS DESIGN. A BLACK, WHITE AND GRAY
CLOSE UP PHOTO APPEARS OF A HUMAN EYE. A BLUE, WHITE, GREEN AND BROWN
EARTH DESIGN APPEARS SUPERIMPOSED OVER THE IRIS OF THE EYE. A BLACK
SHADOW APPEARS ON THE LEFT AREA OF THE EYE.

THE COLOR(S) BLACK, WHITE, GRAY, BLUE, GREEN AND BROWN IS/ARE CLAIMED
AS A FEATURE OF THE MARK.

SER. NO. 76-706,493, FILED 2-22-2011.

SANI KHOURI, EXAMINING ATTORNEY



David J. Kyffers

Director of the United States Patent and Trademark Office

United States of America

United States Patent and Trademark Office

9 ESSENTIAL SKILLS FOR THE LOVE AND LOGIC CLASSROOM

Reg. No. 4,072,288

Registered Dec. 20, 2011

Int. Cl.: 41

SERVICE MARK

PRINCIPAL REGISTER

INSTITUTE FOR PROFESSIONAL DEVELOPMENT, LTD (COLORADO CORPORATION),
DBA THE LOVE AND LOGIC INSTITUTE, INC.
2207 JACKSON STREET
GOLDEN, CO 80401

FOR: PROVIDING TRAINING WORKSHOPS FOR TEACHING HOW TEACHERS AND
OTHER SCHOOL PERSONNEL CAN INTERACT WITH CHILDREN AND DISTRIBUTING
COURSE MATERIALS IN CONNECTION THEREWITH, IN CLASS 41 (U.S. CLS. 100, 101
AND 107).

FIRST USE 10-23-2008; IN COMMERCE 10-23-2008.

THE MARK CONSISTS OF STANDARD CHARACTERS WITHOUT CLAIM TO ANY PAR-
TICULAR FONT, STYLE, SIZE, OR COLOR.

OWNER OF U.S. REG. NOS. 1,813,708, 3,735,570 AND OTHERS.

SER. NO. 76-706,847, FILED 3-16-2011.

BARBARA BROWN, EXAMINING ATTORNEY



David J. Kyffers

Director of the United States Patent and Trademark Office

United States of America

United States Patent and Trademark Office

LONG DOGGERS

Reg. No. 4,072,289

LONG DOGGERS EATERIES, INC. (FLORIDA CORPORATION)
1814 SARNO ROAD
MELBOURNE, FL 32935

Registered Dec. 20, 2011

Int. Cl.: 43

FOR: BAR AND RESTAURANT SERVICES, IN CLASS 43 (U.S. CLS. 100 AND 101).

SERVICE MARK

FIRST USE 4-1-1997; IN COMMERCE 4-1-1997.

PRINCIPAL REGISTER

THE MARK CONSISTS OF STANDARD CHARACTERS WITHOUT CLAIM TO ANY PARTICULAR FONT, STYLE, SIZE, OR COLOR.

SER. NO. 76-706,988, FILED 3-28-2011.

CHARISMA HAMPTON, EXAMINING ATTORNEY



David J. Kyffers

Director of the United States Patent and Trademark Office

United States of America

United States Patent and Trademark Office

MAX'S QUALITY DRY GOODS

Reg. No. 4,072,290

Registered Dec. 20, 2011

Int. Cl.: 25

TRADEMARK

PRINCIPAL REGISTER

SEENA INTERNATIONAL INC. (NEW YORK CORPORATION)
95 HORSE BLOCK ROAD
P.O. BOX 60
YAPHANK, NY 11980

FOR: MENS, WOMENS AND CHILDRENS CLOTHING, NAMELY, TROUSERS, JACKETS, BLOUSES, PANTS, SHIRTS, SHORTS, JEANS, T-SHIRTS, HATS, SWEATSHIRTS, IN CLASS 25 (U.S. CLS. 22 AND 39).

FIRST USE 1-5-2011; IN COMMERCE 1-5-2011.

THE MARK CONSISTS OF STANDARD CHARACTERS WITHOUT CLAIM TO ANY PARTICULAR FONT, STYLE, SIZE, OR COLOR.

NO CLAIM IS MADE TO THE EXCLUSIVE RIGHT TO USE "QUALITY DRY GOODS", APART FROM THE MARK AS SHOWN.

SER. NO. 76-707,056, FILED 4-1-2011.

ANNE FARRELL, EXAMINING ATTORNEY



David J. Kyffers

Director of the United States Patent and Trademark Office

United States of America

United States Patent and Trademark Office

 **CampusTutors**

Reg. No. 4,072,291

ECAMPUSTUTORS, INC. (TEXAS CORPORATION)
9611 BELL MOUNTAIN DRIVE
AUSTIN, TX 78701

Registered Dec. 20, 2011

Int. Cl.: 41

FOR: EDUCATIONAL SERVICES, NAMELY, ONLINE ACADEMIC INSTRUCTION AS A SUPPLEMENT TO COLLEGE CLASSROOM INSTRUCTION THROUGH A COMPUTERIZED ONLINE NETWORK, IN CLASS 41 (U.S. CLS. 100, 101 AND 107).

SERVICE MARK

FIRST USE 3-25-2011; IN COMMERCE 3-25-2011.

PRINCIPAL REGISTER

NO CLAIM IS MADE TO THE EXCLUSIVE RIGHT TO USE "CAMPUS TUTORS", APART FROM THE MARK AS SHOWN.

THE MARK CONSISTS OF THE WORDING "E CAMPUSTUTORS" WITH THE "E" SET APART IN LOWER CASE CONTAINED IN A SOLID CUBE. AN ARROW POINTS TO THE BOTTOM RIGHT CORNER OF THE CUBE. THE "C" AND "T" ARE CAPITALIZED. THE ENTIRE MARK IS SET ON A TRANSPARENT BACKGROUND.

SER. NO. 76-707,064, FILED 4-1-2011.

JOSETTE BEVERLY, EXAMINING ATTORNEY



David J. Kyffers

Director of the United States Patent and Trademark Office

United States of America

United States Patent and Trademark Office

PRESSUREZE

Reg. No. 4,072,292

LUTIN, MATTHEW (UNITED STATES INDIVIDUAL)
6936 QUIET COVE DRIVE
CARLESBAD, CA 92011

Registered Dec. 20, 2011

Int. Cl.: 5

FOR: NASAL PREPARATION IN THE FORM OF SPRAY, MIST OR DROPS FOR TREATING EAR AND SINUS CONGESTION AND PRESSURE, IN CLASS 5 (U.S. CLS. 6, 18, 44, 46, 51 AND 52).

TRADEMARK

FIRST USE 12-15-2000; IN COMMERCE 3-15-2010.

PRINCIPAL REGISTER

THE MARK CONSISTS OF STANDARD CHARACTERS WITHOUT CLAIM TO ANY PARTICULAR FONT, STYLE, SIZE, OR COLOR.

SER. NO. 76-707,084, FILED 4-1-2011.

STEVEN PEREZ, EXAMINING ATTORNEY



David J. Kybas

Director of the United States Patent and Trademark Office

United States of America

United States Patent and Trademark Office

BUTTER SLICK SHINE

Reg. No. 4,072,293

K & W BUTTERSLICK AUTO GROUP, INC. (INDIANA CORPORATION)
835 WEST 5TH AVE
GARY, IN 464041809

Registered Dec. 20, 2011

Int. Cl.: 3

FOR: AUTOMOTIVE WAX, TIRE DRESSING, CAR FRAGRANCE, IN CLASS 3 (U.S. CLS. 1, 4, 6, 50, 51 AND 52).

TRADEMARK

FIRST USE 2-1-2001; IN COMMERCE 2-1-2001.

PRINCIPAL REGISTER

THE MARK CONSISTS OF STANDARD CHARACTERS WITHOUT CLAIM TO ANY PARTICULAR FONT, STYLE, SIZE, OR COLOR.

NO CLAIM IS MADE TO THE EXCLUSIVE RIGHT TO USE "SHINE", APART FROM THE MARK AS SHOWN.

SER. NO. 76-707,325, FILED 4-18-2011.

FRED CARL, EXAMINING ATTORNEY



David J. Kybas

Director of the United States Patent and Trademark Office

United States of America

United States Patent and Trademark Office

SOUTHERN WEDDING CAKE

Reg. No. 4,072,294

Registered Dec. 20, 2011

Int. Cl.: 30

TRADEMARK

PRINCIPAL REGISTER

NEW ORLEANS ROAST, LLC
109 NEW CAMELLIA BOULEVARD, SUITE 201
COVINGTON, LA 70433

FOR: COFFEE BEANS, IN CLASS 30 (U.S. CL. 46).

FIRST USE 8-18-2010; IN COMMERCE 8-18-2010.

THE MARK CONSISTS OF STANDARD CHARACTERS WITHOUT CLAIM TO ANY PARTICULAR FONT, STYLE, SIZE, OR COLOR.

NO CLAIM IS MADE TO THE EXCLUSIVE RIGHT TO USE "WEDDING CAKE", APART FROM THE MARK AS SHOWN.

SER. NO. 76-707,439, FILED S.R. 4-28-2011 AM. P.R. 5-4-2011.

KIMBERLY FRYE, EXAMINING ATTORNEY



David J. Kybas

Director of the United States Patent and Trademark Office

United States of America

United States Patent and Trademark Office



Reg. No. 4,072,295

LOCKWOOD, ROBERT G. (UNITED STATES INDIVIDUAL)
15122 VERMONT AVENUE
PARAMOUNT, CA 90723

Registered Dec. 20, 2011

Int. Cl.: 20

FOR: DISPLAY FURNITURE AND FURNITURE FIXTURES, NAMELY, DISASSEMBLED PRODUCT SHOWCASES, IN CLASS 20 (U.S. CLS. 2, 13, 22, 25, 32 AND 50).

TRADEMARK

FIRST USE 1-1-1990; IN COMMERCE 1-1-1990.

PRINCIPAL REGISTER

THE MARK CONSISTS OF THE LETTERS "SCI" IN STYLIZED FONT SURROUNDED BY AN INCOMPLETE RECTANGLE.

SER. NO. 76-707,449, FILED S.R. 4-29-2011 AM. P.R. 5-4-2011.

ERNEST SHOSHO, EXAMINING ATTORNEY



David J. Kybas

Director of the United States Patent and Trademark Office

United States of America

United States Patent and Trademark Office

BACKSCANS

Reg. No. 4,072,296

BLUMBERGEXCELSIOR, INC. (NEW YORK CORPORATION)
62 WHITE STREET
NEW YORK, NY 10013

Registered Dec. 20, 2011

Int. Cl.: 16

FOR: SCANNABLE LITIGATION COVERS FOR DOCUMENTS, IN CLASS 16 (U.S. CLS. 2, 5, 22, 23, 29, 37, 38 AND 50).

TRADEMARK

FIRST USE 4-29-2011; IN COMMERCE 4-29-2011.

PRINCIPAL REGISTER

THE MARK CONSISTS OF STANDARD CHARACTERS WITHOUT CLAIM TO ANY PARTICULAR FONT, STYLE, SIZE, OR COLOR.

SER. NO. 76-707,554, FILED 5-9-2011.

REBECCA POVARCHUK, EXAMINING ATTORNEY



David J. Kybas

Director of the United States Patent and Trademark Office

United States of America

United States Patent and Trademark Office



Reg. No. 4,072,297

RARE TAX SERVICE CORP. (NEW YORK CORPORATION)
2024 THIRD AVENUE
NEW YORK, NY 10029

Registered Dec. 20, 2011

Int. Cl.: 35

FOR: TAX PREPARATION SERVICES, IN CLASS 35 (U.S. CLS. 100, 101 AND 102).

SERVICE MARK

FIRST USE 4-1-2011; IN COMMERCE 4-1-2011.

PRINCIPAL REGISTER

NO CLAIM IS MADE TO THE EXCLUSIVE RIGHT TO USE "TAX SERVICE", APART FROM THE MARK AS SHOWN.

THE DESIGN CONSISTS OF A BULL INSIDE A SQUARE WITH A DOUBLE LINE BORDER, THE OUTER BORDER WHICH IS BOLD. TO THE RIGHT OF THE SQUARE IS WORD "RARE" IN BOLD LETTERS ABOVE THE WORDS "TAX SERVICE". BELOW THE DESIGN AND THE WORDS ARE TWO HORIZONTAL LINES. WITHIN THESE LINES ARE THE WORDS "YOUR TAX AND FINANCIAL SOLUTIONS' HUB". THE ENTIRE MARK IS PLACED WITHIN A RECTANGULAR BORDER WITH CURVED CORNERS.

SER. NO. 76-707,556, FILED 5-9-2011.

REBECCA POVARCHUK, EXAMINING ATTORNEY



David J. Kybas

Director of the United States Patent and Trademark Office

United States of America

United States Patent and Trademark Office

BOOM MAN

Reg. No. 4,072,298

HALE FIREWORKS, LLC (MISSOURI LIMITED LIABILITY COMPANY)
45 ROCKET RD.
BUFFALO, MO 65622

Registered Dec. 20, 2011

Int. Cl.: 13

FOR: FIREWORKS, IN CLASS 13 (U.S. CLS. 2 AND 9).

TRADEMARK

FIRST USE 10-31-1998; IN COMMERCE 10-31-1998.

PRINCIPAL REGISTER

THE MARK CONSISTS OF STANDARD CHARACTERS WITHOUT CLAIM TO ANY PARTICULAR FONT, STYLE, SIZE, OR COLOR.

SER. NO. 76-707,579, FILED 5-12-2011.

KATHLEEN LORENZO, EXAMINING ATTORNEY



David J. Kyffers

Director of the United States Patent and Trademark Office

United States of America

United States Patent and Trademark Office

KEY

Reg. No. 4,072,299

AGRA SOLUTIONS, LLC (OHIO LIMITED LIABILITY COMPANY)
23778 DELPHOS JENNINGS ROAD
DELPHOS, OH 45833

Registered Dec. 20, 2011

Int. Cl.: 31

FOR: FARM SEEDS, NAMELY, CORN, SOYBEANS, WHEAT, AND OATS, IN CLASS 31 (U.S. CLS. 1 AND 46).

TRADEMARK

FIRST USE 1-11-2011; IN COMMERCE 1-11-2011.

PRINCIPAL REGISTER

THE MARK CONSISTS OF STANDARD CHARACTERS WITHOUT CLAIM TO ANY PARTICULAR FONT, STYLE, SIZE, OR COLOR.

SER. NO. 76-707,591, FILED 5-13-2011.

WARREN L. OLANDRIA, EXAMINING ATTORNEY



David J. Kyffers

Director of the United States Patent and Trademark Office

United States of America

United States Patent and Trademark Office



Reg. No. 4,072,300

CYCLE SYSTEMS, INC. (VIRGINIA CORPORATION)
2580 BROADWAY STREET S.W.
ROANOKE, VA 24014

Registered Dec. 20, 2011

Int. Cl.: 40

FOR: RECYCLING, IN CLASS 40 (U.S. CLS. 100, 103 AND 106).

SERVICE MARK

FIRST USE 0-0-2007; IN COMMERCE 0-0-2007.

PRINCIPAL REGISTER

OWNER OF U.S. REG. NO. 3,260,389.

THE COLOR(S) GREEN AND BLACK IS/ARE CLAIMED AS A FEATURE OF THE MARK.

THE MARK CONSISTS OF THE WORDS SCRAP BOXX SUPERIMPOSED UPON A CIRCULAR DESIGN WHICH CARRIES THREE TRILATERAL SHAPES. THE COLORS GREEN AND BLACK ARE FEATURES OF THE MARK. THE COLOR GREEN APPEARS IN LETTERS COMPRISING THE WORDS SCRAP BOXX AND THE CIRCULAR DESIGN. THE COLOR BLACK SHADOWS THE LETTERS COMPRISING THE WORDS SCRAP BOXX AND APPEARS IN THE THREE TRILATERAL SHAPES.

SER. NO. 76-707,648, FILED 5-17-2011.

MAYUR VAGHANI, EXAMINING ATTORNEY



David J. Kybas

Director of the United States Patent and Trademark Office

United States of America

United States Patent and Trademark Office

HANDICATOR

Reg. No. 4,072,301

AINSWORTH, PETER ROBERT (UNITED KINGDOM INDIVIDUAL)
16 MONKSFIELD, THREE BRIDGES
CRAWLEY, UNITED KINGDOM RH101PL

Registered Dec. 20, 2011

Int. Cl.: 25

FOR: GLOVES; CLOTHING FOR HORSE-RIDING AND CYCLISTS, NAMELY, T-SHIRTS, LONG SLEEVE T-SHIRTS AND CAPS, IN CLASS 25 (U.S. CLS. 22 AND 39).

TRADEMARK

THE MARK CONSISTS OF STANDARD CHARACTERS WITHOUT CLAIM TO ANY PARTICULAR FONT, STYLE, SIZE, OR COLOR.

PRINCIPAL REGISTER

OWNER OF UNITED KINGDOM REG. NO. 2406570, DATED 11-15-2005, EXPIRES 11-15-2015.

SER. NO. 77-023,218, FILED 10-17-2006.

AMY C. KEAN, EXAMINING ATTORNEY



David J. Kyffers

Director of the United States Patent and Trademark Office

United States of America

United States Patent and Trademark Office

CAPETIA

Reg. No. 4,072,302

Registered Dec. 20, 2011

Int. Cl.: 14

TRADEMARK

PRINCIPAL REGISTER

GONTHIEZ, MARC J. (FRANCE INDIVIDUAL)
THE NEMOURS BUILDING, 9TH FLOOR
1007 NORTH ORANGE STREET
WILMINGTON, DE 19801

FOR: BEADS FOR USE IN THE MANUFACTURE OF JEWELRY; BRACELETS; BRONZE JEWELRY; BROOCHES; CHARMS; COSTUME JEWELRY; EARRINGS; IDENTIFICATION BRACELETS; JEWELRY; JEWELRY CHAINS; JEWELRY FOR THE HEAD; JEWELRY PINS FOR USE ON HATS; JEWELRY WATCHES; JEWELRY, NAMELY, AMULETS; JEWELRY, NAMELY, CROSSES; JEWELRY, NAMELY, PRECIOUS METAL PLATED REAL LEAVES AND FLOWERS; LAPEL PINS; NECKLACES; PET JEWELRY; PINS BEING JEWELRY; RINGS BEING JEWELRY; LEATHER JEWELRY, IN CLASS 14 (U.S. CLS. 2, 27, 28 AND 50).

THE MARK CONSISTS OF STANDARD CHARACTERS WITHOUT CLAIM TO ANY PARTICULAR FONT, STYLE, SIZE, OR COLOR.

OWNER OF FRANCE REG. NO. 804318, DATED 7-23-1999, RENEWED AS REG. NO. 2415945, DATED 8-18-2009, EXPIRES 8-18-2019.

SER. NO. 77-098,578, FILED 2-3-2007.

ANDREA BUTLER, EXAMINING ATTORNEY



David J. Kyffers

Director of the United States Patent and Trademark Office

United States of America

United States Patent and Trademark Office

The Bottom Line on Where to Dine

Reg. No. 4,072,303

Registered Dec. 20, 2011

Int. Cl.: 16

TRADEMARK

PRINCIPAL REGISTER

WHERE TO DINE IN, LLC (NEW YORK LIMITED LIABILITY COMPANY)

#7

245-30 GRAND CENTRAL PKWY
BELLEROSE, NY 11426

FOR: PRINTED PUBLICATIONS, NAMELY, MAGAZINES, BOOKS, BULLETINS AND NEWSLETTERS FOCUSING ON THE RESTAURANT INDUSTRY, IN CLASS 16 (U.S. CLS. 2, 5, 22, 23, 29, 37, 38 AND 50).

FIRST USE 1-29-2007; IN COMMERCE 1-29-2007.

THE MARK CONSISTS OF STANDARD CHARACTERS WITHOUT CLAIM TO ANY PARTICULAR FONT, STYLE, SIZE, OR COLOR.

OWNER OF U.S. REG. NO. 3,166,559.

SER. NO. 77-130,430, FILED 3-14-2007.

CHRISTINE COOPER, EXAMINING ATTORNEY



David J. Kyros

Director of the United States Patent and Trademark Office

United States of America

United States Patent and Trademark Office

NO. 4,072,304

Reg. No. 4,072,304

Registered Dec. 20, 2011

Int. Cls.: 9, 18, 20, 21, 24, 25 and 35

2077223 ONTARIO LIMITED (CANADA CORPORATION)
2800 MATHESON BOULEVARD EAST
MISSISSAUGA, ONTARIO, CANADA L4W4X5

FOR: EYEGLASS FRAMES, SUNGLASSES, SUNGLASS COVERS FOR PROTECTIVE PURPOSES, EYEGLASS CASES, CD STORAGE RACKS AND BATTERY CHARGERS, IN CLASS 9 (U.S. CLS. 21, 23, 26, 36 AND 38).

TRADEMARK

SERVICE MARK

PRINCIPAL REGISTER

FOR: BAGS, NAMELY, COSMETIC BAGS AND POUCHES SOLD EMPTY, LUGGAGE BAGS, GYM BAGS, SHOULDER BAGS, CLUTCH BAGS, PURSES, CHANGE PURSES, TOTE BAGS, DRAWSTRING BAGS, DUFFLE BAGS, BACKPACKS AND HANDBAGS; WALLET, KEY CASES AND BRIEFCASE-TYPE PORTFOLIOS, IN CLASS 18 (U.S. CLS. 1, 2, 3, 22 AND 41).

FOR: FURNITURE, NAMELY, FURNITURE MIRRORS AND PICTURE FRAMES; HAND-HELD MIRRORS, BAKER'S BREAD BASKETS, TEXTILE PILLOWS AND TEXTILE CUSHIONS, IN CLASS 20 (U.S. CLS. 2, 13, 22, 25, 32 AND 50).

FOR: COASTERS NOT OF PAPER AND NOT BEING OF TABLE LINEN; AND RELATED COOKING UTENSILS, NAMELY, SERVING WARE FOR SERVING SALAD; BOWLS, PLATES, SERVING PLATTERS, CUPS, SAUCERS, RAMEKINS, CUPS; VASES; MIRROR BALLS; WATERING CANS; CANDLESTICKS; INCENSE BURNERS, CANDLESTICK HOLDERS, SOAP DISHES, TOOTHBRUSH HOLDERS, LOTION PUMPS SOLD EMPTY; CHINA DINNERWARE; FIGURINES OF CRYSTAL, BEVERAGE GLASSWARE, GOBLET, WINE DRINKING GLASSES, PITCHERS AND BASKETS MADE OF AT LEAST ONE OF THE FOLLOWING ITEMS, WICKER, STRAW, WOOD OR CLOTH, IN CLASS 21 (U.S. CLS. 2, 13, 23, 29, 30, 33, 40 AND 50).

FOR: TEXTILE FABRICS FOR THE MANUFACTURE OF CLOTHING AND HOUSEHOLD FURNITURE; TEXTILE ARTICLES, NAMELY, TABLECLOTHS, PLACEMATS, NAPKINS, SMALL LAP RUGS, BED BLANKETS, BED SHEETS, TOWELS, PILLOW CASES, COMFORTERS AND BEDSPREADS; HANDKERCHIEFS, IN CLASS 24 (U.S. CLS. 42 AND 50).

FOR: MEN'S, WOMEN'S AND CHILDREN'S WEARING APPAREL, NAMELY, PANTS, SLACKS, SHORTS, JUMPSUITS, SUITS, SKIRTS, DRESSES, BLAZERS, VESTS, JACKETS, TOPS, SHIRTS, BLOUSES, SWEATERS, T-SHIRTS, TANK TOPS, SWEATSHIRTS, JOGGING SUITS, WARM-UP SUITS, OUTERWEAR, NAMELY, COATS AND JACKETS, CAPES, PONCHOS, BATHING SUITS, BEACH AND SWIMMING COVER-UPS, LOUNGEWEAR,



David J. Kybas

Director of the United States Patent and Trademark Office

Reg. No. 4,072,304 KIMONOS, UNDERSHIRTS, UNDERWEAR, BOXER BRIEFS, BRIEFS, BRAS, NIGHTGOWNS, PAJAMAS, ROBES, HOUSECOATS, TIGHTS, LEGGINGS, STOCKINGS, HEADBANDS, TIES, SUSPENDERS, SOCKS, SCARVES, SHAWLS, SASHES, HATS, CAPS, BELTS, GLOVES; AND FOOTWEAR, NAMELY, SHOES, BOOTS AND SLIPPERS, IN CLASS 25 (U.S. CLS. 22 AND 39).

FOR: RETAIL STORE SERVICES FEATURING CLOTHING, FOOTWEAR AND HEADWEAR, PERSONAL CARE PRODUCTS, HOUSEHOLD FURNISHINGS, LINEN PRODUCTS, HOUSE WARES, SUNGLASSES, JEWELRY, WATCHES, CLOCKS AND FABRICS, IN CLASS 35 (U.S. CLS. 100, 101 AND 102).

THE MARK CONSISTS OF STANDARD CHARACTERS WITHOUT CLAIM TO ANY PARTICULAR FONT, STYLE, SIZE, OR COLOR.

PRIORITY CLAIMED UNDER SEC. 44(D) ON CANADA APPLICATION NO. 1337851, FILED 3-5-2007, REG. NO. TMA760,953, DATED 3-5-2010, EXPIRES 3-5-2025.

SER. NO. 77-145,003, FILED 3-30-2007.

REBECCA EISINGER, EXAMINING ATTORNEY

United States of America

United States Patent and Trademark Office

"Puttin' On The Hits"

Reg. No. 4,072,305

SOUTH CENTRAL COMMUNITY SERVICES, INC. (ILLINOIS CORPORATION)
8316 SOUTH ELLIS AVE.

Registered Dec. 20, 2011

CHICAGO, IL 60619

Int. Cl.: 41

FOR: ENTERTAINMENT IN THE NATURE OF VISUAL AND AUDIO PERFORMANCES,
AND MUSICAL, VARIETY, NEWS AND COMEDY SHOWS, IN CLASS 41 (U.S. CLS. 100,
101 AND 107).

SERVICE MARK

FIRST USE 3-1-1986; IN COMMERCE 3-1-1986.

PRINCIPAL REGISTER

THE MARK CONSISTS OF STANDARD CHARACTERS WITHOUT CLAIM TO ANY PAR-
TICULAR FONT, STYLE, SIZE, OR COLOR.

SER. NO. 77-148,623, FILED 4-4-2007.

PAUL E. FAHRENKOPF, EXAMINING ATTORNEY



David J. Kyffers

Director of the United States Patent and Trademark Office

United States of America

United States Patent and Trademark Office

ALLMAX NUTRITION

Reg. No. 4,072,306

Registered Dec. 20, 2011

Int. Cl.: 5

TRADEMARK

PRINCIPAL REGISTER

ALLMAX NUTRITION INC. (CANADA CORPORATION)
4576 YONGE STREET, SUITE 509
NORTH YORK
ONTARIO, M2N 6N4, CANADA

FOR: NUTRITIONAL SUPPLEMENTS FOR HUMAN CONSUMPTION, FEATURING CARBOHYDRATES, VITAMINS, MINERALS, HERBAL FORMULAS AND ENERGY FORMULAS; FOOD SUPPLEMENTS FOR BODY BUILDING, FEATURING AMINO ACIDS, CREATINE MONOHYDRATE OR DERIVATIVES THEREOF; FOOD SUPPLEMENTS IN THE NATURE OF HERBAL EXTRACTS FOR THE PROMOTION OF HEALTHY DIGESTIVE FUNCTION; FOOD SUPPLEMENTS IN THE NATURE OF HERBAL EXTRACTS FOR THE PROMOTION OF HEALTHY CELL FUNCTION; FOOD SUPPLEMENTS IN THE NATURE OF HERBAL EXTRACTS FOR THE PROMOTION OF HEALTHY CIRCULATORY FUNCTION; FOOD SUPPLEMENTS IN THE NATURE OF HERBAL EXTRACTS FOR THE PROMOTION OF HEALTHY JOINT FUNCTION; FOOD SUPPLEMENTS IN THE NATURE OF HERBAL EXTRACTS FOR THE PROMOTION OF HEALTHY EYE FUNCTION; FOOD SUPPLEMENTS IN THE NATURE OF HERBAL EXTRACTS FOR THE PROMOTION OF HEALTHY CARDIOVASCULAR FUNCTION; FOOD SUPPLEMENTS IN THE NATURE OF HERBAL EXTRACTS FOR THE PROMOTION OF HEALTHY WEIGHT MANAGEMENT; FOOD AND NUTRITIONAL FOOD SUPPLEMENTS, FEATURING VITAMINS AND MINERALS IN CAPSULE, POWDER, TABLET, DRINK AND BAR FORM FOR THE ENHANCEMENT OF STRENGTH AND SPORTS PERFORMANCE; EXCLUDING FOOD AND NUTRITIONAL SUPPLEMENTS IN WHICH THE ACTIVE INGREDIENT IS GARLIC, ALLICIN OR ANY OTHER DERIVATIVE OF GARLIC, IN CLASS 5 (U.S. CLS. 6, 18, 44, 46, 51 AND 52).

FIRST USE 10-0-2002; IN COMMERCE 6-0-2005.

THE MARK CONSISTS OF STANDARD CHARACTERS WITHOUT CLAIM TO ANY PARTICULAR FONT, STYLE, SIZE, OR COLOR.

PRIORITY CLAIMED UNDER SEC. 44(D) ON CANADA APPLICATION NO. 1338711, FILED 3-9-2007, REG. NO. 1338711, DATED 8-13-2008, EXPIRES 8-13-2023.

NO CLAIM IS MADE TO THE EXCLUSIVE RIGHT TO USE "NUTRITION", APART FROM THE MARK AS SHOWN.

SER. NO. 77-155,871, FILED 4-13-2007.



David J. Kyros

Director of the United States Patent and Trademark Office

Reg. No. 4,072,306 DAYNA BROWNE, EXAMINING ATTORNEY

United States of America

United States Patent and Trademark Office

THE MIRACLE FACIAL POLISHER

Reg. No. 4,072,307

Registered Dec. 20, 2011

Int. Cl.: 3

TRADEMARK

PRINCIPAL REGISTER

RWACHSBERG HOLDINGS INC. (CANADA CORPORATION)
20 GRANITERIDGE ROAD
CONCORD, CANADA L4K5M8

FOR: NON-MEDICATED PERSONAL CARE PRODUCTS, NAMELY, FACIAL MOISTURIZERS IN CREAM, LOTION AND GEL FORMS; NON-MEDICATED SKIN CARE PREPARATIONS, NAMELY, UNDER EYE AND EYELID FIRING PREPARATIONS IN LOTION, GEL AND CREAM FORM; SOAPS, NAMELY, FACIAL SOAPS IN LIQUID AND BAR FORM, EYE SOAPS IN LIQUID AND BAR FORM, AND FACIAL SCRUBS AND FACIAL WASH, IN CLASS 3 (U.S. CLS. 1, 4, 6, 50, 51 AND 52).

THE MARK CONSISTS OF STANDARD CHARACTERS WITHOUT CLAIM TO ANY PARTICULAR FONT, STYLE, SIZE, OR COLOR.

PRIORITY CLAIMED UNDER SEC. 44(D) ON CANADA APPLICATION NO. 1323641, FILED 11-9-2006, REG. NO. TMA749290, DATED 10-2-2009, EXPIRES 10-2-2024.

NO CLAIM IS MADE TO THE EXCLUSIVE RIGHT TO USE "FACIAL POLISHER", APART FROM THE MARK AS SHOWN.

SER. NO. 77-158,747, FILED 4-17-2007.

ZHALEH DELANEY, EXAMINING ATTORNEY



David J. Kyros

Director of the United States Patent and Trademark Office

United States of America

United States Patent and Trademark Office



advanced
energy
products

Reg. No. 4,072,308

ADVANCED ENERGY PRODUCTS (CALIFORNIA CORPORATION)
123 C STREET
DAVIS, CA 95616

Registered Dec. 20, 2011

Int. Cl.: 35

FOR: RETAIL SERVICES BY DIRECT SOLICITATION BY SALES AGENTS IN THE FIELD OF HVAC, IN CLASS 35 (U.S. CLS. 100, 101 AND 102).

SERVICE MARK

FIRST USE 4-1-2007; IN COMMERCE 4-1-2007.

PRINCIPAL REGISTER

NO CLAIM IS MADE TO THE EXCLUSIVE RIGHT TO USE "ENERGY PRODUCTS", APART FROM THE MARK AS SHOWN.

THE COLOR(S) GREEN, WHITE AND BLACK IS/ARE CLAIMED AS A FEATURE OF THE MARK.

THE MARK CONSISTS OF A STYLIZED LOWERCASE LETTER "E" FORMING A COMMERCIAL AT SIGN CHARACTER WITH AN ARROW ON THE END IN WHITE ON A GREEN CIRCLE. THE WORDS, "ADVANCED ENERGY PRODUCTS", ALL IN LOWERCASE IN BLACK IS STACKED TO THE RIGHT SIDE OF THE SYMBOL.

SER. NO. 77-173,604, FILED 5-4-2007.

JOHN HWANG, EXAMINING ATTORNEY



David J. Kybas

Director of the United States Patent and Trademark Office

United States of America

United States Patent and Trademark Office

LIPFUSION

Reg. No. 4,072,309

FUSION BRANDS INTERNATIONAL SRL (BARBADOS COMPANY)
GROVE, 21 PINE ROAD

Registered Dec. 20, 2011

BELLEVILLE ST. MICHAEL, BARBADOS BB11113

Int. Cl.: 35

FOR: ONLINE RETAIL STORE SERVICES FEATURING BEAUTY PRODUCTS, NAMELY, NON-MEDICATED LIP PLUMPING GLOSS, LIP PENCILS, LIP SHINES AND LIP GLOSS, IN CLASS 35 (U.S. CLS. 100, 101 AND 102).

SERVICE MARK

FIRST USE 9-1-2005; IN COMMERCE 9-1-2005.

PRINCIPAL REGISTER

THE MARK CONSISTS OF STANDARD CHARACTERS WITHOUT CLAIM TO ANY PARTICULAR FONT, STYLE, SIZE, OR COLOR.

SER. NO. 77-187,693, FILED 5-22-2007.

JESSICA A. POWERS, EXAMINING ATTORNEY



David J. Kyffers

Director of the United States Patent and Trademark Office

United States of America

United States Patent and Trademark Office

UHR-VIT

Reg. No. 4,072,310

Registered Dec. 20, 2011

Int. Cl.: 9

TRADEMARK

PRINCIPAL REGISTER

NEC LCD TECHNOLOGIES, LTD. (JAPAN CORPORATION)
1753, SHIMONUMABE, NAKAHARA-KU
KAWASAKI, KANAGAWA, JAPAN

FOR: LIQUID CRYSTAL DISPLAYS, LIQUID CRYSTAL DISPLAY ELECTRIC LUMINESCENT PANELS, LIQUID CRYSTAL DISPLAY INTEGRATED CIRCUIT MODULES, LIQUID CRYSTAL DISPLAY MONITORS, LIQUID CRYSTAL DISPLAY TELEVISIONS, LIQUID CRYSTAL DISPLAYS FOR MOBILE PHONES AND INSTRUCTIONAL MANUALS SOLD AS A UNIT, IN CLASS 9 (U.S. CLS. 21, 23, 26, 36 AND 38).

THE MARK CONSISTS OF STANDARD CHARACTERS WITHOUT CLAIM TO ANY PARTICULAR FONT, STYLE, SIZE, OR COLOR.

OWNER OF JAPAN REG. NO. 5123551, DATED 3-28-2008, EXPIRES 3-28-2018.

SER. NO. 77-220,114, FILED 7-2-2007.

LOURDES AYALA, EXAMINING ATTORNEY



David J. Kybas

Director of the United States Patent and Trademark Office

United States of America

United States Patent and Trademark Office

HIRERIGHT EXPRESS

Reg. No. 4,072,311

Registered Dec. 20, 2011

Int. Cls.: 42 and 45

SERVICE MARK

PRINCIPAL REGISTER

HIRERIGHT, INC. (CALIFORNIA CORPORATION)
5151 CALIFORNIA AVE.
IRVINE, CA 92617

FOR: PROVIDING TEMPORARY USE OF NON-DOWNLOADABLE COMPUTER SOFTWARE FOR DATABASE MANAGEMENT FOR USE IN THE FIELD OF EMPLOYMENT SCREENING AND PERSONNEL ASSESSMENTS, IN CLASS 42 (U.S. CLS. 100 AND 101).

FIRST USE 1-0-2008; IN COMMERCE 1-0-2008.

FOR: PRE-EMPLOYMENT BACKGROUND SCREENING, IN CLASS 45 (U.S. CLS. 100 AND 101).

FIRST USE 1-0-2008; IN COMMERCE 1-0-2008.

THE MARK CONSISTS OF STANDARD CHARACTERS WITHOUT CLAIM TO ANY PARTICULAR FONT, STYLE, SIZE, OR COLOR.

OWNER OF U.S. REG. NOS. 2,117,799, 2,748,100 AND OTHERS.

NO CLAIM IS MADE TO THE EXCLUSIVE RIGHT TO USE "EXPRESS", APART FROM THE MARK AS SHOWN.

SER. NO. 77-250,700, FILED 8-8-2007.

DARRYL SPRUILL, EXAMINING ATTORNEY



David J. Kyros

Director of the United States Patent and Trademark Office

United States of America

United States Patent and Trademark Office

ORNET

Reg. No. 4,072,312

Registered Dec. 20, 2011

Int. Cl.: 12

TRADEMARK

PRINCIPAL REGISTER

APOLLO INTERNATIONAL LIMITED (INDIA LIMITED LIABILITY COMPANY)
KAUSHALYA PARK, HAUZ KHAS
M - 4, SURYA MANSION
NEW DELHI, INDIA 110016

FOR: TIRES, INNER TUBES AND TIRE FLAPS, NAMELY, FLAPS FOR PROTECTING INNER TUBES FROM WHEEL RIMS, FOR ALL KINDS OF VEHICLES, IN CLASS 12 (U.S. CLS. 19, 21, 23, 31, 35 AND 44).

FIRST USE 11-30-2000; IN COMMERCE 11-30-2000.

THE MARK CONSISTS OF STANDARD CHARACTERS WITHOUT CLAIM TO ANY PARTICULAR FONT, STYLE, SIZE, OR COLOR.

SER. NO. 77-261,406, FILED 8-22-2007.

DORITT L. CARROLL, EXAMINING ATTORNEY



David J. Kybas

Director of the United States Patent and Trademark Office

United States of America

United States Patent and Trademark Office

PADD

Reg. No. 4,072,313

Registered Dec. 20, 2011

Int. Cl.: 9

TRADEMARK

PRINCIPAL REGISTER

TECHNICAL SOLUTIONS GROUP INTERNATIONAL (NEVADA CORPORATION)
3864 BATTERY STREET
LAS VEGAS, NV 89129

FOR: PORTABLE ANTIDOTE AND DECONTAMINATION KITS FOR USE IN THE EVENT OF A CHEMICAL, BIOLOGICAL, RADIOLOGICAL OR NUCLEAR INCIDENT, ENVIRONMENTAL DISASTER OR INDUSTRIAL ACCIDENT, COMPRISED OF ANTHRAX DETECTION ASSAY MONITORING APPARATUS AND INSTRUMENTS, DISPOSABLE NITRILE GLOVES FOR GENERAL USE, RICIN DETECTION ASSAY MONITORING APPARATUS AND INSTRUMENTS, BOTULISM ASSAY MONITORING APPARATUS AND INSTRUMENTS, DETECTOR CARDS THAT CHANGE COLOR IN THE PRESENCE OF HAZARDOUS MATERIALS, STERILE CULTURE COTTON SWABS FOR MEDICAL PURPOSES, STERILE PIPETTES, HAND TOOLS, NAMELY, SAMPLE COLLECTION SCOOPS, POLY CENTRIFUGE TUBES, VIALS FOR COLLECTED SAMPLES SOLD EMPTY, PLASTIC FLEXIBLE FILM PACKETS FOR SEALING VESSELS, PLASTIC SAMPLE BAGS FOR TRANSMITTING MEDICAL SPECIMENS, PLASTIC, RUBBER AND ELASTOMER TAMPER-PROOF SEALS FOR LABORATORY BOTTLES, CUSTODY CONTROL ADHESIVE LABELS, HYPOCHLORITE SANITARY TOWELS, DECONTAMINATION MITTS OF FABRIC FOR CLEANING, ATROPINE AUTO-INJECTORS, NAMELY, INJECTION SYRINGES, PLASTIC ORAL MEDICATION CONTAINERS, BIO-HAZARD MEDICAL WASTE BAGS, EMERGENCY MEDICAL TECHNICIAN (EMT) SCISSORS FOR SURGERY, PENS AND ILLUSTRATED OPERATIONAL GUIDELINES ASSOCIATED THEREWITH ALL SOLD AS A UNIT, IN CLASS 9 (U.S. CLS. 21, 23, 26, 36 AND 38).

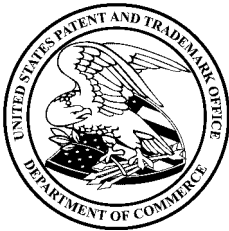

FIRST USE 10-1-2005; IN COMMERCE 10-1-2005.

THE MARK CONSISTS OF STANDARD CHARACTERS WITHOUT CLAIM TO ANY PARTICULAR FONT, STYLE, SIZE, OR COLOR.

SER. NO. 77-270,937, FILED 9-4-2007.

JESSICA A. POWERS, EXAMINING ATTORNEY

David J. Kyffers

Director of the United States Patent and Trademark Office

United States of America

United States Patent and Trademark Office

LITTLE MISS SUNSHINE

Reg. No. 4,072,314

Registered Dec. 20, 2011

**Int. Cls.: 9, 16, 25, 28
and 41**

TRADEMARK

SERVICE MARK

PRINCIPAL REGISTER

THOIP (UNITED KINGDOM COMPANY)
4TH FLOOR ALDWYCH HOUSE, 81 ALDWYCH
LONDON, UNITED KINGDOM WC2B4HN

FOR: AUDIO AND VIDEO TAPES, AND DISCS, NAMELY, AUDIO AND VIDEO TAPES AND AUDIO AND VIDEO RECORDINGS IN THE FORM OF DISCS, DVDS, DVD-ROM, CD-ROM, COMPACT DISCS, LASER DISCS, FLOPPY DISCS, HARD DISCS, OPTICAL DISCS, PRE-RECORDED MAGNETIC DATA CARRIERS, PHONOGRAPH RECORDS, MAGNETIC AND DIGITAL TAPES, ALL FEATURING MUSIC, MUSICAL SOUND RECORDINGS, MUSICAL VIDEO RECORDINGS AND VIDEO RECORDINGS FEATURING CARTOON CHARACTERS, OPTIONALLY ALSO WITH LIVE ACTION SEQUENCES OR IMAGES; PRERECORDED COMPACT DISCS AND PRE-RECORDED VIDEO TAPES RELATING TO CHILDREN'S ENTERTAINMENT AND EDUCATION; TELEVISION FILMS, NAMELY, ANIMATED FILMS, LIVE ACTION FILMS, ALL FEATURING MUSICAL SOUND RECORDINGS, MUSICAL VIDEO RECORDINGS AND VIDEO RECORDINGS FEATURING CARTOON CHARACTERS WITH LIVE ACTION SEQUENCES AND IMAGES; PHONOGRAPH RECORDS FEATURING MUSIC, SPEECH, OR EDUCATIONAL OR ENTERTAINMENT MATERIALS, NAMELY, CHILDREN'S EDUCATIONAL MATERIAL, READING EDUCATIONAL MATERIAL AND MUSIC; MOTION PICTURE FILMS, SOUND RECORDINGS AND VIDEO RECORDINGS, FEATURING COMEDY, DRAMATIC, DOCUMENTARY, MUSICAL; ELECTRONIC DOWNLOADABLE PUBLICATIONS, NAMELY, BOOKS, COMICS, MAGAZINES, NEWSLETTERS, JOURNALS, PAMPHLETS, BROCHURES, BOOKLETS AND A SERIES OF FICTION OR NON-FICTION BOOKS ALL FEATURING CHILDREN'S ENTERTAINMENT; DOWNLOADABLE SOFTWARE, NAMELY, FOR THE DISPLAY, ORGANIZATION, TRANSMISSION, RECEPTION OR SEARCHING OF EDUCATIONAL OR ENTERTAINMENT INFORMATION; MUSICAL SOUND RECORDINGS, MUSICAL VIDEO RECORDINGS AND VIDEO RECORDINGS ALL FEATURING CARTOON CHARACTERS, OPTIONALLY ALSO WITH LIVE ACTION SEQUENCES OR IMAGES DOWNLOADABLE FROM THE INTERNET; BLANK MAGNETIC COMPUTER AUDIO AND VIDEO TAPES, CASSETTE AND CARTRIDGES; RADIOS; RADIOS FOR USE IN THE SHOWER; AUDIO CASSETTE RECORDERS; VIDEO-CASSETTE RECORDERS; COMPACT DISC PLAYERS; MP3 PLAYERS; KARAOKE MACHINES, NAMELY, AUDIO COMPONENTS FOR USE IN KARAOKE, NAMELY, COMPACT DISC PLAYERS, AUDIO AMPLIFIERS, AUDIO MIXERS, MICROPHONES, AUDIO SPEAKERS, AND CABLES FOR USE WITH AUDIO COMPONENTS; CAMERAS; PROJECTORS, NAMELY, MOVIE PROJECTOR AND SLIDE PROJECTOR; CALCULATORS; SUNGLASSES; OFFICE REQUISITES, NAMELY, COMPUTER MOUSE MATS; VIDEO GAMES, NAMELY, VIDEO GAME MACHINES FOR USE WITH TELEVISIONS; ELECTRONIC



David J. Kyros

Director of the United States Patent and Trademark Office

Reg. No. 4,072,314 AMUSEMENT APPARATUS FOR USE WITH TELEVISION RECEIVERS, NAMELY, COMPUTER GAME HARDWARE AND PERIPHERALS; COMPUTER GAME PROGRAMS; ELECTRONIC COMPUTER GAME PROGRAMS DOWNLOADABLE FROM THE INTERNET; COMPUTER SOFTWARE FOR THE DISPLAY, ORGANIZATION, TRANSMISSION, RECEPTION OR SEARCHING OF EDUCATIONAL OR ENTERTAINMENT INFORMATION; CELL PHONES; SNORKELS; BICYCLE HELMETS, FOOTBALL HELMETS, BASEBALL AND SOFTBALL BATTING HELMETS, SKATEBOARD HELMETS, SKI HELMETS, SNOWBOARDING HELMETS; GOGGLES FOR SKIING, SWIMMING, RACKET SPORTS, OR SLEDDING; SWIMMING AIDS, NAMELY, LIFE JACKETS; NOSE PLUGS FOR SWIMMING, IN CLASS 9 (U.S. CLS. 21, 23, 26, 36 AND 38).

FOR: BOOKS AND MAGAZINES, ALL FOR CHILDREN; COMIC BOOKS, COMIC STRIPS IN GENERAL; CHILDREN'S ACTIVITY BOOKS, CHILDREN'S POP-UP BOOKS; PRINTED MATTER, NAMELY, MAGAZINES, JOURNALS, PAMPHLETS, BROCHURES, BOOKLETS AND A SERIES OF FICTION OR NON-FICTION BOOKS, ALL FEATURING CHILDREN'S ENTERTAINMENT; COLORING BOOKS; BOOKMARKS OF PAPER OR CARD; CHILDREN'S BOOKS FEATURING INTERACTIVE MAGNETIC OR FELT ELEMENTS; POSTERS; PAPER BANNERS; MOUNTED PHOTOGRAPHS, UNMOUNTED PHOTOGRAPHS; POSTCARDS; PRINTED CHARTS OF PAPER OR CARD SUCH AS GROWTH CHARTS, SPACE CHARTS, ALPHABET CHARTS, AND MULTIPLICATION CHARTS; GREETING CARDS, BLANK CARDS, CHRISTMAS CARDS, GIFT CARDS, NOTE CARDS; WRAPPING PAPER; PAPER TAGS; PAPER AND CARDBOARD BAGS AND BOXES FOR PACKAGING; CARDBOARD AND CARDBOARD ARTICLES, NAMELY, CARTONS AND CONTAINERS; PACKING PAPER; PAPER RIBBONS; PAPER GIFT WRAPPING RIBBONS; STATIONERY, NOTEPAPER, ENVELOPES, NOTE BOOKS; BLANK, PRINTED OR PARTIALLY PRINTED PAPER LABELS; ADDRESS LABELS; EXERCISE BOOKS; WRITING PADS; ADDRESS BOOKS; PENS, PENCILS, PENCIL CASES, PEN CASES; ARTISTS' MATERIALS, NAMELY, ARTISTS' PENCILS, ARTISTS' BRUSHES, ARTISTS' PENS, STENCILS, POSTER ART SETS, PAINT BOXES, PAINT BRUSHES, DRAWING MATERIALS, NAMELY, INSTRUMENTS, PADS AND PAPER; COLORING MATERIALS, NAMELY, CRAYONS, FELT TIP PENS, COLORING PENCILS, MARKER PENS, HIGHLIGHTERS AND BRUSH PENS, INK PENS; ADHESIVES FOR STATIONERY OR HOUSEHOLD PURPOSES; MODELING MATERIALS AND COMPOUNDS FOR USE BY CHILDREN; MODELING CLAY; MODELING COMPOUNDS; PRINTED TICKETS; PRINTED SOUVENIR PROGRAMS, FLYERS, POSTERS, LEAFLETS, BROCHURES, PAMPHLETS AND BOOKLETS COMMEMORATING CHARITABLE EVENTS; PRINTED INSTRUCTIONAL, EDUCATIONAL AND TEACHING MATERIAL ALL FOR USE WITH INFANTS, BABIES AND CHILDREN; FLASHCARDS; PRINTED TEACHING MATERIALS IN THE FORM OF GAMES FOR USE IN THE FIELDS OF MATHEMATICS, LANGUAGE ARTS, SOCIAL STUDIES, ART, MUSIC, THEATRE ARTS OR LITERATURE; STICKERS; PAPER AND PLASTIC TRANSFERS, NAMELY, RUB-ON, STICK-ON AND IRON-ON TEMPORARY TATTOOS, DECALCOMANIAS, IRON-ON TRANSFERS; STENCILS; PAPER TRANSPARENCIES; CALENDARS; TEAR-OFF CALENDARS; DIARIES; OFFICE REQUISITES, NAMELY, TYPE CORRECTING FLUID, PUNCHES, RUBBER BANDS, PAPER CLIPS, BINDER CLIPS AND FASTENERS, STAPLERS, ADHESIVE TAPE DISPENSERS, ERASERS, PENCIL SHARPENERS, NOTE BINDERS, NAMELY, PAPER FASTENERS, LOOSE LEAF BINDERS, THREE-RING BINDERS, MECHANICAL BINDER SETS COMPRISING RINGS; FILES, NAMELY, DOCUMENT FILES, CARD FILES, FILE FOLDERS AND FILE SORTERS; FOLDERS; MEMO PADS; ELECTRIC TYPEWRITERS; PRINTING BLOCKS; RECEPTACLES FOR HOLDING RUBBER BANDS, PAPER CLIPS, BINDER CLIPS AND PAPER FASTENERS; DISPOSABLE DIAPERS; PAPER BIBS; PAPER NAPKINS AND PAPER TABLECLOTHS; BATHROOM TISSUE; FACIAL TISSUES; PAPER HANDKERCHIEFS; ABSORBENT PAPER FOR USE IN THE KITCHEN; PAPER TOWELS; PAPER FACE TOWELS; TABLE MATS MADE OF PAPER; AND PAPER PLACE MATS; COASTERS MADE OF PAPER; PLASTIC SANDWICH BAGS; GENERAL PURPOSE PLASTIC AND PAPER BAGS; PLASTIC AND PAPER GARBAGE BAGS; PHOTO, SCRAP, COIN AND STAMP ALBUMS; SCRAPBOOKS; ALMANACS; ANNOUNCEMENT CARDS; BLACKBOARDS; BOOKMARKS; BOTTLE WRAPPERS OF CARDBOARD OR PAPER; PAPER AND CARDBOARD BOXES; TRADING CARDS AND TRIVIA CARDS; PRINTED CHARTS; BOOK BINDINGS; EMBROIDERY

Reg. No. 4,072,314 DESIGN PATTERNS; PRINTED DRESS MAKING PATTERNS; PAPER MACHE FIGURINES; PAPER FLAGS; PAPER FLOWER POT COVERS; CONSTRUCTION PAPER; CRAFT PAPER; LOOSE LEAF PAPER; TISSUE PAPER; TRACING PAPER; CHECKBOOK COVERS MADE OF PAPER AND/OR CARDBOARD; PASSPORT HOLDERS MADE OF PAPER AND/OR CARDBOARD; BOOK COVERS; PERSONAL ORGANIZERS MADE OF PAPER AND/OR CARDBOARD; POCKET SECRETARIES MADE OF PAPER AND/OR CARDBOARD ; CHALK BOARDS AND EASELS FOR HOME OR SCHOOL USE , IN CLASS 16 (U.S. CLS. 2, 5, 22, 23, 29, 37, 38 AND 50).

FOR: CLOTHING FOR ADULTS AND CHILDREN, NAMELY, T-SHIRTS AND SWEATSHIRTS, FOOTWEAR, SLIPPERS, FLIP FLOPS, SPORTS SHOES, BASKETBALL SHOES, TENNIS SHOES, BOOTS, BEACH SANDALS, RAIN BOOTS, SKI BOOTS; SHIRTS, PANTS, JEANS, DUNGAREES, SWEATERS; FLEECE TOPS, NAMELY, PULLOVERS, VESTS, SWEATSHIRTS; BLOUSES; JACKETS; TROUSERS; TIES; SHORTS; SOCKS; BELTS; SCARVES; SUITS; COATS; VEST; DRESSES; SKIRTS; MINISKIRTS; LEGGINGS; NIGHTWEAR; PAJAMAS; SHORTS; NIGHTDRESSES; SINGLET; FLEECE DRESSING GOWNS; DRESSING GOWNS MADE OF TERRY CLOTH OR COTTON; TRACKSUITS, TRAINING SUITS, SWEAT PANTS; HOODED TOPS, NAMELY, PULLOVERS, VESTS, SWEATSHIRTS; ZIP UP JOGGING SUITS; HEADWEAR, NAMELY, CAPS AND HATS; HEADBANDS; OVERALLS; CARDIGANS; GLOVES; OVER-COATS; UNDERWEAR; BOXER SHORTS; BRAS; BRIEFS; CAMISOLES; BODYSUITS; SWIMWEAR; TOWELING ROBES; BABIES AND INFANTS CLOTHES, NAMELY, BIBS MADE OF CLOTH, T-SHIRTS FOR BABIES, AND ROMPER SUITS; APRONS; TABARDS; GARDENING APRONS; COSTUMES, NAMELY, PARTY COSTUMES FOR HALLOWEEN AND MASQUERADES, COSTUMES FOR LIVE EVENTS, NAMELY, DANCE AND ROLE-PLAYING; BELTS AS PARTS OF CLOTHES; SUSPENDERS; BATHING CAPS, IN CLASS 25 (U.S. CLS. 22 AND 39).

FOR: FIGURES REPRESENTING CARTOON CHARACTERS; GAMES AND PLAYTHINGS, NAMELY, SOFT-SCULPTURE TOYS; WOODEN TOYS, NAMELY, BUILDING BLOCKS, ALPHABET BLOCKS AND PULL OUT WOODEN PUZZLES; ELECTRICAL AND MECHANICAL ACTION TOYS; ELECTRONIC ACTION TOYS; RADIO CONTROLLED TOYS; SWIMMING AIDS, NAMELY, POOL RINGS, ARM FLOATS FOR RECREATIONAL USE, KICK BOARD FLOTATION DEVICE FOR RECREATIONAL USE, SWIM RINGS, FLOATING RECREATIONAL LOUNGE CHAIRS, AIR BEDS, NAMELY, INFLATABLE FLOAT MATTRESSES FOR RECREATIONAL USE; INFLATABLE RIDE-ON TOYS; SWIM FINS; BEACH BALLS; PADDLING POOLS, NAMELY, PLAY SWIMMING POOLS; PLAY MATS CONTAINING INFANT TOYS; DOLLS; ACTION FIGURES AND PLAY FIGURES; PLUSH TOYS; BEANBAG TOYS; STUFFED TOY ANIMALS; TOY FIGURES; PUPPET TOYS FOR BABIES AND INFANTS, NAMELY, RATTLES, MOBILES, PLAY QUILTS AS DOLL ACCESSORY AND MULTIPLE ACTIVITY TOYS; TOYS DESIGNED TO BE ATTACHED TO CAR SEATS, STROLLERS, CRIBS, HIGH CHAIRS; PLAY SETS DESIGNED TO INTERACT WITH DOLLS, PLAY FIGURES AND ACTION FIGURES; MAKE-BELIEVE SETS, NAMELY, PLAY HOUSES AND PLAY TEA SETS; VEHICLES FOR DOLLS, ACTION FIGURES AND PLAY FIGURES; CARRYING OR COLLECTING CASES FOR ACTION FIGURES; DOLL CLOTHING AND ACCESSORIES; CHILDREN'S MULTIPLE ACTIVITY TOYS, NAMELY, PICTURE ACTIVITY SETS COMPRISED OF FELT, WIPE-AWAY SETS COMPRISED OF DRY ERASE WRITING BOARDS AND WRITING SURFACES, SLATE BOARDS FOR WRITING, WATER COLOR BOARDS, DECORATIVE GLITTER SETS; CHILDREN'S MULTIPLE ACTIVITY TOYS, NAMELY, KNITTING SETS COMPRISED OF STITCH MARKERS, STITCH GAUGES, STITCH HOLDERS, YARN BOBBINS, NEEDLES, AND TOY CONSTRUCTION SETS; JOKES AND NOVELTY ITEMS, NAMELY, PAPER FACE MASKS, RUDE NOISE-MAKERS, FALSE FACES, FALSE NOSES, FALSE EYEGLASSES, FALSE BEARDS, FALSE MOUSTACHES, WINDUP TOYS, WATER SQUIRTING TOYS, MAGIC TRICKS; PARTY FAVORS IN THE NATURE OF SMALL TOYS; KALEIDOSCOPIES; BALLOONS; JIGSAW PUZZLES, MANIPULATIVE PUZZLES AND CUBE-TYPE PUZZLES; TIC-TAC-TOE; DOMINO SETS; EQUIPMENT SOLD AS A UNIT FOR BOARD, CARD AND SKILL ACTION GAMES AND FLOOR GAMES; CHRISTMAS TREE DECORATIONS, NOT INCLUDING CONFECTIONERY OR ILLUMINATION ARTICLES; KNEE, ELBOW AND WRIST PROTECTORS FOR USE IN SKATING AND

Reg. No. 4,072,314 OTHER SPORTS; TOY VEHICLES; CONSTRUCTION TOYS; WOODEN TOY MODEL TRAIN SETS; RIDE-ON TOYS; RIDE ON TOYS, NAMELY, PEDAL CARS AND PEDAL PLANES; TOY BICYCLES, TOY TRICYCLES, TOY SCOOTERS; GYMNAS TIC APPARATUS; SPORTING ARTICLES, NAMELY, SPORT BALLS; TENNIS, SQUASH, BADMINTON, RACQUETBALL, PADDLE BALL AND TABLE TENNIS RACKETS AND RACKET COVERS; BASEBALL AND SOFTBALL MITTS; BASEBALL AND SOFTBALL GLOVES, BATS, CATCHER'S MASKS; LEG GUARDS FOR ATHLETIC USE, ATHLETIC SUPPORTERS AND PROTECTIVE CUPS, SHIN, THIGH, LEG, HIP, SHOULDER, RIB AND ARM PADS FOR ATHLETIC USE; BASEBALL AND SOFTBALL BASES; KICKING TEES; FIELD HOCKEY AND LACROSSE STICKS; MOUTH GUARDS FOR ATHLETIC USE; ARCHERY BOWS, BOW STRINGS, ARROWS, TARGETS, QUIVERS; BASKETBALL GOALS, NETS, AND BACKBOARDS; CROQUET SETS; BOXING GLOVES; BARBELLS; SKIS, SKI POLES; SNOWBOARDS; BOWLING BALLS; GOLF EQUIPMENT AND ACCESSORIES, NAMELY, CLUBS, BAGS, GOLF TEES, GLOVES, BALL MARKERS, CLUB HEAD COVERS, DIVOT REPAIR TOOLS; ICE HOCKEY STICKS AND PUCKS; SHUFFLEBOARD STICKS; BADMINTON SHUTTLECOCKS; VOLLEYBALL, TENNIS, AND TABLE TENNIS NETS; CRICKET STICKS AND WICKETS; SNOW SLEDS FOR RECREATIONAL USE; SURF BOARDS; BODY BOARDS; SKIM BOARDS; WINDSURFING BOARDS; ICE SKATES; ROLLER SKATES; IN-LINE SKATES; SKATE BOARDS; STATIONERY EXERCISE BICYCLES; FLYING DISCS; WATER SKIS; DARTBOARDS; DARTS; FISHING RODS, REELS AND LURES; TRAMPOLINES; BOUNCE-ON INFLATABLE TOYS; WOODEN SKITTLES; YO-YOS; SKIPPING ROPES; KITES; TOY PHONES, TOY TORCHES; ARCADE GAMES; COIN-OPERATED RIDE-ON TOYS; CONFETTI; HOBBY CRAFT SETS CONSISTING OF FELT SHAPES FOR MAKING PICTURES, IN CLASS 28 (U.S. CLS. 22, 23, 38 AND 50).

FOR: TELEVISION PRODUCTION AND TELEVISION PROGRAM SERVICES, NAMELY, SCHEDULING, PROGRAMMING, SYNDICATION; PRODUCTION AND DISTRIBUTION OF RADIO AND TELEVISION PROGRAMS FOR OTHERS; RADIO ENTERTAINMENT PRODUCTION; AND DISTRIBUTION OF RADIO AND TELEVISION PROGRAMS FOR OTHERS; TELEVISION SHOW PRODUCTION; MOTION PICTURE FILM AND VIDEOTAPE PRODUCTION; DISTRIBUTION OF MOTION PICTURES; PUBLICATION OF BOOKS, MAGAZINES, JOURNALS; MUSIC PUBLISHING SERVICES; ENTERTAINMENT IN THE NATURE OF THEATRE PRODUCTIONS OR LIVE PERFORMANCES BY A MUSICAL GROUP; EDUCATIONAL SERVICES FOR CHILDREN, NAMELY, CONDUCTING CLASSES, WORKSHOPS OR SEMINARS IN THE FIELDS OF LANGUAGE ARTS, MATHEMATICS, SCIENCE, SOCIAL STUDIES, COMPUTER SKILLS, FAMILY EDUCATION, VISUAL ARTS, THEATRE OR MUSIC, ALL BY MEANS OF RADIO OR TELEVISION; ENTERTAINMENT SERVICES, NAMELY, ON-LINE BASED COMPUTER GAMES, IN CLASS 41 (U.S. CLS. 100, 101 AND 107).

THE MARK CONSISTS OF STANDARD CHARACTERS WITHOUT CLAIM TO ANY PARTICULAR FONT, STYLE, SIZE, OR COLOR.

PRIORITY CLAIMED UNDER SEC. 44(D) ON UNITED KINGDOM APPLICATION NO. 2466240, FILED 9-6-2007, REG. NO. 2466240, DATED 9-6-2007, EXPIRES 9-6-2017.

OWNER OF U.S. REG. NO. 2,233,157.

SER. NO. 77-284,978, FILED 9-20-2007.

SANDRA BUJA, EXAMINING ATTORNEY

United States of America

United States Patent and Trademark Office



ROARY

Reg. No. 4,072,315

Registered Dec. 20, 2011

**Int. Cls.: 9, 16, 25, 28
and 41**

TRADEMARK

SERVICE MARK

PRINCIPAL REGISTER

CHAPMAN ENTERTAINMENT LIMITED (UNITED KINGDOM CORPORATION)
THE PAVILION, 90 POINT PLEASANT
WANDSWORTH, LONDON, UNITED KINGDOM SW181NN

FOR: AUDIOVISUAL RECORDINGS FEATURING ANIMATED CARTOONS; DOWNLOADABLE ELECTRONIC PUBLICATIONS, NAMELY, MAGAZINES, BOOKS AND COMIC BOOKS FEATURING ANIMATED CARTOONS, CHILDREN'S STORIES AND EDUCATIONAL GAMES, COMPETITIONS AND QUIZZES BASED UPON ANIMATED CARTOONS; CINEMATOGRAPHIC FILMS IN THE FIELD OF CHILDREN'S EDUCATION AND ANIMATED CARTOON ENTERTAINMENT; COMPUTER SOFTWARE CONCERNED WITH CHILDREN'S EDUCATION AND ENTERTAINMENT, NAMELY, COMPUTER GAMES SOFTWARE; ELECTRIC COMPUTER GAMES ADAPTED FOR USE WITH VIDEO APPARATUS AND TELEVISION RECEIVERS; DOWNLOADABLE ELECTRONIC PUBLICATIONS, NAMELY, ELECTRONIC COLORING BOOKS AND POSTERS RECORDED ON COMPUTER MEDIA AND DOWNLOADABLE ELECTRONIC GREETING CARDS; EXPOSED CINEMATOGRAPHIC FILMS; HAND-HELD UNITS FOR PLAYING ELECTRONIC GAMES FOR USE WITH EXTERNAL DISPLAY SCREENS AND MONITORS; ELECTRONIC GAMES ADAPTED FOR USE WITH TELEVISION RECEIVERS ONLY; INTERACTIVE EDUCATIONAL GAMES FOR USE WITH VIDEO APPARATUS AND TELEVISION RECEIVERS, FEATURING ANIMATED CARTOONS, CHILDREN'S STORIES AND EDUCATIONAL GAMES, COMPETITIONS AND QUIZZES BASED ON ANIMATED CARTOONS; INTERACTIVE ENTERTAINMENT SOFTWARE FOR USE WITH COMPUTERS, FEATURING ANIMATED CARTOONS, CHILDREN'S STORIES AND EDUCATIONAL GAMES, COMPETITIONS AND QUIZZES BASED UPON ANIMATED CARTOONS; INTERACTIVE VIDEO GAME SOFTWARE; MOUSE PADS; PRE-RECORDED MEDIA, NAMELY, VIDEO TAPES AND CASSETTES, COMPACT DISCS (CDS), AUDIO CASSETTE TAPES, DVDS, VIDEO GAME CARTRIDGES, COMPUTER DISCS AND PRE RECORDED COMPACT INTERACTIVE DISCS FEATURING ANIMATED CARTOONS, CHILDREN'S STORIES AND EDUCATIONAL GAMES, COMPETITIONS AND QUIZZES BASED UPON ANIMATED CARTOONS; SUNGLASSES AND SPECTACLE FRAMES; CAMERAS; DOWNLOADABLE ELECTRONIC GAMES PROVIDED BY THE INTERNET; NONE OF THE AFORESAID RELATED TO THE SPORT OF AMERICAN FOOTBALL, IN CLASS 9 (U.S. CLS. 21, 23, 26, 36 AND 38).



David J. Kyros

Director of the United States Patent and Trademark Office

FOR: CHILDREN'S ACTIVITY BOOKS; ADDRESS BOOKS; ALBUMS FOR STICKERS, STAMPS AND PHOTOGRAPHS; AUTOGRAPH BOOKS; BINDERS; BOOK MARKERS OF PAPER, CARDBOARD, PLASTIC, PRECIOUS AND COMMON METAL; CHILDREN'S STORY BOOKS; CALENDARS; CARTOON PRINTS; CASES, HOLDERS AND STANDS FOR PENS,

Reg. No. 4,072,315 PENCILS, PASTELS AND CRAYONS; COMIC BOOKS; COLORING BOOKS, DECAL-COMANIA; DIARIES; DOCUMENT FILES AND BOXES FOR STATIONERY AND PAPERS; DRAWING BOOKS, PADS, PENS; EASELS; EMBROIDERY, SEWING AND KNITTING PATTERNS; FOLDERS FOR STATIONERY AND PAPERS; GLUE FOR STATIONERY OR HOUSEHOLD PURPOSES; GREETING CARDS; REFILL INK FOR PENS; MAGAZINES FEATURING ANIMATED CARTOONS, CHILDREN'S STORIES AND EDUCATIONAL GAMES, COMPETITIONS AND QUIZZES BASED UPON ANIMATED CARTOONS; MODELING CLAY; NEWSLETTERS FEATURING ANIMATED CARTOONS, CHILDREN'S STORIES AND EDUCATIONAL GAMES, COMPETITIONS AND QUIZZES BASED UPON ANIMATED CARTOONS; NOTEBOOKS AND PADS; PRINTED PARTY INVITATIONS; PENCIL SHARPENERS; ARTS AND CRAFTS PAINT KITS, PAINT BOXES, PAINTBRUSHES, PASTELS, CRAYONS, PENCILS; POST CARDS; PRINTED PICTURES AND POSTERS; PRINTED PUBLICATIONS AND PRINTED MATTER, NAMELY, TEACHING MATERIALS IN THE FIELD OF PRE-SCHOOL CHILDREN'S EDUCATION; RUBBER ERASERS; DRAWING RULERS; SCRAP BOOKS; STATIONERY; STENCILS; PRINTED STICKERS; IRON ON, VINYL AND PLASTIC TRANSFERS; TABLECLOTHS OF PAPER, MATS OF PAPER, NAPKINS OF PAPER; TABLECLOTHS OF PAPER, MATS OF PAPER, NAPKINS OF PAPER; TEACHING MATERIALS, NAMELY, PRINTED TEACHING MATERIALS FOR PRE-SCHOOL AGE CHILDREN; TRADING CARDS; WRAPPING PAPER; WRITING PADS AND PAPER; MODELING COMPOUND, MODELING COMPOUND AND APPARATUS TO WORK WITH SAID MODELING COMPOUND SOLD AS A UNIT; NONE OF THE AFORESAID RELATED TO THE SPORT OF AMERICAN FOOTBALL, IN CLASS 16 (U.S. CLS. 2, 5, 22, 23, 29, 37, 38 AND 50).

FOR: CLOTHING, NAMELY, APRONS, BANDANAS, BATH ROBES, BATHING SUITS, BATHING TRUNKS, BELTS, BIBS, NAMELY, CLOTH BIBS, CHILDREN'S AND INFANTS' CLOTH EATING BIBS, COATS, FANCY DRESS COSTUMES, DRESSING GOWNS, DRESSES, GLOVES, JACKETS, JERSEYS, JUMPERS, LEGGINGS, MONEY BELTS, NECKTIES, PANTS, PAJAMAS, OVERCOATS, SCARVES, SHAWLS, SHIRTS, SOCKS, TEE SHIRTS, SHORTS, SWEATERS, SKIRTS, TIGHTS, TROUSERS, UNDERWEAR; FOOTWEAR; HEADGEAR, NAMELY, EAR MUFFS, VISORS, CAPS AND HATS; NONE OF THE AFORESAID RELATED TO THE SPORT OF AMERICAN FOOTBALL, IN CLASS 25 (U.S. CLS. 22 AND 39).

FOR: TOY GARDENING SETS; TOY BUCKETS AND SPADES; ACTION FIGURES; ACTION FIGURE ACCESSORIES AND ENVIRONMENTS, NAMELY, TOY SCALED MODELS OF CHARACTERS AND SCENERY FROM AN ANIMATED CARTOON SERIES, TOY BUILDINGS AND TOY RACETRACKS; BUBBLE MAKING WAND AND SOLUTION SETS; BALLOONS; BALLS, NAMELY, PLAYGROUND BALLS AND RUBBER BALLS, SOCCER BALLS, RUGBY BALLS, BALLS FOR RACKET GAMES AND JUGGLING BALLS; BATTERY OPERATED ACTION TOYS; BOARD GAMES; TOY BUILDING BLOCKS; BUILDING GAMES FOR USE WITH TOY BUILDING BLOCKS; CARD GAMES; CHRISTMAS TREE ORNAMENTS AND DECORATION; CLOTHES FOR DOLLS OR SOFT TOYS; DOLL ACCESSORIES; DOLLS; TOYS, NAMELY, DOLL'S PRAMS; GAMES, NAMELY, ACTION SKILL GAMES, ARCADE GAMES, ELECTRONIC EDUCATION GAME MACHINES FOR CHILDREN, LCD GAME MACHINES; GYMNASTIC AND SPORTING ARTICLES, NAMELY, BEAMS, BENCHES, BALLS AND RINGS FOR GYMNASTICS, RACKETS FOR RACKET GAMES; HAND PUPPETS; INFANT RATTLES; INFANT ACTION CRIB TOYS; JIGSAW PUZZLES; KITES; MANIPULATIVE PUZZLES; TOY MASKS; MOBILES, NAMELY, TOY AND CRIB MOBILES; TOY MODEL VEHICLES; HOBBY CRAFT SETS, COMPRISING A BOARD AND FELT CUTOUT FIGURES AND SCENERY; HOBBY CRAFT SETS, NAMELY, ARTS AND CRAFTS MATERIALS FOR CREATING POSTERS AND CARDS; HOBBY CRAFT SETS FOR MAKING DOLLS, FIGURINES AND TOY MOBILES, COMPRISING PARTS FOR DOLLS, FIGURINES AND MOBILES; NOVELTIES FOR PARTIES, NAMELY, PARTY FAVORS IN THE NATURE OF SMALL TOYS; PLAYING CARDS; PLUSH TOYS; PUPPETS; PUZZLES; RIDE-ON-TOYS; SANDBOXES; SLIDES, POOL RINGS, INFLATABLE SWIMMING POOLS, BATH TOYS, POOL TOYS, WATER WINGS FOR RECREATIONAL USE AS SWIMMING AIDS, WATER SQUIRTING TOYS; SKATEBOARDS, ICE SKATES, SKIS, FLYING DISCS, HOCKEY STICKS, SNOW SLEDS; SOAP BUBBLE MAKING SOLUTION; SOFT SCULPTED TOY FIGURES;

Reg. No. 4,072,315 TOY BAKE WARE; TOY BANKS; TOY COOKWARE; TOY FIGURES; TOY TOOLS, TOY TOOL BELTS, TOY HARD HATS; TOY VEHICLES; TOYS, NAMELY, REMOTE CONTROL CARS; TOY TRICYCLES; PAPER PARTY HATS; NONE OF THE AFORESAID RELATED TO THE SPORT OF AMERICAN FOOTBALL, IN CLASS 28 (U.S. CLS. 22, 23, 38 AND 50).

FOR: CHILDREN'S ENTERTAINMENT SERVICES, NAMELY, AMUSEMENT ARCADE SERVICES AND AMUSEMENT PARKS; BOOK PUBLISHING; CHILDREN'S ENTERTAINMENT AND EDUCATION SERVICES, NAMELY, LIVE SHOWS AND ONGOING TELEVISION ANIMATED CARTOON SHOWS; ELECTRONIC PUBLICATION SERVICES; FAN CLUBS; MOTION PICTURE AND ANIMATED FILM PRODUCTION; LIVE PERFORMANCES AND PERSONAL APPEARANCES BY A COSTUMED CHARACTER; ORGANIZATION OF COMPETITIONS, NAMELY, COMPETITIONS FEATURING PUZZLES AND QUIZZES; PROVISION OF ONLINE INFORMATION IN THE FIELD OF CHILDREN'S ENTERTAINMENT AND EDUCATION; RADIO PROGRAM PRODUCTION; ENTERTAINMENT SERVICES, NAMELY, PROVIDING LIVE PERFORMANCES AT STAGE SHOWS; TELEVISION PROGRAM PRODUCTION; ENTERTAINMENT IN THE NATURE OF ON-GOING TELEVISION PROGRAMS IN THE FIELD OF CHILDREN'S ENTERTAINMENT; ON-LINE NON-DOWNLOADABLE ELECTRONIC PUBLICATIONS, NAMELY, ELECTRONIC COLORING BOOKS AND POSTERS; NONE OF THE AFORESAID RELATED TO THE SPORT OF AMERICAN FOOTBALL, IN CLASS 41 (U.S. CLS. 100, 101 AND 107).

PRIORITY CLAIMED UNDER SEC. 44(D) ON UNITED KINGDOM APPLICATION NO. 2454982, FILED 5-9-2007.

THE COLOR(S) RED, WHITE, BLACK, SILVER AND GREY IS/ARE CLAIMED AS A FEATURE OF THE MARK.

OWNER OF UNITED KINGDOM REG. NO. 2484043, DATED 4-3-2008, EXPIRES 4-3-2018.

THE MARK CONSISTS OF THE WORD "ROARY" AND A FANCIFUL ILLUSTRATION OF A CAR; THE CAR FEATURING THE COLOR RED ON MOST OF THE BODY, A WHITE NUMERAL 1 ON THE HOOD, A WHITE STRIPE ON THE REAR OF THE CAR, OVERLOOKING THE DRIVER'S SEAT, HEADLIGHTS IN THE FORM OF TWO FANCIFUL EYES IN WHITE WITH BLACK IRISES, A WHITE SQUARE ON THE SIDE OF THE CAR WITH A BLACK NUMERAL 1 IN THE CENTER, TWO CROSSED FLAGS ON THE SIDE OF THE CAR FEATURING BLACK AND WHITE SQUARES AND WHITE STAFFS, A BLACK ROLL BAR, BACK TIRES, SILVER HUBCAPS, A SET OF FANCIFUL SILVER LIPS ON THE HOOD WITH A BLACK SPACE BETWEEN THEM, A FANCIFUL WHITE CAP SITUATED IN THE DRIVER'S SEAT, FEATURING A RED STAR WITH BLACK TRIM AND A BLACK NUMERAL 1 IN ITS CENTER, AND BLACK AND WHITE SQUARES ON THE VISOR, AND A SILVER OR GREY DRIVER'S SEAT.

SER. NO. 77-295,091, FILED 10-3-2007.

NAPOLEON SHARMA, EXAMINING ATTORNEY

United States of America

United States Patent and Trademark Office

MR. NOISY



Reg. No. 4,072,316

Registered Dec. 20, 2011

**Int. Cls.: 9, 16, 25, 28
and 41**

TRADEMARK

SERVICE MARK

PRINCIPAL REGISTER

THOIP (UNITED KINGDOM COMPANY)
4TH FLOOR ALDWYCH HOUSE, 81 ALDWYCH
LONDON, UNITED KINGDOM WC2B4HN

FOR: AUDIO AND VIDEO TAPES, AND DISCS, NAMELY, AUDIO AND VIDEO TAPES AND AUDIO AND VIDEO RECORDINGS IN THE FORM OF DISCS, DVDS, DVD-ROM, CD-ROM, COMPACT DISCS, LASER DISCS, FLOPPY DISCS, HARD DISCS, OPTICAL DISCS, PRE-RECORDED MAGNETIC DATA CARRIERS, PHONOGRAPH RECORDS, MAGNETIC AND DIGITAL TAPES, ALL FEATURING MUSIC, MUSICAL SOUND RECORDINGS, MUSICAL VIDEO RECORDINGS AND VIDEO RECORDINGS FEATURING CARTOON CHARACTERS, OPTIONALLY ALSO WITH LIVE ACTION SEQUENCES OR IMAGES; PRERECORDED COMPACT DISCS AND PRE-RECORDED VIDEO TAPES RELATING TO CHILDREN'S ENTERTAINMENT AND EDUCATION; TELEVISION FILMS, NAMELY, ANIMATED FILMS, LIVE ACTION FILMS, ALL FEATURING MUSICAL SOUND RECORDINGS, MUSICAL VIDEO RECORDINGS AND VIDEO RECORDINGS FEATURING CARTOON CHARACTERS WITH LIVE ACTION SEQUENCES AND IMAGES; PHONOGRAPH RECORDS FEATURING MUSIC, SPEECH, OR EDUCATIONAL OR ENTERTAINMENT MATERIALS, NAMELY, CHILDREN'S EDUCATIONAL MATERIAL, READING EDUCATIONAL MATERIAL AND MUSIC; MOTION PICTURE FILMS, SOUND RECORDINGS AND VIDEO RECORDINGS, FEATURING COMEDY, DRAMATIC, DOCUMENTARY, MUSICAL; ELECTRONIC DOWNLOADABLE PUBLICATIONS, NAMELY, BOOKS, COMICS, MAGAZINES, NEWSLETTERS, JOURNALS, PAMPHLETS, BROCHURES, BOOKLETS AND A SERIES OF FICTION OR NON-FICTION BOOKS ALL FEATURING CHILDREN'S ENTERTAINMENT; DOWNLOADABLE SOFTWARE, NAMELY, FOR THE DISPLAY, ORGANIZATION, TRANSMISSION, RECEPTION OR SEARCHING OF EDUCATIONAL OR ENTERTAINMENT INFORMATION; MUSICAL SOUND RECORDINGS, MUSICAL VIDEO RECORDINGS AND VIDEO RECORDINGS ALL FEATURING CARTOON CHARACTERS, OPTIONALLY ALSO WITH LIVE ACTION SEQUENCES OR IMAGES DOWNLOADABLE FROM THE INTERNET; BLANK MAGNETIC COMPUTER AUDIO AND VIDEO TAPES, CASSETTE AND CARTRIDGES; RADIOS; RADIOS FOR USE IN THE SHOWER; AUDIO CASSETTE RECORDERS; VIDEO-CASSETTE RECORDERS; COMPACT DISC PLAYERS; MP3 PLAYERS; KARAOKE MACHINES, NAMELY, AUDIO COMPONENTS FOR USE IN KARAOKE, NAMELY, COMPACT DISC PLAYERS, AUDIO AMPLIFIERS, AUDIO MIXERS, MICROPHONES, AUDIO SPEAKERS, AND CABLES FOR USE WITH AUDIO COMPONENTS; CAMERAS; PROJECTORS, NAMELY, MOVIE PROJECTOR AND SLIDE PROJECTOR; CALCULATORS; SUNGLASSES; OFFICE REQUISITES, NAMELY, COMPUTER MOUSE MATS; VIDEO GAMES, NAMELY, VIDEO GAME MACHINES FOR USE WITH TELEVISIONS; ELECTRONIC



David J. Kyffers

Director of the United States Patent and Trademark Office

Reg. No. 4,072,316 AMUSEMENT APPARATUS FOR USE WITH TELEVISION RECEIVERS, NAMELY, COMPUTER GAME HARDWARE AND PERIPHERALS; COMPUTER GAME PROGRAMS; ELECTRONIC COMPUTER GAME PROGRAMS DOWNLOADABLE FROM THE INTERNET; COMPUTER SOFTWARE FOR THE DISPLAY, ORGANIZATION, TRANSMISSION, RECEPTION OR SEARCHING OF EDUCATIONAL OR ENTERTAINMENT INFORMATION; CELL PHONES; SNORKELS; BICYCLE HELMETS, FOOTBALL HELMETS, BASEBALL AND SOFTBALL BATTING HELMETS, SKATEBOARD HELMETS, SKI HELMETS, SNOWBOARDING HELMETS; GOGGLES FOR SKIING, SWIMMING, RACKET SPORTS, OR SLEDDING; SWIMMING AIDS, NAMELY, LIFE JACKETS; NOSE PLUGS FOR SWIMMING, IN CLASS 9 (U.S. CLS. 21, 23, 26, 36 AND 38).

FOR: BOOKS AND MAGAZINES, ALL FOR CHILDREN; COMIC BOOKS, COMIC STRIPS IN GENERAL; CHILDREN'S ACTIVITY BOOKS, CHILDREN'S POP-UP BOOKS; PRINTED MATTER, NAMELY, MAGAZINES, JOURNALS, PAMPHLETS, BROCHURES, BOOKLETS AND A SERIES OF FICTION OR NON-FICTION BOOKS, ALL FEATURING CHILDREN'S ENTERTAINMENT; COLORING BOOKS; BOOKMARKS OF PAPER OR CARD; CHILDREN'S BOOKS FEATURING INTERACTIVE MAGNETIC OR FELT ELEMENTS; POSTERS; PAPER BANNERS; MOUNTED PHOTOGRAPHS, UNMOUNTED PHOTOGRAPHS; POSTCARDS; PRINTED CHARTS OF PAPER OR CARD SUCH AS GROWTH CHARTS, SPACE CHARTS, ALPHABET CHARTS, AND MULTIPLICATION CHARTS; GREETING CARDS, BLANK CARDS, CHRISTMAS CARDS, GIFT CARDS, NOTE CARDS; WRAPPING PAPER; PAPER TAGS; PAPER AND CARDBOARD BAGS AND BOXES FOR PACKAGING; CARDBOARD AND CARDBOARD ARTICLES, NAMELY, CARTONS AND CONTAINERS; PACKING PAPER; PAPER RIBBONS; PAPER GIFT WRAPPING RIBBONS; STATIONERY, NOTEPAPER, ENVELOPES, NOTE BOOKS; BLANK, PRINTED OR PARTIALLY PRINTED PAPER LABELS; ADDRESS LABELS; EXERCISE BOOKS; WRITING PADS; ADDRESS BOOKS; PENS, PENCILS, PENCIL CASES, PEN CASES; ARTISTS' MATERIALS, NAMELY, ARTISTS' PENCILS, ARTISTS' BRUSHES, ARTISTS' PENS, STENCILS, POSTER ART SETS, PAINT BOXES, PAINT BRUSHES, DRAWING MATERIALS, NAMELY, INSTRUMENTS, PADS AND PAPER; COLORING MATERIALS, NAMELY, CRAYONS, FELT TIP PENS, COLORING PENCILS, MARKER PENS, HIGHLIGHTERS AND BRUSH PENS, INK PENS; ADHESIVES FOR STATIONERY OR HOUSEHOLD PURPOSES; MODELING MATERIALS AND COMPOUNDS FOR USE BY CHILDREN; MODELING CLAY; MODELING COMPOUNDS; PRINTED TICKETS; PRINTED SOUVENIR PROGRAMS, FLYERS, POSTERS, LEAFLETS, BROCHURES, PAMPHLETS AND BOOKLETS COMMEMORATING CHARITABLE EVENTS; PRINTED INSTRUCTIONAL, EDUCATIONAL AND TEACHING MATERIAL ALL FOR USE WITH INFANTS, BABIES AND CHILDREN; FLASHCARDS; STICKERS; PAPER TRANSFERS, NAMELY, RUB-ON, STICK-ON AND IRON-ON TEMPORARY TATTOOS, DECALCOMANIAS, IRON-ON TRANSFERS; STENCILS; PAPER TRANSPARENCIES; CALENDARS; TEAR-OFF CALENDARS; DIARIES; OFFICE REQUISITES, NAMELY, TYPE CORRECTING FLUID, PUNCHES, RUBBER BANDS, PAPER CLIPS, BINDER CLIPS AND FASTENERS, STAPLERS, ADHESIVE TAPE DISPENSERS, ERASERS, PENCIL SHARPENERS, NOTE BINDERS, NAMELY, PAPER FASTENERS, LOOSE LEAF BINDERS, THREE-RING BINDERS, MECHANICAL BINDER SETS COMPRISING RINGS; FILES, NAMELY, DOCUMENT FILES, CARD FILES, FILE FOLDERS AND FILE SORTERS; FOLDERS; MEMO PADS; ELECTRIC TYPEWRITERS; PRINTING BLOCKS; RECEPTACLES FOR HOLDING RUBBER BANDS, PAPER CLIPS, BINDER CLIPS AND PAPER FASTENERS; DISPOSABLE DIAPERS; PAPER BIBS; PAPER NAPKINS AND PAPER TABLECLOTHS; BATHROOM TISSUE; FACIAL TISSUES; PAPER HANDKERCHIEFS; ABSORBENT PAPER FOR USE IN THE KITCHEN; PAPER TOWELS; PAPER FACE TOWELS; TABLE MATS MADE OF PAPER; AND PAPER PLACE MATS; COASTERS MADE OF PAPER; PLASTIC SANDWICH BAGS; GENERAL PURPOSE PLASTIC AND PAPER BAGS; PLASTIC AND PAPER GARBAGE BAGS; PHOTO, SCRAP, COIN AND STAMP ALBUMS; SCRAPBOOKS; ALMANACS; ANNOUNCEMENT CARDS; BLACKBOARDS; BOOKMARKS; BOTTLE WRAPPERS OF CARDBOARD OR PAPER; PAPER AND CARDBOARD BOXES; TRADING CARDS AND TRIVIA CARDS; PRINTED CHARTS; BOOK BINDINGS; EMBROIDERY DESIGN PATTERNS; PRINTED DRESS MAKING PATTERNS; PAPER MACHE FIGURINES; PAPER FLAGS; PAPER FLOWER POT COVERS; CONSTRUCTION PAPER; CRAFT PAPER; LOOSE LEAF PAPER; TISSUE PAPER; TRACING

Reg. No. 4,072,316 PAPER; CHECKBOOK COVERS MADE OF PAPER AND/OR CARDBOARD; PASSPORT HOLDERS MADE OF PAPER AND/OR CARDBOARD; BOOK COVERS; PERSONAL ORGANIZERS MADE OF PAPER AND/OR CARDBOARD; POCKET SECRETARIES MADE OF PAPER AND/OR CARDBOARD; CHALK BOARDS AND EASELS FOR HOME OR SCHOOL USE, IN CLASS 16 (U.S. CLS. 2, 5, 22, 23, 29, 37, 38 AND 50).

FOR: CLOTHING FOR ADULTS AND CHILDREN, NAMELY, T-SHIRTS AND SWEATSHIRTS, FOOTWEAR, SLIPPERS, FLIP FLOPS, SPORTS SHOES, BASKETBALL SHOES, TENNIS SHOES, BOOTS, BEACH SANDALS, RAIN BOOTS, SKI BOOTS; SHIRTS, PANTS, JEANS, DUNGAREES, SWEATERS; FLEECE TOPS, NAMELY, PULLOVERS, VESTS, SWEATSHIRTS; BLOUSES; JACKETS; TROUSERS; TIES; SHORTS; SOCKS; BELTS; SCARVES; SUITS; COATS; VEST; DRESSES; SKIRTS; MINISKIRTS; LEGGINGS; NIGHTWEAR; PAJAMAS; SHORTS; NIGHTDRESSES; SINGLET; FLEECE DRESSING GOWNS; DRESSING GOWNS MADE OF TERRY CLOTH OR COTTON; TRACKSUITS, TRAINING SUITS, SWEAT PANTS; HOODED TOPS, NAMELY, PULLOVERS, VESTS, SWEATSHIRTS; ZIP UP JOGGING SUITS; HEADWEAR, NAMELY, CAPS AND HATS; HEADBANDS; OVERALLS; CARDIGANS; GLOVES; OVER-COATS; UNDERWEAR; BOXER SHORTS; BRAS; BRIEFS; CAMISOLES; BODYSUITS; SWIMWEAR; TOWELING ROBES; BABIES AND INFANTS CLOTHES, NAMELY, BIBS MADE OF CLOTH, T-SHIRTS FOR BABIES, AND ROMPER SUITS; APRONS; TABARDS; GARDENING APRONS; COSTUMES, NAMELY, PARTY COSTUMES FOR HALLOWEEN AND MASQUERADES, COSTUMES FOR LIVE EVENTS, NAMELY, DANCE AND ROLE-PLAYING; BELTS AS PARTS OF CLOTHES; SUSPENDERS; BATHING CAPS, IN CLASS 25 (U.S. CLS. 22 AND 39).

FOR: TOY FIGURES REPRESENTING CARTOON CHARACTERS; GAMES AND PLAYTHINGS, NAMELY, SOFT-SCULPTURE TOYS; WOODEN TOYS, NAMELY, BUILDING BLOCKS, ALPHABET BLOCKS AND PULL OUT WOODEN PUZZLES; ELECTRICAL AND MECHANICAL ACTION TOYS; ELECTRONIC ACTION TOYS; RADIO CONTROLLED TOYS; SWIMMING AIDS, NAMELY, POOL RINGS, ARM FLOATS FOR RECREATIONAL USE, KICK BOARD FLOTATION DEVICE FOR RECREATIONAL USE, SWIM RINGS, FLOATING RECREATIONAL LOUNGE CHAIRS, AIR BEDS, NAMELY, INFLATABLE FLOAT MATTRESSES FOR RECREATIONAL USE; INFLATABLE RIDE-ON TOYS; SWIM FINS; BEACH BALLS; PADDLING POOLS, NAMELY, PLAY SWIMMING POOLS; PLAY MATS CONTAINING INFANT TOYS; ACTION FIGURES; PLUSH TOYS; BEANBAG TOYS; STUFFED TOY ANIMALS; TOY FIGURES; PUPPET TOYS FOR BABIES AND INFANTS, NAMELY, RATTLES, MOBILES, PLAY QUILTS AS DOLL ACCESSORY AND MULTIPLE ACTIVITY TOYS; TOYS DESIGNED TO BE ATTACHED TO CAR SEATS, STROLLERS, CRIBS, HIGH CHAIRS; PLAY SETS DESIGNED TO INTERACT WITH DOLLS, PLAY FIGURES AND ACTION FIGURES; MAKE-BELIEVE SETS, NAMELY, PLAY HOUSES AND PLAY TEA SETS; VEHICLES FOR DOLLS, ACTION FIGURES AND PLAY FIGURES; CARRYING OR COLLECTING CASES FOR ACTION FIGURES; DOLL CLOTHING AND ACCESSORIES; CHILDREN'S MULTIPLE ACTIVITY TOYS, NAMELY, PICTURE ACTIVITY SETS COMPRISED OF FELT, WIPE-AWAY SETS COMPRISED OF DRY ERASE WRITING BOARDS AND WRITING SURFACES, SLATE BOARDS FOR WRITING, WATER COLOR BOARDS, DECORATIVE GLITTER SETS; CHILDREN'S MULTIPLE ACTIVITY TOYS, NAMELY, KNITTING SETS COMPRISED OF STITCH MARKERS, STITCH GAUGES, STITCH HOLDERS, YARN BOBBINS, NEEDLES, AND TOY CONSTRUCTION SETS; JOKES AND NOVELTY ITEMS, NAMELY, PAPER FACE MASKS, RUDE NOISE-MAKERS, FALSE FACES, FALSE NOSES, FALSE EYEGLASSES, FALSE BEARDS, FALSE MOUSTACHES, WINDUP TOYS, WATER SQUIRTING TOYS, MAGIC TRICKS; PARTY FAVORS IN THE NATURE OF SMALL TOYS; KALEIDOSCOPES; BALLOONS; JIGSAW PUZZLES, MANIPULATIVE PUZZLES AND CUBE-TYPE PUZZLES; TIC-TAC-TOE; DOMINO SETS; EQUIPMENT SOLD AS A UNIT FOR BOARD, CARD AND SKILL ACTION GAMES AND FLOOR GAMES; CHRISTMAS TREE DECORATIONS, NOT INCLUDING CONFECTIONERY OR ILLUMINATION ARTICLES; KNEE, ELBOW AND WRIST PROTECTORS FOR USE IN SKATING AND OTHER SPORTS; TOY VEHICLES; CONSTRUCTION TOYS; WOODEN TOY MODEL TRAIN SETS; RIDE-ON TOYS; RIDE ON TOYS, NAMELY, PEDAL CARS AND PEDAL PLANES; TOY BICYCLES, TOY TRICYCLES, TOY SCOOTERS; GYMNASTIC APPARATUS;

Reg. No. 4,072,316 SPORTING ARTICLES, NAMELY, SPORT BALLS; TENNIS, SQUASH, BADMINTON, RACQUETBALL, PADDLE BALL AND TABLE TENNIS RACKETS AND RACKET COVERS; BASEBALL AND SOFTBALL MITTS; BASEBALL AND SOFTBALL GLOVES, BATS, CATCHER'S MASKS; LEG GUARDS FOR ATHLETIC USE, ATHLETIC SUPPORTERS AND PROTECTIVE CUPS, SHIN, THIGH, LEG, HIP, SHOULDER, RIB AND ARM PADS FOR ATHLETIC USE; BASEBALL AND SOFTBALL BASES; KICKING TEES; FIELD HOCKEY AND LACROSSE STICKS; MOUTH GUARDS FOR ATHLETIC USE; ARCHERY BOWS, BOW STRINGS, ARROWS, TARGETS, QUIVERS; BASKETBALL GOALS, NETS, AND BACKBOARDS; CROQUET SETS; BOXING GLOVES; BARBELLS; SKIS, SKI POLES; SNOWBOARDS; BOWLING BALLS; GOLF EQUIPMENT AND ACCESSORIES, NAMELY, CLUBS, BAGS, GOLF TEES, GLOVES, BALL MARKERS, CLUB HEAD COVERS, DIVOT REPAIR TOOLS; ICE HOCKEY STICKS AND PUCKS; SHUFFLEBOARD STICKS; BADMINTON SHUTTLECOCKS; VOLLEYBALL, TENNIS, AND TABLE TENNIS NETS; CRICKET STICKS AND WICKETS; SNOW SLEDS FOR RECREATIONAL USE; SURF BOARDS; BODY BOARDS; SKIM BOARDS; WINDSURFING BOARDS; ICE SKATES; ROLLER SKATES; IN-LINE SKATES; SKATE BOARDS; STATIONARY EXERCISE BICYCLES; FLYING DISCS; WATER SKIS; DARTBOARDS; DARTS; FISHING RODS, REELS AND LURES; TRAMPOLINES; BOUNCE-ON INFLATABLE TOYS; WOODEN SKITTLES; YO-YOS; SKIPPING ROPES; KITES; TOY PHONES, TOY TORCHES; ARCADE GAMES; COIN-OPERATED RIDE-ON TOYS; CONFETTI; HOBBY CRAFT SETS CONSISTING OF FELT SHAPES FOR MAKING PICTURES; PRINTED TEACHING MATERIALS IN THE FORM OF GAMES FOR USE IN THE FIELDS OF MATHEMATICS, LANGUAGE ARTS, SOCIAL STUDIES, ART, MUSIC, THEATRE ARTS OR LITERATURE, IN CLASS 28 (U.S. CLS. 22, 23, 38 AND 50).

FOR: TELEVISION PRODUCTION AND TELEVISION PROGRAM SERVICES, NAMELY, SCHEDULING, PROGRAMMING, SYNDICATION; PRODUCTION AND DISTRIBUTION OF RADIO AND TELEVISION PROGRAMS FOR OTHERS; AND DISTRIBUTION OF RADIO AND TELEVISION PROGRAMS FOR OTHERS; TELEVISION SHOW PRODUCTION; MOTION PICTURE FILM AND VIDEOTAPE PRODUCTION; DISTRIBUTION OF MOTION PICTURES; PUBLICATION OF BOOKS, MAGAZINES, JOURNALS; MUSIC PUBLISHING SERVICES; ENTERTAINMENT IN THE NATURE OF THEATRE PRODUCTIONS OR LIVE PERFORMANCES BY A MUSICAL GROUP; EDUCATIONAL SERVICES FOR CHILDREN, NAMELY, CONDUCTING CLASSES, WORKSHOPS OR SEMINARS IN THE FIELDS OF LANGUAGE ARTS, MATHEMATICS, SCIENCE, SOCIAL STUDIES, COMPUTER SKILLS, FAMILY EDUCATION, VISUAL ARTS, THEATRE OR MUSIC, ALL BY MEANS OF RADIO OR TELEVISION; ENTERTAINMENT SERVICES, NAMELY, ON-LINE BASED COMPUTER GAMES, IN CLASS 41 (U.S. CLS. 100, 101 AND 107).

PRIORITY CLAIMED UNDER SEC. 44(D) ON UNITED KINGDOM APPLICATION NO. 2466342, FILED 9-7-2007, REG. NO. 2466342, DATED 9-7-2007, EXPIRES 9-7-2017.

THE COLOR(S) RED, YELLOW AND BLACK IS/ARE CLAIMED AS A FEATURE OF THE MARK.

OWNER OF U.S. REG. NO. 2,233,157.

THE MARK CONSISTS OF A MALE CHARACTER DESIGN WITH RED SKIN AND BLACK EYES AND MOUTH, WEARING YELLOW AND BLACK SHOES THE COLOR BLACK IS USED AS OUTLINING THROUGH THE MARK. THE WORDING IN THE MARK APPEARS IN THE COLOR BLACK.

SER. NO. 77-312,655, FILED 10-24-2007.

SANDRA BUJA, EXAMINING ATTORNEY

United States of America

United States Patent and Trademark Office

ORION

Reg. No. 4,072,317

Registered Dec. 20, 2011

Int. Cls.: 30 and 35

TRADEMARK

SERVICE MARK

PRINCIPAL REGISTER

ORION CORPORATION (REPUBLIC OF KOREA CORPORATION)
30-10 MUNBAI-DONG
YONGSAN-GU, SEOUL, REPUBLIC OF KOREA

FOR: BREAD; CONFECTIONERY, NAMELY, CHOCOLATE, CANDY, LOLLIPOPS, BONBONS, CHEWING GUM, SWEETMEATS, CANDY WITH PEANUTS, CANDY WITH ALMONDS, CANDY WITH CARAMEL, CUSTARDS, BISCUITS, COOKIES, CAKES, PIES, PASTRIES, SPONGE CAKES, IN CLASS 30 (U.S. CL. 46).

FOR: WHOLESALE DISTRIBUTORSHIPS FEATURING CONFECTIONERY, BREADS, CANDY; RETAIL STORES FEATURING CONFECTIONERY, BREADS, CANDY; ON-LINE RETAIL STORE SERVICES FEATURING CONFECTIONERY, BREADS, CANDY; RETAIL OUTLETS FEATURING CONFECTIONERY, BREADS, CANDY; ALL OF THE AFOREMENTIONED SERVICES EXCLUDING PIZZA, IN CLASS 35 (U.S. CLS. 100, 101 AND 102).

THE MARK CONSISTS OF STANDARD CHARACTERS WITHOUT CLAIM TO ANY PARTICULAR FONT, STYLE, SIZE, OR COLOR.

OWNER OF REPUBLIC OF KOREA REG. NO. 40-0327178, DATED 11-23-1995, EXPIRES 11-23-2015.

OWNER OF REPUBLIC OF KOREA REG. NO. 41-0081478, DATED 11-19-2002, EXPIRES 11-19-2012.

SER. NO. 77-320,113, FILED 11-2-2007.

JAY BESCH, EXAMINING ATTORNEY



David J. Kypos

Director of the United States Patent and Trademark Office

United States of America

United States Patent and Trademark Office

KIO

Reg. No. 4,072,318

GESTION IAN OBIDNIAK INC. (CANADA CORPORATION)
18, RUE DE CHINON
BLAINVILLE, CANADA

Registered Dec. 20, 2011

Int. Cl.: 37

FOR: REAL ESTATE DEVELOPMENT, IN CLASS 37 (U.S. CLS. 100, 103 AND 106).

SERVICE MARK

THE MARK CONSISTS OF STANDARD CHARACTERS WITHOUT CLAIM TO ANY PARTICULAR FONT, STYLE, SIZE, OR COLOR.

PRINCIPAL REGISTER

PRIORITY CLAIMED UNDER SEC. 44(D) ON CANADA APPLICATION NO. 1375791, FILED 12-12-2007, REG. NO. TMA801342, DATED 7-5-2011, EXPIRES 7-5-2026.

SER. NO. 77-371,157, FILED 1-14-2008.

LINDSEY RUBIN, EXAMINING ATTORNEY



David J. Kybas

Director of the United States Patent and Trademark Office

United States of America

United States Patent and Trademark Office

EVERYWHERE ON EARTH

Reg. No. 4,072,319

Registered Dec. 20, 2011

**Int. Cls.: 39, 41, 42 and
43**

SERVICE MARK

PRINCIPAL REGISTER

DONVAND LIMITED (UNITED KINGDOM LIMITED COMPANY (LTD.))
27 GOSWELL ROAD
GULLIVERS HOUSE, 3RD FLOOR
LONDON, UNITED KINGDOM EC1M7GT

FOR: TRANSPORT AND TRAVEL ARRANGEMENT AND RESERVATION SERVICES; TRAVEL AND TOURIST AGENCY SERVICES; TOUR OPERATOR SERVICES; FLIGHT ARRANGEMENT SERVICES; TRAVEL GUIDE, COURIER SERVICES; RESERVATION SERVICES FOR TRANSPORTATION OF PASSENGERS; LUGGAGE TRANSPORTATION SERVICES; AIR, BOAT, RAIL, BUS, COACH AND CAR PASSENGER TRANSPORTATION SERVICES; VEHICLE RENTAL SERVICES; VEHICLE TRANSPORT SERVICES; TOURIST OFFICES; ARRANGING OF TOURS, SIGHTSEEING AND EXCURSION ARRANGEMENT SERVICES; ON-LINE TRAVEL CONSULTATION REGARDING HOLIDAY AND VACATION TRAVEL TRANSPORTATION; THE PROVISION OF THE FOREGOING SERVICES AND INFORMATION RELATING THERETO ONLINE FROM A COMPUTER DATABASE, THE INTERNET, TELECOMMUNICATIONS OR ANY OTHER MEDIA, IN CLASS 39 (U.S. CLS. 100 AND 105).

FIRST USE 9-0-2008; IN COMMERCE 9-0-2008.

FOR: PROVIDING ON-LINE PUBLICATIONS IN THE NATURE OF BROCHURES, PAMPHLETS, BOOKLETS, NEWSLETTERS, TRAVEL GUIDES, INFORMATION SHEETS, ITINERARIES, PROGRAMS, PHRASE BOOKS, AND MAPS IN THE FIELD OF TRAVEL TRANSPORTATION; HOLIDAY CAMP SERVICES, IN CLASS 41 (U.S. CLS. 100, 101 AND 107).

FIRST USE 9-0-2008; IN COMMERCE 9-0-2008.

FOR: DESIGN AND DEVELOPMENT OF COMPUTER SOFTWARE RELATING TO TRAVEL AND HOLIDAYS; COMPUTER SOFTWARE DESIGN RELATING TO HOLIDAYS AND TRAVEL; RENTAL OF COMPUTER SOFTWARE RELATING TO TRAVEL AND HOLIDAYS; THE PROVISION OF THE FOREGOING SERVICES AND INFORMATION RELATING THERETO ONLINE FROM A COMPUTER DATABASE, THE INTERNET, TELECOMMUNICATIONS OR ANY OTHER MEDIA, IN CLASS 42 (U.S. CLS. 100 AND 101).

FIRST USE 9-0-2008; IN COMMERCE 9-0-2008.



David J. Kyjars

Director of the United States Patent and Trademark Office

Reg. No. 4,072,319 FOR: ARRANGING AND PROVIDING HOTEL ACCOMMODATION AND TEMPORARY ACCOMMODATION; HOTEL RESERVATION SERVICES; TOURIST HOUSES; THE PROVISION OF THE FOREGOING SERVICES AND INFORMATION RELATING THERETO ONLINE FROM A COMPUTER DATABASE, THE INTERNET, TELECOMMUNICATIONS OR ANY OTHER MEDIA, IN CLASS 43 (U.S. CLS. 100 AND 101).

FIRST USE 9-0-2008; IN COMMERCE 9-0-2008.

THE MARK CONSISTS OF STANDARD CHARACTERS WITHOUT CLAIM TO ANY PARTICULAR FONT, STYLE, SIZE, OR COLOR.

PRIORITY CLAIMED UNDER SEC. 44(D) ON ERPN CMNTY TM OFC APPLICATION NO. 006570311, FILED 1-10-2008.

SER. NO. 77-374,194, FILED 1-17-2008.

ALEX KEAM, EXAMINING ATTORNEY

United States of America

United States Patent and Trademark Office

Markem-Imaje

Reg. No. 4,072,320

Registered Dec. 20, 2011

**Int. Cls.: 2, 7, 9, 16, 37,
40 and 42**

TRADEMARK

SERVICE MARK

PRINCIPAL REGISTER

DOVER (SUISSE) HOLDING SÀRL (SWITZERLAND SOCIÉTÉ À RESPONSABILITÉ LIMITÉE (SARL))
AERGERASTRASSE 12
TENTLINGEN, SWITZERLAND 1734

FOR: INKS, NAMELY, INK JET PRINTERS' INK AND INK PRINTING MACHINES' INK, PRINTERS' INKS; THERMOGRAPHIC INKS; THERMOFUSIBLE INKS AND HOT MELT INKS; MIXTURES FOR THE PREPARATION OF INK; INK THINNERS, SOLVENTS AND ADDITIVES; FILLED INK CARTRIDGES FOR USE IN INKJET PRINTERS AND PRINTING MACHINES; FILLED CARTRIDGES CONTAINING INK SOLVENTS AND ADDITIVES FOR USE IN INK JET PRINTERS AND PRINTING MACHINES, IN CLASS 2 (U.S. CLS. 6, 11 AND 16).

FOR: PRINTING MACHINES FOR COMMERCIAL OR INDUSTRIAL USE; INDUSTRIAL MACHINERY, NAMELY, ELECTROMECHANICAL MARKING MACHINES; INKJET PRINTING MACHINES FOR COMMERCIAL OR INDUSTRIAL USE; MACHINES FOR PRINTING, MARKING AND CODING FOR COMMERCIAL OR INDUSTRIAL USE FOR PRODUCTS AND PRODUCT PACKAGING; THERMAL PRINTING MACHINES; AUTOMATIC INDUSTRIAL LABELING MACHINES FOR APPLYING LABELS TO CONTAINERS AND BOTTLES; MACHINES FOR PRINTING, FITTING, AFFIXING AND APPLYING LABELS; PRINTING AND MARKING MACHINES FOR COMMERCIAL OR INDUSTRIAL USE USED TO CREATE CODES READABLE BY MACHINES AND HUMANS IN THE FORM OF LABELS OR DIRECTLY ONTO A PRODUCT OR PRODUCT PACKING MATERIAL OF A PRODUCT; PROGRAMMABLE THERMAL TRANSFER CODERS; RADIO FREQUENCY TAG READERS AND ENCODERS; PRINTERS FOR APPLYING RADIO FREQUENCY TAG; SMART LABELS CONTAINING IDENTIFICATION INFORMATION OR INFORMATION SENSORS; HEAT TRANSFER PRINTING MACHINES, MACHINES FOR PRINTING LABELS, LASER PRINTING MACHINES FOR MARKING AND CODING INFORMATION, DESIGNS, LOGOS, BARCODES AND MESSAGES ON LABELS, MARKERS AND TAGS, BOXES, PALLETS, PRODUCTS AND PRODUCT PACKAGING, INCLUDING LASER SOURCES, AN ELECTRONIC POWER SUPPLY, COMPUTERS, COMPUTER OPERATING PROGRAMS FOR USE THEREWITH, OPTICAL DEVICES FOR GUIDING AND ALIGNMENT OF LASER BEAM; PRINTERS AND MACHINES FOR INDUSTRIAL AND COMMERCIAL USE FOR PRINTING BY IMPACT, INKJET, INK ROLLER, THERMAL TRANSFER, PERCUSSION AND LASER FOR MARKING AND CODING INFORMATION, DESIGNS, LOGOS, BARCODES AND MESSAGES ON LABELS, MARKERS AND TAGS, BOXES, PALLETS, PRODUCTS AND PRODUCT PACKAGING;



David J. Kyffers

Director of the United States Patent and Trademark Office

Reg. No. 4,072,320 LASER PRINTING MACHINES; MACHINES FOR PRINTING, FITTING AND APPLYING LABELS, IN CLASS 7 (U.S. CLS. 13, 19, 21, 23, 31, 34 AND 35).

FOR: PRINTERS AND MACHINES FOR INDUSTRIAL AND COMMERCIAL USE FOR PRINTING BY IMPACT, INKJET, INK ROLLER, THERMAL TRANSFER, PERCUSSION AND LASER FOR MARKING AND CODING INFORMATION, DESIGNS, LOGOS, BARCODES AND MESSAGES ON LABELS, MARKERS AND TAGS, BOXES, PALLETS, PRODUCTS AND PRODUCT PACKAGING; INKJET PRINTER HEADS; THERMAL PRINTING HEADS; INKJET PRINTING HEADS; LABEL PRINTERS; PRINTERS FOR PRINTING, FITTING AND APPLYING LABELS, SMART LABEL READERS AND ENCODERS; ELECTRONIC LABEL ENCODERS; HEAT TRANSFER PRINTERS, LABEL PRINTERS, LASER PRINTERS FOR MARKING AND CODING INFORMATION, DESIGNS, LOGOS, BARCODES AND MESSAGES ON LABELS, MARKERS AND TAGS, BOXES, PALLETS, PRODUCTS AND PRODUCT PACKAGING, INCLUDING LASER SOURCES, AN ELECTRONIC POWER SUPPLY, COMPUTERS, COMPUTER OPERATING PROGRAMS FOR USE THEREWITH, OPTICAL DEVICES FOR GUIDING AND ALIGNMENT OF LASER BEAM; READERS AND ENCODERS FOR RADIO FREQUENCY IDENTIFICATION MARKERS, NAMELY, TAGS; APPLICATORS FOR RADIO FREQUENCY IDENTIFICATION MARKERS, NAMELY, TAGS; READERS AND ENCODERS FOR INTELLIGENT LABELS; PRINTERS, INKJET PRINTERS; MARKING PRINTERS; PRINTERS FOR PRINTING, MARKING AND CODING FOR PRODUCTS AND PRODUCT PACKAGING; THERMAL PRINTERS; THERMAL TRANSFER PRINTERS; LABELS PRINTERS; PRINTERS FOR PRINTING AND MARKING USED TO CREATE CODES READABLE BY MACHINES AND HUMANS IN THE FORM OF LABELS OR DIRECTLY ONTO A PRODUCT OR THE PACKING MATERIAL OF A PRODUCT; LASER CODERS FOR MARKING AND CODING INFORMATION, DESIGNS, LOGOS, BARCODES AND MESSAGES ON LABELS, MARKERS I.E. TAGS, BOXES, PALLETS, PRODUCTS AND PRODUCT PACKAGING, INCLUDING LASER SOURCES, AN ELECTRONIC POWER SUPPLY, COMPUTERS, COMPUTER OPERATING PROGRAMS FOR USE THEREWITH, OPTICAL DEVICES FOR GUIDING AND ALIGNMENT OF LASER BEAM; PRINTERS BY IMPACT, INKJET, INK ROLLER, THERMAL TRANSFER, PERCUSSION AND LASER FOR MARKING AND CODING INFORMATION, DESIGNS, LOGOS, BARCODES AND MESSAGES ON LABELS, MARKERS AND TAGS, BOXES, PALLETS, PRODUCTS AND PRODUCT PACKAGING; PROGRAMMABLE THERMAL TRANSFER CODERS; INKJET PRINTER HEADS; THERMAL PRINTER HEADS; PRINTERS FOR APPLYING LABELS; PRINTERS FOR PRINTING, FITTING AND APPLYING LABELS; SMART LABELS READERS AND ENCODERS; SMART LABELS APPLICATORS; PRINTERS FOR APPLYING PROTECTIVE AND DECORATIVE COATINGS TO SURFACES; CONTROLS FOR INKJET PRINTERS; CONTROLS FOR INKJET HEADS; CONTROLS FOR THERMAL PRINTERS; CONTROLS FOR THERMAL PRINTING; WIRELESS CONTROLLERS TO MONITOR AND CONTROL THE FUNCTIONING OF THE FOLLOWING ITEMS: PRINTING MACHINES, INKJET PRINTING MACHINES, MARKING MACHINES, PRINTING MACHINES, MARKING AND CODING MACHINES, MARKING AND CODING MACHINES FOR PRODUCTS AND PRODUCT PACKAGING, INKJET PRINTERS, THERMAL PRINTERS, THERMAL TRANSFER PRINTERS, LABELS PRINTERS, INKJET PRINTERS AND PROGRAMMABLE THERMAL TRANSFER CODERS, MACHINES FOR PRINTING BY IMPACT, INKJET, INK ROLLER, THERMAL TRANSFER, PERCUSSION AND LASER FOR MARKING AND CODING INFORMATION, DESIGNS, LOGOS, BARCODES AND MESSAGES ON LABELS, MARKERS AND TAGS, BOXES, PALLETS, PRODUCTS AND PRODUCT PACKAGING, LABEL READERS AND ENCODERS, LABEL APPLICATORS, SMART LABEL APPLICATORS, LASER CODERS FOR MARKING AND CODING; ELECTRONIC CONTROLS FOR PRINTING MACHINES, INKJET PRINTING MACHINES, MARKING MACHINES, PRINTING MACHINES, MARKING AND CODING MACHINES, MARKING AND CODING MACHINES FOR PRODUCTS AND PRODUCT PACKAGING, INKJET PRINTERS, THERMAL PRINTERS, THERMAL TRANSFER PRINTERS, LABELS PRINTERS, INKJET PRINTERS AND PROGRAMMABLE THERMAL TRANSFER ENCODERS, MACHINES FOR PRINTING BY IMPACT, INKJET, INK ROLLER, THERMAL TRANSFER, PERCUSSION AND LASER FOR MARKING AND CODING INFORMATION, DESIGNS, LOGOS, BARCODES AND MESSAGES ON LABELS, MARKERS AND TAGS, BOXES, PALLETS, PRODUCTS AND PRODUCT PACKAGING, LABEL READERS AND ENCODERS, SMART LABELS APPLIC-

Reg. No. 4,072,320 ATORS, LASER CODERS FOR MARKING AND CODING; ELECTRONIC CONTROLS FOR CONVEYERS FOR MOVING ITEMS IN FRONT OF AN INKJET PRINTING STATION; ELECTRONIC CONTROLS AND WIRELESS CONTROLLERS TO MONITOR AND CONTROL THE FUNCTIONING OF THE FOLLOWING ITEMS: ELECTRONIC OVER PRINTERS FOR PRINTING BATCH CODES, EXPIRY DATES, BARCODES AND VARIABLE INFORMATION DIRECTLY ON PACKAGING MATERIALS, LABELS AND PRODUCTS; SOFTWARE FOR CREATING INFORMATION FOR THE IDENTIFICATION OR CODING OF PRODUCTS, SUPERVISION SOFTWARE FOR PRINTING MACHINES, MANAGEMENT SOFTWARE FOR PRODUCT IDENTIFICATION AND TRACEABILITY MANAGEMENT, DATABASE SOFTWARE FOR PRODUCT IDENTIFICATION, INTERACTIVE INDUSTRIAL PRODUCT TRACEABILITY SYSTEMS; COMPUTER PROGRAMS FOR USE IN GENERATING LASER AND PRINT MARKINGS AND CODING PRODUCTS OF OTHERS; COMPUTER PROGRAMS FOR USE IN CONFIGURING AND OPERATING PRINTING SYSTEMS; COMPUTER PROGRAMS FOR USE IN FORMATTING DATA INTO A PRINTABLE FORMAT; COMPUTER PROGRAMS FOR USE IN CONTROLLING MARKING, LASER CODING AND PRINTING MACHINES; COMPUTER PROGRAMS FOR USE IN SYNCHRONIZING AND CONTROLLING DATA OBTAINED FROM MULTIPLE SOURCES; COMPUTER PROGRAMS FOR USE IN PREPARING REPORTS IN GRAPHICAL OR TEXT FORMAT FOR MANAGING SUPPLY CHAIN AND PRODUCTION OF PRODUCTS AND REGULATORY COMPLIANCE; COMPUTER PROGRAMS FOR USE IN MARKING AND CODING PRODUCTS AND PRODUCT PACKAGING AND FOR USE IN OPERATING MARKING AND CODING MACHINES, IN CLASS 9 (U.S. CLS. 21, 23, 26, 36 AND 38).

FOR: INK ROLLS FOR THERMAL PRINTERS AND THERMAL TRANSFER PRINTERS; RIBBONS FOR THERMAL PRINTERS AND THERMAL TRANSFER PRINTERS; LABELS FOR LABEL PRINTERS AND SYSTEMS FOR PRINTING, EXPOSING AND APPLYING LABELS, IN CLASS 16 (U.S. CLS. 2, 5, 22, 23, 29, 37, 38 AND 50).

FOR: INSTALLATION, REPAIR, AND MAINTENANCE OF PRINTING MACHINES FOR COMMERCIAL OR INDUSTRIAL USE; INDUSTRIAL MACHINERY, NAMELY, ELECTROMECHANICAL MARKING MACHINES; INKJET PRINTING MACHINES FOR COMMERCIAL OR INDUSTRIAL USE; MACHINES FOR PRINTING, MARKING AND CODING FOR COMMERCIAL OR INDUSTRIAL USE FOR PRODUCTS AND PRODUCT PACKAGING; THERMAL PRINTING MACHINES; AUTOMATIC INDUSTRIAL LABELING MACHINES FOR APPLYING LABELS TO CONTAINERS AND BOTTLES; MACHINES FOR PRINTING, FITTING, AFFIXING AND APPLYING LABELS; PRINTING AND MARKING MACHINES FOR COMMERCIAL OR INDUSTRIAL USE USED TO CREATE CODES READABLE BY MACHINES AND HUMANS IN THE FORM OF LABELS OR DIRECTLY ONTO A PRODUCT OR PRODUCT PACKING MATERIAL OF A PRODUCT; PROGRAMMABLE THERMAL TRANSFER CODERS; SMART LABELS CONTAINING IDENTIFICATION INFORMATION OR INFORMATION SENSORS; HEAT TRANSFER PRINTING MACHINES, MACHINES FOR PRINTING LABELS, LASER PRINTING MACHINES FOR MARKING AND CODING INFORMATION, DESIGNS, LOGOS, BARCODES AND MESSAGES ON LABELS, MARKERS AND TAGS, BOXES, PALLETS, PRODUCTS AND PRODUCT PACKAGING, INCLUDING LASER SOURCES, AN ELECTRONIC POWER SUPPLY, COMPUTERS, COMPUTER OPERATING PROGRAMS FOR USE THEREWITH, OPTICAL DEVICES FOR GUIDING AND ALIGNMENT OF LASER BEAM; PRINTERS AND MACHINES FOR INDUSTRIAL AND COMMERCIAL USE FOR PRINTING BY IMPACT, INKJET, INK ROLLER, THERMAL TRANSFER, PERCUSSION AND LASER FOR MARKING AND CODING INFORMATION, DESIGNS, LOGOS, BARCODES AND MESSAGES ON LABELS, MARKERS AND TAGS, BOXES, PALLETS, PRODUCTS AND PRODUCT PACKAGING; LASER PRINTING MACHINES; MACHINES FOR PRINTING, FITTING AND APPLYING LABELS; PRINTERS AND MACHINES FOR INDUSTRIAL AND COMMERCIAL USE FOR PRINTING BY IMPACT, INKJET, INK ROLLER, THERMAL TRANSFER, PERCUSSION AND LASER FOR MARKING AND CODING INFORMATION, DESIGNS, LOGOS, BARCODES AND MESSAGES ON LABELS, MARKERS AND TAGS, BOXES, PALLETS, PRODUCTS AND PRODUCT PACKAGING; INKJET PRINTER HEADS; THERMAL PRINTING HEADS; INKJET PRINTING HEADS; LABEL PRINTERS; PRINTERS FOR PRINTING, FITTING AND APPLYING LABELS, SMART LABEL READERS

Reg. No. 4,072,320 AND ENCODERS; ELECTRONIC LABEL ENCODERS; HEAT TRANSFER PRINTERS, LABEL PRINTERS, LASER PRINTERS FOR MARKING AND CODING INFORMATION, DESIGNS, LOGOS, BARCODES AND MESSAGES ON LABELS, MARKERS AND TAGS, BOXES, PALLETS, PRODUCTS AND PRODUCT PACKAGING, INCLUDING LASER SOURCES, AN ELECTRONIC POWER SUPPLY, COMPUTERS, OPTICAL DEVICES FOR GUIDING AND ALIGNMENT OF LASER BEAM; READERS AND ENCODERS FOR INTELLIGENT LABELS; PRINTERS, INKJET PRINTERS; MARKING PRINTERS; PRINTERS FOR PRINTING, MARKING AND CODING FOR PRODUCTS AND PRODUCT PACKAGING; THERMAL PRINTERS; THERMAL TRANSFER PRINTERS; LABELS PRINTERS; PRINTERS FOR PRINTING AND MARKING USED TO CREATE CODES READABLE BY MACHINES AND HUMANS IN THE FORM OF LABELS OR DIRECTLY ONTO A PRODUCT OR THE PACKING MATERIAL OF A PRODUCT; LASER CODERS FOR MARKING AND CODING INFORMATION, DESIGNS, LOGOS, BARCODES AND MESSAGES ON LABELS, MARKERS I.E. TAGS, BOXES, PALLETS, PRODUCTS AND PRODUCT PACKAGING, INCLUDING LASER SOURCES, AN ELECTRONIC POWER SUPPLY, COMPUTERS, COMPUTER OPERATING PROGRAMS FOR USE THEREWITH, OPTICAL DEVICES FOR GUIDING AND ALIGNMENT OF LASER BEAM; PRINTERS BY IMPACT, INKJET, INK ROLLER, THERMAL TRANSFER, PERCUSSION AND LASER FOR MARKING AND CODING INFORMATION, DESIGNS, LOGOS, BARCODES AND MESSAGES ON LABELS, MARKERS AND TAGS, BOXES, PALLETS, PRODUCTS AND PRODUCT PACKAGING; PROGRAMMABLE THERMAL TRANSFER CODERS; INKJET PRINTER HEADS; THERMAL PRINTER HEADS; PRINTERS FOR APPLYING LABELS; PRINTERS FOR PRINTING, FITTING AND APPLYING LABELS; SMART LABELS READERS AND ENCODERS; SMART LABELS APPLICATORS; PRINTERS FOR APPLYING PROTECTIVE AND DECORATIVE COATINGS TO SURFACES; CONTROLS FOR INKJET PRINTERS; CONTROLS FOR INKJET HEADS; CONTROLS FOR THERMAL PRINTERS; CONTROLS FOR THERMAL PRINTING; WIRELESS CONTROLLERS TO MONITOR AND CONTROL THE FUNCTIONING OF THE FOLLOWING ITEMS: PRINTING MACHINES, INKJET PRINTING MACHINES, MARKING MACHINES, PRINTING MACHINES, MARKING AND CODING MACHINES, MARKING AND CODING MACHINES FOR PRODUCTS AND PRODUCT PACKAGING, INKJET PRINTERS, THERMAL PRINTERS, THERMAL TRANSFER PRINTERS, LABELS PRINTERS, INKJET PRINTERS AND PROGRAMMABLE THERMAL TRANSFER CODERS, MACHINES FOR PRINTING BY IMPACT, INKJET, INK ROLLER, THERMAL TRANSFER, PERCUSSION AND LASER FOR MARKING AND CODING INFORMATION, DESIGNS, LOGOS, BARCODES AND MESSAGES ON LABELS, MARKERS AND TAGS, BOXES, PALLETS, PRODUCTS AND PRODUCT PACKAGING, LABEL READERS AND ENCODERS, LABEL APPLICATORS, SMART LABEL APPLICATORS, LASER CODERS FOR MARKING AND CODING; ELECTRONIC CONTROLS FOR PRINTING MACHINES, INKJET PRINTING MACHINES, MARKING MACHINES, PRINTING MACHINES, MARKING AND CODING MACHINES, MARKING AND CODING MACHINES FOR PRODUCTS AND PRODUCT PACKAGING, INKJET PRINTERS, THERMAL PRINTERS, THERMAL TRANSFER PRINTERS, LABELS PRINTERS, INKJET PRINTERS AND PROGRAMMABLE THERMAL TRANSFER ENCODERS, MACHINES FOR PRINTING BY IMPACT, INKJET, INK ROLLER, THERMAL TRANSFER, PERCUSSION AND LASER FOR MARKING AND CODING INFORMATION, DESIGNS, LOGOS, BARCODES AND MESSAGES ON LABELS, MARKERS AND TAGS, BOXES, PALLETS, PRODUCTS AND PRODUCT PACKAGING, LABEL READERS AND ENCODERS, SMART LABELS APPLICATORS, LASER CODERS FOR MARKING AND CODING; ELECTRONIC CONTROLS FOR CONVEYERS FOR MOVING ITEMS IN FRONT OF AN INKJET PRINTING STATION; ELECTRONIC CONTROLS AND WIRELESS CONTROLLERS TO MONITOR AND CONTROL THE FUNCTIONING OF THE FOLLOWING ITEMS: ELECTRONIC OVER PRINTERS FOR PRINTING BATCH CODES, EXPIRY DATES, BARCODES AND VARIABLE INFORMATION DIRECTLY ON PACKAGING MATERIALS, LABELS AND PRODUCTS, IN CLASS 37 (U.S. CLS. 100, 103 AND 106).

FOR: RENTAL OF PRINTERS AND PRINTING MACHINES FOR COMMERCIAL OR INDUSTRIAL USE, INDUSTRIAL MACHINERY, NAMELY, ELECTROMECHANICAL MARKING MACHINES; RECYCLING OF PRINTERS, PRINTING MACHINES, LASER CODERS, READERS, PRINTING, MARKING AND CODING MACHINES; SERVICES FOR THE REFILLING OF CONSUMABLES, NAMELY, INKS, RIBBONS, CARTRIDGES AND PACKAGING,

Reg. No. 4,072,320 IN THE FIELD OF INDUSTRIAL MARKING, PRINTING AND CODING, AND PRODUCT IDENTIFICATION; SERVICES FOR THE RECOVERY OF THE WASTED CONSUMABLES, NAMELY, INKS, RIBBONS, CARTRIDGES, AND PACKAGING, IN THE FIELD OF INDUSTRIAL MARKING, PRINTING AND CODING, AND PRODUCT IDENTIFICATION, IN CLASS 40 (U.S. CLS. 100, 103 AND 106).

FOR: TECHNICAL ASSISTANCE SERVICES, NAMELY, DIAGNOSIS OF PRINTING MACHINES FOR COMMERCIAL OR INDUSTRIAL USE; INDUSTRIAL MACHINERY, NAMELY, ELECTROMECHANICAL MARKING MACHINES; INKJET PRINTING MACHINES FOR COMMERCIAL OR INDUSTRIAL USE; MACHINES FOR PRINTING, MARKING AND CODING FOR COMMERCIAL OR INDUSTRIAL USE FOR PRODUCTS AND PRODUCT PACKAGING; THERMAL PRINTING MACHINES; AUTOMATIC INDUSTRIAL LABELING MACHINES FOR APPLYING LABELS TO CONTAINERS AND BOTTLES; MACHINES FOR PRINTING, FITTING, AFFIXING AND APPLYING LABELS; PRINTING AND MARKING MACHINES FOR COMMERCIAL OR INDUSTRIAL USE USED TO CREATE CODES READABLE BY MACHINES AND HUMANS IN THE FORM OF LABELS OR DIRECTLY ONTO A PRODUCT OR PRODUCT PACKING MATERIAL OF A PRODUCT; PROGRAMMABLE THERMAL TRANSFER CODERS; RADIO FREQUENCY TAG READERS AND ENCODERS; PRINTERS FOR APPLYING RADIO FREQUENCY TAG; SMART LABELS CONTAINING IDENTIFICATION INFORMATION OR INFORMATION SENSORS; HEAT TRANSFER PRINTING MACHINES, MACHINES FOR PRINTING LABELS, LASER PRINTING MACHINES FOR MARKING AND CODING INFORMATION, DESIGNS, LOGOS, BARCODES AND MESSAGES ON LABELS, MARKERS AND TAGS, BOXES, PALLETS, PRODUCTS AND PRODUCT PACKAGING, INCLUDING LASER SOURCES, AN ELECTRONIC POWER SUPPLY, COMPUTERS, COMPUTER OPERATING PROGRAMS FOR USE THEREWITH, OPTICAL DEVICES FOR GUIDING AND ALIGNMENT OF LASER BEAM; PRINTERS AND MACHINES FOR INDUSTRIAL AND COMMERCIAL USE FOR PRINTING BY IMPACT, INKJET, INK ROLLER, THERMAL TRANSFER, PERCUSSION AND LASER FOR MARKING AND CODING INFORMATION, DESIGNS, LOGOS, BARCODES AND MESSAGES ON LABELS, MARKERS AND TAGS, BOXES, PALLETS, PRODUCTS AND PRODUCT PACKAGING; LASER PRINTING MACHINES; MACHINES FOR PRINTING, FITTING AND APPLYING LABELS; PRINTERS AND MACHINES FOR INDUSTRIAL AND COMMERCIAL USE FOR PRINTING BY IMPACT, INKJET, INK ROLLER, THERMAL TRANSFER, PERCUSSION AND LASER FOR MARKING AND CODING INFORMATION, DESIGNS, LOGOS, BARCODES AND MESSAGES ON LABELS, MARKERS AND TAGS, BOXES, PALLETS, PRODUCTS AND PRODUCT PACKAGING; INKJET PRINTER HEADS; THERMAL PRINTING HEADS; INKJET PRINTING HEADS; LABEL PRINTERS; PRINTERS FOR PRINTING, FITTING AND APPLYING LABELS, SMART LABEL READERS AND ENCODERS; ELECTRONIC LABEL ENCODERS; HEAT TRANSFER PRINTERS, LABEL PRINTERS, LASER PRINTERS FOR MARKING AND CODING INFORMATION, DESIGNS, LOGOS, BARCODES AND MESSAGES ON LABELS, MARKERS AND TAGS, BOXES, PALLETS, PRODUCTS AND PRODUCT PACKAGING, INCLUDING LASER SOURCES, AN ELECTRONIC POWER SUPPLY, COMPUTERS, COMPUTER OPERATING PROGRAMS FOR USE THEREWITH, OPTICAL DEVICES FOR GUIDING AND ALIGNMENT OF LASER BEAM; READERS AND ENCODERS FOR RADIO FREQUENCY IDENTIFICATION MARKERS, NAMELY, TAGS; APPLICATORS FOR RADIO FREQUENCY IDENTIFICATION MARKERS, NAMELY, TAGS; READERS AND ENCODERS FOR INTELLIGENT LABELS; PRINTERS, INKJET PRINTERS; MARKING PRINTERS; PRINTERS FOR PRINTING, MARKING AND CODING FOR PRODUCTS AND PRODUCT PACKAGING; THERMAL PRINTERS; THERMAL TRANSFER PRINTERS; LABELS PRINTERS; PRINTERS FOR PRINTING AND MARKING USED TO CREATE CODES READABLE BY MACHINES AND HUMANS IN THE FORM OF LABELS OR DIRECTLY ONTO A PRODUCT OR THE PACKING MATERIAL OF A PRODUCT; LASER CODERS FOR MARKING AND CODING INFORMATION, DESIGNS, LOGOS, BARCODES AND MESSAGES ON LABELS, MARKERS I.E. TAGS, BOXES, PALLETS, PRODUCTS AND PRODUCT PACKAGING, INCLUDING LASER SOURCES, AN ELECTRONIC POWER SUPPLY, COMPUTERS, COMPUTER OPERATING PROGRAMS FOR USE THEREWITH, OPTICAL DEVICES FOR GUIDING AND ALIGNMENT OF LASER BEAM; PRINTERS BY IMPACT, INKJET, INK ROLLER, THERMAL TRANSFER, PERCUSSION AND LASER FOR MARKING AND

Reg. No. 4,072,320 CODING INFORMATION, DESIGNS, LOGOS, BARCODES AND MESSAGES ON LABELS, MARKERS AND TAGS, BOXES, PALLETS, PRODUCTS AND PRODUCT PACKAGING; PROGRAMMABLE THERMAL TRANSFER CODERS; INKJET PRINTER HEADS; THERMAL PRINTER HEADS; PRINTERS FOR APPLYING LABELS; PRINTERS FOR PRINTING, FITTING AND APPLYING LABELS; SMART LABELS READERS AND ENCODERS; SMART LABELS APPLICATORS; PRINTERS FOR APPLYING PROTECTIVE AND DECORATIVE COATINGS TO SURFACES; CONTROLS FOR INKJET PRINTERS; CONTROLS FOR INKJET HEADS; CONTROLS FOR THERMAL PRINTERS; CONTROLS FOR THERMAL PRINTING; WIRELESS CONTROLLERS TO MONITOR AND CONTROL THE FUNCTIONING OF THE FOLLOWING ITEMS: PRINTING MACHINES, INKJET PRINTING MACHINES, MARKING MACHINES, PRINTING MACHINES, MARKING AND CODING MACHINES, MARKING AND CODING MACHINES FOR PRODUCTS AND PRODUCT PACKAGING, INKJET PRINTERS, THERMAL PRINTERS, THERMAL TRANSFER PRINTERS, LABELS PRINTERS, INKJET PRINTERS AND PROGRAMMABLE THERMAL TRANSFER CODERS, MACHINES FOR PRINTING BY IMPACT, INKJET, INK ROLLER, THERMAL TRANSFER, PERCUSSION AND LASER FOR MARKING AND CODING INFORMATION, DESIGNS, LOGOS, BARCODES AND MESSAGES ON LABELS, MARKERS AND TAGS, BOXES, PALLETS, PRODUCTS AND PRODUCT PACKAGING, LABEL READERS AND ENCODERS, LABEL APPLICATORS, SMART LABEL APPLICATORS, LASER CODERS FOR MARKING AND CODING; ELECTRONIC CONTROLS FOR PRINTING MACHINES, INKJET PRINTING MACHINES, MARKING MACHINES, PRINTING MACHINES, MARKING AND CODING MACHINES, MARKING AND CODING MACHINES FOR PRODUCTS AND PRODUCT PACKAGING, INKJET PRINTERS, THERMAL PRINTERS, THERMAL TRANSFER PRINTERS, LABELS PRINTERS, INKJET PRINTERS AND PROGRAMMABLE THERMAL TRANSFER ENCODERS, MACHINES FOR PRINTING BY IMPACT, INKJET, INK ROLLER, THERMAL TRANSFER, PERCUSSION AND LASER FOR MARKING AND CODING INFORMATION, DESIGNS, LOGOS, BARCODES AND MESSAGES ON LABELS, MARKERS AND TAGS, BOXES, PALLETS, PRODUCTS AND PRODUCT PACKAGING, LABEL READERS AND ENCODERS, SMART LABELS APPLICATORS, LASER CODERS FOR MARKING AND CODING; ELECTRONIC CONTROLS FOR CONVEYERS FOR MOVING ITEMS IN FRONT OF AN INKJET PRINTING STATION; ELECTRONIC CONTROLS AND WIRELESS CONTROLLERS TO MONITOR AND CONTROL THE FUNCTIONING OF THE FOLLOWING ITEMS: ELECTRONIC OVER PRINTERS FOR PRINTING BATCH CODES, EXPIRY DATES, BARCODES AND VARIABLE INFORMATION DIRECTLY ON PACKAGING MATERIALS, LABELS AND PRODUCTS; SOFTWARE FOR CREATING INFORMATION FOR THE IDENTIFICATION OR CODING OF PRODUCTS, SUPERVISION SOFTWARE FOR PRINTING MACHINES, MANAGEMENT SOFTWARE FOR PRODUCT IDENTIFICATION AND TRACEABILITY MANAGEMENT, DATABASE SOFTWARE FOR PRODUCT IDENTIFICATION, INTERACTIVE INDUSTRIAL PRODUCT TRACEABILITY SYSTEMS; COMPUTER PROGRAMS FOR USE IN GENERATING LASER AND PRINT MARKINGS AND CODING PRODUCTS OF OTHERS; COMPUTER PROGRAMS FOR USE IN CONFIGURING AND OPERATING PRINTING SYSTEMS; COMPUTER PROGRAMS FOR USE IN FORMATTING DATA INTO A PRINTABLE FORMAT; COMPUTER PROGRAMS FOR USE IN CONTROLLING MARKING, LASER CODING AND PRINTING MACHINES; COMPUTER PROGRAMS FOR USE IN SYNCHRONIZING AND CONTROLLING DATA OBTAINED FROM MULTIPLE SOURCES; COMPUTER PROGRAMS FOR USE IN PREPARING REPORTS IN GRAPHICAL OR TEXT FORMAT FOR MANAGING SUPPLY CHAIN AND PRODUCTION OF PRODUCTS AND REGULATORY COMPLIANCE; COMPUTER PROGRAMS FOR USE IN MARKING AND CODING PRODUCTS AND PRODUCT PACKAGING AND FOR USE IN OPERATING MARKING AND CODING MACHINES; COMPUTER ENGINEERING CONSULTATION SERVICES IN THE FIELD OF INDUSTRIAL MARKING, PRINTING AND CODING AND PRODUCT IDENTIFICATION; UPDATING OF COMPUTER SOFTWARE IN THE FIELD OF INDUSTRIAL MARKING, PRINTING AND CODING AND PRODUCT IDENTIFICATION, PRINTING MACHINES FOR COMMERCIAL OR INDUSTRIAL USE; INDUSTRIAL MACHINERY, NAMELY, ELECTROMECHANICAL MARKING MACHINES; INKJET PRINTING MACHINES FOR COMMERCIAL OR INDUSTRIAL USE; MACHINES FOR PRINTING, MARKING AND CODING FOR COMMERCIAL OR INDUSTRIAL USE FOR PRODUCTS AND PRODUCT PACKAGING; THERMAL PRINTING MACHINES; AUTOMATIC INDUSTRIAL LABELING MACHINES FOR APPLYING

Reg. No. 4,072,320 LABELS TO CONTAINERS AND BOTTLES; MACHINES FOR PRINTING, FITTING, AFFIXING AND APPLYING LABELS; PRINTING AND MARKING MACHINES FOR COMMERCIAL OR INDUSTRIAL USE USED TO CREATE CODES READABLE BY MACHINES AND HUMANS IN THE FORM OF LABELS OR DIRECTLY ONTO A PRODUCT OR PRODUCT PACKING MATERIAL OF A PRODUCT; PROGRAMMABLE THERMAL TRANSFER CODERS; RADIO FREQUENCY TAG READERS AND ENCODERS; PRINTERS FOR APPLYING RADIO FREQUENCY TAG; SMART LABELS CONTAINING IDENTIFICATION INFORMATION OR INFORMATION SENSORS; HEAT TRANSFER PRINTING MACHINES, MACHINES FOR PRINTING LABELS, LASER PRINTING MACHINES FOR MARKING AND CODING INFORMATION, DESIGNS, LOGOS, BARCODES AND MESSAGES ON LABELS, MARKERS AND TAGS, BOXES, PALLETS, PRODUCTS AND PRODUCT PACKAGING, INCLUDING LASER SOURCES, AN ELECTRONIC POWER SUPPLY, COMPUTERS, COMPUTER OPERATING PROGRAMS FOR USE THEREWITH, OPTICAL DEVICES FOR GUIDING AND ALIGNMENT OF LASER BEAM; PRINTERS AND MACHINES FOR INDUSTRIAL AND COMMERCIAL USE FOR PRINTING BY IMPACT, INKJET, INK ROLLER, THERMAL TRANSFER, PERCUSSION AND LASER FOR MARKING AND CODING INFORMATION, DESIGNS, LOGOS, BARCODES AND MESSAGES ON LABELS, MARKERS AND TAGS, BOXES, PALLETS, PRODUCTS AND PRODUCT PACKAGING; LASER PRINTING MACHINES; MACHINES FOR PRINTING, FITTING AND APPLYING LABELS; PRINTERS AND MACHINES FOR INDUSTRIAL AND COMMERCIAL USE FOR PRINTING BY IMPACT, INKJET, INK ROLLER, THERMAL TRANSFER, PERCUSSION AND LASER FOR MARKING AND CODING INFORMATION, DESIGNS, LOGOS, BARCODES AND MESSAGES ON LABELS, MARKERS AND TAGS, BOXES, PALLETS, PRODUCTS AND PRODUCT PACKAGING; INKJET PRINTER HEADS; THERMAL PRINTING HEADS; INKJET PRINTING HEADS; LABEL PRINTERS; PRINTERS FOR PRINTING, FITTING AND APPLYING LABELS, SMART LABEL READERS AND ENCODERS; ELECTRONIC LABEL ENCODERS; HEAT TRANSFER PRINTERS, LABEL PRINTERS, LASER PRINTERS FOR MARKING AND CODING INFORMATION, DESIGNS, LOGOS, BARCODES AND MESSAGES ON LABELS, MARKERS AND TAGS, BOXES, PALLETS, PRODUCTS AND PRODUCT PACKAGING, INCLUDING LASER SOURCES, AN ELECTRONIC POWER SUPPLY, COMPUTERS, COMPUTER OPERATING PROGRAMS FOR USE THEREWITH, OPTICAL DEVICES FOR GUIDING AND ALIGNMENT OF LASER BEAM; READERS AND ENCODERS FOR RADIO FREQUENCY IDENTIFICATION MARKERS, NAMELY, TAGS; APPLICATORS FOR RADIO FREQUENCY IDENTIFICATION MARKERS, NAMELY, TAGS; READERS AND ENCODERS FOR INTELLIGENT LABELS; PRINTERS, INKJET PRINTERS; MARKING PRINTERS; PRINTERS FOR PRINTING, MARKING AND CODING FOR PRODUCTS AND PRODUCT PACKAGING; THERMAL PRINTERS; THERMAL TRANSFER PRINTERS; LABELS PRINTERS; PRINTERS FOR PRINTING AND MARKING USED TO CREATE CODES READABLE BY MACHINES AND HUMANS IN THE FORM OF LABELS OR DIRECTLY ONTO A PRODUCT OR THE PACKING MATERIAL OF A PRODUCT; LASER CODERS FOR MARKING AND CODING INFORMATION, DESIGNS, LOGOS, BARCODES AND MESSAGES ON LABELS, MARKERS I.E. TAGS, BOXES, PALLETS, PRODUCTS AND PRODUCT PACKAGING, INCLUDING LASER SOURCES, AN ELECTRONIC POWER SUPPLY, COMPUTERS, COMPUTER OPERATING PROGRAMS FOR USE THEREWITH, OPTICAL DEVICES FOR GUIDING AND ALIGNMENT OF LASER BEAM; PRINTERS BY IMPACT, INKJET, INK ROLLER, THERMAL TRANSFER, PERCUSSION AND LASER FOR MARKING AND CODING INFORMATION, DESIGNS, LOGOS, BARCODES AND MESSAGES ON LABELS, MARKERS AND TAGS, BOXES, PALLETS, PRODUCTS AND PRODUCT PACKAGING; PROGRAMMABLE THERMAL TRANSFER CODERS; INKJET PRINTER HEADS; THERMAL PRINTER HEADS; PRINTERS FOR APPLYING LABELS; PRINTERS FOR PRINTING, FITTING AND APPLYING LABELS; SMART LABELS READERS AND ENCODERS; SMART LABELS APPLICATORS; PRINTERS FOR APPLYING PROTECTIVE AND DECORATIVE COATINGS TO SURFACES; CONTROLS FOR INKJET PRINTERS; CONTROLS FOR INKJET HEADS; CONTROLS FOR THERMAL PRINTERS; CONTROLS FOR THERMAL PRINTING; WIRELESS CONTROLLERS TO MONITOR AND CONTROL THE FUNCTIONING OF THE FOLLOWING ITEMS: PRINTING MACHINES, INKJET PRINTING MACHINES, MARKING MACHINES, PRINTING MACHINES, MARKING AND CODING MACHINES, MARKING AND CODING MACHINES FOR PRODUCTS AND PRODUCT PACKAGING, INKJET PRINTERS, THERMAL PRINTERS,

Reg. No. 4,072,320 THERMAL TRANSFER PRINTERS, LABELS PRINTERS, INKJET PRINTERS AND PROGRAMMABLE THERMAL TRANSFER CODERS, MACHINES FOR PRINTING BY IMPACT, INKJET, INK ROLLER, THERMAL TRANSFER, PERCUSSION AND LASER FOR MARKING AND CODING INFORMATION, DESIGNS, LOGOS, BARCODES AND MESSAGES ON LABELS, MARKERS AND TAGS, BOXES, PALLETS, PRODUCTS AND PRODUCT PACKAGING, LABEL READERS AND ENCODERS, LABEL APPLICATORS, SMART LABEL APPLICATORS, LASER CODERS FOR MARKING AND CODING; ELECTRONIC CONTROLS FOR PRINTING MACHINES, INKJET PRINTING MACHINES, MARKING MACHINES, PRINTING MACHINES, MARKING AND CODING MACHINES, MARKING AND CODING MACHINES FOR PRODUCTS AND PRODUCT PACKAGING, INKJET PRINTERS, THERMAL PRINTERS, THERMAL TRANSFER PRINTERS, LABELS PRINTERS, INKJET PRINTERS AND PROGRAMMABLE THERMAL TRANSFER ENCODERS, MACHINES FOR PRINTING BY IMPACT, INKJET, INK ROLLER, THERMAL TRANSFER, PERCUSSION AND LASER FOR MARKING AND CODING INFORMATION, DESIGNS, LOGOS, BARCODES AND MESSAGES ON LABELS, MARKERS AND TAGS, BOXES, PALLETS, PRODUCTS AND PRODUCT PACKAGING, LABEL READERS AND ENCODERS, SMART LABELS APPLICATORS, LASER CODERS FOR MARKING AND CODING; ELECTRONIC CONTROLS FOR CONVEYERS FOR MOVING ITEMS IN FRONT OF AN INKJET PRINTING STATION; ELECTRONIC CONTROLS AND WIRELESS CONTROLLERS TO MONITOR AND CONTROL THE FUNCTIONING OF THE FOLLOWING ITEMS: ELECTRONIC OVER PRINTERS FOR PRINTING BATCH CODES, EXPIRY DATES, BARCODES AND VARIABLE INFORMATION DIRECTLY ON PACKAGING MATERIALS, LABELS AND PRODUCTS; INSTALLATION, REPAIR, AND MAINTENANCE OF COMPUTER OPERATING PROGRAMS FOR USE WITH PRINTING MACHINES FOR COMMERCIAL OR INDUSTRIAL USE, INDUSTRIAL MACHINERY, NAMELY, ELECTROMECHANICAL MARKING MACHINES, INKJET PRINTING MACHINES, MACHINES FOR PRINTING, MARKING AND CODING FOR COMMERCIAL OR INDUSTRIAL USE FOR PRODUCTS AND PRODUCT PACKAGING, THERMAL PRINTING MACHINES, HEAT TRANSFER PRINTERS AND PRINTING MACHINES, MACHINES FOR PRINTING LABELS AND LABEL PRINTERS, LASER PRINTING MACHINES FOR MARKING AND CODING INFORMATION, DESIGNS, LOGOS, BARCODES AND MESSAGES ON LABELS, MARKERS AND TAGS, BOXES, PALLETS, PRODUCTS AND PRODUCT PACKAGING, INCLUDING LASER SOURCES, AN ELECTRONIC POWER SUPPLY, COMPUTERS, OPTICAL DEVICES FOR GUIDING AND ALIGNMENT OF LASER BEAM, PRINTERS AND MACHINES FOR INDUSTRIAL AND COMMERCIAL USE FOR PRINTING BY IMPACT, INKJET, INK ROLLER, THERMAL TRANSFER, PERCUSSION AND LASER FOR MARKING AND CODING INFORMATION, DESIGNS, LOGOS, BARCODES AND MESSAGES ON LABELS, MARKERS AND TAGS, BOXES, PALLETS, PRODUCTS AND PRODUCT PACKAGING, AUTOMATIC INDUSTRIAL LABELING MACHINES FOR APPLYING LABELS TO CONTAINERS AND BOTTLES, MACHINES FOR PRINTING, FITTING, AFFIXING AND APPLYING LABELS, PRINTING AND MARKING MACHINES FOR COMMERCIAL OR INDUSTRIAL USE USED TO CREATE CODES READABLE BY MACHINES AND HUMANS IN THE FORM OF LABELS OR DIRECTLY ONTO A PRODUCT OR PRODUCT PACKING MATERIAL OF A PRODUCT, PROGRAMMABLE THERMAL TRANSFER CODERS, INKJET PRINTER HEADS, THERMAL PRINTING HEADS, INKJET PRINTING HEADS, LABEL APPLICATORS, PRINTERS AND MACHINES FOR PRINTING, FITTING AND APPLYING LABELS, SMART LABEL READERS AND ENCODERS, SMART LABELS APPLICATORS, MACHINES FOR APPLYING PROTECTIVE AND DECORATIVE COATINGS FOR SURFACES, READERS AND ENCODERS FOR RADIO FREQUENCY IDENTIFICATION MARKERS, NAMELY, TAGS, APPLICATORS FOR RADIO FREQUENCY IDENTIFICATION MARKERS, NAMELY, TAGS, READERS AND ENCODERS MACHINES FOR INTELLIGENT LABELS, PRINTERS, INKJET PRINTERS, MARKING PRINTERS, PRINTERS FOR PRINTING, MARKING AND CODING FOR PRODUCTS AND PRODUCT PACKAGING, THERMAL PRINTERS, THERMAL TRANSFER PRINTERS, LABELS PRINTERS, PRINTERS FOR PRINTING AND MARKING USED TO CREATE CODES READABLE BY MACHINES AND HUMANS IN THE FORM OF LABELS OR DIRECTLY ONTO A PRODUCT OR THE PACKING MATERIAL OF A PRODUCT, LASER CODERS FOR MARKING AND CODING INFORMATION, DESIGNS, LOGOS, BARCODES AND MESSAGES ON LABELS, MARKERS, NAMELY, TAGS, BOXES, PALLETS, PRODUCTS AND PRODUCT PACKAGING, INCLUDING LASER SOURCES, AN ELECTRONIC POWER

Reg. No. 4,072,320 SUPPLY, COMPUTERS; INSTALLATION, DIAGNOSIS, REPAIR, AND MAINTENANCE OF, AND TECHNICAL ASSISTANCE SERVICES FOR COMPUTER OPERATING PROGRAMS FOR USE WITH PRINTING MACHINES FOR COMMERCIAL OR INDUSTRIAL USE, INDUSTRIAL MACHINERY, NAMELY, SOFTWARE FOR CREATING INFORMATION FOR THE IDENTIFICATION OR CODING OF PRODUCTS, SUPERVISION SOFTWARE FOR PRINTING MACHINES, MANAGEMENT SOFTWARE FOR PRODUCT INFORMATION AND TRACEABILITY MANAGEMENT, DATABASE SOFTWARE FOR PRODUCT IDENTIFICATION, INTERACTIVE INDUSTRIAL PRODUCT TRACEABILITY SYSTEMS, COMPUTER PROGRAMS FOR USE IN GENERATING LASER AND PRINT MARKINGS AND CODING PRODUCTS OF OTHERS, COMPUTER PROGRAMS FOR USE IN CONFIGURING AND OPERATING PRINTING SYSTEMS, COMPUTER PROGRAMS FOR USE IN FORMATTING DATA INTO A PRINTABLE FORMAT, COMPUTER PROGRAMS FOR USE IN CONTROLLING MARKING, LASER CODING AND PRINTING MACHINES, COMPUTER PROGRAMS FOR USE IN SYNCHRONIZING AND CONTROLLING DATA OBTAINED FROM MULTIPLE SOURCES, COMPUTER PROGRAMS FOR USE IN PREPARING REPORTS IN GRAPHICAL OR TEXT FORMAT FOR MANAGING SUPPLY CHAIN AND PRODUCTION OF PRODUCTS AND REGULATORY COMPLIANCE, COMPUTER PROGRAMS FOR USE IN MARKING AND CODING PRODUCTS AND PRODUCT PACKAGING AND FOR USE IN OPERATING MARKING AND CODING MACHINES, RADIO FREQUENCY TAG READERS AND ENCODERS, PRINTERS FOR APPLYING RADIO FREQUENCY TAG, IN CLASS 42 (U.S. CLS. 100 AND 101).

THE MARK CONSISTS OF STANDARD CHARACTERS WITHOUT CLAIM TO ANY PARTICULAR FONT, STYLE, SIZE, OR COLOR.

PRIORITY CLAIMED UNDER SEC. 44(D) ON SWITZERLAND APPLICATION NO. 571936/2008, FILED 2-1-2008, REG. NO. 571936, DATED 2-1-2008, EXPIRES 2-1-2018.

SER. NO. 77-389,468, FILED 2-5-2008.

PAUL F. GAST, EXAMINING ATTORNEY

United States of America

United States Patent and Trademark Office

the team to trust

Reg. No. 4,072,321

Registered Dec. 20, 2011

**Int. Cls.: 2, 7, 9, 16, 37,
40 and 42**

TRADEMARK

SERVICE MARK

PRINCIPAL REGISTER

DOVER (SUISSE) HOLDING SÀRL (SWITZERLAND SOCIÉTÉ À RESPONSABILITÉ LIMITÉE (SARL))
AERGERASTRASSE 12
TENTLINGEN, SWITZERLAND 1734

FOR: INKS, NAMELY, INK JET PRINTERS' INK AND INK PRINTING MACHINES' INK, PRINTERS' INKS; THERMOGRAPHIC INKS; THERMOFUSIBLE INKS AND HOT MELT INKS; MIXTURES FOR THE PREPARATION OF INK; INK THINNERS, SOLVENTS AND ADDITIVES; FILLED INK CARTRIDGES FOR USE IN INKJET PRINTERS AND PRINTING MACHINES; FILLED CARTRIDGES CONTAINING INK SOLVENTS AND ADDITIVES FOR USE IN INK JET PRINTERS AND PRINTING MACHINES, IN CLASS 2 (U.S. CLS. 6, 11 AND 16).

FOR: PRINTING MACHINES FOR COMMERCIAL OR INDUSTRIAL USE; INDUSTRIAL MACHINERY, NAMELY, ELECTROMECHANICAL MARKING MACHINES; INKJET PRINTING MACHINES FOR COMMERCIAL OR INDUSTRIAL USE; MACHINES FOR PRINTING, MARKING AND CODING FOR COMMERCIAL OR INDUSTRIAL USE FOR PRODUCTS AND PRODUCT PACKAGING; THERMAL PRINTING MACHINES; AUTOMATIC INDUSTRIAL LABELING MACHINES FOR APPLYING LABELS TO CONTAINERS AND BOTTLES; MACHINES FOR PRINTING, FITTING, AFFIXING AND APPLYING LABELS; PRINTING AND MARKING MACHINES FOR COMMERCIAL OR INDUSTRIAL USE USED TO CREATE CODES READABLE BY MACHINES AND HUMANS IN THE FORM OF LABELS OR DIRECTLY ONTO A PRODUCT OR PRODUCT PACKING MATERIAL OF A PRODUCT; PROGRAMMABLE THERMAL TRANSFER CODERS; RADIO FREQUENCY TAG READERS AND ENCODERS; PRINTERS FOR APPLYING RADIO FREQUENCY TAG; SMART LABELS CONTAINING IDENTIFICATION INFORMATION OR INFORMATION SENSORS; HEAT TRANSFER PRINTING MACHINES, MACHINES FOR PRINTING LABELS, LASER PRINTING MACHINES FOR MARKING AND CODING INFORMATION, DESIGNS, LOGOS, BARCODES AND MESSAGES ON LABELS, MARKERS AND TAGS, BOXES, PALLETS, PRODUCTS AND PRODUCT PACKAGING, INCLUDING LASER SOURCES, AN ELECTRONIC POWER SUPPLY, COMPUTERS, COMPUTER OPERATING PROGRAMS FOR USE THEREWITH, OPTICAL DEVICES FOR GUIDING AND ALIGNMENT OF LASER BEAM; PRINTERS AND MACHINES FOR INDUSTRIAL AND COMMERCIAL USE FOR PRINTING BY IMPACT, INKJET, INK ROLLER, THERMAL TRANSFER, PERCUSSION AND LASER FOR MARKING AND CODING INFORMATION, DESIGNS, LOGOS, BARCODES AND MESSAGES ON LABELS, MARKERS AND TAGS, BOXES, PALLETS, PRODUCTS AND PRODUCT PACKAGING;



David J. Kyffers

Director of the United States Patent and Trademark Office

Reg. No. 4,072,321 LASER PRINTING MACHINES; MACHINES FOR PRINTING, FITTING AND APPLYING LABELS, IN CLASS 7 (U.S. CLS. 13, 19, 21, 23, 31, 34 AND 35).

FOR: PRINTERS AND MACHINES FOR INDUSTRIAL AND COMMERCIAL USE FOR PRINTING BY IMPACT, INKJET, INK ROLLER, THERMAL TRANSFER, PERCUSSION AND LASER FOR MARKING AND CODING INFORMATION, DESIGNS, LOGOS, BARCODES AND MESSAGES ON LABELS, MARKERS AND TAGS, BOXES, PALLETS, PRODUCTS AND PRODUCT PACKAGING; INKJET PRINTER HEADS; THERMAL PRINTING HEADS; INKJET PRINTING HEADS; LABEL PRINTERS; PRINTERS FOR PRINTING, FITTING AND APPLYING LABELS, SMART LABEL READERS AND ENCODERS; ELECTRONIC LABEL ENCODERS; HEAT TRANSFER PRINTERS, LABEL PRINTERS, LASER PRINTERS FOR MARKING AND CODING INFORMATION, DESIGNS, LOGOS, BARCODES AND MESSAGES ON LABELS, MARKERS AND TAGS, BOXES, PALLETS, PRODUCTS AND PRODUCT PACKAGING, INCLUDING LASER SOURCES, AN ELECTRONIC POWER SUPPLY, COMPUTERS, COMPUTER OPERATING PROGRAMS FOR USE THEREWITH, OPTICAL DEVICES FOR GUIDING AND ALIGNMENT OF LASER BEAM; READERS AND ENCODERS FOR RADIO FREQUENCY IDENTIFICATION MARKERS, NAMELY, TAGS; APPLICATORS FOR RADIO FREQUENCY IDENTIFICATION MARKERS, NAMELY, TAGS; READERS AND ENCODERS FOR INTELLIGENT LABELS; PRINTERS, INKJET PRINTERS; MARKING PRINTERS; PRINTERS FOR PRINTING, MARKING AND CODING FOR PRODUCTS AND PRODUCT PACKAGING; THERMAL PRINTERS; THERMAL TRANSFER PRINTERS; LABELS PRINTERS; PRINTERS FOR PRINTING AND MARKING USED TO CREATE CODES READABLE BY MACHINES AND HUMANS IN THE FORM OF LABELS OR DIRECTLY ONTO A PRODUCT OR THE PACKING MATERIAL OF A PRODUCT; LASER CODERS FOR MARKING AND CODING INFORMATION, DESIGNS, LOGOS, BARCODES AND MESSAGES ON LABELS, MARKERS I.E. TAGS, BOXES, PALLETS, PRODUCTS AND PRODUCT PACKAGING, INCLUDING LASER SOURCES, AN ELECTRONIC POWER SUPPLY, COMPUTERS, COMPUTER OPERATING PROGRAMS FOR USE THEREWITH, OPTICAL DEVICES FOR GUIDING AND ALIGNMENT OF LASER BEAM; PRINTERS BY IMPACT, INKJET, INK ROLLER, THERMAL TRANSFER, PERCUSSION AND LASER FOR MARKING AND CODING INFORMATION, DESIGNS, LOGOS, BARCODES AND MESSAGES ON LABELS, MARKERS AND TAGS, BOXES, PALLETS, PRODUCTS AND PRODUCT PACKAGING; PROGRAMMABLE THERMAL TRANSFER CODERS; INKJET PRINTER HEADS; THERMAL PRINTER HEADS; PRINTERS FOR APPLYING LABELS; PRINTERS FOR PRINTING, FITTING AND APPLYING LABELS; SMART LABELS READERS AND ENCODERS; SMART LABELS APPLICATORS; PRINTERS FOR APPLYING PROTECTIVE AND DECORATIVE COATINGS TO SURFACES; CONTROLS FOR INKJET PRINTERS; CONTROLS FOR INKJET HEADS; CONTROLS FOR THERMAL PRINTERS; CONTROLS FOR THERMAL PRINTING; WIRELESS CONTROLLERS TO MONITOR AND CONTROL THE FUNCTIONING OF THE FOLLOWING ITEMS: PRINTING MACHINES, INKJET PRINTING MACHINES, MARKING MACHINES, PRINTING MACHINES, MARKING AND CODING MACHINES, MARKING AND CODING MACHINES FOR PRODUCTS AND PRODUCT PACKAGING, INKJET PRINTERS, THERMAL PRINTERS, THERMAL TRANSFER PRINTERS, LABELS PRINTERS, INKJET PRINTERS AND PROGRAMMABLE THERMAL TRANSFER CODERS, MACHINES FOR PRINTING BY IMPACT, INKJET, INK ROLLER, THERMAL TRANSFER, PERCUSSION AND LASER FOR MARKING AND CODING INFORMATION, DESIGNS, LOGOS, BARCODES AND MESSAGES ON LABELS, MARKERS AND TAGS, BOXES, PALLETS, PRODUCTS AND PRODUCT PACKAGING, LABEL READERS AND ENCODERS, LABEL APPLICATORS, SMART LABEL APPLICATORS, LASER CODERS FOR MARKING AND CODING; ELECTRONIC CONTROLS FOR PRINTING MACHINES, INKJET PRINTING MACHINES, MARKING MACHINES, PRINTING MACHINES, MARKING AND CODING MACHINES, MARKING AND CODING MACHINES FOR PRODUCTS AND PRODUCT PACKAGING, INKJET PRINTERS, THERMAL PRINTERS, THERMAL TRANSFER PRINTERS, LABELS PRINTERS, INKJET PRINTERS AND PROGRAMMABLE THERMAL TRANSFER ENCODERS, MACHINES FOR PRINTING BY IMPACT, INKJET, INK ROLLER, THERMAL TRANSFER, PERCUSSION AND LASER FOR MARKING AND CODING INFORMATION, DESIGNS, LOGOS, BARCODES AND MESSAGES ON LABELS, MARKERS AND TAGS, BOXES, PALLETS, PRODUCTS AND PRODUCT PACKAGING, LABEL READERS AND ENCODERS, SMART LABELS APPLIC-

Reg. No. 4,072,321 ATORS, LASER CODERS FOR MARKING AND CODING; ELECTRONIC CONTROLS FOR CONVEYERS FOR MOVING ITEMS IN FRONT OF AN INKJET PRINTING STATION; ELECTRONIC CONTROLS AND WIRELESS CONTROLLERS TO MONITOR AND CONTROL THE FUNCTIONING OF THE FOLLOWING ITEMS: ELECTRONIC OVER PRINTERS FOR PRINTING BATCH CODES, EXPIRY DATES, BARCODES AND VARIABLE INFORMATION DIRECTLY ON PACKAGING MATERIALS, LABELS AND PRODUCTS; SOFTWARE FOR CREATING INFORMATION FOR THE IDENTIFICATION OR CODING OF PRODUCTS, SUPERVISION SOFTWARE FOR PRINTING MACHINES, MANAGEMENT SOFTWARE FOR PRODUCT IDENTIFICATION AND TRACEABILITY MANAGEMENT, DATABASE SOFTWARE FOR PRODUCT IDENTIFICATION, INTERACTIVE INDUSTRIAL PRODUCT TRACEABILITY SYSTEMS; COMPUTER PROGRAMS FOR USE IN GENERATING LASER AND PRINT MARKINGS AND CODING PRODUCTS OF OTHERS; COMPUTER PROGRAMS FOR USE IN CONFIGURING AND OPERATING PRINTING SYSTEMS; COMPUTER PROGRAMS FOR USE IN FORMATTING DATA INTO A PRINTABLE FORMAT; COMPUTER PROGRAMS FOR USE IN CONTROLLING MARKING, LASER CODING AND PRINTING MACHINES; COMPUTER PROGRAMS FOR USE IN SYNCHRONIZING AND CONTROLLING DATA OBTAINED FROM MULTIPLE SOURCES; COMPUTER PROGRAMS FOR USE IN PREPARING REPORTS IN GRAPHICAL OR TEXT FORMAT FOR MANAGING SUPPLY CHAIN AND PRODUCTION OF PRODUCTS AND REGULATORY COMPLIANCE; COMPUTER PROGRAMS FOR USE IN MARKING AND CODING PRODUCTS AND PRODUCT PACKAGING AND FOR USE IN OPERATING MARKING AND CODING MACHINES, IN CLASS 9 (U.S. CLS. 21, 23, 26, 36 AND 38).

FOR: INK ROLLS FOR THERMAL PRINTERS AND THERMAL TRANSFER PRINTERS; RIBBONS FOR THERMAL PRINTERS AND THERMAL TRANSFER PRINTERS; LABELS FOR LABEL PRINTERS AND SYSTEMS FOR PRINTING, EXPOSING AND APPLYING LABELS, IN CLASS 16 (U.S. CLS. 2, 5, 22, 23, 29, 37, 38 AND 50).

FOR: INSTALLATION, REPAIR, AND MAINTENANCE OF PRINTING MACHINES FOR COMMERCIAL OR INDUSTRIAL USE; INDUSTRIAL MACHINERY, NAMELY, ELECTROMECHANICAL MARKING MACHINES; INKJET PRINTING MACHINES FOR COMMERCIAL OR INDUSTRIAL USE; MACHINES FOR PRINTING, MARKING AND CODING FOR COMMERCIAL OR INDUSTRIAL USE FOR PRODUCTS AND PRODUCT PACKAGING; THERMAL PRINTING MACHINES; AUTOMATIC INDUSTRIAL LABELING MACHINES FOR APPLYING LABELS TO CONTAINERS AND BOTTLES; MACHINES FOR PRINTING, FITTING, AFFIXING AND APPLYING LABELS; PRINTING AND MARKING MACHINES FOR COMMERCIAL OR INDUSTRIAL USE USED TO CREATE CODES READABLE BY MACHINES AND HUMANS IN THE FORM OF LABELS OR DIRECTLY ONTO A PRODUCT OR PRODUCT PACKING MATERIAL OF A PRODUCT; PROGRAMMABLE THERMAL TRANSFER CODERS; SMART LABELS CONTAINING IDENTIFICATION INFORMATION OR INFORMATION SENSORS; HEAT TRANSFER PRINTING MACHINES, MACHINES FOR PRINTING LABELS, LASER PRINTING MACHINES FOR MARKING AND CODING INFORMATION, DESIGNS, LOGOS, BARCODES AND MESSAGES ON LABELS, MARKERS AND TAGS, BOXES, PALLETS, PRODUCTS AND PRODUCT PACKAGING, INCLUDING LASER SOURCES, AN ELECTRONIC POWER SUPPLY, COMPUTERS, COMPUTER OPERATING PROGRAMS FOR USE THEREWITH, OPTICAL DEVICES FOR GUIDING AND ALIGNMENT OF LASER BEAM; PRINTERS AND MACHINES FOR INDUSTRIAL AND COMMERCIAL USE FOR PRINTING BY IMPACT, INKJET, INK ROLLER, THERMAL TRANSFER, PERCUSSION AND LASER FOR MARKING AND CODING INFORMATION, DESIGNS, LOGOS, BARCODES AND MESSAGES ON LABELS, MARKERS AND TAGS, BOXES, PALLETS, PRODUCTS AND PRODUCT PACKAGING; LASER PRINTING MACHINES; MACHINES FOR PRINTING, FITTING AND APPLYING LABELS; PRINTERS AND MACHINES FOR INDUSTRIAL AND COMMERCIAL USE FOR PRINTING BY IMPACT, INKJET, INK ROLLER, THERMAL TRANSFER, PERCUSSION AND LASER FOR MARKING AND CODING INFORMATION, DESIGNS, LOGOS, BARCODES AND MESSAGES ON LABELS, MARKERS AND TAGS, BOXES, PALLETS, PRODUCTS AND PRODUCT PACKAGING; INKJET PRINTER HEADS; THERMAL PRINTING HEADS; INKJET PRINTING HEADS; LABEL PRINTERS; PRINTERS FOR PRINTING, FITTING AND APPLYING LABELS, SMART LABEL READERS

Reg. No. 4,072,321 AND ENCODERS; ELECTRONIC LABEL ENCODERS; HEAT TRANSFER PRINTERS, LABEL PRINTERS, LASER PRINTERS FOR MARKING AND CODING INFORMATION, DESIGNS, LOGOS, BARCODES AND MESSAGES ON LABELS, MARKERS AND TAGS, BOXES, PALLETS, PRODUCTS AND PRODUCT PACKAGING, INCLUDING LASER SOURCES, AN ELECTRONIC POWER SUPPLY, COMPUTERS, OPTICAL DEVICES FOR GUIDING AND ALIGNMENT OF LASER BEAM; READERS AND ENCODERS FOR INTELLIGENT LABELS; PRINTERS, INKJET PRINTERS; MARKING PRINTERS; PRINTERS FOR PRINTING, MARKING AND CODING FOR PRODUCTS AND PRODUCT PACKAGING; THERMAL PRINTERS; THERMAL TRANSFER PRINTERS; LABELS PRINTERS; PRINTERS FOR PRINTING AND MARKING USED TO CREATE CODES READABLE BY MACHINES AND HUMANS IN THE FORM OF LABELS OR DIRECTLY ONTO A PRODUCT OR THE PACKING MATERIAL OF A PRODUCT; LASER CODERS FOR MARKING AND CODING INFORMATION, DESIGNS, LOGOS, BARCODES AND MESSAGES ON LABELS, MARKERS I.E. TAGS, BOXES, PALLETS, PRODUCTS AND PRODUCT PACKAGING, INCLUDING LASER SOURCES, AN ELECTRONIC POWER SUPPLY, COMPUTERS, COMPUTER OPERATING PROGRAMS FOR USE THEREWITH, OPTICAL DEVICES FOR GUIDING AND ALIGNMENT OF LASER BEAM; PRINTERS BY IMPACT, INKJET, INK ROLLER, THERMAL TRANSFER, PERCUSSION AND LASER FOR MARKING AND CODING INFORMATION, DESIGNS, LOGOS, BARCODES AND MESSAGES ON LABELS, MARKERS AND TAGS, BOXES, PALLETS, PRODUCTS AND PRODUCT PACKAGING; PROGRAMMABLE THERMAL TRANSFER CODERS; INKJET PRINTER HEADS; THERMAL PRINTER HEADS; PRINTERS FOR APPLYING LABELS; PRINTERS FOR PRINTING, FITTING AND APPLYING LABELS; SMART LABELS READERS AND ENCODERS; SMART LABELS APPLICATORS; PRINTERS FOR APPLYING PROTECTIVE AND DECORATIVE COATINGS TO SURFACES; CONTROLS FOR INKJET PRINTERS; CONTROLS FOR INKJET HEADS; CONTROLS FOR THERMAL PRINTERS; CONTROLS FOR THERMAL PRINTING; WIRELESS CONTROLLERS TO MONITOR AND CONTROL THE FUNCTIONING OF THE FOLLOWING ITEMS; PRINTING MACHINES, INKJET PRINTING MACHINES, MARKING MACHINES, PRINTING MACHINES, MARKING AND CODING MACHINES, MARKING AND CODING MACHINES FOR PRODUCTS AND PRODUCT PACKAGING, INKJET PRINTERS, THERMAL PRINTERS, THERMAL TRANSFER PRINTERS, LABELS PRINTERS, INKJET PRINTERS AND PROGRAMMABLE THERMAL TRANSFER CODERS, MACHINES FOR PRINTING BY IMPACT, INKJET, INK ROLLER, THERMAL TRANSFER, PERCUSSION AND LASER FOR MARKING AND CODING INFORMATION, DESIGNS, LOGOS, BARCODES AND MESSAGES ON LABELS, MARKERS AND TAGS, BOXES, PALLETS, PRODUCTS AND PRODUCT PACKAGING, LABEL READERS AND ENCODERS, LABEL APPLICATORS, SMART LABEL APPLICATORS, LASER CODERS FOR MARKING AND CODING; ELECTRONIC CONTROLS FOR PRINTING MACHINES, INKJET PRINTING MACHINES, MARKING MACHINES, PRINTING MACHINES, MARKING AND CODING MACHINES, MARKING AND CODING MACHINES FOR PRODUCTS AND PRODUCT PACKAGING, INKJET PRINTERS, THERMAL PRINTERS, THERMAL TRANSFER PRINTERS, LABELS PRINTERS, INKJET PRINTERS AND PROGRAMMABLE THERMAL TRANSFER ENCODERS, MACHINES FOR PRINTING BY IMPACT, INKJET, INK ROLLER, THERMAL TRANSFER, PERCUSSION AND LASER FOR MARKING AND CODING INFORMATION, DESIGNS, LOGOS, BARCODES AND MESSAGES ON LABELS, MARKERS AND TAGS, BOXES, PALLETS, PRODUCTS AND PRODUCT PACKAGING, LABEL READERS AND ENCODERS, SMART LABELS APPLICATORS, LASER CODERS FOR MARKING AND CODING; ELECTRONIC CONTROLS FOR CONVEYERS FOR MOVING ITEMS IN FRONT OF AN INKJET PRINTING STATION; ELECTRONIC CONTROLS AND WIRELESS CONTROLLERS TO MONITOR AND CONTROL THE FUNCTIONING OF THE FOLLOWING ITEMS: ELECTRONIC OVER PRINTERS FOR PRINTING BATCH CODES, EXPIRY DATES, BARCODES AND VARIABLE INFORMATION DIRECTLY ON PACKAGING MATERIALS, LABELS AND PRODUCTS, IN CLASS 37 (U.S. CLS. 100, 103 AND 106).

FOR: RENTAL OF PRINTERS AND PRINTING MACHINES FOR COMMERCIAL OR INDUSTRIAL USE, INDUSTRIAL MACHINERY, NAMELY, ELECTROMECHANICAL MARKING MACHINES; RECYCLING OF PRINTERS, PRINTING MACHINES, LASER CODERS, READERS, PRINTING, MARKING AND CODING MACHINES; SERVICES FOR THE REFILLING OF CONSUMABLES, NAMELY, INKS, RIBBONS, CARTRIDGES AND PACKAGING,

Reg. No. 4,072,321 IN THE FIELD OF INDUSTRIAL MARKING, PRINTING AND CODING, AND PRODUCT IDENTIFICATION; SERVICES FOR THE RECOVERY OF THE WASTED CONSUMABLES, NAMELY, INKS, RIBBONS, CARTRIDGES, AND PACKAGING, IN THE FIELD OF INDUSTRIAL MARKING, PRINTING AND CODING, AND PRODUCT IDENTIFICATION, IN CLASS 40 (U.S. CLS. 100, 103 AND 106).

FOR: TECHNICAL ASSISTANCE SERVICES, NAMELY, DIAGNOSIS OF PRINTING MACHINES FOR COMMERCIAL OR INDUSTRIAL USE; INDUSTRIAL MACHINERY, NAMELY, ELECTROMECHANICAL MARKING MACHINES; INKJET PRINTING MACHINES FOR COMMERCIAL OR INDUSTRIAL USE; MACHINES FOR PRINTING, MARKING AND CODING FOR COMMERCIAL OR INDUSTRIAL USE FOR PRODUCTS AND PRODUCT PACKAGING; THERMAL PRINTING MACHINES; AUTOMATIC INDUSTRIAL LABELING MACHINES FOR APPLYING LABELS TO CONTAINERS AND BOTTLES; MACHINES FOR PRINTING, FITTING, AFFIXING AND APPLYING LABELS; PRINTING AND MARKING MACHINES FOR COMMERCIAL OR INDUSTRIAL USE USED TO CREATE CODES READABLE BY MACHINES AND HUMANS IN THE FORM OF LABELS OR DIRECTLY ONTO A PRODUCT OR PRODUCT PACKING MATERIAL OF A PRODUCT; PROGRAMMABLE THERMAL TRANSFER CODERS; RADIO FREQUENCY TAG READERS AND ENCODERS; PRINTERS FOR APPLYING RADIO FREQUENCY TAG; SMART LABELS CONTAINING IDENTIFICATION INFORMATION OR INFORMATION SENSORS; HEAT TRANSFER PRINTING MACHINES, MACHINES FOR PRINTING LABELS, LASER PRINTING MACHINES FOR MARKING AND CODING INFORMATION, DESIGNS, LOGOS, BARCODES AND MESSAGES ON LABELS, MARKERS AND TAGS, BOXES, PALLETS, PRODUCTS AND PRODUCT PACKAGING, INCLUDING LASER SOURCES, AN ELECTRONIC POWER SUPPLY, COMPUTERS, COMPUTER OPERATING PROGRAMS FOR USE THEREWITH, OPTICAL DEVICES FOR GUIDING AND ALIGNMENT OF LASER BEAM; PRINTERS AND MACHINES FOR INDUSTRIAL AND COMMERCIAL USE FOR PRINTING BY IMPACT, INKJET, INK ROLLER, THERMAL TRANSFER, PERCUSSION AND LASER FOR MARKING AND CODING INFORMATION, DESIGNS, LOGOS, BARCODES AND MESSAGES ON LABELS, MARKERS AND TAGS, BOXES, PALLETS, PRODUCTS AND PRODUCT PACKAGING; LASER PRINTING MACHINES; MACHINES FOR PRINTING, FITTING AND APPLYING LABELS; PRINTERS AND MACHINES FOR INDUSTRIAL AND COMMERCIAL USE FOR PRINTING BY IMPACT, INKJET, INK ROLLER, THERMAL TRANSFER, PERCUSSION AND LASER FOR MARKING AND CODING INFORMATION, DESIGNS, LOGOS, BARCODES AND MESSAGES ON LABELS, MARKERS AND TAGS, BOXES, PALLETS, PRODUCTS AND PRODUCT PACKAGING; INKJET PRINTER HEADS; THERMAL PRINTING HEADS; INKJET PRINTING HEADS; LABEL PRINTERS; PRINTERS FOR PRINTING, FITTING AND APPLYING LABELS, SMART LABEL READERS AND ENCODERS; ELECTRONIC LABEL ENCODERS; HEAT TRANSFER PRINTERS, LABEL PRINTERS, LASER PRINTERS FOR MARKING AND CODING INFORMATION, DESIGNS, LOGOS, BARCODES AND MESSAGES ON LABELS, MARKERS AND TAGS, BOXES, PALLETS, PRODUCTS AND PRODUCT PACKAGING, INCLUDING LASER SOURCES, AN ELECTRONIC POWER SUPPLY, COMPUTERS, COMPUTER OPERATING PROGRAMS FOR USE THEREWITH, OPTICAL DEVICES FOR GUIDING AND ALIGNMENT OF LASER BEAM; READERS AND ENCODERS FOR RADIO FREQUENCY IDENTIFICATION MARKERS, NAMELY, TAGS; APPLICATORS FOR RADIO FREQUENCY IDENTIFICATION MARKERS, NAMELY, TAGS; READERS AND ENCODERS FOR INTELLIGENT LABELS; PRINTERS, INKJET PRINTERS; MARKING PRINTERS; PRINTERS FOR PRINTING, MARKING AND CODING FOR PRODUCTS AND PRODUCT PACKAGING; THERMAL PRINTERS; THERMAL TRANSFER PRINTERS; LABELS PRINTERS; PRINTERS FOR PRINTING AND MARKING USED TO CREATE CODES READABLE BY MACHINES AND HUMANS IN THE FORM OF LABELS OR DIRECTLY ONTO A PRODUCT OR THE PACKING MATERIAL OF A PRODUCT; LASER CODERS FOR MARKING AND CODING INFORMATION, DESIGNS, LOGOS, BARCODES AND MESSAGES ON LABELS, MARKERS I.E. TAGS, BOXES, PALLETS, PRODUCTS AND PRODUCT PACKAGING, INCLUDING LASER SOURCES, AN ELECTRONIC POWER SUPPLY, COMPUTERS, COMPUTER OPERATING PROGRAMS FOR USE THEREWITH, OPTICAL DEVICES FOR GUIDING AND ALIGNMENT OF LASER BEAM; PRINTERS BY IMPACT, INKJET, INK ROLLER, THERMAL TRANSFER, PERCUSSION AND LASER FOR MARKING AND

Reg. No. 4,072,321 CODING INFORMATION, DESIGNS, LOGOS, BARCODES AND MESSAGES ON LABELS, MARKERS AND TAGS, BOXES, PALLETS, PRODUCTS AND PRODUCT PACKAGING; PROGRAMMABLE THERMAL TRANSFER CODERS; INKJET PRINTER HEADS; THERMAL PRINTER HEADS; PRINTERS FOR APPLYING LABELS; PRINTERS FOR PRINTING, FITTING AND APPLYING LABELS; SMART LABELS READERS AND ENCODERS; SMART LABELS APPLICATORS; PRINTERS FOR APPLYING PROTECTIVE AND DECORATIVE COATINGS TO SURFACES; CONTROLS FOR INKJET PRINTERS; CONTROLS FOR INKJET HEADS; CONTROLS FOR THERMAL PRINTERS; CONTROLS FOR THERMAL PRINTING; WIRELESS CONTROLLERS TO MONITOR AND CONTROL THE FUNCTIONING OF THE FOLLOWING ITEMS: PRINTING MACHINES, INKJET PRINTING MACHINES, MARKING MACHINES, PRINTING MACHINES, MARKING AND CODING MACHINES, MARKING AND CODING MACHINES FOR PRODUCTS AND PRODUCT PACKAGING, INKJET PRINTERS, THERMAL PRINTERS, THERMAL TRANSFER PRINTERS, LABELS PRINTERS, INKJET PRINTERS AND PROGRAMMABLE THERMAL TRANSFER CODERS, MACHINES FOR PRINTING BY IMPACT, INKJET, INK ROLLER, THERMAL TRANSFER, PERCUSSION AND LASER FOR MARKING AND CODING INFORMATION, DESIGNS, LOGOS, BARCODES AND MESSAGES ON LABELS, MARKERS AND TAGS, BOXES, PALLETS, PRODUCTS AND PRODUCT PACKAGING, LABEL READERS AND ENCODERS, LABEL APPLICATORS, SMART LABEL APPLICATORS, LASER CODERS FOR MARKING AND CODING; ELECTRONIC CONTROLS FOR PRINTING MACHINES, INKJET PRINTING MACHINES, MARKING MACHINES, PRINTING MACHINES, MARKING AND CODING MACHINES, MARKING AND CODING MACHINES FOR PRODUCTS AND PRODUCT PACKAGING, INKJET PRINTERS, THERMAL PRINTERS, THERMAL TRANSFER PRINTERS, LABELS PRINTERS, INKJET PRINTERS AND PROGRAMMABLE THERMAL TRANSFER ENCODERS, MACHINES FOR PRINTING BY IMPACT, INKJET, INK ROLLER, THERMAL TRANSFER, PERCUSSION AND LASER FOR MARKING AND CODING INFORMATION, DESIGNS, LOGOS, BARCODES AND MESSAGES ON LABELS, MARKERS AND TAGS, BOXES, PALLETS, PRODUCTS AND PRODUCT PACKAGING, LABEL READERS AND ENCODERS, SMART LABELS APPLICATORS, LASER CODERS FOR MARKING AND CODING; ELECTRONIC CONTROLS FOR CONVEYERS FOR MOVING ITEMS IN FRONT OF AN INKJET PRINTING STATION; ELECTRONIC CONTROLS AND WIRELESS CONTROLLERS TO MONITOR AND CONTROL THE FUNCTIONING OF THE FOLLOWING ITEMS: ELECTRONIC OVER PRINTERS FOR PRINTING BATCH CODES, EXPIRY DATES, BARCODES AND VARIABLE INFORMATION DIRECTLY ON PACKAGING MATERIALS, LABELS AND PRODUCTS; SOFTWARE FOR CREATING INFORMATION FOR THE IDENTIFICATION OR CODING OF PRODUCTS, SUPERVISION SOFTWARE FOR PRINTING MACHINES, MANAGEMENT SOFTWARE FOR PRODUCT IDENTIFICATION AND TRACEABILITY MANAGEMENT, DATABASE SOFTWARE FOR PRODUCT IDENTIFICATION, INTERACTIVE INDUSTRIAL PRODUCT TRACEABILITY SYSTEMS; COMPUTER PROGRAMS FOR USE IN GENERATING LASER AND PRINT MARKINGS AND CODING PRODUCTS OF OTHERS; COMPUTER PROGRAMS FOR USE IN CONFIGURING AND OPERATING PRINTING SYSTEMS; COMPUTER PROGRAMS FOR USE IN FORMATTING DATA INTO A PRINTABLE FORMAT; COMPUTER PROGRAMS FOR USE IN CONTROLLING MARKING, LASER CODING AND PRINTING MACHINES; COMPUTER PROGRAMS FOR USE IN SYNCHRONIZING AND CONTROLLING DATA OBTAINED FROM MULTIPLE SOURCES; COMPUTER PROGRAMS FOR USE IN PREPARING REPORTS IN GRAPHICAL OR TEXT FORMAT FOR MANAGING SUPPLY CHAIN AND PRODUCTION OF PRODUCTS AND REGULATORY COMPLIANCE; COMPUTER PROGRAMS FOR USE IN MARKING AND CODING PRODUCTS AND PRODUCT PACKAGING AND FOR USE IN OPERATING MARKING AND CODING MACHINES; COMPUTER ENGINEERING CONSULTATION SERVICES IN THE FIELD OF INDUSTRIAL MARKING, PRINTING AND CODING AND PRODUCT IDENTIFICATION; UPDATING OF COMPUTER SOFTWARE IN THE FIELD OF INDUSTRIAL MARKING, PRINTING AND CODING AND PRODUCT IDENTIFICATION, PRINTING MACHINES FOR COMMERCIAL OR INDUSTRIAL USE; INDUSTRIAL MACHINERY, NAMELY, ELECTROMECHANICAL MARKING MACHINES; INKJET PRINTING MACHINES FOR COMMERCIAL OR INDUSTRIAL USE; MACHINES FOR PRINTING, MARKING AND CODING FOR COMMERCIAL OR INDUSTRIAL USE FOR PRODUCTS AND PRODUCT PACKAGING; THERMAL PRINTING MACHINES; AUTOMATIC INDUSTRIAL LABELING MACHINES FOR APPLYING

Reg. No. 4,072,321 LABELS TO CONTAINERS AND BOTTLES; MACHINES FOR PRINTING, FITTING, AFFIXING AND APPLYING LABELS; PRINTING AND MARKING MACHINES FOR COMMERCIAL OR INDUSTRIAL USE USED TO CREATE CODES READABLE BY MACHINES AND HUMANS IN THE FORM OF LABELS OR DIRECTLY ONTO A PRODUCT OR PRODUCT PACKING MATERIAL OF A PRODUCT; PROGRAMMABLE THERMAL TRANSFER CODERS; RADIO FREQUENCY TAG READERS AND ENCODERS; PRINTERS FOR APPLYING RADIO FREQUENCY TAG; SMART LABELS CONTAINING IDENTIFICATION INFORMATION OR INFORMATION SENSORS; HEAT TRANSFER PRINTING MACHINES, MACHINES FOR PRINTING LABELS, LASER PRINTING MACHINES FOR MARKING AND CODING INFORMATION, DESIGNS, LOGOS, BARCODES AND MESSAGES ON LABELS, MARKERS AND TAGS, BOXES, PALLETS, PRODUCTS AND PRODUCT PACKAGING, INCLUDING LASER SOURCES, AN ELECTRONIC POWER SUPPLY, COMPUTERS, COMPUTER OPERATING PROGRAMS FOR USE THEREWITH, OPTICAL DEVICES FOR GUIDING AND ALIGNMENT OF LASER BEAM; PRINTERS AND MACHINES FOR INDUSTRIAL AND COMMERCIAL USE FOR PRINTING BY IMPACT, INKJET, INK ROLLER, THERMAL TRANSFER, PERCUSSION AND LASER FOR MARKING AND CODING INFORMATION, DESIGNS, LOGOS, BARCODES AND MESSAGES ON LABELS, MARKERS AND TAGS, BOXES, PALLETS, PRODUCTS AND PRODUCT PACKAGING; LASER PRINTING MACHINES; MACHINES FOR PRINTING, FITTING AND APPLYING LABELS; PRINTERS AND MACHINES FOR INDUSTRIAL AND COMMERCIAL USE FOR PRINTING BY IMPACT, INKJET, INK ROLLER, THERMAL TRANSFER, PERCUSSION AND LASER FOR MARKING AND CODING INFORMATION, DESIGNS, LOGOS, BARCODES AND MESSAGES ON LABELS, MARKERS AND TAGS, BOXES, PALLETS, PRODUCTS AND PRODUCT PACKAGING; INKJET PRINTER HEADS; THERMAL PRINTING HEADS; INKJET PRINTING HEADS; LABEL PRINTERS; PRINTERS FOR PRINTING, FITTING AND APPLYING LABELS, SMART LABEL READERS AND ENCODERS; ELECTRONIC LABEL ENCODERS; HEAT TRANSFER PRINTERS, LABEL PRINTERS, LASER PRINTERS FOR MARKING AND CODING INFORMATION, DESIGNS, LOGOS, BARCODES AND MESSAGES ON LABELS, MARKERS AND TAGS, BOXES, PALLETS, PRODUCTS AND PRODUCT PACKAGING, INCLUDING LASER SOURCES, AN ELECTRONIC POWER SUPPLY, COMPUTERS, COMPUTER OPERATING PROGRAMS FOR USE THEREWITH, OPTICAL DEVICES FOR GUIDING AND ALIGNMENT OF LASER BEAM; READERS AND ENCODERS FOR RADIO FREQUENCY IDENTIFICATION MARKERS, NAMELY, TAGS; APPLICATORS FOR RADIO FREQUENCY IDENTIFICATION MARKERS, NAMELY, TAGS; READERS AND ENCODERS FOR INTELLIGENT LABELS; PRINTERS, INKJET PRINTERS; MARKING PRINTERS; PRINTERS FOR PRINTING, MARKING AND CODING FOR PRODUCTS AND PRODUCT PACKAGING; THERMAL PRINTERS; THERMAL TRANSFER PRINTERS; LABELS PRINTERS; PRINTERS FOR PRINTING AND MARKING USED TO CREATE CODES READABLE BY MACHINES AND HUMANS IN THE FORM OF LABELS OR DIRECTLY ONTO A PRODUCT OR THE PACKING MATERIAL OF A PRODUCT; LASER CODERS FOR MARKING AND CODING INFORMATION, DESIGNS, LOGOS, BARCODES AND MESSAGES ON LABELS, MARKERS I.E. TAGS, BOXES, PALLETS, PRODUCTS AND PRODUCT PACKAGING, INCLUDING LASER SOURCES, AN ELECTRONIC POWER SUPPLY, COMPUTERS, COMPUTER OPERATING PROGRAMS FOR USE THEREWITH, OPTICAL DEVICES FOR GUIDING AND ALIGNMENT OF LASER BEAM; PRINTERS BY IMPACT, INKJET, INK ROLLER, THERMAL TRANSFER, PERCUSSION AND LASER FOR MARKING AND CODING INFORMATION, DESIGNS, LOGOS, BARCODES AND MESSAGES ON LABELS, MARKERS AND TAGS, BOXES, PALLETS, PRODUCTS AND PRODUCT PACKAGING; PROGRAMMABLE THERMAL TRANSFER CODERS; INKJET PRINTER HEADS; THERMAL PRINTER HEADS; PRINTERS FOR APPLYING LABELS; PRINTERS FOR PRINTING, FITTING AND APPLYING LABELS; SMART LABELS READERS AND ENCODERS; SMART LABELS APPLICATORS; PRINTERS FOR APPLYING PROTECTIVE AND DECORATIVE COATINGS TO SURFACES; CONTROLS FOR INKJET PRINTERS; CONTROLS FOR INKJET HEADS; CONTROLS FOR THERMAL PRINTERS; CONTROLS FOR THERMAL PRINTING; WIRELESS CONTROLLERS TO MONITOR AND CONTROL THE FUNCTIONING OF THE FOLLOWING ITEMS: PRINTING MACHINES, INKJET PRINTING MACHINES, MARKING MACHINES, PRINTING MACHINES, MARKING AND CODING MACHINES, MARKING AND CODING MACHINES FOR PRODUCTS AND PRODUCT PACKAGING, INKJET PRINTERS, THERMAL PRINTERS,

Reg. No. 4,072,321 THERMAL TRANSFER PRINTERS, LABELS PRINTERS, INKJET PRINTERS AND PROGRAMMABLE THERMAL TRANSFER CODERS, MACHINES FOR PRINTING BY IMPACT, INKJET, INK ROLLER, THERMAL TRANSFER, PERCUSSION AND LASER FOR MARKING AND CODING INFORMATION, DESIGNS, LOGOS, BARCODES AND MESSAGES ON LABELS, MARKERS AND TAGS, BOXES, PALLETS, PRODUCTS AND PRODUCT PACKAGING, LABEL READERS AND ENCODERS, LABEL APPLICATORS, SMART LABEL APPLICATORS, LASER CODERS FOR MARKING AND CODING; ELECTRONIC CONTROLS FOR PRINTING MACHINES, INKJET PRINTING MACHINES, MARKING MACHINES, PRINTING MACHINES, MARKING AND CODING MACHINES, MARKING AND CODING MACHINES FOR PRODUCTS AND PRODUCT PACKAGING, INKJET PRINTERS, THERMAL PRINTERS, THERMAL TRANSFER PRINTERS, LABELS PRINTERS, INKJET PRINTERS AND PROGRAMMABLE THERMAL TRANSFER ENCODERS, MACHINES FOR PRINTING BY IMPACT, INKJET, INK ROLLER, THERMAL TRANSFER, PERCUSSION AND LASER FOR MARKING AND CODING INFORMATION, DESIGNS, LOGOS, BARCODES AND MESSAGES ON LABELS, MARKERS AND TAGS, BOXES, PALLETS, PRODUCTS AND PRODUCT PACKAGING, LABEL READERS AND ENCODERS, SMART LABELS APPLICATORS, LASER CODERS FOR MARKING AND CODING; ELECTRONIC CONTROLS FOR CONVEYERS FOR MOVING ITEMS IN FRONT OF AN INKJET PRINTING STATION; ELECTRONIC CONTROLS AND WIRELESS CONTROLLERS TO MONITOR AND CONTROL THE FUNCTIONING OF THE FOLLOWING ITEMS: ELECTRONIC OVER PRINTERS FOR PRINTING BATCH CODES, EXPIRY DATES, BARCODES AND VARIABLE INFORMATION DIRECTLY ON PACKAGING MATERIALS, LABELS AND PRODUCTS; INSTALLATION, REPAIR, AND MAINTENANCE OF COMPUTER OPERATING PROGRAMS FOR USE WITH PRINTING MACHINES FOR COMMERCIAL OR INDUSTRIAL USE, INDUSTRIAL MACHINERY, NAMELY, ELECTROMECHANICAL MARKING MACHINES, INKJET PRINTING MACHINES, MACHINES FOR PRINTING, MARKING AND CODING FOR COMMERCIAL OR INDUSTRIAL USE FOR PRODUCTS AND PRODUCT PACKAGING, THERMAL PRINTING MACHINES, HEAT TRANSFER PRINTERS AND PRINTING MACHINES, MACHINES FOR PRINTING LABELS AND LABEL PRINTERS, LASER PRINTING MACHINES FOR MARKING AND CODING INFORMATION, DESIGNS, LOGOS, BARCODES AND MESSAGES ON LABELS, MARKERS AND TAGS, BOXES, PALLETS, PRODUCTS AND PRODUCT PACKAGING, INCLUDING LASER SOURCES, AN ELECTRONIC POWER SUPPLY, COMPUTERS, OPTICAL DEVICES FOR GUIDING AND ALIGNMENT OF LASER BEAM, PRINTERS AND MACHINES FOR INDUSTRIAL AND COMMERCIAL USE FOR PRINTING BY IMPACT, INKJET, INK ROLLER, THERMAL TRANSFER, PERCUSSION AND LASER FOR MARKING AND CODING INFORMATION, DESIGNS, LOGOS, BARCODES AND MESSAGES ON LABELS, MARKERS AND TAGS, BOXES, PALLETS, PRODUCTS AND PRODUCT PACKAGING, AUTOMATIC INDUSTRIAL LABELING MACHINES FOR APPLYING LABELS TO CONTAINERS AND BOTTLES, MACHINES FOR PRINTING, FITTING, AFFIXING AND APPLYING LABELS, PRINTING AND MARKING MACHINES FOR COMMERCIAL OR INDUSTRIAL USE USED TO CREATE CODES READABLE BY MACHINES AND HUMANS IN THE FORM OF LABELS OR DIRECTLY ONTO A PRODUCT OR PRODUCT PACKING MATERIAL OF A PRODUCT, PROGRAMMABLE THERMAL TRANSFER CODERS, INKJET PRINTER HEADS, THERMAL PRINTING HEADS, INKJET PRINTING HEADS, LABEL APPLICATORS, PRINTERS AND MACHINES FOR PRINTING, FITTING AND APPLYING LABELS, SMART LABEL READERS AND ENCODERS, SMART LABELS APPLICATORS, MACHINES FOR APPLYING PROTECTIVE AND DECORATIVE COATINGS FOR SURFACES, READERS AND ENCODERS FOR RADIO FREQUENCY IDENTIFICATION MARKERS, NAMELY, TAGS, APPLICATORS FOR RADIO FREQUENCY IDENTIFICATION MARKERS, NAMELY, TAGS, READERS AND ENCODERS MACHINES FOR INTELLIGENT LABELS, PRINTERS, INKJET PRINTERS, MARKING PRINTERS, PRINTERS FOR PRINTING, MARKING AND CODING FOR PRODUCTS AND PRODUCT PACKAGING, THERMAL PRINTERS, THERMAL TRANSFER PRINTERS, LABELS PRINTERS, PRINTERS FOR PRINTING AND MARKING USED TO CREATE CODES READABLE BY MACHINES AND HUMANS IN THE FORM OF LABELS OR DIRECTLY ONTO A PRODUCT OR THE PACKING MATERIAL OF A PRODUCT, LASER CODERS FOR MARKING AND CODING INFORMATION, DESIGNS, LOGOS, BARCODES AND MESSAGES ON LABELS, MARKERS, NAMELY, TAGS, BOXES, PALLETS, PRODUCTS AND PRODUCT PACKAGING, INCLUDING LASER SOURCES, AN ELECTRONIC POWER

Reg. No. 4,072,321 SUPPLY, COMPUTERS; INSTALLATION, DIAGNOSIS, REPAIR, AND MAINTENANCE OF, AND TECHNICAL ASSISTANCE SERVICES FOR COMPUTER OPERATING PROGRAMS FOR USE WITH PRINTING MACHINES FOR COMMERCIAL OR INDUSTRIAL USE, INDUSTRIAL MACHINERY, NAMELY, SOFTWARE FOR CREATING INFORMATION FOR THE IDENTIFICATION OR CODING OF PRODUCTS, SUPERVISION SOFTWARE FOR PRINTING MACHINES, MANAGEMENT SOFTWARE FOR PRODUCT INFORMATION AND TRACEABILITY MANAGEMENT, DATABASE SOFTWARE FOR PRODUCT IDENTIFICATION, INTERACTIVE INDUSTRIAL PRODUCT TRACEABILITY SYSTEMS, COMPUTER PROGRAMS FOR USE IN GENERATING LASER AND PRINT MARKINGS AND CODING PRODUCTS OF OTHERS, COMPUTER PROGRAMS FOR USE IN CONFIGURING AND OPERATING PRINTING SYSTEMS, COMPUTER PROGRAMS FOR USE IN FORMATTING DATA INTO A PRINTABLE FORMAT, COMPUTER PROGRAMS FOR USE IN CONTROLLING MARKING, LASER CODING AND PRINTING MACHINES, COMPUTER PROGRAMS FOR USE IN SYNCHRONIZING AND CONTROLLING DATA OBTAINED FROM MULTIPLE SOURCES, COMPUTER PROGRAMS FOR USE IN PREPARING REPORTS IN GRAPHICAL OR TEXT FORMAT FOR MANAGING SUPPLY CHAIN AND PRODUCTION OF PRODUCTS AND REGULATORY COMPLIANCE, COMPUTER PROGRAMS FOR USE IN MARKING AND CODING PRODUCTS AND PRODUCT PACKAGING AND FOR USE IN OPERATING MARKING AND CODING MACHINES, RADIO FREQUENCY TAG READERS AND ENCODERS, PRINTERS FOR APPLYING RADIO FREQUENCY TAG, IN CLASS 42 (U.S. CLS. 100 AND 101).

THE MARK CONSISTS OF STANDARD CHARACTERS WITHOUT CLAIM TO ANY PARTICULAR FONT, STYLE, SIZE, OR COLOR.

PRIORITY CLAIMED UNDER SEC. 44(D) ON ERPN CMNTY TM OFC APPLICATION NO. 006677181, FILED 2-1-2008, REG. NO. 006677181, DATED 6-4-2009, EXPIRES 2-18-2018.

OWNER OF SWITZERLAND REG. NO. 513382008, DATED 2-18-2008, EXPIRES 2-18-2018.

SER. NO. 77-389,481, FILED 2-5-2008.

PAUL F. GAST, EXAMINING ATTORNEY

United States of America

United States Patent and Trademark Office

NEATFREAK

Reg. No. 4,072,322

NEATFREAK GROUP, INC. (CANADA CORPORATION)
5320 TIMBERLEA BOULEVARD

Registered Dec. 20, 2011

MISSISSAUGA, ONTARIO, CANADA L4W 2S6

Int. Cls.: 5, 6, 20, 21 and 22

FOR: CLOSET STORAGE ACCESSORIES, NAMELY, CEDAR CLOSET AND DRAWER FRESHENERS, IN CLASS 5 (U.S. CLS. 6, 18, 44, 46, 51 AND 52).

TRADEMARK

FOR: METAL CLOTHING AND ACCESSORY HOOKS AND CLIPS, IN CLASS 6 (U.S. CLS. 2, 12, 13, 14, 23, 25 AND 50).

PRINCIPAL REGISTER

FOR: HOME STORAGE AND ORGANIZING PRODUCTS, NAMELY, CLOTHES HANGERS, PANT HANGERS, SKIRT HANGERS, HANGER CADDIES, NON-METAL CLOTHING AND ACCESSORY HOOKS AND CLIPS, BOOT RACKS, GARMENT RACKS, SHOE RACKS, SHELVES, TIE RACKS, PANT RACKS, SKIRT RACKS, BLOUSE TREES, PLASTIC SWEATER BOXES, PLASTIC SHIRT BOXES, PLASTIC TIE BOXES, WARDROBE STORAGE UNITS WITH COVERS, BASKETS, PLASTIC WALL MOUNTS, OVER-THE-DOOR NON-METAL HOOKS, OVER-THE-DOOR ORGANIZERS, STACKABLE SHELVES, UNDER-THE-SINK SHELVES, STACKABLE BINS, CLOSET AND STORAGE SHELVING.; NON-METAL FABRIC STORAGE BIN ORGANIZER; LAUNDRY ACCESSORIES, NAMELY, LAUNDRY HAMPERS; MODULAR GARAGE SHELVING APPARATUS AND COMPONENTS THEREOF METAL AND NON-METAL, NAMELY, SHELVING UNITS, HANGING UNITS, DRAWERS, CABINETS, NON-METAL HOOKS, RAILINGS, CUPBOARDS, BASKETS, HANGING RODS, AND STORAGE BINS, IN CLASS 20 (U.S. CLS. 2, 13, 22, 25, 32 AND 50).



FOR: SHOE TREES; LAUNDRY ACCESSORIES, NAMELY, CLOTHES PINS, EMPTY SPRAY BOTTLES, LAUNDRY BASKETS, CLOTHES DRYING RACKS, STACKABLE CLOTHES DRYING RACKS, LAUNDRY SORTERS, NAMELY, METAL, PLASTIC OR WOOD FRAMED STRUCTURES WITH CANVAS OR FABRIC BAGS OR CONTAINERS; IRONING BOARDS, IRONING ACCESSORIES, NAMELY, IRON CADDIES AND SILICONE ARM RESTS FOR IRONS, FREE-STANDING, STACKABLE AND NON-STACKABLE LAUNDRY RACKS FOR DRYING CLOTHES, IN CLASS 21 (U.S. CLS. 2, 13, 23, 29, 30, 33, 40 AND 50).

David J. Kyros

FOR: GARMENT BAGS FOR STORAGE, LAUNDRY ACCESSORIES, NAMELY, MESH BAGS, CLOTH AND PLASTIC CLOTHES PIN BAGS, LAUNDRY BAGS, RETRACTABLE CLOTHES LINES, IN CLASS 22 (U.S. CLS. 1, 2, 7, 19, 22, 42 AND 50).

Reg. No. 4,072,322 THE MARK CONSISTS OF STANDARD CHARACTERS WITHOUT CLAIM TO ANY PARTICULAR FONT, STYLE, SIZE, OR COLOR.

OWNER OF CANADA REG. NO. TMA756734, DATED 1-11-2010, EXPIRES 1-11-2025.

SER. NO. 77-436,697, FILED 4-1-2008.

CHRIS WELLS, EXAMINING ATTORNEY

United States of America

United States Patent and Trademark Office



Reg. No. 4,072,323

ASPHALT PAVING CO. (COLORADO CORPORATION)
14802 WEST 44TH AVENUE
GOLDEN, CO 80403

Registered Dec. 20, 2011

Int. Cls.: 19 and 37

FOR: ASPHALT PAVING MATERIALS AND COMPOSITIONS, ALL IN THE NATURE OF ASPHALT, IN CLASS 19 (U.S. CLS. 1, 12, 33 AND 50).

TRADEMARK

FIRST USE 12-15-2007; IN COMMERCE 12-15-2007.

SERVICE MARK

FOR: CONSTRUCTION, PAVING, MAINTENANCE AND REPAIR OF STREETS, ROADS, HIGHWAYS, PARKING LOTS AND THE LIKE, IN CLASS 37 (U.S. CLS. 100, 103 AND 106).

PRINCIPAL REGISTER

FIRST USE 12-15-2007; IN COMMERCE 12-15-2007.

THE MARK CONSISTS OF THE STYLIZED LETTERS "APC" WITH A CURVY ROAD DESIGN DERIVING FROM THE BOTTOM OF THE "A".

SER. NO. 77-485,578, FILED 5-28-2008.

MAUREEN DALL, EXAMINING ATTORNEY



David J. Kybas

Director of the United States Patent and Trademark Office

United States of America

United States Patent and Trademark Office



Reg. No. 4,072,324

APC SOUTHERN CONSTRUCTION CO LLC (COLORADO LIMITED LIABILITY COMPANY)
14802 WEST 44TH AVENUE
GOLDEN, CO 80403

Registered Dec. 20, 2011

Int. Cl.: 37

FOR: CONSTRUCTION, PAVING, MAINTENANCE AND REPAIR OF STREETS, ROADS, HIGHWAYS, PARKING LOTS AND THE LIKE, IN CLASS 37 (U.S. CLS. 100, 103 AND 106).

SERVICE MARK

FIRST USE 3-1-2005; IN COMMERCE 3-1-2005.

PRINCIPAL REGISTER

THE MARK CONSISTS OF THE STYLIZED LETTERS "APC" WITH A CURVY ROAD DESIGN DERIVING FROM THE BOTTOM OF THE "A" AND THE STYLIZED WORD "SOUTHERN" UNDER THE LETTER "C".

SER. NO. 77-485,588, FILED 5-28-2008.

NELSON SNYDER, EXAMINING ATTORNEY



David J. Kybas

Director of the United States Patent and Trademark Office

United States of America

United States Patent and Trademark Office



Reg. No. 4,072,325

Registered Dec. 20, 2011

Int. Cl.: 9

TRADEMARK

PRINCIPAL REGISTER

SONY CORPORATION (JAPAN CORPORATION)
1-7-1 KONAN, MINATO-KU
TOKYO, JAPAN

FOR: DIGITAL AUDIO PLAYERS AND RECORDERS WHICH USE INTEGRATED CIRCUITS AS RECORDING MEDIA, AUDIO TAPE PLAYERS AND RECORDERS; AUDIO DISC PLAYERS AND RECORDERS; HARD DISC AUDIO PLAYERS AND RECORDERS; RADIO TUNERS; AUDIO RECEIVERS; TELEVISION RECEIVERS; LIQUID CRYSTAL DISPLAY (LCD) TELEVISIONS; PLASMA DISPLAY PANEL (PDP) TELEVISIONS; LIQUID CRYSTAL DISPLAYS; LIQUID CRYSTAL DISPLAY PROJECTORS; VIDEO TAPE PLAYERS AND RECORDERS; VIDEO DISC PLAYERS AND RECORDERS; HARD DISC VIDEO PLAYERS AND RECORDERS; TELEVISION SET TOP BOXES; VIDEO CAMERAS; VIDEO CAMERAS COMBINED WITH VIDEO RECORDERS AND PLAYERS; DIGITAL STILL CAMERAS; CELLULAR TELEPHONES; FACSIMILE MACHINES; PERSONAL DIGITAL ASSISTANTS (PDAS); PERSONAL COMPUTERS; SCANNERS; COMPUTER PRINTERS; VIDEO GAME MACHINES FOR USE WITH TELEVISIONS, IN CLASS 9 (U.S. CLS. 21, 23, 26, 36 AND 38).

OWNER OF JAPAN REG. NO. 5193888, DATED 1-9-2009, EXPIRES 1-9-2019.

THE MARK CONSISTS OF A HIGHLY STYLIZED TRIANGLE-LIKE DEVICE THAT IS SEGMENTED, WITH THE LEFT AND TOP SIDES BEING STRAIGHT IN PLANE AND THE LINE EXTENDING FROM THE LOWER LEFT TO THE UPPER RIGHT BEING SLIGHTLY ARCUATE; THE UPPER LEFT PORTION OF THE DESIGN HAS A TRIANGLE IMPRESSED INTO THE LEFT SIDE THAT EXTENDS PARTIALLY INTO THE DESIGN.

SER. NO. 77-497,179, FILED 6-12-2008.

JOHN SCHUYLER YARD, EXAMINING ATTORNEY



David J. Kyros

Director of the United States Patent and Trademark Office

United States of America

United States Patent and Trademark Office



Reg. No. 4,072,326

HELEN DORON LTD. (ISRAEL LIMITED LIABILITY COMPANY)
MISGAV INDUSTRIAL PARK

Registered Dec. 20, 2011

DN MISGAV, ISRAEL 20174

Int. Cl.: 41

FOR: EDUCATION AND PROVIDING OF TRAINING, NAMELY, CLASSES FOR TEACHING MATH TO CHILDREN THROUGH INTERACTIVE HANDS-ON ACTIVITIES IN CLASSROOMS AND THROUGH ON-LINE TEACHING, IN CLASS 41 (U.S. CLS. 100, 101 AND 107).

SERVICE MARK

PRINCIPAL REGISTER

PRIORITY CLAIMED UNDER SEC. 44(D) ON ERPN CMNTY TM OFC APPLICATION NO. 006933361, FILED 5-23-2008, REG. NO. 006933361, DATED 3-12-2009, EXPIRES 5-23-2018.

THE COLOR(S) WHITE, GREEN AND RED IS/ARE CLAIMED AS A FEATURE OF THE MARK.

THE MARK CONSISTS OF A WHITE BACKGROUND AND THE WORDING "MATHRIDERS" IN GREEN LETTERS AT BOTTOM WITH A RED IMAGE OF A JUMPING GIRL WITH A WHITE NUMBER "1" ON HER CHEST TO THE UPPER RIGHT OVER THE LETTER "E" IN "RIDERS".

SER. NO. 77-544,908, FILED 8-12-2008.

ANDREW LEASER, EXAMINING ATTORNEY



David J. Kyffers

Director of the United States Patent and Trademark Office

United States of America

United States Patent and Trademark Office

AVVIO

Reg. No. 4,072,327

Registered Dec. 20, 2011

Int. Cl.: 32

TRADEMARK

PRINCIPAL REGISTER

ROYAL WINE CORPORATION (NEW YORK CORPORATION)
63 NORTH HOOK ROAD
BAYONNE, NJ 07002

FOR: FRUIT JUICES, IN CLASS 32 (U.S. CLS. 45, 46 AND 48).

FIRST USE 3-31-2004; IN COMMERCE 3-31-2004.

THE MARK CONSISTS OF STANDARD CHARACTERS WITHOUT CLAIM TO ANY PARTICULAR FONT, STYLE, SIZE, OR COLOR.

THE ENGLISH TRANSLATION OF "AVVIO" IN THE MARK IS "START".

SER. NO. 77-583,424, FILED 10-1-2008.

JULIE GUTTADAURO, EXAMINING ATTORNEY



David J. Kybas

Director of the United States Patent and Trademark Office

United States of America

United States Patent and Trademark Office

FOSBAC

Reg. No. 4,072,328

Registered Dec. 20, 2011

Int. Cl.: 5

TRADEMARK

PRINCIPAL REGISTER

BEDSON S.A. (ARGENTINA CORPORATION)
RUTA 8, KM. 47, LA LONJA PILAR
BUENOS AIRES, ARGENTINA B163DIK

FOR: WIDE SPECTRUM ANTIBIOTIC TO BE USED IN VETERINARY MEDICINE, IN CLASS 5 (U.S. CLS. 6, 18, 44, 46, 51 AND 52).

THE MARK CONSISTS OF STANDARD CHARACTERS WITHOUT CLAIM TO ANY PARTICULAR FONT, STYLE, SIZE, OR COLOR.

OWNER OF ARGENTINA REG. NO. 1339295, DATED 4-3-1989, RENEWED AS REG. NO. 2376979, DATED 6-15-2010, EXPIRES 6-15-2020.

SER. NO. 77-591,014, FILED 10-12-2008.

CYNTHIA TRIPI, EXAMINING ATTORNEY



David J. Kyffers

Director of the United States Patent and Trademark Office

United States of America

United States Patent and Trademark Office



Reg. No. 4,072,329

Registered Dec. 20, 2011

Int. Cls.: 2 and 3

TRADEMARK

PRINCIPAL REGISTER

UNI-SELECT INC. (CANADA CORPORATION)
170, BOULEVARD INDUSTRIEL
BOUCHERVILLE, CANADA J4B2X3

FOR: AUTO BODY REPAIR AND MAINTENANCE PRODUCTS, NAMELY, PAINTS, IN CLASS 2 (U.S. CLS. 6, 11 AND 16).

FOR: AUTO BODY REPAIR AND MAINTENANCE PRODUCTS, NAMELY, CLEANING SOLVENTS, ABRASIVES, GLASS CLEANERS, WAXES AND DISPOSABLE AUTO BODY WIPES FOR USE BEFORE APPLYING PAINT AND BEING IMPREGNATED WITH CLEANING CHEMICALS OR COMPOUNDS, IN CLASS 3 (U.S. CLS. 1, 4, 6, 50, 51 AND 52).

PRIORITY CLAIMED UNDER SEC. 44(D) ON CANADA APPLICATION NO. 1393594, FILED 4-30-2008, REG. NO. TMA794386, DATED 3-31-2011, EXPIRES 3-31-2026.

NO CLAIM IS MADE TO THE EXCLUSIVE RIGHT TO USE "COLOR" IN CLASS 2, APART FROM THE MARK AS SHOWN.

THE MARK CONSISTS OF THE TERM "COLORXTRA" ON TWO LINES, THREE PARALLEL HORIZONTAL BANDS IN FRONT OF THE "X", ONE LINE ABOVE THE LITERAL ELEMENT, ONE LINE UNDER THE LITERAL ELEMENT, THE WHOLE BEING IN A RECTANGULAR DARK FRAMED.

SER. NO. 77-594,155, FILED 10-16-2008.

MARK RADEMACHER, EXAMINING ATTORNEY



David J. Kybas

Director of the United States Patent and Trademark Office

United States of America

United States Patent and Trademark Office

PINNACLES RANCHES

Reg. No. 4,072,330

Registered Dec. 20, 2011

Int. Cl.: 33

TRADEMARK

PRINCIPAL REGISTER

FRANCISCAN VINEYARDS, INC. (DELAWARE CORPORATION)
1178 GALLERON ROAD
ST. HELENA, CA 94574

FOR: WINES, IN CLASS 33 (U.S. CLS. 47 AND 49).

FIRST USE 5-0-2004; IN COMMERCE 5-0-2004.

THE MARK CONSISTS OF STANDARD CHARACTERS WITHOUT CLAIM TO ANY PARTICULAR FONT, STYLE, SIZE, OR COLOR.

OWNER OF U.S. REG. NO. 997,378.

NO CLAIM IS MADE TO THE EXCLUSIVE RIGHT TO USE "RANCHES", APART FROM THE MARK AS SHOWN.

SER. NO. 77-598,674, FILED 10-23-2008.

JENNY PARK, EXAMINING ATTORNEY



David J. Kyffers

Director of the United States Patent and Trademark Office

United States of America

United States Patent and Trademark Office

GENUINE EXPERT

Reg. No. 4,072,331

Registered Dec. 20, 2011

Int. Cl.: 41

SERVICE MARK

PRINCIPAL REGISTER

GENUINE HEALTH INC. (CANADA CORPORATION)
SUITE 501
317 ADELAIDE STREET WEST
TORONTO, CANADA M5V1P9

FOR: CONDUCTING INFORMAL ON-LINE EDUCATIONAL PROGRAMS FOR RETAILERS IN THE FIELD OF VITAMINS, SUPPLEMENTS, MINERALS AND NUTRITIONAL SUPPLEMENTS, IN CLASS 41 (U.S. CLS. 100, 101 AND 107).

THE MARK CONSISTS OF STANDARD CHARACTERS WITHOUT CLAIM TO ANY PARTICULAR FONT, STYLE, SIZE, OR COLOR.

PRIORITY CLAIMED UNDER SEC. 44(D) ON CANADA APPLICATION NO. 1415128, FILED 10-20-2008, REG. NO. TMA804,588, DATED 8-17-2011, EXPIRES 8-17-2026.

NO CLAIM IS MADE TO THE EXCLUSIVE RIGHT TO USE "EXPERT", APART FROM THE MARK AS SHOWN.

SER. NO. 77-604,813, FILED 10-31-2008.

MICHAEL ENGEL, EXAMINING ATTORNEY



David J. Kyros

Director of the United States Patent and Trademark Office

United States of America

United States Patent and Trademark Office

KAIZEN

Reg. No. 4,072,332

Registered Dec. 20, 2011

**Int. Cls.: 9, 16, 35, 41
and 42**

KAIZEN INSTITUTE LTD. (SWITZERLAND CORPORATION)
BAHNHOFPLATZ
ZUG, SWITZERLAND 6300

FOR: PRE-RECORDED VIDEO AND AUDIO TAPES, CASSETTES AND DISCS FEATURING MUSIC IN THE NATURE OF INSTRUMENTAL PERFORMANCES, IN CLASS 9 (U.S. CLS. 21, 23, 26, 36 AND 38).

TRADEMARK

SERVICE MARK

PRINCIPAL REGISTER

FOR: PRINTED MATTER AND PUBLICATIONS, NAMELY, NEWSPAPERS, PERIODICALS, BOOKS AND MAGAZINES IN THE FIELD OF MANAGEMENT; BLANK JOURNALS, TRADE JOURNALS IN THE FIELD OF MANAGEMENT, MANUALS IN THE FIELD OF MANAGEMENT; STATIONERY; PRINTED FORMS; PAPER; CALENDARS; PAMPHLETS, NEWSLETTERS, CATALOGUES AND LEAFLETS IN THE FIELD OF BUSINESS TRADE NEWS AND MANAGEMENT; COMPUTER MANUALS IN THE FIELD OF MANAGEMENT; BLANK PAPER TAPES AND CARDS FOR THE RECORDAL OF COMPUTER PROGRAMS; PRINTED INSTRUCTIONAL AND TEACHING MATERIAL IN THE FIELD OF MANAGEMENT; BINDERS; COMPUTER PROGRAMS IN PRINTED FORM; BRUSHES FOR DECORATIVE PAINTING; SEALING WAXES; POSTERS, BAGS OF PAPER OR PLASTIC FOR PACKAGING, BOOKKEEPING MATERIALS, NAMELY, BOOKKEEPING JOURNALS AND BOOKKEEPING FORMS; WRITING INSTRUMENTS, IN CLASS 16 (U.S. CLS. 2, 5, 22, 23, 29, 37, 38 AND 50).

FOR: MANAGEMENT AND BUSINESS MANAGEMENT CONSULTING SERVICES IN THE FIELD OF MANUFACTURING, STRATEGIC AND ORGANIZATION PLANNING; ADVICE RELATING TO ORGANIZATION AND MANAGEMENT OF BUSINESS, ADVERTISING, PROMOTION SERVICES AND INFORMATION RELATING THERETO; PERSONNEL AND HUMAN RESOURCE MANAGEMENT; PERSONNEL AND HUMAN RESOURCE PLACEMENT AND RECRUITMENT; TELEVISION ADVERTISING; PREPARING AND PLACING OF ADVERTISEMENTS; RENTAL OF ADVERTISING SPACES; PREPARING AUDIO VISUAL PRESENTATIONS FOR USE IN ADVERTISING; DISSEMINATION OF ADVERTISING MATTER; BUSINESS INFORMATION SERVICES; SERVICES CONSISTING OF THE COLLECTION, TRANSCRIPTION, COMPILATION AND SYSTEMIZATION OF BUSINESS INFORMATION DATA; CONDUCTING MARKETING STUDIES; BUSINESS PLANNING AND BUSINESS APPRAISAL; CONDUCTING BUSINESS SURVEYS; MARKETING AND BUSINESS RESEARCH; COMPILATION AND PROVISION OF BUSINESS, TRADE AND COMMERCIAL INFORMATION; ARRANGING, CONDUCTING AND ORGANIZING BUSINESS OR TRADE SHOWS IN THE FIELD OF MANAGEMENT; BUSINESS ADVISORY SERVICES, NAMELY, SEARCH FOR AND SELECTION OF THE BEST POTENTIAL GOODS AND



David J. Kyffers

Director of the United States Patent and Trademark Office

Reg. No. 4,072,332 SERVICES SUPPLIERS FOR OTHERS; HOTEL MANAGEMENT FOR OTHERS AND RELATED ADVISORY SERVICES; FRANCHISE SERVICES, NAMELY, OFFERING BUSINESS MANAGEMENT ASSISTANCE IN THE ESTABLISHMENT AND OPERATION OF HOTELS; ADVISORY SERVICES IN THE FIELD OF ARRANGING, CONDUCTING, AND ORGANIZING BUSINESS CONFERENCES, SEMINARS, AND EXHIBITIONS; ORGANIZATION OF BUSINESS COMPETITIONS; MANAGEMENT SERVICES IN THE NATURE OF LITERARY AGENCIES, IN CLASS 35 (U.S. CLS. 100, 101 AND 102).

FOR: PUBLICATION OF BOOKS, MAGAZINES, LEAFLETS AND PRINTED MATTER; PROVISION OF EDUCATION TRAINING FACILITIES; COMPUTER EDUCATION TRAINING SERVICES; MANAGEMENT EDUCATION TRAINING SERVICES; EDUCATION SERVICES, NAMELY, ARRANGING AND CONDUCTING CONFERENCES, SEMINARS AND EXHIBITIONS RELATING TO EDUCATION, CULTURAL ACTIVITIES, ENTERTAINMENT AND RECREATION; ORGANIZATION OF SPORTS COMPETITIONS; ENTERTAINMENT SERVICES, NAMELY, PROVIDING NON-DOWNLOADABLE PRE-RECORDED MUSIC IN THE NATURE OF INSTRUMENTAL PERFORMANCES, PROVIDED ONLINE VIA A GLOBAL COMPUTER NETWORK; PRODUCTION, DISTRIBUTION AND PUBLISHING OF FILMS, MOTION PICTURES, TELEVISION AND CABLE TELEVISION PROGRAMS; RENTAL OF FILMS, MOTION PICTURES, VIDEO AND AUDIOTAPES, CASSETTES, DISCS, AND SOUND AND VISUAL RECORDINGS AND APPARATUS THEREFOR, NAMELY, FILM PROJECTION AND AUDIO AND VIDEO PLAYERS; ENTERTAINMENT, NAMELY, LIVE PERFORMANCES BY MUSICAL BANDS; AMUSEMENT PARK SERVICES AND AMUSEMENT PARK SHOWS; AMUSEMENT ARCADE AND FUN FAIR SERVICES; ENTERTAINMENT INFORMATION SERVICES; ENTERTAINER SERVICES, NAMELY, LIVE, TELEVISED AND MOVIE APPEARANCES BY A PROFESSIONAL ENTERTAINER; PROVIDING THEATRE AND CINEMA FACILITIES; PROVIDING RECREATION FACILITIES; ORGANIZATION OF ENTERTAINMENT AND SPORTING COMPETITIONS, NAMELY, LIVE MUSIC CONCERTS AND TENNIS COMPETITIONS; PARTY PLANNING SERVICES; RECORDING STUDIO SERVICES; ENTERTAINMENT IN THE NATURE OF THEATRE PRODUCTIONS; THEATRICAL TICKET AGENCIES; PRODUCTION OF RADIO AND TELEVISION PROGRAMS; BOOKING AGENCY SERVICES FOR PERFORMING ARTISTS, NAMELY, CONCERT BOOKING, IN CLASS 41 (U.S. CLS. 100, 101 AND 107).

FOR: DESIGN SERVICES, NAMELY, DESIGN OF RESTAURANT INTERIOR DECOR AND RESTAURANT EXTERIOR DECOR; DESIGN MAINTENANCE, AND UPDATING OF COMPUTER SOFTWARE; COMPUTER SERVICES, NAMELY, DESIGNING AND IMPLEMENTING COMPUTER WEB SITES FOR OTHERS; HOSTING THE WEB SITES OF OTHERS ON A COMPUTER SERVER FOR A GLOBAL COMPUTER NETWORK; WEB SITE DESIGN; DESIGN OF COMPUTER SOFTWARE APPLICATIONS FOR USE ON GLOBAL COMPUTER NETWORKS AND LOCAL AREA NETWORKS AND INTERNAL BUSINESS COMPUTER SYSTEMS; CREATION OF COMPUTER PROGRAMS FOR DATA PROCESSING; TECHNICAL TESTING OF COMPUTER, TELECOMMUNICATION, ELECTRICAL AND ELECTRONIC APPARATUS AND INSTRUMENTS; COMPUTER PROGRAMMING, CUSTOM DESIGN AND DEVELOPMENT OF COMPUTER SOFTWARE AND COMPUTER HARDWARE; SOFTWARE DESIGN, ENGINEERING DRAWING SERVICES; WRITING OF DATA PROCESSING PROGRAMS; RENTAL OF ELECTRICAL AND ELECTRONIC APPARATUS AND INSTRUMENTS RELATING TO COMPUTING AND TELECOMMUNICATIONS, NAMELY, COMPUTER HARDWARE AND SOFTWARE; RENTAL OF SOFTWARE; APPLICATION SERVICES PROVIDER FEATURING SOFTWARE FOR PROVIDING AN ONLINE DATABASE IN THE FIELD OF MANAGEMENT; UPDATING COMPUTER SOFTWARE; TECHNICAL CONSULTING AND ASSISTANCE WITH COMPUTER-BASED INFORMATION SYSTEMS, IN CLASS 42 (U.S. CLS. 100 AND 101).

THE MARK CONSISTS OF STANDARD CHARACTERS WITHOUT CLAIM TO ANY PARTICULAR FONT, STYLE, SIZE, OR COLOR.

THE 2(F) CLAIM IS RESTRICTED TO CLASS(ES) 16, 35, 41, AND 42, AS FOLLOWS: CLASS 16 -- PRINTED MATTER AND PUBLICATIONS, NAMELY, NEWSPAPERS, PERIODICALS,

Reg. No. 4,072,332 BOOKS AND MAGAZINES IN THE FIELD OF MANAGEMENT; TRADE JOURNALS IN THE FIELD OF MANAGEMENT, MANUALS IN THE FIELD OF MANAGEMENT; PAMPHLETS, NEWSLETTERS, CATALOGUES AND LEAFLETS IN THE FIELD OF BUSINESS TRADE NEWS AND MANAGEMENT; COMPUTER MANUALS IN THE FIELD OF MANAGEMENT; CLASS 35: MANAGEMENT AND BUSINESS MANAGEMENT CONSULTING SERVICES IN THE FIELD OF MANUFACTURING, STRATEGIC AND ORGANIZATION PLANNING; ADVICE RELATING TO ORGANIZATION AND MANAGEMENT OF BUSINESS, ADVERTISING, PROMOTION SERVICES AND INFORMATION RELATING THERETO; PERSONNEL AND HUMAN RESOURCE MANAGEMENT; BUSINESS INFORMATION SERVICES; SERVICES CONSISTING OF THE COLLECTION, TRANSCRIPTION, COMPILATION AND SYSTEMIZATION OF BUSINESS INFORMATION DATA; BUSINESS PLANNING AND BUSINESS APPRAISAL; CONDUCTING BUSINESS SURVEYS; MARKETING AND BUSINESS RESEARCH; COMPILATION AND PROVISION OF BUSINESS, TRADE AND COMMERCIAL INFORMATION; ARRANGING, CONDUCTING AND ORGANIZING BUSINESS OR TRADE SHOWS IN THE FIELD OF MANAGEMENT; BUSINESS ADVISORY SERVICES, NAMELY, SEARCH FOR AND SELECTION OF THE BEST POTENTIAL GOODS AND SERVICES SUPPLIERS FOR OTHERS; HOTEL MANAGEMENT FOR OTHERS AND RELATED ADVISORY SERVICES; FRANCHISE SERVICES, NAMELY, OFFERING BUSINESS MANAGEMENT ASSISTANCE IN THE ESTABLISHMENT AND OPERATION OF HOTELS; ADVISORY SERVICES IN THE FIELD OF BUSINESS CONFERENCES, SEMINARS, AND EXHIBITIONS; ORGANIZATION OF BUSINESS COMPETITIONS; CLASS 41: MANAGEMENT EDUCATION TRAINING SERVICES; AND CLASS 42: APPLICATION SERVICES PROVIDER FEATURING SOFTWARE FOR PROVIDING AN ONLINE DATABASE IN THE FIELD OF MANAGEMENT.

OWNER OF CZECH REPUBLIC REG. NO. 243057, DATED 4-23-2002, EXPIRES 4-23-2012.

OWNER OF HONG KONG REG. NO. 300644670, DATED 5-24-2006, EXPIRES 5-24-2016.

OWNER OF SLOVAKIA REG. NO. 226604, DATED 12-11-2009, EXPIRES 11-20-2018.

OWNER OF U.S. REG. NOS. 1,441,520 AND 3,005,330.

SEC. 2(F).

SER. NO. 77-606,883, FILED 11-4-2008.

KAREN SEVERSON, EXAMINING ATTORNEY

United States of America

United States Patent and Trademark Office

LUMA BAR

Reg. No. 4,072,333

Registered Dec. 20, 2011

Int. Cl.: 11

TRADEMARK

PRINCIPAL REGISTER

AMDOR INC. (CANADA CORPORATION)
3435 SOUTH SERVICE ROAD
BURLINGTON, CANADA L7N3W6

FOR: LIGHTING SYSTEMS, NAMELY, LIGHT BARS COMPRISING LOW VOLTAGE LIGHTING ASSEMBLIES USED IN VEHICULAR APPLICATIONS, NAMELY, LIGHTS, LIGHT BULBS, LIGHT PANELS, LIGHT EMITTING DIODES, ORGANIC LIGHT EMITTING DIODES AND CONTROL CIRCUITRY SOLD TOGETHER AS A UNIT, FOR ILLUMINATION ON ALL MEANS OF TRANSPORTATION EQUIPMENT, NAMELY, ALL MOTORIZED AND NON-MOTORIZED VEHICLES, EMERGENCY VEHICLES, RV'S, TRUCKS, TRAILERS, CARS, BUSES, BOATS, RAILWAYS, VANS AND ASSOCIATED ELEVATING VEHICLES AND PLATFORMS, IN CLASS 11 (U.S. CLS. 13, 21, 23, 31 AND 34).

FIRST USE 3-27-2006; IN COMMERCE 3-27-2006.

THE MARK CONSISTS OF STANDARD CHARACTERS WITHOUT CLAIM TO ANY PARTICULAR FONT, STYLE, SIZE, OR COLOR.

PRIORITY CLAIMED UNDER SEC. 44(D) ON CANADA APPLICATION NO. 1416524, FILED 10-30-2008, REG. NO. TMA760298, DATED 2-25-2010, EXPIRES 2-25-2025.

NO CLAIM IS MADE TO THE EXCLUSIVE RIGHT TO USE "BAR", APART FROM THE MARK AS SHOWN.

SER. NO. 77-611,764, FILED 11-11-2008.

JOHN KELLY, EXAMINING ATTORNEY



David J. Kypos

Director of the United States Patent and Trademark Office

United States of America

United States Patent and Trademark Office

Tenabond

Reg. No. 4,072,334

Registered Dec. 20, 2011

Int. Cl.: 2

TRADEMARK

PRINCIPAL REGISTER

DANRISE INC. (FLORIDA CORPORATION)
16013 OPAL CREEK DR.
WESTON, FL 33331 AND

XIA, QUN (CHINA INDIVIDUAL)
16013 OPAL CREEK DR.
WESTON, FL 33331

FOR: ANTI-CORROSIVE AND FIRE RETARDANT COATINGS; COATING COMPOSITION IN THE NATURE OF PAINT FOR INDUSTRIAL APPLICATIONS; COATING COMPOSITIONS IN THE NATURE OF PAINT FOR INDUSTRIAL APPLICATIONS; COATINGS IN THE NATURE OF FINISHES FOR STAINLESS STEEL SHEET, STRIP, AND PLATE, WHICH PROVIDES A DECORATIVE APPEARANCE; COATINGS IN THE NATURE OF INDUSTRIAL SEALANTS FOR WATERPROOFING AND SURFACE HARDENING; CORROSION INHIBITING PAINT TYPE COATINGS FOR COMMERCIAL MARINE USE; CORROSION INHIBITING PAINT TYPE COATINGS FOR USE IN THE OIL AND/OR GAS DRILLING INDUSTRY; EPOXY COATING FOR USE ON CONCRETE INDUSTRIAL FLOORS; FLOOR COATINGS; HEAT-RESISTANT COATINGS FOR INDUSTRIAL APPLICATIONS WHERE ELEVATED TEMPERATURES OCCUR; INSTANT CURE COATINGS FOR FLOORS; POLYMER COATINGS FOR CONCRETE; POLYURETHANE COATINGS FOR EXTERIOR AND INTERIOR USE ON A VARIETY OF SUBSTRATES; POLYURETHANE COATINGS FOR FLOORS; WATER-BASED ROOF COATINGS, IN CLASS 2 (U.S. CLS. 6, 11 AND 16).

FIRST USE 1-1-2009; IN COMMERCE 8-26-2009.

THE MARK CONSISTS OF STANDARD CHARACTERS WITHOUT CLAIM TO ANY PARTICULAR FONT, STYLE, SIZE, OR COLOR.

SER. NO. 77-621,165, FILED 11-24-2008.

GENE MACIOL, EXAMINING ATTORNEY



David J. Kypos

Director of the United States Patent and Trademark Office

United States of America

United States Patent and Trademark Office

STEP CHANGE

Reg. No. 4,072,335

Registered Dec. 20, 2011

Int. Cls.: 35, 41 and 42

SERVICE MARK

PRINCIPAL REGISTER

ELMWOOD DESIGN LIMITED (UNITED KINGDOM LIMITED LIABILITY COMPANY)
GHYLL ROAD
ELMWOOD HOUSE
GUISELEY, UNITED KINGDOM LS209LT

FOR: DESIGN AND BRAND DESIGN SERVICES, NAMELY, BRAND CONCEPT AND BRAND DEVELOPMENT SERVICES FOR CORPORATE CLIENTS; CONSULTANCY SERVICES RELATING TO BRAND AND IMAGE STRATEGY AND DEVELOPMENT, NAMELY, BRAND IMAGERY CONSULTING SERVICES; BUSINESS CONSULTATION AND MANAGEMENT REGARDING MARKETING ACTIVITIES AND LAUNCHING OF NEW PRODUCTS, IN CLASS 35 (U.S. CLS. 100, 101 AND 102).

FOR: PROFESSIONAL CONSULTANCY SERVICES RELATING TO MARKETING TRAINING, NAMELY, TRAINING COURSES IN STRATEGIC PLANNING RELATING TO MARKETING, IN CLASS 41 (U.S. CLS. 100, 101 AND 107).

FOR: ADVISORY SERVICES IN THE FIELD OF PRODUCT AND SERVICE DEVELOPMENT, IN CLASS 42 (U.S. CLS. 100 AND 101).

THE MARK CONSISTS OF STANDARD CHARACTERS WITHOUT CLAIM TO ANY PARTICULAR FONT, STYLE, SIZE, OR COLOR.

OWNER OF AUSTRALIA REG. NO. 1009141, DATED 7-1-2004, EXPIRES 7-1-2014.

OWNER OF ERPN CMNTY TM OFC REG. NO. 001268333, DATED 10-17-2000, EXPIRES 9-13-2019.

SER. NO. 77-621,212, FILED 11-25-2008.

JANICE KIM, EXAMINING ATTORNEY



David J. Kybas

Director of the United States Patent and Trademark Office

United States of America

United States Patent and Trademark Office

K-TAPE

Reg. No. 4,072,336

Registered Dec. 20, 2011

Int. Cl.: 5

TRADEMARK

PRINCIPAL REGISTER

KUMBRINK, INGO (FED REP GERMANY INDIVIDUAL)
FRIEGSTRASSE 5
DORTMUND, FED REP GERMANY 44229

FOR: ELASTIC, AIR-PERMEABLE MEDICAL ADHESIVE TAPE; WOUND DRESSING MATERIAL AND MEDICAL ADHESIVE TAPE MATERIAL; MEDICATED COMPRESSES, ADHESIVE STRIPS AND ADHESIVE TAPES FOR MEDICAL PURPOSES, ADHESIVE BANDAGES FOR HEALTH AND DRESSING PURPOSES, IN CLASS 5 (U.S. CLS. 6, 18, 44, 46, 51 AND 52).

THE MARK CONSISTS OF STANDARD CHARACTERS WITHOUT CLAIM TO ANY PARTICULAR FONT, STYLE, SIZE, OR COLOR.

OWNER OF ERPN CMNTY TM OFC REG. NO. 006376024, DATED 11-13-2008, EXPIRES 10-18-2017.

SEC. 2(F).

SER. NO. 77-625,590, FILED 12-3-2008.

JOHN E. MICHOS, EXAMINING ATTORNEY



David J. Kyffers

Director of the United States Patent and Trademark Office

United States of America

United States Patent and Trademark Office

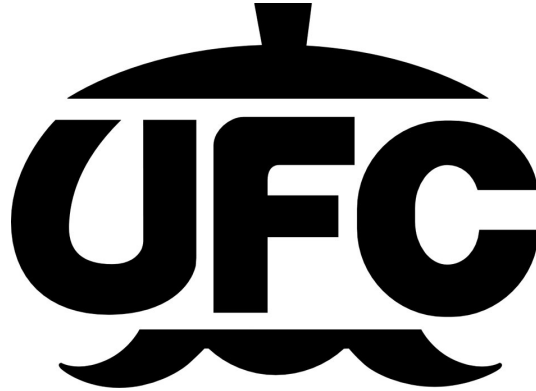

Reg. No. 4,072,337

Registered Dec. 20, 2011

Int. Cl.: 29

TRADEMARK

PRINCIPAL REGISTER

NUTRI-ASIA, INC. (PHILIPPINES CORPORATION)
JULIA VARGAS AVENUE, ORTIGAS CENTER
12TH FLOOR, CENTERPOINT BUILDING
PASIG CITY, METRO MANILLA, PHILIPPINES 1600

FOR: FILIPINO-STYLE SWEET PRESERVES AND PRESERVED FRUIT SPREADS, NAMELY, BANANAS IN SYRUP, CHICK PEAS, COCONUT GEL, COCONUT SPORT STRINGS, JACKFRUIT, MIXED FRUIT AND BEANS, PINEAPPLE GEL, RED MUNG BEANS, SUGAR PALM FRUIT, WHITE BEANS, COCONUT SPREAD, AND PURPLE YAM SPREAD, IN CLASS 29 (U.S. CL. 46).

FIRST USE 6-1-1985; IN COMMERCE 6-23-1986.

THE MARK CONSISTS OF THE TOP SECTION OF A TOMATO, THE LETTERS "UFC" DIRECTLY UNDERNEATH THE TOP SECTION, AND THE BOTTOM SECTION OF A TOMATO DIRECTLY UNDERNEATH THE LETTERS "UFC".

SER. NO. 77-626,720, FILED 12-4-2008.

ELLEN B. AWRICH, EXAMINING ATTORNEY



David J. Kyffers

Director of the United States Patent and Trademark Office

United States of America

United States Patent and Trademark Office

SWAGGER SCHOOL

Reg. No. 4,072,338

MARC STYLES PRODUCTIONS, INC. (NEW YORK CORPORATION)
P.O. BOX 711

Registered Dec. 20, 2011

BALDWIN, NY 11510

Int. Cl.: 41

FOR: ENTERTAINMENT SERVICES IN THE NATURE OF AN ON-GOING REALITY BASED TELEVISION PROGRAM, IN CLASS 41 (U.S. CLS. 100, 101 AND 107).

SERVICE MARK

FIRST USE 11-1-2008; IN COMMERCE 12-8-2008.

PRINCIPAL REGISTER

THE MARK CONSISTS OF STANDARD CHARACTERS WITHOUT CLAIM TO ANY PARTICULAR FONT, STYLE, SIZE, OR COLOR.

SER. NO. 77-636,429, FILED 12-18-2008.

LINDA MICKLEBURGH, EXAMINING ATTORNEY



David J. Kybas

Director of the United States Patent and Trademark Office

United States of America

United States Patent and Trademark Office

SWAGGER 101

Reg. No. 4,072,339

MARC STYLES PRODUCTIONS, INC. (NEW YORK CORPORATION)
PO BOX 711
BALDIN, NY 11510

Registered Dec. 20, 2011

Int. Cl.: 41

FOR: ENTERTAINMENT SERVICES IN THE NATURE OF AN ON-GOING REALITY BASED TELEVISION PROGRAM, IN CLASS 41 (U.S. CLS. 100, 101 AND 107).

SERVICE MARK

FIRST USE 11-1-2008; IN COMMERCE 12-7-2008.

PRINCIPAL REGISTER

THE MARK CONSISTS OF STANDARD CHARACTERS WITHOUT CLAIM TO ANY PARTICULAR FONT, STYLE, SIZE, OR COLOR.

SER. NO. 77-639,488, FILED 12-23-2008.

LINDA MICKLEBURGH, EXAMINING ATTORNEY



David J. Kybas

Director of the United States Patent and Trademark Office

United States of America

United States Patent and Trademark Office

IMAGE TRACKER

Reg. No. 4,072,340

Registered Dec. 20, 2011

Int. Cls.: 9, 35, 42 and 45

TRADEMARK

SERVICE MARK

PRINCIPAL REGISTER

PICSCOUT (ISRAEL) LTD. (ISRAEL CORPORATION)
P.O. BOX 12611
11 GALGALEY HAPLADA STREET
HERZLIA PITUACH, ISRAEL 46733

FOR: COMPUTER SOFTWARE AND COMPUTER USER INTERFACE SOFTWARE PROGRAMS FOR MONITORING AND PREVENTING ILLEGAL FILE SHARING; COMPUTER SOFTWARE FOR MONITORING, PROTECTING, CONTROLLING ACCESS, USE AND REUSE OF DIGITAL VISUAL CONTENT; COMPUTER SOFTWARE FOR CONTROLLING THE STORAGE, RETRIEVAL, DISPLAY, DUPLICATION, MODIFICATION, TRANSMISSION, LINKING TO AND SECURITY OF DIGITAL VISUAL CONTENT, IN CLASS 9 (U.S. CLS. 21, 23, 26, 36 AND 38).

FIRST USE 3-0-2003; IN COMMERCE 3-0-2003.

FOR: DIGITAL RIGHTS MANAGEMENT, NAMELY, CONSULTING SERVICES IN THE FIELD OF MANAGING INTELLECTUAL PROPERTIES; PROVIDING ELECTRONIC TRACKING OF INTELLECTUAL PROPERTY ASSETS TO OTHERS, IN CLASS 35 (U.S. CLS. 100, 101 AND 102).

FIRST USE 3-0-2003; IN COMMERCE 3-0-2003.

FOR: SEARCHING AND RETRIEVING INFORMATION, SITES, AND OTHER RESOURCES AVAILABLE ON COMPUTER NETWORKS FOR OTHERS, IN CLASS 42 (U.S. CLS. 100 AND 101).

FIRST USE 3-0-2003; IN COMMERCE 3-0-2003.

FOR: TECHNICAL SUPPORT, NAMELY, ONLINE MONITORING TO PREVENT ILLEGAL FILE SHARING AND PROVIDING ELECTRONIC REPORTS REGARDING ATTEMPTS AT ILLEGAL FILE SHARING IN CONNECTION THEREWITH ON NETWORKS WORLDWIDE; COPYRIGHT MANAGEMENT, IN CLASS 45 (U.S. CLS. 100 AND 101).

FIRST USE 3-0-2003; IN COMMERCE 3-0-2003.

THE MARK CONSISTS OF STANDARD CHARACTERS WITHOUT CLAIM TO ANY PARTICULAR FONT, STYLE, SIZE, OR COLOR.



David J. Kybas

Director of the United States Patent and Trademark Office

Reg. No. 4,072,340 SEC. 2(F).

SER. NO. 77-640,423, FILED 12-29-2008.

AISHA SALEM, EXAMINING ATTORNEY

United States of America

United States Patent and Trademark Office

Scents of Design

Reg. No. 4,072,341

SONO INC. (WASHINGTON CORPORATION)
803 EVERSON ROAD
EVERSON, WA 98247

Registered Dec. 20, 2011

Int. Cl.: 3

FOR: POTPOURRI, ROOM FRAGRANCES, CLEANING PREPARATIONS, IN CLASS 3 (U.S. CLS. 1, 4, 6, 50, 51 AND 52).

TRADEMARK

FIRST USE 10-1-2008; IN COMMERCE 10-1-2008.

PRINCIPAL REGISTER

THE MARK CONSISTS OF STANDARD CHARACTERS WITHOUT CLAIM TO ANY PARTICULAR FONT, STYLE, SIZE, OR COLOR.

NO CLAIM IS MADE TO THE EXCLUSIVE RIGHT TO USE "SCENTS", APART FROM THE MARK AS SHOWN.

SER. NO. 77-646,033, FILED 1-8-2009.

SARA BENJAMIN, EXAMINING ATTORNEY



David J. Kyffers

Director of the United States Patent and Trademark Office

United States of America

United States Patent and Trademark Office

AGRISOLUTIONS

Reg. No. 4,072,342

WINFIELD SOLUTIONS, LLC (DELAWARE LIMITED LIABILITY COMPANY)
1080 COUNTY ROAD F WEST
SHOREVIEW, MN 55126

Registered Dec. 20, 2011

Int. Cl.: 1

FOR: ADJUVANTS FOR USE IN THE MANUFACTURE OF HERBICIDES, PESTICIDES AND INSECTICIDES; FERTILIZERS; PLANT GROWTH REGULATORS FOR AGRICULTURAL USE; SURFACTANTS FOR USE IN CONNECTION WITH AGRICULTURAL PESTICIDES, IN CLASS 1 (U.S. CLS. 1, 5, 6, 10, 26 AND 46).

TRADEMARK

PRINCIPAL REGISTER

FIRST USE 3-29-2002; IN COMMERCE 3-29-2002.

THE MARK CONSISTS OF STANDARD CHARACTERS WITHOUT CLAIM TO ANY PARTICULAR FONT, STYLE, SIZE, OR COLOR.

SEC. 2(F).

SER. NO. 77-686,167, FILED 3-9-2009.

GRETCHEN ULRICH, EXAMINING ATTORNEY



David J. Kyffers

Director of the United States Patent and Trademark Office

United States of America

United States Patent and Trademark Office

AGRISOLUTIONS

Reg. No. 4,072,343

Registered Dec. 20, 2011

Int. Cl.: 5

TRADEMARK

PRINCIPAL REGISTER

WINFIELD SOLUTIONS, LLC (DELAWARE LIMITED LIABILITY COMPANY)
1080 COUNTY ROAD F WEST
SHOREVIEW, MN 55126

FOR: AGRICULTURAL PESTICIDES; FUNGICIDES FOR AGRICULTURAL USE; HERBICIDES FOR AGRICULTURAL USE; INSECTICIDE FOR AGRICULTURAL USE, IN CLASS 5 (U.S. CLS. 6, 18, 44, 46, 51 AND 52).

FIRST USE 2-28-2001; IN COMMERCE 2-28-2001.

THE MARK CONSISTS OF STANDARD CHARACTERS WITHOUT CLAIM TO ANY PARTICULAR FONT, STYLE, SIZE, OR COLOR.

SEC. 2(F).

SER. NO. 77-686,168, FILED 3-9-2009.

GRETCHEN ULRICH, EXAMINING ATTORNEY



David J. Kybas

Director of the United States Patent and Trademark Office

United States of America

United States Patent and Trademark Office

CHANGES FOR THE BETTER

Reg. No. 4,072,344

Registered Dec. 20, 2011

**Int. Cls.: 7, 9, 11, 12, 37,
38, 41 and 42**

TRADEMARK

SERVICE MARK

PRINCIPAL REGISTER

MITSUBISHI ELECTRIC CORPORATION (JAPAN CORPORATION)
7-3 MARUNOUCHI 2-CHOME
CHIYODA-KU, TOKYO, JAPAN

FOR: METAL WORKING MACHINES, APPARATUS AND EQUIPMENT, NAMELY, ELECTRIC DISCHARGE MACHINES FOR USE IN CUTTING METALS AND FORMING HOLES IN METAL, AND INDUSTRIAL ROBOTS FOR METAL WORKING; ELEVATORS; ESCALATORS; CONVEYORS; PLASTIC PROCESSING MACHINES, APPARATUS AND EQUIPMENT, NAMELY, PLASTIC COMPRESSION MOLDING MACHINES, PLASTIC EXTRUSION MOLDING MACHINES, AND PLASTIC INJECTION MOLDING MACHINES; MOTIVE POWER MACHINES, APPARATUS AND EQUIPMENT, EXCLUDING THOSE FOR LAND VEHICLES, NAMELY, ENGINES NOT FOR LAND VEHICLES; PARTS AND FITTINGS FOR MOTIVE POWER MACHINES FOR LAND VEHICLES, NAMELY, SPARK PLUGS FOR LAND VEHICLE ENGINES, IGNITING MAGNETOS FOR LAND VEHICLE ENGINES AND IGNITION COILS FOR LAND VEHICLE ENGINES; PNEUMATIC AND HYDRAULIC MACHINES, APPARATUS AND EQUIPMENTS, NAMELY, PUMPS FOR USE IN MOTORS AND ENGINES, VACUUM PUMPS, COMPRESSORS FOR AIR CONDITIONERS, MACHINES AND REFRIGERATORS, AND BLOWERS FOR USE IN AIR CONDITIONING AND VENTILATING; SEWING MACHINES; ELECTRIC MOTORS FOR MACHINES; ALTERNATORS FOR AUTOMOBILES; STARTERS FOR VEHICLE ENGINES; ELECTRIC GENERATORS; ELECTRICALLY OPERATED BRUSHES BEING PARTS OF MACHINES; MECHANICAL POWER TRANSMISSION MACHINES, APPARATUS AND EQUIPMENT, NAMELY, TRANSMISSION GEARS FOR MACHINES; BRAKES FOR MACHINES, IN CLASS 7 (U.S. CLS. 13, 19, 21, 23, 31, 34 AND 35).



David J. Kyffers

Director of the United States Patent and Trademark Office

FOR: MEASURING MACHINES, APPARATUS AND EQUIPMENT, NAMELY, MANOMETERS FOR AUTOMOBILES AND AIR FLOW METERS FOR AUTOMOBILES; ELECTRICITY DISTRIBUTION AND CONTROL MACHINES, APPARATUS AND EQUIPMENT, NAMELY, ELECTRIC RELAYS, CIRCUIT BREAKERS, ELECTRIC CONTROLLERS, RECTIFIERS, ELECTRIC CONNECTORS, ELECTRIC SWITCHES, RESISTORS, SWITCHBOARDS, LIGHTING ARRESTERS, TRANSFORMERS, ELECTRIC DISTRIBUTORS, AND ELECTRIC REACTORS; BATTERIES; ELECTRIC AND MAGNETIC MEASURING MACHINES, APPARATUS AND EQUIPMENT, NAMELY, WATT HOUR METERS, VOLTMETERS AND AMMETERS; ELECTRIC WIRES AND CABLES; FIBER OPTIC CABLES; ELECTRIC COMMUNICATION MACHINES, APPARATUS AND EQUIPMENT AND THEIR PARTS AND FITTINGS, NAMELY, TELEPHONES, FACSIMILE MACHINES, CARRIER FREQUENCY REPEATERS, TELEVISION SETS, RADIOS, RADIO COMMUNICATION TRANSMITTERS AND

Reg. No. 4,072,344 RECEIVERS, RADAR, TELEMETERS, COMPACT DISC PLAYERS, VIDEO CAMERAS, VIDEO DISC PLAYERS, VIDEO TAPE RECORDERS, ANTENNA, AND BLANK VIDEO DISKS AND TAPES; APPLIED ELECTRONIC MACHINES, APPARATUS, EQUIPMENT AND THEIR PARTS AND FITTINGS, NAMELY, MAGNETIC OBJECT DETECTORS, ULTRASONIC SENSORS, COMPUTERS, CAR NAVIGATION COMPUTERS, COMPUTER PERIPHERALS, COMPUTER PROGRAMS FOR USE IN DATA PROCESSING, MANAGING, SEARCHING, WAREHOUSING, RETRIEVING, EDITING, STRUCTURING, STORING AND VIEWING, FOR USE IN SIMULATING, CONTROLLING AND SUPERVISING FACTORY AUTOMATION, FOR USE IN SIMULATING AND CONTROLLING ELECTRICITY DISTRIBUTION, FOR USE IN AIR CONDITIONING, FOR USE IN CONTROLLING AND SUPERVISING ELEVATORS, FOR USE IN CONTROLLING AND SUPERVISING ELECTRIC POWER PLANTS, FOR USE IN TRANSMITTING VIDEO, AUDIO AND SOUND CONTENTS, FOR USE IN DESIGNING AND DEVELOPING MACHINES AND ELECTRONIC DEVICES, FOR USE IN SECURING INFORMATION BY MEANS BY CRYPTOGRAPHY, AND FOR USE IN INVENTORY TRACKING AND ORDERING, WORD PROCESSORS, ELECTRON TUBES, SEMICONDUCTORS, TRANSISTORS, ELECTRONIC CIRCUITS, INTEGRATED CIRCUITS, PROGRAMMABLE CONTROLLERS FOR USE IN FACTORY AUTOMATION, ELECTRONIC NUMERICAL CONTROLS FOR USE IN METAL WORKING, AND ELECTRONIC CONTROLS FOR USE IN CONTROLLING FUEL INJECTION, SPARK ADVANCE AND IDLE SPEED FOR VEHICLES; OZONISERS; ELECTRIC IRONS; FIRE ALARMS; PRE-RECORDED VIDEO DISKS AND TAPES FEATURING VIDEO, AUDIO AND SOUND CONTENTS IN THE FIELD OF DESIGNING AND DEVELOPING MACHINES AND ELECTRONIC DEVICES, IN CLASS 9 (U.S. CLS. 21, 23, 26, 36 AND 38).

FOR: ELECTRIC LAMPS AND LIGHTING FIXTURES; OIL HEATERS; SOLAR WATER HEATERS FOR DOMESTIC, COMMERCIAL OR INDUSTRIAL USE; MICROWAVE OVENS FOR COOKING FOR COMMERCIAL USE; REFRIGERATORS AND FREEZERS; HEAT EXCHANGERS; AIR CONDITIONING APPARATUS, NAMELY, ELECTRIC VAPORIZERS, AIR CONDITIONERS, AIR PURIFYING UNITS FOR COMMERCIAL, DOMESTIC OR INDUSTRIAL USE, ELECTRIC FANS, RANGE HOODS, HUMIDIFIERS, DEHUMIDIFIERS AND ELECTRIC AIR DEODORIZERS; ELECTRIC HEATING AND COOKING INSTRUMENTS FOR DOMESTIC USE, NAMELY, ELECTRIC HOT CARPETS, ELECTRIC STOVES, ELECTRIC BLANKETS NOT FOR MEDICAL PURPOSES, BEDCLOTHES' DRYERS, HAND HELD ELECTRIC HAIR DRYERS, ELECTRIC COOKING POTS, MICROWAVE OVENS FOR COOKING, ELECTRIC TOASTERS, ELECTRO MAGNETIC OVENS FOR COOKING, AND ELECTRIC HOT PLATES; WATER PURIFIERS FOR DOMESTIC USE, IN CLASS 11 (U.S. CLS. 13, 21, 23, 31 AND 34).

FOR: ALTERNATING CURRENT MOTORS AND DIRECT CURRENT MOTORS, ALL FOR AUTOMOBILES; ANTI-THEFT ALARMS FOR VEHICLES, IN CLASS 12 (U.S. CLS. 19, 21, 23, 31, 35 AND 44).

FOR: INSTALLATION OF TELECOMMUNICATION MACHINES, APPARATUS AND EQUIPMENTS; INSTALLATION OF ELECTRICITY DISTRIBUTION OR CONTROL MACHINES, APPARATUS AND EQUIPMENT; REPAIR AND MAINTENANCE OF ELEVATORS, AIR CONDITIONERS, REPAIR OF RADIO RECEIVERS AND TELEVISION RECEIVERS, REPAIR OF TELEPHONES, IN CLASS 37 (U.S. CLS. 100, 103 AND 106).

FOR: COMMUNICATION BY MOBILE TELEPHONES, COMPUTER TERMINALS AND TELEPHONES; CABLE TELEVISION BROADCASTING; RENTAL OF TELEPHONES, FACSIMILE MACHINES AND TELECOMMUNICATION MACHINES, APPARATUS AND EQUIPMENT IN GENERAL USE, IN CLASS 38 (U.S. CLS. 100, 101 AND 104).

FOR: EDUCATIONAL SERVICES, NAMELY, PROVIDING INCENTIVES TO PEOPLE, STUDENTS, WORKERS, OR ORGANIZATIONS TO DEMONSTRATE EXCELLENCE IN THE FIELD OF MACHINERY, FACTORY AUTOMATION, COMPUTER AND TELECOMMUNICATION AND CONDUCTING SEMINARS, CONFERENCES OR WORKSHOPS IN THE AFORESAID FIELD; PLANNING FOR THE PRESENTATION OF MOVIE SHOWING AND FOR THE PRESENTATION OF PERFORMANCE OF SHOWS, PLAYS AND MUSIC CON-

Reg. No. 4,072,344 CERTS; PRODUCTION OF RADIO AND TELEVISION PROGRAMS; PLANNING AND ORGANIZING OF GOLF TOURNAMENTS; PROVIDING FACILITIES FOR RECREATION ACTIVITIES; PROVIDING TECHNICAL INFORMATION, NAMELY, OPERATION TRAINING IN THE FIELD OF COMPUTERS, COMPUTER PERIPHERALS, TELECOMMUNICATION EQUIPMENT AND INDUSTRIAL MACHINES, APPARATUS AND EQUIPMENTS, IN CLASS 41 (U.S. CLS. 100, 101 AND 107).

FOR: DESIGN FOR OTHERS IN THE FIELD OF COMPUTERS, COMPUTER PERIPHERALS, TELECOMMUNICATION EQUIPMENT AND INDUSTRIAL MACHINES, APPARATUS AND EQUIPMENTS; DESIGN AND UPDATING OF COMPUTER PROGRAMS FOR OTHERS; RESEARCH FOR OTHERS IN THE FIELD OF COMPUTERS, COMPUTER PERIPHERALS, TELECOMMUNICATION EQUIPMENTS AND INDUSTRIAL MACHINES, APPARATUS AND EQUIPMENTS, IN CLASS 42 (U.S. CLS. 100 AND 101).

THE MARK CONSISTS OF STANDARD CHARACTERS WITHOUT CLAIM TO ANY PARTICULAR FONT, STYLE, SIZE, OR COLOR.

OWNER OF JAPAN REG. NO. 4603937, DATED 9-13-2002, EXPIRES 9-13-2012.

SER. NO. 77-692,534, FILED 3-17-2009.

WILLIAM VERHOSEK, EXAMINING ATTORNEY

United States of America

United States Patent and Trademark Office

MRS

Reg. No. 4,072,345

THE ALLAN CANDY COMPANY LIMITED (CANADA CORPORATION)
3 ROBERT SPECK PARKWAY, SUITE 250
HAMILTON, ONTARIO, CANADA L4Z2G5

Registered Dec. 20, 2011

Int. Cl.: 30

FOR: CONFECTIONS, NAMELY, MOLDED CHOCOLATE, IN CLASS 30 (U.S. CL. 46).

TRADEMARK

THE MARK CONSISTS OF STANDARD CHARACTERS WITHOUT CLAIM TO ANY PARTICULAR FONT, STYLE, SIZE, OR COLOR.

PRINCIPAL REGISTER

PRIORITY CLAIMED UNDER SEC. 44(D) ON CANADA APPLICATION NO. 1430550, FILED 3-11-2009, REG. NO. TMA802275, DATED 7-15-2011, EXPIRES 7-15-2026.

SER. NO. 77-694,765, FILED 3-19-2009.

WON TEAK OH, EXAMINING ATTORNEY



David J. Kybas

Director of the United States Patent and Trademark Office

United States of America

United States Patent and Trademark Office

VELATRA

Reg. No. 4,072,346

Registered Dec. 20, 2011

Int. Cls.: 7, 9 and 11

TRADEMARK

PRINCIPAL REGISTER

SAMSUNG ELECTRONICS CO., LTD. (REPUBLIC OF KOREA CORPORATION)
416, MAETAN-DONG, YEONGTONG-GU
SUWON-SI, GYEONGGI-DO, REPUBLIC OF KOREA

FOR: ELECTRIC WASHING MACHINES FOR CLOTHING; ELECTRIC VACUUM CLEANERS; ELECTRIC MIXERS FOR HOUSEHOLD PURPOSES; ELECTRIC WHISKS FOR HOUSEHOLD PURPOSES; AUTOMATIC DISHWASHERS; VACUUM CLEANER BAGS; ROBOTIC VACUUM CLEANERS; LAWNMOWERS; ELECTRIC LAWNMOWERS; FOOD WASTE DISPOSERS; BREAD BAKING MACHINES; SEWING MACHINES FOR HOUSEHOLD PURPOSES; MUFFLERS FOR MOTORS AND ENGINES; AIR COMPRESSORS; AUTOMATIC WASHING MACHINES FOR VEHICLES; DC GENERATORS; ELECTRIC MOTORS FOR WASHING MACHINES; ELECTRIC MOTORS FOR MACHINES, IN CLASS 7 (U.S. CLS. 13, 19, 21, 23, 31, 34 AND 35).

FOR: SEMICONDUCTORS; USB CARDS; COMPUTER NETWORK HUBS, SWITCHES AND ROUTERS; MODEMS; SMARTPHONES; MOBILE TELEPHONES; WIRELESS CELLULAR PHONE HEADSETS; ELECTRIC MOBILE PHONE BATTERY CHARGERS; COMPUTER SERVER; DIGITAL SET-TOP BOXES, NAMELY, DIGITAL MEDIA RECEIVERS AND DECODERS, CABLE TELEVISION CONVERTERS, ETHERNET STREAMING MEDIA CONVERTERS; HARD DISC DRIVES; OPTICAL DISC DRIVES; NOTEBOOK COMPUTERS; COMPUTERS; PRINTERS FOR COMPUTERS; MONITORS FOR COMPUTERS; PERSONAL DIGITAL ASSISTANT; TELEVISION RECEIVERS; FACSIMILE MACHINES; CASH REGISTERS; BATTERIES FOR USE WITH MOBILE PHONES; OPTICAL FIBER CABLES; ELECTRIC FLAT IRONS; AMUSEMENT APPARATUS ADAPTED FOR USE WITH TELEVISION RECEIVERS ONLY; VIDEO TELEPHONES; TELEPHONES; VIDEO TAPE RECORDERS; DVD PLAYERS; MP3 PLAYERS; PORTABLE MULTIMEDIA PLAYERS; AUDIO SPEAKERS FOR COMPUTERS; COMPACT DISC PLAYERS; BLANK COMPACT DISCS FOR AUDIO AND VIDEO; CATHODE RAY TUBES; CAMCORDERS; VIDEO CAMERAS; MOVIE PROJECTORS; DIGITAL CAMERAS; DOWNLOADABLE ELECTRONIC MUSIC VIA THE INTERNET AND WIRELESS DEVICES; DOWNLOADABLE DIGITAL IMAGES, NAMELY, PHOTOGRAPHIC OR VIDEO IMAGES VIA THE INTERNET AND WIRELESS DEVICES; GAME SOFTWARE, RECORDED; COMPUTER MICE; COMPUTER MOUSE PADS; VIDEO RECORDERS; VIDEO DISC PLAYERS; HOME THEATER SYSTEMS COMPRISING TELEVISION RECEIVERS, DVD PLAYERS, AUDIO AMPLIFIERS AND AUDIO SPEAKERS; PARKING METERS, EXCEPT ELECTRONIC, IN CLASS 9 (U.S. CLS. 21, 23, 26, 36 AND 38).



David J. Kyjars

Director of the United States Patent and Trademark Office

Reg. No. 4,072,346 FOR: DENTAL OVENS; WATER PURIFIERS FOR HOUSEHOLD PURPOSES; ICE-COOLING REFRIGERATORS, NON-ELECTRIC; GAS RANGES; BIDET; GAS STOVES; AIR CONDITIONERS; VENTILATORS FOR HOUSE VENTILATION; GAS LAMPS; ORNAMENTAL FOUNTAINS; AIR CONDITIONERS FOR AUTOMOBILES; AIR FILTERING INSTALLATIONS; AIR PURIFYING APPARATUS AND MACHINES; ICE MACHINES AND APPARATUS; GERMICIDAL LAMPS FOR PURIFYING AIR; FLUORESCENT LAMPS; INFRARED LAMPS; ELECTRIC FANS; ELECTRIC REFRIGERATORS; HUMIDIFIERS; HAIR DRYERS; ELECTRIC RANGES; ELECTRIC LAUNDRY DRYERS; ELECTRIC TOASTERS; ELECTRICALLY HEATED CARPETS; MICROWAVE RANGES; BED WARMERS; GAS COOKING OVENS; INDUCTION RANGES, IN CLASS 11 (U.S. CLS. 13, 21, 23, 31 AND 34).

THE MARK CONSISTS OF STANDARD CHARACTERS WITHOUT CLAIM TO ANY PARTICULAR FONT, STYLE, SIZE, OR COLOR.

OWNER OF REPUBLIC OF KOREA REG. NO. 0809710, DATED 12-23-2009, EXPIRES 12-23-2019.

THE WORDING "VELATRA" HAS NO MEANING IN A FOREIGN LANGUAGE.

SER. NO. 77-697,132, FILED 3-23-2009.

BARBARA RUTLAND, EXAMINING ATTORNEY

United States of America

United States Patent and Trademark Office

GOICO TABS

Reg. No. 4,072,347

Registered Dec. 20, 2011

Int. Cl.: 5

TRADEMARK

PRINCIPAL REGISTER

GENOMMA LAB INTERNACIONAL, S.A.B. DE C.V. (MEXICO CORPORATION)
3-A COL. JUAREZ
AV. PASEO DE LA REFORMA #122
C.P., MEXICO 06600

FOR: MEDICATED PREPARATIONS FOR USE IN THE TREATMENT OF SYMPTOMS OF CHRONIC AND PERIPHERAL VENOUS INSUFFICIENCY, IN CLASS 5 (U.S. CLS. 6, 18, 44, 46, 51 AND 52).

THE MARK CONSISTS OF STANDARD CHARACTERS WITHOUT CLAIM TO ANY PARTICULAR FONT, STYLE, SIZE, OR COLOR.

OWNER OF MEXICO REG. NO. 1171098, DATED 3-5-2003, EXPIRES 3-5-2013.

NO CLAIM IS MADE TO THE EXCLUSIVE RIGHT TO USE "TABS", APART FROM THE MARK AS SHOWN.

SER. NO. 77-727,084, FILED 5-1-2009.

GEOFFREY FOSDICK, EXAMINING ATTORNEY



David J. Kyfos

Director of the United States Patent and Trademark Office

United States of America

United States Patent and Trademark Office



Reg. No. 4,072,348

CORSTANGE, DAVID (UNITED STATES INDIVIDUAL)
1749 EAST CENTRE AVENUE
PORTAGE, MI 49024

Registered Dec. 20, 2011

Int. Cl.: 31

FOR: LIVE PLANTS, NAMELY, BEDDING PLANTS, IN CLASS 31 (U.S. CLS. 1 AND 46).

TRADEMARK

FIRST USE 12-1-2008; IN COMMERCE 3-1-2009.

PRINCIPAL REGISTER

NO CLAIM IS MADE TO THE EXCLUSIVE RIGHT TO USE "GARDEN" , APART FROM THE MARK AS SHOWN.

THE STIPLING IS FOR SHADING PURPOSES ONLY.

THE MARK CONSISTS OF THE STYLIZED LETTERS AND WORDS "CG GREEN GARDEN". AN IMAGE OF A SMALL PLANT INSIDE THE LETTER "G".

SER. NO. 77-733,725, FILED 5-11-2009.

HENRY S. ZAK, EXAMINING ATTORNEY



David J. Kyffers

Director of the United States Patent and Trademark Office

United States of America

United States Patent and Trademark Office

REBAT

Reg. No. 4,072,349

Registered Dec. 20, 2011

Int. Cls.: 35, 39, 40 and 42

SERVICE MARK

PRINCIPAL REGISTER

CCR LOGISTICS SYSTEMS AG (FED REP GERMANY CORPORATION)
KARL-HAMMERSCHMIDT-STR. 36
DORNACH, FED REP GERMANY D-85609

FOR: ADVERTISING SERVICES; BUSINESS MANAGEMENT; BUSINESS ADMINISTRATION; PROVIDING OFFICE FUNCTIONS; PROVIDING ASSISTANCE IN BUSINESS ACTIVITIES, NAMELY, CONDUCTING FLOW RATE TESTS IN THE NATURE OF BUSINESS SURVEYS OF MARKETED OR SOLD, AS WELL AS RETURNED, RECYCLED OR DISPOSED PRODUCTS; BUSINESS PROJECT MANAGEMENT SERVICES, NAMELY, PERFORMING BUSINESS RESEARCH, COLLECTING BUSINESS DATA, CONDUCTING BUSINESS AND STATISTICAL DATA ANALYSIS AND REPORTING, PREPARING BUSINESS REPORTS, AND PERFORMING BUSINESS RECORDS MANAGEMENT IN THE FIELD OF FLOW-RATE CERTIFICATES OF OTHERS OF MARKETED OR SOLD, AS WELL AS RETURNED, RECYCLED OR DISPOSED PRODUCTS; CONDUCTING BUSINESS RESEARCH AND SURVEYS TO OBTAIN DOCUMENTATION AND DATA THAT EVIDENCES AND VERIFIES FLOWS OF AMOUNTS OF MARKETED OR SOLD, AS WELL AS RETURNED, RECYCLED OR DISPOSED PRODUCTS; BUSINESS ADMINISTRATION, NAMELY, MANAGING FLOW-RATE CERTIFICATES FOR OTHERS; PROVIDING STATISTICAL EVALUATIONS AND ANALYSIS FOR BUSINESS PURPOSES; ECONOMIC CONSULTING IN THE ENVIRONMENTAL MANAGEMENT AND WASTE DISPOSAL INDUSTRIES; OUTSOURCING SERVICES; HUMAN RESOURCES SERVICES, NAMELY, TEMPORARY EMPLOYEE LEASING; PERSONNEL SERVICES, NAMELY, TEMPORARY EMPLOYEE LEASING; INFORMATION AND DATA COMPILING AND ANALYZING RELATING TO BUSINESS MANAGEMENT; COMPILATION AND SYSTEMATIZATION OF DATA INTO COMPUTER DATABASES; COMPUTERIZED FILE MANAGEMENT; BUSINESS MANAGEMENT ASSISTANCE; PROVIDING INFORMATION AND ANALYSIS IN THE FIELDS OF ECONOMICS AND BUSINESS; BUSINESS CONSULTATION; BUSINESS INFORMATION; BUSINESS INQUIRIES AND INVESTIGATIONS; RELOCATION SERVICES FOR BUSINESSES; ACCOUNTING SERVICES; BOOKKEEPING; PAYROLL PREPARATION; BUSINESS AUDITING; INVOICING SERVICES; BILLING; WORD PROCESSING; DOCUMENT REPRODUCTION; SECRETARIAL SERVICES; TELEPHONE ANSWERING SERVICE; PERSONNEL MANAGEMENT CONSULTANCY; PERSONNEL RECRUITMENT; ADMINISTRATIVE PROCESSING OF PURCHASE ORDERS; ARRANGING SUBSCRIPTIONS TO TELECOMMUNICATION SERVICES FOR OTHERS; EXPORT AND IMPORT AGENCY SERVICES; SERVICES IN THE FIELD OF DISPOSAL AND EXPLOITATION LOGISTICS MANAGEMENT, IN CLASS 35 (U.S. CLS. 100, 101 AND 102).



David J. Kyffers

Director of the United States Patent and Trademark Office

Reg. No. 4,072,349 FOR: TRANSPORT, INTERMEDIATE STORAGE, STORAGE AND SAFEKEEPING OF PRODUCTS AND THEIR COMPONENTS, INCLUDING PACKAGING, AND OF WASTE OF ALL KINDS, IN PARTICULAR BATTERIES AS WELL AS ELECTRIC AND ELECTRONIC APPARATUS; TRANSPORT AND STORAGE OF SECONDARY RAW MATERIALS AND OTHER UTILITY GOODS; PACKAGING OF ARTICLES FOR TRANSPORTATION; STORAGE OF GOODS; TRANSPORT OF GOODS BY MOTOR VEHICLES, RAIL VEHICLES, SHIPS AND AIRPLANES; TRANSPORT OF CARGO BY MOTOR VEHICLES, RAIL VEHICLES, SHIPS AND AIRPLANES; UNLOADING OF CARGO; CARGO HANDLING, TRUCK HAULING; TRANSPORT BY CAR; RENTAL OF STORAGE CONTAINERS; TRANSPORT BY BARGE; TRANSPORT BY AIR; TRANSPORT BY BOAT; FREIGHT BROKERAGE; MARINE TRANSPORT SERVICES; FREIGHT SHIPPING AND FORWARDING AGENCY SERVICES; TRANSPORTATION INFORMATION; RENTAL OF STORAGE CONTAINERS, INCLUDING BARRELS, SKELETON CONTAINERS, BOX PALLETS, FLUID COLLECTORS, AND BRAKE FLUID COLLECTORS AND CONTAINERS; SUPPLY CHAIN LOGISTICS AND REVERSE LOGISTICS SERVICES, NAMELY, STORAGE, TRANSPORTATION AND DELIVERY OF GOODS FOR OTHERS BY AIR, RAIL, SHIP OR TRUCK; SHIPPING CONTAINER RENTAL, STORAGE AND TRANSPORT SERVICES, IN CLASS 39 (U.S. CLS. 100 AND 105).

FOR: RECYCLING, TREATMENT, DISPOSAL AND PROCESSING OF WASTE OF ALL KINDS, PARTICULARLY BATTERIES, ELECTRIC AND ELECTRONIC PRODUCTS AND PACKAGING THEREFOR; RECYCLING SERVICES FOR OTHERS; WASTE DESTRUCTION BY MEANS OF PROCESSING OR INCINERATION; RECYCLING AND RECLAMATION OF REUSABLE GOODS, PARTICULARLY BATTERIES AS WELL AS ELECTRIC AND ELECTRONIC APPARATUS, PACKAGING THEREFOR, AND WASTE, FOR THE PRODUCTION OF POST-RECYCLING PRODUCTS; MATERIAL TREATMENT SERVICES IN CONNECTION WITH RECYCLING; WASTE PROCESSING SERVICES, NAMELY, WASTE DESTRUCTION, INCINERATION OR RECYCLING; PROVIDING INFORMATION IN THE FIELD OF MATERIAL TREATMENT; CUSTOM ASSEMBLY OF PRODUCTS FOR OTHERS; METAL TREATMENT; RUBBISH AND WASTE INCINERATION; RUBBISH AND WASTE DESTRUCTION; RECYCLING AND DISPOSAL OF WASTE AND RUBBISH; RECLAMATION OF WASTE AND RUBBISH FOR THE PRODUCTION OF POST RECYCLING PRODUCTS; SORTING OF RUBBISH, WASTE, SECONDARY RAW MATERIALS AND REUSABLE MATERIALS FOR RECYCLING PURPOSES; CONSULTATION IN THE FIELD OF RECYCLING AND WASTE MATERIAL TREATMENT; WASTE RECYCLING AND WASTE TREATMENT FACILITY FEATURING THE SORTING, RECYCLING AND PROCESSING OF WASTE PRODUCTS OF ALL TYPES BY MEANS OF CRUSHING, COMPRESSING, SEPARATING, PRESSING, EXTRUDING, GRANULATING, AGGLOMERATING AND RAW MATERIAL SEPARATION USING THERMAL AND CHEMICAL TREATMENT TECHNOLOGIES; RECYCLING OF WASTE AND RUBBISH; SORTING OF WASTE AND RECYCLABLE MATERIAL, NAMELY, BATTERIES AND PARTS AND PACKAGING THEREFOR, IN CLASS 40 (U.S. CLS. 100, 103 AND 106).

FOR: DESIGN AND DEVELOPMENT OF FACILITIES FOR RECYCLING, TREATMENT, RECLAMATION, AND DISPOSAL OF WASTE PRODUCTS OF ALL KINDS, INCLUDING ELECTRIC AND ELECTRONIC PRODUCTS, BATTERIES, AND THEIR ASSOCIATED PACKAGING; SCIENTIFIC AND TECHNOLOGICAL SERVICES, RESEARCH AND DESIGN IN THE FIELDS OF RECYCLING, WASTE DISPOSAL, WASTE RE-USE AND ENVIRONMENTAL SCIENCE; INDUSTRIAL RESEARCH SERVICES IN THE FIELDS OF RECYCLING, WASTE DISPOSAL, WASTE RE-USE AND ENVIRONMENTAL SCIENCE; DESIGN AND DEVELOPMENT OF COMPUTER HARDWARE AND SOFTWARE; COMPUTER PROGRAMMING; TECHNICAL CONSULTING IN THE FIELDS OF DESIGN AND DEVELOPMENT OF ENVIRONMENTAL TECHNOLOGIES FOR WASTE DISPOSAL; TECHNICAL CONSULTANCY IN THE FIELD OF ENVIRONMENTAL SCIENCE; TECHNICAL CONSULTANCY FOR CONSUMERS AND BUSINESSES WITH REGARD TO ENVIRONMENTAL SCIENCE; RESEARCH AND DEVELOPMENT FOR OTHERS WITH REGARD TO NEW PRODUCTS; PROVIDING EXPERT TECHNICAL OPINIONS IN THE FIELD OF ENVIRONMENTAL SCIENCES DEALING WITH RECYCLING, WASTE DISPOSAL, AND WASTE RE-USE; SURVEYING; ENGINEERING SERVICES; CONSTRUCTION DRAFTING; CONDUCTING FEASIBILITY

Reg. No. 4,072,349 STUDIES CONCERNING TECHNICAL WASTE DISPOSAL, UTILIZATION, AND RECYCLING PROJECTS; TECHNICAL CONSULTING IN THE FIELD OF ENVIRONMENTAL SCIENCE AND ENGINEERING DEALING WITH WASTE DISPOSAL, UTILIZATION, AND RECYCLING; TESTING, ANALYSIS AND EVALUATION OF FLOW-RATES OF BATTERIES AS WELL AS ELECTRIC AND ELECTRONIC APPARATUS OF OTHERS FOR THE PURPOSE OF CERTIFICATION; DATA AUTOMATION AND COLLECTION SERVICE USING PROPRIETARY SOFTWARE TO EVALUATE, ANALYZE AND COLLECT SERVICE DATA; DEVELOPMENT, UPDATING AND MAINTENANCE OF SOFTWARE AND DATABASES; SEARCHING AND RETRIEVING INFORMATION, SITES AND OTHER RESOURCES AVAILABLE ON COMPUTER NETWORKS FOR OTHERS; INSPECTION, QUANTITY AND QUALITY CONTROL, SUPERVISION AND VERIFICATION OF THE QUALITY AND QUANTITY OF FLOW AMOUNTS IN THE WASTE INDUSTRY AND THEIR CONFORMITY WITH NATIONAL AND INTERNATIONAL NORMS, LAWS, RULES, PRACTICE AND STANDARDS AND WITH CLIENTS' CONTRACTUAL REQUIREMENTS, IN CLASS 42 (U.S. CLS. 100 AND 101).

THE MARK CONSISTS OF STANDARD CHARACTERS WITHOUT CLAIM TO ANY PARTICULAR FONT, STYLE, SIZE, OR COLOR.

PRIORITY CLAIMED UNDER SEC. 44(D) ON ERPN CMNTY TM OFC APPLICATION NO. 007410574, FILED 11-20-2008, REG. NO. 007410574, DATED 6-7-2011, EXPIRES 11-20-2018.

SER. NO. 77-733,873, FILED 5-11-2009.

BARBARA A. GOLD, EXAMINING ATTORNEY

United States of America

United States Patent and Trademark Office

Vortex

Reg. No. 4,072,350

Registered Dec. 20, 2011

Int. Cl.: 7

TRADEMARK

PRINCIPAL REGISTER

WOODBOLT DISTRIBUTION LLC (TEXAS LIMITED LIABILITY COMPANY)
715 NORTH MAIN STREET
BRYAN, TX 77803

FOR: ELECTRIC MIXERS FOR HOUSEHOLD PURPOSES, IN CLASS 7 (U.S. CLS. 13, 19, 21, 23, 31, 34 AND 35).

FIRST USE 12-16-2008; IN COMMERCE 1-15-2009.

THE MARK CONSISTS OF STANDARD CHARACTERS WITHOUT CLAIM TO ANY PARTICULAR FONT, STYLE, SIZE, OR COLOR.

SER. NO. 77-736,035, FILED 5-13-2009.

RUSS HERMAN, EXAMINING ATTORNEY



David J. Kyffers

Director of the United States Patent and Trademark Office

United States of America

United States Patent and Trademark Office



Reg. No. 4,072,351

Registered Dec. 20, 2011

Int. Cl.: 35

SERVICE MARK

PRINCIPAL REGISTER

USA SOLAR STORE (VERMONT CORPORATION), FORMERLY CET SOLAR STORE
7290 ROUTE 131
CAVENDISH, VT 05142

FOR: RETAIL STORE SERVICES FEATURING ALTERNATE ENERGY SUPPLIES, IN CLASS
35 (U.S. CLS. 100, 101 AND 102).

FIRST USE 1-12-2005; IN COMMERCE 1-12-2005.

OWNER OF U.S. REG. NO. 2,699,649.

NO CLAIM IS MADE TO THE EXCLUSIVE RIGHT TO USE "USA SOLAR STORE", APART
FROM THE MARK AS SHOWN.

THE MARK CONSISTS OF THE DESIGN OF A RISING SUN CONTAINING THE WORDING
"USA" ABOVE A BENT POLYGON BORDER CONTAINING THE WORDING "SOLAR
STORE" ABOVE A PORTION OF A GLOBE CONTAINING THE OUTLINE OF PORTIONS
OF CONTINENTS ON THE SOUTHERN HEMISPHERE.

SER. NO. 77-739,115, FILED 5-18-2009.

ANDREA K. NADELMAN, EXAMINING ATTORNEY



David J. Kybas

Director of the United States Patent and Trademark Office

United States of America

United States Patent and Trademark Office

PROPHECY

Reg. No. 4,072,352

SUN, GARRY C. (UNITED STATES INDIVIDUAL), AKA PROPHECY
1111 S. ORLANDO AVE.
LOS ANGELES, CA 90035

Registered Dec. 20, 2011

Int. Cl.: 41

FOR: ENTERTAINMENT SERVICES, NAMELY, THE PRESENTATION OF LIVE PERFORMANCES BY A MUSICAL ARTIST, IN CLASS 41 (U.S. CLS. 100, 101 AND 107).

SERVICE MARK

FIRST USE 0-0-1997; IN COMMERCE 0-0-1998.

PRINCIPAL REGISTER

THE MARK CONSISTS OF STANDARD CHARACTERS WITHOUT CLAIM TO ANY PARTICULAR FONT, STYLE, SIZE, OR COLOR.

THE NAME "PROPHECY" IS THE STAGE NAME WHICH IDENTIFIES A LIVING INDIVIDUAL, GARRY C. SUN, WHOSE CONSENT IS OF RECORD.

SER. NO. 77-739,378, FILED 5-18-2009.

LAKEISHA LEWIS, EXAMINING ATTORNEY



David J. Kyffers

Director of the United States Patent and Trademark Office

United States of America

United States Patent and Trademark Office

eCMS

Reg. No. 4,072,353

Registered Dec. 20, 2011

Int. Cl.: 9

TRADEMARK

PRINCIPAL REGISTER

COMPUTER GUIDANCE CORPORATION (ARIZONA CORPORATION)
15035 N. 75TH STREET
SCOTTSDALE, AZ 85050

FOR: DOWNLOADABLE COMPUTER SOFTWARE FOR THE CONSTRUCTION INDUSTRY FOR USE WITH GENERAL LEDGERS, ACCOUNTS RECEIVABLE AND CONTRACTS, ACCOUNTS PAYABLE AND SUBCONTRACTS, TIME AND MATERIALS BILLINGS, EQUIPMENT ACCOUNTING, EQUIPMENT MAINTENANCE, ORDER ENTRY, INVENTORY, BILLING OF MATERIALS, PURCHASING, SERVICE REQUESTS, PAYROLL, CANADIAN PAYROLL, HUMAN RESOURCES, JOB COSTS, PROJECT MANAGEMENT, BUSINESS INTELLIGENCE, PROPERTY MANAGEMENT, PLANT SALES, SERVICE MANAGEMENT, DOCUMENT IMAGING, ELECTRONIC WORKFLOW, ELECTRONIC FORMS, BID SOLICITATION, E-MAIL, MESSAGING, AND LOGS, IN CLASS 9 (U.S. CLS. 21, 23, 26, 36 AND 38).

FIRST USE 1-1-2001; IN COMMERCE 1-1-2001.

THE MARK CONSISTS OF STANDARD CHARACTERS WITHOUT CLAIM TO ANY PARTICULAR FONT, STYLE, SIZE, OR COLOR.

SER. NO. 77-780,461, FILED 7-14-2009.

KATHERINE M. DUBRAY, EXAMINING ATTORNEY



David J. Kyros

Director of the United States Patent and Trademark Office

United States of America

United States Patent and Trademark Office

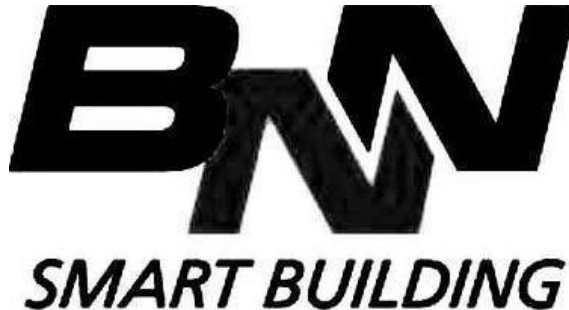

Reg. No. 4,072,354

Registered Dec. 20, 2011

Int. Cls.: 37 and 42

SERVICE MARK

PRINCIPAL REGISTER

NUCONSTEEL CORPORATION (DELAWARE CORPORATION)
TRUST CO. CORPORATE TRUST CTR.
1209 ORANGE STREET C/O THE CORPORATION
WILMINGTON, DE 19801

FOR: CONSTRUCTION CONSULTANCY, CONSTRUCTION PLANNING, IN CLASS 37 (U.S. CLS. 100, 103 AND 106).

FIRST USE 1-31-2009; IN COMMERCE 1-31-2009.

FOR: ENGINEERING CONSULTING, IN CLASS 42 (U.S. CLS. 100 AND 101).

FIRST USE 1-31-2009; IN COMMERCE 1-31-2009.

NO CLAIM IS MADE TO THE EXCLUSIVE RIGHT TO USE "SMART BUILDING", APART FROM THE MARK AS SHOWN.

THE MARK CONSISTS OF A STYLIZED TERM "BNN" ABOVE THE STYLIZED PHRASE "SMART BUILDING" WHEREIN THE FIRST LETTER "N" IN "BNN" SITS BELOW THE LETTER "B" AND THE SECOND LETTER "N" CUTS OFF THE TOP RIGHT PORTION OF THE FIRST LETTER "N".

SER. NO. 77-800,566, FILED 8-10-2009.

SUSAN STIGLITZ, EXAMINING ATTORNEY



David J. Kybas

Director of the United States Patent and Trademark Office

United States of America

United States Patent and Trademark Office



Reg. No. 4,072,355

Registered Dec. 20, 2011

Int. Cl.: 20

TRADEMARK

PRINCIPAL REGISTER

ROPAK CORPORATION (DELAWARE CORPORATION)
SUITE 200W
10540 TALBERT AVE
FOUNTAIN VALLEY, CA 92708

FOR: RECYCLABLE AND SUSTAINABLE PLASTIC CONTAINERS FOR COMMERCIAL USE, IN CLASS 20 (U.S. CLS. 2, 13, 22, 25, 32 AND 50).

FIRST USE 2-28-2009; IN COMMERCE 2-28-2009.

NO CLAIM IS MADE TO THE EXCLUSIVE RIGHT TO USE "DIAMOND WEAVE TECHNOLOGY FOR SUSTAINABLE PACKAGING", "RECYCLABLE" AND "SUSTAINABLE PACKAGING" AND THE DESIGN OF THE RECYCLING SYMBOL, APART FROM THE MARK AS SHOWN.

THE MARK CONSISTS OF THE STYLIZED WORDING "DIAMOND WEAVE TECHNOLOGY FOR SUSTAINABLE PACKAGING" INSIDE THE DESIGN OF AN INCOMPLETE DIAMOND SHAPE HAVING CONCENTRIC OUTLINES AND THE REPETITIVE PATTERN OF SMALLER DIAMONDS INSIDE THE LARGE DIAMOND SHAPE, AND THE STYLIZED WORDING "RECYCLABLE" AND "SUSTAINABLE PACKAGING" IN A CIRCULAR ORIENTATION WITHIN OUTLINES OF CONCENTRIC CIRCLES AND TWO SMALL CIRCLES SEPARATING THE WORDING. INSIDE THE CIRCLE DESIGN IS THE DESIGN OF THREE ARROWS FORMING A GENERALLY TRIANGULAR SHAPE AROUND THE DESIGN OF A CIRCLE HAVING TWO ARC-SHAPED BANDS COMING FROM THE BOTTOM AND ONE GOING TO THE RIGHT AND ONE GOING TO THE LEFT, AND A DIAMOND SHAPE ABOVE THE ARC-SHAPED BANDS.

SER. NO. 77-802,884, FILED 8-12-2009.

JAY BESCH, EXAMINING ATTORNEY



David J. Kyros

Director of the United States Patent and Trademark Office

United States of America

United States Patent and Trademark Office

ReMIND.org

Reg. No. 4,072,356

Registered Dec. 20, 2011

Int. Cls.: 35, 36 and 43

SERVICE MARK

PRINCIPAL REGISTER

BOB WOODRUFF FAMILY FOUNDATION, INC. (NEW YORK CORPORATION), AKA BOB WOODRUFF FOUNDATION
127 EAST 59TH STREET - THIRD FLOOR
NEW YORK, NY 10022

FOR: CHARITABLE SERVICES, NAMELY, PROMOTING PUBLIC AWARENESS OF THE NEEDS OF WOUNDED SERVICE MEMBERS RETURNING FROM WAR AND REINTEGRATING INTO CIVILIAN LIFE, IN CLASS 35 (U.S. CLS. 100, 101 AND 102).

FIRST USE 7-1-2008; IN COMMERCE 9-1-2008.

FOR: CHARITABLE FUNDRAISING SERVICES, NAMELY, ORGANIZING AND CONDUCTING FUNDRAISING EVENTS TO PROVIDE FOOD, SHELTER, FINANCIAL ASSISTANCE OR OTHER HUMANITARIAN RELIEF TO WOUNDED MILITARY SERVICE MEMBERS, VETERANS AND THEIR FAMILIES, IN CLASS 36 (U.S. CLS. 100, 101 AND 102).

FIRST USE 7-1-2008; IN COMMERCE 9-1-2008.

FOR: CHARITABLE SERVICES, NAMELY, PROVIDING FOOD AND TEMPORARY HOUSING TO WOUNDED SERVICE MEMBERS RETURNING HOME FROM COMBAT AND THEIR FAMILIES WHO HAVE BEEN DISPLACED FROM THEIR HOMES DUE TO ECONOMIC HARDSHIP, IN CLASS 43 (U.S. CLS. 100 AND 101).

FIRST USE 7-1-2008; IN COMMERCE 9-1-2008.

THE MARK CONSISTS OF STANDARD CHARACTERS WITHOUT CLAIM TO ANY PARTICULAR FONT, STYLE, SIZE, OR COLOR.

SER. NO. 77-807,430, FILED 8-18-2009.

BERYL GARDNER, EXAMINING ATTORNEY



David J. Kyffers

Director of the United States Patent and Trademark Office

United States of America

United States Patent and Trademark Office

ATA

ARCHERY TRADE ASSOCIATION

Reg. No. 4,072,357

Registered Dec. 20, 2011

Int. Cl.: 41

SERVICE MARK

PRINCIPAL REGISTER

ARCHERY TRADE ASSOCIATION, INC. (VIRGINIA CORPORATION)
9646 MASTERWORKS DRIVE
VIENNA, VA 22181

FOR: EDUCATIONAL SERVICES, NAMELY, CONDUCTING PROGRAMS, CLASSES, SEMINARS, CONFERENCES AND WORKSHOPS AND EXHIBITIONS, DISPLAYS AND INTERACTIVE EXHIBITS ON SPORTING AND HUNTING AND WILDLIFE CONSERVATION AND PUBLISHING SERVICES, NAMELY, PUBLICATION OF TEXT AND GRAPHIC WORKS OF OTHERS IN MAGAZINES, BOOKS, MANUALS, TARGETS, RULE BOOKS, TEXT BOOKS AND ARTICLES FEATURING INTEREST TO THOSE WITH INTEREST IN SPORTING AND HUNTING, IN CLASS 41 (U.S. CLS. 100, 101 AND 107).

FIRST USE 6-10-2009; IN COMMERCE 6-10-2009.

OWNER OF U.S. REG. NOS. 3,064,554 AND 3,112,340.

NO CLAIM IS MADE TO THE EXCLUSIVE RIGHT TO USE "TRADE ASSOCIATION", APART FROM THE MARK AS SHOWN.

THE MARK CONSISTS OF "ARCHERY TRADE ASSOCIATION" AND THE LETTERS "ATA" IN THE SHAPE OF AN ARCH.

SEC. 2(F) AS TO "ARCHERY TRADE ASSOCIATION".

SER. NO. 77-814,360, FILED 8-27-2009.

PAUL E. FAHRENKOPF, EXAMINING ATTORNEY



David J. Kybas

Director of the United States Patent and Trademark Office

United States of America

United States Patent and Trademark Office

J K ROWLING

Reg. No. 4,072,358

Registered Dec. 20, 2011

Int. Cls.: 9, 16, 25 and 28

TRADEMARK

PRINCIPAL REGISTER

JOANNE ROWLING (UNITED KINGDOM INDIVIDUAL)
CHRISTOPHER LITTLE LITERACY AGENCY
10 EEL BROOK STUDIOS 125 MOORE PARK ROAD
LONDON SW64PS, UNITED KINGDOM

FOR: INSTRUCTIONAL AND TEACHING APPARATUS AND INSTRUMENTS, NAMELY, APPARATUS FOR THE PROCESSING, RECORDING, TRANSMISSION OR REPRODUCTION OF SOUND, VIDEO OR IMAGES, NAMELY, AUDIO CASSETTE AND DISC PLAYERS, DVD PLAYERS, VIDEO CASSETTE AND DISC RECORDERS AND PLAYERS' COMPACT DISC PLAYERS, DIGITAL AUDIO TAPE RECORDERS AND PLAYERS, TELEPHONES AND PAGERS, RADIOS; VIDEO GAME MACHINES FOR USE WITH TELEVISIONS; COMPUTER PROGRAMS AND SOFTWARE FOR PROVIDING SOUND AND IMAGES IN THE FIELD OF ENTERTAINMENT OR EDUCATION; COMPUTER PROGRAMS FOR THE TRANSMISSION OR REPRODUCTION OF SOUND AND IMAGES IN THE FIELD OF ENTERTAINMENT OR EDUCATION RECORDED IN COMPUTER ACCESSIBLE FORM, NAMELY, CD-ROMS, DVDS, CASSETTES, TAPES AND DISCS FEATURING COMEDY, DRAMA, ACTION AND ADVENTURE; PRE-RECORDED MAGNETIC TAPES AND MAGNETIC AND OPTICAL DISCS, NAMELY, PRE-RECORDED AUDIO-VIDEO TAPES, AUDIO-VIDEO CASSETTES, AUDIO-VIDEO DISCS, AND DVDS FEATURING MUSICAL, COMEDY, DRAMA, ACTION, ADVENTURE AND/OR ANIMATION SOUND OR VIDEO RECORDINGS; MUSICAL, COMEDY, DRAMA, ACTION, ADVENTURE AND/OR ANIMATION VIDEO AND SOUND RECORDINGS; DOWNLOADABLE ELECTRONIC PUBLICATIONS IN THE NATURE OF BOOKS OR MAGAZINES IN THE FIELD OF COMEDY, DRAMA, ACTION, AND/OR ADVENTURE; DOWNLOADABLE ELECTRONIC CHILDREN'S BOOKS; ELECTRONIC PUBLICATIONS, NAMELY, ELECTRONIC BOOKS OR MAGAZINES FEATURING COMEDY, DRAMA, ACTION AND/OR ADVENTURE RECORDED ON DISCS, CASSETTES, TAPES, CD-ROMS AND DVDS; ELECTRONIC CHILDREN'S BOOKS RECORDED ON COMPUTER MEDIA, IN CLASS 9 (U.S. CLS. 21, 23, 26, 36 AND 38).



David J. Kybas

Director of the United States Patent and Trademark Office

FOR: PERIODICAL PUBLICATIONS, NAMELY, NEWSPAPERS AND MAGAZINES IN THE FIELD OF COMEDY, DRAMA, ACTION AND ADVENTURE; COLORING BOOKS; PUZZLE BOOKS; CHILDREN'S ACTIVITIES BOOKS; SCRAP BOOKS; WRITING OR DRAWING BOOKS; MOUNTED AND/OR UNMOUNTED PHOTOGRAPHS; STATIONERY; PRINTED INSTRUCTIONAL AND TEACHING MATERIALS, NAMELY, WORKBOOKS FEATURING COMEDY, DRAMA, ACTION AND ADVENTURE, WRITING BOOKS; POSTERS; PENS; BOOKMARKS; CALENDARS; WRAPPING PAPER; NOTEPADS; GREETING CARDS; ADDRESS BOOKS; NOTE BOOKS; TRADING CARDS; LITHOGRAPHS; PHOTOGRAPH AL-

Reg. No. 4,072,358 BUMS; FILES, NAMELY, CARD FILES, DOCUMENT FILES, LETTER FILES AND PAPER EXPANDING FILES, IN CLASS 16 (U.S. CLS. 2, 5, 22, 23, 29, 37, 38 AND 50).

FOR: CLOTHING, NAMELY, T-SHIRTS, SWEATSHIRTS, SHIRTS, TROUSERS, SHORTS, SKIRTS, BLOUSES, DRESSES, SWEATERS, JACKETS, COATS, SLEEPWEAR, UNDERWEAR, SWIMWEAR, JUMPERS, FOOTWEAR, AND HEADGEAR, NAMELY, HATS, CAPS, BASEBALL CAPS AND HEADBANDS, IN CLASS 25 (U.S. CLS. 22 AND 39).

FOR: GAMES, NAMELY, BOARD GAMES, CARD GAMES, PARLOR GAMES, ARCADE GAMES, TARGET GAMES; JIGSAW PUZZLES; HANDHELD UNITS FOR PLAYING ELECTRONIC GAMES; TOYS, NAMELY, PLUSH TOYS, WIND-UP TOYS, BATH TOYS, TOY VEHICLES, DOLLS, DOLL ACCESSORIES AND PLAYING CARDS AND CHRISTMAS TREE ORNAMENTS, IN CLASS 28 (U.S. CLS. 22, 23, 38 AND 50).

THE MARK CONSISTS OF STANDARD CHARACTERS WITHOUT CLAIM TO ANY PARTICULAR FONT, STYLE, SIZE, OR COLOR.

OWNER OF UNITED KINGDOM REG. NO. 2218081, DATED 7-21-2000, EXPIRES 12-22-2019.

OWNER OF U.S. REG. NOS. 2,757,849 AND 2,818,636.

THE NAME SHOWN IN THE MARK IDENTIFIED IS THAT OF "JOANNE ROWLING" A/K/A "J K ROWLING", A LIVING INDIVIDUAL WHOSE CONSENT IS OF RECORD

SER. NO. 77-818,966, FILED 9-2-2009.

RON FAIRBANKS, EXAMINING ATTORNEY

United States of America

United States Patent and Trademark Office

CARICOM

Reg. No. 4,072,359

Registered Dec. 20, 2011

Int. Cl.: 41

SERVICE MARK

PRINCIPAL REGISTER

L.MEGAN HUTCHINSON (JAMAICA INDIVIDUAL)
GREATER PORTMORE P.O.
LOT 575 3 EAST GREATER PORTMORE
SAINT CATHERINE, JAMAICA JAMAICAW.

FOR: ENTERTAINMENT SERVICES, NAMELY, PROVIDING WEBSITE THAT FEATURES INFORMATION ON CARIBBEAN CULTURAL AND ENTERTAINMENT NEWS, ENTERTAINMENT, CULTURAL AND SPORTING EVENTS; PRODUCING AN ONGOING TELEVISION SERIES AND RADIO SHOW ON CARIBBEAN CULTURE; ENTERTAINMENT SERVICES, NAMELY, PRODUCING AN ONGOING TELEVISION SERIES FEATURING NEWS OF CARIBBEAN LOCALS AND CELEBRITIES AND OF CELEBRITIES VISITING CARIBBEAN ISLANDS; ENTERTAINMENT SERVICES, NAMELY, PROVIDING A WEBSITE THAT FEATURES NON-DOWNLOADABLE MUSICAL PERFORMANCES, SPOKEN WORD PERFORMANCES, DRAMATIC PERFORMANCES, MUSICAL VIDEOS, RELATED FILM CLIPS, PHOTOGRAPHS AND OTHER MULTIMEDIA MATERIALS FEATURING CARIBBEAN MUSIC AND ENTERTAINMENT PRODUCTIONS; ORGANIZING COMMUNITY FESTIVALS FEATURING A VARIETY OF ACTIVITIES, NAMELY, SPORTING EVENTS, ART EXHIBITIONS, ETHNIC DANCE PERFORMANCES, FLEA MARKETS, DINNER THEATERS AND MUSIC PERFORMANCES; PHOTOGRAPHY, PHOTOGRAPHY SERVICES, PHOTOGRAPHIC REPORTING, PHOTOGRAPHIC AND VIDEO SERVICES, NAMELY, PHOTOGRAPHIC AND VIDEO CAPTURE, IN CLASS 41 (U.S. CLS. 100, 101 AND 107).

FIRST USE 7-15-1982; IN COMMERCE 9-27-1990.

THE MARK CONSISTS OF STANDARD CHARACTERS WITHOUT CLAIM TO ANY PARTICULAR FONT, STYLE, SIZE, OR COLOR.

SEC. 2(F).

SER. NO. 77-822,094, FILED 9-8-2009.

SUSAN LESLIE DUBOIS, EXAMINING ATTORNEY



David J. Kypos

Director of the United States Patent and Trademark Office

United States of America

United States Patent and Trademark Office

FUJI

Reg. No. 4,072,360

ADVANCED SPORTS, INC. (NEW JERSEY CORPORATION)
10940 DUTTON ROAD
PHILADELPHIA, PA 19154

Registered Dec. 20, 2011

Int. Cls.: 9, 18 and 25

FOR: BICYCLE HELMETS; RIDING HELMETS; SAFETY HELMETS, IN CLASS 9 (U.S. CLS. 21, 23, 26, 36 AND 38).

TRADEMARK

FIRST USE 2-0-2007; IN COMMERCE 10-0-2007.

PRINCIPAL REGISTER

FOR: BAGS FOR CYCLING, NAMELY, SHOULDER BAGS, BACKPACKS, SPORTS BAGS AND MESSENGER BAGS, IN CLASS 18 (U.S. CLS. 1, 2, 3, 22 AND 41).

FIRST USE 0-0-2001; IN COMMERCE 0-0-2001.

FOR: CLOTHING FOR CYCLING, NAMELY, JACKETS, T-SHIRTS, VEST, SHIRTS, SHORTS, HATS, VISORS, SHOES, SWEATSHIRTS, GLOVES, SOCKS, SHOES AND JERSEYS, IN CLASS 25 (U.S. CLS. 22 AND 39).

FIRST USE 0-0-2001; IN COMMERCE 0-0-2001.

THE MARK CONSISTS OF STANDARD CHARACTERS WITHOUT CLAIM TO ANY PARTICULAR FONT, STYLE, SIZE, OR COLOR.

OWNER OF U.S. REG. NOS. 938,564, 1,253,734, AND 2,410,764.

SER. NO. 77-827,131, FILED 9-15-2009.

MEGHAN REINHART, EXAMINING ATTORNEY



David J. Kybas

Director of the United States Patent and Trademark Office

United States of America

United States Patent and Trademark Office

阿里巴巴云计算

Reg. No. 4,072,361

Registered Dec. 20, 2011

**Int. Cls.: 9, 35, 36, 38, 39,
41 and 42**

TRADEMARK

SERVICE MARK

PRINCIPAL REGISTER

ALIBABA GROUP HOLDING LIMITED (CAYMAN ISLANDS CORPORATION)
FOURTH FLOOR, ONE CAPITAL PLACE
P.O. BOX 847
GRAND CAYMAN, CAYMAN ISLANDS

FOR: SCIENTIFIC, NAUTICAL, SURVEYING, PHOTOGRAPHIC, CINEMATOGRAPHIC, OPTICAL, WEIGHING, MEASURING, SIGNALLING, CHECKING, LIFE-SAVING AND TEACHING APPARATUS AND INSTRUMENTS, NAMELY, TELEPHONES, PUNCH CLOCKS, TIME RECORDING DEVICES, NAMELY, TIME CLOCKS, SCALES AND BALANCES, GRADUATED RULERS, ELECTRONIC POCKET TRANSLATORS, NEON SIGNS, ELECTRONIC NOTICE BOARDS, TRANSPARENCY PROJECTION APPARATUS, KILOMETER RECORDERS IN THE NATURE OF ODOMETERS FOR VEHICLES, TELESCOPES, MECHANISMS FOR COUNTER OPERATED APPARATUS, NAMELY, POINT-OF-SALE TERMINALS, FIRE EXTINGUISHERS, ACOUSTIC ALARMS, NAMELY, SMOKE AND FIRE ALARMS, EYEGLASSES, BATTERIES, EXPOSED FILMS, NAMELY, EXPOSED CAMERA FILM; APPARATUS AND INSTRUMENTS FOR CONDUCTING, SWITCHING, TRANSFORMING, ACCUMULATING, REGULATING OR CONTROLLING ELECTRICITY, NAMELY, ELECTRIC WIRES; ELECTRIC SWITCHES; ELECTROPLATING APPARATUS, NAMELY, ELECTROPLATING MACHINES, ELECTRIC WELDING APPARATUS, NAMELY, TORCHES; ELECTRIFIED FENCES, NAMELY, ELECTRIC FENCES; APPARATUS FOR RECORDING, TRANSMISSION OR REPRODUCTION OF SOUND OR IMAGES; BLANK MAGNETIC DATA CARRIERS AND RECORDING DISCS; AUTOMATIC VENDING MACHINES AND MECHANISMS FOR COIN-OPERATED APPARATUS; CASH REGISTERS, CALCULATING MACHINES, DATA PROCESSING EQUIPMENT AND COMPUTERS; NOTEBOOK COMPUTERS; LAPTOP COMPUTERS; PORTABLE COMPUTERS; HANDHELD COMPUTERS; PERSONAL DIGITAL ASSISTANTS; PORTABLE MEDIA PLAYERS; MOBILE TELEPHONES; SMART PHONES; DIGITAL CAMERAS; COMPUTER WORKSTATIONS COMPRISED OF COMPUTERS AND COMPUTER MONITORS; SERVERS, NAMELY, COMPUTER SERVERS; COMPUTER AND TELECOMMUNICATIONS NETWORKING COMPUTER HARDWARE; COMPUTER NETWORK ADAPTORS, SWITCHES, ROUTERS AND HUBS; WIRELESS AND WIRED MODEMS AND COMPUTER EQUIPMENT, NAMELY, WIRELESS CARDS; LAPTOP HOLDERS IN THE NATURE OF PROTECTIVE SLEEVES AND CARRYING CASES, COMPUTER BAGS; FIRE EXTINGUISHING APPARATUS; COMPUTER HARDWARE; COMPUTER SOFTWARE AND DOWNLOADABLE SOFTWARE FOR USE IN CONNECTION WITH THE PROVISION OF AN INTERACTIVE WEBSITE, NAMELY, FOR USE BY THIRD PARTIES TO POST INFORMATION, CREATE ELECTRONIC PRODUCT CATALOGS, RESPOND TO REQUESTS AND PLACE AND FULFILL ORDERS FOR PRODUCTS, SERVICES AND



David J. Kappas

Director of the United States Patent and Trademark Office

Reg. No. 4,072,361 BUSINESS OPPORTUNITIES VIA LOCAL AND GLOBAL COMPUTER NETWORKS, FOR USE IN DOCUMENT MANAGEMENT, FOR SEARCHING, BROWSING AND RECEIVING TRANSMISSIONS OF TEXT, ELECTRONIC DOCUMENTS, GRAPHICS AND AUDIOVISUAL INFORMATION ON LOCAL REMOTE AREA, GLOBAL COMPUTER NETWORKS, ON INTRANETS OR DIRECTORIES OF INFORMATION AVAILABLE ON COMPUTER NETWORKS, FOR USE IN SOFTWARE DEVELOPMENT AND WEB AUTHORING, FOR USE IN EXCHANGING INFORMATION VIA GLOBAL COMPUTER NETWORKS AND ONLINE FROM A COMPUTER DATABASE AND THE INTERNET, FOR BUSINESS USE FOR FINANCIAL MANAGEMENT, FINANCIAL PLANNING, BUSINESS MANAGEMENT, CUSTOMER RELATIONSHIP MANAGEMENT (CRM), INVENTORY MANAGEMENT, SALES FORCE MANAGEMENT, PLANNING AND MANAGEMENT OF PERSONAL AND BUSINESS FINANCES, AND MARKETING INFORMATION MANAGEMENT, DATA MINING, HIGH-SPEED MASSIVE ECOMMERCE DATA PROCESSING, AND DATA CUSTOMIZATION ALL IN THE FIELD OF E-COMMERCE; COMPACT DISCS FEATURING MUSIC, COMPUTER PROGRAMS AND COMPUTER SOFTWARE IN THE FIELD OF BUSINESS FOR USE IN FINANCIAL MANAGEMENT, FINANCIAL PLANNING, BUSINESS MANAGEMENT, CUSTOMER RELATIONSHIP MANAGEMENT (CRM), INVENTORY MANAGEMENT, SALES FORCE MANAGEMENT, PLANNING AND MANAGEMENT OF PERSONAL AND BUSINESS FINANCES, AND MARKETING INFORMATION MANAGEMENT, ALL IN THE FIELD OF E-COMMERCE; DIGITAL MUSIC DOWNLOADABLE FROM THE INTERNET; TELECOMMUNICATIONS APPARATUS DEVICES, NAMELY, VOIP PHONES, ELECTRONIC FACSIMILE APPARATUS, PORTABLE DIGITAL ELECTRONIC DEVICE FOR SENDING AND RECEIVING ELECTRONIC MAILS, AND INSTANT MESSAGING COMMUNICATION TOOL IN THE NATURE OF PORTABLE TELECOMMUNICATION INSTANT MESSAGING DEVICES; MOUSE PADS; MOBILE PHONE HANDSETS, NAMELY, MOBILE PHONES; MOBILE PHONE ACCESSORIES DEVICES, NAMELY, BATTERY CHARGERS, CASES, COVERS, EAR PHONES AND DEVICES FOR HANDS-FREE USE OF MOBILE PHONES; SPECTACLES AND SUNGLASSES, IN CLASS 9 (U.S. CLS. 21, 23, 26, 36 AND 38).

FOR: ADVERTISING; BUSINESS MANAGEMENT; BUSINESS ADMINISTRATION; PROVIDING OFFICE FUNCTIONS; DATABASE MANAGEMENT; MARKET RESEARCH AND BUSINESS CONSULTING SERVICES; BUSINESS CONSULTANCY SERVICES RELATING TO FACILITATING THE TRANSACTION OF BUSINESS VIA LOCAL AND GLOBAL COMPUTER NETWORKS BY LOCATING AND PROVIDING REFERRALS FOR THE DELIVERY OF A WIDE VARIETY OF BUSINESS AND CONSUMER PRODUCTS AND SERVICES; PROVIDING OF BUSINESS INFORMATION OF GOODS AND SERVICES OF OTHERS VIA LOCAL AND GLOBAL COMPUTER NETWORKS; BUSINESS CONSULTANCY SERVICES IN THE FIELD OF GLOBAL COMPUTER WEB SITES WHERE THIRD PARTIES CAN OFFER AND SOURCE GOODS AND SERVICES, PLACE, DETERMINE THE STATUS OF AND FULFILL TRADE LEADS AND ORDERS, ENTER INTO CONTRACTS AND TRANSACT BUSINESS; PROVIDING COMPUTERIZED ONLINE ORDERING SERVICES FEATURING A WIDE VARIETY OF CONSUMER, BUSINESS AND INDUSTRIAL PRODUCTS; ADVERTISING OF GOODS AND SERVICES OF OTHERS VIA LOCAL AND GLOBAL COMPUTER NETWORKS; INTERNATIONAL IMPORT AND EXPORT AGENCY SERVICES; RENTAL OF ADVERTISING SPACE ON COMMUNICATION MEDIA; ONLINE TRADING SERVICES IN THE NATURE OF ONLINE AUCTIONEERING SERVICES VIA THE INTERNET AND PROVIDING ONLINE BUSINESS EVALUATION RELATING THERETO; ONLINE RETAIL STORE SERVICES FEATURING A WIDE VARIETY OF CONSUMER GOODS OF OTHERS; BUSINESS CONSULTANCY SERVICES IN THE FIELD OF OPERATING AN ELECTRONIC MARKETPLACE FOR THE BUYERS AND SELLERS OF GOODS AND/OR SERVICES ON A GLOBAL COMPUTER NETWORK; BUSINESS ADMINISTRATION AND MANAGEMENT ASSISTANCE FOR OTHERS IN THE FIELD OF FACILITATING BUSINESS TRANSACTION VIA LOCAL AND GLOBAL COMPUTER NETWORKS; CORPORATE BUSINESS MANAGEMENT CONSULTANCY SERVICES; MARKETING AND PROMOTION SERVICES; PUBLICATION OF PUBLICITY MATERIALS; REAL ESTATE MARKETING SERVICES, NAMELY, MARKETING OF VACANT PROPERTY IN THE NATURE OF CONDOMINIUMS, APARTMENTS, HOMES, COMMERCIAL STOREFRONTS, OFFICE BUILDINGS, WAREHOUSES, AND FACTORIES; DISSEMINATION OF ADVERTISING MATERIALS, UPDATING OF

Reg. No. 4,072,361 ADVERTISING MATERIALS, COMPILATION OF ADVERTISEMENTS FOR USE AS WEB PAGES ON THE INTERNET; RENTAL OF ADVERTISING SPACE; COMPUTER DATA PROCESSING; PROVIDING INFORMATION CONCERNING COMMERCIAL SALES, PROVIDING BUSINESS INFORMATION, PROMOTIONAL INFORMATION SERVICES, NAMELY, PROMOTING THE GOODS OF OTHERS BY PROVIDING INFORMATION REGARDING DISCOUNTS, COUPONS, REBATES, VOUCHERS AND SPECIAL OFFERS FOR THE GOODS OF OTHERS; TELEPHONE ANSWERING SERVICE; AUCTIONEERING PROVIDED ON THE INTERNET; PERSONNEL MANAGEMENT; PROVISION OF COMMERCIAL SALES INFORMATION, BUSINESS INFORMATION, ADVERTISING AND COMMERCIAL INFORMATION THROUGH A GLOBAL COMPUTER NETWORK AND VIA THE INTERNET; PRESENTATION OF GOODS ON COMMUNICATION MEDIA FOR RETAIL PURPOSES; THE BRINGING TOGETHER, FOR THE BENEFIT OF OTHERS, OF A VARIETY OF GOODS, ENABLING CUSTOMERS TO CONVENIENTLY VIEW AND PURCHASE THOSE GOODS FROM A GENERAL MERCHANDISE INTERNET WEB SITE SPECIALIZING IN THE MARKETING OF THE SALE OF GOODS AND SERVICES OF OTHERS; RETAIL AND WHOLESALE STORE SERVICES FEATURING TELEPHONES, MOBILE PHONE HANDSETS, MOBILE PHONE ACCESSORIES, ELECTRONIC AND TELECOMMUNICATIONS GOODS, COMPUTER HARDWARE AND COMPUTER SOFTWARE, BATTERIES, BATTERY CHARGERS, APPARATUS AND INSTRUMENTS FOR RECORDING, RECEIVING, TRANSMITTING AND/OR REPRODUCING DATA, INFORMATION, PICTURES, IMAGES AND/OR SOUND, PRECIOUS METALS, JEWELLERY, PRECIOUS STONES, PRINTED MATTER, STATIONERY AND MAGNETIC AND NON MAGNETICALLY ENCODED CARDS, FURNITURE, PICTURE FRAMES, HOUSEHOLD AND KITCHEN UTENSILS, GLASSWARE, PORCELAIN AND EARTHENWARE, TEXTILES, CLOTHING, FOOTWEAR, HEADGEAR, LACES AND EMBROIDERY, BUTTONS, RIBBONS, PINS AND NEEDLES, ARTIFICIAL FLOWERS, CARPETS, RUGS, GAMES AND ELECTRONIC TOYS, CHEMICALS USED IN INDUSTRY, SCIENCE, PHOTOGRAPHY AND AGRICULTURE, PAINTS, VARNISHES AND LACQUERS, PERSONAL HYGIENE PRODUCTS, SOAPS, PERFUMERY, COSMETICS, HAIR AND BODY LOTIONS, ESSENTIAL OILS, CLEANING AND BLEACHING PREPARATIONS, LUBRICANTS, FUELS, CANDLES, PHARMACEUTICAL, VETERINARY AND SANITARY PREPARATIONS, IRONMONGERY AND SMALL ITEMS OF METAL HARDWARE, MACHINES AND MACHINE TOOLS, CUTLERY, RAZORS AND HAND TOOLS, COMPUTERS, CALCULATING MACHINES, ELECTRICAL, PHOTOGRAPHIC, CINEMATOGRAPHIC AND OPTICAL APPARATUS AND INSTRUMENTS, SPECTACLES AND SUN GLASSES, SURGICAL AND MEDICAL APPARATUS AND INSTRUMENTS, APPARATUS FOR LIGHTING, HEATING, STEAM GENERATING, COOKING, REFRIGERATING, DRYING, VENTILATING, WATER SUPPLY AND SANITARY PURPOSES, VEHICLES, FIREARMS, FIREWORKS, SILVERWARE, HOROLOGICAL AND CHRONOMETRIC INSTRUMENTS, MUSICAL INSTRUMENTS, MAGAZINE, CARDS, PAPER AND CARDBOARD PRODUCTS, PICTURE, TYPEWRITERS AND OFFICE REQUISITES, PACKAGING MATERIALS, RUBBER AND PLASTICS FOR MANUFACTURE USE, PACKING AND INSULATING MATERIALS, LEATHER AND IMITATIONS OF LEATHER AND GOODS MADE FROM THESE MATERIALS, HANDBAGS, PURSES, WALLETS, LEATHER HOLDERS, BAGS, LUGGAGE, UMBRELLAS, MIRRORS, ROPES, STRING, NETS, TENTS, YARNS AND THREADS FOR TEXTILE USE, COAT HANGERS, PLACE MATS, DRESSMAKER'S ARTICLES, BED AND TABLE COVERS, PLAYTHINGS AND SPORTING ARTICLES, FOODSTUFFS AND BEVERAGES, MEAT, FISH, POULTRY, PRESERVED, DRIED AND COOKED FRUITS AND VEGETABLES, JAMS AND FRUIT SAUCES, EGGS, MILK AND MILK PRODUCTS, EDIBLE OILS AND FATS, COFFEE, TEA, COCOA, SUGAR, RICE, FLOUR, BREAD AND CAKES, CONDIMENTS, FRESH FRUIT AND VEGETABLES, BEER, MINERAL WATER, FRUIT JUICES AND OTHER NONALCOHOLIC DRINKS, ALCOHOLIC BEVERAGES, FLORAL PRODUCTS, TOBACCO, SMOKERS' ARTICLES AND MATCHES; DIRECT MAIL ADVERTISING; BUYING AND SELLING AGENCY SERVICES, NAMELY, PURCHASING A WIDE VARIETY OF CONSUMER, BUSINESS AND INDUSTRIAL PRODUCTS AND SERVICES FOR OTHERS; SELECTION AND PROCUREMENT OF GOODS, NAMELY, PURCHASING OF A WIDE VARIETY OF CONSUMER, BUSINESS AND INDUSTRIAL PRODUCTS AND SERVICES FOR INDIVIDUALS AND BUSINESSES; CATALOG AND ONLINE ORDERING SERVICES FEATURING THE GENERAL CONSUMER GOODS OF OTHERS; SECRETARIAL SERVICES; PROVIDING

Reg. No. 4,072,361 STATISTICAL INFORMATION; ORGANIZATION OF EXHIBITIONS FOR COMMERCIAL OR ADVERTISING PURPOSES; BUSINESS SERVICES, NAMELY, THE COMPILATION AND RENTAL OF MARKETING MAILING LISTS; BUSINESS INVESTIGATION; BUSINESS ADMINISTRATION CONSULTATION SERVICES IN THE FIELD OF PROCESSING OF SALES MADE ON THE INTERNET; BUSINESS NETWORKING SERVICES AND PERSONNEL PLACEMENT; IMPORT-EXPORT AGENCIES; SUBSCRIPTIONS TO NEWSPAPERS; DOCUMENT REPRODUCTION; TRANSCRIPTION SERVICES, NAMELY, CONFERENCE CALL, MESSAGE AND STENOGRAPHIC TRANSCRIPTION; RENTAL OF OFFICE EQUIPMENT; CUSTOMER RELATIONSHIP MANAGEMENT; BUSINESS MANAGEMENT SERVICES RELATING TO ELECTRONIC COMMERCE; TAX INFORMATION SERVICES; AND ART GALLERY SERVICES, IN CLASS 35 (U.S. CLS. 100, 101 AND 102).

FOR: INSURANCE AGENCIES; FINANCIAL AFFAIRS AND MONETARY AFFAIRS, NAMELY, FINANCIAL ANALYSIS AND ONLINE ESCROW SERVICE FOR EXCHANGE OF GOODS AND SERVICES; REAL ESTATE AFFAIRS, NAMELY, ASSESSMENT AND MANAGEMENT OF REAL ESTATE, PROVIDING INFORMATION IN THE FIELD OF REAL ESTATE VIA THE INTERNET; CLEARING AND RECONCILING FINANCIAL TRANSACTIONS VIA A GLOBAL COMPUTER NETWORK, NAMELY, PROVIDING SECURE COMMERCIAL TRANSACTIONS AND PAYMENT OPTIONS; ONLINE BANKING SERVICES AND ONLINE FINANCIAL PLANNING SERVICES; CREDIT CARD SERVICES; ELECTRONIC PAYMENT, NAMELY, ELECTRONIC PROCESSING AND TRANSMISSION OF BILL PAYMENT DATA; INSURANCE UNDERWRITING FOR FINANCIAL TRANSACTIONS; ELECTRONIC FUNDS TRANSFER SERVICES; TRANSFER OF FUNDS BY ELECTRONIC MEANS FOR OTHERS; TRANSMISSION OF ELECTRONIC PAYMENT DATA FOR OTHERS VIA THE INTERNET; FINANCIAL SERVICES IN THE NATURE OF CREDIT CARD AND DEBIT CARD PAYMENT PROCESSING SERVICES; REAL ESTATE SERVICES, NAMELY, ARRANGEMENT AND MANAGEMENT OF LEASES AND TENANCY; RENTING AND LEASING OF REAL ESTATE; REAL ESTATE APPRAISAL; REAL ESTATE VALUATION, REAL ESTATE FINANCING, REAL ESTATE INVESTMENT; REAL ESTATE BROKERAGE SERVICES; REAL ESTATE AGENCY SERVICES; HOUSING AGENCY SERVICES; ACTUARIAL SERVICES; REAL ESTATE MANAGEMENT AND CONSULTANCY SERVICES; RENT COLLECTION; RENTAL OF OFFICES; RENTAL OF APARTMENTS AND FLATS; PROVISION OF FINANCIAL INFORMATION VIA THE INTERNET; SAFETY DEPOSIT BOX SERVICES AND ISSUING OF TRAVEL VOUCHERS SERVICES, NAMELY, PROVIDING VOUCHERS FOR PAYMENT OF TRANSPORTATION EXPENSES; CAPITAL INVESTMENT SERVICES; FINANCIAL EVALUATION; FINANCIAL AND FINANCIAL ASSET MANAGEMENT SERVICES; INSURANCE AND FINANCIAL INFORMATION AND CONSULTANCY SERVICES; FINANCIAL ANALYSIS SERVICES PROVIDED BY TELECOMMUNICATION MEANS; FINANCIAL CONSULTANCY AND ADVISORY SERVICES; HOME BANKING; BANKING SERVICES PROVIDED ON-LINE FROM A COMPUTER DATABASE OR THE INTERNET; SECURITIES BROKERAGE SERVICES, STOCK EXCHANGE QUOTATION SERVICES; STOCKS AND BONDS BROKERAGE, FINANCIAL ANALYSIS; DEBIT CARD SERVICES, CHARGE CARD SERVICES AND CHECK VERIFICATION SERVICES; BANKING, SAVINGS ACCOUNT AND INVESTMENT BANKING SERVICES; FINANCIAL CLEARING HOUSE SERVICES; CREDIT CARD VERIFICATION VIA GLOBAL COMPUTER INFORMATION NETWORK; ELECTRONIC CREDIT RISK MANAGEMENT SERVICES; PRE-PAID PURCHASE CARD SERVICES, NAMELY, PROCESSING ELECTRONIC PAYMENTS MADE THROUGH PREPAID CARDS AND ELECTRONIC BILL PAYMENT SERVICES; FINANCIAL SERVICES, NAMELY, DEBT SETTLEMENT AND PROVIDING ELECTRONIC PROCESSING OF CREDIT CARD TRANSACTIONS AND ELECTRONIC PAYMENTS VIA A GLOBAL COMPUTER NETWORK; ELECTRONIC BANKING SERVICES VIA GLOBAL COMPUTER NETWORK; ISSUANCE OF STORED VALUE CARDS, AND CHARGE CARDS AND DEBIT CARD SERVICES; TELEPHONE CREDIT CARDS SERVICES, NAMELY, TELEPHONE CALLING CARDS SERVICES; PROVIDING FINANCE AND INSURANCE INFORMATION ONLINE FROM A COMPUTER DATABASE OR INTERNET; COLLECTION AGENCY FOR COLLECTION OF GAS AND ELECTRICITY FEES; ANTIQUE APPRAISAL; ART APPRAISAL; JEWELRY APPRAISAL; USED CAR APPRAISAL; CHARITABLE FUND RAISING; RENTAL OF PAPER MONEY AND COIN COUNTING MACHINES; RENTAL OF CASH DISPENSERS OR

Reg. No. 4,072,361 AUTOMATED-TELLER MACHINES; ONLINE PAYMENT SERVICES, NAMELY, ELECTRONIC PROCESSING OF CREDIT CARD TRANSACTIONS AND ELECTRONIC PAYMENTS VIA A GLOBAL COMPUTER NETWORK; AUTHENTICATION AND VERIFICATION SERVICES, NAMELY, CREDIT CARD AND CHECK VERIFICATION IN RELATION TO ONLINE PAYMENT OR TRANSFER OF FUNDS; MAILING LIST BROKERAGE SERVICES, IN CLASS 36 (U.S. CLS. 100, 101 AND 102).

FOR: TELECOMMUNICATIONS ACCESS SERVICES; PROVISION OF TELECOMMUNICATION ACCESS TO COMPUTER DATABASE AND TO THE INTERNET AND PROVIDING ONLINE COMMUNICATIONS LINKS WHICH TRANSFER THE USER TO OTHER LOCAL AND GLOBAL WEB PAGES; TELECOMMUNICATIONS SERVICES, NAMELY, THE ELECTRONIC TRANSMISSION OF DATA AND DOCUMENTS; PROVIDING TELECOMMUNICATIONS CONNECTIONS TO THE INTERNET OR DATA BASES; PROVISION OF TELECOMMUNICATION ACCESS TO THE WORLD-WIDE WEB; COMMUNICATION BY COMPUTER TERMINALS; COMMUNICATION BY FIBER OPTIC NETWORKS; ELECTRONIC TRANSMISSION OF MESSAGES AND IMAGES BY COMPUTER; FACSIMILE TRANSMISSION; MESSAGE SENDING; PAGING SERVICES; RENTAL OF MODEMS; TRANSMISSION OF DATA BY ELECTRONIC MEANS; RENTAL OF TELECOMMUNICATION EQUIPMENT; ELECTRONIC MESSAGE SENDING, RECEIVING AND FORWARDING SERVICES; TRANSMISSION AND DELIVERY OF DATA BY ELECTRONIC MEANS; ELECTRONIC TRANSMISSION AND DELIVERY OF MAIL MESSAGES, STILL PICTURE AND/OR MOVING PICTURE INFORMATION SUCH AS CHARACTERS, MESSAGES, MUSIC AND IMAGES, TELEGRAMS, INFORMATION AND DATA BY ELECTRONIC, TELEPHONE, TELEGRAPH, CABLE, COMPUTER AND SATELLITE MEANS; TRANSMISSION, BROADCAST AND RECEPTION OF AUDIO, VIDEO, STILL AND MOVING IMAGES AND DATA WHETHER IN COMPRESSED OR UNCOMPRESSED FORM AND WHETHER IN REAL OR DELAYED TIME; ELECTRONIC MESSAGING SERVICES, TELEPHONE, VIDEO AND WEB CONFERENCING SERVICES AND ORDER TRANSMISSION SERVICES; VIDEO CONFERENCING SERVICES; PROVIDING AN ELECTRONIC BULLETIN BOARD THAT ENABLES USERS TO PERFORM A REAL-TIME INTERACTIVE TALK BETWEEN A COMPUTER TERMINAL AND AN ELECTRONIC BULLETIN BOARD CONTAINING STILL PICTURE AND MOVING PICTURE INFORMATION AND VOICE INFORMATION CONCERNING BUSINESS AND E-COMMERCE; PROVIDING ELECTRONIC BULLETIN BOARDS AND MESSAGE BOARDS FOR TRANSMISSION OF MESSAGES AMONG USERS CONCERNING BUSINESS AND E-COMMERCE; PROVIDING AN ONLINE DISCUSSION FORUMS FOR TRANSMISSION OF MESSAGES AMONG COMPUTER USERS CONCERNING BUSINESS AND E-COMMERCE; TELEVISION BROADCASTING SERVICES; BROADCASTING AND TRANSMISSION OF RADIO AND TELEVISION PROGRAMS; MUSIC BROADCASTING IN THE NATURE OF AUDIO BROADCASTING; TRANSMISSION OF MUSIC, FILMS, VIDEOS, VIA A GLOBAL COMPUTER NETWORK OR THE INTERNET; ELECTRONIC TRANSMISSION OF INFORMATION IN THE FIELD OF ON-LINE SHOPPING AND GENERAL RETAIL SERVICES; VIDEO-ON-DEMAND TRANSMISSION SERVICES; NEWS AGENCY SERVICES FOR ELECTRONIC TRANSMISSION; PROVIDING ACCESS TO COMPUTER DATABASES ON THE GLOBAL COMPUTER NETWORK; PROVIDING CHAT ROOM SERVICES OR TRANSMISSION OF MESSAGES AMONG COMPUTER USERS CONCERNING BUSINESS AND E-COMMERCE; PROVIDING MULTIPLE USER ACCESS TO GLOBAL COMPUTER INFORMATION NETWORKS; COMMUNICATION SERVICES, NAMELY, TEXT AND NUMERIC WIRELESS DIGITAL MESSAGING SERVICES; TRANSMISSION OF INFORMATION AND DATA COMMUNICATIONS FOR ASSISTING DECISION MAKING; TRANSMISSION OF INFORMATION THROUGH VIDEO COMMUNICATION SYSTEMS; WEB CONFERENCING SERVICES; PROVIDING ELECTRONIC BULLETIN BOARDS FOR THE POSTING AND TRANSMISSION OF MESSAGES AMONG AND BETWEEN COMPUTER USERS CONCERNING CONSUMER PRODUCTS, SERVICES AND BUSINESS LEADS AND OPPORTUNITIES; PROVIDING AN ONLINE INTERACTIVE BULLETIN BOARD FOR THE POSTING, PROMOTION, SALE AND RESALE OF ITEMS VIA A GLOBAL COMPUTER NETWORK; PROVIDING ELECTRONIC MAIL AND ELECTRONIC MAIL FORWARDING SERVICES; AUDIO AND VIDEO COMMUNICATION VIA COMPUTERS AND COMPUTER NETWORKS, AND VIA A GLOBAL COMMUNICATIONS NETWORK; PROVIDING COMPUTER ACCESS TO ONLINE

Reg. No. 4,072,361 INTERACTIVE BULLETIN BOARDS AND DATABASES, IN CLASS 38 (U.S. CLS. 100, 101 AND 104).

FOR: TRANSPORT, NAMELY, TRANSPORTATION OF PASSENGERS AND GOODS BY RAIL; PACKAGING OF ARTICLES FOR TRANSPORTATION AND STORAGE OF GOODS; ARRANGING TRAVEL TOURS; ELECTRONIC STORAGE OF DATA OR DOCUMENTS; TRANSPORTATION INFORMATION; SHIP BROKERAGE; CAR TRANSPORT; AIR TRANSPORT; VEHICLE RENTAL; WATER SUPPLYING; MESSAGE DELIVERY; TRAVEL RESERVATION, NAMELY, MAKING RESERVATIONS AND BOOKING FOR TRANSPORTATION; TRANSPORT BY PIPELINE; DELIVERY OF GOODS BY MAIL ORDER; COURIER SERVICES; LOGISTIC MANAGEMENT RELATING TO TRANSPORT, NAMELY, STORAGE, TRANSPORTATION AND DELIVERY OF GOODS FOR OTHERS BY AIR, RAIL, SHIP OR TRUCK; CAR RENTAL SERVICES; CAR PARKING SERVICES; YACHT AND BOAT CHARTERING; TRAVEL AGENCY SERVICES, NAMELY, MAKING RESERVATIONS AND BOOKINGS FOR TRANSPORTATION; ONLINE TRAVEL RESERVATION SERVICES AND PROVIDING TRAVEL INFORMATION; TRAVEL TICKET RESERVATION SERVICES; ARRANGING TRAVEL TOURS, AND PROVIDING TRAVEL INFORMATION ON-LINE FROM A COMPUTER DATABASE OR THE INTERNET; PROVISION OF INFORMATION RELATING TO TRAVEL AND TOUR THROUGH THE INTERNET OR THROUGH TELECOMMUNICATION NETWORKS; TRANSPORT OF GOODS AND PASSENGERS; MERCHANDISE PACKAGING FOR OTHERS; PROVIDING ROAD AND TRAFFIC INFORMATION, CHAUFFEUR SERVICES; LOADING AND UNLOADING OF CARGO; FREIGHT BROKERAGE; RENTAL, LEASING AND CHARTERING OF SHIPS AND BOATS; SALVAGE AND REFLOATING OF SHIPS AND BOATS; PILOTING; GAS DISTRIBUTION AND SUPPLY; ELECTRICITY DISTRIBUTION; HEAT DISTRIBUTION AND SUPPLY; WATER DISTRIBUTION AND SUPPLY; PROVIDING MOORING FACILITY SERVICES; RENTAL OF WAREHOUSES; RENTAL OR LEASING OF WHEEL CHAIRS; PROVIDING CAR PARKING FACILITIES; RENTAL AND LEASING OF AIRPLANES; RENTAL AND LEASING OF DELIVERY OR STORAGE CONTAINERS; RENTAL AND LEASING OF BICYCLES; RENTAL AND LEASING OF CARS; RENTAL AND LEASING OF SHIPS OR BOATS; RENTAL AND LEASING OF MAN-POWERED VEHICLES; RENTAL AND LEASING OF MECHANICAL PARKING SYSTEMS; RENTAL AND LEASING OF PALLETS; RENTAL AND LEASING OF PACKAGING OR WRAPPING MACHINES; RENTAL AND LEASING OF REFRIGERATORS; COLLECTION OF DOMESTIC WASTE AND TRASH; COLLECTION OF INDUSTRIAL WASTE AND TRASH, IN CLASS 39 (U.S. CLS. 100 AND 105).

FOR: EDUCATION SERVICES, NAMELY, PROVIDING SEMINARS AND CONFERENCES IN THE FIELD OF BUSINESS AND E-COMMERCE; PROVIDING OF TRAINING IN THE FIELD OF BUSINESS AND E-COMMERCE; ORGANIZING SPORTING AND CULTURAL EVENTS; PUBLICATION OF TEXTS, BOOKS AND JOURNALS; PUBLICATION OF NEWSPAPERS, MAGAZINES AND PERIODICALS CONTAINING DIAGRAMS, IMAGES AND PHOTOGRAPHS; EDUCATION, NAMELY, TRAINING COURSES AND INSTRUCTIONAL CLASSES IN THE FIELD OF TELECOMMUNICATIONS HARDWARE AND SOFTWARE, OPERATION OF COMPUTERS, COMPUTER PROGRAMMING, WEB SITE DESIGN, E-COMMERCE, BUSINESS MANAGEMENT AND ADVERTISING; PROVIDING INFORMATION ABOUT EDUCATION, RECREATION ACTIVITIES, INSTRUCTION AND TRAINING BOTH INTERACTIVE AND NON-INTERACTIVE IN THE FIELD OF BUSINESS AND E-COMMERCE; DEVELOPMENT OF EDUCATIONAL COURSES AND EXAMINATIONS FOR OTHERS; ENTERTAINMENT PROVIDED VIA ELECTRONIC AND DIGITAL INTERACTIVE MEDIA, NAMELY, PROVIDING ON-LINE COMPUTER GAMES; PROVISION OF INFORMATION ABOUT EDUCATION, ENTERTAINMENT INFORMATION, INFORMATION IN THE FIELD OF SPORTS AND SPORTING EVENTS, AND INFORMATION IN THE FIELD OF RECREATION AND LEISURE ACTIVITIES AND CULTURAL ACTIVITIES AND EXHIBITIONS; PROVIDING ON-LINE NON-DOWNLOADABLE ELECTRONIC PUBLICATIONS IN THE NATURE OF BOOKS, JOURNALS, NEWSLETTERS AND ARTICLES IN THE FIELD OF BUSINESS AND E-COMMERCE; ARRANGING, ORGANIZING, HOSTING AND CONDUCTING SINGING COMPETITIONS; ARRANGING, ORGANIZING, HOSTING AND CONDUCTING MUSICAL CONCERTS; ENTERTAINMENT TICKET AGENCY SERVICES; ENTERTAINMENT

Reg. No. 4,072,361 INFORMATION AND INFORMATION ABOUT EDUCATION, PROVIDED ONLINE FROM A COMPUTER DATABASE OR THE INTERNET; PROVIDING NON-DOWNLOADABLE PRERECORDED DIGITAL MUSIC FROM THE INTERNET; PROVIDING NON-DOWNLOADABLE PRERECORDED DIGITAL MUSIC FROM MP3 INTERNET WEB SITES; ENTERTAINMENT AND EDUCATION SERVICES, NAMELY, PROVIDING COURSES OF INSTRUCTION ABOUT PLANNING, PRODUCTION AND DISTRIBUTION OF SOUND, IMAGES, DIGITAL MUSIC, MOVIES AND LIVE OR RECORDED AUDIO, VISUAL OR AUDIOVISUAL MATERIAL FOR BROADCASTING ON TERRESTRIAL CABLE, SATELLITE CHANNELS, THE INTERNET, WIRELESS OR WIRE-LINK SYSTEMS AND OTHER MEANS OF COMMUNICATIONS; MUSIC ENTERTAINMENT SERVICES, NAMELY, LIVE MUSIC CONCERTS; RENTAL OF SOUND RECORDINGS; PROVIDING ON-GOING TELEVISION PROGRAMS IN THE FIELDS OF BUSINESS AND E-COMMERCE; ENTERTAINMENT, NAMELY, TELEVISION PROGRAMS IN THE NATURE OF GAME SHOWS; EDUCATIONAL, DOCUMENTARY AND NEWS PROGRAMS IN THE FIELD OF BUSINESS AND E-COMMERCE; NEWS REPORTERS SERVICES; PROVIDING NEWS IN THE FIELD OF SPORTING OR CULTURAL EVENTS AND CURRENT EVENTS REPORTING PROVIDED BY SATELLITE TELEVISION, THE INTERNET OR RADIO; PRODUCTION OF TELEVISION AND RADIO PROGRAMS AND FILM PRODUCTION; PROVISION OF FACILITIES FOR RECREATION ACTIVITY, SPORTING AND GYMNASIUM FACILITIES; LIVE PERFORMANCES BY MUSICAL BANDS; NIGHT CLUB SERVICES, DISCOTHEQUES, AND ARRANGING FASHION SHOWS FOR ENTERTAINMENT PURPOSES; ORGANIZING AND CONDUCTING EXHIBITIONS FOR CULTURAL OR EDUCATIONAL PURPOSES; ARRANGING, CONDUCTING AND PROVISION OF CONFERENCES, CONVENTIONS, SEMINARS AND TRAINING WORKSHOPS IN THE FIELD OF BUSINESS AND E-COMMERCE; ART EXHIBITIONS; ART SERVICES, NAMELY, RENTAL OF ARTWORK; TRAINING SERVICES IN THE FIELD OF OCCUPATIONAL HEALTH AND SAFETY, AND ENVIRONMENTAL CONSERVATION; PROVISION OF CIGAR CLASSES, WINE TASTING CLASSES; PROVIDING EDUCATIONAL RESEARCH AND INFORMATION ABOUT EDUCATIONAL RESEARCH; ARRANGING, ORGANIZING, PLANNING AND RUNNING SEMINARS IN THE FIELD OF BUSINESS AND E-COMMERCE; ANIMAL TRAINING; DIRECTION IN PRODUCING PROGRAMS, NAMELY, OPERATION OF AUDIOVISUAL MACHINES AND EQUIPMENT FOR RADIO AND TELEVISION PROGRAMS; INSTRUCTIONAL SERVICES, NAMELY, TRAINING IN THE OPERATION OF AUDIOVISUAL MACHINES AND EQUIPMENT USED FOR THE PRODUCTION OF BROADCASTING PROGRAMS; PROVIDING AUDIO AND VISUAL STUDIOS; PROVIDING SPORTS FACILITIES; PROVIDING FACILITIES FOR MOVIES, SHOWS, PLAYS, MUSIC OR EDUCATIONAL TRAINING; ENTERTAINMENT BOOKING AGENCIES, NAMELY, BOOKING OF SEATS FOR SHOWS AND SPORTS EVENTS; RENTAL OF MOTION PICTURES; RENTAL AND LEASING OF MUSICAL INSTRUMENTS; RENTAL AND LEASING OF TELEVISION SETS; LENDING LIBRARIES; ARCHIVE LIBRARY SERVICES; SUBTITLING SERVICES, NAMELY, PREPARING SUBTITLES FOR MOVIES; SIGN LANGUAGE INTERPRETATION SERVICES; RENTAL OF COMPUTER GAME SOFTWARE; PROVIDING ONLINE VIDEO GAMES, COMPUTER GAMES; ENTERTAINMENT SERVICES, NAMELY, PROVIDING ON-LINE VIDEO GAMES, COMPUTER GAMES AND ARRANGING COMPUTER GAME CONTESTS; RENTAL OF PRE-RECORDED VIDEO TAPES; RENTAL AND LEASING OF GAME MACHINES; RENTAL OF ARCADE GAME EQUIPMENT; RENTAL OF MOTION PICTURES; PHOTOGRAPHY; TRANSLATION; LANGUAGE INTERPRETATION; PROVISION OF NEWS IN THE NATURE OF CURRENT EVENT REPORTING, IN CLASS 41 (U.S. CLS. 100, 101 AND 107).

FOR: SCIENTIFIC AND TECHNOLOGICAL SERVICES AND RESEARCH AND DESIGN RELATING THERETO, NAMELY, PROVIDING TEMPORARY USE OF ONLINE NON-DOWNLOADABLE SOFTWARE AND TEMPORARY USE OF ONLINE NON-DOWNLOADABLE CLOUD COMPUTING SOFTWARE FOR PLANNING AND MANAGEMENT OF PERSONAL AND BUSINESS FINANCES, E-COMMERCE DATA MINING, HIGH-SPEED MASSIVE E-COMMERCE DATA PROCESSING, AND DATA CUSTOMIZATION, CUSTOMER RELATIONSHIP MANAGEMENT, INVENTORY MANAGEMENT, SALES FORCE MANAGEMENT, AND MARKETING INFORMATION MANAGEMENT; DESIGN AND DEVELOPMENT OF COMPUTER HARDWARE AND SOFTWARE; DESIGN OF COMPUTERS, NOTEBOOK

Reg. No. 4,072,361 COMPUTERS, LAPTOP COMPUTERS, PORTABLE COMPUTERS AND HANDHELD COMPUTERS; DESIGN FOR OTHERS IN THE FIELD OF PERSONAL DIGITAL ASSISTANTS AND PERSONAL MEDIA PLAYERS; DESIGN FOR OTHERS IN THE FIELD OF MOBILE TELEPHONES AND SMART PHONES; DESIGN FOR OTHERS IN THE FIELD OF DIGITAL CAMERAS; COMPUTER SERVICES, NAMELY, COMPUTER SYSTEM ADMINISTRATION FOR OTHERS; COMPUTER PROGRAMMING; COMPUTER SYSTEM SOFTWARE SERVICES, NAMELY, DESIGN AND DEVELOPMENT OF ON-LINE COMPUTER SOFTWARE SYSTEMS; PROVIDING DIRECT CONNECTION SERVICES BETWEEN COMPUTER USERS FOR EXCHANGING DATA, NAMELY, PROVIDING TEMPORARY USE OF ONLINE NON-DOWNLOADABLE SOFTWARE FOR THE EXCHANGE OF DATA; COMPUTER SOFTWARE DESIGN; COMPUTER SYSTEM DESIGN; DESIGN AND DEVELOPMENT OF WEBPAGES; HOSTING WEBPAGES FOR OTHERS; HOSTING COMPUTER APPLICATION SOFTWARE FOR OTHERS FOR USE IN SEARCHING AND RETRIEVING INFORMATION FROM DATABASES AND COMPUTER NETWORKS; PROVIDING TECHNICAL INFORMATION AT THE SPECIFIC REQUEST OF END-USERS BY MEANS OF TELEPHONE OR GLOBAL COMPUTER NETWORK; COMPUTER SERVICES RELATING TO CUSTOMIZED SEARCHING OF COMPUTER DATABASES AND WEBSITES, NAMELY, PROVIDING CUSTOMIZED ONLINE WEB PAGES FEATURING USER-DEFINED INFORMATION WHICH INCLUDES ONLINE LINKS TO THIRD PARTY WEB SITES, IN CLASS 42 (U.S. CLS. 100 AND 101).

PRIORITY CLAIMED UNDER SEC. 44(D) ON HONG KONG APPLICATION NO. 301428598, FILED 9-15-2009, REG. NO. 301428598AA, DATED 9-15-2009, EXPIRES 9-15-2019.

THE NON-LATIN CHARACTERS IN THE MARK TRANSLITERATE TO A LI BA BA YUN JI SUAN, WHICH HAS NO MEANING AS A WHOLE. THE FIRST FOUR CHINESE CHARACTERS CAN MEAN "ALIBABA" AND THE LAST THREE CHINESE CHARACTERS CAN MEAN "CLOUD COMPUTING" IN ENGLISH.

PRIORITY CLAIMED UNDER SEC. 44(D) ON HONG KONG APPLICATION NO. 301428589, FILED 9-15-2009, REG. NO. 301428589AA, DATED 9-15-2009, EXPIRES 9-15-2019.

OWNER OF U.S. REG. NOS. 2,579,498, 2,851,634 AND OTHERS.

NO CLAIM IS MADE TO THE EXCLUSIVE RIGHT TO USE THE NON-LATIN CHARACTERS THAT TRANSLITERATE TO YUN JI SUAN, APART FROM THE MARK AS SHOWN.

THE MARK CONSISTS OF THE WORDS ALIBABA CLOUD COMPUTING IN CHINESE CHARACTERS.

SER. NO. 77-829,039, FILED 9-17-2009.

ELLEN PERKINS, EXAMINING ATTORNEY

United States of America

United States Patent and Trademark Office

阿里云计算

Reg. No. 4,072,362

Registered Dec. 20, 2011

**Int. Cls.: 9, 35, 36, 38, 39,
41 and 42**

TRADEMARK

SERVICE MARK

PRINCIPAL REGISTER

ALIBABA GROUP HOLDING LIMITED (CAYMAN ISLANDS CORPORATION)
FOURTH FLOOR, ONE CAPITAL PLACE
P.O. BOX 847
GRAND CAYMAN, CAYMAN ISLANDS

FOR: SCIENTIFIC, NAUTICAL, SURVEYING, PHOTOGRAPHIC, CINEMATOGRAPHIC, OPTICAL, WEIGHING, MEASURING, SIGNALLING, CHECKING, LIFE-SAVING AND TEACHING APPARATUS AND INSTRUMENTS, NAMELY, TELEPHONES, PUNCH CLOCKS, TIME RECORDING DEVICES, NAMELY, TIME CLOCKS, SCALES AND BALANCES, GRADUATED RULERS, ELECTRONIC POCKET TRANSLATORS, NEON SIGNS, ELECTRONIC NOTICE BOARDS, TRANSPARENCY PROJECTION APPARATUS, KILOMETER RECORDERS IN THE NATURE OF ODOMETERS FOR VEHICLES, TELESCOPES, MECHANISMS FOR COUNTER OPERATED APPARATUS, NAMELY, POINT-OF-SALE TERMINALS, FIRE EXTINGUISHERS, ACOUSTIC ALARMS, NAMELY, SMOKE AND FIRE ALARMS, EYEGLASSES, BATTERIES, EXPOSED FILMS, NAMELY, EXPOSED CAMERA FILM; APPARATUS AND INSTRUMENTS FOR CONDUCTING, SWITCHING, TRANSFORMING, ACCUMULATING, REGULATING OR CONTROLLING ELECTRICITY, NAMELY, ELECTRIC WIRES; ELECTRIC SWITCHES; ELECTROPLATING APPARATUS, NAMELY, ELECTROPLATING MACHINES, ELECTRIC WELDING APPARATUS, NAMELY, TORCHES; ELECTRIFIED FENCES, NAMELY, ELECTRIC FENCES; APPARATUS FOR RECORDING, TRANSMISSION OR REPRODUCTION OF SOUND OR IMAGES; BLANK MAGNETIC DATA CARRIERS AND RECORDING DISCS; AUTOMATIC VENDING MACHINES AND MECHANISMS FOR COIN-OPERATED APPARATUS; CASH REGISTERS, CALCULATING MACHINES, DATA PROCESSING EQUIPMENT AND COMPUTERS; NOTEBOOK COMPUTERS; LAPTOP COMPUTERS; PORTABLE COMPUTERS; HANDHELD COMPUTERS; PERSONAL DIGITAL ASSISTANTS; PORTABLE MEDIA PLAYERS; MOBILE TELEPHONES; SMART PHONES; DIGITAL CAMERAS; COMPUTER WORKSTATIONS COMPRISED OF COMPUTERS AND COMPUTER MONITORS; SERVERS, NAMELY, COMPUTER SERVERS; COMPUTER AND TELECOMMUNICATIONS NETWORKING COMPUTER HARDWARE; COMPUTER NETWORK ADAPTORS, SWITCHES, ROUTERS AND HUBS; WIRELESS AND WIRED MODEMS AND COMPUTER EQUIPMENT, NAMELY, WIRELESS CARDS; LAPTOP HOLDERS IN THE NATURE OF PROTECTIVE SLEEVES AND CARRYING CASES, COMPUTER BAGS; FIRE EXTINGUISHING APPARATUS; COMPUTER HARDWARE; COMPUTER SOFTWARE AND DOWNLOADABLE SOFTWARE FOR USE IN CONNECTION WITH THE PROVISION OF AN INTERACTIVE WEBSITE, NAMELY, FOR USE BY THIRD PARTIES TO POST INFORMATION, CREATE ELECTRONIC PRODUCT CATALOGS, RESPOND TO REQUESTS AND PLACE AND FULFILL ORDERS FOR PRODUCTS, SERVICES AND



David J. Kappas

Director of the United States Patent and Trademark Office

Reg. No. 4,072,362 BUSINESS OPPORTUNITIES VIA LOCAL AND GLOBAL COMPUTER NETWORKS, FOR USE IN DOCUMENT MANAGEMENT, FOR SEARCHING, BROWSING AND RECEIVING TRANSMISSIONS OF TEXT, ELECTRONIC DOCUMENTS, GRAPHICS AND AUDIOVISUAL INFORMATION ON LOCAL REMOTE AREA, GLOBAL COMPUTER NETWORKS, ON INTRANETS OR DIRECTORIES OF INFORMATION AVAILABLE ON COMPUTER NETWORKS, FOR USE IN SOFTWARE DEVELOPMENT AND WEB AUTHORING, FOR USE IN EXCHANGING INFORMATION VIA GLOBAL COMPUTER NETWORKS AND ONLINE FROM A COMPUTER DATABASE AND THE INTERNET, FOR BUSINESS USE FOR FINANCIAL MANAGEMENT, FINANCIAL PLANNING, BUSINESS MANAGEMENT, CUSTOMER RELATIONSHIP MANAGEMENT (CRM), INVENTORY MANAGEMENT, SALES FORCE MANAGEMENT, PLANNING AND MANAGEMENT OF PERSONAL AND BUSINESS FINANCES, AND MARKETING INFORMATION MANAGEMENT, DATA MINING, HIGH-SPEED MASSIVE ECOMMERCE DATA PROCESSING, AND DATA CUSTOMIZATION ALL IN THE FIELD OF E-COMMERCE; COMPACT DISCS FEATURING MUSIC, COMPUTER PROGRAMS AND COMPUTER SOFTWARE IN THE FIELD OF BUSINESS FOR USE IN FINANCIAL MANAGEMENT, FINANCIAL PLANNING, BUSINESS MANAGEMENT, CUSTOMER RELATIONSHIP MANAGEMENT (CRM), INVENTORY MANAGEMENT, SALES FORCE MANAGEMENT, PLANNING AND MANAGEMENT OF PERSONAL AND BUSINESS FINANCES, AND MARKETING INFORMATION MANAGEMENT, ALL IN THE FIELD OF E-COMMERCE; DIGITAL MUSIC DOWNLOADABLE FROM THE INTERNET; TELECOMMUNICATIONS APPARATUS DEVICES, NAMELY, VOIP PHONES, ELECTRONIC FACSIMILE APPARATUS, PORTABLE DIGITAL ELECTRONIC DEVICE FOR SENDING AND RECEIVING ELECTRONIC MAILS, AND INSTANT MESSAGING COMMUNICATION TOOL IN THE NATURE OF PORTABLE TELECOMMUNICATION INSTANT MESSAGING DEVICES; MOUSE PADS; MOBILE PHONE HANDSETS, NAMELY, MOBILE PHONES; MOBILE PHONE ACCESSORIES DEVICES, NAMELY, BATTERY CHARGERS, CASES, COVERS, EAR PHONES AND DEVICES FOR HANDS-FREE USE OF MOBILE PHONES; SPECTACLES AND SUNGLASSES, IN CLASS 9 (U.S. CLS. 21, 23, 26, 36 AND 38).

FOR: ADVERTISING; BUSINESS MANAGEMENT; BUSINESS ADMINISTRATION; PROVIDING OFFICE FUNCTIONS; DATABASE MANAGEMENT; MARKET RESEARCH AND BUSINESS CONSULTING SERVICES; BUSINESS CONSULTANCY SERVICES RELATING TO FACILITATING THE TRANSACTION OF BUSINESS VIA LOCAL AND GLOBAL COMPUTER NETWORKS BY LOCATING AND PROVIDING REFERRALS FOR THE DELIVERY OF A WIDE VARIETY OF BUSINESS AND CONSUMER PRODUCTS AND SERVICES; PROVIDING OF BUSINESS INFORMATION OF GOODS AND SERVICES OF OTHERS VIA LOCAL AND GLOBAL COMPUTER NETWORKS; BUSINESS CONSULTANCY SERVICES IN THE FIELD OF GLOBAL COMPUTER WEB SITES WHERE THIRD PARTIES CAN OFFER AND SOURCE GOODS AND SERVICES, PLACE, DETERMINE THE STATUS OF AND FULFILL TRADE LEADS AND ORDERS, ENTER INTO CONTRACTS AND TRANSACT BUSINESS; PROVIDING COMPUTERIZED ONLINE ORDERING SERVICES FEATURING A WIDE VARIETY OF CONSUMER, BUSINESS AND INDUSTRIAL PRODUCTS; ADVERTISING OF GOODS AND SERVICES OF OTHERS VIA LOCAL AND GLOBAL COMPUTER NETWORKS; INTERNATIONAL IMPORT AND EXPORT AGENCY SERVICES; RENTAL OF ADVERTISING SPACE ON COMMUNICATION MEDIA; ONLINE TRADING SERVICES IN THE NATURE OF ONLINE AUCTIONEERING SERVICES VIA THE INTERNET AND PROVIDING ONLINE BUSINESS EVALUATION RELATING THERETO; ONLINE RETAIL STORE SERVICES FEATURING A WIDE VARIETY OF CONSUMER GOODS OF OTHERS; BUSINESS CONSULTANCY SERVICES IN THE FIELD OF OPERATING AN ELECTRONIC MARKETPLACE FOR THE BUYERS AND SELLERS OF GOODS AND/OR SERVICES ON A GLOBAL COMPUTER NETWORK; BUSINESS ADMINISTRATION AND MANAGEMENT ASSISTANCE FOR OTHERS IN THE FIELD OF FACILITATING BUSINESS TRANSACTION VIA LOCAL AND GLOBAL COMPUTER NETWORKS; CORPORATE BUSINESS MANAGEMENT CONSULTANCY SERVICES; MARKETING AND PROMOTION SERVICES; PUBLICATION OF PUBLICITY MATERIALS; REAL ESTATE MARKETING SERVICES, NAMELY, MARKETING OF VACANT PROPERTY IN THE NATURE OF CONDOMINIUMS, APARTMENTS, HOMES, COMMERCIAL STOREFRONTS, OFFICE BUILDINGS, WAREHOUSES, AND FACTORIES; DISSEMINATION OF ADVERTISING MATERIALS, UPDATING OF

Reg. No. 4,072,362 ADVERTISING MATERIALS, COMPILATION OF ADVERTISEMENTS FOR USE AS WEB PAGES ON THE INTERNET; RENTAL OF ADVERTISING SPACE; COMPUTER DATA PROCESSING; PROVIDING INFORMATION CONCERNING COMMERCIAL SALES, PROVIDING BUSINESS INFORMATION, PROMOTIONAL INFORMATION SERVICES, NAMELY, PROMOTING THE GOODS OF OTHERS BY PROVIDING INFORMATION REGARDING DISCOUNTS, COUPONS, REBATES, VOUCHERS AND SPECIAL OFFERS FOR THE GOODS OF OTHERS; TELEPHONE ANSWERING SERVICE; AUCTIONEERING PROVIDED ON THE INTERNET; PERSONNEL MANAGEMENT; PROVISION OF COMMERCIAL SALES INFORMATION, BUSINESS INFORMATION, ADVERTISING AND COMMERCIAL INFORMATION THROUGH A GLOBAL COMPUTER NETWORK AND VIA THE INTERNET; PRESENTATION OF GOODS ON COMMUNICATION MEDIA FOR RETAIL PURPOSES; THE BRINGING TOGETHER, FOR THE BENEFIT OF OTHERS, OF A VARIETY OF GOODS, ENABLING CUSTOMERS TO CONVENIENTLY VIEW AND PURCHASE THOSE GOODS FROM A GENERAL MERCHANDISE INTERNET WEB SITE SPECIALIZING IN THE MARKETING OF THE SALE OF GOODS AND SERVICES OF OTHERS; RETAIL AND WHOLESALE STORE SERVICES FEATURING TELEPHONES, MOBILE PHONE HANDSETS, MOBILE PHONE ACCESSORIES, ELECTRONIC AND TELECOMMUNICATIONS GOODS, COMPUTER HARDWARE AND COMPUTER SOFTWARE, BATTERIES, BATTERY CHARGERS, APPARATUS AND INSTRUMENTS FOR RECORDING, RECEIVING, TRANSMITTING AND/OR REPRODUCING DATA, INFORMATION, PICTURES, IMAGES AND/OR SOUND, PRECIOUS METALS, JEWELLERY, PRECIOUS STONES, PRINTED MATTER, STATIONERY AND MAGNETIC AND NON MAGNETICALLY ENCODED CARDS, FURNITURE, PICTURE FRAMES, HOUSEHOLD AND KITCHEN UTENSILS, GLASSWARE, PORCELAIN AND EARTHENWARE, TEXTILES, CLOTHING, FOOTWEAR, HEADGEAR, LACES AND EMBROIDERY, BUTTONS, RIBBONS, PINS AND NEEDLES, ARTIFICIAL FLOWERS, CARPETS, RUGS, GAMES AND ELECTRONIC TOYS, CHEMICALS USED IN INDUSTRY, SCIENCE, PHOTOGRAPHY AND AGRICULTURE, PAINTS, VARNISHES AND LACQUERS, PERSONAL HYGIENE PRODUCTS, SOAPS, PERFUMERY, COSMETICS, HAIR AND BODY LOTIONS, ESSENTIAL OILS, CLEANING AND BLEACHING PREPARATIONS, LUBRICANTS, FUELS, CANDLES, PHARMACEUTICAL, VETERINARY AND SANITARY PREPARATIONS, IRONMONGERY AND SMALL ITEMS OF METAL HARDWARE, MACHINES AND MACHINE TOOLS, CUTLERY, RAZORS AND HAND TOOLS, COMPUTERS, CALCULATING MACHINES, ELECTRICAL, PHOTOGRAPHIC, CINEMATOGRAPHIC AND OPTICAL APPARATUS AND INSTRUMENTS, SPECTACLES AND SUN GLASSES, SURGICAL AND MEDICAL APPARATUS AND INSTRUMENTS, APPARATUS FOR LIGHTING, HEATING, STEAM GENERATING, COOKING, REFRIGERATING, DRYING, VENTILATING, WATER SUPPLY AND SANITARY PURPOSES, VEHICLES, FIREARMS, FIREWORKS, SILVERWARE, HOROLOGICAL AND CHRONOMETRIC INSTRUMENTS, MUSICAL INSTRUMENTS, MAGAZINE, CARDS, PAPER AND CARDBOARD PRODUCTS, PICTURE, TYPEWRITERS AND OFFICE REQUISITES, PACKAGING MATERIALS, RUBBER AND PLASTICS FOR MANUFACTURE USE, PACKING AND INSULATING MATERIALS, LEATHER AND IMITATIONS OF LEATHER AND GOODS MADE FROM THESE MATERIALS, HANDBAGS, PURSES, WALLETS, LEATHER HOLDERS, BAGS, LUGGAGE, UMBRELLAS, MIRRORS, ROPES, STRING, NETS, TENTS, YARNS AND THREADS FOR TEXTILE USE, COAT HANGERS, PLACE MATS, DRESSMAKER'S ARTICLES, BED AND TABLE COVERS, PLAYTHINGS AND SPORTING ARTICLES, FOODSTUFFS AND BEVERAGES, MEAT, FISH, POULTRY, PRESERVED, DRIED AND COOKED FRUITS AND VEGETABLES, JAMS AND FRUIT SAUCES, EGGS, MILK AND MILK PRODUCTS, EDIBLE OILS AND FATS, COFFEE, TEA, COCOA, SUGAR, RICE, FLOUR, BREAD AND CAKES, CONDIMENTS, FRESH FRUIT AND VEGETABLES, BEER, MINERAL WATER, FRUIT JUICES AND OTHER NONALCOHOLIC DRINKS, ALCOHOLIC BEVERAGES, FLORAL PRODUCTS, TOBACCO, SMOKERS' ARTICLES AND MATCHES; DIRECT MAIL ADVERTISING; BUYING AND SELLING AGENCY SERVICES, NAMELY, PURCHASING A WIDE VARIETY OF CONSUMER, BUSINESS AND INDUSTRIAL PRODUCTS AND SERVICES FOR OTHERS; SELECTION AND PROCUREMENT OF GOODS, NAMELY, PURCHASING OF A WIDE VARIETY OF CONSUMER, BUSINESS AND INDUSTRIAL PRODUCTS AND SERVICES FOR INDIVIDUALS AND BUSINESSES; CATALOG AND ONLINE ORDERING SERVICES FEATURING THE GENERAL CONSUMER GOODS OF OTHERS; SECRETARIAL SERVICES; PROVIDING

Reg. No. 4,072,362 STATISTICAL INFORMATION; ORGANIZATION OF EXHIBITIONS FOR COMMERCIAL OR ADVERTISING PURPOSES; BUSINESS SERVICES, NAMELY, THE COMPILATION AND RENTAL OF MARKETING MAILING LISTS; BUSINESS INVESTIGATION; BUSINESS ADMINISTRATION CONSULTATION SERVICES IN THE FIELD OF PROCESSING OF SALES MADE ON THE INTERNET; BUSINESS NETWORKING SERVICES AND PERSONNEL PLACEMENT; IMPORT-EXPORT AGENCIES; SUBSCRIPTIONS TO NEWSPAPERS; DOCUMENT REPRODUCTION; TRANSCRIPTION SERVICES, NAMELY, CONFERENCE CALL, MESSAGE AND STENOGRAPHIC TRANSCRIPTION; RENTAL OF OFFICE EQUIPMENT; CUSTOMER RELATIONSHIP MANAGEMENT; BUSINESS MANAGEMENT SERVICES RELATING TO ELECTRONIC COMMERCE; TAX INFORMATION SERVICES; AND ART GALLERY SERVICES, IN CLASS 35 (U.S. CLS. 100, 101 AND 102).

FOR: INSURANCE AGENCIES; FINANCIAL AFFAIRS AND MONETARY AFFAIRS, NAMELY, FINANCIAL ANALYSIS AND ONLINE ESCROW SERVICE FOR EXCHANGE OF GOODS AND SERVICES; REAL ESTATE AFFAIRS, NAMELY, ASSESSMENT AND MANAGEMENT OF REAL ESTATE, PROVIDING INFORMATION IN THE FIELD OF REAL ESTATE VIA THE INTERNET; CLEARING AND RECONCILING FINANCIAL TRANSACTIONS VIA A GLOBAL COMPUTER NETWORK, NAMELY, PROVIDING SECURE COMMERCIAL TRANSACTIONS AND PAYMENT OPTIONS; ONLINE BANKING SERVICES AND ONLINE FINANCIAL PLANNING SERVICES; CREDIT CARD SERVICES; ELECTRONIC PAYMENT, NAMELY, ELECTRONIC PROCESSING AND TRANSMISSION OF BILL PAYMENT DATA; INSURANCE UNDERWRITING FOR FINANCIAL TRANSACTIONS; ELECTRONIC FUNDS TRANSFER SERVICES; TRANSFER OF FUNDS BY ELECTRONIC MEANS FOR OTHERS; TRANSMISSION OF ELECTRONIC PAYMENT DATA FOR OTHERS VIA THE INTERNET; FINANCIAL SERVICES IN THE NATURE OF CREDIT CARD AND DEBIT CARD PAYMENT PROCESSING SERVICES; REAL ESTATE SERVICES, NAMELY, ARRANGEMENT AND MANAGEMENT OF LEASES AND TENANCY; RENTING AND LEASING OF REAL ESTATE; REAL ESTATE APPRAISAL; REAL ESTATE VALUATION, REAL ESTATE FINANCING, REAL ESTATE INVESTMENT; REAL ESTATE BROKERAGE SERVICES; REAL ESTATE AGENCY SERVICES; HOUSING AGENCY SERVICES; ACTUARIAL SERVICES; REAL ESTATE MANAGEMENT AND CONSULTANCY SERVICES; RENT COLLECTION; RENTAL OF OFFICES; RENTAL OF APARTMENTS AND FLATS; PROVISION OF FINANCIAL INFORMATION VIA THE INTERNET; SAFETY DEPOSIT BOX SERVICES AND ISSUING OF TRAVEL VOUCHERS SERVICES, NAMELY, PROVIDING VOUCHERS FOR PAYMENT OF TRANSPORTATION EXPENSES; CAPITAL INVESTMENT SERVICES; FINANCIAL EVALUATION; FINANCIAL AND FINANCIAL ASSET MANAGEMENT SERVICES; INSURANCE AND FINANCIAL INFORMATION AND CONSULTANCY SERVICES; FINANCIAL ANALYSIS SERVICES PROVIDED BY TELECOMMUNICATION MEANS; FINANCIAL CONSULTANCY AND ADVISORY SERVICES; HOME BANKING; BANKING SERVICES PROVIDED ON-LINE FROM A COMPUTER DATABASE OR THE INTERNET; SECURITIES BROKERAGE SERVICES, STOCK EXCHANGE QUOTATION SERVICES; STOCKS AND BONDS BROKERAGE, FINANCIAL ANALYSIS; DEBIT CARD SERVICES, CHARGE CARD SERVICES AND CHECK VERIFICATION SERVICES; BANKING, SAVINGS ACCOUNT AND INVESTMENT BANKING SERVICES; FINANCIAL CLEARING HOUSE SERVICES; CREDIT CARD VERIFICATION VIA GLOBAL COMPUTER INFORMATION NETWORK; ELECTRONIC CREDIT RISK MANAGEMENT SERVICES; PRE-PAID PURCHASE CARD SERVICES, NAMELY, PROCESSING ELECTRONIC PAYMENTS MADE THROUGH PREPAID CARDS AND ELECTRONIC BILL PAYMENT SERVICES; FINANCIAL SERVICES, NAMELY, DEBT SETTLEMENT AND PROVIDING ELECTRONIC PROCESSING OF CREDIT CARD TRANSACTIONS AND ELECTRONIC PAYMENTS VIA A GLOBAL COMPUTER NETWORK; ELECTRONIC BANKING SERVICES VIA GLOBAL COMPUTER NETWORK; ISSUANCE OF STORED VALUE CARDS, AND CHARGE CARDS AND DEBIT CARD SERVICES; TELEPHONE CREDIT CARDS SERVICES, NAMELY, TELEPHONE CALLING CARDS SERVICES; PROVIDING FINANCE AND INSURANCE INFORMATION ONLINE FROM A COMPUTER DATABASE OR INTERNET; COLLECTION AGENCY FOR COLLECTION OF GAS AND ELECTRICITY FEES; ANTIQUE APPRAISAL; ART APPRAISAL; JEWELRY APPRAISAL; USED CAR APPRAISAL; CHARITABLE FUND RAISING; RENTAL OF PAPER MONEY AND COIN COUNTING MACHINES; RENTAL OF CASH DISPENSERS OR

Reg. No. 4,072,362 AUTOMATED-TELLER MACHINES; ONLINE PAYMENT SERVICES, NAMELY, ELECTRONIC PROCESSING OF CREDIT CARD TRANSACTIONS AND ELECTRONIC PAYMENTS VIA A GLOBAL COMPUTER NETWORK; AUTHENTICATION AND VERIFICATION SERVICES, NAMELY, CREDIT CARD AND CHECK VERIFICATION IN RELATION TO ONLINE PAYMENT OR TRANSFER OF FUNDS; MAILING LIST BROKERAGE SERVICES, IN CLASS 36 (U.S. CLS. 100, 101 AND 102).

FOR: TELECOMMUNICATIONS ACCESS SERVICES; PROVISION OF TELECOMMUNICATION ACCESS TO COMPUTER DATABASE AND TO THE INTERNET AND PROVIDING ONLINE COMMUNICATIONS LINKS WHICH TRANSFER THE USER TO OTHER LOCAL AND GLOBAL WEB PAGES; TELECOMMUNICATIONS SERVICES, NAMELY, THE ELECTRONIC TRANSMISSION OF DATA AND DOCUMENTS; PROVIDING TELECOMMUNICATIONS CONNECTIONS TO THE INTERNET OR DATA BASES; PROVISION OF TELECOMMUNICATION ACCESS TO THE WORLD-WIDE WEB; COMMUNICATION BY COMPUTER TERMINALS; COMMUNICATION BY FIBER OPTIC NETWORKS; ELECTRONIC TRANSMISSION OF MESSAGES AND IMAGES BY COMPUTER; FACSIMILE TRANSMISSION; MESSAGE SENDING; PAGING SERVICES; RENTAL OF MODEMS; TRANSMISSION OF DATA BY ELECTRONIC MEANS; RENTAL OF TELECOMMUNICATION EQUIPMENT; ELECTRONIC MESSAGE SENDING, RECEIVING AND FORWARDING SERVICES; TRANSMISSION AND DELIVERY OF DATA BY ELECTRONIC MEANS; ELECTRONIC TRANSMISSION AND DELIVERY OF MAIL MESSAGES, STILL PICTURE AND/OR MOVING PICTURE INFORMATION SUCH AS CHARACTERS, MESSAGES, MUSIC AND IMAGES, TELEGRAMS, INFORMATION AND DATA BY ELECTRONIC, TELEPHONE, TELEGRAPH, CABLE, COMPUTER AND SATELLITE MEANS; TRANSMISSION, BROADCAST AND RECEPTION OF AUDIO, VIDEO, STILL AND MOVING IMAGES AND DATA WHETHER IN COMPRESSED OR UNCOMPRESSED FORM AND WHETHER IN REAL OR DELAYED TIME; ELECTRONIC MESSAGING SERVICES, TELEPHONE, VIDEO AND WEB CONFERENCING SERVICES AND ORDER TRANSMISSION SERVICES; VIDEO CONFERENCING SERVICES; PROVIDING AN ELECTRONIC BULLETIN BOARD THAT ENABLES USERS TO PERFORM A REAL-TIME INTERACTIVE TALK BETWEEN A COMPUTER TERMINAL AND AN ELECTRONIC BULLETIN BOARD CONTAINING STILL PICTURE AND MOVING PICTURE INFORMATION AND VOICE INFORMATION CONCERNING BUSINESS AND E-COMMERCE; PROVIDING ELECTRONIC BULLETIN BOARDS AND MESSAGE BOARDS FOR TRANSMISSION OF MESSAGES AMONG USERS CONCERNING BUSINESS AND E-COMMERCE; PROVIDING AN ONLINE DISCUSSION FORUMS FOR TRANSMISSION OF MESSAGES AMONG COMPUTER USERS CONCERNING BUSINESS AND E-COMMERCE; TELEVISION BROADCASTING SERVICES; BROADCASTING AND TRANSMISSION OF RADIO AND TELEVISION PROGRAMS; MUSIC BROADCASTING IN THE NATURE OF AUDIO BROADCASTING; TRANSMISSION OF MUSIC, FILMS, VIDEOS, VIA A GLOBAL COMPUTER NETWORK OR THE INTERNET; ELECTRONIC TRANSMISSION OF INFORMATION IN THE FIELD OF ON-LINE SHOPPING AND GENERAL RETAIL SERVICES; VIDEO-ON-DEMAND TRANSMISSION SERVICES; NEWS AGENCY SERVICES FOR ELECTRONIC TRANSMISSION; PROVIDING ACCESS TO COMPUTER DATABASES ON THE GLOBAL COMPUTER NETWORK; PROVIDING CHAT ROOM SERVICES OR TRANSMISSION OF MESSAGES AMONG COMPUTER USERS CONCERNING BUSINESS AND E-COMMERCE; PROVIDING MULTIPLE USER ACCESS TO GLOBAL COMPUTER INFORMATION NETWORKS; COMMUNICATION SERVICES, NAMELY, TEXT AND NUMERIC WIRELESS DIGITAL MESSAGING SERVICES; TRANSMISSION OF INFORMATION AND DATA COMMUNICATIONS FOR ASSISTING DECISION MAKING; TRANSMISSION OF INFORMATION THROUGH VIDEO COMMUNICATION SYSTEMS; WEB CONFERENCING SERVICES; PROVIDING ELECTRONIC BULLETIN BOARDS FOR THE POSTING AND TRANSMISSION OF MESSAGES AMONG AND BETWEEN COMPUTER USERS CONCERNING CONSUMER PRODUCTS, SERVICES AND BUSINESS LEADS AND OPPORTUNITIES; PROVIDING AN ONLINE INTERACTIVE BULLETIN BOARD FOR THE POSTING, PROMOTION, SALE AND RESALE OF ITEMS VIA A GLOBAL COMPUTER NETWORK; PROVIDING ELECTRONIC MAIL AND ELECTRONIC MAIL FORWARDING SERVICES; AUDIO AND VIDEO COMMUNICATION VIA COMPUTERS AND COMPUTER NETWORKS, AND VIA A GLOBAL COMMUNICATIONS NETWORK; PROVIDING COMPUTER ACCESS TO ONLINE

Reg. No. 4,072,362 INTERACTIVE BULLETIN BOARDS AND DATABASES, IN CLASS 38 (U.S. CLS. 100, 101 AND 104).

FOR: TRANSPORT, NAMELY, TRANSPORTATION OF PASSENGERS AND GOODS BY RAIL; PACKAGING OF ARTICLES FOR TRANSPORTATION AND STORAGE OF GOODS; ARRANGING TRAVEL TOURS; ELECTRONIC STORAGE OF DATA OR DOCUMENTS; TRANSPORTATION INFORMATION; SHIP BROKERAGE; CAR TRANSPORT; AIR TRANSPORT; VEHICLE RENTAL; WATER SUPPLYING; MESSAGE DELIVERY; TRAVEL RESERVATION, NAMELY, MAKING RESERVATIONS AND BOOKING FOR TRANSPORTATION; TRANSPORT BY PIPELINE; DELIVERY OF GOODS BY MAIL ORDER; COURIER SERVICES; LOGISTIC MANAGEMENT RELATING TO TRANSPORT, NAMELY, STORAGE, TRANSPORTATION AND DELIVERY OF GOODS FOR OTHERS BY AIR, RAIL, SHIP OR TRUCK; CAR RENTAL SERVICES; CAR PARKING SERVICES; YACHT AND BOAT CHARTERING; TRAVEL AGENCY SERVICES, NAMELY, MAKING RESERVATIONS AND BOOKINGS FOR TRANSPORTATION; ONLINE TRAVEL RESERVATION SERVICES AND PROVIDING TRAVEL INFORMATION; TRAVEL TICKET RESERVATION SERVICES; ARRANGING TRAVEL TOURS, AND PROVIDING TRAVEL INFORMATION ON-LINE FROM A COMPUTER DATABASE OR THE INTERNET; PROVISION OF INFORMATION RELATING TO TRAVEL AND TOUR THROUGH THE INTERNET OR THROUGH TELECOMMUNICATION NETWORKS; TRANSPORT OF GOODS AND PASSENGERS; MERCHANDISE PACKAGING FOR OTHERS; PROVIDING ROAD AND TRAFFIC INFORMATION, CHAUFFEUR SERVICES; LOADING AND UNLOADING OF CARGO; FREIGHT BROKERAGE; RENTAL, LEASING AND CHARTERING OF SHIPS AND BOATS; SALVAGE AND REFLOATING OF SHIPS AND BOATS; PILOTING; GAS DISTRIBUTION AND SUPPLY; ELECTRICITY DISTRIBUTION; HEAT DISTRIBUTION AND SUPPLY; WATER DISTRIBUTION AND SUPPLY; PROVIDING MOORING FACILITY SERVICES; RENTAL OF WAREHOUSES; RENTAL OR LEASING OF WHEEL CHAIRS; PROVIDING CAR PARKING FACILITIES; RENTAL AND LEASING OF AIRPLANES; RENTAL AND LEASING OF DELIVERY OR STORAGE CONTAINERS; RENTAL AND LEASING OF BICYCLES; RENTAL AND LEASING OF CARS; RENTAL AND LEASING OF SHIPS OR BOATS; RENTAL AND LEASING OF MAN-POWERED VEHICLES; RENTAL AND LEASING OF MECHANICAL PARKING SYSTEMS; RENTAL AND LEASING OF PALLETS; RENTAL AND LEASING OF PACKAGING OR WRAPPING MACHINES; RENTAL AND LEASING OF REFRIGERATORS; COLLECTION OF DOMESTIC WASTE AND TRASH; COLLECTION OF INDUSTRIAL WASTE AND TRASH, IN CLASS 39 (U.S. CLS. 100 AND 105).

FOR: EDUCATION SERVICES, NAMELY, PROVIDING SEMINARS AND CONFERENCES IN THE FIELD OF BUSINESS AND E-COMMERCE; PROVIDING OF TRAINING IN THE FIELD OF BUSINESS AND E-COMMERCE; ORGANIZING SPORTING AND CULTURAL EVENTS; PUBLICATION OF TEXTS, BOOKS AND JOURNALS; PUBLICATION OF NEWSPAPERS, MAGAZINES AND PERIODICALS CONTAINING DIAGRAMS, IMAGES AND PHOTOGRAPHS; EDUCATION, NAMELY, TRAINING COURSES AND INSTRUCTIONAL CLASSES IN THE FIELD OF TELECOMMUNICATIONS HARDWARE AND SOFTWARE, OPERATION OF COMPUTERS, COMPUTER PROGRAMMING, WEB SITE DESIGN, E-COMMERCE, BUSINESS MANAGEMENT AND ADVERTISING; PROVIDING INFORMATION ABOUT EDUCATION, RECREATION ACTIVITIES, INSTRUCTION AND TRAINING BOTH INTERACTIVE AND NON-INTERACTIVE IN THE FIELD OF BUSINESS AND E-COMMERCE; DEVELOPMENT OF EDUCATIONAL COURSES AND EXAMINATIONS FOR OTHERS; ENTERTAINMENT PROVIDED VIA ELECTRONIC AND DIGITAL INTERACTIVE MEDIA, NAMELY, PROVIDING ON-LINE COMPUTER GAMES; PROVISION OF INFORMATION ABOUT EDUCATION, ENTERTAINMENT INFORMATION, INFORMATION IN THE FIELD OF SPORTS AND SPORTING EVENTS, AND INFORMATION IN THE FIELD OF RECREATION AND LEISURE ACTIVITIES AND CULTURAL ACTIVITIES AND EXHIBITIONS; PROVIDING ON-LINE NON-DOWNLOADABLE ELECTRONIC PUBLICATIONS IN THE NATURE OF BOOKS, JOURNALS, NEWSLETTERS AND ARTICLES IN THE FIELD OF BUSINESS AND E-COMMERCE; ARRANGING, ORGANIZING, HOSTING AND CONDUCTING SINGING COMPETITIONS; ARRANGING, ORGANIZING, HOSTING AND CONDUCTING MUSICAL CONCERTS; ENTERTAINMENT TICKET AGENCY SERVICES; ENTERTAINMENT

Reg. No. 4,072,362 INFORMATION AND INFORMATION ABOUT EDUCATION, PROVIDED ONLINE FROM A COMPUTER DATABASE OR THE INTERNET; PROVIDING NON-DOWNLOADABLE PRERECORDED DIGITAL MUSIC FROM THE INTERNET; PROVIDING NON-DOWNLOADABLE PRERECORDED DIGITAL MUSIC FROM MP3 INTERNET WEB SITES; ENTERTAINMENT AND EDUCATION SERVICES, NAMELY, PROVIDING COURSES OF INSTRUCTION ABOUT PLANNING, PRODUCTION AND DISTRIBUTION OF SOUND, IMAGES, DIGITAL MUSIC, MOVIES AND LIVE OR RECORDED AUDIO, VISUAL OR AUDIOVISUAL MATERIAL FOR BROADCASTING ON TERRESTRIAL CABLE, SATELLITE CHANNELS, THE INTERNET, WIRELESS OR WIRE-LINK SYSTEMS AND OTHER MEANS OF COMMUNICATIONS; MUSIC ENTERTAINMENT SERVICES, NAMELY, LIVE MUSIC CONCERTS; RENTAL OF SOUND RECORDINGS; PROVIDING ON-GOING TELEVISION PROGRAMS IN THE FIELDS OF BUSINESS AND E-COMMERCE; ENTERTAINMENT, NAMELY, TELEVISION PROGRAMS IN THE NATURE OF GAME SHOWS; EDUCATIONAL, DOCUMENTARY AND NEWS PROGRAMS IN THE FIELD OF BUSINESS AND E-COMMERCE; NEWS REPORTERS SERVICES; PROVIDING NEWS IN THE FIELD OF SPORTING OR CULTURAL EVENTS AND CURRENT EVENTS REPORTING PROVIDED BY SATELLITE TELEVISION, THE INTERNET OR RADIO; PRODUCTION OF TELEVISION AND RADIO PROGRAMS AND FILM PRODUCTION; PROVISION OF FACILITIES FOR RECREATION ACTIVITY, SPORTING AND GYMNASIUM FACILITIES; LIVE PERFORMANCES BY MUSICAL BANDS; NIGHT CLUB SERVICES, DISCOTHEQUES, AND ARRANGING FASHION SHOWS FOR ENTERTAINMENT PURPOSES; ORGANIZING AND CONDUCTING EXHIBITIONS FOR CULTURAL OR EDUCATIONAL PURPOSES; ARRANGING, CONDUCTING AND PROVISION OF CONFERENCES, CONVENTIONS, SEMINARS AND TRAINING WORKSHOPS IN THE FIELD OF BUSINESS AND E-COMMERCE; ART EXHIBITIONS; ART SERVICES, NAMELY, RENTAL OF ARTWORK; TRAINING SERVICES IN THE FIELD OF OCCUPATIONAL HEALTH AND SAFETY, AND ENVIRONMENTAL CONSERVATION; PROVISION OF CIGAR CLASSES, WINE TASTING CLASSES; PROVIDING EDUCATIONAL RESEARCH AND INFORMATION ABOUT EDUCATIONAL RESEARCH; ARRANGING, ORGANIZING, PLANNING AND RUNNING SEMINARS IN THE FIELD OF BUSINESS AND E-COMMERCE; ANIMAL TRAINING; DIRECTION IN PRODUCING PROGRAMS, NAMELY, OPERATION OF AUDIOVISUAL MACHINES AND EQUIPMENT FOR RADIO AND TELEVISION PROGRAMS; INSTRUCTIONAL SERVICES, NAMELY, TRAINING IN THE OPERATION OF AUDIOVISUAL MACHINES AND EQUIPMENT USED FOR THE PRODUCTION OF BROADCASTING PROGRAMS; PROVIDING AUDIO AND VISUAL STUDIOS; PROVIDING SPORTS FACILITIES; PROVIDING FACILITIES FOR MOVIES, SHOWS, PLAYS, MUSIC OR EDUCATIONAL TRAINING; ENTERTAINMENT BOOKING AGENCIES, NAMELY, BOOKING OF SEATS FOR SHOWS AND SPORTS EVENTS; RENTAL OF MOTION PICTURES; RENTAL AND LEASING OF MUSICAL INSTRUMENTS; RENTAL AND LEASING OF TELEVISION SETS; LENDING LIBRARIES; ARCHIVE LIBRARY SERVICES; SUBTITLING SERVICES, NAMELY, PREPARING SUBTITLES FOR MOVIES; SIGN LANGUAGE INTERPRETATION SERVICES; RENTAL OF COMPUTER GAME SOFTWARE; PROVIDING ONLINE VIDEO GAMES, COMPUTER GAMES; ENTERTAINMENT SERVICES, NAMELY, PROVIDING ON-LINE VIDEO GAMES, COMPUTER GAMES AND ARRANGING COMPUTER GAME CONTESTS; RENTAL OF PRE-RECORDED VIDEO TAPES; RENTAL AND LEASING OF GAME MACHINES; RENTAL OF ARCADE GAME EQUIPMENT; RENTAL OF MOTION PICTURES; PHOTOGRAPHY; TRANSLATION; LANGUAGE INTERPRETATION; PROVISION OF NEWS IN THE NATURE OF CURRENT EVENT REPORTING, IN CLASS 41 (U.S. CLS. 100, 101 AND 107).

FOR: SCIENTIFIC AND TECHNOLOGICAL SERVICES AND RESEARCH AND DESIGN RELATING THERETO, NAMELY, PROVIDING TEMPORARY USE OF ONLINE NON-DOWNLOADABLE SOFTWARE AND TEMPORARY USE OF ONLINE NON-DOWNLOADABLE CLOUD COMPUTING SOFTWARE FOR PLANNING AND MANAGEMENT OF PERSONAL AND BUSINESS FINANCES, E-COMMERCE DATA MINING, HIGH-SPEED MASSIVE E-COMMERCE DATA PROCESSING, AND DATA CUSTOMIZATION, CUSTOMER RELATIONSHIP MANAGEMENT, INVENTORY MANAGEMENT, SALES FORCE MANAGEMENT, AND MARKETING INFORMATION MANAGEMENT; DESIGN AND DEVELOPMENT OF COMPUTER HARDWARE AND SOFTWARE; DESIGN OF COMPUTERS, NOTEBOOK

Reg. No. 4,072,362 COMPUTERS, LAPTOP COMPUTERS, PORTABLE COMPUTERS AND HANDHELD COMPUTERS; DESIGN FOR OTHERS IN THE FIELD OF PERSONAL DIGITAL ASSISTANTS AND PERSONAL MEDIA PLAYERS; DESIGN FOR OTHERS IN THE FIELD OF MOBILE TELEPHONES AND SMART PHONES; DESIGN FOR OTHERS IN THE FIELD OF DIGITAL CAMERAS; COMPUTER SERVICES, NAMELY, COMPUTER SYSTEM ADMINISTRATION FOR OTHERS; COMPUTER PROGRAMMING; COMPUTER SYSTEM SOFTWARE SERVICES, NAMELY, DESIGN AND DEVELOPMENT OF ON-LINE COMPUTER SOFTWARE SYSTEMS; PROVIDING DIRECT CONNECTION SERVICES BETWEEN COMPUTER USERS FOR EXCHANGING DATA, NAMELY, PROVIDING TEMPORARY USE OF ONLINE NON-DOWNLOADABLE SOFTWARE FOR THE EXCHANGE OF DATA; COMPUTER SOFTWARE DESIGN; COMPUTER SYSTEM DESIGN; DESIGN AND DEVELOPMENT OF WEBPAGES; HOSTING WEBPAGES FOR OTHERS; HOSTING COMPUTER APPLICATION SOFTWARE FOR OTHERS FOR USE IN SEARCHING AND RETRIEVING INFORMATION FROM DATABASES AND COMPUTER NETWORKS; PROVIDING TECHNICAL INFORMATION AT THE SPECIFIC REQUEST OF END-USERS BY MEANS OF TELEPHONE OR GLOBAL COMPUTER NETWORK; COMPUTER SERVICES RELATING TO CUSTOMIZED SEARCHING OF COMPUTER DATABASES AND WEBSITES, NAMELY, PROVIDING CUSTOMIZED ONLINE WEB PAGES FEATURING USER-DEFINED INFORMATION WHICH INCLUDES ONLINE LINKS TO THIRD PARTY WEB SITES, IN CLASS 42 (U.S. CLS. 100 AND 101).

PRIORITY CLAIMED UNDER SEC. 44(D) ON HONG KONG APPLICATION NO. 301431378, FILED 9-17-2009, REG. NO. 301431378AA, DATED 9-17-2009, EXPIRES 9-17-2019.

THE NON-LATIN CHARACTERS IN THE MARK TRANSLITERATE TO A LIYUN JU SUAN, AND THIS MEANS "ALICLOUD COMPUTING" IN ENGLISH.

PRIORITY CLAIMED UNDER SEC. 44(D) ON HONG KONG APPLICATION NO. 301431369, FILED 9-17-2009, REG. NO. 301431369AA, DATED 9-17-2009, EXPIRES 9-17-2019.

NO CLAIM IS MADE TO THE EXCLUSIVE RIGHT TO USE THE NON-LATIN CHARACTERS THAT TRANSLITERATE TO JU SUAN, APART FROM THE MARK AS SHOWN.

THE MARK CONSISTS OF THE WORDS ALICLOUD COMPUTING IN CHINESE CHARACTERS.

SER. NO. 77-832,021, FILED 9-22-2009.

ELLEN PERKINS, EXAMINING ATTORNEY

United States of America

United States Patent and Trademark Office



Reg. No. 4,072,363

Registered Dec. 20, 2011

Int. Cl.: 25

TRADEMARK

PRINCIPAL REGISTER

FAT BELLY KNIFE COMPANY LLC (MICHIGAN LIMITED LIABILITY COMPANY)
6400 TRIPP ROAD
HOLLY, MI 48442

FOR: CLOTHING, NAMELY, T-SHIRTS, V-NECK T-SHIRTS, SWEATSHIRTS, HATS, SKULL CAPS, IN CLASS 25 (U.S. CLS. 22 AND 39).

FIRST USE 8-12-2009; IN COMMERCE 8-12-2009.

THE MARK CONSISTS OF A PERSON WITH A FAT BELLY LAYING DOWN.

SER. NO. 77-835,009, FILED 9-25-2009.

JACQUELINE A. LAVINE, EXAMINING ATTORNEY



David J. Kybas

Director of the United States Patent and Trademark Office

United States of America

United States Patent and Trademark Office

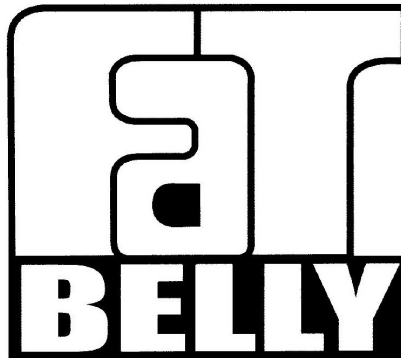

Reg. No. 4,072,364

FAT BELLY KNIFE COMPANY LLC (MICHIGAN LIMITED LIABILITY COMPANY)
6400 TRIPP ROAD
HOLLY, MI 48442

Registered Dec. 20, 2011

Int. Cl.: 25

FOR: CLOTHING, NAMELY, T-SHIRTS, V-NECK T-SHIRTS, SWEATSHIRTS, HATS, SKULL CAPS, IN CLASS 25 (U.S. CLS. 22 AND 39).

TRADEMARK

FIRST USE 8-12-2009; IN COMMERCE 8-12-2009.

PRINCIPAL REGISTER

THE MARK CONSISTS OF THE WORD "FAT" WRITTEN IN STYLIZED FORM.

SER. NO. 77-835,033, FILED 9-25-2009.

JACQUELINE A. LAVINE, EXAMINING ATTORNEY



David J. Kybas

Director of the United States Patent and Trademark Office

United States of America

United States Patent and Trademark Office



Reg. No. 4,072,365

FAT BELLY KNIFE COMPANY LLC (MICHIGAN LIMITED LIABILITY COMPANY)
6400 TRIPP ROAD
HOLLY, MI 48442

Registered Dec. 20, 2011

Int. Cl.: 25

FOR: CLOTHING, NAMELY, T-SHIRTS, V-NECK T-SHIRTS, SWEATSHIRTS, HATS, SKULL CAPS, IN CLASS 25 (U.S. CLS. 22 AND 39).

TRADEMARK

FIRST USE 8-12-2009; IN COMMERCE 8-12-2009.

PRINCIPAL REGISTER

THE MARK CONSISTS OF A PERSON WITH A FAT BELLY LAYING DOWN.

SER. NO. 77-835,050, FILED 9-25-2009.

JACQUELINE A. LAVINE, EXAMINING ATTORNEY



David J. Kyros

Director of the United States Patent and Trademark Office

United States of America

United States Patent and Trademark Office

AL(ECO)

Reg. No. 4,072,366

Registered Dec. 20, 2011

Int. Cl.: 11

TRADEMARK

PRINCIPAL REGISTER

ALICO INDUSTRIES INC. (CANADA CORPORATION)
UNIT 2
2570 JOHN STREET
MARKHAM, ONTARIO, CANADA L3R2W4

FOR: LIGHTING FIXTURES, IN CLASS 11 (U.S. CLS. 13, 21, 23, 31 AND 34).

THE MARK CONSISTS OF STANDARD CHARACTERS WITHOUT CLAIM TO ANY PARTICULAR FONT, STYLE, SIZE, OR COLOR.

PRIORITY CLAIMED UNDER SEC. 44(D) ON CANADA APPLICATION NO. 1,452,538, FILED 9-21-2009, REG. NO. TMA779,794, DATED 10-14-2010, EXPIRES 10-14-2025.

SER. NO. 77-839,290, FILED 10-1-2009.

KAREN BRACEY, EXAMINING ATTORNEY



David J. Kybas

Director of the United States Patent and Trademark Office

United States of America

United States Patent and Trademark Office



GreenEdge

Reg. No. 4,072,367

Registered Dec. 20, 2011

Int. Cl.: 1

TRADEMARK

PRINCIPAL REGISTER

GREENTECHNOLOGIES, LLC (FLORIDA LIMITED LIABILITY COMPANY)
PO BOX 357905
GAINESVILLE, FL 326357905

FOR: FERTILIZERS, IN CLASS 1 (U.S. CLS. 1, 5, 6, 10, 26 AND 46).

FIRST USE 5-10-1999; IN COMMERCE 1-5-2000.

THE MARK CONSISTS OF A BLADE OF GRASS APPEARING IN GREEN AND THE WORDS "GREENEDGE" APPEARING IN BLACK.

THE COLOR(S) GREEN AND BLACK IS/ARE CLAIMED AS A FEATURE OF THE MARK.

SER. NO. 77-840,790, FILED 10-3-2009.

CHARLES L. JENKINS, EXAMINING ATTORNEY



David J. Kybas

Director of the United States Patent and Trademark Office

United States of America

United States Patent and Trademark Office



Reg. No. 4,072,368

Registered Dec. 20, 2011

Int. Cl.: 45

SERVICE MARK

PRINCIPAL REGISTER

LOCATEPLUS HOLDINGS CORPORATION (DELAWARE CORPORATION)
100 CUMMINGS CENTER, SUITE 235M
BEVERLY, MA 01915

FOR: IDENTIFICATION VERIFICATION SERVICES, NAMELY, PROVIDING AUTHENTICATION OF PERSONAL IDENTIFICATION INFORMATION; IDENTIFICATION VERIFICATION SERVICES, NAMELY, PROVIDING AUTHENTICATION OF PERSONAL IDENTIFICATION INFORMATION VIA SECURE STORAGE AND TRANSMITTING SUCH INFORMATION VIA THE INTERNET; PROVIDING AN INTERACTIVE WEB SITE THAT FACILITATES THE VERIFICATION OF A PERSON'S BACKGROUND CREDENTIALS, IN CLASS 45 (U.S. CLS. 100 AND 101).

FIRST USE 4-5-2008; IN COMMERCE 4-5-2008.

NO CLAIM IS MADE TO THE EXCLUSIVE RIGHT TO USE "LOCATE", APART FROM THE MARK AS SHOWN.

THE COLOR(S) BLACK, WHITE, RED AND BLUE IS/ARE CLAIMED AS A FEATURE OF THE MARK.

THE MARK CONSISTS OF THE WORD "LOCATE" IN STYLIZED BLACK LETTERS WITH THE BOTTOM OF THE LETTER "L" EXTENDING HORIZONTALLY TO FORM A BANNER CONTAINING 15 LATERAL STRIPES, 8 OF WHICH ARE BLACK AND 7 OF WHICH ARE BLUE, OVER WHICH IS SUPERIMPOSED THE WORD "PLUS" IN THE COLOR WHITE. THE LETTER "O" OF THE WORD "LOCATE" CONTAINS A TARGET-LIKE RED DOT IN ITS CENTER AND WHITE OPAQUE CROSS HAIRS ON THE TOP, BOTTOM, LEFT AND RIGHT SIDES OF THE LETTER "O", OVER WHICH IS SUPERIMPOSED A LARGER WHITE OPAQUE CIRCLE MIMICKING THE VIEW OF A RIFLE SCOPE.

SER. NO. 77-843,711, FILED 10-7-2009.

RUSS HERMAN, EXAMINING ATTORNEY



David J. Kyffers

Director of the United States Patent and Trademark Office

United States of America

United States Patent and Trademark Office



Reg. No. 4,072,369

BAD BABY INC. (ILLINOIS CORPORATION)
11124 S. LEAMINGTON
ALSIP, IL 60803

Registered Dec. 20, 2011

Int. Cl.: 25

FOR: CHILDREN'S AND INFANTS' CLOTH BIBS; CREEPERS; SHORT-SLEEVED OR LONG-SLEEVED T-SHIRTS, IN CLASS 25 (U.S. CLS. 22 AND 39).

TRADEMARK

FIRST USE 8-1-2009; IN COMMERCE 9-10-2009.

PRINCIPAL REGISTER

THE MARK CONSISTS OF TWO "BB" BLOCKS REPRESENTING BAD BABY. ONE BLOCK ON TOP, THE SECOND BLOCK BELOW AND UPSIDE DOWN.

SER. NO. 77-846,621, FILED 10-12-2009.

MIDGE BUTLER, EXAMINING ATTORNEY



David J. Kybas

Director of the United States Patent and Trademark Office

United States of America

United States Patent and Trademark Office

BIOLIFE

Reg. No. 4,072,370

Registered Dec. 20, 2011

Int. Cls.: 17, 19 and 27

TRADEMARK

PRINCIPAL REGISTER

LG HAUSYS, LTD. (REPUBLIC OF KOREA COMPANY)
20, YEUIDO-DONG, YEONGDEUNGPO-GU
SEOUL, REPUBLIC OF KOREA 150-721

FOR: SEMI-WORKED PLASTIC FILM; VINYL SHEETS; FLEXIBLE PLASTIC PIPES AND TUBING FOR PLUMBING PURPOSES; PLASTIC RODS AND BARS; PLASTIC SHEETS; LAMINATED BOARDS OF PLASTICS FOR USE IN MANUFACTURING; SYNTHETIC PLASTIC AS SEMI-FINISHED PRODUCTS IN THE FORM OF BOARDS AND PLATES; PLASTIC FILM, NOT FOR WRAPPING; PLASTIC LAWN HOSES; PLASTIC PLUMBING HOSES; PLASTIC SWIMMING POOL HOSES; SYNTHETIC RESINS-FACED SHEETS, IN CLASS 17 (U.S. CLS. 1, 5, 12, 13, 35 AND 50).

FOR: BUILDING PANELS, NOT OF METAL; FLOORING, NOT OF METAL; FLOORS, NOT OF METAL; CEILING PANELS, NOT OF METAL; DOORS, NOT OF METAL; WINDOW FRAMES, NOT OF METAL; CASEMENT WINDOWS, NOT OF METAL; TILES, NOT OF METAL; VINYL TILES; PLASTIC TILES, IN CLASS 19 (U.S. CLS. 1, 12, 33 AND 50).

FOR: LINOLEUM SHEETS, IN CLASS 27 (U.S. CLS. 19, 20, 37, 42 AND 50).

THE MARK CONSISTS OF STANDARD CHARACTERS WITHOUT CLAIM TO ANY PARTICULAR FONT, STYLE, SIZE, OR COLOR.

PRIORITY CLAIMED UNDER SEC. 44(D) ON REPUBLIC OF KOREA APPLICATION NO. 402009003669, FILED 7-31-2009, REG. NO. 0842841, DATED 11-12-2010, EXPIRES 11-12-2020.

OWNER OF REPUBLIC OF KOREA REG. NO. 0842840, DATED 11-12-2010, EXPIRES 11-12-2020.

SER. NO. 77-850,614, FILED 10-16-2009.

SEAN CROWLEY, EXAMINING ATTORNEY



David J. Kybas

Director of the United States Patent and Trademark Office

United States of America

United States Patent and Trademark Office

AHAM

Reg. No. 4,072,371

Registered Dec. 20, 2011

**Int. Cls.: 35, 37, 41, 42
and 45**

SERVICE MARK

PRINCIPAL REGISTER

ASSOCIATION OF HOME APPLIANCE MANUFACTURERS (ILLINOIS CORPORATION)
SUITE 402
1111 19TH STREET, N.W.
WASHINGTON, DC 20036

FOR: ASSOCIATION SERVICES, NAMELY, PROMOTING THE INTERESTS OF THE HOME APPLIANCE INDUSTRY IN THE FIELD OF HOME APPLIANCES; PROVIDING A WEB SITE FEATURING CONSUMER PRODUCT INFORMATION ABOUT HOME APPLIANCES; PROVIDING A WEB SITE FEATURING STATISTICAL INFORMATION USED FOR BUSINESS PURPOSES IN THE FIELD OF HOME APPLIANCES; PROVIDING A WEB SITE FEATURING COMMERCIAL AND TRADE INFORMATION ABOUT BUSINESSES, GOVERNMENT AGENCIES, ASSOCIATIONS, AND TRADE AND BUSINESS MAGAZINES IN THE FIELD OF HOME APPLIANCES VIA HYPERLINK TEXTS TO OTHER WEB SITES, IN CLASS 35 (U.S. CLS. 100, 101 AND 102).

FIRST USE 0-0-1967; IN COMMERCE 0-0-1967.

FOR: PROVIDING A WEB SITE IN THE FIELD OF MAINTAINING HOME APPLIANCES FOR CONSUMERS, IN CLASS 37 (U.S. CLS. 100, 103 AND 106).

FIRST USE 0-0-1996; IN COMMERCE 0-0-1996.

FOR: EDUCATIONAL SERVICES, NAMELY, ORGANIZING EVENTS AND PROVIDING SEMINARS, WORKSHOPS AND CONFERENCES IN THE FIELD OF HOME APPLIANCES; ONLINE JOURNALS, NAMELY, BLOGS IN THE FIELD OF HOME APPLIANCES; PROVIDING ON-LINE NEWSLETTERS IN THE FIELDS OF HOME APPLIANCES, ONLINE MARKET RESEARCH STUDIES, ONLINE MARKET DATA ON TRENDS IN THE HOME APPLIANCE INDUSTRY, INFORMATION ON ENERGY CONSERVATION AND RECYCLING IN THE HOME APPLIANCE INDUSTRY; PROVIDING A WEB SITE FEATURING CURRENT EVENT NEWS IN THE FIELD OF HOME APPLIANCES FOR MANUFACTURERS AND CONSUMERS, IN CLASS 41 (U.S. CLS. 100, 101 AND 107).

FIRST USE 0-0-1967; IN COMMERCE 0-0-1967.

FOR: PROVIDING A WEBSITE FEATURING INFORMATION ON THE TESTING, ANALYSIS AND EVALUATION OF HOME APPLIANCE PRODUCTS FOR VERIFICATION PURPOSES; PROVIDING A WEBSITE FEATURING CONSUMER PRODUCT SAFETY INFORMATION



David J. Kyjars

Director of the United States Patent and Trademark Office

Reg. No. 4,072,371 IN THE FIELD OF HOME APPLIANCES FOR MANUFACTURERS AND CONSUMERS; PROVIDING A WEBSITE FEATURING INFORMATION ON SCIENTIFIC RESEARCH REGARDING PERFORMANCE AND ENGINEERING OF HOME APPLIANCES FOR MANUFACTURERS AND CONSUMERS, IN CLASS 42 (U.S. CLS. 100 AND 101).

FIRST USE 0-0-1996; IN COMMERCE 0-0-1996.

FOR: PROVIDING A WEBSITE FEATURING INFORMATION ON REGULATORY COMPLIANCE AND TECHNICAL PERFORMANCE STANDARDS FOR HOME APPLIANCES; AND PROVIDING A WEBSITE FEATURING INFORMATION ON CONSUMER PRODUCT SAFETY INFORMATION IN THE FIELD OF HOME APPLIANCES FOR CONSUMERS, IN CLASS 45 (U.S. CLS. 100 AND 101).

FIRST USE 0-0-1996; IN COMMERCE 0-0-1996.

THE MARK CONSISTS OF STANDARD CHARACTERS WITHOUT CLAIM TO ANY PARTICULAR FONT, STYLE, SIZE, OR COLOR.

OWNER OF U.S. REG. NOS. 2,088,840, 3,267,022 AND OTHERS.

SER. NO. 77-851,369, FILED 10-19-2009.

VERNA BETH RIRIE, EXAMINING ATTORNEY

United States of America

United States Patent and Trademark Office

PRINCE BAY

Reg. No. 4,072,372

Registered Dec. 20, 2011

Int. Cls.: 37 and 42

SERVICE MARK

PRINCIPAL REGISTER

PRINCE BAY DEVELOPMENTS INC. (CANADA CORPORATION)
77 LAKESHORE ROAD WEST, UNIT 2
OAKVILLE, ONTARIO, CANADA L6K1C9

FOR: REAL ESTATE DEVELOPMENT SERVICES, REAL ESTATE CONSTRUCTION AND RENOVATION SERVICES, NAMELY, CONSTRUCTION AND RENOVATION OF RESIDENTIAL AND COMMERCIAL BUILDINGS, IN CLASS 37 (U.S. CLS. 100, 103 AND 106).

FOR: REAL ESTATE DESIGN, NAMELY, ARCHITECTURAL DESIGN SERVICES; LANDSCAPING SERVICES, NAMELY, LANDSCAPE ARCHITECTURAL DESIGN SERVICES, IN CLASS 42 (U.S. CLS. 100 AND 101).

THE MARK CONSISTS OF STANDARD CHARACTERS WITHOUT CLAIM TO ANY PARTICULAR FONT, STYLE, SIZE, OR COLOR.

OWNER OF CANADA REG. NO. TMA751827, DATED 11-2-2009, EXPIRES 11-2-2024.

SER. NO. 77-851,597, FILED 10-19-2009.

EUGENIA MARTIN, EXAMINING ATTORNEY



David J. Kyfos

Director of the United States Patent and Trademark Office

United States of America

United States Patent and Trademark Office

NEW MOON

Reg. No. 4,072,373

Registered Dec. 20, 2011

Int. Cl.: 4

TRADEMARK

PRINCIPAL REGISTER

SUMMIT ENTERTAINMENT, LLC (DELAWARE LIMITED LIABILITY COMPANY)
1630 STEWART STREET, SUITE 120
SANTA MONICA, CA 90404

FOR: CANDLES, IN CLASS 4 (U.S. CLS. 1, 6 AND 15).

FIRST USE 9-0-2009; IN COMMERCE 9-0-2009.

THE MARK CONSISTS OF STANDARD CHARACTERS WITHOUT CLAIM TO ANY PARTICULAR FONT, STYLE, SIZE, OR COLOR.

SER. NO. 77-859,318, FILED 10-28-2009.

ALLISON HOLTZ, EXAMINING ATTORNEY



David J. Kyffers

Director of the United States Patent and Trademark Office

United States of America

United States Patent and Trademark Office

NEW MOON

Reg. No. 4,072,374

Registered Dec. 20, 2011

Int. Cl.: 5

TRADEMARK

PRINCIPAL REGISTER

SUMMIT ENTERTAINMENT, LLC (DELAWARE LIMITED LIABILITY COMPANY)
1630 STEWART STREET, SUITE 120
SANTA MONICA, CA 90404

FOR: BANDAGES FOR SKIN WOUNDS, IN CLASS 5 (U.S. CLS. 6, 18, 44, 46, 51 AND 52).

FIRST USE 10-0-2009; IN COMMERCE 10-0-2009.

THE MARK CONSISTS OF STANDARD CHARACTERS WITHOUT CLAIM TO ANY PARTICULAR FONT, STYLE, SIZE, OR COLOR.

SER. NO. 77-859,320, FILED 10-28-2009.

ALLISON HOLTZ, EXAMINING ATTORNEY



David J. Kyffers

Director of the United States Patent and Trademark Office

United States of America

United States Patent and Trademark Office

ETHERMEDICA

Reg. No. 4,072,375

Registered Dec. 20, 2011

Int. Cl.: 9

TRADEMARK

PRINCIPAL REGISTER

MILUX HOLDING S.A. (LUXEMBOURG CORPORATION)
12, RUE GUILLAUME SCHNEIDER
LUXEMBOURG, LUXEMBOURG L-2522

FOR: SOFTWARE, IN PARTICULAR FOR ACTIVE MEDICAL IMPLANTS, FOR MEASURING, RECEIVING, SENDING, CHECKING, TRANSFERRING, CALCULATING, PROCESSING, CONTROLLING, PRESENTING AND ANALYZING OF DATA, NAMELY, DATA ABOUT ELECTRICITY, ENERGY, PHYSICAL PARAMETERS, AND COMMUNICATION AND PROGRAMMING DATA IN MEDICAL IMPLANTS; SOFTWARE, IN PARTICULAR FOR MEASURING, RECEIVING, SENDING, CHECKING, TRANSFERRING, CALCULATING, PROCESSING, CONTROLLING, PRESENTING AND ANALYZING OF DATA, NAMELY, DATA ABOUT ELECTRICITY, ENERGY, PHYSICAL PARAMETERS, COMMUNICATION AND PROGRAMMING DATA IN APPARATUS, DEVICES AND INSTRUMENTS FOR COMMUNICATING WITH, ENERGIZING AND PROGRAMMING OF MEDICAL IMPLANTS; AND DATA PROCESSING EQUIPMENT AND COMPUTERS, IN CLASS 9 (U.S. CLS. 21, 23, 26, 36 AND 38).

THE MARK CONSISTS OF STANDARD CHARACTERS WITHOUT CLAIM TO ANY PARTICULAR FONT, STYLE, SIZE, OR COLOR.

PRIORITY CLAIMED UNDER SEC. 44(D) ON ERPN CMNTY TM OFC APPLICATION NO. 008276231, FILED 5-4-2009, REG. NO. 008276231, DATED 1-28-2010, EXPIRES 5-4-2019.

SER. NO. 77-861,229, FILED 10-30-2009.

ALEX KEAM, EXAMINING ATTORNEY



David J. Kyros

Director of the United States Patent and Trademark Office

United States of America

United States Patent and Trademark Office



Reg. No. 4,072,376

LG ELECTRONICS INC. (REPUBLIC OF KOREA CORPORATION)
20, YOIDO-DONG, YONGDUNGPO-GU
SEOUL, REPUBLIC OF KOREA

Registered Dec. 20, 2011

Int. Cl.: 9

FOR: COMPUTER MONITORS; TELEVISION RECEIVERS, IN CLASS 9 (U.S. CLS. 21, 23, 26, 36 AND 38).

TRADEMARK

PRIORITY CLAIMED UNDER SEC. 44(D) ON REPUBLIC OF KOREA APPLICATION NO. 40-2009-0045, FILED 9-15-2009, REG. NO. 0845978, DATED 12-10-2010, EXPIRES 12-10-2020.

PRINCIPAL REGISTER

NO CLAIM IS MADE TO THE EXCLUSIVE RIGHT TO USE "5MS", APART FROM THE MARK AS SHOWN.

THE MARK CONSISTS OF THE WORDS "5MS LIGHTN RESPON" WITH HORIZONTAL LINES EXTENDING FROM THE "5".

SER. NO. 77-864,176, FILED 11-3-2009.

ADA HAN, EXAMINING ATTORNEY



David J. Kybas

Director of the United States Patent and Trademark Office

United States of America

United States Patent and Trademark Office

LIGHT WORK

Reg. No. 4,072,377

Registered Dec. 20, 2011

Int. Cls.: 9 and 11

TRADEMARK

PRINCIPAL REGISTER

LIGHT BLUE OPTICS LTD. (UNITED KINGDOM LIMITED COMPANY (LTD.))
ST. JOHN'S INNOVATION PARK, COWLEY ROAD
2ND FLOOR, PLATINUM BUILDING
CAMBRIDGE, UNITED KINGDOM CB40WS

FOR: APPARATUS AND INSTRUMENTS FOR DISPLAYING INFORMATION, NAMELY, APPARATUS FOR THE GRAPHIC DISPLAY OF DATA, NAMELY, VIDEO DISPLAY PROJECTORS, VIDEO DISPLAY MONITORS AND ELECTRONIC DISPLAY SCREENS; MEASUREMENT INSTRUMENTATION, NAMELY, ELECTRONIC INSTRUMENTS FOR USE IN REMOTE INSPECTION AND MEASUREMENT OF INDUSTRIAL COMPONENTS USING REMOTE VISUAL DEVICES, DISTANCE MEASURING APPARATUS, INSTRUMENTS FOR MEASURING LENGTH APPARATUS FOR THE GRAPHIC DISPLAY OF DATA AND SYMBOLOGY, NAMELY, ELECTRONIC APPARATUS IN THE NATURE OF ELECTRONIC DISPLAY BOARDS, PLASMA DISPLAY BOARDS, AND ELECTRONIC DISPLAY SCREENS; COMPUTER SOFTWARE, COMPUTER PROGRAMS AND COMPUTER HARDWARE FOR USE WITH LASERS FOR USE IN IMAGE AND DATA PROJECTION; TOUCH-ENABLED APPLICATION PLATFORMS, NAMELY, COMPUTER TOUCHSCREENS; PROJECTION APPARATUS, NAMELY, VIDEO DISPLAY PROJECTORS AND VIDEO DISPLAY MONITORS AND TRANSPARENCY PROJECTION APPARATUS, IN CLASS 9 (U.S. CLS. 21, 23, 26, 36 AND 38).

FOR: LASER INSTRUMENTS AND INSTALLATIONS, NAMELY, LASER LIGHT PROJECTORS, IN CLASS 11 (U.S. CLS. 13, 21, 23, 31 AND 34).

THE MARK CONSISTS OF STANDARD CHARACTERS WITHOUT CLAIM TO ANY PARTICULAR FONT, STYLE, SIZE, OR COLOR.

OWNER OF ERPN CMNTY TM OFC REG. NO. 008688211, DATED 5-19-2010, EXPIRES 11-16-2019.

SER. NO. 77-873,991, FILED 11-17-2009.

ROBIN MITTLER, EXAMINING ATTORNEY



David J. Kyffers

Director of the United States Patent and Trademark Office

United States of America

United States Patent and Trademark Office

μGL

Reg. No. 4,072,378

Registered Dec. 20, 2011

Int. Cls.: 1, 5, 9 and 10

TRADEMARK

PRINCIPAL REGISTER

SHIMADZU CORPORATION (JAPAN CORPORATION)
1, NISHINOKYO-KUWABARACHO, NAKAGYO-KU
KYOTO, JAPAN

FOR: REAGENT FOR CHEMICAL ANALYSES; REAGENTS FOR RESEARCH PURPOSES; REAGENTS FOR SCIENTIFIC OR MEDICAL RESEARCH USE; ASSAYS AND REAGENTS FOR USE IN GENETIC RESEARCH; DIAGNOSTIC REAGENTS FOR CLINICAL OR MEDICAL LABORATORY USE; DIAGNOSTIC REAGENTS FOR IN VITRO USE IN BIOCHEMISTRY, CLINICAL CHEMISTRY AND MICROBIOLOGY; DIAGNOSTIC REAGENTS AND PREPARATIONS, EXCEPT FOR MEDICAL OR VETERINARY USE; GENETIC IDENTITY TESTS COMPRISED OF REAGENTS; AND REAGENT KITS COMPRISING DNA CHIPS FOR USE IN BIOTECHNOLOGY FIELDS; REAGENTS FOR DETECTING BACTERIA FOOD POISONING, IN CLASS 1 (U.S. CLS. 1, 5, 6, 10, 26 AND 46).

FOR: MEDICAL DIAGNOSTIC REAGENTS; MEDICAL DIAGNOSTIC REAGENTS COMPRISING DNA CHIPS FOR CLINICAL DIAGNOSIS; REAGENTS FOR MEDICAL USE; REAGENTS AND MEDIA FOR MEDICAL AND VETERINARY DIAGNOSTIC PURPOSES; REAGENTS FOR CLINICAL GENETIC DIAGNOSIS; REAGENTS FOR CLINICAL BIOCHEMICAL DIAGNOSIS; CHEMICAL REAGENTS FOR MEDICAL PURPOSES; CHEMICAL REAGENTS FOR CLINICAL GENETIC DIAGNOSTICS; CHEMICAL REAGENTS FOR CLINICAL BIOCHEMICAL DIAGNOSTICS; CHEMICAL REAGENTS IN KIT FORM FOR MEDICAL PURPOSES; CHEMICAL REAGENTS IN KIT FORM FOR CLINICAL GENETIC DIAGNOSTICS; CHEMICAL REAGENTS IN KIT FORM FOR CLINICAL BIOCHEMICAL DIAGNOSTICS; DIAGNOSTIC REAGENTS AND CONTRAST MEDIA FOR MEDICAL USE; DIAGNOSTIC REAGENTS FOR MEDICINAL USE; TEST KITS COMPRISED OF DIAGNOSTIC REAGENTS FOR CLINICAL AND MEDICAL USE; DIAGNOSTIC PREPARATIONS IN KIT FORM FOR MEDICAL PURPOSES; PHARMACEUTICAL PREPARATIONS FOR USE IN GENETIC DISEASES; TEST REAGENTS FOR BLOOD ANALYSIS FOR MEDICAL PURPOSE, IN CLASS 5 (U.S. CLS. 6, 18, 44, 46, 51 AND 52).

FOR: LABORATORY APPARATUS AND INSTRUMENTS, NAMELY, GENOME AND GENE TESTERS, DETECTORS, AND ANALYZERS; COMPUTER SOFTWARE FOR OPERATING GENETIC TESTING, DETECTING, AND ANALYZING LABORATORY EQUIPMENT; COMPUTER SOFTWARE FOR SCIENTIFIC ANALYSIS OF GENETIC SEQUENCES; MEASURING AND TESTING INSTRUMENTS, NAMELY, GENETIC POLYMORPHISM ANALYZERS, DETECTORS, AND TESTING DEVICE; ELECTRICAL EQUIPMENT FOR



David J. Kybas

Director of the United States Patent and Trademark Office

Reg. No. 4,072,378 THE GENETIC MODIFICATION OF CELLS FOR RESEARCH PURPOSES, IN CLASS 9 (U.S. CLS. 21, 23, 26, 36 AND 38).

FOR: MEDICAL APPARATUS AND INSTRUMENTS FOR MEDICAL DIAGNOSIS AND GENETIC DIAGNOSTICS; MEDICAL APPARATUS AND INSTRUMENTS FOR IMMUNODIAGNOSTICS; MEDICAL APPARATUS AND INSTRUMENTS FOR BIOCHEMICAL DIAGNOSTICS; ANALYZERS FOR MEDICAL PURPOSES, NAMELY, APPARATUS USED TO CARRY OUT AUTOMATIC TESTING OF BIOLOGICAL SAMPLES; MEDICAL APPARATUS AND INSTRUMENTS FOR FACILITATING THE ANALYSIS OF BIOLOGICAL AND CHEMICAL MATTER IN THE FIELD OF GENETIC TESTING, NAMELY BLOOD, BRAIN, URINE, CEREBROSPINAL FLUID (CSF) ANALYSIS AND TESTING APPARATUS; MEDICAL DIAGNOSIS DEVICES, NAMELY, ANALYZERS AND DETECTORS OF AMPLIFIED VIRUSES, EXTRACTED FROM HUMAN BODIES; APPARATUS FOR CLINICAL DIAGNOSIS; MEDICAL CONTAINERS FOR MEDICAL REAGENT KITS; MEDICAL DIAGNOSTIC DEVICES, NAMELY, KITS CONSISTING OF CONTAINERS, TUBES, AND GENETIC PROBES FOR EXTRACTING NUCLEIC ACID FROM BIOLOGICAL SAMPLES; MEDICAL DIAGNOSTIC TEST KITS CONSISTING OF TESTING CONTAINERS AND REAGENTS FOR THE PURPOSE OF DETECTION AND MONITORING OF INHERITED DISEASE, GENETIC PREDISPOSITIONS FOR MEDICAL CONDITIONS, DRUG RESPONSES, TUMORS OR DNA CONDITIONS; MEDICAL DIAGNOSTIC APPARATUS AND INSTRUMENTS, NAMELY, DEVICES WITH TEMPERATURE CONTROLLER AND FLUORESCENCE DETECTOR FOR TESTING, ANALYZING, AND EVALUATING BIOLOGICAL MATERIAL AND SAMPLES FOR PURPOSE OF DETECTION AND MONITORING OF INHERITED DISEASE, GENETIC PREDISPOSITIONS FOR MEDICAL CONDITIONS, DRUG RESPONSES, TUMORS, AND DNA CONDITIONS; DIAGNOSTIC APPARATUS FOR MEDICAL APPLICATIONS, NAMELY, PCR MACHINES, FLUORESCENT DETECTORS; APPARATUS FOR DIAGNOSING HUMAN GENETIC DISEASE, INFECTION DISEASE, CARDIAC DISEASE, TUMORS, AND DIABETES BY THE APPLICATION OF BIOCHEMICAL REACTION, IN CLASS 10 (U.S. CLS. 26, 39 AND 44).

THE MARK CONSISTS OF STANDARD CHARACTERS WITHOUT CLAIM TO ANY PARTICULAR FONT, STYLE, SIZE, OR COLOR.

OWNER OF JAPAN REG. NO. 5303950, DATED 2-26-2010, EXPIRES 2-26-2020.

OWNER OF JAPAN REG. NO. 5423678, DATED 7-8-2011, EXPIRES 7-8-2021.

SER. NO. 77-874,351, FILED 11-17-2009.

DAVID TOOLEY, EXAMINING ATTORNEY

United States of America

United States Patent and Trademark Office



Reg. No. 4,072,379

Registered Dec. 20, 2011

Int. Cl.: 29

TRADEMARK

PRINCIPAL REGISTER

PARIS CROISSANT CO., LTD. (REPUBLIC OF KOREA CORPORATION)
SONGNAM-SHI
149-3, SANGDAEWON-DONG, JOONGWON-KU
KYOUNGKI-DO, REPUBLIC OF KOREA 462-807

FOR: FRUIT JELLIES; JAMS; FRUITS, TINNED; VEGETABLES, TINNED; MARMALADE; FERMENTED MILK; YOGHURT; MILK; MILK-BASED BEVERAGES CONTAINING LACTIC AND BACTERIA; CHEESE; WHIPPED CREAM; SOUPS; VEGETABLE SALADS; FRUIT SALADS; APPLE PURÉE; TOMATO PURÉE; BUTTERCREAM; CRYSTALLIZED FRUITS; FROSTED FRUITS; FRUIT STEWED; FRUIT PRESERVED IN ALCOHOL; VEGETABLE PRESERVED IN ALCOHOL; PICKLES; COMPOTES CONTAINING CRANBERRY SAUCE, IN CLASS 29 (U.S. CL. 46).

PRIORITY CLAIMED UNDER SEC. 44(D) ON REPUBLIC OF KOREA APPLICATION NO. 2009-0035353, FILED 7-24-2009, REG. NO. 0836809, DATED 9-17-2010, EXPIRES 9-17-2020.

THE COLOR(S) BLUE AND WHITE IS/ARE CLAIMED AS A FEATURE OF THE MARK.

OWNER OF U.S. REG. NOS. 3,571,356, 3,665,546 AND OTHERS.

THE MARK CONSISTS OF THE LETTERS "P" AND "B" IN WHITE WITH A REPRESENTATION OF A TOWER THEREBETWEEN IN WHITE, WITHIN A BLUE RECTANGLE BACKGROUND.

SER. NO. 77-876,935, FILED 11-19-2009.

ERNEST SHOSHO, EXAMINING ATTORNEY



David J. Kyffers

Director of the United States Patent and Trademark Office

United States of America

United States Patent and Trademark Office



Reg. No. 4,072,380

Registered Dec. 20, 2011

Int. Cl.: 29

TRADEMARK

PRINCIPAL REGISTER

PARIS CROISSANT CO., LTD. (REPUBLIC OF KOREA CORPORATION)
SONGNAM-SHI
149-3, SANGDAEWON-DONG, JOONGWON-KU
KYOUNGKI-DO, REPUBLIC OF KOREA 462-807

FOR: FRUIT JELLIES; JAMS; FRUITS, TINNED; VEGETABLES, TINNED; MARMALADE; FERMENTED MILK; YOGHURT; MILK; MILK-BASED BEVERAGES CONTAINING LACTIC AND BACTERIA; CHEESE; WHIPPED CREAM; SOUPS; VEGETABLE SALADS; FRUIT SALADS; APPLE PURÉE; TOMATO PURÉE; BUTTERCREAM; CRYSTALLIZED FRUITS; FROSTED FRUITS; FRUIT STEWED; FRUIT PRESERVED IN ALCOHOL; VEGETABLE PRESERVED IN ALCOHOL; PICKLES; COMPOTES CONTAINING CRANBERRY SAUCE, IN CLASS 29 (U.S. CL. 46).

PRIORITY CLAIMED UNDER SEC. 44(D) ON REPUBLIC OF KOREA APPLICATION NO. 2009-0035291, FILED 7-24-2009, REG. NO. 40-0836888, DATED 9-17-2010, EXPIRES 9-17-2020.

THE COLOR(S) BLUE AND WHITE IS/ARE CLAIMED AS A FEATURE OF THE MARK.

OWNER OF U.S. REG. NOS. 3,445,144, 3,665,546 AND OTHERS.

THE MARK CONSISTS OF THE WORDS "PARIS BAGUETTE" IN WHITE WITH A REPRESENTATION OF A TOWER IN WHITE THERE BETWEEN, WITHIN A BLUE RECTANGLE BACKGROUND.

SER. NO. 77-876,946, FILED 11-19-2009.

ERNEST SHOSHO, EXAMINING ATTORNEY



David J. Kypos

Director of the United States Patent and Trademark Office

United States of America

United States Patent and Trademark Office



Reg. No. 4,072,381

Registered Dec. 20, 2011

Int. Cl.: 30

TRADEMARK

PRINCIPAL REGISTER

PARIS CROISSANT CO., LTD. (REPUBLIC OF KOREA CORPORATION)
SONGNAM-SHI
149-3, SANGDAEWON-DONG, JOONGWON-KU
KYOUNGKI-DO, REPUBLIC OF KOREA 462-807

FOR: SANDWICHES; TOAST; BISCUITS; ICE CREAM; CAKES; BEAN JAM BUNS; BREAD; GREEN TEA; COFFEE; COFFEE-BASED BEVERAGES; BREAD ROLLS; EDIBLE DECORATIONS FOR CAKES; CANDY FOR FOOD; CARAMELS; CHOCOLATE; CONFECTIONERY FOR DECORATING CHRISTMAS TREES; COCOA-BASED BEVERAGES; COOKIES; CORN FLAKES; CRACKERS; CUSTARD; DRESSINGS FOR SALAD; FONDANTS; FROZEN YOGHURT; FRUIT JELLIES; ICED TEA; KETCHUP; TOMATO SAUCE; FOOD LEAVENING AGENTS; MAYONNAISE; MACARONI; PASTA; SPAGHETTI; PIES; PIZZAS; PUDDING; RIBBON VERMICELLI; RUSK; SHERBETS; SPONGE CAKE; BLACK TEA; UNLEAVENED BREAD; WAFFLES; CREAM PUFF; ICED CAKES; LUMP SUGAR; SUGAR; CINNAMON POWDER; COOKING SALT; COFFEE FLAVORED SYRUP USED IN MAKING FOOD BEVERAGES, IN CLASS 30 (U.S. CL. 46).

PRIORITY CLAIMED UNDER SEC. 44(D) ON REPUBLIC OF KOREA APPLICATION NO. 2009-0035354, FILED 7-24-2009, REG. NO. 40-0836895, DATED 9-17-2010, EXPIRES 9-17-2020.

THE COLOR(S) BLUE AND WHITE IS/ARE CLAIMED AS A FEATURE OF THE MARK.

OWNER OF U.S. REG. NOS. 3,571,356, 3,665,546 AND OTHERS.

THE MARK CONSISTS OF THE LETTERS "P" AND "B" IN WHITE WITH A REPRESENTATION OF A TOWER THERE BETWEEN IN WHITE, ALL SET ON A BLUE RECTANGLE BACKGROUND.

SER. NO. 77-877,018, FILED 11-19-2009.

ERNEST SHOSHO, EXAMINING ATTORNEY



David J. Kypos

Director of the United States Patent and Trademark Office

United States of America

United States Patent and Trademark Office



Reg. No. 4,072,382

Registered Dec. 20, 2011

Int. Cl.: 31

TRADEMARK

PRINCIPAL REGISTER

PARIS CROISSANT CO., LTD. (REPUBLIC OF KOREA CORPORATION)
SONGNAM-SHI
149-3, SANGDAEWON-DONG, JOONGWON-KU
KYOUNGKI-DO, REPUBLIC OF KOREA 462-807

FOR: CARROTS, FRESH; CABBAGES, FRESH; TOMATOES, FRESH; PIMIENTOS, FRESH; MALT FOR BREWING AND DISTILLING; STRAWBERRIES, FRESH; LEMONS, FRESH; MELONS, FRESH; APPLES, FRESH; ORANGES, FRESH; GRAPES, FRESH; OLIVES, FRESH; POTATOES, FRESH; SWEET POTATOES, FRESH; WATERMELONS, FRESH; KIWIFRUITS, FRESH; PINEAPPLES, FRESH; PEACHES, FRESH; ONIONS, FRESH; PUMPKIN, FRESH; CUCUMBERS, FRESH; BANANAS, FRESH; GRAPEFRUITS, FRESH; FRUIT, FRESH; VEGETABLES, FRESH, IN CLASS 31 (U.S. CLS. 1 AND 46).

PRIORITY CLAIMED UNDER SEC. 44(D) ON REPUBLIC OF KOREA APPLICATION NO. 2009-0035355, FILED 7-24-2009, REG. NO. 40-0836763, DATED 9-17-2010, EXPIRES 9-17-2020.

THE COLOR(S) BLUE AND WHITE IS/ARE CLAIMED AS A FEATURE OF THE MARK.

OWNER OF U.S. REG. NOS. 3,571,356, 3,665,546 AND OTHERS.

THE MARK CONSISTS OF THE LETTERS "P" AND "B" IN WHITE WITH A REPRESENTATION OF A TOWER THERE BETWEEN IN WHITE, WITHIN A BLUE RECTANGLE BACKGROUND.

SER. NO. 77-877,027, FILED 11-19-2009.

ERNEST SHOSHO, EXAMINING ATTORNEY



David J. Kybas

Director of the United States Patent and Trademark Office

United States of America

United States Patent and Trademark Office



Reg. No. 4,072,383

Registered Dec. 20, 2011

Int. Cl.: 31

TRADEMARK

PRINCIPAL REGISTER

PARIS CROISSANT CO., LTD. (REPUBLIC OF KOREA CORPORATION)
SONGNAM-SHI
149-3, SANGDAEWON-DONG, JOONGWON-KU
KYOUNGKI-DO, REPUBLIC OF KOREA 462-807

FOR: CARROTS, FRESH; CABBAGES, FRESH; TOMATOES, FRESH; PIMIENTOS, FRESH; MALT FOR BREWING AND DISTILLING; STRAWBERRIES, FRESH; LEMONS, FRESH; MELONS, FRESH; APPLES, FRESH; ORANGES, FRESH; GRAPES, FRESH; OLIVES, FRESH; POTATOES, FRESH; SWEET POTATOES, FRESH; WATERMELONS, FRESH; KIWIFRUIT, FRESH; PINEAPPLES, FRESH; PEACHES, FRESH; ONIONS, FRESH; PUMPKIN, FRESH; CUCUMBERS, FRESH; BANANAS, FRESH; GRAPEFRUITS, FRESH; FRUIT, FRESH; VEGETABLES, FRESH, IN CLASS 31 (U.S. CLS. 1 AND 46).

PRIORITY CLAIMED UNDER SEC. 44(D) ON REPUBLIC OF KOREA APPLICATION NO. 2009-0035293, FILED 7-24-2009, REG. NO. 40-0836778, DATED 9-17-2010, EXPIRES 9-17-2020.

THE COLOR(S) BLUE AND WHITE IS/ARE CLAIMED AS A FEATURE OF THE MARK.

OWNER OF U.S. REG. NOS. 3,445,144, 3,665,546 AND OTHERS.

THE MARK CONSISTS OF THE WORDS "PARIS BAGUETTE" IN WHITE WITH A REPRESENTATION OF A TOWER IN WHITE THERE BETWEEN, WITHIN A BLUE RECTANGLE BACKGROUND.

SER. NO. 77-877,029, FILED 11-19-2009.

ERNEST SHOSHO, EXAMINING ATTORNEY



David J. Kypos

Director of the United States Patent and Trademark Office

United States of America

United States Patent and Trademark Office



Reg. No. 4,072,384

Registered Dec. 20, 2011

Int. Cl.: 32

TRADEMARK

PRINCIPAL REGISTER

PARIS CROISSANT CO., LTD. (REPUBLIC OF KOREA CORPORATION)
SONGNAM-SHI
149-3, SANGDAEWON-DONG, JOONGWON-KU
KYOUNGKI-DO, REPUBLIC OF KOREA 462-807

FOR: VEGETABLE JUICES; NON-ALCOHOLIC FRUIT EXTRACTS USED IN THE PREPARATION OF BEVERAGES; COCKTAILS, NON-ALCOHOLIC; SODA WATER; ORANGE JUICE; TOMATO JUICES; PINEAPPLE JUICES; WATERS, NAMELY, DRINKING WATER, BOTTLED WATER AND SPRING WATER; MINERAL WATER; FRUIT JUICE BEVERAGES; LEMONADES; SYRUPS FOR LEMONADE; SYRUPS FOR BEVERAGES; NON-ALCOHOLIC BEVERAGES, NAMELY, NON-ALCOHOLIC BEER AND WINE; NON-ALCOHOLIC FRUIT JUICE BEVERAGES; AERATED WATER; FRUIT POWDERS USED IN THE PREPARATION OF FRUIT-BASED BEVERAGES; CIDER, NON-ALCOHOLIC; SHERBETS; FRUIT NECTARS, NON-ALCOHOLIC; GRAPE MUST, UNFERMENTED; FRUIT JUICE , IN CLASS 32 (U.S. CLS. 45, 46 AND 48).

PRIORITY CLAIMED UNDER SEC. 44(D) ON REPUBLIC OF KOREA APPLICATION NO. 40-2009-0035, FILED 7-24-2009.

THE COLOR(S) BLUE AND WHITE IS/ARE CLAIMED AS A FEATURE OF THE MARK.

OWNER OF REPUBLIC OF KOREA REG. NO. 40-0836785, DATED 9-17-2010, EXPIRES 9-17-2020.

OWNER OF U.S. REG. NOS. 3,571,356, 3,665,546 AND OTHERS.

THE MARK CONSISTS OF THE LETTERS "P" AND "B" IN WHITE WITH A REPRESENTATION OF A TOWER THEREBETWEEN IN WHITE, WITHIN A BLUE RECTANGLE BACKGROUND.

SER. NO. 77-877,032, FILED 11-19-2009.

ERNEST SHOSHO, EXAMINING ATTORNEY



David J. Kyffers

Director of the United States Patent and Trademark Office

United States of America

United States Patent and Trademark Office



Reg. No. 4,072,385

Registered Dec. 20, 2011

Int. Cl.: 32

TRADEMARK

PRINCIPAL REGISTER

PARIS CROISSANT CO., LTD. (REPUBLIC OF KOREA CORPORATION)
SONGNAM-SHI
149-3, SANGDAEWON-DONG, JOONGWON-KU
KYOUNGKI-DO, REPUBLIC OF KOREA 462-807

FOR: VEGETABLE JUICES; NON-ALCOHOLIC FRUIT EXTRACTS USED IN THE PREPARATION OF BEVERAGES; COCKTAILS, NON-ALCOHOLIC; SODA WATER; ORANGE JUICE; TOMATO JUICES; PINEAPPLE JUICES; WATERS, NAMELY, DRINKING WATER, BOTTLED WATER AND SPRING WATER; MINERAL WATER; FRUIT JUICE BEVERAGES; LEMONADES; SYRUPS FOR LEMONADE; SYRUPS FOR BEVERAGES; NON-ALCOHOLIC BEVERAGES, NAMELY, NON-ALCOHOLIC BEER AND WINE; NON-ALCOHOLIC FRUIT JUICE BEVERAGES; AERATED WATER; FRUIT POWDERS USED IN THE PREPARATION OF FRUIT-BASED BEVERAGES; CIDER, NON-ALCOHOLIC; SHERBETS; FRUIT NECTARS, NONALCOHOLIC; GRAPE MUST, UNFERMENTED; FRUIT JUICE, IN CLASS 32 (U.S. CLS. 45, 46 AND 48).

PRIORITY CLAIMED UNDER SEC. 44(D) ON REPUBLIC OF KOREA APPLICATION NO. 40-2009-0035, FILED 7-24-2009.

THE COLOR(S) BLUE AND WHITE IS/ARE CLAIMED AS A FEATURE OF THE MARK.

OWNER OF REPUBLIC OF KOREA REG. NO. 40-0836827, DATED 9-17-2010, EXPIRES 9-17-2020.

OWNER OF U.S. REG. NOS. 3,445,144, 3,665,546 AND OTHERS.

THE MARK CONSISTS OF THE WORDS "PARIS BAGUETTE" IN WHITE WITH A REPRESENTATION OF A TOWER IN WHITE THEREBETWEEN, WITHIN A BLUE RECTANGLE BACKGROUND.

SER. NO. 77-877,034, FILED 11-19-2009.

ERNEST SHOSHO, EXAMINING ATTORNEY



David J. Kyffers

Director of the United States Patent and Trademark Office

United States of America

United States Patent and Trademark Office



Reg. No. 4,072,386

Registered Dec. 20, 2011

Int. Cl.: 43

SERVICE MARK

PRINCIPAL REGISTER

PARIS CROISSANT CO., LTD. (REPUBLIC OF KOREA CORPORATION)
SONGNAM-SHI
149-3, SANGDAEWON-DONG, JOONGWON-KU
KYOUNGKI-DO, REPUBLIC OF KOREA 462-807

FOR: CAFES FEATURING BAKERY PRODUCTS; COFFEE SHOP SERVICES; RESTAURANTS; SNACK-BARS; CAFE; CAFETERIAS; CANTEEN SERVICES; SELF-SERVICE RESTAURANTS; SERVING OF FOOD; FOOD AND DRINK CATERING; NON-STOP RESTAURANT SERVICES PROVIDED AT HIGHWAY REST AREAS, IN CLASS 43 (U.S. CLS. 100 AND 101).

PRIORITY CLAIMED UNDER SEC. 44(D) ON REPUBLIC OF KOREA APPLICATION NO. 41-2009-0016, FILED 7-24-2009.

THE COLOR(S) BLUE AND WHITE IS/ARE CLAIMED AS A FEATURE OF THE MARK.

OWNER OF REPUBLIC OF KOREA REG. NO. 40-0201228, DATED 9-17-2010, EXPIRES 9-17-2020.

OWNER OF U.S. REG. NOS. 3,571,356, 3,665,546 AND OTHERS.

THE MARK CONSISTS OF THE LETTERS "P" AND "B" IN WHITE WITH A REPRESENTATION OF A TOWER THEREBETWEEN IN WHITE, ALL SET ON A BLUE RECTANGLE BACKGROUND.

SER. NO. 77-877,041, FILED 11-19-2009.

ERNEST SHOSHO, EXAMINING ATTORNEY



David J. Kybas

Director of the United States Patent and Trademark Office

United States of America

United States Patent and Trademark Office



Reg. No. 4,072,387

Registered Dec. 20, 2011

Int. Cl.: 30

TRADEMARK

PRINCIPAL REGISTER

COMPAÑIA NACIONAL DE CHOCOLATES, S.A. (COLOMBIA CORPORATION)
CARRERA 43 A NO. 1 A SUR
143 MEDELLÍN, COLOMBIA

FOR: CHOCOLATES; CHOCOLATE BARS; SEMI-BITTER CHOCOLATE; BITTER CHOCOLATE; TOASTED COCOA ROOKS COVERED WITH CHOCOLATE; CHOCOLATE COVERED COCA NIBS, IN CLASS 30 (U.S. CL. 46).

FIRST USE 11-1-2007; IN COMMERCE 11-1-2007.

OWNER OF U.S. REG. NOS. 2,937,162 AND 3,752,707.

THE COLOR(S) ORANGE, BROWN AND WHITE IS/ARE CLAIMED AS A FEATURE OF THE MARK.

NO CLAIM IS MADE TO THE EXCLUSIVE RIGHT TO USE "CHOCOLATE, SANTANDER, COLOMBIAN SINGLE ORIGIN" AND "CHOCOLATES", APART FROM THE MARK AS SHOWN.

THE MARK CONSISTS OF THE WORDS "CHOCOLATE SANTANDER COLOMBIAN SINGLE ORIGIN NACIONAL DE CHOCOLATES". BELOW THE WORDS "COLOMBIAN SINGLE ORIGIN" AND ABOVE THE WORDS "NACIONAL DE CHOCOLATES" APPEARS A HOT CHOCOLATE CUP ON A SMALL PLATE WITH SMOKE COMING OUT OF IT OVER A HORIZONTALLY POSITIONED OVAL. THE COLOR BROWN APPEARS IN THE WORDS "CHOCOLATE SANTANDER COLOMBIAN SINGLE ORIGIN NACIONAL DE CHOCOLATE", IN THE HOT CHOCOLATE INSIDE THE CUP, IN THE SMOKE AND IN THE BORDER AREA OF THE OVAL. THE COLOR ORANGE APPEARS IN THE BACKGROUND AND INSIDE THE OVAL. THE COLOR WHITE APPEARS IN THE HOT CHOCOLATE CUP AND ON THE SMALL PLATE.

THE ENGLISH TRANSLATION OF "NACIONAL DE CHOCOLATES" IN THE MARK IS "NATIONAL OF CHOCOLATES".

SER. NO. 77-880,730, FILED 11-25-2009.

WILLIAM P. SHANAHAN, EXAMINING ATTORNEY



David J. Kyros

Director of the United States Patent and Trademark Office

United States of America

United States Patent and Trademark Office

J WEAR

Reg. No. 4,072,388

Registered Dec. 20, 2011

Int. Cl.: 25

TRADEMARK

PRINCIPAL REGISTER

JACOBS, RUTH A (CALIFORNIA SOLE PROPRIETORSHIP), DBA J WEAR
23804 GAVEA CIRCLE
VALENCIA, CA 91355

FOR: ATHLETIC APPAREL, EXCLUDING BALLROOM AND ICE DANCE WEAR, NAMELY, SHIRTS, PANTS, JACKETS, FOOTWEAR, HATS AND CAPS, ATHLETIC UNIFORMS; ATHLETIC UNIFORMS; CHILDREN'S AND INFANT'S APPAREL, NAMELY, JUMPERS, OVERALL SLEEPWEAR, PAJAMAS, ROMPERS AND ONE-PIECE GARMENTS; GYM PANTS; JOGGING PANTS; LEOTARDS; LEOTARDS AND TIGHTS FOR WOMEN, MEN AND CHILDREN OF NYLON, COTTON OR OTHER TEXTILE FIBERS; MOISTURE-WICKING SPORTS PANTS; STRETCH PANTS; SWEAT PANTS; SWEAT SHIRTS; YOGA PANTS, IN CLASS 25 (U.S. CLS. 22 AND 39).

FIRST USE 5-18-2005; IN COMMERCE 5-18-2005.

THE MARK CONSISTS OF STANDARD CHARACTERS WITHOUT CLAIM TO ANY PARTICULAR FONT, STYLE, SIZE, OR COLOR.

NO CLAIM IS MADE TO THE EXCLUSIVE RIGHT TO USE "WEAR", APART FROM THE MARK AS SHOWN.

SER. NO. 77-881,831, FILED 11-29-2009.

ALLISON HOLTZ, EXAMINING ATTORNEY



David J. Kyros

Director of the United States Patent and Trademark Office

United States of America

United States Patent and Trademark Office

Green Way

Reg. No. 4,072,389

Registered Dec. 20, 2011

Int. Cls.: 7 and 10

TRADEMARK

PRINCIPAL REGISTER

LG ELECTRONICS INC. (REPUBLIC OF KOREA CORPORATION)
20, YEOUIDO-DONG, YEONGDEUNGPO-GU
SEOUL, REPUBLIC OF KOREA 150-721

FOR: ELECTRIC VACUUM CLEANERS; ELECTRIC CLOTHES WASHING MACHINES;
AUTOMATIC DISHWASHERS, IN CLASS 7 (U.S. CLS. 13, 19, 21, 23, 31, 34 AND 35).

FOR: MASSAGE APPARATUS; VIBRATING MASSAGE APPARATUS; ELECTRIC MASSAGE
APPARATUS FOR HOUSEHOLD USE; MASSAGE APPARATUS FOR HUMAN BODY; BED
VIBRATORS; CHAIRS FOR ELECTRIC MASSAGE; ESTHETIC MASSAGE APPARATUS,
IN CLASS 10 (U.S. CLS. 26, 39 AND 44).

THE MARK CONSISTS OF STANDARD CHARACTERS WITHOUT CLAIM TO ANY PAR-
TICULAR FONT, STYLE, SIZE, OR COLOR.

PRIORITY CLAIMED UNDER SEC. 44(D) ON REPUBLIC OF KOREA APPLICATION NO.
2009-0004094, FILED 11-6-2009, REG. NO. 0034764, DATED 5-19-2011, EXPIRES 5-19-2021.

NO CLAIM IS MADE TO THE EXCLUSIVE RIGHT TO USE "GREEN", APART FROM THE
MARK AS SHOWN.

SER. NO. 77-882,086, FILED 11-30-2009.

ESTHER A. BORSUK, EXAMINING ATTORNEY



David J. Kyros

Director of the United States Patent and Trademark Office

United States of America
United States Patent and Trademark Office

BASCONI

Reg. No. 4,072,390

Registered Dec. 20, 2011

Int. Cl.: 25

TRADEMARK

PRINCIPAL REGISTER

VITALI, IFRAIMOV (RUSSIAN FED. INDIVIDUAL)
SHELKOWSKOE - SHOSSE
HOUS 44 KORPUS 5 ROOM 75
MOSKOW, RUSSIAN FED. MOSKOW

FOR: BELTS FOR CLOTHING; CAPS; DRESSES; FOOTWEAR; JACKETS; SKIRTS;
TROUSERS, IN CLASS 25 (U.S. CLS. 22 AND 39).

FIRST USE 0-0-2001; IN COMMERCE 0-0-2001.

THE MARK CONSISTS OF STANDARD CHARACTERS WITHOUT CLAIM TO ANY PAR-
TICULAR FONT, STYLE, SIZE, OR COLOR.

SEC. 2(F).

SER. NO. 77-882,715, FILED 11-30-2009.

DAVID H. STINE, EXAMINING ATTORNEY



David J. Kybas

Director of the United States Patent and Trademark Office

United States of America

United States Patent and Trademark Office

SUGAR MOUNTAIN

Reg. No. 4,072,391

3948919 CANADA INC. (CANADA CORPORATION)
286 ELGIN STREET, 2ND FLOOR

Registered Dec. 20, 2011

OTTAWA, ONTARIO, CANADA K2P1M3

Int. Cls.: 9 and 16

FOR: MOTION PICTURE FILMS FEATURING CHILDREN'S ENTERTAINMENT, IN CLASS 9 (U.S. CLS. 21, 23, 26, 36 AND 38).

TRADEMARK

FOR: CHILDREN'S BOOKS, IN CLASS 16 (U.S. CLS. 2, 5, 22, 23, 29, 37, 38 AND 50).

PRINCIPAL REGISTER

THE MARK CONSISTS OF STANDARD CHARACTERS WITHOUT CLAIM TO ANY PARTICULAR FONT, STYLE, SIZE, OR COLOR.

OWNER OF CANADA REG. NO. TMA509515, DATED 6-28-2011, EXPIRES 6-28-2026.

OWNER OF U.S. REG. NOS. 3,112,503 AND 3,268,730.

SER. NO. 77-887,377, FILED 12-7-2009.

CARRIE GENOVESE, EXAMINING ATTORNEY



David J. Kyros

Director of the United States Patent and Trademark Office

United States of America

United States Patent and Trademark Office

COACH KELLY

Reg. No. 4,072,392

Registered Dec. 20, 2011

Int. Cl.: 41

SERVICE MARK

PRINCIPAL REGISTER

COACH KELLY, LLC (WASHINGTON LIMITED LIABILITY COMPANY)
6947 COAL CREEK, LLC, #230
NEWCASTLE, WA 98059

FOR: COACHING SERVICES IN THE FIELD OF BUSINESS MANAGEMENT, AND EXECUTIVE, ORGANIZATIONAL, MANAGEMENT, AND LEADERSHIP DEVELOPMENT, IN CLASS 41 (U.S. CLS. 100, 101 AND 107).

FIRST USE 4-1-2007; IN COMMERCE 4-1-2007.

THE MARK CONSISTS OF STANDARD CHARACTERS WITHOUT CLAIM TO ANY PARTICULAR FONT, STYLE, SIZE, OR COLOR.

NO CLAIM IS MADE TO THE EXCLUSIVE RIGHT TO USE "COACH", APART FROM THE MARK AS SHOWN.

THE NAME(S), PORTRAIT(S), AND/OR SIGNATURE(S) SHOWN IN THE MARK IDENTIFIES THE PSEUDONYM/NICKNAME OF "KELLY" HOLM, A LIVING INDIVIDUAL, WHOSE CONSENT(S) TO REGISTER IS MADE OF RECORD.

SER. NO. 77-889,646, FILED 12-9-2009.

KEVON CHISOLM, EXAMINING ATTORNEY



David J. Kyros

Director of the United States Patent and Trademark Office

United States of America

United States Patent and Trademark Office

ONE WORLD FOUNDATION

Reg. No. 4,072,393

Registered Dec. 20, 2011

Int. Cl.: 9

TRADEMARK

PRINCIPAL REGISTER

GOLDEN SHELTERS PRIVATE LIMITED (INDIA COMPANY)
33, SHAFEE MOHAMMED ROAD
4TH FLOOR, RUTLAND TOWERS
CHENNAI, TAMIL NADU, INDIA 600006

FOR: COMPUTER SOFTWARE FOR COLLECTING, EDITING, ORGANIZING AND SHARING OF DATA AND INFORMATION ON SELF-IMPROVEMENT AND EMPOWERMENT, RELIGION, AND SPIRITUALITY; DOWNLOADABLE ELECTRONIC PUBLICATIONS IN THE NATURE OF MAGAZINES, NEWSLETTERS, BROCHURES AND CATALOGS IN THE FIELD OF SELF-IMPROVEMENT AND PERSONAL EMPOWERMENT, RELIGION, AND SPIRITUALITY; VIDEO TAPES AND VIDEO CASSETTES FEATURING SUBJECT MATTER RELATING TO SELF IMPROVEMENT AND PERSONAL EMPOWERMENT, RELIGION, AND SPIRITUALITY, IN CLASS 9 (U.S. CLS. 21, 23, 26, 36 AND 38).

THE MARK CONSISTS OF STANDARD CHARACTERS WITHOUT CLAIM TO ANY PARTICULAR FONT, STYLE, SIZE, OR COLOR.

PRIORITY CLAIMED UNDER SEC. 44(D) ON ERPN CMNTY TM OFC APPLICATION NO. 008763229, FILED 12-16-2009, REG. NO. 008763229, DATED 6-11-2010, EXPIRES 12-16-2019.

NO CLAIM IS MADE TO THE EXCLUSIVE RIGHT TO USE "FOUNDATION", APART FROM THE MARK AS SHOWN.

SER. NO. 77-895,762, FILED 12-17-2009.

MAYUR VAGHANI, EXAMINING ATTORNEY



David J. Kypos

Director of the United States Patent and Trademark Office

United States of America

United States Patent and Trademark Office

RE TEE

Reg. No. 4,072,394

Registered Dec. 20, 2011

Int. Cl.: 28

TRADEMARK

PRINCIPAL REGISTER

MCCRIMMON, JAMES (CANADA INDIVIDUAL)
4402 - 48 STREET
VEGREVILLE, ALBERTA, CANADA T9C1A9

FOR: GOLF EQUIPMENT, NAMELY, DIVOT REPAIR TOOL, GOLF TEE HOLDER, GOLF TEE SHARPENER AND COMBINATIONS THEREOF, IN CLASS 28 (U.S. CLS. 22, 23, 38 AND 50).

THE MARK CONSISTS OF STANDARD CHARACTERS WITHOUT CLAIM TO ANY PARTICULAR FONT, STYLE, SIZE, OR COLOR.

PRIORITY CLAIMED UNDER SEC. 44(D) ON CANADA APPLICATION NO. 1,422,705, FILED 6-25-2009, REG. NO. TMA783,408, DATED 11-25-2010, EXPIRES 11-25-2025.

NO CLAIM IS MADE TO THE EXCLUSIVE RIGHT TO USE "TEE", APART FROM THE MARK AS SHOWN.

SER. NO. 77-899,535, FILED 12-22-2009.

HELENE LIWINSKI, EXAMINING ATTORNEY



David J. Kyffers

Director of the United States Patent and Trademark Office

United States of America

United States Patent and Trademark Office



Reg. No. 4,072,395

Registered Dec. 20, 2011

Int. Cls.: 35, 42 and 45

SERVICE MARK

PRINCIPAL REGISTER

COURTROOM SCIENCES INC. (TEXAS CORPORATION)
4950 N. O'CONNOR BLVD.
IRVING, TX 75062

FOR: DEPOSITION SCHEDULING; DATA PROCESSING; PERSONNEL PLACEMENT, NAMELY, PROVIDING TRIAL TECHNICIANS; PROVIDING ON-LINE DIRECTORY INFORMATION SERVICES FEATURING HYPERLINKS TO OTHER WEB SITES AND DOCUMENT REPOSITORIES; LEGAL DOCUMENT PRODUCTION MANAGEMENT SERVICES FOR OTHERS; REPROGRAPHIC SERVICES; PREPARATION AND PRESENTATION OF DEPOSITION TRANSCRIPT; PROVIDING TRIAL TECHNICIANS; PROVIDING TRIAL TECHNICIANS FOR THE PURPOSE OF PROVIDING TECHNICAL CONSULTANCY IN RELATION TO TECHNOLOGIES AND TECHNICAL EQUIPMENT USED IN TRIALS, IN CLASS 35 (U.S. CLS. 100, 101 AND 102).

FIRST USE 7-1-2009; IN COMMERCE 7-1-2009.

FOR: CONDUCTING ELECTRONIC DISCOVERY SERVICES VIA GLOBAL COMPUTER NETWORKS; FORENSIC COLLECTION AND ANALYSIS; COMPUTER DATA RESTORATION AND FILTERING; CREATING GRAPHIC AND TRIAL BOARDS; PUBLIC RECORDS AND DOCUMENT RETRIEVAL; COMPUTER GRAPHIC DEVELOPMENT FOR OTHERS; GRAPHIC DESIGN SERVICES, NAMELY, CREATING 2-D AND 3-D ANIMATIONS FOR OTHERS; CREATIVE GRAPHIC ILLUSTRATION SERVICES FOR OTHERS; DOCUMENT IMAGING, IN CLASS 42 (U.S. CLS. 100 AND 101).

FIRST USE 7-1-2009; IN COMMERCE 7-1-2009.

FOR: LITIGATION SUPPORT SERVICES, NAMELY, CREATION OF PRIVILEGE LOGS; REAL-TIME AND TRADITIONAL COURT REPORTING; REAL-TIME COURT REPORTING VIA THE INTERNET; SUBPOENA PREPARATION SERVICES; OBTAINING RECORDINGS OF AFFIDAVITS; PREPARING AFFIDAVITS; PROCESS SERVING; LEGAL DOCUMENT REVIEW; LITIGATION CONSULTATION IN WITNESS TRAINING, JURY RESEARCH AND JURY PROFILES RESEARCH, TRIAL VENUE SURVEY; MOCK TRIALS, LEGAL RESEARCH USING FOCUS GROUPS, JURY SIMULATIONS, MOCK BENCH TRIALS, MOCK ARBITRATIONS, ONLINE MOCK TRIALS, VOIR DIRE DEVELOPMENT, JURY SELECTION AND QUESTIONNAIRES, TRIAL TECHNICIANS AND PRESENTATION TECHNOLOGY; POST-TRIAL JURY INTERVIEWS; LEGAL CONSULTING IN THE FIELD OF LITIGATION SUPPORT; PROVIDING TRIAL DATABASES, IN CLASS 45 (U.S. CLS. 100 AND 101).



David J. Kybas

Director of the United States Patent and Trademark Office

Reg. No. 4,072,395 FIRST USE 7-1-2009; IN COMMERCE 7-1-2009.

OWNER OF U.S. REG. NOS. 2,258,889 AND 2,280,614.

THE COLOR(S) BLUE (THREE SHADES OF BLUE) AND WHITE IS/ARE CLAIMED AS A FEATURE OF THE MARK.

NO CLAIM IS MADE TO THE EXCLUSIVE RIGHT TO USE "GLOBAL DEPOSITION SERVICES WWW.COURTROOMSCIENCES.COM", APART FROM THE MARK AS SHOWN.

THE MARK CONSISTS OF THE WORDS "GLOBAL DEPOSITION SERVICES" OVER THE WORDS "WWW.COURTROOMSCIENCES.COM", WITH "GLOBAL" AND "SERVICES" AND "WWW.COURTROOMSCIENCES.COM" BEING IN DARK NAVY BLUE, AND "DEPOSITION" (MINUS THE FIRST "I") BEING IN LIGHT BLUE. THE LETTERS "CSI" APPEAR STACKED ON TOP OF EACH OTHER WITH THE "C" BEING WHITE IN A DARK NAVY BLUE BOX, THE "S" BEING WHITE IN A MEDIUM BLUE BOX, AND "I" BEING WHITE IN A LIGHT BLUE BOX. THE "I" OF THE STACKED "CSI" APPEARS IN PLACE OF THE FIRST "I" IN "DEPOSITION". IN ADDITION THERE ARE FIVE BOXES FLOATING AROUND THE STACKED "CSI", OUTLINED IN VARIOUS SHADES OF DARK, MEDIUM, AND LIGHT BLUE, WITH WHITE INTERIORS.

SER. NO. 77-900,147, FILED 12-23-2009.

JANET LEE, EXAMINING ATTORNEY

United States of America

United States Patent and Trademark Office



Reg. No. 4,072,396

Registered Dec. 20, 2011

Int. Cls.: 35, 42 and 45

SERVICE MARK

PRINCIPAL REGISTER

COURTROOM SCIENCES INC. (TEXAS CORPORATION)
4950 N. O'CONNOR BLVD.
IRVING, TX 75062

FOR: DEPOSITION SCHEDULING; DATA PROCESSING; PERSONNEL PLACEMENT, NAMELY, PROVIDING TRIAL TECHNICIANS; PROVIDING ON-LINE DIRECTORY INFORMATION SERVICES FEATURING HYPERLINKS TO OTHER WEB SITES AND DOCUMENT REPOSITORIES; LEGAL DOCUMENT PRODUCTION MANAGEMENT SERVICES FOR OTHERS; REPROGRAPHIC SERVICES; PREPARATION AND PRESENTATION OF DEPOSITION TRANSCRIPT; PROVIDING TRIAL TECHNICIANS; PROVIDING TRIAL TECHNICIANS FOR THE PURPOSE OF PROVIDING TECHNICAL CONSULTANCY IN RELATION TO TECHNOLOGIES AND TECHNICAL EQUIPMENT USED IN TRIALS, IN CLASS 35 (U.S. CLS. 100, 101 AND 102).

FIRST USE 7-1-2009; IN COMMERCE 7-1-2009.

FOR: CONDUCTING ELECTRONIC DISCOVERY SERVICES VIA GLOBAL COMPUTER NETWORKS; FORENSIC COLLECTION AND ANALYSIS; COMPUTER DATA RESTORATION AND FILTERING; CREATING GRAPHIC AND TRIAL BOARDS; PUBLIC RECORDS AND DOCUMENT RETRIEVAL; COMPUTER GRAPHIC DEVELOPMENT FOR OTHERS; GRAPHIC DESIGN SERVICES, NAMELY, CREATING 2-D AND 3-D ANIMATIONS FOR OTHERS; CREATIVE GRAPHIC ILLUSTRATION SERVICES FOR OTHERS; DOCUMENT IMAGING, IN CLASS 42 (U.S. CLS. 100 AND 101).

FIRST USE 7-1-2009; IN COMMERCE 7-1-2009.

FOR: LITIGATION SUPPORT SERVICES, NAMELY, CREATION OF PRIVILEGE LOGS; REAL-TIME AND TRADITIONAL COURT REPORTING; REAL-TIME COURT REPORTING VIA THE INTERNET; SUBPOENA PREPARATION SERVICES; OBTAINING RECORDINGS OF AFFIDAVITS; PREPARING AFFIDAVITS; PROCESS SERVING; LEGAL DOCUMENT REVIEW; LITIGATION CONSULTATION IN WITNESS TRAINING, JURY RESEARCH AND JURY PROFILES RESEARCH, TRIAL VENUE SURVEY; MOCK TRIALS, LEGAL RESEARCH USING FOCUS GROUPS, JURY SIMULATIONS, MOCK BENCH TRIALS, MOCK ARBITRATIONS, ONLINE MOCK TRIALS, VOIR DIRE DEVELOPMENT, JURY SELECTION AND QUESTIONNAIRES, TRIAL TECHNICIANS AND PRESENTATION TECHNOLOGY; POST-TRIAL JURY INTERVIEWS; LEGAL CONSULTING IN THE FIELD OF LITIGATION SUPPORT; PROVIDING TRIAL DATABASES, IN CLASS 45 (U.S. CLS. 100 AND 101).



David J. Kybas

Director of the United States Patent and Trademark Office

Reg. No. 4,072,396 FIRST USE 7-1-2009; IN COMMERCE 7-1-2009.

OWNER OF U.S. REG. NOS. 2,258,889, 2,280,614, AND 2,306,920.

THE COLOR(S) BLUE (THREE SHADES OF BLUE) AND WHITE IS/ARE CLAIMED AS A FEATURE OF THE MARK.

NO CLAIM IS MADE TO THE EXCLUSIVE RIGHT TO USE "COURTROOM SCIENCES INC. WWW.COURTROOMSCIENCES.COM", APART FROM THE MARK AS SHOWN.

THE MARK CONSISTS OF THE WORDS "COURTROOM SCIENCES INC" OVER THE WORDS "WWW.COURTROOMSCIENCES.COM", WITH "COURTROOM" AND "INC" AND "WWW.COURTROOMSCIENCES.COM" BEING IN DARK NAVY BLUE, AND "SCIENCES" (MINUS THE "I") BEING IN LIGHT BLUE. THE LETTERS "CSI" APPEAR STACKED ON TOP OF EACH OTHER WITH THE "C" BEING WHITE IN A DARK NAVY BLUE BOX, THE "S" BEING WHITE IN A MEDIUM BLUE BOX, AND "I" BEING WHITE IN A LIGHT BLUE BOX. THE "I" OF THE STACKED "CSI" APPEARS IN PLACE OF THE "I" IN "SCIENCES". IN ADDITION THERE ARE FIVE BOXES FLOATING AROUND THE STACKED "CSI", OUTLINED IN VARIOUS SHADES OF DARK, MEDIUM, AND LIGHT BLUE, WITH WHITE INTERIORS.

SER. NO. 77-900,149, FILED 12-23-2009.

JANET LEE, EXAMINING ATTORNEY

United States of America

United States Patent and Trademark Office

UltraFire



Reg. No. 4,072,397

Registered Dec. 20, 2011

Int. Cl.: 11

TRADEMARK

PRINCIPAL REGISTER

BIN ZHAO (CHINA INDIVIDUAL)
HEDONG ROAD, NANSHAN DISTRICT
NO. 5C BUILDING 3, WANPAN GARDEN
SHENZHEN, GUANGDONG, CHINA

FOR: BICYCLE LAMPS; BICYCLE LIGHTS; ELECTRIC LUMINAIRES; FLASHING STROBE LIGHT APPARATUS; FLUORESCENT LAMPS; HIGH INTENSITY SEARCH LIGHTS; INCANDESCENT LAMPS; INFRARED LAMPS; LAMP BULBS; LIGHTING APPARATUS FOR SPORTS ARENAS; LIGHTING APPARATUS FOR THEATRES AND CLUBS; LIGHTING DEVICES FOR SHOWCASES; LIGHT BULBS; OVERHEAD LAMPS; RED LED FLASHLIGHTS FOR ILLUMINATION PURPOSES, IN CLASS 11 (U.S. CLS. 13, 21, 23, 31 AND 34).

FIRST USE 7-1-2007; IN COMMERCE 7-1-2007.

THE MARK CONSISTS OF ENGLISH LETTERS "ULTRAFIRE", AND AN IMAGE OF FLAME.

SER. NO. 77-900,946, FILED 12-24-2009.

TASNEEM HUSSAIN, EXAMINING ATTORNEY



David J. Kyros

Director of the United States Patent and Trademark Office

United States of America

United States Patent and Trademark Office



Reg. No. 4,072,398

Registered Dec. 20, 2011

Int. Cl.: 41

SERVICE MARK

PRINCIPAL REGISTER

TEXAS COUNSELING ASSOCIATION (TEXAS NON-PROFIT CORPORATION)
1204 SAN ANTONIO, SUITE 201
AUSTIN, TX 78701

FOR: PROVIDING CONTINUING PROFESSIONAL EDUCATION SERVICES, CLASSES, CONFERENCES, SEMINARS, AND WORKSHOPS ON MATTERS RELATED TO PROFESSIONAL COUNSELORS AND THE ACADEMIC, CAREER, PERSONAL AND EMOTIONAL GROWTH AND WELL BEING OF INDIVIDUALS AND FAMILIES; ARRANGING AND CONDUCTING CLASSES, CONFERENCES, SEMINARS AND WORKSHOPS FOR PROFESSIONAL COUNSELORS AND OTHERS INTERESTED IN THE ACADEMIC, CAREER, PERSONAL AND EMOTIONAL GROWTH AND WELL BEING OF INDIVIDUALS AND FAMILIES; PROVIDING INFORMATIONAL AND MOTIVATIONAL SPEAKING SERVICES IN THE FIELD OF LEADERSHIP, ADVOCACY AND EDUCATION ON ISSUES RELATED TO PROFESSIONAL COUNSELORS AND ACADEMIC, CAREER, PERSONAL AND EMOTIONAL GROWTH AND WELLBEING; AND, PUBLISHING OF ELECTRONIC PUBLICATIONS, JOURNALS, NEWSLETTERS, AND POSITION PAPERS ON ISSUES RELATED TO PROFESSIONAL COUNSELORS AND THE ACADEMIC, CAREER, PERSONAL AND EMOTIONAL GROWTH AND WELL BEING OF INDIVIDUALS AND FAMILIES, IN CLASS 41 (U.S. CLS. 100, 101 AND 107).

FIRST USE 4-21-2000; IN COMMERCE 4-21-2000.

NO CLAIM IS MADE TO THE EXCLUSIVE RIGHT TO USE "TEXAS COUNSELING ASSOCIATION" AND THE OUTLINE MAP OF THE STATE OF TEXAS, APART FROM THE MARK AS SHOWN.

THE MARK CONSISTS OF THE LETTERS "T", "C", "A" THE LETTERS ARE IN AN OUTLINE MAP OF THE STATE OF TEXAS; THE OUTLINE MAP OF THE STATE OF TEXAS IS ON A SQUARE WITH LINES; THE BOTTOM LEFT QUADRANT OF THE SQUARE WITH LINES INCLUDES THE WORDS "TEXAS COUNSELING ASSOCIATION".

SER. NO. 77-903,705, FILED 12-31-2009.

DAVID TAYLOR, EXAMINING ATTORNEY



David J. Kyros

Director of the United States Patent and Trademark Office

United States of America

United States Patent and Trademark Office

HEALTHY STEPS

Reg. No. 4,072,399

JOKARI/US, INC. (TEXAS CORPORATION)

Registered Dec. 20, 2011

1220 CHAMPION CIRCLE #100
CARROLLTON, TX 75006

Int. Cls.: 8 and 21

FOR: NON-ELECTRIC KITCHEN UTENSILS FOR THE PURPOSE OF MEASURING, PREPARING AND DISPENSING FRUIT, NAMELY, PEELERS AND ZESTERS; NON-ELECTRIC KITCHEN UTENSILS FOR THE PURPOSE OF SLICING AND DICING FOOD, NAMELY, SLICERS, IN CLASS 8 (U.S. CLS. 23, 28 AND 44).

TRADEMARK

PRINCIPAL REGISTER

FIRST USE 12-4-2009; IN COMMERCE 12-4-2009.

FOR: FLAVOR INFUSERS FOR BEVERAGES AND COOKING, NAMELY, SPOON INFUSERS, MESH BALL INFUSERS FOR USE IN A PITCHER, INFUSERS FOR USE WITH WATER BOTTLES; KITCHEN UTENSILS FOR THE PURPOSE OF MEASURING, PREPARING AND DISPENSING DRY FOOD ITEMS, NAMELY, SHAKERS; KITCHEN UTENSILS FOR THE PURPOSE OF MEASURING, PREPARING AND DISPENSING PROTEINS AND/OR STARCHES, NAMELY, LADLES AND SPATULAS; KITCHEN UTENSILS FOR THE PURPOSE OF PREPARING AND DISPENSING PROTEINS AND/OR STARCHES, NAMELY, MIXING SPOONS; NON-ELECTRIC KITCHEN UTENSILS FOR THE PURPOSE OF MEASURING, PREPARING AND DISPENSING VEGETABLES, NAMELY, STEAMERS, COLANDERS, BOWLS; NON-ELECTRIC KITCHEN UTENSILS FOR THE PURPOSE OF MEASURING, PREPARING AND DISPENSING FRUIT, NAMELY, GRATERS; NON-ELECTRIC KITCHEN UTENSILS FOR THE PURPOSE OF SLICING AND DICING FOOD, NAMELY, GRATERS; NOVELTY SERVING DISHES; NOVELTY HOUSEHOLD CONTAINERS FOR FOOD STORAGE; NON-ELECTRIC HOUSEHOLD UTENSILS FOR THE PURPOSE OF OPENING BOTTLES, JARS AND CANS, NAMELY, BOTTLE OPENERS, JAR OPENERS, IN CLASS 21 (U.S. CLS. 2, 13, 23, 29, 30, 33, 40 AND 50).

FIRST USE 12-4-2009; IN COMMERCE 12-4-2009.

THE MARK CONSISTS OF STANDARD CHARACTERS WITHOUT CLAIM TO ANY PARTICULAR FONT, STYLE, SIZE, OR COLOR.

SER. NO. 77-907,639, FILED 1-8-2010.

SANI KHOURI, EXAMINING ATTORNEY



David J. Kyros

Director of the United States Patent and Trademark Office

United States of America

United States Patent and Trademark Office

American Grid

Reg. No. 4,072,400

AMERICAN GRID INC. (DELAWARE CORPORATION)
14112 BIG BRANCH DRIVE
DAYTON, MD 21306

Registered Dec. 20, 2011

Int. Cl.: 9

FOR: HOME AND OFFICE AUTOMATION SYSTEMS COMPRISING WIRELESS AND WIRED CONTROLLERS, CONTROLLED DEVICES, AND SOFTWARE FOR LIGHTING, HVAC, SECURITY, SAFETY AND OTHER HOME AND OFFICE MONITORING AND CONTROL APPLICATIONS, IN CLASS 9 (U.S. CLS. 21, 23, 26, 36 AND 38).

TRADEMARK

PRINCIPAL REGISTER

FIRST USE 1-1-2005; IN COMMERCE 1-1-2005.

THE MARK CONSISTS OF STANDARD CHARACTERS WITHOUT CLAIM TO ANY PARTICULAR FONT, STYLE, SIZE, OR COLOR.

SEC. 2(F).

SER. NO. 77-908,759, FILED 1-11-2010.

ELISSA GARBER KON, EXAMINING ATTORNEY



David J. Kyffers

Director of the United States Patent and Trademark Office

United States of America

United States Patent and Trademark Office

RAPPLEBERRY BAGELS

Reg. No. 4,072,401

Registered Dec. 20, 2011

Int. Cl.: 30

TRADEMARK

PRINCIPAL REGISTER

VIBRANT HEALTH PRODUCTS INC. (CANADA CORPORATION), DBA SILVER HILLS
BAKERY
30971 PEARDONVILLE ROAD
ABBOTSFORD, BC, CANADA V2T6K3

FOR: BAKED GOODS, NAMELY, BAGELS, IN CLASS 30 (U.S. CL. 46).

THE MARK CONSISTS OF STANDARD CHARACTERS WITHOUT CLAIM TO ANY PARTICULAR FONT, STYLE, SIZE, OR COLOR.

PRIORITY CLAIMED UNDER SEC. 44(D) ON CANADA APPLICATION NO. 1,466,025, FILED 1-15-2010, REG. NO. TMA798,500, DATED 5-25-2011, EXPIRES 5-25-2026.

NO CLAIM IS MADE TO THE EXCLUSIVE RIGHT TO USE "BAGELS", APART FROM THE MARK AS SHOWN.

SER. NO. 77-914,150, FILED 1-18-2010.

TARA PATE, EXAMINING ATTORNEY



David J. Kyros

Director of the United States Patent and Trademark Office

United States of America

United States Patent and Trademark Office

Accredited Investment Fiduciary Analyst

Reg. No. 4,072,402

Registered Dec. 20, 2011

CERTIFICATION MARK

PRINCIPAL REGISTER

CENTER FOR FIDUCIARY STUDIES, LLC (PENNSYLVANIA LIMITED LIABILITY COMPANY)

ABELE OFFICE PARK
10 EMERSON LANE, SUITE 801-3
BRIDGEVILLE, PA 15017

FOR: FIDUCIARY AUDITING, IN CLASS B (U.S. CL. B).

FIRST USE 6-2-2006; IN COMMERCE 6-2-2006.

THE MARK CONSISTS OF STANDARD CHARACTERS WITHOUT CLAIM TO ANY PARTICULAR FONT, STYLE, SIZE, OR COLOR.

NO CLAIM IS MADE TO THE EXCLUSIVE RIGHT TO USE "ACCREDITED" OR "ANALYST", APART FROM THE MARK AS SHOWN.

THE CERTIFICATION MARK, AS USED BY AUTHORIZED PERSONS, CERTIFIES THAT THEY HAVE MET CERTAIN STANDARDS AND LEVELS OF EXPERIENCE, EDUCATION, ETHICS, AND TESTS OF COMPETENCY AND STANDARDS SET BY THE CERTIFIER.

SEC. 2(F).

SER. NO. 77-915,891, FILED 1-20-2010.

RENEE MCCRAY, EXAMINING ATTORNEY



David J. Kybas

Director of the United States Patent and Trademark Office

United States of America

United States Patent and Trademark Office

RotorFix

Reg. No. 4,072,403

Registered Dec. 20, 2011

Int. Cl.: 37

SERVICE MARK

PRINCIPAL REGISTER

O & L SOLUTIONS, INC. (FLORIDA CORPORATION), DBA ROTORFIX
SUITE 800
201 S. BISCAYNE BOULEVARD
MIAMI, FL 33131

FOR: AIRCRAFT REPAIR AND MAINTENANCE, IN CLASS 37 (U.S. CLS. 100, 103 AND 106).

FIRST USE 10-12-2009; IN COMMERCE 10-12-2009.

THE MARK CONSISTS OF STANDARD CHARACTERS WITHOUT CLAIM TO ANY PARTICULAR FONT, STYLE, SIZE, OR COLOR.

SER. NO. 77-919,373, FILED 1-25-2010.

H. M. FISHER, EXAMINING ATTORNEY



David J. Kyffers

Director of the United States Patent and Trademark Office

United States of America

United States Patent and Trademark Office

Frusano

Reg. No. 4,072,404

HERRMANN, ULF (FED REP GERMANY INDIVIDUAL), DBA FRUSANO E.KFM.
GROSCHENWEG 41B

Registered Dec. 20, 2011

MUENCHEN, FED REP GERMANY 81825

Int. Cls.: 29, 30 and 32

FOR: JAMS AND MARMALADES; JELLIES, JAMS, IN CLASS 29 (U.S. CL. 46).

TRADEMARK

FOR: CAKES; CANDIES; CHOCOLATE AND CHOCOLATES; CHOCOLATE BARS;
CHOCOLATE CHIPS; CHOCOLATE TRUFFLES; CHOCOLATES AND CHOCOLATE BASED
READY TO EAT CANDIES AND SNACKS; CHOCOLATES CONTAINING NUTRIENTS;
COOKIES; FILLED CHOCOLATE; PEPPERMINT SWEETS; SNACK FOODS, NAMELY,
CHOCOLATE-BASED SNACK FOODS, IN CLASS 30 (U.S. CL. 46).

PRINCIPAL REGISTER

FOR: CONCENTRATES, SYRUPS OR POWDERS USED IN THE PREPARATION OF SOFT
DRINKS; ENERGY DRINKS; FRUIT DRINKS AND JUICES; SOFT DRINKS; SYRUPS FOR
BEVERAGES, IN CLASS 32 (U.S. CLS. 45, 46 AND 48).

THE MARK CONSISTS OF STANDARD CHARACTERS WITHOUT CLAIM TO ANY PAR-
TICULAR FONT, STYLE, SIZE, OR COLOR.

OWNER OF FED REP GERMANY REG. NO. 30619260, DATED 3-23-2006, EXPIRES 3-31-
2016.

SER. NO. 77-920,299, FILED 1-26-2010.

MARY CRAWFORD, EXAMINING ATTORNEY



David J. Kybas

Director of the United States Patent and Trademark Office

United States of America

United States Patent and Trademark Office

eDevelopment
The art of Ideas

Reg. No. 4,072,405

EDEVELOPMENT CORPORATION (NEVADA CORPORATION)
800 E. CHARLESTON BLVD
LAS VEGAS, NV 89104

Registered Dec. 20, 2011

Int. Cl.: 9

FOR: COMPUTER SOFTWARE FOR PERSONAL COMPUTER SYSTEM MANAGEMENT, AUDITING OF COMPUTER SYSTEM CONFIGURATIONS, SYSTEM INVENTORY, AND REPORTING, IN CLASS 9 (U.S. CLS. 21, 23, 26, 36 AND 38).

TRADEMARK

FIRST USE 11-30-2006; IN COMMERCE 11-30-2006.

PRINCIPAL REGISTER

THE MARK CONSISTS OF A ROUGH HAND SKETCHED WORDING "EDEVELOPMENT" THAT IS HOLLOW ON THE INSIDE. BELOW APPEARS "THE ART OF IDEAS".

SER. NO. 77-924,070, FILED 1-29-2010.

ELIZABETH KAJUBI, EXAMINING ATTORNEY



David J. Kybas

Director of the United States Patent and Trademark Office

United States of America

United States Patent and Trademark Office

KNIT WORKS

Reg. No. 4,072,406

KWDZ MANUFACTURING, LLC (DELAWARE LIMITED LIABILITY COMPANY)
337 S. ANDERSON ST.

Registered Dec. 20, 2011

LOS ANGELES, CA 90033

Int. Cl.: 25

FOR: WOMEN'S AND GIRLS' APPAREL, NAMELY, WOVEN, KNIT AND OTHER TOPS, BLOUSES, SWEATERS, SHIRTS, HOODS, HATS, DRESSES, SKIRTS, BOTTOMS, PANTS AND SHORTS, IN CLASS 25 (U.S. CLS. 22 AND 39).

TRADEMARK

FIRST USE 9-1-1982; IN COMMERCE 9-1-1982.

PRINCIPAL REGISTER

THE MARK CONSISTS OF STANDARD CHARACTERS WITHOUT CLAIM TO ANY PARTICULAR FONT, STYLE, SIZE, OR COLOR.

NO CLAIM IS MADE TO THE EXCLUSIVE RIGHT TO USE "KNIT", APART FROM THE MARK AS SHOWN.

SEC. 2(F).

SER. NO. 77-933,993, FILED 2-11-2010.

ALLISON SCHRODY, EXAMINING ATTORNEY



David J. Kyros

Director of the United States Patent and Trademark Office

United States of America

United States Patent and Trademark Office

SORVINO

Reg. No. 4,072,407

Registered Dec. 20, 2011

Int. Cl.: 33

TRADEMARK

PRINCIPAL REGISTER

PAUL SORVINO FOODS, INC. (DELAWARE CORPORATION)
SUITE 134
4001 KENNETT PIKE
GREENVILLE, DE 19807

FOR: WINES, IN CLASS 33 (U.S. CLS. 47 AND 49).

FIRST USE 12-0-2010; IN COMMERCE 12-0-2010.

THE MARK CONSISTS OF STANDARD CHARACTERS WITHOUT CLAIM TO ANY PARTICULAR FONT, STYLE, SIZE, OR COLOR.

OWNER OF U.S. REG. NOS. 3,363,583 AND 3,786,823.

THE NAME "SORVINO" IDENTIFIES A LIVING INDIVIDUAL WHOSE CONSENT IS OF RECORD.

SEC. 2(F).

SER. NO. 77-935,261, FILED 2-13-2010.

ODESSA BIBBINS, EXAMINING ATTORNEY



David J. Kybas

Director of the United States Patent and Trademark Office

United States of America

United States Patent and Trademark Office



Artesano Iron Works

Reg. No. 4,072,408

Registered Dec. 20, 2011

Int. Cls.: 6, 21 and 35

TRADEMARK

SERVICE MARK

PRINCIPAL REGISTER

908 WESTMORELAND ST., LLC (PENNSYLVANIA LIMITED LIABILITY COMPANY), DBA
ARTESANO IRON WORKS
4446 CRESSON STREET
PHILADELPHIA, PA 19127

FOR: METAL GATES; METAL FENCES; METAL DOORS; METAL RAILINGS FOR STAIRS;
METAL BALCONY ENCLOSURES; HARDWARE ACCESSORIES, NAMELY, METAL DOOR
KNOCKERS, METAL DOOR HANDLES, METAL DOOR PULLS AND METAL DOOR KNOBS,
IN CLASS 6 (U.S. CLS. 2, 12, 13, 14, 23, 25 AND 50).

FIRST USE 6-1-2005; IN COMMERCE 6-1-2005.

FOR: BATHROOM ACCESSORIES, NAMELY, TOWEL BARS, TOWEL RINGS AND TOILET
TISSUE HOLDERS, IN CLASS 21 (U.S. CLS. 2, 13, 23, 29, 30, 33, 40 AND 50).

FIRST USE 6-1-2005; IN COMMERCE 6-1-2005.

FOR: ART GALLERIES, IN CLASS 35 (U.S. CLS. 100, 101 AND 102).

FIRST USE 6-1-2005; IN COMMERCE 6-1-2005.

NO CLAIM IS MADE TO THE EXCLUSIVE RIGHT TO USE "ARTESANO IRON WORKS",
APART FROM THE MARK AS SHOWN.

THE MARK CONSISTS OF CIRCULAR SEAL WITH ANVIL IN CENTER SURROUNDED
BY TWO WREATHS AND DECORATIVE BORDER. ANVIL, WREATHS AND BORDER ARE
RAISED. BELOW THE SEAL ARE THE WORDS "ARTESANO IRON WORKS" IN STYLIZED
FONT.

THE ENGLISH TRANSLATION OF "ARTESANO" IN THE MARK IS "ARTISAN".

SER. NO. 77-943,280, FILED 2-24-2010.

LEIGH CAROLINE CASE, EXAMINING ATTORNEY



David J. Kyffers

Director of the United States Patent and Trademark Office

United States of America

United States Patent and Trademark Office

RefractFACT

Reg. No. 4,072,409

STEVENS, JULIAN (UNITED KINGDOM INDIVIDUAL)
11 SHELDON AVENUE

Registered Dec. 20, 2011

LONDON, UNITED KINGDOM N64JS

Int. Cl.: 9

FOR: MEDICAL SOFTWARE PROGRAM FOR USE DURING REFRACTIVE OPHTHALMOLOGICAL SURGERY, IN CLASS 9 (U.S. CLS. 21, 23, 26, 36 AND 38).

TRADEMARK

THE MARK CONSISTS OF STANDARD CHARACTERS WITHOUT CLAIM TO ANY PARTICULAR FONT, STYLE, SIZE, OR COLOR.

PRINCIPAL REGISTER

PRIORITY CLAIMED UNDER SEC. 44(D) ON ERPN CMNTY TM OFC APPLICATION NO. 008915969, FILED 2-26-2010, REG. NO. 008915969, DATED 8-2-2010, EXPIRES 2-26-2020.

SER. NO. 77-945,646, FILED 2-26-2010.

BENJAMIN OKEKE, EXAMINING ATTORNEY



David J. Kybas

Director of the United States Patent and Trademark Office

United States of America

United States Patent and Trademark Office

Optimal

MEDICAL STAFFING

Reg. No. 4,072,410

Registered Dec. 20, 2011

Int. Cl.: 35

SERVICE MARK

PRINCIPAL REGISTER

OPTIMAL STAFFING SOLUTIONS, INC. (MICHIGAN CORPORATION), TA OPTIMAL
MEDICAL STAFFING
15945 WOOD ROAD
LANSING, MI 48906

FOR: PERSONNEL PLACEMENT SERVICES, NAMELY, TEMPORARY AND PERMANENT
PLACEMENT OF HEALTH CARE PROFESSIONALS, IN CLASS 35 (U.S. CLS. 100, 101 AND
102).

FIRST USE 1-1-2008; IN COMMERCE 1-1-2008.

NO CLAIM IS MADE TO THE EXCLUSIVE RIGHT TO USE "MEDICAL STAFFING", APART
FROM THE MARK AS SHOWN.

SER. NO. 77-945,896, FILED 2-26-2010.

DEBRA LEE, EXAMINING ATTORNEY



David J. Kyffers

Director of the United States Patent and Trademark Office

United States of America

United States Patent and Trademark Office

DSH

Reg. No. 4,072,411

Registered Dec. 20, 2011

Int. Cls.: 7, 37 and 42

TRADEMARK

SERVICE MARK

PRINCIPAL REGISTER

STARRAGHECKERT AG (SWITZERLAND AKTIENGESELLSCHAFT)
SEEBLEICHESTRASSE 10
RORSCHACHERBERG, SWITZERLAND 9404

FOR: METAL CUTTING MACHINING CENTERS WITH ONE OR MORE SPINDLES; JIG BORERS, IN CLASS 7 (U.S. CLS. 13, 19, 21, 23, 31, 34 AND 35).

FOR: ASSEMBLY, INSTALLATION, REPAIR, COMMISSIONING, MAINTENANCE, SERVICING, AND OVERHAULING OF MACHINE TOOLS FOR MACHINING METALS, MACHINING HEADS, AND PARTS THEREFOR, IN CLASS 37 (U.S. CLS. 100, 103 AND 106).

FOR: ENGINEERING AND COMPUTER SOFTWARE PROGRAMMING FOR OTHERS IN THE MANUFACTURING SECTOR, IN PARTICULAR IN CONNECTION WITH MACHINING PROCESSES USING MACHINE TOOLS; COMPUTER PROGRAMMING, NAMELY, PROGRAMMING OF COMPUTER SOFTWARE FOR OTHERS FOR CONTROLLING MACHINING PROCESSES OF METALWORKING MACHINES AND MACHINES FOR THE CUTTING OF METALS, MILLING MACHINES, LATHES, DRILLING MACHINES, JIB BORING MACHINES, AND MACHINING CENTERS, IN CLASS 42 (U.S. CLS. 100 AND 101).

THE MARK CONSISTS OF STANDARD CHARACTERS WITHOUT CLAIM TO ANY PARTICULAR FONT, STYLE, SIZE, OR COLOR.

PRIORITY CLAIMED UNDER SEC. 44(D) ON ERPN CMNTY TM OFC APPLICATION NO. 008603235, FILED 10-8-2009, REG. NO. 008603235, DATED 3-30-2010, EXPIRES 10-8-2019.

SER. NO. 77-946,358, FILED 2-26-2010.

ALICIA COLLINS, EXAMINING ATTORNEY



David J. Kyffers

Director of the United States Patent and Trademark Office

United States of America

United States Patent and Trademark Office

ACAI BERRY BLAST

Reg. No. 4,072,412

ENERGY KITCHEN INC. (NEW YORK CORPORATION)
300 EAST 41ST STREET
NEW YORK, NY 10017

Registered Dec. 20, 2011

Int. Cl.: 32

FOR: FRUIT SMOOTHIES CONTAINING ACAI BERRIES, IN CLASS 32 (U.S. CLS. 45, 46 AND 48).

TRADEMARK

FIRST USE 5-1-2008; IN COMMERCE 1-16-2009.

PRINCIPAL REGISTER

THE MARK CONSISTS OF STANDARD CHARACTERS WITHOUT CLAIM TO ANY PARTICULAR FONT, STYLE, SIZE, OR COLOR.

NO CLAIM IS MADE TO THE EXCLUSIVE RIGHT TO USE "ACAI BERRY", APART FROM THE MARK AS SHOWN.

SER. NO. 77-951,688, FILED 3-5-2010.

ROBERT C. CLARK JR., EXAMINING ATTORNEY



David J. Kyffers

Director of the United States Patent and Trademark Office

United States of America

United States Patent and Trademark Office

EZ life 

Reg. No. 4,072,413

RHEE BROS., INC. (MARYLAND CORPORATION)
7461 COCA COLA DRIVE
HANOVER, MD 21076

Registered Dec. 20, 2011

Int. Cl.: 11

FOR: ELECTRIC SPACE HEATERS, IN CLASS 11 (U.S. CLS. 13, 21, 23, 31 AND 34).

TRADEMARK

FIRST USE 9-1-2009; IN COMMERCE 9-1-2009.

PRINCIPAL REGISTER

THE MARK CONSISTS OF THE ITALICIZED LETTERS "EZ" IN RED FOLLOWED BY THE WORD "LIFE" IN BLACK WITH AN INCOMPLETE ARROW-CIRCLE IN RED OVER THE LETTER "E" IN "LIFE".

THE COLOR(S) RED AND BLACK IS/ARE CLAIMED AS A FEATURE OF THE MARK.

SER. NO. 77-955,191, FILED 3-10-2010.

KATHERINE CHANG, EXAMINING ATTORNEY



David J. Kyffers

Director of the United States Patent and Trademark Office

United States of America

United States Patent and Trademark Office

CARTEL MANAGEMENT

Reg. No. 4,072,414

Registered Dec. 20, 2011

Int. Cls.: 35 and 41

SERVICE MARK

PRINCIPAL REGISTER

UPFRONT MEGATAINMENT, INC. (GEORGIA CORPORATION)
SUITE 3310
101 MARIETTA STREET
ATLANTA, GA 30303

FOR: PROVISION OF BUSINESS GUIDANCE TO CLIENTS IN ALL FACETS OF THE ARTS, NAMELY, PROVIDING ADVICE AND INFORMATION FOR MUSIC, VIDEO, TELEVISION, LITERARY BOOK PUBLISHING, AND FILM ENGAGEMENTS AND APPEARANCES, IN CLASS 35 (U.S. CLS. 100, 101 AND 102).

FIRST USE 8-1-2007; IN COMMERCE 8-1-2007.

FOR: PROVISION OF CREATIVE GUIDANCE TO CLIENTS IN ALL FACETS OF THE ARTS, NAMELY, PROVIDING ADVICE AND INFORMATION FOR MUSIC, VIDEO, TELEVISION, LITERARY BOOK PUBLISHING, AND FILM CONCEPTS AND SCRIPT DEVELOPMENT, IN CLASS 41 (U.S. CLS. 100, 101 AND 107).

FIRST USE 8-1-2007; IN COMMERCE 8-1-2007.

THE MARK CONSISTS OF STANDARD CHARACTERS WITHOUT CLAIM TO ANY PARTICULAR FONT, STYLE, SIZE, OR COLOR.

NO CLAIM IS MADE TO THE EXCLUSIVE RIGHT TO USE "MANAGEMENT", APART FROM THE MARK AS SHOWN.

SER. NO. 77-956,226, FILED 3-11-2010.

KAELIE KUNG, EXAMINING ATTORNEY



David J. Kyffers

Director of the United States Patent and Trademark Office

United States of America

United States Patent and Trademark Office

TAG TREND AND GENERIC

Reg. No. 4,072,415

EFFIGI INC. (CANADA CORPORATION)

Registered Dec. 20, 2011

1155 AUTOROUTE 13
LAVAL, QUEBEC, CANADA H7W5J8

Int. Cl.: 35

FOR: RETAIL STORE SERVICES FEATURING CLOTHING AND FASHION ACCESSORIES, HOUSEHOLD LINENS, FURNITURE PRODUCTS, AND ACCESSORIES FOR THE KITCHEN, BEDROOM, BATHROOM AND HOME, IN CLASS 35 (U.S. CLS. 100, 101 AND 102).

SERVICE MARK

THE MARK CONSISTS OF STANDARD CHARACTERS WITHOUT CLAIM TO ANY PARTICULAR FONT, STYLE, SIZE, OR COLOR.

PRINCIPAL REGISTER

PRIORITY CLAIMED UNDER SEC. 44(D) ON CANADA APPLICATION NO. 858974, FILED 9-18-2009, REG. NO. TMA505641, DATED 11-9-2010, EXPIRES 12-16-2013.

OWNER OF U.S. REG. NOS. 2,620,821 AND 3,135,057.

SER. NO. 77-962,505, FILED 3-18-2010.

GISELLE AGOSTO, EXAMINING ATTORNEY



David J. Kybas

Director of the United States Patent and Trademark Office

United States of America

United States Patent and Trademark Office

OXONIUM

Reg. No. 4,072,416

HELLAND, RONALD J. (UNITED STATES INDIVIDUAL)
6650 N. LOCAN AVENUE
CLOVIS, CA 93619

Registered Dec. 20, 2011

Int. Cl.: 1

FOR: ADJUVANT FOR USE WITH AGRICULTURAL CHEMICALS; CHEMICAL PREPARATIONS FOR USE IN AGRICULTURE, HORTICULTURE AND FORESTRY, NAMELY, CHEMICAL PREPARATIONS FOR THE TREATMENT OF SEEDS; CHEMICALS FOR USE IN AGRICULTURE, EXCEPT FUNGICIDES, HERBICIDES, INSECTICIDES AND PARASITICIDES; FERTILIZERS FOR AGRICULTURAL USE; SOIL CONDITIONERS FOR AGRICULTURAL USE, IN CLASS 1 (U.S. CLS. 1, 5, 6, 10, 26 AND 46).

TRADEMARK

PRINCIPAL REGISTER

FIRST USE 3-1-2010; IN COMMERCE 3-1-2010.

THE MARK CONSISTS OF STANDARD CHARACTERS WITHOUT CLAIM TO ANY PARTICULAR FONT, STYLE, SIZE, OR COLOR.

SER. NO. 77-962,711, FILED 3-18-2010.

DARRYL SPRUILL, EXAMINING ATTORNEY



David J. Kyffers

Director of the United States Patent and Trademark Office

United States of America

United States Patent and Trademark Office



Reg. No. 4,072,417

Registered Dec. 20, 2011

Int. Cls.: 16 and 28

TRADEMARK

PRINCIPAL REGISTER

ZZIMA INTERNATIONAL, SARL (LUXEMBOURG SOCIETE A RESPONSABILITE LIMITEE
(LIMITED LIABILITY COMPANY))
75, PARC D'ACTIVITES
CAPELLEN, LUXEMBOURG L-8308

FOR: PRINTED MATERIALS, NAMELY, PRINTED CALENDARS, PRINTED FORMS, PRINTED GAME INSTRUCTION MANUALS, PRINTED GAME BOOKS FEATURING GAME TIPS AND TECHNIQUES, PRINTED GAME ALBUMS, PRINTED BOOKLETS FEATURING SCENES AND CHARACTERS BASED ON VIDEO GAMES; STATIONERY, POSTCARDS, INFORMATIONAL SHEETS ABOUT COMPUTER GAMES, SOCIAL NETWORKING, GAME COMMUNITIES; POSTERS, AND BROCHURES ABOUT GAME MONETIZATION, COMPUTER GAMES, SOCIAL NETWORKING AND GAME COMMUNITIES, IN CLASS 16 (U.S. CLS. 2, 5, 22, 23, 29, 37, 38 AND 50).

FIRST USE 9-11-2008; IN COMMERCE 6-2-2009.

FOR: PORTABLE ELECTRONIC GAMES AND HANDHELD UNITS FOR PLAYING ELECTRONIC GAMES OTHER THAN THOSE ADAPTED FOR USE WITH TELEVISION RECEIVERS ONLY, IN CLASS 28 (U.S. CLS. 22, 23, 38 AND 50).

FIRST USE 9-11-2008; IN COMMERCE 6-2-2009.

THE MARK CONSISTS OF A STYLIZED ZIGZAG BELOW WHICH IS THE WORD "ZZIMA".

SER. NO. 77-965,498, FILED 3-22-2010.

WON TEAK OH, EXAMINING ATTORNEY



David J. Kyros

Director of the United States Patent and Trademark Office

United States of America

United States Patent and Trademark Office

Wake up to a better world

Reg. No. 4,072,418

Registered Dec. 20, 2011

Int. Cls.: 35 and 43

SERVICE MARK

PRINCIPAL REGISTER

NH HOTELES, S.A. (SPAIN CORPORATION)
SANTA ENGRACIA, 120
MADRID, SPAIN 28003

FOR: ADVERTISING AGENCIES; DIRECT MAIL ADVERTISING; PUBLIC RELATIONS; BUSINESS ACQUISITION AND MERGER CONSULTATION; BUSINESS MANAGEMENT; BUSINESS MARKETING CONSULTING SERVICES; BUSINESS MERCHANDISING DISPLAY SERVICES; MARKET ANALYSIS AND RESEARCH; FRANCHISING, NAMELY, OFFERING TECHNICAL ASSISTANCE IN THE ESTABLISHMENT AND/OR OPERATION OF HOTELS, RESTAURANTS, CATERING, BARS AND COCKTAIL LOUNGES, IN CLASS 35 (U.S. CLS. 100, 101 AND 102).

FOR: HOTEL SERVICES; RESTAURANT, CATERING, BAR AND COCKTAIL LOUNGE SERVICES; RESORTS LODGING SERVICES; RESERVATION SERVICES FOR HOTEL ACCOMMODATIONS AND RESTAURANT RESERVATIONS FOR OTHERS, IN CLASS 43 (U.S. CLS. 100 AND 101).

THE MARK CONSISTS OF STANDARD CHARACTERS WITHOUT CLAIM TO ANY PARTICULAR FONT, STYLE, SIZE, OR COLOR.

OWNER OF SPAIN REG. NO. 2914788, DATED 3-10-2011, EXPIRES 2-22-2020.

SER. NO. 77-966,210, FILED 3-23-2010.

JAMES GRIFFIN, EXAMINING ATTORNEY



David J. Kyffers

Director of the United States Patent and Trademark Office

United States of America

United States Patent and Trademark Office



Claremont

GRADUATE UNIVERSITY

Reg. No. 4,072,419

Registered Dec. 20, 2011

Int. Cl.: 41

SERVICE MARK

PRINCIPAL REGISTER

CLAREMONT GRADUATE UNIVERSITY (CALIFORNIA CORPORATION)
150 EAST TENTH STREET
CLAREMONT, CA 91711

FOR: EDUCATIONAL SERVICES, NAMELY, PROVIDING COURSES OF INSTRUCTION AND PROVIDING TRAINING IN THE FIELD OF SCIENTIFIC RESEARCH AT THE POST BACCALAUREATE LEVEL, IN CLASS 41 (U.S. CLS. 100, 101 AND 107).

FIRST USE 5-31-1997; IN COMMERCE 5-31-1997.

NO CLAIM IS MADE TO THE EXCLUSIVE RIGHT TO USE "GRADUATE UNIVERSITY", APART FROM THE MARK AS SHOWN.

THE MARK CONSISTS OF A HORIZONTAL LINE WITH THE WORD "CLAREMONT" ABOVE AND THE WORDS "GRADUATE UNIVERSITY" BELOW, WITH TWO VERTICAL WAVY LINES TO THE LEFT REPRESENTING A FLAME.

SEC. 2(F).

SER. NO. 77-967,749, FILED 3-24-2010.

MARCIE MILONE, EXAMINING ATTORNEY



David J. Kyffers

Director of the United States Patent and Trademark Office

United States of America

United States Patent and Trademark Office

PETVILLE

Reg. No. 4,072,420

Registered Dec. 20, 2011

Int. Cls.: 9 and 41

TRADEMARK

SERVICE MARK

PRINCIPAL REGISTER

ZYNGA INC. (DELAWARE CORPORATION)
365 VERMONT STREET
SAN FRANCISCO, CA 94103

FOR: COMPUTER GAME SOFTWARE; VIDEO GAME PROGRAMS; AND GAME RELATED COMPUTER SOFTWARE APPLICATIONS, NAMELY, COMPUTER SOFTWARE FOR PLAYING SOCIAL GAMES; INTERACTIVE VIDEO GAME PROGRAMS; COMPUTER SOFTWARE TO ENABLE UPLOADING, POSTING, SHOWING, DISPLAYING, TAGGING, BLOGGING, SHARING OR OTHERWISE PROVIDING ELECTRONIC MEDIA OR INFORMATION IN THE FIELDS OF VIRTUAL COMMUNITIES, ELECTRONIC GAMING, ENTERTAINMENT, AND GENERAL INTEREST VIA THE INTERNET OR OTHER COMMUNICATIONS NETWORKS WITH THIRD PARTIES, IN CLASS 9 (U.S. CLS. 21, 23, 26, 36 AND 38).

FIRST USE 12-2-2009; IN COMMERCE 12-2-2009.

FOR: ENTERTAINMENT SERVICES, NAMELY, PROVIDING ONLINE COMPUTER, VIDEO AND ELECTRONIC GAMES; ENTERTAINMENT SERVICES, NAMELY, PROVIDING ONLINE COMPUTER GAMES, ENHANCEMENTS WITHIN ONLINE COMPUTER GAMES, AND GAME APPLICATIONS WITHIN ONLINE COMPUTER GAMES; PROVIDING ONLINE REVIEWS OF COMPUTER GAMES, PROVIDING OF INFORMATION RELATING TO COMPUTER GAMES; PROVIDING AN INTERNET WEBSITE PORTAL IN THE FIELD OF COMPUTER GAMES AND GAMING; ENTERTAINMENT SERVICES, NAMELY, PROVIDING VIRTUAL ENVIRONMENTS IN WHICH USERS CAN INTERACT THROUGH SOCIAL GAMES FOR RECREATIONAL, LEISURE OR ENTERTAINMENT PURPOSES, IN CLASS 41 (U.S. CLS. 100, 101 AND 107).

FIRST USE 12-2-2009; IN COMMERCE 12-2-2009.

THE MARK CONSISTS OF STANDARD CHARACTERS WITHOUT CLAIM TO ANY PARTICULAR FONT, STYLE, SIZE, OR COLOR.

PRIORITY CLAIMED UNDER SEC. 44(D) ON UNITED KINGDOM APPLICATION NO. 2525525, FILED 9-7-2009, REG. NO. 2525525, DATED 9-1-2009, EXPIRES 9-7-2019.

SER. NO. 77-979,543, FILED 11-21-2009.

GINA FINK, EXAMINING ATTORNEY



David J. Kyros

Director of the United States Patent and Trademark Office

United States of America

United States Patent and Trademark Office



Reg. No. 4,072,421

Registered Dec. 20, 2011

Int. Cl.: 35

SERVICE MARK

PRINCIPAL REGISTER

VITERRA INC. (CANADA CORPORATION)
2625 VICTORIA AVENUE
REGINA, CANADA S4T7T9

FOR: RETAIL AND WHOLESALE RETAIL STORE SERVICES FEATURING AGRICULTURAL COMMODITIES; RETAIL STORE SERVICES FEATURING AGRICULTURAL PRODUCTS, NAMELY, GRAINS, OIL SEEDS, LEGUMES AND FORAGES, AND SEEDS OF AGRICULTURAL PRODUCTS AND PRIMARY BY PRODUCTS OF AGRICULTURAL PRODUCTS; RETAIL STORE SERVICES FEATURING ANIMAL FEES, NAMELY, COMPLETE FEEDS, CONCENTRATED VITAMIN PREMIX FEEDS, MINERAL PREMIX FEEDS, CONCENTRATED VITAMIN AND MINERAL PREMIX FEEDS, SUPPLEMENT FEEDS AND FEED CONCENTRATES; RETAIL STORE SERVICES FEATURING ANIMAL FEED NUTRIENTS AND ADDITIVES; RETAIL STORE SERVICES FEATURING ANIMAL FEED MEDICATIONS AND INJECTABLES TO TREAT AND PREVENT DISEASE IN ANIMALS; MERCHANDISING SERVICES, NAMELY, DEVELOPMENT OF MARKETING STRATEGIES AND CONCEPTS, AND ADVERTISEMENT AND MARKETING SERVICES RELATING TO THE PRODUCTION AND PURCHASE OF THE FOLLOWING PRODUCTS OF OTHERS, SPECIFICALLY, AGRICULTURAL PRODUCTS, NAMELY, GRAINS, OILSEEDS, LEGUMES AND FORAGES AND SEEDS OF AGRICULTURAL PRODUCTS AND PRIMARY BY-PRODUCTS OF LIVE CATTLE, HOGS, PIGS, SWINE AND LIVESTOCK, IN CLASS 35 (U.S. CLS. 100, 101 AND 102).

PRIORITY CLAIMED UNDER SEC. 44(D) ON CANADA APPLICATION NO. 1362317, FILED 9-4-2007, REG. NO. TMA766,652, DATED 5-13-2010, EXPIRES 5-13-2025.

THE COLOR(S) GREEN IS/ARE CLAIMED AS A FEATURE OF THE MARK.

THE MARK CONSISTS OF AN ARC DESIGN IN THE COLOR GREEN.

SER. NO. 77-981,152, FILED 2-7-2008.

TEJBIR SINGH, EXAMINING ATTORNEY



David J. Kybas

Director of the United States Patent and Trademark Office

United States of America

United States Patent and Trademark Office



Reg. No. 4,072,422

VITERRA INC. (CANADA CORPORATION)
2625 VICTORIA AVENUE
REGINA, CANADA S4T7T9

Registered Dec. 20, 2011

Int. Cl.: 35

SERVICE MARK

PRINCIPAL REGISTER

FOR: RETAIL AND WHOLESALE RETAIL STORE SERVICES FEATURING AGRICULTURAL COMMODITIES; RETAIL STORE SERVICES FEATURING AGRICULTURAL PRODUCTS, NAMELY, GRAINS, OIL SEEDS, LEGUMES AND FORAGES, AND SEEDS OF AGRICULTURAL PRODUCTS AND PRIMARY BY PRODUCTS OF AGRICULTURAL PRODUCTS; RETAIL STORE SERVICES FEATURING ANIMAL FEES, NAMELY, COMPLETE FEEDS, CONCENTRATED VITAMIN PREMIX FEEDS, MINERAL PREMIX FEEDS, CONCENTRATED VITAMIN AND MINERAL PREMIX FEEDS, SUPPLEMENT FEEDS AND FEED CONCENTRATES; RETAIL STORE SERVICES FEATURING ANIMAL FEED NUTRIENTS AND ADDITIVES; RETAIL STORE SERVICES FEATURING ANIMAL FEED MEDICATIONS AND INJECTABLES TO TREAT AND PREVENT DISEASE IN ANIMALS; MERCHANDISING SERVICES, NAMELY, DEVELOPMENT OF MARKETING STRATEGIES AND CONCEPTS, AND ADVERTISEMENT AND MARKETING SERVICES RELATING TO THE PRODUCTION AND PURCHASE OF THE FOLLOWING PRODUCTS OF OTHERS, SPECIFICALLY, AGRICULTURAL PRODUCTS, NAMELY, GRAINS, OILSEEDS, LEGUMES AND FORAGES AND SEEDS OF AGRICULTURAL PRODUCTS AND PRIMARY BY-PRODUCTS OF LIVE CATTLE, HOGS, PIGS, SWINE AND LIVESTOCK, IN CLASS 35 (U.S. CLS. 100, 101 AND 102).

PRIORITY CLAIMED UNDER SEC. 44(D) ON CANADA APPLICATION NO. 1362321, FILED 9-4-2007, REG. NO. TMA766,654, DATED 5-13-2010, EXPIRES 5-13-2025.



THE MARK CONSISTS OF AN ARC DESIGN.

SER. NO. 77-981,153, FILED 2-7-2008.

TEJBIR SINGH, EXAMINING ATTORNEY

David J. Kybas

Director of the United States Patent and Trademark Office

United States of America

United States Patent and Trademark Office

RETURNING CREATIVITY TO THE CLASSROOM

Reg. No. 4,072,423

LAUREATE EDUCATION, INC. (MARYLAND CORPORATION)
650 S. EXETER STREET
BALTIMORE, MD 21202

Registered Dec. 20, 2011

Int. Cl.: 41

FOR: EDUCATIONAL SERVICES AND ONLINE EDUCATIONAL SERVICES, NAMELY, CONDUCTING COURSES SEMINARS, WORKSHOPS AND VIDEO-BASED COURSES PROVIDING INSTRUCTION ON TECHNIQUES AND STRATEGIES ON HOW TO FOSTER DYNAMIC LEARNING IN A CLASSROOM, IN CLASS 41 (U.S. CLS. 100, 101 AND 107).

SERVICE MARK

PRINCIPAL REGISTER

FIRST USE 8-0-2009; IN COMMERCE 8-0-2009.

THE MARK CONSISTS OF STANDARD CHARACTERS WITHOUT CLAIM TO ANY PARTICULAR FONT, STYLE, SIZE, OR COLOR.

SER. NO. 77-982,389, FILED 1-13-2010.

KIMBERLY FRYE, EXAMINING ATTORNEY



David J. Kybas

Director of the United States Patent and Trademark Office

United States of America

United States Patent and Trademark Office



Reg. No. 4,072,424

Registered Dec. 20, 2011

Int. Cl.: 41

SERVICE MARK

PRINCIPAL REGISTER

ANIA BOHACHEVSKY LONKEYVCH (UNITED STATES INDIVIDUAL)
109 MAJOR DRIVE
NORTH WALES, PA 19454

FOR: EDUCATION SERVICES, NAMELY, PROVIDING CLASSES AND INSTRUCTION IN THE FIELD OF DANCE; ENTERTAINMENT IN THE NATURE OF DANCE PERFORMANCES, IN CLASS 41 (U.S. CLS. 100, 101 AND 107).

FIRST USE 5-0-1997; IN COMMERCE 5-0-1997.

THE MARK CONSISTS OF TWO DANCER SILHOUETTES WITH A DIAMOND BACKGROUND.

SER. NO. 77-982,721, FILED 3-27-2009.

SAMUEL E. SHARPER JR., EXAMINING ATTORNEY



David J. Kyffers

Director of the United States Patent and Trademark Office

United States of America

United States Patent and Trademark Office

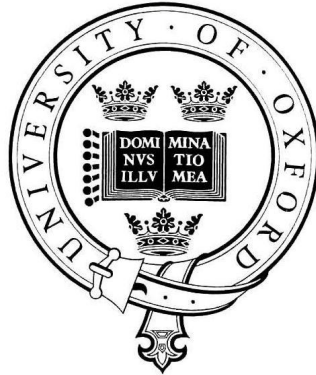

Reg. No. 4,072,425

Registered Dec. 20, 2011

Int. Cls.: 41 and 42

SERVICE MARK

PRINCIPAL REGISTER

THE CHANCELLOR MASTERS AND SCHOLARS OF THE UNIVERSITY OF OXFORD
(UNITED KINGDOM CORPORATION)
UNIVERSITY OFFICES, WELLINGTON SQUARE
OXFORD, UNITED KINGDOM OX1 2JD

FOR: EDUCATIONAL SERVICES AT THE UNDERGRADUATE, GRADUATE, POST-GRADUATE AND PROFESSIONAL LEVELS, NAMELY, PROVIDING COURSES OF INSTRUCTION AND TRAINING, ARRANGING AND CONDUCTING EDUCATIONAL SEMINARS, LECTURES, SYMPOSIA, CONFERENCES, AND CONGRESSES AND PROVIDING TUTORIAL SERVICES, EDUCATIONAL TESTING AND DEVELOPMENT AND DISSEMINATION OF EDUCATIONAL MATERIALS ASSOCIATED THEREWITH; EDUCATIONAL SERVICES, NAMELY, PROVIDING INSTRUCTION AND TRAINING AT THE UNDERGRADUATE, GRADUATE, POST-GRADUATE LEVELS RENDERED THROUGH CORRESPONDENCE COURSES; EDUCATIONAL SERVICES, NAMELY, PROVIDING INSTRUCTION AND TRAINING AT THE UNDERGRADUATE, GRADUATE, POSTGRADUATE LEVELS RENDERED THROUGH PROVIDING COURSES AND LEARNING VIA A GLOBAL COMPUTER NETWORK; PROVIDING COURSES AND LEARNING VIA A GLOBAL COMPUTER NETWORK AT THE UNDERGRADUATE, GRADUATE, POST-GRADUATE AND PROFESSIONAL LEVELS; ENTERTAINMENT SERVICES, NAMELY, ORGANIZING SPORTING EVENTS, CONCERTS AND DRAMATIC PRODUCTIONS; PROVIDING MUSEUM SERVICES; CONSULTING SERVICES IN THE FIELD OF UNDERGRADUATE, GRADUATE, POST-GRADUATE EDUCATION; UNIVERSITY SERVICES AT THE UNDERGRADUATE, GRADUATE, POST-GRADUATE AND PROFESSIONAL LEVELS, NAMELY, CONFERRAL OF DEGREES, ARRANGING AND CONDUCTING SEMINARS, SYMPOSIA, CONFERENCES AND CONGRESSES, CONDUCTING CORRESPONDENCE COURSES, CONDUCTING COURSES VIA A GLOBAL COMPUTER NETWORK, TEACHING LECTURING AND TUTORIAL SERVICES, PROVIDING EDUCATIONAL EXAMINATION SERVICES, ORGANIZATION OF EXHIBITIONS FOR EDUCATIONAL PURPOSES, PROVIDING LENDING LIBRARIES AND LIBRARY SERVICES, AND PROVIDING EDUCATIONAL RESEARCH AT THE UNDERGRADUATE, GRADUATE, POST-GRADUATE LEVELS FOR OTHERS IN THE FIELD OF ANTHROPOLOGY, GEOGRAPHY, BIOSCIENCES, CLINICAL MEDICINE, MATHEMATICAL SCIENCES, PHYSICAL SCIENCES, PSYCHOLOGICAL STUDIES, HUMANITIES, SOCIAL SCIENCES, CLASSICS, DRAWING AND FINE ART, HISTORY, MEDIEVAL AND MODERN LANGUAGES, MUSIC, ORIENTAL STUDIES, ENGLISH, EDUCATIONAL STUDIES, LAW, SOCIAL STUDIES, ARCHAEOLOGY, PHILOSOPHY OF PHYSICS, ANAESTHETICS, BIOCHEMISTRY, BIOLOGICAL ANTHROPOLOGY, CARDIOVASCULAR MEDICINE, CELLULAR SCIENCE, CHEMISTRY, CLINICAL BIOCHEMISTRY, CLINICAL



David J. Kyffers

Director of the United States Patent and Trademark Office

Reg. No. 4,072,425 NEUROLOGY, CLINICAL PHARMACOLOGY, COMPUTING SERVICES, DIABETES, EARTH SCIENCE, ENGINEERING SCIENCE, ENVIRONMENTAL CHANGES, HUMAN ANATOMY, MATERIALS, MEDICAL ONCOLOGY, MOLECULAR MEDICINE, OBSTETRICS, GYNECOLOGY, OPHTHALMOLOGY, ORTHOPAEDIC ENGINEERING, ORTHOPAEDIC SURGERY, METABOLISM, PEDIATRICS, PATHOLOGY, BACTERIOLOGY, ASTROPHYSICS, NUCLEAR PHYSICS, CONDENSED MATTER PHYSICS, ATOMIC AND LASER PHYSICS, ATMOSPHERIC OCEANIC AND PLANETARY PHYSICS, THEORETICAL PHYSICS, PLANT SCIENCES PSYCHIATRY, PUBLIC HEALTH AND PRIMARY CARE, STATISTICS, SURGERY, AND ZOOLOGY; PROVIDING AN ONLINE DATABASE IN THE FIELD OF EDUCATION, IN CLASS 41 (U.S. CLS. 100, 101 AND 107).

FIRST USE 0-0-1990; IN COMMERCE 0-0-1990.

FOR: PROFESSIONAL CONSULTANCY FOR OTHERS IN THE FIELDS OF SCIENCE AND ENGINEERING, MEDICINE AND CLINICAL STUDIES; EXPERT WITNESS SERVICES AND PROVIDING EXPERTS FOR MEDIA INTERVIEWS IN THE FIELDS OF ANTHROPOLOGY, GEOGRAPHY, BIOSCIENCES, CLINICAL MEDICINE, MATHEMATICAL SCIENCES, PHYSICAL SCIENCES, PSYCHOLOGICAL STUDIES, HUMANITIES, SOCIAL SCIENCES, CLASSICS, DRAWING AND FINE ART, HISTORY, MEDIEVAL AND MODERN LANGUAGES, MUSIC, ORIENTAL STUDIES, ENGLISH, EDUCATIONAL STUDIES, LAW, SOCIAL STUDIES, ARCHAEOLOGY, PHILOSOPHY OF PHYSICS, ANAESTHETICS, BIOCHEMISTRY, BIOLOGICAL ANTHROPOLOGY, CARDIOVASCULAR MEDICINE, CELLULAR SCIENCE, CHEMISTRY, CLINICAL BIOCHEMISTRY, CLINICAL NEUROLOGY, CLINICAL PHARMACOLOGY, COMPUTING SERVICES, DIABETES, EARTH SCIENCE, ENGINEERING SCIENCE, ENVIRONMENTAL CHANGES, HUMAN ANATOMY, MATERIALS, MEDICAL ONCOLOGY, MOLECULAR MEDICINE, OBSTETRICS, GYNECOLOGY, OPHTHALMOLOGY, ORTHOPAEDIC ENGINEERING, ORTHOPAEDIC SURGERY, METABOLISM, PEDIATRICS, PATHOLOGY, BACTERIOLOGY, ASTROPHYSICS, NUCLEAR PHYSICS, CONDENSED MATTER PHYSICS, ATOMIC AND LASER PHYSICS, ATMOSPHERIC OCEANIC AND PLANETARY PHYSICS, THEORETICAL PHYSICS, PLANT SCIENCES PSYCHIATRY, PUBLIC HEALTH AND PRIMARY CARE, STATISTICS, SURGERY, AND ZOOLOGY; LABORATORY RESEARCH SERVICES IN THE FIELDS OF PHYSICS, ANAESTHETICS, BIOCHEMISTRY, BIOLOGICAL ANTHROPOLOGY, CARDIOVASCULAR MEDICINE, CELLULAR SCIENCE, CHEMISTRY, CLINICAL BIOCHEMISTRY, NEUROLOGY, PHARMACOLOGY, DIABETES, EARTH SCIENCE, ENVIRONMENTAL CHANGES, HUMAN ANATOMY, ONCOLOGY, MOLECULAR MEDICINE, OBSTETRICS, GYNECOLOGY, OPHTHALMOLOGY, ORTHOPAEDIC ENGINEERING, ORTHOPAEDIC SURGERY, METABOLISM, PEDIATRICS, PATHOLOGY, BACTERIOLOGY, ASTROPHYSICS, NUCLEAR PHYSICS, CONDENSED MATTER PHYSICS, ATOMIC AND LASER PHYSICS, ATMOSPHERIC OCEANIC AND PLANETARY PHYSICS, THEORETICAL PHYSICS, PLANT SCIENCES, SURGERY, AND ZOOLOGY; CAFE AND RESTAURANT SERVICES; RENTAL AND LEASING OF LABORATORY EQUIPMENT, IN CLASS 42 (U.S. CLS. 100 AND 101).

FIRST USE 0-0-1990; IN COMMERCE 0-0-1990.

PRIORITY CLAIMED UNDER SEC. 44(D) ON UNITED KINGDOM APPLICATION NO. 2256108, FILED 12-18-2000.

NO CLAIM IS MADE TO THE EXCLUSIVE RIGHT TO USE "UNIVERSITY", APART FROM THE MARK AS SHOWN.

THE MARK CONSISTS OF THE WORDS "UNIVERSITY OF OXFORD" INSIDE A BELTED CREST SHOWING THREE CROWNS AND AN OPEN BOOK WITH THE WORDS "DOMINUS ILLUMINATIO MEA".

THE ENGLISH TRANSLATION OF THE WORD "DOMINUS ILLUMINATIO MEA" IN THE MARK IS "THE LORD IS MY LIGHT".

Reg. No. 4,072,425 SEC. 2(F) AS TO "UNIVERSITY OF OXFORD".

SER. NO. 78-056,982, FILED 4-5-2001.

BRIAN NEVILLE, EXAMINING ATTORNEY

United States of America

United States Patent and Trademark Office

D2

Reg. No. 4,072,426

LES BOXERS BOYZ INC. (CANADA CORPORATION)

385 DE LOUVAIN OUEST

Registered Dec. 20, 2011

MONTREAL, QUEBEC, CANADA H2N2J1

Int. Cl.: 25

FOR: SKI APPAREL, NAMELY, SKI JACKETS, SKI PANTS, SKI SUITS, OUTERWEAR JACKETS, OUTERWEAR PANTS, OUTERWEAR SUITS, SNOWBOARD JACKETS, SNOWBOARD PANTS, SNOWBOARD SUITS, FLEECE JACKETS, FLEECE TOPS, SWEATERS, GLOVES, MITTS, HATS, IN CLASS 25 (U.S. CLS. 22 AND 39).

TRADEMARK

PRINCIPAL REGISTER

FIRST USE 11-0-2003; IN COMMERCE 11-0-2003.

SER. NO. 78-268,123, FILED 6-27-2003.

BARBARA GAYNOR, EXAMINING ATTORNEY



David J. Kyffers

Director of the United States Patent and Trademark Office

United States of America

United States Patent and Trademark Office

POPPERS

Reg. No. 4,072,427

TRADEMARK MANAGEMENT COMPANY (DELAWARE CORPORATION)

Registered Dec. 20, 2011

877 WEST MAIN STREET, SUITE 604
BOISE, ID 83702

Int. Cl.: 29

FOR: FROZEN APPETIZERS CONSISTING PRIMARILY OF VEGETABLES, BEEF, CHICKEN,
PORK AND/OR CHEESE, NOT INCLUDING SHRIMP, IN CLASS 29 (U.S. CL. 46).

TRADEMARK

FIRST USE 8-17-1993; IN COMMERCE 8-17-1993.

PRINCIPAL REGISTER

OWNER OF U.S. REG. NO. 1,922,249.

SER. NO. 78-287,014, FILED 8-13-2003.

RICHARD WHITE, EXAMINING ATTORNEY



David J. Kybas

Director of the United States Patent and Trademark Office

United States of America

United States Patent and Trademark Office



Poppers

Reg. No. 4,072,428

Registered Dec. 20, 2011

Int. Cl.: 29

TRADEMARK

PRINCIPAL REGISTER

TRADEMARK MANAGEMENT COMPANY (DELAWARE CORPORATION)
877 WEST MAIN STREET, SUITE 604
BOISE, ID 83702

FOR: FROZEN APPETIZERS CONSISTING PRIMARILY OF VEGETABLES, BEEF, CHICKEN,
PORK AND/OR CHEESE, NOT INCLUDING SHRIMP, IN CLASS 29 (U.S. CL. 46).

FIRST USE 12-31-2002; IN COMMERCE 12-31-2002.

OWNER OF U.S. REG. NO. 1,922,249.

SER. NO. 78-287,041, FILED 8-13-2003.

RICHARD WHITE, EXAMINING ATTORNEY



David J. Kybas

Director of the United States Patent and Trademark Office

United States of America

United States Patent and Trademark Office



Reg. No. 4,072,429

MOTOVAN CORPORATION (CANADA CORPORATION)
1391, RUE GAY LUSSAC, BOUCHERVILLE
QUEBEC, CANADA J4B 7K1

Registered Dec. 20, 2011

Int. Cls.: 9, 12, 18 and 25

FOR: BODY ARMOR, BACK PROTECTORS AND KNEE SLIDERS FOR USE IN THE FIELD OF MOTORCYCLING; PROTECTIVE MOTORCYCLE GLOVES; SAFETY HELMETS; FACE SHIELDS, IN CLASS 9 (U.S. CLS. 21, 23, 26, 36 AND 38).

TRADEMARK

FOR: MOTORCYCLE BAGS, NAMELY, TANK BAGS, IN CLASS 12 (U.S. CLS. 19, 21, 23, 31, 35 AND 44).

PRINCIPAL REGISTER

FOR: BACKPACKS, GEAR BAGS, NAMELY, ALL-PURPOSE CARRY BAGS, IN CLASS 18 (U.S. CLS. 1, 2, 3, 22 AND 41).

FOR: BOOTS AND CLOTHING, NAMELY, GLOVES, JACKETS, JACKET LINERS, PANTS, RACING SUITS, AND VESTS, ALL FOR USE IN THE FIELD OF MOTORCYCLING, IN CLASS 25 (U.S. CLS. 22 AND 39).

PRIORITY CLAIMED UNDER SEC. 44(D) ON CANADA APPLICATION NO. 1183776, FILED 7-22-2003, REG. NO. TMA646472, DATED 8-24-2005, EXPIRES 8-24-2020.

SER. NO. 78-340,184, FILED 12-12-2003.

RON FAIRBANKS, EXAMINING ATTORNEY



David J. Kybas

Director of the United States Patent and Trademark Office

United States of America

United States Patent and Trademark Office

GERRESHEIMER

Reg. No. 4,072,430

Registered Dec. 20, 2011

**Int. Cls.: 6, 9, 10, 20, 21
and 42**

TRADEMARK

SERVICE MARK

PRINCIPAL REGISTER

GERRESHEIMER GLAS GMBH (FED REP GERMANY CORPORATION)
BENRATHER STRASSE 18-20
DUSSELDORF, FED REP GERMANY 40213

FOR: FLACONS, CANS, TUBES AND FLASKS, ALL SOLD EMPTY, CLOSURES FOR THE FOREGOING GOODS, AND CLAMPS, THE FOREGOING GOODS BEING ESPECIALLY FOR THE PERFUME, COSMETIC, BEVERAGE AND FOOD INDUSTRIES, AND ALL MADE OF NON-PRECIOUS METAL, IN CLASS 6 (U.S. CLS. 2, 12, 13, 14, 23, 25 AND 50).

FOR: LABORATORY GLASSWARE, NAMELY, JARS, FLACONS, GLASS TUBES, AMPULS, BEAKERS, BURETS, FLASKS, FUNNELS, PIPETTES, CUVETTES, ELECTRICAL CONNECTORS, ACCUMULATOR JARS, IN CLASS 9 (U.S. CLS. 21, 23, 26, 36 AND 38).

FOR: MEDICAL INSTRUMENTS AND APPARATUS, NAMELY, CUVETTES, TABLET AND OINTMENT APPLICATORS, INHALERS, MEASURING SPOONS AND CAPS; SYRINGES AND NEEDLES FOR MEDICAL PURPOSES; MEDICAL SYSTEMS COMPRISING BOTTLES, DROPPER BOTTLES, SPRAY AND PUMP BOTTLES OR PUMPS FOR INFUSION, TRANSFUSION AND DOSING PURPOSES OF DIAGNOSTIC AND PHARMACEUTICAL SUBSTANCES; AEROSOL DISPENSERS FOR MEDICAL USE; CATHETERS; INJECTORS, NAMELY, INJECTION SYRINGES, INJECTION INSTRUMENTS AND INJECTION NEEDLES, SYRINGE ACCESSORIES; BOTTLES FOR MEDICAL USE, NAMELY, BOTTLES FOR INTRAVENOUS APPLICATION, FEEDING BOTTLES, TABLET BOTTLES, PET BOTTLES FOR LIQUIDS, SERUM BOTTLES, IN CLASS 10 (U.S. CLS. 26, 39 AND 44).

FOR: PLASTIC CLOSURES FOR CONTAINERS AND PLASTIC CLAMPS, BEING ESPECIALLY FOR THE PERFUME, COSMETIC, PHARMACEUTICAL, BEVERAGE AND FOOD INDUSTRIES, IN CLASS 20 (U.S. CLS. 2, 13, 22, 25, 32 AND 50).

FOR: FUNNELS; TUBES AND TUBINGS; STORAGE JARS, FLACONS, AMPULS, BEAKERS, FLASKS, CONTAINERS, VIALS, CANS, REACTORS, JOINTS, CARTRIDGES, INJECTORS, RODS, ALL OF THE FOREGOING MADE OF GLASS BEING ESPECIALLY FOR THE PERFUME, COSMETIC, PHARMACEUTICAL, BEVERAGE AND FOOD INDUSTRIES, AND GLASS STOPPERS FOR THE FOREGOING GOODS; BOTTLES SOLD EMPTY, NAMELY, SPRAY BOTTLES, SYRUP BOTTLES, DROPPER BOTTLES, TABLET BOTTLES, SERUM BOTTLES, TRANSFUSION BOTTLES, SCREW-CAP BOTTLES, CROWN-CAP BOTTLES, SCREW-TOP BOTTLES AND BOTTLES FOR STORAGE PURPOSES BEING ESPECIALLY FOR THE PERFUME, COSMETIC, PHARMACEUTICAL, BEVERAGE OR FOOD INDUSTRIES,



David J. Kybas

Director of the United States Patent and Trademark Office

Reg. No. 4,072,430 ALL OF THE FOREGOING BOTTLES BEING BOTTLES BEING MADE FROM GLASS OR PLASTIC, IN CLASS 21 (U.S. CLS. 2, 13, 23, 29, 30, 33, 40 AND 50).

FOR: TECHNICAL CONSULTATION AND RESEARCH AND NEW PRODUCT DEVELOPMENT FOR OTHERS IN THE FIELD OF BOTTLES, JARS, FLACONS, CANS, TUBES, PODS, ADAPTERS, AMPULS, BEAKERS, BURETS, CLAMPS, DISPENSERS, REACTORS, FLASKS, SYRINGES, FUNNELS, JOINTS, PIPETTES, CONNECTORS, CARTRIDGES, INJECTORS, DOSING AND SPRAY PUMPS, CUVETTES AND CLOSURES FOR THE FOREGOING GOODS, BEING ESPECIALLY FOR THE PERFUME, COSMETIC, PHARMACEUTICAL, MEDICAL, LABORATORY, BEVERAGE AND FOOD INDUSTRIES, IN CLASS 42 (U.S. CLS. 100 AND 101).

THE MARK CONSISTS OF STANDARD CHARACTERS WITHOUT CLAIM TO ANY PARTICULAR FONT, STYLE, SIZE, OR COLOR.

OWNER OF ERPN CMNTY TM OFC REG. NO. 003883964, DATED 8-31-2005, EXPIRES 6-14-2014.

SER. NO. 78-446,396, FILED 7-6-2004.

MICHELE SWAIN, EXAMINING ATTORNEY

United States of America

United States Patent and Trademark Office

POWER. ON THE GO.

Reg. No. 4,072,431

Registered Dec. 20, 2011

Int. Cl.: 7

TRADEMARK

PRINCIPAL REGISTER

AURA SYSTEMS, INC. (DELAWARE CORPORATION)
2335 ALASKA AVENUE
EL SEGUNDO, CA 90245

FOR: ELECTRIC GENERATORS, GENERATORS FOR LAND VEHICLES, ALTERNATORS FOR LAND VEHICLES, STARTER ALTERNATORS, ENGINES NOT FOR LAND VEHICLES, IN CLASS 7 (U.S. CLS. 13, 19, 21, 23, 31, 34 AND 35).

FIRST USE 2-28-1998; IN COMMERCE 2-28-1998.

THE MARK CONSISTS OF STANDARD CHARACTERS WITHOUT CLAIM TO ANY PARTICULAR FONT, STYLE, SIZE, OR COLOR.

OWNER OF U.S. REG. NO. 2,477,031.

NO CLAIM IS MADE TO THE EXCLUSIVE RIGHT TO USE "POWER", APART FROM THE MARK AS SHOWN.

SER. NO. 78-562,053, FILED 2-7-2005.

MARY BOAGNI, EXAMINING ATTORNEY



David J. Kyros

Director of the United States Patent and Trademark Office

United States of America

United States Patent and Trademark Office

AMERICAN MOTORS

Reg. No. 4,072,432

Registered Dec. 20, 2011

Int. Cl.: 12

TRADEMARK

PRINCIPAL REGISTER

NEW CARCO ACQUISITION LLC (DELAWARE LIMITED LIABILITY COMPANY)
1000 CHRYSLER DRIVE
CIMS 485-13-32
AUBURN HILLS, MI 48326

FOR: DOOR SILLS FOR MOTOR VEHICLES, IN CLASS 12 (U.S. CLS. 19, 21, 23, 31, 35 AND 44).

FIRST USE 0-0-1969; IN COMMERCE 0-0-1969.

THE MARK CONSISTS OF STANDARD CHARACTERS WITHOUT CLAIM TO ANY PARTICULAR FONT, STYLE, SIZE, OR COLOR.

NO CLAIM IS MADE TO THE EXCLUSIVE RIGHT TO USE "MOTORS", APART FROM THE MARK AS SHOWN.

SEC. 2(F).

SER. NO. 78-723,951, FILED 9-30-2005.

SARA BENJAMIN, EXAMINING ATTORNEY



David J. Kyffers

Director of the United States Patent and Trademark Office

United States of America

United States Patent and Trademark Office

ITEL

Reg. No. 4,072,433

Registered Dec. 20, 2011

Int. Cls.: 9, 16, 38 and 42

TRADEMARK

SERVICE MARK

PRINCIPAL REGISTER

TELNIC LIMITED (UNITED KINGDOM CORPORATION)
37 PERCY STREET
LONDON, UNITED KINGDOM W1T 2DJ

FOR: COMPUTER NETWORK BASED AUDIO COMMUNICATION SYSTEMS COMPRISING COMPUTER SOFTWARE FOR PROCESSING, TRANSMITTING, AND RECEIVING AUDIO AND VISUAL DATA AND INFORMATION; COMPUTER SEARCH ENGINE SOFTWARE; COMPUTER SOFTWARE CONNECTING COMPUTER NETWORK USERS AND GLOBAL COMPUTER NETWORKS; DOWNLOADABLE ELECTRONIC PUBLICATIONS, NAMELY, GLOBAL ADDRESS BOOKS, TELEPHONE DIRECTORIES, FAX DIRECTORIES, WEBSITE DIRECTORIES, NEWSLETTERS RELATING TO TELECOMMUNICATIONS, INSTRUCTION MANUALS, SERVICE MANUALS, CONFIGURATION MANUALS, INSTALLATION MANUALS, SET-UP MANUALS AND RECOVERY MANUALS IN THE FIELDS OF TELECOMMUNICATIONS, COMPUTERS AND RELATED ELECTRONICS, IN CLASS 9 (U.S. CLS. 21, 23, 26, 36 AND 38).

FOR: PRINTED PUBLICATIONS, NAMELY, BOOKS, BOOKLETS, BROCHURES, CATALOGUES, LEAFLETS AND PAMPHLETS ALL IN THE FIELDS OF TELECOMMUNICATIONS; PERIODICAL PUBLICATIONS, NAMELY, NEWSPAPERS, MAGAZINES AND NEWSLETTERS, ALL IN THE FIELDS OF TELECOMMUNICATIONS, COMPUTERS AND RELATED ELECTRONICS; TELECOMMUNICATION DIRECTORIES, IN CLASS 16 (U.S. CLS. 2, 5, 22, 23, 29, 37, 38 AND 50).

FOR: TELECOMMUNICATIONS SERVICES THAT USE DNS (DOMAIN-NAMES SYSTEM) TO COMMUNICATE BETWEEN PARTIES; TEXT-ADDRESSING SERVICES, NAMELY, TELECOMMUNICATION OR INTERNET ADDRESSING SERVICES USING WORDS OR LETTERS AS WELL AS NUMERALS TO FACILITATE CONNECTION, IN CLASS 38 (U.S. CLS. 100, 101 AND 104).

FOR: COMPILATION, CREATION AND MAINTENANCE OF A REGISTER OF DOMAIN NAMES; DESIGN, DEVELOPMENT, MAINTENANCE AND UPDATING OF COMPUTER SOFTWARE, IN CLASS 42 (U.S. CLS. 100 AND 101).

THE MARK CONSISTS OF STANDARD CHARACTERS WITHOUT CLAIM TO ANY PARTICULAR FONT, STYLE, SIZE, OR COLOR.



David J. Kyros

Director of the United States Patent and Trademark Office

Reg. No. 4,072,433 OWNER OF ERPN CMNTY TM OFC REG. NO. 004626776, DATED 10-7-2009, EXPIRES 9-29-2015.

OWNER OF U.S. REG. NO. 2,543,151.

SER. NO. 78-724,880, FILED 10-3-2005.

JAMES GRIFFIN, EXAMINING ATTORNEY

United States of America

United States Patent and Trademark Office

BELLYDANCE BOOTCAMP

Reg. No. 4,072,434

HAWK, TRUDY (UNITED STATES INDIVIDUAL)
1840 NAUSIKA

Registered Dec. 20, 2011

ROWLAND HEIGHTS, CA 91748

Int. Cl.: 41

FOR: INSTRUCTION IN THE ART OF BELLYDANCING AND CHOREOGRAPHY OF BELLYDANCING; WORKSHOPS, SEMINARS AND LIVE PERFORMANCES OF BELLYDANCE, IN CLASS 41 (U.S. CLS. 100, 101 AND 107).

SERVICE MARK

FIRST USE 1-1-2006; IN COMMERCE 1-1-2006.

PRINCIPAL REGISTER

THE MARK CONSISTS OF STANDARD CHARACTERS WITHOUT CLAIM TO ANY PARTICULAR FONT, STYLE, SIZE, OR COLOR.

SEC. 2(F).

SER. NO. 78-787,410, FILED 1-9-2006.

DAVID TAYLOR, EXAMINING ATTORNEY



David J. Kyffers

Director of the United States Patent and Trademark Office

United States of America

United States Patent and Trademark Office



Reg. No. 4,072,435

Registered Dec. 20, 2011

Int. Cl.: 41

SERVICE MARK

PRINCIPAL REGISTER

THE GOOD LIFE RADIO, LLC (GEORGIA LIMITED LIABILITY COMPANY)
C/O FTA 2386 CLOWER STREET, F 201
SNELLVILLE, GA 30078

FOR: ENTERTAINMENT, NAMELY, AN ONGOING RADIO BROADCAST FEATURING
MUSIC, IN CLASS 41 (U.S. CLS. 100, 101 AND 107).

FIRST USE 1-1-2004; IN COMMERCE 11-1-2004.

THE MARK CONSISTS OF A RADIO WITH TWO SPEAKERS; ONE SPEAKER WITH THE
LETTER "G" IMPRINTED, WHICH REPRESENTS GOOD, AND THE OTHER SPEAKER
WITH THE LETTER "L", WHICH REPRESENTS LIFE. THE "GOOD LIFE RADIO" IS PRINTED
IN THE CENTER OF THE TWO SPEAKERS.

SER. NO. 78-874,430, FILED 5-2-2006.

CURTIS FRENCH, EXAMINING ATTORNEY



David J. Kybas

Director of the United States Patent and Trademark Office

United States of America

United States Patent and Trademark Office



Reg. No. 4,072,436

Registered Dec. 20, 2011

Int. Cls.: 38 and 41

SERVICE MARK

PRINCIPAL REGISTER

ADMINISTRADORA DE MARCAS RD, S. DE R.L. DE C.V. (MEXICO CORPORATION)
LAGO ALBERTO NO. 366, COL. ANAHUAC, DELE
GACION MIGUEL HIDALGO;
C.P. 11320, MEXICO, D.F., MEXICO

FOR: (BASED ON MEXICAN REGISTRATION 681325) TELECOMMUNICATION SERVICES, NAMELY, PERSONAL COMMUNICATION SERVICES; TELEMATIC SERVICES, NAMELY, TELECOMMUNICATION SERVICES, NAMELY, PROVISION OF MOBILE TELECOMMUNICATIONS SERVICES, NAMELY, VOICE AND DATA TRANSMISSIONS, ACCESSIBLE BY ACCESS CODE OR TERMINALS, TELEPHONE, TELEVISION, RADIO AND DATA TRANSMISSIONS ACCESSIBLE BY ACCESS CODE OR TERMINALS, TELEPHONE, TELEVISION, RADIO AND TELEPRINTER; ELECTRONIC TRANSMISSION OF MESSAGES AND CODED IMAGES; ELECTRONIC TRANSMISSION OF MESSAGES AND DATA; WIRELESS DIGITAL MESSAGING SERVICES; ELECTRONIC STORE-AND-FORWARD MESSAGING; ELECTRONIC TRANSMISSION OF DATA AND DOCUMENTS VIA COMPUTER TERMINALS; COMPUTER TELECOMMUNICATIONS, NAMELY, PROVIDING MULTIPLE USER ACCESS TO THE INTERNET; FACSIMILE TRANSMISSIONS; ELECTRONIC MAIL SERVICES; TELEPHONE COMMUNICATION SERVICES; PROVIDING INFORMATION IN THE FIELD OF TELECOMMUNICATIONS, IN CLASS 38 (U.S. CLS. 100, 101 AND 104).

FOR: (BASED ON MEXICAN REGISTRATION 892425) EDUCATIONAL SERVICES, NAMELY, CONDUCTING SEMINARS, CONFERENCES AND WORKSHOPS IN THE FIELD OF TELECOMMUNICATIONS SERVICES; ENTERTAINMENT SERVICES, NAMELY, CONDUCTING CONTEST RAFFLES, COMPETITIONS, SOCIAL FUNCTIONS, SPONSORED EVENTS, OUTINGS AND CULTURAL EVENTS IN THE FIELD OF TELECOMMUNICATIONS, SPORTS, MUSIC, ACTING, ARTS AND ENTERTAINMENT; ENTERTAINMENT, RECREATION AND EDUCATION, NAMELY, CONDUCTING SEMINARS, CONFERENCES AND WORKSHOPS IN THE FIELD OF TELECOMMUNICATIONS, CULTURE, SPORTS, MUSIC, ACTING, ARTS, AND ENTERTAINMENT, IN CLASS 41 (U.S. CLS. 100, 101 AND 107).

OWNER OF MEXICO REG. NO. 892425, DATED 7-27-2005, EXPIRES 7-27-2015.

THE COLOR(S) PURPLE, GOLD, AND BLUE IS/ARE CLAIMED AS A FEATURE OF THE MARK.



David J. Kyjars

Director of the United States Patent and Trademark Office

Reg. No. 4,072,436 OWNER OF MEXICO REG. NO. 681325, DATED 12-18-2000, RENEWED AS REG. NO. 166779/2011, DATED 10-4-2010, EXPIRES 12-18-2020.

NO CLAIM IS MADE TO THE EXCLUSIVE RIGHT TO USE "KIT", APART FROM THE MARK AS SHOWN.

THE MARK CONSISTS OF THE WORDS "AMIGO KIT" IN SPECIAL FORM IN BLUE, AND AN ARBITRARY DESIGN IN PURPLE AND GOLD.

THE ENGLISH TRANSLATION OF THE WORD "AMIGO" IN THE MARK IS "FRIEND".

SER. NO. 78-981,432, FILED 6-9-2005.

WILLIAM BRECKENFELD, EXAMINING ATTORNEY

United States of America

United States Patent and Trademark Office

DUJJOC

Reg. No. 4,072,437

Registered Dec. 20, 2011

Int. Cl.: 5

TRADEMARK

PRINCIPAL REGISTER

BOEHRINGER INGELHEIM INTERNATIONAL GMBH (FED REP GERMANY CORPORATION)
55218 INGELHEIM
FED REP GERMANY

FOR: PHARMACEUTICAL PREPARATIONS FOR THE TREATMENT OF DISEASES AND DISORDERS OF THE ALIMENTARY TRACT AND METABOLISM, AND BLOOD AND BLOOD FORMING ORGANS; PHARMACEUTICAL PREPARATIONS FOR THE TREATMENT OF DISEASES AND DISORDERS OF THE CARDIOVASCULAR SYSTEM, MUSCULOSKELETAL SYSTEM, CENTRAL NERVOUS SYSTEM, PERIPHERAL NERVOUS SYSTEM, GENITOURINARY SYSTEM AND RESPIRATORY SYSTEM; PHARMACEUTICAL PREPARATIONS FOR THE TREATMENT OF DERMATOLOGICAL, HORMONAL, INFECTIOUS, VIRAL AND ONCOLOGICAL DISEASES AND DISORDERS, IN CLASS 5 (U.S. CLS. 6, 18, 44, 46, 51 AND 52).

THE MARK CONSISTS OF STANDARD CHARACTERS WITHOUT CLAIM TO ANY PARTICULAR FONT, STYLE, SIZE, OR COLOR.

PRIORITY DATE OF 11-16-2007 IS CLAIMED.

OWNER OF INTERNATIONAL REGISTRATION 0962478 DATED 4-2-2008, EXPIRES 4-2-2018.

SER. NO. 79-053,179, FILED 4-2-2008.

JASON BLAIR, EXAMINING ATTORNEY



David J. Kyffers

Director of the United States Patent and Trademark Office

United States of America

United States Patent and Trademark Office



Reg. No. 4,072,438

Registered Dec. 20, 2011

Int. Cls.: 3, 5, 8, 9, 10, 11, 16, 21, 29, 30, 32, 35, 36, 37, 38, 39, 40, 41, 42 and 44

TRADEMARK

SERVICE MARK

PRINCIPAL REGISTER

APOTHEKE DOCMORRIS HOLDING GMBH (FED REP GERMANY GESELLSCHAFT MIT BESCHRÄNKTER HAFTUNG (GMBH))
NECKARTALSTRASSE 155
70376 STUTTGART
FED REP GERMANY

FOR: BODY AND BEAUTY CARE PRODUCTS, NAMELY, LOTIONS AND CREAMS; COSMETIC PREPARATIONS FOR THE HAIR AND SCALP; COSMETICS AND COSMETIC PREPARATIONS; HAIR LOTIONS; COSMETIC GOODS, NAMELY, BATH AND SHOWER PREPARATIONS, NAMELY, BATH AND SHOWER GELS; SOAPS IN SOLID AND LIQUID FORM, NAMELY, MEDICATED SOAPS; PERFUMERY; PREPARATIONS FOR CLEANING TEETH, IN CLASS 3 (U.S. CLS. 1, 4, 6, 50, 51 AND 52).

FOR: PHARMACEUTICAL PRODUCTS, NAMELY, PREPARATIONS FOR HEALTH AND BODY CARE FOR MEDICAL PURPOSES AND PERSONAL HYGIENE, NAMELY, ACNE MEDICATIONS, ANTIHISTAMINES, ANTISEPTICS AND GENERAL PURPOSE GERMICIDES, ANTACIDS, ANTIBIOTIC CREAM, COLD MEDICINE, COUGH DROPS, DANDRUFF SHAMPOO, DECONGESTANT TABLETS, DIARRHEA MEDICATION, EYE DROPS, HYDRO-CORTISONE CREAM, LAXATIVES, LIP BALM, NASAL SPRAY PREPARATIONS, PAIN RELIEVERS, NAMELY, ASPIRIN AND NON ASPIRIN, VITAMIN SUPPLEMENTS, PHARMACEUTICAL PREPARATIONS FOR SKIN CARE; BIOLOGICAL PREPARATIONS FOR MEDICAL PURPOSES FOOD FOR BABIES; SWEETS FOR MEDICAL PURPOSES, NAMELY, CHEST AND COUGH DROPS; TEST STRIPS FOR DIABETES AND PREGNANCY TESTS KITS, STRIPS FOR CHOLESTEROL TESTS; MEDICAL PLASTERS AND MATERIALS FOR DRESSINGS, NAMELY, BANDAGES; HYGIENIC ARTICLES FOR WOMEN, NAMELY, SANITARY TOWELS, PANTY LINERS, TAMPONS, SANITARY PANTS; PASTILLES FOR PHARMACEUTICAL PURPOSES, IN CLASS 5 (U.S. CLS. 6, 18, 44, 46, 51 AND 52).

FOR: NAIL SCISSORS AND MANICURE SETS, IN CLASS 8 (U.S. CLS. 23, 28 AND 44).

FOR: SCIENTIFIC, ELECTRICAL, ELECTRONIC, AND PHOTOGRAPHIC WEIGHING, MEASURING, SIGNALING, CHECKING, TEACHING, AND LIFE-SAVING APPARATUS AND INSTRUMENTS PARTICULARLY FOR USE IN LABORATORIES, PHARMACIES, AND DRUG STORES, NAMELY, EMERGENCY SIGNAL TRANSMITTERS; COMPUTER PERIPHERY DEVICES, COMPUTER PROGRAMS FOR CONTROLLING AND MANAGING PATIENT MEDICAL INFORMATION, PARTICULARLY FOR USE IN PHARMACIES, DRUG STORES, LABORATORIES AND PHYSICIAN PRACTICES; COMPUTER SOFTWARE,



David J. Kybas

Director of the United States Patent and Trademark Office

Reg. No. 4,072,438 NAMELY, COMPUTER SOFTWARE FOR CONTROLLING AND MANAGING PATIENT MEDICAL INFORMATION, PARTICULARLY FOR USE IN PHARMACIES, DRUG STORES, LABORATORIES AND PHYSICIAN PRACTICES, IN CLASS 9 (U.S. CLS. 21, 23, 26, 36 AND 38).

FOR: SURGICAL AND MEDICAL INSTRUMENTS AND APPARATUS, NAMELY, BLOOD PRESSURE GAUGES, BLOOD GLUCOSE METERS AND TESTING STRIPS, AND CHOLESTEROL METERS; ORTHOPEDIC ARTICLES, NAMELY, ORTHOPEDIC SUPPORT BANDAGES AND SURGICAL STOCKINGS; MEDICAL ANALYSIS EQUIPMENT, NAMELY, BLOOD PRESSURE MONITORS, BLOOD GLUCOSE MONITORS, AND HEART MONITORS, IN CLASS 10 (U.S. CLS. 26, 39 AND 44).

FOR: LIGHTING FIXTURES, LIGHT BULBS, ELECTRIC MICROWAVE OVENS; ELECTRIC SPACE HEATERS AND WATER HEATERS; ELECTRIC FANS; ELECTRIC HAIR DRYERS, HUMIDIFIERS; HOT WATER BOTTLES, WATER FILTERS, AND WATER FILTERING APPARATUS; WATER TREATMENT DEVICES AND MACHINERY, NAMELY, CARTRIDGE FILTRATION UNITS, CHEMICAL STERILIZATION UNITS, REVERSE OSMOSIS FILTRATION UNITS, AND ULTRAVIOLET STERILIZATION UNITS; WATER-SOFTENING APPARATUS AND INSTILLATIONS, WATER DISTILLATION UNITS; DISTILLATION UNITS, AIR HUMIDIFIERS FOR CENTRAL HEATING RADIATORS, IN CLASS 11 (U.S. CLS. 13, 21, 23, 31 AND 34).

FOR: PRINTED MATTER, NAMELY, BOOKS, PRINTED PERIODICALS, JOURNALS, NEWSPAPERS, CATALOGUES, PROSPECTUSES, BROCHURES ALL IN THE FIELD OF MEDICINE, PHARMACEUTICALS, AND HEALTHCARE; BABIES' DIAPERS OF PAPER OR CELLULOSE, PAPER TISSUES FOR COSMETIC USE; OFFICE EQUIPMENT FOR PHARMACIES, NAMELY, CELLULOID COVERS, CELLULOID CARD SHEETS, CELLULOID PROTECTIVE SIGNS, PRINTED PRESCRIPTION LABELS, NON-MECHANICAL LABEL MOISTENERS, IN CLASS 16 (U.S. CLS. 2, 5, 22, 23, 29, 37, 38 AND 50).

FOR: BRUSHES, NAMELY, HAIRBRUSHES, NAIL BRUSHES, TOILET BRUSHES, SHOE BRUSHES, DISHWASHING BRUSHES, FLOOR BRUSHES, CLOTHES BRUSHES, SHAVING BRUSHES; TOOTHBRUSHES, ELECTRIC TOOTHBRUSHES; COMBS; SPONGES FOR HOUSEHOLD PURPOSES, IN CLASS 21 (U.S. CLS. 2, 13, 23, 29, 30, 33, 40 AND 50).

FOR: DIETETIC FOODSTUFFS FOR NON-MEDICAL PURPOSES BASED ON FATS, WITH ADDED FATTY ACIDS, VITAMINS, MINERALS, TRACE ELEMENTS, NAMELY, FRUIT AND VEGETABLE BASED SNACK FOODS, SNACK BARS, NAMELY, NUT BASED SNACK BARS, FRUIT BASED SNACK BARS, FRUIT AND VEGETABLE CONCENTRATES USED AS INGREDIENTS OF FOODS; PRESERVED, DRIED, AND COOKED FRUITS, IN CLASS 29 (U.S. CL. 46).

FOR: DIETETIC FOODSTUFFS AND FOOD ADDITIVES FOR NON-MEDICAL PURPOSES BASED ON CARBOHYDRATES, ROUGHAGE, WITH ADDED VITAMINS, MINERALS, TRACE ELEMENTS, NAMELY, CEREAL BASED SNACK FOODS, RICE BASED SNACK BARS AND GRANOLA-BASED SNACK BARS; COFFEE, TEA, BEVERAGES MADE FROM TEA; COCOA-BASED PRODUCTS, CHOCOLATE, MILK CHOCOLATE, CHOCOLATE BARS, FILLED CHOCOLATES; SUGAR, GLUCOSE FOR FOOD, CANDY STICKS; JELLIED FRUITS; FRUIT SAUCES EXCLUDING CRANBERRY SAUCE AND APPLESAUCE; FRUIT GUMS ALSO IN VARIOUS SHAPES AND FORMS, INCLUDING BEARS; LIQUORICE, STICK LIQUORICE; SWEETS, CARAMELS, PEPPERMINT CANDY SWEETS, IN CLASS 30 (U.S. CL. 46).

FOR: ENERGY DRINKS; MINERAL AND AERATED WATERS; NON-ALCOHOLIC DRINKS, NAMELY, FRUIT DRINKS AND FRUIT JUICES, PARTICULARLY FRUIT NECTARS; VEGETABLE JUICES; SYRUPS AND NONALCOHOLIC PREPARATIONS, NAMELY, JUICE CONCENTRATES, SIMPLE SYRUPS, AND APERITIFS, FOR MAKING BEVERAGES, IN CLASS 32 (U.S. CLS. 45, 46 AND 48).

Reg. No. 4,072,438 FOR: BUSINESS COMPANY CONSULTATION AND BUSINESS MANAGEMENT CONSULTATION, PARTICULARLY FOR PHARMACIES, DRUG STORES, PHYSICIAN PRACTICES, CLINICS AND DISPATCH CENTERS, AND PARTICULARLY FOR TURNOVER, COST, AND RESULTS MANAGEMENT; BUSINESS MANAGEMENT AND BUSINESS ADMINISTRATION FOR THIRD PARTIES, PARTICULARLY FOR PHARMACIES, DRUG STORES, PHYSICIANS' PRACTICES, CLINICS AND DISPATCH CENTERS; ADVERTISING SERVICES ON THE INTERNET; TELEVISION ADVERTISING AGENCY; RADIO ADVERTISING AGENCY; ADVERTISING BY MAIL ORDER; ADVERTISING AGENCY SERVICES; DISTRIBUTION OF ADVERTISEMENTS; ONLINE ADVERTISING ON A COMPUTER NETWORK; PRESENTATION OF GOODS FOR THIRD PARTIES FOR PRESENTATION AND SALES PURPOSES; SHOP WINDOW DECORATION; UPDATING, ENTRY, ORGANIZATION AND COLLECTION OF DATA IN COMPUTER DATABASES, IN CLASS 35 (U.S. CLS. 100, 101 AND 102).

FOR: REAL ESTATE CONSULTATION; FINANCIAL CONSULTATION; INSURANCE AGENCIES; REAL ESTATE BROKERAGE SERVICES FOR THIRD PARTIES; REAL ESTATE MANAGEMENT FOR THIRD PARTIES, PARTICULARLY FOR PHARMACIES, DRUG STORES, WAREHOUSES AND DISPATCH CENTERS; BROKERAGE, RENTAL AND LEASING OF REAL ESTATE, NAMELY, OF OFFICES, FOR PHARMACIES, DRUG STORES, WAREHOUSES AND DISPATCH CENTERS; FINANCIAL CONSULTANCY; FINANCIAL CONSULTANCY FOR FRANCHISING CONCEPTS; REAL ESTATE MANAGEMENT OF WAREHOUSE BUILDINGS FOR PHARMACEUTICAL WHOLESALERS, IN CLASS 36 (U.S. CLS. 100, 101 AND 102).

FOR: CONSTRUCTION, NAMELY, CONSTRUCTION OF BUILDINGS FOR PHARMACIES, DRUG STORES, WAREHOUSES AND DISPATCH CENTERS; REPAIR WORK ON BUILDINGS, PARTICULARLY FOR PHARMACIES, DRUG STORES, WAREHOUSES AND DISPATCH CENTERS; AND UNDERGROUND BUILDING CONSTRUCTION WORK; INSTALLATION AND MAINTENANCE OF HARDWARE FOR THE OPERATION OF COMPUTER NETWORK SERVERS AND NETWORK SYSTEMS, IN CLASS 37 (U.S. CLS. 100, 103 AND 106).

FOR: TELECOMMUNICATIONS; BROADCASTING OF TELEVISION BROADCASTS/PROGRAMMES; BROADCASTING OF RADIO PROGRAMMES; PRESS AGENCY SERVICES, NAMELY, THE TRANSMISSION OF NEWS; PROVISION OF TELECOMMUNICATIONS CONNECTIONS AND ACCESS TO A WORLDWIDE COMPUTER NETWORK; PROVISION OF ACCESS TO A COMPUTER NETWORK; ELECTRONIC MESSAGE TRANSMISSION; E-COMMERCE SERVICES, NAMELY, PROVIDING ACCESS TO INFORMATION ON THE INTERNET, PROVIDING PLATFORMS ON THE INTERNET, PARTICULARLY FOR OTHERS, FORWARDING MESSAGES OF ALL KINDS TO INTERNET ADDRESSES, NAMELY, WEB MESSAGING; PROVIDING ACCESS TO INFORMATION WITH REGARD TO CURRENT FINDINGS OF PHARMACEUTICAL RESEARCH ON THE INTERNET; PROVIDING ACCESS TO PHARMACEUTICAL INFORMATION ON THE INTERNET, IN CLASS 38 (U.S. CLS. 100, 101 AND 104).

FOR: TRANSPORT BY AIR, CAR, TRAIN, AND SEA; PACKAGING AND STORAGE OF GOODS; DELIVERY OF GOODS, PARTICULARLY OF MEDICATIONS, BODY CARE AND BEAUTY PRODUCTS, DIETETIC FOODS AND DRINKS AND FOOD SUPPLEMENTS TO PHARMACIES, DRUG STORES, CLINICS, WHOLESALERS, PHYSICIANS' PRACTICES AND MEDICAL REPRESENTATIVES; DELIVERY OF GOODS TO PATIENTS AND END CONSUMERS; STORAGE OF GOODS, PARTICULARLY OF MEDICATIONS, BODY CARE AND BEAUTY PRODUCTS, DIETETIC FOODS AND DRINKS AND FOOD SUPPLEMENTS; GOODS WAREHOUSING; DELIVERY OF GOODS TO CUSTOMERS; COURIER SERVICE, IN CLASS 39 (U.S. CLS. 100 AND 105).

FOR: CUSTOM ASSEMBLING OF MATERIALS, NAMELY, ASSEMBLY OF PRODUCTS FOR OTHERS, IN CLASS 40 (U.S. CLS. 100, 103 AND 106).

Reg. No. 4,072,438 FOR: PROVISION OF TRAINING AND FURTHER TRAINING IN THE FIELD OF MEDICINE, PHARMACY AND HEALTH CARE; TEACHING IN THE FIELD OF MEDICINE, PHARMACY AND HEALTHCARE; CONDUCTING OF SEMINARS, TEACHING, TRAINING AND FURTHER TRAINING MEASURES, NAMELY, IN THE FIELD OF HOW TO PROVIDE MEDICAL AND PHARMACEUTICAL PRODUCTS FOR INDUSTRIAL AND TEST PURPOSES, ARRANGEMENT AND CONDUCTING OF WORKSHOPS IN THE FIELD OF MEDICINE, PHARMACY AND HEALTHCARE; PRODUCTION OF INTERNET TELEVISION PROGRAMS IN THE FIELD OF MEDICINE, PHARMACY AND HEALTHCARE; EDITORIAL SUPERVISION OF INTERNET SITES, NAMELY, EDITING OF TEXTS FOR PUBLICATION ON THE INTERNET, EXCEPT FOR ADVERTISING PURPOSES, IN CLASS 41 (U.S. CLS. 100, 101 AND 107).

FOR: DEVELOPMENT OF COMPUTER PROGRAMS, PARTICULARLY IN THE HEALTH FIELD FOR DATA PROCESSING AND CONTROLLING AND MANAGING PATIENT MEDICAL INFORMATION; UPDATING COMPUTER SOFTWARE; COMPUTER CONSULTANCY SERVICES; DEVELOPMENT OF OPERATING SYSTEMS FOR COMPUTERS; PRODUCTION OF SOFTWARE FOR INTERNET PORTALS AND INTERNET PLATFORMS; DESIGN AND MAINTENANCE OF WEB SITES FOR THIRD PARTIES; CONSULTANCY ON THE DESIGN OF HOMEPAGES AND INTERNET SITES; DEVELOPMENT AND DESIGN OF HOMEPAGES AND INTERNET SITES, PARTICULARLY FOR PHARMACIES, DRUG STORES, PHYSICIANS' PRACTICES AND CLINICS; MEDICAL/PHARMACEUTICAL RESEARCH; FOLLOW-UP RESEARCH AND RESEARCH IN DATABASES AND ON THE INTERNET FOR SCIENTIFIC AND RESEARCH PURPOSES; SCIENTIFIC ANALYSIS OF PHARMACEUTICAL PRODUCTS; CIVIL ENGINEERING; SERVICES OF A MEDICAL LABORATORY, IN CLASS 42 (U.S. CLS. 100 AND 101).

FOR: CONSULTANCY RELATING TO PHARMACEUTICAL PRODUCTS, NAMELY, THROUGH A PHARMACIST OR DRUG STORE OPERATOR, PHARMACIST SERVICES, NAMELY, PREPARATION OF PHARMACEUTICAL PREPARATIONS AND MEDICINES FOR THIRD PARTIES ON THE BASIS OF MEDICAL PRESCRIPTIONS; PHARMACIST SERVICES, NAMELY, PREPARATION OF MEDICAL PRESCRIPTIONS FOR THIRD PARTIES; HEALTH AND NUTRITION CONSULTANCY, PARTICULARLY IN THE FIELD OF CARE AND HYGIENE OF THE SICK AND BABIES; HYGIENIC AND BEAUTY CARE FOR HUMAN BEINGS AND ANIMALS; PERFORMANCE OF MEDICAL TESTING; PSYCHOLOGICAL CONSULTATION OF PERSONNEL FOR MEDICAL PURPOSES; MEDICAL CONSULTATION ON THE APPROVAL OF MEDICATIONS FOR THIRD PARTIES, IN CLASS 44 (U.S. CLS. 100 AND 101).

THE MARK CONSISTS OF A GREEN CROSS WITH "DOCMORRIS" WRITTEN IN WHITE IN THE MIDDLE. THE CROSS HAS A WHITE BORDER AND A GREEN OUTLINE.

PRIORITY DATE OF 4-20-2007 IS CLAIMED.

OWNER OF INTERNATIONAL REGISTRATION 0976372 DATED 10-16-2007, EXPIRES 10-16-2017.

THE COLOR(S) GREEN AND WHITE IS/ARE CLAIMED AS A FEATURE OF THE MARK.

SER. NO. 79-058,508, FILED 10-16-2007.

SHAUNIA CARLYLE, EXAMINING ATTORNEY

United States of America

United States Patent and Trademark Office

K+S Salt

Reg. No. 4,072,439

Registered Dec. 20, 2011

Int. Cls.: 1, 5, 16, 30 and 31

TRADEMARK

PRINCIPAL REGISTER

K+S AKTIENGESELLSCHAFT (FED REP GERMANY INCORPORATED COMPANY)
BERTHA-VON-SUTTNER-STRASSE 7
34131 KASSEL
FED REP GERMANY

FOR: CHEMICALS USED IN INDUSTRY, INDUSTRIAL SALT FOR USE IN WATER SOFTENING. FOR USE AS REGENERATING ION-EXCHANGE RESINS, FOR USE AS CONSERVING SALT, FOR USE AS DISHWASHER SALT, FOR USE AS ROAD SALT, FOR DISINFECTION OF SWIMMING POOL WATER FOR USE AS ULTRA CURE SALT FOR THE PHARMACEUTICAL INDUSTRY, SALT FOR CHEMICAL INDUSTRY FOR USE IN WATER SOFTENING, FOR USE AS REGENERATING ION-EXCHANGE RESINS, FOR USE AS CONSERVING SALT, FOR USE AS DISHWASHER SALT, FOR USE AS ROAD SALT, FOR DISINFECTION OF SWIMMING POOL WATER FOR USE AS ULTRA PURE SALT FOR THE PHARMACEUTICAL INDUSTRY, DE-ICING ROCK SALT; WATER SOFTENING SALT, IN CLASS 1 (U.S. CLS. 1, 5, 6, 10, 26 AND 46).

FOR: DIETETIC SUBSTANCES CONTAINING SALT FOR MEDICAL PURPOSES; DIETETIC NUTRITIONAL SUPPLEMENTS CONTAINING SALT FOR NON-MEDICAL PURPOSES ON THE BASIS OF VITAMINS, MINERAL NUTRIENTS AND TRACE ELEMENTS; PHARMACEUTICAL PRODUCTS, IN PARTICULAR HIGH PURITY SALTS FOR USE AS IN FUSION SOLUTIONS OR AS MEDICINAL SUBSTANCES FOR MEDICAL PURPOSES FOR THE PHARMACEUTICAL INDUSTRY, IN CLASS 5 (U.S. CLS. 6, 18, 44, 46, 51 AND 52).

FOR: PAPER BAGS; PRINTED MATTER, NAMELY, NEWSPAPERS, PHOTOGRAPHS, MAGAZINES BOOKS, PRINTED PERIODICALS, NEWSLETTERS AND BROCHURES FOR ADVERTISING AND FOR PROVIDING PRODUCT INFORMATION CONCERNING SALT PRODUCTS; PACKAGING MATERIAL OF PLASTIC, NAMELY, COVERS, BAGS AND FOILS, IN CLASS 16 (U.S. CLS. 2, 5, 22, 23, 29, 37, 38 AND 50).

FOR: SALT, TABLE SALT, SPICES; CONDIMENTS, NAMELY, SAUCE, IN CLASS 30 (U.S. CL. 46).

FOR: FEEDSTUFFS AND ADDITIVES FOR FEEDSTUFFS ALL CONTAINING SALT FOR NON-MEDICAL PURPOSES, LICKSTONES AND UNTREATED SALT ROCKS INCLUDED IN THIS CLASS, IN CLASS 31 (U.S. CLS. 1 AND 46).



David J. Kappas

Director of the United States Patent and Trademark Office

Reg. No. 4,072,439 THE MARK CONSISTS OF STANDARD CHARACTERS WITHOUT CLAIM TO ANY PARTICULAR FONT, STYLE, SIZE, OR COLOR.

PRIORITY DATE OF 11-14-2008 IS CLAIMED.

OWNER OF INTERNATIONAL REGISTRATION 1005794 DATED 5-11-2009, EXPIRES 5-11-2019.

NO CLAIM IS MADE TO THE EXCLUSIVE RIGHT TO USE "SALT", APART FROM THE MARK AS SHOWN.

SER. NO. 79-070,134, FILED 5-11-2009.

DARRYL SPRUILL, EXAMINING ATTORNEY

United States of America

United States Patent and Trademark Office

DAFI

Reg. No. 4,072,440

FORMASTER S.A. (POLAND SPÓLKA AKCYJNA (SA))
24, UL. FABRYCZNA

Registered Dec. 20, 2011

PL-25-818 KIELCE, POLAND

**Int. Cls.: 6, 7, 8, 9, 11, 17,
20 and 21**

FOR: METALLIC TAPS FOR METAL WATER PIPES, METALLIC PIPE COUPLINGS, METALLIC PIPES, METALLIC FERRULES BEING METAL PIPE CONNECTORS, IN CLASS 6 (U.S. CLS. 2, 12, 13, 14, 23, 25 AND 50).

TRADEMARK

FOR: FILTERING APPLIANCES INSERTS, NAMELY, AIR FILTERS FOR MECHANICAL PURPOSES; HEAT EXCHANGERS BEING PARTS OF MACHINES; BOTTLE CAPPING MACHINES; BOTTLING MACHINES; BOTTLE CLOSING MACHINES; ELECTRIC BREAD CUTTING MACHINES; STEAM CLEANING MACHINES; HIGH-PRESSURE CLEANING APPLIANCES, NAMELY, MACHINES FOR CLEANING SURFACES USING HIGH PRESSURE WATER; SEWAGE PULVERIZERS; WATER SEPARATORS AS MACHINE PARTS; AIR SUCTION MACHINES, IN CLASS 7 (U.S. CLS. 13, 19, 21, 23, 31, 34 AND 35).

PRINCIPAL REGISTER

FOR: HAND-OPERATED VACUUM PUMPS; HAND-OPERATED INSECTICIDE ATOMIZERS, IN CLASS 8 (U.S. CLS. 23, 28 AND 44).

FOR: ELECTRIC SOCKETS, PLUGS AND OTHER CONNECTORS, IN CLASS 9 (U.S. CLS. 21, 23, 26, 36 AND 38).



FOR: WATER HEATERS; PARTS FOR PLUMBING INSTALLATIONS, NAMELY, TAPS, SPOUTS; ELECTRIC HEATING APPLIANCES, NAMELY, ELECTRIC HEATING FANS, ELECTRIC RADIATORS FOR HEATING BUILDINGS; APPLIANCES AND INSTALLATIONS FOR WATER TREATMENT, NAMELY, CHEMICAL STERILIZATION UNITS, WATER FLOW REGULATORS FOR SANITARY INSTALLATIONS, WATER HEATING INSTALLATIONS, BOILER PIPES FOR CENTRAL HEATING, EXCHANGERS AS PARTS OF WATER HEATING INSTALLATIONS; SHOWERS; SHOWER CUBICLES; ELECTRIC RADIATORS; WATER FILTERING APPLIANCES; PORTABLE AND BOILER WATER TREATMENT FILTERS; WATER DISTRIBUTING INSTALLATIONS, NAMELY, SINKS, WATER FOUNTAINS; AQUARIUM FILTRATION APPARATUS; DISINFECTANT DISPENSERS FOR TOILETS; WATER HEATING ELEMENTS IN THE NATURE OF IMMERSION HEATERS, ELECTRIC KETTLES; INHALERS AS DEVICES FOR HUMIDIFYING AIR IN THE NATURE OF HUMIDIFIERS FOR HOUSEHOLD PURPOSES; SAUNAS; INSTALLATIONS FOR SEA WATER DESALINATION; LAVATORY PANS IN THE NATURE OF LAVATORY BOWLS; FLUSHING CISTERNS FOR LAVATORY PANS, NAMELY, FLUSH LEVERS; AIR IONIZATION APPLI-

David J. Kypas

Director of the United States Patent and Trademark Office

Reg. No. 4,072,440 ANCES IN THE NATURE OF AIR PURIFIERS; AIR FRESHENING APPLIANCES, NAMELY, DISPENSING UNITS FOR AIR FRESHENERS; ELECTRIC AIR DEODORIZERS; BATHROOM HAND DRYERS IN THE NATURE OF ELECTRIC HAND DRYERS AND TOUCHLESS HAND DRYING APPARATUS; AIR DRYERS, NAMELY, ELECTRIC HOT AIR HAND DRYERS; DRYING APPLIANCES, NAMELY, CLOTHES DRYERS, MOUNTABLE ELECTRIC HAND DRYING APPLIANCES; AIR VENTILATION AND AIR CONDITIONING APPLIANCES; APPLIANCES AND INSTALLATIONS FOR WATER SOFTENING; WATER STERILIZERS; DRAIN BOARD SINKS; ELECTRICAL FEET HEATERS, IN CLASS 11 (U.S. CLS. 13, 21, 23, 31 AND 34).

FOR: NON-METALLIC FLEXIBLE HOSES FOR DOMESTIC WATER SUPPLY, AGRICULTURAL USE; NON-METALLIC PIPE CONNECTORS; NON-METALLIC CONNECTORS IN THE NATURE OF RINGS OF RUBBER FOR USE AS PIPE CONNECTION SEALS; NON-METALLIC RUBBER CORDS; WATERING HOSES; FLEXIBLE COMPRESSED AIR PIPE FITTINGS NOT OF METAL; RUBBER BUMPERS FOR LOADING DOCKS, IN CLASS 17 (U.S. CLS. 1, 5, 12, 13, 35 AND 50).

FOR: BOTTLE CORKS; PLASTIC CONTAINERS IN THE NATURE OF PACKING CONTAINERS OF PLASTIC MATERIAL; NON-METALLIC AUTOMOTIVE ACCESSORIES BEING CUP HOLDERS, CLOTHING HANGERS, MOBILE PHONE HOLDERS, IN CLASS 20 (U.S. CLS. 2, 13, 22, 25, 32 AND 50).

FOR: KITCHEN ACCESSORIES NOT OF PRECIOUS METALS, NAMELY, LADLES, SPLATTER SCREENS; RECEPTACLES FOR HOUSEHOLD AND KITCHEN USE, NAMELY, FOODSTUFFS STORAGE CONTAINERS; VACUUM PUMPS FOR VACUUM BOTTLES FOR STORING FOODSTUFFS AND VACUUM VALVES IN THE FORM OF CORKS BEING BOTTLE STOPPERS FOR FOOD STUFF STORAGE CONTAINERS; JUGS; BOTTLES NOT OF PRECIOUS METALS; RECEPTACLES NOT OF PRECIOUS METALS, NAMELY, BASINS; HOUSEHOLD UTENSILS NOT OF PRECIOUS METALS, NAMELY, SHOE HORNS; UTENSILS FOR APPLYING COSMETICS APPLICATIONS IN THE FORM OF SPOONS, IN CLASS 21 (U.S. CLS. 2, 13, 23, 29, 30, 33, 40 AND 50).

THE MARK CONSISTS OF STANDARD CHARACTERS WITHOUT CLAIM TO ANY PARTICULAR FONT, STYLE, SIZE, OR COLOR.

OWNER OF INTERNATIONAL REGISTRATION 1022339 DATED 4-20-2009, EXPIRES 4-20-2019.

THE WORDING "DAFI" HAS NO MEANING IN A FOREIGN LANGUAGE.

SER. NO. 79-076,417, FILED 4-20-2009.

KRISTINA MORRIS, EXAMINING ATTORNEY

United States of America

United States Patent and Trademark Office



Reg. No. 4,072,441

METSÄ TISSUE OYJ (FINLAND FINNISH PUBLIC JOINT STOCK COMPANY)
REVONTULENTIE 8 C

Registered Dec. 20, 2011

FI-02100 ESPOO, FINLAND

Int. Cls.: 3, 4, 16, 21 and 28

FOR: CLEANING PREPARATIONS; SOAPS; PERFUMERY, ESSENTIAL OILS, COSMETICS, NAMELY, PRE-MOISTENED COSMETIC WIPES FOR SANITARY AND COSMETIC PURPOSES; HAIR LOTIONS, IN CLASS 3 (U.S. CLS. 1, 4, 6, 50, 51 AND 52).

TRADEMARK

FOR: CANDLES AND WICKS FOR CANDLES AND OIL LAMPS FOR LIGHTING, IN CLASS 4 (U.S. CLS. 1, 6 AND 15).

PRINCIPAL REGISTER

FOR: PAPER, CARDBOARD AND GOODS MADE FROM THESE MATERIALS, NOT INCLUDED IN OTHER CLASSES, NAMELY, SOFT PAPER PRODUCTS IN THE NATURE OF PAPER TOWELS FOR DRYING AND CLEANING FOR USE IN SERVICE INSTALLATIONS AND IN INDUSTRY, PAPER NAPKINS, PAPER TABLE CLOTHS; WRAPPING AND PACKAGING MATERIALS, NAMELY, WRAPPING PAPER; FACE TOWELS OF PAPER, TOILET PAPER, DISPOSABLE WIPES NOT IMPREGNATED WITH CHEMICALS OR COMPOUNDS, CELLULOSE WIPES, PAPER HANDKERCHIEFS, AND BABIES' DIAPERS OF PAPER CELLULOSE; PRINTED MATTER, NAMELY, INFORMATIONAL LEAFLETS IN THE FIELD OF PAPER AND TISSUE PRODUCTS, CHILDREN'S BOOKS, COLORING BOOKS; PLASTIC MATERIALS FOR PACKAGING NOT INCLUDED IN OTHER CLASSES, NAMELY, PLASTIC BAGS; CLOTHS OF PAPER, NAMELY, PAPER TOWELS, IN CLASS 16 (U.S. CLS. 2, 5, 22, 23, 29, 37, 38 AND 50).

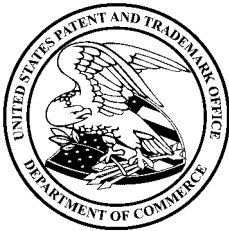

FOR: HOUSEHOLD AND KITCHEN UTENSILS AND CONTAINERS, NAMELY, DISPOSABLE TABLEWARE OTHER THAN KNIVES, FORKS AND SPOONS IN THE NATURE OF PLASTIC STORAGE CONTAINERS FOR HOUSEHOLD USE; HOLDERS, CONTAINERS AND DISPENSERS FOR KITCHEN ROLLS, TOILET PAPER, NAPKINS AND HAND TOWELS; ARTICLES FOR CLEANING PURPOSES, NAMELY, SOAP DISHES, SOAP BOXES, SOAP DISPENSERS, TOWELS AND CLOTHS FOR CLEANING, NOT OF WOVEN FABRICS, IN CLASS 21 (U.S. CLS. 2, 13, 23, 29, 30, 33, 40 AND 50).

David J. Kyros

FOR: GAMES AND PLAYTHINGS, NAMELY, CARD GAMES, BOARD GAMES, TOY ANIMALS, STUFFED TOYS, TOY FIGURES, DOLLS; DECORATIONS, NAMELY, PAPER PARTY HATS, IN CLASS 28 (U.S. CLS. 22, 23, 38 AND 50).

Reg. No. 4,072,441 THE MARK CONSISTS OF A PICTURE OF A LAMB AND A BANNER WITH THE WORD "LAMBI" THEREON.

PRIORITY DATE OF 5-20-2009 IS CLAIMED.

OWNER OF INTERNATIONAL REGISTRATION 1023384 DATED 11-19-2009, EXPIRES 11-19-2019.

THE WORDING "LAMBI" HAS NO MEANING IN A FOREIGN LANGUAGE.

SER. NO. 79-076,774, FILED 11-19-2009.

RAMONA ORTIGA, EXAMINING ATTORNEY

United States of America

United States Patent and Trademark Office

MIG

Reg. No. 4,072,442

Registered Dec. 20, 2011

Int. Cl.: 9

TRADEMARK

PRINCIPAL REGISTER

MIG TECHNOLOGY INC. (CHINA CORPORATION)
CUN-TOU-CUN INDUSTRIAL AREA
HENG-LI TOWN, DONG-GUAN CITY, GUANG-DONG PROVINCE
CHINA

FOR: COMPUTER KEYBOARDS; COMPUTER PERIPHERAL DEVICES; COMPUTER MONITORS; DATA PROCESSING EQUIPMENT IN THE NATURE OF COMPUTER MOUSE; PRINTERS FOR USE WITH COMPUTERS; CABINETS FOR LOUDSPEAKERS; LOUDSPEAKERS; CAMERAS; ELECTRIC SOCKETS, ELECTRIC PLUGS AND OTHER CONTACTS, NAMELY, ELECTRIC CONNECTIONS, IN CLASS 9 (U.S. CLS. 21, 23, 26, 36 AND 38).

THE MARK CONSISTS OF THE TERM "MIG" WITH A DIAMOND APPEARING IN THE LETTER "I".

OWNER OF INTERNATIONAL REGISTRATION 1023478 DATED 8-26-2009, EXPIRES 8-26-2019.

SER. NO. 79-076,804, FILED 8-26-2009.

JAMES STEIN, EXAMINING ATTORNEY



David J. Kyfos

Director of the United States Patent and Trademark Office

United States of America

United States Patent and Trademark Office

EOLINES

Reg. No. 4,072,443

Registered Dec. 20, 2011

**Int. Cls.: 7, 9, 12, 37 and
42**

TRADEMARK

SERVICE MARK

PRINCIPAL REGISTER

TECHSPACE AERO SA (BELGIUM SOCIETE ANONYME)
ROUTE DE LIERS, 121
B-4041 HERSTAL (MILMORT)
BELGIUM

FOR: MACHINES AND MACHINE TOOLS FOR THE CUTTING AND FORMING OF MATERIALS USED IN THE AEROSPACE SECTOR; MOTORS AND ENGINES EXCEPT FOR LAND VEHICLES AND ENGINES FOR AERONAUTICAL VEHICLES, TURBOMOTORS, TURBOJET ENGINES, TURBOPROPS COMPRISED OF TURBINE-POWERED PROPELLERS AND PROPULSION ENGINES ALL FOR ROCKETS AND SPACE MACHINES; COMPRESSORS FOR MACHINES; PARTS AND SPARE PARTS, NAMELY, NACELLES FOR ENGINES AND FOR DRIVES FOR AERONAUTICAL AND SPACE VEHICLES; PARTS AND SPARE PARTS FOR THRUST REVERSERS FOR AERONAUTICAL AND SPACE VEHICLES, NAMELY, INVERTER MOTORS; PARTS AND SPARE PARTS FOR ENGINES, NAMELY, EXHAUST NOZZLES AND EXHAUST CONES; NACELLES FOR JET ENGINES FOR AERONAUTICAL VEHICLES; LUBRICATION SYSTEMS PRIMARILY COMPRISED OF PUMPS, DISTRIBUTORS, VALVES, FILTERS, AND CONTROL DEVICES FOR AIRCRAFT ENGINES AND PROPULSION ENGINES; COUPLINGS FOR MACHINES AND OTHER TRANSMISSION COMPONENTS EXCEPT FOR LAND VEHICLES; PARTS AND SPARE PARTS FOR ENGINES AND DRIVES, NAMELY, NACELLES, COUPLINGS AND TRANSMISSIONS FOR AIRCRAFT ENGINES, ENGINE AIR INTAKE MANIFOLDS, PROPULSION ENGINE COMPONENTS, FAN AIR EXHAUST MANIFOLD FOR ENGINES, ENGINE EXHAUST TIPS, AND THRUST REVERSERS FOR AIRCRAFT ENGINES, ALL FOR AERONAUTICAL AND SPACE VEHICLES, IN CLASS 7 (U.S. CLS. 13, 19, 21, 23, 31, 34 AND 35).



David J. Kyffers

Director of the United States Patent and Trademark Office

FOR: SCIENTIFIC, ELECTRIC AND ELECTRONIC APPARATUS, NAMELY, ELECTRONIC APPARATUS AND INSTRUMENTS FOR CONTROLLING, ADJUSTING AND TESTING OF PROPULSION ENGINES AND AIRCRAFT ENGINES; APPARATUS FOR RECORDING, TRANSMISSION, OR REPRODUCTION OF SOUND OR IMAGES; DATA PROCESSING EQUIPMENT AND COMPUTERS; COMPUTER PROGRAMS AND SOFTWARE ASSOCIATED WITH THE AEROSPACE SECTOR, NAMELY, SOFTWARE FOR RE-CREATING OPERATING CONDITIONS FOR AERONAUTICAL AND SPACE VEHICLE ENGINES, PROPULSION ENGINES AND NACELLES; COMPUTER PROGRAMS AND SOFTWARE FOR PROCESSING TEST RIGS FOR MOTORS, ENGINES AND OTHER PROPULSION ENGINES FOR AERONAUTICAL AND SPACE VEHICLES, INCLUDING NACELLES, AND OTHER MEASURING EQUIPMENT; SENSORS FOR PROCESSING TEST RIGS FOR MOTORS, AIRCRAFT ENGINES AND OTHER PROPULSION ENGINES FOR AERONAUTICAL AND SPACE VEHICLES;

Reg. No. 4,072,443 TEST RIGS PRIMARILY COMPRISED OF TURBULENCE CONTROL VIDEO MONITOR SCREENS AND AIR FLOW CONTROL SENSORS USED FOR TESTING AIRCRAFT ENGINES AND PROPULSION ENGINES FOR AERONAUTICAL AND SPACE VEHICLES, INCLUDING NACELLES, IN CLASS 9 (U.S. CLS. 21, 23, 26, 36 AND 38).

FOR: APPARATUS FOR LOCOMOTION BY AIR IN THE NATURE OF AERONAUTICAL VEHICLES, NAMELY, AIRCRAFT, HELICOPTERS, AND SPACE VEHICLES, IN CLASS 12 (U.S. CLS. 19, 21, 23, 31, 35 AND 44).

FOR: REPAIR OF COMPLETE ENGINES AND PROPULSION ENGINES AND OF THEIR SUBASSEMBLIES FOR AERONAUTICAL AND SPACE VEHICLES, INCLUDING NACELLES FOR ENGINES, JETS, PROPULSION ENGINES AND THRUST REVERSERS, AND OF TEST CELLS FOR AIRCRAFT ENGINES AND OTHER PROPULSION ENGINES; INSTALLATION SERVICES, NAMELY, INSTALLING COMPLETE ENGINES AND PROPULSION ENGINES AND THEIR SUBASSEMBLIES FOR AERONAUTICAL AND SPACE VEHICLES, INCLUDING NACELLES FOR ENGINES, JETS, PROPULSION ENGINES AND THRUST REVERSERS, AND OF TEST CELLS FOR AIRCRAFT ENGINES AND OTHER PROPULSION ENGINES; MAINTENANCE, REPAIR AND OVERHAUL OF COMPLETE ENGINES AND PROPULSION SYSTEMS AND OF THEIR SUBASSEMBLIES FOR AERONAUTICAL AND SPACE VEHICLES, INCLUDING NACELLES FOR ENGINES, JETS, PROPULSION ENGINES AND THRUST REVERSERS; TECHNICAL SUPPORT SERVICES, NAMELY, PROVIDING TECHNICAL ADVICE IN THE FIELDS OF AIRCRAFT ENGINE MANUFACTURE, MAINTENANCE, REPAIR AND OVERHAUL FOR AERONAUTICAL VEHICLES AND THEIR COMPONENTS, INCLUDING NACELLES FOR THEIR ENGINES, JETS, PROPULSION ENGINES OR THRUST REVERSERS; ON-SITE CONSTRUCTION AND INSTALLATION OF AEROSPACE TEST RIGS FOR COMPLETE ENGINES, MOTORS AND PROPULSION ENGINES AND THEIR SUBASSEMBLIES FOR AERONAUTICAL AND SPACE VEHICLES, IN CLASS 37 (U.S. CLS. 100, 103 AND 106).

FOR: MATERIAL TESTING; TEST RIG SERVICES, NAMELY, TESTING, ANALYZING AND EVALUATING THE PERFORMANCE, EFFICIENCY AND DEPENDABILITY OF AIRCRAFT ENGINES, MOTORS, PROPULSION ENGINES, NACELLES AND THEIR SUBASSEMBLIES; TECHNICAL STUDIES AND PROJECTS, NAMELY, ENGINEERING STUDIES, DESIGN FOR OTHERS IN THE FIELD OF AIRCRAFT ENGINES, AND CONDUCTING FEASIBILITY STUDIES RELATING TO AERONAUTICAL VEHICLES; TECHNICAL, SCIENTIFIC AND INDUSTRIAL RESEARCH FOR TEST RIGS IN THE AEROSPACE SECTOR; COMPUTER PROGRAMMING; DEVELOPMENT AND DESIGN OF COMPUTER SOFTWARE IN THE AEROSPACE SECTOR; SURVEYING; ENGINEERING, RESEARCH AND PRODUCT DEVELOPMENT RELATING TO AERODYNAMICS, TURBO-ENGINES, HIGH-TEMPERATURE METALLURGY, SPECIAL INDUSTRIAL BRAZING PROCESSES, WELDING TECHNIQUES, LASER APPLICATIONS AND DATA CAPTURE SYSTEMS FOR TEST RIGS FOR OTHERS; TECHNICAL ADVICE, RESEARCH AND TECHNICAL ASSISTANCE CONCERNING THE DESIGN OF AERONAUTICAL VEHICLES AND THEIR COMPONENTS, INCLUDING AIRCRAFT ENGINES, NACELLES FOR THEIR ENGINES, JETS, PROPULSION ENGINES AND THRUST REVERSERS, IN CLASS 42 (U.S. CLS. 100 AND 101).

THE MARK CONSISTS OF STANDARD CHARACTERS WITHOUT CLAIM TO ANY PARTICULAR FONT, STYLE, SIZE, OR COLOR.

PRIORITY DATE OF 5-28-2009 IS CLAIMED.

OWNER OF INTERNATIONAL REGISTRATION 1023861 DATED 8-10-2009, EXPIRES 8-10-2019.

THE WORDING "EOLINES" HAS NO MEANING IN A FOREIGN LANGUAGE.

SER. NO. 79-076,947, FILED 8-10-2009.

Reg. No. 4,072,443 CHARISMA HAMPTON, EXAMINING ATTORNEY

United States of America

United States Patent and Trademark Office

G.B. Conte 1757

Reg. No. 4,072,444

Registered Dec. 20, 2011

Int. Cls.: 24 and 25

TRADEMARK

PRINCIPAL REGISTER

LANIFICIO G.B. CONTE SRL (ITALY SOCIÉTÉ À RESPONSABILITÉ LIMITÉE)
LARGO FUSINELLE, 6/B
I-36015 SCHIO (VI)
ITALY

FOR: TEXTILES, NAMELY, WOOL, COTTON, NYLON, LINEN, SILK, COTTON-WOOL MIXED FABRICS, NYLON-WOOL MIXED FABRICS, LINEN-WOOL MIXED FABRICS, SILK-WOOL MIXED FABRICS, IN CLASS 24 (U.S. CLS. 42 AND 50).

FOR: CLOTHING, NAMELY, TROUSERS, PANTS, SKIRTS, SUITS, DRESSES, JACKETS, COATS, THREE-QUARTER COATS, FOOTWEAR, HEADGEAR, NAMELY, HATS AND CAPS, IN CLASS 25 (U.S. CLS. 22 AND 39).

THE MARK CONSISTS OF STANDARD CHARACTERS WITHOUT CLAIM TO ANY PARTICULAR FONT, STYLE, SIZE, OR COLOR.

OWNER OF INTERNATIONAL REGISTRATION 1025144 DATED 6-23-2009, EXPIRES 6-23-2019.

OWNER OF U.S. REG. NO. 3,324,848.

NO CLAIM IS MADE TO THE EXCLUSIVE RIGHT TO USE "1757", APART FROM THE MARK AS SHOWN.

THE NAME(S), PORTRAIT(S), AND/OR SIGNATURE(S) SHOWN IN THE MARK DOES NOT IDENTIFY A PARTICULAR LIVING INDIVIDUAL.

SER. NO. 79-077,409, FILED 6-23-2009.

LESLEY LAMOTHE, EXAMINING ATTORNEY



David J. Kybas

Director of the United States Patent and Trademark Office

United States of America

United States Patent and Trademark Office



Reg. No. 4,072,445

Registered Dec. 20, 2011

Int. Cls.: 36, 41 and 42

STICHTING INTERNATIONAL INSTITUTE FOR; COMMUNICATION AND DEVELOPMENT
(NETHERLANDS STICHTING)
RAAMWEG 5
NL-2596 HL DEN HAAG
NETHERLANDS

SERVICE MARK

PRINCIPAL REGISTER

FOR: FUNDRAISING, IN PARTICULAR, CHARITABLE FUNDRAISING FOR HUMANITARIAN AID AND FOR SUBSIDIES AND SPONSORSHIP; PROVISION OF MICRO-CREDIT AND MEDIATION AND CONSULTANCY RELATING THERETO, NAMELY, CREDIT CONSULTATION, CREDIT UNIONS, FINANCING AND LOAN SERVICES; FINANCING OF HUMANITARIAN AID; FINANCIAL MANAGEMENT OF FUNDS; CHARITABLE FUNDRAISING; FINANCIAL ANALYSIS FOR ASSESSING PROJECTS IN DEVELOPING COUNTRIES, IN CLASS 36 (U.S. CLS. 100, 101 AND 102).

FOR: EDUCATIONAL PROGRAMS THROUGH A WEBSITE AND SUPPORTED BY AN EMAIL PROGRAM, NAMELY, PROVIDING CLASSES, WORKSHOPS AND SEMINARS IN THE FIELD OF ENHANCING COMPETENCY IN COACHING SKILLS AND TRAINING SKILLS TO USERS OF INFORMATION AND COMMUNICATION TECHNOLOGIES IN DEVELOPING COUNTRIES AND DEVELOPMENT AND QUALITY IMPROVEMENT OF COACHING AND TRAINING SKILLS THROUGH INFORMATION AND COMMUNICATION TECHNOLOGIES; CONSULTATION SERVICES RELATING TO THE AFOREMENTIONED EDUCATIONAL PROGRAMS; ORGANIZATION OF ONLINE EDUCATIONAL DISCUSSION GROUPS THROUGH A WEBSITE AND SUPPORTED BY EMAIL PROGRAMS, NAMELY, ONLINE EDUCATIONAL DISCUSSION PANELS IN THE FIELD OF EDUCATION, ENVIRONMENT, HEALTH, GOVERNANCE AND LIVELIHOODS IN DEVELOPING COUNTRIES; PUBLISHING AND EDITING OF ARTICLES, NEWSLETTERS, REPORTS, BOOKS AND MAGAZINES; CHARITABLE SERVICES IN THE NATURE OF PROVIDING PEOPLE WITH BOOKS, BROCHURES AND OTHER PRINTED MATTER RELATING TO EDUCATION; IMPLEMENTATION OF EDUCATIONAL PROGRAMS, NAMELY, DEVELOPING, ORGANIZING, CONDUCTING AND MONITORING EDUCATIONAL PROGRAMS IN THE FIELD OF ENHANCING SKILLS IN USING INFORMATION AND COMMUNICATION TECHNOLOGIES AND COACHING AND TRAINING SKILLS TO USERS OF INFORMATION AND COMMUNICATION TECHNOLOGIES, BOTH IN DEVELOPING COUNTRIES; DEVELOPING CURRICULUM FOR TEACHERS; ORGANIZATION OF EDUCATIONAL CONFERENCES, SEMINARS, EDUCATIONAL INFORMATION MEETINGS AND OTHER ENTERTAINMENT GATHERINGS AND EDUCATIONAL EVENTS, NAMELY, WORKSHOPS, SEMINARS, CLASSES AND ROUNDTABLE WORKSHOPS IN THE FIELD OF ENHANCING COMPET-



David J. Kybas

Director of the United States Patent and Trademark Office

Reg. No. 4,072,445 ENCY IN COACHING SKILLS AND TRAINING SKILLS TO USERS OF INFORMATION AND COMMUNICATION TECHNOLOGIES IN DEVELOPING COUNTRIES; TRAINING AND COACHING RELATING TO THE USE OF THE INTERNET FOR EDUCATIONAL PURPOSES; EDUCATION, NAMELY, WORKSHOPS, SEMINARS, CLASSES AND ROUNDTABLE WORKSHOPS RELATING TO DEVELOPMENT COOPERATION AND TO THE SOCIAL ASPECTS OF PROJECTS AND PROGRAMS IN DEVELOPING COUNTRIES, INCLUDING, ADVICE RELATING THERETO, IN CLASS 41 (U.S. CLS. 100, 101 AND 107).

FOR: DEVELOPMENT OF SOFTWARE FOR EDUCATIONAL PROGRAMS; ADVICE RELATING TO THE USE AND DEVELOPMENT OF INFORMATION AND COMMUNICATIONS TECHNOLOGY (ICT); DEVELOPMENT AND DESIGN OF TELECOMMUNICATIONS SOLUTIONS BASED ON ICT AND MEDIA, NAMELY, INTERNET, TELEVISION AND RADIO NETWORKS, MOBILE TELEPHONE NETWORKS, CABLE, SATELLITE AND ETHERNET NETWORKS; COMPUTERIZATION CONSULTANCY RELATING TO THE USE AND APPLICATION OF COMMUNICATION SOLUTIONS BASED ON SATELLITE AND ETHERNET NETWORKS; AFOREMENTIONED SERVICES IN PARTICULAR RELATING TO AND ON BEHALF OF EDUCATION RELATING TO DEVELOPMENT COOPERATION, IN CLASS 42 (U.S. CLS. 100 AND 101).

NO CLAIM IS MADE TO THE EXCLUSIVE RIGHT TO USE "GLOBAL TEENAGER PROJECT", APART FROM THE MARK AS SHOWN.

PRIORITY DATE OF 5-18-2009 IS CLAIMED.

OWNER OF INTERNATIONAL REGISTRATION 1025849 DATED 11-16-2009, EXPIRES 11-16-2019.

THE COLOR(S) BLUE, ORANGE, YELLOW AND WHITE IS/ARE CLAIMED AS A FEATURE OF THE MARK.

THE MARK CONSISTS OF A CIRCLE DIVIDED IN HALF WHERE THE TOP PORTION IS BLUE AND FORMS A SPEECH BALLOON WHICH EXTENDS INTO THE ORANGE BOTTOM PORTION OF THE CIRCLE. THE WORD "GLOBAL" APPEARS CENTERED ABOVE THE WORD "TEENAGER" WHICH IS CENTERED ABOVE THE WORD "PROJECT" IN WHITE STYLIZED IN THE TOP PORTION OF THE CIRCLE. THE LINE DIVIDING THE CIRCLE IN HALF IS WHITE. THERE IS A PERSON FORMED IN THE SHAPE OF A LOWERCASE LETTER "I" IN THE LOWER LEFT PORTION OF THE CIRCLE. THE COLOR YELLOW APPEARS IN THE LOWERCASE LETTER "I" FIGURE AND THE CIRCLE REPRESENTING THE DOT ABOVE THE LOWERCASE LETTER "I" FIGURE AND BOTH PORTIONS ARE OUTLINED IN WHITE.

SER. NO. 79-077,656, FILED 11-16-2009.

TINA BROWN, EXAMINING ATTORNEY

United States of America

United States Patent and Trademark Office

bogimac

Reg. No. 4,072,446

Registered Dec. 20, 2011

Int. Cl.: 9

TRADEMARK

PRINCIPAL REGISTER

BOGIMAC NV-SA (BELGIUM NAAMLOZE VENNOOTSCHAP-SOCIÉTÉ ANONYME)
ERNEST CAMBIERLAAN, 97B
B-1030 BRUSSEL
BELGIUM

FOR: MACHINES FOR TESTING TENSION, TORSION, COMPRESSION, SHEAR, BENDING, IMPACT AND WEAR ON WIRE, CORD, BELT OR ROPE; MATERIAL TESTING INSTRUMENTS AND MACHINES FOR DYNAMIC TESTING OF MECHANICAL FATIGUE OF SOLIDS; ENDURANCE TESTING MACHINES FOR DYNAMIC TESTING OF MECHANICAL FATIGUE OF SOLIDS; COMPUTER CONTROLLED AUTOMATIC TESTING APPARATUS FOR DYNAMIC TESTING OF MECHANICAL FATIGUE OF SOLIDS; TEST APPARATUS FOR SCIENTIFIC USE FOR DYNAMIC TESTING OF MECHANICAL FATIGUE OF SOLIDS; PORTABLE TEST APPARATUS FOR DYNAMIC TESTING OF MECHANICAL FATIGUE OF SOLIDS; NON-DESTRUCTIVE TESTING APPARATUS FOR DYNAMIC TESTING OF MECHANICAL FATIGUE OF SOLIDS; MATERIAL TESTING APPARATUS FOR DYNAMIC TESTING OF MECHANICAL FATIGUE OF SOLIDS; TEST APPARATUS FOR INDUSTRIAL USE FOR DYNAMIC TESTING OF MECHANICAL FATIGUE OF SOLIDS; AUTOMATIC TEST APPARATUS OTHER THAN FOR MEDICAL USE FOR DYNAMIC TESTING OF MECHANICAL FATIGUE OF SOLIDS; VIBRATION GENERATORS, OR SHAKERS, FOR THE PURPOSE OF INTRODUCING FORCES INTO SOLIDS TEST SAMPLES; VIBRATION GENERATORS, OR SHAKERS, FOR THE PURPOSE OF SHAKING SOLIDS TEST SAMPLES; ELECTRONIC EQUIPMENT FOR TESTING TEMPERATURE AND HUMIDITY CONDITIONS OF THE TESTING ENVIRONMENT OF THE ABOVE MACHINES AND APPARATUS; PORTABLE TEST INSTRUMENTS FOR DYNAMIC TESTING OF MECHANICAL FATIGUE OF SOLIDS; ENVIRONMENTAL TEST CHAMBER INTEGRATED IN THE ABOVE DYNAMIC TESTING EQUIPMENT, FOR SIMULATING TEMPERATURE AND HUMIDITY CONDITIONS AND CORROSIVE SUBSTANCES AND THEIR EFFECT ON THE SOLID TEST SAMPLES; APPARATUS FOR DYNAMIC TESTING OF THE WEAR CHARACTERISTICS OF SOLIDS SUBMITTED TO MECHANICAL FATIGUE CONDITIONS; ELECTRONIC SENSORS FOR MEASURING MECHANICAL FATIGUE RESISTANCE OF SOLIDS; MEASUREMENT SENSORS, OTHER THAN FOR MEDICAL USE, FOR MEASURING MECHANICAL FATIGUE RESISTANCE OF SOLIDS; SENSOR APPARATUS FOR THE DETERMINATION OF PHYSICAL PARAMETERS OTHER THAN MEDICAL USE, FOR MEASURING MECHANICAL FATIGUE RESISTANCE OF SOLIDS; SENSORS FOR MEASURING MECHANICAL FATIGUE RESISTANCE OF SOLIDS, FOR REAL TIME DATA INPUT APPARATUS; SENSORS USED IN PLANT CONTROL FOR MEASURING MECHANICAL FATIGUE RESISTANCE OF SOLIDS; TEXTILE TESTING MACHINES; ELECTRONIC AND COMPUTER CONTROL IN-



David J. Kyjars

Director of the United States Patent and Trademark Office

Reg. No. 4,072,446 CORPORATING MICROPROCESSORS FOR PROCESS MONITORING AND CONTROL OF COMPLEX MULTI-MOVEMENT INDUSTRIAL MACHINES; MICROPROCESSOR BASED DIAGNOSTIC INSTRUMENTS FOR TESTING OF MECHANICAL FATIGUE RESISTANCE OF SOLIDS; COMPUTER SOFTWARE FOR USE IN CONTROLLING COMPLEX MULTI-MOVEMENT INDUSTRIAL MACHINES; COMPUTER CONTROL UNITS FOR CONTROLLING COMPLEX MULTI-MOVEMENT INDUSTRIAL MACHINES; INDUSTRIAL AUTOMATION CONTROLS INCORPORATING SOFTWARE FOR PROCESS MONITORING AND CONTROL OF COMPLEX MULTI-MOVEMENT INDUSTRIAL MACHINES; INDUSTRIAL AUTOMATION CONTROLS INCORPORATING COMPUTER APPARATUS FOR PROCESS MONITORING AND CONTROL OF COMPLEX MULTI-MOVEMENT INDUSTRIAL MACHINES; INDUSTRIAL AUTOMATION CONTROLS FOR PROCESS MONITORING AND CONTROL OF COMPLEX MULTI-MOVEMENT INDUSTRIAL MACHINES, ENGINES OR MOTORS; COMPUTER CONTROLLED APPARATUS FOR ANALYSING SAMPLES FOR USE IN EQUIPMENT FOR DYNAMIC TESTING OF MECHANICAL FATIGUE RESISTANCE OF SOLIDS; SPECIMEN MANIPULATORS FOR AUTOMATIC REPLACEMENT OF TEST SAMPLES FOR USE IN EQUIPMENT FOR DYNAMIC TESTING OF MECHANICAL FATIGUE RESISTANCE OF SOLIDS; SPECIMEN TREATMENT EQUIPMENT FOR PREPARING SAMPLES SUITABLE FOR TESTING THROUGH VULCANISATION IN MOLD, CUTTING ON LENGTH, STRAIGHTENING, CONDITIONING OF THE ENDS, HEAT TREATMENT, OR DRYING AND MOISTENING, FOR USE IN EQUIPMENT FOR DYNAMIC TESTING OF MECHANICAL FATIGUE RESISTANCE OF SOLIDS; CALCULATING MACHINES AND DATA PROCESSING EQUIPMENT FOR DYNAMIC TESTING OF MECHANICAL FATIGUE RESISTANCE OF SOLIDS; COMPUTER PROGRAMS FOR ANALYSIS OF SCIENTIFIC DATA RELATING TO DYNAMIC TESTING OF MECHANICAL FATIGUE RESISTANCE OF SOLIDS, IN CLASS 9 (U.S. CLS. 21, 23, 26, 36 AND 38).

THE MARK CONSISTS OF STANDARD CHARACTERS WITHOUT CLAIM TO ANY PARTICULAR FONT, STYLE, SIZE, OR COLOR.

OWNER OF INTERNATIONAL REGISTRATION 1030366 DATED 1-20-2010, EXPIRES 1-20-2020.

THE WORDING "BOGIMAC" HAS NO MEANING IN A FOREIGN LANGUAGE.

SER. NO. 79-079,488, FILED 1-20-2010.

JULIE VEPPUMTHARA, EXAMINING ATTORNEY

United States of America
United States Patent and Trademark Office

sneaxx

Reg. No. 4,072,447

Registered Dec. 20, 2011

Int. Cl.: 26

TRADEMARK

PRINCIPAL REGISTER

JOERG AUMUELLER (FED REP GERMANY INDIVIDUAL)
ALBANISTRASSE 5
81541 MÜNCHEN
FED REP GERMANY

FOR: LACE AND EMBROIDERY, RIBBONS AND BRAID; BUTTONS, HOOKS AND EYES, PINS AND NEEDLES; ARTIFICIAL FLOWERS, IN CLASS 26 (U.S. CLS. 37, 39, 40, 42 AND 50).

THE MARK CONSISTS OF STANDARD CHARACTERS WITHOUT CLAIM TO ANY PARTICULAR FONT, STYLE, SIZE, OR COLOR.

PRIORITY DATE OF 9-30-2009 IS CLAIMED.

OWNER OF INTERNATIONAL REGISTRATION 1031258 DATED 2-16-2010, EXPIRES 2-16-2020.

SER. NO. 79-079,838, FILED 2-16-2010.

RAMONA ORTIGA, EXAMINING ATTORNEY



David J. Kyffers

Director of the United States Patent and Trademark Office

United States of America

United States Patent and Trademark Office

BOIS DE ROSE

Reg. No. 4,072,448

CHRISTIAN DIOR COUTURE (FRANCE SOCIÉTÉ ANONYME (SA))
30 AVENUE MONTAIGNE
F-75008 PARIS, FRANCE

Registered Dec. 20, 2011

Int. Cl.: 14

FOR: JEWELRY; GOLD AND SILVER WARE, NAMELY, FINERY OR DECORATIONS OF PRECIOUS METALS, NAMELY, RINGS, EARRINGS, NECKLACES, BRACELETS, BROOCHES; PRECIOUS AND SEMI-PRECIOUS STONES AND IMITATIONS THEREOF; TIMEPIECES AND CHRONOMETRIC INSTRUMENTS; PRECIOUS METALS AND THEIR ALLOYS AND GOODS MADE FROM THESE MATERIALS OR COATED THEREWITH, NAMELY, CHARMS; COINS, NAMELY, COLLECTABLE COINS; WORKS OF ART OF PRECIOUS METALS; JEWELRY CASES; BOXES OF PRECIOUS METALS; WATCH CASES; WATCH BANDS; CHAINS, KEY RINGS, AS TRINKETS OR FOBS, OF PRECIOUS METAL; STATUES OR FIGURINES, NAMELY, STATUETTES OF PRECIOUS METALS; CLOCK AND WATCH CASES; MEDALS; BUCKLES OF PRECIOUS METALS, WATCH CHAINS, NONE OF THE FOREGOING MADE OF WOOD, IN CLASS 14 (U.S. CLS. 2, 27, 28 AND 50).

TRADEMARK

PRINCIPAL REGISTER

THE MARK CONSISTS OF STANDARD CHARACTERS WITHOUT CLAIM TO ANY PARTICULAR FONT, STYLE, SIZE, OR COLOR.

PRIORITY DATE OF 1-29-2010 IS CLAIMED.

OWNER OF INTERNATIONAL REGISTRATION 1035102 DATED 2-15-2010, EXPIRES 2-15-2020.

SER. NO. 79-081,220, FILED 2-15-2010.

ADA HAN, EXAMINING ATTORNEY



David J. Kyros

Director of the United States Patent and Trademark Office

United States of America
United States Patent and Trademark Office

BERETTA

Reg. No. 4,072,449

SALUMIFICIO F.LLI BERETTA S.P.A. (ITALY CORPORATION)

Registered Dec. 20, 2011

I-22062 BARZANÒ BRIANZA
ITALY

Int. Cl.: 29

FOR: MEAT, FISH, POULTRY AND GAME; MEAT EXTRACTS; JELLIES, JAMS; EGGS, MILK AND MILK PRODUCTS, NAMELY, BUTTER, CHEESE; EDIBLE OILS AND FATS; TINNED FOODSTUFFS, NAMELY, TINNED MEATS AND FISH; PICKLES, IN CLASS 29 (U.S. CL. 46).

TRADEMARK

PRINCIPAL REGISTER

OWNER OF U.S. REG. NO. 2,178,516.

OWNER OF INTERNATIONAL REGISTRATION 0365537 DATED 2-21-1970, EXPIRES 2-21-2020.

SER. NO. 79-081,409, FILED 2-22-2010.

SUZANNE BLANE, EXAMINING ATTORNEY



David J. Kyfos

Director of the United States Patent and Trademark Office

United States of America

United States Patent and Trademark Office

ZENKER

Reg. No. 4,072,450

Registered Dec. 20, 2011

Int. Cl.: 21

TRADEMARK

PRINCIPAL REGISTER

ALEXANDER FACKELMANN (FED REP GERMANY CORPORATION)
SCHMALZBERGSTRASSE 12
90607 RÜCKERSDORF
FED REP GERMANY

FOR: CONTAINERS NOT OF PRECIOUS METAL OR COATED THEREWITH, NAMELY, ALL-PURPOSE PORTABLE HOUSEHOLD CONTAINERS, BASINS AND BOWLS, PORTABLE PLASTIC CONTAINERS FOR STORING HOUSEHOLD AND KITCHEN GOODS, CONTAINERS FOR FOODS, CREAMER PITCHERS, EMPTY SPRAY BOTTLES; HOUSEHOLD AND KITCHEN UTENSILS, NAMELY, CAKE MOLDS, CHOCOLATE MOLDS, PASTRY MOLDS, CONFECTIONERS' MOLDS, COOKERY MOLDS, CUP CAKE MOLDS, PUDDING MOLDS, BAKING SHEETS, OVEN-TO-TABLE RACKS, ROLLING PINS, DOUGH ROLLERS, ICING BAGS FOR DECORATING CONFECTIONERY, CAKE SERVERS, COCKTAIL SHAKERS, COLANDERS FOR HOUSEHOLD USE, COOKING SKEWERS, STRAINERS AND TURNERS, KITCHEN LADLES, KNIFE BLOCKS, KNIFE BOARDS, KNIFE RESTS, LEMON SQUEEZERS, MEAL TRAYS, MELON BALLERS, MUFFIN TINS, PASTRY BOARDS, PASTRY CUTTERS, PIE SERVERS, SCOOPS, TENSION CLOSING DEVICES FOR POT LIDS, CUTTING BOARDS AND PASTRY BOARDS, TART TRAYS NOT OF PRECIOUS METAL, CRUMB BRUSHES, CRUMB TRAYS, BASTING SPOONS, BRUSHES FOR BASTING MEAT, CAKE PANS, SPRINGFORM PANS, PIE PANS, FLAN PANS, QUICHE PANS, MUFFIN PANS, CAKE RESTS, CAKE STANDS, HOUSEHOLD GRATERS, COOKING SIEVES, SKIMMERS, SPATULAS, MIXING SPOONS, SERVING SPOONS, SERVING TONGS, SLOTTED SPOONS, SQUEEGEES FOR HOUSEHOLD USE; GLASSWARE, NAMELY, PLATES, GLASSES, VASES, CUPS; PORCELAIN WARE AND EARTHENWARE, NAMELY, DISHES, PLATES, GLASSES, VASES, CUPS, IN CLASS 21 (U.S. CLS. 2, 13, 23, 29, 30, 33, 40 AND 50).



THE MARK CONSISTS OF STANDARD CHARACTERS WITHOUT CLAIM TO ANY PARTICULAR FONT, STYLE, SIZE, OR COLOR.

OWNER OF INTERNATIONAL REGISTRATION 0884927 DATED 3-21-2006, EXPIRES 3-21-2016.

SEC. 2(F).

SER. NO. 79-081,420, FILED 3-8-2010.

LINDA MICKLEBURGH, EXAMINING ATTORNEY

David J. Kyffers

Director of the United States Patent and Trademark Office

United States of America

United States Patent and Trademark Office

WAVE

Reg. No. 4,072,451

ROLAND KÜPER, DIPL.-ING. (FED REP GERMANY INDIVIDUAL)
METTESTR. 23

Registered Dec. 20, 2011

BOCHUM, FED REP GERMANY 44803

Int. Cls.: 6 and 17

FOR: COMMON METAL ALLOYS, IN CLASS 6 (U.S. CLS. 2, 12, 13, 14, 23, 25 AND 50).

TRADEMARK

FOR: SEMI-PROCESSED PLASTICS, IN PARTICULAR IN THE FORM OF SHAPED PARTS, BARS AND PLATES, IN CLASS 17 (U.S. CLS. 1, 5, 12, 13, 35 AND 50).

PRINCIPAL REGISTER

THE MARK CONSISTS OF STANDARD CHARACTERS WITHOUT CLAIM TO ANY PARTICULAR FONT, STYLE, SIZE, OR COLOR.

PRIORITY DATE OF 11-4-2009 IS CLAIMED.

OWNER OF INTERNATIONAL REGISTRATION 1036531 DATED 12-29-2009, EXPIRES 12-29-2019.

SER. NO. 79-081,793, FILED 12-29-2009.

FRED CARL, EXAMINING ATTORNEY



David J. Kybas

Director of the United States Patent and Trademark Office

United States of America

United States Patent and Trademark Office

SPDS

Reg. No. 4,072,452

Registered Dec. 20, 2011

Int. Cls.: 35 and 42

SERVICE MARK

PRINCIPAL REGISTER

SIEMENS AKTIENGESELLSCHAFT (FED REP GERMANY JOINT STOCK COMPANY)
WITTELSBACHERPLATZ 2
80333 MÜNCHEN
FED REP GERMANY

FOR: BUSINESS CONSULTANCY, NOT IN THE FIELD OF SURGE PROTECTION DEVICES,
IN CLASS 35 (U.S. CLS. 100, 101 AND 102).

FOR: TECHNICAL CONSULTANCY IN THE FIELD OF PRODUCT DEVELOPMENT, NOT
INCLUDING SURGE PROTECTION DEVICES, IN CLASS 42 (U.S. CLS. 100 AND 101).

THE MARK CONSISTS OF STANDARD CHARACTERS WITHOUT CLAIM TO ANY PAR-
TICULAR FONT, STYLE, SIZE, OR COLOR.

PRIORITY DATE OF 11-19-2009 IS CLAIMED.

OWNER OF INTERNATIONAL REGISTRATION 1036740 DATED 3-18-2010, EXPIRES 3-18-
2020.

SER. NO. 79-081,856, FILED 3-18-2010.

ANDREA BUTLER, EXAMINING ATTORNEY



David J. Kyffers

Director of the United States Patent and Trademark Office

United States of America

United States Patent and Trademark Office

SWAPCLEAR

Reg. No. 4,072,453

Registered Dec. 20, 2011

Int. Cls.: 9 and 36

TRADEMARK

SERVICE MARK

PRINCIPAL REGISTER

LCH.CLEARNET LIMITED (UNITED KINGDOM LIMITED COMPANY)
ALDGATE HOUSE
33 ALDGATE HIGH STREET; LONDON EC3N 1EA
UNITED KINGDOM

FOR: COMPUTERS; COMPUTER HARDWARE; COMPUTER SOFTWARE FOR ORGANIZING AND CONDUCTING FINANCIAL CLEARING AND SETTLEMENT, NAMELY, SOFTWARE THAT ALLOWS FOR THE RECORDING, ORGANIZING, MANAGING, TRACKING, CLEARING, VALUATION, RISK ASSESSMENT, REPORTING, AND SETTLEMENT OF TRANSACTIONS TAKING PLACE BETWEEN BUYERS AND SELLERS IN FINANCIAL MARKETS, INCLUDING OVER-THE-COUNTER TRANSACTIONS; MODEMS; PRE-RECORDED MAGNETIC DATA CARRIERS, NAMELY, HARD DISCS AND FLOPPY DISCS FOR COMPUTERS CONTAINING COMPUTER SOFTWARE FOR ORGANIZING AND CONDUCTING FINANCIAL CLEARING AND SETTLEMENT, NAMELY, SOFTWARE THAT ALLOWS FOR THE RECORDING, ORGANIZING, MANAGING, TRACKING, CLEARING, VALUATION, RISK ASSESSMENT, REPORTING, AND SETTLEMENT OF TRANSACTIONS TAKING PLACE BETWEEN BUYERS AND SELLERS IN FINANCIAL MARKETS, INCLUDING OVER-THE-COUNTER TRANSACTIONS; PRE-RECORDED OPTICAL DISCS CONTAINING COMPUTER SOFTWARE FOR ORGANIZING AND CONDUCTING FINANCIAL CLEARING AND SETTLEMENT, NAMELY, SOFTWARE THAT ALLOWS FOR THE RECORDING, ORGANIZING, MANAGING, TRACKING, CLEARING, VALUATION, RISK ASSESSMENT, REPORTING, AND SETTLEMENT OF TRANSACTIONS TAKING PLACE BETWEEN BUYERS AND SELLERS IN FINANCIAL MARKETS, INCLUDING OVER-THE-COUNTER TRANSACTIONS; PRE-RECORDED OPTICAL DISCS CONTAINING INSTRUCTIONAL MATERIAL RELATING TO THE USE OF COMPUTERS AND DATA TO PERFORM FINANCIAL CLEARING AND SETTLEMENT SERVICES, NAMELY, THE CLEARING AND SETTLEMENT OF TRANSACTIONS TAKING PLACE BETWEEN BUYERS AND SELLERS IN FINANCIAL MARKETS, INCLUDING OVER-THE-COUNTER TRANSACTIONS; PRE-RECORDED OPTICAL DISCS FEATURING TOPICS RELATED TO FINANCIAL CLEARING AND SETTLEMENT, NAMELY, THE CLEARING AND SETTLEMENT OF TRANSACTIONS TAKING PLACE BETWEEN BUYERS AND SELLERS IN FINANCIAL MARKETS, INCLUDING OVER-THE-COUNTER TRANSACTIONS; PRE-RECORDED DVD'S AND CD-ROMS FEATURING INSTRUCTIONAL MATERIAL RELATED TO FINANCIAL CLEARING AND SETTLEMENT, NAMELY, TRANSACTIONS TAKING PLACE BETWEEN BUYERS AND SELLERS IN FINANCIAL MARKETS, INCLUDING OVER-THE-COUNTER TRANSACTIONS, IN CLASS 9 (U.S. CLS. 21, 23, 26, 36 AND 38).



David J. Kyjars

Director of the United States Patent and Trademark Office

Reg. No. 4,072,453 FOR: FINANCIAL CLEARING AND SETTLEMENT SERVICES, NAMELY, THE FINANCIAL MANAGEMENT OF TRANSACTIONS TAKING PLACE BETWEEN BUYERS AND SELLERS IN FINANCIAL MARKETS, INCLUDING OVER-THE-COUNTER TRANSACTIONS; FINANCIAL TRADE REGISTRATION SERVICES, NAMELY, THE FINANCIAL MANAGEMENT OF TRANSACTIONS BETWEEN BUYERS AND SELLERS IN FINANCIAL MARKETS, INCLUDING OVER-THE-COUNTER TRANSACTIONS; FINANCIAL RISK MANAGEMENT REGARDING BUYERS AND SELLERS IN TRANSACTIONS, INCLUDING OVER-THE-COUNTER TRANSACTIONS; FINANCIAL CLEARING HOUSE SERVICES, NAMELY, CLEARING AND RECONCILING TRANSACTIONS BETWEEN BUYERS AND SELLERS, INCLUDING OVER-THE-COUNTER TRANSACTIONS; FINANCIAL INFORMATION AND ADVISORY SERVICES RELATING TO THE AFORESAID SERVICES, IN CLASS 36 (U.S. CLS. 100, 101 AND 102).

THE MARK CONSISTS OF STANDARD CHARACTERS WITHOUT CLAIM TO ANY PARTICULAR FONT, STYLE, SIZE, OR COLOR.

PRIORITY DATE OF 10-6-2009 IS CLAIMED.

OWNER OF INTERNATIONAL REGISTRATION 1037089 DATED 3-23-2010, EXPIRES 3-23-2020.

SER. NO. 79-081,991, FILED 3-23-2010.

ANDREW RHIM, EXAMINING ATTORNEY

United States of America

United States Patent and Trademark Office



Reg. No. 4,072,454

Registered Dec. 20, 2011

Int. Cls.: 9, 38 and 42

TRADEMARK

SERVICE MARK

PRINCIPAL REGISTER

STICHTING GREENTOUCH (NETHERLANDS FOUNDATION)
DAM 7
NL-1012 JS AMSTERDAM
NETHERLANDS

FOR: TELECOMMUNICATIONS AND DATA PROCESSING APPARATUS AND EQUIPMENT, NAMELY, TELECOMMUNICATION ROUTERS, TELECOMMUNICATION SWITCHES, MULTIPLEXERS, DEMULTIPLEXERS, GATEWAY HARDWARE, AND SERVERS, LAN (LOCAL AREA NETWORK), MAN (METROPOLITAN AREA NETWORK), WAN (WIDE AREA NETWORK), SAN (STORAGE AREA NETWORK) AND VPN (VIRTUAL PRIVATE NETWORK) HARDWARE AND OPERATING SOFTWARE; COMPUTER SOFTWARE FOR ACCESSING, MANAGING, SECURING, OPERATING AND MONITORING TELECOMMUNICATIONS NETWORKS AND TELEPHONY SYSTEMS; SOFTWARE FOR QUALITY CONTROL AND DETECTION OF DEFAULTS AND INCIDENTS IN TELECOMMUNICATIONS NETWORKS; SOFTWARE FOR FACILITATING ELECTRONIC MAIL; SOFTWARE FOR FACILITATING VOICE MESSAGING; COMPUTER E-COMMERCE SOFTWARE TO ALLOW USERS TO PERFORM ELECTRONIC BUSINESS TRANSACTIONS VIA A GLOBAL COMPUTER NETWORK; SOFTWARE FOR ACCOUNTING AND FOR BILLING TELECOMMUNICATIONS COSTS; SOFTWARE FOR ANALYZING TELECOMMUNICATIONS FLOW, TIME AND COSTS; SOFTWARE FOR MANAGING TELEPHONE DIRECTORIES; SOFTWARE FOR MAINTAINING CONFIDENTIALITY OF COMPUTER COMMUNICATIONS BY USING PERSONAL USER IDENTIFICATIONS, ACCESS CONTROL AND ENCRYPTION; ELECTRONIC APPARATUS, INSTRUMENTS AND UNITS FOR GENERATING, CALCULATING, CHECKING, INPUTTING, STORING, CONVERTING, PROCESSING, GATHERING, TRANSMITTING, SWITCHING AND RECEIVING DATA, INFORMATION, SIGNALS AND MESSAGES, NAMELY, CALCULATORS, COMPUTERS, ELECTRONIC COMPONENTS FOR COMPUTERS AND COMPUTER PERIPHERAL DEVICES; APPARATUS FOR RECORDING, TRANSMISSION OR REPRODUCTION OF SOUND OR IMAGES; BLANK MAGNETIC AND BLANK OPTICAL DATA STORAGE MEDIA; ALL OF THE ABOVE PRODUCTS ARE ENVIRONMENTALLY BENEFICIAL, IN CLASS 9 (U.S. CLS. 21, 23, 26, 36 AND 38).



David J. Kybas

Director of the United States Patent and Trademark Office

FOR: TELECOMMUNICATIONS, NAMELY, ELECTRONIC, ELECTRIC, DIGITAL, AND RADIO TRANSMISSION OF VOICE, DATA, IMAGES, SIGNALS, AND MESSAGES; TRANSMISSION OF INFORMATION AND DATA; COMMUNICATIONS BY COMPUTER TERMINALS; ELECTRONIC MESSAGING SERVICES; RENTAL OF TELECOMMUNICATIONS APPARATUS AND EQUIPMENT; INFORMATION ON TELECOMMUNICATIONS; RENTAL OF ACCESS TIME TO GLOBAL COMPUTER NETWORKS; RENTAL OF ACCESS

Reg. No. 4,072,454 TIME TO DATABASE SERVER CENTERS, NAMELY, RENTAL OF ACCESS TIME TO GLOBAL COMPUTER NETWORKS TO ALLOW ACCESS TO TELECOMMUNICATIONS EQUIPMENT IN THE FORM OF SERVERS, IN CLASS 38 (U.S. CLS. 100, 101 AND 104).

FOR: SCIENTIFIC, TECHNOLOGICAL AND INDUSTRIAL RESEARCH, TECHNICAL PROJECT STUDIES, NAMELY, TECHNICAL RESEARCH, AND ENGINEERING SERVICES, ALL FOR ENERGY SAVING, ENVIRONMENTAL PROTECTION AND SUSTAINABLE DEVELOPMENT IN THE FIELDS OF TELECOMMUNICATIONS AND DATA PROCESSING; CONSULTING REGARDING PRODUCT DESIGN IN THE FIELDS OF TELECOMMUNICATIONS AND DATA PROCESSING WITH RESPECT TO ENERGY SAVING, ENVIRONMENTAL PROTECTION AND SUSTAINABLE DEVELOPMENT; DESIGN, UPDATING, MAINTENANCE, INSTALLATION AND RENTAL OF SOFTWARE; RENTAL OF DATA PROCESSING APPARATUS AND EQUIPMENT; DESIGN AND HOSTING OF INTERNET SITES, IN CLASS 42 (U.S. CLS. 100 AND 101).

THE MARK CONSISTS OF A SINGLE LEAF IN THE CENTER OF THREE CONCENTRIC CIRCLES.

PRIORITY DATE OF 12-30-2009 IS CLAIMED.

OWNER OF INTERNATIONAL REGISTRATION 1039119 DATED 4-13-2010, EXPIRES 4-13-2020.

SER. NO. 79-082,706, FILED 4-13-2010.

KRISTINA MORRIS, EXAMINING ATTORNEY

United States of America

United States Patent and Trademark Office



Reg. No. 4,072,455

Registered Dec. 20, 2011

Int. Cl.: 32

TRADEMARK

PRINCIPAL REGISTER

BAVARIA N.V. (NETHERLANDS NAAMLOZE VENNOOTSCHAP (NV))
DE STATER 1
NL-5737 RV LIESHOUT
NETHERLANDS

FOR: BEERS; NON-ALCOHOLIC BEERS; FRUIT DRINKS AND FRUIT JUICES; PREPARATIONS FOR MAKING BEVERAGES, NAMELY, FRUIT DRINKS, IN CLASS 32 (U.S. CLS. 45, 46 AND 48).

SEC. 2(F) AS TO "BAVARIA HOLLAND" .

PRIORITY DATE OF 10-7-2009 IS CLAIMED.

OWNER OF INTERNATIONAL REGISTRATION 1040226 DATED 3-22-2010, EXPIRES 3-22-2020.

THE COLOR(S) BLUE (PMS 287), GOLD (PMS 871), WHITE IS/ARE CLAIMED AS A FEATURE OF THE MARK.

THE MARK CONSISTS OF A DESIGN OF A LABEL TRIMMED IN WHITE AND SHADED IN BLUE. THE DESIGN IS OUTLINED IN GOLD AND HAS A GOLD COMPASS. THE STYLIZED WORDING "BAVARIA" APPEARS IN WHITE ABOVE THE STYLIZED WORDING "HOLLAND" IN GOLD.

SER. NO. 79-083,101, FILED 3-22-2010.

MARILYN IZZI, EXAMINING ATTORNEY



David J. Kyros

Director of the United States Patent and Trademark Office

United States of America

United States Patent and Trademark Office



Reg. No. 4,072,456

I.S.O ITALIA S.P.A. (ITALY SOCIÉTÉ PAR ACTIONS)

Registered Dec. 20, 2011

VIA G. DI VITTORIO, 30

I-30029 S. STINO DI LIVENZA (VE), ITALY

Int. Cls.: 10 and 11

FOR: LAMPS FOR MEDICAL PURPOSES, NAMELY, HEAT LAMPS FOR MEDICAL USE, MEDICAL EXAMINATION LAMPS, QUARTZ LAMPS FOR MEDICAL PURPOSES, SURGICAL LAMPS, SURGICAL LAMPS FOR MEDICAL USE, ULTRAVIOLET LAMPS FOR MEDICAL PURPOSES, LED LIGHTING SYSTEM WITH CHROMO-THERAPY EFFECT, IN CLASS 10 (U.S. CLS. 26, 39 AND 44).

TRADEMARK

PRINCIPAL REGISTER

FOR: APPARATUS FOR LIGHTING, HEATING, STEAM GENERATING, COOKING, REFRIGERATING, DRYING, VENTILATING, WATER SUPPLY AND SANITARY PURPOSES, NAMELY, MERCURY STEAM LAMPS, HIGH PRESSURE LAMPS, HIGH INTENSITY DISCHARGE LAMPS, LAMPS FOR BEAUTY PURPOSES, SUN LAMPS AND TANNING LAMPS, COLLAGEN ACTIVATOR LAMPS, TANNING BEDS AND SHOWERS, IN CLASS 11 (U.S. CLS. 13, 21, 23, 31 AND 34).

NO CLAIM IS MADE TO THE EXCLUSIVE RIGHT TO USE "ITALIA", APART FROM THE MARK AS SHOWN.

OWNER OF INTERNATIONAL REGISTRATION 1040456 DATED 4-7-2010, EXPIRES 4-7-2020.



THE MARK CONSISTS OF THE WORD "ISO" IN HIGHLY STYLIZED FONT, OVER THE WORD "ITALIA".

THE WORDING "ISO" HAS NO MEANING IN A FOREIGN LANGUAGE.

SER. NO. 79-083,180, FILED 4-7-2010.

FRANK LATTUCA, EXAMINING ATTORNEY

David J. Kypos

Director of the United States Patent and Trademark Office

United States of America

United States Patent and Trademark Office

LEWA EcoPrime

Reg. No. 4,072,457

Registered Dec. 20, 2011

Int. Cls.: 7, 9, 11 and 42

TRADEMARK

SERVICE MARK

PRINCIPAL REGISTER

LEWA GMBH (FED REP GERMANY LIMITED LIABILITY COMPANY)
ULMER STRASSE 10
71229 LEONBERG
FED REP GERMANY

FOR: PUMPS AND MACHINES IN THE NATURE OF RECIPROCATING AND DIAPHRAGM METERING PUMPS AND COMPONENT PARTS THEREOF; PNEUMATIC AND HYDRAULIC ACTUATORS FOR PUMPS; VALVES AS MACHINE COMPONENTS; MIXING MACHINES FOR INDUSTRIAL PROCESSES, IN CLASS 7 (U.S. CLS. 13, 19, 21, 23, 31, 34 AND 35).

FOR: APPARATUS AND INSTRUMENTS FOR SCIENTIFIC, NAUTICAL, SURVEYING, PHOTOGRAPHIC, CINEMATOGRAPHIC, OPTICAL, WEIGHING, METERING, SIGNALING, LIFE-SAVING AND TEACHING PURPOSES, NAMELY, HIGH-PRESSURE PUMPS FOR PROPORTIONING AND TESTING PURPOSES, AND CHROMATOGRAPHY COLUMNS FOR USE IN PURIFICATION IN THE LABORATORY; CHEMICAL APPARATUS AND INSTRUMENTS, NAMELY, CHROMATOGRAPHY APPARATUS FOR LABORATORY PURPOSES, APPARATUS FOR AUTOMATIC CHROMATOGRAPHY, AND LIQUID CHROMATOGRAPHY APPARATUS; ELECTRIC SENSORS, IN CLASS 9 (U.S. CLS. 21, 23, 26, 36 AND 38).

FOR: DISTILLATION COLUMNS, IN CLASS 11 (U.S. CLS. 13, 21, 23, 31 AND 34).

FOR: ENGINEERING; TECHNICAL CONSULTANCY IN THE FIELDS OF IMPROVEMENT OF ENGINEERING PROCESSES, INDUSTRIAL ENGINEERING, AND ENVIRONMENTAL ENGINEERING, FEATURING EVALUATION, APPRAISALS, INVESTIGATIONS AND TECHNICAL SURVEYS; SCIENTIFIC RESEARCH; INDUSTRIAL ANALYSIS AND RESEARCH SERVICES IN THE FIELD OF PUMP APPLICATIONS FOR INDUSTRIAL USES; DESIGN AND DEVELOPMENT OF COMPUTER HARDWARE AND SOFTWARE, IN CLASS 42 (U.S. CLS. 100 AND 101).

THE MARK CONSISTS OF STANDARD CHARACTERS WITHOUT CLAIM TO ANY PARTICULAR FONT, STYLE, SIZE, OR COLOR.

PRIORITY DATE OF 1-19-2010 IS CLAIMED.

OWNER OF INTERNATIONAL REGISTRATION 1040661 DATED 4-27-2010, EXPIRES 4-27-2020.



David J. Kyjars

Director of the United States Patent and Trademark Office

Reg. No. 4,072,457 OWNER OF U.S. REG. NOS. 1,223,985 AND 3,265,273.

SER. NO. 79-083,249, FILED 4-27-2010.

TRACY FLETCHER, EXAMINING ATTORNEY

United States of America

United States Patent and Trademark Office

Q P R

Reg. No. 4,072,458

Registered Dec. 20, 2011

Int. Cls.: 9, 35 and 41

TRADEMARK

SERVICE MARK

PRINCIPAL REGISTER

QPR SOFTWARE OYJ (FINLAND CORPORATION)
HUOPALAHDENTIE 24
HELSINKI, FINLAND FI00350

FOR: COMPUTER PROGRAMS FOR MANAGING, PLANNING, DESIGNING AND ANALYZING BUSINESS PRODUCTIVITY; COMPUTER PROGRAMS FOR OPTIMIZING AND MONITORING BUSINESS OPERATIONS PRODUCTIVITY, BUSINESS PERFORMANCE, AND IT SYSTEMS PERFORMANCE; COMPUTER PROGRAMS FOR MANAGING EMPLOYEES, BUSINESS FINANCIAL TRANSACTIONS, CUSTOMER RELATIONSHIPS, BUSINESS ENTERPRISE RESOURCES, STAKEHOLDERS ENVIRONMENTAL ISSUES OF BUSINESS AND SOCIAL RESPONSIBILITY ISSUES OF BUSINESSES; COMPUTER PROGRAMS FOR MONITORING BUSINESS MANAGEMENT METHODOLOGIES, TECHNIQUES AND PROCESSES, IN CLASS 9 (U.S. CLS. 21, 23, 26, 36 AND 38).

FOR: BUSINESS MANAGEMENT CONSULTANCY SERVICES, IN CLASS 35 (U.S. CLS. 100, 101 AND 102).

FOR: EDUCATION SERVICES, NAMELY, PROVIDING EDUCATIONAL ACTIVITIES, NAMELY, TRAINING, CLASSES, SEMINARS, WORKSHOPS, WEB-BASED EDUCATIONAL TRAINING, CLASSES AND SEMINARS, AUTOMATED EDUCATION TRAINING, CLASSES, AND SEMINARS IN THE FIELD OF BUSINESS MANAGEMENT, BUSINESS MANAGEMENT COMPUTER PROGRAMS AND BUSINESS MANAGEMENT METHODOLOGIES, IN CLASS 41 (U.S. CLS. 100, 101 AND 107).

THE MARK CONSISTS OF STANDARD CHARACTERS WITHOUT CLAIM TO ANY PARTICULAR FONT, STYLE, SIZE, OR COLOR.

OWNER OF INTERNATIONAL REGISTRATION 0684475 DATED 12-3-1997, EXPIRES 12-3-2017.

SER. NO. 79-084,013, FILED 12-29-2009.

JOHN WILKE, EXAMINING ATTORNEY



David J. Kyros

Director of the United States Patent and Trademark Office

United States of America

United States Patent and Trademark Office

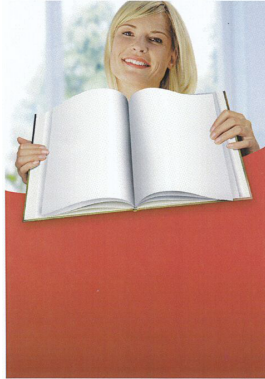

Reg. No. 4,072,459

Registered Dec. 20, 2011

Int. Cls.: 16 and 40

CEWE COLOR AG & CO. OHG (FED REP GERMANY GENERAL PARTNERSHIP ("OFFENE
HANDELSGESELLSCHAFT"))
MEERWEG 30-32
26133 OLDENBURG
FED REP GERMANY

TRADEMARK

FOR: PRINTED MATTER, NAMELY, PHOTO BOOKS, IN CLASS 16 (U.S. CLS. 2, 5, 22, 23, 29, 37, 38 AND 50).

SERVICE MARK

FOR: SERVICES OF A PHOTOGRAPHIC LABORATORY, NAMELY, PRINTING OF PHOTOGRAPHS AND PRINTING OF PHOTO BOOKS, IN CLASS 40 (U.S. CLS. 100, 103 AND 106).

PRINCIPAL REGISTER

THE NAME(S), PORTRAIT(S), AND/OR SIGNATURE(S) SHOWN IN THE MARK IDENTIFIES ILLE DÖPCKE, WHOSE CONSENT(S) TO REGISTER IS MADE OF RECORD.

PRIORITY DATE OF 12-9-2009 IS CLAIMED.

OWNER OF INTERNATIONAL REGISTRATION 1043309 DATED 5-6-2010, EXPIRES 5-6-2020.

THE COLOR(S) RED, LIGHT BLUE, FAWN, GREEN AND WHITE IS/ARE CLAIMED AS A FEATURE OF THE MARK.

THE MARK CONSISTS OF A FAWN-COLORED HEAD OF A WOMAN WITH FAWN-COLORED HANDS, HOLDING A WHITE BOOK WHICH PARTIALLY COVERS AN ALMOST RECTANGULAR RED SHAPE; BEHIND THE WOMAN ARE A WHITE AND LIGHT BLUE BACKGROUND AND A GREEN TREE.

SER. NO. 79-084,268, FILED 5-6-2010.

ANNE MADDEN, EXAMINING ATTORNEY



David J. Kybas

Director of the United States Patent and Trademark Office

United States of America

United States Patent and Trademark Office



Reg. No. 4,072,460

Registered Dec. 20, 2011

**Int. Cls.: 25, 35, 38, 41
and 43**

TRADEMARK

SERVICE MARK

PRINCIPAL REGISTER

MAC GROUP S.R.L. (ITALY LIMITED LIABILITY COMPANY)
VIA FIORENZO SEMINI, 28 C
I-16163 GENOVA
ITALY

FOR: LEATHER COATS; LEATHER JACKETS; TROUSERS OF LEATHER; COATS; OVERCOATS; RAINCOATS; JACKETS BEING CLOTHING; ANORAKS; PARKAS; SPORTS JACKETS; OVERALLS; WAISTCOATS; TROUSERS; JEANS; TRACKSUITS; BERMUDA SHORTS; SKIRTS; SWEATERS; SINGLET; VESTS; SHIRTS; T-SHIRTS; SWEAT SHIRTS; BLOUSES; CHEMISETTES; CAMISOLES; CARDIGANS; JERSEYS BEING CLOTHING; DRESSING GOWNS; PULLOVERS; JUMPERS; SUITS AND DRESSES; HOSIERY; NIGHTGOWNS; PYJAMAS; UNDERWEAR; PANTS; SLIPS; PANTIES; UNDERPANTS; BRASSIERES; PETTICOATS; SOCKS; STOCKINGS; STOCKING SUSPENDERS; GARTERS; LEGGINGS; TIGHTS; GLOVES BEING CLOTHING; MUFFS BEING CLOTHING; HEADBANDS BEING CLOTHING; SCARVES; FOULARDS BEING CLOTHING ARTICLE; SHAWLS; NECKERCHIEFS; NECKTIES; BELTS BEING CLOTHING; SASHES; BRACES FOR CLOTHING; WRISTBANDS BEING CLOTHING; BATHING SUITS; BATH ROBES; PAREOS; HATS; BERETS; CAPS BEING HEADWEAR; CAP PEAKS; SHOES; BOOTS; SANDALS; ESPADRILLES; SLIPPERS; CLOGS; SKI BOOTS; SNOWBOARD BOOTS; TRACK SHOES; RUNNING SHOES; GYMNAS TIC SHOES; BEACH SHOES; KNICKERS, IN CLASS 25 (U.S. CLS. 22 AND 39).



David J. Kybas

Director of the United States Patent and Trademark Office

FOR: ORGANIZATION OF EVENTS, EXHIBITIONS, FAIRS AND SHOWS FOR COMMERCIAL, PROMOTIONAL AND ADVERTISING PURPOSES; ORGANIZING, PROMOTING AND CONDUCTING EXHIBITIONS, TRADE SHOWS AND EVENTS FOR BUSINESS PURPOSES; PROVIDING MARKETING AND PROMOTION OF SPECIAL EVENTS; PUBLIC RELATIONS; ADVERTISING, MARKETING AND PROMOTION SERVICES; CONTESTS AND INCENTIVE AWARD PROGRAMS TO PROMOTE THE SALE OF PRODUCTS AND SERVICES OF OTHERS; PROMOTING THE SALE OF GOODS AND SERVICES OF OTHERS THROUGH THE DISTRIBUTION OF PRINTED MATERIAL AND PROMOTIONAL CONTESTS; PROMOTING THE GOODS AND SERVICES OF OTHERS BY ARRANGING FOR SPONSORS TO AFFILIATE THEIR GOODS AND SERVICES WITH AN AWARDS PROGRAM, A SPORTS COMPETITION AND SPORTING ACTIVITIES; ORGANIZATION OF BUSINESS CONVENTIONS; ADVERTISING AND MARKETING; ADVERTISING CONSULTATION; BUSINESS ADMINISTRATION CONSULTANCY, IN CLASS 35 (U.S. CLS. 100, 101 AND 102).

Reg. No. 4,072,460 FOR: PROVISION OF ACCESS TO A GLOBAL COMPUTER NETWORK; STREAMING OF AUDIO, VISUAL AND AUDIOVISUAL MATERIAL VIA A GLOBAL COMPUTER NETWORK; TRANSMISSION AND DISTRIBUTION OF DATA OR AUDIO VISUAL IMAGES VIA A GLOBAL COMPUTER NETWORK OR THE INTERNET; COMMUNICATION SERVICES, NAMELY, TRANSMISSION OF VOICE, AUDIO, VISUAL IMAGES AND DATA BY TELECOMMUNICATIONS NETWORKS, WIRELESS COMMUNICATION NETWORKS, THE INTERNET, INFORMATION SERVICES NETWORKS AND DATA NETWORKS; PROVIDING ON-LINE CHAT ROOMS AND ELECTRONIC BULLETIN BOARDS FOR TRANSMISSION OF MESSAGES AMONG USERS IN THE FIELD OF SPECIAL EVENTS, EXHIBITIONS, FAIRS AND SHOWS, CONTESTS AND COMPETITIONS; NEWS AGENCY SERVICES FOR ELECTRONIC TRANSMISSION; PROVIDING AN ON-LINE FORUM FOR COMPANIES TO SHOWCASE, DISPLAY, DEMONSTRATE AND PROMOTE NEW AND INNOVATIVE IDEAS, PRODUCTS AND SERVICES IN THE CONVENTION/MEETING MANAGEMENT ARENA; COMMUNICATION SERVICES, NAMELY, ELECTRONIC TRANSMISSION OF DATA AND DOCUMENTS AMONG USERS OF COMPUTERS; PROVIDING ACCESS TO DATABASES, IN CLASS 38 (U.S. CLS. 100, 101 AND 104).

FOR: ORGANIZING AND ARRANGING EXHIBITIONS FOR ENTERTAINMENT PURPOSES; ENTERTAINMENT SERVICES, NAMELY, CONDUCTING FAIRS NOT FOR COMMERCIAL PURPOSES; ARRANGING AND CONDUCTING SPECIAL EVENTS FOR SOCIAL ENTERTAINMENT PURPOSES; ORGANIZING CULTURAL AND ARTS EVENTS; SPECIAL EVENT PLANNING FOR SOCIAL ENTERTAINMENT PURPOSES; ARRANGING OF CONTESTS; ARRANGING OF BEAUTY CONTESTS; CONDUCTING AND ORGANIZING ENTERTAINMENT AND SOCIAL EVENTS, NAMELY, CAR SHOWS, CAR EXHIBITIONS, CAR COMPETITIONS; ENTERTAINMENT SERVICES IN THE NATURE OF AUTOMOBILE RACING AND EXHIBITIONS; MEETING AND SEMINAR ARRANGING; ORGANIZING COMMUNITY SPORTING AND CULTURAL EVENTS; ORGANISATION OF SPORTS COMPETITIONS; ENTERTAINMENT, NAMELY, LIVE MUSIC CONCERTS; PUBLICATION OF MANUALS, BOOKS, MAGAZINES, BROCHURES, PAMPHLETS, AND PRINTED EDUCATIONAL AND TEACHING MATERIAL, IN CLASS 41 (U.S. CLS. 100, 101 AND 107).

FOR: PROVIDING CONVENTION FACILITIES; PROVIDING FACILITIES FOR EXHIBITIONS; PROVIDING SOCIAL MEETING, BANQUET AND SOCIAL FUNCTION FACILITIES; PROVIDING BANQUET AND SOCIAL FUNCTION FACILITIES FOR SPECIAL OCCASIONS; RESTAURANT, BAR AND CATERING SERVICES; PROVIDING TEMPORARY ACCOMMODATION, IN CLASS 43 (U.S. CLS. 100 AND 101).

THE MARK CONSISTS OF THE WORDING "UNIQUES SPECIAL ONES" IN STYLIZED FONT PLACED ON A SHADED SQUARE BACKGROUND. THE WORD "UNIQUES" APPEARS IN LARGER FONT ABOVE THE WORDING "SPECIAL ONES". THE BACKGROUND FEATURES A SHADED GRADIENT, WHICH GROWS LIGHTER FROM LEFT TO RIGHT. IN THE UPPER LEFT PORTION OF THE BACKGROUND IS A PATTERN OF SQUARES AND OVALS FORMED FROM A REPEATING ARRAY OF THE STYLIZED LETTER "Q".

PRIORITY DATE OF 3-23-2010 IS CLAIMED.

OWNER OF INTERNATIONAL REGISTRATION 1043513 DATED 3-30-2010, EXPIRES 3-30-2020.

SER. NO. 79-084,395, FILED 3-30-2010.

STEVEN PEREZ, EXAMINING ATTORNEY

United States of America
United States Patent and Trademark Office

MYSILO

Reg. No. 4,072,461

Registered Dec. 20, 2011

Int. Cls.: 6 and 7

CIFTK KARTAL TAHIL DEPOLAMA SISTEMLERI SANAYI VE TICARET LIMITED SIRKETI
(TURKEY LIMITED COMPANY)
ORGANIZE SANAYI BOLGESI 1.
CAD. NO:52/B
AKSARAY, TURKEY

TRADEMARK

PRINCIPAL REGISTER

FOR: GRAIN STORAGE SYSTEMS, NAMELY, METAL SILOS AND METAL SILOS COMPRISING NON-MECHANICAL METAL HOPPERS, METAL LADDERS AND PREFABRICATED METAL CATWALKS, METAL SAFETY CAGES, METAL ROOF VENTS FOR VENTILATION, METAL HOPPER ACCESS DOORS, METAL FLOORS, METAL DOORS, METAL WALL PANELS, METAL ROOFING, METAL STAIRS AND GRAB RAILS, PREFABRICATED METAL PLATFORMS, BOTH STATIONARY AND MOBILE, METAL STORAGE TANKS, METAL SILO AND GRAIN STORAGE MEASURING SENSORS, AND METAL STRUCTURAL PARTS FOR THE AFOREMENTIONED GOODS, IN CLASS 6 (U.S. CLS. 2, 12, 13, 14, 23, 25 AND 50).

FOR: GRAIN HANDLING EQUIPMENT, NAMELY, MACHINERY USED IN CONNECTION WITH GRAIN STORAGE SYSTEMS AND METAL SILOS, NAMELY, TELESCOPING CONVEYING MACHINES, MAN AND LOAD ELEVATORS, ELEVATING WORK PLATFORMS, POWERED LOADING RAMPS, LIFTS, NAMELY, BUCKET ELEVATORS, CRANES, CHAIN HOISTS, ESCALATORS, BELT CONVEYORS, SPIRAL BINDING MACHINES FOR INDUSTRIAL USE, AERATION SYSTEMS, NAMELY, FANS FOR MACHINE ENGINES, AND MONITORING SENSORS FOR MAINTAINING TEMPERATURE, HUMIDITY, AND DESIRED GRAIN AND FEED LEVELS; THE AFOREMENTIONED GRAIN HANDLING MACHINES USED FOR SEPARATING, SORTING, PROCESSING, LOADING, UNLOADING, STORING AND TRANSPORTING GRAIN AND FEED, IN CLASS 7 (U.S. CLS. 13, 19, 21, 23, 31, 34 AND 35).



THE MARK CONSISTS OF STANDARD CHARACTERS WITHOUT CLAIM TO ANY PARTICULAR FONT, STYLE, SIZE, OR COLOR.

OWNER OF INTERNATIONAL REGISTRATION 1044886 DATED 1-26-2010, EXPIRES 1-26-2020.

David J. Kyros

SER. NO. 79-084,968, FILED 1-26-2010.

LEIGH LOWRY, EXAMINING ATTORNEY

United States of America
United States Patent and Trademark Office

SARscape

Reg. No. 4,072,462

Registered Dec. 20, 2011

Int. Cls.: 9 and 42

TRADEMARK

SERVICE MARK

PRINCIPAL REGISTER

SARMAP SA (SWITZERLAND SOCIÉTÉ ANONYME (SA))
BANCO
CH-6981 BEDIGLIORA
SWITZERLAND

FOR: DETECTION DEVICES FOR COLLECTING DATA ON LAND REMOTE SENSING DIGITAL FUNCTIONS THROUGH REMOTE SENSING SATELLITE AND AERIAL DATA FOR GENERATING DIGITAL TERRAIN MODELS, DIGITAL TOPOGRAPHIC, LAND DISPLACEMENTS AND THEMATIC MAPS, AND FOR MONITORING LAND COVER, NAMELY, SOFTWARE FOR THE PROCESSING OF REMOTE SENSING RADAR AND OPTICAL DATA, IN CLASS 9 (U.S. CLS. 21, 23, 26, 36 AND 38).

FOR: ENGINEERING WORKS, NAMELY, ENGINEERING SERVICES FEATURING DIGITAL INFORMATION OF LAND COVER, GENERATED BY THE USE OF A SERIES OF REMOTE SENSING DIGITAL FUNCTIONS THROUGH A REMOTE SENSING SATELLITE AND AERIAL DATA, FOR GENERATING DIGITAL TERRAIN MODELS, DIGITAL TOPOGRAPHICS, LAND DISPLACEMENTS, AND THEMATIC MAPS, AND FOR MONITORING LAND COVER, IN CLASS 42 (U.S. CLS. 100 AND 101).

OWNER OF INTERNATIONAL REGISTRATION 1045682 DATED 6-14-2010, EXPIRES 6-14-2020.

SER. NO. 79-085,304, FILED 6-14-2010.

JAMES MACFARLANE, EXAMINING ATTORNEY



David J. Kybas

Director of the United States Patent and Trademark Office

United States of America

United States Patent and Trademark Office

MARSH ALPHA

Reg. No. 4,072,463

Registered Dec. 20, 2011

Int. Cl.: 36

SERVICE MARK

PRINCIPAL REGISTER

MARSH LIMITED (ENGLAND LTD COMPANY)
1 TOWER PLACE WEST
TOWER PLACE
LONDON EC3R 5BU, UNITED KINGDOM

FOR: INSURANCE BROKERAGE SERVICES; INSURANCE BROKERAGE SERVICES, NAMELY, ARRANGING INSURANCE POLICIES FOR DIRECTORS AND OFFICERS AND OTHER SENIOR MANAGERS ARRANGED WITH VARIOUS UNDERWRITERS PROVIDING INSURANCE IN EXCESS OF ANY OTHER DIRECTORS AND OFFICERS POLICIES OR PROVIDING PRIMARY INSURANCE, IN CLASS 36 (U.S. CLS. 100, 101 AND 102).

THE MARK CONSISTS OF STANDARD CHARACTERS WITHOUT CLAIM TO ANY PARTICULAR FONT, STYLE, SIZE, OR COLOR.

PRIORITY DATE OF 1-29-2010 IS CLAIMED.

OWNER OF INTERNATIONAL REGISTRATION 1046113 DATED 4-8-2010, EXPIRES 4-8-2020.

OWNER OF U.S. REG. NOS. 3,705,475 AND 3,725,761.

SER. NO. 79-085,476, FILED 4-8-2010.

KRISTINA MORRIS, EXAMINING ATTORNEY



David J. Kybas

Director of the United States Patent and Trademark Office

United States of America

United States Patent and Trademark Office

ARCANGO

Reg. No. 4,072,464

Registered Dec. 20, 2011

Int. Cl.: 30

GESTION PARTICIPATIONS FINANCIERES ET IMMOBILIERES (FRANCE SOCIÉTÉ PAR
ACTIONS SIMPLIFIÉE)
ROUTE DE CONCHES
F-27240 LE RONCENAY-AUTHENAY
FRANCE

TRADEMARK

PRINCIPAL REGISTER

FOR: COCOA; CHOCOLATE; CHOCOLATE TOPPING; BEVERAGES WITH A CHOCOLATE
BASE; CHOCOLATE POWDER; CHOCOLATE FOR CONFECTIONERY AND BREAD;
PASTRIES; CONFECTIONERY FOR DECORATING CHRISTMAS TREES; CONFECTIONERY
MADE OF SUGAR; CONFECTIONERY, NAMELY, PASTILLES; FROZEN CONFECTIONERY;
EDIBLE ICES; SHERBET; SHERBETS IN THE NATURE OF SORBETS, IN CLASS 30 (U.S.
CL. 46).

THE MARK CONSISTS OF STANDARD CHARACTERS WITHOUT CLAIM TO ANY PAR-
TICULAR FONT, STYLE, SIZE, OR COLOR.

OWNER OF INTERNATIONAL REGISTRATION 1046843 DATED 5-18-2010, EXPIRES 5-18-
2020.

SER. NO. 79-085,763, FILED 5-18-2010.

CORY BOONE, EXAMINING ATTORNEY



David J. Kyffers

Director of the United States Patent and Trademark Office

United States of America

United States Patent and Trademark Office



Reg. No. 4,072,465

Registered Dec. 20, 2011

Int. Cls.: 9, 38 and 42

TRADEMARK

SERVICE MARK

PRINCIPAL REGISTER

LANTIQ DEUTSCHLAND GMBH (FED REP GERMANY LIMITED LIABILITY COMPANY)
AM CAMPEON 3
85579 NEUBIBERG
FED REP GERMANY

FOR: MICROPROCESSORS; INTEGRATED CIRCUIT CHIPS; SEMICONDUCTORS; TELEPHONES; PORTABLE TELEPHONES; SOFTWARE FOR MICROPROCESSORS INTENDED FOR TELECOMMUNICATION; FIRMWARE FOR MICROPROCESSORS; DOWNLOADABLE ELECTRONIC PUBLICATIONS, NAMELY, PRODUCT BRIEFS, MANUALS, TECHNICAL DISCLOSURE BULLETINS, MAGAZINES ON THE SUBJECT OF TELECOMMUNICATIONS, DATA SHEETS, AND NEWSLETTERS, IN CLASS 9 (U.S. CLS. 21, 23, 26, 36 AND 38).

FOR: TELECOMMUNICATION SERVICES, NAMELY, NETWORK COMMUNICATION SERVICES, HOME NETWORKING SERVICES, VIDEO-CONFERENCING SERVICES, TELEPHONE COMMUNICATION SERVICES, AND CUSTOMER PREMISES SERVICES, NAMELY, CONSULTING SERVICES IN THE FIELD OF CUSTOMER PREMISES TELECOMMUNICATION SYSTEMS, EQUIPMENT AND TELECOMMUNICATION CHANNELS, ANALYSIS AND QUALITY ASSESSMENT OF CUSTOMER PREMISES TELECOMMUNICATION SYSTEMS AND EQUIPMENT AND TELECOMMUNICATION CHANNELS, CONSULTATION REGARDING IMPROVING THE QUALITY AND EFFICIENCY OF THE TELECOMMUNICATION SYSTEMS, EQUIPMENT AND CHANNELS, AND CONSULTATION REGARDING THE SELECTION OF TELECOMMUNICATIONS EQUIPMENT AND TELECOMMUNICATION CHANNELS, IN CLASS 38 (U.S. CLS. 100, 101 AND 104).

FOR: CONSULTANCY IN THE FIELD OF TELECOMMUNICATION TECHNOLOGY; DESIGN OF MICROPROCESSORS, INTEGRATED CIRCUIT CHIPS AND SEMICONDUCTORS; DESIGN OF SOFTWARE FOR MICROPROCESSORS INTENDED FOR TELECOMMUNICATION; DESIGN OF FIRMWARE FOR MICROPROCESSORS; RESEARCH AND DEVELOPMENT IN THE FIELD OF ELECTRONICS AND TELECOMMUNICATION TECHNOLOGY, IN CLASS 42 (U.S. CLS. 100 AND 101).

THE WORDING "LANTIQ" HAS NO MEANING IN A FOREIGN LANGUAGE.

PRIORITY DATE OF 9-23-2009 IS CLAIMED.

OWNER OF INTERNATIONAL REGISTRATION 1047108 DATED 3-23-2010, EXPIRES 3-23-2020.



David J. Kyjars

Director of the United States Patent and Trademark Office

Reg. No. 4,072,465 SER. NO. 79-085,876, FILED 3-23-2010.

MATTHEW KLINE, EXAMINING ATTORNEY

United States of America

United States Patent and Trademark Office

San ten

Reg. No. 4,072,466

Registered Dec. 20, 2011

Int. Cls.: 5 and 10

TRADEMARK

PRINCIPAL REGISTER

SANTEN PHARMACEUTICAL CO., LTD. (JAPAN CORPORATION)
9-19, SHIMOSHINJO 3-CHOME
HIGASHIYODOGAWA-KU.; OSAKA-SHI; OSAKA-FU533-8651
JAPAN

FOR: PHARMACEUTICAL PREPARATIONS FOR USE IN OPHTHALMOLOGY; EYE DROPS AND EYEWASHES; EYE DROPS AND EYEWASHES FOR ANTISEPTICISING; EYE DROPS AND EYEWASHES FOR GLAUCOMA; EYE DROPS AND EYEWASHES FOR CATARACT; EYE DROPS AND EYEWASHES FOR DRY EYE; PHARMACEUTICAL PREPARATIONS FOR TREATMENT OF CATARACTS AND GLAUCOMA; VETERINARY PHARMACEUTICAL PREPARATIONS FOR USE IN OPHTHALMOLOGY; VETERINARY EYE DROPS AND EYEWASHES; VETERINARY EYE DROPS AND EYEWASHES FOR ANTISEPTICISING; VETERINARY EYE DROPS AND EYEWASHES FOR GLAUCOMA; VETERINARY EYE DROPS AND EYEWASHES FOR CATARACT; VETERINARY EYE DROPS AND EYEWASHES FOR DRY EYE; VETERINARY PHARMACEUTICAL PREPARATIONS FOR TREATMENT OF CATARACTS AND GLAUCOMA; SANITARY PREPARATIONS FOR MEDICAL USE; OILED PAPER FOR MEDICAL PURPOSES; ADHESIVE WAFER MEDICAL DRESSINGS; GAUZE FOR DRESSINGS; EMPTY CAPSULES FOR PHARMACEUTICALS; EYE PATCHES FOR MEDICAL PURPOSES; ADHESIVE EAR BANDAGES; MENSTRUATION BANDAGES; MENSTRUATION TAMPONS; SANITARY NAPKINS; SANITARY PANTIES; ABSORBENT COTTON FOR MEDICAL PURPOSES; ADHESIVE MEDICAL PLASTERS; BANDAGES FOR DRESSINGS; COLLODION FOR PHARMACEUTICAL PURPOSES, NAMELY, MEDICAL ADHESIVES FOR BINDING WOUNDS; BREAST-NURSING PADS; DENTAL MATERIALS, NAMELY, DENTAL COMPOSITE MATERIALS, DENTAL IMPRESSION MATERIALS, DENTAL PORCELAIN MATERIALS, AND LINING MATERIALS FOR DENTAL PURPOSES; MAGNETIC BRACELETS FOR MEDICAL PURPOSES; INCONTINENCE DIAPERS; MOTHPROOFING PAPER; COTTON SWABS FOR MEDICAL USE, IN CLASS 5 (U.S. CLS. 6, 18, 44, 46, 51 AND 52).



David J. Kyros

Director of the United States Patent and Trademark Office

FOR: INTRAOCULAR LENSES FOR SURGICAL IMPLANTATION; MEDICAL APPARATUS AND INSTRUMENTS FOR USE IN GENERAL SURGERY, NAMELY, INTRAOCULAR LENS INJECTOR; MEDICAL MACHINES, NAMELY, CONTAINERS ESPECIALLY MADE FOR MEDICAL WASTE, NEEDLES FOR MEDICAL PURPOSES, KERATOSCOPIES, TONOMETERS, ARTIFICIAL EYES, EYE TESTING MACHINES AND APPARATUS; MEDICAL APPARATUS FOR USE IN GENERAL SURGERY; ICE BAG PILLOWS FOR MEDICAL PURPOSES; TRIANGULAR BANDAGES, NAMELY, ELASTIC BANDAGES, COMPRESSION BANDAGES, SUPPORT BANDAGES; SUPPORTIVE BANDAGES; SURGICAL CATGUTS; FEEDING CUPS

Reg. No. 4,072,466 FOR MEDICAL PURPOSES; DROPPING PIPETTES FOR MEDICAL PURPOSES; TEATS; MEDICAL ICE BAGS; HOLDERS SPECIALLY ADAPTED FOR ICE BAGS FOR MEDICAL PURPOSES; NURSING APPLIANCES, NAMELY, NURSING BOTTLES; VACUUM BOTTLES FOR NURSING; FINGER GUARDS FOR MEDICAL PURPOSES; CONTRACEPTIVES; ARTIFICIAL TYMPANIC MEMBRANES; PROSTHETIC OR FILLING MATERIALS NOT FOR DENTAL USE, NAMELY, ARTIFICIAL MATERIALS FOR USE IN THE REPLACEMENT OF BONES; ESTHETIC MASSAGE APPARATUS FOR INDUSTRIAL PURPOSES; ELECTRIC MASSAGE APPARATUS FOR HOUSEHOLD USE; GLOVES FOR MEDICAL PURPOSES; SANITARY MASKS FOR MEDICAL PURPOSES, IN CLASS 10 (U.S. CLS. 26, 39 AND 44).

OWNER OF U.S. REG. NOS. 1,928,919, 1,975,555, AND 3,142,302.

PRIORITY DATE OF 3-31-2010 IS CLAIMED.

OWNER OF INTERNATIONAL REGISTRATION 1047701 DATED 4-12-2010, EXPIRES 4-12-2020.

SER. NO. 79-086,086, FILED 4-12-2010.

KATHERINE E. HALMEN, EXAMINING ATTORNEY

United States of America

United States Patent and Trademark Office

Philtre
de cacao



PIERRE MARCOLINI
BRUSSELS

Reg. No. 4,072,467

Registered Dec. 20, 2011

Int. Cl.: 30

TRADEMARK

PRINCIPAL REGISTER

LES CHOCOLATS DE L'IRIS SA/NV (BELGIUM SOCIÉTÉ ANONYME)
RUE DU BASSIN COLLECTEUR 4
B-1130 HAREN
BELGIUM

FOR: COCOA-BASED NON-MEDICINAL INFUSIONS; COCOA-BASED BEVERAGES;
CHOCOLATE-BASED BEVERAGES; TEAS; FLAVORINGS, OTHER THAN ESSENTIAL
OILS, FOR BEVERAGES, IN CLASS 30 (U.S. CL. 46).

OWNER OF U.S. REG. NO. 3,071,215.

PRIORITY DATE OF 3-12-2010 IS CLAIMED.

OWNER OF INTERNATIONAL REGISTRATION 1048776 DATED 7-1-2010, EXPIRES 7-1-2020.

NO CLAIM IS MADE TO THE EXCLUSIVE RIGHT TO USE "CACAO" AND "BRUSSELS",
APART FROM THE MARK AS SHOWN.

THE NAME "PIERRE MARCOLINI" IDENTIFIES A LIVING INDIVIDUAL WHOSE CONSENT
IS OF RECORD.

THE MARK CONSISTS OF THE WORDING "PHILTRE DE CACAO" ABOVE A STYLIZED
VERSION OF A COCOA BEAN WITH SHADOWING ABOVE THE WORDING "PIERRE
MARCOLINI BRUSSELS".

THE ENGLISH TRANSLATION OF THE WORDS "PHILTRE DE CACAO" IS "COCOA PO-
TION".

SER. NO. 79-086,490, FILED 7-1-2010.

JESSICA FATHY, EXAMINING ATTORNEY



David J. Kybas

Director of the United States Patent and Trademark Office

United States of America

United States Patent and Trademark Office



Reg. No. 4,072,468

Registered Dec. 20, 2011

**Int. Cls.: 9, 35, 37, 38, 41
and 45**

TRADEMARK

SERVICE MARK

PRINCIPAL REGISTER

TELIASONERA AB (NETHERLANDS LIMITED LIABILITY COMPANY)
STUREPLAN 8
STOCKHOLM, SWEDEN

FOR: APPARATUS FOR RECORDING, TRANSMISSION OR REPRODUCTION OF SOUND OR IMAGES, NAMELY, MOBILE PHONES, CELL PHONES, MODEMS, VIDEO TELEPHONES, VIDEO SCREENS, ANTENNA MASTS FOR AERIALS, TELEPHONE WIRES, TELEPHONES; AUTOMATIC VENDING MACHINES AND MECHANISMS FOR COIN-OPERATED APPARATUS; CASH REGISTERS, CALCULATING MACHINES, DATA PROCESSING EQUIPMENT AND COMPUTERS; DOWNLOADABLE COMPUTER PROGRAMS, NAMELY, DOWNLOADABLE SOFTWARE FOR GAMES, MUSIC, RINGING TONES, PROVIDING ACCESS TO COMPUTERS AND NETWORKS, SECURITY PROGRAMS, UPDATING COMPUTERS AND MOBILE PHONES IN THE FIELD OF TELECOMMUNICATIONS, IN CLASS 9 (U.S. CLS. 21, 23, 26, 36 AND 38).

FOR: ADVERTISING AND MARKETING SERVICES; BUSINESS ADMINISTRATION AND MANAGEMENT; AND PROVIDING OFFICE FUNCTIONS, IN CLASS 35 (U.S. CLS. 100, 101 AND 102).

FOR: BUILDING CONSTRUCTION; REPAIR OF COMPUTER AND TELECOMMUNICATION EQUIPMENT, SYSTEMS AND NETWORKS; INSTALLATION SERVICES, NAMELY, INSTALLATION OF TELECOMMUNICATION AND COMPUTER EQUIPMENT, SYSTEMS AND NETWORKS, IN CLASS 37 (U.S. CLS. 100, 103 AND 106).

FOR: TELECOMMUNICATION ACCESS SERVICES, NAMELY, LOCAL AND LONG DISTANCE TRANSMISSION OF VOICE, DATA, GRAPHICS BY MEANS OF TELEPHONE, TELEGRAPHIC, CABLE AND SATELLITE TRANSMISSIONS, ELECTRONIC MAIL SERVICES, TELECONFERENCING SERVICES AND COMPUTER AIDED TRANSMISSION OF MESSAGES AND IMAGES, PROVIDING USER ACCESS AND TELECOMMUNICATION CONNECTIONS TO A GLOBAL COMPUTER NETWORK, IN CLASS 38 (U.S. CLS. 100, 101 AND 104).

FOR: EDUCATIONAL SERVICES, NAMELY, PROVIDING CLASSES, SEMINARS, AND WORKSHOPS IN THE FIELD OF TELECOMMUNICATIONS; PROVIDING TRAINING SERVICES, NAMELY, COMPUTER TRAINING SERVICES AND EMPLOYEE TRAINING, IN THE FIELD OF TELECOMMUNICATIONS, IN CLASS 41 (U.S. CLS. 100, 101 AND 107).



David J. Kybas

Director of the United States Patent and Trademark Office

Reg. No. 4,072,468 FOR: LEGAL SERVICES; SECURITY SERVICES, NAMELY, PROVIDING SECURITY ASSESSMENTS OF PHYSICAL LOCATIONS, INFORMATION SYSTEMS, AND WORKING ENVIRONMENTS AND MONITORING OF BURGLAR AND SECURITY ALARMS VIA TELECOMMUNICATION AND COMPUTER NETWORKS; PERSONAL AND SOCIAL SERVICES RENDERED BY OTHERS TO MEET THE NEEDS OF INDIVIDUALS, NAMELY, INTERNET-BASED SOCIAL NETWORKING, ON-LINE SOCIAL NETWORKING SERVICES, IN CLASS 45 (U.S. CLS. 100 AND 101).

THE MARK CONSISTS OF A DESIGN OF AN OVAL SHAPE INCLUDING AMOEBA-LIKE SHAPES AND IRREGULAR OVAL SHAPES WITH BANDS OR LINES AROUND THE MARK.

OWNER OF INTERNATIONAL REGISTRATION 0996333 DATED 1-28-2009, EXPIRES 1-28-2019.

SER. NO. 79-086,807, FILED 9-9-2010.

SUSAN RICHARDS, EXAMINING ATTORNEY

United States of America

United States Patent and Trademark Office

Sonolith i-move

Reg. No. 4,072,469

Registered Dec. 20, 2011

Int. Cl.: 10

TRADEMARK

PRINCIPAL REGISTER

EDAP TMS FRANCE (FRANCE SOCIÉTÉ PAR ACTIONS SIMPLIFIÉE)
PARC D'ACTIVITÉ LA POUDRETTE LAMARTINE,
4/6 RUE DU DAUPHINÉ; F-69120 VAULX EN VELIN
FRANCE

FOR: SURGICAL AND MEDICAL APPARATUS AND INSTRUMENTS, NAMELY, LITHO-TRIPTORS AND UROLOGICAL APPARATUS; APPARATUS AND INSTRUMENTS FOR MEDICAL PURPOSES USING A HIGH-INTENSITY CONVERGENT BEAM OF ULTRASOUND PRODUCED BY HIGH-POWER SENSORS FOR GENERATING HEAT, HEAT THERAPY APPARATUS, NAMELY, HOT AIR VIBRATORS FOR MEDICAL PURPOSES; APPARATUS FOR USE IN MEDICAL ANALYSIS, NAMELY, BLOOD TESTING APPARATUS; ANAESTHETIC DELIVERY APPARATUS, DIAGNOSTIC APPARATUS FOR MEDICAL PURPOSES, NAMELY, SCANNERS AND STONES LOCALIZATION MACHINES FOR MEDICAL DIAGNOSTIC USE; DIALYSIS MACHINES; RADIOLOGY SCREENS FOR MEDICAL PURPOSES; ELECTROCARDIOGRAPHS; ELECTRODES FOR MEDICAL USE; ENEMA APPARATUS FOR MEDICAL PURPOSES; LASERS FOR MEDICAL PURPOSES; X-RAY PHOTOGRAPHS FOR MEDICAL PURPOSES; RADIOLOGY APPARATUS FOR MEDICAL PURPOSES; APPARATUS AND INSTALLATIONS FOR THE PRODUCTION OF X-RAYS, FOR MEDICAL PURPOSES; PROBES FOR MEDICAL PURPOSES; URETHRAL PROBES; URINALS FOR MEDICAL PURPOSES; UROLOGICAL APPARATUS AND INSTRUMENTS, NAMELY, UROLOGICAL IMAGING AND TREATING MACHINES; UTERINE SYRINGES; LITHO-TRIPTORS USING EXTRACORPOREAL SHOCK WAVES FOR MEDICAL PURPOSES, IN CLASS 10 (U.S. CLS. 26, 39 AND 44).



OWNER OF U.S. REG. NOS. 3,436,390 AND 3,742,585.

PRIORITY DATE OF 2-16-2010 IS CLAIMED.

OWNER OF INTERNATIONAL REGISTRATION 1050098 DATED 8-16-2010, EXPIRES 8-16-2020.

THE MARK COMPRISES THE WORDS "SONOLITH I-MOVE".

THE WORDING "SONOLITH" HAS NO MEANING IN A FOREIGN LANGUAGE.

SER. NO. 79-086,981, FILED 8-16-2010.

David J. Kypos

Director of the United States Patent and Trademark Office

Reg. No. 4,072,469 JERI J. FICKES, EXAMINING ATTORNEY

United States of America

United States Patent and Trademark Office



Reg. No. 4,072,470

Registered Dec. 20, 2011

Int. Cl.: 25

TRADEMARK

PRINCIPAL REGISTER

AMERICAN CLUB INTERNATIONAL CO., LTD. (JAPAN CORPORATION)
18-14, NISHISHINSAIBASHI 2-CHOME
CHUO-KU., OSAKA-SHI; OSAKA 542-0086
JAPAN

FOR: SHOES; BOOTS; SANDALS; CLOTHING FOR SPORTS, NAMELY, SPORT COATS, SPORTS SHIRTS, SPORTS JACKETS, SPORTS JERSEYS, SPORTS PANTS, AND SPORTS VESTS; BOOTS FOR SPORTS; CLOTHING, NAMELY, SUITS, SKIRTS, PANTS, PARKAS, AND JACKETS; COATS; SWEATERS; SHIRTS; NIGHT CLOTHES, NAMELY, NIGHT GOWNS, AND NIGHT SHIRTS; UNDERWEAR; BATHING SUITS; BATHING CAPS; GARTERS; SUSPENDERS; BELTS, IN CLASS 25 (U.S. CLS. 22 AND 39).

OWNER OF U.S. REG. NO. 3,104,661.

OWNER OF INTERNATIONAL REGISTRATION 1051407 DATED 8-31-2010, EXPIRES 8-31-2020.

THE MARK CONSISTS OF THE WORDING "DRAGON BEARD" AND DESIGNS. A STYLIZED CURVING SHAPE RESEMBLING FLAMES APPEARS ABOVE THE WORDING. THE LETTER "N" IN THE WORDING APPEARS WITHIN A SHADED CIRCLE.

SER. NO. 79-087,478, FILED 8-31-2010.

CORY BOONE, EXAMINING ATTORNEY



David J. Kybas

Director of the United States Patent and Trademark Office

United States of America

United States Patent and Trademark Office

LTP MUSIC GAMEPLAY

Reg. No. 4,072,471

Registered Dec. 20, 2011

**Int. Cls.: 9, 15, 16, 28, 35
and 41**

TRADEMARK

SERVICE MARK

PRINCIPAL REGISTER

GARY TURNER (AUSTRALIA INDIVIDUAL)
APARTMENT # 7
202 TOWER ROAD,; SLIEMA, SLM1602
MALTA

FOR: DIGITAL MATERIALS, NAMELY, DOWNLOADABLE ELECTRONIC PUBLICATIONS IN THE NATURE OF INSTRUCTION BOOKS, TECHNIQUE BOOKS, THEORY BOOKS, SONG BOOKS, TABLATURE AND SHEET MUSIC INCLUDING SHEET MUSIC IN THE FORM OF TABLATURE, IN THE FIELD OF MUSIC AND MUSICAL INSTRUCTION, DOWNLOADABLE COMPUTER PROGRAMS FOR MUSICAL INSTRUCTION, MUSICAL TECHNIQUE AND MUSIC THEORY, DOWNLOADABLE MULTIMEDIA FILES CONTAINING ARTWORK, TEXT, AUDIO, MUSIC, VIDEO, GAMES AND INTERNET WEB LINKS RELATING TO MUSIC, MUSICAL INSTRUCTION, MUSICAL TECHNIQUE AND MUSIC THEORY, DOWNLOADABLE AUDIO AND VIDEO RECORDINGS FEATURING MUSIC, MUSICAL INSTRUCTION, MUSICAL TECHNIQUE AND MUSIC THEORY, DOWNLOADABLE SOFTWARE FOR USE IN MUSICAL INSTRUCTION, COMPACT DISCS COMPACT DISCS AND DDS FEATURING MUSIC, MUSICAL INSTRUCTION, MUSICAL TECHNIQUE AND MUSICAL THEORY; APPARATUS FOR THE RECORDING, TRANSMISSION, AMPLIFICATION AND REPRODUCTION OF SOUND; MUSICAL ACCESSORIES BEING ELECTRONIC EQUIPMENT USED IN CONJUNCTION WITH MUSICAL INSTRUMENTS OR MUSICAL INSTRUCTION, NAMELY, METRONOMES, AMPLIFIERS AND ELECTRONIC EFFECT PEDALS FOR USE WITH SOUND AMPLIFIERS; MUSICAL SOUND RECORDINGS; MUSICAL VIDEO RECORDINGS; AUDIO AND VIDEO RECORDINGS FEATURING MUSIC, EDUCATION, ENTERTAINMENT, AND ANIMATION; AUDIO DISCS FEATURING MUSIC, EDUCATION, ENTERTAINMENT, AND ANIMATION; DVDS FEATURING MUSIC, EDUCATION, ENTERTAINMENT, AND ANIMATION; LASER DISCS FEATURING MUSIC, EDUCATION, ENTERTAINMENT, AND ANIMATION; APPARATUS FOR RECORDING, TRANSMISSION OF REPRODUCTION OF SOUND OR IMAGES; MAGNETIC DATA CARRIERS AND RECORDING DISCS BOTH BLANK AND FEATURING MUSIC, EDUCATION, ENTERTAINMENT, AND ANIMATION; CD PLAYERS; CHILDREN'S EDUCATIONAL SOFTWARE; CHILDREN'S EDUCATIONAL MUSIC CDS AND DVDS; CHILDREN'S VIDEO TAPES; DATA PROCESSING EQUIPMENT AND COMPUTERS; COMPUTER GAME CARTRIDGES; COMPUTER GAME CASSETTES; COMPUTER GAME DISCS; COMPUTER GAME JOYSTICKS; COMPUTER GAME PROGRAMS; COMPUTER GAME SOFTWARE; COMPUTER HARDWARE; COMPUTER KEYBOARDS; COMPUTER MEMORIES; COMPUTER MONITORS; COMPUTER MOUSE; COMPUTER TRACKBALL; COMPUTER PERIPHERALS; COMPUTER PRINTERS; COMPUTER SCREEN SAVER SOFTWARE; COMPUTER SEARCH



David J. Kybas

Director of the United States Patent and Trademark Office

Reg. No. 4,072,471 ENGINE SOFTWARE; COMPUTER SOFTWARE FOR INTERACTIVE EDUCATIONAL PROGRAMS AND ENTERTAINMENT; COMPUTERS; DIGITAL VIDEO DISC DRIVES; DIGITAL VIDEO RECORDERS; DISPOSABLE CAMERAS; DOWNLOADABLE AUDIO FILES, MULTIMEDIA FILES, TEXT FILES, EMAILS, WRITTEN DOCUMENTS, AUDIO MATERIAL, VIDEO MATERIAL AND GAMES FEATURING MUSIC, MUSICAL INSTRUCTION, MUSICAL TECHNIQUE AND MUSICAL THEORY; DOWNLOADABLE COMPUTER GAME SOFTWARE; EDUCATIONAL SOFTWARE FEATURING INSTRUCTION IN MUSIC; ELECTRONIC DIARIES; ELECTRONIC GAMES (ADAPTED FOR USE WITH AN EXTERNAL MONITOR OR DISPLAY); GAME CONTROLLERS FOR COMPUTER GAMES; GAME SOFTWARE; HANDHELD COMPUTERS, HANDHELD COMPUTER, ELECTRONIC AND VIDEO GAME CONSOLES; HEADPHONES; MEDIA PLAYERS; MICROPHONES; MP3 PLAYERS; PERSONAL STEREO; PROGRAMMED VIDEO GAMES(SOFTWARE); RADIOS; SOUND RECORDING APPARATUS; WEBCAMS; VIDEO GAME SOFTWARE; VIDEO GAME COMPUTER PROGRAMS, IN CLASS 9 (U.S. CLS. 21, 23, 26, 36 AND 38).

FOR: MUSICAL INSTRUMENTS; MUSICAL INSTRUMENT STANDS; SHEET MUSIC STANDS; TUNERS FOR MUSICAL INSTRUMENTS; CARRYING CASES FOR MUSICAL INSTRUMENTS; BOWS FOR MUSICAL INSTRUMENTS; REEDS FOR USE AS MOUTHPIECES OF WOODWIND MUSICAL INSTRUMENTS; MUSICAL ACCESSORIES, NAMELY, GUITAR STRINGS, GUITAR STRAPS, GUITAR PICKS, DRUM STICKS, SOUND EFFECT PEDALS FOR MUSICAL INSTRUMENTS, IN CLASS 15 (U.S. CLS. 2, 21 AND 36).

FOR: PRINTED MATTER, NAMELY, SONG BOOKS, MANUSCRIPT BOOKS AND SHEET MUSIC; BOOKS IN THE FIELD OF MUSIC; SHEET MUSIC IN THE FORM OF TABLATURE AND MUSICAL SCORES; STAFF PAPER FOR WRITING MUSIC; PRINTED LESSONS ON MUSIC, MUSICAL INSTRUCTION, MUSICAL TECHNIQUE AND MUSIC THEORY; POSTERS; PRINTED MUSIC CHARTS, IN CLASS 16 (U.S. CLS. 2, 5, 22, 23, 29, 37, 38 AND 50).

FOR: HAND HELD UNITS FOR PLAYING ELECTRONIC GAMES OTHER THAN THOSE ADAPTED FOR USE WITH AN EXTERNAL DISPLAY SCREEN OR MONITOR; ELECTRONIC GAMES OTHER THAN THOSE ADAPTED FOR USE WITH TELEVISION RECEIVERS ONLY; STAND ALONE VIDEO GAME MACHINES; TOY MUSICAL INSTRUMENTS; MINIATURE TOY MUSICAL INSTRUMENTS, IN CLASS 28 (U.S. CLS. 22, 23, 38 AND 50).

FOR: ONLINE RETAIL STORE SERVICES FEATURING MUSICAL SOUND RECORDINGS, MUSICAL VIDEO RECORDINGS, AND MUSICAL EDUCATIONAL RECORDINGS AND DOWNLOADABLE MUSICAL SOUND, MUSICAL VIDEO, AND MUSICAL EDUCATIONAL RECORDINGS VIA A GLOBAL COMPUTER NETWORK, IN CLASS 35 (U.S. CLS. 100, 101 AND 102).

FOR: ENTERTAINMENT SERVICES, PRODUCTION OF TELEVISION AND RADIO PROGRAMS, ANIMATED AND LIVE ACTION TELEVISION SERIES AND THEATRICAL PRODUCTION; AUDIO RECORDING AND PRODUCTION; VIDEO RECORDING AND PRODUCTION; ENTERTAINMENT SERVICES, NAMELY, PROVIDING ONLINE COMPUTER AND VIDEO GAMES; MOTION PICTURE FILM PRODUCTION AND MOTION PICTURE SONG PRODUCTION; MUSIC VIDEO PRODUCTION; LIVE PERFORMANCE BY A MUSICAL GROUP, IN CLASS 41 (U.S. CLS. 100, 101 AND 107).

THE MARK CONSISTS OF STANDARD CHARACTERS WITHOUT CLAIM TO ANY PARTICULAR FONT, STYLE, SIZE, OR COLOR.

PRIORITY DATE OF 2-18-2010 IS CLAIMED.

OWNER OF INTERNATIONAL REGISTRATION 1051453 DATED 8-16-2010, EXPIRES 8-16-2020.

OWNER OF U.S. REG. NO. 3,832,088.

Reg. No. 4,072,471 NO CLAIM IS MADE TO THE EXCLUSIVE RIGHT TO USE "MUSIC GAMEPLAY", APART FROM THE MARK AS SHOWN.

SER. NO. 79-087,494, FILED 8-16-2010.

EDWARD NELSON, EXAMINING ATTORNEY

United States of America

United States Patent and Trademark Office

Tsé & Tsé

associées

Reg. No. 4,072,472

Registered Dec. 20, 2011

Int. Cls.: 11 and 21

TRADEMARK

PRINCIPAL REGISTER

CATHERINE LEVY (FRANCE INDIVIDUAL)
15 RUE DE LA FORGE ROYALE
PARIS, FRANCE F75011 AND

SIGOLÈNE PREBOIS (FRANCE INDIVIDUAL)
62 RUE DE MONTREUIL
PARIS, FRANCE F75011

FOR: LIGHTING APPARATUS, NAMELY, DECORATIVE LAMPS , IN CLASS 11 (U.S. CLS. 13, 21, 23, 31 AND 34).

FOR: TABLEWARE, NAMELY, SERVING FORKS, SERVING SPOONS, DISHES, PLATES, DRINKING GLASSES, BOWLS, TEA POTS, TEA CUPS, COFFEE CUPS, SALT FLASKS, PEPPER FLASKS, CARAFES AND HOUSEHOLD UTENSILS, NAMELY, ROLLING PINS, SPATULAS, WHISKS, TURNERS, KITCHEN LADLES, BOTTLE OPENERS, CORKSCREWS; VASES NOT OF PRECIOUS METAL, IN CLASS 21 (U.S. CLS. 2, 13, 23, 29, 30, 33, 40 AND 50).

NO CLAIM IS MADE TO THE EXCLUSIVE RIGHT TO USE "ASSOCIÉES", APART FROM THE MARK AS SHOWN.

OWNER OF INTERNATIONAL REGISTRATION 1052274 DATED 7-1-2010, EXPIRES 7-1-2020.

THE MARK CONSISTS OF THE LITERAL ELEMENTS "TSÉ & TSÉ ASSOCIÉES" WITH DESIGNS OF TWO BUTTERFLIES APPEARING ABOVE "ASSOCIÉES" AND BELOW "TSÉ & TSÉ".

THE ENGLISH TRANSLATION OF "ASSOCIÉES" IN THE MARK IS "ASSOCIATES".

SER. NO. 79-087,774, FILED 7-1-2010.

ELIZABETH KAJUBI, EXAMINING ATTORNEY



David J. Kybas

Director of the United States Patent and Trademark Office

United States of America

United States Patent and Trademark Office

BrainSourz 

Reg. No. 4,072,473

Registered Dec. 20, 2011

Int. Cls.: 9, 35 and 42

TRADEMARK

SERVICE MARK

PRINCIPAL REGISTER

REBSTÖCK MARTIN (CZECH REPUBLIC INDIVIDUAL)
VÁCLAVSKÉ NÁMESTÍ 832/19
CZ-110 00 PRAHA
CZECH REPUBLIC

FOR: COMPUTER SOFTWARE FOR USE IN DATA MANAGEMENT, IN CLASS 9 (U.S. CLS. 21, 23, 26, 36 AND 38).

FOR: DATA PROCESSING, DATA BASE MANAGEMENT, HUMAN RESOURCES CONSULTANCY, ONLINE RETAIL STORE SERVICES IN THE FIELD OF COMPUTER SOFTWARE, COMPUTER NETWORK SERVICES IN THE FIELD OF THE PERSONAL MANAGEMENT, NAMELY, ON-LINE EMPLOYMENT PLACEMENT SERVICES, NAMELY, MATCHING RESUMES AND POTENTIAL EMPLOYERS VIA A GLOBAL NETWORK, IN CLASS 35 (U.S. CLS. 100, 101 AND 102).

FOR: SOFTWARE DEVELOPMENT, CONSULTANCY IN THE FIELD OF COMPUTER SOFTWARE AND HARDWARE IN THE FIELD OF PERSONAL MANAGEMENT, IN CLASS 42 (U.S. CLS. 100 AND 101).

THE MARK CONSISTS OF THE WORDING "BRAINSOURZ" WITH A DESIGN OF A MOLECULAR STRUCTURE WITH 5 BRANCHES OF MOLECULES EMANATING FROM THE CENTER WITHIN A RECTANGULAR BACKGROUND. THE COLOR BLACK APPEARS IN THE WORD "BRAINSOURZ", THE COLOR BLUE APPEARS IN THE DOT OVER THE LETTER "I" AND THE RECTANGULAR BACKGROUND, AND THE COLOR WHITE APPEARS IN THE DESIGN OF THE MOLECULAR STRUCTURE.

PRIORITY DATE OF 4-13-2010 IS CLAIMED.

OWNER OF INTERNATIONAL REGISTRATION 1052846 DATED 4-26-2010, EXPIRES 4-26-2020.

THE COLOR(S) BLACK, BLUE AND WHITE IS/ARE CLAIMED AS A FEATURE OF THE MARK.

SER. NO. 79-087,987, FILED 4-26-2010.

CARYN GLASSER, EXAMINING ATTORNEY



David J. Kyros

Director of the United States Patent and Trademark Office

United States of America

United States Patent and Trademark Office

Norres

Reg. No. 4,072,474

Registered Dec. 20, 2011

Int. Cl.: 17

TRADEMARK

PRINCIPAL REGISTER

NORRES SCHLAUCHTECHNIK GMBH & CO. KG (FED REP GERMANY GMBH & CO. KG)
FREILIGRATHSTR. 38
GELSENKIRCHEN, FED REP GERMANY 45881

FOR: NON METAL HOSES FOR USE IN INDUSTRIAL APPLICATIONS; NON METAL HOSES FOR USE IN THE CHEMICAL INDUSTRY; NON METAL HOSES FOR USE IN THE FOOD INDUSTRY; PLASTIC HOSES, IN PARTICULAR FLEXIBLE PLASTIC HOSES FOR USE IN INDUSTRIAL APPLICATIONS; PLASTIC HOSES, IN PARTICULAR FLEXIBLE PLASTIC HOSES FOR USE IN THE CHEMICAL INDUSTRY; PLASTIC HOSES IN PARTICULAR FLEXIBLE PLASTIC HOSES FOR USE IN THE FOOD INDUSTRY; PLASTIC WOUND HOSES, PLASTIC SPIRAL HOSES, PLASTIC SPIRAL HOSES WITH SUPPORT COILS FOR USE IN INDUSTRIAL APPLICATIONS; PLASTIC WOUND HOSES, PLASTIC SPIRAL HOSES, PLASTIC SPIRAL HOSES WITH SUPPORT COILS FOR USE IN THE CHEMICAL INDUSTRY; PLASTIC WOUND HOSES, PLASTIC SPIRAL HOSES, PLASTIC SPIRAL HOSES WITH SUPPORT COILS FOR USE IN THE FOOD INDUSTRY; PLASTIC EXTRACTION HOSES, PLASTIC FEET HOSES AND NON-METAL CONNECTION PIECES FOR HOSES FOR USE IN INDUSTRIAL APPLICATIONS; PLASTIC EXTRACTION HOSES, PLASTIC FEET HOSES AND NON-METAL CONNECTION PIECES FOR HOSES FOR USE IN THE CHEMICAL INDUSTRY; PLASTIC EXTRACTION HOSES, PLASTIC FEET HOSES AND NON-METAL CONNECTION PIECES FOR HOSES FOR USE IN THE FOOD INDUSTRY, IN CLASS 17 (U.S. CLS. 1, 5, 12, 13, 35 AND 50).



OWNER OF INTERNATIONAL REGISTRATION 0903406 DATED 7-20-2006, EXPIRES 7-20-2016.

SER. NO. 79-088,058, FILED 10-1-2010.

KRISTIN CARLSON, EXAMINING ATTORNEY

David J. Kyjars

Director of the United States Patent and Trademark Office

United States of America

United States Patent and Trademark Office

TRIMANO

Reg. No. 4,072,475

Registered Dec. 20, 2011

Int. Cl.: 10

MAQUET GMBH & CO.KG (FED REP GERMANY LIMITED PARTNERSHIP WITH A LIMITED LIABILITY COMPANY AS GENERAL PARTNER)
KEHLER STRAÙE 31
76437 RASTATT
FED REP GERMANY

TRADEMARK

PRINCIPAL REGISTER

FOR: OPERATING TABLES; ACCESSORIES FOR OPERATING TABLES, NAMELY, HEAD RESTS, ARM RESTS, LEG RESTS, BODY SUPPORTS, BODY CUSHIONS, BODY STRAPS AND RESTRAINTS, KNEE CRUTCHES, STIRRUPS, TUBE HOLDERS, INFUSION STANDS, RADIAL SETTING CLAMPS, ANAESTHESIA SCREENS, INSTRUMENT TRAYS, TABLE EXTENDERS, SECRETIONS BASINS, SPLASH GUARD COVERS, PAPER ROLL HOLDERS, SIDE RAILS, PVC PROTECTIVE COVERS, X-RAY CASSETTE HOLDERS, IMAGE INTENSIFIERS; TABLES AND CHAIRS FOR THE EXAMINATION AND TREATMENT OF PATIENTS; AS WELL AS ACCESSORIES FOR TABLES AND CHAIRS FOR THE EXAMINATION AND TREATMENT OF PATIENTS, NAMELY, HEAD RESTS, ARM RESTS, LEG RESTS, BODY SUPPORTS, BODY CUSHIONS, BODY STRAPS AND RESTRAINTS, KNEE CRUTCHES, STIRRUPS, TUBE HOLDERS, INFUSION STANDS, RADIAL SETTING CLAMPS, ANAESTHESIA SCREENS, INSTRUMENT TRAYS, TABLE EXTENDERS, SECRETIONS BASINS, SPLASH GUARD COVERS, PAPER ROLL HOLDERS, SIDE RAILS, PVC PROTECTIVE COVERS, X-RAY CASSETTE HOLDERS, IMAGE INTENSIFIERS; SUPPORT ARMS FOR SUPPORTING, CARRYING AND ALIGNING MEDICAL DEVICES AND MEDICAL ACCESSORIES, NAMELY, HEAD RESTS, ARM RESTS, LEG RESTS, BODY SUPPORTS, BODY CUSHIONS, BODY STRAPS AND RESTRAINTS, KNEE CRUTCHES, STIRRUPS, TUBE HOLDERS, INFUSION STANDS, RADIAL SETTING CLAMPS, ANAESTHESIA SCREENS, INSTRUMENT TRAYS, TABLE EXTENDERS, SECRETIONS BASINS, SPLASH GUARD COVERS, PAPER ROLL HOLDERS, SIDE RAILS, PVC PROTECTIVE COVERS, X-RAY CASSETTE HOLDERS, IMAGE INTENSIFIERS, IN CLASS 10 (U.S. CLS. 26, 39 AND 44).



THE MARK CONSISTS OF STANDARD CHARACTERS WITHOUT CLAIM TO ANY PARTICULAR FONT, STYLE, SIZE, OR COLOR.

PRIORITY DATE OF 4-6-2010 IS CLAIMED.

David J. Kyffers

OWNER OF INTERNATIONAL REGISTRATION 1053951 DATED 9-14-2010, EXPIRES 9-14-2020.

Director of the United States Patent and Trademark Office

SER. NO. 79-088,358, FILED 9-14-2010.

Reg. No. 4,072,475 LAURIE MAYES, EXAMINING ATTORNEY

United States of America

United States Patent and Trademark Office

ENTRON

Reg. No. 4,072,476

Registered Dec. 20, 2011

Int. Cl.: 7

TRADEMARK

PRINCIPAL REGISTER

ULVAC, INC. (JAPAN CORPORATION)
2500 HAGISONO
CHIGASAKI-SHI; KANAGAWA 253-8543
JAPAN

FOR: VACUUM VAPOR DEPOSITION APPARATUS FOR MANUFACTURING SEMICONDUCTOR DEVICES; SPUTTERING APPARATUS FOR MANUFACTURING SEMICONDUCTOR DEVICES; CHEMICAL VAPOR DEPOSITION APPARATUS FOR MANUFACTURING SEMICONDUCTOR DEVICES; PLASMA CVD (CHEMICAL VAPOR DEPOSITION) APPARATUS FOR MANUFACTURING SEMICONDUCTOR DEVICES; INTEGRATED CIRCUITS MANUFACTURING MACHINES; SEMICONDUCTOR WAFER PROCESSING APPARATUS, IN CLASS 7 (U.S. CLS. 13, 19, 21, 23, 31, 34 AND 35).

THE MARK CONSISTS OF STANDARD CHARACTERS WITHOUT CLAIM TO ANY PARTICULAR FONT, STYLE, SIZE, OR COLOR.

PRIORITY DATE OF 8-10-2010 IS CLAIMED.

OWNER OF INTERNATIONAL REGISTRATION 1054069 DATED 8-25-2010, EXPIRES 8-25-2020.

SER. NO. 79-088,391, FILED 8-25-2010.

MARILYN IZZI, EXAMINING ATTORNEY



David J. Kyffers

Director of the United States Patent and Trademark Office

United States of America

United States Patent and Trademark Office

WEGO 威高

Reg. No. 4,072,477

Registered Dec. 20, 2011

Int. Cl.: 10

TRADEMARK

PRINCIPAL REGISTER

WEIGAO GROUP CO., LTD. (CHINA CORPORATION)
NO. 312 SHICHANG ROAD
WEIHAI; SHANDONG
CHINA

FOR: SYRINGES FOR MEDICAL PURPOSES AND FOR INJECTIONS; DROPPERS FOR ADMINISTERING MEDICATION, SOLD EMPTY; INJECTORS FOR MEDICAL PURPOSES; MEDICAL APPARATUS AND INSTRUMENTS, NAMELY, APPARATUS FOR TAKING BLOOD, TUBES FOR TAKING BLOOD, PUNCTURE NEEDLES, CHAIRS FOR USE IN TAKING BLOOD, ULTRAVIOLET, VISIBLE OR INFRA-RED LIGHT BOXES FOR KILLING BACTERIA AND VIRUS IN BLOOD, BOXES FOR BLOOD PRECIPITATION, BLOOD STORAGE DEVICE; MEDICAL APPARATUS AND INSTRUMENTS, NAMELY, STERILIZATION UNITS FOR MEDICAL AND SURGICAL PURPOSES; MEDICAL APPARATUS AND INSTRUMENTS, NAMELY, ANESTHESIA MACHINES FOR MEDICAL AND SURGICAL PURPOSES; MEDICAL APPARATUS AND INSTRUMENTS, NAMELY, MEDICAL STENTS FOR USE IN ESOPHAGUS, BILIARY TRACT AND URINARY TRACT; MEDICAL APPARATUS AND INSTRUMENTS, NAMELY, MEDICAL ENDOSCOPES FOR USE IN NOSE, EARS, UTERUS, THROAT, URETHRA, SIGMOID COLON AND RECTUM, MEDICAL SUPPORTING LARYNGOSCOPE; MEDICAL APPARATUS AND INSTRUMENTS, NAMELY, SURGICAL ENDOSCOPES FOR USE IN NOSE, URETHRA AND SIGMOID COLON, SURGICAL SUPPORTING LARYNGOSCOPE; MEDICAL APPARATUS AND INSTRUMENTS, NAMELY, DIALYSIS MACHINES FOR TREATING DISEASE IN THE BLOOD SYSTEM; MEDICAL APPARATUS AND INSTRUMENTS, NAMELY, MEDICAL AND SURGICAL BLOOD TRANSFUSION APPARATUS; MEDICAL APPARATUS AND INSTRUMENTS, NAMELY, MEDICAL APPARATUS AND INSTRUMENTS FOR TREATING CARDIOVASCULAR DISEASE, SURGICAL APPARATUS FOR USE IN CARDIAC SURGERIES; APPARATUS FOR USE IN MEDICAL ANALYSIS, NAMELY, BLOOD PRESSURE MONITORS, DEVICES FOR ANALYZING BLOOD PRESSURE; APPARATUS FOR USE IN MEDICAL ANALYSIS, NAMELY, MEDICAL DEVICES FOR DETECTING AND MEASURING TUMOR MARKERS BY CHEMILUMINESCENCE, MEDICAL DEVICE FOR DETECTING CANCER; APPARATUS FOR USE IN MEDICAL ANALYSIS, NAMELY, MEDICAL DEVICE FOR DETECTING DIABETES BY CHEMILUMINESCENCE; APPARATUS FOR USE IN MEDICAL ANALYSIS, NAMELY, ELECTROCARDIOGRAPHS; APPARATUS FOR USE IN MEDICAL ANALYSIS, NAMELY, HEART PACEMAKERS; ARTIFICIAL TEETH; ROENTGEN APPARATUS FOR MEDICAL PURPOSES, NAMELY, X-RAY APPARATUS FOR MEDICAL USE; HEARING AIDS FOR THE DEAF; SURGICAL IMPLANTS COMPRISING ARTIFICIAL MATERIAL; SUTURE MATERIALS, IN CLASS 10 (U.S. CLS. 26, 39 AND 44).



David J. Kyros

Director of the United States Patent and Trademark Office

Reg. No. 4,072,477 THE MARK CONSISTS OF THE WORD "WEGO" AND TWO CHINESE CHARACTERS.

OWNER OF INTERNATIONAL REGISTRATION 1054179 DATED 8-17-2010, EXPIRES 8-17-2020.

THE NON-LATIN CHARACTERS IN THE MARK TRANSLITERATE TO "WEI GAO" AND THIS HAS NO MEANING IN A FOREIGN LANGUAGE.

THE WORDING "WEGO" HAS NO MEANING IN A FOREIGN LANGUAGE.

SER. NO. 79-088,420, FILED 8-17-2010.

RICHARD WHITE, EXAMINING ATTORNEY

United States of America

United States Patent and Trademark Office

MARIS Omega-3

Reg. No. 4,072,478

Registered Dec. 20, 2011

Int. Cls.: 4 and 5

IMPERIAL-OEL-IMPORT HANDELSGESELLSCHAFT MBH (FED REP GERMANY LIMITED LIABILITY COMPANY)
BERGSTRASSE 11
20095 HAMBURG
FED REP GERMANY

TRADEMARK

PRINCIPAL REGISTER

FOR: OILS FOR USE IN THE MANUFACTURE OF OTHER PRODUCTS, NAMELY, NON-EDIBLE FISH OIL ENRICHED WITH OMEGA-3 IN THE FORM OF POWDER, GRANULATE MATERIAL, AND EMULSION, NOT FOR MEDICAL PURPOSES, USED IN THE FURTHER MANUFACTURE OF FOODS PRODUCTS, BEVERAGES AND DIETARY SUPPLEMENTS, IN CLASS 4 (U.S. CLS. 1, 6 AND 15).

FOR: NUTRITIONAL ADDITIVES CONTAINING OMEGA-3 FOR MEDICAL PURPOSES USED IN FOODS, BEVERAGES AND DIETARY SUPPLEMENTS FOR HUMAN CONSUMPTION, IN CLASS 5 (U.S. CLS. 6, 18, 44, 46, 51 AND 52).

THE MARK CONSISTS OF STANDARD CHARACTERS WITHOUT CLAIM TO ANY PARTICULAR FONT, STYLE, SIZE, OR COLOR.

PRIORITY DATE OF 1-15-2010 IS CLAIMED.

OWNER OF INTERNATIONAL REGISTRATION 1054182 DATED 7-15-2010, EXPIRES 7-15-2020.

NO CLAIM IS MADE TO THE EXCLUSIVE RIGHT TO USE "OMEGA-3", APART FROM THE MARK AS SHOWN.

SER. NO. 79-088,422, FILED 7-15-2010.

CARRIE GENOVESE, EXAMINING ATTORNEY



David J. Kyffers

Director of the United States Patent and Trademark Office

United States of America

United States Patent and Trademark Office



Reg. No. 4,072,479

Registered Dec. 20, 2011

**Int. Cls.: 9, 25, 28, 41
and 42**

INTERNATIONAL ASSOCIATION OF ATHLETICS FEDERATIONS (MONACO
ASSOCIATION DE DROIT MONÉGASQUE)
17 RUE PRINCESSE FLORESTINE
MC-98000 MONACO
MONACO

TRADEMARK

SERVICE MARK

PRINCIPAL REGISTER

FOR: WEIGHING AND MEASURING APPARATUS AND INSTRUMENTS, NAMELY, HIGH JUMP MEASURING DEVICES, POLE VAULT HEIGHT MEASURERS, SCALES, BALANCES, LASER MEASURING SYSTEMS, TIMERS, ELECTRONIC TIMERS, TIME CLOCKS, SPEED INDICATORS, SPEEDOMETERS, INSTRUMENTS FOR MEASURING LENGTH, SENSORS FOR THE DETERMINATION OF TEMPERATURES, POSITIONS AND DISTANCES, MEASURING TAPES, WIND SLEEVES, WIND SOCKS FOR INDICATING WIND DIRECTION AND INTENSITY; SOUND RECORDING APPARATUS AND INSTRUMENTS; ACCESS CONTROL AND ALARM MONITORING SYSTEMS; ELECTRONIC SCOREBOARDS; IMPLEMENT CERTIFICATION UNITS, NAMELY, DEVICES FOR CERTIFYING THE ACCURACY OF MEASURING IMPLEMENTS; LIFE-SAVING AND TEACHING APPARATUS AND INSTRUMENTS, NAMELY, LIFE JACKETS, LIFE PRESERVERS, LIFE NETS, LIFE BELTS, LIFE-SAVING RAFTS, MEDICAL TEACHING MANNEQUINS; SURVEYING APPARATUS AND INSTRUMENTS, NAMELY, SURVEYING MACHINES AND INSTRUMENTS; APPARATUS AND INSTRUMENTS FOR CONDUCTING, SWITCHING, TRANSFORMING, ACCUMULATING, REGULATING OR CONTROLLING ELECTRICITY, NAMELY, ADAPTERS, CONDUITS, WINDING WIRES, ELECTRICAL CONDUCTORS, ELECTRIC SWITCHES, POWER SWITCHES, TRANSFORMERS, ELECTRIC ACCUMULATORS, VOLTAGE REGULATORS, ELECTRIC CONTROL PANELS, ELECTRICAL CONTROLLERS; PHOTOGRAPHIC AND CINEMATOGRAPHIC APPARATUS AND INSTRUMENTS, NAMELY, PHOTOGRAPHIC CAMERAS, PHOTOGRAPHIC PROJECTORS, PHOTOGRAPHIC FLASH UNITS FOR CAMERAS, CASES FOR PHOTOGRAPHIC APPARATUS, EXPOSED CAMERA AND SLIDE FILMS, EXPOSED CINEMATOGRAPHIC FILMS AND CINEMATOGRAPHIC FILMS FEATURING ATHLETICS AND SPORTS, CINEMATOGRAPHIC CAMERAS, CINEMATOGRAPHIC MACHINES AND APPARATUS; OPTICAL APPARATUS AND INSTRUMENTS, NAMELY, OPTICAL GLASSES, OPTICAL FRAMES, SUNGLASSES; APPARATUS FOR RECORDING, TRANSMISSION OR REPRODUCTION OF SOUND OR IMAGES; MOBILE PHONES AND ACCESSORIES FOR MOBILE PHONES, NAMELY, CASES FOR MOBILE PHONES, HANDS-FREE DEVICES FOR MOBILE PHONES, HEADSETS FOR MOBILE PHONES, KEYBOARDS FOR MOBILE PHONES, AND STRAPS FOR MOBILE PHONES; TELEVISIONS; VIDEO PROJECTORS, VIDEO RECORDERS, VIDEO SCREENS, VIDEO DISK PLAYERS; PERSONAL STEREOS, AUDIO SPEAKERS, AUDIO RECORDERS, DIGITAL AUDIO PLAYERS, AUDIO



David J. Kyjars

Director of the United States Patent and Trademark Office

Reg. No. 4,072,479 CABLES, AUDIO HEADPHONES; BLANK MAGNETIC DATA CARRIERS AND PRERECORDED MAGNETIC DATA CARRIERS FEATURING ATHLETICS AND SPORTS, RECORDING DISCS, NAMELY, BLANK RECORD DISKS, BLANK RECORDABLE OPTICAL DISCS AND PRE-RECORDED DIGITAL VIDEO DISCS FEATURING ATHLETICS AND SPORTS; AUTOMATIC VENDING MACHINES AND MECHANISMS FOR COIN-OPERATED APPARATUS; CASH REGISTERS, CALCULATING MACHINES, DATA PROCESSING EQUIPMENT AND COMPUTERS; FIRE EXTINGUISHERS, IN CLASS 9 (U.S. CLS. 21, 23, 26, 36 AND 38).

FOR: CLOTHING, NAMELY, SHIRTS, T-SHIRTS, TEAM SHIRTS, POLO SHIRTS, RUGBY SHIRTS, JERSEYS, PANTS, SHORTS, TOPS, BOTTOMS, DRESSES, SKIRTS, BLOUSES, UNDERWEAR, TRACK SUITS, TRACK PANTS, JOGGING SUITS, JOGGING OUTFITS, SWEAT JACKETS, SWEAT PANTS, SWEAT SHIRTS, SWEAT SHORTS, SWEAT SUITS, SINGLETS, JACKETS, COATS, COACHES' COATS, TIGHTS, ATHLETIC TIGHTS, UNDERGARMENTS, WRIST BANDS, RAIN PONCHOS; COMPRESSION GARMENTS FOR ATHLETIC OR OTHER NON-MEDICAL USE, NAMELY, COMPRESSION SOCKS, STOCKINGS, LEGGINGS, JERSEYS, VESTS, TROUSERS; KNIT SPORTSWEAR, NAMELY, KNIT BOTTOMS, KNIT TOPS, KNIT SHIRTS, KNIT SKIRTS, KNIT DRESSES AND POLO KNIT TOPS; OUTDOOR CLOTHING, NAMELY, JACKETS, COATS, MITTENS, GLOVES, RAINWEAR, PONCHOS, PULLOVERS, ANORAKS, COVERALLS, GILETS, SKIWEAR; FOOTWEAR, ATHLETIC FOOTWEAR, SHOES, SOCKS, STOCKINGS; HEADWEAR, HEADBANDS, HATS, CAPS, IN CLASS 25 (U.S. CLS. 22 AND 39).

FOR: GAMES, NAMELY, BOARD GAMES, CARD GAMES, DICE GAMES, ACTION SKILL GAMES, ACTION TARGET GAMES, AND ARCADE GAMES; PLAYTHINGS, NAMELY, TOY FIGURES, PLUSH TOYS, SQUEEZE TOYS, SOFT SCULPTURE TOYS, STUFFED TOY ANIMALS, MECHANICAL TOYS, MUSICAL TOYS, INFLATABLE TOYS, BATH TOYS, TOY VEHICLES, TOY WEAPONS, RUBBER CHARACTER TOYS, TOY CONSTRUCTION SETS, TOY HOOP SETS, PLASTIC CHARACTER TOYS; TRACK AND FIELD SPORTS EQUIPMENT, NAMELY, STARTING BLOCKS, HURDLES, NON-MOTORIZED HURDLE CARTS, SPARE HURDLE BARS, RELAY BATONS, LANE MARKERS, STEEPLE CHASE BARRIERS, STARTER'S STANDS, HIGH JUMP STANDARDS, HIGH JUMP CROSS BARS, HIGH JUMP LANDING AREAS COMPRISING LANDING MATS, FITTED COVERS FOR TRACK AND FIELD EQUIPMENT, POLE VAULT STANDARDS, POLE VAULT BAR PLACERS, POLE VAULT CROSS BARS, POLE VAULT FLEX BARS, POLE VAULT LANDING AREAS COMPRISING LANDING MATS, POLE VAULT RACKS, LONG JUMP DISTANCE INDICATORS IN THE NATURE OF DISTANCE MARKER BOARDS, TRIPLE JUMP DISTANCE INDICATORS IN THE NATURE OF DISTANCE MARKER BOARDS, TAKEOFF BOARDS AND TAKEOFF SYSTEMS COMPRISED PRIMARILY OF TAKEOFF BOARDS, DISCUSES, DISCUS CARRIER RACKS, DISCUS MARKER BOXES, DISCUS CAGES, MESH NETS FOR DISCUS CENTERS, JAVELINS, JAVELIN CARRIER RACKS, RUN UP MARKERS FOR USE IN TRACK AND FIELD EVENTS, TRACK AND FIELD EQUIPMENT IN THE NATURE OF HAMMERS, HAMMER CAGES FOR TRACK AND FIELD HAMMERS, HAMMER CONVERSION CIRCLES FOR TRACK AND FIELD, HAMMER CARRIER RACKS FOR TRACK AND FIELD HAMMERS, HAMMER HANDLES FOR TRACK AND FIELD HAMMERS, HAMMER WIRES FOR TRACK AND FIELD HAMMERS, SHOTS FOR USE IN SHOT PUT COMPETITIONS, SHOT PUT RETURN CHANNELS, CARRIER RACKS FOR SHOTS USED IN SHOT PUT COMPETITIONS, STOP BOARDS FOR USE IN SHOT PUT COMPETITIONS, DISTANCE MARKER BOXES FOR SHOT PUT, EXERCISE BENCHES, JUDGES FLAGS FOR USE IN ATHLETICS COMPETITIONS, NAMELY, TRACK AND FIELD EVENTS, WORLD RECORD INDICATOR MARKERS FOR USE IN ATHLETICS COMPETITIONS, NAMELY, TRACK AND FIELD EVENTS, CHAMPION RECORD INDICATOR MARKERS FOR USE IN ATHLETICS COMPETITIONS, NAMELY, TRACK AND FIELD EVENTS, QUALIFYING MARK INDICATOR MARKERS FOR USE IN ATHLETICS COMPETITIONS, NAMELY, TRACK AND FIELD EVENTS, SECTOR MARKING TAPE FOR USE IN ATHLETIC EVENTS, NAMELY, TRACK AND FIELD EVENTS, CHALK DISPENSERS FOR USE IN ATHLETIC EVENTS, RUN UP MARKERS FOR USE IN ATHLETIC EVENTS, NAMELY, TRACK AND FIELD EVENTS, LAP COUNTERS FOR USE IN TRACK AND FIELD EVENTS; SPORTS

Reg. No. 4,072,479 BALLS; BALLS FOR GAMES; SOCCER BALLS; VOLLEYBALLS; BASKETBALLS; RUGBY BALLS; FOOTBALLS; BALLS FOR INDOOR SOCCER; BEACH BALLS; FITNESS BALLS, NAMELY, EXERCISE BALLS; EXERCISE EQUIPMENT, NAMELY, INFLATABLE BALLS, PLAY BALLS, PLAYGROUND BALLS AND SURF BOARDS FOR PLAY USE; CHRISTMAS TREE DECORATIONS, IN CLASS 28 (U.S. CLS. 22, 23, 38 AND 50).

FOR: EDUCATION SERVICES, NAMELY, PROVIDING LIVE AND ON-LINE CLASSES, SEMINARS AND WORKSHOPS IN THE FIELDS OF ATHLETICS AND SPORTS; PROVIDING TRAINING COURSES IN THE FIELD OF SPORTS; ENTERTAINMENT SERVICES PROVIDED AT OR IN CONNECTION WITH ATHLETIC AND SPORTS EVENTS, NAMELY, ENTERTAINMENT IN THE NATURE OF LASER SHOWS, LIGHT SHOWS, AUDIO AND VISUAL PERFORMANCES BY ACTORS, MUSICAL BANDS, AND DANCERS, LIVE PERFORMANCES BY A MUSICAL BAND, PREPARATION OF SPECIAL EFFECTS, AND FIREWORKS DISPLAYS; ORGANIZATION OF SPORTS COMPETITIONS AND ORGANIZATION OF LOTTERIES; BETTING AND CASINO GAMING SERVICES LINKED TO SPORTING EVENTS; ENTERTAINMENT SERVICES FOR CLIENTS AND GUESTS AT SPORTING EVENTS, NAMELY, ARRANGING, ORGANIZING, CONDUCTING, AND HOSTING PARTIES AND SOCIAL ENTERTAINMENT EVENTS AT SPORTS AND ENTERTAINMENT EVENTS; ENTERTAINMENT SERVICES FOR CLIENTS AND GUESTS AT SPORTING EVENTS, NAMELY, PROVIDING FACILITIES FOR RECREATION ACTIVITIES AND PROVIDING TOURS OF STADIUMS AND SPORTS VENUES; PROVIDING A WEB SITE FEATURING PHOTOGRAPHS IN THE FIELD TRACK AND FIELD AND NON-DOWNLOADABLE AUDIO AND VIDEO RECORDINGS IN THE FIELD OF TRACK AND FIELD; TICKET RESERVATION AND BOOKING SERVICES FOR ENTERTAINMENT, SPORTING AND CULTURAL EVENTS; SPORTING AND CULTURAL ACTIVITIES, NAMELY, ORGANIZING ATHLETIC COMPETITIONS FEATURING TRACK AND FIELD EVENTS AND ORGANIZING EXHIBITIONS FOR SPORTING AND CULTURAL PURPOSES; ORGANIZING COMMUNITY SPORTING AND CULTURAL EVENTS; ORGANIZATION OF SPORTING AND CULTURAL EVENTS; ORGANIZING AND HOSTING SOCIAL ENTERTAINMENT, SPORTING, AND CULTURAL EVENTS RELATED TO AMERICAN FOOTBALL; PROVIDING SPORTS FACILITIES; RENTAL OF VIDEO AND AUDIOVISUAL SYSTEMS; PRODUCTION, PRESENTATION, DISTRIBUTION AND RENTAL OF CINEMATOGRAPHIC RECORDINGS AND AUDIO AND VIDEO RECORDINGS; PRODUCTION AND RENTAL OF INTERACTIVE GOODS FOR EDUCATIONAL AND ENTERTAINMENT PURPOSES, NAMELY, INTERACTIVE COMPACT DISCS, DVDS, MINIDISCS, CD-ROMS AND COMPUTER GAMES; PRODUCTION SERVICES FOR RADIO AND TELEVISION PROGRAMS AND VIDEOTAPES; BOOKING SEATS FOR SPORTS AND ENTERTAINMENT EVENTS, ARRANGING TICKET RESERVATIONS FOR SPORTS AND ENTERTAINMENT EVENTS, AND PROVIDING INFORMATION ABOUT TICKET RESERVATIONS FOR SPORTS AND ENTERTAINMENT EVENTS; ENTERTAINMENT TICKET AGENCY SERVICES; TICKET AGENCY SERVICES FOR SPORTING AND ENTERTAINMENT EVENTS; TIMING OF SPORTING EVENTS; INTERACTIVE ENTERTAINMENT, NAMELY, PROVIDING ON-LINE COMPUTER GAMES THAT MAY BE ACCESSED NETWORK-WIDE BY NETWORK USERS AND PROVIDING ON-LINE GAMES OVER A GLOBAL COMPUTER NETWORK AND VIA WIRELESS ELECTRONIC COMMUNICATION DEVICES; ON-LINE INTERNET GAMBLING AND BETTING SERVICES ON ALL WIRELESS ELECTRONIC COMMUNICATION NETWORKS; PROVIDING LOTTERY SERVICES; PROVIDING INFORMATION IN THE FIELDS OF ENTERTAINMENT AND SPORTS AND PROVIDING INFORMATION IN THE FIELDS OF ENTERTAINMENT AND SPORTS VIA ONLINE COMPUTER DATABASE, THE INTERNET, AND WIRELESS ELECTRONIC COMMUNICATION NETWORKS; ELECTRONIC GAME SERVICES PROVIDED BY MEANS OF THE INTERNET AND MOBILE PHONES; PUBLICATION OF BOOKS; ON-LINE EDITING OF ELECTRONIC BOOKS AND JOURNALS; AUDIO AND VIDEO RECORDING SERVICES; PRODUCTION OF ANIMATED CARTOONS FOR THE CINEMA; PRODUCTION OF ANIMATED CARTOONS FOR TELEVISION; RENTAL OF SOUND AND MOTION PICTURE RECORDINGS, FOR ENTERTAINMENT PURPOSES; PROVIDING EDUCATIONAL INFORMATION IN THE FIELD OF ATHLETICS AND SPORTS PROVIDED ON-LINE VIA A COMPUTER DATABASE, THE INTERNET, AND WIRELESS ELECTRONIC COMMUNICATION NETWORKS; TRANSLATION SERVICES; PHOTOGRAPHY SERVICES; PROVIDING

Reg. No. 4,072,479 AMUSEMENT FACILITIES, PROVIDING FACILITIES FOR RECREATION ACTIVITIES, PROVIDING VARIOUS FACILITIES FOR AN ARRAY OF SPORTING EVENTS, SPORTS AND ATHLETIC COMPETITIONS AND AWARDS PROGRAMS, PROVIDING FACILITIES FOR SPORTS TOURNAMENTS, PROVIDING PLAY FACILITIES FOR CHILDREN, RENTAL OF STADIUM FACILITIES, IN CLASS 41 (U.S. CLS. 100, 101 AND 107).

FOR: COMPUTER HARDWARE AND SOFTWARE CONSULTING SERVICES; DEVELOPMENT AND CREATION OF COMPUTER PROGRAMS FOR DATA PROCESSING; COMPUTER PROGRAMMING; PROVIDING TEMPORARY USE OF NON-DOWNLOADABLE COMPUTER SOFTWARE FOR DESIGNING AND IMPLEMENTING ON DEMAND WEB SITES IN THE NATURE OF TURNKEY PACKAGES ALLOWING CUSTOMERS TO CREATE E-COMMERCE WEB SITES; RENTAL OF COMPUTERS; DESIGN OF WEB SITES ON COMPUTER NETWORKS, THE INTERNET, OR VIA WIRELESS ELECTRONIC COMMUNICATION DEVICES; UPLOADING WEB SITES ONTO INTERNET SERVERS FOR COMPUTER NETWORKS, THE INTERNET, OR VIA WIRELESS ELECTRONIC COMMUNICATION DEVICES; HOSTING INTERNET WEB SITES; HOSTING ON-LINE WEB FACILITIES FOR OTHERS FOR ORGANIZING AND CONDUCTING ONLINE MEETINGS, GATHERINGS, AND INTERACTIVE DISCUSSIONS; HOSTING ON-LINE WEB FACILITIES FOR OTHERS; HOSTING OF WEBSITES ON WIRELESS ELECTRONIC COMMUNICATION NETWORKS; DESIGN AND MAINTENANCE OF INTERNET SITES FOR OTHERS; DESIGN OF WIRELESS ELECTRONIC COMMUNICATION NETWORKS FOR OTHERS; DEVELOPMENT OF NETWORKING COMPUTER PROGRAMS, NAMELY, DEVELOPMENT OF COMPUTER PROGRAMS FOR SECURE NETWORK OPERATIONS AND INTEGRATION OF COMPUTER SOFTWARE INTO MULTIPLE SYSTEMS AND NETWORKS; INSTALLATION AND MAINTENANCE OF COMPUTER SOFTWARE; DEVELOPMENT OF COMPUTER SOFTWARE; PROVIDING SEARCH ENGINES FOR THE INTERNET; TESTING, ANALYSIS AND EVALUATION OF MOTORS, ENGINES, AND MACHINES INCLUDING USE OF MODELS AND INCLUDING ROOT CAUSE TESTING, ANALYSIS, AND EVALUATION OF FAULTS AND MALFUNCTIONS; PROVIDING ADVICE IN THE FIELD OF PRODUCT FAILURE ANALYSIS IN THE FIELDS OF MOTORS, ENGINES AND MACHINES; QUALITY CONTROL SERVICES FOR OTHERS FOR THE TESTING, LUBRICATION, MAINTENANCE AND REPAIR OF VEHICLES, MOTORS, ENGINES AND MACHINES; ELECTRONIC CALIBRATION SERVICES FOR MOTORS, ENGINES AND TRANSMISSIONS, IN CLASS 42 (U.S. CLS. 100 AND 101).

OWNER OF U.S. REG. NOS. 2,679,839 AND 3,867,612.

PRIORITY DATE OF 2-26-2010 IS CLAIMED.

OWNER OF INTERNATIONAL REGISTRATION 1054419 DATED 4-30-2010, EXPIRES 4-30-2020.

NO CLAIM IS MADE TO THE EXCLUSIVE RIGHT TO USE "ATHLETICS" FOR INTERNATIONAL CLASSES 9, 25, 28 AND 41, APART FROM THE MARK AS SHOWN.

THE MARK CONSISTS OF THE LETTERS "IAAF" ABOVE THE TERM "ATHLETICS"; THREE CURVED LINES REPRESENTING A TRACK AND A STYLIZED RUNNER WITH HIS ARMS EXTENDED UPWARD APPEAR TO THE LEFT OF THE "IAAF" AND "ATHLETICS" ELEMENTS.

SER. NO. 79-088,516, FILED 4-30-2010.

CHRISTOPHER BUONGIORNO, EXAMINING ATTORNEY

United States of America

United States Patent and Trademark Office

MY IC PHONE

Reg. No. 4,072,480

Registered Dec. 20, 2011

Int. Cl.: 9

TRADEMARK

PRINCIPAL REGISTER

ALCATEL LUCENT (FRANCE SOCIÉTÉ ANONYME)
3 AVENUE OCTAVE GRÉARD
F-75007 PARIS
FRANCE

FOR: TELEPHONE APPARATUS, IN CLASS 9 (U.S. CLS. 21, 23, 26, 36 AND 38).

THE MARK CONSISTS OF STANDARD CHARACTERS WITHOUT CLAIM TO ANY PARTICULAR FONT, STYLE, SIZE, OR COLOR.

PRIORITY DATE OF 4-2-2010 IS CLAIMED.

OWNER OF INTERNATIONAL REGISTRATION 1054626 DATED 9-27-2010, EXPIRES 9-27-2020.

NO CLAIM IS MADE TO THE EXCLUSIVE RIGHT TO USE "PHONE", APART FROM THE MARK AS SHOWN.

SER. NO. 79-088,613, FILED 9-27-2010.

TINA BROWN, EXAMINING ATTORNEY



David J. Kyros

Director of the United States Patent and Trademark Office

United States of America

United States Patent and Trademark Office

ME US WE

Reg. No. 4,072,481

Registered Dec. 20, 2011

Int. Cl.: 20

SCHIAVELLO (VIC) PTY LTD (AUSTRALIA AN AUSTRALIAN PRIVATE CORPORATION
LIMITED BY SHARES)
1 SHARPS ROAD
TULLAMARINE VIC 3043
AUSTRALIA

TRADEMARK

PRINCIPAL REGISTER

FOR: OFFICE FURNITURE, IN CLASS 20 (U.S. CLS. 2, 13, 22, 25, 32 AND 50).

THE MARK CONSISTS OF STANDARD CHARACTERS WITHOUT CLAIM TO ANY PARTICULAR FONT, STYLE, SIZE, OR COLOR.

OWNER OF INTERNATIONAL REGISTRATION 1054866 DATED 9-1-2010, EXPIRES 9-1-2020.

SER. NO. 79-088,695, FILED 9-1-2010.

REBECCA SMITH, EXAMINING ATTORNEY



David J. Kyffers

Director of the United States Patent and Trademark Office

United States of America

United States Patent and Trademark Office

STAYCONNECTED

Reg. No. 4,072,482

Registered Dec. 20, 2011

Int. Cls.: 16, 35 and 41

TRADEMARK

SERVICE MARK

PRINCIPAL REGISTER

RADIO FREQUENCY SYSTEMS FRANCE (FRANCE SOCIÉTÉ PAR ACTIONS SIMPLIFIÉE)
32 AVENUE KLÉBER
F-92700 COLOMBES
FRANCE

FOR: PUBLICATIONS, NAMELY, MAGAZINES FEATURING THE SUBJECT OF RADIO COMMUNICATION SYSTEMS AND EQUIPMENT, IN CLASS 16 (U.S. CLS. 2, 5, 22, 23, 29, 37, 38 AND 50).

FOR: ORGANIZATION OF EXHIBITIONS FOR COMMERCIAL OR ADVERTISING PURPOSES RELATING TO RADIO COMMUNICATION SYSTEMS AND EQUIPMENT, IN CLASS 35 (U.S. CLS. 100, 101 AND 102).

FOR: ORGANIZATION OF CONFERENCES, COLLOQUIUMS, SEMINARS, EXHIBITIONS FOR EDUCATIONAL PURPOSES AND TRAINING WORKSHOPS RELATING TO RADIO COMMUNICATION SYSTEMS AND EQUIPMENT; PUBLICATION OF BOOKS AND MAGAZINES ON LINE RELATING TO RADIO COMMUNICATION SYSTEMS AND EQUIPMENT, IN CLASS 41 (U.S. CLS. 100, 101 AND 107).

THE MARK CONSISTS OF STANDARD CHARACTERS WITHOUT CLAIM TO ANY PARTICULAR FONT, STYLE, SIZE, OR COLOR.

PRIORITY DATE OF 4-2-2010 IS CLAIMED.

OWNER OF INTERNATIONAL REGISTRATION 1055162 DATED 9-29-2010, EXPIRES 9-29-2020.

SER. NO. 79-088,812, FILED 9-29-2010.

JOHN DALIER, EXAMINING ATTORNEY



David J. Kyffers

Director of the United States Patent and Trademark Office

United States of America
United States Patent and Trademark Office

KENDO

Reg. No. 4,072,483

Registered Dec. 20, 2011

Int. Cl.: 8

TRADEMARK

PRINCIPAL REGISTER

LINEAR TOOLS LTD (UNITED KINGDOM LIMITED)
UNIT 1, CLOCKTOWER INDUSTRIAL ESTATE
CLOCKTOWER ROAD
ISLEWORTH, MIDDLESEX TW7 6DT, UNITED KINGDOM

FOR: HAND TOOLS AND HAND-OPERATED IMPLEMENTS, NAMELY, PLIERS, CUTTERS, NAMELY, WIRE CUTTERS AND PIPE CUTTERS; WRENCHES, SPANNERS, RATCHET WRENCHES, SOCKET SETS, EXTENSION BARS, SLIDING T-BARS, ADAPTERS, SPARK PLUG SOCKETS, SPINNERS, BIT ADAPTERS, SCREWDRIVERS, HEXAGON NUT DRIVERS, SCREWDRIVER BITS HOLDERS, HEX KEY WRENCHES, TORQUE KEY WRENCHES, HOBBY KNIFES, HAMMERS, MALLETS, CHISELS, STEEL FILES, WOOD RASPS, NEEDLE FILES, SANDING BOARDS, SAWS, SNAP OFF KNIFES, UTILITY KNIFES, CUTTERS, ELECTRICIAN'S KNIFES, SCISSORS, CABLE CUTTERS, TAILOR'S SCISSORS, PLANER FILES, SHAVE AND BLOCK PLANERS, AVIATION TIN SNIPS, BRUSHES FOR PUTTING A FINISH ON CONCRETE AND FOR APPLYING ADHESIVES; METAL VICE JAWS FOR PVC-COATED PIPE AND CONDUIT; CLAMPS, VISES, SCRAPERS, BRICKLAYING TROWELS, CAULKING GUNS, HAND RIVETERS, PLASTERBOARD PLANERS, MANUALLY OPERATED BOARD AND DOOR LIFTERS, SCREW RETAINERS, MAGNETIC PICK-UP TOOLS, STAPLE GUNS, HAMMER TACKERS, PLASTERING TROWELS, TAPPING KNIFES, WALLPAPER SMOOTHERS, SEALANT SMOOTHERS, IN CLASS 8 (U.S. CLS. 23, 28 AND 44).

OWNER OF INTERNATIONAL REGISTRATION 1055233 DATED 9-30-2010, EXPIRES 9-30-2020.

SER. NO. 79-088,836, FILED 9-30-2010.

RON FAIRBANKS, EXAMINING ATTORNEY



David J. Kypos

Director of the United States Patent and Trademark Office

United States of America

United States Patent and Trademark Office

Andres Machado

Reg. No. 4,072,484

Registered Dec. 20, 2011

Int. Cl.: 25

TRADEMARK

PRINCIPAL REGISTER

ANDRÉS MACHADO FERNANDEZ (SPAIN INDIVIDUAL)
AVENIDA SANTIAGO BERNABEU, 43
SANTA POLA; E-03130 ALICANTE
SPAIN

FOR: SHOES FOR MEN AND WOMEN INCLUDING HIGH HEEL AND LOW HEEL SHOES, BOOTS, LOAFERS, LACE SHOES, SANDALS, FLIP FLOPS, THONG SANDALS, AND CASUALS, IN CLASS 25 (U.S. CLS. 22 AND 39).

THE NAME "ANDRES MACHADO" IDENTIFIES A LIVING INDIVIDUAL WHOSE CONSENT IS OF RECORD.

PRIORITY DATE OF 5-5-2010 IS CLAIMED.

OWNER OF INTERNATIONAL REGISTRATION 1055482 DATED 5-10-2010, EXPIRES 5-10-2020.

SER. NO. 79-088,922, FILED 5-10-2010.

REBECCA POVARCHUK, EXAMINING ATTORNEY



David J. Kyffers

Director of the United States Patent and Trademark Office

United States of America

United States Patent and Trademark Office

ICEBERG

Reg. No. 4,072,485

Registered Dec. 20, 2011

**Int. Cls.: 3, 9, 14, 18, 21
and 25**

SEMINVEST INVESTMENTS B.V. (NETHERLANDS PRIVATE LIMITED LIABILITY CORPORATION)
BARONIELAAN 139
NL-4818 PD BREDA
NETHERLANDS

FOR: SOAPS; PERFUMERY, ESSENTIAL OILS, COSMETICS, HAIR LOTIONS, IN CLASS 3 (U.S. CLS. 1, 4, 6, 50, 51 AND 52).

TRADEMARK

PRINCIPAL REGISTER

FOR: OPTICAL APPARATUS AND INSTRUMENTS, NAMELY, GOGGLES, SPECTACLES, SUNGLASSES, EYE-GLASSES, LENSES, FRAMES, BARS IN THE NATURE OF PARTS OF EYEGLASS FRAMES, CASES AND CONTAINERS, ALL FOR SPECTACLES, PARTS OF, FITTINGS AND ACCESSORIES FOR ALL THE AFORESAID GOODS, IN CLASS 9 (U.S. CLS. 21, 23, 26, 36 AND 38).

FOR: PRECIOUS METALS AND THEIR ALLOYS; GOODS IN PRECIOUS METALS OR COATED THEREWITH, NOT INCLUDED IN OTHER CLASSES, NAMELY, CLOCKS, WATCHES, CHRONOMETERS; JEWELLERY, PRECIOUS STONES; HOROLOGICAL AND CHRONOMETRIC INSTRUMENTS, NAMELY, WATCHES, WRISTWATCHES, CLOCKS, CHRONOMETERS, TABLE CLOCKS, POCKET WATCHES, ALARM CLOCKS, IN CLASS 14 (U.S. CLS. 2, 27, 28 AND 50).

FOR: LEATHER AND IMITATIONS OF LEATHER; GOODS MADE OF LEATHER AND IMITATIONS OF LEATHER, NAMELY, BRIEFCASES, BAGS, WALLETS, BUSINESS CARD CASES, ATTACHE CASES, GARMENT BAGS FOR TRAVEL, SUITCASES, OVERNIGHT CASES, VANITY CASES SOLD EMPTY, KEY CASES; ANIMAL SKINS AND HIDES; TRUNKS AND TRAVELLING BAGS; UMBRELLAS, PARASOLS AND WALKING STICKS, IN CLASS 18 (U.S. CLS. 1, 2, 3, 22 AND 41).



David J. Kyffers

Director of the United States Patent and Trademark Office

FOR: HOUSEHOLD OR KITCHEN UTENSILS, NAMELY, NAPKIN HOLDERS, TOOTHPICK HOLDERS, BOTTLE OPENERS, CORK SCREWS, REAMERS FOR FRUIT JUICES, NON-ELECTRIC JUICERS, COFFEE STIRRERS; HOUSEHOLD OR KITCHEN CONTAINERS, NAMELY, TRASH CANS, BREAD BOXES, WINE BUCKETS, PLASTIC BUCKETS; JUGS, CANISTER SETS, INSULATING JARS, PITCHERS, BUTTER DISHES, DECANTERS, ICE BUCKETS; COMBS AND SPONGES FOR HOUSEHOLD USE; STEELWOOL; UNWORKED OR SEMI-WORKED GLASS (EXCEPT GLASS USED IN BUILDING); GLASSWARE, PORCELAIN AND EARTHENWARE, NAMELY,, CHINA ORNAMENTS, PLATES, SERVING

Reg. No. 4,072,485 PLATTERS, SAUCEPANS, SAUCERS, SOUP TUREENS, SERVING TRAYS NOT OF PRECIOUS METALS, CUPS, MUGS, DRINKING GLASSES, TEA AND COFFEE SERVICES NOT OF PRECIOUS METAL, TEA POTS NOT PRECIOUS METALS; BOWLS, MUGS, CUPS, DISHES, PITCHERS, PLATTERS AND SERVING TRAYS, IN CLASS 21 (U.S. CLS. 2, 13, 23, 29, 30, 33, 40 AND 50).

FOR: FOOTWEAR, IN CLASS 25 (U.S. CLS. 22 AND 39).

OWNER OF U.S. REG. NOS. 1,813,742, 3,583,201 AND OTHERS.

OWNER OF INTERNATIONAL REGISTRATION 1055684 DATED 10-12-2010, EXPIRES 10-12-2020.

SER. NO. 79-088,991, FILED 10-12-2010.

CAROLINE WOOD, EXAMINING ATTORNEY

United States of America

United States Patent and Trademark Office

Humming Heads Defense Platform

Reg. No. 4,072,486

Registered Dec. 20, 2011

Int. Cls.: 9 and 42

TRADEMARK

SERVICE MARK

PRINCIPAL REGISTER

HUMMING HEADS KABUSHIKI KAISHA (JAPAN CORPORATION)
2-13, 1-CHOME, TSUKISHIMA
CHUO-KU; TOKYO 104-0052
JAPAN

FOR: BLUEPRINTING MACHINES; CASH REGISTERS; COIN COUNTING OR SORTING MACHINES; ELECTRIC SIGN BOARDS FOR DISPLAYING TARGET FIGURES AND CURRENT OUTPUTS; PHOTO-COPYING MACHINES; COMPUTER SOFTWARE FOR COMPUTER AIDED DRAWING; TIME AND DATE STAMPING MACHINES; TIME CLOCKS; PUNCHED CARD OFFICE MACHINES, NAMELY, PUNCH CLOCKS; VOTING MACHINES; POSTAGE STAMP CHECKING APPARATUS MEASURING OR TESTING MACHINES AND INSTRUMENTS, NAMELY, POSTAGE STAMP METERS; STANDARD-UNIT MEASURING MACHINES AND APPARATUS, NAMELY, WEIGHING APPARATUS AND INSTRUMENTS, TEMPERATURE INDICATORS, THERMOMETERS, WATER METERS, WEIGHING BALANCES, PLANIMETERS, MEASURING RULES, DERIVED-UNIT MEASURING MACHINES AND APPARATUS, PRESSURE GAUGES, LEVEL INDICATORS, ACOUSTIC METERS, TACHOMETERS, ACCELEROMETERS, REFRACTOMETERS, LUMINOUS FLUX METERS, PHOTOMETERS, ALTIMETERS, HYGROMETERS, ILLUMINOMETERS, VIBRATION METERS, NOISEMETERS, SPEED INDICATORS, CALORIMETERS, VISCOSIMETERS, CONCENTRATION METERS, GRAVIMETERS, DENSIMETERS, DYNAMOMETERS, FLOWMETERS, PROFILE PROJECTORS; GRADUATION CHECKERS; AUTOMATED MACHINES AND INSTRUMENTS THAT ADJUST OR REGULATE THE PHYSICAL OR CHEMICAL PROPERTIES OF MATERIALS OR MACHINES; MACHINES AND INSTRUMENTS USED TO TEST PHYSICAL OR CHEMICAL PROPERTIES, OF METALLIC, CERAMIC, CONCRETE, AND ORGANIC MATERIALS; SURVEYING MACHINES AND INSTRUMENTS; DISTANCE MEASURING APPARATUS; ANALYSIS INSTRUMENTS FOR PHOTOGRAMMETRIC PURPOSES; PRECISION THEODOLITES; TELEPHONE APPARATUS; MOBILE PHONE; TELETYPEWRITERS; AUTOMATIC TELEGRAPH APPARATUS; PHOTOTELEGRAPHY APPARATUS; MANUAL TELEGRAPH APPARATUS; REPEATING EXCHANGE MACHINES, TELECOMMUNICATION SWITCHES; AUTOMATIC TELEPHONE EXCHANGE APPARATUS; APPARATUS FOR BROADCASTING, RECORDING, TRANSMISSION OR REPRODUCTION OF SOUNDS AND IMAGES AND APPARATUS FOR THE BROADCASTING, TRANSMISSION OR REPRODUCTION OF SIGNALS, NAMELY, RADIO RECEIVERS AND MONITORS FOR THE REPRODUCTION OF SOUND AND SIGNALS, APPARATUS FOR RECORDING AND REPRODUCTION OF SOUND, IMAGES AND DATA; DEVICES FOR WIRELESS RADIO TRANSMISSION; AERONAUTICAL RADIO COMMUNICATION MACHINES AND APPARATUS; MULTICHANNEL RADIO COMMUNICATION



David J. Kyffers

Director of the United States Patent and Trademark Office

Reg. No. 4,072,486 MACHINES AND APPARATUS FOR FIXED STATIONS; SINGLE-CHANNEL RADIO COMMUNICATION MACHINES AND APPARATUS FOR FIXED STATIONS; RADIO COMMUNICATION MACHINES AND APPARATUS FOR USE IN LAND VEHICLES; MARINE RADIO COMMUNICATION MACHINES AND APPARATUS; RADIO BEACON; RADIO DIRECTION FINDERS; REMOTE CONTROL TELEMETERS; COMPACT DISC PLAYERS; TAPE RECORDERS; RECORD PLAYERS; SOUND RECORDING MACHINES AND APPARATUS, NAMELY, AUDIO FREQUENCY APPARATUS IN THE NATURE OF ELECTRONIC PRODUCTS FOR THE MANIPULATION OF THE FREQUENCY OF AUDIO SIGNALS, NAMELY, AUDIO PROCESSORS; VIDEO FREQUENCY MACHINES AND APPARATUS, NAMELY, DIGITAL CAMERAS, VIDEO CAMERAS, VIDEODISC PLAYERS, VIDEOTAPE RECORDERS, DVD PLAYERS, DVD RECORDERS; LOUDSPEAKERS; TELEPHONE CONNECTORS, MICROPHONES FOR TELECOMMUNICATION APPARATUS; ELECTROSTATIC COPYING MACHINES; COMPUTERS; ELECTRONIC DESK CALCULATORS; HARD DISK DRIVES; WORD PROCESSORS; INTEGRATED CIRCUITS; VIDEO GAME MACHINES FOR USE WITH AN EXTERNAL DISPLAY SCREEN OR MONITOR; ELECTRONIC CIRCUITS AND CD-ROMS RECORDED WITH PROGRAMS FOR HAND-HELD GAMES WITH LIQUID CRYSTAL DISPLAYS; SOUND RECORDED MAGNETIC CARDS, SHEETS AND TAPES; COMPUTER GAME DISCS; ELECTRONIC CIRCUITS AND CD-ROMS RECORDED WITH AUTOMATIC PERFORMANCE PROGRAMS FOR ELECTRONIC MUSICAL INSTRUMENTS; DOWNLOADABLE MUSIC FILES; EXPOSED CINEMATOGRAPHIC FILMS; EXPOSED SLIDE FILMS; SLIDE FILM MOUNTS; DOWNLOADABLE IMAGE FILES FOR BUSINESS, ENTERTAINMENT AND EDUCATION PURPOSES; ELECTRONIC PUBLICATIONS, NAMELY, BOOKS OF POEMS, SHORT STORIES AND PLAYS, BOOKS IN THE FIELDS OF SOCIAL SCIENCE, POLITICS, BUSINESS, ECONOMICS, SCIENCE, TECHNOLOGY, ART, AND HOBBIES, GUIDE BOOKS, DICTIONARIES, AND ENCYCLOPEDIAS, AND GENERAL FEATURE MAGAZINES AND NEWSPAPERS, IN CLASS 9 (U.S. CLS. 21, 23, 26, 36 AND 38).

FOR: DESIGNING OF COMPUTERS AND COMPUTER-AIDED MACHINES, APPARATUS AND INSTRUMENTS INCLUDING THEIR PARTS OR SYSTEMS COMPOSED OF SUCH MACHINES, APPARATUS AND INSTRUMENTS; COMPUTER SOFTWARE DESIGN, COMPUTER PROGRAMMING, OR MAINTENANCE OF COMPUTER SOFTWARE; TECHNICAL ADVICE RELATING TO PERFORMANCE AND OPERATION OF COMPUTERS AND COMPUTER-AIDED MACHINES, APPARATUS AND INSTRUMENTS; TESTING OR RESEARCH ON MACHINES, APPARATUS AND INSTRUMENTS; RENTAL OF COMPUTERS, IN CLASS 42 (U.S. CLS. 100 AND 101).

THE MARK CONSISTS OF STANDARD CHARACTERS WITHOUT CLAIM TO ANY PARTICULAR FONT, STYLE, SIZE, OR COLOR.

PRIORITY DATE OF 3-18-2010 IS CLAIMED.

OWNER OF INTERNATIONAL REGISTRATION 1055717 DATED 6-29-2010, EXPIRES 6-29-2020.

OWNER OF U.S. REG. NOS. 3,440,212 AND 3,445,361.

NO CLAIM IS MADE TO THE EXCLUSIVE RIGHT TO USE "PLATFORM", APART FROM THE MARK AS SHOWN.

SER. NO. 79-089,003, FILED 6-29-2010.

SAIMA MAKHDOOM, EXAMINING ATTORNEY

United States of America
United States Patent and Trademark Office

Signom

Reg. No. 4,072,487

Registered Dec. 20, 2011

Int. Cls.: 35 and 45

SERVICE MARK

PRINCIPAL REGISTER

SIGNOM OY (FINLAND CORPORATION)
MIKONKATU 19
FI-00100 HELSINKI
FINLAND

FOR: ADVERTISING; BUSINESS MANAGEMENT; BUSINESS ADMINISTRATION; OFFICE FUNCTIONS, IN CLASS 35 (U.S. CLS. 100, 101 AND 102).

FOR: LEGAL SERVICES; SECURITY SERVICES FOR THE PROTECTION OF PROPERTY AND INDIVIDUALS; IDENTIFICATION VERIFICATION SERVICES, NAMELY, PROVIDING AUTHENTICATION OF PERSONAL IDENTIFICATION INFORMATION; LICENSING OF SOFTWARE RELATED TO ELECTRONIC SIGNING, ELECTRONIC IDENTIFICATION OF THE SIGNATORIES, ELECTRONIC CONFIRMATION OF THE SIGNATORY AUTHORITY AND ELECTRONIC VERIFICATION OF THE CONTENT OF DOCUMENTS TO BE SIGNED, IN CLASS 45 (U.S. CLS. 100 AND 101).

THE WORDING "SIGNOM" HAS NO MEANING IN A FOREIGN LANGUAGE.

OWNER OF INTERNATIONAL REGISTRATION 1056044 DATED 10-8-2010, EXPIRES 10-8-2020.

SER. NO. 79-089,096, FILED 10-8-2010.

WENDY GOODMAN, EXAMINING ATTORNEY



David J. Kyjars

Director of the United States Patent and Trademark Office

United States of America

United States Patent and Trademark Office



Reg. No. 4,072,488

Registered Dec. 20, 2011

Int. Cls.: 7, 11, 37 and 42

TRADEMARK

SERVICE MARK

PRINCIPAL REGISTER

BPM S.P.A. (ITALY JOINT STOCK COMPANY)
VIA GIOVANNI GUTENBERG, 3
I-24124 REGGIO EMILIA
ITALY AND

CFT PACKAGING S.P.A.
VIA PARADIGNA, 94/A
I-43122 PARMA
ITALY

FOR: FILLING MACHINES AND INSTALLATIONS; MACHINES AND APPARATUS IN THE NATURE OF POWER-OPERATED LIFTS FOR TRANSPORT AND HANDLING, PACKAGING, PALLETIZING AND DEPALLETIZING OF GOODS FOR THE FOOD AND DRINK INDUSTRY; RINSING MACHINES, BOTTLE WASHING MACHINES, PREFORM BLOWERS, FILLING MACHINES, NAMELY, STERILE FILLING MACHINES, CORKING MACHINES AND SEAMERS, PACKAGING MACHINES AND UNPACKAGING MACHINES, BOXING MACHINES, STRAIGHTENERS FOR CONTAINERS BEING MACHINES FOR ALIGNING THE CONTAINERS IN AN UPRIGHT POSITION, LABELER MACHINES, ANTHROPOMORPHOUS ROBOTS, DE-AERATORS, SUGAR DISSOLVING AND CARBONATION MACHINES, PREMIXERS AND MIXERS, HOMOGENIZERS, PALLET WRAPPING MACHINES, MACHINES FOR THE AUTOMATIC STORAGE OF GOODS, IN CLASS 7 (U.S. CLS. 13, 19, 21, 23, 31, 34 AND 35).

FOR: APPARATUS FOR PASTEURIZATION, STERILIZATION AND SANITIZATION FOR THE FOOD AND BEVERAGE INDUSTRY, NAMELY, PASTEURIZERS, STERILIZERS AND SANITIZING UNITS, HEAT EXCHANGERS, EVAPORATORS, IN CLASS 11 (U.S. CLS. 13, 21, 23, 31 AND 34).

FOR: INSTALLATION AND REPAIR OF MACHINES AND INSTALLATIONS FOR THE FOOD AND BEVERAGE INDUSTRY, IN CLASS 37 (U.S. CLS. 100, 103 AND 106).

FOR: DESIGN OF MACHINES AND INSTALLATIONS FOR THE FOOD AND BEVERAGE INDUSTRY, TECHNICAL PROJECT STUDIES IN THE FOOD PLANT ENGINEERING SECTOR, IN CLASS 42 (U.S. CLS. 100 AND 101).

NO CLAIM IS MADE TO THE EXCLUSIVE RIGHT TO USE "BOTTLING & CANNING", APART FROM THE MARK AS SHOWN.



David J. Kyros

Director of the United States Patent and Trademark Office

Reg. No. 4,072,488 OWNER OF INTERNATIONAL REGISTRATION 0978695 DATED 5-6-2008, EXPIRES 5-6-2018.

THE MARK CONSISTS OF A CUBIC FIGURE ENCOMPASSING STYLIZED OBJECTS, NAMELY, A CAN, WINE BOTTLE, AND SPORTS BOTTLE, AND BESIDES THE CUBE APPEARS THE WORDING "SBC BOTTLING & CANNING" ALL ABOVE A CURVILINEAR ELEMENT.

SER. NO. 79-089,123, FILED 10-18-2010.

DARRYL SPRUILL, EXAMINING ATTORNEY

United States of America

United States Patent and Trademark Office

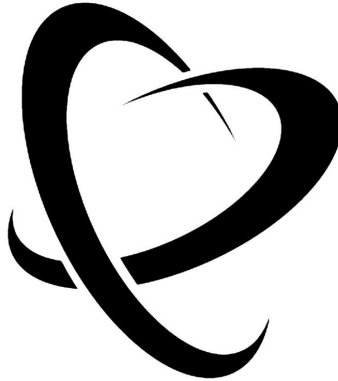

Reg. No. 4,072,489

SYMETIS SA (SWITZERLAND SOCIÉTÉ ANONYME)
AVENUE DU TEMPLE 19

Registered Dec. 20, 2011

LAUSANNE, SWITZERLAND CH1012

Int. Cls.: 5, 10 and 42

FOR: SURGICAL IMPLANTS COMPRISING LIVING TISSUE, IN CLASS 5 (U.S. CLS. 6, 18, 44, 46, 51 AND 52).

TRADEMARK

FOR: SURGICAL IMPLANTS COMPRISING ARTIFICIAL MATERIALS, IN PARTICULAR ARTIFICIAL TISSUE FOR SURGICAL PURPOSES, ARTIFICIAL HEART VALVES FOR SURGICAL PURPOSES, IN CLASS 10 (U.S. CLS. 26, 39 AND 44).

SERVICE MARK

PRINCIPAL REGISTER

FOR: RESEARCH AND DEVELOPMENT OF MEDICAL PRODUCTS FOR OTHERS, IN CLASS 42 (U.S. CLS. 100 AND 101).

THE MARK CONSISTS OF TWO INCOMPLETE CIRCLES INTERSECTING ON OPPOSITE DIAGONALS.

PRIORITY DATE OF 4-13-2010 IS CLAIMED.

OWNER OF INTERNATIONAL REGISTRATION 1056179 DATED 10-8-2010, EXPIRES 10-8-2020.

SER. NO. 79-089,168, FILED 10-8-2010.

WENDY GOODMAN, EXAMINING ATTORNEY



David J. Kybas

Director of the United States Patent and Trademark Office

United States of America

United States Patent and Trademark Office

GIUSEPPE ZANOTTI

Reg. No. 4,072,490

Registered Dec. 20, 2011

Int. Cl.: 14

TRADEMARK

PRINCIPAL REGISTER

VICINI S.P.A. (ITALY JOINT STOCK COMPANY)
VIA DELL'ARTIGIANATO, 28
I-47030 SAN MAURO PASCOLI
ITALY

FOR: PRECIOUS METALS AND THEIR ALLOYS AND GOODS IN PRECIOUS METALS OR COATED THEREWITH, NOT INCLUDED IN OTHER CLASSES, NAMELY, BASKETS AND BADGES OF PRECIOUS METAL; PRECIOUS AND SEMI-PRECIOUS STONES; JEWELRY, IMITATION JEWELRY AND COSTUME JEWELRY OF PRECIOUS, SEMI-PRECIOUS AND NON-PRECIOUS METALS AND STONES, INCLUDING IN PARTICULAR RINGS, NECKLACES, BRACELETS, EARRINGS, CHARMS, CUFFLINKS, TIE CLIPS, TIE PINS, NECK CHAINS, WATCH CHAINS, JEWELRY CHAINS, KEY RINGS OF PRECIOUS METAL, PENDANTS, BADGES OF PRECIOUS METAL; WATCHES AND WATCH STRAPS, IN CLASS 14 (U.S. CLS. 2, 27, 28 AND 50).

THE MARK CONSISTS OF STANDARD CHARACTERS WITHOUT CLAIM TO ANY PARTICULAR FONT, STYLE, SIZE, OR COLOR.

PRIORITY DATE OF 9-17-2010 IS CLAIMED.

OWNER OF INTERNATIONAL REGISTRATION 1056466 DATED 9-23-2010, EXPIRES 9-23-2020.

OWNER OF U.S. REG. NO. 3,591,440.

SER. NO. 79-089,273, FILED 9-23-2010.

SAIMA MAKHDOOM, EXAMINING ATTORNEY



David J. Kybas

Director of the United States Patent and Trademark Office

United States of America

United States Patent and Trademark Office



Reg. No. 4,072,491

Registered Dec. 20, 2011

Int. Cls.: 35, 36 and 41

SERVICE MARK

PRINCIPAL REGISTER

EBUZZING (FRANCE SOCIÉTÉ ANONYME À CONSEIL D'ADMINISTRATION)
3 RUE MILTON
F-75009 PARIS
FRANCE

FOR: ADVERTISING; BUSINESS MANAGEMENT; BUSINESS ADMINISTRATION; PROVIDING OFFICE FUNCTIONS; DIRECT MAIL ADVERTISING; ARRANGING NEWSPAPER SUBSCRIPTIONS FOR OTHERS; BUSINESS MANAGEMENT AND ORGANIZATION CONSULTANCY; BOOK-KEEPING; DOCUMENT REPRODUCTION; EMPLOYMENT AGENCIES; COMPUTERIZED FILE MANAGEMENT; ORGANIZATION OF EXHIBITIONS FOR COMMERCIAL OR ADVERTISING PURPOSES; ONLINE ADVERTISING ON A COMPUTER NETWORK; RENTAL OF ADVERTISING TIME ON COMMUNICATION MEDIA; PUBLICATION OF PUBLICITY TEXTS; RENTAL OF ADVERTISING SPACE; DISSEMINATION OF ADVERTISING MATTER; PUBLIC RELATIONS, IN CLASS 35 (U.S. CLS. 100, 101 AND 102).

FOR: INSURANCE UNDERWRITING; FINANCIAL AFFAIRS, NAMELY, CREDIT AND FINANCIAL CONSULTATION, FINANCIAL FORECASTING, FINANCIAL PLANNING, FINANCIAL INFORMATION PROVIDED BY ELECTRONIC MEANS; BANKING; REAL ESTATE AFFAIRS, NAMELY, REAL ESTATE LISTING, PROVIDING INFORMATION IN THE FIELD OF REAL ESTATE BY MEANS OF LINKING THE WEB SITE TO OTHER WEB SITES FEATURING REAL ESTATE INFORMATION, PROVIDING INFORMATION IN THE FIELD OF REAL ESTATE VIA THE INTERNET, REAL ESTATE CONSULTATION, REAL ESTATE CONSULTANCY, SAVINGS BANKS; HOME BANKING; ISSUANCE OF TRAVELER'S CHECKS OR CREDIT CARDS; REAL ESTATE APPRAISAL; REAL ESTATE MANAGEMENT; FINANCING SERVICES; FINANCIAL ANALYSIS; CAPITAL ACCUMULATION OR INVESTMENT; FINANCIAL CONSULTANCY; FINANCIAL EVALUATION FOR INSURANCE, BANKING AND REAL ESTATE PURPOSES; CAPITAL INVESTMENTS, IN CLASS 36 (U.S. CLS. 100, 101 AND 102).

FOR: EDUCATION, NAMELY, EDUCATION INFORMATION PROVIDED LIVE AND ONLINE FROM A COMPUTER DATABASE OR THE INTERNET, PROVIDING LIVE AND ONLINE CLASSES, SEMINARS, WORKSHOPS IN THE FIELD OF CUSTOMIZED LEADERSHIP AND EXECUTIVE DEVELOPMENT PROGRAMS, OF EXECUTIVE COACHING SERVICES, OF BUSINESS EDUCATION PROGRAMS TO EMPLOYEES AND EXECUTIVES, PROVIDING A WEB SITE WHERE USERS CAN POST RATINGS, REVIEWS AND RECOMMENDATIONS ON EVENTS AND ACTIVITIES IN THE FIELD OF EDUCATION; TRAINING IN THE FIELD



David J. Kyjars

Director of the United States Patent and Trademark Office

Reg. No. 4,072,491 OF CUSTOMIZED LEADERSHIP AND EXECUTIVE DEVELOPMENT PROGRAMS, OF EXECUTIVE COACHING SERVICES, OF BUSINESS EDUCATION PROGRAMS TO EMPLOYEES AND EXECUTIVES; ENTERTAINMENT, NAMELY, ENTERTAINMENT INFORMATION, PROVIDING ON-LINE COMPUTER GAMES, ARRANGING, ORGANIZING, CONDUCTING, AND HOSTING SOCIAL ENTERTAINMENT EVENTS, ENTERTAINMENT EVENT BOOKING AGENCIES, ENTERTAINMENT IN THE NATURE OF VISUAL AND AUDIO PERFORMANCES, AND MUSICAL, VARIETY, NEWS AND COMEDY SHOWS, ENTERTAINMENT IN THE NATURE OF PROVIDING AN INFORMATIONAL AND ENTERTAINMENT WEBSITE IN THE FIELDS OF CELEBRITY GOSSIP, ENTERTAINMENT, SPORTS AND FITNESS, PROVIDING ON-LINE REVIEWS OF MOVIES, BOOKS, MUSIC, ENTERTAINMENT IN THE NATURE OF COMPUTER GAMES, ENTERTAINMENT IN THE NATURE OF PROVIDING VIRTUAL ENVIRONMENTS IN WHICH USERS CAN INTERACT FOR RECREATIONAL, LEISURE OR ENTERTAINMENT PURPOSES, ENTERTAINMENT IN THE NATURE OF PROVIDING GAMES OF CHANCE VIA THE INTERNET; PROVISION OF INFORMATION RELATING TO ORGANIZING COMMUNITY SPORTING AND CULTURAL ACTIVITIES; INFORMATION ON ENTERTAINMENT OR EDUCATION; PROVIDING RECREATION FACILITIES; PUBLICATION OF BOOKS; LENDING LIBRARIES; ANIMAL TRAINING; VIDEOTAPE FILM PRODUCTION; RENTAL OF MOTION PICTURES; RENTAL OF SOUND RECORDINGS; RENTAL OF VIDEO CASSETTE RECORDERS OR OF RADIO AND TELEVISION SETS; RENTAL OF SHOW SCENERY; VIDEOTAPE EDITING; PHOTOGRAPHY; ORGANIZATION OF COMPETITIONS FOR EDUCATION OR ENTERTAINMENT PURPOSES; ARRANGING AND CONDUCTING OF COLLOQUIUMS, CONFERENCES OR CONGRESSES IN THE FIELD OF EDUCATION, CULTURE, SPORTS AND ENTERTAINMENT FOR NON-BUSINESS AND NON-COMMERCIAL PURPOSES; ORGANIZATION OF EXHIBITIONS FOR CULTURAL OR EDUCATIONAL PURPOSES; BOOKING OF SEATS FOR SHOWS; GAME SERVICES PROVIDED ON-LINE FROM A COMPUTER NETWORK; PUBLICATION OF ELECTRONIC BOOKS AND JOURNALS ON-LINE; ELECTRONIC DESKTOP PUBLISHING, IN CLASS 41 (U.S. CLS. 100, 101 AND 107).

THE MARK CONSISTS OF A LOWERCASE LETTER STYLIZED "E" ROTATED ANTICLOCKWISE AND CONTAINED INSIDE OF A BLUE CIRCLE WITH IRREGULAR LINING/CIRCULAR ELEMENTS EMANATING FROM THE NORTHWEST QUARTER OF THE DESIGN; NEXT TO THIS APPEARS THE WORD "BUZZING" IN LOWERCASE DARK GRAY FONTS. THE UPPER HALF OF THE ENTIRE MARK APPEARS TO BE A LIGHTER SHADE OF THE COLORS CLAIMED, AND BENEATH THE MARK APPEARS AN INCOMPLETE, LIGHTER REFLECTION OF THE MARK. THE COLOR WHITE REPRESENTS BACKGROUND AND IS NOT CLAIMED AS A FEATURE OF THE MARK. THE REPRESENTATION OF THE STYLIZED "E" IS LIGHT AND DARK BLUE; THE REPRESENTATION OF THE WORD "BUZZING" IS DARK GRAY.

OWNER OF INTERNATIONAL REGISTRATION 1056566 DATED 9-30-2010, EXPIRES 9-30-2020.

THE COLOR(S) BLUE AND DARK GRAY IS/ARE CLAIMED AS A FEATURE OF THE MARK.

SER. NO. 79-089,307, FILED 9-30-2010.

RON FAIRBANKS, EXAMINING ATTORNEY

United States of America
United States Patent and Trademark Office

WOOLSTAR

Reg. No. 4,072,492

PRAIRIEVAL PTY LTD (AUSTRALIA CORPORATION)
6 SHAW ROAD

Registered Dec. 20, 2011

INGLEBURN NSW 2565, AUSTRALIA

Int. Cl.: 24

FOR: QUILTS, BLANKETS, BABY BLANKETS, BABY QUILTS, PILLOW PROTECTORS, PILLOW SHAMS, PILLOW CASES, CRIB BUMPERS, BASSINET, STROLLER AND PRAM LINENS, MATTRESS COVERS, MATTRESS PADS, BED SHEETS, BED SPREADS, DUST RUFFLES, TABLE LINENS; ALL OF THE FOREGOING GOODS MADE OF WOOL OR MADE SUBSTANTIALLY IN PART OF WOOL, IN CLASS 24 (U.S. CLS. 42 AND 50).

TRADEMARK

PRINCIPAL REGISTER

THE MARK CONSISTS OF STANDARD CHARACTERS WITHOUT CLAIM TO ANY PARTICULAR FONT, STYLE, SIZE, OR COLOR.

OWNER OF INTERNATIONAL REGISTRATION 1047258 DATED 5-4-2010, EXPIRES 5-4-2020.

SER. NO. 79-089,428, FILED 10-15-2010.

KELLY TRUSILO, EXAMINING ATTORNEY



David J. Kybas

Director of the United States Patent and Trademark Office

United States of America

United States Patent and Trademark Office

AFFINIDEALS

Reg. No. 4,072,493

Registered Dec. 20, 2011

Int. Cls.: 39, 41 and 43

PVC PUBLICITE ET COMMUNICATION VISUELLE (FRANCE SOCIÉTÉ PAR ACTIONS SIMPLIFIÉE)
1 RUE DE LA LANDELLE
F-22360 LANGUEUX
FRANCE

SERVICE MARK

PRINCIPAL REGISTER

FOR: TRANSPORTATION INFORMATION, PACKAGING AND STORAGE OF GOODS, ARRANGEMENT OF TOURS, ARRANGING OF CRUISES, ESCORTING OF TRAVELLERS, AIR TRANSPORTATION, CAR TRANSPORTATION, TRANSPORTATION RESERVATIONS, DELIVERY OF GOODS, CAR RENTAL, GARAGE RENTAL, PARKING SPACE RENTAL, TAXI TRANSPORTATION, CHAUFFEUR SERVICES, IN CLASS 39 (U.S. CLS. 100 AND 105).

FOR: PUBLICATION OF BOOKS, REVIEWS; LENDING LIBRARIES; ORGANIZATION OF EXHIBITIONS FOR CULTURAL OR EDUCATIONAL PURPOSES; ORGANIZATION OF SPORTS COMPETITIONS; INFORMATION ON EDUCATION AND ENTERTAINMENT; PUBLICATION OF ELECTRONIC BOOKS AND JOURNALS ON-LINE; PHOTOGRAPHY, PHOTOGRAPHIC REPORTING; NEWS REPORTERS SERVICES; PROVIDING RECREATION FACILITIES; HOLIDAY CAMP SERVICES IN THE FIELDS OF EDUCATION OR ENTERTAINMENT, IN CLASS 41 (U.S. CLS. 100, 101 AND 107).

FOR: TEMPORARY ACCOMMODATION SERVICES; SNACK-BARS, SELF-SERVICE RESTAURANTS, CAFETERIAS, TEA ROOMS, CAFES; FOOD AND DRINK CATERING; BAR SERVICES; HOTELS; BOARDING-HOUSES, IN CLASS 43 (U.S. CLS. 100 AND 101).



THE MARK CONSISTS OF STANDARD CHARACTERS WITHOUT CLAIM TO ANY PARTICULAR FONT, STYLE, SIZE, OR COLOR.

PRIORITY DATE OF 3-31-2010 IS CLAIMED.

OWNER OF INTERNATIONAL REGISTRATION 1057391 DATED 9-24-2010, EXPIRES 9-24-2020.

SER. NO. 79-089,659, FILED 9-24-2010.

BARBARA GAYNOR, EXAMINING ATTORNEY

David J. Kyffers

Director of the United States Patent and Trademark Office

United States of America
United States Patent and Trademark Office

PROYIELD

Reg. No. 4,072,494

Registered Dec. 20, 2011

Int. Cl.: 5

TRADEMARK

PRINCIPAL REGISTER

FRIESLAND BRANDS BV (NETHERLANDS PRIVATE LIMITED LIABILITY COMPANY)
BLANKENSTEIN 142
NL-7943 PE MEPPEL
NETHERLANDS

FOR: FOOD SUPPLEMENTS FOR MEDICAL USE; MILK FERMENTS FOR PHARMACEUTICAL PURPOSES; DIETETIC SUBSTANCES AND FOODSTUFFS FOR MEDICAL, NAMELY, DIETETIC FOODS ADAPTED FOR MEDICAL USE, IN CLASS 5 (U.S. CLS. 6, 18, 44, 46, 51 AND 52).

THE MARK CONSISTS OF STANDARD CHARACTERS WITHOUT CLAIM TO ANY PARTICULAR FONT, STYLE, SIZE, OR COLOR.

PRIORITY DATE OF 6-14-2010 IS CLAIMED.

OWNER OF INTERNATIONAL REGISTRATION 1057403 DATED 10-20-2010, EXPIRES 10-20-2020.

SER. NO. 79-089,664, FILED 10-20-2010.

BARBARA RUTLAND, EXAMINING ATTORNEY



David J. Kyffers

Director of the United States Patent and Trademark Office

United States of America

United States Patent and Trademark Office



Reg. No. 4,072,495

MONAYES AB (SWEDEN AKTIEBOLAG (AB))
FRIHETSVÄGEN 41
SE-177 53 JÄRFÄLLA, SWEDEN

Registered Dec. 20, 2011

Int. Cl.: 35

FOR: RETAIL STORE SERVICES FEATURING MINERAL AND AERATED WATERS AND OTHER NON-ALCOHOLIC DRINKS, FRUIT DRINKS AND FRUIT JUICES, SYRUPS AND OTHER PREPARATIONS FOR MAKING BEVERAGES; ALL THE AFORESAID GOODS FROM IRAQ, IN CLASS 35 (U.S. CLS. 100, 101 AND 102).

SERVICE MARK

PRINCIPAL REGISTER

NO CLAIM IS MADE TO THE EXCLUSIVE RIGHT TO USE "BASRA DATE SYRUP", APART FROM THE MARK AS SHOWN.

OWNER OF INTERNATIONAL REGISTRATION 1057559 DATED 10-25-2010, EXPIRES 10-25-2020.

THE COLOR(S) RED, WHITE, BROWN, BLUE, BLACK AND GREEN IS/ARE CLAIMED AS A FEATURE OF THE MARK.

THE NON-LATIN CHARACTERS IN THE MARK TRANSLITERATE TO "DIBIS TAMOR ELBASRE," AND THIS MEANS "BASRA DATE SYRUP" IN ENGLISH.

THE NAME(S), PORTRAIT(S), AND/OR SIGNATURE(S) SHOWN IN THE MARK DOES NOT IDENTIFY A PARTICULAR LIVING INDIVIDUAL.



THE MARK CONSISTS OF A PICTURE OF A MAN WEARING A SHIRT AND HAT STANDING UNDER A DATE PALM TREE WITH THE WORDS "BASRA DATE SYRUP" WITHIN A BANNER-STYLE RECTANGLE ABOVE AND ARABIC WORDS BELOW WITHIN A RECTANGLE, ALL WITHIN A RECTANGULAR BACKGROUND. THE COLOR RED APPEARS IN THE WORDS "BASRA DATE SYRUP" AND IN SOME OF THE FOLIAGE OF THE DATE TREE; THE COLOR WHITE APPEARS IN THE MAN'S SHIRT AND HAT AND IN THE BACKGROUND OF THE RECTANGLES. THE COLOR BLUE APPEARS AS THE SKY, THE COLOR BROWN APPEARS AS PART OF THE TREE AND AS THE SKIN TONE OF THE MAN, THE COLOR BLACK APPEARS AS PART OF THE TREE AND IN THE LETTERING OF THE ARABIC WORDS, AND THE COLOR GREEN APPEARS AS SOME OF THE FOLIAGE OF THE DATE TREE.

David J. Kybas

Director of the United States Patent and Trademark Office

Reg. No. 4,072,495 THE ENGLISH TRANSLATION OF THE NON-LATIN CHARACTERS IN THE MARK IS
"BASRA DATE SYRUP".

SER. NO. 79-089,715, FILED 10-25-2010.

CARYN GLASSER, EXAMINING ATTORNEY

United States of America

United States Patent and Trademark Office

AUBION

Reg. No. 4,072,496

Registered Dec. 20, 2011

Int. Cls.: 9, 37, 41 and 42

TRADEMARK

SERVICE MARK

PRINCIPAL REGISTER

DSPECIALISTS DIGITALE AUDIO- UND MESSSYSTEME GMBH (FED REP GERMANY GESELLSCHAFT MIT BESCHRÄNKTER HAFTUNG (GMBH))
HELMHOLTZSTRASSE 2-9L
10587 BERLIN, FED REP GERMANY AND

SDA SOFTWARE DESIGN AHNERT GMBH (FED REP GERMANY GESELLSCHAFT MIT BESCHRÄNKTER HAFTUNG (GMBH))
ARKONASTRASSE 45-49
13189 BERLIN, FED REP GERMANY

FOR: SCIENTIFIC, MEASURING, SIGNALING, MONITORING APPARATUS AND INSTRUMENTS, NAMELY, ELECTRONIC PRODUCTS FOR THE GENERATION, MEASUREMENT, AND ANALYSIS OF AUDIO SIGNALS, NAMELY, AUDIO ANALYZERS; ELECTRICAL CONTROLLERS, SWITCHES, TRANSFORMERS, ACCUMULATORS, CONNECTORS AND CONDUCTORS; APPARATUS FOR RECORDING, TRANSMISSION OR REPRODUCTION OF SOUND; APPARATUS FOR RECORDING, TRANSMISSION OR REPRODUCTION OF SOUND AND IMAGES; AUDIO RECEIVERS AND VIDEO RECEIVERS; SOUND RECORDING APPARATUS; MEASURING INSTRUMENTS FOR MEASURING AND PROCESSING DIGITAL AND ANALOG AUDIO SIGNALS; AMPLIFIERS; DATA PROCESSING EQUIPMENT AND COMPUTER; COMPUTER OPERATING PROGRAMS, RECORDED; COMPUTER PROGRAMS AND DOWNLOADABLE SOFTWARE IN THE FIELD OF AUDIO MEASURING EQUIPMENT; COMPUTER PERIPHERAL DEVICES, IN CLASS 9 (U.S. CLS. 21, 23, 26, 36 AND 38).

FOR: ELECTRIC APPLIANCE INSTALLATION AND REPAIR; INTERFERENCE SUPPRESSION FOR ELECTRICAL APPARATUS; INSTALLATION AND REPAIR OF APPARATUS FOR RECORDING, TRANSMISSION OR REPRODUCTION OF SOUND; INSTALLATION AND REPAIR OF COMPUTERS, MEASURING, SIGNALING AND MONITORING APPARATUS AND INSTRUMENTS, IN CLASS 37 (U.S. CLS. 100, 103 AND 106).

FOR: TRAINING RELATING COMPUTERIZED MEASURING EQUIPMENT; EDUCATIONAL SERVICES, NAMELY, COURSES AND WORKSHOPS IN THE FIELD OF AUDIO EQUIPMENT; PROVIDING CLASSES, SEMINARS AND WORKSHOPS IN THE FIELD OF AUDIO MEASURING EQUIPMENT; TRAINING RELATING TO THE USE OF AUDIO MEASURING EQUIPMENT; EDUCATIONAL DEMONSTRATIONS; RECORDING AND TELEVISION STUDIO SERVICES; EDUCATION IN THE FIELD AUDIO EQUIPMENT RENDERED THROUGH CORRESPONDENCE COURSES; RENTAL OF AUDIO EQUIPMENT, IN CLASS 41 (U.S. CLS. 100, 101 AND 107).



David J. Kyjars

Director of the United States Patent and Trademark Office

Reg. No. 4,072,496 FOR: SCIENTIFIC AND TECHNOLOGICAL SERVICES, NAMELY RESEARCH AND DESIGN IN THE FIELD OF SOUND AND IMAGE CARRIERS AND DIGITAL AND ANALOG SOUND AMPLIFICATION; ENGINEERING; SURVEYING; UPDATING OF COMPUTER SOFTWARE; UPDATING OF SOFTWARE; COMPUTER HARDWARE AND SOFTWARE CONSULTANCY; COMPUTER SOFTWARE DESIGN; DESIGN AND DEVELOPMENT OF COMPUTER HARDWARE AND SOFTWARE; COMPUTER PROGRAMMING; INSTALLATION AND MAINTENANCE OF SOFTWARE; TECHNICAL COMPUTER PROJECT MANAGEMENT; RENTAL OF COMPUTER SOFTWARE, IN CLASS 42 (U.S. CLS. 100 AND 101).

THE MARK CONSISTS OF STANDARD CHARACTERS WITHOUT CLAIM TO ANY PARTICULAR FONT, STYLE, SIZE, OR COLOR.

PRIORITY DATE OF 4-14-2010 IS CLAIMED.

OWNER OF INTERNATIONAL REGISTRATION 1057762 DATED 10-11-2010, EXPIRES 10-11-2020.

SER. NO. 79-089,786, FILED 10-11-2010.

H. M. FISHER, EXAMINING ATTORNEY

United States of America

United States Patent and Trademark Office



Reg. No. 4,072,497

Registered Dec. 20, 2011

Int. Cl.: 11

TRADEMARK

PRINCIPAL REGISTER

ZHEJIANG PINGHU AONISI SANITARY WARE CO., LTD. (CHINA LIMITED COMPANY)
XINSHENG VILLAGE
XIUXI TOWNSHIP; PINGHU; ZHEJIANG
CHINA

FOR: FLUSHING TANKS BEING TOILET TANKS; SHOWER CUBICLES BEING ENCLOSURES; SINKS; SHOWER CUBICLES; BATH TUBS, IN CLASS 11 (U.S. CLS. 13, 21, 23, 31 AND 34).

THE MARK CONSISTS OF TWO CONCENTRIC OVALS CONTAINING THE STYLIZED LETTERS "AS" ABOVE TWO CHINESE CHARACTERS.

OWNER OF INTERNATIONAL REGISTRATION 1057996 DATED 11-12-2010, EXPIRES 11-12-2020.

THE NON-LATIN CHARACTERS IN THE MARK TRANSLITERATE TO JI NI AND THIS HAS NO MEANING IN A FOREIGN LANGUAGE.

SER. NO. 79-089,858, FILED 11-12-2010.

MARY BOAGNI, EXAMINING ATTORNEY



David J. Kyfos

Director of the United States Patent and Trademark Office

United States of America

United States Patent and Trademark Office

VIBMAX

Reg. No. 4,072,498

Registered Dec. 20, 2011

Int. Cl.: 10

TRADEMARK

PRINCIPAL REGISTER

GUILIN HBM HEALTHCARES, INC. (CHINA LIMITED LIABILITY COMPANY)
NO.6 WUSHAN RD.
541001 GUILIN
CHINA

FOR: SURGICAL STERILE SHEETS, NAMELY, MEDICAL TABLE SHEETS FOR OPERATING TABLES; BANDAGES, ELASTIC; GLOVES FOR MEDICAL PURPOSES; MASSAGE APPARATUS; CLOTHING ESPECIALLY FOR OPERATING ROOMS, NAMELY, SURGICAL SCRUB SUITS, SCRUB TOPS, AND SCRUB PANTS; VIBROMASSAGE APPARATUS; CONDOMS, IN CLASS 10 (U.S. CLS. 26, 39 AND 44).

THE MARK CONSISTS OF THE WORDING "VIBMAX" APPEARING IN STYLIZED FONT WITH A LINE RUNNING THROUGH ALL OF THE LETTERS.

OWNER OF INTERNATIONAL REGISTRATION 1058014 DATED 11-9-2010, EXPIRES 11-9-2020.

SER. NO. 79-089,867, FILED 11-9-2010.

CHRISTINE MARTIN, EXAMINING ATTORNEY



David J. Kyffers

Director of the United States Patent and Trademark Office

United States of America

United States Patent and Trademark Office

SMARTmatic

Reg. No. 4,072,499

Registered Dec. 20, 2011

Int. Cl.: 10

TRADEMARK

PRINCIPAL REGISTER

KALTENBACH & VOIGT GMBH (FED REP GERMANY LIMITED LIABILITY COMPANY)
BISMARCKRING 39
88400 BIBERACH A. D. RISS
FED REP GERMANY

FOR: DENTAL INSTRUMENTS, NAMELY, HAND AND ANGLE PIECES, ELECTRIC AND PNEUMATIC DRIVES FOR THESE INSTRUMENTS, IN CLASS 10 (U.S. CLS. 26, 39 AND 44).

THE MARK CONSISTS OF STANDARD CHARACTERS WITHOUT CLAIM TO ANY PARTICULAR FONT, STYLE, SIZE, OR COLOR.

PRIORITY DATE OF 4-20-2010 IS CLAIMED.

OWNER OF INTERNATIONAL REGISTRATION 1058078 DATED 10-12-2010, EXPIRES 10-12-2020.

SER. NO. 79-089,886, FILED 10-12-2010.

COURTNEY ALVAREZ, EXAMINING ATTORNEY



David J. Kyffers

Director of the United States Patent and Trademark Office

United States of America

United States Patent and Trademark Office



Reg. No. 4,072,500

Registered Dec. 20, 2011

Int. Cls.: 25 and 35

TRADEMARK

SERVICE MARK

PRINCIPAL REGISTER

FACTORY INTERNACIONL DEL CALZADO, S.L. (SPAIN SOCIEDAD LIMITADA)
AVENIDA DE LA MÚSICA, 161,
ALHAURÍN DE LA TORRE; E-29130 MÁLAGA
SPAIN

FOR: CLOTHING, NAMELY, SHIRTS, PANTS, SKIRTS, DRESSES, T-SHIRTS; FOOTWEAR;
HEADGEAR, NAMELY, HATS AND CAPS, IN CLASS 25 (U.S. CLS. 22 AND 39).

FOR: RETAIL STORE SERVICES FEATURING CLOTHING, FOOTWEAR, HEADGEAR;
ASSISTANCE FOR THE OPERATION OF COMMERCIAL COMPANIES AS FRANCHISES,
NAMELY, ASSISTANCE IN FRANCHISED COMMERCIAL BUSINESS MANAGEMENT OF
CLOTHING AND SHOES STORES, IN CLASS 35 (U.S. CLS. 100, 101 AND 102).

NO CLAIM IS MADE TO THE EXCLUSIVE RIGHT TO USE "FOOTWEAR", APART FROM
THE MARK AS SHOWN.

PRIORITY DATE OF 6-17-2010 IS CLAIMED.

OWNER OF INTERNATIONAL REGISTRATION 1058386 DATED 6-24-2010, EXPIRES 6-24-
2020.

THE COLOR(S) GREEN, YELLOW, PINK, ORANGE, BEIGE, BROWN, GRAY, BLACK,
PURPLE AND WHITE IS/ARE CLAIMED AS A FEATURE OF THE MARK.



David J. Kyffers

Director of the United States Patent and Trademark Office

THE MARK CONSISTS OF A BEIGE DOLL OUTLINED IN BLACK. THE DOLL IS WEARING
A PURPLE TIARA, OUTLINED IN BLACK, AND HAS NUMEROUS REPEATING BLACK
CIRCLES AND A GREEN STAR OUTLINED IN BLACK. THE TIARA HAS A HAIR BAND
IN THE COLORS BLACK AND GREEN. THE DOLL HAS BLACK EYE BROWS, A BROWN
NOSE AND A PINK MOUTH WITH RED LIPS. THE DOLL IS WEARING BLACK
SUNGLASSES WITH TWO WHITE CIRCLES ON EACH LENSE. THE DOLL IS WEARING
A GREEN DRESS OUTLINED IN BLACK AND GREEN SHOES OUTLINED IN BLACK. THE
DOLL IS STANDING ON A BLACK OBLONG. INSIDE THE OBLONG APPEAR THE LETTERS
"CHK" IN WHITE AND THE COLOR GREEN AT THE TOP OF THE RIGHT OF THE LETTER
"H" AND A GREEN SQUARE HANGING FROM THE LETTER "K". TO THE RIGHT OF THE
LETTERS APPEARS THE NUMBER TEN IN GREEN WITH MALE AND FEMALE BIOLOGICAL
SYMBOLS IN THE COLOR BLACK IN THE GREEN RING PORTION OF THE
NUMBER "0". BLACK IS THE COLOR INSIDE THE NUMBER "0". ONE WHITE PAREN-

Reg. No. 4,072,500 THESIS APPEARS ON THE RIGHT SIDE OF THE OBLONG AND TWO WHITE SEMI CIRCLES APPEAR ON THE LEFT SIDE OF THE OBLONG. ON THE OBLONG BEHIND THE DOLL APPEAR THE BROWN AND WHITE SKYLINE OF A CITY AND A GREEN STAR, YELLOW STAR AND ORANGE, ALL OF THE STARS OUTLINED IN BLACK. CIRCLES IN BLACK AND WHITE ARE IN THE BACKGROUND BEHIND THE STARS AND SKYLINE. ON THE BOTTOM RIGHT OF THE OBLONG APPEARS THE WORD "FOOTWEAR" IN WHITE.

SER. NO. 79-090,021, FILED 6-24-2010.

MICHAEL WIENER, EXAMINING ATTORNEY

United States of America

United States Patent and Trademark Office

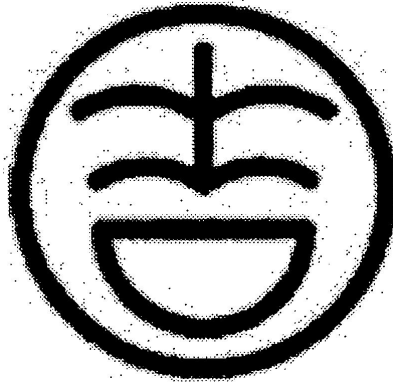

Reg. No. 4,072,501

Registered Dec. 20, 2011

Int. Cls.: 9, 41 and 42

TRADEMARK

SERVICE MARK

PRINCIPAL REGISTER

YOSHIMOTO KOGYO CO., LTD. (JAPAN CORPORATION)
SENNICHI-MAE 11-6
NANBA, CHUO-KU., OSAKA-SHI;
OSAKA 542-0075, JAPAN

FOR: VIDEO GAME MACHINES FOR USE WITH EXTERNAL DISPLAY SCREEN OR MONITOR; ROM-CARTRIDGES RECORDED ELECTRONIC GAME PROGRAMS FOR HAND-HELD GAMES WITH LIQUID CRYSTAL DISPLAYS; PHONOGRAPH RECORDS FEATURING MUSIC; METRONOMES; DOWNLOADABLE MUSICAL SOUND RECORDINGS; EXPOSED CINEMATOGRAPHIC FILMS; EXPOSED SLIDE FILMS; SLIDE FILM MOUNTS; DOWNLOADABLE GRAPHIC IMAGE FILES CONSISTING OF TELEVISION SHOWS AND MOVIES IN A WIDE VARIETY OF GENRES, COMEDY VIDEOS, VARIETY PROGRAMS FEATURING MUSIC, COMEDY AND INTERVIEWS, AND ADVERTISEMENTS, ALL VIA A GLOBAL COMPUTER NETWORK AND WIRELESS DEVICES; RECORDED VIDEO DISCS AND TAPES FEATURING ANIMATION, MUSIC, GRAPHICS, MOVIES; ELECTRONIC PUBLICATIONS, NAMELY, BOOKS, MAGAZINES, NEWSLETTERS, CATALOGUES AND MANUALS FEATURING MUSIC, TELEVISION SHOWS IN A WIDE VARIETY OF GENRES, COMEDY VIDEOS, VARIETY PROGRAMS FEATURING MUSIC, COMEDY AND INTERVIEWS, MOVIES AND COMIC BOOK CHARACTERS; CELL PHONE STRAPS; CELL PHONE COVERS; CELL PHONE BACK PLATES, NAMELY, FLAT PIECES OF METAL OR PLASTIC FOR MOUNTING ON THE BACK OF A CELL PHONE FOR DECORATIVE PURPOSES; CELL PHONE BATTERY CHARGERS; CELL PHONE FACE PLATES, NAMELY, FLAT PIECES OF METAL OR PLASTIC FOR MOUNTING ON THE FRONT OF A CELL PHONE FOR DECORATIVE PURPOSES; TELECOMMUNICATION MACHINES AND APPARATUS, NAMELY, TELEPHONE SETS, CELLULAR PHONES, TELEVISION SETS, RADIO RECEIVERS, VIDEODISC PLAYERS, VIDEODISC RECORDERS, VIDEOTAPE RECORDERS, VIDEO MONITORS, VIDEO PROJECTORS, HARD DISC VIDEO RECORDERS, DIGITAL VERSATILE DISC PLAYERS AND RECORDERS, ANTENNAS, CONNECTORS FOR TELECOMMUNICATIONS APPARATUS; COMPUTER GAME PROGRAMS; COMPUTER SOFTWARE FOR USE IN AUTHORIZING, DOWNLOADING, TRANSMITTING, RECEIVING, EDITING, EXTRACTING, ENCODING, DECODING, PLAYING, STORING AND ORGANIZING TEXT, DATA, IMAGES, AUDIO FILES AND VIDEO FILES; ELECTRONIC AGENDAS; ELECTRONIC POCKET TRANSLATORS; COMPUTERS; NOTEBOOK COMPUTERS; COMPUTER KEYBOARDS; MOUSE PADS; ELECTRONIC DESK CALCULATORS, IN CLASS 9 (U.S. CLS. 21, 23, 26, 36 AND 38).



David J. Kyjars

Director of the United States Patent and Trademark Office

Reg. No. 4,072,501 FOR: EDUCATIONAL SERVICES, NAMELY, CONDUCTING CLASSES, SEMINARS, CONFERENCES, WORKSHOPS IN THE FIELD OF ARTS AND CRAFTS, ENTERTAINMENT, MUSIC, CULTURE, SCIENCE, CIVICS, HISTORY, ECONOMICS, BUSINESS, HUMANITIES, MATHEMATICS AND COMPUTERS; ARRANGING OF SEMINARS; PUBLICATION OF BOOKS; PLANNING AND ARRANGEMENT OF SHOWING MOVIES, SHOWS, PLAYS OR MUSICAL PERFORMANCES, NAMELY, PLANNING ARRANGEMENT OF SHOWING MOVIES, SHOWS, PLAYS OR MUSIC PERFORMANCES; MOTION PICTURE, FILM PRODUCTION AND MOVIE FILM DISTRIBUTION; PRESENTATION OF LIVE SHOW PERFORMANCES; DIRECTION OR PRESENTATION OF PLAYS; PRESENTATION OF MUSICAL PERFORMANCE; PRODUCTION OF RADIO OR TELEVISION PROGRAMS; PRODUCTION OF VIDEO TAPE FILMS IN THE FIELDS OF EDUCATION, CULTURE, ENTERTAINMENT OR SPORTS NOT FOR MOVIES, RADIO OR TELEVISION PROGRAMS AND NOT FOR ADVERTISING AND PUBLICITY; DIRECTION OF MAKING RADIO OR TELEVISION PROGRAMS, NAMELY, DIRECTION OF MAKING RADIO OR TELEVISION PROGRAMS; OPERATION OF VIDEO EQUIPMENT OR AUDIO EQUIPMENT FOR PRODUCTION OF RADIO OR TELEVISION PROGRAMS; ORGANIZING AND ARRANGING EXHIBITIONS FOR ENTERTAINMENT PURPOSES; PROVIDING AUDIO OR VIDEO STUDIOS; PROVIDING FACILITIES FOR MOVIES, SHOWS, PLAYS, MUSIC OR EDUCATIONAL TRAINING; ENTERTAINMENT TICKET AGENCY SERVICES, IN CLASS 41 (U.S. CLS. 100, 101 AND 107).

FOR: PROVIDING TEMPORARY USE OF ON-LINE NON-DOWNLOADABLE COMPUTER PROGRAMS FOR DOWNLOADING OR VIEWING AUDIO-VIDEO ENTERTAINMENT AND MUSIC; RENTAL OF COMPUTERS; DESIGNING OF MACHINES, APPARATUS, INSTRUMENTS AND THEIR PARTS OR SYSTEMS COMPOSED OF SUCH MACHINES, APPARATUS AND INSTRUMENTS; COMPUTER SOFTWARE DESIGN; COMPUTER SOFTWARE PROGRAMMING OR MAINTENANCE OF COMPUTER SOFTWARE, IN CLASS 42 (U.S. CLS. 100 AND 101).

THE MARK CONSISTS OF A STYLIZED REPRESENTATION OF A SMILING FACE.

OWNER OF INTERNATIONAL REGISTRATION 1058691 DATED 7-1-2010, EXPIRES 7-1-2020.

SER. NO. 79-090,112, FILED 7-1-2010.

MICHAEL WIENER, EXAMINING ATTORNEY

United States of America

United States Patent and Trademark Office

STATPRO REVOLUTION

Reg. No. 4,072,502

Registered Dec. 20, 2011

**Int. Cls.: 9, 16, 35, 36
and 42**

TRADEMARK

SERVICE MARK

PRINCIPAL REGISTER

STATPRO GROUP PLC (UNITED KINGDOM PUBLIC LIMITED COMPANY)
STATPRO HOUSE
81-87 HARTFIELD ROAD
WIMBLEDON, LONDON SW19 3TJ, UNITED KINGDOM

FOR: COMPUTER SOFTWARE FOR COLLATION, MANIPULATION, ANALYSIS AND REPORTING OF FINANCIAL INFORMATION FOR USE IN THE MANAGEMENT OF FINANCIAL ASSETS; INTERNET ACCESS SOFTWARE; SOFTWARE FOR PROVIDING ACCESS TO PROPRIETARY DATABASES ONLINE FOR USE IN MANAGING, ANALYZING AND REPORTING FINANCIAL ASSET INFORMATION; COMPUTER SOFTWARE FOR ACCESSING DATABASES OF INFORMATION RELATING TO FINANCIAL INFORMATION; MULTI-MEDIA SOFTWARE FOR USE IN CREATING PRESENTATIONS, MANAGING DATABASES AND ACCESSING AND DISPLAYING INFORMATION FOR MANAGING, ANALYZING AND REPORTING OF FINANCIAL ASSET INFORMATION; SPREADSHEET SOFTWARE; SOFTWARE TO SEARCH AND DISPLAY CHARGES INCURRED IN ADMINISTERING FINANCIAL ASSETS; PRE-RECORDED TAPES, CASSETTES, DISCS, VIDEO TAPES AND CINEMATOGRAPHIC FILMS, ALL FEATURING CONTENT RELATING TO THE FIELD OF FINANCIAL ASSETS; PRERECORDED COMPUTER DISCS, INTER-ACTIVE CDS, VIDEO CDS, CD ROMS, DVDS, ALL FEATURING CONTENT RELATING TO THE FIELD OF MANAGING AND REPORTING FINANCIAL ASSETS; COMPUTER HARDWARE; DOWNLOADABLE ELECTRONIC PUBLICATIONS, NAMELY, BOOKS, MAGAZINES AND NEWSPAPERS, NEWSLETTERS, MANUALS, DIRECTORIES, AND BROCHURES AND LEAFLETS, ALL IN THE FIELD OF FINANCIAL ASSETS, IN CLASS 9 (U.S. CLS. 21, 23, 26, 36 AND 38).

FOR: PRINTED PUBLICATIONS, NAMELY, BOOKS, MAGAZINES AND NEWSPAPERS, NEWSLETTERS, MANUALS, DIRECTORIES, AND BROCHURES AND LEAFLETS, ALL IN THE FIELD OF FINANCIAL ASSETS; STATIONERY; DIARIES AND CALENDARS; PRINTED INSTRUCTIONAL AND TEACHING MATERIALS IN THE FIELD OF FINANCIAL ASSETS, IN CLASS 16 (U.S. CLS. 2, 5, 22, 23, 29, 37, 38 AND 50).

FOR: ELECTRONIC PROVISION OF BUSINESS AND TRADE INFORMATION; PREPARATION OF REPORTS RELATING TO FINANCIAL ASSETS; ELECTRONIC PROVISION OF STATISTICAL INFORMATION; BUSINESS MANAGEMENT; BUSINESS ADMINISTRATION; PROVIDING OFFICE FUNCTIONS; COMPILATION AND SYSTEMISATION OF INFORMATION INTO COMPUTER DATABASES; ARRANGING AND CONDUCTING TRADE SHOWS



David J. Kyjars

Director of the United States Patent and Trademark Office

Reg. No. 4,072,502 IN THE FIELD OF FINANCIAL ASSETS; RETAIL STORE SERVICES FEATURING SOFTWARE AND PRINTED PUBLICATIONS, IN CLASS 35 (U.S. CLS. 100, 101 AND 102).

FOR: PROVISION OF FINANCIAL INFORMATION; FINANCIAL ANALYSIS; FINANCIAL ASSET EVALUATION; COMPUTERISED FINANCIAL ANALYSIS; COMPUTERISED FINANCIAL ASSET EVALUATION; COMPUTERISED FINANCIAL INFORMATION; FINANCIAL ANALYSIS AND PROVISION OF FINANCIAL INFORMATION IN THE NATURE OF FINANCIAL REPORTS; FINANCIAL MARKET INFORMATION SERVICES; FINANCIAL PORTFOLIOS MANAGEMENT, IN CLASS 36 (U.S. CLS. 100, 101 AND 102).

FOR: DESIGN AND DEVELOPMENT OF COMPUTER HARDWARE AND SOFTWARE; COMPUTER PROGRAMMING; INSTALLATION, MAINTENANCE AND REPAIR OF COMPUTER SOFTWARE; COMPUTER CONSULTANCY SERVICES; CREATING, MAINTAINING AND HOSTING THE WEB SITES OF OTHERS, IN CLASS 42 (U.S. CLS. 100 AND 101).

THE MARK CONSISTS OF STANDARD CHARACTERS WITHOUT CLAIM TO ANY PARTICULAR FONT, STYLE, SIZE, OR COLOR.

PRIORITY DATE OF 11-24-2009 IS CLAIMED.

OWNER OF INTERNATIONAL REGISTRATION 1059026 DATED 5-21-2010, EXPIRES 5-21-2020.

OWNER OF U.S. REG. NO. 2,481,442.

SER. NO. 79-090,232, FILED 5-21-2010.

SUE LAWRENCE, EXAMINING ATTORNEY

United States of America
United States Patent and Trademark Office

MUTSY

Reg. No. 4,072,503

Registered Dec. 20, 2011

Int. Cls.: 12, 18 and 20

TRADEMARK

PRINCIPAL REGISTER

MUTSY B.V. (NETHERLANDS LIMITED LIABILITY COMPANY)
14, NIEUWKERKSEDIJK
NL-5051 HT GOIRLE
NETHERLANDS

FOR: STROLLERS, PUSHCHAIRS, BABY BUGGIES, BICYCLE TRAILERS; BICYCLE SEATS FOR CHILDREN, CAR SEATS FOR CHILDREN, STROLLER AND BABY BUGGY ACCESSORIES, NAMELY, BEAN-BAG FOOTMUFFS SPECIALLY ADAPTED FOR USE WITH STROLLERS AND BABY BUGGIES, IN CLASS 12 (U.S. CLS. 19, 21, 23, 31, 35 AND 44).

FOR: EMPTY CARE BAGS FOR CARRYING BABIES' ACCESSORIES; NAPPY BAGS FOR BABIES; PARASOLS FOR STROLLERS, PUSHCHAIRS, OR BABY BUGGIES; CHILDREN'S SLINGS MADE OF TEXTILE CLOTHS AND CLOTH BANDS FOR THE CARRYING OF BABIES AND CHILDREN; SLING BAG POUCHES AND CARRYING FRAMES FOR THE CARRYING OF BABIES AND CHILDREN, IN CLASS 18 (U.S. CLS. 1, 2, 3, 22 AND 41).

FOR: CHILDREN'S FURNITURE; CHILDREN'S BEDSTEADS, COTS AND CRADLES; PORTABLE COTS; SEATS FOR CHILDREN; BOOSTER SEATS, IN CLASS 20 (U.S. CLS. 2, 13, 22, 25, 32 AND 50).

THE MARK CONSISTS OF STANDARD CHARACTERS WITHOUT CLAIM TO ANY PARTICULAR FONT, STYLE, SIZE, OR COLOR.

PRIORITY DATE OF 5-17-2010 IS CLAIMED.

OWNER OF INTERNATIONAL REGISTRATION 1059613 DATED 8-16-2010, EXPIRES 8-16-2020.

THE WORDING "MUTSY" HAS NO MEANING IN A FOREIGN LANGUAGE.

SER. NO. 79-090,391, FILED 8-16-2010.

DAVID ELTON, EXAMINING ATTORNEY



David J. Kyffers

Director of the United States Patent and Trademark Office

United States of America
United States Patent and Trademark Office

KYBER

Reg. No. 4,072,504

Registered Dec. 20, 2011

**Int. Cls.: 9, 16, 25, 35
and 42**

TRADEMARK

SERVICE MARK

PRINCIPAL REGISTER

O-RID CO., LTD. (JAPAN CORPORATION)
2172-35 OAZA MINAMITATEISHI,
BEPPU CITY; OITA 874-0839
JAPAN

FOR: COMPUTER PROGRAMS FOR CONVERTING TEXT IMAGES INTO DIGITAL TEXT AND AUTOMATIC DOCUMENT CLASSIFICATION; COMPUTER SOFTWARE FOR CONVERTING TEXT IMAGES INTO DIGITAL TEXT AND AUTOMATIC DOCUMENT CLASSIFICATION; DIGITAL CAMERAS, IN CLASS 9 (U.S. CLS. 21, 23, 26, 36 AND 38).

FOR: STATIONERY, IN CLASS 16 (U.S. CLS. 2, 5, 22, 23, 29, 37, 38 AND 50).

FOR: CLOTHING, NAMELY, JACKETS, SHIRTS, SKIRTS, PANTS, DRESSES; UNIFORMS; CLOTHES FOR SPORTS, NAMELY, ATHLETIC UNIFORMS, BASKETBALL UNIFORMS, CHEERLEADING UNIFORMS; BOOTS FOR SPORTS, EXCLUDING BOOTS FOR HORSE RIDING, IN CLASS 25 (U.S. CLS. 22 AND 39).

FOR: PUBLICITY SERVICES; RETAIL STORE SERVICES OR WHOLESALE DISTRIBUTORSHIP SERVICES FOR PAPER AND STATIONERY; RETAIL STORE SERVICES OR WHOLESALE DISTRIBUTORSHIP SERVICES FOR PHOTOGRAPHIC MACHINES AND APPARATUS AND PHOTOGRAPHIC SUPPLIES; RETAIL STORE SERVICES OR WHOLESALE DISTRIBUTORSHIP SERVICES FOR CLOTHING, IN CLASS 35 (U.S. CLS. 100, 101 AND 102).

FOR: COMPUTER SOFTWARE DESIGN, COMPUTER PROGRAMMING, OR MAINTENANCE OF COMPUTER SOFTWARE; RENTAL OF WEB SERVERS, IN CLASS 42 (U.S. CLS. 100 AND 101).

THE MARK CONSISTS OF STANDARD CHARACTERS WITHOUT CLAIM TO ANY PARTICULAR FONT, STYLE, SIZE, OR COLOR.

PRIORITY DATE OF 4-27-2010 IS CLAIMED.

OWNER OF INTERNATIONAL REGISTRATION 1059682 DATED 10-27-2010, EXPIRES 10-27-2020.

SER. NO. 79-090,408, FILED 10-27-2010.



David J. Kybas

Director of the United States Patent and Trademark Office

Reg. No. 4,072,504 JASON BLAIR, EXAMINING ATTORNEY

United States of America

United States Patent and Trademark Office

GRANDJEAN

Reg. No. 4,072,505

Registered Dec. 20, 2011

Int. Cl.: 14

TRADEMARK

PRINCIPAL REGISTER

SELLITA WATCH CO S.A. (SWITZERLAND SOCIÉTÉ ANONYME (SA))
LE CRÊT-DU-LOCLE 11
CH-2301 LA CHAUX-DE-FONDS
SWITZERLAND

FOR: TIMEPIECES AND CHRONOMETRIC INSTRUMENTS AND COMPONENTS THEREOF, NAMELY, MOVEMENTS, DIALS, CASES, AND CONTAINERS FOR WATCHES, INCLUDED IN THIS CLASS, IN CLASS 14 (U.S. CLS. 2, 27, 28 AND 50).

THE MARK CONSISTS OF STANDARD CHARACTERS WITHOUT CLAIM TO ANY PARTICULAR FONT, STYLE, SIZE, OR COLOR.

OWNER OF INTERNATIONAL REGISTRATION 1059745 DATED 11-2-2010, EXPIRES 11-2-2020.

SER. NO. 79-090,468, FILED 11-2-2010.

WILLIAM ROSSMAN, EXAMINING ATTORNEY



David J. Kyffers

Director of the United States Patent and Trademark Office

United States of America

United States Patent and Trademark Office



Reg. No. 4,072,506

Registered Dec. 20, 2011

Int. Cl.: 28

TRADEMARK

PRINCIPAL REGISTER

PROYECTES COMERCIALS NANBE, S.L. (SPAIN SOCIEDAD LIMITADA)
LA MASÍA, 26
E-08711 ODENA-IGUALADA (BARCELONA)
SPAIN

FOR: TOY ELECTRIC CARS; TOY ELECTRIC VEHICLE TRACKS; AND BOARD GAMES,
IN CLASS 28 (U.S. CLS. 22, 23, 38 AND 50).

NO CLAIM IS MADE TO THE EXCLUSIVE RIGHT TO USE "MODEL CAR COMPETITION
PARTS", APART FROM THE MARK AS SHOWN.

OWNER OF INTERNATIONAL REGISTRATION 1059763 DATED 11-2-2010, EXPIRES 11-
2-2020.

THE MARK CONSISTS OF THE WORDING "SCALEAUTO MODEL CAR COMPETITION
PARTS" IN STYLIZED FONT INSIDE THE SILHOUETTE OF THE ENGINE OF AN ELECTRIC
CAR.

SER. NO. 79-090,473, FILED 11-2-2010.

WILLIAM ROSSMAN, EXAMINING ATTORNEY



David J. Kyros

Director of the United States Patent and Trademark Office

United States of America

United States Patent and Trademark Office

MADO ET LES AUTRES

Reg. No. 4,072,507

Registered Dec. 20, 2011

Int. Cl.: 25

TRADEMARK

PRINCIPAL REGISTER

S.A.S. GROUPE MADO (FRANCE S.A.S.)
LA CROIX
F-42470 NEAUX
FRANCE

FOR: CLOTHING, NAMELY, SHIRTS, TANK TOPS, SCARVES, SUITS, SKIRTS, PANTS, SHORT TROUSERS, LEGGINGS, SHORTS, DRESSES, TEE-SHIRTS, TUNICS AND JACKETS; FOOTWEAR; HEADGEAR, NAMELY, HATS AND CAPS, IN CLASS 25 (U.S. CLS. 22 AND 39).

THE ENGLISH TRANSLATION OF "ET LES AUTRES" IN THE MARK IS AND OTHERS. THE WORDING "MADO" HAS NO MEANING IN A FOREIGN LANGUAGE.

OWNER OF INTERNATIONAL REGISTRATION 1059779 DATED 10-28-2010, EXPIRES 10-28-2020.

SER. NO. 79-090,476, FILED 10-28-2010.

WENDY GOODMAN, EXAMINING ATTORNEY



David J. Kybas

Director of the United States Patent and Trademark Office

United States of America

United States Patent and Trademark Office

EAT THE PUCK

Reg. No. 4,072,508

Registered Dec. 20, 2011

**Int. Cls.: 16, 25, 30 and
35**

EAT THE BALL HOLDING GMBH (AUSTRIA GESELLSCHAFT MIT BESCHRÄNKTER
HAFTUNG)

LASSERSTRASSE 2A

A-5020 SALZBURG

AUSTRIA

FOR: PACKAGING OF PAPER OR CARDBOARD, IN PARTICULAR PACKAGING CONTAINERS AND BAGS FOR PACKAGING, IN CLASS 16 (U.S. CLS. 2, 5, 22, 23, 29, 37, 38 AND 50).

FOR: CLOTHING, NAMELY, T-SHIRTS, CAPS, IN CLASS 25 (U.S. CLS. 22 AND 39).

FOR: BREAD, PASTRIES, PASTRY AND CONFECTIONERY MADE OF SUGAR, PREPARATIONS MADE FROM CEREAL, NAMELY, CEREAL BASED SNACK FOODS; MIXES FOR THE PREPARATION OF BAKERY GOODS; BAKERY GOODS AND BAKERY GOODS IN FROZEN FORM; PREPARED PASTRIES, IN CLASS 30 (U.S. CL. 46).

FOR: PROFESSIONAL BUSINESS CONSULTANCY FOR COMPANIES IN THE FOOD SECTOR, IN CLASS 35 (U.S. CLS. 100, 101 AND 102).

THE MARK CONSISTS OF STANDARD CHARACTERS WITHOUT CLAIM TO ANY PARTICULAR FONT, STYLE, SIZE, OR COLOR.

PRIORITY DATE OF 6-8-2010 IS CLAIMED.

OWNER OF INTERNATIONAL REGISTRATION 1059861 DATED 11-3-2010, EXPIRES 11-3-2020.

SER. NO. 79-090,508, FILED 11-3-2010.

KATHLEEN M. VANSTON, EXAMINING ATTORNEY



David J. Kyffers

Director of the United States Patent and Trademark Office

United States of America
United States Patent and Trademark Office

SERENDI

Reg. No. 4,072,509

Registered Dec. 20, 2011

Int. Cl.: 35

SERVICE MARK

PRINCIPAL REGISTER

SERENDI INTERNATIONAL AG (SWITZERLAND AKTIENGESELLSCHAFT)
RUE DE LA RÔTISSERIE 2
CH-1204 GENÈVE
SWITZERLAND

FOR: CONSULTING ON PERSONNEL-RELATED QUESTIONS, NAMELY, PERSONNEL CONSULTANCY; PLACEMENT OF PERSONNEL AND MANAGERS; PERSONNEL RECRUITMENT FOR OTHERS; EMPLOYMENT RECRUITING SERVICES, NAMELY, EVALUATION AND SELECTION OF QUALIFIED PERSONNEL AND HIGH-LEVEL MANAGERS, IN CLASS 35 (U.S. CLS. 100, 101 AND 102).

THE MARK CONSISTS OF STANDARD CHARACTERS WITHOUT CLAIM TO ANY PARTICULAR FONT, STYLE, SIZE, OR COLOR.

PRIORITY DATE OF 7-13-2010 IS CLAIMED.

OWNER OF INTERNATIONAL REGISTRATION 1059872 DATED 11-4-2010, EXPIRES 11-4-2020.

THE WORDING "SERENDI" HAS NO MEANING IN A FOREIGN LANGUAGE.

SER. NO. 79-090,511, FILED 11-4-2010.

PAM WILLIS, EXAMINING ATTORNEY



David J. Kybas

Director of the United States Patent and Trademark Office

United States of America

United States Patent and Trademark Office

KAYAMBE

Reg. No. 4,072,510

Registered Dec. 20, 2011

Int. Cl.: 30

GESTION PARTICIPATIONS FINANCIERES ET IMMOBILIERES (FRANCE SOCIÉTÉ PAR
ACTIONS SIMPLIFIÉE)
ROUTE DE CONCHES
F-27240 LE RONCENAY-AUTHENAY
FRANCE

TRADEMARK

PRINCIPAL REGISTER

FOR: COCOA, CHOCOLATE, CHOCOLATE TOPPINGS, CHOCOLATE-BASED BEVERAGES
WITH MILK, CHOCOLATE POWDER; CHOCOLATE PREPARATIONS FOR MAKING
PASTRIES AND CONFECTIONERY; CONFECTIONERY PRODUCTS, NAMELY,
CHOCOLATE; CONFECTIONERY FOR DECORATING CHRISTMAS TREES; CONFECTION-
ERY MADE OF SUGAR; PASTRIES; CONFECTIONERY, NAMELY, FONDANTS; SUGAR
CONFECTIONERY; EDIBLE ICES AND SHERBETS MADE WITH CHOCOLATE; COFFEE,
TEA, IN CLASS 30 (U.S. CL. 46).

THE MARK CONSISTS OF THE WORDING "KAYAMBE" IN A STYLIZED FONT.

PRIORITY DATE OF 5-3-2010 IS CLAIMED.

OWNER OF INTERNATIONAL REGISTRATION 1059977 DATED 11-3-2010, EXPIRES 11-
3-2020.

SER. NO. 79-090,550, FILED 11-3-2010.

ALYSSA STEEL, EXAMINING ATTORNEY



David J. Kyffers

Director of the United States Patent and Trademark Office

United States of America

United States Patent and Trademark Office

JR

Reg. No. 4,072,511

Registered Dec. 20, 2011

Int. Cls.: 18, 25 and 37

TRADEMARK

SERVICE MARK

PRINCIPAL REGISTER

JOH. RENDENBACH JR. GMBH & CO. KG (FED REP GERMANY GMBH & CO. KG)
KARTHAEUERSTRASSE 24
54290 TRIER
FED REP GERMANY

FOR: LEATHER, UNWORKED OR SEMI-WORKED; SADDLERY, IN CLASS 18 (U.S. CLS. 1, 2, 3, 22 AND 41).

FOR: SHOE SOLES; SHOE HEELS, IN CLASS 25 (U.S. CLS. 22 AND 39).

FOR: SHOE REPAIR, IN CLASS 37 (U.S. CLS. 100, 103 AND 106).

THE MARK CONSISTS OF A STYLIZED LETTER "JR" WHERE THE TOPS OF THE LETTERS ARE JOINED TOGETHER.

PRIORITY DATE OF 10-11-2010 IS CLAIMED.

OWNER OF INTERNATIONAL REGISTRATION 1060193 DATED 11-11-2010, EXPIRES 11-11-2020.

SER. NO. 79-090,639, FILED 11-11-2010.

TASNEEM HUSSAIN, EXAMINING ATTORNEY



David J. Kybas

Director of the United States Patent and Trademark Office

United States of America

United States Patent and Trademark Office

ace|b|io

Reg. No. 4,072,512

Registered Dec. 20, 2011

Int. Cls.: 3, 5 and 42

TIANJIN ACELBIO CO., LTD (CHINA LIMITED COMPANY)

N602, NO. 220 DONGTING ROAD,

TIANJIN INTERNATIONAL JOINT ACADEMY OF;BIOTECHNOLOGY & MEDICINE,;

TEDA; TIANJIN

CHINA

TRADEMARK

SERVICE MARK

PRINCIPAL REGISTER

FOR: COSMETICS; ESSENTIAL OILS; PERFUMED EXTRACTS FOR TISSUES AND PERFUMES; MEDICATED SOAP; HAIR SHAMPOOS; COSMETIC PREPARATIONS FOR SKIN CARE; SKIN WHITENING CREAMS; COSMETIC PREPARATIONS FOR SLIMMING PURPOSES; COSMETIC SUNSCREEN PREPARATIONS; ANTIPERSPIRANTS; NON-MEDICATED TOILETRIES, IN CLASS 3 (U.S. CLS. 1, 4, 6, 50, 51 AND 52).

FOR: OPIUM ALKALOID PREPARATIONS FOR MEDICAL PURPOSES; BIOLOGICAL PREPARATIONS FOR THE TREATMENT OF CANCER, CARDIOVASCULAR DISEASE AND CRANIAL NERVE DISEASES; CHEMICAL PREPARATIONS FOR PHARMACEUTICAL OR MEDICAL PURPOSES, NAMELY, FOR CANCER, CARDIOVASCULAR DISEASE AND CRANIAL NERVE DISEASES; FERMENTS FOR PHARMACEUTICAL PURPOSES; DIETETIC FOOD ADAPTED FOR MEDICAL PURPOSES; MEDICINAL HERBS; HORMONES FOR MEDICAL PURPOSES; RADIO-ISOTOPE MARKERS FOR THERAPEUTIC OR DIAGNOSTIC USE; BIOLOGICAL TISSUE CULTURES FOR MEDICAL AND VETERINARY USE; NUTRITIONAL FOOD ADDITIVES FOR MEDICAL PURPOSES IN THE NATURE OF NATURAL FOOD EXTRACTS DERIVED FROM PLANTS; ORGAN THERAPY PREPARATIONS FOR PHARMACEUTICAL OR MEDICAL PURPOSES, NAMELY, FOR CANCER, CARDIOVASCULAR DISEASE AND CRANIAL NERVE DISEASES; PHARMACEUTICAL PREPARATIONS FOR THE TREATMENT OF CANCER, CARDIOVASCULAR DISEASE AND CRANIAL NERVE DISEASES; PHARMACEUTICAL PREPARATIONS FOR SKIN CARE; VITAMIN PREPARATIONS, IN CLASS 5 (U.S. CLS. 6, 18, 44, 46, 51 AND 52).

FOR: BIOLOGICAL RESEARCH; BACTERIOLOGICAL RESEARCH; CHEMICAL ANALYSIS; CHEMISTRY RESEARCH; CHEMISTRY SERVICES, NAMELY, THE PRODUCTION OF SMALL MOLECULE DRUGS, THE PRODUCTION OF PLANT EXTRACTS AND THE PRODUCTION OF ACTIVE ELEMENT OF PLANT; COSMETICS RESEARCH; MATERIAL TESTING; QUALITY CONTROL FOR OTHERS; RESEARCH AND DEVELOPMENT OF NEW PRODUCTS FOR OTHERS; TECHNICAL PROJECT STUDIES IN THE FIELD OF MEDICAL SUPPLIES AND HEALTHCARE PRODUCTS DEVELOPMENT; CONSULTATION IN THE FIELD OF ENVIRONMENTAL PROTECTION, NAMELY, DETECTION OF PLANT SPECIES CONSERVATION ADVICE; TECHNICAL CONSULTANCY IN RELATION TO RESEARCH



David J. Kyffers

Director of the United States Patent and Trademark Office

Reg. No. 4,072,512 SERVICES RELATING TO FOODS AND DIETARY SUPPLEMENTS, IN CLASS 42 (U.S. CLS. 100 AND 101).

THE MARK CONSISTS OF THE WORDING "ACELBIO" IN STYLIZED FONT.

OWNER OF INTERNATIONAL REGISTRATION 1060311 DATED 11-3-2010, EXPIRES 11-3-2020.

SER. NO. 79-090,693, FILED 11-3-2010.

LOURDES AYALA, EXAMINING ATTORNEY

United States of America

United States Patent and Trademark Office



Reg. No. 4,072,513

Registered Dec. 20, 2011

Int. Cls.: 16 and 24

MANK GMBH (FED REP GERMANY GESELLSCHAFT MIT BESCHRÄNKTER HAFTUNG (GMBH))
RINGSTR. 36
56307 DERNBACH
FED REP GERMANY

TRADEMARK

PRINCIPAL REGISTER

FOR: PAPER GOODS, NAMELY, TABLE LINEN, TABLECLOTHS, NAPKINS; NAPKIN POUCHES, NAMELY, PAPER NAPKINS ADAPTED FOR USE AS A COVER FOR CUTLERY OR SNACKS, BIODEGRADABLE WOOD PULP PAPER NAPKINS ADAPTED FOR USE AS A COVER FOR CUTLERY AND SNACKS AND AIRLAD, NAMELY, NONWOVEN WOOD PULP PAPER NAPKINS ADAPTED FOR USE AS A COVER FOR CUTLERY AND SNACK, IN CLASS 16 (U.S. CLS. 2, 5, 22, 23, 29, 37, 38 AND 50).

FOR: TEXTILES, NAMELY, COTTON FABRIC, NON-WOVEN MATERIAL, NAMELY, TABLE LINEN, TABLE CLOTHS, NAPKINS, NAPKIN POUCHES, NAMELY, NAPKINS ADAPTED FOR USE AS A COVER FOR CUTLERY AND SNACKS, AND TEXTILE GOODS, NAMELY, TABLE LINEN, TABLE CLOTHS, NAPKINS AND NAPKIN POUCHES, NAMELY, NAPKINS ADAPTED FOR USE AS A COVER FOR CUTLERY AND SNACKS, IN CLASS 24 (U.S. CLS. 42 AND 50).

NO CLAIM IS MADE TO THE EXCLUSIVE RIGHT TO USE "SOFTER THAN LINEN", APART FROM THE MARK AS SHOWN.

OWNER OF INTERNATIONAL REGISTRATION 1060438 DATED 8-20-2010, EXPIRES 8-20-2020.

THE COLOR(S) BROWN, RED, GRAY AND YELLOW IS/ARE CLAIMED AS A FEATURE OF THE MARK.

THE MARK CONSISTS OF FOUR CONCENTRIC OVALS WHICH CONTAIN THE WORDING "LINFLAIR SOFTER THAN LINEN"; ALL WORDING IS IN BROWN EXCEPT THE LETTER "F" THE LOWER HORIZONTAL PORTION OF THE LETTER CONSISTS OF TWO WAVY RED BARS: THE INNER CONCENTRIC OVALS IS YELLOW: THE SECOND CONCENTRIC OVAL BROWN: THE THIRD CONCENTRIC OVAL IS GRAY; AND THE OUTER CONCENTRIC CIRCLE IS BROWN.

THE WORDING "LINFLAIR" HAS NO MEANING IN A FOREIGN LANGUAGE.



David J. Kyffers

Director of the United States Patent and Trademark Office

Reg. No. 4,072,513 SER. NO. 79-090,732, FILED 8-20-2010.

BILL DAWE, EXAMINING ATTORNEY

United States of America

United States Patent and Trademark Office

SVETLITSA

Reg. No. 4,072,514

Registered Dec. 20, 2011

Int. Cls.: 29 and 30

TRADEMARK

PRINCIPAL REGISTER

OTKRYTOE AKTSIONERNOE OBSHCHESTVO "ASTON PRODUKTY PITANIA I
PISHCHEVYE INGREDIENY" (RUSSIAN FED. JOINT STOCK COMPANY)
3B, UL. 1-YA LUGOVAYA
RU-344002 ROSTOV-NA-DONU
RUSSIAN FED.

FOR: MEAT, FISH, POULTRY AND GAME; MEAT EXTRACTS; PRESERVED, FROZEN,
DRIED AND COOKED FRUITS AND VEGETABLES; JELLIES, JAMS, COMPOTES; EGGS,
MILK AND MILK PRODUCTS, NAMELY, KEFIR, KUMISS, BUTTERMILK, SOUR CREAM,
CURDLED MILK, CURD, YOGHURT; EDIBLE OILS AND FATS, IN CLASS 29 (U.S. CL. 46).

FOR: SUGAR; RICE; FLOUR AND PREPARATIONS MADE FROM CEREALS, NAMELY,
HOMINY GRITS, CORN FLAKES, CRUSHED OATS, HUSKED OATS, CRUSHED BARLEY,
MUESLI, MILLED MAIZE; BREAD, PASTRY AND CONFECTIONERY, NAMELY, PIES,
BISCUITS, CHOCOLATE, HALVAH, TARTS, PUDDINGS, PASTILLES, MARZIPAN, CANDY
FOR FOOD, CRACKERS, SWEETMEATS, WAFFLES, COOKIES, SPICE-CAKES; ICES;
HONEY, TREACLE; YEAST, BAKING-POWDER; SALT, MUSTARD; VINEGAR, SAUCES;
SPICES; PROCESSED GRAINS FOR HUMAN FOOD, IN CLASS 30 (U.S. CL. 46).

THE MARK CONSISTS OF THE TERM "SVETLITSA".

OWNER OF INTERNATIONAL REGISTRATION 1028907 DATED 12-3-2009, EXPIRES 12-
3-2019.

THE WORDING "SVETLITSA" HAS NO MEANING IN A FOREIGN LANGUAGE.

SER. NO. 79-090,807, FILED 10-26-2010.

CHRISTOPHER BUONGIORNO, EXAMINING ATTORNEY



David J. Kyros

Director of the United States Patent and Trademark Office

United States of America

United States Patent and Trademark Office

T-wine

Reg. No. 4,072,515

Registered Dec. 20, 2011

Int. Cls.: 33, 35 and 38

TRADEMARK

SERVICE MARK

PRINCIPAL REGISTER

CHAMPAGNE ALAIN THIENOT (FRANCE SOCIÉTÉ PAR ACTIONS SIMPLIFIÉE)
14 RUE DES MOISSONS
F-51100 REIMS
FRANCE

FOR: WINES OF FRENCH ORIGIN, NAMELY, CHAMPAGNE, IN CLASS 33 (U.S. CLS. 47 AND 49).

FOR: BUSINESS MANAGEMENT AND ORGANIZATION CONSULTANCY; DIRECT MAIL ADVERTISING; CONDUCTING MARKETING STUDIES; ORGANIZATION OF EXHIBITIONS FOR COMMERCIAL OR ADVERTISING PURPOSES; ORGANIZATION OF TRADE FAIRS FOR COMMERCIAL OR ADVERTISING PURPOSES; ADVERTISING AGENCIES; ON-LINE ADVERTISING ON A COMPUTER NETWORK, IN CLASS 35 (U.S. CLS. 100, 101 AND 102).

FOR: COMMUNICATIONS BY AND BETWEEN COMPUTERS AND COMPUTER TERMINALS; COMPUTER-AIDED TRANSMISSION OF MESSAGES AND IMAGES, IN CLASS 38 (U.S. CLS. 100, 101 AND 104).

THE MARK CONSISTS OF A STYLIZED LETTER "T" FOLLOWED BY A HYPHEN AND THE TERM "WINE."

PRIORITY DATE OF 5-4-2010 IS CLAIMED.

OWNER OF INTERNATIONAL REGISTRATION 1060693 DATED 11-4-2010, EXPIRES 11-4-2020.

SER. NO. 79-090,848, FILED 11-4-2010.

CHRISTOPHER BUONGIORNO, EXAMINING ATTORNEY



David J. Kyros

Director of the United States Patent and Trademark Office

United States of America

United States Patent and Trademark Office

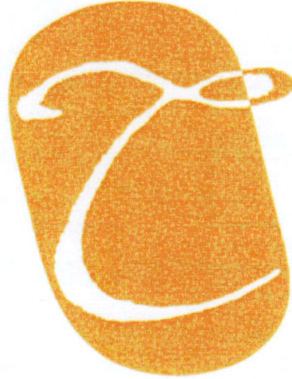

Reg. No. 4,072,516

Registered Dec. 20, 2011

Int. Cls.: 33, 35 and 38

TRADEMARK

SERVICE MARK

PRINCIPAL REGISTER

CHAMPAGNE ALAIN THIENOT (FRANCE SOCIÉTÉ PAR ACTIONS SIMPLIFIÉE)
14 RUE DES MOISSONS
F-51100 REIMS
FRANCE

FOR: WINES OF FRENCH ORIGIN, NAMELY, CHAMPAGNE, IN CLASS 33 (U.S. CLS. 47 AND 49).

FOR: BUSINESS MANAGEMENT AND ORGANIZATION CONSULTANCY; DIRECT MAIL ADVERTISING; CONDUCTING MARKETING STUDIES; ORGANIZATION OF EXHIBITIONS FOR COMMERCIAL OR ADVERTISING PURPOSES; ORGANIZATION OF TRADE FAIRS FOR COMMERCIAL OR ADVERTISING PURPOSES; ADVERTISING AGENCIES; ON-LINE ADVERTISING ON A COMPUTER NETWORK, IN CLASS 35 (U.S. CLS. 100, 101 AND 102).

FOR: COMMUNICATIONS BY AND BETWEEN COMPUTERS AND COMPUTER TERMINALS; COMPUTER-AIDED TRANSMISSION OF MESSAGES AND IMAGES, IN CLASS 38 (U.S. CLS. 100, 101 AND 104).

THE MARK CONSISTS OF A STYLIZED, WHITE LETTER "T" OUTLINED AGAINST AN ORANGE OVAL DESIGN.

PRIORITY DATE OF 5-4-2010 IS CLAIMED.

OWNER OF INTERNATIONAL REGISTRATION 1060698 DATED 11-4-2010, EXPIRES 11-4-2020.

THE COLOR(S) ORANGE AND WHITE IS/ARE CLAIMED AS A FEATURE OF THE MARK.

SER. NO. 79-090,851, FILED 11-4-2010.

CHRISTOPHER BUONGIORNO, EXAMINING ATTORNEY



David J. Kybas

Director of the United States Patent and Trademark Office

United States of America

United States Patent and Trademark Office



Reg. No. 4,072,517

Registered Dec. 20, 2011

Int. Cls.: 1 and 2

TRADEMARK

PRINCIPAL REGISTER

AKZO NOBEL COATINGS INTERNATIONAL B.V. (NETHERLANDS ANTILLES LIMITED LIABILITY COMPANY)
VELPERWEG 76
NL-6824 BM ARNHEM, NETHERLANDS

FOR: ADHESIVES IN THE FORM OF AN ADHESIVE COATED SUBSTRATE FOR THE AUTOMOTIVE INDUSTRY, IN CLASS 1 (U.S. CLS. 1, 5, 6, 10, 26 AND 46).

FOR: PAINTS, VARNISHES, LACQUERS, ANTI-RUST PRODUCTS IN THE FORM OF A PAINT PATCH FOR USE IN THE AUTOMOTIVE INDUSTRY, IN CLASS 2 (U.S. CLS. 6, 11 AND 16).

THE MARK CONSISTS OF "STICKERFIX" IN A SHADED RECTANGLE WITH A CURLED, FRINGED OR SCALLOPED LEFT CORNER.

PRIORITY DATE OF 6-9-2010 IS CLAIMED.

OWNER OF INTERNATIONAL REGISTRATION 1060811 DATED 11-8-2010, EXPIRES 11-8-2020.

SER. NO. 79-090,901, FILED 11-8-2010.

FLORENTINA BLANDU, EXAMINING ATTORNEY



David J. Kybas

Director of the United States Patent and Trademark Office

United States of America

United States Patent and Trademark Office

VARILAIR

Reg. No. 4,072,518

Registered Dec. 20, 2011

Int. Cl.: 11

TRADEMARK

PRINCIPAL REGISTER

SPIREC (SOCIÉTÉ PAR ACTIONS SIMPLIFIÉE) (FRANCE SOCIÉTÉ PAR ACTIONS SIMPLIFIÉE)
120/122 RUE LÉON JOUHAUX
F-78500 SARTROUVILLE, FRANCE

FOR: APPARATUS FOR HEATING, COOLING, AIR CONDITIONING, VENTILATION, DRYING AND FOR REGULATION OF AN AIR FLOW FOR FLOW RATE AND TEMPERATURE, NAMELY, HEATING INSTALLATIONS, AIR CONDITIONERS, HEATING SYSTEMS COMPOSED PRIMARILY OF TUBES, PIPES AND MANIFOLDS THROUGH WHICH WARM OR HIGH TEMPERATURE WATER CIRCULATES; HEATING SYSTEMS COMPOSED PRIMARILY OF TUBES, PIPES AND MANIFOLDS THROUGH WHICH COLD OR LOW TEMPERATURE WATER CIRCULATES; APPARATUS FOR THE EXCHANGE OF SUBSTANCES AND HEAT FOR USE IN REFRIGERATION; HEAT ACCUMULATORS AND REGENERATORS; AIR-CONDITIONING APPARATUS AND INSTALLATIONS; HEAT EXCHANGERS; AIR-COOLING AND VENTILATION APPARATUS AND INSTRUMENTS; DRYING APPARATUS FOR USE IN HEATING, VENTILATION SYSTEMS, AIR CONDITIONING SYSTEMS AND REFRIGERATION SYSTEMS; TEMPERATURE AND AIR FLOW REGULATORS FOR USE IN HEATING INSTALLATIONS, AIR COOLING, AIR CONDITIONING AND VENTILATION APPARATUS AND INSTRUMENTS, IN CLASS 11 (U.S. CLS. 13, 21, 23, 31 AND 34).

THE MARK CONSISTS OF STANDARD CHARACTERS WITHOUT CLAIM TO ANY PARTICULAR FONT, STYLE, SIZE, OR COLOR.

OWNER OF INTERNATIONAL REGISTRATION 0787087 DATED 6-25-2002, EXPIRES 6-25-2012.

THE WORD "VARILAIR" HAS NO MEANING IN A FOREIGN LANGUAGE.

SER. NO. 79-091,076, FILED 6-22-2010.

ROBERT C. CLARK JR., EXAMINING ATTORNEY



David J. Kyffers

Director of the United States Patent and Trademark Office

United States of America
United States Patent and Trademark Office

H2NO

Reg. No. 4,072,519

AB LUDVIG SVENSSON (SWEDEN LIMITED LIABILITY COMPANY)
SE-511 82 KINNA
SWEDEN

Registered Dec. 20, 2011

Int. Cl.: 22

FOR: AWNINGS, NAMELY, SHADING AND ENERGY SAVING FABRIC SCREENS FOR USE IN GREENHOUSES, IN CLASS 22 (U.S. CLS. 1, 2, 7, 19, 22, 42 AND 50).

TRADEMARK

THE MARK CONSISTS OF STANDARD CHARACTERS WITHOUT CLAIM TO ANY PARTICULAR FONT, STYLE, SIZE, OR COLOR.

PRINCIPAL REGISTER

PRIORITY DATE OF 2-1-2010 IS CLAIMED.

OWNER OF INTERNATIONAL REGISTRATION 1061270 DATED 7-28-2010, EXPIRES 7-28-2020.

SER. NO. 79-091,123, FILED 7-28-2010.

EDWARD NELSON, EXAMINING ATTORNEY



David J. Kyffers

Director of the United States Patent and Trademark Office

United States of America

United States Patent and Trademark Office

T-time

Reg. No. 4,072,520

Registered Dec. 20, 2011

Int. Cls.: 33, 35 and 38

TRADEMARK

SERVICE MARK

PRINCIPAL REGISTER

CHAMPAGNE ALAIN THIENOT (FRANCE SOCIÉTÉ PAR ACTIONS SIMPLIFIÉE)
14 RUE DES MOISSONS
F-51100 REIMS
FRANCE

FOR: WINES OF FRENCH ORIGIN, NAMELY, CHAMPAGNE, IN CLASS 33 (U.S. CLS. 47 AND 49).

FOR: BUSINESS MANAGEMENT AND ORGANIZATION CONSULTANCY; DIRECT MAIL ADVERTISING; CONDUCTING MARKETING STUDIES; ORGANIZATION OF EXHIBITIONS FOR COMMERCIAL OR ADVERTISING PURPOSES; ORGANIZATION OF TRADE FAIRS FOR COMMERCIAL OR ADVERTISING PURPOSES; ADVERTISING AGENCIES; ON-LINE ADVERTISING ON A COMPUTER NETWORK, IN CLASS 35 (U.S. CLS. 100, 101 AND 102).

FOR: COMMUNICATIONS BY AND BETWEEN COMPUTERS AND COMPUTER TERMINALS; COMPUTER-AIDED TRANSMISSION OF MESSAGES AND IMAGES, IN CLASS 38 (U.S. CLS. 100, 101 AND 104).

THE MARK CONSISTS OF A STYLIZED LETTER "T" FOLLOWED BY A HYPHEN AND THE TERM "TIME."

PRIORITY DATE OF 5-4-2010 IS CLAIMED.

OWNER OF INTERNATIONAL REGISTRATION 1061466 DATED 11-4-2010, EXPIRES 11-4-2020.

SER. NO. 79-091,186, FILED 11-4-2010.

CHRISTOPHER BUONGIORNO, EXAMINING ATTORNEY



David J. Kybas

Director of the United States Patent and Trademark Office

United States of America

United States Patent and Trademark Office

FINA Swimming World Championships

Reg. No. 4,072,521

FÉDÉRATION INTERNATIONALE DE NATATION (SWITZERLAND ASSOCIATION)
AVENUE DE L'AVANT-POSTE 4

Registered Dec. 20, 2011

LAUSANNE, SWITZERLAND CH1005

Int. Cls.: 25, 32 and 41

FOR: CLOTHING, NAMELY, TRAINING SUITS, TRACKSUITS FOR SPORTS, SHIRTS, POLO SHIRTS, PULLOVERS, T-SHIRTS, SHORTS, TROUSERS, SCARVES, RAINWEAR, SWIMWEAR INCLUDING BATHING COSTUMES, SWIMMING COSTUMES, SWIMSUITS, BATHING SUITS, BATHING TRUNKS AND SWIMMING TRUNKS; WATERPROOF CLOTHING, NAMELY, WATERPROOF JACKETS, SHOES, UNIFORMS; BIBS, NAMELY, CLOTH BIBS AND BIBS NOT OF CLOTH OR PAPER; FOOTWEAR; HEADGEAR, NAMELY, HEADWEAR INCLUDING SWIM CAPS, HATS, AND CAPS, IN CLASS 25 (U.S. CLS. 22 AND 39).

TRADEMARK

SERVICE MARK

PRINCIPAL REGISTER

FOR: BEER; MINERAL AND AERATED WATERS; OTHER NON-ALCOHOLIC DRINKS, NAMELY, DIET SOFT DRINKS, SOFT DRINKS, ENERGY DRINKS, LOW CALORIE SOFT DRINKS, SPORTS DRINKS, HERBAL JUICES, FLAVORED WATERS, ISOTONIC DRINKS, FROZEN FRUIT DRINKS, AND HEALTH AND WELLNESS DRINKS NOT FOR MEDICAL PURPOSES IN THE NATURE OF FRUIT DRINKS AND LEMONADES; FRUIT DRINKS AND FRUIT JUICES; CONCENTRATES, SYRUPS, OR POWDERS FOR MAKING SOFT DRINKS, SPORTS AND ENERGY DRINKS, AND TEA-FLAVORED BEVERAGES; SYRUPS FOR MAKING LEMONADES, BEVERAGES, FLAVORED MINERAL WATERS, FRUIT-FLAVORED DRINKS, SOFT DRINKS, FRUIT DRINKS AND ENERGY DRINKS, IN CLASS 32 (U.S. CLS. 45, 46 AND 48).



FOR: EDUCATION, NAMELY, PROVIDING CLASSES, SEMINARS AND WORKSHOPS IN THE FIELD OF SPORTS; TRAINING IN THE FIELD OF SPORTS; ENTERTAINMENT SERVICES DURING OR IN CONNECTION WITH SPORTS EVENTS AND COMPETITIONS, NAMELY, LASER SHOWS, LIGHT SHOWS, AIR SHOWS, MAGIC SHOWS, FASHION SHOWS, LIVE SHOW PERFORMANCES, FESTIVALS FEATURING PRIMARILY SPORTING EVENTS AND LIVE MUSIC CONCERTS; ORGANIZING COMMUNITY SPORTING AND CULTURAL EVENTS AND ACTIVITIES; ORGANIZING AND ARRANGING WATER SPORTS EVENTS AND COMPETITIONS FEATURING SWIMMING, SYNCHRONIZED SWIMMING AND OPEN-WATER SWIMMING, IN CLASS 41 (U.S. CLS. 100, 101 AND 107).

David J. Kybas

THE MARK CONSISTS OF STANDARD CHARACTERS WITHOUT CLAIM TO ANY PARTICULAR FONT, STYLE, SIZE, OR COLOR.

Reg. No. 4,072,521 PRIORITY DATE OF 6-15-2010 IS CLAIMED.

OWNER OF INTERNATIONAL REGISTRATION 1061488 DATED 11-16-2010, EXPIRES 11-16-2020.

OWNER OF U.S. REG. NOS. 2,617,218, 3,737,448 AND OTHERS.

NO CLAIM IS MADE TO THE EXCLUSIVE RIGHT TO USE "SWIMMING" FOR INTERNATIONAL CLASS 25 AND "SWIMMING WORLD CHAMPIONSHIPS" FOR INTERNATIONAL CLASS 41, APART FROM THE MARK AS SHOWN.

SER. NO. 79-091,194, FILED 11-16-2010.

RAMONA ORTIGA, EXAMINING ATTORNEY

United States of America

United States Patent and Trademark Office

FAMOUS NAMES

Reg. No. 4,072,522

Registered Dec. 20, 2011

Int. Cl.: 30

TRADEMARK

PRINCIPAL REGISTER

ELIZABETH SHAW LIMITED (UNITED KINGDOM LIMITED COMPANY)
12 BECKET COURT
PUCKLECHURCH; BRISTOL BS16 9QG
UNITED KINGDOM

FOR: CONFECTIONERY MADE OF SUGAR; CHOCOLATE; CHOCOLATES; HARD AND
SOFT CANDIES, IN CLASS 30 (U.S. CL. 46).

OWNER OF U.S. REG. NO. 1,427,683.

PRIORITY DATE OF 2-22-2010 IS CLAIMED.

OWNER OF INTERNATIONAL REGISTRATION 1061587 DATED 8-18-2010, EXPIRES 8-18-
2020.

THE COLOR(S) GOLD IS/ARE CLAIMED AS A FEATURE OF THE MARK.

THE MARK CONSISTS OF THE WORDS "FAMOUS NAMES" IN GOLD UNDERLINED BY
A GOLD LINE BROKEN IN THE MIDDLE.

SER. NO. 79-091,214, FILED 8-18-2010.

JESSICA A. POWERS, EXAMINING ATTORNEY



David J. Kyros

Director of the United States Patent and Trademark Office

United States of America

United States Patent and Trademark Office

JOIZ

Reg. No. 4,072,523

Registered Dec. 20, 2011

Int. Cls.: 35, 38 and 41

SERVICE MARK

PRINCIPAL REGISTER

JOIZ AG (SWITZERLAND SOCIÉTÉ ANONYME)
LIMMATSTRASSE 40
CH-8005 ZÜRICH
SWITZERLAND

FOR: ADVERTISING; BUSINESS MANAGEMENT; BUSINESS ADMINISTRATION; PROVIDING OFFICE FUNCTIONS; MANAGEMENT AND PROCESSING OF DATA; COMPILATION AND SYSTEMATIZATION OF DATA INTO COMPUTER DATABASES, IN CLASS 35 (U.S. CLS. 100, 101 AND 102).

FOR: BROADCASTING OF RADIO AND TELEVISION PROGRAMS; BROADCASTING, DISTRIBUTION AND REPEAT BROADCASTING OF TELEVISION SIGNALS, RADIO SIGNALS, TELECOMMUNICATION SIGNALS AND INFORMATION SIGNALS VIA DIGITAL NETWORKS AND ANALOG NETWORKS BOTH HARDWIRED AND NOT HARDWIRED, AND ON-LINE AND OFF-LINE IN THE FORM OF INTERACTIVE MEDIA SERVICES BY ELECTRONIC MEANS AS WELL AS BY COMPUTER; RECEIVING AND SENDING MESSAGES; RECEIVING AND SENDING DATA, MESSAGES AND DATABASE INFORMATION FOR NEWS AGENCIES VIA TELECOMMUNICATION MEANS, IN CLASS 38 (U.S. CLS. 100, 101 AND 104).

FOR: EDUCATION SERVICES, NAMELY, PROVIDING SEMINARS, WORKSHOPS IN THE FIELD OF MUSIC AND LIFESTYLE; ENTERTAINMENT BY MEANS OF RADIO AND TELEVISION BROADCASTS AND PROGRAMS, NAMELY, CONTINUING RADIO AND TELEVISION PROGRAMS, MOVIES, SHOWS, FEATURING NEWS, COMEDY, MUSIC, FASHION BROADCAST OVER RADIO AND TELEVISION; PRODUCTION OF FILMS, SOUND, VIDEOS AND TELEVISION PROGRAMS; LIVE MUSICAL PERFORMANCES; ORGANIZATION OF SPORTS AND CULTURAL ACTIVITIES, IN PARTICULAR ORGANIZATION OF CONCERTS, CONFERENCES, CONGRESSES, SEMINARS, TALKS IN THE FIELD OF MUSIC AND LIFESTYLE; ORGANIZATION OF SPORTS COMPETITIONS; EXHIBITIONS FOR CULTURAL OR EDUCATIONAL PURPOSES, IN CLASS 41 (U.S. CLS. 100, 101 AND 107).

THE MARK CONSISTS OF STANDARD CHARACTERS WITHOUT CLAIM TO ANY PARTICULAR FONT, STYLE, SIZE, OR COLOR.

PRIORITY DATE OF 5-7-2010 IS CLAIMED.



David J. Kybas

Director of the United States Patent and Trademark Office

Reg. No. 4,072,523 OWNER OF INTERNATIONAL REGISTRATION 1061673 DATED 11-5-2010, EXPIRES 11-5-2020.

SER. NO. 79-091,250, FILED 11-5-2010.

MATTHEW EINSTEIN, EXAMINING ATTORNEY

United States of America

United States Patent and Trademark Office

iBalance

Reg. No. 4,072,524

Registered Dec. 20, 2011

Int. Cls.: 9 and 11

JUDO WASSERAUFBEREITUNG GMBH (FED REP GERMANY GMBH (GESELLSCHAFT
MIT BESCHRÄNKTER HAFTUNG))
HOHREUSCHSTR. 39-41
71364 WINNENDEN
FED REP GERMANY

TRADEMARK

FOR: MECHANICAL DEVICES, NAMELY, DOSAGE DISPENSERS OF PRESENT PORTIONS
OF FLUIDS FOR DOSING PURPOSES FOR USE IN THE TREATMENT OF WATER, NOT
FOR MEDICAL USE, IN CLASS 9 (U.S. CLS. 21, 23, 26, 36 AND 38).

PRINCIPAL REGISTER

FOR: WATER PURIFICATION APPARATUS, IN PARTICULAR FOR THE ECO-FRIENDLY
AND/OR CHEMICAL FREE TREATMENT OF WATER; WATER SOFTENING UNITS; WATER
CONDITIONING APPARATUS AND UNITS; WATER FILTERS; DESALINATION UNITS,
IN CLASS 11 (U.S. CLS. 13, 21, 23, 31 AND 34).

THE MARK CONSISTS OF STANDARD CHARACTERS WITHOUT CLAIM TO ANY PAR-
TICULAR FONT, STYLE, SIZE, OR COLOR.

PRIORITY DATE OF 5-8-2010 IS CLAIMED.

OWNER OF INTERNATIONAL REGISTRATION 1061838 DATED 11-4-2010, EXPIRES 11-
4-2020.

OWNER OF U.S. REG. NO. 3,761,497.

SER. NO. 79-091,309, FILED 11-4-2010.

CHRISTOPHER BUONGIORNO, EXAMINING ATTORNEY



David J. Kypos

Director of the United States Patent and Trademark Office

United States of America

United States Patent and Trademark Office

NOMKOY

Reg. No. 4,072,525

Registered Dec. 20, 2011

Int. Cls.: 25 and 35

TRADEMARK

SERVICE MARK

PRINCIPAL REGISTER

NOMKOY S.R.L. (ITALY LIMITED LIABILITY COMPANY)
VIA CASTELLO, 46/1
I-35028 PIOVE DI SACCO (PADOVA)
ITALY

FOR: SOCKS, STOCKINGS, TIGHTS, UNDERWEAR, BEACHWEAR, LEGGINGS, FOUNDATION GARMENTS, PULLOVERS, GLOVES, CARDIGANS, JERSEYS, SWEATERS, TROUSERS, SKIRTS, JACKETS, JERKINS, SHIRTS, VESTS, WAISTCOATS, JUMPERS, TRACK SUITS, BLOUSES, BLOUSONS, JEANS, SWEAT PANTS, GYM SUITS, KNICKERS, PANTS, SHORTS, T-SHIRTS, SWEAT SHIRTS, SUITS AND DRESSES, OVERCOATS, COATS, ANORAKS, RAINWEAR, BELTS, SUSPENDERS, INFANT WEAR, DANCE SHOES AND COSTUMES, SKIWEAR, NECKWEAR, LOUNGEWEAR, SLEEPWEAR, FOOTWEAR, HEADWEAR, IN CLASS 25 (U.S. CLS. 22 AND 39).

FOR: THE BRINGING TOGETHER, FOR THE BENEFIT OF OTHERS, OF GARMENTS, HOSIERY, UNDERWEAR, FOOTWEAR AND HEADWEAR, EXCLUDING THE TRANSPORT THEREOF, ENABLING CUSTOMERS TO CONVENIENTLY VIEW AND PURCHASE THOSE GOODS; GOOD IMPORT AND EXPORT AGENCIES; ONLINE RETAIL STORE SERVICES AND RETAIL AND WHOLESALE STORE SERVICES, ALL FEATURING GARMENTS, HOSIERY, UNDERWEAR, FOOTWEAR AND HEADWEAR; BUSINESS MANAGEMENT ADVISORY SERVICES; ORGANIZATION OF EVENTS AND EXHIBITIONS FOR COMMERCIAL AND ADVERTISING PURPOSES; CONSULTANCY AND ADVISORY IN THE FIELD OF BUSINESS STRATEGY; ALL THE AFORE SAID SERVICES ON BEHALF OF THIRD PARTIES, IN CLASS 35 (U.S. CLS. 100, 101 AND 102).

THE MARK CONSISTS OF STANDARD CHARACTERS WITHOUT CLAIM TO ANY PARTICULAR FONT, STYLE, SIZE, OR COLOR.

OWNER OF INTERNATIONAL REGISTRATION 1061978 DATED 10-29-2010, EXPIRES 10-29-2020.

THE WORD(S) "NOMKOY" HAS NO MEANING IN A FOREIGN LANGUAGE.

SER. NO. 79-091,373, FILED 10-29-2010.

SUE LAWRENCE, EXAMINING ATTORNEY



David J. Kyffers

Director of the United States Patent and Trademark Office

United States of America
United States Patent and Trademark Office

IMAGECARE

Reg. No. 4,072,526

Registered Dec. 20, 2011

Int. Cl.: 11

TRADEMARK

PRINCIPAL REGISTER

KONINKLIJKE PHILIPS ELECTRONICS N.V. (NETHERLANDS PUBLIC LIMITED COMPANY)
GROENEWOUDSEWEG 1
NL-5621 BA
EINDHOVEN, NETHERLANDS

FOR: PROJECTOR LAMPS, IN CLASS 11 (U.S. CLS. 13, 21, 23, 31 AND 34).

THE MARK CONSISTS OF STANDARD CHARACTERS WITHOUT CLAIM TO ANY PARTICULAR FONT, STYLE, SIZE, OR COLOR.

PRIORITY DATE OF 4-29-2010 IS CLAIMED.

OWNER OF INTERNATIONAL REGISTRATION 1062007 DATED 10-28-2010, EXPIRES 10-28-2020.

SER. NO. 79-091,384, FILED 10-28-2010.

TOBY BULLOFF, EXAMINING ATTORNEY



David J. Kyffers

Director of the United States Patent and Trademark Office

United States of America

United States Patent and Trademark Office

BROWHAUS

Reg. No. 4,072,527

Registered Dec. 20, 2011

Int. Cl.: 44

SPA ESPRIT GROUP FRANCHISE PTE. LTD. (SINGAPORE COMPANY LIMITED BY SHARES)
8D DEMPSEY ROAD
#01-03/04; SINGAPORE 249672
SINGAPORE

SERVICE MARK

PRINCIPAL REGISTER

FOR: HYGIENIC AND BEAUTY CARE OF HUMAN BEINGS; EYE BROW TRIMMING; EYE BROW THREADING; EYELASH PERMING; LASER HAIR REMOVAL SERVICES; BODY HAIR WAXING SERVICES; TATTOOING; MANICURE SERVICES; MAKE-UP APPLICATION SERVICES; AROMATHERAPY SERVICES; HEALTH SPA SERVICES, NAMELY, COSMETIC BODY CARE SERVICES; MASSAGE SERVICES, IN CLASS 44 (U.S. CLS. 100 AND 101).

THE MARK CONSISTS OF STANDARD CHARACTERS WITHOUT CLAIM TO ANY PARTICULAR FONT, STYLE, SIZE, OR COLOR.

PRIORITY DATE OF 6-18-2010 IS CLAIMED.

OWNER OF INTERNATIONAL REGISTRATION 1062136 DATED 11-22-2010, EXPIRES 11-22-2020.

OWNER OF U.S. REG. NO. 3,420,788.

THE ENGLISH TRANSLATION OF THE WORD "HAUS" IN THE MARK IS "HOUSE".

SER. NO. 79-091,419, FILED 11-22-2010.

ROBERT STRUCK, EXAMINING ATTORNEY



David J. Kyffers

Director of the United States Patent and Trademark Office

United States of America
United States Patent and Trademark Office

NUANCE

Reg. No. 4,072,528

Registered Dec. 20, 2011

Int. Cl.: 19

TRADEMARK

PRINCIPAL REGISTER

CREATON AG (FED REP GERMANY AKTIENGESELLSCHAFT)
DILLINGER STRASSE 60
86637 WERTINGEN
FED REP GERMANY

FOR: TILES MADE OF CLAY, IN CLASS 19 (U.S. CLS. 1, 12, 33 AND 50).

THE MARK CONSISTS OF THE STYLIZED WORDING "NUANCE".

OWNER OF INTERNATIONAL REGISTRATION 0636987 DATED 5-3-1995, EXPIRES 5-3-2015.

SER. NO. 79-091,501, FILED 11-8-2010.

COURTNEY ALVAREZ, EXAMINING ATTORNEY



David J. Kybas

Director of the United States Patent and Trademark Office

United States of America

United States Patent and Trademark Office

PRIMUR

Reg. No. 4,072,529

Registered Dec. 20, 2011

Int. Cls.: 1 and 17

TRADEMARK

PRINCIPAL REGISTER

SIGA SERVICES AG (SWITZERLAND SOCIÉTÉ ANONYME)
RÜTMATTSTRASSE 7
CH-6017 RUSWIL
SWITZERLAND

FOR: ADHESIVES FOR INDUSTRIAL PURPOSES, FOR WALL TILES AS WELL AS THE REPAIR OF BROKEN OBJECTS, IN CLASS 1 (U.S. CLS. 1, 5, 6, 10, 26 AND 46).

FOR: ADHESIVE TAPES OTHER THAN STATIONERY AND NOT FOR MEDICAL OR HOUSEHOLD PURPOSES, NAMELY, FOR INDUSTRIAL OR COMMERCIAL USE, IN CLASS 17 (U.S. CLS. 1, 5, 12, 13, 35 AND 50).

THE MARK CONSISTS OF STANDARD CHARACTERS WITHOUT CLAIM TO ANY PARTICULAR FONT, STYLE, SIZE, OR COLOR.

OWNER OF INTERNATIONAL REGISTRATION 0734388 DATED 5-16-2000, EXPIRES 5-16-2020.

OWNER OF U.S. REG. NO. 2,318,148.

THE WORDING "PRIMUR" HAS NO MEANING IN A FOREIGN LANGUAGE.

SER. NO. 79-091,512, FILED 11-2-2010.

WILLIAM ROSSMAN, EXAMINING ATTORNEY



David J. Kyffers

Director of the United States Patent and Trademark Office

United States of America

United States Patent and Trademark Office

CATHERINE MALANDRINO

Reg. No. 4,072,530

Registered Dec. 20, 2011

Int. Cl.: 25

TRADEMARK

PRINCIPAL REGISTER

CATHERINE MALANDRINO (MADAME) (FRANCE INDIVIDUAL)
67, RUE DE MIROMESNIL
F-75008 PARIS
FRANCE

FOR: CLOTHING, NAMELY, SHIRTS, SHORTS, PANTS AND JACKETS, FOOTWEAR, HEADWEAR, HEADGEAR, NAMELY, HATS AND CAPS; SHIRTS; LEATHER OR IMITATION LEATHER CLOTHING, NAMELY, JACKETS; BELTS; FURS, NAMELY, FUR COATS AND JACKETS; GLOVES; FOULARDS; TIES, HOSIERY; SOCKS; SLIPPERS; BEACH, SKI OR SPORTS FOOTWEAR; UNDERWEAR, STOCKINGS, TIGHTS, IN CLASS 25 (U.S. CLS. 22 AND 39).

THE MARK CONSISTS OF STANDARD CHARACTERS WITHOUT CLAIM TO ANY PARTICULAR FONT, STYLE, SIZE, OR COLOR.

OWNER OF INTERNATIONAL REGISTRATION 0827400 DATED 5-19-2004, EXPIRES 5-19-2014.

OWNER OF U.S. REG. NOS. 3,066,099 AND 3,307,483.

THE NAME(S), PORTRAIT(S), AND/OR SIGNATURE(S) SHOWN IN THE MARK IDENTIFIES "CATHERINE MALANDRINO", WHOSE CONSENT(S) TO REGISTER IS MADE OF RECORD.

SER. NO. 79-091,518, FILED 10-29-2010.

SUE LAWRENCE, EXAMINING ATTORNEY



David J. Kyffers

Director of the United States Patent and Trademark Office

United States of America

United States Patent and Trademark Office



Reg. No. 4,072,531

Registered Dec. 20, 2011

Int. Cl.: 9

TRADEMARK

PRINCIPAL REGISTER

SIEMENS AKTIENGESELLSCHAFT (FED REP GERMANY JOINT STOCK COMPANY)
WITTELSBACHERPLATZ 2
80333 MÜNCHEN
FED REP GERMANY

FOR: ELECTRICAL APPARATUS, NAMELY, CHARGING STATIONS FOR CHARGING ELECTRIC VEHICLES; APPARATUS FOR THE INPUT, PROCESSING, TRANSMISSION, STORAGE AND DISPLAY OF ELECTRICAL DATA; DISTRIBUTION UNITS FOR THE TRANSMISSION OF ELECTRIC ENERGY FROM THE PRODUCER TO THE CONSUMER AT ELECTRIC VEHICLE CHARGING STATIONS, IN CLASS 9 (U.S. CLS. 21, 23, 26, 36 AND 38).

NO CLAIM IS MADE TO THE EXCLUSIVE RIGHT TO USE "PARK & CHARGE", APART FROM THE MARK AS SHOWN.

PRIORITY DATE OF 6-2-2010 IS CLAIMED.

OWNER OF INTERNATIONAL REGISTRATION 1062472 DATED 12-1-2010, EXPIRES 12-1-2020.

THE MARK CONSISTS OF THE WORDING "PARK & CHARGE" TO THE RIGHT OF A STYLIZED LETTER "E", WITH AN ELECTRICAL PLUG FORMING THE BOTTOM PART OF THE "E". THE MARK APPEARS ON A SHADED RECTANGULAR BACKGROUND.

SER. NO. 79-091,613, FILED 12-1-2010.

KIMBERLY FRYE, EXAMINING ATTORNEY



David J. Kybas

Director of the United States Patent and Trademark Office

United States of America

United States Patent and Trademark Office

RHODIA COLOURED TOW

Reg. No. 4,072,532

Registered Dec. 20, 2011

Int. Cls.: 1, 17, 22 and 34

TRADEMARK

PRINCIPAL REGISTER

RHODIA ACETOW GMBH (FED REP GERMANY GMBH)
ENGESSERSTRASSE 8
79108 FREIBURG
FED REP GERMANY

FOR: CHEMICALS USED IN INDUSTRY; UNPROCESSED ACETATE OF CELLULOSE, CELLULOSE DERIVATIVES; UNPROCESSED PLASTICS FOR USE AS FILTERING MATERIALS, CHEMICALS FOR USE IN FILTERING TOBACCO SMOKE FILTERS AND MORE GENERALLY IN THE TOBACCO INDUSTRY, IN CLASS 1 (U.S. CLS. 1, 5, 6, 10, 26 AND 46).

FOR: SEMI-PROCESSED CELLULOSE ACETATE FOR USE IN TOBACCO SMOKE FILTERS, INSULATING MATERIALS, FABRICS OF INSULATING FIBERS, THREADS, MONOFILAMENTS AND FABRICS AND NON-WOVEN THREADS, IN PARTICULAR OF PLASTIC MATERIALS, NOT FOR TEXTILE USE; FILTERING MATERIALS, NAMELY, SEMI-PROCESSED FOAMS OR FILMS OF PLASTIC FOR ABSORBING AEROSOLS AND EMULSIONS, AS WELL AS FOR FILTERING WATER FROM ORGANIC FLUIDS AND FILTERING ORGANIC FLUIDS FROM WATER; ASBESTOS AND RUBBER ELASTIC YARNS, NOT FOR USE IN TEXTILES; FLEXIBLE PIPES, NOT OF METAL; INSULATING MATERIALS AND INSULATORS, INCLUDING INSULATING FABRICS, INSULATING FELT, NON-CONDUCTING MATERIALS FOR RETAINING HEAT, INSULATORS FOR ELECTRIC MAINS AND INSULATORS FOR CABLES; INSULATING GLOVES; INSULATING MATERIALS TO PREVENT THE RADIATION OF HEAT; ARCHITECTURAL ACOUSTIC MATERIALS, NAMELY, SOUND ABSORBERS AND DIFFUSERS; FLOATING ANTI-POLLUTION BARRIERS, NOT OF METAL; PADDING MATERIALS OF RUBBER OR PLASTICS FOR USE IN BEDS, CUSHIONS AND MATTRESSES, IN CLASS 17 (U.S. CLS. 1, 5, 12, 13, 35 AND 50).

FOR: TWINE FOR NETS; RAW TEXTILE FIBERS; PLASTIC FIBERS FOR TEXTILE USE; NON-WOVEN FABRICS FOR QUILTING AND PADDING; PACKAGING MATERIALS OF TEXTILE MATERIALS, WADDING FOR FILTERING; TENTS, AWNINGS, TARPAULINS, AND SAILS, SACKS AND BAGS FOR THE TRANSPORTATION OR STORAGE OF MATERIALS IN BULK; PADDING MATERIALS FOR BEDS, CUSHIONS AND MATTRESSES, NOT OF RUBBER OR PLASTICS; POUCHES AND BAGS OF TEXTILE, FOR PACKAGING; ROPES AND STRINGS OF NATURAL AND CHEMICAL FIBERS; ROPES AND STRING; FISHING NETS; COTTON WASTE FOR PADDING AND STUFFING, IN CLASS 22 (U.S. CLS. 1, 2, 7, 19, 22, 42 AND 50).



David J. Kyros

Director of the United States Patent and Trademark Office

Reg. No. 4,072,532 FOR: FILTERS FOR TOBACCO SMOKE; CIGARETTE FILTERS AND FILTER ENDS, CIGARS AND TOBACCO PIPES, CIGARETTE PAPER; TOBACCO SUBSTITUTES, NOT FOR MEDICAL PURPOSES, IN CLASS 34 (U.S. CLS. 2, 8, 9 AND 17).

THE MARK CONSISTS OF STANDARD CHARACTERS WITHOUT CLAIM TO ANY PARTICULAR FONT, STYLE, SIZE, OR COLOR.

PRIORITY DATE OF 5-21-2010 IS CLAIMED.

OWNER OF INTERNATIONAL REGISTRATION 1062807 DATED 11-15-2010, EXPIRES 11-15-2020.

NO CLAIM IS MADE TO THE EXCLUSIVE RIGHT TO USE "COLOURED TOW", APART FROM THE MARK AS SHOWN.

THE WORDING "RHODIA" HAS NO MEANING IN A FOREIGN LANGUAGE.

SER. NO. 79-091,740, FILED 11-15-2010.

DAVID TOOLEY, EXAMINING ATTORNEY

United States of America

United States Patent and Trademark Office

BITmarketing

Reg. No. 4,072,533

Registered Dec. 20, 2011

Int. Cl.: 35

SERVICE MARK

PRINCIPAL REGISTER

ALMAZÁN CABALLERO, CARLOS (SPAIN INDIVIDUAL)
AVENIDA ALFONSO X EL SABIO, 46
3º IZQUIERDA; E-03004 ALICANTE
SPAIN

FOR: ADVERTISING AND MARKETING ON-LINE WEBSITES OF OTHERS, IN CLASS 35
(U.S. CLS. 100, 101 AND 102).

THE MARK CONSISTS OF STANDARD CHARACTERS WITHOUT CLAIM TO ANY PARTICULAR FONT, STYLE, SIZE, OR COLOR.

OWNER OF INTERNATIONAL REGISTRATION 1063198 DATED 12-27-2010, EXPIRES 12-27-2020.

SER. NO. 79-091,859, FILED 12-27-2010.

RONALD AIKENS, EXAMINING ATTORNEY



David J. Kyffers

Director of the United States Patent and Trademark Office

United States of America

United States Patent and Trademark Office



力诺瑞特

Reg. No. 4,072,534

Registered Dec. 20, 2011

Int. Cl.: 11

TRADEMARK

PRINCIPAL REGISTER

SHANDONG LINUO PARADIGMA CO., LTD. (CHINA CORPORATION)
NO. 30766, EAST JINGSHI ROAD
GANGGOU TOWN,; LICHENG DISTRICT,; JINANCITY; SHANDONG PROVINCE
CHINA

FOR: SOLAR COLLECTORS; SOLAR ENERGY HOT WATER HEATER; ICE BOXES; REFRIGERATING APPLIANCES AND INSTALLATIONS; AIR CONDITIONING INSTALLATIONS; RADIATORS; SOLAR POWERED FURNACES; DESICCATING APPARATUS FOR REMOVING LIQUID AND MOISTURE IN SOLID MATERIALS; STEAM GENERATING INSTALLATIONS; STEAM ACCUMULATORS, IN CLASS 11 (U.S. CLS. 13, 21, 23, 31 AND 34).

THE MARK CONSISTS OF A STYLIZED LETTER "B" WITHIN A SQUARE BACKGROUND WITH CHINESE CHARACTERS APPEARING DIRECTLY UNDERNEATH WHICH TRANSLITERATE TO LI NUO RUI TE. LI MEANS POWER, NUO MEANS PROMISE, RUI MEANS LUCKY, TE MEANS SPECIAL. THE CHINESE CHARACTERS TAKEN AS A WHOLE DO NOT HAVE A DIRECT MEANING IN ENGLISH AS A PHRASE.

PRIORITY DATE OF 6-30-2010 IS CLAIMED.

OWNER OF INTERNATIONAL REGISTRATION 1063201 DATED 10-8-2010, EXPIRES 10-8-2020.

THE TRANSLITERATION OF THE NON-LATIN CHARACTERS IN THE MARK IS: LI NUO RUI TE.

THE ENGLISH TRANSLATION OF THE FOREIGN WORDS IN THE MARK IS LI MEANS POWER, NUO MEANS PROMISE, RUI MEANS LUCKY, TE MEANS SPECIAL; THE WHOLE WORD HAS NO MEANING.

SER. NO. 79-091,861, FILED 10-8-2010.

JACLYN KIDWELL WALKER, EXAMINING ATTORNEY



David J. Kybas

Director of the United States Patent and Trademark Office

United States of America

United States Patent and Trademark Office

Humming Heads DeP

Reg. No. 4,072,535

Registered Dec. 20, 2011

Int. Cls.: 9 and 42

TRADEMARK

SERVICE MARK

PRINCIPAL REGISTER

HUMMING HEADS KABUSHIKI KAISHA (JAPAN CORPORATION)
2-13, 1-CHOME, TSUKISHIMA
CHUO-KU
TOKYO, JAPAN 1040052

FOR: BLUEPRINTING MACHINES; CASH REGISTERS; COIN COUNTING OR SORTING MACHINES; ELECTRIC SIGN BOARDS FOR DISPLAYING TARGET FIGURES AND CURRENT OUTPUTS; PHOTO-COPYING MACHINES; COMPUTER SOFTWARE FOR COMPUTER AIDED DRAWING; TIME AND DATE STAMPING MACHINES; TIME CLOCKS; PUNCHED CARD OFFICE MACHINES, NAMELY, PUNCH CLOCKS; VOTING MACHINES; POSTAGE STAMP CHECKING APPARATUS MEASURING OR TESTING MACHINES AND INSTRUMENTS, NAMELY, POSTAGE STAMP METERS; STANDARD-UNIT MEASURING MACHINES AND APPARATUS, NAMELY, WEIGHING APPARATUS AND INSTRUMENTS, TEMPERATURE INDICATORS, THERMOMETERS, WATER METERS, WEIGHING BALANCES, PLANIMETERS, MEASURING RULES, DERIVED-UNIT MEASURING MACHINES AND APPARATUS, PRESSURE GAUGES, LEVEL INDICATORS, ACOUSTIC METERS, TACHOMETERS, ACCELEROMETERS, REFRACTOMETERS, LUMINOUS FLUX METERS, PHOTOMETERS, ALTIMETERS, HYGROMETERS, ILLUMINOMETERS, VIBRATION METERS, NOISEMETERS, SPEED INDICATORS, CALORIMETERS, VISCOSIMETERS, CONCENTRATION METERS, GRAVIMETERS, DENSIMETERS, DYNAMOMETERS, FLOWMETERS, PROFILE PROJECTORS; GRADUATION CHECKERS; AUTOMATED MACHINES AND INSTRUMENTS THAT ADJUST OR REGULATE THE PHYSICAL OR CHEMICAL PROPERTIES OF MATERIALS OR MACHINES; MACHINES AND INSTRUMENTS USED TO TEST PHYSICAL OR CHEMICAL PROPERTIES, OF METALLIC, CERAMIC, CONCRETE, AND ORGANIC MATERIALS; SURVEYING MACHINES AND INSTRUMENTS; DISTANCE MEASURING APPARATUS; ANALYSIS INSTRUMENTS FOR PHOTOGRAMMETRIC PURPOSES; PRECISION THEODOLITES; TELEPHONE APPARATUS; MOBILE PHONE; TELETYPEWRITERS; AUTOMATIC TELEGRAPH APPARATUS; PHOTOTELEGRAPHY APPARATUS; MANUAL TELEGRAPH APPARATUS; REPEATING EXCHANGE MACHINES, TELECOMMUNICATION SWITCHES; AUTOMATIC TELEPHONE EXCHANGE APPARATUS; APPARATUS FOR BROADCASTING, RECORDING, TRANSMISSION OR REPRODUCTION OF SIGNALS, SOUND OR IMAGES; DEVICES FOR WIRELESS RADIO TRANSMISSION; AERONAUTICAL RADIO COMMUNICATION MACHINES AND APPARATUS; MULTICHANNEL RADIO COMMUNICATION MACHINES AND APPARATUS FOR FIXED STATIONS; SINGLE-CHANNEL RADIO COMMUNICATION MACHINES AND APPARATUS FOR FIXED STATIONS; RADIO COMMUNICATION MACHINES AND APPARATUS FOR USE IN LAND VEHICLES; MARINE RADIO COMMUNICATION MACHINES



David J. Kyffers

Director of the United States Patent and Trademark Office

Reg. No. 4,072,535 AND APPARATUS; RADIO BEACON; RADIO DIRECTION FINDERS; REMOTE CONTROL TELEMETERS; COMPACT DISC PLAYERS; TAPE RECORDERS; RECORD PLAYERS; SOUND RECORDING MACHINES AND APPARATUS, NAMELY, AUDIO FREQUENCY APPARATUS IN THE NATURE OF ELECTRONIC PRODUCTS FOR THE MANIPULATION OF THE FREQUENCY OF AUDIO SIGNALS, NAMELY, AUDIO PROCESSORS; VIDEO FREQUENCY MACHINES AND APPARATUS, NAMELY, DIGITAL CAMERAS, VIDEO CAMERAS, VIDEODISC PLAYERS, VIDEOTAPE RECORDERS, DVD PLAYERS, DVD RECORDERS; LOUDSPEAKERS; TELEPHONE CONNECTORS, MICROPHONES FOR TELECOMMUNICATION APPARATUS; ELECTROSTATIC COPYING MACHINES; COMPUTERS; ELECTRONIC DESK CALCULATORS; HARD DISK DRIVES; WORD PROCESSORS; INTEGRATED CIRCUITS; VIDEO GAME MACHINES FOR USE WITH AN EXTERNAL DISPLAY SCREEN OR MONITOR; ELECTRONIC CIRCUITS AND CD-ROMS RECORDED WITH PROGRAMS FOR HAND-HELD GAMES WITH LIQUID CRYSTAL DISPLAYS; SOUND RECORDED MAGNETIC CARDS, SHEETS AND TAPES; COMPUTER GAME DISCS; ELECTRONIC CIRCUITS AND CD-ROMS RECORDED WITH AUTOMATIC PERFORMANCE PROGRAMS FOR ELECTRONIC MUSICAL INSTRUMENTS; DOWNLOADABLE MUSIC FILES; EXPOSED CINEMATOGRAPHIC FILMS; EXPOSED SLIDE FILMS; SLIDE FILM MOUNTS; DOWNLOADABLE IMAGE FILES, NAMELY, ART WORK AND TEXT FOR BUSINESS, ENTERTAINMENT AND EDUCATION PURPOSES; ELECTRONIC PUBLICATIONS, NAMELY, BOOKS OF POEMS, SHORT STORIES AND PLAYS, BOOKS IN THE FIELDS OF SOCIAL SCIENCE, POLITICS, BUSINESS, ECONOMICS, SCIENCE, TECHNOLOGY, ART, AND HOBBIES, GUIDE BOOKS, DICTIONARIES, AND ENCYCLOPEDIAS, AND GENERAL FEATURE MAGAZINES AND NEWSPAPERS, IN CLASS 9 (U.S. CLS. 21, 23, 26, 36 AND 38).

FOR: DESIGNING OF COMPUTERS AND COMPUTER-AIDED MACHINES, APPARATUS AND INSTRUMENTS INCLUDING THEIR PARTS OR SYSTEMS COMPOSED OF SUCH MACHINES, APPARATUS AND INSTRUMENTS; COMPUTER SOFTWARE DESIGN, COMPUTER PROGRAMMING, AND MAINTENANCE OF COMPUTER SOFTWARE; TECHNICAL ADVICE RELATING TO PERFORMANCE AND OPERATION OF COMPUTERS AND COMPUTER-AIDED MACHINES, APPARATUS AND INSTRUMENTS; TESTING OR RESEARCH ON MACHINES, APPARATUS AND INSTRUMENTS; RENTAL OF COMPUTERS, IN CLASS 42 (U.S. CLS. 100 AND 101).

THE MARK CONSISTS OF STANDARD CHARACTERS WITHOUT CLAIM TO ANY PARTICULAR FONT, STYLE, SIZE, OR COLOR.

PRIORITY DATE OF 3-18-2010 IS CLAIMED.

OWNER OF INTERNATIONAL REGISTRATION 1063213 DATED 6-29-2010, EXPIRES 6-29-2020.

OWNER OF U.S. REG. NOS. 3,340,212 AND 3,445,361.

SER. NO. 79-091,867, FILED 6-29-2010.

JACLYN KIDWELL WALKER, EXAMINING ATTORNEY

United States of America

United States Patent and Trademark Office



Reg. No. 4,072,536

Registered Dec. 20, 2011

Int. Cls.: 12, 37 and 42

BERINGER (SOCIÉTÉ PAR ACTIONS SIMPLIFIÉE) (FRANCE SOCIÉTÉ PAR ACTIONS SIMPLIFIÉE)
309 RUE LE SOU
F-69220 SAINT-JEAN-D'ARDIERES
FRANCE

TRADEMARK

FOR: VEHICLE BRAKES; BRAKE LININGS FOR VEHICLES; BRAKE CALIPERS FOR VEHICLES, BRAKE MASTER CYLINDERS FOR VEHICLES, BRAKE DISCS, HYDRAULIC CIRCUITS FOR MOTORCYCLES, QUADS, SIDE-CARS, MOTORCYCLES, AUTOMOBILES, LIGHT PLANES, IN CLASS 12 (U.S. CLS. 19, 21, 23, 31, 35 AND 44).

SERVICE MARK

PRINCIPAL REGISTER

FOR: VEHICLE REPAIR, NAMELY, BREAKDOWN ASSISTANCE SERVICES, IN CLASS 37 (U.S. CLS. 100, 103 AND 106).

FOR: RESEARCH AND DESIGN SERVICES IN CONNECTION WITH CARS, PARTICULARLY HIGH-PERFORMANCE BRAKING; MATERIALS TESTING; INDUSTRIAL DESIGN; TECHNICAL PROJECT STUDIES IN THE FIELD OF CARS, PARTICULARLY HIGH-PERFORMANCE BRAKING, IN CLASS 42 (U.S. CLS. 100 AND 101).

OWNER OF U.S. REG. NO. 2,359,669.

PRIORITY DATE OF 6-10-2010 IS CLAIMED.

OWNER OF INTERNATIONAL REGISTRATION 1063241 DATED 11-15-2010, EXPIRES 11-15-2020.

THE MARK CONSISTS OF A BROKEN CIRCLE CONTAINING A STYLIZED "B" FOLLOWED BY THE STYLIZED LETTERS "ERINGER" COMPOSING THE TERM "BERINGER" UNDERLINED BY TWO LINES.

SER. NO. 79-091,878, FILED 11-15-2010.

DAVID TOOLEY, EXAMINING ATTORNEY



David J. Kyffers

Director of the United States Patent and Trademark Office

United States of America

United States Patent and Trademark Office

SOKOL

Reg. No. 4,072,537

Registered Dec. 20, 2011

Int. Cl.: 9

TRADEMARK

PRINCIPAL REGISTER

E.SIGMA SYSTEMS GMBH (FED REP GERMANY LIMITED LIABILITY COMPANY)
KARL-HAMMERSCHMIDT-STR. 38
85609 DORNACH/MÜNCHEN
FED REP GERMANY

FOR: ELECTRONIC SIMULATION AND EXERCISE APPARATUS FOR PARACHUTE TRAINING, NAMELY, ELECTRONIC PARACHUTE SIMULATORS FOR INDOOR TRAINING OF PARACHUTISTS; PARTS AND SPARE PARTS ALL SOLD AS COMPONENT PARTS FOR THE AFORESAID APPARATUS; PARACHUTE SIMULATION SOFTWARE; COMPUTER HARDWARE AND SOFTWARE FOR PARACHUTE TRAINING; ELECTRONIC DATABASES IN THE FIELD OF 3D ENVIRONMENT GENERATION, NAMELY, BY THE USE OF 3D TEXTURES, 3D MODELS AND IMAGE AND SCENARIO GENERATORS, RECORDED ON COMPUTER MEDIA, IN CLASS 9 (U.S. CLS. 21, 23, 26, 36 AND 38).

THE MARK CONSISTS OF STANDARD CHARACTERS WITHOUT CLAIM TO ANY PARTICULAR FONT, STYLE, SIZE, OR COLOR.

PRIORITY DATE OF 11-4-2010 IS CLAIMED.

OWNER OF INTERNATIONAL REGISTRATION 1063250 DATED 11-11-2010, EXPIRES 11-11-2020.

THE ENGLISH TRANSLATION OF "SOKOL" IN THE MARK IS "FALCON".

SER. NO. 79-091,883, FILED 11-11-2010.

HAI-LY LAM, EXAMINING ATTORNEY



David J. Kyffers

Director of the United States Patent and Trademark Office

United States of America

United States Patent and Trademark Office

NINA SKARRA

Reg. No. 4,072,538

Registered Dec. 20, 2011

Int. Cls.: 24, 25 and 42

TRADEMARK

SERVICE MARK

PRINCIPAL REGISTER

NINA SKARRA DESIGN (NORWAY SOLE PROPRIETORSHIP)
ORELUND 1
N-3216 SANDEFJORD
NORWAY

FOR: TEXTILES AND TEXTILE GOODS, NAMELY, TEXTILE FABRICS FOR THE MANUFACTURING OF CLOTHING; TEXTILE LABELS, IN CLASS 24 (U.S. CLS. 42 AND 50).

FOR: CLOTHING, NAMELY, SHIRTS, PANTS, SHORTS, DRESSES, BLOUSES, TOPS, JACKETS AND COATS; FOOTWEAR; HEADGEAR, NAMELY, HATS AND CAPS, IN CLASS 25 (U.S. CLS. 22 AND 39).

FOR: INDUSTRIAL DESIGN; FASHION DESIGN CONSULTING SERVICES; DRESS DESIGN SERVICES; DESIGN FOR OTHERS IN THE FIELD OF CLOTHING, FOOTWEAR AND HEADGEAR; DESIGN OF ACCESSORIES FOR CLOTHING, FOOTWEAR AND HEADGEAR, IN CLASS 42 (U.S. CLS. 100 AND 101).

THE MARK CONSISTS OF STANDARD CHARACTERS WITHOUT CLAIM TO ANY PARTICULAR FONT, STYLE, SIZE, OR COLOR.

OWNER OF INTERNATIONAL REGISTRATION 1063300 DATED 7-22-2010, EXPIRES 7-22-2020.

THE NAME(S), PORTRAIT(S), AND/OR SIGNATURE(S) SHOWN IN THE MARK IDENTIFIES "NINA SKARRA", WHOSE CONSENT(S) TO REGISTER IS MADE OF RECORD.

SER. NO. 79-091,901, FILED 7-22-2010.

LAKEISHA LEWIS, EXAMINING ATTORNEY



David J. Kyjars

Director of the United States Patent and Trademark Office

Reg. No. 4,072,539 FRUIT JUICE BEVERAGES; VEGETABLE JUICE BEVERAGES; WHEY BEVERAGES; EXTRACTS OF HOPS FOR MAKING BEER; BEER, IN CLASS 32 (U.S. CLS. 45, 46 AND 48).

THE MARK CONSISTS OF A RECTANGULAR DESIGN COMPRISED OF MULTIPLE HORIZONTAL BANDS, WHERE THE TOP MOST BAND IS IN THE COLOR DARK BLUE, THE NEXT BAND DOWN IS A GRADIENT FROM DARK RED ON THE LEFT TO RED ON THE RIGHT, THE NEXT BAND DOWN IS A GRADIENT FROM ORANGE ON THE LEFT TO DARK RED ON THE RIGHT, THE NEXT BAND DOWN IS A GRADIENT FROM LIGHT RED ON THE LEFT TO RED ON THE RIGHT, THE NEXT BAND DOWN IS A GRADIENT FROM FLAT RED ON THE LEFT TO LIGHT RED ON THE RIGHT, THE NEXT BAND DOWN IS A GRADIENT FROM RED ON THE LEFT TO ORANGE ON THE RIGHT, THE NEXT BAND DOWN IS A GRADIENT FROM FLAT RED ON THE LEFT TO LIGHT RED ON THE RIGHT, THE NEXT BAND DOWN IS A GRADIENT FROM ORANGE ON THE LEFT TO RED ON THE RIGHT, THE NEXT BAND DOWN IS A GRADIENT FROM LIGHT RED ON THE LEFT TO DARK RED ON THE RIGHT, THE NEXT BAND DOWN IS A GRADIENT FROM DARK RED ON THE LEFT TO RED ON THE RIGHT, THE NEXT BAND DOWN IS A GRADIENT FROM RED ON THE LEFT TO FLAT RED ON THE RIGHT, AND THE BOTTOM BAND IS A GRADIENT FROM YELLOW ON THE LEFT TO ORANGE ON THE RIGHT.

OWNER OF INTERNATIONAL REGISTRATION 1063687 DATED 12-1-2010, EXPIRES 12-1-2020.

THE COLOR(S) DARK BLUE, RED, DARK RED, LIGHT RED, FLAT RED, ORANGE AND YELLOW IS/ARE CLAIMED AS A FEATURE OF THE MARK.

SER. NO. 79-092,050, FILED 12-1-2010.

JAY BESCH, EXAMINING ATTORNEY

United States of America

United States Patent and Trademark Office

AEmotics

Reg. No. 4,072,540

ANDREAS EPSTEIN (AUSTRIA INDIVIDUAL)
WIDENMAYERSTR. 49

Registered Dec. 20, 2011

80538 MÜNCHEN, FED REP GERMANY

Int. Cls.: 7, 12, 25 and 28

FOR: BALL BEARINGS FOR SKATEBOARDS, INLINE SKATES, ROLLER SKATES AND KICKBOARDS, IN CLASS 7 (U.S. CLS. 13, 19, 21, 23, 31, 34 AND 35).

TRADEMARK

FOR: APPARATUS FOR LOCOMOTION BY LAND, NAMELY, MOTORCYCLES, SCOOTERS, BICYCLES, MOUNTAIN BIKES; PARTS OF SCOOTERS AND BICYCLES, NAMELY, FRAMES, SADDLES, HANDLEBARS, HANDLEBAR STEMS, SADDLE PILLARS, BRACKETS, WHEELS, BOTTOM BRACKETS, PEDALS; ACCESSORIES FOR SCOOTERS AND BICYCLES, NAMELY, DRESS GUARDS FOR BICYCLES, CARRIERS IN THE NATURE OF BASKETS ADAPTED FOR BICYCLES, TRAINING WHEELS AND BICYCLE STANDS, BELLS, AIR PUMPS, PANNIERS BAGS, SAFETY SEATS FOR CHILDREN, SAFETY BARS AND PROTECTIVE COATINGS FOR CHAINS AND GEAR SHIFTS, IN CLASS 12 (U.S. CLS. 19, 21, 23, 31, 35 AND 44).

PRINCIPAL REGISTER

FOR: CLOTHING, IN THE NATURE OF SPORTSWEAR; NAMELY, RAINWEAR; FOOTWEAR; HEADGEAR, IN PARTICULAR HATS, CAPS AND HEADBANDS; STOCKINGS; GLOVES AND SPATS, NAMELY, SHOE COVERS FOR USE WHEN WEARING SHOES, IN CLASS 25 (U.S. CLS. 22 AND 39).



FOR: GYMNASTIC AND SPORTING ARTICLES, NAMELY, INLINE SKATES, ROLLER SKATES, SWIMMING KICKBOARDS; SKATEBOARD WHEELS; AXLES AND SPACER RINGS FOR SKATEBOARDS, INLINE SKATES, ROLLER SKATES AND KICKBOARDS; PROTECTIVE PADDING FOR SKATEBOARDING, INLINE-SKATING AND ROLLER SKATING; WRIST GUARDS, KNEE GUARDS, ELBOW GUARDS AND PROTECTIVE GLOVES AS SPORTING ARTICLES, INCLUDED IN THIS CLASS; SPECIAL BAGS FOR SPORTS EQUIPMENT, NAMELY, BAGS SPECIALLY ADAPTED FOR SPORTS EQUIPMENT; WORKOUT APPARATUS AND SPORTING APPARATUS, NAMELY, SKATE BOARDS, INLINE SKATES, ROLLER SKATES AND SWIMMING KICKBOARDS, IN CLASS 28 (U.S. CLS. 22, 23, 38 AND 50).

David J. Kyros

THE MARK CONSISTS OF STANDARD CHARACTERS WITHOUT CLAIM TO ANY PARTICULAR FONT, STYLE, SIZE, OR COLOR.

Director of the United States Patent and Trademark Office

PRIORITY DATE OF 2-23-2010 IS CLAIMED.

Reg. No. 4,072,540 OWNER OF INTERNATIONAL REGISTRATION 1063705 DATED 8-23-2010, EXPIRES 8-23-2020.

THE WORD(S) "AEMOTICS" HAS NO MEANING IN A FOREIGN LANGUAGE.

SER. NO. 79-092,054, FILED 8-23-2010.

CHRISTINE MARTIN, EXAMINING ATTORNEY

United States of America

United States Patent and Trademark Office



Reg. No. 4,072,541

Registered Dec. 20, 2011

Int. Cl.: 28

TRADEMARK

PRINCIPAL REGISTER

DAISY ONG PECK LIAN TRADING AS RESIDENT BUTLER (MALAYSIA INDIVIDUAL)
P.O. BOX 140, FARRER ROAD POST OFFICE
SINGAPORE 912805
SINGAPORE

FOR: BOARD GAMES, IN CLASS 28 (U.S. CLS. 22, 23, 38 AND 50).

NO CLAIM IS MADE TO THE EXCLUSIVE RIGHT TO USE "COMPASS" AND "HOUSE HUNTING GAME", APART FROM THE MARK AS SHOWN.

PRIORITY DATE OF 6-10-2010 IS CLAIMED.

OWNER OF INTERNATIONAL REGISTRATION 1063789 DATED 12-1-2010, EXPIRES 12-1-2020.

THE COLOR(S) BLACK, GREEN, YELLOW, BLUE AND WHITE IS/ARE CLAIMED AS A FEATURE OF THE MARK.

THE MARK CONSISTS OF A RECTANGULAR CARRIER HAVING A BLACK OUTLINE, A GREEN FILL ON THE TOP PORTION AND A BLUE FILL ON THE BOTTOM PORTION. THE MARK ALSO CONSISTS OF THE STYLIZED WORDING "COMPASS" IN THE COLOUR WHITE WITH A BLUE AND BLACK OUTLINE ABOVE THE STYLIZED WORDING "THE HOUSEHUNTING GAME" IN THE COLOUR YELLOW, ALL WITHIN THE RECTANGULAR CARRIER. THE DESIGN OF A COMPASS IS TO THE LEFT OF THE WORDING WITHIN THE RECTANGULAR CARRIER HAVING FEATURES OUTLINED IN BLACK, INCLUDING THE LETTERS "N", "W", "S", AND "E" AND THE NEEDLE, HAVING A YELLOW FACE, AND BLUE ON THE SIDES.

SER. NO. 79-092,084, FILED 12-1-2010.

JAY BESCH, EXAMINING ATTORNEY



David J. Kybas

Director of the United States Patent and Trademark Office

United States of America

United States Patent and Trademark Office



Reg. No. 4,072,542

Registered Dec. 20, 2011

Int. Cl.: 11

TRADEMARK

PRINCIPAL REGISTER

FINTECO S.P.A. (ITALY JOINT STOCK COMPANY)
PIAZZALE PRINCIPESSA CLOTILDE, 8
I-20121 MILANO
ITALY

FOR: COMPONENTS FOR AIR CONDITIONING AND COOLING SYSTEMS, NAMELY, AXIAL AND CENTRIFUGAL FANS; VENTILATING FANS FOR COMMERCIAL AND INDUSTRIAL USE; ELECTRIC FANS; CEILING FANS; BATHROOM EXHAUST FANS; VENTILATION FAN ACCESSORIES, NAMELY, GRILLES; GAS CONDENSERS FOR REFRIGERATORS AND OTHER THAN PARTS FOR MACHINES; ELECTRIC HEATING FANS; ROOFTOP GREASE CONTAINMENT SYSTEM COMPRISING AN EXHAUST FAN, GREASE DEFLECTOR, AND FILTER FOR TRAPPING GREASE VENTED FROM ROOFTOP EXHAUST FANS FOR COOKING AREAS WITHIN THE BUILDING; EVAPORATORS FOR AIR CONDITIONERS; LOCALLY INDUCED AIR-CONDITIONERS FOR INDUSTRIAL PURPOSES; OXYGEN CONCENTRATORS FOR USE WITH FUEL CELLS USED IN HEATING, VENTILATION, AIR CONDITIONING, LIGHTING, AND POWER SYSTEMS FOR BUILDINGS; PARTS FOR HEATING AND AIR CONDITIONING SYSTEMS, NAMELY, HEATER CORES AND GAS COOLERS FOR VEHICLES; FABRIC AIR DISPERSION DUCTS FOR DISTRIBUTING AND DISPENSING AIR AS PART OF A HVAC SYSTEM; HOT AIR BLOWERS; COMPONENTS FOR AIR CONDITIONING AND COOLING SYSTEMS, NAMELY, EVAPORATIVE AIR COOLERS; AIR-CONDITIONING APPARATUS FOR INDUSTRIAL PURPOSES; AIR PURIFYING APPARATUS AND MACHINES; AIR FILTERS FOR INDUSTRIAL INSTALLATIONS; AIR COOLING APPARATUS; VENTILATORS CONVEYING INDUSTRIAL FLUIDS; REFRIGERATING APPLIANCES AND INSTALLATIONS; REFRIGERATING MACHINES; AIR-CONDITIONING, AIR COOLING AND VENTILATION APPARATUS AND INSTRUMENTS; APPARATUS AND INSTRUMENTS FOR USE IN THE PURIFICATION, SEPARATION AND STERILIZATION OF LIQUIDS AND GASES USED IN THE BIOTECHNOLOGY, PHARMACEUTICAL, MEDICAL, BIOPHARMACEUTICAL AND FOOD AND BEVERAGE INDUSTRIES; HOT-AIR SPACE HEATING APPARATUS FOR INDUSTRIAL PURPOSES; HOT-WATER SPACE HEATING APPARATUS FOR INDUSTRIAL PURPOSES; VENTILATION APPARATUS, NAMELY, CORDLESS FLOOR DRYING CONE DOLLY; INTERIOR ENVIRONMENT CONTROL SYSTEM FOR COMMERCIAL BUILDINGS, NAMELY, HEATERS, VENTILATORS AND HUMIDIFIERS ALL SOLD AS A UNIT; REFRIGERATOR CONDENSERS; FILTERS AND FILTERING DEVICES FOR AIR AND GAS CONDITIONING; INCINERATORS; GARBAGE INCINERATORS FOR INDUSTRIAL PURPOSES, IN CLASS 11 (U.S. CLS. 13, 21, 23, 31 AND 34).



David J. Kappas

Director of the United States Patent and Trademark Office

Reg. No. 4,072,542 THE MARK CONSISTS OF A SQUARE DESIGN FEATURING A SPIRAL LIKE INTERIOR DESIGN NEXT TO THE LETTERS "CCB" IN STYLIZED FORM.

PRIORITY DATE OF 12-21-2009 IS CLAIMED.

OWNER OF INTERNATIONAL REGISTRATION 1063859 DATED 3-5-2010, EXPIRES 3-5-2020.

SER. NO. 79-092,109, FILED 3-5-2010.

JOHN DALIER, EXAMINING ATTORNEY

United States of America

United States Patent and Trademark Office

ONCO  **STORE**

Reg. No. 4,072,543

Registered Dec. 20, 2011

Int. Cls.: 10, 11, 16 and 20

TRADEMARK

PRINCIPAL REGISTER

ONCOSCIENCE AG (FED REP GERMANY AKTIENGESELLSCHAFT (JOINT-STOCK COMPANY))
HAFENSTR. 32
22880 WEDEL, FED REP GERMANY

FOR: SPECIALLY DESIGNED CONTAINERS FOR THE STORAGE AND TRANSPORT OF CELLS, NAMELY, TISSUE SPECIMENS, CELL SPECIMENS, CELL CULTURE MATERIAL, FOR MEDICAL PURPOSES, IN CLASS 10 (U.S. CLS. 26, 39 AND 44).

FOR: LABORATORY FREEZERS FOR THE FREEZING OF TISSUE SPECIMENS, CELL SPECIMENS AND CELL CULTURE MATERIAL, IN CLASS 11 (U.S. CLS. 13, 21, 23, 31 AND 34).

FOR: BUBBLE PACKS MADE OF PLASTIC FOR WRAPPING OR PACKAGING PURPOSES AND FOR THE TRANSPORT AND MAILING OF TISSUE SPECIMENS, CELL SPECIMENS AND CELL CULTURE MATERIAL, IN CLASS 16 (U.S. CLS. 2, 5, 22, 23, 29, 37, 38 AND 50).

FOR: SHELVES IN THE NATURE OF FURNITURE FOR THE STORAGE OF TISSUE SPECIMENS, CELL SPECIMENS AND CELL CULTURE MATERIAL, IN CLASS 20 (U.S. CLS. 2, 13, 22, 25, 32 AND 50).

NO CLAIM IS MADE TO THE EXCLUSIVE RIGHT TO USE "STORE", APART FROM THE MARK AS SHOWN.

PRIORITY DATE OF 4-30-2010 IS CLAIMED.

OWNER OF INTERNATIONAL REGISTRATION 1063883 DATED 10-28-2010, EXPIRES 10-28-2020.

THE COLOR(S) GREY AND RED IS/ARE CLAIMED AS A FEATURE OF THE MARK.

THE MARK CONSISTS OF THE WORDING "ONCO STORE" IN GREY, WITH A DESIGN OF A HELIX APPEARING BETWEEN THE WORDS, APPEARING IN GREY AND RED.

SER. NO. 79-092,117, FILED 10-28-2010.

MARK PILARO, EXAMINING ATTORNEY



David J. Kyffers

Director of the United States Patent and Trademark Office

United States of America

United States Patent and Trademark Office

ECO VISION

Reg. No. 4,072,544

Registered Dec. 20, 2011

Int. Cls.: 21 and 43

TRADEMARK

SERVICE MARK

PRINCIPAL REGISTER

ECO VISION DINNERWARE GMBH (SWITZERLAND GESELLSCHAFT MIT
BESCHRÄNKTER HAFTUNG (GMBH))
BELLEVUESTRASSE 3
CH-3073 GÜMLIGEN, SWITZERLAND

FOR: TABLEWARE MADE OF PALM LEAVES, NAMELY, DISPOSABLE AND COM-
POSTABLE TABLE PLATES, BOWLS AND GOBLETs, IN CLASS 21 (U.S. CLS. 2, 13, 23,
29, 30, 33, 40 AND 50).

FOR: SERVING OF FOOD AND DRINK, IN CLASS 43 (U.S. CLS. 100 AND 101).

THE MARK CONSISTS OF STANDARD CHARACTERS WITHOUT CLAIM TO ANY PAR-
TICULAR FONT, STYLE, SIZE, OR COLOR.

PRIORITY DATE OF 11-23-2010 IS CLAIMED.

OWNER OF INTERNATIONAL REGISTRATION 1063916 DATED 12-8-2010, EXPIRES 12-
8-2020.

SER. NO. 79-092,132, FILED 12-8-2010.

JENNIFER DIXON, EXAMINING ATTORNEY



David J. Kybas

Director of the United States Patent and Trademark Office

United States of America

United States Patent and Trademark Office



PRIMARY
WOUND
DRESSING

Reg. No. 4,072,545

Registered Dec. 20, 2011

Int. Cl.: 5

TRADEMARK

PRINCIPAL REGISTER

PHYTOCEUTICALS AG (SWITZERLAND SOCIÉTÉ ANONYME (SA))
ZOLLIKERSTRASSE 44
CH-8008 ZÜRICH, SWITZERLAND

FOR: SPRAY FOR MEDICAL PURPOSES, NAMELY WOUND SPRAY, IN CLASS 5 (U.S. CLS. 6, 18, 44, 46, 51 AND 52).

NO CLAIM IS MADE TO THE EXCLUSIVE RIGHT TO USE "PRIMARY WOUND DRESSING", APART FROM THE MARK AS SHOWN.

PRIORITY DATE OF 6-15-2010 IS CLAIMED.

OWNER OF INTERNATIONAL REGISTRATION 1063934 DATED 11-18-2010, EXPIRES 11-18-2020.

THE MARK CONSISTS OF THE NUMBER "1" WITHIN A CIRCLE AND THE WORDING "PRIMARY WOUND DRESSING".

SER. NO. 79-092,138, FILED 11-18-2010.

MICHELLE DUBOIS, EXAMINING ATTORNEY



David J. Kybas

Director of the United States Patent and Trademark Office

United States of America

United States Patent and Trademark Office



Reg. No. 4,072,546

Registered Dec. 20, 2011

Int. Cls.: 29, 30 and 32

TRADEMARK

PRINCIPAL REGISTER

EMMI AG (SWITZERLAND SOCIÉTÉ ANONYME)
HABSBURGERSTRASSE 12,
POSTFACH; CH-6002 LUZERN
SWITZERLAND

FOR: MILK AND DAIRY PRODUCTS, EXCLUDING ICE CREAM, ICE MILK AND FROZEN YOGURT; ALL THE AFORESAID GOODS OF SWISS ORIGIN, IN CLASS 29 (U.S. CL. 46).

FOR: EDIBLE ICES OF SWISS ORIGIN, IN CLASS 30 (U.S. CL. 46).

FOR: MINERAL AND AERATED WATERS AND OTHER NON-ALCOHOLIC DRINKS, NAMELY, SOFT DRINKS; FRUIT DRINKS AND FRUIT JUICES; SYRUPS FOR MAKING BEVERAGES; PREPARATIONS FOR MAKING BEVERAGES, NAMELY, FRUIT DRINKS, SOFT DRINKS; ALL THE AFORESAID GOODS OF SWISS ORIGIN, IN CLASS 32 (U.S. CLS. 45, 46 AND 48).

OWNER OF U.S. REG. NOS. 2,344,670, 3,458,171 AND OTHERS.

PRIORITY DATE OF 7-21-2010 IS CLAIMED.

OWNER OF INTERNATIONAL REGISTRATION 1064024 DATED 12-21-2010, EXPIRES 12-21-2020.

NO CLAIM IS MADE TO THE EXCLUSIVE RIGHT TO USE "SWITZERLAND", APART FROM THE MARK AS SHOWN.

THE MARK CONSISTS OF A BANNER FEATURING A GENERALLY OVAL SHAPE CONTAINING THE STYLIZED WORDING "EMMI" WITH A CROWN ABOVE IT OVER A WAVY RECTANGULAR SHAPE ABOVE THE STYLIZED WORDING "KALTBACH", A STRAIGHT LINE, AND THE STYLIZED WORDING "SWITZERLAND". AROUND THE EDGE OF THE BANNER IS A LINE THAT FOLLOWS THE SHAPE OF THE BANNER.

SER. NO. 79-092,159, FILED 12-21-2010.

KRISTINA MORRIS, EXAMINING ATTORNEY



David J. Kybas

Director of the United States Patent and Trademark Office

United States of America

United States Patent and Trademark Office

bestcair

Reg. No. 4,072,547

Registered Dec. 20, 2011

Int. Cls.: 7, 36 and 37

BOGE & CO. MASCHINENHANDELSGESELLSCHAFT GMBH & CO. KG (FED REP GERMANY CORPORATION)

OTTO-BOGE-STR. 1-7

33739 BIELEFELD

FED REP GERMANY

TRADEMARK

SERVICE MARK

PRINCIPAL REGISTER

FOR: AIR COMPRESSORS; AIR COMPRESSORS FOR VEHICLES; COMPRESSORS AS PARTS OF MACHINES, MOTORS AND ENGINES; COMPRESSORS FOR AIR CONDITIONERS; COMPRESSORS FOR DEHUMIDIFYING MACHINES; COMPRESSORS FOR MACHINES; ELECTRIC COMPRESSORS; COMPRESSORS AS PARTS FOR COMPRESSED AIR TOOLS; AIR COMPRESSORS FOR WATER AERATION SYSTEMS, IN CLASS 7 (U.S. CLS. 13, 19, 21, 23, 31, 34 AND 35).

FOR: INSURANCE BROKERAGE SERVICES; FINANCIAL ADVICE AND CONSULTANCY SERVICES, IN CLASS 36 (U.S. CLS. 100, 101 AND 102).

FOR: BUILDING CONSTRUCTION SERVICES; INSTALLATION AND REPAIR OF AIR COMPRESSORS AND GAS COMPRESSORS; MAINTENANCE OF AIR COMPRESSOR AND GAS COMPRESSOR INSTALLATIONS, IN CLASS 37 (U.S. CLS. 100, 103 AND 106).

THE MARK CONSISTS OF STANDARD CHARACTERS WITHOUT CLAIM TO ANY PARTICULAR FONT, STYLE, SIZE, OR COLOR.

PRIORITY DATE OF 7-21-2010 IS CLAIMED.

OWNER OF INTERNATIONAL REGISTRATION 1064230 DATED 1-10-2011, EXPIRES 1-10-2021.

SER. NO. 79-092,265, FILED 1-10-2011.

DAWN FELDMAN, EXAMINING ATTORNEY



David J. Kypos

Director of the United States Patent and Trademark Office

United States of America
United States Patent and Trademark Office

Wokart

Reg. No. 4,072,548

Registered Dec. 20, 2011

Int. Cl.: 12

TRADEMARK

PRINCIPAL REGISTER

SCHUHMACHER ALFRED (SWITZERLAND INDIVIDUAL)
IN DER BREITE 33
CH-8162 STEINMAUR
SWITZERLAND

FOR: VEHICLES, NAMELY, BOATS, AUTOMOBILES, AIRPLANES, APPARATUS FOR LOCOMOTION BY LAND, AIR OR WATER, NAMELY, BOATS, AUTOMOBILES, AIRPLANES, IN CLASS 12 (U.S. CLS. 19, 21, 23, 31, 35 AND 44).

THE MARK CONSISTS OF STANDARD CHARACTERS WITHOUT CLAIM TO ANY PARTICULAR FONT, STYLE, SIZE, OR COLOR.

OWNER OF INTERNATIONAL REGISTRATION 1064242 DATED 12-21-2010, EXPIRES 12-21-2020.

THE WORDING "WOKART" HAS NO MEANING IN A FOREIGN LANGUAGE.

SER. NO. 79-092,268, FILED 12-21-2010.

KRISTINA MORRIS, EXAMINING ATTORNEY



David J. Kybas

Director of the United States Patent and Trademark Office

United States of America

United States Patent and Trademark Office

TETRA CASENSO

Reg. No. 4,072,549

Registered Dec. 20, 2011

Int. Cls.: 7, 9 and 11

TRADEMARK

PRINCIPAL REGISTER

TETRA LAVAL HOLDINGS & FINANCE S.A. (SWITZERLAND SOCIÉTÉ ANONYME (SA))
AVENUE GÉNÉRAL-GUISAN 70
CH-1009 PULLY, SWITZERLAND

FOR: MACHINES AND APPARATUS FOR THE PROCESSING, TREATMENT AND FINISHING OF FOOD AND LIQUID PRODUCTS, NAMELY, MACHINES AND APPARATUS FOR RAW MATERIAL RECEPTION, BULK AND UNIT HANDLING, STORAGE AND DISTRIBUTION WHEN MAKING FOOD, MACHINES AND APPARATUS FOR POWDER MIXING AND DISSOLVING FOR MAKING FOOD, MACHINES AND APPARATUS FOR USE IN INDUSTRIAL FOOD PROCESSING DESIGNED FOR THE THERMAL TREATMENT OF FOOD PRODUCTS, MACHINES AND APPARATUS FOR ASEPTIC STORAGE OF FOOD, STIRRING MACHINES, ELECTRIC FOOD PROCESSORS, AGITATORS, PACKAGING MACHINES FOR FOOD; EXTRACTING MACHINES FOR EXTRACTION OF FOOD AND LIQUID PRODUCTS; EXTRACTING MACHINES FOR EXTRACTING JUICE FROM FRUITS AND VEGETABLES; MACHINES, NAMELY, CENTRIFUGES; SEPARATOR MACHINES, NAMELY, SEPARATORS FOR SEPARATING INGREDIENTS WHEN MAKING FOOD; MACHINES AND APPARATUS FOR BLENDING OR DOSING FOOD AND LIQUID PRODUCTS, NAMELY, BLENDER MACHINES FOR FOOD AND LIQUID PRODUCTS FOR USE IN INDUSTRIAL OR COMMERCIAL APPLICATIONS, DOSING MACHINES FOR ADDING INGREDIENTS IN THE PROCESSING OF FOOD AND BEVERAGES; MIXING MACHINES FOR MIXTURE AND DILUTION OF FOOD AND LIQUID PRODUCTS; MIXING MACHINES FOR RECOMBINATION OF FOOD AND LIQUID PRODUCTS; MACHINES AND APPARATUS FOR THE CONCENTRATION OF FOOD AND LIQUID PRODUCTS, NAMELY, MACHINES FOR THE EXTRACTION OF EXCESS WATER FROM FOODS AND LIQUID PRODUCTS; MIXING MACHINES FOR MIXING FOOD OR LIQUID PRODUCTS; REGULATING MACHINES FOR REGULATION OF FAT CONTENTS IN FOOD AND LIQUID PRODUCTS; MACHINE PARTS, NAMELY, PUMPS AND VALVES DESIGNED FOR THE FOODSTUFF INDUSTRY; HEAT EXCHANGERS BEING PARTS OF MACHINES; FILTERS, NAMELY, MEMBRANE FILTERS, WATER FILTERS, STERILE AIR FILTERS, FILTERS FOR BACTERIA AND SPORE REMOVAL AND FILTERS FOR FILTERING PARTICLES WHEN MAKING FOOD AND LIQUID PRODUCTS; MACHINES AND APPARATUS FOR USE IN THE BREWERY AND BEVERAGE INDUSTRY, NAMELY, YEAST PROPAGATION MACHINES, YEAST MIXING MACHINES; AERATORS, NAMELY, MACHINES FOR CARBONATING BEVERAGES; MACHINES AND APPARATUS FOR BIOTECHNOLOGICAL PRODUCTION OF NEUTRACEUTICALS; FEEDERS, NAMELY, INGREDIENT FEEDERS FOR USE IN FOOD MANUFACTURE; EXTRUSION MOLDING MACHINES; CONVEYORS; FILLING AND PACKAGING MACHINES FOR FOOD AND LIQUID PRODUCTS; WRAPPING MACHINES; HOMOGENIZER MACHINES FOR INDUSTRIAL



David J. Kybas

Director of the United States Patent and Trademark Office

Reg. No. 4,072,549 USE; MACHINE PARTS FOR FOOD PROCESSING MACHINES; MACHINES FOR MEMBRANE FILTRATION OF FOOD AND LIQUID PRODUCTS; ELECTRIC FOOD PREPARATION APPARATUS, NAMELY, MACHINES AND APPARATUS FOR THE RESTITUTION OF AROMAS OF FOOD AND LIQUID PRODUCTS; MACHINES AND APPARATUS FOR WASHING AND CLEANING OF PROCESS SYSTEMS AND MACHINES AS WELL AS FOR TANK AND CONTAINER CLEANING; MACHINE TOOLS, IN CLASS 7 (U.S. CLS. 13, 19, 21, 23, 31, 34 AND 35).

FOR: APPARATUS AND INSTRUMENT FOR MONITORING, CONTROLLING, OPERATING, DOSING, SUPERVISING, WEIGHING, CHECKING AND MEASURING IN THE PROCESSING, TREATMENT AND FINISHING OF FOOD, RACKING, FILLING AND PACKAGING OF FOOD, NAMELY, ELECTRONIC CONTROL SYSTEMS FOR FOOD PROCESSING MACHINES, ELECTRONIC REGULATING AND CONTROL DEVICES FOR THE OPERATION OF FOOD PROCESSING MACHINES, COMPUTER SOFTWARE AND HARDWARE TO MONITOR AND CONTROL FACTORY MANUFACTURING PROCESSES, NAMELY, FOOD PROCESSING, DOSIMETERS, WEIGHING APPARATUS AND INSTRUMENTS, INSTRUMENTS FOR MEASURING FOOD QUALITY PARAMETERS; COMPUTER SOFTWARE PROGRAMS FOR MONITORING, CONTROLLING, OPERATING, DOSING, SUPERVISING, WEIGHING, CHECKING AND MEASURING IN THE PROCESSING, TREATMENT AND FINISHING OF FOOD AND LIQUID PRODUCTS, RACKING, FILLING AND PACKAGING OF FOOD AND LIQUID PRODUCTS; FLOW-METERS; FLOW INDICATORS; PRESSURE INDICATORS; THERMOMETERS , IN CLASS 9 (U.S. CLS. 21, 23, 26, 36 AND 38).

FOR: APPARATUS AND INSTRUMENTS FOR HEATING, HEAT RECOVERING, COOLING, REFRIGERATION, VENTILATION, BOILING, LIGHTING, COOKING, STEAM GENERATION, CONCENTRATION, DRYING, PASTEURISATION, DISTILLATION, STERILISATION, DISINFECTION AND DESALINATION, ALL THE AFOREMENTIONED GOODS FOR USE IN THE FOOD AND LIQUID PROCESSING INDUSTRY, NAMELY, HEATING AND COOLING UNITS, REFRIGERATING MACHINES, VENTILATORS, ELECTRICAL BOILERS, LIGHTING APPARATUS, COOKING OVENS, STEAM GENERATORS, INDUSTRIAL DRYERS, PASTEURIZERS, DISTILLERS, STERILIZERS, DISINFECTANT APPARATUS FOR INDUSTRIAL PURPOSES AND DESALINATION UNITS ALL THE AFOREMENTIONED GOODS FOR USE IN THE FOOD PROCESSING INDUSTRY; FILTERS, NAMELY, MEMBRANE FILTERS; APPARATUS, NAMELY, THERMOELECTRIC HEATER FOR THE THERMAL TREATMENT OF FOOD AND LIQUID PRODUCTS; HEAT EXCHANGERS; EVAPORATORS; FREEZERS; APPARATUS AND INSTRUMENTS, NAMELY, FREEZERS FOR HARDENING AND FREEZING WHEN MANUFACTURING FOOD AND LIQUID PRODUCTS; APPARATUS AND TANKS FOR STERILE STORAGE OF STERILIZED FOOD AND LIQUID PRODUCTS, IN CLASS 11 (U.S. CLS. 13, 21, 23, 31 AND 34).

THE MARK CONSISTS OF STANDARD CHARACTERS WITHOUT CLAIM TO ANY PARTICULAR FONT, STYLE, SIZE, OR COLOR.

PRIORITY DATE OF 3-5-2010 IS CLAIMED.

OWNER OF INTERNATIONAL REGISTRATION 1064270 DATED 8-31-2010, EXPIRES 8-31-2020.

OWNER OF U.S. REG. NOS. 580,219, 1,013,119, AND 3,870,285.

THE WORDING "TETRA CASENSO" HAS NO MEANING IN A FOREIGN LANGUAGE.

SER. NO. 79-092,278, FILED 8-31-2010.

KELLY TRUSILO, EXAMINING ATTORNEY

United States of America
United States Patent and Trademark Office

NORTEC

Reg. No. 4,072,550

Registered Dec. 20, 2011

Int. Cl.: 9

TRADEMARK

PRINCIPAL REGISTER

NORTEC SYSTEM A/S (DENMARK PRIVATE LIMITED COMPANY)
ELLEHAMMERSVEJ 16
DK-7100 VEJLE
DENMARK

FOR: MEASURING, SIGNALING AND CHECKING APPARATUS AND INSTRUMENTS, NAMELY, DERIVED-UNIT MEASURING MACHINES AND APPARATUS, ELECTRONIC INSTRUMENTS FOR USE IN REMOTE INSPECTION AND MEASUREMENT OF INDUSTRIAL COMPONENTS USING REMOTE VISUAL DEVICES, DIGITAL SIGNAL PROCESSORS, SIGNAL PROCESSORS, ALL THE AFOREMENTIONED APPARATUS AND INSTRUMENTS FOR USE IN CONNECTION WITH LAUNDROMATS AND PAYMENT AND RESERVATION SYSTEMS IN CONNECTION HERETO; ACCESS CONTROL SYSTEMS FOR USE IN CONNECTION WITH LAUNDROMATS; PAYMENT SYSTEMS AND RESERVATION SYSTEMS FOR USE IN CONNECTION WITH LAUNDROMATS COMPRISED PRIMARILY OF ELECTRONIC PAYMENT AND RESERVATION TERMINALS, AND ELECTRONIC AND MAGNETIC ID CARDS FOR USE IN CONNECTION WITH PAYMENT FOR LAUNDROMAT SERVICES; DEVICES FOR COIN-OPERATED APPARATUS, NAMELY, MECHANISMS FOR COIN OPERATED APPARATUS FOR USE IN CONNECTION WITH LAUNDROMATS; REMOTE CONTROL APPARATUS, NAMELY, ELECTRONIC APPARATUS FOR THE REMOTE CONTROL OF INDUSTRIAL OPERATIONS, ALL FOR USE IN CONNECTION WITH LAUNDROMATS; ELECTRIC INSTALLATIONS FOR THE REMOTE CONTROL OF INDUSTRIAL OPERATIONS FOR USE IN CONNECTION WITH LAUNDROMATS; ELECTRICAL CONTROL PANELS FOR USE IN CONNECTION WITH LAUNDROMATS; ELECTRICAL CONTROL APPARATUS, NAMELY, ELECTRIC CONTROL PANELS, DATA ACCESS PORT FOR USE WITH ELECTRICAL CONTROL PANELS FOR CONNECTING MULTIPLE DATA AND ELECTRICAL DEVICES, AND ELECTRONIC CONTROL SYSTEMS FOR MACHINES, ALL FOR USE IN CONNECTION WITH LAUNDROMATS; ELECTRO-DYNAMIC APPARATUS FOR THE REMOTE CONTROL OF SIGNALS, NAMELY, TRANSCIVERS USED IN CONNECTION WITH LAUNDROMATS; MAGNETIC CODED CARDS, NAMELY, MAGNETICALLY CODED STORED VALUE CARDS FOR MAKING USE OF MACHINERY IN LAUNDROMATS, IN CLASS 9 (U.S. CLS. 21, 23, 26, 36 AND 38).



David J. Kyros

Director of the United States Patent and Trademark Office

THE MARK CONSISTS OF STANDARD CHARACTERS WITHOUT CLAIM TO ANY PARTICULAR FONT, STYLE, SIZE, OR COLOR.

PRIORITY DATE OF 6-3-2010 IS CLAIMED.

Reg. No. 4,072,550 OWNER OF INTERNATIONAL REGISTRATION 1064291 DATED 12-1-2010, EXPIRES 12-1-2020.

"NORTEC" APPEARING IN THE MARK HAS NO SIGNIFICANCE NOR IS IT A TERM OF ART IN THE RELEVANT TRADE OR INDUSTRY OR AS APPLIED TO THE GOODS/SERVICES LISTED IN THE APPLICATION, OR ANY GEOGRAPHICAL SIGNIFICANCE.

SER. NO. 79-092,281, FILED 12-1-2010.

JAY BESCH, EXAMINING ATTORNEY

United States of America

United States Patent and Trademark Office

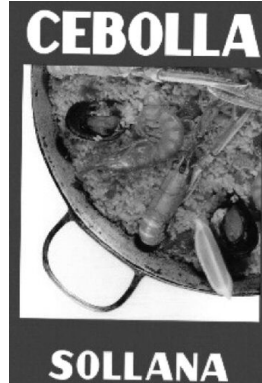

Reg. No. 4,072,551

Registered Dec. 20, 2011

Int. Cl.: 30

TRADEMARK

PRINCIPAL REGISTER

ARROCERIAS ANTONIO TOMAS, S.L. (SPAIN SOCIEDAD LIMITADA)
ALBUFERA 1-3
SOLLANA; E-46430 VALENCIA ,
SPAIN

FOR: RICE, IN CLASS 30 (U.S. CL. 46).

NO CLAIM IS MADE TO THE EXCLUSIVE RIGHT TO USE "CEBOLLA" AND "SOLLANA",
APART FROM THE MARK AS SHOWN.

PRIORITY DATE OF 8-9-2010 IS CLAIMED.

OWNER OF INTERNATIONAL REGISTRATION 1064328 DATED 10-8-2010, EXPIRES 10-
8-2020.

THE MARK CONSISTS OF THE WORDING "CEBOLLA" ABOVE A DESIGN OF RICE,
SHRIMPS, CLAMS, VEGETABLES AND A SLICE OF LIME IN A PAN WITH A HANDLE
WITHIN A RECTANGULAR CARRIER AND THE WORDING "SOLLANA" BELOW IT ALL
WITHIN A RECTANGULAR CARRIER.

THE ENGLISH TRANSLATION OF THE FOREIGN WORD(S) IN THE MARK IS: "ONION
SOLLANA".

SER. NO. 79-092,301, FILED 10-8-2010.

SALLY SHIH, EXAMINING ATTORNEY



David J. Kybas

Director of the United States Patent and Trademark Office

United States of America

United States Patent and Trademark Office

Surgifix zerolates

Reg. No. 4,072,552

Registered Dec. 20, 2011

Int. Cls.: 5 and 10

TRADEMARK

PRINCIPAL REGISTER

FRA PRODUCTION S.P.A. (ITALY JOINT STOCK COMPANY)
SAN MATTEO FONDO, 38
I-14010 CISTERNA D'ASTI (AT)
ITALY

FOR: SURGICAL DRESSING, BANDAGES, NAMELY, TUBULAR ELASTIC NET MATERIALS AND NETTING FOR KEEPING BANDAGING IN PLACE; HYGIENIC PANTIES IN THE NATURE OF SANITARY PANTIES; PANTS FOR INCONTINENT PEOPLE; SANITARY TOWELS; PANTIE SHAPED SANITARY TOWELS; ALL OF THESE GOODS CONTAIN NO LATEX, IN CLASS 5 (U.S. CLS. 6, 18, 44, 46, 51 AND 52).

FOR: SURGICAL ARTICLES CONTAINING NO LATEX FOR USE IN GENERAL SURGERY, IN CLASS 10 (U.S. CLS. 26, 39 AND 44).

THE MARK CONSISTS OF STANDARD CHARACTERS WITHOUT CLAIM TO ANY PARTICULAR FONT, STYLE, SIZE, OR COLOR.

PRIORITY DATE OF 10-18-2010 IS CLAIMED.

OWNER OF INTERNATIONAL REGISTRATION 1064369 DATED 11-25-2010, EXPIRES 11-25-2020.

OWNER OF U.S. REG. NO. 2,252,306.

NO CLAIM IS MADE TO THE EXCLUSIVE RIGHT TO USE "ZEROLATEX", APART FROM THE MARK AS SHOWN.

SER. NO. 79-092,315, FILED 11-25-2010.

SUZANNE BLANE, EXAMINING ATTORNEY



David J. Kyffers

Director of the United States Patent and Trademark Office

United States of America

United States Patent and Trademark Office



Reg. No. 4,072,553

Registered Dec. 20, 2011

Int. Cl.: 3

TRADEMARK

PRINCIPAL REGISTER

IUVIS LABORATORIES, D.O.O. (SERBIA SOCIÉTÉ À RESPONSABILITÉ LIMITÉE)
PARISKE KOMUNE 31/1-4
34000 KRAGUJEVAC
SERBIA

FOR: COSMETICS, NON-MEDIATED SKIN CREAMS AND COSMETIC OILS, IN CLASS 3
(U.S. CLS. 1, 4, 6, 50, 51 AND 52).

THE MARK CONSISTS OF THE WORDING "HYALLUX" UNDER A DESIGN OF TWO TOUCHING TRIANGLES; THE COLOR GRAY APPEARS ON THE LETTERS OF THE WORDING "HYALLUX" AND ON THE TRIANGLE APPEARING ON THE LEFT ABOVE THE LETTER "A" IN THE WORDING OF THE MARK; THE COLOR RED APPEARS ON THE RIGHT AND ABOVE THE LETTER "L" IN THE WORDING OF THE MARK.

PRIORITY DATE OF 7-28-2010 IS CLAIMED.

OWNER OF INTERNATIONAL REGISTRATION 1064376 DATED 12-8-2010, EXPIRES 12-8-2020.

THE COLOR(S) RED, GRAY IS/ARE CLAIMED AS A FEATURE OF THE MARK.

SER. NO. 79-092,321, FILED 12-8-2010.

SAMUEL E. SHARPER JR., EXAMINING ATTORNEY



David J. Kybas

Director of the United States Patent and Trademark Office

United States of America

United States Patent and Trademark Office

HENGBO

Reg. No. 4,072,554

Registered Dec. 20, 2011

Int. Cl.: 7

TRADEMARK

PRINCIPAL REGISTER

ZHEJIANG HENGBO AIR-FILTER CO., LTD. (CHINA CORPORATION)
NO. 888-20, EAST MAIZHIQIAO ROAD
LUQIAO DISTRICT
TAIZHOU CITY, ZHAJIANG PROVINCE, CHINA

FOR: AGRICULTURAL MACHINES, NAMELY, LAWN MOWERS; DYNAMOS; EXHAUSTS FOR MOTORS AND ENGINES; OIL SEPARATORS; FILTERING MACHINES, NAMELY, AIR FILTERS FOR AUTOMOBILE ENGINES, FILTERS FOR MOTOR AND ENGINES; FILTERS FOR CLEANING COOLING AIR, FOR ENGINES; EXHAUSTS FOR MOTORS AND ENGINES, NAMELY, ENGINE EXHAUST SYSTEMS COMPRISED OF PIPES, COLLECTOR AND MUFFLER; ANTI-POLLUTION DEVICES FOR MOTORS AND ENGINES; FANS FOR MOTORS AND ENGINES; COOLING RADIATORS FOR MOTORS AND ENGINES, IN CLASS 7 (U.S. CLS. 13, 19, 21, 23, 31, 34 AND 35).

THE MARK CONSISTS OF THE WORD "HENGBO".

OWNER OF INTERNATIONAL REGISTRATION 1064470 DATED 11-5-2010, EXPIRES 11-5-2020.

THE WORDING "HENGBO" HAS NO MEANING IN A FOREIGN LANGUAGE.

SER. NO. 79-092,347, FILED 11-5-2010.

PAUL F. GAST, EXAMINING ATTORNEY



David J. Kyffers

Director of the United States Patent and Trademark Office

United States of America
United States Patent and Trademark Office

ICHIJO

Reg. No. 4,072,555

Registered Dec. 20, 2011

Int. Cls.: 36, 37 and 42

SERVICE MARK

PRINCIPAL REGISTER

ICHIJO CO., LTD. (JAPAN CORPORATION)
5-10-10, KIBA
KOTO-KU; TOKYO 135-0042
JAPAN

FOR: MANAGEMENT OF BUILDINGS; REAL ESTATE AGENCY OR BROKER SERVICES FOR THE RENTAL OF BUILDINGS; LEASING OR RENTING OF BUILDINGS; REAL ESTATE AGENCY SERVICES RELATING TO THE PURCHASE AND SALE OF BUILDINGS; REAL ESTATE AGENCY OR BROKER SERVICES RELATING TO THE PURCHASE AND SALE OF BUILDINGS; REAL ESTATE APPRAISAL; REAL ESTATE SERVICES, NAMELY, RENTAL PROPERTY MANAGEMENT; REAL ESTATE AGENCY OR BROKER SERVICES FOR THE RENTAL OR LEASING OF LAND; LEASING OF LAND; REAL ESTATE AGENCY SERVICES RELATING TO THE PURCHASE AND SALE OF LAND; REAL ESTATE AGENCY OR BROKER SERVICES RELATING TO THE PURCHASE AND SALE OF LAND, IN CLASS 36 (U.S. CLS. 100, 101 AND 102).

FOR: CONSTRUCTION OF BUILDINGS, IN CLASS 37 (U.S. CLS. 100, 103 AND 106).

FOR: ARCHITECTURAL DESIGN; SURVEYING; GEOLOGICAL SURVEYS OR RESEARCH, IN CLASS 42 (U.S. CLS. 100 AND 101).

THE MARK CONSISTS OF THE TERM "ICHIJO" IN STYLIZED FONT.

PRIORITY DATE OF 9-22-2010 IS CLAIMED.

OWNER OF INTERNATIONAL REGISTRATION 1064553 DATED 10-22-2010, EXPIRES 10-22-2020.

THE ENGLISH TRANSLATION OF "ICHIJO" IN THE MARK IS "FIRST STREET".

SER. NO. 79-092,378, FILED 10-22-2010.

KAREN SEVERSON, EXAMINING ATTORNEY



David J. Kyros

Director of the United States Patent and Trademark Office

United States of America

United States Patent and Trademark Office

EFA Inspection

Reg. No. 4,072,556

Registered Dec. 20, 2011

Int. Cl.: 9

LEBERT SOFTWARE ENGINEERING LTD. & CO. KG (FED REP GERMANY LTD. & CO. KG)
MAYBACHSTR. 15
63456 HANAU
FED REP GERMANY

TRADEMARK

PRINCIPAL REGISTER

FOR: RECORDED COMPUTER SOFTWARE AND DOWNLOADABLE COMPUTER PROGRAMS FOR QUALITY ASSURANCE IN ELECTRONICS MANUFACTURING; DOWNLOADABLE ELECTRONIC PUBLICATIONS, NAMELY, NEWSLETTERS, BROCHURES, INFORMATIONAL SHEETS, FACT SHEETS, MANUALS AND CASE STUDIES, RELATING TO QUALITY ASSURANCE IN ELECTRONICS MANUFACTURING, IN CLASS 9 (U.S. CLS. 21, 23, 26, 36 AND 38).

THE MARK CONSISTS OF STANDARD CHARACTERS WITHOUT CLAIM TO ANY PARTICULAR FONT, STYLE, SIZE, OR COLOR.

PRIORITY DATE OF 5-7-2010 IS CLAIMED.

OWNER OF INTERNATIONAL REGISTRATION 1064845 DATED 11-5-2010, EXPIRES 11-5-2020.

NO CLAIM IS MADE TO THE EXCLUSIVE RIGHT TO USE "INSPECTION", APART FROM THE MARK AS SHOWN.

SER. NO. 79-092,461, FILED 11-5-2010.

BRENDAN REGAN, EXAMINING ATTORNEY



David J. Kyffers

Director of the United States Patent and Trademark Office

United States of America

United States Patent and Trademark Office



SUNKI

Reg. No. 4,072,557

Registered Dec. 20, 2011

Int. Cl.: 7

TRADEMARK

PRINCIPAL REGISTER

MAGICAL CARBON GROUP, LTD. (CHINA CORPORATION)
QILIGANG NO. 1 INDUSTRIAL ZONE
YUEQING, ZHEJIANG
CHINA

FOR: CARBON BRUSHES BEING PARTS OF OR FOR USE IN THE STARTING MOTOR OF THE AUTOMOBILE; ELECTROGRAPHITE BRUSHES BEING PARTS OF OR FOR USE IN THE STARTING MOTOR OF THE AUTOMOBILE; GRAPHITE BRUSHES BEING PARTS OF OR FOR USE IN THE STARTING MOTOR OF THE AUTOMOBILE, IN CLASS 7 (U.S. CLS. 13, 19, 21, 23, 31, 34 AND 35).

THE MARK CONSISTS OF AN OVAL DESIGN BISECTED BY THE LETTER "S". THE WORD "SUNKI" APPEARS BELOW THE DESIGN.

OWNER OF INTERNATIONAL REGISTRATION 1064914 DATED 11-4-2010, EXPIRES 11-4-2020.

THE WORDING "SUNKI" HAS NO MEANING IN A FOREIGN LANGUAGE.

SER. NO. 79-092,496, FILED 11-4-2010.

STEVEN JACKSON, EXAMINING ATTORNEY



David J. Kyfos

Director of the United States Patent and Trademark Office

United States of America

United States Patent and Trademark Office

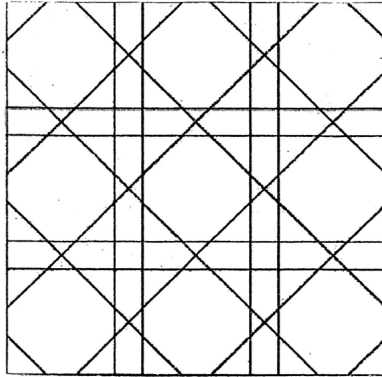

Reg. No. 4,072,558

Registered Dec. 20, 2011

**Int. Cls.: 3, 20, 21, 35
and 44**

TRADEMARK

SERVICE MARK

PRINCIPAL REGISTER

PARFUMS CHRISTIAN DIOR (FRANCE SOCIÉTÉ ANONYME)
33 AVENUE HOCHÉ
F-75008 PARIS
FRANCE

FOR: TOILET SOAP; PERFUMES; COSMETICS; FACE AND BODY CARE AND MAKE-UP PRODUCTS, NAMELY, LOTIONS FOR FACE AND BODY CARE, EYE MAKE-UP; ESSENTIAL OILS FOR PERSONAL USE; BODY MILKS AND LOTIONS; PERFUMED FACE AND BODY GELS; DEODORANTS FOR PERSONAL USE; HAIR LOTIONS; MAKE-UP REMOVING PRODUCTS, NAMELY, MAKE-UP REMOVER, MAKE-UP REMOVING LOTIONS; BEAUTY MASKS; LIPSTICK; DEPILATORY PREPARATIONS; SHAVING PRODUCTS, NAMELY, SHAVING CREAM, SHAVING SOAP, IN CLASS 3 (U.S. CLS. 1, 4, 6, 50, 51 AND 52).

FOR: FURNITURE; MIRRORS; PROMOTIONAL MATERIALS AND COUNTERS, NAMELY, FURNITURE AND DISPLAY STANDS; WOODEN HOLDERS FOR SIGNS; INFLATABLE PLASTIC SIGNS, IN CLASS 20 (U.S. CLS. 2, 13, 22, 25, 32 AND 50).

FOR: ACCESSORIES FOR COSMETIC USE OR CARE, NAMELY, COMBS AND SPONGES, COSMETIC BRUSHES; TOILET CASES IN THE NATURE OF FITTED VANITY CASES; POWDER COMPACTS SOLD EMPTY, IN CLASS 21 (U.S. CLS. 2, 13, 23, 29, 30, 33, 40 AND 50).

FOR: RETAIL STORE SERVICES FEATURING PERFUMERY, BEAUTY AND PERSONAL CARE PRODUCTS, IN CLASS 35 (U.S. CLS. 100, 101 AND 102).

FOR: HYGIENIC AND BEAUTY CARE FOR HUMAN BEINGS; BEAUTY SALONS AND PARLORS; MASSAGE; CONSULTATION SERVICES IN THE FIELD OF COSMETOLOGY, IN CLASS 44 (U.S. CLS. 100 AND 101).

THE MARK CONSISTS OF A SQUARE COVERED WITH A GEOMETRIC PATTERN OF DOUBLED HORIZONTAL AND DOUBLED VERTICAL LINES INTERSECTING TO FORM SMALLER SQUARES AND RECTANGLES, OVERLAYED WITH PARALLEL DIAGONAL LINES FORMING DIAMOND SHAPES AND TRIANGLES.

PRIORITY DATE OF 3-23-2010 IS CLAIMED.



David J. Kyros

Director of the United States Patent and Trademark Office

Reg. No. 4,072,558 OWNER OF INTERNATIONAL REGISTRATION 1064983 DATED 9-16-2010, EXPIRES 9-16-2020.

SER. NO. 79-092,518, FILED 9-16-2010.

STEVEN JACKSON, EXAMINING ATTORNEY

United States of America

United States Patent and Trademark Office



Reg. No. 4,072,559

ALEKSEJS USAKOV (RUSSIAN FED. INDIVIDUAL)

Registered Dec. 20, 2011

LACPLESA IELA 51-4
LV-1011 RIGA, LATVIA

Int. Cls.: 9 and 14

FOR: ELECTRONIC STEREO-AUDIO APPARATUS AND DEVICES FOR RECORDING, TRANSMISSION OR REPRODUCTION OF SOUND, VOICE OR IMAGES, IN CLASS 9 (U.S. CLS. 21, 23, 26, 36 AND 38).

TRADEMARK

FOR: NECKLACES, MEDALLIONS, NECK CHAINS, IN CLASS 14 (U.S. CLS. 2, 27, 28 AND 50).

PRINCIPAL REGISTER

THE MARK CONSISTS OF THE WORD "NECKTEC" IN STYLIZED LETTERING, WITH THE FIRST "E" REVERSED, WITH A CIRCLE ATTACHED TO THE LONG SIDES OF BOTH "E"'S SURROUNDING THE LETTERS "CKT". THERE ARE TWO VERTICAL LINES IN THE CENTER, ONE EXTENDING FROM THE LEFT SIDE OF THE "K" AND ONE BEHIND THE "K", WITH A SET OF HEADPHONES OVER THE TOP OF THE LINES. THE WORD "NECKTEC" APPEARS AGAIN UNDER THE "CKT" DESIGN IN THE CENTER.

PRIORITY DATE OF 7-15-2010 IS CLAIMED.

OWNER OF INTERNATIONAL REGISTRATION 1065063 DATED 11-16-2010, EXPIRES 11-16-2020.

THE ENGLISH TRANSLATION OF THE FOREIGN WORD(S) IN THE MARK IS "CORK-SCREW".

SER. NO. 79-092,548, FILED 11-16-2010.

ELISSA GARBER KON, EXAMINING ATTORNEY



David J. Kybas

Director of the United States Patent and Trademark Office

United States of America
United States Patent and Trademark Office

Maxx Bar

Reg. No. 4,072,560

Registered Dec. 20, 2011

Int. Cl.: 30

AUSTRALIAN VENTURES GROUP PTY LTD (AUSTRALIA PROPRIETARY LIMITED COMPANY)
12A OLIVE STREET
FAIRFIELD NSW 2165
AUSTRALIA

TRADEMARK

FOR: MUESLI BARS; MUESLI BARS CONTAINING A MIXTURE OF GRAINS, NUTS AND DRIED FRUIT, IN CLASS 30 (U.S. CL. 46).

PRINCIPAL REGISTER

THE MARK CONSISTS OF STANDARD CHARACTERS WITHOUT CLAIM TO ANY PARTICULAR FONT, STYLE, SIZE, OR COLOR.

PRIORITY DATE OF 6-29-2010 IS CLAIMED.

OWNER OF INTERNATIONAL REGISTRATION 1065089 DATED 11-29-2010, EXPIRES 11-29-2020.

NO CLAIM IS MADE TO THE EXCLUSIVE RIGHT TO USE "BAR", APART FROM THE MARK AS SHOWN.

SER. NO. 79-092,557, FILED 11-29-2010.

TASNEEM HUSSAIN, EXAMINING ATTORNEY



David J. Kybas

Director of the United States Patent and Trademark Office

United States of America

United States Patent and Trademark Office

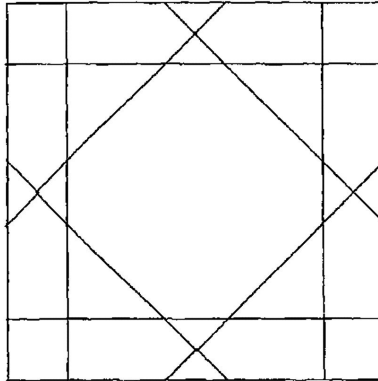

Reg. No. 4,072,561

Registered Dec. 20, 2011

**Int. Cls.: 3, 20, 21, 35
and 44**

TRADEMARK

SERVICE MARK

PRINCIPAL REGISTER

PARFUMS CHRISTIAN DIOR (FRANCE SOCIÉTÉ ANONYME)
33 AVENUE HOCHÉ
PARIS, FRANCE F75008

FOR: TOILET SOAP; PERFUMES; COSMETICS; FACE AND BODY CARE AND MAKE-UP PRODUCTS, NAMELY, LOTIONS FOR FACE AND BODY CARE, EYE MAKE-UP; ESSENTIAL OILS FOR PERSONAL USE; BODY MILKS AND LOTIONS; PERFUMED FACE AND BODY GELS; DEODORANTS FOR PERSONAL USE; HAIR LOTIONS; MAKE-UP REMOVING PRODUCTS, NAMELY, MAKE-UP REMOVER, MAKE-UP REMOVING LOTIONS; BEAUTY MASKS; LIPSTICK; DEPILATORY PREPARATIONS; SHAVING PRODUCTS, NAMELY, SHAVING CREAM, SHAVING SOAP, IN CLASS 3 (U.S. CLS. 1, 4, 6, 50, 51 AND 52).

FOR: FURNITURE; MIRRORS; PROMOTIONAL MEDIA AND COUNTERS, NAMELY, FURNITURE AND DISPLAY STANDS; WOODEN SIGNS; PLASTIC SIGNS, IN CLASS 20 (U.S. CLS. 2, 13, 22, 25, 32 AND 50).

FOR: ACCESSORIES FOR COSMETIC USE OR CARE, NAMELY, COMBS, SPONGES AND BRUSHES; TOILET CASES IN THE NATURE OF FITTED VANITY CASES; POWDER COMPACTS, IN CLASS 21 (U.S. CLS. 2, 13, 23, 29, 30, 33, 40 AND 50).

FOR: RETAIL STORE SERVICES FEATURING PERFUMERY, BEAUTY AND PERSONAL CARE PRODUCTS, IN CLASS 35 (U.S. CLS. 100, 101 AND 102).

FOR: HYGIENIC AND BEAUTY CARE FOR HUMAN BEINGS; BEAUTY SALONS AND PARLORS; MASSAGE; PROVIDING COSMETOLOGY ADVICE AND INFORMATION, IN CLASS 44 (U.S. CLS. 100 AND 101).

THE MARK CONSISTS OF A SQUARE CONTAINING TWO VERTICAL AND TWO HORIZONTAL STRAIGHT LINES BISECTED BY LINES FORMING A DIAMOND SHAPE.

PRIORITY DATE OF 3-23-2010 IS CLAIMED.

OWNER OF INTERNATIONAL REGISTRATION 1065293 DATED 9-16-2010, EXPIRES 9-16-2020.

SER. NO. 79-092,628, FILED 9-16-2010.



David J. Kybas

Director of the United States Patent and Trademark Office

Reg. No. 4,072,561 TOBY BULLOFF, EXAMINING ATTORNEY

United States of America

United States Patent and Trademark Office

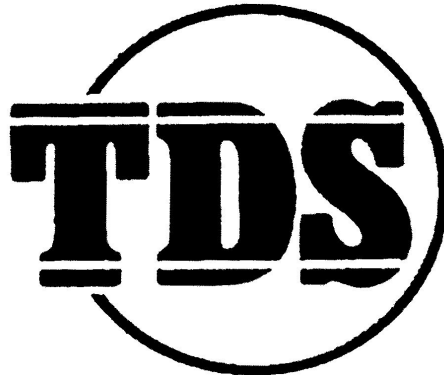

Reg. No. 4,072,562

Registered Dec. 20, 2011

Int. Cl.: 9

TRADEMARK

PRINCIPAL REGISTER

TDS CO., LTD. (JAPAN CORPORATION)
2-5-5, SHINMEI-CHO
OKAYA-CITY; NAGANO PREF. 394-0004
JAPAN

FOR: SOLENOIDS AND SOLENOID VALVES, IN CLASS 9 (U.S. CLS. 21, 23, 26, 36 AND 38).

THE MARK CONSISTS OF THE INITIALS "TDS" INSIDE AN INCOMPLETE CIRCLE AND TWO LINES RUNNING THROUGH THE TOP AND THE BOTTOM PART OF THE INITIALS.

OWNER OF INTERNATIONAL REGISTRATION 1065505 DATED 11-30-2010, EXPIRES 11-30-2020.

SER. NO. 79-092,692, FILED 11-30-2010.

FLORENTINA BLANDU, EXAMINING ATTORNEY



David J. Kyffers

Director of the United States Patent and Trademark Office

United States of America

United States Patent and Trademark Office



Reg. No. 4,072,563

Registered Dec. 20, 2011

Int. Cl.: 32

TRADEMARK

PRINCIPAL REGISTER

32 VIA DEI BIRRAI S.R.L. (ITALY LIMITED LIABILITY COMPANY)
VIA CAL LUSENT, 41
I-31040 ONIGO DI PEDEROBBA (TREVISO)
ITALY

FOR: BEERS, IN CLASS 32 (U.S. CLS. 45, 46 AND 48).

OWNER OF INTERNATIONAL REGISTRATION 1065647 DATED 12-2-2010, EXPIRES 12-2-2020.

SER. NO. 79-092,747, FILED 12-2-2010.

SUSAN LESLIE DUBOIS, EXAMINING ATTORNEY



David J. Kyffers

Director of the United States Patent and Trademark Office

United States of America

United States Patent and Trademark Office



Reg. No. 4,072,564

Registered Dec. 20, 2011

**Int. Cls.: 1, 9, 11, 12, 17,
22 and 27**

TRADEMARK

PRINCIPAL REGISTER

GRUPO ANTOLIN-INGENIERIA, S.A. (SPAIN SOCIEDAD ANÓNIMA)
CTRA. MADRID-IRÚN, KM. 244,8
E-09007 BURGOS
SPAIN

FOR: ARTIFICIAL GRAPHITE, CARBON AND GRAPHENE, NAMELY, A SINGLE SHEET OF ARTIFICIAL GRAPHITE FOR INDUSTRIAL PURPOSES, IN CLASS 1 (U.S. CLS. 1, 5, 6, 10, 26 AND 46).

FOR: SEMICONDUCTORS, MICROPROCESSORS, COMPUTERS, BLANK HARD DRIVES FOR COMPUTERS, PHOTOVOLTAIC CELLS, APPARATUS AND INSTRUMENTS FOR CONDUCTING, SWITCHING, TRANSFORMING, ACCUMULATING, REGULATING, OR CONTROLLING ELECTRICITY; APPARATUS FOR RECORDING, TRANSMISSION OR REPRODUCTION OF SOUND OR IMAGES, CONDENSERS, OPTICAL CONDENSERS, COMPUTER MONITORS; SUITS, NAMELY, DIVING SUITS, SPACE SUITS, PROTECTIVE SUITS FOR AVIATORS AND PROTECTIVE SUITS FOR WORKERS FOR PROTECTION AGAINST ACCIDENT OR INJURY, STRENGTHENED FOOTWEAR, HELMETS AND FACE-SHIELDS FOR PROTECTION AGAINST ACCIDENTS, BODY ARMOR, IN CLASS 9 (U.S. CLS. 21, 23, 26, 36 AND 38).

FOR: LIGHTING APPARATUS FOR VEHICLES, VEHICLE REFLECTORS, IN CLASS 11 (U.S. CLS. 13, 21, 23, 31 AND 34).

FOR: WINDSHIELDS FOR VEHICLES, SWIVEL JOINTS AND ARMS FOR STEERING FOR VEHICLES; STEERING WHEELS FOR VEHICLES; SEATS FOR VEHICLES; COVERS AND FRAMES FOR SEATS FOR VEHICLES; VEHICLE ROOFS; PANELS FOR DOORS FOR VEHICLES; TRIMS FOR DOORS FOR VEHICLES, NAMELY, ARTIFICIAL GRAPHITE, CARBON AND GRAPHENE PARTS FOR VEHICLES, NAMELY, AUTOMOTIVE EXTERIOR AND INTERIOR DECORATIVE AND PROTECTIVE TRIM; LOCKS AND ANCHORS FOR THE HOOD AND THE REAR DOOR FOR VEHICLES; TRAYS FOR VEHICLES IN THE NATURE OF VEHICLE ACCESSORIES, NAMELY, TAILGATE TRAYS; SWIVEL JOINTS AND WHEEL SUSPENSIONS FOR VEHICLES; ANCHORS FOR DOORS FOR VEHICLES AND BRAKES FOR DOORS FOR VEHICLES; VEHICLE STRUCTURAL PARTS, NAMELY, MANUAL, ELECTRIC AND ELECTRONIC WINDOW LIFTS FOR VEHICLES; SUMPS FOR VEHICLES, NAMELY, AUTOMOBILE STRUCTURAL PARTS, NAMELY, SUMP GUARDS; TRANSMISSION MECHANISMS AND TRANSMISSIONS FOR VEHICLES; AUTOMOTIVE INTERIOR TRIMS FOR VEHICLES, VEHICLE BODYWORKS; FITTED COVERINGS FOR



David J. Kybas

Director of the United States Patent and Trademark Office

Reg. No. 4,072,564 ROOFS, DASHBOARDS AND INTERIORS FOR VEHICLES; FITTED COVERINGS FOR SHOCK ABSORBERS FOR VIBRATION AND IMPACT FOR INTERIOR USE FOR VEHICLES, IN CLASS 12 (U.S. CLS. 19, 21, 23, 31, 35 AND 44).

FOR: NON-METAL HOSEPIPES AND CONNECTING HOSE FOR VEHICLE RADIATORS, ARTIFICIAL AND SYNTHETICAL RESINS IN EXTRUDED FORM FOR GENERAL INDUSTRIAL USE AS SEMI-FINISHED PRODUCTS; INSULATORS, NAMELY, AUTOMOTIVE INTERIOR ELECTRIC, THERMAL AND ACOUSTIC INSULATORS FOR VEHICLES, INSULATING FABRICS, CARBON FIBERS OTHER THAN FOR TEXTILE USE, IN CLASS 17 (U.S. CLS. 1, 5, 12, 13, 35 AND 50).

FOR: CARBON FIBERS FOR TEXTILE USE, IN CLASS 22 (U.S. CLS. 1, 2, 7, 19, 22, 42 AND 50).

FOR: FLOOR COVERINGS, IN CLASS 27 (U.S. CLS. 19, 20, 37, 42 AND 50).

THE WORDING "GRANPH" HAS NO MEANING IN A FOREIGN LANGUAGE.

OWNER OF INTERNATIONAL REGISTRATION 1065838 DATED 12-3-2010, EXPIRES 12-3-2020.

THE COLOR(S) RED AND BLACK IS/ARE CLAIMED AS A FEATURE OF THE MARK.

THE TRADEMARK CONTAINS THE WORD "GRANPH" IN BLACK LETTERS, EXCEPT THE "N" WHICH IS IN LOWER CASE AND COLORED RED; ALSO THERE IS A SERIES OF HEXAGONS IN RED PLACED RANDOMLY.

SER. NO. 79-092,833, FILED 12-3-2010.

TASNEEM HUSSAIN, EXAMINING ATTORNEY

United States of America

United States Patent and Trademark Office



Reg. No. 4,072,565

Registered Dec. 20, 2011

Int. Cl.: 8

TRADEMARK

PRINCIPAL REGISTER

DA LIAN YA TU TOU ZI ZI XUN YOU XIAN GONG SI (CHINA LIMITED COMPANY (LTD.))
NO. 439 HUANGPU ROAD, FLOOR 13,
02-2 ROOM,; GANJINGZI DISTRICT,; DALIANCITY; LIAONING PROVINCE
CHINA

FOR: HAND OPERATED AGRICULTURAL IMPLEMENTS, NAMELY, BROADFORKS, CIDER PRESSES, RAKES; HAND OPERATED GARDEN TOOLS, NAMELY, TROWELS, WEEDING FORKS, SPADES, HOES; HARPOONS FOR COMMERCIAL FISHING; BEARD CLIPPERS; MANICURE SETS; HAND TOOLS, NAMELY, SCRAPING TOOLS; HAND TOOLS, NAMELY, GRAVING TOOLS; KNIVES; SWORDS; TABLEWARE, NAMELY, KNIVES, FORKS AND SPOONS, IN CLASS 8 (U.S. CLS. 23, 28 AND 44).

THE MARK CONSISTS OF A STYLIZED SHIELD DESIGN WITH ALTERNATING BORDER SEGMENTS CONTAINING, FROM LEFT TO RIGHT, THREE STARS, THREE STARS, THREE STARS AND A CIRCULAR-ARROW DESIGN (RESEMBLING THE MALE GENDER SYMBOL) AT THE BOTTOM. THERE IS A STYLIZED ASTROLOGICAL TAURUS SYMBOL ABOVE THE LETTERS "A", "B", WITH AN ARROW INSIDE A CIRCULAR DESIGN LOCATED AT THE INTERSECTION OF THE TAURUS SYMBOL AND "A", "B", AT THE CENTER OF THE SHIELD.

OWNER OF INTERNATIONAL REGISTRATION 1065873 DATED 1-18-2011, EXPIRES 1-18-2021.

SER. NO. 79-092,843, FILED 1-18-2011.

KARANENDRA S. CHHINA, EXAMINING ATTORNEY



David J. Kyffers

Director of the United States Patent and Trademark Office

United States of America

United States Patent and Trademark Office

The logo for "NEW SPOOL" features the word "NEW" in a bold, sans-serif font, followed by a circular graphic containing a stylized wheel with five spokes. To the right of this graphic is the word "SPOOL" in a larger, bold, sans-serif font.

Reg. No. 4,072,566

Registered Dec. 20, 2011

Int. Cls.: 6 and 7

TRADEMARK

PRINCIPAL REGISTER

NEW SPOOL S.R.L. (ITALY LIMITED LIABILITY COMPANY)
VIA DELL'INDUSTRIA, 11/A
I-38012 MOLLARO (TN)
ITALY

FOR: WINDING SPOOLS OF METAL, NON-MECHANICAL, FOR FLEXIBLE WIRES, IN CLASS 6 (U.S. CLS. 2, 12, 13, 14, 23, 25 AND 50).

FOR: MACHINERY FOR THE PRODUCTION AND PROCESSING OF WIRES, SPOOLS AND BOBBINS, NAMELY, ASSEMBLY MACHINES; MACHINERY AND ACCESSORIES FOR WORKING STEEL, NAMELY, SPOKE CUTTING MACHINES AND RING FORMING MACHINES, IN CLASS 7 (U.S. CLS. 13, 19, 21, 23, 31, 34 AND 35).

THE MARK CONSISTS OF THE STYLIZED WORDING "NEW" AND "SPOOL" SEPARATED BY A CIRCULAR SHAPE WHOSE CIRCUMFERENCE IS INTERRUPTED BY THE LETTER "W" AND HAVING FIVE VISIBLE SPOKES.

PRIORITY DATE OF 8-6-2010 IS CLAIMED.

OWNER OF INTERNATIONAL REGISTRATION 1065970 DATED 9-21-2010, EXPIRES 9-21-2020.

SER. NO. 79-092,888, FILED 9-21-2010.

MAYUR VAGHANI, EXAMINING ATTORNEY



David J. Kybas

Director of the United States Patent and Trademark Office

United States of America
United States Patent and Trademark Office

PayGay

Reg. No. 4,072,567

Registered Dec. 20, 2011

Int. Cls.: 35, 36 and 38

SERVICE MARK

PRINCIPAL REGISTER

PAYGAY GMBH (FED REP GERMANY GMBH)
MOTZSTR. 6
10777 BERLIN
FED REP GERMANY

FOR: ADVERTISING, ONLINE ADVERTISING ON A COMPUTER NETWORK, BUSINESS MANAGEMENT CONSULTANCY, IN CLASS 35 (U.S. CLS. 100, 101 AND 102).

FOR: FINANCIAL AFFAIRS AND MONETARY AFFAIRS, NAMELY, ISSUANCE OF CREDIT CARDS, INSURANCE BROKERAGE, IN CLASS 36 (U.S. CLS. 100, 101 AND 102).

FOR: TELECOMMUNICATION SERVICES BY E-MAIL, COMMUNICATION BY MOBILE TELEPHONE AND FACSIMILE AS WELL AS ELECTRONIC MESSAGING, IN CLASS 38 (U.S. CLS. 100, 101 AND 104).

THE MARK CONSISTS OF STANDARD CHARACTERS WITHOUT CLAIM TO ANY PARTICULAR FONT, STYLE, SIZE, OR COLOR.

OWNER OF INTERNATIONAL REGISTRATION 1066121 DATED 9-21-2010, EXPIRES 9-21-2020.

THE WORD(S) "PAYGAY" HAS NO MEANING IN A FOREIGN LANGUAGE.

SER. NO. 79-092,932, FILED 9-21-2010.

CARYN GLASSER, EXAMINING ATTORNEY



David J. Kybas

Director of the United States Patent and Trademark Office

United States of America

United States Patent and Trademark Office

PIK-SEL

Reg. No. 4,072,568

Registered Dec. 20, 2011

Int. Cl.: 21

TRADEMARK

PRINCIPAL REGISTER

PIK-SEL LIMITED (UNITED KINGDOM LIMITED COMPANY (LTD.))
PO BOX 1
PORTLAND HOUSE,; STATION ROAD; BALLASALLA, ISLE OF MAN IM99 6AB
UNITED KINGDOM

FOR: CONTAINERS FOR HOUSEHOLD USE, TOOTHPICKS, CONTAINERS FOR TOOTH-
PICKS, TOOTHPICK HOLDERS , IN CLASS 21 (U.S. CLS. 2, 13, 23, 29, 30, 33, 40 AND 50).

THE MARK CONSISTS OF STANDARD CHARACTERS WITHOUT CLAIM TO ANY PAR-
TICULAR FONT, STYLE, SIZE, OR COLOR.

OWNER OF INTERNATIONAL REGISTRATION 1066433 DATED 12-31-2010, EXPIRES 12-
31-2020.

SER. NO. 79-093,031, FILED 12-31-2010.

HEATHER BIDDULPH, EXAMINING ATTORNEY



David J. Kybas

Director of the United States Patent and Trademark Office

United States of America

United States Patent and Trademark Office



Reg. No. 4,072,569

Registered Dec. 20, 2011

Int. Cl.: 25

TRADEMARK

PRINCIPAL REGISTER

HUB BUB B.V. (NETHERLANDS LIMITED LIABILITY COMPANY)
TURFSCHIPPER 70-72
NL-2292 JB WATERINGEN
NETHERLANDS

FOR: FOOTWEAR, IN CLASS 25 (U.S. CLS. 22 AND 39).

THE MARK CONSISTS OF THE WORD "HUB" WITH THE LETTER "H" IN BLACK IN THE CENTER WITH THE LETTER "U" IN ORANGE CENTERED OVER THE MIDDLE BAR OF THE "H" AND THE LETTER "B" IN BLACK CENTERED UNDER THE MIDDLE BAR OF THE "H".

OWNER OF INTERNATIONAL REGISTRATION 1066476 DATED 11-26-2010, EXPIRES 11-26-2020.

THE COLOR(S) ORANGE AND BLACK IS/ARE CLAIMED AS A FEATURE OF THE MARK.

SER. NO. 79-093,040, FILED 11-26-2010.

JOSETTE BEVERLY, EXAMINING ATTORNEY



David J. Kybas

Director of the United States Patent and Trademark Office

United States of America

United States Patent and Trademark Office

browhaus

Reg. No. 4,072,570

Registered Dec. 20, 2011

Int. Cl.: 44

SPA ESPRIT GROUP FRANCHISE PTE. LTD. (SINGAPORE COMPANY LIMITED BY SHARES)
8D DEMPSEY ROAD,
#01-03/04; SINGAPORE 249672
SINGAPORE

SERVICE MARK

PRINCIPAL REGISTER

FOR: HYGIENIC AND BEAUTY CARE OF HUMAN BEINGS; EYE BROW TRIMMING; EYE BROW THREADING; EYELASH PERMING; LASER HAIR REMOVAL SERVICES; BODY HAIR WAXING SERVICES; TATTOOING; MANICURE SERVICES; MAKE-UP APPLICATION SERVICES; AROMATHERAPY SERVICES; HEALTH SPA SERVICES, NAMELY, COSMETIC BODY CARE SERVICES; MASSAGE SERVICES, IN CLASS 44 (U.S. CLS. 100 AND 101).

OWNER OF U.S. REG. NO. 3,420,788.

PRIORITY DATE OF 6-18-2010 IS CLAIMED.

OWNER OF INTERNATIONAL REGISTRATION 1066525 DATED 11-22-2010, EXPIRES 11-22-2020.

THE COLOR(S) "LIGHT GREEN" AND "DARK GREEN" IS/ARE CLAIMED AS A FEATURE OF THE MARK.

THE MARK CONSISTS OF THE STYLIZED WORDING "BROWHAUS" WITH "BRO" AND "HAUS" APPEARING IN LIGHT GREEN AND THE "W" APPEARING IN DARK GREEN.

THE ENGLISH TRANSLATION OF THE WORD "HAUS" IN THE MARK IS "HOUSE".

SER. NO. 79-093,053, FILED 11-22-2010.

ROBERT STRUCK, EXAMINING ATTORNEY



David J. Kyffers

Director of the United States Patent and Trademark Office

United States of America
United States Patent and Trademark Office

CASA GI

Reg. No. 4,072,571

Registered Dec. 20, 2011

Int. Cl.: 14

TRADEMARK

PRINCIPAL REGISTER

CASA GI INTERNATIONAL, NAAMLOZE VENNOOTSCHAP (BELGIUM JOINT STOCK COMPANY)
APPELMANSSTRAAT 12, BUS 5
B-2018 ANTWERPEN
BELGIUM

FOR: JEWELLERY, IN CLASS 14 (U.S. CLS. 2, 27, 28 AND 50).

THE MARK CONSISTS OF STANDARD CHARACTERS WITHOUT CLAIM TO ANY PARTICULAR FONT, STYLE, SIZE, OR COLOR.

OWNER OF INTERNATIONAL REGISTRATION 0778200 DATED 2-8-2002, EXPIRES 2-8-2012.

THE ENGLISH TRANSLATION OF THE WORD "CASA" IN THE MARK IS HOUSE.

SER. NO. 79-093,101, FILED 12-6-2010.

ALLISON SCHRODY, EXAMINING ATTORNEY



David J. Kyffers

Director of the United States Patent and Trademark Office

United States of America

United States Patent and Trademark Office

L'Occitane Fresh Skincare

Reg. No. 4,072,572

Registered Dec. 20, 2011

Int. Cl.: 3

TRADEMARK

PRINCIPAL REGISTER

L'OCCITANE (FRANCE SOCIÉTÉ ANONYME)
ZONE INDUSTRIELLE SAINT-MAURICE
F-04100 MANOSQUE
FRANCE

FOR: SOAP; PERFUMERY; PERFUMES; TOILET WATER; ESSENTIAL OILS; COSMETICS; HAIR LOTIONS; DENTIFRICES; INCENSE; ROOM FRAGRANCING PREPARATIONS; OILS FOR COSMETIC PURPOSES; OILS FOR PERFUMES AND SCENTS; SHAMPOOS, SHOWER GELS, BUBBLE BATHS; BEAUTY MASKS; COSMETIC PREPARATIONS FOR SKIN CARE; COSMETIC PENCILS; MAKE-UP AND MAKE-UP REMOVING PREPARATIONS; CLEANSING MILK FOR TOILET PURPOSES; LOTIONS FOR COSMETIC PURPOSES; DEODORANTS FOR PERSONAL USE; NON-MEDICATED TOILETRIES; SACHETS FOR PERFUMING LINEN; AFTER-SHAVE LOTIONS; COSMETIC PREPARATIONS FOR SLIMMING PURPOSES; COSMETIC SUNTANNING PREPARATIONS; COSMETIC SUNSCREEN PREPARATIONS, IN CLASS 3 (U.S. CLS. 1, 4, 6, 50, 51 AND 52).

NO CLAIM IS MADE TO THE EXCLUSIVE RIGHT TO USE "SKINCARE", APART FROM THE MARK AS SHOWN.

PRIORITY DATE OF 7-7-2010 IS CLAIMED.

OWNER OF INTERNATIONAL REGISTRATION 1066760 DATED 1-5-2011, EXPIRES 1-5-2021.

THE WORDING "L'OCCITANE" HAS NO MEANING IN A FOREIGN LANGUAGE.

SER. NO. 79-093,180, FILED 1-5-2011.

LEIGH LOWRY, EXAMINING ATTORNEY



David J. Kypos

Director of the United States Patent and Trademark Office

United States of America

United States Patent and Trademark Office

CHCÊDO
自然堂

Reg. No. 4,072,573

Registered Dec. 20, 2011

Int. Cl.: 3

TRADEMARK

PRINCIPAL REGISTER

JALA GROUP INC. (CHINA CORPORATION)
NO. 12, LI FENG ROAD
SHANGHAI
CHINA

FOR: COSMETICS; FACIAL CLEANSING CREAM; FACIAL CLEANSING MILK; LAUNDRY BLEACH; LAUNDRY PREPARATIONS, NAMELY, LAUNDRY DETERGENT, FABRIC SOFTENERS; WASHING PREPARATIONS, NAMELY, LAUNDRY DETERGENT, FABRIC SOFTENERS; STAIN REMOVERS; POLISHING PREPARATIONS; ESSENTIAL OILS; DENTIFRICES; TOOTHPASTES; POTPOURRIS IN THE NATURE OF FRAGRANCES; COSMETICS FOR ANIMALS, IN CLASS 3 (U.S. CLS. 1, 4, 6, 50, 51 AND 52).

THE MARK CONSISTS OF A WORD "CHCEDO" WITH A DASH ON THE TOP OF THE LETTER "E", AND THREE CHINESE CHARACTERS.

OWNER OF INTERNATIONAL REGISTRATION 1067049 DATED 1-21-2011, EXPIRES 1-21-2021.

THE TRANSLITERATION OF THE CHINESE CHARACTERS IN THE MARK IS "ZI RAN TANG". "ZI RAN" MEANS "AT EASE" IN ENGLISH, WHILE "TANG" MEANS "HALL" IN ENGLISH. WHEN USED IN COMBINATION, THE THREE CHINESE CHARACTERS AS A WHOLE HAVE NO MEANING IN ENGLISH.

THE LATIN CHARACTERS "CHCEDO" HAVE NO SIGNIFICANCE IN A FOREIGN LANGUAGE.

SER. NO. 79-093,338, FILED 1-21-2011.

ELI HELLMAN, EXAMINING ATTORNEY



David J. Kypos

Director of the United States Patent and Trademark Office

United States of America

United States Patent and Trademark Office

Generia

Reg. No. 4,072,574

Registered Dec. 20, 2011

**Int. Cls.: 9, 11, 35, 37, 40,
41 and 42**

TRADEMARK

SERVICE MARK

PRINCIPAL REGISTER

DTL CORPORACIÓN, S.L. (SPAIN SOCIEDAD LIMITADA)
C/ PRINCESA, 2
E-28008 MADRID
SPAIN

FOR: APPARATUS AND INSTRUMENTS FOR CONVEYING, CONDUCTING, DISTRIBUTING, TRANSFORMING, STORING, REGULATING OR CONTROLLING ELECTRIC CURRENT PRODUCED VIA SOLAR, THERMAL, PHOTOVOLTAIC OR WIND ENERGY AND VIA ANY OTHER KIND OF RENEWABLE ENERGY; PHOTOVOLTAIC CELLS; SOLAR PANELS FOR PRODUCTION OF ELECTRICITY; SOLAR MODULES FOR PRODUCTION OF ELECTRICITY; SOLAR POWER PLANTS, NAMELY, ASSEMBLIES OF PHOTOVOLTAIC MODULES COMPRISED OF SEVERAL PHOTOVOLTAIC CELLS; SOLAR POWER STATIONS, NAMELY, ASSEMBLIES OF PHOTOVOLTAIC MODULES COMPRISED OF SEVERAL PHOTOVOLTAIC CELLS, IN CLASS 9 (U.S. CLS. 21, 23, 26, 36 AND 38).

FOR: LIGHTING, HEATING, STEAM GENERATING, COOKING, REFRIGERATING, DRYING, VENTILATING AND WATER SUPPLY APPARATUS RELATING TO SOLAR, THERMAL, PHOTOVOLTAIC AND WIND ENERGY AND TO ANY OTHER KIND OF RENEWABLE ENERGY, NAMELY, SOLAR COLLECTORS, SOLAR COLLECTORS FOR HEATING, SOLAR ENERGY BASED COOLING APPARATUS, SOLAR ENERGY RECEIVERS, SOLAR HEAT COLLECTION PANELS, SOLAR REACTORS, SOLAR THERMAL INSTALLATIONS, NAMELY, SOLAR THERMAL MODULES, IN CLASS 11 (U.S. CLS. 13, 21, 23, 31 AND 34).



David J. Kyros

Director of the United States Patent and Trademark Office

FOR: ADVERTISING; NEWS CLIPPING SERVICES; PUBLIC OPINION POLLING; DEMONSTRATION OF GOODS; COMMERCIAL INFORMATION AND ADVICE FOR CONSUMERS; SALES PROMOTION FOR OTHERS; PUBLICATION OF PUBLICITY TEXTS; ASSISTANCE, CONSULTING AND ADVISORY SERVICES ON BUSINESS AND COMPANY MANAGEMENT AND ORGANIZATION; BUSINESS INQUIRIES; BUSINESS MANAGEMENT; BUSINESS ADMINISTRATION; BUSINESS INVESTIGATIONS; COMMERCIAL INFORMATION AGENCIES; EFFICIENCY EXPERTS; BUSINESS APPRAISALS; COMMERCIAL ADMINISTRATION OF THE LICENSING OF THE GOODS AND SERVICES OF OTHERS; OFFICE FUNCTIONS; PROCUREMENT, NAMELY, PURCHASING SOLAR ENERGY APPARATUS AND SERVICES OF CONSTRUCTION, INSTALLATION AND ENGINEERING OF SOLAR ENERGY APPARATUS AND PLANTS FOR OTHER BUSINESSES; BOOK-KEEPING; COST PRICE ANALYSIS; ECONOMIC FORECASTING; COMPILATION OF STATISTICS; COMPILATION OF INFORMATION INTO COMPUTER DATABASES; ORGANIZATION OF EXHIBITIONS AND TRADE FAIRS FOR COMMERCIAL OR ADVERTISING PURPOSES;

Reg. No. 4,072,574 PRESENTATION OF GOODS ON COMMUNICATION MEDIA, FOR RETAIL PURPOSES; ALL RELATING TO SOLAR, THERMAL, PHOTOVOLTAIC AND WIND ENERGY AND TO ANY OTHER KIND OF RENEWABLE ENERGY, IN CLASS 35 (U.S. CLS. 100, 101 AND 102).

FOR: CONSTRUCTION, REPAIR, MAINTENANCE AND INSTALLATION OF SYSTEMS TO CAPTURE AND GENERATE SOLAR, THERMAL, PHOTOVOLTAIC AND WIND ENERGY AND ANY OTHER RENEWABLE ENERGY, NAMELY, RENEWABLE ENERGY GENERATION EQUIPMENT, RENEWABLE ENERGY BASED POWER PLANTS; CONSTRUCTION, REPAIR, MAINTENANCE AND INSTALLATION OF SOLAR ENERGY BASED POWER PLANTS; CONSTRUCTION, REPAIR, MAINTENANCE AND INSTALLATION OF SOLAR ENERGY BASED POWER STATIONS, IN CLASS 37 (U.S. CLS. 100, 103 AND 106).

FOR: PRODUCTION OF SOLAR, THERMAL, PHOTOVOLTAIC AND WIND ENERGY AND OF ANY OTHER KIND OF RENEWABLE ENERGY; CONSULTANCY SERVICES FOR OTHERS RELATING TO THE PRODUCTION OF SOLAR POWER, IN CLASS 40 (U.S. CLS. 100, 103 AND 106).

FOR: EDUCATION AND TRAINING, NAMELY, PROVIDING CLASSES, SEMINARS, WORKSHOPS RELATING TO SOLAR, THERMAL, PHOTOVOLTAIC AND WIND ENERGY AND ANY OTHER KIND OF RENEWABLE ENERGY; ARRANGING AND CONDUCTING OF EDUCATIONAL COLLOQUIUMS, CONFERENCES, CONGRESSES, SEMINARS AND SYMPOSIUMS RELATING TO SOLAR, THERMAL, PHOTOVOLTAIC AND WIND ENERGY AND ANY OTHER KIND OF RENEWABLE ENERGY; PUBLICATION OF BOOKS AND OTHER TEXTS, OTHER THAN FOR PUBLICITY TEXTS, RELATING TO SOLAR, THERMAL, PHOTOVOLTAIC AND WIND ENERGY AND ANY OTHER KIND OF RENEWABLE ENERGY; PUBLICATION OF ELECTRONIC BOOKS AND JOURNALS ON-LINE RELATING TO SOLAR, THERMAL, PHOTOVOLTAIC AND WIND ENERGY AND ANY OTHER KIND OF RENEWABLE ENERGY, IN CLASS 41 (U.S. CLS. 100, 101 AND 107).

FOR: DESIGN OF PHOTOVOLTAIC CELLS, SOLAR PANELS, SOLAR MODULES, SOLAR PLANTS, SOLAR POWER STATIONS, SEMI-CONDUCTORS AND, IN GENERAL, DESIGN OF ALL TYPES OF APPARATUS AND INSTRUMENTS FOR GENERATING, CONDUCTING, DISTRIBUTING, TRANSFORMING, ACCUMULATING, REGULATING OR CONTROLLING ELECTRICITY PRODUCED VIA SOLAR, THERMAL, PHOTOVOLTAIC AND WIND ENERGY AND OF ANY OTHER KIND OF RENEWABLE ENERGY; TECHNOLOGICAL CONSULTING IN THE TECHNOLOGY FIELD OF PHOTOVOLTAIC CELLS, SOLAR PANELS, SOLAR MODULES, SOLAR PLANTS, SOLAR POWER STATIONS, SEMI-CONDUCTORS AND, IN GENERAL, TECHNOLOGICAL CONSULTING IN THE TECHNOLOGY FIELD OF ALL TYPES OF APPARATUS AND INSTRUMENTS FOR GENERATING, CONDUCTING, DISTRIBUTING, TRANSFORMING, ACCUMULATING, REGULATING OR CONTROLLING ELECTRICITY PRODUCED VIA SOLAR, THERMAL, PHOTOVOLTAIC AND WIND ENERGY AND OF ANY OTHER KIND OF RENEWABLE ENERGY; RESEARCH IN THE FIELD OF RENEWABLE ENERGY, NAMELY OF PHOTOVOLTAIC CELLS, SOLAR PANELS, SOLAR MODULES, SOLAR PLANTS, SOLAR POWER STATIONS, SEMI-CONDUCTORS AND, IN GENERAL, RESEARCH OF ALL TYPES OF APPARATUS AND INSTRUMENTS USED IN THE FIELD OF RENEWABLE ENERGY, NAMELY, APPARATUS AND INSTRUMENTS USED FOR GENERATING, CONDUCTING, DISTRIBUTING, TRANSFORMING, ACCUMULATING, REGULATING OR CONTROLLING ELECTRICITY PRODUCED VIA SOLAR, THERMAL, PHOTOVOLTAIC AND WIND ENERGY AND OF ANY OTHER KIND OF RENEWABLE ENERGY; CERTIFICATION AND CHECKING IN THE NATURE OF TESTING, ANALYSIS AND EVALUATION OF THE GOODS OF OTHERS FOR THE PURPOSE OF CERTIFICATION, NAMELY, TESTING, ANALYSIS AND EVALUATION OF PHOTOVOLTAIC CELLS, SOLAR PANELS, SOLAR MODULES, SOLAR PLANTS, SOLAR POWER STATIONS, SEMI-CONDUCTORS AND, IN GENERAL, TESTING, ANALYSIS AND EVALUATION OF ALL TYPES OF APPARATUS AND INSTRUMENTS FOR GENERATING, CONDUCTING, DISTRIBUTING, TRANSFORMING, ACCUMULATING, REGULATING OR CONTROLLING ELECTRICITY PRODUCED VIA SOLAR, THERMAL, PHOTOVOLTAIC AND WIND ENERGY AND OF ANY OTHER KIND OF RENEWABLE ENERGY; ENGINEER-

Reg. No. 4,072,574 ING IN THE FIELD OF SOLAR, THERMAL, PHOTOVOLTAIC AND WIND ENERGY AND OF ANY OTHER KIND OF RENEWABLE ENERGY; TECHNOLOGICAL CONSULTANCY IN THE TECHNOLOGY FIELD OF ENERGY EFFICIENCY; RESEARCH IN THE FIELD OF ENVIRONMENTAL PROTECTION, IN CLASS 42 (U.S. CLS. 100 AND 101).

THE MARK CONSISTS OF STANDARD CHARACTERS WITHOUT CLAIM TO ANY PARTICULAR FONT, STYLE, SIZE, OR COLOR.

PRIORITY DATE OF 1-25-2010 IS CLAIMED.

OWNER OF INTERNATIONAL REGISTRATION 1067891 DATED 7-23-2010, EXPIRES 7-23-2020.

THE WORDING "GENERIA" HAS NO MEANING IN A FOREIGN LANGUAGE.

SER. NO. 79-093,852, FILED 7-23-2010.

KRISTIN CARLSON, EXAMINING ATTORNEY

United States of America

United States Patent and Trademark Office



Reg. No. 4,072,575

Registered Dec. 20, 2011

Int. Cl.: 42

SERVICE MARK

PRINCIPAL REGISTER

GEN GESELLSCHAFT FÜR ERBENERMITTLUNG MBH (FED REP GERMANY GMBH)
BENNOSTR. 2
13053 BERLIN, FED REP GERMANY

FOR: SCIENTIFIC RESEARCH AND CONDUCTING SCIENTIFIC STUDIES IN THE FIELD OF ONOMASTICS WITH THE OBJECTIVE OF CREATING ONOMASTIC EXPERTISES , IN CLASS 42 (U.S. CLS. 100 AND 101).

"PROF. UDOLPH" IDENTIFIES PROF. DR. JÜRGEN UDOLPH, A LIVING INDIVIDUAL WHOSE CONSENT IS OF RECORD.

PRIORITY DATE OF 11-10-2010 IS CLAIMED.

OWNER OF INTERNATIONAL REGISTRATION 1067980 DATED 1-18-2011, EXPIRES 1-18-2021.

THE COLOR(S) RED, BLUE, GREEN AND BLACK IS/ARE CLAIMED AS A FEATURE OF THE MARK.

THE MARK CONSISTS OF THE STYLIZED RED WORDING "ICFNS" WITH BLACK OUTLINES, APPEARING WITH A GREEN AND BLUE GLOBE DESIGN WITH BLACK OUTLINE CONTAINED WITHIN THE LETTER "C", ALL APPEARING ABOVE THE BLACK UNDERLINED BLACK WORDING "PROF. UDOLPH".

THE ENGLISH TRANSLATION OF THE FOREIGN WORD(S) IN THE MARK IS "ICFNS" = INTERNATIONAL CENTER FOR NAME STUDIES.

SER. NO. 79-093,880, FILED 1-18-2011.

KALIE KUNG, EXAMINING ATTORNEY



David J. Kybas

Director of the United States Patent and Trademark Office

United States of America

United States Patent and Trademark Office

Prof.Udolph- International Center for Name Studies

Reg. No. 4,072,576

GEN GESELLSCHAFT FÜR ERBENERMITTLUNG MBH (FED REP GERMANY GMBH)
BENNOSTR. 2

Registered Dec. 20, 2011

13053 BERLIN, FED REP GERMANY

Int. Cl.: 42

FOR: SCIENTIFIC RESEARCH AND CONDUCTING SCIENTIFIC STUDIES IN THE FIELD OF ONOMASTICS WITH THE OBJECTIVE OF ONOMASTIC EXPERTISES , IN CLASS 42 (U.S. CLS. 100 AND 101).

SERVICE MARK

THE MARK CONSISTS OF STANDARD CHARACTERS WITHOUT CLAIM TO ANY PARTICULAR FONT, STYLE, SIZE, OR COLOR.

PRINCIPAL REGISTER

PRIORITY DATE OF 11-10-2010 IS CLAIMED.

OWNER OF INTERNATIONAL REGISTRATION 1068124 DATED 1-18-2011, EXPIRES 1-18-2021.

NO CLAIM IS MADE TO THE EXCLUSIVE RIGHT TO USE "INTERNATIONAL CENTER FOR NAME STUDIES", APART FROM THE MARK AS SHOWN.

"PROF. UDOLPH" IDENTIFIES PROF. DR. JÜRGEN UDOLPH, A LIVING INDIVIDUAL WHOSE CONSENT IS OF RECORD.

SER. NO. 79-093,935, FILED 1-18-2011.

KAELIE KUNG, EXAMINING ATTORNEY



David J. Kybas

Director of the United States Patent and Trademark Office

United States of America

United States Patent and Trademark Office

MEDIFOLDER

Reg. No. 4,072,577

AVIDIAMED GMBH (FED REP GERMANY GMBH (LIMITED LIABILITY COMPANY))
NAGELSWEG 33-35

Registered Dec. 20, 2011

20097 HAMBURG, FED REP GERMANY

Int. Cls.: 5, 6, 16, 35 and 44

FOR: COMPOSITIONS OF PHARMACEUTICAL PREPARATIONS INDIVIDUALLY COMPILED BASED UPON A PATIENT'S PRESCRIBED MEDICATION FOR TREATMENT OF CHRONIC DISEASE PATTERNS REGARDING THE CARDIOVASCULAR SYSTEM, HORMONAL SYSTEM, SKELETAL SYSTEM, PSYCHOLOGICAL DISORDERS, NEUROPATHY AND PAIN THERAPY, GASTRO-INTESTINAL SYSTEM, GENITO-URINARY SYSTEM, RESPIRATORY SYSTEM, LYMPHATIC SYSTEM, MUSCULAR SYSTEM AND INTEGUMENTARY SYSTEM; COMPOSITIONS OF VETERINARY PREPARATIONS INDIVIDUALLY COMPILED BASED UPON AN ANIMAL'S PRESCRIBED MEDICATION FOR TREATMENT OF CHRONIC DISEASE PATTERNS REGARDING THE CARDIOVASCULAR SYSTEM, HORMONAL SYSTEM, SKELETAL SYSTEM, PSYCHOLOGICAL DISORDERS, NEUROPATHY AND PAIN THERAPY, GASTRO-INTESTINAL SYSTEM, GENITO-URINARY SYSTEM, RESPIRATORY SYSTEM, LYMPHATIC SYSTEM, MUSCULAR SYSTEM AND INTEGUMENTARY SYSTEM; SANITARY PREPARATIONS FOR MEDICAL PURPOSES; DIETETIC FOOD AND SUGAR ADAPTED FOR MEDICAL USE; FOOD FOR BABIES; PLASTERS FOR MEDICAL PURPOSES; MATERIALS FOR DRESSINGS, NAMELY, BANDAGES FOR DRESSINGS, GAUZE FOR DRESSINGS, DRESSINGS FOR WOUNDS, DRESSINGS FOR BURNS, DRESSINGS FOR SURGERY, MEDICAL DRESSINGS, SURGICAL DRESSINGS, SELF ADHESIVE DRESSINGS, WOUND DRESSINGS, NAMELY, PLEDGETS; DISINFECTANTS, NAMELY, DISINFECTANTS FOR CONTACT LENSES, DISINFECTANTS FOR HYGIENIC PURPOSES, DISINFECTANTS FOR MEDICAL INSTRUMENTS, DISINFECTANTS FOR SANITARY PURPOSES, IN CLASS 5 (U.S. CLS. 6, 18, 44, 46, 51 AND 52).

TRADEMARK

SERVICE MARK

PRINCIPAL REGISTER



FOR: BLISTERS, NAMELY, FLEXIBLE METAL FOILS PACKAGING MATERIALS FOR USE IN THE MANUFACTURE OF CONTAINERS; PACKING CONTAINERS OF METAL, IN CLASS 6 (U.S. CLS. 2, 12, 13, 14, 23, 25 AND 50).

FOR: PRINTED MATTER, NAMELY, BROCHURES AND PAMPHLETS IN THE FIELD OF INDIVIDUAL PATIENT MEDICATION MACHINES AND SYSTEMS, PRINTED VISUALS IN THE NATURE OF PROMOTIONAL MATERIALS, PRINTED CARDBOARD BOXES IN THE FIELD OF INDIVIDUAL PATIENT MEDICATION MACHINES AND SYSTEMS; PACKAGING MATERIALS, PACKING MATERIALS, AND PACKING INLAY CARDS ALL MADE OF PAPER, PAPERBOARD, CARDBOARD OR SYNTHETIC PAPER; PACKAGING MATERIALS AND PACKING MATERIALS, ALL MADE OF PLASTIC, NAMELY, PLASTIC

David J. Kyffers

Director of the United States Patent and Trademark Office

Reg. No. 4,072,577 BAGS FOR PACKAGING AND PLASTIC BUBBLE PACKS FOR PACKAGING; PLASTIC PACKAGING FOILS; PAPERBOARD BLANKS FOR PACKAGING, IN CLASS 16 (U.S. CLS. 2, 5, 22, 23, 29, 37, 38 AND 50).

FOR: WHOLESALE AND RETAIL STORE SERVICES FEATURING PHARMACEUTICAL AND MEDICAL GOODS; ON-LINE WHOLESALE AND RETAIL STORE SERVICES FEATURING PHARMACEUTICAL AND MEDICAL GOODS; WHOLESALE DISTRIBUTORSHIPS FEATURING PHARMACEUTICAL AND MEDICAL GOODS; WHOLESALE ORDERING SERVICES FEATURING PHARMACEUTICAL AND MEDICAL GOODS, IN CLASS 35 (U.S. CLS. 100, 101 AND 102).

FOR: MEDICAL AND VETERINARY SERVICES; HYGIENIC AND BEAUTY CARE FOR HUMAN BEINGS OR ANIMALS; HEALTH CONSULTANCY; TELEMEDICINE SERVICES; PHARMACEUTICAL FORMULATION SERVICES, NAMELY, FORMULATING PATIENT-SPECIFIC COMPOSITIONS OF PHARMACEUTICAL PREPARATIONS ACCORDING TO THE PATIENTS PRESCRIBED MEDICATION AND MEDICAL CARE; PHARMACIST'S SERVICES, NAMELY, PREPARATION OF PRESCRIPTIONS IN PHARMACIES; MEDICAL SERVICES, NAMELY, MEDICAL AND CLINICAL EXAMINATIONS; PHARMACY ADVICE, NAMELY, PHARMACEUTICAL ADVICE, IN CLASS 44 (U.S. CLS. 100 AND 101).

THE MARK CONSISTS OF STANDARD CHARACTERS WITHOUT CLAIM TO ANY PARTICULAR FONT, STYLE, SIZE, OR COLOR.

PRIORITY DATE OF 7-23-2010 IS CLAIMED.

OWNER OF INTERNATIONAL REGISTRATION 1068130 DATED 1-21-2011, EXPIRES 1-21-2021.

SER. NO. 79-093,939, FILED 1-21-2011.

CHRISTINA SOBRAL, EXAMINING ATTORNEY

United States of America

United States Patent and Trademark Office

DIVA ROSE

Reg. No. 4,072,578

Registered Dec. 20, 2011

Int. Cl.: 3

TRADEMARK

PRINCIPAL REGISTER

EMANUEL UNGARO ITALIA S.R.L. (ITALY LIMITED LIABILITY COMPANY)
VIA VITTOR PISANI, 12/A
I-20124 MILANO
ITALY

FOR: PERFUMES, EAU DE PARFUM, COLOGNE, TOILET WATER, ESSENTIAL OILS, COLD CREAM, PERSONAL DEODORANTS, ANTIPERSPIRANTS, SKIN CLEANSING LOTIONS, SKIN MOISTURIZER, BODY OIL, SKIN EMOLLIENTS, BATH AND SHOWER GELS, BODY LOTIONS, SKIN LOTIONS, IN CLASS 3 (U.S. CLS. 1, 4, 6, 50, 51 AND 52).

THE MARK CONSISTS OF STANDARD CHARACTERS WITHOUT CLAIM TO ANY PARTICULAR FONT, STYLE, SIZE, OR COLOR.

PRIORITY DATE OF 9-29-2010 IS CLAIMED.

OWNER OF INTERNATIONAL REGISTRATION 1068173 DATED 12-29-2010, EXPIRES 12-29-2020.

OWNER OF U.S. REG. NOS. 1,366,196, 1,372,041, AND 1,457,922.

NO CLAIM IS MADE TO THE EXCLUSIVE RIGHT TO USE "ROSE" , APART FROM THE MARK AS SHOWN.

SER. NO. 79-093,971, FILED 12-29-2010.

CHARLOTTE CORWIN, EXAMINING ATTORNEY



David J. Kyffers

Director of the United States Patent and Trademark Office

United States of America

United States Patent and Trademark Office



Reg. No. 4,072,579

Registered Dec. 20, 2011

Int. Cls.: 9, 35 and 42

TRADEMARK

SERVICE MARK

PRINCIPAL REGISTER

JETMOBILE SAS (FRANCE SAS)
141, AVENUE DE VERDUN BÂTIMENT A
F-92130 ISSY LES MOULINEAUX
FRANCE

FOR: PROGRAMMABLE APPARATUS FOR AUDITING OF FACSIMILE MACHINES BY MEANS OF ACCESS CODES; PROGRAMMABLE APPARATUS FOR MANAGING PHOTOCOPIERS BY MEANS OF ACCESS CODES; PROGRAMMABLE APPARATUS FOR CONTROLLING PHOTOCOPIERS BY MEANS OF ACCESS CODES; MULTIFUNCTIONAL DEVICES WITH PHOTOCOPYING, FAXING, SCANNING AND PRINTING FUNCTIONS; APPARATUS AND PARTS OF APPARATUS FOR THE TRANSMISSION OF DATA AND SIGNALS BY TELEPHONE, FACSIMILE, TELEGRAPH, TELEPRINTER, TELETXT MACHINE, CABLE; SOFTWARE FOR IMAGE PROCESSING, DOCUMENT MANAGEMENT, PRINT MANAGEMENT, NETWORK RECEPTION AND TRANSMISSION, DOCUMENT CREATION, DATABASE MANAGEMENT AND DOCUMENT AND IMAGE PROCESSING; CONTROL SOFTWARE FOR COMPUTER PRINTERS; MULTIFUNCTIONAL DEVICES WITH PHOTOCOPYING, FAXING, SCANNING AND PRINTING FUNCTIONS; PRINTER SHARING DEVICES; OUT OF SYNC PRINTING SOFTWARE; PRINTERS AND PRINTING APPARATUS FOR USE WITH COMPUTERS AND COMPUTER APPARATUS AND INSTRUMENTS; COST ESTIMATING SOFTWARE; SOFTWARE FOR CREATING, PRODUCING, CONVERTING, RECORDING, INDEXING, ARCHIVING, PRINTING, VISUALIZING, DISPLAYING, PUBLISHING, TRANSMITTING, ENCRYPTING, MANAGING, TYPOGRAPHY AND DISTRIBUTING OF DOCUMENTS; COMPUTER PROGRAMS FOR PRINTING; DISTRIBUTION APPARATUS FOR PRINTING; COMMUNICATION APPARATUS FOR PRINTING; PROGRAMMABLE APPARATUS FOR MANAGING PHOTOCOPIERS BY MEANS OF ACCESS CODES; PROGRAMMABLE APPARATUS FOR CONTROLLING PHOTOCOPIERS BY MEANS OF ACCESS CODES; APPARATUS FOR REMOTE METER READING; SOFTWARE FOR REMOTE CONTROL OF METERS; COMPUTER APPARATUS FOR REMOTE METER READING; SOFTWARE FOR REMOTE METER READING; COMPUTER PROGRAMS FOR DOCUMENT MANAGEMENT; COMPUTER SOFTWARE AND HARDWARE FOR SECURE STORING AND MANAGEMENT OF PRIVATE DATA; SOFTWARE FOR CREATING, PRODUCING, CONVERTING, RECORDING, INDEXING, ARCHIVING, PRINTING, VISUALIZING, DISPLAYING, PUBLISHING, TRANSMITTING, ENCRYPTING, MANAGING, TYPOGRAPHY AND DISTRIBUTING OF DOCUMENTS; SOFTWARE FOR IMAGE PROCESSING, DOCUMENT MANAGEMENT; SOFTWARE FOR IMAGE PROCESSING, DOCUMENT MANAGEMENT, PRINT MANAGEMENT, NETWORK RECEPTION AND TRANSMISSION, DOCUMENT CREATION, DATABASE MANAGEMENT AND DOCUMENT AND IMAGE PROCESSING;



David J. Kybas

Director of the United States Patent and Trademark Office

Reg. No. 4,072,579 OUT OF SYNC PRINTING SOFTWARE; COMPUTER SOFTWARE FOR ENCRYPTION; SOFTWARE RELATED TO ENCRYPTION OF DATA, SIGNALS, IMAGES AND SOUND; FINGERPRINT IMAGE SENSORS; FINGERPRINT SCANNERS; APPARATUS AND INSTRUMENTS FOR AUTOMATIC IDENTIFICATION OR RECOGNITION OF PEOPLE, FINGERPRINTS OR HANDPRINTS, IN CLASS 9 (U.S. CLS. 21, 23, 26, 36 AND 38).

FOR: RENTAL OF PHOTOCOPYING MACHINES; MANAGEMENT COST ACCOUNTING; COST EVALUATION SERVICES, NOT FOR REPAIR COST EVALUATION PURPOSE; COST PRICE ANALYSIS, IN CLASS 35 (U.S. CLS. 100, 101 AND 102).

FOR: DESIGN AND DEVELOPMENT OF COMPUTER HARDWARE AND SOFTWARE, IN CLASS 42 (U.S. CLS. 100 AND 101).

OWNER OF U.S. REG. NO. 2,703,436.

PRIORITY DATE OF 11-16-2010 IS CLAIMED.

OWNER OF INTERNATIONAL REGISTRATION 1068199 DATED 1-13-2011, EXPIRES 1-13-2021.

THE COLOR(S) BLUE, WHITE AND GREEN IS/ARE CLAIMED AS A FEATURE OF THE MARK.

THE MARK CONSISTS OF A GREEN DIAMOND CONTAINING THE WHITE LETTERS "SJ" WITH A SMALL GREEN CIRCLE ON THE TOP RIGHT, AND THE BLUE WORDING "SECUREJET" TO THE RIGHT OF THIS DESIGN.

SER. NO. 79-093,986, FILED 1-13-2011.

TOBY BULLOFF, EXAMINING ATTORNEY

United States of America

United States Patent and Trademark Office

ROOGEY

Reg. No. 4,072,580

Registered Dec. 20, 2011

Int. Cl.: 9

SHANGHAI YONGJI ELECTRICAL HOLDING CO., LTD. (CHINA LIMITED COMPANY
(LTD.))
NO. 2239, SOUTH JINSHI ROAD
JINSHANWEI TOWN, JINSHAN DISTRICT; 201515 SHANGHAI
CHINA

TRADEMARK

PRINCIPAL REGISTER

FOR: MUTUAL INDUCTANCE WARE, NAMELY, ELECTRICAL INDUCTORS, INDUCTION
VOLTAGE REGULATORS; LOW VOLTAGE ELECTRICAL COMPONENTS, NAMELY,
VOLTAGE REGULATORS, VOLTAGE STABILIZERS, STATIC VOLTAGE REGULATORS,
IN CLASS 9 (U.S. CLS. 21, 23, 26, 36 AND 38).

THE MARK CONSISTS OF A WORD, WHICH INCLUDES FOUR LETTERS, NAMELY, "R",
"O", "G", "Y".

OWNER OF INTERNATIONAL REGISTRATION 1068297 DATED 11-24-2010, EXPIRES 11-
24-2020.

SER. NO. 79-094,033, FILED 11-24-2010.

KATHERINE E. HALMEN, EXAMINING ATTORNEY



David J. Kyffers

Director of the United States Patent and Trademark Office

United States of America

United States Patent and Trademark Office



Reg. No. 4,072,581

Registered Dec. 20, 2011

Int. Cls.: 29 and 30

TRADEMARK

PRINCIPAL REGISTER

SOCIETE AGRICOLE DU DOMAINE D'ESTOUBLON (NOT ON LIST SOCIETE PAR ACTIONS SIMPLIFIEE)

DOMAINE D'ESTOUBLON

F-13990 FONTVIEILLE

FRANCE

FOR: OLIVE OIL FROM THE BAUX-DE-PROVENCE VALLEY, IN CLASS 29 (U.S. CL. 46).

FOR: CONDIMENTS, NAMELY, SAUCES, IN CLASS 30 (U.S. CL. 46).

NO CLAIM IS MADE TO THE EXCLUSIVE RIGHT TO USE "HUILE D'OLIVE", "VALLÉE DES BAUX DE PROVENCE", "APPELLATION HUILE D'OLIVE DE LA VALLÉE DES BAUX DE PROVENCE CONTRÔLÉE", "A.O.C.", "PRODUCT OF FRANCE" AND "10ML", APART FROM THE MARK AS SHOWN.

OWNER OF INTERNATIONAL REGISTRATION 1068454 DATED 1-28-2011, EXPIRES 1-28-2021.

THE COLOR(S) SILVER AND BLACK IS/ARE CLAIMED AS A FEATURE OF THE MARK.

THE WORDINGS AND DESIGN OF THE CASTLE ARE BLACK; THE BACKGROUND OF THE LABEL IS SILVER.



THE MARK CONSISTS OF THE BLACK WORDING: "CHÂTEAU D'ESTOUBLON MOGADOR" ABOVE THE DESIGN OF A BLACK TWO - FLOORS AND A GROUND FLOOR CASTLE WHICH HAS TWO TOWERS: ONE TOWER ON EACH SIDE, TWO BIG TREES: ONE BIG TREE ON EACH SIDE, TWO STAIRS: ONE STAIR ON EACH SIDE OF THE FRONT DOOR, SEVEN WINDOWS ON THE FIRST AND SECOND FLOOR AND ONE WINDOW ON EACH THREE TOWER FLOORS, WHICH IS ABOVE THE BLACK WORDING "HUILE D'OLIVE" "VALLÉE DES BAUX DE PROVENCE", "APPELLATION HUILE D'OLIVE DE LA VALLÉE DES BAUX DE PROVENCE CONTRÔLÉE" "A.O.C.", "PRODUCT OF FRANCE" AND "10ML", ALL SURROUNDED BY A BLACK RECTANGLE, ALL ON A SILVER BACKGROUND.

David J. Kappas

Director of the United States Patent and Trademark Office

THE ENGLISH TRANSLATION OF "CHATEAU D'ESTOUBLON" IN THE MARK IS "CASTLE OF ESTOUBLON". THE ENGLISH TRANSLATION OF "HUILE D'OLIVE" IN THE MARK IS "OLIVE OIL". THE ENGLISH TRANSLATION OF "VALLÉE DES BAUX DE PROVENCE" IN THE MARK IS "VALLEY OF BAUX DE PROVENCE". THE ENGLISH TRANSLATION

Reg. No. 4,072,581 OF "APPELATION HUILE D'OLIVE DE LA VALLÉE DES BAUX DE PROVENCE CONTRÔLÉE" IN THE MARK IS "LABEL OF ORIGIN CONTROLLED OLIVE OIL FROM THE VALLEY OF BAUX DE PROVENCE".

SER. NO. 79-094,083, FILED 1-28-2011.

MATTHEW EINSTEIN, EXAMINING ATTORNEY

United States of America

United States Patent and Trademark Office

WIKISTRAT

Reg. No. 4,072,582

WIKISTRAT LTD (ISRAEL CORPORATION)
4 WEITZMAN ST.

Registered Dec. 20, 2011

64239 TEL-AVIV, ISRAEL

Int. Cl.: 35

SERVICE MARK

PRINCIPAL REGISTER

FOR: BUSINESS INTELLIGENCE SERVICES AND BUSINESS CONSULTATION IN THE FIELDS OF POLITICAL AND GEOPOLITICAL ANALYSIS, NAMELY, PROVIDING INFORMATION ABOUT GEOPOLITICAL EVENTS, NATIONAL AFFAIRS, AND INTERNATIONAL AFFAIRS FROM HUMAN INTELLIGENCE AND TECHNOLOGICAL INTELLIGENCE; PROVIDING ANALYSIS OF THE SIGNIFICANCE OF GEOPOLITICAL EVENTS; PROVIDING FORECASTS ABOUT FUTURE GEOPOLITICAL EVENTS AND STRATEGIC SOLUTIONS FOR SPECIFIC CUSTOMERS BASED UPON THEIR INDIVIDUAL CIRCUMSTANCES; BUSINESS ASSISTANCE AND ADVISORY SERVICES AND BUSINESS CONSULTATION IN THE FIELD OF ECONOMICS, NAMELY, PROVIDING STRATEGIC ECONOMIC SOLUTIONS THROUGH BUSINESS AND MARKET ANALYSIS; PROVIDING BUSINESS PLANNING, BUSINESS MANAGEMENT, BUSINESS ORGANIZATION AND BUSINESS RISK MANAGEMENT ADVICE, AND FORECASTING COMMERCIAL OPPORTUNITIES BASED UPON ECONOMIC ANALYSIS AND RESEARCH; PUBLIC SECTOR BUSINESS AND MARKET INTELLIGENCE SERVICES IN THE FIELDS OF POLITICAL AND GEOPOLITICAL ANALYSIS, NAMELY, PROVIDING INFORMATION ABOUT GEOPOLITICAL EVENTS, NATIONAL AFFAIRS, AND INTERNATIONAL AFFAIRS FROM HUMAN AND TECHNOLOGICAL SOURCES; PROVIDING ANALYSIS OF THE SIGNIFICANCE OF GEOPOLITICAL EVENTS; PROVIDING FORECASTS ABOUT FUTURE GEOPOLITICAL EVENTS AND STRATEGIC SOLUTIONS FOR SPECIFIC CUSTOMERS BASED ON THEIR INDIVIDUAL CIRCUMSTANCES, IN CLASS 35 (U.S. CLS. 100, 101 AND 102).



THE MARK CONSISTS OF STANDARD CHARACTERS WITHOUT CLAIM TO ANY PARTICULAR FONT, STYLE, SIZE, OR COLOR.

PRIORITY DATE OF 10-28-2010 IS CLAIMED.

OWNER OF INTERNATIONAL REGISTRATION 1068897 DATED 11-9-2010, EXPIRES 11-9-2020.

SER. NO. 79-094,259, FILED 11-9-2010.

JILL C. ALT, EXAMINING ATTORNEY

David J. Kyros

Director of the United States Patent and Trademark Office

United States of America

United States Patent and Trademark Office

HemaCAM

Reg. No. 4,072,583

Registered Dec. 20, 2011

Int. Cls.: 10, 42 and 44

TRADEMARK

SERVICE MARK

PRINCIPAL REGISTER

FRAUNHOFER-GESELLSCHAFT ZUR FÖRDERUNG DER ANGEWANDTEN FORSCHUNG
E.V. (FED REP GERMANY NON-PROFIT ASSOCIATION)
HANSASTRASSE 27C
80686 MÜNCHEN, FED REP GERMANY

FOR: MEDICAL INSTRUMENTS AND APPARATUS, NAMELY, A MICROSCOPE-BASED ANALYSIS SYSTEM FOR PROVIDING BLOOD COUNTS COMPRISING A COMPUTER AND A CAMERA, IN CLASS 10 (U.S. CLS. 26, 39 AND 44).

FOR: SCIENTIFIC RESEARCH, IN THE FIELD OF BLOOD ANALYSIS; COMPUTER SOFTWARE DESIGN IN THE FIELD OF SOFTWARE FOR PROVIDING MEDICAL REPORTS BY MEANS OF AN INTERNET-BASED SYSTEM COMPRISING A COMPUTER AND A CAMERA, IN CLASS 42 (U.S. CLS. 100 AND 101).

FOR: MEDICAL TESTING FOR DIAGNOSTIC OR TREATMENT SERVICES, NAMELY, BLOOD ANALYSIS, IN CLASS 44 (U.S. CLS. 100 AND 101).

THE MARK CONSISTS OF STANDARD CHARACTERS WITHOUT CLAIM TO ANY PARTICULAR FONT, STYLE, SIZE, OR COLOR.

OWNER OF INTERNATIONAL REGISTRATION 1068937 DATED 12-21-2010, EXPIRES 12-21-2020.

SER. NO. 79-094,284, FILED 12-21-2010.

JILL C. ALT, EXAMINING ATTORNEY



David J. Kybas

Director of the United States Patent and Trademark Office

United States of America

United States Patent and Trademark Office

ORTHOSPEED

Reg. No. 4,072,584

Registered Dec. 20, 2011

Int. Cl.: 5

TRADEMARK

PRINCIPAL REGISTER

INSTITUTO DE INVESTIGACION EN ORTODONCIA, S.L. (SPAIN SOCIEDAD LIMITADA)
C/ HERREROS DE TEJADA, 24
E-28016 MADRID
SPAIN

FOR: MEDICATED PREPARATION TO EASE TOOTH MOVEMENT; ADHESIVES AND SEALING AGENTS FOR MEDICAL AND DENTAL USE, DENTAL ADHESIVES; DENTAL CEMENT; DENTAL IMPRESSION MATERIALS; MATERIALS FOR MAKING DENTAL IMPRESSIONS, HEMOSTATIC PRODUCTS, NAMELY, DISSOLVABLE STRIPS FOR CONTROLLING BLEEDING IN THE ORAL CAVITY, IN CLASS 5 (U.S. CLS. 6, 18, 44, 46, 51 AND 52).

THE MARK CONSISTS OF STANDARD CHARACTERS WITHOUT CLAIM TO ANY PARTICULAR FONT, STYLE, SIZE, OR COLOR.

PRIORITY DATE OF 7-22-2010 IS CLAIMED.

OWNER OF INTERNATIONAL REGISTRATION 1069110 DATED 1-14-2011, EXPIRES 1-14-2021.

SER. NO. 79-094,347, FILED 1-14-2011.

ADA HAN, EXAMINING ATTORNEY



David J. Kyffers

Director of the United States Patent and Trademark Office

United States of America

United States Patent and Trademark Office

FIBROSCAN

Reg. No. 4,072,585

Registered Dec. 20, 2011

Int. Cls.: 9 and 42

ECHOSENS (FRANCE SOCIÉTÉ ANONYME À DIRECTOIRE ET CONSEIL DE SURVEILLANCE)
153 AVENUE D'ITALIE
F-75013 PARIS
FRANCE

TRADEMARK

SERVICE MARK

PRINCIPAL REGISTER

FOR: COMPUTER SOFTWARE FOR USE IN PATIENT DATA MANAGEMENT; COMPUTER SOFTWARE FOR USE IN DETERMINING THE TYPE OF PROBE TEST SUITED TO A PATIENT'S MORPHOLOGY IN THE FIELD OF DISEASE MANAGEMENT; COMPUTER SOFTWARE FOR USE IN GENERATING AND EDITING PATIENT HISTORY REPORTS IN THE FIELD OF DISEASE MANAGEMENT; COMPUTER SOFTWARE FOR INTERPRETATION OF SCANS PROVIDED BY DIAGNOSTIC IMAGING EQUIPMENT; MEDICAL SOFTWARE FOR PROCESSING AND DISPLAYING IMAGES ON ULTRASOUND MEDICAL IMAGING MACHINES; COMPUTER SOFTWARE PROGRAM FOR CREATING SEARCHABLE DATABASES OF MEDICAL PATIENT INFORMATION AND DATA, IN CLASS 9 (U.S. CLS. 21, 23, 26, 36 AND 38).

FOR: DESIGN AND DEVELOPMENT OF COMPUTERS AND SOFTWARE, IN CLASS 42 (U.S. CLS. 100 AND 101).

THE MARK CONSISTS OF STANDARD CHARACTERS WITHOUT CLAIM TO ANY PARTICULAR FONT, STYLE, SIZE, OR COLOR.

PRIORITY DATE OF 9-3-2010 IS CLAIMED.

OWNER OF INTERNATIONAL REGISTRATION 1069114 DATED 1-27-2011, EXPIRES 1-27-2021.

OWNER OF U.S. REG. NO. 3,209,344.

SER. NO. 79-094,348, FILED 1-27-2011.

MARK SHINER, EXAMINING ATTORNEY



David J. Kyffers

Director of the United States Patent and Trademark Office

United States of America

United States Patent and Trademark Office

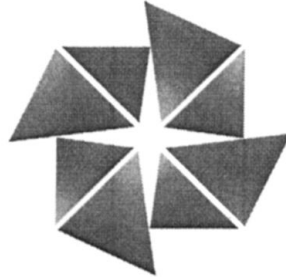

SEA+STAR

Reg. No. 4,072,586

Registered Dec. 20, 2011

Int. Cl.: 9

SHENZHEN SEA STAR TECHNOLOGY CO., LTD (CHINA CORPORATION)
ROOM 310
BUILDING COMPLEX TSINGHUA HI-TECH.; PARKNORTH DISTRICT.; SHENZHEN
HI-TECH & INDUSTRIAL ESTATE; NANSHAN, SHENZHEN
CHINA

TRADEMARK

PRINCIPAL REGISTER

FOR: CABINETS FOR LOUDSPEAKERS; RECORD PLAYERS; TELEVISION APPARATUS, NAMELY, TELEVISION SETS; DVD PLAYERS; MP3 PLAYERS; NETWORK PLAYERS, NAMELY, COMPUTER NETWORK ADAPTERS; VIDEO RECORDERS; CAMCORDERS; CAMERAS; ELECTRONIC PLAYERS AND RECORDING APPARATUS FOR HOUSEHOLD USE, NAMELY, COMBINATION VIDEO PLAYERS AND RECORDERS, WEBCAMS, VIDEO PROJECTORS, DIGITAL PICTURE DISPLAY SCREENS AND FRAMES AND ELECTRONIC BOOK READERS; DIGITAL CAMERAS; MONITORS, NAMELY, COMPUTER MONITORS; ELECTRONIC POCKET TRANSLATORS; LAPTOP COMPUTERS; SATELLITE NAVIGATIONAL APPARATUS, NAMELY, GLOBAL POSITIONING SYSTEMS; PORTABLE TELEPHONES; NETWORK COMMUNICATION EQUIPMENT, NAMELY, COMPUTER HARDWARE FOR COMMUNICATION AUDIO, VIDEO AND DATA BETWEEN COMPUTERS VIA A GLOBAL COMPUTER NETWORK, WIDE-AREA COMPUTER NETWORKS, AND PEER-TO-PEER COMPUTER NETWORKS; ELECTRONIC NOTICE BOARDS; PRINTED CIRCUITS; SET-TOP BOXES; WIRELESS HEADSETS FOR TELEPHONES AND WIRELESS CELLULAR PHONE HEADSETS, IN CLASS 9 (U.S. CLS. 21, 23, 26, 36 AND 38).

THE MARK CONSISTS OF THE WORDING "SEA STAR" WITH A STAR DESIGN ELEMENT IN BETWEEN THE WORDING "SEA" AND "STAR", ALL UNDERNEATH A DESIGN ELEMENT COMPRISED OF DIAMONDS ARRANGED TO FOR THE OUTLINE OF A STAR.

OWNER OF INTERNATIONAL REGISTRATION 1069444 DATED 7-5-2010, EXPIRES 7-5-2020.

SER. NO. 79-094,456, FILED 7-5-2010.

ANGELA DUONG, EXAMINING ATTORNEY



David J. Kyros

Director of the United States Patent and Trademark Office

United States of America

United States Patent and Trademark Office



TowerMill

Reg. No. 4,072,587

Registered Dec. 20, 2011

Int. Cl.: 7

TRADEMARK

PRINCIPAL REGISTER

MASCHINENFABRIK GUSTAV EIRICH GMBH & CO. KG (FED REP GERMANY GMBH & CO. KG)
WALLDÜRNER STR. 50
74736 HARDHEIM, FED REP GERMANY

FOR: POWER-OPERATED MILLS FOR THE CHEMICAL, CERAMIC AND METALLURGICAL INDUSTRIES, THE MINING INDUSTRY, CARBON INDUSTRY, ALUMINIUM INDUSTRY, GLASS INDUSTRY, BUILDING MATERIAL INDUSTRY, PAPER INDUSTRY, RECYCLING INDUSTRY, ENVIRONMENTAL INDUSTRY, WASTE INDUSTRY AND FOR THE ANIMAL FOODSTUFFS INDUSTRY, IN PARTICULAR AGITATING BALL MILLS, WET-GRINDING MILLS, DRY MIXER GRINDERS AND BALL MILLS, AND REPLACEMENT PARTS FOR THE AFORESAID GOODS, IN CLASS 7 (U.S. CLS. 13, 19, 21, 23, 31, 34 AND 35).

OWNER OF U.S. REG. NOS. 2,187,036 AND 2,550,379.

PRIORITY DATE OF 8-10-2010 IS CLAIMED.

OWNER OF INTERNATIONAL REGISTRATION 1069530 DATED 2-7-2011, EXPIRES 2-7-2021.

THE COLOR(S) BLUE, BLACK IS/ARE CLAIMED AS A FEATURE OF THE MARK.

THE MARK CONSISTS OF THE WORDING "TOWERMILL" IN STYLIZED BLACK FONT TO THE RIGHT OF THE BLUE CIRCULAR DESIGN WITH THREE BLUE HORIZONTAL LINES WITHIN ITS UPPER RIGHT QUADRANT.

SER. NO. 79-094,512, FILED 2-7-2011.

STEVEN PEREZ, EXAMINING ATTORNEY



David J. Kybas

Director of the United States Patent and Trademark Office

United States of America

United States Patent and Trademark Office

B P M

Reg. No. 4,072,588

Registered Dec. 20, 2011

Int. Cl.: 3

PORTLAND HOLDINGS & INVESTMENTS LIMITED (UNITED KINGDOM REGISTERED LIMITED COMPANY)
34 ST WILFRIDS ROAD
DONCASTER, SOUTH YORKSHIRE DN4 6AB
UNITED KINGDOM

TRADEMARK

PRINCIPAL REGISTER

FOR: ANTI-PERSPIRANTS; TALCUM POWDER; DEODORANTS FOR PERSONAL USE; SOAPS FOR PERSONAL USE; SHOWER GELS; SHAMPOOS; HAIR CONDITIONERS; HAIR STYLING PREPARATIONS; HAIR WAX; HAIR CREAMS; HAIR GELS; HAIR MOUSSES; AEROSOL HAIR SPRAY; HAIR COLOURANTS; HAIR LOTIONS; FACE AND BODY LOTIONS; HAND LOTIONS; FACE AND BODY CREAMS; HAND CREAMS; DEPILATORIES; SHAVING GELS; SHAVING CREAMS; SHAVING FOAMS; AFTERSHAVE LOTIONS AND GELS; PERFUMERY; SCENTED BODY SPRAY; ESSENTIAL OILS; COSMETICS; DENTIFRICES, IN CLASS 3 (U.S. CLS. 1, 4, 6, 50, 51 AND 52).

THE MARK CONSISTS OF STANDARD CHARACTERS WITHOUT CLAIM TO ANY PARTICULAR FONT, STYLE, SIZE, OR COLOR.

PRIORITY DATE OF 11-15-2010 IS CLAIMED.

OWNER OF INTERNATIONAL REGISTRATION 1069718 DATED 12-3-2010, EXPIRES 12-3-2020.

SER. NO. 79-094,581, FILED 12-3-2010.

JULIE VEPPUMTHARA, EXAMINING ATTORNEY



David J. Kybas

Director of the United States Patent and Trademark Office

United States of America

United States Patent and Trademark Office

blueForge

Reg. No. 4,072,589

Registered Dec. 20, 2011

Int. Cls.: 7, 37 and 42

TRADEMARK

SERVICE MARK

PRINCIPAL REGISTER

SMS MEER GMBH (FED REP GERMANY LIMITED LIABILITY COMPANY)
OHLERKIRCHWEG 66
41069 MÖNCHENGLADBACH
FED REP GERMANY

FOR: PRESSES, IN PARTICULAR, FORGING PRESSES, CLOSE-DIE FORGING PRESSES, OPEN-DIE FORGING PRESSES, AUTOMATIC FORGING HAMMERS, PIERCING PRESSES, COUNTER BLOW HAMMERS, MECHANICAL PRESSES, HYDRAULIC PRESSES; FORGING MANIPULATORS, NAMELY, MANIPULATORS FOR FORGING PRESSES AND FOR FORGING MACHINES; AUTOMATION DEVICES, NAMELY, MECHANICAL EQUIPMENT AND TOOLS AS PARTS AND ACCESSORIES FOR THE AFOREMENTIONED PRESSES, NAMELY, FORGING MOLDS; CLUTCHES FOR FORGING PRESSES, CLOSE-DIE FORGING PRESSES, OPEN-DIE FORGING PRESSES, AUTOMATIC FORGING HAMMERS, PIERCING PRESSES, COUNTER BLOW HAMMERS, MECHANICAL PRESSES, HYDRAULIC PRESSES, TUBE ROLLING MACHINES, SHAPE ROLLING MACHINES, RING ROLLING MACHINES, FORGING LINES; DEVICES FOR THE POWER TRANSMISSION FOR FORGING PRESSES, CLOSE-DIE FORGING PRESSES, OPEN-DIE FORGING PRESSES, MECHANICAL PRESSES, NAMELY, TRANSMISSIONS AND TRANSMISSION GEARS, TUBE ROLLING MACHINES, SHAPE ROLLING MACHINES, RING ROLLING MACHINES, FORGING LINES, IN CLASS 7 (U.S. CLS. 13, 19, 21, 23, 31, 34 AND 35).

FOR: MAINTENANCE OF FORGING PRESSES, CLOSE-DIE FORGING PRESSES, OPEN-DIE FORGING PRESSES, AUTOMATIC FORGING HAMMERS, PIERCING PRESSES, COUNTER BLOW HAMMERS, MECHANICAL PRESSES, HYDRAULIC PRESSES, TUBE ROLLING MACHINES, SHAPE ROLLING MACHINES, RING ROLLING MACHINES, FORGING LINES, IN CLASS 37 (U.S. CLS. 100, 103 AND 106).

FOR: DESIGN AND DEVELOPMENT OF CONTROL, REGULATING AND CHECKING SOFTWARE PROGRAMS FOR FORGING PRESSES, CLOSE-DIE FORGING PRESSES, OPEN-DIE FORGING PRESSES, AUTOMATIC FORGING HAMMERS, PIERCING PRESSES, COUNTER BLOW HAMMERS, MECHANICAL PRESSES, HYDRAULIC PRESSES, TUBE ROLLING MACHINES, SHAPE ROLLING MACHINES, RING ROLLING MACHINES, FORGING LINES, IN CLASS 42 (U.S. CLS. 100 AND 101).

THE MARK CONSISTS OF STANDARD CHARACTERS WITHOUT CLAIM TO ANY PARTICULAR FONT, STYLE, SIZE, OR COLOR.



David J. Kyjars

Director of the United States Patent and Trademark Office

Reg. No. 4,072,589 PRIORITY DATE OF 8-2-2010 IS CLAIMED.

OWNER OF INTERNATIONAL REGISTRATION 1069799 DATED 1-7-2011, EXPIRES 1-7-2021.

SER. NO. 79-094,604, FILED 1-7-2011.

SALLY SHIH, EXAMINING ATTORNEY

United States of America

United States Patent and Trademark Office

We will not rest  **UBS**

Reg. No. 4,072,590

Registered Dec. 20, 2011

Int. Cl.: 36

SERVICE MARK

PRINCIPAL REGISTER

UBS AG (SWITZERLAND SOCIÉTÉ ANONYME)
BAHNHOFSTRASSE 45
CH-8001 ZÜRICH
SWITZERLAND

FOR: BANKING AND FINANCIAL SERVICES, NAMELY, BANKING, FINANCIAL ANALYSIS AND CONSULTATION, FINANCIAL PLANNING, FINANCIAL PORTFOLIO MANAGEMENT, AND ASSET MANAGEMENT FOR PRIVATE, CORPORATE, AND INSTITUTIONAL CLIENTS; SERVICES IN THE AREA OF WEALTH MANAGEMENT AND ASSET MANAGEMENT FOR PRIVATE, CORPORATE AND INSTITUTIONAL CLIENTS; SERVICES OF AN INVESTMENT BANK; ALL THE AFORESAID SERVICES ALSO ACCESSIBLE ELECTRONICALLY VIA THE INTERNET OR A SIMILAR ELECTRONIC NETWORK, IN CLASS 36 (U.S. CLS. 100, 101 AND 102).

OWNER OF U.S. REG. NOS. 1,573,828, 3,025,058 AND OTHERS.

PRIORITY DATE OF 8-19-2010 IS CLAIMED.

OWNER OF INTERNATIONAL REGISTRATION 1069874 DATED 2-8-2011, EXPIRES 2-8-2021.

THE MARK CONSISTS OF THE WORDING "WE WILL NOT REST", THE LETTERS "U", "B", "S", AND A DESIGN CONSISTING OF THREE KEYS.

SER. NO. 79-094,632, FILED 2-8-2011.

PAUL MORENO, EXAMINING ATTORNEY



David J. Kyffers

Director of the United States Patent and Trademark Office

United States of America

United States Patent and Trademark Office



Reg. No. 4,072,591

Registered Dec. 20, 2011

Int. Cl.: 35

SERVICE MARK

PRINCIPAL REGISTER

ANDREAS HALIN (FED REP GERMANY INDIVIDUAL)
CRONSTETTENSTRASSE 19
60322 FRANKFURT
FED REP GERMANY

FOR: CONSULTING IN THE FIELD OF EMPLOYMENT RECRUITMENT; PERSONNEL MANAGEMENT CONSULTANCY; PSYCHOLOGICAL TESTING FOR THE SELECTION OF PERSONNEL; PERSONNEL RECRUITMENT AGENCIES, NAMELY, SERVICES OF A HEADHUNTER; PERSONNEL RECRUITMENT, RECRUITMENT AGENCIES AND EMPLOYMENT AGENCIES, IN CLASS 35 (U.S. CLS. 100, 101 AND 102).

NO CLAIM IS MADE TO THE EXCLUSIVE RIGHT TO USE "EXECUTIVE SEARCH CONSULTANTS", APART FROM THE MARK AS SHOWN.

OWNER OF INTERNATIONAL REGISTRATION 1069879 DATED 12-13-2010, EXPIRES 12-13-2020.

THE MARK CONSISTS OF THE WORDING "GLOBALMIND EXECUTIVE SEARCH CONSULTANTS" AND A CIRCULAR DESIGN COMPRISED OF THREE CURVED BANDS.

SER. NO. 79-094,635, FILED 12-13-2010.

MELISSA VALLILLO, EXAMINING ATTORNEY



David J. Kybas

Director of the United States Patent and Trademark Office

United States of America

United States Patent and Trademark Office



Reg. No. 4,072,592

Registered Dec. 20, 2011

Int. Cl.: 33

TRADEMARK

PRINCIPAL REGISTER

SHAANXI BAISHUIDUKANG LIQUOR CO., LTD. (CHINA CORPORATION)
DUKANG TOWN
BAISHUI COUNTY; 715600 SHAANXI PROVINCE
CHINA

FOR: SPIRITS, IN CLASS 33 (U.S. CLS. 47 AND 49).

THE MARK CONSISTS OF THE CHINESE CHARACTERS DU KANG APPEARING IN A CIRCLE DESIGN. THE CHINESE CHARACTERS "BAI SHUI", AND THE WORDING "BAISHUIDUKANG" APPEAR IN A RING THAT ENCOMPASSES THE CIRCLE DESIGN.

OWNER OF INTERNATIONAL REGISTRATION 1070081 DATED 2-22-2011, EXPIRES 2-22-2021.

THE CHINESE CHARACTERS IS THE MARK TRANSLITERATE TO "BAI SHUI DU KANG", AND HAVE NO MEANING IN ENGLISH. THE WORD "BAISHUIDUKANG" HAS NO MEANING IN ENGLISH.

SER. NO. 79-094,715, FILED 2-22-2011.

ELI HELLMAN, EXAMINING ATTORNEY



David J. Kyros

Director of the United States Patent and Trademark Office

United States of America

United States Patent and Trademark Office



Reg. No. 4,072,593

Registered Dec. 20, 2011

Int. Cl.: 12

TRADEMARK

PRINCIPAL REGISTER

CHINA NATIONAL HEAVY DUTY TRUCK GROUP CO., LTD. (CHINA CORPORATION)
NO.53, WUYINGSHAN ZHONG ROAD
JINAN; SHANDONG PROVINCE
CHINA

FOR: LAND VEHICLES, NAMELY, AUTOMOBILES, CARS, LORRIES, WAGONS, AND MILITARY VEHICLES FOR TRANSPORT, NAMELY, LAND VEHICLES; ENGINES FOR LAND VEHICLES; TRANSMISSION MECHANISMS, FOR LAND VEHICLES; AUTOMOBILE CHASSIS; AUTOMOBILE SPARE WHEEL HOLDERS; TIRES FOR LAND VEHICLES, IN CLASS 12 (U.S. CLS. 19, 21, 23, 31, 35 AND 44).

OWNER OF U.S. REG. NO. 3,303,015.

PRIORITY DATE OF 7-21-2010 IS CLAIMED.

OWNER OF INTERNATIONAL REGISTRATION 1070104 DATED 10-8-2010, EXPIRES 10-8-2020.

THE MARK CONSISTS OF THE WORD "SITRAK" APPEARING UPON A RECTANGLE AND A SERIES OF TRIANGLES THAT HELPS TO FORM AN IRREGULARLY SHAPED GEOMETRIC DESIGN.

THE WORDING "SITRAK" HAS NO MEANING IN A FOREIGN LANGUAGE.

SER. NO. 79-094,726, FILED 10-8-2010.

EDWARD NELSON, EXAMINING ATTORNEY



David J. Kyffers

Director of the United States Patent and Trademark Office

United States of America

United States Patent and Trademark Office

OPVIZOR

Reg. No. 4,072,594

Registered Dec. 20, 2011

Int. Cls.: 9, 38 and 42

TRADEMARK

SERVICE MARK

PRINCIPAL REGISTER

ICOMASOFT AG (SWITZERLAND SOCIÉTÉ ANONYME (SA))
BAARERSTRASSE 25
CH-6300 ZUG
SWITZERLAND

FOR: COMPUTER SOFTWARE AND COMPUTER SOFTWARE PLATFORMS FOR OPERATING SOFTWARE DISTRIBUTION MODELS ON THE INTERNET, IN PARTICULAR FOR SOFTWARE-AS-A-SERVICE APPLICATIONS FOR DATACENTERS AND FOR IT INFRASTRUCTURES PROVIDED OVER A NETWORK AND CUSTOMIZED TO THE NEEDS OF USERS IN THE NATURE OF CLOUD COMPUTING; COMPUTER SOFTWARE TO PARTICIPATE IN A DECENTRALIZED DATA STORAGE SYSTEM, AND TO PUBLISH DATA AND SHARE ACCESS TO DATA; COMPUTER SOFTWARE FOR ERROR PREDICTIVE ANALYSIS AND ISSUE PREVENTION AS WELL AS DISPLAY OF POSSIBLE SOLUTIONS IN THE IT INFRASTRUCTURE; COMPUTER SOFTWARE FOR LOG FILE ANALYSIS AND REPORTS OF RESPECTIVE RESULTS; COMPUTER SOFTWARE FOR DISPLAYING AN OVERVIEW OF INSTALLED AND OPERATED INFRASTRUCTURE COMPONENTS IN DATACENTERS; COMPUTER SOFTWARE FOR EXCHANGE OF COMPUTER INFRASTRUCTURE DATA WITH OTHER USERS; COMPUTER SOFTWARE TO BRING TOGETHER SOLUTION PROVIDERS WITH USERS SEEKING SOLUTIONS; COMPUTER SOFTWARE FOR LOGICAL CONNECTIONS OF DATACENTER COMPONENTS WITHIN SOFTWARE-AS-A-SERVICE APPLICATIONS, IN PARTICULAR OF STORAGE UNITS, NETWORK COMPONENTS, FILE SERVERS AND SOFTWARE APPLICATIONS; COMPUTER SOFTWARE FOR DATA MANAGEMENT, DATA PROCESSING, MOBILE SOLUTIONS, DATA MIGRATION, DATA ARCHIVING, DATA DESTRUCTION, NAMELY, DATA DECOMMISSIONING, DATA CLEANSING, AND COMBINING DATA FROM DIFFERENT SOURCES INTO A TARGET DATABASE, NAMELY, ETL; DATABASES, NAMELY, HARDWARE AND SOFTWARE FOR ORGANIZING, STORING AND ACCESSING DATA, IN CLASS 9 (U.S. CLS. 21, 23, 26, 36 AND 38).

FOR: PROVIDING ACCESS TO DATABASES AND DOCUMENTS STORED ELECTRONICALLY IN CENTRAL FILES FOR REMOTE CONSULTATION, NAMELY, ELECTRONIC PUBLICATIONS; PROVIDING ACCESS TO COMPUTER NETWORKS, INTERNET PLATFORMS, DATABASES AND DOCUMENTS STORED ELECTRONICALLY IN CENTRAL FILES FOR REMOTE CONSULTATION, NAMELY, ELECTRONIC PUBLICATIONS; PROVIDING ACCESS TO GLOBAL COMPUTER NETWORKS AND COMPUTER DATABASES; PROVIDING REMOTE DATA ACCESS, NAMELY, PROVISION OF ACCESS TO DATA STORED ELECTRONICALLY IN CENTRAL FILES FOR REMOTE CONSULTATION;



David J. Kybas

Director of the United States Patent and Trademark Office

Reg. No. 4,072,594 RENTAL OF ACCESS TIME TO AN ELECTRONIC INFORMATION PLATFORM, NAMELY, WEBSITE FOR THE DIGITAL INFORMATION GATHERING, MANAGEMENT AND STORAGE; SERVICES OF AN INTERNET ACCESS PROVIDER, NAMELY, PROVIDING USER ACCESS TO DIGITAL NETWORKS, DATA NETWORKS AND COMPUTER NETWORKS, NAMELY, THE INTERNET, IN CLASS 38 (U.S. CLS. 100, 101 AND 104).

FOR: COMPUTER SERVICES, NAMELY, THE DESIGN, DEVELOPMENT, INSTALLATION, INTEGRATION, MAINTENANCE AND RENTAL OF COMPUTER SOFTWARE IN DATA NETWORKS, IN PARTICULAR ON THE INTERNET AND WORLD WIDE WEB, PLATFORM AS A SERVICES FEATURING INTERNET PLATFORMS FOR OPERATING A SOFTWARE DISTRIBUTION MODEL ON THE INTERNET, ESPECIALLY SOFTWARE-AS-A-SERVICE APPLICATIONS FOR DATACENTERS; PLANNING AND DESIGN OF HETEROGENEOUS NETWORKS FOR OTHERS, NAMELY, CONNECTING INDIVIDUAL COMPUTERS AND COMPUTER SYSTEMS AND THEIR SOFTWARE COMPONENTS USING TELECOMMUNICATION; COMPUTER SYSTEMS ANALYSIS, NAMELY, ANALYSIS FOR THE SET UP FOR COMPUTER SYSTEMS; INSTALLATION, INTEGRATION, MAINTENANCE, RENTAL, UPDATING, MAINTENANCE OF COMPUTER SOFTWARE; APPLICATIONS SERVICE PROVIDER, NAMELY, HOSTING COMPUTER SOFTWARE APPLICATION OF OTHERS; HOSTING OF WEB SITES, NAMELY, RENTAL OF ELECTRONIC STORAGE SPACE IN THE NATURE OF WEB SPACE ON THE INTERNET; PROVIDING A WEB SITE HOSTING PLATFORM, NAMELY, PROVIDING ELECTRONIC STORAGE SPACE ON THE INTERNET OR OTHER COMMUNICATIONS DATA MANAGEMENT NETWORKS, FOR DATA PROCESSING, DATA QUERIES AND PROCESSING OF TEST DATA FOR THIRD PARTIES; COMPUTER WEBSITE HOSTING, IN CLASS 42 (U.S. CLS. 100 AND 101).

THE MARK CONSISTS OF STANDARD CHARACTERS WITHOUT CLAIM TO ANY PARTICULAR FONT, STYLE, SIZE, OR COLOR.

PRIORITY DATE OF 11-24-2010 IS CLAIMED.

OWNER OF INTERNATIONAL REGISTRATION 1070303 DATED 2-2-2011, EXPIRES 2-2-2021.

THE WORDING "OPVIZOR" HAS NO MEANING IN A FOREIGN LANGUAGE.

SER. NO. 79-094,812, FILED 2-2-2011.

COURTNEY ALVAREZ, EXAMINING ATTORNEY

United States of America

United States Patent and Trademark Office

SHEPHERD'S LIFE

Reg. No. 4,072,595

Registered Dec. 20, 2011

Int. Cl.: 25

TRADEMARK

PRINCIPAL REGISTER

SUZHOU CITY ZHAOYI SHOES CO., LTD. (CHINA CORPORATION)
FANGBANG VILLAGE, HUANGQIAO ZHEN
XIANGCHENG DISTRICT.; SUZHOU CITY; JIANGSU PROVINCE
CHINA

FOR: CLOTHING, NAMELY, SHIRTS, SKIRTS, COATS, TROUSERS, T-SHIRTS, SWEATERS, PANTS, UNDERWEAR, JACKETS, SPORTS JERSEYS, KNITWEAR, NAMELY, KNIT SHIRTS, KNIT DRESSES, KNIT BOTTOMS, KNIT SKIRTS, KNIT TOPS, KNIT JACKETS; SHOES; HATS AND CAPS; STOCKINGS AND SOCKS; GLOVES; NECKTIES; LAYETTE; RAIN COATS; LEATHER BELTS FOR CLOTHING; MASKS FOR SLEEPING, IN CLASS 25 (U.S. CLS. 22 AND 39).

PRIORITY DATE OF 8-16-2010 IS CLAIMED.

OWNER OF INTERNATIONAL REGISTRATION 1070975 DATED 12-30-2010, EXPIRES 12-30-2020.

SER. NO. 79-095,074, FILED 12-30-2010.

CHRISTINE MARTIN, EXAMINING ATTORNEY



David J. Kyffers

Director of the United States Patent and Trademark Office

United States of America

United States Patent and Trademark Office



Reg. No. 4,072,596

Registered Dec. 20, 2011

Int. Cl.: 9

TRADEMARK

PRINCIPAL REGISTER

NINGBO TAISUO TECHNOLOGY CO., LTD (CHINA CORPORATION)
NO. 2 EAST YUZHOU ROAD
YUYAO CITY; 315400 ZHEJIANG
CHINA

FOR: PYROMETERS; TEMPERATURE INDICATORS; ACOUSTIC COUPLERS; ELECTRIC MEASURING DEVICES, NAMELY, CLAMP METERS FOR MEASURING ELECTRICITY; ELECTRICAL INDUCTORS; INDICATORS, NAMELY, ELECTRONIC INDICATOR BOARDS, ELECTRONIC INDICATOR PANELS; SURVEYING APPARATUS AND INSTRUMENTS, NAMELY, SURVEYING MACHINES AND INSTRUMENTS; GASOMETERS; THERMOSTATS; ELECTRICAL WIRES; PHOTOVOLTAIC CELLS; LENS HOODS; QUANTITY INDICATORS, NAMELY, MEASURING COUPLINGS FOR MEASURING QUANTITY OF FLUIDS IN HYDRAULIC OR PNEUMATIC SYSTEMS; ELECTRIC BRANCH BOXES, NAMELY, ELECTRICAL CONNECTION BOXES, ELECTRICAL DISTRIBUTION BOXES; ELECTRIC JUNCTION BOXES; ELECTRIC SENSORS, IN CLASS 9 (U.S. CLS. 21, 23, 26, 36 AND 38).

THE MARK CONSISTS OF THE WORD "TAISUO" WITH A DESIGN ABOVE CONSISTING OF A STYLIZED CONNECTED FORMATION OF THE LETTERS "TS".

OWNER OF INTERNATIONAL REGISTRATION 1071995 DATED 3-1-2011, EXPIRES 3-1-2021.

THE WORDING "TAISUO" HAS NO MEANING IN A FOREIGN LANGUAGE.

SER. NO. 79-095,385, FILED 3-1-2011.

CARYN GLASSER, EXAMINING ATTORNEY



David J. Kybas

Director of the United States Patent and Trademark Office

United States of America

United States Patent and Trademark Office

KARTALIN

Reg. No. 4,072,597

Registered Dec. 20, 2011

Int. Cl.: 3

TRADEMARK

PRINCIPAL REGISTER

OBSHCHESTVO O OGRANICHENNOY OTVETSTVENNOSTYU "ASTROFARMA" (RUSSIAN FED. LIMITED LIABILITY COMPANY)
STR. 26, 4, UL. IVANOVSKOGO
TOMSK; RU-634040 TOMSKAYA OBL.
RUSSIAN FED.

FOR: CREAMS FOR LEATHER; TOILETRIES, NAMELY, NON-MEDICATED TOILETRIES, IN CLASS 3 (U.S. CLS. 1, 4, 6, 50, 51 AND 52).

THE WORDING "KARTALIN" HAS NO MEANING IN A FOREIGN LANGUAGE.

OWNER OF INTERNATIONAL REGISTRATION 1047619 DATED 6-15-2010, EXPIRES 6-15-2020.

SER. NO. 79-095,413, FILED 12-27-2010.

JAMES STEIN, EXAMINING ATTORNEY



David J. Kyffers

Director of the United States Patent and Trademark Office

United States of America

United States Patent and Trademark Office



Reg. No. 4,072,598

Registered Dec. 20, 2011

Int. Cls.: 9 and 41

TRADEMARK

SERVICE MARK

PRINCIPAL REGISTER

M.A.R.I.D.I, SIA (LATVIA LIMITED LIABILITY COMPANY)
STIRNU IELA 45-22
RIGA, LATVIA LV1084

FOR: COMPUTER SOFTWARE RECORDED ON CD-ROM FEATURING LANGUAGE INSTRUCTION; PRERECORDED VIDEO CASSETTES FEATURING LANGUAGE INSTRUCTION, IN CLASS 9 (U.S. CLS. 21, 23, 26, 36 AND 38).

FOR: LANGUAGE INSTRUCTION, IN CLASS 41 (U.S. CLS. 100, 101 AND 107).

THE MARK CONSISTS OF THE STYLIZED WORDING "QUICK SPEAK" DEPICTED ON A DESIGN OF A TRAIN WITH A HUMAN FACE WEARING EYEGLASSES.

PRIORITY DATE OF 8-20-2010 IS CLAIMED.

OWNER OF INTERNATIONAL REGISTRATION 1072275 DATED 2-18-2011, EXPIRES 2-18-2021.

SER. NO. 79-095,490, FILED 2-18-2011.

EVELYN BRADLEY, EXAMINING ATTORNEY



David J. Kyros

Director of the United States Patent and Trademark Office

United States of America

United States Patent and Trademark Office



アール・ジェイ・ビー

Reg. No. 4,072,599

Registered Dec. 20, 2011

Int. Cl.: 25

TRADEMARK

PRINCIPAL REGISTER

R.J.B CO., LTD. (JAPAN CORPORATION)
125-3, OAZA UCHIKAWA
CHIKUMA-SHI; NAGANO 389-0802
JAPAN

FOR: CLOTHING, NAMELY, SHIRTS, JEANS, SWEATSHIRTS, T-SHIRTS, AND BASEBALL JACKETS; GARTERS; SOCK SUSPENDERS; SUSPENDERS (BRACES); WAISTBANDS; BELTS (CLOTHING); FOOTWEAR; MASQUERADE COSTUMES; CLOTHES FOR SPORTS; BOOTS FOR SPORTS, IN CLASS 25 (U.S. CLS. 22 AND 39).

THE NAME "R.J.B" DOES NOT IDENTIFY A LIVING INDIVIDUAL.

OWNER OF INTERNATIONAL REGISTRATION 1072497 DATED 3-10-2011, EXPIRES 3-10-2021.

THE NON-LATIN CHARACTERS IN THE MARK TRANSLITERATE TO ARU.JIEI.BI AND THIS HAS NO MEANING IN A FOREIGN LANGUAGE.

THE MARK CONSISTS OF THE STYLIZED LETTERING "R.J.B" SITUATED NEXT TO THE LETTERING "R.J.B" ABOVE JAPANESE LETTERING THAT TRANSLITERATE TO "ARU.JIEI.BI".

THE WORDING "R.J.B" HAS NO MEANING IN A FOREIGN LANGUAGE.

SER. NO. 79-095,549, FILED 3-10-2011.

NAKIA HENRY, EXAMINING ATTORNEY



David J. Kyros

Director of the United States Patent and Trademark Office

United States of America
United States Patent and Trademark Office

Crazy Bee

Reg. No. 4,072,600

Registered Dec. 20, 2011

Int. Cl.: 30

TRADEMARK

PRINCIPAL REGISTER

DOTCHIRNE PIDPRIEMSTVO "KONDITIONERSKA KORPORATZIA "ROSHEN" (UKRAINE CORPORATION)
VUL. PAVLA USENKA, 8
KYIV 02105
UKRAINE

FOR: CONFECTIONERY, NAMELY, FRUIT JELLIES AND PASTILLES, IN CLASS 30 (U.S. CL. 46).

THE MARK CONSISTS OF STANDARD CHARACTERS WITHOUT CLAIM TO ANY PARTICULAR FONT, STYLE, SIZE, OR COLOR.

OWNER OF INTERNATIONAL REGISTRATION 1038563 DATED 4-20-2010, EXPIRES 4-20-2020.

SER. NO. 79-095,637, FILED 2-10-2011.

KRISTIN CARLSON, EXAMINING ATTORNEY



David J. Kyffers

Director of the United States Patent and Trademark Office

United States of America

United States Patent and Trademark Office



Reg. No. 4,072,601

Registered Dec. 20, 2011

Int. Cl.: 21

TRADEMARK

PRINCIPAL REGISTER

BORMIOLI ROCCO & FIGLIO S.P.A. (ITALY JOINT STOCK COMPANY)
VIALE MARTIRI DELLA LIBERTÀ, 1
I-43036 FIDENZA - PARMA, ITALY

FOR: HOUSEHOLD UTENSILS NOT OF PRECIOUS METAL OR COATED THEREWITH, NAMELY, POT AND PAN SCRAPERS, ROLLING PINS, SPATULAS, TURNERS, WHISKS; AND CONTAINERS FOR HOUSEHOLD OR KITCHEN USE NOT OF PRECIOUS METAL OR COATED THEREWITH; UNWORKED OR SEMI-WORKED GLASS; BEVERAGE GLASSWARE, PORCELAIN AND EARTHENWARE, NAMELY, MUGS, JARS, POTS AND VASES; GLASS GOODS, NAMELY, PLATES, BOTTLES, VASES, DRINKING GLASSES, DECANTERS, GLASS CONTAINERS FOR HOUSEHOLD USE FOR FOODSTUFFS, CRUET STANDS FOR OIL NOT OF PRECIOUS METAL; SALT SHAKERS OF GLASS, BOWLS, SMALL BOWLS, SALAD BOWLS, TRAYS FOR DOMESTIC PURPOSES NOT OF PRECIOUS METAL, CUPS, COFFEE CUPS; STAINLESS FLATWARE, NAMELY, PLATES AND DISHES; COVERS FOR VASES AND PLATES; FLASKS NOT OF PRECIOUS METAL, BOTTLE HOLDERS MADE OF PLASTIC, NAMELY, PLASTIC HOLDER FOR BEVERAGE CONTAINERS, IN CLASS 21 (U.S. CLS. 2, 13, 23, 29, 30, 33, 40 AND 50).

OWNER OF U.S. REG. NOS. 3,112,149 AND 3,112,150.

PRIORITY DATE OF 12-22-2010 IS CLAIMED.

OWNER OF INTERNATIONAL REGISTRATION 1073008 DATED 12-22-2010, EXPIRES 12-22-2020.

THE NAME(S), PORTRAIT(S), AND/OR SIGNATURE(S) SHOWN IN THE MARK DOES NOT IDENTIFY A PARTICULAR LIVING INDIVIDUAL.

THE MARK CONSISTS OF TWO SQUARE BOXES, ONE CONTAINING THE WORDING "BORMIOLI ROCCO" WITH A STAR DESIGN, AND THE OTHER CONTAINING THE WORDING "MYBUSINESS".

SER. NO. 79-095,771, FILED 12-22-2010.

CARYN GLASSER, EXAMINING ATTORNEY



David J. Kappas

Director of the United States Patent and Trademark Office

United States of America

United States Patent and Trademark Office



Reg. No. 4,072,602

CALLIDUS INVESTMENTS B.V. (NETHERLANDS LIMITED LIABILITY COMPANY)
MORSEWEG 2

Registered Dec. 20, 2011

NL-8503 AD JOURE, NETHERLANDS

Int. Cl.: 7

FOR: ELEVATORS AND PARTS OF ELEVATORS; HANDLING SYSTEMS, NAMELY, MECHANICAL AND PNEUMATIC HOISTING APPARATUS; HYDRAULIC PUMPS MOVING STAIRCASES, NAMELY, ESCALATORS; INDUSTRIAL MACHINES, NAMELY, DRILLING MACHINES USED IN THE OIL AND GAS FIELDS; OFF-SHORE INDUSTRIAL OIL ELECTRIC WELDING MACHINES AND GAS WELDING MACHINES; FUEL INJECTORS, HYDRAULIC TORQUE CONVERTERS; MACHINES, NAMELY, HYDRAULIC POWER GENERATORS; OIL FIELD EQUIPMENT, NAMELY, DRILLING RIG MECHANICAL HANDLING MACHINES AND DEVICES; CLEANING MACHINES FOR MACHINES FOR CREATING CHEMICAL PREPARATIONS, IN CLASS 7 (U.S. CLS. 13, 19, 21, 23, 31, 34 AND 35).

TRADEMARK

PRINCIPAL REGISTER

THE MARK CONSISTS OF A CURVED LINE WITH AN ANGLED LINE INTERSECTING AT THE BOTTOM OF THE CURVE.

PRIORITY DATE OF 9-2-2010 IS CLAIMED.

OWNER OF INTERNATIONAL REGISTRATION 1073343 DATED 1-21-2011, EXPIRES 1-21-2021.

SER. NO. 79-095,882, FILED 1-21-2011.

CHRISTOPHER BUONGIORNO, EXAMINING ATTORNEY



David J. Kybas

Director of the United States Patent and Trademark Office

United States of America
United States Patent and Trademark Office

Descorapid

Reg. No. 4,072,603

Registered Dec. 20, 2011

Int. Cl.: 5

TRADEMARK

PRINCIPAL REGISTER

ANTISEPTICA CHEMISCH-PHARMAZEUTISCHE PRODUKTE GMBH (FED REP GERMANY
GESELLSCHAFT MIT BESCHRÄNKTER HAFTUNG (GMBH))
BOSCHSTRASSE 35
50259 PULHEIM, FED REP GERMANY

FOR: ALL PURPOSE DISINFECTANTS, IN CLASS 5 (U.S. CLS. 6, 18, 44, 46, 51 AND 52).

OWNER OF INTERNATIONAL REGISTRATION 0510613 DATED 4-1-1987, EXPIRES 4-1-2017.

SER. NO. 79-095,919, FILED 1-20-2011.

KATHERINE M. DUBRAY, EXAMINING ATTORNEY



David J. Kybas

Director of the United States Patent and Trademark Office

United States of America

United States Patent and Trademark Office

TONIMBO

Reg. No. 4,072,604

BOEHRINGER INGELHEIM INTERNATIONAL GMBH (FED REP GERMANY GMBH)
55218 INGELHEIM
FED REP GERMANY

Registered Dec. 20, 2011

Int. Cls.: 41 and 42

FOR: PUBLICATION OF PRINTED MATTER, INCLUDING IN ELECTRONIC FORM, WITH THE RESULTS OF CLINICAL STUDIES INVOLVING PHARMACEUTICAL PREPARATIONS, IN CLASS 41 (U.S. CLS. 100, 101 AND 107).

SERVICE MARK

FOR: CONDUCTING OF CLINICAL STUDIES FOR PHARMACEUTICAL PREPARATIONS, IN CLASS 42 (U.S. CLS. 100 AND 101).

PRINCIPAL REGISTER

THE MARK CONSISTS OF STANDARD CHARACTERS WITHOUT CLAIM TO ANY PARTICULAR FONT, STYLE, SIZE, OR COLOR.

PRIORITY DATE OF 12-29-2010 IS CLAIMED.

OWNER OF INTERNATIONAL REGISTRATION 1073680 DATED 3-16-2011, EXPIRES 3-16-2021.

THE TERM "TONIMBO" HAS NO MEANING IN A FOREIGN LANGUAGE.

SER. NO. 79-096,057, FILED 3-16-2011.

MARY BOAGNI, EXAMINING ATTORNEY



David J. Kyffers

Director of the United States Patent and Trademark Office

United States of America

United States Patent and Trademark Office

ANHELTO

Reg. No. 4,072,605

BOEHRINGER INGELHEIM INTERNATIONAL GMBH (FED REP GERMANY GMBH)
55218 INGELHEIM
FED REP GERMANY

Registered Dec. 20, 2011

Int. Cls.: 41 and 42

FOR: PUBLICATION OF PRINTED MATTER, INCLUDING IN ELECTRONIC FORM, WITH THE RESULTS OF CLINICAL STUDIES INVOLVING PHARMACEUTICAL PREPARATIONS, IN CLASS 41 (U.S. CLS. 100, 101 AND 107).

SERVICE MARK

FOR: CONDUCTING OF CLINICAL STUDIES FOR PHARMACEUTICAL PREPARATIONS, IN CLASS 42 (U.S. CLS. 100 AND 101).

PRINCIPAL REGISTER

THE MARK CONSISTS OF STANDARD CHARACTERS WITHOUT CLAIM TO ANY PARTICULAR FONT, STYLE, SIZE, OR COLOR.

PRIORITY DATE OF 12-29-2010 IS CLAIMED.

OWNER OF INTERNATIONAL REGISTRATION 1073681 DATED 3-16-2011, EXPIRES 3-16-2021.

SER. NO. 79-096,058, FILED 3-16-2011.

MARY BOAGNI, EXAMINING ATTORNEY



David J. Kyjars

Director of the United States Patent and Trademark Office

United States of America

United States Patent and Trademark Office

TIVACTION

Reg. No. 4,072,606

BOEHRINGER INGELHEIM INTERNATIONAL GMBH (FED REP GERMANY GMBH)
55218 INGELHEIM
FED REP GERMANY

Registered Dec. 20, 2011

Int. Cls.: 41 and 42

FOR: PUBLICATION OF PRINTED MATTER, INCLUDING IN ELECTRONIC FORM, WITH THE RESULTS OF CLINICAL STUDIES INVOLVING PHARMACEUTICAL PREPARATIONS, IN CLASS 41 (U.S. CLS. 100, 101 AND 107).

SERVICE MARK

FOR: CONDUCTING OF CLINICAL STUDIES FOR PHARMACEUTICAL PREPARATIONS, IN CLASS 42 (U.S. CLS. 100 AND 101).

PRINCIPAL REGISTER

THE MARK CONSISTS OF STANDARD CHARACTERS WITHOUT CLAIM TO ANY PARTICULAR FONT, STYLE, SIZE, OR COLOR.

PRIORITY DATE OF 12-29-2010 IS CLAIMED.

OWNER OF INTERNATIONAL REGISTRATION 1073701 DATED 3-16-2011, EXPIRES 3-16-2021.

SER. NO. 79-096,067, FILED 3-16-2011.

MARY BOAGNI, EXAMINING ATTORNEY



David J. Kyjars

Director of the United States Patent and Trademark Office

United States of America

United States Patent and Trademark Office

symica

Reg. No. 4,072,607

Registered Dec. 20, 2011

Int. Cl.: 42

TOVARYSTVO Z OBMEZHENOIU VIDPOVIDALNISTIU "SIMIKA" (UKRAINE LIMITED LIABILITY COMPANY)
VUL. GLUSHKOVA, 22, APT. 174
KYIV 03187
UKRAINE

SERVICE MARK

FOR: COMPUTER SOFTWARE DESIGN; COMPUTER PROGRAMMING; INSTALLATION OF COMPUTER SOFTWARE; MAINTENANCE OF COMPUTER SOFTWARE; COMPUTER SOFTWARE CONSULTANCY, IN CLASS 42 (U.S. CLS. 100 AND 101).

PRINCIPAL REGISTER

THE MARK CONSISTS OF THE WORD "SYMICA" WITH THE LETTER "S" IN RED AND THE LETTERS "YMICA" IN GRAY.

PRIORITY DATE OF 1-18-2011 IS CLAIMED.

OWNER OF INTERNATIONAL REGISTRATION 1073717 DATED 3-10-2011, EXPIRES 3-10-2021.

THE COLOR(S) RED AND GRAY IS/ARE CLAIMED AS A FEATURE OF THE MARK.

THE WORDING "SYMICA" HAS NO MEANING IN A FOREIGN LANGUAGE.

SER. NO. 79-096,076, FILED 3-10-2011.

ANNE FARRELL, EXAMINING ATTORNEY



David J. Kyros

Director of the United States Patent and Trademark Office

United States of America

United States Patent and Trademark Office



Reg. No. 4,072,608

Registered Dec. 20, 2011

Int. Cls.: 24 and 27

TRADEMARK

PRINCIPAL REGISTER

RAINBOW CLASSIC TEXTILE CO., LTD. (CHINA CORPORATION)
KANSHAN INDUSTRY ZONE
XIAOSHAN; HANGZHOU
CHINA

FOR: CURTAIN FABRIC; NON-WOVEN FABRICS; TAPESTRY STYLE WALL HANGINGS OF TEXTILE; FELT; TOWELS OF TEXTILE; BED COVERS; FITTED FURNITURE COVERINGS OF TEXTILE; DOOR CURTAINS; BED LINEN; WASHING MITTS, IN CLASS 24 (U.S. CLS. 42 AND 50).

FOR: CARPETS; AREA RUGS; FLOOR MATS, BATH MATS AND DOOR MATS; FLOOR MATS; FLOOR COVERINGS; AUTOMOBILE CARPETS; NON-SLIP FLOOR MATS, BATH MATS AND DOOR MATS; CARPET UNDERLAY; VINYL FLOOR COVERINGS; WALLPAPER, IN CLASS 27 (U.S. CLS. 19, 20, 37, 42 AND 50).

THE MARK CONSISTS OF A STRIPED STYLIZED LETTER "R" THAT HAS A TAIL THAT CURVES TO THE LEFT AND BELOW THE LETTER "R" AND REPRESENTS A HALF MOON DESIGN WITH TWO SLIT DESIGNS LOCATED IN THE TAIL DESIGN.

OWNER OF INTERNATIONAL REGISTRATION 1073732 DATED 1-21-2011, EXPIRES 1-21-2021.

SER. NO. 79-096,082, FILED 1-21-2011.

JENNIFER VASQUEZ, EXAMINING ATTORNEY



David J. Kybas

Director of the United States Patent and Trademark Office

United States of America

United States Patent and Trademark Office

HOGIA

Reg. No. 4,072,609

Registered Dec. 20, 2011

Int. Cls.: 9, 16, 38 and 41

TRADEMARK

SERVICE MARK

PRINCIPAL REGISTER

HOGIA AB (SWEDEN LIMITED LIABILITY COMPANY)
HYVELVÄGEN 1
SE-444 22 STENUNGSUND
SWEDEN

FOR: BUSINESS ADMINISTRATION SOFTWARE FOR USE IN BOOKKEEPING, ACCOUNTING, SALARY ADMINISTRATION, INVOICING, SALES SUPPORT AND ECONOMIC ANALYSIS OF BUSINESS; COMMUNICATION SOFTWARE FOR USE IN THE ELECTRONIC TRANSMISSION OF MESSAGES AND DATA, IN CLASS 9 (U.S. CLS. 21, 23, 26, 36 AND 38).

FOR: COMPUTER SOFTWARE INSTRUCTION MANUALS, IN CLASS 16 (U.S. CLS. 2, 5, 22, 23, 29, 37, 38 AND 50).

FOR: TELECOMMUNICATION SERVICES, NAMELY, THE ELECTRONIC TRANSMISSION OF MESSAGES AND DATA, IN CLASS 38 (U.S. CLS. 100, 101 AND 104).

FOR: EDUCATIONAL SERVICES, NAMELY, PROVIDING SEMINARS, WORKSHOPS AND COURSES IN THE FIELD OF BUSINESS ADMINISTRATION, IN CLASS 41 (U.S. CLS. 100, 101 AND 107).

THE MARK CONSISTS OF STANDARD CHARACTERS WITHOUT CLAIM TO ANY PARTICULAR FONT, STYLE, SIZE, OR COLOR.

OWNER OF INTERNATIONAL REGISTRATION 1073805 DATED 4-5-2011, EXPIRES 4-5-2021.

SER. NO. 79-096,119, FILED 4-5-2011.

IRA J. GOODSaid, EXAMINING ATTORNEY



David J. Kyros

Director of the United States Patent and Trademark Office

United States of America

United States Patent and Trademark Office



Reg. No. 4,072,610

Registered Dec. 20, 2011

Int. Cl.: 41

SERVICE MARK

PRINCIPAL REGISTER

STEP INTO LIFE INTERNATIONAL PTY LTD (AUSTRALIA LIMITED LIABILITY COMPANY)
148 CHESTERVILLE ROAD
UNIT 24
MOORABBIN, AUSTRALIA VIC 3189

FOR: FITNESS AND EXERCISE CLUBS AND PROVISION OF EXERCISE FACILITIES; INSTRUCTION IN PHYSICAL FITNESS; OPERATION OF PHYSICAL FITNESS CENTRES; PHYSICAL FITNESS INSTRUCTION; PHYSICAL FITNESS TRAINING SERVICES; PHYSICAL FITNESS TUITION IN THE NATURE OF PERSONAL TRAINING, IN CLASS 41 (U.S. CLS. 100, 101 AND 107).

NO CLAIM IS MADE TO THE EXCLUSIVE RIGHT TO USE "GROUP OUTDOOR PERSONAL TRAINING", APART FROM THE MARK AS SHOWN.

OWNER OF INTERNATIONAL REGISTRATION 1073897 DATED 2-21-2011, EXPIRES 2-21-2021.

THE COLOR(S) BLACK AND WHITE IS/ARE CLAIMED AS A FEATURE OF THE MARK.

THE MARK CONSISTS OF A RECTANGULAR IMAGE CONSISTING OF A BLACK BACKGROUND. NEAR THE TOP OF THE RECTANGULAR IMAGE ARE THE WORDS "STEP INTO LIFE" IN LARGE WHITE LOWER CASE LETTERS. BELOW THE WORDS "STEP INTO LIFE" IS A HORIZONTAL BANNER DESIGN OUTLINED IN WHITE WITH A BLACK BACKGROUND. THE WORDS "GROUP OUTDOOR PERSONAL TRAINING" APPEAR IN WHITE LETTERS AND IN TITLE CASE INSIDE THE BANNER. BENEATH THE BANNER ARE THE WORDS "WE DO IT OUTDOORS" IN WHITE LETTERS AND IN SENTENCE CASE WITH A PERIOD AT THE END OF THE SENTENCE.

SER. NO. 79-096,156, FILED 2-21-2011.

KIMBERLY PERRY, EXAMINING ATTORNEY



David J. Kyjars

Director of the United States Patent and Trademark Office

United States of America

United States Patent and Trademark Office

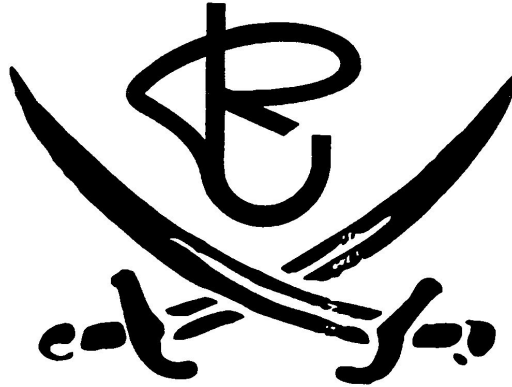

Reg. No. 4,072,611

Registered Dec. 20, 2011

Int. Cl.: 25

TRADEMARK

PRINCIPAL REGISTER

R.J.B CO., LTD. (JAPAN CORPORATION)
125-3, OAZA UCHIKAWA
CHIKUMA-SHI; NAGANO 389-0802
JAPAN

FOR: CLOTHING, NAMELY, SHIRTS, JEANS, SWEATSHIRTS, T-SHIRTS AND BASEBALL JACKETS; GARTERS; SOCK SUSPENDERS; SUSPENDERS, NAMELY, BRACES; WAIST-BANDS; BELTS FOR CLOTHING; MASQUERADE COSTUMES, IN CLASS 25 (U.S. CLS. 22 AND 39).

THE NAME(S), PORTRAIT(S), AND/OR SIGNATURE(S) SHOWN IN THE MARK DOES NOT IDENTIFY A PARTICULAR LIVING INDIVIDUAL.

OWNER OF INTERNATIONAL REGISTRATION 1074340 DATED 3-10-2011, EXPIRES 3-10-2021.

THE MARK CONSISTS OF THE STYLIZED LETTERING "RJB" SITUATED ABOVE TWO INTERSECTING SWORDS.

THE WORDING "RJB" HAS NO MEANING IN A FOREIGN LANGUAGE.

SER. NO. 79-096,351, FILED 3-10-2011.

NAKIA HENRY, EXAMINING ATTORNEY



David J. Kyffers

Director of the United States Patent and Trademark Office

United States of America

United States Patent and Trademark Office

The logo for WineLink features the word "wine" in a black, lowercase, sans-serif font, followed by "link" in the same font. The two 'i's in "wine" are replaced by gold wine bottles. Below the word "link", there is a gold, upward-curving arc that resembles a smile or a wine drop.

Reg. No. 4,072,612

Registered Dec. 20, 2011

Int. Cl.: 35

SERVICE MARK

PRINCIPAL REGISTER

M.O.T CO., LTD.
6-20, KOSAKA-HONMACHI 1-CHOME,
HIGASHI-OSAKA-SHIOSAKA 577-0802
JAPAN

FOR: PROVIDING INFORMATION RELATING TO RETAIL SALES AND WHOLESALE SALES OF WINES; RETAIL STORE SERVICES AND ONLINE WHOLESALE STORE SERVICES FEATURING WINES; MAIL ORDER CATALOG SERVICES FEATURING WINES, IN CLASS 35 (U.S. CLS. 100, 101 AND 102).

PRIORITY DATE OF 9-21-2010 IS CLAIMED.

OWNER OF INTERNATIONAL REGISTRATION 1074357 DATED 3-17-2011, EXPIRES 3-17-2021.

THE COLOR(S) GOLD AND BLACK IS/ARE CLAIMED AS A FEATURE OF THE MARK.

THE MARK CONSISTS OF THE WORD "WINELINK" IN BLACK WITH THE EXCEPTION OF THE "I" LETTERS, WHICH ARE IN THE SHAPE OF A WINE BOTTLE AND ARE GOLD. THERE'S AN UPSIDE DOWN GOLD COLORED ARC BELOW THE WORD AND EXTENDING FROM ONE LETTER "I" TO THE OTHER LETTER "I".

SER. NO. 79-096,361, FILED 3-17-2011.

JENNIFER VASQUEZ, EXAMINING ATTORNEY



David J. Kyros

Director of the United States Patent and Trademark Office

United States of America

United States Patent and Trademark Office



Reg. No. 4,072,613

Registered Dec. 20, 2011

Int. Cl.: 21

TRADEMARK

PRINCIPAL REGISTER

BORMIOLI ROCCO & FIGLIO S.P.A. (ITALY JOINT STOCK COMPANY)
VIALE MARTIRI DELLA LIBERTÀ, 1
I-43036 FIDENZA - PARMA
ITALY

FOR: HOUSEHOLD UTENSILS NOT OF PRECIOUS METAL OR COATED THEREWITH, NAMELY, POT AND PAN SCRAPERS, ROLLING PINS, SPATULAS, TURNERS, WHISKS; AND CONTAINERS FOR HOUSEHOLD OR KITCHEN USE NOT OF PRECIOUS METAL OR COATED THEREWITH; UNWORKED OR SEMI-WORKED GLASS; BEVERAGE GLASSWARE, PORCELAIN AND EARTHENWARE, NAMELY, MUGS, JARS, POTS AND VASES; GLASS GOODS, NAMELY, PLATES, BOTTLES, VASES, DRINKING GLASSES, DECANTERS, GLASS CONTAINERS FOR HOUSEHOLD USE FOR FOODSTUFFS, CRUET STANDS FOR OIL NOT OF PRECIOUS METAL; SALT SHAKERS OF GLASS, BOWLS, SMALL BOWLS, SALAD BOWLS, TRAYS FOR DOMESTIC PURPOSES NOT OF PRECIOUS METAL, CUPS, COFFEE CUPS; STAINLESS FLATWARE, NAMELY, PLATES AND DISHES; COVERS FOR VASES AND PLATES; FLASKS NOT OF PRECIOUS METAL, BOTTLE HOLDERS MADE OF PLASTIC, NAMELY, PLASTIC HOLDER FOR BEVERAGE CONTAINERS, IN CLASS 21 (U.S. CLS. 2, 13, 23, 29, 30, 33, 40 AND 50).

OWNER OF U.S. REG. NOS. 3,112,149 AND 3,112,150.

PRIORITY DATE OF 12-22-2010 IS CLAIMED.

OWNER OF INTERNATIONAL REGISTRATION 1074488 DATED 12-22-2010, EXPIRES 12-22-2020.

THE NAME(S), PORTRAIT(S), AND/OR SIGNATURE(S) SHOWN IN THE MARK DOES NOT IDENTIFY A PARTICULAR LIVING INDIVIDUAL.

THE MARK CONSISTS OF TWO SQUARE BOXES, ONE CONTAINING THE STYLIZED WORDING "BORMIOLI ROCCO" UNDER A STAR DESIGN ON THE LEFT, AND THE OTHER CONTAINING THE STYLIZED WORDING "MYHOME" ON THE RIGHT.

SER. NO. 79-096,409, FILED 12-22-2010.

TASNEEM HUSSAIN, EXAMINING ATTORNEY



David J. Kyros

Director of the United States Patent and Trademark Office

United States of America

United States Patent and Trademark Office

The logo for 'dealextrême' features the word in a lowercase, bold, sans-serif font. Above the letter 'x', there is a graphic element consisting of three stylized flames or a flame-like shape.

Reg. No. 4,072,614

Registered Dec. 20, 2011

Int. Cl.: 35

BEIJING HUAKAI FUGUI INFORMATION TECHNOLOGY CO., LTD. (CHINA CORPORATION)
ROOM 404, BUILDING B,
JINGYI PLAZA,; NO. 9 DAZHONGSI EAST ROAD,; HAIDIAN DISTRICT; 100098 BEIJING CHINA

SERVICE MARK

PRINCIPAL REGISTER

FOR: DEMONSTRATION OF GOODS; ADVERTISING; ADVERTISING BY MAIL ORDER; ON-LINE ADVERTISING ON A COMPUTER NETWORK; PRESENTATION OF GOODS ON COMMUNICATION MEDIA, FOR RETAIL PURPOSES; BUSINESS MANAGEMENT CONSULTANCY; IMPORT-EXPORT AGENCIES; AUCTIONEERING; SALES PROMOTION FOR OTHERS; PROCUREMENT SERVICES FOR OTHERS IN THE NATURE OF PURCHASING GOODS AND SERVICES FOR OTHER BUSINESSES, IN CLASS 35 (U.S. CLS. 100, 101 AND 102).

THE MARK CONSISTS OF THE WORD "DEALEXTREME" IN STYLIZED LETTERS AND A DESIGN ELEMENT FEATURING THREE FLAMES LOCATED ABOVE THE LETTER "X".

PRIORITY DATE OF 10-21-2010 IS CLAIMED.

OWNER OF INTERNATIONAL REGISTRATION 1074529 DATED 4-5-2011, EXPIRES 4-5-2021.

SER. NO. 79-096,424, FILED 4-5-2011.

LAURIE KAUFMAN, EXAMINING ATTORNEY



David J. Kyffers

Director of the United States Patent and Trademark Office

United States of America

United States Patent and Trademark Office

SG SOLAR ESSENSUN

Reg. No. 4,072,615

Registered Dec. 20, 2011

Int. Cls.: 9, 11 and 19

TRADEMARK

PRINCIPAL REGISTER

SAINT-GOBAIN GLASS FRANCE (FRANCE SOCIÉTÉ ANONYME)
"LES MIROIRS"
18, AVENUE D'ALSACE; F-92400 COURBEVOIE
FRANCE

FOR: APPARATUS AND INSTRUMENTS FOR CONDUCTING, SWITCHING, TRANSFORMING, ACCUMULATING, REGULATING OR CONTROLLING ELECTRICITY, NAMELY, TRANSFORMERS, ELECTRICAL SWITCHES, ELECTRICAL CONTROLLERS; PHOTOVOLTAIC ELEMENTS, NAMELY, PHOTOVOLTAIC CELLS; COMPONENTS OF PHOTOVOLTAIC ROOFS AND HYBRID THERMO-SOLAR MODULES, NAMELY, PHOTOVOLTAIC CELLS AND MODULES; PHOTOVOLTAIC SOLAR MODULES FOR GENERATING ELECTRICITY; SOLAR LIGHT SENSORS AND PHOTOVOLTAIC SOLAR PANELS FOR GENERATING ELECTRICITY; APPARATUS AND INSTALLATIONS FOR GENERATING PHOTOVOLTAIC ENERGY, NAMELY, PHOTOVOLTAIC CELLS; SOLAR HEAT CAPTURE PANELS, IN CLASS 9 (U.S. CLS. 21, 23, 26, 36 AND 38).

FOR: APPARATUS AND INSTALLATIONS FOR GENERATING HEAT ENERGY USING SOLAR ENERGY, NAMELY, SOLAR COLLECTORS, IN CLASS 11 (U.S. CLS. 13, 21, 23, 31 AND 34).

FOR: CONSTRUCTION MATERIALS, NOT OF METAL, NAMELY, BUILDING GLASS, GLASS-LIKE COVERINGS FOR WALLS AND PARTITIONS IN THE NATURE OF NON-METAL WALL PANELS AS WELL AS NON-METAL GLASS-LIKE COVERINGS FOR ROOFS AND ROOFING TRUSSES INCORPORATING PHOTOVOLTAIC ELEMENTS; ROOFING, NOT OF METAL FEATURING SOLAR CELLS, IN CLASS 19 (U.S. CLS. 1, 12, 33 AND 50).

NO CLAIM IS MADE TO THE EXCLUSIVE RIGHT TO USE "SOLAR", APART FROM THE MARK AS SHOWN.

PRIORITY DATE OF 6-29-2010 IS CLAIMED.

OWNER OF INTERNATIONAL REGISTRATION 1074904 DATED 12-27-2010, EXPIRES 12-27-2020.

THE WORDING "ESSENSUN" HAS NO MEANING IN A FOREIGN LANGUAGE.

SER. NO. 79-096,575, FILED 12-27-2010.



David J. Kyffers

Director of the United States Patent and Trademark Office

Reg. No. 4,072,615 MELISSA VALLILLO, EXAMINING ATTORNEY

United States of America
United States Patent and Trademark Office

fanpastico

Reg. No. 4,072,616

Registered Dec. 20, 2011

Int. Cls.: 30 and 43

TRADEMARK

SERVICE MARK

PRINCIPAL REGISTER

S. LÄUCHLI CONSULTING GMBH (SWITZERLAND SOCIÉTÉ À RESPONSABILITÉ
LIMITÉE)
SEEDAMMSTRASSE 3
CH-8808 PFÄFFIKON SZ
SWITZERLAND

FOR: COFFEE, TEA, COCOA, SUGAR, RICE, TAPIOCA, SAGO, ARTIFICIAL COFFEE;
FLOUR AND PREPARATIONS MADE FROM CEREALS, NAMELY, BREAD, AND PASTRY;
CONFECTIONERY, NAMELY, CANDY, ICES; HONEY, TREACLE; YEAST, BAKING-
POWDER; SALT, MUSTARD; VINEGAR, SAUCES; SPICES; ICE FOR REFRESHMENT, IN
CLASS 30 (U.S. CL. 46).

FOR: PROVIDING FOOD AND DRINK; PROVIDING TEMPORARY ACCOMMODATION,
IN CLASS 43 (U.S. CLS. 100 AND 101).

THE MARK CONSISTS OF STANDARD CHARACTERS WITHOUT CLAIM TO ANY PAR-
TICULAR FONT, STYLE, SIZE, OR COLOR.

OWNER OF INTERNATIONAL REGISTRATION 1075075 DATED 3-28-2011, EXPIRES 3-28-
2021.

SER. NO. 79-096,647, FILED 3-28-2011.

GEOFFREY FOSDICK, EXAMINING ATTORNEY



David J. Kypos

Director of the United States Patent and Trademark Office

United States of America

United States Patent and Trademark Office

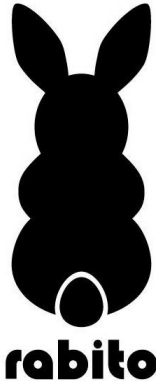

Reg. No. 4,072,617

Registered Dec. 20, 2011

Int. Cl.: 9

TRADEMARK

PRINCIPAL REGISTER

KWAG MINA (REPUBLIC OF KOREA INDIVIDUAL)
706-1203, PANGYOWON MAEUL APT.
637 PANGYO-DONG,; BUNDANG-GU, SEONGNAM-SI; GYEONGGI-DO
REPUBLIC OF KOREA

FOR: CASES FOR MOBILE PHONES; DEVICES FOR HANDS-FREE USE OF MOBILE PHONES; EARPHONES; HOLDERS FOR MOBILE PHONES; COMPUTER STANDS SPECIFICALLY DESIGNED FOR SUPPORTING A COMPUTER; DECORATIVE MAGNETS; MOUSE PADS; WRIST RESTS FOR USE WITH COMPUTERS; INTERFACES FOR COMPUTERS; COMPUTER PERIPHERAL DEVICES, IN CLASS 9 (U.S. CLS. 21, 23, 26, 36 AND 38).

THE ENGLISH TRANSLATION OF THE WORD "RABITO" IN THE MARK IS "LITTLE TAIL".

PRIORITY DATE OF 9-9-2010 IS CLAIMED.

OWNER OF INTERNATIONAL REGISTRATION 1075106 DATED 2-25-2011, EXPIRES 2-25-2021.

SER. NO. 79-096,659, FILED 2-25-2011.

MARGARET POWER, EXAMINING ATTORNEY



David J. Kybas

Director of the United States Patent and Trademark Office

United States of America

United States Patent and Trademark Office

ENDOSPAN

Reg. No. 4,072,618

Registered Dec. 20, 2011

Int. Cl.: 10

TRADEMARK

PRINCIPAL REGISTER

ENDOSPAN LTD. (ISRAEL LIMITED COMPANY)
4 MASKIT ST.,
P.O. BOX 12058; 46733 HERZILYA PITUACH
ISRAEL

FOR: MEDICAL DEVICES FOR CARDIOVASCULAR PROCEDURES, NAMELY, SYNTHETIC STENT GRAFTS AND ACCESSORIES, NAMELY, MEDICAL INSTRUMENTS FOR TREATING CARDIOVASCULAR CONDITIONS, IN CLASS 10 (U.S. CLS. 26, 39 AND 44).

THE MARK CONSISTS OF STANDARD CHARACTERS WITHOUT CLAIM TO ANY PARTICULAR FONT, STYLE, SIZE, OR COLOR.

PRIORITY DATE OF 9-6-2010 IS CLAIMED.

OWNER OF INTERNATIONAL REGISTRATION 1075248 DATED 2-21-2011, EXPIRES 2-21-2021.

SER. NO. 79-096,716, FILED 2-21-2011.

STEVEN PEREZ, EXAMINING ATTORNEY



David J. Kyffers

Director of the United States Patent and Trademark Office

United States of America

United States Patent and Trademark Office

Luminos Agile

Reg. No. 4,072,619

SIEMENS AKTIENGESELLSCHAFT (FED REP GERMANY JOINT STOCK COMPANY)
WITTELSBACHERPLATZ 2

Registered Dec. 20, 2011

80333 MÜNCHEN, FED REP GERMANY

Int. Cl.: 10

FOR: ELECTROMEDICAL, MEDICAL AND SURGICAL APPARATUS AND DEVICES FOR X-RAY DIAGNOSTICS AND X-RAY THERAPY AS WELL AS SYSTEMS CONSISTING OF SUCH APPARATUS AND DEVICES AND PARTS THEREOF, IN CLASS 10 (U.S. CLS. 26, 39 AND 44).

TRADEMARK

PRINCIPAL REGISTER

THE MARK CONSISTS OF STANDARD CHARACTERS WITHOUT CLAIM TO ANY PARTICULAR FONT, STYLE, SIZE, OR COLOR.

PRIORITY DATE OF 1-12-2011 IS CLAIMED.

OWNER OF INTERNATIONAL REGISTRATION 1075766 DATED 3-7-2011, EXPIRES 3-7-2021.

OWNER OF U.S. REG. NO. 3,274,469.

SER. NO. 79-096,890, FILED 3-7-2011.

SCOTT BIBB, EXAMINING ATTORNEY



David J. Kybas

Director of the United States Patent and Trademark Office

United States of America
United States Patent and Trademark Office

Luminos

Reg. No. 4,072,620

SIEMENS AKTIENGESELLSCHAFT (FED REP GERMANY JOINT STOCK COMPANY)
WITTELSBACHERPLATZ 2

Registered Dec. 20, 2011

80333 MÜNCHEN, FED REP GERMANY

Int. Cl.: 10

FOR: ELECTROMEDICAL, MEDICAL AND SURGICAL APPARATUS AND DEVICES FOR X-RAY DIAGNOSTICS AND X-RAY THERAPY AS WELL AS SYSTEMS CONSISTING OF SUCH APPARATUS AND DEVICES AND PARTS THEREOF, IN CLASS 10 (U.S. CLS. 26, 39 AND 44).

TRADEMARK

PRINCIPAL REGISTER

THE MARK CONSISTS OF STANDARD CHARACTERS WITHOUT CLAIM TO ANY PARTICULAR FONT, STYLE, SIZE, OR COLOR.

PRIORITY DATE OF 12-1-2010 IS CLAIMED.

OWNER OF INTERNATIONAL REGISTRATION 1075805 DATED 2-24-2011, EXPIRES 2-24-2021.

OWNER OF U.S. REG. NO. 3,274,469.

SER. NO. 79-096,902, FILED 2-24-2011.

SCOTT BIBB, EXAMINING ATTORNEY



David J. Kyfos

Director of the United States Patent and Trademark Office

United States of America

United States Patent and Trademark Office



Reg. No. 4,072,621

Registered Dec. 20, 2011

Int. Cl.: 33

TRADEMARK

PRINCIPAL REGISTER

BERINGER BLOSS ITALIA S.R.L. (ITALY CORPORATION)
VIA GABBIANO, 22
MERCATALE; I-50024 VAL DI PESA, ITALY

FOR: WINES, IN CLASS 33 (U.S. CLS. 47 AND 49).

OWNER OF U.S. REG. NO. 2,183,204.

PRIORITY DATE OF 10-28-2010 IS CLAIMED.

OWNER OF INTERNATIONAL REGISTRATION 1076401 DATED 3-25-2011, EXPIRES 3-25-2021.

THE COLOR(S) BLUE, BLACK, RED, BROWN, YELLOW, ORANGE, LIGHT BROWN, GREEN, WHITE, SILVER AND GRAY IS/ARE CLAIMED AS A FEATURE OF THE MARK.

THE MARK CONSISTS OF A SILVER, BLACK AND GRAY HORSE WITH A YELLOW AND BLACK EYE, OUTLINED IN BLACK, WEARING A RED HOODED COVERING OUTLINED IN BLACK WITH BROWN AND BLUE CHECKERED MARKINGS, WITH PORTIONS OF THE COVERING CURLED BACK TO REVEAL A GREEN INTERIOR LINING. A SOLDIER IS RIDING THE HORSE, CARRYING A RED FLAG WITH BROWN AND BLUE CHECKERED MARKINGS ON A BLACK FLAGPOLE AND A RED SHIELD WITH BROWN AND BLUE CHECKERED MARKINGS. THE SOLDIER IS HOLDING A BLACK AND WHITE CHECKED REIN THAT IS ATTACHED TO THE HORSE'S HEAD, AND THE SOLDIER WEARING A LONG RED COVERING WITH BLUE AND BROWN CHECKERED MARKINGS AND YELLOW LINING AT THE BOTTOM. THE SOLDIER'S LEG IS COVERED WITH A LINED BROWN AND WHITE LEGGING. THE SOLDIER IS WEARING A BROWN, LIGHT BROWN AND BLACK MASK AND HAS BLUE, YELLOW, ORANGE AND BLACK FEATHERS ON EITHER SIDE.

SER. NO. 79-097,108, FILED 3-25-2011.

ANDREA K. NADELMAN, EXAMINING ATTORNEY



David J. Kybas

Director of the United States Patent and Trademark Office

United States of America

United States Patent and Trademark Office



Reg. No. 4,072,622

Registered Dec. 20, 2011

Int. Cl.: 9

TRADEMARK

PRINCIPAL REGISTER

NINGBO CMC CO., LTD (CHINA CORPORATION)
INVESTMENT PIONEERING PARK
JIANGBEI DISTRICT,; NINGBO; ZHEJIANG
CHINA

FOR: PROTECTION DEVICES FOR PERSONAL USE AGAINST ACCIDENTS, NAMELY, INFLATABLE FLOTATION DEVICES, FIRE BLANKETS AND FIRE EXTINGUISHERS; CLOTHING FOR PROTECTION AGAINST ACCIDENTS, IRRADIATION AND FIRE; PROTECTIVE HELMETS; DIVING SUITS; GLOVES FOR PROTECTION AGAINST ACCIDENTS; CLOTHING FOR PROTECTION AGAINST FIRE; LIFE BUOYS; LIFE JACKETS; LIFE BELTS; SAFETY RESTRAINTS OTHER THAN FOR VEHICLE SEATS AND SPORTS EQUIPMENT, IN CLASS 9 (U.S. CLS. 21, 23, 26, 36 AND 38).

THE MARK CONSISTS OF A BOLD LETTER "C" WITH A WAVY HORIZONTAL LINE EMANATING FROM THE "C" LEFT TO RIGHT, REPRESENTING THE LETTERS "M", "C".

OWNER OF INTERNATIONAL REGISTRATION 1076452 DATED 4-14-2011, EXPIRES 4-14-2021.

SER. NO. 79-097,126, FILED 4-14-2011.

JANICE KIM, EXAMINING ATTORNEY



David J. Kyffers

Director of the United States Patent and Trademark Office

United States of America

United States Patent and Trademark Office

PEE PRO

Reg. No. 4,072,623

Registered Dec. 20, 2011

Int. Cl.: 28

TRADEMARK

PRINCIPAL REGISTER

MOODY CRAB PTY LTD (AUSTRALIA PROPRIETARY LIMITED COMPANY (PTY LTD))
4 IONA STREET
BROADVIEW SA 5083
AUSTRALIA

FOR: GAMES AND PLAYTHINGS, NAMELY, ELECTRONIC TARGET GAMES, ELECTRONIC ACTION GAMES, ELECTRONIC ACTION SKILL GAMES, ELECTRONIC TARGET GAMES BEING AUTOMATIC OTHER THAN THOSE ADAPTED FOR USE WITH AN EXTERNAL DISPLAY SCREEN OR MONITOR, ELECTRONIC TARGET GAME EQUIPMENT WITH A WATCH FUNCTION OTHER THAN THOSE ADAPTED FOR USE WITH AN EXTERNAL DISPLAY SCREEN OR MONITOR, ELECTRONIC TARGET GAMES INCORPORATING THEIR OWN VISUAL DISPLAY FACILITIES, IN CLASS 28 (U.S. CLS. 22, 23, 38 AND 50).

THE MARK CONSISTS OF STANDARD CHARACTERS WITHOUT CLAIM TO ANY PARTICULAR FONT, STYLE, SIZE, OR COLOR.

PRIORITY DATE OF 10-11-2010 IS CLAIMED.

OWNER OF INTERNATIONAL REGISTRATION 1076936 DATED 4-11-2011, EXPIRES 4-11-2021.

SER. NO. 79-097,324, FILED 4-11-2011.

BRENDAN MCCAULEY, EXAMINING ATTORNEY



David J. Kyffers

Director of the United States Patent and Trademark Office

United States of America

United States Patent and Trademark Office



montara

Reg. No. 4,072,624

Registered Dec. 20, 2011

Int. Cl.: 20

TRADEMARK

PRINCIPAL REGISTER

MONTARA VERPACKEN MIT SYSTEM GMBH (FED REP GERMANY GMBH)
NORDSTRAÙE 4
09603 GROÙSCHIRMA OT SIEBENLEHN
FED REP GERMANY

FOR: PACKAGING CONTAINERS OF PLASTIC, TRANSPORT AND STORAGE CONTAINERS,
NOT OF METAL OR PAPER, IN CLASS 20 (U.S. CLS. 2, 13, 22, 25, 32 AND 50).

THE MARK CONSISTS OF THE WORD "MONTARA" IN BLUE WITH A MISCELLANEOUS
DESIGN CONSISTING OF THREE CURVED LINES IN MAGENTA.

PRIORITY DATE OF 9-13-2010 IS CLAIMED.

OWNER OF INTERNATIONAL REGISTRATION 1077035 DATED 1-24-2011, EXPIRES 1-24-
2021.

THE COLOR(S) BLUE AND MAGENTA IS/ARE CLAIMED AS A FEATURE OF THE MARK.

SER. NO. 79-097,349, FILED 1-24-2011.

JULIE WATSON, EXAMINING ATTORNEY



David J. Kybas

Director of the United States Patent and Trademark Office

United States of America

United States Patent and Trademark Office

SICIS

Reg. No. 4,072,625

SICIS S.R.L. (ITALY LIMITED LIABILITY (JOINT STOCK) COMPANY)
VIA CANALA, 75/79

Registered Dec. 20, 2011

I-48123 RAVENNA, ITALY

Int. Cl.: 14

FOR: PRECIOUS METALS AND THEIR ALLOYS; PRECIOUS STONES; GOODS IN PRECIOUS METALS, THEIR ALLOYS OR COATED THEREWITH, WITH OR WITHOUT PRECIOUS STONES, WITH COSTUME JEWELRY EMBELLISHMENTS, NOT INCLUDED IN OTHER CLASSES, NAMELY, ORNAMENTS FOR TABLE USE, NAMELY, MODEL FIGURINES, DECORATIVE BOXES, JEWELRY CASES AND OTHER BOXES MADE OF PRECIOUS METALS; JEWELRY, NAMELY, EARRINGS, BRACELETS, NECKLACES, RINGS, CHARMS, PINS, CHAINS, MEDALS, MEDALLIONS, CUFF LINKS, TIE CLIPS, HOROLOGICAL AND OTHER CHRONOMETRIC INSTRUMENTS, NAMELY, CLOCKS, WRISTWATCHES, POCKET WATCHES, CHRONOMETERS, CHAINS AND STRAPS FOR WATCHES, TABLE OR WALL CLOCKS, GRANDFATHER CLOCKS, CUCKOO CLOCKS, CASES, BOXES AND OTHER CONTAINERS FOR CLOCKS, AND STRUCTURAL PARTS FOR ALL THE AFORESAID GOODS, IN CLASS 14 (U.S. CLS. 2, 27, 28 AND 50).

TRADEMARK

PRINCIPAL REGISTER

THE MARK CONSISTS OF STANDARD CHARACTERS WITHOUT CLAIM TO ANY PARTICULAR FONT, STYLE, SIZE, OR COLOR.

PRIORITY DATE OF 11-11-2010 IS CLAIMED.

OWNER OF INTERNATIONAL REGISTRATION 1077069 DATED 12-21-2010, EXPIRES 12-21-2020.

SER. NO. 79-097,362, FILED 12-21-2010.

MELISSA VALLILLO, EXAMINING ATTORNEY



David J. Kybas

Director of the United States Patent and Trademark Office

United States of America

United States Patent and Trademark Office

FLEXCILS

Reg. No. 4,072,626

Registered Dec. 20, 2011

Int. Cl.: 16

TRADEMARK

PRINCIPAL REGISTER

RETAIL BRANDS AUSTRALIA PTY LTD (AUSTRALIA PROPRIETARY LIMITED COMPANY
(P/L OR PTY. LTD.))
ATTN: MURRAY ALLEN,
80 BURLINGTON STREET; OAKLEIGH VIC 3166
AUSTRALIA

FOR: ARTISTS' PENCILS SOLD IN TINS OR BOXES; BLACK LEAD PENCILS; CLUTCH PENCILS; ERASING PENCILS; HOLDERS FOR PENCILS; INK PENCILS; PENCILS; PENCILS FOR ARTISTS; PENCILS FOR COLOURING, IN CLASS 16 (U.S. CLS. 2, 5, 22, 23, 29, 37, 38 AND 50).

THE MARK CONSISTS OF STANDARD CHARACTERS WITHOUT CLAIM TO ANY PARTICULAR FONT, STYLE, SIZE, OR COLOR.

OWNER OF INTERNATIONAL REGISTRATION 1077166 DATED 4-5-2011, EXPIRES 4-5-2021.

SER. NO. 79-097,391, FILED 4-5-2011.

GENE MACIOL, EXAMINING ATTORNEY



David J. Kyffers

Director of the United States Patent and Trademark Office

United States of America
United States Patent and Trademark Office

Chipshow

Reg. No. 4,072,627

Registered Dec. 20, 2011

Int. Cl.: 9

TRADEMARK

PRINCIPAL REGISTER

SEHN ZHEN CHIP OPTECH CO., LTD (CHINA CORPORATION)
NO.(7) WEST, 7 FLOOR, 201 BUILDING
TAIRAN FOUR ROAD, CHEGONGMIAO
FUTIAN DISTRICT, SHENZHEN; GUANGDONG, CHINA

FOR: COMPUTER PERIPHERAL DEVICES; ELECTRONIC NOTICE BOARDS; PHOTOGRAPHY DARKROOM LAMPS; AMUSEMENT APPARATUS ADAPTED FOR USE WITH AN EXTERNAL DISPLAY SCREEN OR MONITOR; TRANSPARENCY PROJECTION APPARATUS; PRINTED CIRCUITS; FLUORESCENT SCREENS; ELECTRONIC ADVERTISING DISPLAYS, NAMELY, DIGITAL SIGNAGE; NETWORK COMMUNICATION DEVICES, NAMELY, COMMUNICATIONS SOFTWARE FOR CONNECTING; NEON SIGNS, IN CLASS 9 (U.S. CLS. 21, 23, 26, 36 AND 38).

THE MARK CONSISTS OF STANDARD CHARACTERS WITHOUT CLAIM TO ANY PARTICULAR FONT, STYLE, SIZE, OR COLOR.

OWNER OF INTERNATIONAL REGISTRATION 1077212 DATED 3-1-2011, EXPIRES 3-1-2021.

SER. NO. 79-097,407, FILED 3-1-2011.

TINA L. SNAPP, EXAMINING ATTORNEY



David J. Kyffers

Director of the United States Patent and Trademark Office

United States of America

United States Patent and Trademark Office



Reg. No. 4,072,628

Registered Dec. 20, 2011

Int. Cls.: 41 and 42

SERVICE MARK

PRINCIPAL REGISTER

KAPPA ENGINEERING (FRANCE SOCIÉTÉ ANONYME)
17 RUE EUGÈNE DELACROIX
F-75116 PARIS
FRANCE

FOR: TRAINING SERVICES TO THE USE OF SOFTWARE IN THE FIELD OF EXPLORATION AND PRODUCTION FOR THE OIL AND GAS INDUSTRY; ARRANGING AND CONDUCTING OF EDUCATIONAL TRAINING SERVICES IN THE FIELD OF PRODUCTION AND RESERVOIR ENGINEERING FOR THE OIL AND GAS INDUSTRY, IN CLASS 41 (U.S. CLS. 100, 101 AND 107).

FOR: RESEARCH AND DEVELOPMENT OF SOFTWARE IN THE FIELD OF PRODUCTION AND RESERVOIR ENGINEERING FOR THE OIL AND GAS INDUSTRY; DESIGN AND DEVELOPMENT OF COMPUTERS AND SOFTWARE IN THE FIELD OF EXPLORATION AND PRODUCTION FOR THE OIL AND GAS INDUSTRY; TECHNICAL CONSULTANCY PROJECT STUDIES IN THE FIELD OF EXPLORATION AND PRODUCTION FOR THE OIL AND GAS INDUSTRY; DEVELOPMENT, DESIGN, INSTALLATION, MAINTENANCE, UPDATING OR RENTAL OF COMPUTER SOFTWARE IN THE FIELD OF OIL AND GAS INDUSTRY; COMPUTER PROGRAMMING IN THE FIELD OF EXPLORATION AND PRODUCTION FOR THE OIL AND GAS INDUSTRY; CONSULTANCY IN THE FIELD OF COMPUTER HARDWARE FOR USE IN EXPLORATION AND PRODUCTION FOR THE OIL AND GAS INDUSTRY, IN CLASS 42 (U.S. CLS. 100 AND 101).



THE MARK CONSISTS OF A HIGHLY STYLIZED GREEK LETTER "KAPPA" IN BLUE WITH WHITE INTERIOR. THE WORDING "KAPPA" APPEARS IN BLUE BELOW THE GREEK LETTER DESIGN.

PRIORITY DATE OF 12-6-2010 IS CLAIMED.

OWNER OF INTERNATIONAL REGISTRATION 1077536 DATED 4-11-2011, EXPIRES 4-11-2021.

THE COLOR(S) BLUE AND WHITE IS/ARE CLAIMED AS A FEATURE OF THE MARK.

SER. NO. 79-097,521, FILED 4-11-2011.

DANIEL CAPSHAW, EXAMINING ATTORNEY

David J. Kypos

Director of the United States Patent and Trademark Office

United States of America
United States Patent and Trademark Office

Oli'Sens

Reg. No. 4,072,629

Registered Dec. 20, 2011

Int. Cl.: 29

TRADEMARK

PRINCIPAL REGISTER

MAASSERA BRAHIM ZNIBER (MOROCCO CORPORATION)
HARZALLAH PAR HAJ KADDOUR
EL HAJEB MEKNES
MOROCCO

FOR: EDIBLE OILS AND FATS AND OILS AND FATS FOR FOOD, IN CLASS 29 (U.S. CL. 46).

THE WORDING OLI'SENS HAS NO MEANING IN A FOREIGN LANGUAGE.

OWNER OF INTERNATIONAL REGISTRATION 1077608 DATED 4-12-2011, EXPIRES 4-12-2021.

SER. NO. 79-097,549, FILED 4-12-2011.

MIDGE BUTLER, EXAMINING ATTORNEY



David J. Kyffers

Director of the United States Patent and Trademark Office

United States of America
United States Patent and Trademark Office

MAASSERA

Reg. No. 4,072,630

Registered Dec. 20, 2011

Int. Cl.: 29

TRADEMARK

PRINCIPAL REGISTER

MAASSERA BRAHIM ZNIBER (MOROCCO CORPORATION)
HARZALLAH PAR HAJ KADDOUR
EL HAJEB MEKNES
MOROCCO

FOR: EDIBLE OILS AND FATS AND OILS AND FATS FOR FOOD, IN CLASS 29 (U.S. CL. 46).

THE ENGLISH TRANSLATION OF "MAASSERA" IN THE MARK IS OLIVE MILL

PRIORITY DATE OF 1-18-2011 IS CLAIMED.

OWNER OF INTERNATIONAL REGISTRATION 1077609 DATED 4-12-2011, EXPIRES 4-12-2021.

SER. NO. 79-097,550, FILED 4-12-2011.

MIDGE BUTLER, EXAMINING ATTORNEY



David J. Kyffers

Director of the United States Patent and Trademark Office

United States of America

United States Patent and Trademark Office

CARACTERRE

Reg. No. 4,072,631

Registered Dec. 20, 2011

Int. Cl.: 29

TRADEMARK

PRINCIPAL REGISTER

MAASSERA BRAHIM ZNIBER (MOROCCO CORPORATION)
HARZALLAH PAR HAJ KADDOUR
EL HAJEB MEKNES
MOROCCO

FOR: EDIBLE OILS AND FATS AND OILS AND FATS FOR FOOD, IN CLASS 29 (U.S. CL. 46).

THE ENGLISH TRANSLATION OF "CARACTERRE" IN THE MARK IS CHARACTER.

PRIORITY DATE OF 1-18-2011 IS CLAIMED.

OWNER OF INTERNATIONAL REGISTRATION 1077610 DATED 4-12-2011, EXPIRES 4-12-2021.

SER. NO. 79-097,551, FILED 4-12-2011.

MIDGE BUTLER, EXAMINING ATTORNEY



David J. Kybas

Director of the United States Patent and Trademark Office

United States of America

United States Patent and Trademark Office

TADPOLE
COTTAGE

Reg. No. 4,072,632

Registered Dec. 20, 2011

**Int. Cls.: 9, 41, 42, 44
and 45**

TRADEMARK

SERVICE MARK

PRINCIPAL REGISTER

TADPOLE COTTAGE LIMITED (UNITED KINGDOM LIMITED COMPANY)
TADPOLE COTTAGE
TADPOLE LANE, BLUNSDON
SWINDON, UNITED KINGDOM SN25 2DZ

FOR: COMPUTER SOFTWARE AND DOWNLOADABLE SOFTWARE FOR THE RECORDING, ANALYSIS AND STORAGE OF RECORDS OF BEHAVIOR, TO ALLOW USERS TO RECORD AND REPORT ON BEHAVIOR OVER TIME, IN THE FIELD OF ASSESSMENT AND TREATMENT OF PEOPLE WHO HAVE SOCIAL, PSYCHOLOGICAL, BEHAVIORAL OR PSYCHIATRIC CONDITIONS AND CIRCUMSTANCES; DOWNLOADABLE ELECTRONIC PUBLICATIONS IN THE NATURE OF FORMS, REPORTS, TRAINING MANUALS, AND INSTRUCTION MANUALS IN THE FIELD OF ASSESSMENT AND TREATMENT OF PEOPLE WHO HAVE SOCIAL, PSYCHOLOGICAL, BEHAVIORAL OR PSYCHIATRIC CONDITIONS AND CIRCUMSTANCES, IN CLASS 9 (U.S. CLS. 21, 23, 26, 36 AND 38).

FOR: EDUCATION IN THE NATURE OF NON-DOWNLOADABLE ELECTRONIC PUBLICATIONS, NAMELY, FORMS, REPORTS, TRAINING MANUALS, AND INSTRUCTION MANUALS AND AUDIO AND VIDEO RECORDINGS PROVIDED IN THE FIELD OF ASSESSMENT AND TREATMENT OF SOCIAL, PSYCHOLOGICAL, BEHAVIORAL, OR PSYCHIATRIC CONDITIONS AND CIRCUMSTANCES; TRAINING IN THE NATURE OF SEMINARS AND WEB BASED TRAINING IN THE APPLICATION AND USE OF COMPUTER SOFTWARE AND DOWNLOADABLE SOFTWARE FOR THE RECORDING, ANALYSIS, STORAGE AND REPORTING OF RECORDS OF BEHAVIOR PROVIDED IN THE FIELD OF ASSESSMENT AND TREATMENT OF SOCIAL, PSYCHOLOGICAL, BEHAVIORAL OR PSYCHIATRIC CONDITIONS AND CIRCUMSTANCES, IN CLASS 41 (U.S. CLS. 100, 101 AND 107).

FOR: DESIGN AND DEVELOPMENT OF COMPUTER SOFTWARE, IN CLASS 42 (U.S. CLS. 100 AND 101).

FOR: MEDICAL, PSYCHIATRIC, PSYCHOLOGICAL, SOCIAL AND BEHAVIORAL ANALYSIS FOR THE DIAGNOSIS AND TREATMENT OF PERSONS; MEDICAL CONSULTANCY, IN CLASS 44 (U.S. CLS. 100 AND 101).

FOR: LEGAL CONSULTANCY IN THE FIELDS OF MEDICINE, PSYCHIATRIC, PSYCHOLOGY AND SOCIAL WORK, IN CLASS 45 (U.S. CLS. 100 AND 101).



David J. Kappas

Director of the United States Patent and Trademark Office

Reg. No. 4,072,632 THE MARK CONSISTS OF THE WORDING "TADPOLE COTTAGE" AND A STYLIZED TADPOLE DESIGN ALL IN LIME GREEN OVER A WHITE BACKGROUND.

PRIORITY DATE OF 12-23-2010 IS CLAIMED.

OWNER OF INTERNATIONAL REGISTRATION 1077728 DATED 1-21-2011, EXPIRES 1-21-2021.

THE COLOR(S) LIME GREEN AND WHITE IS/ARE CLAIMED AS A FEATURE OF THE MARK.

SER. NO. 79-097,591, FILED 1-21-2011.

JULIE VEPPUMTHARA, EXAMINING ATTORNEY

United States of America

United States Patent and Trademark Office

KAPPA Engineering

Reg. No. 4,072,633

Registered Dec. 20, 2011

Int. Cls.: 41 and 42

SERVICE MARK

PRINCIPAL REGISTER

KAPPA ENGINEERING (FRANCE SOCIÉTÉ ANONYME)
17 RUE EUGÈNE DELACROIX
F-75116 PARIS
FRANCE

FOR: TRAINING SERVICES TO THE USE OF SOFTWARE IN THE FIELD OF EXPLORATION AND PRODUCTION FOR THE OIL AND GAS INDUSTRY; ARRANGING AND CONDUCTING OF EDUCATIONAL TRAINING SERVICES IN THE FIELD OF PRODUCTION AND RESERVOIR ENGINEERING FOR THE OIL AND GAS INDUSTRY, IN CLASS 41 (U.S. CLS. 100, 101 AND 107).

FOR: RESEARCH AND DEVELOPMENT OF SOFTWARE IN THE FIELD OF PRODUCTION AND RESERVOIR ENGINEERING FOR THE OIL AND GAS INDUSTRY; DESIGN AND DEVELOPMENT OF COMPUTERS AND SOFTWARE IN THE FIELD OF EXPLORATION AND PRODUCTION FOR THE OIL AND GAS INDUSTRY; TECHNICAL CONSULTANCY PROJECT STUDIES IN THE FIELD OF EXPLORATION AND PRODUCTION FOR THE OIL AND GAS INDUSTRY; DEVELOPMENT, DESIGN, INSTALLATION, MAINTENANCE, UPDATING OR RENTAL OF COMPUTER SOFTWARE IN THE FIELD OF OIL AND GAS INDUSTRY; COMPUTER PROGRAMMING IN THE FIELD OF EXPLORATION AND PRODUCTION FOR THE OIL AND GAS INDUSTRY; CONSULTANCY IN THE FIELD OF COMPUTER HARDWARE FOR USE IN EXPLORATION AND PRODUCTION FOR THE OIL AND GAS INDUSTRY, IN CLASS 42 (U.S. CLS. 100 AND 101).

NO CLAIM IS MADE TO THE EXCLUSIVE RIGHT TO USE "ENGINEERING", APART FROM THE MARK AS SHOWN.

PRIORITY DATE OF 12-6-2010 IS CLAIMED.

OWNER OF INTERNATIONAL REGISTRATION 1077944 DATED 4-11-2011, EXPIRES 4-11-2021.

THE MARK CONSISTS OF THE WORDING "KAPPA ENGINEERING" IN STYLIZED FONT.

SER. NO. 79-097,649, FILED 4-11-2011.

DANIEL CAPSHAW, EXAMINING ATTORNEY



David J. Kappas

Director of the United States Patent and Trademark Office

United States of America

United States Patent and Trademark Office



Reg. No. 4,072,634

Registered Dec. 20, 2011

Int. Cls.: 35 and 42

SERVICE MARK

PRINCIPAL REGISTER

RABCOM, SIA (LATVIA LIMITED LIABILITY COMPANY)
DZIRNAVU IELA 62-6
LV-1050 RIGA
LATVIA

FOR: BUSINESS INFORMATION DATA PROCESSING AND ANALYSIS SERVICES, IN CLASS 35 (U.S. CLS. 100, 101 AND 102).

FOR: SOFTWARE DEVELOPMENT, IN CLASS 42 (U.S. CLS. 100 AND 101).

THE MARK CONSISTS OF THREE GREEN AND YELLOW FEATHER TRIANGLE DESIGNS IN AN OBLONG, CURVED SHAPE, ALL CONNECTED AT A POINT IN THE MIDDLE, WITH THE INNER POINT AND HALF OF EACH TRIANGLE IN YELLOW AND THE OUTER HALF OF EACH TRIANGLE IN GREEN, AND WITH EACH HAVING A YELLOW TO GREEN LINE EMANATING OUT FROM THE CENTER POINT WHICH TURNS FROM YELLOW TO GREEN.

OWNER OF INTERNATIONAL REGISTRATION 1061095 DATED 10-6-2010, EXPIRES 10-6-2020.

THE COLOR(S) GREEN, YELLOW AND WHITE IS/ARE CLAIMED AS A FEATURE OF THE MARK.

SER. NO. 79-097,747, FILED 4-7-2011.

LAURA KOVALSKY, EXAMINING ATTORNEY



David J. Kybas

Director of the United States Patent and Trademark Office

United States of America

United States Patent and Trademark Office

MONTARAZ



Reg. No. 4,072,635

Registered Dec. 20, 2011

Int. Cl.: 29

TRADEMARK

PRINCIPAL REGISTER

JAMONES Y EMBUTIDOS JAEM, S.A. (SPAIN SOCIEDAD ANÓNIMA)
POZO, 2
E-37320 VILLAR DE GALLIMAZO (SALAMANCA), SPAIN

FOR: MEAT, FISH, POULTRY AND GAME; MEAT EXTRACTS; PRESERVED, FROZEN, DRIED AND COOKED FRUITS AND VEGETABLES; JELLIES, JAMS, COMPOTES, EGGS; MILK AND MILK PRODUCTS EXCLUDING ICE CREAM, ICE MILK AND FROZEN YOGURT; EDIBLE OILS AND FATS, IN CLASS 29 (U.S. CL. 46).

THE MARK CONSISTS OF THE STYLIZED WORD "MONTARAZ" WITH THE LETTER "M" SHOWN IN BLACK AND THE REMAINING LETTERS "ONTARAZ" SHOWN IN RED; TO THE RIGHT IS A SILHOUETTE OF A MAN WITH A WHITE FACE AND CHEST, WEARING A BLACK HAT AND HOLDING A BLACK WALKING STICK

PRIORITY DATE OF 1-12-2011 IS CLAIMED.

OWNER OF INTERNATIONAL REGISTRATION 1079494 DATED 1-13-2011, EXPIRES 1-13-2021.

THE COLOR(S) RED, BLACK, AND WHITE IS/ARE CLAIMED AS A FEATURE OF THE MARK.

THE ENGLISH TRANSLATION OF THE FOREIGN WORD IN THE MARK IS "MOUNTAINEER".

SER. NO. 79-098,191, FILED 1-13-2011.

JULIE GUTTADAURO, EXAMINING ATTORNEY



David J. Kybas

Director of the United States Patent and Trademark Office

United States of America

United States Patent and Trademark Office

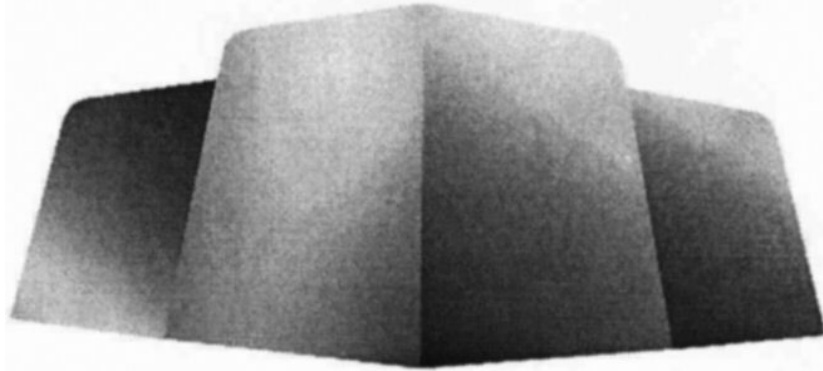

Reg. No. 4,072,636

Registered Dec. 20, 2011

Int. Cls.: 12 and 37

TRADEMARK

SERVICE MARK

PRINCIPAL REGISTER

GREAT WALL MOTOR COMPANY LIMITED (CHINA CORPORATION)
2266 CHAOYANG SOUTH STREET
BAODING; 071000 HEBEI
CHINA

FOR: CARS; TRUCKS; AUTOMOBILES; ELECTRIC VEHICLES, NAMELY, ELECTRIC CARS; VEHICLES, NAMELY, VANS; SPORTS UTILITY VEHICLES; MOTORS FOR LAND VEHICLES; AMBULANCES; MOTOR HOMES; CAMPING CARS, NAMELY, CAMPERS, IN CLASS 12 (U.S. CLS. 19, 21, 23, 31, 35 AND 44).

FOR: MOTOR VEHICLE MAINTENANCE AND REPAIR; VEHICLE SERVICE STATIONS, NAMELY, REFUELING AND MAINTENANCE FOR VEHICLE; VEHICLE FUELING STATIONS; RETREADING OF TYRES; VEHICLE CLEANING; VEHICLE LUBRICATION; ANTI-RUST TREATMENT FOR VEHICLES; VEHICLE POLISHING; VEHICLE REPAIR; CAR WASH SERVICES, IN CLASS 37 (U.S. CLS. 100, 103 AND 106).

THE MARK CONSISTS OF A STYLIZED SHIELD CONSISTING OF FOUR TOUCHING QUADRILATERALS WITH THE CENTER TWO LARGER THAN THE OTHER TWO.

OWNER OF INTERNATIONAL REGISTRATION 1079923 DATED 5-12-2011, EXPIRES 5-12-2021.

SER. NO. 79-098,369, FILED 5-12-2011.

MAYUR VAGHANI, EXAMINING ATTORNEY



David J. Kybas

Director of the United States Patent and Trademark Office

United States of America

United States Patent and Trademark Office

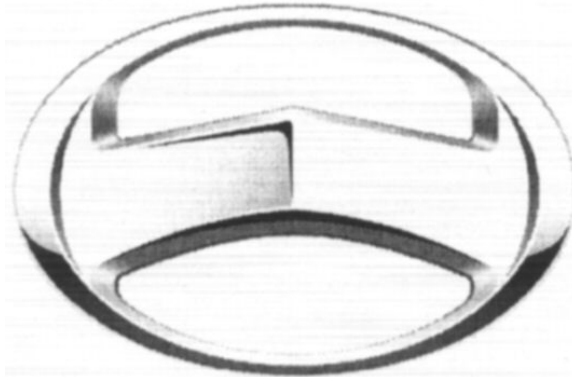

Reg. No. 4,072,637

Registered Dec. 20, 2011

Int. Cls.: 12 and 37

TRADEMARK

SERVICE MARK

PRINCIPAL REGISTER

GREAT WALL MOTOR COMPANY LIMITED (CHINA CORPORATION)
2266 CHAOYANG SOUTH STREET
BAODING; 071000 HEBEI
CHINA

FOR: CARS; TRUCKS; AUTOMOBILES; ELECTRIC VEHICLES, NAMELY, ELECTRIC CARS; VEHICLES, NAMELY, VANS; SPORTS UTILITY VEHICLES; MOTORS FOR LAND VEHICLES; AMBULANCES; MOTOR HOMES; CAMPING CARS, NAMELY, CAMPERS, IN CLASS 12 (U.S. CLS. 19, 21, 23, 31, 35 AND 44).

FOR: MOTOR VEHICLE MAINTENANCE AND REPAIR; VEHICLE SERVICE STATIONS, NAMELY, REFUELING AND MAINTENANCE FOR VEHICLE; VEHICLE FUELING STATIONS; RETREADING OF TYRES; VEHICLE CLEANING; VEHICLE LUBRICATION; ANTI-RUST TREATMENT FOR VEHICLES; VEHICLE POLISHING; VEHICLE REPAIR; CAR WASH SERVICES, IN CLASS 37 (U.S. CLS. 100, 103 AND 106).

THE MARK CONSISTS OF AN OVAL DESIGN WITH AN ARROWHEAD DESIGN IN THE CENTER AND HAVING A CUTOUT ABOVE AND BELOW THE ARROWHEAD DESIGN.

OWNER OF INTERNATIONAL REGISTRATION 1079924 DATED 5-12-2011, EXPIRES 5-12-2021.

SER. NO. 79-098,370, FILED 5-12-2011.

MAYUR VAGHANI, EXAMINING ATTORNEY



David J. Kybas

Director of the United States Patent and Trademark Office

United States of America

United States Patent and Trademark Office

ROTAPLUS

Reg. No. 4,072,638

Registered Dec. 20, 2011

Int. Cl.: 7

TRADEMARK

PRINCIPAL REGISTER

SPERRHOLZWERK SCHWEITZER GMBH (AUSTRIA LIMITED COMPANY (LTD.))
FREUNDORF 9
A-4076 ST. MARIENKIRCHEN
AUSTRIA

FOR: PARTS FOR ROTARY DIE MACHINES, NAMELY, ROTARY DIE SHELLS AND
ROTARY DIE BOARDS, IN CLASS 7 (U.S. CLS. 13, 19, 21, 23, 31, 34 AND 35).

THE MARK CONSISTS OF STANDARD CHARACTERS WITHOUT CLAIM TO ANY PAR-
TICULAR FONT, STYLE, SIZE, OR COLOR.

PRIORITY DATE OF 2-2-2011 IS CLAIMED.

OWNER OF INTERNATIONAL REGISTRATION 1080160 DATED 3-28-2011, EXPIRES 3-28-
2021.

SER. NO. 79-098,467, FILED 3-28-2011.

KELLY TRUSILO, EXAMINING ATTORNEY



David J. Kybas

Director of the United States Patent and Trademark Office

United States of America

United States Patent and Trademark Office

E P R I M A

Reg. No. 4,072,639

Registered Dec. 20, 2011

Int. Cls.: 1 and 2

TRADEMARK

PRINCIPAL REGISTER

ASAHI GLASS COMPANY, LIMITED (JAPAN CORPORATION)
12-1, YURAKUCHO 1-CHOME,
CHIYODA-KU; TOKYO 100-8405
JAPAN

FOR: FLUORINE RESINS, IN CLASS 1 (U.S. CLS. 1, 5, 6, 10, 26 AND 46).

FOR: PRINTER'S PASTES (INK); PRINTING COMPOSITIONS (INK); PRINTING INK, IN CLASS 2 (U.S. CLS. 6, 11 AND 16).

THE MARK CONSISTS OF STANDARD CHARACTERS WITHOUT CLAIM TO ANY PARTICULAR FONT, STYLE, SIZE, OR COLOR.

PRIORITY DATE OF 4-28-2011 IS CLAIMED.

OWNER OF INTERNATIONAL REGISTRATION 1080791 DATED 5-30-2011, EXPIRES 5-30-2021.

SER. NO. 79-098,668, FILED 5-30-2011.

KATINA MISTER, EXAMINING ATTORNEY



David J. Kyfos

Director of the United States Patent and Trademark Office

United States of America

United States Patent and Trademark Office

Meridian-Strumpf

Reg. No. 4,072,640

Registered Dec. 20, 2011

Int. Cls.: 5, 10 and 25

TRADEMARK

PRINCIPAL REGISTER

MEDI GMBH & CO. KG (FED REP GERMANY LIMITED PARTNERSHIP WITH A LIMITED LIABILITY COMPANY AS GENERAL PARTNER)
MEDICUSSTRASSE 1
95448 BAYREUTH, FED REP GERMANY

FOR: PHARMACEUTICAL PREPARATIONS FOR SKIN CARE AND THE TREATMENT OF SKIN DISORDERS AND VEIN DISEASES; PLASTERS FOR MEDICAL PURPOSES; MEDICATED COMPRESSES AND WOUND DRESSINGS; HYDROCOLLOID DRESSINGS FOR WOUNDS; GAUZE FOR DRESSINGS; ALL PURPOSE DISINFECTANTS; TAMPONS AND SANITARY NAPKINS FOR INCONTINENCE PATIENTS, IN CLASS 5 (U.S. CLS. 6, 18, 44, 46, 51 AND 52).

FOR: MEDICAL STOCKINGS AND TIGHTS FOR ARM AND LEG, IN CLASS 10 (U.S. CLS. 26, 39 AND 44).

FOR: CLOTHING, NAMELY, STOCKINGS, SOCKS, FINE STOCKINGS, TIGHTS, HOSIERY, IN CLASS 25 (U.S. CLS. 22 AND 39).

THE MARK CONSISTS OF STANDARD CHARACTERS WITHOUT CLAIM TO ANY PARTICULAR FONT, STYLE, SIZE, OR COLOR.

PRIORITY DATE OF 2-1-2011 IS CLAIMED.

OWNER OF INTERNATIONAL REGISTRATION 1081261 DATED 2-25-2011, EXPIRES 2-25-2021.

THE ENGLISH TRANSLATION OF "STRUMPF" IN THE MARK IS "SOCK" OR "STOCKING."

SER. NO. 79-098,851, FILED 2-25-2011.

TOBY BULLOFF, EXAMINING ATTORNEY



David J. Kypos

Director of the United States Patent and Trademark Office

United States of America

United States Patent and Trademark Office

BWNC

Reg. No. 4,072,641

Registered Dec. 20, 2011

Int. Cl.: 9

TRADEMARK

PRINCIPAL REGISTER

PUNO SYSTEMS UK LIMITED (UNITED KINGDOM LIMITED LIABILITY COMPANY)
16 CHARTFIELD ROAD
REIGATE RH2 7JZ
UNITED KINGDOM

FOR: MOBILE PHONES; CELLULAR PHONES; VIDEO PHONES; COMPUTER APPARATUS, NAMELY, COMPUTER DOCKING STATION; DIGITAL AUDIO PLAYERS; VIDEO DISC PLAYERS, IN CLASS 9 (U.S. CLS. 21, 23, 26, 36 AND 38).

THE MARK CONSISTS OF STANDARD CHARACTERS WITHOUT CLAIM TO ANY PARTICULAR FONT, STYLE, SIZE, OR COLOR.

OWNER OF INTERNATIONAL REGISTRATION 1082841 DATED 3-21-2011, EXPIRES 3-21-2021.

SER. NO. 79-099,456, FILED 3-21-2011.

TOBY BULLOFF, EXAMINING ATTORNEY



David J. Kyffers

Director of the United States Patent and Trademark Office

United States of America
United States Patent and Trademark Office

MASTER

Reg. No. 4,072,642

Registered Dec. 20, 2011

Int. Cl.: 28

TRADEMARK

PRINCIPAL REGISTER

HEAD SPORT GMBH (AUSTRIA CORPORATION)
WUHRKOPFWEG 1
A-6921 KENNELBACH
AUSTRIA

FOR: TENNIS RACQUETS, SQUASH RACQUETS, AND RACQUETBALL RACQUETS, IN CLASS 28 (U.S. CLS. 22, 23, 38 AND 50).

OWNER OF U.S. REG. NO. 3,064,775.

OWNER OF INTERNATIONAL REGISTRATION 0534958 DATED 3-20-1989, EXPIRES 3-20-2019.

THE MARK CONSISTS OF THE STYLIZED WORD "MASTER".

SER. NO. 79-099,662, FILED 2-28-2011.

CHRISTINA SOBRAL, EXAMINING ATTORNEY



David J. Kyffers

Director of the United States Patent and Trademark Office

United States of America
United States Patent and Trademark Office

VYTRATE

Reg. No. 4,072,643

Registered Dec. 20, 2011

Int. Cl.: 5

TRADEMARK

PRINCIPAL REGISTER

JUROX PTY LTD (AUSTRALIA CORPORATION)
85 GARDINERS ROAD
RUTHERFORD NSW 2320
AUSTRALIA

FOR: VETERINARY PHARMACEUTICALS FOR TREATMENT OF SCOURS, DEHYDRATION AND STRESS IN FARM AND DOMESTIC ANIMALS; VETERINARY PHARMACEUTICALS FOR TREATMENT OF PREGNANCY TOXAEMIA IN SHEEP, IN CLASS 5 (U.S. CLS. 6, 18, 44, 46, 51 AND 52).

THE MARK CONSISTS OF STANDARD CHARACTERS WITHOUT CLAIM TO ANY PARTICULAR FONT, STYLE, SIZE, OR COLOR.

PRIORITY DATE OF 5-31-2011 IS CLAIMED.

OWNER OF INTERNATIONAL REGISTRATION 1083549 DATED 6-14-2011, EXPIRES 6-14-2021.

SER. NO. 79-099,785, FILED 6-14-2011.

KATHERINE E. HALMEN, EXAMINING ATTORNEY



David J. Kyros

Director of the United States Patent and Trademark Office

United States of America

United States Patent and Trademark Office

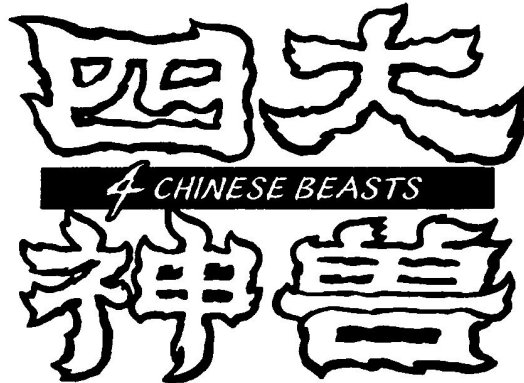

Reg. No. 4,072,644

Registered Dec. 20, 2011

Int. Cls.: 9 and 28

TRADEMARK

PRINCIPAL REGISTER

UNIVERSAL ENTERTAINMENT CORPORATION (JAPAN CORPORATION)
ARIAKE FRONTIER BUILDING, TOWER A
3-7-26 ARIAKE,; KOTO-KU; TOKYO 135-0063
JAPAN

FOR: ELECTRONIC CIRCUITS, OPTICAL DISKS, MAGNETIC TAPES, MAGNETIC DISKS, MAGNETIC CARDS, MAGNETO-OPTICAL DISKS, CD-ROMS, ROM-CARTRIDGES AND DVDS, ALL OF WHICH STORE PROGRAMS FOR ARCADE VIDEO GAME MACHINES; DOWNLOADABLE PROGRAMS FOR ARCADE VIDEO GAME MACHINES; GAMING MACHINES ADAPTED FOR USE WITH AN EXTERNAL DISPLAY SCREEN OR MONITOR; GAMING MACHINES WITH MULTI-TERMINALS ADAPTED FOR USE WITH AN EXTERNAL DISPLAY SCREEN OR MONITOR; ELECTRONIC CIRCUITS, OPTICAL DISKS, MAGNETIC TAPES, MAGNETIC DISKS, MAGNETIC CARDS, MAGNETO-OPTICAL DISKS, CD-ROMS, ROM-CARTRIDGES AND DVDS, ALL OF WHICH STORE PROGRAMS FOR GAMING MACHINES; DOWNLOADABLE PROGRAMS FOR GAMING MACHINES; ELECTRONIC CIRCUITS, OPTICAL DISKS, MAGNETIC TAPES, MAGNETIC DISKS, MAGNETIC CARDS, MAGNETO-OPTICAL DISKS, CD-ROMS, ROM-CARTRIDGES AND DVDS, ALL OF WHICH STORE PROGRAMS FOR SLOT MACHINES; DOWNLOADABLE PROGRAMS FOR SLOT MACHINES; APPARATUS FOR GAMES FOR HOME USE ADAPTED FOR USE WITH AN EXTERNAL DISPLAY SCREEN OR MONITOR; ELECTRONIC CIRCUITS, OPTICAL DISKS, MAGNETIC TAPES, MAGNETIC DISKS, MAGNETIC CARDS, MAGNETO-OPTICAL DISKS, CD-ROMS, ROM-CARTRIDGES AND DVDS, ALL OF WHICH STORE PROGRAMS FOR GAMES FOR HOME USE ADAPTED FOR USE WITH AN EXTERNAL DISPLAY SCREEN OR MONITOR; DOWNLOADABLE PROGRAMS FOR GAMES FOR HOME USE ADAPTED FOR USE WITH AN EXTERNAL DISPLAY SCREEN OR MONITOR; ELECTRONIC CIRCUITS, OPTICAL DISKS, MAGNETIC TAPES, MAGNETIC DISKS, MAGNETIC CARDS, MAGNETO-OPTICAL DISKS, CD-ROMS, ROM-CARTRIDGES AND DVDS, ALL OF WHICH STORE PROGRAMS FOR HAND-HELD GAMES WITH LIQUID CRYSTAL DISPLAYS; DOWNLOADABLE PROGRAMS FOR HAND-HELD GAMES WITH LIQUID CRYSTAL DISPLAYS, IN CLASS 9 (U.S. CLS. 21, 23, 26, 36 AND 38).



David J. Kyros

Director of the United States Patent and Trademark Office

FOR: COIN-OPERATED ARCADE VIDEO GAME MACHINES; MAGNETIC CARD OPERATED ARCADE VIDEO GAME MACHINES; ARCADE VIDEO GAME MACHINES WITH MULTI-TERMINALS; CABINETS FOR ARCADE VIDEO GAME MACHINES; ARCADE VIDEO GAME MACHINES; SLOT MACHINES; CABINETS OF SLOT MACHINES; GAMING MACHINES OTHER THAN THOSE ADAPTED FOR USE WITH AN EXTERNAL DISPLAY SCREEN OR MONITOR; GAMING MACHINES WITH MULTI-TERMINALS OTHER THAN

Reg. No. 4,072,644 THOSE ADAPTED FOR USE WITH AN EXTERNAL DISPLAY SCREEN OR MONITOR;
HAND-HELD GAMES WITH LIQUID CRYSTAL DISPLAYS, IN CLASS 28 (U.S. CLS. 22, 23,
38 AND 50).

THE ENGLISH TRANSLATION OF THE FOREIGN WORD(S) IN THE MARK IS "FOUR
MYTHICAL BEASTS".

PRIORITY DATE OF 4-25-2011 IS CLAIMED.

OWNER OF INTERNATIONAL REGISTRATION 1084116 DATED 4-28-2011, EXPIRES 4-28-
2021.

THE TRANSLITERATION OF THE NON-LATIN CHARACTERS IN THE MARK IS: SI DA
SHEN SHOU.

SER. NO. 79-099,988, FILED 4-28-2011.

EDWARD NELSON, EXAMINING ATTORNEY

United States of America
United States Patent and Trademark Office

19 CRIMES

Reg. No. 4,072,645

Registered Dec. 20, 2011

Int. Cl.: 33

TRADEMARK

PRINCIPAL REGISTER

SOUTHCORP BRANDS PTY LIMITED (AUSTRALIA COMPANY)
77 SOUTHBANK BOULEVARD
SOUTHBANK VIC 3006
AUSTRALIA

FOR: WINE, IN CLASS 33 (U.S. CLS. 47 AND 49).

THE MARK CONSISTS OF STANDARD CHARACTERS WITHOUT CLAIM TO ANY PARTICULAR FONT, STYLE, SIZE, OR COLOR.

PRIORITY DATE OF 2-16-2011 IS CLAIMED.

OWNER OF INTERNATIONAL REGISTRATION 1085968 DATED 6-21-2011, EXPIRES 6-21-2021.

SER. NO. 79-100,758, FILED 6-21-2011.

LESLEY LAMOTHE, EXAMINING ATTORNEY



David J. Kyffers

Director of the United States Patent and Trademark Office

United States of America
United States Patent and Trademark Office

Selcoperm

Reg. No. 4,072,646

Registered Dec. 20, 2011

Int. Cl.: 9

TRADEMARK

PRINCIPAL REGISTER

GRUNDFOS WATER TREATMENT GMBH (FED REP GERMANY LIMITED COMPANY)
REETZSTR. 85
76327 PFINZTAL
FED REP GERMANY

FOR: APPARATUSES AND INSTRUMENTS FOR CONDUCTING ELECTRICITY, NAMELY APPARATUSES PERFORMING ELECTROLYSIS FOR PRODUCING CHLORINE FOR PRODUCING CHEMICALS, IN PARTICULAR CHLORINE BLEACHING, IN CLASS 9 (U.S. CLS. 21, 23, 26, 36 AND 38).

THE MARK CONSISTS OF STANDARD CHARACTERS WITHOUT CLAIM TO ANY PARTICULAR FONT, STYLE, SIZE, OR COLOR.

PRIORITY DATE OF 1-26-2011 IS CLAIMED.

OWNER OF INTERNATIONAL REGISTRATION 1086977 DATED 3-18-2011, EXPIRES 3-18-2021.

SER. NO. 79-101,130, FILED 3-18-2011.

WILLIAM VERHOSEK, EXAMINING ATTORNEY



David J. Kyfos

Director of the United States Patent and Trademark Office

United States of America

United States Patent and Trademark Office

CLAREMONT GRADUATE UNIVERSITY

Reg. No. 4,072,647

Registered Dec. 20, 2011

Int. Cl.: 41

SERVICE MARK

PRINCIPAL REGISTER

CLAREMONT GRADUATE UNIVERSITY (CALIFORNIA CORPORATION)
150 EAST TENTH STREET
CLAREMONT, CA 91711

FOR: EDUCATIONAL SERVICES, NAMELY, PROVIDING COURSES OF INSTRUCTION AND PROVIDING TRAINING IN THE FIELD OF SCIENTIFIC RESEARCH AT THE POST BACCALAUREATE LEVEL, IN CLASS 41 (U.S. CLS. 100, 101 AND 107).

FIRST USE 5-31-1997; IN COMMERCE 5-31-1997.

THE MARK CONSISTS OF STANDARD CHARACTERS WITHOUT CLAIM TO ANY PARTICULAR FONT, STYLE, SIZE, OR COLOR.

NO CLAIM IS MADE TO THE EXCLUSIVE RIGHT TO USE "GRADUATE UNIVERSITY", APART FROM THE MARK AS SHOWN.

SEC. 2(F).

SER. NO. 85-001,406, FILED 3-29-2010.

MARCIE MILONE, EXAMINING ATTORNEY



David J. Kyffers

Director of the United States Patent and Trademark Office

United States of America

United States Patent and Trademark Office

Simplyink

Reg. No. 4,072,648

LD PRODUCTS, INC. (CALIFORNIA CORPORATION)
2500 GRAND AVENUE
LONG BEACH, CA 90815

Registered Dec. 20, 2011

Int. Cl.: 35

FOR: ONLINE RETAIL STORE SERVICES FEATURING INK JET CARTRIDGES AND LASER TONER CARTRIDGES, IN CLASS 35 (U.S. CLS. 100, 101 AND 102).

SERVICE MARK

FIRST USE 9-0-2002; IN COMMERCE 9-0-2002.

PRINCIPAL REGISTER

THE MARK CONSISTS OF STANDARD CHARACTERS WITHOUT CLAIM TO ANY PARTICULAR FONT, STYLE, SIZE, OR COLOR.

SER. NO. 85-002,452, FILED 3-30-2010.

CHRISTOPHER BUONGIORNO, EXAMINING ATTORNEY



David J. Kybas

Director of the United States Patent and Trademark Office

United States of America
United States Patent and Trademark Office

ONEBODE

Reg. No. 4,072,649

1BODE, INC. (ARIZONA CORPORATION)
1718 E. SPEEDWAY BLVD. #213
TUCSON, AZ 85719

Registered Dec. 20, 2011

Int. Cl.: 5

FOR: DIETARY AND NUTRITIONAL SUPPLEMENTS; ENZYME FOOD SUPPLEMENTS;
MINERAL SUPPLEMENTS; NATURAL HERBAL SUPPLEMENTS; NUTRITIONAL SUPPLE-
MENTS; PROTEIN SUPPLEMENTS; VITAMIN AND MINERAL SUPPLEMENTS, IN CLASS
5 (U.S. CLS. 6, 18, 44, 46, 51 AND 52).

TRADEMARK

PRINCIPAL REGISTER

FIRST USE 10-13-2006; IN COMMERCE 10-13-2006.

THE MARK CONSISTS OF STANDARD CHARACTERS WITHOUT CLAIM TO ANY PAR-
TICULAR FONT, STYLE, SIZE, OR COLOR.

SER. NO. 85-002,466, FILED 3-30-2010.

MICHAEL TANNER, EXAMINING ATTORNEY



David J. Kyros

Director of the United States Patent and Trademark Office

United States of America

United States Patent and Trademark Office

ONEBODĒ

Reg. No. 4,072,650

1BODE, INC. (ARIZONA CORPORATION)
1718 E. SPEEDWAY BLVD. #213
TUCSON, AZ 85719

Registered Dec. 20, 2011

Int. Cl.: 5

FOR: DIETARY AND NUTRITIONAL SUPPLEMENTS; ENZYME FOOD SUPPLEMENTS; MINERAL SUPPLEMENTS; NATURAL HERBAL SUPPLEMENTS; NUTRITIONAL SUPPLEMENTS; PROTEIN SUPPLEMENTS; VITAMIN AND MINERAL SUPPLEMENTS, IN CLASS 5 (U.S. CLS. 6, 18, 44, 46, 51 AND 52).

TRADEMARK

PRINCIPAL REGISTER

FIRST USE 10-13-2006; IN COMMERCE 10-13-2006.

THE MARK CONSISTS OF A CURVED LINE FORMING THE BOTTOM OF AN INCOMPLETE RECTANGLE WITH THE LETTERS "ONEBODE" WITHIN THE INCOMPLETE RECTANGLE AND A STRAIGHT LINE ABOVE THE SECOND "E".

SER. NO. 85-002,485, FILED 3-30-2010.

MICHAEL TANNER, EXAMINING ATTORNEY



David J. Kyros

Director of the United States Patent and Trademark Office

United States of America

United States Patent and Trademark Office

BEAUTY FASHION

Reg. No. 4,072,651

BEAUTY FASHION, INC. (NEW YORK CORPORATION)
16 EAST 40TH STREET, SUITE 700
NEW YORK, NY 10016

Registered Dec. 20, 2011

Int. Cl.: 16

FOR: MAGAZINE RELATING TO NEWS AND EVENTS IN THE COSMETIC INDUSTRY,
AND NOT THE APPAREL OR FASHION INDUSTRY, IN CLASS 16 (U.S. CLS. 2, 5, 22, 23,
29, 37, 38 AND 50).

TRADEMARK

FIRST USE 0-0-1938; IN COMMERCE 0-0-1938.

PRINCIPAL REGISTER

THE MARK CONSISTS OF STANDARD CHARACTERS WITHOUT CLAIM TO ANY PAR-
TICULAR FONT, STYLE, SIZE, OR COLOR.

SEC. 2(F).

SER. NO. 85-002,749, FILED 3-31-2010.

ANNE E. GUSTASON, EXAMINING ATTORNEY



David J. Kyffers

Director of the United States Patent and Trademark Office

United States of America

United States Patent and Trademark Office

HIDI

Reg. No. 4,072,652

Registered Dec. 20, 2011

Int. Cl.: 9

TRADEMARK

PRINCIPAL REGISTER

SERATO AUDIO RESEARCH LIMITED (NEW ZEALAND COMPANY)
1 NELSON STREET
AUCKLAND, NEW ZEALAND

FOR: COMPUTER HARDWARE, SOFTWARE, FIRMWARE AND PERIPHERALS FOR USE IN CREATING, MIXING, MANIPULATING OR PERFORMING MUSIC; DATA, SOUND OR MUSIC PROCESSING EQUIPMENT, NAMELY, SIGNAL PROCESSORS AND MICROPROCESSORS, FOR CREATING, MIXING, MANIPULATING OR PERFORMING MUSIC; COMPUTERS FOR CREATING, MIXING, MANIPULATING OR PERFORMING MUSIC; APPARATUS FOR RECORDING, TRANSMITTING, OR REPRODUCING DATA, SOUND OR MUSIC; AUDIO SIGNAL PROCESSORS; REMOTE CONTROL APPARATUS FOR CONTROLLING THE AFORESAID PRODUCTS; DOWNLOADABLE ELECTRONIC PUBLICATIONS, NAMELY, NEWSLETTERS CONCERNING MUSIC AND SYSTEMS FOR CREATING, MIXING, MANIPULATING OR PERFORMING MUSIC, IN CLASS 9 (U.S. CLS. 21, 23, 26, 36 AND 38).

THE MARK CONSISTS OF STANDARD CHARACTERS WITHOUT CLAIM TO ANY PARTICULAR FONT, STYLE, SIZE, OR COLOR.

PRIORITY CLAIMED UNDER SEC. 44(D) ON NEW ZEALAND APPLICATION NO. 814060, FILED 10-12-2009, REG. NO. 814060, DATED 10-12-2009, EXPIRES 10-12-2019.

SER. NO. 85-002,899, FILED 3-31-2010.

JOHN KELLY, EXAMINING ATTORNEY



David J. Kybas

Director of the United States Patent and Trademark Office

United States of America
United States Patent and Trademark Office

KWIKZIPS

Reg. No. 4,072,653

Registered Dec. 20, 2011

Int. Cls.: 41 and 44

SERVICE MARK

PRINCIPAL REGISTER

THE ACADEMIC EDGE, INC. (KENTUCKY CORPORATION)
108 EAST 14TH STREET
BLOOMINGTON, IN 47408

FOR: EDUCATIONAL SERVICES, NAMELY, DISPLAYING A SERIES OF ANIMATED FILMS CONCERNING HEALTH AND MEDICAL RELATED TOPICS, IN CLASS 41 (U.S. CLS. 100, 101 AND 107).

FIRST USE 1-1-2010; IN COMMERCE 1-1-2010.

FOR: PROVIDING HEALTH AND MEDICAL INFORMATION VIA THE INTERNET; AND PROVIDING INFORMATION IN THE FIELDS OF HEATH AND MEDICINE, IN CLASS 44 (U.S. CLS. 100 AND 101).

FIRST USE 1-1-2010; IN COMMERCE 1-1-2010.

THE MARK CONSISTS OF STANDARD CHARACTERS WITHOUT CLAIM TO ANY PARTICULAR FONT, STYLE, SIZE, OR COLOR.

SER. NO. 85-006,511, FILED 4-5-2010.

ANDREW RHIM, EXAMINING ATTORNEY



David J. Kyros

Director of the United States Patent and Trademark Office

United States of America

United States Patent and Trademark Office



Reg. No. 4,072,654

LIGHTBOX NETWORK INC. (CALIFORNIA CORPORATION)
2645 BUTLER CREEK ROAD
ASHLAND, OR 97520

Registered Dec. 20, 2011

Int. Cl.: 9

FOR: COMPUTER SOFTWARE FOR ENTERPRISE LEVEL DIGITAL PROJECT AND ASSET MANAGEMENT, ENABLING ONLINE PROJECT AND ASSET COLLABORATION, INCLUDING UPLOADING OF ASSETS, PREVIEWING, EDITING, APPROVALS, RETOUCHING NOTES, VIDEO EDIT NOTES, BUDGETING, PROOF-SHEET PRINTING, STOCK SALES, MILESTONE TRACKING, MERCHANDISE TRACKING, TEAM COORDINATION, ASSET DELIVERY AND BROADCASTING, PRESENTATION AND BOOK CREATION, METADATA APPLICATION AND ARCHIVING, INSTALLED AND OPERATED ON A SERVER OR PERSONAL COMPUTER, ACCESSED LOCALLY OR OVER A GLOBAL COMPUTER NETWORK, IN CLASS 9 (U.S. CLS. 21, 23, 26, 36 AND 38).

TRADEMARK

PRINCIPAL REGISTER

FIRST USE 2-25-2010; IN COMMERCE 4-4-2010.

THE MARK CONSISTS OF BLUE AND GRAY LETTERING, WHERE THE LETTER "X" IS BLUE AND THE LETTERING "DAM" IS GRAY, WITH ALL LETTERS BEING ON TOP OF A BLACK BACKGROUND

THE COLOR(S) BLUE AND GRAY IS/ARE CLAIMED AS A FEATURE OF THE MARK.

SER. NO. 85-006,544, FILED 4-5-2010.

MARK SPARACINO, EXAMINING ATTORNEY



David J. Kyffers

Director of the United States Patent and Trademark Office

United States of America

United States Patent and Trademark Office



Reg. No. 4,072,655

Registered Dec. 20, 2011

Int. Cls.: 9 and 16

TRADEMARK

PRINCIPAL REGISTER

PRESTON, DAYTON E. (GEORGIA LIMITED LIABILITY COMPANY), DBA WINNING YOUR WEIGHT
8036 WELLINGTON TRACE
MIDLAND, GA 31820

FOR: PRE-RECORDED CDS, VIDEO TAPES, LASER DISKS AND DVDS FEATURING WEIGHT MANAGEMENT AND WELLNESS, IN CLASS 9 (U.S. CLS. 21, 23, 26, 36 AND 38).

FIRST USE 1-1-2010; IN COMMERCE 1-1-2010.

FOR: PUBLICATIONS, NAMELY, BROCHURES, BOOKLETS, AND TEACHING MATERIALS IN THE FIELD OF WEIGHT MANAGEMENT AND WELLNESS, IN CLASS 16 (U.S. CLS. 2, 5, 22, 23, 29, 37, 38 AND 50).

FIRST USE 1-1-2010; IN COMMERCE 1-1-2010.

THE MARK CONSISTS OF THE STYLIZED LETTERING "WYW" APPEARING OVER THE WORDING "WINNING YOUR WEIGHT". THE FIRST "W" IS GREEN, THE "Y" APPEARS IN BLUE WITH A BLUE DOT APPEARING ABOVE IT, AND THE LAST "W" APPEARS IN GREEN. THE WORDING "WINNING YOUR WEIGHT" APPEARS IN GREEN.

THE COLOR(S) GREEN AND BLUE IS/ARE CLAIMED AS A FEATURE OF THE MARK.

SER. NO. 85-007,071, FILED 4-6-2010.

RON FAIRBANKS, EXAMINING ATTORNEY



David J. Kybas

Director of the United States Patent and Trademark Office

United States of America

United States Patent and Trademark Office

IMPRIVIA

Reg. No. 4,072,656

BFC FORMS SERVICE, INC. (ILLINOIS CORPORATION)
1051 N. KIRK RD.
BATAVIA, IL 60510

Registered Dec. 20, 2011

Int. Cl.: 35

FOR: MARKETING APPLICATIONS, NAMELY, ONLINE ORDER FULFILLMENT SERVICES IN THE NATURE OF PROVIDING PRINTED MATERIALS ON DEMAND WHEREBY EITHER THE RECIPIENT OR THE ORIGINAL INFORMATION PROVIDER CAN BE CHARGED FOR THE MATERIALS; OPERATING, ASSISTING AND OUTSOURCING THE REPROGRAPHICS DEPARTMENT OF OTHERS, NAMELY, DUPLICATING AND PRINTING, IN CLASS 35 (U.S. CLS. 100, 101 AND 102).

SERVICE MARK

PRINCIPAL REGISTER

FIRST USE 3-2-2009; IN COMMERCE 3-2-2009.

THE MARK CONSISTS OF STANDARD CHARACTERS WITHOUT CLAIM TO ANY PARTICULAR FONT, STYLE, SIZE, OR COLOR.

SER. NO. 85-007,506, FILED 4-6-2010.

GENE MACIOL, EXAMINING ATTORNEY



David J. Kyffers

Director of the United States Patent and Trademark Office

United States of America

United States Patent and Trademark Office

WAIV

Reg. No. 4,072,657

LESICO TECHNOLOGIES LTD. (ISRAEL CORPORATION)
152 JERUSALEM BLVD.
HOLON, ISRAEL 58827

Registered Dec. 20, 2011

Int. Cls.: 11, 40 and 42

FOR: APPARATUS, SYSTEMS AND INSTALLATIONS FOR THE OUTDOOR EVAPORATION OF WATER, WASTEWATER AND LIQUID WASTE, NAMELY, LIQUID DISTRIBUTION CONDUITS FOR DEPOSITING LIQUID ON EVAPORATION SURFACES, EVAPORATION SURFACES COMPRISED OF SOLID FLEXIBLE OR INFLEXIBLE WETTABLE SURFACES, PURIFICATION INSTALLATIONS AND UNITS, FLOW CONTROLLERS FOR CONTROLLING THE RATE AT WHICH LIQUID IS BROUGHT TO THE EVAPORATION SURFACES AND THE RATE AT WHICH LIQUID IS REMOVED FROM THE APPARATUS, SYSTEMS AND INSTALLATIONS, SEPARATORS, AND MODULES CONTAINING ARRAYS OF EVAPORATION SURFACES; PARTS AND FITTINGS FOR THE AFOREMENTIONED GOODS , IN CLASS 11 (U.S. CLS. 13, 21, 23, 31 AND 34).

TRADEMARK

SERVICE MARK

PRINCIPAL REGISTER

FOR: PURIFICATION, RECYCLING AND TREATMENT SERVICES OF WATER, WASTEWATER AND LIQUID WASTE; CUSTOM MANUFACTURE OF SYSTEMS, UNITS AND INSTALLATIONS ALL FOR PURIFICATION, RECYCLING AND TREATMENT OF WATER, WASTEWATER AND LIQUID WASTE; ADVISORY SERVICES IN THE FIELDS OF PURIFICATION, RECYCLING AND TREATMENT OF WATER, WASTEWATER AND LIQUID WASTE; ADVISORY SERVICES IN THE FIELD OF CUSTOM MANUFACTURE OF SYSTEMS, UNITS AND INSTALLATIONS ALL FOR PURIFICATION, RECYCLING AND TREATMENT OF WATER, WASTEWATER AND LIQUID WASTE, IN CLASS 40 (U.S. CLS. 100, 103 AND 106).



FOR: CUSTOM DESIGN OF SYSTEMS, UNITS AND INSTALLATIONS ALL FOR PURIFICATION, RECYCLING AND TREATMENT OF WATER, WASTEWATER AND LIQUID WASTE; ADVISORY SERVICES IN THE FIELD OF CUSTOM DESIGN OF SYSTEMS, UNITS AND INSTALLATIONS ALL FOR PURIFICATION, RECYCLING AND TREATMENT OF WATER, WASTEWATER AND LIQUID WASTE, IN CLASS 42 (U.S. CLS. 100 AND 101).

THE MARK CONSISTS OF STANDARD CHARACTERS WITHOUT CLAIM TO ANY PARTICULAR FONT, STYLE, SIZE, OR COLOR.

David J. Kybas

PRIORITY CLAIMED UNDER SEC. 44(D) ON ISRAEL APPLICATION NO. 1345761, FILED 2-16-2010, REG. NO. 228527, DATED 12-5-2010, EXPIRES 3-28-2020.

Reg. No. 4,072,657 PRIORITY CLAIMED UNDER SEC. 44(D) ON ISRAEL APPLICATION NO. 1345761, FILED 2-16-2010, REG. NO. 228524, DATED 12-5-2010, EXPIRES 3-28-2020.

SER. NO. 85-009,275, FILED 4-8-2010.

TINA L. SNAPP, EXAMINING ATTORNEY

United States of America

United States Patent and Trademark Office

EVERSMART

Reg. No. 4,072,658

Registered Dec. 20, 2011

Int. Cl.: 25

TRADEMARK

PRINCIPAL REGISTER

EVERSMART ENTERPRISE INVESTMENT LIMITED HONG KONG (HONG KONG LIMITED LIABILITY COMPANY)
ROOM 1103, 11/F, WING KWOK CENTRE
182 WOOSUNG STREET
KOWLOON, HONG KONG AND

EVERSMART INDUSTRY CO., LTD., PUTIAN FUJIAN CHINA (CHINA LIMITED LIABILITY COMPANY)
XINGDU VILLAGE, XINGDU COUNTY
LI CHENG DISTRICT, PUTIAN CITY
FUJIAN PROVINCE, CHINA

FOR: CLOTHING, NAMELY, T-SHIRTS; SHIRTS; DRESSES; TROUSERS; JACKETS; LAYETTES; BABY BELLY WARMERS, NAMELY, UNDERGARMENT FOR BABIES IN THE FORM OF A FABRIC OR KNITTING WOOL BAND USED FOR WRAPPING AROUND THE BELLY OF A BABY TO KEEP THE BABY WARM; SWIMSUITS; CLOTHING FOR GYMNASSTIC USE, NAMELY, GYM PANTS, GYM SHORTS, GYM SUITS; CLOTHING FOR WEAR IN JUDO PRACTICES; WATERPROOF JACKETS AND PANTS; RAINCOATS; FOOTBALL SHOES; GYMNASSTIC SHOES; CLIMBING FOOTWEAR; RUNNING SHOES WITH METAL STUDS; FOOTWEAR; ATHLETIC FOOTWEAR; SANDALS; SLIPPERS; WOODEN SHOES (FOOTWEAR); RAIN BOOTS; HATS; HOSIERY; TIES (CLOTHING); SCARFS; SHOULDER WRAPS FOR CLOTHING; BRACES (SUSPENDERS); BELTS FOR CLOTHING, IN CLASS 25 (U.S. CLS. 22 AND 39).

THE MARK CONSISTS OF STANDARD CHARACTERS WITHOUT CLAIM TO ANY PARTICULAR FONT, STYLE, SIZE, OR COLOR.

OWNER OF HONG KONG REG. NO. 301401731, DATED 8-7-2009, EXPIRES 8-6-2019.

SER. NO. 85-010,083, FILED 4-9-2010.

BARNEY CHARLON, EXAMINING ATTORNEY



David J. Kypos

Director of the United States Patent and Trademark Office

United States of America

United States Patent and Trademark Office

SUPER SULFUR/POTASH

Reg. No. 4,072,659

Registered Dec. 20, 2011

Int. Cl.: 1

TRADEMARK

PRINCIPAL REGISTER

HEART OF NATURE, LLC. (CALIFORNIA LIMITED LIABILITY COMPANY)
34710 7TH STANDARD ROAD
BLDG A
BAKERSFIELD, CA 93314

FOR: ORGANIC SOIL AMENDMENTS; ORGANIC SOIL IMPROVING AGENTS; ORGANIC SOIL CONDITIONING PREPARATIONS, IN CLASS 1 (U.S. CLS. 1, 5, 6, 10, 26 AND 46).

FIRST USE 2-0-2006; IN COMMERCE 2-0-2006.

THE MARK CONSISTS OF STANDARD CHARACTERS WITHOUT CLAIM TO ANY PARTICULAR FONT, STYLE, SIZE, OR COLOR.

SEC. 2(F).

SER. NO. 85-010,890, FILED 4-9-2010.

GEOFFREY FOSDICK, EXAMINING ATTORNEY



David J. Kybas

Director of the United States Patent and Trademark Office

United States of America

United States Patent and Trademark Office

EATING WELL

Reg. No. 4,072,660

Registered Dec. 20, 2011

Int. Cls.: 29 and 30

TRADEMARK

PRINCIPAL REGISTER

EATING WELL, INC. (DELAWARE CORPORATION)
823A FERRY ROAD
CHARLOTTE, VT 05445

FOR: PREPARED FOOD IN THE NATURE OF MEALS, ENTREES, AND SIDE DISHES CONSISTING PRIMARILY OF MEAT, FISH, POULTRY AND/OR VEGETABLES, BASED ON AND MARKETED IN RELATION TO COPYRIGHTED RECIPES THAT HAVE BEEN TESTED IN A TEST KITCHEN AND PUBLISHED IN PUBLICATIONS. THE PREPARED FOODS ARE MADE WITH NATURAL, WHOLESOME INGREDIENTS AND HAVE BEEN THOROUGHLY ANALYZED TO ENSURE HEALTHY NUTRITIONAL CONTENT AND TO CONTROL CALORIES, SATURATED FAT AND SODIUM. THE PREPARED FOODS ARE FORMULATED TO MINIMIZE OR EXCLUDE ADDED SUGARS, TRANS FATS AND REFINED GRAINS, IN CLASS 29 (U.S. CL. 46).

FIRST USE 4-29-2008; IN COMMERCE 4-29-2008.

FOR: PREPARED FOOD IN THE NATURE OF MEALS, ENTREES, AND SIDE DISHES CONSISTING PRIMARILY OF PASTA, RICE, NOODLES OR GRAINS, BASED ON AND MARKETED IN RELATION TO COPYRIGHTED RECIPES THAT HAVE BEEN TESTED IN A TEST KITCHEN AND PUBLISHED IN PUBLICATIONS. THE PREPARED FOODS ARE MADE WITH NATURAL, WHOLESOME INGREDIENTS AND HAVE BEEN THOROUGHLY ANALYZED TO ENSURE HEALTHY NUTRITIONAL CONTENT AND TO CONTROL CALORIES, SATURATED FAT AND SODIUM. THE PREPARED FOODS ARE FORMULATED TO MINIMIZE OR EXCLUDE ADDED SUGARS, TRANS FATS AND REFINED GRAINS, IN CLASS 30 (U.S. CL. 46).

FIRST USE 4-29-2008; IN COMMERCE 4-29-2008.

THE MARK CONSISTS OF STANDARD CHARACTERS WITHOUT CLAIM TO ANY PARTICULAR FONT, STYLE, SIZE, OR COLOR.

OWNER OF U.S. REG. NO. 3,106,102.

SER. NO. 85-011,858, FILED 4-12-2010.

MARK RADEMACHER, EXAMINING ATTORNEY



David J. Kyffers

Director of the United States Patent and Trademark Office

United States of America

United States Patent and Trademark Office

Worry-free Landscapes

Reg. No. 4,072,661

PRESTONWOOD LANDSCAPE SERVICES, LLC (TEXAS LIMITED LIABILITY COMPANY)
10780 SHADY TRAIL, SUITE 200
DALLAS, TX 75220

Registered Dec. 20, 2011

Int. Cl.: 44

FOR: LANDSCAPE DESIGN, IN CLASS 44 (U.S. CLS. 100 AND 101).

SERVICE MARK

FIRST USE 1-1-2009; IN COMMERCE 1-1-2009.

PRINCIPAL REGISTER

THE MARK CONSISTS OF STANDARD CHARACTERS WITHOUT CLAIM TO ANY PARTICULAR FONT, STYLE, SIZE, OR COLOR.

NO CLAIM IS MADE TO THE EXCLUSIVE RIGHT TO USE "LANDSCAPES", APART FROM THE MARK AS SHOWN.

SER. NO. 85-012,572, FILED 4-13-2010.

PAM WILLIS, EXAMINING ATTORNEY



David J. Kyffers

Director of the United States Patent and Trademark Office

United States of America

United States Patent and Trademark Office



Reg. No. 4,072,662

REGAL CUTTING TOOLS, INC. (ILLINOIS CORPORATION)
5330 E. ROCKTON RD.
ROSCOE, IL 61073

Registered Dec. 20, 2011

Int. Cl.: 7

FOR: CUTTING TOOLS, NAMELY, ELECTRIC DRILLS, TAPS; POWER TOOLS, NAMELY END MILLS; POWER TOOLS, NAMELY REAMERS, DIES FOR USE WITH MACHINE TOOLS, IN CLASS 7 (U.S. CLS. 13, 19, 21, 23, 31, 34 AND 35).

TRADEMARK

FIRST USE 1-23-1985; IN COMMERCE 1-23-1985.

PRINCIPAL REGISTER

THE MARK CONSISTS OF THE LOWER CASE LETTERS "NYTD" IN A STYLIZED MANNER WITH A DESIGN ELEMENT BENEATH THE LETTERS.

SER. NO. 85-012,630, FILED 4-13-2010.

JOHN WILKE, EXAMINING ATTORNEY



David J. Kybas

Director of the United States Patent and Trademark Office

United States of America

United States Patent and Trademark Office

PHARME WASTE WIZARD

Reg. No. 4,072,663

WM HEALTHCARE SOLUTIONS, INC. (DELAWARE CORPORATION)
1001 FANNIN, SUITE 4000
HOUSTON, TX 77002

Registered Dec. 20, 2011

Int. Cl.: 40

FOR: PROVIDING INFORMATION IN THE FIELD OF WASTE MANAGEMENT FOR PHARMACEUTICAL WASTE VIA THE INTERNET; CONSULTING SERVICES IN THE FIELD OF WASTE MANAGEMENT FOR PHARMACEUTICAL WASTE; AND PROVIDING A SEARCHABLE INTERNET DATABASE OF INFORMATION IN THE FIELD OF WASTE MANAGEMENT FOR PHARMACEUTICAL WASTE, IN CLASS 40 (U.S. CLS. 100, 103 AND 106).

SERVICE MARK

PRINCIPAL REGISTER

FIRST USE 4-14-2010; IN COMMERCE 4-14-2010.

THE MARK CONSISTS OF STANDARD CHARACTERS WITHOUT CLAIM TO ANY PARTICULAR FONT, STYLE, SIZE, OR COLOR.

OWNER OF U.S. REG. NOS. 3,023,835 AND 3,050,050.

NO CLAIM IS MADE TO THE EXCLUSIVE RIGHT TO USE "WASTE", APART FROM THE MARK AS SHOWN.

SER. NO. 85-014,087, FILED 4-14-2010.

TRACY CROSS, EXAMINING ATTORNEY



David J. Kypos

Director of the United States Patent and Trademark Office

United States of America

United States Patent and Trademark Office



Reg. No. 4,072,664

Registered Dec. 20, 2011

Int. Cl.: 3

TRADEMARK

PRINCIPAL REGISTER

Y.S.PARK PROFESSIONAL INC. (JAPAN LIMITED LIABILITY COMPANY), FORMERLY
PARK WAY CO., LTD.
3-CHOME KAMI-OSAKI 9-2
SHINAGAWA-KU, TOKYO, JAPAN 141-0021

FOR: SHAMPOOS, HAIR OILS, COLOR RINSES, HAIR DYES, PERMANENT WAVE PREPARATIONS, HAIR CREAMS, HAIR SPRAY, HAIR TONICS, HAIR FIXERS, HAIR LACQUERS, HAIR RINSES, HAIR POMADES, HAIR BLEACHES, IN CLASS 3 (U.S. CLS. 1, 4, 6, 50, 51 AND 52).

OWNER OF JAPAN REG. NO. 5290613, DATED 12-25-2009, EXPIRES 12-25-2019.

OWNER OF U.S. REG. NO. 3,389,889.

NO CLAIM IS MADE TO THE EXCLUSIVE RIGHT TO USE "BEST PRO COLLECTION", APART FROM THE MARK AS SHOWN.

THE NAME(S), PORTRAIT(S), AND/OR SIGNATURE(S) SHOWN IN THE MARK IDENTIFIES "Y.S. PARK", WHOSE CONSENT(S) TO REGISTER IS MADE OF RECORD.

THE MARK CONSISTS OF THE MARK CONSISTS OF AN IMAGE OF A GLOBE INCLUDING LINES OF LATITUDE AND LINES OF LONGITUDE AND THE WORDING "Y.S.PARK BEST PRO COLLECTION" WITHIN THE BOUNDARIES OF THE GLOBE.

SER. NO. 85-014,480, FILED 4-15-2010.

ZACHARY BELLO, EXAMINING ATTORNEY



David J. Kypos

Director of the United States Patent and Trademark Office

United States of America

United States Patent and Trademark Office



Reg. No. 4,072,665

Registered Dec. 20, 2011

Int. Cls.: 3, 8, 11, 21 and 26

TRADEMARK

PRINCIPAL REGISTER

Y.S.PARK PROFESSIONAL INC. (JAPAN LIMITED LIABILITY COMPANY), FORMERLY PARK WAY CO., LTD.
3-CHOME KAMI-OSAKI 9-2
SHINAGAWA-KU, TOKYO, JAPAN 141-0021

FOR: SHAMPOOS, HAIR OILS, COLOR RINSES, HAIR DYES, PERMANENT WAVE PREPARATIONS, HAIR CREAMS, HAIR SPRAY, HAIR TONICS, HAIR FIXERS, HAIR LACQUERS, HAIR RINSES, HAIR POMADES, HAIR BLEACHES, IN CLASS 3 (U.S. CLS. 1, 4, 6, 50, 51 AND 52).

FOR: HAIR CUTTING SCISSORS, RAZOR BLADES, STRAIGHT RAZORS, IN CLASS 8 (U.S. CLS. 23, 28 AND 44).

FOR: HAIR DRYERS; CAPS FOR HAIR DRYERS, NAMELY, ION DIFFUSERS AND COVERS FOR THE HEADS OF HAIR DRYERS FOR HEAT PROTECTION, IN CLASS 11 (U.S. CLS. 13, 21, 23, 31 AND 34).

FOR: COMBS, COMB CASES, HAIR BRUSHES, IN CLASS 21 (U.S. CLS. 2, 13, 23, 29, 30, 33, 40 AND 50).

FOR: HAIR BANDS, HAIR PIN AND GRIPS, IN CLASS 26 (U.S. CLS. 37, 39, 40, 42 AND 50).

OWNER OF JAPAN REG. NO. 5306925, DATED 3-5-2010, EXPIRES 3-5-2020.

OWNER OF U.S. REG. NO. 3,389,889.

THE NAME(S), PORTRAIT(S), AND/OR SIGNATURE(S) SHOWN IN THE MARK IDENTIFIES "Y.S. PARK", WHOSE CONSENT(S) TO REGISTER IS MADE OF RECORD.

THE MARK CONSISTS OF AN IMAGE OF AN UNCLOTHED BABY STANDING UPRIGHT AND HOLDING A GLOBE INCLUDING LINES OF LATITUDE AND LINES OF LONGITUDE AND THE WORDING "SAVE THE EARTH BY Y.S.PARK" WITHIN THE BOUNDARIES OF THE GLOBE.

SER. NO. 85-014,499, FILED 4-15-2010.

ZACHARY BELLO, EXAMINING ATTORNEY



David J. Kyffers

Director of the United States Patent and Trademark Office

United States of America

United States Patent and Trademark Office

CLOTHESHEAD

Reg. No. 4,072,666

Registered Dec. 20, 2011

Int. Cl.: 25

TRADEMARK

PRINCIPAL REGISTER

FINE LINE IMPORTS INC. (CANADA CORPORATION)
160 TYCOS DRIVE, SUITE 206
TORONTO, ONTARIO, CANADA M6B1W8

FOR: WOMEN'S CLOTHING, NAMELY, FASHION TOPS, SHIRTS, T-SHIRTS, BLOUSES, SWEATERS, VESTS, SKIRTS, PANTS, SHORTS, JACKETS, BLAZERS, DRESSES, BELTS, IN CLASS 25 (U.S. CLS. 22 AND 39).

FIRST USE 4-0-2010; IN COMMERCE 8-0-2010.

THE MARK CONSISTS OF STANDARD CHARACTERS WITHOUT CLAIM TO ANY PARTICULAR FONT, STYLE, SIZE, OR COLOR.

SER. NO. 85-015,719, FILED 4-16-2010.

JANICE L. MCMORROW, EXAMINING ATTORNEY



David J. Kybas

Director of the United States Patent and Trademark Office

United States of America

United States Patent and Trademark Office

art and science of transformation

Reg. No. 4,072,667

Registered Dec. 20, 2011

Int. Cls.: 35 and 42

SERVICE MARK

PRINCIPAL REGISTER

SCHROEDER & SCHROEDER INC. (CANADA CORPORATION)
70 ALLANHURST DRIVE
TORONTO, ONTARIO, CANADA M9A4K1

FOR: ADVICE AND INFORMATION CONCERNING COMMERCIAL BUSINESS MANAGEMENT; ADVICE IN THE FIELD OF BUSINESS MANAGEMENT AND MARKETING; ADVICE RELATING TO THE ORGANIZATION AND MANAGEMENT OF BUSINESS; ADVISORY SERVICES RELATING TO BUSINESS MANAGEMENT AND BUSINESS OPERATIONS; ASSISTANCE AND ADVICE REGARDING BUSINESS ORGANIZATION AND MANAGEMENT; ASSISTANCE IN MANAGEMENT OF BUSINESS ACTIVITIES; ASSISTANCE WITH BUSINESS MANAGEMENT AND PLANNING; ASSISTANCE, ADVISORY SERVICES AND CONSULTANT WITH REGARD TO BUSINESS PLANNING, BUSINESS ANALYSIS, BUSINESS MANAGEMENT, AND BUSINESS ORGANIZATION; ASSISTANCE, ADVISORY SERVICES AND CONSULTANT WITH REGARD TO BUSINESS PLANNING, BUSINESS ANALYSIS, BUSINESS MANAGEMENT, BUSINESS ORGANIZATION, MARKETING AND CUSTOMER ANALYSIS; BUSINESS ADMINISTRATION AND MANAGEMENT; BUSINESS ASSISTANCE, MANAGEMENT AND INFORMATION SERVICES; BUSINESS CONSULTATION AND MANAGEMENT REGARDING MARKETING ACTIVITIES AND LAUNCHING OF NEW PRODUCTS; BUSINESS CONSULTING SERVICES IN THE FIELD OF ORGANIZATIONAL CHANGE MANAGEMENT; BUSINESS CONSULTING SERVICES RELATING TO THE INTEGRATION OF THE AREAS OF BUSINESS PROCESS TECHNOLOGY, ORGANIZATIONAL LEARNING, CHANGE MANAGEMENT, AND OPERATIONAL SUSTAINABILITY; BUSINESS CONSULTING, MANAGEMENT, PLANNING AND SUPERVISION; BUSINESS INFORMATION MANAGEMENT; BUSINESS MANAGEMENT; BUSINESS MANAGEMENT AND ADVICE; BUSINESS MANAGEMENT AND CONSULTATION; BUSINESS MANAGEMENT AND ENTERPRISE ORGANIZATION CONSULTANT; BUSINESS MANAGEMENT CONSULTANT AND ADVISORY SERVICES; BUSINESS MANAGEMENT CONSULTANT AS WELL AS DEVELOPMENT OF PROCESSES FOR THE ANALYSIS AND THE IMPLEMENTATION OF STRATEGY PLANS AND MANAGEMENT PROJECTS; BUSINESS MANAGEMENT CONSULTANT SERVICES; BUSINESS MANAGEMENT CONSULTANT, ALSO VIA THE INTERNET; BUSINESS MANAGEMENT CONSULTATION; BUSINESS MANAGEMENT CONSULTATION IN THE FIELD OF EXECUTIVE AND LEADERSHIP DEVELOPMENT; BUSINESS MANAGEMENT CONSULTING; BUSINESS MANAGEMENT CONSULTING AND ADVISORY SERVICES; BUSINESS MANAGEMENT CONSULTING IN THE FIELD OF TEAM DEVELOPMENT; BUSINESS MANAGEMENT PLANNING; BUSINESS MANAGEMENT SUPERVISION; BUSINESS ORGANIZATION AND MANAGEMENT CONSULTING SERVICES; BUSINESS ORGANIZATION AND MANAGEMENT



David J. Kyffers

Director of the United States Patent and Trademark Office

Reg. No. 4,072,667 CONSULTANT INCLUDING PERSONNEL MANAGEMENT; BUSINESS ORGANIZATION AND MANAGEMENT CONSULTING; COMMERCIAL AND INDUSTRIAL MANAGEMENT ASSISTANCE; COMMERCIAL ASSISTANCE IN BUSINESS MANAGEMENT; COMMERCIAL BUSINESS MANAGEMENT; COMMERCIAL MANAGEMENT; CONSULTING SERVICES IN BUSINESS ORGANIZATION AND MANAGEMENT; CONSULTING SERVICES IN THE FIELDS OF BUSINESS MANAGEMENT, HUMAN RESOURCES, AND BUSINESS ORGANIZATIONAL DESIGN; CUSTOMER RELATIONSHIP MANAGEMENT; DATABASE MANAGEMENT; HELP IN THE MANAGEMENT OF BUSINESS AFFAIRS OR COMMERCIAL FUNCTIONS OF AN INDUSTRIAL OR COMMERCIAL ENTERPRISE; HUMAN CAPITAL MANAGEMENT OUTSOURCING SERVICES; HUMAN RESOURCES MANAGEMENT; INDUSTRIAL MANAGEMENT ASSISTANCE; INFORMATION, ADVISORY AND CONSULTANT SERVICES RELATING TO BUSINESS AND MANAGEMENT OR BUSINESS ADMINISTRATION, INCLUDING SUCH SERVICES PROVIDED ON LINE OR VIA THE INTERNET; MANAGEMENT AND COMPILATION OF COMPUTERIZED DATABASES; MANAGEMENT ASSISTANCE; PERSONNEL MANAGEMENT; PERSONNEL MANAGEMENT CONSULTATION; PERSONNEL MANAGEMENT CONSULTING; PROVIDING BUSINESS MANAGEMENT INFORMATION IN CONNECTION WITH CONSULTING AND ADVISORY SERVICES IN THE FIELD OF STRATEGIC PLANNING; PROVIDING INFORMATION IN THE FIELDS OF BUSINESS INNOVATION PROCESS, BUSINESS MANAGEMENT AND BUSINESS OPPORTUNITIES; PROVIDING ONLINE BUSINESS MANAGEMENT SERVICES INCLUDING ACCOUNTING, MARKETING, BUSINESS PROJECT MANAGEMENT, AND BUSINESS DEVELOPMENT; PROVIDING PUBLIC SECTOR CHANNEL STRATEGY DEVELOPMENT AND MANAGEMENT SERVICES, IN CLASS 35 (U.S. CLS. 100, 101 AND 102).

FOR: COMPUTER PROGRAMMING SERVICES FOR OTHERS IN THE FIELD OF SOFTWARE CONFIGURATION MANAGEMENT; COMPUTER PROJECT MANAGEMENT SERVICES; COMPUTER SERVICES, NAMELY, REMOTE AND ON-SITE MANAGEMENT OF THE INFORMATION TECHNOLOGY (IT) SYSTEMS OF OTHERS; COMPUTER SERVICES, NAMELY, REMOTE MANAGEMENT OF COMPUTER APPLICATIONS FOR OTHERS; CONSULTING IN THE FIELD OF CONFIGURATION MANAGEMENT FOR COMPUTER HARDWARE AND SOFTWARE; CONSULTING IN THE FIELD OF IT PROJECT MANAGEMENT; TOOL MANAGEMENT SYSTEMS DESIGN SERVICES, IN CLASS 42 (U.S. CLS. 100 AND 101).

THE MARK CONSISTS OF STANDARD CHARACTERS WITHOUT CLAIM TO ANY PARTICULAR FONT, STYLE, SIZE, OR COLOR.

OWNER OF CANADA REG. NO. TMA791656, DATED 2-25-2011, EXPIRES 2-25-2026.

SER. NO. 85-016,464, FILED 4-17-2010.

RONALD AIKENS, EXAMINING ATTORNEY

United States of America

United States Patent and Trademark Office

^{asrt}
Scanner

Reg. No. 4,072,668

Registered Dec. 20, 2011

Int. Cl.: 16

TRADEMARK

PRINCIPAL REGISTER

THE AMERICAN SOCIETY OF RADIOLOGIC TECHNOLOGISTS (ILLINOIS CORPORATION)
15000 CENTRAL AVENUE, SE
ALBUQUERQUE, NM 871233909

FOR: PRINTED PUBLICATIONS, NAMELY, MAGAZINES IN THE FIELD OF RADIOLOGIC TECHNOLOGY AND TOPICS OF INTEREST TO MEMBERS OF AN ASSOCIATION IN THE FIELD OF RADIOLOGIC TECHNOLOGY, IN CLASS 16 (U.S. CLS. 2, 5, 22, 23, 29, 37, 38 AND 50).

FIRST USE 10-0-2008; IN COMMERCE 10-0-2008.

OWNER OF U.S. REG. NOS. 2,342,734, 2,342,735, AND 2,348,261.

THE MARK CONSISTS OF THE LITERAL ELEMENT "SCANNER" IN STYLIZED LETTERING OVER WHICH THE LITERAL ELEMENT "ASRT" APPEARS IN STYLIZED LETTERING OVER THE LETTER "C" IN "SCANNER". THERE IS A CURVED LINE OVER THE TOP OF THE LETTERS "ASRT".

SEC. 2(F) AS TO "SCANNER" .

SER. NO. 85-017,380, FILED 4-19-2010.

MARY BOAGNI, EXAMINING ATTORNEY



David J. Kypos

Director of the United States Patent and Trademark Office

United States of America

United States Patent and Trademark Office



Reg. No. 4,072,669

Registered Dec. 20, 2011

Int. Cl.: 19

TRADEMARK

PRINCIPAL REGISTER

CULZONI, FEDERICO GABRIEL (ARGENTINA INDIVIDUAL)
OBISPO BONEO 263
3000 SANTA FÉ, ARGENTINA AND

CULZONI, GABRIEL ALBERTO (ARGENTINA INDIVIDUAL)
OBISPO BONEO 263
3000 SANTA FÉ, ARGENTINA AND

CULZONI, HERNÁN PABLO (ARGENTINA INDIVIDUAL)
OBISPO BONEO 263
3000 SANTA FÉ, ARGENTINA

FOR: NON-METALLIC CONSTRUCTION MATERIALS, NAMELY, WHITE GRANITE, PRE-ELABORATED VOLCANIC GRANULES, CRUSHED MARBLE, WHITE CEMENT; NON-METALLIC RIGID TUBES FOR CONSTRUCTION, NAMELY, NON-METAL FILTERING TUBES TO PREVENT STORM WATER RUNOFF FROM ENTERING SEWER SYSTEMS; ASPHALT, PITCH AND BITUMEN; NON-METALLIC TRANSPORTABLE CONSTRUCTIONS; NON-METAL MONUMENTS, IN CLASS 19 (U.S. CLS. 1, 12, 33 AND 50).

FIRST USE 8-30-2008; IN COMMERCE 11-30-2008.

NO CLAIM IS MADE TO THE EXCLUSIVE RIGHT TO USE "PATIO", APART FROM THE MARK AS SHOWN.

THE COLOR(S) BROWN, BLACK AND BEIGE IS/ARE CLAIMED AS A FEATURE OF THE MARK.

THE MARK CONSISTS OF A SQUARE INSIDE OF WHICH APPEAR FOUR SMALLER SQUARES, BELOW OF WHICH APPEAR THE WORDS "PATIO BY CULZONI" IN STYLIZED LETTERS. THE COLOR BLACK APPEARS IN THE WORDING "PATIO BY CULZONI"; THE COLOR BEIGE APPEARS IN THE UPPER LEFT SQUARE OF THE DESIGN; AND THE COLOR BROWN APPEARS IN THE REMAINING THREE SQUARES OF THE MARK.

SER. NO. 85-017,740, FILED 4-19-2010.

BILL DAWE, EXAMINING ATTORNEY



David J. Kyffers

Director of the United States Patent and Trademark Office

United States of America

United States Patent and Trademark Office



Reg. No. 4,072,670

Registered Dec. 20, 2011

Int. Cls.: 35 and 39

SERVICE MARK

PRINCIPAL REGISTER

CONSTANTINE LOGISTICS LIMITED (UNITED KINGDOM COMPANY)
PRYSMIAN HOUSE DEW LANE, EASTLEIGH
SOUTHAMPTON, HAMPSHIRE, UNITED KINGDOM SO509PX

FOR: STRATEGIC PLANNING, MANAGEMENT AND CONSULTANCY FOR HUMANITARIAN AID AND RELIEF PROJECTS; STRATEGIC PLANNING, MANAGEMENT AND CONSULTANCY FOR RELOCATION PROJECTS; PREPARATION OF ATA CARNETS, NAMELY, INTERNATIONAL CUSTOMS DOCUMENTS THAT FACILITATE TEMPORARY IMPORT OF GOODS, ON BEHALF OF CLIENTS; PREPARATION OF CUSTOMS, BANKING AND SHIPPING DOCUMENTS ON BEHALF OF CLIENTS; CONSULTANCY SERVICES IN RELATION TO CUSTOMS CLEARANCE PROCEDURE, IN CLASS 35 (U.S. CLS. 100, 101 AND 102).

FOR: TRANSPORTATION AND ARRANGEMENT OF TRANSPORTATION OF PEOPLE OR GOODS; AIR FREIGHT, SEA FREIGHT, RAIL FREIGHT AND ROAD TRANSPORT SERVICES; IMPORT AND EXPORT CARGO HANDLING SERVICES; TRANSPORTATION OF DANGEROUS AND/OR HAZARDOUS GOODS AND SUBSTANCES; WAREHOUSING SERVICES; LOGISTICS MANAGEMENT IN THE FIELD OF TRANSPORTATION OF GOODS AND PEOPLE, IN CLASS 39 (U.S. CLS. 100 AND 105).

PRIORITY CLAIMED UNDER SEC. 44(D) ON ERPN CMNTY TM OFC APPLICATION NO. 009037375, FILED 4-19-2010, REG. NO. 009037375, DATED 10-26-2010, EXPIRES 4-19-2020.

THE COLOR(S) WHITE, BLACK, LIME GREEN, AND YELLOW IS/ARE CLAIMED AS A FEATURE OF THE MARK.

THE MARK CONSISTS OF THE WORDING "CEC" WITH BOTH LETTERS "C" IN WHITE AND THE LETTER "E" IN LIME GREEN. ABOVE THE LETTERS "E" AND "C" IS A STYLIZED GLOBE IN YELLOW WITH A BLACK GRID PATTERN, ALL OF WHICH APPEARS ON A BLACK RECTANGULAR BACKGROUND.

SER. NO. 85-018,246, FILED 4-20-2010.

CAROLYN CATALDO, EXAMINING ATTORNEY



David J. Kappas

Director of the United States Patent and Trademark Office

United States of America
United States Patent and Trademark Office

ROYSONS

Reg. No. 4,072,671

Registered Dec. 20, 2011

Int. Cl.: 27

TRADEMARK

PRINCIPAL REGISTER

ROYSONS CORPORATION (NEW JERSEY CORPORATION)
40 VANDERHOOF AVENUE
ROCKAWAY, NJ 07866

FOR: WALLPAPER AND WALL COVERINGS OF PAPER OR PAPER COATED WITH VINYL PLASTIC, WOVEN AND NON-WOVEN FABRIC SUBSTRATES FOR USE IN CONNECTION WITH WALLPAPER AND WALL COVERINGS; DIGITALLY PRINTED WALL COVERINGS; WALL COVERINGS COMPRISED OF ALL TYPES OF MATERIALS, IN CLASS 27 (U.S. CLS. 19, 20, 37, 42 AND 50).

FIRST USE 6-0-2003; IN COMMERCE 6-0-2003.

THE MARK CONSISTS OF STANDARD CHARACTERS WITHOUT CLAIM TO ANY PARTICULAR FONT, STYLE, SIZE, OR COLOR.

SER. NO. 85-018,303, FILED 4-20-2010.

ASMAT KHAN, EXAMINING ATTORNEY



David J. Kybas

Director of the United States Patent and Trademark Office

United States of America

United States Patent and Trademark Office



Reg. No. 4,072,672

Registered Dec. 20, 2011

Int. Cls.: 35 and 39

SERVICE MARK

PRINCIPAL REGISTER

CONSTANTINE LOGISTICS LIMITED (UNITED KINGDOM COMPANY)
PRYSMIAN HOUSE DEW LANE, EASTLEIGH
SOUTHAMPTON, HAMPSHIRE, UNITED KINGDOM SO509PX

FOR: STRATEGIC PLANNING, MANAGEMENT AND CONSULTANCY FOR HUMANITARIAN AID AND RELIEF PROJECTS; STRATEGIC PLANNING, MANAGEMENT AND CONSULTANCY FOR RELOCATION PROJECTS; PREPARATION OF ATA CARNETS, NAMELY, INTERNATIONAL CUSTOMS DOCUMENTS THAT FACILITATE TEMPORARY IMPORT OF GOODS, ON BEHALF OF CLIENTS; PREPARATION OF CUSTOMS, BANKING AND SHIPPING DOCUMENTS ON BEHALF OF CLIENTS; CONSULTANCY SERVICES IN RELATION TO CUSTOMS CLEARANCE PROCEDURE, IN CLASS 35 (U.S. CLS. 100, 101 AND 102).

FOR: TRANSPORTATION AND ARRANGEMENT OF TRANSPORTATION OF PEOPLE OR GOODS; AIR FREIGHT, SEA FREIGHT, RAIL FREIGHT AND ROAD TRANSPORT SERVICES; IMPORT AND EXPORT CARGO HANDLING SERVICES; TRANSPORTATION OF DANGEROUS AND/OR HAZARDOUS GOODS AND SUBSTANCES; WAREHOUSING SERVICES; LOGISTICS MANAGEMENT IN THE FIELD OF TRANSPORTATION OF GOODS AND PEOPLE, IN CLASS 39 (U.S. CLS. 100 AND 105).

PRIORITY CLAIMED UNDER SEC. 44(D) ON ERPN CMNTY TM OFC APPLICATION NO. 009037318, FILED 4-19-2010, REG. NO. 009037318, DATED 11-2-2010, EXPIRES 4-19-2020.

THE COLOR(S) DARK GREEN, LIGHT GREEN, AND WHITE IS/ARE CLAIMED AS A FEATURE OF THE MARK.

THE MARK CONSISTS OF A DIAMOND UNEVENLY DIVIDED BY A WHITE, WAVY LINE RUNNING FROM LOWER LEFT TO UPPER RIGHT. THE DIAMOND IS DARK GREEN TO THE LEFT OF THE DIVIDING LINE AND LIGHT GREEN TO THE RIGHT OF THE LINE.

SER. NO. 85-018,397, FILED 4-20-2010.

CAROLYN CATALDO, EXAMINING ATTORNEY



David J. Kyjars

Director of the United States Patent and Trademark Office

United States of America

United States Patent and Trademark Office

MI MUNDO INTERNATIONAL

Reg. No. 4,072,673

Registered Dec. 20, 2011

Int. Cl.: 35

SERVICE MARK

PRINCIPAL REGISTER

MI MUNDO INTERNATIONAL LLC (NEW JERSEY LIMITED LIABILITY COMPANY)
6500 DEWEY AVENUE
WEST NEW YORK, NJ 07093

FOR: WHOLESALE AND RETAIL STORE SERVICES FEATURING FOOD AND RESTAURANT SUPPLIES; DISTRIBUTORSHIP SERVICES IN THE FIELD OF WHOLESALE FOODS AND RESTAURANT SUPPLIES, IN CLASS 35 (U.S. CLS. 100, 101 AND 102).

FIRST USE 9-9-2009; IN COMMERCE 9-9-2009.

THE MARK CONSISTS OF STANDARD CHARACTERS WITHOUT CLAIM TO ANY PARTICULAR FONT, STYLE, SIZE, OR COLOR.

NO CLAIM IS MADE TO THE EXCLUSIVE RIGHT TO USE "INTERNATIONAL", APART FROM THE MARK AS SHOWN.

THE ENGLISH TRANSLATION OF "MI MUNDO" IN THE MARK IS MY WORLD.

SER. NO. 85-020,545, FILED 4-22-2010.

JAY BESCH, EXAMINING ATTORNEY



David J. Kyffers

Director of the United States Patent and Trademark Office

United States of America

United States Patent and Trademark Office

RIMMEL GLAM'EYES

Reg. No. 4,072,674

Registered Dec. 20, 2011

Int. Cl.: 3

TRADEMARK

PRINCIPAL REGISTER

COTY GERMANY GMBH (FED REP GERMANY CORPORATION)
RHEINSTRASSE 4E, FORT MALAKOFF PARK
MAINZ, FED REP GERMANY 55116

FOR: COSMETICS, IN CLASS 3 (U.S. CLS. 1, 4, 6, 50, 51 AND 52).

FIRST USE 7-31-2008; IN COMMERCE 7-31-2008.

THE MARK CONSISTS OF STANDARD CHARACTERS WITHOUT CLAIM TO ANY PARTICULAR FONT, STYLE, SIZE, OR COLOR.

OWNER OF U.S. REG. NOS. 2,976,346, 3,722,596 AND OTHERS.

SER. NO. 85-020,638, FILED 4-22-2010.

TINA L. SNAPP, EXAMINING ATTORNEY



David J. Kybas

Director of the United States Patent and Trademark Office

United States of America

United States Patent and Trademark Office



Reg. No. 4,072,675

ATTON, STEFAN (CANADA INDIVIDUAL), TA CHARLES TEA COMPANY
2232 OVERFIELD ROAD
OAKVILLE, ONTARIO, CANADA

Registered Dec. 20, 2011

Int. Cl.: 30

FOR: TEA, IN CLASS 30 (U.S. CL. 46).

TRADEMARK

PRIORITY CLAIMED UNDER SEC. 44(D) ON CANADA APPLICATION NO. 1477512, FILED 4-19-2010, REG. NO. TMA789007, DATED 1-28-2011, EXPIRES 1-28-2027.

PRINCIPAL REGISTER

NO CLAIM IS MADE TO THE EXCLUSIVE RIGHT TO USE "TEA" AND "FINEST CEYLON TEA", APART FROM THE MARK AS SHOWN.

THE MARK CONSISTS OF THE WORDING "CHARLES TEA", WITH A TEA LEAF IN BETWEEN "CHARLES" AND "TEA", OVER A BANNER THAT DEPICTS THE WORDING "FINEST CEYLON TEA".

SER. NO. 85-021,869, FILED 4-23-2010.

LAURIE MAYES, EXAMINING ATTORNEY



David J. Kybas

Director of the United States Patent and Trademark Office

United States of America

United States Patent and Trademark Office

KINECT

Reg. No. 4,072,676

Registered Dec. 20, 2011

Int. Cl.: 9

TRADEMARK

PRINCIPAL REGISTER

MICROSOFT CORPORATION (WASHINGTON CORPORATION)
ONE MICROSOFT WAY
REDMOND, WA 980526399

FOR: COMPUTER SOFTWARE FOR PLAYING VIDEO GAMES AND OPERATING SENSOR DEVICES, COMPUTER HARDWARE, AND COMPUTER PERIPHERALS; COMPUTER AND VIDEO GAME SYSTEM DEVICES, NAMELY, ELECTRONIC SENSOR DEVICES, CAMERAS, PROJECTORS, AND MICROPHONES FOR CAPTURING GESTURE, FACIAL, AND VOICE RECOGNITION; COMPUTER SOFTWARE FOR CONTROLLING PERSONAL COMPUTING AND ENTERTAINMENT DEVICES; COMPUTER SOFTWARE FOR CONTROLLING, VIEWING, ACCESSING, BROWSING AND UTILIZING GLOBAL COMPUTER, COMMUNICATION AND ENTERTAINMENT NETWORKS, IN CLASS 9 (U.S. CLS. 21, 23, 26, 36 AND 38).

FIRST USE 11-4-2010; IN COMMERCE 11-4-2010.

THE MARK CONSISTS OF STANDARD CHARACTERS WITHOUT CLAIM TO ANY PARTICULAR FONT, STYLE, SIZE, OR COLOR.

SER. NO. 85-023,473, FILED 4-26-2010.

DAVID I, EXAMINING ATTORNEY



David J. Kypos

Director of the United States Patent and Trademark Office

United States of America

United States Patent and Trademark Office



Reg. No. 4,072,677

Registered Dec. 20, 2011

Int. Cl.: 44

SERVICE MARK

PRINCIPAL REGISTER

DOCEPSILON LLC (TEXAS LIMITED LIABILITY COMPANY)
SUITE 136
8204 ELMBROOK, SUITE 136
DALLAS, TX 75247

FOR: PHYSICIAN SERVICES, IN CLASS 44 (U.S. CLS. 100 AND 101).

FIRST USE 4-1-2010; IN COMMERCE 4-1-2010.

THE MARK CONSISTS OF SIX DOTS ARRANGED IN 2 VERTICAL ROWS, WITH 3 DOTS IN EACH ROW. THE TOP LEFT DOT IS GREEN TOP RIGHT DOT IS RED; MIDDLE LEFT DOT IS GRAY, MIDDLE RIGHT DOT IS BLUE, BOTTOM LEFT DOT IS BLACK BOTTOM RIGHT DOT IS ORANGE.

THE COLOR(S) GREEN, RED, GRAY, BLUE, BLACK, AND ORANGE IS/ARE CLAIMED AS A FEATURE OF THE MARK.

SEC. 2(F).

SER. NO. 85-025,633, FILED 4-28-2010.

CURTIS FRENCH, EXAMINING ATTORNEY



David J. Kybas

Director of the United States Patent and Trademark Office

United States of America

United States Patent and Trademark Office

THE CONSTANT

Reg. No. 4,072,678

BAGHDADI, STEVEN (UNITED STATES INDIVIDUAL)
2005 EAST 13TH STREET
BROOKLYN, NY 11229

Registered Dec. 20, 2011

Int. Cl.: 9

FOR: MUSICAL SOUND RECORDINGS; PRE-RECORDED AUDIO CASSETTES, COMPACT DISCS, DVD'S AND VIDEO TAPES FEATURING PERFORMANCES BY A MUSICAL BAND, IN CLASS 9 (U.S. CLS. 21, 23, 26, 36 AND 38).

TRADEMARK

FIRST USE 1-2-2003; IN COMMERCE 1-2-2003.

PRINCIPAL REGISTER

THE MARK CONSISTS OF STANDARD CHARACTERS WITHOUT CLAIM TO ANY PARTICULAR FONT, STYLE, SIZE, OR COLOR.

SER. NO. 85-028,654, FILED 5-3-2010.

SETH A. RAPPAPORT, EXAMINING ATTORNEY



David J. Kyffers

Director of the United States Patent and Trademark Office

United States of America

United States Patent and Trademark Office

HIDDEN CHOICES

Reg. No. 4,072,679

HIDDEN CHOICES, INC. (CONNECTICUT NON-PROFIT CORPORATION)
P.O. BOX 194
GREEN FARMS, CT 06838

Registered Dec. 20, 2011

Int. Cls.: 35, 36 and 45

FOR: ASSOCIATION SERVICES, NAMELY, ORGANIZING AN ASSOCIATION OF MATERNITY HOMES AND PROMOTING THE INTERESTS OF MATERNITY HOMES FOR PREGNANT MOTHERS IN CRISIS; PROVIDING CAREER INFORMATION TO PARENTS, IN CLASS 35 (U.S. CLS. 100, 101 AND 102).

SERVICE MARK

PRINCIPAL REGISTER

FIRST USE 6-0-2004; IN COMMERCE 6-0-2004.

FOR: CHARITABLE FUNDRAISING SERVICES FOR MATERNITY HOMES AND THEIR RESIDENTS; PROVIDING FUNDING AND FINANCIAL ASSISTANCE TO MATERNITY HOMES; PROVIDING INFORMATION ON GOVERNMENTAL FINANCIAL ASSISTANCE PROGRAMS FOR PARENTS, IN CLASS 36 (U.S. CLS. 100, 101 AND 102).

FIRST USE 6-0-2004; IN COMMERCE 6-0-2004.

FOR: ADOPTION AND FOSTER CARE COUNSELING; PROVIDING COUNSELING FOR PREGNANT VICTIMS OF SEXUAL TRAFFICKING COMPRISING INTERVIEWING THE VICTIM, IDENTIFYING WHAT THE PROBLEM IS AND SUGGESTING WHERE HELP CAN BE OBTAINED; PROVIDING EMOTIONAL COUNSELING AND EMOTIONAL SUPPORT FOR PREGNANT WOMAN IN CRISIS AND THEIR FAMILIES; PROVIDING COUNSELING AND INFORMATION IN THE FIELD OF IMPROVEMENT OF SOCIAL SKILLS FOR PREGNANT WOMAN IN CRISIS AND THEIR FAMILIES, IN CLASS 45 (U.S. CLS. 100 AND 101).

FIRST USE 6-0-2004; IN COMMERCE 6-0-2004.

THE MARK CONSISTS OF STANDARD CHARACTERS WITHOUT CLAIM TO ANY PARTICULAR FONT, STYLE, SIZE, OR COLOR.

SER. NO. 85-033,982, FILED 5-10-2010.

ZHALEH DELANEY, EXAMINING ATTORNEY



David J. Kyffers

Director of the United States Patent and Trademark Office

United States of America

United States Patent and Trademark Office

TOPCUT BULLMER

Reg. No. 4,072,680

Registered Dec. 20, 2011

Int. Cls.: 7, 8, 9 and 42

TRADEMARK

SERVICE MARK

PRINCIPAL REGISTER

TOPCUT BULLMER GMBH (FED REP GERMANY GESELLSCHAFT MIT BESCHRÄNKTER HAFTUNG (GMBH))
HEUTAL 7
MEHRSTETTEN, FED REP GERMANY D-72537

FOR: MACHINES AND MACHINE TOOLS FOR THE CUTTING AND FORMING OF MATERIALS; MACHINES FOR CONVEYING SOLIDS; HYDRAULIC AND PNEUMATIC CONTROLS FOR MACHINES, MOTORS AND ENGINES; MACHINE PARTS FOR TEXTILE AND LEATHER HANDLING MACHINES, NAMELY, GUIDES AND HANGERS; MACHINES AND LINES COMPOSED THEREOF FOR THE PRODUCTION OF TECHNICAL TEXTILES AND STITCHING OF LEATHER; TEXTILE CUTTING, SEWING AND WEAVING MACHINES; AIR SUCTION MACHINES; SORTING MACHINES; MOTORS AND ENGINES EXCEPT FOR LAND VEHICLES; MACHINE COUPLING AND TRANSMISSION COMPONENTS, EXCEPT FOR LAND VEHICLES; LOADING AND UNLOADING MACHINES; MACHINES IN THE NATURE OF CONVEYORS OF TECHNICAL TEXTILES, COUTURE TEXTILES, HOME TEXTILES AND STITCHING LEATHER; BELTS FOR CONVEYORS; STACKING MACHINES; TEXTILE STRETCHING MACHINES AND MACHINE TOOLS; CUTTING MACHINES; BAND SAWS; MACHINE PARTS, NAMELY, WORK HOLDING FIXTURES FOR PRECISION MACHINING APPLICATIONS, IN CLASS 7 (U.S. CLS. 13, 19, 21, 23, 31, 34 AND 35).

FOR: HAND-OPERATED CUTTING TOOLS, IN CLASS 8 (U.S. CLS. 23, 28 AND 44).

FOR: SURVEYING MACHINES AND INSTRUMENTS; PHOTOGRAPHIC APPARATUS AND INSTRUMENTS, NAMELY, SCANNERS, AND OPTICAL CHARACTER READERS; CINEMATOGRAPHIC MACHINES AND APPARATUS; WEIGHING APPARATUS AND INSTRUMENTS; TECHNICAL MEASURING, TESTING AND CHECKING APPARATUS AND INSTRUMENTS FOR MEASURING, TESTING AND CHECKING THE TENSILE STRENGTH AND THICKNESS OF DRAPERY, FABRICS, LEATHER AND OTHER TEXTILES; EDUCATIONAL SOFTWARE FEATURING MACHINERY OPERATING INSTRUCTION; ELECTRONIC CONTROLS FOR MOTORS; ELECTRIC, FLOW, SOUND LEVEL AND VIBRATION METERS; SCANNERS; LUMINOUS POINTERS; CALCULATING MACHINES AND DATA-PROCESSING EQUIPMENT; COMPUTERS; ELECTRONIC INTERFACE EQUIPMENT FOR MACHINE TOOLS TO INPUT OR OUTPUT CNC, ESPECIALLY FOR AUTOMATIC CUTTING MACHINE DATA, IN CLASS 9 (U.S. CLS. 21, 23, 26, 36 AND 38).



David J. Kyjars

Director of the United States Patent and Trademark Office

Reg. No. 4,072,680 FOR: DESIGN, DEVELOPMENT, INSTALLATION AND MAINTENANCE OF COMPUTER SOFTWARE; DESIGN AND DEVELOPMENT OF COMPUTER HARDWARE, IN CLASS 42 (U.S. CLS. 100 AND 101).

THE MARK CONSISTS OF STANDARD CHARACTERS WITHOUT CLAIM TO ANY PARTICULAR FONT, STYLE, SIZE, OR COLOR.

OWNER OF ERPN CMNTY TM OFC REG. NO. 008678591, DATED 6-28-2010, EXPIRES 11-11-2019.

SER. NO. 85-034,583, FILED 5-10-2010.

IRA J. GOODSaid, EXAMINING ATTORNEY

United States of America

United States Patent and Trademark Office

CRAVE

Reg. No. 4,072,681

Registered Dec. 20, 2011

Int. Cl.: 29

TRADEMARK

PRINCIPAL REGISTER

UPSTATE NIAGARA COOPERATIVE, INC. (NEW YORK CORPORATION)
25 ANDERSON ROAD
BUFFALO, NY 14225

FOR: MILK, NAMELY, FLAVORED, SHELF-STABLE MILK IN SINGLE SERVE, SPECIALLY DESIGNED ALUMINUM BOTTLES THAT CAN BE STORED AT ROOM TEMPERATURE AND CHILLED QUICKLY, PRODUCED BY A NEW YORK STATE DAIRY COOPERATIVE AND SOLD TO RESELLERS, DISTRIBUTORS, AND RETAIL STORE OPERATORS, IN CLASS 29 (U.S. CL. 46).

FIRST USE 10-0-2010; IN COMMERCE 10-0-2010.

THE MARK CONSISTS OF STANDARD CHARACTERS WITHOUT CLAIM TO ANY PARTICULAR FONT, STYLE, SIZE, OR COLOR.

SER. NO. 85-035,040, FILED 5-11-2010.

KATHY DE JONGE, EXAMINING ATTORNEY



David J. Kyffers

Director of the United States Patent and Trademark Office

United States of America

United States Patent and Trademark Office

ECKO-CLIPZ

Reg. No. 4,072,682

Registered Dec. 20, 2011

Int. Cl.: 9

TRADEMARK

PRINCIPAL REGISTER

HPI INTERNATIONAL INC. (NEW YORK CORPORATION)
UNIT 1C
140 58TH STREET
BROOKLYN, NY 11220

FOR: HEADPHONES, IN CLASS 9 (U.S. CLS. 21, 23, 26, 36 AND 38).

FIRST USE 4-15-2010; IN COMMERCE 4-15-2010.

THE MARK CONSISTS OF STANDARD CHARACTERS WITHOUT CLAIM TO ANY PARTICULAR FONT, STYLE, SIZE, OR COLOR.

SER. NO. 85-036,310, FILED 5-12-2010.

CHARLES L. JENKINS, EXAMINING ATTORNEY



David J. Kyffers

Director of the United States Patent and Trademark Office

United States of America

United States Patent and Trademark Office

COLLABINAR

Reg. No. 4,072,683

Registered Dec. 20, 2011

Int. Cl.: 41

SERVICE MARK

PRINCIPAL REGISTER

SIATECH, INC. (CALIFORNIA CORPORATION)
2611 TEMPLE HEIGHTS DRIVE, SUITE A
OCEANSIDE, CA 92056

FOR: EDUCATIONAL SERVICES, NAMELY, CONDUCTING PANEL DISCUSSIONS AND SEMINARS ON TOPICS OF PROFESSIONAL DEVELOPMENT IN THE FIELD OF TEACHING VIA THE INTERNET, IN CLASS 41 (U.S. CLS. 100, 101 AND 107).

FIRST USE 10-31-2009; IN COMMERCE 10-31-2009.

THE MARK CONSISTS OF STANDARD CHARACTERS WITHOUT CLAIM TO ANY PARTICULAR FONT, STYLE, SIZE, OR COLOR.

SER. NO. 85-036,389, FILED 5-12-2010.

DOMINIC J. FERRAIUOLO, EXAMINING ATTORNEY



David J. Kyffers

Director of the United States Patent and Trademark Office

United States of America

United States Patent and Trademark Office

INDOOR GARDEN DEPOT

Reg. No. 4,072,684

IGD, INC. (OREGON CORPORATION), DBA INDOOR GARDEN DEPOT
4912 LOWER DRIVE

Registered Dec. 20, 2011

LAKE OSWEGO, OR 97035

Int. Cl.: 35

FOR: RETAIL LAWN, GARDEN AND NURSERY STORES, IN CLASS 35 (U.S. CLS. 100, 101 AND 102).

SERVICE MARK

FIRST USE 11-6-2007; IN COMMERCE 11-6-2007.

PRINCIPAL REGISTER

THE MARK CONSISTS OF STANDARD CHARACTERS WITHOUT CLAIM TO ANY PARTICULAR FONT, STYLE, SIZE, OR COLOR.

NO CLAIM IS MADE TO THE EXCLUSIVE RIGHT TO USE "INDOOR GARDEN", APART FROM THE MARK AS SHOWN.

SER. NO. 85-036,964, FILED 5-12-2010.

KATHRYN COWARD, EXAMINING ATTORNEY



David J. Kybas

Director of the United States Patent and Trademark Office

United States of America

United States Patent and Trademark Office

PAINT THE STATE

Reg. No. 4,072,685

Registered Dec. 20, 2011

Int. Cl.: 41

SERVICE MARK

PRINCIPAL REGISTER

THE METH PROJECT FOUNDATION (CALIFORNIA CORPORATION)
270 UNIVERSITY AVENUE
PALO ALTO, CA 94301

FOR: ELECTRONIC PUBLISHING SERVICES, NAMELY, PUBLICATION OF VIDEO, TEXT, AUDIO AND GRAPHIC WORKS OF OTHERS ON ELECTRONIC MEDIA, NAMELY, ONLINE WEB AND INTERNET, VIDEOTAPE, CDS, DVDS FEATURING METHAMPHETAMINE ABUSE AND PREVENTION INFORMATION; CONTEST AND INCENTIVE AWARD PROGRAMS TO PROMOTE THE PREVENTION OF METHAMPHETAMINE ABUSE, IN CLASS 41 (U.S. CLS. 100, 101 AND 107).

FIRST USE 5-10-2006; IN COMMERCE 5-15-2006.

THE MARK CONSISTS OF STANDARD CHARACTERS WITHOUT CLAIM TO ANY PARTICULAR FONT, STYLE, SIZE, OR COLOR.

SER. NO. 85-038,240, FILED 5-13-2010.

MATTHEW EINSTEIN, EXAMINING ATTORNEY



David J. Kyffers

Director of the United States Patent and Trademark Office

United States of America

United States Patent and Trademark Office

Studio Suite

Reg. No. 4,072,686

Registered Dec. 20, 2011

Int. Cl.: 9

TRADEMARK

PRINCIPAL REGISTER

ALTERMEDIA, INC. (GEORGIA CORPORATION)
24052 DEARBORN DRIVE
VALENCIA, CA 91354

FOR: COMPUTER SOFTWARE FOR CREATING SEARCHABLE DATABASES OF INFORMATION AND DATA; COMPUTER SOFTWARE FOR THE COLLECTION, EDITING, ORGANIZING, MODIFYING, BOOK MARKING, TRANSMISSION, STORAGE AND SHARING OF DATA AND INFORMATION; COMPUTER SOFTWARE USED BY AUDIO, VIDEO AND MULTI-MEDIA PRODUCTION STUDIOS FOR THE PURPOSE OF SCHEDULING, BUDGETING, INVOICING, PROJECT MANAGEMENT, MANAGING INVENTORIES, LINKING TO RELATED EMAIL, WRITTEN, AND DOCUMENTED VERBAL COMMUNICATIONS, MANAGING PHYSICAL AND DIGITAL MEDIA ASSETS, NAMELY, AUDIO, VIDEO, TEXT COMPUTER FILES AND RELATED METADATA LOCATED ON TAPE, FILM, CARTRIDGE, CD, DVD HARD DRIVES, RAM AND OTHER STORAGE MEDIA; COMPUTER SOFTWARE USED FOR REPORTING ON RESOURCE ALLOCATION FOR RESOURCES ASSOCIATED WITH MEDIA PRODUCTION FACILITIES, SUCH AS ROOMS, EQUIPMENT, PEOPLE, PHYSICAL MEDIA PRODUCTS AND SERVICES; DATABASE MANAGEMENT SOFTWARE FOR USE BY AUDIO, VIDEO AND MULTI-MEDIA PRODUCTION STUDIOS FOR THE PURPOSE OF RESOURCE MANAGEMENT AND TRACKING, BUDGETING, ACTUALIZATION, INVOICING, CONTACT MANAGEMENT, TASK MANAGEMENT, AND THE MANAGEMENT OF PHYSICAL AND DIGITAL MEDIA ASSETS, NAMELY, AUDIO, VIDEO, TEXT COMPUTER FILES AND RELATED METADATA LOCATED ON TAPE, FILM, CARTRIDGE, CD, DVD HARD DRIVES, RAM AND OTHER STORAGE MEDIA, IN CLASS 9 (U.S. CLS. 21, 23, 26, 36 AND 38).



FIRST USE 8-25-1997; IN COMMERCE 8-25-1997.

THE MARK CONSISTS OF STANDARD CHARACTERS WITHOUT CLAIM TO ANY PARTICULAR FONT, STYLE, SIZE, OR COLOR.

NO CLAIM IS MADE TO THE EXCLUSIVE RIGHT TO USE "SUITE", APART FROM THE MARK AS SHOWN.

SEC. 2(F).

SER. NO. 85-039,689, FILED 5-16-2010.

David J. Kybas

Director of the United States Patent and Trademark Office

Reg. No. 4,072,686 WENDY GOODMAN, EXAMINING ATTORNEY

United States of America

United States Patent and Trademark Office

Wags Pet Center

Reg. No. 4,072,687

Registered Dec. 20, 2011

Int. Cl.: 45

SERVICE MARK

PRINCIPAL REGISTER

WAGS PET CENTER INC. (NEW YORK CORPORATION)

#B

3770 LEE MULROY ROAD
SYRACUSE, NY 13108

FOR: PET SITTING, IN CLASS 45 (U.S. CLS. 100 AND 101).

FIRST USE 1-0-2000; IN COMMERCE 3-0-2008.

THE MARK CONSISTS OF STANDARD CHARACTERS WITHOUT CLAIM TO ANY PARTICULAR FONT, STYLE, SIZE, OR COLOR.

NO CLAIM IS MADE TO THE EXCLUSIVE RIGHT TO USE "PET CENTER", APART FROM THE MARK AS SHOWN.

SER. NO. 85-040,866, FILED 5-17-2010.

PAUL E. FAHRENKOPF, EXAMINING ATTORNEY



David J. Kybas

Director of the United States Patent and Trademark Office

United States of America

United States Patent and Trademark Office



Reg. No. 4,072,688

REYNAUD, LEON (UNITED STATES INDIVIDUAL)
8007 CLYDE DENT DR.
SAN ANTONIO, TX 78250

Registered Dec. 20, 2011

Int. Cl.: 41

FOR: RECORD COMPANY SERVICES, NAMELY, SOUND RECORDING AND RECORD PRODUCTION, IN CLASS 41 (U.S. CLS. 100, 101 AND 107).

SERVICE MARK

FIRST USE 12-1-2009; IN COMMERCE 12-1-2009.

PRINCIPAL REGISTER

NO CLAIM IS MADE TO THE EXCLUSIVE RIGHT TO USE "ENTERTAINMENT", APART FROM THE MARK AS SHOWN.

THE MARK CONSISTS OF A PROFILE OF TWO LIONS STANDING ON THEIR HIND LEGS, WITH WINGS, WEARING A CROWN AND TONGUES STICKING OUT, ON THE RIGHT AND LEFT SIDE OF AN ORNAMENTAL CENTERPIECE, WHICH INCORPORATES A CROWN, ABOVE THE WORDS "WE CHANGE LIVES", ARCHED UPWARDS WITHIN A DECORATIVE FRAMING, ABOVE THE STYLIZED LETTERS "NV" SURROUNDED BY DECORATIVE FRAMING AND DESIGN ABOVE THE WORDING "NV ENTERTAINMENT", WITHIN A BANNER.

SER. NO. 85-041,177, FILED 5-18-2010.

PRISCILLA MILTON, EXAMINING ATTORNEY



David J. Kybas

Director of the United States Patent and Trademark Office

United States of America

United States Patent and Trademark Office

IMAGINE NATION LEARNING CENTER

Reg. No. 4,072,689

IMAGINE NATION LEARNING CENTER (NEW JERSEY LIMITED LIABILITY COMPANY)
1 MALANGA CT
SCOTCH PLAINS, NJ 07076

Registered Dec. 20, 2011

Int. Cl.: 43

FOR: PRESCHOOLER AND INFANT CARE AT DAYCARE CENTERS, IN CLASS 43 (U.S. CLS. 100 AND 101).

SERVICE MARK

FIRST USE 1-1-2000; IN COMMERCE 1-1-2003.

PRINCIPAL REGISTER

THE MARK CONSISTS OF STANDARD CHARACTERS WITHOUT CLAIM TO ANY PARTICULAR FONT, STYLE, SIZE, OR COLOR.

NO CLAIM IS MADE TO THE EXCLUSIVE RIGHT TO USE "LEARNING CENTER", APART FROM THE MARK AS SHOWN.

SER. NO. 85-041,366, FILED 5-18-2010.

HEATHER BIDDULPH, EXAMINING ATTORNEY



David J. Kyffers

Director of the United States Patent and Trademark Office

United States of America

United States Patent and Trademark Office

THE NOW PASS

Reg. No. 4,072,690

Registered Dec. 20, 2011

Int. Cl.: 35

SERVICE MARK

PRINCIPAL REGISTER

ESSENTIAL MEDIA PARTNERS, LLC (D.C. LIMITED LIABILITY COMPANY), AKA
ESSENTIAL MEDIA PARTNERS
1875 K STREET NORTH WEST, SUITE 400
WASHINGTON, DC 20006

FOR: MANAGEMENT OF EVENT TICKETING FOR OTHERS; ADVERTISING, MARKETING
AND PROMOTION SERVICES; PROMOTING THE GOODS AND SERVICES OF OTHERS
BY DISTRIBUTING ADVERTISING MATERIALS THROUGH A VARIETY OF METHODS,
IN CLASS 35 (U.S. CLS. 100, 101 AND 102).

FIRST USE 5-1-2010; IN COMMERCE 5-6-2010.

THE MARK CONSISTS OF STANDARD CHARACTERS WITHOUT CLAIM TO ANY PAR-
TICULAR FONT, STYLE, SIZE, OR COLOR.

SER. NO. 85-041,388, FILED 5-18-2010.

ROBERT C. CLARK JR., EXAMINING ATTORNEY



David J. Kybas

Director of the United States Patent and Trademark Office

United States of America

United States Patent and Trademark Office

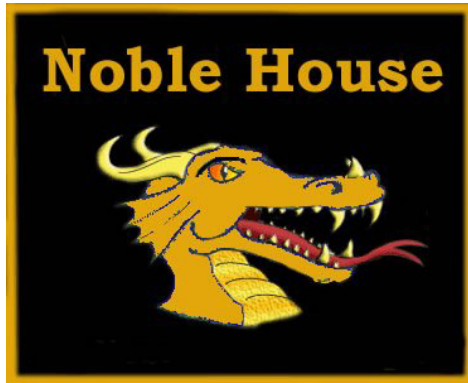

Reg. No. 4,072,691

Registered Dec. 20, 2011

Int. Cl.: 25

TRADEMARK

PRINCIPAL REGISTER

ALEXANDER MEHRINGER + NINA WAGNER (FED REP GERMANY PARTNERSHIP)
FRAUENSTR.122
ULM, FED REP GERMANY 89073

FOR: LEATHER JACKETS, IN CLASS 25 (U.S. CLS. 22 AND 39).

OWNER OF FED REP GERMANY REG. NO. 004585618, DATED 9-12-2005, EXPIRES 9-12-2015.

THE COLOR(S) GOLD, BLACK, YELLOW AND RED IS/ARE CLAIMED AS A FEATURE OF THE MARK.

THE MARK CONSISTS OF A BLACK RECTANGLE WITH A GOLD BORDER. A GOLD DRAGON WITH A RED TONGUE, YELLOW HORNS AND A YELLOW CHEST APPEARS INSIDE THE RECTANGLE. ABOVE THE DRAGON APPEARS THE WORDING "NOBLE HOUSE" IN GOLD.

SER. NO. 85-042,164, FILED 5-19-2010.

CAROLINE WOOD, EXAMINING ATTORNEY



David J. Kyffers

Director of the United States Patent and Trademark Office

United States of America

United States Patent and Trademark Office

SULWHASOO HPF (HEAT PROTECTION FACTOR)

Reg. No. 4,072,692

AMOREPACIFIC CORPORATION (REPUBLIC OF KOREA CORPORATION)
181, 2-KA, HANGANG-RO, YONGSAN-KU
SEOUL, REPUBLIC OF KOREA

Registered Dec. 20, 2011

Int. Cl.: 3

FOR: COSMETICS; BEAUTY MASKS; COSMETIC SOAPS; COSMETIC NOURISHING CREAMS; COSMETIC SKIN FRESHENERS; CREAMY FOUNDATION; COSMETIC MILKS, NAMELY, MOISTURIZING ESSENCE IN THE NATURE OF MILKY LOTION; EYE SHADOWS, IN CLASS 3 (U.S. CLS. 1, 4, 6, 50, 51 AND 52).

TRADEMARK

PRINCIPAL REGISTER

THE MARK CONSISTS OF STANDARD CHARACTERS WITHOUT CLAIM TO ANY PARTICULAR FONT, STYLE, SIZE, OR COLOR.

OWNER OF JAPAN REG. NO. 5356418, DATED 9-24-2010, EXPIRES 9-24-2020.

OWNER OF U.S. REG. NOS. 2,764,970 AND 3,674,914.

NO CLAIM IS MADE TO THE EXCLUSIVE RIGHT TO USE "(HEAT PROTECTION FACTOR)", APART FROM THE MARK AS SHOWN.

THE ENGLISH TRANSLATION OF "SUL WHA SOO" IN THE MARK IS "SNOW FLOWER EXCELLENCE".

SER. NO. 85-042,482, FILED 5-19-2010.

TRICIA SONNEBORN, EXAMINING ATTORNEY



David J. Kyros

Director of the United States Patent and Trademark Office

United States of America

United States Patent and Trademark Office

Paragon Ambulatory Health Resources

Reg. No. 4,072,693

Registered Dec. 20, 2011

Int. Cl.: 44

SERVICE MARK

PRINCIPAL REGISTER

PARAGON AMBULATORY HEALTH RESOURCES, LLC (TEXAS LIMITED LIABILITY COMPANY)
7232 GLENDORA AVE.
DALLAS, TX 75230

FOR: MEDICAL SERVICES, NAMELY, ANESTHESIA FOR IN-OFFICE SURGICAL PROCEDURES IN THE FIELD OF OBSTETRICS AND GYNECOLOGY, NOT INCLUDING ANESTHESIA PROVIDED FOR CRITICAL CARE PURPOSES; PROVIDING MEDICAL INFORMATION, CONSULTANCY AND ADVISORY SERVICES RELATED TO ANESTHESIA FOR IN-OFFICE SURGICAL PROCEDURES IN THE FIELD OF OBSTETRICS AND GYNECOLOGY, NOT INCLUDING ANESTHESIA PROVIDED FOR CRITICAL CARE PURPOSES, IN CLASS 44 (U.S. CLS. 100 AND 101).

FIRST USE 6-19-2008; IN COMMERCE 6-19-2008.

THE MARK CONSISTS OF STANDARD CHARACTERS WITHOUT CLAIM TO ANY PARTICULAR FONT, STYLE, SIZE, OR COLOR.

NO CLAIM IS MADE TO THE EXCLUSIVE RIGHT TO USE "AMBULATORY HEALTH RESOURCES", APART FROM THE MARK AS SHOWN.

SER. NO. 85-042,854, FILED 5-19-2010.

BERYL GARDNER, EXAMINING ATTORNEY



David J. Kyffers

Director of the United States Patent and Trademark Office

United States of America

United States Patent and Trademark Office



Reg. No. 4,072,694

LOEW-CORNELL, LLC (DELAWARE LIMITED LIABILITY COMPANY)
300 GAP WAY
ERLANGER, KY 41018

Registered Dec. 20, 2011

**Int. Cls.: 2, 8, 16, 18, 20
and 25**

FOR: PAINT FOR ARTISTS, IN CLASS 2 (U.S. CLS. 6, 11 AND 16).

FIRST USE 2-28-2008; IN COMMERCE 2-28-2008.

TRADEMARK

FOR: PALETTE KNIVES AND PAINTING KNIVES, IN CLASS 8 (U.S. CLS. 23, 28 AND 44).

PRINCIPAL REGISTER

FIRST USE 2-28-2010; IN COMMERCE 2-28-2010.

FOR: ART KITS, NAMELY, ART SUPPLIES COMBINED INTO A SINGLE SALEABLE KIT COMPRISED OF ITEMS SELECTED FROM PAINT BRUSHES, PAINT, PENCILS, ARTIST PAPER, ERASERS, AND PALETTES; ART MEDIA, NAMELY, WATERCOLORS, PASTELS, MARKERS, ARTIST PENS, AND ARTIST PENCILS; DRAWING SUPPLIES, NAMELY, BLENDING STUMPS IN THE NATURE OF STICKS MADE OF PAPER FOR SMUDGING, BLENDING AND TEXTURING GRAPHITE, CHARCOAL AND COLORED PENCILS, BLENDING TORTILLIONS IN THE NATURE OF STICKS MADE OF PAPER FOR SMUDGING, BLENDING AND TEXTURING GRAPHITE, CHARCOAL AND COLORED PENCILS, SANDPAPER FOR SHARPENING DRAWING PENCILS, PENCIL SHARPENERS, ERASERS, SKETCH PADS, AND ART PAPER AND PADS; PAINTING SUPPLIES, NAMELY, PAINT BRUSHES, PAINT BRUSH SETS, ARTISTS' PAINT PENS, PAINT APPLICATORS IN THE NATURE OF SPONGES, FOAM PAINT APPLICATORS, STENCILS, AND EASELS; ART AND CRAFT ORGANIZATION TOOLS, NAMELY, PAINT TRAYS, IN CLASS 16 (U.S. CLS. 2, 5, 22, 23, 29, 37, 38 AND 50).

FIRST USE 2-28-2008; IN COMMERCE 2-28-2008.

FOR: CANVAS CRAFT SUPPLIES, NAMELY, TOTE BAGS AND ALL-PURPOSE CARRYING BAGS, IN CLASS 18 (U.S. CLS. 1, 2, 3, 22 AND 41).

FIRST USE 2-28-2008; IN COMMERCE 2-28-2008.

FOR: WOOD CRAFT SUPPLIES, NAMELY, WOODEN CRAFT STICKS, WOODEN SHAPES, WOODEN LETTERS, AND OTHER WOODEN PIECES USED AS COMPONENTS OF



David J. Kyjars

Director of the United States Patent and Trademark Office

Reg. No. 4,072,694 ARTISTIC WORK; STANDS, NAMELY, DISPLAY STANDS FOR ARTWORK; NON-METAL ART STORAGE BINS, IN CLASS 20 (U.S. CLS. 2, 13, 22, 25, 32 AND 50).

FIRST USE 2-28-2008; IN COMMERCE 2-28-2008.

FOR: CANVAS ARTIST APRONS, IN CLASS 25 (U.S. CLS. 22 AND 39).

FIRST USE 2-28-2010; IN COMMERCE 2-28-2010.

OWNER OF U.S. REG. NOS. 1,354,002, 2,599,173, AND 3,165,968.

THE MARK CONSISTS OF A SQUARE WITH A PORTION OF A CIRCLE EXTENDING FROM THE UPPER RIGHT HAND CORNER OF THE SQUARE TOWARDS THE CENTER OF THE SQUARE WITH THE LITERAL ELEMENT "LOEW" POSITIONED TO THE RIGHT SIDE OF THE SQUARE ADJACENT THE UPPER RIGHT SIDE OF THE SQUARE ABOVE THE LITERAL ELEMENT "CORNELL" LOCATED ADJACENT TO THE LOWER RIGHT SIDE OF THE SQUARE.

SER. NO. 85-042,996, FILED 5-19-2010.

CHRIS WELLS, EXAMINING ATTORNEY

United States of America

United States Patent and Trademark Office

CLEAN START

Reg. No. 4,072,695

INTERNATIONAL DERMAL INSTITUTE, INC. (CALIFORNIA CORPORATION)
1555 BEACHEY PLACE
CARSON, CA 90746

Registered Dec. 20, 2011

Int. Cls.: 3 and 35

FOR: NON-MEDICATED SKIN CARE PREPARATIONS; SKIN CLEANSERS; SKIN TONERS; SKIN CONDITIONERS; SKIN MASQUES; SKIN MOISTURIZERS; BODY WASHES; BODY SCRUBS; SKIN SCRUBS; NON-MEDICATED SUN CARE PREPARATIONS AND NON-MEDICATED LIP CARE PREPARATIONS, IN CLASS 3 (U.S. CLS. 1, 4, 6, 50, 51 AND 52).

TRADEMARK

SERVICE MARK

FIRST USE 3-0-2009; IN COMMERCE 3-0-2009.

PRINCIPAL REGISTER

FOR: ONLINE RETAIL STORE SERVICES IN THE FIELD OF SKIN CARE PREPARATIONS, IN CLASS 35 (U.S. CLS. 100, 101 AND 102).

FIRST USE 4-0-2009; IN COMMERCE 4-0-2009.

THE MARK CONSISTS OF STANDARD CHARACTERS WITHOUT CLAIM TO ANY PARTICULAR FONT, STYLE, SIZE, OR COLOR.

SER. NO. 85-044,227, FILED 5-20-2010.

CHARLOTTE CORWIN, EXAMINING ATTORNEY



David J. Kypos

Director of the United States Patent and Trademark Office

United States of America

United States Patent and Trademark Office



Reg. No. 4,072,696

MIDWEST INDUSTRIAL SUPPLY, INC. (OHIO CORPORATION)
1101 3RD STREET, S. E.
CANTON, OH 447073230

Registered Dec. 20, 2011

**Int. Cls.: 1, 3, 4, 7, 9, 17,
19 and 37**

FOR: CHEMICAL WATER REPELLENT TREATMENT FOR USE OF CONVEYOR BELTS; CHEMICAL ADHESIVE USED IN CEMENTING SURFACE DUST PARTICLES TOGETHER AND THEN CEMENTING THE BOUND SURFACE LAYER TO THE ROAD BED SUBBASE; CHEMICALS, NAMELY, DE-ICING, ANTI-ICING, AND SNOW MELTING FORMULATIONS FOR USE ON RAILROAD SWITCHES; CHEMICAL DE-ICER AND PREVENTOR FOR USE OF COAL MINING EQUIPMENT; CHEMICAL BLEND OF IONIC AND NON-IONIC SURFACTANTS FOR USE IN ENHANCING THE EFFECTIVENESS OF WATER TO SUPPRESS DUST ON ROADWAY BED SURFACES; CHEMICAL COMPOSITIONS FOR SUPPRESSING LEAD BEARING DUST PARTICLES; CHEMICAL PRODUCT APPLIED TO ROAD SURFACES FOR DUST SUPPRESSION; CHEMICAL PRODUCT APPLIED TO COAL TO CREATE A WIND AND FRACTURE-RESISTANT SURFACE COATING AND TO ELIMINATE WIND-BLOWN DUST AND MATERIAL LOSS FROM UNIT COAL TRAINS; CHEMICAL COMPOSITIONS APPLIED TO COAL, COKE, LIMESTONE, CINDER AND OTHER MATERIALS FOR SHORT-TERM DUST SUPPRESSION; CHEMICAL USED FOR DUST SUPPRESSION, SPECIFICALLY FORMULATED FOR SUPPRESSION OF PM10 AND TSP AT THE SOURCE WITH DOWNSTREAM EFFECTIVENESS; CHEMICAL PRODUCT, NAMELY, SIDE RELEASE AGENT FOR PREVENTING COAL, ORE, SINTER AND OTHER MINERALS FROM FREEZING TO STORAGE AND TRANSPORTATION CONTAINERS; SOIL STABILIZING AGENTS FOR STABILIZING SOILS AND SOIL SURFACE SEALING AGENTS FOR DUST CONTROL; ENVIRONMENTALLY FRIENDLY ANTI-ICING AND DE-ICING LIQUID PREPARATIONS COMPRISING A NON-TOXIC FREEZING POINT DEPRESSANT AND A THICKENER FOR USE ON EXPOSED SURFACES OF RAILWAY EQUIPMENT, MATERIALS HANDLING EQUIPMENT AND MANUFACTURING EQUIPMENT, AND ON ROADWAYS, PARKING LOTS, RUNWAYS AND AIRPLANES FOR THE PREVENTION AND REMOVAL OF ICE ACCUMULATION ON SUCH SURFACES; POLYMER SPRAY-ON FUME AND ODOR SEALANT FOR USE IN MANAGING CONTAMINATED WASTE SITES; CHEMICAL SURFACTANT FOR THE COLLECTION AND SUPPRESSION OF AIRBORNE DUST PARTICLES FOR USE IN COAL MINING OPERATIONS; CHEMICAL SURFACTANT ADHESIVE FOR COAL; SOIL STABILIZATION CHEMICALS FOR EROSION CONTROL AND CONSTRUCTION OF GOLF COURSE SAND TRAPS AND BUNKERS; DUST CONTROL CHEMICAL FOR USE ON INDOOR AND OUTDOOR SPORTS PLAYING FIELDS; CHEMICAL SYNTHETIC FLUID BASED ANTI-STICKING AGENT AND EQUIPMENT MATERIAL FLOW LUBRICANT; DUST SUPPRESSION COMPOSITIONS MADE UP OF SYNTHETIC ORGANIC MATERIAL

TRADEMARK

SERVICE MARK

PRINCIPAL REGISTER



David J. Kyros

Director of the United States Patent and Trademark Office

Reg. No. 4,072,696 IN LIQUID FORM FOR COAL, MINERALS, ORES AND SYNFUEL; CHEMICAL ADHESIVE FOR USE IN COMBINATION WITH RECYCLED ASPHALT PAVEMENT TO FORM A PROSCRIBED DENSE COMPACTED DURABLE DUST-FREE SURFACE; DE-ICER FOR RAILROAD SWITCHES; CHEMICAL ADHESIVE USED IN CEMENTING SURFACE DUST AND SURFACE PARTICLES TOGETHER AND THEN CEMENTING THE BOUND SURFACE LAYER TO A SUBBASE, INCLUDING ROAD BASE EARTHWORK, BARE GROUND ENVIRONMENTS, CLEAR CUT OR EXCAVATED AREAS, AND SUBBASE WHICH IS SUBJECT TO WIND, WATER AND VEHICLE EROSION; CHEMICALS, NAMELY A DUST STABILIZING AGENT SPECIFICALLY FOR USE IN HORSE ARENAS, STABLE AREAS AND RUNNING TRACKS; CHEMICALS USED TO STABILIZE SOIL, PROVIDE DUST CONTROL AND PREVENT EROSION; CHEMICAL SPRAYS FOR TREATING AND BINDING MULCH FIBERS TO PREVENT LOSS DUE TO WIND AND RAIN EROSION; DE-ICING LIQUIDS FOR USE ON RAILWAY EQUIPMENT, MATERIAL HANDLING EQUIPMENT, MANUFACTURING EQUIPMENT, ROADWAYS, PARKING LOTS, RUNWAYS AND AIRPLANES, AND CHEMICAL ADDITIVES FOR USE THEREWITH, IN CLASS 1 (U.S. CLS. 1, 5, 6, 10, 26 AND 46).

FIRST USE 4-30-2009; IN COMMERCE 4-30-2009.

FOR: FOAMABLE LIQUID CLEANING MATERIAL TO REMOVE DUST AND DIRT FROM WALLS, CEILINGS, CEILING GIRDERS AND FRAMEWORK OF MANUFACTURING AND STORAGE FACILITIES, INCLUDING COAL BUNKERS, IN CLASS 3 (U.S. CLS. 1, 4, 6, 50, 51 AND 52).

FIRST USE 4-30-2009; IN COMMERCE 4-30-2009.

FOR: ALL-PURPOSE PENETRATING AND LUBRICATING OILS FOR SURFACE TREATMENTS OF METALS; ORGANIC AND INORGANIC DUST ABSORBING AND STABILIZING COMPOSITIONS FOR USE IN ROAD BUILDING AND COAL MINING APPLICATIONS; ORGANIC AND INORGANIC DUST SUPPRESSION COMPOSITIONS FOR USE IN ROAD BUILDING AND COAL MINING APPLICATIONS; DUST LAYING AND ABSORBING COMPOSITIONS FOR USE ON UNPAVED ROADS, IN CLASS 4 (U.S. CLS. 1, 6 AND 15).

FIRST USE 4-30-2009; IN COMMERCE 4-30-2009.

FOR: PUMPS AND APPLICATORS FOR MACHINES, NAMELY, PUMP AND APPLICATOR FOR LIQUIDS, NAMELY, FOR APPLYING DUST SUPPRESSING COMPOUNDS; POWER OPERATED SPRAY SYSTEMS COMPRISED OF CONTROL PANELS, POWER SUPPLY MODULES, STORAGE TANKS, PUMPS, MOTORS, PRESSURE REGULATORS, CONTROL VALVES, ELECTRIC SOLENOID VALVES AND HOSES, FOR DELIVERING ANTI-ICERS AND DE-ICERS THROUGH ELECTRONIC RAILS USED WITH RAILED TRANSPORT VEHICLES; PORTABLE DUST SUPPRESSION MACHINES FOR APPLYING DUST SUPPRESSION CHEMICALS TO THE GROUND FOR USE IN MINING, STOCK PILES, OPEN AREAS, LANDFILLS, ROAD CONSTRUCTION, UNPAVED ROADWAYS, AISLE WAYS, PARKING LOTS, VEHICLE STAGING AREAS, AIRPORT RUNWAYS, AVIATION TAKE OFF AND LANDING ZONES, CAMPGROUNDS, TRAILS, PATHS, WALKWAYS, ARENAS AND TRUCK TERMINALS; AND POWER OPERATED SELF-CONTAINED VEHICLE MOUNTED SPRAYER SYSTEMS COMPRISED OF HOSES, SPRAYER NOZZLES, STORAGE TANKS AND CONTROL VALVES FOR DUST SUPPRESSING COMPOUNDS, IN CLASS 7 (U.S. CLS. 13, 19, 21, 23, 31, 34 AND 35).

FIRST USE 4-30-2009; IN COMMERCE 4-30-2009.

FOR: MACHINE FOR TESTING THE QUALITY AND STRENGTH OF SOIL, IN CLASS 9 (U.S. CLS. 21, 23, 26, 36 AND 38).

FIRST USE 4-30-2009; IN COMMERCE 4-30-2009.

Reg. No. 4,072,696 FOR: SELF-CONTAINED PORTABLE FOAM INSULATION GENERATING SYSTEM COMPRISED OF CONTROL PANELS, POWER SUPPLY MODULES, STORAGE TANKS, PUMPS, MOTORS, PRESSURE REGULATORS, CONTROL VALVES, NOZZLES, AND HOSES TO SPRAY A DRY CONTENT FOAM ON WALLS, CEILINGS, GIRDERS AND FRAMEWORK OF INDUSTRIAL FACILITIES AND STORAGE AREAS, IN CLASS 17 (U.S. CLS. 1, 5, 12, 13, 35 AND 50).

FIRST USE 4-30-2009; IN COMMERCE 4-30-2009.

FOR: RESIN MODIFIED EMULSION USED AS FLEXIBLE PAVEMENT, IN CLASS 19 (U.S. CLS. 1, 12, 33 AND 50).

FIRST USE 4-30-2009; IN COMMERCE 4-30-2009.

FOR: INSTALLATION SERVICES, NAMELY, THE INSTALLATION OF FOOTING AND FLOORING IN INDOOR AND OUTDOOR EQUINE RIDING ARENAS, IN CLASS 37 (U.S. CLS. 100, 103 AND 106).

FIRST USE 4-30-2009; IN COMMERCE 4-30-2009.

OWNER OF U.S. REG. NO. 3,250,823.

NO CLAIM IS MADE TO THE EXCLUSIVE RIGHT TO USE "MIDWEST", APART FROM THE MARK AS SHOWN.

THE MARK CONSISTS OF THE STYLIZED WORD "MIDWEST" WITH STYLIZED BALLS RANGING FROM SMALL TO LARGE IN SIZE IN A CIRCLE ABOVE THE LETTER "I" OF "MIDWEST".

SER. NO. 85-045,160, FILED 5-21-2010.

ANNE FARRELL, EXAMINING ATTORNEY

United States of America

United States Patent and Trademark Office



Reg. No. 4,072,697

Registered Dec. 20, 2011

Int. Cl.: 7

TRADEMARK

PRINCIPAL REGISTER

SYMMETRY ELEVATING SOLUTIONS LLC (MINNESOTA LIMITED LIABILITY COMPANY)
SUITE A
8915 N. PIONEER ROAD
PEORIA, IL 61615

FOR: ELEVATORS, IN CLASS 7 (U.S. CLS. 13, 19, 21, 23, 31, 34 AND 35).

FIRST USE 5-1-2009; IN COMMERCE 5-1-2009.

NO CLAIM IS MADE TO THE EXCLUSIVE RIGHT TO USE "ELEVATING SOLUTIONS",
APART FROM THE MARK AS SHOWN.

THE COLOR(S) LIGHT RED, DARK RED, AND GRAY IS/ARE CLAIMED AS A FEATURE
OF THE MARK.

THE MARK CONSISTS OF A TRIANGLE ABOVE AN INVERTED TRIANGLE, EACH IN
LIGHT RED AND DARK RED, FOLLOWED BY THE WORD "SYMMETRY" IN GRAY
SUSPENDED ABOVE THE WORDS "ELEVATING SOLUTIONS" IN DARK RED. THE WHITE
SHOWN IN THE MARK IS FOR BACKGROUND PURPOSES ONLY AND IS NOT INTENDED
AS A FEATURE OF THE MARK.

SER. NO. 85-045,220, FILED 5-21-2010.

HEATHER THOMPSON, EXAMINING ATTORNEY



David J. Kybas

Director of the United States Patent and Trademark Office

United States of America

United States Patent and Trademark Office

DIANEX

Reg. No. 4,072,698

Registered Dec. 20, 2011

Int. Cl.: 21

TRADEMARK

PRINCIPAL REGISTER

FACCO GIUSEPPE E C. S.P.A. (ITALY CORPORATION)
CORSO XXII MARZO, 24
MILANO, ITALY 20135

FOR: CLEANING CLOTHS, FLOOR CLEANING CLOTHS, CLEANING SPONGES, TOILET SPONGES, CLEANING RAGS, GLOVES FOR HOUSEHOLD PURPOSES, POLISHING LEATHER, CLEANING BRUSHES FOR HOUSEHOLD USE, CLEANING PADS, CLEANING COMBS, CLOTH CLEANING TOWELS, DUSTERS, BUCKETS, PLASTIC BUCKETS, IN CLASS 21 (U.S. CLS. 2, 13, 23, 29, 30, 33, 40 AND 50).

THE MARK CONSISTS OF STANDARD CHARACTERS WITHOUT CLAIM TO ANY PARTICULAR FONT, STYLE, SIZE, OR COLOR.

PRIORITY CLAIMED UNDER SEC. 44(D) ON ERPN CMNTY TM OFC APPLICATION NO. 9012527, FILED 4-8-2010, REG. NO. 009012527, DATED 9-27-2010, EXPIRES 8-4-2020.

SER. NO. 85-045,845, FILED 5-23-2010.

LINDA MICKLEBURGH, EXAMINING ATTORNEY



David J. Kyfos

Director of the United States Patent and Trademark Office

United States of America

United States Patent and Trademark Office



Reg. No. 4,072,699

Registered Dec. 20, 2011

Int. Cl.: 21

TRADEMARK

PRINCIPAL REGISTER

FACCO GIUSEPPE E C. S.P.A. (ITALY CORPORATION)
CORSO XXII MARZO, 24
MILANO, ITALY 20135

FOR: CLEANING CLOTHS, FLOOR CLEANING CLOTHS, CLEANING SPONGES, TOILET SPONGES, CLEANING RAGS, GLOVES FOR HOUSEHOLD PURPOSES, POLISHING LEATHER, CLEANING BRUSHES FOR HOUSEHOLD USE, CLEANING PADS, CLEANING COMBS, CLOTH CLEANING TOWELS, DUSTERS, BUCKETS, PLASTIC BUCKETS, IN CLASS 21 (U.S. CLS. 2, 13, 23, 29, 30, 33, 40 AND 50).

PRIORITY CLAIMED UNDER SEC. 44(D) ON ERPN CMNTY TM OFC APPLICATION NO. 9012501, FILED 4-8-2010, REG. NO. 009012501, DATED 9-27-2010, EXPIRES 8-4-2020.

THE MARK CONSISTS OF THE WORD "DIANEX" IN WHICH THE LETTER "I" IS TOPPED WITH AN ASTERISK, ALL OF WHICH IS CONTAINED WITHIN A FLOWER ON A STEM.

SER. NO. 85-045,848, FILED 5-23-2010.

LINDA MICKLEBURGH, EXAMINING ATTORNEY



David J. Kybas

Director of the United States Patent and Trademark Office

United States of America

United States Patent and Trademark Office



Reg. No. 4,072,700

Registered Dec. 20, 2011

Int. Cls.: 35 and 39

SERVICE MARK

PRINCIPAL REGISTER

NEW DIRT INC (DELAWARE CORPORATION)
7025 CR 46A, SUITE 1071-523
LAKE MARY, FL 32746

FOR: PROVIDING AN ON-LINE COMPUTER WEBSITE ADVERTISING COMMERCIAL REAL ESTATE AND FEATURING COMMERCIAL REAL ESTATE MARKETING ANALYSIS , IN CLASS 35 (U.S. CLS. 100, 101 AND 102).

FIRST USE 2-1-2011; IN COMMERCE 2-1-2011.

FOR: PROVIDING A WEB SITE FOR THE ELECTRONIC STORAGE OF DIGITAL PHOTOGRAPHS AND VIDEOS FOR USE IN THE FIELD OF COMMERCIAL REAL ESTATE, IN CLASS 39 (U.S. CLS. 100 AND 105).

FIRST USE 2-1-2011; IN COMMERCE 2-1-2011.

NO CLAIM IS MADE TO THE EXCLUSIVE RIGHT TO USE "TARGETED SITE SUBMITTALS", APART FROM THE MARK AS SHOWN.

THE COLOR(S) WHITE, GREEN AND ORANGE IS/ARE CLAIMED AS A FEATURE OF THE MARK.



THE MARK CONSISTS OF THE WORDING "NEW DIRT TARGETED SITE SUBMITTALS" WITHIN STYLIZED FORMATS IN COMBINATION WITH A STYLIZED DESIGN OF A STRUCTURE STANDING ATOP TWO CIRCULAR DESIGNS. THE WORDING "TARGETED SITE SUBMITTALS" IS LOCATED BELOW THE WORDING NEW "DIRT". THE WORDING NEW AND THE UPPER AND LOWER ELEMENTS OF THE STRUCTURE DESIGN ARE GREEN. THE WORDING "TARGETED SITE SUBMITTALS" IS GREEN. THE WORDING "DIRT", THE MIDDLE ELEMENTS OF THE STRUCTURE DESIGN AND THE CIRCULAR DESIGNS ARE ORANGE. THE LINEAR ELEMENT SEPARATING THE SECTIONS OF THE STRUCTURE DESIGN IS WHITE. THE WHITE BACKGROUND IS NOT AN ELEMENT OF THE MARK.

SER. NO. 85-046,402, FILED 5-24-2010.

ANN E. SAPPENFIELD, EXAMINING ATTORNEY

David J. Kappas

Director of the United States Patent and Trademark Office

United States of America

United States Patent and Trademark Office



Reg. No. 4,072,701

Registered Dec. 20, 2011

Int. Cl.: 25

TRADEMARK

PRINCIPAL REGISTER

LAKESHIRTS, INC. (MINNESOTA CORPORATION)
750 RANDOLPH ROAD
DETROIT LAKES, MN 56501

FOR: CAPS; PANTS; SHIRTS, IN CLASS 25 (U.S. CLS. 22 AND 39).

FIRST USE 8-1-1998; IN COMMERCE 8-1-1998.

NO CLAIM IS MADE TO THE EXCLUSIVE RIGHT TO USE "LAKE SHIRTS" , APART FROM THE MARK AS SHOWN.

THE MARK CONSISTS OF A SAIL WITH SUN BACKGROUND WITH THE TEXT "LAKE-SHIRTS" ABOVE THE SAIL AND SUN BACKGROUND.

SER. NO. 85-050,546, FILED 5-28-2010.

ALEX KEAM, EXAMINING ATTORNEY



David J. Kybas

Director of the United States Patent and Trademark Office

United States of America

United States Patent and Trademark Office

Mel's Bracelet

Reg. No. 4,072,702

FRIENDS OF MEL FOUNDATION (MASSACHUSETTS CORPORATION)
20 POND PARK ROAD SUITE 107
HINGHAM, MA 02043

Registered Dec. 20, 2011

Int. Cl.: 14

FOR: BRACELETS, IN CLASS 14 (U.S. CLS. 2, 27, 28 AND 50).

TRADEMARK

FIRST USE 10-1-2005; IN COMMERCE 7-28-2006.

PRINCIPAL REGISTER

THE MARK CONSISTS OF STANDARD CHARACTERS WITHOUT CLAIM TO ANY PARTICULAR FONT, STYLE, SIZE, OR COLOR.

NO CLAIM IS MADE TO THE EXCLUSIVE RIGHT TO USE "BRACELET", APART FROM THE MARK AS SHOWN.

SER. NO. 85-054,212, FILED 6-3-2010.

C. DIONNE CLYBURN, EXAMINING ATTORNEY



David J. Kyffers

Director of the United States Patent and Trademark Office

United States of America

United States Patent and Trademark Office

LIPONOX

Quema la Grasa[†]

Reg. No. 4,072,703

GUERRERO, OMAR (UNITED STATES INDIVIDUAL)
41 CENTRAL SQ.
LYNN, MA 01901

Registered Dec. 20, 2011

Int. Cl.: 5

FOR: DIETARY SUPPLEMENTS, IN CLASS 5 (U.S. CLS. 6, 18, 44, 46, 51 AND 52).

TRADEMARK

FIRST USE 11-1-2009; IN COMMERCE 1-1-2010.

PRINCIPAL REGISTER

NO CLAIM IS MADE TO THE EXCLUSIVE RIGHT TO USE "QUEMA LA GRASA", APART FROM THE MARK AS SHOWN.

THE MARK CONSISTS OF THE TEXT "LIPONOX" IN ALL CAPS LETTERING WITH OUTLINE, AND "QUEMA LA GRASA" BELOW WITH OUTLINE WITH A CROSS TO THE RIGHT AND SLIGHTLY ABOVE THE "A" IN "GRASA."

THE ENGLISH TRANSLATION OF "QUEMA LA GRASA" IS "BURN THE FAT".

SER. NO. 85-056,761, FILED 6-7-2010.

DAVID I, EXAMINING ATTORNEY



David J. Kyffers

Director of the United States Patent and Trademark Office

United States of America

United States Patent and Trademark Office



Reg. No. 4,072,704

Registered Dec. 20, 2011

Int. Cls.: 9, 16 and 25

TRADEMARK

PRINCIPAL REGISTER

SPIN MASTER LTD. (CANADA CORPORATION)
450 FRONT STREET WEST
TORONTO ONTARIO, CANADA M5V1B6

FOR: PRE-RECORDED AUDIO AND VISUAL VIDEOS, CD'S, TAPES, DVD'S COMPRISING BOOKS, MOVIES, TELEVISION PROGRAMS IN THE FIELD OF CHILDREN'S ANIMATION, IN CLASS 9 (U.S. CLS. 21, 23, 26, 36 AND 38).

FOR: INSTRUCTION MANUALS FOR USE WITH TOYS; PRINTED PUBLICATIONS, NAMELY, BOOKS ABOUT ANIMATION AND FEATURING ANIMATION; AND COMIC BOOKS, IN CLASS 16 (U.S. CLS. 2, 5, 22, 23, 29, 37, 38 AND 50).

FIRST USE 11-0-2008; IN COMMERCE 11-0-2008.

FOR: CHILDREN'S CLOTHING, NAMELY, SHIRTS AND PANTS; DRESS-UP CLOTHING, NAMELY, PLAY CLOTHING IN THE NATURE OF COSTUMES FOR USE IN CHILDREN'S DRESS UP PLAY; LOUNGE WEAR; SLEEP WEAR; UNDERGARMENTS, IN CLASS 25 (U.S. CLS. 22 AND 39).

OWNER OF CANADA REG. NO. TMA746,915, DATED 9-3-2009, EXPIRES 9-3-2024.

THE NON-LATIN CHARACTERS IN THE MARK TRANSLITERATE TO "BAKU GAN" AND THIS MEANS "EXPLODING SPHERE" IN ENGLISH.

OWNER OF U.S. REG. NOS. 3,075,864, 3,748,288 AND OTHERS.

THE MARK CONSISTS OF THE LITERAL ELEMENT "BAKUGAN BATTLE BRAWLERS" SUPERIMPOSED ON A DESIGN ELEMENT COMPRISING ASIAN CHARACTERS, A SWORD AND A WHEEL WITH THE ENTIRE MARK SURROUNDED BY A THIN OUTLINE.

THE ENGLISH TRANSLATION OF "BAKUGAN" IN THE MARK IS "EXPLODING SPHERE".

SER. NO. 85-059,197, FILED 6-10-2010.

CHARLOTTE CORWIN, EXAMINING ATTORNEY



David J. Kyros

Director of the United States Patent and Trademark Office

United States of America

United States Patent and Trademark Office



Reg. No. 4,072,705

Registered Dec. 20, 2011

Int. Cls.: 9 and 10

TRADEMARK

PRINCIPAL REGISTER

SHINING UNION LIMITED (HONG KONG LIMITED LIABILITY COMPANY)
SUITES 2601-2, 26/F, TOWER 2, NINA TOWER
TSUEN WAN, N.T., HONG KONG

FOR: FOOD ANALYSIS APPARATUS; SPIRIT LEVELS; SPEED INDICATORS; OZONISERS, OZONATORS; THERMOMETERS, NOT FOR MEDICAL PURPOSES; TESTING APPARATUS, NOT FOR MEDICAL PURPOSES, FOR ELECTRIC, ELECTRONIC, OR ELECTROCHEMICAL OXYGEN MONITORS AND SENSORS FOR ENVIRONMENTAL USE; DOSAGE DISPENSERS, NAMELY, MACHINES FOR DISPENSING PRE-DETERMINED DOSAGES OF MEDICATION; DOSIMETERS, IN CLASS 9 (U.S. CLS. 21, 23, 26, 36 AND 38).

FOR: ALCOHOL BREATH TESTING UNITS; MEDICAL APPARATUS AND INSTRUMENTS, NAMELY, FOR HEALTH DIAGNOSTIC FOR DIAGNOSING CARDIOVASCULAR DISEASE; SPHYGMOMANOMETERS; SPHYGMOTENSIOMETERS; VIBROMASSAGE APPARATUS; THERMOMETERS FOR MEDICAL PURPOSES; DIAGNOSTIC APPARATUS FOR MEDICAL PURPOSES FOR DETECTING ABNORMAL HUMAN CONDITIONS, NAMELY, LOW OR HIGH BLOOD PRESSURE OR OXYGEN LEVEL; APPARATUS AND INSTRUMENTS FOR OTORHINOLARYNGOLOGY, NAMELY, OTORHINOLOGICAL LAMP; PHYSIOTHERAPY APPARATUS, NAMELY, ELECTRO THERAPY DEVICE, MECHANICAL THERAPY DEVICE, ELECTROMECHANICAL THERAPY DEVICE FOR PHYSIOTHERAPY, ULTRASONIC THERAPY, SHOCK THERAPY, SHORTWAVE THERAPY; ELECTRIC ACUPUNCTURE INSTRUMENTS; KNIVES FOR SURGICAL PURPOSES, IN CLASS 10 (U.S. CLS. 26, 39 AND 44).



PRIORITY CLAIMED UNDER SEC. 44(D) ON HONG KONG APPLICATION NO. 301613880, FILED 5-14-2010, REG. NO. 301613880, DATED 5-14-2010, EXPIRES 5-14-2020.

THE MARK CONSISTS OF THE STYLIZED LETTERS "C" AND "MC".

SER. NO. 85-060,243, FILED 6-11-2010.

LESLIE RICHARDS, EXAMINING ATTORNEY

David J. Kybas

Director of the United States Patent and Trademark Office

United States of America

United States Patent and Trademark Office

American Knitworks

Reg. No. 4,072,706

Registered Dec. 20, 2011

Int. Cl.: 25

TRADEMARK

PRINCIPAL REGISTER

BALLINGER, BABETTE (UNITED STATES INDIVIDUAL)
C/O GREENBERG 6 ASCOT CIRCLE
MOUNT KISCO, NY 10549

FOR: MEN'S, WOMEN'S, AND CHILDREN'S CLOTHING, NAMELY, SHIRTS, PANTS, SHORTS, JEANS, UNDERGARMENTS, TANK TOPS, LEGGINGS, PAJAMAS, WETSUITS, SUSPENDERS, TIES, SCARVES, CLOTH DIAPERS, SOCKS, SHIRTS, HATS, BOOTS, SLIPS, SHOES, HEADBANDS, OVERCOATS, JACKETS, WARMUP SUITS, JOGGING SUITS, SWEAT SHIRTS, T-SHIRTS, BELTS, AND WRISTBANDS, IN CLASS 25 (U.S. CLS. 22 AND 39).

FIRST USE 10-24-1994; IN COMMERCE 10-24-1994.

THE MARK CONSISTS OF STANDARD CHARACTERS WITHOUT CLAIM TO ANY PARTICULAR FONT, STYLE, SIZE, OR COLOR.

NO CLAIM IS MADE TO THE EXCLUSIVE RIGHT TO USE "KNITWORKS", APART FROM THE MARK AS SHOWN.

SEC. 2(F).

SER. NO. 85-060,448, FILED S.R. 6-11-2010 AM. P.R. 3-25-2011.

ANNE FARRELL, EXAMINING ATTORNEY



David J. Kybas

Director of the United States Patent and Trademark Office

United States of America

United States Patent and Trademark Office



Rabo

Reg. No. 4,072,707

Registered Dec. 20, 2011

Int. Cls.: 9, 16, 35 and 36

TRADEMARK

SERVICE MARK

PRINCIPAL REGISTER

COÖPERATIEVE CENTRALE RAIFFEISEN-BOERNLEENBANK B.A. (NETHERLANDS LIMITED LIABILITY COMPANY), AKA RABOBANK NEDERLAND
CROESELAAAN 18
3521 CB UTRECHT, NETHERLANDS

FOR: CARRIERS OF IMAGES, SOUND AND OTHER DATA IN ELECTRONIC, MAGNETIC, OPTICAL OR OTHER FORM, NAMELY, BLANK MAGNETIC DISCS, BLANK OPTICAL DISCS AND ELECTRONIC DATA RECORDERS; ELECTRONIC PUBLICATIONS, NAMELY, BOOKS, E-ZINES AND MAGAZINES, IN THE FIELDS OF FINANCING AND INSURANCES, RECORDED ON COMPUTER MEDIA DATA CARRIERS; DOWNLOADABLE ELECTRONIC PUBLICATIONS, NAMELY, BOOK, E-ZINES AND MAGAZINES IN THE FIELDS OF FINANCING AND INSURANCES OBTAINABLE THROUGH ELECTRONIC AND COMMUNICATIONS MEANS; APPARATUS FOR RECORDING, TRANSMISSIONS OR REPRODUCTION OF SOUND, IMAGES OR DATA; DATA PROCESSING EQUIPMENT; COMPUTERS AND COMPUTER PERIPHERAL EQUIPMENT; SOFTWARE FOR DATABASE MANAGEMENT, WORD PROCESSING AND SPREADSHEET CREATION; TELECOMMUNICATION INSTRUMENTS AND APPARATUS FOR RECEIVING, TRANSMITTING, CONVERTING, DIGITALLY DISTRIBUTING AND BROADCASTING OF DATA, SOUND OR IMAGES, NAMELY, COMPUTER HARDWARE FOR TELECOMMUNICATION, TELECOMMUNICATION EXCHANGERS AND DEVICES FOR TRANSPORTING AND AGGREGATING VOICE, DATA, AND VIDEO COMMUNICATIONS ACROSS MULTIPLE NETWORK INFRASTRUCTURES AND COMMUNICATION PROTOCOLS; AUTOMATIC VENDING MACHINES; CASH REGISTERS; CALCULATING MACHINES; AUTOMATED TELLER MACHINES; MAGNETIC CODED CARDS, NAMELY, CREDIT CARDS, BANK CARDS, CHEQUE CARDS AND TELEPHONE CARDS, IN CLASS 9 (U.S. CLS. 21, 23, 26, 36 AND 38).



FOR: PRINTED CONTRACT FORMS; PRINTED POLICY FORMS; DEBIT CARDS WITHOUT MAGNETIC CODING; BLANK BANK CHECKS; BLANK DEPOSIT BOOKS; BLANK BANK SECURITIES; PRINTED PERIODICALS IN THE FIELDS OF FINANCING AND INSURANCE BROKERAGE; PRINTED INSTRUCTIONAL AND TEACHING MATERIALS IN THE FIELDS OF FINANCING AND INSURANCE BROKERAGE; NEWSPAPERS AND BOOKS IN THE FINANCIAL FIELD; PHOTOGRAPHS; STATIONERY; TYPEWRITERS, IN CLASS 16 (U.S. CLS. 2, 5, 22, 23, 29, 37, 38 AND 50).

David J. Kyjars

Director of the United States Patent and Trademark Office

FOR: BUSINESS MANAGEMENT; BUSINESS ADMINISTRATION; OFFICE FUNCTIONS; FINANCIAL STATEMENT PREPARATION FOR BUSINESSES; BUSINESS APPRAISALS; BUSINESS INQUIRIES; BUSINESS RESEARCH; COST PRICE ANALYSIS; ECONOMIC

Reg. No. 4,072,707 FORECASTING; BUSINESS INVESTIGATION; TAX PREPARATION; EFFICIENCY EXPERTS; COMMERCIAL BUSINESS MANAGEMENT OF COMPANIES, ENTERPRISES, INSTITUTIONS AND ORGANIZATIONS; COMMERCIAL ASSISTANCE IN BUSINESS MANAGEMENT, NAMELY, THE RUNNING OF COMPANIES, ENTERPRISES, INSTITUTIONS AND ORGANIZATIONS; COMMERCIAL ASSISTANCE IN BUSINESS MANAGEMENT, NAMELY, THE SETTING UP OR DISSOLVING OF COMPANIES, ENTERPRISES, INSTITUTIONS AND ORGANIZATIONS; BUSINESS MANAGEMENT, NAMELY, MANAGING COMPANIES, ENTERPRISES, INSTITUTIONS AND ORGANIZATIONS; TELEPHONE INFORMATION SERVICE FEATURING INFORMATION IN THE FIELD OF BUSINESS CONSULTING, BUSINESS MANAGEMENT, BUSINESS ADMINISTRATION AFORESAID SERVICES ALSO THROUGH ELECTRONIC AND TELECOMMUNICATIONS MEANS, SUCH AS THE INTERNET, MOBILE TELEPHONE NETWORKS, CABLE, SATELLITE AND ETHER NETWORKS, AND OTHER SIMILAR NETWORKS; FINANCIAL INTERMEDIARY SERVICES IN THE FIELD OF RENDERING SERVICES, NAMELY, FINANCIAL INTERMEDIARY SERVICES REGARDING REAL ESTATE TRANSACTIONS, IN CLASS 35 (U.S. CLS. 100, 101 AND 102).

FOR: FINANCIAL ADVISORY SERVICES IN THE FIELD OF RENDERING SERVICES, NAMELY, CONSULTANCY RELATED TO STOCK, SECURITY AND BOND TRANSACTIONS AND FINANCIAL CONSULTANCY REGARDING REAL ESTATE TRANSACTIONS; FINANCIAL AFFAIRS AND INSURANCE SERVICES, NAMELY, FINANCIAL MANAGEMENT, INSURANCE ADMINISTRATION, INSURANCE BROKERAGE AND INSURANCE CONSULTANCY; MONETARY AFFAIRS, NAMELY, MONETARY EXCHANGE; BANKING, INCLUDING MORTGAGES; FINANCIAL ANALYSIS, ESTIMATES AND BUDGETS FOR LENDER CLIENTS, NAMELY, FINANCIAL PLANNING AND FINANCIAL CONSULTATION; FINANCIAL SERVICES, NAMELY, MONEY LENDING; FINANCIAL FORECASTING AND FINANCIAL CONSULTANCY; FINANCING SERVICES; FISCAL VALUATIONS, ASSESSMENTS AND CONSULTANCY; FINANCIAL INVESTMENT SERVICES, NAMELY, ADMINISTERING THE ISSUANCE, UNDERWRITING AND DISTRIBUTION OF SECURITIES; FINANCIAL MANAGEMENT; FIDUCIARY REPRESENTATIVE SERVICES, NAMELY, TAKING CARE OF THE FINANCIAL INTERESTS OF OTHERS; FINANCING OF DATA COMMUNICATION APPARATUS IN RELATION TO BANKING; MANAGEMENT AND LEASING OF REAL ESTATE; REAL ESTATE APPRAISALS; FINANCIAL MANAGEMENT BY A FINANCE COMPANY; FINANCIAL INVESTMENT IN THE FIELD OF SECURITIES OF COMPANIES, ENTERPRISES, INSTITUTIONS AND PARTICIPATIONS; FINANCIAL AFFAIRS FOR THE BENEFIT OF DAUGHTER COMPANIES AND PARTICIPATIONS, NAMELY, FINANCIAL MANAGEMENT; TELEPHONE INFORMATION SERVICE FEATURING INFORMATION IN THE FIELD OF FINANCIAL CONSULTING, FINANCIAL MANAGEMENT, FINANCIAL ADMINISTRATION OF RETIREMENT PLANS THROUGH ELECTRONIC AND TELECOMMUNICATIONS MEANS, SUCH AS THE INTERNET, MOBILE TELEPHONE NETWORKS, CABLE, SATELLITE AND ETHER NETWORKS, IN CLASS 36 (U.S. CLS. 100, 101 AND 102).

OWNER OF BENELUX REG. NO. 0874258, DATED 12-30-2009, EXPIRES 12-21-2019.

OWNER OF U.S. REG. NOS. 3,254,437, 3,531,305 AND OTHERS.

THE MARK CONSISTS OF A SILHOUETTE OF A MAN WALKING ACROSS A SUNDIAL OVER THE TERM "RABO".

THE ENGLISH TRANSLATION OF "RABO" IN THE MARK IS "TAIL".

SER. NO. 85-060,950, FILED 6-11-2010.

ALYSSA STEEL, EXAMINING ATTORNEY

United States of America

United States Patent and Trademark Office



Reg. No. 4,072,708

Registered Dec. 20, 2011

Int. Cl.: 35

SERVICE MARK

PRINCIPAL REGISTER

MYBPORT, LLC (DELAWARE LIMITED LIABILITY COMPANY)
PO BOX 1180
RIVERBANK, CA 95367

FOR: ADVERTISING AND BUSINESS SERVICES, NAMELY, PROVIDING AN ONLINE WEBSITE WHERE ADVERTISERS, MARKETERS, AND CONTENT PROVIDERS CAN INTERACT WITH USERS FOR ADVERTISING, BRANDING, AND PROMOTING KNOWLEDGE, PRODUCTS, AND SERVICES, AND TRADESHOWS, ON BEHALF OF THEMSELVES AND OTHERS, AND FOR EVALUATING AND RATING THE SAME, ALL THE FOREGOING RELEVANT TO HUMAN ACTIVITIES AFFECTING CLIMATE CHANGE AND RELATED FIELDS; ADVERTISING AND DIRECTORY SERVICES, NAMELY, PROMOTING THE SERVICES OF OTHERS BY PROVIDING A WEB PAGE FEATURING LINKS TO THE WEBSITES OF OTHERS; COMMERCIAL INFORMATION AND DIRECTORY AGENCY; COMPILATION OF BUSINESS DIRECTORIES; ON-LINE BUSINESS DIRECTORIES FEATURING COMMERCIAL INFORMATION OF BUSINESSES, GROUPS, AND ORGANIZATIONS, IN CLASS 35 (U.S. CLS. 100, 101 AND 102).

FIRST USE 11-10-2007; IN COMMERCE 4-18-2009.

NO CLAIM IS MADE TO THE EXCLUSIVE RIGHT TO USE "BRAND", APART FROM THE MARK AS SHOWN.

THE COLOR(S) BLUE, GREY, WHITE, BLACK IS/ARE CLAIMED AS A FEATURE OF THE MARK.

THE MARK CONSISTS OF BLUE EARTH GLOBE WITH GREY CONTINENTS. LEFT SIDE OF THE GLOBE HAS THREE PEOPLE ON IT, WHITE IN COLOR, WITH THEIR ARMS RAISED. NEXT TO THE GLOBE ARE THE WORDS "MYBPORT.COM" AND "BRAND YOURSELF" IN BLACK. "BPORT.COM" IS PARTIALLY UNDERLINED AND OVERLINED IN BLACK. .

SER. NO. 85-061,354, FILED 6-12-2010.

KATHLEEN LORENZO, EXAMINING ATTORNEY



David J. Kyffers

Director of the United States Patent and Trademark Office

United States of America

United States Patent and Trademark Office

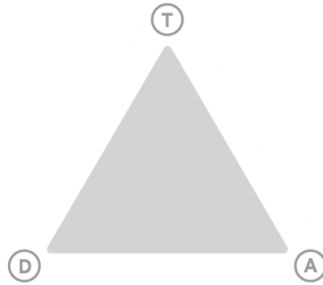

Reg. No. 4,072,709

Registered Dec. 20, 2011

**Int. Cls.: 3, 11, 16, 42
and 44**

TRADEMARK

SERVICE MARK

PRINCIPAL REGISTER

BAINS ULTRA INC. (CANADA CORPORATION)
956, CHEMIN OLIVIER
SAINT-NICOLAS (QUEBEC), CANADA G7A2N1

FOR: ESSENTIAL OILS, NAMELY, ESSENTIAL OILS FOR THE BATH, ESSENTIAL OILS FOR MASSAGE, ESSENTIAL OILS FOR MOISTURIZING THE BODY, ESSENTIAL OILS FOR HAIR CARE, ESSENTIAL OILS FOR AROMA THERAPY; PRODUCTS FOR BODY CARE, NAMELY, MASSAGE OILS, SKIN CREAMS, HYDROLATES IN THE NATURE OF SCENTED LINEN WATER, SEA SALTS FOR THE BATH, IN CLASS 3 (U.S. CLS. 1, 4, 6, 50, 51 AND 52).

FOR: THERAPEUTIC BATHTUBS; THERAPEUTIC SHOWERS; THERAPEUTIC APPARATUS AND EQUIPMENT, NAMELY, CARE UNITS SOLD AS COMPONENTS OF SHOWERS FOR THERMOTHERAPY, AUDIO-THERAPY, AROMA THERAPY, LIGHT THERAPY TREATMENT, AND CHROMOTHERAPY, AND CHAIRS BUILT-IN TO SHOWERS; BATH ACCESSORIES, NAMELY, LATERAL AND MODULAR SHOWER PANELS, IN CLASS 11 (U.S. CLS. 13, 21, 23, 31 AND 34).

FOR: MAGAZINES IN THE FIELD OF HOME DESIGN, HEALTH, FITNESS, AND LIFESTYLE, IN CLASS 16 (U.S. CLS. 2, 5, 22, 23, 29, 37, 38 AND 50).

FOR: INTERIOR DESIGN SERVICES; INTERIOR DESIGN SERVICES FOR THE CREATION OF A SPACE PROVIDING A RELAXING ATMOSPHERE AND PROMOTING THE WELL-BEING OF ITS USERS BY THE INTEGRATION OF THERAPEUTIC APPARATUS AND EQUIPMENTS, NAMELY, THERAPEUTIC BATHS, THERAPEUTIC SHOWERS, AND CARE UNITS BUILT-IN TO SHOWERS FEATURING HEAT THERAPY, SOUND THERAPY, AROMA THERAPY, LIGHT THERAPY TREATMENT, AND CHROMOTHERAPY, IN CLASS 42 (U.S. CLS. 100 AND 101).

FOR: SPA SERVICES, NAMELY, THERAPEUTIC BODY CARE USING THERAPEUTIC BATHS AND SHOWERS, IN CLASS 44 (U.S. CLS. 100 AND 101).

OWNER OF CANADA REG. NO. TMA801198, DATED 6-30-2011, EXPIRES 6-30-2026.

THE MARK CONSISTS OF A TRIANGLE WITH THE LETTER "D" INSIDE A CIRCLE AT THE BOTTOM LEFT POINT, THE LETTER "T" INSIDE A CIRCLE AT THE TOP CENTER POINT, AND THE LETTER "A" INSIDE A CIRCLE AT THE RIGHT BOTTOM POINT.



David J. Kyffers

Director of the United States Patent and Trademark Office

Reg. No. 4,072,709 SER. NO. 85-062,145, FILED 6-14-2010.

DANIEL CAPSHAW, EXAMINING ATTORNEY

United States of America

United States Patent and Trademark Office



ROSS
Companies

Reg. No. 4,072,710

Registered Dec. 20, 2011

Int. Cls.: 35, 36 and 37

SERVICE MARK

PRINCIPAL REGISTER

THE ROSS COMPANIES (MARYLAND CORPORATION)
SUITE 350
7910 WOODMONT AVENUE
BETHESDA, MD 20814

FOR: REAL ESTATE MARKETING SERVICES, NAMELY, THE MARKETING OF CONDOMINIUMS AND APARTMENT BUILDINGS, IN CLASS 35 (U.S. CLS. 100, 101 AND 102).

FIRST USE 1-1-2008; IN COMMERCE 1-1-2010.

FOR: REAL ESTATE INVESTMENT AND ACQUISITION SERVICES, IN CLASS 36 (U.S. CLS. 100, 101 AND 102).

FIRST USE 1-1-2008; IN COMMERCE 1-1-2010.

FOR: REAL ESTATE DEVELOPMENT AND RENOVATION SERVICES, NAMELY, THE RENOVATION AND RESTORATION OF RESIDENTIAL, MULTI-FAMILY BUILDINGS, IN CLASS 37 (U.S. CLS. 100, 103 AND 106).

FIRST USE 1-1-2008; IN COMMERCE 1-1-2010.

NO CLAIM IS MADE TO THE EXCLUSIVE RIGHT TO USE "COMPANIES", APART FROM THE MARK AS SHOWN.

THE COLOR(S) BLUE, WHITE AND GREY IS/ARE CLAIMED AS A FEATURE OF THE MARK.

THIS IS A COLOR LOGO FOR THE "ROSS COMPANIES". IT EXAGGERATES THE LOWER CASE "R" BEFORE THE COMPANY NAME IS WRITTEN OUT.

SER. NO. 85-062,921, FILED 6-15-2010.

RONALD AIKENS, EXAMINING ATTORNEY



David J. Kyffers

Director of the United States Patent and Trademark Office

United States of America

United States Patent and Trademark Office

V-ROOX

Reg. No. 4,072,711

Registered Dec. 20, 2011

Int. Cl.: 18

THOMAS MENDOZA INTERNATIONAL COMPANY LIMITED (HONG KONG LIMITED COMPANY (LTD.))
15/F., CHUNG KIU GODOWN BUILDING
63-71 LEI MUK ROAD
KWAI CHUNG, N.T., HONG KONG

TRADEMARK

PRINCIPAL REGISTER

FOR: BRIEFCASES, SUITCASES IN THE NATURE OF PILOT CASES, ATTACHÉ CASES, CARRYING CASES, BUSINESS CASES, BRIEFCASE-TYPE PORTFOLIOS, FOLIO CASES IN THE NATURE OF BRIEFCASE-TYPE PORTFOLIOS, TRAVELING BAGS, FLEXIBLE GARMENT BAGS, GARMENT BAGS FOR TRAVEL, LUGGAGE, TRUNKS, TRAVELING SUITCASES, WHEELED-SUITCASES, TROLLEY-SUITCASES, PURSES, WALLETS, WAIST BAGS, CREDIT CARD HOLDERS, CARRY-ALL BAGS, SHOULDER BAGS, SPORT BAGS NOT SHAPED TO CONTAIN SPECIFIC APPARATUS USED IN PLAYING SPORTS, SCHOOL BAGS, RUCKSACKS, TOTE BAGS, HANDBAGS, COSMETIC BAGS SOLD EMPTY, TOILETRY BAGS SOLD EMPTY, IN CLASS 18 (U.S. CLS. 1, 2, 3, 22 AND 41).

OWNER OF HONG KONG REG. NO. 300895717, DATED 6-21-2007, EXPIRES 6-20-2017.

THE MARK CONSISTS OF A STYLIZED LETTER "V" FOLLOWING BY A HYPHEN AND STYLIZED LETTERS "ROOX".

SER. NO. 85-063,728, FILED 6-15-2010.

TINA MAI, EXAMINING ATTORNEY



David J. Kybas

Director of the United States Patent and Trademark Office

United States of America

United States Patent and Trademark Office

THE ON-LINE ENCYCLOPEDIA OF INTEGER SEQUENCES

Reg. No. 4,072,712

THE OEIS FOUNDATION, INC. (NEW JERSEY NON-PROFIT CORPORATION)
11 SOUTH ADELAIDE AVENUE
HIGHLAND PARK, NJ 08904

Registered Dec. 20, 2011

Int. Cl.: 41

FOR: ON-LINE REFERENCE ENCYCLOPEDIA FEATURING A SEARCHABLE DATABASE
OF INTEGER SEQUENCES, IN CLASS 41 (U.S. CLS. 100, 101 AND 107).

SERVICE MARK

FIRST USE 12-31-1996; IN COMMERCE 12-31-1996.

PRINCIPAL REGISTER

THE MARK CONSISTS OF STANDARD CHARACTERS WITHOUT CLAIM TO ANY PAR-
TICULAR FONT, STYLE, SIZE, OR COLOR.

NO CLAIM IS MADE TO THE EXCLUSIVE RIGHT TO USE "ON-LINE ENCYCLOPEDIA",
APART FROM THE MARK AS SHOWN.

SEC. 2(F).

SER. NO. 85-064,202, FILED 6-16-2010.

MARCIE MILONE, EXAMINING ATTORNEY



David J. Kyffers

Director of the United States Patent and Trademark Office

United States of America

United States Patent and Trademark Office



Reg. No. 4,072,713

Registered Dec. 20, 2011

Int. Cl.: 41

SERVICE MARK

PRINCIPAL REGISTER

CLEMISTRY MUSIC, INC. (CALIFORNIA CORPORATION)
1941 VASSAR STREET
GLENDALE, CA 912042926

FOR: ENTERTAINMENT SERVICES IN THE NATURE OF RECORDING, PRODUCTION AND POST-PRODUCTION SERVICES IN THE FIELDS OF MUSIC; MUSIC COMPOSITION FOR OTHERS; MUSIC PRODUCTION SERVICES; MUSIC PUBLISHING SERVICES; MUSIC SELECTION SERVICES FOR USE IN TELEVISION, FILM, RADIO AND VIDEO GAMES; POST-PRODUCTION EDITING SERVICES IN THE FIELD OF MUSIC, VIDEOS AND FILM; PRODUCTION OF MUSICAL SOUND RECORDING, IN CLASS 41 (U.S. CLS. 100, 101 AND 107).

FIRST USE 1-1-2003; IN COMMERCE 1-1-2003.

NO CLAIM IS MADE TO THE EXCLUSIVE RIGHT TO USE "MUSIC", APART FROM THE MARK AS SHOWN.

THE MARK CONSISTS OF THE WORDING "CLEMISTRY MUSIC" IN A STYLIZED FONT AND A DESIGN THAT CONSISTS OF A TREBLE CLEF TURNED HORIZONTALLY, REACHING OVER THE FULL LITERAL ELEMENT OF THE MARK.

SER. NO. 85-064,240, FILED 6-16-2010.

RENEE MCCRAY, EXAMINING ATTORNEY



David J. Kybas

Director of the United States Patent and Trademark Office

United States of America

United States Patent and Trademark Office



Reg. No. 4,072,714

Registered Dec. 20, 2011

Int. Cls.: 40 and 42

SERVICE MARK

PRINCIPAL REGISTER

BRILLION IRON WORKS, INC. (DELAWARE CORPORATION)
200 PARK AVENUE
BRILLION, WI 54110

FOR: METAL CASTING SERVICES, IN CLASS 40 (U.S. CLS. 100, 103 AND 106).

FIRST USE 0-0-2003; IN COMMERCE 0-0-2003.

FOR: PRODUCT DEVELOPMENT AND ENGINEERING SERVICES FOR OTHERS IN THE FIELD OF METAL CASTINGS, TOOLING, MOLDS AND PATTERNS; CUSTOM DESIGN OF METAL CASTINGS, TOOLING, MOLDS AND PATTERNS, IN CLASS 42 (U.S. CLS. 100 AND 101).

FIRST USE 0-0-2003; IN COMMERCE 0-0-2003.

NO CLAIM IS MADE TO THE EXCLUSIVE RIGHT TO USE "IRON WORKS", APART FROM THE MARK AS SHOWN.

THE MARK CONSISTS OF A STYLIZED DEPICTION OF THE WORDS "BRILLION IRON WORKS" WITH ARCH OVER "BRILLION" AND A METAL CASTING BUCKET ATTACHED TO THE BOTTOM OF THE LETTER "I".

SEC. 2(F) AS TO "BRILLION IRON WORKS".

SER. NO. 85-064,499, FILED 6-16-2010.

WILLIAM P. SHANAHAN, EXAMINING ATTORNEY



David J. Kybas

Director of the United States Patent and Trademark Office

United States of America

United States Patent and Trademark Office



Reg. No. 4,072,715

Registered Dec. 20, 2011

Int. Cl.: 42

SERVICE MARK

PRINCIPAL REGISTER

EPAY SYSTEMS, INC. (DELAWARE CORPORATION)
8430 W. BRYN MAWR AVENUE
SUITE 450
CHICAGO, IL 60631

FOR: DESIGN AND DEVELOPMENT OF COMPUTER HARDWARE AND SOFTWARE; SOFTWARE AS A SERVICE (SAAS) SERVICES FEATURING SOFTWARE FOR AUTOMATED TIMEKEEPING, CREATING TIMESHEETS, COLLECTING DATA FROM REMOTE SITES, CONSOLIDATING EMPLOYEE TIMESHEETS FOR REVIEW AND APPROVAL OF PAYROLL, AND BUDGETING LABOR EXPENSES IN THE FIELD OF TIME AND LABOR MANAGEMENT, IN CLASS 42 (U.S. CLS. 100 AND 101).

FIRST USE 7-1-2010; IN COMMERCE 7-1-2010.

NO CLAIM IS MADE TO THE EXCLUSIVE RIGHT TO USE "EPAY SYSTEMS", APART FROM THE MARK AS SHOWN.

THE COLOR(S) DARK BLUE AND WHITE IS/ARE CLAIMED AS A FEATURE OF THE MARK.

THE MARK CONSISTS OF A DARK BLUE SQUARE ON THE LEFT WITH THREE CURVED WHITE STRIPES REACHING FROM THE BOTTOM LEFT SIDE OF THE SQUARE TOWARD THE UPPER RIGHT SIDE OF THE SQUARE. TO THE RIGHT OF THE DARK BLUE SQUARE APPEAR THE WORD "EPAY" IN DARK BLUE BOLD BLOCK LETTERING OVER THE WORDS "SYSTEMS" IN SMALLER DARK BLUE BLOCK LETTERING. THE REMAINDER OF WHITE IN THE DRAWING REPRESENTS A TRANSPARENT BACKGROUND THAT IS NOT PART OF THE MARK.

SER. NO. 85-065,108, FILED 6-17-2010.

NELSON SNYDER, EXAMINING ATTORNEY



David J. Kyffers

Director of the United States Patent and Trademark Office

United States of America

United States Patent and Trademark Office



Reg. No. 4,072,716

Registered Dec. 20, 2011

Int. Cl.: 30

TRADEMARK

PRINCIPAL REGISTER

CUNNEEN, CHRISTOPHER (UNITED STATES INDIVIDUAL)
5 SURF AVENUE
ISLIP, NY 11751

FOR: BAGELS, IN CLASS 30 (U.S. CL. 46).

FIRST USE 12-1-2009; IN COMMERCE 2-1-2010.

NO CLAIM IS MADE TO THE EXCLUSIVE RIGHT TO USE "BEST NEW YORK BAGEL.COM", APART FROM THE MARK AS SHOWN.

THE COLOR(S) RED, BEIGE AND BLACK IS/ARE CLAIMED AS A FEATURE OF THE MARK.

THE MARK CONSISTS OF THE DESIGN OF A BAGEL WITH THE BOTTOM PORTION CONTAINING THE DESIGN OF A CITY SKYLINE. A WING IS ON EACH SIDE OF THE BAGEL. THE WORDING "BESTNEWYORKBAGEL.COM" IS ABOVE THE BAGEL DESIGN, AND THE WORDING "NEW YORK BAGELS IN A NEW YORK MINUTE" IS BELOW THE BAGEL DESIGN. THE COLOR BLACK APPEARS IN THE WORDING IN THE MARK, IN THE OUTLINE OF THE BAGEL, IN THE OUTLINE OF THE WINGS, AND IN THE OUTLINE OF THE CITY SKYLINE IN THE MARK. THE COLOR RED APPEARS IN THE WINGS AND IN THE BUILDINGS IN THE CITY SKYLINE IN THE MARK. THE COLOR BEIGE APPEARS IN THE BAGEL, EXCEPT FOR THE PORTION COMPRISING THE CITY SKYLINE. THE WHITE IN THE DRAWING REPRESENTS TRANSPARENT AND BACKGROUND AREAS ONLY AND IS NOT PART OF THE MARK.



SER. NO. 85-065,585, FILED 6-17-2010.

MAUREEN DALL, EXAMINING ATTORNEY

David J. Kappas

Director of the United States Patent and Trademark Office

United States of America

United States Patent and Trademark Office

LEAF ORGANICS

Reg. No. 4,072,717

ROD ROTONDI ENTERPRISES, LLC (CALIFORNIA LIMITED LIABILITY COMPANY)
2629 PURDUE AVENUE
LOS ANGELES, CA 90064

Registered Dec. 20, 2011

Int. Cl.: 43

FOR: RESTAURANT AND CATERING SERVICES FEATURING ORGANIC FOOD, IN CLASS 43 (U.S. CLS. 100 AND 101).

SERVICE MARK

FIRST USE 6-1-2006; IN COMMERCE 10-1-2006.

PRINCIPAL REGISTER

THE MARK CONSISTS OF STANDARD CHARACTERS WITHOUT CLAIM TO ANY PARTICULAR FONT, STYLE, SIZE, OR COLOR.

OWNER OF U.S. REG. NOS. 3,107,789 AND 3,244,091.

NO CLAIM IS MADE TO THE EXCLUSIVE RIGHT TO USE "ORGANICS", APART FROM THE MARK AS SHOWN.

SER. NO. 85-065,930, FILED 6-17-2010.

MICHAEL TANNER, EXAMINING ATTORNEY



David J. Kybas

Director of the United States Patent and Trademark Office

United States of America

United States Patent and Trademark Office

CHANGE GROUP AMERICAS

Reg. No. 4,072,718

Registered Dec. 20, 2011

Int. Cls.: 35 and 36

SERVICE MARK

PRINCIPAL REGISTER

CHANGE GROUP AMERICAS, INC. (NEW YORK CORPORATION)
19TH FLOOR
111 JOHN STREET
NEW YORK, NY 10038

FOR: BUSINESS CONSULTATION; BUSINESS CONSULTATION SERVICES, NAMELY, BUSINESS PLANNING, BUSINESS RISK MANAGEMENT CONSULTATION, CONSULTATION CONCERNING BUSINESS MERGERS AND ACQUISITIONS, BUSINESS PURCHASE AND SALE, DIVESTITURES, STRATEGIC ALLIANCES, AND JOINT VENTURES; CORPORATE DUE DILIGENCE SERVICES, NAMELY, BUSINESS RESEARCH; BUSINESS CONSULTATION SERVICES IN THE AREAS OF CORPORATE GROWTH STRATEGY AND PROCESSES, INNOVATION, AND ORGANIZATIONAL TRANSFORMATION; BUSINESS CONSULTATION SERVICES CONCERNING MARKETING AND SALES, BRANDING, MARKET RESEARCH AND ANALYSIS, MARKET STRATEGY, CONSUMER SURVEYS, PRICING ANALYSIS AND MODELING, MARKET PENETRATION PLANNING AND IMPLEMENTATION, AND BUDGET EFFICIENCY AND EFFECTIVENESS; BUSINESS OPERATION AND ORGANIZATIONAL CONSULTANCY SERVICES; BUSINESS EMERGENCY MANAGEMENT CONSULTATION SERVICES; OUTSOURCING SERVICES; TRANSPORTATION AND FREIGHT LOGISTICS MANAGEMENT; ECONOMIC FORECASTING AND ANALYSIS; AND FORENSIC ACCOUNTING SERVICES, IN CLASS 35 (U.S. CLS. 100, 101 AND 102).

FIRST USE 10-0-2009; IN COMMERCE 10-0-2009.

FOR: FINANCIAL MANAGEMENT; CORPORATE FINANCE SERVICES, NAMELY, CONSULTATION IN THE FIELD OF CAPITAL STRUCTURE, ASSET SALES, AND CORPORATE TRANSACTIONS; FINANCIAL RISK MANAGEMENT CONSULTATION; FINANCIAL DUE DILIGENCE SERVICES; FINANCIAL VALUATIONS AND BUSINESS AND ASSET VALUATIONS, IN CLASS 36 (U.S. CLS. 100, 101 AND 102).

FIRST USE 10-0-2009; IN COMMERCE 10-0-2009.

THE MARK CONSISTS OF STANDARD CHARACTERS WITHOUT CLAIM TO ANY PARTICULAR FONT, STYLE, SIZE, OR COLOR.

NO CLAIM IS MADE TO THE EXCLUSIVE RIGHT TO USE "GROUP" AND "AMERICAS", APART FROM THE MARK AS SHOWN.



David J. Kyffers

Director of the United States Patent and Trademark Office

Reg. No. 4,072,718 SER. NO. 85-066,327, FILED 6-18-2010.

HEATHER BIDDULPH, EXAMINING ATTORNEY

United States of America

United States Patent and Trademark Office

UNDERGROUND HERBAL SPIRIT

Reg. No. 4,072,719

OGDEN'S OWN DISTILLERY, LLC (UTAH LIMITED LIABILITY COMPANY)
2679 MIDLAND #4
OGDEN, UT 84401

Registered Dec. 20, 2011

Int. Cl.: 33

FOR: ALCOHOLIC BEVERAGES, NAMELY, HERBAL LIQUEURS; ALCOHOLIC BITTERS;
DISTILLED SPIRITS, IN CLASS 33 (U.S. CLS. 47 AND 49).

TRADEMARK

FIRST USE 6-1-2010; IN COMMERCE 6-1-2010.

PRINCIPAL REGISTER

THE MARK CONSISTS OF STANDARD CHARACTERS WITHOUT CLAIM TO ANY PARTICULAR FONT, STYLE, SIZE, OR COLOR.

NO CLAIM IS MADE TO THE EXCLUSIVE RIGHT TO USE "HERBAL SPIRIT", APART FROM THE MARK AS SHOWN.

SER. NO. 85-068,865, FILED 6-22-2010.

MICHAEL KEATING, EXAMINING ATTORNEY



David J. Kybas

Director of the United States Patent and Trademark Office

United States of America

United States Patent and Trademark Office

EMS PROFESSIONALS

Reg. No. 4,072,720

Registered Dec. 20, 2011

Int. Cl.: 41

SERVICE MARK

PRINCIPAL REGISTER

WISCONSIN EMERGENCY MEDICAL TECHNICIANS ASSOCIATION, INC. (WISCONSIN CORPORATION), DBA WISCONSIN EMS ASSOCIATION
26422 OAKRIDGE DRIVE
WIND LAKE, WI 53195

FOR: PROVIDING ONLINE NON-DOWNLOADABLE PUBLICATIONS, NAMELY, MAGAZINES CONTAINING REVIEWS OF BEST PRACTICES AND INFORMATION ON CLASSES AND SEMINARS IN THE FIELD OF PRE-HOSPITAL EMERGENCY CARE, IN CLASS 41 (U.S. CLS. 100, 101 AND 107).

FIRST USE 11-1-2002; IN COMMERCE 11-1-2002.

THE MARK CONSISTS OF STANDARD CHARACTERS WITHOUT CLAIM TO ANY PARTICULAR FONT, STYLE, SIZE, OR COLOR.

OWNER OF U.S. REG. NO. 3,840,720.

SEC. 2(F).

SER. NO. 85-070,143, FILED 6-23-2010.

SKYE YOUNG, EXAMINING ATTORNEY



David J. Kybas

Director of the United States Patent and Trademark Office

United States of America

United States Patent and Trademark Office



Reg. No. 4,072,721

THE SAMURAI, INC. (NEW YORK CORPORATION)
8685 NW 53RD TERRACE
MIAMI, FL 33166

Registered Dec. 20, 2011

Int. Cl.: 43

FOR: BAR, RESTAURANT, CATERING, AND RESTAURANT CARRY-OUT SERVICES, IN CLASS 43 (U.S. CLS. 100 AND 101).

SERVICE MARK

FIRST USE 0-0-1997; IN COMMERCE 0-0-1997.

PRINCIPAL REGISTER

NO CLAIM IS MADE TO THE EXCLUSIVE RIGHT TO USE "STEAK - SEAFOOD - SUSHI", APART FROM THE MARK AS SHOWN.

THE MARK CONSISTS OF THE DEPICTION OF A MALE WARRIOR HOLDING A SWORD. CENTERED UNDERNEATH THE MALE WARRIOR IS THE WORD "SAMURAI" IN A STYLIZED TEXT. UNDERNEATH THE WORD "SAMURAI" APPEAR THE WORDS "STEAK - SEAFOOD - SUSHI" IN A SMALLER STYLIZED FONT SUCH THAT THEY LINE UP VERTICALLY WITH THE WORD "SAMURAI".

SER. NO. 85-070,346, FILED 6-24-2010.

GINA FINK, EXAMINING ATTORNEY



David J. Kybas

Director of the United States Patent and Trademark Office

United States of America

United States Patent and Trademark Office



UKON POWER

Reg. No. 4,072,722

Registered Dec. 20, 2011

Int. Cls.: 5, 30 and 32

TRADEMARK

PRINCIPAL REGISTER

HOUSE FOODS CORPORATION (JAPAN CORPORATION)
HIGASHI-OSAKA
1-5-7 MIKURIYA SAKAE-MACHI
OSAKA, JAPAN

FOR: DIETETIC FOODS ADAPTED FOR MEDICAL PURPOSES, MAINLY MADE OF TURMERIC; DIETETIC BEVERAGES ADAPTED FOR MEDICAL PURPOSES, MAINLY MADE OF TURMERIC; DIETETIC SUPPLEMENTS ADAPTED FOR MEDICAL PURPOSES, MAINLY MADE OF TURMERIC, IN CLASS 5 (U.S. CLS. 6, 18, 44, 46, 51 AND 52).

FOR: TURMERIC, AS THE MAIN INGREDIENT IN PROCESSED FOOD, IN THE FORM OF GRANULES, POWDERS, SOLIDS, SEMISOLIDS, LIQUIDS, PASTES OR JELLIES, IN CLASS 30 (U.S. CL. 46).

FOR: CARBONATED AND NON-CARBONATED BEVERAGES IN THE NATURE OF SOFT DRINKS CONTAINING TURMERIC, IN CLASS 32 (U.S. CLS. 45, 46 AND 48).

PRIORITY CLAIMED UNDER SEC. 44(D) ON JAPAN APPLICATION NO. 2010-043296, FILED 6-1-2010, REG. NO. 5360741, DATED 10-15-2010, EXPIRES 10-15-2020.

THE NON-LATIN CHARACTERS IN THE MARK TRANSLITERATE TO "UKON NO CHIKARA" AND THIS MEANS "THE POWER OF TURMERIC" OR "THE STRENGTH OF TURMERIC" OR "THE ENERGY OF TURMERIC" IN ENGLISH.

OWNER OF U.S. REG. NOS. 3,828,755 AND 3,832,181.

NO CLAIM IS MADE TO THE EXCLUSIVE RIGHT TO USE "UKON" AND THE JAPANESE CHARACTER THAT TRANSLITERATES TO "UKON", APART FROM THE MARK AS SHOWN.

THE STIPLING IS A FEATURE OF THE MARK.

THE MARK CONSISTS OF THE WORDING "UKON NO CHIKARA" IN SHADOWED STYLIZED FONT. JAPANESE CHARACTERS WITH SHADOWING APPEAR ABOVE AND BELOW THE WORDING. UNDERNEATH THE JAPANESE CHARACTERS IS THE TERM "UKON POWER".



David J. Kybas

Director of the United States Patent and Trademark Office

Reg. No. 4,072,722 THE ENGLISH TRANSLATION OF "UKON NO CHIKARA" IN THE MARK IS "THE POWER OF TURMERIC" OR "THE STRENGTH OF TURMERIC" OR "THE ENERGY OF TURMERIC".

SER. NO. 85-072,034, FILED 6-25-2010.

ADA HAN, EXAMINING ATTORNEY

United States of America

United States Patent and Trademark Office



TURMERIC POWER

Reg. No. 4,072,723

Registered Dec. 20, 2011

Int. Cls.: 5, 30 and 32

TRADEMARK

PRINCIPAL REGISTER

HOUSE FOODS CORPORATION (JAPAN CORPORATION)
HIGASHI-OSAKA
1-5-7 MIKURIYA SAKAE-MACHI
OSAKA, JAPAN

FOR: DIETETIC FOODS ADAPTED FOR MEDICAL PURPOSES, MAINLY MADE OF TURMERIC; DIETETIC BEVERAGES ADAPTED FOR MEDICAL PURPOSES, MAINLY MADE OF TURMERIC; DIETETIC SUPPLEMENTS ADAPTED FOR MEDICAL PURPOSES, MAINLY MADE OF TURMERIC, IN CLASS 5 (U.S. CLS. 6, 18, 44, 46, 51 AND 52).

FOR: TURMERIC, AS THE MAIN INGREDIENT IN PROCESSED FOOD, IN THE FORM OF GRANULES, POWDERS, SOLIDS, SEMISOLIDS, LIQUIDS, PASTES OR JELLIES, IN CLASS 30 (U.S. CL. 46).

FOR: CARBONATED AND NON-CARBONATED BEVERAGES IN THE NATURE OF SOFT DRINKS CONTAINING TURMERIC, IN CLASS 32 (U.S. CLS. 45, 46 AND 48).

PRIORITY CLAIMED UNDER SEC. 44(D) ON JAPAN APPLICATION NO. 2010-043297, FILED 6-1-2010, REG. NO. 5360742, DATED 10-15-2010, EXPIRES 10-15-2020.

THE NON-LATIN CHARACTERS IN THE MARK TRANSLITERATE TO "UKON NO CHIKARA" AND THIS MEANS "THE POWER OF TURMERIC" OR "THE STRENGTH OF TURMERIC" OR "THE ENERGY OF TURMERIC" IN ENGLISH.

OWNER OF U.S. REG. NOS. 3,828,755 AND 3,832,181.

NO CLAIM IS MADE TO THE EXCLUSIVE RIGHT TO USE "TURMERIC" AND "UKON" AND THE JAPANESE CHARACTER THAT TRANSLITERATES TO "UKON", APART FROM THE MARK AS SHOWN.

THE STIPLING IS A FEATURE OF THE MARK.

THE MARK CONSISTS OF THE WORDING "UKON NO CHIKARA" IN SHADOWED STYLIZED FONT. JAPANESE CHARACTERS WITH SHADOWING APPEAR ABOVE AND BELOW THE WORDING. UNDERNEATH THE JAPANESE CHARACTERS IS THE TERM "TURMERIC POWER".



David J. Kyjars

Director of the United States Patent and Trademark Office

Reg. No. 4,072,723 THE ENGLISH TRANSLATION OF "UKON NO CHIKARA" IN THE MARK IS "THE POWER OF TURMERIC" OR "THE STRENGTH OF TURMERIC" OR "THE ENERGY OF TURMERIC".

SER. NO. 85-072,053, FILED 6-25-2010.

ADA HAN, EXAMINING ATTORNEY

United States of America

United States Patent and Trademark Office

HDR EXPOSE

Reg. No. 4,072,724

Registered Dec. 20, 2011

Int. Cl.: 9

TRADEMARK

PRINCIPAL REGISTER

UNIFIED COLOR TECHNOLOGIES, LLC (CALIFORNIA LIMITED LIABILITY COMPANY)
21 AIRPORT BLVD., SUITE F
SOUTH SAN FRANCISCO, CA 94080

FOR: COMPUTER SOFTWARE FOR CREATING, VIEWING, MANIPULATING AND EDITING
DIGITAL PHOTOGRAPHS, IMAGES, AND GRAPHICS, IN CLASS 9 (U.S. CLS. 21, 23, 26,
36 AND 38).

FIRST USE 6-2-2010; IN COMMERCE 6-2-2010.

THE MARK CONSISTS OF STANDARD CHARACTERS WITHOUT CLAIM TO ANY PAR-
TICULAR FONT, STYLE, SIZE, OR COLOR.

NO CLAIM IS MADE TO THE EXCLUSIVE RIGHT TO USE "HDR", APART FROM THE
MARK AS SHOWN.

SER. NO. 85-073,194, FILED 6-28-2010.

SETH A. RAPPAPORT, EXAMINING ATTORNEY



David J. Kybas

Director of the United States Patent and Trademark Office

United States of America

United States Patent and Trademark Office

TRUTH ON CALL

Reg. No. 4,072,725

SAMADANI, ROSINA (UNITED STATES INDIVIDUAL), DBA TRUTH ON CALL
1120 LAKESHORE DR.

Registered Dec. 20, 2011

BEAVER DAM, WI 53916

Int. Cls.: 35, 42 and 44

FOR: ANALYSIS OF MARKET RESEARCH DATA AND STATISTICS; COLLECTION OF MARKET RESEARCH INFORMATION; CONDUCTING BUSINESS AND MARKET RESEARCH SURVEYS; MARKET RESEARCH; MARKET RESEARCH AND MARKET INTELLIGENCE SERVICES; MARKET RESEARCH BY MEANS OF A COMPUTER DATABASE; MARKET RESEARCH SERVICES; AND PROVISION OF MARKET RESEARCH INFORMATION, IN CLASS 35 (U.S. CLS. 100, 101 AND 102).

SERVICE MARK

PRINCIPAL REGISTER

FIRST USE 9-1-2009; IN COMMERCE 12-1-2009.

FOR: PROVIDING A WEB SITE FEATURING TECHNOLOGY TO ENABLE PHYSICIANS TO GENERATE, MANAGE AND EXCHANGE MEDICAL INFORMATION AND DOCUMENTS REGARDLESS OF MEDICAL ORGANIZATION OR GEOGRAPHIC LOCATION VIA WIRELESS AND MOBILE DEVICES, IN CLASS 42 (U.S. CLS. 100 AND 101).

FIRST USE 9-1-2009; IN COMMERCE 12-1-2009.

FOR: PHYSICIAN SERVICES, IN CLASS 44 (U.S. CLS. 100 AND 101).

FIRST USE 9-1-2009; IN COMMERCE 12-1-2009.

THE MARK CONSISTS OF STANDARD CHARACTERS WITHOUT CLAIM TO ANY PARTICULAR FONT, STYLE, SIZE, OR COLOR.

NO CLAIM IS MADE TO THE EXCLUSIVE RIGHT TO USE "ON CALL", APART FROM THE MARK AS SHOWN.

SER. NO. 85-073,922, FILED 6-29-2010.

ALEX KEAM, EXAMINING ATTORNEY



David J. Kyffers

Director of the United States Patent and Trademark Office

United States of America

United States Patent and Trademark Office

GUADALUPE IMMIGRATION SERVICES

Reg. No. 4,072,726

Registered Dec. 20, 2011

Int. Cls.: 35 and 45

SERVICE MARK

PRINCIPAL REGISTER

GUADALUPE WEDDING CHAPEL (CALIFORNIA CORPORATION)
237 SOUTH BROADWAY STREET
LOS ANGELES, CA 90012

FOR: ASSISTANCE IN THE FIELD OF IMMIGRATION LAW, NAMELY, PROVIDING ADVERTISING SERVICES FEATURING IMMIGRATION LAWYERS AND FIRMS, IN CLASS 35 (U.S. CLS. 100, 101 AND 102).

FIRST USE 7-18-1975; IN COMMERCE 7-18-1975.

FOR: LEGAL SERVICES AND ASSISTANCE IN THE FIELD OF IMMIGRATION LAW, NAMELY, PROVIDING LEGAL RESEARCH AND INFORMATION, IN CLASS 45 (U.S. CLS. 100 AND 101).

FIRST USE 7-18-1975; IN COMMERCE 7-18-1975.

THE MARK CONSISTS OF STANDARD CHARACTERS WITHOUT CLAIM TO ANY PARTICULAR FONT, STYLE, SIZE, OR COLOR.

NO CLAIM IS MADE TO THE EXCLUSIVE RIGHT TO USE "IMMIGRATION SERVICES", APART FROM THE MARK AS SHOWN.

SER. NO. 85-074,190, FILED 6-29-2010.

GENE MACIOL, EXAMINING ATTORNEY



David J. Kybas

Director of the United States Patent and Trademark Office

United States of America
United States Patent and Trademark Office

theKey

Reg. No. 4,072,727

THE KEY MUSIC, LLC (GEORGIA LIMITED LIABILITY COMPANY)
3725 VINEVILLE AVENUE
MACON, GA 31204

Registered Dec. 20, 2011

Int. Cl.: 25

FOR: PROMOTIONAL ITEMS, NAMELY, HATS, T-SHIRTS, WRIST BANDS, IN CLASS 25
(U.S. CLS. 22 AND 39).

TRADEMARK

FIRST USE 1-1-2010; IN COMMERCE 1-1-2010.

PRINCIPAL REGISTER

THE MARK CONSISTS OF THE LOGO, "THEKEY", WITH FADING IN SPOTS FOR EFFECT.

SER. NO. 85-074,585, FILED 6-30-2010.

KIMBERLY PERRY, EXAMINING ATTORNEY



David J. Kyffers

Director of the United States Patent and Trademark Office

United States of America

United States Patent and Trademark Office

DPM

Reg. No. 4,072,728

Registered Dec. 20, 2011

Int. Cl.: 10

TRADEMARK

PRINCIPAL REGISTER

SHENZHEN MINDRAY BIO-MEDICAL ELECTRONICS CO., LTD. (CHINA CORPORATION)
HI-TECH INDUSTRIAL PARK MINDRAY BLDG
KEJI 12TH RD SOUTH
NANSHAN, SHENZHEN, CHINA 518057

FOR: MEDICAL APPARATUS AND INSTRUMENTS FOR MONITORING OXIMETRY, GAS ANALYSIS, VITAL SIGNS, BLOOD PROPERTIES AND RESPIRATORY EVENTS, IN CLASS 10 (U.S. CLS. 26, 39 AND 44).

FIRST USE 3-13-2009; IN COMMERCE 3-13-2009.

THE MARK CONSISTS OF STANDARD CHARACTERS WITHOUT CLAIM TO ANY PARTICULAR FONT, STYLE, SIZE, OR COLOR.

SER. NO. 85-076,445, FILED 7-1-2010.

LOURDES AYALA, EXAMINING ATTORNEY



David J. Kyffers

Director of the United States Patent and Trademark Office

United States of America

United States Patent and Trademark Office

Guacamologist

Reg. No. 4,072,729

Registered Dec. 20, 2011

Int. Cl.: 43

SERVICE MARK

PRINCIPAL REGISTER

THE RITZ-CARLTON HOTEL COMPANY, L.L.C. (DELAWARE LIMITED LIABILITY COMPANY)
10400 FERNWOOD ROAD
BETHESDA, MD 20817

FOR: PROVIDING OF FOOD AND DRINK; PROVIDING OF FOOD AND DRINK FOR GUESTS; PROVISION OF FOOD AND DRINK IN RESTAURANTS; RESTAURANT SERVICES, NAMELY, PROVIDING OF FOOD AND BEVERAGES FOR CONSUMPTION ON AND OFF THE PREMISES; SERVING FOOD AND DRINKS; SERVING OF FOOD AND DRINK/BEVERAGES, IN CLASS 43 (U.S. CLS. 100 AND 101).

FIRST USE 12-21-2006; IN COMMERCE 12-21-2006.

THE MARK CONSISTS OF STANDARD CHARACTERS WITHOUT CLAIM TO ANY PARTICULAR FONT, STYLE, SIZE, OR COLOR.

SER. NO. 85-076,946, FILED 7-2-2010.

STEVEN R. FINE, EXAMINING ATTORNEY



David J. Kyffers

Director of the United States Patent and Trademark Office

United States of America

United States Patent and Trademark Office

Bougainvillea Books

Reg. No. 4,072,730

Registered Dec. 20, 2011

Int. Cl.: 41

SERVICE MARK

PRINCIPAL REGISTER

MILLER, HANS HUGH (UNITED STATES INDIVIDUAL)
164 WOODFORD HILLS DRIVE
AVON, CT 06001

FOR: BOOK PUBLISHING, IN CLASS 41 (U.S. CLS. 100, 101 AND 107).

FIRST USE 6-25-2010; IN COMMERCE 6-25-2010.

THE MARK CONSISTS OF STANDARD CHARACTERS WITHOUT CLAIM TO ANY PARTICULAR FONT, STYLE, SIZE, OR COLOR.

NO CLAIM IS MADE TO THE EXCLUSIVE RIGHT TO USE "BOOKS" FOR INTERNATIONAL CLASS 41, APART FROM THE MARK AS SHOWN.

SER. NO. 85-077,153, FILED 7-2-2010.

MATTHEW PAPPAS, EXAMINING ATTORNEY



David J. Kyppas

Director of the United States Patent and Trademark Office

United States of America

United States Patent and Trademark Office

Energize Your Life

Reg. No. 4,072,731

MSC FRANCHISING, INC. (NEW YORK CORPORATION)
2793 JERUSALEM AVENUE
NORTH BELLMORE, NY 11710

Registered Dec. 20, 2011

Int. Cl.: 32

FOR: SMOOTHIES, IN CLASS 32 (U.S. CLS. 45, 46 AND 48).

TRADEMARK

FIRST USE 11-15-2009; IN COMMERCE 11-15-2009.

PRINCIPAL REGISTER

THE MARK CONSISTS OF STANDARD CHARACTERS WITHOUT CLAIM TO ANY PARTICULAR FONT, STYLE, SIZE, OR COLOR.

SER. NO. 85-078,112, FILED 7-6-2010.

ALLISON SCHRODY, EXAMINING ATTORNEY



David J. Kybas

Director of the United States Patent and Trademark Office

United States of America

United States Patent and Trademark Office

MUNETOSHI

Reg. No. 4,072,732

HAORAN LING (UNITED STATES INDIVIDUAL)
580 UNION AVENUE
POMONA, CA 91768

Registered Dec. 20, 2011

Int. Cl.: 8

FOR: JAPANESE SWORDS; SWORDS, IN CLASS 8 (U.S. CLS. 23, 28 AND 44).

TRADEMARK

FIRST USE 4-26-2009; IN COMMERCE 4-26-2009.

PRINCIPAL REGISTER

THE MARK CONSISTS OF STANDARD CHARACTERS WITHOUT CLAIM TO ANY PARTICULAR FONT, STYLE, SIZE, OR COLOR.

THE WORDING "MUNETOSHI" HAS NO MEANING IN A FOREIGN LANGUAGE.

SER. NO. 85-080,662, FILED 7-8-2010.

KIM SAITO, EXAMINING ATTORNEY



David J. Kyffers

Director of the United States Patent and Trademark Office

United States of America

United States Patent and Trademark Office

ETF HQ

Reg. No. 4,072,733

Registered Dec. 20, 2011

Int. Cls.: 36 and 41

SERVICE MARK

PRINCIPAL REGISTER

CHARLES SCHWAB & CO., INC. (CALIFORNIA CORPORATION)
211 MAIN STREET
SAN FRANCISCO, CA 94105

FOR: FINANCIAL SERVICES, NAMELY, BROKERAGE SERVICES AND INVESTMENT ANALYSIS IN THE FIELD OF EXCHANGE-TRADED FUNDS; PROVIDING A WEBSITE FOR CLIENTS TO ACCESS NEWS, INFORMATION, RESEARCH, DATABASES AND ANALYSIS IN THE FINANCIAL FIELD, NAMELY, THE FIELD OF EXCHANGE-TRADED FUNDS; PROVIDING A WEBSITE FOR CLIENTS TO ACCESS FINANCIAL DECISION-MAKING TOOLS AND INVESTMENT RESEARCH TOOLS IN THE NATURE OF ONLINE, INTERACTIVE FINANCIAL CALCULATORS AND QUESTIONNAIRES FOR USE IN FINANCIAL PLANNING AND ANALYSIS; PROVIDING AN INTERACTIVE ONLINE COMPUTER DATABASE IN THE FIELD OF EXCHANGE-TRADED FUNDS, IN CLASS 36 (U.S. CLS. 100, 101 AND 102).

FIRST USE 4-26-2010; IN COMMERCE 4-26-2010.

FOR: EDUCATIONAL SERVICES, NAMELY, PROVIDING ONLINE TUTORIALS AND WEBCASTS IN THE FIELD OF EXCHANGE TRADED FUNDS; EDUCATIONAL SERVICES, NAMELY, PROVIDING A WEBSITE FEATURING RESOURCES, NAMELY, NON-DOWNLOADABLE PUBLICATIONS IN THE NATURE OF ARTICLES IN THE FIELD OF EXCHANGE TRADED FUNDS, IN CLASS 41 (U.S. CLS. 100, 101 AND 107).

FIRST USE 4-26-2010; IN COMMERCE 4-26-2010.

THE MARK CONSISTS OF STANDARD CHARACTERS WITHOUT CLAIM TO ANY PARTICULAR FONT, STYLE, SIZE, OR COLOR.

NO CLAIM IS MADE TO THE EXCLUSIVE RIGHT TO USE "ETF", APART FROM THE MARK AS SHOWN.

SER. NO. 85-080,853, FILED 7-8-2010.

MEGHAN REINHART, EXAMINING ATTORNEY



David J. Kyffers

Director of the United States Patent and Trademark Office

United States of America

United States Patent and Trademark Office

IZUMI EYEWEAR

Reg. No. 4,072,734

108786 CANADA INC. (CANADA CORPORATION)
4775 COUSENS STREET

Registered Dec. 20, 2011

VILLE ST-LAURENT, QC, CANADA H4S1X5

Int. Cl.: 9

FOR: EYEGLASSES, SUNGLASSES, PRESCRIPTION EYEGLASSES, PRESCRIPTION SUNGLASSES, IN CLASS 9 (U.S. CLS. 21, 23, 26, 36 AND 38).

TRADEMARK

THE MARK CONSISTS OF STANDARD CHARACTERS WITHOUT CLAIM TO ANY PARTICULAR FONT, STYLE, SIZE, OR COLOR.

PRINCIPAL REGISTER

OWNER OF CANADA REG. NO. 1468617, DATED 11-12-2010, EXPIRES 11-12-2025.

NO CLAIM IS MADE TO THE EXCLUSIVE RIGHT TO USE "EYEWEAR", APART FROM THE MARK AS SHOWN.

THE ENGLISH TRANSLATION OF "IZUMI" IN THE MARK IS SPRING OR FOUNTAIN.

SER. NO. 85-081,868, FILED 7-9-2010.

ALYSSA STEEL, EXAMINING ATTORNEY



David J. Kybas

Director of the United States Patent and Trademark Office

United States of America

United States Patent and Trademark Office



Reg. No. 4,072,735

Registered Dec. 20, 2011

Int. Cl.: 37

SERVICE MARK

PRINCIPAL REGISTER

D.A.S. INC (ARIZONA CORPORATION), DBA JIMMY'S BROADWAY AUTOMOTIVE
2448 E BROADWAY BLVD
TUCSON, AZ 85719

FOR: AUTOMOTIVE MAINTENANCE AND REPAIR, IN CLASS 37 (U.S. CLS. 100, 103 AND 106).

FIRST USE 4-1-2010; IN COMMERCE 4-1-2010.

NO CLAIM IS MADE TO THE EXCLUSIVE RIGHT TO USE "AUTOMOTIVE EST 1956" AND THE PICTORIAL REPRESENTATION OF THE CAR, APART FROM THE MARK AS SHOWN.

THE COLOR(S) DARK BLUE, LIGHT BLUE, GOLD, WHITE, BLACK, YELLOW, CHROME, AND BROWN IS/ARE CLAIMED AS A FEATURE OF THE MARK.

THE MARK CONSISTS OF CIRCLE WITH A WIDE BORDER LIKE A TIRE. THE BORDER IS IN DARK BLUE FADING TO LIGHT BLUE, AND THE WHITE AREA INSIDE THE CIRCLE REPRESENTS TRANSPARENT AREAS AND IS NOT PART OF THE MARK. THE TOP PART OF THE BORDER CONTAINS THE WORDING "JIMMY'S BROADWAY" IN WHITE LETTERS WITH A BLACK OUTLINE. THE BOTTOM PART OF THE BORDER CONTAINS THE WORD "AUTOMOTIVE" IN YELLOW LETTERS. THERE IS A DESIGN OF A GOLD CONVERTIBLE CAR OVERLAYING THE CENTER OF THE CIRCLE. THE CAR HAS A BLACK STEERING WHEEL, BLACK TIRES WITH WHITE WALLS, WHITE LIGHTS, WHITE INTERIOR, A BROWN EMBLEM ON THE HOOD AND CHROME TRIM. ABOVE THE CAR IS THE WORDING "EST 1956" IN DARK BLUE LETTERING. ON BOTH SIDES OF THE CIRCLE ARE FEATHERED WING FORMATIONS IN SHADES OF DARK BLUE AND LIGHT BLUE WITH WHITE OUTLINES.

SER. NO. 85-085,585, FILED 7-15-2010.

DEBRA LEE, EXAMINING ATTORNEY



David J. Kybas

Director of the United States Patent and Trademark Office

United States of America

United States Patent and Trademark Office

Grohe Blue Chilled & Sparkling

Reg. No. 4,072,736

Registered Dec. 20, 2011

Int. Cls.: 11 and 32

TRADEMARK

PRINCIPAL REGISTER

GROHE AG (FED REP GERMANY AKTIENGESELLSCHAFT)
HAUPTSTRASSE 137
58675 HEMER, FED REP GERMANY

FOR: WATER SOFTENING APPARATUS AND INSTALLATIONS; WATER FILTERS AND DRINKING WATER FILTERS; WATER FILTERING APPARATUS AND DRINKING WATER FILTERING APPARATUS AND INSTALLATIONS; WATER CONDUIT INSTALLATIONS, NAMELY, PIPES BEING PARTS OF WATER PURIFYING UNITS; WATER PURIFICATION INSTALLATIONS; WATER PURIFICATION APPARATUS AND INSTALLATIONS FOR GENERATING PURIFIED DRINKING WATER; WATER DISTRIBUTION APPARATUS AND INSTALLATIONS, NAMELY, DRINKING FOUNTAINS; WATER INTAKE APPARATUS AND DRINKING WATER INTAKE APPARATUS, NAMELY, FAUCETS, TAPS, MIXER TAPS FOR WATER PIPES, MIXING TAPS, THERMOSTATIC MIXING TAPS; DRINKING WATER DISPENSERS FOR CHILLED AND NON-CHILLED DRINKING WATER; WATER SUPPLY INSTALLATIONS WITH WATER BRANCH PIPES FOR CONNECTING FITTINGS WITH FILTERING FUNCTIONS AND CONNECTABLE DRINKING WATER BOTTLES; DRINKING WATER DISPENSERS FOR CONNECTING TO WATER PIPES, FOR THE OPTIONAL DISPENSING OF PURIFIED DRINKING WATER FROM WATER FEED PIPES BY MEANS OF FILTER INSERTS AND CONNECTIONS FOR APPARATUS FOR TRANSMITTING ULTRAVIOLET LIGHT; FITTINGS WITH WATER FILTERING FUNCTIONS BEING FIXTURES FOR CONNECTING DRINKING WATER NETWORKS AND HEATING WATER NETWORKS WITH HEATING WATER PROTECTIVE FILTERS AND PIPE DISCONNECTORS FOR PREVENTING THE BACKFLOW OF HEATING WATER INTO DRINKING WATER; PARTS AND ACCESSORIES FOR ALL THE AFORESAID GOODS, IN CLASS 11 (U.S. CLS. 13, 21, 23, 31 AND 34).

FOR: MINERAL, AERATED AND NON-AERATED DRINKING WATERS, PURIFIED AND FILTERED DRINKING WATERS, CHILLED AND HEATED DRINKING WATERS FOR MAKING NON-ALCOHOLIC BEVERAGES; NON-ALCOHOLIC FLAVORED WATER, IN CLASS 32 (U.S. CLS. 45, 46 AND 48).

THE MARK CONSISTS OF STANDARD CHARACTERS WITHOUT CLAIM TO ANY PARTICULAR FONT, STYLE, SIZE, OR COLOR.

PRIORITY CLAIMED UNDER SEC. 44(D) ON ERPN CMNTY TM OFC APPLICATION NO. 009249624, FILED 7-15-2010, REG. NO. 009249624, DATED 12-27-2010, EXPIRES 7-15-2020.



David J. Kypos

Director of the United States Patent and Trademark Office

Reg. No. 4,072,736 NO CLAIM IS MADE TO THE EXCLUSIVE RIGHT TO USE "CHILLED & SPARKLING" AS TO THE GOODS IN CLASS 32 ONLY, APART FROM THE MARK AS SHOWN.

SER. NO. 85-085,721, FILED 7-15-2010.

NAAKWAMA ANKRAH, EXAMINING ATTORNEY

United States of America

United States Patent and Trademark Office

Grohe Blue Pure

Reg. No. 4,072,737

Registered Dec. 20, 2011

Int. Cls.: 11 and 32

TRADEMARK

PRINCIPAL REGISTER

GROHE AG (FED REP GERMANY AKTIENGESELLSCHAFT)
HAUPTSTRASSE 137
58675 HEMER, FED REP GERMANY

FOR: WATER SOFTENING APPARATUS AND INSTALLATIONS; WATER FILTERS AND DRINKING WATER FILTERS; WATER FILTERING APPARATUS AND DRINKING WATER FILTERING APPARATUS AND INSTALLATIONS; WATER CONDUIT INSTALLATIONS, NAMELY, PIPES BEING PARTS OF WATER PURIFYING UNITS; WATER PURIFICATION INSTALLATIONS; WATER PURIFICATION APPARATUS AND INSTALLATIONS FOR GENERATING PURIFIED DRINKING WATER; WATER DISTRIBUTION APPARATUS AND INSTALLATIONS, NAMELY, DRINKING FOUNTAINS; WATER INTAKE APPARATUS AND DRINKING WATER INTAKE APPARATUS, NAMELY, FAUCETS, TAPS, MIXER TAPS FOR WATER PIPES, MIXING TAPS, THERMOSTATIC MIXING TAPS; DRINKING WATER DISPENSERS FOR CHILLED AND NON-CHILLED DRINKING WATER; WATER SUPPLY INSTALLATIONS WITH WATER BRANCH PIPES FOR CONNECTING FITTINGS WITH FILTERING FUNCTIONS AND CONNECTABLE DRINKING WATER BOTTLES; DRINKING WATER DISPENSERS FOR CONNECTING TO WATER PIPES, FOR THE OPTIONAL DISPENSING OF PURIFIED DRINKING WATER FROM WATER FEED PIPES BY MEANS OF FILTER INSERTS AND CONNECTIONS FOR APPARATUS FOR TRANSMITTING ULTRAVIOLET LIGHT; FITTINGS WITH WATER FILTERING FUNCTIONS BEING FIXTURES FOR CONNECTING DRINKING WATER NETWORKS AND HEATING WATER NETWORKS WITH HEATING WATER PROTECTIVE FILTERS AND PIPE DISCONNECTORS FOR PREVENTING THE BACKFLOW OF HEATING WATER INTO DRINKING WATER; PARTS AND ACCESSORIES FOR ALL THE AFORESAID GOODS, IN CLASS 11 (U.S. CLS. 13, 21, 23, 31 AND 34).

FOR: MINERAL, AERATED AND NON-AERATED DRINKING WATERS, PURIFIED AND FILTERED DRINKING WATERS, CHILLED AND HEATED DRINKING WATERS FOR MAKING NON-ALCOHOLIC BEVERAGES; NON-ALCOHOLIC FLAVORED WATER, IN CLASS 32 (U.S. CLS. 45, 46 AND 48).

THE MARK CONSISTS OF STANDARD CHARACTERS WITHOUT CLAIM TO ANY PARTICULAR FONT, STYLE, SIZE, OR COLOR.

PRIORITY CLAIMED UNDER SEC. 44(D) ON ERPN CMNTY TM OFC APPLICATION NO. 009249475, FILED 7-15-2010, REG. NO. 009249475, DATED 12-27-2010, EXPIRES 7-15-2020.



David J. Kypos

Director of the United States Patent and Trademark Office

Reg. No. 4,072,737 NO CLAIM IS MADE TO THE EXCLUSIVE RIGHT TO USE "PURE" AS TO THE GOODS IN CLASS 32, APART FROM THE MARK AS SHOWN.

SER. NO. 85-085,764, FILED 7-15-2010.

NAAKWAMA ANKRAH, EXAMINING ATTORNEY

United States of America

United States Patent and Trademark Office

Grohe Blue Pure & Simple

Reg. No. 4,072,738

Registered Dec. 20, 2011

Int. Cls.: 11 and 32

TRADEMARK

PRINCIPAL REGISTER

GROHE AG (FED REP GERMANY AKTIENGESELLSCHAFT)
HAUPTSTRASSE 137
58675 HEMER, FED REP GERMANY

FOR: WATER SOFTENING APPARATUS AND INSTALLATIONS; WATER FILTERS AND DRINKING WATER FILTERS; WATER FILTERING APPARATUS AND DRINKING WATER FILTERING APPARATUS AND INSTALLATIONS; WATER CONDUIT INSTALLATIONS, NAMELY, PIPES BEING PARTS OF WATER PURIFYING UNITS; WATER PURIFICATION INSTALLATIONS; WATER PURIFICATION APPARATUS AND INSTALLATIONS FOR GENERATING PURIFIED DRINKING WATER; WATER DISTRIBUTION APPARATUS AND INSTALLATIONS, NAMELY, DRINKING FOUNTAINS; WATER INTAKE APPARATUS AND DRINKING WATER INTAKE APPARATUS, NAMELY, FAUCETS, TAPS, MIXER TAPS FOR WATER PIPES, MIXING TAPS, THERMOSTATIC MIXING TAPS; DRINKING WATER DISPENSERS FOR CHILLED AND NON-CHILLED DRINKING WATER; WATER SUPPLY INSTALLATIONS WITH WATER BRANCH PIPES FOR CONNECTING FITTINGS WITH FILTERING FUNCTIONS AND CONNECTABLE DRINKING WATER BOTTLES; DRINKING WATER DISPENSERS FOR CONNECTING TO WATER PIPES, FOR THE OPTIONAL DISPENSING OF PURIFIED DRINKING WATER FROM WATER FEED PIPES BY MEANS OF FILTER INSERTS AND CONNECTIONS FOR APPARATUS FOR TRANSMITTING ULTRAVIOLET LIGHT; FITTINGS WITH WATER FILTERING FUNCTIONS BEING FIXTURES FOR CONNECTING DRINKING WATER NETWORKS AND HEATING WATER NETWORKS WITH HEATING WATER PROTECTIVE FILTERS AND PIPE DISCONNECTORS FOR PREVENTING THE BACKFLOW OF HEATING WATER INTO DRINKING WATER; PARTS AND ACCESSORIES FOR ALL THE AFORESAID GOODS, IN CLASS 11 (U.S. CLS. 13, 21, 23, 31 AND 34).

FOR: MINERAL, AERATED AND NON-AERATED DRINKING WATERS, PURIFIED AND FILTERED DRINKING WATERS, CHILLED AND HEATED DRINKING WATERS FOR MAKING NON-ALCOHOLIC BEVERAGES; NON-ALCOHOLIC FLAVORED WATER, IN CLASS 32 (U.S. CLS. 45, 46 AND 48).

THE MARK CONSISTS OF STANDARD CHARACTERS WITHOUT CLAIM TO ANY PARTICULAR FONT, STYLE, SIZE, OR COLOR.

PRIORITY CLAIMED UNDER SEC. 44(D) ON ERPN CMNTY TM OFC APPLICATION NO. 009249566, FILED 7-15-2010, REG. NO. 009249566, DATED 12-27-2010, EXPIRES 7-15-2020.



David J. Kypos

Director of the United States Patent and Trademark Office

Reg. No. 4,072,738 NO CLAIM IS MADE TO THE EXCLUSIVE RIGHT TO USE "PURE" AS TO THE GOODS IN CLASS 32, APART FROM THE MARK AS SHOWN.

SER. NO. 85-085,794, FILED 7-15-2010.

NAAKWAMA ANKRAH, EXAMINING ATTORNEY

United States of America

United States Patent and Trademark Office

Tuscan Chef

Reg. No. 4,072,739

REPUBLIC OF BEANS (NEW YORK CORPORATION)
52 RIVERSIDE DRIVE APT 4BC
NEW YORK, NY 10024

Registered Dec. 20, 2011

Int. Cl.: 41

FOR: EDUCATIONAL SERVICES, NAMELY, PROVIDING CLASSES, WORKSHOPS AND DEMONSTRATIONS IN THE FIELD OF LEARNING ABOUT ITALIAN CULTURE, PRODUCTS, FOOD AND WINE AND DISTRIBUTING WRITTEN MATERIALS IN CONNECTION THEREWITH, IN CLASS 41 (U.S. CLS. 100, 101 AND 107).

SERVICE MARK

PRINCIPAL REGISTER

FIRST USE 3-1-1997; IN COMMERCE 3-1-1997.

THE MARK CONSISTS OF STANDARD CHARACTERS WITHOUT CLAIM TO ANY PARTICULAR FONT, STYLE, SIZE, OR COLOR.

OWNER OF U.S. REG. NO. 2,923,118.

"TUSCAN CHEF" IDENTIFIES THE PSEUDONYM OR NICKNAME OF CESARE CASELLA, WHOSE CONSENT TO REGISTER IS MADE OF RECORD.

SER. NO. 85-086,066, FILED 7-15-2010.

BRENDAN MCCAULEY, EXAMINING ATTORNEY



David J. Kyros

Director of the United States Patent and Trademark Office

United States of America

United States Patent and Trademark Office

North Vector

Reg. No. 4,072,740

Registered Dec. 20, 2011

**Int. Cls.: 9, 35, 41, 42
and 45**

TRADEMARK

SERVICE MARK

PRINCIPAL REGISTER

NORTH VECTOR INC. (DELAWARE CORPORATION)
1376 WILLOW ROAD
MENLO PARK, CA 94025

FOR: SOFTWARE FOR IMAGE PROCESSING, INCLUDING THREE DIMENSIONAL IMAGING AND VISUALIZATION, STRUCTURE SIMULATION, TEXTURE MAPPING, AS WELL AS THE PROCESSING AND EXPLOITATION OF GEOSPATIAL DATA; SOFTWARE TOOLS AND APPLICATIONS FOR THE ANALYSIS OF VISUALIZATIONS FOR PURPOSES OF OPERATIONAL AND STRATEGIC PLANNING, INCLUDING TARGETING AND MEASURING, FOR OPERATORS OF FEDERAL, STATE AND LOCAL FOREIGN AND DOMESTIC AGENCIES, NAMELY, AGENCIES RESPONSIBLE FOR NATIONAL SECURITY, IN CLASS 9 (U.S. CLS. 21, 23, 26, 36 AND 38).

FIRST USE 5-17-2006; IN COMMERCE 5-17-2006.

FOR: COMPILATION OF INFORMATION, NAMELY, EXPLOSIVE BREACHING SEQUENCES, INTO COMPUTER DATABASES, IN CLASS 35 (U.S. CLS. 100, 101 AND 102).

FIRST USE 5-17-2006; IN COMMERCE 5-17-2006.

FOR: TEACHING, INSTRUCTION AND ARRANGING AND CONDUCTING OF DEMONSTRATIONS, SEMINARS, WORKSHOPS, PRACTICAL TRAINING, AND EXERCISES IN THE AREAS OF ASSESSING THE SECURITY OF FACILITIES AND OPERATIONS, MAINTAINING, MANAGING, AND EXECUTING EXPLOSIVE WALL BREACHING, NAMELY, TACTICAL BREACHING, BREACHING IN URBAN ENVIRONMENTS AND FOR ENTRY INTO FORTIFIED LOCATIONS, THE SCIENCE OF EXPLOSIVE MATERIALS INCLUDING CHARGE SELECTION AND PREPARATION, TARGET ASSESSMENT, BLAST PRESSURE EFFECTS AND CALCULATIONS, COLLATERAL DAMAGE AND PERSONNEL HAZARD PREDICTIONS AND VALIDATION, REAL STRUCTURE DATA COLLECTION AND TACTICAL SCENARIOS, MARITIME SEAFARING AND SEAMANSHIP, NAMELY, SAIL, POWER AND COASTAL BOATING, SMALL BOAT HANDLING, OFFSHORE PASSAGE MAKING, BLUE WATER SAILING AND INTERNATIONAL BAREBOAT CHARTERING, MARITIME INTERDICTION, YACHT AND SHIP BROKERING, GLOBAL CHARTERING, DISSIMILAR VESSEL SUPPORT, ASYMMETRICAL WARFARE IN NON-PERMISSIVE ENVIRONMENTS, COUNTER-PIRACY MEASURES AND VESSEL OR SHIP SELF DEFENSE, COUNTER TERRORISM MEASURES INCLUDING HOSTAGE RESCUE OPERATIONS, BUS AND VEHICLE CLOSE QUARTER BATTLE INTERDICTION, AIRCRAFT RECOVERY OPERATIONS,



David J. Kyros

Director of the United States Patent and Trademark Office

Reg. No. 4,072,740 ACTIVE SHOOTER AND SCHOOL RESPONSE, PROTECTING PERSONS, DEFENSE AGAINST SNIPERS, IMPROVISED EXPLOSIVE DEVICES AND TERRORIST DEVICES, SUICIDE AND HOMICIDE BOMBER RECOGNITION; PROVIDING TRAINING FACILITIES, NAMELY, REALISTIC TRAINING STRUCTURES TO BE USED IN SECURITY TRAINING; PUBLICATION OF OPERATOR MANUALS FOR SPECIAL FORCES AND SPECIAL WEAPONS AND TACTICS (SWAT) TEAMS; EDUCATIONAL CERTIFICATION AND EXAMINATION SERVICES, NAMELY, IN THE AREA OF SAFE BOATING, SAILING, AND DEFENSE AGAINST TERRORISM; OPERATION OF EDUCATIONAL TRAINING CENTERS FOR OTHERS IN THE FIELD OF SECURITY RISKS AND TACTICS AND EXPLOSIVE BREACHING, IN CLASS 41 (U.S. CLS. 100, 101 AND 107).

FIRST USE 5-17-2006; IN COMMERCE 5-17-2006.

FOR: ASSESSMENT OF SECURITY RISKS IN RELATION TO COMPUTER SYSTEMS FOR CORPORATIONS, GOVERNMENTS, GOVERNMENT AGENCIES, AND NON-GOVERNMENTAL ORGANIZATIONS; TESTING AND ASSESSMENT OF SECURITY SYSTEMS AND RISKS, NAMELY, SECURITY PENETRATION TESTING FOR CORPORATIONS, GOVERNMENTS, GOVERNMENT AGENCIES, AND NON-GOVERNMENTAL ORGANIZATIONS, IN CLASS 42 (U.S. CLS. 100 AND 101).

FIRST USE 5-17-2006; IN COMMERCE 5-17-2006.

FOR: PROVIDING STRATEGIC ASSESSMENTS AND CONSULTANCY IN THE AREA OF NATIONAL SECURITY; ADVISORY SERVICES RELATING TO SECURITY, NAMELY, RECOMMENDING AND IMPLEMENTING STRATEGIC MEASURES AND OPERATIONAL PROGRAMS TO PROTECT LIFE AND PROPERTY; CONSULTANCY SERVICES RELATING TO THE PROVISION OF SECURITY; SECURITY SERVICES FOR THE PROTECTION OF PROPERTY AND INDIVIDUALS, NAMELY, EXECUTIVE PROTECTION; INSPECTION OF BUILDINGS AND TRANSPORTATION INFRASTRUCTURE FOR PURPOSES OF SAFETY ASSESSMENTS, NAMELY, AIRPORTS, SCHOOLS AND UNIVERSITIES, SPORTS FACILITIES, COMMUNITY AND CORPORATE STRUCTURES, CHEMICAL PLANTS, GOVERNMENT AND MILITARY INSTALLATIONS, PORTS, AND SHIPPING WAYS; SERVICES IN THE AREA OF MARITIME AND AVIATION SECURITY, NAMELY, PHYSICAL SECURITY SERVICES WHICH PROTECT LIFE AND PROPERTY; ADVISORY SERVICES RELATING TO COUNTER-TERRORISM MEASURES AND STRATEGIES, NAMELY, MARITIME CRIMES OR TERRORIST INCIDENTS; MILITARY SCIENCES SERVICES, NAMELY, ANALYZING AND CONSULTING IN THE FIELD OF ASYMMETRICAL WARFARE STRATEGIES IN NON-PERMISSIVE ENVIRONMENTS , IN CLASS 45 (U.S. CLS. 100 AND 101).

FIRST USE 5-17-2006; IN COMMERCE 5-17-2006.

THE MARK CONSISTS OF STANDARD CHARACTERS WITHOUT CLAIM TO ANY PARTICULAR FONT, STYLE, SIZE, OR COLOR.

SER. NO. 85-089,528, FILED 7-21-2010.

PAULA MAHONEY, EXAMINING ATTORNEY

United States of America

United States Patent and Trademark Office

AMERICAS DIAMONDS

Reg. No. 4,072,741

AMERICAS GOLD, INC. (CALIFORNIA CORPORATION)
650 SOUTH HILL STREET, SUITE 224
LOS ANGELES, CA 90014

Registered Dec. 20, 2011

Int. Cl.: 14

FOR: JEWELRY AND WATCHES COMPOSED IN WHOLE OR SIGNIFICANT PART OF DIAMONDS, IN CLASS 14 (U.S. CLS. 2, 27, 28 AND 50).

TRADEMARK

FIRST USE 7-31-1999; IN COMMERCE 7-31-1999.

PRINCIPAL REGISTER

THE MARK CONSISTS OF STANDARD CHARACTERS WITHOUT CLAIM TO ANY PARTICULAR FONT, STYLE, SIZE, OR COLOR.

NO CLAIM IS MADE TO THE EXCLUSIVE RIGHT TO USE "DIAMONDS", APART FROM THE MARK AS SHOWN.

SEC. 2(F).

SER. NO. 85-089,909, FILED 7-21-2010.

ADA HAN, EXAMINING ATTORNEY



David J. Kybas

Director of the United States Patent and Trademark Office

United States of America

United States Patent and Trademark Office

CHOCOCONUT

Reg. No. 4,072,742

NATURE'S PATH FOODS INC. (CANADA CORPORATION)
9100 VAN HORNE WAY
RICHMOND, CANADA V6X1W3

Registered Dec. 20, 2011

Int. Cl.: 30

FOR: GRANOLA BARS, IN CLASS 30 (U.S. CL. 46).

TRADEMARK

FIRST USE 12-31-2009; IN COMMERCE 12-31-2009.

PRINCIPAL REGISTER

THE MARK CONSISTS OF STANDARD CHARACTERS WITHOUT CLAIM TO ANY PARTICULAR FONT, STYLE, SIZE, OR COLOR.

OWNER OF CANADA REG. NO. TMA801643, DATED 7-6-2011, EXPIRES 7-6-2016.

SER. NO. 85-090,986, FILED 7-22-2010.

KEVIN CORWIN, EXAMINING ATTORNEY



David J. Kybas

Director of the United States Patent and Trademark Office

United States of America

United States Patent and Trademark Office

MACHINEX

Reg. No. 4,072,743

MACHINEX INDUSTRIES, INC. (CANADA CORPORATION)
2121 OLIVIER STREET

Registered Dec. 20, 2011

PLESSISVILLE, QUEBEC., CANADA G6L3G9

Int. Cls.: 6, 7, 37, 40 and 42

FOR: (BASED ON 44(E)) METAL DISK SCREENS FOR USE IN SEPARATORS FOR RECYCLING AND SOLID WASTE PLANTS, IN CLASS 6 (U.S. CLS. 2, 12, 13, 14, 23, 25 AND 50).

TRADEMARK

FOR: MACHINES FOR THE RECUPERATION, RECYCLING, RECOVERY AND MANAGEMENT OF WASTE PRODUCTS, NAMELY, SEPARATING MACHINES, PRESSING MACHINES, MIXING MACHINES, SLICING MACHINES, SCREENING MACHINES, GRANULATING MACHINES, FUSION MACHINES, CONVEYORS, CONVEYOR BELTS, APRON STEEL BELTS FOR CONVEYORS FOR RECYCLING AND SOLID WASTE PLANTS, SEPARATORS, NAMELY, SINGLE SCREEN SEPARATORS, DISK SCREEN SEPARATORS; MACHINES FOR THE RECUPERATION, RECYCLING, RECOVERY AND MANAGEMENT OF WASTE PRODUCTS COMPRISING INTEGRATED ELECTRICAL CONTROLS, COMPACTORS, BALERS, TROMMELS, DRUM FEEDERS, BACK SCRAPING DRUMS, PLASTIC PERFORATORS, GLASS PRE-CLEANING UNITS, GLASS CLEAN UP UNIT, BAG OPENERS, AIR CLASSIFIERS, FERROUS AND NON-FERROUS SEPARATORS, SINK FLOATING SYSTEMS, SOLD AS A UNIT; HYDRAULICALLY-DRIVEN MOVING FLOOR FOR HANDLING AND MOVING MATERIAL, IN CLASS 7 (U.S. CLS. 13, 19, 21, 23, 31, 34 AND 35).

SERVICE MARK

PRINCIPAL REGISTER

FIRST USE 1-0-1985; IN COMMERCE 1-0-1992.



FOR: TECHNICAL CONSULTING REGARDING THE INSTALLATION OF SYSTEMS, MACHINES AND EQUIPMENT FOR RECUPERATION, RECYCLING, RECOVERY AND MANAGEMENT OF WASTE PRODUCTS, IN CLASS 37 (U.S. CLS. 100, 103 AND 106).

FIRST USE 1-0-1985; IN COMMERCE 1-0-1992.

FOR: CUSTOM MANUFACTURING OF SYSTEMS, MACHINES AND EQUIPMENT FOR RECUPERATION, RECYCLING, RECOVERY AND MANAGEMENT OF WASTE PRODUCTS, IN CLASS 40 (U.S. CLS. 100, 103 AND 106).

FIRST USE 1-0-1985; IN COMMERCE 1-0-1992.

David J. Kybas

Director of the United States Patent and Trademark Office

Reg. No. 4,072,743 FOR: DESIGN AND ENGINEERING OF SYSTEMS, MACHINES AND EQUIPMENT FOR RECUPERATION, RECYCLING, RECOVERY AND MANAGEMENT OF WASTE PRODUCTS, IN CLASS 42 (U.S. CLS. 100 AND 101).

FIRST USE 1-0-1985; IN COMMERCE 1-0-1992.

THE MARK CONSISTS OF STANDARD CHARACTERS WITHOUT CLAIM TO ANY PARTICULAR FONT, STYLE, SIZE, OR COLOR.

PRIORITY CLAIMED UNDER SEC. 44(D) ON CANADA APPLICATION NO. 1480283, FILED 5-7-2010, REG. NO. TMA596146, DATED 4-26-2011, EXPIRES 4-26-2026.

OWNER OF U.S. REG. NO. 2,538,804.

SER. NO. 85-091,287, FILED 7-23-2010.

MICHELLE DUBOIS, EXAMINING ATTORNEY

United States of America

United States Patent and Trademark Office

Brow Boosters

Reg. No. 4,072,744

VIGLIOTTI, MALYNDA GRACE (UNITED STATES INDIVIDUAL)
56 JANE ST., SUITE 3G
NEW YORK, NY 10014

Registered Dec. 20, 2011

Int. Cl.: 3

FOR: EYEBROW COSMETICS, IN CLASS 3 (U.S. CLS. 1, 4, 6, 50, 51 AND 52).

TRADEMARK

FIRST USE 11-1-2009; IN COMMERCE 11-1-2009.

PRINCIPAL REGISTER

THE MARK CONSISTS OF STANDARD CHARACTERS WITHOUT CLAIM TO ANY PARTICULAR FONT, STYLE, SIZE, OR COLOR.

NO CLAIM IS MADE TO THE EXCLUSIVE RIGHT TO USE "BROW", APART FROM THE MARK AS SHOWN.

SER. NO. 85-091,361, FILED 7-23-2010.

MICHELLE DUBOIS, EXAMINING ATTORNEY



David J. Kyffers

Director of the United States Patent and Trademark Office

United States of America

United States Patent and Trademark Office

SOUNDTRACK

Reg. No. 4,072,745

SOUNDBITE TECHNOLOGY, LLC (CALIFORNIA LIMITED LIABILITY COMPANY)
PO BOX 39814

Registered Dec. 20, 2011

LOS ANGELES, CA 90039

Int. Cl.: 9

FOR: COMPUTER SOFTWARE PLATFORMS FOR LABORATORY MANAGEMENT EXCLUDING SOFTWARE PLATFORMS PROVIDING OPERATIONAL EFFICIENCIES IN HOSPITALS AND HEALTHCARE FACILITIES FOR THE MONITORING OF PATIENT PLACEMENT, TRANSPORT, PROCEDURE STATUS AND MANAGEMENT OF HEALTHCARE PROFESSIONALS AND STAFF, IN CLASS 9 (U.S. CLS. 21, 23, 26, 36 AND 38).

TRADEMARK

PRINCIPAL REGISTER

FIRST USE 3-1-2010; IN COMMERCE 3-1-2010.

THE MARK CONSISTS OF STANDARD CHARACTERS WITHOUT CLAIM TO ANY PARTICULAR FONT, STYLE, SIZE, OR COLOR.

SER. NO. 85-091,499, FILED 7-23-2010.

GINA HAYES, EXAMINING ATTORNEY



David J. Kybas

Director of the United States Patent and Trademark Office

United States of America

United States Patent and Trademark Office

PEANUT BUDDY

Reg. No. 4,072,746

NATURE'S PATH FOODS INC. (CANADA CORPORATION)
9100 VAN HORNE WAY
RICHMOND, CANADA V6X1W3

Registered Dec. 20, 2011

Int. Cl.: 30

FOR: GRANOLA BARS, IN CLASS 30 (U.S. CL. 46).

TRADEMARK

FIRST USE 12-31-2009; IN COMMERCE 12-31-2009.

PRINCIPAL REGISTER

THE MARK CONSISTS OF STANDARD CHARACTERS WITHOUT CLAIM TO ANY PARTICULAR FONT, STYLE, SIZE, OR COLOR.

PRIORITY CLAIMED UNDER SEC. 44(D) ON CANADA APPLICATION NO. 1488118, FILED 7-9-2010, REG. NO. TMA801,793, DATED 7-8-2011, EXPIRES 7-8-2026.

NO CLAIM IS MADE TO THE EXCLUSIVE RIGHT TO USE "PEANUT", APART FROM THE MARK AS SHOWN.

SER. NO. 85-091,671, FILED 7-23-2010.

KEVIN CORWIN, EXAMINING ATTORNEY



David J. Kyffers

Director of the United States Patent and Trademark Office

United States of America

United States Patent and Trademark Office

STYLUS

Reg. No. 4,072,747

Registered Dec. 20, 2011

Int. Cl.: 9

TRADEMARK

PRINCIPAL REGISTER

STYLUS MEDIA GROUP LIMITED (UNITED KINGDOM COMPANY)
239 REGENTS PARK ROAD
LONDON, UNITED KINGDOM N33LF

FOR: ELECTRONIC DOWNLOADABLE PUBLICATIONS NAMELY BOOKS, MANUALS, MAGAZINES, NEWSPAPERS, PERIODICALS, NEWSLETTERS AND DOCUMENTS IN THE FIELD OF ADVERTISING, MARKETING AND BUSINESS, IN CLASS 9 (U.S. CLS. 21, 23, 26, 36 AND 38).

THE MARK CONSISTS OF STANDARD CHARACTERS WITHOUT CLAIM TO ANY PARTICULAR FONT, STYLE, SIZE, OR COLOR.

PRIORITY CLAIMED UNDER SEC. 44(D) ON UNITED KINGDOM APPLICATION NO. 2537146, FILED 1-25-2010, REG. NO. 2537146, DATED 5-21-2010, EXPIRES 1-25-2020.

SER. NO. 85-091,674, FILED 7-23-2010.

DAVID TAYLOR, EXAMINING ATTORNEY



David J. Kybas

Director of the United States Patent and Trademark Office

United States of America

United States Patent and Trademark Office

STYLUS

Reg. No. 4,072,748

Registered Dec. 20, 2011

Int. Cl.: 41

SERVICE MARK

PRINCIPAL REGISTER

STYLUS MEDIA GROUP LIMITED (UNITED KINGDOM COMPANY)
239 REGENTS PARK ROAD
LONDON, UNITED KINGDOM N33LF

FOR: PUBLISHING OF BOOKS, MANUALS, MAGAZINES, NEWSPAPERS, PERIODICALS, NEWSLETTERS, DESIGNS, PHOTOGRAPHS, DOCUMENTS AND MAPS; ON-LINE PUBLISHING OF BOOKS, MANUALS, MAGAZINES, NEWSPAPERS, PERIODICALS, NEWSLETTERS, DESIGNS, PHOTOGRAPHS, DOCUMENTS AND MAPS; ELECTRONIC DESKTOP PUBLISHING; DIGITAL VIDEO, AUDIO AND MULTI-MEDIA PUBLISHING; PUBLICATION OF PRINTED MATTER; DIGITAL IMAGING SERVICES; LAYOUT SERVICES OTHER THAN FOR ADVERTISING SERVICES; ELECTRONIC PUBLISHING AND ON-LINE PUBLISHING OF BOOKS, MANUALS, MAGAZINES, NEWSPAPERS, PERIODICALS, NEWSLETTERS, DESIGNS, PHOTOGRAPHS, DOCUMENTS AND MAPS; CONSULTING SERVICES IN THE FIELD OF PUBLICATION OF BOOKS, MANUALS, MAGAZINES, NEWSPAPERS, PERIODICALS, NEWSLETTERS, DESIGNS, PHOTOGRAPHS, DOCUMENTS AND MAPS, IN CLASS 41 (U.S. CLS. 100, 101 AND 107).

THE MARK CONSISTS OF STANDARD CHARACTERS WITHOUT CLAIM TO ANY PARTICULAR FONT, STYLE, SIZE, OR COLOR.

PRIORITY CLAIMED UNDER SEC. 44(D) ON UNITED KINGDOM APPLICATION NO. 2537146, FILED 1-25-2010, REG. NO. 2537146, DATED 5-21-2010, EXPIRES 1-25-2020.

SER. NO. 85-091,698, FILED 7-23-2010.

DAVID TAYLOR, EXAMINING ATTORNEY



David J. Kyros

Director of the United States Patent and Trademark Office

United States of America

United States Patent and Trademark Office

LOTTA' APRICOTTA

Reg. No. 4,072,749

NATURE'S PATH FOODS INC. (CANADA CORPORATION)
9100 VAN HORNE WAY
RICHMOND, CANADA V6X1W3

Registered Dec. 20, 2011

Int. Cl.: 30

FOR: GRANOLA BARS, IN CLASS 30 (U.S. CL. 46).

TRADEMARK

FIRST USE 12-31-2009; IN COMMERCE 12-31-2009.

PRINCIPAL REGISTER

THE MARK CONSISTS OF STANDARD CHARACTERS WITHOUT CLAIM TO ANY PARTICULAR FONT, STYLE, SIZE, OR COLOR.

PRIORITY CLAIMED UNDER SEC. 44(D) ON CANADA APPLICATION NO. 1488119, FILED 7-9-2010, REG. NO. TMA801803, DATED 7-8-2011, EXPIRES 7-8-2026.

SER. NO. 85-091,751, FILED 7-23-2010.

KEVIN CORWIN, EXAMINING ATTORNEY



David J. Kybas

Director of the United States Patent and Trademark Office

United States of America

United States Patent and Trademark Office

REVIVAL ANTIQUES

Reg. No. 4,072,750

REVIVAL ANTIQUES INC (CALIFORNIA CORPORATION)

Registered Dec. 20, 2011

527 S FAIR OAKS AVE
PASADENA, CA 91105

Int. Cl.: 35

FOR: RETAIL STORE AND ON-LINE RETAIL STORE SERVICES FEATURING ANTIQUE AND PERIOD-APPROPRIATE CUSTOM FURNITURE, LIGHTING AND DECORATIVE ACCESSORIES, IN CLASS 35 (U.S. CLS. 100, 101 AND 102).

SERVICE MARK

FIRST USE 11-23-2002; IN COMMERCE 1-1-2003.

PRINCIPAL REGISTER

THE MARK CONSISTS OF STANDARD CHARACTERS WITHOUT CLAIM TO ANY PARTICULAR FONT, STYLE, SIZE, OR COLOR.

NO CLAIM IS MADE TO THE EXCLUSIVE RIGHT TO USE "ANTIQUES", APART FROM THE MARK AS SHOWN.

SER. NO. 85-092,821, FILED 7-26-2010.

STEPHANIE ALI, EXAMINING ATTORNEY



David J. Kybas

Director of the United States Patent and Trademark Office

United States of America

United States Patent and Trademark Office

BALANCED YOGA

Reg. No. 4,072,751

Registered Dec. 20, 2011

Int. Cl.: 41

SERVICE MARK

PRINCIPAL REGISTER

DEAR, DEBRA (UNITED STATES INDIVIDUAL)
17713 BESITO WAY
BOCA RATON, FL 334961056

FOR: INSTRUCTION IN THE FIELD OF YOGA, PHYSICAL FITNESS, MENTAL FITNESS, SPIRITUAL FITNESS; AND PERSONAL IMPROVEMENT, IN CLASS 41 (U.S. CLS. 100, 101 AND 107).

FIRST USE 8-23-1999; IN COMMERCE 4-10-2000.

THE MARK CONSISTS OF STANDARD CHARACTERS WITHOUT CLAIM TO ANY PARTICULAR FONT, STYLE, SIZE, OR COLOR.

NO CLAIM IS MADE TO THE EXCLUSIVE RIGHT TO USE "YOGA", APART FROM THE MARK AS SHOWN.

SEC. 2(F).

SER. NO. 85-098,029, FILED 8-2-2010.

JEFFERY COWARD, EXAMINING ATTORNEY



David J. Kyffers

Director of the United States Patent and Trademark Office

United States of America

United States Patent and Trademark Office

SONGS ALIVE

Reg. No. 4,072,753

DIANNE BAKER (UNITED STATES INDIVIDUAL)
4385 JOANNE DR.

Registered Dec. 20, 2011

ANN ARBOR, MI 48103

Int. Cls.: 41 and 44

FOR: EDUCATIONAL DEMONSTRATIONS USING INTERACTIVE MUSIC SESSIONS AND SPECIFIC MUSIC COMPOSITIONS TO MEET CURRICULUM GOALS IN SCHOOLS REGARDING STUDENTS LEARNING AND TO ENHANCE EMERGENT READING SKILLS THROUGH SINGING; AND DISTRIBUTION OF EDUCATIONAL MATERIALS IN CONNECTION THEREWITH, IN CLASS 41 (U.S. CLS. 100, 101 AND 107).

SERVICE MARK

PRINCIPAL REGISTER

FIRST USE 4-0-1970; IN COMMERCE 4-0-1971.

FOR: CONSULTING SERVICES, NAMELY, MUSIC INTERVENTION IN THE FIELD OF HEALTHCARE, WELLNESS, AND HEALTH EDUCATION TO BRING ABOUT PERSONAL HAPPINESS; CONDUCTING INTERACTIVE MUSIC PROGRAMS DEMONSTRATING MUSIC INTERVENTIONS AND ORIGINAL MUSIC COMPOSITIONS TO MEET HEALTHCARE GOALS, PROMOTE PERSONAL HAPPINESS, AND TO ENHANCE EMERGENT READING SKILLS, NAMELY, LITERACY BY SINGING, TO HELP MEET CURRICULUM GOALS IN THE CLASSROOM IN BOTH ADULTS AND CHILDREN, AND DISTRIBUTION OF PRINTED MATERIALS IN CONNECTION THEREWITH IN HARD COPY OR ELECTRONIC FORMAT, AND IN RELATED ELECTRONIC DATA CARRIERS, NAMELY, CDS AND DVDS ON THE SAME TOPICS, IN CLASS 44 (U.S. CLS. 100 AND 101).

FIRST USE 4-0-1970; IN COMMERCE 4-0-1971.

THE MARK CONSISTS OF STANDARD CHARACTERS WITHOUT CLAIM TO ANY PARTICULAR FONT, STYLE, SIZE, OR COLOR.

NO CLAIM IS MADE TO THE EXCLUSIVE RIGHT TO USE "SONGS", APART FROM THE MARK AS SHOWN.

SER. NO. 85-098,732, FILED 8-3-2010.

ESTHER A. BORSUK, EXAMINING ATTORNEY



David J. Kyffers

Director of the United States Patent and Trademark Office

United States of America

United States Patent and Trademark Office

NAARI

Reg. No. 4,072,754

Registered Dec. 20, 2011

Int. Cl.: 36

SERVICE MARK

PRINCIPAL REGISTER

NATIONAL AFRICAN AMERICAN RELATIONSHIPS INSTITUTE, INC. (GEORGIA CORPORATION)
1399 MONTREAL ROAD
TUCKER, GA 30084

FOR: COUNSELING RELATED TO HOUSING AGENCIES IN THE FIELDS OF MORTGAGE DELINQUENCY AND DEFAULT, LOSS MITIGATION FOR UNDER OR NON-PERFORMING MORTGAGE LOANS, FINANCING FOR HOME-BUYING, FINANCIAL HOME PRE-PURCHASE AND POST-PURCHASE PLANS, HOME EQUITY CONVERSION MORTGAGES AND REVERSE HOME EQUITY HOME CONVERSION MORTGAGES, MONEY MANAGEMENT, CREDIT MANAGEMENT, DEBT MANAGEMENT, RENTAL OF HOMES, IN CLASS 36 (U.S. CLS. 100, 101 AND 102).

FIRST USE 7-30-2003; IN COMMERCE 7-30-2003.

THE MARK CONSISTS OF STANDARD CHARACTERS WITHOUT CLAIM TO ANY PARTICULAR FONT, STYLE, SIZE, OR COLOR.

SER. NO. 85-099,286, FILED 8-3-2010.

JEAN IM, EXAMINING ATTORNEY



David J. Kypos

Director of the United States Patent and Trademark Office

United States of America

United States Patent and Trademark Office



Reg. No. 4,072,755

Registered Dec. 20, 2011

Int. Cl.: 37

SERVICE MARK

PRINCIPAL REGISTER

D.A.S. INC (ARIZONA CORPORATION), DBA JIMMY'S BROADWAY AUTOMOTIVE
WWW.JIMMYSBROADWAY.COM
2448 E BROADWAY BLVD
TUCSON, AZ 85719

FOR: REPAIR AND MAINTENANCE OF VEHICLES, IN CLASS 37 (U.S. CLS. 100, 103 AND 106).

FIRST USE 1-1-2004; IN COMMERCE 1-1-2004.

NO CLAIM IS MADE TO THE EXCLUSIVE RIGHT TO USE "AUTOMOTIVE" AND THE PICTORIAL REPRESENTATION OF THE CAR, APART FROM THE MARK AS SHOWN.

SER. NO. 85-102,427, FILED 8-6-2010.

DEBRA LEE, EXAMINING ATTORNEY



David J. Kybas

Director of the United States Patent and Trademark Office

United States of America

United States Patent and Trademark Office



Reg. No. 4,072,756

RODRIGUEZ, JAIME (UNITED STATES INDIVIDUAL)
7811 SW 89TH COURT
MIAMI, FL 33173

Registered Dec. 20, 2011

Int. Cl.: 14

FOR: RUBBER OR SILICON WRISTBANDS IN THE NATURE OF A BRACELET, IN CLASS 14 (U.S. CLS. 2, 27, 28 AND 50).

TRADEMARK

FIRST USE 4-1-2010; IN COMMERCE 5-1-2010.

PRINCIPAL REGISTER

THE MARK CONSISTS OF "BIO BALANCE" WITH A YIN YANG SYMBOL AND CHINESE CHARACTERS WHICH TRANSLITERATE TO HUAI AND HAO AND THIS MEANS BAD AND GOOD IN ENGLISH.

THE NON-LATIN CHARACTERS IN THE MARK TRANSLITERATE TO HUAI AND HAO AND THIS MEANS BAD AND GOOD IN ENGLISH.

SER. NO. 85-104,125, FILED 8-10-2010.

PAUL E. FAHRENKOPF, EXAMINING ATTORNEY



David J. Kybas

Director of the United States Patent and Trademark Office

United States of America

United States Patent and Trademark Office



Tichaa

Reg. No. 4,072,757

Registered Dec. 20, 2011

Int. Cl.: 30

TRADEMARK

PRINCIPAL REGISTER

HARNPHANICH, VUDHICHAI (THAILAND INDIVIDUAL), AKA PAUL HARN
98/42 SOI NUAN NOI, NORTH KLONGTON
BANGKOK 10110, THAILAND

FOR: FRUIT TEAS; GREEN TEA; HERB TEA; HERBAL TEA; TEA; TEA BAGS, IN CLASS
30 (U.S. CL. 46).

FIRST USE 6-29-2010; IN COMMERCE 6-29-2010.

THE MARK CONSISTS OF THE WORD "TICHAA" WITH A DESIGN IN THE NATURE OF
DESIGN FEATURING MULBERRY TREES INSIDE A CIRCULAR BORDER.

THE WORDING "TICHAA" HAS NO MEANING IN A FOREIGN LANGUAGE.

SER. NO. 85-104,662, FILED 8-11-2010.

RICHARD WHITE, EXAMINING ATTORNEY



David J. Kybas

Director of the United States Patent and Trademark Office

United States of America

United States Patent and Trademark Office

EnviroSafe
Technologies Ltd.

Reg. No. 4,072,758

ENVIROSAFE TECHNOLOGIES LTD (CANADA CORPORATION)

Registered Dec. 20, 2011

64 PROSPECT POINT RD S
RIDGEWAY, CANADA L0S1N0

Int. Cl.: 35

FOR: BUSINESS CONSULTING IN THE FIELD OF ENVIRONMENTAL MANAGEMENT, NAMELY, ADVISING BUSINESSES AND INDIVIDUALS ON ISSUES OF ENVIRONMENTAL IMPACT, CONSERVATION, PRESERVATION AND PROTECTION, AND ECONOMIC ANALYSIS FOR BUSINESS PURPOSES, IN CLASS 35 (U.S. CLS. 100, 101 AND 102).

SERVICE MARK

PRINCIPAL REGISTER

FIRST USE 5-15-2002; IN COMMERCE 5-15-2002.

NO CLAIM IS MADE TO THE EXCLUSIVE RIGHT TO USE "ENVIRO SAFE TECHNOLOGIES LTD.", APART FROM THE MARK AS SHOWN.

THE MARK CONSISTS OF THE LITERAL ELEMENT "ENVIRO SAFE TECHNOLOGIES LTD" AND A DESIGN WHEREIN THE LITERAL ELEMENT IS REPRESENTED IN STYLIZED FONT WHEREIN FURTHER THE LETTER "O" IS SUBSTITUTED BY A GRAPHIC REPRESENTATION OF A GLOBE AND WHERE THE WORDS "ENVIROSAFE" ARE LOCATED ABOVE THE WORDS "TECHNOLOGIES LTD.".

SER. NO. 85-105,336, FILED 8-11-2010.

RONALD DELGIZZI, EXAMINING ATTORNEY



David J. Kypos

Director of the United States Patent and Trademark Office

United States of America

United States Patent and Trademark Office

M MACHINEX

Reg. No. 4,072,759

MACHINEX INDUSTRIES, INC. (CANADA CORPORATION)
2121, RUE OLIVIER

Registered Dec. 20, 2011

PLESSISVILLE, QUEBEC, CANADA G6L3G9

Int. Cls.: 6, 7, 37, 40 and 42

FOR: (BASED ON 44(E)) METAL DISK SCREENS FOR USE IN SEPARATORS FOR RECYCLING AND SOLID WASTE PLANTS, IN CLASS 6 (U.S. CLS. 2, 12, 13, 14, 23, 25 AND 50).

TRADEMARK

FOR: MACHINES FOR THE RECUPERATION, RECYCLING, RECOVERY AND MANAGEMENT OF WASTE PRODUCTS, NAMELY, SEPARATING MACHINES, PRESSING MACHINES, MIXING MACHINES, SLICING MACHINES, SCREENING MACHINES, GRANULATING MACHINES, FUSION MACHINES, CONVEYORS, CONVEYOR BELTS, APRON STEEL BELTS FOR CONVEYORS FOR RECYCLING AND SOLID WASTE PLANT, SEPARATORS, NAMELY, SINGLE SCREEN SEPARATORS, DISK SCREEN SEPARATORS; MACHINES FOR THE RECUPERATION, RECYCLING, RECOVERY AND MANAGEMENT OF WASTE PRODUCTS COMPRISING INTEGRATED ELECTRICAL CONTROLS, COMPACTORS, BALERS, TROMMELS, DRUM FEEDERS, BACK SCRAPING DRUMS, PLASTIC PERFORATORS, GLASS PRE-CLEANING UNITS, GLASS CLEAN UP UNIT, BAG OPENERS, AIR CLASSIFIERS, FERROUS AND NON-FERROUS SEPARATORS, SINK FLOATING SYSTEMS, SOLD AS A UNIT; HYDRAULICALLY-DRIVEN MOVING FLOOR FOR HANDLING AND MOVING MATERIAL, IN CLASS 7 (U.S. CLS. 13, 19, 21, 23, 31, 34 AND 35).

SERVICE MARK

PRINCIPAL REGISTER

FIRST USE 1-0-2010; IN COMMERCE 1-0-2010.



FOR: TECHNICAL CONSULTING REGARDING THE INSTALLATION OF SYSTEMS, MACHINES AND EQUIPMENT FOR RECUPERATION, RECYCLING, RECOVERY AND MANAGEMENT OF WASTE PRODUCTS, IN CLASS 37 (U.S. CLS. 100, 103 AND 106).

FIRST USE 1-0-2010; IN COMMERCE 1-0-2010.

FOR: CUSTOM MANUFACTURING OF SYSTEMS, MACHINES AND EQUIPMENT FOR RECUPERATION, RECYCLING, RECOVERY AND MANAGEMENT OF WASTE PRODUCTS, IN CLASS 40 (U.S. CLS. 100, 103 AND 106).

FIRST USE 1-0-2010; IN COMMERCE 1-0-2010.

David J. Kybas

Director of the United States Patent and Trademark Office

Reg. No. 4,072,759 FOR: DESIGN AND ENGINEERING OF SYSTEMS, MACHINES AND EQUIPMENT FOR RECUPERATION, RECYCLING, RECOVERY AND MANAGEMENT OF WASTE PRODUCTS, IN CLASS 42 (U.S. CLS. 100 AND 101).

FIRST USE 1-0-2010; IN COMMERCE 1-0-2010.

PRIORITY CLAIMED UNDER SEC. 44(D) ON CANADA APPLICATION NO. 1480284, FILED 5-7-2010, REG. NO. TMA596147, DATED 4-26-2011, EXPIRES 4-26-2026.

OWNER OF U.S. REG. NO. 2,538,804.

THE STIPPLING IS A FEATURE OF THE MARK AND DOES NOT INDICATE COLOR; THE STIPPLING IS FOR SHADING PURPOSES ONLY.

THE MARK CONSISTS OF THE UPPER-CASE LETTER "M" ABOVE THE WORD "MACHINEX" IN UPPER-CASE LETTERS.

SER. NO. 85-106,014, FILED 8-12-2010.

MICHELLE DUBOIS, EXAMINING ATTORNEY

United States of America

United States Patent and Trademark Office

The Raul Jimenez Thanksgiving Dinner

Reg. No. 4,072,760

THE RAUL JIMENEZ THANKSGIVING DINNER FUND, INC. (TEXAS CORPORATION)
8700 CROWNHILL BOULEVARD, SUITE 802
SAN ANTONIO, TX 78209

Registered Dec. 20, 2011

Int. Cl.: 36

FOR: CHARITABLE FUNDRAISING SERVICES BY MEANS OF ORGANIZING AND CONDUCTING SPECIAL EVENTS, IN CLASS 36 (U.S. CLS. 100, 101 AND 102).

SERVICE MARK

FIRST USE 1-1-1995; IN COMMERCE 10-31-1995.

PRINCIPAL REGISTER

NO CLAIM IS MADE TO THE EXCLUSIVE RIGHT TO USE "THANKSGIVING DINNER", APART FROM THE MARK AS SHOWN.

THE NAME "RAUL JIMENEZ" DOES NOT IDENTIFY A LIVING INDIVIDUAL.

THE MARK CONSISTS OF THE WORDS "THE RAUL JIMENEZ" ON THE FIRST LINE AND "THANKSGIVING DINNER" ON THE SECOND LINE. THE WORDS "THE RAUL JIMENEZ" ARE UNDERLINED.

SER. NO. 85-106,452, FILED 8-12-2010.

DOMINICK J. SALEMI, EXAMINING ATTORNEY



David J. Kybas

Director of the United States Patent and Trademark Office

United States of America

United States Patent and Trademark Office

LET IT CAST

Reg. No. 4,072,761

Registered Dec. 20, 2011

**Int. Cls.: 9, 35, 38, 41
and 42**

TRADEMARK

SERVICE MARK

PRINCIPAL REGISTER

HADDAD, YOKTAN AURELE-ELIE (UNITED STATES INDIVIDUAL)
#191
10869 NORTH SCOTTSDALE ROAD
SCOTTSDALE, AZ 85254

FOR: COMPUTER SOFTWARE FOR PRESENTING, PUBLISHING, EDITING AND MANAGING CASTING CALLS AND FOR SUBMITTING SELF-FILMED AUDITIONS FOR PLAYS, MUSIC VIDEOS, TELEVISION PRODUCTIONS AND MOVIES THROUGH ELECTRONIC MEDIA; COMMUNICATION SOFTWARE FOR PROVIDING ACCESS TO THE INTERNET; COMPUTER SOFTWARE, NAMELY, SOFTWARE DEVELOPMENT TOOLS FOR THE CREATION OF MOBILE INTERNET APPLICATIONS AND CLIENT INTERFACES; COMPUTER SOFTWARE USED IN THE FIELD OF HUMAN RESOURCE MANAGEMENT FOR MEASURING EMPLOYEE PERFORMANCE AND MEASURING POTENTIAL, IN CLASS 9 (U.S. CLS. 21, 23, 26, 36 AND 38).

FIRST USE 5-19-2010; IN COMMERCE 5-19-2010.

FOR: PROVIDING ONLINE PERSONNEL RECRUITMENT SERVICES; PROVIDING ONLINE EMPLOYMENT SERVICES IN THE NATURE OF TALENT CASTING IN THE FIELDS OF MUSIC, VIDEO, TELEVISION AND FILMS; ADVERTISING AND PROMOTIONAL SERVICES ON BEHALF OF OTHERS; PROMOTING THE GOODS AND SERVICES OF OTHERS VIA A GLOBAL COMPUTER NETWORK; ADVERTISING AND BUSINESS SERVICES, NAMELY, PROVIDING AN ONLINE WEBSITE WHERE ADVERTISERS, MARKETERS, AND CONTENT PROVIDERS CAN INTERACT WITH USERS FOR ADVERTISING, BRANDING, AND PROMOTING KNOWLEDGE, PRODUCTS, AND SERVICES, IN CLASS 35 (U.S. CLS. 100, 101 AND 102).

FIRST USE 5-19-2010; IN COMMERCE 5-19-2010.

FOR: AUDIO, VIDEO AND MULTIMEDIA BROADCASTING VIA THE INTERNET AND OTHER ELECTRONIC COMMUNICATIONS NETWORKS, NAMELY, TELEVISION, CABLE, SATELLITE, RADIO BROADCASTS, TELEPHONE BROADCASTS, AND VIA THE INTERNET BROADCASTS DELIVERED TO PORTABLE AND WIRELESS COMMUNICATIONS DEVICES; ELECTRONIC TRANSMISSION OF MESSAGES, DATA AND DIGITAL MEDIA CONTENT VIA THE INTERNET AND OTHER ELECTRONIC COMMUNICATIONS NETWORKS, NAMELY, TELEVISION, CABLE, SATELLITE, RADIO BROADCASTS, TELEPHONE BROADCASTS, AND VIA THE INTERNET BROADCASTS DELIVERED TO PORTABLE



David J. Kybas

Director of the United States Patent and Trademark Office

Reg. No. 4,072,761 AND WIRELESS COMMUNICATIONS DEVICES; PROVIDING ON-LINE FORUMS AND INTERNET CHAT ROOMS FOR THE TRANSMISSION OF MESSAGES AMONG USERS IN THE FIELDS OF ACTING, CASTING AND AUDITIONING VIA THE INTERNET AND OTHER ELECTRONIC COMMUNICATIONS NETWORKS, NAMELY, TELEVISION, CABLE, SATELLITE, RADIO BROADCASTS, TELEPHONE BROADCASTS, AND VIA THE INTERNET BROADCASTS DELIVERED TO PORTABLE AND WIRELESS COMMUNICATIONS DEVICES; ELECTRONIC DATA TRANSMISSION; PROVIDING ONLINE COMMUNITY FORUMS FOR USERS TO POST, SEARCH, WATCH, SHARE, CRITIQUE, RATE, AND COMMENT ON VIDEOS AND OTHER MULTIMEDIA CONTENT VIA THE INTERNET AND OTHER ELECTRONIC COMMUNICATIONS NETWORKS, NAMELY, TELEVISION, CABLE, SATELLITE, RADIO BROADCASTS, TELEPHONE BROADCASTS, AND VIA THE INTERNET BROADCASTS DELIVERED TO PORTABLE AND WIRELESS COMMUNICATIONS DEVICES, IN CLASS 38 (U.S. CLS. 100, 101 AND 104).

FIRST USE 5-19-2010; IN COMMERCE 5-19-2010.

FOR: DIGITAL VIDEO, AUDIO, AND MULTIMEDIA PUBLISHING SERVICES; ELECTRONIC DESKTOP PUBLISHING; ARRANGING OF CONTESTS, IN CLASS 41 (U.S. CLS. 100, 101 AND 107).

FIRST USE 5-19-2010; IN COMMERCE 5-19-2010.

FOR: COMPUTER CONSULTATION SERVICES; PROVIDING TEMPORARY USE OF NON-DOWNLOADABLE COMMUNICATION SOFTWARE FOR PROVIDING ACCESS TO THE INTERNET; PROVIDING A WEBSITE FEATURING ON-LINE NON-DOWNLOADABLE SOFTWARE FOR PRESENTING, PUBLISHING, EDITING AND MANAGING CASTING CALLS AND FOR SUBMITTING SELF-FILMED AUDITIONS FOR CASTING CALLS FOR PLAYS, MUSIC VIDEOS, TELEVISION PRODUCTIONS AND MOVIES THROUGH ELECTRONIC MEDIA; PROVIDING TEMPORARY USE OF NON-DOWNLOADABLE ANALYTIC SOFTWARE, NAMELY, SOFTWARE THAT PROVIDES STATISTICS ABOUT THE BEHAVIOR OF VIEWERS OF ONLINE VIDEOS, MOVIES, PICTURES, IMAGES, TEXT, PHOTOS, GAMES AND OTHER USER-GENERATED CONTENT; HOSTING OF WEBSITES FEATURING MULTIMEDIA CONTENT FOR OTHERS; HOSTING MULTIMEDIA ENTERTAINMENT AND EDUCATIONAL CONTENT FOR OTHERS; PROVIDING A WEB SITE THAT GIVES COMPUTER USERS THE ABILITY TO UPLOAD AND SHARE USER-GENERATED VIDEOS AND COMMENTS ON A WIDE VARIETY OF TOPICS AND SUBJECTS PERTAINING TO THE FIELDS OF ACTING, CASTING AND AUDITIONING; PROVIDING TEMPORARY USE OF NON-DOWNLOADABLE COMMUNICATION SOFTWARE, NAMELY, SOFTWARE DEVELOPMENT TOOLS FOR THE CREATION OF MOBILE INTERNET APPLICATIONS AND CLIENT INTERFACES, IN CLASS 42 (U.S. CLS. 100 AND 101).

FIRST USE 5-19-2010; IN COMMERCE 5-19-2010.

THE MARK CONSISTS OF STANDARD CHARACTERS WITHOUT CLAIM TO ANY PARTICULAR FONT, STYLE, SIZE, OR COLOR.

NO CLAIM IS MADE TO THE EXCLUSIVE RIGHT TO USE "CAST", APART FROM THE MARK AS SHOWN.

SER. NO. 85-107,681, FILED 8-14-2010.

ROBERT C. CLARK JR., EXAMINING ATTORNEY

United States of America

United States Patent and Trademark Office



Reg. No. 4,072,762

GREER, REGINA (UNITED STATES INDIVIDUAL)
22543 FIDDLERS COVE
BEVERLY HILLS, MI 48025

Registered Dec. 20, 2011

Int. Cl.: 25

FOR: FITTED SHOE OR BOOT COVERING TO PROTECT THE SHOES OR BOOT FROM WATER OR OTHER DAMAGE, IN CLASS 25 (U.S. CLS. 22 AND 39).

TRADEMARK

FIRST USE 6-15-2010; IN COMMERCE 6-15-2010.

PRINCIPAL REGISTER

OWNER OF U.S. REG. NO. 3,874,637.

THE COLOR(S) RED AND BLACK IS/ARE CLAIMED AS A FEATURE OF THE MARK.

NO CLAIM IS MADE TO THE EXCLUSIVE RIGHT TO USE "SHOE", APART FROM THE MARK AS SHOWN.

THE MARK CONSISTS OF A RED AND BLACK UMBRELLA TO THE LEFT OF THE WORDS "SHOE SLICKERS" WITH "SHOE" IN BLACK AND "SLICKERS" IN RED.

SER. NO. 85-107,723, FILED 8-14-2010.

KATHERINE CHANG, EXAMINING ATTORNEY



David J. Kybas

Director of the United States Patent and Trademark Office

United States of America

United States Patent and Trademark Office

Crystal World

Reg. No. 4,072,763

Registered Dec. 20, 2011

Int. Cl.: 21

TRADEMARK

PRINCIPAL REGISTER

CRYSTAL WORLD, INC. (DELAWARE CORPORATION)
89 LEUNING ST, UNIT A-2
S. HACKENSACK, NJ 07606

FOR: BUSTS OF CRYSTAL; DECORATIVE CRYSTAL PRISMS; DESKTOP STATUARY MADE OF CRYSTAL; FIGURES OF CRYSTAL; FIGURINES OF CRYSTAL; ORNAMENTS OF CRYSTAL; PLAQUES OF CRYSTAL; SCULPTURES OF CRYSTAL; STATUES OF CRYSTAL; STATUETTES OF CRYSTAL; WALL PLAQUES MADE OF CRYSTAL; WORKS OF ART OF CRYSTAL, IN CLASS 21 (U.S. CLS. 2, 13, 23, 29, 30, 33, 40 AND 50).

FIRST USE 11-1-1980; IN COMMERCE 2-1-1983.

THE MARK CONSISTS OF STANDARD CHARACTERS WITHOUT CLAIM TO ANY PARTICULAR FONT, STYLE, SIZE, OR COLOR.

OWNER OF U.S. REG. NOS. 1,584,732, 2,074,606, AND 2,799,935.

NO CLAIM IS MADE TO THE EXCLUSIVE RIGHT TO USE "CRYSTAL", APART FROM THE MARK AS SHOWN.

SEC. 2(F).

SER. NO. 85-108,606, FILED 8-16-2010.

EUGENIA MARTIN, EXAMINING ATTORNEY



David J. Kyffers

Director of the United States Patent and Trademark Office

United States of America

United States Patent and Trademark Office



Reg. No. 4,072,764

Registered Dec. 20, 2011

Int. Cl.: 43

SERVICE MARK

PRINCIPAL REGISTER

LYNN, STEVEN (UNITED STATES INDIVIDUAL), DBA BAD BURGER
131 GRAND ST.
BROOKLYN, NY 11211 AND

MASCO, KEITH (UNITED STATES INDIVIDUAL), DBA BAD BURGER
131 GRAND ST.
BROOKLYN, NY 11211

FOR: RESTAURANT SERVICES, NAMELY, PROVIDING OF FOOD AND BEVERAGES FOR CONSUMPTION ON AND OFF THE PREMISES, IN CLASS 43 (U.S. CLS. 100 AND 101).

FIRST USE 10-1-2009; IN COMMERCE 7-1-2010.

OWNER OF U.S. REG. NO. 3,865,663.

THE COLOR(S) RED IS/ARE CLAIMED AS A FEATURE OF THE MARK.

NO CLAIM IS MADE TO THE EXCLUSIVE RIGHT TO USE "BURGER", APART FROM THE MARK AS SHOWN.

THE MARK CONSISTS OF THE STYLIZED WORDING "BAD BURGER" BETWEEN TWO PIECES OF A HAMBURGER ROLL WITH DEVIL EARS ON THE TOP PART OF THE HAMBURGER ROLL ALL IN RED.

SER. NO. 85-108,941, FILED 8-17-2010.

DAVID TOOLEY, EXAMINING ATTORNEY



David J. Kybas

Director of the United States Patent and Trademark Office

United States of America

United States Patent and Trademark Office



Reg. No. 4,072,765

Registered Dec. 20, 2011

Int. Cl.: 16

TRADEMARK

PRINCIPAL REGISTER

YOUNGSTOWN STATE UNIVERSITY (UNITED STATES STATE UNIVERSITY)
ONE UNIVERSITY PLAZA
YOUNGSTOWN, OH 44555

FOR: PAPER STATIONERY; STATIONERY; STATIONERY BOXES; STICKERS AND TRANSFERS, IN CLASS 16 (U.S. CLS. 2, 5, 22, 23, 29, 37, 38 AND 50).

FIRST USE 1-1-2009; IN COMMERCE 1-1-2009.

OWNER OF U.S. REG. NOS. 3,700,518 AND 3,738,792.

THE COLOR(S) BLACK, WHITE, RED AND YELLOW IS/ARE CLAIMED AS A FEATURE OF THE MARK.

THE MARK CONSISTS OF A PENGUIN WITH A WHITE FRONT, BLACK BACK AND FACE, WHITE SCARF OUTLINED IN BLACK WITH RED BLOCK "Y" OUTLINED IN BLACK, RED CAP WITH WHITE TRIM AND A RED BLOCK "Y" ALL OUTLINED IN BLACK, YELLOW BEAK AND FEET OUTLINED IN BLACK.

SER. NO. 85-109,390, FILED 8-17-2010.

BARBARA RUTLAND, EXAMINING ATTORNEY



David J. Kybas

Director of the United States Patent and Trademark Office

United States of America

United States Patent and Trademark Office

Remotec

Reg. No. 4,072,766

Registered Dec. 20, 2011

Int. Cl.: 9

TRADEMARK

PRINCIPAL REGISTER

REMOTEC TECHNOLOGY LTD (HONG KONG LIMITED LIABILITY COMPANY)
RM 2907-2908 SKYLINE TOWER WANG KWONG RD
KOWLOON BAY KOWLOON, HONG KONG

FOR: REMOTE CONTROL DEVICES FOR TELEVISIONS; AUDIO-VISUAL APPARATUS, NAMELY, AUDIO AND VIDEO RECORDERS; ELECTRICAL HOME APPLIANCES, NAMELY, TELEVISIONS, PERSONAL STEREOS, RADIOS, ELECTRIC SPACE HEATERS; COMPUTER GAME CONSOLES FOR USE WITH AN EXTERNAL DISPLAY SCREEN OR MONITOR; MP3 PLAYERS; MEDIA PLAYERS; POWER SWITCHES; ELECTRIC LIGHT DIMMERS; POWER SUPPLY CONNECTORS AND ADAPTORS FOR USE WITH PORTABLE ELECTRONIC DEVICES; PHOTOGRAPHIC PROJECTORS; VIDEO PROJECTORS; PROJECTION SCREENS; WIRELESS TELEVISION SET FOR PROVIDING VIDEO CONFERENCING AND TELEPHONE SERVICE OVER THE INTERNET; SPEAKERPHONES; VIDEO CAMERAS; DIGITAL CAMERAS; VIDEO MONITORS; APPARATUS FOR BROADCASTING OF SOUND OR IMAGES; TELEPHONES; PERSONAL COMPUTERS; NETBOOK COMPUTERS; TABLET COMPUTERS; DIGITAL PHOTO FRAMES FOR DISPLAYING DIGITAL PICTURES, VIDEO CLIPS AND MUSIC; MEDICAL EQUIPMENT, NAMELY, REMOTE CONTROLS FOR A BLOOD PRESSURE MEASURING DEVICE; GYMNASIUM EQUIPMENT, NAMELY, REMOTE CONTROLS FOR EXERCISE EQUIPMENT; ELECTRONIC CONTROLLERS FOR SAUNA ROOMS; MASSAGE SYSTEM, NAMELY, REMOTE CONTROLS FOR MASSAGE EQUIPMENT, IN CLASS 9 (U.S. CLS. 21, 23, 26, 36 AND 38).

FIRST USE 8-31-1994; IN COMMERCE 8-31-1994.

THE MARK CONSISTS OF STANDARD CHARACTERS WITHOUT CLAIM TO ANY PARTICULAR FONT, STYLE, SIZE, OR COLOR.

SER. NO. 85-109,991, FILED 8-18-2010.

ROBERT C. CLARK JR., EXAMINING ATTORNEY



David J. Kyros

Director of the United States Patent and Trademark Office

United States of America

United States Patent and Trademark Office



Reg. No. 4,072,767

Registered Dec. 20, 2011

Int. Cl.: 16

TRADEMARK

PRINCIPAL REGISTER

DIXON TICONDEROGA COMPANY (DELAWARE CORPORATION)
195 INTERNATIONAL PARKWAY
HEATHROW, FL 32746

FOR: MARKERS, IN CLASS 16 (U.S. CLS. 2, 5, 22, 23, 29, 37, 38 AND 50).

FIRST USE 12-31-2008; IN COMMERCE 12-31-2008.

NO CLAIM IS MADE TO THE EXCLUSIVE RIGHT TO USE "THUMB BUTTON", APART FROM THE MARK AS SHOWN.

THE MARK CONSISTS OF A CIRCLE CONTAINING A MARKER WITH A THUMB PUSHING THE LID OFF THE MARKER, WITH THE WORDS "EASY RELEASE THUMB BUTTON" BENEATH IT.

SER. NO. 85-110,423, FILED 8-18-2010.

JOHN DWYER, EXAMINING ATTORNEY



David J. Kybas

Director of the United States Patent and Trademark Office

United States of America

United States Patent and Trademark Office

KILLIAN'S CLOSET

Reg. No. 4,072,768

KILLIAN'S CLOSET, L.L.C. (ILLINOIS LIMITED LIABILITY COMPANY)
P.O. BOX 41
HUNTLEY, IL 60142

Registered Dec. 20, 2011

Int. Cl.: 35

FOR: ONLINE RETAIL STORE SERVICES FEATURING EQUESTRIAN RELATED PRODUCTS, IN CLASS 35 (U.S. CLS. 100, 101 AND 102).

SERVICE MARK

FIRST USE 8-17-2010; IN COMMERCE 8-17-2010.

PRINCIPAL REGISTER

THE MARK CONSISTS OF STANDARD CHARACTERS WITHOUT CLAIM TO ANY PARTICULAR FONT, STYLE, SIZE, OR COLOR.

THE NAME(S), PORTRAIT(S), AND/OR SIGNATURE(S) SHOWN IN THE MARK DOES NOT IDENTIFY A PARTICULAR LIVING INDIVIDUAL.

SER. NO. 85-111,086, FILED 8-19-2010.

JESSICA FATHY, EXAMINING ATTORNEY



David J. Kybas

Director of the United States Patent and Trademark Office

United States of America

United States Patent and Trademark Office

Hard Exercise Works

Reg. No. 4,072,769

HARD EXERCISE WORKS (FLORIDA LIMITED LIABILITY COMPANY)
240 WEST INDIANTOWN ROAD, SUITE 106
JUPITER, FL 33478

Registered Dec. 20, 2011

Int. Cl.: 41

FOR: PHYSICAL FITNESS STUDIO SERVICES, NAMELY, PROVIDING GROUP EXERCISE INSTRUCTION, EQUIPMENT, AND FACILITIES, IN CLASS 41 (U.S. CLS. 100, 101 AND 107).

SERVICE MARK

FIRST USE 1-1-2002; IN COMMERCE 1-1-2002.

PRINCIPAL REGISTER

THE MARK CONSISTS OF STANDARD CHARACTERS WITHOUT CLAIM TO ANY PARTICULAR FONT, STYLE, SIZE, OR COLOR.

NO CLAIM IS MADE TO THE EXCLUSIVE RIGHT TO USE "EXERCISE", APART FROM THE MARK AS SHOWN.

SER. NO. 85-112,169, FILED 8-20-2010.

MIDGE BUTLER, EXAMINING ATTORNEY



David J. Kyffers

Director of the United States Patent and Trademark Office

United States of America

United States Patent and Trademark Office

REEL  SHIELD

Reg. No. 4,072,770

Registered Dec. 20, 2011

Int. Cl.: 28

TRADEMARK

PRINCIPAL REGISTER

ESPINOSA, CHARLES (UNITED STATES INDIVIDUAL)
#93
10702 DABNEY DRIVE
SAN DIEGO, CA 92126

FOR: CLEAR PROTECTIVE COVERS FOR FISHING REELS, IN CLASS 28 (U.S. CLS. 22, 23, 38 AND 50).

FIRST USE 10-1-2010; IN COMMERCE 10-1-2010.

NO CLAIM IS MADE TO THE EXCLUSIVE RIGHT TO USE "REEL SHIELD", APART FROM THE MARK AS SHOWN.

THE MARK CONSISTS OF THE STYLIZED WORDING "REEL SHIELD"; THE LETTER "S" IN "SHIELD" IS FORMED BY A HIGHLY STYLIZED SHARK DESIGN.

SER. NO. 85-112,813, FILED 8-20-2010.

JULIE GUTTADAURO, EXAMINING ATTORNEY



David J. Kybas

Director of the United States Patent and Trademark Office

United States of America

United States Patent and Trademark Office

Proton Therapy, the Best Kept Secret in Cancer Treatment

Reg. No. 4,072,771

DOERLER, WILLIAM K. (UNITED STATES INDIVIDUAL)
241 COLD SOIL ROAD
PRINCETON, NJ 08540 AND

Registered Dec. 20, 2011

Int. Cl.: 44

MONDLOCH, KARLENE (UNITED STATES INDIVIDUAL)
101 PALISADES LANE
OAKWOOD HILLS, IL 60013

SERVICE MARK

PRINCIPAL REGISTER

FOR: PROVIDING A WEBSITE FEATURING INFORMATION IN THE FIELD OF THE DIAGNOSIS AND TREATMENT OF CANCERS THROUGH PROTON THERAPY TREATMENT; PROVIDING LINKS TO THE WEB SITES OF OTHERS FEATURING INFORMATION ABOUT THE DIAGNOSIS AND TREATMENT OF CANCER, IN CLASS 44 (U.S. CLS. 100 AND 101).

FIRST USE 1-1-2010; IN COMMERCE 8-1-2010.

THE MARK CONSISTS OF STANDARD CHARACTERS WITHOUT CLAIM TO ANY PARTICULAR FONT, STYLE, SIZE, OR COLOR.

SER. NO. 85-112,868, FILED 8-21-2010.

DAVID I, EXAMINING ATTORNEY



David J. Kypos

Director of the United States Patent and Trademark Office

United States of America

United States Patent and Trademark Office

THE CENTER FOR CLIENT RETENTION

Reg. No. 4,072,772

Registered Dec. 20, 2011

Int. Cl.: 35

SERVICE MARK

PRINCIPAL REGISTER

THE CENTER FOR CLIENT RETENTION, LLC (NEW JERSEY LIMITED LIABILITY COMPANY)
SUITE 1200
300 CONNELL DRIVE
BERKELEY HEIGHTS, NJ 07922

FOR: BUSINESS MARKETING CONSULTING SERVICES IN THE FIELD OF CONSUMER SATISFACTION AND LOYALTY; AND CONDUCTING BUSINESS AND MARKET RESEARCH AND SURVEYS IN THE FIELD OF CUSTOMER SATISFACTION AND CUSTOMER LOYALTY, IN CLASS 35 (U.S. CLS. 100, 101 AND 102).

FIRST USE 3-2-1998; IN COMMERCE 3-2-1998.

THE MARK CONSISTS OF STANDARD CHARACTERS WITHOUT CLAIM TO ANY PARTICULAR FONT, STYLE, SIZE, OR COLOR.

SEC. 2(F).

SER. NO. 85-113,146, FILED S.R. 8-23-2010 AM. P.R. 8-2-2011.

ZACHARY BELLO, EXAMINING ATTORNEY



David J. Kyffers

Director of the United States Patent and Trademark Office

United States of America

United States Patent and Trademark Office

BOB EVANS OVEN BAKE

Reg. No. 4,072,773

BOB EVANS FARMS, INC. (OHIO CORPORATION)
3776 SOUTH HIGH STREET
COLUMBUS, OH 43207

Registered Dec. 20, 2011

Int. Cls.: 29 and 30

FOR: PREPARED MEALS OR SIDE DISHES CONSISTING PRIMARILY OF POTATOES, IN CLASS 29 (U.S. CL. 46).

TRADEMARK

FIRST USE 2-14-2011; IN COMMERCE 2-14-2011.

PRINCIPAL REGISTER

FOR: PREPARED MEALS OR SIDE DISHES CONSISTING PRIMARILY OF PASTA, IN CLASS 30 (U.S. CL. 46).

FIRST USE 2-14-2011; IN COMMERCE 2-14-2011.

THE MARK CONSISTS OF STANDARD CHARACTERS WITHOUT CLAIM TO ANY PARTICULAR FONT, STYLE, SIZE, OR COLOR.

OWNER OF U.S. REG. NOS. 846,356, 3,405,250, AND 3,553,608.

NO CLAIM IS MADE TO THE EXCLUSIVE RIGHT TO USE "OVEN BAKE", APART FROM THE MARK AS SHOWN.

THE NAME(S), PORTRAIT(S), AND/OR SIGNATURE(S) SHOWN IN THE MARK DOES NOT IDENTIFY A PARTICULAR LIVING INDIVIDUAL.

SER. NO. 85-113,234, FILED 8-23-2010.

RONALD AIKENS, EXAMINING ATTORNEY



David J. Kyros

Director of the United States Patent and Trademark Office

United States of America

United States Patent and Trademark Office

RESVERLOGIX

Reg. No. 4,072,774

RESVERLOGIX CORP. (CANADA CORPORATION)
202, 279 MIDPARK WAY S.E.

Registered Dec. 20, 2011

CALGARY, ALBERTA T2X, CANADA

Int. Cl.: 42

FOR: SCIENTIFIC AND MEDICAL RESEARCH AND DEVELOPMENT IN RESPECT OF THERAPEUTIC-BASED TREATMENTS AND PREVENTION WITH REGARD TO ARTHRO-SCLEROSIS, ACUTE CORONARY SYNDROME, DIABETES, ALZHEIMER'S DISEASE AND VASCULAR DISORDERS, IN CLASS 42 (U.S. CLS. 100 AND 101).

SERVICE MARK

PRINCIPAL REGISTER

THE MARK CONSISTS OF STANDARD CHARACTERS WITHOUT CLAIM TO ANY PARTICULAR FONT, STYLE, SIZE, OR COLOR.

PRIORITY CLAIMED UNDER SEC. 44(D) ON CANADA APPLICATION NO. 1489726, FILED 7-22-2010, REG. NO. TMA799,726, DATED 6-10-2011, EXPIRES 6-10-2026.

SER. NO. 85-116,194, FILED 8-26-2010.

MIDGE BUTLER, EXAMINING ATTORNEY



David J. Kybas

Director of the United States Patent and Trademark Office

United States of America

United States Patent and Trademark Office

QICLICK

Reg. No. 4,072,775

Registered Dec. 20, 2011

Int. Cl.: 9

TRADEMARK

PRINCIPAL REGISTER

QUANTITATIVE IMAGING CORPORATION (CANADA CORPORATION), DBA QIMAGING
101 - 19535 56TH AVENUE
SURREY, B.C., CANADA V3S6K3

FOR: HIGH-PERFORMANCE DIGITAL CAMERAS, IN CLASS 9 (U.S. CLS. 21, 23, 26, 36 AND 38).

THE MARK CONSISTS OF STANDARD CHARACTERS WITHOUT CLAIM TO ANY PARTICULAR FONT, STYLE, SIZE, OR COLOR.

PRIORITY CLAIMED UNDER SEC. 44(D) ON CANADA APPLICATION NO. 1,476,412, FILED 4-9-2010, REG. NO. TMA798,454, DATED 5-25-2011, EXPIRES 5-25-2026.

SER. NO. 85-117,836, FILED 8-27-2010.

RONALD AIKENS, EXAMINING ATTORNEY



David J. Kyros

Director of the United States Patent and Trademark Office

United States of America

United States Patent and Trademark Office



Reg. No. 4,072,776

SHAPLEY-BOX, DIANE (UNITED STATES INDIVIDUAL)
P.O. BOX 1135
ROCKWALL, TX 75087

Registered Dec. 20, 2011

Int. Cl.: 16

FOR: A SERIES OF BOOKS AND WRITTEN ARTICLES IN THE FIELD OF CHILDREN'S ILLUSTRATED BOOKS; CHILDREN'S ACTIVITY BOOKS; CHILDREN'S BOOKS, IN CLASS 16 (U.S. CLS. 2, 5, 22, 23, 29, 37, 38 AND 50).

TRADEMARK

FIRST USE 9-1-2009; IN COMMERCE 9-1-2009.

PRINCIPAL REGISTER

NO CLAIM IS MADE TO THE EXCLUSIVE RIGHT TO USE "PUBLISHING", APART FROM THE MARK AS SHOWN.

THE COLOR(S) RED AND GREEN IS/ARE CLAIMED AS A FEATURE OF THE MARK.

THE MARK CONSISTS OF THE WORDING "APPLE PIE PUBLISHING" IN RED WITH A STYLIZED LETTER "L" IN "APPLE" FORMING A TREE PARTIALLY OUTLINED IN GREEN WITH SMALL, RED APPLES INSIDE.

SER. NO. 85-118,245, FILED 8-29-2010.

TINA MAI, EXAMINING ATTORNEY



David J. Kybas

Director of the United States Patent and Trademark Office

United States of America

United States Patent and Trademark Office

EVERSIO

Reg. No. 4,072,777

Registered Dec. 20, 2011

Int. Cls.: 8 and 21

TRADEMARK

PRINCIPAL REGISTER

BURLODGE CANADA LTD. (CANADA CORPORATION)
10 EDVAC DRIVE
BRAMPTON, ON, CANADA L6S5P2

FOR: BIODEGRADABLE CUTLERY, NAMELY, CUTLERY, NAMELY, FORKS, SPOONS AND KNIVES MADE OF BIODEGRADABLE MATERIALS, IN CLASS 8 (U.S. CLS. 23, 28 AND 44).

FOR: DISPOSABLE PLATES, BOWLS, LIDS AND PREPARED FOOD CONTAINERS MADE OF BIODEGRADABLE MATERIALS, IN CLASS 21 (U.S. CLS. 2, 13, 23, 29, 30, 33, 40 AND 50).

THE MARK CONSISTS OF STANDARD CHARACTERS WITHOUT CLAIM TO ANY PARTICULAR FONT, STYLE, SIZE, OR COLOR.

PRIORITY CLAIMED UNDER SEC. 44(D) ON CANADA APPLICATION NO. 1471503, FILED 3-2-2010, REG. NO. TMA796,941, DATED 5-9-2011, EXPIRES 5-9-2026.

SER. NO. 85-118,428, FILED 8-30-2010.

SALLY SHIH, EXAMINING ATTORNEY



David J. Kypos

Director of the United States Patent and Trademark Office

United States of America

United States Patent and Trademark Office

TUBEBÉ

Reg. No. 4,072,778

Registered Dec. 20, 2011

Int. Cls.: 38 and 41

SERVICE MARK

PRINCIPAL REGISTER

V-ME MEDIA, INC. (DELAWARE CORPORATION)
450 WEST 33RD STREET, 11TH FLOOR
NEW YORK, NY 10001

FOR: TELEVISION BROADCASTING; CABLE TELEVISION BROADCASTING; SATELLITE TELEVISION BROADCASTING; BROADCASTING PROGRAMS VIA THE INTERNET AND WIRELESS COMMUNICATION DEVICES; RADIO BROADCASTING SERVICES AND INTERNET BROADCASTING SERVICES, NAMELY, STREAMING OF AUDIO MATERIAL ON THE INTERNET, IN CLASS 38 (U.S. CLS. 100, 101 AND 104).

FIRST USE 5-10-2010; IN COMMERCE 5-10-2010.

FOR: EDUCATION AND ENTERTAINMENT SERVICES, NAMELY, PRODUCTION AND DISTRIBUTION OF AN ONGOING TELEVISION SERIES PRIMARILY DIRECTED TOWARD PARENTS AND EXPECTANT PARENTS IN THE FIELD OF CHILD REARING AND THE CARE AND EDUCATION OF INFANTS AND CHILDREN BROADCAST OVER TELEVISION, CABLE, SATELLITE, THE INTERNET, AND WIRELESS COMMUNICATION DEVICES; EDUCATION AND ENTERTAINMENT SERVICES, NAMELY, PRODUCTION AND DISTRIBUTION OF AN ONGOING SERIES OF RADIO PROGRAMS PRIMARILY DIRECTED TOWARD PARENTS AND EXPECTANT PARENTS IN THE FIELD OF CHILD REARING AND THE CARE AND EDUCATION OF INFANTS AND CHILDREN BROADCAST OVER CABLE, SATELLITE, THE INTERNET, AND WIRELESS COMMUNICATION DEVICES; TELEVISION AND RADIO PROGRAMMING; PROVIDING ONLINE INFORMATION ON TELEVISION PROGRAMMING; INTERACTIVE WEB SITE PRIMARILY DIRECTED TOWARD PARENTS AND EXPECTANT PARENTS IN THE FIELD OF THE EDUCATION AND ENTERTAINMENT OF INFANTS AND CHILDREN, IN CLASS 41 (U.S. CLS. 100, 101 AND 107).

FIRST USE 5-10-2010; IN COMMERCE 5-10-2010.

THE MARK CONSISTS OF STANDARD CHARACTERS WITHOUT CLAIM TO ANY PARTICULAR FONT, STYLE, SIZE, OR COLOR.

THE ENGLISH TRANSLATION OF "TU BEBÉ" IN THE MARK IS "YOUR BABY".

SER. NO. 85-118,640, FILED 8-30-2010.

GINA FINK, EXAMINING ATTORNEY



David J. Kyffers

Director of the United States Patent and Trademark Office

United States of America

United States Patent and Trademark Office

Arab-iss

Reg. No. 4,072,779

TAHA, KHALED A. (UNITED STATES INDIVIDUAL), AKA KHALED THE COMIC
180 N. JEFFERSON STREET #1901
CHICAGO, IL 60661

Registered Dec. 20, 2011

Int. Cl.: 41

FOR: ENTERTAINMENT SERVICES IN THE NATURE OF COMEDY SHOWS, IN CLASS 41
(U.S. CLS. 100, 101 AND 107).

SERVICE MARK

FIRST USE 7-10-2010; IN COMMERCE 7-10-2010.

PRINCIPAL REGISTER

THE MARK CONSISTS OF STANDARD CHARACTERS WITHOUT CLAIM TO ANY PARTICULAR FONT, STYLE, SIZE, OR COLOR.

SER. NO. 85-120,150, FILED 8-31-2010.

GEOFFREY FOSDICK, EXAMINING ATTORNEY



David J. Kyros

Director of the United States Patent and Trademark Office

United States of America

United States Patent and Trademark Office

TAKE OUT

Reg. No. 4,072,780

YUPI NORTH AMERICA, LLC (NEW YORK LIMITED LIABILITY COMPANY)
400 OSER AVE. SUITE 2300
HAPPAUGE, NY 11788

Registered Dec. 20, 2011

Int. Cl.: 30

FOR: CANDY, GUMMY CANDIES, IN CLASS 30 (U.S. CL. 46).

TRADEMARK

FIRST USE 5-0-2010; IN COMMERCE 5-0-2010.

PRINCIPAL REGISTER

THE MARK CONSISTS OF STANDARD CHARACTERS WITHOUT CLAIM TO ANY PARTICULAR FONT, STYLE, SIZE, OR COLOR.

SER. NO. 85-120,892, FILED 9-1-2010.

YAT SYE, LEE, EXAMINING ATTORNEY



David J. Kybas

Director of the United States Patent and Trademark Office

United States of America

United States Patent and Trademark Office

Accelerated Spiritual Growth

Reg. No. 4,072,781

Registered Dec. 20, 2011

Int. Cl.: 44

SERVICE MARK

PRINCIPAL REGISTER

THE GROWTH CORPORATION (MICHIGAN CORPORATION)
651 CHERRY STREET SE
PO BOX 3339 GRAND RAPIDS, MI 49501
GRAND RAPIDS, MI 49503

FOR: COUNSELING SERVICES IN THE FIELDS OF HEALTH, HERBALISM, AND LIFESTYLE WELLNESS, IN CLASS 44 (U.S. CLS. 100 AND 101).

FIRST USE 9-1-2008; IN COMMERCE 9-1-2008.

THE MARK CONSISTS OF STANDARD CHARACTERS WITHOUT CLAIM TO ANY PARTICULAR FONT, STYLE, SIZE, OR COLOR.

NO CLAIM IS MADE TO THE EXCLUSIVE RIGHT TO USE "SPIRITUAL GROWTH", APART FROM THE MARK AS SHOWN.

SER. NO. 85-121,322, FILED 9-1-2010.

LAURA HAMMEL, EXAMINING ATTORNEY



David J. Kyffers

Director of the United States Patent and Trademark Office

United States of America

United States Patent and Trademark Office

App-DNA

Reg. No. 4,072,782

APP-DNA, INC. (NEVADA CORPORATION)
3275 SOUTH JONES BLVD.

Registered Dec. 20, 2011

LAS VEGAS, NV 89146

Int. Cl.: 9

FOR: DOWNLOADABLE COMPUTER SOFTWARE FOR USE IN MIGRATION, MANAGEMENT, IMPLEMENTATION, TESTING AND EVALUATION OF APPLICATIONS FOR MIGRATING APPLICATIONS BETWEEN OPERATING SYSTEMS OR PLATFORMS, IN CLASS 9 (U.S. CLS. 21, 23, 26, 36 AND 38).

TRADEMARK

PRINCIPAL REGISTER

FIRST USE 10-1-2007; IN COMMERCE 10-1-2007.

THE MARK CONSISTS OF STANDARD CHARACTERS WITHOUT CLAIM TO ANY PARTICULAR FONT, STYLE, SIZE, OR COLOR.

SER. NO. 85-122,147, FILED 9-2-2010.

JANET LEE, EXAMINING ATTORNEY



David J. Kybas

Director of the United States Patent and Trademark Office

United States of America

United States Patent and Trademark Office



Reg. No. 4,072,783

SIEGFRIED & PARZIFAL, INC. (CALIFORNIA CORPORATION)
18701 ARENTH AVE.
CITY OF INDUSTRY, CA 91748

Registered Dec. 20, 2011

Int. Cl.: 25

FOR: DENIM JACKETS; JACKETS; JEANS; KNIT SHIRTS; PANTS; SHIRTS; SWEAT PANTS;
SWEAT SHIRTS; SWEATERS, IN CLASS 25 (U.S. CLS. 22 AND 39).

TRADEMARK

FIRST USE 7-16-2010; IN COMMERCE 7-16-2010.

PRINCIPAL REGISTER

THE MARK CONSISTS OF A STYLIZED LION.

SER. NO. 85-122,308, FILED 9-2-2010.

INGA ERVIN, EXAMINING ATTORNEY



David J. Kyffers

Director of the United States Patent and Trademark Office

United States of America

United States Patent and Trademark Office

ASSEMBLY

Reg. No. 4,072,784

Registered Dec. 20, 2011

Int. Cls.: 35 and 41

SERVICE MARK

PRINCIPAL REGISTER

BNP MEDIA II, LLC (MICHIGAN LIMITED LIABILITY COMPANY)
SUITE 700
2401 W. BIG BEAVER RD.
TROY, MI 48084

FOR: PROVIDING A RESOURCE WEBSITE FEATURING AN ONLINE BUYER'S GUIDE SERVICE PROVIDING INFORMATION RELATING TO MANUFACTURING INDUSTRIES WHERE ASSEMBLY IS PERFORMED; ADVERTISING SERVICES, NAMELY, PROVIDING SPACE IN PERIODICALS AND ON A WEBSITE FOR ADVERTISING GOODS AND SERVICES; PROVIDING AN ONLINE SEARCHABLE DATABASE FEATURING CLASSIFIED AD LISTINGS; PROVIDING BUSINESS INFORMATION AND NEWS RELATING TO MANUFACTURING INDUSTRIES WHERE ASSEMBLY IS PERFORMED, IN CLASS 35 (U.S. CLS. 100, 101 AND 102).

FIRST USE 1-19-1962; IN COMMERCE 1-19-1962.

FOR: PROVIDING ONLINE NON-DOWNLOADABLE PUBLICATIONS IN THE NATURE OF ARTICLES, MAGAZINES, WHITE PAPERS, HOW-TO-GUIDES, COLUMNS, AND NEWSLETTERS IN THE FIELD OF MANUFACTURING INDUSTRIES WHERE ASSEMBLY IS PERFORMED; PROVIDING DIGITAL MAGAZINES DIRECTED TO TECHNOLOGY APPLICATIONS AND PRODUCTS USED IN MANUFACTURING INDUSTRIES WHERE ASSEMBLY IS PERFORMED VIA EMAIL; PROVIDING ONLINE JOURNALS, NAMELY, BLOGS, FEATURING TOPICS OF INTEREST TO THOSE IN MANUFACTURING INDUSTRIES WHERE ASSEMBLY IS PERFORMED; EDUCATIONAL SERVICES, NAMELY, CONDUCTING WEBINARS AND PROVIDING TRAINING IN THE FORM OF AUDIO AND VIDEO CLIPS RELATING TO MANUFACTURING INDUSTRIES WHERE ASSEMBLY IS PERFORMED VIA THE INTERNET, IN CLASS 41 (U.S. CLS. 100, 101 AND 107).

FIRST USE 12-12-1998; IN COMMERCE 12-12-1998.

THE MARK CONSISTS OF STANDARD CHARACTERS WITHOUT CLAIM TO ANY PARTICULAR FONT, STYLE, SIZE, OR COLOR.

OWNER OF U.S. REG. NO. 2,878,502.

SEC. 2(F).



David J. Kyjars

Director of the United States Patent and Trademark Office

Reg. No. 4,072,784 SER. NO. 85-122,401, FILED 9-2-2010.

MICHELLE DUBOIS, EXAMINING ATTORNEY

United States of America

United States Patent and Trademark Office

C-DENT

Reg. No. 4,072,785

Registered Dec. 20, 2011

Int. Cls.: 9, 10 and 16

TRADEMARK

PRINCIPAL REGISTER

KARL STORZ GMBH & CO. KG (FED REP GERMANY LIMITED PARTNERSHIP)
MITTELSTRASSE 8
D-78532 TUTTLINGEN, FED REP GERMANY

FOR: PHOTOGRAPHY MATERIALS, NAMELY, EXPOSED PHOTOGRAPHIC FILM; OPTICAL, MEASURING, SIGNAL, CONTROL AND SCIENTIFIC INSTRUCTIONAL APPARATUS AND INSTRUMENTS IN THE NATURE OF NON-MEDICAL ENDOSCOPES AND CAMERAS; DEVICES FOR THE RECORDING, TRANSMISSION AND RENDITION OF DATA AND PICTURES; DATA PROCESSORS AND COMPUTERS, IN CLASS 9 (U.S. CLS. 21, 23, 26, 36 AND 38).

FOR: SURGICAL, MEDICAL, AND VETERINARY INSTRUMENTS AND APPARATUS, NAMELY, SURGICAL AND MEDICAL APPARATUS AND INSTRUMENTS FOR USE IN GENERAL AND ENDOSCOPIC SURGERY, IN CLASS 10 (U.S. CLS. 26, 39 AND 44).

FOR: PRINTED MATERIALS, NAMELY, BOOKS, PAMPHLETS, AND INFORMATION SHEETS IN THE FIELD OF MEDICAL TECHNOLOGY; BOOKBINDING MATERIALS; USER AND INSTRUCTION MANUALS FOR MEDICAL TECHNOLOGY AND ENDOSCOPES; BROCHURES; CATALOGS, IN CLASS 16 (U.S. CLS. 2, 5, 22, 23, 29, 37, 38 AND 50).

THE MARK CONSISTS OF STANDARD CHARACTERS WITHOUT CLAIM TO ANY PARTICULAR FONT, STYLE, SIZE, OR COLOR.

OWNER OF FED REP GERMANY REG. NO. 302010022950, DATED 6-8-2010, EXPIRES 4-30-2020.

SER. NO. 85-123,769, FILED 9-7-2010.

HOWARD B. LEVINE, EXAMINING ATTORNEY



David J. Kypos

Director of the United States Patent and Trademark Office

United States of America

United States Patent and Trademark Office

The Gold Standard of Automotive Training

Reg. No. 4,072,786

LEEDOM MANAGEMENT GROUP, INC. (FLORIDA CORPORATION)
3700 SOUTH TAMiami TRAIL
SARASOTA, FL 34239

Registered Dec. 20, 2011

Int. Cl.: 35

FOR: ASSISTANCE, ADVICE AND CONSULTANCY WITH REGARD TO BUSINESS PLANNING, BUSINESS ANALYSIS, BUSINESS MANAGEMENT AND BUSINESS ORGANIZATION RELATING TO PURCHASING FUNCTIONS; ASSISTANCE, ADVISORY SERVICES AND CONSULTANCY WITH REGARD TO BUSINESS PLANNING, BUSINESS ANALYSIS, BUSINESS MANAGEMENT, AND BUSINESS ORGANIZATION; ASSISTANCE, ADVISORY SERVICES AND CONSULTANCY WITH REGARD TO BUSINESS PLANNING, BUSINESS ANALYSIS, BUSINESS MANAGEMENT, BUSINESS ORGANIZATION, MARKETING AND CUSTOMER ANALYSIS; BUSINESS ADVISORY SERVICES, CONSULTANCY AND INFORMATION; BUSINESS CONSULTATION; BUSINESS CONSULTATION IN THE FIELD OF AUTOMOTIVE SALES; BUSINESS MANAGEMENT CONSULTANCY IN THE FIELD OF PURCHASES, NAMELY, ASSISTING BUSINESSES IN IMPROVEMENT OF PURCHASING FUNCTIONS; BUSINESS MANAGEMENT CONSULTANCY, ALSO VIA THE INTERNET; CONSULTANCY SERVICES REGARDING BUSINESS STRATEGIES, IN CLASS 35 (U.S. CLS. 100, 101 AND 102).

SERVICE MARK

PRINCIPAL REGISTER

FIRST USE 4-1-2002; IN COMMERCE 4-1-2002.

THE MARK CONSISTS OF STANDARD CHARACTERS WITHOUT CLAIM TO ANY PARTICULAR FONT, STYLE, SIZE, OR COLOR.



SEC. 2(F).

SER. NO. 85-123,836, FILED 9-7-2010.

JEFFERY COWARD, EXAMINING ATTORNEY

David J. Kyros

Director of the United States Patent and Trademark Office

United States of America

United States Patent and Trademark Office

Audi
Truth in Engineering

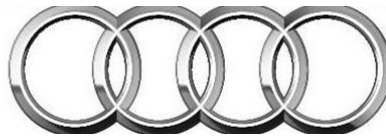

Reg. No. 4,072,787

AUDI AG (FED REP GERMANY CORPORATION)
85045

Registered Dec. 20, 2011

INGOLSTADT, FED REP GERMANY

Int. Cls.: 12 and 35

FOR: AUTOMOBILES, IN CLASS 12 (U.S. CLS. 19, 21, 23, 31, 35 AND 44).

TRADEMARK

FIRST USE 7-31-2009; IN COMMERCE 7-31-2009.

SERVICE MARK

FOR: AUTOMOBILE DEALERSHIP SERVICES, IN CLASS 35 (U.S. CLS. 100, 101 AND 102).

PRINCIPAL REGISTER

FIRST USE 7-31-2009; IN COMMERCE 7-31-2009.

OWNER OF U.S. REG. NOS. 2,987,328, 3,631,819 AND OTHERS.

THE MARK CONSISTS OF THE NAME "AUDI" APPEARING ABOVE THE WORDS "TRUTH IN ENGINEERING" WITH FOUR INTERLOCKING RINGS POSITIONED TO THE RIGHT OF THE WORDS.

SER. NO. 85-125,072, FILED 9-8-2010.

BARBARA GAYNOR, EXAMINING ATTORNEY



David J. Kyffers

Director of the United States Patent and Trademark Office

United States of America

United States Patent and Trademark Office

Telemusica

Reg. No. 4,072,788

Registered Dec. 20, 2011

Int. Cl.: 38

SERVICE MARK

PRINCIPAL REGISTER

TELEMUSICA LLC (NEW YORK LIMITED LIABILITY COMPANY), DBA TELEMUSICA
LLC
117 KENT RD
VALLEY STREAM, NY 11580

FOR: CABLE TELEVISION BROADCASTING SERVICES; SATELLITE TELEVISION BROADCASTING; VIDEO BROADCASTING SERVICES OVER THE INTERNET OR OTHER COMMUNICATIONS NETWORK FEATURING THE UPLOADED, POSTED AND TAGGED VIDEOS OF OTHERS, IN CLASS 38 (U.S. CLS. 100, 101 AND 104).

FIRST USE 3-18-1997; IN COMMERCE 3-18-1997.

THE MARK CONSISTS OF STANDARD CHARACTERS WITHOUT CLAIM TO ANY PARTICULAR FONT, STYLE, SIZE, OR COLOR.

THE WORDING "TELEMUSICA" HAS NO MEANING IN A FOREIGN LANGUAGE.

SER. NO. 85-126,331, FILED 9-9-2010.

BARBARA GAYNOR, EXAMINING ATTORNEY



David J. Kyffers

Director of the United States Patent and Trademark Office

United States of America

United States Patent and Trademark Office



Reg. No. 4,072,789

Registered Dec. 20, 2011

Int. Cl.: 36

SERVICE MARK

PRINCIPAL REGISTER

SERGIO E. CARRILLO (UNITED STATES INDIVIDUAL), DBA GOLD BUYERS OF NEW MEXICO
5459 SALEM COURT, NE
RIO RANCHO, NM 87144

FOR: PROVIDING MONETARY EXCHANGE SERVICES, NAMELY, EXCHANGING GOLD OF OTHERS FOR CASH, IN CLASS 36 (U.S. CLS. 100, 101 AND 102).

FIRST USE 1-1-2009; IN COMMERCE 1-1-2009.

NO CLAIM IS MADE TO THE EXCLUSIVE RIGHT TO USE "GOLD BUYERS OF NEW MEXICO", APART FROM THE MARK AS SHOWN.

THE COLOR(S) BLUE, RED, AND YELLOW IS/ARE CLAIMED AS A FEATURE OF THE MARK.

THE MARK CONSISTS OF A LINED ZIA SUN SYMBOL IN YELLOW AND RED, WITH THE WORDING "GOLD BUYERS OF NEW MEXICO" IN BLUE.

SER. NO. 85-126,540, FILED 9-10-2010.

BRIAN NEVILLE, EXAMINING ATTORNEY



David J. Kybas

Director of the United States Patent and Trademark Office

United States of America

United States Patent and Trademark Office

Bid Express Small Business Network

Reg. No. 4,072,790

Registered Dec. 20, 2011

Int. Cl.: 35

SERVICE MARK

PRINCIPAL REGISTER

INFO TECH, INC. (FLORIDA CORPORATION)
SUITE 1235
5700 SW 34TH STREET
GAINESVILLE, FL 326085371

FOR: BUSINESS SERVICES, NAMELY, PROVIDING AN ONLINE NETWORK FOR CONTRACTORS TO RECEIVE AND PROVIDE SUBCONTRACTING LEADS AND BIDDING OPPORTUNITIES BY MEANS OF AN ONLINE MARKETPLACE FOR THE PURPOSE OF DEVELOPING BUSINESS FOR PUBLICLY BID CONSTRUCTION AND INFRASTRUCTURE PROJECTS AND SERVICES, IN CLASS 35 (U.S. CLS. 100, 101 AND 102).

FIRST USE 6-14-2006; IN COMMERCE 6-14-2006.

THE MARK CONSISTS OF STANDARD CHARACTERS WITHOUT CLAIM TO ANY PARTICULAR FONT, STYLE, SIZE, OR COLOR.

OWNER OF U.S. REG. NOS. 2,368,342 AND 2,606,514.

NO CLAIM IS MADE TO THE EXCLUSIVE RIGHT TO USE "SMALL BUSINESS NETWORK", APART FROM THE MARK AS SHOWN.

SEC. 2(F) AS TO "BID EXPRESS".

SER. NO. 85-126,613, FILED 9-10-2010.

WENDY GOODMAN, EXAMINING ATTORNEY



David J. Kyros

Director of the United States Patent and Trademark Office

United States of America

United States Patent and Trademark Office

Bid Express SBN

Reg. No. 4,072,791

Registered Dec. 20, 2011

Int. Cl.: 35

SERVICE MARK

PRINCIPAL REGISTER

INFO TECH, INC. (FLORIDA CORPORATION)
SUITE 1235
5700 SW 34TH STREET
GAINESVILLE, FL 326085371

FOR: BUSINESS SERVICES, NAMELY, PROVIDING AN ONLINE NETWORK FOR CONTRACTORS TO RECEIVE AND PROVIDE SUBCONTRACTING LEADS AND BIDDING OPPORTUNITIES BY MEANS OF AN ONLINE MARKETPLACE FOR THE PURPOSE OF DEVELOPING BUSINESS FOR PUBLICLY BID CONSTRUCTION AND INFRASTRUCTURE PROJECTS AND SERVICES, IN CLASS 35 (U.S. CLS. 100, 101 AND 102).

FIRST USE 6-14-2006; IN COMMERCE 6-14-2006.

THE MARK CONSISTS OF STANDARD CHARACTERS WITHOUT CLAIM TO ANY PARTICULAR FONT, STYLE, SIZE, OR COLOR.

OWNER OF U.S. REG. NOS. 2,368,342 AND 2,606,514.

SEC. 2(F) AS TO "BID EXPRESS".

SER. NO. 85-126,629, FILED 9-10-2010.

WENDY GOODMAN, EXAMINING ATTORNEY



David J. Kyffers

Director of the United States Patent and Trademark Office

United States of America

United States Patent and Trademark Office

Bid Express

Reg. No. 4,072,792

Registered Dec. 20, 2011

Int. Cl.: 35

SERVICE MARK

PRINCIPAL REGISTER

INFO TECH, INC. (FLORIDA CORPORATION)
SUITE 1235
5700 SW 34TH STREET
GAINESVILLE, FL 326085371

FOR: BUSINESS SERVICES, NAMELY, PROVIDING AN ONLINE NETWORK FOR CONTRACTORS TO RECEIVE LEADS AND BIDDING OPPORTUNITIES BY MEANS OF AN ONLINE MARKETPLACE FOR THE PURPOSE OF DEVELOPING BUSINESS FOR INFRASTRUCTURE CONSTRUCTION PROJECTS AND SERVICES, IN CLASS 35 (U.S. CLS. 100, 101 AND 102).

FIRST USE 4-17-1996; IN COMMERCE 1-17-1997.

THE MARK CONSISTS OF STANDARD CHARACTERS WITHOUT CLAIM TO ANY PARTICULAR FONT, STYLE, SIZE, OR COLOR.

OWNER OF U.S. REG. NOS. 2,368,342 AND 2,606,514.

SEC. 2(F).

SER. NO. 85-126,660, FILED 9-10-2010.

WENDY GOODMAN, EXAMINING ATTORNEY



David J. Kyros

Director of the United States Patent and Trademark Office

United States of America

United States Patent and Trademark Office



Reg. No. 4,072,793

Registered Dec. 20, 2011

Int. Cl.: 35

SERVICE MARK

PRINCIPAL REGISTER

INFO TECH, INC. (FLORIDA CORPORATION)
SUITE 1235
5700 SW 34TH STREET
GAINESVILLE, FL 326085371

FOR: BUSINESS SERVICES, NAMELY, PROVIDING AN ONLINE NETWORK FOR CONTRACTORS TO RECEIVE LEADS AND BIDDING OPPORTUNITIES BY MEANS OF AN ONLINE MARKETPLACE FOR THE PURPOSE OF DEVELOPING BUSINESS FOR INFRASTRUCTURE CONSTRUCTION PROJECTS AND SERVICES, IN CLASS 35 (U.S. CLS. 100, 101 AND 102).

FIRST USE 4-17-1996; IN COMMERCE 1-17-1997.

OWNER OF U.S. REG. NOS. 2,368,342 AND 2,606,514.

NO CLAIM IS MADE TO THE EXCLUSIVE RIGHT TO USE "SECURE INTERNET BIDDING", APART FROM THE MARK AS SHOWN.

THE MARK CONSISTS OF A STYLIZED ARROW INSIDE A SQUARE NEXT TO THE WORDING "BID EXPRESS SECURE INTERNET BIDDING".

SEC. 2(F) AS TO "BID EXPRESS" .

SER. NO. 85-126,664, FILED 9-10-2010.

WENDY GOODMAN, EXAMINING ATTORNEY



David J. Kybas

Director of the United States Patent and Trademark Office

United States of America

United States Patent and Trademark Office



Reg. No. 4,072,794

Registered Dec. 20, 2011

Int. Cls.: 35 and 40

SERVICE MARK

PRINCIPAL REGISTER

GRENVILLE MANAGEMENT INC. (CANADA CORPORATION)
18 EASTERN AVENUE
TORONTO, ONTARIO, CANADA M5A1H5

FOR: MAIL SERVICES, NAMELY, RECEIVING AND PROCESSING INTERNATIONAL AND DOMESTIC MAIL FOR INFUSION INTO ESTABLISHED POSTAL SERVICES; MAIL SORTING, HANDLING AND RECEIVING; COPYING OF DOCUMENTS FOR OTHERS, IN CLASS 35 (U.S. CLS. 100, 101 AND 102).

FOR: PRINTING SERVICES, IN CLASS 40 (U.S. CLS. 100, 103 AND 106).

OWNER OF CANADA REG. NO. TMA792035, DATED 3-2-2011, EXPIRES 3-2-2026.

THE COLOR(S) LIGHT GREEN, GREEN, BLUE IS/ARE CLAIMED AS A FEATURE OF THE MARK.

NO CLAIM IS MADE TO THE EXCLUSIVE RIGHT TO USE "GRENVILLE" AND "MANAGEMENT AND PRINTING", APART FROM THE MARK AS SHOWN.

THE MARK CONSISTS OF A LARGE RECTANGULAR SHAPE TO THE LEFT OF THE WORD "GRENVILLE" AND THE WORDS "GRENVILLE MANAGEMENT AND PRINTING" ARE BLUE, EXCEPT FOR THE DOT ABOVE THE "I" IN "GRENVILLE," THE WORDS "OFTEN COPIED. NEVER DUPLICATED.," THE DOT ABOVE THE "I" IN THE WORD "GRENVILLE" AND THE MIDDLE-SIZED RECTANGULAR SHAPE TO THE LEFT OF THE WORD "GRENVILLE" ARE GREEN, THE SMALLEST-SIZED RECTANGULAR SHAPE TO THE LEFT OF THE WORD "GRENVILLE" IS LIGHT GREEN.

SER. NO. 85-127,519, FILED 9-11-2010.

JOHN DALIER, EXAMINING ATTORNEY



David J. Kybas

Director of the United States Patent and Trademark Office

United States of America

United States Patent and Trademark Office



Reg. No. 4,072,795

GRENVILLE MANAGEMENT INC. (CANADA CORPORATION)
18 EASTERN AVENUE
TORONTO, ONTARIO, CANADA M5A1H5

Registered Dec. 20, 2011

Int. Cls.: 35 and 40

FOR: MAIL SERVICES, NAMELY, RECEIVING AND PROCESSING INTERNATIONAL AND DOMESTIC MAIL FOR INFUSION INTO ESTABLISHED POSTAL SERVICES; MAIL SORTING, HANDLING AND RECEIVING; COPYING OF DOCUMENTS FOR OTHERS, IN CLASS 35 (U.S. CLS. 100, 101 AND 102).

SERVICE MARK

PRINCIPAL REGISTER

FOR: PRINTING SERVICES, IN CLASS 40 (U.S. CLS. 100, 103 AND 106).

OWNER OF CANADA REG. NO. TMA792038, DATED 3-2-2011, EXPIRES 3-2-2026.

THE COLOR(S) LIGHT GREEN, GREEN, BLUE IS/ARE CLAIMED AS A FEATURE OF THE MARK.

NO CLAIM IS MADE TO THE EXCLUSIVE RIGHT TO USE "GRENVILLE" AND "PRINT CENTRE", APART FROM THE MARK AS SHOWN.

THE MARK CONSISTS OF A HUMAN FIGURE AND THE WORDS "GRENVILLE PRINT CENTRE" ARE BLUE, EXCEPT FOR THE DOT ABOVE THE "I" IN "GRENVILLE", THE WORDS "OFTEN COPIED. NEVER DUPLICATED.", THE DOT ABOVE THE "I" IN THE WORD "GRENVILLE" AND THE CENTRE RECTANGULAR SHAPE ABOVE THE HUMAN FIGURE ARE GREEN, THE LEFT HAND-SIDE AND RIGHT HAND-SIDE RECTANGULAR SHAPES ABOVE THE HUMAN FIGURE ARE LIGHT GREEN.

SER. NO. 85-127,525, FILED 9-11-2010.

JOHN DALIER, EXAMINING ATTORNEY



David J. Kybas

Director of the United States Patent and Trademark Office

United States of America

United States Patent and Trademark Office



Reg. No. 4,072,796

Registered Dec. 20, 2011

Int. Cl.: 25

TRADEMARK

PRINCIPAL REGISTER

CARLOS ALBERTO RUIZ VELASCO (MEXICO INDIVIDUAL)
COL. MIRADOR DE SAN ISIDRO
CAMINO A LAS CAÑADAS 900-1
ZAPOPAN, JALISCO, MEXICO 45132

FOR: HEEL PIECES FOR SHOES; LEATHER SHOES; SHOES; STILETTO HEELS; WOMEN'S SHOES, IN CLASS 25 (U.S. CLS. 22 AND 39).

FIRST USE 4-5-2010; IN COMMERCE 4-5-2010.

OWNER OF U.S. REG. NOS. 3,749,528 AND 3,959,367.

THE MARK CONSISTS OF THE LETTERS, "OE", JOINED AT THE CENTER ON ONE SIDE, WITH A SHORT HORIZONTAL ACCENT LINE OVER THE "O".

THE WORDING "OE" HAS NO MEANING IN A FOREIGN LANGUAGE.

SER. NO. 85-127,557, FILED 9-11-2010.

BARBARA A. GOLD, EXAMINING ATTORNEY



David J. Kybas

Director of the United States Patent and Trademark Office

United States of America

United States Patent and Trademark Office



Reg. No. 4,072,797

Registered Dec. 20, 2011

Int. Cl.: 37

SERVICE MARK

PRINCIPAL REGISTER

BRIEN RYLANDER (UNITED STATES INDIVIDUAL), DBA ECO ZONE MOBILE AUTO
DETAILING
55 HITCHING POST DR
WALPOLE, MA 02081

FOR: AUTOMOBILE DETAILING; VEHICLE DETAILING, IN CLASS 37 (U.S. CLS. 100, 103
AND 106).

FIRST USE 8-31-2010; IN COMMERCE 9-5-2010.

NO CLAIM IS MADE TO THE EXCLUSIVE RIGHT TO USE "ECO" AND "MOBILE AUTO
DETAILING", APART FROM THE MARK AS SHOWN.

THE COLOR(S) GREEN IS/ARE CLAIMED AS A FEATURE OF THE MARK.

THE MARK CONSISTS OF THE FOLLOWING: A SIDE VIEW OF A CAR AND TWO WHEELS
WITH A GREEN OUTLINE AND GREEN FILLED-IN WINDOWS; A GREEN SUN WITH
RAYS RISING OVER THE CAR; GREEN PLANT LEAVES UNDER THE CAR; GREEN WATER
DROPS WITH THE WIDER DROP END NOT ENTIRELY SHADED GREEN AND FORMING
AN OVAL AROUND THE TOP AND BOTTOM OF THE DESIGN; THE TERMS "ECO ZONE
MOBILE AUTO DETAILING" TO THE RIGHT OF THE DESIGN SHOWN IN GREEN. THE
COLOR WHITE REPRESENTS TRANSPARENT BACKGROUND AND IS NOT CLAIMED
AS A FEATURE OF THE MARK.

SER. NO. 85-127,635, FILED 9-12-2010.

JENNIFER DIXON, EXAMINING ATTORNEY



David J. Kybas

Director of the United States Patent and Trademark Office

United States of America

United States Patent and Trademark Office



Reg. No. 4,072,798

Registered Dec. 20, 2011

Int. Cl.: 30

TRADEMARK

PRINCIPAL REGISTER

HUNGARY BEES, INC. (CALIFORNIA CORPORATION)
737 CATHEDRAL POINTE LANE
SANTA BARBARA, CA 93111

FOR: ACACIA HONEY, IN CLASS 30 (U.S. CL. 46).

FIRST USE 9-25-2006; IN COMMERCE 12-6-2007.

OWNER OF U.S. REG. NOS. 3,597,557 AND 3,748,315.

NO CLAIM IS MADE TO THE EXCLUSIVE RIGHT TO USE "HUNGARY" AND "WILD ACACIA HONEY" AND "PRODUCT OF HUNGARY", APART FROM THE MARK AS SHOWN.

THE STIPPLING IS FOR SHADING PURPOSES ONLY.

THE MARK CONSISTS OF THE WORDS "HUNGARY BEES" IN AN OVAL SUPERIMPOSED ON A CLOUD AND AN ACACIA TREE BRANCH AND BLOOM, ALL OF WHICH ARE ENCLOSED IN A LARGER IRREGULAR OVAL SHAPE, WITH GRASS AT THE BOTTOM OF THE OVAL AND A RIBBON SHAPED BANNER WITH THE WORDS "WILD ACACIA HONEY" ON THE BANNER, WITH A STYLIZED BEE UNDER THE WORD "ACACIA" SURROUNDED BY A SEMI-CIRCLE OF THE WORDS "PRODUCT OF HUNGARY" AND WITH ADDITIONAL BEES TO THE RIGHT AND LEFT OF THE OVAL AND WORDING.

SEC. 2(F) AS TO "HUNGARY BEES".

SER. NO. 85-131,372, FILED 9-16-2010.

JOHN KELLY, EXAMINING ATTORNEY



David J. Kyros

Director of the United States Patent and Trademark Office

United States of America

United States Patent and Trademark Office



Reg. No. 4,072,799

Registered Dec. 20, 2011

**Int. Cls.: 9, 16, 25, 28
and 41**

TRADEMARK

SERVICE MARK

PRINCIPAL REGISTER

JULIAN BARRATT (UNITED KINGDOM INDIVIDUAL)
C/O PBJ MANAGEMENT LTD.
5 SOHO SQUARE
LONDON W1D 3QA, UNITED KINGDOM AND

NOEL FIELDING (UNITED KINGDOM INDIVIDUAL)
C/O PBJ MANAGEMENT LTD.
5 SOHO SQUARE
LONDON W1D 3QA, UNITED KINGDOM

FOR: PRE-RECORDED COMPACT DISCS FEATURING COMEDY AND MUSIC; COMPUTER GAME PROGRAMMES; INTERACTIVE VIDEO GAME PROGRAMMES; PRE-RECORDED DVDS FEATURING COMEDY AND MUSIC; PRE-RECORDED VIDEO TAPES FEATURING COMEDY AND MUSIC; PRE-RECORDED AUDIO TAPES FEATURING COMEDY AND MUSIC; MOTION PICTURE FILMS ABOUT COMEDY AND MUSIC; MOBILE TELEPHONE COVERS; MOBILE TELEPHONE CASES; DOWNLOADABLE MOBILE TELEPHONE RING TONES; MOBILE TELEPHONE GAMES, NAMELY, ELECTRONIC GAME SOFTWARE FOR CELLULAR TELEPHONES; MEDIA CARRYING ELECTRONIC RECORDINGS OF SOUND, IMAGES OR AUDIO-VISUAL RECORDINGS, AND DATA DOWNLOADABLE FROM THE INTERNET, NAMELY, MP3 PLAYERS; DOWNLOADABLE ELECTRONIC PUBLICATIONS, NAMELY, E-BOOKS IN THE FIELD OF COMEDY AND MUSIC; DOWNLOADABLE AUDIO AND VIDEO RECORDINGS FEATURING COMEDY AND MUSIC; DOWNLOADABLE MOTION PICTURES AND TELEVISION PROGRAMS ABOUT COMEDY AND MUSIC; DOWNLOADABLE GRAPHICS, WALLPAPER GRAPHICS, AND MUSIC VIA A GLOBAL COMPUTER NETWORK AND WIRELESS DEVICES; COMPUTER SCREEN SAVER SOFTWARE; MOUSE PADS; DECORATIVE MAGNETS; REFRIGERATOR MAGNETS; EYEGLASSES; SUNGLASSES, IN CLASS 9 (U.S. CLS. 21, 23, 26, 36 AND 38).

FOR: PAPER, CARDBOARD AND GOODS MADE FROM THESE MATERIALS, NAMELY, POSTERS, EVENT PROGRAMS, GREETING CARDS, CALENDARS; STATIONERY; BOOKS IN THE FIELD OF COMEDY AND MUSIC; BOOK COVERS; NOVELS; JOKE BOOKS; GRAPHIC NOVELS; COMICS; CALENDARS; DECALCOMANIAS; GREETING CARDS; GRAPHIC REPRESENTATIONS; PASSPORT HOLDERS; NEWSPAPERS; NOTE BOOKS; WRITING PADS; DIARIES; POSTCARDS; PAINTINGS; PENS; PEN HOLDERS; PENCILS; PENCIL HOLDERS; PENCIL SHARPENERS; PHOTOGRAPHS; PICTURES; POSTERS; POSTAGE STAMPS; PRINTS; SCRAP BOOKS; STICKERS; WRAPPING PAPER; ADDRESS



David J. Kybas

Director of the United States Patent and Trademark Office

Reg. No. 4,072,799 BOOKS; PERSONAL ORGANISERS; ERASERS; BOOK MARKS; PAPER BAGS; MONEY CLIPS, IN CLASS 16 (U.S. CLS. 2, 5, 22, 23, 29, 37, 38 AND 50).

FOR: HEADWEAR; CLOTHING, NAMELY, SHIRTS, T-SHIRTS, VESTS, SWEATSHIRTS, HOODED SWEATSHIRTS, SWEATERS, JACKETS, JUMPERS, TROUSERS, BOXER SHORTS, UNDERWEAR, SOCKS, HOSIERY, BELTS; VISORS; HATS; CAPS; SCARVES AND NECKWEAR; ARTICLES OF CLOTHING FOR CHILDREN, NAMELY, T-SHIRTS; SLEEPWEAR; SWIMWEAR; BEACHWEAR; BATHROBES; SLIPPERS; FANCY DRESS COSTUMES BASED ON CHARACTERS FROM A TV SHOW; DRESSING GOWNS; DRESSES; SKIRTS; NECKTIES; PYJAMAS; WRISTBANDS; HEADBANDS, IN CLASS 25 (U.S. CLS. 22 AND 39).

FOR: DECORATIONS FOR CHRISTMAS TREES; BALLOONS; BALLS FOR GAMES; BOARD GAMES; BOXING GLOVES; PLAYING CARDS; DICE; DOLLS; DOLLS' CLOTHES; DOLLS' HOUSES; DOMINOS; KALEIDOSCOPES; KITES; TOY MASKS; PUPPETS; SNOW GLOBES; SPINNING TOPS; TABLES FOR TABLE TENNIS; TABLES FOR INDOOR FOOTBALL; TEDDY BEARS; TOY PISTOLS; TOY VEHICLES; ACTION FIGURES; BATHTUB TOYS; PLUSH TOYS; FLYING DISCS; ELECTRONIC HAND HELD GAME UNITS FOR PLAYING VIDEO GAMES OTHER THAN THOSE ADAPTED FOR USE WITH AN EXTERNAL DISPLAY SCREEN OR MONITOR; CARD GAMES; JIGSAW PUZZLES; CUBE PUZZLES; MANIPULATIVE PUZZLES; WATER SQUIRTING TOYS; SWIMMING FLOATS FOR RECREATIONAL USE; CHRISTMAS CRACKERS; CARDBOARD TOY AND NOVELTY FACE MASKS, IN CLASS 28 (U.S. CLS. 22, 23, 38 AND 50).

FOR: PRESENTATION OF LIVE COMEDY SHOWS; ENTERTAINMENT, NAMELY, PRODUCTION AND PERFORMANCE OF LIVE COMEDY SHOWS; ENTERTAINMENT IN THE NATURE OF STAND UP COMEDY PERFORMANCES; LIVE ENTERTAINMENT SERVICES BY A GROUP OF COMEDIC PERFORMERS; ENTERTAINMENT IN THE NATURE OF LIVE PERFORMANCES BY A GROUP OF COMEDIC PERFORMERS; ORGANISATION OF MUSIC FESTIVALS; ENTERTAINMENT IN THE NATURE OF LIVE PERFORMANCES BY A MUSICAL GROUP; FILM PRODUCTION; MUSIC COMPOSITION SERVICES FOR OTHERS; PRODUCTION OF RADIO PROGRAMMES; PRODUCTION OF TELEVISION PROGRAMMES; ENTERTAINMENT, NAMELY, PRODUCTION OF TELEVISION SHOWS; PROVIDING ON-LINE NON-DOWNLOADABLE ELECTRONIC PUBLICATIONS IN THE NATURE OF ELECTRONIC NEWSLETTERS ABOUT COMEDY AND MUSIC; RADIO ENTERTAINMENT, NAMELY, PROVIDING AN ON-GOING RADIO PROGRAM IN THE FIELD OF COMEDY AND MUSIC; TELEVISION ENTERTAINMENT IN THE NATURE OF ON-GOING TELEVISION PROGRAMS IN THE FIELD OF COMEDY AND MUSIC; THEATRICAL ENTERTAINMENT, NAMELY, THEATRICAL, COMEDIC, AND MUSICAL FLOOR SHOWS PROVIDED AT PERFORMANCE VENUES; PRODUCTION OF VIDEOS; PROVIDING ON-LINE ENTERTAINMENT INFORMATION IN THE FIELD OF MOTION PICTURE FILM, TELEVISION PROGRAMMING, THEATRE, VIDEOTAPES, AND DVDS, ALL RELATING TO COMEDY AND MUSIC, VIA A GLOBAL COMMUNICATIONS NETWORK, IN CLASS 41 (U.S. CLS. 100, 101 AND 107).

PRIORITY CLAIMED UNDER SEC. 44(D) ON UNITED KINGDOM APPLICATION NO. 2542396, FILED 3-16-2010, REG. NO. 2542396, DATED 7-30-2010, EXPIRES 3-16-2020.

THE MARK CONSISTS OF A CARICATURE OF A FACE WITH TWO EYES AND A MOUTH WITH UPPER AND LOWER TEETH ROWS INDICATED ENCLOSED IN A RECTANGLE.

SER. NO. 85-131,586, FILED 9-16-2010.

BARBARA GAYNOR, EXAMINING ATTORNEY

United States of America

United States Patent and Trademark Office

CHEMILES

Reg. No. 4,072,800

Registered Dec. 20, 2011

Int. Cls.: 7 and 11

TRADEMARK

PRINCIPAL REGISTER

NAGAOKA INTERNATIONAL CORPORATION (JAPAN CORPORATION)
IZUMIOTSU-SHI
6-1 NAGAISA-CHO
OSAKA, JAPAN 595-0055

FOR: FILTERING DEVICES, NAMELY, FILTERS FOR WATER, WASTEWATER AND GROUNDWATER FILTRATION, IN CLASS 7 (U.S. CLS. 13, 19, 21, 23, 31, 34 AND 35).

FOR: WATER TREATMENT APPARATUS, NAMELY, GROUNDWATER FILTRATION SYSTEMS; WASTEWATER TREATMENT APPARATUS, NAMELY, WASTEWATER FILTRATION SYSTEMS AND PARTS AND FITTINGS THEREOF, IN CLASS 11 (U.S. CLS. 13, 21, 23, 31 AND 34).

THE MARK CONSISTS OF STANDARD CHARACTERS WITHOUT CLAIM TO ANY PARTICULAR FONT, STYLE, SIZE, OR COLOR.

OWNER OF JAPAN REG. NO. 5356621, DATED 9-24-2010, EXPIRES 9-24-2020.

SER. NO. 85-131,891, FILED 9-17-2010.

ROSELLE HERRERA, EXAMINING ATTORNEY



David J. Kyros

Director of the United States Patent and Trademark Office

United States of America

United States Patent and Trademark Office

宗嚴

Reg. No. 4,072,801

Registered Dec. 20, 2011

Int. Cl.: 8

TRADEMARK

PRINCIPAL REGISTER

LING, HAORAN (UNITED STATES INDIVIDUAL)
580 UNION AVENUE
POMONA, CA 91768

FOR: JAPANESE SWORDS; SWORDS, IN CLASS 8 (U.S. CLS. 23, 28 AND 44).

FIRST USE 4-26-2009; IN COMMERCE 4-26-2009.

THE MARK CONSISTS OF THE JAPANESE CHARACTERS FOR "MUNETOSHI".

THE JAPANESE CHARACTERS IN THE MARK TRANSLITERATE TO "MUNETOSHI".

THE WORDING "MUNETOSHI" HAS NO MEANING IN A FOREIGN LANGUAGE.

SER. NO. 85-132,131, FILED 9-17-2010.

KIM SAITO, EXAMINING ATTORNEY



David J. Kybas

Director of the United States Patent and Trademark Office

United States of America

United States Patent and Trademark Office



Reg. No. 4,072,802

Registered Dec. 20, 2011

Int. Cls.: 29 and 30

TRADEMARK

PRINCIPAL REGISTER

MORRISON LAMOTHE INC. (CANADA CORPORATION)
5240 FINCH AVENUE EAST (UNIT 2)
TORONTO, ONTARIO, CANADA M1S5A2

FOR: FROZEN PREPARED FOOD PRODUCTS, NAMELY, SOUPS, APPETIZERS CONSISTING PRIMARILY OF MEAT, CHICKEN, CHEESE, VEGETABLES, FISH OR SEAFOOD, AND ENTREES CONSISTING PRIMARILY OF MEAT, CHICKEN, CHEESE, VEGETABLES, FISH OR SEAFOOD, IN CLASS 29 (U.S. CL. 46).

FOR: FROZEN PREPARED FOOD PRODUCTS, NAMELY, PIES, MEAT PIES, GRAIN AND BREAD BASED APPETIZERS AND HORS D'OEUVRES, DESSERTS CONSISTING OF FRUIT AND CREAM, ENTREES CONSISTING PRIMARILY OF PASTA OR RICE; PUFF PASTRIES, PUFF PASTRY, DOUGH, BISCUITS, FLATBREADS, BREAD, PORTABLE PASTRIES AND SHORT CRUST PASTRIES; PORTABLE PASTRY AND SHORT CRUST PASTRY WITH FILLINGS CONSISTING OF MEAT, POULTRY, FISH AND SEAFOOD, VEGETABLES, SAUCE, FRUIT, EGG, CHEESE, RICE, PASTA, GRAINS AND/OR POTATOES; GROUND AND WHOLE COFFEE BEANS, IN CLASS 30 (U.S. CL. 46).

PRIORITY CLAIMED UNDER SEC. 44(D) ON CANADA APPLICATION NO. 1494316, FILED 9-1-2010, REG. NO. TMA804036, DATED 8-10-2011, EXPIRES 8-10-2026.

THE NAME(S), PORTRAIT(S), AND/OR SIGNATURE(S) SHOWN IN THE MARK DOES NOT IDENTIFY A PARTICULAR LIVING INDIVIDUAL.

THE MARK CONSISTS OF OVALS; THE OUTER OVAL CONTAINS THE WORDS "MORRISON" ON TOP AND "LAMOthe" ON THE BOTTOM, SURROUNDED WITH THIN LINES. THE WORDS ARE SEPARATED WITH DOTS. IN THE CENTER OVAL THERE IS A DRAWING OF A PERSON WITH A MOUSTACHE, HAT, JACKET AND SERVING TRAY, SURROUNDED BY A THIN LINE. THE COLOR GRAY IS INTENDED TO INDICATE SHADING OR CONTRAST ONLY.

SER. NO. 85-133,113, FILED 9-20-2010.

NICHOLAS ALTREE, EXAMINING ATTORNEY



David J. Kyffers

Director of the United States Patent and Trademark Office

United States of America

United States Patent and Trademark Office



Reg. No. 4,072,803

Registered Dec. 20, 2011

Int. Cls.: 11, 20 and 21

TRADEMARK

PRINCIPAL REGISTER

SAMHONGTECH CO., LTD. (REPUBLIC OF KOREA CORPORATION)
1488-7 KWANYANG-DONG
DONGAN-GU
ANYANG-CITY, GYEONGGI, REPUBLIC OF KOREA

FOR: BIDETS; WATER PURIFIERS FOR HOUSEHOLD PURPOSES; BATH TUBS; SHOWERS;
TOILET SEATS; URINALS; SHOWER ENCLOSURES, IN CLASS 11 (U.S. CLS. 13, 21, 23, 31
AND 34).

FOR: WASHSTAND, IN CLASS 20 (U.S. CLS. 2, 13, 22, 25, 32 AND 50).

FOR: WASH-HAND BASIN, IN CLASS 21 (U.S. CLS. 2, 13, 23, 29, 30, 33, 40 AND 50).

OWNER OF REPUBLIC OF KOREA REG. NO. 0595632, DATED 10-12-2004, EXPIRES 10-
12-2014.

THE COLOR(S) DARK BLUE AND LIGHT BLUE IS/ARE CLAIMED AS A FEATURE OF
THE MARK.

THE WORDING "USPA" IN DARK BLUE NEXT TO A SERIES OF NINE DOTS IN LIGHT
BLUE WHERE TWO OF THE DOTS IN THE CENTER ARE DARK BLUE.

SER. NO. 85-133,584, FILED 9-20-2010.

LINDA ORNDORFF, EXAMINING ATTORNEY



David J. Kyjars

Director of the United States Patent and Trademark Office

United States of America

United States Patent and Trademark Office

UNTOLD STORIES OF THE ER

Reg. No. 4,072,804

Registered Dec. 20, 2011

Int. Cl.: 41

SERVICE MARK

PRINCIPAL REGISTER

DISCOVERY COMMUNICATIONS, LLC (DELAWARE LIMITED LIABILITY COMPANY)
ONE DISCOVERY PLACE
SILVER SPRING, MD 20910

FOR: ENTERTAINMENT AND EDUCATIONAL SERVICES IN THE NATURE OF TELEVISION AND MULTIMEDIA PROGRAM SERIES FEATURING SUBJECTS OF GENERAL HUMAN INTEREST DISTRIBUTED VIA VARIOUS PLATFORMS ACROSS MULTIPLE FORMS OF TRANSMISSION MEDIA; PROVIDING ENTERTAINMENT INFORMATION TO OTHERS VIA A GLOBAL COMPUTER NETWORK, IN CLASS 41 (U.S. CLS. 100, 101 AND 107).

FIRST USE 4-12-2004; IN COMMERCE 4-12-2004.

THE MARK CONSISTS OF STANDARD CHARACTERS WITHOUT CLAIM TO ANY PARTICULAR FONT, STYLE, SIZE, OR COLOR.

SER. NO. 85-134,005, FILED 9-20-2010.

SAIMA MAKHDOOM, EXAMINING ATTORNEY



David J. Kyffers

Director of the United States Patent and Trademark Office

United States of America

United States Patent and Trademark Office

KALA LUNA

Reg. No. 4,072,805

SGS SPORTS INC. (CANADA CORPORATION)
6400 COTE DE LIESSE
MONTREAL, QUEBEC, CANADA H4T1E3

Registered Dec. 20, 2011

Int. Cl.: 25

FOR: LADIES SWIMWEAR; COVER UPS, IN CLASS 25 (U.S. CLS. 22 AND 39).

TRADEMARK

THE MARK CONSISTS OF STANDARD CHARACTERS WITHOUT CLAIM TO ANY PARTICULAR FONT, STYLE, SIZE, OR COLOR.

PRINCIPAL REGISTER

PRIORITY CLAIMED UNDER SEC. 44(D) ON CANADA APPLICATION NO. 1477252, FILED 4-16-2010, REG. NO. TMA791449, DATED 2-23-2011, EXPIRES 2-23-2026.

THE ENGLISH TRANSLATION OF "KALA LUNA" IN THE MARK IS "---MOON".

THE WORDING "KALA" HAS NO MEANING IN A FOREIGN LANGUAGE.

SER. NO. 85-134,498, FILED 9-21-2010.

H. M. FISHER, EXAMINING ATTORNEY



David J. Kyffers

Director of the United States Patent and Trademark Office

United States of America

United States Patent and Trademark Office

Nalco Cast Clean

Reg. No. 4,072,806

NALCO COMPANY (DELAWARE CORPORATION)

Registered Dec. 20, 2011

1601 W. DIEHL ROAD
NAPERVILLE, IL 605631198

Int. Cl.: 42

FOR: PROVIDING CONTINUOUS ON-LINE MONITORING AND CONTROL OF WATER CHEMISTRY, IN CLASS 42 (U.S. CLS. 100 AND 101).

SERVICE MARK

FIRST USE 7-1-2007; IN COMMERCE 7-1-2007.

PRINCIPAL REGISTER

THE MARK CONSISTS OF STANDARD CHARACTERS WITHOUT CLAIM TO ANY PARTICULAR FONT, STYLE, SIZE, OR COLOR.

NO CLAIM IS MADE TO THE EXCLUSIVE RIGHT TO USE "CAST CLEAN", APART FROM THE MARK AS SHOWN.

SER. NO. 85-134,700, FILED 9-21-2010.

CHRISTOPHER BUONGIORNO, EXAMINING ATTORNEY



David J. Kyros

Director of the United States Patent and Trademark Office

United States of America

United States Patent and Trademark Office

SPIRIT

Reg. No. 4,072,807

Registered Dec. 20, 2011

Int. Cl.: 38

SERVICE MARK

PRINCIPAL REGISTER

CRISTA MINISTRIES (WASHINGTON NON-PROFIT CORPORATION)
19303 FREMONT AVE. N.
SEATTLE, WA 98133

FOR: RADIO BROADCASTING OF FAMILY-ORIENTED AND CHRISTIAN-ORIENTED AUDIO MATERIAL AND RADIO PROGRAMS, EXCLUDING SATELLITE BROADCASTING SERVICES; STREAMING OF AUDIO MATERIAL ON THE INTERNET, IN THE NATURE OF FAMILY-ORIENTED AND CHRISTIAN PROGRAMS, EXCLUDING AUDIO MATERIALS ORIGINATING FROM SATELLITE BROADCASTS, IN CLASS 38 (U.S. CLS. 100, 101 AND 104).

FIRST USE 9-0-1999; IN COMMERCE 9-0-1999.

THE MARK CONSISTS OF STANDARD CHARACTERS WITHOUT CLAIM TO ANY PARTICULAR FONT, STYLE, SIZE, OR COLOR.

OWNER OF U.S. REG. NOS. 3,100,794, 3,805,792 AND OTHERS.

SER. NO. 85-136,799, FILED 9-23-2010.

ANNE FARRELL, EXAMINING ATTORNEY



David J. Kybas

Director of the United States Patent and Trademark Office

United States of America

United States Patent and Trademark Office

Bemis

Reg. No. 4,072,808

Registered Dec. 20, 2011

Int. Cls.: 16 and 17

TRADEMARK

PRINCIPAL REGISTER

BEMIS COMPANY, INC. (MISSOURI CORPORATION)
ONE NEENAH CENTER, 134 E. WISCONSIN
NEENAH, WI 54956

FOR: PAPER AND CARDBOARD FOR PACKAGING; PAPER TAPE; PLASTIC POUCHES AND BAGS FOR PACKAGING; PRESSURE SENSITIVE ADHESIVE LABELS; ADHESIVES FOR STATIONERY OR HOUSEHOLD PURPOSES, IN CLASS 16 (U.S. CLS. 2, 5, 22, 23, 29, 37, 38 AND 50).

FIRST USE 1-1-1956; IN COMMERCE 1-1-1956.

FOR: PLASTICS IN EXTRUDED FORM FOR USE IN MANUFACTURE; PLASTIC FILM FOR INDUSTRIAL AND COMMERCIAL USE; PLASTIC FILMS USED AS PACKAGING FOR FOOD; PLASTICS IN THE FORM OF SHEETS, FILMS, TUBES; PLASTIC FLORIST TAPE FOR USE WRAPPING OF STEMS, FOR COMMERCIAL USE; PLASTIC ADHESIVE PACKAGING TAPE FOR INDUSTRIAL OR COMMERCIAL USE, NAMELY, IN SEWING CLOSED PAPER OR PLASTIC BAGS CONTAINING FOOD OR CHEMICALS; ADHESIVE TAPE FOR INDUSTRIAL OR COMMERCIAL USE IN PACKAGING, IN CLASS 17 (U.S. CLS. 1, 5, 12, 13, 35 AND 50).

FIRST USE 1-1-1956; IN COMMERCE 1-1-1956.

THE MARK CONSISTS OF STANDARD CHARACTERS WITHOUT CLAIM TO ANY PARTICULAR FONT, STYLE, SIZE, OR COLOR.

OWNER OF U.S. REG. NOS. 416,343, 3,545,351 AND OTHERS.

SEC. 2(F).

SER. NO. 85-137,283, FILED 9-24-2010.

DANIEL CAPSHAW, EXAMINING ATTORNEY



David J. Kyffers

Director of the United States Patent and Trademark Office

United States of America

United States Patent and Trademark Office

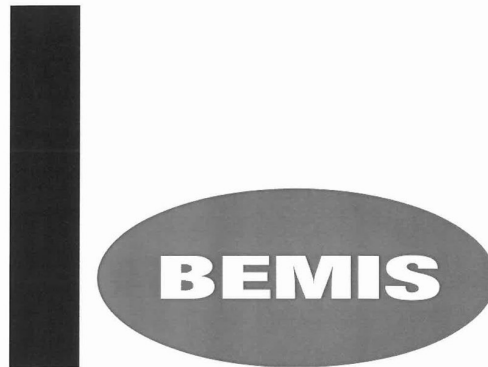

Reg. No. 4,072,809

Registered Dec. 20, 2011

Int. Cls.: 16 and 17

TRADEMARK

PRINCIPAL REGISTER

BEMIS COMPANY, INC. (MISSOURI CORPORATION)
ONE NEENAH CENTER, 134 E. WISCONSIN
NEENAH, WI 54956

FOR: PAPER AND CARDBOARD FOR PACKAGING; PAPER TAPE; PLASTIC POUCHES AND BAGS FOR PACKAGING; PRESSURE SENSITIVE ADHESIVE LABELS; ADHESIVES FOR STATIONERY OR HOUSEHOLD PURPOSES, IN CLASS 16 (U.S. CLS. 2, 5, 22, 23, 29, 37, 38 AND 50).

FIRST USE 4-6-1962; IN COMMERCE 4-6-1962.

FOR: PLASTICS IN EXTRUDED FORM FOR USE IN MANUFACTURE; PLASTIC FILM FOR INDUSTRIAL AND COMMERCIAL USE; PLASTIC FILMS USED AS PACKAGING FOR FOOD; PLASTICS IN THE FORM OF SHEETS, FILMS, TUBES; PLASTIC FLORIST TAPE FOR USE WRAPPING OF STEMS, FOR COMMERCIAL USE; PLASTIC ADHESIVE PACKAGING TAPE FOR INDUSTRIAL OR COMMERCIAL USE, NAMELY, IN SEWING CLOSED PAPER OR PLASTIC BAGS CONTAINING FOOD OR CHEMICALS; ADHESIVE TAPE FOR INDUSTRIAL OR COMMERCIAL USE IN PACKAGING, IN CLASS 17 (U.S. CLS. 1, 5, 12, 13, 35 AND 50).

FIRST USE 9-28-1982; IN COMMERCE 9-28-1982.

OWNER OF U.S. REG. NOS. 506,846, 3,545,351 AND OTHERS.

THE MARK CONSISTS OF A VERTICAL BAR WITH AN OVAL ENCLLOSING THE WORD "BEMIS" RESTING PERPENDICULAR TO THE RIGHT AND AT THE BASE OF THE BAR.

SER. NO. 85-137,419, FILED 9-24-2010.

DANIEL CAPSHAW, EXAMINING ATTORNEY



David J. Kyffers

Director of the United States Patent and Trademark Office

United States of America

United States Patent and Trademark Office

FITDECK

Reg. No. 4,072,810

PHILIP BLACK (UNITED STATES INDIVIDUAL)
7081 WELLER STREET
SAN DIEGO, CA 92122

Registered Dec. 20, 2011

Int. Cl.: 9

FOR: DOWNLOADABLE CARD GAME SOFTWARE PROGRAMS PROVIDING FITNESS AND EXERCISE, IN CLASS 9 (U.S. CLS. 21, 23, 26, 36 AND 38).

TRADEMARK

FIRST USE 6-0-2008; IN COMMERCE 6-0-2008.

PRINCIPAL REGISTER

THE MARK CONSISTS OF STANDARD CHARACTERS WITHOUT CLAIM TO ANY PARTICULAR FONT, STYLE, SIZE, OR COLOR.

OWNER OF U.S. REG. NO. 2,921,727.

SER. NO. 85-137,668, FILED 9-24-2010.

VIVIAN MICZNIK FIRST, EXAMINING ATTORNEY



David J. Kybas

Director of the United States Patent and Trademark Office

United States of America

United States Patent and Trademark Office

YELLOWSIGN CORNZORB

Reg. No. 4,072,811

XVNYTH MANUFACTURING CORP. (CANADA CORPORATION)
122-3989 HENNING DRIVE

Registered Dec. 20, 2011

BURNABY, B.C., CANADA V5C6N5

Int. Cl.: 1

FOR: VEGETABLE-BASED COMPOSITION FOR SOLIDIFICATION OF FLUIDS AND ABSORPTION OF LIQUIDS, NAMELY, DRIED PROCESSED CORN COBS AND CORN PLANT PARTS, IN CLASS 1 (U.S. CLS. 1, 5, 6, 10, 26 AND 46).

TRADEMARK

FIRST USE 7-3-2008; IN COMMERCE 10-4-2008.

PRINCIPAL REGISTER

THE MARK CONSISTS OF STANDARD CHARACTERS WITHOUT CLAIM TO ANY PARTICULAR FONT, STYLE, SIZE, OR COLOR.

SER. NO. 85-138,861, FILED 9-27-2010.

BRIDGETT SMITH, EXAMINING ATTORNEY



David J. Kyros

Director of the United States Patent and Trademark Office

United States of America

United States Patent and Trademark Office

paciplay

Reg. No. 4,072,812

TOES FOR EYES, INC. (FLORIDA CORPORATION), DBA TOES FOR EYES, INC.
825 NE 83 STREET
MIAMI, FL 33138

Registered Dec. 20, 2011

Int. Cl.: 10

FOR: PACIFIER CLIPS; TEETHING RINGS, IN CLASS 10 (U.S. CLS. 26, 39 AND 44).

TRADEMARK

FIRST USE 9-1-2010; IN COMMERCE 9-1-2010.

PRINCIPAL REGISTER

THE MARK CONSISTS OF STANDARD CHARACTERS WITHOUT CLAIM TO ANY PARTICULAR FONT, STYLE, SIZE, OR COLOR.

SER. NO. 85-138,873, FILED 9-27-2010.

BRIDGETT SMITH, EXAMINING ATTORNEY



David J. Kyffers

Director of the United States Patent and Trademark Office

United States of America

United States Patent and Trademark Office

I-PCI

Reg. No. 4,072,813

NUON, INC. (ARIZONA CORPORATION)
1475 N. SCOTTSDALE RD. SUITE 140
SCOTTSDALE, AZ 85257

Registered Dec. 20, 2011

Int. Cl.: 9

FOR: COMPUTER COMMUNICATION ELECTRONICS AND SOFTWARE, SPECIFICALLY, ELECTRONIC COMPONENTS FOR COMPUTERS AND COMPUTER SOFTWARE PROVIDING PERIPHERAL CONTROL INTERFACE (PCI) COMMUNICATION OVER A NETWORK INCLUDING THE INTERNET, IN CLASS 9 (U.S. CLS. 21, 23, 26, 36 AND 38).

TRADEMARK

PRINCIPAL REGISTER

FIRST USE 9-21-2010; IN COMMERCE 9-21-2010.

THE MARK CONSISTS OF "I-PCI" LETTERING WITH LETTER SMALL LETTER "I" JOINED TO CAPITAL LETTER "P" WITH A HATCHED LINE.

SER. NO. 85-139,179, FILED 9-27-2010.

ALLISON HOLTZ, EXAMINING ATTORNEY



David J. Kyffers

Director of the United States Patent and Trademark Office

United States of America

United States Patent and Trademark Office

SANTA NATURA

Reg. No. 4,072,814

Registered Dec. 20, 2011

Int. Cl.: 5

TRADEMARK

PRINCIPAL REGISTER

AGROINDUSTRIAS FLORIS SOCIEDAD ANONIMA CERRADA (PERU CORPORATION)
AV. ÁLVAREZ DE ARENALES N° 2570
DISTRITO DE LINCE
LIMA, LIMA, PERU

FOR: DIETARY AND NUTRITIONAL SUPPLEMENTS CONTAINING MEDICINAL HERBS AND ROOTS; DIETARY AND NUTRITIONALLY FORTIFIED FOOD PRODUCTS ADAPTED FOR MEDICAL USE; DIETARY FOOD SUPPLEMENTS; DIETARY SUPPLEMENTS FOR CHILDREN AND SICK PEOPLE; DIETETIC BEVERAGES ADAPTED FOR MEDICAL PURPOSES; DIETETIC FOODS ADAPTED FOR MEDICAL PURPOSES; DIETETIC FOODS ADAPTED FOR MEDICAL USE; MEDICAL AND SURGICAL DRESSINGS; MEDICAL AND SURGICAL PLASTERS; SANITARY PREPARATIONS FOR MEDICAL USE; SANITARY STERILIZING PREPARATIONS; VITAMINS, IN CLASS 5 (U.S. CLS. 6, 18, 44, 46, 51 AND 52).

THE MARK CONSISTS OF STANDARD CHARACTERS WITHOUT CLAIM TO ANY PARTICULAR FONT, STYLE, SIZE, OR COLOR.

OWNER OF PERU REG. NO. P00048770, DATED 9-15-1998, EXPIRES 9-15-2018.

NO CLAIM IS MADE TO THE EXCLUSIVE RIGHT TO USE "NATURA", APART FROM THE MARK AS SHOWN.

THE ENGLISH TRANSLATION OF "SANTA NATURA" IN THE MARK IS "SAINT" OR "HOLY NATURE".

SER. NO. 85-139,420, FILED 9-27-2010.

RONALD DELGIZZI, EXAMINING ATTORNEY



David J. Kypos

Director of the United States Patent and Trademark Office

United States of America

United States Patent and Trademark Office

PENTACHORDS

Reg. No. 4,072,815

TAUER, ANDREAS (SWITZERLAND INDIVIDUAL)
LIMMATTALSTRASSE 63 CH-8049
ZUERICH, SWITZERLAND

Registered Dec. 20, 2011

Int. Cl.: 3

FOR: SOAPS; PERFUMERY; ESSENTIAL OILS; COSMETICS, IN CLASS 3 (U.S. CLS. 1, 4, 6, 50, 51 AND 52).

TRADEMARK

THE MARK CONSISTS OF STANDARD CHARACTERS WITHOUT CLAIM TO ANY PARTICULAR FONT, STYLE, SIZE, OR COLOR.

PRINCIPAL REGISTER

PRIORITY CLAIMED UNDER SEC. 44(D) ON SWITZERLAND APPLICATION NO. 57595/2010, FILED 7-21-2010, REG. NO. 607727, DATED 11-9-2010, EXPIRES 7-21-2020.

SER. NO. 85-139,484, FILED 9-28-2010.

WILLIAM ROSSMAN, EXAMINING ATTORNEY



David J. Kybas

Director of the United States Patent and Trademark Office

United States of America

United States Patent and Trademark Office

IMPELLICONE

Reg. No. 4,072,816

Registered Dec. 20, 2011

Int. Cl.: 7

TRADEMARK

PRINCIPAL REGISTER

ADVANCED SYSTEMS TECHNOLOGY, INC. D/B/A CDS-JOHN BLUE COMPANY
(DELAWARE CORPORATION)
P. O. BOX 1607
HUNTSVILLE, AL 35807

FOR: FLOW DIVIDER VALVES AS MACHINE COMPONENTS, IN CLASS 7 (U.S. CLS. 13, 19, 21, 23, 31, 34 AND 35).

FIRST USE 9-8-2004; IN COMMERCE 9-8-2004.

THE MARK CONSISTS OF STANDARD CHARACTERS WITHOUT CLAIM TO ANY PARTICULAR FONT, STYLE, SIZE, OR COLOR.

SER. NO. 85-139,768, FILED 9-28-2010.

WENDY GOODMAN, EXAMINING ATTORNEY



David J. Kyffers

Director of the United States Patent and Trademark Office

United States of America

United States Patent and Trademark Office

SKINPRINT

Reg. No. 4,072,817

THE SKIN ATELIER, INC. (NEW YORK CORPORATION)
1997 ROUTE 17M
GOSHEN, NY 10924

Registered Dec. 20, 2011

Int. Cls.: 3, 9 and 44

FOR: SOAPS, BODY SCRUBS, BODY MASSAGE OILS, BODY BUTTER, AND FRAGRANCE SPRAYS FOR THE BODY; FOOT SPRAYS; NON-MEDICATED PEDICURE SOAKS, AND PEDICURE SCRUBS; GEL EYE MASKS FOR COSMETIC PURPOSES; NON-MEDICATED SKIN CARE PRODUCTS, NAMELY, SKIN LOTIONS AND CREAMS, SKIN CLEANSERS, SKIN MOISTURIZERS, SKIN TONERS AND EXFOLIATES, FACE LOTION, BODY LOTION, FOOT LOTION, HAND LOTION, DÉCOLLETAGE LOTION, FACE CREAM, BODY CREAM, FOOT CREAM, HAND CREAM, DÉCOLLETAGE CREAM, FACE SERUM, HAND SERUM, FOOT SERUM, HAND CLEANSER, DÉCOLLETAGE CLEANSER, FACE CLEANSER, BODY CLEANSER, FOOT CLEANSER, SUNSCREEN CREAM AND COSMETIC SUN SCREEN PREPARATIONS; NON-MEDICATED SPA PROFESSIONAL PRODUCTS, NAMELY, FACE LOTION, BODY LOTION, FOOT LOTION, HAND LOTION, DÉCOLLETAGE LOTION, FACE CREAM, BODY CREAM, FOOT CREAM, HAND CREAM, DÉCOLLETAGE CREAM, FACE SERUM, HAND SERUM, FOOT SERUM, HAND CLEANSER, DÉCOLLETAGE CLEANSER, FACE CLEANSER, BODY CLEANSER, FOOT CLEANSER, AND SUNSCREEN PRODUCTS, NAMELY, SUNSCREEN CREAMS AND COSMETIC SUNSCREEN PREPARATIONS; AND NON-MEDICATED BACK BAR PRODUCTS, NAMELY, MASSAGE CREAMS, MASSAGE OILS, FACIAL MASKS FOR COSMETIC PURPOSES, BODY MASKS, FOOT MASKS, HAND MASKS, DÉCOLLETAGE MASKS, FACIAL EXFOLIATORS, BODY EXFOLIATORS, FOOT EXFOLIATORS, HAND EXFOLIATORS AND DÉCOLLETAGE EXFOLIATORS; AND BODY DEODORANTS, IN CLASS 3 (U.S. CLS. 1, 4, 6, 50, 51 AND 52).

TRADEMARK

SERVICE MARK

PRINCIPAL REGISTER



FIRST USE 7-1-2003; IN COMMERCE 7-1-2003.

FOR: DIAGNOSTIC EQUIPMENT FOR SKIN ANALYSIS, NAMELY, OPTICAL SENSORS FOR CAPTURING IMAGES, IN CLASS 9 (U.S. CLS. 21, 23, 26, 36 AND 38).

FIRST USE 7-1-2003; IN COMMERCE 7-1-2003.

FOR: COSMETIC ANALYSIS SERVICES, NAMELY, PROVIDING AN INDIVIDUALIZED EXTERIOR TISSUE DOSSIER RESULTING FROM BIOMETRIC TESTING OF THE SKIN, IN CLASS 44 (U.S. CLS. 100 AND 101).

David J. Kyffers

Director of the United States Patent and Trademark Office

FIRST USE 11-15-2002; IN COMMERCE 11-15-2002.

Reg. No. 4,072,817 THE MARK CONSISTS OF STANDARD CHARACTERS WITHOUT CLAIM TO ANY PARTICULAR FONT, STYLE, SIZE, OR COLOR.

OWNER OF U.S. REG. NOS. 2,968,898 AND 2,993,443.

SER. NO. 85-140,273, FILED 9-28-2010.

AISHA SALEM, EXAMINING ATTORNEY

United States of America

United States Patent and Trademark Office

ETISALAT

Reg. No. 4,072,818

Registered Dec. 20, 2011

Int. Cl.: 38

SERVICE MARK

PRINCIPAL REGISTER

EMIRATES TELECOMMUNICATIONS CORPORATION (UNITED ARAB EMIR. CORPORATION)
P.O. BOX 3838
ABU DHABI, UNITED ARAB EMIR.

FOR: COMMUNICATION SERVICES, NAMELY, TRANSMISSION OF VOICE, AUDIO, VISUAL IMAGES AND DATA BY TELECOMMUNICATIONS NETWORKS, WIRELESS COMMUNICATION NETWORKS, THE INTERNET, INFORMATION SERVICES NETWORKS AND DATA NETWORKS; COMMUNICATION VIA COMPUTER TERMINALS, BY DIGITAL TRANSMISSION OR BY SATELLITE; COMMUNICATIONS BY COMPUTER TERMINALS; COMMUNICATIONS BY MEANS OF MOBILE PHONES; COMMUNICATIONS BY MOBILE PHONES; COMMUNICATIONS BY TELEPHONE; COMMUNICATIONS VIA FIBER-OPTIC NETWORKS; COMMUNICATIONS VIA MULTINATIONAL TELECOMMUNICATION NETWORKS; DIGITAL NETWORK TELECOMMUNICATIONS SERVICES; E-MAIL DATA SERVICES; ELECTRONIC DATA INTERCHANGE (EDI) SERVICES; ELECTRONIC MAIL SERVICES; ELECTRONIC TRANSMISSION OF DATA AND DOCUMENTS VIA COMPUTER TERMINALS; ELECTRONIC TRANSMISSION OF MESSAGES AND DATA; ELECTRONIC, ELECTRIC, AND DIGITAL TRANSMISSION OF VOICE, DATA, IMAGES, SIGNALS, AND MESSAGES; INTERNET ACCESS PROVIDER SERVICES; INTERNET SERVICE PROVIDER (ISP); INTERNET SERVICE PROVIDER SERVICES; ON-LINE DOCUMENT DELIVERY VIA A GLOBAL COMPUTER NETWORK; PROVIDING ACCESS TO TELECOMMUNICATION NETWORKS; PROVIDING ACCESS TO THE INTERNET; PROVIDING ELECTRONIC TELECOMMUNICATION CONNECTIONS; PROVIDING ON-LINE COMMUNICATIONS LINKS WHICH TRANSFER THE WEB SITE USER TO OTHER LOCAL AND GLOBAL WEB PAGES; PROVIDING REMOTE INTERNET ACCESS; PROVIDING TELECOMMUNICATIONS CONNECTIONS TO A GLOBAL COMPUTER NETWORK; SATELLITE COMMUNICATION SERVICES; TELECOMMUNICATION SERVICES, NAMELY, PROVIDING INTERNET ACCESS VIA BROADBAND OPTICAL OR WIRELESS NETWORKS; TELECOMMUNICATION SERVICES, NAMELY, TRANSMISSION OF VOICE, DATA, GRAPHICS, IMAGES, AUDIO AND VIDEO BY MEANS OF TELECOMMUNICATIONS NETWORKS, WIRELESS COMMUNICATION NETWORKS, AND THE INTERNET, IN CLASS 38 (U.S. CLS. 100, 101 AND 104).

FIRST USE 7-0-1999; IN COMMERCE 7-0-1999.

THE MARK CONSISTS OF STANDARD CHARACTERS WITHOUT CLAIM TO ANY PARTICULAR FONT, STYLE, SIZE, OR COLOR.



David J. Kyjars

Director of the United States Patent and Trademark Office

Reg. No. 4,072,818 OWNER OF U.S. REG. NOS. 3,732,110 AND 3,732,111.

THE ENGLISH TRANSLATION OF "ETISALAT" IN THE MARK IS "COMMUNICATIONS".

SEC. 2(F).

SER. NO. 85-140,603, FILED 9-29-2010.

SANJEEV VOHRA, EXAMINING ATTORNEY

United States of America

United States Patent and Trademark Office

RUSSELL PETERS

Reg. No. 4,072,819

Registered Dec. 20, 2011

Int. Cl.: 41

SERVICE MARK

PRINCIPAL REGISTER

JUST THE TIP, INC. (NEVADA CORPORATION)
C/O FRED LEVY, M.B.A., C.A
35 MCCAUL STREET, SUITE 405
TORONTO, ONTARIO, CANADA M5T1V7

FOR: ENTERTAINMENT SERVICES, NAMELY, LIVE, TELEVISED AND FILM APPEARANCES BY A PROFESSIONAL ENTERTAINER; ENTERTAINMENT IN THE NATURE OF AN ONGOING TELEVISION SERIES FEATURING COMEDY ROUTINES AND COMEDY PERFORMANCES; DIGITAL VIDEO, AUDIO, AND MULTIMEDIA PUBLISHING SERVICES; ENTERTAINMENT SERVICES, NAMELY, PROVIDING A WEBSITE FEATURING NON-DOWNLOADABLE ENTERTAINMENT INFORMATION ABOUT LIVE COMEDY TELEVISION PROGRAMS, A COMEDIC PERFORMER, RELATED CLIPS OF PERFORMANCES BY A PROFESSIONAL ENTERTAINER, PHOTOGRAPHS, AND THE BIOGRAPHY OF A COMEDIC PERFORMER; ENTERTAINMENT, NAMELY, PRODUCTION OF TELEVISION PROGRAMS AND PRODUCTION OF MOTION PICTURE FILMS; ENTERTAINMENT IN THE NATURE OF LIVE COMEDY SHOWS AND PRESENTATION OF LIVE COMEDY SHOWS, IN CLASS 41 (U.S. CLS. 100, 101 AND 107).

FIRST USE 11-28-1989; IN COMMERCE 1-14-2006.

THE MARK CONSISTS OF STANDARD CHARACTERS WITHOUT CLAIM TO ANY PARTICULAR FONT, STYLE, SIZE, OR COLOR.

THE NAME(S), PORTRAIT(S), AND/OR SIGNATURE(S) SHOWN IN THE MARK IDENTIFIES "RUSSELL PETERS", WHOSE CONSENT(S) TO REGISTER IS MADE OF RECORD.

SER. NO. 85-141,512, FILED 9-29-2010.

MICHAEL TANNER, EXAMINING ATTORNEY



David J. Kybas

Director of the United States Patent and Trademark Office

United States of America

United States Patent and Trademark Office



Reg. No. 4,072,820

Registered Dec. 20, 2011

Int. Cl.: 3

TRADEMARK

PRINCIPAL REGISTER

RICHARDSON, ALISON A (ENGLAND INDIVIDUAL), DBA SOAP THE EARTH
33874 W. MULHOLLAND HWY,
MALIBU, CA 90265

FOR: AFTER SUN CREAMS; AFTER-SUN LOTIONS; AROMATIC BODY CARE PRODUCTS, NAMELY, BODY LOTION, SHOWER GEL, CUTICLE CREAM, SHAMPOO, CONDITIONER, NON-MEDICATED LIP BALM, SOAP, BODY POLISH, BODY AND FOOT SCRUB AND NON-MEDICATED FOOT CREAM; BAR SOAP; BATH SOAPS; BATH SOAPS IN LIQUID, SOLID OR GEL FORM; BATHING LOTIONS; BEAUTY CREAMS; BEAUTY CREAMS FOR BODY CARE; BEAUTY LOTIONS; BEAUTY SOAP; BODY CREAM; BODY CREAM SOAP; EXFOLIANT CREAMS; FACE AND BODY BEAUTY CREAMS; GRANULATED SOAPS; HAND CREAM; HANDMADE SOAP BARS; LIP CREAM; LIQUID SOAPS FOR HANDS, FACE AND BODY; MASSAGE LOTIONS; NATURAL SOAP BARS, IN CLASS 3 (U.S. CLS. 1, 4, 6, 50, 51 AND 52).

FIRST USE 7-24-2009; IN COMMERCE 9-3-2010.

NO CLAIM IS MADE TO THE EXCLUSIVE RIGHT TO USE "SOAP", APART FROM THE MARK AS SHOWN.

THE COLOR(S) GREEN, DARK GREY, WHITE AND BLUE IS/ARE CLAIMED AS A FEATURE OF THE MARK.

THE MARK CONSISTS OF THE WORDING "SOAP THE EARTH" THE TERM "SOAP" APPEARS IN BRIGHT GREEN, THE TERM "THE" APPEARS IN DARK GRAY, THE TERM "EARTH" APPEARS IN WHITE WITHIN A BRIGHT BLUE CIRCLE.

SER. NO. 85-141,529, FILED 9-29-2010.

ASMAT KHAN, EXAMINING ATTORNEY



David J. Kypos

Director of the United States Patent and Trademark Office

United States of America

United States Patent and Trademark Office



Reg. No. 4,072,821

JD'S BEST GLUTEN FREE PIZZA (CONNECTICUT LIMITED LIABILITY COMPANY)
524 SULLIVAN AVE., #12
SOUTH WINDSOR, CT 06074

Registered Dec. 20, 2011

Int. Cl.: 5

FOR: GLUTEN FREE FOOD FOR MEDICALLY RESTRICTED DIETS, IN CLASS 5 (U.S. CLS. 6, 18, 44, 46, 51 AND 52).

TRADEMARK

FIRST USE 1-1-2010; IN COMMERCE 1-2-2010.

PRINCIPAL REGISTER

NO CLAIM IS MADE TO THE EXCLUSIVE RIGHT TO USE "BEST" AND "GLUTEN FREE", APART FROM THE MARK AS SHOWN.

THE COLOR(S) RED, YELLOW, BLACK, DARK YELLOW, GOLD, DARK GOLD AND WHITE IS/ARE CLAIMED AS A FEATURE OF THE MARK.

THE MARK CONSISTS OF BLACK LETTERS WITH RED OUTLINE SPELLING OUT "JD'S BEST", WITH A CROWN IN GOLD WITH WHITE HIGHLIGHTS AND DARK GOLD OUTLINE ABOVE THE WORDING, AND A DARK YELLOW CURVED TRIANGLE WITH YELLOW EDGES AND DARK GOLD OUTLINE UNDER THE CROWN. UNDER "JD'S BEST" IS A BANNER WITH BLACK LETTERING INSIDE IT SPELLING OUT "GLUTEN FREE". THE BANNER IS GOLD WITH DARK GOLD BACKING AND OUTLINE AND WHITE HIGHLIGHTS. BEHIND THE OTHER ELEMENTS IS A YELLOW SUN WITH RAYS.

SER. NO. 85-142,949, FILED 10-1-2010.

ROBIN MITTLER, EXAMINING ATTORNEY



David J. Kybas

Director of the United States Patent and Trademark Office

United States of America
United States Patent and Trademark Office

ARCHECK

Reg. No. 4,072,822

SUN NUCLEAR CORP. (FLORIDA CORPORATION)
425-A PINEDA CT.

Registered Dec. 20, 2011

MELBOURNE, FL 32940

Int. Cl.: 9

FOR: A DOSIMETRY QUALITY ASSURANCE SYSTEM COMPOSED OF RADIATION MEASUREMENT DETECTORS AND SOFTWARE FOR MEASURING AND ANALYZING DOSE DISTRIBUTIONS FOR USE IN THE FIELD OF RADIATION ONCOLOGY TREATMENT QUALITY CONTROL, IN CLASS 9 (U.S. CLS. 21, 23, 26, 36 AND 38).

TRADEMARK

PRINCIPAL REGISTER

FIRST USE 12-0-2008; IN COMMERCE 12-0-2008.

THE MARK CONSISTS OF STANDARD CHARACTERS WITHOUT CLAIM TO ANY PARTICULAR FONT, STYLE, SIZE, OR COLOR.

SER. NO. 85-143,089, FILED 10-1-2010.

EUGENIA MARTIN, EXAMINING ATTORNEY



David J. Kyffers

Director of the United States Patent and Trademark Office

United States of America

United States Patent and Trademark Office

BENCHMARK SENIOR LIVING

Reg. No. 4,072,823

Registered Dec. 20, 2011

Int. Cl.: 45

SERVICE MARK

PRINCIPAL REGISTER

BENCHMARK SENIOR LIVING (DELAWARE CORPORATION)
40 WILLIAM STREET, SUITE 350
WELLESLEY, MA 02481

FOR: PROVIDING PERSONAL CARE SERVICES TO ASSIST RESIDENTS OF ASSISTED LIVING AND DEMENTIA CARE FACILITIES IN THE ACTIVITIES OF DAILY LIVING, IN CLASS 45 (U.S. CLS. 100 AND 101).

FIRST USE 4-1-2011; IN COMMERCE 4-1-2011.

THE MARK CONSISTS OF STANDARD CHARACTERS WITHOUT CLAIM TO ANY PARTICULAR FONT, STYLE, SIZE, OR COLOR.

NO CLAIM IS MADE TO THE EXCLUSIVE RIGHT TO USE "SENIOR LIVING", APART FROM THE MARK AS SHOWN.

SER. NO. 85-143,355, FILED 10-1-2010.

MICHELLE DUBOIS, EXAMINING ATTORNEY



David J. Kyffers

Director of the United States Patent and Trademark Office

United States of America

United States Patent and Trademark Office

FLOES

Reg. No. 4,072,824

MITSUBISHI UFJ SECURITIES (USA), INC. (NEW YORK CORPORATION)
1633 BROADWAY, 29TH FLOOR
NEW YORK, NY 10019

Registered Dec. 20, 2011

Int. Cl.: 36

FOR: INVESTMENT BANKING AND TRADING IN EQUITY SECURITIES AND SECURITIES
BROKERAGE SERVICES, IN CLASS 36 (U.S. CLS. 100, 101 AND 102).

SERVICE MARK

FIRST USE 10-8-2010; IN COMMERCE 10-8-2010.

PRINCIPAL REGISTER

THE MARK CONSISTS OF STANDARD CHARACTERS WITHOUT CLAIM TO ANY PAR-
TICULAR FONT, STYLE, SIZE, OR COLOR.

SER. NO. 85-144,842, FILED 10-4-2010.

BRIDGETT SMITH, EXAMINING ATTORNEY



David J. Kybas

Director of the United States Patent and Trademark Office

United States of America

United States Patent and Trademark Office

INNOVATORS MARKETPLACE

Reg. No. 4,072,825

Registered Dec. 20, 2011

Int. Cls.: 9, 28 and 41

TRADEMARK

SERVICE MARK

PRINCIPAL REGISTER

YUKIO OHSAWA (JAPAN INDIVIDUAL)
C/O SCHOOL OF ENGR., THE UNIV. OF TOKYO
7-3-1, HONGO, BUNKYO-KU
TOKYO, JAPAN 113-8656

FOR: COMPUTER PROGRAMS FOR USE IN VISUALIZATION OF KNOWLEDGE AND IDEAS AND ONLINE INTERFACE FOR HUMAN COMMUNICATION; COMPUTER GAME CONSOLES FOR USE WITH AN EXTERNAL DISPLAY SCREEN OR MONITOR; ELECTRONIC CIRCUITS RECORDING PROGRAMS FOR AMUSEMENT APPARATUS FOR USE WITH LIQUID CRYSTAL SCREENS; AMUSEMENT MACHINES, NAMELY, HAND-HELD ELECTRONIC GAME UNITS ADAPTED FOR USE WITH AN EXTERNAL DISPLAY SCREEN OR MONITOR, IN CLASS 9 (U.S. CLS. 21, 23, 26, 36 AND 38).

FOR: JAPANESE CHESS (SHOGI GAMES); JAPANESE PLAYING CARDS (UTAGARUTA); DICE; JAPANESE DICE GAMES (SUGOROKU); DICE CUPS; CHESS GAMES; CHECKERS (CHECKER SETS); DOMINOES; PLAYING CARDS; JAPANESE PLAYING CARDS (HANAFUDA), IN CLASS 28 (U.S. CLS. 22, 23, 38 AND 50).

FOR: EDUCATIONAL SERVICES, NAMELY, CONDUCTING SEMINARS, CLASSROOM LESSONS, AND WORKSHOPS IN THE FIELD OF CREATIVITY TRAINING FOR NEW TECHNOLOGY, SERVICE SYSTEMS AND BUSINESS IDEAS; ARRANGING, CONDUCTING AND ORGANIZATION OF SEMINARS RELATING TO METHODS FOR CONCEIVING AND THINKING OF NEW TECHNOLOGIES AND SERVICES; ORGANIZING, ARRANGING, AND CONDUCTING OF EDUCATIONAL SEMINARS FOR CREATIVITY TRAINING AND BUSINESS IDEA TRAINING; PUBLISHING OF ELECTRONIC PUBLICATIONS; REFERENCE LIBRARIES FOR LITERATURE AND DOCUMENTARY RECORDS; PUBLICATION OF BOOKS; ORGANIZING AND ARRANGING EXHIBITIONS OF GAMES FOR EDUCATIONAL AND FOR ENTERTAINMENT PURPOSES; ORGANIZATION OF GAMES, IN CLASS 41 (U.S. CLS. 100, 101 AND 107).



THE MARK CONSISTS OF STANDARD CHARACTERS WITHOUT CLAIM TO ANY PARTICULAR FONT, STYLE, SIZE, OR COLOR.

David J. Kyros

PRIORITY CLAIMED UNDER SEC. 44(D) ON JAPAN APPLICATION NO. 2010-034675, FILED 4-30-2010, REG. NO. 5354657, DATED 9-17-2010, EXPIRES 9-17-2020.

SER. NO. 85-145,151, FILED 10-5-2010.

Reg. No. 4,072,825 SANJEEV VOHRA, EXAMINING ATTORNEY

United States of America

United States Patent and Trademark Office

GO SAFER

Reg. No. 4,072,826

GOEL, NAVIN (UNITED STATES INDIVIDUAL)
8347 CHERRY LANE
LAUREL, MD 20707

Registered Dec. 20, 2011

Int. Cls.: 35 and 45

FOR: COMMERCIAL INFORMATION SERVICES, NAMELY, PROVIDING CONSUMER INFORMATION IN THE FIELDS OF FIRE AND SECURITY MONITORING AND ALARM PRODUCTS AND SERVICES, IN CLASS 35 (U.S. CLS. 100, 101 AND 102).

SERVICE MARK

FIRST USE 8-1-2010; IN COMMERCE 8-15-2010.

PRINCIPAL REGISTER

FOR: SECURITY SYSTEM AND FIRE MONITORING SERVICES, NAMELY ANTI-THEFT AND BREAK-IN ALARM SERVICES AND FIRE ALARM PROTECTION; REMOTELY MONITORING FIRE ALARMS AND SECURITY SYSTEMS FOR SITES, NAMELY, HOMES, BUSINESSES AND COMMERCIAL PROPERTIES USING CLOSED CIRCUIT TELEVISION MONITORING AND MOTION AND THERMAL DETECTORS; CONSULTING REGARDING THE INTEGRATION OF SOLUTIONS WITH REGARD TO FIRE AND PROPERTY AND PERSONAL SECURITY, NAMELY, CONSULTING SERVICES IN THE FIELDS OF FIRE DETECTION, PROPERTY SECURITY, AND PERSONAL SECURITY FROM BREAK-INS; AND MONITORING TELEPHONE CALLS FROM SUBSCRIBERS OF FIRE PROTECTION SYSTEMS AND PROPERTY SECURITY SYSTEMS AND NOTIFYING EMERGENCY FACILITIES, IN CLASS 45 (U.S. CLS. 100 AND 101).

FIRST USE 8-1-2010; IN COMMERCE 8-15-2010.

THE MARK CONSISTS OF STANDARD CHARACTERS WITHOUT CLAIM TO ANY PARTICULAR FONT, STYLE, SIZE, OR COLOR.

SER. NO. 85-145,470, FILED 10-5-2010.

NATALIE POLZER, EXAMINING ATTORNEY



David J. Kybas

Director of the United States Patent and Trademark Office

United States of America

United States Patent and Trademark Office



Reg. No. 4,072,827

Registered Dec. 20, 2011

Int. Cl.: 33

TRADEMARK

PRINCIPAL REGISTER

DOUBLE EAGLE BRANDS N.V. (NETHERLANDS ANTILLES LIMITED LIABILITY COMPANY)

KAYA W.F.G. MENSING 32
WILLEMSTAD, CURACAO

FOR: ALCOHOLIC BEVERAGES, EXCEPT BEERS, IN CLASS 33 (U.S. CLS. 47 AND 49).

FIRST USE 4-30-2010; IN COMMERCE 4-30-2010.

PRIORITY CLAIMED UNDER SEC. 44(D) ON NETHERLANDS ANTILLES APPLICATION NO. D-100153, FILED 4-6-2010, REG. NO. 14691, DATED 9-1-2010, EXPIRES 4-6-2020.

THE COLOR(S) BLACK, ORANGE, GREY, RED, GREEN, BLUE, GOLD, AND WHITE IS/ARE CLAIMED AS A FEATURE OF THE MARK.

OWNER OF U.S. REG. NOS. 1,357,081, 3,798,231 AND OTHERS.

NO CLAIM IS MADE TO THE EXCLUSIVE RIGHT TO USE "THE ORIGINAL DISTILLING" AND "ORANJE" AND "DISTILLERY FOUNDED 1691", APART FROM THE MARK AS SHOWN.

THE MARK CONSISTS OF A LABEL WITH AN ORANGE, GREY, AND WHITE RECTANGULAR TRIPLE BORDER, AND INSIDE THE BORDER AT THE TOP APPEARS A BOX WITH A GREY BORDER CONTAINING A BLACK AND WHITE PICTURE DEPICTING A MAN SHOVELING COAL INTO A LARGE OVEN MARKED WITH THE NUMBER "1", UNDERNEATH AN ARCHED ENTRYWAY. AT THE TOP OF THE GREY BORDER IS THE WORDING "THE ORIGINAL" IN GREY AND BELOW THE BOX IN THE GREY BORDER IS THE WORDING "DISTILLING KETEL NO. 1" IN GREY. BELOW THE PICTURE APPEARS THE WORDING "KETEL ONE" IN A STYLIZED FORMAT WITH ALL THE LETTERS IN BLACK WITH A THIN WHITE AND BLACK DOUBLE BORDER, THE CAPITAL LETTER "K" APPEARS INSIDE A RECTANGLE AND FADES FROM DARK ORANGE AT THE TOP TO LIGHT ORANGE AT THE BOTTOM. EXTENDING FROM THE TOP AND BOTTOM OF THE BOX HAVING A THICK BAR OR LINE IN GOLD, THE WORD "ORANJE" APPEARS IN BLACK AND IS CENTERED BELOW THE "KETEL ONE" WORDING. BENEATH THE WORDING APPEARS A GREY SEAL FEATURING THE WORDING "NOLET DISTILLERY FOUNDED 1691" IN WHITE WITHIN A GOLD BORDER, AND IN THE CENTER OF THE SEAL A BLUE, RED, AND WHITE DESIGN CREST ABOVE AN ORNATE GREEN DESIGN



David J. Kybas

Director of the United States Patent and Trademark Office

Reg. No. 4,072,827 FLANKED BY TWO GOLD UNICORNS. A WHITE ANIMAL HEAD APPEARS INSIDE THE BLUE AND ABOVE THE CREST, AND MULTIPLE SMALL WHITE DESIGN ELEMENTS APPEAR INSIDE THE RED. A THICK ORANGE STRIPE WITH TWO PARALLEL WHITE AND ORANGE STRIPES ON EACH SIDE RUNS DIAGONALLY FROM THE BOTTOM LEFT OF THE LABEL THRU THE SEAL ENDING TO THE RIGHT OF THE WORD "ORANJE". THE BACKGROUND INSIDE THE LABEL IS WHITE AND IS CLAIMED AS A COLOR.

THE ENGLISH TRANSLATION OF "ORANJE" AND "KETEL" IN THE MARK IS "ORANGE" AND "STILL", RESPECTIVELY.

SER. NO. 85-146,061, FILED 10-6-2010.

ROBIN CHOSID, EXAMINING ATTORNEY

United States of America

United States Patent and Trademark Office

STARTING STRENGTH

Reg. No. 4,072,828

Registered Dec. 20, 2011

Int. Cls.: 9 and 41

TRADEMARK

SERVICE MARK

PRINCIPAL REGISTER

THE AASGAARD COMPANY (TEXAS PARTNERSHIP)
3118 BUCHANAN STREET
WICHITA FALLS, TX 76310

FOR: DIGITAL MEDIA, NAMELY, DVDS FEATURING STRENGTH, CONDITIONING AND PHYSICAL FITNESS TRAINING; AUDIO AND VIDEO RECORDINGS FEATURING STRENGTH, CONDITIONING AND PHYSICAL FITNESS TRAINING, IN CLASS 9 (U.S. CLS. 21, 23, 26, 36 AND 38).

FIRST USE 6-1-2008; IN COMMERCE 2-26-2009.

FOR: CONDUCTING WORKSHOPS AND SEMINARS IN STRENGTH, CONDITIONING AND PHYSICAL FITNESS TRAINING; PROVIDING A WEB SITE FEATURING NON-DOWNLOADABLE VIDEOS IN THE FIELD OF STRENGTH, CONDITIONING AND PHYSICAL FITNESS TRAINING, ARTICLES AND INSTRUCTION IN THE FIELD OF STRENGTH, CONDITIONING AND PHYSICAL FITNESS TRAINING, AND PROVIDING A WEBSITE FOR EDUCATIONAL AND ENTERTAINMENT PURPOSES WHERE USERS CAN VIEW AND POST PHOTOS, VIDEOS, AND INFORMATION IN THE FIELD OF STRENGTH, CONDITIONING AND PHYSICAL FITNESS TRAINING; CONSULTING SERVICES IN THE FIELD OF STRENGTH, CONDITIONING AND PHYSICAL FITNESS TRAINING, IN CLASS 41 (U.S. CLS. 100, 101 AND 107).

FIRST USE 1-1-2005; IN COMMERCE 7-1-2005.

THE MARK CONSISTS OF STANDARD CHARACTERS WITHOUT CLAIM TO ANY PARTICULAR FONT, STYLE, SIZE, OR COLOR.

OWNER OF U.S. REG. NO. 3,657,862.

SER. NO. 85-146,322, FILED 10-6-2010.

ZACHARY BELLO, EXAMINING ATTORNEY



David J. Kypos

Director of the United States Patent and Trademark Office

United States of America

United States Patent and Trademark Office

TRUTH AND DESIGN

Reg. No. 4,072,829

Registered Dec. 20, 2011

Int. Cl.: 35

SERVICE MARK

PRINCIPAL REGISTER

STARCOM MEDIAVEST GROUP, INC. (DELAWARE CORPORATION)
35 W. WACKER DRIVE
CHICAGO, IL 60601

FOR: MARKETING RESEARCH AND ANALYSIS SERVICES; PREPARING AND PLACING ADVERTISEMENTS FOR OTHERS; PROVIDING ADVERTISING CONSULTING AND CONSULTING SERVICES IN THE FIELD OF FACILITATING THE PLANNING, BUYING AND SELLING OF MEDIA; MARKETING, ADVERTISING AND BRAND CONSULTING IN THE FIELD OF BRAND COMMUNICATION STRATEGY SERVICES; MARKETING AND ADVERTISING CONSULTING SERVICES FOR OTHERS, NAMELY, MEDIA PLANNING SERVICES AND MEDIA BUYING SERVICES; ADVERTISING AGENCY SERVICES, IN CLASS 35 (U.S. CLS. 100, 101 AND 102).

FIRST USE 9-0-2008; IN COMMERCE 12-0-2009.

THE MARK CONSISTS OF STANDARD CHARACTERS WITHOUT CLAIM TO ANY PARTICULAR FONT, STYLE, SIZE, OR COLOR.

NO CLAIM IS MADE TO THE EXCLUSIVE RIGHT TO USE "DESIGN", APART FROM THE MARK AS SHOWN.

SER. NO. 85-146,706, FILED 10-6-2010.

PRISCILLA MILTON, EXAMINING ATTORNEY



David J. Kyros

Director of the United States Patent and Trademark Office

United States of America

United States Patent and Trademark Office



Reg. No. 4,072,830

OAKVILLE STAMPING & BENDING (CANADA LIMITED COMPANY)
2200 SPEERS ROAD

Registered Dec. 20, 2011

OAKVILLE, ONTARIO, CANADA L6L2X8

Int. Cl.: 11

FOR: WASTE FITTINGS IN THE FIELD OF PLUMBING, NAMELY, TRAPS, LAVATORY DRAINS, CONTINUOUS WASTES, SHOWER DRAINS, TAILPIECES, EXTENSION TUBES, THREADED TUBES, COUPLINGS, WASTE AND OVERFLOW, SINK STRAINERS, IN CLASS 11 (U.S. CLS. 13, 21, 23, 31 AND 34).

TRADEMARK

PRINCIPAL REGISTER

OWNER OF CANADA REG. NO. TMA803803, DATED 8-5-2011, EXPIRES 8-5-2026.

THE MARK CONSISTS OF A STYLIZED LETTER "O" AND "K".

SER. NO. 85-147,105, FILED 10-7-2010.

THOMAS MANOR, EXAMINING ATTORNEY



David J. Kyffers

Director of the United States Patent and Trademark Office

United States of America

United States Patent and Trademark Office



Reg. No. 4,072,831

Registered Dec. 20, 2011

Int. Cl.: 29

TRADEMARK

PRINCIPAL REGISTER

GREAT LAKES KRAUT COMPANY, LLC (WISCONSIN LIMITED LIABILITY COMPANY)
P.O. BOX 217
BEAR CREEK, WI 54922

FOR: SAUERKRAUT, IN CLASS 29 (U.S. CL. 46).

FIRST USE 0-0-1989; IN COMMERCE 0-0-1989.

OWNER OF U.S. REG. NOS. 547,472 AND 1,151,153.

THE COLOR(S) WHITE, RED AND YELLOW IS/ARE CLAIMED AS A FEATURE OF THE MARK.

THE MARK CONSISTS OF THE FOLLOWING: THE WORDING "SILVER FLOSS" IN WHITE; THE COLOR RED AS AN OVAL; THE COLOR YELLOW AS AN OVAL OUTLINE.

SER. NO. 85-147,529, FILED 10-7-2010.

AISHA SALEM, EXAMINING ATTORNEY



David J. Kybas

Director of the United States Patent and Trademark Office

United States of America

United States Patent and Trademark Office

ACCOUNTABLE BILLING

Reg. No. 4,072,832

Registered Dec. 20, 2011

Int. Cl.: 42

SERVICE MARK

PRINCIPAL REGISTER

DOCTATIONS, INC. (DELAWARE CORPORATION)
600 OLD COUNTRY RD STE 541
GARDEN CITY, NY 11530

FOR: APPLICATION SERVICE PROVIDER (ASP) FEATURING SOFTWARE FOR USE IN MEDICAL BILLING; PROVIDING TEMPORARY USE OF A WEB-BASED SOFTWARE APPLICATION FOR MEDICAL BILLING; PROVIDING TEMPORARY USE OF ON-LINE NONDOWNLOADABLE SOFTWARE AND APPLICATIONS FOR MEDICAL BILLING, IN CLASS 42 (U.S. CLS. 100 AND 101).

FIRST USE 8-0-2010; IN COMMERCE 8-0-2010.

THE MARK CONSISTS OF STANDARD CHARACTERS WITHOUT CLAIM TO ANY PARTICULAR FONT, STYLE, SIZE, OR COLOR.

NO CLAIM IS MADE TO THE EXCLUSIVE RIGHT TO USE "BILLING", APART FROM THE MARK AS SHOWN.

SER. NO. 85-147,973, FILED 10-7-2010.

ALICE BENMAMAN, EXAMINING ATTORNEY



David J. Kybas

Director of the United States Patent and Trademark Office

United States of America

United States Patent and Trademark Office

Mudlock

Reg. No. 4,072,833

Registered Dec. 20, 2011

Int. Cl.: 12

TRADEMARK

PRINCIPAL REGISTER

MUD-THROWERS (KANSAS LIMITED LIABILITY COMPANY)
1408 VINE ST.
WAMEGO, KS 66547

FOR: VEHICLE WHEELS, IN CLASS 12 (U.S. CLS. 19, 21, 23, 31, 35 AND 44).

FIRST USE 2-10-2010; IN COMMERCE 9-15-2010.

THE MARK CONSISTS OF STANDARD CHARACTERS WITHOUT CLAIM TO ANY PARTICULAR FONT, STYLE, SIZE, OR COLOR.

SER. NO. 85-148,399, FILED 10-8-2010.

KATHERINE M. DUBRAY, EXAMINING ATTORNEY



David J. Kybas

Director of the United States Patent and Trademark Office

United States of America

United States Patent and Trademark Office



Reg. No. 4,072,834

Registered Dec. 20, 2011

Int. Cl.: 9

TRADEMARK

PRINCIPAL REGISTER

WOVEN ELECTRONICS, LLC (SOUTH CAROLINA LIMITED LIABILITY COMPANY)
PO BOX 189
MAULDIN, SC 29662

FOR: ALARM MONITORING SYSTEMS; CABLE CONNECTORS; CABLES FOR ELECTRICAL AND OPTICAL SIGNAL TRANSMISSION SYSTEMS; CABLES FOR ELECTRICAL OR OPTICAL SIGNAL TRANSMISSION; CONNECTING ELECTRICAL CABLES; CONNECTION CABLES; CONNECTORS FOR ELECTRONIC CIRCUITS; ELECTRIC CONNECTIONS AND CONNECTORS; ELECTRICAL AND ELECTRONIC CONNECTORS; ELECTRICAL CONNECTOR HOUSINGS; ELECTRICAL INTERCONNECT CABLES; ELECTRONIC AND OPTICAL COMMUNICATIONS INSTRUMENTS AND COMPONENTS, NAMELY, OPTICAL TRANSMITTERS; ELECTRONIC CABLES; FIBER OPTIC CABLES; POWER CONNECTORS; SECURITY ALARM CONTROLLERS; SHEATHS FOR ELECTRIC CABLES, IN CLASS 9 (U.S. CLS. 21, 23, 26, 36 AND 38).

FIRST USE 7-5-2011; IN COMMERCE 7-5-2011.

OWNER OF U.S. REG. NOS. 1,930,636 AND 2,035,443.

THE MARK CONSISTS OF A DESIGN COMPRISING A PLURALITY OF LINES CONVERGING INTO PARALLEL LINES TOGETHER WITH THE WORDS "WOVEN ELECTRONICS".

SEC. 2(F).

SER. NO. 85-148,461, FILED 10-8-2010.

KIMBERLY PERRY, EXAMINING ATTORNEY



David J. Kyros

Director of the United States Patent and Trademark Office

United States of America

United States Patent and Trademark Office



Reg. No. 4,072,835

DECISION FORGE LLC (DELAWARE LIMITED LIABILITY COMPANY)
6817 SYDENSTRICKER ROAD
SPRINGFIELD, VA 22152

Registered Dec. 20, 2011

Int. Cl.: 35

FOR: BUSINESS OPERATIONS MANAGEMENT CONSULTING IN THE FIELDS OF BUSINESS OPERATIONS RESEARCH, DECISION ANALYSIS, BUSINESS RISK ANALYSIS, DATA PROCESSING, BUSINESS OPTIMIZATION MODELING, RESOURCE ALLOCATION BEING BUDGETING, IN CLASS 35 (U.S. CLS. 100, 101 AND 102).

SERVICE MARK

PRINCIPAL REGISTER

FIRST USE 7-14-2010; IN COMMERCE 7-14-2010.

OWNER OF U.S. REG. NO. 3,992,674.

THE MARK CONSISTS OF THE LITERAL ELEMENT "DECISION FORGE" IN A STYLIZED FONT PLACED DIRECTLY TO THE LEFT OF AN OUTLINE OF A HUMAN FROM THE WAIST UP; SAID OUTLINE OF A HUMAN IS PITCHED FORWARD WITH ITS RIGHT ARM HOLDING A HAMMER ABOVE ITS HEAD AND ITS LEFT ARM PLACED AT CHEST LEVEL ON THE LETTER SIGMA; AND BEHIND SAID LETTER SIGMA IS A STYLIZED DESIGN OF LINES WHICH RESEMBLES A FIRE.

SER. NO. 85-148,691, FILED 10-8-2010.

LINDA POWELL, EXAMINING ATTORNEY



David J. Kyjars

Director of the United States Patent and Trademark Office

United States of America

United States Patent and Trademark Office

THE WEALTHY CODE

Reg. No. 4,072,836

Registered Dec. 20, 2011

Int. Cl.: 16

TRADEMARK

PRINCIPAL REGISTER

WEALTHCLASSES, LLC (CALIFORNIA LIMITED LIABILITY COMPANY)
1255 TREAT BLVD, SUITE 230
WALNUT CREEK, CA 94597

FOR: A SERIES OF BOOKS AND WRITTEN ARTICLES IN THE FIELD OF FINANCIAL EDUCATION; A SERIES OF BOOKS, WRITTEN ARTICLES, HANDOUTS AND WORKSHEETS IN THE FIELD OF FINANCIAL EDUCATION; BOOKS IN THE FIELD OF FINANCIAL EDUCATION; PUBLICATIONS, NAMELY, HANDOUTS AND WORKBOOKS IN THE FIELDS OF FINANCIAL EDUCATION, IN CLASS 16 (U.S. CLS. 2, 5, 22, 23, 29, 37, 38 AND 50).

FIRST USE 10-5-2010; IN COMMERCE 10-5-2010.

THE MARK CONSISTS OF STANDARD CHARACTERS WITHOUT CLAIM TO ANY PARTICULAR FONT, STYLE, SIZE, OR COLOR.

SER. NO. 85-148,759, FILED 10-8-2010.

JOHN GARTNER, EXAMINING ATTORNEY



David J. Kyffers

Director of the United States Patent and Trademark Office

United States of America

United States Patent and Trademark Office

PJS

Reg. No. 4,072,837

Registered Dec. 20, 2011

Int. Cl.: 14

TRADEMARK

PRINCIPAL REGISTER

TRUJILLO, RICHARD (UNITED STATES INDIVIDUAL)
SUITE 1850
606 SOUTH OLIVE STREET
LOS ANGELES, CA 90014

FOR: JEWELRY, IN CLASS 14 (U.S. CLS. 2, 27, 28 AND 50).

FIRST USE 10-4-1991; IN COMMERCE 10-4-1991.

OWNER OF U.S. REG. NO. 2,943,602.

THE MARK CONSISTS OF A LARGE LETTER "J" WITH A SMALL LETTER "P" ON THE LEFT AND A SMALL LETTER "S" TO THE RIGHT IN STYLIZED FONT.

SER. NO. 85-148,771, FILED 10-8-2010.

NATALIE POLZER, EXAMINING ATTORNEY



David J. Kyffers

Director of the United States Patent and Trademark Office

United States of America

United States Patent and Trademark Office

BANKWISE

Reg. No. 4,072,838

Registered Dec. 20, 2011

Int. Cl.: 36

SERVICE MARK

PRINCIPAL REGISTER

MORRILL & JANES BANK AND TRUST COMPANY (KANSAS CHARTERED BANK)
6740 ANTIOCH RD.
MERRIAM, KS 66204

FOR: BANKING SERVICES, INVESTMENT MANAGEMENT SERVICES, BANK ACCOUNT MANAGEMENT SERVICES, NAMELY, PROVIDING BANK ACCOUNT INFORMATION BY TELEPHONE, FINANCIAL SERVICES, NAMELY, FUNDING ONLINE CASH ACCOUNTS FROM PREPAID CASH CARDS, BANK ACCOUNTS AND CREDIT CARD ACCOUNTS, AND PROVIDING FINANCIAL ADVISORY SERVICES RELATING TO ALL OF THE FOREGOING, IN CLASS 36 (U.S. CLS. 100, 101 AND 102).

FIRST USE 1-1-1995; IN COMMERCE 1-1-1995.

THE MARK CONSISTS OF STANDARD CHARACTERS WITHOUT CLAIM TO ANY PARTICULAR FONT, STYLE, SIZE, OR COLOR.

SER. NO. 85-148,882, FILED 10-8-2010.

TAMARA FRAZIER, EXAMINING ATTORNEY



David J. Kyffers

Director of the United States Patent and Trademark Office

United States of America

United States Patent and Trademark Office



Reg. No. 4,072,839

LEAP FORWARD GAMING, INC. (NEVADA CORPORATION)
10589 DOUBLE R BLVD.
RENO, NV 89521

Registered Dec. 20, 2011

Int. Cl.: 9

FOR: COMPONENTS FOR GAMING MACHINES, NAMELY, CONTROLLERS, DISPLAYS, BUTTON PANELS, BOLSTERS, ELECTRICAL WIRING, AND COMPUTER HARDWARE AND SOFTWARE ASSOCIATED THEREWITH; COMPUTER GAME SOFTWARE FOR GAMING MACHINES INCLUDING SLOT MACHINES OR VIDEO LOTTERY TERMINALS; COMPUTER SOFTWARE AND FIRMWARE FOR GAMES OF CHANCE ON ANY COMPUTERIZED PLATFORM, INCLUDING DEDICATED GAMING CONSOLES, VIDEO BASED SLOT MACHINES, REEL BASED SLOT MACHINES, AND VIDEO LOTTERY TERMINALS; COMPUTERIZED VIDEO TABLE GAMES FOR GAMING PURPOSES; GAMING DEVICES, NAMELY, GAMING MACHINES, SLOT MACHINES, BINGO MACHINES, WITH OR WITHOUT VIDEO OUTPUT; GAMING EQUIPMENT, NAMELY, SLOT MACHINES WITH OR WITHOUT VIDEO OUTPUT; GAMING MACHINES INCLUDING SLOT MACHINES OR VIDEO LOTTERY TERMINALS; GAMING MACHINES THAT GENERATE OR DISPLAY WAGER OUTCOMES; GAMING MACHINES, NAMELY, DEVICES WHICH ACCEPT A WAGER; GAMING SOFTWARE THAT GENERATES OR DISPLAYS WAGER OUTCOMES OF GAMING MACHINES; RECONFIGURABLE CASINO AND LOTTERY GAMING EQUIPMENT, NAMELY, GAMING MACHINES AND OPERATIONAL COMPUTER GAME SOFTWARE THEREFOR, IN CLASS 9 (U.S. CLS. 21, 23, 26, 36 AND 38).

TRADEMARK

PRINCIPAL REGISTER



FIRST USE 8-24-2010; IN COMMERCE 8-24-2010.

OWNER OF U.S. REG. NO. 4,001,192.

THE MARK CONSISTS OF A STYLIZED PERSON WITH ONE LEG OUTSTRETCHED AHEAD OF THE OTHER AS IF LEAPING FORWARD, ABOVE THE TERM "LEAP FORWARD".

SER. NO. 85-149,199, FILED 10-10-2010.

TARA PATE, EXAMINING ATTORNEY

David J. Kyjars

Director of the United States Patent and Trademark Office

United States of America

United States Patent and Trademark Office

420 LTD

Reg. No. 4,072,840

420 LTD (CALIFORNIA LIMITED LIABILITY COMPANY)
8787 PAGODA WAY
SAN DIEGO, CA 92020

Registered Dec. 20, 2011

Int. Cl.: 25

FOR: BANDANAS; BATHING SUITS; CAPS; JERSEYS; PANTS; SHIRTS; SWEATERS, IN CLASS 25 (U.S. CLS. 22 AND 39).

TRADEMARK

FIRST USE 4-1-2010; IN COMMERCE 4-1-2010.

PRINCIPAL REGISTER

THE MARK CONSISTS OF STANDARD CHARACTERS WITHOUT CLAIM TO ANY PARTICULAR FONT, STYLE, SIZE, OR COLOR.

NO CLAIM IS MADE TO THE EXCLUSIVE RIGHT TO USE "LTD", APART FROM THE MARK AS SHOWN.

SER. NO. 85-149,247, FILED 10-10-2010.

RONALD AIKENS, EXAMINING ATTORNEY



David J. Kybas

Director of the United States Patent and Trademark Office

United States of America

United States Patent and Trademark Office



Reg. No. 4,072,841

PAR PHARMACEUTICAL COMPANIES, INC. (DELAWARE CORPORATION)
ONE RAM RIDGE ROAD
SPRING VALLEY, NY 10977

Registered Dec. 20, 2011

Int. Cls.: 35, 40 and 42

FOR: PROVIDING ADVERTISING, MARKETING AND PROMOTIONAL SERVICES FOR THE PHARMACEUTICAL AND MEDICAL INDUSTRY; PROVIDING ADVERTISING, MARKETING AND PROMOTIONAL SERVICES FOR THE PHARMACEUTICAL AND MEDICAL PRODUCTS OF OTHERS, IN CLASS 35 (U.S. CLS. 100, 101 AND 102).

SERVICE MARK

PRINCIPAL REGISTER

FIRST USE 11-3-2010; IN COMMERCE 7-21-2011.

FOR: PROVIDING TECHNICAL INFORMATION IN THE FIELD OF PHARMACEUTICAL MANUFACTURING, IN CLASS 40 (U.S. CLS. 100, 103 AND 106).

FIRST USE 11-3-2010; IN COMMERCE 7-21-2011.

FOR: DEVELOPMENT OF PHARMACEUTICAL PREPARATIONS AND MEDICINES; PHARMACEUTICAL DRUG DEVELOPMENT SERVICES; PHARMACEUTICAL PRODUCT EVALUATION; PHARMACEUTICAL RESEARCH AND DEVELOPMENT; PHARMACEUTICAL RESEARCH SERVICES, IN CLASS 42 (U.S. CLS. 100 AND 101).

FIRST USE 11-3-2010; IN COMMERCE 7-21-2011.

OWNER OF U.S. REG. NOS. 3,118,058 AND 3,340,941.

THE COLOR(S) BLUE AND YELLOW IS/ARE CLAIMED AS A FEATURE OF THE MARK.

NO CLAIM IS MADE TO THE EXCLUSIVE RIGHT TO USE "PHARMACEUTICAL COMPANIES", APART FROM THE MARK AS SHOWN.

THE MARK CONSISTS OF THE WORDS "PAR PHARMACEUTICAL COMPANIES" IN BLUE, HAVING A BLUE AND YELLOW CHEVRON POSITIONED ABOVE AND TO THE RIGHT OF THE WORDING.

SER. NO. 85-149,300, FILED 10-11-2010.

EDWARD NELSON, EXAMINING ATTORNEY



David J. Kyffers

Director of the United States Patent and Trademark Office

United States of America

United States Patent and Trademark Office

XITEBIO

Reg. No. 4,072,842

Registered Dec. 20, 2011

Int. Cls.: 1, 5 and 42

TRADEMARK

SERVICE MARK

PRINCIPAL REGISTER

XITEBIO TECHNOLOGIES INC. (CANADA CORPORATION)
22 WINGATE COURT
WINNIPEG, MANITOBA, CANADA R3P2L5

FOR: AGRICULTURAL BIOTECHNOLOGY AND BIOLOGICAL PRODUCTS, NAMELY, FERTILIZERS, INOCULANTS IN THE NATURE OF BIOLOGICAL MICROORGANISMS USED IN FERMENTATION OF SILAGE, SOIL ADDITIVES, PLANT FERTILIZERS, PLANT GROWTH REGULATORS FOR AGRICULTURAL USE, AND FOOD SUPPLEMENTS FOR AGRICULTURAL PRODUCTS AND OTHER PLANTS, IN CLASS 1 (U.S. CLS. 1, 5, 6, 10, 26 AND 46).

FOR: PESTICIDES, IN CLASS 5 (U.S. CLS. 6, 18, 44, 46, 51 AND 52).

FOR: PRODUCT DEVELOPMENT FOR OTHERS IN THE FIELD OF AGRICULTURE BIOTECHNOLOGY, IN CLASS 42 (U.S. CLS. 100 AND 101).

THE MARK CONSISTS OF STANDARD CHARACTERS WITHOUT CLAIM TO ANY PARTICULAR FONT, STYLE, SIZE, OR COLOR.

PRIORITY CLAIMED UNDER SEC. 44(D) ON CANADA APPLICATION NO. 1476689, FILED 4-13-2010, REG. NO. TMA801,056, DATED 6-29-2011, EXPIRES 6-29-2026.

SER. NO. 85-149,726, FILED 10-11-2010.

VERNA BETH RIRIE, EXAMINING ATTORNEY



David J. Kybas

Director of the United States Patent and Trademark Office

United States of America

United States Patent and Trademark Office



RYDIN DECAL

Reg. No. 4,072,843

Registered Dec. 20, 2011

Int. Cl.: 40

SERVICE MARK

PRINCIPAL REGISTER

DRI-STICK DECAL CORP. (ILLINOIS CORPORATION), DBA RYDIN DECAL
700 PHOENIX LAKE AVE.
STREAMWOOD, IL 34479

FOR: MANUFACTURE OF CUSTOM PRINTED PRESSURE-SENSITIVE DECALS, STICKERS, PARKING PERMITS, HANG TAGS, SPECIAL EVENT TICKETS, VISITOR PASSES AND SIGNS TO ORDER AND/OR SPECIFICATION OF OTHERS, IN CLASS 40 (U.S. CLS. 100, 103 AND 106).

FIRST USE 1-20-2004; IN COMMERCE 1-20-2004.

NO CLAIM IS MADE TO THE EXCLUSIVE RIGHT TO USE "DECAL", APART FROM THE MARK AS SHOWN.

THE COLOR(S) BLUE, GOLD AND WHITE IS/ARE CLAIMED AS A FEATURE OF THE MARK.

THE MARK CONSISTS OF THE WORD "RYDIN" IN WHITE ABOVE A TILTED LETTER "R" IN BLUE BOTH INSIDE A FIRST GOLD SQUARE WITH WHITE BORDER WHICH IN TURN IS INSIDE A SECOND GOLD SQUARE, THE LOWER RIGHT CORNER OF SAID FIRST AND SECOND SQUARES DEPICTED AS PEELED BACK REVEALING A BLUE BACKING; ALL OF THE AFORESAID IS FOLLOWED BY THE WORDS " RYDIN DECAL" IN BLUE.

SER. NO. 85-149,794, FILED 10-11-2010.

STEVEN R. FINE, EXAMINING ATTORNEY



David J. Kybas

Director of the United States Patent and Trademark Office

United States of America

United States Patent and Trademark Office



Reg. No. 4,072,844

Registered Dec. 20, 2011

Int. Cl.: 25

TRADEMARK

PRINCIPAL REGISTER

THE STAIRS (BUTLER-ROTHOLZ, ABRAHAM) (CALIFORNIA SOLE PROPRIETORSHIP),
DBA THE STAIRS
1870 OLYMPIC BLVD. # 120
WALNUT CREEK, CA 94523

FOR: WEARABLE GARMENTS AND CLOTHING, NAMELY, SHIRTS, IN CLASS 25 (U.S.
CLS. 22 AND 39).

FIRST USE 7-24-2010; IN COMMERCE 7-24-2010.

OWNER OF U.S. REG. NO. 3,892,401.

THE COLOR(S) BLACK AND GREEN IS/ARE CLAIMED AS A FEATURE OF THE MARK.

THE MARK CONSISTS OF A BLACK COLOR GRIZZLY BEAR HOLDING A GREEN
MARIJUANA PLANT INSIDE OF THE BEARS MOUTH.

SER. NO. 85-149,868, FILED 10-11-2010.

LINDA MICKLEBURGH, EXAMINING ATTORNEY



David J. Kyffers

Director of the United States Patent and Trademark Office

United States of America

United States Patent and Trademark Office



Reg. No. 4,072,845

Registered Dec. 20, 2011

Int. Cl.: 25

TRADEMARK

PRINCIPAL REGISTER

THE STAIRS (BUTLER-ROTHOLZ, ABRAHAM) (CALIFORNIA SOLE PROPRIETORSHIP),
DBA THE STAIRS
1870 OLYMPIC BLVD. # 120
WALNUT CREEK, CA 94523

FOR: BASEBALL CAPS AND HATS, IN CLASS 25 (U.S. CLS. 22 AND 39).

FIRST USE 9-25-2010; IN COMMERCE 9-25-2010.

OWNER OF U.S. REG. NO. 3,892,401.

THE COLOR(S) BLACK AND PINK IS/ARE CLAIMED AS A FEATURE OF THE MARK.

THE MARK CONSISTS OF A BLACK COLOR GRIZZLY BEAR HOLDING A PINK COLOR SALMON INSIDE OF THE BEARS MOUTH AND RIDING ON A SKATEBOARD WITH THREE FEET ON THE SKATEBOARD AND ONE FOOT PUSHING. UNDER THE BEAR ARE THE WORDS "THE STAIRS".

SER. NO. 85-149,925, FILED 10-11-2010.

LINDA MICKLEBURGH, EXAMINING ATTORNEY



David J. Kyfos

Director of the United States Patent and Trademark Office

United States of America

United States Patent and Trademark Office

VIA ORGANICA

Reg. No. 4,072,846

VIA ORGANICA A.C. (MEXICO ASOCIACIÓN CIVIL (A.C.))
MARGARITO LEDESMA 2

Registered Dec. 20, 2011

SAN MIGUEL DE ALLENDE, MEXICO

Int. Cls.: 35, 41 and 43

FOR: ADVERTISING AND BUSINESS SERVICES, NAMELY, RETAIL STORE SERVICES IN THE FIELD OF ORGANIC AND NATURAL FOOD PRODUCTS; COMPUTERIZED ONLINE RETAIL STORE SERVICES IN THE FIELD OF ORGANIC AND NATURAL FOOD PRODUCTS, WHOLESALE AND RETAIL STORE SERVICES AND ONLINE RETAIL AND WHOLESALE STORE SERVICES FEATURING ORGANIC AND NATURAL FOOD PRODUCTS, IN CLASS 35 (U.S. CLS. 100, 101 AND 102).

SERVICE MARK

PRINCIPAL REGISTER

FIRST USE 2-20-2009; IN COMMERCE 2-20-2009.

FOR: ARRANGING PROFESSIONAL WORKSHOP AND TRAINING COURSES IN THE FIELD OF ORGANIC AND NATURAL FOODS; EDUCATION SERVICES, NAMELY, PROVIDING CLASSES, SEMINARS, WORKSHOPS, TUTORING FOR GROWING, SUSTAINING, MAINTAINING, CULTIVATING AND SELLING ORGANIC AND NATURAL FOOD PRODUCTS, IN CLASS 41 (U.S. CLS. 100, 101 AND 107).

FIRST USE 2-20-2009; IN COMMERCE 2-20-2009.

FOR: RESTAURANT AND SELF-SERVICE RESTAURANT SERVICES FEATURING ORGANIC AND NATURAL FOOD PRODUCTS, IN CLASS 43 (U.S. CLS. 100 AND 101).

FIRST USE 2-20-2009; IN COMMERCE 2-20-2009.

THE MARK CONSISTS OF STANDARD CHARACTERS WITHOUT CLAIM TO ANY PARTICULAR FONT, STYLE, SIZE, OR COLOR.

NO CLAIM IS MADE TO THE EXCLUSIVE RIGHT TO USE "ORGANICA", APART FROM THE MARK AS SHOWN.

THE ENGLISH TRANSLATION OF "VIA ORGANICA" IN THE MARK IS "THE ORGANIC WAY".

SER. NO. 85-150,223, FILED 10-12-2010.



David J. Kybas

Director of the United States Patent and Trademark Office

Reg. No. 4,072,846 ALICIA COLLINS, EXAMINING ATTORNEY

United States of America

United States Patent and Trademark Office

SIGNAL

Reg. No. 4,072,847

Registered Dec. 20, 2011

Int. Cl.: 42

SERVICE MARK

PRINCIPAL REGISTER

MESSAGE MEDIUMS, LLC (ILLINOIS LIMITED LIABILITY COMPANY), DBA SIGNAL
SUITE 4W
656 W RANDOLPH ST
CHICAGO, IL 60661

FOR: PROVIDING INTERNET-BASED, NON-DOWNLOADABLE, SOFTWARE FOR USE IN
CREATING MOBILE MARKETING CAMPAIGNS FOR COMPANIES, IN CLASS 42 (U.S.
CLS. 100 AND 101).

FIRST USE 9-20-2010; IN COMMERCE 9-20-2010.

THE MARK CONSISTS OF STANDARD CHARACTERS WITHOUT CLAIM TO ANY PAR-
TICULAR FONT, STYLE, SIZE, OR COLOR.

SER. NO. 85-150,650, FILED 10-12-2010.

NELSON SNYDER, EXAMINING ATTORNEY



David J. Kybas

Director of the United States Patent and Trademark Office

United States of America

United States Patent and Trademark Office

Senior Care Training elevating eldercare through education and training

Reg. No. 4,072,848

Registered Dec. 20, 2011

Int. Cl.: 41

GREENE MINTZ, TRACY L (UNITED STATES INDIVIDUAL), DBA SENIOR CARE TRAINING
#413
409N PACIFIC COAST HWY
REDONDO BEACH, CA 90277

SERVICE MARK

PRINCIPAL REGISTER

FOR: ARRANGING PROFESSIONAL WORKSHOP AND TRAINING COURSES; CONTINUING EDUCATION SERVICES, NAMELY, PROVIDING LIVE AND ON-LINE CONTINUING PROFESSIONAL EDUCATION SEMINARS IN THE FIELD OF GERIATRIC SOCIAL WORK SERVICES; EDUCATIONAL SERVICES, NAMELY, DEVELOPING AND CONDUCTING TRAINING COURSES AND DISTRIBUTION OF TRAINING MATERIALS IN CONNECTION THEREWITH FOR SUBJECT MATTERS AS REQUESTED BY CUSTOMERS; INTERACTIVE ON-LINE TRAINING SERVICES IN THE FIELD OF GERIATRIC SOCIAL WORK SERVICES, IN CLASS 41 (U.S. CLS. 100, 101 AND 107).

FIRST USE 8-6-2007; IN COMMERCE 8-6-2007.

THE MARK CONSISTS OF STANDARD CHARACTERS WITHOUT CLAIM TO ANY PARTICULAR FONT, STYLE, SIZE, OR COLOR.

NO CLAIM IS MADE TO THE EXCLUSIVE RIGHT TO USE "SENIOR CARE TRAINING", APART FROM THE MARK AS SHOWN.

SER. NO. 85-151,164, FILED 10-13-2010.

ANDREW LEASER, EXAMINING ATTORNEY



David J. Kybas

Director of the United States Patent and Trademark Office

United States of America

United States Patent and Trademark Office

ABC CHARTERS

Reg. No. 4,072,849

ABC CHARTERS, INC. (FLORIDA CORPORATION)
1125 SW 87 AVENUE
MIAMI, FL 33174

Registered Dec. 20, 2011

Int. Cl.: 39

FOR: TRANSPORTATION SERVICES, NAMELY, PROVIDING CHARTERED TRAVEL SERVICES VIA PLANE; PROVIDING PERSONAL TRAVEL COORDINATORS FOR MAKING TRAVEL ARRANGEMENTS FOR INDIVIDUALS AND GROUPS, IN CLASS 39 (U.S. CLS. 100 AND 105).

SERVICE MARK

PRINCIPAL REGISTER

FIRST USE 9-1-2000; IN COMMERCE 9-1-2000.

THE MARK CONSISTS OF STANDARD CHARACTERS WITHOUT CLAIM TO ANY PARTICULAR FONT, STYLE, SIZE, OR COLOR.

NO CLAIM IS MADE TO THE EXCLUSIVE RIGHT TO USE "CHARTERS", APART FROM THE MARK AS SHOWN.

SER. NO. 85-151,197, FILED 10-13-2010.

LINDA MICKLEBURGH, EXAMINING ATTORNEY



David J. Kyffers

Director of the United States Patent and Trademark Office

United States of America

United States Patent and Trademark Office

POSTERGARDEN

Reg. No. 4,072,850

Registered Dec. 20, 2011

Int. Cl.: 20

TRADEMARK

PRINCIPAL REGISTER

BOMBAVIA CREATIVE, INC. (OREGON CORPORATION), DBA POSTERGARDEN.COM
630 NW 14TH AVENUE
PORTLAND, OR 97209

FOR: DISPLAY ASSEMBLIES, NAMELY, PORTABLE EXHIBITION STANDS; FREE-STANDING NON-METAL PANEL UNITS FOR EXHIBITIONS, DISPLAYS, AND PARTITIONING; PLASTIC DISPLAY BOARDS, PLASTIC DISPLAY AND EXHIBITION BOARDS; DISPLAY AND EXHIBITION STANDS; AND PORTABLE DISPLAY AND EXHIBITION STANDS, IN CLASS 20 (U.S. CLS. 2, 13, 22, 25, 32 AND 50).

FIRST USE 6-9-2003; IN COMMERCE 6-9-2003.

THE MARK CONSISTS OF STANDARD CHARACTERS WITHOUT CLAIM TO ANY PARTICULAR FONT, STYLE, SIZE, OR COLOR.

SER. NO. 85-151,443, FILED 10-13-2010.

JUSTINE D. PARKER, EXAMINING ATTORNEY



David J. Kyffers

Director of the United States Patent and Trademark Office

United States of America

United States Patent and Trademark Office

POSTERGARDEN

Reg. No. 4,072,851

Registered Dec. 20, 2011

Int. Cl.: 35

SERVICE MARK

PRINCIPAL REGISTER

BOMBAVIA CREATIVE, INC. (OREGON CORPORATION), DBA POSTERGARDEN.COM
630 NW 14TH AVENUE
PORTLAND, OR 97209

FOR: DESIGN AND CREATION OF ADVERTISING, MARKETING, AND PROMOTIONAL MATERIAL FOR THE GOODS OR SERVICES OF OTHERS; DESIGN OF ADVERTISING MATERIALS FOR OTHERS; AND PREPARATION OF CUSTOM OR NON-CUSTOM GRAPHICAL DISPLAYS IN THE FIELD OF ADVERTISING FOR USE WITH EXHIBITION STANDS, IN CLASS 35 (U.S. CLS. 100, 101 AND 102).

FIRST USE 6-9-2003; IN COMMERCE 6-9-2003.

THE MARK CONSISTS OF STANDARD CHARACTERS WITHOUT CLAIM TO ANY PARTICULAR FONT, STYLE, SIZE, OR COLOR.

SER. NO. 85-151,465, FILED 10-13-2010.

JUSTINE D. PARKER, EXAMINING ATTORNEY



David J. Kyffers

Director of the United States Patent and Trademark Office

United States of America

United States Patent and Trademark Office

Optimal Life

Reg. No. 4,072,852

LEE, CHRISTINE V. (UNITED STATES INDIVIDUAL)
2217 PLAZA DRIVE, SUITE 100
ROCKLIN, CA 95765

Registered Dec. 20, 2011

Int. Cls.: 9 and 16

FOR: DIGITAL MEDIA, NAMELY, DOWNLOADABLE WEBINARS, DVDS, DOWNLOADABLE PODCASTS, AND AUDIO AND VIDEO RECORDINGS FEATURING INFORMATION AND INSTRUCTION IN THE FIELD OF PHYSICAL WELLNESS, HEALTHY LIVING, OR DISEASE STATES, IN CLASS 9 (U.S. CLS. 21, 23, 26, 36 AND 38).

TRADEMARK

PRINCIPAL REGISTER

FIRST USE 9-13-2010; IN COMMERCE 9-13-2010.

FOR: A SERIES OF BOOKS AND WRITTEN ARTICLES IN THE FIELD OF INFORMATION AND INSTRUCTION CONCERNING WELLNESS, HEALTHY LIVING, OR DISEASE STATES, IN CLASS 16 (U.S. CLS. 2, 5, 22, 23, 29, 37, 38 AND 50).

FIRST USE 9-13-2010; IN COMMERCE 9-16-2010.

THE MARK CONSISTS OF STANDARD CHARACTERS WITHOUT CLAIM TO ANY PARTICULAR FONT, STYLE, SIZE, OR COLOR.

SER. NO. 85-151,566, FILED 10-13-2010.

CHRISIE B. KING, EXAMINING ATTORNEY



David J. Kyffers

Director of the United States Patent and Trademark Office

United States of America

United States Patent and Trademark Office

SISTER MARY MARDI GRAS

Reg. No. 4,072,853

JILL SEALE (UNITED STATES INDIVIDUAL)
2744 TRAVELER'S COURT
CHARLOTTE, NC 28226

Registered Dec. 20, 2011

Int. Cl.: 24

FOR: BATH LINEN; DINING LINENS; FABRICS FOR TEXTILE USE; FABRICS USED IN HOME DECORATIVE ITEMS WITH INSPIRATIONAL MESSAGES IMPRINTED OR WOVEN INTO THE FABRICS; HAND TOWELS; HOUSEHOLD LINEN; KITCHEN LINENS; TABLE LINEN; TEXTILE NAPKINS; TOWELS; WASH CLOTHS, IN CLASS 24 (U.S. CLS. 42 AND 50).

TRADEMARK

PRINCIPAL REGISTER

FIRST USE 2-1-2008; IN COMMERCE 2-1-2008.

THE MARK CONSISTS OF STANDARD CHARACTERS WITHOUT CLAIM TO ANY PARTICULAR FONT, STYLE, SIZE, OR COLOR.

THE NAME(S), PORTRAIT(S), AND/OR SIGNATURE(S) SHOWN IN THE MARK DOES NOT IDENTIFY A PARTICULAR LIVING INDIVIDUAL.

SER. NO. 85-151,808, FILED 10-13-2010.

BARBARA A. GOLD, EXAMINING ATTORNEY



David J. Kyffers

Director of the United States Patent and Trademark Office

United States of America

United States Patent and Trademark Office

DOWNLITE

Reg. No. 4,072,854

DOWN LITE INTERNATIONAL (OHIO CORPORATION)
8153 DUKE BOULEVARD
MASON, OH 45040

Registered Dec. 20, 2011

Int. Cls.: 20 and 24

FOR: DOWN AND DOWN FEATHER FILL BEDDING, NAMELY, PILLOWS, FEATHER BEDS AND CUSHIONS, IN CLASS 20 (U.S. CLS. 2, 13, 22, 25, 32 AND 50).

TRADEMARK

FIRST USE 0-0-1973; IN COMMERCE 0-0-1973.

PRINCIPAL REGISTER

FOR: DOWN AND DOWN FEATHER FILL BEDDING, NAMELY, COMFORTERS, BEDDING COMFORTER SETS, BLANKETS, DUVETS, THROWS, MATTRESS PADS, MATTRESS COVERS; BEDDING, NAMELY, PILLOW COVERS AND SHEETS, IN CLASS 24 (U.S. CLS. 42 AND 50).

FIRST USE 0-0-1973; IN COMMERCE 0-0-1973.

THE MARK CONSISTS OF STANDARD CHARACTERS WITHOUT CLAIM TO ANY PARTICULAR FONT, STYLE, SIZE, OR COLOR.

SER. NO. 85-151,810, FILED 10-13-2010.

KHANH LE, EXAMINING ATTORNEY



David J. Kybas

Director of the United States Patent and Trademark Office

United States of America

United States Patent and Trademark Office

EAST COAST MEDIA

Reg. No. 4,072,855

EAST COAST MEDIA, LLC (NEW JERSEY CORPORATION)
14 PARK AVENUE
HILLSBOROUGH, NJ 08844

Registered Dec. 20, 2011

Int. Cls.: 35 and 40

FOR: BUSINESS MARKETING SERVICES; COPYING OF DOCUMENTS; DIRECT MAIL ADVERTISING SERVICES, IN CLASS 35 (U.S. CLS. 100, 101 AND 102).

SERVICE MARK

FIRST USE 1-0-2002; IN COMMERCE 1-0-2002.

PRINCIPAL REGISTER

FOR: BINDERY SERVICES FOR OTHERS, NAMELY, COLLATING, FOLDING, STAPLING, PERFORATING, CUTTING AND BINDING OF PRINTED, PHOTOCOPIED AND TYPEWRITTEN MATERIALS; DOCUMENT BINDING SERVICES; PRINTING, IN CLASS 40 (U.S. CLS. 100, 103 AND 106).

FIRST USE 1-0-2002; IN COMMERCE 1-0-2002.

THE MARK CONSISTS OF STANDARD CHARACTERS WITHOUT CLAIM TO ANY PARTICULAR FONT, STYLE, SIZE, OR COLOR.

SEC. 2(F).

SER. NO. 85-151,877, FILED 10-13-2010.

CHRIS WELLS, EXAMINING ATTORNEY



David J. Kybas

Director of the United States Patent and Trademark Office

United States of America

United States Patent and Trademark Office



PayAnywhere

Reg. No. 4,072,856

Registered Dec. 20, 2011

Int. Cls.: 9 and 36

TRADEMARK

SERVICE MARK

PRINCIPAL REGISTER

PAY ANYWHERE, LLC (DELAWARE LIMITED LIABILITY COMPANY)
250 STEPHENSON HIGHWAY
TROY, MI 48083

FOR: SOFTWARE FOR COMPUTERS, MOBILE PHONES, PORTABLE MEDIA PLAYERS, HANDHELD COMPUTERS TO ALLOW USERS TO PERFORM ELECTRONIC BUSINESS TRANSACTIONS; DOWNLOADABLE SOFTWARE FOR COMPUTERS, MOBILE PHONES, PORTABLE MEDIA PLAYERS, HANDHELD COMPUTERS TO ALLOW USERS TO PERFORM ELECTRONIC BUSINESS TRANSACTIONS; CARD READERS FOR CREDIT CARDS, IN CLASS 9 (U.S. CLS. 21, 23, 26, 36 AND 38).

FIRST USE 10-17-2010; IN COMMERCE 10-17-2010.

FOR: BROAD BASED FINANCIAL SERVICES, NAMELY, CREDIT CARD, DEBIT CARD, CHARGE CARD TRANSACTION PROCESSING SERVICES; BANKING SERVICES; ELECTRONIC CREDIT AND DEBIT TRANSACTION SERVICES; FINANCIAL TRANSACTION SERVICES, NAMELY, PROVIDING SECURE COMMERCIAL TRANSACTIONS AND PAYMENT OPTIONS USING A MOBILE DEVICE AT A POINT OF SALE; CREDIT CARD AND DEBIT CARD AUTHORIZATION SERVICES; PROVIDING ELECTRONIC PROCESSING OF CREDIT CARD AND DEBIT CARD TRANSACTIONS AND ELECTRONIC PAYMENTS VIA A GLOBAL COMPUTER NETWORK; CREDIT CARD AND DEBIT CARD VERIFICATION; CREDIT CARD AND DEBIT CARD PAYMENT TRANSACTION VERIFICATION SERVICES; ELECTRONIC FUNDS TRANSFER, IN CLASS 36 (U.S. CLS. 100, 101 AND 102).

FIRST USE 10-17-2010; IN COMMERCE 10-17-2010.

NO CLAIM IS MADE TO THE EXCLUSIVE RIGHT TO USE "PAY ANYWHERE", APART FROM THE MARK AS SHOWN.

THE MARK CONSISTS OF THE STYLIZED DESIGN OF A CREDIT CARD IN A CIRCULAR BORDER WITH THE WORDING "PAYANYWHERE" APPEARING TO THE RIGHT OF THE DESIGN, WITH THE TERM "PAY" IN "PAYANYWHERE" SET OFF FROM THE TERM "ANYWHERE".

SER. NO. 85-151,892, FILED 10-13-2010.

JOHN DALIER, EXAMINING ATTORNEY



David J. Kyffers

Director of the United States Patent and Trademark Office

United States of America

United States Patent and Trademark Office



Reg. No. 4,072,857

Registered Dec. 20, 2011

Int. Cl.: 42

SERVICE MARK

PRINCIPAL REGISTER

TRIUMVIRATE ENVIRONMENTAL, INC. (MASSACHUSETTS CORPORATION)
61 INNER BELT ROAD
SOMERVILLE, MA 02143

FOR: PROVIDING TEMPORARY USE OF ON-LINE NON-DOWNLOADABLE SOFTWARE FOR HAZARDOUS AND NON-HAZARDOUS WASTE GENERATOR CLIENTS TO STORE, MANAGE, TRACK, ANALYZE AND REPORT DATA IN THE FIELD OF ENVIRONMENTAL SERVICES AND HAZARDOUS WASTE MANAGEMENT, NAMELY, TO PROVIDE A WEBSITE WHERE THE CLIENTS INFORMATION AND DOCUMENTATION INCLUDING BUT NOT LIMITED TO HAZARDOUS WASTE MANIFESTS, PROFILES, DATE OF WASTE PICK-UP, CURRENT INVENTORIES, AND SPECIFIC SITE DATA REQUIRED BY FEDERAL, STATE, AND LOCAL ENVIRONMENTAL LAWS AND REGULATIONS IS ACCESSIBLE TO THE CLIENT, IN CLASS 42 (U.S. CLS. 100 AND 101).

FIRST USE 6-1-2007; IN COMMERCE 5-1-2008.

THE MARK CONSISTS OF THE IMAGE OF AN ORANGE COMPASS WITH GREEN DIRECTIONAL ARROWS, WITH THE WORDING "ADVISE" APPEARING TO THE RIGHT OF THE IMAGE IN DARK GREEN UPPER-CASE CHARACTERS.

THE COLOR(S) GREEN, DARK GREEN AND ORANGE IS/ARE CLAIMED AS A FEATURE OF THE MARK.

SER. NO. 85-152,060, FILED 10-13-2010.

NAAKWAMA ANKRAH, EXAMINING ATTORNEY



David J. Kyjars

Director of the United States Patent and Trademark Office

United States of America

United States Patent and Trademark Office



Reg. No. 4,072,858

Registered Dec. 20, 2011

Int. Cl.: 33

AEROPLANO SPIRITS, S. DE R.L. DE C.V. (MEXICO CORPORATION)
DUQUE DE RIVAS # 65
COL. ARCOS VALLARTA
GUADALAJARA, JALISCO, MEXICO 44130

FOR: TEQUILA, IN CLASS 33 (U.S. CLS. 47 AND 49).

TRADEMARK

FIRST USE 6-8-2010; IN COMMERCE 6-8-2010.

PRINCIPAL REGISTER

THE MARK CONSISTS OF THE WORD "AEROPLANO" IN A STYLIZED BANNER SPANNING THE TOP PORTION OF THE MARK WITH AN AIRPLANE IN THE CENTER OF THE TWO BANNERS.

THE ENGLISH TRANSLATION OF "AEROPLANO" IN THE MARK IS "AIRPLANE".

SER. NO. 85-152,103, FILED 10-13-2010.

RONALD MCMORROW, EXAMINING ATTORNEY



David J. Kyros

Director of the United States Patent and Trademark Office

United States of America

United States Patent and Trademark Office



Reg. No. 4,072,859

Registered Dec. 20, 2011

Int. Cls.: 32 and 40

TRADEMARK

SERVICE MARK

PRINCIPAL REGISTER

NEW HOLLAND BREWING COMPANY, LLC (MICHIGAN LIMITED LIABILITY COMPANY)
66 EAST 8TH STREET
HOLLAND, MI 49423

FOR: BEER, IN CLASS 32 (U.S. CLS. 45, 46 AND 48).

FIRST USE 4-0-2006; IN COMMERCE 4-0-2006.

FOR: BREWERY SERVICES AND DISTILLING SERVICES, IN CLASS 40 (U.S. CLS. 100, 103 AND 106).

FIRST USE 4-0-2006; IN COMMERCE 4-0-2006.

NO CLAIM IS MADE TO THE EXCLUSIVE RIGHT TO USE "BREWING", APART FROM THE MARK AS SHOWN.

THE MARK CONSISTS OF A WINDMILL DESIGN WITH "NEW HOLLAND BREWING" CENTERED THEREIN.

SER. NO. 85-152,392, FILED 10-14-2010.

DAVID TAYLOR, EXAMINING ATTORNEY



David J. Kybas

Director of the United States Patent and Trademark Office

United States of America

United States Patent and Trademark Office



Reg. No. 4,072,860

SACHE, LLC (TENNESSEE LIMITED LIABILITY COMPANY)
525 S. MAIN STREET
MEMPHIS, TN 38103

Registered Dec. 20, 2011

Int. Cl.: 25

FOR: COLLARED SHIRTS; HOODED PULLOVERS; LEGGINGS; LONG-SLEEVED SHIRTS;
SHIRTS AND SHORT-SLEEVED SHIRTS; SHIRTS FOR INFANTS, BABIES, TODDLERS
AND CHILDREN; T-SHIRTS; TANK TOPS , IN CLASS 25 (U.S. CLS. 22 AND 39).

TRADEMARK

FIRST USE 4-0-2009; IN COMMERCE 4-0-2009.

PRINCIPAL REGISTER

THE MARK CONSISTS OF TWO CAPITAL LETTER "E"'S. ONE "E" FACES LEFT AND THE
OTHER "E" FACES RIGHT WITH A DOT CENTERED OVER EACH LETTER.

SER. NO. 85-152,593, FILED 10-14-2010.

KIM SAITO, EXAMINING ATTORNEY



David J. Kybas

Director of the United States Patent and Trademark Office

United States of America

United States Patent and Trademark Office

THE FATHER OF LOUD

Reg. No. 4,072,861

Registered Dec. 20, 2011

Int. Cls.: 9, 15, 16 and 25

TRADEMARK

PRINCIPAL REGISTER

MARSHALL AMPLIFICATION PLC (UNITED KINGDOM PUBLIC LIMITED COMPANY (PLC))
DENBIGH ROAD, BLETCHLEY, MILTON KEYNES
BUCKINGHAMSHIRE MK11DQ, UNITED KINGDOM

FOR: SOUND AMPLIFIERS; VALVE AND DIGITAL GUITAR AMPLIFIERS; SOUND REVERBERATION UNITS; ELECTRONIC SOUND MIXING, PROCESSING AND SYNTHESIZING APPARATUS; MICROPHONES, HEADPHONES; LOUDSPEAKERS; HORN-TYPE AUDIO SPEAKERS, LOUDSPEAKER CABINETS; FOOT PEDALS AND FOOT SWITCHES FOR PROCESSING, AMPLIFYING OR DISTORTING SOUND USED IN CONNECTION WITH SOUND AMPLIFIERS; FOOT SWITCHES AND EFFECTS PEDALS FOR USE IN CONNECTION WITH SOUND AMPLIFIERS; SUSTAIN PEDALS, EXPRESSION PEDALS, DELAY PEDALS, ALL BEING ELECTRONIC EFFECTS PEDALS FOR USE WITH SOUND AMPLIFIERS; RADIOS; MP3 PLAYERS; PORTABLE AND HANDHELD DIGITAL ELECTRONIC DEVICES FOR RECORDING, ORGANIZING, TRANSMITTING AND PROCESSING AUDIO, DATA AND VIDEO FILES; CD, DVD AND MP3 CASES; COMPUTER GAME PROGRAMS; COMPUTER SOFTWARE FOR RECORDING SOUND; COMPUTER SOFTWARE FOR USE WITH ANY OF THE AFORESAID GOODS; PARTS AND FITTINGS FOR THE AFORESAID GOODS; MOUSEPADS; MAGNETS, REFRIGERATOR MAGNETS; CALCULATORS; SUNGLASSES; CASES FOR SUNGLASSES, IN CLASS 9 (U.S. CLS. 21, 23, 26, 36 AND 38).

FOR: FOOT PEDALS AND FOOT SWITCHES FOR USE IN CONNECTION WITH MUSICAL INSTRUMENTS; FOOT SWITCHES AND EFFECTS PEDALS FOR USE WITH ELECTRICAL MUSICAL INSTRUMENTS, IN CLASS 15 (U.S. CLS. 2, 21 AND 36).

FOR: BOOKS, MAGAZINES, NEWSLETTERS AND LEAFLETS IN THE FIELD OF SOUND AMPLIFIERS AND LOUD SPEAKERS; CALENDARS, POSTERS; DECALCOMANIAS; PHOTOGRAPHS; STATIONERY; PENS AND PENCILS; LEATHER PASSPORT HOLDERS, IN CLASS 16 (U.S. CLS. 2, 5, 22, 23, 29, 37, 38 AND 50).

FOR: FOOTWEAR, T-SHIRTS, POLO SHIRTS, SHIRTS, JOGGING BOTTOMS, SWEATPANTS, SWEATSHIRTS, HOODED SWEATSHIRTS AND HOODED SWEATERS, TRACKSUITS, FLEECE TOPS, FLEECE VESTS AND FLEECE PULLOVERS, JACKETS, VESTS; JEANS, TROUSERS, SWEATERS, TIES; BABY ROMPER SUITS, BABY BIBS NOT OF PAPER; BIBS NOT OF PAPER; UNDERWEAR; SOCKS, BOXER SHORTS, KNICKERS; NIGHTWEAR, PYJAMAS; BASEBALL CAPS, BEANIE HATS; SWEATBANDS; BANDANAS; SPORTS SHOES; SNEAKERS; LEATHER WRISTBANDS, IN CLASS 25 (U.S. CLS. 22 AND 39).



David J. Kybas

Director of the United States Patent and Trademark Office

Reg. No. 4,072,861 THE MARK CONSISTS OF STANDARD CHARACTERS WITHOUT CLAIM TO ANY PARTICULAR FONT, STYLE, SIZE, OR COLOR.

OWNER OF ERPN CMNTY TM OFC REG. NO. 008156721, DATED 11-10-2009, EXPIRES 3-13-2019.

SER. NO. 85-152,686, FILED 10-14-2010.

JAY FLOWERS, EXAMINING ATTORNEY

United States of America

United States Patent and Trademark Office

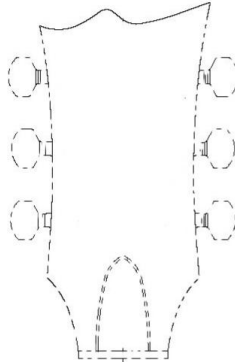

Reg. No. 4,072,862

Registered Dec. 20, 2011

Int. Cl.: 15

TRADEMARK

PRINCIPAL REGISTER

E.S.P. SHIBUYA ENTERPRISES, INC. (CALIFORNIA CORPORATION), DBA ESP GUITAR COMPANY

E.S.P. SHIBUYA ENTERPRISES, INC.
10903 VANOWEN STREET, UNIT A
NORTH HOLLYWOOD, CA 91605

FOR: MUSICAL INSTRUMENTS, NAMELY, GUITARS AND BASS GUITARS, IN CLASS 15 (U.S. CLS. 2, 21 AND 36).

FIRST USE 0-0-1992; IN COMMERCE 0-0-1992.

THE MARK CONSISTS OF THE CONFIGURATION OF A GUITAR HEAD. THE TOP PORTION OF THE GUITAR HEAD, WHICH IS CLAIMED AS THE MARK, HAS A WAVE SHAPE NEAR THE CENTER OF THE HEAD AND ANGLES UP TO THE RIGHT AT THE RIGHT EDGE OF THE GUITAR HEAD. THE MATTER SHOWN IN BROKEN LINES INDICATES THE PLACEMENT OF THE MARK ON THE GOODS AND IS NOT CLAIMED AS A FEATURE OF THE MARK.

SEC. 2(F).

SER. NO. 85-152,767, FILED 10-14-2010.

KIMBERLY FRYE, EXAMINING ATTORNEY



David J. Kybas

Director of the United States Patent and Trademark Office

United States of America

United States Patent and Trademark Office

ClearSignal

Reg. No. 4,072,863

Registered Dec. 20, 2011

Int. Cls.: 1, 37 and 42

TRADEMARK

SERVICE MARK

PRINCIPAL REGISTER

SEVERN MARINE TECHNOLOGIES, LLC (MARYLAND LIMITED LIABILITY COMPANY)
1242 CREEK DRIVE
ANNAPOLIS, MD 21403 AND

MID MOUNTAIN MATERIALS, INC (WASHINGTON CORPORATION)
SUITE 100
2835 82ND AVENUE SE
MERCER ISLAND, WA 98040

FOR: CHEMICAL PREPARATIONS FOR THE BIOFOULING RESISTANT COATING OF UNDERWATER SURFACES, NAMELY, ELECTROACOUSTIC, SONIC, SEISMIC, AND OPTICAL APPARATUS FOR MARINE PURPOSES; CHEMICAL PREPARATIONS FOR USE IN THE FIELD OF CONTROL OF BIOFOULING IN UNDERWATER SURFACES, IN CLASS 1 (U.S. CLS. 1, 5, 6, 10, 26 AND 46).

FIRST USE 12-23-2004; IN COMMERCE 12-23-2004.

FOR: APPLICATION OF COATINGS TO INHIBIT BIOFOULING AND BIOFILM, IN CLASS 37 (U.S. CLS. 100, 103 AND 106).

FIRST USE 12-23-2004; IN COMMERCE 12-23-2004.

FOR: SCIENTIFIC AND TECHNOLOGICAL SERVICES, NAMELY, RESEARCH AND DESIGN SERVICES IN THE FIELD OF BIOFOULING RESISTANCE; SERVICES IN THE FIELD OF INDUSTRIAL ANALYSIS AND INDUSTRIAL RESEARCH, NAMELY, INDUSTRIAL RESEARCH IN THE FIELD OF FOULING, BIOFOULING, SLIME, BIOFILM, AND BIOMASS ACCUMULATIONS IN UNDERWATER SURFACES, IN CLASS 42 (U.S. CLS. 100 AND 101).

FIRST USE 12-23-2004; IN COMMERCE 12-23-2004.

THE MARK CONSISTS OF THE PHRASE "CLEAR SIGNAL" SENT IN A BLUE BACKGROUND WHEREIN "CLEAR" IS IN WHITE AND "SIGNAL" IS IN A DARK BLUE.

THE COLOR(S) WHITE, BLUE AND DARK BLUE IS/ARE CLAIMED AS A FEATURE OF THE MARK.

SER. NO. 85-152,896, FILED 10-14-2010.



David J. Kyros

Director of the United States Patent and Trademark Office

Reg. No. 4,072,863 KEVON CHISOLM, EXAMINING ATTORNEY

United States of America

United States Patent and Trademark Office

SMART CANDY

Reg. No. 4,072,864

SNAP INFUSION LLC (DELAWARE LIMITED LIABILITY COMPANY)
29 STINSON RD.
ANDOVER, MA 01810

Registered Dec. 20, 2011

Int. Cl.: 30

FOR: CANDY; CHEWING GUM, IN CLASS 30 (U.S. CL. 46).

TRADEMARK

FIRST USE 7-17-2011; IN COMMERCE 7-17-2011.

PRINCIPAL REGISTER

THE MARK CONSISTS OF STANDARD CHARACTERS WITHOUT CLAIM TO ANY PARTICULAR FONT, STYLE, SIZE, OR COLOR.

SER. NO. 85-152,901, FILED 10-14-2010.

ANN E. SAPPENFIELD, EXAMINING ATTORNEY



David J. Kybas

Director of the United States Patent and Trademark Office

United States of America
United States Patent and Trademark Office

SWN

Resources Canada

Reg. No. 4,072,865

Registered Dec. 20, 2011

Int. Cls.: 35 and 40

SERVICE MARK

PRINCIPAL REGISTER

SOUTHWESTERN ENERGY COMPANY (DELAWARE CORPORATION)
SUITE 125
2350 NORTH SAM HOUSTON PARKWAY EAST
HOUSTON, TX 77032

FOR: PROMOTING AND MARKETING OF NATURAL GAS PRODUCTION FOR OTHERS,
IN CLASS 35 (U.S. CLS. 100, 101 AND 102).

FIRST USE 6-21-2010; IN COMMERCE 6-21-2010.

FOR: PRODUCTION, REFINING, AND PROCESSING OF OIL AND NATURAL GAS, IN
CLASS 40 (U.S. CLS. 100, 103 AND 106).

FIRST USE 6-21-2010; IN COMMERCE 6-21-2010.

OWNER OF U.S. REG. NO. 3,880,718.

NO CLAIM IS MADE TO THE EXCLUSIVE RIGHT TO USE "RESOURCES CANADA",
APART FROM THE MARK AS SHOWN.

THE MARK CONSISTS OF THE LETTERS "SWN" OVER THE WORDS "RESOURCES
CANADA".

SER. NO. 85-152,926, FILED 10-14-2010.

ANN E. SAPPENFIELD, EXAMINING ATTORNEY



David J. Kybas

Director of the United States Patent and Trademark Office

United States of America

United States Patent and Trademark Office

PetLawn

Reg. No. 4,072,866

INTERNATIONAL PET SOLUTIONS (CALIFORNIA PARTNERSHIP)
16152 QUARTZ STREET
WESTMINSTER, CA 92683

Registered Dec. 20, 2011

Int. Cl.: 31

FOR: REUSABLE PLASTIC LITTER BOX FOR DOGS SOLD FILLED WITH ARTIFICIAL OR FRESH, LIVE SOD, IN CLASS 31 (U.S. CLS. 1 AND 46).

TRADEMARK

FIRST USE 7-1-2010; IN COMMERCE 8-1-2010.

PRINCIPAL REGISTER

THE MARK CONSISTS OF STANDARD CHARACTERS WITHOUT CLAIM TO ANY PARTICULAR FONT, STYLE, SIZE, OR COLOR.

SER. NO. 85-153,187, FILED 10-14-2010.

ANDREW RHIM, EXAMINING ATTORNEY



David J. Kybas

Director of the United States Patent and Trademark Office

United States of America

United States Patent and Trademark Office

Infra Cool

Reg. No. 4,072,867

Registered Dec. 20, 2011

Int. Cls.: 9 and 11

TRADEMARK

PRINCIPAL REGISTER

AUSTIN HUGHES ELECTRONICS LTD. (HONG KONG LIMITED LIABILITY COMPANY)
UNIT 3711-12, CABLE TV TOWER
9 HOI SHING ROAD, N.T., HONG KONG

FOR: AIR ANALYSIS APPARATUS; ANEMOMETERS; DATA PROCESSING APPARATUS;
DETECTORS FOR MEASURING SURROUNDING TEMPERATURE, HUMIDITY AND AIR-
FLOW; ELECTRIC INSTALLATIONS FOR THE REMOTE CONTROL OF INDUSTRIAL OP-
ERATIONS; ELECTRO-DYNAMIC APPARATUS FOR THE REMOTE CONTROL OF SIGNALS;
SPEED INDICATORS; TEMPERATURE INDICATORS; THERMOSTATS, IN CLASS 9 (U.S.
CLS. 21, 23, 26, 36 AND 38).

FIRST USE 9-10-2010; IN COMMERCE 9-10-2010.

FOR: AIR COOLING APPARATUS; AIR CONDITIONING INSTALLATIONS; AIR-CONDI-
TIONING FANS; AIR CONDITIONING APPARATUS; AIR-CONDITIONING VENTILATION
INSTALLATIONS AND APPARATUS; VENTILATING EXHAUST FANS; VENTILATION
HOODS; AIR FILTERING INSTALLATIONS; DRYING APPARATUS AND INSTALLATIONS,
NAMELY, INDUSTRIAL DRYERS FOR HEATING AND DEHUMIDIFYING; HEAT REGU-
LATING APPARATUS PRIMARILY COMPRISED OF MULTIPLE ELECTRIC COOLING
FANS FOR NEARBY COMPUTERS WHICH CAN BE EITHER AUTOMATICALLY CON-
TROLLED BY NEARBY TEMPERATURE OR BY A DATA SIGNAL FROM A NETWORK,
IN CLASS 11 (U.S. CLS. 13, 21, 23, 31 AND 34).

FIRST USE 9-10-2010; IN COMMERCE 9-10-2010.

SER. NO. 85-153,249, FILED 10-14-2010.

SETH A. RAPPAPORT, EXAMINING ATTORNEY



David J. Kyffers

Director of the United States Patent and Trademark Office

United States of America

United States Patent and Trademark Office

CARSESSION

Reg. No. 4,072,868

Registered Dec. 20, 2011

Int. Cl.: 35

SERVICE MARK

PRINCIPAL REGISTER

CHIRILA, ALEXANDRU (ROMANIA INDIVIDUAL)
SC.D AP. 16
STR. CALEA OBCINELOR NR.2 BL.T64
SUCEAVA, ROMANIA

FOR: PROVIDING A WEBSITE FEATURING CONSUMER INFORMATION IN THE FIELD OF MOTOR VEHICLES, IN CLASS 35 (U.S. CLS. 100, 101 AND 102).

FIRST USE 2-20-2009; IN COMMERCE 2-20-2009.

THE MARK CONSISTS OF STANDARD CHARACTERS WITHOUT CLAIM TO ANY PARTICULAR FONT, STYLE, SIZE, OR COLOR.

SER. NO. 85-153,325, FILED 10-15-2010.

MARY CRAWFORD, EXAMINING ATTORNEY



David J. Kyffers

Director of the United States Patent and Trademark Office

United States of America

United States Patent and Trademark Office

by-line

Reg. No. 4,072,869

Registered Dec. 20, 2011

Int. Cl.: 9

TRADEMARK

PRINCIPAL REGISTER

DUBOIS, ROBERT N. (CANADA SOLE PROPRIETORSHIP), DBA BY-LINE ANALYTICAL
31 NOTTINGHAM COURT
SHERWOOD PARK, ALBERTA, CANADA T8A5H7

FOR: RESIDUAL GAS ANALYZERS AND LIQUID ANALYZERS, IN CLASS 9 (U.S. CLS.
21, 23, 26, 36 AND 38).

FIRST USE 9-3-2010; IN COMMERCE 9-3-2010.

THE MARK CONSISTS OF STANDARD CHARACTERS WITHOUT CLAIM TO ANY PAR-
TICULAR FONT, STYLE, SIZE, OR COLOR.

SER. NO. 85-154,095, FILED 10-15-2010.

TEJBIR SINGH, EXAMINING ATTORNEY



David J. Kybas

Director of the United States Patent and Trademark Office

United States of America

United States Patent and Trademark Office

EMBARK

Reg. No. 4,072,870

Registered Dec. 20, 2011

Int. Cls.: 35, 36 and 39

SERVICE MARK

PRINCIPAL REGISTER

EXECUTIVE AIRSHARE, INC. (MISSOURI CORPORATION)
SUITE 150
4150 N. MULBERRY
KANSAS CITY, MO 64116

FOR: BUSINESS MANAGEMENT SERVICES, NAMELY, AIRCRAFT MANAGEMENT FOR OTHERS, IN CLASS 35 (U.S. CLS. 100, 101 AND 102).

FIRST USE 10-15-2010; IN COMMERCE 10-15-2010.

FOR: AIRCRAFT BROKERAGE; AIRCRAFT FINANCING SERVICES; FORMATION, BROKERAGE AND MANAGEMENT OF TIME SHARE INTERESTS IN AIRCRAFT; OFFERING AIRCRAFT FRACTIONAL OWNERSHIP PROGRAMS TO OTHERS, IN CLASS 36 (U.S. CLS. 100, 101 AND 102).

FIRST USE 10-15-2010; IN COMMERCE 10-15-2010.

FOR: LEASING OF AIRCRAFT, RENTAL OF AIRCRAFT; RENTAL OF AIRPLANES; TRANSPORT BY AIRCRAFT, NAMELY, USING PRIVATELY CHARTERED AIR TRANSPORT FOR EXECUTIVE CLASS TRAVELERS THE FOREGOING BEING LIMITED TO PRIVATE AIRCRAFT NOT INVOLVING SINGLE TICKET PURCHASERS, IN CLASS 39 (U.S. CLS. 100 AND 105).

FIRST USE 10-15-2010; IN COMMERCE 10-15-2010.

THE MARK CONSISTS OF STANDARD CHARACTERS WITHOUT CLAIM TO ANY PARTICULAR FONT, STYLE, SIZE, OR COLOR.

SER. NO. 85-154,157, FILED 10-15-2010.

LIEF MARTIN, EXAMINING ATTORNEY



David J. Kyros

Director of the United States Patent and Trademark Office

United States of America
United States Patent and Trademark Office

 **SOLARIS**

Reg. No. 4,072,871

ALPINE CORPORATION (CALIFORNIA CORPORATION)
4901 ZAMBRANO STREET
COMMERCE, CA 90040

Registered Dec. 20, 2011

Int. Cl.: 11

FOR: SOLAR LIGHTS, IN CLASS 11 (U.S. CLS. 13, 21, 23, 31 AND 34).

TRADEMARK

FIRST USE 12-15-2009; IN COMMERCE 2-15-2010.

PRINCIPAL REGISTER

THE MARK CONSISTS OF THE WORD "SOLARIS" WITH A PARTIAL SUN BEHIND THE LETTER "S".

SER. NO. 85-154,200, FILED 10-15-2010.

EDWARD NELSON, EXAMINING ATTORNEY



David J. Kyffers

Director of the United States Patent and Trademark Office

United States of America

United States Patent and Trademark Office

PHOTOPAD

Reg. No. 4,072,872

VIRTUAL GESTURES LLC (WASHINGTON LIMITED LIABILITY COMPANY)
8227 NE 115TH WAY
KIRKLAND, WA 98034

Registered Dec. 20, 2011

Int. Cl.: 42

FOR: PROVIDING TEMPORARY USE OF ON-LINE NON-DOWNLOADABLE SOFTWARE FOR UPLOADING PHOTOGRAPHS, FOR ORGANIZING AND DECORATING PHOTOGRAPHS IN ELECTRONIC PRESENTATIONS THAT ARE NAVIGABLE ONLINE ACCORDING TO A SCRAPBOOK METAPHOR, IN CLASS 42 (U.S. CLS. 100 AND 101).

SERVICE MARK

PRINCIPAL REGISTER

FIRST USE 10-15-2010; IN COMMERCE 10-15-2010.

THE MARK CONSISTS OF STANDARD CHARACTERS WITHOUT CLAIM TO ANY PARTICULAR FONT, STYLE, SIZE, OR COLOR.

SER. NO. 85-154,285, FILED 10-15-2010.

BILL DAWE, EXAMINING ATTORNEY



David J. Kyffers

Director of the United States Patent and Trademark Office

United States of America

United States Patent and Trademark Office

EL TIO PIO

Reg. No. 4,072,873

Registered Dec. 20, 2011

Int. Cl.: 43

SERVICE MARK

PRINCIPAL REGISTER

EL TIO PIO (NEW YORK CORPORATION)
76 WILLOUGHBY ST
BROOKLYN, NY 11201

FOR: PROVIDING FOOD AND DRINK, IN CLASS 43 (U.S. CLS. 100 AND 101).

FIRST USE 11-12-2002; IN COMMERCE 9-1-2003.

THE MARK CONSISTS OF STANDARD CHARACTERS WITHOUT CLAIM TO ANY PARTICULAR FONT, STYLE, SIZE, OR COLOR.

THE ENGLISH TRANSLATION OF "EL TIO PIO" IN THE MARK IS "THE UNCLE TWEET".

SER. NO. 85-154,301, FILED 10-16-2010.

AMY C. KEAN, EXAMINING ATTORNEY



David J. Kappas

Director of the United States Patent and Trademark Office

United States of America

United States Patent and Trademark Office



Reg. No. 4,072,874

BLUCAPP, INC. (WASHINGTON CORPORATION)
4929 STANFORD AVE. NE
SEATTLE, WA 98105

Registered Dec. 20, 2011

Int. Cl.: 42

FOR: SOFTWARE DEVELOPMENT, IN CLASS 42 (U.S. CLS. 100 AND 101).

SERVICE MARK

FIRST USE 10-21-2007; IN COMMERCE 10-21-2007.

PRINCIPAL REGISTER

THE MARK CONSISTS OF THE DESIGN OF A HUMAN BODY WEARING A NAVY BLUE BASEBALL CAP LIFTING A COGWHEEL IN BLUE AND NAVY BLUE ABOVE HIS HEAD WITH A BLUE SHADOW BEHIND IT AT AN OBTUSE ANGLE. APPEARING TO THE RIGHT IS THE STYLIZED WORDING "BLUCAPP" WITH THE WORDING "BLU" IN BLUE LETTERING AND THE WORDING "CAPP" IN NAVY BLUE LETTERING.

THE COLOR(S) BLUE AND NAVY BLUE IS/ARE CLAIMED AS A FEATURE OF THE MARK.

SER. NO. 85-154,308, FILED 10-16-2010.

AMY C. KEAN, EXAMINING ATTORNEY



David J. Kappas

Director of the United States Patent and Trademark Office

United States of America

United States Patent and Trademark Office

The Knowledge to Heal

Reg. No. 4,072,875

Registered Dec. 20, 2011

Int. Cl.: 36

THE INSTITUTE FOR REHABILITATION AND RESEARCH FOUNDATION (TEXAS CORPORATION)
SUITE 222
4605 POST OAK PLACE
HOUSTON, TX 77027

SERVICE MARK

FOR: FINANCING RESEARCH INTO A CURE FOR SPINAL CORD INJURIES, BRAIN INJURIES AND NEUROLOGICAL DISORDERS, IN CLASS 36 (U.S. CLS. 100, 101 AND 102).

PRINCIPAL REGISTER

FIRST USE 10-0-2010; IN COMMERCE 10-0-2010.

THE MARK CONSISTS OF STANDARD CHARACTERS WITHOUT CLAIM TO ANY PARTICULAR FONT, STYLE, SIZE, OR COLOR.

SER. NO. 85-154,919, FILED 10-18-2010.

APRIL ROACH, EXAMINING ATTORNEY



David J. Kyffers

Director of the United States Patent and Trademark Office

United States of America

United States Patent and Trademark Office

EcoAvantixx

Reg. No. 4,072,876

BSH BOSCH UND SIEMENS HAUSGERAETE GMBH (FED REP GERMANY CORPORATION)
CARL-WERY-STRASSE 34

Registered Dec. 20, 2011

MUNICH, FED REP GERMANY 81739

Int. Cl.: 11

FOR: HOUSEHOLD MACHINES AND EQUIPMENT, NAMELY, DRYERS, NAMELY, SPIN CLOTHES DRYERS, TUMBLE LAUNDRY DRYERS; STRUCTURAL PARTS OF ALL AFOREMENTIONED GOODS, IN CLASS 11 (U.S. CLS. 13, 21, 23, 31 AND 34).

TRADEMARK

THE MARK CONSISTS OF STANDARD CHARACTERS WITHOUT CLAIM TO ANY PARTICULAR FONT, STYLE, SIZE, OR COLOR.

PRINCIPAL REGISTER

PRIORITY CLAIMED UNDER SEC. 44(D) ON FED REP GERMANY APPLICATION NO. 302010023759, FILED 4-21-2010, REG. NO. 302010023759, DATED 5-11-2010, EXPIRES 4-30-2020.

SER. NO. 85-155,030, FILED 10-18-2010.

DAVID TAYLOR, EXAMINING ATTORNEY



David J. Kyffers

Director of the United States Patent and Trademark Office

United States of America

United States Patent and Trademark Office

CockTees

Reg. No. 4,072,877

CLAYTON, MARY L (UNITED STATES INDIVIDUAL)
12400 VENTURA BL #360
STUDIO CITY, CA 91604

Registered Dec. 20, 2011

Int. Cl.: 25

FOR: TEE SHIRTS, IN CLASS 25 (U.S. CLS. 22 AND 39).

TRADEMARK

FIRST USE 10-1-2010; IN COMMERCE 10-15-2010.

PRINCIPAL REGISTER

THE MARK CONSISTS OF STANDARD CHARACTERS WITHOUT CLAIM TO ANY PARTICULAR FONT, STYLE, SIZE, OR COLOR.

SER. NO. 85-155,141, FILED 10-18-2010.

EDWARD NELSON, EXAMINING ATTORNEY



David J. Kyfos

Director of the United States Patent and Trademark Office

United States of America

United States Patent and Trademark Office

ETOKEN

Reg. No. 4,072,878

SAFENET, INC. (DELAWARE CORPORATION)
4690 MILLENNIUM DRIVE
BELCAMP, MD 21017

Registered Dec. 20, 2011

Int. Cl.: 9

FOR: COMPUTER SOFTWARE, HARDWARE AND ENCODED SMART CARDS CONTAINING PROGRAMMING USED FOR AUTHENTICATION, ENCRYPTION, PASSWORD MANAGEMENT, WEB ACCESS, REMOTE ACCESS, DATA STORAGE AND DIGITAL SIGNATURES, IN CLASS 9 (U.S. CLS. 21, 23, 26, 36 AND 38).

TRADEMARK

PRINCIPAL REGISTER

FIRST USE 12-31-1998; IN COMMERCE 12-31-1998.

THE MARK CONSISTS OF STANDARD CHARACTERS WITHOUT CLAIM TO ANY PARTICULAR FONT, STYLE, SIZE, OR COLOR.

SER. NO. 85-155,180, FILED 10-18-2010.

TASNEEM HUSSAIN, EXAMINING ATTORNEY



David J. Kybas

Director of the United States Patent and Trademark Office

United States of America

United States Patent and Trademark Office



Reg. No. 4,072,879

Registered Dec. 20, 2011

Int. Cl.: 41

SERVICE MARK

PRINCIPAL REGISTER

JOSHUA COURAGE (UNITED STATES INDIVIDUAL), DBA COURAGE PERFORMANCE
848 PROSPECT ROW
SAN MATEO, CA 94401

FOR: ATHLETIC TRAINING SERVICES, IN CLASS 41 (U.S. CLS. 100, 101 AND 107).

FIRST USE 9-15-2009; IN COMMERCE 9-15-2009.

NO CLAIM IS MADE TO THE EXCLUSIVE RIGHT TO USE "PERFORMANCE", APART FROM THE MARK AS SHOWN.

THE COLOR(S) ORANGE, BLACK, AND WHITE IS/ARE CLAIMED AS A FEATURE OF THE MARK.

THE MARK CONSISTS OF THE STYLIZED AND ORANGE-SHADED WORD "COURAGE" ON THE UPPER AND MIDDLE LEFT EXTENDING TO THE CENTER, THE STYLIZED AND BLACK WORD "PERFORMANCE" IN THE MIDDLE, AND AN ATHLETIC HUMAN FIGURE ON THE RIGHT WHICH IS SHADED IN BLACK WITH WHITE ON THE MAN'S LEFT SHOULDER, RIGHT FOREARM, BOTH KNEES AND BOTH FEET.

SER. NO. 85-155,192, FILED 10-18-2010.

JEFFREY LOOK, EXAMINING ATTORNEY



David J. Kybas

Director of the United States Patent and Trademark Office

United States of America

United States Patent and Trademark Office

TECOPRINT

Reg. No. 4,072,880

Registered Dec. 20, 2011

Int. Cls.: 16, 19 and 20

TRADEMARK

PRINCIPAL REGISTER

BAUSCHLINNEMANN GMBH (FED REP GERMANY GESELLSCHAFT MIT
BESCHRÄNKTER HAFTUNG (GMBH))
ROBERT-LINNEMANN-STR. 21-27
48336 SASSENBERG, FED REP GERMANY

FOR: PAPER, PAPERBOARD, NAMELY, PRINTED PAPER FOR COATING OF SURFACES OF WORK PIECES OF WOOD OR PLASTICS; PRINTED MATTER, NAMELY, PRINTED BROCHURES IN THE FIELD OF BUILDING CONSTRUCTION, IN CLASS 16 (U.S. CLS. 2, 5, 22, 23, 29, 37, 38 AND 50).

FOR: NON-METALLIC BUILDING MATERIALS, NAMELY, SKIRTING BOARDS AND PROFILES OF PLASTICS, SKIRTING BOARDS OF WOOD, WOOD BEADING, FINISHING RAILS, STAIR NOSING, TRANSITION RAILS, FACADE PANELS AND FACADE ELEMENTS, FACADE PROFILES; VENEERS OF PLASTICS, WALL FINISHING RAILS, IN CLASS 19 (U.S. CLS. 1, 12, 33 AND 50).

FOR: FURNITURE, PARTS OF FURNITURE, FRAMES, NAMELY, PICTURE FRAMES OF WOOD AND SUBSTITUTES THEREFOR OR OF PLASTICS; GOODS OF WOOD AND SUBSTITUTES THEREFOR OR PLASTICS, NAMELY, FURNITURE EDGES; EDGE BANDS FOR FURNITURE OF WOOD AND PLASTICS, IN CLASS 20 (U.S. CLS. 2, 13, 22, 25, 32 AND 50).

THE MARK CONSISTS OF STANDARD CHARACTERS WITHOUT CLAIM TO ANY PARTICULAR FONT, STYLE, SIZE, OR COLOR.

PRIORITY CLAIMED UNDER SEC. 44(D) ON FED REP GERMANY APPLICATION NO. 302010029009, FILED 5-12-2010, REG. NO. 302010029009, DATED 6-2-2010, EXPIRES 5-31-2020.

SER. NO. 85-155,919, FILED 10-19-2010.

ANNE MADDEN, EXAMINING ATTORNEY



David J. Kyffers

Director of the United States Patent and Trademark Office

United States of America

United States Patent and Trademark Office

The RESULTS Guy

Reg. No. 4,072,881

JEARY, TONY (UNITED STATES INDIVIDUAL)
8105 FIRESTONE DRIVE
FLOWER MOUND, TX 75022

Registered Dec. 20, 2011

Int. Cl.: 41

FOR: EDUCATIONAL SERVICES, NAMELY, PROVIDING WORKSHOPS, SEMINARS, AND INSTRUCTIONS IN THE FIELD OF PUBLIC SPEAKING AND COMMUNICATION AND DISTRIBUTING WRITTEN COURSE MATERIALS IN CONNECTION THEREWITH, IN CLASS 41 (U.S. CLS. 100, 101 AND 107).

SERVICE MARK

PRINCIPAL REGISTER

FIRST USE 9-1-2010; IN COMMERCE 9-1-2010.

THE MARK CONSISTS OF STANDARD CHARACTERS WITHOUT CLAIM TO ANY PARTICULAR FONT, STYLE, SIZE, OR COLOR.

SER. NO. 85-155,929, FILED 10-19-2010.

MARGARET POWER, EXAMINING ATTORNEY



David J. Kyros

Director of the United States Patent and Trademark Office

United States of America

United States Patent and Trademark Office

HAVE A FIRE SAFE DAY!

Reg. No. 4,072,882

THREE G'S AND A-T INVESTMENT, LLC (KENTUCKY LIMITED LIABILITY COMPANY)
901 ULRICH AVENUE
LOUISVILLE, KY 40219

Registered Dec. 20, 2011

Int. Cls.: 37, 41, 42 and 45

FOR: INSTALLATION OF FIRE SUPPRESSION SYSTEMS, RANGE AND KITCHEN HOOD SYSTEMS, VEHICLE SYSTEMS, PAINT BOOTH SYSTEMS, COMPUTER ROOM SYSTEMS, INDUSTRIAL SYSTEMS, EMERGENCY LIGHTING, SPRINKLER SYSTEMS, FIRE ALARM SYSTEMS; INSTALLATION AND MAINTENANCE OF FIRE EXTINGUISHERS, IN CLASS 37 (U.S. CLS. 100, 103 AND 106).

SERVICE MARK

PRINCIPAL REGISTER

FIRST USE 10-31-2006; IN COMMERCE 10-19-2010.

FOR: FIRE SUPPRESSION TRAINING; FIRE TRAINING FOR FIRE INSPECTORS, BUILDING CODE OFFICIALS, AND FIRE FIGHTERS, IN CLASS 41 (U.S. CLS. 100, 101 AND 107).

FIRST USE 10-31-2006; IN COMMERCE 10-19-2010.

FOR: DESIGN OF FIRE SUPPRESSION SYSTEMS, RANGE AND KITCHEN HOOD SYSTEMS, VEHICLE SYSTEMS, PAINT BOOTH SYSTEMS, COMPUTER ROOM SYSTEMS, INDUSTRIAL SYSTEMS, EMERGENCY LIGHTING, SPRINKLER SYSTEMS, AND FIRE ALARM SYSTEMS, IN CLASS 42 (U.S. CLS. 100 AND 101).

FIRST USE 10-31-2006; IN COMMERCE 10-19-2010.

FOR: FIRE SAFETY INSPECTION; INSPECTION OF FIRE EXTINGUISHERS FOR SAFETY PURPOSES, IN CLASS 45 (U.S. CLS. 100 AND 101).

FIRST USE 10-31-2006; IN COMMERCE 10-19-2010.

THE MARK CONSISTS OF STANDARD CHARACTERS WITHOUT CLAIM TO ANY PARTICULAR FONT, STYLE, SIZE, OR COLOR.

SER. NO. 85-156,129, FILED 10-19-2010.

LEIGH CAROLINE CASE, EXAMINING ATTORNEY



David J. Kyros

Director of the United States Patent and Trademark Office

United States of America

United States Patent and Trademark Office

RICHARD

Reg. No. 4,072,883

Registered Dec. 20, 2011

Int. Cl.: 16

TRADEMARK

PRINCIPAL REGISTER

A. RICHARD TOOLS CO. (CANADA CORPORATION)
120 JACQUES-CARTIER
BERTHIERVILLE, QUEBEC, CANADA J0K1A0

FOR: PAINT ACCESSORIES, NAMELY, PAINT ROLLER COVERS, PAINT TRAYS, ROLLER CAGE FRAMES, PLASTIC CAGE FRAMES, EXTENSION POLES FOR PAINT APPLICATORS, TRIM WHEELS KIT REPLACEMENT PADS, EXTENSION POLE ADAPTORS USED IN CONJUNCTION WITH PAINT BRUSHES AND PAINT ROLLERS TO EXTEND THE REACH OF THE PAINT BRUSHES AND ROLLERS, PAINTER'S MITTS, TRIM BRUSHES, ARTIST PAINT BRUSHES, PAINT BRUSHES, CORNER ROLLERS, PAINT PADS, FITTED PLASTIC LINERS FOR PAINT TRAYS, IN CLASS 16 (U.S. CLS. 2, 5, 22, 23, 29, 37, 38 AND 50).

FIRST USE 8-0-2006; IN COMMERCE 6-0-2007.

THE MARK CONSISTS OF STANDARD CHARACTERS WITHOUT CLAIM TO ANY PARTICULAR FONT, STYLE, SIZE, OR COLOR.

PRIORITY CLAIMED UNDER SEC. 44(D) ON CANADA APPLICATION NO. 1196699, FILED 4-22-2010, REG. NO. TMA628,305, DATED 3-23-2011, EXPIRES 3-23-2026.

OWNER OF U.S. REG. NOS. 3,039,024 AND 3,633,678.

SER. NO. 85-156,345, FILED 10-19-2010.

LIEF MARTIN, EXAMINING ATTORNEY



David J. Kyffers

Director of the United States Patent and Trademark Office

United States of America

United States Patent and Trademark Office

waterPerfect

Reg. No. 4,072,884

BSH BOSCH UND SIEMENS HAUSGERAETE GMBH (FED REP GERMANY CORPORATION)
CARL-WERY-STRASSE 34

Registered Dec. 20, 2011

MUNICH, FED REP GERMANY 81739

Int. Cl.: 7

FOR: HOUSEHOLD AND KITCHEN MACHINES AND EQUIPMENT, NAMELY, DISHWASHERS; STRUCTURAL PARTS OF ALL AFOREMENTIONED GOODS, IN CLASS 7 (U.S. CLS. 13, 19, 21, 23, 31, 34 AND 35).

TRADEMARK

THE MARK CONSISTS OF STANDARD CHARACTERS WITHOUT CLAIM TO ANY PARTICULAR FONT, STYLE, SIZE, OR COLOR.

PRINCIPAL REGISTER

PRIORITY CLAIMED UNDER SEC. 44(D) ON FED REP GERMANY APPLICATION NO. 302010023758, FILED 4-21-2010, REG. NO. 302010023758, DATED 7-19-2010, EXPIRES 4-30-2020.

SER. NO. 85-156,784, FILED 10-20-2010.

DAVID TAYLOR, EXAMINING ATTORNEY



David J. Kyffers

Director of the United States Patent and Trademark Office

United States of America

United States Patent and Trademark Office

waterPerfect

Reg. No. 4,072,885

BSH BOSCH UND SIEMENS HAUSGERAETE GMBH (FED REP GERMANY CORPORATION)
CARL-WERY-STRASSE 34

Registered Dec. 20, 2011

MUNICH, FED REP GERMANY 81739

Int. Cl.: 7

FOR: HOUSEHOLD AND KITCHEN MACHINES AND EQUIPMENT, NAMELY, ELECTRIC MACHINES AND APPLIANCES FOR TREATING LAUNDRY AND CLOTHING, NAMELY, WASHING MACHINES; STRUCTURAL PARTS OF ALL AFOREMENTIONED GOODS, IN CLASS 7 (U.S. CLS. 13, 19, 21, 23, 31, 34 AND 35).

TRADEMARK

PRINCIPAL REGISTER

THE MARK CONSISTS OF STANDARD CHARACTERS WITHOUT CLAIM TO ANY PARTICULAR FONT, STYLE, SIZE, OR COLOR.

PRIORITY CLAIMED UNDER SEC. 44(D) ON FED REP GERMANY APPLICATION NO. 302010023758, FILED 4-21-2010, REG. NO. 302010023758, DATED 7-19-2010, EXPIRES 4-30-2020.

SER. NO. 85-156,882, FILED 10-20-2010.

DAVID TAYLOR, EXAMINING ATTORNEY



David J. Kyffers

Director of the United States Patent and Trademark Office

United States of America

United States Patent and Trademark Office



Reg. No. 4,072,886

Registered Dec. 20, 2011

Int. Cl.: 36

SERVICE MARK

PRINCIPAL REGISTER

CALIFORNIA SOCIETY OF CERTIFIED PUBLIC ACCOUNTANTS (CALIFORNIA CORPORATION), AKA CALCPA
1235 RADIO ROAD
REDWOOD CITY, CA 94065

FOR: ADMINISTRATION AND ELIGIBILITY UNDERWRITING OF GROUP MEDICAL, DENTAL, VISION, LIFE INSURANCE AND LONG-TERM DISABILITY PLANS OFFERED TO ACCOUNTING FIRMS AND FIRMS OFFERING GENERAL FINANCIAL SERVICES, WHICH ARE OWNED BY QUALIFIED MEMBERS IN GOOD STANDING OF CALIFORNIA SOCIETY OF CERTIFIED PUBLIC ACCOUNTANTS, IN CLASS 36 (U.S. CLS. 100, 101 AND 102).

FIRST USE 6-0-2010; IN COMMERCE 6-0-2010.

OWNER OF U.S. REG. NO. 2,484,239.

NO CLAIM IS MADE TO THE EXCLUSIVE RIGHT TO USE "CALCPA", APART FROM THE MARK AS SHOWN.

THE MARK CONSISTS OF THE WORD "CALCPA" ABOVE THE WORD "PROTECTPLUS" AND A SQUARE DESIGN TO THE LEFT OF THE WORDS.

SER. NO. 85-157,007, FILED 10-20-2010.

DEZMONA MIZELLE, EXAMINING ATTORNEY



David J. Kybas

Director of the United States Patent and Trademark Office

United States of America

United States Patent and Trademark Office

IAN MARTIN

Reg. No. 4,072,887

IAN MARTIN LIMITED (CANADA CORPORATION)
465 MORDEN ROAD, 2ND FLOOR
OAKVILLE, ONTARIO, CANADA L6K3W6

Registered Dec. 20, 2011

Int. Cl.: 35

FOR: PROVIDING TEMPORARY AND FULL-TIME PERSONNEL PLACEMENT; PERSONNEL SEARCH AND PLACEMENT FOR THE INFORMATION TECHNOLOGY AND ENGINEERING TECHNICAL FIELD; JOB PLACEMENT SERVICES, IN CLASS 35 (U.S. CLS. 100, 101 AND 102).

SERVICE MARK

PRINCIPAL REGISTER

FIRST USE 12-31-1957; IN COMMERCE 12-31-1963.

THE MARK CONSISTS OF STANDARD CHARACTERS WITHOUT CLAIM TO ANY PARTICULAR FONT, STYLE, SIZE, OR COLOR.

PRIORITY CLAIMED UNDER SEC. 44(D) ON CANADA APPLICATION NO. 1478248, FILED 4-23-2010.

THE NAME(S), PORTRAIT(S), AND/OR SIGNATURE(S) SHOWN IN THE MARK DOES NOT IDENTIFY A PARTICULAR LIVING INDIVIDUAL.

SER. NO. 85-157,054, FILED 10-20-2010.

FRANK LATTUCA, EXAMINING ATTORNEY



David J. Kybas

Director of the United States Patent and Trademark Office

United States of America

United States Patent and Trademark Office

Novitas

Reg. No. 4,072,888

Registered Dec. 20, 2011

Int. Cl.: 4

TRADEMARK

PRINCIPAL REGISTER

NOVITAS CHEM SOLUTIONS, LLC (TEXAS LIMITED LIABILITY COMPANY)
LWEI0606@GMAIL.COM
4928 MAPLE STREET
BELLAIRE, TX 77401

FOR: INDUSTRIAL LUBRICANTS, IN CLASS 4 (U.S. CLS. 1, 6 AND 15).

FIRST USE 6-1-2009; IN COMMERCE 10-1-2010.

THE MARK CONSISTS OF STANDARD CHARACTERS WITHOUT CLAIM TO ANY PARTICULAR FONT, STYLE, SIZE, OR COLOR.

THE ENGLISH TRANSLATION OF "NOVITAS" IS "INNOVATION".

SER. NO. 85-157,127, FILED 10-20-2010.

ALICE BENMAMAN, EXAMINING ATTORNEY



David J. Kybas

Director of the United States Patent and Trademark Office

United States of America

United States Patent and Trademark Office

BABBLETEXT

Reg. No. 4,072,889

BABBLE INC (NORTH CAROLINA CORPORATION)
16126 GLEN MIRO DR
HUNTERSVILLE, NC 28078

Registered Dec. 20, 2011

Int. Cl.: 35

FOR: DISSEMINATION OF ADVERTISING FOR OTHERS VIA PUBLIC AND PRIVATE WIRELESS NETWORKS FOR DISPLAY ON MOBILE DEVICES, IN CLASS 35 (U.S. CLS. 100, 101 AND 102).

SERVICE MARK

FIRST USE 4-18-2010; IN COMMERCE 5-3-2010.

PRINCIPAL REGISTER

THE MARK CONSISTS OF STANDARD CHARACTERS WITHOUT CLAIM TO ANY PARTICULAR FONT, STYLE, SIZE, OR COLOR.

SER. NO. 85-157,305, FILED 10-20-2010.

JOHN GARTNER, EXAMINING ATTORNEY



David J. Kyffers

Director of the United States Patent and Trademark Office

United States of America

United States Patent and Trademark Office

Protection Hold 'Em

Reg. No. 4,072,890

Registered Dec. 20, 2011

Int. Cl.: 41

SERVICE MARK

PRINCIPAL REGISTER

QUINTANILLA, CAVIN C. (UNITED STATES INDIVIDUAL), DBA PROTECTION POKER
PROTECTIONPOKER.COM
2008 W. CARSON ST., STE.104
TORRANCE, CA 90501

FOR: ENTERTAINMENT SERVICES, NAMELY, CONDUCTING LIVE POKER GAMES;
GAMING SERVICES IN THE NATURE OF CASINO GAMING; PROVIDING ON-LINE POKER
GAMES, IN CLASS 41 (U.S. CLS. 100, 101 AND 107).

FIRST USE 5-2-2010; IN COMMERCE 9-30-2010.

THE MARK CONSISTS OF STANDARD CHARACTERS WITHOUT CLAIM TO ANY PAR-
TICULAR FONT, STYLE, SIZE, OR COLOR.

NO CLAIM IS MADE TO THE EXCLUSIVE RIGHT TO USE "HOLD 'EM", APART FROM
THE MARK AS SHOWN.

SER. NO. 85-157,653, FILED 10-21-2010.

JESSICA A. POWERS, EXAMINING ATTORNEY



David J. Kyros

Director of the United States Patent and Trademark Office

United States of America

United States Patent and Trademark Office



Reg. No. 4,072,891

Registered Dec. 20, 2011

Int. Cl.: 19

TRADEMARK

PRINCIPAL REGISTER

PROFIT-ABILITIES, LLC (COLORADO LIMITED LIABILITY COMPANY), DBA CONSTRUKS
1757 PEREGRINE LANE
BROOMFIELD, CO 80020

FOR: NONMETALLIC TRANSPORTABLE CONSTRUCTIONS, IN CLASS 19 (U.S. CLS. 1,
12, 33 AND 50).

FIRST USE 5-23-2010; IN COMMERCE 5-23-2010.

THE MARK CONSISTS OF THE TERM "CONSTRUKS" IN STYLIZED FORM, AND A
HEXAGON APPEARS WITHIN THE LETTER "K".

SER. NO. 85-157,953, FILED 10-21-2010.

TEJBIR SINGH, EXAMINING ATTORNEY



David J. Kybas

Director of the United States Patent and Trademark Office

United States of America

United States Patent and Trademark Office

Word War III

Reg. No. 4,072,892

WESTERN STAR ENTERTAINMENT LLC (OREGON LIMITED LIABILITY COMPANY)
2102 CLAUDIA LN
THE DALLES, OR 97058

Registered Dec. 20, 2011

Int. Cl.: 9

FOR: COMPUTER GAME PROGRAMMES, IN CLASS 9 (U.S. CLS. 21, 23, 26, 36 AND 38).

TRADEMARK

FIRST USE 7-19-2007; IN COMMERCE 3-15-2010.

PRINCIPAL REGISTER

THE MARK CONSISTS OF STANDARD CHARACTERS WITHOUT CLAIM TO ANY PARTICULAR FONT, STYLE, SIZE, OR COLOR.

SER. NO. 85-158,066, FILED 10-21-2010.

ALYSSA STEEL, EXAMINING ATTORNEY



David J. Kybas

Director of the United States Patent and Trademark Office

United States of America

United States Patent and Trademark Office

SAFE+MASK

Reg. No. 4,072,893

A. R. MEDICOM INC. (CANADA CORPORATION)
1200-55TH AVENUE

Registered Dec. 20, 2011

LACHINE QUEBEC, CANADA H8T3J8

Int. Cl.: 10

FOR: SURGICAL AND MEDICAL FACE MASKS, IN CLASS 10 (U.S. CLS. 26, 39 AND 44).

TRADEMARK

FIRST USE 8-0-1989; IN COMMERCE 5-0-1995.

PRINCIPAL REGISTER

THE MARK CONSISTS OF STANDARD CHARACTERS WITHOUT CLAIM TO ANY PARTICULAR FONT, STYLE, SIZE, OR COLOR.

OWNER OF U.S. REG. NO. 2,397,103 AND OTHERS.

SER. NO. 85-158,218, FILED 10-21-2010.

BARBARA BROWN, EXAMINING ATTORNEY



David J. Kybas

Director of the United States Patent and Trademark Office

United States of America

United States Patent and Trademark Office

SUN ELECTRONICS

Reg. No. 4,072,894

Registered Dec. 20, 2011

Int. Cl.: 35

SERVICE MARK

PRINCIPAL REGISTER

SUN ELECTRONICS INTERNATIONAL, INC. (FLORIDA CORPORATION)
555 N.E. 15TH ST., UNIT 14A
MIAMI, FL 33132

FOR: WHOLESALE STORE SERVICES AND DISTRIBUTORSHIPS FEATURING SOLAR ENERGY PRODUCTS AND PRODUCTS RELATING TO SOLAR ENERGY AND ELECTRICITY , IN CLASS 35 (U.S. CLS. 100, 101 AND 102).

FIRST USE 0-0-1993; IN COMMERCE 0-0-1993.

THE MARK CONSISTS OF STANDARD CHARACTERS WITHOUT CLAIM TO ANY PARTICULAR FONT, STYLE, SIZE, OR COLOR.

NO CLAIM IS MADE TO THE EXCLUSIVE RIGHT TO USE "ELECTRONICS", APART FROM THE MARK AS SHOWN.

SEC. 2(F).

SER. NO. 85-158,223, FILED 10-21-2010.

MEGHAN REINHART, EXAMINING ATTORNEY



David J. Kybas

Director of the United States Patent and Trademark Office

United States of America

United States Patent and Trademark Office

CREATURES OF HABITAT

Reg. No. 4,072,895

Registered Dec. 20, 2011

Int. Cls.: 41 and 45

SERVICE MARK

PRINCIPAL REGISTER

ZOOLOGICAL SOCIETY OF PHILADELPHIA (PENNSYLVANIA NON-PROFIT CORPORATION)
3400 WEST GIRARD AVENUE
PHILADELPHIA, PA 19104

FOR: EDUCATIONAL AND ENTERTAINMENT SERVICES IN THE NATURE OF EXHIBITS FEATURING ANIMAL SCULPTURES, PRESENTATIONS ON WILDLIFE HABITAT PRESERVATION, WORKSHOPS, AND LIVE SHOW PERFORMANCES FEATURING ENVIRONMENTAL AND CONSERVATION AWARENESS, IN CLASS 41 (U.S. CLS. 100, 101 AND 107).

FIRST USE 4-0-2010; IN COMMERCE 4-0-2010.

FOR: PROVIDING INFORMATION ON ENVIRONMENTAL AND CONSERVATION ISSUES, SOLUTIONS AND INITIATIVES REGARDING WILDLIFE HABITAT PRESERVATION VIA THE INTERNET, IN CLASS 45 (U.S. CLS. 100 AND 101).

FIRST USE 4-0-2010; IN COMMERCE 4-0-2010.

THE MARK CONSISTS OF STANDARD CHARACTERS WITHOUT CLAIM TO ANY PARTICULAR FONT, STYLE, SIZE, OR COLOR.

SER. NO. 85-159,264, FILED 10-22-2010.

WILLIAM VERHOSEK, EXAMINING ATTORNEY



David J. Kyffers

Director of the United States Patent and Trademark Office

United States of America

United States Patent and Trademark Office

GUNS SAVE LIVES

Reg. No. 4,072,896

VIRGINIA CITIZENS DEFENSE LEAGUE, INC. (VIRGINIA CORPORATION)
P.O. BOX 513
NEWINGTON, VA 22122

Registered Dec. 20, 2011

Int. Cls.: 16 and 26

FOR: BUMPER STICKERS; STICKERS, IN CLASS 16 (U.S. CLS. 2, 5, 22, 23, 29, 37, 38 AND 50).

TRADEMARK

FIRST USE 12-31-1998; IN COMMERCE 12-31-1998.

PRINCIPAL REGISTER

FOR: BUTTONS, IN CLASS 26 (U.S. CLS. 37, 39, 40, 42 AND 50).

FIRST USE 2-5-2005; IN COMMERCE 2-5-2005.

THE MARK CONSISTS OF STANDARD CHARACTERS WITHOUT CLAIM TO ANY PARTICULAR FONT, STYLE, SIZE, OR COLOR.

OWNER OF U.S. REG. NO. 3,844,708.

SER. NO. 85-159,293, FILED 10-22-2010.

MELISSA VALLILLO, EXAMINING ATTORNEY



David J. Kyffers

Director of the United States Patent and Trademark Office

United States of America

United States Patent and Trademark Office

BILLIAN'S

Reg. No. 4,072,897

BILLIAN'S PUBLISHING, INC. (GEORGIA CORPORATION)
2100 RIVEREDGE PARKWAY
ATLANTA, GA 30328

Registered Dec. 20, 2011

Int. Cls.: 9, 16 and 35

FOR: ELECTRONIC DATABASE DIRECTORIES PUBLISHED PERIODICALLY AND RECORDED ON COMPUTER MEDIA PROVIDING INFORMATION IN THE HEALTHCARE FIELDS, IN CLASS 9 (U.S. CLS. 21, 23, 26, 36 AND 38).

TRADEMARK

FIRST USE 10-21-2010; IN COMMERCE 10-21-2010.

SERVICE MARK

FOR: PRINTED DIRECTORIES PROVIDING INFORMATION IN THE HEALTHCARE FIELDS PUBLISHED PERIODICALLY, IN CLASS 16 (U.S. CLS. 2, 5, 22, 23, 29, 37, 38 AND 50).

PRINCIPAL REGISTER

FIRST USE 4-0-2007; IN COMMERCE 6-0-2007.

FOR: ONLINE DIRECTORIES DIRECTED TO BUSINESS AVAILABLE VIA A GLOBAL COMPUTER NETWORK PROVIDING INFORMATION IN THE HEALTHCARE FIELDS, IN CLASS 35 (U.S. CLS. 100, 101 AND 102).

FIRST USE 4-0-2007; IN COMMERCE 6-0-2007.

THE MARK CONSISTS OF STANDARD CHARACTERS WITHOUT CLAIM TO ANY PARTICULAR FONT, STYLE, SIZE, OR COLOR.

SER. NO. 85-159,561, FILED 10-22-2010.

ADA HAN, EXAMINING ATTORNEY



David J. Kyffers

Director of the United States Patent and Trademark Office

United States of America

United States Patent and Trademark Office



Reg. No. 4,072,898

Registered Dec. 20, 2011

Int. Cls.: 9, 16 and 35

TRADEMARK

SERVICE MARK

PRINCIPAL REGISTER

BILLIAN'S PUBLISHING, INC. (GEORGIA CORPORATION)
2100 RIVEREDGE PARKWAY
ATLANTA, GA 30328

FOR: ELECTRONIC DATABASE DIRECTORIES PUBLISHED PERIODICALLY AND RECORDED ON COMPUTER MEDIA PROVIDING INFORMATION IN THE HEALTHCARE FIELDS, IN CLASS 9 (U.S. CLS. 21, 23, 26, 36 AND 38).

FIRST USE 10-21-2010; IN COMMERCE 10-21-2010.

FOR: PRINTED DIRECTORIES PROVIDING INFORMATION IN THE HEALTHCARE FIELDS PUBLISHED PERIODICALLY, IN CLASS 16 (U.S. CLS. 2, 5, 22, 23, 29, 37, 38 AND 50).

FIRST USE 4-0-2007; IN COMMERCE 6-0-2007.

FOR: ONLINE DIRECTORIES DIRECTED TO BUSINESS AVAILABLE VIA A GLOBAL COMPUTER NETWORK PROVIDING INFORMATION IN THE HEALTHCARE FIELDS, IN CLASS 35 (U.S. CLS. 100, 101 AND 102).

FIRST USE 4-0-2007; IN COMMERCE 6-0-2007.

NO CLAIM IS MADE TO THE EXCLUSIVE RIGHT TO USE "HEALTH DATA", APART FROM THE MARK AS SHOWN.

THE MARK CONSISTS OF THE WORDS "BILLIAN'S HEALTHDATA" AND A STYLIZED CUBE DESIGN FORMED BY A SERIES OF ALIGNED HEXAGON SHAPES.

SER. NO. 85-159,568, FILED 10-22-2010.

ADA HAN, EXAMINING ATTORNEY



David J. Kyjars

Director of the United States Patent and Trademark Office

United States of America

United States Patent and Trademark Office



Reg. No. 4,072,899

Registered Dec. 20, 2011

Int. Cls.: 9, 16 and 35

TRADEMARK

SERVICE MARK

PRINCIPAL REGISTER

BILLIAN'S PUBLISHING, INC. (GEORGIA CORPORATION)
2100 RIVEREDGE PARKWAY
ATLANTA, GA 30328

FOR: ELECTRONIC DATABASE DIRECTORIES PUBLISHED PERIODICALLY AND RECORDED ON COMPUTER MEDIA PROVIDING INFORMATION IN THE HEALTHCARE FIELDS, IN CLASS 9 (U.S. CLS. 21, 23, 26, 36 AND 38).

FIRST USE 10-21-2010; IN COMMERCE 10-21-2010.

FOR: PRINTED DIRECTORIES PROVIDING INFORMATION IN THE HEALTHCARE FIELDS PUBLISHED PERIODICALLY, IN CLASS 16 (U.S. CLS. 2, 5, 22, 23, 29, 37, 38 AND 50).

FIRST USE 4-0-2007; IN COMMERCE 6-0-2007.

FOR: ONLINE DIRECTORIES DIRECTED TO BUSINESS AVAILABLE VIA A GLOBAL COMPUTER NETWORK PROVIDING INFORMATION IN THE HEALTHCARE FIELDS, IN CLASS 35 (U.S. CLS. 100, 101 AND 102).

FIRST USE 4-0-2007; IN COMMERCE 6-0-2007.

THE MARK CONSISTS OF A STYLIZED CUBE DESIGN FORMED BY A SERIES OF ALIGNED HEXAGON SHAPES.

SER. NO. 85-159,577, FILED 10-22-2010.

ADA HAN, EXAMINING ATTORNEY



David J. Kybas

Director of the United States Patent and Trademark Office

United States of America

United States Patent and Trademark Office

tumblemonkey

Reg. No. 4,072,900

PHELAN, WILLIAM JEFFREY (UNITED STATES INDIVIDUAL)
481 EDDY ST APT 207

Registered Dec. 20, 2011

SAN FRANCISCO, CA 94109

Int. Cl.: 11

FOR: ELECTRIC LAMPS, IN CLASS 11 (U.S. CLS. 13, 21, 23, 31 AND 34).

TRADEMARK

FIRST USE 3-7-2000; IN COMMERCE 3-31-2004.

PRINCIPAL REGISTER

THE MARK CONSISTS OF STANDARD CHARACTERS WITHOUT CLAIM TO ANY PARTICULAR FONT, STYLE, SIZE, OR COLOR.

SER. NO. 85-159,605, FILED 10-22-2010.

NICHOLAS ALTREE, EXAMINING ATTORNEY



David J. Kybas

Director of the United States Patent and Trademark Office

United States of America

United States Patent and Trademark Office

PIGALLE VODKA Unforgettable like a French Kiss

Reg. No. 4,072,901

LUCIANI, JEAN-MICH (FRANCE INDIVIDUAL)
68 RUE D'AUTEUIL
PARIS, FRANCE 75016

Registered Dec. 20, 2011

Int. Cl.: 33

FOR: VODKA, IN CLASS 33 (U.S. CLS. 47 AND 49).

TRADEMARK

THE MARK CONSISTS OF STANDARD CHARACTERS WITHOUT CLAIM TO ANY PARTICULAR FONT, STYLE, SIZE, OR COLOR.

PRINCIPAL REGISTER

PRIORITY CLAIMED UNDER SEC. 44(D) ON FRANCE APPLICATION NO. 10/3755097, FILED 7-21-2010, REG. NO. 10/3755097, DATED 12-24-2010, EXPIRES 7-21-2020.

NO CLAIM IS MADE TO THE EXCLUSIVE RIGHT TO USE "PIGALLE VODKA", APART FROM THE MARK AS SHOWN.

SER. NO. 85-159,706, FILED 10-23-2010.

GENE MACIOL, EXAMINING ATTORNEY



David J. Kyffers

Director of the United States Patent and Trademark Office

United States of America

United States Patent and Trademark Office

BLOGRONOMIST

Reg. No. 4,072,902

CALCIUM PRODUCTS INCORPORATED (IOWA CORPORATION)
PO BOX 281

Registered Dec. 20, 2011

GILMORE CITY, IA 50541

Int. Cl.: 41

FOR: ON-LINE JOURNALS, NAMELY, BLOGS FEATURING AGRICULTURAL TOPICS, IN CLASS 41 (U.S. CLS. 100, 101 AND 107).

SERVICE MARK

FIRST USE 8-1-2010; IN COMMERCE 8-1-2010.

PRINCIPAL REGISTER

THE MARK CONSISTS OF STANDARD CHARACTERS WITHOUT CLAIM TO ANY PARTICULAR FONT, STYLE, SIZE, OR COLOR.

SER. NO. 85-160,203, FILED 10-25-2010.

DAVID YONTEF, EXAMINING ATTORNEY



David J. Kyffers

Director of the United States Patent and Trademark Office

United States of America

United States Patent and Trademark Office



Reg. No. 4,072,903

Registered Dec. 20, 2011

Int. Cl.: 35

SERVICE MARK

PRINCIPAL REGISTER

CITY OF BEVERLY HILLS (CALIFORNIA MUNICIPAL CORPORATION)
455 N. REXFORD DRIVE, SUITE 220
BEVERLY HILLS, CA 90210

FOR: PROMOTING BUSINESS, TOURISM, SPECIAL EVENTS FOR BUSINESS PURPOSES AND ECONOMIC DEVELOPMENT IN THE CITY OF BEVERLY HILLS; PROMOTION OF TECHNOLOGICAL, ECOLOGICAL AND ENVIRONMENTAL INITIATIVES IN THE CITY OF BEVERLY HILLS; PROMOTION OF SUSTAINABILITY AND SOCIALLY RESPONSIBLE BUSINESS PRACTICES IN THE CITY OF BEVERLY HILLS, IN CLASS 35 (U.S. CLS. 100, 101 AND 102).

FIRST USE 3-31-2010; IN COMMERCE 3-31-2010.

OWNER OF U.S. REG. NOS. 2,766,280, 2,768,789, AND 2,774,666.

NO CLAIM IS MADE TO THE EXCLUSIVE RIGHT TO USE "BEVERLY HILLS" AND "CITY", APART FROM THE MARK AS SHOWN.

THE MARK CONSISTS OF A STYLIZED SHIELD WITH SCROLLWORK ABOVE AND BELOW THE SHIELD AND THE STYLIZED WORDS "BEVERLY HILLS" CONTAINED WITHIN THE SHIELD IN VERTICAL ALIGNMENT, WITH THE STYLIZED WORDS "THE SMART CITY" LOCATED BELOW THE SHIELD.

SER. NO. 85-160,560, FILED 10-25-2010.

APRIL HESIK, EXAMINING ATTORNEY



David J. Kyffers

Director of the United States Patent and Trademark Office

United States of America

United States Patent and Trademark Office



Reg. No. 4,072,904

Registered Dec. 20, 2011

Int. Cl.: 35

SERVICE MARK

PRINCIPAL REGISTER

CITY OF BEVERLY HILLS (CALIFORNIA MUNICIPAL CORPORATION)
455 N. REXFORD DRIVE, SUITE 220
BEVERLY HILLS, CA 90210

FOR: PROMOTING BUSINESS, TOURISM, SPECIAL EVENTS FOR BUSINESS PURPOSES AND ECONOMIC DEVELOPMENT IN THE CITY OF BEVERLY HILLS; PROMOTION OF TECHNOLOGICAL, ECOLOGICAL AND ENVIRONMENTAL INITIATIVES IN THE CITY OF BEVERLY HILLS; PROMOTION OF SUSTAINABILITY AND SOCIALLY RESPONSIBLE BUSINESS PRACTICES IN THE CITY OF BEVERLY HILLS, IN CLASS 35 (U.S. CLS. 100, 101 AND 102).

FIRST USE 3-31-2010; IN COMMERCE 3-31-2010.

OWNER OF U.S. REG. NOS. 2,766,280, 2,768,789, AND 2,774,666.

NO CLAIM IS MADE TO THE EXCLUSIVE RIGHT TO USE "BEVERLY HILLS" AND "CITY", APART FROM THE MARK AS SHOWN.

THE MARK CONSISTS OF A STYLIZED SHIELD WITH SCROLLWORK ABOVE AND BELOW THE SHIELD AND THE STYLIZED WORDS "BEVERLY HILLS" CONTAINED WITHIN THE SHIELD IN VERTICAL ALIGNMENT, WITH THE STYLIZED WORDS "THE SMART CITY" LOCATED TO THE RIGHT OF THE SHIELD.

SER. NO. 85-160,576, FILED 10-25-2010.

APRIL HESIK, EXAMINING ATTORNEY



David J. Kyffers

Director of the United States Patent and Trademark Office

United States of America

United States Patent and Trademark Office

Eternal Faith

Reg. No. 4,072,905

JONATHAN M. FIELDS (UNITED STATES INDIVIDUAL), AKA J-MATTHEW
1440 CORAL RIDGE DR. SUITE 361

Registered Dec. 20, 2011

CORAL SPRINGS, FL 33071

Int. Cl.: 25

FOR: T-SHIRTS, BELTS; BELTS FOR CLOTHING; BOTTOMS; CLOTHING FOR BABIES, TODDLERS AND CHILDREN, TREATED WITH FIRE AND HEAT RETARDANTS, NAMELY, PAJAMAS, JACKETS, SHIRTS, PANTS, JUMPERS; JACKETS; JERSEYS; LEATHER BELTS; TOPS; WEARABLE GARMENTS AND CLOTHING, NAMELY, SHIRTS; WOMEN'S CLOTHING, NAMELY, SHIRTS, DRESSES, SKIRTS, BLOUSES, IN CLASS 25 (U.S. CLS. 22 AND 39).

TRADEMARK

PRINCIPAL REGISTER

FIRST USE 10-1-2010; IN COMMERCE 10-5-2010.

THE MARK CONSISTS OF THE WORDS "ETERNAL FAITH" IN AN OLD ENGLISH FONT WITH AN ORIGINAL, HAND DRAWN REPRESENTATION OF A SOUL OR SPIRIT IN BETWEEN THE TWO WORDS.

SER. NO. 85-160,919, FILED 10-26-2010.

AMY C. KEAN, EXAMINING ATTORNEY



David J. Kappas

Director of the United States Patent and Trademark Office

United States of America

United States Patent and Trademark Office

CERTICELL

Reg. No. 4,072,906

Registered Dec. 20, 2011

Int. Cls.: 9, 37 and 42

TRADEMARK

SERVICE MARK

PRINCIPAL REGISTER

CERTICELL, LLC (PENNSYLVANIA LIMITED LIABILITY COMPANY)
216 CENTERVIEW DRIVE
BRENTWOOD, TN 37027

FOR: REFURBISHED AND RECLAIMED WIRELESS DEVICES, MOBILE HANDSETS AND OTHER HANDHELD ELECTRONIC DEVICES, NAMELY, WIRELESS POS DEVICES, HANDHELD DIGITAL ELECTRONIC DEVICES FOR RECORDING, ORGANIZING, TRANSMITTING, MANIPULATING, AND REVIEWING TEXT, DATA, IMAGE, AND AUDIO FILES; DIGITAL MOBILE DEVICES, NAMELY, PERSONAL DIGITAL ASSISTANT COMPUTERS; MOBILE PHONES; PDA'S; SMART PHONES, NAMELY, TELEPHONES WITH THE CAPABILITY TO ELECTRONICALLY TRANSMIT DATA, VOICE CONTENT AND IMAGES, THE CAPABILITY TO ACCESS THE INTERNET, THE CAPABILITY TO ELECTRONICALLY SEND AND RECEIVE FAXES, AND THE CAPABILITY TO SEND AND RECEIVE ELECTRONIC MAIL MESSAGES; MOBILE TELEPHONE HANDSETS; WIRELESS DEVICES AND OTHER HANDHELD ELECTRONIC DEVICES, NAMELY, WIRELESS POS DEVICES; HANDHELD DIGITAL ELECTRONIC DEVICES FOR RECORDING, ORGANIZING, TRANSMITTING, MANIPULATING, AND REVIEWING TEXT, DATA, IMAGE, AND AUDIO FILES, IN CLASS 9 (U.S. CLS. 21, 23, 26, 36 AND 38).

FIRST USE 1-0-2006; IN COMMERCE 1-0-2006.

FOR: BATTERY REPAIR; LCD REPAIR; REPAIR OF MOBILE HANDSETS, IN CLASS 37 (U.S. CLS. 100, 103 AND 106).

FIRST USE 1-0-2006; IN COMMERCE 1-0-2006.

FOR: BATTERY TESTING; TESTING OF MOBILE HANDSETS, IN CLASS 42 (U.S. CLS. 100 AND 101).

FIRST USE 1-0-2006; IN COMMERCE 1-0-2006.

THE MARK CONSISTS OF STANDARD CHARACTERS WITHOUT CLAIM TO ANY PARTICULAR FONT, STYLE, SIZE, OR COLOR.

OWNER OF U.S. REG. NO. 3,642,699.

SER. NO. 85-160,946, FILED 10-26-2010.



David J. Kyffers

Director of the United States Patent and Trademark Office

Reg. No. 4,072,906 HEATHER THOMPSON, EXAMINING ATTORNEY

United States of America

United States Patent and Trademark Office



Reg. No. 4,072,907

Registered Dec. 20, 2011

Int. Cl.: 41

SERVICE MARK

PRINCIPAL REGISTER

NATIONAL ASSOCIATION OF CHEMICAL DISTRIBUTORS (ILLINOIS NON-PROFIT CORPORATION)
CORPORATION)
SUITE 700
1555 WILSON BLVD.
ARLINGTON, VA 22209

FOR: EDUCATION AND TRAINING SERVICES, NAMELY, PROVIDING SEMINARS, ONE-ON-ONE TRAINING, WORKSHOPS, WEBINARS AND ONLINE COURSES PRIMARILY IN THE FIELD OF SAFE HANDLING AND DISTRIBUTION OF CHEMICALS, IN CLASS 41 (U.S. CLS. 100, 101 AND 107).

FIRST USE 8-18-2010; IN COMMERCE 8-18-2010.

OWNER OF U.S. REG. NOS. 1,760,464 AND 3,356,826.

NO CLAIM IS MADE TO THE EXCLUSIVE RIGHT TO USE "RESPONSIBLE DISTRIBUTION", APART FROM THE MARK AS SHOWN.

THE MARK CONSISTS OF A DESIGN ELEMENT COMPRISED OF THREE CONCENTRIC CIRCLES, WITH THE STYLIZED LETTERING "NACD" AND A STYLIZED DEPICTION OF A MOLECULE SET IN THE INNER-MOST CIRCLE AND THE STYLIZED WORDING "RESPONSIBLE DISTRIBUTION" SET IN THE SECOND-INNERMOST CIRCLE.

SER. NO. 85-160,962, FILED 10-26-2010.

MICHAEL GAAFAR, EXAMINING ATTORNEY



David J. Kyffers

Director of the United States Patent and Trademark Office

United States of America

United States Patent and Trademark Office



Reg. No. 4,072,908

Registered Dec. 20, 2011

Int. Cls.: 9 and 42

TRADEMARK

SERVICE MARK

PRINCIPAL REGISTER

NET-O2 TECHNOLOGIES INC. (DELAWARE CORPORATION)
16 WEST MAIN
CHRISTIANA, DE 19702

FOR: COMPUTER HARDWARE AND SOFTWARE SOLD AS A UNIT FOR TESTING OF EMBEDDED COMPUTER SYSTEMS, IN CLASS 9 (U.S. CLS. 21, 23, 26, 36 AND 38).

FIRST USE 12-1-2010; IN COMMERCE 12-1-2010.

FOR: COMPUTER SERVICES, NAMELY, INTEGRATION OF COMPUTER SOFTWARE INTO MULTIPLE SYSTEMS AND NETWORKS, IN CLASS 42 (U.S. CLS. 100 AND 101).

FIRST USE 12-1-2010; IN COMMERCE 12-1-2010.

THE MARK CONSISTS OF THE WORD VERYX WITH THE LETTER V REPRESENTED AS A "TICK MARK" IMAGE IN RED AND THE DISCRETE LETTERS "ERYX" IN BLACK AND NOT CAPITALIZED.

THE COLOR(S) RED AND BLACK IS/ARE CLAIMED AS A FEATURE OF THE MARK.

SER. NO. 85-161,003, FILED 10-26-2010.

MICHAEL ENGEL, EXAMINING ATTORNEY



David J. Kybas

Director of the United States Patent and Trademark Office

United States of America

United States Patent and Trademark Office

AQUAMATCH

Reg. No. 4,072,909

Registered Dec. 20, 2011

Int. Cls.: 3 and 5

TRADEMARK

PRINCIPAL REGISTER

PANGAEA LABORATORIES LIMITED (UNITED KINGDOM CORPORATION)
58 CREWYS ROAD
LONDON, UNITED KINGDOM NW22AD

FOR: ADHESIVES FOR AFFIXING FALSE HAIR; COLORING PREPARATIONS FOR COSMETIC PURPOSES; COSMETIC HAIR DRESSING PREPARATIONS; COSMETIC PREPARATIONS; COSMETIC PREPARATIONS FOR EYE LASHES; COSMETIC PREPARATIONS FOR SKIN CARE; COSMETIC PREPARATIONS FOR THE HAIR AND SCALP; COSMETICS AND MAKE-UP; EYE MAKE-UP; HAIR CARE KITS COMPRISING NON-MEDICATED HAIR CARE PREPARATIONS, NAMELY, HAIR AND SCALP CAMOUFLAGE, COLOURED COSMETIC PENCILS, SHARPENER, POUCH AND CASE; HAIR COLORING PREPARATIONS; HAIR COLOURING PREPARATIONS; MAKE-UP FOUNDATIONS; MAKE-UP PENCILS; MAKE-UP POWDER; MAKE-UP PREPARATIONS; MAKE-UP PREPARATIONS FOR THE FACE AND BODY; NON-MEDICATED HAIR TREATMENT PREPARATIONS FOR COSMETIC PURPOSES, IN CLASS 3 (U.S. CLS. 1, 4, 6, 50, 51 AND 52).

FOR: MEDICATED DERMATOLOGICAL PREPARATIONS AND SUBSTANCES; MEDICATED HAIR CARE PREPARATIONS; MEDICATED MAKE-UP; MEDICATED SKIN CARE PREPARATIONS; MEDICINAL PREPARATIONS FOR STIMULATING HAIR GROWTH; PHARMACEUTICAL PREPARATIONS FOR SKIN CARE, IN CLASS 5 (U.S. CLS. 6, 18, 44, 46, 51 AND 52).

THE MARK CONSISTS OF STANDARD CHARACTERS WITHOUT CLAIM TO ANY PARTICULAR FONT, STYLE, SIZE, OR COLOR.

PRIORITY CLAIMED UNDER SEC. 44(D) ON ERPN CMNTY TM OFC APPLICATION NO. 009139271, FILED 5-28-2010, REG. NO. 009139271, DATED 7-1-2011, EXPIRES 5-28-2020.

SER. NO. 85-161,400, FILED 10-26-2010.

JOHN DALIER, EXAMINING ATTORNEY



David J. Kypos

Director of the United States Patent and Trademark Office

United States of America

United States Patent and Trademark Office

STAYUP

Reg. No. 4,072,910

Registered Dec. 20, 2011

Int. Cl.: 7

TRADEMARK

PRINCIPAL REGISTER

BURLEN FUEL SYSTEMS LIMITED (UNITED KINGDOM LIMITED CORPORATION)
SPITFIRE HOUSE, CASTLE ROAD
SALISBURY, WILTSHIRE, UNITED KINGDOM SP13SA

FOR: CARBURETTORS AND PARTS AND FITTINGS THEREFOR, IN CLASS 7 (U.S. CLS. 13, 19, 21, 23, 31, 34 AND 35).

THE MARK CONSISTS OF STANDARD CHARACTERS WITHOUT CLAIM TO ANY PARTICULAR FONT, STYLE, SIZE, OR COLOR.

OWNER OF UNITED KINGDOM REG. NO. 008618969, DATED 3-16-2010, EXPIRES 10-15-2019.

SER. NO. 85-161,467, FILED 10-26-2010.

GEOFFREY FOSDICK, EXAMINING ATTORNEY



David J. Kybas

Director of the United States Patent and Trademark Office

United States of America

United States Patent and Trademark Office



Reg. No. 4,072,911

TEG STAFFING, INC. (CALIFORNIA CORPORATION)
2355 NORTHSIDE DRIVE, SUITE 180
SAN DIEGO, CA 92109

Registered Dec. 20, 2011

Int. Cl.: 35

FOR: EMPLOYMENT HIRING, RECRUITING, PLACEMENT, STAFFING AND CAREER NETWORKING SERVICES FOR NON-EXECUTIVES, NAMELY, TECHNICIANS, ADMINISTRATORS, MANAGERS, ANALYSTS, PROCUREMENT, FINANCE AND ACCOUNTING, ENGINEERS AND SCIENTISTS, IN CLASS 35 (U.S. CLS. 100, 101 AND 102).

SERVICE MARK

PRINCIPAL REGISTER

FIRST USE 10-12-2010; IN COMMERCE 10-12-2010.

NO CLAIM IS MADE TO THE EXCLUSIVE RIGHT TO USE "TALENT STAFFING", APART FROM THE MARK AS SHOWN.

THE MARK CONSISTS OF A CURVED ARROW POINT TO THE RIGHT AND A LINE DIVIDING THE ARROW AND THE WORDING "GREEN TALENT STAFFING" WITHIN A RECTANGULAR CARRIER.

SER. NO. 85-161,691, FILED 10-26-2010.

SALLY SHIH, EXAMINING ATTORNEY



David J. Kybas

Director of the United States Patent and Trademark Office

United States of America

United States Patent and Trademark Office

Vrail

Reg. No. 4,072,912

INTENSE LIGHTING, LLC (CALIFORNIA LIMITED LIABILITY COMPANY)
2861 E. LA PALMA AVE.
ANAHEIM, CA 92806

Registered Dec. 20, 2011

Int. Cl.: 6

FOR: LED ILLUMINATED RAILS, NAMELY, STAINLESS STEEL HAND OR GUARDRAILS WITH ATTACHED LEDS; STEEL OR ALUMINUM RAILS WITH ATTACHED LEDS , IN CLASS 6 (U.S. CLS. 2, 12, 13, 14, 23, 25 AND 50).

TRADEMARK

FIRST USE 3-15-2010; IN COMMERCE 3-15-2010.

PRINCIPAL REGISTER

THE MARK CONSISTS OF STANDARD CHARACTERS WITHOUT CLAIM TO ANY PARTICULAR FONT, STYLE, SIZE, OR COLOR.

SER. NO. 85-161,731, FILED 10-26-2010.

BRIAN PINO, EXAMINING ATTORNEY



David J. Kybas

Director of the United States Patent and Trademark Office

United States of America

United States Patent and Trademark Office

BANK OF SAN FRANCISCO

Reg. No. 4,072,913

BANK OF SAN FRANCISCO (CALIFORNIA CORPORATION)
575 MARKET STREET, SUITE 2400
SAN FRANCISCO, CA 94105

Registered Dec. 20, 2011

Int. Cl.: 36

FOR: BANKING SERVICES; ONLINE BANKING SERVICES, IN CLASS 36 (U.S. CLS. 100, 101 AND 102).

SERVICE MARK

FIRST USE 8-15-2005; IN COMMERCE 8-15-2005.

PRINCIPAL REGISTER

THE MARK CONSISTS OF STANDARD CHARACTERS WITHOUT CLAIM TO ANY PARTICULAR FONT, STYLE, SIZE, OR COLOR.

NO CLAIM IS MADE TO THE EXCLUSIVE RIGHT TO USE "BANK", APART FROM THE MARK AS SHOWN.

SEC. 2(F).

SER. NO. 85-161,732, FILED 10-26-2010.

RICHARD WHITE, EXAMINING ATTORNEY



David J. Kybas

Director of the United States Patent and Trademark Office

United States of America

United States Patent and Trademark Office

MAGNA CONSULT

Reg. No. 4,072,914

MOLINA, JOSE (VENEZUELA INDIVIDUAL)
8200 NW 52ND TERR SUITE 110
MIAMI, FL 33166

Registered Dec. 20, 2011

Int. Cl.: 35

FOR: ADVERTISING AND BUSINESS MANAGEMENT CONSULTANCY, IN CLASS 35 (U.S. CLS. 100, 101 AND 102).

SERVICE MARK

FIRST USE 7-15-2005; IN COMMERCE 7-31-2005.

PRINCIPAL REGISTER

THE MARK CONSISTS OF STANDARD CHARACTERS WITHOUT CLAIM TO ANY PARTICULAR FONT, STYLE, SIZE, OR COLOR.

NO CLAIM IS MADE TO THE EXCLUSIVE RIGHT TO USE "CONSULT", APART FROM THE MARK AS SHOWN.

SER. NO. 85-161,985, FILED 10-27-2010.

CHRIS WELLS, EXAMINING ATTORNEY



David J. Kybas

Director of the United States Patent and Trademark Office

United States of America

United States Patent and Trademark Office



Reg. No. 4,072,915

Registered Dec. 20, 2011

Int. Cl.: 41

SERVICE MARK

PRINCIPAL REGISTER

CONFLICT KINETICS, LLC (INDIANA LIMITED LIABILITY COMPANY)
1000 EAST 80TH PLACE, SUITE 415N
MERRILLVILLE, IN 46140

FOR: TRAINING SERVICES IN THE FIELD OF MILITARY WARFARE, LAW ENFORCEMENT, MARKSMANSHIP, FIREARMS, SHOOTER ENHANCEMENT, PHYSICAL TRAINING, MENTAL TRAINING, OCULAR TRAINING, WEAPONRY AND SITUATIONAL AWARENESS, IN CLASS 41 (U.S. CLS. 100, 101 AND 107).

FIRST USE 12-31-2008; IN COMMERCE 12-31-2008.

NO CLAIM IS MADE TO THE EXCLUSIVE RIGHT TO USE "CONFLICT", APART FROM THE MARK AS SHOWN.

THE MARK CONSISTS OF THE WORDS "CONFLICT KINETICS" AND A STYLIZED DESIGN OF THE LETTERS "CK", WITH A DESIGN IN THE NATURE OF A TARGET WITH CROSSHAIRS INSIDE THE LETTER "C".

SER. NO. 85-162,060, FILED 10-27-2010.

RICHARD WHITE, EXAMINING ATTORNEY



David J. Kypos

Director of the United States Patent and Trademark Office

United States of America

United States Patent and Trademark Office

AMERICA'S HOME SECURITY EXPERTS

Reg. No. 4,072,916

PROTECT AMERICA, INC. (TEXAS CORPORATION)
5100 NORTH IH 35, SUITE B
ROUND ROCK, TX 78681

Registered Dec. 20, 2011

Int. Cl.: 37

FOR: INSTALLATION, MAINTENANCE, AND REPAIR OF HOME AND COMMERCIAL SECURITY AND ALARM SERVICES, IN CLASS 37 (U.S. CLS. 100, 103 AND 106).

SERVICE MARK

FIRST USE 12-31-1998; IN COMMERCE 12-31-1998.

PRINCIPAL REGISTER

THE MARK CONSISTS OF STANDARD CHARACTERS WITHOUT CLAIM TO ANY PARTICULAR FONT, STYLE, SIZE, OR COLOR.

NO CLAIM IS MADE TO THE EXCLUSIVE RIGHT TO USE "HOME SECURITY", APART FROM THE MARK AS SHOWN.

SEC. 2(F) AS TO "AMERICA" AND "EXPERTS".

SER. NO. 85-162,139, FILED 10-27-2010.

WILLIAM ROSSMAN, EXAMINING ATTORNEY



David J. Kyfos

Director of the United States Patent and Trademark Office

United States of America

United States Patent and Trademark Office

AMERICA'S HOME SECURITY EXPERTS

Reg. No. 4,072,917

PROTECT AMERICA, INC. (TEXAS CORPORATION)
5100 NORTH IH 35, SUITE B
ROUND ROCK, TX 78681

Registered Dec. 20, 2011

Int. Cl.: 45

FOR: MONITORING HOME AND COMMERCIAL SECURITY AND ALARM SERVICES, IN CLASS 45 (U.S. CLS. 100 AND 101).

SERVICE MARK

FIRST USE 12-31-1998; IN COMMERCE 12-31-1998.

PRINCIPAL REGISTER

THE MARK CONSISTS OF STANDARD CHARACTERS WITHOUT CLAIM TO ANY PARTICULAR FONT, STYLE, SIZE, OR COLOR.

NO CLAIM IS MADE TO THE EXCLUSIVE RIGHT TO USE "HOME SECURITY", APART FROM THE MARK AS SHOWN.

SEC. 2(F) AS TO "AMERICA" AND "EXPERTS".

SER. NO. 85-162,144, FILED 10-27-2010.

WILLIAM ROSSMAN, EXAMINING ATTORNEY



David J. Kyffers

Director of the United States Patent and Trademark Office

United States of America

United States Patent and Trademark Office

ONE MAN

Reg. No. 4,072,918

MAYER, SCOTT LEE (UNITED STATES INDIVIDUAL)
1128 HARMON PLACE, #305
MINNEAPOLIS, MN 55403

Registered Dec. 20, 2011

Int. Cl.: 41

FOR: ENTERTAINMENT SERVICES IN THE NATURE OF EVENTS AND CONTESTS FOR MEN TO DEMONSTRATE EXCELLENCE IN THE FIELD OF COMMUNITY INVOLVEMENT, PERSONALITY, INTELLIGENCE, FITNESS AND OTHER ATTRIBUTES, IN CLASS 41 (U.S. CLS. 100, 101 AND 107).

SERVICE MARK

PRINCIPAL REGISTER

FIRST USE 11-26-2008; IN COMMERCE 11-26-2008.

THE MARK CONSISTS OF STANDARD CHARACTERS WITHOUT CLAIM TO ANY PARTICULAR FONT, STYLE, SIZE, OR COLOR.

SER. NO. 85-162,639, FILED 10-27-2010.

LEIGH CAROLINE CASE, EXAMINING ATTORNEY



David J. Kyffers

Director of the United States Patent and Trademark Office

United States of America
United States Patent and Trademark Office

FLORIDA
SOUTHERN
COLLEGE

Reg. No. 4,072,919

Registered Dec. 20, 2011

Int. Cls.: 25 and 41

TRADEMARK

SERVICE MARK

PRINCIPAL REGISTER

FLORIDA SOUTHERN COLLEGE (FLORIDA NON-PROFIT CORPORATION)
111 LAKE HOLLINGSWORTH DRIVE
LAKELAND, FL 33801

FOR: SHIRTS, IN CLASS 25 (U.S. CLS. 22 AND 39).

FIRST USE 9-1-2001; IN COMMERCE 9-1-2001.

FOR: EDUCATION SERVICES, NAMELY, PROVIDING CLASSES, SEMINARS AND WORKSHOPS IN THE FIELDS OF ART, ECONOMICS, HISTORY, MATHEMATICS, MUSIC AND SCIENCE; EDUCATIONAL SERVICES, NAMELY, PROVIDING COURSES OF INSTRUCTION AT THE COLLEGE LEVEL; ENTERTAINMENT IN THE NATURE OF COMPETITIONS IN THE FIELD OF ATHLETICS; ENTERTAINMENT IN THE NATURE OF BASEBALL, BASKETBALL, CROSS COUNTRY, GOLF, SOCCER, SOFTBALL, TENNIS AND VOLLEYBALL GAMES; ENTERTAINMENT, NAMELY, LIVE MUSIC CONCERTS; ORGANIZING EXHIBITIONS FOR ART, HISTORY, MUSIC, AND SCIENCE FOR EDUCATIONAL PURPOSES, IN CLASS 41 (U.S. CLS. 100, 101 AND 107).

FIRST USE 9-1-2001; IN COMMERCE 9-1-2001.

NO CLAIM IS MADE TO THE EXCLUSIVE RIGHT TO USE "COLLEGE", APART FROM THE MARK AS SHOWN.

THE MARK CONSISTS OF THE WORD "FLORIDA" OVER THE WORD "SOUTHERN" OVER THE WORD "COLLEGE". ALL OF THE LETTERS ARE IN STYLIZED FORM, AND THE WORDING "FLORIDA SOUTHERN" IS IN LARGER FONT THAN THE WORD "COLLEGE".

SEC. 2(F).

SER. NO. 85-162,660, FILED 10-27-2010.

NANCY CLARKE, EXAMINING ATTORNEY



David J. Kybas

Director of the United States Patent and Trademark Office

United States of America
United States Patent and Trademark Office

MYcroarray

Reg. No. 4,072,920

BIODISCOVERY-LLC (MICHIGAN LIMITED LIABILITY COMPANY)
5692 PLYMOUTH RD

Registered Dec. 20, 2011

ANN ARBOR, MI 48105

Int. Cl.: 1

FOR: REAGENTS FOR SCIENTIFIC OR MEDICAL RESEARCH USE, IN CLASS 1 (U.S. CLS. 1, 5, 6, 10, 26 AND 46).

TRADEMARK

FIRST USE 3-13-2008; IN COMMERCE 3-13-2008.

PRINCIPAL REGISTER

THE MARK CONSISTS OF STANDARD CHARACTERS WITHOUT CLAIM TO ANY PARTICULAR FONT, STYLE, SIZE, OR COLOR.

SER. NO. 85-162,684, FILED 10-27-2010.

ARETHA SOMERVILLE, EXAMINING ATTORNEY



David J. Kyjars

Director of the United States Patent and Trademark Office

United States of America

United States Patent and Trademark Office

Red Fish Toys

Reg. No. 4,072,921

DENER ELCI SEYDA (NEW YORK SOLE PROPRIETORSHIP), DBA PERA
315 BAYVILLE AVENUE
BAYVILLE, NY 11709

Registered Dec. 20, 2011

Int. Cl.: 28

FOR: EDUCATIONAL TOYS FOR TEACHING MATH PRINCIPLES TO CHILDREN, NAMELY, MANIPULATIVE BLOCKS FOR DISPLAYING PATTERNS AND GROUPINGS; JIGSAW AND MANIPULATIVE PUZZLES; POSITIONABLE PRINTED TOY FIGURES FOR USE IN PUZZLES; POSITIONABLE WOODEN AND PLASTIC FIGURES FOR USE IN WOODEN AND PLASTIC PUZZLES; PUZZLES; PUZZLES; STACKING TOYS; TOY AIRPLANES; TOY ANIMALS; TOY BOATS; TOY BUILDING BLOCKS; TOY BUILDING BLOCKS CAPABLE OF INTERCONNECTION; TOY BUILDINGS AND ACCESSORIES THEREFOR; TOY CARS; TOY MODEL HOBBY CRAFT KITS FOR CONSTRUCTING TOY MODEL LANDSCAPES, SCENERY, AND ACTION FIGURES; TOY VEHICLES, IN CLASS 28 (U.S. CLS. 22, 23, 38 AND 50).

TRADEMARK

PRINCIPAL REGISTER

FIRST USE 10-9-2010; IN COMMERCE 10-9-2010.

THE MARK CONSISTS OF STANDARD CHARACTERS WITHOUT CLAIM TO ANY PARTICULAR FONT, STYLE, SIZE, OR COLOR.

NO CLAIM IS MADE TO THE EXCLUSIVE RIGHT TO USE "TOYS", APART FROM THE MARK AS SHOWN.

SER. NO. 85-163,647, FILED 10-28-2010.

KELLY TRUSILO, EXAMINING ATTORNEY



David J. Kyros

Director of the United States Patent and Trademark Office

United States of America

United States Patent and Trademark Office

ZonePlay

Reg. No. 4,072,922

Registered Dec. 20, 2011

Int. Cl.: 41

SERVICE MARK

PRINCIPAL REGISTER

BUZZSPORTS LIMITED (UNITED KINGDOM LIMITED COMPANY (LTD.))
GRANDBY HOUSE, 7 OTLEY ROAD
LEEDS, WEST YORKSHIRE, UNITED KINGDOM LS63AA

FOR: SPORTS BETTING SERVICES, PROVISION OF BETTING SERVICES DURING LIVE SPORTS EVENTS, REAL-TIME SPORTS BETTING SERVICES; IN-PLAY SPORTS BETTING SERVICES, IN CLASS 41 (U.S. CLS. 100, 101 AND 107).

THE MARK CONSISTS OF STANDARD CHARACTERS WITHOUT CLAIM TO ANY PARTICULAR FONT, STYLE, SIZE, OR COLOR.

PRIORITY CLAIMED UNDER SEC. 44(D) ON ERPN CMNTY TM OFC APPLICATION NO. 009423039, FILED 10-5-2010, REG. NO. 009423039, DATED 3-14-2011, EXPIRES 10-5-2020.

SER. NO. 85-163,898, FILED 10-28-2010.

KATHRYN COWARD, EXAMINING ATTORNEY



David J. Kyros

Director of the United States Patent and Trademark Office

United States of America

United States Patent and Trademark Office

1Z COAT

Reg. No. 4,072,923

PAWZ DOG BOOTS, LLC (NEW YORK LIMITED LIABILITY COMPANY)
209 11TH STREET
NEW YORK, NY 11215

Registered Dec. 20, 2011

Int. Cl.: 18

FOR: DOG APPAREL, IN CLASS 18 (U.S. CLS. 1, 2, 3, 22 AND 41).

TRADEMARK

FIRST USE 10-23-2009; IN COMMERCE 10-23-2009.

PRINCIPAL REGISTER

THE MARK CONSISTS OF STANDARD CHARACTERS WITHOUT CLAIM TO ANY PARTICULAR FONT, STYLE, SIZE, OR COLOR.

OWNER OF U.S. REG. NO. 3,894,874.

NO CLAIM IS MADE TO THE EXCLUSIVE RIGHT TO USE "COAT", APART FROM THE MARK AS SHOWN.

SER. NO. 85-163,914, FILED 10-28-2010.

ELI HELLMAN, EXAMINING ATTORNEY



David J. Kyffers

Director of the United States Patent and Trademark Office

United States of America

United States Patent and Trademark Office

TAKOREAN

Reg. No. 4,072,924

Registered Dec. 20, 2011

Int. Cl.: 35

SERVICE MARK

PRINCIPAL REGISTER

DC STREET FOOD, INC. (DELAWARE CORPORATION)
#202
1427 CHAPIN ST. NW
WASHINGTON, DC 20009

FOR: MOBILE FOOD TRUCK SERVICES, NAMELY, MOBILE VENDING IN THE FIELD OF FOOD AND DRINK; MOBILE STREET VENDOR SERVICES FEATURING FOOD AND DRINK, IN CLASS 35 (U.S. CLS. 100, 101 AND 102).

FIRST USE 9-0-2010; IN COMMERCE 9-0-2010.

THE MARK CONSISTS OF STANDARD CHARACTERS WITHOUT CLAIM TO ANY PARTICULAR FONT, STYLE, SIZE, OR COLOR.

SER. NO. 85-163,976, FILED 10-28-2010.

MARK PILARO, EXAMINING ATTORNEY



David J. Kyffers

Director of the United States Patent and Trademark Office

United States of America

United States Patent and Trademark Office



Reg. No. 4,072,925

Registered Dec. 20, 2011

Int. Cl.: 42

SERVICE MARK

PRINCIPAL REGISTER

SOL-NEST LLC (IDAHO LIMITED LIABILITY COMPANY)
5306 W. STATE STREET #103
BOISE, ID 83703

FOR: RESIDENTIAL BUILDING DESIGN, IN CLASS 42 (U.S. CLS. 100 AND 101).

FIRST USE 12-4-2008; IN COMMERCE 3-1-2010.

THE MARK CONSISTS OF AN OUTLINED HALF CIRCLE REPRESENTING A STYLIZED SUN SURROUNDING A DOUBLE SHED ROOF HOUSE WITH PROMINENT WINDOWS, CENTERED ABOVE THE NAME "SOL-NEST".

SER. NO. 85-164,232, FILED 10-28-2010.

BRIDGETT SMITH, EXAMINING ATTORNEY



David J. Kybas

Director of the United States Patent and Trademark Office

United States of America

United States Patent and Trademark Office

OXYGEN PUR 

Reg. No. 4,072,926

Registered Dec. 20, 2011

Int. Cl.: 3

TRADEMARK

PRINCIPAL REGISTER

INVENTURES TECHNOLOGIES INCORPORATED (CANADA CORPORATION)
2177 OAKMEAD BOULEVARD
OAKVILLE, ONTARIO, CANADA L6H5N4

FOR: SKIN CONDITIONERS, IN CLASS 3 (U.S. CLS. 1, 4, 6, 50, 51 AND 52).

FIRST USE 7-1-2010; IN COMMERCE 7-1-2010.

NO CLAIM IS MADE TO THE EXCLUSIVE RIGHT TO USE "OXYGEN" AND THE SYMBOL "O₂", APART FROM THE MARK AS SHOWN.

THE MARK CONSISTS OF "OXYGEN PUR" WITH A STYLIZED "O" WITH A SUBSCRIPT "2".

SER. NO. 85-164,457, FILED 10-29-2010.

HENRY S. ZAK, EXAMINING ATTORNEY



David J. Kyffers

Director of the United States Patent and Trademark Office

United States of America

United States Patent and Trademark Office

OXYGEN PÜR  Spa

Reg. No. 4,072,927

INVENTURES TECHNOLOGIES INCORPORATED (CANADA CORPORATION)
2177 OAKMEAD BOULEVARD
OAKVILLE, ONTARIO, CANADA L6H5N4

Registered Dec. 20, 2011

Int. Cl.: 11

FOR: INFUSION APPARATUS FOR PLACING OXYGEN INTO A BATHTUB, SPA OR HOT TUB, IN CLASS 11 (U.S. CLS. 13, 21, 23, 31 AND 34).

TRADEMARK

FIRST USE 10-12-2010; IN COMMERCE 10-12-2010.

PRINCIPAL REGISTER

NO CLAIM IS MADE TO THE EXCLUSIVE RIGHT TO USE "OXYGEN", "SPA" AND THE SYMBOL "O₂", APART FROM THE MARK AS SHOWN.

THE MARK CONSISTS OF "OXYGEN PUR SPA" WITH A STYLIZED "O" WITH A SUBSCRIPT "2".

SER. NO. 85-164,514, FILED 10-29-2010.

HENRY S. ZAK, EXAMINING ATTORNEY



David J. Kybas

Director of the United States Patent and Trademark Office

United States of America

United States Patent and Trademark Office

Fon-B-Gon

Reg. No. 4,072,928

THE CBE GROUP, INC. (IOWA CORPORATION)
1309 TECHNOLOGY PARKWAY
CEDAR FALLS, IA 50613

Registered Dec. 20, 2011

Int. Cl.: 36

FOR: DEBT COLLECTION, IN CLASS 36 (U.S. CLS. 100, 101 AND 102).

SERVICE MARK

FIRST USE 8-1-2009; IN COMMERCE 8-1-2009.

PRINCIPAL REGISTER

THE MARK CONSISTS OF STANDARD CHARACTERS WITHOUT CLAIM TO ANY PARTICULAR FONT, STYLE, SIZE, OR COLOR.

SER. NO. 85-164,574, FILED 10-29-2010.

NAAKWAMA ANKRAH, EXAMINING ATTORNEY



David J. Kyffers

Director of the United States Patent and Trademark Office

United States of America

United States Patent and Trademark Office

TERESA'S SELECT RECIPES

Reg. No. 4,072,929

Registered Dec. 20, 2011

Int. Cl.: 30

TRADEMARK

PRINCIPAL REGISTER

T. MARZETTI COMPANY (OHIO CORPORATION)
1105 SCHROCK ROAD
COLUMBUS, OH 43229

FOR: SALAD DRESSING, IN CLASS 30 (U.S. CL. 46).

FIRST USE 12-0-2005; IN COMMERCE 12-0-2005.

THE MARK CONSISTS OF STANDARD CHARACTERS WITHOUT CLAIM TO ANY PARTICULAR FONT, STYLE, SIZE, OR COLOR.

NO CLAIM IS MADE TO THE EXCLUSIVE RIGHT TO USE "RECIPES", APART FROM THE MARK AS SHOWN.

SER. NO. 85-164,690, FILED 10-29-2010.

SANJEEV VOHRA, EXAMINING ATTORNEY



David J. Kyffers

Director of the United States Patent and Trademark Office

United States of America

United States Patent and Trademark Office

CATHERINE DENEUVE

Reg. No. 4,072,930

Registered Dec. 20, 2011

Int. Cls.: 3 and 9

TRADEMARK

PRINCIPAL REGISTER

CATHERINE DENEUVE (FRANCE INDIVIDUAL)
DOMICILATED AT SOCIÉTÉ DENEUVE SARL
39 RUE DE LA RÉPUBLIQUE
95740 FREPILLON, FRANCE

FOR: (BASED ON 44(E)) PERFUMES; BLEACHING PREPARATIONS AND DETERGENTS FOR LAUNDRY USE; SOAPS; PERFUMERY, ESSENTIAL OILS, COSMETICS, HAIR LOTIONS; DENTIFRICES; ALMOND MILK FOR COSMETIC PURPOSES; ALMOND SOAP; AMBER PERFUME; BEAUTY MASKS; DECORATIVE TRANSFERS FOR COSMETIC PURPOSES; COSMETIC SETS COMPRISED OF COMPACTS AND MAKE UP; COSMETIC CREAMS; LAVENDER WATER FOR COSMETIC PURPOSES; SCENTED LINEN WATER; TOILET WATERS; EXTRACTS OF FLOWERS FOR PERFUMES; BASES OF EXTRACTS FOR FLOWER PERFUMES; MAKE-UP PREPARATIONS; MASCARA; PERFUMES; LIPSTICKS; BARS OF SOAP; TOILET PREPARATIONS IN THE NATURE OF TOILET SOAP, TOILET WATERS, SOAPS FOR TOILET PURPOSES; SHAVING PREPARATIONS, IN CLASS 3 (U.S. CLS. 1, 4, 6, 50, 51 AND 52).

FOR: (BASED ON USE IN COMMERCE) EYE GLASSES; SPECTACLES; (BASED ON 44(E)) SOUND AND VIDEO RECORDINGS FEATURING MUSIC; COMPACT DISCS FEATURING MUSIC; PRE-RECORDED DIGITAL VIDEO DISCS FEATURING MUSIC; CDROMS FEATURING MUSIC; BLANK CD-ROMS; BLANK RECORDABLE DVDS; DVDS FEATURING MOTION PICTURE FILMS; RECORDED SOFTWARE FOR USE IN DATABASE MANAGEMENT; RECORDED COMPUTER PROGRAMMES FOR USE IN DATABASE MANAGEMENT; COMPUTER PROGRAMS DOWNLOADABLE SOFTWARE FOR USE IN DATABASE MANAGEMENT; COMPUTER MEMORIES HARDWARE; PERIPHERALS FOR COMPUTERS; COMPUTERS; COMPUTER SOFTWARE PACKAGES FOR USE IN DATABASE MANAGEMENT; BLANK MAGNETIC DATA CARRIERS; PRERECORDED MAGNETIC DATA CARRIERS FEATURING MOTION PICTURE FILMS; BLANK INTERACTIVE MAGNETIC RECORDING DATA CARRIERS; PRERECORDED INTERACTIVE MAGNETIC RECORDING DATA CARRIERS FEATURING MOTION PICTURE FILMS; AUDIOVISUAL GAMES AND APPARATUS FOR ENTERTAINMENT AND EDUCATION IN THE NATURE OF VIDEO GAME MACHINES, ADAPTED FOR USE WITH TELEVISION RECEIVERS ONLY; FILM PROJECTION APPARATUS, NAMELY, MOVIE PROJECTORS; GRAMOPHONE RECORDS; AUDIO TAPES, VIDEO CASSETTES, LASER DISCS AND OPTICAL DISCS FEATURING MUSIC; INTERACTIVE MULTIMEDIA SOFTWARE PROGRAMS FEATURING MUSIC; HOLOGRAMS APPARATUS; PHOTOGRAPHIC TRANSPARENCIES; VIDEO CAMERAS, NAMELY, CINEMATOGRAPHIC CAMERAS; OPTICS SPECTACLES; OPTICAL GOODS,



David J. Kybas

Director of the United States Patent and Trademark Office

Reg. No. 4,072,930 NAMELY, SUNGLASSES, OPHTHALMIC FRAMES, CASES AND RELATED ACCESSORIES IN THE NATURE OF EYE GLASS CHAINS, EYE GLASS CHORDS, SPECTACLE HOLDERS; MOBILE PHONE; TELEVISION APPARATUS; VIDEOTAPES; SPECTACLE CASES OF PRECIOUS METAL, IN CLASS 9 (U.S. CLS. 21, 23, 26, 36 AND 38).

FIRST USE 10-1-1989; IN COMMERCE 10-1-1989.

THE MARK CONSISTS OF STANDARD CHARACTERS WITHOUT CLAIM TO ANY PARTICULAR FONT, STYLE, SIZE, OR COLOR.

PRIORITY CLAIMED UNDER SEC. 44(D) ON FRANCE APPLICATION NO. 10/3778477, FILED 10-29-2010, REG. NO. 103778477, DATED 10-29-2010, EXPIRES 10-29-2020.

THE NAME "CATHERINE DENEUVE" IDENTIFIES A LIVING INDIVIDUAL WHOSE CONSENT IS OF RECORD.

SER. NO. 85-164,712, FILED 10-29-2010.

AMEEN IMAM, EXAMINING ATTORNEY

United States of America

United States Patent and Trademark Office

FLOW FOR LIFE

Reg. No. 4,072,931

Registered Dec. 20, 2011

Int. Cls.: 7, 37 and 42

TRADEMARK

SERVICE MARK

PRINCIPAL REGISTER

DARCY TECHNOLOGIES LIMITED (UNITED KINGDOM PRIVATE LIMITED COMPANY)
UNIT C1, SITE C SOUTH
KINTORE BUSINESS PARK
KINTORE, UNITED KINGDOM AB510YQ

FOR: TOOLS FOR USE IN OIL OR GAS WELLS, NAMELY, MACHINE TOOLS IN THE NATURE OF SAND CONTROL SCREENS, MACHINE TOOLS FOR CONTROLLING SAND INFLOW AND MACHINE TOOLS FOR WELL FORMATION STRESS CONTROL; MACHINES USED FOR THE DRILLING AND COMPLETION OF OIL AND GAS WELLS; APPARATUS AND EQUIPMENT USED FOR THE DRILLING AND COMPLETION OF OIL AND GAS WELLS, NAMELY, MACHINE TOOLS IN THE NATURE OF SAND CONTROL SCREENS, MACHINE TOOLS FOR CONTROLLING SAND INFLOW AND MACHINE TOOLS FOR WELL FORMATION STRESS CONTROL; DOWNHOLE TOOLS AND APPARATUS, NAMELY, MACHINE TOOLS IN THE NATURE OF SAND CONTROL SCREENS, MACHINE TOOLS FOR CONTROLLING SAND INFLOW AND MACHINE TOOLS FOR WELL FORMATION STRESS CONTROL, IN CLASS 7 (U.S. CLS. 13, 19, 21, 23, 31, 34 AND 35).

FOR: OIL AND GAS WELL DRILLING; WELL COMPLETION, NAMELY, SAND CONTROL AND INFLOW CONTROL COMPLETIONS TO CLEAR WELLS FOR DRILLING, WELL MAINTENANCE AND REMEDIAL SERVICES, NAMELY, SAND CONTROL AND INFLOW CONTROL COMPLETIONS TO CLEAR WELLS FOR DRILLING; RENTAL, REPAIR AND INSTALLATION OF TOOLS FOR USE IN THE CONSTRUCTION, OPERATION, REPAIR, MAINTENANCE AND INSPECTION OF OIL AND GAS WELLS, IN CLASS 37 (U.S. CLS. 100, 103 AND 106).

FOR: ENGINEERING RESEARCH AND DESIGN SERVICES FOR NEW PRODUCT DEVELOPMENT FOR USE WITH SAND CONTROL, INFLOW CONTROL AND FORMATION STRESS CONTROL, IN CLASS 42 (U.S. CLS. 100 AND 101).

THE MARK CONSISTS OF STANDARD CHARACTERS WITHOUT CLAIM TO ANY PARTICULAR FONT, STYLE, SIZE, OR COLOR.

PRIORITY CLAIMED UNDER SEC. 44(D) ON UNITED KINGDOM APPLICATION NO. 2559027, FILED 9-17-2010, REG. NO. 2559027, DATED 9-17-2010, EXPIRES 9-17-2020.

SER. NO. 85-164,764, FILED 10-29-2010.



David J. Kyffers

Director of the United States Patent and Trademark Office

Reg. No. 4,072,931 DOMINIC FATHY, EXAMINING ATTORNEY

United States of America

United States Patent and Trademark Office



Reg. No. 4,072,932

Registered Dec. 20, 2011

Int. Cl.: 25

TRADEMARK

PRINCIPAL REGISTER

JUAN MANUEL LEY LOPEZ (MEXICO INDIVIDUAL)
CARRETERA INTL. NORTE Y CALLE DEPORTIVA
CULIACAN, SINALOA, MEXICO

FOR: CLOTHING, NAMELY, SHIRTS, T-SHIRTS, TANK TOPS, BLOUSES, SWEATERS, SWEATSHIRTS, SWEATPANTS, PANTS, JEANS, SHORTS, SKIRTS, DRESSES, VESTS, UNIFORMS, UNDERWEAR, SWIMWEAR, BEACHWEAR, HEADWEAR, SCARVES, JACKETS, GLOVES, WRISTBANDS, SOCKS, HOSIERY AND FOOTWEAR, IN CLASS 25 (U.S. CLS. 22 AND 39).

OWNER OF MEXICO REG. NO. 499927, DATED 5-31-1995, EXPIRES 5-31-2015.

NO CLAIM IS MADE TO THE EXCLUSIVE RIGHT TO USE "BEISBOL" AND "CULIACAN", APART FROM THE MARK AS SHOWN.

THE MARK CONSISTS OF THE FANCIFUL DESIGN OF A TOMATO, THE TOP HALF OF WHICH INCLUDES A LEAF DESIGN AND THE WORD "TOMATEROS" WRITTEN IN SCRIPT AND THE BOTTOM PORTION OF WHICH IS A BASEBALL. ABOVE THE TOMATO IS THE WORDS "CLUB DE BEISBOL" AND BELOW IT IS THE WORD "CULIACAN".

THE ENGLISH TRANSLATION OF "CLUB DE BEISBOL TOMATEROS" IN THE MARK IS BASEBALL CLUB TOMATO GROWERS.

SER. NO. 85-164,814, FILED 10-29-2010.

ROBERT C. CLARK JR., EXAMINING ATTORNEY



David J. Kyffers

Director of the United States Patent and Trademark Office

United States of America

United States Patent and Trademark Office

XIF

Reg. No. 4,072,933

Registered Dec. 20, 2011

Int. Cl.: 7

TRADEMARK

PRINCIPAL REGISTER

LUDOWICI AUSTRALIA PTY LTD. (AUSTRALIA LIMITED PARTNERSHIP)
67 RANDLE ROAD, PINKENBA
QUEENSLAND, AUSTRALIA 4008

FOR: VIBRATORY SCREEN SEPARATORS FOR USE IN THE MINING INDUSTRY; VIBRATING SCREEN SEPARATORS FOR MOUNTING TO AGITATORS IN MINERAL PROCESSING PLANTS; VIBRATING SCREEN SEPARATORS FOR USE IN SEPARATING MINERALS, ROCKS, SOIL AND MATERIALS EXTRACTED FROM THE EARTH; VIBRATING SCREEN SEPARATORS FOR USE IN MINING AND PROCESSING APPLICATIONS; MOLDED POLYURETHANE PANELS FOR SIEVING MATERIALS, THE PANELS ADAPTED FOR MOUNTING TO MACHINE DRIVEN AGITATORS; MACHINES AND MACHINE TOOLS FOR MINERAL PROCESSING IN THE MINING INDUSTRY; SEPARATORS, SIFTERS, SIEVERS, CHUTES AND SCREENS ALL BEING PARTS OF MINING MACHINES, WATER RECYCLING MACHINES OR ACCESSORIES FOR USE WITH MINING MACHINES, OR WATER RECYCLING MACHINES; MINERAL AND OIL PROCESSING MACHINERY AND SYSTEMS AND PARTS, NAMELY, MACHINES FOR SEPARATING MINERALS EXTRACTED FROM THE EARTH, AND COMPONENTS AND ACCESSORIES THEREFOR; SCREEN RAILS, PINS, MOUNTING COMPONENTS AND RETAINING ASSEMBLIES ALL BEING PARTS OF VIBRATING SCREEN SEPARATORS, IN CLASS 7 (U.S. CLS. 13, 19, 21, 23, 31, 34 AND 35).

PRIORITY CLAIMED UNDER SEC. 44(D) ON AUSTRALIA APPLICATION NO. 1359894, FILED 5-5-2010, REG. NO. 1359894, DATED 5-5-2010, EXPIRES 5-5-2020.

THE MARK CONSISTS OF THE LETTERS "XIF" IN STYLIZED FORMAT.

SER. NO. 85-164,891, FILED 10-29-2010.

ANDREW RHIM, EXAMINING ATTORNEY



David J. Kypos

Director of the United States Patent and Trademark Office

United States of America

United States Patent and Trademark Office

PALM BEACH GARDENS MEDICAL CENTER

Reg. No. 4,072,934

Registered Dec. 20, 2011

Int. Cl.: 44

SERVICE MARK

PRINCIPAL REGISTER

PALM BEACH GARDENS COMMUNITY HOSPITAL, INC. (FLORIDA CORPORATION)
1445 ROSS AVENUE, SUITE 1400
DALLAS, TX 752022703

FOR: HEALTHCARE, IN CLASS 44 (U.S. CLS. 100 AND 101).

FIRST USE 4-0-1996; IN COMMERCE 4-0-1996.

THE MARK CONSISTS OF STANDARD CHARACTERS WITHOUT CLAIM TO ANY PARTICULAR FONT, STYLE, SIZE, OR COLOR.

NO CLAIM IS MADE TO THE EXCLUSIVE RIGHT TO USE "MEDICAL CENTER", APART FROM THE MARK AS SHOWN.

SEC. 2(F).

SER. NO. 85-165,119, FILED 10-29-2010.

JASON TURNER, EXAMINING ATTORNEY



David J. Kyfos

Director of the United States Patent and Trademark Office

United States of America

United States Patent and Trademark Office



Reg. No. 4,072,935

Registered Dec. 20, 2011

Int. Cl.: 44

SERVICE MARK

PRINCIPAL REGISTER

PALM BEACH GARDENS COMMUNITY HOSPITAL, INC. (FLORIDA CORPORATION)
1445 ROSS AVENUE, SUITE 1400
DALLAS, TX 752022703

FOR: HEALTHCARE, IN CLASS 44 (U.S. CLS. 100 AND 101).

FIRST USE 9-0-2008; IN COMMERCE 9-0-2008.

NO CLAIM IS MADE TO THE EXCLUSIVE RIGHT TO USE "MEDICAL CENTER", APART FROM THE MARK AS SHOWN.

THE COLOR(S) GREEN AND GRAY IS/ARE CLAIMED AS A FEATURE OF THE MARK.

THE MARK CONSISTS OF A CURVED OUTLINE OF FOUR PEOPLE IN GREEN AND GRAY OVER THE WORDS "PALM BEACH GARDENS MEDICAL CENTER" IN GRAY.

SEC. 2(F) AS TO "PALM BEACH GARDENS MEDICAL CENTER".

SER. NO. 85-165,155, FILED 10-29-2010.

JASON TURNER, EXAMINING ATTORNEY



David J. Kybas

Director of the United States Patent and Trademark Office

United States of America

United States Patent and Trademark Office

MUMMS PAS

Reg. No. 4,072,936

CPI PROGRAMS, INC. (LOUISIANA CORPORATION)

Registered Dec. 20, 2011

P.O. BOX 56146
NEW ORLEANS, LA 701566146

Int. Cl.: 42

FOR: APPLICATION SERVICE PROVIDER (ASP) FEATURING SOFTWARE FOR USE IN TRACKING PATIENT ACTIVITY IN HOSPICES, HOME HEALTH CARE AGENCIES, AND PALLIATIVE CARE FACILITIES, IN CLASS 42 (U.S. CLS. 100 AND 101).

SERVICE MARK

FIRST USE 5-0-1989; IN COMMERCE 5-0-1989.

PRINCIPAL REGISTER

THE MARK CONSISTS OF STANDARD CHARACTERS WITHOUT CLAIM TO ANY PARTICULAR FONT, STYLE, SIZE, OR COLOR.

OWNER OF U.S. REG. NO. 2,405,853.

NO CLAIM IS MADE TO THE EXCLUSIVE RIGHT TO USE "PAS", APART FROM THE MARK AS SHOWN.

SER. NO. 85-165,239, FILED 10-29-2010.

WILLIAM BRECKENFELD, EXAMINING ATTORNEY



David J. Kyfos

Director of the United States Patent and Trademark Office

United States of America

United States Patent and Trademark Office

MUMMS CPC

Reg. No. 4,072,937

CPI PROGRAMS, INC. (LOUISIANA CORPORATION)

Registered Dec. 20, 2011

P.O. BOX 56146
NEW ORLEANS, LA 701566146

Int. Cl.: 42

FOR: APPLICATION SERVICE PROVIDER (ASP) FEATURING SOFTWARE FOR USE MANAGING CLINICAL CARE OF PATIENTS IN HOSPICES, HOME HEALTH AGENCIES, AND PALLIATIVE CARE FACILITIES, IN CLASS 42 (U.S. CLS. 100 AND 101).

SERVICE MARK

FIRST USE 7-7-2004; IN COMMERCE 7-7-2004.

PRINCIPAL REGISTER

THE MARK CONSISTS OF STANDARD CHARACTERS WITHOUT CLAIM TO ANY PARTICULAR FONT, STYLE, SIZE, OR COLOR.

OWNER OF U.S. REG. NO. 2,405,853.

SER. NO. 85-165,257, FILED 10-29-2010.

WILLIAM BRECKENFELD, EXAMINING ATTORNEY



David J. Kyffers

Director of the United States Patent and Trademark Office

United States of America

United States Patent and Trademark Office

A-T SOLUTIONS

Reg. No. 4,072,938

Registered Dec. 20, 2011

**Int. Cls.: 9, 35, 41, 42
and 45**

TRADEMARK

SERVICE MARK

PRINCIPAL REGISTER

A-T SOLUTIONS, INC. (VIRGINIA CORPORATION)
SUITE 200
10304 SPOTSYLVANIA AVENUE
FREDERICKSBURG, VA 22408

FOR: COMPUTER HARDWARE AND SOFTWARE, SIMULATORS, TRAINING KITS COMPRISED PRIMARILY OF TOOLS AND ITEMS UTILIZED IN DETECTING AND DISARMING BOMBS AND EXPLOSIVE DEVICES, AND INERT IED TRAINING DEVICES, NAMELY, SIMULATED BOMBS AND EXPLOSIVES ACTIVATED BY ELECTRONIC, MECHANICAL, TIMED, PRESSURE, PRESSURE-RELEASE, PULL, LIGHT, RADIO-FREQUENCY, PUSH-BUTTON, WIRE AND OTHER IMPROVISED MEANS, FOR USE IN PROVIDING TRAINING, EDUCATION, AND INSTRUCTION IN THE FIELDS OF ANTI AND COUNTER TERRORISM, IDENTIFICATION AND DETECTION OF IED DEVICES, AND COUNTER IED DEVICES, TOOLS, METHODS AND TECHNIQUES FOR USE BY QUALIFIED MILITARY, GOVERNMENT, AND CIVILIAN BOMB DISPOSAL PERSONNEL; COMPUTER SOFTWARE FOR DOCUMENTATION OF SITE SURVEYS, IED DISRUPTION, POST-BLAST FORENSIC ANALYSIS AND OTHER DATA IN THE AREA OF FIELD REPORTING, IN CLASS 9 (U.S. CLS. 21, 23, 26, 36 AND 38).

FIRST USE 8-31-2006; IN COMMERCE 8-31-2006.

FOR: PROVIDING TECHNICAL INFORMATION ON LOGISTICS MANAGEMENT IN THE FIELD OF COMBAT SUPPLY AND OPERATIONAL SUPPORT, IN CLASS 35 (U.S. CLS. 100, 101 AND 102).

FIRST USE 7-15-2006; IN COMMERCE 7-15-2006.

FOR: EDUCATIONAL SERVICES, NAMELY, PROVIDING TRAINING AND INSTRUCTION IN THE FIELDS OF HUMAN INTELLIGENCE, ANTI AND COUNTER TERRORISM, IDENTIFICATION AND DETECTION OF IED AND OTHER EXPLOSIVE DEVICES, COUNTER IED DEVICES, METHODS, AND TECHNIQUES, AND MARITIME SECURITY FOR QUALIFIED MILITARY, GOVERNMENT, AND CIVILIAN BOMB DISPOSAL PERSONNEL, SWAT TEAMS AND FIRST RESPONDERS, IN CLASS 41 (U.S. CLS. 100, 101 AND 107).

FIRST USE 7-15-2006; IN COMMERCE 7-15-2006.



David J. Kyjars

Director of the United States Patent and Trademark Office

Reg. No. 4,072,938 FOR: RESEARCH SERVICES, NAMELY, FORENSIC COLLECTION AND ANALYSIS OF INFORMATION IN THE FIELD OF EXPLOSIVES; COLLECTION AND ANALYSIS OF TECHNICAL INFORMATION IN THE FIELD OF COMBAT OPERATIONAL SUPPORT, IN CLASS 42 (U.S. CLS. 100 AND 101).

FIRST USE 7-15-2006; IN COMMERCE 7-15-2006.

FOR: PROVIDING CONSULTATION, EVALUATION ASSESSMENTS, RECOMMENDATIONS, INFORMATION AND UPDATES IN THE FIELDS OF HUMAN INTELLIGENCE, ANTI AND COUNTER TERRORISM, IDENTIFICATION AND DETECTION OF IED DEVICES, AND COUNTER IED DEVICES, METHODS, AND TECHNIQUES, IN CLASS 45 (U.S. CLS. 100 AND 101).

FIRST USE 7-15-2006; IN COMMERCE 7-15-2006.

THE MARK CONSISTS OF STANDARD CHARACTERS WITHOUT CLAIM TO ANY PARTICULAR FONT, STYLE, SIZE, OR COLOR.

OWNER OF U.S. REG. NO. 3,412,825.

SER. NO. 85-165,311, FILED 10-29-2010.

WILLIAM BRECKENFELD, EXAMINING ATTORNEY

United States of America

United States Patent and Trademark Office

FORGET SECURITY

Reg. No. 4,072,939

Registered Dec. 20, 2011

Int. Cls.: 9, 42 and 45

PANDA SECURITY, S.L. (SPAIN CORPORATION)
GRAN VIA DE DON DIEGO LOPEZ DE HARO, 4
BILBAO (VIZCAYA), SPAIN 48001

FOR: COMPUTER ANTI-VIRUS SOFTWARE; SOFTWARE FOR ENSURING THE SECURITY OF ELECTRONIC MAIL, IN CLASS 9 (U.S. CLS. 21, 23, 26, 36 AND 38).

TRADEMARK

FIRST USE 12-22-2010; IN COMMERCE 12-22-2010.

SERVICE MARK

FOR: COMPUTER SECURITY SERVICE, NAMELY, RESTRICTING ACCESS TO AND BY COMPUTER NETWORKS TO AND OF UNDESIRE WEB SITES, MEDIA AND INDIVIDUALS AND FACILITIES; COMPUTER VIRUS PROTECTION SERVICES; HOSTING AN ONLINE COMMUNITY WEBSITE FEATURING SHARED COMMUNICATIONS BETWEEN COMMUNITY MEMBERS INTERESTED IN PERSONAL AND SMALL BUSINESS COMPUTER INFORMATION SECURITY; MAINTENANCE OF COMPUTER SOFTWARE RELATING TO COMPUTER SECURITY AND PREVENTION OF COMPUTER RISKS; UPDATING OF COMPUTER SOFTWARE RELATING TO COMPUTER SECURITY AND PREVENTION OF COMPUTER RISKS, IN CLASS 42 (U.S. CLS. 100 AND 101).

PRINCIPAL REGISTER

FIRST USE 12-22-2010; IN COMMERCE 12-22-2010.

FOR: MONITORING OF COMPUTER SYSTEMS FOR SECURITY PURPOSES, IN CLASS 45 (U.S. CLS. 100 AND 101).

FIRST USE 12-22-2010; IN COMMERCE 12-22-2010.

THE MARK CONSISTS OF STANDARD CHARACTERS WITHOUT CLAIM TO ANY PARTICULAR FONT, STYLE, SIZE, OR COLOR.

NO CLAIM IS MADE TO THE EXCLUSIVE RIGHT TO USE "SECURITY", APART FROM THE MARK AS SHOWN.

SER. NO. 85-165,324, FILED 10-29-2010.

WILLIAM BRECKENFELD, EXAMINING ATTORNEY



David J. Kyros

Director of the United States Patent and Trademark Office

United States of America

United States Patent and Trademark Office

MCIT

Reg. No. 4,072,940

Registered Dec. 20, 2011

Int. Cls.: 9 and 41

TRADEMARK

SERVICE MARK

PRINCIPAL REGISTER

A-T SOLUTIONS, INC. (VIRGINIA CORPORATION)
10304 SPOTSYLVANIA AVENUE, SUITE 200
FREDRICKSBURG, VA 22408

FOR: MOBILE INTERACTIVE TRAINING SYSTEMS COMPRISED OF VIDEO AND MULTIMEDIA TRAINING TOOLS, NAMELY, FILMS, AUDIO RECORDINGS, AND INTERACTIVE SIMULATORS, ALL IN THE FIELDS OF ANTI AND COUNTER TERRORISM, IDENTIFICATION AND DETECTION OF IED DEVICES, AND COUNTER IED DEVICES, METHODS AND TECHNIQUES, IN CLASS 9 (U.S. CLS. 21, 23, 26, 36 AND 38).

FIRST USE 3-19-2008; IN COMMERCE 3-19-2008.

FOR: EDUCATIONAL SERVICES, NAMELY, TRAINING SERVICES IN THE FIELDS OF HUMAN INTELLIGENCE, ANTI AND COUNTER TERRORISM, IDENTIFICATION AND DETECTION OF IED DEVICES, AND COUNTER IED DEVICES, METHODS AND TECHNIQUES UTILIZING MOBILE INTERACTIVE TRAINING SYSTEMS COMPRISED OF VIDEO AND MULTIMEDIA TRAINING TOOLS, NAMELY, FILMS, AUDIO RECORDINGS, AND INTERACTIVE SIMULATORS; EDUCATIONAL SERVICES, NAMELY, TRAINING SERVICES IN THE FIELDS OF HUMAN INTELLIGENCE, ANTI AND COUNTER TERRORISM, IDENTIFICATION AND DETECTION OF IED DEVICES, AND COUNTER IED DEVICES, METHODS AND TECHNIQUES UTILIZING MOBILE INTERACTIVE TRAINING SYSTEMS COMPRISED OF VIDEO AND MULTIMEDIA TRAINING TOOLS, NAMELY, FILMS, AUDIO RECORDINGS, AND INTERACTIVE SIMULATORS CUSTOMIZED TO INCORPORATE RAPID ALERTS OF INTELLIGENCE INFORMATION AND FOCUS ON SPECIFIC NEEDS, THREATS AND ENVIRONMENTS, IN CLASS 41 (U.S. CLS. 100, 101 AND 107).

FIRST USE 3-19-2008; IN COMMERCE 3-19-2008.

THE MARK CONSISTS OF STANDARD CHARACTERS WITHOUT CLAIM TO ANY PARTICULAR FONT, STYLE, SIZE, OR COLOR.

SER. NO. 85-165,337, FILED 10-29-2010.

WILLIAM BRECKENFELD, EXAMINING ATTORNEY



David J. Kyffers

Director of the United States Patent and Trademark Office

United States of America

United States Patent and Trademark Office

VUECAD

Reg. No. 4,072,941

Registered Dec. 20, 2011

Int. Cl.: 9

TRADEMARK

PRINCIPAL REGISTER

TITANSAN ENGINEERING INC. (CALIFORNIA CORPORATION)
SUITE 204
2503 EASTBLUFF DRIVE
NEWPORT BEACH, CA 92660

FOR: MOBILE DEVICE SOFTWARE, NAMELY, SOFTWARE FOR USE IN VIEWING AND MARKUP OF CAD MODELS AND ASSEMBLIES; MOBILE DEVICE SOFTWARE FOR IMPORT OF CAD MODELS AND ASSEMBLIES, AND MEASUREMENT DATA VIEWING AND MARKUP, DATA ANALYSIS AND REPORTING OF COMPARISON RESULTS, AND FOR DESIGN AND MANUFACTURING APPLICATIONS, NAMELY, PART-TO-DATA ANALYSIS AND PART-TO-PART COMPARISON, CAD MODEL VIEWING AND MARKUP, DATA VIEWING AND MARKUP, ASSEMBLY DESIGN, QUALITY CONTROL, AND REVERSE ENGINEERING, IN INTERNATIONAL CLASS 009, IN CLASS 9 (U.S. CLS. 21, 23, 26, 36 AND 38).

FIRST USE 10-1-2009; IN COMMERCE 4-12-2010.

THE MARK CONSISTS OF STANDARD CHARACTERS WITHOUT CLAIM TO ANY PARTICULAR FONT, STYLE, SIZE, OR COLOR.

SER. NO. 85-165,390, FILED 10-29-2010.

CHERYL CLAYTON, EXAMINING ATTORNEY



David J. Kybas

Director of the United States Patent and Trademark Office

United States of America
United States Patent and Trademark Office

VitaaleMD

Reg. No. 4,072,942

B. BHARATWAL MD INC. (CALIFORNIA CORPORATION)
11728 DOROTHY ST, SUITE 309
LOS ANGELES, CA 90049

Registered Dec. 20, 2011

Int. Cl.: 3

FOR: COSMETIC CREAMS FOR SKIN CARE, IN CLASS 3 (U.S. CLS. 1, 4, 6, 50, 51 AND 52).

TRADEMARK

FIRST USE 1-1-2008; IN COMMERCE 1-1-2008.

PRINCIPAL REGISTER

THE MARK CONSISTS OF STANDARD CHARACTERS WITHOUT CLAIM TO ANY PARTICULAR FONT, STYLE, SIZE, OR COLOR.

SER. NO. 85-165,536, FILED 10-30-2010.

LOURDES AYALA, EXAMINING ATTORNEY



David J. Kybas

Director of the United States Patent and Trademark Office

United States of America

United States Patent and Trademark Office

Medial Identity

Reg. No. 4,072,943

Registered Dec. 20, 2011

Int. Cl.: 35

SERVICE MARK

PRINCIPAL REGISTER

STRANGE MATTER VENTURES LLC (US VIRGIN ISLANDS LIMITED LIABILITY COMPANY), DBA STRANGE MATTER
ATTN CYRILL GUTSCH
187 LAFAYETTE ST FL 5
NEW YORK, NY 10013

FOR: ADVERTISING AND MARKETING; ADVERTISING AND MARKETING CONSULTANCY; BRAND CONCEPT AND BRAND DEVELOPMENT SERVICES FOR CORPORATE AND INDIVIDUAL CLIENTS; CORPORATE IDENTITY SERVICES, IN CLASS 35 (U.S. CLS. 100, 101 AND 102).

FIRST USE 5-12-2007; IN COMMERCE 5-12-2007.

THE MARK CONSISTS OF STANDARD CHARACTERS WITHOUT CLAIM TO ANY PARTICULAR FONT, STYLE, SIZE, OR COLOR.

NO CLAIM IS MADE TO THE EXCLUSIVE RIGHT TO USE "IDENTITY", APART FROM THE MARK AS SHOWN.

SER. NO. 85-165,587, FILED 10-30-2010.

STEVEN JACKSON, EXAMINING ATTORNEY



David J. Kyffers

Director of the United States Patent and Trademark Office

United States of America

United States Patent and Trademark Office

GET ADS

Reg. No. 4,072,944

Registered Dec. 20, 2011

Int. Cl.: 35

SERVICE MARK

PRINCIPAL REGISTER

GETADS, LLC (COLORADO LIMITED LIABILITY COMPANY)
SUITE 200
1055 AURARIA PKWY
DENVER, CO 80204

FOR: MARKETING AND ADVERTISING; BRAND EVALUATION AND POSITIONING SERVICES; AFFILIATE MARKETING SERVICES, NAMELY PROMOTING THE GOODS AND SERVICES OF OTHERS BY ARRANGING FOR BUSINESSES TO AFFILIATE THEIR GOODS AND SERVICES WITH THE GOODS AND SERVICES OF THIRD PARTIES BY MEANS OF SPONSORSHIP RELATIONSHIPS; ON-LINE ADVERTISING ON COMPUTER NETWORKS; PROVISION OF ADVERTISING SPACE BY ELECTRONIC MEANS AND GLOBAL INFORMATION NETWORKS; PROVIDING ADVERTISING SERVICE TO DISTRIBUTE ADVERTISEMENTS FOR DISPLAY ON INTERNET, NAMELY, IN WEBSITES, E-MAILS, BLOGS, INSTANT MESSAGES, TEXT MESSAGES, IN CLASS 35 (U.S. CLS. 100, 101 AND 102).

FIRST USE 5-1-2008; IN COMMERCE 5-1-2008.

THE MARK CONSISTS OF STANDARD CHARACTERS WITHOUT CLAIM TO ANY PARTICULAR FONT, STYLE, SIZE, OR COLOR.

NO CLAIM IS MADE TO THE EXCLUSIVE RIGHT TO USE "ADS", APART FROM THE MARK AS SHOWN.

SER. NO. 85-165,675, FILED 10-31-2010.

LINDA MICKLEBURGH, EXAMINING ATTORNEY



David J. Kyros

Director of the United States Patent and Trademark Office

United States of America

United States Patent and Trademark Office

WHY GET ADS? BECAUSE WE GET IT.

Reg. No. 4,072,945

Registered Dec. 20, 2011

Int. Cl.: 35

SERVICE MARK

PRINCIPAL REGISTER

GETADS, LLC (COLORADO LIMITED LIABILITY COMPANY)
SUITE 200
1055 AURARIA PKWY
DENVER, CO 80204

FOR: MARKETING AND ADVERTISING; BRAND EVALUATION AND POSITIONING SERVICES; AFFILIATE MARKETING SERVICES, NAMELY, PROMOTING THE GOODS AND SERVICES OF OTHERS BY ARRANGING FOR BUSINESSES TO AFFILIATE THEIR GOODS AND SERVICES WITH THE GOODS AND SERVICES OF THIRD PARTIES BY MEANS OF SPONSORSHIP RELATIONSHIPS; ON-LINE ADVERTISING ON COMPUTER NETWORKS; PROVISION OF ADVERTISING SPACE BY ELECTRONIC MEANS AND GLOBAL INFORMATION NETWORKS; PROVIDING ADVERTISING SERVICE TO DISTRIBUTE ADVERTISEMENTS FOR DISPLAY ON INTERNET, NAMELY, IN WEBSITES, E-MAILS, BLOGS, INSTANT MESSAGES, TEXT MESSAGES, IN CLASS 35 (U.S. CLS. 100, 101 AND 102).

FIRST USE 5-1-2008; IN COMMERCE 5-1-2008.

THE MARK CONSISTS OF STANDARD CHARACTERS WITHOUT CLAIM TO ANY PARTICULAR FONT, STYLE, SIZE, OR COLOR.

SER. NO. 85-165,677, FILED 10-31-2010.

LINDA MICKLEBURGH, EXAMINING ATTORNEY



David J. Kyros

Director of the United States Patent and Trademark Office

United States of America

United States Patent and Trademark Office

MUTT-I-GREES

Reg. No. 4,072,946

Registered Dec. 20, 2011

Int. Cls.: 35, 44 and 45

SERVICE MARK

PRINCIPAL REGISTER

THE PET SAVERS FOUNDATION, INC. (NEW YORK CORPORATION)
59 SOUTH BAYLES STREET
PORT WASHINGTON, NY 11050

FOR: PUBLIC ADVOCACY TO PROMOTE AWARENESS OF PET ADOPTION AND MIXED-BREED DOGS; PROMOTING PUBLIC INTEREST IN MIXED BREED DOGS AND PET ADOPTION; ASSOCIATION SERVICES, NAMELY, PROMOTING THE INTERESTS OF A CLUB FOR MEMBERS WHO WISH TO REGISTER DOGS AND DOG NAMES OF ANIMALS WHOSE MIXED-BREED HAS BEEN DETERMINED; PROVIDING A WEBSITE FEATURING INFORMATION ABOUT DOG REGISTRATION, INCLUDING THE NAMING OF DOGS, AND MAINTAINING A REGISTRY OF DOG BREEDS AND MIXED BREEDS, IN CLASS 35 (U.S. CLS. 100, 101 AND 102).

FIRST USE 1-28-2009, THE MARK WAS FIRST USED ANYWHERE IN A DIFFERENT FORM OTHER THAN THAT SOUGHT TO BE REGISTERED AT LEAST AS EARLY AS 12/14/2001; IN COMMERCE 1-28-2009, THE MARK WAS FIRST USED IN COMMERCE IN A DIFFERENT FORM OTHER THAN THAT SOUGHT TO BE REGISTERED AT LEAST AS EARLY AS 12/14/2001.

FOR: PROVIDING ON-LINE INFORMATION VIA THE INTERNET IN THE FIELD OF PETS, PARTICULARLY RELATING TO MIXED BREED DOGS, NAMELY, PROVIDING INFORMATION REGARDING SELECTION OF PETS, GROOMING, FEEDING AND NUTRITION, IN CLASS 44 (U.S. CLS. 100 AND 101).



FIRST USE 1-28-2009, THE MARK WAS FIRST USED ANYWHERE IN A DIFFERENT FORM OTHER THAN THAT SOUGHT TO BE REGISTERED AT LEAST AS EARLY AS 12/14/2001; IN COMMERCE 1-28-2009, THE MARK WAS FIRST USED IN COMMERCE IN A DIFFERENT FORM OTHER THAN THAT SOUGHT TO BE REGISTERED AT LEAST AS EARLY AS 12/14/2001.

FOR: PROVIDING ON-LINE INFORMATION VIA THE INTERNET IN THE FIELD OF PET ADOPTION, IN CLASS 45 (U.S. CLS. 100 AND 101).

David J. Kybas

FIRST USE 1-28-2009, THE MARK WAS FIRST USED ANYWHERE IN A DIFFERENT FORM OTHER THAN THAT SOUGHT TO BE REGISTERED AT LEAST AS EARLY AS 12/14/2001 ; IN COMMERCE 1-28-2009, THE MARK WAS FIRST USED IN COMMERCE IN A DIFFERENT

Reg. No. 4,072,946 FORM OTHER THAN THAT SOUGHT TO BE REGISTERED AT LEAST AS EARLY AS
12/14/2001.

THE MARK CONSISTS OF STANDARD CHARACTERS WITHOUT CLAIM TO ANY PAR-
TICULAR FONT, STYLE, SIZE, OR COLOR.

OWNER OF U.S. REG. NOS. 3,606,842, 3,787,823 AND OTHERS.

SER. NO. 85-166,137, FILED 11-1-2010.

DOMINIC FATHY, EXAMINING ATTORNEY

United States of America

United States Patent and Trademark Office

ALLURE MOBILE

Reg. No. 4,072,947

ALLURE ENERGY (TEXAS CORPORATION)
2003 SOUTH LAMAR BLVD., SUITE 9
AUSTIN, TX 78704

Registered Dec. 20, 2011

Int. Cl.: 9

FOR: COMPUTER APPLICATION SOFTWARE FOR MOBILE PHONES AND HAND HELD COMPUTERS FOR ENERGY MANAGEMENT CONTROL OF HEATING, COOLING, APPLIANCES AND OTHER ITEMS THAT USE ENERGY , IN CLASS 9 (U.S. CLS. 21, 23, 26, 36 AND 38).

TRADEMARK

PRINCIPAL REGISTER

FIRST USE 8-24-2010; IN COMMERCE 8-24-2010.

THE MARK CONSISTS OF STANDARD CHARACTERS WITHOUT CLAIM TO ANY PARTICULAR FONT, STYLE, SIZE, OR COLOR.

NO CLAIM IS MADE TO THE EXCLUSIVE RIGHT TO USE "MOBILE", APART FROM THE MARK AS SHOWN.

SER. NO. 85-166,302, FILED 11-1-2010.

GIANCARLO CASTRO, EXAMINING ATTORNEY



David J. Kyffers

Director of the United States Patent and Trademark Office

United States of America

United States Patent and Trademark Office



ITDP

Institute for Transportation
& Development Policy

Reg. No. 4,072,948

Registered Dec. 20, 2011

Int. Cls.: 35, 41 and 42

THE INSTITUTE FOR TRANSPORTATION AND DEVELOPMENT POLICY (NEW YORK CORPORATION)
7TH FLOOR
9-11 E 19TH STREET
NEW YORK, NY 10003

SERVICE MARK

PRINCIPAL REGISTER

FOR: PROMOTING PUBLIC AWARENESS OF TRANSPORTATION ISSUES AND INITIATIVES, NAMELY, TRANSPORTATION ISSUES AND INITIATIVES RELATED TO THE ENVIRONMENT AND SOCIETY; PROMOTING PUBLIC AWARENESS OF THE POOR IN DEVELOPING COUNTRIES; PROMOTING PUBLIC AWARENESS OF THE NEED FOR SITUATION-APPROPRIATE AND SUSTAINABLE DEVELOPMENT POLICIES FOR DEVELOPING COUNTRIES, NAMELY, LAND AND COMMUNITY DEVELOPMENT PLANS AND PROCEDURES FOR DEVELOPING COUNTRIES; PROMOTING PUBLIC AWARENESS OF THE NEED FOR ENVIRONMENTAL POLICIES IN THE FIELD OF TRANSPORTATION; CONDUCTING PUBLIC POLICY RESEARCH IN THE FIELDS OF POVERTY, POLLUTION OR FOSSIL-FUEL DEPENDENCE, IN CLASS 35 (U.S. CLS. 100, 101 AND 102).

FIRST USE 9-0-2009; IN COMMERCE 11-0-2009.

FOR: EDUCATIONAL SERVICES, NAMELY, ARRANGING AND CONDUCTING EDUCATIONAL CONFERENCES, EDUCATIONAL SEMINARS, AND EDUCATIONAL EXHIBITIONS IN THE FIELDS OF POVERTY, POLLUTION, FOSSIL-FUEL DEPENDENCE, AND TRANSPORTATION ISSUES AND INITIATIVES RELATED TO ENERGY, THE ENVIRONMENT, AND SOCIETY, IN CLASS 41 (U.S. CLS. 100, 101 AND 107).

FIRST USE 9-0-2009; IN COMMERCE 11-0-2009.

FOR: PROVIDING URBAN DESIGN PLANNING INFORMATION AND TRANSPORTATION PLANNING INFORMATION RELATING TO THE DESIGN AND DEVELOPMENT OF CITIES TO ADDRESS TRANSPORTATION ISSUES RELATING TO CLIMATE CHANGE, POLLUTION, FOSSIL-FUEL DEPENDENCE, URBANIZATION, AND POVERTY, IN CLASS 42 (U.S. CLS. 100 AND 101).

FIRST USE 9-0-2009; IN COMMERCE 11-0-2009.

NO CLAIM IS MADE TO THE EXCLUSIVE RIGHT TO USE "INSTITUTE", APART FROM THE MARK AS SHOWN.



David J. Kyffers

Director of the United States Patent and Trademark Office

Reg. No. 4,072,948 THE MARK CONSISTS OF A STYLIZED EIGHT POINTED STAR ENCLOSED IN A CIRCLE, HALF OF WHICH IS FILLED AND THE OTHER HALF OF WHICH IS NOT, THE PORTION OF THE STAR OVER THE FILLED PORTION OF THE CIRCLE IS NOT FILLED AND THE PORTION OF THE STAR OVER THE UNFILLED PORTION IS SOLID, POSITIONED TO THE LEFT OF THE LITERAL ELEMENT. TO THE RIGHT OF THE DESIGN IS THE WORDING "ITDP" AND "INSTITUTE FOR TRANSPORTATION & DEVELOPMENT POLICY" SEPARATED BY A HORIZONTAL LINE.

SEC. 2(F) "INSTITUTE FOR TRANSPORTATION & DEVELOPMENT POLICY".

SER. NO. 85-166,409, FILED 11-1-2010.

ELLEN B. AWRICH, EXAMINING ATTORNEY

United States of America

United States Patent and Trademark Office

INSTITUTE FOR TRANSPORTATION & DEVELOPMENT POLICY

Reg. No. 4,072,949

Registered Dec. 20, 2011

Int. Cls.: 35, 41 and 42

THE INSTITUTE FOR TRANSPORTATION AND DEVELOPMENT POLICY (NEW YORK CORPORATION)
7TH FLOOR
9-11 E 19TH STREET
NEW YORK, NY 10003

SERVICE MARK

PRINCIPAL REGISTER

FOR: PROMOTING PUBLIC AWARENESS OF TRANSPORTATION ISSUES AND INITIATIVES, NAMELY, TRANSPORTATION ISSUES AND INITIATIVES RELATED TO THE ENVIRONMENT AND SOCIETY; PROMOTING PUBLIC AWARENESS OF THE POOR IN DEVELOPING COUNTRIES; PROMOTING PUBLIC AWARENESS OF THE NEED FOR SITUATION-APPROPRIATE AND SUSTAINABLE DEVELOPMENT POLICIES FOR DEVELOPING COUNTRIES, NAMELY, LAND AND COMMUNITY DEVELOPMENT PLANS AND PROCEDURES FOR DEVELOPING COUNTRIES; PROMOTING PUBLIC AWARENESS OF THE NEED FOR ENVIRONMENTAL POLICIES IN THE FIELD OF TRANSPORTATION; CONDUCTING PUBLIC POLICY RESEARCH IN THE FIELDS OF POVERTY, POLLUTION OR FOSSIL-FUEL DEPENDENCE, IN CLASS 35 (U.S. CLS. 100, 101 AND 102).

FIRST USE 10-0-1985; IN COMMERCE 12-0-1985.

FOR: EDUCATIONAL SERVICES, NAMELY, ARRANGING AND CONDUCTING EDUCATIONAL CONFERENCES, EDUCATIONAL SEMINARS, AND EDUCATIONAL EXHIBITIONS IN THE FIELDS OF POVERTY, POLLUTION, FOSSIL-FUEL DEPENDENCE, AND TRANSPORTATION ISSUES AND INITIATIVES RELATED TO ENERGY, THE ENVIRONMENT, AND SOCIETY, IN CLASS 41 (U.S. CLS. 100, 101 AND 107).

FIRST USE 10-0-1985; IN COMMERCE 12-0-1985.

FOR: PROVIDING URBAN DESIGN PLANNING INFORMATION AND TRANSPORTATION PLANNING INFORMATION RELATING TO THE DESIGN AND DEVELOPMENT OF CITIES TO ADDRESS TRANSPORTATION ISSUES RELATING TO CLIMATE CHANGE, POLLUTION, FOSSIL-FUEL DEPENDENCE, URBANIZATION, AND POVERTY, IN CLASS 42 (U.S. CLS. 100 AND 101).

FIRST USE 10-0-1985; IN COMMERCE 12-0-1985.

THE MARK CONSISTS OF STANDARD CHARACTERS WITHOUT CLAIM TO ANY PARTICULAR FONT, STYLE, SIZE, OR COLOR.



David J. Kyffers

Director of the United States Patent and Trademark Office

Reg. No. 4,072,949 NO CLAIM IS MADE TO THE EXCLUSIVE RIGHT TO USE "INSTITUTE", APART FROM THE MARK AS SHOWN.

SEC. 2(F).

SER. NO. 85-166,437, FILED 11-1-2010.

ELLEN B. AWRICH, EXAMINING ATTORNEY

United States of America

United States Patent and Trademark Office

OUR CITIES OURSELVES

Reg. No. 4,072,950

Registered Dec. 20, 2011

Int. Cls.: 35, 41 and 42

THE INSTITUTE FOR TRANSPORTATION AND DEVELOPMENT POLICY (NEW YORK CORPORATION)
7TH FLOOR
9-11 E 19TH STREET
NEW YORK, NY 10003

SERVICE MARK

PRINCIPAL REGISTER

FOR: PROMOTING PUBLIC AWARENESS OF TRANSPORTATION ISSUES RELATED TO CLIMATE CHANGE AND URBANIZATION AND PROVIDING INFORMATION ABOUT PUBLIC ADVOCACY IN THE FIELD OF PROMOTING PUBLIC AWARENESS OF TRANSPORTATION ISSUES RELATED TO CLIMATE CHANGE AND URBANIZATION PROMOTING PUBLIC AWARENESS OF THE NEED FOR THE DESIGN AND DEVELOPMENT OF CITIES TO ADDRESS TRANSPORTATION ISSUES RELATED TO CLIMATE CHANGE AND URBANIZATION, IN CLASS 35 (U.S. CLS. 100, 101 AND 102).

FIRST USE 9-0-2009; IN COMMERCE 11-0-2009.

FOR: EDUCATIONAL SERVICES, NAMELY, ARRANGING AND CONDUCTING EDUCATIONAL CONFERENCES, EDUCATIONAL SEMINARS, AND EDUCATIONAL EXHIBITIONS IN THE FIELD OF TRANSPORTATION ISSUES RELATED TO CLIMATE CHANGE AND URBANIZATION; EDUCATIONAL SERVICES, NAMELY, ARRANGING AND CONDUCTING EDUCATIONAL CONFERENCES, EDUCATIONAL SEMINARS, AND EDUCATIONAL EXHIBITIONS IN THE FIELD OF THE DESIGN AND DEVELOPMENT OF CITIES TO ADDRESS TRANSPORTATION ISSUES RELATED TO CLIMATE CHANGE AND URBANIZATION, IN CLASS 41 (U.S. CLS. 100, 101 AND 107).

FIRST USE 9-0-2009; IN COMMERCE 11-0-2009.

FOR: PROVIDING URBAN DESIGN PLANNING INFORMATION AND TRANSPORTATION PLANNING INFORMATION IN THE FIELD OF THE DESIGN AND DEVELOPMENT OF CITIES TO ADDRESS TRANSPORTATION ISSUES RELATED TO CLIMATE CHANGE AND URBANIZATION, IN CLASS 42 (U.S. CLS. 100 AND 101).

FIRST USE 9-0-2009; IN COMMERCE 11-0-2009.

THE MARK CONSISTS OF STANDARD CHARACTERS WITHOUT CLAIM TO ANY PARTICULAR FONT, STYLE, SIZE, OR COLOR.



David J. Kyjars

Director of the United States Patent and Trademark Office

Reg. No. 4,072,950 SER. NO. 85-166,446, FILED 11-1-2010.

ELLEN B. AWRICH, EXAMINING ATTORNEY

United States of America

United States Patent and Trademark Office



our cities ourselves

Reg. No. 4,072,951

Registered Dec. 20, 2011

Int. Cls.: 35, 41 and 42

THE INSTITUTE FOR TRANSPORTATION AND DEVELOPMENT POLICY (NEW YORK CORPORATION)
7TH FLOOR
9-11 E 19TH STREET
NEW YORK, NY 10003

SERVICE MARK

PRINCIPAL REGISTER

FOR: PROMOTING PUBLIC AWARENESS OF TRANSPORTATION ISSUES RELATED TO CLIMATE CHANGE AND URBANIZATION AND PROVIDING INFORMATION ABOUT PUBLIC ADVOCACY IN THE FIELD OF PROMOTING PUBLIC AWARENESS OF TRANSPORTATION ISSUES RELATED TO CLIMATE CHANGE AND URBANIZATION; PROMOTING PUBLIC AWARENESS OF THE NEED FOR THE DESIGN AND DEVELOPMENT OF CITIES TO ADDRESS TRANSPORTATION ISSUES RELATED TO CLIMATE CHANGE AND URBANIZATION, IN CLASS 35 (U.S. CLS. 100, 101 AND 102).

FIRST USE 2-0-2010; IN COMMERCE 3-0-2010.

FOR: EDUCATIONAL SERVICES, NAMELY, ARRANGING AND CONDUCTING EDUCATIONAL CONFERENCES, EDUCATIONAL SEMINARS, AND EDUCATIONAL EXHIBITIONS IN THE FIELD OF TRANSPORTATION ISSUES RELATED TO CLIMATE CHANGE AND URBANIZATION; EDUCATIONAL SERVICES, NAMELY, ARRANGING AND CONDUCTING EDUCATIONAL CONFERENCES, EDUCATIONAL SEMINARS, AND EDUCATIONAL EXHIBITIONS IN THE FIELD OF THE DESIGN AND DEVELOPMENT OF CITIES TO ADDRESS TRANSPORTATION ISSUES RELATED TO CLIMATE CHANGE AND URBANIZATION, IN CLASS 41 (U.S. CLS. 100, 101 AND 107).

FIRST USE 2-0-2010; IN COMMERCE 3-0-2010.

FOR: PROVIDING URBAN DESIGN PLANNING INFORMATION AND TRANSPORTATION PLANNING INFORMATION IN THE FIELD OF THE DESIGN AND DEVELOPMENT OF CITIES TO ADDRESS TRANSPORTATION ISSUES RELATED TO CLIMATE CHANGE AND URBANIZATION, IN CLASS 42 (U.S. CLS. 100 AND 101).

FIRST USE 2-0-2010; IN COMMERCE 3-0-2010.

THE MARK CONSISTS OF THE FIVE CONCENTRIC NESTED NEAR-COMPLETE CIRCULAR ARCS, WHERE THE OPENING IN EACH OF THE NEAR-COMPLETE CIRCULAR ARCS



David J. Kyjars

Director of the United States Patent and Trademark Office

Reg. No. 4,072,951 ARE NOT ALIGNED WITH THE ADJACENT NESTED ARC, POSITIONED TO THE LEFT OF THE LITERAL ELEMENT "OUR CITIES OURSELVES".

SER. NO. 85-166,459, FILED 11-1-2010.

ELLEN B. AWRICH, EXAMINING ATTORNEY

United States of America

United States Patent and Trademark Office

ITDP

Reg. No. 4,072,952

Registered Dec. 20, 2011

Int. Cls.: 35, 41 and 42

THE INSTITUTE FOR TRANSPORTATION AND DEVELOPMENT POLICY (NEW YORK CORPORATION)
7TH FLOOR
9-11 E 19TH STREET
NEW YORK, NY 10003

SERVICE MARK

PRINCIPAL REGISTER

FOR: PROMOTING PUBLIC AWARENESS OF TRANSPORTATION ISSUES AND INITIATIVES, NAMELY, TRANSPORTATION ISSUES AND INITIATIVES RELATED TO THE ENVIRONMENT AND SOCIETY; PROMOTING PUBLIC AWARENESS OF THE POOR IN DEVELOPING COUNTRIES; PROMOTING PUBLIC AWARENESS OF THE NEED FOR SITUATION-APPROPRIATE AND SUSTAINABLE DEVELOPMENT POLICIES FOR DEVELOPING COUNTRIES, NAMELY, LAND AND COMMUNITY DEVELOPMENT PLANS AND PROCEDURES FOR DEVELOPING COUNTRIES; PROMOTING PUBLIC AWARENESS OF THE NEED FOR ENVIRONMENTAL POLICIES IN THE FIELD OF TRANSPORTATION; CONDUCTING PUBLIC POLICY RESEARCH IN THE FIELDS OF POVERTY, POLLUTION OR FOSSIL-FUEL DEPENDENCE, IN CLASS 35 (U.S. CLS. 100, 101 AND 102).

FIRST USE 12-0-1985; IN COMMERCE 9-0-1987.

FOR: EDUCATIONAL SERVICES, NAMELY, ARRANGING AND CONDUCTING EDUCATIONAL CONFERENCES, EDUCATIONAL SEMINARS, AND EDUCATIONAL EXHIBITIONS IN THE FIELDS OF POVERTY, POLLUTION, FOSSIL-FUEL DEPENDENCE, AND TRANSPORTATION ISSUES AND INITIATIVES RELATED TO ENERGY, THE ENVIRONMENT, AND SOCIETY, IN CLASS 41 (U.S. CLS. 100, 101 AND 107).

FIRST USE 12-0-1985; IN COMMERCE 9-0-1987.

FOR: PROVIDING URBAN DESIGN PLANNING INFORMATION AND TRANSPORTATION PLANNING INFORMATION RELATING TO THE DESIGN AND DEVELOPMENT OF CITIES TO ADDRESS TRANSPORTATION ISSUES RELATING TO CLIMATE CHANGE, POLLUTION, FOSSIL-FUEL DEPENDENCE, URBANIZATION, AND POVERTY, IN CLASS 42 (U.S. CLS. 100 AND 101).

FIRST USE 12-0-1985; IN COMMERCE 9-0-1987.

THE MARK CONSISTS OF STANDARD CHARACTERS WITHOUT CLAIM TO ANY PARTICULAR FONT, STYLE, SIZE, OR COLOR.



David J. Kyffers

Director of the United States Patent and Trademark Office

Reg. No. 4,072,952 SER. NO. 85-166,462, FILED 11-1-2010.

ELLEN B. AWRICH, EXAMINING ATTORNEY

United States of America

United States Patent and Trademark Office

MTN DEW PITCH BLACK

Reg. No. 4,072,953

PEPSICO, INC. (NORTH CAROLINA CORPORATION)
700 ANDERSON HILL ROAD
PURCHASE, NY 10577

Registered Dec. 20, 2011

Int. Cl.: 32

FOR: CONCENTRATES, SYRUPS OR POWDERS USED IN THE PREPARATION OF SOFT DRINKS; SOFT DRINKS, IN CLASS 32 (U.S. CLS. 45, 46 AND 48).

TRADEMARK

FIRST USE 5-2-2011; IN COMMERCE 5-2-2011.

PRINCIPAL REGISTER

THE MARK CONSISTS OF STANDARD CHARACTERS WITHOUT CLAIM TO ANY PARTICULAR FONT, STYLE, SIZE, OR COLOR.

OWNER OF U.S. REG. NOS. 820,362, 3,157,664 AND OTHERS.

SER. NO. 85-166,490, FILED 11-1-2010.

THOMAS MANOR, EXAMINING ATTORNEY



David J. Kyros

Director of the United States Patent and Trademark Office

United States of America

United States Patent and Trademark Office

DLR DISTRIBUTORS

Reg. No. 4,072,954

DLR DISTRIBUTORS, INC (GEORGIA CORPORATION)

Registered Dec. 20, 2011

PO BOX 870146
STONE MOUNTAIN, GA 30087

Int. Cl.: 35

FOR: DISTRIBUTORSHIP SERVICES IN THE FIELD OF AUTOMOTIVE, MECHANICAL, AND ELECTRONIC COMPONENT PARTS; RESELLER SERVICES, NAMELY, DISTRIBUTORSHIP SERVICES IN THE FIELD OF AUTOMOTIVE, MECHANICAL, AND ELECTRONIC COMPONENT PARTS, IN CLASS 35 (U.S. CLS. 100, 101 AND 102).

SERVICE MARK

PRINCIPAL REGISTER

FIRST USE 11-1-1999; IN COMMERCE 11-1-2000.

THE MARK CONSISTS OF STANDARD CHARACTERS WITHOUT CLAIM TO ANY PARTICULAR FONT, STYLE, SIZE, OR COLOR.

NO CLAIM IS MADE TO THE EXCLUSIVE RIGHT TO USE "DISTRIBUTORS", APART FROM THE MARK AS SHOWN.

SER. NO. 85-166,666, FILED 11-1-2010.

CARYN GLASSER, EXAMINING ATTORNEY



David J. Kyffers

Director of the United States Patent and Trademark Office

United States of America

United States Patent and Trademark Office

COST-EFFECTIVE PURCHASING SOLUTIONS FOR BUSINESS

Reg. No. 4,072,955

DLR DISTRIBUTORS, INC (GEORGIA CORPORATION)
PO BOX 870146

Registered Dec. 20, 2011

STONE MOUNTAIN, GA 30087

Int. Cl.: 35

FOR: DISTRIBUTORSHIP SERVICES IN THE FIELD OF AUTOMOTIVE, MECHANICAL, AND ELECTRONIC COMPONENT PARTS; RESELLER SERVICES, NAMELY, DISTRIBUTORSHIP SERVICES IN THE FIELD OF AUTOMOTIVE, MECHANICAL, AND ELECTRONIC COMPONENT PARTS, IN CLASS 35 (U.S. CLS. 100, 101 AND 102).

SERVICE MARK

PRINCIPAL REGISTER

FIRST USE 11-1-2000; IN COMMERCE 11-1-2000.

THE MARK CONSISTS OF STANDARD CHARACTERS WITHOUT CLAIM TO ANY PARTICULAR FONT, STYLE, SIZE, OR COLOR.

SER. NO. 85-166,669, FILED 11-1-2010.

CARYN GLASSER, EXAMINING ATTORNEY



David J. Kybas

Director of the United States Patent and Trademark Office

United States of America

United States Patent and Trademark Office



Reg. No. 4,072,956

DLR DISTRIBUTORS, INC (GEORGIA CORPORATION)
PO BOX 870146
STONE MOUNTAIN, GA 30087

Registered Dec. 20, 2011

Int. Cl.: 35

FOR: DISTRIBUTORSHIP SERVICES IN THE FIELD OF AUTOMOTIVE, MECHANICAL, AND ELECTRONIC COMPONENT PARTS; RESELLER SERVICES, NAMELY, DISTRIBUTORSHIP SERVICES IN THE FIELD OF AUTOMOTIVE, MECHANICAL, AND ELECTRONIC COMPONENT PARTS, IN CLASS 35 (U.S. CLS. 100, 101 AND 102).

SERVICE MARK

PRINCIPAL REGISTER

FIRST USE 11-1-2000; IN COMMERCE 11-1-2000.

THE MARK CONSISTS OF A SMALL TRIANGLE WITHIN A LARGER TRIANGLE AND A SEMI CIRCLE FORMING THE LETTERS "D", "L", "R". THE COLOR BLUE APPEARS IN THE LARGER "L" AND THE SEMI CIRCLE AND THE COLOR ORANGE APPEARS IN THE SMALLER TRIANGLE.

THE COLOR(S) BLUE AND YELLOW IS/ARE CLAIMED AS A FEATURE OF THE MARK.

SER. NO. 85-166,672, FILED 11-1-2010.

CARYN GLASSER, EXAMINING ATTORNEY



David J. Kyffers

Director of the United States Patent and Trademark Office

United States of America

United States Patent and Trademark Office

BE SAFE AT WORK AND PLAY

Reg. No. 4,072,957

Registered Dec. 20, 2011

Int. Cls.: 16, 36 and 41

TRADEMARK

SERVICE MARK

PRINCIPAL REGISTER

PARK DISTRICT RISK MANAGEMENT AGENCY (ILLINOIS CORPORATION)
2033 BURLINGTON AVENUE
LISLE, IL 60532

FOR: PRINTED EDUCATIONAL MATERIALS, BROCHURES, NEWSLETTERS AND BOOKS IN THE FIELDS OF INSURANCE, HEALTH AND WELLNESS PROGRAMS, WORK AND HOME SAFETY, UNEMPLOYMENT COMPENSATION, HUMAN RESOURCES, PARKS AND RECREATION SAFETY AND RISK MANAGEMENT; PROVIDING CUSTOMIZED PRE-PRINTED EVALUATIONS AND PRINTED PREVENTION EDUCATIONAL MATERIALS RELATING TO EMPLOYEE INJURIES AND ILLNESS, IN CLASS 16 (U.S. CLS. 2, 5, 22, 23, 29, 37, 38 AND 50).

FIRST USE 2-0-2007; IN COMMERCE 2-0-2007.

FOR: ADMINISTRATION OF EMPLOYEE BENEFIT PLANS CONCERNING INSURANCE AND FINANCE, INSURANCE CLAIMS ADMINISTRATION IN THE FIELDS OF RISK MANAGEMENT, HEALTH AND PROPERTY INSURANCE, CONSULTING AND INFORMATION CONCERNING INSURANCE; PROVIDING A WEBSITE THAT PROVIDES MEMBERS WITH INFORMATION RELATED TO FINANCIAL RISK MANAGEMENT, INSURANCE AND UNEMPLOYMENT COMPENSATION, IN CLASS 36 (U.S. CLS. 100, 101 AND 102).

FIRST USE 2-0-2007; IN COMMERCE 2-0-2007.

FOR: PROVIDING TRAINING, NAMELY, COURSES, SEMINARS AND WORKSHOPS ON RISK MANAGEMENT, INSURANCE, HEALTH AND SAFETY; ARRANGING AND CONDUCTING SEMINARS IN THE FIELD OF PARK AND RECREATION FACILITY MAINTENANCE, IN CLASS 41 (U.S. CLS. 100, 101 AND 107).

FIRST USE 2-0-2007; IN COMMERCE 2-0-2007.

THE MARK CONSISTS OF STANDARD CHARACTERS WITHOUT CLAIM TO ANY PARTICULAR FONT, STYLE, SIZE, OR COLOR.

SER. NO. 85-166,967, FILED 11-2-2010.

JOSETTE BEVERLY, EXAMINING ATTORNEY



David J. Kyros

Director of the United States Patent and Trademark Office

United States of America
United States Patent and Trademark Office

BIRDOLA

Reg. No. 4,072,958

SEED RESOURCES, L.L.C. (MICHIGAN LIMITED LIABILITY COMPANY)
1650 BROADWAY, N.W.
GRAND RAPIDS, MI 49504

Registered Dec. 20, 2011

Int. Cls.: 21 and 31

FOR: BIRD FEEDER, SQUIRREL FEEDER, IN CLASS 21 (U.S. CLS. 2, 13, 23, 29, 30, 33, 40 AND 50).

TRADEMARK

FIRST USE 11-1-1989; IN COMMERCE 10-1-1990.

PRINCIPAL REGISTER

FOR: BIRD SEED CAKE, BIRD FOOD, SQUIRREL FOOD, IN CLASS 31 (U.S. CLS. 1 AND 46).

FIRST USE 11-1-1989; IN COMMERCE 10-1-1990.

THE MARK CONSISTS OF STANDARD CHARACTERS WITHOUT CLAIM TO ANY PARTICULAR FONT, STYLE, SIZE, OR COLOR.

OWNER OF U.S. REG. NO. 1,701,830.

SER. NO. 85-167,056, FILED 11-2-2010.

DAVID COLLIER, EXAMINING ATTORNEY



David J. Kyros

Director of the United States Patent and Trademark Office

United States of America

United States Patent and Trademark Office

LIFT COUNTER SPRAY

Reg. No. 4,072,959

ELF VENTURES, INC (WASHINGTON CORPORATION)

Registered Dec. 20, 2011

11527 52ND AVE SE
EVERETT, WA 98208

Int. Cl.: 3

FOR: CLEANER FOR USE ON SMOOTH AND FINISHED SURFACES, IN CLASS 3 (U.S. CLS. 1, 4, 6, 50, 51 AND 52).

TRADEMARK

FIRST USE 7-29-2009; IN COMMERCE 7-29-2009.

PRINCIPAL REGISTER

THE MARK CONSISTS OF STANDARD CHARACTERS WITHOUT CLAIM TO ANY PARTICULAR FONT, STYLE, SIZE, OR COLOR.

NO CLAIM IS MADE TO THE EXCLUSIVE RIGHT TO USE "COUNTER SPRAY", APART FROM THE MARK AS SHOWN.

SER. NO. 85-167,167, FILED 11-2-2010.

MAYUR VAGHANI, EXAMINING ATTORNEY



David J. Kyffers

Director of the United States Patent and Trademark Office

United States of America

United States Patent and Trademark Office

BEACON

Reg. No. 4,072,960

Registered Dec. 20, 2011

Int. Cl.: 9

TRADEMARK

PRINCIPAL REGISTER

CHUDY GROUP, LLC (WISCONSIN LIMITED LIABILITY COMPANY)
N1671 POWERS LAKE ROAD
POWERS LAKE, WI 53159

FOR: PHARMACY INVENTORY AND PRESCRIPTION ORDER MANAGEMENT SYSTEM CONSISTING OF ELECTRONIC INDICATORS OPERABLE TO PROVIDE VISIBLE INFORMATION, COMPUTER HARDWARE AND COMPUTER PERIPHERALS, VIDEO DISPLAYS, AND COMPUTER SOFTWARE FOR CONTROLLING THE ELECTRONIC INDICATORS AND SYSTEM AND MODULAR INVENTORY STORAGE UNITS, NAMELY, SHELVES, DRAWERS, CABINETS, RACKS, STANDS, AND HANGERS EACH HAVING UNIQUE INVENTORY STORAGE LOCATIONS AND AN ELECTRONIC INDICATOR ASSOCIATED WITH EACH STORAGE LOCATION ALL SOLD AS A UNIT TO PROVIDE VISIBLE INFORMATION WHICH ENABLES RAPID IDENTIFICATION OF THE INVENTORY STORAGE LOCATION FROM WHICH AN ITEM IS TO BE RETRIEVED OR TO WHICH AN ITEM IS TO BE PLACED AND PHARMACY INVENTORY AND PRESCRIPTION ORDER MANAGEMENT, IN CLASS 9 (U.S. CLS. 21, 23, 26, 36 AND 38).

FIRST USE 2-17-2009; IN COMMERCE 1-27-2010.

THE MARK CONSISTS OF STANDARD CHARACTERS WITHOUT CLAIM TO ANY PARTICULAR FONT, STYLE, SIZE, OR COLOR.

SER. NO. 85-167,215, FILED 11-2-2010.

WILLIAM ROSSMAN, EXAMINING ATTORNEY



David J. Kyros

Director of the United States Patent and Trademark Office

United States of America

United States Patent and Trademark Office

LEMON KISSED

Reg. No. 4,072,961

ELF VENTURES, INC (WASHINGTON CORPORATION)

Registered Dec. 20, 2011

11527 52ND AVE SE
EVERETT, WA 98208

Int. Cl.: 3

FOR: DISHWASHING DETERGENTS CONTAINING LEMON OIL; LIQUID DISH WASHING SOAPS CONTAINING LEMON OIL, IN CLASS 3 (U.S. CLS. 1, 4, 6, 50, 51 AND 52).

TRADEMARK

FIRST USE 11-11-2009; IN COMMERCE 11-11-2009.

PRINCIPAL REGISTER

THE MARK CONSISTS OF STANDARD CHARACTERS WITHOUT CLAIM TO ANY PARTICULAR FONT, STYLE, SIZE, OR COLOR.

NO CLAIM IS MADE TO THE EXCLUSIVE RIGHT TO USE "LEMON", APART FROM THE MARK AS SHOWN.

SER. NO. 85-167,226, FILED 11-2-2010.

MAYUR VAGHANI, EXAMINING ATTORNEY



David J. Kybas

Director of the United States Patent and Trademark Office

United States of America

United States Patent and Trademark Office

LAVENDER KISSED

Reg. No. 4,072,962

ELF VENTURES, INC (WASHINGTON CORPORATION)

Registered Dec. 20, 2011

11527 52ND AVE SE
EVERETT, WA 98208

Int. Cl.: 3

FOR: DISHWASHING DETERGENTS WITH LAVENDER SCENT; LIQUID DISH WASHING SOAPS WITH LAVENDER SCENT, IN CLASS 3 (U.S. CLS. 1, 4, 6, 50, 51 AND 52).

TRADEMARK

FIRST USE 11-11-2009; IN COMMERCE 11-11-2009.

PRINCIPAL REGISTER

THE MARK CONSISTS OF STANDARD CHARACTERS WITHOUT CLAIM TO ANY PARTICULAR FONT, STYLE, SIZE, OR COLOR.

NO CLAIM IS MADE TO THE EXCLUSIVE RIGHT TO USE "LAVENDER", APART FROM THE MARK AS SHOWN.

SER. NO. 85-167,252, FILED 11-2-2010.

MAYUR VAGHANI, EXAMINING ATTORNEY



David J. Kybas

Director of the United States Patent and Trademark Office

United States of America

United States Patent and Trademark Office

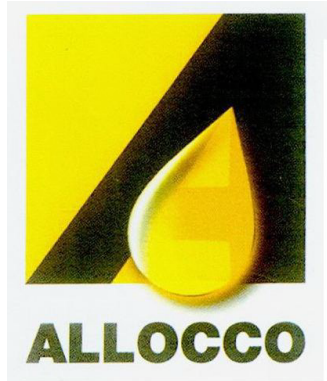

Reg. No. 4,072,963

Registered Dec. 20, 2011

Int. Cls.: 7, 11 and 42

TRADEMARK

SERVICE MARK

PRINCIPAL REGISTER

ALLOCCO S.A. (ARGENTINA CORPORATION)
VILLA GOBERNADOR GÁLVEZ
AVDA. FILIPPINI 1343 S2124DUC
SANTA FE, ARGENTINA

FOR: MACHINES USED TO PROCESS OILSEEDS AND SUNFLOWER IN ORDER TO EXTRACT AND PRODUCE VEGETABLE OILS, NAMELY, MECHANICAL BREAKERS, FLAKERS AND DE-HULLERS USED TO GRIND OILSEEDS AND SUNFLOWER; MACHINES, NAMELY, GRANULATORS USED TO INCREASE THE VOLUME AND DENSITY OF THE FLOUR THAT IS EXTRACTED FROM SUNFLOWER; AGRICULTURAL MACHINES AND INSTRUMENTS, NAMELY, STRAINING MACHINES AND PRESSES USED TO PRESS AND STAIN OIL-RICH SEEDS AS PART OF THE OIL EXTRACTION PROCESS; INDUSTRIAL ROTATING CONDITIONING MACHINES USED TO DRY AND COOL OILSEEDS IN ORDER TO CONDITION THEM PRIOR TO THE FLAKING PROCESS, IN CLASS 7 (U.S. CLS. 13, 19, 21, 23, 31, 34 AND 35).

FOR: INDUSTRIAL ROTATING DRYERS USED TO DRY THE EXTRACTED FLOUR PRIOR TO PACKAGING; INDUSTRIAL DRYERS AND COOLING UNITS USED TO DRY AND COOL OFF EXPANDED OILSEEDS AND SUNFLOWER PRIOR TO OIL EXTRACTION; INDUSTRIAL DRYERS AND COOLING UNITS USED TO DRY AND COOL EXTRACTED FLOUR PRIOR TO STORING IT, IN CLASS 11 (U.S. CLS. 13, 21, 23, 31 AND 34).

FOR: TECHNICAL RESEARCH IN THE FIELDS OF VEGETABLE OIL, PROTECTION FLOURS AND ALTERNATIVE FUEL AND RENEWABLE ENERGY PRODUCTION; ENGINEERING SERVICES, IN CLASS 42 (U.S. CLS. 100 AND 101).

OWNER OF ARGENTINA REG. NO. 2.070.519, DATED 3-6-2006, EXPIRES 3-6-2016.

THE COLOR(S) YELLOW AND GREEN IS/ARE CLAIMED AS A FEATURE OF THE MARK.

OWNER OF ARGENTINA REG. NO. 2.077.506, DATED 4-4-2006, EXPIRES 4-4-2016.

OWNER OF ARGENTINA REG. NO. 2.070.518, DATED 3-6-2006, EXPIRES 3-6-2016.

THE MARK CONSISTS OF THE WORD "ALLOCCO" AND A STYLIZED LETTER "A". THE LETTER GREEN "A" IS INSIDE A SQUARE HALF YELLOW AND HALF GREEN. THE DIVISION OF THE YELLOW AND GREEN SIDES IS DIAGONAL. ON TOP OF THE GREEN



David J. Kybas

Director of the United States Patent and Trademark Office

Reg. No. 4,072,963 SIDE THERE IS A DROP LIKE YELLOW DRAWING. BELOW THE SQUARE DESIGN IS THE WORD "ALLOCCO" IN STYLIZED GREEN LETTERS.

SER. NO. 85-167,422, FILED 11-2-2010.

LOURDES AYALA, EXAMINING ATTORNEY

United States of America

United States Patent and Trademark Office

PREPARING THE PALACE

Reg. No. 4,072,964

Registered Dec. 20, 2011

Int. Cl.: 44

SERVICE MARK

PRINCIPAL REGISTER

DONNA KEEFE (UNITED STATES INDIVIDUAL)
SUITE B129
8950 VILLA LA JOLLA DRIVE
LA JOLLA, CA 92037

FOR: PROVIDING INFORMATION IN THE FIELD OF ACUPUNCTURE RELATED TO FERTILITY; ACUPUNCTURE TREATMENT OF FERTILITY ISSUES; PROVIDING INFORMATION, NEWS AND COMMENTARY IN THE FIELD OF ACUPUNCTURE; PROVIDING INFORMATION, NEWS AND COMMENTARY IN THE FIELD OF HUMAN FERTILITY TREATMENT, IN CLASS 44 (U.S. CLS. 100 AND 101).

FIRST USE 12-31-2002; IN COMMERCE 1-31-2010.

THE MARK CONSISTS OF STANDARD CHARACTERS WITHOUT CLAIM TO ANY PARTICULAR FONT, STYLE, SIZE, OR COLOR.

SER. NO. 85-167,431, FILED 11-2-2010.

NELSON SNYDER, EXAMINING ATTORNEY



David J. Kyfos

Director of the United States Patent and Trademark Office

United States of America

United States Patent and Trademark Office

SAMURAI

Reg. No. 4,072,965

Registered Dec. 20, 2011

Int. Cl.: 18

TRADEMARK

PRINCIPAL REGISTER

KIKKERLAND DESIGN, INC. (NEW YORK CORPORATION)
4TH FLOOR
666 BROADWAY AVE.
NEW YORK, NY 10012

FOR: UMBRELLAS HAVING JAPANESE STYLE SWORD HANDLES, IN CLASS 18 (U.S. CLS. 1, 2, 3, 22 AND 41).

FIRST USE 5-17-2008; IN COMMERCE 5-17-2008.

THE MARK CONSISTS OF STANDARD CHARACTERS WITHOUT CLAIM TO ANY PARTICULAR FONT, STYLE, SIZE, OR COLOR.

SER. NO. 85-167,436, FILED 11-2-2010.

PAUL MORENO, EXAMINING ATTORNEY



David J. Kybas

Director of the United States Patent and Trademark Office

United States of America

United States Patent and Trademark Office

GEO NYLON DIAMOND

Reg. No. 4,072,966

Registered Dec. 20, 2011

Int. Cl.: 28

TRADEMARK

PRINCIPAL REGISTER

BRAINSTORM PRODUCTS (CALIFORNIA LIMITED LIABILITY COMPANY)
SUITE 305
875 PROSPECT
LA JOLLA, CA 92037

FOR: TOYS, NAMELY, KITES AND ACCESSORIES FOR KITES, NAMELY, KITE HANDLES, KITE LINES, KITE REELS, KITE STRING AND KITE TAILS, IN CLASS 28 (U.S. CLS. 22, 23, 38 AND 50).

FIRST USE 6-1-2009; IN COMMERCE 12-14-2009.

THE MARK CONSISTS OF STANDARD CHARACTERS WITHOUT CLAIM TO ANY PARTICULAR FONT, STYLE, SIZE, OR COLOR.

OWNER OF U.S. REG. NO. 2,882,721.

NO CLAIM IS MADE TO THE EXCLUSIVE RIGHT TO USE "NYLON DIAMOND", APART FROM THE MARK AS SHOWN.

SER. NO. 85-167,555, FILED 11-2-2010.

JORDAN BAKER, EXAMINING ATTORNEY



David J. Kyros

Director of the United States Patent and Trademark Office

United States of America

United States Patent and Trademark Office

AZTHETIK

Reg. No. 4,072,967

BENDER, ZACHARY (UNITED STATES INDIVIDUAL)
10985 ST HWY 357

Registered Dec. 20, 2011

FRANKLIN, NY 13775

Int. Cl.: 35

FOR: ADVERTISING AND BUSINESS SERVICES, NAMELY, THE DESIGN AND CREATION OF ADVERTISING MATERIALS, NAMELY, ADVERTISEMENTS, FLIERS, POSTERS, AND BANNERS, IN CLASS 35 (U.S. CLS. 100, 101 AND 102).

SERVICE MARK

FIRST USE 4-1-2009; IN COMMERCE 10-20-2010.

PRINCIPAL REGISTER

THE MARK CONSISTS OF STANDARD CHARACTERS WITHOUT CLAIM TO ANY PARTICULAR FONT, STYLE, SIZE, OR COLOR.

SER. NO. 85-167,705, FILED 11-3-2010.

KIM MONINGHOFF, EXAMINING ATTORNEY



David J. Kybas

Director of the United States Patent and Trademark Office

United States of America

United States Patent and Trademark Office

SECURE RECEIPTS

Reg. No. 4,072,968

Registered Dec. 20, 2011

Int. Cl.: 42

SERVICE MARK

PRINCIPAL REGISTER

BURDOUCCI, ROMELLO J. (UNITED STATES INDIVIDUAL), DBA PHEPHIPHOPHUM VENTURES
P. O. BOX 1852
ESCATAWPA, MS 39552

FOR: PROVIDING A SECURED-ACCESS WEBSITE THAT GIVES REGISTERED INTERNET NETWORKED INSTITUTIONS THE ABILITY TO UPLOAD, VIEW, COPY, PRINT, DOWNLOAD AND SHARE DOCUMENTS AND IMAGES FOR THE PURPOSES OF CONDUCTING CONSUMER-DRIVEN TRANSACTIONS FOR MATCHING COUPON TRADE PROMOTIONS TO TRANSACTION PURCHASES, IN CLASS 42 (U.S. CLS. 100 AND 101).

FIRST USE 10-1-2010; IN COMMERCE 10-2-2010.

THE MARK CONSISTS OF STANDARD CHARACTERS WITHOUT CLAIM TO ANY PARTICULAR FONT, STYLE, SIZE, OR COLOR.

SER. NO. 85-167,918, FILED 11-3-2010.

ANDREA HACK, EXAMINING ATTORNEY



David J. Kybas

Director of the United States Patent and Trademark Office

United States of America

United States Patent and Trademark Office

4AM FINDS

Reg. No. 4,072,969

4 AM FINDS LLC (NEW YORK LIMITED LIABILITY COMPANY)
80 WEST 40TH STREET
NEW YORK, NY 10018

Registered Dec. 20, 2011

Int. Cl.: 41

FOR: ENTERTAINMENT SERVICES, NAMELY, PROVIDING NEWS, INFORMATION, AND RECOMMENDATIONS RELATED TO PRODUCTS AND NOVELTY ITEMS IN THE FIELDS OF FASHION, BEAUTY, HOME FURNISHINGS, HOUSE WARES, ELECTRONICS, TOYS, GAMES, ARTS, LITERATURE AND ENTERTAINMENT ALL EXCLUSIVELY FOR NON-BUSINESS AND NON COMMERCIAL TRANSACTIONS AND PURPOSES; PROVIDING NEWSLETTERS VIA EMAIL RELATED TO PRODUCTS AND NOVELTY ITEMS IN THE FIELD OF FASHION, BEAUTY, HOME FURNISHINGS, HOUSE WARES, ELECTRONICS, TOYS, GAMES, FOOD, DRINK, ARTS, LITERATURE AND ENTERTAINMENT, IN CLASS 41 (U.S. CLS. 100, 101 AND 107).

SERVICE MARK

PRINCIPAL REGISTER

FIRST USE 2-0-2010; IN COMMERCE 2-0-2010.

THE MARK CONSISTS OF STANDARD CHARACTERS WITHOUT CLAIM TO ANY PARTICULAR FONT, STYLE, SIZE, OR COLOR.

SER. NO. 85-167,972, FILED 11-3-2010.

DAVID I, EXAMINING ATTORNEY



David J. Kypos

Director of the United States Patent and Trademark Office

United States of America

United States Patent and Trademark Office

Wheeler Mission Ministries

Reg. No. 4,072,970

Registered Dec. 20, 2011

Int. Cls.: 35, 43 and 45

SERVICE MARK

PRINCIPAL REGISTER

WHEELER MISSION MINISTRIES, INC. (INDIANA CORPORATION)
205 E. NEW YORK STREET
INDIANAPOLIS, IN 46204

FOR: CHARITABLE SERVICES, NAMELY, CONDUCTING VOLUNTEER PROGRAMS AND PROMOTING PUBLIC AWARENESS OF HOMELESSNESS, HUNGER, AND ADDICTION; CHARITABLE SERVICES, NAMELY, PROMOTING PUBLIC INTEREST IN EDUCATION, RECOGNITION, CAREER ADVANCEMENT AND LEADERSHIP FOR THE HOMELESS AND UNDERPRIVILEGED, IN CLASS 35 (U.S. CLS. 100, 101 AND 102).

FIRST USE 9-26-1990; IN COMMERCE 9-26-1990.

FOR: CHARITABLE SERVICES, NAMELY, PROVIDING FOOD AND TEMPORARY SHELTER TO THE HOMELESS AND UNDERPRIVILEGED, IN CLASS 43 (U.S. CLS. 100 AND 101).

FIRST USE 9-26-1990; IN COMMERCE 9-26-1990.

FOR: CHRISTIAN MINISTRY SERVICES; CHARITABLE SERVICES, NAMELY, PROVIDING CLOTHING TO THE HOMELESS AND UNDERPRIVILEGED, IN CLASS 45 (U.S. CLS. 100 AND 101).

FIRST USE 9-26-1990; IN COMMERCE 9-26-1990.

THE MARK CONSISTS OF STANDARD CHARACTERS WITHOUT CLAIM TO ANY PARTICULAR FONT, STYLE, SIZE, OR COLOR.

NO CLAIM IS MADE TO THE EXCLUSIVE RIGHT TO USE "MISSION MINISTRIES", APART FROM THE MARK AS SHOWN.

SEC. 2(F).

SER. NO. 85-167,974, FILED 11-3-2010.

GRETTA YAO, EXAMINING ATTORNEY



David J. Kyffers

Director of the United States Patent and Trademark Office

United States of America

United States Patent and Trademark Office

CMB

Reg. No. 4,072,971

Registered Dec. 20, 2011

MORTGAGE BANKERS ASSOCIATION (ILLINOIS CORPORATION)
1717 RHODE ISLAND AVENUE, NW
WASHINGTON, DC 20036

CERTIFICATION MARK

FOR: MORTGAGE BANKING SERVICES, IN CLASS B (U.S. CL. B).

PRINCIPAL REGISTER

FIRST USE 1-31-1974; IN COMMERCE 1-31-1974.

THE MARK CONSISTS OF STANDARD CHARACTERS WITHOUT CLAIM TO ANY PARTICULAR FONT, STYLE, SIZE, OR COLOR.

OWNER OF U.S. REG. NO. 1,163,237.

THE CERTIFICATION MARK, AS USED BY AUTHORIZED PERSONS, CERTIFIES THE RECIPIENT HAS DEMONSTRATED THROUGH EDUCATION, EXPERIENCE AND PERFORMANCE, A PROFICIENT KNOWLEDGE OF THE BROAD SPECTRUM OF REAL ESTATE FINANCE, HAVING EXEMPLIFIED HIGH COMPETENCE IN THIS CHOSEN PROFESSION, AND HAVING CONSISTENTLY USED THIS EXPERTISE IN A SKILLED MANNER OF THE HIGHEST ORDER THEREBY MERITING THIS PROFESSIONAL STATUS.

SER. NO. 85-168,048, FILED 11-3-2010.

ALLISON HOLTZ, EXAMINING ATTORNEY



David J. Kybas

Director of the United States Patent and Trademark Office

United States of America

United States Patent and Trademark Office

ACE WESTCHESTER

Reg. No. 4,072,972

ACE LIMITED (SWITZERLAND CORPORATION)
BARENGASSE 32

Registered Dec. 20, 2011

ZURICH, SWITZERLAND CH-8001

Int. Cl.: 36

FOR: INSURANCE UNDERWRITING IN THE FIELDS OF ACCIDENT, PROPERTY, CASUALTY, FIRE AND MARINE; INSURANCE ADMINISTRATION; INSURANCE CLAIMS ADMINISTRATION; INSURANCE CLAIMS PROCESSING; CLAIMS ADJUSTMENT SERVICES IN THE FIELDS OF PROPERTY, CASUALTY, ACCIDENT, FIRE AND MARINE INSURANCE; INSURANCE CLAIMS MANAGEMENT SERVICES; INSURANCE AGENCIES; INSURANCE BROKERAGE IN THE FIELDS OF ACCIDENT, PROPERTY CASUALTY, FIRE AND MARINE; ELECTRONIC PROCESSING OF INSURANCE CLAIMS AND PAYMENT DATA; INSURANCE CONSULTATION; FINANCIAL RISK MANAGEMENT, IN CLASS 36 (U.S. CLS. 100, 101 AND 102).

SERVICE MARK

PRINCIPAL REGISTER

FIRST USE 0-0-2003; IN COMMERCE 0-0-2003.

THE MARK CONSISTS OF STANDARD CHARACTERS WITHOUT CLAIM TO ANY PARTICULAR FONT, STYLE, SIZE, OR COLOR.

OWNER OF U.S. REG. NOS. 2,956,379, 3,297,045 AND OTHERS.

SER. NO. 85-168,144, FILED 11-3-2010.

STEVEN PEREZ, EXAMINING ATTORNEY



David J. Kyros

Director of the United States Patent and Trademark Office

United States of America

United States Patent and Trademark Office

TRACY ANDERSON METHOD

Reg. No. 4,072,973

Registered Dec. 20, 2011

Int. Cls.: 9 and 41

TRADEMARK

SERVICE MARK

PRINCIPAL REGISTER

TRACY ANDERSON MIND & BODY LLC (DELAWARE LIMITED LIABILITY COMPANY)
C/O STEVEN PREGIATO, CPA
200 PARK AVENUE SOUTH, 8TH FL.
NEW YORK, NY 10003

FOR: PRE-RECORDED AUDIO AND AUDIO VISUAL PROGRAMS RECORDED ON COMPACT DISKS, DVDS, AUDIO AND VIDEO TAPES AND CASSETTES AND DOWNLOADABLE VIDEO RECORDINGS ON THE SUBJECTS OF HEALTH, FITNESS, EXERCISE, NUTRITION, YOGA, PILATES, PERSONAL CARE, WELLNESS AND GENERAL PHYSICAL FITNESS INSTRUCTION, IN CLASS 9 (U.S. CLS. 21, 23, 26, 36 AND 38).

FIRST USE 8-1-2007; IN COMMERCE 8-1-2007.

FOR: PROVIDING INFORMATION, EDUCATION IN THE NATURE OF CLASS ROOM AND PERSONAL INSTRUCTION IN THE FIELD OF FITNESS AND EXERCISE, CONDUCTING WORKSHOPS AND SEMINARS IN THE FIELD OF FITNESS AND EXERCISE; PROVIDING PERSONAL TRAINER SERVICES AND PHYSICAL FITNESS INSTRUCTION AND CONSULTATION; PROVIDING A WEBSITE FEATURING INFORMATION ON FITNESS AND EXERCISE, AND LINKS TO WEBSITES OF OTHERS FEATURING INFORMATION ON FITNESS AND EXERCISE; PROVIDING A WEBSITE FEATURING INFORMATION ON FITNESS AND EXERCISE PROGRAMS DIRECTED TO IMPROVE HEALTH-RELATED ISSUES; CONDUCTING ON-LINE EDUCATIONAL PROGRAMS IN THE FIELDS OF FITNESS AND EXERCISE AND PRINTABLE MATERIALS DISTRIBUTED THEREWITH, AND ON-LINE PUBLICATIONS IN THE FORM OF NON-DOWNLOADABLE INFORMATION IN THE FIELD OF FITNESS AND EXERCISE; PROVIDING FITNESS AND EXERCISE FACILITIES, IN CLASS 41 (U.S. CLS. 100, 101 AND 107).

FIRST USE 8-1-2007; IN COMMERCE 8-1-2007.

THE MARK CONSISTS OF STANDARD CHARACTERS WITHOUT CLAIM TO ANY PARTICULAR FONT, STYLE, SIZE, OR COLOR.

NO CLAIM IS MADE TO THE EXCLUSIVE RIGHT TO USE "METHOD", APART FROM THE MARK AS SHOWN.

THE NAME(S), PORTRAIT(S), AND/OR SIGNATURE(S) SHOWN IN THE MARK IDENTIFIES "TRACY ANDERSON", WHOSE CONSENT(S) TO REGISTER IS MADE OF RECORD.



David J. Kyjars

Director of the United States Patent and Trademark Office

Reg. No. 4,072,973 SER. NO. 85-168,395, FILED 11-3-2010.

GIANCARLO CASTRO, EXAMINING ATTORNEY

United States of America

United States Patent and Trademark Office



Reg. No. 4,072,974

Registered Dec. 20, 2011

Int. Cl.: 39

SERVICE MARK

PRINCIPAL REGISTER

CITY OF CHICAGO (ILLINOIS MUNICIPAL CORPORATION)
CITY HALL, 121 NORTH LASALLE ST., RM 600
CHICAGO, IL 60602

FOR: TRAVEL ASSISTANCE PROGRAMS AND SERVICES AT AIRPORT FACILITIES, NAMELY, PROVIDING TRAVEL INFORMATION TO PERSONS WITH DISABILITIES, IN CLASS 39 (U.S. CLS. 100 AND 105).

FIRST USE 4-16-2010; IN COMMERCE 4-16-2010.

THE MARK CONSISTS OF A WHITE SILHOUETTE OF AN AIRPLANE CENTERED IN A PURPLE CIRCLE.

THE COLOR(S) PURPLE AND WHITE IS/ARE CLAIMED AS A FEATURE OF THE MARK.

SER. NO. 85-168,471, FILED 11-3-2010.

AISHA SALEM, EXAMINING ATTORNEY



David J. Kyffers

Director of the United States Patent and Trademark Office

United States of America

United States Patent and Trademark Office

BET ONE

Reg. No. 4,072,975

Registered Dec. 20, 2011

Int. Cl.: 41

SERVICE MARK

PRINCIPAL REGISTER

DA VINCI S.A. (COSTA RICA CORPORATION)
EDIFICIO LA COLMENA
SAN JOSE, COSTA RICA

FOR: PROVIDING A WEB-BASED SYSTEM AND AN ON-LINE PORTAL FOR CUSTOMERS TO PARTICIPATE IN ON-LINE GAMING; ENTERTAINMENT SERVICES, NAMELY, PROVIDING ONLINE GAMING, BINGO, BETTING GAMES, GAMBLING, SPORTS WAGERING AND GAMES OF CHANCE; WAGERING SERVICES; CASINO SERVICES; SPORTS WAGERING SERVICES; PROVIDING ON-LINE POKER AND BINGO GAMES; GAMBLING SERVICES, IN CLASS 41 (U.S. CLS. 100, 101 AND 107).

THE MARK CONSISTS OF STANDARD CHARACTERS WITHOUT CLAIM TO ANY PARTICULAR FONT, STYLE, SIZE, OR COLOR.

PRIORITY CLAIMED UNDER SEC. 44(D) ON ERPN CMNTY TM OFC APPLICATION NO. 009416884, FILED 10-1-2010, REG. NO. 009416884, DATED 3-8-2011, EXPIRES 10-1-2020.

NO CLAIM IS MADE TO THE EXCLUSIVE RIGHT TO USE "BET", APART FROM THE MARK AS SHOWN.

SER. NO. 85-169,009, FILED 11-4-2010.

KATHLEEN M. VANSTON, EXAMINING ATTORNEY



David J. Kyros

Director of the United States Patent and Trademark Office

United States of America

United States Patent and Trademark Office

BET UNO

Reg. No. 4,072,976

DA VINCI S.A. (COSTA RICA CORPORATION)
EDIFICIO LA COLMENA
SAN JOSE, COSTA RICA

Registered Dec. 20, 2011

Int. Cl.: 41

FOR: PROVIDING A WEB-BASED SYSTEM AND AN ON-LINE PORTAL FOR CUSTOMERS TO PARTICIPATE IN ON-LINE GAMING; PROVIDING ONLINE GAMING, BINGO, BETTING GAMES, GAMBLING, SPORTS WAGERING AND GAMES OF CHANCE; WAGERING SERVICES; CASINO SERVICES; SPORTS WAGERING SERVICES; PROVIDING ON-LINE POKER AND BINGO GAMES; GAMBLING SERVICES, IN CLASS 41 (U.S. CLS. 100, 101 AND 107).

SERVICE MARK

PRINCIPAL REGISTER

THE MARK CONSISTS OF STANDARD CHARACTERS WITHOUT CLAIM TO ANY PARTICULAR FONT, STYLE, SIZE, OR COLOR.

PRIORITY CLAIMED UNDER SEC. 44(D) ON ERPN CMNTY TM OFC APPLICATION NO. 009416918, FILED 10-1-2010, REG. NO. 009416918, DATED 3-8-2011, EXPIRES 10-1-2020.

NO CLAIM IS MADE TO THE EXCLUSIVE RIGHT TO USE "BET" , APART FROM THE MARK AS SHOWN.

THE ENGLISH TRANSLATION OF "UNO" IN THE MARK IS "ONE".

SER. NO. 85-169,027, FILED 11-4-2010.

KATHLEEN M. VANSTON, EXAMINING ATTORNEY



David J. Kybas

Director of the United States Patent and Trademark Office

United States of America

United States Patent and Trademark Office

DAILY KIBBLE

Reg. No. 4,072,977

DAILY KIBBLE, INC. (WASHINGTON CORPORATION)
21818 NE 84TH STREET
REDMOND, WA 98053

Registered Dec. 20, 2011

Int. Cl.: 41

FOR: PROVIDING NEWSLETTERS IN THE FIELD OF PETS AND COMPANION ANIMALS VIA E-MAIL; PROVIDING ON-LINE NEWSLETTERS IN THE FIELD OF PETS AND COMPANION ANIMALS, IN CLASS 41 (U.S. CLS. 100, 101 AND 107).

SERVICE MARK

FIRST USE 6-5-2006; IN COMMERCE 12-5-2006.

PRINCIPAL REGISTER

THE MARK CONSISTS OF STANDARD CHARACTERS WITHOUT CLAIM TO ANY PARTICULAR FONT, STYLE, SIZE, OR COLOR.

NO CLAIM IS MADE TO THE EXCLUSIVE RIGHT TO USE "DAILY", APART FROM THE MARK AS SHOWN.

SER. NO. 85-169,046, FILED 11-4-2010.

MARY CRAWFORD, EXAMINING ATTORNEY



David J. Kybas

Director of the United States Patent and Trademark Office

United States of America

United States Patent and Trademark Office

HYDROMED

Reg. No. 4,072,978

ADVANSOURCE BIOMATERIALS CORPORATION (DELAWARE CORPORATION)
229 ANDOVER STREET
WILMINGTON, MA 01887

Registered Dec. 20, 2011

Int. Cl.: 17

FOR: POLYURETHANES IN THE FORM OF PELLETS, GRANULES AND SOLUTIONS FOR USE IN THE MANUFACTURE OF MEDICAL DEVICES, IN CLASS 17 (U.S. CLS. 1, 5, 12, 13, 35 AND 50).

TRADEMARK

FIRST USE 11-10-1999; IN COMMERCE 11-10-1999.

PRINCIPAL REGISTER

THE MARK CONSISTS OF STANDARD CHARACTERS WITHOUT CLAIM TO ANY PARTICULAR FONT, STYLE, SIZE, OR COLOR.

SER. NO. 85-169,507, FILED 11-4-2010.

NANCY CLARKE, EXAMINING ATTORNEY



David J. Kyffers

Director of the United States Patent and Trademark Office

United States of America

United States Patent and Trademark Office

SAVAGE CHICKENS

Reg. No. 4,072,979

DOUG SAVAGE (CANADA INDIVIDUAL)
403 - 1245 NICOLA ST.
VANCOUVER, BC, CANADA V6G2E7

Registered Dec. 20, 2011

Int. Cls.: 16 and 25

FOR: COMIC STRIP APPEARING IN PRINT NEWSLETTERS AND MAGAZINES; BOOKS CONTAINING COMPILATIONS OF COMIC STRIPS; BLANK JOURNAL BOOKS; GREETING CARDS; POSTERS, IN CLASS 16 (U.S. CLS. 2, 5, 22, 23, 29, 37, 38 AND 50).

TRADEMARK

FIRST USE 1-30-2005; IN COMMERCE 6-15-2005.

PRINCIPAL REGISTER

FOR: T-SHIRTS, IN CLASS 25 (U.S. CLS. 22 AND 39).

FIRST USE 4-11-2005; IN COMMERCE 6-16-2005.

THE MARK CONSISTS OF STANDARD CHARACTERS WITHOUT CLAIM TO ANY PARTICULAR FONT, STYLE, SIZE, OR COLOR.

SER. NO. 85-169,558, FILED 11-4-2010.

GISELLE AGOSTO, EXAMINING ATTORNEY



David J. Kybas

Director of the United States Patent and Trademark Office

United States of America

United States Patent and Trademark Office

YOU ARE THE CONTROLLER

Reg. No. 4,072,980

Registered Dec. 20, 2011

Int. Cl.: 9

TRADEMARK

PRINCIPAL REGISTER

MICROSOFT CORPORATION (WASHINGTON CORPORATION)
ONE MICROSOFT WAY
REDMOND, WA 980526399

FOR: COMPUTER OPERATING SOFTWARE FOR AUDIO AND MOTION SENSORS AND COMPUTER HARDWARE AND PERIPHERALS; COMPUTER SOFTWARE FOR PLAYING VIDEO GAMES; COMPUTER AND VIDEO GAME SYSTEMS, NAMELY, ELECTRONIC SENSORS, CAMERAS, PROJECTORS AND MICROPHONES FOR VOICE RECOGNITION AND CAPTURING BODY AND FACIAL MOVEMENTS; COMPUTER SOFTWARE FOR CONTROLLING PERSONAL COMPUTING AND ENTERTAINMENT DEVICES; COMPUTER SOFTWARE FOR CONTROLLING, VIEWING, ACCESSING, BROWSING AND UTILIZING GLOBAL COMPUTER, COMMUNICATION AND ENTERTAINMENT NETWORKS, IN CLASS 9 (U.S. CLS. 21, 23, 26, 36 AND 38).

FIRST USE 11-4-2010; IN COMMERCE 11-4-2010.

THE MARK CONSISTS OF STANDARD CHARACTERS WITHOUT CLAIM TO ANY PARTICULAR FONT, STYLE, SIZE, OR COLOR.

SER. NO. 85-169,756, FILED 11-4-2010.

IRA J. GOODSaid, EXAMINING ATTORNEY



David J. Kyffers

Director of the United States Patent and Trademark Office

United States of America

United States Patent and Trademark Office



Reg. No. 4,072,981

KITZKE CELLARS, LLC (WASHINGTON LIMITED LIABILITY COMPANY)
72308 E 260 PR NE
RICHLAND, WA 99352

Registered Dec. 20, 2011

Int. Cl.: 33

FOR: WINES, IN CLASS 33 (U.S. CLS. 47 AND 49).

TRADEMARK

FIRST USE 1-1-2007; IN COMMERCE 1-1-2008.

PRINCIPAL REGISTER

NO CLAIM IS MADE TO THE EXCLUSIVE RIGHT TO USE "CELLARS" , APART FROM THE MARK AS SHOWN.

THE MARK CONSISTS OF A LARGE "Z" AND A LARGE "C" PLACED IN THE CENTER OF THE LOGO. THE "Z" SPELLS OUT PART OF "KITZKE".

SER. NO. 85-169,762, FILED 11-4-2010.

CHRIS WELLS, EXAMINING ATTORNEY



David J. Kyffers

Director of the United States Patent and Trademark Office

United States of America

United States Patent and Trademark Office

BRANDEX

Reg. No. 4,072,982

BRAND INSTITUTE, INC (FLORIDA CORPORATION)
200 SE 1ST STREET 12TH FLOOR
MIAMI, FL 33131

Registered Dec. 20, 2011

Int. Cl.: 16

FOR: CHARTS RELATING TO TRADEMARK AND SERVICE MARK SELECTION, IN CLASS 16 (U.S. CLS. 2, 5, 22, 23, 29, 37, 38 AND 50).

TRADEMARK

FIRST USE 6-1-1994; IN COMMERCE 6-1-1994.

PRINCIPAL REGISTER

THE MARK CONSISTS OF STANDARD CHARACTERS WITHOUT CLAIM TO ANY PARTICULAR FONT, STYLE, SIZE, OR COLOR.

SER. NO. 85-170,007, FILED 11-5-2010.

KATHY DE JONGE, EXAMINING ATTORNEY



David J. Kybas

Director of the United States Patent and Trademark Office

United States of America

United States Patent and Trademark Office

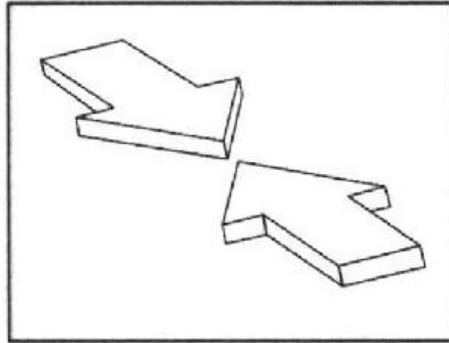

Reg. No. 4,072,983

FORIA GLOBAL S.A. (CHILE CORPORATION)
AV. TOMAS MORO 1075, OF. 1302
LAS CONDES, SANTIAGO, CHILE

Registered Dec. 20, 2011

Int. Cls.: 9, 16, 19 and 35

FOR: LUMINOUS AND MECHANICAL SIGNALS, NAMELY, LUMINOUS SIGNALS FOR DOORS, ROADS AND EXITS; ELECTRICAL, SIGNALLING, CHECKING, SUPERVISION, LIFE-SAVING AND TEACHING APPARATUS AND INSTRUMENTS, NAMELY, LUMINOUS SIGNALS FOR TRAFFIC; APPARATUS FOR RECORDING, TRANSMISSION OR REPRODUCTION OF SOUND OR IMAGES, IN CLASS 9 (U.S. CLS. 21, 23, 26, 36 AND 38).

TRADEMARK

SERVICE MARK

PRINCIPAL REGISTER

FOR: PRINTED INSTRUCTIONAL AND TEACHING MATERIAL IN THE FIELD OF PEDESTRIAN TRAFFIC; PAPER PRINTED SIGNALS; PLASTIC AND IRON-ON TRANSFERS; NEWSPAPERS AND SIGNS FOR BOOKS IN THE FIELD OF PEDESTRIAN TRAFFIC; PAPER CARDBOARD; PRINTED MATTER, NAMELY, GUIDES, MANUALS, POSTERS AND EDUCATIONAL BOOKLETS IN THE FIELD OF PEDESTRIAN TRAFFIC; BOOKBINDING MATERIALS; PHOTOGRAPHS; STATIONERY; ADHESIVES FOR STATIONERY OR HOUSEHOLD PURPOSES; PRINTERS' TYPE; PRINTING BLOCKS, IN CLASS 16 (U.S. CLS. 2, 5, 22, 23, 29, 37, 38 AND 50).

FOR: NON-LUMINOUS, NON-MECHANICAL SIGNS NOT OF METAL, IN CLASS 19 (U.S. CLS. 1, 12, 33 AND 50).



FOR: ADVERTISING AND PUBLICITY SERVICES THROUGH RADIO AND TELEVISION; IMPORT AND EXPORT AGENCIES; PROMOTIONAL MARKETING AND REPRESENTATION SERVICES FOR SALES TO THE PUBLIC SECTOR FEATURING ALL KIND OF PRODUCTS AND ARTICLES; DISTRIBUTION OF SAMPLES FOR PUBLICITY PURPOSES; MARKETING; SERVICES CONSISTING OF THE REGISTRATION, COLLECTION, TRANSCRIPTION, COMPILATION AND SYSTEMIZATION OF WRITTEN COMMUNICATIONS AND DATA, IN CLASS 35 (U.S. CLS. 100, 101 AND 102).

PRIORITY CLAIMED UNDER SEC. 44(D) ON CHILE APPLICATION NO. 904.286, FILED 5-6-2010, REG. NO. 905.088, DATED 12-16-2010, EXPIRES 12-16-2020.

David J. Kyros

PRIORITY CLAIMED UNDER SEC. 44(D) ON CHILE APPLICATION NO. 904.285, FILED 5-6-2010, REG. NO. 905.087, DATED 12-16-2010, EXPIRES 12-16-2020.

Reg. No. 4,072,983 THE MARK CONSISTS OF TWO ARROWS COMING ACROSS EACH OTHER IN DIAGONAL POSITION.

SER. NO. 85-170,029, FILED 11-5-2010.

NAAKWAMA ANKRAH, EXAMINING ATTORNEY

United States of America

United States Patent and Trademark Office

Experience Transcendessence

Reg. No. 4,072,984

STILLPOINT AROMATICS, INC. (ARIZONA CORPORATION)
45 JUNIPER DRIVE
SEDONA, AZ 86336

Registered Dec. 20, 2011

Int. Cl.: 3

FOR: ESSENTIAL OILS; ESSENTIAL OILS FOR AROMATHERAPY USE; ESSENTIAL OILS FOR PERSONAL USE; ESSENTIAL OILS FOR USE IN AROMATHERAPY; NATURAL ESSENTIAL OILS, IN CLASS 3 (U.S. CLS. 1, 4, 6, 50, 51 AND 52).

TRADEMARK

FIRST USE 5-7-2010; IN COMMERCE 5-7-2010.

PRINCIPAL REGISTER

THE MARK CONSISTS OF STANDARD CHARACTERS WITHOUT CLAIM TO ANY PARTICULAR FONT, STYLE, SIZE, OR COLOR.

SER. NO. 85-170,039, FILED 11-5-2010.

VIVIAN MICZNIK FIRST, EXAMINING ATTORNEY



David J. Kybas

Director of the United States Patent and Trademark Office

United States of America

United States Patent and Trademark Office

1 ACCESS

Reg. No. 4,072,985

BRASSIL, DANIEL (UNITED STATES INDIVIDUAL)
221 TREMONT STREET
CARVER, MA 02330

Registered Dec. 20, 2011

Int. Cl.: 38

FOR: INTERNET ACCESS PROVIDER SERVICES, IN CLASS 38 (U.S. CLS. 100, 101 AND 104).

SERVICE MARK

FIRST USE 3-2-2000; IN COMMERCE 3-2-2000.

PRINCIPAL REGISTER

THE MARK CONSISTS OF STANDARD CHARACTERS WITHOUT CLAIM TO ANY PARTICULAR FONT, STYLE, SIZE, OR COLOR.

SER. NO. 85-170,043, FILED 11-5-2010.

VIVIAN MICZNIK FIRST, EXAMINING ATTORNEY



David J. Kybas

Director of the United States Patent and Trademark Office

United States of America

United States Patent and Trademark Office

IRIS UKIYOÉ

Reg. No. 4,072,986

COMPTOIR NOUVEAU DE LA PARFUMERIE (FRANCE SOCIÉTÉ ANONYME (SA))
23, RUE BOISSY D'ANGLAS
75008 PARIS, FRANCE

Registered Dec. 20, 2011

Int. Cl.: 3

FOR: PERFUME, TOILET WATER, PERFUME WATER, ESSENTIAL OILS FOR PERSONAL USE, COSMETICS, COSMETIC LOTIONS FOR THE HAIR AND THE BODY, SOAPS, DENTIFRICES, DEODORANTS FOR PERSONAL USE, BATH AND SHOWER GELS, SHAMPOOS, BEAUTY CREAMS FOR THE BODY, IN CLASS 3 (U.S. CLS. 1, 4, 6, 50, 51 AND 52).

TRADEMARK

PRINCIPAL REGISTER

THE MARK CONSISTS OF STANDARD CHARACTERS WITHOUT CLAIM TO ANY PARTICULAR FONT, STYLE, SIZE, OR COLOR.

PRIORITY CLAIMED UNDER SEC. 44(D) ON FRANCE APPLICATION NO. 103737943, FILED 5-12-2010, REG. NO. 103737943, DATED 5-12-2010, EXPIRES 5-12-2020.

NO CLAIM IS MADE TO THE EXCLUSIVE RIGHT TO USE "IRIS", APART FROM THE MARK AS SHOWN.

THE NAME(S), PORTRAIT(S), AND/OR SIGNATURE(S) SHOWN IN THE MARK DOES NOT IDENTIFY A PARTICULAR LIVING INDIVIDUAL.

THE ENGLISH TRANSLATION OF "UKIYOÉ" IN THE MARK IS A GENRE OF JAPANESE WOODBLOCK PRINTS OR WOODCUTS PAINTINGS.

SER. NO. 85-170,102, FILED 11-5-2010.

ELIZABETH KAJUBI, EXAMINING ATTORNEY



David J. Kyros

Director of the United States Patent and Trademark Office

United States of America

United States Patent and Trademark Office

SLEEP CLEAN · SLEEP COOL ·
SLEEP WELL

Reg. No. 4,072,987

Registered Dec. 20, 2011

Int. Cl.: 24

TRADEMARK

PRINCIPAL REGISTER

GUARD MASTER INC. (NEW YORK CORPORATION)
110 BI-COUNTY BLVD.
SUITE 101
FARMINGDALE, NY 11735

FOR: MATTRESS PROTECTORS; PILLOW SHELLS; PILLOW COVERS; PILLOW PROTECTORS; BED SHEETS, IN CLASS 24 (U.S. CLS. 42 AND 50).

FIRST USE 4-0-2010; IN COMMERCE 4-0-2010.

THE MARK CONSISTS OF STANDARD CHARACTERS WITHOUT CLAIM TO ANY PARTICULAR FONT, STYLE, SIZE, OR COLOR.

SER. NO. 85-170,122, FILED 11-5-2010.

LESLEY LAMOTHE, EXAMINING ATTORNEY



David J. Kyros

Director of the United States Patent and Trademark Office

United States of America

United States Patent and Trademark Office

THE LOGISTICS RESOURCE

Reg. No. 4,072,988

Registered Dec. 20, 2011

Int. Cls.: 35 and 39

SERVICE MARK

PRINCIPAL REGISTER

LOGISOURCE, INC. (SOUTH CAROLINA CORPORATION)
700 MATTHEWS-MINT HILL ROAD
MATTHEWS, NC 28105

FOR: BUSINESS MANAGEMENT IN THE FIELD OF DISTRIBUTION AND TRANSPORTATION; FREIGHT LOGISTICS MANAGEMENT, IN CLASS 35 (U.S. CLS. 100, 101 AND 102).

FIRST USE 10-0-1992; IN COMMERCE 10-0-1992.

FOR: FREIGHT TRANSPORTATION BY MEANS OF TRUCK, RAIL, AIR AND OCEAN, IN CLASS 39 (U.S. CLS. 100 AND 105).

FIRST USE 10-0-1992; IN COMMERCE 10-0-1992.

THE MARK CONSISTS OF STANDARD CHARACTERS WITHOUT CLAIM TO ANY PARTICULAR FONT, STYLE, SIZE, OR COLOR.

SEC. 2(F).

SER. NO. 85-170,130, FILED 11-5-2010.

JESSICA FATHY, EXAMINING ATTORNEY



David J. Kyros

Director of the United States Patent and Trademark Office

United States of America

United States Patent and Trademark Office

TWISTED SOUTH

Reg. No. 4,072,989

TWISTED SOUTH, L.L.C. (TEXAS LIMITED LIABILITY COMPANY)
259 COUNTY ROAD, #2555
CLEVELAND, TX 77327

Registered Dec. 20, 2011

Int. Cl.: 16

FOR: GENERAL FEATURE MAGAZINE IN THE FIELD OF SUBJECTS OF INTEREST
CONSISTING OF MUSIC FASHION ART LITERATURE FOOD GARDENING PHOTOGRAPHY
SPORTS TRAVEL FILM, IN CLASS 16 (U.S. CLS. 2, 5, 22, 23, 29, 37, 38 AND 50).

TRADEMARK

FIRST USE 1-15-2010; IN COMMERCE 4-1-2010.

PRINCIPAL REGISTER

THE MARK CONSISTS OF STANDARD CHARACTERS WITHOUT CLAIM TO ANY PAR-
TICULAR FONT, STYLE, SIZE, OR COLOR.

OWNER OF U.S. REG. NO. 3,899,627.

NO CLAIM IS MADE TO THE EXCLUSIVE RIGHT TO USE "SOUTH", APART FROM THE
MARK AS SHOWN.

SER. NO. 85-170,228, FILED 11-5-2010.

RENEE MCCRAY, EXAMINING ATTORNEY



David J. Kyros

Director of the United States Patent and Trademark Office

United States of America

United States Patent and Trademark Office

IMPACT

Reg. No. 4,072,990

Registered Dec. 20, 2011

Int. Cls.: 9 and 41

TRADEMARK

SERVICE MARK

PRINCIPAL REGISTER

IMPACT APPLICATIONS, INC. (PENNSYLVANIA CORPORATION)
2000 TECHNOLOGY DRIVE, SUITE 150
PITTSBURGH, PA 15219

FOR: COMPUTER SOFTWARE FOR NEUROCOGNITIVE TESTING, ASSESSMENT AND EVALUATION, IN CLASS 9 (U.S. CLS. 21, 23, 26, 36 AND 38).

FIRST USE 6-0-2000; IN COMMERCE 6-0-2000.

FOR: PROVIDING TRAINING, WORKSHOPS, SEMINARS AND PRESENTATIONS FOR NEUROCOGNITIVE TESTING, ASSESSMENT AND EVALUATION, IN CLASS 41 (U.S. CLS. 100, 101 AND 107).

FIRST USE 6-0-2000; IN COMMERCE 6-0-2000.

THE MARK CONSISTS OF STANDARD CHARACTERS WITHOUT CLAIM TO ANY PARTICULAR FONT, STYLE, SIZE, OR COLOR.

SER. NO. 85-170,329, FILED 11-5-2010.

MICHAEL SOUDERS, EXAMINING ATTORNEY



David J. Kybas

Director of the United States Patent and Trademark Office

United States of America

United States Patent and Trademark Office



Reg. No. 4,072,991

Registered Dec. 20, 2011

Int. Cls.: 9 and 41

TRADEMARK

SERVICE MARK

PRINCIPAL REGISTER

IMPACT APPLICATIONS, INC. (PENNSYLVANIA CORPORATION)
2000 TECHNOLOGY DRIVE, SUITE 150
PITTSBURGH, PA 15219

FOR: COMPUTER SOFTWARE FOR NEUROCOGNITIVE TESTING, ASSESSMENT AND EVALUATION, IN CLASS 9 (U.S. CLS. 21, 23, 26, 36 AND 38).

FIRST USE 6-0-2000; IN COMMERCE 6-0-2000.

FOR: PROVIDING TRAINING, WORKSHOPS, SEMINARS AND PRESENTATIONS FOR NEUROCOGNITIVE TESTING, ASSESSMENT AND EVALUATION, IN CLASS 41 (U.S. CLS. 100, 101 AND 107).

FIRST USE 6-0-2000; IN COMMERCE 6-0-2000.

THE MARK CONSISTS OF THE TERM "IMPACT" TO THE RIGHT OF A PROFILE DESIGN OF A FACE AND BRAIN.

SER. NO. 85-170,339, FILED 11-5-2010.

MICHAEL SOUDERS, EXAMINING ATTORNEY



David J. Kyros

Director of the United States Patent and Trademark Office

United States of America

United States Patent and Trademark Office



Reg. No. 4,072,992

SUNENERGY EUROPE GMBH (FED REP GERMANY LIMITED LIABILITY COMPANY)
FUHLENTWIETE 10

Registered Dec. 20, 2011

D-20355 HAMBURG, FED REP GERMANY

Int. Cls.: 35, 37 and 42

FOR: BUSINESS CONSULTANCY, ANALYSIS AND CONDUCTING COMPARATIVE STUDIES FOR BUSINESS PURPOSES WITH REGARD TO OPTIMIZING THE USE OF SOLAR INSTALLATIONS, PHOTOVOLTAIC INSTALLATIONS AND SOLAR POWERED GENERATORS, IN CLASS 35 (U.S. CLS. 100, 101 AND 102).

SERVICE MARK

PRINCIPAL REGISTER

FIRST USE 4-1-2011; IN COMMERCE 4-1-2011.

FOR: INSTALLATION AND MAINTENANCE OF SOLAR ENERGY BASED POWER PLANTS, PHOTOVOLTAIC INSTALLATIONS AND SOLAR POWERED GENERATORS, IN CLASS 37 (U.S. CLS. 100, 103 AND 106).

FIRST USE 4-1-2011; IN COMMERCE 4-1-2011.

FOR: PLANNING AND DESIGNING OF SOLAR ENERGY BASED POWER PLANTS, PHOTOVOLTAIC INSTALLATIONS AND SOLAR POWERED GENERATORS; TECHNICAL CONSULTANCY WITH REGARD TO THE SELECTION OF SOLAR ENERGY PRODUCTION TECHNOLOGY; TECHNOLOGICAL CONSULTANCY, ANALYSIS AND CONDUCTING TECHNOLOGICAL COMPARATIVE STUDIES WITH REGARD TO OPTIMIZING THE USE OF SOLAR INSTALLATIONS, PHOTOVOLTAIC INSTALLATIONS AND SOLAR POWERED GENERATORS, IN CLASS 42 (U.S. CLS. 100 AND 101).

FIRST USE 4-1-2011; IN COMMERCE 4-1-2011.

NO CLAIM IS MADE TO THE EXCLUSIVE RIGHT TO USE "SUN ENERGY AMERICAS", APART FROM THE MARK AS SHOWN.

THE COLOR(S) ORANGE AND BLUE IS/ARE CLAIMED AS A FEATURE OF THE MARK.

THE MARK CONSISTS OF A CIRCULAR DESIGN MADE UP OF A NUMBER OF DOTS COLORED ORANGE TO THE LEFT OF THE STYLIZED WORDS "SUN ENERGY" IN BLUE TO THE LEFT AND ABOVE THE WORD "AMERICAS".



David J. Kyffers

Director of the United States Patent and Trademark Office

SER. NO. 85-170,427, FILED 11-5-2010.

Reg. No. 4,072,992 WILLIAM VERHOSEK, EXAMINING ATTORNEY

United States of America

United States Patent and Trademark Office

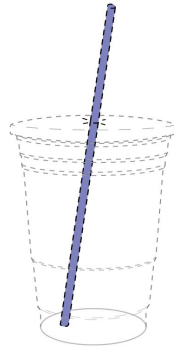

Reg. No. 4,072,993

Registered Dec. 20, 2011

Int. Cl.: 35

SERVICE MARK

PRINCIPAL REGISTER

INTERNATIONAL COFFEE & TEA, LLC (DELAWARE LIMITED LIABILITY COMPANY)
1945 SOUTH LA CIENEGA BOULEVARD
LOS ANGELES, CA 90034

FOR: RETAIL STORE SERVICES, MAIL ORDER SERVICES AND ONLINE RETAIL STORE SERVICES FEATURING COFFEE AND TEA, CHOCOLATE-BASED BEVERAGES, COFFEE-BASED BEVERAGES, TEA-BASED BEVERAGES, MIXES FOR MAKING BEVERAGES, COFFEE BEANS, GROUND COFFEE, LOOSE TEA AND TEA BAGS, CHOCOLATE PRODUCTS AND FOOD, PASTRIES, FLAVORED SHAKES, INCLUDING COFFEE, CHOCOLATE, VANILLA, CARAMEL AND TEA, FRUIT-BASED SHAKES, AND MIXES FOR MAKING THE SAME, COFFEE, ESPRESSO, TEA AND POWDER SOLD IN SINGLE-SERVING CONTAINERS FOR USE IN BREWING MACHINES, ELECTRIC BREWING MACHINES AND ELECTRIC ESPRESSO MACHINES, COFFEE AND TEA PRESSES, POTS AND FILTERS, BEVERAGEWARE, T-SHIRTS, IN CLASS 35 (U.S. CLS. 100, 101 AND 102).

FIRST USE 1-0-2000; IN COMMERCE 1-0-2000.

THE MARK CONSISTS SOLELY OF THE COLOR PURPLE AS APPLIED TO THE SURFACE OF A BEVERAGE STRAW USED IN THE COURSE OF RENDERING THE SERVICES. THE BROKEN LINES SHOWN IN THE DRAWING ARE NOT CLAIMED AS A FEATURE OF THE MARK, BUT ARE INTENDED ONLY TO SHOW POSITION OF THE MARK ON ELEMENTS OF PACKAGING USED IN THE COURSE OF THE SERVICES AND IN THE OFFERING OF THE SERVICES.

THE COLOR(S) PURPLE IS/ARE CLAIMED AS A FEATURE OF THE MARK.

SEC. 2(F).

SER. NO. 85-170,513, FILED 11-5-2010.

HANNO RITTNER, EXAMINING ATTORNEY



David J. Kybas

Director of the United States Patent and Trademark Office

United States of America

United States Patent and Trademark Office

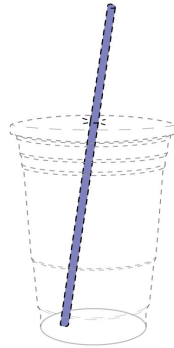

Reg. No. 4,072,994

Registered Dec. 20, 2011

Int. Cl.: 43

SERVICE MARK

PRINCIPAL REGISTER

INTERNATIONAL COFFEE & TEA, LLC (DELAWARE LIMITED LIABILITY COMPANY)
1945 SOUTH LA CIENEGA BOULEVARD
LOS ANGELES, CA 90034

FOR: RESTAURANT SERVICES FEATURING COFFEE AND TEA, CHOCOLATE-BASED BEVERAGES, COFFEE-BASED BEVERAGES, TEA-BASED BEVERAGES, FRUIT-BASED BEVERAGES, MIXES FOR MAKING BEVERAGES, COFFEE BEANS, GROUND COFFEE, LOOSE TEA AND TEA BAGS, CHOCOLATE PRODUCTS AND FOOD, PASTRIES, FLAVORED SHAKES, INCLUDING COFFEE, CHOCOLATE, VANILLA, CARAMEL AND TEA AND FRUIT-BASED SHAKES, AND MIXES FOR MAKING THE SAME, IN CLASS 43 (U.S. CLS. 100 AND 101).

FIRST USE 1-0-2000; IN COMMERCE 1-0-2000.

THE MARK CONSISTS SOLELY OF THE COLOR PURPLE AS APPLIED TO THE SURFACE OF A BEVERAGE STRAW USED IN THE COURSE OF RENDERING THE SERVICES. THE BROKEN LINES SHOWN IN THE DRAWING ARE NOT CLAIMED AS A FEATURE OF THE MARK, BUT ARE INTENDED ONLY TO SHOW POSITION OF THE MARK ON ELEMENTS OF PACKAGING USED IN THE COURSE OF THE SERVICES AND IN THE OFFERING OF THE SERVICES.

THE COLOR(S) PURPLE IS/ARE CLAIMED AS A FEATURE OF THE MARK.

SEC. 2(F).

SER. NO. 85-170,549, FILED 11-5-2010.

HANNO RITTNER, EXAMINING ATTORNEY



David J. Kybas

Director of the United States Patent and Trademark Office

United States of America

United States Patent and Trademark Office

Salzano's Barber Shop

Reg. No. 4,072,995

SALZANO, ANGELO (UNITED STATES INDIVIDUAL)
5051 MALLARD CROSSING LN.
CINCINNATI, OH 45247

Registered Dec. 20, 2011

Int. Cl.: 44

FOR: HAIR SALON SERVICES, NAMELY, HAIR CUTTING, STYLING, COLORING; SCALP MASSAGES AND SALON SERVICES, NAMELY, FACIALS, IN CLASS 44 (U.S. CLS. 100 AND 101).

SERVICE MARK

FIRST USE 10-1-2001; IN COMMERCE 10-2-2002.

PRINCIPAL REGISTER

THE MARK CONSISTS OF STANDARD CHARACTERS WITHOUT CLAIM TO ANY PARTICULAR FONT, STYLE, SIZE, OR COLOR.

NO CLAIM IS MADE TO THE EXCLUSIVE RIGHT TO USE "BARBER SHOP", APART FROM THE MARK AS SHOWN.

SEC. 2(F).

SER. NO. 85-170,663, FILED 11-5-2010.

CHRISTINA SOBRAL, EXAMINING ATTORNEY



David J. Kybas

Director of the United States Patent and Trademark Office

United States of America

United States Patent and Trademark Office

OPENACTION

Reg. No. 4,072,996

Registered Dec. 20, 2011

Int. Cl.: 42

SERVICE MARK

PRINCIPAL REGISTER

OPENACTION, INC. (DELAWARE CORPORATION)
6 CONSTITUTION CT.
MONTVILLE, NJ 07045

FOR: COMPUTER SERVICE, NAMELY, ACTING AS AN APPLICATION SERVICE PROVIDER IN THE FIELD OF KNOWLEDGE MANAGEMENT TO HOST COMPUTER APPLICATION SOFTWARE FOR THE COLLECTION, EDITING, ORGANIZING, MODIFYING, BOOK MARKING, TRANSMISSION, STORAGE AND SHARING OF DATA AND INFORMATION; PROVIDING A WEBSITE FEATURING TEMPORARY USE OF NON-DOWNLOADABLE SOFTWARE ALLOWING WEB SITE USERS TO UPLOAD ON-LINE VIDEOS FOR SHARING WITH OTHERS; PROVIDING ON-LINE NON-DOWNLOADABLE SOFTWARE ENABLING USERS TO EMBED SEARCH AND DISCOVERABILITY FUNCTIONS AND TOOLS INTO THEIR OWN WEBSITES THAT WILL PACKAGE AND INTEGRATE ON-LINE CONTENT BY GENERATING MAPS, LIST VIEWS, TAG CLOUDS, SEARCH BOXES AND CUSTOMIZED SEARCH FILTERS TO ALLOW OTHERS TO SEARCH THEIR WEBSITES; PROVIDING ON-LINE NON-DOWNLOADABLE SOFTWARE WHICH ALLOWS USERS TO EMBED COMPUTER SOFTWARE APPLICATIONS THAT ALLOW EXPLORATION OF CONTENT ON THEIR WEBSITES AND THE WEBSITES OF OTHERS WITHOUT LEAVING THE USERS WEBSITE PLATFORM; PROVIDING TEMPORARY USE OF ON-LINE NON-DOWNLOADABLE SOFTWARE WHICH MAPS, ORGANIZES, TAGS, PROFILES, STREAMS, SYNCs, STORES, ATTACHES, EMBEDS, DIGESTS, CREATES CUSTOMIZED FILTERS, CATALOGUES AND SEARCHES ON-LINE DATA, VIDEO, AUDIO, PHOTOGRAPHS, VIDEO-BLOGS, WEB-LOGS, BLOGS, ON-LINE JOURNALS, DOCUMENTS, PHOTOGRAPHS, TEXT, GRAPHICS, USER-CREATED CONTENT AND USER-SUPPLIED CONTENT FOR SHARING AND TRANSMISSION OF NEWS, DEVELOPMENTS, DATA AND INFORMATION IN REAL TIME; COMPUTER SOFTWARE DEVELOPMENT; PROVIDING TEMPORARY USE OF ON-LINE NON-DOWNLOADABLE COMPUTER SOFTWARE FOR CREATING AN ON-LINE COMMUNITY FOR REGISTERED USERS TO PARTICIPATE IN DISCUSSIONS, GET FEED BACK FROM THEIR PEERS, FORM VIRTUAL COMMUNITIES, AND ENGAGE IN SOCIAL NETWORKING; PROVIDING ONLINE NON-DOWNLOADABLE SOFTWARE FOR THE CREATION OF SCHEDULE TIMELINES BASED ON USER-SUPPLIED INFORMATION, INTERNET SEARCHES, AND INDEXES, AND WHICH ALLOWS USERS TO VIEW THE SCHEDULING TIMELINES OF OTHERS; PROVIDING ON-LINE NON-DOWNLOADABLE SOFTWARE FOR THE CREATION OF SCHEDULING TIMELINES BASED ON DATA RETRIEVED FROM INTERNET SEARCHES, INDEXES, AND USER-SUPPLIED INFORMATION BY TIME, LOCATION, AND TOPIC, AND WHICH ALLOWS USERS TO VIEW THE SCHEDULING TIMELINES OF OTHERS; PROVIDING TEMPORARY USE OF ONLINE NON-



David J. Kybas

Director of the United States Patent and Trademark Office

Reg. No. 4,072,996 DOWNLOADABLE SOFTWARE WHICH ENABLES USERS TO IDENTIFY INTERNET CONTENT, TO BROWSE, NAVIGATE AND SEARCH THE INTERNET FOR OTHER RELATED CONTENT, AND TO EMBED LINKS TO SUCH INTERNET CONTENT IN OTHER CONTENT; PROVIDING TEMPORARY USE OF ONLINE NON-DOWNLOADABLE SOFTWARE WHICH ENABLES USERS TO IDENTIFY INTERNET CONTENT, TO BROWSE, NAVIGATE AND SEARCH THE INTERNET FOR OTHER RELATED CONTENT BY TIME, LOCATION AND TOPIC, AND TO EMBED LINKS TO SUCH INTERNET CONTENT IN OTHER CONTENT, IN CLASS 42 (U.S. CLS. 100 AND 101).

FIRST USE 1-3-2010; IN COMMERCE 6-15-2010.

THE MARK CONSISTS OF STANDARD CHARACTERS WITHOUT CLAIM TO ANY PARTICULAR FONT, STYLE, SIZE, OR COLOR.

SER. NO. 85-170,678, FILED 11-5-2010.

JIM RINGLE, EXAMINING ATTORNEY

United States of America

United States Patent and Trademark Office

ONLINE TRAINING MADE EASY

Reg. No. 4,072,997

Registered Dec. 20, 2011

Int. Cls.: 38 and 42

SERVICE MARK

PRINCIPAL REGISTER

CITRIX ONLINE LLC (DELAWARE LIMITED LIABILITY COMPANY)
7414 HOLLISTER AVENUE
GOLETA, CA 93117

FOR: TELECOMMUNICATION SERVICES, NAMELY, BROADCASTING MEETINGS, EDUCATIONAL COURSES, EVENTS AND REAL TIME INFORMATION VIA A GLOBAL COMPUTER COMMUNICATIONS NETWORKS; COMMUNICATIONS SERVICES, NAMELY, ELECTRONIC TRANSMISSION OF DOCUMENTS, DATA, MESSAGES, IMAGES, VOICE AND TELEPHONY OVER GLOBAL COMPUTER COMMUNICATIONS NETWORKS; INSTANT MESSAGING SERVICES; WEB CONFERENCING SERVICES, IN CLASS 38 (U.S. CLS. 100, 101 AND 104).

FIRST USE 2-16-2010; IN COMMERCE 2-16-2010.

FOR: COMPUTER SERVICES, NAMELY, HOSTING ONLINE WEB FACILITIES FOR OTHERS FOR CONDUCTING ONLINE CONFERENCES, MEETINGS, DEMONSTRATIONS, PRESENTATIONS, EDUCATIONAL COURSES, AND INTERACTIVE DISCUSSIONS, IN CLASS 42 (U.S. CLS. 100 AND 101).

FIRST USE 2-16-2010; IN COMMERCE 2-16-2010.

THE MARK CONSISTS OF STANDARD CHARACTERS WITHOUT CLAIM TO ANY PARTICULAR FONT, STYLE, SIZE, OR COLOR.

NO CLAIM IS MADE TO THE EXCLUSIVE RIGHT TO USE "ONLINE TRAINING", APART FROM THE MARK AS SHOWN.

SER. NO. 85-170,757, FILED 11-5-2010.

SUSAN LESLIE DUBOIS, EXAMINING ATTORNEY



David J. Kyjars

Director of the United States Patent and Trademark Office

United States of America

United States Patent and Trademark Office

INTEGROW

Reg. No. 4,072,998

INTEGROW MALT, LLC (IDAHO LIMITED LIABILITY COMPANY)
505 WEST,
IDAHO FALLS, ID 83402

Registered Dec. 20, 2011

Int. Cls.: 31, 35 and 40

FOR: AGRICULTURAL GRAINS FOR PLANTING; UNPROCESSED GRAIN; MALT FOR BREWING AND DISTILLING, IN CLASS 31 (U.S. CLS. 1 AND 46).

TRADEMARK

FIRST USE 4-14-2010; IN COMMERCE 4-14-2010.

SERVICE MARK

FOR: WHOLESALE GRAIN, BARLEY AND MALT DISTRIBUTION SERVICES, IN CLASS 35 (U.S. CLS. 100, 101 AND 102).

PRINCIPAL REGISTER

FIRST USE 4-14-2010; IN COMMERCE 4-14-2010.

FOR: TREATMENT OF MATERIALS, NAMELY, GRAINS, BARLEY AND MALT EMPLOYING CHEMICAL PROCESSES TO TRANSFORM ORGANIC SUBSTANCES, SUCH AS FOR USE IN MALTING AND DISTILLING, IN CLASS 40 (U.S. CLS. 100, 103 AND 106).

FIRST USE 4-14-2010; IN COMMERCE 4-14-2010.

THE MARK CONSISTS OF STANDARD CHARACTERS WITHOUT CLAIM TO ANY PARTICULAR FONT, STYLE, SIZE, OR COLOR.

SER. NO. 85-171,484, FILED 11-8-2010.

WILLIAM BRECKENFELD, EXAMINING ATTORNEY



David J. Kyros

Director of the United States Patent and Trademark Office

United States of America

United States Patent and Trademark Office

MCM

Reg. No. 4,072,999

Registered Dec. 20, 2011

Int. Cls.: 10 and 24

TRADEMARK

PRINCIPAL REGISTER

HILL-ROM SARL (FRANCE LIMITED LIABILITY COMPANY)
83 BOULEVARD DU MONTPARNASSE
PARIS, FRANCE 75006

FOR: MATTRESS COVERS AND OPERATING ROOM TABLE COVERS THAT HAVE BEEN SPECIALLY ADAPTED FOR MEDICAL PURPOSES IN MANAGING THE TEMPERATURE AND/OR HUMIDITY OF PATIENTS, IN CLASS 10 (U.S. CLS. 26, 39 AND 44).

FOR: MATTRESS PADS AND MATTRESS COVERS FOR USE ON MEDICAL BEDS, IN CLASS 24 (U.S. CLS. 42 AND 50).

THE MARK CONSISTS OF STANDARD CHARACTERS WITHOUT CLAIM TO ANY PARTICULAR FONT, STYLE, SIZE, OR COLOR.

OWNER OF ERPN CMNTY TM OFC REG. NO. 008396186, DATED 1-12-2010, EXPIRES 6-30-2019.

SER. NO. 85-171,629, FILED 11-8-2010.

NORA BUCHANAN WILL, EXAMINING ATTORNEY



David J. Kyffers

Director of the United States Patent and Trademark Office

United States of America

United States Patent and Trademark Office



Reg. No. 4,073,000

Registered Dec. 20, 2011

Int. Cl.: 43

SERVICE MARK

PRINCIPAL REGISTER

TOBIN'S PIZZA, INC. (ILLINOIS CORPORATION), DBA TOBIN'S PIZZA
6727 OLD PEORIA ROAD
DANVERS, IL 61732

FOR: RESTAURANT SERVICES, INCLUDING SIT-DOWN SERVICE AND TAKE-OUT RESTAURANT SERVICES, IN CLASS 43 (U.S. CLS. 100 AND 101).

FIRST USE 6-12-1998; IN COMMERCE 6-12-1998.

NO CLAIM IS MADE TO THE EXCLUSIVE RIGHT TO USE "PIZZA", APART FROM THE MARK AS SHOWN.

THE MARK CONSISTS OF PIZZA CHEF PERSON WEARING A HAT WITH THE WORD "TOBIN'S" BELOW IT AND THE WORD "PIZZA" BELOW THE WORD "TOBIN'S".

SER. NO. 85-171,682, FILED 11-8-2010.

PAUL E. FAHRENKOPF, EXAMINING ATTORNEY



David J. Kyffers

Director of the United States Patent and Trademark Office

United States of America

United States Patent and Trademark Office

BoardSavvy

Reg. No. 4,073,001

THE HIGH BAR, LLC (MASSACHUSETTS LIMITED LIABILITY COMPANY)
82 SHAKER ROAD
HARVARD, MA 01451

Registered Dec. 20, 2011

Int. Cls.: 35, 41 and 42

FOR: BUSINESS ORGANIZATION AND MANAGEMENT CONSULTING; EDUCATION LEADERSHIP DEVELOPMENT; MANAGEMENT AND BUSINESS CONSULTING SERVICES IN THE FIELD OF EDUCATION, LEADERSHIP AND BOARD GOVERNANCE, IN CLASS 35 (U.S. CLS. 100, 101 AND 102).

SERVICE MARK

PRINCIPAL REGISTER

FIRST USE 10-28-2010; IN COMMERCE 10-28-2010.

FOR: EDUCATION SERVICES, NAMELY, PROVIDING ON-LINE WORKSHOPS, EVALUATIONS, CLASSES AND SEMINARS IN THE FIELD OF SCHOOL LEADERSHIP AND BOARD GOVERNANCE; EDUCATION SERVICES, NAMELY, PROVIDING WORKSHOPS, EVALUATIONS, CLASSES AND SEMINARS IN THE FIELDS OF SCHOOL LEADERSHIP AND BOARD GOVERNANCE, IN CLASS 41 (U.S. CLS. 100, 101 AND 107).

FIRST USE 10-28-2010; IN COMMERCE 10-28-2010.

FOR: COMPUTER SERVICES, NAMELY, PROVIDING A WEB-BASED SYSTEM AND ON-LINE PORTAL FEATURING ON-LINE NON-DOWNLOADABLE SOFTWARE THAT ENABLES USERS TO ACCESS TRAINING, EDUCATION, TESTING AND CERTIFICATION MATERIALS IN THE FIELD OF EDUCATION, LEADERSHIP AND BOARD GOVERNANCE, IN CLASS 42 (U.S. CLS. 100 AND 101).

FIRST USE 10-28-2010; IN COMMERCE 10-28-2010.

THE MARK CONSISTS OF STANDARD CHARACTERS WITHOUT CLAIM TO ANY PARTICULAR FONT, STYLE, SIZE, OR COLOR.

SER. NO. 85-172,206, FILED 11-9-2010.

JESSICA FATHY, EXAMINING ATTORNEY



David J. Kyffers

Director of the United States Patent and Trademark Office

United States of America

United States Patent and Trademark Office



Reg. No. 4,073,002

THE HIGH BAR, LLC (MASSACHUSETTS LIMITED LIABILITY COMPANY)
82 SHAKER ROAD
HARVARD, MA 01451

Registered Dec. 20, 2011

Int. Cls.: 35, 41 and 42

FOR: BUSINESS ORGANIZATION AND MANAGEMENT CONSULTING; EDUCATION LEADERSHIP DEVELOPMENT; MANAGEMENT AND BUSINESS CONSULTING SERVICES IN THE FIELD OF EDUCATION, LEADERSHIP AND BOARD GOVERNANCE, IN CLASS 35 (U.S. CLS. 100, 101 AND 102).

SERVICE MARK

PRINCIPAL REGISTER

FIRST USE 6-1-2010; IN COMMERCE 6-1-2010.

FOR: EDUCATIONAL SERVICES, NAMELY, PROVIDING ON-LINE WORKSHOPS, EVALUATIONS, CLASSES AND SEMINARS IN THE FIELD OF SCHOOL LEADERSHIP AND BOARD GOVERNANCE; EDUCATIONAL SERVICES, NAMELY, PROVIDING WORKSHOPS, EVALUATIONS, CLASSES AND SEMINARS IN THE FIELDS OF SCHOOL LEADERSHIP AND BOARD GOVERNANCE, IN CLASS 41 (U.S. CLS. 100, 101 AND 107).

FIRST USE 6-1-2010; IN COMMERCE 6-1-2010.

FOR: COMPUTER SERVICES, NAMELY, PROVIDING A WEB-BASED SYSTEM AND ON-LINE PORTAL FEATURING ON-LINE NON-DOWNLOADABLE SOFTWARE THAT ENABLES USERS TO ACCESS TRAINING, EDUCATION, TESTING AND CERTIFICATION MATERIALS IN THE FIELD OF EDUCATION, LEADERSHIP AND BOARD GOVERNANCE, IN CLASS 42 (U.S. CLS. 100 AND 101).

FIRST USE 6-1-2010; IN COMMERCE 6-1-2010.

THE MARK CONSISTS OF A BLACK CAPITAL LETTER "H" DRAWN AT AN ANGLE. A RED AND BLACK GRADUATION CAP IS SHOOTING THROUGH AND OVER THE TOP PORTION OF THE "H". THE TRAJECTORY OF THE CAP IS SHOWN BY A RED STREAK TRAILING BEHIND THE GRADUATION CAP.

THE COLOR(S) BLACK AND RED IS/ARE CLAIMED AS A FEATURE OF THE MARK.

SER. NO. 85-172,216, FILED 11-9-2010.

JESSICA FATHY, EXAMINING ATTORNEY



David J. Kyffers

Director of the United States Patent and Trademark Office

United States of America

United States Patent and Trademark Office

GRIFFITH

Reg. No. 4,073,003

Registered Dec. 20, 2011

Int. Cl.: 1

TRADEMARK

PRINCIPAL REGISTER

GROBET FILE COMPANY OF AMERICA, INC. (NEW YORK CORPORATION)
750 WASHINGTON AVENUE
CARLSTADT, NJ 07072

FOR: SOLVENTS FOR DISSOLVING LACQUERS AND CEMENTS AND FOR WAX AND PLASTIC MODELS; SOLDER AND CASTING FLUXES AND ANTI-FLUXES AND ANTI-OXIDIZERS FOR USE DURING SOLDERING; ACIDIC PICKLING SOLUTIONS AND DRY CHEMICAL COMPOUNDS FOR REMOVING OXIDATION FROM VARIOUS METALS; DENATURED ALCOHOL, METHYL ALCOHOL, AND CHEMICAL OXIDIZERS FOR VARIOUS METALS; OXALIC ACID FOR REMOVAL OF IRON RESIDUE FROM MINERALS; AND CHEMICAL ADDITIVES FOR MAINTAINING STEAM MACHINES, ALL IN THE JEWELRY INDUSTRY, IN CLASS 1 (U.S. CLS. 1, 5, 6, 10, 26 AND 46).

FIRST USE 12-7-1991; IN COMMERCE 12-7-1991.

THE MARK CONSISTS OF STANDARD CHARACTERS WITHOUT CLAIM TO ANY PARTICULAR FONT, STYLE, SIZE, OR COLOR.

SEC. 2(F).

SER. NO. 85-172,572, FILED 11-9-2010.

BRIAN CALLAGHAN, EXAMINING ATTORNEY



David J. Kyffers

Director of the United States Patent and Trademark Office

United States of America

United States Patent and Trademark Office

NextGenPMO

Reg. No. 4,073,004

Registered Dec. 20, 2011

Int. Cl.: 42

SERVICE MARK

PRINCIPAL REGISTER

CASCADES TECHNOLOGIES INC. (VIRGINIA CORPORATION)
SUITE 225
505 HUNTMAR DRIVE
HERNDON, VA 20170 AND

CASTA, ALFREDO FEDERICO (UNITED STATES INDIVIDUAL)
SUITE 225
505 HUNTMAR DRIVE
HERNDON, VA 20170

FOR: COMPUTER SOFTWARE DEVELOPMENT, COMPUTER PROGRAMMING AND MAINTENANCE OF COMPUTER SOFTWARE FOR INTEGRATED PROGRAM AND PROJECT MANAGEMENT QUALITY ASSURANCE WORK-FLOW ACCOUNTABILITY AND COMPLIANCE REPORTING FOR IT PROJECTS, IN CLASS 42 (U.S. CLS. 100 AND 101).

FIRST USE 12-15-2008; IN COMMERCE 12-15-2008.

THE MARK CONSISTS OF STANDARD CHARACTERS WITHOUT CLAIM TO ANY PARTICULAR FONT, STYLE, SIZE, OR COLOR.

SER. NO. 85-173,155, FILED 11-10-2010.

CHERYL CLAYTON, EXAMINING ATTORNEY



David J. Kybas

Director of the United States Patent and Trademark Office

United States of America

United States Patent and Trademark Office

The Elements of Healing

Reg. No. 4,073,005

Registered Dec. 20, 2011

Int. Cls.: 40 and 42

SERVICE MARK

PRINCIPAL REGISTER

AMENDIA, INC. (GEORGIA CORPORATION)
SUITE 6
1155 ALLGOOD ROAD
MARIETTA, GA 30062

FOR: MANUFACTURING SERVICES FOR OTHERS IN THE FIELD OF MEDICAL DEVICES,
IN CLASS 40 (U.S. CLS. 100, 103 AND 106).

FIRST USE 5-28-2010; IN COMMERCE 5-28-2010.

FOR: PRODUCT DEVELOPMENT, NAMELY, DEVELOPMENT OF MEDICAL DEVICES, IN
CLASS 42 (U.S. CLS. 100 AND 101).

FIRST USE 5-28-2010; IN COMMERCE 5-28-2010.

THE MARK CONSISTS OF STANDARD CHARACTERS WITHOUT CLAIM TO ANY PAR-
TICULAR FONT, STYLE, SIZE, OR COLOR.

SER. NO. 85-173,165, FILED 11-10-2010.

JOHN KELLY, EXAMINING ATTORNEY



David J. Kyfos

Director of the United States Patent and Trademark Office

United States of America

United States Patent and Trademark Office

superbrightleds.com

Reg. No. 4,073,006

Registered Dec. 20, 2011

Int. Cl.: 9

TRADEMARK

PRINCIPAL REGISTER

SUPER BRIGHT LEDS, INC. (MISSOURI CORPORATION)
4400 EARTH CITY EXPRESSWAY
ST. LOUIS, MO 630451328

FOR: LIGHT EMITTING DIODES (LEDS), LED ELECTRONIC COMPONENTS, NAMELY, 5MM LEDS, 3MM LEDS, 5050 SURFACE MOUNT DEVICE (SFD) LEDS, 360 DEGREE VIEWING ANGLE LEDS, BLINKING LEDS, 1 WATT LEDS, 5MM HIGH FLUX LEDS, 3MM HIGH FLUX LEDS, AND HIGH POWER 1 WATT LEDS, RED GREEN BLUE (RGB) LEDS, RGB LEDS COMPONENTS, NAMELY, 5MM LEDS, 3MM LEDS, 5050 SURFACE MOUNT DEVICE (SFD) LEDS, 360 DEGREE VIEWING ANGLE LEDS, BLINKING LEDS, 1 WATT LEDS, 5MM HIGH FLUX LEDS, 3MM HIGH FLUX LEDS, AND HIGH POWER 1 WATT LEDS, LED BULBS, LED FLASHLIGHTS AND BULBS, LEDS FOR 6 VOLT, 12 VOLT, 24 VOLT, 48 VOLT AC/DC, LED BARS, STRIPS, MODULES AND POWER SUPPLIES, ALL FOR USE IN LIGHTS , IN CLASS 9 (U.S. CLS. 21, 23, 26, 36 AND 38).

FIRST USE 0-0-2001; IN COMMERCE 0-0-2002.

THE MARK CONSISTS OF THE WORDS "SUPERBRIGHTLEDS.COM" APPEARING IN PRIMARY COLORS, AND IN STYLIZED, LOWER-CASE LETTERING AS FOLLOWS: "SUPER" APPEARS IN RED, "BRIGHT" APPEARS IN GREEN, "LEDS" APPEARS IN BLUE AND ".COM" APPEARS IN WHITE. THE OUTLINE OF THE LETTERING ".COM" IS NOT A FEATURE OF THE MARK, BUT MERELY IS USED TO OUTLINE THE LETTERS IN ORDER TO INDICATE THE PLACEMENT OF THE WHITE LETTERING.

THE COLOR(S) RED, GREEN, BLUE, AND WHITE IS/ARE CLAIMED AS A FEATURE OF THE MARK.

SEC. 2(F).

SER. NO. 85-173,376, FILED 11-10-2010.

JILL C. ALT, EXAMINING ATTORNEY



David J. Kyffers

Director of the United States Patent and Trademark Office

United States of America

United States Patent and Trademark Office

Bardel Bows

Reg. No. 4,073,007

BARDEL BOWS LLC (GEORGIA LIMITED LIABILITY COMPANY)
1195 TAYLOR'S MILL RD.
FORT VALLEY, GA 31030

Registered Dec. 20, 2011

Int. Cl.: 18

FOR: PET GROOMING BOWS, IN CLASS 18 (U.S. CLS. 1, 2, 3, 22 AND 41).

FIRST USE 9-29-1989; IN COMMERCE 10-1-1989.

TRADEMARK

THE MARK CONSISTS OF STANDARD CHARACTERS WITHOUT CLAIM TO ANY PARTICULAR FONT, STYLE, SIZE, OR COLOR.

PRINCIPAL REGISTER

NO CLAIM IS MADE TO THE EXCLUSIVE RIGHT TO USE "BOWS", APART FROM THE MARK AS SHOWN.

SEC. 2(F).

SER. NO. 85-173,384, FILED 11-10-2010.

DORITT L. CARROLL, EXAMINING ATTORNEY



David J. Kyffers

Director of the United States Patent and Trademark Office

United States of America

United States Patent and Trademark Office



SchrodersLink

Reg. No. 4,073,008

Registered Dec. 20, 2011

Int. Cls.: 9 and 38

TRADEMARK

SERVICE MARK

PRINCIPAL REGISTER

SCHRODERS PLC (UNITED KINGDOM CORPORATION)
31 GRESHAM STREET
LONDON, UNITED KINGDOM EC2V7QA

FOR: DOWNLOADABLE ELECTRONIC IMAGES IN THE NATURE OF CLIENT REPORTS, DATA, NEWSLETTERS, AND INFORMATION SHEETS IN THE FIELD OF FINANCIAL ASSET MANAGEMENT, IN CLASS 9 (U.S. CLS. 21, 23, 26, 36 AND 38).

FIRST USE 12-1-2009; IN COMMERCE 12-1-2009.

FOR: PROVIDING ACCESS TO DATABASES FEATURING FINANCIAL INFORMATION, IN CLASS 38 (U.S. CLS. 100, 101 AND 104).

FIRST USE 12-1-2009; IN COMMERCE 12-1-2009.

THE MARK CONSISTS OF THE TERM "SCHRODERSLINK" TO THE RIGHT OF THE SCHRODERS' CREST.

SER. NO. 85-173,826, FILED 11-10-2010.

CAROLYN CATALDO, EXAMINING ATTORNEY



David J. Kyffers

Director of the United States Patent and Trademark Office

United States of America

United States Patent and Trademark Office



Reg. No. 4,073,009

Registered Dec. 20, 2011

Int. Cl.: 43

SERVICE MARK

PRINCIPAL REGISTER

CC INVESTMENTS, LLC (COLORADO LIMITED LIABILITY COMPANY)
P.O. BOX 2300
GRAND JUNCTION, CO 81502

FOR: RESTAURANT SERVICES, IN CLASS 43 (U.S. CLS. 100 AND 101).

FIRST USE 3-1-2011; IN COMMERCE 3-1-2011.

THE MARK CONSISTS OF A WHITE ROOSTER HEAD WITH RED COMB, RED WATTLE, YELLOW BEAK, WHITE BULL HORNS WITH BLACK TIPS AND A GRAY NOSE RING THROUGH THE BEAK. THE BEAK IS OPEN.

THE COLOR(S) RED, YELLOW, BLACK, WHITE AND GRAY IS/ARE CLAIMED AS A FEATURE OF THE MARK.

SER. NO. 85-173,950, FILED 11-10-2010.

RONALD AIKENS, EXAMINING ATTORNEY



David J. Kyffers

Director of the United States Patent and Trademark Office

United States of America

United States Patent and Trademark Office

VINTAGE JOY

Reg. No. 4,073,010

JOY FAN (UNITED STATES INDIVIDUAL), DBA VINTAGE JOY
1158 SUTTER STREET, NO.10
SAN FRANCISCO, CA 94109

Registered Dec. 20, 2011

Int. Cls.: 25, 35 and 42

FOR: A-SHIRTS; BELTS FOR CLOTHING; BLAZERS; BLOUSES; BUSTIERS; COATS; DRESS PANTS; DRESS SHIRTS; DRESS SUITS; DRESSES; DRESSING GOWNS; EVENING DRESSES; EVENING GOWNS; FUR COATS AND JACKETS; GOWNS; HALTER TOPS; LADIES' SUITS; LEATHER BELTS; LEATHER COATS; LEATHER JACKETS; LEATHER PANTS; LEISURE SUITS; LINGERIE; OVERCOATS; PANTS; POLO SHIRTS; SHIRTS AND SHORT-SLEEVED SHIRTS; SKIRTS AND DRESSES; SUIT COATS; TEE SHIRTS, IN CLASS 25 (U.S. CLS. 22 AND 39).

TRADEMARK

SERVICE MARK

PRINCIPAL REGISTER

FIRST USE 1-1-2003; IN COMMERCE 5-1-2003.

FOR: ON-LINE RETAIL STORE SERVICES FEATURING CLOTHING AND ACCESSORIES; ON-LINE WHOLESALE AND RETAIL STORE SERVICES FEATURING CLOTHING AND ACCESSORIES; RETAIL APPAREL STORES; RETAIL CLOTHING BOUTIQUES; RETAIL CLOTHING STORES; RETAIL STORE AND ON-LINE RETAIL STORE SERVICES FEATURING CLOTHING AND ACCESSORIES; RETAIL CLOTHING STORES, IN CLASS 35 (U.S. CLS. 100, 101 AND 102).

FIRST USE 1-1-2003; IN COMMERCE 5-1-2003.

FOR: CONSULTING SERVICES IN THE FIELD OF THE DESIGN OF CLOTHING; DESIGN FOR OTHERS IN THE FIELD OF FASHION CLOTHING; DRESS DESIGNING; FASHION DESIGN CONSULTING SERVICES, IN CLASS 42 (U.S. CLS. 100 AND 101).

FIRST USE 1-1-2003; IN COMMERCE 5-1-2003.

THE MARK CONSISTS OF STANDARD CHARACTERS WITHOUT CLAIM TO ANY PARTICULAR FONT, STYLE, SIZE, OR COLOR.

NO CLAIM IS MADE TO THE EXCLUSIVE RIGHT TO USE "VINTAGE", APART FROM THE MARK AS SHOWN.

SER. NO. 85-174,139, FILED 11-11-2010.



David J. Kyjars

Director of the United States Patent and Trademark Office

Reg. No. 4,073,010 TASNEEM HUSSAIN, EXAMINING ATTORNEY

United States of America

United States Patent and Trademark Office

FUELING RELATIONSHIPS AROUND THE WORLD

Reg. No. 4,073,011

WORLD FUEL SERVICES CORPORATION (FLORIDA CORPORATION)

Registered Dec. 20, 2011

9800 NW 41ST STREET, SUITE 400
MIAMI, FL 33178

**Int. Cls.: 35, 36, 37 and
39**

FOR: WHOLESALE STORE SERVICES AND DISTRIBUTORSHIP SERVICES FOR FUEL;
PROVIDING FUEL MANAGEMENT SERVICES IN THE FIELD OF AVIATION , IN CLASS
35 (U.S. CLS. 100, 101 AND 102).

SERVICE MARK

FIRST USE 7-0-2003; IN COMMERCE 7-0-2004.

PRINCIPAL REGISTER

FOR: AVIATION CREDIT CARD SERVICES, NAMELY, PROVIDING FINANCING TO
PURCHASERS OF FUEL AND GROUND SERVICES IN AIR TRANSPORTATION, IN CLASS
36 (U.S. CLS. 100, 101 AND 102).

FIRST USE 7-0-2003; IN COMMERCE 7-0-2004.

FOR: FUELING AND REFUELING SEA, LAND, AND AIR VEHICLES, IN CLASS 37 (U.S.
CLS. 100, 103 AND 106).

FIRST USE 7-0-2003; IN COMMERCE 7-0-2004.

FOR: TRAVEL ARRANGEMENTS; DISTRIBUTION, SUPPLY, TRANSPORTATION, AND
STORAGE OF FUEL, OIL PETROLEUM, GAS, AND LUBRICANTS; FUEL TRANSPORTATION
SERVICES; FLIGHT PLANNING SERVICES; TRAVEL ROUTE PLANNING SERVICES;
SUPPLYING FUEL AND FUEL PRODUCTS TO OTHERS, IN CLASS 39 (U.S. CLS. 100 AND
105).

FIRST USE 7-0-2003; IN COMMERCE 7-0-2004.

THE MARK CONSISTS OF STANDARD CHARACTERS WITHOUT CLAIM TO ANY PAR-
TICULAR FONT, STYLE, SIZE, OR COLOR.

SER. NO. 85-174,479, FILED 11-11-2010.

JOHN DALIER, EXAMINING ATTORNEY



David J. Kyros

Director of the United States Patent and Trademark Office

United States of America

United States Patent and Trademark Office

NOVACAIXA GALICIA

Reg. No. 4,073,012

Registered Dec. 20, 2011

Int. Cl.: 39

SERVICE MARK

PRINCIPAL REGISTER

CAIXA DE AFORROS DE VIGO, OURENSE E PONTEVEDRA - CAIXANOVA (SPAIN CORPORATION)
AVENIDA GARCÍA BARBÓN, 1
VIGO, PONTEVEDRA, SPAIN 36201

FOR: TRANSPORT BY CAR; TRANSPORT BY BUS; TRANSPORT BY FERRY; TRANSPORT BY BOAT; TRANSPORT BY RAIL; TRANSPORT BY AIR; TRANSPORT BY HELICOPTER; PACKAGING AND PARCELLING OF GOODS FOR TRANSPORT PURPOSES, NAMELY, THE PACKING OF GOODS USING SUSTAINABLE OR BIODEGRADABLE PACKAGING AND SHIPPING MATERIALS; STORAGE OF GOODS; ARRANGING AND COORDINATING TRAVEL ARRANGEMENTS FOR INDIVIDUALS AND GROUPS, NAMELY, DESTINATIONS STAYS, HONEYMOONS, FAMILY VACATIONS, AND DESTINATION WEDDINGS, IN CLASS 39 (U.S. CLS. 100 AND 105).

THE MARK CONSISTS OF STANDARD CHARACTERS WITHOUT CLAIM TO ANY PARTICULAR FONT, STYLE, SIZE, OR COLOR.

PRIORITY CLAIMED UNDER SEC. 44(D) ON SPAIN APPLICATION NO. 2.954.448, FILED 11-10-2010, REG. NO. 2,954,448, DATED 8-1-2011, EXPIRES 11-10-2020.

OWNER OF U.S. REG. NOS. 2,597,072, 3,118,504, AND 3,182,627.

THE ENGLISH TRANSLATION OF "NOVA" AND "GALICIA" IN THE MARK IS "NEW" AND "BOX" RESPECTIVELY.

SER. NO. 85-174,703, FILED 11-11-2010.

RONALD AIKENS, EXAMINING ATTORNEY



David J. Kyros

Director of the United States Patent and Trademark Office

United States of America

United States Patent and Trademark Office

Giant MOVE

Reg. No. 4,073,013

GIANT-MOVE HOLDING, INC. (NEVADA CORPORATION)

Registered Dec. 20, 2011

3540 W. SAHARA #E6-135
LAS VEGAS, NV 89102

Int. Cl.: 7

FOR: MATERIAL HANDLING MACHINES, NAMELY, PALLETIZERS, CASE ELEVATORS, AUTOMATIC PALLET DISPENSING MACHINES AND AUTOMATIC SLIP SHEET DISPENSING MACHINES, IN CLASS 7 (U.S. CLS. 13, 19, 21, 23, 31, 34 AND 35).

TRADEMARK

FIRST USE 10-19-2009; IN COMMERCE 10-20-2009.

PRINCIPAL REGISTER

THE MARK CONSISTS OF THE WORDS "GIANT" AND "MOVE" AS ONE WORD, "GIANT-MOVE" WITH THE WORD "GIANT" HAVING A CAPITAL "G" AND THE WORD "MOVE" HAVING A CAPITAL "M". THE END OF THE LETTER "M" OF "MOVE" IS EXTENDED TO UNDERLINE THE "OVE" OF "MOVE". "GIANT" IS IN THE COLOR BLACK AND "MOVE" AND THE EXTENDED UNDERLINE ARE IN THE COLOR RED.

THE COLOR(S) BLACK AND RED IS/ARE CLAIMED AS A FEATURE OF THE MARK.

SER. NO. 85-174,704, FILED 11-11-2010.

EDWARD NELSON, EXAMINING ATTORNEY



David J. Kyffers

Director of the United States Patent and Trademark Office

United States of America

United States Patent and Trademark Office

AZENTUS

Reg. No. 4,073,014

VANTAGEPACIFIC HOLDINGS LIMITED (CAYMAN ISLANDS CORPORATION)
PO BOX 309, UGLAND HOUSE
GRAND CAYMAN, CAYMAN ISLANDS KY1-1104

Registered Dec. 20, 2011

Int. Cl.: 36

FOR: FINANCIAL SERVICES, NAMELY, FUND MANAGEMENT SERVICES; FUND INVESTMENT SERVICES; FUND ADVISORY SERVICES; HEDGE FUND MANAGEMENT SERVICES; FINANCIAL ASSET MANAGEMENT SERVICES, IN CLASS 36 (U.S. CLS. 100, 101 AND 102).

SERVICE MARK

PRINCIPAL REGISTER

THE MARK CONSISTS OF STANDARD CHARACTERS WITHOUT CLAIM TO ANY PARTICULAR FONT, STYLE, SIZE, OR COLOR.

PRIORITY CLAIMED UNDER SEC. 44(D) ON HONG KONG APPLICATION NO. 301746874, FILED 10-27-2010, REG. NO. 301746874, DATED 10-27-2010, EXPIRES 10-27-2020.

SER. NO. 85-174,883, FILED 11-11-2010.

EMILY CHUO, EXAMINING ATTORNEY



David J. Kybas

Director of the United States Patent and Trademark Office

United States of America

United States Patent and Trademark Office

THE ALMIGHTY BIBLE

Reg. No. 4,073,015

O'DONNELL, KEVIN, RICHARD (UNITED STATES INDIVIDUAL)
2800 NIELSON WAY, STE. 614
SANTA MONICA, CA 90405

Registered Dec. 20, 2011

Int. Cl.: 16

FOR: A SERIES OF BOOKS AND WRITTEN ARTICLES IN THE FIELD OF RELIGION, IN CLASS 16 (U.S. CLS. 2, 5, 22, 23, 29, 37, 38 AND 50).

TRADEMARK

FIRST USE 8-29-2010; IN COMMERCE 8-29-2010.

PRINCIPAL REGISTER

NO CLAIM IS MADE TO THE EXCLUSIVE RIGHT TO USE "BIBLE", APART FROM THE MARK AS SHOWN.

THE COLOR(S) BLACK AND WHITE AND GRAY IS/ARE CLAIMED AS A FEATURE OF THE MARK.

THE MARK CONSISTS OF THE WORDING "THE ALMIGHTY BIBLE" IN A MARBLED STYLE. EACH LETTER CONTAINS GRADIENTS OF GRAY AND WHITE AND IS OUTLINED IN BLACK.

SER. NO. 85-175,097, FILED 11-11-2010.

KIMBERLY FRYE, EXAMINING ATTORNEY



David J. Kybas

Director of the United States Patent and Trademark Office

United States of America

United States Patent and Trademark Office



Reg. No. 4,073,016

Registered Dec. 20, 2011

Int. Cl.: 9

TRADEMARK

PRINCIPAL REGISTER

GSM (TRADEMARKS) PTY LTD (AUSTRALIA LIMITED LIABILITY COMPANY)
1 BILLABONG PLACE
BURLEIGH HEADS, QLD, AUSTRALIA 4220

FOR: EYEWEAR; SUNGLASSES; PARTS, FITTINGS AND ACCESSORIES FOR EYEWEAR AND SUNGLASSES, NAMELY, CASES, CHAINS, CORDS, FRAMES, SUPPORT BANDS AND STRAPS, IN CLASS 9 (U.S. CLS. 21, 23, 26, 36 AND 38).

PRIORITY CLAIMED UNDER SEC. 44(D) ON AUSTRALIA APPLICATION NO. 1389809, FILED 10-20-2010, REG. NO. 1389809, DATED 7-15-2011, EXPIRES 10-20-2020.

THE MARK CONSISTS OF A DOT, A DASH, AND THE WORDS "DOT DASH", WITH "DASH" IN BOLD PRINT.

SER. NO. 85-175,129, FILED 11-12-2010.

LINDA ESTRADA, EXAMINING ATTORNEY



David J. Kyjars

Director of the United States Patent and Trademark Office

United States of America

United States Patent and Trademark Office



Reg. No. 4,073,017

RAINBOW RECREATION OF MICHIGAN (MICHIGAN CORPORATION)
53535 GRAND RIVER
NEW HUDSON, MI 48165

Registered Dec. 20, 2011

Int. Cl.: 35

FOR: RETAIL STORE AND ONLINE RETAIL STORE SERVICES FEATURING OUTDOOR PLAY EQUIPMENT, IN CLASS 35 (U.S. CLS. 100, 101 AND 102).

SERVICE MARK

FIRST USE 8-1-2010; IN COMMERCE 8-1-2010.

PRINCIPAL REGISTER

THE MARK CONSISTS OF THE WORDS "KIDS GOTTA PLAY", A BASKETBALL, A BOY WITH A SHIRT, SHORTS AND SNEAKERS; GIRL ON SWING, OVERALLS WITH BOW IN HAIR, SHIRT, AND SNEAKERS.

SER. NO. 85-175,217, FILED 11-12-2010.

PATRICIA EVANKO, EXAMINING ATTORNEY



David J. Kybas

Director of the United States Patent and Trademark Office

United States of America

United States Patent and Trademark Office

DMS

Reg. No. 4,073,018

Registered Dec. 20, 2011

Int. Cl.: 9

TRADEMARK

PRINCIPAL REGISTER

TLH, INC. (GEORGIA CORPORATION), DBA DMS INTERNATIONAL
320 B NORTHPOINT PARKWAY
ACWORTH, GA 30102

FOR: FREE-TO-AIR SATELLITE TELEVISION AND RADIO INSTALLATION AND RECEPTION EQUIPMENT, NAMELY, SATELLITE RECEIVERS, SATELLITE DISHES, SATELLITE SIGNAL METERS, CONVERTERS, NAMELY, LOW NOISE BLOCKS, SATELLITE DISH POSITIONING MOTORS, SATELLITE SWITCHES, BRACKETS SPECIALLY ADAPTED FOR MOUNTING SATELLITE DISHES, AUDIO/VIDEO CABLES AND CONNECTORS, REMOTE CONTROLS FOR SATELLITE RECEIVERS, AND ANTENNAS ALL FOR USE IN THE INSTALLATION OF SATELLITE SYSTEMS AND FOR THE RECEPTION AND PLAYBACK OF AUDIO AND VISUAL ENTERTAINMENT, IN CLASS 9 (U.S. CLS. 21, 23, 26, 36 AND 38).

FIRST USE 7-1-1989; IN COMMERCE 7-1-1989.

THE MARK CONSISTS OF STANDARD CHARACTERS WITHOUT CLAIM TO ANY PARTICULAR FONT, STYLE, SIZE, OR COLOR.

SER. NO. 85-175,305, FILED 11-12-2010.

SANJEEV VOHRA, EXAMINING ATTORNEY



David J. Kyros

Director of the United States Patent and Trademark Office

United States of America

United States Patent and Trademark Office

NEF NATIONS EQUIPMENT FINANCE

Reg. No. 4,073,019

Registered Dec. 20, 2011

**Int. Cls.: 36, 37, 39, 40
and 42**

SERVICE MARK

PRINCIPAL REGISTER

NATIONS EQUIPMENT FINANCE, LLC (DELAWARE LIMITED LIABILITY COMPANY)
5TH FLOOR
101 MERRIT SEVEN
NORWALK, CT 06851

FOR: EQUIPMENT FINANCING SERVICES, IN CLASS 36 (U.S. CLS. 100, 101 AND 102).

FIRST USE 10-20-2010; IN COMMERCE 10-20-2010.

FOR: LEASING OF CONSTRUCTION EQUIPMENT, BUILDING MACHINERY, OIL AND GAS INDUSTRY DRILLING EQUIPMENT AND MACHINERY, MINING EXTRACTION MACHINES AND APPARATUS, IN CLASS 37 (U.S. CLS. 100, 103 AND 106).

FIRST USE 10-20-2010; IN COMMERCE 10-20-2010.

FOR: LEASING OF TRUCKS, AIRCRAFT, AND SHIPS, IN CLASS 39 (U.S. CLS. 100 AND 105).

FIRST USE 10-20-2010; IN COMMERCE 10-20-2010.

FOR: LEASING OF MACHINES AND APPARATUS FOR PROCESSING FOODS, PRINTING MACHINES AND APPARATUS, OIL AND GAS INDUSTRY TREATMENT EQUIPMENT AND MACHINERY, IN CLASS 40 (U.S. CLS. 100, 103 AND 106).

FIRST USE 10-20-2010; IN COMMERCE 10-20-2010.

FOR: LEASING OF MINING EXPLORATION MACHINES AND APPARATUS, OIL AND GAS INDUSTRY EXPLORATION EQUIPMENT AND MACHINERY, IN CLASS 42 (U.S. CLS. 100 AND 101).

FIRST USE 10-20-2010; IN COMMERCE 10-20-2010.

THE MARK CONSISTS OF STANDARD CHARACTERS WITHOUT CLAIM TO ANY PARTICULAR FONT, STYLE, SIZE, OR COLOR.

NO CLAIM IS MADE TO THE EXCLUSIVE RIGHT TO USE "EQUIPMENT FINANCE", APART FROM THE MARK AS SHOWN.

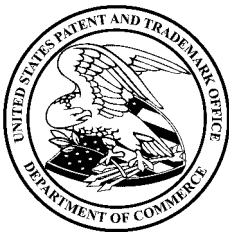

David J. Kybas

Director of the United States Patent and Trademark Office

Reg. No. 4,073,019 SER. NO. 85-175,565, FILED 11-12-2010.

MARIA-VICTORIA SUAREZ, EXAMINING ATTORNEY

United States of America

United States Patent and Trademark Office

PB Purebred Breeders America's Top Breeders

Reg. No. 4,073,020

PUREBRED BREEDERS, LLC (FLORIDA LIMITED LIABILITY COMPANY)
5722 S. FLAMINGO RD., STE 254
COOPER CITY, FL 33330

Registered Dec. 20, 2011

Int. Cl.: 31

FOR: LIVE ANIMALS, NAMELY, PUPPIES AND DOGS, IN CLASS 31 (U.S. CLS. 1 AND 46).

TRADEMARK

FIRST USE 1-1-2010; IN COMMERCE 1-1-2010.

PRINCIPAL REGISTER

THE MARK CONSISTS OF STANDARD CHARACTERS WITHOUT CLAIM TO ANY PARTICULAR FONT, STYLE, SIZE, OR COLOR.

NO CLAIM IS MADE TO THE EXCLUSIVE RIGHT TO USE "PUREBRED BREEDERS" OR "AMERICA'S TOP BREEDERS", APART FROM THE MARK AS SHOWN.

SER. NO. 85-176,198, FILED 11-13-2010.

JAMES GRIFFIN, EXAMINING ATTORNEY



David J. Kyffers

Director of the United States Patent and Trademark Office

United States of America

United States Patent and Trademark Office

Imaging The World

Reg. No. 4,073,021

LISA D ROSS (UNITED STATES INDIVIDUAL), DBA LISA ROSS PHOTOGRAPHY
12845 SILVER ACACIA PLACE
SAN DIEGO, CA 92130

Registered Dec. 20, 2011

Int. Cl.: 16

FOR: ART PICTURES; ART PRINTS; ART PRINTS ON CANVAS, IN CLASS 16 (U.S. CLS. 2, 5, 22, 23, 29, 37, 38 AND 50).

TRADEMARK

FIRST USE 1-1-2001; IN COMMERCE 1-1-2001.

PRINCIPAL REGISTER

THE MARK CONSISTS OF STANDARD CHARACTERS WITHOUT CLAIM TO ANY PARTICULAR FONT, STYLE, SIZE, OR COLOR.

NO CLAIM IS MADE TO THE EXCLUSIVE RIGHT TO USE "IMAGING", APART FROM THE MARK AS SHOWN.

SER. NO. 85-176,359, FILED 11-14-2010.

CIMMERIAN COLEMAN, EXAMINING ATTORNEY



David J. Kappas

Director of the United States Patent and Trademark Office

United States of America

United States Patent and Trademark Office



Reg. No. 4,073,022

Registered Dec. 20, 2011

Int. Cl.: 5

TRADEMARK

PRINCIPAL REGISTER

HAYYIM, DANIEL (UNITED STATES INDIVIDUAL)
#201
19215 CHANDLERS LANDING DR.
CORNELIUS, NC 28031

FOR: VITAMINS, NUTRITIONAL SUPPLEMENTS, IN CLASS 5 (U.S. CLS. 6, 18, 44, 46, 51 AND 52).

FIRST USE 9-17-2010; IN COMMERCE 9-21-2010.

THE MARK CONSISTS OF GREEN LEAVES INSIDE A GRAY CIRCLE, SURROUNDED WITH A WHITE RING, INSIDE A LARGER GRAY CIRCLE. THE GREEN LEAVES EXTEND FROM THE INNER GRAY CIRCLE WITH PORTIONS OVERLAPPING THE WHITE RING. ABOVE THE LEAVES AND AROUND THE TOP OF THE OUTER LARGER GRAY CIRCLE APPEAR THE TERMS "25 -" AND THE HEBREW SYMBOL FOR YOD (Y) AND CHET (CH) IN WHITE. BELOW THE LEAVES AND AROUND THE OUTER GRAY CIRCLE APPEAR THE TERMS "HAI - 25" IN WHITE. THE BACKGROUND COLOR IS NOT CLAIMED.

THE COLOR(S) GRAY, WHITE, AND GREEN IS/ARE CLAIMED AS A FEATURE OF THE MARK.

THE NON-LATIN CHARACTERS IN THE MARK TRANSLITERATE TO CHAI AND THIS MEANS "LIFE" IN ENGLISH.

THE ENGLISH TRANSLATION OF "HAI" IN THE MARK IS "LIVING".

SER. NO. 85-176,393, FILED 11-15-2010.

KRISTIN CARLSON, EXAMINING ATTORNEY



David J. Kybas

Director of the United States Patent and Trademark Office

United States of America

United States Patent and Trademark Office



Reg. No. 4,073,023

Registered Dec. 20, 2011

Int. Cl.: 41

SERVICE MARK

PRINCIPAL REGISTER

CHEGG, INC. (DELAWARE CORPORATION)
SUITE 1400
2350 MISSION COLLEGE BLVD.
SANTA CLARA, CA 95054

FOR: ENTERTAINMENT SERVICES, NAMELY, CONDUCTING SWEEPSTAKES DIRECTED TO STUDENTS; SWEEPSTAKE SERVICES, IN CLASS 41 (U.S. CLS. 100, 101 AND 107).

FIRST USE 7-29-2010; IN COMMERCE 7-29-2010.

OWNER OF U.S. REG. NOS. 3,191,844 AND 3,749,771.

THE COLOR(S) GOLD AND RED IS/ARE CLAIMED AS A FEATURE OF THE MARK.

NO CLAIM IS MADE TO THE EXCLUSIVE RIGHT TO USE "RENT TEXTBOOKS WIN PRIZES", APART FROM THE MARK AS SHOWN.

THE MARK CONSISTS OF A GOLD EGG WITH A GOLD BEAK AND GOLD LEGS BREAKING THROUGH THE SHELL LOCATED TO THE LEFT OF THE TEXT "THE GOLDEN", WRITTEN IN GOLD LOCATED ABOVE THE TEXT "CHEGG", WRITTEN IN RED LOCATED ABOVE THE TEXT "RENT TEXTBOOKS. WIN PRIZES!" WRITTEN IN GOLD.

SER. NO. 85-176,458, FILED 11-15-2010.

LIEF MARTIN, EXAMINING ATTORNEY



David J. Kybas

Director of the United States Patent and Trademark Office

United States of America

United States Patent and Trademark Office



Reg. No. 4,073,024

Registered Dec. 20, 2011

Int. Cls.: 35 and 36

SERVICE MARK

PRINCIPAL REGISTER

WILLIS GROUP LIMITED (UNITED KINGDOM COMPANY)
THE WILLIS BUILDING, 51 LIME STREET
LONDON, UNITED KINGDOM EC3M 7DQ

FOR: ASSESSMENT AND MANAGEMENT OF BUSINESS RISK, IN CLASS 35 (U.S. CLS. 100, 101 AND 102).

FOR: LIFE INSURANCE UNDERWRITING AND INSURANCE UNDERWRITING SERVICES IN THE FIELD OF PERSONAL SAFETY; INSURANCE AND REINSURANCE BROKERAGE SERVICES; ASSESSMENT AND MANAGEMENT OF FINANCIAL AND PERSONAL FINANCIAL RISK; INSURANCE CLAIMS ADJUSTMENT SERVICES; LIFE INSURANCE CLAIMS SETTLEMENT SERVICES; VIATICAL SETTLEMENT SERVICES, IN CLASS 36 (U.S. CLS. 100, 101 AND 102).

PRIORITY CLAIMED UNDER SEC. 44(D) ON ERPN CMNTY TM OFC APPLICATION NO. 9501396, FILED 11-5-2010, REG. NO. 9501396, DATED 5-6-2011, EXPIRES 11-5-2020.

THE MARK CONSISTS OF THE LETTERS "SCR" CONTAINED WITHIN A RECTANGLE.

SER. NO. 85-176,463, FILED 11-15-2010.

BARBARA A. GOLD, EXAMINING ATTORNEY



David J. Kybas

Director of the United States Patent and Trademark Office

United States of America

United States Patent and Trademark Office

MOMENT FOR MORALITY

Reg. No. 4,073,025

ROSS, GLORIA J. (UNITED STATES INDIVIDUAL)
950 LANE STREET
KANNAPOLIS, NC 28083

Registered Dec. 20, 2011

Int. Cl.: 35

FOR: PROMOTING PUBLIC AWARENESS OF THE NEED FOR MORAL VALUES IN SOCIETY, IN CLASS 35 (U.S. CLS. 100, 101 AND 102).

SERVICE MARK

FIRST USE 1-26-2010; IN COMMERCE 1-26-2010.

PRINCIPAL REGISTER

THE MARK CONSISTS OF STANDARD CHARACTERS WITHOUT CLAIM TO ANY PARTICULAR FONT, STYLE, SIZE, OR COLOR.

NO CLAIM IS MADE TO THE EXCLUSIVE RIGHT TO USE "MORALITY", APART FROM THE MARK AS SHOWN.

SER. NO. 85-176,565, FILED 11-15-2010.

WILLIAM BRECKENFELD, EXAMINING ATTORNEY



David J. Kyffers

Director of the United States Patent and Trademark Office

United States of America

United States Patent and Trademark Office



Reg. No. 4,073,026

Registered Dec. 20, 2011

Int. Cl.: 14

TRADEMARK

PRINCIPAL REGISTER

KMT ENTERPRISES LLC (NEW YORK LIMITED LIABILITY COMPANY), DBA KMT
ENTERPRISES LLC
245 WEST 123RD ST.
NEW YORK, NY 10027

FOR: BEADS FOR USE IN THE MANUFACTURE OF JEWELRY; BODY JEWELRY; BRACELETS; BROACHES; BROOCHES; CHARMS; CHARMS FOR COLLAR JEWELRY AND BRACELET; CLIP EARRINGS; CLOISONNE PINS; COSTUME JEWELRY; CUFFLINKS; EAR CLIPS; EAR STUDS; EARRINGS; GEMSTONE JEWELRY; IDENTIFICATION BRACELETS; JEWELRY; JEWELRY AND IMITATION JEWELRY; JEWELRY BOXES; JEWELRY BOXES NOT OF METAL; JEWELRY BOXES OF METAL; JEWELRY CASES; JEWELRY CHAINS; JEWELRY FOR ATTACHMENT TO CLOTHING; JEWELRY PINS FOR USE ON HATS; JEWELRY RING HOLDERS; JEWELRY STICKPINS; JEWELRY WATCHES; JEWELRY, NAMELY, AMULETS; JEWELRY, NAMELY, ANKLETS; JEWELRY, NAMELY, ARM CUFFS; JEWELRY, NAMELY, MAGNETIC NECKLACES; JEWELRY, NAMELY, MAGNETIC PENDANTS; JEWELRY, NAMELY, STONE PENDANTS; KEY RINGS OF PRECIOUS METAL; KEY RINGS OF PRECIOUS METALS; LAPEL PINS; LEATHER JEWELRY AND ACCESSORY BOXES; NECKLACES; ORNAMENTAL LAPEL PINS; ORNAMENTAL PINS; PENDANTS; PET JEWELRY; PLASTIC BRACELETS IN THE NATURE OF JEWELRY; PRECIOUS AND SEMI-PRECIOUS CRYSTAL STONES AND BEADS FOR USE IN JEWELRY; RINGS; RINGS; RINGS BEING JEWELRY; STAINLESS STEEL JEWELRY BRACELETS; TIE PINS; TIE-PINS OF PRECIOUS METAL; WATCHES AND JEWELRY; WOMEN'S JEWELRY, IN CLASS 14 (U.S. CLS. 2, 27, 28 AND 50).

FIRST USE 5-22-2010; IN COMMERCE 5-22-2010.

OWNER OF U.S. REG. NO. 2,699,949.

THE MARK CONSISTS OF THIS MARK IS 2 DIMENSIONAL BLACK-AND-WHITE GRAPHIC OF A SKELETAL STEEL FRAME RUIN OF A BUILDING.

SER. NO. 85-176,678, FILED 11-15-2010.

BILL DAWE, EXAMINING ATTORNEY



David J. Kyfos

Director of the United States Patent and Trademark Office

United States of America

United States Patent and Trademark Office

FOUNDER'S WORKBENCH

Reg. No. 4,073,027

GOODWIN PROCTER LLP (MASSACHUSETTS LIMITED LIABILITY PARTNERSHIP)
EXCHANGE PLACE, 53 STATE STREET
BOSTON, MA 02109

Registered Dec. 20, 2011

Int. Cls.: 9, 35, 41 and 45

FOR: DOWNLOADABLE ELECTRONIC PUBLICATIONS IN THE NATURE OF LEGAL DOCUMENT TEMPLATES RELATING TO FORMING AND OPERATING A BUSINESS, IN CLASS 9 (U.S. CLS. 21, 23, 26, 36 AND 38).

TRADEMARK

FIRST USE 10-1-2010; IN COMMERCE 10-1-2010.

SERVICE MARK

FOR: PROVIDING A WEBSITE FEATURING NEWS, ARTICLES AND MEMORANDA RELATING TO FORMING AND OPERATING A BUSINESS; PROVIDING A WEBSITE FEATURING LINKS TO WEBSITES RELATING TO FORMING AND OPERATING A BUSINESS, IN CLASS 35 (U.S. CLS. 100, 101 AND 102).

PRINCIPAL REGISTER

FIRST USE 10-1-2010; IN COMMERCE 10-1-2010.

FOR: ON-LINE JOURNAL, NAMELY, A BLOG RELATING TO FORMING AND OPERATING A BUSINESS, IN CLASS 41 (U.S. CLS. 100, 101 AND 107).

FIRST USE 10-1-2010; IN COMMERCE 10-1-2010.

FOR: LEGAL SERVICES, IN CLASS 45 (U.S. CLS. 100 AND 101).

FIRST USE 10-1-2010; IN COMMERCE 10-1-2010.

THE MARK CONSISTS OF STANDARD CHARACTERS WITHOUT CLAIM TO ANY PARTICULAR FONT, STYLE, SIZE, OR COLOR.

NO CLAIM IS MADE TO THE EXCLUSIVE RIGHT TO USE "FOUNDER'S", APART FROM THE MARK AS SHOWN.

SER. NO. 85-176,999, FILED 11-15-2010.

JERI J. FICKES, EXAMINING ATTORNEY



David J. Kyffers

Director of the United States Patent and Trademark Office

United States of America

United States Patent and Trademark Office



Reg. No. 4,073,028

Registered Dec. 20, 2011

Int. Cl.: 41

SERVICE MARK

PRINCIPAL REGISTER

FINKLE ROAD ASSOCIATES, INC. (NEW YORK CORPORATION), DBA THE HORSE
INSTITUTE
21 FINKLE ROAD
ANCRAMDALE, NY 12503

FOR: BUSINESS TRAINING; EDUCATIONAL SERVICES, NAMELY, A LEARNING AND INNOVATION CENTER FEATURING FULLY CUSTOMIZED LEADERSHIP, MOTIVATIONAL, EDUCATIONAL, AND BRAINSTORMING TRAINING; EDUCATIONAL SERVICES, NAMELY, CONDUCTING WORKSHOPS IN THE FIELD OF EXPERIENTIAL TRAINING AND DISTRIBUTION OF TRAINING MATERIAL IN CONNECTION THEREWITH; EDUCATIONAL SERVICES, NAMELY, DEVELOPING AND CONDUCTING TRAINING COURSES AND DISTRIBUTION OF TRAINING MATERIALS IN CONNECTION THEREWITH FOR SUBJECT MATTERS AS REQUESTED BY CUSTOMERS; PROVIDING FACILITIES FOR MOVIES, SHOWS, PLAYS, MUSIC OR EDUCATIONAL TRAINING; PROVIDING GROUP COACHING AND LEARNING FORUMS IN THE FIELD OF LEADERSHIP DEVELOPMENT; PROVIDING GROUP COACHING IN THE FIELD OF LEADERSHIP, MANAGEMENT, COMMUNICATIONS, CHANGE; TRAINING COURSES IN STRATEGIC PLANNING RELATING TO ADVERTISING, PROMOTION, MARKETING AND BUSINESS; TRAINING SERVICES IN THE FIELD OF LEADERSHIP, MANAGEMENT, COMMUNICATIONS, CHANGE, IN CLASS 41 (U.S. CLS. 100, 101 AND 107).

FIRST USE 5-3-2006; IN COMMERCE 5-3-2006.

THE MARK CONSISTS OF THE OUTLINE OF A PROFILE OF A PERSON'S FACE INTERTWINED WITH THE OUTLINE OF A PROFILE OF A HORSE'S FACE.

SER. NO. 85-177,015, FILED 11-15-2010.

PAULA MAHONEY, EXAMINING ATTORNEY



David J. Kybas

Director of the United States Patent and Trademark Office

United States of America

United States Patent and Trademark Office

ENTREDEALERSHIP

Reg. No. 4,073,029

Registered Dec. 20, 2011

Int. Cl.: 35

SERVICE MARK

PRINCIPAL REGISTER

PIONEER FAMILY BRANDS, INC. (UTAH CORPORATION)
12674 SO. PONY EXPRESS RD., #1
DRAPER, UT 84020

FOR: PROVIDING BUSINESS MANAGEMENT ASSISTANCE IN THE ESTABLISHMENT AND OPERATION OF DEALERSHIPS IN THE FIELD OF RESTAURANTS AND OTHER FOOD AND BEVERAGE SERVICE RELATED BUSINESSES; PROMOTING DEALERSHIP OPPORTUNITIES IN THE FIELD OF RESTAURANTS AND OTHER FOOD AND BEVERAGE SERVICE RELATED BUSINESSES, IN CLASS 35 (U.S. CLS. 100, 101 AND 102).

FIRST USE 2-0-2010; IN COMMERCE 2-0-2010.

THE MARK CONSISTS OF STANDARD CHARACTERS WITHOUT CLAIM TO ANY PARTICULAR FONT, STYLE, SIZE, OR COLOR.

SER. NO. 85-177,780, FILED 11-16-2010.

TASNEEM HUSSAIN, EXAMINING ATTORNEY



David J. Kybas

Director of the United States Patent and Trademark Office

United States of America

United States Patent and Trademark Office

J.P. TILFORD

Reg. No. 4,073,030

Registered Dec. 20, 2011

Int. Cl.: 25

TRADEMARK

PRINCIPAL REGISTER

HARRY ROSEN INC. (CANADA CORPORATION)
77 BLOOR STREET WEST, SUITE 1600
TORONTO, ONTARIO, CANADA M5S-1M2

FOR: CLOTHING, NAMELY, SUITS, TUXEDOS, SPORT COATS, TROUSERS, DRESS SHIRTS, SPORT SHIRTS, TUXEDO SHIRTS, SWEATERS AND OTHER KNITWEAR, NAMELY, POLO SHIRTS, PULLOVERS, CARDIGANS, JERSEYS, KNITTED TOPS, T-SHIRTS, VESTS, FLEECE PANTS, FLEECE TOPS, FLEECE SWEAT SUITS, JOGGING SUITS, ATHLETIC AND EXERCISE CLOTHES, NAMELY, SPORTS JERSEYS, ATHLETIC UNIFORMS, SPORTS OVER UNIFORMS, SPORTS PANTS, SPORTS VESTS, SPORTS HATS AND CAPS AND ATHLETIC TIGHTS AND SOCKS, SWIM WEAR; CASUAL CLOTHING, NAMELY, KHAKIS, JEANS, SHORTS, CARGO PANTS, SWEAT PANTS, HOODED SWEATSHIRTS AND PULLOVERS; GOLF WEAR, NAMELY, GOLF CAPS AND HATS, GOLF PANTS AND SHIRTS, GOLF SHOES AND CLEATS, GOLF SHORTS, GOLF TROUSERS; OUTERWEAR, NAMELY, COATS, OVERCOATS, JACKETS, TRENCH COATS AND RAIN COATS, NECKWEAR, NAMELY, TIES, BOW TIES AND ASCOTS, BELTS, SOCKS, SUSPENDERS, POCKET SQUARES, UNDERWEAR, HATS, CAPS, GLOVES, SCARVES, ROBES, CUMMERBUNDS, SHOES, IN CLASS 25 (U.S. CLS. 22 AND 39).

THE MARK CONSISTS OF STANDARD CHARACTERS WITHOUT CLAIM TO ANY PARTICULAR FONT, STYLE, SIZE, OR COLOR.

OWNER OF CANADA REG. NO. TMA601274, DATED 2-3-2004, EXPIRES 2-3-2019.

THE NAME "J.P. TILFORD" DOES NOT IDENTIFY A LIVING INDIVIDUAL.

SER. NO. 85-178,042, FILED 11-16-2010.

ERIN FALK, EXAMINING ATTORNEY



David J. Kyjars

Director of the United States Patent and Trademark Office

United States of America

United States Patent and Trademark Office

Triton

Reg. No. 4,073,031

MDT MICRO DIAMOND TECHNOLOGIES LTD (ISRAEL LIMITED LIABILITY COMPANY)
2 HAMAL ST
AFULA, ISRAEL 18110

Registered Dec. 20, 2011

Int. Cl.: 40

FOR: ELECTROPLATING, IN CLASS 40 (U.S. CLS. 100, 103 AND 106).

SERVICE MARK

FIRST USE 2-10-2002; IN COMMERCE 2-10-2002.

PRINCIPAL REGISTER

THE MARK CONSISTS OF STANDARD CHARACTERS WITHOUT CLAIM TO ANY PARTICULAR FONT, STYLE, SIZE, OR COLOR.

SER. NO. 85-178,539, FILED 11-17-2010.

JULIE GUTTADAURO, EXAMINING ATTORNEY



David J. Kybas

Director of the United States Patent and Trademark Office

United States of America

United States Patent and Trademark Office

AIR CHINA

Reg. No. 4,073,032

Registered Dec. 20, 2011

Int. Cls.: 28 and 43

TRADEMARK

SERVICE MARK

PRINCIPAL REGISTER

AIR CHINA LIMITED (CHINA LIMITED COMPANY (LTD.))
9TH FL., LANTIAN MANSION, 28 TIANZHU RD.
ZONE A, TIANZHU AIRPORT INDUSTRIAL ZONE
SHUNYI DISTRICT BEIJING, CHINA

FOR: SCALE MODEL AIRPLANES; BOARD GAMES; CARD GAMES; PLAYING CARDS;
STRESS RELIEF BALLS FOR HAND EXERCISE; STUFFED AND PLUSH TOYS, IN CLASS
28 (U.S. CLS. 22, 23, 38 AND 50).

FOR: RESTAURANT, BAR AND CARRY-OUT SERVICES; RENTAL OF ROOMS FOR SOCIAL
FUNCTIONS; RENTAL OF BUILDINGS FOR TEMPORARY OCCUPANCY; RESERVATION
OF HOTEL ROOMS FOR TRAVELERS, IN CLASS 43 (U.S. CLS. 100 AND 101).

OWNER OF CHINA REG. NO. 6421016, DATED 4-7-2010, EXPIRES 4-6-2020.

OWNER OF CHINA REG. NO. 6421148, DATED 5-21-2010, EXPIRES 5-20-2020.

OWNER OF U.S. REG. NO. 3,909,687.

NO CLAIM IS MADE TO THE EXCLUSIVE RIGHT TO USE "CHINA", APART FROM THE
MARK AS SHOWN.

THE MARK CONSISTS OF THE WORDS "AIR CHINA" IN A STYLIZED FONT.

SER. NO. 85-178,671, FILED 11-17-2010.

ZACHARY BELLO, EXAMINING ATTORNEY



David J. Kypos

Director of the United States Patent and Trademark Office

United States of America

United States Patent and Trademark Office



Reg. No. 4,073,033

Registered Dec. 20, 2011

Int. Cls.: 28 and 43

TRADEMARK

SERVICE MARK

PRINCIPAL REGISTER

AIR CHINA LIMITED (CHINA LIMITED COMPANY (LTD.))
9TH FL., LANTIAN MANSION, 28 TIANZHU RD.
ZONE A, TIANZHU AIRPORT INDUSTRIAL ZONE
SHUNYI DISTRICT BEIJING, CHINA

FOR: SCALE MODEL AIRPLANES; BOARD GAMES; CARD GAMES; PLAYING CARDS;
STRESS RELIEF BALLS FOR HAND EXERCISE; STUFFED AND PLUSH TOYS, IN CLASS
28 (U.S. CLS. 22, 23, 38 AND 50).

FOR: RESTAURANT, BAR AND CARRY-OUT SERVICES; RENTAL OF ROOMS FOR SOCIAL
FUNCTIONS; RENTAL OF BUILDINGS FOR TEMPORARY OCCUPANCY; RESERVATION
OF HOTEL ROOMS FOR TRAVELERS, IN CLASS 43 (U.S. CLS. 100 AND 101).

OWNER OF CHINA REG. NO. 6420909, DATED 4-7-2010, EXPIRES 4-6-2020.

THE NON-LATIN CHARACTERS IN THE MARK TRANSLITERATE TO "ZHONG-GUO-
GUO-JI-HANG-KONG-GONG-SI" AND THIS MEANS "AIR CHINA LIMITED" IN ENGLISH.

OWNER OF CHINA REG. NO. 6421241, DATED 5-21-2010, EXPIRES 5-20-2020.

OWNER OF U.S. REG. NOS. 1,610,138, 3,707,627, AND 3,909,687.

NO CLAIM IS MADE TO THE EXCLUSIVE RIGHT TO USE "CHINA" AND "THE NON-
LATIN CHARACTERS WHICH MEAN LIMITED", APART FROM THE MARK AS SHOWN.

THE MARK CONSISTS OF THREE CURVED LINES DEPICTING A BIRD DESIGN. UNDER-
NEATH THE BIRD DESIGN ARE CHINESE CHARACTERS WHICH TRANSLITERATE TO
"ZHONG-GUO-GUO-JI-HANG-KONG-GONG-SI." THIS MEANS "AIR CHINA LIMITED" IN
ENGLISH. UNDERNEATH THE CHINESE CHARACTERS ARE THE WORDS "AIR CHINA"
IN A STYLIZED FONT.

SER. NO. 85-178,676, FILED 11-17-2010.

ZACHARY BELLO, EXAMINING ATTORNEY



David J. Kyros

Director of the United States Patent and Trademark Office

United States of America

United States Patent and Trademark Office

ULTIMATCH

Reg. No. 4,073,034

Registered Dec. 20, 2011

Int. Cls.: 9 and 36

TRADEMARK

SERVICE MARK

PRINCIPAL REGISTER

ICAP SERVICES NORTH AMERICA LLC (DELAWARE CORPORATION)
HARBORSIDE FINANCIAL CENTER
1100 PLAZA 5
JERSEY CITY, NJ 07311

FOR: COMPUTER SOFTWARE USED IN CALCULATION PROCESSES IN THE PROVISION OF BROKERING AND FINANCIAL SERVICES RELATING TO BONDS, CURRENCY OR INTEREST RATE PRODUCTS AND DERIVATIVES, SWAPS, FORWARD AGREEMENTS, CONTRACTS FOR DIFFERENCES, AND OTHER FINANCIAL OR MONEY PRODUCTS OR AGREEMENTS FOR DEALERS IN SECURITIES, IN CLASS 9 (U.S. CLS. 21, 23, 26, 36 AND 38).

FIRST USE 9-30-2006; IN COMMERCE 9-30-2006.

FOR: FINANCIAL EXCHANGE SERVICES FOR DEALERS IN SECURITIES; SECURITY BROKERAGE SERVICES FOR DEALERS IN SECURITIES; FINANCIAL CONSULTATION FOR DEALERS IN SECURITIES; FINANCIAL SERVICES, NAMELY, PROVIDING DEALERS IN SECURITIES WITH INTERMEDIARY SERVICES FOR THE EXCHANGE AND BROKERING THE SALE, EXCHANGE OR EXECUTION OF BONDS, FOREIGN CURRENCY PRODUCTS, INTEREST RATE PRODUCTS, FINANCIAL DERIVATIVES, SWAPS, FORWARD AGREEMENTS, CONTRACTS FOR DIFFERENCES AND OTHER FINANCIAL AND MONEY PRODUCTS AND AGREEMENTS VIA THE INTERNET AND INTRANET SYSTEMS; CALCULATION SERVICES FOR DEALERS IN SECURITIES FOR THE EXECUTION OR BROKERING OF BONDS, CURRENCY OR INTEREST RATE PRODUCTS AND DERIVATIVES, SWAPS, FORWARD AGREEMENTS, CONTRACTS FOR DIFFERENCES AND OTHER FINANCIAL AND MONEY PRODUCTS AND AGREEMENTS; FINANCIAL INVESTMENT FOR DEALERS IN SECURITIES IN THE FIELD OF BONDS, FOREIGN CURRENCY PRODUCTS, INTEREST RATE PRODUCTS, FINANCIAL DERIVATIVES, SWAPS, FORWARD AGREEMENTS, CONTRACTS FOR DIFFERENCES AND OTHER FINANCIAL AND MONEY PRODUCTS AND AGREEMENTS; MATCHING AND HEDGING SERVICES FOR FORWARD RATE AGREEMENTS (FRAS), NON-DELIVERABLE FORWARDS (NDFS), SPS AND OTHER MONEY MARKET AND FOREIGN EXCHANGE DERIVATIVES; ELECTRONIC FINANCIAL TRADING SERVICES IN THE NATURE OF UNILATERAL TRADE MATCHING SERVICES, IN CLASS 36 (U.S. CLS. 100, 101 AND 102).

FIRST USE 9-30-2006; IN COMMERCE 9-30-2006.



David J. Kyjars

Director of the United States Patent and Trademark Office

Reg. No. 4,073,034 THE MARK CONSISTS OF STANDARD CHARACTERS WITHOUT CLAIM TO ANY PARTICULAR FONT, STYLE, SIZE, OR COLOR.

SER. NO. 85-178,839, FILED 11-17-2010.

RONALD MCMORROW, EXAMINING ATTORNEY

United States of America

United States Patent and Trademark Office

TEKSTEM

Reg. No. 4,073,035

Registered Dec. 20, 2011

**Int. Cls.: 1, 13, 19, 37
and 42**

TRADEMARK

SERVICE MARK

PRINCIPAL REGISTER

MINOVA INTERNATIONAL LTD (ENGLAND LIMITED LIABILITY COMPANY)
UNIT 8 FRESHWATER ROAD
PARK ROAD, HOLMEWOOD INDUSTRIAL ESTATE
CHESTERFIELD DERBYSHIRE, UNITED KINGDOM S425UY

FOR: CHEMICALS USED IN INDUSTRY; CHEMICALS USED IN MINING, TUNNELLING, SEISMIC SURVEYING, OIL EXPLORATION, BUILDING, CIVIL ENGINEERING AND CONSTRUCTION FOR SEALING EXPLOSIVES INTO BLAST HOLES; CHEMICAL COMPOSITIONS FOR USE IN MINING, TUNNELLING, SEISMIC SURVEYING, OIL EXPLORATION, BUILDING, CIVIL ENGINEERING AND CONSTRUCTION; ARTIFICIAL AND SYNTHETIC RESINS FOR USE IN SEISMIC SURVEYING; PLASTICS FOR USE IN SEISMIC SURVEYING, NAMELY, POLYMERIZATION PLASTICS, AND UNPROCESSED PLASTICS IN ALL FORMS; CEMENTITIOUS COMPOUNDS AND OTHER SUBSTANCES AND COMPOUNDS FOR USE IN SEISMIC SURVEYING, NAMELY, THERMOPLASTIC AND THERMOSETTING ADHESIVES AND CEMENTS; RESINS, NAMELY, ARTIFICIAL AND SYNTHETIC RESINS; RESIN POWDERS AND RESINOUS COMPOUNDS, NAMELY, UNPROCESSED ARTIFICIAL RESINS AS RAW MATERIALS IN THE FORM OF POWDERS, LIQUIDS OR PASTES; CHEMICAL SEALING GROUTS, CEMENTS, NAMELY, CONTACT CEMENTS AND SYNTHETIC POLYMER MODIFIED RESIN COMPOUND FOR USE IN CEMENTITIOUS REPAIRS; CEMENTITIOUS MIXTURES AND COMPOSITIONS MADE FROM THE AFORESAID MATERIALS, NAMELY, PREMIXED ADHESIVE FOAM CEMENTS; CHEMICALS, RESINS, PLASTICS AND COMPOUNDS AND SUBSTANCES MADE THEREFROM FOR ADDING TO CEMENTITIOUS MIXTURES, NAMELY, CHEMICALS FOR USE IN THE MANUFACTURE OF CEMENTITIOUS MIXTURES, ARTIFICIAL AND SYNTHETIC RESINS, AND UNPROCESSED PLASTICS IN ALL FORMS; ALL THE AFORESAID GOODS FOR USE IN MINING, TUNNELLING, SEISMIC SURVEYING, OIL EXPLORATION, BUILDING, CIVIL ENGINEERING AND CONSTRUCTION, IN CLASS 1 (U.S. CLS. 1, 5, 6, 10, 26 AND 46).

FOR: EXPLOSIVES; DETONATORS; DETONATING CORD, NAMELY, FUSES FOR BLASTING; FUSES, NAMELY, FUSE, FUSES FOR BLASTING, AND EXPLOSIVE FUSES USED IN MINING; PRIMERS, NAMELY, EXPLOSIVE PRIMERS AND EXPLOSION PRIMERS; SHOCKWAVE CONDUCTORS AND ACCESSORIES FOR THE INITIATION OF EXPLOSIVES, NAMELY, EXPLOSIVE POWDERS, EXPLOSIVE PRIMERS, EXPLOSIVE CAPS, DETONATING PLUGS, IGNITION PELLETS, IN CLASS 13 (U.S. CLS. 2 AND 9).

FOR: NON-METALLIC MATERIALS AND BUILDING MATERIALS, NAMELY, GROUTS, RESINOUS GROUTS AND CEMENTITIOUS GROUTS; RAPID CURE GROUTS; CONCRETE;



David J. Kyros

Director of the United States Patent and Trademark Office

Reg. No. 4,073,035 CEMENT MIXES; MORTAR; CEMENT, NAMELY, CEMENT MIXES, CEMENTITIOUS AND RESINOUS GROUT, CEMENTITIOUS AND RESINOUS GROUTS IN CARTRIDGE FORM; RESINOUS GROUT; PLASTER; GROUT; COMPOSITIONS MADE OF ANY OF THE AFORESAID MATERIALS, NAMELY, CEMENT MIXES AND CEMENT FILLER MATERIALS COMPOSED OF MARBLE, PLASTER, AND GROUT; CEMENTITIOUS PRODUCTS FOR USE IN THE BUILDING, CIVIL ENGINEERING, SEISMIC SURVEYING, CONSTRUCTION, MINING AND TUNNELLING INDUSTRIES, NAMELY, CEMENT, CEMENT MIXES, CEMENTITIOUS AND RESINOUS GROUT, CEMENTITIOUS AND RESINOUS GROUTS IN CARTRIDGE FORM; CEMENT MIXES, NAMELY, CEMENTITIOUS COMPOUNDS, RESINS AND/OR OF FILLERS; GROUT, NAMELY, CEMENTITIOUS AND RESINOUS GROUTS IN CARTRIDGE FORM; ALL THE AFORESAID GOODS FOR USE IN MINING, TUNNELLING, SEISMIC SURVEYING, OIL EXPLORATION, IN CLASS 19 (U.S. CLS. 1, 12, 33 AND 50).

FOR: CONSTRUCTION AND EXCAVATION SERVICES, NAMELY, EXPLOSIVES BLASTING; CONSTRUCTION MANAGEMENT SERVICES, NAMELY, MANAGEMENT OF EXPLOSIVES BLASTING FOR PURPOSES OF EXCAVATION AND CONSTRUCTION; BUILDING CONSTRUCTION; PROVIDING INFORMATION PERSONALLY AND BY MEANS OF AN INFORMATION DISTRIBUTION MEDIUM IN THE FIELD OF BUILDING CONSTRUCTION; CONSTRUCTION, INSTALLATION AND MAINTENANCE IN RELATION TO MINING, TUNNELLING, SEISMIC SURVEYING, OIL EXPLORATION, BUILDING AND CIVIL ENGINEERING, NAMELY, MINE RECLAMATION SERVICES, PIPELINE INSTALLATION AND REPAIR, QUARRY SERVICES, OIL WELL DRILLING, OIL WELL CASING, TUNNELLING, AND DRILL PIPE INSTALLATION, CONSTRUCTION AND REPAIR OF STRUCTURES FOR THE PRODUCTION AND STORAGE OF CRUDE OIL, RENOVATION AND RESTORATION OF BUILDINGS, CONSTRUCTION AND REPAIR OF BUILDINGS, CONSTRUCTION AND REPAIR OF TUNNELS AND UNDERGROUND STRUCTURES; CONSULTATION, ADVICE AND PROVIDING INFORMATION SERVICES IN RELATION TO ALL THE AFORESAID SERVICES, IN CLASS 37 (U.S. CLS. 100, 103 AND 106).

FOR: EXPLOSIVE CIVIL ENGINEERING IN THE SEISMIC SURVEYING, CONSTRUCTION, MINING AND TUNNELLING INDUSTRIES; CONSULTATION AND ADVICE IN THE FIELD OF EXPLOSIVES IN CIVIL ENGINEERING IN SEISMIC SURVEYING, CONSTRUCTION, MINING AND TUNNELLING INDUSTRIES; PROVIDING INFORMATION IN THE FIELD OF EXPLOSIVE CIVIL ENGINEERING IN SEISMIC SURVEYING, CONSTRUCTION, MINING AND TUNNELLING INDUSTRIES, IN CLASS 42 (U.S. CLS. 100 AND 101).

THE MARK CONSISTS OF STANDARD CHARACTERS WITHOUT CLAIM TO ANY PARTICULAR FONT, STYLE, SIZE, OR COLOR.

PRIORITY CLAIMED UNDER SEC. 44(D) ON UNITED KINGDOM APPLICATION NO. 2550296, FILED 6-15-2010, REG. NO. 2550296, DATED 10-8-2010, EXPIRES 6-15-2020.

THE WORDING "TEKSTEM" HAS NO MEANING IN A FOREIGN LANGUAGE.

SER. NO. 85-179,050, FILED 11-17-2010.

JAY BESCH, EXAMINING ATTORNEY

United States of America

United States Patent and Trademark Office



Reg. No. 4,073,036

LICHINE, CAROLINE (FRANCE INDIVIDUAL)
915 CHEMIN DES PLAIDEURS
AIX EN PROVENCE, FRANCE F-13090

Registered Dec. 20, 2011

Int. Cl.: 25

FOR: CLOTHING, NAMELY, T-SHIRTS, SWEAT-SHIRTS, BERMUDAS AND PANTS, IN CLASS 25 (U.S. CLS. 22 AND 39).

TRADEMARK

OWNER OF FRANCE REG. NO. 093643123, DATED 4-9-2009, EXPIRES 4-9-2019.

PRINCIPAL REGISTER

THE COLOR(S) PINK AND BLACK IS/ARE CLAIMED AS A FEATURE OF THE MARK.

OWNER OF U.S. REG. NO. 3,903,188.

NO CLAIM IS MADE TO THE EXCLUSIVE RIGHT TO USE "SHORT", APART FROM THE MARK AS SHOWN.

THE MARK CONSISTS OF THE LITERAL ELEMENT "LE SHORT BY CL" WITHIN A RECTANGLE. THE RECTANGLE IS BORDERED BY DOTS. THE COLOR PINK APPEARS IN THE RECTANGLE. THE COLOR BLACK APPEARS IN THE LITERAL ELEMENT AND THE DOTS.

SER. NO. 85-180,004, FILED 11-18-2010.

MIDGE BUTLER, EXAMINING ATTORNEY



David J. Kybas

Director of the United States Patent and Trademark Office

United States of America

United States Patent and Trademark Office

ORKIN COMFORTZONE

Reg. No. 4,073,037

ORKIN EXPANSION, INC. (DELAWARE CORPORATION)
1105 NORTH MARKET STREET #1106
WILMINGTON, DE 19899

Registered Dec. 20, 2011

Int. Cl.: 37

FOR: INSTALLATION OF RADIANT HEAT BARRIERS IN HOMES AND BUILDINGS, IN CLASS 37 (U.S. CLS. 100, 103 AND 106).

SERVICE MARK

FIRST USE 5-13-2010; IN COMMERCE 6-1-2010.

PRINCIPAL REGISTER

THE MARK CONSISTS OF STANDARD CHARACTERS WITHOUT CLAIM TO ANY PARTICULAR FONT, STYLE, SIZE, OR COLOR.

OWNER OF U.S. REG. NOS. 568,404, 568,406, AND 568,407.

SER. NO. 85-180,779, FILED 11-19-2010.

FRANK LATTUCA, EXAMINING ATTORNEY



David J. Kybas

Director of the United States Patent and Trademark Office

United States of America

United States Patent and Trademark Office

ComprehendRx

Reg. No. 4,073,038

LEARNINGRX INC (NEVADA CORPORATION)
5085 LIST DR

Registered Dec. 20, 2011

COLORADO SPRINGS, CO 80919

Int. Cl.: 16

FOR: PRINTED TRAINING MATERIALS IN THE FIELD OF COMPREHENSION TRAINING,
IN CLASS 16 (U.S. CLS. 2, 5, 22, 23, 29, 37, 38 AND 50).

TRADEMARK

FIRST USE 12-2-2002; IN COMMERCE 12-2-2002.

PRINCIPAL REGISTER

THE MARK CONSISTS OF STANDARD CHARACTERS WITHOUT CLAIM TO ANY PAR-
TICULAR FONT, STYLE, SIZE, OR COLOR.

SER. NO. 85-180,825, FILED 11-19-2010.

SARA BENJAMIN, EXAMINING ATTORNEY



David J. Kyffers

Director of the United States Patent and Trademark Office

United States of America

United States Patent and Trademark Office

FLATSMASTERS

Reg. No. 4,073,039

SMUGGLER'S EVENT MANAGEMENT, LLC (FLORIDA LIMITED LIABILITY COMPANY)
150 LAISHLEY COURT, UNIT 116
PUNTA GORDA, FL 33950

Registered Dec. 20, 2011

Int. Cl.: 41

FOR: ORGANIZING AND CONDUCTING FISHING TOURNAMENTS, IN CLASS 41 (U.S. CLS. 100, 101 AND 107).

SERVICE MARK

FIRST USE 1-1-2001; IN COMMERCE 1-1-2001.

PRINCIPAL REGISTER

THE MARK CONSISTS OF STANDARD CHARACTERS WITHOUT CLAIM TO ANY PARTICULAR FONT, STYLE, SIZE, OR COLOR.

SEC. 2(F).

SER. NO. 85-181,391, FILED 11-19-2010.

LOURDES AYALA, EXAMINING ATTORNEY



David J. Kybas

Director of the United States Patent and Trademark Office

United States of America

United States Patent and Trademark Office

Cruiserman

Reg. No. 4,073,040

Registered Dec. 20, 2011

Int. Cl.: 41

SERVICE MARK

PRINCIPAL REGISTER

HUB EVENT PRODUCTIONS, LLC (ARIZONA LIMITED LIABILITY COMPANY)
1733 N. SIERRA VISTA DR.
TEMPE, AZ 85281

FOR: ENTERTAINMENT SERVICES, NAMELY, ARRANGING AND CONDUCTING ATHLETIC COMPETITIONS CONSISTING OF SWIMMING, BIKING AND RUNNING, IN CLASS 41 (U.S. CLS. 100, 101 AND 107).

FIRST USE 10-16-2010; IN COMMERCE 10-16-2010.

THE MARK CONSISTS OF STANDARD CHARACTERS WITHOUT CLAIM TO ANY PARTICULAR FONT, STYLE, SIZE, OR COLOR.

SER. NO. 85-181,997, FILED 11-21-2010.

DAVID TOOLEY, EXAMINING ATTORNEY



David J. Kyfos

Director of the United States Patent and Trademark Office

United States of America

United States Patent and Trademark Office

GUTNTAG

Reg. No. 4,073,041

Registered Dec. 20, 2011

Int. Cl.: 25

TRADEMARK

PRINCIPAL REGISTER

GUTNTAG, LLC (PENNSYLVANIA LIMITED LIABILITY COMPANY), DBA GUTNTAG
WWW.GUTNTAG.COM
4104 SCAR HILL ROAD
GREENCASTLE, PA 17225

FOR: CLOTHING, NAMELY, SHIRTS, JACKETS, SWEATSHIRTS, HAT AND CAPS, IN CLASS 25 (U.S. CLS. 22 AND 39).

FIRST USE 1-0-2008; IN COMMERCE 9-20-2010.

THE MARK CONSISTS OF STANDARD CHARACTERS WITHOUT CLAIM TO ANY PARTICULAR FONT, STYLE, SIZE, OR COLOR.

THE WORDING "GUTNTAG" HAS NO MEANING IN A FOREIGN LANGUAGE.

SER. NO. 85-182,031, FILED 11-22-2010.

GEOFFREY FOSDICK, EXAMINING ATTORNEY



David J. Kyros

Director of the United States Patent and Trademark Office

United States of America

United States Patent and Trademark Office

Jobst Vascular Institute

Reg. No. 4,073,042

THE TOLEDO HOSPITAL (OHIO NON-PROFIT CORPORATION)
1801 RICHARDS ROAD
TOLEDO, OH 43607

Registered Dec. 20, 2011

Int. Cls.: 41, 42 and 44

FOR: MEDICAL TRAINING AND TEACHING IN THE FIELD OF A VASCULAR MEDICINE FELLOWSHIP TRAINING PROGRAM, IN CLASS 41 (U.S. CLS. 100, 101 AND 107).

SERVICE MARK

FIRST USE 8-30-2010; IN COMMERCE 8-30-2010.

PRINCIPAL REGISTER

FOR: CLINICAL MEDICAL RESEARCH; NON-INVASIVE DIAGNOSTIC VASCULAR LABORATORY SERVICES, IN CLASS 42 (U.S. CLS. 100 AND 101).

FIRST USE 8-30-2010; IN COMMERCE 8-30-2010.

FOR: MEDICAL AND HOSPITAL SERVICES, NAMELY, VASCULAR AND CARDIAC CARE AND SURGERY, REHABILITATION SERVICES, IN CLASS 44 (U.S. CLS. 100 AND 101).

FIRST USE 8-30-2010; IN COMMERCE 8-30-2010.

THE MARK CONSISTS OF STANDARD CHARACTERS WITHOUT CLAIM TO ANY PARTICULAR FONT, STYLE, SIZE, OR COLOR.

NO CLAIM IS MADE TO THE EXCLUSIVE RIGHT TO USE "VASCULAR INSTITUTE", APART FROM THE MARK AS SHOWN.

SEC. 2(F).

SER. NO. 85-182,177, FILED 11-22-2010.

KATHY DE JONGE, EXAMINING ATTORNEY



David J. Kybas

Director of the United States Patent and Trademark Office

United States of America

United States Patent and Trademark Office

SUFFOLK UNIVERSITY

Reg. No. 4,073,043

Registered Dec. 20, 2011

Int. Cl.: 41

SERVICE MARK

PRINCIPAL REGISTER

SUFFOLK UNIVERSITY (MASSACHUSETTS CORPORATION)
8 ASHBURTON PLACE
BOSTON, MA 02108

FOR: EDUCATIONAL SERVICES, NAMELY, PROVIDING COURSES OF INSTRUCTION AND TRAINING AT THE UNDERGRADUATE, GRADUATE, POST-GRADUATE, AND PROFESSIONAL LEVELS; ENTERTAINMENT SERVICES, NAMELY, ORGANIZING, PROMOTING, AND CONDUCTING ATHLETIC EVENTS, IN CLASS 41 (U.S. CLS. 100, 101 AND 107).

FIRST USE 12-31-1937; IN COMMERCE 12-31-1937.

THE MARK CONSISTS OF STANDARD CHARACTERS WITHOUT CLAIM TO ANY PARTICULAR FONT, STYLE, SIZE, OR COLOR.

OWNER OF U.S. REG. NOS. 2,627,835, 2,642,119, AND 2,866,081.

NO CLAIM IS MADE TO THE EXCLUSIVE RIGHT TO USE "UNIVERSITY", APART FROM THE MARK AS SHOWN.

SEC. 2(F).

SER. NO. 85-183,106, FILED 11-23-2010.

EDWARD NELSON, EXAMINING ATTORNEY



David J. Kyffers

Director of the United States Patent and Trademark Office

United States of America

United States Patent and Trademark Office

SUFFOLK

Reg. No. 4,073,044

Registered Dec. 20, 2011

Int. Cl.: 41

SERVICE MARK

PRINCIPAL REGISTER

SUFFOLK UNIVERSITY (MASSACHUSETTS CORPORATION)
8 ASHBURTON PLACE
BOSTON, MA 02108

FOR: EDUCATIONAL SERVICES, NAMELY, PROVIDING COURSES OF INSTRUCTION AND TRAINING AT THE UNDERGRADUATE, GRADUATE, POST-GRADUATE, AND PROFESSIONAL LEVELS; ENTERTAINMENT SERVICES, NAMELY, ORGANIZING, PROMOTING, AND CONDUCTING ATHLETIC EVENTS, IN CLASS 41 (U.S. CLS. 100, 101 AND 107).

FIRST USE 12-31-1937; IN COMMERCE 12-31-1937.

THE MARK CONSISTS OF STANDARD CHARACTERS WITHOUT CLAIM TO ANY PARTICULAR FONT, STYLE, SIZE, OR COLOR.

OWNER OF U.S. REG. NOS. 2,627,835, 2,642,119, AND 2,866,081.

SEC. 2(F).

SER. NO. 85-183,108, FILED 11-23-2010.

EDWARD NELSON, EXAMINING ATTORNEY



David J. Kyffers

Director of the United States Patent and Trademark Office

United States of America

United States Patent and Trademark Office

NEW ENGLAND SCHOOL OF ART & DESIGN

Reg. No. 4,073,045

SUFFOLK UNIVERSITY (MASSACHUSETTS CORPORATION)
8 ASHBURTON PLACE
BOSTON, MA 02108

Registered Dec. 20, 2011

Int. Cl.: 41

FOR: EDUCATIONAL SERVICES, NAMELY, CONDUCTING CLASSES, SEMINARS, WORKSHOPS, AND CONFERENCES IN THE FIELDS OF VISUAL ART AND DESIGN, IN CLASS 41 (U.S. CLS. 100, 101 AND 107).

SERVICE MARK

FIRST USE 12-31-1975; IN COMMERCE 12-31-1975.

PRINCIPAL REGISTER

THE MARK CONSISTS OF STANDARD CHARACTERS WITHOUT CLAIM TO ANY PARTICULAR FONT, STYLE, SIZE, OR COLOR.

NO CLAIM IS MADE TO THE EXCLUSIVE RIGHT TO USE "SCHOOL OF ART & DESIGN", APART FROM THE MARK AS SHOWN.

SEC. 2(F).

SER. NO. 85-183,116, FILED 11-23-2010.

EDWARD NELSON, EXAMINING ATTORNEY



David J. Kyffers

Director of the United States Patent and Trademark Office

United States of America

United States Patent and Trademark Office

SCHOOLSTORE.COM

Reg. No. 4,073,046

ASD.COM, INC. (DELAWARE CORPORATION)

Registered Dec. 20, 2011

180 FREEDOM AVENUE
MURFREESBORO, TN 37129

Int. Cls.: 35 and 36

FOR: ON-LINE RETAIL AND RETAIL CATALOG SHOPPING SERVICES, BOTH FEATURING A WIDE VARIETY OF CONSUMER GOODS AND SERVICES OF PARTICIPATING THIRD-PARTY MERCHANTS THROUGH PRINTED AND COMPUTERIZED ON-LINE CATALOGUES WHEREBY ORDERS ARE PLACED VIA MAIL, TELECOMMUNICATIONS, AND ON-LINE, IN CLASS 35 (U.S. CLS. 100, 101 AND 102).

SERVICE MARK

PRINCIPAL REGISTER

FIRST USE 9-11-1996; IN COMMERCE 9-11-1996.

FOR: SCHOOL FUND RAISING PROGRAM WHEREBY A SCHOOL DESIGNATED BY A CUSTOMER RECEIVES A REBATE ON THE PRICE OF GOODS AND SERVICES OFFERED BY PARTICIPATING THIRD-PARTY MERCHANTS AND ORDERED FROM A PRINTED OR COMPUTERIZED ON-LINE CATALOGUE, IN CLASS 36 (U.S. CLS. 100, 101 AND 102).

FIRST USE 9-11-1996; IN COMMERCE 9-11-1996.

THE MARK CONSISTS OF STANDARD CHARACTERS WITHOUT CLAIM TO ANY PARTICULAR FONT, STYLE, SIZE, OR COLOR.

SEC. 2(F).

SER. NO. 85-183,397, FILED 11-23-2010.

ADA HAN, EXAMINING ATTORNEY



David J. Kyffers

Director of the United States Patent and Trademark Office

United States of America

United States Patent and Trademark Office

MARIA A. ANDROS

Reg. No. 4,073,047

VIDEO MARKETING QUEEN, INC. (CALIFORNIA CORPORATION)
499 NORTH CANON DRIVE, 4TH FLOOR
BEVERLY HILLS, CA 91210

Registered Dec. 20, 2011

Int. Cl.: 35

FOR: ADVERTISING AND MARKETING; ADVERTISING AND MARKETING CONSULTANCY; BUSINESS CONSULTING AND INFORMATION SERVICES; CONSULTING SERVICES IN THE FIELD OF INTERNET MARKETING, IN CLASS 35 (U.S. CLS. 100, 101 AND 102).

SERVICE MARK

PRINCIPAL REGISTER

FIRST USE 5-0-2007; IN COMMERCE 5-0-2007.

THE MARK CONSISTS OF STANDARD CHARACTERS WITHOUT CLAIM TO ANY PARTICULAR FONT, STYLE, SIZE, OR COLOR.

THE NAME(S), PORTRAIT(S), AND/OR SIGNATURE(S) SHOWN IN THE MARK IDENTIFIES "MARIA A. ANDROS", WHOSE CONSENT(S) TO REGISTER IS MADE OF RECORD.

SER. NO. 85-183,662, FILED 11-23-2010.

KAREN K. BUSH, EXAMINING ATTORNEY



David J. Kyffers

Director of the United States Patent and Trademark Office

United States of America

United States Patent and Trademark Office

THE BANKERS CODE

Reg. No. 4,073,048

Registered Dec. 20, 2011

Int. Cl.: 41

SERVICE MARK

PRINCIPAL REGISTER

WEALTHCLASSES, LLC (CALIFORNIA LIMITED LIABILITY COMPANY)
1255 TREAT BLVD., SUITE 230
WALNUT CREEK, CA 94597

FOR: EDUCATION SERVICES, NAMELY, PROVIDING LIVE AND ON-LINE CLASSES, SEMINARS AND WORKSHOPS IN THE FIELD OF FINANCIAL EDUCATION; EDUCATION SERVICES, NAMELY, PROVIDING MENTORING, TUTORING, CLASSES, SEMINARS AND WORKSHOPS IN THE FIELD OF FINANCIAL EDUCATION; EDUCATIONAL SERVICES, NAMELY, CONDUCTING CLASSES, SEMINARS AND WORKSHOPS IN THE FIELDS OF FINANCIAL EDUCATION AND REAL ESTATE AND DISTRIBUTION OF TRAINING MATERIALS IN CONNECTION THEREWITH, ALL NOT RELATED TO EDUCATION SERVICES IN THE FIELDS OF STOCK MARKET ANALYSIS OR TECHNICAL MARKET TRADING, IN CLASS 41 (U.S. CLS. 100, 101 AND 107).

FIRST USE 8-15-2010; IN COMMERCE 8-15-2010.

THE MARK CONSISTS OF STANDARD CHARACTERS WITHOUT CLAIM TO ANY PARTICULAR FONT, STYLE, SIZE, OR COLOR.

NO CLAIM IS MADE TO THE EXCLUSIVE RIGHT TO USE "BANKER'S", APART FROM THE MARK AS SHOWN.

SER. NO. 85-183,917, FILED 11-23-2010.

JOHN GARTNER, EXAMINING ATTORNEY



David J. Kybas

Director of the United States Patent and Trademark Office

United States of America

United States Patent and Trademark Office

Spinoscope

Reg. No. 4,073,049

FAUL, IVAN (CANADA INDIVIDUAL)
4824 STERLING DRIVE
BOULDER, CO 80301

Registered Dec. 20, 2011

Int. Cl.: 10

FOR: ORTHOPEDIC APPARATUS AND INSTRUMENTS FOR DIAGNOSTIC AND THERAPEUTIC USE, IN CLASS 10 (U.S. CLS. 26, 39 AND 44).

TRADEMARK

FIRST USE 2-21-1989; IN COMMERCE 3-22-2004.

PRINCIPAL REGISTER

THE MARK CONSISTS OF STANDARD CHARACTERS WITHOUT CLAIM TO ANY PARTICULAR FONT, STYLE, SIZE, OR COLOR.

SER. NO. 85-184,081, FILED 11-23-2010.

ELIZABETH KAJUBI, EXAMINING ATTORNEY



David J. Kybas

Director of the United States Patent and Trademark Office

United States of America

United States Patent and Trademark Office



Reg. No. 4,073,050

Registered Dec. 20, 2011

Int. Cl.: 25

TRADEMARK

PRINCIPAL REGISTER

EXCLUSIVAS YUMAS, S.L. (SPAIN CORPORATION)
SEVERO OCHOA, 10
ELCHE PARQUE INDUSTRIAL
ELCHE, ALICANTE, SPAIN 03203

FOR: CLOTHING AND SPORTS WEAR FOR MEN, WOMEN AND CHILDREN, NAMELY, SHIRTS, T-SHIRTS, TROUSERS, SHORTS, SKIRTS, PULLOVERS, SWEATERS, CARDIGANS, JACKETS, SWIMWEAR, COATS, ANORAKS, BELTS, TIES, WRISTBANDS, SOCKS, UNDERWEAR; HEADGEAR, NAMELY, HATS, CAPS, HEADBANDS; FOOTWEAR, NAMELY, SHOES, BOOTS, SLIPPERS, SANDALS AND SPORT SHOES, IN CLASS 25 (U.S. CLS. 22 AND 39).

OWNER OF ERPN CMNTY TM OFC REG. NO. 6976716, DATED 6-12-2009, EXPIRES 6-10-2018.

THE MARK CONSISTS OF "YUMAS" IN STYLIZED LETTERS; THE LETTER "Y" IS INSIDE A CIRCLE FOLLOWED BY THE WORD "YUMAS".

THE WORDING "YUMAS" HAS NO MEANING IN A FOREIGN LANGUAGE.

SER. NO. 85-184,090, FILED 11-23-2010.

JOHN DALIER, EXAMINING ATTORNEY



David J. Kyffers

Director of the United States Patent and Trademark Office

United States of America

United States Patent and Trademark Office

WomIntuition

Reg. No. 4,073,051

WOMENKIND LLC (NEW YORK LIMITED LIABILITY COMPANY)
62 WEST 45TH STREET, 10TH FLOOR
NEW YORK, NY 10036

Registered Dec. 20, 2011

Int. Cl.: 35

FOR: BUSINESS CONSULTING, BRAND EVALUATION AND POSITIONING SERVICES, BUSINESS DATA ANALYSIS, AND ADVERTISING AND MARKETING SERVICES TO HELP COMPANIES ATTRACT AND UNCOVER OPPORTUNITIES FOR TARGETING PRODUCTS AND SERVICES TO FEMALE CONSUMERS; BUSINESS RESEARCH AND DEVELOPING FACT-DRIVEN INSIGHTS FOR BUSINESS AND MARKETING CONSULTING REGARDING WOMEN THAT INFLUENCE MARKETING MESSAGES TO WOMEN, IN CLASS 35 (U.S. CLS. 100, 101 AND 102).

SERVICE MARK

PRINCIPAL REGISTER

FIRST USE 3-3-2008; IN COMMERCE 3-31-2008.

THE MARK CONSISTS OF STANDARD CHARACTERS WITHOUT CLAIM TO ANY PARTICULAR FONT, STYLE, SIZE, OR COLOR.

SER. NO. 85-184,964, FILED 11-24-2010.

LINDSEY RUBIN, EXAMINING ATTORNEY



David J. Kyffers

Director of the United States Patent and Trademark Office

United States of America
United States Patent and Trademark Office

BAUHAUS

Reg. No. 4,073,052

GASPARE CORP (NEW YORK CORPORATION)
325 WEST 38TH STREET RM 808
NEW YORK, NY 100189619

Registered Dec. 20, 2011

Int. Cl.: 30

FOR: CHOCOLATE AND CHOCOLATES, IN CLASS 30 (U.S. CL. 46).

TRADEMARK

FIRST USE 7-23-2010; IN COMMERCE 10-20-2010.

PRINCIPAL REGISTER

THE MARK CONSISTS OF STANDARD CHARACTERS WITHOUT CLAIM TO ANY PARTICULAR FONT, STYLE, SIZE, OR COLOR.

SER. NO. 85-185,804, FILED 11-28-2010.

NATALIE POLZER, EXAMINING ATTORNEY



David J. Kyffers

Director of the United States Patent and Trademark Office

United States of America

United States Patent and Trademark Office

BEST OF CHARLOTTE

Reg. No. 4,073,053

Registered Dec. 20, 2011

Int. Cls.: 16 and 35

TRADEMARK

SERVICE MARK

PRINCIPAL REGISTER

CL CHARLOTTE, INC. (GEORGIA CORPORATION)
1911 N. 13TH STREET
SUITE W200
TAMPA, FL 33605

FOR: PRINTED PUBLICATIONS, NAMELY, PERIODIC NEWSPAPERS IN THE FIELD OF LISTING INDIVIDUALS AND BUSINESSES THAT HAVE ACHIEVED EXCELLENCE IN AREAS OF INTEREST TO THE GENERAL PUBLIC, IN CLASS 16 (U.S. CLS. 2, 5, 22, 23, 29, 37, 38 AND 50).

FIRST USE 12-3-1988; IN COMMERCE 12-3-1988.

FOR: CONDUCTING PUBLIC OPINION POLLS FEATURING READERS' CHOICE REGARDING GOODS AND SERVICES; CONDUCTING AWARD PROGRAMS TO PROMOTE THE BUSINESS OF RETAIL ESTABLISHMENTS THROUGH THE DEMONSTRATION OF EXCELLENCE IN CUSTOMER SERVICE, QUALITY OF PRODUCTS AND/OR SERVICES, AND GENERALLY IN THEIR FIELD; PROVIDING INFORMATION OF INTEREST TO SPECIFIC GEOGRAPHICAL AREAS VIA THE GLOBAL COMPUTER NETWORK, NAMELY, ON-LINE BUSINESS AND RESTAURANT DIRECTORY, IN CLASS 35 (U.S. CLS. 100, 101 AND 102).

FIRST USE 9-18-2002; IN COMMERCE 9-18-2002.

THE MARK CONSISTS OF STANDARD CHARACTERS WITHOUT CLAIM TO ANY PARTICULAR FONT, STYLE, SIZE, OR COLOR.

SEC. 2(F).

SER. NO. 85-185,914, FILED 11-29-2010.

DAVID TAYLOR, EXAMINING ATTORNEY



David J. Kypos

Director of the United States Patent and Trademark Office

United States of America

United States Patent and Trademark Office

FLOORING XTRA

Reg. No. 4,073,054

Registered Dec. 20, 2011

**Int. Cls.: 19, 27, 35, 37
and 39**

TRADEMARK

SERVICE MARK

PRINCIPAL REGISTER

FLOORING XTRA LIMITED (NEW ZEALAND COMPANY)
154 CARRUTH ROAD
PAPATOETOE, AUCKLAND, NEW ZEALAND

FOR: FLOOR COVERINGS AND MATERIALS FOR COVERING FLOORS, NAMELY, WOOD FLOORING, LAMINATE FLOORING AND CERAMIC TILE FLOORING, IN CLASS 19 (U.S. CLS. 1, 12, 33 AND 50).

FOR: FLOOR COVERINGS AND MATERIALS FOR COVERING FLOORS, NAMELY, VINYL FLOOR COVERINGS, LINOLEUMS, CARPETS, RUGS, MATS, MATTING, CARPET TILES, HARD SURFACE COVERINGS FOR FLOORS AND RUBBER FLOOR COVERINGS AND MATTING, IN CLASS 27 (U.S. CLS. 19, 20, 37, 42 AND 50).

FOR: WHOLESALE AND RETAIL STORE SERVICES FEATURING HOME FURNISHINGS, FLOOR COVERINGS AND WINDOW TREATMENTS, IN CLASS 35 (U.S. CLS. 100, 101 AND 102).

FOR: INSTALLATION, MAINTENANCE, REPAIR AND CLEANING OF HOME FURNISHINGS, FLOOR COVERINGS AND WINDOW TREATMENTS, IN CLASS 37 (U.S. CLS. 100, 103 AND 106).

FOR: TRANSPORTING AND DELIVERING HOME FURNISHINGS, FLOOR COVERINGS AND WINDOW TREATMENTS, IN CLASS 39 (U.S. CLS. 100 AND 105).

THE MARK CONSISTS OF STANDARD CHARACTERS WITHOUT CLAIM TO ANY PARTICULAR FONT, STYLE, SIZE, OR COLOR.

PRIORITY CLAIMED UNDER SEC. 44(D) ON AUSTRALIA APPLICATION NO. 1389198, FILED 10-18-2010, REG. NO. 1389198, DATED 6-14-2011, EXPIRES 10-18-2020.

NO CLAIM IS MADE TO THE EXCLUSIVE RIGHT TO USE "FLOORING", APART FROM THE MARK AS SHOWN.

SER. NO. 85-186,023, FILED 11-29-2010.

BARBARA BROWN, EXAMINING ATTORNEY



David J. Kyffers

Director of the United States Patent and Trademark Office

United States of America

United States Patent and Trademark Office



Reg. No. 4,073,055

KAPOOR, MALTI (UNITED STATES INDIVIDUAL)
15 LAGUNA CT
MANHATTAN BEACH, CA 90266 AND

Registered Dec. 20, 2011

Int. Cl.: 25

KAPOOR, MAMTA (UNITED STATES INDIVIDUAL)
15 LAGUNA CT
MANHATTAN BEACH, CA 90266

TRADEMARK

PRINCIPAL REGISTER

FOR: APPAREL FOR DANCERS, NAMELY, TEE SHIRTS, SWEATSHIRTS, PANTS, LEGGINGS, SHORTS AND JACKETS, IN CLASS 25 (U.S. CLS. 22 AND 39).

FIRST USE 5-21-2008; IN COMMERCE 12-10-2009.

THE MARK CONSISTS OF THE WORD "RANTZ" IN A SPEECH BUBBLE.

SER. NO. 85-186,819, FILED 11-30-2010.

DOMINICK J. SALEMI, EXAMINING ATTORNEY



David J. Kybas

Director of the United States Patent and Trademark Office

United States of America

United States Patent and Trademark Office

CRYPTERA

Reg. No. 4,073,056

BBS DENMARK A/S (DENMARK CORPORATION)
FABRIKSPARKEN 20
2600 GLOSTRUP, DENMARK

Registered Dec. 20, 2011

**Int. Cls.: 9, 35, 36, 38
and 42**

FOR: COMPUTER HARDWARE, NAMELY, PAYMENT TERMINALS, ATM PIN PADS, SECURE TERMINALS FOR ELECTRONIC TRANSACTIONS, AND UNIVERSAL CONTROL MODULES; COMPUTER SOFTWARE FOR ATM WITHDRAWALS AND SELF-PAYMENT TRANSACTIONS, IN CLASS 9 (U.S. CLS. 21, 23, 26, 36 AND 38).

TRADEMARK

FOR: BUSINESS MANAGEMENT SERVICES, NAMELY, ASSISTANCE AND CONSULTANCY SERVICES IN THE FIELD OF SECURE PAYMENT SOLUTIONS FOR COMPANIES IN THE BANKING AND ATM, DRIVE-THRU AND QSR, PARKING, RETAIL AND SELF-CHECKOUT, TICKETING, GAS STATIONS AND GAMING SECTORS, IN CLASS 35 (U.S. CLS. 100, 101 AND 102).

SERVICE MARK

PRINCIPAL REGISTER

FOR: FINANCIAL SERVICES, NAMELY, PROVIDING SECURE COMMERCIAL TRANSACTIONS AND PAYMENT OPTIONS IN THE BANKING AND ATM, DRIVE-THRU AND QSR, PARKING, RETAIL AND SELF-CHECKOUT, TICKETING, GAS STATIONS AND GAMING SECTORS, IN CLASS 36 (U.S. CLS. 100, 101 AND 102).

FOR: TELECOMMUNICATIONS SERVICES, NAMELY, ELECTRONIC TRANSMISSION OF SECURE PERSONAL IDENTIFICATION AND PAYMENT DATA VIA A GLOBAL COMPUTER NETWORK, IN CLASS 38 (U.S. CLS. 100, 101 AND 104).



FOR: COMPUTER TECHNOLOGY SUPPORT SERVICES, NAMELY, HELP DESK SERVICES; PROVIDING A SECURE ELECTRONIC ONLINE SYSTEM FEATURING TECHNOLOGY WHICH ALLOWS ATM WITHDRAWALS AND SELF-SERVICE PAYMENT SOLUTIONS, IN CLASS 42 (U.S. CLS. 100 AND 101).

THE MARK CONSISTS OF STANDARD CHARACTERS WITHOUT CLAIM TO ANY PARTICULAR FONT, STYLE, SIZE, OR COLOR.

PRIORITY CLAIMED UNDER SEC. 44(D) ON ERPN CMNTY TM OFC APPLICATION NO. 009145517, FILED 6-1-2010, REG. NO. 009145517, DATED 10-19-2010, EXPIRES 6-1-2020.

SER. NO. 85-186,901, FILED 11-30-2010.

David J. Kyffers

Director of the United States Patent and Trademark Office

Reg. No. 4,073,056 PATRICIA EVANKO, EXAMINING ATTORNEY

United States of America

United States Patent and Trademark Office

PEDRONCELLI

Reg. No. 4,073,057

Registered Dec. 20, 2011

Int. Cl.: 33

TRADEMARK

PRINCIPAL REGISTER

PEDRONCELLI WINERY, INC. (CALIFORNIA CORPORATION)
1220 CANYON ROAD
GEYSERVILLE, CA 95441

FOR: WINES, IN CLASS 33 (U.S. CLS. 47 AND 49).

FIRST USE 0-0-1948; IN COMMERCE 0-0-1970.

THE MARK CONSISTS OF STANDARD CHARACTERS WITHOUT CLAIM TO ANY PARTICULAR FONT, STYLE, SIZE, OR COLOR.

SEC. 2(F).

SER. NO. 85-186,983, FILED 11-30-2010.

GEORGE LORENZO, EXAMINING ATTORNEY



David J. Kyffers

Director of the United States Patent and Trademark Office

United States of America

United States Patent and Trademark Office

CONCRETE EARTH

Reg. No. 4,073,058

Registered Dec. 20, 2011

Int. Cl.: 2

TRADEMARK

PRINCIPAL REGISTER

CONCRETE EARTH LLC, AN AFFILIATE OF SPECCO INDUSTRIES, INC. (ILLINOIS LIMITED LIABILITY COMPANY)
13087 MAIN STREET
LEMONT, IL 60439

FOR: CONCRETE AND MASONRY PRODUCTS FOR REPAIR AND NEW CONSTRUCTION, NAMELY, CONCRETE AND MASONRY PRODUCTS FOR REPAIR AND NEW CONSTRUCTION, NAMELY, POLYMER COATINGS, CEMENT-BASED COATINGS, EPOXY COATINGS AND WATER-BASED COATINGS FOR USE ON CONCRETE AND MASONRY PRODUCTS, SEALERS, NAMELY, SOLVENT-BASED AND WATER-BASED SEALERS FOR USE WITH CONCRETE AND MASONRY PRODUCTS, STAINS, NAMELY, STAINS FOR CEMENTS, RELEASES, NAMELY, CEMENT RELEASES, IN CLASS 2 (U.S. CLS. 6, 11 AND 16).

FIRST USE 4-15-2010; IN COMMERCE 4-15-2010.

THE MARK CONSISTS OF STANDARD CHARACTERS WITHOUT CLAIM TO ANY PARTICULAR FONT, STYLE, SIZE, OR COLOR.

NO CLAIM IS MADE TO THE EXCLUSIVE RIGHT TO USE "CONCRETE", APART FROM THE MARK AS SHOWN.

SER. NO. 85-187,024, FILED 11-30-2010.

GIANCARLO CASTRO, EXAMINING ATTORNEY



David J. Kybas

Director of the United States Patent and Trademark Office

United States of America

United States Patent and Trademark Office



Reg. No. 4,073,059

CYCLE PATH CORP. (CALIFORNIA CORPORATION)

Registered Dec. 20, 2011

1400 S. SAN GABRIEL BLVD
SAN GABRIEL, CA 91776

Int. Cl.: 16

FOR: MAGAZINES IN THE FIELD OF MOTORCYCLES, IN CLASS 16 (U.S. CLS. 2, 5, 22, 23, 29, 37, 38 AND 50).

TRADEMARK

FIRST USE 12-1-2009; IN COMMERCE 12-1-2009.

PRINCIPAL REGISTER

NO CLAIM IS MADE TO THE EXCLUSIVE RIGHT TO USE "MAGAZINE", "STREET", "DIRT", "BAGGER" AND "CUSTOM", APART FROM THE MARK AS SHOWN.

THE STIPPLING IS A FEATURE OF THE MARK.

THE MARK CONSISTS OF THE WORD "CYCLEPATH" ABOVE THE WORD "MAGAZINE". THE WORDS "STREET DIRT BAGGER CUSTOM" APPEAR WITHIN A RECTANGLE DESIGN BELOW THE WORD "MAGAZINE".

SER. NO. 85-187,455, FILED 11-30-2010.

ANDREW RHIM, EXAMINING ATTORNEY



David J. Kyros

Director of the United States Patent and Trademark Office

United States of America

United States Patent and Trademark Office

SUMMER CONCERT SERIES AT THE QUEEN MARY

Reg. No. 4,073,060

CITY OF LONG BEACH (CALIFORNIA MUNICIPAL CORPORATION)
333 WEST OCEAN BOULEVARD
LONG BEACH, CA 90802

Registered Dec. 20, 2011

Int. Cl.: 41

FOR: ENTERTAINMENT, NAMELY, PROVIDING LIVE MUSIC CONCERTS, TO BE HELD AT A PERMANENTLY MOORED SHIP NAMED THE QUEEN MARY, IN CLASS 41 (U.S. CLS. 100, 101 AND 107).

SERVICE MARK

FIRST USE 7-21-2010; IN COMMERCE 7-21-2010.

PRINCIPAL REGISTER

THE MARK CONSISTS OF STANDARD CHARACTERS WITHOUT CLAIM TO ANY PARTICULAR FONT, STYLE, SIZE, OR COLOR.

OWNER OF U.S. REG. NOS. 2,341,577 AND 2,432,514.

NO CLAIM IS MADE TO THE EXCLUSIVE RIGHT TO USE "SUMMER CONCERT SERIES", APART FROM THE MARK AS SHOWN.

THE NAME(S), PORTRAIT(S), AND/OR SIGNATURE(S) SHOWN IN THE MARK DOES NOT IDENTIFY A PARTICULAR LIVING INDIVIDUAL.

SER. NO. 85-188,263, FILED 12-1-2010.

H. M. FISHER, EXAMINING ATTORNEY



David J. Kyffers

Director of the United States Patent and Trademark Office

United States of America

United States Patent and Trademark Office



Reg. No. 4,073,061

Registered Dec. 20, 2011

Int. Cl.: 41

SERVICE MARK

PRINCIPAL REGISTER

CITY OF LONG BEACH (CALIFORNIA MUNICIPAL CORPORATION)
333 WEST OCEAN BOULEVARD
LONG BEACH, CA 90802

FOR: ENTERTAINMENT, NAMELY, PROVIDING LIVE MUSIC CONCERTS, TO BE HELD AT A PERMANENTLY MOORED SHIP NAMED THE QUEEN MARY, IN CLASS 41 (U.S. CLS. 100, 101 AND 107).

FIRST USE 7-21-2010; IN COMMERCE 7-21-2010.

OWNER OF U.S. REG. NOS. 2,341,577 AND 2,432,514.

NO CLAIM IS MADE TO THE EXCLUSIVE RIGHT TO USE "SUMMER CONCERT SERIES", APART FROM THE MARK AS SHOWN.

THE NAME(S), PORTRAIT(S), AND/OR SIGNATURE(S) SHOWN IN THE MARK DOES NOT IDENTIFY A PARTICULAR LIVING INDIVIDUAL.

THE MARK CONSISTS OF DESIGN OF GUITARS WITH A SMOKE STACK DESIGN, INCLUDING THE STYLIZED STACKED WORDS "SUMMER CONCERT SERIES AT THE QUEEN MARY" IN THE MIDDLE OF THE GUITARS DESIGN.

SER. NO. 85-188,277, FILED 12-1-2010.

H. M. FISHER, EXAMINING ATTORNEY



David J. Kybas

Director of the United States Patent and Trademark Office

United States of America

United States Patent and Trademark Office

FREESTYLE

Reg. No. 4,073,062

Registered Dec. 20, 2011

Int. Cl.: 21

TRADEMARK

PRINCIPAL REGISTER

STEELITE INTERNATIONAL PLC. (UNITED KINGDOM COMPANY)
ORME STREET, STOKE-ON-TRENT
STAFFORDSHIRE, UNITED KINGDOM ST6 3RB

FOR: POTTERY, NAMELY, PLATES, BOWLS, SERVING DISHES, AND SIDE PLATES;
PORCELAIN AND EARTHENWARE, NAMELY, PLATES, BOWLS, SERVING DISHES, AND
SIDE PLATES, IN CLASS 21 (U.S. CLS. 2, 13, 23, 29, 30, 33, 40 AND 50).

THE MARK CONSISTS OF STANDARD CHARACTERS WITHOUT CLAIM TO ANY PAR-
TICULAR FONT, STYLE, SIZE, OR COLOR.

PRIORITY CLAIMED UNDER SEC. 44(D) ON ERPN CMNTY TM OFC APPLICATION NO.
009551763, FILED 11-25-2010, REG. NO. 009551763, DATED 5-10-2011, EXPIRES 11-25-2020.

SER. NO. 85-188,580, FILED 12-1-2010.

JOHN WILKE, EXAMINING ATTORNEY



David J. Kybas

Director of the United States Patent and Trademark Office

United States of America

United States Patent and Trademark Office

the urban baby bonnet

Reg. No. 4,073,063

URBAN BABY BONNETS, LLC (OHIO LIMITED LIABILITY COMPANY)
611 S. HIGH ST.

Registered Dec. 20, 2011

YELLOW SPRINGS, OH 45387

Int. Cl.: 25

FOR: BLOOMERS; DRESSES; HATS; MITTENS; PANTS; SCARVES; SHIRTS; SKIRTS, IN CLASS 25 (U.S. CLS. 22 AND 39).

TRADEMARK

FIRST USE 5-30-2008; IN COMMERCE 6-1-2008.

PRINCIPAL REGISTER

THE MARK CONSISTS OF STANDARD CHARACTERS WITHOUT CLAIM TO ANY PARTICULAR FONT, STYLE, SIZE, OR COLOR.

NO CLAIM IS MADE TO THE EXCLUSIVE RIGHT TO USE "BABY BONNET", APART FROM THE MARK AS SHOWN.

SER. NO. 85-188,750, FILED 12-1-2010.

ZHALEH DELANEY, EXAMINING ATTORNEY



David J. Kyros

Director of the United States Patent and Trademark Office

United States of America

United States Patent and Trademark Office

UPSIDE DOWN ANIMALS

Reg. No. 4,073,064

TAYLOR BRANDON (UNITED STATES INDIVIDUAL)
3005 MAIN STREET, APT. 513
SANTA MONICA, CA 90405 AND

Registered Dec. 20, 2011

Int. Cl.: 16

NIKO ZINOVII (UNITED STATES INDIVIDUAL)
3005 MAIN STREET, APT. 316
SANTA MONICA, CA 90405

TRADEMARK

PRINCIPAL REGISTER

FOR: CHILDREN'S BOOKS; CHILDREN'S STORYBOOKS, IN CLASS 16 (U.S. CLS. 2, 5, 22, 23, 29, 37, 38 AND 50).

FIRST USE 12-1-2010; IN COMMERCE 12-1-2010.

THE MARK CONSISTS OF STANDARD CHARACTERS WITHOUT CLAIM TO ANY PARTICULAR FONT, STYLE, SIZE, OR COLOR.

NO CLAIM IS MADE TO THE EXCLUSIVE RIGHT TO USE "ANIMALS", APART FROM THE MARK AS SHOWN.

SER. NO. 85-189,562, FILED 12-2-2010.

LAKEISHA LEWIS, EXAMINING ATTORNEY



David J. Kyffers

Director of the United States Patent and Trademark Office

United States of America

United States Patent and Trademark Office

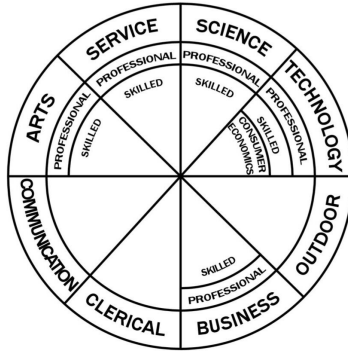

Reg. No. 4,073,065

Registered Dec. 20, 2011

Int. Cl.: 16

TRADEMARK

PRINCIPAL REGISTER

LEE PH.D, LISA JUSTINE KNAPP (UNITED STATES INDIVIDUAL)
P.O. BOX 7234
SAN DIEGO, CA 92167

FOR: PRINTED INSTRUCTIONAL EDUCATIONAL, TEACHING AND TRAINING MATERIALS IN THE FIELD OF CAREER MEASUREMENT, NAMELY, TESTING, SCORING AND INTERPRETATION MATERIALS, IN CLASS 16 (U.S. CLS. 2, 5, 22, 23, 29, 37, 38 AND 50).

FIRST USE 12-31-1978; IN COMMERCE 12-31-1978.

NO CLAIM IS MADE TO THE EXCLUSIVE RIGHT TO USE "ARTS PROFESSIONAL SKILLED SERVICE SCIENCE TECHNOLOGY CONSUMER ECONOMICS OUTDOOR BUSINESS CLERICAL COMMUNICATION", APART FROM THE MARK AS SHOWN.

THE MARK CONSISTS OF A CIRCULAR DESIGN SEPARATED BY EIGHT EQUIDISTANT LINES INTO WEDGES, WITH WORDING APPEARING WITHIN INTERIOR BANDS OF EACH WEDGE; APPEARING WITHIN THE DESIGN, PROCEEDING CLOCKWISE FROM THE FAR LEFT, ARE: THE WORDING "ARTS" WITHIN THE OUTER BAND, BELOW WHICH IS A BAND WITH THE WORDING "PROFESSIONAL", BELOW WHICH IS THE WORDING "SKILLED" WITHIN THE REMAINING WEDGE; THE WORDING "SERVICE" WITHIN THE OUTER BAND, BELOW WHICH IS A BAND WITH THE WORDING "PROFESSIONAL", BELOW WHICH IS THE WORDING "SKILLED" WITHIN THE REMAINING WEDGE; THE WORDING "SCIENCE" WITHIN THE OUTER BAND, BELOW WHICH IS A BAND WITH THE WORDING "PROFESSIONAL", BELOW WHICH IS THE WORDING "SKILLED" WITHIN THE REMAINING WEDGE; THE WORDING "TECHNOLOGY" WITHIN THE OUTER BAND, BELOW WHICH IS A BAND WITH THE WORDING "PROFESSIONAL", BELOW WHICH IS A BAND WITH THE WORDING "SKILLED", BELOW WHICH IS THE WORDING "CONSUMER ECONOMICS" WITHIN THE REMAINING WEDGE; THE WORDING "OUTDOOR" WITHIN THE OUTER BAND; THE WORDING "BUSINESS" WITHIN THE OUTER BAND, ABOVE WHICH IS A BAND WITH THE WORDING "PROFESSIONAL", ABOVE WHICH IS THE WORDING "SKILLED" WITHIN THE REMAINING WEDGE; THE WORDING "CLERICAL" WITHIN THE OUTER BAND; AND IN THE LAST WEDGE, THE WORDING "COMMUNICATION" WITHIN THE OUTER BAND.



David J. Kappas

Director of the United States Patent and Trademark Office

SER. NO. 85-189,671, FILED 12-2-2010.

KAELIE KUNG, EXAMINING ATTORNEY

United States of America

United States Patent and Trademark Office

Energy to Spare

Reg. No. 4,073,066

Registered Dec. 20, 2011

Int. Cls.: 16 and 41

TRADEMARK

SERVICE MARK

PRINCIPAL REGISTER

WELLWORKS INC. (VERMONT CORPORATION), DBA CORPORATE ADVENTURE
10905 THANLET LANE
RESTON, VA 20190

FOR: PRINTED MATERIALS, NAMELY, BOOKS, NEWSLETTERS, BROCHURES, SURVEYS, WORKBOOKS AND BOOKLETS CONCERNING THEORY, IDEAS, AND TECHNIQUES FOR THE PURPOSE OF IMPROVING PERSONAL, INTERPERSONAL, AND ORGANIZATIONAL EFFECTIVENESS WHILE UTILIZING SPIRITUAL, INTERPERSONAL NEUROBIOLOGY, PERSONAL WELL-BEING, AND LEADERSHIP PRACTICES, IN CLASS 16 (U.S. CLS. 2, 5, 22, 23, 29, 37, 38 AND 50).

FIRST USE 9-1-2010; IN COMMERCE 11-1-2010.

FOR: EDUCATIONAL SERVICES, NAMELY, PROVIDING LIVE AND ON-LINE TRAINING, WORKSHOPS, COACHING, INSTRUCTION, LECTURES, AND ASSESSMENTS FOR THE PURPOSE OF IMPROVING PERSONAL, INTERPERSONAL, AND ORGANIZATIONAL EFFECTIVENESS WHILE UTILIZING SPIRITUAL, INTERPERSONAL NEUROBIOLOGY, PERSONAL WELL-BEING, AND LEADERSHIP PRACTICES, IN CLASS 41 (U.S. CLS. 100, 101 AND 107).

FIRST USE 9-1-2010; IN COMMERCE 11-1-2010.

THE MARK CONSISTS OF STANDARD CHARACTERS WITHOUT CLAIM TO ANY PARTICULAR FONT, STYLE, SIZE, OR COLOR.

SER. NO. 85-189,832, FILED 12-2-2010.

DOMINIC J. FERRAIUOLO, EXAMINING ATTORNEY



David J. Kyffers

Director of the United States Patent and Trademark Office

United States of America

United States Patent and Trademark Office

Four Kitchens

Reg. No. 4,073,067

FOUR KITCHENS, LLC (TEXAS LIMITED LIABILITY COMPANY)
PO BOX 66458
AUSTIN, TX 78766

Registered Dec. 20, 2011

Int. Cl.: 42

FOR: PLANNING, DESIGN, DEVELOPMENT, MAINTENANCE AND OPTIMIZATION OF
ONLINE WEBSITES FOR THIRD PARTIES, IN CLASS 42 (U.S. CLS. 100 AND 101).

SERVICE MARK

FIRST USE 4-17-2006; IN COMMERCE 4-17-2006.

PRINCIPAL REGISTER

THE MARK CONSISTS OF STANDARD CHARACTERS WITHOUT CLAIM TO ANY PAR-
TICULAR FONT, STYLE, SIZE, OR COLOR.

SER. NO. 85-189,954, FILED 12-3-2010.

MICHAEL SOUDERS, EXAMINING ATTORNEY



David J. Kyros

Director of the United States Patent and Trademark Office

United States of America

United States Patent and Trademark Office

SERVO-FLO

Reg. No. 4,073,068

Registered Dec. 20, 2011

Int. Cl.: 9

TRADEMARK

PRINCIPAL REGISTER

SEALANT EQUIPMENT & ENGINEERING, INC. (MICHIGAN CORPORATION)
45677 HELM STREET, P.O. BOX 701460
PLYMOUTH, MI 48170

FOR: FLUID METERING AND DISPENSING SYSTEM COMPRISED OF A MATERIAL TRANSFER DEVICE, A METERING DEVICE, AN OUTLET VALVE, A NOZZLE, AN ELECTRIC SERVOMOTOR, AND A CONTROLLER, FOR METERING AND DISPENSING SINGLE AND MULTI-COMPONENT MATERIALS, NAMELY, ADHESIVES, SEALANTS, LUBRICANTS, AND FLOWABLE AND NON-FLOWABLE FORMULATED CHEMICALS, MASTICS, PASTES, AND MATERIALS IN THE NATURE OF SILICONES, POLYURETHANES, EPOXIES, HOT MELTS BEING A TYPE OF ADHESIVE, WARM MELTS, POLYVINYL CHLORIDES, SOUND DEADENERS, MASTICS, ACRYLICS, AND POLYSULFIDES, IN CLASS 9 (U.S. CLS. 21, 23, 26, 36 AND 38).

FIRST USE 5-6-2002; IN COMMERCE 7-31-2002.

THE MARK CONSISTS OF STANDARD CHARACTERS WITHOUT CLAIM TO ANY PARTICULAR FONT, STYLE, SIZE, OR COLOR.

SER. NO. 85-190,051, FILED 12-3-2010.

MELISSA VALLILLO, EXAMINING ATTORNEY



David J. Kyffers

Director of the United States Patent and Trademark Office

United States of America

United States Patent and Trademark Office



Reg. No. 4,073,069

Registered Dec. 20, 2011

Int. Cl.: 10

TRADEMARK

PRINCIPAL REGISTER

SEUNG HWA KIM (REPUBLIC OF KOREA INDIVIDUAL)
235 SOUTH GALE DRIVE #103
BEVERLY HILLS, CA 902113483

FOR: MEDICAL INSTRUMENTS, NAMELY, NEEDLES, ACUPUNCTURE NEEDLES, HAND NEEDLES, CUPPING THERAPY INSTRUMENTS, LANCING DEVICE USED FOR BLOOD SAMPLING, NEEDLE CASE, NEEDLE DEVICE USED FOR PROBING BODY POINTS, MOXA USED FOR HEAT THERAPY, MOXA DEVICE USED FOR CONTROLLING MOXA HEAT, IN CLASS 10 (U.S. CLS. 26, 39 AND 44).

FIRST USE 2-15-1915; IN COMMERCE 2-24-1920.

THE MARK CONSISTS OF THE CHINESE AND KOREAN CHARACTERS, THE WORDING "HAENG LIM SEO WON" AND A CIRCULAR DESIGN AT THE TOP.

THE NON-LATIN CHARACTERS IN THE MARK TRANSLITERATE TO "HAENGLIM SEOWON" AND THIS HAS NO MEANING IN A FOREIGN LANGUAGE.

THE WORDING "HAENGLIM SEOWON" HAS NO MEANING IN A FOREIGN LANGUAGE.

SER. NO. 85-190,278, FILED 12-3-2010.

KEVON CHISOLM, EXAMINING ATTORNEY



David J. Kybas

Director of the United States Patent and Trademark Office

United States of America

United States Patent and Trademark Office

Wood Gun

Reg. No. 4,073,070

ALTERNATE HEATING SYSTEMS, LLC (PENNSYLVANIA LIMITED LIABILITY COMPANY)
5171 LINCOLN WAY WEST
SAINT THOMAS, PA 17252

Registered Dec. 20, 2011

Int. Cl.: 11

FOR: WOOD GASIFICATION HEATING BOILERS WITH LIQUID FUEL BACKUP THAT CAN BE USED BOTH INSIDE AND OUTSIDE FOR RESIDENTIAL, COMMERCIAL OR INDUSTRIAL FACILITIES, IN CLASS 11 (U.S. CLS. 13, 21, 23, 31 AND 34).

TRADEMARK

FIRST USE 7-0-1983; IN COMMERCE 7-0-1983.

PRINCIPAL REGISTER

NO CLAIM IS MADE TO THE EXCLUSIVE RIGHT TO USE "WOOD", APART FROM THE MARK AS SHOWN.

THE MARK CONSISTS OF THE STYLIZED WORDS "WOOD GUN".

SER. NO. 85-190,445, FILED 12-3-2010.

BILL DAWE, EXAMINING ATTORNEY



David J. Kyffers

Director of the United States Patent and Trademark Office

United States of America

United States Patent and Trademark Office

SOUND-C

Reg. No. 4,073,071

Registered Dec. 20, 2011

Int. Cls.: 41, 42 and 44

SERVICE MARK

PRINCIPAL REGISTER

BOEHRINGER INGELHEIM INTERNATIONAL GMBH (FED REP GERMANY CORPORATION)
55218
INGELHEIM, FED REP GERMANY

FOR: PUBLICATION OF THE RESULTS OF CLINICAL TRIALS FOR PHARMACEUTICAL PREPARATIONS AS PRINTED MATTER AND ALSO IN ELECTRONIC FORM , IN CLASS 41 (U.S. CLS. 100, 101 AND 107).

FOR: CONDUCTING CLINICAL TRIALS FOR PHARMACEUTICAL PRODUCTS, IN CLASS 42 (U.S. CLS. 100 AND 101).

FOR: PROVIDING INFORMATION VIA THE INTERNET IN THE FIELD OF MEDICAL AND PHARMACEUTICAL INFORMATION OF PHARMACEUTICAL PREPARATIONS, IN CLASS 44 (U.S. CLS. 100 AND 101).

THE MARK CONSISTS OF STANDARD CHARACTERS WITHOUT CLAIM TO ANY PARTICULAR FONT, STYLE, SIZE, OR COLOR.

PRIORITY CLAIMED UNDER SEC. 44(D) ON FED REP GERMANY APPLICATION NO. 302010042775, FILED 7-15-2010, REG. NO. 302010042775, DATED 10-25-2010, EXPIRES 7-31-2020.

SER. NO. 85-191,028, FILED 12-6-2010.

GISELLE AGOSTO, EXAMINING ATTORNEY



David J. Kybas

Director of the United States Patent and Trademark Office

United States of America

United States Patent and Trademark Office

RE-CONSTRUCT

Reg. No. 4,073,072

Registered Dec. 20, 2011

Int. Cls.: 41, 42 and 44

SERVICE MARK

PRINCIPAL REGISTER

BOEHRINGER INGELHEIM INTERNATIONAL GMBH (FED REP GERMANY CORPORATION)
55218
INGELHEIM, FED REP GERMANY

FOR: PUBLICATION OF THE RESULTS OF CLINICAL TRIALS FOR PHARMACEUTICAL PREPARATIONS AS PRINTED MATTER AND ALSO IN ELECTRONIC FORM , IN CLASS 41 (U.S. CLS. 100, 101 AND 107).

FOR: CONDUCTING CLINICAL TRIALS FOR PHARMACEUTICAL PRODUCTS, IN CLASS 42 (U.S. CLS. 100 AND 101).

FOR: PROVIDING INFORMATION VIA THE INTERNET IN THE FIELD OF MEDICAL AND PHARMACEUTICAL INFORMATION OF PHARMACEUTICAL PREPARATIONS, IN CLASS 44 (U.S. CLS. 100 AND 101).

THE MARK CONSISTS OF STANDARD CHARACTERS WITHOUT CLAIM TO ANY PARTICULAR FONT, STYLE, SIZE, OR COLOR.

PRIORITY CLAIMED UNDER SEC. 44(D) ON FED REP GERMANY APPLICATION NO. 302010049732, FILED 8-24-2010, REG. NO. 302010049732, DATED 10-1-2010, EXPIRES 8-31-2020.

SER. NO. 85-191,048, FILED 12-6-2010.

GISELLE AGOSTO, EXAMINING ATTORNEY



David J. Kybas

Director of the United States Patent and Trademark Office

United States of America

United States Patent and Trademark Office

TERRAIN

Reg. No. 4,073,073

Registered Dec. 20, 2011

Int. Cls.: 41, 42 and 44

SERVICE MARK

PRINCIPAL REGISTER

BOEHRINGER INGELHEIM INTERNATIONAL GMBH (FED REP GERMANY CORPORATION)
55218
INGELHEIM, FED REP GERMANY

FOR: PUBLICATION OF THE RESULTS OF CLINICAL TRIALS FOR PHARMACEUTICAL PREPARATIONS AS PRINTED MATTER AND ALSO IN ELECTRONIC FORM , IN CLASS 41 (U.S. CLS. 100, 101 AND 107).

FOR: CONDUCTING CLINICAL TRIALS FOR PHARMACEUTICAL PRODUCTS, IN CLASS 42 (U.S. CLS. 100 AND 101).

FOR: PROVIDING INFORMATION VIA THE INTERNET IN THE FIELD OF MEDICAL AND PHARMACEUTICAL INFORMATION OF PHARMACEUTICAL PREPARATIONS, IN CLASS 44 (U.S. CLS. 100 AND 101).

THE MARK CONSISTS OF STANDARD CHARACTERS WITHOUT CLAIM TO ANY PARTICULAR FONT, STYLE, SIZE, OR COLOR.

PRIORITY CLAIMED UNDER SEC. 44(D) ON FED REP GERMANY APPLICATION NO. 302010042773, FILED 7-15-2010, REG. NO. 302010042773, DATED 10-25-2010, EXPIRES 7-31-2020.

SER. NO. 85-191,078, FILED 12-6-2010.

GISELLE AGOSTO, EXAMINING ATTORNEY



David J. Kybas

Director of the United States Patent and Trademark Office

United States of America

United States Patent and Trademark Office

FIRST SCHOLARS

Reg. No. 4,073,074

THE SUDER FOUNDATION (TEXAS CORPORATION)
3701 E. PLANO PARKWAY
PLANO, TX 75074

Registered Dec. 20, 2011

Int. Cls.: 36 and 41

FOR: CLASS 36: CHARITABLE FOUNDATION SERVICES, NAMELY, PROVIDING FINANCIAL SUPPORT TO DISADVANTAGED COLLEGE STUDENTS, IN CLASS 36 (U.S. CLS. 100, 101 AND 102).

SERVICE MARK

FIRST USE 5-14-2010; IN COMMERCE 8-31-2010.

PRINCIPAL REGISTER

FOR: CLASS 41: EDUCATION SERVICES, NAMELY, PROVIDING TUTORING, MENTORING, CLASSES, SEMINARS AND WORKSHOPS IN THE FIELDS OF TIME MANAGEMENT, STUDY SKILLS, TRANSITION TO COLLEGE, LEADERSHIP AND COMMUNITY SERVICES, IN CLASS 41 (U.S. CLS. 100, 101 AND 107).

FIRST USE 5-14-2010; IN COMMERCE 8-31-2010.

THE MARK CONSISTS OF STANDARD CHARACTERS WITHOUT CLAIM TO ANY PARTICULAR FONT, STYLE, SIZE, OR COLOR.

NO CLAIM IS MADE TO THE EXCLUSIVE RIGHT TO USE "SCHOLARS", APART FROM THE MARK AS SHOWN.

SER. NO. 85-191,506, FILED 12-6-2010.

JILL C. ALT, EXAMINING ATTORNEY



David J. Kybas

Director of the United States Patent and Trademark Office

United States of America

United States Patent and Trademark Office

Code From Home

Reg. No. 4,073,075

CODE FROM HOME LLC (WASHINGTON LIMITED LIABILITY COMPANY)

Registered Dec. 20, 2011

22447 NE 9TH DR
SAMMAMISH, WA 98074

Int. Cl.: 42

FOR: APPLICATION SERVICE PROVIDER, NAMELY, HOSTING, MANAGING, DEVELOPING, AND MAINTAINING APPLICATIONS, SOFTWARE, AND WEB SITES, IN THE FIELDS OF PERSONAL PRODUCTIVITY, WIRELESS COMMUNICATION, MOBILE INFORMATION ACCESS, AND REMOTE DATA MANAGEMENT FOR WIRELESS DELIVERY OF CONTENT TO HANDHELD COMPUTERS, LAPTOPS AND MOBILE ELECTRONIC DEVICES, IN CLASS 42 (U.S. CLS. 100 AND 101).

SERVICE MARK

PRINCIPAL REGISTER

FIRST USE 12-1-2010; IN COMMERCE 12-1-2010.

THE MARK CONSISTS OF STANDARD CHARACTERS WITHOUT CLAIM TO ANY PARTICULAR FONT, STYLE, SIZE, OR COLOR.

NO CLAIM IS MADE TO THE EXCLUSIVE RIGHT TO USE "CODE", APART FROM THE MARK AS SHOWN.

SER. NO. 85-191,842, FILED 12-7-2010.

KEVIN CORWIN, EXAMINING ATTORNEY



David J. Kybas

Director of the United States Patent and Trademark Office

United States of America

United States Patent and Trademark Office

THERMOSCULPT

Reg. No. 4,073,076

TORNABENE, DEAN G. (UNITED STATES INDIVIDUAL)
11982 MAYFIELD AVENUE, UNIT D
LOS ANGELES, CA 90049

Registered Dec. 20, 2011

Int. Cl.: 5

FOR: HERBAL SUPPLEMENTS AND MEDICATED TOPICAL SKIN CREAM FOR REDUCING BODY FAT, IN CLASS 5 (U.S. CLS. 6, 18, 44, 46, 51 AND 52).

TRADEMARK

FIRST USE 3-21-2011; IN COMMERCE 3-21-2011.

PRINCIPAL REGISTER

THE MARK CONSISTS OF STANDARD CHARACTERS WITHOUT CLAIM TO ANY PARTICULAR FONT, STYLE, SIZE, OR COLOR.

SER. NO. 85-192,388, FILED 12-7-2010.

ROBIN CHOSID, EXAMINING ATTORNEY



David J. Kyffers

Director of the United States Patent and Trademark Office

United States of America

United States Patent and Trademark Office

ShredChef

Reg. No. 4,073,077

JUSTIN CHENTNIK (UNITED STATES INDIVIDUAL), AKA SHREDCHEF
2910 5TH ST

Registered Dec. 20, 2011

BOULDER, CO 80304

Int. Cl.: 41

FOR: PROVIDING EDUCATIONAL TRAINING IN THE FIELD OF MEAL COOKING AND PREPARATION VIA ONLINE TRANSMISSION OF PRE-RECORDED AUDIO AND VIDEO FILES, IN CLASS 41 (U.S. CLS. 100, 101 AND 107).

SERVICE MARK

FIRST USE 4-1-2008; IN COMMERCE 4-1-2008.

PRINCIPAL REGISTER

THE MARK CONSISTS OF STANDARD CHARACTERS WITHOUT CLAIM TO ANY PARTICULAR FONT, STYLE, SIZE, OR COLOR.

SER. NO. 85-192,508, FILED 12-7-2010.

DEZMONA MIZELLE, EXAMINING ATTORNEY



David J. Kybas

Director of the United States Patent and Trademark Office

United States of America

United States Patent and Trademark Office

Your Band Your Brand

Reg. No. 4,073,078

ROXO, LLC (MICHIGAN LIMITED LIABILITY COMPANY)
132 N. OLD WOODWARD
BIRMINGHAM, MI 48009

Registered Dec. 20, 2011

Int. Cl.: 14

FOR: PERSONAL JEWELRY, NAMELY, CHARMS, IN CLASS 14 (U.S. CLS. 2, 27, 28 AND 50).

TRADEMARK

FIRST USE 9-8-2010; IN COMMERCE 9-8-2010.

PRINCIPAL REGISTER

THE MARK CONSISTS OF STANDARD CHARACTERS WITHOUT CLAIM TO ANY PARTICULAR FONT, STYLE, SIZE, OR COLOR.

SER. NO. 85-192,521, FILED 12-7-2010.

DEZMONA MIZELLE, EXAMINING ATTORNEY



David J. Kybas

Director of the United States Patent and Trademark Office

United States of America

United States Patent and Trademark Office

GUY HARVEY

Reg. No. 4,073,079

GUY HARVEY, INC. (FLORIDA CORPORATION)
10408 W. STATE ROAD 84, STE. 104
DAVIE, FL 33324

Registered Dec. 20, 2011

Int. Cl.: 35

FOR: PUBLIC ADVOCACY TO PROMOTE AWARENESS OF MARINE CONSERVATION,
IN CLASS 35 (U.S. CLS. 100, 101 AND 102).

SERVICE MARK

FIRST USE 11-15-2006; IN COMMERCE 11-15-2006.

PRINCIPAL REGISTER

THE MARK CONSISTS OF STANDARD CHARACTERS WITHOUT CLAIM TO ANY PAR-
TICULAR FONT, STYLE, SIZE, OR COLOR.

OWNER OF U.S. REG. NOS. 1,616,722, 3,536,786 AND OTHERS.

THE NAME(S), PORTRAIT(S), AND/OR SIGNATURE(S) SHOWN IN THE MARK IDENTIFIES
"GUY HARVEY", WHOSE CONSENT(S) TO REGISTER IS MADE OF RECORD.

SER. NO. 85-193,027, FILED 12-8-2010.

CAROLINE WOOD, EXAMINING ATTORNEY



David J. Kyffers

Director of the United States Patent and Trademark Office

United States of America

United States Patent and Trademark Office

BE THE CHANGE

Reg. No. 4,073,080

Registered Dec. 20, 2011

Int. Cl.: 35

SERVICE MARK

PRINCIPAL REGISTER

BE THE CHANGE, INC. (MASSACHUSETTS NON-PROFIT CORPORATION)
2 CANAL PARK
CAMBRIDGE, MA 02141

FOR: PROMOTING PUBLIC AWARENESS OF THE NEED TO ADDRESS SOCIAL CHALLENGES, IN CLASS 35 (U.S. CLS. 100, 101 AND 102).

FIRST USE 0-0-2007; IN COMMERCE 0-0-2007.

THE MARK CONSISTS OF STANDARD CHARACTERS WITHOUT CLAIM TO ANY PARTICULAR FONT, STYLE, SIZE, OR COLOR.

OWNER OF U.S. REG. NO. 3,844,170.

SER. NO. 85-193,047, FILED 12-8-2010.

ROBERT C. CLARK JR., EXAMINING ATTORNEY



David J. Kybas

Director of the United States Patent and Trademark Office

United States of America

United States Patent and Trademark Office



Reg. No. 4,073,081

Registered Dec. 20, 2011

Int. Cl.: 27

TRADEMARK

PRINCIPAL REGISTER

E. I. DU PONT DE NEMOURS AND COMPANY (DELAWARE CORPORATION)
1007 MARKET STREET
WILMINGTON, DE 19898

FOR: SYNTHETIC GRASS, IN CLASS 27 (U.S. CLS. 19, 20, 37, 42 AND 50).

FIRST USE 1-11-2010; IN COMMERCE 1-11-2010.

OWNER OF U.S. REG. NOS. 3,620,987, 3,727,044 AND OTHERS.

THE MARK CONSISTS OF THE WORD "DUPONT" INSIDE AN OVAL.

SER. NO. 85-193,438, FILED 12-8-2010.

JULIE WATSON, EXAMINING ATTORNEY



David J. Kyffers

Director of the United States Patent and Trademark Office

United States of America

United States Patent and Trademark Office



Reg. No. 4,073,082

Registered Dec. 20, 2011

Int. Cl.: 18

TRADEMARK

PRINCIPAL REGISTER

JULY MOON PRODUCTIONS, INC. (CALIFORNIA CORPORATION)
C/O NIGRO, KARLIN, SEGAL & FELDSTEIN
10100 SANTA MONICA BLVD., SUITE 1300
LOS ANGELES, CA 90067

FOR: HANDBAGS, BACKPACKS AND SMALL LEATHER GOODS, NAMELY, PURSES, WALLETS, LEATHER KEY CHAINS, AND COIN PURSES, IN CLASS 18 (U.S. CLS. 1, 2, 3, 22 AND 41).

FIRST USE 6-15-2010; IN COMMERCE 6-15-2010.

THE MARK CONSISTS OF A STYLIZED DOVE WITH NO EYES, WITH THE FOREFRONT WING ATTACHED TO THE BODY AND THE BACK WING SLIGHTLY DETACHED FROM THE BODY, AND A WIDE TAIL BASE.

SER. NO. 85-193,514, FILED 12-8-2010.

DEZMONA MIZELLE, EXAMINING ATTORNEY



David J. Kyjars

Director of the United States Patent and Trademark Office

United States of America

United States Patent and Trademark Office



Reg. No. 4,073,083

GRAVITY JACK, INC. (WASHINGTON CORPORATION), DBA GRAVITY JACK
823 S. LIBERTY DR
LIBERTY LAKE, WA 99019

Registered Dec. 20, 2011

Int. Cl.: 9

FOR: COMPUTER APPLICATION SOFTWARE FOR MULTIPLE PLATFORMS, NAMELY, SOFTWARE FOR AUGMENTED REALITY, IN CLASS 9 (U.S. CLS. 21, 23, 26, 36 AND 38).

TRADEMARK

FIRST USE 12-1-2010; IN COMMERCE 12-1-2010.

PRINCIPAL REGISTER

NO CLAIM IS MADE TO THE EXCLUSIVE RIGHT TO USE "BROWSAR", APART FROM THE MARK AS SHOWN.

THE COLOR(S) BLUE, BLACK, RED IS/ARE CLAIMED AS A FEATURE OF THE MARK.

THE MARK CONSISTS OF BLUE "B" AND BLUE "R", THE "O" IS AN IMAGE OF A MAN'S HEAD IN BLACK AND ALSO A MONOCLE ON A ROPE, THE "W" AND "S" ARE BLUE AND THE "A" AND "R" ARE RED. "BROWSAR" STANDS FOR "BROWSER".

THE WORDING "BROWSAR" HAS NO MEANING IN A FOREIGN LANGUAGE.

SER. NO. 85-193,739, FILED 12-8-2010.

DORITT L. CARROLL, EXAMINING ATTORNEY



David J. Kybas

Director of the United States Patent and Trademark Office

United States of America

United States Patent and Trademark Office

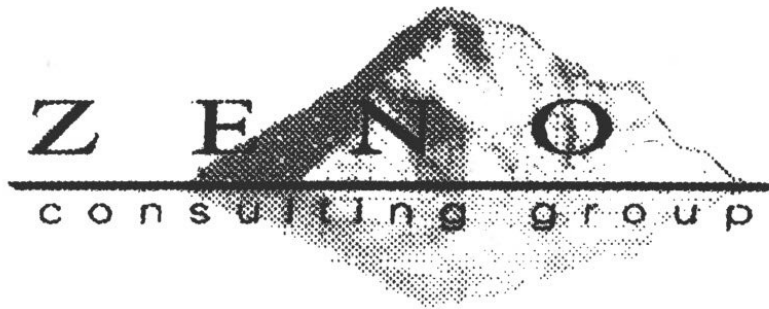

Reg. No. 4,073,084

Registered Dec. 20, 2011

Int. Cl.: 36

SERVICE MARK

PRINCIPAL REGISTER

ZENO CONSULTING GROUP, LLC (CALIFORNIA LIMITED LIABILITY COMPANY)
SUITE 700
3 BETHESDA METRO CENTER
BETHESDA, MD 29814

FOR: INSTITUTIONAL INVESTMENT CONSULTANT SERVICES TO PENSION FUNDS, MUTUAL FUND BOARDS AND INSTITUTIONS EXERCISING OVERSIGHT OVER THIRD PARTY ASSET MANAGERS IN THE FIELD OF MONITORING AND EXERCISING OVERSIGHT OVER EXTERNAL ASSET MANAGERS TO INSURE ADHERENCE TO BEST FINANCIAL PRACTICES AND APPROPRIATE FIDUCIARY STANDARDS AND THE FIELD OF DEVELOPING APPROPRIATE STRATEGIES FOR SUCH PENSION FUNDS, MUTUAL FUND BOARDS AND INSTITUTIONS EXERCISING OVERSIGHT OVER THIRD PARTY ASSET MANAGERS TO TRANSFER INVESTMENT PORTFOLIOS FROM AN EXISTING INVESTMENT MANAGER TO ANOTHER INVESTMENT MANAGER IN ADHERENCE TO BEST FINANCIAL PRACTICES AND APPROPRIATE FIDUCIARY STANDARDS, IN CLASS 36 (U.S. CLS. 100, 101 AND 102).

FIRST USE 3-12-2010; IN COMMERCE 3-12-2010.

NO CLAIM IS MADE TO THE EXCLUSIVE RIGHT TO USE "CONSULTING GROUP", APART FROM THE MARK AS SHOWN.

THE MARK CONSISTS OF THE WORDS "ZEN" ABOVE A HORIZONTAL LINE WITH WORDS "CONSULTING GROUP" BELOW THE HORIZONTAL LINE, THE BACKGROUND BEING AN "ICEBERG".

SER. NO. 85-194,351, FILED 12-9-2010.

RUDY R. SINGLETON, EXAMINING ATTORNEY



David J. Kybas

Director of the United States Patent and Trademark Office

United States of America

United States Patent and Trademark Office



Reg. No. 4,073,085

NOVARTIS AG (SWITZERLAND CORPORATION)
CH-4002

Registered Dec. 20, 2011

BASEL, SWITZERLAND

Int. Cls.: 41 and 44

FOR: EDUCATIONAL SERVICES, NAMELY, ARRANGING AND CONDUCTING SEMINARS AND WORKSHOPS FOR HEALTHCARE PROVIDERS AND FOR PATIENTS IN THE FIELD OF RESPIRATORY DISORDERS AND THE TREATMENT AND MANAGEMENT OF RESPIRATORY DISORDERS; PROVIDING PERSONAL SUPPORT SERVICES FOR PATIENTS AND FAMILIES OF PATIENTS, NAMELY, TRAINING SERVICES IN THE FIELD OF DISEASE MANAGEMENT, IN CLASS 41 (U.S. CLS. 100, 101 AND 107).

SERVICE MARK

PRINCIPAL REGISTER

FIRST USE 3-31-2009; IN COMMERCE 3-31-2009.

FOR: PROVIDING MEDICAL INFORMATION; PROVIDING PERSONAL SUPPORT SERVICES FOR PATIENTS AND FAMILIES OF PATIENTS, NAMELY, HEALTH CARE SERVICES IN THE NATURE OF DISEASE MANAGEMENT PROGRAMS, IN CLASS 44 (U.S. CLS. 100 AND 101).

FIRST USE 3-31-2009; IN COMMERCE 3-31-2009.

NO CLAIM IS MADE TO THE EXCLUSIVE RIGHT TO USE "CF", APART FROM THE MARK AS SHOWN.

THE MARK CONSISTS OF THE WORDING "CF MY WAY", ALL IN STYLIZED FONT, WITH THE LETTERS "CF" APPEARING IN A SINGLE LINE CIRCLE TO THE LEFT OF THE WORDING "MY WAY".

SER. NO. 85-195,147, FILED 12-10-2010.

KAREN SEVERSON, EXAMINING ATTORNEY



David J. Kyjars

Director of the United States Patent and Trademark Office

United States of America

United States Patent and Trademark Office

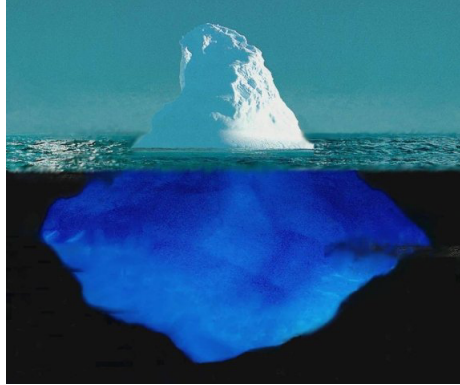

Reg. No. 4,073,086

Registered Dec. 20, 2011

Int. Cl.: 36

SERVICE MARK

PRINCIPAL REGISTER

ZENO CONSULTING GROUP, LLC (CALIFORNIA LIMITED LIABILITY COMPANY)
SUITE 700
3 BETHESDA METRO CENTER
BETHESDA, MD 20814

FOR: INSTITUTIONAL INVESTMENT CONSULTANT SERVICES TO PENSION FUNDS, MUTUAL FUND BOARDS AND INSTITUTIONS EXERCISING OVERSIGHT OVER THIRD PARTY ASSET MANAGERS IN THE FIELD OF MONITORING AND EXERCISING OVERSIGHT OVER EXTERNAL ASSET MANAGERS TO INSURE ADHERENCE TO BEST FINANCIAL PRACTICES AND APPROPRIATE FIDUCIARY STANDARDS AND THE FIELD OF DEVELOPING APPROPRIATE STRATEGIES FOR SUCH PENSION FUNDS, MUTUAL FUND BOARDS AND INSTITUTIONS EXERCISING OVERSIGHT OVER THIRD PARTY ASSET MANAGERS TO TRANSFER INVESTMENT PORTFOLIOS FROM AN EXISTING INVESTMENT MANAGER TO ANOTHER INVESTMENT MANAGER IN ADHERENCE TO BEST FINANCIAL PRACTICES AND APPROPRIATE FIDUCIARY STANDARDS, IN CLASS 36 (U.S. CLS. 100, 101 AND 102).

FIRST USE 5-4-2010; IN COMMERCE 5-4-2010.

THE MARK CONSISTS OF A WHITE AND BLUE ICEBERG AGAINST A BLUE SKY AND IN A SEA, WITH THE SEA SURFACE BEING BLUE AND HAVING WAVES, WITH THE BLUE BOTTOM PORTION OF THE ICEBERG EXTENDING BELOW THE SEA SURFACE INTO A BLACK UNDERWATER

THE COLOR(S) BLUE, WHITE AND BLACK IS/ARE CLAIMED AS A FEATURE OF THE MARK.

SER. NO. 85-195,223, FILED 12-10-2010.

RUDY R. SINGLETON, EXAMINING ATTORNEY



David J. Kyffers

Director of the United States Patent and Trademark Office

United States of America

United States Patent and Trademark Office

KING PINE

Reg. No. 4,073,087

SABA CHEMICAL CORP. (NEW YORK CORPORATION)
18 STEWART STREET
BROOKLYN, NY 11207

Registered Dec. 20, 2011

Int. Cls.: 3 and 5

FOR: CLEANERS AND PREPARATIONS CONTAINING PINE, NAMELY, ALL-PURPOSE CLEANERS; CLEANING PREPARATIONS FOR HOUSEHOLD AND COMMERCIAL USE; DEGREASING PREPARATIONS FOR HOUSEHOLD AND COMMERCIAL USE; GLASS CLEANERS; GLASS CLEANING PREPARATIONS; OVEN CLEANERS, IN CLASS 3 (U.S. CLS. 1, 4, 6, 50, 51 AND 52).

TRADEMARK

PRINCIPAL REGISTER

FIRST USE 0-0-1939; IN COMMERCE 0-0-1939.

FOR: ALL PURPOSE DISINFECTANTS CONTAINING PINE; ANTI-INSECT SPRAY; DISINFECTANT BATHROOM CLEANERS CONTAINING PINE; DISINFECTANT TOILET BOWL CLEANERS CONTAINING PINE; INSECTICIDES, IN CLASS 5 (U.S. CLS. 6, 18, 44, 46, 51 AND 52).

FIRST USE 0-0-1939; IN COMMERCE 0-0-1939.

THE MARK CONSISTS OF STANDARD CHARACTERS WITHOUT CLAIM TO ANY PARTICULAR FONT, STYLE, SIZE, OR COLOR.

OWNER OF U.S. REG. NO. 3,264,362.

NO CLAIM IS MADE TO THE EXCLUSIVE RIGHT TO USE "PINE", APART FROM THE MARK AS SHOWN.

SER. NO. 85-195,258, FILED 12-10-2010.

GIANCARLO CASTRO, EXAMINING ATTORNEY



David J. Kyffers

Director of the United States Patent and Trademark Office

United States of America

United States Patent and Trademark Office

CIRCLE H

Reg. No. 4,073,088

Registered Dec. 20, 2011

Int. Cls.: 37 and 40

SERVICE MARK

PRINCIPAL REGISTER

CIRCLE H CONTRACTORS, LP (TEXAS LIMITED PARTNERSHIP)
P.O. BOX 281
MIDLOTHIAN, TX 76065

FOR: GENERAL BUILDING CONSTRUCTION SERVICES; BORING HORIZONTAL HOLES FOR THE INSTALLATION OF WATER AND SEWER LINES; INSTALLATION AND REPAIR OF FENCES; INSTALLATION OF CONCRETE STORM SEWER DRAINAGE SYSTEMS, IN CLASS 37 (U.S. CLS. 100, 103 AND 106).

FIRST USE 7-0-1995; IN COMMERCE 7-0-1995.

FOR: WELDING, IN CLASS 40 (U.S. CLS. 100, 103 AND 106).

FIRST USE 7-0-1995; IN COMMERCE 7-0-1995.

THE MARK CONSISTS OF STANDARD CHARACTERS WITHOUT CLAIM TO ANY PARTICULAR FONT, STYLE, SIZE, OR COLOR.

SER. NO. 85-195,294, FILED 12-10-2010.

JAMES LOVELACE, EXAMINING ATTORNEY



David J. Kyros

Director of the United States Patent and Trademark Office

United States of America

United States Patent and Trademark Office

GRAND TRAVERSE BAY BEACH GLASS CO.

Reg. No. 4,073,089

SOMA, KATHRYN L. (UNITED STATES INDIVIDUAL), DBA OH MY!
9965 E. AVONDALE LANE
TRAVERSE CITY, MI 49684

Registered Dec. 20, 2011

Int. Cl.: 14

FOR: JEWELRY MADE FROM BEACH GLASS, IN CLASS 14 (U.S. CLS. 2, 27, 28 AND 50).

TRADEMARK

FIRST USE 9-1-2005; IN COMMERCE 9-1-2005.

PRINCIPAL REGISTER

THE MARK CONSISTS OF STANDARD CHARACTERS WITHOUT CLAIM TO ANY PARTICULAR FONT, STYLE, SIZE, OR COLOR.

NO CLAIM IS MADE TO THE EXCLUSIVE RIGHT TO USE "BEACH GLASS CO.", APART FROM THE MARK AS SHOWN.

SEC. 2(F).

SER. NO. 85-195,869, FILED 12-11-2010.

KELLEY WELLS, EXAMINING ATTORNEY



David J. Kyffers

Director of the United States Patent and Trademark Office

United States of America

United States Patent and Trademark Office

natures beauty mark

Reg. No. 4,073,090

Registered Dec. 20, 2011

Int. Cl.: 25

TRADEMARK

PRINCIPAL REGISTER

WILLIAMS, NICHELLE R (UNITED STATES INDIVIDUAL), DBA NATURES BEAUTY
MARK
4407 NORTHLAKE HEIGHTS CIRCLE, NE
ATLANTA, GA 30345

FOR: ATHLETIC APPAREL, NAMELY, SHIRTS, PANTS, JACKETS, FOOTWEAR, HATS
AND CAPS, ATHLETIC UNIFORMS; BASEBALL CAPS AND HATS; CLOTHING FOR BA-
BIES, TODDLERS AND CHILDREN, TREATED WITH FIRE AND HEAT RETARDANTS,
NAMELY, PAJAMAS, JACKETS, SHIRTS, PANTS, JUMPERS; T-SHIRTS, IN CLASS 25 (U.S.
CLS. 22 AND 39).

FIRST USE 9-5-2010; IN COMMERCE 10-10-2010.

THE MARK CONSISTS OF STANDARD CHARACTERS WITHOUT CLAIM TO ANY PAR-
TICULAR FONT, STYLE, SIZE, OR COLOR.

SER. NO. 85-195,945, FILED 12-11-2010.

WILLIAM P. SHANAHAN, EXAMINING ATTORNEY



David J. Kyffers

Director of the United States Patent and Trademark Office

United States of America

United States Patent and Trademark Office

AQUA VAPE

Reg. No. 4,073,091

VAPOR SYSTEMS INTERNATIONAL, LLC (FLORIDA LIMITED LIABILITY COMPANY)
2355 E. SILVER PALM ROAD
BOCA RATON, FL 33432

Registered Dec. 20, 2011

Int. Cl.: 11

FOR: SPILL-PROOF INLINE VAPOR COOLER FOR USE WITH ELECTRIC VAPORIZERS,
IN CLASS 11 (U.S. CLS. 13, 21, 23, 31 AND 34).

TRADEMARK

FIRST USE 5-29-2009; IN COMMERCE 6-1-2009.

PRINCIPAL REGISTER

THE MARK CONSISTS OF STANDARD CHARACTERS WITHOUT CLAIM TO ANY PAR-
TICULAR FONT, STYLE, SIZE, OR COLOR.

SER. NO. 85-195,979, FILED 12-12-2010.

SUZANNE BLANE, EXAMINING ATTORNEY



David J. Kyros

Director of the United States Patent and Trademark Office

United States of America

United States Patent and Trademark Office

TERMINIX

Reg. No. 4,073,092

Registered Dec. 20, 2011

Int. Cls.: 5 and 11

TRADEMARK

PRINCIPAL REGISTER

THE TERMINIX INTERNATIONAL COMPANY LIMITED PARTNERSHIP (DELAWARE LIMITED PARTNERSHIP)
860 RIDGE LAKE BOULEVARD
MEMPHIS, TN 38120

FOR: NATURAL INSECT REPELLENTS IN THE NATURE OF SPRAYS COMPRISED OF PLANT OILS, IN CLASS 5 (U.S. CLS. 6, 18, 44, 46, 51 AND 52).

FIRST USE 6-1-2010; IN COMMERCE 6-1-2010.

FOR: ELECTRICAL DEVICES WHICH DISPENSE INSECT REPELLENTS AND SPRAYS; AUTOMATED MIST SYSTEM FOR INSECT AND PEST CONTROL COMPRISING A POWER SOURCE, A RECEPTACLE, AN AGITATOR, AND A MISTING DEVICE, IN CLASS 11 (U.S. CLS. 13, 21, 23, 31 AND 34).

FIRST USE 6-1-2010; IN COMMERCE 6-1-2010.

THE MARK CONSISTS OF STANDARD CHARACTERS WITHOUT CLAIM TO ANY PARTICULAR FONT, STYLE, SIZE, OR COLOR.

OWNER OF U.S. REG. NOS. 635,715, 3,586,266 AND OTHERS.

SER. NO. 85-196,680, FILED 12-13-2010.

WILLIAM ROSSMAN, EXAMINING ATTORNEY



David J. Kyros

Director of the United States Patent and Trademark Office

United States of America

United States Patent and Trademark Office

Sweet Sugar Gliders

Reg. No. 4,073,093

MA'FRIENDS (IOWA PARTNERSHIP)
PO BOX 4795
DES MOINES, IA 50305

Registered Dec. 20, 2011

Int. Cl.: 31

FOR: ANIMAL FEED; FOOD FOR ANIMALS, IN CLASS 31 (U.S. CLS. 1 AND 46).

TRADEMARK

FIRST USE 5-22-2009; IN COMMERCE 5-22-2009.

PRINCIPAL REGISTER

THE MARK CONSISTS OF STANDARD CHARACTERS WITHOUT CLAIM TO ANY PARTICULAR FONT, STYLE, SIZE, OR COLOR.

NO CLAIM IS MADE TO THE EXCLUSIVE RIGHT TO USE "SUGAR GLIDERS", APART FROM THE MARK AS SHOWN.

SER. NO. 85-196,701, FILED 12-13-2010.

JUSTINE D. PARKER, EXAMINING ATTORNEY



David J. Kyffers

Director of the United States Patent and Trademark Office

United States of America

United States Patent and Trademark Office

Wear Something With Meaning

Reg. No. 4,073,094

Registered Dec. 20, 2011

Int. Cl.: 14

TRADEMARK

PRINCIPAL REGISTER

ONE MEANING (NEW YORK PARTNERSHIP)
321 E 54TH STREET.
#10B
NEW YORK, NY 10022

FOR: BRACELETS; CHARMS; COSTUME JEWELRY; GEMSTONE JEWELRY; JEWELRY; JEWELRY AND IMITATION JEWELRY; JEWELRY, NAMELY, DOG TAGS FOR WEAR BY HUMANS FOR DECORATIVE PURPOSES; JEWELRY, NAMELY, MAGNETIC NECKLACES; PET JEWELRY; PINS BEING JEWELRY; RINGS; STAINLESS STEEL JEWELRY BRACELETS; WOMEN'S JEWELRY, IN CLASS 14 (U.S. CLS. 2, 27, 28 AND 50).

FIRST USE 12-30-2008; IN COMMERCE 12-30-2008.

THE MARK CONSISTS OF STANDARD CHARACTERS WITHOUT CLAIM TO ANY PARTICULAR FONT, STYLE, SIZE, OR COLOR.

NO CLAIM IS MADE TO THE EXCLUSIVE RIGHT TO USE "WEAR", APART FROM THE MARK AS SHOWN.

SER. NO. 85-196,962, FILED 12-13-2010.

INGA ERVIN, EXAMINING ATTORNEY



David J. Kyffers

Director of the United States Patent and Trademark Office

United States of America

United States Patent and Trademark Office

TURTLE JACK'S MUSKOKA GRILL & LOUNGE

Reg. No. 4,073,095

TORTOISE RESTAURANT GROUP INC. (CANADA CORPORATION)
3370 SOUTH SERVICE ROAD
BURLINGTON, ONTARIO, CANADA L7N3M6

Registered Dec. 20, 2011

Int. Cl.: 43

FOR: RESTAURANT AND BAR SERVICES, IN CLASS 43 (U.S. CLS. 100 AND 101).

SERVICE MARK

THE MARK CONSISTS OF STANDARD CHARACTERS WITHOUT CLAIM TO ANY PARTICULAR FONT, STYLE, SIZE, OR COLOR.

PRINCIPAL REGISTER

PRIORITY CLAIMED UNDER SEC. 44(D) ON CANADA APPLICATION NO. 1506855, FILED 12-7-2010, REG. NO. TMA810261, DATED 10-26-2011, EXPIRES 10-26-2026.

OWNER OF U.S. REG. NO. 3,156,935.

NO CLAIM IS MADE TO THE EXCLUSIVE RIGHT TO USE "MUSKOKA" AND "GRILL & LOUNGE", APART FROM THE MARK AS SHOWN.

SER. NO. 85-197,180, FILED 12-14-2010.

CHRISTOPHER BUONGIORNO, EXAMINING ATTORNEY



David J. Kybas

Director of the United States Patent and Trademark Office

United States of America

United States Patent and Trademark Office

SuperSilencePlus

Reg. No. 4,073,096

BSH BOSCH UND SIEMENS HAUSGERAETE GMBH (FED REP GERMANY CORPORATION)
CARL-WERY-STRASSE 34

Registered Dec. 20, 2011

MUNICH, FED REP GERMANY 81739

Int. Cl.: 7

FOR: HOUSEHOLD AND KITCHEN MACHINES AND EQUIPMENT, NAMELY, ELECTRIC KITCHEN MACHINES AND EQUIPMENT, NAMELY, DISHWASHERS; STRUCTURAL PARTS OF ALL AFOREMENTIONED GOODS, IN CLASS 7 (U.S. CLS. 13, 19, 21, 23, 31, 34 AND 35).

TRADEMARK

PRINCIPAL REGISTER

THE MARK CONSISTS OF STANDARD CHARACTERS WITHOUT CLAIM TO ANY PARTICULAR FONT, STYLE, SIZE, OR COLOR.

PRIORITY CLAIMED UNDER SEC. 44(D) ON ERPN CMNTY TM OFC APPLICATION NO. 009196651, FILED 6-23-2010, REG. NO. 009196651, DATED 12-6-2010, EXPIRES 6-23-2020.

SER. NO. 85-197,364, FILED 12-14-2010.

DAVID TAYLOR, EXAMINING ATTORNEY



David J. Kyffers

Director of the United States Patent and Trademark Office

United States of America

United States Patent and Trademark Office



Reg. No. 4,073,097

Registered Dec. 20, 2011

Int. Cl.: 16

TRADEMARK

PRINCIPAL REGISTER

EZ BAGZ, LLC (FLORIDA LIMITED LIABILITY COMPANY)
SUITE 11
2253 VISTA PARKWAY
WEST PALM BEACH, FL 33411

FOR: PLASTIC LINERS FOR TRASH RECEPTACLES; PLASTIC TRASH BAGS; PLASTIC KITCHEN BAGS AND LINERS FOR KITCHEN TRASH RECEPTACLES; PLASTIC GARBAGE BAGS, IN CLASS 16 (U.S. CLS. 2, 5, 22, 23, 29, 37, 38 AND 50).

FIRST USE 1-1-2010; IN COMMERCE 2-15-2010.

OWNER OF U.S. REG. NO. 3,709,730.

NO CLAIM IS MADE TO THE EXCLUSIVE RIGHT TO USE BAGS, APART FROM THE MARK AS SHOWN.

THE MARK CONSISTS OF AN CONTINUOUS ARROW DESIGN WITH THE WORDS "EZ BAGZ EASY FOR YOU...EASY ON THE PLANET" SUPERIMPOSED ON THE ARROW DESIGN.

SER. NO. 85-197,703, FILED 12-14-2010.

ELIZABETH KAJUBI, EXAMINING ATTORNEY



David J. Kybas

Director of the United States Patent and Trademark Office

United States of America

United States Patent and Trademark Office



Reg. No. 4,073,098

Registered Dec. 20, 2011

Int. Cls.: 39 and 43

SERVICE MARK

PRINCIPAL REGISTER

FLY MICRONESIA LIMITED (HONG KONG LIMITED LIABILITY COMPANY)
SUITE 1511, OCEAN CENTRE
5 CANTON ROAD, TSIM SHA TSUI, KOWLOON
HONG KONG, HONG KONG

FOR: AIR CHARTER TRANSPORTATION SERVICES; AIR TRANSPORTATION; AIR TRANSPORTATION OF PASSENGERS AND FREIGHT; AIR TRANSPORTATION SERVICES FEATURING A FREQUENT FLYER BONUS PROGRAM; AIRLINE TRANSPORTATION SERVICES; AIRPLANE CHARTERING, IN CLASS 39 (U.S. CLS. 100 AND 105).

FIRST USE 6-1-2010; IN COMMERCE 6-1-2010.

FOR: AGENCY SERVICES FOR THE RESERVATION OF TEMPORARY ACCOMMODATION; HOTEL ACCOMMODATION SERVICES; PROVIDING IN-FLIGHT MEAL SERVICES IN AN AIRPLANE; PROVIDING TEMPORARY ACCOMMODATION, IN CLASS 43 (U.S. CLS. 100 AND 101).

FIRST USE 6-1-2010; IN COMMERCE 6-1-2010.

NO CLAIM IS MADE TO THE EXCLUSIVE RIGHT TO USE "FLY GUAM", APART FROM THE MARK AS SHOWN.

THE COLOR(S) BLUE, RED, GREEN, AND YELLOW IS/ARE CLAIMED AS A FEATURE OF THE MARK.

THE MARK CONSISTS OF THE WORDS "FLY GUAM" IN BLUE. ABOVE THIS ARE FOUR STYLIZED FISH. THE FISH HAVE ONLY ONE COLOR. FROM LEFT TO RIGHT, THE FISH COLORS ARE RED, GREEN, YELLOW AND BLUE.

SER. NO. 85-198,005, FILED 12-15-2010.

SIMON TENG, EXAMINING ATTORNEY



David J. Kyffers

Director of the United States Patent and Trademark Office

United States of America

United States Patent and Trademark Office

BLINGDAILY

Reg. No. 4,073,099

BLINGDAILY.COM CORP. (NEW YORK CORPORATION)
1408 60TH STREET

Registered Dec. 20, 2011

BROOKLYN, NY 11219

Int. Cl.: 35

FOR: ONLINE RETAIL STORE SERVICES, NAMELY, A DAILY DEAL WEBSITE OFFERING DESIGNER AND LUXURY JEWELRY, WATCHES, SUNGLASSES, FASHION ACCESSORIES AND GIFT ITEMS, IN CLASS 35 (U.S. CLS. 100, 101 AND 102).

SERVICE MARK

FIRST USE 4-1-2008; IN COMMERCE 7-1-2008.

PRINCIPAL REGISTER

THE MARK CONSISTS OF STANDARD CHARACTERS WITHOUT CLAIM TO ANY PARTICULAR FONT, STYLE, SIZE, OR COLOR.

SER. NO. 85-198,669, FILED 12-15-2010.

MARY CRAWFORD, EXAMINING ATTORNEY



David J. Kyffers

Director of the United States Patent and Trademark Office

United States of America

United States Patent and Trademark Office

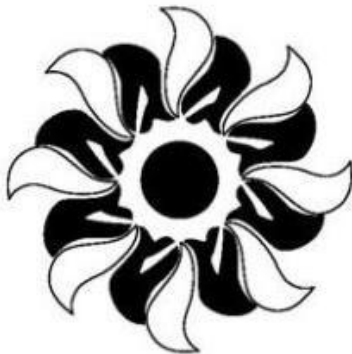

Reg. No. 4,073,100

Registered Dec. 20, 2011

Int. Cls.: 29, 30 and 32

TRADEMARK

PRINCIPAL REGISTER

RAMAR INTERNATIONAL CORPORATION (CALIFORNIA CORPORATION)
1101 RAILROAD LANE
PITTSBURG, CA 94565

FOR: PREPARED MEATS AND SAUSAGES; MARINATED MEATS; SEAFOOD, IN CLASS 29 (U.S. CL. 46).

FIRST USE 1-1-2009; IN COMMERCE 1-1-2009.

FOR: ICE CREAM; ICE MILK BARS; FROZEN FOODS, NAMELY, EGG ROLLS, SPRING ROLLS, DUMPLINGS AND STEAMED BUNS STUFFED WITH MINCED MEAT (NIKU-MANJU), IN CLASS 30 (U.S. CL. 46).

FIRST USE 1-1-2009; IN COMMERCE 1-1-2009.

FOR: FRUIT NECTARS, FRUIT DRINKS AND FRUIT JUICES, IN CLASS 32 (U.S. CLS. 45, 46 AND 48).

FIRST USE 1-1-2009; IN COMMERCE 1-1-2009.

THE MARK CONSISTS OF A SUN DESIGN.

SER. NO. 85-198,920, FILED 12-15-2010.

LOURDES AYALA, EXAMINING ATTORNEY



David J. Kybas

Director of the United States Patent and Trademark Office

United States of America

United States Patent and Trademark Office



Reg. No. 4,073,101

Registered Dec. 20, 2011

Int. Cl.: 9

TRADEMARK

PRINCIPAL REGISTER

VOCALITY INTERNATIONAL LIMITED (UNITED KINGDOM COMPANY)
LYDLING BARN, LYDLING FARM,
PUTTENHAM LANE
SHACKLEFORD, SURREY., UNITED KINGDOM GU86AP

FOR: TELECOMMUNICATIONS EQUIPMENT, NAMELY, TELEPHONES, PERSONAL DIGITAL ASSISTANTS, ELECTRONIC PERSONAL ORGANIZERS, ROUTERS, MULTIPLEXERS, ISDN INTERFACES, GATEWAY ROUTERS IN THE NATURE OF COMPUTER CONTROL HARDWARE, COMPUTER HARDWARE AND SOFTWARE FOR SETTING UP AND CONFIGURING WIDE AREA NETWORKS; SECURE TELECOMMUNICATIONS EQUIPMENT, NAMELY, SECURE TELECOMMUNICATIONS EQUIPMENT, NAMELY, TELEPHONES, PERSONAL DIGITAL ASSISTANTS, ELECTRONIC PERSONAL ORGANIZERS, ROUTERS, MULTIPLEXERS, ISDN INTERFACES, GATEWAY ROUTERS IN THE NATURE OF COMPUTER CONTROL HARDWARE, COMPUTER HARDWARE AND SOFTWARE FOR SETTING UP AND CONFIGURING WIDE AREA NETWORKS; SECURE TELECOMMUNICATIONS EQUIPMENT INCORPORATING DISCRETE COMMUNICATIONS DEVICES, NAMELY, A NETWORK ROUTER AND INTERNET PROTOCOL LINK ENCRYPTOR, NAMELY, ELECTRONIC ENCRYPTION UNITS FOR ENCRYPTING INTERNET PROTOCOL LINK DATA; TELECOMMUNICATIONS EQUIPMENT TO PROVIDE SATELLITE OPTIMIZATION BY MAKING ACCOMMODATION FOR SATELLITE DELAY AND BANDWIDTH RESTRICTIONS, NAMELY, NETWORK ROUTERS AND MULTIPLEXERS; MULTIPLEXERS TO PROVIDE BASEBAND SERVICES OVER INTERNET PROTOCOLS IN MILITARY AND GOVERNMENT NETWORKS; TELECOMMUNICATIONS INTERFACES, NAMELY, MILITARY PHONES FOR USE OVER INTERNET PROTOCOL-BASED WIDE AREA NETWORKS AND TELECOMMUNICATIONS INTERFACES, NAMELY, TACTICAL SECURE TELEPHONES FOR USE OVER INTERNET PROTOCOL-BASED WIDE AREA NETWORKS; TELECOMMUNICATIONS APPARATUS, NAMELY, ROUTERS, MULTIPLEXERS, ISDN INTERFACES, GATEWAY ROUTERS IN THE NATURE OF COMPUTER CONTROL HARDWARE, COMPUTER HARDWARE AND SOFTWARE FOR SETTING UP AND CONFIGURING WIDE AREA NETWORKS; TELEPHONE APPARATUS; RADIO-TELEPHONE APPARATUS; OPTICAL FIBERS, OPTICAL FIBERS SOLD AS A COMPONENT OF FIBER OPTICAL CABLES; TELECOMMUNICATIONS SOFTWARE FOR SETTING UP AND CONFIGURING WIDE AREA NETWORKS; ELECTRONIC ENCRYPTION UNITS FOR ENCRYPTING VIDEO AND/OR SOUND SIGNALS AND/OR DATA; STRUCTURAL PARTS AND ELECTRIC AND/OR ELECTRONIC CONNECTION FITTINGS FOR ALL THE AFORESAID GOODS, IN CLASS 9 (U.S. CLS. 21, 23, 26, 36 AND 38).



David J. Kyjars

Director of the United States Patent and Trademark Office

Reg. No. 4,073,101 OWNER OF EUROPEAN UNION REG. NO. 009569682, DATED 5-10-2011, EXPIRES 12-2-2020.

THE MARK CONSISTS OF A STYLIZED LETTER "V".

SER. NO. 85-200,460, FILED 12-17-2010.

WILLIAM BRECKENFELD, EXAMINING ATTORNEY

United States of America

United States Patent and Trademark Office

Imperial Tea Garden

Reg. No. 4,073,102

Registered Dec. 20, 2011

Int. Cl.: 30

TRADEMARK

PRINCIPAL REGISTER

IMPERIAL TEA GARDEN (MICHIGAN LIMITED LIABILITY COMPANY)
3120 JEANLIN DR., SE
GRAND RAPIDS, MI 49546

FOR: TEA, IN CLASS 30 (U.S. CL. 46).

FIRST USE 11-25-2003; IN COMMERCE 11-25-2003.

THE MARK CONSISTS OF STANDARD CHARACTERS WITHOUT CLAIM TO ANY PARTICULAR FONT, STYLE, SIZE, OR COLOR.

NO CLAIM IS MADE TO THE EXCLUSIVE RIGHT TO USE "TEA", APART FROM THE MARK AS SHOWN.

SER. NO. 85-200,531, FILED 12-17-2010.

ALLISON SCHRODY, EXAMINING ATTORNEY



David J. Kybas

Director of the United States Patent and Trademark Office

United States of America

United States Patent and Trademark Office

TOKIO MARINE GLOBAL

Reg. No. 4,073,103

Registered Dec. 20, 2011

Int. Cl.: 36

SERVICE MARK

PRINCIPAL REGISTER

TOKIO MARINE & NICHIDO FIRE INSURANCE CO., LTD. (JAPAN CORPORATION)
2-1, MARUNOUCHI 1-CHOME
CHIYODA-KU, TOKYO, JAPAN

FOR: CLAIM ADJUSTMENT FOR NON-LIFE INSURANCE; INSURANCE UNDERWRITING SERVICES FOR ALL TYPES OF INSURANCE OTHER THAN LIFE INSURANCE; INSURANCE PREMIUM RATE COMPUTING; CONSULTING ON NON-LIFE INSURANCE; PROVIDING INFORMATION ON INSURANCE; REINSURANCE UNDERWRITING; CONSULTING AND INFORMATION CONCERNING INSURANCE; INSURANCE SERVICES IN THE NATURE OF LOSS CONTROL MANAGEMENT FOR OTHERS; INSURANCE CONSULTANCY SERVICES, NAMELY, PROVIDING ADVICE IN THE FIELD OF PROPERTY AND CASUALTY INSURANCE, IN CLASS 36 (U.S. CLS. 100, 101 AND 102).

FIRST USE 1-1-2005; IN COMMERCE 1-1-2005.

THE MARK CONSISTS OF STANDARD CHARACTERS WITHOUT CLAIM TO ANY PARTICULAR FONT, STYLE, SIZE, OR COLOR.

OWNER OF U.S. REG. NOS. 2,897,133, 3,664,323 AND OTHERS.

SEC. 2(F) AS TO "TOKIO MARINE".

SER. NO. 85-200,973, FILED 12-17-2010.

CAROLYN CATALDO, EXAMINING ATTORNEY



David J. Kybas

Director of the United States Patent and Trademark Office

United States of America

United States Patent and Trademark Office

The Seven-Day Scholar

Reg. No. 4,073,104

Registered Dec. 20, 2011

Int. Cl.: 16

TRADEMARK

PRINCIPAL REGISTER

GAFFNEY, DENNIS RICHARD (UNITED STATES INDIVIDUAL)
51 LAWRIDGE AVE.
ALBANY, NY 12208 AND

GAFFNEY, PETER JONATHAN (UNITED STATES INDIVIDUAL)
916 UNION STREET, APT. 1C
BROOKLYN, NY 11215

FOR: SERIES OF NON-FICTION BOOKS IN THE FIELD OF HISTORY, IN CLASS 16 (U.S. CLS. 2, 5, 22, 23, 29, 37, 38 AND 50).

FIRST USE 12-16-2010; IN COMMERCE 12-16-2010.

THE MARK CONSISTS OF STANDARD CHARACTERS WITHOUT CLAIM TO ANY PARTICULAR FONT, STYLE, SIZE, OR COLOR.

SER. NO. 85-200,974, FILED 12-17-2010.

CAROLYN CATALDO, EXAMINING ATTORNEY



David J. Kybas

Director of the United States Patent and Trademark Office

United States of America

United States Patent and Trademark Office

SLYM

Reg. No. 4,073,105

Registered Dec. 20, 2011

Int. Cl.: 30

TRADEMARK

PRINCIPAL REGISTER

REVIVA MANUFACTURER PTE LTD (SINGAPORE PRIVATE LIMITED COMPANY)
18@TRADEHUB21, #10-153
18 BOON LAY WAY
SINGAPORE, SINGAPORE

FOR: COFFEE; TEA; BEVERAGES MADE OF COFFEE; BEVERAGES MADE OF TEA;
PREPARED COCOA AND COCOA-BASED BEVERAGES; GINGER; PASTA; NOODLES;
PROCESSED CEREALS PREPARED FOR HUMAN CONSUMPTION; SAUCES; SPICES;
NATURAL SWEETENERS; SEASONING; INSTANT PUDDING MIXES; INSTANT CUSTARD
MIXES; CAKE MIXES; AND POWDER FOR MAKING SOFT DRINKS OR TEA-FLAVORED
BEVERAGES, IN CLASS 30 (U.S. CL. 46).

FIRST USE 1-2-2005; IN COMMERCE 2-9-2005.

THE MARK CONSISTS OF STANDARD CHARACTERS WITHOUT CLAIM TO ANY PAR-
TICULAR FONT, STYLE, SIZE, OR COLOR.

SER. NO. 85-201,194, FILED 12-18-2010.

ALEXANDER L. POWERS, EXAMINING ATTORNEY



David J. Kyffers

Director of the United States Patent and Trademark Office

United States of America

United States Patent and Trademark Office



Reg. No. 4,073,106

Registered Dec. 20, 2011

Int. Cl.: 25

TRADEMARK

PRINCIPAL REGISTER

TALAMANTES, RICO (UNITED STATES INDIVIDUAL)
5604 WOODLEA AVENUE
FORT WAYNE, IN 46835 AND

GEYER, KASEY (UNITED STATES INDIVIDUAL)
1934 EMINENCE BREAK PASS
FORT WAYNE, IN 46808 AND

TALAMANTES, ANTON (UNITED STATES INDIVIDUAL)
5528 CHANTILLY DRIVE
FORT WAYNE, IN 46815

FOR: SWEATSHIRTS; T-SHIRTS, IN CLASS 25 (U.S. CLS. 22 AND 39).

FIRST USE 12-1-2010; IN COMMERCE 12-17-2010.

NO CLAIM IS MADE TO THE EXCLUSIVE RIGHT TO USE "WRESTLING", APART FROM THE MARK AS SHOWN.

THE MARK CONSISTS OF AN ATHLETIC STRONGMAN HOLDING WRESTLING PROTECTIVE HEADGEAR IN HIS LEFT HAND WITH HIS RIGHT INDEX FINGER POINTING SKYWARD AS IF TO MAKE THE EXPRESSION, I AM #1 WITH THE ATHLETIC STRONGMAN SURROUNDED BY THE STYLIZED WORD "BLACK" ON HIS RIGHT SIDE AND THE STYLIZED WORD "BELT" ON THIS LEFT, BOTH WORDS AT HIS TORSO LEVEL WITH THE STYLIZED WORD "WRESTLING" CENTERED BELOW HIS FEET.



SEC. 2(F).

SER. NO. 85-201,205, FILED 12-18-2010.

JOHN DWYER, EXAMINING ATTORNEY

David J. Kybas

Director of the United States Patent and Trademark Office

United States of America

United States Patent and Trademark Office

SENSINO

Reg. No. 4,073,107

Registered Dec. 20, 2011

Int. Cls.: 9 and 42

WUXI SENSINGNET INDUSTRIALIZATION RESEARCH INSTITUTE (CHINA CORPORATION)
OFFICE OF DR. JIAN MA
NO.18 ZHENZE ROAD
WUXI, JIANGSU, CHINA 214135

TRADEMARK

SERVICE MARK

PRINCIPAL REGISTER

FOR: PORTABLE HANDHELD AND MOBILE DIGITAL ELECTRONIC DEVICES FOR THE SENDING AND RECEIVING OF TELEPHONE CALLS, FAXES, ELECTRONIC MAIL, AND OTHER DIGITAL DATA IN THE NATURE OF TEXT, DATA, IMAGE AND AUDIO FILES; TELEPHONES; MOBILE CELLULAR TELEPHONES; VIDEOPHONES; CAMERAS; PRERECORDED COMPUTER PROGRAMS FOR MANAGEMENT AND SCHEDULING OF PERSONAL INFORMATION; ELECTRONIC MAIL AND INSTANT MESSAGING SOFTWARE; SOFTWARE FOR USE WITH PAGING EQUIPMENT; DATABASE SYNCHRONIZATION SOFTWARE FOR SYNCHRONIZING MOBILE DEVICE TO THE WIRELESS NETWORK; COMPUTER PROGRAMS FOR ACCESSING, BROWSING AND SEARCHING ONLINE DATABASES; COMPUTER SOFTWARE AND FIRMWARE, NAMELY, OPERATING SYSTEM PROGRAMS AND APPLICATION DEVELOPMENT TOOL PROGRAMS FOR PERSONAL AND HANDHELD COMPUTERS; SOFTWARE FOR THE SYNCHRONIZATION OF ELECTRONIC DATA BETWEEN A REMOTE TRANSCEIVERS STATION WIRELESS MOBILE DEVICE AND A FIXED OR REMOTE TRANSCEIVER STATION, MOBILE DEVICE OR SERVER; RADIO TELECOMMUNICATION SYSTEMS AND NETWORKS FOR TRANSMITTING AND RECEIVING VIDEO, DATA AND VOICE SIGNALS OVER WIRELESS COMMUNICATION NETWORKS OR SYSTEMS, CONSISTING OF MOBILE COMPUTER AND TELEPHONE TERMINALS, BASE TRANSCEIVER STATIONS AND WIRELESS RADIO ELECTRONIC TRANSMISSION CIRCUITS, COMPUTER HARDWARE, MULTIPLEXERS, INTEGRATED CIRCUITS, DIGITAL SIGNAL PROCESSORS, RADIO FREQUENCY SIGNAL PROCESSORS, MOBILE SWITCHING CIRCUITS, AND ANTENNAS; ELECTRONIC CONTROLLERS FOR MOBILE AND/OR REMOTE ACCESS OF RADIO SIGNALS FOR USE IN AIR TRAFFIC CONTROL APPLICATIONS; ELECTRONIC RADIO COMPONENTS FOR MOBILE COMPUTING OF NETWORKING AND OPERATING PLATFORMS CONSISTING OF DATA TRANSCEIVERS AND WIRELESS GATEWAYS FOR COLLECTION, TRANSMISSION AND MANAGEMENT OF DATA, VOICE AND VIDEO; ELECTRONICALLY ENCODED IDENTITY CARDS, NAMELY, SUBSCRIBER IDENTITY MODULE (SIM) CARDS; CITY WIDE TRAFFIC MANAGEMENT AND CONTROL SYSTEMS, COMPRISED OF DIGITAL RECEIVERS FOR GLOBAL POSITIONING AND NAVIGATION EQUIPMENT, AND DIGITAL SENSORS FOR VEHICLE AND TRAFFIC CONTROLS; INTEROPERABLE ELECTRONIC COMMUNICATION SYSTEMS FOR VEHICLES, COMPRISED OF COMPUTER TELECOM-



David J. Kyjars

Director of the United States Patent and Trademark Office

Reg. No. 4,073,107 MUNICATION HARDWARE AND SOFTWARE FOR PROVIDING RADIO AND AUDIO BROADCASTING OF SAFETY AND SECURITY INFORMATION, AND FOR STREAMING OF VIDEO AND WIRELESS SAFETY AND SECURITY INFORMATION VIA THE INTERNET; INTELLIGENT TESTING SYSTEMS COMPRISING MOBILE COMPUTER HARDWARE AND SOFTWARE FOR TESTING OF EMBEDDED COMPUTER CONTROL SYSTEMS IN VEHICLES, IN CLASS 9 (U.S. CLS. 21, 23, 26, 36 AND 38).

FIRST USE 1-1-2010; IN COMMERCE 1-1-2010.

FOR: SCIENTIFIC AND TECHNOLOGICAL SERVICES AND RESEARCH AND DESIGN RELATING THERETO, NAMELY, RESEARCH AND DEVELOPMENT OF COMPUTER SOFTWARE AND COMMUNICATION SOFTWARE, RESEARCH AND DEVELOPMENT OF COMPUTER SYSTEM ARCHITECTURE AND SYSTEM HARDWARE IN THE FIELD OF INFORMATION AND COMMUNICATION TECHNOLOGY; SCIENTIFIC ANALYSIS AND RESEARCH SERVICES REGARDING INDUSTRIAL APPLICATIONS OF WIRELESS COMMUNICATION TECHNOLOGY; CUSTOM DESIGN AND DEVELOPMENT OF COMPUTER HARDWARE AND SOFTWARE; COMPUTER RENTAL; RENTAL OF COMPUTER SOFTWARE AND HARDWARE; UPDATING OF COMPUTER SOFTWARE FOR OTHERS; COMPUTER SOFTWARE CONSULTANCY SERVICES; COMPUTER PROGRAMMING FOR OTHERS; TECHNICAL COMPUTER SYSTEMS ANALYSIS SERVICES; DESIGN OF TELECOMMUNICATION NETWORK SYSTEMS FOR OTHERS; TESTING AND RESEARCH RELATING TO WIRELESS TELECOMMUNICATION APPARATUS AND INSTRUMENTS, NAMELY, MOBILE TELEPHONES, COMPUTERS AND RADIO PAGERS FOR USE IN AIR TRAFFIC CONTROL; CROSS-PLATFORM CONVERSION OF DIGITAL CONTENT INTO OTHER FORMS OF DIGITAL CONTENT; DATA ENCRYPTION SERVICES; COMPUTER DISASTER RECOVERY PLANNING SERVICES; COMPUTER NETWORK SECURITY SERVICES, NAMELY, UPDATING OF COMPUTER SOFTWARE REGARDING POTENTIAL SECURITY RISKS; DEVELOPING SOFTWARE FOR SCANNING AND CLEANING VIRUSES FROM HANDHELD DEVICES AND COMPUTER SYSTEMS; COMPUTER SECURITY SYSTEM CONSULTATION SERVICES; PROVIDING ELECTRONIC VERIFICATION OF ONLINE ORDERS OF DIGITAL CONTENT AND GENERATING ELECTRONIC PERMISSION CODES WHICH THEN ALLOW USERS TO ACCESS SAID DIGITAL CONTENT; CREATING AND MAINTAINING WEB SITES FOR OTHERS; PROVIDING SEARCH ENGINES FOR OBTAINING DATA ON THE INTERNET; COMPUTER PROGRAMMING SERVICES FOR OTHERS; APPLICATION SERVICE PROVIDER, NAMELY, HOSTING COMPUTER SOFTWARE APPLICATIONS FOR OTHERS FOR MOBILE COMMUNICATIONS; HOSTING OF DIGITAL CONTENT ON THE INTERNET; HOSTING THE WEBSITES OF OTHERS ON A COMPUTER SERVER FOR A GLOBAL COMPUTER NETWORK; COMPUTER SERVICES, NAMELY, CREATING INDEXES OF INFORMATION AVAILABLE ON COMPUTER NETWORKS; PROVIDING TECHNOLOGICAL INFORMATION AT THE SPECIFIC REQUEST OF END-USER VIA THE TELEPHONE AND THE GLOBAL COMMUNICATION NETWORKS IN THE FIELD OF TELECOMMUNICATIONS TECHNOLOGY; CONSULTING SERVICES IN THE FIELD OF DESIGN, SELECTION, IMPLEMENTATION AND USE OF COMPUTER HARDWARE AND SOFTWARE SYSTEMS FOR OTHERS; INSTALLATION, MAINTENANCE AND REPAIR OF COMPUTER SOFTWARE; ENGINEERING SERVICES, NAMELY, TECHNICAL PROJECT PLANNING SERVICES RELATED TO TELECOMMUNICATIONS EQUIPMENT; PROVIDING TECHNOLOGICAL INFORMATION AT THE SPECIFIC REQUEST OF END-USERS BY MEANS OF TELEPHONE OR GLOBAL COMMUNICATIONS NETWORKS IN THE FIELD OF WIRELESS AND MOBILE COMMUNICATIONS TECHNOLOGY; PROVIDING TEMPORARY USE OF ONLINE NON-DOWNLOADABLE TELECOMMUNICATIONS SOFTWARE FOR MANAGING LOCAL AREA SENSING NETWORKS; TECHNOLOGICAL CONSULTING IN THE FIELDS OF INFORMATION TECHNOLOGY, SEMICONDUCTOR TECHNOLOGY, SENSING AND DIAGNOSTIC ELECTRONICS, AND DISTRIBUTED TRAFFIC CONTROL DEVICES FOR USE IN CONNECTION WITH VEHICLE NAVIGATION, CONTROL AND COMMUNICATION SYSTEMS; TECHNOLOGICAL CONSULTING IN CONNECTION WITH ELECTRONIC TRAFFIC CONTROL DISPLAY DEVICES, ROBOTICS, CRYPTOGRAPHY AND COMPUTER SECURITY ELECTRONICS, INFORMATION AND DATA ANALYSIS SYSTEMS AND COMPUTER PERFORMANCE ANALYSIS SYSTEMS;

Reg. No. 4,073,107 COMPUTER SOFTWARE DEVELOPMENT OF MOBILE APPLICATIONS; DESIGN OF COMPUTER HARDWARE AND SOFTWARE FOR CONVERSION OF DATA FROM AND TO DIFFERENT PROTOCOLS; DESIGN OF COMPUTER TERMINALS FOR OTHERS; SCIENTIFIC RESEARCH AND DEVELOPMENT SERVICES IN THE FIELDS OF INFORMATION AND COMMUNICATION TECHNOLOGY DEALING WITH SEMICONDUCTORS, RADIO FREQUENCY TRANSCEIVERS, COMMUNICATIONS TRANSMISSION DEVICES, SENSING AND DIAGNOSTIC ELECTRONICS, DISTRIBUTED TRAFFIC CONTROL DEVICES FOR USE IN CONNECTION WITH ELECTRONIC VEHICULAR TRAFFIC DISPLAY AND CONTROL SYSTEMS; SCIENTIFIC RESEARCH AND DEVELOPMENT SERVICES IN THE FIELDS OF ROBOTICS; CRYPTOGRAPHY AND COMPUTER SECURITY ELECTRONICS, COMMUNICATIONS SIGNAL DETECTION DEVICES, DIGITAL COMPRESSION AND PROCESSING DEVICES, ANTENNA TECHNOLOGY, INFORMATION AND DATA ANALYSIS SYSTEMS, AND COMPUTER PERFORMANCE ANALYSIS SYSTEMS; SCIENTIFIC RESEARCH AND DEVELOPMENT IN THE FIELD OF WIRELESS MOBILE SOFTWARE APPLICATIONS AND SOFTWARE NETWORK AND SYSTEMS DESIGN; SCIENTIFIC RESEARCH AND DEVELOPMENT SERVICES DEALING WITH ELECTRONIC CONVERSION OF DATA FROM AND TO DIFFERENT PROTOCOLS AND THE DESIGN OF COMPUTER TERMINALS AND COMPUTER NETWORKS FOR OTHERS, IN CLASS 42 (U.S. CLS. 100 AND 101).

FIRST USE 1-1-2010; IN COMMERCE 1-1-2010.

THE MARK CONSISTS OF STANDARD CHARACTERS WITHOUT CLAIM TO ANY PARTICULAR FONT, STYLE, SIZE, OR COLOR.

SER. NO. 85-201,224, FILED 12-18-2010.

BARBARA A. GOLD, EXAMINING ATTORNEY

United States of America

United States Patent and Trademark Office



Reg. No. 4,073,108

Registered Dec. 20, 2011

Int. Cls.: 25 and 41

TRADEMARK

SERVICE MARK

PRINCIPAL REGISTER

YOGASLACKERS LLP (NORTH DAKOTA LIMITED PARTNERSHIP)
353 3RD ST
CRYSTAL, ND 58222

FOR: ATHLETIC APPAREL, NAMELY, SHIRTS, PANTS, JACKETS, FOOTWEAR, HATS AND CAPS, ATHLETIC UNIFORMS, IN CLASS 25 (U.S. CLS. 22 AND 39).

FIRST USE 9-1-2005; IN COMMERCE 12-1-2008.

FOR: YOGA INSTRUCTION, IN CLASS 41 (U.S. CLS. 100, 101 AND 107).

FIRST USE 9-1-2005; IN COMMERCE 12-1-2006.

THE MARK CONSISTS OF THE SILHOUETTES OF TWO MEN HOLDING A GLOBE OVER THEIR HEADS WHILE BALANCING ON A SLACKLINE ABOVE THE LITERAL ELEMENT "YOGASLACKERS". INSIDE THE GLOBE APPEARS A STYLIZED REPRESENTATION OF THE SANSKRIT SYMBOL FOR OM.

THE NON-LATIN CHARACTER IN THE MARK TRANSLITERATES TO "OM" AND THIS MEANS A SACRED SYLLABLE THAT IS CHANTED AT THE BEGINNING OF HINDU OR BUDDHIST PRAYERS, MANTRAS, AND SCRIPTURES AS A WORD OF INVOCATION AND ADORATION.

SER. NO. 85-201,324, FILED 12-19-2010.

STEVEN PEREZ, EXAMINING ATTORNEY



David J. Kybas

Director of the United States Patent and Trademark Office

United States of America

United States Patent and Trademark Office

Fan Jingo

Reg. No. 4,073,109

Registered Dec. 20, 2011

Int. Cl.: 42

SERVICE MARK

PRINCIPAL REGISTER

2CIMPLE INC (DELAWARE CORPORATION), DBA 2CIMPLE
WWW.2CIMPLE.COM
2745 N DALLAS PARKWAY, SUITE 610
PLANO, TX 75093

FOR: SOFTWARE DESIGN AND DEVELOPMENT, IN CLASS 42 (U.S. CLS. 100 AND 101).

FIRST USE 12-11-2010; IN COMMERCE 12-11-2010.

THE MARK CONSISTS OF STANDARD CHARACTERS WITHOUT CLAIM TO ANY PARTICULAR FONT, STYLE, SIZE, OR COLOR.

SER. NO. 85-201,374, FILED 12-19-2010.

FLORENTINA BLANDU, EXAMINING ATTORNEY



David J. Kybas

Director of the United States Patent and Trademark Office

United States of America

United States Patent and Trademark Office

GOLDEN FARMER

Reg. No. 4,073,110

ZENTIS GMBH & CO. KG (FED REP GERMANY LIMITED PARTNERSHIP)
JÜLICHER STRAÙE 177

Registered Dec. 20, 2011

52070 AACHEN, FED REP GERMANY

Int. Cl.: 29

FOR: JAMS; MARMALADES; FRUIT PRESERVES; SWEET BREAD SPREADS MADE OF FRUIT; FRUIT JELLIES, FRUIT SPREADS, IN CLASS 29 (U.S. CL. 46).

TRADEMARK

THE MARK CONSISTS OF STANDARD CHARACTERS WITHOUT CLAIM TO ANY PARTICULAR FONT, STYLE, SIZE, OR COLOR.

PRINCIPAL REGISTER

OWNER OF ERPN CMNTY TM OFC REG. NO. 2650059, DATED 8-13-2003, EXPIRES 8-13-2013.

SER. NO. 85-202,010, FILED 12-20-2010.

CIMMERIAN COLEMAN, EXAMINING ATTORNEY



David J. Kybas

Director of the United States Patent and Trademark Office

United States of America

United States Patent and Trademark Office

TEAM. WORKS. IN SCHOOLS

Reg. No. 4,073,111

COMPASS BANCSHARES, INC. (ALABAMA CORPORATION)

Registered Dec. 20, 2011

15 SOUTH 20TH STREET, 12TH FLOOR
BIRMINGHAM, AL 35233

Int. Cl.: 37

FOR: COMMUNITY OUTREACH SERVICES IN CONJUNCTION WITH SPORTS THEMED PROMOTIONS, NAMELY, REVITALIZING AND RENOVATING SCHOOLS IN COMMUNITIES IN WHICH OUTREACH SERVICE PROVIDER ALSO PROVIDES BANKING SERVICES, IN CLASS 37 (U.S. CLS. 100, 103 AND 106).

SERVICE MARK

PRINCIPAL REGISTER

FIRST USE 1-13-2011; IN COMMERCE 1-13-2011.

THE MARK CONSISTS OF STANDARD CHARACTERS WITHOUT CLAIM TO ANY PARTICULAR FONT, STYLE, SIZE, OR COLOR.

OWNER OF U.S. REG. NOS. 2,346,029, 2,347,611, AND 2,729,434.

SER. NO. 85-202,020, FILED 12-20-2010.

ELIZABETH HUGHITT, EXAMINING ATTORNEY



David J. Kyros

Director of the United States Patent and Trademark Office

United States of America

United States Patent and Trademark Office

JUST BEE

Reg. No. 4,073,112

JOYCE, SUE (UNITED STATES INDIVIDUAL), DBA THE TRILLIUM COLLECTION
1950 CHICKERING RD.

Registered Dec. 20, 2011

NASHVILLE, TN 37215

Int. Cl.: 30

FOR: HONEY, IN CLASS 30 (U.S. CL. 46).

TRADEMARK

FIRST USE 12-1-2010; IN COMMERCE 12-1-2010.

PRINCIPAL REGISTER

THE MARK CONSISTS OF STANDARD CHARACTERS WITHOUT CLAIM TO ANY PARTICULAR FONT, STYLE, SIZE, OR COLOR.

SER. NO. 85-202,705, FILED S.R. 12-21-2010 AM. P.R. 7-13-2011.

DAVID ELTON, EXAMINING ATTORNEY



David J. Kyfos

Director of the United States Patent and Trademark Office

United States of America

United States Patent and Trademark Office

UNION STATION

Reg. No. 4,073,113

Registered Dec. 20, 2011

Int. Cl.: 9

TRADEMARK

PRINCIPAL REGISTER

BUI, XUAN NINH (NETHERLANDS INDIVIDUAL)
RINGWEG RANDENBROEK 40B
3816 CJ AMERSFOORT, NETHERLANDS AND

LAI, HONGLI (NETHERLANDS INDIVIDUAL)
RIETZANGERWEG 39
7331 KT APELDOORN, NETHERLANDS

FOR: SOFTWARE PROGRAMS FOR THE ANALYSIS OF DATA AND APPLICATIONS;
DATA ANALYSIS SOFTWARE; DATA TRANSMISSION SOFTWARE, IN CLASS 9 (U.S.
CLS. 21, 23, 26, 36 AND 38).

THE MARK CONSISTS OF STANDARD CHARACTERS WITHOUT CLAIM TO ANY PAR-
TICULAR FONT, STYLE, SIZE, OR COLOR.

PRIORITY CLAIMED UNDER SEC. 44(D) ON ERPN CMNTY TM OFC APPLICATION NO.
009209941, FILED 6-29-2010, REG. NO. 009209941, DATED 1-13-2011, EXPIRES 6-29-2020.

SER. NO. 85-202,755, FILED 12-21-2010.

BENJAMIN OKEKE, EXAMINING ATTORNEY



David J. Kyros

Director of the United States Patent and Trademark Office

United States of America

United States Patent and Trademark Office

BLUE WORKS

Reg. No. 4,073,114

WD-40 MANUFACTURING COMPANY (CALIFORNIA CORPORATION)

Registered Dec. 20, 2011

1061 CUDAHY PLACE
SAN DIEGO, CA 92110

Int. Cls.: 2 and 4

FOR: PROTECTIVE COATINGS FOR RUST PREVENTION AND CORROSION CONTROL;
PROTECTIVE COATINGS FOR METAL, IN CLASS 2 (U.S. CLS. 6, 11 AND 16).

TRADEMARK

FIRST USE 12-7-2009; IN COMMERCE 12-7-2009.

PRINCIPAL REGISTER

FOR: ALL-PURPOSE PENETRATING AND LUBRICATING OIL, IN CLASS 4 (U.S. CLS. 1,
6 AND 15).

FIRST USE 12-7-2009; IN COMMERCE 12-7-2009.

THE MARK CONSISTS OF STANDARD CHARACTERS WITHOUT CLAIM TO ANY PAR-
TICULAR FONT, STYLE, SIZE, OR COLOR.

SER. NO. 85-202,952, FILED 12-21-2010.

ANTHONY RINKER, EXAMINING ATTORNEY



David J. Kyros

Director of the United States Patent and Trademark Office

United States of America

United States Patent and Trademark Office

BLUE WORKS

Reg. No. 4,073,115

WD-40 MANUFACTURING COMPANY (CALIFORNIA CORPORATION)

Registered Dec. 20, 2011

1061 CUDAHY PLACE
SAN DIEGO, CA 92110

Int. Cl.: 3

FOR: CLEANING PREPARATION FOR USE ON METAL SURFACES, IN CLASS 3 (U.S. CLS. 1, 4, 6, 50, 51 AND 52).

TRADEMARK

FIRST USE 12-7-2009; IN COMMERCE 12-7-2009.

PRINCIPAL REGISTER

THE MARK CONSISTS OF STANDARD CHARACTERS WITHOUT CLAIM TO ANY PARTICULAR FONT, STYLE, SIZE, OR COLOR.

SER. NO. 85-202,979, FILED 12-21-2010.

ANTHONY RINKER, EXAMINING ATTORNEY



David J. Kybas

Director of the United States Patent and Trademark Office

United States of America

United States Patent and Trademark Office

HEALTHCAREPROFILES.COM
BENCHMARKING TOOLS FOR DOCUMENTATION EXCELLENCE

Reg. No. 4,073,116

Registered Dec. 20, 2011

Int. Cl.: 42

SERVICE MARK

PRINCIPAL REGISTER

J.A. THOMAS & ASSOCIATES, INC. (GEORGIA CORPORATION)
100 NORTHCREEK, SUITE 200
3715 NORTHSIDE PARKWAY
ATLANTA, GA 30327

FOR: PROVIDING ONLINE INTERACTIVE SOFTWARE FOR HOSPITAL AND PHYSICIAN PROFILING AND BENCHMARKING THAT ALLOWS DATA COMPARISON TO RESEARCH AND MONITOR KEY MEDICAL AND SURGICAL SERVICE LINES TO IDENTIFY OPPORTUNITIES TO IMPROVE PHYSICIAN DOCUMENTATION AND CODING, IN CLASS 42 (U.S. CLS. 100 AND 101).

FIRST USE 7-1-2003; IN COMMERCE 7-1-2003.

OWNER OF U.S. REG. NO. 2,974,968.

NO CLAIM IS MADE TO THE EXCLUSIVE RIGHT TO USE "HEALTHCAREPROFILES.COM", APART FROM THE MARK AS SHOWN.

THE MARK CONSISTS OF THE WORDING "HEALTHCAREPROFILES.COM" WITH "BENCHMARKING TOOLS FOR DOCUMENTATION EXCELLENCE" UNDERNEATH. UNDERNEATH THE WORD "EXCELLENCE" THERE IS UNDERLINING HORIZONTAL STROKE.

SEC. 2(F).

SER. NO. 85-204,366, FILED 12-22-2010.

SOPHIA S. KIM, EXAMINING ATTORNEY



David J. Kyffers

Director of the United States Patent and Trademark Office

United States of America

United States Patent and Trademark Office

Perry Ellis Portfolio

Reg. No. 4,073,117

Registered Dec. 20, 2011

Int. Cl.: 3

TRADEMARK

PRINCIPAL REGISTER

PEI LICENSING, INC. (DELAWARE CORPORATION)
LEGAL DEPT.
3000 N.W. 107TH AVENUE
MIAMI, FL 33172

FOR: PERFUME, EAU DE TOILETTE, COLOGNE, HAND CREME, BODY LOTION, SHOWER GEL, AFTER SHAVE LOTION, AFTER SHAVE BALM, SKIN SOAP, BODY POWDER, PERSONAL DEODORANTS , IN CLASS 3 (U.S. CLS. 1, 4, 6, 50, 51 AND 52).

FIRST USE 1-0-2000; IN COMMERCE 1-0-2000.

THE MARK CONSISTS OF STANDARD CHARACTERS WITHOUT CLAIM TO ANY PARTICULAR FONT, STYLE, SIZE, OR COLOR.

OWNER OF U.S. REG. NOS. 1,416,338, 2,324,681, AND 3,248,395.

THE NAME(S), PORTRAIT(S), AND/OR SIGNATURE(S) SHOWN IN THE MARK DOES NOT IDENTIFY A PARTICULAR LIVING INDIVIDUAL.

SER. NO. 85-204,661, FILED 12-23-2010.

JORDAN BAKER, EXAMINING ATTORNEY



David J. Kyffers

Director of the United States Patent and Trademark Office

United States of America

United States Patent and Trademark Office

PROJECT FISHMAP

Reg. No. 4,073,118

Registered Dec. 20, 2011

Int. Cl.: 9

TRADEMARK

PRINCIPAL REGISTER

MONTEREY BAY AQUARIUM FOUNDATION (CALIFORNIA CORPORATION)
886 CANNERY ROW
MONTEREY, CA 93940

FOR: DOWNLOADABLE COMPUTER SOFTWARE FOR SEARCHING, ACCESSING, STORING, UPLOADING, AND SHARING INFORMATION ABOUT SUSTAINABLE SEAFOOD, RESTAURANTS, AND SEAFOOD PURVEYORS, AND FOR PROVIDING INTERACTIVE MAPS IN THE FIELD OF SUSTAINABLE SEAFOOD, RESTAURANTS, AND SEAFOOD PURVEYORS, IN CLASS 9 (U.S. CLS. 21, 23, 26, 36 AND 38).

FIRST USE 12-14-2010; IN COMMERCE 12-14-2010.

THE MARK CONSISTS OF STANDARD CHARACTERS WITHOUT CLAIM TO ANY PARTICULAR FONT, STYLE, SIZE, OR COLOR.

NO CLAIM IS MADE TO THE EXCLUSIVE RIGHT TO USE "FISH MAP", APART FROM THE MARK AS SHOWN.

SER. NO. 85-204,722, FILED 12-23-2010.

KRISTIN CARLSON, EXAMINING ATTORNEY



David J. Kyros

Director of the United States Patent and Trademark Office

United States of America

United States Patent and Trademark Office

ENDURAFIT

Reg. No. 4,073,119

ENDURAFIT, LLC (MARYLAND LIMITED LIABILITY COMPANY)
3706 CRONDALL LANE, SUITE 103
OWINGS MILLS, MD 21117

Registered Dec. 20, 2011

Int. Cl.: 25

FOR: APPAREL WORN UNDER, WITH OR AS ATHLETIC OUTERWEAR AND UNIFORMS MADE FROM MATERIALS WITH MOISTURE WICKING CAPABILITY, NAMELY, SHIRTS, T-SHIRTS, JERSEYS, TANK TOPS, SWEATSHIRTS, BOTTOMS, LEGGINGS, JACKETS, HATS, HEADWEAR, ARM WARMERS, AND BIKING GLOVES, IN CLASS 25 (U.S. CLS. 22 AND 39).

TRADEMARK

PRINCIPAL REGISTER

FIRST USE 5-31-2001; IN COMMERCE 5-31-2001.

THE MARK CONSISTS OF STANDARD CHARACTERS WITHOUT CLAIM TO ANY PARTICULAR FONT, STYLE, SIZE, OR COLOR.

SER. NO. 85-205,081, FILED 12-23-2010.

CORY BOONE, EXAMINING ATTORNEY



David J. Kyffers

Director of the United States Patent and Trademark Office

United States of America

United States Patent and Trademark Office

Indiana Wesleyan University

Reg. No. 4,073,120

Registered Dec. 20, 2011

Int. Cl.: 41

SERVICE MARK

PRINCIPAL REGISTER

INDIANA WESLEYAN UNIVERSITY (INDIANA NON-PROFIT CORPORATION)
4201 S. WASHINGTON STREET
MARION, IN 46953

FOR: EDUCATIONAL SERVICES, NAMELY, PROVIDING INSTRUCTIONAL COURSES, PUBLIC LECTURES, WORKSHOPS, SEMINARS, AND CONFERENCES AT THE UNIVERSITY LEVEL, SPECIFICALLY AT THE UNDERGRADUATE AND GRADUATE LEVELS; ENTERTAINMENT SERVICES, NAMELY, CONDUCTING INTERCOLLEGIATE ATHLETIC COMPETITIONS AND INTERCOLLEGIATE ATHLETIC PROGRAMS AND ARRANGING, ORGANIZING, CONDUCTING, AND HOSTING SOCIAL ENTERTAINMENT EVENTS FOR UNDERGRADUATE AND ALUMNI, IN CLASS 41 (U.S. CLS. 100, 101 AND 107).

FIRST USE 4-6-1988; IN COMMERCE 4-6-1988.

THE MARK CONSISTS OF STANDARD CHARACTERS WITHOUT CLAIM TO ANY PARTICULAR FONT, STYLE, SIZE, OR COLOR.

NO CLAIM IS MADE TO THE EXCLUSIVE RIGHT TO USE "WESLEYAN UNIVERSITY", APART FROM THE MARK AS SHOWN.

SEC. 2(F).

SER. NO. 85-205,116, FILED 12-23-2010.

ROBIN CHOSID, EXAMINING ATTORNEY



David J. Kyros

Director of the United States Patent and Trademark Office

United States of America

United States Patent and Trademark Office

TrainingPower

Reg. No. 4,073,121

Registered Dec. 20, 2011

Int. Cl.: 42

SERVICE MARK

PRINCIPAL REGISTER

MASTERY TECHNOLOGIES (MICHIGAN CORPORATION)
41216 BRIDGE STREET
NOVI, MI 48375

FOR: COMPUTER SERVICES, NAMELY, PROVIDING A WEB-BASED SYSTEM AND ON-LINE PORTAL FEATURING ON-LINE NON-DOWNLOADABLE SOFTWARE THAT ENABLES USERS TO ACCESS TRAINING, EDUCATION, TESTING AND CERTIFICATION MATERIALS IN THE FIELDS OF WORK SKILLS, NAMELY, BUSINESS AND WORKPLACE MANAGEMENT, CAREER DEVELOPMENT, CUSTOMER SERVICE, WORKPLACE SAFETY PRACTICES, WORKPLACE REGULATORY COMPLIANCE, PROJECT PLANNING, PERSONAL COMMUNICATION, AND BUSINESS PRACTICES, IN CLASS 42 (U.S. CLS. 100 AND 101).

FIRST USE 9-27-2010; IN COMMERCE 9-27-2010.

THE MARK CONSISTS OF THE WORDS "TRAININGPOWER". THE "O" IN "POWER" IS A POWER SYMBOL FOUND ON MOST ELECTRONIC DEVICES.

SER. NO. 85-205,768, FILED 12-27-2010.

STEVEN PEREZ, EXAMINING ATTORNEY



David J. Kybas

Director of the United States Patent and Trademark Office

United States of America

United States Patent and Trademark Office

PARALLAX FUND, L.P.

Reg. No. 4,073,122

JESAGA, LLC (CALIFORNIA LIMITED LIABILITY COMPANY)
88 KEARNY STREET, 20TH FLOOR
SAN FRANCISCO, CA 94108

Registered Dec. 20, 2011

Int. Cl.: 36

FOR: INVESTMENT ADVISORY AND INVESTMENT FUND SERVICES, IN CLASS 36 (U.S. CLS. 100, 101 AND 102).

SERVICE MARK

FIRST USE 11-14-1995; IN COMMERCE 11-14-1995.

PRINCIPAL REGISTER

THE MARK CONSISTS OF STANDARD CHARACTERS WITHOUT CLAIM TO ANY PARTICULAR FONT, STYLE, SIZE, OR COLOR.

NO CLAIM IS MADE TO THE EXCLUSIVE RIGHT TO USE "FUND, L.P.", APART FROM THE MARK AS SHOWN.

SER. NO. 85-206,045, FILED 12-27-2010.

KEVON CHISOLM, EXAMINING ATTORNEY



David J. Kybas

Director of the United States Patent and Trademark Office

United States of America

United States Patent and Trademark Office

NCG

Reg. No. 4,073,123

Registered Dec. 20, 2011

Int. Cl.: 9

TRADEMARK

PRINCIPAL REGISTER

OHARA INC. (JAPAN CORPORATION)
15-30, OYAMA 1-CHOME, CHUO-KU
SAGAMIHARA-SHI
KANAGAWA 252-5286, JAPAN

FOR: PROCESSED GLASS, NOT FOR BUILDING, NAMELY, CRYSTALLIZED GLASS FOR USE IN MANUFACTURING MAGNETIC DISKS, IN CLASS 9 (U.S. CLS. 21, 23, 26, 36 AND 38).

FIRST USE 1-3-2011; IN COMMERCE 1-25-2011.

THE MARK CONSISTS OF STANDARD CHARACTERS WITHOUT CLAIM TO ANY PARTICULAR FONT, STYLE, SIZE, OR COLOR.

PRIORITY CLAIMED UNDER SEC. 44(D) ON JAPAN APPLICATION NO. 2010-079629, FILED 10-13-2010.

SER. NO. 85-206,106, FILED 12-27-2010.

ANTHONY RINKER, EXAMINING ATTORNEY



David J. Kybas

Director of the United States Patent and Trademark Office

United States of America

United States Patent and Trademark Office

Bloodline Preservation Trust

Reg. No. 4,073,124

Registered Dec. 20, 2011

Int. Cl.: 36

SERVICE MARK

PRINCIPAL REGISTER

RHB IDEAS, LLC (DELAWARE LIMITED LIABILITY COMPANY)
SUITE 80
900 JORIE BLVD.
OAK BROOK, IL 60523

FOR: ESTATE TRUST PLANNING, IN CLASS 36 (U.S. CLS. 100, 101 AND 102).

FIRST USE 10-1-2010; IN COMMERCE 10-1-2010.

THE MARK CONSISTS OF STANDARD CHARACTERS WITHOUT CLAIM TO ANY PARTICULAR FONT, STYLE, SIZE, OR COLOR.

NO CLAIM IS MADE TO THE EXCLUSIVE RIGHT TO USE "PRESERVATION TRUST", APART FROM THE MARK AS SHOWN.

SER. NO. 85-207,754, FILED 12-30-2010.

DAVID TOOLEY, EXAMINING ATTORNEY



David J. Kyffers

Director of the United States Patent and Trademark Office

United States of America

United States Patent and Trademark Office

SCULPEY KEEPSAKE

Reg. No. 4,073,125

Registered Dec. 20, 2011

Int. Cl.: 16

TRADEMARK

PRINCIPAL REGISTER

POLYFORM PRODUCTS COMPANY (ILLINOIS CORPORATION)
1901 ESTES AVENUE
ELK GROVE VILLAGE, IL 60007

FOR: MODELING COMPOUNDS, IN CLASS 16 (U.S. CLS. 2, 5, 22, 23, 29, 37, 38 AND 50).

FIRST USE 1-1-2003; IN COMMERCE 1-1-2003.

THE MARK CONSISTS OF STANDARD CHARACTERS WITHOUT CLAIM TO ANY PARTICULAR FONT, STYLE, SIZE, OR COLOR.

OWNER OF U.S. REG. NOS. 3,275,269, 3,713,199, AND 3,788,625.

SER. NO. 85-207,844, FILED S.R. 12-30-2010 AM. P.R. 8-18-2011.

DANNEAN HETZEL, EXAMINING ATTORNEY



David J. Kyffers

Director of the United States Patent and Trademark Office

United States of America

United States Patent and Trademark Office

TPG

Reg. No. 4,073,126

TPG HOSPITALITY, INC. (DELAWARE CORPORATION)
1140 RESERVOIR AVENUE
CRANSTON, RI 029206032

Registered Dec. 20, 2011

Int. Cl.: 35

FOR: HOSPITALITY MANAGEMENT SERVICES, NAMELY, HOTEL MANAGEMENT FOR OTHERS, IN CLASS 35 (U.S. CLS. 100, 101 AND 102).

SERVICE MARK

FIRST USE 1-0-2006; IN COMMERCE 1-0-2006.

PRINCIPAL REGISTER

THE MARK CONSISTS OF STANDARD CHARACTERS WITHOUT CLAIM TO ANY PARTICULAR FONT, STYLE, SIZE, OR COLOR.

SER. NO. 85-208,042, FILED 12-30-2010.

KELLEY WELLS, EXAMINING ATTORNEY



David J. Kyffers

Director of the United States Patent and Trademark Office

United States of America

United States Patent and Trademark Office



Reg. No. 4,073,127

Registered Dec. 20, 2011

Int. Cl.: 11

TRADEMARK

PRINCIPAL REGISTER

LETICIA MILLER (UNITED STATES INDIVIDUAL), DBA HAIR DRYER HOLDER COMPANY
104 SAN JUAN AVE
REDLANDS, CA 92374

FOR: HAIR DRYER STAND AND HOLDER, IN CLASS 11 (U.S. CLS. 13, 21, 23, 31 AND 34).

FIRST USE 12-1-2010; IN COMMERCE 12-2-2010.

NO CLAIM IS MADE TO THE EXCLUSIVE RIGHT TO USE "PRO STYLING STAND", "EST. 2000", AND "APARATO DE BELEZA", APART FROM THE MARK AS SHOWN.

THE COLOR(S) PINK, BLACK AND WHITE IS/ARE CLAIMED AS A FEATURE OF THE MARK.

THE MARK CONSISTS OF A BLACK BANNER WITH PINK OUTLINE WITH THE WORDING AND NUMBER "P.S. EST. 2000" IN WHITE AND THE WORDING "PRO STYLING STAND" IN WHITE WITH PINK OUTLINE. BENEATH THE BANNER IS THE WORDING "APARATO DE BELLEZA" IN BLACK WITH A PINK SHADOW, AND BENEATH THE WORDING "APARATO DE BELLEZA" IS THE WORDING AND PUNCTUATION "NOT HEAVY OR BULKY, JUST RIGHT!" IN BLACK WITH A PINK SHADOW. THERE IS A WHITE STAR WITH A PINK STAR AFTER THE WORDING "PRO", AND THERE IS A PINK STAR BEHIND THE WORDING "DE".

SER. NO. 85-208,386, FILED S.R. 12-30-2010 AM. P.R. 5-11-2011.

WANDA KAY PRICE, EXAMINING ATTORNEY



David J. Kyros

Director of the United States Patent and Trademark Office

United States of America

United States Patent and Trademark Office

HOT PURSUIT

Reg. No. 4,073,128

Registered Dec. 20, 2011

Int. Cl.: 28

TRADEMARK

PRINCIPAL REGISTER

GREENLIGHT LLC (INDIANA LIMITED LIABILITY COMPANY), DBA GREENLIGHT
COLLECTIBLES
2605 E. 55TH PLACE
INDIANAPOLIS, IN 46220

FOR: COLLECTIBLE MINIATURE SCALE MODEL TOY VEHICLES AND ACCESSORIES
THEREFOR, IN CLASS 28 (U.S. CLS. 22, 23, 38 AND 50).

FIRST USE 3-1-2009; IN COMMERCE 7-15-2009.

THE MARK CONSISTS OF STANDARD CHARACTERS WITHOUT CLAIM TO ANY PAR-
TICULAR FONT, STYLE, SIZE, OR COLOR.

SER. NO. 85-208,978, FILED 1-3-2011.

MAUREEN DALL, EXAMINING ATTORNEY



David J. Kyffers

Director of the United States Patent and Trademark Office

United States of America

United States Patent and Trademark Office



Reg. No. 4,073,129

Registered Dec. 20, 2011

Int. Cl.: 35

SERVICE MARK

PRINCIPAL REGISTER

GETADS, LLC (COLORADO LIMITED LIABILITY COMPANY)
SUITE 200
1055 AURARIA PKWY
DENVER, CO 80204

FOR: MARKETING AND ADVERTISING; BRAND EVALUATION AND POSITIONING SERVICES; AFFILIATE MARKETING SERVICES, NAMELY, PROMOTING THE GOODS AND SERVICES OF OTHERS BY ARRANGING FOR BUSINESSES TO AFFILIATE THEIR GOODS AND SERVICES WITH THE GOODS AND SERVICES OF THIRD PARTIES BY MEANS OF SPONSORSHIP RELATIONSHIPS; ON-LINE ADVERTISING ON COMPUTER NETWORKS; PROVISION OF ADVERTISING SPACE BY ELECTRONIC MEANS AND GLOBAL INFORMATION NETWORKS; PROVIDING ADVERTISING SERVICE TO DISTRIBUTE ADVERTISEMENTS FOR DISPLAY ON INTERNET, NAMELY, IN WEBSITES, E-MAILS, BLOGS, INSTANT MESSAGES, TEXT MESSAGES, IN CLASS 35 (U.S. CLS. 100, 101 AND 102).

FIRST USE 5-1-2008; IN COMMERCE 5-1-2008.

NO CLAIM IS MADE TO THE EXCLUSIVE RIGHT TO USE "ADS", APART FROM THE MARK AS SHOWN.

THE MARK CONSISTS OF THE WORDS "GET ADS", WITH THE "ADS" TERM WITHIN A CIRCLE.

SER. NO. 85-209,193, FILED 1-3-2011.

LINDA MICKLEBURGH, EXAMINING ATTORNEY



David J. Kyffers

Director of the United States Patent and Trademark Office

United States of America

United States Patent and Trademark Office

EUGENE STOLTZFUS

Reg. No. 4,073,130

Registered Dec. 20, 2011

Int. Cl.: 42

SERVICE MARK

PRINCIPAL REGISTER

EUGENE STOLTZFUS ARCHITECTS, PLC (VIRGINIA LIMITED LIABILITY COMPANY)
SUITE 300
61 S. MAIN STREET
HARRISONBURG, VA 22801

FOR: ARCHITECTURAL AND INDUSTRIAL DESIGN SERVICES, IN CLASS 42 (U.S. CLS. 100 AND 101).

FIRST USE 8-25-2006; IN COMMERCE 8-25-2006.

THE MARK CONSISTS OF STANDARD CHARACTERS WITHOUT CLAIM TO ANY PARTICULAR FONT, STYLE, SIZE, OR COLOR.

THE NAME "EUGENE STOLTZFUS" IDENTIFIES A LIVING INDIVIDUAL WHOSE CONSENT IS OF RECORD.

SER. NO. 85-209,211, FILED 1-3-2011.

STEVEN PEREZ, EXAMINING ATTORNEY



David J. Kyffers

Director of the United States Patent and Trademark Office

United States of America

United States Patent and Trademark Office

BECAUSE YOU LISTEN LORD...

Reg. No. 4,073,131

Registered Dec. 20, 2011

Int. Cl.: 16

TRADEMARK

PRINCIPAL REGISTER

WINSUM PRESS, INC. (FLORIDA CORPORATION)
8920 WOODSIDE COURT
DAVIE, FL 33328

FOR: BOOKS IN THE FIELD OF FAITH, POETRY, SPIRITUALITY AND PRAYER; COFFEE TABLE BOOKS FEATURING COLLECTIONS OF PRAYERS, POEMS AND PROSE; PRAYER BOOKS; PUBLICATIONS, NAMELY, BOOKS AND OTHER PRINTED MATTER, NAMELY, NOTES, CARDS, POSTERS, PAMPHLETS, BOOKMARKS, FLYERS, BROCHURES, PRESS RELEASES, COLLAGES, STATIONERY IN THE FIELDS OF LOSS, LIFE, FAITH, GRIEF, DAILY LIFE LESSONS, CARE-GIVING, NATURE, SPIRITUALITY, AND INSPIRATION; RELIGIOUS BOOKS; RELIGIOUS BOOKS, INT. CL. 16, IN CLASS 16 (U.S. CLS. 2, 5, 22, 23, 29, 37, 38 AND 50).

FIRST USE 4-1-1990; IN COMMERCE 4-1-1990.

THE MARK CONSISTS OF STANDARD CHARACTERS WITHOUT CLAIM TO ANY PARTICULAR FONT, STYLE, SIZE, OR COLOR.

SER. NO. 85-209,304, FILED 1-3-2011.

PRISCILLA MILTON, EXAMINING ATTORNEY



David J. Kyros

Director of the United States Patent and Trademark Office

United States of America

United States Patent and Trademark Office



Reg. No. 4,073,132

Registered Dec. 20, 2011

Int. Cl.: 35

SERVICE MARK

PRINCIPAL REGISTER

GETADS, LLC (COLORADO LIMITED LIABILITY COMPANY)
SUITE 200
1055 AURARIA PKWY
DENVER, CO 80204

FOR: MARKETING AND ADVERTISING; BRAND EVALUATION AND POSITIONING SERVICES; AFFILIATE MARKETING SERVICES, NAMELY, PROMOTING THE GOODS AND SERVICES OF OTHERS BY ARRANGING FOR BUSINESSES TO AFFILIATE THEIR GOODS AND SERVICES WITH THE GOODS AND SERVICES OF THIRD PARTIES BY MEANS OF SPONSORSHIP RELATIONSHIPS; ON-LINE ADVERTISING ON COMPUTER NETWORKS; PROVISION OF ADVERTISING SPACE BY ELECTRONIC MEANS AND GLOBAL INFORMATION NETWORKS; PROVIDING ADVERTISING SERVICE TO DISTRIBUTE ADVERTISEMENTS FOR DISPLAY ON INTERNET, NAMELY, IN WEBSITES, E-MAILS, BLOGS, INSTANT MESSAGES, TEXT MESSAGES, IN CLASS 35 (U.S. CLS. 100, 101 AND 102).

FIRST USE 5-1-2008; IN COMMERCE 5-1-2008.

NO CLAIM IS MADE TO THE EXCLUSIVE RIGHT TO USE "ADS", APART FROM THE MARK AS SHOWN.

THE COLOR(S) GREEN AND WHITE IS/ARE CLAIMED AS A FEATURE OF THE MARK.

THE MARK CONSISTS OF THE WORDS "GET ADS", WITH THE TERM "GET" IN SHADED GREEN COLORS AND "ADS" IN WHITE LETTERING WITHIN A SHADED GREEN CIRCLE NEXT TO "GET".

SER. NO. 85-209,312, FILED 1-3-2011.

LINDA MICKLEBURGH, EXAMINING ATTORNEY



David J. Kyros

Director of the United States Patent and Trademark Office

United States of America

United States Patent and Trademark Office



Reg. No. 4,073,133

Registered Dec. 20, 2011

Int. Cl.: 30

TRADEMARK

PRINCIPAL REGISTER

HEALTH GARDEN OF NY, INC. (NEW YORK CORPORATION)
93 FRANCIS PLACE
SPRING VALLEY, NY 10977

FOR: NATURAL SWEETENER, IN CLASS 30 (U.S. CL. 46).

FIRST USE 10-1-2010; IN COMMERCE 10-1-2010.

NO CLAIM IS MADE TO THE EXCLUSIVE RIGHT TO USE "SWEET" , APART FROM THE MARK AS SHOWN.

SER. NO. 85-209,955, FILED 1-4-2011.

SIMON TENG, EXAMINING ATTORNEY



David J. Kybas

Director of the United States Patent and Trademark Office

United States of America

United States Patent and Trademark Office

RELOFLEET

Reg. No. 4,073,134

Registered Dec. 20, 2011

Int. Cls.: 39 and 40

SERVICE MARK

PRINCIPAL REGISTER

BIOSTORAGE TECHNOLOGIES, INC. (DELAWARE CORPORATION)
2910 FORTUNE CIRCLE WEST, SUITE E
INDIANAPOLIS, IN 46241

FOR: TRANSPORTING, STORING AND PACKAGING OF BIOLOGICAL AND MEDICAL SAMPLES, IN CLASS 39 (U.S. CLS. 100 AND 105).

FIRST USE 12-8-2010; IN COMMERCE 12-8-2010.

FOR: CRYOGENIC PRESERVATION OF BIOLOGICAL AND MEDICAL SAMPLES FOR TRANSPORT; PREPARATION AND TREATMENT OF BIOLOGICAL AND MEDICAL SAMPLES FOR TRANSPORT, IN CLASS 40 (U.S. CLS. 100, 103 AND 106).

FIRST USE 12-8-2010; IN COMMERCE 12-8-2010.

THE MARK CONSISTS OF STANDARD CHARACTERS WITHOUT CLAIM TO ANY PARTICULAR FONT, STYLE, SIZE, OR COLOR.

SER. NO. 85-209,976, FILED 1-4-2011.

MARIA-VICTORIA SUAREZ, EXAMINING ATTORNEY



David J. Kybas

Director of the United States Patent and Trademark Office

United States of America

United States Patent and Trademark Office



Reg. No. 4,073,135

Registered Dec. 20, 2011

Int. Cls.: 29 and 30

TRADEMARK

PRINCIPAL REGISTER

SAGREX FOODS, INCORPORATED (PHILIPPINES CORPORATION)
TGG COMPOUND, KM 9, SASA
DAVAO CITY, PHILIPPINES

FOR: MICROWAVABLE FROZEN NATURAL BANANA; FROZEN NATURAL BANANA
FRIES, IN CLASS 29 (U.S. CL. 46).

FIRST USE 11-10-2008; IN COMMERCE 11-10-2008.

FOR: FROZEN NATURAL BANANA SPRING ROLLS, IN CLASS 30 (U.S. CL. 46).

FIRST USE 11-10-2008; IN COMMERCE 11-10-2008.

OWNER OF U.S. REG. NO. 3,756,308.

THE COLOR(S) GOLD, WHITE, YELLOW, LIGHT GREEN, MEDIUM GREEN, DARK GREEN,
BROWN, AND BLACK IS/ARE CLAIMED AS A FEATURE OF THE MARK.

NO CLAIM IS MADE TO THE EXCLUSIVE RIGHT TO USE "GOLDEN SABA NATURAL
HEALTHY FRUIT", APART FROM THE MARK AS SHOWN.

THE MARK CONSISTS OF A GREEN LEAF WITH THE WORDS "GOLDEN SABA" PRINTED
IN YELLOW OUTLINED BY A DARKER GREEN: A CARTOON BANANA CHARACTER
WITH A YELLOW BODY, BLACK EYES, WHITE TEETH, AND WITH PARTS OF A BANANA
AND PEEL BEING LIGHT GREEN, WHITE, GOLD, AND BROWN, AND WEARING A STRAW
HAT COLORED BROWN AND GOLD. THE WORDS "NATURAL HEALTHY FRUIT" ARE
PRINTED IN GOLD WITH DARK GREEN.

SER. NO. 85-212,316, FILED 1-6-2011.

ODESSA BIBBINS, EXAMINING ATTORNEY



David J. Kybas

Director of the United States Patent and Trademark Office

United States of America

United States Patent and Trademark Office

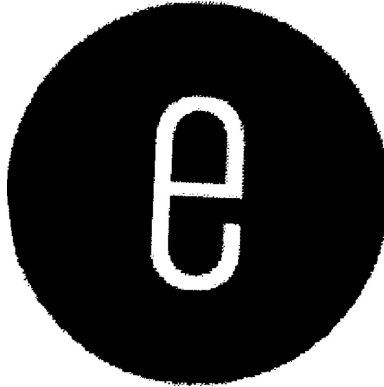

Reg. No. 4,073,136

Registered Dec. 20, 2011

Int. Cl.: 43

SERVICE MARK

PRINCIPAL REGISTER

953 ASSOCIATES, LLC (NEW YORK CORPORATION), DBA EATERY NYC
798 9TH AVENUE
NEW YORK, NY 10019

FOR: RESTAURANT SERVICES, IN CLASS 43 (U.S. CLS. 100 AND 101).

FIRST USE 9-6-2000; IN COMMERCE 9-6-2000.

THE MARK CONSISTS OF A LOWERCASE LETTER "E" IN STYLIZED FONT CENTERED
INSIDE A SOLID CIRCLE CARRIER.

SER. NO. 85-212,361, FILED 1-6-2011.

KEVON CHISOLM, EXAMINING ATTORNEY



David J. Kyffers

Director of the United States Patent and Trademark Office

United States of America

United States Patent and Trademark Office

HAFA ADAI

Reg. No. 4,073,137

Registered Dec. 20, 2011

Int. Cl.: 16

TRADEMARK

PRINCIPAL REGISTER

MICRONESIA PUBLISHING CO. LIMITED (HONG KONG LIMITED LIABILITY COMPANY)
SUITE 1511, OCEAN CENTRE
5 CANTON ROAD, TSIM SHA TSUI, KOWLOON
HONG KONG, HONG KONG

FOR: GENERAL FEATURE MAGAZINES; INFLIGHT MAGAZINES; MAGAZINE PAPER,
IN CLASS 16 (U.S. CLS. 2, 5, 22, 23, 29, 37, 38 AND 50).

FIRST USE 1-6-2010; IN COMMERCE 1-6-2010.

THE MARK CONSISTS OF THE STYLIZED WORDING "HAFA ADAI" IN THE COLOR
BLUE.

THE COLOR(S) BLUE IS/ARE CLAIMED AS A FEATURE OF THE MARK.

THE ENGLISH TRANSLATION OF "HAFA ADAI" IN THE MARK IS "HELLO".

SER. NO. 85-212,460, FILED 1-7-2011.

GEOFFREY FOSDICK, EXAMINING ATTORNEY



David J. Kybas

Director of the United States Patent and Trademark Office

United States of America

United States Patent and Trademark Office

TUBESYNC

Reg. No. 4,073,138

Registered Dec. 20, 2011

Int. Cl.: 9

TRADEMARK

PRINCIPAL REGISTER

KBO DYNAMICS INTERNATIONAL LTD. (UNITED KINGDOM CORPORATION)
UNIT 6, CONSETT INNOVATION CENTRE
GENESIS WAY
CONSETT, COUNTY DURHAM, UNITED KINGDOM DH85XP

FOR: AUDIO EQUIPMENT, NAMELY, PRE-AMPLIFIERS, ANALOG-TO-DIGITAL CONVERTERS, DIGITAL-TO-ANALOG CONVERTERS, MICROPHONE PRE-AMPLIFIERS, MUSICAL INSTRUMENT AMPLIFIERS, AUDIO AMPLIFIERS, BASS AMPLIFIERS, ELECTRICAL PICKUPS FOR USE WITH MUSICAL INSTRUMENTS, ELECTRONIC SOUND PICKUP FOR GUITARS AND BASSES; AMPLIFIERS; GUITAR AMPLIFIERS; ELECTRONIC CONTROL CIRCUITS AND CIRCUIT BOARDS FOR USE WITH AUDIO EQUIPMENT AND AMPLIFIERS; ELECTRONIC COMPONENTS FOR AUDIO EQUIPMENT, NAMELY, AMPLIFIERS, FOR GUITARS AND OTHER MUSICAL INSTRUMENTS; HIGH FIDELITY AUDIO AMPLIFIERS; ELECTRONIC COMPONENTS FOR HIGH-FIDELITY EQUIPMENT, NAMELY, ELECTRONIC COMPONENTS FOR AUDIO AMPLIFIERS; COMPUTER PROGRAMS AND SOFTWARE FOR THE PROCESSING OF AMPLIFIER SIGNALS, FOR TESTING AND DIAGNOSIS OF AMPLIFIERS TO IDENTIFY PROBLEMS IN PERFORMANCE AND FUNCTIONALITY AND TO CONTROL AND IMPROVE AUDIO EQUIPMENT AND SOUND QUALITY, IN CLASS 9 (U.S. CLS. 21, 23, 26, 36 AND 38).

THE MARK CONSISTS OF STANDARD CHARACTERS WITHOUT CLAIM TO ANY PARTICULAR FONT, STYLE, SIZE, OR COLOR.

OWNER OF UNITED KINGDOM REG. NO. 2504844, DATED 12-16-2008, EXPIRES 12-16-2018.

SER. NO. 85-212,762, FILED 1-7-2011.

GRETCHEN ULRICH, EXAMINING ATTORNEY



David J. Kyros

Director of the United States Patent and Trademark Office

United States of America

United States Patent and Trademark Office



Cannoli Queen LLC

Reg. No. 4,073,139

CANNOLI QUEEN, LLC (INDIANA LIMITED LIABILITY COMPANY)
1093 BENNINGTON COURT
GREENWOOD, IN 46143

Registered Dec. 20, 2011

Int. Cl.: 43

FOR: CATERING, IN CLASS 43 (U.S. CLS. 100 AND 101).

SERVICE MARK

FIRST USE 9-1-2010; IN COMMERCE 9-1-2010.

PRINCIPAL REGISTER

NO CLAIM IS MADE TO THE EXCLUSIVE RIGHT TO USE "CANNOLI" AND "LLC" , APART FROM THE MARK AS SHOWN.

SER. NO. 85-212,974, FILED 1-7-2011.

MARIA-VICTORIA SUAREZ, EXAMINING ATTORNEY



David J. Kybas

Director of the United States Patent and Trademark Office

United States of America

United States Patent and Trademark Office

Candle Roses

Reg. No. 4,073,140

Registered Dec. 20, 2011

Int. Cl.: 31

TRADEMARK

PRINCIPAL REGISTER

WEHLAU, KRISTINA (UNITED STATES INDIVIDUAL)
11103 AUBURNDALE ST.
SPRING HILL, FL 34609

FOR: ROSES, IN CLASS 31 (U.S. CLS. 1 AND 46).

FIRST USE 4-28-2010; IN COMMERCE 4-28-2010.

THE MARK CONSISTS OF STANDARD CHARACTERS WITHOUT CLAIM TO ANY PARTICULAR FONT, STYLE, SIZE, OR COLOR.

NO CLAIM IS MADE TO THE EXCLUSIVE RIGHT TO USE "ROSES", APART FROM THE MARK AS SHOWN.

SER. NO. 85-213,782, FILED 1-10-2011.

EUGENIA MARTIN, EXAMINING ATTORNEY



David J. Kyffers

Director of the United States Patent and Trademark Office

United States of America

United States Patent and Trademark Office



Reg. No. 4,073,141

Registered Dec. 20, 2011

Int. Cl.: 41

SERVICE MARK

PRINCIPAL REGISTER

MISSOURI STATE TEACHERS ASSOCIATION, INC. (MISSOURI CORPORATION)
407 S. SIXTH ST.
COLUMBIA, MO 65201

FOR: EDUCATION SERVICES, NAMELY, PROVIDING ASSISTANCE TO TEACHERS IN THE NATURE OF AN EDUCATIONAL PROGRAM FOR THE SELECTION OF READING MATERIAL FOR STUDENTS, AND ADMINISTERING A CERTIFICATE PROGRAM TO ENCOURAGE STUDENTS TO READ, AND EXCLUDING CONDUCTING PROGRAMS IN THE FIELD OF READING PROBLEMS AND CONSULTATION IN THE FIELD OF READING PROBLEMS, IN CLASS 41 (U.S. CLS. 100, 101 AND 107).

FIRST USE 11-0-2010; IN COMMERCE 11-0-2010.

THE MARK CONSISTS OF A STYLIZED "R" AND "C".

SER. NO. 85-214,000, FILED 1-10-2011.

SANI KHOURI, EXAMINING ATTORNEY



David J. Kybas

Director of the United States Patent and Trademark Office

United States of America

United States Patent and Trademark Office

WHY SEND FLOWERS, WHEN YOU CAN SEND A BUSH?

Reg. No. 4,073,142

Registered Dec. 20, 2011

Int. Cl.: 41

SERVICE MARK

PRINCIPAL REGISTER

MORGAN, JOHN (UNITED STATES INDIVIDUAL)
4025 GREENFERN DRIVE
ORLANDO, FL 32810

FOR: PRODUCTION OF EDUCATIONAL AND ENTERTAINMENT IN THE NATURE OF CUSTOMIZED VIDEO PRESENTATIONS PERFORMED BY A CELEBRITY IMPERSONATOR IN THE FIELDS OF MOTIVATION, NAMELY, SELF- AND PERSONAL IMPROVEMENT, RELIGION, AND EDUCATIONAL ENTERTAINMENT, NAMELY, HIGHLIGHTING ACCOMPLISHMENTS OF PEOPLE'S LIVES TO MOTIVATE THEM TO ACHIEVE THEIR PROFESSIONAL AND SPIRITUAL GOALS, IN CLASS 41 (U.S. CLS. 100, 101 AND 107).

FIRST USE 1-31-2010; IN COMMERCE 1-31-2010.

THE MARK CONSISTS OF STANDARD CHARACTERS WITHOUT CLAIM TO ANY PARTICULAR FONT, STYLE, SIZE, OR COLOR.

SER. NO. 85-214,579, FILED 1-11-2011.

RONALD DELGIZZI, EXAMINING ATTORNEY



David J. Kyffers

Director of the United States Patent and Trademark Office

United States of America

United States Patent and Trademark Office

READY U

Reg. No. 4,073,143

Registered Dec. 20, 2011

Int. Cl.: 41

SERVICE MARK

PRINCIPAL REGISTER

THE PROCTER & GAMBLE COMPANY (OHIO CORPORATION)
ONE PROCTER & GAMBLE PLAZA
CINCINNATI, OH 45202

FOR: PROVIDING ON-LINE RESOURCE GUIDES FOR COLLEGE STUDENTS, PROSPECTIVE COLLEGE STUDENTS AND OTHER INTERESTED PARTIES IN THE FIELDS OF ACADEMICS, FITNESS AND LIFESTYLE AT COLLEGE, IN CLASS 41 (U.S. CLS. 100, 101 AND 107).

FIRST USE 7-1-2008; IN COMMERCE 7-1-2008.

THE MARK CONSISTS OF STANDARD CHARACTERS WITHOUT CLAIM TO ANY PARTICULAR FONT, STYLE, SIZE, OR COLOR.

OWNER OF U.S. REG. NO. 3,793,066.

SER. NO. 85-214,663, FILED 1-11-2011.

JOHN KELLY, EXAMINING ATTORNEY



David J. Kyffers

Director of the United States Patent and Trademark Office

United States of America

United States Patent and Trademark Office

JUGGERNAUT TACTICAL

Reg. No. 4,073,144

ZACKARY KASANJIAN-KING (UNITED STATES INDIVIDUAL)

Registered Dec. 20, 2011

P. O. BOX 4608
BLUE JAY, CA 92317

Int. Cl.: 13

FOR: ARTILLERY GUNS; AUTOMATIC GUNS; FIELD GUNS; FIREARM ATTACHMENTS, NAMELY, MOUNTS FOR ATTACHING GUN SIGHTS TO A FIREARM; GUN MOUNTS; GUN PARTS; RECOILLESS GUNS, IN CLASS 13 (U.S. CLS. 2 AND 9).

TRADEMARK

FIRST USE 1-1-2011; IN COMMERCE 1-1-2011.

PRINCIPAL REGISTER

THE MARK CONSISTS OF STANDARD CHARACTERS WITHOUT CLAIM TO ANY PARTICULAR FONT, STYLE, SIZE, OR COLOR.

NO CLAIM IS MADE TO THE EXCLUSIVE RIGHT TO USE "TACTICAL", APART FROM THE MARK AS SHOWN.

SER. NO. 85-214,788, FILED 1-11-2011.

MICHAEL TANNER, EXAMINING ATTORNEY



David J. Kybas

Director of the United States Patent and Trademark Office

United States of America

United States Patent and Trademark Office



Reg. No. 4,073,145

Registered Dec. 20, 2011

Int. Cl.: 41

SERVICE MARK

PRINCIPAL REGISTER

BOLAND, JAMES (UNITED STATES INDIVIDUAL)
129 COLLEGE STREET
WILMINGTON, OH 45177

FOR: EDUCATION SERVICES, NAMELY, PROVIDING CLASSES, SEMINARS, WORKSHOPS, AND PROGRAMS IN THE FIELD OF CHARACTER DEVELOPMENT FOR MIDDLE SCHOOL AND HIGH SCHOOL CHILDREN; EDUCATION SERVICES, NAMELY, TRAINING EDUCATORS TO TEACH THROUGH SERVICE LEARNING AND CIVIC ENGAGEMENT AND PROVIDING CURRICULA IN CONNECTION THEREWITH, IN CLASS 41 (U.S. CLS. 100, 101 AND 107).

FIRST USE 12-14-2010; IN COMMERCE 12-14-2010.

NO CLAIM IS MADE TO THE EXCLUSIVE RIGHT TO USE "PROJECT", APART FROM THE MARK AS SHOWN.

THE MARK CONSISTS OF THE STYLIZED WORDS "PROJECT TRUST". AN IMAGE OF TEN PEOPLE'S SILHOUETTE IN THE BACKGROUND OF THE TEXT.

SER. NO. 85-214,840, FILED 1-11-2011.

ANGELA M. MICHELI, EXAMINING ATTORNEY



David J. Kyjars

Director of the United States Patent and Trademark Office

United States of America

United States Patent and Trademark Office

OUTSIDE IN

Reg. No. 4,073,146

STARR COMMONWEALTH (MICHIGAN CORPORATION)
13725 STARR COMMONWEALTH ROAD
ALBION, MI 49224

Registered Dec. 20, 2011

Int. Cls.: 41 and 44

FOR: EDUCATIONAL SERVICES, NAMELY, CONDUCTING CLASSES, SEMINARS, CONFERENCES AND WORKSHOPS IN THE FIELD OF A TREATMENT PROGRAM FOR YOUTH WITH LEARNING DISORDERS AND DISTRIBUTION OF EDUCATIONAL MATERIALS IN CONNECTION THEREWITH, IN CLASS 41 (U.S. CLS. 100, 101 AND 107).

SERVICE MARK

PRINCIPAL REGISTER

FIRST USE 10-0-2007; IN COMMERCE 10-0-2007.

FOR: PSYCHOLOGICAL SERVICES, NAMELY, PROVIDING A THERAPEUTIC TREATMENT PROGRAM FOR YOUTH WITH LEARNING DISORDERS, IN CLASS 44 (U.S. CLS. 100 AND 101).

FIRST USE 10-1-2007; IN COMMERCE 10-1-2007.

THE MARK CONSISTS OF STANDARD CHARACTERS WITHOUT CLAIM TO ANY PARTICULAR FONT, STYLE, SIZE, OR COLOR.

SER. NO. 85-215,084, FILED 1-11-2011.

SKYE YOUNG, EXAMINING ATTORNEY



David J. Kyffers

Director of the United States Patent and Trademark Office

United States of America

United States Patent and Trademark Office



Reg. No. 4,073,147

Registered Dec. 20, 2011

Int. Cl.: 6

NINGBO LONGXING WELDING CUTTING TECHNOLOGY STOCK CORPORATION (CHINA LIMITED COMPANY (LTD.))
333 JIN DA ROAD
YIN ZHOU TOWN
NING BO, CHINA

TRADEMARK

FOR: BRAZING ALLOYS; METAL RODS FOR BRAZING AND WELDING; NON-ELECTRIC CABLES OF METAL; WELDING WIRE , IN CLASS 6 (U.S. CLS. 2, 12, 13, 14, 23, 25 AND 50).

PRINCIPAL REGISTER

FIRST USE 5-20-2001; IN COMMERCE 4-6-2004.

THE MARK CONSISTS OF A CHEVRON AND A CURVED BAND IN FRONT OF A STYLIZED INCOMPLETE CIRCLE.

SER. NO. 85-215,540, FILED 1-12-2011.

EDWARD NELSON, EXAMINING ATTORNEY



David J. Kyffers

Director of the United States Patent and Trademark Office

United States of America

United States Patent and Trademark Office



Reg. No. 4,073,148

Registered Dec. 20, 2011

Int. Cl.: 7

NINGBO LONGXING WELDING CUTTING TECHNOLOGY STOCK CORPORATION (CHINA LIMITED COMPANY (LTD.))
333 JIN DA ROAD
YIN ZHOU TOWN
NING BO, CHINA

TRADEMARK

FOR: CUTTING TORCHES; ELECTRIC ARC WELDING MACHINES; ELECTRIC WELDING MACHINES; GAS WELDING GUNS; GAS-OPERATED WELDING MACHINES; REGULATORS BEING PARTS OF MACHINES, IN CLASS 7 (U.S. CLS. 13, 19, 21, 23, 31, 34 AND 35).

PRINCIPAL REGISTER

FIRST USE 3-15-1992; IN COMMERCE 8-3-1998.

THE MARK CONSISTS OF A CHEVRON AND A CURVED BAND IN FRONT OF A STYLIZED INCOMPLETE CIRCLE.

SER. NO. 85-215,545, FILED 1-12-2011.

EDWARD NELSON, EXAMINING ATTORNEY



David J. Kyffers

Director of the United States Patent and Trademark Office

United States of America

United States Patent and Trademark Office



Reg. No. 4,073,149

Registered Dec. 20, 2011

Int. Cl.: 7

NINGBO LONGXING WELDING CUTTING TECHNOLOGY STOCK CORPORATION (CHINA LIMITED COMPANY (LTD.))
333 JIN DA ROAD
YIN ZHOU TOWN
NING BO, CHINA

TRADEMARK

PRINCIPAL REGISTER

FOR: CUTTING TORCHES; ELECTRIC ARC WELDING MACHINES; ELECTRIC WELDING MACHINES; GAS WELDING GUNS; GAS-OPERATED WELDING MACHINES; REGULATORS BEING PARTS OF MACHINES, IN CLASS 7 (U.S. CLS. 13, 19, 21, 23, 31, 34 AND 35).

FIRST USE 6-2-1993; IN COMMERCE 8-3-1998.

THE MARK CONSISTS OF THE WORDING "LONG XING", A CHEVRON AND A CURVED BAND IN FRONT OF A STYLIZED INCOMPLETE CIRCLE.

THE WORDING "LONG XING" HAS NO MEANING IN A FOREIGN LANGUAGE.

SER. NO. 85-215,550, FILED 1-12-2011.

EDWARD NELSON, EXAMINING ATTORNEY



David J. Kyffers

Director of the United States Patent and Trademark Office

United States of America

United States Patent and Trademark Office



Reg. No. 4,073,150

Registered Dec. 20, 2011

Int. Cl.: 45

SERVICE MARK

PRINCIPAL REGISTER

R. TED LESLIE PLLC (OKLAHOMA PROFESSIONAL LIMITED LIABILITY COMPANY)
2936 VIA ESPERANZA, SUITE A
EDMOND, OK 73013

FOR: LEGAL SERVICES, IN CLASS 45 (U.S. CLS. 100 AND 101).

FIRST USE 6-23-2009; IN COMMERCE 6-23-2009.

NO CLAIM IS MADE TO THE EXCLUSIVE RIGHT TO USE "BIKER ATTORNEY", APART FROM THE MARK AS SHOWN.

THE MARK CONSISTS OF A HIGHLY STYLIZED DESIGN OF A MOTORCYCLE SEEN SIDEWAYS. THE MOTORCYCLE, FROM HANDLEBAR TO REAR WHEEL, IS COMPOSED OF CAPITAL LETTERS STYLIZED IN SUCH A WAY AS TO FORM THREE-QUARTERS OF A MOTORCYCLE SHAPE. THE LETTERS SPELL "MY BIKER" ON ONE LINE ABOVE THE LETTERING IN "ATTORNEY" AND, IN A SMALL OVAL SHAPE, FITTED BETWEEN THE TWO LARGE MOTORCYCLE-FORMING WORDS, ARE THE LETTERS "RTL" IN CAPITAL LETTERS STYLED DIFFERENTLY FROM THE REST.

SER. NO. 85-215,888, FILED 1-12-2011.

JILL C. ALT, EXAMINING ATTORNEY



David J. Kybas

Director of the United States Patent and Trademark Office

United States of America

United States Patent and Trademark Office



Reg. No. 4,073,151

Registered Dec. 20, 2011

Int. Cl.: 21

TRADEMARK

PRINCIPAL REGISTER

THE CUMBERLAND COMPANIES, LLC (TENNESSEE LIMITED LIABILITY COMPANY)
7037 DUNCANS GLEN DRIVE
KNOXVILLE, TN 37919

FOR: FITTED DISPOSABLE POTTY CHAIR LINERS, IN CLASS 21 (U.S. CLS. 2, 13, 23, 29, 30, 33, 40 AND 50).

FIRST USE 7-20-2010; IN COMMERCE 7-20-2010.

THE MARK CONSISTS OF STYLIZED WORDING "TIDY TOTS" WITH A FANCIFUL DESIGN ELEMENT.

SER. NO. 85-215,968, FILED 1-12-2011.

JACQUELINE A. LAVINE, EXAMINING ATTORNEY



David J. Kyffers

Director of the United States Patent and Trademark Office

United States of America

United States Patent and Trademark Office

United TranzActions

Reg. No. 4,073,152

UNITED TRANZATIONS, LLC (FLORIDA LIMITED LIABILITY COMPANY)
3200 EXECUTIVE WAY
MIRAMAR, FL 33025

Registered Dec. 20, 2011

Int. Cl.: 36

FOR: CHECK VERIFICATION; DEBT COLLECTION, IN CLASS 36 (U.S. CLS. 100, 101 AND 102).

SERVICE MARK

FIRST USE 1-1-2010; IN COMMERCE 1-1-2010.

PRINCIPAL REGISTER

THE MARK CONSISTS OF STANDARD CHARACTERS WITHOUT CLAIM TO ANY PARTICULAR FONT, STYLE, SIZE, OR COLOR.

OWNER OF U.S. REG. NOS. 3,856,745 AND 3,881,597.

NO CLAIM IS MADE TO THE EXCLUSIVE RIGHT TO USE "TRANSACTIONS", APART FROM THE MARK AS SHOWN.

SER. NO. 85-216,043, FILED 1-12-2011.

KYLE PEETE, EXAMINING ATTORNEY



David J. Kyffers

Director of the United States Patent and Trademark Office

United States of America

United States Patent and Trademark Office

United TranzActions, LLC

Reg. No. 4,073,153

UNITED TRANZATIONS, LLC (FLORIDA LIMITED LIABILITY COMPANY)
3200 EXECUTIVE WAY
MIRAMAR, FL 33025

Registered Dec. 20, 2011

Int. Cl.: 36

FOR: CHECK VERIFICATION; DEBT COLLECTION, IN CLASS 36 (U.S. CLS. 100, 101 AND 102).

SERVICE MARK

FIRST USE 1-1-2010; IN COMMERCE 1-1-2010.

PRINCIPAL REGISTER

THE MARK CONSISTS OF STANDARD CHARACTERS WITHOUT CLAIM TO ANY PARTICULAR FONT, STYLE, SIZE, OR COLOR.

OWNER OF U.S. REG. NOS. 3,856,745 AND 3,881,597.

NO CLAIM IS MADE TO THE EXCLUSIVE RIGHT TO USE "TRANSACTIONS, LLC", APART FROM THE MARK AS SHOWN.

SER. NO. 85-216,123, FILED 1-12-2011.

KYLE PEETE, EXAMINING ATTORNEY



David J. Kyffers

Director of the United States Patent and Trademark Office

United States of America

United States Patent and Trademark Office



G&T International Trading INC

Reg. No. 4,073,154

G&T INT'L TRADING INC. (CALIFORNIA CORPORATION)
3117 ADELIA AVE #6
EL MONTE, CA 91733

Registered Dec. 20, 2011

Int. Cl.: 30

FOR: COFFEE; COFFEE BEANS; GROUND COFFEE BEANS; INSTANT COFFEE, IN CLASS 30 (U.S. CL. 46).

TRADEMARK

FIRST USE 12-4-2009; IN COMMERCE 12-4-2009.

PRINCIPAL REGISTER

NO CLAIM IS MADE TO THE EXCLUSIVE RIGHT TO USE "INTERNATIONAL TRADING INC", APART FROM THE MARK AS SHOWN.

THE COLOR(S) BLUE AND ORANGE IS/ARE CLAIMED AS A FEATURE OF THE MARK.

THE MARK CONSISTS OF THE WORDING "G & T INTERNATIONAL TRADING INC" IN BLUE BELOW THE STYLIZED LETTERS "GT" IN BLUE. THERE ARE TWO ORANGE LINES CURVED ALONG THE INSIDE UPPER PORTION OF THE LETTER "G".

SER. NO. 85-216,372, FILED 1-12-2011.

PAULA MAHONEY, EXAMINING ATTORNEY



David J. Kybas

Director of the United States Patent and Trademark Office

United States of America

United States Patent and Trademark Office

Access Senior Housing

Reg. No. 4,073,155

Registered Dec. 20, 2011

Int. Cl.: 35

SERVICE MARK

PRINCIPAL REGISTER

ACCESS SENIOR HOUSING (CALIFORNIA CORPORATION), DBA 2BEMA NETWORK
INC
1613 MONTGOMERY ST
SAN FRANCISCO, CA 94111

FOR: PROVIDING MARKETING SOLUTIONS FOR OPERATORS OF SENIOR HOUSING
COMMUNITIES IN THE SENIORS HOUSING INDUSTRY, IN CLASS 35 (U.S. CLS. 100, 101
AND 102).

FIRST USE 1-13-2011; IN COMMERCE 1-13-2011.

THE MARK CONSISTS OF STANDARD CHARACTERS WITHOUT CLAIM TO ANY PAR-
TICULAR FONT, STYLE, SIZE, OR COLOR.

NO CLAIM IS MADE TO THE EXCLUSIVE RIGHT TO USE "SENIOR HOUSING", APART
FROM THE MARK AS SHOWN.

SER. NO. 85-217,689, FILED 1-14-2011.

TRICIA SONNEBORN, EXAMINING ATTORNEY



David J. Kybas

Director of the United States Patent and Trademark Office

United States of America

United States Patent and Trademark Office

ENOBIA PHARMA

Reg. No. 4,073,156

Registered Dec. 20, 2011

Int. Cls.: 5 and 42

TRADEMARK

SERVICE MARK

PRINCIPAL REGISTER

ENOBIA PHARMA INC. (CANADA CORPORATION)
SUITE 23
2901 RACHEL STREET
EAST MONTREAL, QUEBEC, CANADA H1W4A4

FOR: PHARMACEUTICAL PREPARATIONS FOR THE TREATMENT OF MUSCULO-SKELETAL SYSTEM, NAMELY, BONE DISEASES , IN CLASS 5 (U.S. CLS. 6, 18, 44, 46, 51 AND 52).

FOR: RESEARCH AND DEVELOPMENT OF PHARMACEUTICALS AND TECHNOLOGIES RELATED TO BONE DISEASES AND ENZYME REPLACEMENT THERAPY, IN CLASS 42 (U.S. CLS. 100 AND 101).

THE MARK CONSISTS OF STANDARD CHARACTERS WITHOUT CLAIM TO ANY PARTICULAR FONT, STYLE, SIZE, OR COLOR.

OWNER OF CANADA REG. NO. TMA652182, DATED 11-3-2005, EXPIRES 11-3-2015.

NO CLAIM IS MADE TO THE EXCLUSIVE RIGHT TO USE "PHARMA", APART FROM THE MARK AS SHOWN.

SER. NO. 85-219,082, FILED 1-17-2011.

TARA PATE, EXAMINING ATTORNEY



David J. Kybas

Director of the United States Patent and Trademark Office

United States of America

United States Patent and Trademark Office

ProfessorPie

Reg. No. 4,073,157

Registered Dec. 20, 2011

Int. Cl.: 35

SERVICE MARK

PRINCIPAL REGISTER

BROWN, JARED ALEXANDER (UNITED STATES INDIVIDUAL), DBA PROFESSORPIE.COM
3058 WALNUT RIDGE DR.
ANN ARBOR, MI 48103 AND

BROWN, DONNA T. (UNITED STATES INDIVIDUAL), DBA PROFESSORPIE.COM
3058 WALNUT RIDGE DR.
ANN ARBOR, MI 48103

FOR: ADVERTISING THE SERVICES OF OTHERS VIA WEB PAGES OPTIMIZED FOR ONLINE SEARCH ENGINES; DEVELOPMENT OF MARKETING STRATEGIES, CONCEPTS AND TACTICS, NAMELY, AUDIENCE DEVELOPMENT, BRAND AWARENESS, CUSTOMER RELATIONS, ONLINE COMMUNITY BUILDING AND DIGITAL WORD OF MOUTH COMMUNICATIONS, IN CLASS 35 (U.S. CLS. 100, 101 AND 102).

FIRST USE 1-17-2010; IN COMMERCE 1-18-2010.

THE MARK CONSISTS OF STANDARD CHARACTERS WITHOUT CLAIM TO ANY PARTICULAR FONT, STYLE, SIZE, OR COLOR.

SER. NO. 85-219,631, FILED 1-18-2011.

LOURDES AYALA, EXAMINING ATTORNEY



David J. Kybas

Director of the United States Patent and Trademark Office

United States of America

United States Patent and Trademark Office



Reg. No. 4,073,158

Registered Dec. 20, 2011

Int. Cl.: 35

SERVICE MARK

PRINCIPAL REGISTER

CRUST (CALIFORNIA LIMITED LIABILITY COMPANY)
908 17TH STREET UNIT 7
SANTA MONICA, CA 90403

FOR: DESSERT SHOPS; PASTRY AND DESSERT SHOPS, IN CLASS 35 (U.S. CLS. 100, 101 AND 102).

FIRST USE 9-1-2009; IN COMMERCE 9-1-2009.

NO CLAIM IS MADE TO THE EXCLUSIVE RIGHT TO USE "CRUST", APART FROM THE MARK AS SHOWN.

THE COLOR(S) TEAL/BROWN IS/ARE CLAIMED AS A FEATURE OF THE MARK.

THE MARK CONSISTS OF A TEAL BLUE RIBBON WITH THE WORD "CRUST" IN THE CENTER OF THE TOP PORTION OF THE RIBBON.

SER. NO. 85-220,019, FILED 1-18-2011.

RONALD AIKENS, EXAMINING ATTORNEY



David J. Kyffers

Director of the United States Patent and Trademark Office

United States of America

United States Patent and Trademark Office

PROJECT MAKEOVER

Reg. No. 4,073,159

Registered Dec. 20, 2011

Int. Cl.: 41

SERVICE MARK

PRINCIPAL REGISTER

LORI L. GREENWALD, M.D., P.C. (CONNECTICUT PROFESSIONAL CORPORATION)
1 BARNARD LANE
BLOOMFIELD, CT 06002

FOR: ENTERTAINMENT SERVICES IN THE NATURE OF AN ON-GOING REALITY BASED TELEVISION PROGRAM; ENTERTAINMENT SERVICES, NAMELY, CONDUCTING CONTESTS , IN CLASS 41 (U.S. CLS. 100, 101 AND 107).

FIRST USE 1-14-2011; IN COMMERCE 1-14-2011.

THE MARK CONSISTS OF STANDARD CHARACTERS WITHOUT CLAIM TO ANY PARTICULAR FONT, STYLE, SIZE, OR COLOR.

NO CLAIM IS MADE TO THE EXCLUSIVE RIGHT TO USE "MAKEOVER", APART FROM THE MARK AS SHOWN.

SER. NO. 85-220,827, FILED 1-19-2011.

RICHARD WHITE, EXAMINING ATTORNEY



David J. Kybas

Director of the United States Patent and Trademark Office

United States of America

United States Patent and Trademark Office



Reg. No. 4,073,160

Registered Dec. 20, 2011

Int. Cl.: 41

SERVICE MARK

PRINCIPAL REGISTER

GROOVBOSTON, LLC (MASSACHUSETTS LIMITED LIABILITY COMPANY)
BUILDING A
21 OLYMPIA AVENUE
WOBURN, MA 01801

FOR: ENTERTAINMENT SERVICES IN THE NATURE OF DISC JOCKEYS FOR SPECIAL EVENTS; ARRANGING AND CONDUCTING MOBILE NIGHTCLUB EVENTS , IN CLASS 41 (U.S. CLS. 100, 101 AND 107).

FIRST USE 12-11-2004; IN COMMERCE 2-2-2005.

THE MARK CONSISTS OF THE STYLIZED LETTERS "G","B" AND THE WORD "GROOVBOSTON" WITHIN A MODIFIED OVAL FRAME WITH MULTIPLE LINES ABOVE THE WORD "GROOVBOSTON" DEPICTING AN AUDIO EQUALIZER.

SER. NO. 85-221,404, FILED 1-19-2011.

KYLE PEETE, EXAMINING ATTORNEY



David J. Kyffers

Director of the United States Patent and Trademark Office

United States of America

United States Patent and Trademark Office

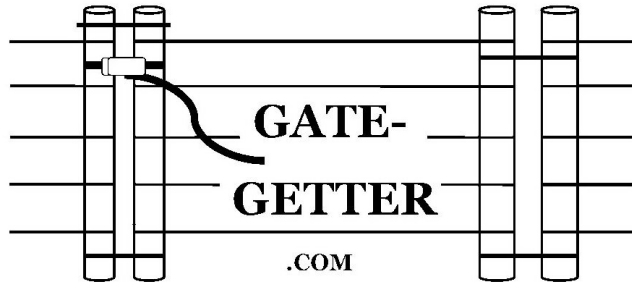

Reg. No. 4,073,161

Registered Dec. 20, 2011

Int. Cl.: 22

TRADEMARK

PRINCIPAL REGISTER

MCLARTY, CAROLYN (UNITED STATES INDIVIDUAL)
48668 SCR 214
MUTUAL, OK 73853

FOR: STRAP AND RATCHET DEVICE WITH A CARRYING POUCH USED TO OPEN AND CLOSE WIRE GATES ON FARMS AND RANCHES, IN CLASS 22 (U.S. CLS. 1, 2, 7, 19, 22, 42 AND 50).

FIRST USE 12-25-2010; IN COMMERCE 12-25-2010.

NO CLAIM IS MADE TO THE EXCLUSIVE RIGHT TO USE "GATE-GETTER.COM", APART FROM THE MARK AS SHOWN.

THE MARK CONSISTS OF A WIRE FENCE GATE WITH A STRAP ON THE POSTS. THE STYLIZED TEXT "GATE-GETTER .COM" APPEARS IN THE CENTER.

SER. NO. 85-221,442, FILED 1-19-2011.

DAVID I, EXAMINING ATTORNEY



David J. Kyfos

Director of the United States Patent and Trademark Office

United States of America

United States Patent and Trademark Office

World Coach Institute

Reg. No. 4,073,162

WORLD COACH INSTITUTE, INC. (FLORIDA CORPORATION)

Registered Dec. 20, 2011

P.O. BOX 398212
MIAMI BEACH, FL 33239

Int. Cl.: 41

FOR: PROVIDING TRAINING COURSES, ONLINE TRAINING COURSES, SELF-STUDY TRAINING COURSES, AND TRAINING TELECLASSES FOR THE PURPOSE OF TRAINING INDIVIDUALS TO BECOME PROFESSIONAL COACHES IN A VARIETY OF FIELDS AND DISCIPLINES, IN CLASS 41 (U.S. CLS. 100, 101 AND 107).

SERVICE MARK

PRINCIPAL REGISTER

FIRST USE 7-25-2006; IN COMMERCE 7-25-2006.

THE MARK CONSISTS OF STANDARD CHARACTERS WITHOUT CLAIM TO ANY PARTICULAR FONT, STYLE, SIZE, OR COLOR.

NO CLAIM IS MADE TO THE EXCLUSIVE RIGHT TO USE "INSTITUTE", APART FROM THE MARK AS SHOWN.

SEC. 2(F).

SER. NO. 85-221,979, FILED 1-20-2011.

DAVID I, EXAMINING ATTORNEY



David J. Kyffers

Director of the United States Patent and Trademark Office

United States of America

United States Patent and Trademark Office

SearchSpring

Reg. No. 4,073,163

Registered Dec. 20, 2011

Int. Cl.: 42

SERVICE MARK

PRINCIPAL REGISTER

B7 INTERACTIVE, LLC (COLORADO LIMITED LIABILITY COMPANY)
SUITE 206
4291 AUSTIN BLUFFS PARKWAY
COLORADO SPRINGS, CO 80918

FOR: SOFTWARE AS A SERVICE (SAAS) SERVICES FEATURING SEARCH ENGINE SOFTWARE FOR USE ON E-COMMERCE WEBSITES AND SOFTWARE FOR OPTIMIZING WEBSITE NAVIGATION OF E-COMMERCE WEBSITES, IN CLASS 42 (U.S. CLS. 100 AND 101).

FIRST USE 1-1-2008; IN COMMERCE 1-1-2008.

THE MARK CONSISTS OF STANDARD CHARACTERS WITHOUT CLAIM TO ANY PARTICULAR FONT, STYLE, SIZE, OR COLOR.

SER. NO. 85-223,452, FILED 1-21-2011.

ANDREA K. NADELMAN, EXAMINING ATTORNEY



David J. Kyffers

Director of the United States Patent and Trademark Office

United States of America

United States Patent and Trademark Office

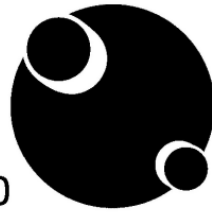

ADVANCED SOUND RETRIEVER

Reg. No. 4,073,164

Registered Dec. 20, 2011

Int. Cl.: 9

TRADEMARK

PRINCIPAL REGISTER

PIONEER KABUSHIKI KAISHA (JAPAN CORPORATION), DBA PIONEER CORPORATION
1-1, SHIN-OGURA, SAIWAI-KU, KAWASAKI-SHI
KANAGAWA-KEN, 212-0031, JAPAN

FOR: AUDIO-RECEIVERS AND VIDEO-RECEIVERS; AUDIO AMPLIFIERS; HOME THEATER SYSTEM, COMPRISING ONE OR MORE OF AUDIO SPEAKERS, AUDIO/VIDEO RECEIVERS, SUBWOOFERS, VIDEO DISC PLAYERS AND TELEVISION SETS; AUDIO SPEAKERS; VIDEO DISC PLAYERS; STEREO TUNERS, IN CLASS 9 (U.S. CLS. 21, 23, 26, 36 AND 38).

OWNER OF JAPAN REG. NO. 5148619, DATED 7-4-2008, EXPIRES 7-4-2018.

NO CLAIM IS MADE TO THE EXCLUSIVE RIGHT TO USE "ADVANCED SOUND", APART FROM THE MARK AS SHOWN.

THE MARK CONSISTS OF THE WORD "ADVANCED" IN STYLIZED FONT TO THE LEFT OF A DARK CIRCLE WITH TWO SHORT LIGHT CYLINDERS WITH DARK TOPS SUPERIMPOSED IN THE 5 O'CLOCK AND 11 O'CLOCK POSITIONS, ALL ABOVE "SOUND RETRIEVER" IN STYLIZED, LARGER FONT.

SER. NO. 85-223,483, FILED 1-21-2011.

NAPOLEON SHARMA, EXAMINING ATTORNEY



David J. Kybas

Director of the United States Patent and Trademark Office

United States of America

United States Patent and Trademark Office

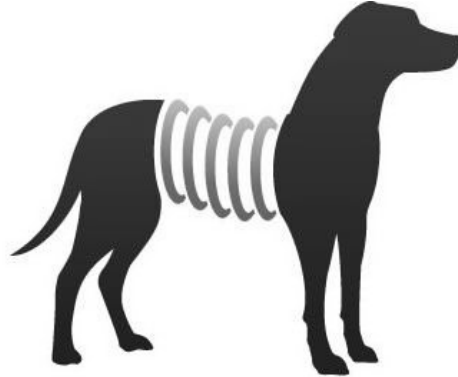

Reg. No. 4,073,165

Registered Dec. 20, 2011

Int. Cl.: 42

SERVICE MARK

PRINCIPAL REGISTER

B7 INTERACTIVE, LLC (COLORADO LIMITED LIABILITY COMPANY)
SUITE 206
4291 AUSTIN BLUFFS PARKWAY
COLORADO SPRINGS, CO 80918

FOR: SOFTWARE AS A SERVICE (SAAS) SERVICES FEATURING SEARCH ENGINE SOFTWARE FOR USE ON E-COMMERCE WEBSITES AND SOFTWARE FOR OPTIMIZING WEBSITE NAVIGATION OF E-COMMERCE WEBSITES, IN CLASS 42 (U.S. CLS. 100 AND 101).

FIRST USE 12-2-2009; IN COMMERCE 12-2-2009.

THE MARK CONSISTS OF A DOG WITH A SPRING BELLY.

SER. NO. 85-223,499, FILED 1-21-2011.

ANDREA K. NADELMAN, EXAMINING ATTORNEY



David J. Kybas

Director of the United States Patent and Trademark Office

United States of America

United States Patent and Trademark Office



Reg. No. 4,073,166

Registered Dec. 20, 2011

Int. Cl.: 3

TRADEMARK

PRINCIPAL REGISTER

PERSONAL CARE PRODUCTS LLC (DELAWARE LIMITED LIABILITY COMPANY)
800 NICOLLET MALL, SUITE 1150
C/O STONE ARCH CAPITAL, LLC
MINNEAPOLIS, MN 55402

FOR: SHOWER GEL, BODY WASH, BODY LOTION, SHAMPOO, CONDITIONER, STYLING GEL, IN CLASS 3 (U.S. CLS. 1, 4, 6, 50, 51 AND 52).

FIRST USE 1-24-2011; IN COMMERCE 1-24-2011.

OWNER OF U.S. REG. NOS. 3,301,688 AND 3,479,656.

NO CLAIM IS MADE TO THE EXCLUSIVE RIGHT TO USE "NATURAL ESSENCE", APART FROM THE MARK AS SHOWN.

THE MARK CONSISTS OF THE WORD "NATURAL" ABOVE THE WORD "ESSENCE" WITH AN IMAGE OF A LEAF ABOVE A PORTION OF THE WORD "NATURAL", AND THE WORDS "BY PERSONAL CARE" LOCATED WITHIN A SOLID BAR BELOW THE WORD "ESSENCE".

SEC. 2(F) AS TO "PERSONAL CARE".

SER. NO. 85-224,257, FILED 1-24-2011.

ROBIN MITTLER, EXAMINING ATTORNEY



David J. Kyffers

Director of the United States Patent and Trademark Office

United States of America

United States Patent and Trademark Office

THERMOWASH

Reg. No. 4,073,167

Registered Dec. 20, 2011

**Int. Cls.: 7, 16, 20, 40
and 42**

TRADEMARK

SERVICE MARK

PRINCIPAL REGISTER

SPEAR GROUP HOLDINGS LIMITED (UNITED KINGDOM PRIVATE LIMITED COMPANY)
CHRISTOPHER GREY COURT, LAKESIDE
LLANTARNAM INDUSTRIAL PARK
CWMBRAN, GWENT, WALES, UNITED KINGDOM NP443SE

FOR: AUTOMATED LABEL APPLICATION EQUIPMENT; MACHINES FOR DISPENSING LABELS; LABEL MAKING MACHINES; LABEL OVER-PRINTERS, NAMELY, MACHINES FOR USE IN OVERPRINTING LABELS ON CARTONS, BOTTLES, LABELS, CATCH COVERS, PLASTIC BAGS, AND POUCHES; AUTOMATIC MACHINES USED TO DISPENSE, APPLY, OR PRINT AND APPLY LABELS TO CONTAINERS, PACKAGES AND BOTTLES, IN CLASS 7 (U.S. CLS. 13, 19, 21, 23, 31, 34 AND 35).

FOR: CELLOPHANE LABELS; CELLOPHANE BLANK, PRINTED AND PARTIALLY-PRINTED LABELS; SELF-ADHESIVE PAPER LABELS; ADHESIVE LABELS; SELF-ADHESIVE BLANK, PRINTED AND PARTIALLY PRINTED PAPER LABELS; BLANK, PRINTED AND PARTIALLY PRINTED PAPER LABELS; LABELS OF PAPER; LABELS OF CARDBOARDS; SHIPPING LABELS; BAR CODE LABELS; MACHINES FOR PRINTING LABELS AND PRINTING MACHINES FOR PRINTING ON LABELS, NAMELY, LABEL PRINTING MACHINES, IN CLASS 16 (U.S. CLS. 2, 5, 22, 23, 29, 37, 38 AND 50).

FOR: LABELS NOT OF TEXTILE, NAMELY, PLASTIC LABELS AND PLASTIC FILM LABELS, IN CLASS 20 (U.S. CLS. 2, 13, 22, 25, 32 AND 50).

FOR: LABEL PRINTING SERVICES; PRINTING LABELS FOR OTHERS; MANUFACTURING CONSULTATION IN THE FIELD OF LABEL APPLICATION PROCESSES; CUSTOM MANUFACTURING IN THE FIELD OF APPLICATION SERVICES, NAMELY, APPLYING LABELS FOR OTHERS, IN CLASS 40 (U.S. CLS. 100, 103 AND 106).

FOR: LABEL AND PACKAGING DESIGN SERVICES, IN CLASS 42 (U.S. CLS. 100 AND 101).

THE MARK CONSISTS OF STANDARD CHARACTERS WITHOUT CLAIM TO ANY PARTICULAR FONT, STYLE, SIZE, OR COLOR.

OWNER OF ERPN CMNTY TM OFC REG. NO. 004702064, DATED 10-2-2006, EXPIRES 10-24-2015.



David J. Kyjars

Director of the United States Patent and Trademark Office

Reg. No. 4,073,167 SER. NO. 85-224,330, FILED 1-24-2011.

JOHN DWYER, EXAMINING ATTORNEY

United States of America

United States Patent and Trademark Office



Reg. No. 4,073,168

Registered Dec. 20, 2011

Int. Cl.: 28

TRADEMARK

PRINCIPAL REGISTER

POTERUCHA, THERESA M. (UNITED STATES INDIVIDUAL), DBA MAGNET LEARNING COMPANY
1521 SW 5TH STREET
ROCHESTER, MN 55902

FOR: EDUCATIONAL CARD GAMES, IN CLASS 28 (U.S. CLS. 22, 23, 38 AND 50).

FIRST USE 6-2-1997; IN COMMERCE 9-20-1997.

NO CLAIM IS MADE TO THE EXCLUSIVE RIGHT TO USE "A MAGNET LEARNING GAME", APART FROM THE MARK AS SHOWN.

THE COLOR(S) PINK, YELLOW, WHITE AND BLACK IS/ARE CLAIMED AS A FEATURE OF THE MARK.

THE MARK CONSISTS OF BACKGROUND IS DARK PINK WITH A PATTERN OF PLUS SIGN AND MINUS SIGN IN BRIGHT YELLOW. IN THE MIDDLE ARE THREE WHITE PLAYING CARDS OUTLINED IN BLACK. IN EACH CARD THERE IS A LARGE PINK NUMBER ONE AND TWO AND THREE AND IN THE RIGHT HAND CORNER OF THE CARD IS A PINK CIRCLE WITH A SMALL WHITE NUMBER THREE IN IT ONLY HALF OF THE CARD SHOWS. OVER THE THREE CARDS THERE ARE THE NUMBER ONE TWO AND THREE DRAWN IN BLACK FILLED WITH BRIGHT YELLOW AND FACES ON EACH CONSIST OF TWO EYES DRAWN IN BLACK WITH WHITE BACKGROUND, A BLACK DRAWN NOSE, A BLACK DRAWN MOUTH AND TWO PINK CIRCLES ON EITHER SIDE OF THE MOUTH SIGNIFYING CHEEKS. THERE IS A "C" IN A CIRCLE TO THE RIGHT BOTTOM OF THE CARDS SIGNIFYING COPYRIGHT AND BELOW THE THREE YELLOW NUMBERS AND THERE IS THE WORD "NUMBERKINS" WHITE LETTERS OUTLINED IN BLACK WITH A PLUS SIGN BEFORE THE WORD AND A MINUS SIGN AFTER THE WORD. BELOW THE WORD "NUMBERKINS" IN WHITE LETTERS SHADOWED IN BLACK ARE THE WORDS "A MAGNET LEARNING GAME".

THE WORD "MAGNET" HAS NO MEANING IN A FOREIGN LANGUAGE.

SER. NO. 85-224,566, FILED 1-24-2011.

ANN E. SAPPENFIELD, EXAMINING ATTORNEY



David J. Kybas

Director of the United States Patent and Trademark Office

United States of America

United States Patent and Trademark Office

Vonbio

Reg. No. 4,073,169

Registered Dec. 20, 2011

Int. Cl.: 3

TRADEMARK

PRINCIPAL REGISTER

CEDOREX, LLC (MARYLAND LIMITED LIABILITY COMPANY)
13945 CARTHAGE CIRCLE
BURTONSVILLE, MD 20866

FOR: BAR SOAP, IN CLASS 3 (U.S. CLS. 1, 4, 6, 50, 51 AND 52).

FIRST USE 1-10-2011; IN COMMERCE 1-10-2011.

THE MARK CONSISTS OF THE STYLIZED WORDING "VONBIO" ENCLOSED WITHIN A THIN, HORIZONTAL OVAL OUTLINE.

SER. NO. 85-224,807, FILED 1-24-2011.

JORDAN BAKER, EXAMINING ATTORNEY



David J. Kyffers

Director of the United States Patent and Trademark Office

United States of America

United States Patent and Trademark Office

Compassion Hospice

Reg. No. 4,073,170

Registered Dec. 20, 2011

Int. Cl.: 44

SERVICE MARK

PRINCIPAL REGISTER

COMPASSION HOSPICE (TEXAS CORPORATION)
2528 CALDER
BEAUMONT, TX 77702

FOR: HOSPICES, IN CLASS 44 (U.S. CLS. 100 AND 101).

FIRST USE 5-27-2007; IN COMMERCE 5-27-2007.

THE MARK CONSISTS OF STANDARD CHARACTERS WITHOUT CLAIM TO ANY PARTICULAR FONT, STYLE, SIZE, OR COLOR.

NO CLAIM IS MADE TO THE EXCLUSIVE RIGHT TO USE "HOSPICE", APART FROM THE MARK AS SHOWN.

SER. NO. 85-224,858, FILED 1-24-2011.

DEIRDRE ROBERTSON, EXAMINING ATTORNEY



David J. Kyffers

Director of the United States Patent and Trademark Office

United States of America

United States Patent and Trademark Office



Reg. No. 4,073,171

Registered Dec. 20, 2011

Int. Cl.: 36

SERVICE MARK

PRINCIPAL REGISTER

WELLFLEET WEALTH INC. (MASSACHUSETTS CORPORATION)
SUITE 100
200 EASTWIND CIRCLE
WELLFLEET, MA 02667

FOR: WEALTH MANAGEMENT AND INVESTMENT CONSULTATIVE SERVICES, IN CLASS 36 (U.S. CLS. 100, 101 AND 102).

FIRST USE 6-1-2010; IN COMMERCE 6-1-2010.

NO CLAIM IS MADE TO THE EXCLUSIVE RIGHT TO USE "WELLFLEET WEALTH INCORPORATED", APART FROM THE MARK AS SHOWN.

THE MARK CONSISTS OF THE STYLIZED TEXT "W WELLFLEET WEALTH INCORPORATED".

SER. NO. 85-224,981, FILED 1-24-2011.

ELIZABETH KAJUBI, EXAMINING ATTORNEY



David J. Kybas

Director of the United States Patent and Trademark Office

United States of America

United States Patent and Trademark Office

EVERY CITIZEN ONLINE

Reg. No. 4,073,172

Registered Dec. 20, 2011

Int. Cls.: 35 and 41

SERVICE MARK

PRINCIPAL REGISTER

CN FINANCIAL SERVICES, LLC (KENTUCKY LIMITED LIABILITY COMPANY)
P.O. BOX 3448
1020 COLLEGE STREET
BOWLING GREEN, KY 421023448

FOR: PROMOTING PUBLIC AWARENESS OF THE BENEFITS OF BROADBAND INTERNET USE; ADVERTISING SERVICES, NAMELY, PROMOTING PUBLIC AWARENESS OF THE BENEFITS OF BROADBAND INTERNET USE; ADVERTISING SERVICES, NAMELY, PROMOTING THE ADOPTION OF HOME BROADBAND INTERNET USE BY PROMOTING THE BROADBAND INTERNET SERVICES OF OTHERS; CHARITABLE SERVICES, NAMELY, PROMOTING PUBLIC AWARENESS OF THE BENEFITS OF BROADBAND INTERNET THROUGH THE PROVISION OF COMPUTERS AT NO COST OR A REDUCED COST TO LIBRARIES, COMMUNITY COLLEGES, AND SIMILAR GOVERNMENTAL AND/OR NON-PROFIT ORGANIZATIONS; PROMOTING PUBLIC AWARENESS OF THE NEED FOR TECHNOLOGY LITERACY, IN CLASS 35 (U.S. CLS. 100, 101 AND 102).

FIRST USE 10-0-2010; IN COMMERCE 10-0-2010.

FOR: TRAINING IN THE USE AND OPERATION OF COMPUTERS; TRAINING IN THE USE AND OPERATION OF COMPUTERS TO ACCESS THE INTERNET VIA BROADBAND; PROMOTING THE BENEFITS OF BROADBAND USE THROUGH CONDUCTING TRAINING SESSIONS IN THE FIELD OF COMPUTERS, IN CLASS 41 (U.S. CLS. 100, 101 AND 107).

FIRST USE 10-0-2010; IN COMMERCE 10-0-2010.

THE MARK CONSISTS OF STANDARD CHARACTERS WITHOUT CLAIM TO ANY PARTICULAR FONT, STYLE, SIZE, OR COLOR.

SER. NO. 85-225,103, FILED 1-25-2011.

SETH A. RAPPAPORT, EXAMINING ATTORNEY



David J. Kyffers

Director of the United States Patent and Trademark Office

United States of America

United States Patent and Trademark Office

BALANCED U

Reg. No. 4,073,173

Registered Dec. 20, 2011

Int. Cl.: 44

SERVICE MARK

PRINCIPAL REGISTER

COMPASS GROUP USA, INC. (DELAWARE CORPORATION)
2400 YORKMONT ROAD
CHARLOTTE, NC 28217

FOR: PROVIDING CONSULTATION TO INDIVIDUALS TO HELP THEM MAKE NUTRITIONAL CHANGES IN THEIR DAILY LIVING TO IMPROVE HEALTH, IN CLASS 44 (U.S. CLS. 100 AND 101).

FIRST USE 11-1-2010; IN COMMERCE 11-1-2010.

THE MARK CONSISTS OF STANDARD CHARACTERS WITHOUT CLAIM TO ANY PARTICULAR FONT, STYLE, SIZE, OR COLOR.

SER. NO. 85-225,607, FILED 1-25-2011.

BERYL GARDNER, EXAMINING ATTORNEY



David J. Kyffers

Director of the United States Patent and Trademark Office

United States of America

United States Patent and Trademark Office



Reg. No. 4,073,174

Registered Dec. 20, 2011

Int. Cl.: 44

SERVICE MARK

PRINCIPAL REGISTER

COMPASS GROUP USA, INC. (DELAWARE CORPORATION)
2400 YORKMONT ROAD
CHARLOTTE, NC 28217

FOR: PROVIDING CONSULTATION TO INDIVIDUALS TO HELP THEM MAKE NUTRITIONAL CHANGES IN THEIR DAILY LIVING TO IMPROVE HEALTH, IN CLASS 44 (U.S. CLS. 100 AND 101).

FIRST USE 11-1-2010; IN COMMERCE 11-1-2010.

THE MARK CONSISTS OF THE WORD "BALANCED" IN BLOCK LETTERS IN THE CENTER OF THE LETTER "U".

SER. NO. 85-225,609, FILED 1-25-2011.

BERYL GARDNER, EXAMINING ATTORNEY



David J. Kyffers

Director of the United States Patent and Trademark Office

United States of America

United States Patent and Trademark Office

WELLDONEDO

Reg. No. 4,073,175

Registered Dec. 20, 2011

Int. Cl.: 44

SERVICE MARK

PRINCIPAL REGISTER

MAXINE, LTD. (ILLINOIS CORPORATION)
712 NORTH RUSH STREET
CHICAGO, IL 60611

FOR: HAIR SALON SERVICES, IN CLASS 44 (U.S. CLS. 100 AND 101).

FIRST USE 5-31-2010; IN COMMERCE 5-31-2010.

THE MARK CONSISTS OF STANDARD CHARACTERS WITHOUT CLAIM TO ANY PARTICULAR FONT, STYLE, SIZE, OR COLOR.

SER. NO. 85-226,718, FILED 1-26-2011.

KRISTIN CARLSON, EXAMINING ATTORNEY



David J. Kybas

Director of the United States Patent and Trademark Office

United States of America

United States Patent and Trademark Office

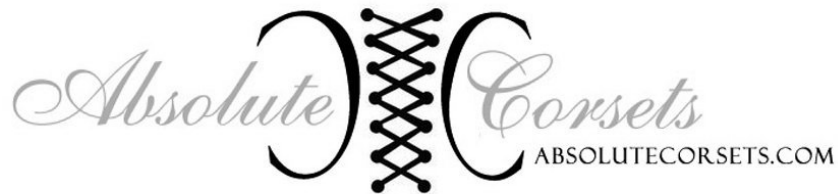

Reg. No. 4,073,176

PAVAO, AMY (UNITED STATES INDIVIDUAL), DBA SERENITY DESIGNS
P.O. BOX 692

Registered Dec. 20, 2011

JUPITER, FL 33468

Int. Cls.: 25 and 35

FOR: CORSETS, IN CLASS 25 (U.S. CLS. 22 AND 39).

TRADEMARK

FIRST USE 8-30-2009; IN COMMERCE 4-21-2010.

SERVICE MARK

FOR: ONLINE RETAIL STORE SERVICES FEATURING CORSETS AND SKIRTS, IN CLASS 35 (U.S. CLS. 100, 101 AND 102).

PRINCIPAL REGISTER

FIRST USE 1-26-2011; IN COMMERCE 1-26-2011.

NO CLAIM IS MADE TO THE EXCLUSIVE RIGHT TO USE "CORSETS", APART FROM THE MARK AS SHOWN.

THE MARK CONSISTS OF THE STYLIZED WORDING "ABSOLUTE CORSETS", THE WORDING "ABSOLUTECORSETS.COM" AND A STYLIZED CORSET.

SER. NO. 85-226,960, FILED 1-26-2011.

DAWN FELDMAN, EXAMINING ATTORNEY



David J. Kybas

Director of the United States Patent and Trademark Office

United States of America

United States Patent and Trademark Office

OPTIREV

Reg. No. 4,073,177

Registered Dec. 20, 2011

Int. Cl.: 35

SERVICE MARK

PRINCIPAL REGISTER

OPTIREV, LLC (CALIFORNIA LIMITED LIABILITY COMPANY), DBA OPTIREV
1034 WINDING RIDGE COURT
SANTA ROSA, CA 95404

FOR: BUSINESS CONSULTING SERVICES FOR THE HOSPITALITY AND HOTEL INDUSTRY; PROVIDING PUBLIC SECTOR CHANNEL MANAGEMENT SERVICES; MARKETING SERVICES, NAMELY, PROMOTING OR ADVERTISING THE GOODS AND SERVICES OF OTHERS IN THE HOSPITALITY AND HOTEL INDUSTRY; CREATION OF MARKETING TOOLS DESIGNED TO INCREASE A CLIENT COMPANY'S KNOWLEDGE OF CUSTOMER NEEDS AND SALES STRATEGY IN THE HOSPITALITY AND HOTEL INDUSTRY, IN CLASS 35 (U.S. CLS. 100, 101 AND 102).

FIRST USE 3-5-2010; IN COMMERCE 3-5-2010.

THE MARK CONSISTS OF STANDARD CHARACTERS WITHOUT CLAIM TO ANY PARTICULAR FONT, STYLE, SIZE, OR COLOR.

SER. NO. 85-227,256, FILED 1-26-2011.

JANICE KIM, EXAMINING ATTORNEY



David J. Kyros

Director of the United States Patent and Trademark Office

United States of America

United States Patent and Trademark Office

ASNAP

Reg. No. 4,073,178

AEGIS FOOD TESTING LABORATORIES, INC. (SOUTH DAKOTA CORPORATION)
224 NORTH DERBY LANE

Registered Dec. 20, 2011

NORTH SIOUX CITY, SD 57049

Int. Cl.: 42

FOR: PROVIDING TEMPORARY USE OF A NON-DOWNLOADABLE WEB-BASED SOFTWARE APPLICATION FOR USE IN DATA MANAGEMENT OF FOOD TESTING DATA AND ALLOWING COMMUNICATION OF FOOD TESTING RELATED RESULTS, IN CLASS 42 (U.S. CLS. 100 AND 101).

SERVICE MARK

PRINCIPAL REGISTER

FIRST USE 10-6-2009; IN COMMERCE 10-6-2009.

THE MARK CONSISTS OF STANDARD CHARACTERS WITHOUT CLAIM TO ANY PARTICULAR FONT, STYLE, SIZE, OR COLOR.

SER. NO. 85-227,953, FILED 1-27-2011.

NAPOLEON SHARMA, EXAMINING ATTORNEY



David J. Kyffers

Director of the United States Patent and Trademark Office

United States of America

United States Patent and Trademark Office

HEALTHY AT NBCU

Reg. No. 4,073,179

NBC UNIVERSAL MEDIA, LLC (DELAWARE LIMITED LIABILITY COMPANY)
30 ROCKEFELLER PLAZA
NEW YORK, NY 10112

Registered Dec. 20, 2011

Int. Cl.: 35

FOR: PROMOTING AWARENESS OF HEALTH-RELATED ISSUES, IN CLASS 35 (U.S. CLS. 100, 101 AND 102).

SERVICE MARK

FIRST USE 6-14-2010; IN COMMERCE 6-14-2010.

PRINCIPAL REGISTER

THE MARK CONSISTS OF STANDARD CHARACTERS WITHOUT CLAIM TO ANY PARTICULAR FONT, STYLE, SIZE, OR COLOR.

OWNER OF U.S. REG. NOS. 3,117,668, 3,117,670 AND OTHERS.

NO CLAIM IS MADE TO THE EXCLUSIVE RIGHT TO USE "HEALTHY", APART FROM THE MARK AS SHOWN.

SER. NO. 85-228,248, FILED 1-27-2011.

CORY BOONE, EXAMINING ATTORNEY



David J. Kybas

Director of the United States Patent and Trademark Office

United States of America

United States Patent and Trademark Office

KA-ZAR

Reg. No. 4,073,180

Registered Dec. 20, 2011

Int. Cl.: 41

SERVICE MARK

PRINCIPAL REGISTER

MARVEL CHARACTERS, INC. (DELAWARE CORPORATION)
1600 ROSECRANS AVENUE
MANHATTAN BEACH, CA 90266

FOR: ENTERTAINMENT SERVICES, NAMELY, PROVIDING ONLINE NON-DOWNLOADABLE COMIC BOOKS AND GRAPHIC NOVELS FEATURING FICTIONAL ACTION ADVENTURE STORIES AND CHARACTERS, IN CLASS 41 (U.S. CLS. 100, 101 AND 107).

FIRST USE 1-20-2011; IN COMMERCE 1-20-2011.

THE MARK CONSISTS OF STANDARD CHARACTERS WITHOUT CLAIM TO ANY PARTICULAR FONT, STYLE, SIZE, OR COLOR.

OWNER OF U.S. REG. NO. 3,944,780.

SER. NO. 85-229,119, FILED 1-28-2011.

ROSELLE HERRERA, EXAMINING ATTORNEY



David J. Kyffers

Director of the United States Patent and Trademark Office

United States of America

United States Patent and Trademark Office



Reg. No. 4,073,181

THE TEACHER'S TECH (KANSAS CORPORATION)
6955 HALLET ST.
SHAWNEE, KS 66216

Registered Dec. 20, 2011

Int. Cl.: 42

FOR: INFORMATION TECHNOLOGY CONSULTATION, IN CLASS 42 (U.S. CLS. 100 AND 101).

SERVICE MARK

FIRST USE 1-1-2006; IN COMMERCE 1-1-2006.

PRINCIPAL REGISTER

NO CLAIM IS MADE TO THE EXCLUSIVE RIGHT TO USE "THE TEACHER'S TECH", APART FROM THE MARK AS SHOWN.

THE COLOR(S) BLUE IS/ARE CLAIMED AS A FEATURE OF THE MARK.

THE MARK CONSISTS OF THE WORDING "THE TEACHER'S TECH" AND DESIGNS, ALL IN BLUE. THE DESIGNS CONSIST OF THREE REPEATED HORIZONTAL LINES THAT INTERSECT WITH THREE SHORTER VERTICAL LINES TO THE TOP AND LEFT OF THE WORDS OF THE MARK. THE INTERSECTING LINES FORM A STYLIZED REPRESENTATION OF THE LETTERS "TTT".

SER. NO. 85-229,599, FILED 1-30-2011.

CORY BOONE, EXAMINING ATTORNEY



David J. Kyjars

Director of the United States Patent and Trademark Office

United States of America

United States Patent and Trademark Office



Reg. No. 4,073,182

Registered Dec. 20, 2011

Int. Cl.: 35

SERVICE MARK

PRINCIPAL REGISTER

BCE TECHNOLOGY INC. (PENNSYLVANIA CORPORATION)
1613 SAND KEY ESTATES COURT
CLEARWATER, FL 33767

FOR: BUSINESS AND MANAGEMENT CONSULTING FOR HEALTHCARE PROVIDERS AND RELATED BUSINESSES, IN CLASS 35 (U.S. CLS. 100, 101 AND 102).

FIRST USE 1-1-2011; IN COMMERCE 1-1-2011.

NO CLAIM IS MADE TO THE EXCLUSIVE RIGHT TO USE "BCE" AND "A HEALTHCARE ADVISORY COMPANY", APART FROM THE MARK AS SHOWN.

THE COLOR(S) DARK BLUE AND LIGHT BLUE IS/ARE CLAIMED AS A FEATURE OF THE MARK.

THE MARK CONSISTS OF THE WORDING "BCE" IN DARK BLUE OVER THREE RECTANGLES ON END IN SHADES OF LIGHTER BLUE THAT GETS LIGHTER FROM LEFT TO RIGHT OVER THE WORDING "A HEALTHCARE ADVISORY COMPANY" IN DARK BLUE.

SER. NO. 85-230,332, FILED 1-31-2011.

MARY CRAWFORD, EXAMINING ATTORNEY



David J. Kyffers

Director of the United States Patent and Trademark Office

United States of America

United States Patent and Trademark Office

Admission Intuition

Reg. No. 4,073,183

ADMISSION INTUITION, LLC. (COLORADO LIMITED LIABILITY COMPANY)
6216 S MACON WAY
ENGLEWOOD, CO 80111

Registered Dec. 20, 2011

Int. Cl.: 41

FOR: ADMISSION CONSULTING SERVICES, NAMELY, CONSULTING IN THE FIELD OF COLLEGE ADMISSIONS, SPECIFICALLY, COLLEGE SELECTION, COMPLETING ADMISSIONS APPLICATIONS, AND PREPARATION FOR COLLEGE ADMISSION INTERVIEWS, IN CLASS 41 (U.S. CLS. 100, 101 AND 107).

SERVICE MARK

PRINCIPAL REGISTER

FIRST USE 1-31-2011; IN COMMERCE 1-31-2011.

THE MARK CONSISTS OF STANDARD CHARACTERS WITHOUT CLAIM TO ANY PARTICULAR FONT, STYLE, SIZE, OR COLOR.

NO CLAIM IS MADE TO THE EXCLUSIVE RIGHT TO USE "ADMISSION", APART FROM THE MARK AS SHOWN.

SER. NO. 85-230,767, FILED 1-31-2011.

KAELIE KUNG, EXAMINING ATTORNEY



David J. Kyffers

Director of the United States Patent and Trademark Office

United States of America

United States Patent and Trademark Office

Vinedos y Bodegas
EL CASTILLO

Reg. No. 4,073,184

Registered Dec. 20, 2011

Int. Cl.: 33

TRADEMARK

PRINCIPAL REGISTER

VIÑEDOS Y BODEGAS EL CASTILLO S.L. (SPAIN SOCIEDAD DE RESPONSABILIDAD LIMITADA (SL))
KM. 1,200
CTRA. OSSA DE MONTIEL
VILLARROBLEDO ALBACETE, SPAIN 02600

FOR: WINES, IN CLASS 33 (U.S. CLS. 47 AND 49).

PRIORITY CLAIMED UNDER SEC. 44(D) ON SPAIN APPLICATION NO. M2943458-0, FILED 8-18-2010, REG. NO. M2943458-0, DATED 8-18-2010, EXPIRES 8-18-2020.

THE COLOR(S) BLACK, RED AND WHITE IS/ARE CLAIMED AS A FEATURE OF THE MARK.

NO CLAIM IS MADE TO THE EXCLUSIVE RIGHT TO USE "VINEDOS Y BODEGAS", APART FROM THE MARK AS SHOWN.

THE MARK CONSISTS OF "VIÑEDOS Y BODEGAS" IS WRITTEN IN BLACK CURSIVE AT THE TOP, AND BELOW IS WRITTEN IN "EL CASTILLO" IN RED, ALL ON A WHITE BACKGROUND.

THE ENGLISH TRANSLATION OF THE WORD "VINEDOS Y BODEGAS EL CASTILLO" IN THE MARK IS VINEYARDS AND WAREHOUSES OF THE CASTLE.

SER. NO. 85-231,056, FILED 2-1-2011.

SUSAN STIGLITZ, EXAMINING ATTORNEY



David J. Kybas

Director of the United States Patent and Trademark Office

United States of America

United States Patent and Trademark Office

PATENT DIRECT

Reg. No. 4,073,185

Registered Dec. 20, 2011

Int. Cls.: 35 and 45

SERVICE MARK

PRINCIPAL REGISTER

MONGOOSE VENTURES, LTD (UNITED KINGDOM LIMITED COMPANY (LTD.))
4 THAMES AVENUE
GEORGE VTH PLACE
WINDSOR, UNITED KINGDOM SL41QP

FOR: ADVERTISING; ADVERTISING AND MARKETING SERVICES; BUSINESS INFORMATION SERVICES PROVIDED ONLINE FROM DATABASE OR THE INTERNET; COMPOSING ADVERTISING PAGES; MARKET SURVEYS; BUSINESS MANAGEMENT SERVICES; PROVISION OF BUSINESS INFORMATION ALL RELATING TO INTELLECTUAL PROPERTY ADVISORY AND CONSULTANCY SERVICES; CONSULTING SERVICES IN THE FIELD OF MANAGING INTELLECTUAL PROPERTIES, IN CLASS 35 (U.S. CLS. 100, 101 AND 102).

FIRST USE 7-30-2010; IN COMMERCE 7-30-2010.

FOR: INTELLECTUAL PROPERTY LEGAL SERVICES, NAMELY, INTELLECTUAL PROPERTY SEARCHING, DRAFTING, FILING, PROSECUTION, OPPOSITION, REGISTRATION, RENEWAL, MAINTENANCE, INVESTIGATION, ENFORCEMENT, REVOCATION, CANCELLATION, INVALIDATION, LICENSING, ASSIGNMENT, CHANGE OF NAME AND ADDRESS SERVICES, PATENT AND TRADEMARK ATTORNEY SERVICES; LEGAL SERVICES; DOMAIN NAME REGISTRATION SERVICES; PROVIDING LEGAL SERVICES WITH REGARD TO IDENTIFICATION AND PROTECTION OF INTELLECTUAL PROPERTY RIGHTS; CONSULTANCY, RESEARCH AND ADVISORY SERVICES, ALL RELATING TO INTELLECTUAL PROPERTY RIGHTS; INFORMATION SERVICES AND INFORMATION PROVIDED ON-LINE FROM A COMPUTER DATABASE OR FROM THE INTERNET IN THE FIELD OF INTELLECTUAL PROPERTY LEGAL SERVICES, IN CLASS 45 (U.S. CLS. 100 AND 101).

FIRST USE 7-30-2010; IN COMMERCE 7-30-2010.

THE MARK CONSISTS OF STANDARD CHARACTERS WITHOUT CLAIM TO ANY PARTICULAR FONT, STYLE, SIZE, OR COLOR.

NO CLAIM IS MADE TO THE EXCLUSIVE RIGHT TO USE "PATENT", APART FROM THE MARK AS SHOWN.

SER. NO. 85-231,062, FILED 2-1-2011.



David J. Kyjars

Director of the United States Patent and Trademark Office

Reg. No. 4,073,185 TIMOTHY FINNEGAN, EXAMINING ATTORNEY

United States of America

United States Patent and Trademark Office

RADIO INDÍGENA

Reg. No. 4,073,186

RICARDO IBARRA (UNITED STATES INDIVIDUAL)

Registered Dec. 20, 2011

321 IVY ST
SAN FRANCISCO, CA 94101

Int. Cl.: 38

FOR: RADIO BROADCASTING; RADIO PROGRAM BROADCASTING, IN CLASS 38 (U.S. CLS. 100, 101 AND 104).

SERVICE MARK

FIRST USE 5-7-2004; IN COMMERCE 5-7-2004.

PRINCIPAL REGISTER

NO CLAIM IS MADE TO THE EXCLUSIVE RIGHT TO USE "RADIO INDÍGENA", APART FROM THE MARK AS SHOWN.

THE MARK CONSISTS OF THE WORDING "RADIO INDÍGENA" IN STYLIZED FONT. THE CHARACTER "O" WITHIN THE WORD "RADIO" DEPICTS A SPIRAL. THE COLOR WHITE IN THE DRAWING REPRESENTS TRANSPARENT AREAS AND A TRANSPARENT BACKGROUND THAT ARE NOT PART OF THE MARK.

THE ENGLISH TRANSLATION OF "INDÍGENA" IN THE MARK IS "INDIGENOUS".

SER. NO. 85-231,111, FILED 2-1-2011.

KIM MONINGHOFF, EXAMINING ATTORNEY



David J. Kyros

Director of the United States Patent and Trademark Office

United States of America

United States Patent and Trademark Office

FANCY

Reg. No. 4,073,187

Registered Dec. 20, 2011

Int. Cl.: 42

SERVICE MARK

PRINCIPAL REGISTER

THING DAEMON, INC. (DELAWARE CORPORATION)
401 WEST 14TH STREET, 4TH FLOOR
NEW YORK, NY 10014

FOR: COMPUTER SERVICES, NAMELY, CREATING ON-LINE VIRTUAL COMMUNITIES FOR REGISTERED USERS TO IDENTIFY, ORGANIZE AND SHARE IMAGES OF GOODS AND SERVICES THAT ARE OF INTEREST TO THEM; COMPUTER SERVICES, NAMELY, CREATING AN ONLINE VIRTUAL ENVIRONMENT FOR USERS TO IDENTIFY AND ATTACH VIRTUAL TAGS TO IMAGES OF GOODS AND SERVICES THAT ARE OF INTEREST TO THEM AND TO SHARE THE IDENTIFIED AND TAGGED IMAGES WITH AND AMONG OTHER USERS; PROVIDING A WEB SITE FEATURING TEMPORARY USE OF NON-DOWNLOADABLE SOFTWARE THAT ENABLES ONLINE USERS TO IDENTIFY, ORGANIZE AND SHARE IMAGES OF GOODS AND SERVICES THAT ARE OF INTEREST TO THEM AND TO TRANSFER SUCH IMAGES TO, AND SHARE SUCH IMAGES WITH, OTHER USERS, IN CLASS 42 (U.S. CLS. 100 AND 101).

FIRST USE 1-1-2011; IN COMMERCE 1-1-2011.

THE MARK CONSISTS OF STANDARD CHARACTERS WITHOUT CLAIM TO ANY PARTICULAR FONT, STYLE, SIZE, OR COLOR.

SER. NO. 85-231,161, FILED 2-1-2011.

MICHAEL GAAFAR, EXAMINING ATTORNEY



David J. Kyffers

Director of the United States Patent and Trademark Office

United States of America

United States Patent and Trademark Office

HOTEL ALCOTT

Reg. No. 4,073,188

Registered Dec. 20, 2011

Int. Cl.: 43

SERVICE MARK

PRINCIPAL REGISTER

NEZA HOSPITALITY INC. (NEW JERSEY CORPORATION)
107-113 GRANT STREET
CAPE MAY, NJ 08204

FOR: HOTEL SERVICES, IN CLASS 43 (U.S. CLS. 100 AND 101).

FIRST USE 8-1-1997; IN COMMERCE 8-1-1997.

THE MARK CONSISTS OF STANDARD CHARACTERS WITHOUT CLAIM TO ANY PARTICULAR FONT, STYLE, SIZE, OR COLOR.

NO CLAIM IS MADE TO THE EXCLUSIVE RIGHT TO USE "HOTEL", APART FROM THE MARK AS SHOWN.

SEC. 2(F).

SER. NO. 85-231,487, FILED 2-1-2011.

DARRYL SPRUILL, EXAMINING ATTORNEY



David J. Kyffers

Director of the United States Patent and Trademark Office

United States of America

United States Patent and Trademark Office

CITY OF WATER DAY FESTIVAL

Reg. No. 4,073,189

Registered Dec. 20, 2011

Int. Cl.: 41

SERVICE MARK

PRINCIPAL REGISTER

METROPOLITAN WATER FRONT ALLIANCE (NEW YORK CORPORATION)
241 WATER STREET
NEW YORK, NY 10038

FOR: ORGANIZING COMMUNITY FESTIVALS FEATURING BOAT TOURS, CHILDREN'S FAIRS, ON-WATER AND WATERFRONT RECREATIONAL ACTIVITIES, LIVE MUSIC AND FOOD; ENTERTAINMENT SERVICES, NAMELY, CONDUCTING WATERFRONT FAIRS FOR COMMUNITY GROUPS AND ORGANIZATIONS FEATURING INFORMATION AND ACTIVITIES FOR PARTICIPANTS, NOT FOR COMMERCIAL PURPOSES, IN CLASS 41 (U.S. CLS. 100, 101 AND 107).

FIRST USE 3-20-2008; IN COMMERCE 3-20-2008.

THE MARK CONSISTS OF STANDARD CHARACTERS WITHOUT CLAIM TO ANY PARTICULAR FONT, STYLE, SIZE, OR COLOR.

NO CLAIM IS MADE TO THE EXCLUSIVE RIGHT TO USE "DAY FESTIVAL", APART FROM THE MARK AS SHOWN.

SER. NO. 85-231,521, FILED 2-1-2011.

SANJEEV VOHRA, EXAMINING ATTORNEY



David J. Kyros

Director of the United States Patent and Trademark Office

United States of America

United States Patent and Trademark Office

UKE LEASH



Reg. No. 4,073,190

APTHORP, LORI ANN (UNITED STATES INDIVIDUAL)
11948 GORHAM AVE. #8
LOS ANGELES, CA 90049

Registered Dec. 20, 2011

Int. Cl.: 15

FOR: GUITAR STRAPS; MUSICAL INSTRUMENT ACCESSORIES, NAMELY, STANDS, CASES, CARRYING BAGS AND STORAGE BAGS, IN CLASS 15 (U.S. CLS. 2, 21 AND 36).

TRADEMARK

FIRST USE 5-11-2010; IN COMMERCE 5-11-2010.

PRINCIPAL REGISTER

NO CLAIM IS MADE TO THE EXCLUSIVE RIGHT TO USE "UKE LEASH", APART FROM THE MARK AS SHOWN.

THE MARK CONSISTS OF THE WORDS "UKE LEASH" WITH A STYLIZED UKE AND LEASH ATTACHED TO THE TOP OF THE NECK.

SER. NO. 85-232,038, FILED 2-2-2011.

LINDA ESTRADA, EXAMINING ATTORNEY



David J. Kybas

Director of the United States Patent and Trademark Office

United States of America

United States Patent and Trademark Office

Bollinger Bands

Reg. No. 4,073,191

BOLLINGER, JOHN A. (UNITED STATES INDIVIDUAL)
465 35TH STREET

Registered Dec. 20, 2011

MANHATTAN BEACH, CA 90266

Int. Cl.: 36

FOR: FINANCIAL ANALYSIS AND RESEARCH SERVICES, IN CLASS 36 (U.S. CLS. 100, 101 AND 102).

SERVICE MARK

FIRST USE 4-4-1989; IN COMMERCE 7-23-1997.

PRINCIPAL REGISTER

THE MARK CONSISTS OF STANDARD CHARACTERS WITHOUT CLAIM TO ANY PARTICULAR FONT, STYLE, SIZE, OR COLOR.

SEC. 2(F).

SER. NO. 85-232,573, FILED 2-2-2011.

LESLEY LAMOTHE, EXAMINING ATTORNEY



David J. Kybas

Director of the United States Patent and Trademark Office

United States of America

United States Patent and Trademark Office

AssetScout

Reg. No. 4,073,192

Registered Dec. 20, 2011

Int. Cl.: 9

TRADEMARK

PRINCIPAL REGISTER

SUNVIEW SOFTWARE (FLORIDA CORPORATION)
SUITE 275
10210 HIGHLAND MANOR DRIVE
TAMPA, FL 33610

FOR: COMPUTER SOFTWARE FOR AUTOMATICALLY DISCOVERING NETWORK DEVICES, NAMELY, SERVERS, DESKTOP COMPUTERS, ROUTERS, SWITCHES, AND NETWORK DEVICES, AND FOR MANAGING THE INFORMATION IN AN INTUITIVE INTERFACE, IN CLASS 9 (U.S. CLS. 21, 23, 26, 36 AND 38).

FIRST USE 5-1-2010; IN COMMERCE 11-4-2010.

THE MARK CONSISTS OF STANDARD CHARACTERS WITHOUT CLAIM TO ANY PARTICULAR FONT, STYLE, SIZE, OR COLOR.

SER. NO. 85-232,752, FILED 2-2-2011.

JEFF DEFORD, EXAMINING ATTORNEY



David J. Kybas

Director of the United States Patent and Trademark Office

United States of America

United States Patent and Trademark Office

MOUNT OLYMPUS

Reg. No. 4,073,193

SWEET CANDY COMPANY (UTAH CORPORATION)

Registered Dec. 20, 2011

3780 W. DIRECTORS ROW
SALT LAKE CITY, UT 84104

Int. Cl.: 30

FOR: CANDY, CHOCOLATES, SALT WATER TAFFY, SUGAR CANDY, CINNAMON CANDY, CHOCOLATE COVERED NUTS, CHOCOLATE COVERED CANDY, CHOCOLATE COVERED FRUIT CANDY, JELLY BEANS, LICORICE, GELATIN CANDY, AND MINT CANDY, IN CLASS 30 (U.S. CL. 46).

TRADEMARK

PRINCIPAL REGISTER

FIRST USE 8-1-1995; IN COMMERCE 8-1-1995.

THE MARK CONSISTS OF STANDARD CHARACTERS WITHOUT CLAIM TO ANY PARTICULAR FONT, STYLE, SIZE, OR COLOR.

SER. NO. 85-233,178, FILED 2-3-2011.

PAM WILLIS, EXAMINING ATTORNEY



David J. Kybas

Director of the United States Patent and Trademark Office

United States of America

United States Patent and Trademark Office

conquest service

Reg. No. 4,073,194

MEDIA REVO CORP (NEW JERSEY CORPORATION)

Registered Dec. 20, 2011

115 RIVER ROAD, SUITE 425
EDGEWATER, NJ 07020

Int. Cl.: 35

SERVICE MARK

PRINCIPAL REGISTER

FOR: ADVERTISING AND MARKETING SERVICES PROVIDED BY MEANS OF INDIRECT METHODS OF MARKETING COMMUNICATIONS, NAMELY, SOCIAL MEDIA, SEARCH ENGINE MARKETING, INQUIRY MARKETING, INTERNET MARKETING, MOBILE MARKETING, BLOGGING AND OTHER FORMS OF PASSIVE, SHARABLE OR VIRAL COMMUNICATIONS CHANNELS FOR AUTO DEALER SERVICE DEPARTMENT; ADVERTISING AND MARKETING SERVICES, NAMELY, PROMOTING THE GOODS AND SERVICES OF OTHERS IN THE FIELD OF AUTO DEALER SERVICE DEPARTMENTS; CONSULTING SERVICES IN THE FIELD OF INTERNET MARKETING FOR AUTO DEALER SERVICE DEPARTMENTS; PROMOTING THE GOODS AND SERVICES OF OTHERS VIA A GLOBAL COMPUTER NETWORK FOR AUTO DEALER SERVICE DEPARTMENTS , IN CLASS 35 (U.S. CLS. 100, 101 AND 102).

FIRST USE 1-1-2009; IN COMMERCE 1-1-2009.

THE MARK CONSISTS OF STANDARD CHARACTERS WITHOUT CLAIM TO ANY PARTICULAR FONT, STYLE, SIZE, OR COLOR.

NO CLAIM IS MADE TO THE EXCLUSIVE RIGHT TO USE "SERVICE", APART FROM THE MARK AS SHOWN.

SER. NO. 85-233,333, FILED 2-3-2011.

SAMUEL E. SHARPER JR., EXAMINING ATTORNEY



David J. Kybas

Director of the United States Patent and Trademark Office

United States of America

United States Patent and Trademark Office

CUBOY

Reg. No. 4,073,195

Registered Dec. 20, 2011

Int. Cl.: 9

TRADEMARK

PRINCIPAL REGISTER

ARBUCKLE, WILLIAM (UNITED KINGDOM INDIVIDUAL)
7/11 ROYAL PARK TERRACE
EDINBURGH, UNITED KINGDOM

FOR: DOWNLOADABLE MULTIMEDIA FILES, NAMELY, VIDEO GAMES AND ANIMATED CARTOONS; DOWNLOADABLE ELECTRONIC GAME PROGRAMS; DOWNLOADABLE ELECTRONIC GAME SOFTWARE; ELECTRONIC GAME PROGRAMS; ELECTRONIC GAME SOFTWARE; VIDEO GAME PROGRAMS; VIDEO GAME SOFTWARE; COMPUTER GAMES PROGRAMS DOWNLOADED VIA THE INTERNET, IN CLASS 9 (U.S. CLS. 21, 23, 26, 36 AND 38).

FIRST USE 2-7-2007; IN COMMERCE 9-30-2009.

THE MARK CONSISTS OF STANDARD CHARACTERS WITHOUT CLAIM TO ANY PARTICULAR FONT, STYLE, SIZE, OR COLOR.

SER. NO. 85-233,682, FILED 2-3-2011.

ADA HAN, EXAMINING ATTORNEY



David J. Kyros

Director of the United States Patent and Trademark Office

United States of America

United States Patent and Trademark Office

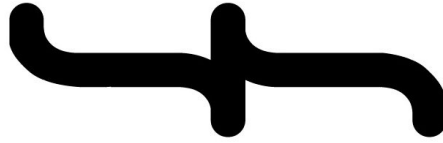

HVLO

Reg. No. 4,073,196

Registered Dec. 20, 2011

Int. Cls.: 9 and 25

TRADEMARK

PRINCIPAL REGISTER

SOFTWARE PTY LTD (AUSTRALIA LIMITED LIABILITY COMPANY)
NAST INTERNATIONAL
5 CREWE PLACE
ROSEBERY NSW 2018, AUSTRALIA

FOR: AUDIO HEADPHONES; EARPHONES; EARPHONES AND HEADPHONES; HEADPHONES; MUSIC HEADPHONES; STEREO HEADPHONES, IN CLASS 9 (U.S. CLS. 21, 23, 26, 36 AND 38).

FIRST USE 2-6-2010; IN COMMERCE 12-1-2010.

FOR: HEAD SWEATBANDS; HEADBANDS; HEADBANDS AGAINST SWEATING; HEADBANDS FOR CLOTHING; SWEATBANDS, IN CLASS 25 (U.S. CLS. 22 AND 39).

FIRST USE 2-6-2010; IN COMMERCE 12-1-2010.

THE MARK CONSISTS OF A DESIGN A STYLIZED DOUBLE LETTER "H" ABOVE THE LETTERING "HVLO."

SER. NO. 85-233,910, FILED 2-3-2011.

VERNA BETH RIRIE, EXAMINING ATTORNEY



David J. Kybas

Director of the United States Patent and Trademark Office

United States of America

United States Patent and Trademark Office

Financial Charisma

Reg. No. 4,073,197

Registered Dec. 20, 2011

Int. Cl.: 41

SERVICE MARK

PRINCIPAL REGISTER

FINANCIAL CHARISMA LTD. (UNITED KINGDOM LIMITED LIABILITY COMPANY)
SUITE 14045 2ND FLOOR
145-157 ST JOHN STREET
LONDON, UNITED KINGDOM EC1V4PY

FOR: BUSINESS EDUCATION AND TRAINING SERVICES, NAMELY, DEVELOPING AND FACILITATING CUSTOMIZED LEADERSHIP AND EXECUTIVE DEVELOPMENT PROGRAMS, PROVIDING EXECUTIVE COACHING SERVICES, AND PROVIDING BUSINESS EDUCATION PROGRAMS TO EMPLOYEES AND EXECUTIVES; BUSINESS EDUCATION AND TRAINING SERVICES, NAMELY, DEVELOPING, AND FACILITATING CUSTOMIZED IN-COMPANY LEADERSHIP AND EXECUTIVE DEVELOPMENT PROGRAMS, PROVIDING EXECUTIVE COACHING SERVICES, AND PROVIDING PUBLIC AND IN-COMPANY KEYNOTE PRESENTATIONS TO BUSINESS LEADERS; CHARITABLE SERVICES, NAMELY, PROVIDING VOCATIONAL EDUCATION IN THE FIELDS OF CONSTRUCTION AND FLIGHT TRAINING TO OBTAIN PILOT'S LICENSE, PROVIDING CAREER GUIDANCE, AND PROVIDING GROUP COACHING IN THE FIELD OF LEADERSHIP DEVELOPMENT TO DISADVANTAGED YOUTH; EDUCATIONAL SERVICES, NAMELY, PROFESSIONAL COACHING OF TEACHERS IN THE FIELD OF FINANCE, MONEY, WEALTH, PROSPERITY, BUSINESS, ABUNDANCE, SUCCESS, HAPPINESS, LEADERSHIP, THE LAW OF ATTRACTION, CONFIDENCE, LIFE COACHING, AND PRESENTATION SKILLS PROVIDED ON A REAL-TIME BASIS DURING CLASSROOM INSTRUCTION; LIFE COACHING SERVICES IN THE FIELD OF FINANCE, MONEY, WEALTH, PROSPERITY, BUSINESS, ABUNDANCE, SUCCESS, HAPPINESS, LEADERSHIP, THE LAW OF ATTRACTION, CONFIDENCE, LIFE COACHING, AND PRESENTATION SKILLS; PEER TO PEER COACHING SERVICES IN THE FIELD OF FINANCE, MONEY, WEALTH, PROSPERITY, BUSINESS, ABUNDANCE, SUCCESS, HAPPINESS, LEADERSHIP, THE LAW OF ATTRACTION, CONFIDENCE, LIFE COACHING, AND PRESENTATION SKILLS; PERSONAL COACHING SERVICES IN THE FIELD OF FINANCE, MONEY, WEALTH, PROSPERITY, BUSINESS, ABUNDANCE, SUCCESS, HAPPINESS, LEADERSHIP, THE LAW OF ATTRACTION, CONFIDENCE, LIFE COACHING, AND PRESENTATION SKILLS; PROFESSIONAL COACHING SERVICES IN THE FIELD OF FINANCE, MONEY, WEALTH, PROSPERITY, BUSINESS, ABUNDANCE, SUCCESS, HAPPINESS, LEADERSHIP, THE LAW OF ATTRACTION, CONFIDENCE, LIFE COACHING, AND PRESENTATION SKILLS; PROVIDING GROUP COACHING AND LEARNING FORUMS IN THE FIELD OF LEADERSHIP DEVELOPMENT; PROVIDING GROUP COACHING IN THE FIELD OF FINANCE, MONEY, WEALTH, PROSPERITY, BUSINESS, ABUNDANCE, SUCCESS, HAPPINESS, LEADERSHIP, THE LAW OF ATTRACTION,



David J. Kappas

Director of the United States Patent and Trademark Office

Reg. No. 4,073,197 TION, CONFIDENCE, LIFE COACHING, AND PRESENTATION SKILLS, IN CLASS 41 (U.S. CLS. 100, 101 AND 107).

FIRST USE 7-20-2010; IN COMMERCE 7-22-2010.

THE MARK CONSISTS OF STANDARD CHARACTERS WITHOUT CLAIM TO ANY PARTICULAR FONT, STYLE, SIZE, OR COLOR.

NO CLAIM IS MADE TO THE EXCLUSIVE RIGHT TO USE "FINANCIAL", APART FROM THE MARK AS SHOWN.

SER. NO. 85-233,989, FILED 2-4-2011.

DANIEL CAPSHAW, EXAMINING ATTORNEY

United States of America

United States Patent and Trademark Office

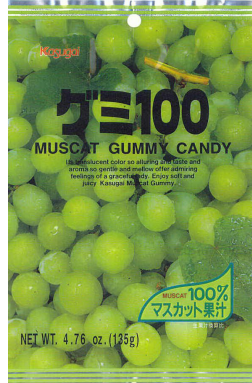

Reg. No. 4,073,198

Registered Dec. 20, 2011

Int. Cl.: 30

TRADEMARK

PRINCIPAL REGISTER

KASUGAI SEIKA CO., LTD. (JAPAN CORPORATION)
1-6-10 HANANOKI, NISHI-KU, NAGOYA-SHI
AICHI-KEN, JAPAN

FOR: GUMMY CANDIES, IN CLASS 30 (U.S. CL. 46).

FIRST USE 2-1-1991; IN COMMERCE 2-1-1991.

OWNER OF U.S. REG. NOS. 3,693,123 AND 3,693,124.

THE COLOR(S) RED, GREEN, BLACK, TAN, SILVER AND WHITE IS/ARE CLAIMED AS A FEATURE OF THE MARK.

NO CLAIM IS MADE TO THE EXCLUSIVE RIGHT TO USE "MUSCAT GUMMY CANDY", "MUSCAT", "100%", "NET WT. 4.76 OZ. (135G)", THE NON-LATIN CHARACTERS THAT TRANSLITERATE TO "GUMI", "MASUKATTO KAJU", "NAMAKAJU KNAZANHI", THE PICTORIAL REPRESENTATION OF THE MUSCAT GRAPES, AND THE OVERALL SHAPE OF THE PRODUCT PACKAGING, APART FROM THE MARK AS SHOWN.

THE MARK CONSISTS OF THE FRONT OF A PACKAGING DESIGN WITH A PHOTOGRAPH OF GREEN MUSCAT GRAPES AND LEAVES AND A TAN STEM; THE WORDING "KASUGAI" IN RED WITH A GREEN BORDER AT THE UPPER LEFT SUPERIMPOSED OVER THE PHOTOGRAPH; STYLIZED JAPANESE CHARACTERS AND THE WORDING "100" IN BLACK CENTERED ABOVE THE WORDING "MUSCAT GUMMY CANDY" IN BLACK, CENTERED ABOVE THE WORDING "ITS TRANSLUCENT COLOR SO ALLURING AND TASTE AND AROMA SO GENTLE AND MELLOW OFFER ADMIRING FEELINGS OF A GRACEFUL LADY. ENJOY SOFT AND JUICY KASUGAI MUSCAT GUMMY", IN BLACK; SILVER AND GREEN STRIPES ARE AT THE TOP AND BOTTOM OF THE PACKAGE; AT THE LOWER RIGHT, SUPERIMPOSED OVER THE GRAPES PHOTOGRAPH, THE WORD "MUSCAT" IN RED, "100%" AND JAPANESE CHARACTERS IN DARK GREEN APPEAR ON A LIGHT GREEN BACKGROUND WITH A DARK GREEN BORDER COMPRISING A CURVED NON-STANDARD SHAPE; BENEATH THIS ARE JAPANESE CHARACTERS IN WHITE; AND AT THE BOTTOM LEFT IS THE WEIGHT STATEMENT "NET WT. 4.76 OZ. (135G)" IN BLACK SUPERIMPOSED OVER THE GRAPES PHOTOGRAPH.



David J. Kybas

Director of the United States Patent and Trademark Office

THE NON-LATIN CHARACTERS IN THE TOP PORTION OF THE MARK TRANSLITERATE TO "GUMI", AND THIS MEANS GUMMY IN ENGLISH. THE NON-LATIN CHARACTERS

Reg. No. 4,073,198 IN THE LOWER PORTION OF THE MARK INSIDE THE THREE-SIDED SHAPE TRANSLITERATE TO "MASUKATTO KAJU", AND THIS MEANS MUSCAT JUICE IN ENGLISH. THE NON-LATIN CHARACTERS IN THE LOWER PORTION OF THE MARK TRANSLITERATE TO "NAMAKAJU KANZANHI", AND THIS MEANS FRESH FRUIT JUICE AND CONVERSION RATIO IN ENGLISH. THE WORDING "KASUGAI" HAS NO MEANING IN A FOREIGN LANGUAGE.

SER. NO. 85-234,239, FILED 2-4-2011.

CHRISTINE COOPER, EXAMINING ATTORNEY

United States of America

United States Patent and Trademark Office

Clutch Gifts

Reg. No. 4,073,199

MAXINE GIFTS, INC. (CALIFORNIA CORPORATION)
418 N. HARPER AVENUE
LOS ANGELES, CA 90048

Registered Dec. 20, 2011

Int. Cl.: 33

FOR: GIFT BASKETS CONTAINING WINE, IN CLASS 33 (U.S. CLS. 47 AND 49).

TRADEMARK

FIRST USE 8-1-2008; IN COMMERCE 8-1-2008.

PRINCIPAL REGISTER

THE MARK CONSISTS OF STANDARD CHARACTERS WITHOUT CLAIM TO ANY PARTICULAR FONT, STYLE, SIZE, OR COLOR.

NO CLAIM IS MADE TO THE EXCLUSIVE RIGHT TO USE "GIFTS", APART FROM THE MARK AS SHOWN.

SER. NO. 85-234,438, FILED 2-4-2011.

FRED CARL, EXAMINING ATTORNEY



David J. Kyffers

Director of the United States Patent and Trademark Office

United States of America

United States Patent and Trademark Office

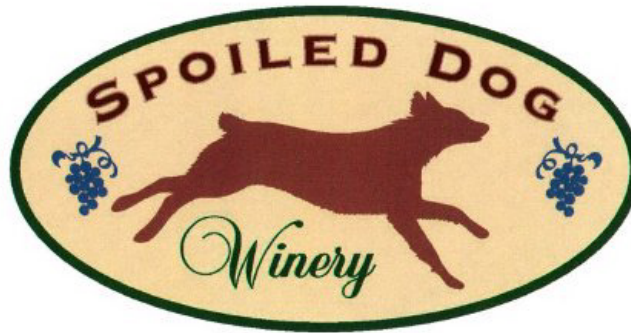

Reg. No. 4,073,200

KRUG, LLC (WASHINGTON LIMITED LIABILITY COMPANY)
5881 MAXWELTON ROAD
LANGLEY, WA 98260

Registered Dec. 20, 2011

Int. Cl.: 33

FOR: GRAPE WINE, IN CLASS 33 (U.S. CLS. 47 AND 49).

TRADEMARK

FIRST USE 1-1-2010; IN COMMERCE 5-1-2010.

PRINCIPAL REGISTER

NO CLAIM IS MADE TO THE EXCLUSIVE RIGHT TO USE "WINERY", APART FROM THE MARK AS SHOWN.

THE COLOR(S) "GOLD", "GREEN", "MAUVE", "PURPLE", "MAROON" IS/ARE CLAIMED AS A FEATURE OF THE MARK.

THE MARK CONSISTS OF A GOLD OVAL WITH A GREEN BORDER SHOWING A MAUVE RUNNING DOG, WITH A CLUSTER OF PURPLE GRAPES ON EACH SIDE. THE WORDS "SPOILED DOG" APPEAR IN MAROON ABOVE THE DOG. THE WORD "WINERY" APPEARS IN GREEN BELOW THE DOG.

SER. NO. 85-234,472, FILED 2-4-2011.

SUSAN STIGLITZ, EXAMINING ATTORNEY



David J. Kyffers

Director of the United States Patent and Trademark Office

United States of America

United States Patent and Trademark Office

Texas Pie Company

Reg. No. 4,073,201

ALBERTSON, JULIE (UNITED STATES INDIVIDUAL)

Registered Dec. 20, 2011

P.O. BOX 1088
KYLE, TX 78640

Int. Cl.: 30

FOR: PIES, IN CLASS 30 (U.S. CL. 46).

TRADEMARK

FIRST USE 8-18-1989; IN COMMERCE 8-18-1989.

PRINCIPAL REGISTER

THE MARK CONSISTS OF STANDARD CHARACTERS WITHOUT CLAIM TO ANY PARTICULAR FONT, STYLE, SIZE, OR COLOR.

NO CLAIM IS MADE TO THE EXCLUSIVE RIGHT TO USE "PIE COMPANY", APART FROM THE MARK AS SHOWN.

SEC. 2(F).

SER. NO. 85-234,732, FILED 2-4-2011.

JEFFREY LOOK, EXAMINING ATTORNEY



David J. Kyffers

Director of the United States Patent and Trademark Office

United States of America

United States Patent and Trademark Office

Edvance

Reg. No. 4,073,202

EDVANCE RESEARCH, INC. (TEXAS CORPORATION)
9901 IH-10 WEST, SUITE 1000
SAN ANTONIO, TX 78230

Registered Dec. 20, 2011

Int. Cls.: 35 and 41

FOR: BUSINESS CONSULTING IN THE FIELD OF BUSINESS MANAGEMENT OF SCHOOLS AND EDUCATIONAL INSTITUTIONS, AND, OF PUBLIC POLICY REGARDING EDUCATION, IN CLASS 35 (U.S. CLS. 100, 101 AND 102).

SERVICE MARK

FIRST USE 3-30-2006; IN COMMERCE 3-30-2006.

PRINCIPAL REGISTER

FOR: CONSULTING SERVICES IN THE FIELD OF EDUCATION RESEARCH, EDUCATION POLICY FOR THE DEVELOPMENT AND IMPLEMENTATION OF PEDAGOGICAL METHODS, AND EDUCATION MANAGEMENT FOR IMPROVING TEACHING RESULTS, IN CLASS 41 (U.S. CLS. 100, 101 AND 107).

FIRST USE 3-30-2006; IN COMMERCE 3-30-2006.

THE MARK CONSISTS OF STANDARD CHARACTERS WITHOUT CLAIM TO ANY PARTICULAR FONT, STYLE, SIZE, OR COLOR.

SER. NO. 85-234,783, FILED 2-4-2011.

HANNO RITTNER, EXAMINING ATTORNEY



David J. Kyffers

Director of the United States Patent and Trademark Office

United States of America

United States Patent and Trademark Office

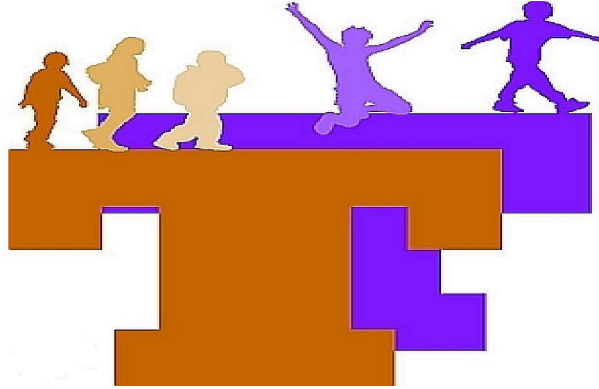

Reg. No. 4,073,203

Registered Dec. 20, 2011

Int. Cl.: 35

SERVICE MARK

PRINCIPAL REGISTER

TREVOR'S TREK FOUNDATION, INC. (IDAHO CORPORATION)
1010 N. COLE ROAD
BOISE, ID 83702

FOR: EDUCATIONAL ASSOCIATION SERVICES, NAMELY, PROMOTING THE PUBLIC INTEREST AND PUBLIC AWARENESS RELATED TO CHILDHOOD CANCER PREVENTIVE, RESEARCH AND EDUCATION, IN CLASS 35 (U.S. CLS. 100, 101 AND 102).

FIRST USE 9-13-2007; IN COMMERCE 9-13-2007.

THE MARK CONSISTS OF THE CAPITAL LETTER "T" IN DARK GOLD WITH A SECOND CAPITAL LETTER "T" IN PURPLE SHOWN JUST BEHIND THE FIRST LETTER "T" AND SLIGHTLY RAISED. ABOVE THE FIRST CAPITAL LETTER "T" ARE THREE SILHOUETTE IMAGES OF CHILDREN, ONE DARK GOLD, ONE GOLD, AND ONE BEIGE, AND ABOVE THE SECOND CAPITAL LETTER "T" ARE TWO SILHOUETTE IMAGES OF CHILDREN, ONE LAVENDER AND ONE PURPLE.

THE COLOR(S) DARK GOLD, GOLD, BEIGE, PURPLE AND LAVENDER IS/ARE CLAIMED AS A FEATURE OF THE MARK.

SER. NO. 85-234,873, FILED 2-4-2011.

BRENDAN MCCAULEY, EXAMINING ATTORNEY



David J. Kybas

Director of the United States Patent and Trademark Office

United States of America

United States Patent and Trademark Office

A Home for the Soul

Reg. No. 4,073,204

CASALINA, ANITA M. (CALIFORNIA SOLE PROPRIETORSHIP)
982 LAS PAVADAS AVE
SAN RAFAEL, CA 94903

Registered Dec. 20, 2011

Int. Cls.: 9 and 41

FOR: PRE-RECORDED CDS, VIDEO TAPES, LASER DISKS AND DVDS FEATURING SELF-HEALING PRACTICES AND MEDITATIONS, IN CLASS 9 (U.S. CLS. 21, 23, 26, 36 AND 38).

TRADEMARK

FIRST USE 1-15-2011; IN COMMERCE 2-2-2011.

SERVICE MARK

FOR: PROVIDING A WEBSITE FEATURING AUDIO AND VIDEO IN-PERSON TEACHINGS OF SELF-HEALING TECHNIQUES AND MEDITATIONS; PROVIDING LIVE WORKSHOPS AND LECTURES, TELESEMINARS AND TELECONFERENCES IN SELF-HEALING PRACTICES AND MEDITATIONS, IN CLASS 41 (U.S. CLS. 100, 101 AND 107).

PRINCIPAL REGISTER

FIRST USE 1-15-2011; IN COMMERCE 2-2-2011.

THE MARK CONSISTS OF STANDARD CHARACTERS WITHOUT CLAIM TO ANY PARTICULAR FONT, STYLE, SIZE, OR COLOR.

SER. NO. 85-235,084, FILED 2-5-2011.

C. DIONNE CLYBURN, EXAMINING ATTORNEY



David J. Kyros

Director of the United States Patent and Trademark Office

United States of America

United States Patent and Trademark Office

CTCLEAN

Reg. No. 4,073,205

COAST TO COAST MEDICAL, INC (FLORIDA CORPORATION)
4800 SW 51ST ST #102
DAVIE, FL 33314

Registered Dec. 20, 2011

Int. Cl.: 3

FOR: STAINLESS STEEL CLEANER, IN CLASS 3 (U.S. CLS. 1, 4, 6, 50, 51 AND 52).

TRADEMARK

FIRST USE 3-14-2011; IN COMMERCE 3-14-2011.

PRINCIPAL REGISTER

THE MARK CONSISTS OF STANDARD CHARACTERS WITHOUT CLAIM TO ANY PARTICULAR FONT, STYLE, SIZE, OR COLOR.

SER. NO. 85-235,500, FILED 2-7-2011.

MARGARET POWER, EXAMINING ATTORNEY



David J. Kyffers

Director of the United States Patent and Trademark Office

United States of America

United States Patent and Trademark Office

REAL PLANS REAL PEOPLE REAL PROGRESS

Reg. No. 4,073,206

Registered Dec. 20, 2011

Int. Cls.: 35, 36 and 37

SERVICE MARK

PRINCIPAL REGISTER

HOUSING VISIONS UNLIMITED, INC. (NEW YORK CORPORATION)
SUITE 26
1201 EAST FAYETTE STREET
SYRACUSE, NY 13210

FOR: ASSOCIATION SERVICES, NAMELY, PROMOTING COLLABORATION AND PARTNERSHIP AMONG COMMUNITY ORGANIZATIONS AND INDIVIDUALS FOR THE PURPOSE OF IMPROVING AND SUSTAINING THE QUALITY OF LIFE AND REDUCING POVERTY, IN CLASS 35 (U.S. CLS. 100, 101 AND 102).

FIRST USE 3-26-2010; IN COMMERCE 3-31-2010.

FOR: RENTAL AND MANAGEMENT SERVICES FOR RESIDENTIAL, COMMERCIAL, AND MIXED USE REAL PROPERTY IN NEIGHBORHOODS THAT REQUIRE REVITALIZATION AND/OR MAINTENANCE OF THE QUALITY OF THE REAL ESTATE AND COMMUNITY SPACES, IN CLASS 36 (U.S. CLS. 100, 101 AND 102).

FIRST USE 3-26-2010; IN COMMERCE 3-31-2010.

FOR: CHARITABLE SERVICES, NAMELY, DEVELOPMENT OF RESIDENTIAL, COMMERCIAL, AND MIXED USE REAL PROPERTY; REPAIR AND IMPROVEMENT OF EXISTING REAL PROPERTY AND NEW CONSTRUCTION IN NEIGHBORHOODS THAT REQUIRE REVITALIZATION, IN CLASS 37 (U.S. CLS. 100, 103 AND 106).

FIRST USE 3-26-2010; IN COMMERCE 3-31-2010.

THE MARK CONSISTS OF STANDARD CHARACTERS WITHOUT CLAIM TO ANY PARTICULAR FONT, STYLE, SIZE, OR COLOR.

SER. NO. 85-236,381, FILED 2-8-2011.

ANDREW LEASER, EXAMINING ATTORNEY



David J. Kyffers

Director of the United States Patent and Trademark Office

United States of America
United States Patent and Trademark Office

AceBuilder

Reg. No. 4,073,207

ACEBUILDER, LLC (NEVADA LIMITED LIABILITY COMPANY)
10001 PARK RUN DRIVE
LAS VEGAS, NV 89145

Registered Dec. 20, 2011

Int. Cl.: 28

FOR: SPORTS EQUIPMENT, NAMELY, A TENNIS TRAINING DEVICE, SPECIFICALLY, A TARGET FOR USE IN IMPROVING THE ACCURACY OF TENNIS SERVES, IN CLASS 28 (U.S. CLS. 22, 23, 38 AND 50).

TRADEMARK

FIRST USE 12-6-2010; IN COMMERCE 1-21-2011.

PRINCIPAL REGISTER

THE MARK CONSISTS OF STANDARD CHARACTERS WITHOUT CLAIM TO ANY PARTICULAR FONT, STYLE, SIZE, OR COLOR.

SER. NO. 85-236,737, FILED 2-8-2011.

JEFFREY LOOK, EXAMINING ATTORNEY



David J. Kybas

Director of the United States Patent and Trademark Office

United States of America

United States Patent and Trademark Office

FECAL-QUIK-PREP

Reg. No. 4,073,208

Registered Dec. 20, 2011

Int. Cl.: 10

TRADEMARK

PRINCIPAL REGISTER

WAMPOLE LABORATORIES, LLC (DELAWARE LIMITED LIABILITY COMPANY)
2 RESEARCH WAY
PRINCETON, NJ 08540

FOR: FECAL SAMPLE SPECIMEN COLLECTION, TRANSPORT AND PREPARATION DEVICE COMPRISED PRIMARILY OF MEDICAL GRADE SYNTHETIC FIBER-TIPPED SWABS, FILTERS FOR THE FECAL SPECIMEN, AND PLASTIC TUBES AND SHAFT FOR CONTAINMENT OF SAMPLE DILUENTS FOR USE IN CLINICAL DIAGNOSTIC TESTING, IN CLASS 10 (U.S. CLS. 26, 39 AND 44).

FIRST USE 12-0-2006; IN COMMERCE 12-0-2006.

THE MARK CONSISTS OF STANDARD CHARACTERS WITHOUT CLAIM TO ANY PARTICULAR FONT, STYLE, SIZE, OR COLOR.

SER. NO. 85-237,482, FILED 2-9-2011.

KATHLEEN LORENZO, EXAMINING ATTORNEY



David J. Kyjars

Director of the United States Patent and Trademark Office

United States of America

United States Patent and Trademark Office

Wyndham Capital Mortgage, Inc.

Reg. No. 4,073,209

WYNDHAM CAPITAL MORTGAGE INC. (NORTH CAROLINA CORPORATION)
6115 PARK SOUTH DRIVE STE 200
CHARLOTTE, NC 28210

Registered Dec. 20, 2011

Int. Cl.: 36

FOR: MORTGAGE BANKING; MORTGAGE BANKING SERVICES, NAMELY, ORIGINATION, ACQUISITION, SERVICING, SECURITIZATION AND BROKERAGE OF MORTGAGE LOANS; MORTGAGE BROKERAGE, IN CLASS 36 (U.S. CLS. 100, 101 AND 102).

SERVICE MARK

FIRST USE 1-1-2001; IN COMMERCE 1-1-2001.

PRINCIPAL REGISTER

THE MARK CONSISTS OF STANDARD CHARACTERS WITHOUT CLAIM TO ANY PARTICULAR FONT, STYLE, SIZE, OR COLOR.

NO CLAIM IS MADE TO THE EXCLUSIVE RIGHT TO USE "CAPITAL MORTGAGE INC.", APART FROM THE MARK AS SHOWN.

SER. NO. 85-237,712, FILED 2-9-2011.

ANNE MADDEN, EXAMINING ATTORNEY



David J. Kybas

Director of the United States Patent and Trademark Office

United States of America

United States Patent and Trademark Office

EVOAUCTION

Reg. No. 4,073,210

EVOLUTION MARKETS, INC. (DELAWARE CORPORATION)
10 BANK STREET
WHITE PLAINS, NY 10606

Registered Dec. 20, 2011

Int. Cl.: 35

FOR: ONLINE AUCTION SERVICES, IN CLASS 35 (U.S. CLS. 100, 101 AND 102).

SERVICE MARK

FIRST USE 5-8-2008; IN COMMERCE 5-8-2008.

PRINCIPAL REGISTER

THE MARK CONSISTS OF STANDARD CHARACTERS WITHOUT CLAIM TO ANY PARTICULAR FONT, STYLE, SIZE, OR COLOR.

SER. NO. 85-238,048, FILED 2-9-2011.

TIMOTHY FINNEGAN, EXAMINING ATTORNEY



David J. Kybas

Director of the United States Patent and Trademark Office

United States of America

United States Patent and Trademark Office

RICK ROSS

Reg. No. 4,073,211

Registered Dec. 20, 2011

Int. Cls.: 9 and 41

TRADEMARK

SERVICE MARK

PRINCIPAL REGISTER

ROBERTS II, WILLIAM L. (UNITED STATES INDIVIDUAL), AKA RICK ROSS
C/O SEDLMAYR & ASSOCIATES, P.C.
200 PARK AVENUE SOUTH SUITE 1408
NEW YORK, NY 10003

FOR: MUSICAL SOUND RECORDINGS; AUDIO AND VIDEO RECORDINGS FEATURING MUSIC AND ARTISTIC PERFORMANCES; DOWNLOADABLE RING TONES, MUSIC, AND VIDEO RECORDINGS VIA THE INTERNET AND WIRELESS DEVICES, IN CLASS 9 (U.S. CLS. 21, 23, 26, 36 AND 38).

FIRST USE 8-0-2006; IN COMMERCE 8-0-2006.

FOR: ENTERTAINMENT SERVICES IN THE NATURE OF LIVE MUSICAL PERFORMANCES; MUSIC PRODUCTION SERVICES; MUSIC VIDEO PRODUCTION; PROVIDING A WEB SITE FEATURING PRE-RECORDED MUSICAL AUDIO AND AUDIO-VISUAL CLIPS, PHOTOGRAPHS, MUSICAL AND ENTERTAINMENT NEWS, INFORMATION ABOUT MUSICAL ARTISTS, SOUND RECORDINGS, AND LIVE MUSIC TOUR SCHEDULES, IN CLASS 41 (U.S. CLS. 100, 101 AND 107).

FIRST USE 8-0-2006; IN COMMERCE 8-0-2006.

THE MARK CONSISTS OF STANDARD CHARACTERS WITHOUT CLAIM TO ANY PARTICULAR FONT, STYLE, SIZE, OR COLOR.

THE NAME(S), PORTRAIT(S), AND/OR SIGNATURE(S) SHOWN IN THE MARK IDENTIFIES APPLICANT, WHOSE CONSENT(S) TO REGISTER IS MADE OF RECORD.

SER. NO. 85-238,134, FILED 2-9-2011.

ESTHER A. BORSUK, EXAMINING ATTORNEY



David J. Kyjars

Director of the United States Patent and Trademark Office

United States of America

United States Patent and Trademark Office

HONEY COMB

Reg. No. 4,073,212

BLACK SWAN COOPERAGE (DELAWARE LIMITED LIABILITY COMPANY)
54473 STATE HIGHWAY 34
OSAGE, MN 56570

Registered Dec. 20, 2011

Int. Cl.: 31

FOR: OAK CHIP AND OAK STAVE INSERTS FOR WINE BARRELS, IN CLASS 31 (U.S. CLS. 1 AND 46).

TRADEMARK

FIRST USE 2-23-2010; IN COMMERCE 2-23-2010.

PRINCIPAL REGISTER

THE MARK CONSISTS OF STANDARD CHARACTERS WITHOUT CLAIM TO ANY PARTICULAR FONT, STYLE, SIZE, OR COLOR.

SER. NO. 85-238,426, FILED 2-9-2011.

SAMUEL E. SHARPER JR., EXAMINING ATTORNEY



David J. Kybas

Director of the United States Patent and Trademark Office

United States of America

United States Patent and Trademark Office

SAY YES TO NO DEBT

Reg. No. 4,073,213

CORPORATE COMMUNITY CONNECTIONS, INC. (NEW JERSEY CORPORATION)
P.O. BOX 561

Registered Dec. 20, 2011

KINGSTON, NJ 085280561

Int. Cl.: 35

SERVICE MARK

PRINCIPAL REGISTER

FOR: ASSISTANCE, ADVISORY SERVICES AND CONSULTANCY WITH REGARD TO BUSINESS PLANNING, BUSINESS ANALYSIS, BUSINESS MANAGEMENT, AND BUSINESS ORGANIZATION; ASSISTANCE, ADVISORY SERVICES AND CONSULTANCY WITH REGARD TO BUSINESS PLANNING, BUSINESS ANALYSIS, BUSINESS MANAGEMENT, AND BUSINESS ORGANIZATION RELATING TO MICRO CREDITS, MICRO FINANCE AND ENERGY PRODUCTS; ASSISTANCE, ADVISORY SERVICES AND CONSULTANCY WITH REGARD TO BUSINESS PLANNING, BUSINESS ANALYSIS, BUSINESS MANAGEMENT, BUSINESS ORGANIZATION, MARKETING AND CUSTOMER ANALYSIS; BUSINESS ACQUISITIONS CONSULTATION; BUSINESS ADMINISTRATION CONSULTANCY; BUSINESS CONSULTATION; BUSINESS CONSULTATION IN THE FIELD OF FINANCIAL LITERACY; BUSINESS CONSULTATION SERVICES TO ASSIST NON-PROFIT ORGANIZATIONS IN PLANNING, MANAGING, AND CONDUCTING FUNDRAISING ACTIVITIES VIA A GLOBAL COMPUTER NETWORK; BUSINESS CONSULTING AND INFORMATION SERVICES; BUSINESS CONSULTING SERVICE THAT PROVIDES TRANSFORMATIONAL STRATEGIES TO COMPANIES WISHING TO MOVE TOWARDS SUSTAINABILITY AND SOCIALLY RESPONSIBLE BUSINESS PRACTICES, PROVIDED MAINLY TO THE CONSUMER PRODUCTS INDUSTRY; BUSINESS CONSULTING SERVICES, NAMELY, PROVIDING A TURNKEY BUSINESS SOLUTION FOR REVIEWING PRODUCTS AND SERVICES, PLANNING DOCUMENTATION AND WORKFLOW, HIRING TECHNICAL WRITERS, MANAGING PROJECTS FOR BUSINESS PURPOSES, TRACKING USER SATISFACTION, AND RUNNING USABILITY STUDIES FOR BUSINESS PURPOSES; BUSINESS CONSULTING SERVICES, NAMELY, PROVIDING ASSISTANCE IN DEVELOPMENT OF BUSINESS STRATEGIES AND CREATIVE IDEATION; BUSINESS DEVELOPMENT CONSULTING SERVICES; BUSINESS MANAGEMENT AND CONSULTATION; BUSINESS MANAGEMENT AND ENTERPRISE ORGANIZATION CONSULTANCY; BUSINESS MANAGEMENT CONSULTANCY AND ADVISORY SERVICES; BUSINESS MANAGEMENT CONSULTANCY AS WELL AS DEVELOPMENT OF PROCESSES FOR THE ANALYSIS AND THE IMPLEMENTATION OF STRATEGY PLANS AND MANAGEMENT PROJECTS; BUSINESS MANAGEMENT CONSULTANCY SERVICES; BUSINESS MANAGEMENT CONSULTANCY, ALSO VIA THE INTERNET; BUSINESS MANAGEMENT CONSULTATION; BUSINESS MANAGEMENT CONSULTATION IN THE FIELD OF EXECUTIVE AND LEADERSHIP DEVELOPMENT; BUSINESS MANAGEMENT CONSULTING AND ADVISORY SERVICES; BUSINESS MANAGEMENT CONSULTING WITH RELATION TO STRATEGY,



David J. Kybas

Director of the United States Patent and Trademark Office

Reg. No. 4,073,213 MARKETING, SALES, OPERATION, PRODUCT DESIGN PARTICULARLY SPECIALIZING IN THE USE OF ANALYTIC AND STATISTIC MODELS FOR THE UNDERSTANDING AND PREDICTING OF CONSUMERS, BUSINESSES, AND MARKET TRENDS AND ACTIONS; BUSINESS ORGANISATION AND MANAGEMENT CONSULTING SERVICES; BUSINESS ORGANISATION CONSULTING; BUSINESS ORGANIZATION AND MANAGEMENT CONSULTING; BUSINESS ORGANIZATION AND OPERATION CONSULTANCY; BUSINESS ORGANIZATIONAL CONSULTATION; CONSULTANCY AND ADVISORY SERVICES IN THE FIELD OF BUSINESS STRATEGY; CONSULTANCY SERVICES REGARDING BUSINESS STRATEGIES; CONSULTING SERVICES IN THE AREA OF SUSTAINABLE BUSINESS SOLUTIONS, IN CLASS 35 (U.S. CLS. 100, 101 AND 102).

FIRST USE 1-1-2010; IN COMMERCE 5-1-2010.

THE MARK CONSISTS OF STANDARD CHARACTERS WITHOUT CLAIM TO ANY PARTICULAR FONT, STYLE, SIZE, OR COLOR.

SER. NO. 85-238,838, FILED 2-10-2011.

NORA BUCHANAN WILL, EXAMINING ATTORNEY

United States of America

United States Patent and Trademark Office

TURTLE

Reg. No. 4,073,214

MOUNTAIN EQUIPMENT CO-OPERATIVE (CANADA CORPORATION)
149 WEST 4TH AVENUE
VANCOUVER, CANADA V5Y4A6

Registered Dec. 20, 2011

Int. Cl.: 11

FOR: EMERGENCY LIGHTS FOR BICYCLES, IN CLASS 11 (U.S. CLS. 13, 21, 23, 31 AND 34).

TRADEMARK

FIRST USE 1-0-2005; IN COMMERCE 1-0-2008.

PRINCIPAL REGISTER

THE MARK CONSISTS OF STANDARD CHARACTERS WITHOUT CLAIM TO ANY PARTICULAR FONT, STYLE, SIZE, OR COLOR.

PRIORITY CLAIMED UNDER SEC. 44(D) ON CANADA APPLICATION NO. 1493412, FILED 8-24-2010, REG. NO. TMA802,099, DATED 7-13-2011, EXPIRES 7-13-2026.

SER. NO. 85-238,906, FILED 2-10-2011.

JENNIFER MARTIN, EXAMINING ATTORNEY



David J. Kybas

Director of the United States Patent and Trademark Office

United States of America

United States Patent and Trademark Office



Reg. No. 4,073,215

Registered Dec. 20, 2011

Int. Cl.: 41

SERVICE MARK

PRINCIPAL REGISTER

XAVIER UNIVERSITY CORPORATION (OHIO CORPORATION), DBA XAVIER UNIVERSITY
3800 VICTORY PARKWAY
CINCINNATI, OH 45207

FOR: ARRANGING AND CONDUCTING ATHLETIC COMPETITIONS; ENCOURAGING AMATEUR SPORTS AND PHYSICAL EDUCATION BY ORGANIZING, SANCTIONING, CONDUCTING, REGULATING AND GOVERNING AMATEUR ATHLETIC PROGRAMS AND ACTIVITIES, IN CLASS 41 (U.S. CLS. 100, 101 AND 107).

FIRST USE 10-1-2010; IN COMMERCE 10-1-2010.

THE MARK CONSISTS OF AN ATHLETIC MASCOT REFERRED TO AS THE BLUE BLOB THAT IS USED TO PROMOTE THE ATHLETIC TEAMS AT XAVIER UNIVERSITY - A FURRY BLOB LIKE CREATURE WITH WHITE HANDS, EYES, AND NOSE, A BLUE BODY, AND BLACK AND WHITE SHOES.

THE COLOR(S) BLUE, WHITE, AND BLACK IS/ARE CLAIMED AS A FEATURE OF THE MARK.

SER. NO. 85-239,233, FILED 2-10-2011.

ANGELA M. MICHELI, EXAMINING ATTORNEY



David J. Kybas

Director of the United States Patent and Trademark Office

United States of America

United States Patent and Trademark Office

NEW CAPTAINS OF INDUSTRY

Reg. No. 4,073,216

JARKESY AND COMPANY (TEXAS CORPORATION)

Registered Dec. 20, 2011

18205 BURKHARDT RD.
TOMBALL, TX 77377

Int. Cl.: 41

FOR: ENTERTAINMENT SERVICES, NAMELY, THE PROVISION OF CONTINUING AUDIO AND VIDEO PROGRAMS FEATURING NEWS AND COMMENTARY IN THE FIELD OF CURRENT EVENTS RELATING TO ECONOMICS, POLITICS, AND BUSINESS DELIVERED BY THE INTERNET; ENTERTAINMENT, NAMELY, A CONTINUING NEWS AND COMMENTARY SHOW FEATURING NEWS AND COMMENTARY IN THE FIELD OF CURRENT EVENTS RELATING TO ECONOMICS, POLITICS, AND BUSINESS BROADCAST OVER THE INTERNET, IN CLASS 41 (U.S. CLS. 100, 101 AND 107).

SERVICE MARK

PRINCIPAL REGISTER

FIRST USE 11-23-2010; IN COMMERCE 11-23-2010.

THE MARK CONSISTS OF STANDARD CHARACTERS WITHOUT CLAIM TO ANY PARTICULAR FONT, STYLE, SIZE, OR COLOR.

SER. NO. 85-239,390, FILED 2-10-2011.

JOHN DALIER, EXAMINING ATTORNEY



David J. Kyros

Director of the United States Patent and Trademark Office

United States of America

United States Patent and Trademark Office

POWDER KEG

Reg. No. 4,073,217

AFTER FIVE, INC. (INDIANA CORPORATION)

Registered Dec. 20, 2011

P.O. BOX 747
JEFFERSONVILLE, IN 47131

Int. Cl.: 35

FOR: RETAIL STORE SERVICES FEATURING FIREWORKS, IN CLASS 35 (U.S. CLS. 100, 101 AND 102).

SERVICE MARK

FIRST USE 6-0-1995; IN COMMERCE 6-0-1995.

PRINCIPAL REGISTER

THE MARK CONSISTS OF STANDARD CHARACTERS WITHOUT CLAIM TO ANY PARTICULAR FONT, STYLE, SIZE, OR COLOR.

SER. NO. 85-239,659, FILED 2-11-2011.

BRENDAN REGAN, EXAMINING ATTORNEY



David J. Kybas

Director of the United States Patent and Trademark Office

United States of America

United States Patent and Trademark Office

Pink Piggy Sweets

Reg. No. 4,073,218

Registered Dec. 20, 2011

Int. Cl.: 40

SERVICE MARK

PRINCIPAL REGISTER

OUT-OF-THIS-WORLD VIRTUAL SERVICES, INC. (FLORIDA CORPORATION), DBA PINK PIGGY SWEETS
22047 AVONWORTH SQ
BROADLANDS, VA 20148

FOR: BAKERY SERVICES, NAMELY, THE MANUFACTURE OF BAKERY PRODUCTS TO ORDER AND/OR SPECIFICATION OF OTHERS, IN CLASS 40 (U.S. CLS. 100, 103 AND 106).

FIRST USE 4-4-2010; IN COMMERCE 4-23-2010.

THE MARK CONSISTS OF STANDARD CHARACTERS WITHOUT CLAIM TO ANY PARTICULAR FONT, STYLE, SIZE, OR COLOR.

NO CLAIM IS MADE TO THE EXCLUSIVE RIGHT TO USE "SWEETS", APART FROM THE MARK AS SHOWN.

SER. NO. 85-240,347, FILED 2-11-2011.

CAROLYN CATALDO, EXAMINING ATTORNEY



David J. Kyjars

Director of the United States Patent and Trademark Office

United States of America

United States Patent and Trademark Office



Reg. No. 4,073,219

OLD WEST MATTRESS CO., LLC (COLORADO LIMITED LIABILITY COMPANY)
1055 SOUTH JASON ST.
DENVER, CO 80223

Registered Dec. 20, 2011

Int. Cl.: 20

FOR: SLEEP PRODUCTS, NAMELY, MATTRESSES, SPRING MATTRESSES, FOAM MATTRESSES, STEEL MATTRESS FOUNDATIONS AND WOOD MATTRESS FOUNDATIONS; LATEX FOAM MATTRESSES; MEMORY FOAM MATTRESSES, IN CLASS 20 (U.S. CLS. 2, 13, 22, 25, 32 AND 50).

TRADEMARK

PRINCIPAL REGISTER

FIRST USE 3-17-2010; IN COMMERCE 3-25-2010.

NO CLAIM IS MADE TO THE EXCLUSIVE RIGHT TO USE "MATTRESS COMPANY LLC EST. 09", APART FROM THE MARK AS SHOWN.

THE STIPLING IS A FEATURE OF THE MARK.

THE MARK CONSISTS OF A DESIGN WHICH HAS THE APPEARANCE OF AN OLD BRANDING IRON MARK WITH THE WORDS "OLD WEST EST. 09" CENTERED IN A CIRCLE WITH AN OUTER RING AROUND THE CENTER CIRCLE CONTAINING THE WORDS "MATTRESS COMPANY LLC".

SER. NO. 85-240,498, FILED 2-11-2011.

ALEX KEAM, EXAMINING ATTORNEY



David J. Kyros

Director of the United States Patent and Trademark Office

United States of America

United States Patent and Trademark Office



Reg. No. 4,073,220

Registered Dec. 20, 2011

Int. Cl.: 35

SERVICE MARK

PRINCIPAL REGISTER

GABRIEL ENTERPRISES CONSULTING GROUP - GEC (VIRGINIA LIMITED LIABILITY COMPANY)
3786 MERSEYSIDE PL.
WALDORF, MD 20602

FOR: ASSISTANCE, ADVISORY SERVICES AND CONSULTANCY WITH REGARD TO BUSINESS PLANNING, BUSINESS ANALYSIS, BUSINESS MANAGEMENT, BUSINESS ORGANIZATION, MARKETING AND CUSTOMER ANALYSIS, IN CLASS 35 (U.S. CLS. 100, 101 AND 102).

FIRST USE 7-23-2010; IN COMMERCE 9-30-2010.

THE MARK CONSISTS OF TWO VERTICAL SPIRAL LIKE VERTICAL WINGS WITH THE SMALLER LEFT VERTICAL WING HAVING AN OLIVE GREEN TYPE COLOR AND THE LARGER RIGHT VERTICAL WING HAVING A CANARY YELLOW TYPE COLOR. THESE TWO OBJECT DESIGNS PARTIALLY OVERLAP EACH OTHER WITH THE COMPANY LETTERS "GEC" CAPITALIZED AND GROUPED OF THE TWO VERTICAL WING DESIGNS JUST DESCRIBED. THE LETTERS "GE" ARE IN THE COLOR DARK BLUE AND THE LETTER "C" IS IN THE COLOR OLIVE GREEN. THE COMPANY LETTERS "GEC" ARE LOCATED TO THE BOTTOM RIGHT PORTION OF THE TWO OVERLAPPING SPIRAL LIKE VERTICAL WING DESIGNS TO CREATE A COMPLETE LOGO DESIGN.

THE COLOR(S) DARK BLUE, OLIVE GREEN, CANARY YELLOW IS/ARE CLAIMED AS A FEATURE OF THE MARK.

SER. NO. 85-240,853, FILED S.R. 2-12-2011 AM. P.R. 5-23-2011.

ANNE E. GUSTASON, EXAMINING ATTORNEY



David J. Kybas

Director of the United States Patent and Trademark Office

United States of America

United States Patent and Trademark Office

EYE BUTLER

Reg. No. 4,073,221

LINDAUER, CAROLYN S. (UNITED STATES INDIVIDUAL)
513 E HASTINGS RD
SPOKANE, WA 99218

Registered Dec. 20, 2011

Int. Cl.: 9

FOR: CONTACT LENSES; EYEGASSES; SUNGLASSES, IN CLASS 9 (U.S. CLS. 21, 23, 26, 36 AND 38).

TRADEMARK

FIRST USE 2-1-2011; IN COMMERCE 2-1-2011.

PRINCIPAL REGISTER

THE MARK CONSISTS OF STANDARD CHARACTERS WITHOUT CLAIM TO ANY PARTICULAR FONT, STYLE, SIZE, OR COLOR.

NO CLAIM IS MADE TO THE EXCLUSIVE RIGHT TO USE "EYE", APART FROM THE MARK AS SHOWN.

SER. NO. 85-240,909, FILED 2-12-2011.

MARK SHINER, EXAMINING ATTORNEY



David J. Kybas

Director of the United States Patent and Trademark Office

United States of America

United States Patent and Trademark Office

EZyApp

Reg. No. 4,073,222

Registered Dec. 20, 2011

Int. Cl.: 9

TRADEMARK

PRINCIPAL REGISTER

EPIC CONCEPTS, LLC (KENTUCKY LIMITED LIABILITY COMPANY)
SUITE 201
410 COMMERCIAL DRIVE
LOUISVILLE, KY 40223

FOR: COMPUTER SOFTWARE THAT PROVIDES WEB-BASED ACCESS TO APPLICATIONS AND SERVICES THROUGH A WEB OPERATING SYSTEM OR PORTAL INTERFACE , IN CLASS 9 (U.S. CLS. 21, 23, 26, 36 AND 38).

FIRST USE 2-10-2011; IN COMMERCE 2-10-2011.

OWNER OF U.S. REG. NO. 3,261,991.

THE MARK CONSISTS OF STYLIZED VERSIONS OF CAPITAL LETTERS "EZ", A LOWER-CASE "Y", CAPITAL LETTER "A", FOLLOWED BY LOWER CASE "PP" WITH NO SPACES.

SER. NO. 85-241,349, FILED 2-14-2011.

KAREN BRACEY, EXAMINING ATTORNEY



David J. Kybas

Director of the United States Patent and Trademark Office

United States of America

United States Patent and Trademark Office



Reg. No. 4,073,223

ENERGY MANAGEMENT RESOURCES OF MISSOURI, INC. (MISSOURI CORPORATION)
1536 NE 96TH STREET
LIBERTY, MO 64068

Registered Dec. 20, 2011

Int. Cl.: 35

FOR: BUSINESS CONSULTING AND ADVISORY SERVICES IN THE FIELD OF ENERGY EFFICIENCY, ENERGY REQUIREMENTS, ENERGY REGULATION, TAX EXEMPTION EVALUATION, TARIFF OPTIMIZATION, RISK ASSESSMENT, BUDGET PREPARATION, BILLING ANALYSIS, AUDITING, CONTRACT NEGOTIATIONS, CARBON MANAGEMENT IN THE FIELD OF ENERGY; CONDUCTING ENERGY AUDITS; ENERGY USAGE AND EFFICIENCY MANAGEMENT SERVICES; ENERGY PROCUREMENT SERVICES; ENERGY PRICE COMPARISON SERVICES; ENERGY USAGE MANAGEMENT AND INFORMATION SERVICES, IN CLASS 35 (U.S. CLS. 100, 101 AND 102).

SERVICE MARK

PRINCIPAL REGISTER

FIRST USE 2-12-2011; IN COMMERCE 2-12-2011.

NO CLAIM IS MADE TO THE EXCLUSIVE RIGHT TO USE "ENERGY MANAGEMENT RESOURCES", APART FROM THE MARK AS SHOWN.

THE MARK CONSISTS OF A SUN DESIGN WITH A BAND EXTENDING UP AND TO THE RIGHT FROM THE SUN. THE WORD "ENERGY" APPEARS ABOVE THE WORDING "MANAGEMENT RESOURCES". THE LETTER "E" IN "ENERGY" IS PARTIALLY COVERING THE SUN DESIGN. THERE'S A HORIZONTAL LINE IN BETWEEN THE WORDING "ENERGY" AND "MANAGEMENT RESOURCES".



SER. NO. 85-241,667, FILED 2-14-2011.

JENNIFER VASQUEZ, EXAMINING ATTORNEY

David J. Kybas

Director of the United States Patent and Trademark Office

United States of America

United States Patent and Trademark Office

The Mary Sue

Reg. No. 4,073,224

DAN ABRAMS (UNITED STATES INDIVIDUAL)
148 WAVERLY PLACE APT C
NEW YORK, NY 10014

Registered Dec. 20, 2011

Int. Cl.: 41

FOR: PROVIDING A WEB SITE FEATURING ENTERTAINMENT INFORMATION FOR WOMEN FEATURING NEWS AND COVERAGE OF TECHNOLOGY AND POP CULTURE, IN CLASS 41 (U.S. CLS. 100, 101 AND 107).

SERVICE MARK

FIRST USE 10-8-2010; IN COMMERCE 2-10-2011.

PRINCIPAL REGISTER

THE MARK CONSISTS OF STANDARD CHARACTERS WITHOUT CLAIM TO ANY PARTICULAR FONT, STYLE, SIZE, OR COLOR.

SER. NO. 85-241,821, FILED 2-14-2011.

KYLE PEETE, EXAMINING ATTORNEY



David J. Kyffers

Director of the United States Patent and Trademark Office

United States of America

United States Patent and Trademark Office



Reg. No. 4,073,225

DAIMLER AG (FED REP GERMANY CORPORATION)
MERCEDSTRASSE 137
STUTT GART, FED REP GERMANY 70327

Registered Dec. 20, 2011

Int. Cl.: 37

FOR: MOTOR VEHICLE SERVICING, IN CLASS 37 (U.S. CLS. 100, 103 AND 106).

SERVICE MARK

PRIORITY CLAIMED UNDER SEC. 44(D) ON UNITED KINGDOM APPLICATION NO. 2556624, FILED 8-23-2010.

PRINCIPAL REGISTER

OWNER OF ERP N CMNTY TM OFC REG. NO. 009752445, DATED 6-30-2011, EXPIRES 2-21-2021.

THE MARK CONSISTS OF THE WORD "COLLECT" OVER WHICH APPEAR TWO ARROW DESIGNS, ONE POINTING RIGHT AND ONE POINTING LEFT, AND THE OUTLINE OF A HOUSE, WITHIN A SQUARE WITH THREE ROUNDED CORNERS.

SER. NO. 85-242,795, FILED 2-15-2011.

BRENDAN MCCAULEY, EXAMINING ATTORNEY



David J. Kybas

Director of the United States Patent and Trademark Office

United States of America

United States Patent and Trademark Office

GO COUNTRY CHUCK WAGON

Reg. No. 4,073,226

MOUNT WILSON FM BROADCASTERS, INC. (CALIFORNIA CORPORATION)
1500 COTNER AVENUE
LOS ANGELES, CA 90025

Registered Dec. 20, 2011

Int. Cl.: 43

FOR: PROVIDING FOOD AND DRINKS; MOBILE CAFE SERVICES FOR PROVIDING FOOD AND DRINKS; CATERING OF FOOD AND DRINKS, IN CLASS 43 (U.S. CLS. 100 AND 101).

SERVICE MARK

FIRST USE 1-24-2011; IN COMMERCE 1-24-2011.

PRINCIPAL REGISTER

THE MARK CONSISTS OF STANDARD CHARACTERS WITHOUT CLAIM TO ANY PARTICULAR FONT, STYLE, SIZE, OR COLOR.

NO CLAIM IS MADE TO THE EXCLUSIVE RIGHT TO USE "CHUCK WAGON", APART FROM THE MARK AS SHOWN.

SER. NO. 85-243,217, FILED 2-15-2011.

CHARLES L. JENKINS, EXAMINING ATTORNEY



David J. Kybas

Director of the United States Patent and Trademark Office

United States of America

United States Patent and Trademark Office

IRON GATE REALTY

Reg. No. 4,073,227

REINERT, RENEE (UNITED STATES INDIVIDUAL)
606 DAGGETT STREET
DANIEL ISLAND, SC 29492

Registered Dec. 20, 2011

Int. Cl.: 36

FOR: REAL ESTATE BROKERAGE; LISTING REAL ESTATE PROPERTIES; SELLING OF REAL ESTATE, NAMELY, REAL ESTATE AGENCIES, IN CLASS 36 (U.S. CLS. 100, 101 AND 102).

SERVICE MARK

FIRST USE 6-15-2010; IN COMMERCE 6-15-2010.

PRINCIPAL REGISTER

THE MARK CONSISTS OF STANDARD CHARACTERS WITHOUT CLAIM TO ANY PARTICULAR FONT, STYLE, SIZE, OR COLOR.

NO CLAIM IS MADE TO THE EXCLUSIVE RIGHT TO USE "REALTY", APART FROM THE MARK AS SHOWN.

SER. NO. 85-243,372, FILED 2-16-2011.

MARK PILARO, EXAMINING ATTORNEY



David J. Kybas

Director of the United States Patent and Trademark Office

United States of America

United States Patent and Trademark Office

PROSORB

Reg. No. 4,073,228

Registered Dec. 20, 2011

Int. Cl.: 9

TRADEMARK

PRINCIPAL REGISTER

LIFE TECHNOLOGIES CORPORATION (DELAWARE CORPORATION)
5791 VAN ALLEN WAY
CARLSBAD, CA 92008

FOR: SUPPLIES FOR BIOTECHNOLOGY IN THE NATURE OF CARTRIDGES, NAMELY, DEVICES IN THE NATURE OF PETRI DISHES FOR PROTEIN AND PEPTIDE CONCENTRATION AND PURIFICATION, MEMBRANES, NAMELY, CELLULAR MIXED ESTER MEMBRANES; THIN SHEETS OF NATURAL OR SYNTHETIC MATERIAL, NAMELY, POLYVINYLIDINEDIFLUORIDE (PVDF), FILTERS, NAMELY, LABORATORY FILTERS, AND VACUUM PLASTIC TUBES, IN CLASS 9 (U.S. CLS. 21, 23, 26, 36 AND 38).

FIRST USE 8-11-1995; IN COMMERCE 8-11-1995.

THE MARK CONSISTS OF STANDARD CHARACTERS WITHOUT CLAIM TO ANY PARTICULAR FONT, STYLE, SIZE, OR COLOR.

SER. NO. 85-244,354, FILED 2-16-2011.

NAAKWAMA ANKRAH, EXAMINING ATTORNEY



David J. Kyffers

Director of the United States Patent and Trademark Office

United States of America

United States Patent and Trademark Office

COMMUNICATION SOLUTIONS PUBLISHING

Reg. No. 4,073,229

GLASER & ASSOCIATES, INC. (OREGON CORPORATION)
1740 CRAIGMONT AVE
EUGENE, OR 97405

Registered Dec. 20, 2011

Int. Cl.: 16

FOR: BOOKS FEATURING COMMUNICATION STRATEGIES, CONFLICT RESOLUTION AND TEAM BUILDING, IN CLASS 16 (U.S. CLS. 2, 5, 22, 23, 29, 37, 38 AND 50).

TRADEMARK

FIRST USE 5-19-2006; IN COMMERCE 5-25-2006.

PRINCIPAL REGISTER

THE MARK CONSISTS OF STANDARD CHARACTERS WITHOUT CLAIM TO ANY PARTICULAR FONT, STYLE, SIZE, OR COLOR.

NO CLAIM IS MADE TO THE EXCLUSIVE RIGHT TO USE "PUBLISHING", APART FROM THE MARK AS SHOWN.

SEC. 2(F).

SER. NO. 85-244,490, FILED 2-17-2011.

RAUL CORDOVA, EXAMINING ATTORNEY



David J. Kybas

Director of the United States Patent and Trademark Office

United States of America

United States Patent and Trademark Office

STEEL GYM

Reg. No. 4,073,230

REDBOX 3-13 LLC (NEW YORK LIMITED LIABILITY COMPANY)
257 WEST 17TH, APT. 4D
NEW YORK, NY 10011

Registered Dec. 20, 2011

Int. Cl.: 41

FOR: HEALTH AND FITNESS CLUB SERVICES; PROVIDING INDIVIDUAL EXERCISE, STRENGTH TRAINING AND WEIGHTLIFTING INSTRUCTION, EQUIPMENT AND FACILITIES; PERSONAL TRAINING SERVICES PROVIDED IN CONNECTION WITH EXERCISE, BODYBUILDING, FITNESS AND WEIGHT LOSS PROGRAMS, IN CLASS 41 (U.S. CLS. 100, 101 AND 107).

SERVICE MARK

PRINCIPAL REGISTER

FIRST USE 0-0-2000; IN COMMERCE 0-0-2000.

THE MARK CONSISTS OF STANDARD CHARACTERS WITHOUT CLAIM TO ANY PARTICULAR FONT, STYLE, SIZE, OR COLOR.

NO CLAIM IS MADE TO THE EXCLUSIVE RIGHT TO USE "GYM", APART FROM THE MARK AS SHOWN.

SER. NO. 85-244,790, FILED 2-17-2011.

ELLEN PERKINS, EXAMINING ATTORNEY



David J. Kyros

Director of the United States Patent and Trademark Office

United States of America

United States Patent and Trademark Office

HELIOPLEX

Reg. No. 4,073,231

NEUTROGENA CORPORATION (DELAWARE CORPORATION)
5760 WEST 96TH STREET
LOS ANGELES, CA 90045

Registered Dec. 20, 2011

Int. Cl.: 3

FOR: COMPACT CONTAINING MAKEUP, IN CLASS 3 (U.S. CLS. 1, 4, 6, 50, 51 AND 52).

TRADEMARK

FIRST USE 1-1-2011; IN COMMERCE 1-1-2011.

PRINCIPAL REGISTER

THE MARK CONSISTS OF STANDARD CHARACTERS WITHOUT CLAIM TO ANY PARTICULAR FONT, STYLE, SIZE, OR COLOR.

OWNER OF U.S. REG. NOS. 3,263,284 AND 3,795,028.

SER. NO. 85-244,809, FILED 2-17-2011.

SANJEEV VOHRA, EXAMINING ATTORNEY



David J. Kyffers

Director of the United States Patent and Trademark Office

United States of America

United States Patent and Trademark Office



Reg. No. 4,073,232

DAIMLER AG (FED REP GERMANY CORPORATION)
MERCEDSTRASSE 137
STUTTGART, FED REP GERMANY 70327

Registered Dec. 20, 2011

Int. Cl.: 37

FOR: MOTOR VEHICLE SERVICING, IN CLASS 37 (U.S. CLS. 100, 103 AND 106).

SERVICE MARK

PRIORITY CLAIMED UNDER SEC. 44(D) ON UNITED KINGDOM APPLICATION NO. 2556628, FILED 8-23-2010.

PRINCIPAL REGISTER

OWNER OF ERPN CMNTY TM OFC REG. NO. 009752361, DATED 6-30-2011, EXPIRES 2-21-2021.

THE MARK CONSISTS OF THE WORD "LOUNGE" ABOVE WHICH APPEARS A CURVE AND THE OUTLINE OF A MUG, WITHIN A SQUARE WITH THREE ROUNDED CORNERS.

SER. NO. 85-244,901, FILED 2-17-2011.

BRENDAN MCCAULEY, EXAMINING ATTORNEY



David J. Kybas

Director of the United States Patent and Trademark Office

United States of America

United States Patent and Trademark Office

A.W. JONES

Reg. No. 4,073,233

Registered Dec. 20, 2011

Int. Cl.: 36

SERVICE MARK

PRINCIPAL REGISTER

A.W. JONES COMPANY (NEW YORK LIMITED PARTNERSHIP)
ONE ROCKEFELLER PLAZA
#302
NEW YORK, NY 10020

FOR: FINANCIAL SERVICES, NAMELY, HEDGE FUND INVESTMENT SERVICES FOR OTHERS, IN CLASS 36 (U.S. CLS. 100, 101 AND 102).

FIRST USE 1-1-1949; IN COMMERCE 1-1-1949.

THE MARK CONSISTS OF STANDARD CHARACTERS WITHOUT CLAIM TO ANY PARTICULAR FONT, STYLE, SIZE, OR COLOR.

THE NAME(S), PORTRAIT(S), AND/OR SIGNATURE(S) SHOWN IN THE MARK DOES NOT IDENTIFY A PARTICULAR LIVING INDIVIDUAL.

SER. NO. 85-245,185, FILED 2-17-2011.

TRACY WHITTAKER-BROWN, EXAMINING ATTORNEY



David J. Kyffers

Director of the United States Patent and Trademark Office

United States of America

United States Patent and Trademark Office

SENIORBRIDGE

Reg. No. 4,073,234

Registered Dec. 20, 2011

Int. Cl.: 45

SERVICE MARK

PRINCIPAL REGISTER

SENIORBRIDGE FAMILY COMPANIES INC (NEW YORK CORPORATION)
7TH FLOOR
845 THIRD AVENUE
NEW YORK, NY 10016

FOR: IN-HOME SUPPORT SERVICES TO SENIOR PERSONS, NAMELY, GERIATRIC CARE MANAGEMENT SERVICES FEATURING THE COORDINATION OF NECESSARY ELDER-CARE SERVICES AND PERSONAL CARE FOR OLDER INDIVIDUALS, IN CLASS 45 (U.S. CLS. 100 AND 101).

FIRST USE 12-31-2001; IN COMMERCE 12-31-2001.

THE MARK CONSISTS OF STANDARD CHARACTERS WITHOUT CLAIM TO ANY PARTICULAR FONT, STYLE, SIZE, OR COLOR.

SER. NO. 85-245,376, FILED 2-17-2011.

RAMONA ORTIGA, EXAMINING ATTORNEY



David J. Kybas

Director of the United States Patent and Trademark Office

United States of America

United States Patent and Trademark Office



Reg. No. 4,073,235

Registered Dec. 20, 2011

Int. Cl.: 45

SERVICE MARK

PRINCIPAL REGISTER

SENIORBRIDGE FAMILY COMPANIES INC. (DELAWARE CORPORATION)
7TH FLOOR
845 THIRD AVENUE
NEW YORK, NY 10016

FOR: IN-HOME SUPPORT SERVICES TO SENIOR PERSONS, NAMELY, GERIATRIC CARE MANAGEMENT SERVICES FEATURING THE COORDINATION OF NECESSARY ELDER-CARE SERVICES AND PERSONAL CARE FOR OLDER INDIVIDUALS, IN CLASS 45 (U.S. CLS. 100 AND 101).

FIRST USE 12-31-2001; IN COMMERCE 12-31-2001.

THE MARK CONSISTS OF THE DEPICTION OF A DOVE CONSISTING OF THE STYLIZED LETTERS "S" AND "B".

SER. NO. 85-245,518, FILED 2-17-2011.

RUSS HERMAN, EXAMINING ATTORNEY



David J. Kybas

Director of the United States Patent and Trademark Office

United States of America

United States Patent and Trademark Office

SNL Kagan

Reg. No. 4,073,236

SNL FINANCIAL LC (VIRGINIA LIMITED LIABILITY COMPANY)
ONE SNL PLAZA
CHARLOTTESVILLE, VA 22902

Registered Dec. 20, 2011

Int. Cls.: 35 and 41

FOR: BUSINESS APPRAISALS IN THE FIELDS OF COMMUNICATIONS, MEDIA, BUSINESS MANAGEMENT AND INVESTMENTS, AND BUSINESS CONSULTATION IN THE FIELDS OF COMMUNICATION, MEDIA, BUSINESS MANAGEMENT AND INVESTMENTS, IN CLASS 35 (U.S. CLS. 100, 101 AND 102).

SERVICE MARK

PRINCIPAL REGISTER

FIRST USE 5-30-2007; IN COMMERCE 5-30-2007.

FOR: PROVIDING ON-LINE NEWSLETTERS, DATA BOOKS, AND SPECIAL REPORTS IN THE FIELDS OF COMMUNICATIONS, MEDIA, BUSINESS MANAGEMENT AND INVESTMENTS, IN CLASS 41 (U.S. CLS. 100, 101 AND 107).

FIRST USE 5-30-2007; IN COMMERCE 5-30-2007.

THE MARK CONSISTS OF STANDARD CHARACTERS WITHOUT CLAIM TO ANY PARTICULAR FONT, STYLE, SIZE, OR COLOR.

SER. NO. 85-245,991, FILED 2-18-2011.

KAREN SEVERSON, EXAMINING ATTORNEY



David J. Kyjars

Director of the United States Patent and Trademark Office

United States of America

United States Patent and Trademark Office

EDVANCE RESEARCH INC.

Reg. No. 4,073,237

Registered Dec. 20, 2011

Int. Cls.: 35 and 41

SERVICE MARK

PRINCIPAL REGISTER

EDVANCE RESEARCH, INC. (TEXAS CORPORATION)
SUITE 1000
9901 IH-10 WEST
SAN ANTONIO, TX 78230

FOR: BUSINESS CONSULTING IN THE FIELD OF BUSINESS MANAGEMENT OF SCHOOLS AND EDUCATIONAL INSTITUTIONS, AND, OF PUBLIC POLICY REGARDING EDUCATION, IN CLASS 35 (U.S. CLS. 100, 101 AND 102).

FIRST USE 12-31-2006; IN COMMERCE 12-31-2006.

FOR: CONSULTING SERVICES IN THE FIELD OF EDUCATION RESEARCH, EDUCATION POLICY FOR THE DEVELOPMENT AND IMPLEMENTATION OF PEDAGOGICAL METHODS, AND EDUCATION MANAGEMENT FOR IMPROVING TEACHING RESULTS, IN CLASS 41 (U.S. CLS. 100, 101 AND 107).

FIRST USE 12-31-2006; IN COMMERCE 12-31-2006.

THE MARK CONSISTS OF STANDARD CHARACTERS WITHOUT CLAIM TO ANY PARTICULAR FONT, STYLE, SIZE, OR COLOR.

NO CLAIM IS MADE TO THE EXCLUSIVE RIGHT TO USE "RESEARCH INC.", APART FROM THE MARK AS SHOWN.

SER. NO. 85-246,268, FILED 2-18-2011.

HANNO RITTNER, EXAMINING ATTORNEY



David J. Kypos

Director of the United States Patent and Trademark Office

United States of America

United States Patent and Trademark Office

GAS CANNIBAL

Reg. No. 4,073,238

Registered Dec. 20, 2011

Int. Cl.: 7

TRADEMARK

PRINCIPAL REGISTER

FLUID INCLUSION TECHNOLOGIES, INC. (OKLAHOMA CORPORATION)
2217 NORTH YELLOWOOD AVENUE
BROKEN ARROW, OK 74012

FOR: GAS EXTRACTING MACHINES, NAMELY, APPARATUS TO EXTRACT GASES FROM SUBTERRANEAN DOWNHOLE DRILLING FLUID, IN CLASS 7 (U.S. CLS. 13, 19, 21, 23, 31, 34 AND 35).

FIRST USE 1-16-2011; IN COMMERCE 1-16-2011.

THE MARK CONSISTS OF STANDARD CHARACTERS WITHOUT CLAIM TO ANY PARTICULAR FONT, STYLE, SIZE, OR COLOR.

NO CLAIM IS MADE TO THE EXCLUSIVE RIGHT TO USE "GAS", APART FROM THE MARK AS SHOWN.

SER. NO. 85-246,582, FILED 2-18-2011.

MARK SPARACINO, EXAMINING ATTORNEY



David J. Kybas

Director of the United States Patent and Trademark Office

United States of America

United States Patent and Trademark Office

ERNEST J. GAINES AWARD FOR LITERARY EXCELLENCE

Reg. No. 4,073,239

Registered Dec. 20, 2011

Int. Cl.: 41

SERVICE MARK

PRINCIPAL REGISTER

THE BATON ROUGE AREA FOUNDATION (LOUISIANA NON-PROFIT CORPORATION)
402 NORTH 4TH STREET
BATON ROUGE, LA 70802

FOR: PROVIDING INCENTIVES TO WRITERS TO DEMONSTRATE EXCELLENCE IN THE FIELD OF WRITING THROUGH THE ISSUANCE OF AWARDS; PROVIDING RECOGNITION AND INCENTIVES TO WRITERS BY THE WAY OF AWARDS AND CONTESTS TO DEMONSTRATE EXCELLENCE IN THE FIELD OF WRITING, IN CLASS 41 (U.S. CLS. 100, 101 AND 107).

FIRST USE 3-14-2007; IN COMMERCE 3-14-2007.

THE MARK CONSISTS OF STANDARD CHARACTERS WITHOUT CLAIM TO ANY PARTICULAR FONT, STYLE, SIZE, OR COLOR.

NO CLAIM IS MADE TO THE EXCLUSIVE RIGHT TO USE "AWARD FOR LITERARY EXCELLENCE", APART FROM THE MARK AS SHOWN.

THE NAME(S), PORTRAIT(S), AND/OR SIGNATURE(S) SHOWN IN THE MARK IDENTIFIES "ERNEST J. GAINES", WHOSE CONSENT(S) TO REGISTER IS MADE OF RECORD.

SER. NO. 85-246,611, FILED 2-18-2011.

TASNEEM HUSSAIN, EXAMINING ATTORNEY



David J. Kyffers

Director of the United States Patent and Trademark Office

United States of America

United States Patent and Trademark Office



Ernest J.

GAINES
award for literary excellence

Reg. No. 4,073,240

Registered Dec. 20, 2011

Int. Cl.: 41

SERVICE MARK

PRINCIPAL REGISTER

THE BATON ROUGE AREA FOUNDATION (LOUISIANA NON-PROFIT CORPORATION)
402 NORTH 4TH STREET
BATON ROUGE, LA 70802

FOR: PROVIDING INCENTIVES TO WRITERS TO DEMONSTRATE EXCELLENCE IN THE FIELD OF WRITING THROUGH THE ISSUANCE OF AWARDS; PROVIDING RECOGNITION AND INCENTIVES TO WRITERS BY THE WAY OF AWARDS AND CONTESTS TO DEMONSTRATE EXCELLENCE IN THE FIELD OF WRITING, IN CLASS 41 (U.S. CLS. 100, 101 AND 107).

FIRST USE 1-24-2008; IN COMMERCE 1-24-2008.

NO CLAIM IS MADE TO THE EXCLUSIVE RIGHT TO USE "AWARD FOR LITERARY EXCELLENCE", APART FROM THE MARK AS SHOWN.

THE NAME(S), PORTRAIT(S), AND/OR SIGNATURE(S) SHOWN IN THE MARK IDENTIFIES "ERNEST J. GAINES", WHOSE CONSENT(S) TO REGISTER IS MADE OF RECORD.

THE MARK CONSISTS OF THE FRONTAL IMAGE OF ERNEST J. GAINES, WITH THE WORDS "ERNEST J. GAINES AWARD FOR LITERARY EXCELLENCE".

SER. NO. 85-246,659, FILED 2-18-2011.

TASNEEM HUSSAIN, EXAMINING ATTORNEY



David J. Kyjars

Director of the United States Patent and Trademark Office

United States of America

United States Patent and Trademark Office



Reg. No. 4,073,241

SHARROCK, KEVIN (UNITED STATES INDIVIDUAL)
PO BOX 85
EATONTOWN, NJ 07724

Registered Dec. 20, 2011

Int. Cl.: 25

FOR: HATS; JACKETS; SHIRTS, IN CLASS 25 (U.S. CLS. 22 AND 39).

TRADEMARK

FIRST USE 4-1-2010; IN COMMERCE 9-7-2010.

PRINCIPAL REGISTER

NO CLAIM IS MADE TO THE EXCLUSIVE RIGHT TO USE "INDIE APPAREL 1976" , APART FROM THE MARK AS SHOWN.

THE MARK CONSISTS OF THE STYLIZED TEXT "EMPTY POOLS INDIE APPAREL 1976" WITH A SILHOUETTE OF A SKATEBOARDER TO THE RIGHT.

SER. NO. 85-246,661, FILED 2-18-2011.

MICHAEL KEATING, EXAMINING ATTORNEY



David J. Kybas

Director of the United States Patent and Trademark Office

United States of America

United States Patent and Trademark Office

LANIER PARKING

Reg. No. 4,073,242

Registered Dec. 20, 2011

**Int. Cls.: 35, 36, 39 and
45**

SERVICE MARK

PRINCIPAL REGISTER

LANIER PARKING HOLDINGS, INC. (GEORGIA CORPORATION)
2600 HARRIS TOWER, SUITE 2600
233 PEACHTREE STREET, NE
ATLANTA, GA 30303

FOR: BUSINESS MANAGEMENT AND BUSINESS MANAGEMENT CONSULTING SERVICES FOR THE PARKING LOT AND PARKING GARAGE INDUSTRIES; BUSINESS MANAGEMENT IN THE FIELDS OF PARKING FACILITIES AND LEASING OF PARKING AND GARAGE SPACES, IN CLASS 35 (U.S. CLS. 100, 101 AND 102).

FIRST USE 0-0-1989; IN COMMERCE 0-0-1989.

FOR: PARKING METER COLLECTIONS SERVICES; PARKING ENFORCEMENT SERVICES, NAMELY, COLLECTING FINES FOR PARKING VIOLATIONS AND REMITTANCE OF COLLECTED FINES TO GOVERNMENT AGENCIES AND PARKING FACILITY OWNERS, IN CLASS 36 (U.S. CLS. 100, 101 AND 102).

FIRST USE 0-0-2002; IN COMMERCE 0-0-2002.

FOR: PARKING LOT AND PARKING GARAGE SERVICES, NAMELY, THE OPERATION OF PARKING FACILITIES AND LEASING OF PARKING AND GARAGE SPACES; VALET PARKING SERVICES; VEHICLE PARKING SERVICES, NAMELY, VEHICLE PARKING SERVICES PROVIDED BY ATTENDANTS AND GREETERS; SHUTTLE TRANSPORTATION SERVICES, NAMELY, TRANSPORTATION OF PASSENGERS BY BUS, IN CLASS 39 (U.S. CLS. 100 AND 105).

FIRST USE 0-0-1989; IN COMMERCE 0-0-1989.

FOR: PARKING LAW ENFORCEMENT SERVICES, NAMELY, ISSUING TICKETS FOR VIOLATIONS OF VEHICLE PARKING LAWS AND REGULATIONS, IN CLASS 45 (U.S. CLS. 100 AND 101).

FIRST USE 0-0-2002; IN COMMERCE 0-0-2002.

THE MARK CONSISTS OF STANDARD CHARACTERS WITHOUT CLAIM TO ANY PARTICULAR FONT, STYLE, SIZE, OR COLOR.



David J. Kyjars

Director of the United States Patent and Trademark Office

Reg. No. 4,073,242 NO CLAIM IS MADE TO THE EXCLUSIVE RIGHT TO USE "PARKING", APART FROM THE MARK AS SHOWN.

SEC. 2(F).

SER. NO. 85-247,374, FILED 2-21-2011.

SETH A. RAPPAPORT, EXAMINING ATTORNEY

United States of America

United States Patent and Trademark Office



Reg. No. 4,073,243

Registered Dec. 20, 2011

Int. Cls.: 35, 36, 39 and 45

SERVICE MARK

PRINCIPAL REGISTER

LANIER PARKING HOLDINGS, INC. (GEORGIA CORPORATION)
2600 HARRIS TOWER, SUITE 2600
233 PEACHTREE STREET, NE
ATLANTA, GA 30303

FOR: BUSINESS MANAGEMENT AND BUSINESS MANAGEMENT CONSULTING SERVICES FOR THE PARKING LOT AND PARKING GARAGE INDUSTRIES; BUSINESS MANAGEMENT IN THE FIELDS OF PARKING FACILITIES AND LEASING OF PARKING AND GARAGE SPACES, IN CLASS 35 (U.S. CLS. 100, 101 AND 102).

FIRST USE 0-0-1989; IN COMMERCE 0-0-1989.

FOR: PARKING METER COLLECTIONS SERVICES; PARKING ENFORCEMENT SERVICES, NAMELY, COLLECTING FINES FOR PARKING VIOLATIONS AND REMITTANCE OF COLLECTED FINES TO GOVERNMENT AGENCIES AND PARKING FACILITY OWNERS, IN CLASS 36 (U.S. CLS. 100, 101 AND 102).

FIRST USE 0-0-2002; IN COMMERCE 0-0-2002.

FOR: PARKING LOT AND PARKING GARAGE SERVICES, NAMELY, THE OPERATION OF PARKING FACILITIES AND LEASING OF PARKING AND GARAGE SPACES; VALET PARKING SERVICES; VEHICLE PARKING SERVICES, NAMELY, VEHICLE PARKING SERVICES PROVIDED BY ATTENDANTS AND GREETERS; SHUTTLE TRANSPORTATION SERVICES, NAMELY, TRANSPORTATION OF PASSENGERS BY BUS, IN CLASS 39 (U.S. CLS. 100 AND 105).

FIRST USE 0-0-1989; IN COMMERCE 0-0-1989.

FOR: PARKING LAW ENFORCEMENT SERVICES, NAMELY, ISSUING TICKETS FOR VIOLATIONS OF VEHICLE PARKING LAWS AND REGULATIONS, IN CLASS 45 (U.S. CLS. 100 AND 101).

FIRST USE 0-0-2002; IN COMMERCE 0-0-2002.

NO CLAIM IS MADE TO THE EXCLUSIVE RIGHT TO USE "PARKING", APART FROM THE MARK AS SHOWN.



David J. Kyffers

Director of the United States Patent and Trademark Office

Reg. No. 4,073,243 THE COLOR(S) GREEN, WHITE, BLACK AND GRAY IS/ARE CLAIMED AS A FEATURE OF THE MARK.

THE MARK CONSISTS OF A WHITE STYLIZED BUILDING ON A GREEN RECTANGLE OVER WHICH IS THE WORD "LANIER" IN WHITE AND UNDER WHICH IS THE WORD "PARKING" IN WHITE, THE GREEN RECTANGLE SHADING TO A BLACK BORDER, ALL OF WHICH IS SURROUNDED BY A SHADED GRAY BORDER.

SER. NO. 85-247,377, FILED 2-21-2011.

SETH A. RAPPAPORT, EXAMINING ATTORNEY

United States of America
United States Patent and Trademark Office

RACASSIST

Reg. No. 4,073,244

Registered Dec. 20, 2011

Int. Cl.: 42

SERVICE MARK

PRINCIPAL REGISTER

HEALTH SCIENCE INSTITUTE, INC (PENNSYLVANIA CORPORATION)
1030 ONTARIO ROAD
IOD INCORPORATED
GREEN BAY, WI 54311

FOR: APPLICATION SERVICE PROVIDER (ASP) FEATURING SOFTWARE FOR USE IN HEALTH INDUSTRY TO MANAGE DATA SUCH AS DENIALS AND APPEALS , IN CLASS 42 (U.S. CLS. 100 AND 101).

FIRST USE 7-21-2008; IN COMMERCE 1-12-2009.

THE MARK CONSISTS OF STANDARD CHARACTERS WITHOUT CLAIM TO ANY PARTICULAR FONT, STYLE, SIZE, OR COLOR.

SER. NO. 85-247,462, FILED 2-21-2011.

CARRIE GENOVESE, EXAMINING ATTORNEY



David J. Kyjars

Director of the United States Patent and Trademark Office

United States of America

United States Patent and Trademark Office

Cinni

Reg. No. 4,073,245

Registered Dec. 20, 2011

Int. Cl.: 11

TRADEMARK

PRINCIPAL REGISTER

MATTHEWS-GERBAR, LTD. (ILLINOIS CORPORATION)
1881 INDUSTRIAL DRIVE
LIBERTYVILLE, IL 60048

FOR: ELECTRIC FANS; PORTABLE ELECTRIC FANS, IN CLASS 11 (U.S. CLS. 13, 21, 23, 31 AND 34).

FIRST USE 1-1-2000, THE MARK WAS FIRST USED ANYWHERE IN A DIFFERENT FORM OTHER THAN THAT SOUGHT TO BE REGISTERED AT LEAST AS EARLY AS 01/01/2002; IN COMMERCE 1-1-2000, THE MARK WAS FIRST USED IN COMMERCE IN A DIFFERENT FORM OTHER THAN THAT SOUGHT TO BE REGISTERED AT LEAST AS EARLY AS 11/09/2004.

THE MARK CONSISTS OF STANDARD CHARACTERS WITHOUT CLAIM TO ANY PARTICULAR FONT, STYLE, SIZE, OR COLOR.

OWNER OF U.S. REG. NO. 2,901,716.

THE WORDING "CINNI" HAS NO MEANING IN A FOREIGN LANGUAGE.

SEC. 2(F).

SER. NO. 85-247,616, FILED 2-21-2011.

REBECCA SMITH, EXAMINING ATTORNEY



David J. Kybas

Director of the United States Patent and Trademark Office

United States of America
United States Patent and Trademark Office

DICE AGE

Reg. No. 4,073,246

CONVERT TRISTAN VLADIMIR (FRANCE INDIVIDUAL)
1423 1/2 CARROLL AVENUE
LOS ANGELES, CA 90026

Registered Dec. 20, 2011

Int. Cl.: 28

FOR: DICE GAMES, IN CLASS 28 (U.S. CLS. 22, 23, 38 AND 50).

TRADEMARK

FIRST USE 12-20-2010; IN COMMERCE 2-18-2011.

PRINCIPAL REGISTER

THE MARK CONSISTS OF THE WORDS "DICE AGE" IN A MEDIEVAL ROUGH LOOKING FONT DERIVED FROM THE "DWARVEN STONECRAFT" FONT, THE DOT ON THE "I" OF THE "DICE" WORD BEING DIAMOND-SHAPED WITH ROUND EDGES AND A CIRCULAR HOLE IN ITS CENTER.

SER. NO. 85-247,732, FILED 2-21-2011.

PATRICIA EVANKO, EXAMINING ATTORNEY



David J. Kybas

Director of the United States Patent and Trademark Office

United States of America

United States Patent and Trademark Office

LOONIC

Reg. No. 4,073,247

Registered Dec. 20, 2011

Int. Cl.: 34

TRADEMARK

PRINCIPAL REGISTER

X-INTERNATIONAL APS (DENMARK PRIVATE LIMITED COMPANY)
P.O. BOX 152
DK-2900 HELLERUP, DENMARK

FOR: TOBACCO; SNUFF WITH AND WITHOUT TOBACCO; MATCHES, IN CLASS 34 (U.S. CLS. 2, 8, 9 AND 17).

THE MARK CONSISTS OF STANDARD CHARACTERS WITHOUT CLAIM TO ANY PARTICULAR FONT, STYLE, SIZE, OR COLOR.

OWNER OF SWEDEN REG. NO. 413981, DATED 11-5-2010, EXPIRES 11-5-2020.

SER. NO. 85-247,895, FILED 2-22-2011.

MICHAEL ENGEL, EXAMINING ATTORNEY



David J. Kybas

Director of the United States Patent and Trademark Office

United States of America

United States Patent and Trademark Office



Reg. No. 4,073,248

Registered Dec. 20, 2011

Int. Cl.: 35

SERVICE MARK

PRINCIPAL REGISTER

SOLCON CORPORATION (WASHINGTON CORPORATION), DBA QUICKMEDICAL
SUITE 120
30200 SE 79TH STREET
ISSAQUAH, WA 98027

FOR: ONLINE RETAIL SERVICES THROUGH DIRECT SOLICITATION BY DISTRIBUTORS DIRECTED TO END-USERS FEATURING HEALTH CARE PROFESSIONAL, HOME CARE AND INDUSTRIAL MEDICAL SUPPLIES AND EQUIPMENT, IN CLASS 35 (U.S. CLS. 100, 101 AND 102).

FIRST USE 1-31-2011; IN COMMERCE 2-1-2011.

THE MARK CONSISTS OF COLOR OF THE LETTERS "QM" ARE WHITE ON A BLUE BACKGROUND. THE WORD "ELITE" IS BLUE IN COLOR ON A WHITE BACKGROUND. THERE IS A BLUE BORDER AROUND THE LOGO AND IS CLAIMED AS A FEATURE OF THE MARK.

THE COLOR(S) BLUE: PMS BLUE 072 AND WHITE IS/ARE CLAIMED AS A FEATURE OF THE MARK.

SER. NO. 85-247,978, FILED 2-22-2011.

FLORENTINA BLANDU, EXAMINING ATTORNEY



David J. Kybas

Director of the United States Patent and Trademark Office

United States of America

United States Patent and Trademark Office

OMNISHIELD

Reg. No. 4,073,249

FIFTH THIRD PROCESSING SOLUTIONS, LLC (DELAWARE LIMITED LIABILITY COMPANY)

Registered Dec. 20, 2011

FIFTH THIRD PROCESSING SOLUTIONS, LLC
38 FOUNTAIN SQUARE PLAZA
CINCINNATI, OH 45263

Int. Cl.: 36

SERVICE MARK

FOR: PROCESSING AND HANDLING OF FINANCIAL AND PAYMENT TRANSACTION DISPUTES, CLAIMS AND CHARGEBACKS, IN CLASS 36 (U.S. CLS. 100, 101 AND 102).

PRINCIPAL REGISTER

FIRST USE 2-10-2011; IN COMMERCE 2-10-2011.

THE MARK CONSISTS OF STANDARD CHARACTERS WITHOUT CLAIM TO ANY PARTICULAR FONT, STYLE, SIZE, OR COLOR.

SER. NO. 85-247,997, FILED 2-22-2011.

FLORENTINA BLANDU, EXAMINING ATTORNEY



David J. Kyffers

Director of the United States Patent and Trademark Office

United States of America

United States Patent and Trademark Office

JAKE SNIDER

Reg. No. 4,073,250

Registered Dec. 20, 2011

Int. Cl.: 41

SERVICE MARK

PRINCIPAL REGISTER

SNIDER, JAKE (UNITED STATES INDIVIDUAL)
C/O 3D MANAGEMENT
1901 MAIN STREET, THIRD FLOOR
SANTA MONICA, CA 90405

FOR: ENTERTAINMENT SERVICES IN THE NATURE OF LIVE MUSICAL PERFORMANCES;
SONG WRITING SERVICES, IN CLASS 41 (U.S. CLS. 100, 101 AND 107).

FIRST USE 12-31-1994; IN COMMERCE 12-31-1994.

THE MARK CONSISTS OF STANDARD CHARACTERS WITHOUT CLAIM TO ANY PARTICULAR FONT, STYLE, SIZE, OR COLOR.

THE NAME "JAKE SNIDER" IDENTIFIES A LIVING INDIVIDUAL WHOSE CONSENT IS OF RECORD.

SER. NO. 85-248,947, FILED 2-22-2011.

NAAKWAMA ANKRAH, EXAMINING ATTORNEY



David J. Kybas

Director of the United States Patent and Trademark Office

United States of America

United States Patent and Trademark Office

G CLEAN

Reg. No. 4,073,251

Registered Dec. 20, 2011

Int. Cls.: 3 and 7

TRADEMARK

PRINCIPAL REGISTER

GREEN EARTH TECHNOLOGIES, INC. (DELAWARE CORPORATION)
46 SOUTHFIELD AVENUE, SUITE 200
STAMFORD, CT 06902

FOR: ALL PURPOSE CLEANSERS, CLEANING PREPARATIONS, AND GLASS CLEANERS FOR AUTOMOTIVE AND HOUSEHOLD USE; CLEANING PRODUCTS FOR USE IN PRESSURE WASHER, NAMELY, DISSOLVABLE POUCHES CONSISTING OF CLEANING SOLUTIONS FOR USE IN CLEANING VEHICLES, RECREATIONAL VEHICLES AND HOMES, IN CLASS 3 (U.S. CLS. 1, 4, 6, 50, 51 AND 52).

FIRST USE 11-1-2009; IN COMMERCE 11-1-2009.

FOR: PRESSURE WASHER; PARTS FOR PRESSURE WASHER, NAMELY, DETERGENT INJECTOR, IN CLASS 7 (U.S. CLS. 13, 19, 21, 23, 31, 34 AND 35).

FIRST USE 11-1-2009; IN COMMERCE 11-1-2009.

THE MARK CONSISTS OF STANDARD CHARACTERS WITHOUT CLAIM TO ANY PARTICULAR FONT, STYLE, SIZE, OR COLOR.

NO CLAIM IS MADE TO THE EXCLUSIVE RIGHT TO USE "CLEAN", APART FROM THE MARK AS SHOWN.

SER. NO. 85-249,114, FILED 2-23-2011.

SHAILA SETTLES, EXAMINING ATTORNEY



David J. Kyros

Director of the United States Patent and Trademark Office

United States of America

United States Patent and Trademark Office

OPTOUTPREScreen

Reg. No. 4,073,252

OPT-OUT SERVICES LLC (DELAWARE LIMITED LIABILITY COMPANY)

Registered Dec. 20, 2011

PO BOX 600344
JACKSONVILLE, FL 32260

Int. Cl.: 35

FOR: BUSINESS REFERRAL AND INFORMATION SERVICES, NAMELY, REFERRAL OF REQUESTS BY CONSUMERS TO THE VARIOUS CONSUMER CREDIT REPORTING AGENCIES TO OPT-IN OR OPT-OUT OF FIRM OFFERS OF CREDIT OR INSURANCE, IN CLASS 35 (U.S. CLS. 100, 101 AND 102).

SERVICE MARK

PRINCIPAL REGISTER

FIRST USE 12-9-2004; IN COMMERCE 12-9-2004.

THE MARK CONSISTS OF STANDARD CHARACTERS WITHOUT CLAIM TO ANY PARTICULAR FONT, STYLE, SIZE, OR COLOR.

SEC. 2(F).

SER. NO. 85-249,439, FILED 2-23-2011.

KATHERINE CHANG, EXAMINING ATTORNEY



David J. Kybas

Director of the United States Patent and Trademark Office

United States of America

United States Patent and Trademark Office



Reg. No. 4,073,253

Registered Dec. 20, 2011

Int. Cls.: 16 and 45

TRADEMARK

SERVICE MARK

PRINCIPAL REGISTER

SHAOHANNAH'S HOPE, INC. (VIRGINIA CORPORATION)
230 FRANKLIN ROAD, SUITE 12Q
BRENTWOOD, TN 37064

FOR: PRINTED MATERIALS, NAMELY, BROCHURES AND NEWSLETTERS IN THE FIELD OF ORPHAN ISSUES AND ADOPTION, IN CLASS 16 (U.S. CLS. 2, 5, 22, 23, 29, 37, 38 AND 50).

FIRST USE 3-8-2009; IN COMMERCE 3-8-2009.

FOR: PROVIDING ON-LINE INFORMATION VIA THE INTERNET IN THE FIELD OF ORPHAN AND ADOPTION ISSUES, IN CLASS 45 (U.S. CLS. 100 AND 101).

FIRST USE 3-28-2009; IN COMMERCE 3-28-2009.

THE MARK CONSISTS OF A TREE WITH LEAVES AND VISIBLE ROOTS.

SER. NO. 85-249,577, FILED 2-23-2011.

RAUL CORDOVA, EXAMINING ATTORNEY



David J. Kybas

Director of the United States Patent and Trademark Office

United States of America

United States Patent and Trademark Office



Reg. No. 4,073,254

Registered Dec. 20, 2011

Int. Cl.: 34

TRADEMARK

PRINCIPAL REGISTER

LEFTHAND DISTRIBUTION LLC (OHIO LIMITED LIABILITY COMPANY)
34 DELAND AVE.
COLUMBUS, OH 43214

FOR: TOBACCO WATER PIPES, IN CLASS 34 (U.S. CLS. 2, 8, 9 AND 17).

FIRST USE 2-23-2011; IN COMMERCE 2-23-2011.

THE MARK CONSISTS OF THE STYLIZED WORDING "O FACE" IN BLACK AND A DESIGN OF A BLACK SPADE WITH SILVER SUNBURST AND BLACK EMBELLISHMENTS AROUND THE BOTTOM AND BLACK SPADES AROUND THE EDGES. INSIDE THE SPADE IS A WHITE FLORAL PATTERN.

THE COLOR(S) BLACK, WHITE AND SILVER IS/ARE CLAIMED AS A FEATURE OF THE MARK.

SER. NO. 85-249,722, FILED 2-23-2011.

ROBERT STRUCK, EXAMINING ATTORNEY



David J. Kyffers

Director of the United States Patent and Trademark Office

United States of America

United States Patent and Trademark Office

STATUSUPDATE CHARMS

Reg. No. 4,073,255

BOAZIZ, EILEEN (UNITED STATES INDIVIDUAL)
4218 SW 130TH AVENUE
DAVIE, FL 33330

Registered Dec. 20, 2011

Int. Cl.: 14

FOR: CHARMS FOR COLLAR JEWELRY AND BRACELET, IN CLASS 14 (U.S. CLS. 2, 27, 28 AND 50).

TRADEMARK

FIRST USE 5-1-2010; IN COMMERCE 2-23-2011.

PRINCIPAL REGISTER

THE MARK CONSISTS OF STANDARD CHARACTERS WITHOUT CLAIM TO ANY PARTICULAR FONT, STYLE, SIZE, OR COLOR.

NO CLAIM IS MADE TO THE EXCLUSIVE RIGHT TO USE "CHARMS", APART FROM THE MARK AS SHOWN.

SER. NO. 85-249,756, FILED 2-23-2011.

TAMARA FRAZIER, EXAMINING ATTORNEY



David J. Kybas

Director of the United States Patent and Trademark Office

United States of America

United States Patent and Trademark Office

ACS WEBINARS

Reg. No. 4,073,256

Registered Dec. 20, 2011

Int. Cl.: 41

SERVICE MARK

PRINCIPAL REGISTER

AMERICAN CHEMICAL SOCIETY (D.C. CONGRESSIONALLY CHARTERED NONPROFIT ORGANIZATION)
1155 SIXTEENTH STREET, NW
WASHINGTON, DC 20036

FOR: EDUCATIONAL SERVICES, NAMELY, PROVIDING ONLINE SEMINARS IN THE FIELD OF CHEMISTRY AND DISTRIBUTION OF SEMINAR MATERIALS IN CONNECTION THEREWITH, IN CLASS 41 (U.S. CLS. 100, 101 AND 107).

FIRST USE 1-5-2010; IN COMMERCE 1-5-2010.

THE MARK CONSISTS OF STANDARD CHARACTERS WITHOUT CLAIM TO ANY PARTICULAR FONT, STYLE, SIZE, OR COLOR.

OWNER OF U.S. REG. NOS. 1,082,875, 3,121,332 AND OTHERS.

NO CLAIM IS MADE TO THE EXCLUSIVE RIGHT TO USE "WEBINARS", APART FROM THE MARK AS SHOWN.

SER. NO. 85-250,253, FILED 2-24-2011.

DAWN FELDMAN, EXAMINING ATTORNEY



David J. Kybas

Director of the United States Patent and Trademark Office

United States of America

United States Patent and Trademark Office

EDVANCE

Reg. No. 4,073,257

Registered Dec. 20, 2011

Int. Cls.: 35 and 41

SERVICE MARK

PRINCIPAL REGISTER

EDVANCE RESEARCH, INC. (TEXAS CORPORATION)
SUITE 1000
9901 IH-10 WEST
SAN ANTONIO, TX 78230

FOR: BUSINESS CONSULTING IN THE FIELD OF BUSINESS MANAGEMENT OF SCHOOLS AND EDUCATIONAL INSTITUTIONS, AND, OF PUBLIC POLICY REGARDING EDUCATION, IN CLASS 35 (U.S. CLS. 100, 101 AND 102).

FIRST USE 4-1-2008; IN COMMERCE 4-1-2008.

FOR: CONSULTING SERVICES IN THE FIELD OF EDUCATION RESEARCH, EDUCATION POLICY FOR THE DEVELOPMENT AND IMPLEMENTATION OF PEDAGOGICAL METHODS, AND EDUCATION MANAGEMENT FOR IMPROVING TEACHING RESULTS, IN CLASS 41 (U.S. CLS. 100, 101 AND 107).

FIRST USE 4-1-2008; IN COMMERCE 4-1-2008.

THE MARK CONSISTS OF THE WORD "EDVANCE" IN STYLIZED FONT.

SER. NO. 85-250,375, FILED 2-24-2011.

HANNO RITTNER, EXAMINING ATTORNEY



David J. Kybas

Director of the United States Patent and Trademark Office

United States of America

United States Patent and Trademark Office



Reg. No. 4,073,258

Registered Dec. 20, 2011

Int. Cl.: 41

SERVICE MARK

PRINCIPAL REGISTER

FLUHARTY, GORDON S. (US), HAMM, KEVIN J. (US) (NEW YORK JOINT VENTURE),
DBA FISTPRINT
6 SEYMOUR STREET
BINGHAMTON, NY 13905

FOR: ENTERTAINMENT IN THE NATURE OF VISUAL AND AUDIO PERFORMANCES,
NAMELY, MUSICAL BAND, ROCK GROUP, GYMNASTIC, DANCE, AND BALLET PER-
FORMANCES, IN CLASS 41 (U.S. CLS. 100, 101 AND 107).

FIRST USE 1-15-2011; IN COMMERCE 2-1-2011.

THE MARK CONSISTS OF A SKULL DESIGN WITH BLACK OUTLINING AND FEATURES
AND WHITE INTERIOR WITH A BLACK CIRCULAR CRACKED DESIGN ON THE FORE-
HEAD WITH THE LETTERS "FP" IN BLACK IN THE CENTER OF THE CIRCLE WHERE
THE "F" IS BACKWARDS; BELOW THE SKULL IS THE WORDING "FISTPRINT" IN RED
WITH BLACK OUTLINING.

THE COLOR(S) RED, BLACK AND WHITE IS/ARE CLAIMED AS A FEATURE OF THE
MARK.

SER. NO. 85-250,515, FILED 2-24-2011.

CHARLOTTE CORWIN, EXAMINING ATTORNEY



David J. Kybas

Director of the United States Patent and Trademark Office

United States of America

United States Patent and Trademark Office

FIND YOUR FIRE

Reg. No. 4,073,259

CURT BANEY (UNITED STATES INDIVIDUAL), DBA BANEY ENTERPRISES
1420 NORTH BURLING ST
CHICAGO, IL 60610

Registered Dec. 20, 2011

Int. Cl.: 44

FOR: COUNSELING SERVICES IN THE FIELD OF BEHAVIOR MODIFICATION, IN CLASS 44 (U.S. CLS. 100 AND 101).

SERVICE MARK

FIRST USE 7-0-2009; IN COMMERCE 3-0-2010.

PRINCIPAL REGISTER

THE MARK CONSISTS OF STANDARD CHARACTERS WITHOUT CLAIM TO ANY PARTICULAR FONT, STYLE, SIZE, OR COLOR.

SER. NO. 85-250,612, FILED 2-24-2011.

ERIN FALK, EXAMINING ATTORNEY



David J. Kybas

Director of the United States Patent and Trademark Office

United States of America

United States Patent and Trademark Office

SMC LTD

Reg. No. 4,073,260

SCIENTIFIC MOLDING CORPORATION, LTD. (WISCONSIN CORPORATION)

Registered Dec. 20, 2011

330 SMC DRIVE
SOMERSET, WI 54025

Int. Cl.: 42

FOR: PRODUCT DESIGN AND DEVELOPMENT IN THE FIELD OF THERMOPLASTIC AND SILICONE PRODUCTION; DESIGN OF ELECTRONIC COMPONENTS AND CIRCUIT BOARD CONFIGURATION; CUSTOM SOFTWARE DEVELOPMENT SERVICES FOR OTHERS; ENGINEERING SERVICES, IN THE FIELD OF MEDICAL DEVICES AND TOOL DESIGN, IN CLASS 42 (U.S. CLS. 100 AND 101).

SERVICE MARK

PRINCIPAL REGISTER

FIRST USE 2-1-1988; IN COMMERCE 2-1-1988.

THE MARK CONSISTS OF STANDARD CHARACTERS WITHOUT CLAIM TO ANY PARTICULAR FONT, STYLE, SIZE, OR COLOR.

OWNER OF U.S. REG. NOS. 1,621,609, 3,907,680, AND 3,916,638.

NO CLAIM IS MADE TO THE EXCLUSIVE RIGHT TO USE "LTD", APART FROM THE MARK AS SHOWN.

SER. NO. 85-250,835, FILED 2-24-2011.

NAAKWAMA ANKRAH, EXAMINING ATTORNEY



David J. Kypos

Director of the United States Patent and Trademark Office

United States of America

United States Patent and Trademark Office

SMC LTD

Reg. No. 4,073,261

SCIENTIFIC MOLDING CORPORATION, LTD. (WISCONSIN CORPORATION)

Registered Dec. 20, 2011

330 SMC DRIVE
SOMERSET, WI 54025

Int. Cl.: 40

FOR: CUSTOM MANUFACTURE OF MICRO MOLDING AND PLASTIC INJECTION MOLDING OF PARTS AND SILICONE PRODUCTION; PRODUCT ASSEMBLY OF MEDICAL DEVICES FOR OTHERS, IN CLASS 40 (U.S. CLS. 100, 103 AND 106).

SERVICE MARK

FIRST USE 2-1-1988; IN COMMERCE 2-1-1988.

PRINCIPAL REGISTER

THE MARK CONSISTS OF STANDARD CHARACTERS WITHOUT CLAIM TO ANY PARTICULAR FONT, STYLE, SIZE, OR COLOR.

OWNER OF U.S. REG. NOS. 1,621,609, 3,916,638 AND OTHERS.

NO CLAIM IS MADE TO THE EXCLUSIVE RIGHT TO USE "LTD", APART FROM THE MARK AS SHOWN.

SER. NO. 85-250,846, FILED 2-24-2011.

NAAKWAMA ANKRAH, EXAMINING ATTORNEY



David J. Kypos

Director of the United States Patent and Trademark Office

United States of America

United States Patent and Trademark Office



Reg. No. 4,073,262

Registered Dec. 20, 2011

Int. Cl.: 33

TRADEMARK

PRINCIPAL REGISTER

ROYAL WINE CORPORATION (NEW YORK CORPORATION)
63 LEFANTE LANE
BAYONNE, NJ 07002

FOR: WINES, IN CLASS 33 (U.S. CLS. 47 AND 49).

FIRST USE 4-30-2008; IN COMMERCE 4-30-2008.

NO CLAIM IS MADE TO THE EXCLUSIVE RIGHT TO USE "RED", APART FROM THE MARK AS SHOWN.

THE COLOR(S) RED (PANTONE SHADE 1807U) AND BEIGE (PANTONE SHADE 871C) IS/ARE CLAIMED AS A FEATURE OF THE MARK.

THE MARK CONSISTS OF A LABEL IN RED AND RECTANGULAR-SHAPED AT THE TOP, WITH THE WORD "RED" IN BOLDDED BEIGE UPPER CASE LETTERING IN THE CENTER OF THE LABEL, BELOW WHICH APPEARS THE WORD "BY" IN BEIGE LOWER CASE SCRIPT LETTERS, BELOW WHICH APPEARS A LARGE STYLIZED LETTER "W" IN BEIGE AND FORMING THE SHAPE OF THE LOWER BORDER OF THE LABEL.

SER. NO. 85-250,880, FILED 2-24-2011.

EDWARD FENNESSY, EXAMINING ATTORNEY



David J. Kybas

Director of the United States Patent and Trademark Office

United States of America

United States Patent and Trademark Office

BATTLE PIRATES

Reg. No. 4,073,263

Registered Dec. 20, 2011

Int. Cls.: 9 and 41

TRADEMARK

SERVICE MARK

PRINCIPAL REGISTER

CASUAL COLLECTIVE (DELAWARE CORPORATION)
433 CALIFORNIA STREET
SUITE 1030
SAN FRANCISCO, CA 94104

FOR: DOWNLOADABLE COMPUTER GAME SOFTWARE FOR TRANSMISSION OF DATA THAT MAY BE ACCESSED VIA THE INTERNET, COMPUTERS, OR WIRELESS DEVICES FOR USE ON MOBILE PHONES, COMPUTERS AND MOBILE DEVICES, IN CLASS 9 (U.S. CLS. 21, 23, 26, 36 AND 38).

FIRST USE 1-28-2011; IN COMMERCE 1-28-2011.

FOR: ENTERTAINMENT SERVICES, NAMELY, PROVIDING COMPUTER GAMES ON-LINE AND IN MOBILE WIRELESS FORM; PROVIDING AN INTERNET WEBSITE PORTAL IN THE FIELD OF COMPUTER GAMES AND GAMING, IN CLASS 41 (U.S. CLS. 100, 101 AND 107).

FIRST USE 1-28-2011; IN COMMERCE 1-28-2011.

THE MARK CONSISTS OF STANDARD CHARACTERS WITHOUT CLAIM TO ANY PARTICULAR FONT, STYLE, SIZE, OR COLOR.

SER. NO. 85-251,486, FILED 2-25-2011.

ZACHARY BELLO, EXAMINING ATTORNEY



David J. Kyffers

Director of the United States Patent and Trademark Office

United States of America

United States Patent and Trademark Office

BACKYARD MONSTERS

Reg. No. 4,073,264

Registered Dec. 20, 2011

Int. Cls.: 9 and 41

TRADEMARK

SERVICE MARK

PRINCIPAL REGISTER

CASUAL COLLECTIVE (DELAWARE CORPORATION)
433 CALIFORNIA STREET
SUITE 1030
SAN FRANCISCO, CA 94104

FOR: DOWNLOADABLE COMPUTER GAME SOFTWARE FOR TRANSMISSION OF DATA THAT MAY BE ACCESSED VIA THE INTERNET, COMPUTERS, OR WIRELESS DEVICES FOR USE ON MOBILE PHONES, COMPUTERS AND MOBILE DEVICES, IN CLASS 9 (U.S. CLS. 21, 23, 26, 36 AND 38).

FIRST USE 3-23-2010; IN COMMERCE 4-13-2010.

FOR: ENTERTAINMENT SERVICES, NAMELY, PROVIDING COMPUTER GAMES ON-LINE AND IN MOBILE WIRELESS FORM; PROVIDING AN INTERNET WEBSITE PORTAL IN THE FIELD OF COMPUTER GAMES AND GAMING, IN CLASS 41 (U.S. CLS. 100, 101 AND 107).

FIRST USE 3-23-2010; IN COMMERCE 4-13-2010.

THE MARK CONSISTS OF STANDARD CHARACTERS WITHOUT CLAIM TO ANY PARTICULAR FONT, STYLE, SIZE, OR COLOR.

SER. NO. 85-251,533, FILED 2-25-2011.

ZACHARY BELLO, EXAMINING ATTORNEY



David J. Kybas

Director of the United States Patent and Trademark Office

United States of America

United States Patent and Trademark Office

Cyber Bridge Marine

Reg. No. 4,073,265

Registered Dec. 20, 2011

Int. Cl.: 35

SERVICE MARK

PRINCIPAL REGISTER

MARKS, JOHN (UNITED STATES INDIVIDUAL), DBA CYBER BRIDGE MARINE
SUITE B167
209 S. STEPHANIE STREET
HENDERSON, NV 89012

FOR: ELECTRONIC CATALOG SERVICES FEATURING MARINE SUPPLIES AND
SOUNDPROOFING MATERIALS, IN CLASS 35 (U.S. CLS. 100, 101 AND 102).

FIRST USE 11-14-2003; IN COMMERCE 11-14-2003.

THE MARK CONSISTS OF STANDARD CHARACTERS WITHOUT CLAIM TO ANY PAR-
TICULAR FONT, STYLE, SIZE, OR COLOR.

NO CLAIM IS MADE TO THE EXCLUSIVE RIGHT TO USE "MARINE", APART FROM THE
MARK AS SHOWN.

SER. NO. 85-252,010, FILED 2-25-2011.

RON FAIRBANKS, EXAMINING ATTORNEY



David J. Kybas

Director of the United States Patent and Trademark Office

United States of America

United States Patent and Trademark Office

HEALTH BONE

Reg. No. 4,073,266

Registered Dec. 20, 2011

Int. Cl.: 31

TRADEMARK

PRINCIPAL REGISTER

OMEGA PAW INC. (CANADA LIMITED LIABILITY COMPANY)
275 VICTORIA ST.
PO 2320
ST. MARYS, CANADA N4X1A2

FOR: PET TREATS, IN CLASS 31 (U.S. CLS. 1 AND 46).

FIRST USE 12-9-1999, THE MARK WAS FIRST USED ANYWHERE IN A DIFFERENT FORM OTHER THAN THAT SOUGHT TO BE REGISTERED AT LEAST AS EARLY AS 12/09/1999; IN COMMERCE 4-1-2000, THE MARK WAS FIRST USED IN COMMERCE IN A DIFFERENT FORM OTHER THAN THAT SOUGHT TO BE REGISTERED AT LEAST AS EARLY AS 12/09/1999.

THE MARK CONSISTS OF STANDARD CHARACTERS WITHOUT CLAIM TO ANY PARTICULAR FONT, STYLE, SIZE, OR COLOR.

NO CLAIM IS MADE TO THE EXCLUSIVE RIGHT TO USE "BONE", APART FROM THE MARK AS SHOWN.

SER. NO. 85-252,050, FILED 2-25-2011.

ALEXANDER L. POWERS, EXAMINING ATTORNEY



David J. Kybas

Director of the United States Patent and Trademark Office

United States of America

United States Patent and Trademark Office

STRATEGIC PLANNING TO THE HIGHEST POWER

Reg. No. 4,073,267

Registered Dec. 20, 2011

Int. Cls.: 9, 16 and 45

TRADEMARK

SERVICE MARK

PRINCIPAL REGISTER

30 60 100 MINISTRIES, INC. (NEW MEXICO CORPORATION)
2501 JUAN TABO NE
SUITE 9
ALBUQUERQUE, NM 87112

FOR: DOWNLOADABLE ELECTRONIC PUBLICATIONS IN THE NATURE OF BOOKS, NEWSLETTERS, WORKBOOKS, BROCHURES AND REFERENCE CARDS, IN THE FIELDS OF CHRISTIAN GROWTH, SPIRITUAL HEALTH, LEADERSHIP DEVELOPMENT, AND STRATEGIC PLANNING, IN CLASS 9 (U.S. CLS. 21, 23, 26, 36 AND 38).

FIRST USE 8-8-2011; IN COMMERCE 8-8-2011.

FOR: PRINTED PUBLICATIONS, NAMELY, BOOKS, NEWSLETTERS, HAND-OUTS, WORKBOOKS, BROCHURES AND REFERENCE CARDS, IN THE FIELDS OF CHRISTIAN GROWTH, SPIRITUAL HEALTH, LEADERSHIP DEVELOPMENT, AND STRATEGIC PLANNING, IN CLASS 16 (U.S. CLS. 2, 5, 22, 23, 29, 37, 38 AND 50).

FIRST USE 1-6-2011; IN COMMERCE 1-6-2011.

FOR: CHRISTIAN MINISTRY SERVICES, IN CLASS 45 (U.S. CLS. 100 AND 101).

FIRST USE 1-6-2011; IN COMMERCE 1-6-2011.

THE MARK CONSISTS OF STANDARD CHARACTERS WITHOUT CLAIM TO ANY PARTICULAR FONT, STYLE, SIZE, OR COLOR.

NO CLAIM IS MADE TO THE EXCLUSIVE RIGHT TO USE "STRATEGIC PLANNING", APART FROM THE MARK AS SHOWN.

SER. NO. 85-252,288, FILED 2-25-2011.

NAPOLEON SHARMA, EXAMINING ATTORNEY



David J. Kyffers

Director of the United States Patent and Trademark Office

United States of America

United States Patent and Trademark Office

SPIRITUALLY HEALTHY LEADER

Reg. No. 4,073,268

Registered Dec. 20, 2011

Int. Cls.: 9, 16 and 45

TRADEMARK

SERVICE MARK

PRINCIPAL REGISTER

30 60 100 MINISTRIES, INC. (NEW MEXICO CORPORATION)
2501 JUAN TABO NE
SUITE 9
ALBUQUERQUE, NM 87112

FOR: DOWNLOADABLE ELECTRONIC PUBLICATIONS IN THE NATURE OF BOOKS, NEWSLETTERS, WORKBOOKS, BROCHURES AND REFERENCE CARDS, IN THE FIELDS OF CHRISTIAN GROWTH, SPIRITUAL HEALTH, LEADERSHIP DEVELOPMENT, AND STRATEGIC PLANNING, IN CLASS 9 (U.S. CLS. 21, 23, 26, 36 AND 38).

FIRST USE 8-8-2011; IN COMMERCE 8-8-2011.

FOR: PRINTED PUBLICATIONS, NAMELY, BOOKS, NEWSLETTERS, HAND-OUTS, WORKBOOKS, BROCHURES AND REFERENCE CARDS, IN THE FIELDS OF CHRISTIAN GROWTH, SPIRITUAL HEALTH, LEADERSHIP DEVELOPMENT, AND STRATEGIC PLANNING, IN CLASS 16 (U.S. CLS. 2, 5, 22, 23, 29, 37, 38 AND 50).

FIRST USE 9-11-2007; IN COMMERCE 9-11-2007.

FOR: CHRISTIAN MINISTRY SERVICES, IN CLASS 45 (U.S. CLS. 100 AND 101).

FIRST USE 9-11-2007; IN COMMERCE 9-11-2007.

THE MARK CONSISTS OF STANDARD CHARACTERS WITHOUT CLAIM TO ANY PARTICULAR FONT, STYLE, SIZE, OR COLOR.

NO CLAIM IS MADE TO THE EXCLUSIVE RIGHT TO USE "LEADER", APART FROM THE MARK AS SHOWN.

SER. NO. 85-252,291, FILED 2-25-2011.

NAPOLEON SHARMA, EXAMINING ATTORNEY



David J. Kyffers

Director of the United States Patent and Trademark Office

United States of America

United States Patent and Trademark Office

30 60 100

Reg. No. 4,073,269

Registered Dec. 20, 2011

Int. Cls.: 16, 41 and 45

TRADEMARK

SERVICE MARK

PRINCIPAL REGISTER

30 60 100 MINISTRIES, INC. (NEW MEXICO CORPORATION)
2501 JUAN TABO NE
SUITE 9
ALBUQUERQUE, NM 87112

FOR: PRINTED PUBLICATIONS, NAMELY, BOOKS, NEWSLETTERS, HAND-OUTS, WORKBOOKS, BROCHURES AND REFERENCE CARDS, IN THE FIELDS OF CHRISTIAN GROWTH, SPIRITUAL HEALTH, LEADERSHIP DEVELOPMENT, AND STRATEGIC PLANNING, IN CLASS 16 (U.S. CLS. 2, 5, 22, 23, 29, 37, 38 AND 50).

FIRST USE 11-19-2010; IN COMMERCE 12-9-2010.

FOR: NON-DOWNLOADABLE ELECTRONIC PUBLICATIONS IN THE NATURE ELECTRONIC BOOKS, NEWSLETTERS, WORKBOOKS, BROCHURES AND REFERENCE CARDS, IN THE FIELDS OF CHRISTIAN GROWTH, SPIRITUAL HEALTH, LEADERSHIP DEVELOPMENT, AND STRATEGIC PLANNING, IN CLASS 41 (U.S. CLS. 100, 101 AND 107).

FIRST USE 11-19-2010; IN COMMERCE 12-9-2010.

FOR: CHRISTIAN MINISTRY SERVICES, IN CLASS 45 (U.S. CLS. 100 AND 101).

FIRST USE 11-8-2010; IN COMMERCE 12-1-2010.

THE MARK CONSISTS OF STANDARD CHARACTERS WITHOUT CLAIM TO ANY PARTICULAR FONT, STYLE, SIZE, OR COLOR.

SER. NO. 85-252,294, FILED 2-25-2011.

NAPOLEON SHARMA, EXAMINING ATTORNEY



David J. Kyros

Director of the United States Patent and Trademark Office

United States of America

United States Patent and Trademark Office

Every Drop

Reg. No. 4,073,270

CONSUMER INSPIRED PRODUCTS, LLC (NEVADA LIMITED LIABILITY COMPANY)
P.O. BOX 12187, 400 DORLA COURT
ZEPHYR COVE, NV 89448

Registered Dec. 20, 2011

Int. Cl.: 21

FOR: HOUSEHOLD UTENSIL, NAMELY, COMBINATION SPATULA AND SCRAPER, IN CLASS 21 (U.S. CLS. 2, 13, 23, 29, 30, 33, 40 AND 50).

TRADEMARK

FIRST USE 2-14-2011; IN COMMERCE 2-14-2011.

PRINCIPAL REGISTER

THE MARK CONSISTS OF THE STYLIZED WORDING "EVERY DROP" WITH THE "E" IN "EVERY" FORMING A SCRAPER OR SPATULA.

SER. NO. 85-252,440, FILED 2-25-2011.

BRIAN PINO, EXAMINING ATTORNEY



David J. Kyffers

Director of the United States Patent and Trademark Office

United States of America

United States Patent and Trademark Office

Crusade Against Anger

Reg. No. 4,073,271

ROBINSON, CLARENCE HENRY (UNITED STATES INDIVIDUAL)
2960 RIVERSIDE DR. #112
CORAL SPRINGS, FL 33065

Registered Dec. 20, 2011

Int. Cl.: 41

FOR: EDUCATIONAL PROGRAM TO INCREASE PERSONAL AWARENESS, NAMELY, CONDUCTING WORKSHOPS AND SEMINARS IN THE FIELD OF ANGER MANAGEMENT, IN CLASS 41 (U.S. CLS. 100, 101 AND 107).

SERVICE MARK

FIRST USE 11-10-2010; IN COMMERCE 11-10-2010.

PRINCIPAL REGISTER

THE MARK CONSISTS OF STANDARD CHARACTERS WITHOUT CLAIM TO ANY PARTICULAR FONT, STYLE, SIZE, OR COLOR.

NO CLAIM IS MADE TO THE EXCLUSIVE RIGHT TO USE "ANGER", APART FROM THE MARK AS SHOWN.

SER. NO. 85-252,754, FILED 2-27-2011.

BRIAN PINO, EXAMINING ATTORNEY



David J. Kyffers

Director of the United States Patent and Trademark Office

United States of America

United States Patent and Trademark Office

Carissa Rose

Reg. No. 4,073,272

CARISSA ROSE DESIGNS LLC (TEXAS LIMITED LIABILITY COMPANY)
606 NORTHLAKE DRIVE
DALLAS, TX 75218

Registered Dec. 20, 2011

Int. Cl.: 35

FOR: COMPUTERIZED ON-LINE RETAIL STORE SERVICES IN THE FIELD OF WOMEN'S APPAREL, IN CLASS 35 (U.S. CLS. 100, 101 AND 102).

SERVICE MARK

FIRST USE 5-1-2009; IN COMMERCE 5-1-2009.

PRINCIPAL REGISTER

THE MARK CONSISTS OF STANDARD CHARACTERS WITHOUT CLAIM TO ANY PARTICULAR FONT, STYLE, SIZE, OR COLOR.

THE NAME(S), PORTRAIT(S), AND/OR SIGNATURE(S) SHOWN IN THE MARK IDENTIFIES "CARISSA" BROWN, WHOSE CONSENT(S) TO REGISTER IS MADE OF RECORD.

SER. NO. 85-252,865, FILED 2-27-2011.

SETH A. RAPPAPORT, EXAMINING ATTORNEY



David J. Kybas

Director of the United States Patent and Trademark Office

United States of America

United States Patent and Trademark Office

PrintsAsia

Reg. No. 4,073,273

Registered Dec. 20, 2011

Int. Cl.: 35

SERVICE MARK

PRINCIPAL REGISTER

PLETOS INC. (NEW YORK CORPORATION)
SUITE 405
244 MADISON AVENUE
NEW YORK, NY 10016

FOR: ON-LINE RETAIL AND WHOLESALE STORE SERVICES FEATURING BOOKS AND PRINTED MATERIAL; ON-LINE CATALOG ORDERING SERVICE FEATURING BOOKS AND PRINTED MATERIAL; ADMINISTRATION OF A BUSINESS PROGRAM FOR THE PURPOSE OF ADVERTISING AND PROMOTING RETAIL SALES OF BOOKS, AND PRINTED MATERIAL; COLLECTION OF MARKET RESEARCH INFORMATION IN THE FIELD OF BOOKS AND PRINTED MATERIAL; OPERATING ONLINE MARKETPLACE FOR SELLERS OF BOOKS AND PRINTED MATERIAL, IN CLASS 35 (U.S. CLS. 100, 101 AND 102).

FIRST USE 8-4-2000; IN COMMERCE 8-4-2000.

THE MARK CONSISTS OF STANDARD CHARACTERS WITHOUT CLAIM TO ANY PARTICULAR FONT, STYLE, SIZE, OR COLOR.

SEC. 2(F).

SER. NO. 85-252,886, FILED 2-28-2011.

DEIRDRE ROBERTSON, EXAMINING ATTORNEY



David J. Kyros

Director of the United States Patent and Trademark Office

United States of America

United States Patent and Trademark Office

AQUAPROOF

Reg. No. 4,073,274

Registered Dec. 20, 2011

Int. Cl.: 1

TRADEMARK

PRINCIPAL REGISTER

FEDERAL PROCESS CORPORATION (OHIO CORPORATION)
4520 RICHMOND ROAD
CLEVELAND, OH 44128

FOR: ALUMINUM ORGANIC-BASED CHEMICAL ADDITIVES FOR USE IN THE MANUFACTURE OF WATER REPELLANT COMPOSITIONS FOR WOOD AND MASONRY CONSTRUCTION SURFACES; ALUMINUM ORGANIC-BASED WATER REPELLING CHEMICAL COMPOSITIONS FOR WOOD AND MASONRY CONSTRUCTION SURFACES, IN CLASS 1 (U.S. CLS. 1, 5, 6, 10, 26 AND 46).

FIRST USE 6-20-2005; IN COMMERCE 6-20-2005.

THE MARK CONSISTS OF STANDARD CHARACTERS WITHOUT CLAIM TO ANY PARTICULAR FONT, STYLE, SIZE, OR COLOR.

OWNER OF U.S. REG. NO. 3,197,744.

SER. NO. 85-252,995, FILED 2-28-2011.

LINDA MICKLEBURGH, EXAMINING ATTORNEY



David J. Kyffers

Director of the United States Patent and Trademark Office

United States of America

United States Patent and Trademark Office

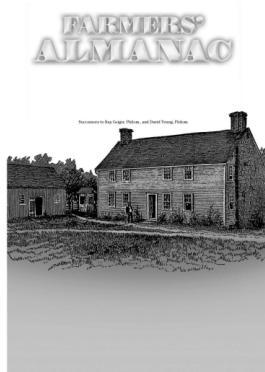

Reg. No. 4,073,275

Registered Dec. 20, 2011

Int. Cl.: 16

TRADEMARK

PRINCIPAL REGISTER

ALMANAC PUBLISHING CO. (MAINE CORPORATION)
70 MOUNT HOPE AVENUE
LEWISTON, ME 04241

FOR: ALMANACS, IN CLASS 16 (U.S. CLS. 2, 5, 22, 23, 29, 37, 38 AND 50).

FIRST USE 3-31-2009; IN COMMERCE 8-31-2009.

OWNER OF U.S. REG. NO. 2,206,908.

NO CLAIM IS MADE TO THE EXCLUSIVE RIGHT TO USE "FARMERS' ALMANAC SUCCESSORS TO RAY GEIGER, PHILOM., AND DAVID YOUNG, PHILOM.", APART FROM THE MARK AS SHOWN.

THE NAME(S), PORTRAIT(S), AND/OR SIGNATURE(S) SHOWN IN THE MARK DOES NOT IDENTIFY A PARTICULAR LIVING INDIVIDUAL.

THE MARK CONSISTS OF THE WORDS "FARMERS' ALMANAC" ABOVE THE WORDS "SUCCESSORS TO RAY GEIGER, PHILOM., AND DAVID YOUNG, PHILOM.", WHICH ALL APPEAR ABOVE A DESIGN ELEMENT. THE DESIGN CONSISTS OF A BARN ON THE LEFT, A WATER WELL, A HOUSE WITH TWO CHIMNEYS ON THE RIGHT, A MAN STANDING IN FRONT OF THE HOUSE, GRASS IN FRONT OF THE HOUSE AND BARN, BUSHES IN FRONT OF THE HOUSE AND TREES BEHIND THE BARN AND WELL.

SER. NO. 85-253,037, FILED 2-28-2011.

MEGHAN REINHART, EXAMINING ATTORNEY



David J. Kyffers

Director of the United States Patent and Trademark Office

United States of America

United States Patent and Trademark Office

MIGHTY HEARTS

Reg. No. 4,073,276

MIGHTY HEARTS INTERNATIONAL (WISCONSIN CORPORATION)
P.O. BOX 773

Registered Dec. 20, 2011

APPLETON, WI 549120773

Int. Cls.: 36, 41 and 44

FOR: ACCEPTING AND ADMINISTERING MONETARY CHARITABLE CONTRIBUTIONS;
CHARITABLE FUND RAISING, IN CLASS 36 (U.S. CLS. 100, 101 AND 102).

SERVICE MARK

FIRST USE 8-1-2010; IN COMMERCE 8-1-2010.

PRINCIPAL REGISTER

FOR: EDUCATIONAL SERVICES, NAMELY, PROVIDING CHRISTIAN, NON-DENOMINA-
TIONAL INSTRUCTION TO CHILDREN, IN CLASS 41 (U.S. CLS. 100, 101 AND 107).

FIRST USE 8-1-2010; IN COMMERCE 8-1-2010.

FOR: CHARITABLE SERVICES, NAMELY, PROVIDING MEDICAL AND HYGIENIC SER-
VICES, IN CLASS 44 (U.S. CLS. 100 AND 101).

FIRST USE 8-1-2010; IN COMMERCE 8-1-2010.

THE MARK CONSISTS OF STANDARD CHARACTERS WITHOUT CLAIM TO ANY PAR-
TICULAR FONT, STYLE, SIZE, OR COLOR.

SER. NO. 85-253,039, FILED 2-28-2011.

MEGHAN REINHART, EXAMINING ATTORNEY



David J. Kybas

Director of the United States Patent and Trademark Office

United States of America

United States Patent and Trademark Office

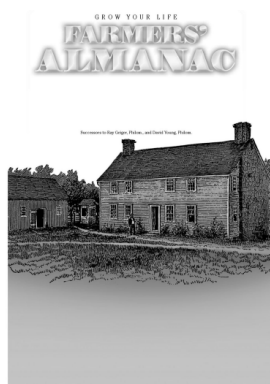

Reg. No. 4,073,277

Registered Dec. 20, 2011

Int. Cl.: 16

TRADEMARK

PRINCIPAL REGISTER

ALMANAC PUBLISHING CO. (MAINE CORPORATION)
70 MOUNT HOPE AVENUE
LEWISTON, ME 04241

FOR: ALMANACS, IN CLASS 16 (U.S. CLS. 2, 5, 22, 23, 29, 37, 38 AND 50).

FIRST USE 3-31-2009; IN COMMERCE 8-31-2009.

OWNER OF U.S. REG. NO. 2,206,908.

NO CLAIM IS MADE TO THE EXCLUSIVE RIGHT TO USE "FARMERS' ALMANAC SUCCESSORS TO RAY GEIGER, PHILOM., AND DAVID YOUNG, PHILOM.", APART FROM THE MARK AS SHOWN.

THE NAME(S), PORTRAIT(S), AND/OR SIGNATURE(S) SHOWN IN THE MARK DOES NOT IDENTIFY A PARTICULAR LIVING INDIVIDUAL.

THE MARK CONSISTS OF THE WORDS "GROW YOUR LIFE" ABOVE THE WORDS "FARMERS' ALMANAC" ABOVE THE WORDS "SUCCESSORS TO RAY GEIGER, PHILOM., AND DAVID YOUNG, PHILOM." ALL OF WHICH APPEAR ABOVE A DESIGN ELEMENT. THE DESIGN CONSISTS OF A BARN ON THE LEFT, A WATER WELL, A HOUSE WITH TWO CHIMNEYS ON THE RIGHT, A MAN STANDING IN FRONT OF THE HOUSE, GRASS IN FRONT OF THE HOUSE AND BARN, BUSHES IN FRONT OF THE HOUSE AND TREES BEHIND THE BARN AND WELL.

SER. NO. 85-253,041, FILED 2-28-2011.

MEGHAN REINHART, EXAMINING ATTORNEY



David J. Kyjars

Director of the United States Patent and Trademark Office

United States of America

United States Patent and Trademark Office

OCTY-ROUND

Reg. No. 4,073,278

Registered Dec. 20, 2011

Int. Cl.: 24

TRADEMARK

PRINCIPAL REGISTER

HOFFMASTER GROUP, INC. (DELAWARE CORPORATION)
2920 N. MAIN STREET
OSHKOSH, WI 54903

FOR: PLASTIC TABLECLOTHS, IN CLASS 24 (U.S. CLS. 42 AND 50).

FIRST USE 1-1-2009; IN COMMERCE 1-1-2009.

THE MARK CONSISTS OF STANDARD CHARACTERS WITHOUT CLAIM TO ANY PARTICULAR FONT, STYLE, SIZE, OR COLOR.

OWNER OF U.S. REG. NO. 2,019,242.

SER. NO. 85-253,072, FILED 2-28-2011.

LINDA ORNDORFF, EXAMINING ATTORNEY



David J. Kyffers

Director of the United States Patent and Trademark Office

United States of America

United States Patent and Trademark Office

MANZANO MILE

Reg. No. 4,073,279

MANZANO, LEONEL (UNITED STATES INDIVIDUAL)

Registered Dec. 20, 2011

PO BOX 684492
AUSTIN, TX 78768

Int. Cl.: 41

FOR: ATHLETIC AND SPORTS EVENT SERVICES, NAMELY, ARRANGING, ORGANIZING, OPERATING AND CONDUCTING RUNNING RACES, IN CLASS 41 (U.S. CLS. 100, 101 AND 107).

SERVICE MARK

FIRST USE 2-1-2010; IN COMMERCE 2-1-2010.

PRINCIPAL REGISTER

THE MARK CONSISTS OF STANDARD CHARACTERS WITHOUT CLAIM TO ANY PARTICULAR FONT, STYLE, SIZE, OR COLOR.

NO CLAIM IS MADE TO THE EXCLUSIVE RIGHT TO USE "MILE", APART FROM THE MARK AS SHOWN.

SER. NO. 85-253,140, FILED 2-28-2011.

KEVIN CORWIN, EXAMINING ATTORNEY



David J. Kybas

Director of the United States Patent and Trademark Office

United States of America

United States Patent and Trademark Office

OPERATION AJAX

Reg. No. 4,073,280

COGNITO COMICS, LLC (CALIFORNIA LIMITED LIABILITY COMPANY)
3375 17TH STREET, #201

Registered Dec. 20, 2011

SAN FRANCISCO, CA 94110

Int. Cl.: 41

FOR: PROVIDING ONLINE NON-DOWNLOADABLE INTERACTIVE COMIC BOOKS AND GRAPHIC NOVELS, IN CLASS 41 (U.S. CLS. 100, 101 AND 107).

SERVICE MARK

FIRST USE 12-22-2010; IN COMMERCE 12-22-2010.

PRINCIPAL REGISTER

THE MARK CONSISTS OF STANDARD CHARACTERS WITHOUT CLAIM TO ANY PARTICULAR FONT, STYLE, SIZE, OR COLOR.

SER. NO. 85-253,367, FILED 2-28-2011.

CURTIS FRENCH, EXAMINING ATTORNEY



David J. Kybas

Director of the United States Patent and Trademark Office

United States of America

United States Patent and Trademark Office

COGNITO COMICS

Reg. No. 4,073,281

COGNITO COMICS, LLC (CALIFORNIA LIMITED LIABILITY COMPANY)

Registered Dec. 20, 2011

3375 17TH STREET, #201
SAN FRANCISCO, CA 94110

Int. Cl.: 41

FOR: DIGITAL VIDEO, AUDIO, AND MULTIMEDIA PUBLISHING SERVICES IN THE FIELD OF COMICS AND GRAPHIC NOVELS; PUBLISHING OF BOOKS, E-BOOKS, AUDIO BOOKS, MUSIC AND ILLUSTRATIONS, IN THE FIELD OF COMICS AND GRAPHIC NOVELS, IN CLASS 41 (U.S. CLS. 100, 101 AND 107).

SERVICE MARK

PRINCIPAL REGISTER

FIRST USE 1-8-2010; IN COMMERCE 1-8-2010.

THE MARK CONSISTS OF STANDARD CHARACTERS WITHOUT CLAIM TO ANY PARTICULAR FONT, STYLE, SIZE, OR COLOR.

NO CLAIM IS MADE TO THE EXCLUSIVE RIGHT TO USE "COMICS", APART FROM THE MARK AS SHOWN.

SER. NO. 85-253,388, FILED 2-28-2011.

CURTIS FRENCH, EXAMINING ATTORNEY



David J. Kybas

Director of the United States Patent and Trademark Office

United States of America

United States Patent and Trademark Office

Ermak USA

Reg. No. 4,073,282

ERMAK USA, INC. (ILLINOIS CORPORATION)
770 N. LASALLE ST., SUITE 700
CHICAGO, IL 60654

Registered Dec. 20, 2011

Int. Cl.: 7

FOR: METAL WORKING MACHINES, IN CLASS 7 (U.S. CLS. 13, 19, 21, 23, 31, 34 AND 35).

FIRST USE 1-26-2011; IN COMMERCE 1-26-2011.

TRADEMARK

THE MARK CONSISTS OF STANDARD CHARACTERS WITHOUT CLAIM TO ANY PARTICULAR FONT, STYLE, SIZE, OR COLOR.

PRINCIPAL REGISTER

NO CLAIM IS MADE TO THE EXCLUSIVE RIGHT TO USE "USA", APART FROM THE MARK AS SHOWN.

THE NAME(S), PORTRAIT(S), AND/OR SIGNATURE(S) SHOWN IN THE MARK DOES NOT IDENTIFY A PARTICULAR LIVING INDIVIDUAL.

SER. NO. 85-253,800, FILED 2-28-2011.

ERIN FALK, EXAMINING ATTORNEY



David J. Kyffers

Director of the United States Patent and Trademark Office

United States of America

United States Patent and Trademark Office

NCS

Reg. No. 4,073,283

Registered Dec. 20, 2011

Int. Cl.: 24

TRADEMARK

PRINCIPAL REGISTER

NCS COLOUR AKTIEBOLAG (SWEDEN JOINT STOCK COMPANY)
IGELDAMMSGATAN 30
100 28 STOCKHOLM, SWEDEN

FOR: TEXTILE COLOR SAMPLES IN THE NATURE OF SWATCHES, IN CLASS 24 (U.S. CLS. 42 AND 50).

THE MARK CONSISTS OF STANDARD CHARACTERS WITHOUT CLAIM TO ANY PARTICULAR FONT, STYLE, SIZE, OR COLOR.

OWNER OF ERPN CMNTY TM OFC REG. NO. 009755497, DATED 7-1-2011, EXPIRES 7-1-2021.

SER. NO. 85-254,937, FILED 3-1-2011.

MICHELLE DUBOIS, EXAMINING ATTORNEY



David J. Kyffers

Director of the United States Patent and Trademark Office

United States of America

United States Patent and Trademark Office

ENTHRONED EMPRESS

Reg. No. 4,073,284

ENTHRONED EMPRESS, INC. (FLORIDA CORPORATION)

Registered Dec. 20, 2011

610 W. LAS OLAS BLVD., #718
FT. LAUDERDALE, FL 33312

Int. Cl.: 35

FOR: PROMOTING THE GOODS AND SERVICES OF OTHERS BY PROVIDING A WEBSITE FEATURING PRODUCT REVIEWS; ONLINE BUSINESS NETWORKING SERVICES , IN CLASS 35 (U.S. CLS. 100, 101 AND 102).

SERVICE MARK

FIRST USE 11-17-2010; IN COMMERCE 11-17-2010.

PRINCIPAL REGISTER

THE MARK CONSISTS OF STANDARD CHARACTERS WITHOUT CLAIM TO ANY PARTICULAR FONT, STYLE, SIZE, OR COLOR.

SER. NO. 85-255,758, FILED 3-2-2011.

NICHOLAS ALTREE, EXAMINING ATTORNEY



David J. Kybas

Director of the United States Patent and Trademark Office

United States of America

United States Patent and Trademark Office



Reg. No. 4,073,285

Registered Dec. 20, 2011

Int. Cl.: 41

SERVICE MARK

PRINCIPAL REGISTER

JIMMYMAKESMOVIES, INC. (WISCONSIN CORPORATION)
1518 NORTH CASS STREET
MILWAUKEE, WI 53202

FOR: MOTION PICTURE FILM PRODUCTION SERVICES, IN CLASS 41 (U.S. CLS. 100, 101 AND 107).

FIRST USE 1-25-2010; IN COMMERCE 1-25-2010.

THE NAME "JIMMY" IDENTIFIES A LIVING INDIVIDUAL WHOSE CONSENT IS OF RECORD.

THE MARK CONSISTS OF "JIMMY MAKES MOVIES" UNDERNEATH A SILHOUETTE OF A MAN WALKING IN FRONT OF A LIGHT AND CASTING A SHADOW.

SER. NO. 85-255,826, FILED 3-2-2011.

VERNA BETH RIRIE, EXAMINING ATTORNEY



David J. Kybas

Director of the United States Patent and Trademark Office

United States of America

United States Patent and Trademark Office

Senior *U* Select

Reg. No. 4,073,286

AIKEN ELECTRIC COOPERATIVE (SOUTH CAROLINA COOPERATIVE CORPORATION)
PO BOX 417
AIKEN, SC 298020417

Registered Dec. 20, 2011

Int. Cl.: 35

FOR: BILLING SUPPORT SERVICES FOR CUSTOMERS OF ELECTRIC UTILITIES, IN CLASS 35 (U.S. CLS. 100, 101 AND 102).

SERVICE MARK

FIRST USE 2-1-2011; IN COMMERCE 2-1-2011.

PRINCIPAL REGISTER

NO CLAIM IS MADE TO THE EXCLUSIVE RIGHT TO USE "SENIOR", APART FROM THE MARK AS SHOWN.

THE MARK CONSISTS OF THE STYLIZED WORDING "SENIOR U SELECT".

SER. NO. 85-256,027, FILED 3-2-2011.

ERIN FALK, EXAMINING ATTORNEY



David J. Kybas

Director of the United States Patent and Trademark Office

United States of America

United States Patent and Trademark Office

Ajax Capital Advisors

Reg. No. 4,073,287

Registered Dec. 20, 2011

Int. Cl.: 36

SERVICE MARK

PRINCIPAL REGISTER

AJAX CAPITAL ADVISORS (GEORGIA CORPORATION)
2401 MACY DRIVE
ROSWELL, GA 30076

FOR: INVESTMENT ADVISORY SERVICES, IN CLASS 36 (U.S. CLS. 100, 101 AND 102).

FIRST USE 3-18-2009; IN COMMERCE 3-18-2009.

THE MARK CONSISTS OF STANDARD CHARACTERS WITHOUT CLAIM TO ANY PARTICULAR FONT, STYLE, SIZE, OR COLOR.

NO CLAIM IS MADE TO THE EXCLUSIVE RIGHT TO USE "CAPITAL ADVISORS", APART FROM THE MARK AS SHOWN.

SER. NO. 85-256,756, FILED 3-3-2011.

RON FAIRBANKS, EXAMINING ATTORNEY



David J. Kyffers

Director of the United States Patent and Trademark Office

United States of America

United States Patent and Trademark Office

WABER

Reg. No. 4,073,288

TRIPPE MANUFACTURING COMPANY (ILLINOIS CORPORATION)
1111 W. 35TH STREET
CHICAGO, IL 60609

Registered Dec. 20, 2011

Int. Cl.: 9

FOR: MULTI-OUTLET SOCKET POWER STRIPS AND VOLTAGE SURGE SUPPRESSORS,
IN CLASS 9 (U.S. CLS. 21, 23, 26, 36 AND 38).

TRADEMARK

FIRST USE 9-0-2001, THE MARK WAS FIRST USED ANYWHERE IN A DIFFERENT FORM
OTHER THAN THAT SOUGHT TO BE REGISTERED AT LEAST AS EARLY AS 11/00/1972;
IN COMMERCE 9-0-2001, THE MARK WAS FIRST USED IN COMMERCE IN A DIFFERENT
FORM OTHER THAN THAT SOUGHT TO BE REGISTERED AT LEAST AS EARLY AS
11/00/1972.

PRINCIPAL REGISTER

THE MARK CONSISTS OF STANDARD CHARACTERS WITHOUT CLAIM TO ANY PAR-
TICULAR FONT, STYLE, SIZE, OR COLOR.

SER. NO. 85-256,813, FILED 3-3-2011.

WARREN L. OLANDRIA, EXAMINING ATTORNEY



David J. Kybas

Director of the United States Patent and Trademark Office

United States of America

United States Patent and Trademark Office

The Credit Card Dr.

Reg. No. 4,073,289

Registered Dec. 20, 2011

Int. Cl.: 36

SERVICE MARK

PRINCIPAL REGISTER

BETTER BUSINESS SOLUTIONS, INC. (MINNESOTA CORPORATION)
3632 10TH LANE NW
ROCHESTER, MN 55901

FOR: CREDIT CARD PAYMENT PROCESSING SERVICES FOR BUSINESSES, RETAILERS AND VENDORS; CREDIT CARD SERVICES FOR BUSINESSES, RETAILERS AND VENDORS; CREDIT CARD TRANSACTION PROCESSING SERVICES; ELECTRONIC CREDIT CARD TRANSACTION SERVICES FOR BUSINESSES, RETAILERS AND VENDORS; PAYMENT PROCESSING SERVICES, NAMELY, CREDIT CARD AND DEBIT CARD TRANSACTION PROCESSING SERVICES FOR BUSINESSES, RETAILERS AND VENDORS, IN CLASS 36 (U.S. CLS. 100, 101 AND 102).

FIRST USE 3-18-2010; IN COMMERCE 3-18-2010.

THE MARK CONSISTS OF STANDARD CHARACTERS WITHOUT CLAIM TO ANY PARTICULAR FONT, STYLE, SIZE, OR COLOR.

NO CLAIM IS MADE TO THE EXCLUSIVE RIGHT TO USE "CREDIT CARD", APART FROM THE MARK AS SHOWN.

SER. NO. 85-256,952, FILED 3-3-2011.

DOMINIC J. FERRAIUOLO, EXAMINING ATTORNEY



David J. Kyros

Director of the United States Patent and Trademark Office

United States of America

United States Patent and Trademark Office



Reg. No. 4,073,290

Registered Dec. 20, 2011

Int. Cl.: 36

SERVICE MARK

PRINCIPAL REGISTER

CENTRAL ASIA INSTITUTE (DELAWARE NON-PROFIT CORPORATION)
P.O. BOX 7209
BOZEMAN, MT 59771

FOR: CHARITABLE SERVICES, NAMELY, CHARITABLE FUNDRAISING TO PROMOTE AND SUPPORT COMMUNITY-BASED EDUCATION IN PAKISTAN AND AFGHANISTAN, IN CLASS 36 (U.S. CLS. 100, 101 AND 102).

FIRST USE 1-1-1996; IN COMMERCE 1-1-1996.

NO CLAIM IS MADE TO THE EXCLUSIVE RIGHT TO USE "CENTRAL ASIA INSTITUTE", APART FROM THE MARK AS SHOWN.

THE COLOR(S) BLUE, DARK BLUE, LIGHT PURPLE AND WHITE IS/ARE CLAIMED AS A FEATURE OF THE MARK.

THE MARK CONSISTS OF THE WORDING "CENTRAL ASIA INSTITUTE" IN THE COLOR WHITE, WITH A RECTANGLE IN THE COLOR DARK BLUE SURROUNDING THE WORDING. A ROAD IN THE COLOR WHITE APPEARS TO THE LEFT OF AN IMAGE OF A WOMAN HOLDING A BABY IN THE COLORS WHITE AND DARK BLUE. MOUNTAINS IN THE COLOR BLUE, SKY IN THE COLOR LIGHT PURPLE, AND A MOON AND STAR DESIGN IN THE COLOR WHITE APPEAR BEHIND THE WOMEN AND BABY DESIGN. A LARGER RECTANGLE DESIGN WITH BORDER IN THE COLOR WHITE AND DARK BLUE SURROUNDS THE WORDING AND DESIGNS OF THE MARK.

SER. NO. 85-257,088, FILED 3-3-2011.

ANDREW RHIM, EXAMINING ATTORNEY



David J. Kybas

Director of the United States Patent and Trademark Office

United States of America

United States Patent and Trademark Office

CENTRAL ASIA INSTITUTE

Reg. No. 4,073,291

CENTRAL ASIA INSTITUTE (DELAWARE CHARITABLE, NON-PROFIT CORPORATION)
P.O. BOX 7209
BOZEMAN, MT 59771

Registered Dec. 20, 2011

Int. Cl.: 36

FOR: CHARITABLE SERVICES, NAMELY, CHARITABLE FUNDRAISING TO PROMOTE AND SUPPORT COMMUNITY-BASED EDUCATION IN PAKISTAN AND AFGHANISTAN , IN CLASS 36 (U.S. CLS. 100, 101 AND 102).

SERVICE MARK

FIRST USE 1-1-1996; IN COMMERCE 1-1-1996.

PRINCIPAL REGISTER

THE MARK CONSISTS OF STANDARD CHARACTERS WITHOUT CLAIM TO ANY PARTICULAR FONT, STYLE, SIZE, OR COLOR.

NO CLAIM IS MADE TO THE EXCLUSIVE RIGHT TO USE "INSTITUTE", APART FROM THE MARK AS SHOWN.

SEC. 2(F).

SER. NO. 85-257,094, FILED 3-3-2011.

ANDREW RHIM, EXAMINING ATTORNEY



David J. Kybas

Director of the United States Patent and Trademark Office

United States of America

United States Patent and Trademark Office



Reg. No. 4,073,292

Registered Dec. 20, 2011

Int. Cl.: 9

TRADEMARK

PRINCIPAL REGISTER

CWEB, INC (CALIFORNIA CORPORATION), AKA PARIS JEWELRY
10624 S EASTERN AVE # A-978
HENDERSON, NV 89052

FOR: SUNGLASS AND EYEGLASS FRAMES DECORATED WITH DIAMONDS; EYEWEAR DECORATED WITH DIAMONDS AND INCLUDING RHINESTONES AND COLORED RHINESTONES; ANTI-GLARE GLASSES; EYEGLASS CASES, CASES FOR EYEGLASSES AND SUNGLASSES, LENSES FOR SUNGLASSES, CHAINS FOR SPECTACLES AND FOR SUNGLASSES, IN CLASS 9 (U.S. CLS. 21, 23, 26, 36 AND 38).

FIRST USE 12-26-2009; IN COMMERCE 12-26-2009.

OWNER OF U.S. REG. NO. 3,928,679.

THE COLOR(S) WHITE AND GREY IS/ARE CLAIMED AS A FEATURE OF THE MARK.

NO CLAIM IS MADE TO THE EXCLUSIVE RIGHT TO USE "DIAMOND", APART FROM THE MARK AS SHOWN.

THE MARK CONSISTS OF THE WORDING "DIAMOND X" IN GREY WITH A DIAMOND GEM ON TOP OF THE LETTER "O" AND SLIGHTLY LEFT OF THE LETTER "O". THE DIAMOND DESIGN IS WHITE AND GREY. THE BACKGROUND IS NOT CLAIMED AS A FEATURE OF THE MARK.

SER. NO. 85-257,205, FILED S.R. 3-3-2011 AM. P.R. 8-24-2011.

DANIEL CAPSHAW, EXAMINING ATTORNEY



David J. Kyros

Director of the United States Patent and Trademark Office

United States of America

United States Patent and Trademark Office



Reg. No. 4,073,293

Registered Dec. 20, 2011

Int. Cl.: 16

TRADEMARK

PRINCIPAL REGISTER

ENVELOPMENTS, INC. (CALIFORNIA CORPORATION)
1209 E. WAKEHAM AVE.
SANTA ANA, CA 92705

FOR: PAPER GOODS, NAMELY, WRITING, TISSUE AND LUMINOUS PAPER, NOTE CARDS, ANNOUNCEMENT CARDS, BLANK CARDS, PAPER SEALS FOR STATIONERY USE, STICKERS AND ENVELOPES, IN CLASS 16 (U.S. CLS. 2, 5, 22, 23, 29, 37, 38 AND 50).

FIRST USE 3-0-2009; IN COMMERCE 3-0-2009.

OWNER OF U.S. REG. NO. 2,048,998.

THE MARK CONSISTS OF A STYLIZED OUTLINE OF A FANNED-OUT DECK OF DESIGN SWATCHES WITH A LOWERCASE "E" INTEGRATED INTO THE UPPER RIGHT OF THE DESIGN.

SER. NO. 85-257,394, FILED 3-3-2011.

STEVEN JACKSON, EXAMINING ATTORNEY



David J. Kyffers

Director of the United States Patent and Trademark Office

United States of America

United States Patent and Trademark Office



Reg. No. 4,073,294

Registered Dec. 20, 2011

Int. Cl.: 16

TRADEMARK

PRINCIPAL REGISTER

ENVELOPMENTS, INC. (CALIFORNIA CORPORATION)
1209 E. WAKEHAM AVE.
SANTA ANA, CA 92705

FOR: PAPER GOODS, NAMELY, WRITING, TISSUE AND LUMINOUS PAPER, NOTE CARDS, ANNOUNCEMENT CARDS, BLANK CARDS, PAPER SEALS FOR STATIONERY USE, STICKERS AND ENVELOPES, IN CLASS 16 (U.S. CLS. 2, 5, 22, 23, 29, 37, 38 AND 50).

FIRST USE 3-0-2009; IN COMMERCE 3-0-2009.

OWNER OF U.S. REG. NO. 2,048,998.

THE MARK CONSISTS OF A STYLIZED OUTLINE OF A FANNED-OUT DECK OF DESIGN SWATCHES WITH THE WORD "ENVELOPMENTS" INCORPORATED INTO THE DESIGN BY THE LOWERCASE "E".

SER. NO. 85-257,414, FILED 3-3-2011.

STEVEN JACKSON, EXAMINING ATTORNEY



David J. Kyffers

Director of the United States Patent and Trademark Office

United States of America

United States Patent and Trademark Office



Reg. No. 4,073,295

Registered Dec. 20, 2011

Int. Cl.: 42

SERVICE MARK

PRINCIPAL REGISTER

ARROYO BIOSCIENCES, INC. (DELAWARE CORPORATION)
35 FIELDSTON RD.
PRINCETON, NJ 085406429

FOR: DIAGNOSTIC SERVICES IN THE FIELD OF MOLECULAR IMAGING PROBES; DRUG DISCOVERY SERVICES; RESEARCH AND DEVELOPMENT IN THE FIELD OF PHARMACEUTICALS AND AGENTS FOR TREATMENT OF CANCER; RESEARCH AND DEVELOPMENT IN THE PHARMACEUTICAL AND BIOTECHNOLOGY FIELDS, IN CLASS 42 (U.S. CLS. 100 AND 101).

FIRST USE 2-11-2011; IN COMMERCE 2-11-2011.

THE MARK CONSISTS OF THE OUTLINE OF A STYLIZED WATER DROP THAT IS OPEN AT THE BOTTOM WITH A SMALL WAVE.

SER. NO. 85-257,956, FILED 3-4-2011.

BILL DAWE, EXAMINING ATTORNEY



David J. Kyffers

Director of the United States Patent and Trademark Office

United States of America

United States Patent and Trademark Office

Import Genius

Reg. No. 4,073,296

DBASE VI, LLC (US VIRGIN ISLANDS LIMITED LIABILITY COMPANY)
ONE HIBISCUS ALLEY

Registered Dec. 20, 2011

ST. THOMAS, US VIRGIN ISLANDS 00802

Int. Cl.: 35

FOR: PROVIDING A SEARCHABLE ONLINE DATABASE FEATURING INTERNATIONAL
IMPORT AND EXPORT SHIPMENT DATA, IN CLASS 35 (U.S. CLS. 100, 101 AND 102).

SERVICE MARK

FIRST USE 11-7-2007; IN COMMERCE 11-8-2007.

PRINCIPAL REGISTER

THE MARK CONSISTS OF STANDARD CHARACTERS WITHOUT CLAIM TO ANY PAR-
TICULAR FONT, STYLE, SIZE, OR COLOR.

NO CLAIM IS MADE TO THE EXCLUSIVE RIGHT TO USE "IMPORT", APART FROM THE
MARK AS SHOWN.

SER. NO. 85-258,100, FILED 3-4-2011.

REBECCA EISINGER, EXAMINING ATTORNEY



David J. Kybas

Director of the United States Patent and Trademark Office

United States of America

United States Patent and Trademark Office



Reg. No. 4,073,297

VO-VI MULTIMEDIA COMMUNICATION (CALIFORNIA PUBLIC BENEFIT CORPORATION)
98 FLINTWELL WAY
SAN JOSE, CA 951381615

Registered Dec. 20, 2011

Int. Cls.: 9, 16, 41 and 45

FOR: AUDIO AND VIDEO RECORDINGS FEATURING CONFERENCES, SEMINARS, LECTURES, CLASSES, INFORMATION SESSIONS, TEACHING TECHNIQUES AND INSTRUCTIONS, AND CONCERTS, ALL IN THE FIELD OF SPIRITUALITY AND MEDITATION, IN CLASS 9 (U.S. CLS. 21, 23, 26, 36 AND 38).

TRADEMARK

SERVICE MARK

FIRST USE 0-0-1997; IN COMMERCE 0-0-1997.

PRINCIPAL REGISTER

FOR: PRINTED PUBLICATIONS, NAMELY BOOKLETS, MAGAZINES, NEWSLETTERS, NEWSPAPERS, PERIODICALS, POSTERS, PAMPHLETS, TRANSCRIPTIONS OF LECTURES, AND PRINTED TEACHING MATERIALS, ALL IN THE FIELD OF SPIRITUALITY AND MEDITATION, IN CLASS 16 (U.S. CLS. 2, 5, 22, 23, 29, 37, 38 AND 50).

FIRST USE 0-0-1997; IN COMMERCE 0-0-1997.

FOR: INSTRUCTION IN THE FIELD OF SPIRITUALITY AND MEDITATION, IN CLASS 41 (U.S. CLS. 100, 101 AND 107).

FIRST USE 7-7-1998; IN COMMERCE 7-7-1998.

FOR: PROVIDING A WEBSITE FEATURING EDUCATIONAL INFORMATION IN THE FIELD OF SPIRITUALITY AND MEDITATION, IN CLASS 45 (U.S. CLS. 100 AND 101).

FIRST USE 7-7-1998; IN COMMERCE 7-7-1998.

THE MARK CONSISTS OF A LARGE RIMMED CIRCLE ON WHICH ARE SUPERIMPOSED TWO SMALLER INTERCONNECTED ELLIPSES AND A CIRCLE, ALL THE FOREGOING SHADED.

SER. NO. 85-258,349, FILED 3-4-2011.

ANNE MADDEN, EXAMINING ATTORNEY



David J. Kyros

Director of the United States Patent and Trademark Office

United States of America

United States Patent and Trademark Office

YARAL

Reg. No. 4,073,298

Registered Dec. 20, 2011

Int. Cls.: 5 and 10

TRADEMARK

PRINCIPAL REGISTER

IBSA INSTITUT BIOCHIMIQUE S.A. (SWITZERLAND JOINT STOCK COMPANY)
13, VIA AL PONTE
CH-6903 LUGANO, SWITZERLAND

FOR: PHARMACEUTICAL PREPARATIONS FOR THE TREATMENT OF PAIN, ARTHROSIS, AND REDUCED MOBILITY DUE TO DEGENERATIVE DISEASE, POST-TRAUMATIC DISEASE OR JOINT ALTERATION; SYRINGES SOLD FILLED WITH PHARMACEUTICAL PREPARATION CONTAINING HYALURONIC ACID, IN CLASS 5 (U.S. CLS. 6, 18, 44, 46, 51 AND 52).

FOR: MEDICAL APPARATUS FOR INTRODUCING PHARMACEUTICAL PREPARATIONS INTO THE HUMAN BODY, IN CLASS 10 (U.S. CLS. 26, 39 AND 44).

THE MARK CONSISTS OF STANDARD CHARACTERS WITHOUT CLAIM TO ANY PARTICULAR FONT, STYLE, SIZE, OR COLOR.

OWNER OF SWITZERLAND REG. NO. 526745, DATED 10-15-2004, EXPIRES 8-6-2014.

OWNER OF ERPN CMNTY TM OFC REG. NO. 003960937, DATED 11-22-2005, EXPIRES 7-29-2014.

SER. NO. 85-258,442, FILED 3-4-2011.

CYNTHIA TRIPI, EXAMINING ATTORNEY



David J. Kybas

Director of the United States Patent and Trademark Office

United States of America

United States Patent and Trademark Office

CUBELITE

Reg. No. 4,073,299

Registered Dec. 20, 2011

Int. Cl.: 18

TRADEMARK

PRINCIPAL REGISTER

SAMSONITE IP HOLDINGS S.À R.L. (LUXEMBOURG PRIVATE LIMITED LIABILITY COMPANY)
20, AVENUE MONTEREY
LUXEMBOURG, LUXEMBOURG L-2163

FOR: ALL-PURPOSE CARRYING BAGS; LUGGAGE; SUITCASES; TRAVELING BAGS, IN CLASS 18 (U.S. CLS. 1, 2, 3, 22 AND 41).

THE MARK CONSISTS OF STANDARD CHARACTERS WITHOUT CLAIM TO ANY PARTICULAR FONT, STYLE, SIZE, OR COLOR.

OWNER OF ERPN CMNTY TM OFC REG. NO. 009378282, DATED 2-1-2011, EXPIRES 9-15-2020.

SER. NO. 85-258,532, FILED 3-4-2011.

ANNE MADDEN, EXAMINING ATTORNEY



David J. Kyffers

Director of the United States Patent and Trademark Office

United States of America

United States Patent and Trademark Office

THE WINNER'S CHOICE

Reg. No. 4,073,300

Registered Dec. 20, 2011

Int. Cl.: 14

TRADEMARK

PRINCIPAL REGISTER

MULLER, JANEICE M (UNITED STATES INDIVIDUAL), DBA THE WINNER'S CHOICE
JAN MULLER
3401 GOLDEN RAIN ROAD #13
WALNUT CREEK, CA 94595

FOR: CHARMS, IN CLASS 14 (U.S. CLS. 2, 27, 28 AND 50).

FIRST USE 1-23-1993; IN COMMERCE 1-23-1993.

THE MARK CONSISTS OF STANDARD CHARACTERS WITHOUT CLAIM TO ANY PARTICULAR FONT, STYLE, SIZE, OR COLOR.

SER. NO. 85-259,005, FILED 3-5-2011.

FRED CARL, EXAMINING ATTORNEY



David J. Kyffers

Director of the United States Patent and Trademark Office

United States of America

United States Patent and Trademark Office

dirtpage

Reg. No. 4,073,301

JASON YANOFSKI (UNITED STATES INDIVIDUAL)
10 GAVIN ROAD
WEST ORANGE, NJ 07052

Registered Dec. 20, 2011

Int. Cl.: 41

FOR: PROVIDING A WEBSITE FOR ENTERTAINMENT PURPOSES WHERE USERS CAN VIEW AND POST MESSAGES AND PICTURES FEATURING MATTERS OF GENERAL INTEREST FOR ENTERTAINMENT PURPOSES AND POPULAR CULTURE, IN CLASS 41 (U.S. CLS. 100, 101 AND 107).

SERVICE MARK

PRINCIPAL REGISTER

FIRST USE 5-1-2010; IN COMMERCE 5-1-2010.

THE MARK CONSISTS OF STANDARD CHARACTERS WITHOUT CLAIM TO ANY PARTICULAR FONT, STYLE, SIZE, OR COLOR.

SER. NO. 85-259,133, FILED 3-6-2011.

MATTHEW PAPPAS, EXAMINING ATTORNEY



David J. Kypas

Director of the United States Patent and Trademark Office

United States of America

United States Patent and Trademark Office

Laser Dark

Reg. No. 4,073,302

LASER DARK, LLC (WISCONSIN LIMITED LIABILITY COMPANY)
2425 SEYMOUR RD.

Registered Dec. 20, 2011

EAU CLAIRE, WI 54703

Int. Cl.: 2

FOR: COATINGS FOR WOOD AS PAINTS, IN CLASS 2 (U.S. CLS. 6, 11 AND 16).

TRADEMARK

FIRST USE 2-1-2011; IN COMMERCE 2-1-2011.

PRINCIPAL REGISTER

THE MARK CONSISTS OF STANDARD CHARACTERS WITHOUT CLAIM TO ANY PARTICULAR FONT, STYLE, SIZE, OR COLOR.

SER. NO. 85-259,620, FILED 3-7-2011.

KATHY DE JONGE, EXAMINING ATTORNEY



David J. Kybas

Director of the United States Patent and Trademark Office

United States of America

United States Patent and Trademark Office

HEAVY DUTY AFTERMARKET WEEK

Reg. No. 4,073,303

Registered Dec. 20, 2011

Int. Cl.: 35

SERVICE MARK

PRINCIPAL REGISTER

AUTOMOTIVE AFTERMARKET INDUSTRY ASSOCIATION (ILLINOIS NON-PROFIT CORPORATION)
CORPORATION)
SUITE 1300
7101 WISCONSIN AVENUE
BETHESDA, MD 20814 AND

COMMERCIAL VEHICLE SOLUTIONS NETWORK (MICHIGAN NON-PROFIT CORPORATION)
CORPORATION)
3943-2 BAYMEADOWS ROAD
JACKSONVILLE, FL 32217 AND

MOTOR & EQUIPMENT MANUFACTURERS ASSOCIATION (ILLINOIS NON-PROFIT CORPORATION)
CORPORATION)
10 LABORATORY DRIVE, PO BOX 13966
RESEARCH TRIANGLE PARK, NC 27709

FOR: ARRANGING AND CONDUCTING TRADE SHOWS IN THE FIELD OF THE MOTOR VEHICLE AFTERMARKET INDUSTRY, IN CLASS 35 (U.S. CLS. 100, 101 AND 102).

FIRST USE 6-28-2005; IN COMMERCE 6-28-2005.

THE MARK CONSISTS OF STANDARD CHARACTERS WITHOUT CLAIM TO ANY PARTICULAR FONT, STYLE, SIZE, OR COLOR.

OWNER OF U.S. REG. NOS. 3,094,510 AND 3,306,855.

SEC. 2(F).

SER. NO. 85-259,833, FILED 3-7-2011.

VERNA BETH RIRIE, EXAMINING ATTORNEY



David J. Kyffers

Director of the United States Patent and Trademark Office

United States of America

United States Patent and Trademark Office

TASTE OF BEVERLY HILLS

Reg. No. 4,073,304

CITY OF BEVERLY HILLS (CALIFORNIA MUNICIPAL CORPORATION)
455 N. REXFORD DRIVE, SUITE 220
BEVERLY HILLS, CA 90210

Registered Dec. 20, 2011

Int. Cl.: 41

FOR: ENTERTAINMENT SERVICES, NAMELY, ORGANIZING COMMUNITY FESTIVALS
FEATURING FOOD AND DRINKS, IN CLASS 41 (U.S. CLS. 100, 101 AND 107).

SERVICE MARK

FIRST USE 6-17-2010; IN COMMERCE 6-17-2010.

PRINCIPAL REGISTER

THE MARK CONSISTS OF STANDARD CHARACTERS WITHOUT CLAIM TO ANY PAR-
TICULAR FONT, STYLE, SIZE, OR COLOR.

SEC. 2(F).

SER. NO. 85-260,031, FILED 3-7-2011.

JAY FLOWERS, EXAMINING ATTORNEY



David J. Kybas

Director of the United States Patent and Trademark Office

United States of America

United States Patent and Trademark Office



Reg. No. 4,073,305

Registered Dec. 20, 2011

Int. Cls.: 6 and 9

TRADEMARK

PRINCIPAL REGISTER

GIGA SOLAR MATERIALS CORP. (TAIWAN CORPORATION)
HSINCHU INDUSTRIAL PARK
1F, NO. 3, KUNG YEH FIRST RD.
HSINCHU, TAIWAN

FOR: SOLDER CREAM; SOLDER PASTES; PHOTOVOLTAIC CELL PASTE, NAMELY, METALLIZATION PASTE, IN CLASS 6 (U.S. CLS. 2, 12, 13, 14, 23, 25 AND 50).

FIRST USE 12-28-2009; IN COMMERCE 12-28-2009.

FOR: PHOTOELECTRIC CELLS; SEMICONDUCTOR DEVICES; CIRCUIT BOARDS; SOLAR WAFERS; SEMICONDUCTOR POWER ELEMENTS; APPARATUS FOR CONVERTING ELECTRONIC RADIATION TO ELECTRICAL ENERGY, NAMELY, PHOTOVOLTAIC SOLAR MODULES; APPARATUS FOR CONVERTING ELECTRONIC RADIATION TO ELECTRICAL ENERGY, NAMELY, PHOTOVOLTAIC SOLAR HYBRID MODULES; SOLAR BATTERIES; SOLAR CELLS, IN CLASS 9 (U.S. CLS. 21, 23, 26, 36 AND 38).

FIRST USE 12-28-2009; IN COMMERCE 12-28-2009.

THE MARK CONSISTS OF A HORIZONTAL CRESCENT WITH A CIRCLE AT ITS CENTER, BOTH ABOVE THE LETTERS "GSMC".

SER. NO. 85-260,398, FILED 3-7-2011.

KRISTIN CARLSON, EXAMINING ATTORNEY



David J. Kybas

Director of the United States Patent and Trademark Office

United States of America

United States Patent and Trademark Office

Mixed

Reg. No. 4,073,306

SSC MIXED LLC (SOUTH DAKOTA LIMITED LIABILITY COMPANY)
2604 S. LOUISE AVE
SIOUX FALLS, SD 57106

Registered Dec. 20, 2011

Int. Cl.: 43

FOR: RESTAURANT AND CATERING SERVICES; RESTAURANT SERVICES FEATURING MADE-TO-ORDER SALADS, WRAPS, PANINIS, SANDWICHES, PASTA, AND DESSERTS, IN CLASS 43 (U.S. CLS. 100 AND 101).

SERVICE MARK

FIRST USE 5-1-2010; IN COMMERCE 6-15-2010.

PRINCIPAL REGISTER

THE MARK CONSISTS OF STANDARD CHARACTERS WITHOUT CLAIM TO ANY PARTICULAR FONT, STYLE, SIZE, OR COLOR.

SER. NO. 85-260,595, FILED 3-8-2011.

JESSICA FATHY, EXAMINING ATTORNEY



David J. Kybas

Director of the United States Patent and Trademark Office

United States of America

United States Patent and Trademark Office



Reg. No. 4,073,307

Registered Dec. 20, 2011

Int. Cl.: 30

TRADEMARK

PRINCIPAL REGISTER

C.I. BOMCAFFE LTDA (COLOMBIA CORPORATION)
CRA 5 108A-33
BOGOTA, COLOMBIA

FOR: COFFEE, IN CLASS 30 (U.S. CL. 46).

FIRST USE 1-1-2008; IN COMMERCE 2-22-2011.

THE MARK CONSISTS OF TWO COFFEE BEANS WITH GREY AND WHITE FADED COLORS, ONE VERTICAL ON TOP, SLIGHTLY TILTED TO THE RIGHT AND ONE HORIZONTAL BELOW INTERCONNECTING. BELOW THE COFFEE BEANS THERE IS THE WORD "HACIENDA" ON THE TOP RIGHT PART OF THE WORD "BOMBONÁ" WRITTEN IN WHITE COLOR; BELOW IT THERE IS THE WORD "BOMBONÁ" WITH A BIG AND STYLIZED B AND WRITTEN IN A FADED GOLDEN COLOR. THE COFFEE BEANS AND THE WORDS ARE PLACED OVER A BLACK BACKGROUND.

THE COLOR(S) "BLACK", "WHITE", "GREY" AND "GOLD" IS/ARE CLAIMED AS A FEATURE OF THE MARK.

THE ENGLISH TRANSLATION OF "HACIENDA BOMBONÁ" IS "RANCH, HOUSE OR PROPERTY LOCATED IN BOMBONÁ".

SER. NO. 85-260,601, FILED 3-8-2011.

BENJAMIN OKEKE, EXAMINING ATTORNEY



David J. Kyffers

Director of the United States Patent and Trademark Office

United States of America

United States Patent and Trademark Office



THE ONLY **REAL GYM** IN NEW YORK CITY

Reg. No. 4,073,308

Registered Dec. 20, 2011

Int. Cl.: 41

SERVICE MARK

PRINCIPAL REGISTER

REDBOX 3-13 LLC (NEW YORK LIMITED LIABILITY COMPANY)
257 WEST 17TH
APT. 4D
NEW YORK, NY 10011

FOR: HEALTH AND FITNESS CLUB SERVICES; PROVIDING INDIVIDUAL EXERCISE, STRENGTH TRAINING AND WEIGHTLIFTING INSTRUCTION, EQUIPMENT AND FACILITIES; PERSONAL TRAINING SERVICES PROVIDED IN CONNECTION WITH EXERCISE, BODYBUILDING, FITNESS AND WEIGHT LOSS PROGRAMS, IN CLASS 41 (U.S. CLS. 100, 101 AND 107).

FIRST USE 3-0-2008; IN COMMERCE 3-0-2008.

NO CLAIM IS MADE TO THE EXCLUSIVE RIGHT TO USE "GYM", APART FROM THE MARK AS SHOWN.

THE MARK CONSISTS OF THE WORD "STEEL" ABOVE A BAR BELL DESIGN AND THE WORD "GYM" BELOW THE BAR BELL DESIGN. THE WORDS "THE ONLY REAL GYM IN NEW YORK CITY" APPEAR UNDERNEATH THE ENTIRE BAR BELL DESIGN.

SER. NO. 85-260,814, FILED 3-8-2011.

ELLEN PERKINS, EXAMINING ATTORNEY



David J. Kyros

Director of the United States Patent and Trademark Office

United States of America

United States Patent and Trademark Office

guythem

Reg. No. 4,073,309

Registered Dec. 20, 2011

Int. Cl.: 42

SERVICE MARK

PRINCIPAL REGISTER

PIERRE AZNAR (FRANCE INDIVIDUAL), TA GUYLHEM
POUR GUYLHEM
18 RUE DE LA PEPINIERE
TOULOUSE, FRANCE 31200

FOR: COMPUTER PROGRAMMING IN THE MEDICAL FIELD, IN CLASS 42 (U.S. CLS. 100 AND 101).

FIRST USE 8-13-1997; IN COMMERCE 1-1-2001.

THE MARK CONSISTS OF STANDARD CHARACTERS WITHOUT CLAIM TO ANY PARTICULAR FONT, STYLE, SIZE, OR COLOR.

"GUYLHEM" IDENTIFIES THE PSEUDONYM OF "PIERRE AZNAR", A LIVING INDIVIDUAL WHOSE CONSENT IS OF RECORD.

SER. NO. 85-260,863, FILED 3-8-2011.

SIMON TENG, EXAMINING ATTORNEY



David J. Kyffers

Director of the United States Patent and Trademark Office

United States of America

United States Patent and Trademark Office

JACKPOT

Reg. No. 4,073,310

LEGACY NURSERY PRODUCTS, LLC (FLORIDA LIMITED LIABILITY COMPANY)
3701 SW BOAT RAMP AVE.

Registered Dec. 20, 2011

PALM CITY, FL 34990

Int. Cl.: 21

FOR: FABRIC PLANT CONTAINERS USED FOR GROWING PLANTS, IN CLASS 21 (U.S. CLS. 2, 13, 23, 29, 30, 33, 40 AND 50).

TRADEMARK

FIRST USE 9-30-2005; IN COMMERCE 9-30-2005.

PRINCIPAL REGISTER

THE MARK CONSISTS OF STANDARD CHARACTERS WITHOUT CLAIM TO ANY PARTICULAR FONT, STYLE, SIZE, OR COLOR.

SER. NO. 85-260,972, FILED 3-8-2011.

CHARLES L. JENKINS, EXAMINING ATTORNEY



David J. Kybas

Director of the United States Patent and Trademark Office

United States of America

United States Patent and Trademark Office

FILMOTYPE NEMO

Reg. No. 4,073,311

FONT DINER, INC. (MINNESOTA CORPORATION)
3224 ANRIC DRIVE
EAU CLAIRE, WI 54701

Registered Dec. 20, 2011

Int. Cl.: 9

FOR: PRINTING FONTS THAT CAN BE DOWNLOADED PROVIDED BY MEANS OF ELECTRONIC TRANSMISSION, IN CLASS 9 (U.S. CLS. 21, 23, 26, 36 AND 38).

TRADEMARK

FIRST USE 3-3-2011; IN COMMERCE 3-3-2011.

PRINCIPAL REGISTER

THE MARK CONSISTS OF STANDARD CHARACTERS WITHOUT CLAIM TO ANY PARTICULAR FONT, STYLE, SIZE, OR COLOR.

OWNER OF U.S. REG. NO. 3,358,052.

SEC. 2(F).

SER. NO. 85-261,000, FILED 3-8-2011.

CHRIS WELLS, EXAMINING ATTORNEY



David J. Kybas

Director of the United States Patent and Trademark Office

United States of America

United States Patent and Trademark Office



THE CHARLESTON GROUP LAWYERS

Reg. No. 4,073,312

Registered Dec. 20, 2011

Int. Cl.: 45

SERVICE MARK

PRINCIPAL REGISTER

R. JONATHAN CHARLESTON, P.A. (NORTH CAROLINA PROFESSIONAL CORPORATION)
SUITE 200
201 HAY ST.
FAYETTEVILLE, NC 28302

FOR: LEGAL SERVICES, IN CLASS 45 (U.S. CLS. 100 AND 101).

FIRST USE 0-0-2003; IN COMMERCE 0-0-2003.

NO CLAIM IS MADE TO THE EXCLUSIVE RIGHT TO USE "GROUP" AND "LAWYERS",
APART FROM THE MARK AS SHOWN.

THE MARK CONSISTS OF STYLIZED "CG"; BELOW THE "CG" IS "THE CHARLESTON
GROUP" IN STYLIZED LETTERS WITH "LAWYERS" BELOW THIS.

SEC. 2(F) AS TO "THE CHARLESTON GROUP".

SER. NO. 85-261,224, FILED 3-8-2011.

DANNEAN HETZEL, EXAMINING ATTORNEY



David J. Kybas

Director of the United States Patent and Trademark Office

United States of America

United States Patent and Trademark Office

WEATHER QUICKIE

Reg. No. 4,073,313

Registered Dec. 20, 2011

Int. Cl.: 9

TRADEMARK

PRINCIPAL REGISTER

THE WEATHER UNDERGROUND, INC. (MICHIGAN CORPORATION)
SUITE 240
300 NORTH FIFTH
ANN ARBOR, MI 48104

FOR: MOBILE DEVICE APPLICATION SOFTWARE PROVIDING WEATHER FORECASTS,
IN CLASS 9 (U.S. CLS. 21, 23, 26, 36 AND 38).

FIRST USE 10-29-2010; IN COMMERCE 10-29-2010.

THE MARK CONSISTS OF STANDARD CHARACTERS WITHOUT CLAIM TO ANY PAR-
TICULAR FONT, STYLE, SIZE, OR COLOR.

NO CLAIM IS MADE TO THE EXCLUSIVE RIGHT TO USE "WEATHER", APART FROM
THE MARK AS SHOWN.

SER. NO. 85-261,439, FILED 3-8-2011.

LINDA MICKLEBURGH, EXAMINING ATTORNEY



David J. Kyros

Director of the United States Patent and Trademark Office

United States of America
United States Patent and Trademark Office

HAMPTON

Reg. No. 4,073,314

HAMPTON MARINE CO., LTD. (BR.VIRGIN ISLANDS LIMITED COMPANY (LTD.))
P.O. BOX 3321, ROAD TOWN
TORTOLA, BR.VIRGIN ISLANDS

Registered Dec. 20, 2011

Int. Cl.: 12

FOR: BOATS AND STRUCTURAL PARTS THEREFOR; SAILBOATS; YACHTS, IN CLASS
12 (U.S. CLS. 19, 21, 23, 31, 35 AND 44).

TRADEMARK

FIRST USE 9-27-2005; IN COMMERCE 9-27-2005.

PRINCIPAL REGISTER

THE MARK CONSISTS OF STANDARD CHARACTERS WITHOUT CLAIM TO ANY PAR-
TICULAR FONT, STYLE, SIZE, OR COLOR.

THE WORDING "HAMPTON" HAS NO MEANING IN A FOREIGN LANGUAGE.

SER. NO. 85-261,670, FILED 3-9-2011.

MARY CRAWFORD, EXAMINING ATTORNEY



David J. Kybas

Director of the United States Patent and Trademark Office

United States of America

United States Patent and Trademark Office

VIDEO GAME ERA

Reg. No. 4,073,315

Registered Dec. 20, 2011

Int. Cl.: 35

SERVICE MARK

PRINCIPAL REGISTER

VIDEO GAME ERA LLC (WASHINGTON LIMITED LIABILITY COMPANY), DBA VIDEO GAME ERA
1838 138TH PL SE
BELLEVUE, WA 98005

FOR: RETAIL STORE AND ON-LINE RETAIL STORE SERVICES FEATURING NEW AND USED VIDEO, COMPUTER AND ELECTRONIC GAMES, VIDEOS, DVDS, MOVIES, BOOKS, MAGAZINES, STRATEGY GUIDE, COMPUTER HARDWARE, COMPUTER AND VIDEO GAME ACCESSORIES, TOYS AND ACTION FIGURES; ADMINISTRATION OF A DISCOUNT PROGRAM FOR ENABLING PARTICIPANTS TO OBTAIN DISCOUNTS ON GOODS AND SERVICES THROUGH USE OF A DISCOUNT MEMBERSHIP CARD, IN CLASS 35 (U.S. CLS. 100, 101 AND 102).

FIRST USE 12-28-2010; IN COMMERCE 12-28-2010.

THE MARK CONSISTS OF STANDARD CHARACTERS WITHOUT CLAIM TO ANY PARTICULAR FONT, STYLE, SIZE, OR COLOR.

NO CLAIM IS MADE TO THE EXCLUSIVE RIGHT TO USE "VIDEO GAME", APART FROM THE MARK AS SHOWN.

SER. NO. 85-261,680, FILED 3-9-2011.

DAVID HOFFMAN, EXAMINING ATTORNEY



David J. Kyffers

Director of the United States Patent and Trademark Office

United States of America

United States Patent and Trademark Office

Cover Guard

Reg. No. 4,073,316

VU-FLOW FILTERS INC. (FLORIDA CORPORATION)
13370 CHAMBORD ST
BROOKSVILLE, FL 34613

Registered Dec. 20, 2011

Int. Cl.: 17

FOR: OPAQUE PLASTIC FILM FOR BLOCKING SUNLIGHT, IN CLASS 17 (U.S. CLS. 1, 5, 12, 13, 35 AND 50).

TRADEMARK

FIRST USE 4-7-1997; IN COMMERCE 4-7-1997.

PRINCIPAL REGISTER

THE MARK CONSISTS OF STANDARD CHARACTERS WITHOUT CLAIM TO ANY PARTICULAR FONT, STYLE, SIZE, OR COLOR.

NO CLAIM IS MADE TO THE EXCLUSIVE RIGHT TO USE "COVER", APART FROM THE MARK AS SHOWN.

SEC. 2(F).

SER. NO. 85-261,805, FILED 3-9-2011.

JANICE L. MCMORROW, EXAMINING ATTORNEY



David J. Kyffers

Director of the United States Patent and Trademark Office

United States of America

United States Patent and Trademark Office



Reg. No. 4,073,317

APPLIED SYNERGISTICS INTERNATIONAL, INC. (ARIZONA CORPORATION)
P.O. BOX 5737
SCOTTSDALE, AZ 85261

Registered Dec. 20, 2011

Int. Cl.: 41

FOR: LIFE COACHING SERVICES IN THE FIELD OF SEXUAL FULFILLMENT AND WORK-LIFE BALANCE, IN CLASS 41 (U.S. CLS. 100, 101 AND 107).

SERVICE MARK

FIRST USE 7-1-2007; IN COMMERCE 7-1-2007.

PRINCIPAL REGISTER

NO CLAIM IS MADE TO THE EXCLUSIVE RIGHT TO USE "CENTER", APART FROM THE MARK AS SHOWN.

THE COLOR(S) BLUE, MEDIUM BLUE, AND BROWN IS/ARE CLAIMED AS A FEATURE OF THE MARK.

THE MARK CONSISTS OF THE WORDS "CENTER FOR", IN SMALL FONT SITUATED DIRECTLY ABOVE THE WORDS "WORKING LIVES" IN LARGER BOLD FONT, ALL IN BROWN LETTERS, TO THE RIGHT OF A GEOMETRIC AND SYMMETRICAL DESIGN OF A FLOWER WITH FOUR BLUE AND MEDIUM BLUE PETALS AND A BROWN CIRCULAR CENTER, WITH NO CLAIM TO ANY BACKGROUND COLOR.

SER. NO. 85-262,725, FILED 3-9-2011.

HEATHER BIDDULPH, EXAMINING ATTORNEY



David J. Kyros

Director of the United States Patent and Trademark Office

United States of America

United States Patent and Trademark Office

We Grow Storytellers

Reg. No. 4,073,318

Registered Dec. 20, 2011

Int. Cl.: 41

NATIONAL STORYTELLING MEMBERSHIP ASSOCIATION, INC. (TENNESSEE CORPORATION), DBA NATIONAL STORYTELLING NETWORK
STE 8
132 BOONE STREET
JONESBOROUGH, TN 37659

SERVICE MARK

FOR: MEMBERSHIP CLUB SERVICES, NAMELY, PROVIDING TRAINING TO MEMBERS IN THE FIELD OF STORYTELLING, IN CLASS 41 (U.S. CLS. 100, 101 AND 107).

PRINCIPAL REGISTER

FIRST USE 1-31-2011; IN COMMERCE 1-31-2011.

THE MARK CONSISTS OF STANDARD CHARACTERS WITHOUT CLAIM TO ANY PARTICULAR FONT, STYLE, SIZE, OR COLOR.

NO CLAIM IS MADE TO THE EXCLUSIVE RIGHT TO USE "STORYTELLERS", APART FROM THE MARK AS SHOWN.

SER. NO. 85-263,019, FILED 3-10-2011.

PAM WILLIS, EXAMINING ATTORNEY



David J. Kyffers

Director of the United States Patent and Trademark Office

United States of America

United States Patent and Trademark Office

MICROASSIST

Reg. No. 4,073,319

MICROASSIST, INC. (TEXAS CORPORATION)
8500 SHOAL CREEK, SUITE 4-225
AUSTIN, TX 78757

Registered Dec. 20, 2011

Int. Cls.: 37, 38, 41 and 42

FOR: INSTALLATION, MAINTENANCE, REPAIR AND UPGRADING OF COMPUTER HARDWARE, COMPUTER HARDWARE SYSTEMS, AND COMPUTER NETWORK HARDWARE, IN CLASS 37 (U.S. CLS. 100, 103 AND 106).

SERVICE MARK

FIRST USE 7-1-1988; IN COMMERCE 7-1-1988.

PRINCIPAL REGISTER

FOR: PROVIDING MULTIPLE-USER ACCESS AND TELECOMMUNICATIONS CONNECTIONS TO A GLOBAL COMPUTER INFORMATION NETWORK, IN CLASS 38 (U.S. CLS. 100, 101 AND 104).

FIRST USE 7-1-1988; IN COMMERCE 7-1-1988.

FOR: COMPUTER EDUCATION TRAINING SERVICES, SCHEDULING OF PROGRAMS ON A GLOBAL COMPUTER NETWORK, AND ON-LINE LIBRARY SERVICES, NAMELY, PROVIDING ELECTRONIC LIBRARY SERVICES WHICH FEATURE NEWSPAPERS, MAGAZINES, PHOTOGRAPHS AND PICTURES VIA AN ON-LINE COMPUTER NETWORK, IN CLASS 41 (U.S. CLS. 100, 101 AND 107).

FIRST USE 7-1-1988; IN COMMERCE 7-1-1988.

FOR: COMPUTER SERVICES, FOR OTHERS, NAMELY, COMPUTER HARDWARE DEVELOPMENT; COMPUTER SOFTWARE DESIGN, DEVELOPMENT, INSTALLATION, MAINTENANCE, REPAIR AND UPDATING; COMPUTER PROGRAMMING; COMPUTER CODE CONVERSION FOR OTHERS; DATA CONVERSION OF COMPUTER PROGRAM DATA OR INFORMATION; COMPUTER SYSTEMS AND NETWORK ANALYSIS AND DESIGN; INTEGRATION OF COMPUTER SYSTEMS AND NETWORKS; CONSULTING SERVICES IN THE FIELD OF DESIGN, SELECTION, IMPLEMENTATION AND USE OF COMPUTER HARDWARE AND SOFTWARE SYSTEMS FOR OTHERS; COMPUTER GRAPHICS SERVICES; DESIGNING, CREATING, IMPLEMENTING, HOSTING, MANAGING, MAINTAINING AND DISPLAYING WEB OR NETWORK PAGES AND WEB OR NETWORK SITES FOR OTHERS; PROVIDING SEARCH ENGINES FOR OBTAINING DATA ON A GLOBAL COMPUTER NETWORK; COMPUTER SERVICES, NAMELY, CREATING COMPUTER NETWORK-BASED INDEXES OF INFORMATION, SITES AND OTHER RESOURCES AVAILABLE ON



David J. Kybas

Director of the United States Patent and Trademark Office

Reg. No. 4,073,319 COMPUTER NETWORKS; REDIRECTING ELECTRONIC MAIL TO CHANGED PERSONAL ELECTRONIC ADDRESS; CUSTOMIZED SEARCHING, NAMELY, PROVIDING INFORMATION AT THE SPECIFIC REQUEST OF END-USERS BY MEANS OF TELEPHONE OR GLOBAL COMPUTER NETWORKS; COMPUTER PROJECT MANAGEMENT SERVICES; ON-LINE BATCH COMPUTER SERVICES, NAMELY, CONFIGURATION OF MULTIPLE FILES INTO A SINGLE GROUP; MONITORING THE COMPUTER SYSTEMS OF OTHERS FOR TECHNICAL PURPOSES AND PROVIDING BACK-UP COMPUTER PROGRAMS AND FACILITIES; COMPUTER DIAGNOSTIC SERVICES; TROUBLESHOOTING OF COMPUTER HARDWARE AND SOFTWARE PROBLEMS; COMPUTER DISASTER RECOVERY PLANNING; COMPUTER DATA RECOVERY SERVICES; AND APPLICATION SERVICE PROVIDER (ASP) SERVICES, NAMELY, HOSTING COMPUTER SOFTWARE APPLICATIONS OF OTHERS, IN CLASS 42 (U.S. CLS. 100 AND 101).

FIRST USE 7-1-1988; IN COMMERCE 7-1-1988.

THE MARK CONSISTS OF STANDARD CHARACTERS WITHOUT CLAIM TO ANY PARTICULAR FONT, STYLE, SIZE, OR COLOR.

SER. NO. 85-263,351, FILED 3-10-2011.

JAMES MACFARLANE, EXAMINING ATTORNEY

United States of America

United States Patent and Trademark Office

CHAMBORD

Reg. No. 4,073,320

BROWN-FORMAN CORPORATION (DELAWARE CORPORATION)
850 DIXIE HIGHWAY
LOUISVILLE, KY 40210

Registered Dec. 20, 2011

Int. Cl.: 33

FOR: ALCOHOLIC BEVERAGES, NAMELY, DISTILLED SPIRITS, IN CLASS 33 (U.S. CLS. 47 AND 49).

TRADEMARK

FIRST USE 12-18-1975; IN COMMERCE 12-18-1975.

PRINCIPAL REGISTER

THE MARK CONSISTS OF STANDARD CHARACTERS WITHOUT CLAIM TO ANY PARTICULAR FONT, STYLE, SIZE, OR COLOR.

OWNER OF U.S. REG. NOS. 1,220,239 AND 3,443,941.

SEC. 2(F).

SER. NO. 85-263,417, FILED 3-10-2011.

LINDA MICKLEBURGH, EXAMINING ATTORNEY



David J. Kybas

Director of the United States Patent and Trademark Office

United States of America

United States Patent and Trademark Office

methodshop

Reg. No. 4,073,321

METHODSHOP, LLC (NEW JERSEY LIMITED LIABILITY COMPANY)
PO BOX 6171
HOBOKEN, NJ 07030

Registered Dec. 20, 2011

Int. Cl.: 42

FOR: PROVIDING A WEB SITE THAT FEATURES INFORMATION ON COMPUTER TECHNOLOGY AND PROGRAMMING, IN CLASS 42 (U.S. CLS. 100 AND 101).

SERVICE MARK

FIRST USE 1-1-1996; IN COMMERCE 1-1-1996.

PRINCIPAL REGISTER

THE MARK CONSISTS OF STANDARD CHARACTERS WITHOUT CLAIM TO ANY PARTICULAR FONT, STYLE, SIZE, OR COLOR.

SER. NO. 85-263,687, FILED 3-10-2011.

KAREN SEVERSON, EXAMINING ATTORNEY



David J. Kybas

Director of the United States Patent and Trademark Office

United States of America

United States Patent and Trademark Office

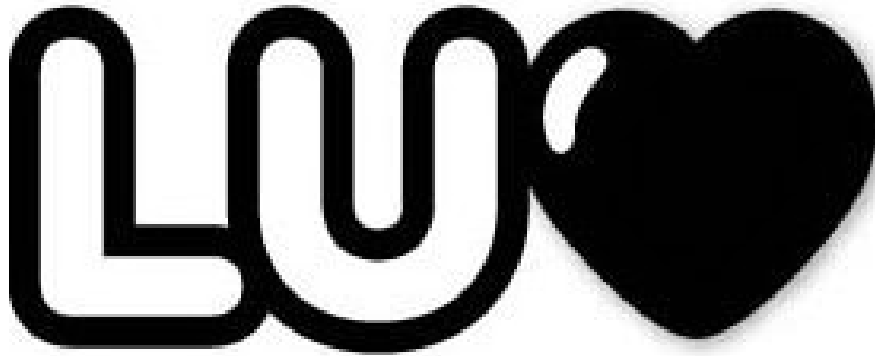

Reg. No. 4,073,322

ASCEND EAGLE, INC (CALIFORNIA CORPORATION)
828 SAN PABLO AVE
PINOLE, CA 94564

Registered Dec. 20, 2011

Int. Cl.: 10

FOR: DENTAL GLOVES; GLOVES FOR MEDICAL PURPOSES; GLOVES FOR MEDICAL USE; NITRILE GLOVES FOR MEDICAL USE, IN CLASS 10 (U.S. CLS. 26, 39 AND 44).

TRADEMARK

FIRST USE 1-1-2011; IN COMMERCE 1-1-2011.

PRINCIPAL REGISTER

THE MARK CONSISTS OF THE STYLIZED WORD "LUV" WITH THE "V" DEPICTED AS A HEART.

SER. NO. 85-263,734, FILED 3-10-2011.

JERI J. FICKES, EXAMINING ATTORNEY



David J. Kyffers

Director of the United States Patent and Trademark Office

United States of America

United States Patent and Trademark Office

THE WORLD'S HARVEST

Reg. No. 4,073,323

Registered Dec. 20, 2011

Int. Cls.: 29 and 31

TRADEMARK

PRINCIPAL REGISTER

ASTRO FOOD SERVICE CORPORATION (CALIFORNIA CORPORATION)
1211 EAST WHOLESALE STREET
LOS ANGELES, CA 90021

FOR: FROZEN PROCESSED FRUIT AND VEGETABLES, IN CLASS 29 (U.S. CL. 46).

FIRST USE 8-1-2010; IN COMMERCE 8-1-2010.

FOR: FRESH FRUIT AND VEGETABLES, IN CLASS 31 (U.S. CLS. 1 AND 46).

FIRST USE 3-31-2010; IN COMMERCE 3-31-2011.

THE MARK CONSISTS OF STANDARD CHARACTERS WITHOUT CLAIM TO ANY PARTICULAR FONT, STYLE, SIZE, OR COLOR.

OWNER OF U.S. REG. NO. 2,914,704.

SER. NO. 85-263,920, FILED S.R. 3-10-2011 AM. P.R. 8-10-2011.

MATTHEW KLINE, EXAMINING ATTORNEY



David J. Kypas

Director of the United States Patent and Trademark Office

United States of America

United States Patent and Trademark Office

MUNCHKIN

Reg. No. 4,073,324

Registered Dec. 20, 2011

**Int. Cls.: 10, 11, 12, 20,
21, 22, 26 and 28**

TRADEMARK

PRINCIPAL REGISTER

MUNCHKIN, INC. (DELAWARE CORPORATION)
16689 SCHOENBORN STREET
NORTH HILLS, CA 91343

FOR: PLASTIC MICROWAVE STERILIZER CONTAINER FOR HOLDING BABY BOTTLES, BABY BOTTLE NIPPLES, AND BABY BOTTLE ACCESSORIES WHEN PLACED IN THE MICROWAVE FOR STERILIZATION; MICROWAVE STERILIZER BAGS FOR HOLDING BABY BOTTLES, BABY BOTTLE NIPPLES, AND BABY BOTTLE ACCESSORIES WHEN PLACED IN THE MICROWAVE FOR STERILIZATION, IN CLASS 10 (U.S. CLS. 26, 39 AND 44).

FIRST USE 5-22-2007; IN COMMERCE 5-22-2007.

FOR: ELECTRIC FOOD AND BOTTLE WARMERS; ELECTRIC BOTTLE WARMERS FOR USE IN CARS; TOILET SEAT ADAPTORS FOR CHILDREN IN THE NATURE OF A PLASTIC DEVICE THAT IS SPECIALLY ADAPTED TO REST ON A TOILET SEAT; ELECTRIC CRIB LIGHTS; ELECTRIC WARMERS FOR DISPOSABLE BABY WIPES, IN CLASS 11 (U.S. CLS. 13, 21, 23, 31 AND 34).

FIRST USE 12-31-2002; IN COMMERCE 12-31-2002.

FOR: CAR WINDOW SHADES; CAR SEAT PROTECTORS; CHILD-VIEW MIRRORS FOR THE BACKSEATS OF CARS; CAR BOOSTER SEATS; STROLLER ORGANIZERS IN THE NATURE OF BAGS SPECIALLY ADAPTED FOR BABY STROLLERS, IN CLASS 12 (U.S. CLS. 19, 21, 23, 31, 35 AND 44).

FIRST USE 5-31-2002; IN COMMERCE 5-31-2002.

FOR: DIAPER CHANGING MATS; CHILD'S PORTABLE HOOK-ON CHAIR; BED RAILS; FURNITURE IN THE NATURE OF A COMBINATION NURSERY STORAGE CART AND SHELVING UNIT; FURNITURE, NAMELY, NON-METAL DIAPER ORGANIZERS; REPLACEMENT DRINKING STRAWS FOR PLASTIC CUPS, IN CLASS 20 (U.S. CLS. 2, 13, 22, 25, 32 AND 50).

FIRST USE 2-7-2005; IN COMMERCE 2-7-2005.



David J. Kappas

Director of the United States Patent and Trademark Office

Reg. No. 4,073,324 FOR: BABY STROLLER CUP HOLDERS; DISHWASHER BASKETS FOR USE WITH WASHING BABY NIPPLES, BOTTLES AND BABY BOTTLE ACCESSORIES; BABY FOOD ORGANIZERS; BABY BATH TUBS; CLEANING BRUSHES FOR BABY BOTTLES; BOWLS; PLATES; BOTTLE DRYING RACKS; HAND-OPERATED FOOD GRINDERS; INSULATED BAGS FOR FOOD OR BEVERAGES FOR DOMESTIC USE; INSULATED CONTAINERS FOR FOOD OR BEVERAGES FOR DOMESTIC USE; POTTIES FOR CHILDREN; PLASTIC SHAMPOO RINSING PITCHERS; TUB SPOUT GUARDS, NAMELY, POURING SPOUT GUARDS FOR USE IN TUBS FOR HOUSEHOLD USE, IN CLASS 21 (U.S. CLS. 2, 13, 23, 29, 30, 33, 40 AND 50).

FIRST USE 12-31-1995; IN COMMERCE 12-31-1995.

FOR: BATH TOY ORGANIZERS IN THE NATURE OF NET BAGS SECURED BY SUCTION CUPS, IN CLASS 22 (U.S. CLS. 1, 2, 7, 19, 22, 42 AND 50).

FIRST USE 8-27-2004; IN COMMERCE 8-27-2004.

FOR: HARNESES FOR GUIDING CHILDREN, IN CLASS 26 (U.S. CLS. 37, 39, 40, 42 AND 50).

FIRST USE 9-9-2008; IN COMMERCE 1-20-2009.

FOR: TOYS DESIGNED TO BE ATTACHED TO STROLLERS; BATH TOYS; CRIB TOYS; INFANT DEVELOPMENT TOYS IN THE NATURE OF CRIB MIRRORS, IN CLASS 28 (U.S. CLS. 22, 23, 38 AND 50).

FIRST USE 10-31-2000; IN COMMERCE 10-31-2000.

THE MARK CONSISTS OF STANDARD CHARACTERS WITHOUT CLAIM TO ANY PARTICULAR FONT, STYLE, SIZE, OR COLOR.

OWNER OF U.S. REG. NOS. 2,101,757, 3,578,309 AND OTHERS.

SER. NO. 85-263,956, FILED 3-10-2011.

ANDREW RHIM, EXAMINING ATTORNEY

United States of America

United States Patent and Trademark Office

THESAFECIG.COM

Reg. No. 4,073,325

Registered Dec. 20, 2011

Int. Cl.: 35

SERVICE MARK

PRINCIPAL REGISTER

THE SAFE CIG, LLC (CALIFORNIA LIMITED LIABILITY COMPANY)
SUITE A
1051 COLE AVENUE
LOS ANGELES, CA 90038

FOR: PROVIDING A WEBSITE FEATURING CONSUMER INFORMATION ABOUT ELECTRONIC CIGARETTES; COMPUTERIZED ONLINE RETAIL STORE SERVICES FEATURING ELECTRONIC CIGARETTES, IN CLASS 35 (U.S. CLS. 100, 101 AND 102).

FIRST USE 6-1-2010; IN COMMERCE 6-1-2010.

THE MARK CONSISTS OF STANDARD CHARACTERS WITHOUT CLAIM TO ANY PARTICULAR FONT, STYLE, SIZE, OR COLOR.

OWNER OF U.S. REG. NOS. 3,797,890 AND 3,961,222.

SER. NO. 85-263,966, FILED 3-10-2011.

DAVID TOOLEY, EXAMINING ATTORNEY



David J. Kybas

Director of the United States Patent and Trademark Office

United States of America

United States Patent and Trademark Office

BAGBY

Reg. No. 4,073,326

Registered Dec. 20, 2011

Int. Cl.: 37

SERVICE MARK

PRINCIPAL REGISTER

BAGBY ELEVATOR COMPANY, INC. (ALABAMA CORPORATION)
4240 1ST AVENUE SOUTH
BIRMINGHAM, AL 35232

FOR: MAINTENANCE, REPAIR, MODERNIZATION, AND INSTALLATION OF ELEVATORS AND OTHER VERTICAL TRANSPORTATION EQUIPMENT, IN CLASS 37 (U.S. CLS. 100, 103 AND 106).

FIRST USE 12-0-1972; IN COMMERCE 12-0-1972.

THE MARK CONSISTS OF STANDARD CHARACTERS WITHOUT CLAIM TO ANY PARTICULAR FONT, STYLE, SIZE, OR COLOR.

OWNER OF U.S. REG. NO. 1,788,474.

SEC. 2(F).

SER. NO. 85-264,232, FILED 3-11-2011.

ARETHA SOMERVILLE, EXAMINING ATTORNEY



David J. Kyffers

Director of the United States Patent and Trademark Office

United States of America

United States Patent and Trademark Office



Reg. No. 4,073,327

Registered Dec. 20, 2011

Int. Cls.: 35 and 41

SERVICE MARK

PRINCIPAL REGISTER

PALM BEACH MOTORING ACCESSORIES, INC. (FLORIDA CORPORATION)
7744 S.W. JACK JAMES DRIVE
STUART, FL 34997

FOR: ON-LINE RETAIL STORE SERVICES FEATURING PRODUCTS FOR CLEANING, POLISHING AND DETAILING MOTOR VEHICLES, IN CLASS 35 (U.S. CLS. 100, 101 AND 102).

FIRST USE 4-21-1999; IN COMMERCE 4-21-1999.

FOR: PROVIDING ON-LINE PUBLICATIONS IN THE NATURE OF ON-LINE INSTRUCTIONAL GUIDES IN THE FIELDS OF CLEANING, POLISHING AND DETAILING OF MOTOR VEHICLES, IN CLASS 41 (U.S. CLS. 100, 101 AND 107).

FIRST USE 4-21-1999; IN COMMERCE 4-21-1999.

THE MARK CONSISTS OF THE DESIGN OF AN "S" CURVED ROAD AND TWO PALM TREES AT THE RIGHT SIDE OF THE ROAD AT THE TOP OF THE MARK.

SER. NO. 85-264,276, FILED 3-11-2011.

GIANCARLO CASTRO, EXAMINING ATTORNEY



David J. Kybas

Director of the United States Patent and Trademark Office

United States of America

United States Patent and Trademark Office



Reg. No. 4,073,328

Registered Dec. 20, 2011

Int. Cl.: 35

SERVICE MARK

PRINCIPAL REGISTER

VERACITY CORPORATION (TENNESSEE CORPORATION)
P.O. BOX 31161
KNOXVILLE, TN 379301161

FOR: ARRANGING AND CONDUCTING INCENTIVE REWARD PROGRAMS TO PROMOTE THE SALE OF RETAIL MERCHANDISE OF OTHERS, IN CLASS 35 (U.S. CLS. 100, 101 AND 102).

FIRST USE 9-30-2010; IN COMMERCE 9-30-2010.

THE MARK CONSISTS OF THE STYLIZED LIGHT GRAY, GRAY, AND DARK GRAY WORD "POINTS" ABOVE THE STYLIZED LIGHT GRAY, GRAY, AND DARK GRAY WORD "VAULT" WITH THE "O" IN "POINTS" REPLACED WITH A STYLIZED LIGHT GRAY, GRAY, AND DARK GRAY BANK VAULT DOOR.

THE COLOR(S) LIGHT GRAY, GRAY, AND DARK GRAY IS/ARE CLAIMED AS A FEATURE OF THE MARK.

SER. NO. 85-264,354, FILED 3-11-2011.

DAVID TOOLEY, EXAMINING ATTORNEY



David J. Kyros

Director of the United States Patent and Trademark Office

United States of America

United States Patent and Trademark Office

ANNIE OAKLEY SOCIETY

Reg. No. 4,073,329

Registered Dec. 20, 2011

**Int. Cls.: 16, 35, 36 and
41**

NATIONAL COWBOY AND WESTERN HERITAGE MUSEUM (OKLAHOMA NON-PROFIT CORPORATION)
1700 N.E. 63RD ST.
OKLAHOMA CITY, OK 73111

FOR: PRINTED PUBLICATIONS, NAMELY, BOOKS AND NEWSLETTERS IN THE FIELD OF OUTSTANDING WOMEN, IN CLASS 16 (U.S. CLS. 2, 5, 22, 23, 29, 37, 38 AND 50).

TRADEMARK

FIRST USE 10-1-2010; IN COMMERCE 2-1-2011.

SERVICE MARK

FOR: PROMOTING PUBLIC AWARENESS OF OUTSTANDING WOMEN, IN CLASS 35 (U.S. CLS. 100, 101 AND 102).

PRINCIPAL REGISTER

FIRST USE 10-1-2010; IN COMMERCE 2-1-2011.

FOR: CHARITABLE FUNDRAISING SERVICES ON BEHALF OF A WESTERN HERITAGE MUSEUM, IN CLASS 36 (U.S. CLS. 100, 101 AND 102).

FIRST USE 10-1-2010; IN COMMERCE 2-1-2011.

FOR: SOCIAL CLUB SERVICES FOR WOMEN, NAMELY, ARRANGING, ORGANIZING, AND HOSTING SOCIAL EVENTS, GET-TOGETHERS, AND PARTIES FOR CLUB MEMBERS, IN CLASS 41 (U.S. CLS. 100, 101 AND 107).

FIRST USE 10-1-2010; IN COMMERCE 2-1-2011.

THE MARK CONSISTS OF STANDARD CHARACTERS WITHOUT CLAIM TO ANY PARTICULAR FONT, STYLE, SIZE, OR COLOR.

SER. NO. 85-264,825, FILED 3-11-2011.

SUE LAWRENCE, EXAMINING ATTORNEY



David J. Kyffers

Director of the United States Patent and Trademark Office

United States of America

United States Patent and Trademark Office

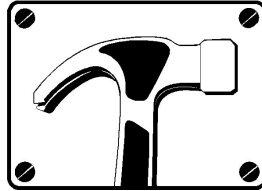

**BUILDER
FLASH**

Eat. Sleep. Build.

Reg. No. 4,073,330

Registered Dec. 20, 2011

Int. Cl.: 35

SERVICE MARK

PRINCIPAL REGISTER

BUILDER, FLASH (NORTH CAROLINA CORPORATION)
1333 SEATTLE SLEW LA
CARY, NC 27519

FOR: PROVIDING A SEARCHABLE ONLINE ADVERTISING WEBSITE AND INFORMATIONAL GUIDE FEATURING THE GOODS AND SERVICES OF OTHER VENDORS VIA THE INTERNET IN THE FIELD OF GENERAL CONTRACTING, IN CLASS 35 (U.S. CLS. 100, 101 AND 102).

FIRST USE 8-0-2010; IN COMMERCE 8-0-2010.

NO CLAIM IS MADE TO THE EXCLUSIVE RIGHT TO USE "BUILDER" OR "BUILD", APART FROM THE MARK AS SHOWN.

THE MARK CONSISTS OF A RECTANGULAR BOX OUTLINE WITH A SCREW IN EACH CORNER AND A HAMMER IN THE MIDDLE. BELOW THIS IS THE STYLIZED WORDING "BUILDER FLASH" AND "EAT. SLEEP. BUILD.".

SER. NO. 85-264,991, FILED 3-11-2011.

DAWN HAN, EXAMINING ATTORNEY



David J. Kyffers

Director of the United States Patent and Trademark Office

United States of America

United States Patent and Trademark Office

Outlaw Comedy

Reg. No. 4,073,331

OUTLAW COMEDY (ARIZONA CORPORATION)

Registered Dec. 20, 2011

P.O. BOX 7336
TEMPE, AZ 85281

Int. Cl.: 41

FOR: ENTERTAINMENT SERVICES IN THE NATURE OF COMEDY SHOWS, IN CLASS 41
(U.S. CLS. 100, 101 AND 107).

SERVICE MARK

FIRST USE 8-1-2008; IN COMMERCE 2-1-2009.

PRINCIPAL REGISTER

THE MARK CONSISTS OF STANDARD CHARACTERS WITHOUT CLAIM TO ANY PARTICULAR FONT, STYLE, SIZE, OR COLOR.

NO CLAIM IS MADE TO THE EXCLUSIVE RIGHT TO USE "COMEDY", APART FROM THE MARK AS SHOWN.

SER. NO. 85-265,248, FILED 3-11-2011.

LESLEY LAMOTHE, EXAMINING ATTORNEY



David J. Kybas

Director of the United States Patent and Trademark Office

United States of America

United States Patent and Trademark Office

WEALTHCASTER

Reg. No. 4,073,332

SCHULTZ COLLINS LAWSON CHAMBERS, INC. (CALIFORNIA CORPORATION)
455 MARKET STREET, SUITE 1450
SAN FRANCISCO, CA 941052420

Registered Dec. 20, 2011

Int. Cl.: 9

FOR: SOFTWARE FOR FINANCIAL ANALYSIS, FOR USE IN THE FIELD OF INVESTMENT RISK AND ANALYSIS OF SUCH RISK, IN CLASS 9 (U.S. CLS. 21, 23, 26, 36 AND 38).

TRADEMARK

FIRST USE 3-7-2011; IN COMMERCE 3-7-2011.

PRINCIPAL REGISTER

THE MARK CONSISTS OF STANDARD CHARACTERS WITHOUT CLAIM TO ANY PARTICULAR FONT, STYLE, SIZE, OR COLOR.

SER. NO. 85-265,249, FILED 3-11-2011.

JAMES MACFARLANE, EXAMINING ATTORNEY



David J. Kybas

Director of the United States Patent and Trademark Office

United States of America

United States Patent and Trademark Office

Fashion Saverz

Reg. No. 4,073,333

HAKOBYAN, LILIT (UNITED STATES INDIVIDUAL)

Registered Dec. 20, 2011

3525 DEL MAR HEIGHTS RD, 128
SAN DIEGO, CA 92130

Int. Cl.: 3

FOR: SPONGES THAT REMOVE DEODORANT MARKS OFF OF CLOTHES, IN CLASS 3
(U.S. CLS. 1, 4, 6, 50, 51 AND 52).

TRADEMARK

FIRST USE 1-15-2011; IN COMMERCE 1-17-2011.

PRINCIPAL REGISTER

THE MARK CONSISTS OF STANDARD CHARACTERS WITHOUT CLAIM TO ANY PARTICULAR FONT, STYLE, SIZE, OR COLOR.

SER. NO. 85-265,427, FILED 3-12-2011.

RONALD AIKENS, EXAMINING ATTORNEY



David J. Kybas

Director of the United States Patent and Trademark Office

United States of America

United States Patent and Trademark Office

DealPulp

Reg. No. 4,073,334

SAZZE, INC. (CALIFORNIA CORPORATION)
4320 STEVENS CREEK BLVD, SUITE 165
SAN JOSE, CA 95129

Registered Dec. 20, 2011

Int. Cl.: 42

FOR: PROMOTING THE GOODS AND SERVICES OF OTHERS BY PROVIDING A WEBSITE FEATURING DISCOUNTS AND DISCOUNT INFORMATION, IN CLASS 42 (U.S. CLS. 100 AND 101).

SERVICE MARK

FIRST USE 1-4-2011; IN COMMERCE 1-4-2011.

PRINCIPAL REGISTER

THE MARK CONSISTS OF STANDARD CHARACTERS WITHOUT CLAIM TO ANY PARTICULAR FONT, STYLE, SIZE, OR COLOR.

SER. NO. 85-265,431, FILED 3-12-2011.

RONALD AIKENS, EXAMINING ATTORNEY



David J. Kyffers

Director of the United States Patent and Trademark Office

United States of America

United States Patent and Trademark Office

BODY BY PAGODA

Reg. No. 4,073,335

Registered Dec. 20, 2011

Int. Cl.: 35

SERVICE MARK

PRINCIPAL REGISTER

TXDC, L.P. (TEXAS LIMITED PARTNERSHIP)
901 W. WALNUT HILL LANE
IRVING, TX 75038

FOR: RETAIL JEWELRY STORES, IN CLASS 35 (U.S. CLS. 100, 101 AND 102).

FIRST USE 8-1-2004; IN COMMERCE 8-1-2004.

THE MARK CONSISTS OF STANDARD CHARACTERS WITHOUT CLAIM TO ANY PARTICULAR FONT, STYLE, SIZE, OR COLOR.

OWNER OF U.S. REG. NOS. 2,740,056, 2,929,410, AND 3,432,046.

SER. NO. 85-265,838, FILED 3-14-2011.

STEVEN JACKSON, EXAMINING ATTORNEY



David J. Kyffers

Director of the United States Patent and Trademark Office

United States of America

United States Patent and Trademark Office

GROWSAFE SYSTEMS

Reg. No. 4,073,336

GROWSAFE SYSTEMS LTD. (CANADA CORPORATION)
273216 RANGE RD. 23 RR#1 SITE #2 BOX 29
AIRDRIE, CANADA T4B2A3

Registered Dec. 20, 2011

Int. Cl.: 42

FOR: DEVELOPMENT SERVICES OF SYSTEMS THAT ARE USED TO MEASURE AND MONITOR FEED INTAKE AND BEHAVIOR IN LIVESTOCK; TRACK INDIVIDUAL LIVESTOCK TO IDENTIFY SICK ANIMALS AND TO MONITOR FEED INTAKE AND GROWTH IN LIVESTOCK, IN CLASS 42 (U.S. CLS. 100 AND 101).

SERVICE MARK

PRINCIPAL REGISTER

FIRST USE 1-1-1990; IN COMMERCE 1-1-1990.

THE MARK CONSISTS OF STANDARD CHARACTERS WITHOUT CLAIM TO ANY PARTICULAR FONT, STYLE, SIZE, OR COLOR.

NO CLAIM IS MADE TO THE EXCLUSIVE RIGHT TO USE "SYSTEMS", APART FROM THE MARK AS SHOWN.

SER. NO. 85-265,881, FILED 3-14-2011.

MIDGE BUTLER, EXAMINING ATTORNEY



David J. Kyffers

Director of the United States Patent and Trademark Office

United States of America

United States Patent and Trademark Office

The Fashion of Fine Jewelry

Reg. No. 4,073,337

Registered Dec. 20, 2011

Int. Cl.: 14

TRADEMARK

PRINCIPAL REGISTER

PACIFIC PASSAGE LLC (OHIO LIMITED LIABILITY COMPANY), DBA SHARON WEI
DESIGNS
6724 PERIMETER LOOP #112
DUBLIN, OH 43017 AND

SHARON W. FRANK (UNITED STATES INDIVIDUAL)
4766 DONEGAL CLIFFS DRIVE
DUBLIN, OH 43017

FOR: BEADS FOR USE IN THE MANUFACTURE OF JEWELRY; BRACELETS; CHARMS; DIAMOND JEWELRY; GEMSTONE JEWELRY; HAIR JEWELRY IN THE NATURE OF JEWELRY FOR USE IN THE HAIR; JEWELRY; JEWELRY BOXES; JEWELRY CASES; JEWELRY CASES NOT OF PRECIOUS METAL; JEWELRY CHAINS; JEWELRY FINDINGS; JEWELRY FOR ATTACHMENT TO CLOTHING; JEWELRY FOR THE HEAD; JEWELRY IN THE NATURE OF ARMBANDS; JEWELRY MAKING KITS; JEWELRY PINS FOR USE ON HATS; JEWELRY, NAMELY, ANKLETS; JEWELRY, NAMELY, CROSSES; JEWELRY, NAMELY, MAGNETIC NECKLACES; JEWELRY, NAMELY, MAGNETIC PENDANTS; JEWELRY, NAMELY, PRECIOUS METAL PLATED REAL LEAVES AND FLOWERS; JEWELRY, NAMELY, STONE PENDANTS; LAPEL PINS; PET JEWELRY; PINS BEING JEWELRY; PRECIOUS AND SEMI-PRECIOUS CRYSTAL STONES AND BEADS FOR USE IN JEWELRY; WOMEN'S JEWELRY, IN CLASS 14 (U.S. CLS. 2, 27, 28 AND 50).

FIRST USE 1-19-2010; IN COMMERCE 2-19-2011.

THE MARK CONSISTS OF STANDARD CHARACTERS WITHOUT CLAIM TO ANY PARTICULAR FONT, STYLE, SIZE, OR COLOR.

NO CLAIM IS MADE TO THE EXCLUSIVE RIGHT TO USE "FINE JEWELRY" , APART FROM THE MARK AS SHOWN.

SER. NO. 85-265,929, FILED 3-14-2011.

ANTHONY RINKER, EXAMINING ATTORNEY



David J. Kyffers

Director of the United States Patent and Trademark Office

United States of America

United States Patent and Trademark Office

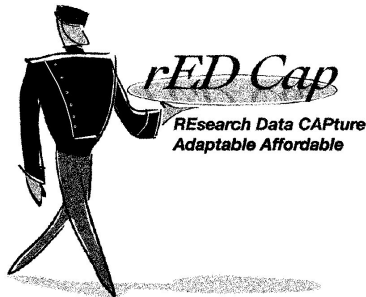

Reg. No. 4,073,338

Registered Dec. 20, 2011

Int. Cl.: 42

SERVICE MARK

PRINCIPAL REGISTER

BIOSTAT INTERNATIONAL, INC. (FLORIDA CORPORATION)
14506A UNIVERSITY POINT PLACE
TAMPA, FL 33613

FOR: PROVIDING TEMPORARY USE OF A WEB-BASED SOFTWARE APPLICATION FOR DATA CAPTURE FOR RESEARCH STUDIES, IN CLASS 42 (U.S. CLS. 100 AND 101).

FIRST USE 8-21-2008; IN COMMERCE 8-21-2008.

NO CLAIM IS MADE TO THE EXCLUSIVE RIGHT TO USE "RED CAP" AND "RESEARCH DATA CAPTURE", APART FROM THE MARK AS SHOWN.

THE STIPPLING IS FOR SHADING PURPOSES ONLY.

THE MARK CONSISTS OF AN ABSTRACT DESIGN OF A PERSON CARRYING A TRAY, AND THE TEXT "RED CAP RESEARCH DATA CAPTURE ADAPTABLE AFFORDABLE".

SER. NO. 85-266,711, FILED 3-14-2011.

LAKEISHA LEWIS, EXAMINING ATTORNEY



David J. Kybas

Director of the United States Patent and Trademark Office

United States of America

United States Patent and Trademark Office

KING HENRY'S

Reg. No. 4,073,339

Registered Dec. 20, 2011

Int. Cls.: 29, 30 and 31

TRADEMARK

PRINCIPAL REGISTER

KING HENRY'S INC. (CALIFORNIA CORPORATION)
29124 HANCOCK PARKWAY
VALENCIA, CA 91355

FOR: BEEF JERKY; PROCESSED NUTS; TRAIL MIXES AND SNACK MIXES CONSISTING PRIMARILY OF A MIX OF PROCESSED NUTS, SEEDS, DRIED FRUIT, DRIED VEGETABLES, CRACKERS, IN CLASS 29 (U.S. CL. 46).

FIRST USE 5-1-1996; IN COMMERCE 5-1-1996.

FOR: CANDY; COOKIES; PRETZELS, IN CLASS 30 (U.S. CL. 46).

FIRST USE 5-1-1996; IN COMMERCE 5-1-1996.

FOR: RAW NUTS; UNPROCESSED EDIBLE SEEDS, NAMELY, SUNFLOWER SEEDS, IN CLASS 31 (U.S. CLS. 1 AND 46).

FIRST USE 5-1-1996; IN COMMERCE 5-1-1996.

THE MARK CONSISTS OF STANDARD CHARACTERS WITHOUT CLAIM TO ANY PARTICULAR FONT, STYLE, SIZE, OR COLOR.

SER. NO. 85-266,774, FILED 3-14-2011.

SCOTT BIBB, EXAMINING ATTORNEY



David J. Kybas

Director of the United States Patent and Trademark Office

United States of America

United States Patent and Trademark Office

THIEN THAO TRA

Reg. No. 4,073,340

PHAM, HUNG H (UNITED STATES INDIVIDUAL)
1141 GERANIO DRIVE
ALHAMBRA, CA 91801

Registered Dec. 20, 2011

Int. Cl.: 30

FOR: TEA, IN CLASS 30 (U.S. CL. 46).

TRADEMARK

FIRST USE 3-1-2009; IN COMMERCE 3-1-2009.

PRINCIPAL REGISTER

THE MARK CONSISTS OF STANDARD CHARACTERS WITHOUT CLAIM TO ANY PARTICULAR FONT, STYLE, SIZE, OR COLOR.

NO CLAIM IS MADE TO THE EXCLUSIVE RIGHT TO USE "TRA", APART FROM THE MARK AS SHOWN.

THE ENGLISH TRANSLATION OF THE WORD "THIEN THAO TRA" IN THE MARK IS "HEAVENLY VEGETATION TEA".

SER. NO. 85-267,535, FILED 3-15-2011.

MATTHEW KLINE, EXAMINING ATTORNEY



David J. Kappas

Director of the United States Patent and Trademark Office

United States of America

United States Patent and Trademark Office

PINGO'S HOLD'EM FOLD'EM BINGO

Reg. No. 4,073,341

AEON GAMING LLC (MINNESOTA LIMITED LIABILITY COMPANY)
801 TRANSFER ROAD
ST. PAUL, MN 55114

Registered Dec. 20, 2011

Int. Cl.: 9

FOR: COMPUTER GAME SOFTWARE FOR USE IN OPERATING AN ELECTRONIC BINGO GAME THAT INCORPORATES SKILL ASPECTS OF POKER, IN CLASS 9 (U.S. CLS. 21, 23, 26, 36 AND 38).

TRADEMARK

FIRST USE 1-0-2011; IN COMMERCE 1-0-2011.

PRINCIPAL REGISTER

THE MARK CONSISTS OF STANDARD CHARACTERS WITHOUT CLAIM TO ANY PARTICULAR FONT, STYLE, SIZE, OR COLOR.

OWNER OF U.S. REG. NO. 3,756,145.

NO CLAIM IS MADE TO THE EXCLUSIVE RIGHT TO USE "HOLD'EM" AND "BINGO", APART FROM THE MARK AS SHOWN.

SER. NO. 85-267,584, FILED 3-15-2011.

ANNE FARRELL, EXAMINING ATTORNEY



David J. Kyfos

Director of the United States Patent and Trademark Office

United States of America

United States Patent and Trademark Office

ARIZONA HOME INSURANCE

Reg. No. 4,073,342

Registered Dec. 20, 2011

Int. Cl.: 36

SERVICE MARK

PRINCIPAL REGISTER

ARIZONA HOME INSURANCE COMPANY (ARIZONA CORPORATION)
#106
3233 W. PEORIA AVE.
PHOENIX, AZ 85029

FOR: INSURANCE UNDERWRITING SERVICES IN THE FIELDS OF HOME, PROPERTY,
AND CASUALTY, IN CLASS 36 (U.S. CLS. 100, 101 AND 102).

FIRST USE 0-0-1990; IN COMMERCE 0-0-1990.

THE MARK CONSISTS OF STANDARD CHARACTERS WITHOUT CLAIM TO ANY PAR-
TICULAR FONT, STYLE, SIZE, OR COLOR.

NO CLAIM IS MADE TO THE EXCLUSIVE RIGHT TO USE "HOME INSURANCE", APART
FROM THE MARK AS SHOWN.

SEC. 2(F).

SER. NO. 85-267,698, FILED 3-15-2011.

DAVID C. REIHNER, EXAMINING ATTORNEY



David J. Kyffers

Director of the United States Patent and Trademark Office

United States of America

United States Patent and Trademark Office

active water 

Reg. No. 4,073,343

ACTIVE WATER (MICHIGAN NON-PROFIT CORPORATION)

Registered Dec. 20, 2011

40888 CR 653
PAWPAW, MI 49079

Int. Cl.: 36

FOR: CHARITABLE FUNDRAISING SERVICES; CHARITABLE SERVICES, NAMELY, ORGANIZING FUNDRAISING SERVICES AND EVENTS TO RAISE FUNDS FOR CLEAN WATER AND SANITATION PROJECTS TO PERSONS IN NEED, IN CLASS 36 (U.S. CLS. 100, 101 AND 102).

SERVICE MARK

PRINCIPAL REGISTER

FIRST USE 4-15-2009; IN COMMERCE 4-15-2009.

NO CLAIM IS MADE TO THE EXCLUSIVE RIGHT TO USE "WATER" AND DESIGN OF A WATER DROP, APART FROM THE MARK AS SHOWN.

THE MARK CONSISTS OF THE WORDS "ACTIVE WATER" AND A WATER DROP WITH A HAND WITHIN IT.

SER. NO. 85-268,035, FILED 3-16-2011.

DAVID C. REIHNER, EXAMINING ATTORNEY



David J. Kybas

Director of the United States Patent and Trademark Office

United States of America

United States Patent and Trademark Office

LIQUIDXPRESS

Reg. No. 4,073,344

LIQUIDXPRESS, LLC (CALIFORNIA LIMITED LIABILITY COMPANY)
26431 CROWN VALLEY PARKWAY SUITE 260
MISSION VIEJO, CA 92691

Registered Dec. 20, 2011

Int. Cl.: 34

FOR: TOBACCO SUBSTITUTES NOT FOR MEDICAL PURPOSES, IN CLASS 34 (U.S. CLS. 2, 8, 9 AND 17).

TRADEMARK

FIRST USE 8-1-2009; IN COMMERCE 8-1-2009.

PRINCIPAL REGISTER

THE MARK CONSISTS OF STANDARD CHARACTERS WITHOUT CLAIM TO ANY PARTICULAR FONT, STYLE, SIZE, OR COLOR.

SER. NO. 85-268,048, FILED 3-16-2011.

SUSAN RICHARDS, EXAMINING ATTORNEY



David J. Kybas

Director of the United States Patent and Trademark Office

United States of America

United States Patent and Trademark Office

LOSE YOUR DEBT. LIVE YOUR
LIFE.

Reg. No. 4,073,345

Registered Dec. 20, 2011

Int. Cls.: 35 and 45

SERVICE MARK

PRINCIPAL REGISTER

C.J. ADVERTISING, LLC (TENNESSEE LIMITED LIABILITY COMPANY)
SUITE 500
209 TENTH AVENUE SOUTH
NASHVILLE, TN 372034101

FOR: ADVERTISING AGENCY SERVICES DIRECTED TO LAW FIRMS, IN CLASS 35 (U.S. CLS. 100, 101 AND 102).

FIRST USE 7-1-2011; IN COMMERCE 7-1-2011.

FOR: LEGAL SERVICES, IN CLASS 45 (U.S. CLS. 100 AND 101).

FIRST USE 7-1-2011; IN COMMERCE 7-1-2011.

THE MARK CONSISTS OF STANDARD CHARACTERS WITHOUT CLAIM TO ANY PARTICULAR FONT, STYLE, SIZE, OR COLOR.

SER. NO. 85-268,180, FILED 3-16-2011.

MICHAEL KEATING, EXAMINING ATTORNEY



David J. Kyjars

Director of the United States Patent and Trademark Office

United States of America

United States Patent and Trademark Office

RIGHT HERE, RIGHT NOW

Reg. No. 4,073,346

Registered Dec. 20, 2011

Int. Cls.: 35 and 45

SERVICE MARK

PRINCIPAL REGISTER

C.J. ADVERTISING, LLC (TENNESSEE LIMITED LIABILITY COMPANY)
SUITE 500
209 TENTH AVENUE SOUTH
NASHVILLE, TN 372034101

FOR: ADVERTISING AGENCY SERVICES DIRECTED TO LAW FIRMS, IN CLASS 35 (U.S. CLS. 100, 101 AND 102).

FIRST USE 7-1-2011; IN COMMERCE 7-1-2011.

FOR: LEGAL SERVICES, IN CLASS 45 (U.S. CLS. 100 AND 101).

FIRST USE 7-1-2011; IN COMMERCE 7-1-2011.

THE MARK CONSISTS OF STANDARD CHARACTERS WITHOUT CLAIM TO ANY PARTICULAR FONT, STYLE, SIZE, OR COLOR.

SER. NO. 85-268,201, FILED 3-16-2011.

MICHAEL KEATING, EXAMINING ATTORNEY



David J. Kybas

Director of the United States Patent and Trademark Office

United States of America

United States Patent and Trademark Office



Reg. No. 4,073,347

Registered Dec. 20, 2011

Int. Cls.: 16, 41 and 42

TRADEMARK

SERVICE MARK

PRINCIPAL REGISTER

TOMORROWS LEARNING LTD. (UNITED KINGDOM LIMITED LIABILITY COMPANY)
237 WHITTON DENE
ISLEWORTH, UNITED KINGDOM TW77NJ

FOR: PUBLICATIONS, NAMELY, BROCHURES, BOOKLETS, AND TEACHING MATERIALS IN THE FIELD OF EDUCATIONAL SERVICES FOR STUDENT IMPROVEMENT AND PROFESSIONAL DEVELOPMENT, IN CLASS 16 (U.S. CLS. 2, 5, 22, 23, 29, 37, 38 AND 50).

FOR: EDUCATION SERVICES, NAMELY, PROVIDING LIVE AND ON-LINE CLASSES, SEMINARS, AND WORKSHOPS IN THE FIELD OF STUDENT IMPROVEMENT AND PROFESSIONAL DEVELOPMENT, IN CLASS 41 (U.S. CLS. 100, 101 AND 107).

FOR: DESIGN AND DEVELOPMENT OF COMPUTER SOFTWARE, IN CLASS 42 (U.S. CLS. 100 AND 101).

OWNER OF UNITED KINGDOM REG. NO. 2545764, DATED 4-23-2010, EXPIRES 4-23-2020.

THE COLOR(S) CYAN, PURPLE, GREEN, AND WHITE IS/ARE CLAIMED AS A FEATURE OF THE MARK.

NO CLAIM IS MADE TO THE EXCLUSIVE RIGHT TO USE "HOT TOOLS", APART FROM THE MARK AS SHOWN.

THE MARK CONSISTS OF THE WORD "HOT", IN PURPLE STYLISTIC LETTERING; WITH CYAN TRAPEZOIDS EXTENDING FROM THE BASE OF THE "H" AND THE "T"; ABOVE AND CONNECTED TO A GREEN PARALLELOGRAM CONTAINING THE WORD "TOOLS", IN WHITE STYLISTIC LETTERING; ALL SET AGAINST A WHITE BACKGROUND.

SER. NO. 85-268,249, FILED 3-16-2011.

BARNEY CHARLON, EXAMINING ATTORNEY



David J. Kybas

Director of the United States Patent and Trademark Office

United States of America

United States Patent and Trademark Office

النبيد
nabeel

Reg. No. 4,073,348

Registered Dec. 20, 2011

Int. Cl.: 3

TRADEMARK

PRINCIPAL REGISTER

ASGHAR, ADAM ALI (YEMEN INDIVIDUAL)
PLOT D4/10, SAIF ZONE
SHARJAH, UNITED ARAB EMIR.

FOR: PERFUMERY; DEODORANTS FOR PERSONAL USE; BATH AND BODY PRODUCTS, NAMELY, SHOWER GELS, BATH OILS AND SOAPS; INCENSE; ROOM SPRAYS; SACHETS AND SPRAYS FOR PERFUMING LINEN; COSMETICS; HAIR CARE PREPARATIONS; NON-MEDICATED SKIN CARE PREPARATIONS; DENTIFRICES, IN CLASS 3 (U.S. CLS. 1, 4, 6, 50, 51 AND 52).

OWNER OF UNITED ARAB EMIR. REG. NO. 62576, DATED 8-27-2006, EXPIRES 12-20-2015.

THE NON-LATIN CHARACTERS IN THE MARK TRANSLITERATE TO NABEEL AND THIS HAS NO MEANING IN A FOREIGN LANGUAGE.

THE NAME(S), PORTRAIT(S), AND/OR SIGNATURE(S) SHOWN IN THE MARK DOES NOT IDENTIFY A PARTICULAR LIVING INDIVIDUAL.

THE MARK CONSISTS OF AN ARABIC WORD IN A STYLIZED FONT WHICH TRANSLATES INTO ENGLISH AS NABEEL. BENEATH THE WORD IS NABEEL IN A STYLIZED LATIN FONT.

SER. NO. 85-268,332, FILED 3-16-2011.

THEODORE MCBRIDE, EXAMINING ATTORNEY



David J. Kyros

Director of the United States Patent and Trademark Office

United States of America

United States Patent and Trademark Office



Reg. No. 4,073,349

Registered Dec. 20, 2011

Int. Cl.: 33

TRADEMARK

PRINCIPAL REGISTER

VIVE! BRANDS LLC (CALIFORNIA LIMITED LIABILITY COMPANY), DBA TEQUILA LA
PINATA
601 UNIVERSITY AVENUE
STE 278
SACRAMENTO, CA 95825

FOR: TEQUILA, IN CLASS 33 (U.S. CLS. 47 AND 49).

FIRST USE 8-1-2010; IN COMMERCE 8-31-2010.

THE MARK CONSISTS OF A THREE-DIMENSIONAL CONFIGURATION OF A BOTTLE FOR THE GOODS HAVING BASE-RELIEF CURVED CONTOURS IN THE SHAPE OF PINATE LEAVES. THE BROKEN LINES DEPICTING THE FLAT BOTTOM, BOTTLE NECK, BOTTLE OPENING AND BOTTLE CAP INDICATE PLACEMENT OF THE MARK ON THE GOODS AND ARE NOT PART OF THE MARK.

SER. NO. 85-268,557, FILED 3-16-2011.

JOHN DWYER, EXAMINING ATTORNEY



David J. Kybas

Director of the United States Patent and Trademark Office

United States of America

United States Patent and Trademark Office



Reg. No. 4,073,350

Registered Dec. 20, 2011

Int. Cl.: 41

SERVICE MARK

PRINCIPAL REGISTER

MILTON HERSHEY SCHOOL (PENNSYLVANIA NON-PROFIT CORPORATION)
801 SPARTAN LANE
HERSHEY, PA 17033

FOR: EDUCATIONAL SERVICES, NAMELY, PROVIDING COURSES OF INSTRUCTION AT THE PRIMARY AND SECONDARY (K-12) LEVEL AND DISTRIBUTION OF COURSE MATERIAL IN CONNECTION THEREWITH, IN CLASS 41 (U.S. CLS. 100, 101 AND 107).

FIRST USE 0-0-2006; IN COMMERCE 0-0-2006.

OWNER OF U.S. REG. NO. 3,630,342.

NO CLAIM IS MADE TO THE EXCLUSIVE RIGHT TO USE "SCHOOL AND FOUNDED 1909", APART FROM THE MARK AS SHOWN.

THE NAME(S), PORTRAIT(S), AND/OR SIGNATURE(S) SHOWN IN THE MARK DOES NOT IDENTIFY A PARTICULAR LIVING INDIVIDUAL.

THE MARK CONSISTS OF THE WORDING "MILTON HERSHEY SCHOOL FOUNDED 1909" AND A LIKENESS OF MILTON HERSHEY HOLDING A BOY WITHIN A CIRCULAR DESIGN.

SER. NO. 85-268,610, FILED 3-16-2011.

KAREN BRACEY, EXAMINING ATTORNEY



David J. Kybas

Director of the United States Patent and Trademark Office

United States of America

United States Patent and Trademark Office

FLEXROOM

Reg. No. 4,073,351

Registered Dec. 20, 2011

Int. Cl.: 17

TRADEMARK

PRINCIPAL REGISTER

SHOREVIEW INDUSTRIES, LLC (DELAWARE LIMITED LIABILITY COMPANY)
#3130
222 SOUTH NINTH STREET
MINNEAPOLIS, MN 55402

FOR: FLEXIBLE PLASTIC SHEETING USED AS HANGING CURTAIN WALLS TO DIVIDE,
ENCLOSE AND CONTAIN ROOMS, IN CLASS 17 (U.S. CLS. 1, 5, 12, 13, 35 AND 50).

FIRST USE 10-1-1996; IN COMMERCE 10-1-1996.

THE MARK CONSISTS OF STANDARD CHARACTERS WITHOUT CLAIM TO ANY PAR-
TICULAR FONT, STYLE, SIZE, OR COLOR.

OWNER OF U.S. REG. NOS. 3,073,391, 3,082,236, AND 3,161,742.

SER. NO. 85-268,719, FILED 3-16-2011.

LOURDES AYALA, EXAMINING ATTORNEY



David J. Kybas

Director of the United States Patent and Trademark Office

United States of America

United States Patent and Trademark Office

CASINOLEAKS

Reg. No. 4,073,352

Registered Dec. 20, 2011

Int. Cls.: 35, 36, 41 and 45

SERVICE MARK

PRINCIPAL REGISTER

INTERNATIONAL UNION OF OPERATING ENGINEERS (D.C. UNINCORPORATED ASSOCIATION)
1125 17TH ST.
WASHINGTON, DC 20036

FOR: PROVIDING BUSINESS AND EMPLOYMENT INFORMATION VIA THE INTERNET IN THE FIELD OF BUSINESS OPERATIONS OF CASINOS; PROVIDING BUSINESS AND EMPLOYMENT INFORMATION VIA THE INTERNET ABOUT CASINOS, NAMELY, INFORMATION REGARDING BUSINESS STRUCTURE, ADMINISTRATION, OWNERSHIP, AREA STANDARDS FOR WAGES AND BENEFITS, VIP OPERATIONS, NAMELY, PROVISION OF LEASED GAMING ROOMS AND JUNKET OPERATIONS, NAMELY, SECURING ATTENDANCE OF SPECIALLY SELECTED GAMBLERS, IN CLASS 35 (U.S. CLS. 100, 101 AND 102).

FIRST USE 3-16-2011; IN COMMERCE 3-16-2011.

FOR: PROVIDING FINANCIAL INFORMATION VIA THE INTERNET REGARDING CASINOS, IN CLASS 36 (U.S. CLS. 100, 101 AND 102).

FIRST USE 3-16-2011; IN COMMERCE 3-16-2011.

FOR: PROVIDING INFORMATION, NEWS, AND COMMENTARY IN THE FIELD OF CURRENT EVENTS RELATING TO CASINOS, THEIR OWNERS, DIRECTORS, EXECUTIVES, PARTNERS, OFFICERS AND ADMINISTRATORS AND THE GAMING INDUSTRY, IN CLASS 41 (U.S. CLS. 100, 101 AND 107).

FIRST USE 3-16-2011; IN COMMERCE 3-16-2011.

FOR: PROVIDING LEGAL, REGULATORY AND POLICE INFORMATION, NAMELY, POLICE REPORTS AND SUMMARIES OF POLICE REPORTS REGARDING CASINOS, IN CLASS 45 (U.S. CLS. 100 AND 101).

FIRST USE 3-16-2011; IN COMMERCE 3-16-2011.

THE MARK CONSISTS OF STANDARD CHARACTERS WITHOUT CLAIM TO ANY PARTICULAR FONT, STYLE, SIZE, OR COLOR.



David J. Kyffers

Director of the United States Patent and Trademark Office

Reg. No. 4,073,352 SER. NO. 85-269,530, FILED 3-17-2011.

INGA ERVIN, EXAMINING ATTORNEY

United States of America

United States Patent and Trademark Office

PREFENSE

Reg. No. 4,073,353

Registered Dec. 20, 2011

Int. Cls.: 9 and 10

TRADEMARK

PRINCIPAL REGISTER

NIHON KOHDEN AMERICA (CALIFORNIA CORPORATION)
90 ICON STREET
FOOTHILL RANCH, CA 92610

FOR: COMPUTER HARDWARE AND SOFTWARE, FOR USE WITH MEDICAL PATIENT MONITORING EQUIPMENT, FOR RECEIVING, PROCESSING, TRANSMITTING AND DISPLAYING DATA; INTERACTIVE MULTIMEDIA SOFTWARE FEATURING AUDIO AND VIDEO INFORMATION FOR PATIENTS ON THE SUBJECT OF TREATMENTS, PROCEDURES AND ALTERNATIVES RELATED TO DENTISTRY, IN CLASS 9 (U.S. CLS. 21, 23, 26, 36 AND 38).

FIRST USE 9-6-2007; IN COMMERCE 9-6-2007.

FOR: PATIENT MONITORING SYSTEMS FEATURING COMBINATIONS OF MONITORS, SENSORS, AND ALARMS FOR MEASURING BLOOD PRESSURE, HEART RATE, SURGICAL STIMULATION, ANALGESIA, HYPNOTIC RELATED RESPONSES, AND RESPIRATION, IN CLASS 10 (U.S. CLS. 26, 39 AND 44).

FIRST USE 9-6-2007; IN COMMERCE 9-6-2007.

THE MARK CONSISTS OF STANDARD CHARACTERS WITHOUT CLAIM TO ANY PARTICULAR FONT, STYLE, SIZE, OR COLOR.

SER. NO. 85-269,784, FILED 3-17-2011.

DAVID C. REIHNER, EXAMINING ATTORNEY



David J. Kyros

Director of the United States Patent and Trademark Office

United States of America

United States Patent and Trademark Office



Reg. No. 4,073,354

Registered Dec. 20, 2011

Int. Cl.: 35

SERVICE MARK

PRINCIPAL REGISTER

WAKEFERN FOOD CORP. (NEW JERSEY CORPORATION)
5000 RIVERSIDE DRIVE
KEASBEY, NJ 08832

FOR: ADMINISTRATION OF A CONSUMER LOYALTY PROGRAM PROVIDING DISCOUNTS, COUPONS, AND FREE GOODS FOR PURCHASING DESIGNATED ITEMS IN SUPERMARKETS, IN CLASS 35 (U.S. CLS. 100, 101 AND 102).

FIRST USE 4-8-2009; IN COMMERCE 4-8-2009.

OWNER OF U.S. REG. NOS. 2,776,497, 3,063,282, AND 3,294,435.

THE MARK CONSISTS OF THE TERM "SHOPRITE" IN SCRIPT LETTERING ATOP THE WORD "FAMILY", WITH THE "A" IN "FAMILY" SHAPED LIKE A HOUSE WITH THREE WINDOWS AND A DOOR.

SER. NO. 85-270,055, FILED 3-17-2011.

SANJEEV VOHRA, EXAMINING ATTORNEY



David J. Kybas

Director of the United States Patent and Trademark Office

United States of America

United States Patent and Trademark Office

PROPOSITIONS

Reg. No. 4,073,355

Registered Dec. 20, 2011

Int. Cls.: 35 and 41

SERVICE MARK

PRINCIPAL REGISTER

PROPOSITIONS, INC. (IOWA CORPORATION)
4600 WESTOWN PARKWAY
SUITE 100
WEST DES MOINES, IA 502661000

FOR: JOB TRANSITION SERVICES, NAMELY, PROVIDING EMPLOYMENT COUNSELING INFORMATION ON HOW TO SUCCESSFULLY TRANSITION JOBS; EMPLOYMENT OUTSOURCING SERVICES; PROVIDING ON-LINE EMPLOYMENT PLACEMENT SERVICES; PROVIDING ON-LINE INFORMATION IN THE FIELDS OF EMPLOYMENT RECRUITMENT, CAREERS, PERSONNEL PLACEMENT; PROVIDING INTERACTIVE COMPUTER DATABASE FEATURING CAREER INFORMATION AND JOB PLACEMENT RESOURCES; CAREER NETWORKING SERVICES, IN CLASS 35 (U.S. CLS. 100, 101 AND 102).

FIRST USE 12-22-2010; IN COMMERCE 1-31-2011.

FOR: CAREER COUNSELING, IN CLASS 41 (U.S. CLS. 100, 101 AND 107).

FIRST USE 12-22-2010; IN COMMERCE 1-31-2011.

THE MARK CONSISTS OF STANDARD CHARACTERS WITHOUT CLAIM TO ANY PARTICULAR FONT, STYLE, SIZE, OR COLOR.

SER. NO. 85-270,058, FILED 3-17-2011.

LAURIE MAYES, EXAMINING ATTORNEY



David J. Kybas

Director of the United States Patent and Trademark Office

United States of America

United States Patent and Trademark Office



Reg. No. 4,073,356

Registered Dec. 20, 2011

Int. Cl.: 9

TRADEMARK

PRINCIPAL REGISTER

TANG, WAI L (UNITED STATES INDIVIDUAL)
2505 W 2ND AVE
UNIT 7
DENVER, CO 80219

FOR: WIRELESS ACCESSORIES IN GENERAL, NAMELY, LEATHER POUCH FOR CELLULAR PHONE, PLASTIC HOLSTER FOR CELLULAR PHONE, CELLULAR PHONE PLASTIC SNAP ON FACEPLATE, WIRED HANDS FREE DEVICES FOR CELLULAR PHONE, WIRELESS HANDS FREE DEVICES FOR CELLULAR PHONE, SILICONE CELLULAR PHONE CASE, FITTED PLASTIC FILMS KNOWN AS SKINS FOR PROTECTING CELLULAR PHONE SCREENS, CELLULAR PHONE BATTERY CHARGER, NYLON NECK STRAP FOR CELLULAR PHONE, THERMOPLASTIC POLYURETHANE FITTED CASE KNOWN AS TPU FOR CELLULAR PHONE, IN CLASS 9 (U.S. CLS. 21, 23, 26, 36 AND 38).

FIRST USE 1-1-2007; IN COMMERCE 1-1-2007.

THE MARK CONSISTS OF "JUST IN" IN THE COLOR OF GREEN, THE COLOR WHITE REPRESENTS BACKGROUND AND IS NOT A PART OF THE MARK

THE COLOR(S) GREEN IS/ARE CLAIMED AS A FEATURE OF THE MARK.

SER. NO. 85-270,074, FILED S.R. 3-17-2011 AM. P.R. 6-23-2011.

HEATHER BIDDULPH, EXAMINING ATTORNEY



David J. Kybas

Director of the United States Patent and Trademark Office

United States of America

United States Patent and Trademark Office

Aqua-Care
usa

Solutions for Life.

Reg. No. 4,073,357

Registered Dec. 20, 2011

Int. Cls.: 11 and 12

TRADEMARK

PRINCIPAL REGISTER

HIGH PLAINS CONSTRUCTION, INC. (IOWA CORPORATION)
3850 SE BEISSER DRIVE
GRIMES, IA 50111

FOR: WALK-IN HYDROTHERAPY TUBS; WALK-IN SHOWERS, IN CLASS 11 (U.S. CLS. 13, 21, 23, 31 AND 34).

FIRST USE 7-1-2009; IN COMMERCE 7-1-2009.

FOR: CHAIR LIFTS, IN CLASS 12 (U.S. CLS. 19, 21, 23, 31, 35 AND 44).

FIRST USE 7-1-2009; IN COMMERCE 7-1-2009.

NO CLAIM IS MADE TO THE EXCLUSIVE RIGHT TO USE "USA", APART FROM THE MARK AS SHOWN.

THE MARK CONSISTS OF A DESIGN THAT BEGINS WITH A CAPITALIZED LETTER "A" STARTING THE WORD "AQUA", THIS IS THEN FOLLOWED BY A HYPHEN, CONTINUING WITH A CAPITAL LETTER "C" BEGINNING THE WORD "CARE". IN THE LOGO, THE NEXT SEGMENT IS "USA" IN LOWER CASE LETTERS IN THE LOGO. THERE ARE THREE STYLIZED LINES MOVING IN AN UNDULATING FASHION UNDER THE "AQUA-CARE" SCRIPT, INTERSECTING THE LOWER CASE "USA", LOCATED BENEATH THE "ARE" SEGMENT OF "AQUA-CARE". ALL ABOVE THE WORDING "SOLUTIONS FOR LIFE."

SER. NO. 85-270,195, FILED 3-17-2011.

KATHERINE M. DUBRAY, EXAMINING ATTORNEY



David J. Kyros

Director of the United States Patent and Trademark Office

United States of America

United States Patent and Trademark Office

Kool Kila

Reg. No. 4,073,358

RASHIDI, AHKILAH S (UNITED STATES INDIVIDUAL)
4587 VALLEY PKWY SE, APT F
SMYRNA, GA 30082

Registered Dec. 20, 2011

Int. Cl.: 41

FOR: ENTERTAINMENT SERVICES, NAMELY, LIVE VISUAL AND AUDIO PERFORMANCES BY MUSICAL BANDS, JAZZ BANDS, HIP HOP BANDS, POP BANDS, ROCK BANDS, CLASSICAL AND EASY LISTENING BANDS AND ORCHESTRAS, DISC JOCKEYS, AND DANCE PERFORMERS; DISC JOCKEY SERVICES; ENTERTAINMENT SERVICES, NAMELY, DISPLAYING A SERIES OF FILMS; ENTERTAINMENT IN THE NATURE OF THEATER PRODUCTIONS; PROVIDING VOICE-OVERS FOR RECORDED MEDIA FOR ENTERTAINMENT AND EDUCATION PURPOSES; PROVIDING INFORMATION AND ADVICE IN THE FIELDS OF MUSIC, VIDEO, AND FILM PRODUCTION; CREATING AND DEVELOPING CONCEPTS FOR MUSICAL RECORDINGS, VIDEO PRODUCTIONS, AND FILM PRODUCTION; COMPOSITION OF MUSIC FOR OTHERS; ENTERTAINMENT SERVICES IN THE NATURE OF RECORDING, PRODUCTION, AND POST-PRODUCTION SERVICES IN THE FIELD OF MUSIC, IN CLASS 41 (U.S. CLS. 100, 101 AND 107).

SERVICE MARK

PRINCIPAL REGISTER

FIRST USE 1-1-1997; IN COMMERCE 9-29-1999.

THE MARK CONSISTS OF STANDARD CHARACTERS WITHOUT CLAIM TO ANY PARTICULAR FONT, STYLE, SIZE, OR COLOR.

THE NAME "KOOL KILA" IDENTIFIES THE STAGE NAME OF THE APPLICANT "AHKILAH S. RASHIDI", A LIVING INDIVIDUAL WHOSE CONSENT IS OF RECORD.

SER. NO. 85-270,239, FILED 3-17-2011.

CORY BOONE, EXAMINING ATTORNEY



David J. Kybas

Director of the United States Patent and Trademark Office

United States of America

United States Patent and Trademark Office

Hit Rotation

Reg. No. 4,073,359

Registered Dec. 20, 2011

Int. Cl.: 41

SERVICE MARK

PRINCIPAL REGISTER

IRABOR, AMBER (UNITED STATES INDIVIDUAL)
13426 TOWNWOOD DRIVE
HOUSTON, TX 77045 AND

WILSON, SOLANDRA (UNITED STATES INDIVIDUAL)
#1722
10965 SOUTH GESSNER
HOUSTON, TX 77071

FOR: ENTERTAINMENT SERVICES BY A MUSICAL ARTIST AND PRODUCER, NAMELY, MUSICAL COMPOSITION FOR OTHERS AND PRODUCTION OF MUSICAL SOUND RECORDINGS; MUSIC COMPOSITION FOR OTHERS; MUSIC PRODUCTION SERVICES; PRODUCTION OF MUSICAL SOUND RECORDING; SONG WRITING SERVICES, IN CLASS 41 (U.S. CLS. 100, 101 AND 107).

FIRST USE 12-23-2009; IN COMMERCE 2-11-2011.

THE MARK CONSISTS OF STANDARD CHARACTERS WITHOUT CLAIM TO ANY PARTICULAR FONT, STYLE, SIZE, OR COLOR.

SER. NO. 85-270,818, FILED 3-18-2011.

MICHAEL WIENER, EXAMINING ATTORNEY



David J. Kyros

Director of the United States Patent and Trademark Office

United States of America

United States Patent and Trademark Office

Marianna Jewelry

Reg. No. 4,073,360

KOZLOWSKI, LAURA (UNITED STATES INDIVIDUAL)
103 PALERMO PLACE
THE VILLAGES, FL 32159

Registered Dec. 20, 2011

Int. Cl.: 14

FOR: WOMEN'S JEWELRY, IN CLASS 14 (U.S. CLS. 2, 27, 28 AND 50).

TRADEMARK

FIRST USE 3-1-2011; IN COMMERCE 3-1-2011.

PRINCIPAL REGISTER

THE MARK CONSISTS OF STANDARD CHARACTERS WITHOUT CLAIM TO ANY PARTICULAR FONT, STYLE, SIZE, OR COLOR.

NO CLAIM IS MADE TO THE EXCLUSIVE RIGHT TO USE "JEWELRY", APART FROM THE MARK AS SHOWN.

THE NAME "MARIANNA" DOES NOT IDENTIFY A LIVING INDIVIDUAL.

SER. NO. 85-270,823, FILED 3-18-2011.

MICHAEL WIENER, EXAMINING ATTORNEY



David J. Kyffers

Director of the United States Patent and Trademark Office

United States of America

United States Patent and Trademark Office

Helm

Reg. No. 4,073,361

Registered Dec. 20, 2011

Int. Cl.: 5

TRADEMARK

PRINCIPAL REGISTER

HELM AGRO US, INC. (TENNESSEE CORPORATION)
8275 TOURNAMENT DRIVE, SUITE 340
MEMPHIS, TN 38125

FOR: AGRICULTURAL PESTICIDES, IN CLASS 5 (U.S. CLS. 6, 18, 44, 46, 51 AND 52).

FIRST USE 3-1-2003, THE MARK WAS FIRST USED ANYWHERE IN A DIFFERENT FORM OTHER THAN THAT SOUGHT TO BE REGISTERED AT LEAST AS EARLY AS 03/01/2003; IN COMMERCE 6-1-2003, THE MARK WAS FIRST USED IN COMMERCE IN A DIFFERENT FORM OTHER THAN THAT SOUGHT TO BE REGISTERED AT LEAST AS EARLY AS 06/01/2003.

THE MARK CONSISTS OF STANDARD CHARACTERS WITHOUT CLAIM TO ANY PARTICULAR FONT, STYLE, SIZE, OR COLOR.

SER. NO. 85-270,900, FILED 3-18-2011.

JENNY PARK, EXAMINING ATTORNEY



David J. Kyffers

Director of the United States Patent and Trademark Office

United States of America

United States Patent and Trademark Office

Helosate

Reg. No. 4,073,362

Registered Dec. 20, 2011

Int. Cl.: 5

HELM AGRO US, INC. (TENNESSEE CORPORATION)
ATTN: BRENDA DOWDY
8275 TOURNAMENT DRIVE, SUITE 340
MEMPHIS, TN 38125

FOR: AGRICULTURAL PESTICIDES, IN CLASS 5 (U.S. CLS. 6, 18, 44, 46, 51 AND 52).

TRADEMARK

FIRST USE 3-1-2003, THE MARK WAS FIRST USED ANYWHERE IN A DIFFERENT FORM OTHER THAN THAT SOUGHT TO BE REGISTERED AT LEAST AS EARLY AS 03/01/2003; IN COMMERCE 6-1-2003, THE MARK WAS FIRST USED IN COMMERCE IN A DIFFERENT FORM OTHER THAN THAT SOUGHT TO BE REGISTERED AT LEAST AS EARLY AS 06/01/2003.

PRINCIPAL REGISTER

THE MARK CONSISTS OF STANDARD CHARACTERS WITHOUT CLAIM TO ANY PARTICULAR FONT, STYLE, SIZE, OR COLOR.

SER. NO. 85-271,045, FILED 3-18-2011.

JENNY PARK, EXAMINING ATTORNEY



David J. Kyffers

Director of the United States Patent and Trademark Office

United States of America

United States Patent and Trademark Office

FOODIEPALOOZA

Reg. No. 4,073,363

Registered Dec. 20, 2011

Int. Cl.: 35

SERVICE MARK

PRINCIPAL REGISTER

THE VEGAS FOODIE, LLC (NEVADA LIMITED LIABILITY COMPANY)
#B107-130
7345 S DURANGO DR
LAS VEGAS, NV 89113

FOR: PROVIDING MARKETING AND PROMOTION OF THE GOODS AND SERVICES OF OTHERS IN THE FIELD OF FOOD, ART, AND MUSIC, IN CLASS 35 (U.S. CLS. 100, 101 AND 102).

FIRST USE 2-20-2011; IN COMMERCE 2-20-2011.

THE MARK CONSISTS OF STANDARD CHARACTERS WITHOUT CLAIM TO ANY PARTICULAR FONT, STYLE, SIZE, OR COLOR.

SER. NO. 85-271,174, FILED 3-18-2011.

CARYN GLASSER, EXAMINING ATTORNEY



David J. Kyffers

Director of the United States Patent and Trademark Office

United States of America

United States Patent and Trademark Office

FOOD ROCKS

Reg. No. 4,073,364

Registered Dec. 20, 2011

Int. Cl.: 35

SERVICE MARK

PRINCIPAL REGISTER

THE VEGAS FOODIE, LLC (NEVADA LIMITED LIABILITY COMPANY)
#B107-130
7345 S DURANGO DR
LAS VEGAS, NV 89113

FOR: PROVIDING MARKETING AND PROMOTION OF SPECIAL EVENTS, IN CLASS 35
(U.S. CLS. 100, 101 AND 102).

FIRST USE 2-20-2011; IN COMMERCE 2-20-2011.

THE MARK CONSISTS OF STANDARD CHARACTERS WITHOUT CLAIM TO ANY PARTICULAR FONT, STYLE, SIZE, OR COLOR.

NO CLAIM IS MADE TO THE EXCLUSIVE RIGHT TO USE "FOOD", APART FROM THE MARK AS SHOWN.

SER. NO. 85-271,194, FILED 3-18-2011.

CARYN GLASSER, EXAMINING ATTORNEY



David J. Kyjars

Director of the United States Patent and Trademark Office

United States of America

United States Patent and Trademark Office

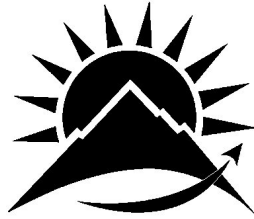

AdvantaCoach

Your Coach, Your Advisor..... Your Success!

Reg. No. 4,073,365

Registered Dec. 20, 2011

Int. Cl.: 41

SERVICE MARK

PRINCIPAL REGISTER

ADVANTACOACH (WYOMING LIMITED LIABILITY COMPANY)
7077 CRITTENDEN ROAD
SUFFOLK, VA 23432

FOR: BUSINESS EDUCATION AND TRAINING SERVICES, NAMELY, DEVELOPING, AND FACILITATING CUSTOMIZED IN-COMPANY LEADERSHIP AND EXECUTIVE DEVELOPMENT PROGRAMS, PROVIDING EXECUTIVE COACHING SERVICES, AND PROVIDING PUBLIC AND IN-COMPANY KEYNOTE PRESENTATIONS TO BUSINESS LEADERS ; BUSINESS EDUCATION AND TRAINING SERVICES, NAMELY, DEVELOPING AND FACILITATING CUSTOMIZED LEADERSHIP AND EXECUTIVE DEVELOPMENT PROGRAMS, PROVIDING EXECUTIVE COACHING SERVICES, AND PROVIDING BUSINESS EDUCATION PROGRAMS TO EMPLOYEES AND EXECUTIVES ; EDUCATIONAL SERVICES, NAMELY, CONDUCTING ONE-ON-ONE AND GROUP COACHING IN CLASSES, SEMINARS, CONFERENCES, WORKSHOPS, AND VIA ELECTRONIC MEDIA INCLUDING TELEPHONE AND INTERNET IN THE FIELDS OF PERSONAL MOTIVATION, PERSONAL GROWTH, GENERAL BUSINESS ADVICE, AND CORPORATE GOVERNANCE AND DISTRIBUTION OF TRAINING MATERIALS IN CONNECTION THEREWITH ; PROVIDING GROUP COACHING IN THE FIELDS OF PERSONAL MOTIVATION, PERSONAL GROWTH, GENERAL BUSINESS ADVICE, AND CORPORATE GOVERNANCE ; PERSONAL COACHING SERVICES IN THE FIELDS OF PERSONAL MOTIVATION, PERSONAL GROWTH, GENERAL BUSINESS ADVICE, AND CORPORATE GOVERNANCE, IN CLASS 41 (U.S. CLS. 100, 101 AND 107).

FIRST USE 1-1-2011; IN COMMERCE 1-1-2011.

THE MARK CONSISTS OF A STYLIZED MOUNTAIN LOGO AGAINST A SUNRISE, WITH A POINTED CRESCENT UNDERNEATH IT, ALL OF WHICH IS OVER THE TEXT "ADVANTACOACH", WHICH IS DISPLAYED OVER THE TEXT "YOUR COACH, YOUR ADVISOR..... YOUR SUCCESS!".

SER. NO. 85-271,376, FILED 3-18-2011.

RONALD AIKENS, EXAMINING ATTORNEY



David J. Kyffers

Director of the United States Patent and Trademark Office

United States of America

United States Patent and Trademark Office

Funsies

Reg. No. 4,073,366

3N1 CREATIVE (TEXAS LIMITED LIABILITY COMPANY)
PO BOX 4815
EL PASO, TX 79914

Registered Dec. 20, 2011

Int. Cl.: 9

FOR: DOWNLOADABLE VIRTUAL GOODS, NAMELY, COMPUTER PROGRAMS FEATURING DOLLS REPRESENTING BABIES AND TODDLERS, AND ACCESSORIES, CLOTHING AND FURNITURE FOR THESE DOLLS FOR USE IN ONLINE VIRTUAL WORLDS, IN CLASS 9 (U.S. CLS. 21, 23, 26, 36 AND 38).

TRADEMARK

PRINCIPAL REGISTER

FIRST USE 3-1-2011; IN COMMERCE 3-1-2011.

THE MARK CONSISTS OF STANDARD CHARACTERS WITHOUT CLAIM TO ANY PARTICULAR FONT, STYLE, SIZE, OR COLOR.

SER. NO. 85-271,612, FILED 3-20-2011.

PRISCILLA MILTON, EXAMINING ATTORNEY



David J. Kybas

Director of the United States Patent and Trademark Office

United States of America

United States Patent and Trademark Office

BaseCamp5

Reg. No. 4,073,367

LAKE BLUFF MANAGEMENT, LLC (ILLINOIS LIMITED LIABILITY COMPANY)
300 E. SHERIDAN PLACE

Registered Dec. 20, 2011

LAKE BLUFF, IL 60044

Int. Cl.: 35

FOR: PROVIDING AN INTERACTIVE ONLINE WEBSITE WHERE ADVERTISERS, MARKETERS, CONSUMERS AND CONTENT PROVIDERS COMMUNICATE WITH OTHER USERS VIA NEWSLETTERS, DATABASES, SUBSCRIPTIONS, ADVERTISING, BRANDING, TO PROMOTE KNOWLEDGE OF PRODUCTS, AND SERVICES, ON BEHALF OF OTHERS, FOR EVALUATING AND RATING PURPOSES, IN CLASS 35 (U.S. CLS. 100, 101 AND 102).

SERVICE MARK

PRINCIPAL REGISTER

FIRST USE 3-1-2011; IN COMMERCE 3-1-2011.

THE MARK CONSISTS OF STANDARD CHARACTERS WITHOUT CLAIM TO ANY PARTICULAR FONT, STYLE, SIZE, OR COLOR.

SER. NO. 85-271,725, FILED 3-20-2011.

C. DIONNE CLYBURN, EXAMINING ATTORNEY



David J. Kyros

Director of the United States Patent and Trademark Office

United States of America

United States Patent and Trademark Office

Doc's Ranch Vineyard

Reg. No. 4,073,368

Registered Dec. 20, 2011

Int. Cls.: 31 and 44

TRADEMARK

SERVICE MARK

PRINCIPAL REGISTER

SHEETS, BRYON T. (UNITED STATES INDIVIDUAL)
8 DEL MAR COURT
ORINDA, CA 945631711 AND

SHEETS, ANDREA D. (UNITED STATES INDIVIDUAL)
8 DEL MAR COURT
ORINDA, CA 945631711

FOR: FRESH GRAPES FOR WINEMAKING, IN CLASS 31 (U.S. CLS. 1 AND 46).

FIRST USE 1-1-2007; IN COMMERCE 1-1-2007.

FOR: VITICULTURE SERVICES, NAMELY, GRAPE GROWING AND CULTIVATION OF GRAPES FOR OTHERS, IN CLASS 44 (U.S. CLS. 100 AND 101).

FIRST USE 1-1-2007; IN COMMERCE 1-1-2007.

THE MARK CONSISTS OF STANDARD CHARACTERS WITHOUT CLAIM TO ANY PARTICULAR FONT, STYLE, SIZE, OR COLOR.

NO CLAIM IS MADE TO THE EXCLUSIVE RIGHT TO USE "RANCH VINEYARD", APART FROM THE MARK AS SHOWN.

SER. NO. 85-271,785, FILED 3-20-2011.

EDWARD FENNESSY, EXAMINING ATTORNEY



David J. Kyros

Director of the United States Patent and Trademark Office

United States of America

United States Patent and Trademark Office



Reg. No. 4,073,369

W.I. ORLANDO, INC. (FLORIDA CORPORATION)
626 LOCHSMERE LANE
ORLANDO, FL 32828

Registered Dec. 20, 2011

Int. Cl.: 43

FOR: RESTAURANT SERVICES, IN CLASS 43 (U.S. CLS. 100 AND 101).

SERVICE MARK

FIRST USE 8-11-2009; IN COMMERCE 8-11-2009.

PRINCIPAL REGISTER

NO CLAIM IS MADE TO THE EXCLUSIVE RIGHT TO USE "TENDERS" , APART FROM THE MARK AS SHOWN.

THE COLOR(S) RED, YELLOW, ORANGE AND WHITE IS/ARE CLAIMED AS A FEATURE OF THE MARK.

THE MARK CONSISTS OF THE WORD "TENDERS" STYLIZED IN RED WHEREIN THE LETTER "D" IS A DESIGN OF A CHICKEN AND THE WORD OUTLINED WITH YELLOW AND FURTHER OUTLINED WITH ORANGE AND INSIDE THE REMAINING SPACE WHITE, AND ABOVE THE SECOND OCCURRENCE OF THE LETTER "E" A DESIGN OF TWO FEATHERS, YELLOW AND ORANGE.

SER. NO. 85-271,927, FILED 3-21-2011.

KATHERINE M. DUBRAY, EXAMINING ATTORNEY



David J. Kyjars

Director of the United States Patent and Trademark Office

United States of America

United States Patent and Trademark Office

GILT

Reg. No. 4,073,370

Registered Dec. 20, 2011

Int. Cl.: 35

SERVICE MARK

PRINCIPAL REGISTER

GILT GROUPE, INC. (DELAWARE CORPORATION)
2 PARK AVENUE, 4TH FLOOR
NEW YORK, NY 10016

FOR: ON-LINE RETAIL STORE SERVICES FEATURING LUXURY AND FASHION CLOTHING, APPAREL, FOOTWEAR, CLOTHING ACCESSORIES, COSMETICS, HOME GOODS, ELECTRONICS, AND RELATED GOODS SOLD AT DISCOUNT PRICES, IN CLASS 35 (U.S. CLS. 100, 101 AND 102).

FIRST USE 11-13-2007; IN COMMERCE 11-13-2007.

THE MARK CONSISTS OF STANDARD CHARACTERS WITHOUT CLAIM TO ANY PARTICULAR FONT, STYLE, SIZE, OR COLOR.

OWNER OF U.S. REG. NOS. 3,680,404, 3,920,768, AND 3,967,967.

SER. NO. 85-271,939, FILED 3-21-2011.

SUE LAWRENCE, EXAMINING ATTORNEY



David J. Kybas

Director of the United States Patent and Trademark Office

United States of America

United States Patent and Trademark Office

INCHARGE

Reg. No. 4,073,371

Registered Dec. 20, 2011

Int. Cls.: 36 and 41

SERVICE MARK

PRINCIPAL REGISTER

INCHARGE INSTITUTE OF AMERICA, INC. (DELAWARE NON-PROFIT CORPORATION)
SUITE 300
5750 MAJOR BLVD.
ORLANDO, FL 32819

FOR: FINANCIAL SERVICES, NAMELY, CREDIT COUNSELING, BANKRUPTCY CREDIT COUNSELING, BUDGETING, HOUSING COUNSELING AND DEBT MANAGEMENT, ALL OF THE FOREGOING PROVIDED TO INDIVIDUALS; PROVIDING INFORMATION TO CONSUMERS REGARDING PERSONAL FINANCES, DEBT MANAGEMENT, BANKRUPTCY, AND HOME BUYING AND MORTGAGES; PROVIDING INFORMATION TO CONSUMERS REGARDING CREDIT COUNSELING, CREDIT REPORTING, BUDGETING, PERSONAL FINANCES, DEBT MANAGEMENT, BANKRUPTCY AND HOME BUYING AND MORTGAGES VIA A GLOBAL COMPUTER NETWORK; PROVIDING ONLINE TOOLS TO DEVELOP BUDGETS AND DEBT REPAYMENT PLANS, TO CALCULATE AUTOMOBILE AND HOME LOANS AND PAYOFFS AND CREDIT CARD PAYOFFS, AND FOR USE IN PERSONAL FINANCE PLANNING, RETIREMENT PLANNING, SAVING AND INVESTING, IN CLASS 36 (U.S. CLS. 100, 101 AND 102).

FIRST USE 6-1-1999; IN COMMERCE 6-1-1999.

FOR: EDUCATIONAL SERVICES, NAMELY, CONDUCTING CLASSES, WORKSHOPS AND SEMINARS REGARDING CREDIT COUNSELING, BUDGETING, BANKRUPTCY, CREDIT REPORTING, HOME BUYING AND MORTGAGES, AND DISTRIBUTING COURSE MATERIALS IN CONNECTION THEREWITH; EDUCATIONAL SERVICES IN THE NATURE OF ONLINE CLASSES, WORKSHOPS AND SEMINARS IN THE FIELD OF PERSONAL FINANCE AND BANKRUPTCY, AND DISTRIBUTING COURSE MATERIALS IN CONNECTION THEREWITH, IN CLASS 41 (U.S. CLS. 100, 101 AND 107).

FIRST USE 6-1-1999; IN COMMERCE 6-1-1999.

THE MARK CONSISTS OF STANDARD CHARACTERS WITHOUT CLAIM TO ANY PARTICULAR FONT, STYLE, SIZE, OR COLOR.

OWNER OF U.S. REG. NOS. 2,375,451, 3,187,375 AND OTHERS.

SER. NO. 85-271,958, FILED 3-21-2011.



David J. Kyjars

Director of the United States Patent and Trademark Office

Reg. No. 4,073,371 CAROLYN CATALDO, EXAMINING ATTORNEY

United States of America

United States Patent and Trademark Office



Reg. No. 4,073,372

NSF INTERNATIONAL (MICHIGAN CORPORATION)

Registered Dec. 20, 2011

789 N. DIXBORO ROAD
ANN ARBOR, MI 48105

Int. Cl.: 42

FOR: SCIENTIFIC LABORATORY SERVICES; TESTING, ANALYSIS AND EVALUATION OF PHARMACEUTICAL AND MEDICAL DEVICE PRODUCTS OF OTHERS; PERFORMANCE OF CHEMICAL ANALYSES; DEVELOPMENT AND VALIDATION OF PHARMACEUTICAL TEST METHODS; CONSULTING SERVICES REGARDING LABORATORY PRACTICES IN THE BIOTECHNOLOGY, MEDICAL DEVICES, AND PHARMACEUTICAL INDUSTRIES; QUALITY MANAGEMENT SERVICES, NAMELY, QUALITY EVALUATION AND ANALYSIS, QUALITY ASSURANCE, AND QUALITY CONTROL, IN THE FIELDS OF BIOTECHNOLOGY, MEDICAL DEVICES, AND PHARMACEUTICALS, IN CLASS 42 (U.S. CLS. 100 AND 101).

SERVICE MARK

PRINCIPAL REGISTER

FIRST USE 2-15-2011; IN COMMERCE 2-15-2011.

THE MARK CONSISTS OF THE LETTERS "NSF" INSIDE A CIRCLE WHICH IS TO THE LEFT OF THE TERM "PHARMALYTICA".

SER. NO. 85-272,012, FILED 3-21-2011.

TIMOTHY FINNEGAN, EXAMINING ATTORNEY



David J. Kyros

Director of the United States Patent and Trademark Office

United States of America

United States Patent and Trademark Office

SUPERGREEN HOSTING

Reg. No. 4,073,373

Registered Dec. 20, 2011

Int. Cls.: 38, 42 and 45

SERVICE MARK

PRINCIPAL REGISTER

THE BRITANNIA INTERNATIONAL GROUP, INC. (DELAWARE CORPORATION)
70 BLANCHARD ROAD
BURLINGTON, MA 01803

FOR: PROVIDING E-MAIL SERVICES; E-MAIL FORWARDING SERVICES; PROVIDING MULTIPLE-USER ACCESS TO A GLOBAL COMPUTER INFORMATION NETWORK , IN CLASS 38 (U.S. CLS. 100, 101 AND 104).

FIRST USE 10-0-2009; IN COMMERCE 10-0-2009.

FOR: WEB SITE HOSTING SERVICES; WEBSITE DESIGN AND DEVELOPMENT FOR OTHERS; PLANNING, DESIGNING, DEVELOPMENT, MAINTENANCE AND OPTIMIZATION OF ONLINE WEBSITES FOR THIRD PARTIES; DOMAIN NAME SEARCH SERVICES, NAMELY, CONDUCTING ONLINE COMPUTERIZED SEARCHES FOR THE AVAILABILITY OF DOMAIN NAMES; COMPUTER SERVICES, NAMELY, SEARCH ENGINE OPTIMIZATION; PROVIDING TEMPORARY USE OF ONLINE NON-DOWNLOADABLE SOFTWARE DEVELOPMENT TOOLS FOR CREATING WEBSITES, ONLINE STORES, ELECTRONIC BULLETIN BOARDS AND BLOGS, AND FOR PERFORMING WEBSITE BACK-UPS AND RESTORATIONS; PROVIDING TEMPORARY USE OF ONLINE NON-DOWNLOADABLE SOFTWARE FOR MAINTAINING WEB SITE SECURITY AND PROTECTING WEB SITES FROM IDENTITY THEFT, FRAUD, SPAM, SPYWARE, VIRUSES, AND ONLINE SCAMS; DATA ENCRYPTION SERVICES; COMPUTER VIRUS PROTECTION SERVICES; PROVIDING TEMPORARY USE OF ONLINE NON-DOWNLOADABLE SOFTWARE FOR USE IN E-COMMERCE TO ALLOW USERS TO PERFORM ELECTRONIC TRANSACTIONS AND TO DESIGN AND DEVELOP ADVERTISEMENTS AND MARKETING CAMPAIGNS; TECHNICAL SUPPORT SERVICES, NAMELY, TROUBLESHOOTING OF COMPUTER SOFTWARE PROBLEMS AND WEB APPLICATION PROBLEMS; COMPUTER SERVICES, NAMELY, DOMAIN FORWARDING SERVICES, IN CLASS 42 (U.S. CLS. 100 AND 101).

FIRST USE 10-0-2009; IN COMMERCE 10-0-2009.

FOR: DOMAIN NAME REGISTRATION SERVICES, IN CLASS 45 (U.S. CLS. 100 AND 101).

FIRST USE 10-0-2009; IN COMMERCE 10-0-2009.

THE MARK CONSISTS OF STANDARD CHARACTERS WITHOUT CLAIM TO ANY PARTICULAR FONT, STYLE, SIZE, OR COLOR.



David J. Kyros

Director of the United States Patent and Trademark Office

Reg. No. 4,073,373 NO CLAIM IS MADE TO THE EXCLUSIVE RIGHT TO USE "HOSTING", APART FROM THE MARK AS SHOWN.

SER. NO. 85-272,155, FILED 3-21-2011.

EUGENIA MARTIN, EXAMINING ATTORNEY

United States of America

United States Patent and Trademark Office

JUST HOST

Reg. No. 4,073,374

THE BRITANNIA INTERNATIONAL GROUP, INC. (DELAWARE CORPORATION)
70 BLANCHARD ROAD
BURLINGTON, MA 01803

Registered Dec. 20, 2011

Int. Cls.: 38, 42 and 45

FOR: PROVIDING E-MAIL SERVICES; E-MAIL FORWARDING SERVICES; PROVIDING MULTIPLE-USER ACCESS TO A GLOBAL COMPUTER INFORMATION NETWORK , IN CLASS 38 (U.S. CLS. 100, 101 AND 104).

SERVICE MARK

FIRST USE 7-0-2008; IN COMMERCE 7-0-2008.

PRINCIPAL REGISTER

FOR: WEB SITE HOSTING SERVICES; WEBSITE DESIGN AND DEVELOPMENT FOR OTHERS; PLANNING, DESIGNING, DEVELOPMENT, MAINTENANCE AND OPTIMIZATION OF ONLINE WEBSITES FOR THIRD PARTIES; DOMAIN NAME SEARCH SERVICES, NAMELY, CONDUCTING ONLINE COMPUTERIZED SEARCHES FOR THE AVAILABILITY OF DOMAIN NAMES; COMPUTER SERVICES, NAMELY, SEARCH ENGINE OPTIMIZATION; PROVIDING TEMPORARY USE OF ONLINE NON-DOWNLOADABLE SOFTWARE DEVELOPMENT TOOLS FOR CREATING WEBSITES, ONLINE STORES, ELECTRONIC BULLETIN BOARDS AND BLOGS, AND FOR PERFORMING WEBSITE BACK-UPS AND RESTORATIONS; PROVIDING TEMPORARY USE OF ONLINE NON-DOWNLOADABLE SOFTWARE FOR MAINTAINING WEB SITE SECURITY AND PROTECTING WEB SITES FROM IDENTITY THEFT, FRAUD, SPAM, SPYWARE, VIRUSES, AND ONLINE SCAMS; DATA ENCRYPTION SERVICES; COMPUTER VIRUS PROTECTION SERVICES; PROVIDING TEMPORARY USE OF ONLINE NON-DOWNLOADABLE SOFTWARE FOR USE IN E-COMMERCE TO ALLOW USERS TO PERFORM ELECTRONIC TRANSACTIONS AND TO DESIGN AND DEVELOP ADVERTISEMENTS AND MARKETING CAMPAIGNS; TECHNICAL SUPPORT SERVICES, NAMELY, TROUBLESHOOTING OF COMPUTER SOFTWARE PROBLEMS AND WEB APPLICATION PROBLEMS; COMPUTER SERVICES, NAMELY, DOMAIN FORWARDING SERVICES, IN CLASS 42 (U.S. CLS. 100 AND 101).

FIRST USE 7-0-2008; IN COMMERCE 7-0-2008.

FOR: DOMAIN NAME REGISTRATION SERVICES, IN CLASS 45 (U.S. CLS. 100 AND 101).

FIRST USE 7-0-2008; IN COMMERCE 7-0-2008.

THE MARK CONSISTS OF STANDARD CHARACTERS WITHOUT CLAIM TO ANY PARTICULAR FONT, STYLE, SIZE, OR COLOR.



David J. Kyros

Director of the United States Patent and Trademark Office

Reg. No. 4,073,374 NO CLAIM IS MADE TO THE EXCLUSIVE RIGHT TO USE "HOST", APART FROM THE MARK AS SHOWN.

SER. NO. 85-272,156, FILED 3-21-2011.

EUGENIA MARTIN, EXAMINING ATTORNEY

United States of America

United States Patent and Trademark Office

HOSTCLEAR

Reg. No. 4,073,375

Registered Dec. 20, 2011

Int. Cls.: 38, 42 and 45

SERVICE MARK

PRINCIPAL REGISTER

THE BRITANNIA INTERNATIONAL GROUP, INC. (DELAWARE CORPORATION)
70 BLANCHARD ROAD
BURLINGTON, MA 01803

FOR: PROVIDING E-MAIL SERVICES; E-MAIL FORWARDING SERVICES; PROVIDING MULTIPLE-USER ACCESS TO A GLOBAL COMPUTER INFORMATION NETWORK , IN CLASS 38 (U.S. CLS. 100, 101 AND 104).

FIRST USE 10-0-2008; IN COMMERCE 10-0-2008.

FOR: WEB SITE HOSTING SERVICES; WEBSITE DESIGN AND DEVELOPMENT FOR OTHERS; PLANNING, DESIGNING, DEVELOPMENT, MAINTENANCE AND OPTIMIZATION OF ONLINE WEBSITES FOR THIRD PARTIES; DOMAIN NAME SEARCH SERVICES, NAMELY, CONDUCTING ONLINE COMPUTERIZED SEARCHES FOR THE AVAILABILITY OF DOMAIN NAMES; COMPUTER SERVICES, NAMELY, SEARCH ENGINE OPTIMIZATION; PROVIDING TEMPORARY USE OF ONLINE NON-DOWNLOADABLE SOFTWARE DEVELOPMENT TOOLS FOR CREATING WEBSITES, ONLINE STORES, ELECTRONIC BULLETIN BOARDS AND BLOGS, AND FOR PERFORMING WEBSITE BACK-UPS AND RESTORATIONS; PROVIDING TEMPORARY USE OF ONLINE NON-DOWNLOADABLE SOFTWARE FOR MAINTAINING WEB SITE SECURITY AND PROTECTING WEB SITES FROM IDENTITY THEFT, FRAUD, SPAM, SPYWARE, VIRUSES, AND ONLINE SCAMS; DATA ENCRYPTION SERVICES; COMPUTER VIRUS PROTECTION SERVICES; PROVIDING TEMPORARY USE OF ONLINE NON-DOWNLOADABLE SOFTWARE FOR USE IN E-COMMERCE TO ALLOW USERS TO PERFORM ELECTRONIC TRANSACTIONS AND TO DESIGN AND DEVELOP ADVERTISEMENTS AND MARKETING CAMPAIGNS; TECHNICAL SUPPORT SERVICES, NAMELY, TROUBLESHOOTING OF COMPUTER SOFTWARE PROBLEMS AND WEB APPLICATION PROBLEMS; COMPUTER SERVICES, NAMELY, DOMAIN FORWARDING SERVICES, IN CLASS 42 (U.S. CLS. 100 AND 101).

FIRST USE 10-0-2008; IN COMMERCE 10-0-2008.

FOR: DOMAIN NAME REGISTRATION SERVICES, IN CLASS 45 (U.S. CLS. 100 AND 101).

FIRST USE 10-0-2008; IN COMMERCE 10-0-2008.

THE MARK CONSISTS OF STANDARD CHARACTERS WITHOUT CLAIM TO ANY PARTICULAR FONT, STYLE, SIZE, OR COLOR.



David J. Kyffers

Director of the United States Patent and Trademark Office

Reg. No. 4,073,375 SER. NO. 85-272,162, FILED 3-21-2011.

EUGENIA MARTIN, EXAMINING ATTORNEY

United States of America

United States Patent and Trademark Office



Reg. No. 4,073,376

CAPITOL MEDICAL SUPPLY LLC (FLORIDA LIMITED LIABILITY COMPANY)
2323 CURLEW RD., STE. 7E
DUNEDIN, FL 34698

Registered Dec. 20, 2011

Int. Cl.: 5

FOR: TEST STRIPS FOR MEASURING BLOOD GLUCOSE LEVELS, IN CLASS 5 (U.S. CLS. 6, 18, 44, 46, 51 AND 52).

TRADEMARK

FIRST USE 6-1-2010; IN COMMERCE 6-1-2010.

PRINCIPAL REGISTER

NO CLAIM IS MADE TO THE EXCLUSIVE RIGHT TO USE "MEDICAL SUPPLY LLC", APART FROM THE MARK AS SHOWN.

THE COLOR(S) RED, BLUE, BLACK, AND WHITE IS/ARE CLAIMED AS A FEATURE OF THE MARK.

THE MARK CONSISTS OF BLUE CAPITAL "C", BLUE "PITOL", RED "MEDICAL SUPPLY LLC", BLACK AND WHITE US CAPITOL DOME, THREE HORIZONTAL RED LINES BELOW "MEDICAL SUPPLY LLC". THE BACKGROUND OF THE MARK IS TRANSPARENT.

SER. NO. 85-272,296, FILED 3-21-2011.

ANDREA HACK, EXAMINING ATTORNEY



David J. Kyffers

Director of the United States Patent and Trademark Office

United States of America

United States Patent and Trademark Office

MONEY CAN BUY LOVE

Reg. No. 4,073,377

Registered Dec. 20, 2011

Int. Cl.: 45

SERVICE MARK

PRINCIPAL REGISTER

SYED MOAZAM SAIFULLAH SHAH (CANADA INDIVIDUAL), DBA MONEY CAN BUY LOVE
1 WEST SUPERIOR, UNIT 1416
CHICAGO, IL 60654

FOR: COMPUTER DATING SERVICES; DATING SERVICES; INTERNET BASED SOCIAL NETWORKING, INTRODUCTION, AND DATING SERVICES; INTERNET-BASED DATING, SOCIAL INTRODUCTION AND SOCIAL NETWORKING SERVICES, IN CLASS 45 (U.S. CLS. 100 AND 101).

FIRST USE 3-16-2011; IN COMMERCE 3-16-2011.

THE MARK CONSISTS OF STANDARD CHARACTERS WITHOUT CLAIM TO ANY PARTICULAR FONT, STYLE, SIZE, OR COLOR.

SER. NO. 85-272,358, FILED 3-21-2011.

PRISCILLA MILTON, EXAMINING ATTORNEY



David J. Kybas

Director of the United States Patent and Trademark Office

United States of America

United States Patent and Trademark Office



Reg. No. 4,073,378

Registered Dec. 20, 2011

Int. Cl.: 35

SERVICE MARK

PRINCIPAL REGISTER

INNOVATION NETWORK TECHNOLOGIES CORPORATION (TEXAS CORPORATION)
SUITE 144, BOX 308
5729 LEBANON ROAD
FRISCO, TX 75034

FOR: VALUE-ADDED RESELLER SERVICES, NAMELY, DISTRIBUTORSHIP SERVICES
FEATURING COMPUTER SOFTWARE, IN CLASS 35 (U.S. CLS. 100, 101 AND 102).

FIRST USE 5-9-2010; IN COMMERCE 5-9-2010.

NO CLAIM IS MADE TO THE EXCLUSIVE RIGHT TO USE "NETWORK TECHNOLOGIES",
APART FROM THE MARK AS SHOWN.

THE COLOR(S) BLUE AND BLACK IS/ARE CLAIMED AS A FEATURE OF THE MARK.

THE MARK CONSISTS OF THE WORDS "INNET" IN BLUE AND BLACK WITH A BLUE
HALO AROUND THE "I". THE FULL COMPANY NAME "INNOVATION NETWORK
TECHNOLOGIES" IS BELOW THAT IN BLACK.

THE WORDING "INNET" HAS NO MEANING IN A FOREIGN LANGUAGE.

SER. NO. 85-272,570, FILED 3-21-2011.

EUGENIA MARTIN, EXAMINING ATTORNEY



David J. Kyros

Director of the United States Patent and Trademark Office

United States of America

United States Patent and Trademark Office

USBiQ

Reg. No. 4,073,379

MCNULTY, SCOTT (UNITED STATES INDIVIDUAL)
22 ENSIGN ROAD
NORWALK, CT 06853

Registered Dec. 20, 2011

Int. Cl.: 9

FOR: CELL PHONES, COMPUTERS, TABLET COMPUTERS, MODEMS, DIGITAL CAMERAS, BIOMETRIC DEVICES, NAMELY, FINGERPRINT READERS AND MEDIA STORAGE DEVICES, NAMELY, COMPUTER TABLETS, SMART PHONES, DIGITAL AUDIO PLAYERS, PERSONAL DIGITAL ASSISTANTS WITH COMPUTER OPERATING SOFTWARE, ELECTRONIC BOOK READERS, BLANK DIGITAL STORAGE MEDIA, AND PRERECORDED DIGITAL STORAGE MEDIA FEATURING MUSIC, FICTION AND NON-FICTION AUDIO BOOKS, VIDEO RECORDINGS AND TELEVISION PROGRAMS IN THE FIELD DRAMA, COMEDY, ACTION, HORROR, MUSIC, SCIENCE FICTION, SPORTS AND PHYSICAL FITNESS, CLASSICS, ANIMATION, DOCUMENTARIES, CURRENT EVENT NEWS, AND CHILDREN AND FAMILY ENTERTAINMENT, ALL INTEGRATED WITH USB PORTS, IN CLASS 9 (U.S. CLS. 21, 23, 26, 36 AND 38).

TRADEMARK

PRINCIPAL REGISTER

FIRST USE 1-13-2011; IN COMMERCE 1-14-2011.

THE MARK CONSISTS OF STANDARD CHARACTERS WITHOUT CLAIM TO ANY PARTICULAR FONT, STYLE, SIZE, OR COLOR.

SER. NO. 85-272,812, FILED 3-21-2011.

EVELYN BRADLEY, EXAMINING ATTORNEY



David J. Kybas

Director of the United States Patent and Trademark Office

United States of America

United States Patent and Trademark Office



guest | METRICS

Reg. No. 4,073,380

Registered Dec. 20, 2011

Int. Cl.: 43

SERVICE MARK

PRINCIPAL REGISTER

GUESTMETRICS, INC. (DELAWARE CORPORATION)
1 LANDMARK SQUARE
STAMFORD, CT 06901

FOR: CONSULTING SERVICES IN THE FIELD OF HOSPITALITY, IN CLASS 43 (U.S. CLS. 100 AND 101).

FIRST USE 5-11-2005; IN COMMERCE 5-11-2005.

THE MARK CONSISTS OF THE WORDS "GUEST" IN LOWER CASE GREEN LETTERS AND "METRICS" IN UPPER CASE BLACK LETTERS, SEPARATED BY A BLACK VERTICAL LINE, ALL UNDERNEATH A SQUARE OUTLINED IN GREEN WITH ROUNDED CORNERS CONTAINING TWO L-SHAPED HALVES OF A DIVIDED SQUARE, ALL ON A WHITE BACKGROUND, ONE L-SHAPE IS DARK GREEN, THE OTHER L-SHAPE IS LIGHT GREEN AND PARTIALLY OUTLINED IN DARK GREEN.

THE COLOR(S) GREEN, WHITE, AND BLACK IS/ARE CLAIMED AS A FEATURE OF THE MARK.

SER. NO. 85-272,842, FILED 3-21-2011.

CURTIS FRENCH, EXAMINING ATTORNEY



David J. Kybas

Director of the United States Patent and Trademark Office

United States of America

United States Patent and Trademark Office

Videolicious

Reg. No. 4,073,381

THE TALK MARKET, INC. (DELAWARE CORPORATION)
1255 PARK AVENUE
NEW YORK, NY 10029

Registered Dec. 20, 2011

Int. Cls.: 38, 41 and 45

FOR: MESSAGE SENDING AND RECEIVING SERVICES, IN CLASS 38 (U.S. CLS. 100, 101 AND 104).

SERVICE MARK

FIRST USE 2-3-2011; IN COMMERCE 2-3-2011.

PRINCIPAL REGISTER

FOR: DIGITAL VIDEO, AUDIO, AND MULTIMEDIA PUBLISHING SERVICES, IN CLASS 41 (U.S. CLS. 100, 101 AND 107).

FIRST USE 2-3-2011; IN COMMERCE 2-3-2011.

FOR: INTERNET-BASED SOCIAL NETWORKING SERVICES, IN CLASS 45 (U.S. CLS. 100 AND 101).

FIRST USE 2-3-2011; IN COMMERCE 2-3-2011.

THE MARK CONSISTS OF STANDARD CHARACTERS WITHOUT CLAIM TO ANY PARTICULAR FONT, STYLE, SIZE, OR COLOR.

SER. NO. 85-272,932, FILED 3-22-2011.

KIMBERLY PERRY, EXAMINING ATTORNEY



David J. Kybas

Director of the United States Patent and Trademark Office

United States of America

United States Patent and Trademark Office

KANTAR RETAIL IQ

Reg. No. 4,073,382

Registered Dec. 20, 2011

Int. Cl.: 35

SERVICE MARK

PRINCIPAL REGISTER

WPP PROPERTIES (DELAWARE PARTNERSHIP)
4TH FLOOR
100 PARK AVENUE
NEW YORK, NY 10017

FOR: BUSINESS MARKETING CONSULTING SERVICES IN THE FIELD OF RETAIL MARKETS, RETAILERS, RETAIL AND SHOPPER INSIGHTS AND TRENDS, AND CONSUMER PURCHASE BEHAVIOR; BUSINESS MARKETING CONSULTING SERVICES IN THE FIELD OF MARKETING AND ADVERTISING IN THE RETAIL INDUSTRY; MARKET RESEARCH AND ANALYSIS SERVICES IN THE FIELD OF RETAIL MARKETS, RETAILERS, RETAIL AND SHOPPER INSIGHTS AND TRENDS, AND CONSUMER PURCHASE BEHAVIOR; MARKET RESEARCH IN THE NATURE OF AUDIENCE MEASUREMENT, AUDIENCE RESEARCH AND AUDIENCE ANALYSIS SERVICES; CONDUCTING MARKETING STUDIES AND SURVEYS; BUSINESS MARKETING CONSULTING SERVICES USING MARKETING AND ADVERTISING CONTENT, SHOPPER PURCHASE BEHAVIOR DATA AND ONLINE PANELS TO EVALUATE CONSUMER ATTITUDINAL AND BEHAVIORAL RESPONSE; STATISTICAL INFORMATION SERVICES, NAMELY, PROVIDING STATISTICAL INFORMATION FOR BUSINESS PURPOSES; TRADE INFORMATION SERVICES, NAMELY, PROVIDING TRADE INFORMATION; PUBLIC OPINION POLLING SERVICES; DATA PROCESSING SERVICES AND MARKET DATA ANALYSIS SERVICES, IN CLASS 35 (U.S. CLS. 100, 101 AND 102).

FIRST USE 12-0-2009; IN COMMERCE 12-0-2009.

THE MARK CONSISTS OF STANDARD CHARACTERS WITHOUT CLAIM TO ANY PARTICULAR FONT, STYLE, SIZE, OR COLOR.

OWNER OF U.S. REG. NO. 2,149,876.

NO CLAIM IS MADE TO THE EXCLUSIVE RIGHT TO USE "RETAIL", APART FROM THE MARK AS SHOWN.

SER. NO. 85-273,238, FILED 3-22-2011.

COURTNEY ALVAREZ, EXAMINING ATTORNEY



David J. Kyros

Director of the United States Patent and Trademark Office

United States of America

United States Patent and Trademark Office

VEGAN EXPRESSIONS

Reg. No. 4,073,383

Registered Dec. 20, 2011

Int. Cl.: 30

TRADEMARK

PRINCIPAL REGISTER

GOLDSMITH, BRIDGET (UNITED STATES INDIVIDUAL)
821 NOSTRAND AVENUE
BROOKLYN, NY 11225

FOR: ICE-CREAM, IN CLASS 30 (U.S. CL. 46).

FIRST USE 4-1-2010; IN COMMERCE 4-1-2010.

THE MARK CONSISTS OF STANDARD CHARACTERS WITHOUT CLAIM TO ANY PARTICULAR FONT, STYLE, SIZE, OR COLOR.

OWNER OF U.S. REG. NO. 3,889,730.

NO CLAIM IS MADE TO THE EXCLUSIVE RIGHT TO USE "VEGAN", APART FROM THE MARK AS SHOWN.

SER. NO. 85-273,376, FILED 3-22-2011.

C. DIONNE CLYBURN, EXAMINING ATTORNEY



David J. Kyffers

Director of the United States Patent and Trademark Office

United States of America

United States Patent and Trademark Office

NATURE'S BEST SOLUTION

Reg. No. 4,073,384

BIOLARGO, INC. (CALIFORNIA CORPORATION)
16333 PHOEBE AVENUE
LA MIRADA, CA 90638

Registered Dec. 20, 2011

Int. Cls.: 1 and 5

FOR: CHEMICALS FOR THE TREATMENT OF WATER AND WASTEWATER; SOLUTIONS FOR CONTAMINATED WATER, NAMELY, IODINE FOR INDUSTRIAL CHEMICAL PURPOSES, IN CLASS 1 (U.S. CLS. 1, 5, 6, 10, 26 AND 46).

TRADEMARK

FIRST USE 6-19-2009; IN COMMERCE 6-19-2009.

PRINCIPAL REGISTER

FOR: ALL PURPOSE DISINFECTANTS, IN CLASS 5 (U.S. CLS. 6, 18, 44, 46, 51 AND 52).

FIRST USE 2-6-2009; IN COMMERCE 2-6-2009.

THE MARK CONSISTS OF STANDARD CHARACTERS WITHOUT CLAIM TO ANY PARTICULAR FONT, STYLE, SIZE, OR COLOR.

NO CLAIM IS MADE TO THE EXCLUSIVE RIGHT TO USE "BEST SOLUTION", APART FROM THE MARK AS SHOWN.

SER. NO. 85-273,431, FILED 3-22-2011.

LESLEY LAMOTHE, EXAMINING ATTORNEY



David J. Kyffers

Director of the United States Patent and Trademark Office

United States of America

United States Patent and Trademark Office

US Liquids of Louisiana

Reg. No. 4,073,385

US LIQUIDS OF LA, L.P. (DELAWARE LIMITED PARTNERSHIP)
16945 NORTHCHASE DRIVE, SUITE 2200
HOUSTON, TX 77060

Registered Dec. 20, 2011

Int. Cls.: 37, 39 and 40

FOR: ENVIRONMENTAL REMEDIATION SERVICES, NAMELY, WASTE DISPOSAL;
WASTE OIL COLLECTION FOR RECYCLING, IN CLASS 37 (U.S. CLS. 100, 103 AND 106).

SERVICE MARK

FIRST USE 0-0-1996; IN COMMERCE 0-0-1996.

PRINCIPAL REGISTER

FOR: RECYCLED WATER DISTRIBUTION SERVICES FOR OTHERS, IN CLASS 39 (U.S. CLS. 100 AND 105).

FIRST USE 0-0-1996; IN COMMERCE 0-0-1996.

FOR: ENVIRONMENTAL REMEDIATION SERVICES, NAMELY, SOIL, WASTE AND/OR WATER TREATMENT SERVICES; PROVISION OF INFORMATION, ADVICE AND CONSULTANCY IN RELATION TO THE PRODUCTION OF ENERGY, AND THE TREATMENT, MANAGEMENT, RECYCLING, TRANSFORMATION AND INCINERATION OF WASTE; RECYCLING; RECYCLING OF WASTE; SUSTAINABLE ON-SITE WATER RECYCLING AND WASTEWATER TREATMENT SERVICES; TREATMENT OF WASTE WATER; WASTE WATER REPROCESSING; WASTE WATER TREATMENT SERVICES; WASTE WATER TREATMENT SERVICES FOR INDUSTRIAL PURPOSES; WATER RECYCLING AND DESALINATION SERVICES, IN CLASS 40 (U.S. CLS. 100, 103 AND 106).

FIRST USE 0-0-1996; IN COMMERCE 0-0-1996.

THE MARK CONSISTS OF STANDARD CHARACTERS WITHOUT CLAIM TO ANY PARTICULAR FONT, STYLE, SIZE, OR COLOR.

NO CLAIM IS MADE TO THE EXCLUSIVE RIGHT TO USE "LIQUIDS", APART FROM THE MARK AS SHOWN.

SEC. 2(F).

SER. NO. 85-273,479, FILED 3-22-2011.

LOURDES AYALA, EXAMINING ATTORNEY



David J. Kyfos

Director of the United States Patent and Trademark Office

United States of America

United States Patent and Trademark Office

The Essentials

Reg. No. 4,073,386

HAROLD IMPORT COMPANY INC. (NEW JERSEY CORPORATION)
747 VASSAR AVENUE
LAKEWOOD, NJ 08701

Registered Dec. 20, 2011

Int. Cls.: 8 and 21

FOR: HOUSEHOLD UTENSILS, NAMELY, COOKING SPOONS, TABLE FORKS AND LADLES FOR WINE; HOUSEHOLD GRABBERS, NAMELY, ICE TONGS, IN CLASS 8 (U.S. CLS. 23, 28 AND 44).

TRADEMARK

FIRST USE 1-5-2010; IN COMMERCE 1-5-2010.

PRINCIPAL REGISTER

FOR: HOUSEHOLD UTENSILS, NAMELY, SPATULA, COLANDER, STRAINER, SPLATTER SCREEN, MUFFIN PAN, CAKE PAN, LOAF PAN, BUNDT PAN, SKIMMER, TURNER, STAINLESS STEEL SERVING FORK AND SPOON, SERVING LADLE, MIXING BOWL, A GRABBER, NAMELY, A SERVING TONG, SILICONE TRIVET, SCRAPER, TRIVET, SILICONE BRUSH, SPOON SPATULA, IN CLASS 21 (U.S. CLS. 2, 13, 23, 29, 30, 33, 40 AND 50).

FIRST USE 1-1-2010; IN COMMERCE 1-1-2010.

THE MARK CONSISTS OF STANDARD CHARACTERS WITHOUT CLAIM TO ANY PARTICULAR FONT, STYLE, SIZE, OR COLOR.

SER. NO. 85-273,564, FILED 3-22-2011.

HANNO RITTNER, EXAMINING ATTORNEY



David J. Kyros

Director of the United States Patent and Trademark Office

United States of America

United States Patent and Trademark Office

DEADTIME STORIES

Reg. No. 4,073,387

CASCONE, ANNETTE (UNITED STATES INDIVIDUAL)
266 JEFFERSON AVENUE
RAHWAY, NJ 07065 AND

Registered Dec. 20, 2011

Int. Cl.: 16

CASCONE, GINA (UNITED STATES INDIVIDUAL)
17 PADDOCK DRIVE
LAWRENCEVILLE, NJ 08648

TRADEMARK

PRINCIPAL REGISTER

FOR: CHILDREN'S BOOKS, IN CLASS 16 (U.S. CLS. 2, 5, 22, 23, 29, 37, 38 AND 50).

FIRST USE 7-0-1995; IN COMMERCE 7-0-1996.

THE MARK CONSISTS OF STANDARD CHARACTERS WITHOUT CLAIM TO ANY PARTICULAR FONT, STYLE, SIZE, OR COLOR.

NO CLAIM IS MADE TO THE EXCLUSIVE RIGHT TO USE "STORIES", APART FROM THE MARK AS SHOWN.

SER. NO. 85-273,650, FILED 3-22-2011.

MARK PILARO, EXAMINING ATTORNEY



David J. Kybas

Director of the United States Patent and Trademark Office

United States of America

United States Patent and Trademark Office

CyberWolf

Reg. No. 4,073,388

Registered Dec. 20, 2011

Int. Cl.: 42

SERVICE MARK

PRINCIPAL REGISTER

CYBERWOLF INC. (NEW MEXICO CORPORATION)
1596 PACHECO STREET #203
SANTA FE, NM 87505

FOR: COMPUTER SERVICES, NAMELY, REMOTE AND ON-SITE MANAGEMENT OF CLOUD COMPUTING SYSTEMS AND APPLICATIONS FOR OTHERS; COMPUTER SERVICES, NAMELY, REMOTE AND ON-SITE MANAGEMENT OF THE INFORMATION TECHNOLOGY (IT) CLOUD COMPUTING SYSTEMS OF OTHERS; COMPUTER SOFTWARE DEVELOPMENT; COMPUTER SOFTWARE DEVELOPMENT, COMPUTER PROGRAMMING AND MAINTENANCE OF COMPUTER SOFTWARE FOR PUBLISHERS, IN CLASS 42 (U.S. CLS. 100 AND 101).

FIRST USE 1-25-2000; IN COMMERCE 2-2-2000.

THE MARK CONSISTS OF STANDARD CHARACTERS WITHOUT CLAIM TO ANY PARTICULAR FONT, STYLE, SIZE, OR COLOR.

SER. NO. 85-273,657, FILED 3-22-2011.

STEVEN JACKSON, EXAMINING ATTORNEY



David J. Kyffers

Director of the United States Patent and Trademark Office

United States of America
United States Patent and Trademark Office

POP'N BITES

Reg. No. 4,073,389

Registered Dec. 20, 2011

Int. Cl.: 31

TRADEMARK

PRINCIPAL REGISTER

CROSSWIND INDUSTRIES, INC. (KANSAS CORPORATION)
SUITE 220
10502 NW AMBASSADOR DRIVE
KANSAS CITY, MO 64153

FOR: PET TREATS, IN CLASS 31 (U.S. CLS. 1 AND 46).

FIRST USE 5-26-2011; IN COMMERCE 5-26-2011.

THE MARK CONSISTS OF STANDARD CHARACTERS WITHOUT CLAIM TO ANY PARTICULAR FONT, STYLE, SIZE, OR COLOR.

NO CLAIM IS MADE TO THE EXCLUSIVE RIGHT TO USE "BITES", APART FROM THE MARK AS SHOWN.

SER. NO. 85-274,040, FILED 3-22-2011.

SHAILA SETTLES, EXAMINING ATTORNEY



David J. Kyffers

Director of the United States Patent and Trademark Office

United States of America

United States Patent and Trademark Office

FERCO AEROSPACE GROUP

Reg. No. 4,073,390

FERCO TECH CORPORATION (OHIO CORPORATION)
231 CONOVER DR.

Registered Dec. 20, 2011

FRANKLIN, OH 45005

Int. Cls.: 6, 35 and 37

FOR: GAS TURBINE ENGINE SHEET METAL FABRICATIONS, METAL BRACKETS AND METAL TUBES AND TUBE ASSEMBLIES FOR USE IN THE MEDICAL, TRANSPORTATION, AND ENERGY INDUSTRIES, IN CLASS 6 (U.S. CLS. 2, 12, 13, 14, 23, 25 AND 50).

TRADEMARK

FIRST USE 3-0-2011; IN COMMERCE 7-27-2011.

SERVICE MARK

FOR: DISTRIBUTORSHIP SERVICES IN THE FIELD OF GAS TURBINE ENGINE SHEET METAL FABRICATIONS, METAL BRACKETS AND METAL TUBES AND TUBE ASSEMBLIES FOR USE IN THE MEDICAL, TRANSPORTATION, AND ENERGY INDUSTRIES, IN CLASS 35 (U.S. CLS. 100, 101 AND 102).

PRINCIPAL REGISTER

FIRST USE 3-0-2011; IN COMMERCE 7-27-2011.

FOR: PROVIDING TECHNICAL SUPPORT SERVICES, NAMELY, TECHNICAL ADVICE CONCERNING THE INSTALLATION, REPAIR AND MAINTENANCE OF GAS TURBINE ENGINE SHEET METAL FABRICATIONS, METAL BRACKETS AND METAL TUBE AND TUBE ASSEMBLIES, IN CLASS 37 (U.S. CLS. 100, 103 AND 106).

FIRST USE 3-0-2011; IN COMMERCE 7-27-2011.

THE MARK CONSISTS OF STANDARD CHARACTERS WITHOUT CLAIM TO ANY PARTICULAR FONT, STYLE, SIZE, OR COLOR.

NO CLAIM IS MADE TO THE EXCLUSIVE RIGHT TO USE "AEROSPACE GROUP", APART FROM THE MARK AS SHOWN.

SER. NO. 85-274,676, FILED 3-23-2011.

STEVEN JACKSON, EXAMINING ATTORNEY



David J. Kyfos

Director of the United States Patent and Trademark Office

United States of America

United States Patent and Trademark Office

EUROGESTION

Reg. No. 4,073,391

EUROGESTION & PARTNERS S.A. (SWITZERLAND CORPORATION)
RUE DE MUZY

Registered Dec. 20, 2011

8 CH - 1207 GENEVA, SWITZERLAND

Int. Cls.: 35, 36 and 39

FOR: ADVERTISING; BUSINESS MANAGEMENT; MANAGEMENT RELATING TO HOTELS; MANAGEMENT RELATING TO RESTAURANTS; MANAGEMENT RELATING TO BARS; BUSINESS MANAGEMENT, NAMELY, INTERIM MANAGEMENT OF COMPANIES; ACCOUNTING, ACCOUNTING ADVICE, ACCOUNTING ADVICE ON TAX; BUSINESS ADMINISTRATION; PROVIDING OFFICE FUNCTIONS; ADVERTISING SERVICES PROVIDED VIA THE INTERNET; ACCOUNTANCY; AUCTIONEERING; CONSULTATION RELATING TO TRADE FAIRS; PUBLIC OPINION POLLING; MARKET OPINION POLLING; DATA PROCESSING; PROVISION OF BUSINESS INFORMATION; BUSINESS CONSULTING AND ADVICE CONNECTED WITH THE SALE OF GOODS AND COMMODITIES, IRON ORE, CRUDE OIL, COAL, ETHANOL, SUGAR, COFFEE BEANS, CHOCOLATE, CHOCOLATES, SOYBEANS, ALUMINUM, RICE, WHEAT, GOLD AND SILVER, FARM PRODUCTS, PRECIOUS METALS, PRECIOUS STONES, JEWELS, METALS, TEA, SUGAR, MEDICAL EQUIPMENT; RETAIL SERVICES BY DIRECT SOLICITATION BY SALES AGENTS IN THE FIELD OF GOODS AND COMMODITIES, NAMELY, IRON ORE, CRUDE OIL, COAL, ETHANOL, SUGAR, COFFEE BEANS, CHOCOLATE, CHOCOLATES, SOYBEANS, ALUMINUM, RICE, WHEAT, GOLD AND SILVER, FARM PRODUCTS, PRECIOUS METALS, PRECIOUS STONES, JEWELS, METALS, TEA, SUGAR, MEDICAL EQUIPMENT; MARKETING CONSULTATION IN FIELD OF INVESTMENT MANAGEMENT, IN CLASS 35 (U.S. CLS. 100, 101 AND 102).

SERVICE MARK

PRINCIPAL REGISTER



David J. Kybas

Director of the United States Patent and Trademark Office

FOR: INSURANCE AGENCIES; INSURANCE BROKERAGE; INSURANCE ADMINISTRATION; INSURANCE UNDERWRITING IN THE FIELD OF COMMODITIES, ACCIDENT, FIRE, SALVAGE; ADMINISTRATION OF EMPLOYEE PENSION PLAN, MANAGEMENT OF PENSION FUNDS, FINANCIAL ADVICE NAMELY ADMINISTRATION OF PENSION FUNDS, ACTUARIAL SERVICES; FINANCIAL SERVICES, NAMELY, ADMINISTRATION OF FINANCIAL PORTFOLIOS, ADMINISTRATION OF HEDGE FUNDS, ADMINISTRATION OF PENSIONS, ADMINISTRATION OF REAL ESTATE FUNDS; BANKING; FUNDS INVESTMENT; STOCK BROKERAGE; FINANCIAL SERVICES PROVIDED VIA THE INTERNET, NAMELY, ADMINISTRATION OF FINANCIAL PORTFOLIOS, ADMINISTRATION OF HEDGE FUNDS, ADMINISTRATION OF PENSIONS, ADMINISTRATION OF REAL ESTATE FUNDS, ACTUARIAL ADVICE TO PENSION FUNDS; HEDGE FUND INVESTMENT SERVICES; PRIVATE PLACEMENT OF HEDGE FUNDS FOR OTHERS; AGENCY FOR COMMODITIES FUTURES TRADING; PROVISION OF FINANCIAL INFORMATION; INVEST-

Reg. No. 4,073,391 MENT ADVISORY SERVICES, MANAGEMENT OF A CAPITAL INVESTMENT FUND, MANAGEMENT OF PRIVATE EQUITY FUNDS; MUTUAL FUND DISTRIBUTION; GOODS AND COMMODITIES BROKERAGE SERVICES CONNECTED WITH IRON ORE, CRUDE OIL, COAL, ETHANOL, SUGAR, COFFEE BEANS, CHOCOLATE, CHOCOLATES, SOY-BEANS, ALUMINUM, RICE, WHEAT, GOLD AND SILVER, FARM PRODUCTS, PRECIOUS METALS, PRECIOUS STONES, JEWELS, METALS, TEA, SUGAR, MEDICAL EQUIPMENT; FINANCIAL CONSULTING AND ADVICE IN RELATION TO THE FOREGOING, IN CLASS 36 (U.S. CLS. 100, 101 AND 102).

FOR: ELECTRONIC DATA STORAGE, IN CLASS 39 (U.S. CLS. 100 AND 105).

THE MARK CONSISTS OF STANDARD CHARACTERS WITHOUT CLAIM TO ANY PARTICULAR FONT, STYLE, SIZE, OR COLOR.

OWNER OF ERPN CMNTY TM OFC REG. NO. 008156581, DATED 10-7-2009, EXPIRES 3-13-2019.

SER. NO. 85-274,685, FILED 3-23-2011.

KAREN SEVERSON, EXAMINING ATTORNEY

United States of America

United States Patent and Trademark Office

Barnabas Prayer

Reg. No. 4,073,392

Registered Dec. 20, 2011

Int. Cl.: 16

TRADEMARK

PRINCIPAL REGISTER

BARNABAS FUND (VIRGINIA CORPORATION), DBA BARNABAS AID
6731 CURRAN STREET
MCLEAN, VA 22101

FOR: MAGAZINES FEATURING DIARIES OF PRAYER POINTS AND INFORMATION ABOUT PROGRAMS CONCERNING AND PROVIDING PRACTICAL HELP TO CHRISTIANS IN MUSLIM ENVIRONMENTS, BRINGING HOPE AND AID TO THE PERSECUTED CHURCH IN OVER 50 COUNTRIES AND OFFERING INFORMATION AND EDUCATION ON MUSLIM PRACTICES AROUND THE WORLD AND THE PLIGHT OF CHRISTIANS IN MUSLIM-MAJORITY COUNTRIES, IN CLASS 16 (U.S. CLS. 2, 5, 22, 23, 29, 37, 38 AND 50).

FIRST USE 3-1-2005; IN COMMERCE 3-1-2005.

THE MARK CONSISTS OF STANDARD CHARACTERS WITHOUT CLAIM TO ANY PARTICULAR FONT, STYLE, SIZE, OR COLOR.

OWNER OF U.S. REG. NOS. 3,610,907 AND 3,748,088.

NO CLAIM IS MADE TO THE EXCLUSIVE RIGHT TO USE "PRAYER", APART FROM THE MARK AS SHOWN.

SER. NO. 85-275,370, FILED 3-24-2011.

TIMOTHY FINNEGAN, EXAMINING ATTORNEY



David J. Kyros

Director of the United States Patent and Trademark Office

United States of America

United States Patent and Trademark Office

GREAT AMERICAN LINES

Reg. No. 4,073,393

Registered Dec. 20, 2011

Int. Cl.: 39

SERVICE MARK

PRINCIPAL REGISTER

GREAT AMERICAN LINES, INC. (DELAWARE CORPORATION)
5 BECKER FARM ROAD
ROSELAND, NJ 07068

FOR: FREIGHT TRANSPORTATION BY SHIP, IN CLASS 39 (U.S. CLS. 100 AND 105).

FIRST USE 12-31-1978; IN COMMERCE 12-31-1978.

THE MARK CONSISTS OF STANDARD CHARACTERS WITHOUT CLAIM TO ANY PARTICULAR FONT, STYLE, SIZE, OR COLOR.

NO CLAIM IS MADE TO THE EXCLUSIVE RIGHT TO USE "LINES", APART FROM THE MARK AS SHOWN.

SEC. 2(F).

SER. NO. 85-275,402, FILED 3-24-2011.

WENDY JUN, EXAMINING ATTORNEY



David J. Kyffers

Director of the United States Patent and Trademark Office

United States of America

United States Patent and Trademark Office

BE NEXT

Reg. No. 4,073,394

EARL G. GRAVES PUBLISHING CO. (NEW YORK CORPORATION)
130 FIFTH AVENUE
NEW YORK, NY 10011

Registered Dec. 20, 2011

Int. Cl.: 16

FOR: MAGAZINE COLUMNS ON TOPICS OF INTEREST TO BUSINESS LEADERS COMPRISED OF ENTREPRENEURS, CORPORATE PROFESSIONALS AND TECHNOLOGY INNOVATORS FEATURING A GROUP OF BUSINESS LEADERS COMPRISED OF ENTREPRENEURS, CORPORATE PROFESSIONALS AND TECHNOLOGY INNOVATORS, IN CLASS 16 (U.S. CLS. 2, 5, 22, 23, 29, 37, 38 AND 50).

TRADEMARK

PRINCIPAL REGISTER

FIRST USE 1-31-2010; IN COMMERCE 1-31-2010.

THE MARK CONSISTS OF THE WORDS "BE NEXT", WHERE THE "X" CONTAINS A STYLIZED HIGHWAY DESIGN.

SER. NO. 85-275,429, FILED 3-24-2011.

LINDA ORNDORFF, EXAMINING ATTORNEY



David J. Kyffers

Director of the United States Patent and Trademark Office

United States of America

United States Patent and Trademark Office

LOANCIERGE

Reg. No. 4,073,395

Registered Dec. 20, 2011

Int. Cls.: 9 and 42

TRADEMARK

SERVICE MARK

PRINCIPAL REGISTER

FISERV, INC. (WISCONSIN CORPORATION)
255 FISERV DRIVE
BROOKFIELD, WI 53045

FOR: COMPUTER SOFTWARE FOR ACCOUNT AND DATA PROCESSING, PREPARATION AND GENERATION OF DOCUMENTS, MANAGING BUSINESS PROCESSES AND BUSINESS WORKFLOWS, AND TRACKING, SEARCHING AND CLOSING LOAN APPLICATIONS FOR USE BY CREDIT UNIONS IN THE FIELD OF CONSUMER LOAN ORIGINATION, IN CLASS 9 (U.S. CLS. 21, 23, 26, 36 AND 38).

FIRST USE 9-9-2008; IN COMMERCE 9-9-2008.

FOR: APPLICATION SERVICE PROVIDER (ASP) FEATURING COMPUTER SOFTWARE FOR ACCOUNT AND DATA PROCESSING, PREPARATION AND GENERATION OF DOCUMENTS, MANAGING BUSINESS PROCESSES AND BUSINESS WORKFLOWS, AND TRACKING, SEARCHING AND CLOSING LOAN APPLICATIONS FOR USE BY CREDIT UNIONS IN THE FIELD OF CONSUMER LOAN ORIGINATION, IN CLASS 42 (U.S. CLS. 100 AND 101).

FIRST USE 9-9-2008; IN COMMERCE 9-9-2008.

THE MARK CONSISTS OF STANDARD CHARACTERS WITHOUT CLAIM TO ANY PARTICULAR FONT, STYLE, SIZE, OR COLOR.

SER. NO. 85-275,598, FILED 3-24-2011.

JUDITH HELFMAN, EXAMINING ATTORNEY



David J. Kyros

Director of the United States Patent and Trademark Office

United States of America

United States Patent and Trademark Office

JIM PORTER

Reg. No. 4,073,396

LA REPUBLICANA S.A. (URUGUAY JOINT STOCK COMPANY)
CNEL. FRANCISCO TAJES 1125
MONTEVIDEO, URUGUAY

Registered Dec. 20, 2011

Int. Cl.: 34

FOR: CIGARETTES, IN CLASS 34 (U.S. CLS. 2, 8, 9 AND 17).

TRADEMARK

THE MARK CONSISTS OF STANDARD CHARACTERS WITHOUT CLAIM TO ANY PARTICULAR FONT, STYLE, SIZE, OR COLOR.

PRINCIPAL REGISTER

OWNER OF URUGUAY REG. NO. 88955, DATED 5-22-1964, EXPIRES 6-10-2013.

THE NAME(S), PORTRAIT(S), AND/OR SIGNATURE(S) SHOWN IN THE MARK DOES NOT IDENTIFY A PARTICULAR LIVING INDIVIDUAL.

SER. NO. 85-275,618, FILED 3-24-2011.

DAVID TAYLOR, EXAMINING ATTORNEY



David J. Kyffers

Director of the United States Patent and Trademark Office

United States of America

United States Patent and Trademark Office

AOPL

Association of Oil Pipe Lines

Reg. No. 4,073,397

Registered Dec. 20, 2011

Int. Cl.: 35

SERVICE MARK

PRINCIPAL REGISTER

ASSOCIATION OF OIL PIPE LINES (D.C. INCORPORATED ASSOCIATION), AKA AOPL
1808 EYE ST NW
SUITE 300
WASHINGTON, DC 20006

FOR: TRADE ASSOCIATION SERVICES, NAMELY, PROMOTING THE INTERESTS OF OPERATORS OF LIQUIDS PIPELINE COMPANIES, IN CLASS 35 (U.S. CLS. 100, 101 AND 102).

FIRST USE 6-4-2007; IN COMMERCE 6-4-2007.

NO CLAIM IS MADE TO THE EXCLUSIVE RIGHT TO USE "ASSOCIATION OF OIL PIPE LINES", APART FROM THE MARK AS SHOWN.

THE COLOR(S) BLUE, WHITE IS/ARE CLAIMED AS A FEATURE OF THE MARK.

THE MARK CONSISTS OF THE LETTERS "AOPL"; THE COLOR BLUE USED TO SPELL OUT "AOPL" AND COLORING AN IMAGE OF A PIPE BELOW THE LETTERS; AND A PIPE REPRESENTATION (DESIGN CODE 14.01.01) ON THE BOTTOM OF THE LOGO, UNDERLINING "AOPL".

SER. NO. 85-275,649, FILED 3-24-2011.

INGA ERVIN, EXAMINING ATTORNEY



David J. Kyros

Director of the United States Patent and Trademark Office

United States of America

United States Patent and Trademark Office

Zapped the App

Reg. No. 4,073,398

Registered Dec. 20, 2011

Int. Cl.: 38

SERVICE MARK

PRINCIPAL REGISTER

MOBILE2METRICS (DELAWARE CORPORATION)
66 HULL ROAD
BERNARDSVILLE, NJ 07924

FOR: WIRELESS DIGITAL MESSAGING SERVICES, IN CLASS 38 (U.S. CLS. 100, 101 AND 104).

FIRST USE 1-15-2011; IN COMMERCE 1-15-2011.

THE MARK CONSISTS OF STANDARD CHARACTERS WITHOUT CLAIM TO ANY PARTICULAR FONT, STYLE, SIZE, OR COLOR.

NO CLAIM IS MADE TO THE EXCLUSIVE RIGHT TO USE "APP", APART FROM THE MARK AS SHOWN.

SER. NO. 85-275,734, FILED 3-24-2011.

JOHN GARTNER, EXAMINING ATTORNEY



David J. Kybas

Director of the United States Patent and Trademark Office

United States of America

United States Patent and Trademark Office

TADAH

Reg. No. 4,073,399

Registered Dec. 20, 2011

Int. Cl.: 30

TRADEMARK

PRINCIPAL REGISTER

EAT GOOD DO GOOD, LLC (VIRGINIA LIMITED LIABILITY COMPANY)
6020 KATELYN CT.
ALEXANDRIA, VA 22310

FOR: FALAFEL SANDWICH WRAPS, IN CLASS 30 (U.S. CL. 46).

FIRST USE 1-15-2011; IN COMMERCE 3-10-2011.

THE MARK CONSISTS OF STANDARD CHARACTERS WITHOUT CLAIM TO ANY PARTICULAR FONT, STYLE, SIZE, OR COLOR.

SER. NO. 85-276,453, FILED 3-25-2011.

CHRIS WELLS, EXAMINING ATTORNEY



David J. Kyffers

Director of the United States Patent and Trademark Office

United States of America

United States Patent and Trademark Office

DIGITAL EVENT STRATEGIST

Reg. No. 4,073,400

VIRTUAL EDGE INSTITUTE, BIZ DEV GROUP, INC. (NEVADA CORPORATION)
340 MULLIN CT
PLEASANTON, CA 94566

Registered Dec. 20, 2011

Int. Cl.: 41

FOR: BUSINESS EDUCATION SERVICES, NAMELY, PROVIDING TRAINING COURSES IN THE FIELD OF DIGITAL ENVIRONMENTS FOR EVENTS, MEETINGS, MARKETING AND LEARNING, IN CLASS 41 (U.S. CLS. 100, 101 AND 107).

SERVICE MARK

FIRST USE 1-4-2011; IN COMMERCE 2-28-2011.

PRINCIPAL REGISTER

THE MARK CONSISTS OF STANDARD CHARACTERS WITHOUT CLAIM TO ANY PARTICULAR FONT, STYLE, SIZE, OR COLOR.

NO CLAIM IS MADE TO THE EXCLUSIVE RIGHT TO USE "DIGITAL EVENT", APART FROM THE MARK AS SHOWN.

SER. NO. 85-276,464, FILED 3-25-2011.

ANNE MADDEN, EXAMINING ATTORNEY



David J. Kyffers

Director of the United States Patent and Trademark Office

United States of America

United States Patent and Trademark Office

EMUMAGIC

Reg. No. 4,073,401

CONSTANS, GEORGE (UNITED STATES INDIVIDUAL)
24200 FAIRWOOD LANE
NEVIS, MN 56467

Registered Dec. 20, 2011

Int. Cl.: 3

FOR: NON-MEDICATED SKIN CARE PREPARATIONS, FACE AND BODY LOTIONS, LIP BALM, SKIN SOAPS, HAND SOAPS, BAR SOAP, SHAMPOOS, ALL DERIVED FROM EMU OIL, IN CLASS 3 (U.S. CLS. 1, 4, 6, 50, 51 AND 52).

TRADEMARK

FIRST USE 3-5-1997; IN COMMERCE 3-5-1997.

PRINCIPAL REGISTER

THE MARK CONSISTS OF STANDARD CHARACTERS WITHOUT CLAIM TO ANY PARTICULAR FONT, STYLE, SIZE, OR COLOR.

OWNER OF U.S. REG. NO. 3,138,349.

SER. NO. 85-276,490, FILED 3-25-2011.

CORY BOONE, EXAMINING ATTORNEY



David J. Kyffers

Director of the United States Patent and Trademark Office

United States of America

United States Patent and Trademark Office

Transforming Transportation

Reg. No. 4,073,402

Registered Dec. 20, 2011

Int. Cl.: 41

SERVICE MARK

PRINCIPAL REGISTER

WORLD RESOURCES INSTITUTE (DELAWARE NON-PROFIT CORPORATION), AKA WRI
SUITE 800
10 G STREET NE
WASHINGTON, DC 20002

FOR: CONVENING SENIOR DECISION MAKERS AND TRANSPORT EXPERTS FROM
AROUND THE WORLD TO SHARE THE LATEST EXPERIENCE AND INFORMATION IN
SUSTAINABLE TRANSPORTATION, AIR QUALITY, AND CLIMATE PROTECTION,
NAMELY, PROVIDING WORKSHOPS, ONLINE CONFERENCES AND TRAININGS IN THE
FIELD OF SUSTAINABLE TRANSPORTATION, AIR QUALITY AND CLIMATE PROTEC-
TION, IN CLASS 41 (U.S. CLS. 100, 101 AND 107).

FIRST USE 0-0-2004; IN COMMERCE 0-0-2004.

THE MARK CONSISTS OF STANDARD CHARACTERS WITHOUT CLAIM TO ANY PAR-
TICULAR FONT, STYLE, SIZE, OR COLOR.

NO CLAIM IS MADE TO THE EXCLUSIVE RIGHT TO USE "TRANSPORTATION", APART
FROM THE MARK AS SHOWN.

SER. NO. 85-276,538, FILED 3-25-2011.

INGRID C. EULIN, EXAMINING ATTORNEY



David J. Kyros

Director of the United States Patent and Trademark Office

United States of America

United States Patent and Trademark Office

SMARTJOG

Reg. No. 4,073,403

SMARTJOG USA, INC. (DELAWARE CORPORATION)
10351 SANTA MONICA BLVD., SUITE 404
LOS ANGELES, CA 90025

Registered Dec. 20, 2011

Int. Cls.: 9, 38, 39 and 42

FOR: COMPUTER SERVERS, NAMELY, DATA PROCESSING, GATEWAY AND DATA STORAGE COMPUTER SERVERS, IN CLASS 9 (U.S. CLS. 21, 23, 26, 36 AND 38).

TRADEMARK

FIRST USE 8-13-2002; IN COMMERCE 8-13-2002.

SERVICE MARK

FOR: COMMUNICATIONS SERVICES, NAMELY, THE ELECTRONIC TRANSMISSION OF DATA IN THE NATURE OF DIGITAL MEDIA CONTENT VIA A COMMUNICATIONS NETWORK; ELECTRONIC TRANSMISSION AND STREAMING OF DIGITAL MEDIA CONTENT FOR OTHERS VIA GLOBAL AND LOCAL COMMUNICATIONS NETWORKS; VIDEO-ON-DEMAND AND AUDIO-ON-DEMAND TRANSMISSION SERVICES, IN CLASS 38 (U.S. CLS. 100, 101 AND 104).

PRINCIPAL REGISTER

FIRST USE 8-13-2002; IN COMMERCE 8-13-2002.

FOR: ELECTRONIC DATA STORAGE FOR CUSTOMERS VIA GLOBAL AND LOCAL COMMUNICATIONS NETWORKS, IN CLASS 39 (U.S. CLS. 100 AND 105).

FIRST USE 8-13-2002; IN COMMERCE 8-13-2002.

FOR: PROVIDING VIRTUAL COMPUTER SYSTEMS AND VIRTUAL COMPUTER ENVIRONMENTS THROUGH CLOUD COMPUTING; COMPUTER SERVICES, NAMELY, CLOUD HOSTING PROVIDER SERVICES, IN CLASS 42 (U.S. CLS. 100 AND 101).

FIRST USE 8-13-2002; IN COMMERCE 8-13-2002.

THE MARK CONSISTS OF STANDARD CHARACTERS WITHOUT CLAIM TO ANY PARTICULAR FONT, STYLE, SIZE, OR COLOR.

SER. NO. 85-276,560, FILED 3-25-2011.

ELI HELLMAN, EXAMINING ATTORNEY



David J. Kyros

Director of the United States Patent and Trademark Office

United States of America

United States Patent and Trademark Office

MEDSOL

Reg. No. 4,073,404

PSS WORLD MEDICAL, INC. (FLORIDA CORPORATION)
4345 SOUTHPOINT BOULEVARD
JACKSONVILLE, FL 32216

Registered Dec. 20, 2011

Int. Cl.: 35

FOR: BUSINESS CONSULTING SERVICES IN THE FIELD OF CLINICAL LABORATORIES,
IN CLASS 35 (U.S. CLS. 100, 101 AND 102).

SERVICE MARK

FIRST USE 0-0-2003; IN COMMERCE 0-0-2003.

PRINCIPAL REGISTER

THE MARK CONSISTS OF STANDARD CHARACTERS WITHOUT CLAIM TO ANY PARTICULAR FONT, STYLE, SIZE, OR COLOR.

SER. NO. 85-276,841, FILED 3-25-2011.

AMY C. KEAN, EXAMINING ATTORNEY



David J. Kappas

Director of the United States Patent and Trademark Office

United States of America

United States Patent and Trademark Office

CALLED TO SERVE SENIORS

Reg. No. 4,073,405

Registered Dec. 20, 2011

Int. Cls.: 43 and 44

SERVICE MARK

PRINCIPAL REGISTER

ALBRIGHT CARE SERVICES (PENNSYLVANIA CORPORATION)
90 MAPLEWOOD DRIVE
LEWISBURG, PA 17837

FOR: PROVIDING ASSISTED AND INDEPENDENT LIVING FACILITIES FOR SENIORS,
IN CLASS 43 (U.S. CLS. 100 AND 101).

FIRST USE 2-0-2011; IN COMMERCE 2-0-2011.

FOR: PROVIDING NURSING CARE AND SHORT-TERM PHYSICAL REHABILITATION
FOR SENIORS, IN CLASS 44 (U.S. CLS. 100 AND 101).

FIRST USE 2-0-2011; IN COMMERCE 2-0-2011.

THE MARK CONSISTS OF STANDARD CHARACTERS WITHOUT CLAIM TO ANY PAR-
TICULAR FONT, STYLE, SIZE, OR COLOR.

NO CLAIM IS MADE TO THE EXCLUSIVE RIGHT TO USE "SENIORS", APART FROM THE
MARK AS SHOWN.

SER. NO. 85-276,912, FILED 3-25-2011.

LAURA KOVALSKY, EXAMINING ATTORNEY



David J. Kybas

Director of the United States Patent and Trademark Office

United States of America

United States Patent and Trademark Office

MY STUDENT CENTER

Reg. No. 4,073,406

Registered Dec. 20, 2011

Int. Cl.: 41

SERVICE MARK

PRINCIPAL REGISTER

NATIONAL STUDENT CLEARINGHOUSE (VIRGINIA NON-PROFIT CORPORATION)
SUITE 300
2300 DULLES STATION BLVD.
HERNDON, VA 20171

FOR: PROVIDING ONLINE INFORMATION AND DATABASES REGARDING POST-SECONDARY STUDENT ENROLLMENT AND EDUCATIONAL ACHIEVEMENT, IN CLASS 41 (U.S. CLS. 100, 101 AND 107).

FIRST USE 3-2-2011; IN COMMERCE 3-2-2011.

THE MARK CONSISTS OF STANDARD CHARACTERS WITHOUT CLAIM TO ANY PARTICULAR FONT, STYLE, SIZE, OR COLOR.

NO CLAIM IS MADE TO THE EXCLUSIVE RIGHT TO USE "STUDENT CENTER", APART FROM THE MARK AS SHOWN.

SER. NO. 85-276,974, FILED 3-25-2011.

APRIL HESIK, EXAMINING ATTORNEY



David J. Kyffers

Director of the United States Patent and Trademark Office

United States of America

United States Patent and Trademark Office

Why share just a photo?

Reg. No. 4,073,407

Registered Dec. 20, 2011

Int. Cl.: 9

TRADEMARK

PRINCIPAL REGISTER

TIMELINES, INC. (DELAWARE CORPORATION)
1802 WEST BERTEAU AVENUE, SUITE 203
CHICAGO, IL 60613

FOR: COMPUTER SOFTWARE FOR USE IN CAPTURING, ORGANIZING, SEARCHING, INDEXING, STORING, SYNCHRONIZING, RECOGNIZING, SHARING, TRANSMITTING AND DISPLAYING DIGITAL FILES, INCLUDING AUDIO, VIDEO, TEXT, BINARY, STILL IMAGES, GRAPHICS, DIGITAL CONTENT AND MULTIMEDIA FILES; DOWNLOADABLE COMPUTER SOFTWARE FOR USE IN CAPTURING, ORGANIZING, SEARCHING, INDEXING, STORING, SYNCHRONIZING, RECOGNIZING, SHARING AND TRANSMITTING DIGITAL FILES, INCLUDING AUDIO, VIDEO, TEXT, BINARY, STILL IMAGES, GRAPHICS, DIGITAL CONTENT, AND MULTIMEDIA FILES, IN CLASS 9 (U.S. CLS. 21, 23, 26, 36 AND 38).

FIRST USE 6-15-2011; IN COMMERCE 6-15-2011.

THE MARK CONSISTS OF STANDARD CHARACTERS WITHOUT CLAIM TO ANY PARTICULAR FONT, STYLE, SIZE, OR COLOR.

SER. NO. 85-277,135, FILED 3-25-2011.

HEATHER BIDDULPH, EXAMINING ATTORNEY



David J. Kybas

Director of the United States Patent and Trademark Office

United States of America

United States Patent and Trademark Office

CV-700 Enzyme Water Cleaner & Phosphate Remover

Reg. No. 4,073,408

Registered Dec. 20, 2011

Int. Cl.: 1

TRADEMARK

PRINCIPAL REGISTER

PURE PLANET SCIENCE & TECHNOLOGY, INC. (TEXAS CORPORATION), DBA ORENDA
TECHNOLOGIES
760 RIVER OAKS CIRCLE
FAIRVIEW, TX 75069

FOR: WATER PURIFYING CHEMICALS FOR SWIMMING POOLS; WATER TREATMENT
CHEMICALS FOR USE IN SWIMMING POOLS AND SPAS, IN CLASS 1 (U.S. CLS. 1, 5, 6,
10, 26 AND 46).

FIRST USE 1-1-2010; IN COMMERCE 1-1-2010.

THE MARK CONSISTS OF STANDARD CHARACTERS WITHOUT CLAIM TO ANY PAR-
TICULAR FONT, STYLE, SIZE, OR COLOR.

NO CLAIM IS MADE TO THE EXCLUSIVE RIGHT TO USE "ENZYME WATER CLEANER
& PHOSPHATE REMOVER", APART FROM THE MARK AS SHOWN.

SER. NO. 85-277,329, FILED 3-25-2011.

MARIA-VICTORIA SUAREZ, EXAMINING ATTORNEY



David J. Kybas

Director of the United States Patent and Trademark Office

United States of America

United States Patent and Trademark Office

PR-

Reg. No. 4,073,409

Registered Dec. 20, 2011

Int. Cl.: 1

TRADEMARK

PRINCIPAL REGISTER

PURE PLANET SCIENCE & TECHNOLOGY, INC. (TEXAS CORPORATION), DBA ORENDA
TECHNOLOGIES
760 RIVER OAKS CIRCLE
FAIRVIEW, TX 75069

FOR: WATER PURIFYING CHEMICALS FOR SWIMMING POOLS; WATER TREATMENT
CHEMICALS FOR USE IN SWIMMING POOLS AND SPAS, IN CLASS 1 (U.S. CLS. 1, 5, 6,
10, 26 AND 46).

FIRST USE 1-1-2010; IN COMMERCE 1-1-2010.

THE MARK CONSISTS OF STANDARD CHARACTERS WITHOUT CLAIM TO ANY PAR-
TICULAR FONT, STYLE, SIZE, OR COLOR.

SER. NO. 85-277,454, FILED 3-25-2011.

MARIA-VICTORIA SUAREZ, EXAMINING ATTORNEY



David J. Kybas

Director of the United States Patent and Trademark Office

United States of America

United States Patent and Trademark Office



Reg. No. 4,073,410

Registered Dec. 20, 2011

Int. Cl.: 41

SERVICE MARK

PRINCIPAL REGISTER

ALERS, FERNANDO (UNITED STATES INDIVIDUAL)
366 VILLAGE STREET
BRISTOL, CT 06010

FOR: EDUCATION SERVICES, NAMELY, PROVIDING CLASSES AND INSTRUCTION IN THE FIELD OF DANCE; DANCE EVENTS; DANCE INSTRUCTION FOR CHILDREN; ENTERTAINMENT IN THE NATURE OF DANCE PERFORMANCES; MUSIC PRODUCTION SERVICES; ENTERTAINMENT, NAMELY, LIGHTING PRODUCTION; RENTAL OF STAGE EQUIPMENT, NAMELY, LIGHTING EQUIPMENT AND GRIP EQUIPMENT; PHOTOGRAPHY SERVICES; DISC JOCKEY SERVICES; VIDEOGRAPHY SERVICES, IN CLASS 41 (U.S. CLS. 100, 101 AND 107).

FIRST USE 6-1-1991; IN COMMERCE 6-1-1991.

THE MARK CONSISTS OF THE LITERAL ELEMENTS "U R", WHEREIN THE IMAGE SHOWS THE LETTER "U" CONNECTED TO THE LETTER "R" PLACED BELOW IT WITH A NAIL LIKE FIGURE AS SHOWN IN THE MARK.

SER. NO. 85-277,879, FILED 3-26-2011.

ERNEST SHOSHO, EXAMINING ATTORNEY



David J. Kyffers

Director of the United States Patent and Trademark Office

United States of America

United States Patent and Trademark Office

RAINDRAIN

Reg. No. 4,073,411

ALTUS VINYL LLC (WISCONSIN LIMITED LIABILITY COMPANY)
3801 S MEMORIAL DR
RACINE, WI 53403

Registered Dec. 20, 2011

Int. Cl.: 19

FOR: PLASTIC CONDUIT FOR DRAINAGE; PLASTIC CONDUIT FOR DRAINAGE AND IRRIGATION, IN CLASS 19 (U.S. CLS. 1, 12, 33 AND 50).

TRADEMARK

FIRST USE 2-1-2006; IN COMMERCE 2-1-2006.

PRINCIPAL REGISTER

THE MARK CONSISTS OF STANDARD CHARACTERS WITHOUT CLAIM TO ANY PARTICULAR FONT, STYLE, SIZE, OR COLOR.

OWNER OF U.S. REG. NO. 3,189,151.

SEC. 2(F).

SER. NO. 85-278,131, FILED 3-27-2011.

ANGELA M. MICHELI, EXAMINING ATTORNEY



David J. Kybas

Director of the United States Patent and Trademark Office

United States of America

United States Patent and Trademark Office



Reg. No. 4,073,412

Registered Dec. 20, 2011

Int. Cls.: 25 and 43

TRADEMARK

SERVICE MARK

PRINCIPAL REGISTER

THE TIPSY GOAT LLC (CALIFORNIA LIMITED LIABILITY COMPANY)
159 EAST THOUSAND OAKS BOULEVARD
THOUSAND OAKS, CA 91360

FOR: CLOTHING, NAMELY, T-SHIRTS, SWEATSHIRTS AND SHORTS, IN CLASS 25 (U.S. CLS. 22 AND 39).

FIRST USE 11-25-2010; IN COMMERCE 3-7-2011.

FOR: IRISH PUB; RESTAURANT SERVICES, IN CLASS 43 (U.S. CLS. 100 AND 101).

FIRST USE 11-25-2010; IN COMMERCE 3-7-2011.

THE MARK CONSISTS OF A TILTING GOAT STANDING ON THE WORDS "THE TIPSY GOAT". THE GOAT HAS A FOUR LEAF CLOVER ON THE COLLAR AROUND ITS NECK. THREE BUBBLES AND ONE POPPED BUBBLE ARE TO THE RIGHT OF THE GOAT'S MOUTH. QUOTATION MARKS APPEAR TO THE UPPER LEFT OF THE WORD "TIPSY" AND TO THE BOTTOM RIGHT OF THE WORD "GOAT".

SER. NO. 85-278,422, FILED 3-28-2011.

COLLEEN DOMBROW, EXAMINING ATTORNEY



David J. Kybas

Director of the United States Patent and Trademark Office

United States of America

United States Patent and Trademark Office

GILT NOIR

Reg. No. 4,073,413

GILT GROUPE, INC. (DELAWARE CORPORATION)
2 PARK AVENUE, 4TH FLOOR
NEW YORK, NY 10016

Registered Dec. 20, 2011

Int. Cl.: 35

FOR: ON-LINE RETAIL STORE SERVICES FEATURING LUXURY AND FASHION CLOTHING, APPAREL, FOOTWEAR, CLOTHING ACCESSORIES, COSMETICS, HOME GOODS, ELECTRONICS, AND RELATED GOODS SOLD AT DISCOUNT PRICES, IN CLASS 35 (U.S. CLS. 100, 101 AND 102).

SERVICE MARK

PRINCIPAL REGISTER

FIRST USE 11-30-2009; IN COMMERCE 11-30-2009.

THE MARK CONSISTS OF STANDARD CHARACTERS WITHOUT CLAIM TO ANY PARTICULAR FONT, STYLE, SIZE, OR COLOR.

OWNER OF U.S. REG. NOS. 3,680,404, 3,920,768, AND 3,967,967.

SER. NO. 85-278,937, FILED 3-28-2011.

SUE LAWRENCE, EXAMINING ATTORNEY



David J. Kybas

Director of the United States Patent and Trademark Office

United States of America

United States Patent and Trademark Office



Reg. No. 4,073,414

DATA CASH LTD (UNITED KINGDOM LIMITED COMPANY (LTD.))
71 KINGSWAY

Registered Dec. 20, 2011

LONDON, UNITED KINGDOM WC2B6ST

Int. Cls.: 35, 36 and 42

FOR: DATA PROCESSING, IN CLASS 35 (U.S. CLS. 100, 101 AND 102).

SERVICE MARK

FOR: FINANCIAL AFFAIRS, NAMELY, FINANCIAL SERVICES IN THE NATURE OF CREDIT AND DEBIT CARD PROCESSING AND PAYMENT GATEWAY SERVICES IN THE NATURE OF PROVIDING ONLINE CREDIT CARD AND DEBIT CARD PROCESSING FOR MERCHANTS, IN CLASS 36 (U.S. CLS. 100, 101 AND 102).

PRINCIPAL REGISTER

FOR: DESIGN AND DEVELOPMENT OF COMPUTER HARDWARE AND SOFTWARE, IN CLASS 42 (U.S. CLS. 100 AND 101).

OWNER OF UNITED KINGDOM REG. NO. 2434120, DATED 6-8-2007, EXPIRES 9-30-2016.

THE COLOR(S) GRAY AND BLUE IS/ARE CLAIMED AS A FEATURE OF THE MARK.

THE MARK CONSISTS OF A SQUARE MADE UP OF NINE ROUNDED BOXES, THE FIRST OF WHICH IS GRAY AND THE REMAINDER BLUE, ALIGNED IN THREE ROWS OF THREE FOLLOWED BY THE WORD "DATACASH" WITH "DATA" IN BLUE AND "CASH" IN GRAY.

SER. NO. 85-279,358, FILED 3-29-2011.

HOWARD B. LEVINE, EXAMINING ATTORNEY



David J. Kybas

Director of the United States Patent and Trademark Office

United States of America

United States Patent and Trademark Office

Crystal Fire

Reg. No. 4,073,415

Registered Dec. 20, 2011

Int. Cl.: 11

TRADEMARK

PRINCIPAL REGISTER

DAN SHIMEK (MINNESOTA CORPORATION), DBA THE OUTDOOR GREATROOM
COMPANY
2015 SILVER BELL ROAD
EAGAN, MN 55122

FOR: GAS FIRES, IN CLASS 11 (U.S. CLS. 13, 21, 23, 31 AND 34).

FIRST USE 2-1-2005; IN COMMERCE 2-1-2005.

THE MARK CONSISTS OF STANDARD CHARACTERS WITHOUT CLAIM TO ANY PARTICULAR FONT, STYLE, SIZE, OR COLOR.

NO CLAIM IS MADE TO THE EXCLUSIVE RIGHT TO USE "FIRE", APART FROM THE MARK AS SHOWN.

SER. NO. 85-279,396, FILED 3-29-2011.

NORA BUCHANAN WILL, EXAMINING ATTORNEY



David J. Kybas

Director of the United States Patent and Trademark Office

United States of America

United States Patent and Trademark Office

smart
bottoms

Reg. No. 4,073,416

SMART BOTTOMS, INC. (MICHIGAN CORPORATION)
185 CALAIS CT. SE
GRAND RAPIDS, MI 49546

Registered Dec. 20, 2011

Int. Cl.: 25

FOR: BABY BOTTOMS; CLOTH DIAPERS; INFANT AND TODDLER ONE PIECE CLOTHING; INFANT CLOTH DIAPERS; INFANT DIAPER COVERS; INFANT WEAR; INSERTS SPECIALLY ADAPTED FOR CLOTH DIAPERS MADE OF BAMBOO; INSERTS SPECIALLY ADAPTED FOR CLOTH DIAPERS MADE OF HEMP; INSERTS SPECIALLY ADAPTED FOR CLOTH DIAPERS MADE OF MICROFIBER; NON-DISPOSABLE CLOTH TRAINING PANTS; ONE PIECE GARMENT FOR INFANTS AND TODDLERS, IN CLASS 25 (U.S. CLS. 22 AND 39).

TRADEMARK

PRINCIPAL REGISTER

FIRST USE 1-12-2010; IN COMMERCE 6-10-2010.

NO CLAIM IS MADE TO THE EXCLUSIVE RIGHT TO USE "BOTTOMS", APART FROM THE MARK AS SHOWN.

THE COLOR(S) BROWN, ORANGE, WHITE, AND PINK IS/ARE CLAIMED AS A FEATURE OF THE MARK.

THE MARK CONSISTS OF STYLIZED WORDING "SMART" WITH THE LETTERS "S", "M", "R", AND "T" ALL IN BROWN, THE LETTER "A" STYLIZED AS THE LEFT-FACING PROFILE OF AN ORANGE CARTOON BIRD WITH A BROWN BEAK, A BROWN SINGLE-LINE ARC FOR THE EYE, AND A WHITE EGG-SHAPED WING WITH A PINK HEART IN THE CENTER, AND WITH STYLIZED ORANGE WORDING "BOTTOMS" DIRECTLY BELOW "SMART" IN SMALLER LETTERING.

SER. NO. 85-279,404, FILED 3-29-2011.

NORA BUCHANAN WILL, EXAMINING ATTORNEY



David J. Kyffers

Director of the United States Patent and Trademark Office

United States of America

United States Patent and Trademark Office

VUWI

Reg. No. 4,073,417

Registered Dec. 20, 2011

Int. Cls.: 9 and 42

TRADEMARK

SERVICE MARK

PRINCIPAL REGISTER

COIN FREE, INC. (FLORIDA CORPORATION)
7044 STAPOINT COURT
WINTER PARK, FL 32792

FOR: INTERACTIVE COMPUTER KIOSKS COMPRISING COMPUTERS, COMPUTER HARDWARE, COMPUTER PERIPHERALS, AND COMPUTER OPERATING SOFTWARE, FOR USE IN MONETARY TRANSACTIONS, IN CLASS 9 (U.S. CLS. 21, 23, 26, 36 AND 38).

FIRST USE 2-18-2011; IN COMMERCE 3-11-2011.

FOR: DESIGN AND DEVELOPMENT OF SOFTWARE AND HARDWARE FOR PAYMENT SYSTEMS; TECHNICAL SUPPORT SERVICES, NAMELY, TROUBLESHOOTING OF COMPUTER SOFTWARE PROBLEMS IN PROCESSING PURCHASES THROUGH A CELL PHONE, IN CLASS 42 (U.S. CLS. 100 AND 101).

FIRST USE 2-18-2011; IN COMMERCE 3-11-2011.

THE MARK CONSISTS OF STANDARD CHARACTERS WITHOUT CLAIM TO ANY PARTICULAR FONT, STYLE, SIZE, OR COLOR.

SER. NO. 85-279,533, FILED 3-29-2011.

CHERYL CLAYTON, EXAMINING ATTORNEY



David J. Kybas

Director of the United States Patent and Trademark Office

United States of America

United States Patent and Trademark Office

Westside TMS

Reg. No. 4,073,418

WESTSIDE TMS, LLC (CALIFORNIA LIMITED LIABILITY COMPANY)
11936 W JEFFERSON BLVD., SUITE B
CULVER CITY, CA 90230

Registered Dec. 20, 2011

Int. Cl.: 44

FOR: MEDICAL SERVICES, NAMELY, TRANSCRANIAL MAGNETIC STIMULATION, IN CLASS 44 (U.S. CLS. 100 AND 101).

SERVICE MARK

FIRST USE 1-1-2011; IN COMMERCE 1-1-2011.

PRINCIPAL REGISTER

THE MARK CONSISTS OF STANDARD CHARACTERS WITHOUT CLAIM TO ANY PARTICULAR FONT, STYLE, SIZE, OR COLOR.

NO CLAIM IS MADE TO THE EXCLUSIVE RIGHT TO USE "TMS", APART FROM THE MARK AS SHOWN.

SER. NO. 85-279,721, FILED 3-29-2011.

SOPHIA S. KIM, EXAMINING ATTORNEY



David J. Kybas

Director of the United States Patent and Trademark Office

United States of America

United States Patent and Trademark Office



Reg. No. 4,073,419

Registered Dec. 20, 2011

Int. Cls.: 9 and 42

TRADEMARK

SERVICE MARK

PRINCIPAL REGISTER

COIN FREE, INC. (FLORIDA CORPORATION)
7044 STAPOINT COURT
WINTER PARK, FL 32792

FOR: INTERACTIVE COMPUTER KIOSKS COMPRISING COMPUTERS, COMPUTER HARDWARE, COMPUTER PERIPHERALS, AND COMPUTER OPERATING SOFTWARE, FOR USE IN MONETARY TRANSACTIONS, IN CLASS 9 (U.S. CLS. 21, 23, 26, 36 AND 38).

FIRST USE 2-18-2011; IN COMMERCE 3-11-2011.

FOR: DESIGN AND DEVELOPMENT OF SOFTWARE AND HARDWARE FOR PAYMENT SYSTEMS; TECHNICAL SUPPORT SERVICES, NAMELY, TROUBLESHOOTING OF COMPUTER SOFTWARE PROBLEMS IN PROCESSING PURCHASES THROUGH A CELL PHONE, IN CLASS 42 (U.S. CLS. 100 AND 101).

FIRST USE 2-18-2011; IN COMMERCE 3-11-2011.

THE MARK CONSISTS OF THE TERM "VUWI" IN LARGE BLUE BLOCK LETTERS AND A GREEN CIRCLE BEHIND THE "U" WITH A GRAY DOT IN THE CENTER, TWO BLUE LEGS BENEATH, AND THREE BLUE TRANSMISSION WAVES COMING FROM THE TOP.

THE COLOR(S) BLUE, GRAY AND GREEN IS/ARE CLAIMED AS A FEATURE OF THE MARK.

SER. NO. 85-279,965, FILED 3-29-2011.

CHERYL CLAYTON, EXAMINING ATTORNEY



David J. Kybas

Director of the United States Patent and Trademark Office

United States of America

United States Patent and Trademark Office



Reg. No. 4,073,420

Registered Dec. 20, 2011

Int. Cl.: 9

TRADEMARK

PRINCIPAL REGISTER

THE O'KEEFE GROUP, INC. (MASSACHUSETTS CORPORATION)
P.O. BOX 1240
ATTLEBORO, MA 02703

FOR: COMPUTER SOFTWARE FOR BUSINESS ACCOUNTING, NAMELY, ACCOUNTING, BILL PAYMENT, PROJECT MANAGEMENT, BILLING, EXPENSE REPORTING, INVENTORY MANAGEMENT, FIXED ASSET MANAGEMENT AND CONTACT MANAGEMENT, PROVIDED TO USERS IN DOWNLOADABLE FORM OR RECORDED ON COMPUTER MEDIA, IN CLASS 9 (U.S. CLS. 21, 23, 26, 36 AND 38).

FIRST USE 1-1-2005; IN COMMERCE 1-1-2007.

THE MARK CONSISTS OF THE WORDING "WASTEHOUND.COM" IN STYLIZED FONT WITHIN AN OBLONG BORDER. ON THE RIGHT SIDE OF THE MARK IS A DESIGN OF A STYLIZED HOUND DOG'S HEAD.

SER. NO. 85-280,087, FILED 3-29-2011.

STEVEN PEREZ, EXAMINING ATTORNEY



David J. Kyffers

Director of the United States Patent and Trademark Office

United States of America

United States Patent and Trademark Office

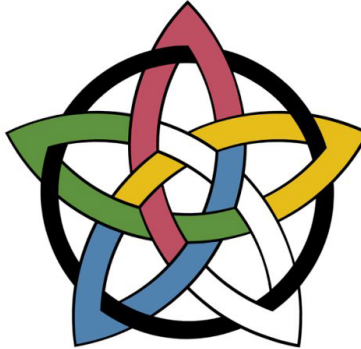

Reg. No. 4,073,421

Registered Dec. 20, 2011

Int. Cl.: 41

SERVICE MARK

PRINCIPAL REGISTER

REUTIMANN, ROGER (UNITED STATES INDIVIDUAL)
330 NORTON STREET
BOULDER, CO 80305

FOR: EDUCATIONAL SERVICES, NAMELY, CONDUCTING CLASSES, SEMINARS, CONFERENCES AND WORKSHOPS IN THE FIELD OF HEALTH AND WELLNESS BY PRACTICING SPECIFIC PROGRAMS OF PHYSICAL EDUCATION AND ACQUIRING LIFE SKILLS BASED ON THE TEACHINGS OF TRADITIONAL CHINESE MEDICINE AND THE "FIVE ELEMENTS" THEORY AND DISTRIBUTION OF COURSE AND EDUCATIONAL MATERIALS IN CONNECTION THEREWITH; YOGA INSTRUCTION, IN CLASS 41 (U.S. CLS. 100, 101 AND 107).

FIRST USE 1-15-2011; IN COMMERCE 2-1-2011.

THE MARK CONSISTS OF A FIVE-POINTED STAR FORMED BY AN INTERWOVEN AND INTERCONNECTED CONTINUOUS COLORED RIBBON WHEREIN THE COLORS OF THE FIVE POINTS ARE RED, YELLOW, WHITE, BLUE AND GREEN AND EACH COLOR CHANGES AT INTERSECTIONS OF RIBBONS; THERE IS A BLACK RING CONNECTING ALL FIVE POINTS OF THE STAR, AND THE RIBBON FORMING THE STAR IS OUTLINED IN BLACK.

THE COLOR(S) RED, YELLOW, WHITE, BLUE, GREEN AND BLACK IS/ARE CLAIMED AS A FEATURE OF THE MARK.

SER. NO. 85-280,741, FILED 3-30-2011.

JOHN KELLY, EXAMINING ATTORNEY



David J. Kyffers

Director of the United States Patent and Trademark Office

United States of America

United States Patent and Trademark Office



Reg. No. 4,073,422

CLASSROOM PRODUCTS LLC (OHIO LIMITED LIABILITY COMPANY)
3313 WOONSOCKET STREET
SPRINGFIELD, OH 45503

Registered Dec. 20, 2011

Int. Cl.: 20

FOR: FURNITURE, NAMELY, STUDY CARRELS, IN CLASS 20 (U.S. CLS. 2, 13, 22, 25, 32 AND 50).

TRADEMARK

FIRST USE 1-1-2011; IN COMMERCE 1-1-2011.

PRINCIPAL REGISTER

NO CLAIM IS MADE TO THE EXCLUSIVE RIGHT TO USE "CLASSROOM PRODUCTS.COM", APART FROM THE MARK AS SHOWN.

THE COLOR(S) BLUE, ORANGE, AND RED IS/ARE CLAIMED AS A FEATURE OF THE MARK.

THE MARK CONSISTS OF THE WORDING "CLASSROOM" IN BLUE COLOR AT THE TOP OF THE MARK. THE WORDING "PRODUCTS.COM" IN BLUE COLOR FOR THE NEXT LINE OF TEXT IN THE CENTER LEFT A DEPICTION OF OUR STUDY CARREL IN BLUE WITH A DASHED LINE RUNNING THROUGH. A PARTIALLY HIDDEN RED TRIANGLE IN THE LOWER LEFT. AN ORANGE CIRCLE ABOVE THE RED TRIANGLE. THE WORDING "HELPING STUDENTS FOCUS" IN ITALICIZED FONT, RED COLOR BELOW THE TEXT "PRODUCTS.COM".



SER. NO. 85-280,828, FILED S.R. 3-30-2011 AM. P.R. 6-27-2011.

JOHN E. MICHOS, EXAMINING ATTORNEY

David J. Kybas

Director of the United States Patent and Trademark Office

United States of America

United States Patent and Trademark Office

Esque

Reg. No. 4,073,423

Registered Dec. 20, 2011

Int. Cl.: 9

TRADEMARK

PRINCIPAL REGISTER

BURKE, GRANT CAMERON (UNITED STATES INDIVIDUAL), AKA ESQUE
133 NE 2ND AVE APT 402
MIAMI, FL 33132

FOR: AUDIO AND VIDEO RECORDINGS FEATURING MUSIC AND ARTISTIC PERFORMANCES; AUDIO TAPES FEATURING MUSIC; COMPACT DISCS FEATURING MUSIC; DIGITAL MUSIC DOWNLOADABLE FROM THE INTERNET, IN CLASS 9 (U.S. CLS. 21, 23, 26, 36 AND 38).

FIRST USE 1-1-1996; IN COMMERCE 1-1-1996.

THE MARK CONSISTS OF STANDARD CHARACTERS WITHOUT CLAIM TO ANY PARTICULAR FONT, STYLE, SIZE, OR COLOR.

SER. NO. 85-280,887, FILED 3-30-2011.

STEVEN PEREZ, EXAMINING ATTORNEY



David J. Kyffers

Director of the United States Patent and Trademark Office

United States of America

United States Patent and Trademark Office



Reg. No. 4,073,424

Registered Dec. 20, 2011

Int. Cl.: 9

TRADEMARK

PRINCIPAL REGISTER

EXTREME NETWORKS, INC. (DELAWARE CORPORATION)
3585 MONROE STREET
SANTA CLARA, CA 95051

FOR: NETWORK SERVICE MANAGEMENT SOFTWARE FOR THE PURPOSE OF MONITORING, CONFIGURING, AND TROUBLESHOOTING NETWORKS CONNECTING COMPUTERS, DEVICES AND MACHINES, IN CLASS 9 (U.S. CLS. 21, 23, 26, 36 AND 38).

FIRST USE 6-1-2010; IN COMMERCE 6-1-2010.

THE MARK CONSISTS OF THE DESIGN OF A SQUARE IN WHICH IS DEPICTED AND CONSISTS OF A LANDSCAPE DESIGN CONTAINING THE IMAGES OF A MOUNTAINOUS RIDGELINE, HORIZON, AND METEOR SHOWER AND IN FRONT OF WHICH IS A LARGE STYLIZED AND TRANSPARENT CAPITAL LETTER "R" UNDERNEATH WHICH IS A TRANSPARENT RECTANGULAR BAR.

SER. NO. 85-280,950, FILED 3-30-2011.

STEVEN PEREZ, EXAMINING ATTORNEY



David J. Kybas

Director of the United States Patent and Trademark Office

United States of America

United States Patent and Trademark Office

StrikeMeter

Reg. No. 4,073,425

MARTIAL ARTS INSTRUMENTS, LLC (MICHIGAN LIMITED LIABILITY COMPANY)
570 NORTHVIEW DRIVE
FRANKENMUTH, MI 48734

Registered Dec. 20, 2011

Int. Cl.: 28

FOR: MARTIAL ARTS TRAINING AID, NAMELY, AN INSTRUMENT THAT MEASURES THE STRIKE INTENSITY OF A MARTIAL ARTS STRIKE, SUCH AS A PUNCH OR KICK, ON A MARTIAL ARTS PUNCHING BAG, IN CLASS 28 (U.S. CLS. 22, 23, 38 AND 50).

TRADEMARK

FIRST USE 11-5-2010; IN COMMERCE 6-27-2011.

PRINCIPAL REGISTER

THE MARK CONSISTS OF STANDARD CHARACTERS WITHOUT CLAIM TO ANY PARTICULAR FONT, STYLE, SIZE, OR COLOR.

SER. NO. 85-280,974, FILED 3-30-2011.

JULIE VEPPUMTHARA, EXAMINING ATTORNEY



David J. Kyffers

Director of the United States Patent and Trademark Office

United States of America

United States Patent and Trademark Office

TABLEAU DE PARFUMS

Reg. No. 4,073,426

TAUER, ANDREAS (SWITZERLAND INDIVIDUAL)
LIMMATTALSTRASSE 63

Registered Dec. 20, 2011

ZUERICH, SWITZERLAND CH-8049

Int. Cl.: 3

FOR: PERFUMES; EAU DE TOILETTES; EAU DE PARFUMS; PARFUMS, IN CLASS 3 (U.S. CLS. 1, 4, 6, 50, 51 AND 52).

TRADEMARK

THE MARK CONSISTS OF STANDARD CHARACTERS WITHOUT CLAIM TO ANY PARTICULAR FONT, STYLE, SIZE, OR COLOR.

PRINCIPAL REGISTER

PRIORITY CLAIMED UNDER SEC. 44(D) ON SWITZERLAND APPLICATION NO. 538922011, FILED 3-31-2011, REG. NO. 616764, DATED 7-1-2011, EXPIRES 3-31-2021.

NO CLAIM IS MADE TO THE EXCLUSIVE RIGHT TO USE "PARFUMS", APART FROM THE MARK AS SHOWN.

THE ENGLISH TRANSLATION OF "TABLEAU DE PARFUMS" IS "CHART OR TABLE OF PERFUMES".

SER. NO. 85-281,934, FILED 3-31-2011.

KARANENDRA S. CHHINA, EXAMINING ATTORNEY



David J. Kybas

Director of the United States Patent and Trademark Office

United States of America

United States Patent and Trademark Office

Southern Charm Yorkies

Reg. No. 4,073,427

Registered Dec. 20, 2011

Int. Cl.: 31

TRADEMARK

PRINCIPAL REGISTER

ROBERTS, KATHRYN A. (UNITED STATES INDIVIDUAL), DBA SOUTHERN CHARM
YORKIES
525 PICKETT LEVEL RD.
ELLOREE, SC 29047

FOR: LIVESTOCK, NAMELY, DOGS, IN CLASS 31 (U.S. CLS. 1 AND 46).

FIRST USE 6-7-2007; IN COMMERCE 2-1-2009.

THE MARK CONSISTS OF STANDARD CHARACTERS WITHOUT CLAIM TO ANY PARTICULAR FONT, STYLE, SIZE, OR COLOR.

NO CLAIM IS MADE TO THE EXCLUSIVE RIGHT TO USE "YORKIES", APART FROM THE MARK AS SHOWN.

SER. NO. 85-281,987, FILED 3-31-2011.

MARGARET POWER, EXAMINING ATTORNEY



David J. Kybas

Director of the United States Patent and Trademark Office

United States of America

United States Patent and Trademark Office



Reg. No. 4,073,428

FASTEST BARTENDER INC. (VIRGINIA CORPORATION)
9915 COLONY ROAD
FAIRFAX, VA 22030

Registered Dec. 20, 2011

Int. Cl.: 41

FOR: ENTERTAINMENT SERVICES, NAMELY, CONDUCTING A CONTEST FOR BARTENDER EFFICIENCY, IN CLASS 41 (U.S. CLS. 100, 101 AND 107).

SERVICE MARK

FIRST USE 3-31-1989; IN COMMERCE 2-28-2001.

PRINCIPAL REGISTER

NO CLAIM IS MADE TO THE EXCLUSIVE RIGHT TO USE "FASTEST BARTENDER CONTEST ACCURACY SPEED FINESSE", APART FROM THE MARK AS SHOWN.

THE MARK COMPRISES A BLACK RING WITH A BANNER POSITIONED OVER THE RING AT A LOWER PORTION OF THE RING. AROUND THE OUTSIDE OF THE BLACK RING AND ABOVE THE BANNER ARE THE WORDS "FASTEST", "BARTENDER", AND "CONTEST" IN CAPITAL LETTERS. THE WORDS "FASTEST" AND "BARTENDER" ARE SEPARATED FROM ONE ANOTHER BY A FIRST UPSIDE-DOWN BOTTLE THAT ANGLES FROM LEFT TO RIGHT GOING DOWN, EXTENDS FROM OUTSIDE THE BLACK RING TO INSIDE THE BLACK RING, AND LAYS OVER THE BLACK RING. THE WORDS "BARTENDER" AND "CONTEST" ARE SEPARATED FROM ONE ANOTHER BY A SECOND UPSIDE-DOWN BOTTLE THAT ANGLES FROM RIGHT TO LEFT GOING DOWN, EXTENDS FROM OUTSIDE THE BLACK RING TO INSIDE THE BLACK RING, AND LAYS OVER THE BLACK RING. ON THE BLACK RING AND ABOVE THE BANNER ARE THE WORDS "ACCURACY", "SPEED", AND "FINESSE" IN CAPITAL LETTERS. THE WORDS "ACCURACY" AND "SPEED" ARE SEPARATED FROM ONE ANOTHER BY THE FIRST UPSIDE-DOWN BOTTLE. THE WORDS "SPEED" AND "FINESSE" ARE SEPARATED FROM ONE ANOTHER BY THE SECOND UPSIDE-DOWN BOTTLE. PARTIALLY COVERED BY THE BANNER, OUTSIDE THE BLACK RING, ARE A SERIES OF THREE STARS ON EACH SIDE OF THE BANNER THAT EXTENDS OUTSIDE OF THE BLACK RING. INSIDE THE BLACK RING AND MOSTLY IN THE LOWER PORTION OF THE AREA INSIDE THE BLACK RING ARE TWO OPEN FOAMING BOTTLES OF BEER SEPARATED BY A HIGH-BALL DRINK GLASS HAVING A FRUIT TWIST ON THE RIM THEREOF. LIQUID IS SHOWN EXITING THE FIRST AND SECOND BOTTLES THROUGH RESPECTIVE POUR SPOUTS AND THE LIQUID IS GENERALLY SHOWN DIRECTED TOWARD THE HIGH-BALL DRINK GLASS. THE BANNER PARTIALLY COVERS THE TWO FOAMING BEER BOTTLES AND THE HIGH-BALL DRINK GLASS.



David J. Kybas

Director of the United States Patent and Trademark Office

Reg. No. 4,073,428 SER. NO. 85-282,071, FILED 3-31-2011.

LINDA ORNDORFF, EXAMINING ATTORNEY

United States of America

United States Patent and Trademark Office

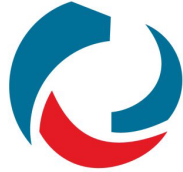

MLIRB

MidLands Independent Review Board

Reg. No. 4,073,429

Registered Dec. 20, 2011

Int. Cl.: 42

SERVICE MARK

PRINCIPAL REGISTER

MIDLANDS INDEPENDENT REVIEW BOARD, LLC (KANSAS LIMITED LIABILITY COMPANY)
8417 SANTA FE DRIVE, SUITE 100
OVERLAND PARK, KS 66212

FOR: REVIEWING THE SAFETY AND ETHICS OF RESEARCH PROTOCOL FOR PHARMACEUTICAL STUDIES AND TESTING ON HUMANS, NAMELY INVESTIGATING TESTING PROCEDURES AND REVIEWING CONSENT FORMS, INVESTIGATOR QUALIFICATIONS AND FACILITY DESCRIPTIONS TO ENSURE THE SAFETY AND WELFARE OF HUMAN SUBJECTS, IN CLASS 42 (U.S. CLS. 100 AND 101).

FIRST USE 3-28-2011; IN COMMERCE 3-28-2011.

OWNER OF U.S. REG. NO. 2,784,320.

THE COLOR(S) WHITE, RED AND BLUE IS/ARE CLAIMED AS A FEATURE OF THE MARK.

NO CLAIM IS MADE TO THE EXCLUSIVE RIGHT TO USE "INDEPENDENT REVIEW BOARD", APART FROM THE MARK AS SHOWN.

THE MARK CONSISTS OF A WHITE RECTANGLE WITH THE LETTERS "M", "L", "I", "R", AND "B" IN DARK BLUE COLOR AND THE WORDS "MIDLANDS INDEPENDENT REVIEW BOARD" IMMEDIATELY BELOW THAT IN THE SAME DARK BLUE COLOR. THERE ARE THREE TRIANGULAR-LIKE SHAPES DESIGNED TO GIVE THE IMPRESSION OF A CIRCULAR PATTERN CENTERED AT THE TOP WITH THE LEFT AND RIGHT SHAPES BEING THE SAME DARK BLUE COLOR AND THE LOWER SHAPE BEING RED IN COLOR.

SER. NO. 85-282,414, FILED 3-31-2011.

AMY C. KEAN, EXAMINING ATTORNEY



David J. Kappas

Director of the United States Patent and Trademark Office

United States of America

United States Patent and Trademark Office



Reg. No. 4,073,430

Registered Dec. 20, 2011

Int. Cl.: 31

TRADEMARK

PRINCIPAL REGISTER

JENNIFER SILBERG (UNITED STATES INDIVIDUAL)
271 CLORINDA AVENUE
SAN RAFAEL, CA 94901

FOR: NON HUMAN FOOD, NAMELY, HUMAN GRADE PET FOOD, ORGANIC ANIMAL FOOD, DOG FOOD, ORGANIC DOG FOOD, ANIMAL FOOD, IN CLASS 31 (U.S. CLS. 1 AND 46).

FIRST USE 7-1-2008; IN COMMERCE 11-1-2008.

THE MARK CONSISTS OF A BLACK BACKGROUND HAVING THEREON IN WHITE, THE DESIGN OF A DOG'S FACE ENCIRCLED BY A WHITE BORDER WITH THE DOG'S EARS OVERLAPPING AND EXTENDING BEYOND THE BORDER AT THE TOP.

SER. NO. 85-282,675, FILED 3-31-2011.

HOWARD SMIGA, EXAMINING ATTORNEY



David J. Kyffers

Director of the United States Patent and Trademark Office

United States of America

United States Patent and Trademark Office



Reg. No. 4,073,431

COOKSHACK, INC. (OKLAHOMA CORPORATION)
2304 N. ASH ST.
PONCA CITY, OK 74601

Registered Dec. 20, 2011

Int. Cl.: 11

FOR: BARBECUE SMOKERS, IN CLASS 11 (U.S. CLS. 13, 21, 23, 31 AND 34).

TRADEMARK

FIRST USE 11-0-2002; IN COMMERCE 11-0-2002.

PRINCIPAL REGISTER

OWNER OF U.S. REG. NO. 1,488,328.

THE MARK CONSISTS OF THE STYLIZED WORDS "FAST EDDY'S", SET PARTIALLY OVER WAVING CHECKERED FLAG ON FLAGPOLE.

SER. NO. 85-282,685, FILED 3-31-2011.

HOWARD B. LEVINE, EXAMINING ATTORNEY



David J. Kyffers

Director of the United States Patent and Trademark Office

United States of America

United States Patent and Trademark Office



Reg. No. 4,073,432

Registered Dec. 20, 2011

**COLLECTIVE
MEMBERSHIP**

PRINCIPAL REGISTER

PHI UPSILON OMICRON, INC. (WEST VIRGINIA CORPORATION)
309 CLEVELAND AVENUE, SUITE 508
FAIRMONT, WV 26554

FOR: INDICATING MEMBERSHIP IN A NATIONAL HONOR SOCIETY IN FAMILY AND CONSUMER SCIENCES, IN CLASS 200 (U.S. CL. 200).

FIRST USE 12-31-1915; IN COMMERCE 1-1-1916.

THE MARK CONSISTS OF THE GREEK LETTERS PHI, UPSILON, AND OMICRON, EACH IN BLOCK FORM, SUPERIMPOSED OVER AN IMAGE OF A CANDLE HAVING A CANDLE-STICK HOLDER AT ITS BOTTOM END AND A FLAME ABOVE ITS TOP END, THE CANDLE AND THE GREEK LETTERS BEING SUPERIMPOSED OVER A RING DEFINED BY AN INTERIOR CIRCLE AND AN EXTERIOR CIRCLE.

SER. NO. 85-283,397, FILED 4-1-2011.

HELENE LIWINSKI, EXAMINING ATTORNEY



David J. Kyffers

Director of the United States Patent and Trademark Office

United States of America

United States Patent and Trademark Office

Thursday Therapy

Reg. No. 4,073,433

Registered Dec. 20, 2011

Int. Cls.: 35 and 41

SERVICE MARK

PRINCIPAL REGISTER

SAGE WEDDING PROS (TEXAS PARTNERSHIP)
4921 RIVIERA DRIVE
CORAL GABLES, FL 33146

FOR: ADVERTISING, MARKETING AND PROMOTIONAL SERVICES RELATED TO ALL INDUSTRIES FOR THE PURPOSE OF FACILITATING NETWORKING AND SOCIALIZING OPPORTUNITIES FOR BUSINESS PURPOSES, IN CLASS 35 (U.S. CLS. 100, 101 AND 102).

FIRST USE 10-1-2009; IN COMMERCE 10-1-2009.

FOR: EDUCATIONAL SERVICES, NAMELY, CONDUCTING PROFESSIONAL COACHING IN THE FIELDS OF BUSINESS NETWORKING AND DISTRIBUTION OF TRAINING MATERIAL IN CONNECTION THEREWITH, IN CLASS 41 (U.S. CLS. 100, 101 AND 107).

FIRST USE 3-1-2011; IN COMMERCE 3-1-2011.

THE MARK CONSISTS OF STANDARD CHARACTERS WITHOUT CLAIM TO ANY PARTICULAR FONT, STYLE, SIZE, OR COLOR.

NO CLAIM IS MADE TO THE EXCLUSIVE RIGHT TO USE "THURSDAY", APART FROM THE MARK AS SHOWN.

SER. NO. 85-283,718, FILED 4-1-2011.

JOHN GARTNER, EXAMINING ATTORNEY



David J. Kybas

Director of the United States Patent and Trademark Office

United States of America

United States Patent and Trademark Office

Uncle Tad Baker's
Loon Show

Reg. No. 4,073,434

Registered Dec. 20, 2011

Int. Cl.: 41

SERVICE MARK

PRINCIPAL REGISTER

LESLIE H. ROBERTS (UNITED STATES INDIVIDUAL), AKA UNCLE TAD BAKER
3883 ADDYS LANE
OROVILLE, CA 95965

FOR: ENTERTAINMENT IN THE NATURE OF LIVE PERFORMANCES BY AMATEUR COMEDIANS; ENTERTAINMENT IN THE NATURE OF VISUAL AND AUDIO PERFORMANCES, AND MUSICAL, VARIETY, NEWS AND COMEDY SHOWS; ENTERTAINMENT SERVICES IN THE NATURE OF COMEDY SHOWS; ENTERTAINMENT SERVICES, NAMELY, CONDUCTING CONTESTS; ENTERTAINMENT SERVICES, NAMELY, PROVIDING A WEB SITE FEATURING PHOTOGRAPHIC, VIDEO AND PROSE PRESENTATIONS FEATURING AMATEUR COMEDIANS, IN CLASS 41 (U.S. CLS. 100, 101 AND 107).

FIRST USE 2-2-1990; IN COMMERCE 2-2-1990.

NO CLAIM IS MADE TO THE EXCLUSIVE RIGHT TO USE "SHOW", APART FROM THE MARK AS SHOWN.

"TAD BAKER" IDENTIFIES THE STAGE NAME OF LESLIE H. ROBERTS, A LIVING INDIVIDUAL WHOSE CONSENT TO REGISTER IS MADE OF RECORD.

THE MARK CONSISTS OF HAND-WRITTEN STYLIZED LETTERING. THE NAME "UNCLE TAD BAKER" USES CAPITAL LETTERS TO BEGIN EACH WORD BUT IS PLACED HORIZONTALLY. BELOW THE NAME IS "LOON SHOW" IN MAGNIFIED, STYLIZED LETTERING, WRITTEN AT AN UPWARD ANGLE GOING RIGHT. THERE ARE 2 ASTERISK-TYPE MARKS WHICH SURROUND THE WRITING AND 2 MUSICAL NOTES.

SER. NO. 85-284,080, FILED 4-1-2011.

MARGARET POWER, EXAMINING ATTORNEY



David J. Kybas

Director of the United States Patent and Trademark Office

United States of America

United States Patent and Trademark Office

TANUKI SOFTWARE

Reg. No. 4,073,435

TANUKI SOFTWARE, LTD. (JAPAN LIMITED COMPANY (LTD.))

Registered Dec. 20, 2011

6-16-7-1001 NISHI-KASAI
EDOGAWA-KU, JAPAN 134-0088

Int. Cls.: 9 and 42

FOR: COMPUTER SOFTWARE, NAMELY, SOFTWARE DEVELOPMENT TOOLS FOR THE CREATION OF MOBILE INTERNET APPLICATIONS AND CLIENT INTERFACES; COMPUTER SOFTWARE FOR COMPUTER SYSTEM AND APPLICATION DEVELOPMENT, DEPLOYMENT AND MANAGEMENT; COMPUTER SOFTWARE DEVELOPMENT TOOLS; COMPUTER SOFTWARE FOR APPLICATION INTEGRATION, IN CLASS 9 (U.S. CLS. 21, 23, 26, 36 AND 38).

TRADEMARK

SERVICE MARK

PRINCIPAL REGISTER

FIRST USE 3-11-2004; IN COMMERCE 3-11-2004.

FOR: COMPUTER AND TECHNOLOGICAL PROFESSIONAL SERVICES, NAMELY, DEVELOPMENT OF PROGRAMS FOR COMPUTERS AND DEVELOPMENT OF ON-LINE COMPUTER SOFTWARE SYSTEMS; COMPUTER SOFTWARE DEVELOPMENT, IN CLASS 42 (U.S. CLS. 100 AND 101).

FIRST USE 3-11-2004; IN COMMERCE 3-11-2004.

THE MARK CONSISTS OF STANDARD CHARACTERS WITHOUT CLAIM TO ANY PARTICULAR FONT, STYLE, SIZE, OR COLOR.

NO CLAIM IS MADE TO THE EXCLUSIVE RIGHT TO USE "SOFTWARE", APART FROM THE MARK AS SHOWN.

SER. NO. 85-284,470, FILED 4-2-2011.

STEVEN JACKSON, EXAMINING ATTORNEY



David J. Kyros

Director of the United States Patent and Trademark Office

United States of America

United States Patent and Trademark Office



Reg. No. 4,073,436

TANUKI SOFTWARE, LTD. (JAPAN LIMITED COMPANY (LTD.))
6-16-7-1001 NISHI-KASAI

Registered Dec. 20, 2011

EDOGAWA-KU, JAPAN 134-0088

Int. Cls.: 9 and 42

FOR: COMPUTER SOFTWARE, NAMELY, SOFTWARE DEVELOPMENT TOOLS FOR THE CREATION OF MOBILE INTERNET APPLICATIONS AND CLIENT INTERFACES; COMPUTER SOFTWARE FOR COMPUTER SYSTEM AND APPLICATION DEVELOPMENT, DEPLOYMENT AND MANAGEMENT; COMPUTER SOFTWARE DEVELOPMENT TOOLS; COMPUTER SOFTWARE FOR APPLICATION INTEGRATION, IN CLASS 9 (U.S. CLS. 21, 23, 26, 36 AND 38).

TRADEMARK

SERVICE MARK

PRINCIPAL REGISTER

FIRST USE 3-11-2004; IN COMMERCE 3-11-2004.

FOR: COMPUTER AND TECHNOLOGICAL PROFESSIONAL SERVICES, NAMELY, DEVELOPMENT OF PROGRAMS FOR COMPUTERS AND DEVELOPMENT OF ON-LINE COMPUTER SOFTWARE SYSTEMS; COMPUTER SOFTWARE DEVELOPMENT, IN CLASS 42 (U.S. CLS. 100 AND 101).

FIRST USE 3-11-2004; IN COMMERCE 3-11-2004.

NO CLAIM IS MADE TO THE EXCLUSIVE RIGHT TO USE "SOFTWARE", APART FROM THE MARK AS SHOWN.

THE COLOR(S) GREEN, BLACK AND WHITE IS/ARE CLAIMED AS A FEATURE OF THE MARK.

THE MARK CONSISTS OF THE LITERAL ELEMENTS "TANUKI SOFTWARE" IN BLACK COLOR WHEREIN THE WORD "SOFTWARE" IS PLACED BELOW THE WORD "TANUKI" AND THE DOT OF THE LETTER "I" OF THE WORD "TANUKI" IS IN GREEN COLOR. THERE IS AN IMAGE OF RACCOON DOG IN GREEN AND WHITE COLORS BESIDE THE WORDS "TANUKI SOFTWARE" AS SHOWN IN THE MARK.

SER. NO. 85-284,471, FILED 4-2-2011.

STEVEN JACKSON, EXAMINING ATTORNEY



David J. Kappas

Director of the United States Patent and Trademark Office

United States of America

United States Patent and Trademark Office

CIBT

Reg. No. 4,073,437

Registered Dec. 20, 2011

Int. Cl.: 39

SERVICE MARK

PRINCIPAL REGISTER

CIBT, INC (DELAWARE CORPORATION)
1650 TYSON'S BLVD, SUITE 1350
MCLEAN, VA 22102

FOR: ARRANGING FOR TRAVEL VISAS, PASSPORTS AND TRAVEL DOCUMENTS FOR PERSONS TRAVELING ABROAD, IN CLASS 39 (U.S. CLS. 100 AND 105).

FIRST USE 12-31-1994; IN COMMERCE 12-31-1994.

THE MARK CONSISTS OF STANDARD CHARACTERS WITHOUT CLAIM TO ANY PARTICULAR FONT, STYLE, SIZE, OR COLOR.

OWNER OF U.S. REG. NO. 3,198,779.

SER. NO. 85-284,897, FILED 4-4-2011.

MARGARET POWER, EXAMINING ATTORNEY



David J. Kybas

Director of the United States Patent and Trademark Office

United States of America

United States Patent and Trademark Office

ReadyTalk 

Reg. No. 4,073,438

ECOVATE, INC. (DELAWARE CORPORATION)
1598 WYNKOOP STREET
DENVER, CO 80202

Registered Dec. 20, 2011

Int. Cl.: 38

FOR: TELECOMMUNICATION CONFERENCING SERVICES, IN CLASS 38 (U.S. CLS. 100, 101 AND 104).

SERVICE MARK

FIRST USE 12-31-2002; IN COMMERCE 12-31-2002.

PRINCIPAL REGISTER

OWNER OF U.S. REG. NO. 3,142,062.

THE MARK CONSISTS OF THE WORD "READYTALK" TO THE LEFT OF AND SLIGHTLY BELOW A SHADED SPEECH BUBBLE.

SER. NO. 85-285,139, FILED 4-4-2011.

HELENE LIWINSKI, EXAMINING ATTORNEY



David J. Kybas

Director of the United States Patent and Trademark Office

United States of America

United States Patent and Trademark Office

GOOD MANNERS ARE GOOD BUSINESS

Reg. No. 4,073,439

GROTTS, LISA M (UNITED STATES INDIVIDUAL), AKA THE AML GROUP
1927 JACKSON STREET
SAN FRANCISCO, CA 94107

Registered Dec. 20, 2011

Int. Cl.: 45

FOR: ETIQUETTE AND PROTOCOL CONSULTING SERVICES, IN CLASS 45 (U.S. CLS. 100 AND 101).

SERVICE MARK

FIRST USE 8-30-1999; IN COMMERCE 8-30-1999.

PRINCIPAL REGISTER

THE MARK CONSISTS OF STANDARD CHARACTERS WITHOUT CLAIM TO ANY PARTICULAR FONT, STYLE, SIZE, OR COLOR.

SER. NO. 85-285,266, FILED 4-4-2011.

DARRYL SPRUILL, EXAMINING ATTORNEY



David J. Kybas

Director of the United States Patent and Trademark Office

United States of America

United States Patent and Trademark Office

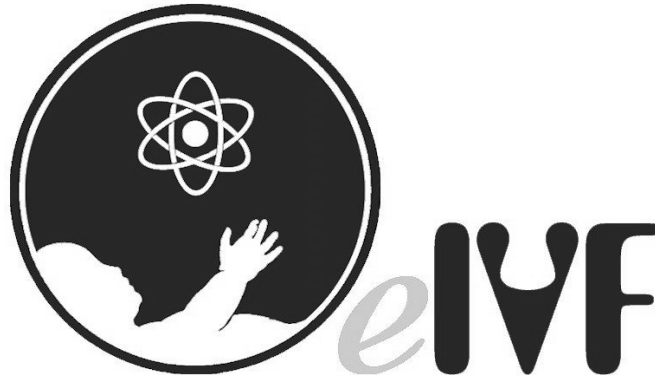

Reg. No. 4,073,440

Registered Dec. 20, 2011

Int. Cl.: 9

TRADEMARK

PRINCIPAL REGISTER

PRACTICEHWY.COM, INC. (TEXAS CORPORATION), DBA EIVF
1300 WEST WALNUT HILL LANE
SUITE 160
IRVING, TX 75038

FOR: COMPUTER PROGRAMS FOR DOCUMENT MANAGEMENT; COMPUTER SOFTWARE FOR THE COLLECTION, EDITING, ORGANIZING, MODIFYING, BOOK MARKING, TRANSMISSION, STORAGE AND SHARING OF DATA AND INFORMATION; MEDICAL SOFTWARE FOR CREATING AND MANAGING ELECTRONIC MEDICAL RECORDS, IN CLASS 9 (U.S. CLS. 21, 23, 26, 36 AND 38).

FIRST USE 4-1-2006; IN COMMERCE 4-1-2006.

NO CLAIM IS MADE TO THE EXCLUSIVE RIGHT TO USE "EIVF", APART FROM THE MARK AS SHOWN.

THE MARK CONSISTS OF A DEVELOPED HUMAN BABY IN A WOMB REACHING FOR A SCIENTIFIC MOLECULAR ELEMENT TO THE LEFT OF THE LETTERS.

SEC. 2(F).

SER. NO. 85-285,343, FILED 4-4-2011.

NORA BUCHANAN WILL, EXAMINING ATTORNEY



David J. Kyffers

Director of the United States Patent and Trademark Office

United States of America

United States Patent and Trademark Office



Reg. No. 4,073,441

Registered Dec. 20, 2011

Int. Cl.: 41

SERVICE MARK

PRINCIPAL REGISTER

WORKOUT KID, INC. (GEORGIA CORPORATION)
P.O. BOX 82914
HAPEVILLE, GA 30254

FOR: PRODUCTION AND DISTRIBUTION OF VIDEOS IN THE FIELD OF CHILDREN'S EXERCISE AND FITNESS; PROVIDING A WEB SITE FEATURING INFORMATION ON EXERCISE AND FITNESS, IN CLASS 41 (U.S. CLS. 100, 101 AND 107).

FIRST USE 6-1-2010; IN COMMERCE 11-1-2010.

NO CLAIM IS MADE TO THE EXCLUSIVE RIGHT TO USE "WORKOUT KID", APART FROM THE MARK AS SHOWN.

THE COLOR(S) BLACK, RED, AND WHITE IS/ARE CLAIMED AS A FEATURE OF THE MARK.

THE MARK CONSISTS OF THE LETTERS "WK" AND THE WORDS "WORKOUT KID" WITHIN A BROKEN RED AND BLACK OVAL ON A WHITE BACKGROUND. THE LETTERS "WK" CONSISTS OF A BLACK "W" AND A RED "K", BOTH WITH WHITE BOARDERS. THE WORDS "WORKOUT KID" CONSISTS OF RED A "W", "O", AND "K", THE REMAINING LETTERS ARE BLACK.

SER. NO. 85-285,350, FILED 4-4-2011.

ALEXANDER L. POWERS, EXAMINING ATTORNEY



David J. Kyffers

Director of the United States Patent and Trademark Office

United States of America

United States Patent and Trademark Office

PERFECT SOLUTION

Reg. No. 4,073,442

Registered Dec. 20, 2011

Int. Cls.: 1 and 9

TRADEMARK

PRINCIPAL REGISTER

CAROLINA BIOLOGICAL SUPPLY COMPANY (NORTH CAROLINA CORPORATION)
2700 YORK ROAD
BURLINGTON, NC 27215

FOR: CHEMICAL PRODUCTS AND PREPARATIONS FOR SCIENTIFIC PURPOSES, NAMELY, LIQUIDS FOR PRESERVATION OF BIOLOGICAL SPECIMENS, IN CLASS 1 (U.S. CLS. 1, 5, 6, 10, 26 AND 46).

FIRST USE 3-22-2001; IN COMMERCE 3-22-2001.

FOR: BIOLOGICAL SPECIMENS EMBALMED IN PRESERVATION LIQUID, NAMELY, NON-LIVING ANIMAL SUCH AS RATS AND MICE, FOR LABORATORY USE, SOLD TOGETHER WITH THE PRESERVATION LIQUID AS A UNIT, IN CLASS 9 (U.S. CLS. 21, 23, 26, 36 AND 38).

FIRST USE 3-22-2001; IN COMMERCE 3-22-2001.

THE MARK CONSISTS OF STANDARD CHARACTERS WITHOUT CLAIM TO ANY PARTICULAR FONT, STYLE, SIZE, OR COLOR.

OWNER OF U.S. REG. NO. 2,802,079.

SER. NO. 85-285,550, FILED 4-4-2011.

RUDY R. SINGLETON, EXAMINING ATTORNEY



David J. Kyros

Director of the United States Patent and Trademark Office

United States of America

United States Patent and Trademark Office



Reg. No. 4,073,443

COURIER BOX LLC (FLORIDA LIMITED LIABILITY COMPANY)
1770 NW 96 AVE. DORAL FL
MIAMI, FL 33172

Registered Dec. 20, 2011

Int. Cl.: 39

FOR: PICK-UP, TRANSPORTATION, STORAGE AND INTERNATIONAL DELIVERY OF DOCUMENTS, PACKAGES AND FREIGHT BY LAND AND AIR, IN CLASS 39 (U.S. CLS. 100 AND 105).

SERVICE MARK

FIRST USE 2-2-2011; IN COMMERCE 2-2-2011.

PRINCIPAL REGISTER

NO CLAIM IS MADE TO THE EXCLUSIVE RIGHT TO USE "COURIER BOX NETWORK", APART FROM THE MARK AS SHOWN.

THE COLOR(S) PURPLE, ORANGE AND WHITE IS/ARE CLAIMED AS A FEATURE OF THE MARK.

THE MARK CONSISTS OF THE WORD "COURIER" IN WHITE CAPITAL LETTERS BEGINNING WITH A LARGE LETTER "C", FOLLOWED BY THE WORD "BOX" IN ORANGE LETTERS, THE LETTER "O" BEING AN ORANGE GLOBE WITH WHITE MERIDIANS AND PARALLEL PATHS AND THE LETTER "X" FORMED BY TWO SEMI CIRCLES. IN THE LOWER LEFT SIDE APPEARS SEVEN ALTERNATING WHITE AND PURPLE HORIZONTAL LINES, DECREASING IN THICKNESS FROM TOP TO BOTTOM. IN THE LOWER RIGHT SIDE APPEARS THE WORD NETWORK IN WHITE. ALL OF THE AFOREMENTIONED APPEARS IN A PURPLE RECTANGULAR BACKGROUND.



SER. NO. 85-285,699, FILED 4-4-2011.

KAREN SEVERSON, EXAMINING ATTORNEY

David J. Kybas

Director of the United States Patent and Trademark Office

United States of America

United States Patent and Trademark Office

VIRUSBARRIER

Reg. No. 4,073,444

Registered Dec. 20, 2011

Int. Cl.: 9

TRADEMARK

PRINCIPAL REGISTER

INTEGO S.A. (FRANCE CORPORATION)
41 RUE CONDORCET
PARIS, FRANCE 75009

FOR: COMPUTER UTILITY SOFTWARE; COMPUTER SOFTWARE FOR DETECTION AND REMOVAL OF COMPUTER VIRUSES, FOR MANAGEMENT, ADMINISTRATION AND OPTIMIZATION OF COMPUTER NETWORKS AND APPLICATIONS, FOR ANALYSIS OF FAULT AND PERFORMANCE OF COMPUTER NETWORKS AND APPLICATIONS, FOR ANALYSIS OF COMPUTER NETWORK TRAFFIC, FOR SURVEILLANCE OF COMPUTER NETWORK TRAFFIC AND DETECTION OF INTRUSIONS, FOR ENCRYPTION AND AUTHENTICATION OF DATA, FOR SOFTWARE DISTRIBUTION, FOR SOFTWARE AND HARDWARE INVENTORY, FOR REMOTE ACCESS TO AND CONTROL OF COMPUTER NETWORKS, FOR UPDATING OF COMPUTER SOFTWARE, FOR DETECTION AND REPAIR OF COMPUTER SOFTWARE AND HARDWARE PROBLEMS, FOR PRIVACY OF COMMUNICATIONS AND TRANSACTIONS OVER ELECTRONIC COMMUNICATIONS NETWORKS, FOR CREATION AND MAINTENANCE OF WEB SITES, FOR CRASH PROTECTION, FOR COMPRESSION AND EXPANSION OF COMPUTER FILES, FOR RECOVERY OF DELETED COMPUTER FILES, FOR DEVELOPMENT OF COMPUTER SOFTWARE, FOR TRANSMITTAL AND RETRIEVAL OF DATA AND DOCUMENTS, FOR COMMUNICATIONS, AND FOR BUSINESS APPLICATIONS, FOR TRANSMITTING, LOCATING AND RETRIEVING DOCUMENTS, EXECUTABLES, FILES AND ALL OTHERS TYPES OF INFORMATION OVER GLOBAL COMPUTER NETWORKS AND OTHER COMPUTER AND COMMUNICATIONS NETWORKS, FOR SYNCHRONIZING FILES STORED ON DIFFERENT COMPUTERS; COMPUTER SOFTWARE AND DATABASES FOR USE IN DIAGNOSIS, REPAIR AND CONFIGURATION OF COMPUTERS AND COMPUTER PERIPHERALS, IN CLASS 9 (U.S. CLS. 21, 23, 26, 36 AND 38).



FIRST USE 7-19-2000; IN COMMERCE 7-19-2000.

THE MARK CONSISTS OF STANDARD CHARACTERS WITHOUT CLAIM TO ANY PARTICULAR FONT, STYLE, SIZE, OR COLOR.

SER. NO. 85-285,811, FILED 4-4-2011.

KATHERINE M. DUBRAY, EXAMINING ATTORNEY

David J. Kyros

Director of the United States Patent and Trademark Office

United States of America

United States Patent and Trademark Office

Novus ordo seclorum nova
ecclesia mundo est

Reg. No. 4,073,445

Registered Dec. 20, 2011

Int. Cl.: 45

SERVICE MARK

PRINCIPAL REGISTER

HIPPOCRATES UNIVERSITY (OREGON CORPORATION)
5516 BOULDER HIGHWAY
SUITE 2F #113
LAS VEGAS, NV 89122 AND

HRABAL, ANTONIN (CZECH REPUBLIC INDIVIDUAL)
5516 BOULDER HIGHWAY
SUITE 2F #113
LAS VEGAS, NV 89122

FOR: RELIGIOUS AND SPIRITUAL SERVICES, NAMELY, PROVIDING GATHERINGS AND RETREATS TO DEVELOP AND ENHANCE THE SPIRITUAL LIVES OF INDIVIDUALS, IN CLASS 45 (U.S. CLS. 100 AND 101).

FIRST USE 5-1-1997; IN COMMERCE 5-1-1997.

THE MARK CONSISTS OF STANDARD CHARACTERS WITHOUT CLAIM TO ANY PARTICULAR FONT, STYLE, SIZE, OR COLOR.

THE ENGLISH TRANSLATION OF "NOVUS ORDO SECLORUM NOVA ECCLESIA MUNDO EST" IN THE MARK IS "NEW ORDER OF THE AGES AND NEW WORLD CHURCH".

SER. NO. 85-285,925, FILED 4-4-2011.

JACQUELINE A. LAVINE, EXAMINING ATTORNEY



David J. Kyffers

Director of the United States Patent and Trademark Office

United States of America

United States Patent and Trademark Office

The Nutty Nutritionist

Reg. No. 4,073,446

Registered Dec. 20, 2011

Int. Cl.: 44

SERVICE MARK

PRINCIPAL REGISTER

HOEFER, BARBARA A. (UNITED STATES INDIVIDUAL), DBA THE NUTTY NUTRITIONIST
6102 DUNMOOR VALLEY CT.
CHARLOTTE, NC 28226

FOR: CONSULTING SERVICES IN THE FIELDS OF HEALTH AND NUTRITION; COUNSELING SERVICES IN THE FIELDS OF HEALTH, NUTRITION AND LIFESTYLE WELLNESS; DIETARY AND NUTRITIONAL GUIDANCE; FOOD NUTRITION CONSULTATION; NUTRITION COUNSELING; PROVIDING A WEB SITE FEATURING EDUCATIONAL INFORMATION REGARDING NUTRITION AND GENETICS; PROVIDING A WEB SITE FEATURING INFORMATION ON HEALTH AND NUTRITION; PROVIDING A WEB SITE THAT FEATURES INFORMATION ON CHILDREN'S NUTRITION; PROVIDING A WEBSITE FEATURING INFORMATION ABOUT HEALTH, WELLNESS AND NUTRITION; PROVIDING AN ON-LINE COMPUTER DATABASE FEATURING INFORMATION REGARDING HEALTH AND NUTRITION; PROVIDING ASSISTANCE, FITNESS EVALUATION AND CONSULTATION TO CORPORATE CLIENTS TO HELP THEIR EMPLOYEES MAKE HEALTH, WELLNESS AND NUTRITIONAL CHANGES IN THEIR DAILY LIVING TO IMPROVE HEALTH; PROVIDING ASSISTANCE, FITNESS EVALUATION AND CONSULTATION TO INDIVIDUALS TO HELP THEM MAKE HEALTH, WELLNESS AND NUTRITIONAL CHANGES IN THEIR DAILY LIVING TO IMPROVE HEALTH; PROVIDING HEALTHY LIFESTYLE AND NUTRITION SERVICES, NAMELY, PERSONAL ASSESSMENTS, PERSONALIZED ROUTINES, MAINTENANCE SCHEDULES, AND COUNSELING; PROVIDING INFORMATION ABOUT DIETARY SUPPLEMENTS AND NUTRITION; PROVIDING INFORMATION, NEWS AND COMMENTARY IN THE FIELD OF NUTRITION, HEALTH AND WELLNESS; PROVIDING WELLNESS SERVICES, NAMELY, PERSONAL ASSESSMENTS, PERSONALIZED ROUTINES, MAINTENANCE SCHEDULES, AND COUNSELING, IN CLASS 44 (U.S. CLS. 100 AND 101).

FIRST USE 5-8-2008; IN COMMERCE 5-8-2008.

THE MARK CONSISTS OF STANDARD CHARACTERS WITHOUT CLAIM TO ANY PARTICULAR FONT, STYLE, SIZE, OR COLOR.

NO CLAIM IS MADE TO THE EXCLUSIVE RIGHT TO USE "NUTRITIONIST", APART FROM THE MARK AS SHOWN.

SER. NO. 85-285,955, FILED 4-4-2011.

STEVEN PEREZ, EXAMINING ATTORNEY



David J. Kyros

Director of the United States Patent and Trademark Office

United States of America

United States Patent and Trademark Office

ACCESSENGINEERING

Reg. No. 4,073,447

THE MCGRAW-HILL COMPANIES, INC. (NEW YORK CORPORATION)
1221 AVENUE OF THE AMERICAS
NEW YORK, NY 10020

Registered Dec. 20, 2011

Int. Cls.: 9, 41 and 42

FOR: COMPUTER SOFTWARE THAT CAN BE DOWNLOADED TO A MOBILE DEVICE CONTAINING EDUCATIONAL CONTENT IN THE FIELD OF ENGINEERING, IN CLASS 9 (U.S. CLS. 21, 23, 26, 36 AND 38).

TRADEMARK

FIRST USE 3-0-2009; IN COMMERCE 3-0-2009.

SERVICE MARK

PRINCIPAL REGISTER

FOR: PROVIDING A WEBSITE CONTAINING NON-DOWNLOADABLE EDUCATIONAL PUBLICATIONS IN THE FIELD OF ENGINEERING, NAMELY, TEXT BOOKS AND GLOSSARIES; PROVIDING A WEBSITE FEATURING INTERACTIVE SELF-ASSESSMENT DIAGNOSTIC TOOLS IN THE NATURE OF NON-DOWNLOADABLE STANDARDIZED TESTS TO ALLOW ENGINEERING STUDENTS TO ASSESS EDUCATIONAL PROGRESS, IN CLASS 41 (U.S. CLS. 100, 101 AND 107).

FIRST USE 3-0-2009; IN COMMERCE 3-0-2009.

FOR: PROVIDING A WEBSITE FEATURING NON-DOWNLOADABLE EDUCATIONAL MATERIALS FEATURING INFORMATION IN THE FIELD OF ENGINEERING, NAMELY, VIDEOS, ANIMATIONS, AUDIO LECTURES, PHOTOS AND ILLUSTRATIONS; PROVIDING AN ONLINE DATABASE FEATURING INFORMATION IN THE FIELD OF ENGINEERING, IN CLASS 42 (U.S. CLS. 100 AND 101).

FIRST USE 3-0-2009; IN COMMERCE 3-0-2009.

THE MARK CONSISTS OF STANDARD CHARACTERS WITHOUT CLAIM TO ANY PARTICULAR FONT, STYLE, SIZE, OR COLOR.

SER. NO. 85-286,148, FILED 4-5-2011.

MELISSA VALLILLO, EXAMINING ATTORNEY



David J. Kyffers

Director of the United States Patent and Trademark Office

United States of America

United States Patent and Trademark Office

ACCESSPHYSIOTHERAPY

Reg. No. 4,073,448

THE MCGRAW-HILL COMPANIES, INC. (NEW YORK CORPORATION)
1221 AVENUE OF THE AMERICAS
NEW YORK, NY 10020

Registered Dec. 20, 2011

Int. Cls.: 9, 41 and 42

FOR: COMPUTER SOFTWARE THAT CAN BE DOWNLOADED TO A MOBILE DEVICE CONTAINING EDUCATIONAL CONTENT IN THE FIELD OF PHYSIOLOGY AND CONTINUING MEDICAL EDUCATIONAL MATERIALS, IN CLASS 9 (U.S. CLS. 21, 23, 26, 36 AND 38).

TRADEMARK

SERVICE MARK

FIRST USE 3-22-2010; IN COMMERCE 3-22-2010.

PRINCIPAL REGISTER

FOR: PROVIDING A WEBSITE FEATURING NON-DOWNLOADABLE EDUCATIONAL PUBLICATIONS FOR USE IN CONTINUING MEDICAL EDUCATION IN THE FIELD OF PHYSIOLOGY, NAMELY, MEDICAL BOOKS, CASE FILES, CLINICAL CASE STUDIES WITH ASSESSMENTS AND GLOSSARIES; PROVIDING A WEBSITE FEATURING INTERACTIVE SELF-ASSESSMENT DIAGNOSTIC TOOLS IN THE NATURE OF NON-DOWNLOADABLE STANDARDIZED TESTS TO ALLOW MEDICAL STUDENTS TO ASSESS EDUCATIONAL PROGRESS, IN CLASS 41 (U.S. CLS. 100, 101 AND 107).

FIRST USE 3-22-2010; IN COMMERCE 3-22-2010.

FOR: PROVIDING A WEBSITE FEATURING NON-DOWNLOADABLE EDUCATIONAL CONTENT FEATURING INFORMATION IN THE FIELD OF PHYSIOLOGY, NAMELY, VIDEOS, ANIMATIONS, AUDIO LECTURES, PHOTOS AND ILLUSTRATIONS; PROVIDING A WEBSITE FEATURING A DRUG DATABASE THAT PROVIDES SCIENTIFIC AND MEDICAL RESEARCH INFORMATION ABOUT PHARMACEUTICALS, IN CLASS 42 (U.S. CLS. 100 AND 101).

FIRST USE 3-22-2010; IN COMMERCE 3-22-2010.

THE MARK CONSISTS OF STANDARD CHARACTERS WITHOUT CLAIM TO ANY PARTICULAR FONT, STYLE, SIZE, OR COLOR.

SER. NO. 85-286,203, FILED 4-5-2011.

MELISSA VALLILLO, EXAMINING ATTORNEY



David J. Kyffers

Director of the United States Patent and Trademark Office

United States of America

United States Patent and Trademark Office

WESCO

Reg. No. 4,073,449

Registered Dec. 20, 2011

Int. Cls.: 7 and 12

TRADEMARK

PRINCIPAL REGISTER

WESCO INDUSTRIAL PRODUCTS, INC. (PENNSYLVANIA CORPORATION)
1250 WELSH ROAD
LANSDALE, PA 19446

FOR: MATERIAL HANDLING MACHINERY, NAMELY, 55-GALLON STEEL DRUM LIFTERS, HANDLERS AND CRADLES FOR THE LIFTING AND ROTATING OF INDUSTRIAL DRUMS; HYDRAULIC LIFT TABLES, HYDRAULIC SCISSOR LIFT TABLES, GANTRY CRANES, HOISTS, AND PARTS THEREFOR, ALL OF A HEAVY DUTY DESIGN FOR COMMERCIAL AND INDUSTRIAL USE, IN CLASS 7 (U.S. CLS. 13, 19, 21, 23, 31, 34 AND 35).

FIRST USE 12-31-1961; IN COMMERCE 12-31-1961.

FOR: HAND TRUCKS, APPLIANCE TRUCKS, HYDRAULIC PALLET TRUCKS, PLATFORM TRUCKS, STAIR CLIMBING HAND TRUCKS, PEDALIFT HAND TRUCKS, 55-GALLON STEEL DRUM DOLLIES, 55-GALLON STEEL DRUM CARRIERS SPECIALLY ADAPTED FOR ATTACHMENT TO HAND TRUCKS AND FORK LIFT TRUCKS, HYDRAULIC FORK STACKER TRUCKS IN THE NATURE OF A HAND TRUCK WITH A FORK LIFT CAPABILITY, HYDRAULIC PLATFORM STACKER TRUCKS IN THE NATURE OF A HAND TRUCK WITH A PLATFORM FOR LIFTING GOODS, WINCH FORK STACKER TRUCKS AND WINCH PLATFORM STACKER TRUCKS IN THE NATURE OF A HAND TRUCK WITH A WINCH CAPABILITY, MAINTENANCE WORK PLATFORMS SPECIALLY ADAPTED FOR USE WITH FORK LIFT HAND TRUCKS, PANEL CARTS, OFFICE CARTS, PALLET LEVELERS IN THE NATURE OF A SPRING LOADED PLATFORM SPECIALLY ADAPTED FOR USE WITH FORK LIFTS TO AUTOMATICALLY RAISE PALLETS UP AS THEY ARE UNLOADED, IN CLASS 12 (U.S. CLS. 19, 21, 23, 31, 35 AND 44).

FIRST USE 12-31-1961; IN COMMERCE 12-31-1961.

THE MARK CONSISTS OF STANDARD CHARACTERS WITHOUT CLAIM TO ANY PARTICULAR FONT, STYLE, SIZE, OR COLOR.

SER. NO. 85-286,291, FILED 4-5-2011.

AMY HELLA, EXAMINING ATTORNEY



David J. Kyffers

Director of the United States Patent and Trademark Office

United States of America

United States Patent and Trademark Office

CORION

Reg. No. 4,073,450

NEWPORT CORPORATION (NEVADA CORPORATION)
1791 DEERE AVE.
IRVINE, CA 92606

Registered Dec. 20, 2011

Int. Cl.: 9

FOR: OPTICAL FILTERS AND OTHER COATED OPTICS, NAMELY, LENSES, PRISMS, OPTICAL FLATS, OPTICAL WINDOWS, AND OPTICAL MIRRORS FOR USE IN SCIENTIFIC INSTRUMENTS SUCH AS MICROSCOPES, IN CLASS 9 (U.S. CLS. 21, 23, 26, 36 AND 38).

TRADEMARK

FIRST USE 5-1-1986; IN COMMERCE 5-1-1986.

PRINCIPAL REGISTER

THE MARK CONSISTS OF STANDARD CHARACTERS WITHOUT CLAIM TO ANY PARTICULAR FONT, STYLE, SIZE, OR COLOR.

SER. NO. 85-286,554, FILED 4-5-2011.

HENRY S. ZAK, EXAMINING ATTORNEY



David J. Kyffers

Director of the United States Patent and Trademark Office

United States of America

United States Patent and Trademark Office

MEGAFEST

Reg. No. 4,073,451

AMFM BROADCASTING, INC. (DELAWARE CORPORATION)
200 EAST BASSE ROAD
SAN ANTONIO, TX 78209

Registered Dec. 20, 2011

Int. Cl.: 41

FOR: ENTERTAINMENT SERVICES IN THE NATURE OF LIVE MUSICAL PERFORMANCES,
IN CLASS 41 (U.S. CLS. 100, 101 AND 107).

SERVICE MARK

FIRST USE 6-1-2010; IN COMMERCE 6-1-2010.

PRINCIPAL REGISTER

THE MARK CONSISTS OF STANDARD CHARACTERS WITHOUT CLAIM TO ANY PARTICULAR FONT, STYLE, SIZE, OR COLOR.

SER. NO. 85-287,021, FILED 4-5-2011.

EUGENIA MARTIN, EXAMINING ATTORNEY



David J. Kybas

Director of the United States Patent and Trademark Office

United States of America

United States Patent and Trademark Office



ACCREDITED

Reg. No. 4,073,452

Registered Dec. 20, 2011

Int. Cl.: 42

ASIAN ASSOCIATION OF SCHOOLS OF BUSINESS INTERNATIONAL INCORPORATED
(DELAWARE CORPORATION)

#400
2711 CENTERVILLE ROAD
WILMINGTON, DE 19808

SERVICE MARK

PRINCIPAL REGISTER

FOR: ACCREDITATION SERVICES, NAMELY, ESTABLISHING EDUCATION PRINCIPLE STANDARDS, AND SETTING STANDARDS FOR AUDITING CONCERNED WITH THE EXPRESSION OF AN OPINION AS TO THE DEGREE OF COMPLIANCE WITH THE AFORESAID EDUCATIONAL PRINCIPLE STANDARDS, IN THE FIELD OF BUSINESS ADMINISTRATION, IN CLASS 42 (U.S. CLS. 100 AND 101).

FIRST USE 3-6-2011; IN COMMERCE 3-6-2011.

NO CLAIM IS MADE TO THE EXCLUSIVE RIGHT TO USE "ACCREDITED", APART FROM THE MARK AS SHOWN.

THE MARK CONSISTS OF A DESIGN OF A STYLIZED LOTUS FLOWER WITH THE CENTER AND SIDES BEING SHADED APPEARING NEXT TO THE LETTERS "AASBI" APPEARING IN STYLIZED FONT AND ALL ABOVE A HORIZONTAL LINE AND THE WORDING "ACCREDITED" APPEARING IN STYLIZED FONT.

SER. NO. 85-287,153, FILED 4-5-2011.

CHRISTINE MARTIN, EXAMINING ATTORNEY



David J. Kybas

Director of the United States Patent and Trademark Office

United States of America

United States Patent and Trademark Office

Sonne Film Studios

Reg. No. 4,073,453

LINO, KATHERINE VANESSA (BOLIVIA INDIVIDUAL)
32633 COMET CHASE CT.
MENIFEE, CA 92584

Registered Dec. 20, 2011

Int. Cl.: 41

FOR: FILM AND VIDEO FILM PRODUCTION; MEDIA PRODUCTION SERVICES, NAMELY, VIDEO AND FILM PRODUCTION; MOTION PICTURE FILM PRODUCTION, IN CLASS 41 (U.S. CLS. 100, 101 AND 107).

SERVICE MARK

FIRST USE 4-24-2010; IN COMMERCE 4-24-2010.

PRINCIPAL REGISTER

THE MARK CONSISTS OF STANDARD CHARACTERS WITHOUT CLAIM TO ANY PARTICULAR FONT, STYLE, SIZE, OR COLOR.

NO CLAIM IS MADE TO THE EXCLUSIVE RIGHT TO USE "FILM STUDIOS", APART FROM THE MARK AS SHOWN.

THE ENGLISH TRANSLATION OF "SONNE" IN THE MARK IS "SUN".

SER. NO. 85-287,255, FILED 4-5-2011.

JERI J. FICKES, EXAMINING ATTORNEY



David J. Kyffers

Director of the United States Patent and Trademark Office

United States of America
United States Patent and Trademark Office

ENTERTAINMENT 
DESIGN GROUP, INC.

Reg. No. 4,073,454

ENTERTAINMENT DESIGN GROUP, INC. (GEORGIA CORPORATION)
7115 OAK RIDGE PARKWAY
AUSTELL, GA 30168

Registered Dec. 20, 2011

Int. Cl.: 41

FOR: ENTERTAINMENT SERVICES, NAMELY, PRODUCTION OF LIVE THEATRICAL SHOWS AND EVENTS, IN CLASS 41 (U.S. CLS. 100, 101 AND 107).

SERVICE MARK

FIRST USE 10-31-1990; IN COMMERCE 10-31-1990.

PRINCIPAL REGISTER

NO CLAIM IS MADE TO THE EXCLUSIVE RIGHT TO USE "INC.", APART FROM THE MARK AS SHOWN.

THE MARK CONSISTS OF THE STYLIZED WORDING "ENTERTAINMENT DESIGN GROUP, INC.", A SILHOUETTE OF A MAN PAINTING, AND AN UNDERLINE BENEATH THE WORDING "ENTERTAINMENT".

SEC. 2(F) AS TO "ENTERTAINMENT DESIGN GROUP, INC.".

SER. NO. 85-287,877, FILED 4-6-2011.

JEAN IM, EXAMINING ATTORNEY



David J. Kyros

Director of the United States Patent and Trademark Office

United States of America

United States Patent and Trademark Office



Reg. No. 4,073,455

Registered Dec. 20, 2011

Int. Cl.: 28

TRADEMARK

PRINCIPAL REGISTER

QUBADI, WASEA (UNITED STATES INDIVIDUAL), DBA PRO FIGHT SHOP
1062 VINE STREET
LOS ANGELES, CA 90038

FOR: ATHLETIC EQUIPMENT, NAMELY, GUARDS FOR THE HEAD, SHINS AND GROIN FOR MIXED MARTIAL ARTS AND BOXING; ATHLETIC EQUIPMENT, NAMELY, HAND WRAPS; ATHLETIC SPORTING GOODS, NAMELY, A LIFE-SIZE INFLATABLE DUMMY WITH WATER-FILLED BASE, FOR USE AS TARGET PRACTICE FOR KICKBOXING WORKOUTS; BLOCKING DUMMIES; BODY PROTECTORS FOR MARTIAL ARTS AND BOXING; BOXING RINGS; KARATE KICK PADS; KARATE TARGET PADS; MARTIAL ARTS TRAINING EQUIPMENT; PADS FOR USE IN MIXED MARTIAL ARTS AND BOXING, NAMELY, KICK SHIELDS, PUNCH SHIELDS AND TARGET PUNCH MITTS; PROTECTIVE ATHLETIC CUPS; PUNCHING BAGS; PUNCHING BALLS; SPORTS EQUIPMENT FOR BOXING AND MARTIAL ARTS, NAMELY, BOXING GLOVES, BOXING BAGS, PUNCHING MITTS, BELLY PROTECTORS, GROIN PROTECTORS AND SHIN GUARDS; SPORTS EQUIPMENT FOR BOXING AND MARTIAL ARTS, NAMELY, BOXING GLOVES, MIXED MARTIAL ARTS GLOVES, PUNCHING MITTS, AND SHIN GUARDS; TRAINING APPARATUS FOR BOXING, MARTIAL ARTS, AND SIMILAR SPORTS, IN CLASS 28 (U.S. CLS. 22, 23, 38 AND 50).

FIRST USE 4-3-2010; IN COMMERCE 4-3-2010.

THE MARK CONSISTS OF THE STYLIZED WORD "PROLAST".

SER. NO. 85-288,214, FILED 4-6-2011.

JEAN IM, EXAMINING ATTORNEY



David J. Kyffers

Director of the United States Patent and Trademark Office

United States of America

United States Patent and Trademark Office



Reg. No. 4,073,456

Registered Dec. 20, 2011

Int. Cl.: 41

SERVICE MARK

PRINCIPAL REGISTER

LIL OMM, LLC (D.C. LIMITED LIABILITY COMPANY)
3810 FULTON ST NW
WASHINGTON, DC 20007

FOR: PHYSICAL FITNESS INSTRUCTION, IN CLASS 41 (U.S. CLS. 100, 101 AND 107).

FIRST USE 6-0-2008; IN COMMERCE 6-0-2008.

THE MARK CONSISTS OF THE WORDING "LIL OMM" IN BLACK, LEAVES IN DARKER AND LIGHTER SHADES OF GREEN, AND THE SANSKRIT WORD FOR "OMM" IN WHITE.

THE COLOR(S) BLACK, GREEN AND WHITE IS/ARE CLAIMED AS A FEATURE OF THE MARK.

THE NON-LATIN CHARACTERS IN THE MARK TRANSLITERATE TO "OMM" AND THIS MEANS "THE SOUND OF LIFE" IN ENGLISH.

THE ENGLISH TRANSLATION OF "OMM" IN THE MARK IS "THE SOUND OF LIFE".

SER. NO. 85-288,364, FILED 4-6-2011.

ANGELA DUONG, EXAMINING ATTORNEY



David J. Kybas

Director of the United States Patent and Trademark Office

United States of America

United States Patent and Trademark Office



Reg. No. 4,073,457

Registered Dec. 20, 2011

Int. Cl.: 16

TRADEMARK

PRINCIPAL REGISTER

THUNDERBIRD SCHOOL OF GLOBAL MANAGEMENT (ARIZONA CORPORATION)
15249 NORTH 59TH AVENUE
GLENDALE, AZ 85306

FOR: BOOKS IN THE FIELDS OF INTERNATIONAL MANAGEMENT AND BUSINESS STUDIES AND PRINTED PUBLICATIONS, NAMELY, NEWSPAPERS; MAGAZINES IN THE FIELDS OF INTERNATIONAL MANAGEMENT AND BUSINESS STUDIES; PRINTED MATTER, NAMELY, BROCHURES IN THE FIELDS OF INTERNATIONAL MANAGEMENT AND BUSINESS STUDIES, IN CLASS 16 (U.S. CLS. 2, 5, 22, 23, 29, 37, 38 AND 50).

FIRST USE 2-2-2007; IN COMMERCE 2-2-2007.

THE MARK CONSISTS OF A BIRD WITH A GLOBE DESIGN IN THE MIDDLE.

SER. NO. 85-288,812, FILED 4-7-2011.

KRISTINA MORRIS, EXAMINING ATTORNEY



David J. Kybas

Director of the United States Patent and Trademark Office

United States of America

United States Patent and Trademark Office

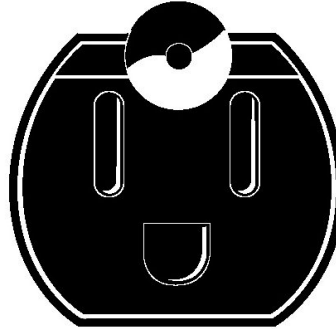

Reg. No. 4,073,458

Registered Dec. 20, 2011

Int. Cl.: 37

SERVICE MARK

PRINCIPAL REGISTER

MACFARLAND, MIKE (UNITED STATES INDIVIDUAL)
5950 LA QUINTA COURT
REDDING, CA 96003

FOR: INSTALLATION, CONSTRUCTION, AND REPAIR OF BUILDING INSTALLATION TO PROVIDE ENERGY SAVINGS TO HOMES AND STRUCTURES, NAMELY RESIDENTIAL HOMES, IN CLASS 37 (U.S. CLS. 100, 103 AND 106).

FIRST USE 1-24-2011; IN COMMERCE 3-1-2011.

THE MARK CONSISTS OF AN ENLARGED, CLOSEUP, RENDITION OF AN ELECTRICAL OUTLET CREATING A HAPPY FACE WITH A DOCTOR'S HEADLAMP REFLECTOR ON THE FOREHEAD AREA, AND THE GROUNDING OUTLET FORMING THE MOUTH SMILE.

SER. NO. 85-288,928, FILED 4-7-2011.

NAKIA HENRY, EXAMINING ATTORNEY



David J. Kybas

Director of the United States Patent and Trademark Office

United States of America

United States Patent and Trademark Office

The Original MLM Success Planner

Reg. No. 4,073,459

BREWSTER, JASPER (UNITED STATES INDIVIDUAL)
4312 GOLDEN HILLS DRIVE
NASHVILLE, TN 37218

Registered Dec. 20, 2011

Int. Cl.: 16

FOR: DAY PLANNER AND PERSONAL ORGANIZER FOR THE PROFESSIONAL NETWORK
MARKETER, IN CLASS 16 (U.S. CLS. 2, 5, 22, 23, 29, 37, 38 AND 50).

TRADEMARK

FIRST USE 10-1-2009; IN COMMERCE 10-1-2009.

PRINCIPAL REGISTER

THE MARK CONSISTS OF STANDARD CHARACTERS WITHOUT CLAIM TO ANY PAR-
TICULAR FONT, STYLE, SIZE, OR COLOR.

NO CLAIM IS MADE TO THE EXCLUSIVE RIGHT TO USE "ORIGINAL MLM" AND
"PLANNER", APART FROM THE MARK AS SHOWN.

SER. NO. 85-288,935, FILED 4-7-2011.

KELLY TRUSILO, EXAMINING ATTORNEY



David J. Kybas

Director of the United States Patent and Trademark Office

United States of America
United States Patent and Trademark Office

**Wealth
For Life**

Reg. No. 4,073,460

EARL G. GRAVES PUBLISHING CO. (NEW YORK CORPORATION)
130 FIFTH AVENUE
NEW YORK, NY 10011

Registered Dec. 20, 2011

Int. Cl.: 16

FOR: MAGAZINE COLUMN ON TOPICS OF INTEREST TO BUSINESS LEADERS COMPRISED OF ENTREPRENEURS, CORPORATE PROFESSIONALS AND TECHNOLOGY INNOVATORS FEATURING A GROUP OF BUSINESS LEADERS COMPRISED OF ENTREPRENEURS, CORPORATE PROFESSIONALS AND TECHNOLOGY INNOVATORS, IN CLASS 16 (U.S. CLS. 2, 5, 22, 23, 29, 37, 38 AND 50).

TRADEMARK

PRINCIPAL REGISTER

FIRST USE 6-1-2009; IN COMMERCE 6-1-2009.

THE MARK CONSISTS OF THE WORD "WEALTH" WITH THE WORD "FOR" UNDERNEATH IN A SMALLER FONT NEXT TO THE WORD "LIFE".

SER. NO. 85-289,063, FILED 4-7-2011.

LINDA ORNDORFF, EXAMINING ATTORNEY



David J. Kybas

Director of the United States Patent and Trademark Office

United States of America

United States Patent and Trademark Office



ZEO HEALTH

Reg. No. 4,073,461

Registered Dec. 20, 2011

Int. Cl.: 40

SERVICE MARK

PRINCIPAL REGISTER

PORTNEY, MICAH (UNITED STATES INDIVIDUAL)
29 SUNSET VIEW DRIVE
WEST NYACK, NY 10994

FOR: MANUFACTURING SERVICES FOR OTHERS IN THE FIELD OF HEALTH AND NUTRITION PRODUCTS, NAMELY, DIETARY AND NUTRITIONAL SUPPLEMENTS, DIETARY FOOD SUPPLEMENTS, DIETARY SUPPLEMENTS, DIETARY SUPPLEMENTS FOR HUMAN CONSUMPTION, FOOD SUPPLEMENTS, HERBAL SUPPLEMENTS, AND HOMEOPATHIC SUPPLEMENTS; PROVIDING TECHNICAL INFORMATION IN THE FIELD OF PHARMACEUTICAL MANUFACTURING, IN CLASS 40 (U.S. CLS. 100, 103 AND 106).

FIRST USE 1-28-2003; IN COMMERCE 1-28-2003.

OWNER OF U.S. REG. NO. 3,492,026.

THE COLOR(S) PURPLE, GOLD, BLACK, AND WHITE IS/ARE CLAIMED AS A FEATURE OF THE MARK.

NO CLAIM IS MADE TO THE EXCLUSIVE RIGHT TO USE "HEALTH", APART FROM THE MARK AS SHOWN.

THE MARK CONSISTS OF THE WORDING "ZEO" IN PURPLE LETTERS WHICH IS SET AGAINST A GOLD RECTANGULAR BOX. BEHIND THE WORD "ZEO" IS WHITE STIPPLING. UNDER THAT IMAGE IS THE WORDING "ZEO HEALTH" IN BLACK LETTERS. THE MARK APPEARS ON A WHITE BACKGROUND.

SER. NO. 85-289,435, FILED 4-7-2011.

BARBARA GAYNOR, EXAMINING ATTORNEY



David J. Kybas

Director of the United States Patent and Trademark Office

United States of America

United States Patent and Trademark Office

ZEO HEALTH

Reg. No. 4,073,462

Registered Dec. 20, 2011

Int. Cl.: 40

SERVICE MARK

PRINCIPAL REGISTER

PORTNEY, MICAH (UNITED STATES INDIVIDUAL)
29 SUNSET VIEW DRIVE
WEST NYACK, NY 10994

FOR: MANUFACTURING SERVICES FOR OTHERS IN THE FIELD OF HEALTH AND NUTRITION PRODUCTS, NAMELY, DIETARY AND NUTRITIONAL SUPPLEMENTS, DIETARY FOOD SUPPLEMENTS, DIETARY SUPPLEMENTS, DIETARY SUPPLEMENTS FOR HUMAN CONSUMPTION, FOOD SUPPLEMENTS, HERBAL SUPPLEMENTS, AND HOMEOPATHIC SUPPLEMENTS; PROVIDING TECHNICAL INFORMATION IN THE FIELD OF PHARMACEUTICAL MANUFACTURING, IN CLASS 40 (U.S. CLS. 100, 103 AND 106).

FIRST USE 5-8-2003; IN COMMERCE 5-8-2003.

THE MARK CONSISTS OF STANDARD CHARACTERS WITHOUT CLAIM TO ANY PARTICULAR FONT, STYLE, SIZE, OR COLOR.

OWNER OF U.S. REG. NO. 3,492,026.

NO CLAIM IS MADE TO THE EXCLUSIVE RIGHT TO USE "HEALTH", APART FROM THE MARK AS SHOWN.

SER. NO. 85-289,470, FILED 4-7-2011.

BARBARA GAYNOR, EXAMINING ATTORNEY



David J. Kypos

Director of the United States Patent and Trademark Office

United States of America

United States Patent and Trademark Office

Your Hometown Paint Experts

Reg. No. 4,073,463

FLORIDA PAINT CENTERS, INC. (FLORIDA CORPORATION)
26379 TRINILAS DR.

Registered Dec. 20, 2011

PUNTA GORDA, FL 33983

Int. Cl.: 35

FOR: RETAIL PAINT STORE SERVICES, IN CLASS 35 (U.S. CLS. 100, 101 AND 102).

SERVICE MARK

FIRST USE 10-1-1992; IN COMMERCE 10-1-1992.

PRINCIPAL REGISTER

THE MARK CONSISTS OF STANDARD CHARACTERS WITHOUT CLAIM TO ANY PARTICULAR FONT, STYLE, SIZE, OR COLOR.

NO CLAIM IS MADE TO THE EXCLUSIVE RIGHT TO USE "PAINT EXPERTS", APART FROM THE MARK AS SHOWN.

SER. NO. 85-289,856, FILED 4-8-2011.

JEFFREY LOOK, EXAMINING ATTORNEY



David J. Kyffers

Director of the United States Patent and Trademark Office

United States of America

United States Patent and Trademark Office



Reg. No. 4,073,464

2ND THIEF MINISTRIES (VIRGINIA CORPORATION)
4703 ANGUS DRIVE
GAINESVILLE, VA 20155

Registered Dec. 20, 2011

Int. Cl.: 45

FOR: MINISTERIAL SERVICES, IN CLASS 45 (U.S. CLS. 100 AND 101).

SERVICE MARK

FIRST USE 7-7-2005; IN COMMERCE 9-18-2005.

PRINCIPAL REGISTER

NO CLAIM IS MADE TO THE EXCLUSIVE RIGHT TO USE "LUKE 4:18", "ACTS 11:21", "RIDERS", OR "M/M", APART FROM THE MARK AS SHOWN.

THE MARK CONSISTS OF A SHIELD WITH AN OVAL IN THE CENTER AND A U.S. FLAG FLYING AS THE BACKGROUND. THREE CROSSES ARE OVERLAY IN THE BACKGROUND WITH A SILHOUETTE MOTORCYCLE WITH RIDER OVERLAYING THE CROSSES. THE STYLIZED TEXT ""DECLARING THE GOOD NEWS" LUKE 4:18" ARE ABOVE AND FOLLOW THE CURVE OF THE OVAL. THE STYLIZED TEXT "RIDING FOR HIS GLORY ACTS 11:21" ARE BELOW AND FOLLOW THE CURVE OF THE OVAL. THERE IS AN UPPER ROCKER IN WITH STYLIZED TEXT "2ND THIEF" AND A LOWER ROCKER WITH THE STYLIZED TEXT "RIDERS". TO THE RIGHT OF THE OVAL THERE IS THE STYLIZED TEXT "M/M".

SER. NO. 85-289,957, FILED 4-8-2011.

KATHERINE M. DUBRAY, EXAMINING ATTORNEY



David J. Kyjars

Director of the United States Patent and Trademark Office

United States of America

United States Patent and Trademark Office

NIA

Reg. No. 4,073,465

Registered Dec. 20, 2011

Int. Cl.: 41

SERVICE MARK

PRINCIPAL REGISTER

NIA TECHNIQUE INC. (OREGON CORPORATION)
918 SW YAMHILL, 3RD FLOOR
PORTLAND, OR 97205

FOR: PHYSICAL FITNESS STUDIO SERVICES, NAMELY, PROVIDING EXERCISE CLASSES, BODY SCULPTING CLASSES, AND GROUP FITNESS CLASSES; EDUCATIONAL SERVICES, NAMELY, CONDUCTING CLASSES, SEMINARS, AND WORKSHOPS IN THE FIELDS OF FITNESS, HEALTH, WELLNESS, EXERCISE, DANCE, YOGA, MARTIAL ARTS, AND T'AI CHI, AND DISTRIBUTION OF EDUCATIONAL AND TRAINING MATERIALS IN CONNECTION THEREWITH, IN CLASS 41 (U.S. CLS. 100, 101 AND 107).

FIRST USE 2-18-1984; IN COMMERCE 2-18-1984.

THE MARK CONSISTS OF STANDARD CHARACTERS WITHOUT CLAIM TO ANY PARTICULAR FONT, STYLE, SIZE, OR COLOR.

OWNER OF U.S. REG. NOS. 1,828,625, 3,707,838, AND 3,707,839.

SER. NO. 85-290,629, FILED 4-8-2011.

MICHELLE DUBOIS, EXAMINING ATTORNEY



David J. Kyffers

Director of the United States Patent and Trademark Office

United States of America

United States Patent and Trademark Office

STYLEMINT

Reg. No. 4,073,466

BEACHMINT, INC. (DELAWARE CORPORATION)
101 SOUTH ROSSMORE AVENUE
LOS ANGELES, CA 90004

Registered Dec. 20, 2011

Int. Cls.: 35, 41, 42 and 45

FOR: RETAIL STORE AND ON-LINE RETAIL STORE SERVICES FEATURING HAND BAGS, ACCESSORIES, SHOES, JEWELRY, AND CLOTHING, IN CLASS 35 (U.S. CLS. 100, 101 AND 102).

SERVICE MARK

FIRST USE 8-25-2007; IN COMMERCE 8-25-2007.

PRINCIPAL REGISTER

FOR: PROVIDING ON-LINE ARTICLES AND MAGAZINES IN THE FIELD OF FASHION, FASHION DESIGN, FASHION COLLECTION, AND FASHION TRENDS, IN CLASS 41 (U.S. CLS. 100, 101 AND 107).

FIRST USE 8-25-2007; IN COMMERCE 8-25-2007.

FOR: PROVIDING A WEB SITE FEATURING INFORMATION IN THE FIELD OF FASHION DESIGN, IN CLASS 42 (U.S. CLS. 100 AND 101).

FIRST USE 8-25-2007; IN COMMERCE 8-25-2007.

FOR: ONLINE SOCIAL NETWORKING SERVICES PROVIDED THROUGH A FASHION COMMUNITY WEBSITE; PROVIDING A WEB SITE FEATURING INFORMATION IN THE FIELD OF FASHION, FASHION TRENDS AND FASHION CLOTHING COLLECTIONS, IN CLASS 45 (U.S. CLS. 100 AND 101).

FIRST USE 8-25-2007; IN COMMERCE 8-25-2007.

THE MARK CONSISTS OF STANDARD CHARACTERS WITHOUT CLAIM TO ANY PARTICULAR FONT, STYLE, SIZE, OR COLOR.

SER. NO. 85-290,792, FILED 4-8-2011.

THEODORE MCBRIDE, EXAMINING ATTORNEY



David J. Kyros

Director of the United States Patent and Trademark Office

United States of America

United States Patent and Trademark Office

EC Innovations

empower communications

Reg. No. 4,073,467

Registered Dec. 20, 2011

Int. Cls.: 9 and 41

TRADEMARK

SERVICE MARK

PRINCIPAL REGISTER

EC INNOVATIONS (USA), INC. (DELAWARE CORPORATION)
STE 105
501 SILVERSIDE ROAD
WILMINGTON, DE 19809

FOR: COMPUTER SOFTWARE AND COMPUTER HARDWARE FOR USE IN LANGUAGE LOCALIZATION, NAMELY, FOR LANGUAGE TRANSLATION, SUBTITLING, DUBBING, CLOSED CAPTIONING AND TELETEXT FOR FEATURE FILMS, TELEVISION PROGRAMS, VIDEOS AND DIGITAL MEDIA IN GENERAL, IN CLASS 9 (U.S. CLS. 21, 23, 26, 36 AND 38).

FIRST USE 3-17-2011; IN COMMERCE 3-17-2011.

FOR: TRANSLATION SERVICES, IN CLASS 41 (U.S. CLS. 100, 101 AND 107).

FIRST USE 3-17-2011; IN COMMERCE 3-17-2011.

NO CLAIM IS MADE TO THE EXCLUSIVE RIGHT TO USE "COMMUNICATIONS", APART FROM THE MARK AS SHOWN.

THE MARK CONSISTS OF THE STYLIZED TEXT "EC INNOVATIONS EMPOWER COMMUNICATIONS" WITH A SWOOSH ON THE TOP.

SER. NO. 85-290,859, FILED 4-8-2011.

REGINA DRUMMOND, EXAMINING ATTORNEY



David J. Kybas

Director of the United States Patent and Trademark Office

United States of America

United States Patent and Trademark Office

Spiritual Republic Co.

Reg. No. 4,073,468

Registered Dec. 20, 2011

Int. Cl.: 35

SERVICE MARK

PRINCIPAL REGISTER

PEREZ VICTORIA M (UNITED STATES INDIVIDUAL), AKA VICTORIA HARAMBOURE
523 56TH ST
WEST NEW YORK, NJ 07093

FOR: PROVIDING ADVERTISING SERVICE TO DISTRIBUTE ADVERTISEMENTS FOR DISPLAY ON INTERNET, NAMELY, IN WEBSITES, SOCIAL CONVERSATIONS OVER THE INTERNET, E-MAILS, MICROBLOGS, BLOGS, ELECTRONIC MESSAGES, INSTANT MESSAGES, TEXT MESSAGES, MULTIMEDIA MESSAGES, SOCIAL NETWORKS, STATUS UPDATES, FORUMS, ELECTRONIC BULLETIN BOARDS, IN CLASS 35 (U.S. CLS. 100, 101 AND 102).

FIRST USE 4-9-2011; IN COMMERCE 4-9-2011.

THE MARK CONSISTS OF STANDARD CHARACTERS WITHOUT CLAIM TO ANY PARTICULAR FONT, STYLE, SIZE, OR COLOR.

NO CLAIM IS MADE TO THE EXCLUSIVE RIGHT TO USE "CO.", APART FROM THE MARK AS SHOWN.

SER. NO. 85-291,062, FILED 4-9-2011.

MARK T. MULLEN, EXAMINING ATTORNEY



David J. Kyros

Director of the United States Patent and Trademark Office

United States of America

United States Patent and Trademark Office

BABY BLANKET MUSIC

Reg. No. 4,073,469

BABY BLANKET MUSIC, LLC (NEW YORK LIMITED LIABILITY COMPANY)
PO BOX 202

Registered Dec. 20, 2011

NEW ROCHELLE, NY 10804

Int. Cl.: 9

FOR: PRERECORDED COMPACT DISCS AND DOWNLOADABLE DIGITAL MUSIC FILES
FEATURING MUSIC, IN CLASS 9 (U.S. CLS. 21, 23, 26, 36 AND 38).

TRADEMARK

FIRST USE 12-3-2009; IN COMMERCE 12-3-2009.

PRINCIPAL REGISTER

THE MARK CONSISTS OF STANDARD CHARACTERS WITHOUT CLAIM TO ANY PARTICULAR FONT, STYLE, SIZE, OR COLOR.

NO CLAIM IS MADE TO THE EXCLUSIVE RIGHT TO USE "MUSIC", APART FROM THE MARK AS SHOWN.

SER. NO. 85-291,320, FILED 4-11-2011.

ANNE MADDEN, EXAMINING ATTORNEY



David J. Kyffers

Director of the United States Patent and Trademark Office

United States of America

United States Patent and Trademark Office



Reg. No. 4,073,470

BABY BLANKET MUSIC, LLC (NEW YORK LIMITED LIABILITY COMPANY)
PO BOX 202

Registered Dec. 20, 2011

NEW ROCHELLE, NY 10804

Int. Cl.: 9

FOR: PRERECORDED COMPACT DISCS AND DOWNLOADABLE DIGITAL MUSIC FILES
FEATURING MUSIC, IN CLASS 9 (U.S. CLS. 21, 23, 26, 36 AND 38).

TRADEMARK

FIRST USE 12-3-2009; IN COMMERCE 12-3-2009.

PRINCIPAL REGISTER

NO CLAIM IS MADE TO THE EXCLUSIVE RIGHT TO USE "MUSIC", APART FROM THE
MARK AS SHOWN.

THE MARK CONSISTS OF A LOGO CONSISTING OF TWO RECTANGULAR SHAPES
SIMULATING A BLANKET, ON THE LEFT SIDE OF THE LOGO IS THE HEAD AND FACE
OF A CHILD WEARING HEADPHONES, AND ON THE RIGHT SIDE OF THE LOGO ARE
THE WORDS "BABY BLANKET MUSIC" IN STYLIZED FONT, WHERE THE WORD "BABY"
RESTS ON TOP OF THE WORD "BLANKET" AND THE WORD "BLANKET" RESTS ON
TOP OF THE WORD "MUSIC".

SER. NO. 85-291,325, FILED 4-11-2011.

ANNE MADDEN, EXAMINING ATTORNEY



David J. Kybas

Director of the United States Patent and Trademark Office

United States of America

United States Patent and Trademark Office

PATRIOT PAC

Reg. No. 4,073,471

GERDIN, JOEY (UNITED STATES INDIVIDUAL), DBA PATRIOT PAC
728 SUMMIT AVENUE
SAINT PAUL, MN 55105

Registered Dec. 20, 2011

Int. Cls.: 35 and 36

FOR: POLITICAL ACTION COMMITTEE SERVICES, NAMELY, PROMOTING THE INTERESTS OF ALL LOCAL AND STATE CANDIDATES WHO BELIEVE IN THE LIBERTY, FREEDOM AND THE CONSTITUTION OF THE UNITED STATES, PROMOTING THE INTERESTS OF CANDIDATES ON BOTH SIDES OF THE AISLE WHO UNDERSTAND THE ONGOING SUPPORT OUR VETERANS AND ACTIVE DUTY PERSONNEL NEED AND DESERVE, PROMOTING OUR BELIEF THAT AMERICA'S GREATEST STRENGTHS BEGINS WITH THE BRAVE MEN AND WOMEN WHO FIGHT FOR US, AND PROMOTING THE INTERESTS OF VETERANS AND THOSE WHO SUPPORT OUR MILITARY AND THEIR MISSION ON THE GLOBAL WAR ON TERRORISM TO MAKE THE LEAP INTO RUNNING FOR PUBLIC OFFICE, IN CLASS 35 (U.S. CLS. 100, 101 AND 102).

SERVICE MARK

PRINCIPAL REGISTER

FIRST USE 12-26-2008; IN COMMERCE 12-26-2008.

FOR: POLITICAL FUNDRAISING SERVICES FOR LOCAL AND STATE CANDIDATES WHO BELIEVE IN THE LIBERTY, FREEDOM AND THE CONSTITUTION OF THE UNITED STATES; POLITICAL FUND RAISING SERVICES FOR CANDIDATES ON BOTH SIDES OF THE AISLE WHO UNDERSTAND THE ONGOING SUPPORT OUR VETERANS AND ACTIVE DUTY PERSONNEL NEED AND DESERVE, IN CLASS 36 (U.S. CLS. 100, 101 AND 102).

FIRST USE 12-26-2008; IN COMMERCE 12-26-2008.

THE MARK CONSISTS OF STANDARD CHARACTERS WITHOUT CLAIM TO ANY PARTICULAR FONT, STYLE, SIZE, OR COLOR.

NO CLAIM IS MADE TO THE EXCLUSIVE RIGHT TO USE "PAC", APART FROM THE MARK AS SHOWN.

SER. NO. 85-291,553, FILED 4-11-2011.

KELLY BOULTON, EXAMINING ATTORNEY



David J. Kyffers

Director of the United States Patent and Trademark Office

United States of America

United States Patent and Trademark Office

JuggerVault

Reg. No. 4,073,472

Registered Dec. 20, 2011

Int. Cl.: 42

SERVICE MARK

PRINCIPAL REGISTER

THE TECHNOLOGY STOP LLC (TEXAS LIMITED LIABILITY COMPANY)
SUITE 122
1110 E. COLLINS BLVD.
RICHARDSON, TX 75081

FOR: COMPUTER DISASTER RECOVERY PLANNING; REMOTE COMPUTER BACKUP SERVICES, IN CLASS 42 (U.S. CLS. 100 AND 101).

FIRST USE 10-26-2009; IN COMMERCE 1-19-2010.

THE MARK CONSISTS OF STANDARD CHARACTERS WITHOUT CLAIM TO ANY PARTICULAR FONT, STYLE, SIZE, OR COLOR.

SER. NO. 85-291,728, FILED 4-11-2011.

SUSAN STIGLITZ, EXAMINING ATTORNEY



David J. Kybas

Director of the United States Patent and Trademark Office

United States of America

United States Patent and Trademark Office

TERROR MANSION

Reg. No. 4,073,473

Registered Dec. 20, 2011

Int. Cl.: 41

SERVICE MARK

PRINCIPAL REGISTER

ALANIS, NANCY K (UNITED STATES INDIVIDUAL), DBA TERROR MANSION
ALANISNK@AOL.COM
PO BOX 15524
SAN ANTONIO, TX 78212

FOR: ENTERTAINMENT SERVICES, NAMELY, LIVE, TELEVISED AND MOVIE APPEARANCES BY A PROFESSIONAL ENTERTAINER; ENTERTAINMENT SERVICES, NAMELY, PERSONAL APPEARANCES BY A VARIETY OF PEOPLE WHO CAN SHARE HORROR GENRE/PARANORMAL EXPERIENCES; ENTERTAINMENT SERVICES, NAMELY, PRODUCTION OF SPECIAL EFFECTS INCLUDING MODEL-MAKING SERVICES, COMPUTER-GENERATED IMAGERY AND COMPUTER-GENERATED GRAPHICS FOR THE PRODUCTION OF MOTION PICTURES, VIDEOS, AND MOVIE TRAILERS; ENTERTAINMENT SERVICES, NAMELY, PROVIDING ON-LINE REVIEWS OF PARANORMAL AND HORROR GENRE BOOKS, MOVIES AND ENTERTAINMENT EXHIBITS; ENTERTAINMENT SERVICES, NAMELY, THE PROVISION OF CONTINUING PROGRAMS, MOVIES, SHOWS FEATURING NEWS, COMEDY, HORROR GENRE, COMMENTARY, PARANORMAL DELIVERED BY LIVE THEATER, TV, RADIO, CABLE, SATELLITE, INTERNET, LIVE, CELL PHONES AND BY LIVE PERFORMANCE BY INDIVIDUALS; MOVIE STUDIOS; MOVIE THEATERS; PLANNING ARRANGEMENT OF SHOWING MOVIES, SHOWS, PLAYS OR MUSICAL PERFORMANCES; PREPARING SUBTITLES FOR MOVIES; PRODUCTION AND DISTRIBUTION OF TELEVISION SHOWS AND MOVIES; PROVIDING FACILITIES FOR MOVIES, SHOWS, PLAYS, MUSIC OR EDUCATIONAL TRAINING; PROVIDING ONLINE INTERVIEWS FEATURING CELEBRITIES AND ENTERTAINERS IN THE FIELD OF PARANORMAL AND HORROR GENRE BOOKS, MOVIES AND ENTERTAINMENT EXHIBITS OR ENTERTAINMENT PURPOSES; PROVIDING RATINGS FOR TELEVISION, MOVIE, MUSIC, VIDEO AND VIDEO GAME CONTENT; PROVISION OF NON-DOWNLOADABLE FILMS AND MOVIES VIA A VIDEO-ON-DEMAND SERVICE; RENTAL AND COMPUTERIZED ON-LINE RENTAL SERVICES FEATURING INTERACTIVE SOFTWARE AND HARDWARE HOME ENTERTAINMENT AND CONSUMER ELECTRONICS IN THE NATURE OF MOTION PICTURES, FILMS, MOVIES, PRERECORDED DIGITAL VERSATILE DISCS (OR DVDS), PRERECORDED VIDEOTAPE CASSETTES, AUDIO, AUDIO RECORDINGS IN A VARIETY OF GENRES; RENTAL OF MOVIE PROJECTORS AND ACCESSORIES; RENTAL OF MOVIE PROJECTORS AND THEIR ACCESSORIES; RENTAL OF STAGE AND MOVIE EQUIPMENT, NAMELY, CAMERA EQUIPMENT, LIGHTING EQUIPMENT AND GRIP EQUIPMENT; TELEVISION, VIDEO AND MOVIE FILMING SERVICES, IN CLASS 41 (U.S. CLS. 100, 101 AND 107).



David J. Kybas

Director of the United States Patent and Trademark Office

Reg. No. 4,073,473 FIRST USE 9-1-1999; IN COMMERCE 9-1-1999.

THE MARK CONSISTS OF STANDARD CHARACTERS WITHOUT CLAIM TO ANY PARTICULAR FONT, STYLE, SIZE, OR COLOR.

SER. NO. 85-292,104, FILED 4-11-2011.

DANIEL CAPSHAW, EXAMINING ATTORNEY

United States of America

United States Patent and Trademark Office

MML Investors Services

Reg. No. 4,073,474

Registered Dec. 20, 2011

Int. Cl.: 36

SERVICE MARK

PRINCIPAL REGISTER

MML INVESTORS SERVICES, LLC (MASSACHUSETTS LIMITED LIABILITY COMPANY)
1295 STATE STREET
SPRINGFIELD, MA 01111

FOR: INVESTMENT BROKERAGE IN THE NATURE OF BROKER DEALER SERVICES FOR DISTRIBUTION OF MUTUAL FUNDS, UNIT INVESTMENT TRUSTS, DIRECT PARTICIPATION PROGRAMS, STOCKS, BONDS, AND VARIABLE INSURANCE PRODUCTS; SECURITIES UNDERWRITING; ASSET MANAGEMENT; FINANCIAL PLANNING; INVESTMENT ADVISORY SERVICES, IN CLASS 36 (U.S. CLS. 100, 101 AND 102).

FIRST USE 1-1-2011; IN COMMERCE 1-1-2011.

THE MARK CONSISTS OF STANDARD CHARACTERS WITHOUT CLAIM TO ANY PARTICULAR FONT, STYLE, SIZE, OR COLOR.

OWNER OF U.S. REG. NOS. 1,974,906 AND 1,978,170.

NO CLAIM IS MADE TO THE EXCLUSIVE RIGHT TO USE "INVESTORS SERVICES", APART FROM THE MARK AS SHOWN.

SER. NO. 85-292,275, FILED 4-11-2011.

ANNE MADDEN, EXAMINING ATTORNEY



David J. Kyros

Director of the United States Patent and Trademark Office

United States of America

United States Patent and Trademark Office

DIE STRONG

Reg. No. 4,073,475

Registered Dec. 20, 2011

Int. Cl.: 25

TRADEMARK

PRINCIPAL REGISTER

MATRIX DIRECT, INC. (CALIFORNIA CORPORATION) (CALIFORNIA CORPORATION),
AKA MATRIX DIRECT
9640 GRANITE RIDGE DRIVE
SAN DIEGO, CA 92123

FOR: ATHLETIC APPAREL, NAMELY, SHIRTS, PANTS, JACKETS, FOOTWEAR, HATS
AND CAPS, ATHLETIC UNIFORMS; WRISTBANDS, IN CLASS 25 (U.S. CLS. 22 AND 39).

FIRST USE 3-10-2011; IN COMMERCE 3-20-2011.

THE MARK CONSISTS OF STANDARD CHARACTERS WITHOUT CLAIM TO ANY PAR-
TICULAR FONT, STYLE, SIZE, OR COLOR.

SER. NO. 85-292,306, FILED 4-11-2011.

ELIZABETH KAJUBI, EXAMINING ATTORNEY



David J. Kyffers

Director of the United States Patent and Trademark Office

United States of America

United States Patent and Trademark Office



Reg. No. 4,073,476

Registered Dec. 20, 2011

Int. Cl.: 11

TRADEMARK

PRINCIPAL REGISTER

SHENZHEN MASON TECHNOLOGIES CO.,LTD. (CHINA CORPORATION)
BUILDING B, YA SHENG INDUSTRIAL PARK
ZHEN MEI-GONG CHANG ROAD
SHENZHEN, CHINA

FOR: CANDLE LAMPS; CEILING LIGHTS; CULTIVATION LAMPS AND PARTS THEREOF, NAMELY, HIGH PRESSURE SODIUM (HPS), METAL HALIDE, PLASMA, AND LIGHT EMITTING DIODE (LED); DOWNLIGHTERS; ELECTRIC DISCHARGE TUBES FOR LIGHTING; ELECTRIC HOLIDAY LIGHTS; ELECTRIC LIGHT BULBS; ELECTRIC LIGHTING FIXTURES; ELECTRIC LIGHTING FIXTURES, NAMELY, POWER FAILURE BACKUP SAFETY LIGHTING; ELECTRIC LUMINAIRES; ELECTRIC NIGHT LIGHTS; FLASHLIGHTS; FLAT PANEL LIGHTING APPARATUS; FLOODLIGHTS; FLUORESCENT ELECTRIC LIGHT BULBS; FLUORESCENT LAMP TUBES; FLUORESCENT LAMPS; FLUORESCENT LIGHTING TUBES; INFRARED LAMPS; LAMP BULBS; LAMPS FOR OUTDOOR USE; LED (LIGHT EMITTING DIODE) LIGHTING FIXTURES; LED (LIGHT EMITTING DIODES) LIGHTING FIXTURES FOR USE IN DISPLAY, COMMERCIAL, INDUSTRIAL, RESIDENTIAL, AND ARCHITECTURAL ACCENT LIGHTING APPLICATIONS; LED LIGHT ASSEMBLIES FOR STREET LIGHTS, SIGNS, COMMERCIAL LIGHTING, AUTOMOBILES, BUILDINGS, AND OTHER ARCHITECTURAL USES; LED LIGHT BULBS; LED LIGHTING FIXTURES FOR INDOOR AND OUTDOOR LIGHTING APPLICATIONS; LED LIGHTING SYSTEMS, NAMELY, LED MODULES, POWER SUPPLIES, AND WIRING; LED LIGHTS FOR LIGHTING PURPOSES INCORPORATED INTO KEY CHAINS, SMALL TOYS OR OTHER SIMILAR PERSONAL ITEMS; LED LUMINAIRES; LIGHT BULBS; LIGHT EMITTING DIODE (LED) PLANT GROW LIGHT; LIGHTING FIXTURES FOR USE IN PARKING LOTS AND WALKWAYS; LIGHTING TUBES; LIGHTS FOR ILLUMINATING STAIRS, DOORS AND OTHER PORTIONS OF BUILDINGS; LIGHTS FOR USE IN GROWING PLANTS; LIGHTS FOR USE IN ILLUMINATING SIGNS AND DISPLAYS; LIGHTS FOR VEHICLES; LUMINAIRES; SPOT LIGHTS, IN CLASS 11 (U.S. CLS. 13, 21, 23, 31 AND 34).

FIRST USE 5-0-2006; IN COMMERCE 5-0-2006.

THE MARK CONSISTS OF A CIRCLE WITH ARC DESIGNS THEREIN.

SER. NO. 85-292,836, FILED 4-12-2011.

VIVIAN MICZNIK FIRST, EXAMINING ATTORNEY



David J. Kypos

Director of the United States Patent and Trademark Office

United States of America

United States Patent and Trademark Office

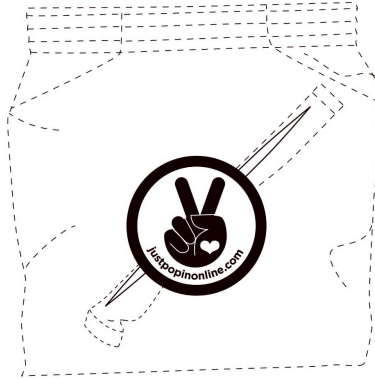

Reg. No. 4,073,477

Registered Dec. 20, 2011

Int. Cl.: 30

TRADEMARK

PRINCIPAL REGISTER

JUST POP IN, INC. (INDIANA CORPORATION)
6302 N. GUILFORD AVE
INDIANAPOLIS, IN 46220

FOR: POPCORN, IN CLASS 30 (U.S. CL. 46).

FIRST USE 5-0-2009; IN COMMERCE 6-0-2009.

OWNER OF U.S. REG. NOS. 3,188,728, 3,617,398, AND 3,824,614.

THE MARK CONSISTS OF TRADE DRESS PRODUCT PACKAGING CONSISTING OF A TOOTHPICK APPLIED TO A POPCORN CONTAINER WITH THE CIRCULAR STICKER SHOWN. THE STICKER CONSISTS OF A HEART WITHIN A STYLIZED DRAWING OF A HAND MAKING A "PEACE" SIGN ABOVE THE TERM "JUSTPOPINONLINE.COM", ALL OF WHICH IS LOCATED WITHIN A CIRCULAR BORDER. THE DOTTED LINES IN THE DRAWING ARE NOT CLAIMED AS A FEATURE OF THE MARK BUT SHOW THE MARK AS APPLIED TO ONE TYPE OF CONTAINER; NAMELY, A POPCORN BAG.

SER. NO. 85-293,073, FILED 4-12-2011.

GRETTA YAO, EXAMINING ATTORNEY



David J. Kyffers

Director of the United States Patent and Trademark Office

United States of America

United States Patent and Trademark Office



Reg. No. 4,073,478

Registered Dec. 20, 2011

Int. Cl.: 44

SERVICE MARK

PRINCIPAL REGISTER

INTERNATIONAL FORMULA COUNCIL (ILLINOIS INCORPORATED ASSOCIATION)
SUITE 300
1100 JOHNSON FERRY ROAD NE
ATLANTA, GA 30342

FOR: PROVIDING SCIENCE-BASED INFORMATION IN THE FIELD OF INFANT FEEDING HEALTH ISSUES TO INDIVIDUALS, HEALTHCARE PROFESSIONALS AND THE MEDIA , IN CLASS 44 (U.S. CLS. 100 AND 101).

FIRST USE 1-0-2010; IN COMMERCE 1-0-2010.

NO CLAIM IS MADE TO THE EXCLUSIVE RIGHT TO USE "INTERNATIONAL FORMULA COUNCIL", APART FROM THE MARK AS SHOWN.

THE COLOR(S) TEAL, YELLOW, MARIGOLD AND WHITE IS/ARE CLAIMED AS A FEATURE OF THE MARK.

THE MARK CONSISTS OF THE STYLIZED LETTERS "IFC" IN TEAL ON THE LEFT WITH THREE SWOOSHES - THE LOWEST IN TEAL, THE MIDDLE IN YELLOW AND THE TOP IN MARIGOLD - FLOATING ABOVE THEM AS WELL AS THE WORDS "INTERNATIONAL FORMULA COUNCIL" ON THE RIGHT, IN TEAL, ALL ON A WHITE BACKGROUND.

SER. NO. 85-293,108, FILED 4-12-2011.

WARREN L. OLANDRIA, EXAMINING ATTORNEY



David J. Kybas

Director of the United States Patent and Trademark Office

United States of America

United States Patent and Trademark Office

Story Runners

Reg. No. 4,073,479

Registered Dec. 20, 2011

Int. Cls.: 35, 41 and 45

CAMPUS CRUSADE FOR CHRIST, INC. (CALIFORNIA CORPORATION), AKA CAMPUS CRUSADE FOR CHRIST INTERNATIONAL; CAMPUS CRUSADE FOR CHRIST; CCCI
ATTN: GENERAL COUNSEL'S OFFICE IP TEAM
100 LAKE HART DRIVE-3500
ORLANDO, FL 32832

SERVICE MARK

PRINCIPAL REGISTER

FOR: RECRUITING FOR, ORGANIZING AND CONDUCTING SHORT TERM VOLUNTEER COMMUNITY SERVICE PROJECTS IN THE FIELD OF TRANSLATING OF BIBLE STORIES FOR INDIGENOUS PEOPLES UTILIZING ORAL STORYING TECHNIQUES, IN CLASS 35 (U.S. CLS. 100, 101 AND 102).

FIRST USE 2-27-2009; IN COMMERCE 2-27-2009.

FOR: EVANGELISTIC AND MINISTERIAL SERVICES, NAMELY, PROVIDING RELIGIOUS INSTRUCTION INFORMATION VIA A WEBSITE, IN THE FORM OF DIGITAL MEDIA AND OTHER CONTENT PERTAINING TO INDIGENOUSLY LED EVANGELISM, DISCIPLESHIP, AND CHURCH PLANTING, UTILIZING ORAL COMMUNICATION TECHNIQUES, IN CLASS 41 (U.S. CLS. 100, 101 AND 107).

FIRST USE 2-27-2009; IN COMMERCE 2-27-2009.

FOR: EVANGELISTIC, MINISTERIAL, AND MISSIONARY SERVICES, NAMELY, FACILITATING THE TRANSLATION OF BIBLE STORIES FOR INDIGENOUS PEOPLES UTILIZING ORAL STORYING TECHNIQUES; EVANGELISTIC AND MINISTERIAL SERVICES, NAMELY, PROVIDING A WEBSITE FEATURING INFORMATION IN THE FIELD OF INDIGENOUSLY LED EVANGELISM, DISCIPLESHIP, AND CHURCH PLANTING UTILIZING ORAL COMMUNICATION TECHNIQUES, IN CLASS 45 (U.S. CLS. 100 AND 101).

FIRST USE 2-27-2009; IN COMMERCE 2-27-2009.

THE MARK CONSISTS OF THE WORD "STORYRUNNERS" IN STYLIZED SCRIPT PRECEDED BY FIVE ELONGATED, HORIZONTAL TRIANGLES WITH BASES ADJACENT TO THE LETTER "S".

SER. NO. 85-293,128, FILED 4-12-2011.

LIEF MARTIN, EXAMINING ATTORNEY



David J. Kyros

Director of the United States Patent and Trademark Office

United States of America

United States Patent and Trademark Office

LDR

Reg. No. 4,073,480

Registered Dec. 20, 2011

Int. Cls.: 9 and 38

TRADEMARK

SERVICE MARK

PRINCIPAL REGISTER

LISTENER DRIVEN RADIO LLC (OHIO LIMITED LIABILITY COMPANY)
2602 DETROIT ROAD, SUITE 300
WESTLAKE, OH 44145

FOR: COMPUTER SERVICES FOR USE WITH BROADCAST PROGRAMMING WHICH INCORPORATES AUDIENCE INPUT, IN CLASS 9 (U.S. CLS. 21, 23, 26, 36 AND 38).

FIRST USE 7-30-2009; IN COMMERCE 7-30-2009.

FOR: SERVICES RELATING TO BROADCAST PROGRAMMING, NAMELY, AUDIO BROADCASTING WHICH INCORPORATES AUDIENCE INPUT, IN CLASS 38 (U.S. CLS. 100, 101 AND 104).

FIRST USE 7-30-2009; IN COMMERCE 7-30-2009.

THE MARK CONSISTS OF STANDARD CHARACTERS WITHOUT CLAIM TO ANY PARTICULAR FONT, STYLE, SIZE, OR COLOR.

SER. NO. 85-293,143, FILED 4-12-2011.

JAY FLOWERS, EXAMINING ATTORNEY



David J. Kypos

Director of the United States Patent and Trademark Office

United States of America

United States Patent and Trademark Office

LISTENER DRIVEN RADIO

Reg. No. 4,073,481

Registered Dec. 20, 2011

Int. Cls.: 9 and 38

TRADEMARK

SERVICE MARK

PRINCIPAL REGISTER

LISTENER DRIVEN RADIO LLC (OHIO LIMITED LIABILITY COMPANY)
2602 DETROIT ROAD, SUITE 300
WESTLAKE, OH 44145

FOR: COMPUTER SERVICES FOR USE WITH BROADCAST PROGRAMMING WHICH INCORPORATES AUDIENCE INPUT, IN CLASS 9 (U.S. CLS. 21, 23, 26, 36 AND 38).

FIRST USE 7-30-2009; IN COMMERCE 7-30-2009.

FOR: SERVICES RELATING TO BROADCAST PROGRAMMING, NAMELY, AUDIO BROADCASTING WHICH INCORPORATES AUDIENCE INPUT, IN CLASS 38 (U.S. CLS. 100, 101 AND 104).

FIRST USE 7-30-2009; IN COMMERCE 7-30-2009.

THE MARK CONSISTS OF STANDARD CHARACTERS WITHOUT CLAIM TO ANY PARTICULAR FONT, STYLE, SIZE, OR COLOR.

NO CLAIM IS MADE TO THE EXCLUSIVE RIGHT TO USE "LISTENER" AND "RADIO", APART FROM THE MARK AS SHOWN.

SER. NO. 85-293,180, FILED 4-12-2011.

JAY FLOWERS, EXAMINING ATTORNEY



David J. Kyffers

Director of the United States Patent and Trademark Office

United States of America

United States Patent and Trademark Office

Caffè del Doge

Reg. No. 4,073,482

DELLA MEA, BERNARDO (ITALY INDIVIDUAL), DBA CAFFÈ DEL DOGE SRL
SAN MARCO 589

Registered Dec. 20, 2011

VENEZIA, ITALY 30124

Int. Cls.: 30 and 43

FOR: BEVERAGES MADE OF COFFEE; COFFEE; COFFEE BASED BEVERAGES; COFFEE BEANS; ESPRESSO; ESPRESSO DRINKS; GROUND COFFEE BEANS; PREPARED COFFEE AND COFFEE-BASED BEVERAGES; ROASTED COFFEE BEANS; UNROASTED COFFEE, IN CLASS 30 (U.S. CL. 46).

TRADEMARK

SERVICE MARK

FIRST USE 2-1-1999; IN COMMERCE 9-1-1999.

PRINCIPAL REGISTER

FOR: COFFEE BARS; COFFEE SHOPS; COFFEE-HOUSE AND SNACK-BAR SERVICES, IN CLASS 43 (U.S. CLS. 100 AND 101).

FIRST USE 9-5-2003; IN COMMERCE 12-23-2005.

THE MARK CONSISTS OF STANDARD CHARACTERS WITHOUT CLAIM TO ANY PARTICULAR FONT, STYLE, SIZE, OR COLOR.

NO CLAIM IS MADE TO THE EXCLUSIVE RIGHT TO USE "CAFFÈ", APART FROM THE MARK AS SHOWN.

THE ENGLISH TRANSLATION OF "CAFFÈ DEL" IN THE MARK IS "COFFEE OF THE".

SER. NO. 85-293,213, FILED 4-12-2011.

CHRIS WELLS, EXAMINING ATTORNEY



David J. Kyros

Director of the United States Patent and Trademark Office

United States of America

United States Patent and Trademark Office

MURALITY

Reg. No. 4,073,483

ARTISTS 4 ISRAEL, INC. (UNITED STATES NON-PROFIT CORPORATION)
201 EAST 66TH STREET, SUITE 12D
NEW YORK, NY 10065

Registered Dec. 20, 2011

Int. Cl.: 35

FOR: CHARITABLE SERVICES, NAMELY, PROMOTING PUBLIC AWARENESS OF ISSUES RELATING TO ISRAEL THROUGH THE ARTS, IN CLASS 35 (U.S. CLS. 100, 101 AND 102).

SERVICE MARK

FIRST USE 4-24-2010; IN COMMERCE 4-24-2010.

PRINCIPAL REGISTER

THE MARK CONSISTS OF STANDARD CHARACTERS WITHOUT CLAIM TO ANY PARTICULAR FONT, STYLE, SIZE, OR COLOR.

SER. NO. 85-293,217, FILED 4-12-2011.

KRISTINA MORRIS, EXAMINING ATTORNEY



David J. Kyjars

Director of the United States Patent and Trademark Office

United States of America

United States Patent and Trademark Office



Reg. No. 4,073,484

Registered Dec. 20, 2011

Int. Cl.: 32

TRADEMARK

PRINCIPAL REGISTER

ANHEUSER-BUSCH INCORPORATED (MISSOURI CORPORATION)
ONE BUSCH PLACE
ST. LOUIS, MO 63118

FOR: BEER, IN CLASS 32 (U.S. CLS. 45, 46 AND 48).

FIRST USE 10-31-2002; IN COMMERCE 10-31-2002.

OWNER OF U.S. REG. NOS. 2,926,426, 3,809,364 AND OTHERS.

THE MARK CONSISTS OF A CROWN.

SER. NO. 85-293,322, FILED 4-12-2011.

EUGENIA MARTIN, EXAMINING ATTORNEY



David J. Kybas

Director of the United States Patent and Trademark Office

United States of America

United States Patent and Trademark Office

HydroGuard

Reg. No. 4,073,485

ASCEND EAGLE, INC (CALIFORNIA CORPORATION)
140 DODD COURT

Registered Dec. 20, 2011

AMERICAN CANYON, CA 94503

Int. Cl.: 10

FOR: FACE MASKS FOR USE BY DENTAL CARE PROVIDERS, IN CLASS 10 (U.S. CLS. 26, 39 AND 44).

TRADEMARK

FIRST USE 7-1-2010; IN COMMERCE 7-1-2010.

PRINCIPAL REGISTER

THE MARK CONSISTS OF STANDARD CHARACTERS WITHOUT CLAIM TO ANY PARTICULAR FONT, STYLE, SIZE, OR COLOR.

SER. NO. 85-293,409, FILED 4-12-2011.

JERI J. FICKES, EXAMINING ATTORNEY



David J. Kybas

Director of the United States Patent and Trademark Office

United States of America

United States Patent and Trademark Office

SMOK'N PIG B-B-Q EXPRESS

Reg. No. 4,073,486

O'NEAL'S SMOK'N PIG, L.L.C. (GEORGIA LIMITED LIABILITY COMPANY)
4428 NORTH VALDOSTA ROAD
VALDOSTA, GA 31602

Registered Dec. 20, 2011

Int. Cls.: 25, 29 and 43

FOR: T-SHIRTS, IN CLASS 25 (U.S. CLS. 22 AND 39).

FIRST USE 3-16-2011; IN COMMERCE 3-17-2011.

TRADEMARK

FOR: MEAT, FISH, POULTRY AND GAME, IN CLASS 29 (U.S. CL. 46).

SERVICE MARK

FIRST USE 3-16-2011; IN COMMERCE 3-17-2011.

PRINCIPAL REGISTER

FOR: PROVISION OF FOOD AND DRINK IN RESTAURANTS, IN CLASS 43 (U.S. CLS. 100 AND 101).

FIRST USE 3-16-2011; IN COMMERCE 3-17-2011.

THE MARK CONSISTS OF STANDARD CHARACTERS WITHOUT CLAIM TO ANY PARTICULAR FONT, STYLE, SIZE, OR COLOR.

OWNER OF U.S. REG. NOS. 3,862,931 AND 3,862,932.

NO CLAIM IS MADE TO THE EXCLUSIVE RIGHT TO USE "BBQ EXPRESS" FOR INTERNATIONAL CLASS 43, APART FROM THE MARK AS SHOWN.

SER. NO. 85-293,691, FILED 4-13-2011.

EMILY CARLSEN, EXAMINING ATTORNEY



David J. Kyffers

Director of the United States Patent and Trademark Office

United States of America

United States Patent and Trademark Office

A.S.A.P.

Reg. No. 4,073,487

A.S.A.P. ADVISOR SERVICES, INC. (NEW YORK CORPORATION)
41 EAST 11TH STREET, 11TH FLOOR
NEW YORK, NY 10003

Registered Dec. 20, 2011

Int. Cls.: 35 and 36

FOR: MARKETING AND ADVERTISING SERVICES, NAMELY, PROMOTING THAT SERVICES OF INVESTMENT MANAGEMENT PROFESSIONALS BY ADVERTISING THEIR SERVICES VIA A GLOBAL COMPUTER INFORMATION NETWORK; FINANCIAL DATABASE MANAGEMENT, IN CLASS 35 (U.S. CLS. 100, 101 AND 102).

SERVICE MARK

PRINCIPAL REGISTER

FIRST USE 12-27-2002; IN COMMERCE 12-27-2002.

FOR: PROVIDING INFORMATION ABOUT FINANCIAL INVESTMENTS TO INVESTMENT MANAGEMENT PROFESSIONALS, IN CLASS 36 (U.S. CLS. 100, 101 AND 102).

FIRST USE 12-27-2002; IN COMMERCE 12-27-2002.

THE MARK CONSISTS OF STANDARD CHARACTERS WITHOUT CLAIM TO ANY PARTICULAR FONT, STYLE, SIZE, OR COLOR.

SER. NO. 85-293,970, FILED 4-13-2011.

GINA HAYES, EXAMINING ATTORNEY



David J. Kybas

Director of the United States Patent and Trademark Office

United States of America

United States Patent and Trademark Office



Reg. No. 4,073,488

Registered Dec. 20, 2011

Int. Cl.: 30

TRADEMARK

PRINCIPAL REGISTER

DELLA MEA, BERNARDO (ITALY INDIVIDUAL), DBA CAFFÈ DEL DOGE SRL
SAN MARCO 589
VENEZIA, ITALY 30124

FOR: BEVERAGES MADE OF COFFEE; COFFEE; COFFEE BASED BEVERAGES; COFFEE BEANS; ESPRESSO; ESPRESSO DRINKS; GROUND COFFEE BEANS; PREPARED COFFEE AND COFFEE-BASED BEVERAGES; ROASTED COFFEE BEANS; UNROASTED COFFEE, IN CLASS 30 (U.S. CL. 46).

FIRST USE 5-0-2008; IN COMMERCE 5-0-2008.

NO CLAIM IS MADE TO THE EXCLUSIVE RIGHT TO USE "CAFFÈ" AND "IL CAFFÈ DI VENEZIA", APART FROM THE MARK AS SHOWN.

THE MARK CONSISTS OF A DRAWING OF A PERSON'S HEAD FACING TO THE RIGHT AND WEARING A CAP WITH AN INTERSECTING LINE DESIGN ON IT TO THE LEFT OF THE STYLIZED WORDING "CAFFÈ DEL DOGE IL CAFFÈ DI VENEZIA".

THE ENGLISH TRANSLATION OF "CAFFÈ DEL" IN THE MARK IS COFFEE OF THE AND THE TRANSLATION OF "IL CAFFÈ DI VENEZIA" IN THE MARK IS THE COFFEE OF VENICE.

SER. NO. 85-294,003, FILED 4-13-2011.

CHRIS WELLS, EXAMINING ATTORNEY



David J. Kybas

Director of the United States Patent and Trademark Office

United States of America

United States Patent and Trademark Office



Reg. No. 4,073,489

Registered Dec. 20, 2011

Int. Cl.: 28

TRADEMARK

PRINCIPAL REGISTER

DUNN, CLAUDETTE (UNITED STATES INDIVIDUAL)
27940 STAGE LINE ROAD
CASTAIC, CA 91384

FOR: BOARD GAMES, BALLOONS, IN CLASS 28 (U.S. CLS. 22, 23, 38 AND 50).

FIRST USE 5-29-2003; IN COMMERCE 5-29-2003.

THE MARK CONSISTS OF THE STYLIZED CARICATURE OF A SPERM HAVING A FACE.

SER. NO. 85-294,230, FILED 4-13-2011.

JAY BESCH, EXAMINING ATTORNEY



David J. Kybas

Director of the United States Patent and Trademark Office

United States of America

United States Patent and Trademark Office

VAVICI

Reg. No. 4,073,490

Registered Dec. 20, 2011

Int. Cl.: 44

SERVICE MARK

PRINCIPAL REGISTER

CMX CAPITAL, LLC (CALIFORNIA LIMITED LIABILITY COMPANY)
#528
5580 LA JOLLA BOULEVARD
LA JOLLA, CA 92037

FOR: MEDICAL AND BEAUTY SERVICES, NAMELY, LOW LEVEL LIGHT THERAPY FOR MUSCULOSKELETAL PAIN, NAIL FUNGUS, TREATMENT OF WRINKLES, AND THE ADMINISTRATION OF LIGHT THERAPIES FOR CELL REGENERATION, AND STEM CELL AND BLOOD PRODUCTS FOR TRANSFUSIONS AND INJECTIONS TO PROMOTE HEALING AND TISSUE REGENERATION, IN CLASS 44 (U.S. CLS. 100 AND 101).

FIRST USE 1-1-2011; IN COMMERCE 3-15-2011.

THE MARK CONSISTS OF STANDARD CHARACTERS WITHOUT CLAIM TO ANY PARTICULAR FONT, STYLE, SIZE, OR COLOR.

THE WORDING "VAVICI" HAS NO MEANING IN A FOREIGN LANGUAGE.

SER. NO. 85-294,768, FILED 4-14-2011.

WILLIAM VERHOSEK, EXAMINING ATTORNEY



David J. Kyffers

Director of the United States Patent and Trademark Office

United States of America

United States Patent and Trademark Office

NOSTALGIA CO.

Mitchell & Ness

PHILADELPHIA, PA. U.S.A.

Reg. No. 4,073,491

Registered Dec. 20, 2011

Int. Cl.: 25

TRADEMARK

PRINCIPAL REGISTER

SPORTS LICENSED DIVISION OF THE ADIDAS GROUP, LLC (DELAWARE LIMITED LIABILITY COMPANY)
1895 J.W. FOSTER BOULEVARD
CANTON, MA 02021

FOR: SPORTS JERSEYS, JACKETS, SHIRTS, TOPS, SWEATERS, CAPS, HATS, HEAD BANDS AND WRIST BANDS, IN CLASS 25 (U.S. CLS. 22 AND 39).

FIRST USE 0-0-1987; IN COMMERCE 0-0-1987.

OWNER OF U.S. REG. NOS. 2,836,694, 2,860,284 AND OTHERS.

NO CLAIM IS MADE TO THE EXCLUSIVE RIGHT TO USE "CO." AND "PHILADELPHIA, PA. U.S.A.", APART FROM THE MARK AS SHOWN.

THE MARK CONSISTS OF THE WORDS "NOSTALGIA CO." ABOVE THE LEFT END OF THE WORD "MITCHELL & NESS" WHICH ARE UNDERLINED AND "PHILADELPHIA PA. U.S.A." UNDERNEATH THE RIGHT END OF THE UNDERLINED WORDS.

SER. NO. 85-294,827, FILED 4-14-2011.

BRIAN CALLAGHAN, EXAMINING ATTORNEY



David J. Kyros

Director of the United States Patent and Trademark Office

United States of America

United States Patent and Trademark Office

SECUREPHARMA

Reg. No. 4,073,492

Registered Dec. 20, 2011

Int. Cl.: 36

SERVICE MARK

PRINCIPAL REGISTER

SECUREPHARMA LTD (UNITED KINGDOM CORPORATION)
FLAT 1, NASH HOUSE
18-20 PARK VILLAGE EAST
LONDON, UNITED KINGDOM NW17PY

FOR: FINANCIAL SERVICES, NAMELY, FINANCIAL CONSULTANCY SERVICES IN THE AREA OF HEALTHCARE, STRATEGIC CORPORATE FINANCIAL ADVISORY SERVICES, FINANCIAL CONSULTING SERVICES, NAMELY, ADVISING OTHERS REGARDING INTELLECTUAL PROPERTY INVESTMENTS, FINANCIAL SERVICES, NAMELY, RAISING DEBT AND EQUITY CAPITAL FOR OTHERS, FINANCIAL ASSET MANAGEMENT; BANKING; PROVISION OF FINANCIAL INFORMATION, IN CLASS 36 (U.S. CLS. 100, 101 AND 102).

THE MARK CONSISTS OF STANDARD CHARACTERS WITHOUT CLAIM TO ANY PARTICULAR FONT, STYLE, SIZE, OR COLOR.

OWNER OF UNITED KINGDOM REG. NO. 2561357, DATED 10-14-2010, EXPIRES 10-14-2020.

SER. NO. 85-294,856, FILED 4-14-2011.

KARANENDRA S. CHHINA, EXAMINING ATTORNEY



David J. Kyros

Director of the United States Patent and Trademark Office

United States of America

United States Patent and Trademark Office

一生劍命

Kendo For Life

Reg. No. 4,073,493

MASHAHIRO IMAFUJI (JAPAN INDIVIDUAL)
123 N LANSDOWN WAY
ANDERSON, IN 46012

Registered Dec. 20, 2011

Int. Cl.: 25

FOR: ATHLETIC APPAREL, NAMELY, SHIRTS, PANTS, JACKETS, FOOTWEAR, HATS AND CAPS, ATHLETIC UNIFORMS; GOLF SHIRTS; KNIT SHIRTS; TEE SHIRTS, IN CLASS 25 (U.S. CLS. 22 AND 39).

TRADEMARK

FIRST USE 1-1-2009; IN COMMERCE 1-1-2011.

PRINCIPAL REGISTER

THE MARK CONSISTS OF THE LITERAL WORDS "KENDO FOR LIFE" BELOW JAPANESE CHARACTERS MEANING "KENDO FOR LIFE" WITH THE CHARACTERS HAVING SHADOWS.

THE NON-LATIN CHARACTERS IN THE MARK TRANSLITERATE TO EESH-SHOW-KEN-MAY AND THIS MEANS "KENDO FOR LIFE" IN ENGLISH.

SER. NO. 85-295,265, FILED 4-14-2011.

KEVIN CORWIN, EXAMINING ATTORNEY



David J. Kybas

Director of the United States Patent and Trademark Office

United States of America

United States Patent and Trademark Office



Reg. No. 4,073,494

PRESIDENT AND TRUSTEES OF BATES COLLEGE (MAINE NON-PROFIT CORPORATION)
2 ANDREWS RD.

Registered Dec. 20, 2011

LEWISTON, ME 04240

Int. Cl.: 41

FOR: EDUCATIONAL SERVICES, NAMELY, PROVIDING COURSES OF INSTRUCTION
AT THE COLLEGE LEVEL, IN CLASS 41 (U.S. CLS. 100, 101 AND 107).

SERVICE MARK

FIRST USE 6-6-1981; IN COMMERCE 6-6-1981.

PRINCIPAL REGISTER

NO CLAIM IS MADE TO THE EXCLUSIVE RIGHT TO USE "ACADEMIA", "CONDITA 1855"
AND "1855", APART FROM THE MARK AS SHOWN.

THE MARK CONSISTS OF A CONCENTRIC DESIGN, BEGINNING WITH A NARROW CIRCULAR OUTLINE; IN THE NEXT CONCENTRIC LEVEL, THE LATIN WORD "ACADEMIA" APPEARS ALONG THE TOP OF THE CIRCLE, AND THE LATIN WORD "BATESINA" APPEARS ALONG THE BOTTOM; THE NUMBER "1855" APPEARS ACROSS THE CENTER, WITH "18" ON THE LEFT SIDE AND "55" ON THE RIGHT SIDE. THE NEXT CONCENTRIC LEVEL CONSISTS OF A BAND OF LEAVES, WHICH SURROUNDS A CIRCULAR BELT DESIGN; THE BELT DESIGN INCLUDES A BUCKLE PLACED LOW CENTER ON THE LEFT AND A V DESIGN PLACED LOW CENTER ON THE RIGHT, TOGETHER WITH THE LATIN PHRASES "AMORE AC STUDIO" WITHIN THE TOP HALF OF THE BELT DESIGN AND "CONDITA 1855" WITHIN THE BOTTOM HALF OF THE BELT DESIGN. WITHIN THE INNERMOST CONCENTRIC LEVEL IS A SHIELD DESIGN, WITH A DEPICTION OF A LIT LAMP AT THE TOP OF THE CIRCLE WHICH OVERLAPS THE SHIELD; THE LEFT HALF OF THE SHIELD INCLUDES A DEPICTION OF A MOOSE RESTING BENEATH A PINE TREE; THE TOP RIGHT HALF OF THE SHIELD INCLUDES A DEPICTION OF AN OPEN BOOK; AND THE BOTTOM RIGHT HALF OF THE SHIELD INCLUDES A DEPICTION OF A SHEAF OF WHEAT.



THE ENGLISH TRANSLATION OF "ACADEMIA" IS "UNIVERSITY". THE ENGLISH TRANSLATION OF "AMORE AC STUDIO" IS "LOVE" AND "PURSUIT OF". THE ENGLISH TRANSLATION OF "CONDITA" IS "FOUNDED".

David J. Kypos

SER. NO. 85-295,297, FILED 4-14-2011.

WON TEAK OH, EXAMINING ATTORNEY

United States of America

United States Patent and Trademark Office



Reg. No. 4,073,495

TALON/LPE LTD. (TEXAS LIMITED PARTNERSHIP)
921 N. BIVINS
AMARILLO, TX 79107

Registered Dec. 20, 2011

Int. Cls.: 37, 40 and 42

FOR: BUILDING CONSTRUCTION; BUILDING CONSTRUCTION AND REPAIR; BUILDING CONSTRUCTION INFORMATION; BUILDING CONSTRUCTION SERVICES; BUILDING CONSTRUCTION SUPERVISION; BUILDING CONSTRUCTION, REMODELING AND REPAIR; CONSTRUCTION AND RENOVATION OF BUILDINGS; CONSTRUCTION AND REPAIR OF BUILDINGS; CONSTRUCTION CONSULTATION; CONSTRUCTION GRADING SERVICES; CONSTRUCTION MANAGEMENT; CONSTRUCTION OF BUILDINGS; CONSTRUCTION OF ROADS, UNDERGROUND UTILITIES, AND HOUSING PADS; CONSTRUCTION OF STRUCTURES FOR THE PRODUCTION OF CRUDE OIL; CONSTRUCTION OF STRUCTURES FOR THE PRODUCTION OF NATURAL GAS; CONSTRUCTION PLANNING; CONSTRUCTION PROJECT MANAGEMENT SERVICES; CONSTRUCTION SERVICES, NAMELY, INSTALLATION OF ENVIRONMENTAL CONTAINMENT SYSTEMS; CONSTRUCTION, MAINTENANCE AND RENOVATION OF PROPERTY; DRILLING OF WELLS; GENERAL CONSTRUCTION CONTRACTING; PHYSICAL CLEAN-UP OF EXPLORATION AND DRILLING PROJECT LOCATIONS TO RESTORE THEM TO THEIR ORIGINAL CONDITION; ROAD CONSTRUCTION; TECHNICAL CONSULTATION IN THE FIELD OF BUILDING CONSTRUCTION; WATER WELL DRILLING; WELL DRILLING, IN CLASS 37 (U.S. CLS. 100, 103 AND 106).

SERVICE MARK

PRINCIPAL REGISTER



FIRST USE 8-1-1999; IN COMMERCE 8-1-1999.

FOR: ENVIRONMENTAL REMEDIATION SERVICES, NAMELY, TREATMENT OF SOIL AND WATER, IN CLASS 40 (U.S. CLS. 100, 103 AND 106).

FIRST USE 8-1-1999; IN COMMERCE 8-1-1999.

FOR: CONSTRUCTION DRAFTING; CONSULTING SERVICES IN THE FIELD OF ENVIRONMENTAL ASSESSMENT AND PLANNING; ENGINEERING SERVICES IN THE FIELD OF ENVIRONMENTAL COMPLIANCE; ENVIRONMENTAL ENGINEERING, TESTING AND INSPECTION SERVICES; ENVIRONMENTAL SERVICES, NAMELY, DESIGN FOR OTHERS IN THE FIELD OF ENVIRONMENTAL ENGINEERING; ENVIRONMENTAL SERVICES, NAMELY, TECHNICAL CONSULTATION IN THE FIELD OF ENVIRONMENTAL SCIENCE; ENVIRONMENTAL SERVICES, NAMELY, TECHNICAL CONSULTATION IN THE FIELD OF ENVIRONMENTAL SCIENCE, ENGINEERING SERVICES AND DESIGN FOR OTHERS

David J. Kyffers

Director of the United States Patent and Trademark Office

Reg. No. 4,073,495 IN THE FIELD OF ENVIRONMENTAL ENGINEERING; ENVIRONMENTAL TESTING AND INSPECTION SERVICES; TECHNICAL CONSULTANCY IN THE FIELD OF ENVIRONMENTAL SCIENCE; TECHNICAL CONSULTING IN THE FIELD OF ENVIRONMENTAL ENGINEERING, IN CLASS 42 (U.S. CLS. 100 AND 101).

FIRST USE 8-1-1999; IN COMMERCE 8-1-1999.

THE MARK CONSISTS OF THE WORDS "TALON" AND "LPE" WITH "TALON" ABOVE AND SLIGHTLY TO THE LEFT OF "LPE" (RIGHT JUSTIFIED) AND THE IMAGE OF AN EAGLE DIVING FEET-FIRST TO THE LEFT OF "LPE".

SER. NO. 85-295,325, FILED 4-14-2011.

JEAN IM, EXAMINING ATTORNEY

United States of America

United States Patent and Trademark Office



Reg. No. 4,073,496

Registered Dec. 20, 2011

Int. Cl.: 43

SERVICE MARK

PRINCIPAL REGISTER

NO PAIN NO GAIN, INC. (CALIFORNIA CORPORATION)
SUITE 364
171 PEER AVE.
SANTA MONICA, CA 904055311

FOR: JUICE BAR SERVICES, IN CLASS 43 (U.S. CLS. 100 AND 101).

FIRST USE 12-22-2009; IN COMMERCE 12-22-2009.

OWNER OF U.S. REG. NO. 3,878,892.

THE MARK CONSISTS OF A TURTLE RIDING A MOTORSCOOTER WITH AN OPEN JUICE BLENDER ON THE BACK.

SER. NO. 85-295,632, FILED 4-14-2011.

ANNE MADDEN, EXAMINING ATTORNEY



David J. Kyffers

Director of the United States Patent and Trademark Office

United States of America

United States Patent and Trademark Office

Life Changing Food

Reg. No. 4,073,497

TRADEMARK FOODS, INC. (PENNSYLVANIA CORPORATION)
3718 PENN AVENUE
PITTSBURGH, PA 15201

Registered Dec. 20, 2011

Int. Cl.: 44

FOR: CONSULTING SERVICES IN THE FIELDS OF HEALTH AND NUTRITION; COUNSELING SERVICES IN THE FIELDS OF HEALTH, NUTRITION AND LIFESTYLE WELLNESS; DIETARY AND NUTRITIONAL GUIDANCE; NUTRITION COUNSELING, IN CLASS 44 (U.S. CLS. 100 AND 101).

SERVICE MARK

PRINCIPAL REGISTER

FIRST USE 5-31-2011; IN COMMERCE 5-31-2011.

THE MARK CONSISTS OF STANDARD CHARACTERS WITHOUT CLAIM TO ANY PARTICULAR FONT, STYLE, SIZE, OR COLOR.

NO CLAIM IS MADE TO THE EXCLUSIVE RIGHT TO USE "FOOD", APART FROM THE MARK AS SHOWN.

SER. NO. 85-295,959, FILED 4-15-2011.

MARTHA FROMM, EXAMINING ATTORNEY



David J. Kyffers

Director of the United States Patent and Trademark Office

United States of America

United States Patent and Trademark Office

HOLLER CLUB

Reg. No. 4,073,498

APPLE FARM MANAGEMENT, INC. (WISCONSIN CORPORATION)
5006 S. SYLVANIA AVENUE
STURTEVANT, WI 53177

Registered Dec. 20, 2011

Int. Cl.: 35

FOR: PROMOTING GOODS AND SERVICES BY MEANS OF THE ISSUANCE OF LOYALTY REWARDS CARDS, IN CLASS 35 (U.S. CLS. 100, 101 AND 102).

SERVICE MARK

FIRST USE 5-23-2007; IN COMMERCE 5-23-2007.

PRINCIPAL REGISTER

THE MARK CONSISTS OF STANDARD CHARACTERS WITHOUT CLAIM TO ANY PARTICULAR FONT, STYLE, SIZE, OR COLOR.

NO CLAIM IS MADE TO THE EXCLUSIVE RIGHT TO USE "CLUB", APART FROM THE MARK AS SHOWN.

SER. NO. 85-296,048, FILED 4-15-2011.

GRETTA YAO, EXAMINING ATTORNEY



David J. Kybas

Director of the United States Patent and Trademark Office

United States of America

United States Patent and Trademark Office

AZHotSeats

Reg. No. 4,073,499

Registered Dec. 20, 2011

Int. Cl.: 41

SERVICE MARK

PRINCIPAL REGISTER

NALC ENTERTAINMENT GROUP (ARIZONA LIMITED LIABILITY COMPANY), DBA
AZHOTSEATS
202-127
5115 N DYSART RD
LITCHFIELD PARK, AZ 85340

FOR: ENTERTAINMENT TICKET AGENCY SERVICES, IN CLASS 41 (U.S. CLS. 100, 101
AND 107).

FIRST USE 7-1-2008; IN COMMERCE 1-8-2010.

THE MARK CONSISTS OF STANDARD CHARACTERS WITHOUT CLAIM TO ANY PAR-
TICULAR FONT, STYLE, SIZE, OR COLOR.

SER. NO. 85-296,138, FILED 4-15-2011.

KAREN SEVERSON, EXAMINING ATTORNEY



David J. Kyffers

Director of the United States Patent and Trademark Office

United States of America

United States Patent and Trademark Office

Hump Jumper

Reg. No. 4,073,500

SANDRA S NEWMAN (UNITED STATES INDIVIDUAL), DBA SN DESIGNS CO
20 PORTSMOUTH AVE 41
STRATHAM, NH 03885

Registered Dec. 20, 2011

Int. Cl.: 8

FOR: SEWING SCISSORS, IN CLASS 8 (U.S. CLS. 23, 28 AND 44).

TRADEMARK

FIRST USE 5-19-1989; IN COMMERCE 5-19-1989.

PRINCIPAL REGISTER

THE MARK CONSISTS OF STANDARD CHARACTERS WITHOUT CLAIM TO ANY PARTICULAR FONT, STYLE, SIZE, OR COLOR.

SER. NO. 85-296,286, FILED 4-15-2011.

KARANENDRA S. CHHINA, EXAMINING ATTORNEY



David J. Kybas

Director of the United States Patent and Trademark Office

United States of America

United States Patent and Trademark Office

TRI-MEDICS

Reg. No. 4,073,501

Registered Dec. 20, 2011

Int. Cl.: 10

TRADEMARK

PRINCIPAL REGISTER

TRI-MEDICS, LLC (DELAWARE LIMITED LIABILITY COMPANY)
2 HAMPSHIRE #201
FOXBORO, MA 02035

FOR: MEDICAL APPARATUS AND INSTRUMENTS, NAMELY, SCISSORS, FORCEPS AND NEEDLE HOLDERS; SURGICAL AND MEDICAL APPARATUS AND INSTRUMENTS FOR USE IN PLASTIC, HAND, VASCULAR AND CARDIO-VASCULAR SURGERY; MEDICAL CUTTING DEVICES; MEDICAL APPARATUS, NAMELY, A PATIENT MANIPULATION DEVICE CONSISTING OF A ERGONOMICALLY DESIGNED AND ADJUSTABLE TRIANGULAR PLATFORM TO FACILITATE PATIENT POSITIONING DURING X-RAY PROCEDURE, IN CLASS 10 (U.S. CLS. 26, 39 AND 44).

FIRST USE 1-1-2011; IN COMMERCE 1-1-2011.

THE MARK CONSISTS OF STANDARD CHARACTERS WITHOUT CLAIM TO ANY PARTICULAR FONT, STYLE, SIZE, OR COLOR.

SER. NO. 85-296,703, FILED 4-15-2011.

INGRID C. EULIN, EXAMINING ATTORNEY



David J. Kybas

Director of the United States Patent and Trademark Office

United States of America

United States Patent and Trademark Office



Reg. No. 4,073,502

Registered Dec. 20, 2011

Int. Cls.: 29 and 30

TRADEMARK

PRINCIPAL REGISTER

CLOVER SPECIALTIES, INC (CALIFORNIA CORPORATION)
1702 WEST EL SEGUNDO BLVD
GARDENA, CA 90249 AND

BOTENGAN, RUTH (UNITED STATES INDIVIDUAL)
1702 WEST EL SEGUNDO BLVD
GARDENA, CA 90249 AND

REUX, THIERRY (UNITED STATES INDIVIDUAL)
1702 WEST EL SEGUNDO BLVD
GARDENA, CA 90249

FOR: COOKING OIL; DRIED TRUFFLES; INFUSED OILS FOR COOKING; MUSHROOMS PUREE; OLIVE OIL; PRESERVED TRUFFLES; PROCESSED MUSHROOMS; PROCESSED OLIVES; TAPENADES; TRUFFLE JUICE, IN CLASS 29 (U.S. CL. 46).

FIRST USE 9-1-1994; IN COMMERCE 9-1-1994.

FOR: HONEY, IN CLASS 30 (U.S. CL. 46).

FIRST USE 11-11-2003; IN COMMERCE 11-11-2003.

THE MARK CONSISTS OF A CHEF WITH A MEDAL HANGING FROM HIS NECK AND HOLDING A TRAY OF TRUFFLES. HE IS TRAILING BEHIND A SMALL UPRIGHT PIG, ALSO WITH A MEDAL HANGING FROM HIS NECK, CARRYING A BASKET OF TRUFFLES. A WAVY LINE DEPICTS THE EDGE OF A SIDEWALK.

SER. NO. 85-296,724, FILED 4-15-2011.

KATHERINE CHANG, EXAMINING ATTORNEY



David J. Kybas

Director of the United States Patent and Trademark Office

United States of America

United States Patent and Trademark Office



Reg. No. 4,073,503

Registered Dec. 20, 2011

Int. Cl.: 10

TRADEMARK

PRINCIPAL REGISTER

TRI-MEDICS, LLC (DELAWARE LIMITED LIABILITY COMPANY)
2 HAMPSHIRE
#201
FOXBORO, MA 02035

FOR: MEDICAL APPARATUS AND INSTRUMENTS, NAMELY, SCISSORS, FORCEPS AND NEEDLE HOLDERS; SURGICAL AND MEDICAL APPARATUS AND INSTRUMENTS FOR USE IN PLASTIC, HAND, VASCULAR AND CARDIO-VASCULAR SURGERY; MEDICAL CUTTING DEVICES; MEDICAL APPARATUS, NAMELY, A PATIENT MANIPULATION DEVICE CONSISTING OF A ERGONOMICALLY DESIGNED AND ADJUSTABLE TRIANGULAR PLATFORM TO FACILITATE PATIENT POSITIONING DURING X-RAY PROCEDURE, IN CLASS 10 (U.S. CLS. 26, 39 AND 44).

FIRST USE 1-1-2011; IN COMMERCE 8-1-2011.

THE MARK CONSISTS OF A THREE TRIANGLE DESIGN WITH THE WORD "TRI-MEDICS" APPEARING TO THE RIGHT THEREOF. THE "I"'S ARE DOTTED WITH TRIANGLES. A LINE APPEARS UNDERNEATH THE DESIGN AND WORD "TRI-MEDICS". UNDERNEATH THE LINE ARE THE WORDS "THE SHEAR ADVANTAGE". THE COLOR GRAY IS NOT CLAIMED AS A COLOR OR FEATURE OF THE MARK.

SER. NO. 85-296,748, FILED 4-15-2011.

INGRID C. EULIN, EXAMINING ATTORNEY



David J. Kybas

Director of the United States Patent and Trademark Office

United States of America

United States Patent and Trademark Office



Reg. No. 4,073,504

VITALIZE NUTRITION, INC. (FLORIDA CORPORATION)
4940 SW 55TH PL
OCALA, FL 34474

Registered Dec. 20, 2011

Int. Cl.: 35

FOR: RETAIL STORE SERVICES FEATURING HEALTH FOODS, GLUTEN FREE FOODS, NUTRITIONAL SUPPLEMENTS, VITAMINS, DIET AND WEIGHT LOSS SUPPLEMENTS, HOMEOPATHY, SPORTS NUTRITION, HERBS, MINERALS, COSMETICS, BODY CARE, APPAREL, FITNESS PRODUCTS, HEALTH EDUCATION MATERIALS, IN CLASS 35 (U.S. CLS. 100, 101 AND 102).

SERVICE MARK

PRINCIPAL REGISTER

FIRST USE 2-1-2011; IN COMMERCE 4-7-2011.

NO CLAIM IS MADE TO THE EXCLUSIVE RIGHT TO USE "NUTRITION COMPANY", APART FROM THE MARK AS SHOWN.

THE COLOR(S) DARK GRAY AND GREEN IS/ARE CLAIMED AS A FEATURE OF THE MARK.

THE MARK CONSISTS OF A DARK GRAY COLORED "V" FORMING REPRESENTATION OF A PART OF HUMAN BEING HOLDING GREEN LEAVES WITH A GREEN ELLIPSE UNDER THE FIGURE; FOLLOWED BY THE WORD "VITALIZE" WITH A MODIFIED "V" AND "ITA" IN DARK GRAY AND "LIZE" IN GREEN WITH THE "Z", "E" BEING ATTACHED AND "E" BEING A PLANT THAT FORMS INTO THE DOT OF THE "I". UNDERNEATH "VITALIZE" IS "NUTRITION COMPANY" TYPE WRITTEN IN UPPER-CASE TIMES NEW ROMAN FONT.



SER. NO. 85-297,053, FILED 4-16-2011.

JACQUELINE A. LAVINE, EXAMINING ATTORNEY

David J. Kyros

Director of the United States Patent and Trademark Office

United States of America

United States Patent and Trademark Office

GTL Fuel

Reg. No. 4,073,505

GTL FUEL, LLC (FLORIDA LIMITED LIABILITY COMPANY)
2201 SW LAWRENCE ST
PORT ST LUCIE, FL 34952

Registered Dec. 20, 2011

Int. Cl.: 17

FOR: PLASTIC TUBES FOR PACKAGING OF NON-ALCOHOLIC DRINKS IN TEST TUBE
SHAPE CONTAINER, IN CLASS 17 (U.S. CLS. 1, 5, 12, 13, 35 AND 50).

TRADEMARK

FIRST USE 1-3-2011; IN COMMERCE 1-14-2011.

PRINCIPAL REGISTER

THE MARK CONSISTS OF STANDARD CHARACTERS WITHOUT CLAIM TO ANY PAR-
TICULAR FONT, STYLE, SIZE, OR COLOR.

SER. NO. 85-297,143, FILED 4-16-2011.

KATINA MISTER, EXAMINING ATTORNEY



David J. Kybas

Director of the United States Patent and Trademark Office

United States of America

United States Patent and Trademark Office

RASPBERRY ISLE

Reg. No. 4,073,506

Registered Dec. 20, 2011

Int. Cl.: 33

TRADEMARK

PRINCIPAL REGISTER

THOUSAND ISLANDS WINERY, LLC (NEW YORK LIMITED LIABILITY COMPANY)
43298 SEAWAY AVENUE
SUITE #1
ALEXANDRIA BAY, NY 13607

FOR: GRAPE WINE, IN CLASS 33 (U.S. CLS. 47 AND 49).

FIRST USE 4-14-2008; IN COMMERCE 4-14-2008.

THE MARK CONSISTS OF STANDARD CHARACTERS WITHOUT CLAIM TO ANY PARTICULAR FONT, STYLE, SIZE, OR COLOR.

NO CLAIM IS MADE TO THE EXCLUSIVE RIGHT TO USE "RASPBERRY", APART FROM THE MARK AS SHOWN.

SER. NO. 85-297,343, FILED 4-18-2011.

DANIEL CAPSHAW, EXAMINING ATTORNEY



David J. Kyffers

Director of the United States Patent and Trademark Office

United States of America

United States Patent and Trademark Office

WELLESLEY ISLAND WHITE

Reg. No. 4,073,507

Registered Dec. 20, 2011

Int. Cl.: 33

TRADEMARK

PRINCIPAL REGISTER

THOUSAND ISLANDS WINERY, LLC (NEW YORK LIMITED LIABILITY COMPANY)
SUITE #1
43298 SEAWAY AVENUE
ALEXANDRIA BAY, NY 13607

FOR: WHITE WINE, IN CLASS 33 (U.S. CLS. 47 AND 49).

FIRST USE 6-6-2003; IN COMMERCE 6-6-2003.

THE MARK CONSISTS OF STANDARD CHARACTERS WITHOUT CLAIM TO ANY PARTICULAR FONT, STYLE, SIZE, OR COLOR.

NO CLAIM IS MADE TO THE EXCLUSIVE RIGHT TO USE "WHITE", APART FROM THE MARK AS SHOWN.

SEC. 2(F).

SER. NO. 85-297,365, FILED 4-18-2011.

DANIEL CAPSHAW, EXAMINING ATTORNEY



David J. Kyffers

Director of the United States Patent and Trademark Office

United States of America

United States Patent and Trademark Office

PHONIX

Reg. No. 4,073,508

LIDOCHEM, INC. (NEW JERSEY CORPORATION)
20 VILLAGE COURT
HAZLET, NJ 07730

Registered Dec. 20, 2011

Int. Cl.: 1

FOR: FERTILIZERS AND NUTRITIVE SEED TREATMENT ADDITIVES FOR TURF AND AGRICULTURAL, ARBOREAL, HORTICULTURAL, AND ORNAMENTAL CROPS, TREES AND PLANTS TO ENHANCE THE BIOLOGICAL ACTIVITY OF SEEDS AND PLANTS FOR PURPOSES OF FERTILIZATION, IN CLASS 1 (U.S. CLS. 1, 5, 6, 10, 26 AND 46).

TRADEMARK

PRINCIPAL REGISTER

FIRST USE 3-20-2011; IN COMMERCE 3-20-2011.

THE MARK CONSISTS OF STANDARD CHARACTERS WITHOUT CLAIM TO ANY PARTICULAR FONT, STYLE, SIZE, OR COLOR.

SER. NO. 85-297,462, FILED 4-18-2011.

MAYUR VAGHANI, EXAMINING ATTORNEY



David J. Kybas

Director of the United States Patent and Trademark Office

United States of America

United States Patent and Trademark Office



Reg. No. 4,073,509

BUTTENHEIM, MEGHA NANCY (UNITED STATES INDIVIDUAL)
53 ELMVIEW TERRACE
PITTSFIELD, MA 01201

Registered Dec. 20, 2011

Int. Cl.: 41

FOR: EDUCATION SERVICES, NAMELY, PROVIDING WORKSHOPS, CLASSES, SEMINARS, CONFERENCES, TEACHER TRAININGS AND RETREATS IN THE FIELDS OF DANCE, YOGA, MOVEMENT, BREATH TECHNIQUES, EXPRESSIVE MOVEMENT THERAPY AND SELF-EMPOWERMENT, IN CLASS 41 (U.S. CLS. 100, 101 AND 107).

SERVICE MARK

PRINCIPAL REGISTER

FIRST USE 0-0-2003; IN COMMERCE 0-0-2003.

THE MARK CONSISTS OF A STYLIZED FANCIFUL FIGURE OF A DANCING HUMAN.

SER. NO. 85-297,502, FILED 4-18-2011.

MARGERIE A. TIERNEY, EXAMINING ATTORNEY



David J. Kybas

Director of the United States Patent and Trademark Office

United States of America

United States Patent and Trademark Office



endless
CREATIVE

Reg. No. 4,073,510

Registered Dec. 20, 2011

Int. Cl.: 42

SERVICE MARK

PRINCIPAL REGISTER

BLUM, JENNIFER (UNITED STATES INDIVIDUAL)
375 2ND AVE N
TIERRA VERDE, FL 33715

FOR: GRAPHIC DESIGN, IN CLASS 42 (U.S. CLS. 100 AND 101).

FIRST USE 2-1-2009; IN COMMERCE 4-1-2009.

NO CLAIM IS MADE TO THE EXCLUSIVE RIGHT TO USE "CREATIVE" , APART FROM THE MARK AS SHOWN.

THE MARK CONSISTS OF A CLOUD WITH THE LETTER "E" INSIDE. TO THE RIGHT THERE IS THE STYLIZED TEXT "ENDLESS CREATIVE".

SER. NO. 85-297,552, FILED 4-18-2011.

ELIZABETH HUGHITT, EXAMINING ATTORNEY



David J. Kybas

Director of the United States Patent and Trademark Office

United States of America

United States Patent and Trademark Office

VENTURE OUTDOORS

Reg. No. 4,073,511

Registered Dec. 20, 2011

Int. Cls.: 20 and 27

TRADEMARK

PRINCIPAL REGISTER

VENTURE PRODUCTS, LLC (NEW JERSEY LIMITED LIABILITY COMPANY)
SUITE 209
376 HOLLYWOOD AVENUE
FAIRFIELD, NJ 07004

FOR: CAMPING MATS, CAMPING PADS AND INFLATABLE CAMPING MATS ALL FOR SLEEPING PURPOSES, IN CLASS 20 (U.S. CLS. 2, 13, 22, 25, 32 AND 50).

FIRST USE 2-2-2011; IN COMMERCE 2-2-2011.

FOR: FLOOR COVERINGS AND CAMPING PADS AND MATS USED FOR FLOOR COVERING, IN CLASS 27 (U.S. CLS. 19, 20, 37, 42 AND 50).

FIRST USE 2-2-2011; IN COMMERCE 2-2-2011.

THE MARK CONSISTS OF STANDARD CHARACTERS WITHOUT CLAIM TO ANY PARTICULAR FONT, STYLE, SIZE, OR COLOR.

NO CLAIM IS MADE TO THE EXCLUSIVE RIGHT TO USE "OUTDOORS", APART FROM THE MARK AS SHOWN.

SER. NO. 85-297,606, FILED 4-18-2011.

JEFFREY LOOK, EXAMINING ATTORNEY



David J. Kypos

Director of the United States Patent and Trademark Office

United States of America

United States Patent and Trademark Office

CARMA

Reg. No. 4,073,512

Registered Dec. 20, 2011

Int. Cl.: 9

TRADEMARK

PRINCIPAL REGISTER

COMBS, TAMMARA T. A. (UNITED STATES INDIVIDUAL), DBA SERENDIPITY
INTERACTIVE
4TH FLOOR
301 MCCULLOUGH DRIVE
CHARLOTTE, NC 28262

FOR: COMPUTER SOFTWARE USED TO CONDUCT VARIOUS RISK PROFILING OF
CONSUMER, COMMERCIAL AND SOVEREIGN LOANS, IN CLASS 9 (U.S. CLS. 21, 23, 26,
36 AND 38).

FIRST USE 4-4-2011; IN COMMERCE 4-15-2011.

THE MARK CONSISTS OF STANDARD CHARACTERS WITHOUT CLAIM TO ANY PAR-
TICULAR FONT, STYLE, SIZE, OR COLOR.

SER. NO. 85-297,641, FILED 4-18-2011.

CHRISTINA SOBRAL, EXAMINING ATTORNEY



David J. Kyffers

Director of the United States Patent and Trademark Office

United States of America
United States Patent and Trademark Office

ZUMOGO

Reg. No. 4,073,513

PROPAY, INC. (UTAH CORPORATION)
3400 ASTON BLVD. SUITE 200
LEHI, UT 84043

Registered Dec. 20, 2011

Int. Cl.: 36

FOR: FINANCIAL TRANSACTION SERVICES, NAMELY, PROVIDING SECURE COMMERCIAL TRANSACTIONS AND PAYMENT OPTIONS USING A MOBILE DEVICE AT A POINT OF SALE, IN CLASS 36 (U.S. CLS. 100, 101 AND 102).

SERVICE MARK

FIRST USE 2-2-2011; IN COMMERCE 2-2-2011.

PRINCIPAL REGISTER

THE MARK CONSISTS OF STANDARD CHARACTERS WITHOUT CLAIM TO ANY PARTICULAR FONT, STYLE, SIZE, OR COLOR.

THE WORD "ZUMOGO" DOES NOT HAVE ANY MEANING IN A FOREIGN LANGUAGE.

SER. NO. 85-297,784, FILED 4-18-2011.

WILLIAM VERHOSEK, EXAMINING ATTORNEY



David J. Kyffers

Director of the United States Patent and Trademark Office

United States of America

United States Patent and Trademark Office



WYMOND ASSOCIATES, LLC

Reg. No. 4,073,514

Registered Dec. 20, 2011

Int. Cl.: 42

SERVICE MARK

PRINCIPAL REGISTER

WYMOND ASSOCIATES, LLC (DELAWARE LIMITED LIABILITY COMPANY)
5845 RICHMOND HIGHWAY, SUITE 600
ALEXANDRIA, VA 22303

FOR: IT CONSULTING SERVICES, IN CLASS 42 (U.S. CLS. 100 AND 101).

FIRST USE 8-17-2001; IN COMMERCE 8-17-2001.

NO CLAIM IS MADE TO THE EXCLUSIVE RIGHT TO USE "ASSOCIATES, LLC", APART FROM THE MARK AS SHOWN.

THE COLOR(S) BLUE AND YELLOW IS/ARE CLAIMED AS A FEATURE OF THE MARK.

THE MARK CONSISTS OF A STYLIZED "W" IN BLUE, BROKEN ON THE RIGHT BY A DOWNWARD ANGLED LINE IN YELLOW, ALL ABOVE THE WORDING "WYMOND ASSOCIATES, LLC" IN BLUE.

SER. NO. 85-297,840, FILED 4-18-2011.

KAELIE KUNG, EXAMINING ATTORNEY



David J. Kyffers

Director of the United States Patent and Trademark Office

United States of America

United States Patent and Trademark Office



Reg. No. 4,073,515

JA CAPITAL IMAGING CORPORATION (FLORIDA CORPORATION)
2275 N.W. 84TH AVENUE
DORAL, FL 331331519

Registered Dec. 20, 2011

Int. Cl.: 35

FOR: WHOLESALE ORDERING AND DISTRIBUTORSHIP SERVICES, FEATURING CAMERAS, CAMCORDERS, DIGITAL STORAGE MEDIA, PHOTOGRAPHIC FILM AND PAPER, DIGITAL AND CLASSICAL PHOTO FRAMES, LCD TELEVISIONS, AND ACCESSORIES FOR CAMERAS AND CAMCORDERS, IN CLASS 35 (U.S. CLS. 100, 101 AND 102).

SERVICE MARK

PRINCIPAL REGISTER

FIRST USE 1-1-2011; IN COMMERCE 1-1-2011.

NO CLAIM IS MADE TO THE EXCLUSIVE RIGHT TO USE "IMAGING", APART FROM THE MARK AS SHOWN.

THE COLOR(S) RED AND BLACK IS/ARE CLAIMED AS A FEATURE OF THE MARK.

THE MARK CONSISTS OF A CIRCULAR DESIGN (AS DESCRIBED BELOW) WITH THE WORDS "REDDOT" IN CAPITAL LETTERS, APPEARING TO THE RIGHT OF THE DESIGN. THE WORD "RED" IS IN THE COLOR RED. THE WORD "DOT" IS BLACK IN COLOR. PARTIAL SHADOWS OF THE WORDS "REDDOT" APPEAR BELOW THE WORDS "REDDOT", WITH THE PARTIAL SHADOW OF THE WORD "RED" APPEARING IN THE COLOR RED AND THE PARTIAL SHADOW OF THE WORD "DOT" APPEARING IN THE COLOR BLACK. THE WORD "IMAGING" IN SMALLER CAPITAL LETTERS, APPEARING BELOW THE WORDS "REDDOT". THE WORD "IMAGING" IS BLACK IN THE COLOR. THE CIRCULAR DESIGN COMPRISES AN OUTER RED CIRCLE AND AN INNER RED DOT. THE AREA BETWEEN THE OUTER RED CIRCLE AND INNER RED DOT IS SHADED IN BLACK. EXTENDING FROM THE INNER RED DOT TOWARD THE OUTER RED CIRCLE ARE SIX EQUALLY SPACED RED ARCS.



SER. NO. 85-298,062, FILED 4-18-2011.

SAMUEL E. SHARPER JR., EXAMINING ATTORNEY

David J. Kyffers

Director of the United States Patent and Trademark Office

United States of America

United States Patent and Trademark Office



Reg. No. 4,073,516

BRANDON MOLINA (UNITED STATES INDIVIDUAL)
2502 S CENTRAL AVE
LOS ANGELES, CA 90011

Registered Dec. 20, 2011

Int. Cl.: 41

FOR: DIGITAL IMAGING SERVICES; PHOTOGRAPHY SERVICES; PORTRAIT PHOTOGRAPHY; VIDEOGRAPHY SERVICES, IN CLASS 41 (U.S. CLS. 100, 101 AND 107).

SERVICE MARK

FIRST USE 8-31-2006; IN COMMERCE 8-31-2006.

PRINCIPAL REGISTER

NO CLAIM IS MADE TO THE EXCLUSIVE RIGHT TO USE "GLAMOUR STUDIO", APART FROM THE MARK AS SHOWN.

THE MARK CONSISTS OF LETTERS "RGS" WITHIN A CIRCULAR DESIGN WITH BARS, BANDS AND WAVY LINES, AND THE WORDS "REAL GLAMOUR STUDIOS".

SER. NO. 85-298,129, FILED 4-18-2011.

PRISCILLA MILTON, EXAMINING ATTORNEY



David J. Kybas

Director of the United States Patent and Trademark Office

United States of America

United States Patent and Trademark Office



Reg. No. 4,073,517

WEBDESK LLC (UTAH LIMITED LIABILITY COMPANY)
2057 PHEASANT RIDGE TRAIL
LEHI, UT 84043

Registered Dec. 20, 2011

Int. Cl.: 42

FOR: COMPUTER SERVICES, NAMELY, PROVIDING A WEB-BASED SYSTEM AND ON-LINE PORTAL FEATURING ON-LINE NON-DOWNLOADABLE SOFTWARE THAT ENABLES USERS TO ACCESS TRAINING, EDUCATION, TESTING AND CERTIFICATION MATERIALS IN THE FIELD OF ONLINE BUSINESS; COMPUTER TECHNOLOGY SUPPORT SERVICES, NAMELY, HELP DESK SERVICES; DESIGN, CREATION, HOSTING, MAINTENANCE OF WEBSITES FOR OTHERS; GRAPHIC DESIGN SERVICES; WEB SITE DESIGN, IN CLASS 42 (U.S. CLS. 100 AND 101).

SERVICE MARK

PRINCIPAL REGISTER

FIRST USE 8-1-2010; IN COMMERCE 9-9-2010.

NO CLAIM IS MADE TO THE EXCLUSIVE RIGHT TO USE "WEBSITE & ONLINE BUSINESS HELPDESK", APART FROM THE MARK AS SHOWN.

THE MARK CONSISTS OF THE STYLIZED WORDING "WEBDESK.CO" IN LARGE FONT ABOVE THE STYLIZED WORDING "WEBSITE & ONLINE BUSINESS HELPDESK" IN SMALLER FONT; TO THE LEFT IS A DESIGN OF FOUR RECTANGLES ARRANGED IN THE SHAPE OF A DIAMOND; ALL OF THE ELEMENTS ARE SURROUNDED BY A STYLIZED BORDER.



SER. NO. 85-298,187, FILED 4-18-2011.

JULIE GUTTADAURO, EXAMINING ATTORNEY

David J. Kyros

Director of the United States Patent and Trademark Office

United States of America

United States Patent and Trademark Office

FRICANO'S DELI

authentic



delicious

Sandwiches • Salads • Soups • Italian Meats • Cheeses

Reg. No. 4,073,518

Registered Dec. 20, 2011

Int. Cl.: 43

SERVICE MARK

PRINCIPAL REGISTER

FRIMUBA, LLC (TEXAS LIMITED LIABILITY COMPANY), DBA FRICANO'S DELI & CATERING
SUITE C
104 EAST 31ST STREET
AUSTIN, TX 78705

FOR: RESTAURANT SERVICES, IN CLASS 43 (U.S. CLS. 100 AND 101).

FIRST USE 1-1-2008; IN COMMERCE 1-1-2008.

NO CLAIM IS MADE TO THE EXCLUSIVE RIGHT TO USE "DELI", "AUTHENTIC", "DELICIOUS", "SANDWICHES", "SALADS", "SOUPS", "ITALIAN MEATS", AND "CHEESES", APART FROM THE MARK AS SHOWN.

THE LIKENESS (OR, "PORTRAIT") IN THE MARK DOES NOT IDENTIFY A LIVING INDIVIDUAL.

THE MARK CONSISTS OF THE STYLIZED WORDING "FRICANO'S DELI" ABOVE THE STYLIZED WORDING "AUTHENTIC" AND "DELICIOUS" SEPARATED BY AN IMAGE OF AN OLDER ADULT MALE WEARING A LONG SLEEVE SHIRT, TIE, APRON, SLACKS AND SHOES AND HOLDING A SPOON IN ONE HAND AND A PLATE WITH A SANDWICH IN THE OTHER HAND; BELOW IS THE STYLIZED WORDING "SANDWICHES · SALADS · SOUPS · ITALIAN MEATS · CHEESES".

SER. NO. 85-298,194, FILED 4-18-2011.

JULIE GUTTADAURO, EXAMINING ATTORNEY



David J. Kyffers

Director of the United States Patent and Trademark Office

United States of America

United States Patent and Trademark Office

GROUPMAIL

Reg. No. 4,073,519

Registered Dec. 20, 2011

Int. Cl.: 9

TRADEMARK

PRINCIPAL REGISTER

INFAC TA LTD. (IRELAND LIMITED LIABILITY COMPANY)
FLOOR 1, HANSON BUILDING
CLEVERAGH, SLIGO, IRELAND

FOR: COMPUTER SOFTWARE FOR GROUP BASED E-MAIL LIST MANAGEMENT AND FOR SENDING E-MAIL TO GROUPS OF RECIPIENTS, IN CLASS 9 (U.S. CLS. 21, 23, 26, 36 AND 38).

FIRST USE 0-0-1996; IN COMMERCE 0-0-1996.

THE MARK CONSISTS OF STANDARD CHARACTERS WITHOUT CLAIM TO ANY PARTICULAR FONT, STYLE, SIZE, OR COLOR.

OWNER OF U.S. REG. NO. 2,926,107.

SEC. 2(F).

SER. NO. 85-298,356, FILED 4-19-2011.

ANGELA DUONG, EXAMINING ATTORNEY



David J. Kybas

Director of the United States Patent and Trademark Office

United States of America

United States Patent and Trademark Office



FLUOR

CONSTRUCTORS

Reg. No. 4,073,520

Registered Dec. 20, 2011

Int. Cls.: 37 and 42

SERVICE MARK

PRINCIPAL REGISTER

FLUOR CORPORATION (DELAWARE CORPORATION)
6700 LAS COLINAS BLVD.
IRVING, TX 75039

FOR: CONSTRUCTION, MAINTENANCE AND REPAIR SERVICES ON A CUSTOM BASIS FOR BUILDINGS, PLANTS, STRUCTURES, OPERATING AND PROCESSING FACILITIES, WELLS, LABORATORIES, PILOT PLANTS AND EQUIPMENT FOR THE AEROSPACE, AUTOMOTIVE, BIOTECHNOLOGY, CHEMICAL, ELECTRICAL POWER GENERATING, ELECTRONICS, ENVIRONMENTAL, GENERAL COMMERCIAL, MANUFACTURING, MATERIAL PROCESSING, METALLURGICAL MINING, NATURAL GAS, NUCLEAR ENERGY, OFFSHORE PETROLEUM, PETROCHEMICAL, PETROLEUM, PHARMACEUTICAL, PLASTICS, PULP/PAPER TELECOMMUNICATION, THERMAL ENERGY AND TRANSPORTATION INDUSTRIES; CONSULTATION SERVICES ON A CUSTOM BASIS RELATING TO THE DISPOSAL OF HAZARDOUS WASTES AND ENVIRONMENTAL POLLUTANTS, IN CLASS 37 (U.S. CLS. 100, 103 AND 106).

FIRST USE 7-31-2008; IN COMMERCE 7-31-2008.

FOR: ARCHITECTURAL AND ENGINEERING SERVICES ON A CUSTOM BASIS FOR THE DESIGN OF BUILDINGS, PLANTS, STRUCTURES, OPERATING AND PROCESSING FACILITIES, WELLS, LABORATORIES, PILOT PLANTS AND EQUIPMENT, AND RELATED STRUCTURES FOR AEROSPACE, AUTOMOTIVE, BIOTECHNOLOGY, CHEMICAL, ELECTRICAL POWER GENERATING, ELECTRONICS, ENVIRONMENTAL, GENERAL COMMERCIAL, MANUFACTURING, MATERIAL PROCESSING, METALLURGICAL MINING, NATURAL GAS, NUCLEAR ENERGY, OFFSHORE PETROLEUM, PETROCHEMICAL, PETROLEUM, PHARMACEUTICAL, PLASTICS, PULP/PAPER, TELECOMMUNICATION, THERMAL ENERGY AND TRANSPORTATION INDUSTRIES, IN CLASS 42 (U.S. CLS. 100 AND 101).

FIRST USE 7-31-2008; IN COMMERCE 7-31-2008.

OWNER OF U.S. REG. NOS. 591,442, 3,813,316 AND OTHERS.

NO CLAIM IS MADE TO THE EXCLUSIVE RIGHT TO USE "CONSTRUCTORS", APART FROM THE MARK AS SHOWN.



David J. Kyjars

Director of the United States Patent and Trademark Office

Reg. No. 4,073,520 THE MARK CONSISTS OF FOUR TRIANGLES. THE MIDDLE TRIANGLE IS LONGER AND IS POINTING UPWARD. THERE IS A SMALL TRIANGLE ON THE BOTTOM THAT POINTS DOWNWARDS. THERE ARE TWO MEDIUM SIZE TRIANGLES ON THE SIDES THAT POINT OUTWARDS. TOGETHER THEY CREATE AN ARROW POINTING DOWNWARDS.

SER. NO. 85-298,540, FILED 4-19-2011.

MARGERY A. TIERNEY, EXAMINING ATTORNEY

United States of America

United States Patent and Trademark Office

BOBSLED

Reg. No. 4,073,521

Registered Dec. 20, 2011

Int. Cls.: 9, 38 and 42

TRADEMARK

SERVICE MARK

PRINCIPAL REGISTER

T-MOBILE USA, INC. (DELAWARE CORPORATION)
12920 S.E. 38TH STREET
BELLEVUE, WA 98006

FOR: DOWNLOADABLE SOFTWARE THAT ENABLES IP-BASED VOICE COMMUNICATIONS AMONG COMPUTERS; DOWNLOADABLE SOFTWARE THAT ENABLES THE CREATION, TRANSMISSION AND RECEIPT OF TEXT MESSAGES AND AUDIO MESSAGES AMONG COMPUTERS; DOWNLOADABLE SOFTWARE THAT SYNCHRONIZES TEXT MESSAGES AND ADDRESS BOOK INFORMATION AMONG COMPUTERS, MOBILE COMMUNICATIONS DEVICES AND CLOUD-BASED DATABASES, IN CLASS 9 (U.S. CLS. 21, 23, 26, 36 AND 38).

FIRST USE 4-19-2011; IN COMMERCE 4-19-2011.

FOR: TELECOMMUNICATIONS SERVICES, NAMELY, ELECTRONIC TRANSMISSION OF IP-BASED AUDIO COMMUNICATIONS AMONG COMPUTERS; ELECTRONIC TRANSMISSION OF DATA CONSISTING OF TEXT AND AUDIO CONTENT; IP-BASED TEXT AND VOICE COMMUNICATIONS SERVICES, NAMELY, WIRELESS DIGITAL TEXT MESSAGING AND AUDIO MESSAGING SERVICES AMONG COMPUTERS, IN CLASS 38 (U.S. CLS. 100, 101 AND 104).

FIRST USE 4-19-2011; IN COMMERCE 4-19-2011.

FOR: PROVIDING TEMPORARY USE OF ONLINE, NON-DOWNLOADABLE SOFTWARE THAT ALLOWS USERS TO UTILIZE IP-BASED VOICE COMMUNICATIONS SERVICES AMONG COMPUTERS; PROVIDING TEMPORARY USE OF ONLINE, NON-DOWNLOADABLE SOFTWARE THAT ENABLES THE CREATION, TRANSMISSION AND RECEIPT OF TEXT MESSAGES AND AUDIO MESSAGES AMONG COMPUTERS; ASP SERVICES IN THE NATURE OF HOSTING, MAINTAINING AND SYNCHRONIZING DATABASES CONSISTING OF TEXT MESSAGES ADDRESS BOOK INFORMATION AMONG COMPUTERS AND MOBILE COMMUNICATIONS DEVICES, IN CLASS 42 (U.S. CLS. 100 AND 101).

FIRST USE 4-19-2011; IN COMMERCE 4-19-2011.

THE MARK CONSISTS OF STANDARD CHARACTERS WITHOUT CLAIM TO ANY PARTICULAR FONT, STYLE, SIZE, OR COLOR.



David J. Kyjars

Director of the United States Patent and Trademark Office

Reg. No. 4,073,521 SER. NO. 85-298,579, FILED 4-19-2011.

TRACY FLETCHER, EXAMINING ATTORNEY

United States of America

United States Patent and Trademark Office



Reg. No. 4,073,522

Registered Dec. 20, 2011

Int. Cls.: 9, 38 and 42

TRADEMARK

SERVICE MARK

PRINCIPAL REGISTER

T-MOBILE USA, INC. (DELAWARE CORPORATION)
12920 S.E. 38TH STREET
BELLEVUE, WA 98006

FOR: DOWNLOADABLE SOFTWARE THAT ENABLES IP-BASED VOICE COMMUNICATIONS AMONG COMPUTERS; DOWNLOADABLE SOFTWARE THAT ENABLES THE CREATION, TRANSMISSION AND RECEIPT OF TEXT MESSAGES AND AUDIO MESSAGES AMONG COMPUTERS; DOWNLOADABLE SOFTWARE THAT SYNCHRONIZES TEXT MESSAGES AND ADDRESS BOOK INFORMATION AMONG COMPUTERS, MOBILE COMMUNICATIONS DEVICES AND CLOUD-BASED DATABASES, IN CLASS 9 (U.S. CLS. 21, 23, 26, 36 AND 38).

FIRST USE 4-19-2011; IN COMMERCE 4-19-2011.

FOR: TELECOMMUNICATIONS SERVICES, NAMELY, ELECTRONIC TRANSMISSION OF IP-BASED AUDIO COMMUNICATIONS AMONG COMPUTERS; ELECTRONIC TRANSMISSION OF DATA CONSISTING OF TEXT AND AUDIO CONTENT; IP-BASED TEXT AND VOICE COMMUNICATIONS SERVICES, NAMELY, WIRELESS DIGITAL TEXT MESSAGING AND AUDIO MESSAGING SERVICES AMONG COMPUTERS, IN CLASS 38 (U.S. CLS. 100, 101 AND 104).

FIRST USE 4-19-2011; IN COMMERCE 4-19-2011.

FOR: PROVIDING TEMPORARY USE OF ONLINE, NON-DOWNLOADABLE SOFTWARE THAT ALLOWS USERS TO UTILIZE IP-BASED VOICE COMMUNICATIONS SERVICES AMONG COMPUTERS; PROVIDING TEMPORARY USE OF ONLINE, NON-DOWNLOADABLE SOFTWARE THAT ENABLES THE CREATION, TRANSMISSION AND RECEIPT OF TEXT MESSAGES AND AUDIO MESSAGES AMONG COMPUTERS; ASP SERVICES IN THE NATURE OF HOSTING, MAINTAINING AND SYNCHRONIZING DATABASES CONSISTING OF TEXT MESSAGES ADDRESS BOOK INFORMATION AMONG COMPUTERS AND MOBILE COMMUNICATIONS DEVICES, IN CLASS 42 (U.S. CLS. 100 AND 101).

FIRST USE 4-19-2011; IN COMMERCE 4-19-2011.

THE MARK CONSISTS OF A BOBSLEDDER, PRESENTED PREDOMINANTLY IN MAGENTA WITH A HELMET VISOR PRESENTED IN CHARCOAL GRAY, IN SLIGHTLY CROUCHED POSITION TO THE LEFT OF THE DESIGN, WHO IS GRASPING THE FIRST "B" IN THE



David J. Kybas

Director of the United States Patent and Trademark Office

Reg. No. 4,073,522 WORD "BOBSLED" WHICH IS PRESENTED IN SLIGHTLY ITALICIZED LOWER CASE LETTERS IN CHARCOAL GRAY.

THE COLOR(S) MAGENTA AND CHARCOAL GRAY IS/ARE CLAIMED AS A FEATURE OF THE MARK.

SER. NO. 85-298,603, FILED 4-19-2011.

TRACY FLETCHER, EXAMINING ATTORNEY

United States of America

United States Patent and Trademark Office

LIGHT RAIL DEPOT

Reg. No. 4,073,523

Registered Dec. 20, 2011

Int. Cl.: 35

SERVICE MARK

PRINCIPAL REGISTER

LIGHT RAIL DEPOT, INC. (COLORADO CORPORATION)
12689 PRINCE CREEK DRIVE
PARKER, CO 80134

FOR: ON-LINE RETAIL STORE SERVICES FEATURING PARTS AND SYSTEMS FOR PASSENGER RAIL VEHICLES; ON-LINE WHOLESALE AND RETAIL STORE SERVICES FEATURING PARTS AND SYSTEMS FOR PASSENGER RAIL VEHICLES; RETAIL STORE AND ON-LINE RETAIL STORE SERVICES FEATURING PARTS AND SYSTEMS FOR PASSENGER RAIL VEHICLES; RETAIL STORE SERVICES FEATURING PARTS AND SYSTEMS FOR PASSENGER RAIL VEHICLES; WHOLESALE AND RETAIL STORE SERVICES AND ON-LINE RETAIL AND WHOLESALE STORE SERVICES FEATURING PARTS AND SYSTEMS FOR PASSENGER RAIL VEHICLES; WHOLESALE AND RETAIL STORE SERVICES FEATURING PARTS AND SYSTEMS FOR PASSENGER RAIL VEHICLES; WHOLESALE ORDERING SERVICES IN THE FIELD OF PARTS AND SYSTEMS FOR PASSENGER RAIL VEHICLES, IN CLASS 35 (U.S. CLS. 100, 101 AND 102).

FIRST USE 3-31-2009; IN COMMERCE 3-31-2009.

THE MARK CONSISTS OF STANDARD CHARACTERS WITHOUT CLAIM TO ANY PARTICULAR FONT, STYLE, SIZE, OR COLOR.

NO CLAIM IS MADE TO THE EXCLUSIVE RIGHT TO USE "LIGHT RAIL", APART FROM THE MARK AS SHOWN.

SER. NO. 85-298,699, FILED 4-19-2011.

SUE LAWRENCE, EXAMINING ATTORNEY



David J. Kyros

Director of the United States Patent and Trademark Office

United States of America

United States Patent and Trademark Office

from miami with love

Reg. No. 4,073,524

Registered Dec. 20, 2011

Int. Cl.: 41

SERVICE MARK

PRINCIPAL REGISTER

NOISEMATCH, INC. (FLORIDA CORPORATION)
169 NW 23RD STREET
MIAMI, FL 33127

FOR: ENTERTAINMENT SERVICES, NAMELY, THE PROVISION OF CONTINUING BLOGS FEATURING THE LATEST NEWS, INFORMATION AND COMMENTARY ON TECHNOLOGY, ART AND ENTERTAINMENT DELIVERED BY THE INTERNET; PROVIDING A WEBSITE FEATURING BLOGS AND NON-DOWNLOADABLE PUBLICATIONS IN THE NATURE OF BLOGS IN THE FIELD(S) OF TECHNOLOGY, ART AND ENTERTAINMENT, IN CLASS 41 (U.S. CLS. 100, 101 AND 107).

FIRST USE 3-1-2011; IN COMMERCE 3-1-2011.

THE MARK CONSISTS OF STANDARD CHARACTERS WITHOUT CLAIM TO ANY PARTICULAR FONT, STYLE, SIZE, OR COLOR.

NO CLAIM IS MADE TO THE EXCLUSIVE RIGHT TO USE "FROM MIAMI", APART FROM THE MARK AS SHOWN.

SER. NO. 85-298,763, FILED 4-19-2011.

PRISCILLA MILTON, EXAMINING ATTORNEY



David J. Kybas

Director of the United States Patent and Trademark Office

United States of America

United States Patent and Trademark Office



Reg. No. 4,073,525

Registered Dec. 20, 2011

Int. Cl.: 43

SERVICE MARK

PRINCIPAL REGISTER

SATEK INC. (MICHIGAN CORPORATION), DBA B&C PIZZA
476 N. TUSCOLA
BAY CITY, MI 48708

FOR: RESTAURANT SERVICES, INCLUDING SIT-DOWN SERVICE OF FOOD AND TAKE-OUT RESTAURANT SERVICES, IN CLASS 43 (U.S. CLS. 100 AND 101).

FIRST USE 12-1-1979; IN COMMERCE 12-1-1979.

OWNER OF U.S. REG. NO. 3,031,683.

THE COLOR(S) BLACK, RED, WHITE, AND BEIGE IS/ARE CLAIMED AS A FEATURE OF THE MARK.

NO CLAIM IS MADE TO THE EXCLUSIVE RIGHT TO USE "PIZZA", APART FROM THE MARK AS SHOWN.

THE STIPPLING IS A FEATURE OF THE MARK AND DOES NOT INDICATE COLOR.

THE MARK CONSISTS OF CHEF CARRYING PIZZA WITH "B&C" IN BLACK LETTERS IN MIDDLE OF CHEF'S HAT, BLACK PIZZA IN CHEF'S HANDS WITH RED WORD "PIZZA" OUTLINED IN BLACK FLOATING ABOVE IT. CHEF HAS BLACK MUSTACHE AND BLACK HAIR AND BLACK PANTS, AND SHIRT BUTTONS. FACE AND HANDS OF CHEF ARE BEIGE, AND SHIRT AND HAT ARE WHITE. ONE HAND IS HOLDING PIZZA AND THE OTHER HAND IS AT CHEF'S MOUTH WITH A PINCH GESTURE. CHEF IS WALKING. THE BACKGROUND OF THE MARK IS TRANSPARENT.

SER. NO. 85-298,773, FILED 4-19-2011.

ANDREA HACK, EXAMINING ATTORNEY



David J. Kybas

Director of the United States Patent and Trademark Office

United States of America

United States Patent and Trademark Office

PSEN

Reg. No. 4,073,526

Registered Dec. 20, 2011

Int. Cls.: 41 and 44

SERVICE MARK

PRINCIPAL REGISTER

AMERICAN SOCIETY OF PLASTIC SURGEONS (ILLINOIS NON-PROFIT CORPORATION)
444 EAST ALGONQUIN ROAD
ARLINGTON HEIGHTS, IL 60005

FOR: EDUCATION AND CONTINUING PROFESSIONAL EDUCATION SERVICES, NAMELY, PROVIDING LIVE AND ON-LINE CLASSES, SEMINARS, LECTURE PRESENTATIONS IN THE FIELD OF PLASTIC SURGERY AND PROVIDING A WEB SITE FEATURING NON-DOWNLOADABLE INSTRUCTIONAL PROCEDURAL VIDEOS IN THE FIELD OF PLASTIC SURGERY, IN CLASS 41 (U.S. CLS. 100, 101 AND 107).

FIRST USE 4-1-2011; IN COMMERCE 4-1-2011.

FOR: PROVIDING INFORMATION IN THE FIELD OF PLASTIC SURGERY VIA AN INTERNET WEBSITE PORTAL THROUGH TEXT, PHOTOS AND NON-DOWNLOADABLE VIDEOS, IN CLASS 44 (U.S. CLS. 100 AND 101).

FIRST USE 4-1-2011; IN COMMERCE 4-1-2011.

THE MARK CONSISTS OF STANDARD CHARACTERS WITHOUT CLAIM TO ANY PARTICULAR FONT, STYLE, SIZE, OR COLOR.

SER. NO. 85-298,917, FILED 4-19-2011.

FRED CARL, EXAMINING ATTORNEY



David J. Kyffers

Director of the United States Patent and Trademark Office

United States of America

United States Patent and Trademark Office

MODEL 11

Reg. No. 4,073,527

LUXUS ARMS (OHIO LIMITED LIABILITY COMPANY)
222 HOMAN WAY
MOUNT ORAB, OH 45154

Registered Dec. 20, 2011

Int. Cl.: 13

FOR: FIREARMS, IN CLASS 13 (U.S. CLS. 2 AND 9).

TRADEMARK

FIRST USE 4-1-2011; IN COMMERCE 4-1-2011.

PRINCIPAL REGISTER

THE MARK CONSISTS OF STANDARD CHARACTERS WITHOUT CLAIM TO ANY PARTICULAR FONT, STYLE, SIZE, OR COLOR.

NO CLAIM IS MADE TO THE EXCLUSIVE RIGHT TO USE "MODEL", APART FROM THE MARK AS SHOWN.

SER. NO. 85-299,018, FILED 4-19-2011.

KAREN SEVERSON, EXAMINING ATTORNEY



David J. Kyffers

Director of the United States Patent and Trademark Office

United States of America

United States Patent and Trademark Office

McCall Air

Reg. No. 4,073,528

Registered Dec. 20, 2011

Int. Cl.: 39

SERVICE MARK

PRINCIPAL REGISTER

MCCALL AVIATION, INC. (IDAHO CORPORATION), DBA MCCALL AIR
300 DEINHARD LANE
MCCALL, ID 83638

FOR: AIR CHARTER SERVICES; AIR CHARTER TRANSPORTATION SERVICES; AIR
TRANSPORT SERVICES; AIR TRANSPORTATION; AIR TRANSPORTATION OF PASSENGERS
AND FREIGHT, IN CLASS 39 (U.S. CLS. 100 AND 105).

FIRST USE 11-1-1976; IN COMMERCE 11-1-1976.

THE MARK CONSISTS OF STANDARD CHARACTERS WITHOUT CLAIM TO ANY PARTICULAR
FONT, STYLE, SIZE, OR COLOR.

NO CLAIM IS MADE TO THE EXCLUSIVE RIGHT TO USE "AIR", APART FROM THE
MARK AS SHOWN.

SEC. 2(F).

SER. NO. 85-299,082, FILED 4-19-2011.

DANIEL CAPSHAW, EXAMINING ATTORNEY



David J. Kyros

Director of the United States Patent and Trademark Office

United States of America

United States Patent and Trademark Office

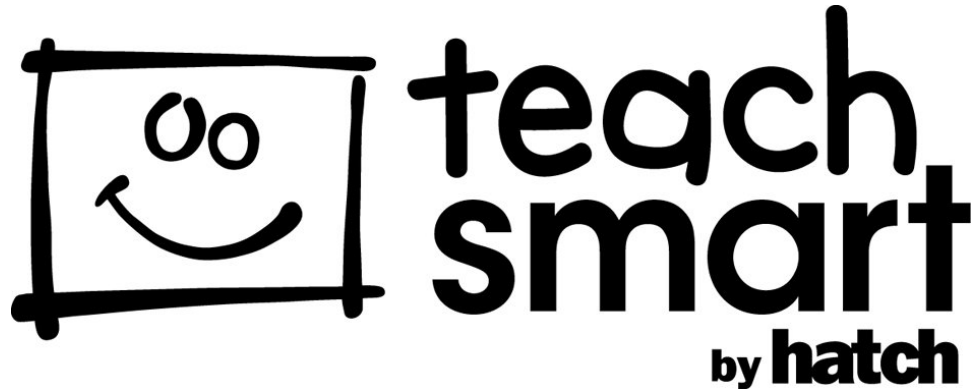

Reg. No. 4,073,529

Registered Dec. 20, 2011

Int. Cl.: 9

TRADEMARK

PRINCIPAL REGISTER

HATCH, INC. (NORTH CAROLINA CORPORATION)
301 N. MAIN STREET, SUITE 101
WINSTON-SALEM, NC 27101

FOR: EDUCATIONAL KIT COMPRISED PRIMARILY OF CLASSROOM COMPUTER WHITEBOARD WITH INTEGRATED PROJECTOR, COMPUTER, KEYBOARD, MOUSE, SPEAKERS, COMPUTER SOFTWARE, AND TEACHING MANUALS ALL SOLD TOGETHER AS A UNIT, DESIGNED TO PROMOTE PRE-LITERACY AND MATHEMATICS CONCEPT ACQUISITION IN PRESCHOOL AND KINDERGARTEN; COMPUTER SOFTWARE FOR OPERATING A CLASSROOM COMPUTER WHITEBOARD, IN CLASS 9 (U.S. CLS. 21, 23, 26, 36 AND 38).

FIRST USE 4-15-2011; IN COMMERCE 4-15-2011.

OWNER OF U.S. REG. NO. 3,605,352.

NO CLAIM IS MADE TO THE EXCLUSIVE RIGHT TO USE "TEACH", APART FROM THE MARK AS SHOWN.

THE MARK CONSISTS OF THE WORDS "TEACH SMART" IN LOWERCASE LETTERS. THE ICON TO THE LEFT OF THE WORDS IS DEPICTED BY A RECTANGLE SHAPE WITH A SMILING FACE IN THE CENTER OF THE RECTANGLE. IN A HANDWRITTEN FONT, "TEACH" IS SHOWN ABOVE THE WORD "SMART" IN A LOWERCASE SANS SERIF FONT. BENEATH THE WORD "SMART" IS "BY HATCH" IN A SMALLER SANS SERIF FONT BEGINNING BENEATH "A" IN "SMART".

SER. NO. 85-299,084, FILED 4-19-2011.

STEVEN R. FINE, EXAMINING ATTORNEY



David J. Kyjars

Director of the United States Patent and Trademark Office

United States of America

United States Patent and Trademark Office

911 DRIVING SCHOOL

Reg. No. 4,073,530

Registered Dec. 20, 2011

Int. Cl.: 41

SERVICE MARK

PRINCIPAL REGISTER

911 FRANCHISING CORPORATION (WASHINGTON CORPORATION)
C/O WEISS BROWN, PLLC, SUITE 143
6263 NORTH SCOTTSDALE ROAD
SCOTTSDALE, AZ 85250

FOR: DRIVER EDUCATION SERVICES, NAMELY, CONDUCTING CLASSES, SEMINARS, WORKSHOPS AND BEHIND-THE-WHEEL INSTRUCTION, IN THE FIELD OF AUTOMOBILE SAFETY, DRUNK DRIVING AWARENESS, ADVANCED DRIVING SKILLS, DRIVING INSTRUCTION, ADVERSE WEATHER DRIVING, POINT AND INSURANCE REDUCTION CLASSROOM COURSES, AUTOMOBILE DRIVER EDUCATION, INSTRUCTION IN THE FIELD OF BEHIND-THE-WHEEL VEHICLE DRIVING, IN CLASS 41 (U.S. CLS. 100, 101 AND 107).

FIRST USE 8-15-2004; IN COMMERCE 10-15-2004.

THE MARK CONSISTS OF STANDARD CHARACTERS WITHOUT CLAIM TO ANY PARTICULAR FONT, STYLE, SIZE, OR COLOR.

OWNER OF U.S. REG. NO. 3,099,251.

NO CLAIM IS MADE TO THE EXCLUSIVE RIGHT TO USE "DRIVING SCHOOL", APART FROM THE MARK AS SHOWN.

SER. NO. 85-299,290, FILED 4-19-2011.

FRED CARL, EXAMINING ATTORNEY



David J. Kyffers

Director of the United States Patent and Trademark Office

United States of America
United States Patent and Trademark Office

anycal

Reg. No. 4,073,531

MATTEA, NICK (UNITED STATES INDIVIDUAL)
44 CLOVER LEAF CIRCLE
BRENTWOOD, CA 94513

Registered Dec. 20, 2011

Int. Cl.: 25

FOR: HATS; SHIRTS, IN CLASS 25 (U.S. CLS. 22 AND 39).

TRADEMARK

FIRST USE 11-19-2008; IN COMMERCE 1-25-2009.

PRINCIPAL REGISTER

OWNER OF U.S. REG. NO. 3,440,059.

THE MARK CONSISTS OF THE STYLIZED TEXT "ANYCAL".

SER. NO. 85-299,296, FILED 4-19-2011.

H. M. FISHER, EXAMINING ATTORNEY



David J. Kyffers

Director of the United States Patent and Trademark Office

United States of America

United States Patent and Trademark Office

Care Courses

Reg. No. 4,073,532

Registered Dec. 20, 2011

Int. Cls.: 9 and 16

TRADEMARK

PRINCIPAL REGISTER

THE CARE COURSES SCHOOL, INC. (VIRGINIA CORPORATION), DBA CARE COURSES
P.O. BOX 10526
MCLEAN, VA 22102

FOR: DOWNLOADABLE ELECTRONIC PUBLICATIONS IN THE NATURE OF E-BOOKS
AND DOWNLOADABLE DOCUMENTS IN THE FIELD OF CHILDCARE EDUCATION, IN
CLASS 9 (U.S. CLS. 21, 23, 26, 36 AND 38).

FIRST USE 8-1-1992; IN COMMERCE 9-1-1992.

FOR: CATALOGS IN THE FIELD OF CHILDCARE EDUCATION; EDUCATIONAL PUBLIC-
ATIONS, NAMELY, BOOKS AND WORKBOOKS IN THE FIELDS OF CHILDCARE EDUCA-
TION, IN CLASS 16 (U.S. CLS. 2, 5, 22, 23, 29, 37, 38 AND 50).

FIRST USE 8-1-1992; IN COMMERCE 9-1-1992.

THE MARK CONSISTS OF STANDARD CHARACTERS WITHOUT CLAIM TO ANY PAR-
TICULAR FONT, STYLE, SIZE, OR COLOR.

SEC. 2(F).

SER. NO. 85-299,347, FILED 4-19-2011.

H. M. FISHER, EXAMINING ATTORNEY



David J. Kybas

Director of the United States Patent and Trademark Office

United States of America

United States Patent and Trademark Office



Reg. No. 4,073,533

Registered Dec. 20, 2011

Int. Cl.: 45

SERVICE MARK

PRINCIPAL REGISTER

CIENFUEGOS, APLC (CALIFORNIA CORPORATION), DBA TU GRUPO LEGAL
1875 CENTURY PARK EAST, 6TH FLOOR
CENTURY CITY, CA 90067

FOR: LEGAL CONSULTATION SERVICES; LEGAL SERVICES, IN CLASS 45 (U.S. CLS. 100 AND 101).

FIRST USE 2-1-2010; IN COMMERCE 3-1-2011.

THE MARK CONSISTS OF A STYLIZED BIRD DESIGN.

SER. NO. 85-299,447, FILED 4-20-2011.

LAURIE MAYES, EXAMINING ATTORNEY



David J. Kyffers

Director of the United States Patent and Trademark Office

United States of America

United States Patent and Trademark Office

MR. DRAIN PLUMBING

Reg. No. 4,073,534

Registered Dec. 20, 2011

Int. Cl.: 37

SERVICE MARK

PRINCIPAL REGISTER

RESCUE RESPONSE GROUP INC (CALIFORNIA CORPORATION), DBA MR. DRAIN INC
SUITE 12
4231 BUSINESS CENTER DR
FREMONT, CA 94538

FOR: COMMERCIAL AND RESIDENTIAL PLUMBING, PLUMBING CONTRACTOR,
PLUMBING REPAIR, SEWER, GREASE TRAP AND DRAIN CLEANING SERVICES , IN
CLASS 37 (U.S. CLS. 100, 103 AND 106).

FIRST USE 10-0-2008; IN COMMERCE 10-0-2008.

THE MARK CONSISTS OF STANDARD CHARACTERS WITHOUT CLAIM TO ANY PAR-
TICULAR FONT, STYLE, SIZE, OR COLOR.

OWNER OF U.S. REG. NO. 3,714,864.

NO CLAIM IS MADE TO THE EXCLUSIVE RIGHT TO USE "PLUMBING", APART FROM
THE MARK AS SHOWN.

SER. NO. 85-299,468, FILED 4-20-2011.

BARBARA BROWN, EXAMINING ATTORNEY



David J. Kyffers

Director of the United States Patent and Trademark Office

United States of America

United States Patent and Trademark Office

BOXERCRAFT AMERICA'S #1 SPIRITWEAR SOURCE

Reg. No. 4,073,535

Registered Dec. 20, 2011

Int. Cls.: 25 and 35

TRADEMARK

SERVICE MARK

PRINCIPAL REGISTER

BOXERCRAFT, INC. (GEORGIA CORPORATION)
P.O. BOX 20016
ATLANTA, GA 30325

FOR: CAPRI PANTS; CARGO PANTS; JOGGING PANTS; LOUNGE PANTS; PANTS; SWEAT PANTS; BOXER BRIEFS; BOXER SHORTS; SHORT-SLEEVED OR LONG-SLEEVED T-SHIRTS; T-SHIRTS; HEADBANDS AGAINST SWEATING; SWEAT BANDS; SWEAT SHIRTS; SWEAT SHORTS; SWEAT SUITS; FLEECE PULLOVERS; FLEECE SHORTS; SCARVES; BOARD SHORTS; GYM SHORTS; SHORTS; MUSCLE TOPS; TANK-TOPS; SCRUBS NOT FOR MEDICAL PURPOSES; FLIP FLOPS; HATS; PLUSH PANTS; PLUSH SHORTS; BURNOUT T-SHIRTS; BOY SHORTS; LEGGINGS; YOGA TOPS; HENLEY TOPS; JAM SHORTS; PAJAMAS; NIGHTSHIRT; WORKOUT PANTS; WOMEN'S BOXERS; YOGA PANTS; CAMISOLE; SPANDEX SHORTS; WORKOUT JACKETS; RUNNING SHORTS; CHEERLEADING SHORTS; ATHLETIC UNIFORMS; BOXER BRIEFS; CAPRI PANTS; SWEATSHIRTS; CREWNECK SWEATSHIRTS; AND TANK TOPS, IN CLASS 25 (U.S. CLS. 22 AND 39).

FIRST USE 3-0-2009; IN COMMERCE 3-0-2009.

FOR: CATALOG ORDERING SERVICE FEATURING AFGHANS, TIE-DYE SHIRTS AND PANTS, CUSTOM LINED HOODED SWEATSHIRTS, PANTS, SHORTS, SHIRTS, FOOTWEAR, BOXER SHORTS, BLANKETS, PILLOW CASES, HATS, AIRBRUSH DESIGNS, TRANSFERS, TWILL DESIGNS, RHINESTONE DESIGNS, FOIL PRINTS, AND PRINT DESIGNS; ELECTRONIC CATALOG SERVICES FEATURING AFGHANS, TIE-DYE SHIRTS AND PANTS, CUSTOM LINED HOODED SWEATSHIRTS, PANTS, SHORTS, SHIRTS, FOOTWEAR, BOXER SHORTS, BLANKETS, PILLOW CASES, HATS, AIRBRUSH DESIGNS, TRANSFERS, TWILL DESIGNS, RHINESTONE DESIGNS, FOIL PRINTS, AND PRINT DESIGNS; MAIL ORDER CATALOG SERVICES FEATURING AFGHANS, TIE-DYE SHIRTS AND PANTS, CUSTOM LINED HOODED SWEATSHIRTS, PANTS, SHORTS, SHIRTS, FOOTWEAR, BOXER SHORTS, BLANKETS, PILLOW CASES, HATS, AIRBRUSH DESIGNS, TRANSFERS, TWILL DESIGNS, RHINESTONE DESIGNS, FOIL PRINTS, AND PRINT DESIGNS; PROMOTING THE GOODS AND SERVICES OF OTHERS THROUGH ON-LINE ORDERING AND CATALOGING OF THOSE GOODS AND SERVICES; COMPUTERIZED ON-LINE ORDERING SERVICES IN THE FIELD OF AFGHANS, TIE-DYE SHIRTS AND PANTS, CUSTOM LINED HOODED SWEATSHIRTS, PANTS, SHORTS, SHIRTS, FOOTWEAR, BOXER SHORTS, BLANKETS, PILLOW CASES, HATS, AIRBRUSH DESIGNS, TRANSFERS, TWILL DESIGNS, RHINESTONE DESIGNS, FOIL PRINTS, AND PRINT DESIGNS; COMPUTERIZED ON-LINE RETAIL STORE SERVICES IN THE FIELD OF AFGHANS, TIE-DYE SHIRTS AND PANTS,

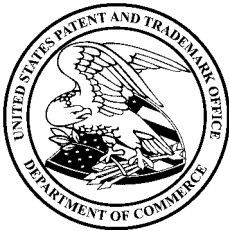

David J. Kyros

Director of the United States Patent and Trademark Office

Reg. No. 4,073,535 CUSTOM LINED HOODED SWEATSHIRTS, PANTS, SHORTS, SHIRTS, FOOTWEAR, BOXER SHORTS, BLANKETS, PILLOW CASES, HATS, AIRBRUSH DESIGNS, TRANSFERS, TWILL DESIGNS, RHINESTONE DESIGNS, FOIL PRINTS, AND PRINT DESIGNS; ON-LINE ORDERING SERVICES FEATURING AFGHANS, TIE-DYE SHIRTS AND PANTS, CUSTOM LINED HOODED SWEATSHIRTS, PANTS, SHORTS, SHIRTS, FOOTWEAR, BOXER SHORTS, BLANKETS, PILLOW CASES, HATS, AIRBRUSH DESIGNS, TRANSFERS, TWILL DESIGNS, RHINESTONE DESIGNS, FOIL PRINTS, AND PRINT DESIGNS. ON-LINE RETAIL STORE SERVICES FEATURING AFGHANS, TIE-DYE SHIRTS AND PANTS, CUSTOM LINED HOODED SWEATSHIRTS, PANTS, SHORTS, SHIRTS, FOOTWEAR, BOXER SHORTS, BLANKETS, PILLOW CASES, HATS, AIRBRUSH DESIGNS, TRANSFERS, TWILL DESIGNS, RHINESTONE DESIGNS, FOIL PRINTS, AND PRINT DESIGNS, IN CLASS 35 (U.S. CLS. 100, 101 AND 102).

FIRST USE 3-0-2009; IN COMMERCE 3-0-2009.

THE MARK CONSISTS OF STANDARD CHARACTERS WITHOUT CLAIM TO ANY PARTICULAR FONT, STYLE, SIZE, OR COLOR.

OWNER OF U.S. REG. NOS. 3,310,652 AND 3,479,785.

NO CLAIM IS MADE TO THE EXCLUSIVE RIGHT TO USE "AMERICA'S #1 SPIRITWEAR SOURCE", APART FROM THE MARK AS SHOWN.

SER. NO. 85-299,523, FILED 4-20-2011.

CHRIS DONINGER, EXAMINING ATTORNEY

United States of America

United States Patent and Trademark Office

Healthy Churches Thrive!

Reg. No. 4,073,536

Registered Dec. 20, 2011

Int. Cl.: 45

SERVICE MARK

PRINCIPAL REGISTER

CHURCH GROWTH AND ANALYSIS CENTER (MICHIGAN LIMITED LIABILITY COMPANY), DBA CHURCH DOCTOR MINISTRIES

PO BOX 145
1230 US HIGHWAY SIX
CORUNNA, IN 467300145

FOR: CHRISTIAN MINISTRY SERVICES, IN CLASS 45 (U.S. CLS. 100 AND 101).

FIRST USE 4-7-2010; IN COMMERCE 4-20-2010.

THE MARK CONSISTS OF STANDARD CHARACTERS WITHOUT CLAIM TO ANY PARTICULAR FONT, STYLE, SIZE, OR COLOR.

NO CLAIM IS MADE TO THE EXCLUSIVE RIGHT TO USE "CHURCHES", APART FROM THE MARK AS SHOWN.

SER. NO. 85-299,552, FILED 4-20-2011.

ELIZABETH KAJUBI, EXAMINING ATTORNEY



David J. Kyffers

Director of the United States Patent and Trademark Office

United States of America

United States Patent and Trademark Office



Reg. No. 4,073,537

Registered Dec. 20, 2011

Int. Cl.: 9

TRADEMARK

PRINCIPAL REGISTER

VERDATUM, LLC (DELAWARE LIMITED LIABILITY COMPANY)
SUITE 300
E ETHEL ROAD
EDISON, NJ 08818

FOR: COMPUTER HARDWARE AND SOFTWARE USED FOR THE CONTROL OF VOICE CONTROLLED INFORMATION AND COMMUNICATION DEVICES, IN CLASS 9 (U.S. CLS. 21, 23, 26, 36 AND 38).

FIRST USE 1-1-2006; IN COMMERCE 1-1-2006.

THE MARK CONSISTS OF A STYLIZED 4 LEAF CLOVER, WITH GRADATIONS OF COLOR FROM THE OUTSIDE OF THE INDIVIDUAL LEAFS TO THE CENTER OF THE 4 LEAF CLOVER SHADING FROM RED ON THE OUTSIDE TO BLACK IN THE MIDDLE, TOGETHER WITH THE WORD "VERDATUM" WRITTEN IN BLACK.

THE COLOR(S) RED AND BLACK IS/ARE CLAIMED AS A FEATURE OF THE MARK.

SEC. 2(F).

SER. NO. 85-299,660, FILED 4-20-2011.

FRANK LATTUCA, EXAMINING ATTORNEY



David J. Kyffers

Director of the United States Patent and Trademark Office

United States of America

United States Patent and Trademark Office



Reg. No. 4,073,538

Registered Dec. 20, 2011

Int. Cl.: 35

SERVICE MARK

PRINCIPAL REGISTER

SEMINOLE COUNTY GOVERNMENT (FLORIDA MUNICIPAL CORPORATION)
1101 E FIRST STREET
SANFORD, FL 32771

FOR: COUNTY GOVERNMENT SERVICES, NAMELY, PROMOTING THE ECONOMIC DEVELOPMENT, BUSINESS, TOURISM AND GOVERNMENTAL SERVICES OF SEMINOLE COUNTY, FLORIDA, IN CLASS 35 (U.S. CLS. 100, 101 AND 102).

FIRST USE 5-1-1994; IN COMMERCE 5-1-1994.

NO CLAIM IS MADE TO THE EXCLUSIVE RIGHT TO USE "SEMINOLE COUNTY", APART FROM THE MARK AS SHOWN.

THE COLOR(S) BLUE, GREEN AND WHITE IS/ARE CLAIMED AS A FEATURE OF THE MARK.

THE MARK CONSISTS OF THE COLORS BLUE GREEN AND WHITE WITH THE COLOR BLUE APPEARING THE TOP BRUSH STROKE DESIGN AND IN THE WORDS "SEMINOLE COUNTY" WITH THE COLOR GREEN APPEARING IN THE BOTTOM BRUSH STROKE DESIGN AND THE WORDS "FLORIDA'S NATURAL CHOICE" AND WITH THE COLOR WHITE APPEARING IN THE SAILBOAT AND IN BACKGROUND. THE ENTIRE MARK IS OUTLINED IN BLUE.

SER. NO. 85-299,702, FILED 4-20-2011.

HOWARD SMIGA, EXAMINING ATTORNEY



David J. Kybas

Director of the United States Patent and Trademark Office

United States of America

United States Patent and Trademark Office



Reg. No. 4,073,539

BIC, LLC (INDIANA LIMITED LIABILITY COMPANY)
130 N PASADENA
INDIANAPOLIS, IN 46219

Registered Dec. 20, 2011

Int. Cl.: 32

FOR: SOFT DRINKS, NAMELY, NON-CARBONATED MILK OR WATER BASED SOFT DRINK FLAVORED WITH CHOCOLATE, IN CLASS 32 (U.S. CLS. 45, 46 AND 48).

TRADEMARK

FIRST USE 4-5-2010; IN COMMERCE 4-5-2010.

PRINCIPAL REGISTER

OWNER OF U.S. REG. NO. 3,839,007.

THE COLOR(S) YELLOW, BROWN AND WHITE IS/ARE CLAIMED AS A FEATURE OF THE MARK.

THE MARK CONSISTS OF A BROWN SHADED-IN CIRCLE BACKGROUND UPON WHICH IS A STYLIZED COW WITH THE UPPER PORTION OF ITS HEAD COLORED WHITE AND THE LOWER PORTION COLORED YELLOW AND THE FEATURES OF THE COW'S FACE COLORED BROWN, AND A WHITE COW BELL HANGING BELOW THE HEAD. ALSO WITHIN THE SHADED CIRCLE AND ARCHED ABOVE THE COW IN YELLOW LETTERING ARE THE WORDS "COW POWER" AND BELOW THE COW IN WHITE LETTERING IS THE WORD "CHOC-OLA".

SER. NO. 85-299,806, FILED 4-20-2011.

ASMAT KHAN, EXAMINING ATTORNEY



David J. Kybas

Director of the United States Patent and Trademark Office

United States of America

United States Patent and Trademark Office

TEXAS MANHANDLER

Reg. No. 4,073,540

FAMOUS DAVE'S OF AMERICA, INC. (MINNESOTA CORPORATION)
12701 WHITEWATER DRIVE, SUITE 200
MINNETONKA, MN 55343

Registered Dec. 20, 2011

Int. Cl.: 30

FOR: SANDWICH CONSISTING PRIMARILY OF MEAT; PREPARED SANDWICH SERVED IN RESTAURANTS, CONSISTING PRIMARILY OF MEAT; SANDWICH CONSISTING PRIMARILY OF MEAT FOR CONSUMPTION ON OR OFF RESTAURANT PREMISES, IN CLASS 30 (U.S. CL. 46).

TRADEMARK

PRINCIPAL REGISTER

FIRST USE 4-12-2004; IN COMMERCE 4-12-2004.

THE MARK CONSISTS OF STANDARD CHARACTERS WITHOUT CLAIM TO ANY PARTICULAR FONT, STYLE, SIZE, OR COLOR.

OWNER OF U.S. REG. NO. 3,053,209.

NO CLAIM IS MADE TO THE EXCLUSIVE RIGHT TO USE "TEXAS", APART FROM THE MARK AS SHOWN.

SER. NO. 85-299,816, FILED 4-20-2011.

LINDA ESTRADA, EXAMINING ATTORNEY



David J. Kyffers

Director of the United States Patent and Trademark Office

United States of America

United States Patent and Trademark Office

InstruTech

Reg. No. 4,073,541

Registered Dec. 20, 2011

Int. Cl.: 9

TRADEMARK

PRINCIPAL REGISTER

INSTRUTECH INC. (COLORADO CORPORATION)
1475 S. FORDHAM ST.
LONGMONT, CO 80503

FOR: MICROPROCESSOR BASED VACUUM GAUGE PRESSURE SENSORS, VACUUM PRESSURE MEASUREMENT HARDWARE, NAMELY, HOT CATHODE IONIZATION GAUGES, COLD CATHODE IONIZATION GAUGES, CONVECTION ENHANCED TRANSDUCERS, IONIZATION GAUGE TRANSDUCERS, CAPACITANCE DIAPHRAGM GAUGE TRANSDUCERS, LOW PRESSURE INDICATORS, VACUUM PRESSURE INDICATORS, HIGH VACUUM PRESSURE INDICATORS, ULTRA-HIGH VACUUM PRESSURE INDICATORS, THERMAL CONDUCTIVITY VACUUM PRESSURE TRANSDUCERS, THERMOCOUPLE VACUUM PRESSURE TRANSDUCERS, DIFFERENTIAL PRESSURE TRANSDUCERS; VACUUM PRESSURE GAUGES AND AUTOMATIC VACUUM VALVES FOR PRESSURE FLOW CONTROL, IN CLASS 9 (U.S. CLS. 21, 23, 26, 36 AND 38).

FIRST USE 9-1-2002; IN COMMERCE 9-1-2002.

THE MARK CONSISTS OF STANDARD CHARACTERS WITHOUT CLAIM TO ANY PARTICULAR FONT, STYLE, SIZE, OR COLOR.

SER. NO. 85-299,835, FILED 4-20-2011.

SETH A. RAPPAPORT, EXAMINING ATTORNEY



David J. Kyros

Director of the United States Patent and Trademark Office

United States of America

United States Patent and Trademark Office

Liquid Magic

Reg. No. 4,073,542

ENVIRONMENTAL ESSENTIALS LLC (OHIO LIMITED LIABILITY COMPANY)
8656 WEST BOWLING GREEN LN
LANCASTER, OH 43130

Registered Dec. 20, 2011

Int. Cl.: 3

FOR: ALL-PURPOSE CLEANERS, IN CLASS 3 (U.S. CLS. 1, 4, 6, 50, 51 AND 52).

TRADEMARK

FIRST USE 3-3-2009; IN COMMERCE 12-10-2009.

PRINCIPAL REGISTER

THE MARK CONSISTS OF STANDARD CHARACTERS WITHOUT CLAIM TO ANY PARTICULAR FONT, STYLE, SIZE, OR COLOR.

NO CLAIM IS MADE TO THE EXCLUSIVE RIGHT TO USE "LIQUID", APART FROM THE MARK AS SHOWN.

SER. NO. 85-299,926, FILED 4-20-2011.

LESLEY LAMOTHE, EXAMINING ATTORNEY



David J. Kyffers

Director of the United States Patent and Trademark Office

United States of America

United States Patent and Trademark Office

EVE
EMERGING VENTURES ECOSYSTEM

Reg. No. 4,073,543

Registered Dec. 20, 2011

Int. Cl.: 35

SERVICE MARK

PRINCIPAL REGISTER

RENSELAER POLYTECHNIC INSTITUTE (NEW YORK CORPORATION)
110 EIGHTH STREET
TROY, NY 12180

FOR: BUSINESS INCUBATION AND DEVELOPMENT SERVICES, NAMELY, PROVIDING START-UP SUPPORT FOR BUSINESSES OF OTHERS IN THE DEVELOPMENT OF BUSINESS STRATEGIES AND IDEA CREATION FOR NEWLY-DEVELOPING TECHNOLOGY BUSINESSES AND UNIVERSITY BUSINESSES, IN CLASS 35 (U.S. CLS. 100, 101 AND 102).

FIRST USE 2-7-2011; IN COMMERCE 2-7-2011.

NO CLAIM IS MADE TO THE EXCLUSIVE RIGHT TO USE "VENTURES", APART FROM THE MARK AS SHOWN.

THE COLOR(S) RED AND BLACK IS/ARE CLAIMED AS A FEATURE OF THE MARK.

THE MARK CONSISTS OF THE WORD "EVE" IN UPPER CASE RED LETTERS. CENTERED UNDER THE WORD "EVE" ARE THE WORDS "EMERGING VENTURES ECOSYSTEM" IN BLACK.

SER. NO. 85-300,032, FILED 4-20-2011.

KAPIL BHANOT, EXAMINING ATTORNEY



David J. Kyffers

Director of the United States Patent and Trademark Office

United States of America
United States Patent and Trademark Office

ZORAVAR

Reg. No. 4,073,544

CHEERS DISTRIBUTORS, INC. (FLORIDA CORPORATION)
2283 NE 164 ST.

Registered Dec. 20, 2011

NORTH MIAMI BEACH, FL 33160

Int. Cl.: 33

FOR: ALCOHOLIC BEVERAGES, NAMELY, BRANDY, IN CLASS 33 (U.S. CLS. 47 AND 49).

TRADEMARK

FIRST USE 10-25-2007; IN COMMERCE 10-25-2007.

PRINCIPAL REGISTER

THE MARK CONSISTS OF STANDARD CHARACTERS WITHOUT CLAIM TO ANY PARTICULAR FONT, STYLE, SIZE, OR COLOR.

THE ENGLISH TRANSLATION OF "ZORAVAR" IN THE MARK IS COMMANDER OF TROOPS.

SER. NO. 85-300,065, FILED 4-20-2011.

RICHARD WHITE, EXAMINING ATTORNEY



David J. Kyffers

Director of the United States Patent and Trademark Office

United States of America

United States Patent and Trademark Office

NOVROZSKY'S HAMBURGERS, ETC.

Reg. No. 4,073,545

STEENBOK, INC. (TEXAS CORPORATION)
150 N. CALDWOOD
BEAUMONT, TX 77707

Registered Dec. 20, 2011

Int. Cl.: 43

FOR: RESTAURANTS; TAKE-OUT RESTAURANT SERVICES, IN CLASS 43 (U.S. CLS. 100 AND 101).

SERVICE MARK

FIRST USE 0-0-1982; IN COMMERCE 0-0-1982.

PRINCIPAL REGISTER

THE MARK CONSISTS OF STANDARD CHARACTERS WITHOUT CLAIM TO ANY PARTICULAR FONT, STYLE, SIZE, OR COLOR.

NO CLAIM IS MADE TO THE EXCLUSIVE RIGHT TO USE "HAMBURGERS", APART FROM THE MARK AS SHOWN.

SER. NO. 85-300,389, FILED 4-20-2011.

KHANH LE, EXAMINING ATTORNEY



David J. Kyffers

Director of the United States Patent and Trademark Office

United States of America

United States Patent and Trademark Office

McCall Aviation

Reg. No. 4,073,546

Registered Dec. 20, 2011

Int. Cl.: 37

SERVICE MARK

PRINCIPAL REGISTER

MCCALL AVIATION, INC. (IDAHO CORPORATION), DBA MCCALL AIR, SALMON AIR
300 DEINHARD LANE
MCCALL, ID 83638

FOR: AIRCRAFT ENGINE REPAIR AND MAINTENANCE; AIRCRAFT FUELING SERVICES;
AIRCRAFT MAINTENANCE AND REPAIR SERVICES; AIRCRAFT MAINTENANCE OR
REPAIR; AIRCRAFT REPAIR AND MAINTENANCE; AIRPLANE DE-ICING SERVICES;
AIRPLANE DEICING SERVICES; FUELING SERVICES FOR AIRCRAFT; REPAIR AND
MAINTENANCE OF AIRCRAFT, IN CLASS 37 (U.S. CLS. 100, 103 AND 106).

FIRST USE 4-30-2002; IN COMMERCE 4-30-2002.

THE MARK CONSISTS OF STANDARD CHARACTERS WITHOUT CLAIM TO ANY PAR-
TICULAR FONT, STYLE, SIZE, OR COLOR.

NO CLAIM IS MADE TO THE EXCLUSIVE RIGHT TO USE "AVIATION", APART FROM
THE MARK AS SHOWN.

SEC. 2(F).

SER. NO. 85-300,403, FILED 4-20-2011.

DANIEL CAPSHAW, EXAMINING ATTORNEY



David J. Kypos

Director of the United States Patent and Trademark Office

United States of America

United States Patent and Trademark Office

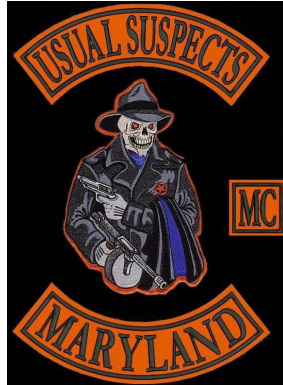

Reg. No. 4,073,547

Registered Dec. 20, 2011

**COLLECTIVE
MEMBERSHIP**

PRINCIPAL REGISTER

JEFFREY ALLEN WALTERS (UNITED STATES INDIVIDUAL)
355 WILLIAMS RD
PRINCE FREDERICK, MD 20678 AND

EDWARD SCOTT FINN (UNITED STATES INDIVIDUAL)
418 CAMBRIDGE PL
PRINCE FREDERICK, MD 20678

FOR: INDICATING MEMBERSHIP IN A MOTORCYCLE CLUB, IN CLASS 200 (U.S. CL. 200).

FIRST USE 12-11-2008; IN COMMERCE 12-11-2008.

NO CLAIM IS MADE TO THE EXCLUSIVE RIGHT TO USE "MARYLAND" OR "MC", APART FROM THE MARK AS SHOWN.

THE COLOR(S) ORANGE, BLACK, GREY, RED, BLUE, BROWN AND WHITE IS/ARE CLAIMED AS A FEATURE OF THE MARK.

THE MARK CONSISTS OF A SKELETON GUNMAN WITH A WHITE SKULL AND RED EYES, WEARING A GREY FEDORA HAT WITH A BLACK RIBBON, A BLACK AND GREY OVER COAT, AND GREY GLOVES, AND IN HIS RIGHT HAND HE IS HOLDING A GREY AND BLACK TOMMY GUN WITH A BROWN HANDLE, AND IN HIS LEFT HAND HE IS HOLDING A GREY AND BLACK HANDGUN, AND A BLACK AND BLUE FLAG IS DRAPED OVER HIS ARM. HE IS WEARING A BLUE SCARF AROUND HIS NECK AND HAS AN ORANGE STAR WITHIN AN ORANGE CIRCLE BADGE ON HIS LEFT CHEST. HE IS FACING TO THE LEFT AND LOOKING DOWN. THE FOREGOING DESIGN IS OUTLINED IN ORANGE. ABOVE THE DESIGN APPEARS THE STYLIZED WORDING "USUAL SUSPECTS" IN GREY WITHIN A GREY ARCHED RECTANGULAR BORDER, ALL AGAINST AN ORANGE ARCHED RECTANGULAR BACKGROUND. TO THE RIGHT OF THE DESIGN APPEARS WITH LETTERS "MC" IN GREY WITHIN A GREY SQUARE BORDER, ALL AGAINST AN ORANGE SQUARE BACKGROUND. BELOW THE DESIGN APPEARS THE STYLIZED WORD "MARYLAND" IN GREY WITHIN A GREY CURVED RECTANGULAR BORDER, ALL AGAINST A CURVED ORANGE RECTANGULAR BACKGROUND. THE COLOR BLACK APPEARING IN THE REST OF THE MARK REPRESENTS BACKGROUND AND/OR TRANSPARENT AREAS AND IS NOT CLAIMED AS A FEATURE OF THE MARK.



David J. Kybas

Director of the United States Patent and Trademark Office

Reg. No. 4,073,547 SER. NO. 85-300,484, FILED 4-20-2011.

ANDREW LEASER, EXAMINING ATTORNEY

United States of America

United States Patent and Trademark Office

KRINGLE'S INVENTIONASIUM

Reg. No. 4,073,548

IMAGINIF, INC. (OHIO CORPORATION)

Registered Dec. 20, 2011

8223 TWIN OAKS DRIVE
BROADVIEW HEIGHTS, OH 44147

Int. Cl.: 41

FOR: ENTERTAINMENT IN THE NATURE OF THEATER PRODUCTIONS, IN CLASS 41
(U.S. CLS. 100, 101 AND 107).

SERVICE MARK

FIRST USE 0-0-2007; IN COMMERCE 0-0-2009.

PRINCIPAL REGISTER

THE MARK CONSISTS OF STANDARD CHARACTERS WITHOUT CLAIM TO ANY PARTICULAR FONT, STYLE, SIZE, OR COLOR.

SER. NO. 85-300,729, FILED 4-21-2011.

BARBARA A. GOLD, EXAMINING ATTORNEY



David J. Kybas

Director of the United States Patent and Trademark Office

United States of America

United States Patent and Trademark Office

KneeBees

Reg. No. 4,073,549

NEFTIN, JEAN (UNITED STATES INDIVIDUAL)
12 GIRARD STREET
BROOKLYN, NY 11235

Registered Dec. 20, 2011

Int. Cl.: 9

FOR: CLOTHING FOR PROTECTION AGAINST ACCIDENTS, IN CLASS 9 (U.S. CLS. 21, 23, 26, 36 AND 38).

TRADEMARK

FIRST USE 5-1-2011; IN COMMERCE 6-1-2011.

PRINCIPAL REGISTER

THE MARK CONSISTS OF STANDARD CHARACTERS WITHOUT CLAIM TO ANY PARTICULAR FONT, STYLE, SIZE, OR COLOR.

SER. NO. 85-300,793, FILED S.R. 4-21-2011 AM. P.R. 8-10-2011.

SHANNON TWOHIG, EXAMINING ATTORNEY



David J. Kyffers

Director of the United States Patent and Trademark Office

United States of America

United States Patent and Trademark Office

WARP SPEED

Reg. No. 4,073,550

Registered Dec. 20, 2011

Int. Cl.: 12

TRADEMARK

PRINCIPAL REGISTER

BROOKINS HYBRID DRIVE SYSTEMS LLC (NORTH DAKOTA LIMITED LIABILITY COMPANY)
PO BOX 701
WEST FARGO, ND 58078

FOR: TRANSMISSIONS FOR LAND VEHICLES; TORQUE CONVERTORS FOR LAND VEHICLES, IN CLASS 12 (U.S. CLS. 19, 21, 23, 31, 35 AND 44).

FIRST USE 3-3-2011; IN COMMERCE 3-3-2011.

THE MARK CONSISTS OF STANDARD CHARACTERS WITHOUT CLAIM TO ANY PARTICULAR FONT, STYLE, SIZE, OR COLOR.

NO CLAIM IS MADE TO THE EXCLUSIVE RIGHT TO USE "SPEED", APART FROM THE MARK AS SHOWN.

SER. NO. 85-300,994, FILED 4-21-2011.

FRED CARL, EXAMINING ATTORNEY



David J. Kyfos

Director of the United States Patent and Trademark Office

United States of America

United States Patent and Trademark Office



DETROIT FAMOUS
C L O T H I N G

Reg. No. 4,073,551

PRITULA, NICHOLAS (UNITED STATES INDIVIDUAL)
15524 BAINBRIDGE ST.
LIVONIA, MI 48154

Registered Dec. 20, 2011

Int. Cl.: 25

FOR: HATS; HOODED SWEAT SHIRTS; JACKETS; SHIRTS, IN CLASS 25 (U.S. CLS. 22 AND 39).

TRADEMARK

FIRST USE 11-8-2010; IN COMMERCE 11-8-2010.

PRINCIPAL REGISTER

NO CLAIM IS MADE TO THE EXCLUSIVE RIGHT TO USE "DETROIT" AND "CLOTHING", APART FROM THE MARK AS SHOWN.

THE MARK CONSISTS OF THE TEXT "DF" WITH A STAR OVER THE "D", AND THE WORDS "DETROIT FAMOUS CLOTHING" UNDERNEATH.

SER. NO. 85-301,136, FILED 4-21-2011.

AMY C. KEAN, EXAMINING ATTORNEY



David J. Kybas

Director of the United States Patent and Trademark Office

United States of America

United States Patent and Trademark Office

B WOOD

Reg. No. 4,073,552

Registered Dec. 20, 2011

Int. Cl.: 25

TRADEMARK

PRINCIPAL REGISTER

BRIAN WOOD EXCLUSIVE, INC. (NEW YORK CORPORATION)
1224 ST. NICHOLAS AVE, SUITE 1F
NEW YORK, NY 10032

FOR: ATHLETIC APPAREL, NAMELY, SHIRTS, PANTS, JACKETS, FOOTWEAR, HATS AND CAPS, ATHLETIC UNIFORMS; HOODED SWEATSHIRTS; JACKETS; SHORT-SLEEVED OR LONG-SLEEVED T-SHIRTS; SPORTS CAPS AND HATS; SWEAT JACKETS; SWEATSHIRTS; T-SHIRTS; TANK-TOPS; V-NECK SWEATERS, IN CLASS 25 (U.S. CLS. 22 AND 39).

FIRST USE 5-0-2009; IN COMMERCE 1-0-2010.

THE MARK CONSISTS OF STANDARD CHARACTERS WITHOUT CLAIM TO ANY PARTICULAR FONT, STYLE, SIZE, OR COLOR.

THE NAME(S), PORTRAIT(S), AND/OR SIGNATURE(S) SHOWN IN THE MARK IDENTIFIES BRIAN "WOOD", WHOSE CONSENT(S) TO REGISTER IS MADE OF RECORD.

SER. NO. 85-301,238, FILED 4-21-2011.

SKYE YOUNG, EXAMINING ATTORNEY



David J. Kybas

Director of the United States Patent and Trademark Office

United States of America

United States Patent and Trademark Office



Reg. No. 4,073,553

ATTIC BREEZE (TEXAS LIMITED LIABILITY COMPANY)
1370 FM 116

Registered Dec. 20, 2011

GATESVILLE, TX 76528

Int. Cl.: 11

FOR: PHOTOVOLTAIC POWERED ATTIC FANS, IN CLASS 11 (U.S. CLS. 13, 21, 23, 31 AND 34).

TRADEMARK

FIRST USE 4-21-2011; IN COMMERCE 4-21-2011.

PRINCIPAL REGISTER

NO CLAIM IS MADE TO THE EXCLUSIVE RIGHT TO USE THE DESIGN OF THE FAN, APART FROM THE MARK AS SHOWN.

THE MARK CONSISTS OF A SPINNING FAN; THE STYLIZED LETTERS OF "ULTRAFLO"; AND A SQUIGGLE LINE OVER THE LETTER "O".

SER. NO. 85-301,418, FILED 4-21-2011.

PAUL E. FAHRENKOPF, EXAMINING ATTORNEY



David J. Kybas

Director of the United States Patent and Trademark Office

United States of America

United States Patent and Trademark Office



LEE BROS.
FOODSERVICE

Reg. No. 4,073,554

LEE BROS. FOODSERVICES, INC. (CALIFORNIA CORPORATION)
660 E. GISH ROAD
SAN JOSE, CA 95112

Registered Dec. 20, 2011

Int. Cl.: 43

FOR: CAFE AND RESTAURANT SERVICES; RESTAURANT SERVICES FEATURING SANDWICHES, COFFEE AND BAKED GOODS, NAMELY, BREAD, PIES AND CAKES, IN CLASS 43 (U.S. CLS. 100 AND 101).

SERVICE MARK

FIRST USE 1-23-1985; IN COMMERCE 1-23-1985.

PRINCIPAL REGISTER

NO CLAIM IS MADE TO THE EXCLUSIVE RIGHT TO USE "BROS. AND FOODSERVICE", APART FROM THE MARK AS SHOWN.

THE MARK CONSISTS OF STYLIZED WORD "LEE BROS. FOODSERVICES" NEXT TO A STYLIZED WORD "LEE" CONTAINED IN A CIRCULAR FORMAT.

SER. NO. 85-301,472, FILED 4-21-2011.

SAIMA MAKHDOOM, EXAMINING ATTORNEY



David J. Kyros

Director of the United States Patent and Trademark Office

United States of America

United States Patent and Trademark Office

Touch 'N Go Mobile Massage

Reg. No. 4,073,555

SHERRY WELDON (UNITED STATES INDIVIDUAL)
22431 ANTONIO PARKWAY, SUITE B160-682
RANCHO SANTA MARGARITA, CA 92688

Registered Dec. 20, 2011

Int. Cl.: 44

FOR: HEALTH SPA SERVICES FOR HEALTH AND WELLNESS OF THE BODY AND SPIRIT, NAMELY, PROVIDING MASSAGE, FACIAL AND BODY TREATMENT SERVICES, COSMETIC BODY CARE SERVICES; MASSAGE THERAPY SERVICES; MESSAGES, IN CLASS 44 (U.S. CLS. 100 AND 101).

SERVICE MARK

PRINCIPAL REGISTER

FIRST USE 5-1-2010; IN COMMERCE 5-10-2010.

THE MARK CONSISTS OF STANDARD CHARACTERS WITHOUT CLAIM TO ANY PARTICULAR FONT, STYLE, SIZE, OR COLOR.

NO CLAIM IS MADE TO THE EXCLUSIVE RIGHT TO USE "MOBILE MASSAGE", APART FROM THE MARK AS SHOWN.

SER. NO. 85-301,478, FILED 4-21-2011.

DOMINICK J. SALEMI, EXAMINING ATTORNEY



David J. Kybas

Director of the United States Patent and Trademark Office

United States of America

United States Patent and Trademark Office

Lashes with Wings

Reg. No. 4,073,556

LEUZZI, NOREEN (UNITED STATES INDIVIDUAL)
335 POINCIANA ISLAND DR
SUNNY ISLES BEACH, FL 33160

Registered Dec. 20, 2011

Int. Cl.: 3

FOR: COSMETICS, IN CLASS 3 (U.S. CLS. 1, 4, 6, 50, 51 AND 52).

TRADEMARK

FIRST USE 10-22-2010; IN COMMERCE 10-22-2010.

PRINCIPAL REGISTER

THE MARK CONSISTS OF STANDARD CHARACTERS WITHOUT CLAIM TO ANY PARTICULAR FONT, STYLE, SIZE, OR COLOR.

SER. NO. 85-301,513, FILED 4-21-2011.

DANNEAN HETZEL, EXAMINING ATTORNEY



David J. Kyffers

Director of the United States Patent and Trademark Office

United States of America
United States Patent and Trademark Office

ULTRAFLO

Reg. No. 4,073,557

ATTIC BREEZE (TEXAS LIMITED LIABILITY COMPANY)
1370 FM 116

Registered Dec. 20, 2011

GATESVILLE, TX 76528

Int. Cl.: 11

FOR: PHOTOVOLTAIC POWERED ATTIC FANS, IN CLASS 11 (U.S. CLS. 13, 21, 23, 31 AND 34).

TRADEMARK

FIRST USE 4-21-2011; IN COMMERCE 4-21-2011.

PRINCIPAL REGISTER

THE MARK CONSISTS OF STANDARD CHARACTERS WITHOUT CLAIM TO ANY PARTICULAR FONT, STYLE, SIZE, OR COLOR.

SER. NO. 85-301,572, FILED 4-21-2011.

PAUL E. FAHRENKOPF, EXAMINING ATTORNEY



David J. Kyffers

Director of the United States Patent and Trademark Office

United States of America

United States Patent and Trademark Office

John Waller Award

Reg. No. 4,073,558

THE OSS SOCIETY, INC. (VIRGINIA CORPORATION)
6723 WHITTIER AVE., #200
MCLEAN, VA 22101

Registered Dec. 20, 2011

Int. Cl.: 41

FOR: PROVIDING RECOGNITION AND INCENTIVES BY THE WAY OF AWARDS TO DEMONSTRATE EXCELLENCE IN THE FIELD OF STRATEGIC INTELLIGENCE AND PUBLIC SERVICE, IN CLASS 41 (U.S. CLS. 100, 101 AND 107).

SERVICE MARK

FIRST USE 4-8-2011; IN COMMERCE 4-8-2011.

PRINCIPAL REGISTER

THE MARK CONSISTS OF STANDARD CHARACTERS WITHOUT CLAIM TO ANY PARTICULAR FONT, STYLE, SIZE, OR COLOR.

NO CLAIM IS MADE TO THE EXCLUSIVE RIGHT TO USE "AWARD", APART FROM THE MARK AS SHOWN.

THE NAME(S), PORTRAIT(S), AND/OR SIGNATURE(S) SHOWN IN THE MARK DOES NOT IDENTIFY A PARTICULAR LIVING INDIVIDUAL.

SER. NO. 85-301,893, FILED 4-22-2011.

KELLY TRUSILO, EXAMINING ATTORNEY



David J. Kyjars

Director of the United States Patent and Trademark Office

United States of America

United States Patent and Trademark Office

BOWS ON TOES

Reg. No. 4,073,559

Registered Dec. 20, 2011

Int. Cl.: 25

TRADEMARK

PRINCIPAL REGISTER

BRITANNICA HOME FASHIONS, INC. (NEW YORK CORPORATION)
214 W. 39TH STREET, SUITE 1202
NEW YORK, NY 10018

FOR: SANDALS, IN CLASS 25 (U.S. CLS. 22 AND 39).

FIRST USE 2-15-2011; IN COMMERCE 2-15-2011.

THE MARK CONSISTS OF STANDARD CHARACTERS WITHOUT CLAIM TO ANY PARTICULAR FONT, STYLE, SIZE, OR COLOR.

NO CLAIM IS MADE TO THE EXCLUSIVE RIGHT TO USE "BOWS", APART FROM THE MARK AS SHOWN.

SER. NO. 85-302,253, FILED 4-22-2011.

TINA L. SNAPP, EXAMINING ATTORNEY



David J. Kyffers

Director of the United States Patent and Trademark Office

United States of America

United States Patent and Trademark Office

The Quarter Roll Financial Entertainment

Reg. No. 4,073,560

BOWMAN, MICHAEL BRUCE (UNITED STATES INDIVIDUAL)
1517 HULTON ROAD
VERONA, PA 15147

Registered Dec. 20, 2011

Int. Cl.: 16

FOR: GENERAL FEATURE MAGAZINE IN THE FIELD OF PERSONAL FINANCIAL ISSUES,
IN CLASS 16 (U.S. CLS. 2, 5, 22, 23, 29, 37, 38 AND 50).

TRADEMARK

FIRST USE 5-1-2010; IN COMMERCE 2-1-2011.

PRINCIPAL REGISTER

THE MARK CONSISTS OF STANDARD CHARACTERS WITHOUT CLAIM TO ANY PAR-
TICULAR FONT, STYLE, SIZE, OR COLOR.

NO CLAIM IS MADE TO THE EXCLUSIVE RIGHT TO USE "FINANCIAL ENTERTAIN-
MENT", APART FROM THE MARK AS SHOWN.

SER. NO. 85-302,560, FILED 4-22-2011.

TEJBIR SINGH, EXAMINING ATTORNEY



David J. Kybas

Director of the United States Patent and Trademark Office

United States of America

United States Patent and Trademark Office



PURPLE AURA JEWELS

Reg. No. 4,073,561

Registered Dec. 20, 2011

Int. Cl.: 14

TRADEMARK

PRINCIPAL REGISTER

PURPLE AURA JEWELS, LLC (DELAWARE LIMITED LIABILITY COMPANY), DBA PURPLE AURA JEWELS
3213 DUKE ST. #674
ALEXANDRIA, VA 22314

FOR: BRACELETS; COSTUME JEWELRY; GEMSTONE JEWELRY, IN CLASS 14 (U.S. CLS. 2, 27, 28 AND 50).

FIRST USE 10-16-2010; IN COMMERCE 11-2-2010.

NO CLAIM IS MADE TO THE EXCLUSIVE RIGHT TO USE "JEWELS", APART FROM THE MARK AS SHOWN.

THE MARK CONSISTS OF THE WORDING "PURPLE AURA JEWELS" UNDERNEATH A DESIGN THAT APPEARS AS A STYLIZED LETTER "P" SLANTED AND ANOTHER STYLIZED LETTER "P" UPSIDE DOWN AND SLANTED WHICH ALSO CREATES THE ILLUSION OF THE LETTERS "A" AND "J" AS WELL.

SER. NO. 85-302,642, FILED 4-22-2011.

KIM MONINGHOFF, EXAMINING ATTORNEY



David J. Kyffers

Director of the United States Patent and Trademark Office

United States of America

United States Patent and Trademark Office



Reg. No. 4,073,562

Registered Dec. 20, 2011

Int. Cl.: 35

SERVICE MARK

PRINCIPAL REGISTER

TAXBIZ, INC. (CALIFORNIA CORPORATION), DBA INCOMPASS TAX, ESTATE & BUSINESS SOLUTIONS
4600 ROSEVILLE ROAD, SUITE 150
SACRAMENTO, CA 95660

FOR: ADMINISTRATION OF BUSINESS PAYROLL FOR OTHERS; ADMINISTRATIVE ACCOUNTING; BOOKKEEPING; BOOKKEEPING FOR ELECTRONIC FUNDS TRANSFER; BRAND CONCEPT AND BRAND DEVELOPMENT SERVICES FOR CORPORATE AND INDIVIDUAL CLIENTS; BRAND CONCEPT AND BRAND DEVELOPMENT SERVICES FOR CORPORATE CLIENTS; BUSINESS ACQUISITION AND MERGER CONSULTATION; BUSINESS ACQUISITIONS CONSULTATION; BUSINESS ADMINISTRATION AND MANAGEMENT; BUSINESS ADMINISTRATION AND OFFICE WORK; BUSINESS ADMINISTRATION ASSISTANCE; BUSINESS ADMINISTRATION CONSULTANCY; BUSINESS ADVICE AND COMMERCIAL INFORMATION; BUSINESS ADVICE AND INFORMATION; BUSINESS ADVICE AND INFORMATION RELATING TO LOANS, FINANCE AND CAPITAL; BUSINESS ADVICE, INQUIRIES OR INFORMATION; BUSINESS ADVISORY SERVICES, CONSULTANCY AND INFORMATION; BUSINESS APPRAISAL CONSULTATION; BUSINESS APPRAISALS AND EVALUATIONS IN BUSINESS MATTERS; BUSINESS ASSISTANCE, ADVISORY AND CONSULTING SERVICES IN THE FIELD OF TAXATION, BOOKKEEPING, PAYROLL SERVICES, ACCOUNTING; BUSINESS ASSISTANCE, ADVISORY SERVICES AND CONSULTANCY IN THE FIELDS OF BUDGETING, BOOKKEEPING, PREPARATION AND FILING OF CLAIMS, PREPARATION AND FILING OF FORMS, BILL PAYING, ORGANIZING AND PROCESSING PAPERWORK, DEVELOPMENT OF PLAN TO ACHIEVE GOALS AND REFERRAL SERVICES TO BEREAVEMENT COUNSELORS; BUSINESS ASSISTANCE, MANAGEMENT AND INFORMATION SERVICES; BUSINESS AUDITING; BUSINESS CONSULTATION; BUSINESS CONSULTATION SERVICES; BUSINESS CONSULTATION SERVICES TO ASSIST NON-PROFIT ORGANIZATIONS IN PLANNING, MANAGING, AND CONDUCTING FUNDRAISING ACTIVITIES VIA A GLOBAL COMPUTER NETWORK; BUSINESS CONSULTING AND BUSINESS INFORMATION FOR ENTERPRISES; BUSINESS CONSULTING AND INFORMATION SERVICES; BUSINESS CONSULTING SERVICES, NAMELY, PROVIDING ASSISTANCE IN DEVELOPMENT OF BUSINESS STRATEGIES AND CREATIVE IDEATION; BUSINESS CONSULTING, INQUIRIES OR INFORMATION; BUSINESS CONSULTING, MANAGEMENT, PLANNING AND SUPERVISION; BUSINESS DEVELOPMENT CONSULTING SERVICES; BUSINESS DEVELOPMENT SERVICES; BUSINESS EFFICIENCY ADVICE; BUSINESS EFFICIENCY EXPERT SERVICES; BUSINESS INFORMATION AND ACCOUNTING ADVISORY SERVICES; BUSINESS INFORMATION AND INQUIRIES; BUSINESS INFORMATION MANAGEMENT; BUSINESS



David J. Kybas

Director of the United States Patent and Trademark Office

Reg. No. 4,073,562 INVOICING SERVICES; BUSINESS MANAGEMENT; BUSINESS MANAGEMENT ADVICE; BUSINESS MANAGEMENT AND ADVICE; BUSINESS MANAGEMENT AND CONSULTATION; BUSINESS MANAGEMENT CONSULTANCY AND ADVISORY SERVICES; BUSINESS MANAGEMENT CONSULTANCY SERVICES; BUSINESS MANAGEMENT CONSULTANCY, ALSO VIA THE INTERNET; BUSINESS MANAGEMENT CONSULTATION; BUSINESS MANAGEMENT CONSULTATION AND SERVICES, NAMELY, MANAGING AND ADMINISTERING NON-CORE FUNCTIONS, NAMELY, MAILING AND SHIPPING, RECORDS MANAGEMENT, INFORMATION SERVICES, ADMINISTRATION, PAYROLL AND ACCOUNTING, AND TELEMARKETING SERVICES; BUSINESS MANAGEMENT CONSULTATION IN THE FIELD OF EXECUTIVE AND LEADERSHIP DEVELOPMENT; BUSINESS MANAGEMENT CONSULTING; BUSINESS MANAGEMENT CONSULTING AND ADVISORY SERVICES; BUSINESS MANAGEMENT CONSULTING IN THE FIELD OF TEAM DEVELOPMENT; BUSINESS MANAGEMENT INFORMATION ON A WIDE VARIETY OF TOPICS TO SERVICE PROVIDING PROFESSIONALS; BUSINESS MANAGEMENT OF THE NON-PROFIT CORPORATIONS AND TRADE ASSOCIATIONS OF OTHERS; BUSINESS MANAGEMENT PLANNING; BUSINESS MANAGEMENT SUPERVISION; BUSINESS MARKETING CONSULTING SERVICES; BUSINESS MARKETING SERVICES; BUSINESS MERGER CONSULTATION; BUSINESS ORGANISATION AND MANAGEMENT CONSULTING SERVICES; BUSINESS ORGANISATION CONSULTING; BUSINESS ORGANIZATION ADVICE; BUSINESS ORGANIZATION AND MANAGEMENT CONSULTANCY INCLUDING PERSONNEL MANAGEMENT; BUSINESS ORGANIZATION AND MANAGEMENT CONSULTING; BUSINESS ORGANIZATION AND OPERATION CONSULTANCY; BUSINESS ORGANIZATION CONSULTING; BUSINESS ORGANIZATIONAL CONSULTATION; BUSINESS PLANNING; BUSINESS SERVICES, NAMELY, ASSISTING OTHERS IN THE ESTABLISHMENT OF CHARITABLE ORGANIZATIONS; BUSINESS SERVICES, NAMELY, PROCURING QUALIFIED AND CREDENTIALLED THIRD-PARTY EXPERTS, PROFESSIONALS AND OTHER QUALIFIED PERSONNEL, AND DOCUMENTATION AND INFORMATION ALL ON BEHALF OF OTHERS; BUSINESS STRATEGIC PLANNING SERVICES; BUSINESS STRATEGY DEVELOPMENT SERVICES; BUSINESS SUCCESSION PLANNING; BUSINESS SUPERVISION; BUSINESS SUPPORT SERVICES, NAMELY, BUSINESS CONSULTING TO FREELANCERS, START-UPS, EXISTING BUSINESSES AND NON-PROFIT ORGANIZATIONS; COMMERCIAL BUSINESS MANAGEMENT; CONSULTANCY AND ADVISORY SERVICES IN THE FIELD OF BUSINESS STRATEGY; CONSULTANCY SERVICES REGARDING BUSINESS STRATEGIES; CONSULTATION IN THE FIELD OF BUSINESS ACQUISITIONS; CONSULTING SERVICES IN BUSINESS LEADERSHIP DEVELOPMENT AND BUSINESS MANAGEMENT; CONSULTING SERVICES IN BUSINESS ORGANIZATION AND MANAGEMENT; CONSULTING SERVICES IN THE FIELD OF HUMAN RESOURCES DEVELOPMENT, NAMELY, FOR THE PROMOTION OF EMPLOYEE RETENTION, CAREER GROWTH, AND INCREASED PRODUCTIVITY FOR EMPLOYEES AND EMPLOYERS; CONSULTING SERVICES IN THE FIELD OF HUMAN RESOURCES DEVELOPMENT, NAMELY, UTILIZING TECHNOLOGY FOR THE PROMOTION OF EMPLOYEE RETENTION, CAREER GROWTH AND INCREASED PRODUCTIVITY FOR EMPLOYEES AND EMPLOYERS; CONSULTING SERVICES IN THE FIELDS OF BUSINESS MANAGEMENT, HUMAN RESOURCES, AND BUSINESS ORGANIZATIONAL DESIGN; CONSULTING SERVICES RELATED TO THE ADMINISTRATIVE COORDINATION OF ORGANIZATIONS PROVIDING HUMANITARIAN ACTIVITIES; CORPORATE MANAGEMENT ASSISTANCE; DEVELOPING AND COORDINATING VOLUNTEER PROJECTS FOR CHARITABLE ORGANIZATIONS; DEVELOPING AND MANAGING THE CHARITABLE GIVING PROGRAMS OF OTHERS; DEVELOPMENT OF CONCEPTS FOR BUSINESS ECONOMY; ESTATE MANAGEMENT, NAMELY, ASSISTANCE IN THE GATHERING AND ORGANIZATION OF PERSONAL VITAL AND FINANCIAL RECORDS IN CONJUNCTION WITH INSTRUCTIONS FOR HANDLING OF SUCH DOCUMENTS BY OTHERS, INCLUDING EXECUTORS AND ATTORNEYS, UPON DEATH OR WHEN OTHERWISE NECESSARY; EXPERT EVALUATIONS AND REPORTS RELATING TO BUSINESS MATTERS; FINANCIAL STATEMENT PREPARATION AND ANALYSIS FOR BUSINESSES; HELP IN THE MANAGEMENT OF BUSINESS AFFAIRS OR COMMERCIAL FUNCTIONS OF AN INDUSTRIAL OR COMMERCIAL ENTERPRISE; HUMAN RESOURCE ANALYSIS AND CONSULTING SERVICES; HUMAN RESOURCE SERVICES, NAMELY, COLLECTING, ANALYZING, REPORTING, AND PROVIDING FEEDBACK

Reg. No. 4,073,562 FROM INDIVIDUALS WHO SEPARATE FROM AN ORGANIZATION; HUMAN RESOURCES CONSULTANCY; HUMAN RESOURCES CONSULTATION; HUMAN RESOURCES MANAGEMENT; INCOME TAX CONSULTATION; INCOME TAX PREPARATION; INFORMATION IN BUSINESS MATTERS; INFORMATION SERVICES RELATING TO BUSINESS MATTERS; INFORMATION, ADVISORY AND CONSULTANCY SERVICES RELATING TO BUSINESS AND MANAGEMENT OR BUSINESS ADMINISTRATION, INCLUDING SUCH SERVICES PROVIDED ON LINE OR VIA THE INTERNET; MANAGEMENT AND OPERATION ASSISTANCE TO COMMERCIAL BUSINESSES; MANAGEMENT CONSULTING AND ADVISORY SERVICES IN THE AREAS OF CORPORATE GROWTH STRATEGY, INNOVATION AND GROWTH PROCESSES, ORGANIZATIONAL TRANSFORMATION, AND TALENT MANAGEMENT AND DEVELOPMENT STRATEGIES; MANAGEMENT OF TAX FILES; MARKETING CONSULTING SERVICES RELATING TO LONG-TERM BUSINESS STRATEGY DEVELOPMENT FOR NON-PROFIT ORGANIZATIONS; MARKETING PLAN DEVELOPMENT; MARKETING SERVICES, NAMELY, PROMOTIONAL SERVICES IN THE FIELD OF PLANNED-GIVING FOR NON-PROFIT AND CHARITABLE ORGANIZATIONS; MATCHING INDIVIDUALS TO SERVE ON NON-PROFIT BOARDS OF DIRECTORS THROUGH PROFILING SURVEYS AND ANALYSIS; NEW BUSINESS VENTURE DEVELOPMENT AND FORMATION CONSULTING SERVICES; OPERATION OF A BUSINESS FOR OTHERS, NAMELY, ACCOUNTING, BOOKKEEPING, TAX PREPARATION, TAX PLANNING; OPERATIONAL BUSINESS ASSISTANCE TO ENTERPRISES; ORGANIZATIONAL SERVICES FOR BUSINESS PURPOSES; ORGANIZING AND CONDUCTING CHARITY AUCTIONS FOR CHARITABLE FUNDRAISING PURPOSES; PAYROLL ADMINISTRATION AND MANAGEMENT SERVICES; PAYROLL PREPARATION; PAYROLL PROCESSING SERVICES; PLANNING CONCERNING BUSINESS MANAGEMENT, NAMELY, SEARCHING FOR PARTNERS FOR AMALGAMATIONS AND BUSINESS TAKE-OVERS AS WELL AS FOR BUSINESS ESTABLISHMENTS; PREPARATION AND PRESENTATION OF BUSINESS PROSPECTUSES; PREPARATION OF BUSINESS REPORTS; PREPARING BUSINESS REPORTS; PROFESSIONAL BUSINESS CONSULTATION; PROFESSIONAL BUSINESS CONSULTING; PROMOTION OF BUSINESS OPPORTUNITIES; PROVIDING ADVICE AND ASSISTANCE TO COMMERCIAL ENTITIES RELATING TO THE ESTABLISHMENT AND MAINTENANCE OF BUSINESS AND CONTRACTUAL RELATIONSHIPS WITH FEDERAL, STATE AND LOCAL GOVERNMENTS; PROVIDING BUSINESS MARKETING INFORMATION; PROVIDING BUSINESS PLANNING AND MARKETING SOLUTIONS FOR REAL ESTATE PROFESSIONALS; PROVIDING BUSINESS SUPPORT STAFF SERVICES; PROVIDING INFORMATION AND NEWS IN THE FIELD OF BUSINESS; PROVIDING INFORMATION IN THE FIELDS OF BUSINESS INNOVATION PROCESS, BUSINESS MANAGEMENT AND BUSINESS OPPORTUNITIES; PROVIDING ONLINE BUSINESS MANAGEMENT SERVICES INCLUDING ACCOUNTING, MARKETING, BUSINESS PROJECT MANAGEMENT, AND BUSINESS DEVELOPMENT; SERVING AS A HUMAN RESOURCES DEPARTMENT FOR OTHERS; TAX ADVISORY SERVICES; TAX AND TAXATION PLANNING, ADVICE, INFORMATION AND CONSULTANCY SERVICES; TAX CONSULTATION; TAX FILING SERVICES; TAX PREPARATION; WAGE PAYROLL PREPARATION, IN CLASS 35 (U.S. CLS. 100, 101 AND 102).

FIRST USE 4-18-2011; IN COMMERCE 4-18-2011.

THE MARK CONSISTS OF A SILVER DIRECTIONAL COMPASS WITH A RING ATTACHED ON ITS LEFT SIDE. THE INTERIOR OF THE COMPASS HAS A WHITE BACKGROUND, AND THE WORD "INCOMPASS" WITH THE LETTERS "I," "COM," AND "PAS" IN BLUE, AND THE LETTERS "N," "E," AND "S" IN BLACK LETTERS CORRESPONDING TO THE CARDINAL DIRECTIONS ON A COMPASS. THE RED END OF THE COMPASS NEEDLE IS POINTING TO THE "N," AND THE WHITE END OF THE NEEDLE IS POINTING TO THE "S." THE EDGES OF THE COMPASS HAVE GRAY DIRECTIONAL HASH MARKS.

THE COLOR(S) SILVER, WHITE, BLACK, GRAY, RED AND BLUE IS/ARE CLAIMED AS A FEATURE OF THE MARK.

SER. NO. 85-302,794, FILED 4-22-2011.

Reg. No. 4,073,562 JASON BLAIR, EXAMINING ATTORNEY

United States of America

United States Patent and Trademark Office

AppzOnUs

Reg. No. 4,073,563

Registered Dec. 20, 2011

Int. Cl.: 9

APPZONUS.COM LLC (US VIRGIN ISLANDS LIMITED LIABILITY COMPANY), DBA
APPZONUS
1937 S. LIMEKILN PIKE
1937 S. LIMEKILN PIKE
DRESHER, PA 190251714

TRADEMARK

PRINCIPAL REGISTER

FOR: AD SERVER, NAMELY, A COMPUTER SERVER FOR STORING ADVERTISEMENTS AND DELIVERING ADVERTISEMENTS TO WEBSITES; COMPUTER APPLICATION SOFTWARE FOR MOBILE PHONES, NAMELY, SOFTWARE FOR DISPLAYING FULL SCREEN INTERSTITIAL ADS UPON THE LOADING OF A MOBILE DEVICE APPLICATION VIA A MICRO-APP, IN CLASS 9 (U.S. CLS. 21, 23, 26, 36 AND 38).

FIRST USE 1-13-2011; IN COMMERCE 4-11-2011.

THE MARK CONSISTS OF STANDARD CHARACTERS WITHOUT CLAIM TO ANY PARTICULAR FONT, STYLE, SIZE, OR COLOR.

SER. NO. 85-303,086, FILED 4-24-2011.

ALICIA COLLINS, EXAMINING ATTORNEY



David J. Kybas

Director of the United States Patent and Trademark Office

United States of America

United States Patent and Trademark Office

GHOULMASTER

Reg. No. 4,073,564

PETER CARTER (UNITED STATES INDIVIDUAL)
953 HARRISON ROAD
TOMS RIVER, NJ 08753

Registered Dec. 20, 2011

Int. Cl.: 41

FOR: ENTERTAINMENT IN THE NATURE OF LIVE PERFORMANCES FEATURING HALLOWEEN STYLE SCARE SHOWS, IN CLASS 41 (U.S. CLS. 100, 101 AND 107).

SERVICE MARK

FIRST USE 9-1-2007; IN COMMERCE 9-1-2007.

PRINCIPAL REGISTER

THE MARK CONSISTS OF STANDARD CHARACTERS WITHOUT CLAIM TO ANY PARTICULAR FONT, STYLE, SIZE, OR COLOR.

SER. NO. 85-303,193, FILED 4-25-2011.

ANTHONY RINKER, EXAMINING ATTORNEY



David J. Kybas

Director of the United States Patent and Trademark Office

United States of America

United States Patent and Trademark Office

KNOWLEDGEBEAT

Reg. No. 4,073,565

KNOWLEDGEBEAT, INC. (DELAWARE CORPORATION)
404 EL CENTRO ROAD
HILLSBOROUGH, CA 94010

Registered Dec. 20, 2011

Int. Cls.: 35, 36 and 41

FOR: CHARITABLE SERVICES, NAMELY, ORGANIZING AND DEVELOPING CHILDREN'S EDUCATIONAL, HEALTH, AND ENVIRONMENT PROJECTS IN SUPPORT OF NON-GOVERNMENTAL ORGANIZATION PROGRAMS, IN CLASS 35 (U.S. CLS. 100, 101 AND 102).

SERVICE MARK

PRINCIPAL REGISTER

FIRST USE 3-1-2007; IN COMMERCE 3-1-2007.

FOR: CHARITABLE FUNDRAISING SERVICES, NAMELY, RAISING FUNDS TO SUPPORT EDUCATION, ACADEMIC CAMPS AND SCHOLARSHIPS FOR UNDERPRIVILEGED CHILDREN, IN CLASS 36 (U.S. CLS. 100, 101 AND 102).

FIRST USE 3-1-2007; IN COMMERCE 3-1-2007.

FOR: EDUCATIONAL SERVICES FOR CHILDREN, NAMELY, DEVELOPING COMMUNITY-DRIVEN EDUCATIONAL PROGRAMS AND CAMPS IN THE FIELDS OF HEALTH, ENVIRONMENT AND EDUCATIONAL ADVANCEMENT, IN CLASS 41 (U.S. CLS. 100, 101 AND 107).

FIRST USE 3-1-2007; IN COMMERCE 3-1-2007.

THE MARK CONSISTS OF STANDARD CHARACTERS WITHOUT CLAIM TO ANY PARTICULAR FONT, STYLE, SIZE, OR COLOR.

SER. NO. 85-303,401, FILED 4-25-2011.

JEFFREY LOOK, EXAMINING ATTORNEY



David J. Kyffers

Director of the United States Patent and Trademark Office

United States of America

United States Patent and Trademark Office



Reg. No. 4,073,566

KNOWLEDGEBEAT, INC. (DELAWARE CORPORATION)
404 EL CENTRO ROAD
HILLSBOROUGH, CA 94010

Registered Dec. 20, 2011

Int. Cls.: 35, 36 and 41

FOR: CHARITABLE SERVICES, NAMELY, ORGANIZING AND DEVELOPING CHILDREN'S EDUCATIONAL, HEALTH, AND ENVIRONMENT PROJECTS IN SUPPORT OF NON-GOVERNMENTAL ORGANIZATION PROGRAMS, IN CLASS 35 (U.S. CLS. 100, 101 AND 102).

SERVICE MARK

PRINCIPAL REGISTER

FIRST USE 2-8-2011; IN COMMERCE 2-8-2011.

FOR: CHARITABLE FUNDRAISING SERVICES, NAMELY, RAISING FUNDS TO SUPPORT EDUCATION, ACADEMIC CAMPS AND SCHOLARSHIPS FOR UNDERPRIVILEGED CHILDREN, IN CLASS 36 (U.S. CLS. 100, 101 AND 102).

FIRST USE 2-8-2011; IN COMMERCE 2-8-2011.

FOR: EDUCATIONAL SERVICES FOR CHILDREN, NAMELY, DEVELOPING COMMUNITY-DRIVEN EDUCATIONAL PROGRAMS AND CAMPS IN THE FIELDS OF HEALTH, ENVIRONMENT AND EDUCATIONAL ADVANCEMENT, IN CLASS 41 (U.S. CLS. 100, 101 AND 107).

FIRST USE 2-8-2011; IN COMMERCE 2-8-2011.

THE MARK CONSISTS OF TWO STYLIZED TREES PLACED ON A HORIZONTAL LINE, WITH THE WORD "KNOWLEDGEBEAT" ON ONE LINE AND THE PHRASE "EDUCATE CHILDREN. TRANSFORM COMMUNITIES" ON A SECOND LINE.

SER. NO. 85-303,415, FILED 4-25-2011.

JEFFREY LOOK, EXAMINING ATTORNEY



David J. Kybas

Director of the United States Patent and Trademark Office

United States of America

United States Patent and Trademark Office

Thanks, Bro

The way we say thanks - beef jerky + beer

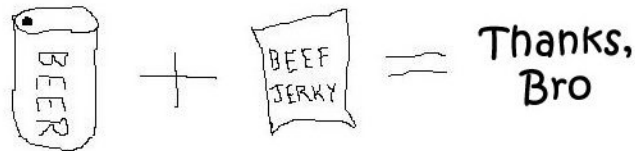

Reg. No. 4,073,567

Registered Dec. 20, 2011

Int. Cl.: 39

SERVICE MARK

PRINCIPAL REGISTER

THANKS BRO LLC (NEW YORK LIMITED LIABILITY COMPANY)
#15C
154 E 29TH ST
NEW YORK, NY 10016

FOR: DELIVERY OF GIFT BASKETS WITH SELECTED ITEMS REGARDING A PARTICULAR OCCASION OR THEME, IN CLASS 39 (U.S. CLS. 100 AND 105).

FIRST USE 3-29-2011; IN COMMERCE 3-29-2011.

NO CLAIM IS MADE TO THE EXCLUSIVE RIGHT TO USE "BEER" AND "BEEF JERKY", APART FROM THE MARK AS SHOWN.

THE MARK CONSISTS OF THE STYLIZED WORDING "THANKS, BRO" APPEARING ABOVE THE STYLIZED WORDING "THE WAY WE SAY THANKS - BEEF JERKY & BEER". BELOW THE WORDING "THE WAY WE SAY THANKS - BEEF JERKY & BEER" APPEARS THE STYLIZED DRAWING OF A CAN LABELED "BEER" AND A STYLIZED DRAWING OF A CAN LABELED "BEER" THE A STYLIZED DRAWING OF A FOOD BAG LABELED "BEEF JERKY" APPEARS A "+" SIGN; TO THE RIGHT OF THE STYLIZED DRAWING OF A FOOD BAG LABELED "BEEF JERKY" APPEARS AN "=" SIGN FOLLOWED BY THE STYLIZED WORDING "THANKS", APPEARING ABOVE THE WORD "BRO".

SER. NO. 85-303,547, FILED 4-25-2011.

MICHAEL TANNER, EXAMINING ATTORNEY



David J. Kyffers

Director of the United States Patent and Trademark Office

United States of America

United States Patent and Trademark Office

MORNING GLOW

Reg. No. 4,073,568

Registered Dec. 20, 2011

Int. Cl.: 3

TRADEMARK

PRINCIPAL REGISTER

JOHNSON & JOHNSON (NEW JERSEY CORPORATION)
ONE JOHNSON & JOHNSON PLAZA
NEW BRUNSWICK, NJ 089337001

FOR: SKIN MOISTURIZER, IN CLASS 3 (U.S. CLS. 1, 4, 6, 50, 51 AND 52).

FIRST USE 3-3-2005; IN COMMERCE 3-3-2005.

THE MARK CONSISTS OF STANDARD CHARACTERS WITHOUT CLAIM TO ANY PARTICULAR FONT, STYLE, SIZE, OR COLOR.

OWNER OF U.S. REG. NO. 2,973,822.

SER. NO. 85-303,597, FILED 4-25-2011.

LAURIE MAYES, EXAMINING ATTORNEY



David J. Kyffers

Director of the United States Patent and Trademark Office

United States of America

United States Patent and Trademark Office

MORNING BURST

Reg. No. 4,073,569

JOHNSON & JOHNSON (NEW JERSEY CORPORATION)
ONE JOHNSON & JOHNSON PLAZA
NEW BRUNSWICK, NJ 089337001

Registered Dec. 20, 2011

Int. Cl.: 3

FOR: SKIN CLEANSER, FACIAL SCRUB, FACIAL AND BODY WASH, IN CLASS 3 (U.S. CLS. 1, 4, 6, 50, 51 AND 52).

TRADEMARK

FIRST USE 3-3-2005; IN COMMERCE 3-3-2005.

PRINCIPAL REGISTER

THE MARK CONSISTS OF STANDARD CHARACTERS WITHOUT CLAIM TO ANY PARTICULAR FONT, STYLE, SIZE, OR COLOR.

OWNER OF U.S. REG. NO. 2,979,284.

SER. NO. 85-303,602, FILED 4-25-2011.

LAURIE MAYES, EXAMINING ATTORNEY



David J. Kyffers

Director of the United States Patent and Trademark Office

United States of America

United States Patent and Trademark Office

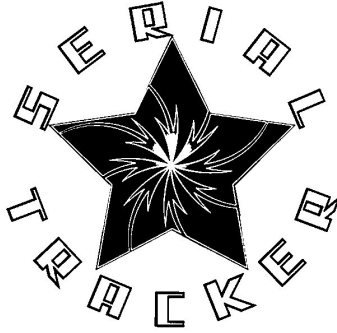

Reg. No. 4,073,570

SERIALTRACKER.COM, LLC (TEXAS LIMITED LIABILITY COMPANY)
17103 KETTLE CREEK DR.
SPRING, TX 77379

Registered Dec. 20, 2011

Int. Cl.: 39

FOR: ELECTRONIC STORAGE OF DATA AND INFORMATION, IN CLASS 39 (U.S. CLS. 100 AND 105).

SERVICE MARK

FIRST USE 2-21-2010; IN COMMERCE 9-21-2010.

PRINCIPAL REGISTER

NO CLAIM IS MADE TO THE EXCLUSIVE RIGHT TO USE "SERIAL TRACKER", APART FROM THE MARK AS SHOWN.

THE MARK CONSISTS OF A STAR WITH SHADED BACKGROUND AND ARROWS INSIDE POINTING TO THE CENTER IN A CIRCULAR MOTION, WITH THE WORDING "SERIAL TRACKER" PLACED IN A CIRCULAR FASHION AROUND THE STAR DESIGN.

SER. NO. 85-303,653, FILED 4-25-2011.

PAM WILLIS, EXAMINING ATTORNEY



David J. Kybas

Director of the United States Patent and Trademark Office

United States of America

United States Patent and Trademark Office

Netmark

Reg. No. 4,073,571

NETMARK ESSENTIALS, LLC (IDAHO LIMITED LIABILITY COMPANY)
2265 E 25TH ST.

Registered Dec. 20, 2011

IDAHO FALLS, ID 83404

Int. Cl.: 35

SERVICE MARK

PRINCIPAL REGISTER

FOR: ADVERTISEMENT FOR OTHERS ON THE INTERNET; ADVERTISING AGENCY SPECIALIZING IN THE DESIGN AND EXECUTION OF WORD OF MOUTH, VIRAL, BUZZ AND EXPERIENTIAL MARKETING PROGRAMS; ADVERTISING AND COMMERCIAL INFORMATION SERVICES, VIA THE INTERNET; ADVERTISING AND MARKETING; ADVERTISING AND MARKETING CONSULTANCY; ADVERTISING AND MARKETING SERVICES PROVIDED BY MEANS OF INDIRECT METHODS OF MARKETING COMMUNICATIONS, NAMELY, SOCIAL MEDIA, SEARCH ENGINE MARKETING, INQUIRY MARKETING, INTERNET MARKETING, MOBILE MARKETING, BLOGGING AND OTHER FORMS OF PASSIVE, SHARABLE OR VIRAL COMMUNICATIONS CHANNELS; ADVERTISING AND MARKETING SERVICES, NAMELY, PROMOTING THE GOODS AND SERVICES OF OTHERS; ADVERTISING AND PUBLICITY SERVICES, NAMELY, PROMOTING THE GOODS, SERVICES, BRAND IDENTITY AND COMMERCIAL INFORMATION AND NEWS OF THIRD PARTIES THROUGH PRINT, AUDIO, VIDEO, DIGITAL AND ON-LINE MEDIUM; ADVERTISING ON THE INTERNET FOR OTHERS; ADVERTISING VIA ELECTRONIC MEDIA AND SPECIFICALLY THE INTERNET; ADVERTISING, MARKETING AND PROMOTION SERVICES; ADVERTISING, PROMOTION AND MARKETING SERVICES IN THE NATURE OF E-MAIL BLAST CAMPAIGNS FOR OTHERS; ADVERTISING, PROMOTION, AND MARKETING SERVICES IN THE NATURE OF VIRAL MARKETING, SEARCH ENGINE MARKETING, SEARCH ENGINE OPTIMIZATION, E-MAIL MARKETING, COMPARISON SHOPPING, PAY-PER-CLICK, AND CONVERSION RATE OPTIMIZATION FOR ONLINE WEBSITES; ANALYSIS OF MARKET RESEARCH DATA AND STATISTICS; BRANDING SERVICES, NAMELY, CONSULTING, DEVELOPMENT, MANAGEMENT AND MARKETING OF BRANDS FOR BUSINESSES; BUSINESS ADVICE AND ANALYSIS OF MARKETS; BUSINESS CONSULTATION AND MANAGEMENT REGARDING MARKETING ACTIVITIES AND LAUNCHING OF NEW PRODUCTS; BUSINESS MARKETING CONSULTING SERVICES; BUSINESS MARKETING SERVICES; BUSINESS MONITORING AND CONSULTING SERVICES, NAMELY, TRACKING WEB SITES AND APPLICATIONS OF OTHERS TO PROVIDE STRATEGY, INSIGHT, MARKETING, SALES, OPERATION, PRODUCT DESIGN, PARTICULARLY SPECIALIZING IN THE USE OF ANALYTIC AND STATISTIC MODELS FOR THE UNDERSTANDING AND PREDICTING OF CONSUMERS, BUSINESSES, AND MARKET TRENDS AND ACTIONS; BUSINESS TO BUSINESS DIRECT MARKETING SERVICES; COLLECTION OF MARKET RESEARCH INFORMATION; COMPARISON SHOPPING SERVICES; COMPUTERIZED MARKET RESEARCH SERVICES; CONSULTA-



David J. Kybas

Director of the United States Patent and Trademark Office

Reg. No. 4,073,571 TION SERVICES, NAMELY, CREATIVE AND STRATEGIC CONSULTATION REGARDING DEVELOPMENT AND PRODUCTION OF MARKETING CAMPAIGNS FOR OTHERS; CONSULTING SERVICES IN THE FIELD OF INTERNET MARKETING; CREATION OF MARKETING TOOLS DESIGNED TO INCREASE A CLIENT COMPANY'S KNOWLEDGE OF CUSTOMER NEEDS, AND ITS COMPETITORS' PRODUCTS AND SERVICES, PRICING, ADVERTISING STRATEGY AND SALES STRATEGY; CREATIVE MARKETING DESIGN SERVICES; CUSTOM WRITING SERVICES COMPRISING PUBLIC RELATIONS AND MARKETING MATERIALS FOR THE AUDIO, VIDEO AND TECHNOLOGY INDUSTRIES; DESIGN OF INTERNET ADVERTISING; DEVELOPMENT OF MARKETING STRATEGIES AND CONCEPTS; DEVELOPMENT OF MARKETING STRATEGIES, CONCEPTS AND TACTICS, NAMELY, AUDIENCE DEVELOPMENT, BRAND AWARENESS, CUSTOMER RELATIONS, ONLINE COMMUNITY BUILDING AND DIGITAL WORD OF MOUTH COMMUNICATIONS; DEVELOPMENT OF MARKETING STRATEGIES, CONCEPTS AND TACTICS, NAMELY, AUDIENCE DEVELOPMENT, BRAND AWARENESS, ONLINE COMMUNITY BUILDING AND DIGITAL WORD OF MOUTH COMMUNICATIONS; DISSEMINATION OF ADVERTISING FOR OTHERS VIA THE INTERNET; INFORMATION, ADVISORY, CONSULTING, BUSINESS RESEARCH AND PLANNING SERVICES RELATING TO PUBLICITY, MARKETING COMMUNICATIONS, REPUTATION MANAGEMENT OR BUSINESS ADMINISTRATION, INCLUDING SUCH SERVICES PROVIDED ONLINE OR VIA THE INTERNET; INTERNET ADVERTISING SERVICES; MARKET ANALYSIS AND RESEARCH SERVICES; MARKET REPORTS AND STUDIES; MARKET RESEARCH; MARKETING AND BRANDING SERVICES, NAMELY, PERFORMING CONSUMER INSIGHT AND BRAND STRATEGY OF COMPANY LOGOS; MARKETING CONSULTATION IN THE FIELD OF VIRAL MARKETING, SEARCH ENGINE MARKETING, SEARCH ENGINE OPTIMIZATION, E-MAIL MARKETING, COMPARISON SHOPPING, PAY-PER-CLICK, AND CONVERSION RATE OPTIMIZATION; MARKETING CONSULTING; MARKETING PLAN DEVELOPMENT; MARKETING RESEARCH SERVICES; MARKETING SERVICES, NAMELY, CONDUCTING CONSUMER TRACKING BEHAVIOR RESEARCH AND CONSUMER TREND ANALYSIS; MARKETING SERVICES, NAMELY, CONSUMER MARKETING RESEARCH; MARKETING SERVICES, NAMELY, PROVIDING INFORMATIONAL WEB PAGES DESIGNED TO GENERATE SALES TRAFFIC VIA HYPERLINKS TO OTHER WEB SITES; MARKETING SERVICES, NAMELY, PROVIDING VIDEOS TO PROMOTE GOODS AND SERVICES; ON-LINE ADVERTISING AND MARKETING SERVICES; ONLINE MEDIA MONITORING SERVICES USING COMPUTER SOFTWARE TO AUTOMATICALLY MONITOR INTERNET WEBSITES AND ONLINE PUBLICATIONS FOR CUSTOMER-SPECIFIED TOPICS AND TO CAPTURE RELEVANT CONTENT ON THOSE TOPICS, AND PROVIDING DOCUMENTATION AND ANALYSIS OF THAT ONLINE CONTENT TO OTHERS FOR BUSINESS PURPOSES; PAY PER CLICK (PPC) ADVERTISING MANAGEMENT SERVICES; PLANNING, DESIGN, DEVELOPMENT, MAINTENANCE, TRACKING AND REPORTING OF ONLINE MARKETING ACTIVITIES FOR THIRD PARTIES; PREPARING ADVERTISEMENTS FOR OTHERS, NAMELY, PREPARING VIDEO ADVERTISING AND PROMOTIONAL VIDEOS FOR COMMERCIAL USE VIA THE INTERNET AND TELEVISION, DIGITAL CABLE AND VIDEO-ON-DEMAND OR DOWNLOAD; PRODUCING AUDIO OR VIDEO INFOMERCIALS; PROMOTING THE GOODS AND SERVICES OF OTHERS BY MEANS OF DISTRIBUTING ADVERTISING ON THE INTERNET; PROMOTING THE GOODS AND SERVICES OF OTHERS BY MEANS OF WORD-OF-MOUTH AND NONTRADITIONAL MARKETING PROGRAMS; PROMOTING, ADVERTISING AND MARKETING OF THE BRANDS, PRODUCTS, SERVICES OR ONLINE WEBSITES OF INDIVIDUALS, BUSINESSES AND NONPROFIT ORGANIZATIONS; PROMOTING, ADVERTISING AND MARKETING OF THE ON-LINE WEB SITES OF OTHERS; PROMOTION AND MARKETING SERVICES AND RELATED CONSULTING; PROMOTION, ADVERTISING AND MARKETING OF ON-LINE WEBSITES; PROMOTIONAL MARKETING SERVICES USING AUDIOVISUAL MEDIA; PROVIDING A SEARCHABLE ON-LINE ADVERTISING WEBSITE AND GUIDE FEATURING THE GOODS AND SERVICES OF OTHER VENDORS VIA THE INTERNET; PROVIDING A SEARCHABLE ONLINE ADVERTISING GUIDE FEATURING THE GOODS AND SERVICES OF OTHER ON-LINE VENDORS ON THE INTERNET; PROVIDING ADVERTISING SERVICE TO DISTRIBUTE ADVERTISEMENTS FOR DISPLAY ON INTERNET, NAMELY, IN WEBSITES, SOCIAL CONVERSATIONS OVER THE INTERNET, E-MAILS, MICROBLOGS,

Reg. No. 4,073,571 BLOGS, ELECTRONIC MESSAGES, INSTANT MESSAGES, TEXT MESSAGES, MULTIMEDIA MESSAGES, SOCIAL NETWORKS, STATUS UPDATES, FORUMS, ELECTRONIC BULLETIN BOARDS; PROVIDING INFORMATION IN THE FIELD OF MARKETING AND ON-LINE MARKETING MEDIA VIA THE INTERNET; PROVIDING MARKETING AND PROMOTION OF SPECIAL EVENTS; SOCIAL MEDIA STRATEGY AND MARKETING CONSULTANCY FOCUSING ON HELPING CLIENTS CREATE AND EXTEND THEIR PRODUCT AND BRAND STRATEGIES BY BUILDING VIRALLY ENGAGING MARKETING SOLUTIONS, IN CLASS 35 (U.S. CLS. 100, 101 AND 102).

FIRST USE 2-22-2007; IN COMMERCE 2-22-2007.

THE MARK CONSISTS OF STANDARD CHARACTERS WITHOUT CLAIM TO ANY PARTICULAR FONT, STYLE, SIZE, OR COLOR.

SER. NO. 85-303,654, FILED S.R. 4-25-2011 AM. P.R. 8-10-2011.

PAM WILLIS, EXAMINING ATTORNEY

United States of America

United States Patent and Trademark Office



Reg. No. 4,073,572

CELците MANAGEMENT SOLUTIONS, LLC (DELAWARE LIMITED LIABILITY COMPANY)
13800 COPPERMINE ROAD
HERNDON, VA 20171

Registered Dec. 20, 2011

Int. Cl.: 38

FOR: DIGITAL NETWORK TELECOMMUNICATIONS SERVICES, IN CLASS 38 (U.S. CLS. 100, 101 AND 104).

SERVICE MARK

FIRST USE 2-1-2011; IN COMMERCE 2-1-2011.

PRINCIPAL REGISTER

THE MARK CONSISTS OF THE LITERAL ELEMENT "CELците" IN STYLIZED LETTERING AND THE ASSOCIATED DESIGN OF SIX STACKED HEXAGONS FORMING ONE OVERALL TRIANGULAR-SHAPED DESIGN.

SEC. 2(F) AS TO "CELците".

SER. NO. 85-303,921, FILED 4-25-2011.

JUDITH HELFMAN, EXAMINING ATTORNEY



David J. Kybas

Director of the United States Patent and Trademark Office

United States of America

United States Patent and Trademark Office



Celcrite

Reg. No. 4,073,573

CELCRITE MANAGEMENT SOLUTIONS, LLC (DELAWARE LIMITED LIABILITY COMPANY)
13800 COPPERMINE ROAD
HERNDON, VA 20171

Registered Dec. 20, 2011

Int. Cl.: 38

FOR: DIGITAL NETWORK TELECOMMUNICATIONS SERVICES, IN CLASS 38 (U.S. CLS. 100, 101 AND 104).

SERVICE MARK

FIRST USE 1-1-2004; IN COMMERCE 1-1-2004.

PRINCIPAL REGISTER

THE MARK CONSISTS OF THE LITERAL ELEMENT "CELCRITE" IN STYLIZED LETTERING AND THE ASSOCIATED DESIGN OF SIX STACKED HEXAGONS FORMING ONE OVERALL TRIANGULAR-SHAPED DESIGN THAT IS ENCIRCLED BY THREE ELLIPSES TOUCHING AT THEIR TOPS AND BOTTOMS.

SEC. 2(F) "CELCRITE".

SER. NO. 85-303,976, FILED 4-25-2011.

JUDITH HELFMAN, EXAMINING ATTORNEY



David J. Kyffers

Director of the United States Patent and Trademark Office

United States of America

United States Patent and Trademark Office

PIANO PEANUTS

Reg. No. 4,073,574

DEBBY BURZYNSKI (UNITED STATES INDIVIDUAL)
5 SPRING LANE
SAUGUS, MA 01906

Registered Dec. 20, 2011

Int. Cl.: 41

FOR: PIANO INSTRUCTION, IN CLASS 41 (U.S. CLS. 100, 101 AND 107).

SERVICE MARK

FIRST USE 1-1-2007; IN COMMERCE 1-1-2007.

PRINCIPAL REGISTER

THE MARK CONSISTS OF STANDARD CHARACTERS WITHOUT CLAIM TO ANY PARTICULAR FONT, STYLE, SIZE, OR COLOR.

NO CLAIM IS MADE TO THE EXCLUSIVE RIGHT TO USE "PIANO", APART FROM THE MARK AS SHOWN.

SER. NO. 85-304,053, FILED 4-25-2011.

RONALD AIKENS, EXAMINING ATTORNEY



David J. Kyffers

Director of the United States Patent and Trademark Office

United States of America

United States Patent and Trademark Office

Lower the Risk - Test with the Best

Reg. No. 4,073,575

MOON, WOCHUL (REPUBLIC OF KOREA INDIVIDUAL), DBA GOODGEN, LLC
10301 STELLA LINK RD
HOUSTON, TX 77025

Registered Dec. 20, 2011

Int. Cl.: 9

FOR: LABORATORY DEVICES FOR DETECTING GENETIC SEQUENCES, IN CLASS 9
(U.S. CLS. 21, 23, 26, 36 AND 38).

TRADEMARK

FIRST USE 4-25-2011; IN COMMERCE 4-25-2011.

PRINCIPAL REGISTER

THE MARK CONSISTS OF STANDARD CHARACTERS WITHOUT CLAIM TO ANY PARTICULAR FONT, STYLE, SIZE, OR COLOR.

SER. NO. 85-304,060, FILED 4-25-2011.

DORITT L. CARROLL, EXAMINING ATTORNEY



David J. Kybas

Director of the United States Patent and Trademark Office

United States of America

United States Patent and Trademark Office

NOGGIN ROCKERS

Reg. No. 4,073,576

RICHARD P. HATCH (UNITED STATES INDIVIDUAL)
4747 S 1300 E

Registered Dec. 20, 2011

SALT LAKE CITY, UT 84117 AND

Int. Cl.: 9

JESSE CURTIS (UNITED STATES INDIVIDUAL)
949 EAST SEARLE AVE
SALT LAKE CITY, UT 84117

TRADEMARK

PRINCIPAL REGISTER

FOR: PERSONAL PNEUMATIC AMPLIFYING HEADSETS FOR ELECTRIC GUITARS AND
STRINGED INSTRUMENTS, IN CLASS 9 (U.S. CLS. 21, 23, 26, 36 AND 38).

FIRST USE 8-1-2004; IN COMMERCE 8-1-2004.

THE MARK CONSISTS OF STANDARD CHARACTERS WITHOUT CLAIM TO ANY PAR-
TICULAR FONT, STYLE, SIZE, OR COLOR.

SER. NO. 85-304,150, FILED 4-25-2011.

FRED CARL, EXAMINING ATTORNEY



David J. Kyffers

Director of the United States Patent and Trademark Office

United States of America

United States Patent and Trademark Office

BLUEPRINT

Reg. No. 4,073,577

Registered Dec. 20, 2011

Int. Cl.: 35

BLUEPRINT CONSTRUCTION SERVICES, LLC (CALIFORNIA LIMITED LIABILITY COMPANY)
SUITE 115
125 RYAN INDUSTRIAL COURT
SAN RAMON, CA 94583

SERVICE MARK

PRINCIPAL REGISTER

FOR: EMPLOYMENT STAFFING AND RECRUITING SERVICES; EMPLOYMENT STAFFING AND RECRUITING SERVICES IN THE FIELDS OF CONSTRUCTION, PROPERTY MANAGEMENT, BUILDING MAINTENANCE, REAL ESTATE DEVELOPMENT AND ENERGY, NAMELY, SOLAR ENERGY; AND PAYROLL SERVICES, NAMELY, PAYROLL ADMINISTRATION AND MANAGEMENT FOR WORKERS PLACED UNDER SAID EMPLOYMENT STAFFING SERVICES, IN CLASS 35 (U.S. CLS. 100, 101 AND 102).

FIRST USE 4-20-2006; IN COMMERCE 5-31-2007.

THE MARK CONSISTS OF STANDARD CHARACTERS WITHOUT CLAIM TO ANY PARTICULAR FONT, STYLE, SIZE, OR COLOR.

SER. NO. 85-304,202, FILED 4-25-2011.

GRETTA YAO, EXAMINING ATTORNEY



David J. Kyffers

Director of the United States Patent and Trademark Office

United States of America

United States Patent and Trademark Office



Reg. No. 4,073,578

Registered Dec. 20, 2011

Int. Cl.: 25

TRADEMARK

PRINCIPAL REGISTER

LANGE, JOHN A (UNITED STATES INDIVIDUAL)
6671 SUBSET BLVD, STE 1525-6
HOLLYWOOD, CA 90028

FOR: BANDANAS; BEANIES; BOTTOMS; G-STRINGS; HATS; HEADWEAR; JACKETS;
SHIRTS; SHORTS; SWEAT SHIRTS; TANK-TOPS; THONGS; TOPS; UNDERWEAR, IN
CLASS 25 (U.S. CLS. 22 AND 39).

FIRST USE 0-0-2005; IN COMMERCE 0-0-2005.

THE MARK CONSISTS OF THREE WOMEN STRADDLING A DANCER'S POLE, WITH THE
WORDING "STRIP CLUB CHOPPERS".

SEC. 2(F).

SER. NO. 85-304,379, FILED 4-26-2011.

ERIN FALK, EXAMINING ATTORNEY



David J. Kybas

Director of the United States Patent and Trademark Office

United States of America

United States Patent and Trademark Office

Shock Lock

Reg. No. 4,073,579

SHOCK LOCK LLC (DELAWARE LIMITED LIABILITY COMPANY)
1320 WINDING WAYE LANE
SILVER SPRING, MD 20902

Registered Dec. 20, 2011

Int. Cl.: 28

FOR: GOLF ACCESSORY, NAMELY, SUPPORT FOR HOLDING A GOLF CLUB; GOLF CLUB INSERTS; GOLF CLUB SHAFTS; SPORTS EQUIPMENT, NAMELY, VIBRATION DAMPENERS FOR RACKETS , IN CLASS 28 (U.S. CLS. 22, 23, 38 AND 50).

TRADEMARK

FIRST USE 7-14-2010; IN COMMERCE 7-14-2010.

PRINCIPAL REGISTER

THE MARK CONSISTS OF STANDARD CHARACTERS WITHOUT CLAIM TO ANY PARTICULAR FONT, STYLE, SIZE, OR COLOR.

OWNER OF U.S. REG. NOS. 3,993,788 AND 4,002,278.

NO CLAIM IS MADE TO THE EXCLUSIVE RIGHT TO USE "SHOCK", APART FROM THE MARK AS SHOWN.

SER. NO. 85-304,399, FILED 4-26-2011.

FRANK LATTUCA, EXAMINING ATTORNEY



David J. Kyros

Director of the United States Patent and Trademark Office

United States of America

United States Patent and Trademark Office

GLOBAL GIVE BACK CIRCLE

Reg. No. 4,073,580

Registered Dec. 20, 2011

Int. Cl.: 35

SERVICE MARK

PRINCIPAL REGISTER

GLOBAL GIVE BACK CIRCLE (TEXAS UNINCORPORATED ASSOCIATION)
400 EAST 59TH STREET, SUITE 12B
NEW YORK, NY 10022

FOR: CHARITABLE SERVICES, NAMELY, ORGANIZING AND CONDUCTING VOLUNTEER PROGRAMS FOR THE MENTORING OF DISADVANTAGED YOUTH IN THE AREAS OF PROFESSIONAL LEADERSHIP, PERSONAL DEVELOPMENT, CHARACTER, EMPLOYMENT READINESS, AND CITIZENSHIP, AND RECRUITING PRIVATE SECTOR VOLUNTEERS TO PARTICIPATE IN SUCH PROGRAMS AND PROMOTING PUBLIC AWARENESS OF THE NEED FOR MENTORING DISADVANTAGED YOUTH, IN CLASS 35 (U.S. CLS. 100, 101 AND 102).

FIRST USE 10-0-2007; IN COMMERCE 10-0-2007.

THE MARK CONSISTS OF STANDARD CHARACTERS WITHOUT CLAIM TO ANY PARTICULAR FONT, STYLE, SIZE, OR COLOR.

NO CLAIM IS MADE TO THE EXCLUSIVE RIGHT TO USE "GLOBAL" , APART FROM THE MARK AS SHOWN.

SER. NO. 85-304,484, FILED 4-26-2011.

KIMBERLY FRYE, EXAMINING ATTORNEY



David J. Kybas

Director of the United States Patent and Trademark Office

United States of America

United States Patent and Trademark Office

Floor99

Reg. No. 4,073,581

Registered Dec. 20, 2011

Int. Cl.: 42

SERVICE MARK

PRINCIPAL REGISTER

COST EFFECTIVE TECHNOLOGIES, INC. (NEBRASKA CORPORATION)
121 S. 13TH STREET
LINCOLN, NE 68508

FOR: APPLICATION SERVICE PROVIDER (ASP), NAMELY, HOSTING COMPUTER SOFTWARE APPLICATIONS OF OTHERS; COMPUTER SERVICES, NAMELY, REMOTE AND ON-SITE MANAGEMENT OF THE INFORMATION TECHNOLOGY (IT) CLOUD COMPUTING SYSTEMS OF OTHERS; SOFTWARE AS A SERVICE (SAAS) SERVICES, NAMELY, HOSTING SOFTWARE FOR USE BY OTHERS FOR USE IN ALL ASPECTS OF RUNNING A BUSINESS; TECHNICAL SUPPORT SERVICES, NAMELY, REMOTE AND ON-SITE INFRASTRUCTURE MANAGEMENT SERVICES FOR MONITORING, ADMINISTRATION AND MANAGEMENT OF PUBLIC AND PRIVATE CLOUD COMPUTING IT AND APPLICATION SYSTEMS, IN CLASS 42 (U.S. CLS. 100 AND 101).

FIRST USE 2-17-2011; IN COMMERCE 2-17-2011.

THE MARK CONSISTS OF STANDARD CHARACTERS WITHOUT CLAIM TO ANY PARTICULAR FONT, STYLE, SIZE, OR COLOR.

SER. NO. 85-304,488, FILED 4-26-2011.

KIMBERLY FRYE, EXAMINING ATTORNEY



David J. Kybas

Director of the United States Patent and Trademark Office

United States of America

United States Patent and Trademark Office



Reg. No. 4,073,582

Registered Dec. 20, 2011

Int. Cl.: 26

TRADEMARK

PRINCIPAL REGISTER

GOGNA, KARAN (NEW ZEALAND INDIVIDUAL)
36 REVANS STREET, MIRAMAR
WELLINGTON, NEW ZEALAND 6022

FOR: FALSE HAIR MADE ENTIRELY FROM HUMAN HAIR; HAIR ACCESSORIES, NAMELY, CLAW CLIPS; HAIR ACCESSORIES, NAMELY, HAIR STICKS; HAIR ACCESSORIES, NAMELY, JAW CLIPS; HAIR ACCESSORIES, NAMELY, PLASTIC STYLING INSERTS THAT CREATE HEIGHT AND VOLUME ON THE CROWN OF THE HEAD; HAIR ACCESSORIES, NAMELY, SNAP CLIPS; HAIR ACCESSORIES, NAMELY, TWISTERS; HAIR BANDS; HAIR BOWS; HAIR CHOPSTICKS; HAIR CLAMPS; HAIR CLIPS; HAIR COLORING CAPS; HAIR CURL CLIPS; HAIR CURLERS; HAIR EXTENSIONS MADE ENTIRELY FROM HUMAN HAIR; HAIR ORNAMENTS IN THE FORM OF COMBS; HAIR PIECES MADE ENTIRELY FROM HUMAN HAIR; HAIR PIECES AND WIGS MADE ENTIRELY FROM HUMAN HAIR; HAIR SCRUNCHIES; PONYTAIL HOLDERS AND HAIR RIBBONS; RUBBER BANDS FOR HAIR; TOUPEES MADE ENTIRELY FROM HUMAN HAIR; WIGS, HAIRPIECES, AND ADD-IN AND ADD-ON HAIR ACCESSORIES CONSTRUCTED ENTIRELY FROM HUMAN HAIR, IN CLASS 26 (U.S. CLS. 37, 39, 40, 42 AND 50).

FIRST USE 2-5-2008; IN COMMERCE 3-1-2010.

NO CLAIM IS MADE TO THE EXCLUSIVE RIGHT TO USE "HAIR EXTENSIONS 100% HUMAN HAIR EXTENSIONS", APART FROM THE MARK AS SHOWN.

THE COLOR(S) MAGENTA PINK, WHITE AND BLACK IS/ARE CLAIMED AS A FEATURE OF THE MARK.

THE MARK CONSISTS OF "BE" IN MAGENTA PINK AND "GORGEOUS" IN WHITE WITH ITC AVANT-GARDE FONT AND "HAIR EXTENSIONS" UNDERNEATH IT AND ALSO "100% HUMAN HAIR EXTENSIONS" UNDERNEATH THAT ALL IN WHITE, WITH THE BLACK BACKGROUND.

SER. NO. 85-304,497, FILED 4-26-2011.

JOHN DWYER, EXAMINING ATTORNEY



David J. Kyffers

Director of the United States Patent and Trademark Office

United States of America
United States Patent and Trademark Office

ROLAND

Reg. No. 4,073,583

AMERICAN ROLAND FOOD CORP. (NEW YORK CORPORATION)
71 WEST 23RD STREET
NEW YORK, NY 10010

Registered Dec. 20, 2011

Int. Cls.: 30 and 32

FOR: DANISH; ÉCLAIRS; CREPES; CREAM PUFFS; CHOCOLATE CUPS WITH FILLINGS;
CAKES; TIRAMISU; DESSERT SOUFFLÉ; CRACKERS; CROSTATA; MARZIPAN;
BREAKFAST CEREAL; OATMEAL; ALMOND PASTE; MISO BEAN PASTE; DRIED TOASTS;
CANAPÉS; BLINI; CHOCOLATE; PARFAIT, IN CLASS 30 (U.S. CL. 46).

TRADEMARK

PRINCIPAL REGISTER

FIRST USE 12-0-2008; IN COMMERCE 12-0-2008.

FOR: OLIVE JUICE, IN CLASS 32 (U.S. CLS. 45, 46 AND 48).

FIRST USE 7-0-2009; IN COMMERCE 7-0-2009.

THE MARK CONSISTS OF STANDARD CHARACTERS WITHOUT CLAIM TO ANY PARTICULAR FONT, STYLE, SIZE, OR COLOR.

OWNER OF U.S. REG. NOS. 1,098,745, 2,450,462 AND OTHERS.

SER. NO. 85-304,499, FILED 4-26-2011.

DAVID COLLIER, EXAMINING ATTORNEY



David J. Kyros

Director of the United States Patent and Trademark Office

United States of America

United States Patent and Trademark Office

PILLOWSAFE

Reg. No. 4,073,584

MATTRESS SAFE, INC. (GEORGIA CORPORATION)
P.O. BOX 2267
CUMMING, GA 30041

Registered Dec. 20, 2011

Int. Cl.: 24

FOR: BED PRODUCTS, NAMELY, ENCASEMENTS IN THE NATURE OF PILLOW COVERS FOR PILLOWS, IN CLASS 24 (U.S. CLS. 42 AND 50).

TRADEMARK

FIRST USE 12-0-2004; IN COMMERCE 12-0-2004.

PRINCIPAL REGISTER

THE MARK CONSISTS OF STANDARD CHARACTERS WITHOUT CLAIM TO ANY PARTICULAR FONT, STYLE, SIZE, OR COLOR.

OWNER OF U.S. REG. NOS. 3,184,575 AND 3,224,992.

NO CLAIM IS MADE TO THE EXCLUSIVE RIGHT TO USE "PILLOW", APART FROM THE MARK AS SHOWN.

SER. NO. 85-304,507, FILED 4-26-2011.

DAVID COLLIER, EXAMINING ATTORNEY



David J. Kyffers

Director of the United States Patent and Trademark Office

United States of America

United States Patent and Trademark Office

Roland

Reg. No. 4,073,585

AMERICAN ROLAND FOOD CORP. (NEW YORK CORPORATION)
71 WEST 23RD STREET
NEW YORK, NY 10010

Registered Dec. 20, 2011

Int. Cls.: 30 and 32

FOR: DANISH; ÉCLAIRS; CREPES; CREAM PUFFS; CHOCOLATE CUPS WITH FILLINGS; CAKES; TIRAMISU; DESSERT SOUFFLÉ; CRACKERS; CROSTATA; MARZIPAN; BREAKFAST CEREAL; OATMEAL; ALMOND PASTE; MISO BEAN PASTE; DRIED TOASTS; CANAPÉS; BLINI; CHOCOLATE; PARFAIT, IN CLASS 30 (U.S. CL. 46).

TRADEMARK

PRINCIPAL REGISTER

FIRST USE 12-0-2008; IN COMMERCE 12-0-2008.

FOR: OLIVE JUICE, IN CLASS 32 (U.S. CLS. 45, 46 AND 48).

FIRST USE 7-0-2009; IN COMMERCE 7-0-2009.

OWNER OF U.S. REG. NOS. 627,935, 3,594,163 AND OTHERS.

THE MARK CONSISTS OF THE WORD "ROLAND" IN STYLIZED FORMAT.

SER. NO. 85-304,514, FILED 4-26-2011.

DAVID COLLIER, EXAMINING ATTORNEY



David J. Kyros

Director of the United States Patent and Trademark Office

United States of America

United States Patent and Trademark Office



Reg. No. 4,073,586

Registered Dec. 20, 2011

Int. Cl.: 37

SERVICE MARK

PRINCIPAL REGISTER

ATLANTA'S RELIABLE ROOFING CO. (GEORGIA CORPORATION), DBA RELIABLE ROOFING, INC.
4594 WINTERS CHAPEL ROAD
ATLANTA, GA 30306

FOR: ROOFING CONSULTATION; ROOFING CONTRACTING; ROOFING INSTALLATION; ROOFING REPAIR; ROOFING SERVICES, IN CLASS 37 (U.S. CLS. 100, 103 AND 106).

FIRST USE 2-28-2011, THE MARK WAS FIRST USED ANYWHERE IN A DIFFERENT FORM OTHER THAN THAT SOUGHT TO BE REGISTERED AT LEAST AS EARLY AS 11/30/2004.; IN COMMERCE 2-28-2011, THE MARK WAS FIRST USED IN COMMERCE IN A DIFFERENT FORM OTHER THAN THAT SOUGHT TO BE REGISTERED AT LEAST AS EARLY AS 11/30/2004..

NO CLAIM IS MADE TO THE EXCLUSIVE RIGHT TO USE "ROOFING", APART FROM THE MARK AS SHOWN.

THE COLOR(S) RED, BLACK, WHITE, BROWN, TAN, AND BLUE IS/ARE CLAIMED AS A FEATURE OF THE MARK.

THE MARK CONSISTS OF A SMILING HUMANOID STANDING GORILLA LEANING AGAINST A ROOFLINE WHICH SURMOUNTS THE WORDS "RELIABLE ROOFING". UNDER THE GORILLA'S FEET IS A BLACK SHADOW AND THE WORD "ROOFUS" IN CURSIVE. THE GORILLA IS PRINCIPALLY BROWN WITH EARS, LOWER FACE, FEET AND CHEST IN TAN, WEARING BLUE OVERALLS AND A WHITE HAT WITH A RED DESIGN IN THE HAT. THE ROOF DESIGN IS IN RED AND OUTLINED IN BLACK. THE HAMMER HANDLE IS BROWN. THE WORDS "ROOFUS" AND "RELIABLE ROOFING" ARE IN BLACK, ALL ON A WHITE BACKGROUND.

SER. NO. 85-304,515, FILED 4-26-2011.

DAVID COLLIER, EXAMINING ATTORNEY



David J. Kypos

Director of the United States Patent and Trademark Office

United States of America

United States Patent and Trademark Office

BOBS BY SKECHERS

Reg. No. 4,073,587

SKECHERS U.S.A., INC. II (DELAWARE CORPORATION)
228 MANHATTAN BEACH BLVD.
MANHATTAN BEACH, CA 90266

Registered Dec. 20, 2011

Int. Cl.: 25

FOR: FOOTWEAR, IN CLASS 25 (U.S. CLS. 22 AND 39).

TRADEMARK

FIRST USE 8-31-2010; IN COMMERCE 8-31-2010.

PRINCIPAL REGISTER

THE MARK CONSISTS OF STANDARD CHARACTERS WITHOUT CLAIM TO ANY PARTICULAR FONT, STYLE, SIZE, OR COLOR.

OWNER OF U.S. REG. NO. 3,995,186.

SER. NO. 85-304,588, FILED 4-26-2011.

KATHRYN COWARD, EXAMINING ATTORNEY



David J. Kybas

Director of the United States Patent and Trademark Office

United States of America
United States Patent and Trademark Office

condoatlanta

Reg. No. 4,073,588

CONDOATLANTA.COM, INC. (GEORGIA CORPORATION)
PO BOX 346

Registered Dec. 20, 2011

MURPHY, NC 28906

Int. Cl.: 36

FOR: COMMERCIAL AND RESIDENTIAL REAL ESTATE AGENCY SERVICES, IN CLASS 36 (U.S. CLS. 100, 101 AND 102).

SERVICE MARK

FIRST USE 9-1-1998; IN COMMERCE 9-1-1998.

PRINCIPAL REGISTER

THE MARK CONSISTS OF STANDARD CHARACTERS WITHOUT CLAIM TO ANY PARTICULAR FONT, STYLE, SIZE, OR COLOR.

SEC. 2(F).

SER. NO. 85-304,624, FILED 4-26-2011.

CARYN GLASSER, EXAMINING ATTORNEY



David J. Kyjars

Director of the United States Patent and Trademark Office

United States of America

United States Patent and Trademark Office



Reg. No. 4,073,589

Registered Dec. 20, 2011

Int. Cl.: 16

TRADEMARK

PRINCIPAL REGISTER

LOZINAK PROFESSIONAL BASEBALL, LLC (PENNSYLVANIA LIMITED LIABILITY COMPANY)
1000 PARK AVE
ALTOONA, PA 16602

FOR: PAPER GOODS AND PRINTED MATTER, NAMELY, AUTOGRAPH BOOKS, BINDERS, BOOKMARKS, BUMPER STICKERS, CALENDARS, CATALOGS IN THE FIELD OF BASEBALL, DECALS, MERCHANDISE BAGS, NEWSLETTERS IN THE FIELD OF BASEBALL, NOTE PADS, PAPER CONTAINERS, PAPER PENNANTS, PAPER GAME SCHEDULES, PENS, PENCILS, POSTCARDS, POSTERS, PRINTED AWARDS, PRINTED GAME TICKETS, PRINTED GUIDES IN THE FIELD OF BASEBALL, REFERENCE BOOKS IN THE FIELD OF BASEBALL, SCORE BOOKS, SCORE CARDS, SCORE SHEETS, STATIONERY, STICKERS, STICKER ALBUMS AND TRADING CARDS, IN CLASS 16 (U.S. CLS. 2, 5, 22, 23, 29, 37, 38 AND 50).

FIRST USE 11-22-2010; IN COMMERCE 11-22-2010.

OWNER OF U.S. REG. NOS. 2,314,329 AND 2,389,310.

NO CLAIM IS MADE TO THE EXCLUSIVE RIGHT TO USE "ALTOONA", APART FROM THE MARK AS SHOWN.

THE MARK CONSISTS OF A CONDUCTOR WEARING A SCARF AND HAT WITH THE LETTER "A"; THE WORDING "ALTOONA CURVE" STYLIZED ABOVE HIS HEAD; AND ALL WORDING AND DESIGN ELEMENTS IN THE MARK ARE SUPERIMPOSED ON AN INCOMPLETE KEYSTONE.

SER. NO. 85-304,629, FILED 4-26-2011.

BILL DAWE, EXAMINING ATTORNEY



David J. Kyffers

Director of the United States Patent and Trademark Office

United States of America

United States Patent and Trademark Office

FUNKSHION: FASHION WEEK MIAMI BEACH

Reg. No. 4,073,590

FUNKSHION (FLORIDA LIMITED LIABILITY COMPANY)

Registered Dec. 20, 2011

1900 PURDY AVE APT. 715
MIAMI BEACH, FL 33139

Int. Cl.: 41

FOR: ENTERTAINMENT IN THE NATURE OF FASHION SHOWS, IN CLASS 41 (U.S. CLS. 100, 101 AND 107).

SERVICE MARK

FIRST USE 1-1-1999; IN COMMERCE 2-4-2003.

PRINCIPAL REGISTER

THE MARK CONSISTS OF STANDARD CHARACTERS WITHOUT CLAIM TO ANY PARTICULAR FONT, STYLE, SIZE, OR COLOR.

NO CLAIM IS MADE TO THE EXCLUSIVE RIGHT TO USE "FASHION WEEK" OR "MIAMI BEACH", APART FROM THE MARK AS SHOWN.

SER. NO. 85-304,641, FILED 4-26-2011.

THEODORE MCBRIDE, EXAMINING ATTORNEY



David J. Kybas

Director of the United States Patent and Trademark Office

United States of America

United States Patent and Trademark Office



Reg. No. 4,073,591

Registered Dec. 20, 2011

Int. Cl.: 35

SERVICE MARK

PRINCIPAL REGISTER

AMERICAN MARKETING ASSOCIATION, NEW YORK CHAPTER, INC. (NEW YORK
NON-PROFIT CORPORATION)
116 EAST 27TH STREET, 6TH FLOOR
NEW YORK, NY 10016

FOR: ASSOCIATION SERVICES, NAMELY PROMOTING THE PRACTICE AND UNDER-
STANDING OF EFFECTIVE MARKETING THROUGH INTERNATIONAL DIRECTORIES,
AWARDS, PUBLICATIONS, CONFERENCES, WEBSITES AND CAREER DEVELOPMENT
RESOURCES, IN CLASS 35 (U.S. CLS. 100, 101 AND 102).

FIRST USE 4-11-2011; IN COMMERCE 4-11-2011.

OWNER OF U.S. REG. NO. 2,674,215.

THE MARK CONSISTS OF THREE CIRCULAR BANDS NESTLED INSIDE EACH OTHER,
COMPRISING AN OUTER INCOMPLETE CIRCLE, A MIDDLE INCOMPLETE CIRCLE AND
A CENTER INCOMPLETE CIRCLE AND THE LETTERS "NYAMA".

SER. NO. 85-304,660, FILED 4-26-2011.

MARK SPARACINO, EXAMINING ATTORNEY



David J. Kyffers

Director of the United States Patent and Trademark Office

United States of America

United States Patent and Trademark Office

Severed Cinema

Reg. No. 4,073,592

MAYO, CHRIS (CANADA INDIVIDUAL)
PO BOX 1591

Registered Dec. 20, 2011

ST. JOHN'S, NL, CANADA A1C5P3

Int. Cl.: 41

FOR: ENTERTAINMENT SERVICES, NAMELY, PROVIDING ON-LINE REVIEWS OF HORROR MOVIES, IN CLASS 41 (U.S. CLS. 100, 101 AND 107).

SERVICE MARK

FIRST USE 5-30-2005; IN COMMERCE 10-23-2005.

PRINCIPAL REGISTER

THE MARK CONSISTS OF STANDARD CHARACTERS WITHOUT CLAIM TO ANY PARTICULAR FONT, STYLE, SIZE, OR COLOR.

NO CLAIM IS MADE TO THE EXCLUSIVE RIGHT TO USE "CINEMA", APART FROM THE MARK AS SHOWN.

SER. NO. 85-304,665, FILED 4-26-2011.

PAUL E. FAHRENKOPF, EXAMINING ATTORNEY



David J. Kyffers

Director of the United States Patent and Trademark Office

United States of America

United States Patent and Trademark Office



Reg. No. 4,073,593

Registered Dec. 20, 2011

Int. Cl.: 35

SERVICE MARK

PRINCIPAL REGISTER

AMERICAN MARKETING ASSOCIATION, NEW YORK CHAPTER, INC. (NEW YORK
NON-PROFIT CORPORATION)
116 EAST 27TH STREET, 6TH FLOOR
NEW YORK, NY 10016

FOR: ASSOCIATION SERVICES, NAMELY PROMOTING THE PRACTICE AND UNDER-
STANDING OF EFFECTIVE MARKETING THROUGH INTERNATIONAL DIRECTORIES,
AWARDS, PUBLICATIONS, CONFERENCES, WEBSITES AND CAREER DEVELOPMENT
RESOURCES, IN CLASS 35 (U.S. CLS. 100, 101 AND 102).

FIRST USE 4-11-2011; IN COMMERCE 4-11-2011.

OWNER OF U.S. REG. NO. 2,674,215.

THE COLOR(S) GREEN, LIGHT BLUE, AND DARK BLUE IS/ARE CLAIMED AS A FEATURE
OF THE MARK.

THE MARK CONSISTS OF THREE CIRCULAR BANDS NESTLED INSIDE EACH OTHER,
COMPRISING A GREEN OUTER INCOMPLETE CIRCLE, A LIGHT BLUE MIDDLE INCOM-
plete CIRCLE AND A DARK BLUE CENTER INCOMPLETE CIRCLE AND THE LETTERS
"NYAMA", THE LETTERS "NY" BEING GREEN AND THE LETTERS "AMA" BEING DARK
BLUE.

SER. NO. 85-304,678, FILED 4-26-2011.

MARK SPARACINO, EXAMINING ATTORNEY



David J. Kyffers

Director of the United States Patent and Trademark Office

United States of America

United States Patent and Trademark Office



Reg. No. 4,073,594

Registered Dec. 20, 2011

Int. Cl.: 25

TRADEMARK

PRINCIPAL REGISTER

LOZINAK PROFESSIONAL BASEBALL, LLC (PENNSYLVANIA LIMITED LIABILITY COMPANY)
1000 PARK AVE.
ALTOONA, PA 16602

FOR: CLOTHING, NAMELY, APRONS, ATHLETIC UNIFORMS, BANDANAS, BOXER SHORTS, CAPS, CLOTH BABY BIBS, COATS, GOLF SHIRTS, GYM SHORTS, GYM SUITS, HATS, JACKETS, JERSEYS, JOGGING SUITS, KNIT SHIRTS, PAJAMAS, POLO SHIRTS, PONCHOS, PULLOVERS, RAIN COATS, RAINWEAR, SWEATERS, SWEAT PANTS, SWEAT SHIRTS, SWEAT SUITS, SOCKS, SPORT SHIRTS, T- SHIRTS, TANK TOPS, TIES, VISORS, WIND RESISTANT JACKETS AND WRISTBANDS, IN CLASS 25 (U.S. CLS. 22 AND 39).

FIRST USE 11-22-2010; IN COMMERCE 11-22-2010.

OWNER OF U.S. REG. NOS. 2,314,329 AND 2,389,310.

NO CLAIM IS MADE TO THE EXCLUSIVE RIGHT TO USE "ALTOONA", APART FROM THE MARK AS SHOWN.

THE MARK CONSISTS OF A CONDUCTOR WEARING A SCARF AND HAT WITH THE LETTER "A"; THE WORDING "ALTOONA CURVE" STYLIZED ABOVE HIS HEAD; AND ALL WORDING AND DESIGN ELEMENTS IN THE MARK ARE SUPERIMPOSED ON AN INCOMPLETE KEYSTONE.

SER. NO. 85-304,681, FILED 4-26-2011.

BILL DAWE, EXAMINING ATTORNEY



David J. Kybas

Director of the United States Patent and Trademark Office

United States of America

United States Patent and Trademark Office

Out of Scandinavia

Reg. No. 4,073,595

Registered Dec. 20, 2011

Int. Cl.: 35

SERVICE MARK

PRINCIPAL REGISTER

OUT OF SCANDINAVIA LLC (MASSACHUSETTS LIMITED LIABILITY COMPANY)
49 SCHOOL STREET
MIDDLEBORO, MA 02346

FOR: ONLINE RETAIL GIFT SHOPS FEATURING GOODS PRIMARILY ORIGINATING IN THE SCANDINAVIAN COUNTRIES, IN CLASS 35 (U.S. CLS. 100, 101 AND 102).

FIRST USE 1-1-2005; IN COMMERCE 1-1-2005.

THE MARK CONSISTS OF STANDARD CHARACTERS WITHOUT CLAIM TO ANY PARTICULAR FONT, STYLE, SIZE, OR COLOR.

NO CLAIM IS MADE TO THE EXCLUSIVE RIGHT TO USE "SCANDINAVIA", APART FROM THE MARK AS SHOWN.

SER. NO. 85-304,688, FILED 4-26-2011.

JILL C. ALT, EXAMINING ATTORNEY



David J. Kybas

Director of the United States Patent and Trademark Office

United States of America

United States Patent and Trademark Office



Reg. No. 4,073,596

OHIO HIGH SCHOOL ATHLETIC ASSOCIATION (OHIO INCORPORATED ASSOCIATION)
4080 ROSELEA PLACE
COLUMBUS, OH 43214

Registered Dec. 20, 2011

Int. Cls.: 35, 36 and 41

FOR: PROMOTING PUBLIC AWARENESS OF, AND THE IMPORTANCE OF SPORTSMANSHIP, ADHERENCE TO RULES OF THE GAME AND MUTUAL RESPECT AMONG OFFICIALS, TEAMMATES, OPPONENTS AND FANS; RECRUITMENT OF SPORTS OFFICIALS, IN CLASS 35 (U.S. CLS. 100, 101 AND 102).

SERVICE MARK

PRINCIPAL REGISTER

FIRST USE 6-6-2006; IN COMMERCE 6-6-2006.

FOR: EDUCATIONAL SERVICES, NAMELY, PROVIDING INCENTIVES IN THE FORM OF SCHOLARSHIPS TO SCHOLAR-ATHLETES AND OTHERS TO DEMONSTRATE EXCELLENCE IN THE FIELDS OF ACADEMICS, ATHLETICS, SPORTSMANSHIP, GOOD CITIZENSHIP, VALUES AND ETHICS, IN CLASS 36 (U.S. CLS. 100, 101 AND 102).

FIRST USE 6-6-2006; IN COMMERCE 6-6-2006.

FOR: REGULATING AND ADMINISTERING INTERSCHOLASTIC ATHLETIC COMPETITIONS; ARRANGING AND CONDUCTING ATHLETIC TOURNAMENTS AND AWARDS AND RECOGNITION EVENTS; ARRANGING AND CONDUCTING EDUCATIONAL CONFERENCES; TRAINING OF SPORTS OFFICIALS; AND PROVIDING RECOGNITION AND INCENTIVES BY THE WAY OF AWARDS TO DEMONSTRATE EXCELLENCE IN THE FIELDS OF ACADEMICS, ATHLETICS, SPORTSMANSHIP, GOOD CITIZENSHIP, VALUES AND ETHICS, IN CLASS 41 (U.S. CLS. 100, 101 AND 107).

FIRST USE 6-6-2006; IN COMMERCE 6-6-2006.

OWNER OF U.S. REG. NOS. 3,214,943 AND 3,346,879.

NO CLAIM IS MADE TO THE EXCLUSIVE RIGHT TO USE "ATHLETIC ASSOCIATION", APART FROM THE MARK AS SHOWN.

THE MARK CONSISTS OF A LARGE LETTER "O" WITH A TORCH TO THE RIGHT AND THE WORDS "OHSAA OHIO HIGH SCHOOL ATHLETIC ASSOCIATION" BENEATH THE "O", SUPERIMPOSED ON AN OUTLINE OF THE STATE OF OHIO.



David J. Kyros

Director of the United States Patent and Trademark Office

Reg. No. 4,073,596 SEC. 2(F) AS TO "OHIO HIGH SCHOOL".

SER. NO. 85-304,724, FILED 4-26-2011.

SHARON MEIER, EXAMINING ATTORNEY

United States of America

United States Patent and Trademark Office



Reg. No. 4,073,597

Registered Dec. 20, 2011

Int. Cl.: 35

SERVICE MARK

PRINCIPAL REGISTER

THE COMMERCIAL CLUB OF CHICAGO (ILLINOIS NON-PROFIT CORPORATION)
21 S. CLARK STREET, SUITE 3120
CHICAGO, IL 60603

FOR: PROMOTING PUBLIC AWARENESS OF THE FINANCIAL CRISES OF THE STATE OF ILLINOIS, IN CLASS 35 (U.S. CLS. 100, 101 AND 102).

FIRST USE 4-9-2010; IN COMMERCE 4-9-2010.

THE MARK CONSISTS OF A STYLIZED IMAGE OF ABRAHAM LINCOLN, DRESSED IN TUXEDO, WITH TWO FRONT PANTS POCKETS PULLED OUT AND EMPTY, AND COINS TO LEFT AND RIGHT OF FEET.

SER. NO. 85-304,784, FILED 4-26-2011.

DAVID ELTON, EXAMINING ATTORNEY



David J. Kybas

Director of the United States Patent and Trademark Office

United States of America

United States Patent and Trademark Office

Full Brain

Reg. No. 4,073,598

HECKES, DEBBIE JO (UNITED STATES INDIVIDUAL)
6207 PAN AMERICAN FEY NE
ALBUQUERQUE, NM 87109

Registered Dec. 20, 2011

Int. Cl.: 35

FOR: INFORMATION, ADVISORY, CONSULTING, BUSINESS RESEARCH AND PLANNING SERVICES RELATING TO PUBLICITY, MARKETING COMMUNICATIONS, REPUTATION MANAGEMENT OR BUSINESS ADMINISTRATION, INCLUDING SUCH SERVICES PROVIDED ONLINE OR VIA THE INTERNET, SOCIAL MEDIA STRATEGY AND MARKETING CONSULTANCY FOCUSING ON HELPING CLIENTS CREATE AND EXTEND THEIR PRODUCT AND BRAND STRATEGIES BY BUILDING VIRALLY ENGAGING MARKETING SOLUTIONS, IN CLASS 35 (U.S. CLS. 100, 101 AND 102).

SERVICE MARK

PRINCIPAL REGISTER

FIRST USE 11-1-2009; IN COMMERCE 11-15-2009.

THE MARK CONSISTS OF STANDARD CHARACTERS WITHOUT CLAIM TO ANY PARTICULAR FONT, STYLE, SIZE, OR COLOR.

SER. NO. 85-304,785, FILED S.R. 4-26-2011 AM. P.R. 8-16-2011.

DAVID ELTON, EXAMINING ATTORNEY



David J. Kyros

Director of the United States Patent and Trademark Office

United States of America

United States Patent and Trademark Office

FRESH START WOMEN'S FOUNDATION

Reg. No. 4,073,599

Registered Dec. 20, 2011

Int. Cl.: 41

SERVICE MARK

PRINCIPAL REGISTER

FRESH START WOMEN'S FOUNDATION (ARIZONA NON-PROFIT CORPORATION)
1130 E. MCDOWELL ROAD
PHOENIX, AZ 85006

FOR: PROVIDING EDUCATIONAL MENTORING SERVICES AND PROGRAMS IN THE AREAS OF CAREER AND PROFESSIONAL DEVELOPMENT, ECONOMIC SELF-SUFFICIENCY AND MICRO-ENTREPRENEURSHIP; EDUCATIONAL SERVICES, NAMELY, PROVIDING LIVE CLASSES, SEMINARS, WORKSHOPS, AND PRESENTATIONS DIRECTED TO THE EMPOWERMENT AND LIFE IMPROVEMENT OF WOMEN; PROFESSIONAL COACHING SERVICES IN THE FIELD OF CAREER AND PROFESSIONAL DEVELOPMENT; LIBRARIES; EDUCATIONAL SERVICES, NAMELY, PROVIDING ON-LINE CLASSES, SEMINARS, WORKSHOPS, PRESENTATIONS, AND BLOGS DIRECTED TO THE PERSONAL EMPOWERMENT AND PERSONAL LIFE IMPROVEMENT OF WOMEN, AND PROVIDING ONLINE NONDOWNLOADABLE VIDEOS AND ARTICLES AS SUPPLEMENTAL MATERIALS FOR USE IN CONJUNCTION WITH ALL OF THE FOREGOING EDUCATIONAL SERVICES, IN CLASS 41 (U.S. CLS. 100, 101 AND 107).

FIRST USE 0-0-1998; IN COMMERCE 0-0-1998.

THE MARK CONSISTS OF STANDARD CHARACTERS WITHOUT CLAIM TO ANY PARTICULAR FONT, STYLE, SIZE, OR COLOR.

NO CLAIM IS MADE TO THE EXCLUSIVE RIGHT TO USE "WOMEN'S FOUNDATION", APART FROM THE MARK AS SHOWN.

SER. NO. 85-304,806, FILED 4-26-2011.

ELLEN BURNS, EXAMINING ATTORNEY



David J. Kyjars

Director of the United States Patent and Trademark Office

United States of America

United States Patent and Trademark Office

GENIE AIR CONDITIONING & HEATING

Reg. No. 4,073,600

Registered Dec. 20, 2011

Int. Cls.: 9 and 11

TRADEMARK

PRINCIPAL REGISTER

GENIE AIR CONDITIONING & HEATING, INC. (CALIFORNIA CORPORATION)
15041 CALVERT ST
VAN NUYS, CA 91411

FOR: CLIMATE CONTROL SYSTEMS CONSISTING OF DIGITAL THERMOSTATS, AIR
CONDITIONING, HEATING, VENTILATION AND DRYING CONTROL DEVICES, IN CLASS
9 (U.S. CLS. 21, 23, 26, 36 AND 38).

FIRST USE 6-1-1986; IN COMMERCE 6-1-1986.

FOR: AIR CONDITIONERS, IN CLASS 11 (U.S. CLS. 13, 21, 23, 31 AND 34).

FIRST USE 6-1-1986; IN COMMERCE 6-1-1986.

THE MARK CONSISTS OF STANDARD CHARACTERS WITHOUT CLAIM TO ANY PAR-
TICULAR FONT, STYLE, SIZE, OR COLOR.

NO CLAIM IS MADE TO THE EXCLUSIVE RIGHT TO USE "AIR CONDITIONING &
HEATING", APART FROM THE MARK AS SHOWN.

SER. NO. 85-304,809, FILED 4-26-2011.

PATRICIA EVANKO, EXAMINING ATTORNEY



David J. Kybas

Director of the United States Patent and Trademark Office

United States of America

United States Patent and Trademark Office



Reg. No. 4,073,601

Registered Dec. 20, 2011

Int. Cl.: 41

SERVICE MARK

PRINCIPAL REGISTER

FRESH START WOMEN'S FOUNDATION (ARIZONA NON-PROFIT CORPORATION)
1130 E. MCDOWELL ROAD
PHOENIX, AZ 85006

FOR: PROVIDING EDUCATIONAL MENTORING SERVICES AND PROGRAMS IN THE AREAS OF CAREER AND PROFESSIONAL DEVELOPMENT, ECONOMIC SELF-SUFFICIENCY AND MICRO-ENTREPRENEURSHIP; EDUCATIONAL SERVICES, NAMELY, PROVIDING LIVE CLASSES, SEMINARS, WORKSHOPS, AND PRESENTATIONS DIRECTED TO THE PERSONAL EMPOWERMENT AND PERSONAL LIFE IMPROVEMENT OF WOMEN; PROFESSIONAL COACHING SERVICES IN THE FIELD OF CAREER AND PROFESSIONAL DEVELOPMENT; LIBRARIES, IN CLASS 41 (U.S. CLS. 100, 101 AND 107).

FIRST USE 0-0-1998; IN COMMERCE 0-0-1998.

NO CLAIM IS MADE TO THE EXCLUSIVE RIGHT TO USE "WOMEN'S FOUNDATION", APART FROM THE MARK AS SHOWN.

THE MARK CONSISTS OF THE WORDS "FRESH START WOMEN'S FOUNDATION" AND THE DESIGN ELEMENTS OF THE SILHOUETTE OF THE UPPER HALF OF A WOMAN WITH HER ARMS RAISED ABOVE HER HEAD AGAINST A SHADED OVAL BACKGROUND DESIGN.

SER. NO. 85-304,915, FILED 4-26-2011.

JUDITH HELFMAN, EXAMINING ATTORNEY



David J. Kybas

Director of the United States Patent and Trademark Office

United States of America

United States Patent and Trademark Office

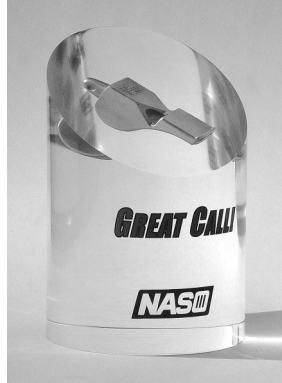

Reg. No. 4,073,602

Registered Dec. 20, 2011

Int. Cl.: 41

SERVICE MARK

PRINCIPAL REGISTER

NATIONAL ASSOCIATION OF SPORTS OFFICIALS, INC. (WISCONSIN CORPORATION)
2017 LATHROP AVENUE
RACINE, WI 53405

FOR: PROVIDING RECOGNITION AND INCENTIVES BY WAY OF AWARDS FOR CONTRIBUTION IN THE FIELD OF SPORTS OFFICIATING, IN CLASS 41 (U.S. CLS. 100, 101 AND 107).

FIRST USE 3-10-2005; IN COMMERCE 3-10-2005.

OWNER OF U.S. REG. NO. 3,781,054.

THE MARK CONSISTS OF PHOTOGRAPH OF A THREE-DIMENSIONAL CYLINDER WITH THE TOP OF THE CYLINDER SLANTED AT AN ANGLE WITH A WHISTLE DESIGN CARVED INTO THE TOP OF THE CYLINDER, THE STYLIZED WORDING "GREAT CALL!" ON THE FRONT MIDDLE OF THE CYLINDER AND BELOW "GREAT CALL!" IS THE STYLIZED WORD "NASO" INSIDE A RECTANGLE WITH THE O HAVING THREE VERTICAL LINES IN THE CENTER. THE ENTIRE MARK APPEARS INSIDE A SINGLE LINE RECTANGLE.

SER. NO. 85-304,921, FILED 4-26-2011.

DORITT L. CARROLL, EXAMINING ATTORNEY



David J. Kyffers

Director of the United States Patent and Trademark Office

United States of America

United States Patent and Trademark Office



Fresh Start
Women's Foundation

Reg. No. 4,073,603

Registered Dec. 20, 2011

Int. Cl.: 41

SERVICE MARK

PRINCIPAL REGISTER

FRESH START WOMEN'S FOUNDATION (ARIZONA NON-PROFIT CORPORATION)
1130 E. MCDOWELL ROAD
PHOENIX, AZ 85006

FOR: EDUCATIONAL SERVICES, NAMELY, PROVIDING ONLINE CLASSES, SEMINARS, WORKSHOPS, PRESENTATIONS, AND BLOGS DIRECTED TO THE PERSONAL EMPOWERMENT AND PERSONAL LIFE IMPROVEMENT OF WOMEN, AND PROVIDING ONLINE NON-DOWNLOADABLE VIDEOS AND ARTICLES AS SUPPLEMENTAL MATERIALS FOR USE IN CONJUNCTION WITH ALL OF THE FOREGOING EDUCATIONAL SERVICES, IN CLASS 41 (U.S. CLS. 100, 101 AND 107).

FIRST USE 3-31-2011; IN COMMERCE 3-31-2011.

NO CLAIM IS MADE TO THE EXCLUSIVE RIGHT TO USE "WOMEN'S FOUNDATION", APART FROM THE MARK AS SHOWN.

THE MARK CONSISTS OF THE WORDS "FRESH START WOMEN'S FOUNDATION" AND THE DESIGN ELEMENTS OF THE SILHOUETTE OF THE UPPER HALF OF A WOMAN WITH HER ARMS RAISED ABOVE HER HEAD AGAINST A SHADED OVAL BACKGROUND DESIGN.

SER. NO. 85-304,923, FILED 4-26-2011.

JUDITH HELFMAN, EXAMINING ATTORNEY



David J. Kyros

Director of the United States Patent and Trademark Office

United States of America

United States Patent and Trademark Office



Reg. No. 4,073,604

Registered Dec. 20, 2011

Int. Cl.: 43

SERVICE MARK

PRINCIPAL REGISTER

FRESH START WOMEN'S FOUNDATION (ARIZONA NON-PROFIT CORPORATION)
1130 E. MCDOWELL ROAD
PHOENIX, AZ 85006

FOR: CHILD CARE SERVICES, IN CLASS 43 (U.S. CLS. 100 AND 101).

FIRST USE 10-0-2002; IN COMMERCE 10-0-2002.

NO CLAIM IS MADE TO THE EXCLUSIVE RIGHT TO USE "WOMEN'S FOUNDATION",
APART FROM THE MARK AS SHOWN.

THE MARK CONSISTS OF THE WORDS "FRESH START WOMEN'S FOUNDATION" AND
THE DESIGN ELEMENTS OF THE SILHOUETTE OF THE UPPER HALF OF A WOMAN
WITH HER ARMS RAISED ABOVE HER HEAD AGAINST A SHADED OVAL BACKGROUND
DESIGN.

SER. NO. 85-304,928, FILED 4-26-2011.

JUDITH HELFMAN, EXAMINING ATTORNEY



David J. Kybas

Director of the United States Patent and Trademark Office

United States of America

United States Patent and Trademark Office

PRT

Reg. No. 4,073,605

PREMIERE, INC. (LOUISIANA CORPORATION)
615 N LANADRY RD.
NEW IBERIA, LA 70563

Registered Dec. 20, 2011

Int. Cl.: 7

FOR: MACHINE FOR PICKING UP AND SCREWING PIPES TOGETHER; APPARATUS FOR ROTATING PIPES IN AN OIL WELL, IN CLASS 7 (U.S. CLS. 13, 19, 21, 23, 31, 34 AND 35).

TRADEMARK

FIRST USE 0-0-2009; IN COMMERCE 0-0-2009.

PRINCIPAL REGISTER

THE MARK CONSISTS OF STANDARD CHARACTERS WITHOUT CLAIM TO ANY PARTICULAR FONT, STYLE, SIZE, OR COLOR.

SER. NO. 85-304,986, FILED 4-26-2011.

TEJBIR SINGH, EXAMINING ATTORNEY



David J. Kybas

Director of the United States Patent and Trademark Office

United States of America

United States Patent and Trademark Office

PINK WATER

Reg. No. 4,073,606

THE BIOSOLVE COMPANY (MASSACHUSETTS LIMITED LIABILITY COMPANY)
329 MASSACHUSETTS AVENUE
LEXINGTON, MA 02420

Registered Dec. 20, 2011

Int. Cl.: 1

FOR: CHEMICALS, NAMELY, WATER-BASED CLEANING AND HYDROCARBON MITIGATION AGENTS USED IN SOIL REMEDIATION, SURFACE CLEANING, VAPOR SUPPRESSION AND BIOREMEDIATION OF ORGANIC MATERIAL, IN CLASS 1 (U.S. CLS. 1, 5, 6, 10, 26 AND 46).

TRADEMARK

PRINCIPAL REGISTER

FIRST USE 11-9-1994; IN COMMERCE 11-9-1994.

THE MARK CONSISTS OF STANDARD CHARACTERS WITHOUT CLAIM TO ANY PARTICULAR FONT, STYLE, SIZE, OR COLOR.

OWNER OF U.S. REG. NO. 2,720,429.

SEC. 2(F).

SER. NO. 85-305,094, FILED 4-26-2011.

ALYSSA STEEL, EXAMINING ATTORNEY



David J. Kyros

Director of the United States Patent and Trademark Office

United States of America

United States Patent and Trademark Office

MAKE THE MOVE

Reg. No. 4,073,607

KINGMAN INTERNATIONAL CORPORATION (CALIFORNIA CORPORATION)
14010 LIVE OAK AVENUE
BALDWIN PARK, CA 91706

Registered Dec. 20, 2011

Int. Cl.: 28

FOR: PAINTBALL MARKERS; BODY PROTECTORS FOR PAINTBALL; AND PROTECTIVE PADDING FOR PAINTBALL, IN CLASS 28 (U.S. CLS. 22, 23, 38 AND 50).

TRADEMARK

FIRST USE 5-1-2009; IN COMMERCE 5-1-2009.

PRINCIPAL REGISTER

THE MARK CONSISTS OF STANDARD CHARACTERS WITHOUT CLAIM TO ANY PARTICULAR FONT, STYLE, SIZE, OR COLOR.

SER. NO. 85-305,171, FILED 4-26-2011.

JASON TURNER, EXAMINING ATTORNEY



David J. Kybas

Director of the United States Patent and Trademark Office

United States of America

United States Patent and Trademark Office



Reg. No. 4,073,608

Registered Dec. 20, 2011

Int. Cls.: 37, 39 and 40

CHOICE ENVIRONMENTAL SERVICES, INC. (FLORIDA CORPORATION)
STE 103
2860 S.R. 84
FORT LAUDERDALE, FL 333124810

FOR: TRASH COLLECTION, IN CLASS 37 (U.S. CLS. 100, 103 AND 106).

SERVICE MARK

FIRST USE 9-24-2009; IN COMMERCE 9-24-2009.

PRINCIPAL REGISTER

FOR: GARBAGE COLLECTION; JUNK, TRASH AND DEBRIS REMOVAL; HAZARDOUS WASTE TRANSPORTATION SERVICES; TRASH SERVICES, NAMELY, RENTAL OF DUMPSTERS, IN CLASS 39 (U.S. CLS. 100 AND 105).

FIRST USE 9-24-2009; IN COMMERCE 9-24-2009.

FOR: RECYCLING; RECYCLING SERVICES, NAMELY, RENTAL OF RECYCLING CONTAINERS, IN CLASS 40 (U.S. CLS. 100, 103 AND 106).

FIRST USE 9-24-2009; IN COMMERCE 9-24-2009.

NO CLAIM IS MADE TO THE EXCLUSIVE RIGHT TO USE "ENVIRONMENTAL", APART FROM THE MARK AS SHOWN.

THE MARK CONSISTS OF THE WORDING "CHOICE ENVIRONMENTAL" WITH TWO ARROWS AND TWO HORIZONTAL LINES, ONE ABOVE THE WORD "CHOICE" AND ONE TO THE LEFT OF THE TERM "ENVIRONMENTAL".

SER. NO. 85-305,178, FILED 4-26-2011.

PAM WILLIS, EXAMINING ATTORNEY



David J. Kyros

Director of the United States Patent and Trademark Office

United States of America

United States Patent and Trademark Office



Reg. No. 4,073,609

Registered Dec. 20, 2011

Int. Cl.: 35

SERVICE MARK

PRINCIPAL REGISTER

SRSANDCO, LLC (GEORGIA LIMITED LIABILITY COMPANY)
SUITE 612
2487 CEDARCREST ROAD
ACWORTH, GA 30101

FOR: BUSINESS MARKETING AND DIRECT MAIL CONSULTING SERVICES; DIRECT MAIL ADVERTISING SERVICES; DIRECT MARKETING ADVERTISING FOR OTHERS , IN CLASS 35 (U.S. CLS. 100, 101 AND 102).

FIRST USE 8-1-2008; IN COMMERCE 8-1-2008.

NO CLAIM IS MADE TO THE EXCLUSIVE RIGHT TO USE "MAIL", APART FROM THE MARK AS SHOWN.

THE COLOR(S) YELLOW, RED, DARK RED, BROWN, PEACH, WHITE, BLUE, GREEN AND BLACK IS/ARE CLAIMED AS A FEATURE OF THE MARK.

THE MARK CONSISTS OF A CIRCULAR IMAGE OUTLINED IN YELLOW WITH A DARK RED FILLED BORDER WITH THE WORD "MUDLICK" APPEARING IN YELLOW CAPITALIZED LETTERS AT THE TOP OF THE CIRCULAR IMAGE AND THE WORD "MAIL" APPEARING IN YELLOW CAPITALIZED LETTERS AT THE BOTTOM OF THE CIRCULAR IMAGE. THE WORDS "MUDLICK" AND "MAIL" ARE SEPARATED BY A YELLOW DOT ON EACH SIDE OF THE CIRCULAR IMAGE. THE INSIDE OF THE DARK RED BORDER IS ALSO OUTLINED IN YELLOW. IN THE INTERIOR OF THE CIRCULAR MARK APPEARS THE CARICATURE IMAGES OF A HORSE ON THE LEFT SIDE OF THE INTERIOR AND A YOUNG GIRL ON THE RIGHT SIDE OF THE INTERIOR. THE HORSE IS BROWN AND WHITE WITH A RED TONGUE, WHITE TEETH AND A BLACK HOOF WITH THE HOOF HAVING A BLUE UNDERLINE. THE YOUNG GIRL HAS PEACH SKIN, BLUE EYES, WHITE TEETH AND RED LIPS AND IS WEARING A BROWN COWBOY HAT, RED BANDANA SCARF AND HAS BROWN HAIR IN PIG TAILS WITH RED RIBBONS. BEHIND THE HORSE AND THE YOUNG GIRL APPEAR A BLUE SKY, GREEN GRASS, AND AN ABSTRACT IMAGE OF A BARN IN BLUE AND BROWN.



David J. Kyros

SER. NO. 85-305,226, FILED 4-26-2011.

SHANNON TWOHIG, EXAMINING ATTORNEY

United States of America

United States Patent and Trademark Office

Lean Specialists

Reg. No. 4,073,610

Registered Dec. 20, 2011

Int. Cl.: 35

LEAN SPECIALISTS, LLC (TEXAS LIMITED LIABILITY COMPANY), DBA LEAN SPECIALISTS, LLC
APT 1717
14500 BLANCO ROAD
SAN ANTONIO, TX 78216

SERVICE MARK

PRINCIPAL REGISTER

FOR: BUSINESS CONSULTING IN THE FIELD OF ENVIRONMENTAL MANAGEMENT, NAMELY, ADVISING BUSINESSES AND INDIVIDUALS ON ISSUES OF ENVIRONMENTAL IMPACT, CONSERVATION, PRESERVATION AND PROTECTION, AND ECONOMIC ANALYSIS FOR BUSINESS PURPOSES; BUSINESS EFFICIENCY ADVICE; BUSINESS EFFICIENCY EXPERT SERVICES; BUSINESS MANAGEMENT; BUSINESS MANAGEMENT ADVICE; BUSINESS MANAGEMENT AND ADVICE; BUSINESS MANAGEMENT AND CONSULTATION; BUSINESS MANAGEMENT CONSULTANCY IN THE FIELD OF INSOURCING, NAMELY, ASSISTING BUSINESSES IN THE DEVELOPMENT OF PROCESSES FOR THE ANALYSIS AND THE IMPLEMENTATION OF THE DELEGATION OF OPERATIONS OR JOBS FROM PRODUCTION WITHIN A BUSINESS TO AN INTERNAL ENTITY THAT SPECIALIZES IN THAT OPERATION; BUSINESS MANAGEMENT SERVICES, NAMELY, MANAGING LOGISTICS, REVERSE LOGISTICS, SUPPLY CHAIN SERVICES, SUPPLY CHAIN VISIBILITY AND SYNCHRONIZATION, SUPPLY AND DEMAND FORECASTING AND PRODUCT DISTRIBUTION PROCESSES FOR OTHERS, IN CLASS 35 (U.S. CLS. 100, 101 AND 102).

FIRST USE 0-0-2010; IN COMMERCE 4-0-2011.

THE MARK CONSISTS OF STANDARD CHARACTERS WITHOUT CLAIM TO ANY PARTICULAR FONT, STYLE, SIZE, OR COLOR.

NO CLAIM IS MADE TO THE EXCLUSIVE RIGHT TO USE "SPECIALISTS", APART FROM THE MARK AS SHOWN.

SER. NO. 85-305,281, FILED 4-26-2011.

SALLY SHIH, EXAMINING ATTORNEY



David J. Kyffers

Director of the United States Patent and Trademark Office

United States of America

United States Patent and Trademark Office

BOOT CAMP H2O

Reg. No. 4,073,611

BOOT CAMP H2O LLC (CALIFORNIA LIMITED LIABILITY COMPANY)
137 N. HARPER AVE
LOS ANGELES, CA 90048

Registered Dec. 20, 2011

Int. Cl.: 41

FOR: PHYSICAL FITNESS INSTRUCTION; PHYSICAL FITNESS TRAINING SERVICES;
SWIMMING INSTRUCTION, IN CLASS 41 (U.S. CLS. 100, 101 AND 107).

SERVICE MARK

FIRST USE 12-6-2009; IN COMMERCE 2-10-2010.

PRINCIPAL REGISTER

THE MARK CONSISTS OF STANDARD CHARACTERS WITHOUT CLAIM TO ANY PARTICULAR FONT, STYLE, SIZE, OR COLOR.

NO CLAIM IS MADE TO THE EXCLUSIVE RIGHT TO USE "BOOT CAMP", APART FROM THE MARK AS SHOWN.

SER. NO. 85-305,322, FILED 4-26-2011.

ALICE BENMAMAN, EXAMINING ATTORNEY



David J. Kyros

Director of the United States Patent and Trademark Office

United States of America

United States Patent and Trademark Office

JUKEBOXU

Reg. No. 4,073,612

JBTV, LLC (DELAWARE LIMITED LIABILITY COMPANY)
1 S FAIR OAKS AVENUE, SUITE #202
PASADENA, CA 91105

Registered Dec. 20, 2011

Int. Cl.: 38

FOR: STREAMING OF VIDEO MATERIAL ON THE INTERNET, IN CLASS 38 (U.S. CLS. 100, 101 AND 104).

SERVICE MARK

FIRST USE 11-8-2010; IN COMMERCE 3-20-2011.

PRINCIPAL REGISTER

THE MARK CONSISTS OF STANDARD CHARACTERS WITHOUT CLAIM TO ANY PARTICULAR FONT, STYLE, SIZE, OR COLOR.

SER. NO. 85-305,334, FILED 4-26-2011.

ROBERT C. CLARK JR., EXAMINING ATTORNEY



David J. Kybas

Director of the United States Patent and Trademark Office

United States of America

United States Patent and Trademark Office

I PLAY FOR

Reg. No. 4,073,613

Registered Dec. 20, 2011

Int. Cl.: 25

TRADEMARK

PRINCIPAL REGISTER

I PLAY FOR (NEW YORK PARTNERSHIP)
66 CHRISTOPHER STREET
MONTCLAIR, NJ 07042

FOR: SHOES; SPORTS JERSEYS; T-SHIRTS, IN CLASS 25 (U.S. CLS. 22 AND 39).

FIRST USE 6-10-2010; IN COMMERCE 6-10-2010.

THE MARK CONSISTS OF STANDARD CHARACTERS WITHOUT CLAIM TO ANY PARTICULAR FONT, STYLE, SIZE, OR COLOR.

SER. NO. 85-305,340, FILED 4-26-2011.

FRED CARL, EXAMINING ATTORNEY



David J. Kyffers

Director of the United States Patent and Trademark Office

United States of America

United States Patent and Trademark Office

LIQUID BRAND EXCHANGE

Reg. No. 4,073,614

Registered Dec. 20, 2011

Int. Cl.: 35

SERVICE MARK

PRINCIPAL REGISTER

LIQUID AGENCY, INC. (CALIFORNIA CORPORATION)
448 SOUTH MARKET STREET
SAN JOSE, CA 95113

FOR: PROVIDING INFORMATION VIA A WEBSITE AND BLOG IN THE FIELDS OF BUSINESS, ADVERTISING, MARKETING, BRAND PROMOTION AND BRAND DEVELOPMENT, IN CLASS 35 (U.S. CLS. 100, 101 AND 102).

FIRST USE 5-16-2007; IN COMMERCE 5-16-2007.

THE MARK CONSISTS OF STANDARD CHARACTERS WITHOUT CLAIM TO ANY PARTICULAR FONT, STYLE, SIZE, OR COLOR.

OWNER OF U.S. REG. NO. 2,809,913.

NO CLAIM IS MADE TO THE EXCLUSIVE RIGHT TO USE "BRAND EXCHANGE", APART FROM THE MARK AS SHOWN.

SER. NO. 85-305,373, FILED 4-26-2011.

RONALD MCMORROW, EXAMINING ATTORNEY



David J. Kybas

Director of the United States Patent and Trademark Office

United States of America

United States Patent and Trademark Office

LIQUID BRAND SUMMIT

Reg. No. 4,073,615

Registered Dec. 20, 2011

Int. Cl.: 35

SERVICE MARK

PRINCIPAL REGISTER

LIQUID AGENCY, INC. (CALIFORNIA CORPORATION)
448 SOUTH MARKET STREET
SAN JOSE, CA 95113

FOR: CONFERENCE COORDINATING AND PLANNING SERVICES, NAMELY, ARRANGING AND CONDUCTING CONFERENCES IN THE FIELDS OF BUSINESS, ADVERTISING, MARKETING, BRAND PROMOTION AND BRAND DEVELOPMENT; PROVIDING INFORMATION VIA A WEBSITE AND BLOG IN THE FIELDS OF BUSINESS, ADVERTISING, MARKETING, BRAND PROMOTION AND BRAND DEVELOPMENT, IN CLASS 35 (U.S. CLS. 100, 101 AND 102).

FIRST USE 3-18-2002; IN COMMERCE 3-18-2002.

THE MARK CONSISTS OF STANDARD CHARACTERS WITHOUT CLAIM TO ANY PARTICULAR FONT, STYLE, SIZE, OR COLOR.

OWNER OF U.S. REG. NO. 2,809,913.

NO CLAIM IS MADE TO THE EXCLUSIVE RIGHT TO USE "BRAND SUMMIT", APART FROM THE MARK AS SHOWN.

SER. NO. 85-305,382, FILED 4-26-2011.

RONALD MCMORROW, EXAMINING ATTORNEY



David J. Kyffers

Director of the United States Patent and Trademark Office

United States of America

United States Patent and Trademark Office

Energy
Resource
Group



Reg. No. 4,073,616

Registered Dec. 20, 2011

Int. Cl.: 35

SERVICE MARK

PRINCIPAL REGISTER

ENERGY RESOURCE GROUP TECHNOLOGIES, INC. (CONNECTICUT CORPORATION)
90 FOREST VIEW ROAD
NORTHFORD, CT 06472

FOR: CONSULTING SERVICES IN THE FIELDS OF ENERGY CONSUMPTION AND USAGE CONSERVATION TO IMPROVE ENERGY EFFICIENCY, IN CLASS 35 (U.S. CLS. 100, 101 AND 102).

FIRST USE 10-0-1995; IN COMMERCE 10-0-1995.

NO CLAIM IS MADE TO THE EXCLUSIVE RIGHT TO USE "ENERGY RESOURCE GROUP", APART FROM THE MARK AS SHOWN.

THE MARK CONSISTS OF STYLIZED TEXT WITH A SUN SURROUNDED BY BORDER ON TWO SIDES.

SER. NO. 85-305,444, FILED 4-26-2011.

MARK SHINER, EXAMINING ATTORNEY



David J. Kyffers

Director of the United States Patent and Trademark Office

United States of America
United States Patent and Trademark Office

Happy Head

foot reflexology and massage

Reg. No. 4,073,617

Registered Dec. 20, 2011

Int. Cl.: 44

SERVICE MARK

PRINCIPAL REGISTER

FASTBIZ (WYOMING CORPORATION), DBA HAPPY HEAD FOOT REFLEXOLOGY AND MASSAGE
534 UNIVERSITY AVENUE
SAN DIEGO, CA 92103

FOR: MASSAGE THERAPY SERVICES, IN CLASS 44 (U.S. CLS. 100 AND 101).

FIRST USE 4-25-2011; IN COMMERCE 4-25-2011.

NO CLAIM IS MADE TO THE EXCLUSIVE RIGHT TO USE "HEAD" AND "FOOT REFLEXOLOGY AND MASSAGE", APART FROM THE MARK AS SHOWN.

THE COLOR(S) LAVENDER, PINK AND PURPLE IS/ARE CLAIMED AS A FEATURE OF THE MARK.

THE MARK CONSISTS OF THE WORDS "HAPPY HEAD" IN LAVENDER AND PINK COLOR AND THE WORDS "FOOT REFLEXOLOGY AND MASSAGE" IN PURPLE COLOR. THE LETTER "A" IN "HAPPY" AND THE LETTER "A" IN "HEAD" APPEAR AS AN IMAGE OF A HAPPY FACE.

SER. NO. 85-305,496, FILED 4-26-2011.

BARBARA GAYNOR, EXAMINING ATTORNEY



David J. Kybas

Director of the United States Patent and Trademark Office

United States of America

United States Patent and Trademark Office

SCADAEnterprisePlatform

Reg. No. 4,073,618

Registered Dec. 20, 2011

Int. Cl.: 9

BONT SOFTWARE & CONTROL SYSTEMS, INC. (TEXAS CORPORATION), DBA BONT
SOFTWARE
2002 SOUTH STEMMONS FWY
SUITE 1000
LAKE DALLAS, TX 75065

TRADEMARK

PRINCIPAL REGISTER

FOR: AUTOMATED PROCESS CONTROL SYSTEM, NAMELY, MICRO-PROCESSOR BASED
HARDWARE AND SOFTWARE USED TO MONITOR THE STATUS OF INDUSTRIAL
PROCESSES, NAMELY, POWER GENERATION, ELECTRICAL DISTRIBUTION AND OIL
AND GAS PROCESSING, IN CLASS 9 (U.S. CLS. 21, 23, 26, 36 AND 38).

FIRST USE 2-1-2011; IN COMMERCE 2-1-2011.

OWNER OF U.S. REG. NO. 3,675,920.

NO CLAIM IS MADE TO THE EXCLUSIVE RIGHT TO USE "SCADAENTERPRISEPLAT-
FORM", APART FROM THE MARK AS SHOWN.

THE MARK CONSISTS OF THE STYLIZED WORDING "SCADAENTERPRISEPLATFORM"
AND THE DESIGN OF THREE PARTIALLY CONCENTRIC SWIRLS.

SER. NO. 85-305,629, FILED 4-27-2011.

BRIAN PINO, EXAMINING ATTORNEY



David J. Kybas

Director of the United States Patent and Trademark Office

United States of America

United States Patent and Trademark Office



Reg. No. 4,073,619

Registered Dec. 20, 2011

Int. Cl.: 9

TRADEMARK

PRINCIPAL REGISTER

SEISMIC MICRO-TECHNOLOGY, INC. (TEXAS CORPORATION)
SUITE 400
8584 KATY FREEWAY
HOUSTON, TX 77024

FOR: COMPUTER SOFTWARE AND PROGRAMS FOR PERFORMING GEOSCIENTIFIC INTERPRETATION, MODELING, AND ANALYSIS OF SEISMIC DATA IN THE FIELD OF OIL AND GAS EXPLORATION AND PRODUCTION, IN CLASS 9 (U.S. CLS. 21, 23, 26, 36 AND 38).

FIRST USE 4-1-2011; IN COMMERCE 4-1-2011.

THE MARK CONSISTS OF A STYLIZED DEPICTION OF A SPHERE WITH RED, LIGHT RED, SILVER AND LIGHT SILVER BANDS.

THE COLOR(S) RED AND SILVER IS/ARE CLAIMED AS A FEATURE OF THE MARK.

SER. NO. 85-305,633, FILED 4-27-2011.

GRETCHEN ULRICH, EXAMINING ATTORNEY



David J. Kyffers

Director of the United States Patent and Trademark Office

United States of America

United States Patent and Trademark Office

Swaggies

Reg. No. 4,073,620

SWAGGIES, INC. (ILLINOIS CORPORATION)
3338 LAKE KNOLL DRIVE
NORTHBROOK, IL 60062

Registered Dec. 20, 2011

Int. Cl.: 18

FOR: ALL-PURPOSE WATERPROOF CARRYING BAGS FOR CLOTHING AND BATHING SUITS, IN CLASS 18 (U.S. CLS. 1, 2, 3, 22 AND 41).

TRADEMARK

FIRST USE 3-1-2011; IN COMMERCE 3-1-2011.

PRINCIPAL REGISTER

THE MARK CONSISTS OF STANDARD CHARACTERS WITHOUT CLAIM TO ANY PARTICULAR FONT, STYLE, SIZE, OR COLOR.

SER. NO. 85-305,641, FILED 4-27-2011.

MICHAEL SOUDERS, EXAMINING ATTORNEY



David J. Kybas

Director of the United States Patent and Trademark Office

United States of America

United States Patent and Trademark Office

EMBEDDED GURUS

Reg. No. 4,073,621

Registered Dec. 20, 2011

Int. Cls.: 41 and 42

SERVICE MARK

PRINCIPAL REGISTER

NETRINO, LLC (MARYLAND LIMITED LIABILITY COMPANY)
6030 MARSHALEE DRIVE
SUITE 355
ELKRIDGE, MD 21075

FOR: TRAINING SERVICES IN THE FIELD OF DESIGN OF COMPUTER HARDWARE, INTEGRATED CIRCUITS, COMMUNICATIONS HARDWARE AND SOFTWARE AND COMPUTER NETWORKS FOR OTHERS, IN CLASS 41 (U.S. CLS. 100, 101 AND 107).

FIRST USE 11-23-2005; IN COMMERCE 11-23-2005.

FOR: DESIGN OF COMPUTER HARDWARE, INTEGRATED CIRCUITS, COMMUNICATIONS HARDWARE AND SOFTWARE AND COMPUTER NETWORKS FOR OTHERS, IN CLASS 42 (U.S. CLS. 100 AND 101).

FIRST USE 11-23-2005; IN COMMERCE 11-23-2005.

THE MARK CONSISTS OF STANDARD CHARACTERS WITHOUT CLAIM TO ANY PARTICULAR FONT, STYLE, SIZE, OR COLOR.

NO CLAIM IS MADE TO THE EXCLUSIVE RIGHT TO USE "EMBEDDED" , APART FROM THE MARK AS SHOWN.

SER. NO. 85-305,644, FILED 4-27-2011.

JOHN WILKE, EXAMINING ATTORNEY



David J. Kybas

Director of the United States Patent and Trademark Office

United States of America

United States Patent and Trademark Office

EMBEDDED SOFTWARE BOOT CAMP

Reg. No. 4,073,622

Registered Dec. 20, 2011

Int. Cl.: 41

SERVICE MARK

PRINCIPAL REGISTER

NETRINO, LLC (MARYLAND LIMITED LIABILITY COMPANY)
6030 MARSHALEE DR.
SUITE 355
ELKRIDGE, MD 21075

FOR: TRAINING SERVICES IN THE FIELD OF DESIGN OF COMPUTER HARDWARE, INTEGRATED CIRCUITS, COMMUNICATIONS HARDWARE AND SOFTWARE AND COMPUTER NETWORKS FOR OTHERS , IN CLASS 41 (U.S. CLS. 100, 101 AND 107).

FIRST USE 4-15-2008; IN COMMERCE 4-15-2008.

THE MARK CONSISTS OF STANDARD CHARACTERS WITHOUT CLAIM TO ANY PARTICULAR FONT, STYLE, SIZE, OR COLOR.

NO CLAIM IS MADE TO THE EXCLUSIVE RIGHT TO USE "EMBEDDED SOFTWARE", APART FROM THE MARK AS SHOWN.

SER. NO. 85-305,654, FILED 4-27-2011.

JOHN WILKE, EXAMINING ATTORNEY



David J. Kyffers

Director of the United States Patent and Trademark Office

United States of America

United States Patent and Trademark Office

ArborPro Tree Care

Reg. No. 4,073,623

ARBOR PRO TREE CARE, LLC (IOWA LIMITED LIABILITY COMPANY)
1108 5TH AVENUE NORTH
FORT DODGE, IA 50501

Registered Dec. 20, 2011

Int. Cl.: 44

FOR: TREE REMOVAL SERVICES, IN CLASS 44 (U.S. CLS. 100 AND 101).

SERVICE MARK

FIRST USE 8-20-2010; IN COMMERCE 8-20-2010.

PRINCIPAL REGISTER

THE MARK CONSISTS OF STANDARD CHARACTERS WITHOUT CLAIM TO ANY PARTICULAR FONT, STYLE, SIZE, OR COLOR.

NO CLAIM IS MADE TO THE EXCLUSIVE RIGHT TO USE "TREE CARE", APART FROM THE MARK AS SHOWN.

SER. NO. 85-305,661, FILED 4-27-2011.

ADA HAN, EXAMINING ATTORNEY



David J. Kyffers

Director of the United States Patent and Trademark Office

United States of America

United States Patent and Trademark Office

DEAL MONKEY

Reg. No. 4,073,624

DEAL MONKEY INC. (CANADA CORPORATION)

Registered Dec. 20, 2011

1881 STEELES AVE. WEST, STE. 420
TORONTO, CANADA M3H0A1

Int. Cl.: 35

FOR: PROMOTING THE GOODS AND SERVICES OF OTHERS BY PROVIDING A WEBSITE FEATURING COUPONS, REBATES, PRICE-COMPARISON INFORMATION, PRODUCT REVIEWS, LINKS TO THE RETAIL WEBSITES OF OTHERS, AND DISCOUNT INFORMATION, IN CLASS 35 (U.S. CLS. 100, 101 AND 102).

SERVICE MARK

PRINCIPAL REGISTER

FIRST USE 11-30-2010; IN COMMERCE 11-30-2010.

THE MARK CONSISTS OF STANDARD CHARACTERS WITHOUT CLAIM TO ANY PARTICULAR FONT, STYLE, SIZE, OR COLOR.

NO CLAIM IS MADE TO THE EXCLUSIVE RIGHT TO USE "DEAL", APART FROM THE MARK AS SHOWN.

SER. NO. 85-305,723, FILED 4-27-2011.

JULIE WATSON, EXAMINING ATTORNEY



David J. Kyffers

Director of the United States Patent and Trademark Office

United States of America

United States Patent and Trademark Office

Body SHAPER

Reg. No. 4,073,625

Registered Dec. 20, 2011

Int. Cl.: 41

SERVICE MARK

PRINCIPAL REGISTER

MORALES, JAIME (UNITED STATES INDIVIDUAL)
16 B
420 WEST 24 STREET
NEW YORK, NY 10011

FOR: EDUCATIONAL SERVICES, NAMELY, PROVIDING INSTRUCTION IN THE FIELD OF PHYSICAL EXERCISE, IN CLASS 41 (U.S. CLS. 100, 101 AND 107).

FIRST USE 9-1-2010; IN COMMERCE 9-1-2010.

THE MARK CONSISTS OF STANDARD CHARACTERS WITHOUT CLAIM TO ANY PARTICULAR FONT, STYLE, SIZE, OR COLOR.

NO CLAIM IS MADE TO THE EXCLUSIVE RIGHT TO USE "BODY", APART FROM THE MARK AS SHOWN.

SER. NO. 85-305,753, FILED 4-27-2011.

KAREN K. BUSH, EXAMINING ATTORNEY



David J. Kybas

Director of the United States Patent and Trademark Office

United States of America

United States Patent and Trademark Office



Reg. No. 4,073,626

DEAL MONKEY INC. (CANADA CORPORATION)
1881 STEELES AVE. WEST, STE. 420
TORONTO, CANADA M3H0A1

Registered Dec. 20, 2011

Int. Cl.: 35

FOR: PROMOTING THE GOODS AND SERVICES OF OTHERS BY PROVIDING A WEBSITE FEATURING COUPONS, REBATES, PRICE-COMPARISON INFORMATION, PRODUCT REVIEWS, LINKS TO THE RETAIL WEBSITES OF OTHERS, AND DISCOUNT INFORMATION, IN CLASS 35 (U.S. CLS. 100, 101 AND 102).

SERVICE MARK

PRINCIPAL REGISTER

FIRST USE 11-30-2010; IN COMMERCE 11-30-2010.

NO CLAIM IS MADE TO THE EXCLUSIVE RIGHT TO USE "DEAL", APART FROM THE MARK AS SHOWN.

THE MARK CONSISTS OF A MONKEY HOLDING A BRIEFCASE THAT SAYS "DEAL MONKEY" ON IT IN ONE HAND AND HOLDING MONEY IN THE OTHER HAND.

SER. NO. 85-305,768, FILED 4-27-2011.

JULIE WATSON, EXAMINING ATTORNEY



David J. Kybas

Director of the United States Patent and Trademark Office

United States of America

United States Patent and Trademark Office

Hopocalypse

Reg. No. 4,073,627

ARTISAN BREWERS, LLC (CALIFORNIA LIMITED LIABILITY COMPANY)
1933 DAVIS ST., STE. 177
SAN LEANDRO, CA 94577

Registered Dec. 20, 2011

Int. Cls.: 25 and 32

FOR: TOPS, IN CLASS 25 (U.S. CLS. 22 AND 39).

TRADEMARK

FIRST USE 1-31-2011; IN COMMERCE 1-31-2011.

PRINCIPAL REGISTER

FOR: BEER, IN CLASS 32 (U.S. CLS. 45, 46 AND 48).

FIRST USE 10-31-2008; IN COMMERCE 3-31-2011.

THE MARK CONSISTS OF STANDARD CHARACTERS WITHOUT CLAIM TO ANY PARTICULAR FONT, STYLE, SIZE, OR COLOR.

SER. NO. 85-305,777, FILED 4-27-2011.

TINA MAI, EXAMINING ATTORNEY



David J. Kyffers

Director of the United States Patent and Trademark Office

United States of America

United States Patent and Trademark Office

Gnombies

Reg. No. 4,073,628

THE DARK GARDEN, INC. (MASSACHUSETTS CORPORATION)
PO BOX 590537
NEWTON, MA 02459

Registered Dec. 20, 2011

Int. Cl.: 20

FOR: STATUES OF RESIN, PLASTIC AND VINYL, IN CLASS 20 (U.S. CLS. 2, 13, 22, 25, 32 AND 50).

TRADEMARK

FIRST USE 4-24-2011; IN COMMERCE 4-24-2011.

PRINCIPAL REGISTER

THE MARK CONSISTS OF STANDARD CHARACTERS WITHOUT CLAIM TO ANY PARTICULAR FONT, STYLE, SIZE, OR COLOR.

SER. NO. 85-305,795, FILED 4-27-2011.

AMY KERTGATE, EXAMINING ATTORNEY



David J. Kyffers

Director of the United States Patent and Trademark Office

United States of America

United States Patent and Trademark Office

MAKING IT MOBILE

Reg. No. 4,073,629

Registered Dec. 20, 2011

Int. Cl.: 42

SERVICE MARK

PRINCIPAL REGISTER

AVAI MOBILE SOLUTIONS, LLC (TEXAS LIMITED LIABILITY COMPANY)
3801 S. CAPITAL OF TEXAS HWY
AUSTIN, TX 78704

FOR: COMPUTER SOFTWARE DESIGN AND DEVELOPMENT OF MOBILE APPLICATIONS FOR CONTENT-BASED AND RELATIONSHIP MANAGEMENT MOBILE APPLICATIONS; CONSULTING IN THE FIELD OF DESIGN AND DEVELOPMENT OF MOBILE APPLICATION SOFTWARE IN THE NATURE OF PROVIDING STRATEGIES FOR DEVELOPING AND DESIGNING MOBILE APPLICATION SOLUTIONS FOR CONTENT-BASED AND RELATIONSHIP MANAGEMENT APPLICATIONS, IN CLASS 42 (U.S. CLS. 100 AND 101).

FIRST USE 4-4-2011; IN COMMERCE 4-26-2011.

THE MARK CONSISTS OF STANDARD CHARACTERS WITHOUT CLAIM TO ANY PARTICULAR FONT, STYLE, SIZE, OR COLOR.

SER. NO. 85-305,834, FILED 4-27-2011.

CHRISTINA SOBRAL, EXAMINING ATTORNEY



David J. Kyffers

Director of the United States Patent and Trademark Office

United States of America

United States Patent and Trademark Office

CACI MICROLIFT

Reg. No. 4,073,630

Registered Dec. 20, 2011

Int. Cl.: 10

TRADEMARK

PRINCIPAL REGISTER

MICROMODE MEDICAL LIMITED (UNITED KINGDOM CORPORATION)
9 SPRING VILLA PARK, SPRING VILLA ROAD
EDGWARE, MIDDLESEX, UNITED KINGDOM HA87EB

FOR: FACE AND BODY TONING MACHINES AND APPARATUS FOR COSMETIC AND NON-SURGICAL PURPOSES; PARTS, FITTINGS AND ACCESSORIES FOR ALL THE AFORESAID GOODS, IN CLASS 10 (U.S. CLS. 26, 39 AND 44).

THE MARK CONSISTS OF STANDARD CHARACTERS WITHOUT CLAIM TO ANY PARTICULAR FONT, STYLE, SIZE, OR COLOR.

OWNER OF ERPN CMNTY TM OFC REG. NO. 008882821, DATED 7-5-2010, EXPIRES 2-15-2020.

OWNER OF U.S. REG. NOS. 2,203,453, 2,222,118, AND 2,223,532.

SER. NO. 85-305,841, FILED 4-27-2011.

KAREN SEVERSON, EXAMINING ATTORNEY



David J. Kybas

Director of the United States Patent and Trademark Office

United States of America

United States Patent and Trademark Office

ROYAL RED HONEYCRISP

Reg. No. 4,073,631

WILLOW DRIVE NURSERY, INC. (WASHINGTON CORPORATION)
3539 ROAD 5 N.W.
EPHRATA, WA 98823

Registered Dec. 20, 2011

Int. Cl.: 31

FOR: LIVE APPLE TREES, IN CLASS 31 (U.S. CLS. 1 AND 46).

TRADEMARK

FIRST USE 12-6-2010; IN COMMERCE 12-6-2010.

PRINCIPAL REGISTER

THE MARK CONSISTS OF STANDARD CHARACTERS WITHOUT CLAIM TO ANY PARTICULAR FONT, STYLE, SIZE, OR COLOR.

NO CLAIM IS MADE TO THE EXCLUSIVE RIGHT TO USE "RED HONEYCRISP", APART FROM THE MARK AS SHOWN.

SER. NO. 85-305,902, FILED 4-27-2011.

ANNE E. GUSTASON, EXAMINING ATTORNEY



David J. Kyffers

Director of the United States Patent and Trademark Office

United States of America

United States Patent and Trademark Office

all LabTests /// fast
"BECAUSE YOU NEED TO KNOW"

Reg. No. 4,073,632

Registered Dec. 20, 2011

Int. Cl.: 44

SERVICE MARK

PRINCIPAL REGISTER

ALL TESTS FRANCHISING, INC. (FLORIDA CORPORATION)
100 ANDALUSIA AVENUE
UNIT 512
CORAL GABLES, FL 33134

FOR: COLLECTION OF HUMAN PRODUCTS FOR MEDICAL TESTING IN THE NATURE OF COLLECTION AND PRESERVATION OF HUMAN BLOOD, URINE, HAIR FOLLICLES, AND SALIVA , IN CLASS 44 (U.S. CLS. 100 AND 101).

FIRST USE 3-1-2010; IN COMMERCE 3-1-2010.

NO CLAIM IS MADE TO THE EXCLUSIVE RIGHT TO USE "LAB TESTS", APART FROM THE MARK AS SHOWN.

THE COLOR(S) PALE BLUE AND MIDNIGHT BLUE IS/ARE CLAIMED AS A FEATURE OF THE MARK.

THE MARK CONSISTS OF THE COLOR PALE BLUE APPEARS IN THE WORDING "ALL", "TESTS", AND "FAST" AND IN THE THREE SLASHES; THE COLOR MIDNIGHT BLUE APPEARS IN THE WORDING "LAB" AND "BECAUSE YOU NEED TO KNOW".

SER. NO. 85-306,008, FILED 4-27-2011.

REBECCA EISINGER, EXAMINING ATTORNEY



David J. Kyjars

Director of the United States Patent and Trademark Office

United States of America

United States Patent and Trademark Office

When Tragedy Strikes Spaulding Decon is there to help.

Reg. No. 4,073,633

Registered Dec. 20, 2011

Int. Cl.: 40

SERVICE MARK

PRINCIPAL REGISTER

SPAULDING DECON (FLORIDA LIMITED LIABILITY COMPANY)
SUITE 11
6201 JOHNS RD
TAMPA, FL 33634

FOR: BIO-HAZARD BIOLOGICAL DECONTAMINATION SERVICES; BIOLOGICAL DECONTAMINATION SERVICES; CONSULTATION IN THE FIELD OF CLANDESTINE DRUG LAB SITE DECONTAMINATION; DECONTAMINATION OF HAZARDOUS MATERIALS; DECONTAMINATION OF ILLEGAL CLANDESTINE DRUG LAB SITES; MEDICAL WASTE, BLOOD AND BODILY FLUID DECONTAMINATION SERVICES; MOLD REMEDIATION SERVICES; ODOR NEUTRALIZATION SERVICES, IN CLASS 40 (U.S. CLS. 100, 103 AND 106).

FIRST USE 6-1-2008; IN COMMERCE 6-1-2008.

THE MARK CONSISTS OF STANDARD CHARACTERS WITHOUT CLAIM TO ANY PARTICULAR FONT, STYLE, SIZE, OR COLOR.

SER. NO. 85-306,280, FILED 4-27-2011.

NAKIA HENRY, EXAMINING ATTORNEY



David J. Kyffers

Director of the United States Patent and Trademark Office

United States of America

United States Patent and Trademark Office



Reg. No. 4,073,634

PACIFIC CREST WEALTH MANAGEMENT, INC. (IDAHO CORPORATION)
450 W. STATE ST., STE 215
EAGLE, ID 83616

Registered Dec. 20, 2011

Int. Cl.: 36

FOR: INSURANCE ADMINISTRATION IN THE FIELD OF FIRE, LIFE, CASUALTY, PROPERTY AND HEALTH; INSURANCE AGENCIES IN THE FIELD OF FIRE, LIFE, CASUALTY, PROPERTY AND HEALTH; INSURANCE CONSULTING IN THE FIELD OF FIRE, LIFE, CASUALTY, PROPERTY AND HEALTH INSURANCE, IN CLASS 36 (U.S. CLS. 100, 101 AND 102).

SERVICE MARK

PRINCIPAL REGISTER

FIRST USE 4-13-2011; IN COMMERCE 4-13-2011.

NO CLAIM IS MADE TO THE EXCLUSIVE RIGHT TO USE "INDEPENDENT INSURANCE ALLIANCE", APART FROM THE MARK AS SHOWN.

THE MARK CONSISTS OF THE WORDS "PACIFIC CREST" ABOVE THE WORDS "INDEPENDENT INSURANCE ALLIANCE" WITH THREE DIAMOND SHAPES WITH ROUNDED CORNERS IN AN OFFSET LINE TO THE RIGHT.

SER. NO. 85-306,310, FILED 4-27-2011.

PATRICIA EVANKO, EXAMINING ATTORNEY



David J. Kyjars

Director of the United States Patent and Trademark Office

United States of America

United States Patent and Trademark Office

CUE BALL CAPITAL

Reg. No. 4,073,635

Registered Dec. 20, 2011

Int. Cl.: 36

SERVICE MARK

PRINCIPAL REGISTER

THE CUE BALL GROUP, LLC (DELAWARE LIMITED LIABILITY COMPANY)
SUITE 700
ONE FANEUIL HALL SQUARE
BOSTON, MA 02109

FOR: INVESTMENT OF FUNDS FOR OTHERS; INVESTMENT MANAGEMENT; VENTURE CAPITAL FUNDING SERVICES TO EMERGING AND START-UP BUSINESSES , IN CLASS 36 (U.S. CLS. 100, 101 AND 102).

FIRST USE 2-19-2007; IN COMMERCE 2-19-2007.

THE MARK CONSISTS OF STANDARD CHARACTERS WITHOUT CLAIM TO ANY PARTICULAR FONT, STYLE, SIZE, OR COLOR.

OWNER OF U.S. REG. NOS. 3,160,719 AND 3,294,852.

NO CLAIM IS MADE TO THE EXCLUSIVE RIGHT TO USE "CAPITAL", APART FROM THE MARK AS SHOWN.

SER. NO. 85-306,359, FILED 4-27-2011.

CHARLOTTE CORWIN, EXAMINING ATTORNEY



David J. Kybas

Director of the United States Patent and Trademark Office

United States of America

United States Patent and Trademark Office

BABY GENIUS

Reg. No. 4,073,636

PACIFIC ENTERTAINMENT CORP. (CALIFORNIA CORPORATION)

Registered Dec. 20, 2011

C/O 12702 VIA CORTINA, SUITE 100
DEL MAR, CA 92014

Int. Cl.: 16

FOR: A SERIES OF BOOKS AND WRITTEN ARTICLES IN THE FIELD OF EARLY CHILDHOOD EDUCATION; ADDRESS BOOKS AND DIARIES; BABY BOOKS; BANNERS OF PAPER; BOOK ENDS; BOOK MARKERS; CHILDREN'S ACTIVITY BOOKS; CHILDREN'S BOOKS; CHILDREN'S INTERACTIVE EDUCATIONAL BOOKS; COLORING BOOKS; CRAYONS; DECALS; DECORATIVE DECALS FOR VEHICLE WINDOWS; DECORATIVE PENCIL-TOP ORNAMENTS; DISPOSABLE DIAPERS; FLASH CARDS; GIFT CARDS; GREETING CARDS; NOTE BOOKS; NOTE CARDS; PAPER PARTY DECORATIONS; PEN AND PENCIL CASES; PEN AND PENCIL TRAYS; PEN OR PENCIL HOLDERS; PENCIL OR PEN BOXES; PENCILS; PENS; PICTURE BOOKS; PICTURE CARDS; PLACE MATS OF PAPER; POSTERS; PRINTED INSTRUCTIONAL, EDUCATIONAL, AND TEACHING MATERIALS IN THE FIELD OF MUSIC, LITERACY, MATH, AND SCIENCE; SCRAP BOOKS; SHEET MUSIC; SONG BOOKS; STICKERS; STORY BOOKS; TEMPORARY TATTOOS; WRAPPING PAPER, IN CLASS 16 (U.S. CLS. 2, 5, 22, 23, 29, 37, 38 AND 50).

TRADEMARK

PRINCIPAL REGISTER

FIRST USE 8-24-1998; IN COMMERCE 8-24-1998.

THE MARK CONSISTS OF STANDARD CHARACTERS WITHOUT CLAIM TO ANY PARTICULAR FONT, STYLE, SIZE, OR COLOR.

OWNER OF U.S. REG. NOS. 2,274,490, 2,276,151, AND 2,605,113.

NO CLAIM IS MADE TO THE EXCLUSIVE RIGHT TO USE "BABY", APART FROM THE MARK AS SHOWN.

SER. NO. 85-306,388, FILED 4-27-2011.

INGA ERVIN, EXAMINING ATTORNEY



David J. Kyros

Director of the United States Patent and Trademark Office

United States of America

United States Patent and Trademark Office



Reg. No. 4,073,637

H.T.L. AUTOMOTIVE (CALIFORNIA CORPORATION)
4401 E. PACIFIC COAST HIGHWAY
LONG BEACH, CA 90804

Registered Dec. 20, 2011

Int. Cls.: 35 and 37

FOR: AUTOMOBILE DEALERSHIPS; DEALERSHIPS IN THE FIELD OF NEW AND USED AUTOMOBILES, IN CLASS 35 (U.S. CLS. 100, 101 AND 102).

SERVICE MARK

FIRST USE 9-30-2002; IN COMMERCE 9-30-2002.

PRINCIPAL REGISTER

FOR: AUTOMOBILE BODY REPAIR AND FINISHING FOR OTHERS; GARAGE SERVICES, NAMELY, REPAIR OF AUTOMOBILES; REPAIR OF AUTOMOBILES; REPAIR OR MAINTENANCE OF AUTOMOBILES, IN CLASS 37 (U.S. CLS. 100, 103 AND 106).

FIRST USE 9-30-2002; IN COMMERCE 9-30-2002.

THE MARK CONSISTS OF THE WORD "HOO MAN" IN A GOLD AND WHITE OVAL ON A BLACK BACKGROUND.

THE COLOR(S) BLACK, WHITE AND GOLD IS/ARE CLAIMED AS A FEATURE OF THE MARK.

SEC. 2(F).

SER. NO. 85-306,531, FILED 4-27-2011.

MARGERY A. TIERNEY, EXAMINING ATTORNEY



David J. Kybas

Director of the United States Patent and Trademark Office

United States of America

United States Patent and Trademark Office



mybloodtypedating
my type your type

Reg. No. 4,073,638

Registered Dec. 20, 2011

Int. Cl.: 45

SERVICE MARK

PRINCIPAL REGISTER

MYBLOODTYPEDATING.COM L.L.C. (FLORIDA LIMITED LIABILITY COMPANY)
#203
1520 WHITE HALL DRIVE
DAVIE, FL 33324

FOR: ONLINE DATING AND MATCH-MAKING SERVICES, IN CLASS 45 (U.S. CLS. 100 AND 101).

FIRST USE 1-12-2011; IN COMMERCE 2-4-2011.

THE MARK CONSISTS OF A HEART SHAPED BLOOD DROP WITH THE WORDING "MYBLOODTYPEDATING" OVER THE WORDING "MY TYPE YOUR TYPE" APPEARING OFF TO THE RIGHT OF THE DESIGN ELEMENT IN THE MARK.

SER. NO. 85-306,540, FILED 4-27-2011.

JACLYN KIDWELL WALKER, EXAMINING ATTORNEY



David J. Kyros

Director of the United States Patent and Trademark Office

United States of America
United States Patent and Trademark Office

HOOUMAN

Reg. No. 4,073,639

H.T.L. AUTOMOTIVE (CALIFORNIA CORPORATION)
4401 E. PACIFIC COAST HIGHWAY
LONG BEACH, CA 90804

Registered Dec. 20, 2011

Int. Cls.: 35 and 37

FOR: AUTOMOBILE DEALERSHIPS; DEALERSHIPS IN THE FIELD OF NEW AND USED AUTOMOBILES, IN CLASS 35 (U.S. CLS. 100, 101 AND 102).

SERVICE MARK

FIRST USE 9-30-2002; IN COMMERCE 9-30-2002.

PRINCIPAL REGISTER

FOR: AUTOMOBILE BODY REPAIR AND FINISHING FOR OTHERS; GARAGE SERVICES, NAMELY, REPAIR OF AUTOMOBILES; REPAIR OF AUTOMOBILES; REPAIR OR MAINTENANCE OF AUTOMOBILES, IN CLASS 37 (U.S. CLS. 100, 103 AND 106).

FIRST USE 9-30-2002; IN COMMERCE 9-30-2002.

THE MARK CONSISTS OF STANDARD CHARACTERS WITHOUT CLAIM TO ANY PARTICULAR FONT, STYLE, SIZE, OR COLOR.

SEC. 2(F).

SER. NO. 85-306,557, FILED 4-27-2011.

MARGERY A. TIERNEY, EXAMINING ATTORNEY



David J. Kybas

Director of the United States Patent and Trademark Office

United States of America

United States Patent and Trademark Office



Reg. No. 4,073,640

BETZ CELLARS LLC (WASHINGTON LIMITED LIABILITY COMPANY)
4930 E. PALOMINO ROAD
PHOENIX, AZ 85018

Registered Dec. 20, 2011

Int. Cl.: 33

FOR: WINES, IN CLASS 33 (U.S. CLS. 47 AND 49).

TRADEMARK

FIRST USE 4-0-2000; IN COMMERCE 4-0-2000.

PRINCIPAL REGISTER

THE MARK CONSISTS OF THE WORD "BETZ" IN STYLIZED FORM IN GOLD AND WHITE COLORS, OVER A BLUE BACKGROUND, SURROUNDED BY A RECTANGULAR BORDER COMPOSED OF A THIN SOLID GOLD LINE, A SMALL GAP WITH BLUE BACKGROUND, AND ANOTHER GENERALLY RECTANGULAR BORDER COMPOSED OF A GOLD FRINGE PATTERN AND BLUE AND GOLD LINES.

THE COLOR(S) WHITE, BLUE AND GOLD IS/ARE CLAIMED AS A FEATURE OF THE MARK.

SER. NO. 85-306,685, FILED 4-27-2011.

RAMONA ORTIGA, EXAMINING ATTORNEY



David J. Kybas

Director of the United States Patent and Trademark Office

United States of America

United States Patent and Trademark Office

SPIRIT DRIVES

Reg. No. 4,073,641

Registered Dec. 20, 2011

Int. Cl.: 9

TRADEMARK

PRINCIPAL REGISTER

MARKET QUEST GROUP, INC. (CALIFORNIA CORPORATION), DBA ALL-IN-ONE MFG.,
INC.
9600 KEARNY VILLA RD.
SAN DIEGO, CA 92126

FOR: COMPUTER STORAGE DEVICES, NAMELY, BLANK FLASH DRIVES, IN CLASS 9
(U.S. CLS. 21, 23, 26, 36 AND 38).

FIRST USE 4-21-2011; IN COMMERCE 4-21-2011.

THE MARK CONSISTS OF STANDARD CHARACTERS WITHOUT CLAIM TO ANY PAR-
TICULAR FONT, STYLE, SIZE, OR COLOR.

NO CLAIM IS MADE TO THE EXCLUSIVE RIGHT TO USE "DRIVES", APART FROM THE
MARK AS SHOWN.

SER. NO. 85-306,743, FILED 4-28-2011.

JOHN E. MICHOS, EXAMINING ATTORNEY



David J. Kyffers

Director of the United States Patent and Trademark Office

United States of America

United States Patent and Trademark Office



Reg. No. 4,073,642

HOMEINSURANCE.COM LLC (NORTH CAROLINA LIMITED LIABILITY COMPANY)
4829 CAROLINA BEACH RD
WILMINGTON, NC 28412

Registered Dec. 20, 2011

Int. Cl.: 36

FOR: INSURANCE AGENCIES IN THE FIELD OF HOMEOWNERS' INSURANCE; INSURANCE AGENCY AND BROKERAGE; INSURANCE BROKERAGE IN THE FIELD OF HOMEOWNERS' INSURANCE, IN CLASS 36 (U.S. CLS. 100, 101 AND 102).

SERVICE MARK

FIRST USE 2-0-2011; IN COMMERCE 2-0-2011.

PRINCIPAL REGISTER

OWNER OF U.S. REG. NO. 3,488,066.

THE COLOR(S) BLUE, WHITE, GREEN AND GRAY IS/ARE CLAIMED AS A FEATURE OF THE MARK.

NO CLAIM IS MADE TO THE EXCLUSIVE RIGHT TO USE "HOMEOWNERSINSURANCE.COM", APART FROM THE MARK AS SHOWN.

THE MARK CONSISTS OF THE IMAGE OF A HOUSE IN BLUE AND WHITE, WITH THE WORDING "HOMEOWNERSINSURANCE.COM" IN GREEN AND GRAY.

SER. NO. 85-306,747, FILED 4-28-2011.

JOHN E. MICHOS, EXAMINING ATTORNEY



David J. Kybas

Director of the United States Patent and Trademark Office

United States of America

United States Patent and Trademark Office

SNAP & BUY

Reg. No. 4,073,643

MADUBUIKE, CHIMAObI (UNITED STATES INDIVIDUAL)
P.O. BOX 1721
SIMPSONVILLE, SC 29681

Registered Dec. 20, 2011

Int. Cl.: 35

FOR: OPERATING ON-LINE MARKETPLACES FOR SELLERS OF GOODS AND/OR SERVICES, IN CLASS 35 (U.S. CLS. 100, 101 AND 102).

SERVICE MARK

FIRST USE 4-16-2011; IN COMMERCE 4-16-2011.

PRINCIPAL REGISTER

THE MARK CONSISTS OF STANDARD CHARACTERS WITHOUT CLAIM TO ANY PARTICULAR FONT, STYLE, SIZE, OR COLOR.

NO CLAIM IS MADE TO THE EXCLUSIVE RIGHT TO USE "BUY", APART FROM THE MARK AS SHOWN.

SER. NO. 85-306,767, FILED 4-28-2011.

ANDREW LEASER, EXAMINING ATTORNEY



David J. Kybas

Director of the United States Patent and Trademark Office

United States of America

United States Patent and Trademark Office

Sophisticated and elegant,
yet ridiculously fun!

Reg. No. 4,073,644

Registered Dec. 20, 2011

Int. Cl.: 41

SERVICE MARK

PRINCIPAL REGISTER

OLSON, SHELLI R (FLORIDA SOLE PROPRIETORSHIP), DBA GET THE PICTURE
SUITE L
2525 PASADENA AVE. S
SOUTH PASADENA, FL 33707

FOR: PHOTOGRAPHY SERVICES, NAMELY, RENTAL OF PORTABLE PHOTOGRAPHY
BOOTHES FOR TAKING OF PICTURES, IN CLASS 41 (U.S. CLS. 100, 101 AND 107).

FIRST USE 1-1-2010; IN COMMERCE 1-1-2010.

THE MARK CONSISTS OF STANDARD CHARACTERS WITHOUT CLAIM TO ANY PAR-
TICULAR FONT, STYLE, SIZE, OR COLOR.

SER. NO. 85-306,809, FILED 4-28-2011.

ANDREW LEASER, EXAMINING ATTORNEY



David J. Kybas

Director of the United States Patent and Trademark Office

United States of America

United States Patent and Trademark Office

SERENITY WRAP

Reg. No. 4,073,645

THE BEAUTYWRAP, INC. (FLORIDA CORPORATION)
2333 FEATHERSOUND DRIVE #B604
CLEARWATER, FL 33762

Registered Dec. 20, 2011

Int. Cl.: 44

FOR: COSMETIC BODY CARE SERVICES; COSMETIC BODY CARE SERVICES IN THE NATURE OF BODY WRAPS, IN CLASS 44 (U.S. CLS. 100 AND 101).

SERVICE MARK

FIRST USE 8-0-2009; IN COMMERCE 8-0-2009.

PRINCIPAL REGISTER

THE MARK CONSISTS OF STANDARD CHARACTERS WITHOUT CLAIM TO ANY PARTICULAR FONT, STYLE, SIZE, OR COLOR.

NO CLAIM IS MADE TO THE EXCLUSIVE RIGHT TO USE "WRAP", APART FROM THE MARK AS SHOWN.

SER. NO. 85-306,823, FILED 4-28-2011.

KAPIL BHANOT, EXAMINING ATTORNEY



David J. Kyffers

Director of the United States Patent and Trademark Office

United States of America

United States Patent and Trademark Office

como nuevo, cada día

Reg. No. 4,073,646

Registered Dec. 20, 2011

Int. Cl.: 43

SERVICE MARK

PRINCIPAL REGISTER

LA QUINTA WORLDWIDE, L.L.C. (DELAWARE LIMITED LIABILITY COMPANY)
SUITE 850 101 CONVENTION CENTER DRIVE
LAS VEGAS, NV 89109

FOR: HOTEL AND MOTEL SERVICES, IN CLASS 43 (U.S. CLS. 100 AND 101).

FIRST USE 4-21-2011; IN COMMERCE 4-21-2011.

THE MARK CONSISTS OF STANDARD CHARACTERS WITHOUT CLAIM TO ANY PARTICULAR FONT, STYLE, SIZE, OR COLOR.

THE ENGLISH TRANSLATION OF THE FOREIGN WORDING IN THE MARK IS "LIKE NEW, EVERY DAY".

SER. NO. 85-306,844, FILED 4-28-2011.

KAPIL BHANOT, EXAMINING ATTORNEY



David J. Kyffers

Director of the United States Patent and Trademark Office

United States of America

United States Patent and Trademark Office

VITALITY WRAP

Reg. No. 4,073,647

THE BEAUTYWRAP, INC. (FLORIDA CORPORATION)
2333 FEATHERSOUND DRIVE, #B604
CLEARWATER, FL 33762

Registered Dec. 20, 2011

Int. Cl.: 44

FOR: COSMETIC BODY CARE SERVICES; COSMETIC BODY CARE SERVICES IN THE NATURE OF BODY WRAPS, IN CLASS 44 (U.S. CLS. 100 AND 101).

SERVICE MARK

FIRST USE 8-0-2009; IN COMMERCE 8-0-2009.

PRINCIPAL REGISTER

THE MARK CONSISTS OF STANDARD CHARACTERS WITHOUT CLAIM TO ANY PARTICULAR FONT, STYLE, SIZE, OR COLOR.

NO CLAIM IS MADE TO THE EXCLUSIVE RIGHT TO USE "WRAP", APART FROM THE MARK AS SHOWN.

SER. NO. 85-306,867, FILED 4-28-2011.

KAPIL BHANOT, EXAMINING ATTORNEY



David J. Kyffers

Director of the United States Patent and Trademark Office

United States of America

United States Patent and Trademark Office

WILD TURKEY HAND MADE

Reg. No. 4,073,648

TURKEY CREEK TRADING COMPANY (MARYLAND CORPORATION)
15 AZAR CT

Registered Dec. 20, 2011

BALTIMORE, MD 21227

Int. Cl.: 8

FOR: HUNTING KNIVES AND POCKET KNIVES, IN CLASS 8 (U.S. CLS. 23, 28 AND 44).

TRADEMARK

FIRST USE 8-30-2000; IN COMMERCE 8-30-2000.

PRINCIPAL REGISTER

THE MARK CONSISTS OF STANDARD CHARACTERS WITHOUT CLAIM TO ANY PARTICULAR FONT, STYLE, SIZE, OR COLOR.

NO CLAIM IS MADE TO THE EXCLUSIVE RIGHT TO USE "HAND MADE", APART FROM THE MARK AS SHOWN.

SER. NO. 85-306,883, FILED 4-28-2011.

EDWARD NELSON, EXAMINING ATTORNEY



David J. Kybas

Director of the United States Patent and Trademark Office

United States of America

United States Patent and Trademark Office

INTEXTUAL

Reg. No. 4,073,649

AD.COM INTERACTIVE MEDIA, INC. (CALIFORNIA CORPORATION)
5027 ZELZAH AVE.
ENCINO, CA 91316

Registered Dec. 20, 2011

Int. Cl.: 35

FOR: INTERNET ADVERTISING AND MARKETING SERVICES, IN CLASS 35 (U.S. CLS. 100, 101 AND 102).

SERVICE MARK

FIRST USE 10-0-2010; IN COMMERCE 10-0-2010.

PRINCIPAL REGISTER

THE MARK CONSISTS OF STANDARD CHARACTERS WITHOUT CLAIM TO ANY PARTICULAR FONT, STYLE, SIZE, OR COLOR.

SER. NO. 85-306,905, FILED 4-28-2011.

DAVID TAYLOR, EXAMINING ATTORNEY



David J. Kybas

Director of the United States Patent and Trademark Office

United States of America

United States Patent and Trademark Office

Queens West Villager

Reg. No. 4,073,650

HOLLY KING EMMA (UNITED STATES INDIVIDUAL)
4-74 48TH AVENUE, SUITE 24J
LONG ISLAND CITY, NY 11109

Registered Dec. 20, 2011

Int. Cl.: 41

FOR: PROVIDING ON-LINE NON-DOWNLOADABLE NEWSPAPERS, IN CLASS 41 (U.S. CLS. 100, 101 AND 107).

SERVICE MARK

FIRST USE 3-1-2011; IN COMMERCE 3-1-2011.

PRINCIPAL REGISTER

THE MARK CONSISTS OF STANDARD CHARACTERS WITHOUT CLAIM TO ANY PARTICULAR FONT, STYLE, SIZE, OR COLOR.

NO CLAIM IS MADE TO THE EXCLUSIVE RIGHT TO USE "QUEENS WEST", APART FROM THE MARK AS SHOWN.

SER. NO. 85-306,934, FILED 4-28-2011.

ANGELA DUONG, EXAMINING ATTORNEY



David J. Kyffers

Director of the United States Patent and Trademark Office

United States of America

United States Patent and Trademark Office



Reg. No. 4,073,651

Registered Dec. 20, 2011

Int. Cl.: 43

SERVICE MARK

PRINCIPAL REGISTER

WINSTEAD ENTERPRISES HOLDING COMPANY, LLC (FLORIDA LIMITED LIABILITY COMPANY)
P.O. BOX 2350
WINTER PARK, FL 32790

FOR: CAFE AND RESTAURANT SERVICES; CATERING SERVICES, IN CLASS 43 (U.S. CLS. 100 AND 101).

FIRST USE 12-1-1998; IN COMMERCE 12-1-1998.

THE MARK CONSISTS OF A MAN WEARING A CHEF'S HAT WITH "B2" ON THE HAT AND CLOTHING WITH SANDALS ON HIS FEET, AND WITH BOTH OF HIS THUMBS UP; THE CLOTHING AND HAT APPEAR IN THE COLOR RED AND ARE OUTLINED IN BLACK; THE SKIN COLOR OF THE MAN IS BEIGE AND THE MAN'S EYES ARE WHITE WITH PUPILS THAT ARE BLACK WITH A GRAY SHADOW; THE MUSTACHE AND EYEBROWS APPEAR IN BLACK; THE INNER EAR IS GRAY; THE COLLAR OF THE SHIRT IS WHITE; THE SANDALS HAVE AN OLIVE GREEN STRAP; THE TOP OF THE SANDAL IS GRAY AND THE BOTTOM OF THE SOLE IS BLACK; THE B2 APPEARS IN BLACK AND IS OUTLINED IN WHITE; AND ALL ELEMENTS OF THE DRAWING, EXCEPT FOR THE SANDALS, ARE OUTLINED IN BLACK.

THE COLOR(S) RED, BEIGE, WHITE, OLIVE GREEN, GRAY AND BLACK IS/ARE CLAIMED AS A FEATURE OF THE MARK.

SER. NO. 85-306,985, FILED 4-28-2011.

BILL DAWE, EXAMINING ATTORNEY



David J. Kyffers

Director of the United States Patent and Trademark Office

United States of America

United States Patent and Trademark Office

LEADERSHIPGENOMIX

Reg. No. 4,073,652

HOSKINS, JOHN (UNITED STATES INDIVIDUAL)
10801 E. HAPPY VALLEY RD, LOT 64
SCOTTSDALE, AZ 85255 AND

Registered Dec. 20, 2011

Int. Cl.: 35

SHINEMAN, EDWARD (UNITED STATES INDIVIDUAL)
31 ATKINSON LANE
SUDBURY, MA 01776

SERVICE MARK

PRINCIPAL REGISTER

FOR: TESTING TO DETERMINE EMPLOYMENT SKILLS; EMPLOYMENT SKILLS ASSESSMENT TESTING AND COUNSELING; EMPLOYMENT AGENCY SERVICES, NAMELY, FILLING THE TEMPORARY AND PERMANENT STAFFING NEEDS OF BUSINESSES; EMPLOYMENT AGENCY SERVICES; EMPLOYMENT COUNSELING AND RECRUITING; EMPLOYMENT HIRING, RECRUITING, PLACEMENT, STAFFING AND CAREER NETWORKING SERVICES; EMPLOYMENT RECRUITING CONSULTATION; EMPLOYMENT STAFFING CONSULTATION SERVICES; PROVIDING EMPLOYMENT INFORMATION; PROVIDING ON-LINE INTERACTIVE EMPLOYMENT COUNSELING AND RECRUITMENT SERVICES, IN CLASS 35 (U.S. CLS. 100, 101 AND 102).

FIRST USE 4-27-2011; IN COMMERCE 4-27-2011.

THE MARK CONSISTS OF STANDARD CHARACTERS WITHOUT CLAIM TO ANY PARTICULAR FONT, STYLE, SIZE, OR COLOR.

OWNER OF U.S. REG. NO. 3,987,281.

SER. NO. 85-306,992, FILED 4-28-2011.

ELIZABETH HUGHITT, EXAMINING ATTORNEY



David J. Kybas

Director of the United States Patent and Trademark Office

United States of America

United States Patent and Trademark Office

TALENTGENOMIX

Reg. No. 4,073,653

HOSKINS, JOHN (UNITED STATES INDIVIDUAL)
10801 E. HAPPY VALLEY RD, LOT 64
SCOTTSDALE, AZ 85255 AND

Registered Dec. 20, 2011

Int. Cl.: 35

SHINEMAN, EDWARD (UNITED STATES INDIVIDUAL)
31 ATKINSON LANE
SUDBURY, MA 01776

SERVICE MARK

PRINCIPAL REGISTER

FOR: TESTING TO DETERMINE EMPLOYMENT SKILLS; EMPLOYMENT SKILLS ASSESSMENT TESTING AND COUNSELING; EMPLOYMENT AGENCY SERVICES, NAMELY, FILLING THE TEMPORARY AND PERMANENT STAFFING NEEDS OF BUSINESSES; EMPLOYMENT AGENCY SERVICES; EMPLOYMENT COUNSELING AND RECRUITING; EMPLOYMENT HIRING, RECRUITING, PLACEMENT, STAFFING AND CAREER NETWORKING SERVICES; EMPLOYMENT RECRUITING CONSULTATION; EMPLOYMENT STAFFING CONSULTATION SERVICES; PROVIDING EMPLOYMENT INFORMATION; PROVIDING ON-LINE INTERACTIVE EMPLOYMENT COUNSELING AND RECRUITMENT SERVICES, IN CLASS 35 (U.S. CLS. 100, 101 AND 102).

FIRST USE 4-27-2011; IN COMMERCE 4-27-2011.

THE MARK CONSISTS OF STANDARD CHARACTERS WITHOUT CLAIM TO ANY PARTICULAR FONT, STYLE, SIZE, OR COLOR.

OWNER OF U.S. REG. NO. 3,987,281.

SER. NO. 85-307,023, FILED 4-28-2011.

ELIZABETH HUGHITT, EXAMINING ATTORNEY



David J. Kybas

Director of the United States Patent and Trademark Office

United States of America

United States Patent and Trademark Office

SERVICEGENOMIX

Reg. No. 4,073,654

HOSKINS, JOHN (UNITED STATES INDIVIDUAL)
10801 E. HAPPY VALLEY RD, LOT 64
SCOTTSDALE, AZ 85255 AND

Registered Dec. 20, 2011

Int. Cl.: 35

SHINEMAN, EDWARD (UNITED STATES INDIVIDUAL)
31 ATKINSON LANE
SUDBURY, MA 01776

SERVICE MARK

PRINCIPAL REGISTER

FOR: TESTING TO DETERMINE EMPLOYMENT SKILLS; EMPLOYMENT SKILLS ASSESSMENT TESTING AND COUNSELING; EMPLOYMENT AGENCY SERVICES, NAMELY, FILLING THE TEMPORARY AND PERMANENT STAFFING NEEDS OF BUSINESSES; EMPLOYMENT AGENCY SERVICES; EMPLOYMENT COUNSELING AND RECRUITING; EMPLOYMENT HIRING, RECRUITING, PLACEMENT, STAFFING AND CAREER NETWORKING SERVICES; EMPLOYMENT RECRUITING CONSULTATION; EMPLOYMENT STAFFING CONSULTATION SERVICES; PROVIDING EMPLOYMENT INFORMATION; PROVIDING ON-LINE INTERACTIVE EMPLOYMENT COUNSELING AND RECRUITMENT SERVICES, IN CLASS 35 (U.S. CLS. 100, 101 AND 102).

FIRST USE 4-27-2011; IN COMMERCE 4-27-2011.

THE MARK CONSISTS OF STANDARD CHARACTERS WITHOUT CLAIM TO ANY PARTICULAR FONT, STYLE, SIZE, OR COLOR.

OWNER OF U.S. REG. NO. 3,987,281.

SER. NO. 85-307,029, FILED 4-28-2011.

ELIZABETH HUGHITT, EXAMINING ATTORNEY



David J. Kybas

Director of the United States Patent and Trademark Office

United States of America

United States Patent and Trademark Office

HEITS BUILDING SERVICES

Reg. No. 4,073,655

Registered Dec. 20, 2011

Int. Cl.: 37

SERVICE MARK

PRINCIPAL REGISTER

HEITS BUILDING SERVICES, INC. (NEW JERSEY CORPORATION)
777 TERRACE AVENUE, SUITE 3
HASBROUCK HEIGHTS, NJ 07604

FOR: CLEANING AND MAINTENANCE OF BUILDINGS, INCLUDING WALLS; CLEANING OF FLOORS; CLEANING OF HOUSES; CARPET CLEANING; REFUSE CLEAN-UP; WINDOW CLEANING; PAINTING, IN CLASS 37 (U.S. CLS. 100, 103 AND 106).

FIRST USE 10-6-2003; IN COMMERCE 10-6-2003.

THE MARK CONSISTS OF STANDARD CHARACTERS WITHOUT CLAIM TO ANY PARTICULAR FONT, STYLE, SIZE, OR COLOR.

OWNER OF U.S. REG. NOS. 2,905,038, 2,918,960, AND 3,526,830.

NO CLAIM IS MADE TO THE EXCLUSIVE RIGHT TO USE "BUILDING SERVICES", APART FROM THE MARK AS SHOWN.

SER. NO. 85-307,030, FILED 4-28-2011.

ELIZABETH HUGHITT, EXAMINING ATTORNEY



David J. Kypos

Director of the United States Patent and Trademark Office

United States of America
United States Patent and Trademark Office

PANALOG

Reg. No. 4,073,656

LEFFINGWELL, MARIE (UNITED STATES INDIVIDUAL), DBA PANALOG
407 HILLSIDE DRIVE

Registered Dec. 20, 2011

ROUND ROCK, TX 78681

Int. Cl.: 9

FOR: COMPUTER SOFTWARE SPECIFICALLY FOR GATHERING PHONE CALL INFORMATION FOR BUSINESS OFFICES AND PROVIDING BUSINESS OWNERS WITH REPORTS AND GRAPHS ABOUT PHONE CALL ACTIVITY, IN CLASS 9 (U.S. CLS. 21, 23, 26, 36 AND 38).

TRADEMARK

PRINCIPAL REGISTER

FIRST USE 1-1-2000; IN COMMERCE 1-31-2002.

THE MARK CONSISTS OF STANDARD CHARACTERS WITHOUT CLAIM TO ANY PARTICULAR FONT, STYLE, SIZE, OR COLOR.

THE WORDING "PANALOG" HAS NO MEANING IN A FOREIGN LANGUAGE.

SER. NO. 85-307,089, FILED 4-28-2011.

BILL DAWE, EXAMINING ATTORNEY



David J. Kybas

Director of the United States Patent and Trademark Office

United States of America

United States Patent and Trademark Office

FAMILY TREE AND TURF CARE

Reg. No. 4,073,657

DRONE, TERENCE (UNITED STATES INDIVIDUAL)
6 RALEIGH RD

Registered Dec. 20, 2011

KENDALL PARK, NJ 08824

Int. Cl.: 44

FOR: LAWN AND TREE CARE SERVICES, IN CLASS 44 (U.S. CLS. 100 AND 101).

SERVICE MARK

FIRST USE 8-1-2010; IN COMMERCE 9-1-2010.

PRINCIPAL REGISTER

THE MARK CONSISTS OF STANDARD CHARACTERS WITHOUT CLAIM TO ANY PARTICULAR FONT, STYLE, SIZE, OR COLOR.

NO CLAIM IS MADE TO THE EXCLUSIVE RIGHT TO USE "AND TURF CARE", APART FROM THE MARK AS SHOWN.

SER. NO. 85-307,167, FILED 4-28-2011.

ZHALEH DELANEY, EXAMINING ATTORNEY



David J. Kyffers

Director of the United States Patent and Trademark Office

United States of America

United States Patent and Trademark Office



Reg. No. 4,073,658

HEATHER LAWTON (UNITED STATES INDIVIDUAL)
20 WEST ST. 5C
NEW YORK, NY 10004

Registered Dec. 20, 2011

Int. Cl.: 25

FOR: CLOTHING, NAMELY, TOPS, DRESSES, BLOUSES, SHIRTS, PANTS, JACKETS, SHOES, HATS, CAPS, IN CLASS 25 (U.S. CLS. 22 AND 39).

TRADEMARK

FIRST USE 3-15-2011; IN COMMERCE 3-15-2011.

PRINCIPAL REGISTER

THE NAME "HEATHER LAWTON" IDENTIFIES A LIVING INDIVIDUAL WHOSE CONSENT IS OF RECORD.

THE MARK CONSISTS OF A STYLIZED VERSION OF THE MARK WITH THE NAME "HEATHER LAWTON". IN BETWEEN THE FIRST AND LAST NAME IS A STYLIZED "H","L".

SER. NO. 85-307,245, FILED 4-28-2011.

WON TEAK OH, EXAMINING ATTORNEY



David J. Kybas

Director of the United States Patent and Trademark Office

United States of America

United States Patent and Trademark Office

WillowTree Apps

Reg. No. 4,073,659

Registered Dec. 20, 2011

Int. Cl.: 42

SERVICE MARK

PRINCIPAL REGISTER

WILLOWTREE APPS, INC. (VIRGINIA CORPORATION), FORMERLY WILLOWTREE CONSULTING GROUP, INC.
107 5TH ST. SE, STE. B
CHARLOTTESVILLE, VA 22902

FOR: COMPUTER PROGRAMMING SERVICES, NAMELY, DESIGN AND DEVELOPMENT OF COMPUTER SOFTWARE AND MOBILE APPLICATIONS, IN CLASS 42 (U.S. CLS. 100 AND 101).

FIRST USE 3-8-2010; IN COMMERCE 3-8-2010.

THE MARK CONSISTS OF STANDARD CHARACTERS WITHOUT CLAIM TO ANY PARTICULAR FONT, STYLE, SIZE, OR COLOR.

NO CLAIM IS MADE TO THE EXCLUSIVE RIGHT TO USE "APPS", APART FROM THE MARK AS SHOWN.

SER. NO. 85-307,288, FILED 4-28-2011.

WON TEAK OH, EXAMINING ATTORNEY



David J. Kyffers

Director of the United States Patent and Trademark Office

United States of America

United States Patent and Trademark Office

FASPLINT FULLBODY

Reg. No. 4,073,660

HARTWELL MEDICAL CORP. (CALIFORNIA CORPORATION)
6354 CORTE DEL ABETO, SUITE F
CARLSBAD, CA 92011

Registered Dec. 20, 2011

Int. Cl.: 10

FOR: SPLINTS; SPLINTS FOR IMMOBILIZING BODY PARTS, IN CLASS 10 (U.S. CLS. 26, 39 AND 44).

TRADEMARK

FIRST USE 4-14-2011; IN COMMERCE 4-14-2011.

PRINCIPAL REGISTER

THE MARK CONSISTS OF STANDARD CHARACTERS WITHOUT CLAIM TO ANY PARTICULAR FONT, STYLE, SIZE, OR COLOR.

OWNER OF U.S. REG. NO. 3,536,979.

NO CLAIM IS MADE TO THE EXCLUSIVE RIGHT TO USE "FULL BODY", APART FROM THE MARK AS SHOWN.

SER. NO. 85-307,290, FILED 4-28-2011.

WON TEAK OH, EXAMINING ATTORNEY



David J. Kyffers

Director of the United States Patent and Trademark Office

United States of America

United States Patent and Trademark Office

MIDCOUNTRY

Reg. No. 4,073,661

Registered Dec. 20, 2011

Int. Cl.: 36

SERVICE MARK

PRINCIPAL REGISTER

MIDCOUNTRY FINANCIAL CORP. (GEORGIA CORPORATION)
201 SECOND STREET, SUITE 950
MACON, GA 31201

FOR: BANKING SERVICES; EQUIPMENT FINANCING SERVICES; FINANCIAL INVESTMENT BROKERAGE SERVICES; FINANCIAL PLANNING AND INVESTMENT ADVISORY SERVICES; FINANCIAL PORTFOLIO MANAGEMENT; FINANCIAL VALUATION OF PERSONAL PROPERTY AND REAL ESTATE; INSURANCE BROKERAGE SERVICES; INVESTMENT BANKING SERVICES; MORTGAGE BANKING; MORTGAGE LENDING, IN CLASS 36 (U.S. CLS. 100, 101 AND 102).

FIRST USE 0-0-2004; IN COMMERCE 0-0-2004.

OWNER OF U.S. REG. NOS. 2,919,723, 3,018,389, AND 3,303,310.

THE COLOR(S) GREEN IS/ARE CLAIMED AS A FEATURE OF THE MARK.

THE MARK CONSISTS OF THE STYLIZED WORD "MIDCOUNTRY" WITH A LINE UNDERNEATH IT ALL IN THE COLOR GREEN.

SER. NO. 85-307,325, FILED 4-28-2011.

PATRICIA EVANKO, EXAMINING ATTORNEY



David J. Kybas

Director of the United States Patent and Trademark Office

United States of America

United States Patent and Trademark Office

DCG SYSTEMS

Reg. No. 4,073,662

Registered Dec. 20, 2011

Int. Cl.: 9

TRADEMARK

PRINCIPAL REGISTER

DCG SYSTEMS, INC. (DELAWARE CORPORATION)
45900 NORTHPORT LOOP EAST
FREMONT, CA 94538

FOR: CAPITAL EQUIPMENT FOR THE SEMICONDUCTOR MANUFACTURING INDUSTRY, NAMELY, INSPECTION, TEST AND DEBUG, AND CIRCUIT ALTERATION APPARATUS WHICH MEASURES PERFORMANCE CHARACTERISTICS OF SEMICONDUCTOR CIRCUITS, NAMELY, THE EMISSION OF LIGHT FROM TRANSISTORS, THE MODULATION OF LIGHT BY TRANSISTORS, THE INJECTION OF LIGHT INTO TRANSISTORS AND CIRCUITRY, THE CONTACT NANO-PROBING OF TRANSISTORS AND CIRCUITRY, THE MILLING OF CHIPS AND ALTERATION OF CIRCUITS, NAMELY, CREATING SHORTS AND BREAKS, FOR USE IN THE DESIGN AND MANUFACTURING OF SEMICONDUCTOR INTEGRATED CIRCUITS, IN CLASS 9 (U.S. CLS. 21, 23, 26, 36 AND 38).

FIRST USE 4-16-2008; IN COMMERCE 4-16-2008.

THE MARK CONSISTS OF STANDARD CHARACTERS WITHOUT CLAIM TO ANY PARTICULAR FONT, STYLE, SIZE, OR COLOR.

NO CLAIM IS MADE TO THE EXCLUSIVE RIGHT TO USE "SYSTEMS", APART FROM THE MARK AS SHOWN.

SER. NO. 85-307,328, FILED 4-28-2011.

ELLEN BURNS, EXAMINING ATTORNEY



David J. Kybas

Director of the United States Patent and Trademark Office

United States of America

United States Patent and Trademark Office

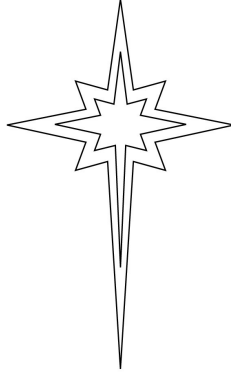

Reg. No. 4,073,663

Registered Dec. 20, 2011

Int. Cls.: 41, 42 and 44

SERVICE MARK

PRINCIPAL REGISTER

SAINT LUKE'S HOSPITAL OF BETHLEHEM, PENNSYLVANIA (PENNSYLVANIA CORPORATION)
801 OSTRUM STREET
BETHLEHEM, PA 18104

FOR: EDUCATIONAL SERVICES, NAMELY, MEDICAL RESIDENCY PROGRAMS AND NURSING SCHOOLS; AND PROVIDING FITNESS AND EXERCISING FACILITIES , IN CLASS 41 (U.S. CLS. 100, 101 AND 107).

FIRST USE 1-1-1946; IN COMMERCE 1-1-1946.

FOR: MEDICAL RESEARCH, NAMELY, CONDUCTING CLINICAL TRIALS, IN CLASS 42 (U.S. CLS. 100 AND 101).

FIRST USE 1-1-1946; IN COMMERCE 1-1-1946.

FOR: HEALTHCARE SERVICES, NAMELY, CARDIAC SURGERY SERVICES, ONCOLOGY SERVICES, RADIOLOGY SERVICES, NEUROSCIENCES SERVICES, TRAUMA AND EMERGENCY MEDICINE SERVICES, WOMEN'S AND CHILDREN'S MEDICAL SERVICES, ORTHOPEDIC SERVICES, MEDICAL CLINICS, HOSPITALS, MEDICAL SERVICES, MEDICAL IMAGING SERVICES, MEDICAL TESTING SERVICES, NURSING CARE, NURSING HOMES, EMERGENCY MEDICAL ASSISTANCE, AMBULATORY SURGERY CENTERS, HEALTH MAINTENANCE ORGANIZATIONS, HOME HEALTHCARE SERVICES, HOSPICES, MANAGED HEALTHCARE SERVICES, MEDICAL COUNSELING, PHYSICAL REHABILITATION, PHYSICAL THERAPY, OCCUPATIONAL THERAPY, PHYSICIAN SERVICES, PSYCHIATRIC CONSULTATION, AND COSMETIC BODY CARE SERVICES, IN CLASS 44 (U.S. CLS. 100 AND 101).

FIRST USE 1-1-1946; IN COMMERCE 1-1-1946.

THE MARK CONSISTS OF AN EIGHT-POINTED STAR WITH AN ELONGATED BOTTOM POINT WITHIN A CORRESPONDING LARGER EIGHT-POINTED STAR.

SER. NO. 85-307,344, FILED 4-28-2011.

BENJAMIN OKEKE, EXAMINING ATTORNEY



David J. Kyffers

Director of the United States Patent and Trademark Office

United States of America

United States Patent and Trademark Office

spalab

Reg. No. 4,073,664

COSTA LAWRENCE (UNITED STATES INDIVIDUAL)
40 WEST 36TH ST
NEW YORK, NY 10018

Registered Dec. 20, 2011

Int. Cl.: 3

FOR: COSMETIC PREPARATIONS FOR SKIN CARE, IN CLASS 3 (U.S. CLS. 1, 4, 6, 50, 51 AND 52).

TRADEMARK

FIRST USE 4-1-2010; IN COMMERCE 4-1-2010.

PRINCIPAL REGISTER

THE MARK CONSISTS OF STANDARD CHARACTERS WITHOUT CLAIM TO ANY PARTICULAR FONT, STYLE, SIZE, OR COLOR.

OWNER OF U.S. REG. NO. 3,992,548.

SER. NO. 85-307,499, FILED 4-28-2011.

JULIE VEPPUMTHARA, EXAMINING ATTORNEY



David J. Kyffers

Director of the United States Patent and Trademark Office

United States of America

United States Patent and Trademark Office



Reg. No. 4,073,665

Registered Dec. 20, 2011

Int. Cl.: 38

SERVICE MARK

PRINCIPAL REGISTER

SCHICKSA CHICK LIMITED (UNITED KINGDOM LIMITED COMPANY)
800 FIFTH AVENUE, SUITE 202
NEW YORK, NY 10021

FOR: THE PROVIDING OF ONLINE FORUMS FOR TRANSMISSION OF MESSAGES AMONG COMPUTER USERS; TELECOMMUNICATION SERVICES, NAMELY, PROVIDING INTERNET ACCESS VIA BROADBAND OPTICAL OR WIRELESS NETWORKS, WIRELESS SERVICES, PROVIDING E-MAIL AND INSTANT MESSAGING SERVICES, PROVISION OF TELEPHONE, PERSONAL, SATELLITE AND ELECTRONIC COMMUNICATION SERVICES FOR OTHERS; PROVIDING ON-LINE CHAT ROOMS FOR TRANSMISSION OF MESSAGES AMONG COMPUTER USERS CONCERNING NEWS, SPORTS, SOCIAL AFFAIRS AND ENTERTAINMENT, IN CLASS 38 (U.S. CLS. 100, 101 AND 104).

FIRST USE 1-1-2009; IN COMMERCE 1-1-2009.

THE MARK CONSISTS OF THE STYLIZED WORDING AND INITIALS "SC SCHICKSACHICK" AND GENDER SYMBOL FOR FEMALE, WITH THE LETTER "S" IN THE INITIALS "SC" APPEARING IN DARK PINK, WITH THE LETTER "C" IN THE INITIALS "SC" COMBINED INTO AN IMAGE OF THE GENDER SYMBOL FOR FEMALE, APPEARING HALF IN DARK PINK, HALF IN LIGHT PINK, AND WITH THE WORDS "SCHICKSACHICK" APPEARING IN GRAY TO THE RIGHT OF THE INITIALS AND SYMBOL.

THE COLOR(S) PINK, LIGHT PINK AND GREY IS/ARE CLAIMED AS A FEATURE OF THE MARK.

THE ENGLISH TRANSLATION OF "SCHICKSA" IN THE MARK IS "NON-JEWISH FEMALE".

SER. NO. 85-307,510, FILED 4-28-2011.

JERI J. FICKES, EXAMINING ATTORNEY



David J. Kybas

Director of the United States Patent and Trademark Office

United States of America

United States Patent and Trademark Office

King Lion



Reg. No. 4,073,666

Registered Dec. 20, 2011

Int. Cls.: 29 and 30

TRADEMARK

PRINCIPAL REGISTER

AMERICAN KEY FOOD PRODUCTS, LLC (NEW JERSEY LIMITED LIABILITY COMPANY)
ONE REUTEN DRIVE
CLOSTER, NJ 07624

FOR: FOOD ADDITIVES AND BAKING INGREDIENTS, NAMELY, PROCESSED NUTS, FRUIT-BASED FILLINGS FOR CAKES AND PIES, AND PROCESSED EDIBLE SEEDS, IN CLASS 29 (U.S. CL. 46).

FIRST USE 1-1-2002; IN COMMERCE 1-1-2002.

FOR: FOOD ADDITIVES AND BAKING INGREDIENTS, NAMELY, FOOD STARCHES, SEASONINGS, SPICES, CONFECTIONERY CHIPS, SALTS, PEPPERS, CHOCOLATE-BASED FILLINGS FOR CAKES AND PIES, CUSTARD-BASED FILLINGS FOR CAKES AND PIES, ICINGS AND GLAZES, IN CLASS 30 (U.S. CL. 46).

FIRST USE 1-1-2002; IN COMMERCE 1-1-2002.

OWNER OF U.S. REG. NO. 2,941,097.

THE MARK CONSISTS OF THE STYLIZED WORDS "KING LION" APPEARING IN A LINE OVER THE STYLIZED HEAD OF A LION.

SER. NO. 85-307,515, FILED 4-28-2011.

JERI J. FICKES, EXAMINING ATTORNEY



David J. Kybas

Director of the United States Patent and Trademark Office

United States of America

United States Patent and Trademark Office



Reg. No. 4,073,667

CHRETIEN, EDWARD (UNITED STATES INDIVIDUAL)
94 HOLMES RD
PITTSFIELD, MA 01201

Registered Dec. 20, 2011

Int. Cl.: 41

FOR: PROVIDING A WEB-BASED SYSTEM AND ON-LINE PORTAL FOR CUSTOMERS TO PARTICIPATE IN ON-LINE GAMING, OPERATION AND COORDINATION OF GAME TOURNAMENTS, LEAGUES AND TOURS , IN CLASS 41 (U.S. CLS. 100, 101 AND 107).

SERVICE MARK

FIRST USE 1-1-2003; IN COMMERCE 1-1-2003.

PRINCIPAL REGISTER

NO CLAIM IS MADE TO THE EXCLUSIVE RIGHT TO USE "CLAN" AND "US", APART FROM THE MARK AS SHOWN.

THE MARK CONSISTS OF 2 CIRCLES AROUND A 8 POINT STAR WITH 8 HALF POINTS. AROUND THERE IS THE STYLIZED TEXT "CLAN US EAST".

SER. NO. 85-307,543, FILED 4-28-2011.

MARGARET POWER, EXAMINING ATTORNEY



David J. Kybas

Director of the United States Patent and Trademark Office

United States of America

United States Patent and Trademark Office

PENNAKEM

Reg. No. 4,073,668

PENN A KEM, LLC (DELAWARE LIMITED LIABILITY COMPANY)
3324 CHELSEA AVENUE
MEMPHIS, TN 38108

Registered Dec. 20, 2011

Int. Cl.: 40

FOR: CUSTOM MANUFACTURE OF CHEMICALS AND PHARMACEUTICALS FOR OTHERS,
IN CLASS 40 (U.S. CLS. 100, 103 AND 106).

SERVICE MARK

FIRST USE 4-15-2011; IN COMMERCE 4-15-2011.

PRINCIPAL REGISTER

OWNER OF U.S. REG. NOS. 3,660,320, 3,660,337 AND OTHERS.

THE MARK CONSISTS OF THE LETTERS "P", "E", "N", "N" AND "K", "E", "M" IN A SHADED
STYLIZED FONT AND THE LETTER "A" IN A STYLIZED FONT WITH A FADING SHADOW
BENEATH EACH LETTER.

SER. NO. 85-307,620, FILED 4-28-2011.

STEVEN JACKSON, EXAMINING ATTORNEY



David J. Kyffers

Director of the United States Patent and Trademark Office

United States of America

United States Patent and Trademark Office

DCG

* Systems

Reg. No. 4,073,669

Registered Dec. 20, 2011

Int. Cl.: 9

TRADEMARK

PRINCIPAL REGISTER

DCG SYSTEMS, INC. (DELAWARE CORPORATION)
45900 NORTHPORT LOOP EAST
FREEMONT, CA 94538

FOR: CAPITAL EQUIPMENT FOR THE SEMICONDUCTOR MANUFACTURING INDUSTRY, NAMELY, INSPECTION, TEST AND DEBUG, AND CIRCUIT ALTERATION APPARATUS WHICH MEASURES PERFORMANCE CHARACTERISTICS OF SEMICONDUCTOR CIRCUITS, NAMELY, THE EMISSION OF LIGHT FROM TRANSISTORS, THE MODULATION OF LIGHT BY TRANSISTORS, THE INJECTION OF LIGHT INTO TRANSISTORS AND CIRCUITRY, THE CONTACT NANO-PROBING OF TRANSISTORS AND CIRCUITRY, THE MILLING OF CHIPS AND ALTERATION OF CIRCUITS, NAMELY, CREATING SHORTS AND BREAKS, FOR USE IN THE DESIGN AND MANUFACTURING OF SEMICONDUCTOR INTEGRATED CIRCUITS, IN CLASS 9 (U.S. CLS. 21, 23, 26, 36 AND 38).

FIRST USE 4-16-2008; IN COMMERCE 4-16-2008.

NO CLAIM IS MADE TO THE EXCLUSIVE RIGHT TO USE "SYSTEMS", APART FROM THE MARK AS SHOWN.

THE MARK CONSISTS OF THE LETTERS "DCG" ON THE TOP LINE AND THE WORD "SYSTEMS" BELOW "DCG" AND A STARBURST DESIGN UNDER THE "D" AT THE BEGINNING OF "SYSTEMS" WITH A CURVED LINE OVER THE "S" IN "SYSTEMS" AND A STRAIGHT LINE UNDER "STEMS" IN "SYSTEMS".

SER. NO. 85-307,671, FILED 4-28-2011.

ELLEN BURNS, EXAMINING ATTORNEY



David J. Kyros

Director of the United States Patent and Trademark Office

United States of America

United States Patent and Trademark Office

Berry Quick Snacks

Reg. No. 4,073,670

MUNGER BROS., LLC (CALIFORNIA CORPORATION)
2619 ROAD 192
DELANO, CA 93215

Registered Dec. 20, 2011

Int. Cl.: 31

FOR: FRESH FRUIT; FRESH FRUITS; FRUITS, NAMELY, FRESH BLUEBERRIES AND FRESH STRAWBERRIES; RAW FRUITS, IN CLASS 31 (U.S. CLS. 1 AND 46).

TRADEMARK

FIRST USE 6-30-2009; IN COMMERCE 4-15-2011.

PRINCIPAL REGISTER

THE MARK CONSISTS OF STANDARD CHARACTERS WITHOUT CLAIM TO ANY PARTICULAR FONT, STYLE, SIZE, OR COLOR.

NO CLAIM IS MADE TO THE EXCLUSIVE RIGHT TO USE "SNACKS", APART FROM THE MARK AS SHOWN.

SER. NO. 85-307,713, FILED 4-28-2011.

MIDGE BUTLER, EXAMINING ATTORNEY



David J. Kybas

Director of the United States Patent and Trademark Office

United States of America

United States Patent and Trademark Office

MEMBERPLUS

Reg. No. 4,073,671

TRUHEARING, INC. (UTAH CORPORATION)
9071 SOUTH 1300 WEST
WEST JORDAN, UT 84088

Registered Dec. 20, 2011

Int. Cl.: 44

FOR: HEARING AID SERVICES, IN CLASS 44 (U.S. CLS. 100 AND 101).

SERVICE MARK

FIRST USE 4-26-2011; IN COMMERCE 4-26-2011.

PRINCIPAL REGISTER

THE MARK CONSISTS OF STANDARD CHARACTERS WITHOUT CLAIM TO ANY PARTICULAR FONT, STYLE, SIZE, OR COLOR.

SER. NO. 85-307,773, FILED 4-28-2011.

KATHERINE CONNOLLY, EXAMINING ATTORNEY



David J. Kybas

Director of the United States Patent and Trademark Office

United States of America

United States Patent and Trademark Office

TECHMENTO

Reg. No. 4,073,672

CENTIAL MEDIA LLC (TEXAS LIMITED LIABILITY COMPANY)
1846 E ROSEMEADE PKWY, SUITE 200
CARROLLTON, TX 75007

Registered Dec. 20, 2011

Int. Cls.: 35, 41 and 42

FOR: ADVERTISING AND MARKETING SERVICES PROVIDED BY MEANS OF INDIRECT METHODS OF MARKETING COMMUNICATIONS, NAMELY, SOCIAL MEDIA, SEARCH ENGINE MARKETING, INQUIRY MARKETING, INTERNET MARKETING, MOBILE MARKETING, BLOGGING AND OTHER FORMS OF PASSIVE, SHARABLE OR VIRAL COMMUNICATIONS CHANNELS; PROVIDING ADVERTISING SERVICE TO DISTRIBUTE ADVERTISEMENTS FOR DISPLAY ON INTERNET, NAMELY, IN WEBSITES, SOCIAL CONVERSATIONS OVER THE INTERNET, E-MAILS, MICROBLOGS, BLOGS, ELECTRONIC MESSAGES, INSTANT MESSAGES, TEXT MESSAGES, MULTIMEDIA MESSAGES, SOCIAL NETWORKS, STATUS UPDATES, FORUMS, ELECTRONIC BULLETIN BOARDS, IN CLASS 35 (U.S. CLS. 100, 101 AND 102).

SERVICE MARK

PRINCIPAL REGISTER

FIRST USE 1-1-2011; IN COMMERCE 1-1-2011.

FOR: ON-LINE JOURNALS, NAMELY, BLOGS FEATURING TECHNOLOGY; PROVIDING A WEBSITE FEATURING BLOGS AND NON-DOWNLOADABLE PUBLICATIONS IN THE NATURE OF BOOKS, MAGAZINES AND BROCHURES IN THE FIELD OF TECHNOLOGY, IN CLASS 41 (U.S. CLS. 100, 101 AND 107).

FIRST USE 1-1-2011; IN COMMERCE 1-1-2011.

FOR: CREATING AND MAINTAINING BLOGS FOR OTHERS; PROVIDING CUSTOMIZED ON-LINE WEB PAGES AND DATA FEEDS FEATURING USER-DEFINED INFORMATION, WHICH INCLUDES BLOG POSTS, NEW MEDIA CONTENT, OTHER ON-LINE CONTENT, AND ON-LINE WEB LINKS TO OTHER WEBSITES, IN CLASS 42 (U.S. CLS. 100 AND 101).

FIRST USE 1-1-2011; IN COMMERCE 1-19-2011.

THE MARK CONSISTS OF STANDARD CHARACTERS WITHOUT CLAIM TO ANY PARTICULAR FONT, STYLE, SIZE, OR COLOR.

SER. NO. 85-307,862, FILED 4-28-2011.

BARBARA RUTLAND, EXAMINING ATTORNEY



David J. Kyffers

Director of the United States Patent and Trademark Office

United States of America

United States Patent and Trademark Office



Reg. No. 4,073,673

MUNGER BROS., LLC (CALIFORNIA CORPORATION)
2619 ROAD 192
DELANO, CA 93215

Registered Dec. 20, 2011

Int. Cl.: 31

FOR: FRESH FRUIT; FRESH FRUITS; FRUITS, NAMELY, FRESH BLUEBERRIES AND FRESH STRAWBERRIES; RAW FRUITS, IN CLASS 31 (U.S. CLS. 1 AND 46).

TRADEMARK

FIRST USE 6-30-2009; IN COMMERCE 4-15-2011.

PRINCIPAL REGISTER

NO CLAIM IS MADE TO THE EXCLUSIVE RIGHT TO USE "SNACKS", APART FROM THE MARK AS SHOWN.

THE COLOR(S) BLACK, WHITE, PURPLE AND RED IS/ARE CLAIMED AS A FEATURE OF THE MARK.

THE MARK CONSISTS OF THE WORDS "BERRYQUICK" IN AN ARCHED BUBBLE FONT, WITH WHITE LETTERS, WHICH HAVE A BLACK OUTLINE, WHICH IS FURTHER SURROUNDED BY A PURPLE BACKGROUND AND ANOTHER BLACK OUTLINE. THE "Q" IN "QUICK" HAS A SWEATING BLUEBERRY IN THE PLACE OF THE "Q" HOLE; AND THE WORD "SNACKS" IS IMMEDIATELY UNDER THE LETTERS "UICK" FROM "QUICK", WITH WHITE LETTERS, WHICH HAVE A BLACK OUTLINE, FURTHER SURROUNDED BY A RED BACKGROUND, WHICH HAS ANOTHER BLACK OUTLINE.

SER. NO. 85-307,891, FILED 4-28-2011.

MIDGE BUTLER, EXAMINING ATTORNEY



David J. Kybas

Director of the United States Patent and Trademark Office

United States of America

United States Patent and Trademark Office

PPURE NAGCHAMPA

Reg. No. 4,073,674

BIG BAZAAR (CALIFORNIA SOLE PROPRIETORSHIP)
560 S. LOS ANGELES STREET, SUITE 80
LOS ANGELES, CA 90013

Registered Dec. 20, 2011

Int. Cl.: 3

FOR: NAG CHAMPA INCENSE AND INCENSE STICKS, IN CLASS 3 (U.S. CLS. 1, 4, 6, 50, 51 AND 52).

TRADEMARK

FIRST USE 7-15-2010; IN COMMERCE 7-15-2010.

PRINCIPAL REGISTER

THE MARK CONSISTS OF STANDARD CHARACTERS WITHOUT CLAIM TO ANY PARTICULAR FONT, STYLE, SIZE, OR COLOR.

NO CLAIM IS MADE TO THE EXCLUSIVE RIGHT TO USE "NAG CHAMPA", APART FROM THE MARK AS SHOWN.

SER. NO. 85-307,914, FILED 4-28-2011.

PAUL E. FAHRENKOPF, EXAMINING ATTORNEY



David J. Kyffers

Director of the United States Patent and Trademark Office

United States of America

United States Patent and Trademark Office

MAILBOX MANDEVILLA

Reg. No. 4,073,675

Registered Dec. 20, 2011

Int. Cl.: 31

TRADEMARK

PRINCIPAL REGISTER

COSTA FARMS, LLC (FLORIDA LIMITED LIABILITY COMPANY)
22290 SW 162ND AVENUE
GOULDS, FL 33170

FOR: LIVE FLOWERS AND LIVING PLANTS, IN CLASS 31 (U.S. CLS. 1 AND 46).

FIRST USE 3-11-2011; IN COMMERCE 3-11-2011.

THE MARK CONSISTS OF STANDARD CHARACTERS WITHOUT CLAIM TO ANY PARTICULAR FONT, STYLE, SIZE, OR COLOR.

NO CLAIM IS MADE TO THE EXCLUSIVE RIGHT TO USE "MANDEVILLA", APART FROM THE MARK AS SHOWN.

SER. NO. 85-307,921, FILED 4-28-2011.

INGA ERVIN, EXAMINING ATTORNEY



David J. Kyffers

Director of the United States Patent and Trademark Office

United States of America

United States Patent and Trademark Office

VIRTRA SYSTEMS

Reg. No. 4,073,676

Registered Dec. 20, 2011

Int. Cl.: 9

TRADEMARK

PRINCIPAL REGISTER

VIRTRA SYSTEMS, INC. (TEXAS CORPORATION)
7970 S. KYRENE ROAD
TEMPE, AZ 85284

FOR: FIREARM TRAINING SIMULATORS, NAMELY, INTERACTIVE VIDEOS OF FIREARM SHOOTING COMPRISING COMPUTER HARDWARE, COMPUTER GAME SOFTWARE, AND PROJECTION SCREENS, IN CLASS 9 (U.S. CLS. 21, 23, 26, 36 AND 38).

FIRST USE 9-27-2002; IN COMMERCE 1-1-2004.

THE MARK CONSISTS OF STANDARD CHARACTERS WITHOUT CLAIM TO ANY PARTICULAR FONT, STYLE, SIZE, OR COLOR.

NO CLAIM IS MADE TO THE EXCLUSIVE RIGHT TO USE "SYSTEMS", APART FROM THE MARK AS SHOWN.

SER. NO. 85-307,926, FILED 4-29-2011.

APRIL HESIK, EXAMINING ATTORNEY



David J. Kyffers

Director of the United States Patent and Trademark Office

United States of America

United States Patent and Trademark Office

WORKSMART MD

Reg. No. 4,073,677

Registered Dec. 20, 2011

Int. Cl.: 35

SERVICE MARK

PRINCIPAL REGISTER

WORKSMART MD, INC. (FLORIDA CORPORATION)
SUITE 230
1540 CORNERSTONE BOULEVARD
DAYTONA BEACH, FL 32117

FOR: MEDICAL BILLING SUPPORT SERVICES; BUSINESS MANAGEMENT AND OPERATION ASSISTANCE TO MEDICAL PRACTICES, IN CLASS 35 (U.S. CLS. 100, 101 AND 102).

FIRST USE 6-1-2000; IN COMMERCE 6-1-2000.

THE MARK CONSISTS OF STANDARD CHARACTERS WITHOUT CLAIM TO ANY PARTICULAR FONT, STYLE, SIZE, OR COLOR.

NO CLAIM IS MADE TO THE EXCLUSIVE RIGHT TO USE "MD", APART FROM THE MARK AS SHOWN.

SER. NO. 85-307,937, FILED 4-29-2011.

JEFF DEFORD, EXAMINING ATTORNEY



David J. Kyffers

Director of the United States Patent and Trademark Office

United States of America

United States Patent and Trademark Office



Reg. No. 4,073,678

Registered Dec. 20, 2011

Int. Cl.: 35

SERVICE MARK

PRINCIPAL REGISTER

WORKSMART MD, INC. (FLORIDA CORPORATION)
SUITE 230
1540 CORNERSTONE BOULEVARD
DAYTONA BEACH, FL 32117

FOR: MEDICAL BILLING SUPPORT SERVICES; BUSINESS MANAGEMENT AND OPERATION ASSISTANCE TO MEDICAL PRACTICES, IN CLASS 35 (U.S. CLS. 100, 101 AND 102).

FIRST USE 6-1-2000; IN COMMERCE 6-1-2000.

NO CLAIM IS MADE TO THE EXCLUSIVE RIGHT TO USE "MD", APART FROM THE MARK AS SHOWN.

THE COLOR(S) BLACK, WHITE, DEEP GREEN, MAROON AND YELLOW IS/ARE CLAIMED AS A FEATURE OF THE MARK.

THE MARK CONSISTS OF WORDS "WORKSMART MD" WHEREIN THE WORD "WORK" IS WRITTEN IN BLACK COLOR ABOVE THE WORD "SMART" WRITTEN IN WHITE COLOR ON A CAPSULE SHAPED BACKGROUND WHICH IS IN DEEP GREEN COLOR. THE WORD "MD" IS WRITTEN IN YELLOW COLOR ON MAROON COLOR BACKGROUND AT THE BOTTOM RIGHT CORNER OF THE WORD "SMART" AS SHOWN IN THE MARK.

SER. NO. 85-307,942, FILED 4-29-2011.

JEFF DEFORD, EXAMINING ATTORNEY



David J. Kybas

Director of the United States Patent and Trademark Office

United States of America

United States Patent and Trademark Office

SPECapc

Reg. No. 4,073,679

Registered Dec. 20, 2011

Int. Cl.: 42

SERVICE MARK

PRINCIPAL REGISTER

STANDARD PERFORMANCE EVALUATION CORPORATION (CALIFORNIA CORPORATION), AKA SPEC
7001 HERITAGE VILLAGE PLAZA STE 225
GAINESVILLE, VA 20155

FOR: COMPUTER SOFTWARE DEVELOPMENT, NAMELY, DEVELOPING BENCHMARK COMPUTER PROGRAMS USED IN MEASURING THE PERFORMANCE OF COMPUTERS AND COMPUTER SOFTWARE, IN CLASS 42 (U.S. CLS. 100 AND 101).

FIRST USE 8-9-1999; IN COMMERCE 8-9-1999.

THE MARK CONSISTS OF STANDARD CHARACTERS WITHOUT CLAIM TO ANY PARTICULAR FONT, STYLE, SIZE, OR COLOR.

OWNER OF U.S. REG. NOS. 1,845,459, 2,340,156 AND OTHERS.

SER. NO. 85-307,982, FILED 4-29-2011.

EVELYN BRADLEY, EXAMINING ATTORNEY



David J. Kybas

Director of the United States Patent and Trademark Office

United States of America

United States Patent and Trademark Office



Reg. No. 4,073,680

Registered Dec. 20, 2011

Int. Cl.: 25

TRADEMARK

PRINCIPAL REGISTER

GRASS ROOTS LURE COMPANY (MICHIGAN CORPORATION)
7135 DEER HILL DRIVE
CLARKSTON, MI 48346

FOR: A-SHIRTS; ATHLETIC APPAREL, NAMELY, SHIRTS, PANTS, JACKETS, FOOTWEAR, HATS AND CAPS, ATHLETIC UNIFORMS; BASEBALL CAPS AND HATS; BODY SHIRTS; BUTTON DOWN SHIRTS; BUTTON-FRONT ALOHA SHIRTS; CAMOUFLAGE SHIRTS; CAMP SHIRTS; CHEF'S HATS; COLLARED SHIRTS; DRESS SHIRTS; FISHING SHIRTS; FUR HATS; GOLF PANTS, SHIRTS AND SKIRTS; GOLF SHIRTS; HATS; HATS FOR INFANTS, BABIES, TODDLERS AND CHILDREN; HOODED SWEAT SHIRTS; HUNTING SHIRTS; KNIT SHIRTS; LEATHER HATS; LEATHER SHIRTS; LONG-SLEEVED SHIRTS; MOISTURE-WICKING SPORTS SHIRTS; NIGHT SHIRTS; OPEN-NECKED SHIRTS; OVER SHIRTS; PIQUE SHIRTS; POLO SHIRTS; RAIN HATS; RUGBY SHIRTS; SCIENTIFIC AND TECHNOLOGICAL APPAREL, NAMELY, SHIRTS, PANTS, JACKETS, FOOTWEAR, HATS AND CAPS, UNIFORMS; SHIRTS; SHIRTS AND SHORT-SLEEVED SHIRTS; SHIRTS AND SLIPS; SHIRTS FOR INFANTS, BABIES, TODDLERS AND CHILDREN; SHIRTS FOR SUITS; SHORT-SLEEVED OR LONG-SLEEVED T-SHIRTS; SHORT-SLEEVED SHIRTS; SLEEP SHIRTS; SLEEVES WORN SEPARATE AND APART FROM BLOUSES, SHIRTS AND OTHER TOPS; SNAP CROTCH SHIRTS FOR INFANTS AND TODDLERS; SPORT SHIRTS; SPORTS CAPS AND HATS; SPORTS SHIRTS; SPORTS SHIRTS WITH SHORT SLEEVES; SWEAT SHIRTS; T-SHIRTS; TEE SHIRTS; TURTLE NECK SHIRTS; WEARABLE GARMENTS AND CLOTHING, NAMELY, SHIRTS; WOMEN'S CLOTHING, NAMELY, SHIRTS, DRESSES, SKIRTS, BLOUSES; WOMEN'S HATS AND HOODS; WOOLLY HATS, IN CLASS 25 (U.S. CLS. 22 AND 39).

FIRST USE 3-1-2009; IN COMMERCE 3-1-2009.

NO CLAIM IS MADE TO THE EXCLUSIVE RIGHT TO USE "CO", APART FROM THE MARK AS SHOWN.

THE MARK CONSISTS OF A STYLIZED FISH WITH A WAVE FLOW INCORPORATED INTO THE DESIGN OF THE FISH AND THE STYLIZED WORDING "GRLURE CO" WITH A LINE NEXT TO "CO".

SER. NO. 85-307,985, FILED 4-29-2011.

JEAN IM, EXAMINING ATTORNEY



David J. Kyros

Director of the United States Patent and Trademark Office

United States of America

United States Patent and Trademark Office



Reg. No. 4,073,681

Registered Dec. 20, 2011

Int. Cl.: 25

TRADEMARK

PRINCIPAL REGISTER

GRASS ROOTS LURE COMPANY (MICHIGAN CORPORATION)
7135 DEER HILL DRIVE
CLARKSTON, MI 48346

FOR: A-SHIRTS; ATHLETIC APPAREL, NAMELY, SHIRTS, PANTS, JACKETS, FOOTWEAR, HATS AND CAPS, ATHLETIC UNIFORMS; BASEBALL CAPS AND HATS; BODY SHIRTS; BUTTON DOWN SHIRTS; BUTTON-FRONT ALOHA SHIRTS; CAMOUFLAGE SHIRTS; CAMP SHIRTS; CHEF'S HATS; CLOTHING SHIELDS, NAMELY, PADS APPLIED TO THE UNDERARMS OF SHIRTS, BLOUSES AND SWEATERS; COLLARED SHIRTS; DRESS SHIRTS; FISHING SHIRTS; FUR HATS; GOLF PANTS, SHIRTS AND SKIRTS; GOLF SHIRTS; HATS; HATS FOR INFANTS, BABIES, TODDLERS AND CHILDREN; HOODED SWEAT SHIRTS; HUNTING SHIRTS; KNIT SHIRTS; LEATHER HATS; LEATHER SHIRTS; LONG-SLEEVED SHIRTS; MOISTURE-WICKING SPORTS SHIRTS; NIGHT SHIRTS; OPEN-NECKED SHIRTS; OVER SHIRTS; PIQUE SHIRTS; POLO SHIRTS; RAIN HATS; RUGBY SHIRTS; SCIENTIFIC AND TECHNOLOGICAL APPAREL, NAMELY, SHIRTS, PANTS, JACKETS, FOOTWEAR, HATS AND CAPS, UNIFORMS; SHIRTS; SHIRTS AND SHORT-SLEEVED SHIRTS; SHIRTS AND SLIPS; SHIRTS FOR INFANTS, BABIES, TODDLERS AND CHILDREN; SHIRTS FOR SUITS; SHORT-SLEEVED OR LONG-SLEEVED T-SHIRTS; SHORT-SLEEVED SHIRTS; SLEEP SHIRTS; SMALL HATS; SNAP CROTCH SHIRTS FOR INFANTS AND TODDLERS; SPORT SHIRTS; SPORTS CAPS AND HATS; SPORTS SHIRTS; SPORTS SHIRTS WITH SHORT SLEEVES; SWEAT SHIRTS; T-SHIRTS; TEE SHIRTS; TURTLE NECK SHIRTS; WEARABLE GARMENTS AND CLOTHING, NAMELY, SHIRTS; WIND SHIRTS; WOMEN'S CLOTHING, NAMELY, SHIRTS, DRESSES, SKIRTS, BLOUSES; WOMEN'S HATS AND HOODS; WOOLLY HATS, IN CLASS 25 (U.S. CLS. 22 AND 39).

FIRST USE 3-1-2009; IN COMMERCE 3-1-2009.

THE MARK CONSISTS OF A STYLIZED FISH WITH A WAVE FLOW INCORPORATED INTO THE DESIGN OF THE FISH.

SER. NO. 85-307,989, FILED 4-29-2011.

JEAN IM, EXAMINING ATTORNEY



David J. Kyffers

Director of the United States Patent and Trademark Office

United States of America

United States Patent and Trademark Office

SPECgpc

Reg. No. 4,073,682

Registered Dec. 20, 2011

Int. Cl.: 42

SERVICE MARK

PRINCIPAL REGISTER

STANDARD PERFORMANCE EVALUATION CORPORATION (CALIFORNIA CORPORATION), AKA SPEC
7001 HERITAGE VILLAGE PLAZA STE 225
GAINESVILLE, VA 20155

FOR: COMPUTER SOFTWARE DEVELOPMENT, NAMELY, DEVELOPING BENCHMARK COMPUTER PROGRAMS USED IN MEASURING THE PERFORMANCE OF COMPUTERS AND COMPUTER SOFTWARE, IN CLASS 42 (U.S. CLS. 100 AND 101).

FIRST USE 8-30-2007; IN COMMERCE 8-30-2007.

THE MARK CONSISTS OF STANDARD CHARACTERS WITHOUT CLAIM TO ANY PARTICULAR FONT, STYLE, SIZE, OR COLOR.

OWNER OF U.S. REG. NOS. 1,845,459, 2,340,156 AND OTHERS.

SER. NO. 85-307,990, FILED 4-29-2011.

EVELYN BRADLEY, EXAMINING ATTORNEY



David J. Kyjars

Director of the United States Patent and Trademark Office

United States of America

United States Patent and Trademark Office

shop2gro

Reg. No. 4,073,683

Registered Dec. 20, 2011

Int. Cl.: 42

SERVICE MARK

PRINCIPAL REGISTER

MYWEBGROCER, INC. (DELAWARE CORPORATION)
SUITE 350
354 MOUNTAIN VIEW DRIVE
COLCHESTER, VT 05446

FOR: COMPUTER SERVICES, NAMELY, CREATING, MAINTAINING, DESIGNING AND IMPLEMENTING WEB SITES FOR OTHERS; COMPUTER SERVICES, NAMELY, HOSTING AND MAINTAINING AN ON-LINE WEB SITE FOR OTHERS TO SELL GROCERY PRODUCTS, IN CLASS 42 (U.S. CLS. 100 AND 101).

FIRST USE 4-15-2011; IN COMMERCE 4-15-2011.

THE MARK CONSISTS OF STANDARD CHARACTERS WITHOUT CLAIM TO ANY PARTICULAR FONT, STYLE, SIZE, OR COLOR.

SER. NO. 85-307,998, FILED 4-29-2011.

TINA L. SNAPP, EXAMINING ATTORNEY



David J. Kybas

Director of the United States Patent and Trademark Office

United States of America

United States Patent and Trademark Office



Reg. No. 4,073,684

J.T.'S PARTS & ACCESSORIES (WASHINGTON CORPORATION)
5980 GOODWIN RD.
CASHMERE, WA 98815

Registered Dec. 20, 2011

Int. Cl.: 12

FOR: GEARS FOR VEHICLES, IN CLASS 12 (U.S. CLS. 19, 21, 23, 31, 35 AND 44).

TRADEMARK

FIRST USE 1-1-2007; IN COMMERCE 3-1-2007.

PRINCIPAL REGISTER

NO CLAIM IS MADE TO THE EXCLUSIVE RIGHT TO USE "GEAR & AXLE", APART FROM THE MARK AS SHOWN.

THE MARK CONSISTS OF THE STYLIZED WORDING "NITRO GEAR & AXLE" WHEREIN THE LETTER "O" RESEMBLES A GEAR DESIGN.

SER. NO. 85-308,046, FILED 4-29-2011.

JAMES STEIN, EXAMINING ATTORNEY



David J. Kyffers

Director of the United States Patent and Trademark Office

United States of America

United States Patent and Trademark Office

DARB

Reg. No. 4,073,685

Registered Dec. 20, 2011

Int. Cl.: 33

TRADEMARK

PRINCIPAL REGISTER

DOUBLE EIGHT BEVERAGES, INC. (NEW YORK CORPORATION)
162-18 71ST AVENUE
FRESH MEADOWS, NY 11365

FOR: WINES, IN CLASS 33 (U.S. CLS. 47 AND 49).

FIRST USE 1-20-2011; IN COMMERCE 1-20-2011.

THE MARK CONSISTS OF STANDARD CHARACTERS WITHOUT CLAIM TO ANY PARTICULAR FONT, STYLE, SIZE, OR COLOR.

SER. NO. 85-308,056, FILED 4-29-2011.

KAPIL BHANOT, EXAMINING ATTORNEY



David J. Kybas

Director of the United States Patent and Trademark Office

United States of America

United States Patent and Trademark Office

PRINCESS KITTY

Reg. No. 4,073,686

Registered Dec. 20, 2011

Int. Cl.: 41

SERVICE MARK

PRINCIPAL REGISTER

PRINCESS KITTY, INC. (FLORIDA CORPORATION)
4728 S.W. 67TH AVE. #J-12
MIAMI, FL 33155

FOR: ENTERTAINMENT IN THE NATURE OF VISUAL AND AUDIO PERFORMANCES BY A TRAINED CAT IN THE NATURE OF ACTING, MODELING AND PERFORMING; ENTERTAINMENT SERVICES, NAMELY, PROVIDING A WEB SITE FEATURING PHOTOGRAPHIC AND PROSE PRESENTATIONS FEATURING A TRAINED CAT IN THE NATURE OF ACTING, MODELING AND PERFORMING; FAN CLUBS, IN CLASS 41 (U.S. CLS. 100, 101 AND 107).

FIRST USE 6-10-1987; IN COMMERCE 7-27-1987.

THE MARK CONSISTS OF STANDARD CHARACTERS WITHOUT CLAIM TO ANY PARTICULAR FONT, STYLE, SIZE, OR COLOR.

NO CLAIM IS MADE TO THE EXCLUSIVE RIGHT TO USE "KITTY", APART FROM THE MARK AS SHOWN.

SER. NO. 85-308,079, FILED 4-29-2011.

BARNEY CHARLON, EXAMINING ATTORNEY



David J. Kyffers

Director of the United States Patent and Trademark Office

United States of America

United States Patent and Trademark Office



Inter-American Investment Corporation

Reg. No. 4,073,687

Registered Dec. 20, 2011

Int. Cl.: 36

SERVICE MARK

PRINCIPAL REGISTER

INTER-AMERICAN INVESTMENT CORPORATION (D.C. CORPORATION)
1350 NEW YORK AVENUE, NW
WASHINGTON, DC 20577

FOR: PROVIDING FOR THE ECONOMIC DEVELOPMENT OF LATIN AMERICAN AND CARIBBEAN COUNTRIES BY FINANCING PRIVATE ENTERPRISES, NAMELY, FINANCING IN THE FORMS OF DIRECT LOANS, GUARANTEES, EQUITY INVESTMENTS, LINES OF CREDIT TO LOCAL FINANCIAL INTERMEDIARIES AND INVESTMENTS IN LOCAL AND REGIONAL INVESTMENT FUNDS, NAMELY, FOR PROVIDING LOANS TO SMALL AND MEDIUM SIZE COMPANIES, IN CLASS 36 (U.S. CLS. 100, 101 AND 102).

FIRST USE 10-12-1984; IN COMMERCE 9-12-1986.

NO CLAIM IS MADE TO THE EXCLUSIVE RIGHT TO USE "INTER-AMERICAN INVESTMENT CORPORATION", APART FROM THE MARK AS SHOWN.

THE MARK CONSISTS OF A GLOBE SHOWING SOUTH AMERICA, CENTRAL AMERICA AND PARTS OF NORTH AMERICA, AN OPEN FRAME EXTENDING AROUND THREE QUARTERS OF THE GLOBE, A FOURTH QUARTER OF THE FRAME IS DARKENED IN AND SEPARATED FROM THE GLOBE, AND THE WORDS "INTER-AMERICAN INVESTMENT CORPORATION" TO THE RIGHT OF THE GLOBE AND FRAME.

SER. NO. 85-308,086, FILED 4-29-2011.

EDWARD NELSON, EXAMINING ATTORNEY



David J. Kyffers

Director of the United States Patent and Trademark Office

United States of America

United States Patent and Trademark Office

Adhesi-Med

Reg. No. 4,073,688

ADVANCED DEVICES INC. (NEW YORK CORPORATION)

Registered Dec. 20, 2011

P.O. BOX 370599
BROOKLYN, NY 11237

Int. Cl.: 5

FOR: MEDICAL LIQUID SKIN ADHESIVE FOR USE WITH PROSTHETICS, OSTOMY CARE, BODY APPLIANCES, COSTUMES, FORESKIN RESTORATION, AND URINARY CATHETERS, IN CLASS 5 (U.S. CLS. 6, 18, 44, 46, 51 AND 52).

TRADEMARK

FIRST USE 4-15-2011; IN COMMERCE 4-15-2011.

PRINCIPAL REGISTER

THE MARK CONSISTS OF STANDARD CHARACTERS WITHOUT CLAIM TO ANY PARTICULAR FONT, STYLE, SIZE, OR COLOR.

SER. NO. 85-308,113, FILED 4-29-2011.

LOURDES AYALA, EXAMINING ATTORNEY



David J. Kybas

Director of the United States Patent and Trademark Office

United States of America

United States Patent and Trademark Office

PAINTBLOCK

Reg. No. 4,073,689

SHURTAPE TECHNOLOGIES, LLC (NORTH CAROLINA LIMITED LIABILITY COMPANY)
1985 TATE BOULEVARD S.E.
HICKORY, NC 28603

Registered Dec. 20, 2011

Int. Cls.: 16 and 17

FOR: ADHESIVE TAPES FOR STATIONERY OR HOUSEHOLD PURPOSES, IN CLASS 16
(U.S. CLS. 2, 5, 22, 23, 29, 37, 38 AND 50).

TRADEMARK

FIRST USE 2-17-2009; IN COMMERCE 2-17-2009.

PRINCIPAL REGISTER

FOR: MASKING TAPE, IN CLASS 17 (U.S. CLS. 1, 5, 12, 13, 35 AND 50).

FIRST USE 2-17-2009; IN COMMERCE 2-17-2009.

THE MARK CONSISTS OF STANDARD CHARACTERS WITHOUT CLAIM TO ANY PARTICULAR FONT, STYLE, SIZE, OR COLOR.

OWNER OF U.S. REG. NO. 3,234,253.

SER. NO. 85-308,147, FILED 4-29-2011.

CHRISTINA SOBRAL, EXAMINING ATTORNEY



David J. Kybas

Director of the United States Patent and Trademark Office

United States of America

United States Patent and Trademark Office

ATTENUATOR-X

Reg. No. 4,073,690

Registered Dec. 20, 2011

Int. Cl.: 10

TRADEMARK

PRINCIPAL REGISTER

SHIELDING INTERNATIONAL, INC. (OREGON CORPORATION)
P.O. BOX Z
2150 N.W. ANDREWS DRIVE
MADRAS, OR 97741

FOR: RADIATION SHIELDING GLOVES FOR MEDICAL USE FOR RADIATION-CONTAINING ENVIRONMENTS AND PROTECTIVE PURPOSES, IN CLASS 10 (U.S. CLS. 26, 39 AND 44).

FIRST USE 12-0-2009; IN COMMERCE 12-0-2009.

THE MARK CONSISTS OF STANDARD CHARACTERS WITHOUT CLAIM TO ANY PARTICULAR FONT, STYLE, SIZE, OR COLOR.

SER. NO. 85-308,148, FILED 4-29-2011.

SETH A. RAPPAPORT, EXAMINING ATTORNEY



David J. Kybas

Director of the United States Patent and Trademark Office

United States of America

United States Patent and Trademark Office

Tag Along Teddy

Reg. No. 4,073,691

THOMAS-RAMSEY, DENAY (UNITED STATES INDIVIDUAL)
P.O. BOX 3578

Registered Dec. 20, 2011

SAN LEANDRO, CA 945783578

Int. Cl.: 18

FOR: BACKPACKS, IN CLASS 18 (U.S. CLS. 1, 2, 3, 22 AND 41).

TRADEMARK

FIRST USE 6-1-2011; IN COMMERCE 6-1-2011.

PRINCIPAL REGISTER

THE MARK CONSISTS OF STANDARD CHARACTERS WITHOUT CLAIM TO ANY PARTICULAR FONT, STYLE, SIZE, OR COLOR.

NO CLAIM IS MADE TO THE EXCLUSIVE RIGHT TO USE "TEDDY", APART FROM THE MARK AS SHOWN.

SER. NO. 85-308,149, FILED 4-29-2011.

IRA J. GOODSaid, EXAMINING ATTORNEY



David J. Kyffers

Director of the United States Patent and Trademark Office

United States of America

United States Patent and Trademark Office

ZAYO FIBER SOLUTIONS

Reg. No. 4,073,692

ZAYO GROUP, LLC (DELAWARE LIMITED LIABILITY COMPANY)
400 CENTENNIAL PKWY, SUITE 200
LOUISVILLE, CO 80027

Registered Dec. 20, 2011

Int. Cl.: 38

FOR: TELECOMMUNICATIONS SERVICES, NAMELY, PROVIDING FIBER OPTIC NETWORK SERVICES, IN CLASS 38 (U.S. CLS. 100, 101 AND 104).

SERVICE MARK

FIRST USE 7-1-2010; IN COMMERCE 7-1-2010.

PRINCIPAL REGISTER

THE MARK CONSISTS OF STANDARD CHARACTERS WITHOUT CLAIM TO ANY PARTICULAR FONT, STYLE, SIZE, OR COLOR.

OWNER OF U.S. REG. NOS. 3,500,857 AND 3,500,859.

NO CLAIM IS MADE TO THE EXCLUSIVE RIGHT TO USE "FIBER SOLUTIONS", APART FROM THE MARK AS SHOWN.

THE ENGLISH TRANSLATION OF THE WORD "ZAYO" IN THE MARK IS "FORTHCOMING".

SER. NO. 85-308,155, FILED 4-29-2011.

JORDAN BAKER, EXAMINING ATTORNEY



David J. Kybas

Director of the United States Patent and Trademark Office

United States of America

United States Patent and Trademark Office

ZAYO ENTERPRISE NETWORKS

Reg. No. 4,073,693

ZAYO GROUP, LLC (DELAWARE LIMITED LIABILITY COMPANY)
400 CENTENNIAL PARKWAY, SUITE 200
LOUISVILLE, CO 80027

Registered Dec. 20, 2011

Int. Cl.: 38

SERVICE MARK

PRINCIPAL REGISTER

FOR: COMMUNICATION SERVICES, NAMELY, TRANSMISSION OF VOICE, AUDIO, VISUAL IMAGES AND DATA BY TELECOMMUNICATIONS NETWORKS, WIRELESS COMMUNICATION NETWORKS, THE INTERNET, INFORMATION SERVICES NETWORKS AND DATA NETWORKS; DATA TRANSMISSION AND RECEPTION SERVICES VIA TELECOMMUNICATION MEANS; LEASING OF TELECOMMUNICATIONS LINES; LEASING OF TELECOMMUNICATION EQUIPMENT; PROVIDING ACCESS TO TELECOMMUNICATION NETWORKS; TELECOMMUNICATION ACCESS SERVICES; TELECOMMUNICATION SERVICES, NAMELY, LOCAL AND LONG DISTANCE TRANSMISSION OF VOICE, DATA, GRAPHICS AND VIDEO BY MEANS OF BROADBAND OPTICAL AND WIRELESS NETWORKS; TELECOMMUNICATION SERVICES, NAMELY, PROVIDING INTERNET ACCESS VIA BROADBAND OPTICAL AND WIRELESS NETWORKS; TELECOMMUNICATION SERVICES, NAMELY, LOCAL AND LONG DISTANCE TRANSMISSION OF VOICE, DATA, GRAPHICS AND VIDEO BY MEANS OF BROADBAND, COPPER AND OPTICAL OR WIRELESS NETWORKS; TELECOMMUNICATION SERVICES, NAMELY, TRANSMISSION OF VOICE, DATA, GRAPHICS, SOUND AND VIDEO BY MEANS OF BROADBAND POWER LINE OR WIRELESS NETWORKS; TELECOMMUNICATION SERVICES IN THE NATURE OF PROVIDING TELEPHONE FEATURES, NAMELY, CALL WAITING, CALL IDENTIFICATION, CALL FORWARDING, AND MESSAGE WAITING; TELECOMMUNICATION SERVICES IN THE NATURE OF PROVIDING TELEPHONE SERVICES WITH VARIOUS TELEPHONE FEATURES, NAMELY, A DEDICATED TOLL-FREE NUMBER, VOICEMAIL, MULTIPLE MAILBOX EXTENSIONS, TELEPHONE MESSAGE NOTIFICATION, FAX CAPABILITIES, DETAILED CALL REPORTS, CALL WAITING, CALL IDENTIFICATION, CALL FORWARDING, AND MESSAGE WAITING; TELECOMMUNICATIONS BY E-MAIL; COMMUNICATIONS BY TELEPHONE; COMMUNICATIONS VIA FIBER-OPTIC NETWORKS; DATA TRANSMISSION AND RECEPTION SERVICES VIA TELECOMMUNICATION MEANS; PROVIDING CO-LOCATION SERVICES FOR VOICE, VIDEO AND DATA COMMUNICATIONS APPLICATIONS; PROVIDING E-MAIL AND INSTANT MESSAGING SERVICES; PROVIDING E-MAIL FAX SERVICES; PROVIDING TELEPHONE CONFERENCING SERVICES; PROVIDING VOICE COMMUNICATION SERVICES VIA THE INTERNET; PROVISION OF ACCESS TO THE INTERNET, IN CLASS 38 (U.S. CLS. 100, 101 AND 104).



David J. Kappas

Director of the United States Patent and Trademark Office

FIRST USE 5-12-2009; IN COMMERCE 5-12-2009.

Reg. No. 4,073,693 THE MARK CONSISTS OF STANDARD CHARACTERS WITHOUT CLAIM TO ANY PARTICULAR FONT, STYLE, SIZE, OR COLOR.

OWNER OF U.S. REG. NOS. 3,500,857 AND 3,500,859.

NO CLAIM IS MADE TO THE EXCLUSIVE RIGHT TO USE "ENTERPRISE NETWORKS", APART FROM THE MARK AS SHOWN.

THE ENGLISH TRANSLATION OF THE WORD "ZAYO" IN THE MARK IS "FORTHCOMING".

SER. NO. 85-308,157, FILED 4-29-2011.

JORDAN BAKER, EXAMINING ATTORNEY

United States of America

United States Patent and Trademark Office

MyHometownStores

Reg. No. 4,073,694

Registered Dec. 20, 2011

Int. Cl.: 35

SERVICE MARK

PRINCIPAL REGISTER

MYHOMETOWNBRONXVILLE, LLC (NEW YORK LIMITED LIABILITY COMPANY), DBA
MYHOMETOWNSTORES.COM
55 PRESCOTT AVENUE
BRONXVILLE, NY 10708

FOR: COMPUTERIZED ON-LINE RETAIL STORE SERVICES FEATURING A WIDE VARIETY OF CONSUMER GOODS OF LOCAL MERCHANTS; MARKETING SERVICES, NAMELY, RETAIL STORE SERVICES FEATURING A WIDE VARIETY OF CONSUMER GOODS OF LOCAL MERCHANTS; ON-LINE RETAIL STORE SERVICES FEATURING A WIDE VARIETY OF CONSUMER GOODS OF OTHERS; RETAIL STORE AND ON-LINE RETAIL STORE SERVICES FEATURING LOCAL FASHION, APPAREL, HOME GOODS AND LOCAL PRODUCTS, IN CLASS 35 (U.S. CLS. 100, 101 AND 102).

FIRST USE 2-1-2011; IN COMMERCE 2-1-2011.

THE MARK CONSISTS OF STANDARD CHARACTERS WITHOUT CLAIM TO ANY PARTICULAR FONT, STYLE, SIZE, OR COLOR.

SER. NO. 85-308,174, FILED 4-29-2011.

KATHRYN COWARD, EXAMINING ATTORNEY



David J. Kyros

Director of the United States Patent and Trademark Office

United States of America

United States Patent and Trademark Office

Pharmgirl

Reg. No. 4,073,695

PHARMGIRL PLLC (WASHINGTON LIMITED LIABILITY COMPANY)
1208 FRANKLIN ST
PORT TOWNSEND, WA 98368

Registered Dec. 20, 2011

Int. Cl.: 44

FOR: PROVIDING PHARMACY CONSULTING SERVICES TO PATIENTS TO OPTIMIZE MEDICATION USAGE, NAMELY, PROVIDING INFORMATION TO PATIENTS IN THE FIELD OF ADMINISTERING MEDICATIONS AND PROVIDING MEDICAL INFORMATION AND CONSULTANCY, IN CLASS 44 (U.S. CLS. 100 AND 101).

SERVICE MARK

PRINCIPAL REGISTER

FIRST USE 1-2-2011; IN COMMERCE 1-25-2011.

THE MARK CONSISTS OF STANDARD CHARACTERS WITHOUT CLAIM TO ANY PARTICULAR FONT, STYLE, SIZE, OR COLOR.

SER. NO. 85-308,215, FILED 4-29-2011.

Laurie Kaufman, Examining Attorney



David J. Kyffers

Director of the United States Patent and Trademark Office

United States of America

United States Patent and Trademark Office



Reg. No. 4,073,696

NOSH CREATIVE, LLC. (TEXAS LIMITED LIABILITY COMPANY)
7120 LEHIGH DRIVE
DALLAS, TX 75214

Registered Dec. 20, 2011

Int. Cl.: 42

FOR: GRAPHIC DESIGN SERVICES, IN CLASS 42 (U.S. CLS. 100 AND 101).

SERVICE MARK

FIRST USE 9-1-2010; IN COMMERCE 12-1-2010.

PRINCIPAL REGISTER

NO CLAIM IS MADE TO THE EXCLUSIVE RIGHT TO USE "CREATIVE LIMITED LIABILITY COMPANY EST. 2010", APART FROM THE MARK AS SHOWN.

THE MARK CONSISTS OF THE STYLIZED TEXT "NOSH CREATIVE LIMITED LIABILITY COMPANY EST. 2010". THE "O" IN THE WORD "NOSH" IS A FACE WITH A CROWN. SWIRLS AND DOTS EMPHASIZE THE TEXT.

SER. NO. 85-308,227, FILED 4-29-2011.

BRENDAN REGAN, EXAMINING ATTORNEY



David J. Kybas

Director of the United States Patent and Trademark Office

United States of America

United States Patent and Trademark Office

CMDR. CHEW

Reg. No. 4,073,697

MERRICK PET CARE, INC. (TEXAS CORPORATION)
P.O. BOX 9800
AMARILLO, TX 79105

Registered Dec. 20, 2011

Int. Cl.: 31

FOR: DOG TREATS, IN CLASS 31 (U.S. CLS. 1 AND 46).

TRADEMARK

FIRST USE 5-0-2010; IN COMMERCE 5-0-2010.

PRINCIPAL REGISTER

THE MARK CONSISTS OF STANDARD CHARACTERS WITHOUT CLAIM TO ANY PARTICULAR FONT, STYLE, SIZE, OR COLOR.

NO CLAIM IS MADE TO THE EXCLUSIVE RIGHT TO USE "CHEW", APART FROM THE MARK AS SHOWN.

SER. NO. 85-308,239, FILED 4-29-2011.

JORDAN BAKER, EXAMINING ATTORNEY



David J. Kyffers

Director of the United States Patent and Trademark Office

United States of America

United States Patent and Trademark Office

POLICY PRESCRIPTIONS

Reg. No. 4,073,698

POLICY PRESCRIPTIONS, LLC (MARYLAND LIMITED LIABILITY COMPANY)
4712 LONGHORN DRIVE
BELTSVILLE, MD 20705

Registered Dec. 20, 2011

Int. Cl.: 35

FOR: PUBLIC POLICY CONSULTANCY SERVICES; PUBLIC POLICY RESEARCH SERVICES,
IN CLASS 35 (U.S. CLS. 100, 101 AND 102).

SERVICE MARK

FIRST USE 12-12-2009; IN COMMERCE 12-12-2009.

PRINCIPAL REGISTER

THE MARK CONSISTS OF STANDARD CHARACTERS WITHOUT CLAIM TO ANY PARTICULAR FONT, STYLE, SIZE, OR COLOR.

NO CLAIM IS MADE TO THE EXCLUSIVE RIGHT TO USE "POLICY", APART FROM THE MARK AS SHOWN.

SER. NO. 85-308,251, FILED 4-29-2011.

MICHAEL WIENER, EXAMINING ATTORNEY



David J. Kyffers

Director of the United States Patent and Trademark Office

United States of America

United States Patent and Trademark Office

STARBUCKS TRIBUTE BLEND

Reg. No. 4,073,699

Registered Dec. 20, 2011

Int. Cls.: 21 and 30

TRADEMARK

PRINCIPAL REGISTER

STARBUCKS CORPORATION (WASHINGTON CORPORATION), DBA STARBUCKS COFFEE COMPANY
2401 UTAH AVENUE SOUTH
SEATTLE, WA 98134

FOR: COFFEE CUPS; TEA CUPS; MUGS; DISHES; STORAGE CANISTERS; NON-ELECTRIC PLUNGER-STYLE COFFEE MAKERS, IN CLASS 21 (U.S. CLS. 2, 13, 23, 29, 30, 33, 40 AND 50).

FIRST USE 3-8-2011; IN COMMERCE 3-8-2011.

FOR: GROUND AND WHOLE BEAN COFFEE; NON-ALCOHOLIC BEVERAGES MADE WITH A BASE OF COFFEE; READY-TO-DRINK COFFEE, IN CLASS 30 (U.S. CL. 46).

FIRST USE 3-8-2011; IN COMMERCE 3-8-2011.

THE MARK CONSISTS OF STANDARD CHARACTERS WITHOUT CLAIM TO ANY PARTICULAR FONT, STYLE, SIZE, OR COLOR.

OWNER OF U.S. REG. NOS. 1,815,938, 2,266,351 AND OTHERS.

NO CLAIM IS MADE TO THE EXCLUSIVE RIGHT TO USE "BLEND", APART FROM THE MARK AS SHOWN.

SER. NO. 85-308,270, FILED 4-29-2011.

JOHN WILKE, EXAMINING ATTORNEY



David J. Kybas

Director of the United States Patent and Trademark Office

United States of America

United States Patent and Trademark Office

THE INSIDE DRIVERS

Reg. No. 4,073,700

Registered Dec. 20, 2011

Int. Cl.: 41

SERVICE MARK

PRINCIPAL REGISTER

STEVEN G. KELLY (UNITED STATES JOINT APPLICANT)
61 VICTORIA DRIVE
EATONTOWN, NJ 07724 AND

ALAN GOWA (UNITED STATES JOINT APPLICANT)
51 LLOYD RD
MORGANVILLE, NJ 07751 AND

WILLIAM EDWARD PENN (UNITED STATES JOINT APPLICANT)
182 BROADWAY
LONG BRANCH, NJ 07740 AND

CHARLES MCINTOSH (UNITED STATES JOINT APPLICANT)
152 B PROVIDENCE WAY
MONROE TOWNSHIP, NJ 08831

FOR: ENTERTAINMENT SERVICES, NAMELY, LIVE PERFORMANCES BY A MUSICAL GROUP, IN CLASS 41 (U.S. CLS. 100, 101 AND 107).

FIRST USE 4-1-2010; IN COMMERCE 4-1-2010.

THE MARK CONSISTS OF STANDARD CHARACTERS WITHOUT CLAIM TO ANY PARTICULAR FONT, STYLE, SIZE, OR COLOR.

SER. NO. 85-308,276, FILED 4-29-2011.

EDWARD NELSON, EXAMINING ATTORNEY



David J. Kybas

Director of the United States Patent and Trademark Office

United States of America

United States Patent and Trademark Office

Finders Keepers

Reg. No. 4,073,701

HMK ASSOCIATES, INC. (PENNSYLVANIA CORPORATION)
6507 WILKINS AVENUE SUITE 108
PITTSBURGH, PA 15217

Registered Dec. 20, 2011

Int. Cl.: 35

FOR: CONSULTING SERVICES IN THE FIELD OF HUMAN RESOURCES DEVELOPMENT, NAMELY, FOR THE PROMOTION OF EMPLOYEE RETENTION, EMPLOYEE RECRUITING, AND EMPLOYEE PUBLIC POLICIES AND EMPLOYEE RELATIONS, IN CLASS 35 (U.S. CLS. 100, 101 AND 102).

SERVICE MARK

PRINCIPAL REGISTER

FIRST USE 7-1-2008; IN COMMERCE 7-1-2008.

THE MARK CONSISTS OF STANDARD CHARACTERS WITHOUT CLAIM TO ANY PARTICULAR FONT, STYLE, SIZE, OR COLOR.

SER. NO. 85-308,281, FILED 4-29-2011.

STEVEN JACKSON, EXAMINING ATTORNEY



David J. Kybas

Director of the United States Patent and Trademark Office

United States of America

United States Patent and Trademark Office

MOVEMENT FIRST

Reg. No. 4,073,702

Registered Dec. 20, 2011

Int. Cl.: 44

SERVICE MARK

PRINCIPAL REGISTER

CHRISTOPHER J. MCGRATH (UNITED STATES INDIVIDUAL)
160 WEST 71ST STREET #5M
160 WEST 71ST STREET #5M
NEW YORK, NY 10023

FOR: PROVIDING ASSISTANCE, FITNESS EVALUATION AND CONSULTATION TO CORPORATE CLIENTS TO HELP THEIR EMPLOYEES MAKE HEALTH, WELLNESS AND NUTRITIONAL CHANGES IN THEIR DAILY LIVING TO IMPROVE HEALTH; PROVIDING ASSISTANCE, FITNESS EVALUATION AND CONSULTATION TO INDIVIDUALS TO HELP THEM MAKE HEALTH, WELLNESS AND NUTRITIONAL CHANGES IN THEIR DAILY LIVING TO IMPROVE HEALTH, IN CLASS 44 (U.S. CLS. 100 AND 101).

FIRST USE 11-30-2009; IN COMMERCE 12-31-2009.

THE MARK CONSISTS OF STANDARD CHARACTERS WITHOUT CLAIM TO ANY PARTICULAR FONT, STYLE, SIZE, OR COLOR.

NO CLAIM IS MADE TO THE EXCLUSIVE RIGHT TO USE "MOVEMENT" , APART FROM THE MARK AS SHOWN.

SER. NO. 85-308,282, FILED 4-29-2011.

EDWARD NELSON, EXAMINING ATTORNEY



David J. Kyffers

Director of the United States Patent and Trademark Office

United States of America

United States Patent and Trademark Office

NEW YORK JOCKEY CLUB

Reg. No. 4,073,703

Registered Dec. 20, 2011

Int. Cl.: 20

TRADEMARK

PRINCIPAL REGISTER

NYJC, LLC (NEW JERSEY LIMITED LIABILITY COMPANY)
73 CONOVER ROAD
COLTS NECK, NJ 07722

FOR: PILLOWS, IN CLASS 20 (U.S. CLS. 2, 13, 22, 25, 32 AND 50).

FIRST USE 4-1-2011; IN COMMERCE 4-1-2011.

THE MARK CONSISTS OF STANDARD CHARACTERS WITHOUT CLAIM TO ANY PARTICULAR FONT, STYLE, SIZE, OR COLOR.

NO CLAIM IS MADE TO THE EXCLUSIVE RIGHT TO USE "NEW YORK", APART FROM THE MARK AS SHOWN.

SER. NO. 85-308,306, FILED 4-29-2011.

ANGELA DUONG, EXAMINING ATTORNEY



David J. Kyffers

Director of the United States Patent and Trademark Office

United States of America

United States Patent and Trademark Office

DFTView

Reg. No. 4,073,704

Registered Dec. 20, 2011

Int. Cl.: 9

TRADEMARK

PRINCIPAL REGISTER

SOURCE III, INC. (CALIFORNIA CORPORATION)
3941 PARK DRIVE, SUITE# 20-342
EL DORADO HILLS, CA 95762

FOR: COMPUTER SOFTWARE FOR GRAPHICALLY DISPLAYING THE WAVEFORM EQUIVALENT OF TEST PROGRAM SOURCE FILES WRITTEN IN WGL, STIL (IEEE-1450) AND OTHER ATE FORMATS , IN CLASS 9 (U.S. CLS. 21, 23, 26, 36 AND 38).

FIRST USE 8-6-2010; IN COMMERCE 3-19-2011.

THE MARK CONSISTS OF STANDARD CHARACTERS WITHOUT CLAIM TO ANY PARTICULAR FONT, STYLE, SIZE, OR COLOR.

SER. NO. 85-308,310, FILED 4-29-2011.

GIANCARLO CASTRO, EXAMINING ATTORNEY



David J. Kybas

Director of the United States Patent and Trademark Office

United States of America

United States Patent and Trademark Office



Reg. No. 4,073,705

Registered Dec. 20, 2011

Int. Cl.: 20

TRADEMARK

PRINCIPAL REGISTER

NYJC, LLC (NEW JERSEY LIMITED LIABILITY COMPANY)
73 CONOVER ROAD
COLTS NECK, NJ 07722

FOR: PILLOWS, IN CLASS 20 (U.S. CLS. 2, 13, 22, 25, 32 AND 50).

FIRST USE 4-1-2011; IN COMMERCE 4-1-2011.

NO CLAIM IS MADE TO THE EXCLUSIVE RIGHT TO USE "NEW YORK", APART FROM THE MARK AS SHOWN.

THE MARK CONSISTS OF THE WORDING "NEW YORK JOCKEY CLUB" IN STYLIZED TYPE OUTSIDE A CIRCLE, WITH A DEPICTION INSIDE THE CIRCLE OF A STYLIZED IMAGE OF TWO JOCKEYS EACH RIDING A HORSE. THE PHRASE "NEW YORK" LOCATED ON THE TOP OF THE CIRCLE, IS SEPARATED FROM THE PHRASE "JOCKEY CLUB" LOCATED ON THE BOTTOM, WITH A SOLID DOT LOCATED ON EACH SIDE OF THE CIRCLE.

SER. NO. 85-308,322, FILED 4-29-2011.

ANGELA DUONG, EXAMINING ATTORNEY



David J. Kybas

Director of the United States Patent and Trademark Office

United States of America

United States Patent and Trademark Office



Reg. No. 4,073,706

Registered Dec. 20, 2011

Int. Cl.: 39

SERVICE MARK

PRINCIPAL REGISTER

UNITED SUPPLIERS, INC. (IOWA CORPORATION)
P.O. BOX 538
30473 260TH STREET
ELDORA, IA 50627

FOR: TRUCKING SERVICES, NAMELY, HAULING OF FERTILIZER PRODUCTS FOR AGRICULTURAL PURPOSES, IN CLASS 39 (U.S. CLS. 100 AND 105).

FIRST USE 4-1-2011; IN COMMERCE 4-1-2011.

NO CLAIM IS MADE TO THE EXCLUSIVE RIGHT TO USE "TRANSPORTATION EXPRESS, INC.", APART FROM THE MARK AS SHOWN.

THE MARK CONSISTS OF AN OVAL SHAPE WITH THE WORD "TRANSPORTATION" IN THE TOP PORTION OF THE OVAL AND THE WORDS "EXPRESS, INC." IN THE LOWER PORTION OF THE OVAL AND THE LETTERS "TEX" APPEAR WITHIN THE CENTER OF THE OVAL SHAPE.

SER. NO. 85-308,379, FILED 4-29-2011.

BARBARA BROWN, EXAMINING ATTORNEY



David J. Kyffers

Director of the United States Patent and Trademark Office

United States of America

United States Patent and Trademark Office



雄獅旅遊
LION TRAVEL

Reg. No. 4,073,707

LION TRAVEL SERVICE CO., LTD. (TAIWAN CORPORATION)
NO. 111, RUIHU ST., NEIHU DISTRICT
TAIPEI CITY, TAIWAN 11494

Registered Dec. 20, 2011

Int. Cl.: 39

FOR: ARRANGING AND COORDINATING TRAVEL ARRANGEMENTS FOR INDIVIDUALS AND GROUPS, NAMELY, DESTINATIONS STAYS, HONEYMOONS, FAMILY VACATIONS, AND DESTINATION WEDDINGS; ARRANGING TRAVEL TOURS, IN CLASS 39 (U.S. CLS. 100 AND 105).

SERVICE MARK

PRINCIPAL REGISTER

FIRST USE 2-14-2003; IN COMMERCE 2-14-2003.

NO CLAIM IS MADE TO THE EXCLUSIVE RIGHT TO USE "TRAVEL" AND THE NON-LATIN CHARACTER THAT TRANSLATES TO "TRAVEL", APART FROM THE MARK AS SHOWN.

THE NON-LATIN CHARACTERS IN THE MARK TRANSLITERATE TO XIONG SHI LIV YOU AND THIS MEANS MALE LION TRAVEL IN ENGLISH.

THE MARK CONSISTS OF A LION'S HEAD WITHIN A SQUARE TO THE LEFT OF FOUR CHINESE CHARACTERS ABOVE THE STYLIZED WORDING "LION TRAVEL".

SER. NO. 85-308,424, FILED 4-29-2011.

THOMAS MANOR, EXAMINING ATTORNEY



David J. Kyros

Director of the United States Patent and Trademark Office

United States of America

United States Patent and Trademark Office

CARROUSEL

Reg. No. 4,073,708

QUIKSPRAY, INC. (OHIO CORPORATION)

Registered Dec. 20, 2011

PO BOX 327
PORT CLINTON, OH 43452

Int. Cl.: 7

FOR: PERISTALTIC PUMP FOR USE WITH NON-SOLID COMMERCIAL COATINGS SUCH AS CEMENT, PLASTER AND EPOXY, IN CLASS 7 (U.S. CLS. 13, 19, 21, 23, 31, 34 AND 35).

TRADEMARK

FIRST USE 4-28-2011; IN COMMERCE 4-28-2011.

PRINCIPAL REGISTER

THE MARK CONSISTS OF STANDARD CHARACTERS WITHOUT CLAIM TO ANY PARTICULAR FONT, STYLE, SIZE, OR COLOR.

OWNER OF U.S. REG. NO. 3,322,302.

SER. NO. 85-308,468, FILED 4-29-2011.

APRIL ROACH, EXAMINING ATTORNEY



David J. Kyffers

Director of the United States Patent and Trademark Office

United States of America

United States Patent and Trademark Office



Reg. No. 4,073,709

J. E. HIGGINS LUMBER COMPANY (CALIFORNIA CORPORATION)
6999 SOUTHFRONT ROAD
LIVERMORE, CA 94551

Registered Dec. 20, 2011

Int. Cl.: 19

FOR: FLOOR BOARDS; FLOOR TILES OF WOOD; HARDWOOD FLOORING; LAMINATE FLOORING; PARQUET WOOD FLOORING, IN CLASS 19 (U.S. CLS. 1, 12, 33 AND 50).

TRADEMARK

FIRST USE 4-25-2011; IN COMMERCE 4-25-2011.

PRINCIPAL REGISTER

NO CLAIM IS MADE TO THE EXCLUSIVE RIGHT TO USE "ESTABLISHED 1877" AND "FINE CRAFTED WOOD FLOORS", APART FROM THE MARK AS SHOWN.

THE NAME(S), PORTRAIT(S), AND/OR SIGNATURE(S) SHOWN IN THE MARK DOES NOT IDENTIFY A PARTICULAR LIVING INDIVIDUAL.

THE MARK CONSISTS OF A RECTANGULAR SHAPE WITH A NARROW BORDER MADE TO RESEMBLE WOOD GRAIN WITH THE WORD "ESTABLISHED 1877" IN STYLIZED FORM ABOVE THE UNDERLINED PHRASE OF "ALLEN & TUGGLE" IN STYLIZED FORM WHICH IS ABOVE THE WORDS "FINE CRAFTED WOOD FLOORS" IN STYLIZED FORM, ALL INSIDE THE BORDER.

SER. NO. 85-308,471, FILED 4-29-2011.

EMILY CHUO, EXAMINING ATTORNEY



David J. Kyjars

Director of the United States Patent and Trademark Office

United States of America

United States Patent and Trademark Office

STOP FRAUD BEFORE IT STARTS

Reg. No. 4,073,710

ADAPTIVE MARKETING LLC (DELAWARE LIMITED LIABILITY COMPANY)
20 GLOVER AVENUE
NORWALK, CT 06850

Registered Dec. 20, 2011

Int. Cls.: 35, 36, 42 and 45

FOR: MONITORING CONSUMER CREDIT REPORTS AND PROVIDING AN ALERT AS TO ANY CHANGES THEREIN, IN CLASS 35 (U.S. CLS. 100, 101 AND 102).

FIRST USE 4-27-2011; IN COMMERCE 4-27-2011.

SERVICE MARK

FOR: PROVIDING REIMBURSEMENTS FOR COSTS RELATED TO IDENTITY THEFT AND FRAUD; PROVIDING CONSUMER CREDIT REPORTS AND CONSUMER CREDIT REPORT HISTORY, IN CLASS 36 (U.S. CLS. 100, 101 AND 102).

PRINCIPAL REGISTER

FIRST USE 4-27-2011; IN COMMERCE 4-27-2011.

FOR: PROVIDING TEMPORARY USE OF ONLINE NON-DOWNLOADABLE SOFTWARE THAT PROACTIVELY DETECTS AND PREVENTS IDENTITY THEFT AND FRAUD, IN CLASS 42 (U.S. CLS. 100 AND 101).

FIRST USE 4-27-2011; IN COMMERCE 4-27-2011.

FOR: MONITORING OF CREDIT REPORTS, THE INTERNET, AND PUBLIC RECORDS TO FACILITATE THE DETECTION AND PREVENTION OF IDENTITY THEFT AND FRAUD; CONSULTATION IN THE FIELD OF IDENTITY THEFT AND FRAUD PREVENTION; INVESTIGATION SERVICES IN THE FIELD OF IDENTITY THEFT AND FRAUD; PREPARATION OF DOCUMENTATION IN THE FIELD OF IDENTITY THEFT; ACTING AS A LIAISON BETWEEN INDIVIDUALS AND FINANCIAL INSTITUTIONS TO ADDRESS IDENTITY THEFT AND CHECK FRAUD; CONSULTATION SERVICES IN THE FIELD OF IDENTITY RESTORATION AFTER IDENTITY THEFT AND CHECK FRAUD; PROVIDING INFORMATION TO INDIVIDUALS CONCERNING CONSEQUENCES OF IDENTITY THEFT; PROVIDING ASSISTANCE TO INDIVIDUALS WITH RESPECT TO THE REPAIR, RECOVERY AND RESTORATION OF PERSONAL IDENTITY; PROVIDING ASSISTANCE TO INDIVIDUALS WHO ARE VICTIMS OF IDENTITY THEFT WITH RESPECT TO NOTIFYING AND FILING REPORTS WITH APPLICABLE AGENCIES, AUTHORITIES AND OTHER THIRD PARTIES, IN CLASS 45 (U.S. CLS. 100 AND 101).

FIRST USE 4-27-2011; IN COMMERCE 4-27-2011.



David J. Kyros

Director of the United States Patent and Trademark Office

Reg. No. 4,073,710 THE MARK CONSISTS OF STANDARD CHARACTERS WITHOUT CLAIM TO ANY PARTICULAR FONT, STYLE, SIZE, OR COLOR.

SER. NO. 85-308,480, FILED 4-29-2011.

ANDREA K. NADELMAN, EXAMINING ATTORNEY

United States of America

United States Patent and Trademark Office



Advanced Concepts Enterprises, Inc.

Reg. No. 4,073,711

ADVANCED CONCEPTS ENTERPRISES, INC. (FLORIDA CORPORATION), DBA ACES
51 3RD ST., BLDG 3

Registered Dec. 20, 2011

SHALIMAR, FL 32579

Int. Cl.: 35

FOR: GOVERNMENT RELATIONS CONSULTANCY SERVICES, IN CLASS 35 (U.S. CLS. 100, 101 AND 102).

SERVICE MARK

FIRST USE 12-11-2002; IN COMMERCE 12-11-2002.

PRINCIPAL REGISTER

NO CLAIM IS MADE TO THE EXCLUSIVE RIGHT TO USE "ENTERPRISES, INC.", APART FROM THE MARK AS SHOWN.

THE COLOR(S) RED, WHITE, BLUE, LIGHT BLUE, AND BLACK IS/ARE CLAIMED AS A FEATURE OF THE MARK.

THE MARK CONSISTS OF THE BLUE WORD "ACES" OUTLINED IN LIGHT BLUE AND RED ABOVE THE BLACK WORDING "ADVANCED CONCEPTS ENTERPRISES, INC." AND A DESIGN OF THREE FIGHTER JETS IN WHITE AND OUTLINED WITH BLACK WITH TAILS OUTLINED IN BLACK, ONE BEING RED, ONE BEING WHITE, AND THE OTHER BEING BLUE.

SER. NO. 85-308,527, FILED 4-29-2011.

LAURA HAMMEL, EXAMINING ATTORNEY



David J. Kybas

Director of the United States Patent and Trademark Office

United States of America

United States Patent and Trademark Office

Colonet

Reg. No. 4,073,712

Registered Dec. 20, 2011

Int. Cl.: 10

TRADEMARK

PRINCIPAL REGISTER

PRIME PACIFIC HEALTH INNOVATIONS CORP. (CANADA CORPORATION), AKA PPHIC
WWW.PPHIC.COM
#8 - 145 RIVERSIDE DRIVE WEST
NORTH VANCOUVER, CANADA V7H1T6

FOR: ENEMA APPARATUS, IN CLASS 10 (U.S. CLS. 26, 39 AND 44).

FIRST USE 2-2-1998; IN COMMERCE 2-2-1999.

THE MARK CONSISTS OF STANDARD CHARACTERS WITHOUT CLAIM TO ANY PARTICULAR FONT, STYLE, SIZE, OR COLOR.

SER. NO. 85-308,561, FILED 4-29-2011.

RICHARD WHITE, EXAMINING ATTORNEY



David J. Kybas

Director of the United States Patent and Trademark Office

United States of America

United States Patent and Trademark Office

InnerGold Changing the World One Person at a Time

Reg. No. 4,073,713

INNERGOLD COUNSELING SERVICES INC. (UTAH CORPORATION)
5072 FOX HOLLOW WAY
LEHI, UT 84043

Registered Dec. 20, 2011

Int. Cl.: 44

FOR: ADDICTION TREATMENT SERVICES, IN CLASS 44 (U.S. CLS. 100 AND 101).

SERVICE MARK

FIRST USE 10-1-2004; IN COMMERCE 10-1-2004.

PRINCIPAL REGISTER

THE MARK CONSISTS OF STANDARD CHARACTERS WITHOUT CLAIM TO ANY PARTICULAR FONT, STYLE, SIZE, OR COLOR.

SER. NO. 85-308,576, FILED 4-29-2011.

DAVID H. STINE, EXAMINING ATTORNEY



David J. Kyffers

Director of the United States Patent and Trademark Office

United States of America

United States Patent and Trademark Office

ARCMESA EDUCATORS

Reg. No. 4,073,714

Registered Dec. 20, 2011

Int. Cl.: 41

SERVICE MARK

PRINCIPAL REGISTER

ARCMESA EDUCATORS, LLC (NEW JERSEY LIMITED LIABILITY COMPANY)
666 PLAINSBORO ROAD
SUITE 440
PLAINSBORO, NJ 08536

FOR: EDUCATIONAL SERVICES, NAMELY PROVIDING CONTINUING EDUCATION COURSE FOR LICENSED PROFESSIONALS IN THE FIELD OF MEDICINE, PHARMACOLOGY, NURSING, RADIOLOGY, DENTISTRY, DIETETICS AND CHIROPRACTIC, IN CLASS 41 (U.S. CLS. 100, 101 AND 107).

FIRST USE 0-0-1996; IN COMMERCE 0-0-1996.

THE MARK CONSISTS OF STANDARD CHARACTERS WITHOUT CLAIM TO ANY PARTICULAR FONT, STYLE, SIZE, OR COLOR.

NO CLAIM IS MADE TO THE EXCLUSIVE RIGHT TO USE "EDUCATORS", APART FROM THE MARK AS SHOWN.

SER. NO. 85-308,586, FILED 4-29-2011.

JENNIFER VASQUEZ, EXAMINING ATTORNEY



David J. Kyffers

Director of the United States Patent and Trademark Office

United States of America

United States Patent and Trademark Office

MARKETMAN

Reg. No. 4,073,715

326 ASSOCIATES, L.P. (DELAWARE LIMITED PARTNERSHIP)
1201 NORTH ORANGE STREET, SUITE 700
WILLIMINGTON, DE 19801

Registered Dec. 20, 2011

Int. Cl.: 35

FOR: FARMERS' MARKETS; FLEA MARKETS; RETAIL GROCERY STORES, IN CLASS 35
(U.S. CLS. 100, 101 AND 102).

SERVICE MARK

FIRST USE 3-18-2009; IN COMMERCE 3-18-2009.

PRINCIPAL REGISTER

THE MARK CONSISTS OF STANDARD CHARACTERS WITHOUT CLAIM TO ANY PARTICULAR FONT, STYLE, SIZE, OR COLOR.

SER. NO. 85-308,663, FILED 4-29-2011.

MARK SHINER, EXAMINING ATTORNEY



David J. Kybas

Director of the United States Patent and Trademark Office

United States of America

United States Patent and Trademark Office

EXPRESSPARK, INC.

Reg. No. 4,073,716

Registered Dec. 20, 2011

Int. Cl.: 39

SERVICE MARK

PRINCIPAL REGISTER

EXPRESSPARK, INC. (PENNSYLVANIA CORPORATION)
900 EAST SECOND STREET
ESSINGTON, PA 19029

FOR: VEHICLE PARKING SERVICES; PROVIDING REMOTE AIRPORT VEHICLE PARKING FACILITIES; PASSENGER TRANSPORTATION SERVICES BETWEEN PARKING FACILITIES AND AIRPORT TERMINALS; AIRPORT PARKING LOT SERVICES AND PASSENGER SHUTTLE SERVICES BETWEEN THE AIRPORT PARKING FACILITIES AND THE AIRPORT; PROVIDING PARK-AND-RIDE TRANSPORTATION SERVICES IN THE NATURE OF PARKING AREAS AND PUBLIC TRANSPORTATION SERVICES FOR COMMUTERS, IN CLASS 39 (U.S. CLS. 100 AND 105).

FIRST USE 4-16-1998; IN COMMERCE 5-0-1998.

THE MARK CONSISTS OF STANDARD CHARACTERS WITHOUT CLAIM TO ANY PARTICULAR FONT, STYLE, SIZE, OR COLOR.

OWNER OF U.S. REG. NO. 3,792,105.

NO CLAIM IS MADE TO THE EXCLUSIVE RIGHT TO USE "INC.", APART FROM THE MARK AS SHOWN.

SEC. 2(F) AS TO "EXPRESSPARK".

SER. NO. 85-308,694, FILED 4-29-2011.

KEVIN DINALLO, EXAMINING ATTORNEY



David J. Kyffers

Director of the United States Patent and Trademark Office

United States of America

United States Patent and Trademark Office

BCA

Reg. No. 4,073,717

ISOPUR FLUID TECHNOLOGIES, INC. (CONNECTICUT CORPORATION)
183 PROVIDENCE-NEW LONDON TPK SUITE W-3
NO. STONINGTON, CT 06359

Registered Dec. 20, 2011

Int. Cl.: 9

FOR: ELECTRICAL APPARATUS FOR REMOVING IMPURITIES FROM OILS, IN CLASS 9 (U.S. CLS. 21, 23, 26, 36 AND 38).

TRADEMARK

FIRST USE 3-31-2011; IN COMMERCE 3-31-2011.

PRINCIPAL REGISTER

THE MARK CONSISTS OF STANDARD CHARACTERS WITHOUT CLAIM TO ANY PARTICULAR FONT, STYLE, SIZE, OR COLOR.

SER. NO. 85-308,727, FILED 4-29-2011.

ESTHER BELENKER, EXAMINING ATTORNEY



David J. Kybas

Director of the United States Patent and Trademark Office

United States of America

United States Patent and Trademark Office

PLANET DJ

Reg. No. 4,073,718

PLANET DJ, INC. (NEVADA CORPORATION)
1315 GREG STREET, SUITE 101
SPARKS, NV 89431

Registered Dec. 20, 2011

Int. Cl.: 35

FOR: RETAIL STORE, MAIL ORDER, ONLINE ORDERING AND RETAIL STORE SERVICES, ALL FEATURING DJ EQUIPMENT, MUSICAL INSTRUMENTS, SOUND AND LIGHTING EQUIPMENT, ACCESSORIES AND SUPPLIES, IN CLASS 35 (U.S. CLS. 100, 101 AND 102).

SERVICE MARK

FIRST USE 10-1-1996; IN COMMERCE 10-1-1996.

PRINCIPAL REGISTER

THE MARK CONSISTS OF STANDARD CHARACTERS WITHOUT CLAIM TO ANY PARTICULAR FONT, STYLE, SIZE, OR COLOR.

NO CLAIM IS MADE TO THE EXCLUSIVE RIGHT TO USE "DJ", APART FROM THE MARK AS SHOWN.

SER. NO. 85-308,731, FILED 4-29-2011.

HENRY S. ZAK, EXAMINING ATTORNEY



David J. Kyffers

Director of the United States Patent and Trademark Office

United States of America

United States Patent and Trademark Office



Reg. No. 4,073,719

Registered Dec. 20, 2011

Int. Cl.: 35

SERVICE MARK

PRINCIPAL REGISTER

PLANET DJ, INC. (NEVADA CORPORATION)
1315 GREG STREET, SUITE 101
SPARKS, NV 89431

FOR: RETAIL STORE, MAIL ORDER, ONLINE ORDERING AND RETAIL STORE SERVICES, ALL FEATURING DJ EQUIPMENT, MUSICAL INSTRUMENTS, SOUND AND LIGHTING EQUIPMENT, ACCESSORIES AND SUPPLIES, IN CLASS 35 (U.S. CLS. 100, 101 AND 102).

FIRST USE 10-1-1996; IN COMMERCE 10-1-1996.

NO CLAIM IS MADE TO THE EXCLUSIVE RIGHT TO USE "DJ", APART FROM THE MARK AS SHOWN.

THE MARK CONSISTS OF AN IMAGE OF THE EARTH WITH THE WORD "PLANET" APPEARING ON THE TOP CURVE, THE WORD "DJ" IN THE LOWER RIGHT HAND CORNER OF THE GLOBE, AND A SWOOSH DESIGN TO THE LEFT OF THE GLOBE.

SER. NO. 85-308,755, FILED 4-29-2011.

HENRY S. ZAK, EXAMINING ATTORNEY



David J. Kybas

Director of the United States Patent and Trademark Office

United States of America

United States Patent and Trademark Office



Reg. No. 4,073,720

Registered Dec. 20, 2011

Int. Cl.: 29

TRADEMARK

PRINCIPAL REGISTER

GRUPO BIMBO, S.A. B. DE C.V. (MEXICO CORPORATION)
PROLONGACION PASEO DE LA REFORMA
NO. 1000, COL. PENA BLANCA SANTA FE
MEXICO CITY, MEXICO 01210

FOR: POTATO CHIPS, IN CLASS 29 (U.S. CL. 46).

FIRST USE 9-30-2004; IN COMMERCE 9-30-2004.

OWNER OF U.S. REG. NO. 3,783,818.

THE MARK CONSISTS OF A KETTLE CONTAINING SLICED POTATOES AND A SPOON HANDLE SITTING ON LOGS AND FIRE FLAMES.

SER. NO. 85-308,786, FILED 4-29-2011.

ROBIN MITTLER, EXAMINING ATTORNEY



David J. Kyffers

Director of the United States Patent and Trademark Office

United States of America

United States Patent and Trademark Office



Reg. No. 4,073,721

Registered Dec. 20, 2011

Int. Cls.: 6, 11, 20 and 21

TRADEMARK

PRINCIPAL REGISTER

GLOBE UNION INDUSTRIAL CORP. (TAIWAN CORPORATION)
TAICHUNG EXPORT PROCESSING ZONE
22, CHIEN-KUO ROAD
TAICHUNG, TAIWAN

FOR: METAL CLOTHES HOOKS, METAL HOOKS, METAL BATHTUB GRAB BARS, METAL SHOWER GRAB BARS, IN CLASS 6 (U.S. CLS. 2, 12, 13, 14, 23, 25 AND 50).

FIRST USE 8-27-2003; IN COMMERCE 6-29-2005.

FOR: PLUMBING FIXTURES, NAMELY, FAUCETS, SHOWER HEADS, TOILETS, BIDETS, BATHTUBS, WHIRLPOOL BATHS, SINKS, WATER CLOSETS, AND LAVATORIES, IN CLASS 11 (U.S. CLS. 13, 21, 23, 31 AND 34).

FIRST USE 8-27-2003; IN COMMERCE 6-29-2005.

FOR: FURNITURE, BATHROOM FURNITURE, KITCHEN CABINETS, BATHROOM VANITIES, MIRRORS FOR FURNITURE, BATHROOM SHELVES, NON-METAL CLOTHES HOOKS, BATHTUB GRAB BARS NOT MADE OF METAL, SHOWER GRAB BARS NOT OF METAL, IN CLASS 20 (U.S. CLS. 2, 13, 22, 25, 32 AND 50).

FIRST USE 8-27-2003; IN COMMERCE 6-29-2005.

FOR: BATHROOM ACCESSORIES, NAMELY, TOWEL RINGS, TOWEL RAILS, TOWEL BARS, SOAP DISHES, SOAP BOXES, TOOTHBRUSH HOLDERS, CUP HOLDERS, HOLDERS FOR TOILET PAPER, TOILET TISSUE HOLDERS, SOAP DISPENSERS, IN CLASS 21 (U.S. CLS. 2, 13, 23, 29, 30, 33, 40 AND 50).

FIRST USE 8-27-2003; IN COMMERCE 6-29-2005.

OWNER OF U.S. REG. NO. 3,033,607.

THE MARK CONSISTS OF STYLIZED LETTERS "CORREGO".

THE ENGLISH TRANSLATION OF "CORREGO" IS "STREAM".

SER. NO. 85-308,799, FILED 4-29-2011.



David J. Kybas

Director of the United States Patent and Trademark Office

Reg. No. 4,073,721 ALEX KEAM, EXAMINING ATTORNEY

United States of America

United States Patent and Trademark Office

Freepon

Reg. No. 4,073,722

DABESTANI, PENNY (UNITED STATES INDIVIDUAL)
6509 SYBIL CT.

Registered Dec. 20, 2011

INDIAN TRAIL, NC 28079

Int. Cl.: 35

FOR: PROMOTING THE GOODS AND SERVICES OF OTHERS BY PROVIDING A WEBSITE FEATURING COUPONS, IN CLASS 35 (U.S. CLS. 100, 101 AND 102).

SERVICE MARK

FIRST USE 1-1-2011; IN COMMERCE 1-1-2011.

PRINCIPAL REGISTER

THE MARK CONSISTS OF STANDARD CHARACTERS WITHOUT CLAIM TO ANY PARTICULAR FONT, STYLE, SIZE, OR COLOR.

SER. NO. 85-308,812, FILED 4-29-2011.

KATHERINE E. HALMEN, EXAMINING ATTORNEY



David J. Kybas

Director of the United States Patent and Trademark Office

United States of America

United States Patent and Trademark Office

Good Science Makes Good Business

Reg. No. 4,073,723

Registered Dec. 20, 2011

Int. Cl.: 36

SERVICE MARK

PRINCIPAL REGISTER

FOUNDATION VENTURE CAPITAL GROUP LLC (NEW JERSEY LIMITED LIABILITY COMPANY)
8TH FLOOR
120 ALBANY STREET
NEW BRUNSWICK, NJ 08901

FOR: FINANCIAL SERVICES, NAMELY, INVESTMENT FUNDING FOR THE HEALTHCARE INDUSTRY, IN CLASS 36 (U.S. CLS. 100, 101 AND 102).

FIRST USE 4-15-2010; IN COMMERCE 4-15-2010.

THE MARK CONSISTS OF STANDARD CHARACTERS WITHOUT CLAIM TO ANY PARTICULAR FONT, STYLE, SIZE, OR COLOR.

SER. NO. 85-308,819, FILED 4-29-2011.

DAVID I, EXAMINING ATTORNEY



David J. Kyffers

Director of the United States Patent and Trademark Office

United States of America

United States Patent and Trademark Office



Reg. No. 4,073,724

Registered Dec. 20, 2011

Int. Cl.: 43

SERVICE MARK

PRINCIPAL REGISTER

FNK CATERING CORP. (NEW YORK CORPORATION)
30-46 HOBART STREET
WOODSIDE, NY 11377

FOR: RESTAURANT SERVICES, IN CLASS 43 (U.S. CLS. 100 AND 101).

FIRST USE 4-1-2010; IN COMMERCE 4-1-2010.

NO CLAIM IS MADE TO THE EXCLUSIVE RIGHT TO USE "TRADITIONAL GREEK CUISINE EST. 1971", APART FROM THE MARK AS SHOWN.

THE MARK CONSISTS OF PARTHENON IN THE CENTER WITH ONE OLIVE BRANCH ON EACH SIDE OF IT AND A DOUBLE ARCH AROUND IT. THE STYLIZED TEXT "TRADITIONAL GREEK CUISINE" APPEARS BELOW THE PARTHENON WITH ONE LINE ABOVE AND ONE LINE BELOW THOSE WORDS. ABOVE THE PARTHENON IS THE STYLIZED TEXT "UNCLE GUSSY'S" UNDER STYLIZED TEXT "EST. 1971".

SER. NO. 85-308,853, FILED 4-29-2011.

EMILY CARLSEN, EXAMINING ATTORNEY



David J. Kyffers

Director of the United States Patent and Trademark Office

United States of America

United States Patent and Trademark Office

tWIStED

Reg. No. 4,073,725

SIMON USA GROUP (TEXAS CORPORATION)
2529 ROYAL LANE #225
DALLAS, TX 75229

Registered Dec. 20, 2011

Int. Cl.: 25

FOR: FOOTWEAR FOR MEN AND WOMEN, IN CLASS 25 (U.S. CLS. 22 AND 39).

TRADEMARK

FIRST USE 4-11-2011; IN COMMERCE 4-15-2011.

PRINCIPAL REGISTER

THE MARK CONSISTS OF THE WORD "TWISTED" APPEARING IN STYLIZED FONT INSIDE A RECTANGLE SHAPE.

SER. NO. 85-308,862, FILED 4-29-2011.

KATHERINE E. HALMEN, EXAMINING ATTORNEY



David J. Kybas

Director of the United States Patent and Trademark Office

United States of America

United States Patent and Trademark Office



Reg. No. 4,073,726

Registered Dec. 20, 2011

Int. Cls.: 39 and 40

SERVICE MARK

PRINCIPAL REGISTER

GREENWASTE RECOVERY, INC. (CALIFORNIA CORPORATION), AKA ZANKER ROAD RESOURCE MANAGEMENT, LTD.
1500 BERGER DR.
SAN JOSE, CA 95112

FOR: TRASH SERVICES, NAMELY, RENTAL OF DUMPSTERS, IN CLASS 39 (U.S. CLS. 100 AND 105).

FIRST USE 8-19-1991; IN COMMERCE 8-19-1991.

FOR: MATERIAL TREATMENT SERVICES IN CONNECTION WITH RECYCLING; RECYCLING; RECYCLING OF CHEMICALS; RECYCLING OF WASTE; RECYCLING OF WASTE AND RUBBISH; RECYCLING OF WASTE AND TRASH; RECYCLING SERVICES, NAMELY, RECLAMATION OF WASTE PAINT FOR PRODUCTION OF POST-RECYCLING PRODUCT; ALL THE ABOVE SERVICES PROVIDED IN AN ENVIRONMENTALLY RESPONSIBLE MANNER, IN CLASS 40 (U.S. CLS. 100, 103 AND 106).

FIRST USE 8-19-1991; IN COMMERCE 8-19-1991.

NO CLAIM IS MADE TO THE EXCLUSIVE RIGHT TO USE "GREEN WASTE", APART FROM THE MARK AS SHOWN.

THE COLOR(S) GREEN IS/ARE CLAIMED AS A FEATURE OF THE MARK.

THE MARK CONSISTS OF THE WORDING "GREENWASTE" WHICH APPEARS ABOVE THE WORDING "A BRIGHTER SHADE OF GREEN", A DESIGN ELEMENT CONSISTING OF 7 SUNRAY SHAPES IN A 1/2 CIRCLE APPEARS ABOVE THE WORDING "GREENWASTE;" AND FROM LEFT TO RIGHT, THE ALL THE WORDING AND THE DESIGN ELEMENTS FADE FROM A DARKER SHADE OF GREEN TO A LIGHTER SHADE OF GREEN.

SER. NO. 85-308,865, FILED 4-29-2011.

BILL DAWE, EXAMINING ATTORNEY



David J. Kyffers

Director of the United States Patent and Trademark Office

United States of America

United States Patent and Trademark Office



Reg. No. 4,073,727

Registered Dec. 20, 2011

Int. Cls.: 35 and 42

SERVICE MARK

PRINCIPAL REGISTER

DIGITALSMITHS CORPORATION (DELAWARE CORPORATION)
SUITE 200
320 BLACKWELL STREET
DURHAM, NC 27701

FOR: BUSINESS CONSULTING SERVICES, NAMELY, ASSISTING OTHERS IN IDENTIFYING AND INDEXING METADATA FOR MULTIMEDIA AND VIDEO CONTENT TO ENABLE SEARCHING, CROSS-REFERENCING, IDENTIFICATION OF AD OR OTHER BREAKS IN THE VIDEO CONTENT THAT ARE SUITABLE FOR INSERTS OF ADVERTISEMENTS OR OTHER CONTENT, AND FOR IDENTIFYING AND SELECTING PORTIONS, SCENES, OR SEGMENTS IN SUCH MULTIMEDIA AND VIDEO CONTENT; ADVERTISING CONSULTATION SERVICES IN THE FIELD OF ONLINE VIDEO INDEXING AND SEARCH CAPABILITIES, NAMELY, IDENTIFYING RELEVANT ADVERTISEMENT INSERTION OPPORTUNITIES FOR BROADCASTS AND VIDEOS OF TELEVISION, FILM, AND USER-GENERATED-CONTENT MEDIA USING ONLINE VIDEO INDEXING AND SEARCH CAPABILITIES OF SUCH MEDIA, IN CLASS 35 (U.S. CLS. 100, 101 AND 102).

FIRST USE 3-23-2011, THE MARK WAS FIRST USED ANYWHERE IN A DIFFERENT FORM OTHER THAN THAT SOUGHT TO BE REGISTERED AT LEAST AS EARLY AS 02/00/1998.; IN COMMERCE 3-23-2011, THE MARK WAS FIRST USED IN COMMERCE IN A DIFFERENT FORM OTHER THAN THAT SOUGHT TO BE REGISTERED AT LEAST AS EARLY AS 02/00/1998..



FOR: COMPUTER SERVICES, NAMELY, PROVIDING ONLINE NONDOWNLOADABLE SOFTWARE THAT ENABLES USERS TO UPLOAD MULTIMEDIA AND VIDEO CONTENT, AND TO STORE, EDIT, VIEW, DISTRIBUTE, SEARCH, AND ASSOCIATE AND IDENTIFY TIME-BASED METADATA THEREWITH; COMPUTER CONSULTING SERVICES, NAMELY, ASSISTING OTHERS IN IDENTIFYING AND INDEXING METADATA FOR MULTIMEDIA AND VIDEO CONTENT, IN CLASS 42 (U.S. CLS. 100 AND 101).

FIRST USE 3-23-2011, THE MARK WAS FIRST USED ANYWHERE IN A DIFFERENT FORM OTHER THAN THAT SOUGHT TO BE REGISTERED AT LEAST AS EARLY AS 02/00/1998.; IN COMMERCE 3-23-2011, THE MARK WAS FIRST USED IN COMMERCE IN A DIFFERENT FORM OTHER THAN THAT SOUGHT TO BE REGISTERED AT LEAST AS EARLY AS 02/00/1998..

David J. Kybas

Director of the United States Patent and Trademark Office

OWNER OF U.S. REG. NOS. 3,380,356 AND 3,809,540.

Reg. No. 4,073,727 NO CLAIM IS MADE TO THE EXCLUSIVE RIGHT TO USE "VIDEO", APART FROM THE MARK AS SHOWN.

THE MARK CONSISTS OF A SYMBOL DEPICTING, IN PERSPECTIVE, A PARTIAL OUTLINE OF A DISC-SHAPED OBJECT TO THE LEFT OF THE WORD "DIGITALSMITHS" IN LARGE BOLD FONT WITH THE TAGLINE "FANATICAL VIDEO DISCOVERY" IN SMALLER FONT BELOW THE WORD DIGITALSMITHS AND ALSO TO THE RIGHT OF THE DISC-SHAPED SYMBOL.

SER. NO. 85-308,876, FILED 4-29-2011.

Laurie Kaufman, Examining Attorney

United States of America

United States Patent and Trademark Office

CREATIONSWAP

Reg. No. 4,073,728

Registered Dec. 20, 2011

Int. Cl.: 42

SERVICE MARK

PRINCIPAL REGISTER

CREATIONSWAP, LLC (OREGON LIMITED LIABILITY COMPANY)
2462 NW MORNINGWOOD WAY
BEND, OR 97701

FOR: PROVIDING A WEBSITE THAT GIVES COMPUTER USERS THE ABILITY TO UPLOAD GRAPHIC ART, WEBSITE TEMPLATES, DESIGN TEMPLATES, VIDEO, AUDIO AND OTHER MEDIA AND ALLOWS USERS TO DOWNLOAD FOR FREE OR FOR PURCHASE GRAPHIC ART, WEBSITE TEMPLATES, DESIGN TEMPLATES, VIDEO, AUDIO AND OTHER MEDIA, AND GIVES GRAPHIC ARTISTS THE ABILITY TO INTERACT WITH OTHER ARTISTS, USERS OF ART MEDIA, AND ORGANIZATIONS AND FEATURE THEIR ARTWORK, DESIGN TEMPLATES, VIDEO, AUDIO AND OTHER MEDIA FOR COMMENT AND INTERACTION WITH OTHER USERS AND PROMOTE THEMSELVES, THEIR SERVICES AND THEIR PRODUCTS, IN CLASS 42 (U.S. CLS. 100 AND 101).

FIRST USE 4-1-2011; IN COMMERCE 4-1-2011.

THE MARK CONSISTS OF STANDARD CHARACTERS WITHOUT CLAIM TO ANY PARTICULAR FONT, STYLE, SIZE, OR COLOR.

SER. NO. 85-308,901, FILED 4-29-2011.

JEFFREY LOOK, EXAMINING ATTORNEY



David J. Kyffers

Director of the United States Patent and Trademark Office

United States of America

United States Patent and Trademark Office

WMB World's Most Beautiful

Reg. No. 4,073,729

Registered Dec. 20, 2011

Int. Cl.: 9

TRADEMARK

PRINCIPAL REGISTER

SLICKFORCE INC. (CALIFORNIA CORPORATION)
C/O NICK SAGLIMBENI
155 WEST WASHINGTON BLVD. #650
LOS ANGELES, CA 90015

FOR: ELECTRONIC PUBLICATIONS, NAMELY, MAGAZINE FEATURING PHOTOS AND TEXT PERTAINING TO CELEBRITIES, MODELS, CARS, TRAVEL LOCATIONS, AND LIFESTYLE RECORDED ON COMPUTER MEDIA, IN CLASS 9 (U.S. CLS. 21, 23, 26, 36 AND 38).

FIRST USE 11-15-2010; IN COMMERCE 1-15-2011.

THE MARK CONSISTS OF STANDARD CHARACTERS WITHOUT CLAIM TO ANY PARTICULAR FONT, STYLE, SIZE, OR COLOR.

NO CLAIM IS MADE TO THE EXCLUSIVE RIGHT TO USE "WORLD'S MOST BEAUTIFUL", APART FROM THE MARK AS SHOWN.

SER. NO. 85-308,979, FILED 4-29-2011.

ODESSA BIBBINS, EXAMINING ATTORNEY



David J. Kyffers

Director of the United States Patent and Trademark Office

United States of America

United States Patent and Trademark Office

Camping Connection

Reg. No. 4,073,730

Registered Dec. 20, 2011

Int. Cls.: 35 and 37

SERVICE MARK

PRINCIPAL REGISTER

CAMPING CONNECTION INC (FLORIDA CORPORATION)
9140 W IRLO BRONSON HWY.
KISSIMMEE, FL 34747

FOR: RETAIL STORE AND ON-LINE RETAIL STORE SERVICES FEATURING RV PARTS AND ACCESSORIES, IN CLASS 35 (U.S. CLS. 100, 101 AND 102).

FIRST USE 7-1-1996; IN COMMERCE 7-1-1996.

FOR: INSTALLATION AND REPAIR OF RECREATIONAL VEHICLES, IN CLASS 37 (U.S. CLS. 100, 103 AND 106).

FIRST USE 7-1-1996; IN COMMERCE 7-1-1996.

THE MARK CONSISTS OF STANDARD CHARACTERS WITHOUT CLAIM TO ANY PARTICULAR FONT, STYLE, SIZE, OR COLOR.

NO CLAIM IS MADE TO THE EXCLUSIVE RIGHT TO USE "CAMPING", APART FROM THE MARK AS SHOWN.

SER. NO. 85-308,981, FILED 4-29-2011.

ODESSA BIBBINS, EXAMINING ATTORNEY



David J. Kyffers

Director of the United States Patent and Trademark Office

United States of America

United States Patent and Trademark Office



Humidifall

Reg. No. 4,073,731

HUMIDIFALL, LLC (DELAWARE LIMITED LIABILITY COMPANY)
5988 MID RIVERS MALL DRIVE
ST. CHARLES, MO 63304

Registered Dec. 20, 2011

Int. Cl.: 11

FOR: HUMIDIFIERS AND DEHUMIDIFIERS; INDOOR DECORATIVE WATERFALL HUMIDIFIERS AND DEHUMIDIFIERS, IN CLASS 11 (U.S. CLS. 13, 21, 23, 31 AND 34).

TRADEMARK

FIRST USE 6-0-1998; IN COMMERCE 6-0-1998.

PRINCIPAL REGISTER

THE MARK CONSISTS OF A LOGO DESIGN WITH A HIGHLY STYLIZED SERIES OF VERTICAL LINES THAT ARE UPTURNED AND CURLED AT THE BOTTOM RESEMBLING A WATERFALL, WITH THE WORD "HUMIDIFALL" TO THE RIGHT OF THE VERTICAL LINE DESIGN.

SER. NO. 85-309,034, FILED 4-30-2011.

APRIL ROACH, EXAMINING ATTORNEY



David J. Kyffers

Director of the United States Patent and Trademark Office

United States of America

United States Patent and Trademark Office

AUDITION FITNESS

Reg. No. 4,073,732

LEDERER, DANIEL (UNITED STATES INDIVIDUAL)

Registered Dec. 20, 2011

940 N. ARDMORE AVENUE, APT. 201
LOS ANGELES, CA 90029

Int. Cl.: 41

FOR: EDUCATION AND ENTERTAINMENT SERVICES, NAMELY, PROVIDING ASSISTANCE, INFORMATION, INSTRUCTION, COACHING, PERSONAL TRAINING AND PHYSICAL FITNESS CONSULTATION TO INDIVIDUALS TO HELP THEM MAKE PHYSICAL FITNESS, STRENGTH, CONDITIONING, AND EXERCISE IMPROVEMENT IN THEIR DAILY LIVING, IN CLASS 41 (U.S. CLS. 100, 101 AND 107).

SERVICE MARK

PRINCIPAL REGISTER

FIRST USE 3-19-2011; IN COMMERCE 3-19-2011.

THE MARK CONSISTS OF STANDARD CHARACTERS WITHOUT CLAIM TO ANY PARTICULAR FONT, STYLE, SIZE, OR COLOR.

NO CLAIM IS MADE TO THE EXCLUSIVE RIGHT TO USE "FITNESS", APART FROM THE MARK AS SHOWN.

SER. NO. 85-309,044, FILED 4-30-2011.

MARK RADEMACHER, EXAMINING ATTORNEY



David J. Kyffers

Director of the United States Patent and Trademark Office

United States of America

United States Patent and Trademark Office

SWIVEL SHOTS

Reg. No. 4,073,733

Registered Dec. 20, 2011

Int. Cl.: 41

SERVICE MARK

PRINCIPAL REGISTER

SWIVEL SHOTS INC. (CONNECTICUT CORPORATION)
21 GREENFIELD DRIVE
WESTON, CT 06883

FOR: PHOTOGRAPHY SERVICES, IN CLASS 41 (U.S. CLS. 100, 101 AND 107).

FIRST USE 9-22-2010; IN COMMERCE 9-23-2010.

THE MARK CONSISTS OF STANDARD CHARACTERS WITHOUT CLAIM TO ANY PARTICULAR FONT, STYLE, SIZE, OR COLOR.

NO CLAIM IS MADE TO THE EXCLUSIVE RIGHT TO USE "SHOTS", APART FROM THE MARK AS SHOWN.

SER. NO. 85-309,079, FILED 4-30-2011.

MARC LEIPZIG, EXAMINING ATTORNEY



David J. Kyffers

Director of the United States Patent and Trademark Office

United States of America

United States Patent and Trademark Office

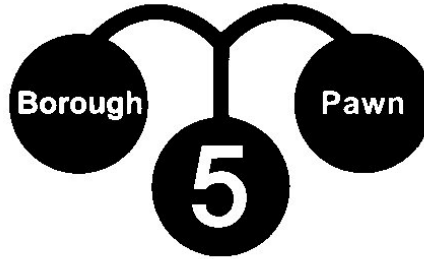

Reg. No. 4,073,734

Registered Dec. 20, 2011

Int. Cl.: 36

SERVICE MARK

PRINCIPAL REGISTER

5 BOROUGH PAWN (NEW YORK LIMITED LIABILITY COMPANY)
UNIT A
93-45 104TH STREET
OZONE PARK, NY 11416

FOR: PAWN SHOPS, IN CLASS 36 (U.S. CLS. 100, 101 AND 102).

FIRST USE 8-1-2005; IN COMMERCE 8-1-2005.

NO CLAIM IS MADE TO THE EXCLUSIVE RIGHT TO USE "PAWN", APART FROM THE MARK AS SHOWN.

THE MARK CONSISTS OF A STYLIZED VERSION OF THE INTERNATIONAL SYMBOL FOR PAWN BROKERS, NAMELY, A DESIGN OF THREE CIRCLES CONNECTED BY CURVED LINES, AND THE WORDING "5 BOROUGH PAWN" IN THE DESIGN

SER. NO. 85-309,102, FILED 4-30-2011.

CURTIS FRENCH, EXAMINING ATTORNEY



David J. Kybas

Director of the United States Patent and Trademark Office

United States of America

United States Patent and Trademark Office

Red Hook Films

Reg. No. 4,073,735

RED HOOK FILMS (NEW JERSEY LIMITED LIABILITY COMPANY)
21 WELDON RD
MATAWAN, NJ 07747

Registered Dec. 20, 2011

Int. Cl.: 41

FOR: MOTION PICTURE FILM PRODUCTION, IN CLASS 41 (U.S. CLS. 100, 101 AND 107).

SERVICE MARK

FIRST USE 1-9-1997; IN COMMERCE 1-9-1997.

PRINCIPAL REGISTER

THE MARK CONSISTS OF STANDARD CHARACTERS WITHOUT CLAIM TO ANY PARTICULAR FONT, STYLE, SIZE, OR COLOR.

NO CLAIM IS MADE TO THE EXCLUSIVE RIGHT TO USE "FILMS", APART FROM THE MARK AS SHOWN.

SER. NO. 85-309,145, FILED 4-30-2011.

DOMINIC J. FERRAIUOLO, EXAMINING ATTORNEY



David J. Kyffers

Director of the United States Patent and Trademark Office

United States of America

United States Patent and Trademark Office

Amazing Times Photo Booths

Reg. No. 4,073,736

Registered Dec. 20, 2011

Int. Cl.: 41

SERVICE MARK

PRINCIPAL REGISTER

PLUMLEY FAMILY PARTNERSHIP (PENNSYLVANIA PARTNERSHIP)
390 N. BROAD STREET
KENNETT SQUARE, PA 19348

FOR: RENTAL OF PORTABLE PHOTO BOOTHS FOR ALL TYPES OF EVENTS, IN CLASS 41 (U.S. CLS. 100, 101 AND 107).

FIRST USE 1-1-2010; IN COMMERCE 1-1-2010.

THE MARK CONSISTS OF STANDARD CHARACTERS WITHOUT CLAIM TO ANY PARTICULAR FONT, STYLE, SIZE, OR COLOR.

NO CLAIM IS MADE TO THE EXCLUSIVE RIGHT TO USE "PHOTO BOOTHS", APART FROM THE MARK AS SHOWN.

SER. NO. 85-309,147, FILED 4-30-2011.

KATINA MISTER, EXAMINING ATTORNEY



David J. Kybas

Director of the United States Patent and Trademark Office

United States of America

United States Patent and Trademark Office

Roline's
Uniquely Filipino

Reg. No. 4,073,737

CASPER, ROLINE (UNITED STATES INDIVIDUAL)
322 BALD EAGLE DR
VACAVILLE, CA 95688

Registered Dec. 20, 2011

Int. Cl.: 35

FOR: RETAIL STORE SERVICES FEATURING FOOD ITEMS, IN CLASS 35 (U.S. CLS. 100, 101 AND 102).

SERVICE MARK

FIRST USE 1-1-2009; IN COMMERCE 1-1-2009.

PRINCIPAL REGISTER

NO CLAIM IS MADE TO THE EXCLUSIVE RIGHT TO USE "FILIPINO", APART FROM THE MARK AS SHOWN.

THE NAME "ROLINE'S" IDENTIFIES A LIVING INDIVIDUAL WHOSE CONSENT IS OF RECORD.

THE MARK CONSISTS OF THE STYLIZED TEXT "ROLINE'S UNIQUELY FILIPINO" WITH A HAT HANGING OUT OF THE LETTER "R".

SER. NO. 85-309,152, FILED 4-30-2011.

BARNEY CHARLON, EXAMINING ATTORNEY



David J. Kyffers

Director of the United States Patent and Trademark Office

United States of America

United States Patent and Trademark Office

bayou bucks

Reg. No. 4,073,738

Registered Dec. 20, 2011

Int. Cls.: 16 and 41

TRADEMARK

SERVICE MARK

PRINCIPAL REGISTER

LIMELIGHT PRODUCTIONS, LLC (LOUISIANA LIMITED LIABILITY COMPANY), DBA
BAYOU BUCKS
1216 SOUTH MORRISON BOULEVARD SUITE 7
HAMMOND, LA 70403

FOR: MAGAZINES FEATURING HUNTING AND FISHING, IN CLASS 16 (U.S. CLS. 2, 5, 22, 23, 29, 37, 38 AND 50).

FIRST USE 9-8-2006; IN COMMERCE 3-31-2011.

FOR: ENTERTAINMENT SERVICES, NAMELY, PROVIDING PODCASTS IN THE FIELD OF HUNTING AND FISHING; PROVIDING A WEBSITE FEATURING INFORMATION ABOUT HUNTING AND FISHING; PROVIDING FACILITIES FOR RECREATIONAL ACTIVITIES, NAMELY, HUNTING AND FISHING; TELEVISION SHOW PRODUCTION, IN CLASS 41 (U.S. CLS. 100, 101 AND 107).

FIRST USE 9-8-2006; IN COMMERCE 7-1-2008.

THE MARK CONSISTS OF STANDARD CHARACTERS WITHOUT CLAIM TO ANY PARTICULAR FONT, STYLE, SIZE, OR COLOR.

NO CLAIM IS MADE TO THE EXCLUSIVE RIGHT TO USE "BUCKS", APART FROM THE MARK AS SHOWN.

SER. NO. 85-309,155, FILED 4-30-2011.

ERNEST SHOSHO, EXAMINING ATTORNEY



David J. Kyffers

Director of the United States Patent and Trademark Office

United States of America

United States Patent and Trademark Office

CARPET PRODUCTIVITY

Reg. No. 4,073,739

R.E. WHITTAKER COMPANY (PENNSYLVANIA CORPORATION)
302 S. CROTON AVE.
NEW CASTLE, PA 16101

Registered Dec. 20, 2011

Int. Cls.: 3 and 7

FOR: CARPET CLEANERS; CARPET CLEANERS WITH DEODORIZER; CARPET CLEANING PREPARATIONS; CARPET SHAMPOO, IN CLASS 3 (U.S. CLS. 1, 4, 6, 50, 51 AND 52).

TRADEMARK

FIRST USE 3-31-2011; IN COMMERCE 3-31-2011.

PRINCIPAL REGISTER

FOR: CARPET CLEANING MACHINES, IN CLASS 7 (U.S. CLS. 13, 19, 21, 23, 31, 34 AND 35).

FIRST USE 3-31-2011; IN COMMERCE 3-31-2011.

THE MARK CONSISTS OF STANDARD CHARACTERS WITHOUT CLAIM TO ANY PARTICULAR FONT, STYLE, SIZE, OR COLOR.

NO CLAIM IS MADE TO THE EXCLUSIVE RIGHT TO USE "CARPET", APART FROM THE MARK AS SHOWN.

SER. NO. 85-309,162, FILED 4-30-2011.

MARC LEIPZIG, EXAMINING ATTORNEY



David J. Kybas

Director of the United States Patent and Trademark Office

United States of America

United States Patent and Trademark Office



Reg. No. 4,073,740

Registered Dec. 20, 2011

Int. Cl.: 41

SERVICE MARK

PRINCIPAL REGISTER

SALYERS, KEITH, WINN (UNITED STATES INDIVIDUAL), DBA LYONS LEGACY PUBLISHING
123 EAST UNAKA AVENUE
JOHNSON CITY, TN 37601 AND

O'HARA-SALYERS, MELANIE (UNITED STATES INDIVIDUAL), DBA LYONS LEGACY PUBLISHING
123 EAST UNAKA AVENUE
JOHNSON CITY, TN 37601

FOR: PUBLISHING OF BOOKS, E-BOOKS, AUDIO BOOKS, MUSIC AND ILLUSTRATIONS, EXCLUDING MULTIMEDIA, VIDEO AND AUDIO MATERIALS, NAMELY, VIDEO TAPES, AUDIO TAPES AND DVDS IN THE FIELD OF TRAINING HORSES AND PRINTED MATERIALS, NAMELY, BOOKS IN THE FIELD OF TRAINING HORSES, IN CLASS 41 (U.S. CLS. 100, 101 AND 107).

FIRST USE 1-1-2011; IN COMMERCE 1-1-2011.

NO CLAIM IS MADE TO THE EXCLUSIVE RIGHT TO USE "PUBLISHING", APART FROM THE MARK AS SHOWN.

THE MARK CONSISTS OF A LION SEATED ON THREE LARGE BOOKS WITH THE WORDS "LYONS LEGACY PUBLISHING" BENEATH BOOKS.

SER. NO. 85-309,192, FILED 4-30-2011.

DOMINIC J. FERRAIUOLO, EXAMINING ATTORNEY



David J. Kybas

Director of the United States Patent and Trademark Office

United States of America

United States Patent and Trademark Office

Qwink

Reg. No. 4,073,741

VON SCHLEGELL, VICTOR (UNITED STATES INDIVIDUAL)
13287 BLUFF RD.

Registered Dec. 20, 2011

TRAVERSE CITY, MI 49686

Int. Cl.: 9

FOR: SOFTWARE FOR DESKTOPS, LAPTOPS AND MOBILE DEVICES FOR VIEWING THE ONLINE AVAILABILITY STATUS OF THE CONTACTS THAT USERS WISH TO REACH AND COMMUNICATE WITH BY VOICE AND TEXT AND TO REACH THEM BASED ON THEIR STATUS, IN CLASS 9 (U.S. CLS. 21, 23, 26, 36 AND 38).

TRADEMARK

PRINCIPAL REGISTER

FIRST USE 4-1-2010; IN COMMERCE 4-1-2011.

THE MARK CONSISTS OF STANDARD CHARACTERS WITHOUT CLAIM TO ANY PARTICULAR FONT, STYLE, SIZE, OR COLOR.

SER. NO. 85-309,206, FILED 4-30-2011.

HANNO RITTNER, EXAMINING ATTORNEY



David J. Kyffers

Director of the United States Patent and Trademark Office

United States of America

United States Patent and Trademark Office

Ministry of the Third Cross

Reg. No. 4,073,742

Registered Dec. 20, 2011

Int. Cl.: 45

SERVICE MARK

PRINCIPAL REGISTER

MINISTRY OF THE THIRD CROSS (TEXAS NON-PROFIT CORPORATION)
14207 SPOTTED CEDAR
SAN ANTONIO, TX 78249

FOR: PROVIDING SPIRITUAL REHABILITATION SERVICES; PROVIDING SPIRITUAL RETREATS IN THE FIELD OF PROVIDING FOR THE NEEDS OF MEN, WOMEN AND TEENS IN THE CRIMINAL JUSTICE SYSTEM BY PROVIDING CHRISTIAN LEADERSHIP, TRAINING AND MENTORING, EXTENDED COMMUNITY SUPPORT, SUBSTANCE ABUSE REFERRALS, JOB AND INDIVIDUAL COUNSELING AND BIBLE STUDY; PROVIDING SPIRITUAL RETREATS IN THE FIELDS OF TOGETHERNESS AND HOW TO BE BETTER MEN; RELIGIOUS AND SPIRITUAL SERVICES, NAMELY, PROVIDING GATHERINGS AND RETREATS TO DEVELOP AND ENHANCE THE SPIRITUAL LIVES OF INDIVIDUALS, IN CLASS 45 (U.S. CLS. 100 AND 101).

FIRST USE 7-1-2003; IN COMMERCE 7-1-2003.

THE MARK CONSISTS OF STANDARD CHARACTERS WITHOUT CLAIM TO ANY PARTICULAR FONT, STYLE, SIZE, OR COLOR.

NO CLAIM IS MADE TO THE EXCLUSIVE RIGHT TO USE "MINISTRY", APART FROM THE MARK AS SHOWN.

SER. NO. 85-309,208, FILED 4-30-2011.

HANNO RITTNER, EXAMINING ATTORNEY



David J. Kyffers

Director of the United States Patent and Trademark Office

United States of America

United States Patent and Trademark Office



Reg. No. 4,073,743

Registered Dec. 20, 2011

Int. Cl.: 35

SERVICE MARK

PRINCIPAL REGISTER

GROUPIGG, LLC (MISSOURI LIMITED LIABILITY COMPANY)
3010 LOCUST STREET, SUITE 100
ST. LOUIS, MO 63103

FOR: ADVERTISING AND PROMOTIONAL SERVICES; PROMOTING THE GOODS AND SERVICES OF OTHERS VIA A GLOBAL COMPUTER NETWORK BY PROVIDING A WEBSITE PROMOTING THE GOODS AND SERVICES OF OTHERS, NAMELY, FEATURING COUPONS, DISCOUNTS, REBATES, VOUCHERS, SPECIAL OFFERS, PRICE-COMPARISON INFORMATION, PRODUCT REVIEWS, AND HYPERTEXT LINKS TO THE WEBSITES OF OTHERS FOR THE GOODS AND SERVICES OF OTHERS IN PARTICULAR GEOGRAPHIC LOCATIONS, IN CLASS 35 (U.S. CLS. 100, 101 AND 102).

FIRST USE 5-0-2010; IN COMMERCE 5-0-2010.

OWNER OF U.S. REG. NO. 3,922,784.

THE COLOR(S) PINK, GRAY, BLACK, AND WHITE IS/ARE CLAIMED AS A FEATURE OF THE MARK.

THE MARK CONSISTS OF THREE PINK PIGS WITH ONE PIG IN FRONT AND TWO IN BACK WITH THEIR FEATURES IN BLACK AND SHADED IN GRAY ON TOP OF THE WORD "GROUPIGG" IN GRAY WITH THE PIGS AND WORDING IN FRONT OF A WHITE BACKGROUND.

SER. NO. 85-309,209, FILED 4-30-2011.

HANNO RITTNER, EXAMINING ATTORNEY



David J. Kybas

Director of the United States Patent and Trademark Office

United States of America

United States Patent and Trademark Office



Reg. No. 4,073,744

Registered Dec. 20, 2011

Int. Cl.: 9

TRADEMARK

PRINCIPAL REGISTER

SOBANSKI, JESSICA (UNITED STATES INDIVIDUAL)
APT 507
1399 9TH AVENUE
SAN DIEGO, CA 92101

FOR: CHILDREN'S EDUCATIONAL SOFTWARE; EDUCATIONAL SOFTWARE FEATURING INSTRUCTION IN MATH, IN CLASS 9 (U.S. CLS. 21, 23, 26, 36 AND 38).

FIRST USE 1-1-2004; IN COMMERCE 12-1-2004.

NO CLAIM IS MADE TO THE EXCLUSIVE RIGHT TO USE ".ORG", APART FROM THE MARK AS SHOWN.

THE COLOR(S) BLACK, WHITE, PINK, PURPLE, AND BLUE IS/ARE CLAIMED AS A FEATURE OF THE MARK.

THE MARK CONSISTS OF THE TEXT "MATHLIBS.ORG" IS INCLUDED IN A WHITE SPEECH BUBBLE. THE SPEECH BUBBLE IS WHITE AND OUTLINED IN BLACK. THE TEXT "MATH" IS BLUE, THE TEXT "LIBS" IS PURPLE, AND THE TEXT ".ORG" IS PINK.

SER. NO. 85-309,226, FILED 4-30-2011.

KATHRYN COWARD, EXAMINING ATTORNEY



David J. Kybas

Director of the United States Patent and Trademark Office

United States of America

United States Patent and Trademark Office

Green Creative

Reg. No. 4,073,745

Registered Dec. 20, 2011

Int. Cl.: 11

TRADEMARK

PRINCIPAL REGISTER

GREEN CREATIVE LLC (CALIFORNIA LIMITED LIABILITY COMPANY)
577 SHOTWELL STREET
SAN FRANCISCO, CA 94110

FOR: LED LIGHT BULBS, IN CLASS 11 (U.S. CLS. 13, 21, 23, 31 AND 34).

FIRST USE 1-1-2011; IN COMMERCE 4-1-2011.

THE MARK CONSISTS OF STANDARD CHARACTERS WITHOUT CLAIM TO ANY PARTICULAR FONT, STYLE, SIZE, OR COLOR.

NO CLAIM IS MADE TO THE EXCLUSIVE RIGHT TO USE "GREEN", APART FROM THE MARK AS SHOWN.

SER. NO. 85-309,251, FILED 5-1-2011.

LAURA HAMMEL, EXAMINING ATTORNEY



David J. Kyffers

Director of the United States Patent and Trademark Office

United States of America

United States Patent and Trademark Office

Stress Killer

Reg. No. 4,073,746

D'ANDREA BROTHERS LLC (CALIFORNIA LIMITED LIABILITY COMPANY)
332 S GLENROY AVE
LOS ANGELES, CA 90049

Registered Dec. 20, 2011

Int. Cl.: 32

FOR: NON-ALCOHOLIC BEVERAGES, NAMELY, FRUIT DRINKS AND FRUIT JUICES, SPORTS DRINKS, ENERGY DRINKS; SYRUPS OR OTHER PREPARATIONS FOR MAKING BEVERAGES, NAMELY, SPORTS DRINKS AND ENERGY DRINKS, IN CLASS 32 (U.S. CLS. 45, 46 AND 48).

TRADEMARK

PRINCIPAL REGISTER

FIRST USE 5-1-2011; IN COMMERCE 5-1-2011.

THE MARK CONSISTS OF STANDARD CHARACTERS WITHOUT CLAIM TO ANY PARTICULAR FONT, STYLE, SIZE, OR COLOR.

SER. NO. 85-309,305, FILED 5-1-2011.

KIMBERLY FRYE, EXAMINING ATTORNEY



David J. Kybas

Director of the United States Patent and Trademark Office

United States of America

United States Patent and Trademark Office

Dent Recon

Reg. No. 4,073,747

DENT RECON (ILLINOIS LIMITED LIABILITY COMPANY)
2700 WEST HIGGINS ROAD
HOFFMAN ESTATES, IL 60195

Registered Dec. 20, 2011

Int. Cl.: 37

FOR: AUTOMOBILE BODY REPAIR AND FINISHING FOR OTHERS; AUTOMOBILE CLEANING; AUTOMOBILE DETAILING; AUTOMOBILE PAINTING; AUTOMOBILE PIN-STRIPING; AUTOMOBILE POLISHING; AUTOMOBILE RECONDITIONING SERVICES; AUTOMOBILE REPAIR AND MAINTENANCE, IN CLASS 37 (U.S. CLS. 100, 103 AND 106).

SERVICE MARK

PRINCIPAL REGISTER

FIRST USE 4-29-2011; IN COMMERCE 4-29-2011.

THE MARK CONSISTS OF STANDARD CHARACTERS WITHOUT CLAIM TO ANY PARTICULAR FONT, STYLE, SIZE, OR COLOR.

NO CLAIM IS MADE TO THE EXCLUSIVE RIGHT TO USE "DENT", APART FROM THE MARK AS SHOWN.

SER. NO. 85-309,307, FILED 5-1-2011.

KIMBERLY FRYE, EXAMINING ATTORNEY



David J. Kybas

Director of the United States Patent and Trademark Office

United States of America

United States Patent and Trademark Office

STEEL STANDING

Reg. No. 4,073,748

Registered Dec. 20, 2011

Int. Cl.: 20

TRADEMARK

PRINCIPAL REGISTER

KMT ENTERPRISES LLC (NEW YORK LIMITED LIABILITY COMPANY)
245 WEST 123RD ST. SUITE #3
NEW YORK, NY 10027

FOR: COLD CAST RESIN FIGURINES; PLAQUES OF RESIN, PLASTIC, WAX, PLASTER, AND WOOD; PLASTIC SCULPTURES; SCULPTURES OF RESIN, PLASTIC, WAX, PLASTER, AND WOOD; SOFT SCULPTURE WALL DECORATIONS; WALL PLAQUES MADE OF PLASTIC OR WOOD; WALL PLAQUES MADE OF RESIN, PLASTIC, WAX, PLASTER, AND WOOD, IN CLASS 20 (U.S. CLS. 2, 13, 22, 25, 32 AND 50).

FIRST USE 5-11-2002; IN COMMERCE 5-11-2002.

THE MARK CONSISTS OF STANDARD CHARACTERS WITHOUT CLAIM TO ANY PARTICULAR FONT, STYLE, SIZE, OR COLOR.

OWNER OF U.S. REG. NOS. 2,649,252 AND 3,893,175.

SER. NO. 85-309,310, FILED 5-1-2011.

KIMBERLY FRYE, EXAMINING ATTORNEY



David J. Kyffers

Director of the United States Patent and Trademark Office

United States of America

United States Patent and Trademark Office



Reg. No. 4,073,749

Registered Dec. 20, 2011

Int. Cls.: 44 and 45

SERVICE MARK

PRINCIPAL REGISTER

BOWERS, DANIEL J (UNITED STATES INDIVIDUAL), DBA URBAN PAWS
4817 LISTRA ROAD
ROCKVILLE, MD 20853

FOR: DOG WALKING SERVICES, IN CLASS 44 (U.S. CLS. 100 AND 101).

FIRST USE 1-1-2009; IN COMMERCE 1-1-2009.

FOR: HOUSE SITTING; PET SITTING, IN CLASS 45 (U.S. CLS. 100 AND 101).

FIRST USE 1-1-2009; IN COMMERCE 1-1-2009.

THE MARK CONSISTS OF A BLACK CITY SKYLINE WITH TEAL WINDOWS TURNING INTO A BLACK PAW PRINT. THE WORDS "URBAN" AND "PAWS" ARE WRITTEN OUT, WITH "URBAN" IN BLACK AND "PAWS" IN TEAL.

THE COLOR(S) BLACK AND TEAL IS/ARE CLAIMED AS A FEATURE OF THE MARK.

SER. NO. 85-309,339, FILED 5-1-2011.

HELENE LIWINSKI, EXAMINING ATTORNEY



David J. Kybas

Director of the United States Patent and Trademark Office

United States of America
United States Patent and Trademark Office

TROVINA

Reg. No. 4,073,750

TROVINA, LLC (KANSAS LIMITED LIABILITY COMPANY)
405 CENTER STREET
CARBONDALE, KS 66414

Registered Dec. 20, 2011

Int. Cl.: 3

FOR: HANDMADE SOAP BARS; HANDMADE LIQUID SOAP; BATH SALTS; BATH LOTIONS, IN CLASS 3 (U.S. CLS. 1, 4, 6, 50, 51 AND 52).

TRADEMARK

FIRST USE 12-0-2010; IN COMMERCE 12-0-2010.

PRINCIPAL REGISTER

THE MARK CONSISTS OF STANDARD CHARACTERS WITHOUT CLAIM TO ANY PARTICULAR FONT, STYLE, SIZE, OR COLOR.

THE ENGLISH TRANSLATION OF "TROVINA" IN THE MARK IS "FIND".

SER. NO. 85-309,357, FILED 5-1-2011.

MARK RADEMACHER, EXAMINING ATTORNEY



David J. Kybas

Director of the United States Patent and Trademark Office

United States of America

United States Patent and Trademark Office

Style Wear

Reg. No. 4,073,751

TEXTILE CENTER, INC. (FLORIDA CORPORATION)
6073 NW 167TH ST, STE C-6
MIAMI, FL 33015

Registered Dec. 20, 2011

Int. Cl.: 25

FOR: SHORT-SLEEVED OR LONG-SLEEVED T-SHIRTS; T-SHIRTS; T-SHIRTS FOR MEN, WOMEN AND CHILDREN, IN CLASS 25 (U.S. CLS. 22 AND 39).

TRADEMARK

FIRST USE 2-1-2011; IN COMMERCE 2-1-2011.

PRINCIPAL REGISTER

THE MARK CONSISTS OF STANDARD CHARACTERS WITHOUT CLAIM TO ANY PARTICULAR FONT, STYLE, SIZE, OR COLOR.

NO CLAIM IS MADE TO THE EXCLUSIVE RIGHT TO USE "WEAR", APART FROM THE MARK AS SHOWN.

SER. NO. 85-309,373, FILED 5-1-2011.

APRIL ROACH, EXAMINING ATTORNEY



David J. Kyffers

Director of the United States Patent and Trademark Office

United States of America

United States Patent and Trademark Office

SAFE ZONE SHELTERS INC.

Reg. No. 4,073,752

SAFE ZONE SHELTERS, INC. (VIRGINIA CORPORATION)

Registered Dec. 20, 2011

P.O. BOX 397
RUTHER GLEN, VA 22546

Int. Cl.: 37

FOR: BUILDING CONSTRUCTION SERVICES, NAMELY, CONSTRUCTION OF STEEL AND FIBERGLASS STORM SHELTERS, HOME CONSTRUCTION, HOME RENOVATION, AND COMMERCIAL BUILD OUTS, IN CLASS 37 (U.S. CLS. 100, 103 AND 106).

SERVICE MARK

FIRST USE 5-1-2008; IN COMMERCE 5-1-2008.

PRINCIPAL REGISTER

THE MARK CONSISTS OF STANDARD CHARACTERS WITHOUT CLAIM TO ANY PARTICULAR FONT, STYLE, SIZE, OR COLOR.

NO CLAIM IS MADE TO THE EXCLUSIVE RIGHT TO USE "SHELTERS INC.", APART FROM THE MARK AS SHOWN.

SER. NO. 85-309,387, FILED 5-1-2011.

LIEF MARTIN, EXAMINING ATTORNEY



David J. Kyffers

Director of the United States Patent and Trademark Office

United States of America

United States Patent and Trademark Office

EARTH TURF

Reg. No. 4,073,753

Registered Dec. 20, 2011

Int. Cl.: 31

TRADEMARK

PRINCIPAL REGISTER

EARTH TURF, LLC (OREGON LIMITED LIABILITY COMPANY)
1712 SE ANKENY ST
PORTLAND, OR 97214

FOR: GRASS SEED MIXTURE, IN CLASS 31 (U.S. CLS. 1 AND 46).

FIRST USE 5-1-2009; IN COMMERCE 6-1-2009.

THE MARK CONSISTS OF STANDARD CHARACTERS WITHOUT CLAIM TO ANY PARTICULAR FONT, STYLE, SIZE, OR COLOR.

NO CLAIM IS MADE TO THE EXCLUSIVE RIGHT TO USE "TURF", APART FROM THE MARK AS SHOWN.

SER. NO. 85-309,388, FILED 5-1-2011.

CHRISTINE MARTIN, EXAMINING ATTORNEY



David J. Kyffers

Director of the United States Patent and Trademark Office

United States of America

United States Patent and Trademark Office

searchmejob

Reg. No. 4,073,754

Registered Dec. 20, 2011

Int. Cl.: 35

SERVICE MARK

PRINCIPAL REGISTER

LEE, MICHAEL S. (UNITED STATES INDIVIDUAL)
P.O. BOX 68513
SCHAUMBURG, IL 60168

FOR: CONSULTANCY OF PERSONNEL RECRUITMENT; EMPLOYMENT COUNSELING AND RECRUITING; EMPLOYMENT HIRING, RECRUITING, PLACEMENT, STAFFING AND CAREER NETWORKING SERVICES; EMPLOYMENT RECRUITING CONSULTATION; EMPLOYMENT SERVICES, NAMELY, PROVIDING A WEB SITE WITH ONLINE VIDEO, AUDIO AND TEXTUAL INTERVIEWING APPLICATIONS TO SUPPORT RECRUITING, ADMISSIONS, AND GENERAL CANDIDATE SCREENING PROCESSES; EXECUTIVE RECRUITING SERVICES; HUMAN RESOURCES SERVICES IN THE FIELD OF EDUCATION, NAMELY, RECRUITING AND PLACING TEACHERS AT INTERNATIONAL SCHOOLS; JOB AND PERSONNEL PLACEMENT; JOB PLACEMENT; MANAGEMENT AND BUSINESS CONSULTING SERVICES IN THE FIELD OF TRAINING AND RECRUITMENT; ORGANIZING AND CONDUCTING JOB FAIRS; PERSONNEL PLACEMENT AND RECRUITMENT; PERSONNEL RECRUITMENT SERVICES AND EMPLOYMENT AGENCIES; PROFESSIONAL STAFFING AND RECRUITING SERVICES; PROVIDING AN ON-LINE SEARCHABLE DATABASE FEATURING CLASSIFIED AD LISTINGS AND EMPLOYMENT OPPORTUNITIES; PROVIDING EMPLOYMENT COUNSELING INFORMATION ON HOW TO SUCCESSFULLY TRANSITION JOBS; PROVIDING ON-LINE EMPLOYMENT INFORMATION IN THE FIELD OF RECRUITMENT, CAREERS, JOB RESOURCES AND LISTINGS, RESUME; PROVIDING ON-LINE INTERACTIVE EMPLOYMENT COUNSELING AND RECRUITMENT SERVICES; PROVIDING ONLINE DATABASES FEATURING INFORMATION RELATING TO EMPLOYERS AND EMPLOYEES AND PLACES OF EMPLOYMENT, IN CLASS 35 (U.S. CLS. 100, 101 AND 102).



FIRST USE 4-6-2009; IN COMMERCE 4-6-2009.

THE MARK CONSISTS OF THE WORDS "SEARCH ME" IN BLACK AND "JOB" IN GREEN, ATTACHED TO EACH OTHER SHOWING AS "SEARCHMEJOB".

THE COLOR(S) BLACK AND GREEN IS/ARE CLAIMED AS A FEATURE OF THE MARK.

SER. NO. 85-309,395, FILED 5-2-2011.

DOMINIC J. FERRAIUOLO, EXAMINING ATTORNEY

David J. Kyffers

Director of the United States Patent and Trademark Office

United States of America

United States Patent and Trademark Office

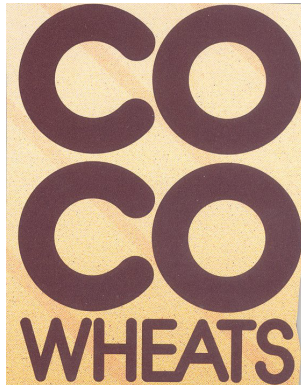

Reg. No. 4,073,755

Registered Dec. 20, 2011

Int. Cl.: 30

TRADEMARK

PRINCIPAL REGISTER

LITTLE CROW MILLING COMPANY, INC. (INDIANA CORPORATION)
P.O. BOX 1038
WARSAW, IN 46581

FOR: BREAKFAST CEREAL, IN CLASS 30 (U.S. CL. 46).

FIRST USE 9-15-1975, THE MARK WAS FIRST USED ANYWHERE IN A DIFFERENT FORM OTHER THAN THAT SOUGHT TO BE REGISTERED AT LEAST AS EARLY AS 09/01/1933; IN COMMERCE 9-15-1975, THE MARK WAS FIRST USED IN COMMERCE IN A DIFFERENT FORM OTHER THAN THAT SOUGHT TO BE REGISTERED AT LEAST AS EARLY AS 09/01/1933.

OWNER OF U.S. REG. NO. 557,139.

THE COLOR(S) BROWN IS/ARE CLAIMED AS A FEATURE OF THE MARK.

THE MARK CONSISTS OF THE WORDS "CO CO WHEATS". THE MARK ALSO INCLUDES "CO" OVER "CO" AND THE WORD "WHEATS" UNDERNEATH.

SEC. 2(F).

SER. NO. 85-309,419, FILED 5-2-2011.

MATTHEW KLINE, EXAMINING ATTORNEY



David J. Kybas

Director of the United States Patent and Trademark Office

United States of America

United States Patent and Trademark Office



Reg. No. 4,073,756

Registered Dec. 20, 2011

Int. Cl.: 35

SERVICE MARK

PRINCIPAL REGISTER

WHALE INDUSTRIES, LLC (DELAWARE LIMITED LIABILITY COMPANY)
C/O GREENBERG TRAURIG, LLP
3290 NORTHSIDE PARKWAY, SUITE 400
ATLANTA, GA 30327

FOR: PROVIDING BUSINESS INFORMATION IN THE FIELD OF MUSIC; ONLINE BUSINESS RESEARCH SERVICES THAT ALLOW USERS TO ANALYZE MUSIC INDUSTRY TRENDS, IN CLASS 35 (U.S. CLS. 100, 101 AND 102).

FIRST USE 1-0-2009; IN COMMERCE 1-0-2009.

NO CLAIM IS MADE TO THE EXCLUSIVE RIGHT TO USE "REPORT" AND "MUSIC INDUSTRY TRENDS & ANALYSIS", APART FROM THE MARK AS SHOWN.

THE COLOR(S) BLUE, GREY, BLACK AND WHITE IS/ARE CLAIMED AS A FEATURE OF THE MARK.

THE MARK CONSISTS OF THE WORD "WHALE" IN THICK BLUE LETTERS AND WRITTEN DIRECTLY UNDERNEATH IS THE WORD "REPORT" IN THIN BLUE LETTERS. UNDER THAT IS THE PROFILE DRAWING OF A GREY WHALE OUTLINED IN BLACK WITH BLACK HEADPHONES ON ITS HEAD, A BLACK MOUTH, A BLACK EYEBROW AND BLACK EYE THAT IS RIMMED IN WHITE. THE WORDS "MUSIC INDUSTRY TRENDS & ANALYSIS" ARE WRITTEN IN BLUE BENEATH THE WHALE.

SER. NO. 85-309,480, FILED 5-2-2011.

TRACY WHITTAKER-BROWN, EXAMINING ATTORNEY



David J. Kyffers

Director of the United States Patent and Trademark Office

United States of America

United States Patent and Trademark Office

WHALE REPORT

Reg. No. 4,073,757

Registered Dec. 20, 2011

Int. Cl.: 35

SERVICE MARK

PRINCIPAL REGISTER

WHALE INDUSTRIES, LLC (DELAWARE LIMITED LIABILITY COMPANY)
C/O GREENBERG TRAURIG, LLP
3290 NORTHSIDE PARKWAY, SUITE 400
ATLANTA, GA 30327

FOR: PROVIDING BUSINESS INFORMATION IN THE FIELD OF MUSIC; ONLINE BUSINESS RESEARCH SERVICES THAT ALLOW USERS TO ANALYZE MUSIC INDUSTRY TRENDS, IN CLASS 35 (U.S. CLS. 100, 101 AND 102).

FIRST USE 1-0-2009; IN COMMERCE 1-0-2009.

THE MARK CONSISTS OF STANDARD CHARACTERS WITHOUT CLAIM TO ANY PARTICULAR FONT, STYLE, SIZE, OR COLOR.

NO CLAIM IS MADE TO THE EXCLUSIVE RIGHT TO USE "REPORT", APART FROM THE MARK AS SHOWN.

SER. NO. 85-309,486, FILED 5-2-2011.

TRACY WHITTAKER-BROWN, EXAMINING ATTORNEY



David J. Kyffers

Director of the United States Patent and Trademark Office

United States of America

United States Patent and Trademark Office



The GREEN Alternative to Frying

Reg. No. 4,073,758

Registered Dec. 20, 2011

Int. Cl.: 1

TRADEMARK

PRINCIPAL REGISTER

PRICE-DAVIS, INC. (NORTH CAROLINA CORPORATION)
3882 EAST HIGHWAY 27
IRON STATION, NC 28080

FOR: ENVIRONMENTALLY FRIENDLY FILTER POWDER, NAMELY, A HYDROUS, AMORPHOUS, SYNTHETIC MAGNESIUM SILICATE USED FOR THE REMOVAL OF SOLID AND DISSOLVED IMPURITIES FOUND IN COMMERCIAL COOKING OILS, IN CLASS 1 (U.S. CLS. 1, 5, 6, 10, 26 AND 46).

FIRST USE 3-10-2011; IN COMMERCE 3-15-2011.

NO CLAIM IS MADE TO THE EXCLUSIVE RIGHT TO USE "FILTER POWDER" AND "THE GREEN ALTERNATIVE TO FRYING", APART FROM THE MARK AS SHOWN.

THE MARK CONSISTS OF THE STYLIZED WORDS "OILEXTENZ FILTER POWDER THE GREEN ALTERNATIVE TO FRYING". TWO ARCHING LEAF PATTERNS WHICH FORM A CLOCKWISE PATTERN IN THE SHAPE OF A CIRCLE. AN IMAGE OF A OIL DROP IN THE CENTER.

SER. NO. 85-309,577, FILED 5-2-2011.

RENEE MCCRAY, EXAMINING ATTORNEY



David J. Kyros

Director of the United States Patent and Trademark Office

United States of America

United States Patent and Trademark Office

PARAGON TRAILER SALES

Reg. No. 4,073,759

Registered Dec. 20, 2011

Int. Cl.: 12

TRADEMARK

PRINCIPAL REGISTER

PARAGON ENTERPRISES, LLC (WISCONSIN LIMITED LIABILITY COMPANY)
400 E. WISCONSIN, AVE., SUITE 300
MILWAUKEE, WI 53202

FOR: TANK TRAILERS; TANK TRUCK EQUIPMENT FOR DISCHARGING LIQUID OR BULK MATERIAL FROM TANK TRAILERS, IN CLASS 12 (U.S. CLS. 19, 21, 23, 31, 35 AND 44).

FIRST USE 12-31-2006; IN COMMERCE 12-31-2006.

THE MARK CONSISTS OF STANDARD CHARACTERS WITHOUT CLAIM TO ANY PARTICULAR FONT, STYLE, SIZE, OR COLOR.

NO CLAIM IS MADE TO THE EXCLUSIVE RIGHT TO USE "TRAILER SALES", APART FROM THE MARK AS SHOWN.

SER. NO. 85-309,604, FILED 5-2-2011.

KATINA MISTER, EXAMINING ATTORNEY



David J. Kyffers

Director of the United States Patent and Trademark Office

United States of America

United States Patent and Trademark Office

PARAGON TANK TRUCK EQUIPMENT

Reg. No. 4,073,760

Registered Dec. 20, 2011

Int. Cl.: 12

TRADEMARK

PRINCIPAL REGISTER

PARAGON ENTERPRISES, LLC (WISCONSIN LIMITED LIABILITY COMPANY)
400 E. WISCONSIN AVE., SUITE 300
MILWAUKEE, WI 53202

FOR: TANK TRAILERS; TANK TRUCK EQUIPMENT FOR DISCHARGING LIQUID OR BULK MATERIAL FROM TANK TRAILERS, IN CLASS 12 (U.S. CLS. 19, 21, 23, 31, 35 AND 44).

FIRST USE 10-31-2008; IN COMMERCE 10-31-2008.

THE MARK CONSISTS OF STANDARD CHARACTERS WITHOUT CLAIM TO ANY PARTICULAR FONT, STYLE, SIZE, OR COLOR.

NO CLAIM IS MADE TO THE EXCLUSIVE RIGHT TO USE "TANK TRUCK EQUIPMENT", APART FROM THE MARK AS SHOWN.

SER. NO. 85-309,646, FILED 5-2-2011.

KATINA MISTER, EXAMINING ATTORNEY



David J. Kyffers

Director of the United States Patent and Trademark Office

United States of America

United States Patent and Trademark Office

PARAGON TANK LEASING

Reg. No. 4,073,761

PARAGON ENTERPRISES, LLC (WISCONSIN LIMITED LIABILITY COMPANY)
400 E. WISCONSIN AVE., SUITE 300
MILWAUKEE, WI 53202

Registered Dec. 20, 2011

Int. Cl.: 39

FOR: RENTAL OF TANK TRAILERS, IN CLASS 39 (U.S. CLS. 100 AND 105).

SERVICE MARK

FIRST USE 12-31-2006; IN COMMERCE 12-31-2006.

PRINCIPAL REGISTER

THE MARK CONSISTS OF STANDARD CHARACTERS WITHOUT CLAIM TO ANY PARTICULAR FONT, STYLE, SIZE, OR COLOR.

NO CLAIM IS MADE TO THE EXCLUSIVE RIGHT TO USE "TANK LEASING", APART FROM THE MARK AS SHOWN.

SER. NO. 85-309,682, FILED 5-2-2011.

KATINA MISTER, EXAMINING ATTORNEY



David J. Kybas

Director of the United States Patent and Trademark Office

United States of America

United States Patent and Trademark Office

SIMPLY SASSY KIDS SPA

Reg. No. 4,073,762

SIMPLY SASSY KIDS SPA, INC. (NORTH CAROLINA CORPORATION)
163 JONESTOWN ROAD
WINSTON-SALEM, NC 27104

Registered Dec. 20, 2011

Int. Cl.: 44

FOR: DAY SPA SERVICES, NAMELY, MANICURES, PEDICURES, AND FACIALS FOR KIDS; DAY SPA MAKEOVER SERVICES FOR KIDS IN THE NATURE OF HAIR STYLING AND MAKE-UP APPLICATION SERVICES, IN CLASS 44 (U.S. CLS. 100 AND 101).

SERVICE MARK

FIRST USE 10-1-2008; IN COMMERCE 10-1-2008.

PRINCIPAL REGISTER

THE MARK CONSISTS OF STANDARD CHARACTERS WITHOUT CLAIM TO ANY PARTICULAR FONT, STYLE, SIZE, OR COLOR.

NO CLAIM IS MADE TO THE EXCLUSIVE RIGHT TO USE "KIDS SPA", APART FROM THE MARK AS SHOWN.

SER. NO. 85-309,717, FILED 5-2-2011.

NELSON SNYDER, EXAMINING ATTORNEY



David J. Kybas

Director of the United States Patent and Trademark Office

United States of America

United States Patent and Trademark Office

FLAPJACK TOYS

Reg. No. 4,073,763

Registered Dec. 20, 2011

Int. Cls.: 18 and 28

TRADEMARK

PRINCIPAL REGISTER

NISHKA, INC. (WASHINGTON CORPORATION), DBA FLAPJACK TOYS
941 ORANGE AVE #110
CORONADO, CA 92118

FOR: LEATHER AND IMITATIONS OF LEATHER, AND GOODS MADE OF THESE MATERIALS, NAMELY, LUGGAGE TAGS, IN CLASS 18 (U.S. CLS. 1, 2, 3, 22 AND 41).

FIRST USE 7-1-2009; IN COMMERCE 7-1-2009.

FOR: TOYS, NAMELY, DOLLS; TOY FIGURES; PLUSH TOYS, IN CLASS 28 (U.S. CLS. 22, 23, 38 AND 50).

FIRST USE 7-1-2006; IN COMMERCE 7-1-2006.

THE MARK CONSISTS OF STANDARD CHARACTERS WITHOUT CLAIM TO ANY PARTICULAR FONT, STYLE, SIZE, OR COLOR.

NO CLAIM IS MADE TO THE EXCLUSIVE RIGHT TO USE "TOYS", APART FROM THE MARK AS SHOWN.

SER. NO. 85-309,733, FILED 5-2-2011.

SAIMA MAKHDOOM, EXAMINING ATTORNEY



David J. Kyros

Director of the United States Patent and Trademark Office

United States of America

United States Patent and Trademark Office



Reg. No. 4,073,764

Registered Dec. 20, 2011

Int. Cl.: 12

TRADEMARK

PRINCIPAL REGISTER

PARAGON ENTERPRISES, LLC (WISCONSIN LIMITED LIABILITY COMPANY)
400 E. WISCONSIN AVE., SUITE 300
MILWAUKEE, WI 53202

FOR: TANK TRAILERS; TANK TRUCK EQUIPMENT FOR DISCHARGING LIQUID OR BULK MATERIAL FROM TANK TRAILERS, IN CLASS 12 (U.S. CLS. 19, 21, 23, 31, 35 AND 44).

FIRST USE 1-31-1996; IN COMMERCE 1-31-1996.

THE MARK CONSISTS OF THE WORD "PARAGON" ENCLOSED BY A RECTANGLE WITH THE CENTER LETTER "A" STYLIZED, WITHOUT CLAIM TO ANY PARTICULAR FONT, SIZE OR COLOR.

SER. NO. 85-309,749, FILED 5-2-2011.

KATINA MISTER, EXAMINING ATTORNEY



David J. Kyffers

Director of the United States Patent and Trademark Office

United States of America

United States Patent and Trademark Office

TRX

Reg. No. 4,073,765

Registered Dec. 20, 2011

Int. Cl.: 39

SERVICE MARK

PRINCIPAL REGISTER

TRX, INC. (MINNESOTA CORPORATION)
SUITE 250
3300 5TH STREET
MINNEAPOLIS, MN 55418

FOR: DELIVERY OF GOODS BY TRUCK, IN CLASS 39 (U.S. CLS. 100 AND 105).

FIRST USE 11-15-2002; IN COMMERCE 11-15-2002.

THE MARK CONSISTS OF STANDARD CHARACTERS WITHOUT CLAIM TO ANY PARTICULAR FONT, STYLE, SIZE, OR COLOR.

OWNER OF U.S. REG. NO. 2,948,988.

SER. NO. 85-309,792, FILED 5-2-2011.

DORITT L. CARROLL, EXAMINING ATTORNEY



David J. Kybas

Director of the United States Patent and Trademark Office

United States of America

United States Patent and Trademark Office

BRAIN-O-MAGIC

Reg. No. 4,073,766

BRAIN-O-MAGIC USA LLC (CALIFORNIA LIMITED LIABILITY COMPANY)
37804 FRUITWOOD COURT
FREMONT, CA 94536

Registered Dec. 20, 2011

Int. Cl.: 41

FOR: EDUCATION SERVICES, NAMELY, PROVIDING CLASSES AND WORKSHOPS IN THE FIELD OF MATH, IN CLASS 41 (U.S. CLS. 100, 101 AND 107).

SERVICE MARK

FIRST USE 1-1-2010; IN COMMERCE 1-1-2010.

PRINCIPAL REGISTER

THE MARK CONSISTS OF STANDARD CHARACTERS WITHOUT CLAIM TO ANY PARTICULAR FONT, STYLE, SIZE, OR COLOR.

OWNER OF U.S. REG. NO. 3,935,605.

SER. NO. 85-309,813, FILED 5-2-2011.

JAMES LOVELACE, EXAMINING ATTORNEY



David J. Kyffers

Director of the United States Patent and Trademark Office

United States of America

United States Patent and Trademark Office

RETRO TAGS

Reg. No. 4,073,767

NISHKA, INC. (WASHINGTON CORPORATION), DBA FLAPIACK TOYS
941 ORANGE AVE #110
CORONADO, CA 92118

Registered Dec. 20, 2011

Int. Cl.: 18

FOR: LEATHER AND IMITATIONS OF LEATHER, AND GOODS MADE OF THESE MATERIALS, NAMELY, LUGGAGE TAGS, IN CLASS 18 (U.S. CLS. 1, 2, 3, 22 AND 41).

TRADEMARK

FIRST USE 7-1-2009; IN COMMERCE 7-1-2009.

PRINCIPAL REGISTER

THE MARK CONSISTS OF STANDARD CHARACTERS WITHOUT CLAIM TO ANY PARTICULAR FONT, STYLE, SIZE, OR COLOR.

NO CLAIM IS MADE TO THE EXCLUSIVE RIGHT TO USE "TAGS", APART FROM THE MARK AS SHOWN.

SER. NO. 85-309,830, FILED 5-2-2011.

SAIMA MAKHDOOM, EXAMINING ATTORNEY



David J. Kyffers

Director of the United States Patent and Trademark Office

United States of America

United States Patent and Trademark Office



Reg. No. 4,073,768

Registered Dec. 20, 2011

Int. Cl.: 42

SERVICE MARK

PRINCIPAL REGISTER

AMORILLO, MICHAEL (UNITED STATES INDIVIDUAL), DBA MONSTRINHO
1621 N. VULCAN AVENUE
ENCINITAS, CA 92024

FOR: GRAPHIC ART DESIGN, IN CLASS 42 (U.S. CLS. 100 AND 101).

FIRST USE 11-24-2010; IN COMMERCE 11-24-2010.

THE MARK CONSISTS OF THE WORD "MONSTRINHO" IN A CUSTOM CREATED FONT.

THE ENGLISH TRANSLATION OF "MONSTRINHO" IN THE MARK IS "LITTLE MONSTER".

SER. NO. 85-309,894, FILED 5-2-2011.

BRENDAN MCCAULEY, EXAMINING ATTORNEY



David J. Kybas

Director of the United States Patent and Trademark Office

United States of America

United States Patent and Trademark Office

got tow truck?

Reg. No. 4,073,769

Registered Dec. 20, 2011

Int. Cl.: 35

SERVICE MARK

PRINCIPAL REGISTER

TOWINGEQUIPMENT.COM, INC (FLORIDA CORPORATION), DBA FLORIDA WRECKER
SALES
6301 E HILLSBOROUGH AVE
TAMPA, FL 33549

FOR: AUTOMOBILE DEALERSHIPS, IN CLASS 35 (U.S. CLS. 100, 101 AND 102).

FIRST USE 4-15-2011; IN COMMERCE 4-15-2011.

THE MARK CONSISTS OF STANDARD CHARACTERS WITHOUT CLAIM TO ANY PARTICULAR FONT, STYLE, SIZE, OR COLOR.

NO CLAIM IS MADE TO THE EXCLUSIVE RIGHT TO USE "TOW TRUCK", APART FROM THE MARK AS SHOWN.

SER. NO. 85-309,904, FILED 5-2-2011.

JENNIFER VASQUEZ, EXAMINING ATTORNEY



David J. Kybas

Director of the United States Patent and Trademark Office

United States of America

United States Patent and Trademark Office

CALCAPS

Reg. No. 4,073,770

VAN BEEK NATURAL SCIENCE, LLC (DELAWARE LIMITED LIABILITY COMPANY)
3689 460TH STREET
ORANGE CITY, IA 51041

Registered Dec. 20, 2011

Int. Cl.: 5

FOR: ANIMAL FEED SUPPLEMENTS, IN CLASS 5 (U.S. CLS. 6, 18, 44, 46, 51 AND 52).

TRADEMARK

FIRST USE 1-1-2007; IN COMMERCE 1-1-2007.

PRINCIPAL REGISTER

THE MARK CONSISTS OF STANDARD CHARACTERS WITHOUT CLAIM TO ANY PARTICULAR FONT, STYLE, SIZE, OR COLOR.

OWNER OF U.S. REG. NO. 3,654,737.

SER. NO. 85-309,997, FILED 5-2-2011.

MICHAEL WIENER, EXAMINING ATTORNEY



David J. Kyffers

Director of the United States Patent and Trademark Office

United States of America

United States Patent and Trademark Office

Make Nashville Weirder

Reg. No. 4,073,771

ALPHIN, ERNEST, CLINTON (UNITED STATES INDIVIDUAL), AKA CLINT ALPHIN
2174 SPRING HILL CIRCLE
SPRING HILL, TN 37174

Registered Dec. 20, 2011

Int. Cls.: 35 and 41

FOR: PROMOTING THE CONCERTS OF OTHERS, IN CLASS 35 (U.S. CLS. 100, 101 AND 102).

SERVICE MARK

FIRST USE 9-16-2010; IN COMMERCE 9-16-2010.

PRINCIPAL REGISTER

FOR: CONCERT BOOKING; ENTERTAINMENT IN THE NATURE OF LIVE STAGE PERFORMANCES IN THE NATURE OF CONCERTS OR LECTURE FOR HIRE IN THE FIELD OF MUSIC, PHILOSOPHY, RELIGION, AND EDUCATION BY AN INDIVIDUAL; ENTERTAINMENT, NAMELY, LIVE MUSIC CONCERTS, IN CLASS 41 (U.S. CLS. 100, 101 AND 107).

FIRST USE 9-16-2010; IN COMMERCE 9-16-2010.

THE MARK CONSISTS OF STANDARD CHARACTERS WITHOUT CLAIM TO ANY PARTICULAR FONT, STYLE, SIZE, OR COLOR.

NO CLAIM IS MADE TO THE EXCLUSIVE RIGHT TO USE "NASHVILLE", APART FROM THE MARK AS SHOWN.

SER. NO. 85-310,001, FILED 5-2-2011.

KATINA MISTER, EXAMINING ATTORNEY



David J. Kybas

Director of the United States Patent and Trademark Office

United States of America

United States Patent and Trademark Office



Reg. No. 4,073,772

Registered Dec. 20, 2011

Int. Cl.: 41

SERVICE MARK

PRINCIPAL REGISTER

TO KNOW JOY, INC. (MISSOURI CORPORATION)
601 CEDAR FALLS COURT
RAYMORE, MO 64083

FOR: LIFE COACHING SERVICES IN THE FIELD OF PERSONAL AND PROFESSIONAL PLANNING, GROWTH, DEVELOPMENT, AND IMPROVEMENT; EDUCATIONAL SERVICES, NAMELY, CONDUCTING INDIVIDUALIZED AND GROUP PROGRAMS, CLASSES, WORKSHOPS AND SEMINARS IN THE FIELD OF PERSONAL AND PROFESSIONAL PLANNING, GROWTH, DEVELOPMENT, AND IMPROVEMENT, IN CLASS 41 (U.S. CLS. 100, 101 AND 107).

FIRST USE 5-31-2010; IN COMMERCE 5-31-2010.

THE MARK CONSISTS OF THE PROFILE OF HUMMING BIRD, THE HUMMINGBIRD HAVING PRONOUNCED LONG EYELASHES.

SER. NO. 85-310,030, FILED 5-2-2011.

CAROLINE WOOD, EXAMINING ATTORNEY



David J. Kyffers

Director of the United States Patent and Trademark Office

United States of America

United States Patent and Trademark Office

DREAM.DELIVER.DRIVE

Reg. No. 4,073,773

H.E. MCGONIGAL, INC. (INDIANA CORPORATION)
1220 EAST BOULEVARD
KOKOMO, IN 46902

Registered Dec. 20, 2011

Int. Cl.: 35

FOR: ADVERTISING, MARKETING AND PROMOTIONAL SERVICES FOR AUTOMOTIVE DEALERSHIPS, IN CLASS 35 (U.S. CLS. 100, 101 AND 102).

SERVICE MARK

FIRST USE 9-28-2004; IN COMMERCE 9-28-2004.

PRINCIPAL REGISTER

THE MARK CONSISTS OF STANDARD CHARACTERS WITHOUT CLAIM TO ANY PARTICULAR FONT, STYLE, SIZE, OR COLOR.

SER. NO. 85-310,045, FILED 5-2-2011.

KATINA MISTER, EXAMINING ATTORNEY



David J. Kybas

Director of the United States Patent and Trademark Office

United States of America

United States Patent and Trademark Office



Reg. No. 4,073,774

YONGCHANG SHEN (UNITED STATES INDIVIDUAL)
1065 86TH STREET
BROOKLYN, NY 11228

Registered Dec. 20, 2011

Int. Cl.: 43

FOR: RESTAURANTS; CAFE; AND PROVIDING OF FOOD AND DRINK, IN CLASS 43 (U.S. CLS. 100 AND 101).

SERVICE MARK

FIRST USE 10-7-1997; IN COMMERCE 10-7-1997.

PRINCIPAL REGISTER

THE MARK CONSISTS OF AN ANIMATED PERSON HOLDING DIM SUM BY THE RIGHT HAND WITH A PAIR OF CHOPSTICK.

SER. NO. 85-310,052, FILED 5-2-2011.

ROSELLE HERRERA, EXAMINING ATTORNEY



David J. Kyffers

Director of the United States Patent and Trademark Office

United States of America

United States Patent and Trademark Office

WHAT'S IN YOUR TACO?

Reg. No. 4,073,775

Registered Dec. 20, 2011

Int. Cl.: 21

TRADEMARK

PRINCIPAL REGISTER

FUZZY'S TACO HOLDINGS, LLC (TEXAS LIMITED LIABILITY COMPANY)
SUITE 100
200 BAILEY AVENUE
FORT WORTH, TX 76107

FOR: INSULATED BEVERAGE HOLDERS, CUPS, MUGS, DRINKING GLASSES, IN CLASS
21 (U.S. CLS. 2, 13, 23, 29, 30, 33, 40 AND 50).

FIRST USE 12-21-2009; IN COMMERCE 12-21-2009.

THE MARK CONSISTS OF STANDARD CHARACTERS WITHOUT CLAIM TO ANY PAR-
TICULAR FONT, STYLE, SIZE, OR COLOR.

SER. NO. 85-310,110, FILED 5-2-2011.

KATHLEEN LORENZO, EXAMINING ATTORNEY



David J. Kyffers

Director of the United States Patent and Trademark Office

United States of America

United States Patent and Trademark Office



Reg. No. 4,073,776

Registered Dec. 20, 2011

**Int. Cls.: 35, 37, 39, 40,
41 and 45**

SERVICE MARK

PRINCIPAL REGISTER

CITY OF MESA MUNICIPAL DEVELOPMENT CORP. (ARIZONA CORPORATION)
P.O. BOX 1466
MESA, AZ 852111466

FOR: LOBBYING SERVICES, NAMELY, PROMOTING THE INTERESTS OF THE CITIZENS OF MESA IN THE FIELDS OF LEGISLATION AND REGULATION; PROMOTING PUBLIC AWARENESS OF LAND CONSERVATION AND PROTECTION; PROMOTING PUBLIC AWARENESS OF EDUCATIONAL OPPORTUNITIES; COMMERCIAL ADMINISTRATION OF THE LICENSING OF THE BUSINESSES AND PROFESSIONAL LICENSURE OF OTHERS; AND PROMOTING THE ECONOMIC DEVELOPMENT IN THE STATE OF ARIZONA; INFORMATION IN THE FIELD OF GOVERNMENT AFFAIRS, IN CLASS 35 (U.S. CLS. 100, 101 AND 102).

FIRST USE 1-1-2009; IN COMMERCE 1-1-2009.

FOR: CONSTRUCTION PLANNING; STREET CLEANING; STREET CONSTRUCTION; INSTALLATION, MAINTENANCE AND REPAIR OF STREETS AND TRANSPORTATION SYSTEMS; AND BUILDING INSPECTION, IN CLASS 37 (U.S. CLS. 100, 103 AND 106).

FIRST USE 1-1-2009; IN COMMERCE 1-1-2009.

FOR: MUNICIPAL SERVICES IN THE NATURE OF UTILITY SERVICES, WHERE WATER AND SEWER SERVICES ARE PROVIDED TO THE PUBLIC AND PUBLIC UTILITY SERVICES IN THE NATURE OF ELECTRICITY AND NATURAL GAS DISTRIBUTION, AND PROVIDING PUBLIC TRANSPORTATION IN THE NATURE OF BUS AND RAIL, IN CLASS 39 (U.S. CLS. 100 AND 105).

FIRST USE 1-1-2009; IN COMMERCE 1-1-2009.

FOR: WASTE MANAGEMENT AND RECYCLING OF WASTE, IN CLASS 40 (U.S. CLS. 100, 103 AND 106).

FIRST USE 1-1-2009; IN COMMERCE 1-1-2009.

FOR: LIBRARIES; MOBILE LIBRARY SERVICES; ON-LINE LIBRARY SERVICES, NAMELY, PROVIDING ELECTRONIC LIBRARY SERVICES WHICH FEATURE NEWSPAPERS, MAGAZINES, PHOTOGRAPHS AND PICTURES VIA AN ON-LINE COMPUTER NETWORK;



David J. Kyffers

Director of the United States Patent and Trademark Office

Reg. No. 4,073,776 REFERENCE LIBRARIES OF LITERATURE AND DOCUMENTARY RECORDS; PROVIDING RECOGNITION BY WAY OF AWARDS TO DEMONSTRATE EXCELLENCE IN THE FIELD OF ECONOMIC DEVELOPMENT, NAMELY, PROVIDING AN ANNUAL AWARDS PROGRAM IN THE FIELD OF ECONOMIC DEVELOPMENT TO RECOGNIZE THE EFFORTS OF INDIVIDUALS, GOVERNMENT AGENCIES, AND BUSINESSES WHO PROMOTE JOB CREATION AND ECONOMIC REVITALIZATION; CABLE TELEVISION PROGRAMMING; RECREATIONAL PARK SERVICES; MUSEUM SERVICES; RENTAL OF STADIUM FACILITIES; ORGANIZING CULTURAL AND ARTS EVENTS, AND BOOKING OF SEATS FOR SHOWS AND BOOKING OF THEATRE TICKETS, IN CLASS 41 (U.S. CLS. 100, 101 AND 107).

FIRST USE 1-1-2009; IN COMMERCE 1-1-2009.

FOR: MUNICIPAL SERVICES, NAMELY, LEGAL SERVICES; REVIEWING STANDARDS AND PRACTICES TO ASSURE COMPLIANCE WITH LAWS AND REGULATIONS IN THE FIELDS OF UTILITIES, RESIDENTIAL AND COMMERCIAL BUILDING CONSTRUCTION, ROADS AND OPERATION OF BUSINESSES, BUILDING CODES, ZONING CODES, LAND DEVELOPMENT, AND REAL ESTATE DEVELOPMENT, IN CLASS 45 (U.S. CLS. 100 AND 101).

FIRST USE 1-1-2009; IN COMMERCE 1-1-2009.

THE MARK CONSISTS OF THREE SUCCESSIVE PLATEAUS POSITIONED ONE ABOVE THE OTHER.

SER. NO. 85-310,124, FILED 5-2-2011.

ELLEN B. AWRICH, EXAMINING ATTORNEY

United States of America

United States Patent and Trademark Office



Reg. No. 4,073,777

Registered Dec. 20, 2011

Int. Cl.: 35

SERVICE MARK

PRINCIPAL REGISTER

GILD CORPORATION (ARKANSAS CORPORATION), DBA MACADOODLES
53 MACADOODLE LANE
PINEVILLE, MO 64856

FOR: RETAIL CONVENIENCE STORES; RETAIL STORE SERVICES FEATURING LIQUOR,
IN CLASS 35 (U.S. CLS. 100, 101 AND 102).

FIRST USE 2-4-1997; IN COMMERCE 2-4-1997.

OWNER OF U.S. REG. NO. 2,812,641.

NO CLAIM IS MADE TO THE EXCLUSIVE RIGHT TO USE "EST. 1997", "FINE WINE" OR
"BEER SPIRITS", APART FROM THE MARK AS SHOWN.

THE MARK CONSISTS OF A STYLIZED DESIGN FEATURING A DOUBLE LINED OVAL
THAT HAS AN IMAGE OF A MAN WITH A BEARD, MUSTACHE AND FRECKLES,
SMOKING A PIPE AND WEARING A BOWLER-TYPE HAT WITH A THREE-LEAF CLOVER
ON THE BRIM, ALL OF WHICH IS OVER A BANNER EMBLAZONED WITH THE WORD
"MACADOODLES" OVER A SMALLER DOUBLE LINED OVAL WITH "EST. 1997" THAT
IS OVER THE WORDS "FINE WINE" THAT ARE OVER THE WORDS "BEER SPIRITS".

SER. NO. 85-310,135, FILED 5-2-2011.

MARK RADEMACHER, EXAMINING ATTORNEY



David J. Kybas

Director of the United States Patent and Trademark Office

United States of America

United States Patent and Trademark Office

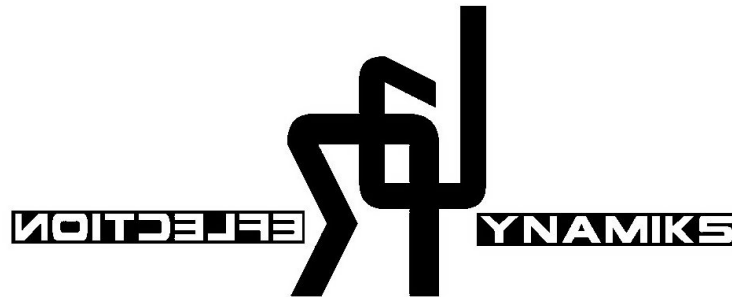

Reg. No. 4,073,778

Registered Dec. 20, 2011

Int. Cl.: 25

TRADEMARK

PRINCIPAL REGISTER

REFLECTION DYNAMIKS CORP (NEW YORK CORPORATION)
4TH FLOOR
84-38 GRAND AVE.
ELMHURST, NY 11373

FOR: CLOTHING, NAMELY, T-SHIRTS, SWEATERS, AND JEANS, IN CLASS 25 (U.S. CLS. 22 AND 39).

FIRST USE 6-1-2010; IN COMMERCE 10-1-2010.

THE MARK CONSISTS OF THE TERM "EFLECTION" SPELLED BACKWARDS IN A RECTANGLE, FOLLOWED BY A BACKWARDS "R" FORMING THE WORD "REFLECTION" SPELLED BACKWARDS, AND A STYLIZED "D", THEN THE TERM "YNAMIKS" GOING THE OPPOSITE DIRECTION AND IN A RECTANGLE, FORMING THE WORD "DYNAMIKS".

SER. NO. 85-310,332, FILED 5-2-2011.

AMY HELLA, EXAMINING ATTORNEY



David J. Kyffers

Director of the United States Patent and Trademark Office

United States of America

United States Patent and Trademark Office

my song is radio ready

Reg. No. 4,073,779

Registered Dec. 20, 2011

Int. Cl.: 35

SERVICE MARK

PRINCIPAL REGISTER

CADET, JERRY (UNITED STATES INDIVIDUAL)
APT. #2H
2940 WEST 31ST STREET
BROOKLYN, NY 11224

FOR: PROMOTING THE GOODS AND SERVICES OF OTHERS BY ARRANGING AND CONDUCTING MUSICAL SHOWS FEATURING UP-AND-COMING AND UNKNOWN MUSICAL ARTISTS, DISC JOCKEYS, MUSIC PRODUCERS, AND ANY ARTIST WORKING OR ASSOCIATED WITH THE MUSIC INDUSTRY FOR THE PURPOSE OF SHOWCASING THEM TO A WIDE AUDIENCE FOR PROMOTING THEIR TALENTS AND IMPROVING THEIR CHANCES OF BEING EMPLOYED IN THE MUSIC INDUSTRY, IN CLASS 35 (U.S. CLS. 100, 101 AND 102).

FIRST USE 3-10-2010; IN COMMERCE 3-10-2010.

THE MARK CONSISTS OF STANDARD CHARACTERS WITHOUT CLAIM TO ANY PARTICULAR FONT, STYLE, SIZE, OR COLOR.

SER. NO. 85-310,366, FILED 5-2-2011.

ANTHONY RINKER, EXAMINING ATTORNEY



David J. Kyffers

Director of the United States Patent and Trademark Office

United States of America

United States Patent and Trademark Office



Reg. No. 4,073,780

Registered Dec. 20, 2011

Int. Cl.: 37

SERVICE MARK

PRINCIPAL REGISTER

OLD FAMILY CONSTRUCTION INC. (PENNSYLVANIA CORPORATION)
1509 EGYPT RD, PO BOX 1097
OAKES, PA 19456

FOR: BASEMENT WATERPROOFING; CEMENT PARGING OF INTERIOR AND EXTERIOR
STONE BLOCK AND CONCRETE FOUNDATIONS, IN CLASS 37 (U.S. CLS. 100, 103 AND
106).

FIRST USE 4-0-2009; IN COMMERCE 4-0-2009.

NO CLAIM IS MADE TO THE EXCLUSIVE RIGHT TO USE "BASEMENT WATERPROOFING
SPECIALISTS", APART FROM THE MARK AS SHOWN.

THE COLOR(S) BLUE AND WHITE IS/ARE CLAIMED AS A FEATURE OF THE MARK.

THE MARK CONSISTS OF THE IMAGE OF A DROP OF WATER IN BLUE CONTAINED
WITHIN A CIRCULAR BLUE AND WHITE CARRIER, WITH THE WHITE WORDING
"BASEMENT WATERPROOFING SPECIALISTS" APPEARING IN WHITE AROUND THE
OUTER EDGES OF THE CIRCULAR CARRIER, WITH TWO WHITE DOTS SEPARATING
THE WORDING "BASEMENT WATERPROOFING" FROM THE WORDING "SPECIALISTS".

SER. NO. 85-310,455, FILED 5-3-2011.

LAURA HAMMEL, EXAMINING ATTORNEY



David J. Kybas

Director of the United States Patent and Trademark Office

United States of America

United States Patent and Trademark Office

ONE LOVE PHOTO

Reg. No. 4,073,781

GILSON, HEATHER M (UNITED STATES INDIVIDUAL)
4102 N 31ST ST
TACOMA, WA 98407

Registered Dec. 20, 2011

Int. Cl.: 41

FOR: WEDDING PHOTOGRAPHY SERVICES, IN CLASS 41 (U.S. CLS. 100, 101 AND 107).

SERVICE MARK

FIRST USE 0-0-2003; IN COMMERCE 0-0-2003.

PRINCIPAL REGISTER

THE MARK CONSISTS OF STANDARD CHARACTERS WITHOUT CLAIM TO ANY PARTICULAR FONT, STYLE, SIZE, OR COLOR.

NO CLAIM IS MADE TO THE EXCLUSIVE RIGHT TO USE "PHOTO", APART FROM THE MARK AS SHOWN.

SER. NO. 85-310,457, FILED 5-3-2011.

ADA HAN, EXAMINING ATTORNEY



David J. Kyffers

Director of the United States Patent and Trademark Office

United States of America

United States Patent and Trademark Office

LANILAI

Reg. No. 4,073,782

LANILAI, INC. (DELAWARE CORPORATION)
8533 NE 14TH LANE
VANCOUVER, WA 98664

Registered Dec. 20, 2011

Int. Cl.: 32

FOR: BEAUTY BEVERAGES, NAMELY, FRUIT JUICES AND ENERGY DRINKS CONTAINING NUTRITIONAL SUPPLEMENTS, IN CLASS 32 (U.S. CLS. 45, 46 AND 48).

TRADEMARK

FIRST USE 4-1-2011; IN COMMERCE 4-15-2011.

PRINCIPAL REGISTER

THE MARK CONSISTS OF STANDARD CHARACTERS WITHOUT CLAIM TO ANY PARTICULAR FONT, STYLE, SIZE, OR COLOR.

THE ENGLISH TRANSLATION OF "LANI" IS "BEAUTIFUL", AND THE ENGLISH TRANSLATION OF "LAI" IS "CALM AFTER THE STORM".

SER. NO. 85-310,477, FILED 5-3-2011.

ALYSSA STEEL, EXAMINING ATTORNEY



David J. Kybas

Director of the United States Patent and Trademark Office

United States of America

United States Patent and Trademark Office

TALKKO

Reg. No. 4,073,783

LAU, TED C (UNITED STATES INDIVIDUAL), DBA TALKKO
10421 DEL NORTE WAY
LOS ALAMITOS, CA 90720

Registered Dec. 20, 2011

Int. Cl.: 16

FOR: COMICS, IN CLASS 16 (U.S. CLS. 2, 5, 22, 23, 29, 37, 38 AND 50).

TRADEMARK

FIRST USE 2-16-2011; IN COMMERCE 2-16-2011.

PRINCIPAL REGISTER

THE MARK CONSISTS OF STANDARD CHARACTERS WITHOUT CLAIM TO ANY PARTICULAR FONT, STYLE, SIZE, OR COLOR.

SER. NO. 85-310,487, FILED 5-3-2011.

JORDAN BAKER, EXAMINING ATTORNEY



David J. Kyffers

Director of the United States Patent and Trademark Office

United States of America

United States Patent and Trademark Office

A SWEET STATE OF MIND

Reg. No. 4,073,784

Registered Dec. 20, 2011

Int. Cl.: 35

SERVICE MARK

PRINCIPAL REGISTER

ALLYSON AMES COMPANY, INC. (NEVADA CORPORATION)
SUITE 134
3535 EAST PACIFIC COAST HIGHWAY
CORONA DEL MAR, CA 92625

FOR: RETAIL BAKERY SHOPS; RETAIL STORE SERVICES FEATURING PAPER PARTY PRODUCTS, CLOTHING, TOYS, GAMES, BAKEWARE, GIFTWARE, ARTS AND CRAFTS PRODUCTS, PET PRODUCTS AND VIDEO GAMES, IN CLASS 35 (U.S. CLS. 100, 101 AND 102).

FIRST USE 1-1-2005; IN COMMERCE 1-1-2011.

THE MARK CONSISTS OF STANDARD CHARACTERS WITHOUT CLAIM TO ANY PARTICULAR FONT, STYLE, SIZE, OR COLOR.

SER. NO. 85-310,516, FILED 5-3-2011.

DAVID YONTEF, EXAMINING ATTORNEY



David J. Kyffers

Director of the United States Patent and Trademark Office

United States of America

United States Patent and Trademark Office



Reg. No. 4,073,785

Registered Dec. 20, 2011

Int. Cl.: 35

SERVICE MARK

PRINCIPAL REGISTER

CRAFT YARN COUNCIL OF AMERICA, INC. (NORTH CAROLINA CORPORATION)
SUITE E, 2ND FLOOR
469 HOSPITAL DRIVE
GASTONIA, NC 28054

FOR: ASSOCIATION SERVICES, NAMELY, PROMOTING THE INTERESTS OF THE YARN INDUSTRY, IN CLASS 35 (U.S. CLS. 100, 101 AND 102).

FIRST USE 7-30-2010; IN COMMERCE 7-30-2010.

OWNER OF U.S. REG. NO. 1,593,620.

NO CLAIM IS MADE TO THE EXCLUSIVE RIGHT TO USE "CRAFT YARN COUNCIL", APART FROM THE MARK AS SHOWN.

THE MARK CONSISTS OF A BALL OF YARN WITH KNITTING NEEDLES AND A CROCHET HOOK IN IT PLACED TO THE LEFT OF THE WORDS "CRAFT YARN COUNCIL".

SER. NO. 85-310,578, FILED 5-3-2011.

KIMBERLY FRYE, EXAMINING ATTORNEY



David J. Kybas

Director of the United States Patent and Trademark Office

United States of America

United States Patent and Trademark Office

PITA INN

Reg. No. 4,073,786

Registered Dec. 20, 2011

Int. Cl.: 43

SERVICE MARK

PRINCIPAL REGISTER

PITA INN, INC. (ILLINOIS CORPORATION)
3910 DEMPSTER STREET
SKOKIE, IL 60076

FOR: CAFE AND RESTAURANT SERVICES; CAFE-RESTAURANTS; CARRY-OUT RESTAURANTS; CATERING; CATERING FOR THE PROVISION OF FOOD AND BEVERAGES; CATERING OF FOOD AND DRINKS; CATERING SERVICES; FAST FOOD AND NON-STOP RESTAURANT SERVICES; FAST-FOOD RESTAURANT SERVICES; FAST-FOOD RESTAURANTS; PROVIDING PROGRESSIVE DINNER EVENTS WHERE PARTICIPANTS SAMPLE MEALS AND DRINKS AT A SERIES OF RESTAURANTS; PROVIDING REVIEWS OF RESTAURANTS; PROVISION OF FOOD AND DRINK IN RESTAURANTS; RESTAURANT; RESTAURANT AND CAFE SERVICES; RESTAURANT SERVICES FEATURING SANDWICHES; RESTAURANT SERVICES FEATURING MEDITERRANEAN AND MIDDLE EASTERN CUISINE; RESTAURANT SERVICES, INCLUDING SIT-DOWN SERVICE OF FOOD AND TAKE-OUT RESTAURANT SERVICES; RESTAURANT SERVICES, NAMELY, PROVIDING OF FOOD AND BEVERAGES FOR CONSUMPTION ON AND OFF THE PREMISES; RESTAURANTS; SELF SERVICE RESTAURANTS; SELF-SERVICE RESTAURANTS; TAKE-OUT RESTAURANT SERVICES, IN CLASS 43 (U.S. CLS. 100 AND 101).

FIRST USE 5-27-1982; IN COMMERCE 5-27-1982.

THE MARK CONSISTS OF STANDARD CHARACTERS WITHOUT CLAIM TO ANY PARTICULAR FONT, STYLE, SIZE, OR COLOR.

OWNER OF U.S. REG. NO. 2,561,059.

NO CLAIM IS MADE TO THE EXCLUSIVE RIGHT TO USE "INN", APART FROM THE MARK AS SHOWN.

SEC. 2(F).

SER. NO. 85-310,603, FILED 5-3-2011.

EDWARD NELSON, EXAMINING ATTORNEY



David J. Kyros

Director of the United States Patent and Trademark Office

United States of America

United States Patent and Trademark Office

Smoken Dakota Kennels

Reg. No. 4,073,787

SMOKEN DAKOTA KENNELS, LLC (SOUTH DAKOTA LIMITED LIABILITY COMPANY)
46573 269TH STREET
SIOUX FALLS, SD 57106

Registered Dec. 20, 2011

Int. Cl.: 41

FOR: ANIMAL TRAINING; KENNEL SERVICES, NAMELY, DOG TRAINING SERVICES;
OBEDIENCE SCHOOL TRAINING FOR ANIMALS; TRAINING ANIMALS FOR OTHERS ,
IN CLASS 41 (U.S. CLS. 100, 101 AND 107).

SERVICE MARK

FIRST USE 1-1-2007; IN COMMERCE 1-1-2007.

PRINCIPAL REGISTER

THE MARK CONSISTS OF STANDARD CHARACTERS WITHOUT CLAIM TO ANY PAR-
TICULAR FONT, STYLE, SIZE, OR COLOR.

NO CLAIM IS MADE TO THE EXCLUSIVE RIGHT TO USE "DAKOTA KENNELS", APART
FROM THE MARK AS SHOWN.

SER. NO. 85-310,631, FILED 5-3-2011.

ESTHER BELENKER, EXAMINING ATTORNEY



David J. Kybas

Director of the United States Patent and Trademark Office

United States of America

United States Patent and Trademark Office

MobiControl

Reg. No. 4,073,788

Registered Dec. 20, 2011

Int. Cl.: 9

TRADEMARK

PRINCIPAL REGISTER

SOTI INC. (CANADA CORPORATION)
30-5155 SPECTRUM WAY
MISSISSAUGA, ONTARIO, CANADA L4W5A1

FOR: COMPUTER SOFTWARE, NAMELY, FOR SOFTWARE FOR THE SYNCHRONIZATION, MANAGEMENT, TRACKING AND SECURITY OF DATA TRANSMITTED OVER WIRELESS DATA NETWORKS BETWEEN A STATIONARY UNIT AND MULTIPLE MOBILE COMPUTERS OR ELECTRONIC DEVICES IN THE FIELD OF MOBILE DEVICE MANAGEMENT, IN CLASS 9 (U.S. CLS. 21, 23, 26, 36 AND 38).

FIRST USE 12-31-2004; IN COMMERCE 12-31-2004.

THE MARK CONSISTS OF STANDARD CHARACTERS WITHOUT CLAIM TO ANY PARTICULAR FONT, STYLE, SIZE, OR COLOR.

OWNER OF CANADA REG. NO. TMA799686, DATED 6-9-2011, EXPIRES 6-9-2026.

SER. NO. 85-310,681, FILED 5-3-2011.

LINDA POWELL, EXAMINING ATTORNEY



David J. Kybas

Director of the United States Patent and Trademark Office

United States of America

United States Patent and Trademark Office

AT Consult



Reg. No. 4,073,789

Registered Dec. 20, 2011

Int. Cl.: 35

SERVICE MARK

PRINCIPAL REGISTER

AT CONSULT HOLDING, INC. (DELAWARE CORPORATION), DBA AT CONSULT
SUITE 134-665
4023 KENNETT PIKE
GREENVILLE, DE 19807

FOR: BUSINESS CONSULTING SERVICES, NAMELY: CONSULTING FOR INTERNATIONALIZATION, STRATEGIC BUSINESS CONSULTING, EXPORT- AND MARKETING CONSULTING, HUMAN RESOURCES CONSULTING, IN CLASS 35 (U.S. CLS. 100, 101 AND 102).

FIRST USE 4-2-2001; IN COMMERCE 4-2-2001.

THE MARK CONSISTS OF THE WORDING "AT CONSULT", WITH A CURVED UNDERLINE (UNICOLOR BLACK).

SER. NO. 85-310,842, FILED 5-3-2011.

BRIAN NEVILLE, EXAMINING ATTORNEY



David J. Kybas

Director of the United States Patent and Trademark Office

United States of America

United States Patent and Trademark Office

WILD DOG

Reg. No. 4,073,790

Registered Dec. 20, 2011

Int. Cl.: 32

FLYING DOG BREWERY, LLLP (COLORADO LIMITED LIABILITY LIMITED
PARTNERSHIP)
SUITE 104
2330 BROADWAY
DENVER, CO 80205

TRADEMARK

FOR: BREWED MALT-BASED ALCOHOLIC BEVERAGE IN THE NATURE OF A BEER, IN
CLASS 32 (U.S. CLS. 45, 46 AND 48).

PRINCIPAL REGISTER

FIRST USE 9-0-2004; IN COMMERCE 10-0-2004.

THE MARK CONSISTS OF STANDARD CHARACTERS WITHOUT CLAIM TO ANY PAR-
TICULAR FONT, STYLE, SIZE, OR COLOR.

OWNER OF U.S. REG. NOS. 3,448,951 AND 3,546,139.

SER. NO. 85-310,938, FILED 5-3-2011.

WILLIAM P. SHANAHAN, EXAMINING ATTORNEY



David J. Kyffers

Director of the United States Patent and Trademark Office

United States of America
United States Patent and Trademark Office

YOUNG^{at}
HEART

Reg. No. 4,073,791

Registered Dec. 20, 2011

Int. Cl.: 41

SERVICE MARK

PRINCIPAL REGISTER

BOYD GAMING CORPORATION (NEVADA CORPORATION)
ATTN: MR. LOU NUNZIATA
6465 SOUTH RAINBOW BOULEVARD
LAS VEGAS, NV 89118

FOR: PROVIDING CASINO SERVICES FEATURING STORED VALUE MEMBERSHIP CARDS FOR REDEEMING CASH, DISCOUNTS, AND OTHER BENEFITS, IN CLASS 41 (U.S. CLS. 100, 101 AND 107).

FIRST USE 10-1-1999; IN COMMERCE 10-1-1999.

NO CLAIM IS MADE TO THE EXCLUSIVE RIGHT TO USE "50+", APART FROM THE MARK AS SHOWN.

THE MARK CONSISTS OF THE STYLIZED, UNDERLINED WORDING "YOUNG AT HEART" WITH THE WORDS "YOUNG AT" APPEARING ABOVE "HEART" AND WITH A STYLIZED HEART CONTAINING THE TERM "50+" REPLACING THE LETTER "A" IN "HEART".

SER. NO. 85-310,942, FILED 5-3-2011.

AMY KERTGATE, EXAMINING ATTORNEY



David J. Kappas

Director of the United States Patent and Trademark Office

United States of America

United States Patent and Trademark Office



HIT AND RUN
MUSICAL IMPROV

Reg. No. 4,073,792

Registered Dec. 20, 2011

Int. Cl.: 41

SERVICE MARK

PRINCIPAL REGISTER

TALKING MUFFIN PRODUCTIONS LLC (COLORADO LIMITED LIABILITY COMPANY)
PO BOX 351443
WESTMINSTER, CO 80035

FOR: ENTERTAINMENT IN THE NATURE OF VISUAL AND AUDIO PERFORMANCES, AND MUSICAL, VARIETY, NEWS AND COMEDY SHOWS; ENTERTAINMENT SERVICES IN THE NATURE OF COMEDY SHOWS; ENTERTAINMENT SERVICES IN THE NATURE OF DEVELOPMENT, CREATION, PRODUCTION AND POST-PRODUCTION SERVICES OF MULTIMEDIA ENTERTAINMENT CONTENT; ENTERTAINMENT SERVICES IN THE NATURE OF LIVE MUSICAL PERFORMANCES; ENTERTAINMENT SERVICES IN THE NATURE OF PRESENTING LIVE MUSICAL PERFORMANCES; PRESENTATION OF LIVE COMEDY SHOWS; TEACHING IN THE FIELD OF IMPROVISED MUSICAL THEATER, IN CLASS 41 (U.S. CLS. 100, 101 AND 107).

FIRST USE 7-22-2006; IN COMMERCE 7-22-2006.

NO CLAIM IS MADE TO THE EXCLUSIVE RIGHT TO USE "MUSICAL IMPROV", APART FROM THE MARK AS SHOWN.

THE MARK CONSISTS OF A BLOCK FIGURE OF A SILHOUETTED HUMAN, POSED WITH ARMS AND LEGS OUTSTRETCHED AS IF WALKING. TO THE UPPER RIGHT OF THE HUMAN'S HEAD IS A SILHOUETTED PAIR OF MUSICAL NOTES. UNDERNEATH THE HUMAN IN BLOCK LETTERS IS "HIT AND RUN" ON ONE LINE, AND "MUSICAL IMPROV" ON ANOTHER LINE IMMEDIATELY BENEATH. ACCENT LINES ARE PLACED ABOVE AND BELOW THE WORD "AND", WHICH IS SLIGHTLY SMALLER THAN THE WORDS "HIT" AND "RUN". ACCENT LINES ARE ALSO PLACED AT EITHER END OF THE WORDS "MUSICAL IMPROV", SLOPING INTO THE "M" AND THE "V" AT BOTH ENDS OF THE WORDS.

SER. NO. 85-310,969, FILED 5-3-2011.

ELI HELLMAN, EXAMINING ATTORNEY



David J. Kybas

Director of the United States Patent and Trademark Office

United States of America

United States Patent and Trademark Office

the minor league of poker

Reg. No. 4,073,793

Registered Dec. 20, 2011

Int. Cls.: 35 and 41

SERVICE MARK

PRINCIPAL REGISTER

BERTRAND FINANCIAL, LLC (ILLINOIS LIMITED LIABILITY COMPANY)
528 WILLIAMSBURG DRIVE, APT. D
BELLEVILLE, IL 62221

FOR: ORGANIZATION OF EVENTS, EXHIBITIONS, FAIRS AND SHOWS FOR COMMERCIAL, PROMOTIONAL AND ADVERTISING PURPOSES, IN CLASS 35 (U.S. CLS. 100, 101 AND 102).

FIRST USE 8-30-2010; IN COMMERCE 8-30-2010.

FOR: ENTERTAINMENT IN THE NATURE OF COMPETITIONS IN THE FIELD OF POKER; ENTERTAINMENT IN THE NATURE OF POKER GAMES; ENTERTAINMENT IN THE NATURE OF POKER TOURNAMENTS; ENTERTAINMENT SERVICES, NAMELY, CASINO GAMING; ENTERTAINMENT SERVICES, NAMELY, CONDUCTING LIVE POKER GAMES; PROVIDING INSTRUCTIONAL INFORMATION ON POKER; ORGANIZING EXHIBITIONS FOR POKER TOURNAMENTS, IN CLASS 41 (U.S. CLS. 100, 101 AND 107).

FIRST USE 8-30-2010; IN COMMERCE 8-30-2010.

THE MARK CONSISTS OF STANDARD CHARACTERS WITHOUT CLAIM TO ANY PARTICULAR FONT, STYLE, SIZE, OR COLOR.

NO CLAIM IS MADE TO THE EXCLUSIVE RIGHT TO USE "POKER", APART FROM THE MARK AS SHOWN.

SER. NO. 85-310,987, FILED 5-3-2011.

STEVEN R. FINE, EXAMINING ATTORNEY



David J. Kybas

Director of the United States Patent and Trademark Office

United States of America

United States Patent and Trademark Office

Egret Baits

Reg. No. 4,073,794

Registered Dec. 20, 2011

Int. Cl.: 28

TRADEMARK

PRINCIPAL REGISTER

STANLEY JIGS, INC. (TEXAS CORPORATION)
P.O. BOX 1327
107 N. MAIN STREET
HUNTINGTON, TX 75949

FOR: LURES FOR FISHING, IN CLASS 28 (U.S. CLS. 22, 23, 38 AND 50).

FIRST USE 4-1-2011; IN COMMERCE 5-2-2011.

THE MARK CONSISTS OF STANDARD CHARACTERS WITHOUT CLAIM TO ANY PARTICULAR FONT, STYLE, SIZE, OR COLOR.

NO CLAIM IS MADE TO THE EXCLUSIVE RIGHT TO USE "BAITS", APART FROM THE MARK AS SHOWN.

SER. NO. 85-311,003, FILED 5-3-2011.

JORDAN BAKER, EXAMINING ATTORNEY



David J. Kybas

Director of the United States Patent and Trademark Office

United States of America

United States Patent and Trademark Office

TIRE BITE

Reg. No. 4,073,795

Registered Dec. 20, 2011

Int. Cl.: 32

FLYING DOG BREWERY, LLLP (COLORADO LIMITED LIABILITY LIMITED PARTNERSHIP)

SUITE 104
2330 BROADWAY
DENVER, CO 80205

TRADEMARK

FOR: BREWED MALT-BASED ALCOHOLIC BEVERAGE IN THE NATURE OF A BEER, IN CLASS 32 (U.S. CLS. 45, 46 AND 48).

PRINCIPAL REGISTER

FIRST USE 6-0-1999; IN COMMERCE 9-0-1999.

THE MARK CONSISTS OF STANDARD CHARACTERS WITHOUT CLAIM TO ANY PARTICULAR FONT, STYLE, SIZE, OR COLOR.

OWNER OF U.S. REG. NOS. 3,448,951, 3,495,109, AND 3,546,139.

SER. NO. 85-311,015, FILED 5-3-2011.

WILLIAM P. SHANAHAN, EXAMINING ATTORNEY



David J. Kyffers

Director of the United States Patent and Trademark Office

United States of America

United States Patent and Trademark Office

Fresh Roots

Reg. No. 4,073,796

FRESH ROOTS, LLC (CALIFORNIA LIMITED LIABILITY COMPANY)
P.O. BOX 7621

Registered Dec. 20, 2011

SPRECKELS, CA 939627621

Int. Cl.: 39

FOR: DELIVERY AND STORAGE OF GOODS; FREIGHT TRANSPORTATION BY TRUCK OR RAIL; MOVING AND STORAGE OF AGRICULTURAL PRODUCTS; PACKAGING AND PARCELLING OF GOODS FOR TRANSPORT PURPOSES, NAMELY, THE PACKING OF GOODS USING SUSTAINABLE OR BIODEGRADABLE PACKAGING AND SHIPPING MATERIALS; STORAGE AND DELIVERY OF GOODS; STORAGE OF AGRICULTURAL PRODUCTS; SUPPLY CHAIN LOGISTICS AND REVERSE LOGISTICS SERVICES, NAMELY, STORAGE, TRANSPORTATION AND DELIVERY OF GOODS FOR OTHERS BY AIR, RAIL, SHIP OR TRUCK; TRANSPORT AND DELIVERY OF GOODS; TRANSPORT AND STORAGE OF GOODS; TRANSPORTATION AND STORAGE OF GOODS; TRANSPORTATION AND STORAGE OF GOODS IN REFRIGERATED CONDITIONS , IN CLASS 39 (U.S. CLS. 100 AND 105).

SERVICE MARK

PRINCIPAL REGISTER

FIRST USE 1-19-2011; IN COMMERCE 2-8-2011.

THE MARK CONSISTS OF STANDARD CHARACTERS WITHOUT CLAIM TO ANY PARTICULAR FONT, STYLE, SIZE, OR COLOR.

SER. NO. 85-311,032, FILED 5-3-2011.

MARK SHINER, EXAMINING ATTORNEY



David J. Kyffers

Director of the United States Patent and Trademark Office

United States of America

United States Patent and Trademark Office

K-9 CRUISER

Reg. No. 4,073,797

Registered Dec. 20, 2011

Int. Cl.: 32

TRADEMARK

PRINCIPAL REGISTER

FLYING DOG BREWERY, LLLP (COLORADO LIMITED LIABILITY LIMITED
PARTNERSHIP)
SUITE 104
2330 BROADWAY
DENVER, CO 80205

FOR: BREWED MALT-BASED ALCOHOLIC BEVERAGE IN THE NATURE OF A BEER, IN
CLASS 32 (U.S. CLS. 45, 46 AND 48).

FIRST USE 9-0-2002; IN COMMERCE 11-0-2002.

THE MARK CONSISTS OF STANDARD CHARACTERS WITHOUT CLAIM TO ANY PAR-
TICULAR FONT, STYLE, SIZE, OR COLOR.

OWNER OF U.S. REG. NOS. 3,448,951, 3,495,109, AND 3,546,139.

SER. NO. 85-311,048, FILED 5-3-2011.

WILLIAM P. SHANAHAN, EXAMINING ATTORNEY



David J. Kyffers

Director of the United States Patent and Trademark Office

United States of America

United States Patent and Trademark Office

FAMILETIME

Reg. No. 4,073,798

Registered Dec. 20, 2011

Int. Cl.: 39

SERVICE MARK

PRINCIPAL REGISTER

FAMILETIME GROUP LLC (GEORGIA LIMITED LIABILITY COMPANY)
2401 WEST DOUBLEGATE DRIVE
ALBANY, GA 31721

FOR: PROVIDING A SECURED ACCESS WEB SITE FOR THE ELECTRONIC STORAGE OF DIGITAL PHOTOGRAPHS, IMAGES, TEXT AND AUDIO AND VIDEO DATA ALL FEATURING PERSONAL AND HISTORICAL FAMILY INFORMATION, IN CLASS 39 (U.S. CLS. 100 AND 105).

FIRST USE 5-1-2011; IN COMMERCE 5-1-2011.

THE MARK CONSISTS OF STANDARD CHARACTERS WITHOUT CLAIM TO ANY PARTICULAR FONT, STYLE, SIZE, OR COLOR.

SER. NO. 85-311,064, FILED 5-3-2011.

MICHAEL TANNER, EXAMINING ATTORNEY



David J. Kyffers

Director of the United States Patent and Trademark Office

United States of America

United States Patent and Trademark Office

QUICK CO₂OL

Reg. No. 4,073,799

SOWDER, WILLIAM E. (UNITED STATES INDIVIDUAL)
2293 PEAR LANE
MADRID, IA 50156

Registered Dec. 20, 2011

Int. Cl.: 12

FOR: COOLING APPARATUS COMPRISED OF LINES OF FLUID COOLED BY DRY ICE FOR USE PRIMARILY IN COOLING RACE CAR DRIVERS AND THEIR VEHICLES, IN CLASS 12 (U.S. CLS. 19, 21, 23, 31, 35 AND 44).

TRADEMARK

FIRST USE 12-12-2010; IN COMMERCE 12-12-2010.

PRINCIPAL REGISTER

THE MARK CONSISTS OF STANDARD CHARACTERS WITHOUT CLAIM TO ANY PARTICULAR FONT, STYLE, SIZE, OR COLOR.

SER. NO. 85-311,076, FILED 5-3-2011.

DORITT L. CARROLL, EXAMINING ATTORNEY



David J. Kybas

Director of the United States Patent and Trademark Office

United States of America

United States Patent and Trademark Office

GARDE DOG

Reg. No. 4,073,800

Registered Dec. 20, 2011

Int. Cl.: 32

FLYING DOG BREWERY, LLLP (COLORADO LIMITED LIABILITY LIMITED
PARTNERSHIP)
SUITE 104
2330 BROADWAY
DENVER, CO 80205

TRADEMARK

FOR: BREWED MALT-BASED ALCOHOLIC BEVERAGE IN THE NATURE OF A BEER, IN
CLASS 32 (U.S. CLS. 45, 46 AND 48).

PRINCIPAL REGISTER

FIRST USE 12-0-2007; IN COMMERCE 1-0-2008.

THE MARK CONSISTS OF STANDARD CHARACTERS WITHOUT CLAIM TO ANY PAR-
TICULAR FONT, STYLE, SIZE, OR COLOR.

OWNER OF U.S. REG. NOS. 3,448,951, 3,495,109, AND 3,546,139.

SER. NO. 85-311,106, FILED 5-3-2011.

WILLIAM P. SHANAHAN, EXAMINING ATTORNEY



David J. Kyffers

Director of the United States Patent and Trademark Office

United States of America

United States Patent and Trademark Office

STRONG AS AN OX

Reg. No. 4,073,801

ROBERT KING AND JAMES NOWAK, PARTNERSHIP (CALIFORNIA PARTNERSHIP)
1424 S. RITCHEY, UNIT C
SANTA ANA, CA 92705

Registered Dec. 20, 2011

Int. Cl.: 6

FOR: HOSE HANGERS OF METAL; METAL HOOKS, IN CLASS 6 (U.S. CLS. 2, 12, 13, 14, 23, 25 AND 50).

TRADEMARK

FIRST USE 4-15-2011; IN COMMERCE 4-15-2011.

PRINCIPAL REGISTER

THE MARK CONSISTS OF STANDARD CHARACTERS WITHOUT CLAIM TO ANY PARTICULAR FONT, STYLE, SIZE, OR COLOR.

SER. NO. 85-311,129, FILED 5-3-2011.

DAVID COLLIER, EXAMINING ATTORNEY



David J. Kyffers

Director of the United States Patent and Trademark Office

United States of America

United States Patent and Trademark Office

plex

Reg. No. 4,073,802

Registered Dec. 20, 2011

Int. Cl.: 9

TRADEMARK

PRINCIPAL REGISTER

INCIPIO TECHNOLOGIES, INC. (CALIFORNIA CORPORATION)
1842 BARRANCA PARKWAY
IRVINE, CA 92606

FOR: FITTED PLASTIC FILMS FOR COVERING AND PROVIDING A SCRATCH RESISTANT BARRIER OR PROTECTION FOR PORTABLE ELECTRONIC DEVICES, NAMELY, MOBILE PHONES, MEDIA PLAYERS, EBOOK READERS AND TABLET COMPUTERS, IN CLASS 9 (U.S. CLS. 21, 23, 26, 36 AND 38).

FIRST USE 3-1-2011; IN COMMERCE 3-1-2011.

THE MARK CONSISTS OF STANDARD CHARACTERS WITHOUT CLAIM TO ANY PARTICULAR FONT, STYLE, SIZE, OR COLOR.

SER. NO. 85-311,143, FILED 5-3-2011.

APRIL ROACH, EXAMINING ATTORNEY



David J. Kyffers

Director of the United States Patent and Trademark Office

United States of America

United States Patent and Trademark Office

GRASSROOTS COFFEE

Reg. No. 4,073,803

GRASSROOTS COFFEE ROASTERS LLC (GEORGIA LIMITED LIABILITY COMPANY)
123 SOUTH BROAD STREET
THOMASVILLE, GA 31792

Registered Dec. 20, 2011

Int. Cl.: 30

FOR: COFFEE; GROUND COFFEE BEANS; ROASTED COFFEE BEANS, IN CLASS 30 (U.S. CL. 46).

TRADEMARK

FIRST USE 11-6-2009; IN COMMERCE 11-6-2009.

PRINCIPAL REGISTER

THE MARK CONSISTS OF STANDARD CHARACTERS WITHOUT CLAIM TO ANY PARTICULAR FONT, STYLE, SIZE, OR COLOR.

NO CLAIM IS MADE TO THE EXCLUSIVE RIGHT TO USE "COFFEE", APART FROM THE MARK AS SHOWN.

SER. NO. 85-311,169, FILED 5-3-2011.

STEVEN R. FINE, EXAMINING ATTORNEY



David J. Kybas

Director of the United States Patent and Trademark Office

United States of America

United States Patent and Trademark Office

CONNECTICUT COMMUNITY BANK, N.A.

Reg. No. 4,073,804

Registered Dec. 20, 2011

Int. Cl.: 36

SERVICE MARK

PRINCIPAL REGISTER

CONNECTICUT COMMUNITY BANK, NATIONAL ASSOCIATION (UNITED STATES
NATIONAL BANKING ASSOCIATION)
1495 POST ROAD EAST
WESTPORT, CT 06881

FOR: BANKING, IN CLASS 36 (U.S. CLS. 100, 101 AND 102).

FIRST USE 12-1-2003; IN COMMERCE 12-1-2003.

THE MARK CONSISTS OF STANDARD CHARACTERS WITHOUT CLAIM TO ANY PAR-
TICULAR FONT, STYLE, SIZE, OR COLOR.

OWNER OF U.S. REG. NOS. 3,094,552 AND 3,129,754.

NO CLAIM IS MADE TO THE EXCLUSIVE RIGHT TO USE "BANK, N.A.", APART FROM
THE MARK AS SHOWN.

SEC. 2(F).

SER. NO. 85-311,184, FILED 5-3-2011.

LAURIE KAUFMAN, EXAMINING ATTORNEY



David J. Kyffers

Director of the United States Patent and Trademark Office

United States of America

United States Patent and Trademark Office



Reg. No. 4,073,805

NA-CHURS PLANT FOOD COMPANY (DELAWARE CORPORATION)
421 LEADER STREET
MARION, OH 43302

Registered Dec. 20, 2011

Int. Cl.: 1

FOR: CHEMICAL PREPARATIONS FOR MELTING SNOW AND ICE, IN CLASS 1 (U.S. CLS. 1, 5, 6, 10, 26 AND 46).

TRADEMARK

FIRST USE 2-15-2011; IN COMMERCE 2-15-2011.

PRINCIPAL REGISTER

OWNER OF U.S. REG. NOS. 3,168,423 AND 3,173,828.

THE COLOR(S) BLACK AND BLUE IS/ARE CLAIMED AS A FEATURE OF THE MARK.

THE MARK CONSISTS OF THE TERM "ALPINE" AND A SNOWFLAKE DESIGN IN THE COLOR BLACK, A BLACK HORIZONTAL LINE UNDERNEATH, AND THE TERM "VS-11" IN THE COLOR BLUE.

SER. NO. 85-311,200, FILED 5-3-2011.

SUNG IN, EXAMINING ATTORNEY



David J. Kyfos

Director of the United States Patent and Trademark Office

United States of America

United States Patent and Trademark Office



ALPINE
VS-11E

Reg. No. 4,073,806

NA-CHURS PLANT FOOD COMPANY (DELAWARE CORPORATION)
421 LEADER STREET
MARION, OH 43302

Registered Dec. 20, 2011

Int. Cl.: 1

FOR: CHEMICAL PREPARATIONS FOR MELTING SNOW AND ICE, IN CLASS 1 (U.S. CLS. 1, 5, 6, 10, 26 AND 46).

TRADEMARK

FIRST USE 4-12-2011; IN COMMERCE 4-12-2011.

PRINCIPAL REGISTER

OWNER OF U.S. REG. NOS. 3,168,423 AND 3,173,828.

THE COLOR(S) BLACK AND BLUE IS/ARE CLAIMED AS A FEATURE OF THE MARK.

THE MARK CONSISTS OF THE TERM "ALPINE" AND A SNOWFLAKE DESIGN IN THE COLOR BLACK, A BLACK HORIZONTAL LINE UNDERNEATH, AND THE TERM "VS-11E" IN THE COLOR BLUE.

SER. NO. 85-311,203, FILED 5-3-2011.

SUNG IN, EXAMINING ATTORNEY



David J. Kyfos

Director of the United States Patent and Trademark Office

United States of America

United States Patent and Trademark Office



Reg. No. 4,073,807

NA-CHURS PLANT FOOD COMPANY (DELAWARE CORPORATION)
421 LEADER STREET
MARION, OH 43302

Registered Dec. 20, 2011

Int. Cl.: 1

FOR: CHEMICAL PREPARATIONS FOR MELTING SNOW AND ICE, IN CLASS 1 (U.S. CLS. 1, 5, 6, 10, 26 AND 46).

TRADEMARK

FIRST USE 1-14-2011; IN COMMERCE 1-14-2011.

PRINCIPAL REGISTER

OWNER OF U.S. REG. NOS. 3,168,423 AND 3,173,828.

THE COLOR(S) BLACK AND BLUE IS/ARE CLAIMED AS A FEATURE OF THE MARK.

THE MARK CONSISTS OF THE TERM "ALPINE" AND A SNOWFLAKE DESIGN IN THE COLOR BLACK, A BLACK HORIZONTAL LINE UNDERNEATH, AND THE TERM "WT-11" IN THE COLOR BLUE.

SER. NO. 85-311,210, FILED 5-3-2011.

SUNG IN, EXAMINING ATTORNEY



David J. Kyfos

Director of the United States Patent and Trademark Office

United States of America

United States Patent and Trademark Office



ALPINE

RF-11

Reg. No. 4,073,808

NA-CHURS PLANT FOOD COMPANY (DELAWARE CORPORATION)
421 LEADER STREET
MARION, OH 43302

Registered Dec. 20, 2011

Int. Cl.: 1

FOR: CHEMICAL PREPARATIONS FOR MELTING SNOW AND ICE, IN CLASS 1 (U.S. CLS. 1, 5, 6, 10, 26 AND 46).

TRADEMARK

FIRST USE 11-22-2010; IN COMMERCE 11-22-2010.

PRINCIPAL REGISTER

OWNER OF U.S. REG. NOS. 3,168,423 AND 3,173,828.

THE COLOR(S) BLACK AND BLUE IS/ARE CLAIMED AS A FEATURE OF THE MARK.

THE MARK CONSISTS OF THE TERM "ALPINE" AND A SNOWFLAKE DESIGN IN THE COLOR BLACK, A BLACK HORIZONTAL LINE UNDERNEATH, AND THE TERM "RF-11" IN THE COLOR BLUE.

SER. NO. 85-311,219, FILED 5-3-2011.

SUNG IN, EXAMINING ATTORNEY



David J. Kyfos

Director of the United States Patent and Trademark Office

United States of America

United States Patent and Trademark Office

MOAI

Reg. No. 4,073,809

Registered Dec. 20, 2011

Int. Cls.: 9 and 42

TRADEMARK

SERVICE MARK

PRINCIPAL REGISTER

ZIPLINE GAMES, INC. (DELAWARE CORPORATION)
7683 SE 27TH ST., SUITE 210
MERCER ISLAND, WA 98040

FOR: COMPUTER GAME SOFTWARE, NAMELY, A MOBILE GAME DEVELOPMENT PLATFORM FOR USE BY DEVELOPERS OF GAMES FOR MOBILE DEVICES, IN CLASS 9 (U.S. CLS. 21, 23, 26, 36 AND 38).

FIRST USE 1-3-2011; IN COMMERCE 1-3-2011.

FOR: SOFTWARE AS A SERVICE (SAAS) SERVICES, NAMELY, HOSTING SOFTWARE FOR USE BY OTHERS FOR USE IN GAME DEVELOPMENT, IN CLASS 42 (U.S. CLS. 100 AND 101).

FIRST USE 1-3-2011; IN COMMERCE 1-3-2011.

THE MARK CONSISTS OF STANDARD CHARACTERS WITHOUT CLAIM TO ANY PARTICULAR FONT, STYLE, SIZE, OR COLOR.

THE WORDING "MOAI" HAS NO MEANING IN A FOREIGN LANGUAGE.

SER. NO. 85-311,275, FILED 5-3-2011.

JANICE KIM, EXAMINING ATTORNEY



David J. Kybas

Director of the United States Patent and Trademark Office

United States of America

United States Patent and Trademark Office

EUROFIT

Reg. No. 4,073,810

PINK MOUSSE EQUESTRIAN, INC. (CALIFORNIA CORPORATION)
5401 FAIRVIEW PLACE
AGOURA, CA 92301

Registered Dec. 20, 2011

Int. Cl.: 25

FOR: EQUESTRIAN APPAREL, NAMELY, BREECHES, JACKETS AND CAPS, IN CLASS 25 (U.S. CLS. 22 AND 39).

TRADEMARK

FIRST USE 4-1-2001; IN COMMERCE 4-1-2001.

PRINCIPAL REGISTER

THE MARK CONSISTS OF STANDARD CHARACTERS WITHOUT CLAIM TO ANY PARTICULAR FONT, STYLE, SIZE, OR COLOR.

SEC. 2(F).

SER. NO. 85-311,288, FILED 5-3-2011.

DANNEAN HETZEL, EXAMINING ATTORNEY



David J. Kybas

Director of the United States Patent and Trademark Office

United States of America

United States Patent and Trademark Office



Reg. No. 4,073,811

Registered Dec. 20, 2011

Int. Cl.: 39

SERVICE MARK

PRINCIPAL REGISTER

FRESH N LEAN.COM (WYOMING CORPORATION)
SUITE 1123
2710 THOMES AVE
CHEYENNE, WY 82001

FOR: HEALTHY FOOD DELIVERY SERVICES, IN CLASS 39 (U.S. CLS. 100 AND 105).

FIRST USE 1-1-2010; IN COMMERCE 1-1-2010.

NO CLAIM IS MADE TO THE EXCLUSIVE RIGHT TO USE "FRESH 'N LEAN" AND "NUTRITIOUS, DELICIOUS, & DELIVERED", APART FROM THE MARK AS SHOWN.

THE MARK CONSISTS OF A YOUNG GIRL RIDING A MOTOR SCOOTER DELIVERING FOOD. INSIDE A CIRCLE IS THE WORDING "FRESH 'N LEAN" AND "NUTRITIOUS, DELICIOUS, & DELIVERED".

SER. NO. 85-311,334, FILED 5-3-2011.

PAUL F. GAST, EXAMINING ATTORNEY



David J. Kybas

Director of the United States Patent and Trademark Office

United States of America

United States Patent and Trademark Office

CLASSY Awards

Reg. No. 4,073,812

STAYCLASSY PRODUCTIONS INC. (CALIFORNIA CORPORATION)

Registered Dec. 20, 2011

533 F STREET, SUITE 300
SAN DIEGO, CA 92101

Int. Cls.: 41 and 42

FOR: PROVIDING RECOGNITION AND INCENTIVES BY THE WAY OF AWARDS TO DEMONSTRATE EXCELLENCE IN THE FIELD OF PHILANTHROPY; PROVIDING A WEBSITE FEATURING INFORMATION ON AN AWARD PROGRAM FOR EXCELLENCE IN THE FIELD OF PHILANTHROPY, IN CLASS 41 (U.S. CLS. 100, 101 AND 107).

SERVICE MARK

PRINCIPAL REGISTER

FIRST USE 11-14-2009; IN COMMERCE 11-14-2009.

FOR: PROVIDING A WEBSITE FEATURING NON-DOWNLOADABLE SOFTWARE FOR NOMINATING AND VOTING FOR NOMINEES IN THE FIELD OF OUTSTANDING PHILANTHROPIC ACHIEVEMENT, IN CLASS 42 (U.S. CLS. 100 AND 101).

FIRST USE 11-14-2009; IN COMMERCE 11-14-2009.

THE MARK CONSISTS OF STANDARD CHARACTERS WITHOUT CLAIM TO ANY PARTICULAR FONT, STYLE, SIZE, OR COLOR.

NO CLAIM IS MADE TO THE EXCLUSIVE RIGHT TO USE "AWARDS", APART FROM THE MARK AS SHOWN.

SER. NO. 85-311,352, FILED 5-3-2011.

KHANH LE, EXAMINING ATTORNEY



David J. Kyros

Director of the United States Patent and Trademark Office

United States of America

United States Patent and Trademark Office

Look Good, Do Good, Feel
Good

Reg. No. 4,073,813

BEADFORLIFE (COLORADO NON-PROFIT CORPORATION)
2336 CANYON BOULEVARD, SUITE 202
BOULDER, CO 80302

Registered Dec. 20, 2011

Int. Cl.: 3

FOR: EAST AFRICAN PURE SHEA BUTTER FOR COSMETIC PURPOSES AND COSMETIC PRODUCTS, NAMELY, COSMETICS, IN CLASS 3 (U.S. CLS. 1, 4, 6, 50, 51 AND 52).

TRADEMARK

FIRST USE 9-1-2009; IN COMMERCE 9-1-2009.

PRINCIPAL REGISTER

THE MARK CONSISTS OF STANDARD CHARACTERS WITHOUT CLAIM TO ANY PARTICULAR FONT, STYLE, SIZE, OR COLOR.

SER. NO. 85-311,391, FILED 5-3-2011.

SETH A. RAPPAPORT, EXAMINING ATTORNEY



David J. Kyffers

Director of the United States Patent and Trademark Office

United States of America

United States Patent and Trademark Office

EL PROGRESO SE TRABAJA

Reg. No. 4,073,814

Registered Dec. 20, 2011

Int. Cl.: 36

SERVICE MARK

PRINCIPAL REGISTER

ORIENTAL FINANCIAL GROUP INC. (PUERTO RICO CORPORATION)
PROFESSIONAL OFFICE PARK V
997 SAN ROBERTO STREET
SAN JUAN, PUERTO RICO 00926

FOR: BANKING AND FINANCING SERVICES; FINANCIAL PLANNING FOR RETIREMENT; INDIVIDUAL RETIREMENT ACCOUNT SERVICES; INSURANCE AGENCY AND BROKERAGE; INVESTMENT BANKING SERVICES; SECURITIES BROKERAGE; TRUSTEE SERVICES, IN CLASS 36 (U.S. CLS. 100, 101 AND 102).

FIRST USE 8-17-2010; IN COMMERCE 8-17-2010.

THE MARK CONSISTS OF STANDARD CHARACTERS WITHOUT CLAIM TO ANY PARTICULAR FONT, STYLE, SIZE, OR COLOR.

THE ENGLISH TRANSLATION OF "EL PROGRESO SE TRABAJA" IN THE MARK IS PROGRESS REQUIRES WORK.

SER. NO. 85-311,396, FILED 5-3-2011.

DEIRDRE ROBERTSON, EXAMINING ATTORNEY



David J. Kyjars

Director of the United States Patent and Trademark Office

United States of America

United States Patent and Trademark Office

TRIALWERX

Reg. No. 4,073,815

AGRITHORITY LLC (MISSOURI LIMITED LIABILITY COMPANY)
11125 NW AMBASSADOR DRIVE, SUITE 120
KANSAS CITY, MO 64153

Registered Dec. 20, 2011

Int. Cl.: 42

FOR: PROVIDING TEMPORARY USE OF A WEB-BASED SOFTWARE APPLICATION FOR MANAGING DATABASES OF INFORMATION REGARDING AGRICULTURAL PRODUCT COMPARISONS AND HYBRIDS AND VARIETIES THEREFROM FOR PRODUCT PERFORMANCE AND EFFICACY, IN CLASS 42 (U.S. CLS. 100 AND 101).

SERVICE MARK

PRINCIPAL REGISTER

FIRST USE 1-31-2010; IN COMMERCE 1-31-2010.

THE MARK CONSISTS OF STANDARD CHARACTERS WITHOUT CLAIM TO ANY PARTICULAR FONT, STYLE, SIZE, OR COLOR.

SER. NO. 85-311,420, FILED 5-3-2011.

DAVID YONTEF, EXAMINING ATTORNEY



David J. Kyffers

Director of the United States Patent and Trademark Office

United States of America

United States Patent and Trademark Office

Astro Nuts

Reg. No. 4,073,816

Registered Dec. 20, 2011

Int. Cl.: 28

TRADEMARK

PRINCIPAL REGISTER

RIEDEL SHOES, INC. (MINNESOTA CORPORATION)
PO BOX 21
122 CANNON RIVER AVE.
RED WING, MN 55066

FOR: NUTS FOR ROLLER SKATE WHEEL AXLES, IN CLASS 28 (U.S. CLS. 22, 23, 38 AND 50).

FIRST USE 4-15-2011; IN COMMERCE 4-15-2011.

THE MARK CONSISTS OF STANDARD CHARACTERS WITHOUT CLAIM TO ANY PARTICULAR FONT, STYLE, SIZE, OR COLOR.

NO CLAIM IS MADE TO THE EXCLUSIVE RIGHT TO USE "NUTS", APART FROM THE MARK AS SHOWN.

SER. NO. 85-311,426, FILED 5-3-2011.

DANIEL CAPSHAW, EXAMINING ATTORNEY



David J. Kyfos

Director of the United States Patent and Trademark Office

United States of America

United States Patent and Trademark Office



Reg. No. 4,073,817

AGRITHORITY LLC (MISSOURI LIMITED LIABILITY COMPANY)
11125 NW AMBASSADOR DRIVE, SUITE 120
KANSAS CITY, MO 64153

Registered Dec. 20, 2011

Int. Cl.: 42

FOR: PROVIDING TEMPORARY USE OF A WEB-BASED SOFTWARE APPLICATION FOR MANAGING DATABASES OF INFORMATION REGARDING AGRICULTURAL PRODUCT COMPARISONS AND HYBRIDS AND VARIETIES THEREFROM FOR PRODUCT PERFORMANCE AND EFFICACY, IN CLASS 42 (U.S. CLS. 100 AND 101).

SERVICE MARK

PRINCIPAL REGISTER

FIRST USE 1-31-2010; IN COMMERCE 1-31-2010.

THE MARK CONSISTS OF THE WORDS "TRIALWERX" IN GREEN STYLIZED FONT WITH A SMALL BLACK RECTANGLE OVER THE LETTER "I" ALONGSIDE THREE STAGGERED RECTANGLES SHOWN IN THE COLORS BLACK, GREEN AND ORANGE.

THE COLOR(S) GREEN, BLACK AND ORANGE IS/ARE CLAIMED AS A FEATURE OF THE MARK.

SER. NO. 85-311,427, FILED 5-3-2011.

DAVID YONTEF, EXAMINING ATTORNEY



David J. Kypos

Director of the United States Patent and Trademark Office

United States of America

United States Patent and Trademark Office



Reg. No. 4,073,818

Registered Dec. 20, 2011

Int. Cl.: 41

SERVICE MARK

PRINCIPAL REGISTER

HAAG, JESSE C (UNITED STATES INDIVIDUAL)
426 INDEPENDENCE RD.
TROY, MT 59935

FOR: AUDIO AND VIDEO RECORDING SERVICES; AUDIO RECORDING AND PRODUCTION; ENTERTAINMENT SERVICES IN THE NATURE OF RECORDING, PRODUCTION AND POST-PRODUCTION SERVICES IN THE FIELD OF MUSIC; PRODUCTION OF AUDIO RECORDING; PRODUCTION OF SOUND AND MUSIC VIDEO RECORDINGS; RECORD MASTERING; RECORD PRODUCTION; RECORDING STUDIO SERVICES; RECORDING STUDIOS; SOUND RECORDING STUDIOS; VIDEO RECORDING SERVICES, IN CLASS 41 (U.S. CLS. 100, 101 AND 107).

FIRST USE 1-18-2007; IN COMMERCE 3-19-2008.

THE MARK CONSISTS OF A "SKULL AND CROSSBONES" SYMBOL WHERE THE SKULL IS WEARING A SET OF HEADPHONES AND THE "CROSSBONES" ARE REPLACED BY A PAIR OF MICROPHONES.

SER. NO. 85-311,450, FILED 5-3-2011.

SETH A. RAPPAPORT, EXAMINING ATTORNEY



David J. Kyffers

Director of the United States Patent and Trademark Office

United States of America

United States Patent and Trademark Office

DOGGIE FITNESS ADVENTURES

Reg. No. 4,073,819

YOUNG, GILLIAN (UNITED STATES INDIVIDUAL)
PO BOX 1746
SOLANA BEACH, CA 92075

Registered Dec. 20, 2011

Int. Cl.: 45

FOR: PET SITTING, IN CLASS 45 (U.S. CLS. 100 AND 101).

SERVICE MARK

FIRST USE 2-1-2010; IN COMMERCE 2-1-2010.

PRINCIPAL REGISTER

THE MARK CONSISTS OF STANDARD CHARACTERS WITHOUT CLAIM TO ANY PARTICULAR FONT, STYLE, SIZE, OR COLOR.

NO CLAIM IS MADE TO THE EXCLUSIVE RIGHT TO USE "DOGGIE FITNESS", APART FROM THE MARK AS SHOWN.

SER. NO. 85-311,474, FILED 5-3-2011.

SAMUEL E. SHARPER JR., EXAMINING ATTORNEY



David J. Kyffers

Director of the United States Patent and Trademark Office

United States of America

United States Patent and Trademark Office



Reg. No. 4,073,820

HANDGIENE CORP. (DELAWARE CORPORATION)
7 FLOYD STREET
JERSEY CITY, NJ 07306

Registered Dec. 20, 2011

Int. Cls.: 9, 11 and 21

FOR: APPARATUS FOR MONITORING HAND HYGIENE COMPOSED OF IDENTIFICATION BADGES AND/OR BRACELETS, HAND CLEANING STATIONS, AND IDENTIFICATION SENSORS THAT MONITOR HAND WASHING BY SENSING THE PRESENCE OF THE BADGES AND/OR BRACELETS, IN CLASS 9 (U.S. CLS. 21, 23, 26, 36 AND 38).

TRADEMARK

PRINCIPAL REGISTER

FIRST USE 4-10-2009; IN COMMERCE 4-10-2010.

FOR: HAND-SANITIZING APPARATUS FOR WASHROOMS, NAMELY, HAND WASHING STATIONS THAT DISPENSE WATER AND HAND-SANITIZING SOLUTION, IN CLASS 11 (U.S. CLS. 13, 21, 23, 31 AND 34).

FIRST USE 4-10-2009; IN COMMERCE 4-10-2010.

FOR: DISPENSERS FOR HAND-SANITIZING SOLUTIONS, IN CLASS 21 (U.S. CLS. 2, 13, 23, 29, 30, 33, 40 AND 50).

FIRST USE 4-10-2009; IN COMMERCE 4-10-2010.

THE MARK CONSISTS OF A CIRCLE WITH THE WORDING "CLEAN HANDS WORK HERE" INSIDE THE TOP PORTION OF THE CIRCLE, A WATER DROP IN THE CENTER OF THE CIRCLE AND TWO HANDS WITH BUBBLES AT THE BOTTOM OF THE CIRCLE.

SER. NO. 85-311,487, FILED 5-3-2011.

KELLY BOULTON, EXAMINING ATTORNEY



David J. Kybas

Director of the United States Patent and Trademark Office

United States of America

United States Patent and Trademark Office

FOXX

Reg. No. 4,073,821

SIMONSEN, MARK S. (UNITED STATES INDIVIDUAL)
3214 N. UNIVERSITY AVE. #136
PROVO, UT 84604

Registered Dec. 20, 2011

Int. Cl.: 9

FOR: ELECTRONIC EFFECT PEDALS FOR USE WITH SOUND AMPLIFIERS; GUITAR EFFECTS PROCESSORS, IN CLASS 9 (U.S. CLS. 21, 23, 26, 36 AND 38).

TRADEMARK

FIRST USE 1-15-1999; IN COMMERCE 1-15-1999.

PRINCIPAL REGISTER

THE MARK CONSISTS OF STANDARD CHARACTERS WITHOUT CLAIM TO ANY PARTICULAR FONT, STYLE, SIZE, OR COLOR.

SER. NO. 85-311,520, FILED 5-3-2011.

PAULA MAHONEY, EXAMINING ATTORNEY



David J. Kyffers

Director of the United States Patent and Trademark Office

United States of America

United States Patent and Trademark Office

RICH PUSH

Reg. No. 4,073,822

URBAN AIRSHIP, INC. (DELAWARE CORPORATION)
1227 NW DAVIS STREET
PORTLAND, OR 97209

Registered Dec. 20, 2011

Int. Cl.: 42

FOR: APPLICATION SERVICE PROVIDER FEATURING SOFTWARE FOR USE IN DELIVERING ELECTRONIC MESSAGES AND CONTENT FROM A THIRD PARTY APPLICATION PROVIDER TO USERS OF MOBILE COMMUNICATION DEVICES, IN CLASS 42 (U.S. CLS. 100 AND 101).

SERVICE MARK

PRINCIPAL REGISTER

FIRST USE 1-0-2011; IN COMMERCE 1-0-2011.

THE MARK CONSISTS OF STANDARD CHARACTERS WITHOUT CLAIM TO ANY PARTICULAR FONT, STYLE, SIZE, OR COLOR.

NO CLAIM IS MADE TO THE EXCLUSIVE RIGHT TO USE "PUSH", APART FROM THE MARK AS SHOWN.

SER. NO. 85-311,553, FILED 5-3-2011.

ANGELA DUONG, EXAMINING ATTORNEY



David J. Kyffers

Director of the United States Patent and Trademark Office

United States of America

United States Patent and Trademark Office

COCOA CANARD

Reg. No. 4,073,823

CELEBRIDUCKS, INC. (CALIFORNIA CORPORATION)

Registered Dec. 20, 2011

28 MOUNTAIN VIEW AVE
SAN RAFAEL, CA 94901

Int. Cl.: 25

FOR: APRONS; BOTTOMS; BOXER BRIEFS; FOOTWEAR; GLOVES; HATS; HEADBANDS;
HEADWEAR; JACKETS; PANTS; SHIRTS; SHORTS; SWEAT SHIRTS; TOPS, IN CLASS 25
(U.S. CLS. 22 AND 39).

TRADEMARK

FIRST USE 1-0-2009; IN COMMERCE 1-0-2009.

PRINCIPAL REGISTER

THE MARK CONSISTS OF STANDARD CHARACTERS WITHOUT CLAIM TO ANY PAR-
TICULAR FONT, STYLE, SIZE, OR COLOR.

SER. NO. 85-311,587, FILED 5-3-2011.

TINA MAI, EXAMINING ATTORNEY



David J. Kyffers

Director of the United States Patent and Trademark Office

United States of America

United States Patent and Trademark Office

Meeting Demands

Reg. No. 4,073,824

Registered Dec. 20, 2011

Int. Cl.: 35

SERVICE MARK

PRINCIPAL REGISTER

BOYNE, DEBRAH A. (OKLAHOMA LIMITED LIABILITY COMPANY), DBA MEETING
DEMANDS
6007 EAST 56TH PLACE
TULSA, OK 74135

FOR: ARRANGING AND CONDUCTING SPECIAL EVENTS FOR BUSINESS PURPOSES,
IN CLASS 35 (U.S. CLS. 100, 101 AND 102).

FIRST USE 11-10-2001; IN COMMERCE 11-10-2001.

THE MARK CONSISTS OF STANDARD CHARACTERS WITHOUT CLAIM TO ANY PAR-
TICULAR FONT, STYLE, SIZE, OR COLOR.

SER. NO. 85-311,595, FILED 5-3-2011.

JESSICA A. POWERS, EXAMINING ATTORNEY



David J. Kyffers

Director of the United States Patent and Trademark Office

United States of America

United States Patent and Trademark Office



egn ebre

Reg. No. 4,073,825

MEMEL, JEAN-JACQUES L. (VIRGINIA SOLE PROPRIETORSHIP)
P.O. BOX 1513
HERNDON, VA 20172

Registered Dec. 20, 2011

Int. Cl.: 25

FOR: ATHLETIC APPAREL, NAMELY, SHIRTS, PANTS, JACKETS, FOOTWEAR, HATS AND CAPS, ATHLETIC UNIFORMS, IN CLASS 25 (U.S. CLS. 22 AND 39).

TRADEMARK

FIRST USE 4-26-2011; IN COMMERCE 4-26-2011.

PRINCIPAL REGISTER

THE MARK CONSISTS OF TWO STYLIZED "E"'S FACING AWAY FROM EACH OTHER WITH THE WORDS "EGN EBRE" UNDERNEATH.

SER. NO. 85-311,617, FILED 5-4-2011.

BENJAMIN OKEKE, EXAMINING ATTORNEY



David J. Kybas

Director of the United States Patent and Trademark Office

United States of America

United States Patent and Trademark Office

Xcella Rig

Reg. No. 4,073,826

GARLAND, TODD (UNITED STATES INDIVIDUAL)
16420 SW 84 PL
MIAMI, FL 33157

Registered Dec. 20, 2011

Int. Cl.: 9

FOR: CAMERA STABILITY ACCESSORY, NAMELY, A SUPPORT ARM, VEST AND SLED FOR FILM AND VIDEO CAMERAS TO ABSORB SHAKING MOVES WHILE SHOOTING, IN CLASS 9 (U.S. CLS. 21, 23, 26, 36 AND 38).

TRADEMARK

FIRST USE 1-4-2011; IN COMMERCE 1-4-2011.

PRINCIPAL REGISTER

THE MARK CONSISTS OF STANDARD CHARACTERS WITHOUT CLAIM TO ANY PARTICULAR FONT, STYLE, SIZE, OR COLOR.

NO CLAIM IS MADE TO THE EXCLUSIVE RIGHT TO USE "RIG", APART FROM THE MARK AS SHOWN.

SER. NO. 85-311,659, FILED 5-4-2011.

ALYSSA STEEL, EXAMINING ATTORNEY



David J. Kyros

Director of the United States Patent and Trademark Office

United States of America

United States Patent and Trademark Office

THE LEADER IN PORK SOLUTIONS

Reg. No. 4,073,827

CLEMENS FOOD GROUP, LLC (PENNSYLVANIA LIMITED LIABILITY COMPANY)
2700 CLEMENS ROAD
HATFIELD, PA 19440

Registered Dec. 20, 2011

Int. Cls.: 35, 40 and 44

FOR: LOGISTICS MANAGEMENT SERVICES FOR OTHERS, NAMELY, ARRANGING THE TRANSPORTATION OF FOOD PRODUCTS FOR OTHERS, IN CLASS 35 (U.S. CLS. 100, 101 AND 102).

SERVICE MARK

FIRST USE 8-21-2009; IN COMMERCE 8-21-2009.

PRINCIPAL REGISTER

FOR: FOOD PROCESSING, IN CLASS 40 (U.S. CLS. 100, 103 AND 106).

FIRST USE 8-21-2009; IN COMMERCE 8-21-2009.

FOR: HOG FARMS, IN CLASS 44 (U.S. CLS. 100 AND 101).

FIRST USE 8-21-2009; IN COMMERCE 8-21-2009.

THE MARK CONSISTS OF STANDARD CHARACTERS WITHOUT CLAIM TO ANY PARTICULAR FONT, STYLE, SIZE, OR COLOR.

NO CLAIM IS MADE TO THE EXCLUSIVE RIGHT TO USE "PORK", APART FROM THE MARK AS SHOWN.

SER. NO. 85-311,705, FILED S.R. 5-4-2011 AM. P.R. 8-17-2011.

CHRISTINA SOBRAL, EXAMINING ATTORNEY



David J. Kyros

Director of the United States Patent and Trademark Office

United States of America

United States Patent and Trademark Office

Crazy Mango

Reg. No. 4,073,828

RAVI CANDY'S LLC (TEXAS LIMITED LIABILITY COMPANY)
1714 S. 28 AVE
EDINBURG, TX 78542

Registered Dec. 20, 2011

Int. Cl.: 30

FOR: CANDIES; SWEETS, IN CLASS 30 (U.S. CL. 46).

TRADEMARK

FIRST USE 10-20-2009; IN COMMERCE 10-20-2009.

PRINCIPAL REGISTER

THE MARK CONSISTS OF STANDARD CHARACTERS WITHOUT CLAIM TO ANY PARTICULAR FONT, STYLE, SIZE, OR COLOR.

NO CLAIM IS MADE TO THE EXCLUSIVE RIGHT TO USE "MANGO", APART FROM THE MARK AS SHOWN.

SER. NO. 85-311,707, FILED 5-4-2011.

MARK T. MULLEN, EXAMINING ATTORNEY



David J. Kyffers

Director of the United States Patent and Trademark Office

United States of America

United States Patent and Trademark Office

**Crazy
Mango**

Reg. No. 4,073,829

RAVI CANDY'S LLC (TEXAS LIMITED LIABILITY COMPANY)
1714 S. 28 AVE
EDINBURG, TX 78542

Registered Dec. 20, 2011

Int. Cl.: 30

FOR: CANDIES; SWEETS, IN CLASS 30 (U.S. CL. 46).

TRADEMARK

FIRST USE 10-20-2009; IN COMMERCE 10-20-2009.

PRINCIPAL REGISTER

NO CLAIM IS MADE TO THE EXCLUSIVE RIGHT TO USE "MANGO", APART FROM THE MARK AS SHOWN.

THE COLOR(S) RED AND YELLOW IS/ARE CLAIMED AS A FEATURE OF THE MARK.

THE MARK CONSISTS OF THE WORD, "CRAZY", IN STYLISTIC YELLOW LETTERS OUTLINED IN RED; ABOVE AND TO THE RIGHT OF THE WORD, "MANGO", IN LARGER STYLISTIC YELLOW LETTERS OUTLINED IN RED.

SER. NO. 85-311,716, FILED 5-4-2011.

MARK T. MULLEN, EXAMINING ATTORNEY



David J. Kyros

Director of the United States Patent and Trademark Office

United States of America

United States Patent and Trademark Office

MobileLink-Rx

Reg. No. 4,073,830

Registered Dec. 20, 2011

Int. Cl.: 38

SERVICE MARK

PRINCIPAL REGISTER

VOICE-TECH, INC. (FLORIDA CORPORATION)
SUITE 104
720 COMMERCE DRIVE
VENICE, FL 34292

FOR: TELECOMMUNICATION SERVICES, NAMELY, PROVIDING AUTOMATED TEXT MESSAGING SERVICES ENABLING PHARMACIES TO NOTIFY PATIENTS VIA HAND-HELD MOBILE DEVICES WHEN PRESCRIPTIONS ARE READY FOR PICK-UP, AUTOMATED TEXT MESSAGING SERVICES TO SEND FOLLOW-UP PICK-UP AND REFILL REMINDERS, AND AUTOMATED TEXT MESSAGING SERVICES FOR SENDING HEALTH ALERTS AND HEALTH-RELATED PROMOTIONAL MESSAGES, IN CLASS 38 (U.S. CLS. 100, 101 AND 104).

FIRST USE 1-31-2011; IN COMMERCE 1-31-2011.

THE MARK CONSISTS OF STANDARD CHARACTERS WITHOUT CLAIM TO ANY PARTICULAR FONT, STYLE, SIZE, OR COLOR.

SER. NO. 85-311,742, FILED 5-4-2011.

TEJBIR SINGH, EXAMINING ATTORNEY



David J. Kypos

Director of the United States Patent and Trademark Office

United States of America
United States Patent and Trademark Office

T H E
Stanley
H O T E L

Reg. No. 4,073,831

Registered Dec. 20, 2011

Int. Cls.: 35 and 43

SERVICE MARK

PRINCIPAL REGISTER

NEW STANLEY ASSOCIATES, LLLP (COLORADO LIMITED LIABILITY LIMITED PARTNERSHIP)
333 WONDERVIEW
ESTES PARK, CO 80517

FOR: HOTEL LOYALTY REWARDS PROGRAM AND LOYALTY SCHEMES IN THE NATURE OF CUSTOMER LOYALTY SERVICES AND CUSTOMER CLUB SERVICES FOR COMMERCIAL, PROMOTIONAL AND ADVERTISING PURPOSES, ADMINISTRATIVE HOTEL MANAGEMENT SERVICES AND BUSINESS MANAGEMENT ASSISTANCE IN THE ESTABLISHMENT AND OPERATION OF HOTELS, IN CLASS 35 (U.S. CLS. 100, 101 AND 102).

FIRST USE 8-0-1998; IN COMMERCE 8-0-1998.

FOR: HOTEL SERVICES; HOTEL RESERVATION SERVICES; BAR SERVICES; CAFES; RESTAURANT SERVICES; FOOD CATERING SERVICES; PROVISION OF CONFERENCE, CONVENTION AND EXHIBITION FACILITIES; RENTAL OF CHAIRS, TABLES, TABLE LINENS, GLASSWARE; RENTAL OF MEETING ROOMS; RENTAL OF TEMPORARY ACCOMMODATION, IN CLASS 43 (U.S. CLS. 100 AND 101).

FIRST USE 8-0-1998; IN COMMERCE 8-0-1998.

OWNER OF U.S. REG. NOS. 3,179,149, 3,239,365, AND 3,762,592.

NO CLAIM IS MADE TO THE EXCLUSIVE RIGHT TO USE "HOTEL", APART FROM THE MARK AS SHOWN.

THE MARK CONSISTS OF THE TERMS "THE STANLEY HOTEL" WITH "STANLEY" SHOWN IN STYLIZED TYPEFACE.

SER. NO. 85-311,798, FILED 5-4-2011.

DOMINIC FATHY, EXAMINING ATTORNEY



David J. Kypos

Director of the United States Patent and Trademark Office

United States of America

United States Patent and Trademark Office

VAGISIL

Reg. No. 4,073,832

Registered Dec. 20, 2011

Int. Cl.: 3

TRADEMARK

PRINCIPAL REGISTER

COMBE INCORPORATED (DELAWARE CORPORATION)
1101 WESTCHESTER AVENUE
WHITE PLAINS, NY 10604

FOR: NON-MEDICATED FEMININE WASHES, IN CLASS 3 (U.S. CLS. 1, 4, 6, 50, 51 AND 52).

FIRST USE 12-14-2009; IN COMMERCE 12-14-2009.

THE MARK CONSISTS OF STANDARD CHARACTERS WITHOUT CLAIM TO ANY PARTICULAR FONT, STYLE, SIZE, OR COLOR.

OWNER OF U.S. REG. NOS. 1,104,172, 2,046,035 AND OTHERS.

SER. NO. 85-311,816, FILED 5-4-2011.

DOMINIC FATHY, EXAMINING ATTORNEY



David J. Kybas

Director of the United States Patent and Trademark Office

United States of America

United States Patent and Trademark Office

GREEN CUPBOARDS

Reg. No. 4,073,833

Registered Dec. 20, 2011

Int. Cl.: 35

SERVICE MARK

PRINCIPAL REGISTER

GREENCUPBOARDS, INC. (WASHINGTON CORPORATION)
221 N. WALL ST., SUITE 628
SPOKANE, WA 99201

FOR: ONLINE RETAIL STORE SERVICES FEATURING ALL OF THE FOLLOWING ENVIRONMENTALLY FRIENDLY PRODUCTS: ENVIRONMENTALLY FRIENDLY PRODUCTS FOR BABIES AND CHILDREN, NAMELY, BABY GIFTS, BUBBLE BATH, BABY CREAMS AND OINTMENTS; BABY SHAMPOO AND BABY BODY WASH; BABY CLOTHING, NAMELY, BABY BIBS; BABY BODY SUITS; BABY BOTTOMS; BABY OUTERWEAR; AND BABY SOCKS; CHANGING PADS, DIAPER BAGS; AND BABY WIPES; MATTRESS PADS; BABY FOOD AND FORMULA; BABY BOTTLES; BABY BEDDING; BABY FURNITURE; AND SOFT TOYS; SMALL APPLIANCES, NAMELY, CLOCKS AND RADIOS; SOLAR PANELS, SOLAR LIGHTING, AND SOLAR POWERED ACCESSORIES, NAMELY, RECHARGEABLE BATTERIES, SOLAR PAVING STONES, AND SOLAR POWERED LIGHTING ORNAMENTS; WIND TURBINES; VOLTAGE CONVERTERS; AND WIND TURBINE TOWERS; GROCERY AND BAKING SUPPLIES, NAMELY, BAKING POWDER, FLOUR, BAKING MIXES, BEVERAGES; CEREALS; COFFEE AND TEA; FOOD EXTRACTS; FOOD FLAVORING; FOOD STORAGE CONTAINERS; CRACKERS; ENERGY BARS; FOOD SEASONINGS; FOOD SPICES; FOOD SWEETENERS; CANDIES; TABLEWARE, NAMELY, BOWLS, CUPS, CUTLERY AND PLATES; VEGETARIAN FOOD PRODUCTS, NAMELY, SOY AND DAIRY SUBSTITUTES; HOUSEHOLD APPLIANCES, NAMELY, BREAD, PASTA AND JUICE PREPARATION TOOLS INCLUDING BREADSTICK MAKER, PASTA MAKERS; GLASS JUICE PITCHERS; PLASTIC AND WOODEN PLUNGERS; DRIP TRAYS AND COARSE SCREENS; BATHROOM CLEANERS, BATHROOM FURNITURE, BATHROOM PAPER PRODUCTS; BATHROOM RUGS AND BATHROOM TOWELS AND ROBES; BEDDING COMFORTERS; DUVET COVERS; MATTRESSES; PILLOWS, PILLOW COVERS AND SHAMS; SHEETS; BLANKETS; ALL PURPOSE CLEANERS; BATHROOM CLEANERS; CLEANING CLOTHS FOR COUNTERS, FLOORS, KITCHEN, LAUNDRY AND SINKS; CANDLES, FURNITURE CLEANERS AND POLISHES; PICTURE FRAMES; RUGS, SHELVES AND STORAGE UNITS; CLEANING SUPPLIES, DISHWASHING DETERGENTS; DRINK WARE; FOOD PREPARATION UTENSILS; GARBAGE BAGS; PAPER TOWELS; KITCHEN STORAGE CONTAINERS; WASTE BASKETS; WATER FILTERS; LAUNDRY DETERGENT. DRYER SHEETS; FABRIC SOFTENERS; OFFICE SUPPLIES, NAMELY, FILE BINDERS; FILE CABINETS; FILE FOLDERS; STORAGE BOXES; FILE TABS AND INSERTS; DISPLAY BOARDS AND EASELS; COAT RACKS; MIRRORS; CALCULATORS; CLIPBOARDS; DESK PADS; LABELS; PRINTED ORGANIZERS; PRINTED PLANNERS; SCISSORS AND PAPER CUTTERS; STAMPS, ENVELOPES AND PACKAGING; STAPLES, STAPLERS; STAPLE



David J. Kybas

Director of the United States Patent and Trademark Office

Reg. No. 4,073,833 REMOVERS AND PAPERCLIPS; TAPE AND TAPE HOLDERS; CORRECTION FLUID; BOOKCASES; CHAIRS; DESKS; DESK LIGHTING; PODIUMS; SHELVES; TABLES; PRINTED AWARDS AND CERTIFICATES; CONSTRUCTION PAPER; EASEL PADS; MEMO AND LEGAL PADS; MULTIPURPOSE PAPER; NOTEBOOKS; PAPER ROLLS; STATIONARY; STICKY PAPER NOTES; MARKERS AND HIGHLIGHTERS; PENS, AND PENCILS; SEPTIC SYSTEM CARE PRODUCTS, NAMELY, SEPTIC TANK TREATMENT FOR ELIMINATING SEPTIC BACKUP IN BOTH STATIONARY AND RECREATIONAL VEHICLE AND BOAT SEPTIC SYSTEMS; FERTILIZERS, AND COMPOSTING SUPPLIES, NAMELY, LEAF WASTE BAGS AND COMPOSTING BUCKETS; FLOWER POTS; SEEDS; YARD TOOLS; WEEDING TOOLS; OUTDOOR PATIO FURNITURE, NAMELY, CHAIRS AND TABLES; BICYCLES; YOGA MATS; BATH BODY WASH, BATH SCRUBS AND BATH SALTS; DEODORANT; BODY LOTION, BODY CREAMS AND BODY OILS; BREATH STRIPS; DENTAL FLOSS; MOUTHWASH; TOOTHBRUSHES; TOOTHPASTE; DIVACUPS; COLOGNE; DEODORANT; FACE WASHES; SHAVING CREAMS; BRUSHES AND COMBS; HAIR CONDITIONERS; HAIR SHAMPOO; INCENSE OIL; ESSENTIAL OILS; SUN PROTECTION PRODUCTS, NAMELY, SUNSCREENS, LIP BALMS; SELF TANNING LOTIONS; AND SKIN SOFTENERS; PET SUPPLIES, NAMELY, PET BLANKETS, BIODEGRADABLE PET REFUSE BAGS; PET COLLARS AND PET LEASES; PET CLOTHING; PET HAIR CONDITIONERS; PET HAIR DETANGLING SPRAYS; PET WIPES; PET TREATS; PET AIR FRESHENER; PET CARPET CLEANING SUPPLIES, NAMELY, CARPET CLEANER; PET TOYS; ARTS AND CRAFT SUPPLIES INCLUDING PAPER AND PAPER BOARDS FOR ART PURPOSES, EASELS, WOODEN LOOMS; COLORED PENCILS. WHITEBOARD MARKERS; CHALKBOARD ERASERS; BICYCLES, CHILDREN'S ROCKERS; CHILDREN'S SCOOTERS; CHILDREN'S SLEDS; CHILDREN'S WAGONS; DOLLS; JUMBO PLUSH ANIMALS; CHILDREN'S PUPPETS; CHILDREN'S CHAIRS; CHILDREN'S COTS; SHELVES; STOOLS; TABLES; TOY BINS; CHILDREN'S VANITIES; CHILDREN'S BOARD GAMES; CHILDREN'S CARD GAMES; PUZZLES; MUSICAL TOYS; RELIGIOUS TOYS; CHILDREN'S PLAYHOUSES; CHILDREN'S SANDBOXES; CHILDREN'S TOY LAND SHIPS; CHILDREN'S TOY SPACESHIPS; CHILDREN'S TOY TRAIN SETS; AND CHILDREN'S TOY WATER SHIPS, IN CLASS 35 (U.S. CLS. 100, 101 AND 102).

FIRST USE 9-1-2008; IN COMMERCE 9-1-2008.

THE MARK CONSISTS OF STANDARD CHARACTERS WITHOUT CLAIM TO ANY PARTICULAR FONT, STYLE, SIZE, OR COLOR.

NO CLAIM IS MADE TO THE EXCLUSIVE RIGHT TO USE "GREEN", APART FROM THE MARK AS SHOWN.

SER. NO. 85-311,896, FILED 5-4-2011.

KHANH LE, EXAMINING ATTORNEY

United States of America

United States Patent and Trademark Office

THE WELL TRAINED STUDENTS OF TODAY ARE THE STARS OF TOMORROW

Reg. No. 4,073,834

Registered Dec. 20, 2011

Int. Cl.: 41

SERVICE MARK

PRINCIPAL REGISTER

RICHARDS - OLSON SCHOOL OF DANCE, LLC (WISCONSIN LIMITED LIABILITY COMPANY)
7361 MEADOWRIDGE DRIVE
PICKETT, WI 54964

FOR: DANCE EVENTS; DANCE INSTRUCTION; DANCE INSTRUCTION FOR CHILDREN; DANCE RESERVATION SERVICES, NAMELY, ARRANGING FOR ADMISSION TO DANCE EVENTS; DANCE SCHOOLS; DANCE STUDIOS; EDUCATION SERVICES, NAMELY, PROVIDING CLASSES AND INSTRUCTION IN THE FIELD OF DANCE; EDUCATIONAL SERVICES, NAMELY, PROVIDING GROUP AND PRIVATE DANCE CLASS INSTRUCTION FOR CHILDREN, TEENAGERS, AND ADULTS IN THE FIELDS OF DANCE; ENTERTAINMENT AND EDUCATION SERVICES IN THE NATURE OF LIVE DANCE AND MUSICAL PERFORMANCES; ENTERTAINMENT IN THE NATURE OF DANCE PERFORMANCES; ENTERTAINMENT IN THE NATURE OF VISUAL AND AUDIO PERFORMANCES, NAMELY, MUSICAL BAND, ROCK GROUP, GYMNASTIC, DANCE, AND BALLET PERFORMANCES; ORGANIZATION OF DANCING EVENTS, IN CLASS 41 (U.S. CLS. 100, 101 AND 107).

FIRST USE 1-1-1948; IN COMMERCE 1-1-1948.

THE MARK CONSISTS OF STANDARD CHARACTERS WITHOUT CLAIM TO ANY PARTICULAR FONT, STYLE, SIZE, OR COLOR.

SER. NO. 85-311,937, FILED 5-4-2011.

RAUL CORDOVA, EXAMINING ATTORNEY



David J. Kyros

Director of the United States Patent and Trademark Office

United States of America

United States Patent and Trademark Office

Precious Kitty

Reg. No. 4,073,835

REGER INTERNATIONAL (MICHIGAN CORPORATION)
2804 ELMHURST AVENUE
ROYAL OAK, MI 480733015

Registered Dec. 20, 2011

Int. Cl.: 25

FOR: CLOTHING, NAMELY, T-SHIRTS, PANTIES, BRAS, HATS, PANTS, SHORTS, HOODED SWEATSHIRTS, SWEATSUITS, SOCKS, IN CLASS 25 (U.S. CLS. 22 AND 39).

TRADEMARK

FIRST USE 11-24-2010; IN COMMERCE 2-6-2011.

PRINCIPAL REGISTER

THE MARK CONSISTS OF STANDARD CHARACTERS WITHOUT CLAIM TO ANY PARTICULAR FONT, STYLE, SIZE, OR COLOR.

SER. NO. 85-311,939, FILED 5-4-2011.

RAUL CORDOVA, EXAMINING ATTORNEY



David J. Kybas

Director of the United States Patent and Trademark Office

United States of America

United States Patent and Trademark Office

DISCOUNT CATHOLIC PRODUCTS

Reg. No. 4,073,836

VERITAS COMMERCE LLC (DELAWARE LIMITED LIABILITY COMPANY)
28 E 3RD AVE, STE 200
SAN MATEO, CA 94401

Registered Dec. 20, 2011

Int. Cl.: 35

FOR: ON-LINE RETAIL STORE SERVICES FEATURING A WIDE VARIETY OF GIFTS, HOME FURNISHINGS, AND RELIGIOUS GOODS, IN CLASS 35 (U.S. CLS. 100, 101 AND 102).

SERVICE MARK

FIRST USE 11-1-2003; IN COMMERCE 11-1-2003.

PRINCIPAL REGISTER

THE MARK CONSISTS OF STANDARD CHARACTERS WITHOUT CLAIM TO ANY PARTICULAR FONT, STYLE, SIZE, OR COLOR.

NO CLAIM IS MADE TO THE EXCLUSIVE RIGHT TO USE "PRODUCTS", APART FROM THE MARK AS SHOWN.

SEC. 2(F).

SER. NO. 85-311,954, FILED 5-4-2011.

ALYSSA STEEL, EXAMINING ATTORNEY



David J. Kybas

Director of the United States Patent and Trademark Office

United States of America

United States Patent and Trademark Office



**MAYWOOD
FURNITURE
CORP.**

Reg. No. 4,073,837

Registered Dec. 20, 2011

Int. Cl.: 20

TRADEMARK

PRINCIPAL REGISTER

DESAUSSURE EQUIPMENT CO. (NEW JERSEY CORPORATION), DBA MAYWOOD FURNITURE CORP.
23 WEST HOWCROFT ROAD
MAYWOOD, NJ 07607

FOR: TABLES, IN CLASS 20 (U.S. CLS. 2, 13, 22, 25, 32 AND 50).

FIRST USE 3-18-1992; IN COMMERCE 3-18-1992.

OWNER OF U.S. REG. NOS. 2,379,668 AND 3,651,017.

THE COLOR(S) RED, WHITE AND BLACK IS/ARE CLAIMED AS A FEATURE OF THE MARK.

NO CLAIM IS MADE TO THE EXCLUSIVE RIGHT TO USE "FURNITURE CORP.", APART FROM THE MARK AS SHOWN.

THE MARK CONSISTS OF THE LETTER "M" IN RED WITH SIX WHITE TABLE LEGS EXTENDING FROM IT. THE WORDING "MAYWOOD FURNITURE CORP." IS IN BLACK TO THE RIGHT OF THE LETTER "M".

SER. NO. 85-311,964, FILED 5-4-2011.

SHANNON TWOHIG, EXAMINING ATTORNEY



David J. Kybas

Director of the United States Patent and Trademark Office

United States of America

United States Patent and Trademark Office

JANNUS LIVE

Reg. No. 4,073,838

KNIGHT GLOBAL ENTERTAINMENT, LLC (FLORIDA LIMITED LIABILITY COMPANY)
200 1ST AVENUE NORTH, SUITE 206
ST. PETERSBURG, FL 33701

Registered Dec. 20, 2011

Int. Cl.: 41

FOR: ENTERTAINMENT, NAMELY, LIVE MUSIC CONCERTS, IN CLASS 41 (U.S. CLS. 100, 101 AND 107).

SERVICE MARK

FIRST USE 3-25-2010; IN COMMERCE 3-25-2010.

PRINCIPAL REGISTER

THE MARK CONSISTS OF STANDARD CHARACTERS WITHOUT CLAIM TO ANY PARTICULAR FONT, STYLE, SIZE, OR COLOR.

NO CLAIM IS MADE TO THE EXCLUSIVE RIGHT TO USE "LIVE", APART FROM THE MARK AS SHOWN.

SER. NO. 85-311,991, FILED 5-4-2011.

FRANK LATTUCA, EXAMINING ATTORNEY



David J. Kyffers

Director of the United States Patent and Trademark Office

United States of America

United States Patent and Trademark Office

J. McLaughlin

Reg. No. 4,073,839

Registered Dec. 20, 2011

Int. Cls.: 14, 18, 25 and 35

SEA ISLAND CLOTHIERS INC. (NEW YORK CORPORATION)
#6, 2ND FLOOR
236-250 GREENPOINT AVENUE
BROOKLYN, NY 11222

FOR: JEWELRY, IN CLASS 14 (U.S. CLS. 2, 27, 28 AND 50).

FIRST USE 1-1-2008; IN COMMERCE 1-1-2008.

TRADEMARK

FOR: HANDBAGS; LUGGAGE; TOTE BAGS, IN CLASS 18 (U.S. CLS. 1, 2, 3, 22 AND 41).

SERVICE MARK

FIRST USE 1-1-2008; IN COMMERCE 1-1-2008.

PRINCIPAL REGISTER

FOR: MENS, WOMEN'S AND CHILDREN'S CLOTHING, NAMELY, BLOUSES, SKIRTS, SWEATERS, T-SHIRTS, HATS, SCARVES, BELTS, SHIRTS, PANTS, SOCKS, PANTYHOSE, SHOES, GLOVES, ROBES, SLEEPWEAR, DRESS SHIRTS, TIES, SPORTS SHIRTS, SUITS, SPORTS COATS, UNDERWEAR, KNIT SHIRTS, COATS, JACKETS, SWIMWEAR AND DRESSES, IN CLASS 25 (U.S. CLS. 22 AND 39).

FIRST USE 1-1-2008; IN COMMERCE 1-1-2008.

FOR: RETAIL STORE SERVICES FEATURING CLOTHING, HANDBAGS, JEWELRY AND FASHION ACCESSORIES; ON-LINE RETAIL STORE SERVICES FEATURING CLOTHING, HANDBAGS AND FASHION ACCESSORIES, IN CLASS 35 (U.S. CLS. 100, 101 AND 102).

FIRST USE 1-1-2008; IN COMMERCE 1-1-2008.

OWNER OF U.S. REG. NOS. 1,282,552 AND 3,123,298.

THE NAME "J. MCLAUGHLIN" DOES NOT IDENTIFY A LIVING INDIVIDUAL.

THE MARK CONSISTS OF THE WORDING "J. MCLAUGHLIN" IN STYLIZED FORM.

SEC. 2(F).

SER. NO. 85-312,021, FILED 5-4-2011.



David J. Kyjars

Director of the United States Patent and Trademark Office

Reg. No. 4,073,839 RONALD MCMORROW, EXAMINING ATTORNEY

United States of America

United States Patent and Trademark Office

J.McL augh hlin

Reg. No. 4,073,840

Registered Dec. 20, 2011

Int. Cls.: 25 and 35

SEA ISLAND CLOTHIERS INC. (NEW YORK CORPORATION)
#6, 2ND FLOOR
236-250 GREENPOINT AVENUE
BROOKLYN, NY 11222

FOR: CLOTHING, NAMELY, SOCKS, IN CLASS 25 (U.S. CLS. 22 AND 39).

TRADEMARK

FIRST USE 1-1-2008; IN COMMERCE 1-1-2008.

SERVICE MARK

FOR: RETAIL STORE SERVICES FEATURING CLOTHING, HANDBAGS, JEWELRY AND FASHION ACCESSORIES; ON-LINE RETAIL STORE SERVICES FEATURING CLOTHING, HANDBAGS AND FASHION ACCESSORIES, IN CLASS 35 (U.S. CLS. 100, 101 AND 102).

PRINCIPAL REGISTER

FIRST USE 1-1-2008; IN COMMERCE 1-1-2008.

OWNER OF U.S. REG. NOS. 1,282,552 AND 3,123,298.

THE NAME "J. MCLAUGHLIN" DOES NOT IDENTIFY A LIVING INDIVIDUAL.

THE MARK CONSISTS OF THE LETTERS "J. M C L A U G H L I N" IN A RECTANGULAR FORM.

SER. NO. 85-312,029, FILED 5-4-2011.

RONALD MCMORROW, EXAMINING ATTORNEY



David J. Kybas

Director of the United States Patent and Trademark Office

United States of America

United States Patent and Trademark Office

STYLE YOUR WAY

Reg. No. 4,073,841

Registered Dec. 20, 2011

Int. Cl.: 42

SERVICE MARK

PRINCIPAL REGISTER

CHARMING DIRECT, INC. (DELAWARE CORPORATION)
1105 NORTH MARKET STREET
WILMINGTON, DE 19801

FOR: PROVIDING TEMPORARY USE OF A WEB-BASED SOFTWARE APPLICATION THAT SELECTS CLOTHING STYLES FOR CONSUMERS BASED ON USER INPUTS, IN CLASS 42 (U.S. CLS. 100 AND 101).

FIRST USE 5-20-2011; IN COMMERCE 5-20-2011.

THE MARK CONSISTS OF STANDARD CHARACTERS WITHOUT CLAIM TO ANY PARTICULAR FONT, STYLE, SIZE, OR COLOR.

NO CLAIM IS MADE TO THE EXCLUSIVE RIGHT TO USE "STYLE", APART FROM THE MARK AS SHOWN.

SER. NO. 85-312,033, FILED 5-4-2011.

H. M. FISHER, EXAMINING ATTORNEY



David J. Kyros

Director of the United States Patent and Trademark Office

United States of America

United States Patent and Trademark Office

JSP PROPERTIES

Reg. No. 4,073,842

Registered Dec. 20, 2011

Int. Cls.: 35 and 36

SERVICE MARK

PRINCIPAL REGISTER

JSP PROPERTIES LLC (MINNESOTA LIMITED LIABILITY COMPANY)
SUITE 140
1043 GRAND AVENUE
ST. PAUL, MN 55105

FOR: ADVERTISING OF RESIDENTIAL REAL ESTATE; ADVERTISING SERVICES, NAMELY, PROVIDING INFORMATION AS TO THE AVAILABILITY OF REAL ESTATE FOR RENT; PROVIDING AN INTERACTIVE REAL ESTATE WEBSITE WHICH PROMOTES HOUSING AND APARTMENT PROPERTIES THROUGH OFFERING PROSPECTIVE TENANTS PROPERTY DESCRIPTIONS, TEXT, PRICE, LOCATION, MAPS AND OTHER INFORMATION THAT WOULD BE INFLUENTIAL TO A PROSPECTIVE TENANT IN MAKING A RENTAL DECISION; REAL ESTATE MARKETING SERVICES, NAMELY, ON-LINE SERVICES FEATURING PHOTOS AND OTHER INFORMATION ABOUT RESIDENTIAL REAL ESTATE, IN CLASS 35 (U.S. CLS. 100, 101 AND 102).

FIRST USE 12-31-2000; IN COMMERCE 12-31-2000.

FOR: REAL ESTATE MANAGEMENT SERVICES; REAL ESTATE SERVICES, NAMELY, RENTAL PROPERTY MANAGEMENT; ARRANGING OF LEASES AND RENTAL AGREEMENTS FOR REAL ESTATE; ASSESSMENT AND MANAGEMENT OF REAL ESTATE; PROVIDING A DATABASE OF INFORMATION ABOUT RESIDENTIAL RENTAL REAL ESTATE LISTINGS; PROVIDING REAL ESTATE LISTINGS AND REAL ESTATE PROPERTY MANAGEMENT INFORMATION VIA THE INTERNET; REAL ESTATE RENTAL SERVICES, NAMELY, RENTAL OF RESIDENTIAL HOUSING; REAL ESTATE SERVICE, NAMELY, RENTAL PROPERTY MANAGEMENT; REAL ESTATE SERVICES, NAMELY, PROPERTY MANAGEMENT SERVICES FOR CONDOMINIUM ASSOCIATIONS, HOMEOWNER ASSOCIATIONS, APARTMENT BUILDINGS, AND ABSENTEE OWNERS; PROVIDING INFORMATION IN THE FIELD OF REAL ESTATE VIA THE INTERNET, IN CLASS 36 (U.S. CLS. 100, 101 AND 102).

FIRST USE 12-31-2000; IN COMMERCE 12-31-2000.

THE MARK CONSISTS OF STANDARD CHARACTERS WITHOUT CLAIM TO ANY PARTICULAR FONT, STYLE, SIZE, OR COLOR.

NO CLAIM IS MADE TO THE EXCLUSIVE RIGHT TO USE "PROPERTIES", APART FROM THE MARK AS SHOWN.



David J. Kyffers

Director of the United States Patent and Trademark Office

Reg. No. 4,073,842 SER. NO. 85-312,111, FILED 5-4-2011.

ROBIN MITTLER, EXAMINING ATTORNEY

United States of America

United States Patent and Trademark Office

GOLDORADO

Reg. No. 4,073,843

GATEWAY GAMING LLC (SOUTH CAROLINA LIMITED LIABILITY COMPANY)
1243 PIEDMONT HWY
PIEDMONT, SC 29673

Registered Dec. 20, 2011

Int. Cl.: 9

FOR: GAMING EQUIPMENT, NAMELY, GAMING MACHINES, IN CLASS 9 (U.S. CLS. 21, 23, 26, 36 AND 38).

TRADEMARK

FIRST USE 11-30-2010; IN COMMERCE 11-30-2010.

PRINCIPAL REGISTER

THE MARK CONSISTS OF STANDARD CHARACTERS WITHOUT CLAIM TO ANY PARTICULAR FONT, STYLE, SIZE, OR COLOR.

SER. NO. 85-312,170, FILED 5-4-2011.

IRA J. GOODSaid, EXAMINING ATTORNEY



David J. Kyffers

Director of the United States Patent and Trademark Office

United States of America

United States Patent and Trademark Office

LIFE HAPPENS HERE.

Reg. No. 4,073,844

Registered Dec. 20, 2011

Int. Cl.: 35

SERVICE MARK

PRINCIPAL REGISTER

DOWNTOWN CINCINNATI, INC. (OHIO CORPORATION)
35 E. SEVENTH STREET, SUITE 202
CINCINNATI, OH 45202

FOR: PROMOTING ECONOMIC DEVELOPMENT, RESIDENCY, TRAVEL, CONVENTIONS AND TOURISM IN THE GREATER CINCINNATI AREA; PROVIDING AN ON-LINE CINCINNATI AREA BUSINESS DIRECTORY; PROMOTING CULTURAL EVENTS AND ACTIVITIES; PROMOTING SPORTING, THEATRICAL, EDUCATIONAL AND ENTERTAINMENT EVENTS AND PERFORMANCES, IN CLASS 35 (U.S. CLS. 100, 101 AND 102).

FIRST USE 7-23-2008; IN COMMERCE 7-23-2008.

THE MARK CONSISTS OF STANDARD CHARACTERS WITHOUT CLAIM TO ANY PARTICULAR FONT, STYLE, SIZE, OR COLOR.

SER. NO. 85-312,210, FILED 5-4-2011.

ELI HELLMAN, EXAMINING ATTORNEY



David J. Kyffers

Director of the United States Patent and Trademark Office

United States of America

United States Patent and Trademark Office

PAINTBLOCK 

Reg. No. 4,073,845

Registered Dec. 20, 2011

Int. Cls.: 16 and 17

TRADEMARK

PRINCIPAL REGISTER

SHURTAPE TECHNOLOGIES, LLC (NORTH CAROLINA LIMITED LIABILITY COMPANY)
1985 TATE BOULEVARD S.E.
HICKORY, NC 28603

FOR: ADHESIVE TAPES FOR STATIONERY OR HOUSEHOLD PURPOSES, IN CLASS 16
(U.S. CLS. 2, 5, 22, 23, 29, 37, 38 AND 50).

FIRST USE 2-17-2009; IN COMMERCE 2-17-2009.

FOR: MASKING TAPE, IN CLASS 17 (U.S. CLS. 1, 5, 12, 13, 35 AND 50).

FIRST USE 2-17-2009; IN COMMERCE 2-17-2009.

OWNER OF U.S. REG. NO. 3,234,253.

THE MARK CONSISTS OF THE WORD "PAINTBLOCK" IN STYLIZED LETTERS SUPER-
IMPOSED ON A DESIGN OF A PAINTBRUSH STROKE EXTENDING TO THE RIGHT OF
THE WORDS.

SER. NO. 85-312,212, FILED 5-4-2011.

CHRISTINA SOBRAL, EXAMINING ATTORNEY



David J. Kybas

Director of the United States Patent and Trademark Office

United States of America

United States Patent and Trademark Office

BRIGHT IDEAS

Reg. No. 4,073,846

Registered Dec. 20, 2011

Int. Cls.: 18 and 24

TRADEMARK

PRINCIPAL REGISTER

THE DOLLFUS MIEG COMPANY, INC. (DELAWARE CORPORATION)
10 BASIN DRIVE, SUITE 130
KEARNY, NJ 07032

FOR: SHOULDER BAGS MADE OF FABRIC, IN CLASS 18 (U.S. CLS. 1, 2, 3, 22 AND 41).

FIRST USE 0-0-2006; IN COMMERCE 0-0-2006.

FOR: PRECUT FABRICS FOR NEEDLECRAFT, IN CLASS 24 (U.S. CLS. 42 AND 50).

FIRST USE 0-0-2006; IN COMMERCE 0-0-2006.

THE MARK CONSISTS OF STANDARD CHARACTERS WITHOUT CLAIM TO ANY PARTICULAR FONT, STYLE, SIZE, OR COLOR.

SER. NO. 85-312,233, FILED 5-4-2011.

JUDITH HELFMAN, EXAMINING ATTORNEY



David J. Kybas

Director of the United States Patent and Trademark Office

United States of America

United States Patent and Trademark Office

SLIMLINE

Reg. No. 4,073,847

ELEMENTAL IDEAS, LLC (GEORGIA LIMITED LIABILITY COMPANY)
1094 PARKWAY INDUSTRIAL PARK DRIVE
BUFORD, GA 30518

Registered Dec. 20, 2011

Int. Cl.: 20

FOR: MODULAR, CONVERTIBLE, AND ADAPTABLE FOOD PROTECTION SYSTEMS, NAMELY, SNEEZE GUARDS FOR PROTECTING SALAD BARS AND FOOD COUNTERS AND DISPLAY CASES FOR USE IN THE FOOD SERVICE INDUSTRY, IN CLASS 20 (U.S. CLS. 2, 13, 22, 25, 32 AND 50).

TRADEMARK

PRINCIPAL REGISTER

FIRST USE 12-13-2004; IN COMMERCE 9-14-2005.

THE MARK CONSISTS OF STANDARD CHARACTERS WITHOUT CLAIM TO ANY PARTICULAR FONT, STYLE, SIZE, OR COLOR.

OWNER OF U.S. REG. NO. 3,490,764.

SEC. 2(F).

SER. NO. 85-312,255, FILED 5-4-2011.

ROBIN CHOSID, EXAMINING ATTORNEY



David J. Kyffers

Director of the United States Patent and Trademark Office

United States of America

United States Patent and Trademark Office

DERMESSE

Reg. No. 4,073,848

Registered Dec. 20, 2011

Int. Cl.: 3

TRADEMARK

PRINCIPAL REGISTER

AXIA MEDICAL SOLUTIONS, LLC (CALIFORNIA LIMITED LIABILITY COMPANY)
2105 CAMINO VIDA ROBLE, SUITE L
CARLSBAD, CA 92009

FOR: SKIN TONERS, IN CLASS 3 (U.S. CLS. 1, 4, 6, 50, 51 AND 52).

FIRST USE 12-1-2003; IN COMMERCE 12-1-2003.

SER. NO. 85-312,297, FILED 5-4-2011.

JUDITH HELFMAN, EXAMINING ATTORNEY



David J. Kyffers

Director of the United States Patent and Trademark Office

United States of America

United States Patent and Trademark Office

GETTAKEOUT

Reg. No. 4,073,849

GET TAKEOUT LLC (DELAWARE LIMITED LIABILITY COMPANY)
4300 SW FAIRVIEW CIRCUS
PORTLAND, OR 97221

Registered Dec. 20, 2011

Int. Cl.: 35

FOR: PROMOTING AND ADVERTISING RESTAURANT SERVICES OF OTHERS OVER THE INTERNET/GLOBAL COMMUNICATIONS NETWORK, IN CLASS 35 (U.S. CLS. 100, 101 AND 102).

SERVICE MARK

FIRST USE 10-20-2002; IN COMMERCE 2-4-2003.

PRINCIPAL REGISTER

THE MARK CONSISTS OF STANDARD CHARACTERS WITHOUT CLAIM TO ANY PARTICULAR FONT, STYLE, SIZE, OR COLOR.

SER. NO. 85-312,323, FILED 5-4-2011.

JUDITH HELFMAN, EXAMINING ATTORNEY



David J. Kyffers

Director of the United States Patent and Trademark Office

United States of America

United States Patent and Trademark Office



Reg. No. 4,073,850

GATEWAY GAMING LLC (SOUTH CAROLINA LIMITED LIABILITY COMPANY)
1243 PIEDMONT HWY
PIEDMONT, SC 29673

Registered Dec. 20, 2011

Int. Cl.: 9

FOR: GAMING EQUIPMENT, NAMELY, GAMING MACHINES, IN CLASS 9 (U.S. CLS. 21, 23, 26, 36 AND 38).

TRADEMARK

FIRST USE 3-1-2011; IN COMMERCE 3-1-2011.

PRINCIPAL REGISTER

THE MARK CONSISTS OF THE STYLIZED WORDS "NEPTUNE'S BOOTY" ACROSS A SEASHELL ON WHICH IS NEPTUNE HOLDING A TRIDENT AND TETHERS TO TWO SEAHORSES.

SER. NO. 85-312,399, FILED 5-4-2011.

IRA J. GOODSaid, EXAMINING ATTORNEY



David J. Kybas

Director of the United States Patent and Trademark Office

United States of America

United States Patent and Trademark Office

PRO HEAR

Reg. No. 4,073,851

ALTUS BRANDS L.L.C. (MICHIGAN LIMITED LIABILITY COMPANY)
484 W. WELCH CT.

Registered Dec. 20, 2011

TRAVERSE CITY, MI 49686

Int. Cl.: 9

FOR: SOUND AMPLIFIERS, IN CLASS 9 (U.S. CLS. 21, 23, 26, 36 AND 38).

TRADEMARK

FIRST USE 12-0-2009; IN COMMERCE 12-0-2009.

PRINCIPAL REGISTER

THE MARK CONSISTS OF STANDARD CHARACTERS WITHOUT CLAIM TO ANY PARTICULAR FONT, STYLE, SIZE, OR COLOR.

NO CLAIM IS MADE TO THE EXCLUSIVE RIGHT TO USE "HEAR", APART FROM THE MARK AS SHOWN.

SER. NO. 85-312,402, FILED 5-4-2011.

LIEF MARTIN, EXAMINING ATTORNEY



David J. Kyffers

Director of the United States Patent and Trademark Office

United States of America

United States Patent and Trademark Office



USCTS

US Certified Translation Service

Reg. No. 4,073,852

Registered Dec. 20, 2011

Int. Cl.: 41

SERVICE MARK

PRINCIPAL REGISTER

1WORLD RESOURCES, INC. (FLORIDA CORPORATION), DBA US CERTIFIED
TRANSLATION SERVICE
544 RIO LANE
INDIALANTIC, FL 32903

FOR: TRANSLATION SERVICES, IN CLASS 41 (U.S. CLS. 100, 101 AND 107).

FIRST USE 1-1-2008; IN COMMERCE 1-1-2008.

NO CLAIM IS MADE TO THE EXCLUSIVE RIGHT TO USE "US CERTIFIED TRANSLATION SERVICE", APART FROM THE MARK AS SHOWN.

THE MARK CONSISTS OF THE WORDING "USCTS" WITH THE WORDING "US CERTIFIED TRANSLATION SERVICE" BELOW IN MUCH SMALLER LETTERS. TO THE LEFT ARE THREE WAVY DIAGONAL LINES WITH SEMI-CIRCULAR GROUPS OF STARS ABOVE AND BELOW THE WAVY LINES.

SER. NO. 85-312,422, FILED 5-4-2011.

KATHERINE CHANG, EXAMINING ATTORNEY



David J. Kyffers

Director of the United States Patent and Trademark Office

United States of America

United States Patent and Trademark Office

SMT KINGDOM

Reg. No. 4,073,853

Registered Dec. 20, 2011

Int. Cl.: 9

TRADEMARK

PRINCIPAL REGISTER

SEISMIC MICRO-TECHNOLOGY, INC. (TEXAS CORPORATION)
SUITE 400
8584 KATY FREEWAY
HOUSTON, TX 77024

FOR: COMPUTER SOFTWARE AND PROGRAMS FOR PERFORMING GEOSCIENTIFIC INTERPRETATION, MODELING, AND ANALYSIS OF SEISMIC DATA IN THE FIELD OF OIL AND GAS EXPLORATION AND PRODUCTION, IN CLASS 9 (U.S. CLS. 21, 23, 26, 36 AND 38).

FIRST USE 4-1-2011; IN COMMERCE 4-1-2011.

OWNER OF U.S. REG. NOS. 3,226,516, 3,593,567 AND OTHERS.

THE MARK CONSISTS OF THE WORDS "SMT KINGDOM" IN A STYLIZED FORM. THE LETTERS "SMT" ARE PRESENTED IN LARGE FONT AND STACKED ABOVE "KINGDOM" WHICH IS PRESENTED IN SMALLER FONT.

SER. NO. 85-312,437, FILED 5-4-2011.

GRETCHEN ULRICH, EXAMINING ATTORNEY



David J. Kyffers

Director of the United States Patent and Trademark Office

United States of America

United States Patent and Trademark Office



Reg. No. 4,073,854

DRL ENTERPRISES, INC. (DELAWARE CORPORATION)
2301 RAVINE WAY
GLENVIEW, IL 60025

Registered Dec. 20, 2011

Int. Cl.: 34

FOR: CIGARETTE ROLLING PAPERS, IN CLASS 34 (U.S. CLS. 2, 8, 9 AND 17).

TRADEMARK

FIRST USE 3-0-2011; IN COMMERCE 3-0-2011.

PRINCIPAL REGISTER

THE MARK CONSISTS OF A STYLIZED IMAGE OF A FACE WITH THE RIGHT HALF BEING DARK AND THE LEFT HALF BEING LIGHT WITH A TONGUE HANGING OUT AT THE BOTTOM.

SER. NO. 85-312,441, FILED 5-4-2011.

TRICIA SONNEBORN, EXAMINING ATTORNEY



David J. Kybas

Director of the United States Patent and Trademark Office

United States of America

United States Patent and Trademark Office



SMT
KINGDOM

Reg. No. 4,073,855

Registered Dec. 20, 2011

Int. Cl.: 9

TRADEMARK

PRINCIPAL REGISTER

SEISMIC MICRO-TECHNOLOGY, INC. (TEXAS CORPORATION)
SUITE 400
8584 KATY FREEWAY
HOUSTON, TX 77024

FOR: COMPUTER SOFTWARE AND PROGRAMS FOR PERFORMING GEOSCIENTIFIC INTERPRETATION, MODELING, AND ANALYSIS OF SEISMIC DATA IN THE FIELD OF OIL AND GAS EXPLORATION AND PRODUCTION, IN CLASS 9 (U.S. CLS. 21, 23, 26, 36 AND 38).

FIRST USE 4-1-2011; IN COMMERCE 4-1-2011.

OWNER OF U.S. REG. NOS. 3,226,516, 3,593,567 AND OTHERS.

THE COLOR(S) RED, SILVER, AND GRAY IS/ARE CLAIMED AS A FEATURE OF THE MARK.

THE MARK CONSISTS OF A SPHERE HAVING RED, LIGHT RED, LIGHT SILVER AND SILVER INTERLOCKING BANDS, A SILVER VERTICAL LINE SEPARATOR, AND THE WORD "SMT" IN RED IN A STYLIZED FORM THAT FADES FROM LIGHT RED AT ITS TOP TO DARKER RED AT ITS BASE. THE WORD "KINGDOM" IS IN GRAY STYLIZED FORM AND LOCATED BENEATH THE WORD "SMT".

SER. NO. 85-312,461, FILED 5-4-2011.

GRETCHEN ULRICH, EXAMINING ATTORNEY



David J. Kybas

Director of the United States Patent and Trademark Office

United States of America

United States Patent and Trademark Office

MAGI

Reg. No. 4,073,856

Registered Dec. 20, 2011

Int. Cl.: 41

SERVICE MARK

PRINCIPAL REGISTER

CHURCH OF SACRED MIRRORS (COSM) (NEW YORK TRUST)
46 DEAR HILL ROAD
WAPPINGERS FALLS, NY 12590

FOR: PROVIDING TRAINING COURSES FOR MYSTIC ARTISTS; DEVELOPING CURRICULUM FOR OTHERS IN THE FIELD OF MYSTIC ARTS, IN CLASS 41 (U.S. CLS. 100, 101 AND 107).

FIRST USE 2-15-2011; IN COMMERCE 2-15-2011.

THE MARK CONSISTS OF STANDARD CHARACTERS WITHOUT CLAIM TO ANY PARTICULAR FONT, STYLE, SIZE, OR COLOR.

SER. NO. 85-312,490, FILED 5-4-2011.

MARGERY A. TIERNEY, EXAMINING ATTORNEY



David J. Kyffers

Director of the United States Patent and Trademark Office

United States of America

United States Patent and Trademark Office

CONCH HARBOR MARINA

Reg. No. 4,073,857

CONCH HARBOR RETAIL CENTER LLC (FLORIDA LIMITED LIABILITY COMPANY)
951 CAROLINE STREET
KEY WEST, FL 33040

Registered Dec. 20, 2011

Int. Cl.: 39

FOR: BOAT STORAGE; LEASING OF BOAT SLIPS; MARINA SERVICES, IN CLASS 39 (U.S. CLS. 100 AND 105).

SERVICE MARK

FIRST USE 0-0-1998; IN COMMERCE 0-0-1998.

PRINCIPAL REGISTER

THE MARK CONSISTS OF STANDARD CHARACTERS WITHOUT CLAIM TO ANY PARTICULAR FONT, STYLE, SIZE, OR COLOR.

NO CLAIM IS MADE TO THE EXCLUSIVE RIGHT TO USE "HARBOR MARINA", APART FROM THE MARK AS SHOWN.

SER. NO. 85-312,516, FILED 5-4-2011.

KIMBERLY FRYE, EXAMINING ATTORNEY



David J. Kybas

Director of the United States Patent and Trademark Office

United States of America

United States Patent and Trademark Office

THE CLIENT'S WORLD

Reg. No. 4,073,858

Registered Dec. 20, 2011

Int. Cl.: 36

SERVICE MARK

PRINCIPAL REGISTER

MORGAN STANLEY SMITH BARNEY HOLDINGS LLC (DELAWARE LIMITED LIABILITY COMPANY)
2000 WESTCHESTER AVENUE
PURCHASE, NY 10577

FOR: FINANCIAL AND INVESTMENT ADVISORY SERVICES, IN CLASS 36 (U.S. CLS. 100, 101 AND 102).

FIRST USE 4-25-2011; IN COMMERCE 4-25-2011.

THE MARK CONSISTS OF STANDARD CHARACTERS WITHOUT CLAIM TO ANY PARTICULAR FONT, STYLE, SIZE, OR COLOR.

SER. NO. 85-312,608, FILED 5-4-2011.

BENJAMIN OKEKE, EXAMINING ATTORNEY



David J. Kyffers

Director of the United States Patent and Trademark Office

United States of America

United States Patent and Trademark Office

CraZy TACKz

Reg. No. 4,073,859

CTZ GLOBAL, LLC (NEVADA LIMITED LIABILITY COMPANY)
7437 S. EASTERN AVE #301
LAS VEGAS, NV 89123

Registered Dec. 20, 2011

Int. Cl.: 16

FOR: THUMB TACKS, IN CLASS 16 (U.S. CLS. 2, 5, 22, 23, 29, 37, 38 AND 50).

TRADEMARK

FIRST USE 4-25-2011; IN COMMERCE 4-25-2011.

PRINCIPAL REGISTER

THE MARK CONSISTS OF STANDARD CHARACTERS WITHOUT CLAIM TO ANY PARTICULAR FONT, STYLE, SIZE, OR COLOR.

NO CLAIM IS MADE TO THE EXCLUSIVE RIGHT TO USE "TACKS", APART FROM THE MARK AS SHOWN.

SER. NO. 85-312,693, FILED 5-4-2011.

DAWN FELDMAN, EXAMINING ATTORNEY



David J. Kyffers

Director of the United States Patent and Trademark Office

United States of America

United States Patent and Trademark Office

DISCOUNT
CARDSTOCK.COM

Reg. No. 4,073,860

SAVAGE INDUSTRIES, INC. (UTAH CORPORATION), DBA DISCOUNTCARDSTOCK.COM
580 13TH AVE.

Registered Dec. 20, 2011

SALT LAKE CITY, UT 84103

Int. Cl.: 16

FOR: ACID-RESISTANT PAPER; ADHESIVE FOILS STATIONERY; ADHESIVES FOR STATIONERY AND HOUSEHOLD USE; ANNOUNCEMENT CARDS; ART PAPER; BLANK CARDS; BLANK NOTE CARDS; BLANK OR PARTIALLY PRINTED POSTCARDS; BUSINESS CARD PAPER; CHRISTMAS CARDS; ENVELOPES; ENVELOPES FOR STATIONERY USE; GREETING CARDS; HOLIDAY CARDS; INVITATION CARDS; JAPANESE HANDICRAFT PAPER; KRAFT PAPER; MAGNETIC PAPER; MARKING PENS; MARKING STAMPS; OCCASION CARDS; OFFSET PAPER; OPAQUE PAPER; PAPER; PAPER CONTAINING MICA; PAPER CUTTERS; PAPER FOR USE IN THE GRAPHIC ARTS INDUSTRY; PAPER MADE FROM PAPER MULBERRY (KOHZO-GAMI); PAPER MADE FROM PAPER MULBERRY (TENGUJOSI); PAPER STATIONERY; PAPER STOCK; PAPERBOARD; PARCHMENT PAPER; POSTCARD PAPER; POSTCARDS; RECYCLED PAPER; SCRAPBOOK ALBUMS; SCRAPBOOK PAGES; SCRAPBOOKS; STATIONERY; STATIONERY WRITING PAPER AND ENVELOPES, IN CLASS 16 (U.S. CLS. 2, 5, 22, 23, 29, 37, 38 AND 50).

TRADEMARK

PRINCIPAL REGISTER

FIRST USE 1-18-2009; IN COMMERCE 1-18-2009.

NO CLAIM IS MADE TO THE EXCLUSIVE RIGHT TO USE "DISCOUNT CARDSTOCK.COM", APART FROM THE MARK AS SHOWN.

THE MARK CONSISTS OF A STYLIZED "DISCOUNT" PLACED IN LARGER TYPE OVER A STYLIZED "CARDSTOCK.COM", THE "O" OF "DISCOUNT" INCLUDING ARROWS FORMING A COMMONLY-RECOGNIZED RECYCLING SYMBOL.

SER. NO. 85-312,699, FILED 5-4-2011.

DAWN FELDMAN, EXAMINING ATTORNEY



David J. Kyros

Director of the United States Patent and Trademark Office

United States of America

United States Patent and Trademark Office



Reg. No. 4,073,861

Registered Dec. 20, 2011

Int. Cl.: 41

SERVICE MARK

PRINCIPAL REGISTER

YETI BOOM FILMS LLC (TENNESSEE LIMITED LIABILITY COMPANY)
808 WATERLOO COURT
NASHVILLE, TN 37209

FOR: AUDIO RECORDING AND PRODUCTION; ENTERTAINMENT SERVICES, NAMELY, PRODUCTION OF SPECIAL EFFECTS INCLUDING MODEL-MAKING SERVICES, COMPUTER-GENERATED IMAGERY AND COMPUTER-GENERATED GRAPHICS FOR THE PRODUCTION OF MOTION PICTURES, VIDEOS, AND MOVIE TRAILERS; FILM AND VIDEO PRODUCTION; TRANSLATION SERVICES; VIDEO PRODUCTION SERVICES, IN CLASS 41 (U.S. CLS. 100, 101 AND 107).

FIRST USE 3-13-2011; IN COMMERCE 3-27-2011.

NO CLAIM IS MADE TO THE EXCLUSIVE RIGHT TO USE "FILMS", APART FROM THE MARK AS SHOWN.

THE STIPPLING IS A FEATURE OF THE MARK AND DOES NOT INDICATE COLOR.

THE MARK CONSISTS OF A HAIRY MAN-LIKE CREATURE HOLDING A SPILLING TUB OF POPCORN. BELOW THERE IS THE STYLIZED TEXT "YETIBOOM FILMS".

SER. NO. 85-312,711, FILED 5-4-2011.

INGRID C. EULIN, EXAMINING ATTORNEY



David J. Kybas

Director of the United States Patent and Trademark Office

United States of America

United States Patent and Trademark Office

GRAND VOIR DIRE

Reg. No. 4,073,862

Registered Dec. 20, 2011

Int. Cl.: 9

TRADEMARK

PRINCIPAL REGISTER

DREWRY, DONALD G. (UNITED STATES INDIVIDUAL)
14895 EAST 14TH STREET SUITE 485
SAN LEANDRO, CA 94578

FOR: COMPUTER APPLICATION SOFTWARE FOR MOBILE PHONES, NAMELY, SOFTWARE FOR RECORDING AND DISPLAYING JUROR PERSONAL INFORMATION IN VOIR DIRE; COMPUTER APPLICATION SOFTWARE FOR DESKTOPS, LAPTOPS AND HAND-HELD COMPUTERS, NAMELY, SOFTWARE FOR RECORDING AND DISPLAYING JUROR PERSONAL INFORMATION IN VOIR DIRE; COMPUTER SOFTWARE FOR CREATING SEARCHABLE DATABASES OF INFORMATION AND DATA; COMPUTER SOFTWARE THAT PROVIDES REAL-TIME, INTEGRATED BUSINESS MANAGEMENT INTELLIGENCE BY COMBINING INFORMATION FROM VARIOUS DATABASES AND PRESENTING IT IN AN EASY-TO-UNDERSTAND USER INTERFACE, IN CLASS 9 (U.S. CLS. 21, 23, 26, 36 AND 38).

FIRST USE 10-1-2007; IN COMMERCE 10-1-2007.

THE MARK CONSISTS OF STANDARD CHARACTERS WITHOUT CLAIM TO ANY PARTICULAR FONT, STYLE, SIZE, OR COLOR.

NO CLAIM IS MADE TO THE EXCLUSIVE RIGHT TO USE "VOIR DIRE", APART FROM THE MARK AS SHOWN.

SER. NO. 85-312,714, FILED 5-4-2011.

INGRID C. EULIN, EXAMINING ATTORNEY



David J. Kyros

Director of the United States Patent and Trademark Office

United States of America

United States Patent and Trademark Office

The Hair Whisperer

Reg. No. 4,073,863

TORREZ, PATRICIO (UNITED STATES INDIVIDUAL)
1720 N STANTON PL
LONG BEACH, CA 90804

Registered Dec. 20, 2011

Int. Cl.: 44

FOR: BEAUTY SALON SERVICES; HAIR SALON SERVICES, IN CLASS 44 (U.S. CLS. 100 AND 101).

SERVICE MARK

FIRST USE 2-11-2009; IN COMMERCE 2-11-2009.

PRINCIPAL REGISTER

THE MARK CONSISTS OF STANDARD CHARACTERS WITHOUT CLAIM TO ANY PARTICULAR FONT, STYLE, SIZE, OR COLOR.

NO CLAIM IS MADE TO THE EXCLUSIVE RIGHT TO USE "HAIR", APART FROM THE MARK AS SHOWN.

SER. NO. 85-312,724, FILED 5-4-2011.

MAYUR VAGHANI, EXAMINING ATTORNEY



David J. Kyffers

Director of the United States Patent and Trademark Office

United States of America

United States Patent and Trademark Office

VAPO-SEAL

Reg. No. 4,073,864

SPICHER, SAMUEL (UNITED STATES INDIVIDUAL), DBA SURGICAL HOUSEWARES
149 GRANDVIEW DR.

Registered Dec. 20, 2011

HARRISONBURG, VA 22802

Int. Cl.: 21

FOR: COOKWARE, NAMELY, SKILLETTS, POTS, PANS, PIZZA PLATES, COOKIE SHEETS,
NON-ELECTRIC GRIDDLES AND COVERS FOR POTS AND PANS, IN CLASS 21 (U.S. CLS.
2, 13, 23, 29, 30, 33, 40 AND 50).

TRADEMARK

FIRST USE 0-0-1991; IN COMMERCE 0-0-1991.

PRINCIPAL REGISTER

THE MARK CONSISTS OF STANDARD CHARACTERS WITHOUT CLAIM TO ANY PAR-
TICULAR FONT, STYLE, SIZE, OR COLOR.

SER. NO. 85-312,725, FILED 5-4-2011.

KAPIL BHANOT, EXAMINING ATTORNEY



David J. Kybas

Director of the United States Patent and Trademark Office

United States of America

United States Patent and Trademark Office

COZY·SPUN

Reg. No. 4,073,865

E & E CO., LTD. (CALIFORNIA CORPORATION)
45875 NORTHPORT LOOP E
FREMONT, CA 94538

Registered Dec. 20, 2011

Int. Cl.: 24

FOR: BLANKET THROWS; COMFORTERS; PILLOW CASES; PILLOW SHAMS; SHAMS;
SHEET SETS; THROWS, IN CLASS 24 (U.S. CLS. 42 AND 50).

TRADEMARK

FIRST USE 3-7-2011; IN COMMERCE 3-7-2011.

PRINCIPAL REGISTER

THE MARK CONSISTS OF THE TERM "COZY" IN DARK GRAY TO THE LEFT THE TERM
"SPUN" IN LIGHT GRAY WITH A LIGHT GRAY DOT BETWEEN THEM.

THE COLOR(S) LIGHT GRAY AND DARK GRAY IS/ARE CLAIMED AS A FEATURE OF
THE MARK.

SER. NO. 85-312,744, FILED 5-4-2011.

SALLY SHIH, EXAMINING ATTORNEY



David J. Kybas

Director of the United States Patent and Trademark Office

United States of America

United States Patent and Trademark Office

Brazzle Berry

Reg. No. 4,073,866

Registered Dec. 20, 2011

Int. Cl.: 43

SERVICE MARK

PRINCIPAL REGISTER

BRAZZLE BERRY L.L.C (CALIFORNIA LIMITED LIABILITY COMPANY), DBA BRAZZLE BERRY
1201 UNIVERSITY DRIVE
MENLO PARK, CA 94025

FOR: FROZEN YOGURT SHOP SERVICES IN THE NATURE OF A RESTAURANT, IN CLASS 43 (U.S. CLS. 100 AND 101).

FIRST USE 11-1-2008; IN COMMERCE 6-1-2010.

THE MARK CONSISTS OF STANDARD CHARACTERS WITHOUT CLAIM TO ANY PARTICULAR FONT, STYLE, SIZE, OR COLOR.

NO CLAIM IS MADE TO THE EXCLUSIVE RIGHT TO USE "BERRY", APART FROM THE MARK AS SHOWN.

SER. NO. 85-312,766, FILED 5-4-2011.

JULIE WATSON, EXAMINING ATTORNEY



David J. Kybas

Director of the United States Patent and Trademark Office

United States of America

United States Patent and Trademark Office

Just Maid It

Reg. No. 4,073,867

Registered Dec. 20, 2011

Int. Cl.: 37

SERVICE MARK

PRINCIPAL REGISTER

JUST MAID IT INC (CANADA CORPORATION), DBA JUST MAID IT
SUITE 110
250 LAKE STREET
ST CATHARINES, CANADA L2R5Z4

FOR: CLEANING OF RESIDENTIAL HOUSES, IN CLASS 37 (U.S. CLS. 100, 103 AND 106).

FIRST USE 1-6-2006; IN COMMERCE 1-9-2006.

THE MARK CONSISTS OF STANDARD CHARACTERS WITHOUT CLAIM TO ANY PARTICULAR FONT, STYLE, SIZE, OR COLOR.

SER. NO. 85-312,775, FILED 5-4-2011.

SETH A. RAPPAPORT, EXAMINING ATTORNEY



David J. Kybas

Director of the United States Patent and Trademark Office

United States of America

United States Patent and Trademark Office

WEDDING WEAVER

Reg. No. 4,073,868

Registered Dec. 20, 2011

Int. Cl.: 35

SERVICE MARK

PRINCIPAL REGISTER

LEWIS, BRANDON (UNITED STATES INDIVIDUAL)
107C JENKINS RANCH RD
DURANGO, CO 81301

FOR: PROVIDING A WEB SITE WHEREBY BUYERS OF GOODS OR SERVICES LOCATE AND RECEIVE QUOTATIONS FROM MULTIPLE COMPETITIVE SOURCES AND SELLERS OF GOODS OR SERVICES IDENTIFY AND BID ON MULTIPLE NEW SALES OPPORTUNITIES IN CONNECTION WITH WEDDINGS; ONLINE RETAIL STORE SERVICES FEATURING PACKAGED AND NON-PACKAGED WEDDING SERVICES AND PRODUCTS TO THE PUBLIC; ONLINE RETAIL STORE SERVICES FEATURING WEDDING MARKET INFORMATION, VENDOR DIRECTORY, GOODS AND SERVICES CLASSIFIED SECTION, AND ALSO FEATURING GIFT REGISTRY, BLOG, AND PAYMENT ACCEPTANCE SERVICES FOR VENDORS, IN CLASS 35 (U.S. CLS. 100, 101 AND 102).

FIRST USE 7-7-2007; IN COMMERCE 3-29-2011.

THE MARK CONSISTS OF STANDARD CHARACTERS WITHOUT CLAIM TO ANY PARTICULAR FONT, STYLE, SIZE, OR COLOR.

NO CLAIM IS MADE TO THE EXCLUSIVE RIGHT TO USE "WEDDING", APART FROM THE MARK AS SHOWN.

SER. NO. 85-312,811, FILED 5-5-2011.

DORITT L. CARROLL, EXAMINING ATTORNEY



David J. Kybas

Director of the United States Patent and Trademark Office

United States of America

United States Patent and Trademark Office

APEX MIXED MARTIAL ARTS

Reg. No. 4,073,869

Registered Dec. 20, 2011

Int. Cl.: 41

SERVICE MARK

PRINCIPAL REGISTER

APEX MIXED MARTIAL ARTS, LLC (ARIZONA LIMITED LIABILITY COMPANY)
2973 WEST SHAWNA PLACE
TUCSON, AZ 85745

FOR: ENTERTAINMENT SERVICES IN THE NATURE OF LIVE MIXED MARTIAL ARTS (MMA) EVENTS; PROVIDING CLASSES, WORKSHOPS, SEMINARS AND CAMPS IN THE FIELDS OF FITNESS, EXERCISE, BOXING, KICK BOXING AND MIXED MARTIAL ARTS; PROVIDING GENERAL FITNESS AND MIXED MARTIAL ARTS FACILITIES THAT REQUIRE MEMBERSHIPS AND ARE FOCUSED IN THE FIELDS OF GENERAL FITNESS, EXERCISE, AND MIXED MARTIAL ARTS, IN CLASS 41 (U.S. CLS. 100, 101 AND 107).

FIRST USE 9-1-2008; IN COMMERCE 9-1-2008.

THE MARK CONSISTS OF STANDARD CHARACTERS WITHOUT CLAIM TO ANY PARTICULAR FONT, STYLE, SIZE, OR COLOR.

NO CLAIM IS MADE TO THE EXCLUSIVE RIGHT TO USE "MIXED MARTIAL ARTS" , APART FROM THE MARK AS SHOWN.

SER. NO. 85-312,835, FILED 5-5-2011.

DORITT L. CARROLL, EXAMINING ATTORNEY



David J. Kyffers

Director of the United States Patent and Trademark Office

United States of America

United States Patent and Trademark Office

JOB CURE

Reg. No. 4,073,870

Registered Dec. 20, 2011

Int. Cl.: 35

SERVICE MARK

PRINCIPAL REGISTER

INTELLISPHERE, LLC (DELAWARE LIMITED LIABILITY COMPANY)
BLDG 300
666 PLAINSBORO ROAD
PLAINSBORO, NJ 08536

FOR: ONLINE COMPUTER SERVICES, NAMELY, PROVIDING A WEBSITE FEATURING INFORMATION IN THE FIELDS OF EMPLOYMENT OPPORTUNITIES AND CAREER PLACEMENT; AND PROVIDING AN ONLINE SEARCHABLE DATABASE FEATURING EMPLOYMENT OPPORTUNITIES, IN CLASS 35 (U.S. CLS. 100, 101 AND 102).

FIRST USE 9-25-2007; IN COMMERCE 9-25-2007.

THE MARK CONSISTS OF STANDARD CHARACTERS WITHOUT CLAIM TO ANY PARTICULAR FONT, STYLE, SIZE, OR COLOR.

NO CLAIM IS MADE TO THE EXCLUSIVE RIGHT TO USE "JOB", APART FROM THE MARK AS SHOWN.

SER. NO. 85-312,904, FILED 5-5-2011.

MARC LEIPZIG, EXAMINING ATTORNEY



David J. Kyffers

Director of the United States Patent and Trademark Office

United States of America

United States Patent and Trademark Office

pure tots

Reg. No. 4,073,871

Registered Dec. 20, 2011

Int. Cl.: 35

SERVICE MARK

PRINCIPAL REGISTER

A LEARNING ODYSSEY DAYCARE INC. (NEW YORK CORPORATION)
1-L
30-83 30TH STREET
ASTORIA, NY 11102

FOR: ON-LINE RETAIL STORE SERVICES FEATURING TOYS, CLOTHING AND ORGANIC FOOD FOR INFANTS, TODDLERS AND PRESCHOOLERS, IN CLASS 35 (U.S. CLS. 100, 101 AND 102).

FIRST USE 4-28-2011; IN COMMERCE 4-28-2011.

THE MARK CONSISTS OF STANDARD CHARACTERS WITHOUT CLAIM TO ANY PARTICULAR FONT, STYLE, SIZE, OR COLOR.

NO CLAIM IS MADE TO THE EXCLUSIVE RIGHT TO USE "TOTS", APART FROM THE MARK AS SHOWN.

SER. NO. 85-312,974, FILED 5-5-2011.

ALICE BENMAMAN, EXAMINING ATTORNEY



David J. Kyffers

Director of the United States Patent and Trademark Office

United States of America

United States Patent and Trademark Office



Reg. No. 4,073,872

Registered Dec. 20, 2011

Int. Cl.: 43

SERVICE MARK

PRINCIPAL REGISTER

YOLANDA'S UNLIMITED CORPORATION (COLORADO CORPORATION)
9612 E. ARAPAHOE ROAD
GREENWOOD VILLAGE, CO 80112

FOR: CAFE-RESTAURANTS; CARRY-OUT RESTAURANTS; DELICATESSENS; FAST-FOOD RESTAURANTS AND SNACKBARS; BAR SERVICES; RESTAURANT SERVICES; TAKE-OUT RESTAURANT SERVICES, IN CLASS 43 (U.S. CLS. 100 AND 101).

FIRST USE 9-1-2003, THE MARK WAS FIRST USED ANYWHERE IN A DIFFERENT FORM OTHER THAN THAT SOUGHT TO BE REGISTERED AT LEAST AS EARLY AS 09/01/2003.; IN COMMERCE 9-1-2003, THE MARK WAS FIRST USED IN COMMERCE IN A DIFFERENT FORM OTHER THAN THAT SOUGHT TO BE REGISTERED AT LEAST AS EARLY AS 09/01/2003..

OWNER OF U.S. REG. NO. 3,158,229.

NO CLAIM IS MADE TO THE EXCLUSIVE RIGHT TO USE "TACOS", APART FROM THE MARK AS SHOWN.

THE MARK CONSISTS OF STYLIZED "YOLANDA'S TACOS" ENCLOSED IN AN OVAL BOUNDARY.

SER. NO. 85-313,039, FILED 5-5-2011.

MATTHEW KLINE, EXAMINING ATTORNEY



David J. Kyros

Director of the United States Patent and Trademark Office

United States of America

United States Patent and Trademark Office



Reg. No. 4,073,873

Registered Dec. 20, 2011

Int. Cl.: 35

SERVICE MARK

PRINCIPAL REGISTER

A LEARNING ODYSSEY DAYCARE INC. (NEW YORK CORPORATION)

1-L
30-83 30TH STREET
ASTORIA, NY 11102

FOR: ON-LINE RETAIL STORE SERVICES FEATURING TOYS, CLOTHING AND ORGANIC FOOD FOR INFANTS, TODDLERS AND PRESCHOOLERS, IN CLASS 35 (U.S. CLS. 100, 101 AND 102).

FIRST USE 4-28-2011; IN COMMERCE 4-28-2011.

NO CLAIM IS MADE TO THE EXCLUSIVE RIGHT TO USE "TOTS", APART FROM THE MARK AS SHOWN.

THE COLOR(S) YELLOW, BLUE, GREEN, BLACK AND BEIGE IS/ARE CLAIMED AS A FEATURE OF THE MARK.

THE MARK CONSISTS OF A CHILD'S FACE IN BEIGE WITH THE FACE, EYES, SMILE AND EARS OUTLINED IN BLACK, INCLUDING ONE HAIR ON CENTER OF HEAD IN BLACK; AROUND THE FACE IS A WIDE YELLOW OUTLINE SURROUNDED BY A THIN BLUE OUTLINE; THE TEXT "PURE TOTS" APPEARS AT THE BOTTOM OF THE MARK IN BLUE; A GREEN LEAF IS FEATURED AS GROWING OUT OF THE LETTER "S".

SER. NO. 85-313,044, FILED 5-5-2011.

ALICE BENMAMAN, EXAMINING ATTORNEY



David J. Kybas

Director of the United States Patent and Trademark Office

United States of America

United States Patent and Trademark Office

BRAND PORTRAIT

Reg. No. 4,073,874

BRAND INSTITUTE, INC. (FLORIDA CORPORATION)
200 SE 1ST ST, 12TH FLOOR
MIAMI, FL 33131

Registered Dec. 20, 2011

Int. Cl.: 35

FOR: MARKET RESEARCH AND CREATIVE IDEATION SERVICE RELATING TO THE DEVELOPMENT OF PRODUCT AND SERVICE NAMES, IN CLASS 35 (U.S. CLS. 100, 101 AND 102).

SERVICE MARK

FIRST USE 5-5-2011; IN COMMERCE 5-5-2011.

PRINCIPAL REGISTER

THE MARK CONSISTS OF STANDARD CHARACTERS WITHOUT CLAIM TO ANY PARTICULAR FONT, STYLE, SIZE, OR COLOR.

NO CLAIM IS MADE TO THE EXCLUSIVE RIGHT TO USE "BRAND", APART FROM THE MARK AS SHOWN.

SER. NO. 85-313,058, FILED 5-5-2011.

MARK T. MULLEN, EXAMINING ATTORNEY



David J. Kyffers

Director of the United States Patent and Trademark Office

United States of America

United States Patent and Trademark Office

Sandex

Reg. No. 4,073,875

NEMETH, RICHARD ERIC (UNITED STATES INDIVIDUAL)
P.O. BOX 3052
SIVERDALE, WA 98383

Registered Dec. 20, 2011

Int. Cl.: 1

FOR: WET SANDING CHEMICAL ADJUVANTS FOR USE WITH ABRASIVE MATERIALS FOR REMOVING COATINGS FROM WOOD, PLASTIC AND METAL SURFACES, IN CLASS 1 (U.S. CLS. 1, 5, 6, 10, 26 AND 46).

TRADEMARK

FIRST USE 3-1-2011; IN COMMERCE 3-9-2011.

PRINCIPAL REGISTER

THE MARK CONSISTS OF STANDARD CHARACTERS WITHOUT CLAIM TO ANY PARTICULAR FONT, STYLE, SIZE, OR COLOR.

SER. NO. 85-313,117, FILED 5-5-2011.

MARTHA FROMM, EXAMINING ATTORNEY



David J. Kybas

Director of the United States Patent and Trademark Office

United States of America

United States Patent and Trademark Office



Reg. No. 4,073,876

Registered Dec. 20, 2011

Int. Cl.: 35

SERVICE MARK

PRINCIPAL REGISTER

5 6 7 8 DANCEWEAR, INC. (TEXAS CORPORATION), DBA THE DANCE SHOP
7113 WALDON COURT
COLLEYVILLE, TX 76034

FOR: RETAIL STORE AND ON-LINE RETAIL STORE SERVICES FEATURING DANCEWEAR, CLOTHING, SHOES, COSTUMES, BAGS, JEWELRY, TOYS AND ACCESSORIES, IN CLASS 35 (U.S. CLS. 100, 101 AND 102).

FIRST USE 4-15-2011; IN COMMERCE 5-1-2011.

NO CLAIM IS MADE TO THE EXCLUSIVE RIGHT TO USE "THE DANCE SHOP", APART FROM THE MARK AS SHOWN.

THE MARK CONSISTS OF THE WORDING "THE DANCE SHOP" ACCOMPANIED BY AN ARTISTS SKETCH OF A PAIR OF POINTE SHOES.

SER. NO. 85-313,125, FILED 5-5-2011.

BILL DAWE, EXAMINING ATTORNEY



David J. Kyros

Director of the United States Patent and Trademark Office

United States of America

United States Patent and Trademark Office

COUPON SHERPA

Reg. No. 4,073,877

CAPABLE ANT, LLC (MONTANA LIMITED LIABILITY COMPANY)
1302 24TH STREET W #350
BILLINGS, MT 59102

Registered Dec. 20, 2011

Int. Cl.: 35

FOR: PROMOTING THE GOODS AND SERVICES OF OTHERS BY PROVIDING A WEB SITE AND MOBILE APPLICATION FEATURING ONLINE COUPONS, COUPON CODES, PRINTABLE COUPONS, MOBILE COUPONS, FREE SHIPPING OFFERS, DISCOUNTS, SALES, REBATES, PRODUCT REVIEWS, AND LINKS TO THE RETAIL WEB SITES OF OTHERS, IN CLASS 35 (U.S. CLS. 100, 101 AND 102).

SERVICE MARK

PRINCIPAL REGISTER

FIRST USE 3-31-2009; IN COMMERCE 3-31-2009.

THE MARK CONSISTS OF STANDARD CHARACTERS WITHOUT CLAIM TO ANY PARTICULAR FONT, STYLE, SIZE, OR COLOR.

NO CLAIM IS MADE TO THE EXCLUSIVE RIGHT TO USE "COUPON", APART FROM THE MARK AS SHOWN.

SER. NO. 85-313,194, FILED 5-5-2011.

CHRISTINA SOBRAL, EXAMINING ATTORNEY



David J. Kybas

Director of the United States Patent and Trademark Office

United States of America

United States Patent and Trademark Office



Reg. No. 4,073,878

Registered Dec. 20, 2011

Int. Cls.: 41 and 43

SERVICE MARK

PRINCIPAL REGISTER

GEO. L. SMITH II GEORGIA WORLD CONGRESS CENTER AUTHORITY (GEORGIA PUBLIC CORPORATION)
285 ANDREW YOUNG INTERNATIONAL BLVD., NW
ATLANTA, GA 303131591

FOR: PROVIDING FACILITIES FOR EDUCATIONAL CONVENTIONS; PROVIDING FACILITIES FOR SPORTS TOURNAMENTS; PROVIDING VARIOUS FACILITIES FOR AN ARRAY OF SPORTING EVENTS, SPORTS AND ATHLETIC COMPETITIONS AND AWARDS PROGRAMMES; RENTAL OF STADIUM FACILITIES, IN CLASS 41 (U.S. CLS. 100, 101 AND 107).

FIRST USE 8-1-1989; IN COMMERCE 8-1-1989.

FOR: ARENA SERVICES, NAMELY, PROVIDING FACILITIES FOR SPORTS, CONCERTS, CONVENTIONS AND EXHIBITIONS; PROVIDING CONVENTION FACILITIES; PROVIDING FACILITIES FOR EXHIBITIONS; PROVISION OF CONFERENCE FACILITIES; PROVISION OF CONFERENCE, EXHIBITION AND MEETING FACILITIES; PROVISION OF EXHIBITION FACILITIES; PROVISION OF FACILITIES FOR CONVENTIONS, IN CLASS 43 (U.S. CLS. 100 AND 101).

FIRST USE 8-1-1989; IN COMMERCE 8-1-1989.

THE MARK CONSISTS OF THE WORDS "GEORGIA DOME" WITH A STYLIZED DEPICTION OF A STRIPED, DOME-LIKE SHAPE ABOVE THE WORDS.

SEC. 2(F) AS TO "GEORGIA DOME".

SER. NO. 85-313,196, FILED 5-5-2011.

JIM RINGLE, EXAMINING ATTORNEY



David J. Kyffers

Director of the United States Patent and Trademark Office

United States of America

United States Patent and Trademark Office

Transformation Boot Camp

Reg. No. 4,073,879

Registered Dec. 20, 2011

Int. Cl.: 41

SERVICE MARK

PRINCIPAL REGISTER

FITNESS NOW, LLC (TEXAS LIMITED LIABILITY COMPANY), DBA TRANSFORMATION
BOOT CAMP
13580 VALENCIA DRIVE
FRISCO, TX 75035

FOR: PHYSICAL FITNESS INSTRUCTION, IN CLASS 41 (U.S. CLS. 100, 101 AND 107).

FIRST USE 4-28-2006; IN COMMERCE 4-28-2006.

THE MARK CONSISTS OF STANDARD CHARACTERS WITHOUT CLAIM TO ANY PARTICULAR FONT, STYLE, SIZE, OR COLOR.

NO CLAIM IS MADE TO THE EXCLUSIVE RIGHT TO USE "BOOT CAMP", APART FROM THE MARK AS SHOWN.

SER. NO. 85-313,197, FILED 5-5-2011.

JIM RINGLE, EXAMINING ATTORNEY



David J. Kyffers

Director of the United States Patent and Trademark Office

United States of America

United States Patent and Trademark Office

YOUR NEEDS. YOUR BUDGET.
YOUR MOVE.

Reg. No. 4,073,880

MOVING SOLUTIONS, INC. (ARKANSAS CORPORATION)
3801 OLD GREENWOOD ROAD
FORT SMITH, AR 72903

Registered Dec. 20, 2011

Int. Cl.: 39

FOR: MOVING COMPANY SERVICES FOR HOUSEHOLD AND COMMERCIAL PURPOSES;
TRANSPORTATION SERVICES, NAMELY, FREIGHT FORWARDING THE GOODS OF
OTHERS BY TRUCK AND SHIP, IN CLASS 39 (U.S. CLS. 100 AND 105).

SERVICE MARK

FIRST USE 2-0-2010; IN COMMERCE 2-0-2010.

PRINCIPAL REGISTER

THE MARK CONSISTS OF STANDARD CHARACTERS WITHOUT CLAIM TO ANY PAR-
TICULAR FONT, STYLE, SIZE, OR COLOR.

SER. NO. 85-313,205, FILED 5-5-2011.

KIM MONINGHOFF, EXAMINING ATTORNEY



David J. Kyffers

Director of the United States Patent and Trademark Office

United States of America

United States Patent and Trademark Office

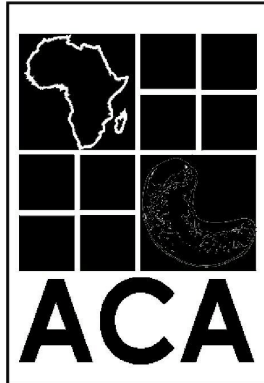

Reg. No. 4,073,881

AFRICAN CASHEW ALLIANCE (GHANA CORPORATION)
32, NORTEI ABABIO ST., AIRPORT RES. AREA
ACCRA, GHANA

Registered Dec. 20, 2011

Int. Cl.: 35

FOR: PROMOTING THE INTERESTS OF THE AFRICAN CASHEW INDUSTRY, IN CLASS 35 (U.S. CLS. 100, 101 AND 102).

SERVICE MARK

FIRST USE 7-16-2006; IN COMMERCE 7-16-2006.

PRINCIPAL REGISTER

THE MARK CONSISTS OF A SQUARE CONSISTING OF EIGHT SMALLER SQUARES AND TWO LARGER SQUARES ABOVE THE LETTERS "ACA". THE FIRST LARGER SQUARE CONTAINS AN ILLUSTRATION DEPICTING THE CONTINENT OF AFRICA. THE SECOND LARGER SQUARE CONTAINS AN ILLUSTRATION DEPICTING A CASHEW.

SER. NO. 85-313,320, FILED 5-5-2011.

KELLEY WELLS, EXAMINING ATTORNEY



David J. Kybas

Director of the United States Patent and Trademark Office

United States of America

United States Patent and Trademark Office

thi**m**bles

Reg. No. 4,073,882

HANNA LEI TAYLOR (UNITED STATES INDIVIDUAL)
5581 FLORIDA AVENUE
CAMP LEJEUNE, NC 28547

Registered Dec. 20, 2011

Int. Cl.: 25

FOR: COATS FOR MEN AND WOMEN; MEN'S AND WOMEN'S JACKETS, COATS, TROUSERS, VESTS; SHORT SETS; SUSPENDER BELTS FOR WOMEN; SWEATSHIRTS FOR WOMEN; T-SHIRTS FOR WOMEN; TIES; TOPS; WEARABLE GARMENTS AND CLOTHING, NAMELY, SHIRTS; WOMEN'S CEREMONIAL DRESSES; WOMEN'S CLOTHING, NAMELY, SHIRTS, DRESSES, SKIRTS, BLOUSES; WOMEN'S HATS AND HOODS; WOMEN'S TOPS, NAMELY, CAMIS, IN CLASS 25 (U.S. CLS. 22 AND 39).

TRADEMARK

PRINCIPAL REGISTER

FIRST USE 3-7-2011; IN COMMERCE 3-7-2011.

THE MARK CONSISTS OF LETTERS "THIBLES" IN GREY, WITH STYLIZED "M" ROTATED 90 DEGREES, TO APPEAR AS THE NUMBER "3", IN CHARTREUSE, POSITIONED BETWEEN THE LETTERS "I" AND "B".

THE COLOR(S) GREY AND CHARTREUSE IS/ARE CLAIMED AS A FEATURE OF THE MARK.

SER. NO. 85-313,344, FILED 5-5-2011.

JORDAN BAKER, EXAMINING ATTORNEY



David J. Kyffers

Director of the United States Patent and Trademark Office

United States of America

United States Patent and Trademark Office

CEREBOCA

Reg. No. 4,073,883

Registered Dec. 20, 2011

Int. Cls.: 9, 25 and 41

TRADEMARK

SERVICE MARK

PRINCIPAL REGISTER

CEREBOCA INC. (ILLINOIS CORPORATION)
1421 BRENTWOOD DRIVE
ROUND LAKE BEACH, IL 60073

FOR: SERIES OF MUSICAL SOUND RECORDINGS, MUSICAL VIDEO RECORDINGS, DOWNLOADABLE MUSICAL SOUND RECORDINGS, AND DOWNLOADABLE MUSICAL VIDEO RECORDINGS, INCLUDING PRE-RECORDED COMPACT DISCS, AND DVDS, ALL FEATURING MUSIC AND MUSIC RELATED ENTERTAINMENT, IN CLASS 9 (U.S. CLS. 21, 23, 26, 36 AND 38).

FIRST USE 12-31-2009; IN COMMERCE 12-31-2009.

FOR: CLOTHING FOR MEN, WOMEN AND CHILDREN, NAMELY, SHIRTS, T-SHIRTS, LONG SLEEVE SHIRTS, TOPS, TANK TOPS, SWEATSHIRTS, JACKETS, HOODED SWEATSHIRTS, HOODED JACKETS, HEADWEAR AND HATS, IN CLASS 25 (U.S. CLS. 22 AND 39).

FIRST USE 12-31-2009; IN COMMERCE 12-31-2009.

FOR: ENTERTAINMENT SERVICES, NAMELY, LIVE MUSICAL PERFORMANCES; MUSIC COMPOSITION AND MUSIC PRODUCTION SERVICES; MUSIC PUBLISHING SERVICES; PROVIDING A WEBSITE FEATURING NON-DOWNLOADABLE PRERECORDED MUSIC SELECTABLE BY INDIVIDUAL WEBSITE USERS; PROVIDING A WEBSITE FEATURING ENTERTAINMENT IN THE NATURE OF NON-DOWNLOADABLE MUSICAL PERFORMANCES, MUSICAL VIDEOS, RELATED FILM CLIPS, PHOTOGRAPHS, AND OTHER MULTIMEDIA MATERIALS FEATURING MUSIC AND MUSIC RELATED ENTERTAINMENT; PROVIDING INFORMATION ABOUT THE PERFORMANCES, RECORDINGS, APPEARANCES, THE BIOGRAPHY, AND OTHER ENTERTAINMENT RELATED INFORMATION ABOUT A MUSICAL GROUP VIA WEBSITES ON A GLOBAL COMPUTER NETWORK, IN CLASS 41 (U.S. CLS. 100, 101 AND 107).

FIRST USE 12-31-2009; IN COMMERCE 12-31-2009.

THE MARK CONSISTS OF STANDARD CHARACTERS WITHOUT CLAIM TO ANY PARTICULAR FONT, STYLE, SIZE, OR COLOR.

SER. NO. 85-313,419, FILED 5-5-2011.



David J. Kyros

Director of the United States Patent and Trademark Office

Reg. No. 4,073,883 JOHN GARTNER, EXAMINING ATTORNEY

United States of America

United States Patent and Trademark Office



Back Pain Relief4Life

Reg. No. 4,073,884

Registered Dec. 20, 2011

Int. Cl.: 44

SERVICE MARK

PRINCIPAL REGISTER

RELIEF4LIFE (SOUTH CAROLINA LIMITED LIABILITY COMPANY)
20A MARKET
BEAUFORT, SC 29906

FOR: PROVIDING A WEBSITE FEATURING NON-DOWNLOADABLE VIDEOS AND INFORMATION IN THE FIELD OF PHYSICAL THERAPY FOR RELIEVING BACK PAIN, IN CLASS 44 (U.S. CLS. 100 AND 101).

FIRST USE 10-1-2010; IN COMMERCE 3-19-2011.

NO CLAIM IS MADE TO THE EXCLUSIVE RIGHT TO USE "BACK PAIN", APART FROM THE MARK AS SHOWN.

THE MARK CONSISTS OF A UNISEX FRAME OF A PERSON WITH HIS/HER RIGHT HAND ON THE LOWER BACK AND LEFT HAND ON THE NECK. THERE IS A CIRCULAR BORDER AROUND THE DRAWING. NEXT TO THE CIRCULAR DRAWING THERE IS THE STYLIZED TEXT: "BACK PAIN" (ON TOP) "RELIEF4LIFE" (BELOW).

SER. NO. 85-313,420, FILED 5-5-2011.

DORITT L. CARROLL, EXAMINING ATTORNEY



David J. Kyffers

Director of the United States Patent and Trademark Office

United States of America

United States Patent and Trademark Office

NUTRAFOODS

Reg. No. 4,073,885

Registered Dec. 20, 2011

Int. Cl.: 29

TRADEMARK

PRINCIPAL REGISTER

ADVANCED NUTRISOLUTIONS, INC. (CALIFORNIA CORPORATION)
3970 SORRENTO VALLEY BLVD., SUITE 300
SAN DIEGO, CA 92121

FOR: DAIRY PRODUCTS EXCLUDING ICE CREAM, ICE MILK AND FROZEN YOGURT; DAIRY-BASED BEVERAGES; DAIRY-BASED CHOCOLATE FOOD BEVERAGES; DAIRY-BASED DIPS; DAIRY-BASED FOOD BEVERAGES; DAIRY-BASED FOOD BEVERAGES ALSO CONTAINING COCOA; DAIRY-BASED POWDERS FOR MAKING DAIRY-BASED FOOD BEVERAGES AND SHAKES; DAIRY-BASED SNACK FOODS EXCLUDING ICE CREAM, ICE MILK AND FROZEN YOGURT; DAIRY-BASED SPREADS; FOOD ADDITIVES IN THE NATURE OF FAT ACIDS MADE FROM MEAT, FISH, FRUITS, VEGETABLES, EGGS, MILK AND EDIBLE OILS AND FATS; FOOD ADDITIVES, NAMELY, NATURAL FOOD EXTRACTS DERIVED FROM FISH, FISH OIL, FISH PROTEIN, ALGAE, SEAWEED, FISH OR SHARK CARTILAGE, OR SEASHELLS NOT FOR MEDICINAL PURPOSES AND FOR HUMAN CONSUMPTION; FRUIT-BASED FOOD BEVERAGE; FRUIT-BASED ORGANIC FOOD BARS; FRUIT-BASED ORGANIC FOOD BARS, ALSO CONTAINING GRAINS, VEGETABLES, NUTS, SEEDS AND CHOCOLATE; FRUIT-BASED RAW FOOD BARS; FRUIT-BASED SNACK FOOD, IN CLASS 29 (U.S. CL. 46).

FIRST USE 5-2-2011; IN COMMERCE 5-2-2011.

THE MARK CONSISTS OF STANDARD CHARACTERS WITHOUT CLAIM TO ANY PARTICULAR FONT, STYLE, SIZE, OR COLOR.

SER. NO. 85-313,470, FILED 5-5-2011.

MICHAEL TANNER, EXAMINING ATTORNEY



David J. Kyffers

Director of the United States Patent and Trademark Office

United States of America

United States Patent and Trademark Office

MOSOM PLUS

Reg. No. 4,073,886

Registered Dec. 20, 2011

Int. Cl.: 12

TRADEMARK

PRINCIPAL REGISTER

SHRIN CORP (CALIFORNIA CORPORATION), DBA COVERKING
WWW.COVERKING.COM
900 W. ARLEE PLACE
ANAHEIM, CA 92805

FOR: AFTERMARKET AUTOMOBILE ACCESSORIES, NAMELY, ARM RESTS FOR VEHICLE SEATS, IN CLASS 12 (U.S. CLS. 19, 21, 23, 31, 35 AND 44).

FIRST USE 8-22-2006; IN COMMERCE 8-22-2006.

THE MARK CONSISTS OF STANDARD CHARACTERS WITHOUT CLAIM TO ANY PARTICULAR FONT, STYLE, SIZE, OR COLOR.

NO CLAIM IS MADE TO THE EXCLUSIVE RIGHT TO USE "PLUS", APART FROM THE MARK AS SHOWN.

THE ENGLISH TRANSLATION OF THE HUNGARIAN WORD "MOSOM" IN THE MARK IS "I WASH".

SER. NO. 85-313,577, FILED 5-5-2011.

MAYUR VAGHANI, EXAMINING ATTORNEY



David J. Kyros

Director of the United States Patent and Trademark Office

United States of America

United States Patent and Trademark Office

GABRIALLA

Reg. No. 4,073,887

ITA-MED (CALIFORNIA CORPORATION), FORMERLY INERNATIONAL TRADE ALLIANCE
310 LITTLEFIELD AVE.

Registered Dec. 20, 2011

SOUTH SAN FRANCISCO, CA 94080

Int. Cl.: 10

FOR: MATERNITY SUPPORT BELTS FOR MEDICAL PURPOSES; MEDICAL HOSIERY, NAMELY, SUPPORT PANTYHOSE; POST-NATAL GIRDLES FOR MEDICAL PURPOSES; POST-SURGICAL GIRDLES FOR MEDICAL PURPOSES; PREGNANCY GIRDLES FOR MEDICAL PURPOSES, IN CLASS 10 (U.S. CLS. 26, 39 AND 44).

TRADEMARK

PRINCIPAL REGISTER

FIRST USE 9-1-1996; IN COMMERCE 9-1-1996.

THE MARK CONSISTS OF STANDARD CHARACTERS WITHOUT CLAIM TO ANY PARTICULAR FONT, STYLE, SIZE, OR COLOR.

THE NAME(S), PORTRAIT(S), AND/OR SIGNATURE(S) SHOWN IN THE MARK DOES NOT IDENTIFY A PARTICULAR LIVING INDIVIDUAL.

SER. NO. 85-313,651, FILED 5-5-2011.

GRETTA YAO, EXAMINING ATTORNEY



David J. Kypos

Director of the United States Patent and Trademark Office

United States of America

United States Patent and Trademark Office

GRANDPET NATURAL GOURMET

Reg. No. 4,073,888

MULTISERVICIOS 2001, S.A. DE C.V. (MEXICO CORPORATION)
KM. 1 CARR. LA PIEDAD -MANUEL DOBLADO
SANTA ANA PACUECO, MEXICO

Registered Dec. 20, 2011

Int. Cl.: 31

FOR: FOOD FOR ANIMALS, IN CLASS 31 (U.S. CLS. 1 AND 46).

TRADEMARK

THE MARK CONSISTS OF STANDARD CHARACTERS WITHOUT CLAIM TO ANY PARTICULAR FONT, STYLE, SIZE, OR COLOR.

PRINCIPAL REGISTER

OWNER OF MEXICO REG. NO. 1123608, DATED 9-29-2009, EXPIRES 8-25-2019.

NO CLAIM IS MADE TO THE EXCLUSIVE RIGHT TO USE "NATURAL GOURMET", APART FROM THE MARK AS SHOWN.

SER. NO. 85-313,671, FILED 5-5-2011.

ALICE BENMAMAN, EXAMINING ATTORNEY



David J. Kyffers

Director of the United States Patent and Trademark Office

United States of America

United States Patent and Trademark Office

Green Dan

Reg. No. 4,073,889

MARSH, DAN (UNITED STATES INDIVIDUAL)
511 LASSO LOOP
CANYON LAKE, TX 78133

Registered Dec. 20, 2011

Int. Cl.: 41

FOR: EDUCATIONAL AND ENTERTAINMENT SERVICES, NAMELY, PROVIDING PUBLIC SPEAKING SERVICES IN THE FIELD OF RENEWABLE ENERGY AND ENERGY CONSERVATION, IN CLASS 41 (U.S. CLS. 100, 101 AND 107).

SERVICE MARK

FIRST USE 1-15-2010; IN COMMERCE 3-16-2010.

PRINCIPAL REGISTER

THE MARK CONSISTS OF STANDARD CHARACTERS WITHOUT CLAIM TO ANY PARTICULAR FONT, STYLE, SIZE, OR COLOR.

NO CLAIM IS MADE TO THE EXCLUSIVE RIGHT TO USE "GREEN", APART FROM THE MARK AS SHOWN.

SER. NO. 85-313,731, FILED 5-5-2011.

JANICE L. MCMORROW, EXAMINING ATTORNEY



David J. Kybas

Director of the United States Patent and Trademark Office

United States of America

United States Patent and Trademark Office



Reg. No. 4,073,890

Registered Dec. 20, 2011

Int. Cl.: 36

SERVICE MARK

PRINCIPAL REGISTER

CREDIT IS CRAZY, LLC (TEXAS LIMITED LIABILITY COMPANY)

#B

311 S. FANNIN AVENUE
DENISON, TX 75020

FOR: FINANCIAL SERVICES, NAMELY, CREDIT REPAIR AND RESTORATION, IN CLASS 36 (U.S. CLS. 100, 101 AND 102).

FIRST USE 1-0-2010; IN COMMERCE 1-0-2010.

NO CLAIM IS MADE TO THE EXCLUSIVE RIGHT TO USE "CREDIT", ".COM", AND "PROFESSIONAL CREDIT REPAIR", APART FROM THE MARK AS SHOWN.

THE MARK CONSISTS OF THE STYLIZED WORDS "CREDIT IS CRAZY" TO THE LEFT OF A SOLID OVAL CARRIER WITH THE STYLIZED WORD ".COM". CENTERED BELOW THE WORDS "CREDIT IS CRAZY" IS A SOLID HORIZONTAL LINE, CENTERED BELOW WHICH ARE THE WORDS "PROFESSIONAL CREDIT REPAIR" IN STYLIZED FONTS. TO THE LEFT OF THE DESCRIBED WORDS AND DESIGN IS A DRAWING OF A WAVY DOCUMENT AND A STYLIZED CIRCULAR ARROW.

SER. NO. 85-313,760, FILED 5-5-2011.

TARA PATE, EXAMINING ATTORNEY



David J. Kyjars

Director of the United States Patent and Trademark Office

United States of America

United States Patent and Trademark Office

malibu Local



Reg. No. 4,073,891

LAIRD, JANET (UNITED STATES INDIVIDUAL), DBA MALIBU LOCAL
402 1/2 IRIS AVENUE
CORONA DEL MAR, CA 92625

Registered Dec. 20, 2011

Int. Cl.: 25

FOR: CLOTHING, NAMELY, MEN'S, WOMEN'S AND CHILDREN'S T-SHIRTS AND TANK TOPS; BABY JUMPERS, IN CLASS 25 (U.S. CLS. 22 AND 39).

TRADEMARK

FIRST USE 1-15-2011; IN COMMERCE 4-16-2011.

PRINCIPAL REGISTER

NO CLAIM IS MADE TO THE EXCLUSIVE RIGHT TO USE "MALIBU LOCAL", APART FROM THE MARK AS SHOWN.

THE COLOR(S) BLUE, BLACK AND YELLOW IS/ARE CLAIMED AS A FEATURE OF THE MARK.

THE MARK CONSISTS OF THE WORDING "MALIBU LOCAL" IN BLACK APPEARING ABOVE A BLUE LIFEGUARD TOWER AND YELLOW SUN.

SER. NO. 85-313,792, FILED S.R. 5-5-2011 AM. P.R. 5-5-2011.

KATHERINE CHANG, EXAMINING ATTORNEY



David J. Kybas

Director of the United States Patent and Trademark Office

United States of America

United States Patent and Trademark Office



Reg. No. 4,073,892

OLGOONIK DEVELOPMENT LLC (ALASKA LIMITED LIABILITY COMPANY)
3201 C STREET, SUITE 700
ANCHORAGE, AK 99503

Registered Dec. 20, 2011

Int. Cl.: 35

FOR: MANAGEMENT AND OPERATION ASSISTANCE TO COMMERCIAL BUSINESSES,
IN CLASS 35 (U.S. CLS. 100, 101 AND 102).

SERVICE MARK

FIRST USE 12-27-1999; IN COMMERCE 6-1-2000.

PRINCIPAL REGISTER

NO CLAIM IS MADE TO THE EXCLUSIVE RIGHT TO USE "DEVELOPMENT LLC", APART
FROM THE MARK AS SHOWN.

THE MARK CONSISTS OF THE STYLIZED TEXT "OLGOONIK DEVELOPMENT LLC"
WITH A WHALE ON THE RIGHT.

THE ENGLISH TRANSLATION OF THE INUPIAT WORD "OLGOONIK" IN THE MARK IS
"WHERE THE LAND SLOPES TO THE SEA".

SER. NO. 85-313,796, FILED 5-5-2011.

MAYUR VAGHANI, EXAMINING ATTORNEY



David J. Kyffers

Director of the United States Patent and Trademark Office

United States of America

United States Patent and Trademark Office

DOGBAG BUTLER



Reg. No. 4,073,893

Registered Dec. 20, 2011

Int. Cl.: 20

TRADEMARK

PRINCIPAL REGISTER

DOGGIE WALK BAGS, INC. (CALIFORNIA CORPORATION)
PO BOX 228
BALBOA ISLAND, CA 926620228

FOR: FIXED DISPENSERS NOT OF METAL FOR PET WASTE BAGS, IN CLASS 20 (U.S. CLS. 2, 13, 22, 25, 32 AND 50).

FIRST USE 8-3-2010; IN COMMERCE 8-3-2010.

SER. NO. 85-313,802, FILED 5-5-2011.

LAURIE KAUFMAN, EXAMINING ATTORNEY



David J. Kyros

Director of the United States Patent and Trademark Office

United States of America
United States Patent and Trademark Office

GOOD AIR

Reg. No. 4,073,894

THE YANKEE CANDLE COMPANY, INC. (MASSACHUSETTS CORPORATION)
POST OFFICE BOX 110
SOUTH DEERFIELD, MA 013730110

Registered Dec. 20, 2011

Int. Cl.: 3

FOR: ELECTRIC FRAGRANCE DISPENSER REFILLS; ROOM FRAGRANCES, IN CLASS 3
(U.S. CLS. 1, 4, 6, 50, 51 AND 52).

TRADEMARK

FIRST USE 12-22-2008; IN COMMERCE 12-22-2008.

PRINCIPAL REGISTER

THE MARK CONSISTS OF STANDARD CHARACTERS WITHOUT CLAIM TO ANY PARTICULAR FONT, STYLE, SIZE, OR COLOR.

NO CLAIM IS MADE TO THE EXCLUSIVE RIGHT TO USE "AIR", APART FROM THE MARK AS SHOWN.

SER. NO. 85-313,827, FILED 5-5-2011.

ADA HAN, EXAMINING ATTORNEY



David J. Kybas

Director of the United States Patent and Trademark Office

United States of America
United States Patent and Trademark Office

GOOD AIR

Reg. No. 4,073,895

Registered Dec. 20, 2011

Int. Cl.: 4

TRADEMARK

PRINCIPAL REGISTER

THE YANKEE CANDLE COMPANY, INC. (MASSACHUSETTS CORPORATION)
POST OFFICE BOX 110
SOUTH DEERFIELD, MA 013730110

FOR: CANDLES, IN CLASS 4 (U.S. CLS. 1, 6 AND 15).

FIRST USE 12-12-2008; IN COMMERCE 12-12-2008.

THE MARK CONSISTS OF STANDARD CHARACTERS WITHOUT CLAIM TO ANY PARTICULAR FONT, STYLE, SIZE, OR COLOR.

NO CLAIM IS MADE TO THE EXCLUSIVE RIGHT TO USE "AIR", APART FROM THE MARK AS SHOWN.

SER. NO. 85-313,829, FILED 5-5-2011.

ADA HAN, EXAMINING ATTORNEY



David J. Kyffers

Director of the United States Patent and Trademark Office

United States of America

United States Patent and Trademark Office

GOOD AIR

Reg. No. 4,073,896

THE YANKEE CANDLE COMPANY, INC. (MASSACHUSETTS CORPORATION)
POST OFFICE BOX 110
SOUTH DEERFIELD, MA 013730110

Registered Dec. 20, 2011

Int. Cl.: 5

FOR: AIR FRESHENERS; ROOM DEODORANTS, IN CLASS 5 (U.S. CLS. 6, 18, 44, 46, 51 AND 52).

TRADEMARK

FIRST USE 12-12-2008; IN COMMERCE 12-12-2008.

PRINCIPAL REGISTER

THE MARK CONSISTS OF STANDARD CHARACTERS WITHOUT CLAIM TO ANY PARTICULAR FONT, STYLE, SIZE, OR COLOR.

NO CLAIM IS MADE TO THE EXCLUSIVE RIGHT TO USE "AIR", APART FROM THE MARK AS SHOWN.

SER. NO. 85-313,835, FILED 5-5-2011.

ADA HAN, EXAMINING ATTORNEY



David J. Kyffers

Director of the United States Patent and Trademark Office

United States of America

United States Patent and Trademark Office

GOOD AIR

Reg. No. 4,073,897

THE YANKEE CANDLE COMPANY, INC. (MASSACHUSETTS CORPORATION)
POST OFFICE BOX 110
SOUTH DEERFIELD, MA 013730110

Registered Dec. 20, 2011

Int. Cl.: 11

FOR: ELECTRIC AIR FRESHENER FRAGRANCE DISPENSERS, IN CLASS 11 (U.S. CLS. 13, 21, 23, 31 AND 34).

TRADEMARK

FIRST USE 12-22-2008; IN COMMERCE 12-22-2008.

PRINCIPAL REGISTER

THE MARK CONSISTS OF STANDARD CHARACTERS WITHOUT CLAIM TO ANY PARTICULAR FONT, STYLE, SIZE, OR COLOR.

NO CLAIM IS MADE TO THE EXCLUSIVE RIGHT TO USE "AIR", APART FROM THE MARK AS SHOWN.

SER. NO. 85-313,840, FILED 5-5-2011.

ADA HAN, EXAMINING ATTORNEY



David J. Kyffers

Director of the United States Patent and Trademark Office

United States of America

United States Patent and Trademark Office

ASSETPLUS

Reg. No. 4,073,898

Registered Dec. 20, 2011

Int. Cl.: 36

SERVICE MARK

PRINCIPAL REGISTER

ASSETPLUS INVESTMENT MANAGEMENT CORPORATION (CALIFORNIA CORPORATION)
3699 WILSHIRE BLVD., SUITE 700-3
LOS ANGELES, CA 90010

FOR: FINANCIAL SERVICES, NAMELY, INVESTMENT MANAGEMENT SERVICES, ASSET MANAGEMENT SERVICES, INVESTMENT ADVISORY SERVICES, AND INVESTMENT FUND MANAGEMENT SERVICES, IN CLASS 36 (U.S. CLS. 100, 101 AND 102).

FIRST USE 5-1-2009; IN COMMERCE 5-1-2009.

THE MARK CONSISTS OF STANDARD CHARACTERS WITHOUT CLAIM TO ANY PARTICULAR FONT, STYLE, SIZE, OR COLOR.

SER. NO. 85-313,851, FILED 5-5-2011.

BRENDAN MCCAULEY, EXAMINING ATTORNEY



David J. Kyffers

Director of the United States Patent and Trademark Office

United States of America

United States Patent and Trademark Office



Reg. No. 4,073,899

Registered Dec. 20, 2011

Int. Cl.: 30

TRADEMARK

PRINCIPAL REGISTER

RAVI CANDY'S LLC (TEXAS LIMITED LIABILITY COMPANY)
1714 S. 28 AVE
EDINBURG, TX 78542

FOR: CANDIES; SWEETS, IN CLASS 30 (U.S. CL. 46).

FIRST USE 10-20-2009; IN COMMERCE 10-20-2009.

THE MARK CONSISTS OF A STYLISTIC YELLOW SPLAT CONTAINING THE WORD, "RAVI", IN STYLISTIC RED LETTERS OUTLINED IN WHITE; WITH A STYLISTIC WHITE RABBIT WITH OUTSTRETCHED ARMS, OUTLINED IN RED AND EXTENDING OUT OFF THE "V".

THE COLOR(S) RED, YELLOW, AND WHITE IS/ARE CLAIMED AS A FEATURE OF THE MARK.

THE ENGLISH TRANSLATION OF THE WORD "RAVI" IN THE MARK IS "SUN".

SER. NO. 85-313,913, FILED 5-6-2011.

MARK T. MULLEN, EXAMINING ATTORNEY



David J. Kyffers

Director of the United States Patent and Trademark Office

United States of America

United States Patent and Trademark Office

SUNTSB
圣蒂斯堡

Reg. No. 4,073,900

Registered Dec. 20, 2011

Int. Cl.: 20

TRADEMARK

PRINCIPAL REGISTER

DONGGUAN WANHENG TONG FURNITURE CO., LTD. (CHINA LIMITED LIABILITY COMPANY)

FU MA INDUSTRIAL PARK
CHI GANG VILLAGE, HUMEN TOWN
DONGGUAN, GUANGDONG, CHINA

FOR: BEDS; CHAIRS; COAT HANGERS; DRESSING TABLES; FURNITURE; FURNITURE CHESTS; OFFICE FURNITURE; SOFAS; TABLES; TEA TABLES, IN CLASS 20 (U.S. CLS. 2, 13, 22, 25, 32 AND 50).

FIRST USE 10-1-2009; IN COMMERCE 9-1-2010.

THE MARK CONSISTS OF A STYLIZED WORDS "SUNTSB" AND FOUR CHINESE CHARACTERS SHENG DI SI BAO.

THE NON-LATIN CHARACTERS IN THE MARK TRANSLITERATE TO SHENG DI SI BAO AND THIS HAS NO MEANING IN A FOREIGN LANGUAGE.

THE WORDING "SUNTSB" HAS NO MEANING IN A FOREIGN LANGUAGE.

SER. NO. 85-313,948, FILED 5-6-2011.

ELLEN PERKINS, EXAMINING ATTORNEY



David J. Kybas

Director of the United States Patent and Trademark Office

United States of America

United States Patent and Trademark Office

SHARE THE WEALTH

Reg. No. 4,073,901

SUPERMEDIA LLC (DELAWARE LIMITED LIABILITY COMPANY)

Registered Dec. 20, 2011

2200 W. AIRFIELD DRIVE
DFW AIRPORT, TX 752619810

Int. Cl.: 35

FOR: ADMINISTRATION OF A CUSTOMER LOYALTY PROGRAM FOR EXISTING ADVERTISING CUSTOMERS TO REFER NEW ADVERTISING CUSTOMERS WHICH PROVIDES DISCOUNTS ON FUTURE ADVERTISING CAMPAIGNS, IN CLASS 35 (U.S. CLS. 100, 101 AND 102).

SERVICE MARK

PRINCIPAL REGISTER

FIRST USE 9-0-2008; IN COMMERCE 9-0-2008.

THE MARK CONSISTS OF STANDARD CHARACTERS WITHOUT CLAIM TO ANY PARTICULAR FONT, STYLE, SIZE, OR COLOR.

SER. NO. 85-314,115, FILED 5-6-2011.

TAMARA FRAZIER, EXAMINING ATTORNEY



David J. Kybas

Director of the United States Patent and Trademark Office

United States of America

United States Patent and Trademark Office

CLHRP

Reg. No. 4,073,902

Registered Dec. 20, 2011

CERTIFICATION MARK

PRINCIPAL REGISTER

THE SOCIETY FOR CLINICAL AND MEDICAL HAIR REMOVAL INC. (NEW YORK
NON-PROFIT CORPORATION), FORMERLY THE SOCIETY OF CLINICAL AND MEDICAL
ELECTROLOGISTS INC.
2810 CROSSROADS DRIVE, SUITE 3800
MADISON, WI 53718

FOR: LASER HAIR REMOVAL SERVICES, IN CLASS B (U.S. CL. B).

FIRST USE 3-0-2004; IN COMMERCE 3-0-2004.

THE MARK CONSISTS OF STANDARD CHARACTERS WITHOUT CLAIM TO ANY PAR-
TICULAR FONT, STYLE, SIZE, OR COLOR.

OWNER OF U.S. REG. NO. 3,946,696.

THE CERTIFICATION MARK, AS USED BY PERSONS AUTHORIZED BY CERTIFIER, IS
TO INDICATE THAT THE LASER HAIR REMOVAL SERVICES PERFORMED OR TO BE
PERFORMED HAVE BEEN OR WILL BE PERFORMED BY A PERSON WHOSE SERVICES
ARE COMPETENT IN THE LASER HAIR REMOVAL FIELD, SUCH INDIVIDUAL'S SERVICES
HAVING MET CERTAIN EDUCATIONAL STANDARDS IN THE LASER HAIR REMOVAL
FIELD SET BY THE CERTIFIER AND HAVING PASSED EXAMINATIONS CERTIFIED BY
THE CERTIFIER.

SER. NO. 85-314,127, FILED 5-6-2011.

KELLEY WELLS, EXAMINING ATTORNEY



David J. Kybas

Director of the United States Patent and Trademark Office

United States of America

United States Patent and Trademark Office

PAK 'N MOVE

Reg. No. 4,073,903

NEW HAVEN COMPANIES, INC (CONNECTICUT CORPORATION)
41 WASHINGTON STREET
EAST HAVEN, CT 06512

Registered Dec. 20, 2011

Int. Cl.: 16

FOR: MOVING AND PACKAGING SUPPLIES FOR MOVING AND STORAGE OF PERSONAL PROPERTY, NAMELY, CORRUGATED CARDBOARD BOXES, WRAPPING PAPER, PAPER ADHESIVE TAPE, AND PAPER PACKING MATERIALS, NAMELY, DISH PACKS, PADS, AND CELL-KITS, IN CLASS 16 (U.S. CLS. 2, 5, 22, 23, 29, 37, 38 AND 50).

TRADEMARK

PRINCIPAL REGISTER

FIRST USE 7-4-2003; IN COMMERCE 7-4-2003.

THE MARK CONSISTS OF STANDARD CHARACTERS WITHOUT CLAIM TO ANY PARTICULAR FONT, STYLE, SIZE, OR COLOR.

SER. NO. 85-314,195, FILED 5-6-2011.

KELLY TRUSILO, EXAMINING ATTORNEY



David J. Kyffers

Director of the United States Patent and Trademark Office

United States of America

United States Patent and Trademark Office

THE BIG DANCE

Reg. No. 4,073,904

Registered Dec. 20, 2011

Int. Cl.: 41

SERVICE MARK

PRINCIPAL REGISTER

THE NATIONAL COLLEGIATE ATHLETIC ASSOCIATION (INDIANA UNINCORPORATED ASSOCIATION)
P.O. BOX 6222
INDIANAPOLIS, IN 46206

FOR: ENTERTAINMENT SERVICES, NAMELY, ARRANGING AND CONDUCTING CONCERTS AND MUSIC FESTIVALS, IN CLASS 41 (U.S. CLS. 100, 101 AND 107).

FIRST USE 4-1-2006; IN COMMERCE 4-1-2006.

THE MARK CONSISTS OF STANDARD CHARACTERS WITHOUT CLAIM TO ANY PARTICULAR FONT, STYLE, SIZE, OR COLOR.

OWNER OF U.S. REG. NOS. 2,446,721, 2,719,537 AND OTHERS.

SER. NO. 85-314,212, FILED 5-6-2011.

ANDREA BUTLER, EXAMINING ATTORNEY



David J. Kyffers

Director of the United States Patent and Trademark Office

United States of America

United States Patent and Trademark Office



Reg. No. 4,073,905

Registered Dec. 20, 2011

Int. Cl.: 29

TRADEMARK

PRINCIPAL REGISTER

EURO FOODS, INC. (PENNSYLVANIA CORPORATION), DBA CITTERIO U.S.A.
CORPORATION
2008 STATE ROUTE 940
FREELAND, PA 18224

FOR: DELI MEATS, IN CLASS 29 (U.S. CL. 46).

FIRST USE 5-5-2011; IN COMMERCE 5-5-2011.

THE MARK CONSISTS OF LEAVES IN VARIOUS SHADES OF GREEN WITH ONE YELLOW LEAF IN THE MIDDLE. THE LEAVES RADIATE FROM A YELLOW PARTIAL SUN LIKE DESIGN.

THE COLOR(S) GREEN AND YELLOW IS/ARE CLAIMED AS A FEATURE OF THE MARK.

SER. NO. 85-314,325, FILED 5-6-2011.

JACLYN KIDWELL WALKER, EXAMINING ATTORNEY



David J. Kybas

Director of the United States Patent and Trademark Office

United States of America

United States Patent and Trademark Office



Reg. No. 4,073,906

Registered Dec. 20, 2011

Int. Cl.: 13

TRADEMARK

PRINCIPAL REGISTER

WILLIAM D. HOBER, INC. (KANSAS CORPORATION)
P.O. BOX 27
ONE THOUSAND ONE SWIFT AVENUE
QUINTER, KS 67752

FOR: BULLETS, IN CLASS 13 (U.S. CLS. 2 AND 9).

FIRST USE 6-0-1996; IN COMMERCE 6-0-1996.

THE MARK CONSISTS OF THE STYLIZED WORD "SWIFT" IN THE COLOR RED WITH AN IMAGE OF A RED BULLET ON THE RIGHT; A SPACE DIVIDES THE LETTERS "SWIFT" SIMULATING THE BULLET WENT THROUGH THE WORD "SWIFT".

THE COLOR(S) RED IS/ARE CLAIMED AS A FEATURE OF THE MARK.

SER. NO. 85-314,362, FILED 5-6-2011.

TRACY CROSS, EXAMINING ATTORNEY



David J. Kybas

Director of the United States Patent and Trademark Office

United States of America

United States Patent and Trademark Office

iPASS

Reg. No. 4,073,907

Registered Dec. 20, 2011

Int. Cl.: 41

SERVICE MARK

PRINCIPAL REGISTER

THE UNIVERSITY OF SOUTHERN MISSISSIPPI (MISSISSIPPI BODY POLITIC AND CORPORATE)
P. O. BOX 5016
HATTIESBURG, MS 39406

FOR: EDUCATIONAL SERVICES, NAMELY, PROVIDING ONLINE, CLASSROOM, E-LEARNING, AND INTERNSHIP EDUCATIONAL COURSES OF INSTRUCTION, CONFERENCES, TRAINING, PROGRAMS, CLASSES, WORKSHOPS, SEMINARS, CERTIFICATION PROGRAMS, AND WEB-BASED TRAINING COURSES AT THE UNIVERSITY UNDERGRADUATE AND GRADUATE LEVELS IN THE FIELD OF CASINO, HOSPITALITY, AND TOURISM MANAGEMENT, AND DISTRIBUTION OF COURSE MATERIALS IN CONNECTION THEREWITH; EDUCATIONAL SERVICES, NAMELY, PROVIDING MOTIVATIONAL AND EDUCATIONAL SPEAKERS IN THE FIELD OF CASINO, HOSPITALITY, AND TOURISM MANAGEMENT, AND DISTRIBUTION OF COURSE MATERIALS IN CONNECTION THEREWITH, IN CLASS 41 (U.S. CLS. 100, 101 AND 107).

FIRST USE 8-28-2008; IN COMMERCE 8-28-2008.

THE MARK CONSISTS OF STANDARD CHARACTERS WITHOUT CLAIM TO ANY PARTICULAR FONT, STYLE, SIZE, OR COLOR.

SER. NO. 85-314,452, FILED 5-6-2011.

TARA PATE, EXAMINING ATTORNEY



David J. Kyjars

Director of the United States Patent and Trademark Office

United States of America

United States Patent and Trademark Office

Folie à Deux



Ménage à Trois

Reg. No. 4,073,908

Registered Dec. 20, 2011

Int. Cl.: 33

TRADEMARK

PRINCIPAL REGISTER

SUTTER HOME WINERY, INC. (CALIFORNIA CORPORATION)
100 ST. HELENA HIGHWAY SOUTH, PO BOX 248
ST. HELENA, CA 94574

FOR: ALCOHOLIC BEVERAGES EXCEPT BEERS, IN CLASS 33 (U.S. CLS. 47 AND 49).

FIRST USE 2-28-2004; IN COMMERCE 2-28-2004.

OWNER OF U.S. REG. NOS. 2,766,319, 3,147,087, AND 3,147,845.

THE MARK CONSISTS OF THE STYLIZED WORDS FOLIE A DEUX APPEARING ABOVE THE SILHOUETTE IMAGE OF TWO DANCERS, BENEATH WHICH APPEAR THE STYLIZED WORDS MENAGE A TROIS.

THE ENGLISH TRANSLATION OF MENAGE A TROIS IN THE MARK IS FAMILY OF THREE.

SER. NO. 85-314,515, FILED 5-6-2011.

RICHARD WHITE, EXAMINING ATTORNEY



David J. Kyffers

Director of the United States Patent and Trademark Office

United States of America

United States Patent and Trademark Office



Reg. No. 4,073,909

MICKMAN BROTHERS, INC. (MINNESOTA CORPORATION)

Registered Dec. 20, 2011

14630 HWY 65 NE
HAM LAKE, MN 55304

Int. Cl.: 35

FOR: RETAIL STORE AND ONLINE RETAIL STORE SERVICES FEATURING SUSTAINABLE PLANTS, TREES AND LANDSCAPING THAT IS ENVIRONMENTALLY FRIENDLY, IN CLASS 35 (U.S. CLS. 100, 101 AND 102).

SERVICE MARK

FIRST USE 4-28-2011; IN COMMERCE 4-28-2011.

PRINCIPAL REGISTER

NO CLAIM IS MADE TO THE EXCLUSIVE RIGHT TO USE "SUSTAINABLE SOLUTIONS", APART FROM THE MARK AS SHOWN.

THE COLOR(S) GREEN, LIGHT GREEN, DARK GREEN, BLUE AND WHITE IS/ARE CLAIMED AS A FEATURE OF THE MARK.

THE MARK CONSISTS OF A CIRCULAR LOGO WITH THE WORDS "SUSTAINABLE" "SOLUTIONS" IN WHITE TEXT SEPARATED BY A WHITE DOT WITH GREEN BACKGROUND, OUTLINED IN WHITE FRAMING THE OUTSIDE OF THE CIRCLE ENDING IN A GREEN TREE THAT APPEARS ON THE RIGHT SIDE OF THE LOGO. INSIDE THE MIDDLE OF THE TREE ARE THREE "Y"'S INSIDE A CIRCULAR DESIGN ALL IN WHITE. ONE HALF OF THE INNER CIRCLE OF THE DESIGN IS LIGHT GREEN, ONE HALF IS BLUE SEPARATED BY A DARK GREEN REVERSE "S" SWOOSH. RAINDROPS APPEAR ON THE LIGHT GREEN HALF OF THE CIRCLE.

SER. NO. 85-314,688, FILED 5-6-2011.

JEFFREY LOOK, EXAMINING ATTORNEY



David J. Kybas

Director of the United States Patent and Trademark Office

United States of America

United States Patent and Trademark Office

Big Ol' Boy

Reg. No. 4,073,910

BIG OL' COMPANY, INC. (TEXAS CORPORATION)
3683 CORAL GABLES DR
DALLAS, TX 752292620

Registered Dec. 20, 2011

Int. Cl.: 25

FOR: WEARABLE GARMENTS AND CLOTHING, NAMELY, SHIRTS, IN CLASS 25 (U.S. CLS. 22 AND 39).

TRADEMARK

FIRST USE 2-18-2011; IN COMMERCE 2-18-2011.

PRINCIPAL REGISTER

THE MARK CONSISTS OF STANDARD CHARACTERS WITHOUT CLAIM TO ANY PARTICULAR FONT, STYLE, SIZE, OR COLOR.

SER. NO. 85-314,714, FILED 5-6-2011.

SANI KHOURI, EXAMINING ATTORNEY



David J. Kyffers

Director of the United States Patent and Trademark Office

United States of America

United States Patent and Trademark Office

LET'S PLAY!

Reg. No. 4,073,911

Registered Dec. 20, 2011

Int. Cl.: 1

TRADEMARK

PRINCIPAL REGISTER

M2 POLYMER TECHNOLOGIES, INC. (ILLINOIS CORPORATION)
PO BOX 365, WEST DUNDEE, IL 60118
17N580 ADAMS DRIVE
WEST DUNDEE, IL 60118

FOR: CHEMICAL COMPOSITION FOR SOLIDIFICATION OF FLUIDS AND FOR ABSORBING SPILLS, IN CLASS 1 (U.S. CLS. 1, 5, 6, 10, 26 AND 46).

FIRST USE 5-4-2011; IN COMMERCE 5-4-2011.

THE MARK CONSISTS OF STANDARD CHARACTERS WITHOUT CLAIM TO ANY PARTICULAR FONT, STYLE, SIZE, OR COLOR.

SER. NO. 85-314,737, FILED 5-6-2011.

JULIE VEPPUMTHARA, EXAMINING ATTORNEY



David J. Kyffers

Director of the United States Patent and Trademark Office

United States of America

United States Patent and Trademark Office

BOCA RATON RESORT & MARINA

Reg. No. 4,073,912

PANTHERS BRHC LLC (DELAWARE LIMITED LIABILITY COMPANY)
345 PARK AVENUE
NEW YORK, NY 10154

Registered Dec. 20, 2011

Int. Cl.: 39

FOR: MARINA SERVICES, IN CLASS 39 (U.S. CLS. 100 AND 105).

SERVICE MARK

FIRST USE 10-31-1998; IN COMMERCE 10-31-1998.

PRINCIPAL REGISTER

THE MARK CONSISTS OF STANDARD CHARACTERS WITHOUT CLAIM TO ANY PARTICULAR FONT, STYLE, SIZE, OR COLOR.

OWNER OF U.S. REG. NOS. 2,272,223, 2,323,314 AND OTHERS.

NO CLAIM IS MADE TO THE EXCLUSIVE RIGHT TO USE "RESORT & MARINA", APART FROM THE MARK AS SHOWN.

SEC. 2(F) AS TO "BOCA RATON".

SER. NO. 85-314,811, FILED 5-6-2011.

RENEE MCCRAY, EXAMINING ATTORNEY



David J. Kyros

Director of the United States Patent and Trademark Office

United States of America

United States Patent and Trademark Office

TextExpander

Reg. No. 4,073,913

Registered Dec. 20, 2011

Int. Cl.: 9

TRADEMARK

PRINCIPAL REGISTER

SMILEONMYMAC, LLC (OREGON LIMITED LIABILITY COMPANY), DBA SMILE
PMB 278 350 BAY STREET, SUITE 100
SAN FRANCISCO, CA 94133

FOR: COMPUTER SOFTWARE FOR SAVING THE USER KEYSTROKES BY CUSTOMIZED ABBREVIATIONS FOR FREQUENTLY USED TEXT STRINGS AND IMAGES VIA USE OF SHORT ABBREVIATIONS TO INSERT SNIPPETS CONTAINING FREQUENTLY USED PHRASES AND IMAGES BY ALLOWING INSERTION OF STANDARD GREETINGS AND SIGNATURES, INCLUDING FORMATTED TEXT AND PICTURES, ASSIGNING OF HOTKEYS TO SAVE FURTHER TIME WHEN CREATING, EDITING, AND SEARCHING SNIPPETS, REPOSITIONING THE CURSOR IN THE EXPANDED SNIPPET, FILL-IN-THE-BLANK SNIPPETS TO ENTER VARIABLE DATA IN MULTIPLE FIELDS, ORGANIZING SNIPPETS INTO GROUPS, AUTOMATING MANAGEMENT OF SNIPPETS AND GROUPS VIA SCRIPTS, ADDING SNIPPET GROUPS FROM EXTERNAL FILE AND ONLINE SOURCES, SYNC SNIPPETS VIA INTERNET-BASED DATA SYNCHRONIZATION SERVICES, INSERTION OF THE CURRENT DATE AND TIME IN USER-PREFERRED FORMAT, CORRECTION OF COMMON TYPOGRAPHICAL ERRORS, TYPING OF SPECIAL CHARACTERS WITHOUT HAVING TO LAUNCH A SPECIAL CHARACTERS PALETTE, TRIGGERING OF SNIPPET EXPANSIONS AUTOMATICALLY BY TYPING USER-SPECIFIED ABBREVIATIONS OR MORE THAN THIRTY DELIMITER CHARACTERS AS A TRIGGER, CREATION OF EDITOR-INDEPENDENT CODE TEMPLATES AND INVOCATION OF SCRIPTS, IN CLASS 9 (U.S. CLS. 21, 23, 26, 36 AND 38).

FIRST USE 5-22-2006; IN COMMERCE 5-22-2006.

THE MARK CONSISTS OF STANDARD CHARACTERS WITHOUT CLAIM TO ANY PARTICULAR FONT, STYLE, SIZE, OR COLOR.

SER. NO. 85-314,831, FILED 5-6-2011.

FRANK LATTUCA, EXAMINING ATTORNEY



David J. Kyros

Director of the United States Patent and Trademark Office

United States of America

United States Patent and Trademark Office

Radovent

Reg. No. 4,073,914

Registered Dec. 20, 2011

Int. Cl.: 37

SERVICE MARK

PRINCIPAL REGISTER

JEWELL, TRAVIS (UNITED STATES INDIVIDUAL)
#250
7069 SOUTH HIGHLAND DRIVE
COTTONWOOD HEIGHTS, UT 84121

FOR: MAINTENANCE AND REPAIR OF BUILDINGS; BUILDING REPAIR, NAMELY, MITIGATION OF RADON, IN CLASS 37 (U.S. CLS. 100, 103 AND 106).

FIRST USE 1-8-2007; IN COMMERCE 1-8-2007.

THE MARK CONSISTS OF STANDARD CHARACTERS WITHOUT CLAIM TO ANY PARTICULAR FONT, STYLE, SIZE, OR COLOR.

SER. NO. 85-314,908, FILED 5-6-2011.

SUZANNE BLANE, EXAMINING ATTORNEY



David J. Kybas

Director of the United States Patent and Trademark Office

United States of America

United States Patent and Trademark Office

salonsolids

Reg. No. 4,073,915

MCCOY, SARAH (UNITED STATES INDIVIDUAL)
2311 N. 116TH ST.
SEATTLE, WA 98133

Registered Dec. 20, 2011

Int. Cl.: 3

FOR: HAIR SHAMPOOS AND CONDITIONERS, IN CLASS 3 (U.S. CLS. 1, 4, 6, 50, 51 AND 52).

TRADEMARK

FIRST USE 1-1-2011; IN COMMERCE 5-6-2011.

PRINCIPAL REGISTER

THE MARK CONSISTS OF STANDARD CHARACTERS WITHOUT CLAIM TO ANY PARTICULAR FONT, STYLE, SIZE, OR COLOR.

SER. NO. 85-315,013, FILED 5-6-2011.

CARYN GLASSER, EXAMINING ATTORNEY



David J. Kyffers

Director of the United States Patent and Trademark Office

United States of America

United States Patent and Trademark Office

startupr

Reg. No. 4,073,916

EASTBIZ.COM, INC. (NEVADA CORPORATION)
2972 COLUMBIA ST
TORRANCE, CA 90503

Registered Dec. 20, 2011

Int. Cl.: 45

FOR: PREPARING AND FILING INCORPORATION PAPERS, IN CLASS 45 (U.S. CLS. 100 AND 101).

SERVICE MARK

FIRST USE 3-18-2011; IN COMMERCE 4-16-2011.

PRINCIPAL REGISTER

THE MARK CONSISTS OF STANDARD CHARACTERS WITHOUT CLAIM TO ANY PARTICULAR FONT, STYLE, SIZE, OR COLOR.

SER. NO. 85-315,124, FILED 5-7-2011.

BRENDAN REGAN, EXAMINING ATTORNEY



David J. Kybas

Director of the United States Patent and Trademark Office

United States of America

United States Patent and Trademark Office

JAMAL

Reg. No. 4,073,917

Registered Dec. 20, 2011

Int. Cl.: 15

TRADEMARK

PRINCIPAL REGISTER

MOHMED, JAMES (UNITED STATES INDIVIDUAL), AKA JAMAL
1016 HAINES AVE.
DALLAS, TX 75208

FOR: MUSICAL INSTRUMENTS, IN CLASS 15 (U.S. CLS. 2, 21 AND 36).

FIRST USE 6-4-1983; IN COMMERCE 6-4-1983.

THE MARK CONSISTS OF STANDARD CHARACTERS WITHOUT CLAIM TO ANY PARTICULAR FONT, STYLE, SIZE, OR COLOR.

THE ENGLISH TRANSLATION OF "JAMAL" IN THE MARK IS "INNER BEAUTY FROM THE HEART".

SER. NO. 85-315,125, FILED 5-7-2011.

BRENDAN REGAN, EXAMINING ATTORNEY



David J. Kybas

Director of the United States Patent and Trademark Office

United States of America

United States Patent and Trademark Office

MR. HALLOWEENSTER

Reg. No. 4,073,918

WOODSPHERE PUBLISHING LLC (PENNSYLVANIA LIMITED LIABILITY COMPANY)
2222 WALLACE STREET
PHILADELPHIA, PA 19130

Registered Dec. 20, 2011

Int. Cl.: 16

FOR: STENCILS AND PATTERNS, BEING OF PAPER AND PLASTIC, FOR THE TRANSFER-
RING OF GRAPHIC DESIGNS TO PUMPKINS, MINI-PUMPKINS, GOURDS, AND OTHER
FRUITS AND VEGETABLES; POSTERS; AND STICKERS, IN CLASS 16 (U.S. CLS. 2, 5, 22,
23, 29, 37, 38 AND 50).

TRADEMARK

PRINCIPAL REGISTER

FIRST USE 10-20-2010; IN COMMERCE 10-20-2010.

THE MARK CONSISTS OF STANDARD CHARACTERS WITHOUT CLAIM TO ANY PAR-
TICULAR FONT, STYLE, SIZE, OR COLOR.

SER. NO. 85-315,317, FILED 5-9-2011.

MATTHEW KLINE, EXAMINING ATTORNEY



David J. Kyffers

Director of the United States Patent and Trademark Office

United States of America

United States Patent and Trademark Office

MR. HALL  WEENSTER

Reg. No. 4,073,919

WOODSPHERE PUBLISHING LLC (PENNSYLVANIA LIMITED LIABILITY COMPANY)
2222 WALLACE STREET
PHILADELPHIA, PA 19130

Registered Dec. 20, 2011

Int. Cl.: 16

FOR: STENCILS AND PATTERNS, BEING OF PAPER AND PLASTIC, FOR THE TRANSFER-
RING OF GRAPHIC DESIGNS TO PUMPKINS, MINI-PUMPKINS, GOURDS, AND OTHER
FRUITS AND VEGETABLES; POSTERS; AND STICKERS, IN CLASS 16 (U.S. CLS. 2, 5, 22,
23, 29, 37, 38 AND 50).

TRADEMARK

PRINCIPAL REGISTER

FIRST USE 10-20-2010; IN COMMERCE 10-20-2010.

THE MARK CONSISTS OF THE WORDING "MR. HALLOWEENSTER" IN THE COLOR
BLACK WITH A STYLIZED PUMPKIN APPEARING AS THE LETTER "O" IN THE COLORS
YELLOW, BLACK AND ORANGE.

THE COLOR(S) BLACK, YELLOW AND ORANGE IS/ARE CLAIMED AS A FEATURE OF
THE MARK.

SER. NO. 85-315,318, FILED 5-9-2011.

MATTHEW KLINE, EXAMINING ATTORNEY



David J. Kyffers

Director of the United States Patent and Trademark Office

United States of America

United States Patent and Trademark Office



Reg. No. 4,073,920

Registered Dec. 20, 2011

Int. Cl.: 35

SERVICE MARK

PRINCIPAL REGISTER

LEONARD HOLDINGS, LLC (FLORIDA LIMITED LIABILITY COMPANY)
1356 POINT CRISP ROAD
SARASOTA, FL 34242

FOR: RETAIL STORE AND ON-LINE RETAIL STORE SERVICES FEATURING UTILITY, FORESTRY AND CONSTRUCTION EQUIPMENT, IN CLASS 35 (U.S. CLS. 100, 101 AND 102).

FIRST USE 8-30-2006; IN COMMERCE 8-30-2006.

OWNER OF U.S. REG. NO. 3,783,453.

THE COLOR(S) BLACK, WHITE AND ORANGE IS/ARE CLAIMED AS A FEATURE OF THE MARK.

NO CLAIM IS MADE TO THE EXCLUSIVE RIGHT TO USE "EQUIPMENT", APART FROM THE MARK AS SHOWN.

THE MARK CONSISTS OF THE STYLIZED TEXT "SKYCO EQUIPMENT" IN BLACK TEXT WITH A WHITE BORDER WITH AN ORANGE INVERTED TRIANGLE LOCATED NEAR THE TOP OF THE LETTER "Y".

SER. NO. 85-315,378, FILED 5-9-2011.

ANN E. SAPPENFIELD, EXAMINING ATTORNEY



David J. Kyffers

Director of the United States Patent and Trademark Office

United States of America

United States Patent and Trademark Office



Reg. No. 4,073,921

PINELAND FARMS, INC. (MAINE NON-PROFIT CORPORATION)
32 FARM VIEW DRIVE
NEW GLOUCESTER, ME 04260

Registered Dec. 20, 2011

Int. Cl.: 29

FOR: PACKAGED FRESH AND FROZEN MEAT AND FROZEN ENTREES CONSISTING
PRIMARILY OF MEAT, FISH, POULTRY, OR VEGETABLES, IN CLASS 29 (U.S. CL. 46).

TRADEMARK

FIRST USE 6-30-2010; IN COMMERCE 6-30-2010.

PRINCIPAL REGISTER

NO CLAIM IS MADE TO THE EXCLUSIVE RIGHT TO USE "FARMS", "NATURAL" AND
"MEATS", APART FROM THE MARK AS SHOWN.

THE COLOR(S) GREEN, RED, YELLOW, BROWN, GRAY AND WHITE IS/ARE CLAIMED
AS A FEATURE OF THE MARK.

THE MARK CONSISTS OF A WHITE BACKGROUND CONTAINED WITHIN A RECTANGLE
WITH THE WORDS "PINELAND FARMS NATURAL MEATS" IN RED AND STYLIZED
BARN IN RED, WHITE AND GRAY, SILOS IN GRAY, FARMHOUSE BUILDINGS IN
YELLOW AND GRAY, TREES AND A FIELD IN GREEN, A ROAD IN GREEN AND BROWN
AND A SKY IN YELLOW WITHIN A STYLIZED OVAL.

SER. NO. 85-315,442, FILED 5-9-2011.

PAM WILLIS, EXAMINING ATTORNEY



David J. Kyros

Director of the United States Patent and Trademark Office

United States of America

United States Patent and Trademark Office

Linkterest

Reg. No. 4,073,922

CHRISTOPHERSEN, JOSHUA (UNITED STATES INDIVIDUAL)
3741 WALNUT ST
KANSAS CITY, MO 64111

Registered Dec. 20, 2011

Int. Cl.: 42

FOR: COMPUTER SERVICES, NAMELY, CREATING AN ON-LINE COMMUNITY FOR REGISTERED USERS TO DISCOVER AND SHARE LINKS THAT THEY ARE INTERESTED IN, IN CLASS 42 (U.S. CLS. 100 AND 101).

SERVICE MARK

FIRST USE 1-21-2009; IN COMMERCE 2-8-2011.

PRINCIPAL REGISTER

THE MARK CONSISTS OF STANDARD CHARACTERS WITHOUT CLAIM TO ANY PARTICULAR FONT, STYLE, SIZE, OR COLOR.

SER. NO. 85-315,504, FILED 5-9-2011.

KIM SAITO, EXAMINING ATTORNEY



David J. Kybas

Director of the United States Patent and Trademark Office

United States of America

United States Patent and Trademark Office

YES! Youth Engaged in Science

Reg. No. 4,073,923

YES! YOUTH ENGAGED IN SCIENCE LLC (GEORGIA LIMITED LIABILITY COMPANY)
4275 AUTUMN CT
CANTON, GA 30114

Registered Dec. 20, 2011

Int. Cl.: 41

FOR: ACADEMIC ENRICHMENT PROGRAMS IN THE FIELD(S) OF SCIENCE, TECHNOLOGY, ENGINEERING AND MATH, IN CLASS 41 (U.S. CLS. 100, 101 AND 107).

SERVICE MARK

FIRST USE 3-4-2008; IN COMMERCE 3-4-2008.

PRINCIPAL REGISTER

THE MARK CONSISTS OF STANDARD CHARACTERS WITHOUT CLAIM TO ANY PARTICULAR FONT, STYLE, SIZE, OR COLOR.

SER. NO. 85-315,533, FILED 5-9-2011.

REBECCA EISINGER, EXAMINING ATTORNEY



David J. Kybas

Director of the United States Patent and Trademark Office

United States of America

United States Patent and Trademark Office



Reg. No. 4,073,924

DETROIT SERVICE LEARNING ACADEMY (MICHIGAN NON-PROFIT ORGANIZATION)
21605 WEST SEVEN MILE ROAD
DETROIT, MI 48219

Registered Dec. 20, 2011

Int. Cl.: 41

FOR: EDUCATION SERVICES, NAMELY, PROVIDING PRE-KINDERGARTEN THROUGH 8TH GRADE CLASSROOM INSTRUCTION, IN CLASS 41 (U.S. CLS. 100, 101 AND 107).

SERVICE MARK

FIRST USE 8-1-2009; IN COMMERCE 8-1-2009.

PRINCIPAL REGISTER

NO CLAIM IS MADE TO THE EXCLUSIVE RIGHT TO USE "DETROIT SERVICE LEARNING ACADEMY", APART FROM THE MARK AS SHOWN.

THE MARK CONSISTS OF AN IMAGE OF A MAN, HIS BODY IS MADE UP OF TWO CURVED LINES AND HIS HEAD IS A CIRCLE. HE HOLDS A FLAG, THE FLAG POLE CONSIST OF THREE WAVY LINES. TO THE RIGHT THERE IS THE STYLIZED TEXT "DETROIT SERVICE LEARNING ACADEMY".

SER. NO. 85-315,564, FILED 5-9-2011.

BILL DAWE, EXAMINING ATTORNEY



David J. Kyffers

Director of the United States Patent and Trademark Office

United States of America

United States Patent and Trademark Office

Side Styles

Reg. No. 4,073,925

Registered Dec. 20, 2011

Int. Cl.: 12

TRADEMARK

PRINCIPAL REGISTER

GREENLIGHT LLC (INDIANA LIMITED LIABILITY COMPANY), DBA GREENLIGHT
COLLECTIBLES
2605 E. 55TH PLACE
INDIANAPOLIS, IN 46231

FOR: AFTERMARKET AUTOMOBILE ACCESSORIES, NAMELY, DECORATIVE SIDEVIEW
MIRROR COVERS, IN CLASS 12 (U.S. CLS. 19, 21, 23, 31, 35 AND 44).

FIRST USE 4-21-2011; IN COMMERCE 4-21-2011.

THE MARK CONSISTS OF STANDARD CHARACTERS WITHOUT CLAIM TO ANY PAR-
TICULAR FONT, STYLE, SIZE, OR COLOR.

SER. NO. 85-315,654, FILED 5-9-2011.

DEBRA LEE, EXAMINING ATTORNEY



David J. Kyffers

Director of the United States Patent and Trademark Office

United States of America

United States Patent and Trademark Office



Reg. No. 4,073,926

Registered Dec. 20, 2011

Int. Cl.: 9

TRADEMARK

PRINCIPAL REGISTER

PREMIERE HOTEL CONCEPTS, LLC (WISCONSIN LIMITED LIABILITY COMPANY)
3170 SOUTH 7TH STREET
MILWAUKEE, WI 53215

FOR: INTERACTIVE HIGH DEFINITION COMPUTER KIOSKS COMPRISING COMPUTERS, COMPUTER HARDWARE, COMPUTER PERIPHERALS, AND COMPUTER OPERATING SOFTWARE, FOR USE IN HOTELS, CONVENTION CENTERS CAMPUSES, OR WHEREVER PEOPLE CONGREGATE, PROVIDING USERS WITH TRAVEL INFORMATION, DIRECT LINKS TO AIRPORTS, INTERNET ACCESS, GAMES AND ADVERTISEMENTS, AND ALLOWING USERS TO PRINT MAPS, DIRECTIONS, BOARDING PASSES, AND MAKE PURCHASES DIRECT FROM THE KIOSK, IN CLASS 9 (U.S. CLS. 21, 23, 26, 36 AND 38).

FIRST USE 10-29-2008; IN COMMERCE 10-29-2008.

THE MARK CONSISTS OF THREE LOWERCASE LETTERS, "A", "V", AND "U". THE "U" IS TOPPED WITH AN UMLAUT. THE THREE LETTERS ARE ENCASED INSIDE A BORDERLESS OVAL. THE TOP OF THE OVAL LEANS RIGHT.

SER. NO. 85-315,688, FILED 5-9-2011.

ANDREW LEASER, EXAMINING ATTORNEY



David J. Kybas

Director of the United States Patent and Trademark Office

United States of America

United States Patent and Trademark Office

COTTONWOOD ANIMAL HOSPITAL

Reg. No. 4,073,927

Registered Dec. 20, 2011

Int. Cl.: 44

SERVICE MARK

PRINCIPAL REGISTER

COTTONWOOD ANIMAL HOSPITAL (UTAH CORPORATION)
6360 HIGHLAND DRIVE
SALT LAKE CITY, UT 84121

FOR: VETERINARY SERVICES, IN CLASS 44 (U.S. CLS. 100 AND 101).

FIRST USE 1-1-1987; IN COMMERCE 1-1-1987.

THE MARK CONSISTS OF STANDARD CHARACTERS WITHOUT CLAIM TO ANY PARTICULAR FONT, STYLE, SIZE, OR COLOR.

NO CLAIM IS MADE TO THE EXCLUSIVE RIGHT TO USE "ANIMAL HOSPITAL", APART FROM THE MARK AS SHOWN.

SER. NO. 85-315,729, FILED 5-9-2011.

KIMBERLY PERRY, EXAMINING ATTORNEY



David J. Kybas

Director of the United States Patent and Trademark Office

United States of America

United States Patent and Trademark Office

Hip Hop Arsenal

Reg. No. 4,073,928

Registered Dec. 20, 2011

Int. Cl.: 41

SERVICE MARK

PRINCIPAL REGISTER

URBAN DYNAMICS LLC (NEW YORK LIMITED LIABILITY COMPANY)
#5B
5635 NETHERLAND AVENUE
BRONX, NY 10471

FOR: PROVIDING A WEBSITE FEATURING NON-DOWNLOADABLE PHOTOGRAPHIC, AUDIO, AND VIDEO PRESENTATIONS IN THE FIELD OF MUSIC AND LYRICS, IN CLASS 41 (U.S. CLS. 100, 101 AND 107).

FIRST USE 11-10-2010; IN COMMERCE 3-11-2011.

THE MARK CONSISTS OF STANDARD CHARACTERS WITHOUT CLAIM TO ANY PARTICULAR FONT, STYLE, SIZE, OR COLOR.

NO CLAIM IS MADE TO THE EXCLUSIVE RIGHT TO USE "HIP HOP", APART FROM THE MARK AS SHOWN.

SER. NO. 85-315,743, FILED 5-9-2011.

RONALD MCMORROW, EXAMINING ATTORNEY



David J. Kyffers

Director of the United States Patent and Trademark Office

United States of America

United States Patent and Trademark Office

AMERICAN MUSCLE

Reg. No. 4,073,929

Registered Dec. 20, 2011

Int. Cl.: 28

TRADEMARK

PRINCIPAL REGISTER

SCIENTIFIC GAMES INTERNATIONAL, INC. (DELAWARE CORPORATION)
1500 BLUEGRASS LAKES PARKWAY
ALPHARETTA, GA 30004

FOR: PRINTED LOTTERY TICKETS, IN CLASS 28 (U.S. CLS. 22, 23, 38 AND 50).

FIRST USE 5-2-2011; IN COMMERCE 5-2-2011.

THE MARK CONSISTS OF STANDARD CHARACTERS WITHOUT CLAIM TO ANY PARTICULAR FONT, STYLE, SIZE, OR COLOR.

OWNER OF U.S. REG. NO. 3,954,466.

NO CLAIM IS MADE TO THE EXCLUSIVE RIGHT TO USE "AMERICAN", APART FROM THE MARK AS SHOWN.

SER. NO. 85-315,752, FILED 5-9-2011.

STEPHANIE ALI, EXAMINING ATTORNEY



David J. Kyffers

Director of the United States Patent and Trademark Office

United States of America

United States Patent and Trademark Office

FRANKLIN PAINT

Reg. No. 4,073,930

FRANKLIN PAINT COMPANY, INC. (MASSACHUSETTS CORPORATION)
259 COTTAGE STREET
FRANKLIN, MA 02038

Registered Dec. 20, 2011

Int. Cl.: 2

FOR: PAINTS FOR MARKING ROAD SURFACES AND ATHLETIC FIELDS, IN CLASS 2
(U.S. CLS. 6, 11 AND 16).

TRADEMARK

FIRST USE 12-31-1947; IN COMMERCE 12-31-1947.

PRINCIPAL REGISTER

THE MARK CONSISTS OF STANDARD CHARACTERS WITHOUT CLAIM TO ANY PARTICULAR FONT, STYLE, SIZE, OR COLOR.

NO CLAIM IS MADE TO THE EXCLUSIVE RIGHT TO USE "PAINT", APART FROM THE MARK AS SHOWN.

SER. NO. 85-315,753, FILED 5-9-2011.

STEPHANIE ALI, EXAMINING ATTORNEY



David J. Kybas

Director of the United States Patent and Trademark Office

United States of America

United States Patent and Trademark Office

TEAZE PARLOUR

Reg. No. 4,073,931

TAMARA CIASULLI (UNITED STATES INDIVIDUAL)
4 GLANNON ROAD
LIVINGSTON, NJ 07039

Registered Dec. 20, 2011

Int. Cl.: 44

FOR: BEAUTY CARE, NAMELY, HAIRCUTS, HAIR STYLING, HAIR COLORING, HAIR HIGHLIGHTS, MAKE UP, AND HAIR EXTENSIONS, IN CLASS 44 (U.S. CLS. 100 AND 101).

SERVICE MARK

FIRST USE 3-3-2011; IN COMMERCE 3-3-2011.

PRINCIPAL REGISTER

THE MARK CONSISTS OF STANDARD CHARACTERS WITHOUT CLAIM TO ANY PARTICULAR FONT, STYLE, SIZE, OR COLOR.

NO CLAIM IS MADE TO THE EXCLUSIVE RIGHT TO USE "PARLOUR", APART FROM THE MARK AS SHOWN.

SER. NO. 85-315,787, FILED 5-9-2011.

ELI HELLMAN, EXAMINING ATTORNEY



David J. Kybas

Director of the United States Patent and Trademark Office

United States of America

United States Patent and Trademark Office

REHAB 1000

Reg. No. 4,073,932

Registered Dec. 20, 2011

Int. Cls.: 3 and 5

TRADEMARK

PRINCIPAL REGISTER

LONGEVITY NETWORK, LLC (NEVADA LIMITED LIABILITY COMPANY)
SUITE 401
2764 N GREEN VALLEY PKWY
HENDERSON, NV 89014

FOR: MASSAGE CREAMS; NON-MEDICATED SKIN CREAMS, IN CLASS 3 (U.S. CLS. 1, 4, 6, 50, 51 AND 52).

FIRST USE 5-1-2009; IN COMMERCE 2-15-2010.

FOR: SPORTS CREAM FOR RELIEF OF PAIN, IN CLASS 5 (U.S. CLS. 6, 18, 44, 46, 51 AND 52).

FIRST USE 5-1-2009; IN COMMERCE 2-15-2010.

THE MARK CONSISTS OF STANDARD CHARACTERS WITHOUT CLAIM TO ANY PARTICULAR FONT, STYLE, SIZE, OR COLOR.

SER. NO. 85-315,799, FILED 5-9-2011.

JACLYN KIDWELL WALKER, EXAMINING ATTORNEY



David J. Kybas

Director of the United States Patent and Trademark Office

United States of America

United States Patent and Trademark Office

TURNING YOUR IDEAS INTO PLASTIC

Reg. No. 4,073,933

METRO CUSTOM PLASTICS, INC. (TEXAS CORPORATION)
615 109TH STREET
ARLINGTON, TX 76011

Registered Dec. 20, 2011

Int. Cl.: 40

FOR: MANUFACTURING SERVICES, NAMELY, CUSTOM PLASTIC INJECTION MOLDING SERVICES, CUSTOM PLASTIC ROTATIONAL MOLDING SERVICES, CUSTOM PLASTIC EXTRUSION SERVICES AND CUSTOM PLASTIC STAMPING SERVICES, IN CLASS 40 (U.S. CLS. 100, 103 AND 106).

SERVICE MARK

PRINCIPAL REGISTER

FIRST USE 10-1-2002; IN COMMERCE 10-1-2002.

THE MARK CONSISTS OF STANDARD CHARACTERS WITHOUT CLAIM TO ANY PARTICULAR FONT, STYLE, SIZE, OR COLOR.

SER. NO. 85-315,800, FILED 5-9-2011.

JACLYN KIDWELL WALKER, EXAMINING ATTORNEY



David J. Kybas

Director of the United States Patent and Trademark Office

United States of America
United States Patent and Trademark Office

ICUT-PRO

Reg. No. 4,073,934

Registered Dec. 20, 2011

Int. Cl.: 8

TRADEMARK

PRINCIPAL REGISTER

DEXTER-RUSSELL, INC. (MASSACHUSETTS CORPORATION)
44 RIVER STREET
SOUTHBRIDGE, MA 01550

FOR: HAND TOOLS, NAMELY, FORGED KNIVES, IN CLASS 8 (U.S. CLS. 23, 28 AND 44).

FIRST USE 12-24-2010; IN COMMERCE 12-24-2010.

THE MARK CONSISTS OF STANDARD CHARACTERS WITHOUT CLAIM TO ANY PARTICULAR FONT, STYLE, SIZE, OR COLOR.

OWNER OF U.S. REG. NOS. 3,427,646, 3,427,733, AND 3,454,684.

SER. NO. 85-315,823, FILED 5-9-2011.

JAY BESCH, EXAMINING ATTORNEY



David J. Kyffers

Director of the United States Patent and Trademark Office

United States of America

United States Patent and Trademark Office

Chef Joe Youkhan's Tasting Spoon

Reg. No. 4,073,935

Registered Dec. 20, 2011

Int. Cl.: 43

SERVICE MARK

PRINCIPAL REGISTER

CHEF JOE YOUKHAN'S TASTING SPOON, LLC (CALIFORNIA LIMITED LIABILITY COMPANY)
P.O. BOX 832
TRABUCO CANYON, CA 92678

FOR: CATERING; PROVIDING OF FOOD AND DRINK VIA A MOBILE TRUCK, IN CLASS 43 (U.S. CLS. 100 AND 101).

FIRST USE 3-0-2011; IN COMMERCE 3-0-2011.

THE MARK CONSISTS OF STANDARD CHARACTERS WITHOUT CLAIM TO ANY PARTICULAR FONT, STYLE, SIZE, OR COLOR.

THE NAME(S), PORTRAIT(S), AND/OR SIGNATURE(S) SHOWN IN THE MARK IDENTIFIES JOE YOUKHAN, WHOSE CONSENT(S) TO REGISTER IS MADE OF RECORD.

SER. NO. 85-315,829, FILED 5-9-2011.

JAY BESCH, EXAMINING ATTORNEY



David J. Kyffers

Director of the United States Patent and Trademark Office

United States of America

United States Patent and Trademark Office

ANY NEED. ANY SPEED.
GUARANTEED.

Reg. No. 4,073,936

YRC WORLDWIDE INC. (DELAWARE CORPORATION)

Registered Dec. 20, 2011

10990 ROE AVENUE
OVERLAND PARK, KS 66211

Int. Cls.: 35 and 39

SERVICE MARK

PRINCIPAL REGISTER

FOR: BUSINESS CONSULTING SERVICES RELATING TO PRODUCT DISTRIBUTION, OPERATIONS MANAGEMENT SERVICES, LOGISTICS, REVERSE LOGISTICS, SUPPLY CHAIN, AND PRODUCTION SYSTEMS AND DISTRIBUTION SOLUTIONS; BUSINESS MANAGEMENT SERVICES, NAMELY, MANAGING LOGISTICS, REVERSE LOGISTICS, SUPPLY CHAIN SERVICES, SUPPLY CHAIN VISIBILITY AND SYNCHRONIZATION, SUPPLY AND DEMAND FORECASTING AND PRODUCT DISTRIBUTION PROCESSES FOR OTHERS; TRANSPORTATION LOGISTICS SERVICES, NAMELY, ARRANGING THE TRANSPORTATION OF GOODS FOR OTHERS; TRANSPORTATION LOGISTICS SERVICES, NAMELY, PLANNING AND SCHEDULING SHIPMENTS FOR USERS OF TRANSPORTATION SERVICES; COMPUTERIZED TRACKING AND TRACING OF PACKAGES IN TRANSIT; INFORMATION MANAGEMENT SERVICES, NAMELY, SHIPMENT PROCESSING, PREPARING SHIPPING DOCUMENTS AND INVOICES, TRACKING DOCUMENTS, PACKAGES AND FREIGHT OVER COMPUTER NETWORKS, INTRANETS AND INTERNETS; MONITORING AND TRACKING OF PACKAGE SHIPMENTS; PROVIDING ELECTRONIC TRACKING OF FREIGHT INFORMATION TO OTHERS; TRACKING, LOCATING AND MONITORING OF VEHICLES, MARITIME VESSELS AND AIRCRAFT SERVICES FOR COMMERCIAL PURPOSES; CUSTOMS CLEARANCE SERVICES; ARRANGING FOR PICKUP, DELIVERY, STORAGE AND TRANSPORTATION OF DOCUMENTS, PACKAGES, FREIGHT AND PARCELS VIA GROUND AND AIR CARRIERS; ORDER FULFILLMENT SERVICES, IN CLASS 35 (U.S. CLS. 100, 101 AND 102).



FIRST USE 4-19-2011; IN COMMERCE 4-19-2011.

FOR: DOMESTIC AND INTERNATIONAL COMMON CARRIER FREIGHT TRANSPORTATION BY MEANS OF TRUCK, AIR, OR SEA, AND DOMESTIC AND INTERNATIONAL FREIGHT FORWARDING SERVICES; SUPPLY CHAIN, LOGISTICS AND REVERSE LOGISTICS SERVICES, NAMELY, STORAGE, TRANSPORTATION AND DELIVERY OF DOCUMENTS, PACKAGES, RAW MATERIALS, AND OTHER FREIGHT FOR OTHERS BY AIR, RAIL, SHIP OR TRUCK; WAREHOUSING SERVICES, NAMELY, STORAGE, DISTRIBUTION, PICK-UP, AND PACKING FOR SHIPMENT OF DOCUMENTS, PACKAGES, RAW MATERIALS, AND OTHER FREIGHT FOR OTHERS, IN CLASS 39 (U.S. CLS. 100 AND 105).

David J. Kyffers

Director of the United States Patent and Trademark Office

FIRST USE 4-19-2011; IN COMMERCE 4-19-2011.

Reg. No. 4,073,936 THE MARK CONSISTS OF STANDARD CHARACTERS WITHOUT CLAIM TO ANY PARTICULAR FONT, STYLE, SIZE, OR COLOR.

SER. NO. 85-315,834, FILED 5-9-2011.

JAY BESCH, EXAMINING ATTORNEY

United States of America

United States Patent and Trademark Office

AMERICA'S #1 GOLF LESSON

Reg. No. 4,073,937

Registered Dec. 20, 2011

Int. Cl.: 41

SERVICE MARK

PRINCIPAL REGISTER

GOLFTEC INTELLECTUAL PROPERTY LLC (COLORADO LIMITED LIABILITY COMPANY)
12450 E. ARAPAHOE ROAD, #B
CENTENNIAL, CO 80112

FOR: GOLF INSTRUCTION, FEATURING DIGITAL VIDEO AND MOTION ANALYSIS COMPUTERS WHICH UTILIZE A PROPRIETARY DATABASE OF THE SWINGS OF TOP TOUR PROFESSIONALS; CORPORATE ENTERTAINMENT SERVICES, NAMELY, CONDUCTING GOLF CONTESTS; AND CUSTOM FITTING OF GOLF CLUBS TO INDIVIDUALS USERS, IN CLASS 41 (U.S. CLS. 100, 101 AND 107).

FIRST USE 2-28-2002; IN COMMERCE 2-28-2002.

THE MARK CONSISTS OF STANDARD CHARACTERS WITHOUT CLAIM TO ANY PARTICULAR FONT, STYLE, SIZE, OR COLOR.

NO CLAIM IS MADE TO THE EXCLUSIVE RIGHT TO USE "GOLF LESSON", APART FROM THE MARK AS SHOWN.

SEC. 2(F).

SER. NO. 85-315,873, FILED 5-9-2011.

DOMINIC J. FERRAIUOLO, EXAMINING ATTORNEY



David J. Kybas

Director of the United States Patent and Trademark Office

United States of America

United States Patent and Trademark Office

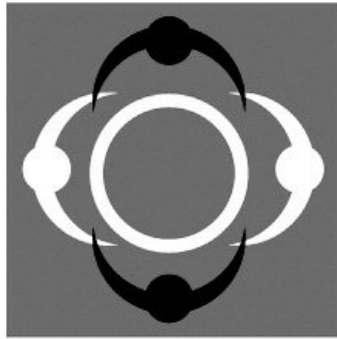

GGBC
GLOBAL GIVE BACK CIRCLE

Reg. No. 4,073,938

Registered Dec. 20, 2011

Int. Cl.: 35

SERVICE MARK

PRINCIPAL REGISTER

GLOBAL GIVE BACK CIRCLE (TEXAS UNINCORPORATED ASSOCIATION)
400 EAST 59TH STREET, SUITE 12B
NEW YORK, NY 10022

FOR: CHARITABLE SERVICES, NAMELY, ORGANIZING AND CONDUCTING VOLUNTEER PROGRAMS FOR THE MENTORING OF DISADVANTAGED YOUTH IN THE AREAS OF PROFESSIONAL LEADERSHIP, PERSONAL DEVELOPMENT, CHARACTER, EMPLOYMENT READINESS, AND CITIZENSHIP, AND RECRUITING PRIVATE SECTOR VOLUNTEERS TO PARTICIPATE IN SUCH PROGRAMS AND PROMOTING PUBLIC AWARENESS OF THE NEED FOR MENTORING DISADVANTAGED YOUTH, IN CLASS 35 (U.S. CLS. 100, 101 AND 102).

FIRST USE 10-0-2007; IN COMMERCE 10-0-2007.

NO CLAIM IS MADE TO THE EXCLUSIVE RIGHT TO USE "GLOBAL", APART FROM THE MARK AS SHOWN.

THE MARK CONSISTS OF THE LETTERS "GGBC" AND THE WORDS "GLOBAL GIVE BACK CIRCLE" WITH FOUR (2 LIGHT AND 2 DARK) INTERLOCKING HUMAN FIGURES FORMING A CIRCLE AROUND A CIRCLE TO THE LEFT OF THE WORDS. THE FIGURES APPEAR ON A SHADED SQUARE BACKGROUND.

SER. NO. 85-315,903, FILED 5-9-2011.

KIMBERLY FRYE, EXAMINING ATTORNEY



David J. Kybas

Director of the United States Patent and Trademark Office

United States of America

United States Patent and Trademark Office

ESV GreekTools

Reg. No. 4,073,939

Registered Dec. 20, 2011

Int. Cl.: 45

SERVICE MARK

PRINCIPAL REGISTER

GOOD NEWS PUBLISHERS (ILLINOIS NON-PROFIT CORPORATION)
1300 CRESCENT ST.
WHEATON, IL 60187

FOR: PROVIDING AN ON-LINE COMPUTER DATABASE IN THE FIELD OF RELIGION,
IN CLASS 45 (U.S. CLS. 100 AND 101).

FIRST USE 4-12-2011; IN COMMERCE 4-12-2011.

THE MARK CONSISTS OF STANDARD CHARACTERS WITHOUT CLAIM TO ANY PAR-
TICULAR FONT, STYLE, SIZE, OR COLOR.

OWNER OF U.S. REG. NOS. 3,746,832, 3,746,835 AND OTHERS.

SER. NO. 85-315,939, FILED 5-9-2011.

RONALD AIKENS, EXAMINING ATTORNEY



David J. Kyffers

Director of the United States Patent and Trademark Office

United States of America

United States Patent and Trademark Office

THE THIRD FLOOR

Reg. No. 4,073,940

THE THIRD FLOOR, INC. (CALIFORNIA CORPORATION)
5410 WILSHIRE BLVD., SUITE 1000
LOS ANGELES, CA 90034

Registered Dec. 20, 2011

Int. Cl.: 41

FOR: MOTION PICTURE FILM PRODUCTION, IN CLASS 41 (U.S. CLS. 100, 101 AND 107).

SERVICE MARK

FIRST USE 10-1-2004; IN COMMERCE 10-1-2004.

PRINCIPAL REGISTER

THE MARK CONSISTS OF STANDARD CHARACTERS WITHOUT CLAIM TO ANY PARTICULAR FONT, STYLE, SIZE, OR COLOR.

SER. NO. 85-315,955, FILED 5-9-2011.

FONG HSU, EXAMINING ATTORNEY



David J. Kybas

Director of the United States Patent and Trademark Office

United States of America

United States Patent and Trademark Office

AUDUBON

Reg. No. 4,073,941

NATIONAL AUDUBON SOCIETY, INC. (NEW YORK CORPORATION)
225 VARICK STREET, 7TH FLOOR
NEW YORK, NY 10014

Registered Dec. 20, 2011

Int. Cl.: 21

FOR: BIRDBATHS, IN CLASS 21 (U.S. CLS. 2, 13, 23, 29, 30, 33, 40 AND 50).

TRADEMARK

FIRST USE 6-7-2002; IN COMMERCE 6-7-2002.

PRINCIPAL REGISTER

THE MARK CONSISTS OF STANDARD CHARACTERS WITHOUT CLAIM TO ANY PARTICULAR FONT, STYLE, SIZE, OR COLOR.

OWNER OF U.S. REG. NOS. 1,190,696, 3,786,249 AND OTHERS.

SER. NO. 85-316,077, FILED 5-9-2011.

AMY C. KEAN, EXAMINING ATTORNEY



David J. Kappas

Director of the United States Patent and Trademark Office

United States of America

United States Patent and Trademark Office

SOLARSTAFF

Reg. No. 4,073,942

MEMSTAFF INC. (MASSACHUSETTS CORPORATION)
8 PINE STREET
NEWBURYPORT, MA 01950

Registered Dec. 20, 2011

Int. Cl.: 35

FOR: EMPLOYMENT AGENCY SERVICES, IN CLASS 35 (U.S. CLS. 100, 101 AND 102).

SERVICE MARK

FIRST USE 8-25-2008; IN COMMERCE 8-25-2008.

PRINCIPAL REGISTER

THE MARK CONSISTS OF STANDARD CHARACTERS WITHOUT CLAIM TO ANY PARTICULAR FONT, STYLE, SIZE, OR COLOR.

SEC. 2(F).

SER. NO. 85-316,092, FILED 5-9-2011.

JERI J. FICKES, EXAMINING ATTORNEY



David J. Kyffers

Director of the United States Patent and Trademark Office

United States of America

United States Patent and Trademark Office

Silent Single Coil (SSC)

Reg. No. 4,073,943

JS TECHNOLOGIES INC. (CALIFORNIA CORPORATION)
601 CRANE STREET,
LAKE ELSINORE., CA 92530

Registered Dec. 20, 2011

Int. Cl.: 9

FOR: NOISE CANCELLING SYSTEM COMPRISED OF NOISE CANCELLING PICKUPS FOR ELECTRIC GUITARS AND ELECTRIC BASS GUITARS, IN CLASS 9 (U.S. CLS. 21, 23, 26, 36 AND 38).

TRADEMARK

FIRST USE 7-0-2005; IN COMMERCE 7-0-2005.

PRINCIPAL REGISTER

THE MARK CONSISTS OF STANDARD CHARACTERS WITHOUT CLAIM TO ANY PARTICULAR FONT, STYLE, SIZE, OR COLOR.

NO CLAIM IS MADE TO THE EXCLUSIVE RIGHT TO USE "SILENT SINGLE COIL", APART FROM THE MARK AS SHOWN.

SER. NO. 85-316,184, FILED 5-9-2011.

KATHY DE JONGE, EXAMINING ATTORNEY



David J. Kyffers

Director of the United States Patent and Trademark Office

United States of America

United States Patent and Trademark Office

It Pays To Be Informed In Life

Reg. No. 4,073,944

Registered Dec. 20, 2011

Int. Cl.: 36

SERVICE MARK

PRINCIPAL REGISTER

BYRON UDELL & ASSOCIATES, INC. (CALIFORNIA CORPORATION)
BUILDING 500
1400 S. WOLF ROAD
WHEELING, IL 60090

FOR: LIFE INSURANCE BROKERAGE, IN CLASS 36 (U.S. CLS. 100, 101 AND 102).

FIRST USE 1-1-1999; IN COMMERCE 1-1-1999.

THE MARK CONSISTS OF STANDARD CHARACTERS WITHOUT CLAIM TO ANY PARTICULAR FONT, STYLE, SIZE, OR COLOR.

SER. NO. 85-316,213, FILED 5-9-2011.

BRIAN PINO, EXAMINING ATTORNEY



David J. Kyffers

Director of the United States Patent and Trademark Office

United States of America

United States Patent and Trademark Office

Backplate Silent Single Coil (BPSSC)

Reg. No. 4,073,945

Registered Dec. 20, 2011

Int. Cl.: 9

TRADEMARK

PRINCIPAL REGISTER

JS TECHNOLOGIES INC. (CALIFORNIA CORPORATION)
601 CRANE STREET,
LAKE ELSINORE, CA 92530

FOR: NOISE CANCELLING SYSTEM COMPRISED OF NOISE CANCELLING PICKUPS FOR ELECTRIC GUITARS AND ELECTRIC BASS GUITARS, IN CLASS 9 (U.S. CLS. 21, 23, 26, 36 AND 38).

FIRST USE 7-0-2005; IN COMMERCE 7-0-2005.

THE MARK CONSISTS OF STANDARD CHARACTERS WITHOUT CLAIM TO ANY PARTICULAR FONT, STYLE, SIZE, OR COLOR.

NO CLAIM IS MADE TO THE EXCLUSIVE RIGHT TO USE "BACKPLATE SILENT SINGLE COIL", APART FROM THE MARK AS SHOWN.

SER. NO. 85-316,217, FILED 5-9-2011.

KATHY DE JONGE, EXAMINING ATTORNEY



David J. Kyffers

Director of the United States Patent and Trademark Office

United States of America

United States Patent and Trademark Office

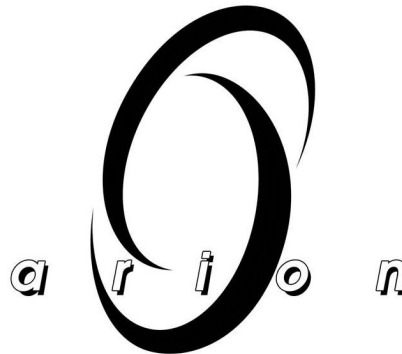

Reg. No. 4,073,946

Registered Dec. 20, 2011

Int. Cl.: 42

SERVICE MARK

PRINCIPAL REGISTER

ARION INTERNATIONAL INCORPORATED (CALIFORNIA CORPORATION)
2391 S. BATEMAN AVE.
IRWINDALE, CA 91010

FOR: BARCODE RELATED SERVICES, NAMELY THE DESIGN AND MANAGEMENT OF BARCODE BASED INFORMATION SYSTEMS FOR OTHERS, HOSTING ONLINE WEB FACILITIES FOR OTHERS FOR BARCODE BASED COMMUNICATIONS WITH CUSTOMERS AND PROSPECTS; APPLICATION SERVICE PROVIDER, NAMELY, HOSTING, MANAGING, DEVELOPING, AND MAINTAINING APPLICATIONS, SOFTWARE, AND WEBSITES, IN THE FIELDS OF BARCODE BASED ADVERTISING, MARKETING, CUSTOMER EDUCATION, AND AFTER SALES SERVICES, IN CLASS 42 (U.S. CLS. 100 AND 101).

FIRST USE 12-23-2010; IN COMMERCE 12-23-2010.

THE MARK CONSISTS OF THE WORD "ARION" AND TWO OPPOSITE-FACING CRESCENTS. THE WORD "ARION" IS STYLIZED IN OUTLINED TEXT, WITH A DROP SHADOW BEHIND EACH LETTER. THE CRESCENTS ARE ORIENTED SUCH THAT THEY ROUGHLY FORM A TILTED OVAL AROUND THE LETTERS "RI", WITH THE LETTERS "RI" SITUATED INSIDE THE BOTTOM OF THE OVAL.

SER. NO. 85-316,228, FILED 5-9-2011.

KELLY TRUSILO, EXAMINING ATTORNEY



David J. Kybas

Director of the United States Patent and Trademark Office

United States of America

United States Patent and Trademark Office

ETWATER

Reg. No. 4,073,947

Registered Dec. 20, 2011

Int. Cls.: 9 and 42

TRADEMARK

SERVICE MARK

PRINCIPAL REGISTER

ET WATER SYSTEMS, INC. (DELAWARE CORPORATION)
SUITE 145
384 BEL MARIN KEYS BLVD.
NOVATO, CA 94949

FOR: ELECTRONIC APPARATUS, FIRMWARE, AND SOFTWARE, ALL FOR USE IN ACCESSING WEATHER INFORMATION, AND IN MONITORING AND CONTROLLING IRRIGATION SYSTEMS, IN CLASS 9 (U.S. CLS. 21, 23, 26, 36 AND 38).

FIRST USE 12-12-2004; IN COMMERCE 12-12-2004.

FOR: SOFTWARE AS A SERVICE (SAAS) SERVICES, NAMELY, HOSTING SOFTWARE FOR USE BY OTHERS FOR USE IN ACCESSING WEATHER INFORMATION, AND IN MONITORING AND CONTROLLING IRRIGATION SYSTEMS, IN CLASS 42 (U.S. CLS. 100 AND 101).

FIRST USE 12-12-2004; IN COMMERCE 12-12-2004.

THE MARK CONSISTS OF STANDARD CHARACTERS WITHOUT CLAIM TO ANY PARTICULAR FONT, STYLE, SIZE, OR COLOR.

SER. NO. 85-316,255, FILED 5-9-2011.

EDWARD NELSON, EXAMINING ATTORNEY



David J. Kyros

Director of the United States Patent and Trademark Office

United States of America

United States Patent and Trademark Office



Reg. No. 4,073,948

SIEGE USA (CALIFORNIA LIMITED LIABILITY COMPANY)
45698 SHASTA LN
TEMECULA, CA 92592

Registered Dec. 20, 2011

Int. Cl.: 35

FOR: RETAIL STORE SERVICES FEATURING A WIDE VARIETY OF CONSUMER GOODS OF OTHERS, IN CLASS 35 (U.S. CLS. 100, 101 AND 102).

SERVICE MARK

FIRST USE 3-7-2011; IN COMMERCE 3-7-2011.

PRINCIPAL REGISTER

NO CLAIM IS MADE TO THE EXCLUSIVE RIGHT TO USE "USA LLC", APART FROM THE MARK AS SHOWN.

THE STIPPLING IS FOR SHADING PURPOSES ONLY.

THE MARK CONSISTS OF A CREST WITH A SKULL AND WINGS IN THE CENTER. IN FRONT THERE IS THE STYLIZED TEXT "SIEGE USA LLC".

SER. NO. 85-316,297, FILED 5-9-2011.

ANNE E. GUSTASON, EXAMINING ATTORNEY



David J. Kybas

Director of the United States Patent and Trademark Office

United States of America

United States Patent and Trademark Office

THE CALL CENTER GROUP A-Z

Reg. No. 4,073,949

THE CALL CENTER GROUP A-Z , LLC (ARIZONA LIMITED LIABILITY COMPANY)
11811 N. TATUM BLVD. SUITE 3031

Registered Dec. 20, 2011

PHOENIX, AZ 85028

Int. Cl.: 35

FOR: MANAGER AND EXECUTIVE RECRUITING SERVICES; PROFESSIONAL STAFFING AND RECRUITING SERVICES; EMPLOYMENT RECRUITING AND STAFFING SERVICES , IN CLASS 35 (U.S. CLS. 100, 101 AND 102).

SERVICE MARK

FIRST USE 11-1-2006; IN COMMERCE 11-1-2006.

PRINCIPAL REGISTER

THE MARK CONSISTS OF STANDARD CHARACTERS WITHOUT CLAIM TO ANY PARTICULAR FONT, STYLE, SIZE, OR COLOR.

NO CLAIM IS MADE TO THE EXCLUSIVE RIGHT TO USE "THE CALL CENTER GROUP", APART FROM THE MARK AS SHOWN.

SER. NO. 85-316,311, FILED 5-9-2011.

HELENE LIWINSKI, EXAMINING ATTORNEY



David J. Kyffers

Director of the United States Patent and Trademark Office

United States of America

United States Patent and Trademark Office

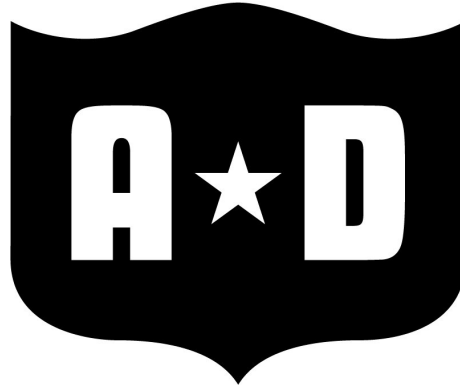

Reg. No. 4,073,950

ANDREWS & DUNHAM, LTD. (MARYLAND CORPORATION)
5701 GREENLEAF ROAD
CHEVERLY, MD 20785

Registered Dec. 20, 2011

Int. Cl.: 30

FOR: BLACK TEA; GREEN TEA; JAPANESE GREEN TEA; OOLONG TEA; TEA; TEA FOR INFUSIONS, IN CLASS 30 (U.S. CL. 46).

TRADEMARK

FIRST USE 6-10-2007; IN COMMERCE 2-2-2009.

PRINCIPAL REGISTER

THE MARK CONSISTS OF THE LETTERS A AND D SEPARATED BY A STAR, SET AGAINST A DARKENED BACKGROUND IN THE SHAPE OF A BADGE.

SER. NO. 85-316,404, FILED 5-9-2011.

BRIAN NEVILLE, EXAMINING ATTORNEY



David J. Kybas

Director of the United States Patent and Trademark Office

United States of America

United States Patent and Trademark Office



Reg. No. 4,073,951

ANDREWS & DUNHAM, LTD. (MARYLAND CORPORATION)
5701 GREENLEAF ROAD
CHEVERLY, MD 20785

Registered Dec. 20, 2011

Int. Cl.: 30

FOR: BLACK TEA; GREEN TEA; JAPANESE GREEN TEA; OOLONG TEA; TEA; TEA FOR INFUSIONS, IN CLASS 30 (U.S. CL. 46).

TRADEMARK

FIRST USE 6-10-2007; IN COMMERCE 2-2-2009.

PRINCIPAL REGISTER

NO CLAIM IS MADE TO THE EXCLUSIVE RIGHT TO USE "TEA", APART FROM THE MARK AS SHOWN.

THE MARK CONSISTS OF THE WORDING ANDREWS & DUNHAM, WITH ANDREWS OVER DUNHAM, THE LATTER NAME BEING IN LARGER FONT AND THE TWO WORDS BEING SEPARATED BY THE "&" AND TWO STYLIZED LINES ON EITHER SIDE OF THE "&," WITH A STAR ABOVE THE WORDING AND THE PHRASE "DAMN FINE TEA" BELOW THE WORDING AND BETWEEN TWO SMALL CIRCLES, AND WITH ALL THE AFOREMENTIONED ELEMENTS BEING SET AGAINST A DARKENED BACKGROUND IN THE SHAPE OF A BADGE.

SER. NO. 85-316,415, FILED 5-9-2011.

BRIAN NEVILLE, EXAMINING ATTORNEY



David J. Kyffers

Director of the United States Patent and Trademark Office

United States of America

United States Patent and Trademark Office

DAMN FINE TEA

Reg. No. 4,073,952

ANDREWS & DUNHAM, LTD. (MARYLAND CORPORATION)
5701 GREENLEAF ROAD
CHEVERLY, MD 20785

Registered Dec. 20, 2011

Int. Cl.: 30

FOR: BLACK TEA; GREEN TEA; JAPANESE GREEN TEA; OOLONG TEA; TEA; TEA FOR INFUSIONS, IN CLASS 30 (U.S. CL. 46).

TRADEMARK

FIRST USE 6-10-2007; IN COMMERCE 2-2-2009.

PRINCIPAL REGISTER

THE MARK CONSISTS OF STANDARD CHARACTERS WITHOUT CLAIM TO ANY PARTICULAR FONT, STYLE, SIZE, OR COLOR.

NO CLAIM IS MADE TO THE EXCLUSIVE RIGHT TO USE "TEA", APART FROM THE MARK AS SHOWN.

SER. NO. 85-316,419, FILED 5-9-2011.

BRIAN NEVILLE, EXAMINING ATTORNEY



David J. Kybas

Director of the United States Patent and Trademark Office

United States of America

United States Patent and Trademark Office

ANDREWS & DUNHAM

Reg. No. 4,073,953

ANDREWS & DUNHAM, LTD. (MARYLAND CORPORATION)
5701 GREENLEAF ROAD
CHEVERLY, MD 20785

Registered Dec. 20, 2011

Int. Cl.: 30

FOR: BLACK TEA; GREEN TEA; JAPANESE GREEN TEA; OOLONG TEA; TEA; TEA FOR INFUSIONS, IN CLASS 30 (U.S. CL. 46).

TRADEMARK

FIRST USE 6-10-2007; IN COMMERCE 2-2-2009.

PRINCIPAL REGISTER

THE MARK CONSISTS OF STANDARD CHARACTERS WITHOUT CLAIM TO ANY PARTICULAR FONT, STYLE, SIZE, OR COLOR.

SER. NO. 85-316,428, FILED 5-9-2011.

BRIAN NEVILLE, EXAMINING ATTORNEY



David J. Kybas

Director of the United States Patent and Trademark Office

United States of America

United States Patent and Trademark Office

Supporting the development
of formulation solutions for
everyday life

Reg. No. 4,073,954

DEWOLF CHEMICAL, INC. (RHODE ISLAND CORPORATION)
300 JEFFERSON BOULEVARD SUITE 206
WARWICK, RI 02888

Registered Dec. 20, 2011

Int. Cl.: 39

FOR: DISTRIBUTION SERVICES, NAMELY, DELIVERY OF CHEMICALS, IN CLASS 39
(U.S. CLS. 100 AND 105).

SERVICE MARK

FIRST USE 9-23-2010; IN COMMERCE 9-23-2010.

PRINCIPAL REGISTER

THE MARK CONSISTS OF STANDARD CHARACTERS WITHOUT CLAIM TO ANY PARTICULAR FONT, STYLE, SIZE, OR COLOR.

SER. NO. 85-316,526, FILED 5-10-2011.

JASON TURNER, EXAMINING ATTORNEY



David J. Kybas

Director of the United States Patent and Trademark Office

United States of America

United States Patent and Trademark Office

ROADMAP FOR ACTION

Reg. No. 4,073,955

Registered Dec. 20, 2011

Int. Cl.: 36

SERVICE MARK

PRINCIPAL REGISTER

BLACKARCH, INC. (NORTH CAROLINA CORPORATION)
121 WEST TRADE STREET, SUITE 2800
CHARLOTTE, NC 28202

FOR: PROVISION OF FINANCIAL ADVISORY AND CONSULTING SERVICES TO PRIVATE BUSINESS OWNERS CONTEMPLATING A CORPORATE FINANCE TRANSACTION, NAMELY, A MERGER OR ACQUISITION, A DEBT RECAPITALIZATION, AN EQUITY CAPITAL RAISE OR IMPLEMENTATION OF AN EMPLOYEE STOCK OWNERSHIP PLAN; FINANCIAL PLANNING AND MANAGEMENT SERVICES, AND INVESTMENT BANKING SERVICES TO PRIVATE BUSINESS OWNERS, IN CLASS 36 (U.S. CLS. 100, 101 AND 102).

FIRST USE 2-15-2011; IN COMMERCE 2-15-2011.

THE MARK CONSISTS OF STANDARD CHARACTERS WITHOUT CLAIM TO ANY PARTICULAR FONT, STYLE, SIZE, OR COLOR.

SER. NO. 85-316,533, FILED 5-10-2011.

JAMES LOVELACE, EXAMINING ATTORNEY



David J. Kyffers

Director of the United States Patent and Trademark Office

United States of America

United States Patent and Trademark Office

UBTC

Reg. No. 4,073,956

Registered Dec. 20, 2011

Int. Cl.: 36

SERVICE MARK

PRINCIPAL REGISTER

UNITED BANK & TRUST COMPANY (IOWA CORPORATION)
400 CENTRAL AVENUE E
HAMPTON, IA 50441

FOR: PROVIDING PERSONAL, COMMERCIAL AND AGRICULTURAL BANKING AND FINANCING SERVICES, BANKING CONSULTATION, TELEPHONE BANKING, ON-LINE BANKING SERVICES PROVIDED VIA THE INTERNET, ON-LINE BANKING SERVICES PROVIDED BY MOBILE TELEPHONE CONNECTIONS, ATM BANKING, MORTGAGE BANKING AND TRUST SERVICES, NAMELY, ESTATE TRUST MANAGEMENT AND PLANNING, FINANCIAL TRUST OPERATIONS AND PLANNING, REAL ESTATE INVESTMENT TRUST SERVICES, REAL ESTATE INVESTMENT TRUST MANAGEMENT AND ADVISORY SERVICES, TRUST MANAGEMENT ACCOUNTS; TRUST SERVICES, NAMELY, INVESTMENT AND TRUST COMPANY SERVICES, IN CLASS 36 (U.S. CLS. 100, 101 AND 102).

FIRST USE 5-17-2000; IN COMMERCE 5-17-2000.

THE MARK CONSISTS OF STANDARD CHARACTERS WITHOUT CLAIM TO ANY PARTICULAR FONT, STYLE, SIZE, OR COLOR.

SER. NO. 85-316,555, FILED 5-10-2011.

JAMES LOVELACE, EXAMINING ATTORNEY



David J. Kypos

Director of the United States Patent and Trademark Office

United States of America

United States Patent and Trademark Office

FUNTAINER

Reg. No. 4,073,957

THERMOS L.L.C. (DELAWARE LIMITED LIABILITY COMPANY)
475 N. MARTINGALE ROAD, SUITE 1100
SCHAUMBURG, IL 60173

Registered Dec. 20, 2011

Int. Cl.: 21

FOR: BOTTLES, SOLD EMPTY; DRINKING VESSELS; HOUSEHOLD CONTAINERS FOR FOODS; INSULATED VACUUM FLASKS; REUSABLE STAINLESS STEEL WATER BOTTLES SOLD EMPTY; THERMAL INSULATED CONTAINERS FOR FOOD OR BEVERAGES; VACUUM BOTTLES, IN CLASS 21 (U.S. CLS. 2, 13, 23, 29, 30, 33, 40 AND 50).

TRADEMARK

PRINCIPAL REGISTER

FIRST USE 6-30-2002; IN COMMERCE 6-30-2002.

THE MARK CONSISTS OF STANDARD CHARACTERS WITHOUT CLAIM TO ANY PARTICULAR FONT, STYLE, SIZE, OR COLOR.

SER. NO. 85-316,598, FILED 5-10-2011.

FRANK LATTUCA, EXAMINING ATTORNEY



David J. Kyffers

Director of the United States Patent and Trademark Office

United States of America

United States Patent and Trademark Office

GFI MAILESENTIALS

Reg. No. 4,073,958

Registered Dec. 20, 2011

Int. Cl.: 9

TRADEMARK

PRINCIPAL REGISTER

GFI SOFTWARE LTD. (BR. VIRGIN ISLANDS LIMITED LIABILITY COMPANY)
WICKHAMS CAY 1, P.O. BOX 3149
ROAD TOWN, TORTOLA, BR. VIRGIN ISLANDS

FOR: SOFTWARE FOR MANAGING ELECTRONIC MAIL (E-MAIL); ANTI-SPAM SOFTWARE; ANTI-PHISHING SOFTWARE; NON-DOWNLOADABLE SOFTWARE FOR MANAGING E-MAIL AND SECURING E-MAIL AGAINST JUNK E-MAIL (SPAM) AND PHISHING ATTACKS; SOFTWARE FOR FILTERING JUNK E-MAIL AND OTHER UNSOLICITED E-MAIL MESSAGES; SOFTWARE FOR DETECTING AND BLOCKING PHISHING E-MAILS, IN CLASS 9 (U.S. CLS. 21, 23, 26, 36 AND 38).

FIRST USE 6-17-2002; IN COMMERCE 6-17-2002.

THE MARK CONSISTS OF STANDARD CHARACTERS WITHOUT CLAIM TO ANY PARTICULAR FONT, STYLE, SIZE, OR COLOR.

SER. NO. 85-316,645, FILED 5-10-2011.

RICHARD WHITE, EXAMINING ATTORNEY



David J. Kybas

Director of the United States Patent and Trademark Office

United States of America

United States Patent and Trademark Office

GAYMERS

Reg. No. 4,073,959

C&C IP SARL (LUXEMBOURG LIMITED LIABILITY COMPANY)
18 AVENUE MARIE-THERESE
L-2132 LUXEMBOURG, LUXEMBOURG

Registered Dec. 20, 2011

Int. Cl.: 33

FOR: HARD CIDER; PERRY, IN CLASS 33 (U.S. CLS. 47 AND 49).

TRADEMARK

THE MARK CONSISTS OF STANDARD CHARACTERS WITHOUT CLAIM TO ANY PARTICULAR FONT, STYLE, SIZE, OR COLOR.

PRINCIPAL REGISTER

OWNER OF ERPN CMNTY TM OFC REG. NO. 004638409, DATED 7-10-2006, EXPIRES 9-16-2015.

OWNER OF U.S. REG. NOS. 1,133,283 AND 3,931,134.

SER. NO. 85-316,649, FILED 5-10-2011.

BRIAN NEVILLE, EXAMINING ATTORNEY



David J. Kyffers

Director of the United States Patent and Trademark Office

United States of America

United States Patent and Trademark Office

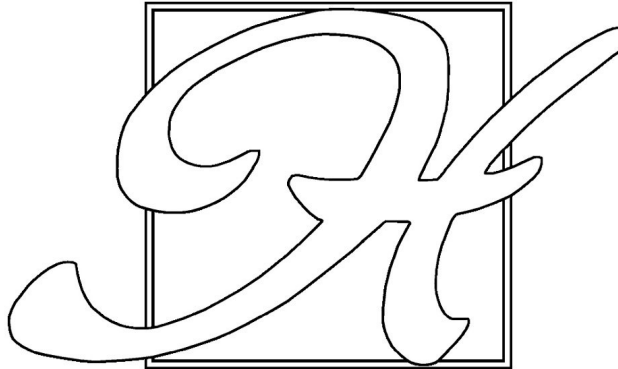

Reg. No. 4,073,960

Registered Dec. 20, 2011

Int. Cl.: 35

SERVICE MARK

PRINCIPAL REGISTER

HUDSON JEWELERS, LTD. (ILLINOIS CORPORATION)
3244 NAMEOKI ROAD
GRANITE CITY, IL 62040

FOR: RETAIL JEWELRY STORES, IN CLASS 35 (U.S. CLS. 100, 101 AND 102).

FIRST USE 1-1-2008; IN COMMERCE 1-1-2008.

THE MARK CONSISTS OF THE LETTER "H" IN A STYLIZED FONT AND ENCLOSED BY A BOX.

SER. NO. 85-316,661, FILED 5-10-2011.

KATHERINE E. HALMEN, EXAMINING ATTORNEY



David J. Kappas

Director of the United States Patent and Trademark Office

United States of America

United States Patent and Trademark Office

The Christian Bill of Rights

Reg. No. 4,073,961

Registered Dec. 20, 2011

Int. Cl.: 16

TRADEMARK

PRINCIPAL REGISTER

LUCAS, CHARLES (UNITED STATES INDIVIDUAL)
7011 BENNINGTON LANE
CUMMING, GA 300411983

FOR: BOOKS IN THE FIELD OF RELIGION; POSTERS, IN CLASS 16 (U.S. CLS. 2, 5, 22, 23, 29, 37, 38 AND 50).

FIRST USE 1-4-2002; IN COMMERCE 3-1-2009.

THE MARK CONSISTS OF STANDARD CHARACTERS WITHOUT CLAIM TO ANY PARTICULAR FONT, STYLE, SIZE, OR COLOR.

SER. NO. 85-316,693, FILED 5-10-2011.

VIVIAN MICZNIK FIRST, EXAMINING ATTORNEY



David J. Kappas

Director of the United States Patent and Trademark Office

United States of America

United States Patent and Trademark Office

BACKYARD HUMANITARIAN

Reg. No. 4,073,962

Registered Dec. 20, 2011

Int. Cl.: 35

SERVICE MARK

PRINCIPAL REGISTER

ANGELA MALIZIA (UNITED STATES INDIVIDUAL)
C/O SEYFARTH SHAW LLP
131 S. DEARBORN, SUITE 2400
CHICAGO, IL 60603

FOR: CHARITABLE SERVICES, NAMELY, ORGANIZING AND CONDUCTING VOLUNTEER PROGRAMS AND COMMUNITY SERVICE PROJECTS; CHARITABLE SERVICES, NAMELY, PROVIDING A FREE ONLINE RESOURCE IN THE NATURE OF A WEBSITE FOR CONNECTING PEOPLE WHO HAVE SERVICE NEEDS WITH PEOPLE WHO ARE WILLING TO PROVIDE VOLUNTEER SERVICES; DEVELOPING AND COORDINATING VOLUNTEER PROJECTS FOR CHARITABLE ORGANIZATIONS, IN CLASS 35 (U.S. CLS. 100, 101 AND 102).

FIRST USE 9-10-2010; IN COMMERCE 9-10-2010.

THE MARK CONSISTS OF STANDARD CHARACTERS WITHOUT CLAIM TO ANY PARTICULAR FONT, STYLE, SIZE, OR COLOR.

SER. NO. 85-316,702, FILED 5-10-2011.

MARK T. MULLEN, EXAMINING ATTORNEY



David J. Kybas

Director of the United States Patent and Trademark Office

United States of America

United States Patent and Trademark Office



Reg. No. 4,073,963

Registered Dec. 20, 2011

Int. Cl.: 20

TRADEMARK

PRINCIPAL REGISTER

ATTICMAXX, LLC (NORTH CAROLINA LIMITED LIABILITY COMPANY)
3204 SHOPTON DRIVE
APEX, NC 27502

FOR: SHELVES FOR STORAGE; SHELVING AND COMPONENT PARTS THEREOF, NAMELY, SHELVES AND BRACKETS SOLD AS A UNIT, IN CLASS 20 (U.S. CLS. 2, 13, 22, 25, 32 AND 50).

FIRST USE 4-29-2011; IN COMMERCE 4-29-2011.

NO CLAIM IS MADE TO THE EXCLUSIVE RIGHT TO USE "SHELVING SYSTEM", APART FROM THE MARK AS SHOWN.

THE MARK CONSISTS OF THE STYLIZED WORDING "ATTICMAXX SHELVING SYSTEM" AS WELL AS THE DEPICTION OF STYLIZED ATTIC TRUSSES WITH SUSPENDED SHELVES AND A PARTIALLY COMPLETED RECTANGLE ALL OF WHICH IS SURROUNDED BY AN OVAL. THE LETTER "A" OF "ATTIC" AND "M" OF "MAXX" APPEAR AS STYLIZED ATTIC TRUSSES WITH SHELVING SUSPENDED UNDER THE WORDING. THE PARTIALLY COMPLETED RECTANGLE STARTS FROM THE LETTER "A" OF "ATTIC" AND SURROUNDS THE WORDING "ATTICMAXX". THE WORDING "SHELVING SYSTEM" APPEARS BELOW THE WORDING "ATTICMAXX".

SER. NO. 85-316,713, FILED 5-10-2011.

MICHAEL TANNER, EXAMINING ATTORNEY



David J. Kybas

Director of the United States Patent and Trademark Office

United States of America

United States Patent and Trademark Office

DIYA

Reg. No. 4,073,964

Registered Dec. 20, 2011

Int. Cls.: 18 and 24

TRADEMARK

PRINCIPAL REGISTER

LEATHER LINKS INC. (VIRGINIA CORPORATION)
9408-H GUNSTON COVER ROAD
LORTON, VA 22079

FOR: BACKPACKS; LUGGAGE, IN CLASS 18 (U.S. CLS. 1, 2, 3, 22 AND 41).

FIRST USE 6-0-2007; IN COMMERCE 6-0-2007.

FOR: BED BLANKETS; BLANKET THROWS , IN CLASS 24 (U.S. CLS. 42 AND 50).

FIRST USE 6-0-2007; IN COMMERCE 6-0-2007.

THE MARK CONSISTS OF STANDARD CHARACTERS WITHOUT CLAIM TO ANY PARTICULAR FONT, STYLE, SIZE, OR COLOR.

SER. NO. 85-316,718, FILED 5-10-2011.

VERNA BETH RIRIE, EXAMINING ATTORNEY



David J. Kybas

Director of the United States Patent and Trademark Office

United States of America

United States Patent and Trademark Office



Reg. No. 4,073,965

AIR CRITICAL CARE, LLC (FLORIDA LIMITED LIABILITY COMPANY)
7348 N. FICUS TREE
PUNTA GORDA, FL 33955

Registered Dec. 20, 2011

Int. Cl.: 39

FOR: MEDICAL TRANSPORT SERVICES, IN CLASS 39 (U.S. CLS. 100 AND 105).

SERVICE MARK

FIRST USE 3-0-2010; IN COMMERCE 3-0-2010.

PRINCIPAL REGISTER

NO CLAIM IS MADE TO THE EXCLUSIVE RIGHT TO USE "AIR CRITICAL CARE LLC",
APART FROM THE MARK AS SHOWN.

THE COLOR(S) BLUE AND RED IS/ARE CLAIMED AS A FEATURE OF THE MARK.

THE MARK CONSISTS OF THE BLUE LETTERS "ACC" WITH A BLUE SHADOW BELOW.
THERE IS A RED AIRPLANE WITH A RED TRAIL GOING THROUGH THE MIDDLE OF
THE LETTER "A". BELOW THE LETTERS ARE THE BLUE WORDS "AIR CRITICAL CARE
LLC" WHICH OVERLAP THE SHADOW.

SER. NO. 85-316,725, FILED 5-10-2011.

MICHAEL SOUDERS, EXAMINING ATTORNEY



David J. Kyffers

Director of the United States Patent and Trademark Office

United States of America

United States Patent and Trademark Office

SHREDMYRECORD.COM

Reg. No. 4,073,966

Registered Dec. 20, 2011

Int. Cl.: 45

SERVICE MARK

PRINCIPAL REGISTER

EAS TECHNOLOGIES (KENTUCKY LIMITED LIABILITY COMPANY)
250 WEST MAIN STREET
LEXINGTON, KY 40507

FOR: WEBSITE SERVICES TO ASSIST PEOPLE IN CLEARING CRIMINAL RECORDS BY OBTAINING PARDONS, SEALINGS, EXPUNGEMENTS OR COPIES OF DOCUMENTS RELATING TO SAME; PERSONAL SERVICES FOR OTHERS IN ASSISTING INDIVIDUALS IN CLEARING THEIR CRIMINAL RECORDS; WEBSITE SERVICES TO MONITOR ACTIVITIES RELATING TO AN INDIVIDUAL'S CRIMINAL RECORD, IN CLASS 45 (U.S. CLS. 100 AND 101).

FIRST USE 1-1-2011; IN COMMERCE 2-16-2011.

THE MARK CONSISTS OF STANDARD CHARACTERS WITHOUT CLAIM TO ANY PARTICULAR FONT, STYLE, SIZE, OR COLOR.

SER. NO. 85-316,738, FILED 5-10-2011.

MICHAEL ENGEL, EXAMINING ATTORNEY



David J. Kybas

Director of the United States Patent and Trademark Office

United States of America

United States Patent and Trademark Office

COMFORT INNOVATIONS

Reg. No. 4,073,967

Registered Dec. 20, 2011

Int. Cl.: 20

TRADEMARK

PRINCIPAL REGISTER

EASTERN SLEEP PRODUCTS CO., INC. (VIRGINIA CORPORATION), DBA SYMBOL
MATTRESS
4901 FITZHUGH AVENUE, SUITE #300
RICHMOND, VA 23230

FOR: MATTRESSES, IN CLASS 20 (U.S. CLS. 2, 13, 22, 25, 32 AND 50).

FIRST USE 0-0-2004; IN COMMERCE 0-0-2004.

THE MARK CONSISTS OF STANDARD CHARACTERS WITHOUT CLAIM TO ANY PARTICULAR FONT, STYLE, SIZE, OR COLOR.

NO CLAIM IS MADE TO THE EXCLUSIVE RIGHT TO USE "COMFORT", APART FROM THE MARK AS SHOWN.

SER. NO. 85-316,773, FILED 5-10-2011.

MARIA-VICTORIA SUAREZ, EXAMINING ATTORNEY



David J. Kybas

Director of the United States Patent and Trademark Office

United States of America

United States Patent and Trademark Office

A-PRO

Reg. No. 4,073,968

MANGIARACINA, GREG (UNITED STATES INDIVIDUAL)
1141 N. LOOP 1604 E 105-176
SAN ANTONIO, TX 78232

Registered Dec. 20, 2011

Int. Cl.: 42

FOR: HOME AND BUILDING INSPECTIONS, NOT IN THE COURSE OF CONSTRUCTION,
IN CLASS 42 (U.S. CLS. 100 AND 101).

SERVICE MARK

FIRST USE 10-1-1994; IN COMMERCE 10-1-1994.

PRINCIPAL REGISTER

THE MARK CONSISTS OF STANDARD CHARACTERS WITHOUT CLAIM TO ANY PAR-
TICULAR FONT, STYLE, SIZE, OR COLOR.

OWNER OF U.S. REG. NO. 3,179,214.

SER. NO. 85-316,820, FILED 5-10-2011.

JASON BLAIR, EXAMINING ATTORNEY



David J. Kybas

Director of the United States Patent and Trademark Office

United States of America

United States Patent and Trademark Office

LuvyDuvy

Reg. No. 4,073,969

Registered Dec. 20, 2011

Int. Cl.: 30

TRADEMARK

PRINCIPAL REGISTER

LUVYDUVY CORPORATION (FLORIDA CORPORATION)
#402
6574 N. STATE RD. 7
COCONUT CREEK, FL 33073

FOR: CANDIES, IN CLASS 30 (U.S. CL. 46).

FIRST USE 6-1-1987; IN COMMERCE 6-1-1987.

THE MARK CONSISTS OF STANDARD CHARACTERS WITHOUT CLAIM TO ANY PARTICULAR FONT, STYLE, SIZE, OR COLOR.

SER. NO. 85-316,872, FILED 5-10-2011.

SUNG IN, EXAMINING ATTORNEY



David J. Kybas

Director of the United States Patent and Trademark Office

United States of America

United States Patent and Trademark Office



Reg. No. 4,073,970

Registered Dec. 20, 2011

Int. Cl.: 25

TRADEMARK

PRINCIPAL REGISTER

TAH HSIN INDUSTRIAL CORP. (TAIWAN CORPORATION)
NO. 51
35TH ROAD TAICHUNG INDUSTRIAL PARK
TAICHUNG CITY, TAIWAN

FOR: RAINCOATS, AND OUTERWEAR, NAMELY OVERCOATS, JACKETS, PANTS, VEST, PARKAS, OVERALLS, TWO PIECE RAIN SUITS, AND SKIWEAR, IN CLASS 25 (U.S. CLS. 22 AND 39).

FIRST USE 4-15-2005; IN COMMERCE 4-15-2005.

THE MARK CONSISTS OF TWO ARBITRARY INTERCONNECTED SHAPES WITHIN A SQUARE WITH ROUNDED EDGES.

SER. NO. 85-316,898, FILED 5-10-2011.

PAUL E. FAHRENKOPF, EXAMINING ATTORNEY



David J. Kyffers

Director of the United States Patent and Trademark Office

United States of America

United States Patent and Trademark Office

NDisp

Reg. No. 4,073,971

Registered Dec. 20, 2011

Int. Cl.: 38

SERVICE MARK

PRINCIPAL REGISTER

NDISP CORPORATION (IDAHO CORPORATION)
305 S 3RD E
C/O LEGAL
REXBURG, ID 83440

FOR: AUDIO AND VIDEO BROADCASTING SERVICES OVER THE INTERNET; BROADCASTING OF VIDEO AND AUDIO PROGRAMMING OVER THE INTERNET; BROADCASTING SERVICES AND PROVISION OF TELECOMMUNICATION ACCESS TO VIDEO AND AUDIO CONTENT PROVIDED VIA A VIDEO-ON-DEMAND SERVICE VIA THE INTERNET; COMMUNICATION SERVICES, NAMELY, TRANSMISSION OF VOICE, AUDIO, VISUAL IMAGES AND DATA BY TELECOMMUNICATIONS NETWORKS, WIRELESS COMMUNICATION NETWORKS, THE INTERNET, INFORMATION SERVICES NETWORKS AND DATA NETWORKS; COMMUNICATIONS SERVICES, NAMELY, TRANSMITTING STREAMED SOUND AND AUDIOVISUAL RECORDINGS VIA THE INTERNET; INTERNET ACCESS PROVIDER SERVICES; INTERNET BROADCASTING SERVICES; INTERNET CAFE SERVICES, NAMELY, PROVIDING TELECOMMUNICATIONS CONNECTIONS TO THE INTERNET IN A CAFE ENVIRONMENT; INTERNET PROTOCOL TELEVISION (IPTV) TRANSMISSION SERVICES; INTERNET RADIO BROADCASTING SERVICES; INTERNET RADIO SERVICES, NAMELY, TRANSMISSION OF AUDIO MATERIAL VIA THE INTERNET; INTERNET SERVICE PROVIDER (ISP); INTERNET SERVICE PROVIDER SERVICES; INTERNET SERVICES, NAMELY, PROVIDING MULTIPLE-USER ACCESS TO INFORMATION ON THE INTERNET CONCERNING THE DEVELOPMENT AND GENERATION OF COMPUTER SOFTWARE FOR USE IN BUSINESSES AS WELL AS THE FUNCTIONS AND APPLICATION OF SUCH BUSINESS SOFTWARE; INTERNET TELEPHONY SERVICES; PEER-TO-PEER PHOTO SHARING SERVICES, NAMELY, ELECTRONIC TRANSMISSION OF DIGITAL PHOTO FILES AMONG INTERNET USERS; PROVIDING ACCESS TO DIGITAL MUSIC WEBSITES ON THE INTERNET; PROVIDING ACCESS TO THE INTERNET; PROVIDING CHAT LINES UTILIZING THE INTERNET; PROVIDING ELECTRONIC TRANSMISSION OF INFORMATION TO PERSONS WHO ARE DEAF OR HEARING IMPAIRED VIA THE INTERNET, TELEPHONES AND WIRELESS DEVICES; PROVIDING INTERNET ACCESS; PROVIDING INTERNET CHAT ROOMS; PROVIDING INTERNET CHAT ROOMS; PROVIDING MULTIPLE USER DIAL-UP AND DEDICATED ACCESS TO THE INTERNET; PROVIDING MULTIPLE USER WIRELESS ACCESS TO THE INTERNET; PROVIDING REMOTE INTERNET ACCESS; PROVIDING TELECOMMUNICATION CONNECTIONS TO THE INTERNET OR DATABASES; PROVIDING TELECOMMUNICATIONS CONNECTIONS TO THE INTERNET OR DATABASES; PROVIDING VOICE COMMUNICATION SERVICES VIA THE INTERNET; PROVISION OF ACCESS TO THE INTERNET;



David J. Kyros

Director of the United States Patent and Trademark Office

Reg. No. 4,073,971 STREAMING OF AUDIO MATERIAL ON THE INTERNET; STREAMING OF VIDEO MATERIAL ON THE INTERNET; TELECOMMUNICATION SERVICES, NAMELY, PROVIDING E-MAIL NOTIFICATION ALERTS VIA THE INTERNET; TELECOMMUNICATION SERVICES, NAMELY, PROVIDING ELECTRONIC MESSAGE ALERTS VIA THE INTERNET; TELECOMMUNICATION SERVICES, NAMELY, PROVIDING INTERNET ACCESS VIA BROADBAND OPTICAL OR WIRELESS NETWORKS; TELECOMMUNICATION SERVICES, NAMELY, TRANSMISSION OF VOICE, DATA, GRAPHICS, IMAGES, AUDIO AND VIDEO BY MEANS OF TELECOMMUNICATIONS NETWORKS, WIRELESS COMMUNICATION NETWORKS, AND THE INTERNET; TELECOMMUNICATIONS RESELLER SERVICES FOR BUSINESSES, NAMELY, PROVIDING LONG DISTANCE TELECOMMUNICATION SERVICES, VOICE TELECOMMUNICATION SERVICES, LOCAL TELEPHONE SERVICE, AND INTERNET ACCESS SERVICES; TRANSMISSION AND DISTRIBUTION OF DATA OR AUDIO VISUAL IMAGES VIA A GLOBAL COMPUTER NETWORK OR THE INTERNET; TRANSMISSION SERVICES VIA THE INTERNET, FEATURING MP3 FILES AND MUSIC VIDEOS; VIDEO BROADCASTING AND TRANSMISSION SERVICES VIA THE INTERNET, FEATURING FILMS AND MOVIES; VIDEO BROADCASTING SERVICES OVER THE INTERNET OR OTHER COMMUNICATIONS NETWORK FEATURING THE UPLOADED, POSTED AND TAGGED VIDEOS OF OTHERS; VIDEO BROADCASTING SERVICES OVER THE INTERNET OR OTHER COMMUNICATIONS NETWORK, NAMELY, ELECTRONICALLY TRANSMITTING VIDEO CLIPS; VIDEO BROADCASTING SERVICES VIA THE INTERNET; VIDEO STREAMING SERVICES VIA THE INTERNET, FEATURING INDEPENDENT FILMS AND MOVIES; VIDEO-ON-DEMAND TRANSMISSION SERVICES VIA THE INTERNET; VOICE OVER INTERNET PROTOCOL (VOIP) SERVICES, IN CLASS 38 (U.S. CLS. 100, 101 AND 104).

FIRST USE 4-1-2010; IN COMMERCE 4-1-2010.

THE MARK CONSISTS OF STANDARD CHARACTERS WITHOUT CLAIM TO ANY PARTICULAR FONT, STYLE, SIZE, OR COLOR.

SER. NO. 85-316,935, FILED 5-10-2011.

DAWN FELDMAN, EXAMINING ATTORNEY

United States of America

United States Patent and Trademark Office

Goodgen

Reg. No. 4,073,972

Registered Dec. 20, 2011

Int. Cl.: 9

TRADEMARK

PRINCIPAL REGISTER

MOON, WOO CHUL (REPUBLIC OF KOREA INDIVIDUAL), DBA GOODGEN, LLC
10301 STELLA LINK RD, SUITE C
HOUSTON, TX 77025

FOR: LABORATORY DEVICES FOR DETECTING GENETIC SEQUENCES, IN CLASS 9
(U.S. CLS. 21, 23, 26, 36 AND 38).

FIRST USE 11-1-2010; IN COMMERCE 11-1-2010.

THE MARK CONSISTS OF STANDARD CHARACTERS WITHOUT CLAIM TO ANY PARTICULAR FONT, STYLE, SIZE, OR COLOR.

SER. NO. 85-316,972, FILED 5-10-2011.

DORITT L. CARROLL, EXAMINING ATTORNEY



David J. Kybas

Director of the United States Patent and Trademark Office

United States of America

United States Patent and Trademark Office

SILUET SLIM

Reg. No. 4,073,973

NATURAL LIFE, LLC (FLORIDA LIMITED LIABILITY COMPANY)
2100 W. 76TH STREET, SUITE 202
MIAMI, FL 33016

Registered Dec. 20, 2011

Int. Cl.: 3

FOR: BEAUTY CREAMS; COSMETIC NOURISHING CREAMS; COSMETIC PREPARATIONS, NAMELY, FIRING CREAMS; CREAMS FOR CELLULITE REDUCTION; SKIN CREAM, IN CLASS 3 (U.S. CLS. 1, 4, 6, 50, 51 AND 52).

TRADEMARK

FIRST USE 2-24-2011; IN COMMERCE 2-24-2011.

PRINCIPAL REGISTER

THE MARK CONSISTS OF STANDARD CHARACTERS WITHOUT CLAIM TO ANY PARTICULAR FONT, STYLE, SIZE, OR COLOR.

THE WORDING "SILUET" HAS NO MEANING IN A FOREIGN LANGUAGE.

SER. NO. 85-317,045, FILED 5-10-2011.

JIM RINGLE, EXAMINING ATTORNEY



David J. Kybas

Director of the United States Patent and Trademark Office

United States of America

United States Patent and Trademark Office

RAINPERFECT

Reg. No. 4,073,974

Registered Dec. 20, 2011

Int. Cl.: 7

TRADEMARK

PRINCIPAL REGISTER

ITT CORPORATION (INDIANA CORPORATION)
1133 WESTCHESTER AVENUE
WHITE PLAINS, NY 10604

FOR: SOLAR POWERED PUMP SYSTEM FOR PUMPING WATER, COMPRISED OF A SUBMERSIBLE PUMP, PUMP CONTROLLER, RECHARGEABLE BATTERY, A SOLAR PANEL FOR PRODUCTION OF ELECTRICITY, NON-METAL GARDEN STAKE FOR SECURING THE SOLAR PANEL AND PLASTIC INTAKE HOSE, IN CLASS 7 (U.S. CLS. 13, 19, 21, 23, 31, 34 AND 35).

FIRST USE 2-16-2011; IN COMMERCE 2-16-2011.

THE MARK CONSISTS OF STANDARD CHARACTERS WITHOUT CLAIM TO ANY PARTICULAR FONT, STYLE, SIZE, OR COLOR.

SER. NO. 85-317,060, FILED 5-10-2011.

CAROLINE WOOD, EXAMINING ATTORNEY



David J. Kyffers

Director of the United States Patent and Trademark Office

United States of America

United States Patent and Trademark Office

COMPANIONS FOR LIFE

Reg. No. 4,073,975

Registered Dec. 20, 2011

Int. Cl.: 40

SERVICE MARK

PRINCIPAL REGISTER

COMPANIONS FOR LIFE BY CEDAR MEMORIAL LLC (IOWA LIMITED LIABILITY COMPANY)
4200 1ST AVE NE
CEDAR RAPIDS, IA 52402

FOR: PET CREMATION SERVICES, IN CLASS 40 (U.S. CLS. 100, 103 AND 106).

FIRST USE 12-0-2010; IN COMMERCE 12-0-2010.

THE MARK CONSISTS OF STANDARD CHARACTERS WITHOUT CLAIM TO ANY PARTICULAR FONT, STYLE, SIZE, OR COLOR.

SER. NO. 85-317,063, FILED 5-10-2011.

JIM RINGLE, EXAMINING ATTORNEY



David J. Kybas

Director of the United States Patent and Trademark Office

United States of America

United States Patent and Trademark Office

RainPerfect

Reg. No. 4,073,976

ITT CORPORATION (INDIANA CORPORATION)
1133 WESTCHESTER AVENUE
WHITE PLAINS, NY 10604

Registered Dec. 20, 2011

Int. Cl.: 7

FOR: SOLAR POWERED PUMP SYSTEM FOR PUMPING WATER, COMPRISED OF A SUBMERSIBLE PUMP, PUMP CONTROLLER, RECHARGEABLE BATTERY, A SOLAR PANEL FOR PRODUCTION OF ELECTRICITY, NON-METAL GARDEN STAKE FOR SECURING THE SOLAR PANEL AND PLASTIC INTAKE HOSE, IN CLASS 7 (U.S. CLS. 13, 19, 21, 23, 31, 34 AND 35).

TRADEMARK

PRINCIPAL REGISTER

FIRST USE 2-16-2011; IN COMMERCE 2-16-2011.

THE MARK CONSISTS OF THE WORD "RAIN" ADJACENT TO THE WORD "PERFECT" WITH A LEAF CROSSING THE LETTER "T".

SER. NO. 85-317,071, FILED 5-10-2011.

CAROLINE WOOD, EXAMINING ATTORNEY



David J. Kyros

Director of the United States Patent and Trademark Office

United States of America

United States Patent and Trademark Office

GIRL ON A LIMB

Reg. No. 4,073,977

Registered Dec. 20, 2011

Int. Cl.: 41

SERVICE MARK

PRINCIPAL REGISTER

SERENA MINOTT (UNITED STATES INDIVIDUAL)
SUITE 2800
201 S. BISCAYNE BLVD.
MIAMI, FL 33131

FOR: PROVIDING A WEBSITE FEATURING BLOGS AND NON-DOWNLOADABLE PUBLICATIONS IN THE NATURE OF ARTICLES, VIDEOS, PHOTOS, BLOGS, AND JOURNAL ENTRIES IN THE FIELD(S) OF BUSINESS, FASHION, FOOD, TRAVEL, MUSIC, AND ENTERTAINMENT, IN CLASS 41 (U.S. CLS. 100, 101 AND 107).

FIRST USE 9-1-2010; IN COMMERCE 9-1-2010.

THE MARK CONSISTS OF STANDARD CHARACTERS WITHOUT CLAIM TO ANY PARTICULAR FONT, STYLE, SIZE, OR COLOR.

SER. NO. 85-317,076, FILED 5-10-2011.

ZACHARY BELLO, EXAMINING ATTORNEY



David J. Kyffers

Director of the United States Patent and Trademark Office

United States of America

United States Patent and Trademark Office

LOCALRESPONSE

Reg. No. 4,073,978

Registered Dec. 20, 2011

Int. Cls.: 35 and 42

SERVICE MARK

PRINCIPAL REGISTER

LOCALRESPONSE, INC. (DELAWARE CORPORATION)
37 W. 28TH STREET
5TH FLOOR
NEW YORK, NY 10001

FOR: ADVERTISING AND PROMOTIONAL SERVICES, IN CLASS 35 (U.S. CLS. 100, 101 AND 102).

FIRST USE 8-0-2010; IN COMMERCE 8-0-2010.

FOR: SOFTWARE AS A SERVICE (SAAS) SERVICES FEATURING SOFTWARE FOR USE IN COMMUNICATING WITH EXISTING CUSTOMERS AND PROVIDING ANALYTICS TO MEASURE ADVERTISING EFFECTIVENESS, IN CLASS 42 (U.S. CLS. 100 AND 101).

FIRST USE 8-0-2010; IN COMMERCE 8-0-2010.

THE MARK CONSISTS OF STANDARD CHARACTERS WITHOUT CLAIM TO ANY PARTICULAR FONT, STYLE, SIZE, OR COLOR.

SER. NO. 85-317,078, FILED 5-10-2011.

ZACHARY BELLO, EXAMINING ATTORNEY



David J. Kyffers

Director of the United States Patent and Trademark Office

United States of America

United States Patent and Trademark Office



Reg. No. 4,073,979

EMRGENCE LLC (FLORIDA LIMITED LIABILITY COMPANY), AKA VEINSPEC EMR
12221 TOWNE LAKE DR STE A
FORT MYERS, FL 33913

Registered Dec. 20, 2011

Int. Cl.: 9

FOR: COMPUTER SOFTWARE FOR CONTROLLING AND MANAGING PATIENT MEDICAL INFORMATION, IN CLASS 9 (U.S. CLS. 21, 23, 26, 36 AND 38).

TRADEMARK

FIRST USE 11-14-2008; IN COMMERCE 11-14-2008.

PRINCIPAL REGISTER

NO CLAIM IS MADE TO THE EXCLUSIVE RIGHT TO USE "VEIN SPEC" OR "EMR", APART FROM THE MARK AS SHOWN.

THE COLOR(S) GREEN, WHITE, AND GRAY IS/ARE CLAIMED AS A FEATURE OF THE MARK.

THE MARK CONSISTS THE WORDING "VEIN SPEC EMR POWERED BY EMRGENCE" WITH A SQUARE. THE COLOR WHITE APPEARS IN THE WORDING "VEIN SPEC". THE COLOR GRAY APPEARS IN THE LETTERS "EMR". THE COLOR GREEN APPEARS IN THE WORDING "POWERED BY EMRGENCE" AND IN THE SQUARE.

SER. NO. 85-317,081, FILED 5-10-2011.

EVELYN BRADLEY, EXAMINING ATTORNEY



David J. Kyjars

Director of the United States Patent and Trademark Office

United States of America

United States Patent and Trademark Office

R1

Reg. No. 4,073,980

REVOLUTION DISTRIBUTORS LLC (NEW JERSEY LIMITED LIABILITY COMPANY)
22B NORTH WHITTIER STREET
CARTERET, NJ 07008

Registered Dec. 20, 2011

Int. Cl.: 3

FOR: EAU DE PARFUM; PERFUMES, IN CLASS 3 (U.S. CLS. 1, 4, 6, 50, 51 AND 52).

TRADEMARK

FIRST USE 9-1-2010; IN COMMERCE 9-1-2010.

PRINCIPAL REGISTER

THE MARK CONSISTS OF A STYLIZED VERSION OF A COMBINATION OF THE LETTER "R" AND A PART OF THE LETTER "M".

SER. NO. 85-317,153, FILED 5-10-2011.

SEAN CROWLEY, EXAMINING ATTORNEY



David J. Kyffers

Director of the United States Patent and Trademark Office

United States of America

United States Patent and Trademark Office

MEAN GREEN

Reg. No. 4,073,981

Registered Dec. 20, 2011

Int. Cl.: 34

TRADEMARK

PRINCIPAL REGISTER

BBK TOBACCO & FOODS, LLP (ARIZONA LIMITED LIABILITY PARTNERSHIP), DBA
HBI INTERNATIONAL
3315 W. BUCKEYE ROAD #4
PHOENIX, AZ 85009

FOR: CIGAR TUBES; CIGARS; TOBACCO, IN CLASS 34 (U.S. CLS. 2, 8, 9 AND 17).

FIRST USE 11-18-2009; IN COMMERCE 11-3-2010.

THE MARK CONSISTS OF STANDARD CHARACTERS WITHOUT CLAIM TO ANY PARTICULAR FONT, STYLE, SIZE, OR COLOR.

SER. NO. 85-317,285, FILED 5-10-2011.

JOHN GARTNER, EXAMINING ATTORNEY



David J. Kyffers

Director of the United States Patent and Trademark Office

United States of America

United States Patent and Trademark Office



Reg. No. 4,073,982

POLY PERFORMANCE, INC. (CALIFORNIA CORPORATION)
870 INDUSTRIAL WAY
SAN LUIS OBISPO, CA 93401

Registered Dec. 20, 2011

Int. Cl.: 12

FOR: SUSPENSION SYSTEMS FOR LAND VEHICLES, IN CLASS 12 (U.S. CLS. 19, 21, 23, 31, 35 AND 44).

TRADEMARK

FIRST USE 11-1-2010; IN COMMERCE 11-1-2010.

PRINCIPAL REGISTER

OWNER OF U.S. REG. NO. 3,467,057.

THE COLOR(S) RED, BLACK AND WHITE IS/ARE CLAIMED AS A FEATURE OF THE MARK.

NO CLAIM IS MADE TO THE EXCLUSIVE RIGHT TO USE "SUSPENSION", APART FROM THE MARK AS SHOWN.

THE MARK CONSISTS OF THE WORD "SYNERGY" IN RED AND OUTLINED IN WHITE AND THE WORD "SUSPENSION" IN WHITE, ALL SUPERIMPOSED ON A BLACK BACKGROUND.

SER. NO. 85-317,350, FILED 5-10-2011.

BRENDAN REGAN, EXAMINING ATTORNEY



David J. Kybas

Director of the United States Patent and Trademark Office

United States of America

United States Patent and Trademark Office

*Provocative
Publishers*

Reg. No. 4,073,983

Registered Dec. 20, 2011

Int. Cl.: 16

TRADEMARK

PRINCIPAL REGISTER

PIC INC. (TENNESSEE CORPORATION), DBA PROVOCATIVE PUBLISHERS, INC.
839 CLAYBROOK COURT
KNOXVILLE, TN 37923

FOR: SERIES OF FICTION AND NON-FICTION BOOKS ON A VARIETY OF TOPICS; SERIES OF FICTION AND NON-FICTION BOOKS ON A VARIETY OF TOPICS, IN CLASS 16 (U.S. CLS. 2, 5, 22, 23, 29, 37, 38 AND 50).

FIRST USE 4-22-2011; IN COMMERCE 4-25-2011.

NO CLAIM IS MADE TO THE EXCLUSIVE RIGHT TO USE "PUBLISHERS", APART FROM THE MARK AS SHOWN.

THE MARK CONSISTS OF THE WORDS "PROVOCATIVE PUBLISHERS" WITH STYLIZED LINES UNDERNEATH AND TO THE LEFT OF THE WORDING.

SER. NO. 85-317,376, FILED 5-10-2011.

JANICE L. MCMORROW, EXAMINING ATTORNEY



David J. Kybas

Director of the United States Patent and Trademark Office

United States of America

United States Patent and Trademark Office

MY BLOW

Reg. No. 4,073,984

Registered Dec. 20, 2011

Int. Cl.: 44

SERVICE MARK

PRINCIPAL REGISTER

BLOW LA, INC. (CALIFORNIA CORPORATION)
SUITE 284
269 S. BEVERLY DRIVE
BEVERLY HILLS, CA 90212

FOR: HAIR COLOR SALON SERVICES; HAIR COLOURING SERVICES; HAIR CUTTING; HAIR CUTTING SERVICES; HAIR SALON SERVICES; HAIR SALON SERVICES, NAMELY, HAIR CUTTING, STYLING, COLORING, AND HAIR EXTENSION SERVICES; HAIR SALON SERVICES, NAMELY, TREATMENTS TO PROTECT HAIR FROM EFFECTS OF EXPOSURE TO SUNLIGHT, HEAT, HUMIDITY AND CHLORINATED WATER; HAIR STYLING, IN CLASS 44 (U.S. CLS. 100 AND 101).

FIRST USE 7-1-2010; IN COMMERCE 7-1-2010.

THE MARK CONSISTS OF STANDARD CHARACTERS WITHOUT CLAIM TO ANY PARTICULAR FONT, STYLE, SIZE, OR COLOR.

SER. NO. 85-317,383, FILED 5-10-2011.

SAMUEL E. SHARPER JR., EXAMINING ATTORNEY



David J. Kyffers

Director of the United States Patent and Trademark Office

United States of America

United States Patent and Trademark Office

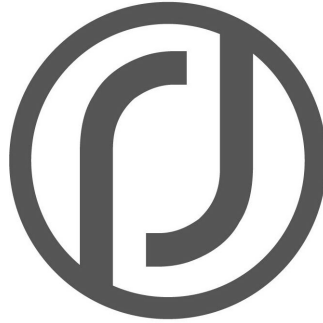

Reg. No. 4,073,985

Registered Dec. 20, 2011

Int. Cls.: 18, 25 and 28

TRADEMARK

PRINCIPAL REGISTER

JASEBOARDS LLC (HAWAII LIMITED LIABILITY COMPANY)
SUITE B3
56-565 KAMEHAMEHA HIGHWAY
KAHUKU, HI 96731

FOR: BACKPACKS; SCHOOLCHILDREN'S BACKPACKS, IN CLASS 18 (U.S. CLS. 1, 2, 3, 22 AND 41).

FIRST USE 12-10-2010; IN COMMERCE 12-10-2010.

FOR: ATHLETIC SHOES; BASEBALL CAPS AND HATS; HATS; SPORTS SHIRTS, IN CLASS 25 (U.S. CLS. 22 AND 39).

FIRST USE 12-10-2010; IN COMMERCE 12-10-2010.

FOR: BAGS FOR SKATEBOARDS; BAGS SPECIALLY ADAPTED FOR SPORTS EQUIPMENT; BALL BEARINGS FOR SKATEBOARDS; CASES SPECIALLY ADAPTED FOR SPORTS EQUIPMENT; PROTECTIVE PADDING FOR SKATEBOARDING; SKATEBOARD DECKS; SKATEBOARD GRIP TAPES; SKATEBOARD RISER PADS; SKATEBOARD TRUCKS; SKATEBOARD WHEELS; SKATEBOARDS, IN CLASS 28 (U.S. CLS. 22, 23, 38 AND 50).

FIRST USE 12-10-2010; IN COMMERCE 12-10-2010.

THE MARK CONSISTS OF ONE RIGHT SIDE UP LETTER "J", AND ONE UPSIDE DOWN LETTER "J" INSIDE A CIRCLE.

SER. NO. 85-317,387, FILED 5-10-2011.

SAMUEL E. SHARPER JR., EXAMINING ATTORNEY



David J. Kybas

Director of the United States Patent and Trademark Office

United States of America

United States Patent and Trademark Office

SELF-REALIZATION FELLOWSHIP

Reg. No. 4,073,986

Registered Dec. 20, 2011

Int. Cls.: 9 and 16

TRADEMARK

PRINCIPAL REGISTER

SELF-REALIZATION FELLOWSHIP CHURCH (CALIFORNIA CORPORATION)
3880 SAN RAFAEL AVENUE
LOS ANGELES, CA 90065

FOR: DIGITAL MEDIA, NAMELY, PRE-RECORDED COMPACT DISCS AND DVDS FEATURING INSTRUMENTAL MUSIC, SONGS, AND/OR SPOKEN WORD, IN CLASS 9 (U.S. CLS. 21, 23, 26, 36 AND 38).

FIRST USE 12-31-1997; IN COMMERCE 12-31-1997.

FOR: PRINTED MATTER, NAMELY, BOOKS AND MAGAZINES ON THE SUBJECT OF RELIGION AND SPIRITUALITY, IN CLASS 16 (U.S. CLS. 2, 5, 22, 23, 29, 37, 38 AND 50).

FIRST USE 12-31-1957; IN COMMERCE 12-31-1957.

THE MARK CONSISTS OF STANDARD CHARACTERS WITHOUT CLAIM TO ANY PARTICULAR FONT, STYLE, SIZE, OR COLOR.

OWNER OF U.S. REG. NOS. 1,637,873, 2,885,480, AND 2,898,414.

SEC. 2(F).

SER. NO. 85-317,404, FILED 5-10-2011.

ESTHER A. BORSUK, EXAMINING ATTORNEY



David J. Kyros

Director of the United States Patent and Trademark Office

United States of America

United States Patent and Trademark Office

Severson Sisters

Reg. No. 4,073,987

CARRIE SEVERSON (UNITED STATES INDIVIDUAL)
6929 N. HAYDEN RD. C4 #466
SCOTTSDALE, AZ 85250

Registered Dec. 20, 2011

Int. Cl.: 41

FOR: EDUCATION SERVICES, NAMELY, PROVIDING MENTORING, TUTORING, CLASSES, SEMINARS AND WORKSHOPS IN THE FIELD OF BUILDING SELF-ESTEEM AS A FUNDAMENTAL TOOL THAT WILL HELP YOUNG GIRLS DEVELOP, ENHANCE AND DEEPEN THEIR RELATIONSHIPS WITH OTHER FEMALES, IN CLASS 41 (U.S. CLS. 100, 101 AND 107).

SERVICE MARK

PRINCIPAL REGISTER

FIRST USE 4-1-2011; IN COMMERCE 5-1-2011.

THE MARK CONSISTS OF STANDARD CHARACTERS WITHOUT CLAIM TO ANY PARTICULAR FONT, STYLE, SIZE, OR COLOR.

SER. NO. 85-317,406, FILED 5-10-2011.

ESTHER A. BORSUK, EXAMINING ATTORNEY



David J. Kybas

Director of the United States Patent and Trademark Office

United States of America

United States Patent and Trademark Office

WebCapsule

Reg. No. 4,073,988

TJ87, INC. (UTAH CORPORATION)
1492 SILICON WAY
ST. GEORGE, UT 84770

Registered Dec. 20, 2011

Int. Cl.: 42

SERVICE MARK

PRINCIPAL REGISTER

FOR: COMPUTER SERVICES, NAMELY, CREATING AN ON-LINE COMMUNITY FOR REGISTERED USERS TO UPLOAD, STORE, VIEW, AND SHARE PERSONAL AND FAMILY INFORMATION, PROFILES, STORIES, PHOTOS AND OTHER MEDIA; COMPUTER SERVICES, NAMELY, HOSTING AND MAINTAINING AN ON-LINE WEB SITE FOR OTHERS TO UPLOAD, STORE, VIEW, AND SHARE PERSONAL AND FAMILY INFORMATION, PROFILES, STORIES, PHOTOS AND OTHER MEDIA; PROVIDING A MEMBERS-ONLY WEBSITE FEATURING TECHNOLOGY WHICH PROVIDES MEMBERS WITH THE ABILITY TO UPLOAD, STORE, VIEW, AND SHARE PERSONAL AND FAMILY INFORMATION, PROFILES, STORIES, PHOTOS AND OTHER MEDIA; PROVIDING A SECURED-ACCESS, MEMBERS ONLY WEBSITE FEATURING TECHNOLOGY THAT GIVES MEMBERS THE ABILITY TO UPLOAD, STORE, VIEW, AND SHARE PERSONAL AND FAMILY INFORMATION, PROFILES, STORIES, PHOTOS AND OTHER MEDIA, IN CLASS 42 (U.S. CLS. 100 AND 101).

FIRST USE 1-1-2011; IN COMMERCE 1-1-2011.

THE MARK CONSISTS OF STANDARD CHARACTERS WITHOUT CLAIM TO ANY PARTICULAR FONT, STYLE, SIZE, OR COLOR.

SER. NO. 85-317,416, FILED 5-10-2011.

DARRYL SPRUILL, EXAMINING ATTORNEY



David J. Kyffers

Director of the United States Patent and Trademark Office

United States of America

United States Patent and Trademark Office

Easy Quotes. Smart Advice.
Save Up To 70%

Reg. No. 4,073,989

Registered Dec. 20, 2011

Int. Cl.: 36

SERVICE MARK

PRINCIPAL REGISTER

BYRON UDELL & ASSOCIATES, INC. (ILLINOIS CORPORATION)
1400 S. WOLF ROAD
BUILDING 500
WHEELING, IL 60090

FOR: LIFE INSURANCE BROKERAGE, IN CLASS 36 (U.S. CLS. 100, 101 AND 102).

FIRST USE 12-7-2001; IN COMMERCE 12-7-2001.

THE MARK CONSISTS OF STANDARD CHARACTERS WITHOUT CLAIM TO ANY PARTICULAR FONT, STYLE, SIZE, OR COLOR.

NO CLAIM IS MADE TO THE EXCLUSIVE RIGHT TO USE "SAVE UP TO 70%", APART FROM THE MARK AS SHOWN.

SER. NO. 85-317,428, FILED 5-10-2011.

BRIAN PINO, EXAMINING ATTORNEY



David J. Kyffers

Director of the United States Patent and Trademark Office

United States of America

United States Patent and Trademark Office

DRIVING OUT BREAST CANCER

Reg. No. 4,073,990

PATRICIA ANN MCELROY (UNITED STATES INDIVIDUAL)
9578 NORDMAN WAY
ELK GROVE, CA 95624

Registered Dec. 20, 2011

Int. Cl.: 12

FOR: ACCESSORIES FOR VEHICLES, NAMELY STEERING WHEEL COVERS SOLD TO RAISE FUNDS FOR BREAST CANCER RESEARCH AND CANCER VICTIMS CAUSES, IN CLASS 12 (U.S. CLS. 19, 21, 23, 31, 35 AND 44).

TRADEMARK

FIRST USE 10-2-2010; IN COMMERCE 10-15-2010.

PRINCIPAL REGISTER

THE MARK CONSISTS OF STANDARD CHARACTERS WITHOUT CLAIM TO ANY PARTICULAR FONT, STYLE, SIZE, OR COLOR.

SER. NO. 85-317,429, FILED 5-10-2011.

JACQUELINE A. LAVINE, EXAMINING ATTORNEY



David J. Kybas

Director of the United States Patent and Trademark Office

United States of America

United States Patent and Trademark Office

JUDITH MARCH

Reg. No. 4,073,991

JUDITH MARCH, LLC (FLORIDA LIMITED LIABILITY COMPANY)
790 NORTH COUNTY HIGHWAY 393
SANTA ROSA BEACH, FL 32459

Registered Dec. 20, 2011

Int. Cl.: 25

FOR: DRESSES, IN CLASS 25 (U.S. CLS. 22 AND 39).

TRADEMARK

FIRST USE 3-30-2010; IN COMMERCE 3-30-2010.

PRINCIPAL REGISTER

THE MARK CONSISTS OF STANDARD CHARACTERS WITHOUT CLAIM TO ANY PARTICULAR FONT, STYLE, SIZE, OR COLOR.

THE NAME "JUDITH MARCH" IDENTIFIES A LIVING INDIVIDUAL WHOSE CONSENT IS OF RECORD.

SER. NO. 85-317,430, FILED 5-10-2011.

JACQUELINE A. LAVINE, EXAMINING ATTORNEY



David J. Kyffers

Director of the United States Patent and Trademark Office

United States of America

United States Patent and Trademark Office

The ScientifiK Feel the pulse

Reg. No. 4,073,992

Registered Dec. 20, 2011

Int. Cl.: 35

SERVICE MARK

PRINCIPAL REGISTER

KAKODKAR, DEEPA (INDIA INDIVIDUAL)
N112
350 SHARON PARK DRIVE
MENLO PARK, CA 940256849

FOR: BUSINESS CONSULTING AND INFORMATION SERVICES; BUSINESS DATA ANALYSIS; BUSINESS RESEARCH; PROVIDING A WEB SITE FEATURING BUSINESS INFORMATION IN THE FORM OF AUDIO AND VIDEO INTERVIEWS, TRANSCRIPTS AND OTHER EDUCATIONAL MATERIALS; PROVIDING INFORMATION AND NEWS IN THE FIELD OF BUSINESS, IN CLASS 35 (U.S. CLS. 100, 101 AND 102).

FIRST USE 10-1-2010; IN COMMERCE 10-1-2010.

THE MARK CONSISTS OF STANDARD CHARACTERS WITHOUT CLAIM TO ANY PARTICULAR FONT, STYLE, SIZE, OR COLOR.

SER. NO. 85-317,433, FILED 5-10-2011.

JACQUELINE A. LAVINE, EXAMINING ATTORNEY



David J. Kyjars

Director of the United States Patent and Trademark Office

United States of America

United States Patent and Trademark Office

EVILGOOD



UNDERGROUND

Reg. No. 4,073,993

Registered Dec. 20, 2011

Int. Cl.: 25

TRADEMARK

PRINCIPAL REGISTER

THE EVILGOODS, LLC (CALIFORNIA LIMITED LIABILITY COMPANY)
1503 STEWART STREET
OCENSIDE, CA 92054

FOR: BOTTOMS; FOOTWEAR; TOPS, IN CLASS 25 (U.S. CLS. 22 AND 39).

FIRST USE 9-1-2010; IN COMMERCE 9-1-2010.

THE MARK CONSISTS OF THE STYLIZED TEXT "EVILGOOD UNDERGROUND". IN THE CENTER THERE ARE TWO HANDS CLASPED TOGETHER/SHAKING HANDS, STILL/NOT MOVING WITH CUFFS AND SUIT SLEEVES SHOWING.

SER. NO. 85-317,462, FILED 5-10-2011.

ODESSA BIBBINS, EXAMINING ATTORNEY



David J. Kyffers

Director of the United States Patent and Trademark Office

United States of America

United States Patent and Trademark Office

WOMEN CAN DO MORE THAN WOMAN

Reg. No. 4,073,994

THE SAN DIEGO FOUNDATION (CALIFORNIA CORPORATION)
2508 HISTORIC DECATUR ROAD, SUITE 200
SAN DIEGO, CA 92106

Registered Dec. 20, 2011

Int. Cl.: 36

FOR: CHARITABLE FUNDRAISING, IN CLASS 36 (U.S. CLS. 100, 101 AND 102).

SERVICE MARK

FIRST USE 3-9-2011; IN COMMERCE 3-9-2011.

PRINCIPAL REGISTER

THE MARK CONSISTS OF STANDARD CHARACTERS WITHOUT CLAIM TO ANY PARTICULAR FONT, STYLE, SIZE, OR COLOR.

SER. NO. 85-317,500, FILED 5-10-2011.

BARBARA RUTLAND, EXAMINING ATTORNEY



David J. Kybas

Director of the United States Patent and Trademark Office

United States of America

United States Patent and Trademark Office

Ruby J Entertainment

Reg. No. 4,073,995

RUBY J ENTERTAINMENT LLC (ARIZONA LIMITED LIABILITY COMPANY)
1331 W. FAIRWAY DRIVE
NOGALES, AZ 85621

Registered Dec. 20, 2011

Int. Cl.: 35

FOR: ENTERTAINMENT MARKETING SERVICES, NAMELY, MARKETING, PROMOTION AND ADVERTISING FOR RECORDING AND PERFORMING ARTISTS; PROMOTING THE CONCERTS OF OTHERS , IN CLASS 35 (U.S. CLS. 100, 101 AND 102).

SERVICE MARK

FIRST USE 4-0-2011; IN COMMERCE 4-0-2011.

PRINCIPAL REGISTER

THE MARK CONSISTS OF STANDARD CHARACTERS WITHOUT CLAIM TO ANY PARTICULAR FONT, STYLE, SIZE, OR COLOR.

NO CLAIM IS MADE TO THE EXCLUSIVE RIGHT TO USE "ENTERTAINMENT", APART FROM THE MARK AS SHOWN.

SER. NO. 85-317,502, FILED 5-10-2011.

BARBARA RUTLAND, EXAMINING ATTORNEY



David J. Kyffers

Director of the United States Patent and Trademark Office

United States of America

United States Patent and Trademark Office

pH Boss

Reg. No. 4,073,996

Registered Dec. 20, 2011

Int. Cl.: 11

TRADEMARK

PRINCIPAL REGISTER

JONES IAN PILKINGTON (AUSTRALIA INDIVIDUAL)
UNIT 6 31-33 LORIKEET DRIVE
PEREGIAN BEACH, AUSTRALIA 4573

FOR: WATER CONDITIONING UNITS, IN CLASS 11 (U.S. CLS. 13, 21, 23, 31 AND 34).

THE MARK CONSISTS OF STANDARD CHARACTERS WITHOUT CLAIM TO ANY PARTICULAR FONT, STYLE, SIZE, OR COLOR.

OWNER OF AUSTRALIA REG. NO. 1372964, DATED 7-20-2010, EXPIRES 7-20-2020.

NO CLAIM IS MADE TO THE EXCLUSIVE RIGHT TO USE "PH", APART FROM THE MARK AS SHOWN.

SER. NO. 85-317,548, FILED 5-10-2011.

JOHN WILKE, EXAMINING ATTORNEY



David J. Kybas

Director of the United States Patent and Trademark Office

United States of America

United States Patent and Trademark Office

HAPPY RABBIT

Reg. No. 4,073,997

DEAN ELLIOTT (UNITED STATES INDIVIDUAL)
158 EXPRESS STREET
DALLAS, TX 75207

Registered Dec. 20, 2011

Int. Cl.: 10

FOR: ADULT SEXUAL STIMULATION AIDS, NAMELY, VIBRATORS, IN CLASS 10 (U.S. CLS. 26, 39 AND 44).

TRADEMARK

FIRST USE 2-6-2011; IN COMMERCE 2-6-2011.

PRINCIPAL REGISTER

THE MARK CONSISTS OF STANDARD CHARACTERS WITHOUT CLAIM TO ANY PARTICULAR FONT, STYLE, SIZE, OR COLOR.

SER. NO. 85-317,564, FILED 5-10-2011.

EDWARD NELSON, EXAMINING ATTORNEY



David J. Kyffers

Director of the United States Patent and Trademark Office

United States of America

United States Patent and Trademark Office

ASTRONAUTS AND INDIANS

Reg. No. 4,073,998

Registered Dec. 20, 2011

Int. Cl.: 25

TRADEMARK

PRINCIPAL REGISTER

GOLDBERG, SCOTT DANIEL (UNITED STATES INDIVIDUAL)
808 PACIFIC AVENUE
VENICE, CA 90291

FOR: CLOTHING, NAMELY, SHIRTS, POLO SHIRTS, KNIT SHIRTS, BUTTON UP SHIRTS, COLLARD SHIRTS, T-SHIRTS, PANTS, JEANS, SHORTS, SWEATERS, SWEATSHIRTS, SWEATPANTS, SOCKS, UNDERGARMENTS, SLEEPWEAR, PAJAMAS, ROBES, CAPS, HATS, COATS, JACKETS, BLAZERS, SUITS, KERCHIEFS, BLOUSES, SKIRTS, DRESSES, NECKTIES, SCARVES, SKIRTS, SWIMWEAR, BATHING SUITS, BIKINIS, COVER-UPS, TANK TOPS, JUMPERS, CAPRIS, LEGGINGS, JERSEYS, GLOVES, BELTS, TIES, AND VESTS; HEADWEAR, NAMELY, CAPS AND VISORS; FOOTWEAR, NAMELY, SANDALS, SLIPPERS, BOOTS, AND SHOES, IN CLASS 25 (U.S. CLS. 22 AND 39).

FIRST USE 9-16-2010; IN COMMERCE 4-30-2011.

THE MARK CONSISTS OF STANDARD CHARACTERS WITHOUT CLAIM TO ANY PARTICULAR FONT, STYLE, SIZE, OR COLOR.

SER. NO. 85-317,585, FILED 5-10-2011.

CURTIS FRENCH, EXAMINING ATTORNEY



David J. Kypos

Director of the United States Patent and Trademark Office

United States of America

United States Patent and Trademark Office

FASCINATION

Reg. No. 4,073,999

Registered Dec. 20, 2011

Int. Cl.: 33

TRADEMARK

PRINCIPAL REGISTER

O'BRIEN FAMILY VINEYARD, LLC (CALIFORNIA LIMITED LIABILITY COMPANY), DBA
O'BRIEN ESTATE
PO BOX 6020
NAPA, CA 94581

FOR: WHITE WINE, IN CLASS 33 (U.S. CLS. 47 AND 49).

FIRST USE 4-7-2011; IN COMMERCE 5-7-2011.

THE MARK CONSISTS OF STANDARD CHARACTERS WITHOUT CLAIM TO ANY PARTICULAR FONT, STYLE, SIZE, OR COLOR.

SER. NO. 85-317,617, FILED 5-11-2011.

ROBIN MITTLER, EXAMINING ATTORNEY



David J. Kyffers

Director of the United States Patent and Trademark Office

United States of America

United States Patent and Trademark Office

Pilate-ology

Reg. No. 4,074,000

PILATE-LOGY, LLC (CALIFORNIA LIMITED LIABILITY COMPANY)
13630 VENTURA BLVD.

Registered Dec. 20, 2011

SHERMAN OAKS, CA 914233700

Int. Cl.: 41

FOR: PROVIDING FITNESS AND EXERCISE STUDIO SERVICES, NAMELY, PILATES INSTRUCTION AND TRAINING, IN CLASS 41 (U.S. CLS. 100, 101 AND 107).

SERVICE MARK

FIRST USE 1-24-2011; IN COMMERCE 5-5-2011.

PRINCIPAL REGISTER

THE MARK CONSISTS OF STANDARD CHARACTERS WITHOUT CLAIM TO ANY PARTICULAR FONT, STYLE, SIZE, OR COLOR.

SER. NO. 85-317,619, FILED 5-11-2011.

ROBIN MITTLER, EXAMINING ATTORNEY



David J. Kyffers

Director of the United States Patent and Trademark Office

United States of America

United States Patent and Trademark Office

SKINLICIOUS

Reg. No. 4,074,001

SKINLICIOUS SOAPS LTD. (CANADA LIMITED COMPANY (LTD.))
202 SEATON STREET

Registered Dec. 20, 2011

TORONTO, CANADA M5A2T4

Int. Cl.: 3

FOR: NON-MEDICATED SKIN CARE PREPARATIONS; NON-MEDICATED BATH PREPARATIONS ; SOAPS FOR PERSONAL USE, IN CLASS 3 (U.S. CLS. 1, 4, 6, 50, 51 AND 52).

TRADEMARK

FIRST USE 3-10-2003; IN COMMERCE 8-19-2003.

PRINCIPAL REGISTER

THE MARK CONSISTS OF STANDARD CHARACTERS WITHOUT CLAIM TO ANY PARTICULAR FONT, STYLE, SIZE, OR COLOR.

SER. NO. 85-317,623, FILED 5-11-2011.

ROBIN MITTLER, EXAMINING ATTORNEY



David J. Kyffers

Director of the United States Patent and Trademark Office

United States of America

United States Patent and Trademark Office

AOMEI

Reg. No. 4,074,002

Registered Dec. 20, 2011

Int. Cl.: 9

TRADEMARK

PRINCIPAL REGISTER

CHENGDU AOMEI TECHNOLOGY CO., LTD. (CHINA LIMITED COMPANY (LTD.))
ROOM 404, BUILDING 1, DISTRICT 2
FIRST CIRCLE ROAD, 108 EAST 5 DUAN
CHENGDU, CHINA 610000

FOR: COMPUTER PROGRAMS FOR DISK AND PARTITION MANAGEMENT; COMPUTER SOFTWARE FOR STORAGE AND BACKUP; COMPUTER PROGRAMS FOR RECOVERING DATA ON COMPUTER DATA STORAGE DEVICES; COMPUTER SOFTWARE FOR DESKTOP UTILITY; COMPUTER UTILITY PROGRAMS AND DATABASE INTEGRATION THAT MAY BE DOWNLOADED FROM THE GLOBAL COMPUTER NETWORK; COMPUTER SOFTWARE FOR MANAGING VIRTUAL MACHINE; COMPUTER GAME SOFTWARE FOR USE ON MOBILE AND CELLULAR PHONES; COMPUTER APPLICATION SOFTWARE FOR USE ON MOBILE AND CELLULAR PHONES, IN CLASS 9 (U.S. CLS. 21, 23, 26, 36 AND 38).

FIRST USE 5-1-2010; IN COMMERCE 6-3-2010.

THE MARK CONSISTS OF STANDARD CHARACTERS WITHOUT CLAIM TO ANY PARTICULAR FONT, STYLE, SIZE, OR COLOR.

SER. NO. 85-317,642, FILED 5-11-2011.

KATHRYN COWARD, EXAMINING ATTORNEY



David J. Kybas

Director of the United States Patent and Trademark Office

United States of America

United States Patent and Trademark Office

Visionary Search

Reg. No. 4,074,003

VISIONARY SEARCH, INC (GEORGIA CORPORATION)

Registered Dec. 20, 2011

3506 PECOS LANE
NORCROSS, GA 30092

Int. Cl.: 35

FOR: ADVERTISING AND MARKETING CONSULTANCY, IN CLASS 35 (U.S. CLS. 100, 101 AND 102).

SERVICE MARK

FIRST USE 12-20-2004; IN COMMERCE 12-20-2004.

PRINCIPAL REGISTER

THE MARK CONSISTS OF STANDARD CHARACTERS WITHOUT CLAIM TO ANY PARTICULAR FONT, STYLE, SIZE, OR COLOR.

NO CLAIM IS MADE TO THE EXCLUSIVE RIGHT TO USE "SEARCH", APART FROM THE MARK AS SHOWN.

SER. NO. 85-317,651, FILED 5-11-2011.

SUSAN STIGLITZ, EXAMINING ATTORNEY



David J. Kyffers

Director of the United States Patent and Trademark Office

United States of America

United States Patent and Trademark Office

Visionarysearch.com

Reg. No. 4,074,004

VISIONARY SEARCH, INC (GEORGIA CORPORATION)

Registered Dec. 20, 2011

3506 PECOS LANE
NORCROSS, GA 30092

Int. Cl.: 35

FOR: ADVERTISING AND MARKETING CONSULTANCY, IN CLASS 35 (U.S. CLS. 100, 101 AND 102).

SERVICE MARK

FIRST USE 12-20-2004; IN COMMERCE 12-20-2004.

PRINCIPAL REGISTER

THE MARK CONSISTS OF STANDARD CHARACTERS WITHOUT CLAIM TO ANY PARTICULAR FONT, STYLE, SIZE, OR COLOR.

SER. NO. 85-317,658, FILED 5-11-2011.

SUSAN STIGLITZ, EXAMINING ATTORNEY



David J. Kybas

Director of the United States Patent and Trademark Office

United States of America

United States Patent and Trademark Office

CHANGE:HEALTHCARE

Reg. No. 4,074,005

Registered Dec. 20, 2011

Int. Cls.: 9 and 35

TRADEMARK

SERVICE MARK

PRINCIPAL REGISTER

CHANGEHEALTHCARE, INC. (DELAWARE CORPORATION)
12 CADILLAC DRIVE
SUITE 240
BRENTWOOD, TN 37027

FOR: SOFTWARE ANALYZING EMPLOYER HEALTHCARE PLANS AND PROVIDING DATA AS TO HOW EMPLOYEES CAN BEST UTILIZE EXISTING HEALTHCARE PLANS, IN CLASS 9 (U.S. CLS. 21, 23, 26, 36 AND 38).

FIRST USE 3-1-2008; IN COMMERCE 3-1-2008.

FOR: BUSINESS CONSULTING SERVICES, NAMELY, ADVISING EMPLOYERS, FOR BUSINESS PURPOSES, ON HOW EMPLOYEES CAN BEST UTILIZE EXISTING HEALTHCARE PLANS BY PROVIDING HEALTH PLAN COST INFORMATION, IN CLASS 35 (U.S. CLS. 100, 101 AND 102).

FIRST USE 3-1-2008; IN COMMERCE 3-1-2008.

THE MARK CONSISTS OF STANDARD CHARACTERS WITHOUT CLAIM TO ANY PARTICULAR FONT, STYLE, SIZE, OR COLOR.

SER. NO. 85-317,676, FILED 5-11-2011.

JORDAN BAKER, EXAMINING ATTORNEY



David J. Kyffers

Director of the United States Patent and Trademark Office

United States of America

United States Patent and Trademark Office

ABUYO

Reg. No. 4,074,006

ABUYO, LLC (COLORADO LIMITED LIABILITY COMPANY)
5925 SOUTH LEWISTON ST.
CENTENNIAL, CO 80016

Registered Dec. 20, 2011

Int. Cl.: 36

FOR: BANKING; FINANCIAL INVESTMENT IN THE FIELD OF REAL ESTATE, IN CLASS 36 (U.S. CLS. 100, 101 AND 102).

SERVICE MARK

FIRST USE 3-0-2010; IN COMMERCE 3-0-2010.

PRINCIPAL REGISTER

THE MARK CONSISTS OF STANDARD CHARACTERS WITHOUT CLAIM TO ANY PARTICULAR FONT, STYLE, SIZE, OR COLOR.

SER. NO. 85-317,730, FILED 5-11-2011.

KATHRYN COWARD, EXAMINING ATTORNEY



David J. Kybas

Director of the United States Patent and Trademark Office

United States of America

United States Patent and Trademark Office



Reg. No. 4,074,007

Registered Dec. 20, 2011

Int. Cl.: 43

SERVICE MARK

PRINCIPAL REGISTER

CARLSON, INC. (MINNESOTA CORPORATION)
CARLSON PARKWAY, P.O. BOX 59159
MINNEAPOLIS, MN 554598249

FOR: HOTEL SERVICES FEATURING AN INCENTIVE PROGRAM PROVIDING SPECIAL GUEST SERVICES, AMENITIES AND AWARDS TO MEMBERS, IN CLASS 43 (U.S. CLS. 100 AND 101).

FIRST USE 3-31-2011; IN COMMERCE 3-31-2011.

OWNER OF U.S. REG. NOS. 2,485,545, 3,925,553 AND OTHERS.

THE COLOR(S) BLACK, RED AND YELLOW IS/ARE CLAIMED AS A FEATURE OF THE MARK.

NO CLAIM IS MADE TO THE EXCLUSIVE RIGHT TO USE "CLUB", APART FROM THE MARK AS SHOWN.

THE MARK CONSISTS OF THE WORD "CLUB" IN RED SCRIPT ABOVE THE WORD "CARLSON" IN BLACK FOLLOWED BY A STYLIZED FLOWER DESIGN CONSISTING OF FOUR PETAL SHAPES IN RED WITH FOUR YELLOW OVALS BETWEEN THE PETALS.

SER. NO. 85-317,736, FILED 5-11-2011.

HELENE LIWINSKI, EXAMINING ATTORNEY



David J. Kyffers

Director of the United States Patent and Trademark Office

United States of America

United States Patent and Trademark Office

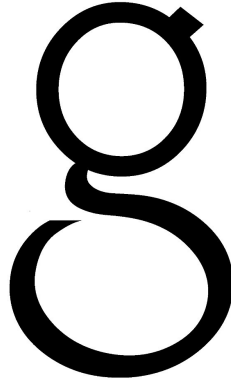

Reg. No. 4,074,008

GOODNIGHTS HEADQUARTERS, INC. (NEBRASKA CORPORATION)
1302 WEBSTER STREET
OMAHA, NE 681024701

Registered Dec. 20, 2011

Int. Cl.: 30

FOR: PIZZA THAT IS PREPARED FOR CONSUMPTION ON OR OFF THE PREMISES, IN CLASS 30 (U.S. CL. 46).

TRADEMARK

FIRST USE 1-22-2009; IN COMMERCE 1-22-2009.

PRINCIPAL REGISTER

THE MARK CONSISTS OF A STYLIZED LOWERCASE LETTER "G".

SER. NO. 85-317,737, FILED 5-11-2011.

GRETCHEN ULRICH, EXAMINING ATTORNEY



David J. Kybas

Director of the United States Patent and Trademark Office

United States of America

United States Patent and Trademark Office



Reg. No. 4,074,009

Registered Dec. 20, 2011

Int. Cl.: 25

TRADEMARK

PRINCIPAL REGISTER

JUDITH MARCH, LLC (FLORIDA LIMITED LIABILITY COMPANY)
790 NORTH COUNTY HIGHWAY 393
SANTA ROSA BEACH, FL 32459

FOR: DRESSES, IN CLASS 25 (U.S. CLS. 22 AND 39).

FIRST USE 3-30-2010; IN COMMERCE 3-30-2010.

THE NAME "JUDITH MARCH" IDENTIFIES A LIVING INDIVIDUAL WHOSE CONSENT IS OF RECORD.

THE MARK CONSISTS OF THE WORDS "JUDITH MARCH" IN ALL CAPS WITH THE WORD "JUDITH" VERTICALLY POSITIONED DIRECTLY ABOVE THE WORD "MARCH". THE WORD "JUDITH" IS IN MORE OF A BOLD FONT TYPE THAN THE WORD "MARCH". SURROUNDING THOSE WORDS IS AN INTRICATE SWIRL AND FEATHER BORDER; THE LEFT AND RIGHT EDGES OF THE BORDER COME TO A POINTED EDGE; THE WHOLE BORDER IS SYMMETRICAL FROM TOP TO BOTTOM AND LEFT TO RIGHT.

SER. NO. 85-317,745, FILED 5-11-2011.

JACQUELINE A. LAVINE, EXAMINING ATTORNEY



David J. Kyffers

Director of the United States Patent and Trademark Office

United States of America

United States Patent and Trademark Office

goodnights

Reg. No. 4,074,010

GOODNIGHTS HEADQUARTERS, INC. (NEBRASKA CORPORATION)
1302 WEBSTER STREET
OMAHA, NE 681024701

Registered Dec. 20, 2011

Int. Cl.: 30

FOR: PIZZA THAT IS PREPARED FOR CONSUMPTION ON OR OFF THE PREMISES, IN CLASS 30 (U.S. CL. 46).

TRADEMARK

FIRST USE 1-22-2009; IN COMMERCE 1-22-2009.

PRINCIPAL REGISTER

THE MARK CONSISTS OF STANDARD CHARACTERS WITHOUT CLAIM TO ANY PARTICULAR FONT, STYLE, SIZE, OR COLOR.

SER. NO. 85-317,753, FILED 5-11-2011.

GRETCHEN ULRICH, EXAMINING ATTORNEY



David J. Kybas

Director of the United States Patent and Trademark Office

United States of America

United States Patent and Trademark Office

AmeriCU CREDIT UNION

Reg. No. 4,074,011

AMERICU CREDIT UNION (NEW YORK CREDIT UNION)
1916 BLACK RIVER BLVD.
ROME, NY 13440

Registered Dec. 20, 2011

Int. Cl.: 36

FOR: CREDIT UNIONS, IN CLASS 36 (U.S. CLS. 100, 101 AND 102).

SERVICE MARK

FIRST USE 9-1-2000; IN COMMERCE 9-1-2000.

PRINCIPAL REGISTER

THE MARK CONSISTS OF STANDARD CHARACTERS WITHOUT CLAIM TO ANY PARTICULAR FONT, STYLE, SIZE, OR COLOR.

NO CLAIM IS MADE TO THE EXCLUSIVE RIGHT TO USE "CREDIT UNION", APART FROM THE MARK AS SHOWN.

SER. NO. 85-317,762, FILED 5-11-2011.

JOHN HWANG, EXAMINING ATTORNEY



David J. Kyffers

Director of the United States Patent and Trademark Office

United States of America

United States Patent and Trademark Office

PPM

Reg. No. 4,074,012

Registered Dec. 20, 2011

Int. Cl.: 16

TRADEMARK

PRINCIPAL REGISTER

ARBITRON INC. (DELAWARE CORPORATION)
9705 PATUXENT WOODS DRIVE
COLUMBIA, MD 21046

FOR: PRINTED MATTER, NAMELY REPORTS IN THE FIELD OF AUDIENCE MEASUREMENT, MEDIA EXPOSURE MEASUREMENT, MARKET RESEARCH AND BUSINESS RESEARCH; USER MANUALS FOR SOFTWARE IN THE FIELD OF AUDIENCE MEASUREMENT MEDIA EXPOSURE MEASUREMENT, MARKET RESEARCH AND BUSINESS RESEARCH, IN CLASS 16 (U.S. CLS. 2, 5, 22, 23, 29, 37, 38 AND 50).

FIRST USE 5-31-2001; IN COMMERCE 9-18-2002.

THE MARK CONSISTS OF STANDARD CHARACTERS WITHOUT CLAIM TO ANY PARTICULAR FONT, STYLE, SIZE, OR COLOR.

SER. NO. 85-317,793, FILED 5-11-2011.

ELI HELLMAN, EXAMINING ATTORNEY



David J. Kyffers

Director of the United States Patent and Trademark Office

United States of America

United States Patent and Trademark Office



Reg. No. 4,074,013

NOBUKAZU F. SHIOYA (UNITED STATES INDIVIDUAL)
453 PALMER AVENUE
MAMARONECK, NY 10543

Registered Dec. 20, 2011

Int. Cl.: 3

FOR: FRAGRANCES, NAMELY, PERFUMES, COLOGNES AND TOILET WATER, IN CLASS 3 (U.S. CLS. 1, 4, 6, 50, 51 AND 52).

TRADEMARK

FIRST USE 10-29-2010; IN COMMERCE 10-29-2010.

PRINCIPAL REGISTER

THE MARK CONSISTS OF A SCIENCE BEAKER AGAINST A FLAME IN THE BACKGROUND.

SER. NO. 85-317,804, FILED 5-11-2011.

LIEF MARTIN, EXAMINING ATTORNEY



David J. Kybas

Director of the United States Patent and Trademark Office

United States of America

United States Patent and Trademark Office



Reg. No. 4,074,014

Registered Dec. 20, 2011

Int. Cl.: 25

TRADEMARK

PRINCIPAL REGISTER

JUDITH MARCH, LLC (FLORIDA LIMITED LIABILITY COMPANY)
790 NORTH COUNTY HIGHWAY 393
SANTA ROSA BEACH, FL 32459

FOR: DRESSES, IN CLASS 25 (U.S. CLS. 22 AND 39).

FIRST USE 3-30-2010; IN COMMERCE 3-30-2010.

THE MARK CONSISTS OF A WOMAN IN A STANDING POSITION WITH SLIGHTLY BENT KNEES, TOUCHING HER HEAD WITH HER LEFT HAND AND HER RIGHT ARM IS BENT WITH HER PALM OPEN TO THE SKY; HER HEAD IS TILTED TO HER RIGHT; HER LEGS ARE CLOSE TOGETHER; SHE IS WEARING A VINTAGE PIN-UP-STYLE CORSET AND HIGH-HEELED SHOES; SHE HAS DARK HAIR.

SER. NO. 85-317,815, FILED 5-11-2011.

ELI HELLMAN, EXAMINING ATTORNEY



David J. Kyffers

Director of the United States Patent and Trademark Office

United States of America

United States Patent and Trademark Office

MAKING RESPONSIBLE CHOICES POSSIBLE!

Reg. No. 4,074,015

PARADIGM GROUP (NEW YORK CORPORATION)
350 MICHAEL DRIVE
SYOSSET, NY 11791

Registered Dec. 20, 2011

Int. Cl.: 16

FOR: FACIAL TISSUE; PAPER NAPKINS; PAPER TOWELS; TOILET TISSUE, IN CLASS 16
(U.S. CLS. 2, 5, 22, 23, 29, 37, 38 AND 50).

TRADEMARK

FIRST USE 1-1-2011; IN COMMERCE 1-1-2011.

PRINCIPAL REGISTER

THE MARK CONSISTS OF STANDARD CHARACTERS WITHOUT CLAIM TO ANY PARTICULAR FONT, STYLE, SIZE, OR COLOR.

SER. NO. 85-317,851, FILED 5-11-2011.

DAVID COLLIER, EXAMINING ATTORNEY



David J. Kyros

Director of the United States Patent and Trademark Office

United States of America

United States Patent and Trademark Office



Catholic United Financial CREDIT UNION

Reg. No. 4,074,016

CATHOLIC UNITED FINANCIAL (MINNESOTA NON-PROFIT CORPORATION)
3499 LEXINGTON AVENUE NORTH
ST. PAUL, MN 55126

Registered Dec. 20, 2011

Int. Cl.: 36

FOR: CREDIT UNION SERVICES, IN CLASS 36 (U.S. CLS. 100, 101 AND 102).

SERVICE MARK

FIRST USE 1-1-2011; IN COMMERCE 1-1-2011.

PRINCIPAL REGISTER

OWNER OF U.S. REG. NOS. 4,013,385, 4,013,387 AND OTHERS.

NO CLAIM IS MADE TO THE EXCLUSIVE RIGHT TO USE "CATHOLIC" AND "FINANCIAL CREDIT UNION", APART FROM THE MARK AS SHOWN.

THE MARK CONSISTS OF A STYLIZED "U" APPEARING ABOVE THE WORDS "CATHOLIC UNITED FINANCIAL" WHICH ARE ABOVE THE WORDS "CREDIT UNION".

SER. NO. 85-317,855, FILED 5-11-2011.

JOHN HWANG, EXAMINING ATTORNEY



David J. Kyffers

Director of the United States Patent and Trademark Office

United States of America

United States Patent and Trademark Office

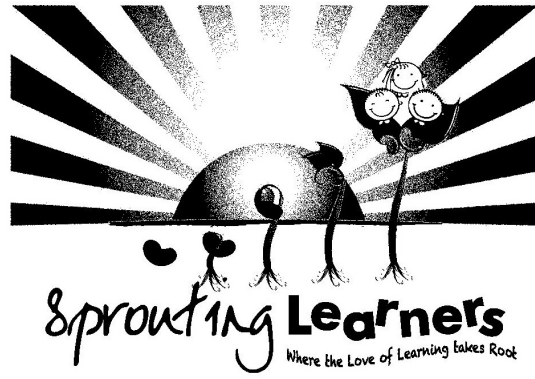

Reg. No. 4,074,017

Registered Dec. 20, 2011

Int. Cl.: 43

SERVICE MARK

PRINCIPAL REGISTER

STEIN-ROSALES, MARY (UNITED STATES INDIVIDUAL)
2 BUCKINGHAM RD
NANUET, NY 10954

FOR: DAY CARE CENTERS, IN CLASS 43 (U.S. CLS. 100 AND 101).

FIRST USE 1-1-2011; IN COMMERCE 4-1-2011.

THE STIPPLING IS FOR SHADING PURPOSES ONLY.

THE MARK CONSISTS OF A SEQUENCE OF A SPROUTING BEAN WITH THREE CHILDREN'S FACES COMING FROM THE LAST SPROUT AND A SUN IN THE BACKGROUND. AT THE BOTTOM THERE IS THE STYLIZED TEXT "SPROUTING LEARNERS WHERE THE LOVE OF LEARNING TAKES ROOT".

SER. NO. 85-317,862, FILED 5-11-2011.

JOHN WILKE, EXAMINING ATTORNEY



David J. Kybas

Director of the United States Patent and Trademark Office

United States of America

United States Patent and Trademark Office

CEOLOGY

Reg. No. 4,074,018

Registered Dec. 20, 2011

Int. Cl.: 35

SERVICE MARK

PRINCIPAL REGISTER

CEOLOGY COMMUNICATIONS GROUP, LLC (GEORGIA LIMITED LIABILITY COMPANY)
SUITE 900
400 PERIMTER CENTER TERRACE (NORTH)
ATLANTA, GA 30346

FOR: PROMOTION OF BUSINESS OPPORTUNITIES, IN CLASS 35 (U.S. CLS. 100, 101 AND 102).

FIRST USE 8-19-2010; IN COMMERCE 8-19-2010.

THE MARK CONSISTS OF STANDARD CHARACTERS WITHOUT CLAIM TO ANY PARTICULAR FONT, STYLE, SIZE, OR COLOR.

SER. NO. 85-317,871, FILED 5-11-2011.

DAVID COLLIER, EXAMINING ATTORNEY



David J. Kyffers

Director of the United States Patent and Trademark Office

United States of America

United States Patent and Trademark Office

SPA4THEPINK

Reg. No. 4,074,019

SPA4THEPINK (COLORADO NON-PROFIT CORPORATION)
10622 CLEARVIEW LANE
HIGHLANDS RANCH, CO 80126

Registered Dec. 20, 2011

Int. Cl.: 36

FOR: CHARITABLE FUNDRAISING, IN CLASS 36 (U.S. CLS. 100, 101 AND 102).

SERVICE MARK

FIRST USE 11-18-2010; IN COMMERCE 11-18-2010.

PRINCIPAL REGISTER

THE MARK CONSISTS OF STANDARD CHARACTERS WITHOUT CLAIM TO ANY PARTICULAR FONT, STYLE, SIZE, OR COLOR.

SER. NO. 85-317,874, FILED 5-11-2011.

MICHAEL WEBSTER, EXAMINING ATTORNEY



David J. Kybas

Director of the United States Patent and Trademark Office

United States of America

United States Patent and Trademark Office

We Want To Be Your Hero

Reg. No. 4,074,020

Registered Dec. 20, 2011

Int. Cl.: 37

SERVICE MARK

PRINCIPAL REGISTER

ARCHER RESTORATION SERVICES, INC. (GEORGIA CORPORATION)
4200 INDUSTRIAL CENTER LANE
SUITE 102
ACWORTH, GA 30101

FOR: BUILDING CONSTRUCTION; BUILDING RESTORATION; CRIME SCENE CLEAN-UP SERVICES, IN CLASS 37 (U.S. CLS. 100, 103 AND 106).

FIRST USE 2-1-2010; IN COMMERCE 2-1-2010.

THE MARK CONSISTS OF STANDARD CHARACTERS WITHOUT CLAIM TO ANY PARTICULAR FONT, STYLE, SIZE, OR COLOR.

SER. NO. 85-317,883, FILED 5-11-2011.

DAVID COLLIER, EXAMINING ATTORNEY



David J. Kyffers

Director of the United States Patent and Trademark Office

United States of America

United States Patent and Trademark Office

PEACHWEAR

Reg. No. 4,074,021

CHITWOOD, DEREK S. (UNITED STATES INDIVIDUAL)
1163 JACKSON BRIDGE RD.
CANON, GA 30520

Registered Dec. 20, 2011

Int. Cl.: 25

FOR: CAMOUFLAGE SHIRTS; COLLARED SHIRTS; HATS; LONG-SLEEVED SHIRTS;
POLO SHIRTS; SHORT-SLEEVED OR LONG-SLEEVED T-SHIRTS; T-SHIRTS, IN CLASS
25 (U.S. CLS. 22 AND 39).

TRADEMARK

FIRST USE 7-0-2009; IN COMMERCE 7-0-2009.

PRINCIPAL REGISTER

THE MARK CONSISTS OF STANDARD CHARACTERS WITHOUT CLAIM TO ANY PAR-
TICULAR FONT, STYLE, SIZE, OR COLOR.

SER. NO. 85-317,888, FILED 5-11-2011.

DAVID COLLIER, EXAMINING ATTORNEY



David J. Kyffers

Director of the United States Patent and Trademark Office

United States of America

United States Patent and Trademark Office

Rockstah Mod 5

Reg. No. 4,074,022

ABRAHAMIAN, MARK H. (UNITED STATES INDIVIDUAL)
1650 STATE HWY 71 W
CEDAR CREEK, TX 78612

Registered Dec. 20, 2011

Int. Cl.: 9

FOR: GUITAR AMPLIFIERS, IN CLASS 9 (U.S. CLS. 21, 23, 26, 36 AND 38).

TRADEMARK

FIRST USE 5-22-2007; IN COMMERCE 1-28-2008.

PRINCIPAL REGISTER

THE MARK CONSISTS OF STANDARD CHARACTERS WITHOUT CLAIM TO ANY PARTICULAR FONT, STYLE, SIZE, OR COLOR.

SER. NO. 85-317,890, FILED 5-11-2011.

KATHY DE JONGE, EXAMINING ATTORNEY



David J. Kybas

Director of the United States Patent and Trademark Office

United States of America

United States Patent and Trademark Office



Reg. No. 4,074,023

SUNRISE CORPORATION (FLORIDA CORPORATION)
5019 NW 165TH ST.
MIAMI, FL 33014

Registered Dec. 20, 2011

Int. Cl.: 3

FOR: ADHESIVES FOR ARTIFICIAL NAILS; NAIL CARE PREPARATIONS; NAIL ENAMEL;
NAIL GEL; NAIL POLISH; NAIL POLISH REMOVER; NAIL STRENGTHENERS; NAIL
VARNISH, IN CLASS 3 (U.S. CLS. 1, 4, 6, 50, 51 AND 52).

TRADEMARK

FIRST USE 5-0-2010; IN COMMERCE 5-0-2010.

PRINCIPAL REGISTER

THE MARK CONSISTS OF TWO MERGED HEXAGONS WITH THE STYLIZED LETTER
"S" IN THE MIDDLE.

SER. NO. 85-317,903, FILED 5-11-2011.

GEORGE LORENZO, EXAMINING ATTORNEY



David J. Kybas

Director of the United States Patent and Trademark Office

United States of America

United States Patent and Trademark Office

Siren Song

Reg. No. 4,074,024

KEVIN BROWN (UNITED STATES INDIVIDUAL)
1613 46TH AVE. SW
SEATTLE, WA 98116

Registered Dec. 20, 2011

Int. Cl.: 33

FOR: WINE, IN CLASS 33 (U.S. CLS. 47 AND 49).

TRADEMARK

FIRST USE 9-1-2009; IN COMMERCE 1-1-2010.

PRINCIPAL REGISTER

THE MARK CONSISTS OF STANDARD CHARACTERS WITHOUT CLAIM TO ANY PARTICULAR FONT, STYLE, SIZE, OR COLOR.

SER. NO. 85-317,910, FILED 5-11-2011.

NICHOLAS COLEMAN, EXAMINING ATTORNEY



David J. Kybas

Director of the United States Patent and Trademark Office

United States of America

United States Patent and Trademark Office

Don't Miss the Bus!

Reg. No. 4,074,025

Registered Dec. 20, 2011

Int. Cl.: 39

SERVICE MARK

PRINCIPAL REGISTER

RUSSO'S TRANSPORTATION SOLUTIONS, INC. (FLORIDA CORPORATION), DBA
RECREATION EXPRESS
POST OFFICE BOX 342714
TAMPA, FL 33694

FOR: TRANSPORTATION OF PASSENGERS AND/OR GOODS BY BUS, IN CLASS 39 (U.S.
CLS. 100 AND 105).

FIRST USE 3-0-2011; IN COMMERCE 3-0-2011.

THE MARK CONSISTS OF STANDARD CHARACTERS WITHOUT CLAIM TO ANY PAR-
TICULAR FONT, STYLE, SIZE, OR COLOR.

SER. NO. 85-317,913, FILED 5-11-2011.

ANNE E. GUSTASON, EXAMINING ATTORNEY



David J. Kyffers

Director of the United States Patent and Trademark Office

United States of America

United States Patent and Trademark Office

JanStaff



Reg. No. 4,074,026

MDX GROUP INC. (ARKANSAS CORPORATION), DBA JANSTAFF
2882 WEST WALNUT STREET, SUITE 8
ROGERS, AR 72756

Registered Dec. 20, 2011

Int. Cl.: 37

FOR: CLEANING OF COMMERCIAL PREMISES, IN CLASS 37 (U.S. CLS. 100, 103 AND 106).

SERVICE MARK

FIRST USE 2-23-2009; IN COMMERCE 2-23-2009.

PRINCIPAL REGISTER

THE MARK CONSISTS OF THE WORD "JANSTAFF" IN GREEN LETTERING WITH THREE GREEN OVERLAPPING DIAMONDS TO THE RIGHT OF "JANSTAFF" WITH A YELLOW LINE BELOW THE WORD "JANSTAFF".

THE COLOR(S) GREEN AND YELLOW IS/ARE CLAIMED AS A FEATURE OF THE MARK.

SER. NO. 85-317,931, FILED 5-11-2011.

GEORGE LORENZO, EXAMINING ATTORNEY



David J. Kybas

Director of the United States Patent and Trademark Office

United States of America

United States Patent and Trademark Office

IL BASTARDO

Reg. No. 4,074,027

Registered Dec. 20, 2011

Int. Cl.: 29

TRADEMARK

PRINCIPAL REGISTER

RS/RG ASSOCIATES, LLC (NEW YORK LIMITED LIABILITY COMPANY)
SUITE 15F
201 E. 25TH STREET
NEW YORK, NY 10010

FOR: EDIBLE OILS; OLIVE OIL; VEGETABLE OILS, IN CLASS 29 (U.S. CL. 46).

FIRST USE 4-1-2011; IN COMMERCE 4-1-2011.

THE MARK CONSISTS OF STANDARD CHARACTERS WITHOUT CLAIM TO ANY PARTICULAR FONT, STYLE, SIZE, OR COLOR.

OWNER OF U.S. REG. NOS. 3,422,877 AND 3,527,904.

THE ENGLISH TRANSLATION OF IL BASTARDO IN THE MARK IS THE BASTARD.

SER. NO. 85-317,959, FILED 5-11-2011.

SUSAN STIGLITZ, EXAMINING ATTORNEY



David J. Kybas

Director of the United States Patent and Trademark Office

United States of America

United States Patent and Trademark Office

KOZI

Reg. No. 4,074,028

Registered Dec. 20, 2011

Int. Cl.: 25

TRADEMARK

PRINCIPAL REGISTER

KOZI DESIGNS, LLC (NORTH CAROLINA LIMITED LIABILITY COMPANY)
331 CLINARD ROAD
THOMASVILLE, NC 27360

FOR: NECK WARMERS; SCARVES, IN CLASS 25 (U.S. CLS. 22 AND 39).

FIRST USE 0-0-2005; IN COMMERCE 0-0-2005.

THE MARK CONSISTS OF STANDARD CHARACTERS WITHOUT CLAIM TO ANY PARTICULAR FONT, STYLE, SIZE, OR COLOR.

SER. NO. 85-317,978, FILED 5-11-2011.

RONALD MCMORROW, EXAMINING ATTORNEY



David J. Kybas

Director of the United States Patent and Trademark Office

United States of America

United States Patent and Trademark Office

NUSCRIPTRX

Reg. No. 4,074,029

ND ACQUISITIONS CORP. (DELAWARE CORPORATION)
5215 LINBAR DRIVE, #210
NASHVILLE, TN 37211

Registered Dec. 20, 2011

Int. Cl.: 35

FOR: PHARMACY SERVICES, NAMELY, INSTITUTIONAL RETAIL PHARMACY SERVICES,
IN CLASS 35 (U.S. CLS. 100, 101 AND 102).

SERVICE MARK

FIRST USE 10-15-2010; IN COMMERCE 10-15-2010.

PRINCIPAL REGISTER

THE MARK CONSISTS OF STANDARD CHARACTERS WITHOUT CLAIM TO ANY PAR-
TICULAR FONT, STYLE, SIZE, OR COLOR.

SER. NO. 85-317,996, FILED 5-11-2011.

APRIL HESIK, EXAMINING ATTORNEY



David J. Kybas

Director of the United States Patent and Trademark Office

United States of America

United States Patent and Trademark Office



Reg. No. 4,074,030

Registered Dec. 20, 2011

Int. Cl.: 35

SERVICE MARK

PRINCIPAL REGISTER

GOOD DONOR, LLC (MINNESOTA LIMITED LIABILITY COMPANY)
15800 51ST AVENUE NORTH
PLYMOUTH, MN 55446

FOR: BUSINESS SERVICES, NAMELY, MATCHING INDIVIDUALS, BUSINESSES, CLUBS, GROUPS AND ORGANIZATIONS WITH NONPROFIT ORGANIZATIONS FOR THE PURPOSE OF FACILITATING DONATION OF GOODS TO THE NONPROFIT ORGANIZATIONS AND THE PICK UP OR DROP OFF OF THE DONATED GOODS, IN CLASS 35 (U.S. CLS. 100, 101 AND 102).

FIRST USE 2-28-2008; IN COMMERCE 2-28-2008.

THE MARK CONSISTS OF THE LETTERS "GD" WITH A SIDEWISE SMILEY FACE IN THE PARTIAL CIRCLE CREATED BY THE LETTER "D".

SER. NO. 85-317,998, FILED 5-11-2011.

APRIL HESIK, EXAMINING ATTORNEY



David J. Kyffers

Director of the United States Patent and Trademark Office

United States of America

United States Patent and Trademark Office

DEALSAVER

Reg. No. 4,074,031

Registered Dec. 20, 2011

Int. Cl.: 35

SERVICE MARK

PRINCIPAL REGISTER

MCCLATCHY MANAGEMENT SERVICES, INC. (DELAWARE CORPORATION)
2100 Q STREET
SACRAMENTO, CA 95816

FOR: PROMOTIONAL SERVICES, NAMELY, PROMOTING THE GOODS AND SERVICES OF OTHERS BY PROVIDING ONLINE VOUCHERS, IN CLASS 35 (U.S. CLS. 100, 101 AND 102).

FIRST USE 4-17-2011; IN COMMERCE 4-17-2011.

THE MARK CONSISTS OF STANDARD CHARACTERS WITHOUT CLAIM TO ANY PARTICULAR FONT, STYLE, SIZE, OR COLOR.

SER. NO. 85-318,022, FILED 5-11-2011.

SUSAN STIGLITZ, EXAMINING ATTORNEY



David J. Kyffers

Director of the United States Patent and Trademark Office

United States of America

United States Patent and Trademark Office

SWIM & SWEAT

Reg. No. 4,074,032

SWIM & SWEAT, INC. (NEW JERSEY CORPORATION)
39 STANGL ROAD
FLEMINGTON, NJ 08822

Registered Dec. 20, 2011

Int. Cl.: 35

FOR: RETAIL STORE SERVICES FEATURING CLOTHING, IN CLASS 35 (U.S. CLS. 100, 101 AND 102).

SERVICE MARK

FIRST USE 4-0-1988; IN COMMERCE 4-0-1988.

PRINCIPAL REGISTER

THE MARK CONSISTS OF STANDARD CHARACTERS WITHOUT CLAIM TO ANY PARTICULAR FONT, STYLE, SIZE, OR COLOR.

SER. NO. 85-318,083, FILED 5-11-2011.

MARTHA FROMM, EXAMINING ATTORNEY



David J. Kyffers

Director of the United States Patent and Trademark Office

United States of America

United States Patent and Trademark Office

DUSTY FEET

Reg. No. 4,074,033

Registered Dec. 20, 2011

Int. Cl.: 36

SERVICE MARK

PRINCIPAL REGISTER

DUSTY FEET, INC. (MISSOURI CORPORATION)
1440 STATE HIWAY 248, SUITE Q 199
BRANSON, MO 65616

FOR: CHARITABLE FUNDRAISING SERVICES FOR THE IMPROVEMENT OF THE LIVES OF UNDERPRIVILEGED AND IMPOVERISHED PEOPLE IN AFRICA, IN CLASS 36 (U.S. CLS. 100, 101 AND 102).

FIRST USE 1-1-2006; IN COMMERCE 1-1-2006.

THE MARK CONSISTS OF STANDARD CHARACTERS WITHOUT CLAIM TO ANY PARTICULAR FONT, STYLE, SIZE, OR COLOR.

SER. NO. 85-318,097, FILED 5-11-2011.

SCOTT BIBB, EXAMINING ATTORNEY



David J. Kyffers

Director of the United States Patent and Trademark Office

United States of America

United States Patent and Trademark Office

ECUMEN

Reg. No. 4,074,034

Registered Dec. 20, 2011

**Int. Cls.: 35, 36, 43, 44
and 45**

SERVICE MARK

PRINCIPAL REGISTER

ECUMEN (MINNESOTA NON-PROFIT CORPORATION)
3350 LEXINGTON AVENUE NORTH
SHOREVIEW, MN 55126

FOR: CHARITABLE SERVICES, NAMELY PROVIDING ADMINISTRATION AND MANAGEMENT OF CARE FACILITIES, HOUSING FACILITIES, ASSISTED LIVING FACILITIES AND NURSING HOME FACILITIES FOR SENIOR CITIZENS, IN CLASS 35 (U.S. CLS. 100, 101 AND 102).

FIRST USE 8-15-2004; IN COMMERCE 8-15-2004.

FOR: REAL ESTATE CONSULTANCY SERVICES IN THE FIELD OF SENIOR HOUSING; CHARITABLE FOUNDATION SERVICES, NAMELY, PROVIDING FUNDRAISING ACTIVITIES AND INVESTMENT MANAGEMENT SERVICES TO SUPPORT EDUCATION AND RESEARCH REGARDING AGING, IN CLASS 36 (U.S. CLS. 100, 101 AND 102).

FIRST USE 8-15-2004; IN COMMERCE 8-15-2004.

FOR: PROVIDING ASSISTANCE TO SENIOR CITIZENS SEEKING TO DETERMINE ASSISTED LIVING FACILITIES APPROPRIATE FOR THEIR NEEDS; PROVIDING ASSISTED LIVING FACILITIES; PROVIDING MEMORY CARE HOUSING, IN CLASS 43 (U.S. CLS. 100 AND 101).

FIRST USE 8-15-2004; IN COMMERCE 8-15-2004.

FOR: NURSING HOMES, HEALTH CARE, IN-HOME NURSING CARE, HOME HEALTH CARE SERVICES, AND PHYSICAL REHABILITATION, IN CLASS 44 (U.S. CLS. 100 AND 101).

FIRST USE 8-15-2004; IN COMMERCE 8-15-2004.

FOR: IN-HOME SUPPORT SERVICES TO SENIOR PERSONS, NAMELY, GERIATRIC CARE MANAGEMENT SERVICES IN THE NATURE OF THE COORDINATION OF NECESSARY SERVICES AND PERSONAL CARE FOR OLDER INDIVIDUALS; SOCIAL SERVICE, NAMELY, COMPANIONSHIP SERVICES FOR ELDERLY PEOPLE; PROVIDING NON-MEDICAL IN-HOME PERSONAL SERVICES FOR INDIVIDUALS INCLUDING CHECKING HOME CONDITION, SUPPLIES AND INDIVIDUAL WELL-BEING, SCHEDULING APPOINT-



David J. Kyffers

Director of the United States Patent and Trademark Office

Reg. No. 4,074,034 MENTS, RUNNING ERRANDS, MAKING SAFETY CHECKS, AND PROVIDING ON-LINE INFORMATION RELATED TO THESE PERSONAL SERVICES, IN CLASS 45 (U.S. CLS. 100 AND 101).

FIRST USE 8-15-2004; IN COMMERCE 8-15-2004.

THE MARK CONSISTS OF STANDARD CHARACTERS WITHOUT CLAIM TO ANY PARTICULAR FONT, STYLE, SIZE, OR COLOR.

OWNER OF U.S. REG. NO. 3,074,550.

SER. NO. 85-318,107, FILED 5-11-2011.

DAVID I, EXAMINING ATTORNEY

United States of America

United States Patent and Trademark Office



Reg. No. 4,074,035

Registered Dec. 20, 2011

Int. Cls.: 16, 25 and 37

TRADEMARK

SERVICE MARK

PRINCIPAL REGISTER

L.F. JENNINGS, INC. (VIRGINIA CORPORATION)
407 N. WASHINGTON STREET, SUITE 200
FALLS CHURCH, VA 22046

FOR: STATIONERY, IN CLASS 16 (U.S. CLS. 2, 5, 22, 23, 29, 37, 38 AND 50).

FIRST USE 1-1-1980; IN COMMERCE 1-1-1980.

FOR: CLOTHING, NAMELY TEE-SHIRTS AND HEADWEAR, IN CLASS 25 (U.S. CLS. 22 AND 39).

FIRST USE 1-1-1980; IN COMMERCE 1-1-1980.

FOR: BUILDING CONSTRUCTION SERVICES, IN CLASS 37 (U.S. CLS. 100, 103 AND 106).

FIRST USE 1-1-1980; IN COMMERCE 1-1-1980.

THE MARK CONSISTS OF LOGO CONFIGURATION OF CAPITAL LETTERS L, F AND J STYLIZED TO FORM A RECTANGLE.

SER. NO. 85-318,118, FILED 5-11-2011.

SCOTT BIBB, EXAMINING ATTORNEY



David J. Kyffers

Director of the United States Patent and Trademark Office

United States of America

United States Patent and Trademark Office

RAW

Reg. No. 4,074,036

Registered Dec. 20, 2011

Int. Cl.: 34

TRADEMARK

PRINCIPAL REGISTER

BBK TOBACCO & FOODS, LLP (ARIZONA LIMITED LIABILITY PARTNERSHIP), DBA
HBI INTERNATIONAL
3315 W. BUCKEYE ROAD
PHOENIX, AZ 85009

FOR: CIGARETTE FILTERS; CIGARETTE TUBES; CIGARETTE-ROLLING MACHINES, IN
CLASS 34 (U.S. CLS. 2, 8, 9 AND 17).

FIRST USE 12-3-2007; IN COMMERCE 12-3-2007.

THE MARK CONSISTS OF STANDARD CHARACTERS WITHOUT CLAIM TO ANY PAR-
TICULAR FONT, STYLE, SIZE, OR COLOR.

OWNER OF U.S. REG. NO. 2,989,221.

SER. NO. 85-318,131, FILED 5-11-2011.

JOHN GARTNER, EXAMINING ATTORNEY



David J. Kyffers

Director of the United States Patent and Trademark Office

United States of America

United States Patent and Trademark Office

JASUNY

Reg. No. 4,074,037

Registered Dec. 20, 2011

Int. Cl.: 9

TRADEMARK

PRINCIPAL REGISTER

YIM, FRANK (HONG KONG INDIVIDUAL)
SUITE B-1
4413 POST ROAD
VINELAND, NJ 08360

FOR: POWER SUPPLIES ; UNINTERRUPTIBLE ELECTRICAL POWER SUPPLIES ; SWITCHING POWER SUPPLIES ; VOLTAGE STABILIZING POWER SUPPLIES ; STANDARD AND CUSTOM DESIGNED PARTS AND FITTINGS, NAMELY, CONNECTORS WHICH ARE USED TO CREATE A CONDUCTIVE PATH TO CONNECT BATTERIES AND OTHER COMPONENTS TO COMPUTER POWER SUPPLIES, INDUSTRIAL AND OTHER ELECTRONIC POWER SUPPLIES, IN CLASS 9 (U.S. CLS. 21, 23, 26, 36 AND 38).

FIRST USE 12-1-1999; IN COMMERCE 12-1-1999.

THE MARK CONSISTS OF STANDARD CHARACTERS WITHOUT CLAIM TO ANY PARTICULAR FONT, STYLE, SIZE, OR COLOR.

SER. NO. 85-318,142, FILED 5-11-2011.

JOHN WILKE, EXAMINING ATTORNEY



David J. Kyffers

Director of the United States Patent and Trademark Office

United States of America

United States Patent and Trademark Office

EYE-FI

Reg. No. 4,074,038

Registered Dec. 20, 2011

Int. Cl.: 9

TRADEMARK

PRINCIPAL REGISTER

EYE-FI, INC. (CALIFORNIA CORPORATION)
305 W. EVELYN AVENUE
MOUNTAIN VIEW, CA 94041

FOR: ELECTRONIC STORAGE DEVICE IN THE NATURE OF MEMORY MEDIA FOR STORING PHOTOGRAPHS AND VIDEO; COMPUTER SOFTWARE FOR ORGANIZING AND VIEWING DIGITAL IMAGES AND PHOTOGRAPHS , IN CLASS 9 (U.S. CLS. 21, 23, 26, 36 AND 38).

FIRST USE 4-25-2006; IN COMMERCE 10-15-2007.

THE MARK CONSISTS OF STANDARD CHARACTERS WITHOUT CLAIM TO ANY PARTICULAR FONT, STYLE, SIZE, OR COLOR.

OWNER OF U.S. REG. NO. 3,934,326.

SER. NO. 85-318,163, FILED 5-11-2011.

JOHN WILKE, EXAMINING ATTORNEY



David J. Kybas

Director of the United States Patent and Trademark Office

United States of America

United States Patent and Trademark Office

MOBILE WING FLEX

Reg. No. 4,074,039

SIMS, LYNWOOD (UNITED STATES INDIVIDUAL)
2704 OAKHURST DRIVE
ROCK HILL, SC 29732

Registered Dec. 20, 2011

Int. Cl.: 28

FOR: MANUALLY-OPERATED EXERCISE EQUIPMENT FOR PHYSICAL FITNESS PURPOSES; PHYSICAL FITNESS EQUIPMENT, NAMELY, EXERCISE BANDS AND TRAINING BARS, IN CLASS 28 (U.S. CLS. 22, 23, 38 AND 50).

TRADEMARK

FIRST USE 8-15-2010; IN COMMERCE 8-15-2010.

PRINCIPAL REGISTER

THE MARK CONSISTS OF STANDARD CHARACTERS WITHOUT CLAIM TO ANY PARTICULAR FONT, STYLE, SIZE, OR COLOR.

SER. NO. 85-318,166, FILED 5-11-2011.

GIANCARLO CASTRO, EXAMINING ATTORNEY



David J. Kyffers

Director of the United States Patent and Trademark Office

United States of America

United States Patent and Trademark Office

GET WET

Reg. No. 4,074,040

Registered Dec. 20, 2011

Int. Cl.: 41

SERVICE MARK

PRINCIPAL REGISTER

FAST TRACK ENTERTAINMENT (NEW YORK CORPORATION)
3F
1425 BROADWAY
ASTORIA, NY 11106

FOR: ARRANGING AND CONDUCTING SPECIAL EVENTS, FOR SOCIAL ENTERTAINMENT PURPOSES, IN THE NATURE OF POOL PARTIES, IN CLASS 41 (U.S. CLS. 100, 101 AND 107).

FIRST USE 3-1-2004; IN COMMERCE 3-1-2004.

THE MARK CONSISTS OF STANDARD CHARACTERS WITHOUT CLAIM TO ANY PARTICULAR FONT, STYLE, SIZE, OR COLOR.

SER. NO. 85-318,176, FILED 5-11-2011.

LESLIE RICHARDS, EXAMINING ATTORNEY



David J. Kybas

Director of the United States Patent and Trademark Office

United States of America

United States Patent and Trademark Office



Reg. No. 4,074,041

Registered Dec. 20, 2011

Int. Cls.: 35 and 45

SERVICE MARK

PRINCIPAL REGISTER

TAX GROUP CENTER, INC. (CALIFORNIA CORPORATION)
5010 PARKWAY CALABASAS, SUITE 110
CALABASAS, CA 91302

FOR: INCOME TAX CONSULTATION; INCOME TAX PREPARATION; TAX ADVISORY SERVICES; TAX CONSULTATION; TAX FILING SERVICES; TAX PREPARATION , IN CLASS 35 (U.S. CLS. 100, 101 AND 102).

FIRST USE 4-1-2011; IN COMMERCE 4-1-2011.

FOR: REPRESENTATION OF CLIENTS IN TAX MATTERS BEFORE TAX AUTHORITIES, IN CLASS 45 (U.S. CLS. 100 AND 101).

FIRST USE 4-1-2011; IN COMMERCE 4-1-2011.

NO CLAIM IS MADE TO THE EXCLUSIVE RIGHT TO USE "TAX GROUP CENTER" AND "SERVICE", APART FROM THE MARK AS SHOWN.

THE MARK CONSISTS OF THE WORDING "TAX GROUP CENTER" BELOW A BROKEN HORIZONTAL LINE, THE LINE IS SEPARATED BY A GRAPHIC IMAGE OF AN EAGLE WITH WINGS SPREAD, THE WORDS "SERVICE", "SOLUTION" AND "SUCCESS" SEPARATED INDIVIDUALLY BY A SOLID DOT BETWEEN THE WORDS "SERVICE", "SOLUTION" AND "SUCCESS".

SER. NO. 85-318,179, FILED 5-11-2011.

HOWARD SMIGA, EXAMINING ATTORNEY



David J. Kybas

Director of the United States Patent and Trademark Office

United States of America

United States Patent and Trademark Office

FSNBCC

Reg. No. 4,074,042

STARKS, TERRY B. (GEORGIA CORPORATION)
1895 BEAVER RIDGE CIRCLE, SUITE C & D
NORCROSS, GA 30071

Registered Dec. 20, 2011

Int. Cl.: 45

FOR: CONDUCTING RELIGIOUS PRAYER SERVICES; PROVIDING A WEBSITE FEATURING INFORMATION ABOUT RELIGIOUS BELIEF SYSTEMS; RELIGIOUS AND SPIRITUAL SERVICES, NAMELY, CONDUCTING RELIGIOUS WORSHIP, MARRIAGE CEREMONIES, BAPTISMAL CEREMONIES, BABY DEDICATIONS, BEREAVEMENT CEREMONIES, AND RELIGIOUS COUNSELING; RELIGIOUS AND SPIRITUAL SERVICES, NAMELY, PROVIDING GATHERINGS AND RETREATS TO DEVELOP AND ENHANCE THE SPIRITUAL LIVES OF INDIVIDUALS; RELIGIOUS MASS INTENTIONS SERVICES, NAMELY, PROVIDING FOR THE ARRANGEMENT OF MASS INTENTIONS FOR THE DECEASED AND OR LIVING; RELIGIOUS SERVICES, NAMELY, PRAYER MEETINGS, IN CLASS 45 (U.S. CLS. 100 AND 101).

SERVICE MARK

PRINCIPAL REGISTER

FIRST USE 4-15-2011; IN COMMERCE 4-25-2011.

THE MARK CONSISTS OF STANDARD CHARACTERS WITHOUT CLAIM TO ANY PARTICULAR FONT, STYLE, SIZE, OR COLOR.

SER. NO. 85-318,189, FILED 5-11-2011.

C. DIONNE CLYBURN, EXAMINING ATTORNEY



David J. Kyros

Director of the United States Patent and Trademark Office

United States of America

United States Patent and Trademark Office

PaveWest

Reg. No. 4,074,043

MANGAN, RICHARD (UNITED STATES INDIVIDUAL)
13939 SUMMIT DRIVE
WHITTIER, CA 90602

Registered Dec. 20, 2011

Int. Cl.: 37

FOR: CONSTRUCTION SERVICES, NAMELY, CONCRETE PAVING, GRADING, AND ASPHALT PAVING SERVICES, IN CLASS 37 (U.S. CLS. 100, 103 AND 106).

SERVICE MARK

FIRST USE 1-1-1992; IN COMMERCE 1-1-1992.

PRINCIPAL REGISTER

THE MARK CONSISTS OF STANDARD CHARACTERS WITHOUT CLAIM TO ANY PARTICULAR FONT, STYLE, SIZE, OR COLOR.

SER. NO. 85-318,190, FILED 5-11-2011.

LINDA MICKLEBURGH, EXAMINING ATTORNEY



David J. Kybas

Director of the United States Patent and Trademark Office

United States of America

United States Patent and Trademark Office

CRIMSON

Reg. No. 4,074,044

CRIMSON, LLC (CALIFORNIA LIMITED LIABILITY COMPANY)
8555 CASHIO STREET, SUITE 203

Registered Dec. 20, 2011

LOS ANGELES, CA 90035

Int. Cl.: 9

FOR: ELECTRICAL PLUGS; ELECTRICAL SOCKETS; ELECTRICAL TRANSFORMERS; STEREO AMPLIFIERS; DIGITAL AUDIO PLAYERS; EARPHONES; CELL PHONE CASES; PROTECTIVE COVERS AND CASES FOR CELL PHONES; STANDS SPECIALLY DESIGNED FOR HOLDING CELLULAR PHONES; DEVICES FOR HANDS-FREE USE OF MOBILE PHONES; ELECTRICAL POWER SUPPLIES; BATTERY CHARGERS; CELL PHONE BATTERY CHARGERS FOR USE IN VEHICLES; CELL PHONE BATTERY CHARGERS; LOUDSPEAKERS; TABLET COMPUTER BAGS; CARRYING CASES SPECIALLY ADAPTED FOR TABLET COMPUTERS; TABLET COMPUTER FACEPLATES; SCREEN PROTECTORS SPECIALLY FOR CELL PHONES AND TABLET COMPUTER, IN CLASS 9 (U.S. CLS. 21, 23, 26, 36 AND 38).

TRADEMARK

PRINCIPAL REGISTER

FIRST USE 2-1-2011; IN COMMERCE 2-1-2011.

THE MARK CONSISTS OF STANDARD CHARACTERS WITHOUT CLAIM TO ANY PARTICULAR FONT, STYLE, SIZE, OR COLOR.

SER. NO. 85-318,210, FILED 5-11-2011.

MARK SHINER, EXAMINING ATTORNEY



David J. Kybas

Director of the United States Patent and Trademark Office

United States of America

United States Patent and Trademark Office

TOP SCORE

Reg. No. 4,074,045

MINNESOTA PUBLIC RADIO (MINNESOTA NON-PROFIT CORPORATION)
480 CEDAR STREET
ST. PAUL, MN 55101

Registered Dec. 20, 2011

Int. Cl.: 41

FOR: ENTERTAINMENT SERVICES, NAMELY, PROVIDING PODCASTS IN THE FIELD OF COMMENTARY AND INTERVIEWS ABOUT MUSIC AND VIDEO GAMES, IN CLASS 41 (U.S. CLS. 100, 101 AND 107).

SERVICE MARK

FIRST USE 4-12-2011; IN COMMERCE 4-12-2011.

PRINCIPAL REGISTER

THE MARK CONSISTS OF STANDARD CHARACTERS WITHOUT CLAIM TO ANY PARTICULAR FONT, STYLE, SIZE, OR COLOR.

SER. NO. 85-318,211, FILED 5-11-2011.

ERIN FALK, EXAMINING ATTORNEY



David J. Kyffers

Director of the United States Patent and Trademark Office

United States of America
United States Patent and Trademark Office

WILDFIRE

Reg. No. 4,074,046

Registered Dec. 20, 2011

Int. Cl.: 30

TRADEMARK

PRINCIPAL REGISTER

SALTWORKS, INC. (WASHINGTON CORPORATION)
15000 WOODINVILLE REDMOND ROAD, B-900
WOODINVILLE, WA 98072

FOR: SALT, IN CLASS 30 (U.S. CL. 46).

FIRST USE 5-6-2011; IN COMMERCE 5-6-2011.

THE MARK CONSISTS OF STANDARD CHARACTERS WITHOUT CLAIM TO ANY PARTICULAR FONT, STYLE, SIZE, OR COLOR.

SER. NO. 85-318,274, FILED 5-11-2011.

ASMAT KHAN, EXAMINING ATTORNEY



David J. Kybas

Director of the United States Patent and Trademark Office

United States of America

United States Patent and Trademark Office

Go Human...Give what you
need!

Reg. No. 4,074,047

REAL INSPIRATION INC. (CALIFORNIA CORPORATION)
811 TYLER DR
AUBURN, CA 95603

Registered Dec. 20, 2011

Int. Cl.: 41

FOR: EDUCATIONAL SERVICES, NAMELY, CONDUCTING PROGRAMS IN THE FIELD OF LEADERSHIP, DIVERSITY TRAINING, AND IMPROVEMENT OF SCHOOL AND WORK ENVIRONMENTS, IN CLASS 41 (U.S. CLS. 100, 101 AND 107).

SERVICE MARK

FIRST USE 1-17-2007; IN COMMERCE 3-15-2008.

PRINCIPAL REGISTER

THE MARK CONSISTS OF STANDARD CHARACTERS WITHOUT CLAIM TO ANY PARTICULAR FONT, STYLE, SIZE, OR COLOR.

SER. NO. 85-318,275, FILED 5-11-2011.

EDWARD NELSON, EXAMINING ATTORNEY



David J. Kybas

Director of the United States Patent and Trademark Office

United States of America
United States Patent and Trademark Office

HELLFIRE

Reg. No. 4,074,048

Registered Dec. 20, 2011

Int. Cl.: 30

TRADEMARK

PRINCIPAL REGISTER

SALTWORKS, INC. (WASHINGTON CORPORATION)
15000 WOODINVILLE REDMOND ROAD, B-900
WOODINVILLE, WA 98072

FOR: SALT, IN CLASS 30 (U.S. CL. 46).

FIRST USE 5-6-2011; IN COMMERCE 5-6-2011.

THE MARK CONSISTS OF STANDARD CHARACTERS WITHOUT CLAIM TO ANY PARTICULAR FONT, STYLE, SIZE, OR COLOR.

SER. NO. 85-318,276, FILED 5-11-2011.

ASMAT KHAN, EXAMINING ATTORNEY



David J. Kybas

Director of the United States Patent and Trademark Office

United States of America

United States Patent and Trademark Office



Reg. No. 4,074,049

Registered Dec. 20, 2011

Int. Cls.: 9, 16 and 41

TRADEMARK

SERVICE MARK

PRINCIPAL REGISTER

ALTEC INDUSTRIES, INC. (ALABAMA CORPORATION), AKA ALTEC
210 INVERNESS CENTER DRIVE
BIRMINGHAM, AL 35242

FOR: PRERECORDED VIDEO CASSETTE TAPES AND CD ROM DISKETTES FEATURING INFORMATION RELATING TO THE SAFE OPERATION AND USE OF EQUIPMENT AND ACCESSORIES IN THE FIELD OF ELECTRIC UTILITIES, TELECOMMUNICATIONS, CONSTRUCTION AND TREE CARE, NAMELY, TRUCKS, AERIAL BUCKETS, AERIAL LIFTS, DIGGER DERRICKS, WINCHES, HYDRAULIC AUGER UNITS, DIGGERS AND JACKS, BOOMS FOR AERIAL LIFTS, SINGLE AND TWO-MAN PLATFORMS, OUTRIGGERS AND SUB FRAMES, LINE BODIES, DUMP BODIES, CAB GUARDS, WIRE REEL RACKS, HOSE REELS AND UTILITY BODY PARTS, MOTOR DRIVEN TOOLS, NAMELY, WOOD CHIPPER FOR CUTTING TREE LIMBS AND BRUSH INTO SMALL CHIPS, IN CLASS 9 (U.S. CLS. 21, 23, 26, 36 AND 38).

FIRST USE 4-26-2011; IN COMMERCE 4-26-2011.

FOR: BOOKS, PAMPHLETS, AND PRINTED TRAINING MATERIALS RELATING TO THE SAFE OPERATION AND USE OF EQUIPMENT AND ACCESSORIES IN THE FIELD OF ELECTRIC UTILITIES, TELECOMMUNICATIONS, CONSTRUCTION AND TREE CARE, NAMELY, TRUCKS, AERIAL BUCKETS, AERIAL LIFTS, DIGGER DERRICKS, WINCHES, HYDRAULIC AUGER UNITS, DIGGERS AND JACKS, BOOMS FOR AERIAL LIFTS, SINGLE AND TWO-MAN PLATFORMS, OUTRIGGERS AND SUB FRAMES, LINE BODIES, DUMP BODIES, CAB GUARDS, WIRE REEL RACKS, HOSE REELS AND UTILITY BODY PARTS, MOTOR DRIVEN TOOLS, NAMELY, WOOD CHIPPER FOR CUTTING TREE LIMBS AND BRUSH INTO SMALL CHIPS, IN CLASS 16 (U.S. CLS. 2, 5, 22, 23, 29, 37, 38 AND 50).

FIRST USE 4-26-2011; IN COMMERCE 4-26-2011.

FOR: TRAINING, EDUCATIONAL TESTING SERVICES AND SEMINARS ON THE PROPER AND SAFE USE AND OPERATION OF EQUIPMENT AND ACCESSORIES IN THE FIELD OF ELECTRIC UTILITIES, TELECOMMUNICATIONS, CONSTRUCTION AND TREE CARE, NAMELY, TRUCKS, AERIAL BUCKETS, AERIAL LIFTS, DIGGER DERRICKS, WINCHES, HYDRAULIC AUGER UNITS, DIGGERS AND JACKS, BOOMS FOR AERIAL LIFTS, SINGLE AND TWO-MAN PLATFORMS, OUTRIGGERS AND SUB FRAMES, LINE BODIES, DUMP BODIES, CAB GUARDS, WIRE REEL RACKS, HOSE REELS AND UTILITY BODY PARTS,



David J. Kybas

Director of the United States Patent and Trademark Office

Reg. No. 4,074,049 MOTOR DRIVEN TOOLS, NAMELY, WOOD CHIPPERS FOR CUTTING TREE LIMBS AND BRUSH INTO SMALL CHIPS, IN CLASS 41 (U.S. CLS. 100, 101 AND 107).

FIRST USE 4-26-2011; IN COMMERCE 4-26-2011.

OWNER OF U.S. REG. NOS. 849,304, 3,053,226 AND OTHERS.

THE COLOR(S) RED AND WHITE IS/ARE CLAIMED AS A FEATURE OF THE MARK.

NO CLAIM IS MADE TO THE EXCLUSIVE RIGHT TO USE "PROFESSIONAL OPERATOR SAFETY TRAINING", APART FROM THE MARK AS SHOWN.

THE MARK CONSISTS OF A CIRCULAR STAMP IMAGE WITH A THIN, RED OUTER CIRCLE FOLLOWED BY A CLEAR CIRCLE, FOLLOWED BY A THICKER, RED, INNER CIRCLE. THE TOP HALF OF THE INSIDE CIRCLE FOLLOWING THE THICKER, RED CIRCLE, IS CLEAR WITH A RED IMAGE OF A SAFETY HELMET CENTERED IN IT. CENTERED UNDER THE RED SAFETY HELMET IN RED LETTERS ARE THE WORDS, "PROFESSIONAL OPERATOR SAFETY TRAINING". UNDERNEATH THE WORDS "PROFESSIONAL OPERATOR SAFETY TRAINING" IS A RED BAND REACHING ACROSS THE LOWER THIRD OF THE CLEAR CIRCLE REACHING THE EDGE OF THE RED, THICK INNER CIRCLE. CENTERED ON THE RED BAND IS A WHITE STYLIZED CAPITAL "A" WITH A CLEAR STYLIZED CAPITAL "A" INSIDE OF THE OF THE WHITE STYLIZED CAPITAL "A", FOLLOWED BY THE STYLIZED WORD "ALTEC" IN WHITE LETTERS. THE WORD "SENTRY" IN WHITE LETTERS IS CENTERED BELOW THE "A" DESIGN AND THE WORD "ALTEC". UNDERNEATH THE "A ALTEC SENTRY" WORDS ON THE RED BACKGROUND IS A CLEAR WEDGE REACHING TO THE BOTTOM OF THE RED, INNER, THICKER CIRCLE.

SER. NO. 85-318,294, FILED 5-11-2011.

DAVID H. STINE, EXAMINING ATTORNEY

United States of America

United States Patent and Trademark Office

88 TACTICAL

Reg. No. 4,074,050

Registered Dec. 20, 2011

Int. Cl.: 41

SERVICE MARK

PRINCIPAL REGISTER

SIGNAL 88 SECURITY GROUP, LLC (NEBRASKA LIMITED LIABILITY COMPANY)
SUITE 108
3880 SOUTH 149TH STREET
OMAHA, NE 68144

FOR: DEVELOPING TRAINING SYSTEMS FOR OTHERS; TRAINING IN THE USE AND OPERATION OF FIREARMS; TRAINING SERVICES IN THE FIELD OF TECHNIQUES FOR USE OF FIREARMS; CONDUCTING CLASSES AND COURSES IN THE SAFE AND PROFICIENT USE OF FIREARMS; PROVIDING TRAINING, CLASSES, AND SEMINARS IN THE FIELD OF PERSONAL DEFENSE AND FIREARMS SAFETY, IN CLASS 41 (U.S. CLS. 100, 101 AND 107).

FIRST USE 8-31-2009; IN COMMERCE 12-31-2010.

THE MARK CONSISTS OF STANDARD CHARACTERS WITHOUT CLAIM TO ANY PARTICULAR FONT, STYLE, SIZE, OR COLOR.

SER. NO. 85-318,303, FILED 5-11-2011.

KAREN SEVERSON, EXAMINING ATTORNEY



David J. Kyjars

Director of the United States Patent and Trademark Office

United States of America

United States Patent and Trademark Office

GOODFLOW

Reg. No. 4,074,051

Registered Dec. 20, 2011

Int. Cl.: 30

TRADEMARK

PRINCIPAL REGISTER

CROFUT HOLDING CO., LLC (TEXAS LIMITED LIABILITY COMPANY), DBA GOODFLOW
HONEY & JUICE COMPANY
1411 DWYCE DRIVE
AUSTIN, TX 78757

FOR: HONEY, IN CLASS 30 (U.S. CL. 46).

FIRST USE 0-0-1981; IN COMMERCE 0-0-2006.

THE MARK CONSISTS OF STANDARD CHARACTERS WITHOUT CLAIM TO ANY PARTICULAR FONT, STYLE, SIZE, OR COLOR.

SER. NO. 85-318,307, FILED 5-11-2011.

THEODORE MCBRIDE, EXAMINING ATTORNEY



David J. Kybas

Director of the United States Patent and Trademark Office

United States of America

United States Patent and Trademark Office



Reg. No. 4,074,052

Registered Dec. 20, 2011

Int. Cl.: 17

TRADEMARK

PRINCIPAL REGISTER

PROGRESSIVE ENERGY SOLUTIONS, INC. (NORTH CAROLINA CORPORATION)
6428 W. WILKINSON BLVD, SUITE 204
BELMONT, NC 28012

FOR: SEALING AND INSULATING MATERIALS, IN CLASS 17 (U.S. CLS. 1, 5, 12, 13, 35 AND 50).

FIRST USE 12-13-2010; IN COMMERCE 12-13-2010.

OWNER OF U.S. REG. NOS. 3,698,350, 3,708,157, AND 3,837,789.

THE COLOR(S) BLACK, WHITE, DESERT BLUE, YELLOW, RED, GRADIENT COLORS DARK BLUE TO LIGHT BLUE IS/ARE CLAIMED AS A FEATURE OF THE MARK.

NO CLAIM IS MADE TO THE EXCLUSIVE RIGHT TO USE "INC" AND "PRODUCTS", APART FROM THE MARK AS SHOWN.

THE MARK CONSISTS OF THREE ELLIPTICAL RINGS FILLED WITH THE COLOR DESERT BLUE AND OUTLINED IN BLACK, WITH THREE SMALL CIRCLES SUPERIMPOSED OVER THE ELLIPTICAL RINGS FILLED WITH THE COLOR YELLOW AND OUTLINED IN BLACK, WITH THE LETTERS "P", "E", "S" IN BLACK OVER THE ELLIPTICAL RINGS DESIGN AND THE LETTERS "INC" IN WHITE LOCATED AT THE TOP OF THE LETTER "S" OF "P", "E", "S" AN OVERLAY OF FLAMES THAT USES THE GRADIENT COLORS RED TO YELLOW IS PLACED OVER THE BOTTOM OF THE ELLIPTICAL RINGS AND THE LOWER CIRCLE THAT IS FILLED WITH THE COLOR YELLOW OUTLINED IN BLACK AND IS LOCATED ABOVE THE TYPED LETTERING "SEAL N SHIELD PRODUCTS". TYPED LETTERING "SEAL N SHIELD PRODUCTS" ARE IN BLACK COLOR AND ICICLES FILLED WITH GRADIENT COLORS FROM DARK BLUE TO LIGHT BLUE ARE LOCATED BELOW THE TYPED LETTERING.



SER. NO. 85-318,316, FILED 5-11-2011.

CAROLINE WOOD, EXAMINING ATTORNEY

David J. Kyjars

Director of the United States Patent and Trademark Office

United States of America

United States Patent and Trademark Office

Big Shoulders Fund

Reg. No. 4,074,053

Registered Dec. 20, 2011

Int. Cl.: 36

SERVICE MARK

PRINCIPAL REGISTER

BIG SHOULDERS FUND (ILLINOIS NON-PROFIT CORPORATION)
309 W. WASHINGTON SUITE 550
CHICAGO, IL 60606

FOR: CHARITABLE FUNDRAISING, IN CLASS 36 (U.S. CLS. 100, 101 AND 102).

FIRST USE 8-1-1986; IN COMMERCE 8-1-1986.

THE MARK CONSISTS OF STANDARD CHARACTERS WITHOUT CLAIM TO ANY PARTICULAR FONT, STYLE, SIZE, OR COLOR.

NO CLAIM IS MADE TO THE EXCLUSIVE RIGHT TO USE "FUND", APART FROM THE MARK AS SHOWN.

SER. NO. 85-318,319, FILED 5-11-2011.

CAROLINE WOOD, EXAMINING ATTORNEY



David J. Kyffers

Director of the United States Patent and Trademark Office

United States of America

United States Patent and Trademark Office

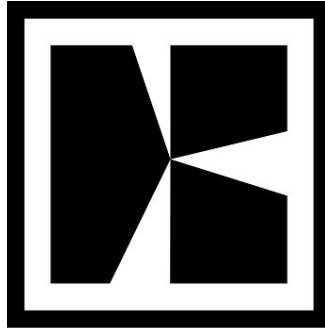

design republica

Reg. No. 4,074,054

Registered Dec. 20, 2011

Int. Cl.: 42

SERVICE MARK

PRINCIPAL REGISTER

DESIGN REPUBLICA, INC. (D.C. CORPORATION)
1909 19TH STREET NW #404
WASHINGTON, DC 20009

FOR: ARCHITECTURAL DESIGN; FASHION DESIGN CONSULTING SERVICES; FURNITURE DESIGN SERVICES; GRAPHIC DESIGN; INTERIOR DESIGN SERVICES; NEW PRODUCT DESIGN SERVICES, IN CLASS 42 (U.S. CLS. 100 AND 101).

FIRST USE 8-1-2010; IN COMMERCE 8-1-2010.

NO CLAIM IS MADE TO THE EXCLUSIVE RIGHT TO USE "DESIGN", APART FROM THE MARK AS SHOWN.

THE COLOR(S) BLACK AND RED IS/ARE CLAIMED AS A FEATURE OF THE MARK.

THE MARK CONSISTS OF A BLACK SQUARE CONTAINING BLACK STYLIZED SHAPES ABOVE THE BLACK WORDS DESIGN REPUBLICA. THE A IN REPUBLICA IS DISPLAYED IN RED.

THE ENGLISH TRANSLATION OF REPUBLICA IN THE MARK IS REPUBLIC.

SER. NO. 85-318,321, FILED 5-11-2011.

CAROLINE WOOD, EXAMINING ATTORNEY



David J. Kyros

Director of the United States Patent and Trademark Office

United States of America

United States Patent and Trademark Office



Reg. No. 4,074,055

Registered Dec. 20, 2011

Int. Cls.: 9, 16 and 41

TRADEMARK

SERVICE MARK

PRINCIPAL REGISTER

ALTEC INDUSTRIES, INC. (ALABAMA CORPORATION), AKA ALTEC
210 INVERNESS CENTER DRIVE
BIRMINGHAM, AL 35242

FOR: PRERECORDED VIDEO CASSETTE TAPES AND CD ROM DISKETTES FEATURING INFORMATION RELATING TO THE SAFE OPERATION AND USE OF EQUIPMENT AND ACCESSORIES IN THE FIELD OF ELECTRIC UTILITIES, TELECOMMUNICATIONS, CONSTRUCTION AND TREE CARE, NAMELY, TRUCKS, AERIAL BUCKETS, AERIAL LIFTS, DIGGER DERRICKS, WINCHES, HYDRAULIC AUGER UNITS, DIGGERS AND JACKS, BOOMS FOR AERIAL LIFTS, SINGLE AND TWO-MAN PLATFORMS, OUTRIGGERS AND SUB FRAMES, LINE BODIES, DUMP BODIES, CAB GUARDS, WIRE REEL RACKS, HOSE REELS AND UTILITY BODY PARTS, MOTOR DRIVEN TOOLS, NAMELY, WOOD CHIPPER FOR CUTTING TREE LIMBS AND BRUSH INTO SMALL CHIPS, IN CLASS 9 (U.S. CLS. 21, 23, 26, 36 AND 38).

FIRST USE 4-26-2011; IN COMMERCE 4-26-2011.

FOR: BOOKS, PAMPHLETS, AND PRINTED TRAINING MATERIALS RELATING TO THE SAFE OPERATION AND USE OF EQUIPMENT AND ACCESSORIES IN THE FIELD OF ELECTRIC UTILITIES, TELECOMMUNICATIONS, CONSTRUCTION AND TREE CARE, NAMELY, TRUCKS, AERIAL BUCKETS, AERIAL LIFTS, DIGGER DERRICKS, WINCHES, HYDRAULIC AUGER UNITS, DIGGERS AND JACKS, BOOMS FOR AERIAL LIFTS, SINGLE AND TWO-MAN PLATFORMS, OUTRIGGERS AND SUB FRAMES, LINE BODIES, DUMP BODIES, CAB GUARDS, WIRE REEL RACKS, HOSE REELS AND UTILITY BODY PARTS, MOTOR DRIVEN TOOLS, NAMELY, WOOD CHIPPER FOR CUTTING TREE LIMBS AND BRUSH INTO SMALL CHIPS, IN CLASS 16 (U.S. CLS. 2, 5, 22, 23, 29, 37, 38 AND 50).

FIRST USE 4-26-2011; IN COMMERCE 4-26-2011.

FOR: TRAINING, EDUCATIONAL TESTING SERVICES AND SEMINARS ON THE PROPER AND SAFE USE AND OPERATION OF EQUIPMENT AND ACCESSORIES IN THE FIELD OF ELECTRIC UTILITIES, TELECOMMUNICATIONS, CONSTRUCTION AND TREE CARE, NAMELY, TRUCKS, AERIAL BUCKETS, AERIAL LIFTS, DIGGER DERRICKS, WINCHES, HYDRAULIC AUGER UNITS, DIGGERS AND JACKS, BOOMS FOR AERIAL LIFTS, SINGLE AND TWO-MAN PLATFORMS, OUTRIGGERS AND SUB FRAMES, LINE BODIES, DUMP BODIES, CAB GUARDS, WIRE REEL RACKS, HOSE REELS AND UTILITY BODY PARTS,



David J. Kyffers

Director of the United States Patent and Trademark Office

Reg. No. 4,074,055 MOTOR DRIVEN TOOLS, NAMELY, WOOD CHIPPER FOR CUTTING TREE LIMBS AND BRUSH INTO SMALL CHIPS, IN CLASS 41 (U.S. CLS. 100, 101 AND 107).

FIRST USE 4-26-2011; IN COMMERCE 4-26-2011.

OWNER OF U.S. REG. NOS. 849,304, 3,053,226 AND OTHERS.

THE COLOR(S) GOLD AND BLACK IS/ARE CLAIMED AS A FEATURE OF THE MARK.

THE MARK CONSISTS OF A GOLD STYLIZED CAPITAL "A" WITH A CLEAR STYLIZED CAPITAL "A" INSIDE OF THE GOLD STYLIZED CAPITAL "A", FOLLOWED BY THE STYLIZED WORD "ALTEC" IN BLACK LETTERS. THE WORD "SENTRY" IN BLACK LETTERS IS CENTERED BELOW THE "A" DESIGN AND THE WORD "ALTEC". THE ENTIRE MARK IS SET AGAINST A CLEAR BACKGROUND.

SER. NO. 85-318,336, FILED 5-11-2011.

DAVID H. STINE, EXAMINING ATTORNEY

United States of America

United States Patent and Trademark Office

iGoldline

Reg. No. 4,074,056

Registered Dec. 20, 2011

Int. Cl.: 9

TRADEMARK

PRINCIPAL REGISTER

GOLDLINE INTERNATIONAL, INC. (CALIFORNIA CORPORATION)
1601 CLOVERFIELD BLVD., 100 TOWER
SANTA MONICA, CA 90404

FOR: DOWNLOADABLE SOFTWARE IN THE NATURE OF A MOBILE APPLICATION FOR OBTAINING CURRENT PRECIOUS METALS MARKET PRICES, STOCK MARKET PRICES, HISTORIC DATA AND INDUSTRY NEWS, IN CLASS 9 (U.S. CLS. 21, 23, 26, 36 AND 38).

FIRST USE 5-18-2011; IN COMMERCE 5-18-2011.

THE MARK CONSISTS OF STANDARD CHARACTERS WITHOUT CLAIM TO ANY PARTICULAR FONT, STYLE, SIZE, OR COLOR.

OWNER OF U.S. REG. NOS. 1,040,091, 3,615,534 AND OTHERS.

SER. NO. 85-318,337, FILED 5-11-2011.

MAYUR VAGHANI, EXAMINING ATTORNEY



David J. Kyros

Director of the United States Patent and Trademark Office

United States of America

United States Patent and Trademark Office

APOLLO

H O R T I C U L T U R E

Reg. No. 4,074,057

GEORGE LI (UNITED STATES INDIVIDUAL)
2300 S. RESERVOIR ST. #401
POMONA, CA 91766

Registered Dec. 20, 2011

Int. Cl.: 11

FOR: HYDROPONICS GROW BOX IN THE NATURE OF A CLOSED ENVIRONMENT EQUIPPED WITH LIGHTS, EXHAUST SYSTEM, HYDROPONICS GROWING CONTAINER AND ODOR CONTROL SYSTEM, IN CLASS 11 (U.S. CLS. 13, 21, 23, 31 AND 34).

TRADEMARK

FIRST USE 1-1-2011; IN COMMERCE 1-1-2011.

PRINCIPAL REGISTER

NO CLAIM IS MADE TO THE EXCLUSIVE RIGHT TO USE "HORTICULTURE", APART FROM THE MARK AS SHOWN.

THE MARK IS MADE UP OF ALL CAPITAL LETTERING "APOLLO HORTICULTURE" THERE IS A BIG SUN INSIDE THE FIRST "O" OF THE WORD "APOLLO".

SER. NO. 85-318,403, FILED 5-11-2011.

JOHN HWANG, EXAMINING ATTORNEY



David J. Kybas

Director of the United States Patent and Trademark Office

United States of America

United States Patent and Trademark Office

TWIRL

Reg. No. 4,074,058

Registered Dec. 20, 2011

Int. Cl.: 12

TRADEMARK

PRINCIPAL REGISTER

INVACARE CORPORATION (OHIO CORPORATION)
LEGAL DEPARTMENT
ONE INVACARE WAY
ELYRIA, OH 44035

FOR: ADULT AND PEDIATRIC WHEELCHAIRS; PARTS FOR ADULT AND PEDIATRIC WHEELCHAIRS, IN CLASS 12 (U.S. CLS. 19, 21, 23, 31, 35 AND 44).

FIRST USE 8-1-2010; IN COMMERCE 8-1-2010.

THE MARK CONSISTS OF STANDARD CHARACTERS WITHOUT CLAIM TO ANY PARTICULAR FONT, STYLE, SIZE, OR COLOR.

SER. NO. 85-318,427, FILED 5-11-2011.

AISHA CLARKE, EXAMINING ATTORNEY



David J. Kyros

Director of the United States Patent and Trademark Office

United States of America

United States Patent and Trademark Office

EARL MILLER

Reg. No. 4,074,059

EARL MILLER PHOTOGRAPHY INC. (CALIFORNIA CORPORATION)
9800 D. TOPANGA CANYON BLVD. #115
CHATSWORTH, CA 91311

Registered Dec. 20, 2011

Int. Cl.: 41

FOR: ENTERTAINMENT SERVICES, NAMELY, PROVIDING A WEB SITE FEATURING NON-DOWNLOADABLE ADULT-THEMED PHOTOGRAPHS AND VIDEOS, IN CLASS 41 (U.S. CLS. 100, 101 AND 107).

SERVICE MARK

FIRST USE 2-19-1998; IN COMMERCE 2-19-1998.

PRINCIPAL REGISTER

THE MARK CONSISTS OF STANDARD CHARACTERS WITHOUT CLAIM TO ANY PARTICULAR FONT, STYLE, SIZE, OR COLOR.

OWNER OF U.S. REG. NOS. 2,615,074, 3,039,696 AND OTHERS.

THE NAME(S), PORTRAIT(S), AND/OR SIGNATURE(S) SHOWN IN THE MARK IDENTIFIES EARL MILLER, WHOSE CONSENT(S) TO REGISTER IS MADE OF RECORD.

SER. NO. 85-318,491, FILED 5-11-2011.

GEOFFREY FOSDICK, EXAMINING ATTORNEY



David J. Kyfos

Director of the United States Patent and Trademark Office

United States of America

United States Patent and Trademark Office

Black Fox Technology

Reg. No. 4,074,060

BLACK FOX TECHNOLOGY, INC. (IOWA CORPORATION)
2230 STORM ST., SUITE 300
AMES, IA 50014

Registered Dec. 20, 2011

Int. Cl.: 35

FOR: BUSINESS CONSULTATION IN THE FIELD OF TELECOMMUNICATIONS MANAGEMENT; ARRANGING SUBSCRIPTIONS TO TELECOMMUNICATIONS SERVICES FOR OTHERS; MATCHING SELLERS OF TELECOMMUNICATIONS SERVICES WITH BUYERS OF TELECOMMUNICATIONS SERVICES, IN CLASS 35 (U.S. CLS. 100, 101 AND 102).

SERVICE MARK

PRINCIPAL REGISTER

FIRST USE 8-31-2007; IN COMMERCE 9-15-2007.

THE MARK CONSISTS OF STANDARD CHARACTERS WITHOUT CLAIM TO ANY PARTICULAR FONT, STYLE, SIZE, OR COLOR.

NO CLAIM IS MADE TO THE EXCLUSIVE RIGHT TO USE "TECHNOLOGY", APART FROM THE MARK AS SHOWN.

SER. NO. 85-318,640, FILED 5-11-2011.

CHRISTINE COOPER, EXAMINING ATTORNEY



David J. Kyffers

Director of the United States Patent and Trademark Office

United States of America

United States Patent and Trademark Office



Reg. No. 4,074,061

GOODWOOD, INC. (CALIFORNIA CORPORATION)
4456 BALDWIN AVE.
EL MONTE, CA 91731

Registered Dec. 20, 2011

Int. Cl.: 35

FOR: WHOLESALE AND RETAIL STORE SERVICES FEATURING FLOORING, FLOORING ACCESSORIES, SIDING, DOORS, PLYWOOD, WOOD MOLDING, WINDOW SHUTTERS, CABINETS, AND FURNITURE, IN CLASS 35 (U.S. CLS. 100, 101 AND 102).

SERVICE MARK

FIRST USE 3-1-2011; IN COMMERCE 3-1-2011.

PRINCIPAL REGISTER

NO CLAIM IS MADE TO THE EXCLUSIVE RIGHT TO USE "HOMEWARE", APART FROM THE MARK AS SHOWN.

THE COLOR(S) BLACK, WHITE, AND RED IS/ARE CLAIMED AS A FEATURE OF THE MARK.

THE MARK CONSISTS OF TWO CONCENTRIC OVALS WITH A SMALLER OVAL IN SOLID RED COLOR INSIDE A LARGER OVAL IN BLACK COLOR. INSIDE THE SMALLER OVAL IS "HOMEWARE DEPOT" WRITTEN IN STYLIZED FORM IN WHITE WITH BLACK SHADE UNDERNEATH. THERE ARE 20 WHITE STARS IN VARYING SIZES CIRCLING THE INSIDE OF THE LARGER OVAL, EACH WHITE STAR HAS AN OUTLINE OF A BLACK STAR INLAY WITHIN THE WHITE STAR.

SER. NO. 85-318,642, FILED 5-11-2011.

TINA MAI, EXAMINING ATTORNEY



David J. Kyros

Director of the United States Patent and Trademark Office

United States of America

United States Patent and Trademark Office



Reg. No. 4,074,062

BLACK FOX TECHNOLOGY, INC. (IOWA CORPORATION)
2230 STORM ST., SUITE 300
AMES, IA 50014

Registered Dec. 20, 2011

Int. Cl.: 35

FOR: BUSINESS CONSULTATION IN THE FIELD OF TELECOMMUNICATIONS MANAGEMENT; ARRANGING SUBSCRIPTIONS TO TELECOMMUNICATIONS SERVICES FOR OTHERS; MATCHING SELLERS OF TELECOMMUNICATIONS SERVICES WITH BUYERS OF TELECOMMUNICATIONS SERVICES, IN CLASS 35 (U.S. CLS. 100, 101 AND 102).

SERVICE MARK

PRINCIPAL REGISTER

FIRST USE 8-31-2007; IN COMMERCE 9-15-2007.

THE MARK CONSISTS OF A SHIELD WITH A HALF WHITE HALF BLACK DIAGONAL LINE THROUGH THE MIDDLE DIVIDING THE SHIELD INTO A BLACK LOWER HALF WITH A WHITE BORDER AND AN UPPER HALF WITH A BLACK BORDER AND THE IMAGE OF THE HEAD OF A FOX IN THE FOREGROUND IN THE CENTER OF THE SHIELD.

SER. NO. 85-318,651, FILED 5-11-2011.

CHRISTINE COOPER, EXAMINING ATTORNEY



David J. Kybas

Director of the United States Patent and Trademark Office

United States of America

United States Patent and Trademark Office

FLOODPRO

Reg. No. 4,074,063

STONERIVER NATIONAL FLOOD SERVICES, INC. (DELAWARE CORPORATION)
555 CORPORATE DRIVE
KALISPELL, MT 59901

Registered Dec. 20, 2011

Int. Cls.: 9 and 42

FOR: SOFTWARE FOR ADMINISTRATION OF INSURANCE POLICIES AND PROCESSING OF INSURANCE CLAIMS , IN CLASS 9 (U.S. CLS. 21, 23, 26, 36 AND 38).

TRADEMARK

FIRST USE 0-0-2002; IN COMMERCE 0-0-2002.

SERVICE MARK

FOR: SOFTWARE AS A SERVICE (SAAS) SERVICES, NAMELY, HOSTING SOFTWARE FOR USE BY OTHERS FOR ADMINISTRATION OF INSURANCE POLICIES AND PROCESSING OF INSURANCE CLAIMS, IN CLASS 42 (U.S. CLS. 100 AND 101).

PRINCIPAL REGISTER

FIRST USE 0-0-2002; IN COMMERCE 0-0-2002.

THE MARK CONSISTS OF STANDARD CHARACTERS WITHOUT CLAIM TO ANY PARTICULAR FONT, STYLE, SIZE, OR COLOR.

SER. NO. 85-318,662, FILED 5-11-2011.

CARRIE GENOVESE, EXAMINING ATTORNEY



David J. Kybas

Director of the United States Patent and Trademark Office

United States of America

United States Patent and Trademark Office

Courageous Coaching

Reg. No. 4,074,064

Registered Dec. 20, 2011

Int. Cl.: 41

SERVICE MARK

PRINCIPAL REGISTER

HEART OF SUCCESS, INC (ARIZONA CORPORATION)
117 9121 E TANQUE VERDE
SUITE 105
TUCSON, AZ 85749

FOR: EDUCATIONAL AND ENTERTAINMENT SERVICES, NAMELY, CONDUCTING CLASSES, WORKSHOPS, SEMINARS IN THE FIELD OF MONEY ACQUISITION AND MANAGEMENT AND DISTRIBUTION OF COURSE MATERIALS IN CONNECTION THEREWITH, AND EDUCATION CONSULTING RELATED THERETO; PROFESSIONAL COACHING SERVICES IN THE FIELD OF MONEY ACQUISITION AND MANAGEMENT, IN CLASS 41 (U.S. CLS. 100, 101 AND 107).

FIRST USE 2-2-2011; IN COMMERCE 2-2-2011.

THE MARK CONSISTS OF STANDARD CHARACTERS WITHOUT CLAIM TO ANY PARTICULAR FONT, STYLE, SIZE, OR COLOR.

NO CLAIM IS MADE TO THE EXCLUSIVE RIGHT TO USE "COACHING", APART FROM THE MARK AS SHOWN.

SER. NO. 85-318,675, FILED 5-11-2011.

DAVID TAYLOR, EXAMINING ATTORNEY



David J. Kyffers

Director of the United States Patent and Trademark Office

United States of America

United States Patent and Trademark Office



Reg. No. 4,074,065

Registered Dec. 20, 2011

Int. Cl.: 44

SERVICE MARK

PRINCIPAL REGISTER

VETERINARY DIAGNOSTICS INSTITUTE, INC. (CALIFORNIA CORPORATION)
SUITE K
4685 RUNWAY STREET
SIMI VALLEY, CA 93063

FOR: SPECIALTY ANIMAL DIAGNOSTIC TESTING SERVICES USING BLOOD-BASED BIO-MARKERS, IN CLASS 44 (U.S. CLS. 100 AND 101).

FIRST USE 3-15-2011, THE MARK WAS FIRST USED ANYWHERE IN A DIFFERENT FORM OTHER THAN THAT SOUGHT TO BE REGISTERED AT LEAST AS EARLY AS 03/31/2006; IN COMMERCE 3-15-2011, THE MARK WAS FIRST USED IN COMMERCE IN A DIFFERENT FORM OTHER THAN THAT SOUGHT TO BE REGISTERED AT LEAST AS EARLY AS 03/31/2006.

OWNER OF U.S. REG. NO. 3,244,450.

THE MARK CONSISTS OF THE LETTERS "VDI" AND TO THE LEFT OF THE WORDS IS A PAW PRINT IN WHITE SUPERIMPOSED OVER A CIRCLE IN BLACK WITH THREE HORIZONTAL WHITE LINES AND THREE VERTICAL WHITE LINES AND WHITE LINES FORMING A SQUARE WITH LINES WAVED INWARD IN A CONCAVE FASHION.

SER. NO. 85-318,681, FILED 5-11-2011.

DAVID TAYLOR, EXAMINING ATTORNEY



David J. Kyffers

Director of the United States Patent and Trademark Office

United States of America

United States Patent and Trademark Office

FEISHENG

飞盛

Reg. No. 4,074,066

Registered Dec. 20, 2011

Int. Cl.: 9

TRADEMARK

PRINCIPAL REGISTER

CHEN HEFEI (CHINA INDIVIDUAL)
1006 YULONGXUAN, BUILDING 6
GUANCHENGSHIJI, 10 ZONE, BAOCHENG
BAOAN, SHENZHEN, CHINA

FOR: BATTERIES AND BATTERY CHARGERS; MOBILE TELEPHONES; TELEPHONE APPARATUS; TELEPHONE CONNECTORS; TELEPHONE HEADSETS, IN CLASS 9 (U.S. CLS. 21, 23, 26, 36 AND 38).

FIRST USE 3-17-2009; IN COMMERCE 3-17-2009.

THE MARK CONSISTS OF STYLIZED WORD "FEISHENG" AND TWO CHINESE CHARACTERS.

THE NON-LATIN CHARACTERS IN THE MARK TRANSLITERATE TO "FEISHENG" AND THIS MEANS "FLY FLOURISH" IN ENGLISH.

THE ENGLISH TRANSLATION OF "FEISHENG" IN THE MARK IS "FLY FLOURISH".

SER. NO. 85-318,738, FILED 5-11-2011.

GRETCHEN ULRICH, EXAMINING ATTORNEY



David J. Kyros

Director of the United States Patent and Trademark Office

United States of America

United States Patent and Trademark Office

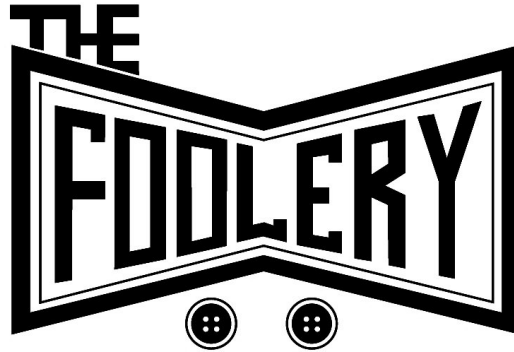

Reg. No. 4,074,067

JAVONN ASKINS (UNITED STATES INDIVIDUAL), DBA THE FOOLERY
11518 WATERWELL CT.
RIVERSIDE, CA 92505

Registered Dec. 20, 2011

Int. Cl.: 25

FOR: WEARABLE GARMENTS AND CLOTHING, NAMELY, SHIRTS, IN CLASS 25 (U.S. CLS. 22 AND 39).

TRADEMARK

FIRST USE 11-20-2010; IN COMMERCE 4-15-2011.

PRINCIPAL REGISTER

THE MARK CONSISTS OF SOLID LINES FORMING A BOW TIE SHAPE WITH TWO ROUND CIRCLE AS BUTTONS AT THE BOTTOM OF SHAPE, WITH THE WORD "THE" OVER THE TOP LEFT OF THE SHAPE AND THE WORD "FOOLERY" WITHIN THE SHAPE.

SER. NO. 85-318,771, FILED 5-12-2011.

KATHERINE CONNOLLY, EXAMINING ATTORNEY



David J. Kyffers

Director of the United States Patent and Trademark Office

United States of America

United States Patent and Trademark Office

VENNTIS

Reg. No. 4,074,068

Registered Dec. 20, 2011

Int. Cl.: 42

SERVICE MARK

PRINCIPAL REGISTER

VENNTIS LLC (MICHIGAN LIMITED LIABILITY COMPANY)
1261 S WAVERLY RD
HOLLAND, MI 49423

FOR: CONSULTING SERVICES IN THE FIELD OF THE DESIGN OF WIRELESS COMMUNICATIONS, LED LIGHTING, ENVIRONMENTAL AND SUSTAINABILITY TECHNOLOGY, AND INTEGRATED, FLEXIBLE AND RIGID CIRCUIT DESIGN; ENGINEERING SERVICES IN THE FIELD OF WIRELESS COMMUNICATIONS, LED LIGHTING, ENVIRONMENTAL AND SUSTAINABILITY TECHNOLOGY, AND INTEGRATED, FLEXIBLE AND RIGID CIRCUIT DESIGN, IN CLASS 42 (U.S. CLS. 100 AND 101).

FIRST USE 1-6-2009; IN COMMERCE 1-6-2009.

THE MARK CONSISTS OF STANDARD CHARACTERS WITHOUT CLAIM TO ANY PARTICULAR FONT, STYLE, SIZE, OR COLOR.

SER. NO. 85-318,781, FILED 5-12-2011.

WILLIAM P. SHANAHAN, EXAMINING ATTORNEY



David J. Kyros

Director of the United States Patent and Trademark Office

United States of America

United States Patent and Trademark Office

Flavor Lock

Reg. No. 4,074,069

CONAIR CORPORATION (DELAWARE CORPORATION)
ONE CUMMINGS POINT ROAD
STAMFORD, CT 06902

Registered Dec. 20, 2011

Int. Cl.: 21

FOR: COOKWARE, NAMELY, POTS AND PANS; COOKWARE, NAMELY, ROASTING PANS, IN CLASS 21 (U.S. CLS. 2, 13, 23, 29, 30, 33, 40 AND 50).

TRADEMARK

FIRST USE 12-30-2002; IN COMMERCE 12-30-2002.

PRINCIPAL REGISTER

THE MARK CONSISTS OF STANDARD CHARACTERS WITHOUT CLAIM TO ANY PARTICULAR FONT, STYLE, SIZE, OR COLOR.

SER. NO. 85-318,801, FILED 5-12-2011.

JENNIFER MARTIN, EXAMINING ATTORNEY



David J. Kybas

Director of the United States Patent and Trademark Office

United States of America

United States Patent and Trademark Office

CREATING VALUE WITH EVERY TRADE

Reg. No. 4,074,070

Registered Dec. 20, 2011

Int. Cl.: 35

SERVICE MARK

PRINCIPAL REGISTER

ACTIVE MEDIA SERVICES, INC. (DELAWARE CORPORATION)
ONE BLUE HILL PLAZA, P.O. BOX 1705
PEARL RIVER, NY 10965

FOR: BUSINESS AND ADVERTISING SERVICES, NAMELY, PREPARING AND PLANNING MEDIA ADVERTISING PLANS AND PROCURING AND SECURING ALL FORMS OF MEDIA ADVERTISING, NAMELY, ELECTRONIC, BROADCAST, PRINT, OUTDOOR AND INTERNET, FOR THE PURPOSE OF PROMOTING THE GOODS AND SERVICES OF OTHERS; EXCHANGE SERVICES, NAMELY BARTERING OF GOODS, SERVICES AND REAL PROPERTY FOR OTHERS, IN CLASS 35 (U.S. CLS. 100, 101 AND 102).

FIRST USE 4-1-2011; IN COMMERCE 4-1-2011.

THE MARK CONSISTS OF STANDARD CHARACTERS WITHOUT CLAIM TO ANY PARTICULAR FONT, STYLE, SIZE, OR COLOR.

SER. NO. 85-318,819, FILED 5-12-2011.

DANIEL CAPSHAW, EXAMINING ATTORNEY



David J. Kyffers

Director of the United States Patent and Trademark Office

United States of America

United States Patent and Trademark Office

PROOF POSITIVE

Reg. No. 4,074,071

Registered Dec. 20, 2011

Int. Cls.: 9 and 45

TRADEMARK

SERVICE MARK

PRINCIPAL REGISTER

SOUTHWIRE COMPANY (DELAWARE CORPORATION)
ONE SOUTHWIRE DRIVE
CARROLLTON, GA 30119

FOR: ELECTRIC WIRE AND CABLE, IN CLASS 9 (U.S. CLS. 21, 23, 26, 36 AND 38).

FIRST USE 5-17-2010; IN COMMERCE 5-17-2010.

FOR: OWNERSHIP VERIFICATION SERVICES, NAMELY, PROVIDING AUTHENTICATION OF OWNERSHIP INFORMATION AND TRANSMITTING SUCH INFORMATION VIA THE INTERNET, IN CLASS 45 (U.S. CLS. 100 AND 101).

FIRST USE 5-17-2010; IN COMMERCE 5-17-2010.

THE MARK CONSISTS OF STANDARD CHARACTERS WITHOUT CLAIM TO ANY PARTICULAR FONT, STYLE, SIZE, OR COLOR.

SER. NO. 85-318,822, FILED 5-12-2011.

HOWARD SMIGA, EXAMINING ATTORNEY



David J. Kyffers

Director of the United States Patent and Trademark Office

United States of America

United States Patent and Trademark Office

HVENT

Reg. No. 4,074,072

LAWRENCE J. GORDON, MD (UNITED STATES INDIVIDUAL)
8 LAKEVIEW DRIVE
GOSHEN, NY 10924

Registered Dec. 20, 2011

Int. Cl.: 44

FOR: PHYSICIAN SERVICES, IN CLASS 44 (U.S. CLS. 100 AND 101).

SERVICE MARK

FIRST USE 3-1-2006; IN COMMERCE 3-1-2006.

PRINCIPAL REGISTER

THE MARK CONSISTS OF STANDARD CHARACTERS WITHOUT CLAIM TO ANY PARTICULAR FONT, STYLE, SIZE, OR COLOR.

SER. NO. 85-318,847, FILED 5-12-2011.

RENEE MCCRAY, EXAMINING ATTORNEY



David J. Kybas

Director of the United States Patent and Trademark Office

United States of America

United States Patent and Trademark Office

TOTALIFT

Reg. No. 4,074,073

Registered Dec. 20, 2011

Int. Cl.: 35

SERVICE MARK

PRINCIPAL REGISTER

CLARK MATERIAL HANDLING COMPANY (DELAWARE CORPORATION)
700 ENTERPRISE DRIVE
LEXINGTON, KY 40510

FOR: ON-LINE ORDERING SERVICES FEATURING AFTERMARKET PARTS, ACCESSORIES, AND SUPPLIES FOR MATERIAL HANDLING EQUIPMENT, IN CLASS 35 (U.S. CLS. 100, 101 AND 102).

FIRST USE 1-14-2011; IN COMMERCE 1-14-2011.

OWNER OF U.S. REG. NOS. 1,467,603 AND 2,380,664.

THE MARK CONSISTS OF THE WORD "TOTALIFT" IN UPPER CASE LETTERS HAVING A STRAIGHT LINE RUNNING THROUGH THE TOP OF EACH LETTER AND THE TWO LETTERS "T" CONNECTED ABOVE AND ATTACHED TO THE LETTER "O" AND INSIDE THE LETTER "O" IS A PERIOD AND LOWER CASE LETTERS "COM".

SER. NO. 85-318,851, FILED 5-12-2011.

BARNEY CHARLON, EXAMINING ATTORNEY



David J. Kybas

Director of the United States Patent and Trademark Office

United States of America

United States Patent and Trademark Office

HYDROPHAST

Reg. No. 4,074,074

Registered Dec. 20, 2011

Int. Cl.: 2

TRADEMARK

PRINCIPAL REGISTER

FRANKLIN PAINT COMPANY, INC. (MASSACHUSETTS CORPORATION)
259 COTTAGE STREET
FRANKLIN, MA 02038

FOR: TRAFFIC PAINTS SOLD ONLY TO STATE AND MUNICIPAL GOVERNMENTS AND TO PRIVATE PAVEMENT MARKING CONTRACTORS, IN CLASS 2 (U.S. CLS. 6, 11 AND 16).

FIRST USE 8-23-1996; IN COMMERCE 8-26-1996.

THE MARK CONSISTS OF STANDARD CHARACTERS WITHOUT CLAIM TO ANY PARTICULAR FONT, STYLE, SIZE, OR COLOR.

OWNER OF U.S. REG. NO. 2,188,818.

SER. NO. 85-318,852, FILED 5-12-2011.

MICHAEL ENGEL, EXAMINING ATTORNEY



David J. Kyffers

Director of the United States Patent and Trademark Office

United States of America

United States Patent and Trademark Office

Master Idea

Reg. No. 4,074,075

BRIGHTHOUSE LLC (GEORGIA LIMITED LIABILITY COMPANY)
790 MARIETTA STREET
ATLANTA, GA 30318

Registered Dec. 20, 2011

Int. Cl.: 35

FOR: CONSULTANCY AND ADVISORY SERVICES IN THE FIELD OF BUSINESS STRATEGY, IN CLASS 35 (U.S. CLS. 100, 101 AND 102).

SERVICE MARK

FIRST USE 12-31-1998; IN COMMERCE 12-31-1998.

PRINCIPAL REGISTER

THE MARK CONSISTS OF STANDARD CHARACTERS WITHOUT CLAIM TO ANY PARTICULAR FONT, STYLE, SIZE, OR COLOR.

SER. NO. 85-318,863, FILED 5-12-2011.

HELENE LIWINSKI, EXAMINING ATTORNEY



David J. Kyffers

Director of the United States Patent and Trademark Office

United States of America

United States Patent and Trademark Office

AlSentis

Reg. No. 4,074,076

ALSENTIS, LLC (DELAWARE LIMITED LIABILITY COMPANY)
1261 S WAVERLY RD
HOLLAND, MI 49423

Registered Dec. 20, 2011

Int. Cl.: 42

FOR: CONSULTING SERVICES IN THE FIELD OF THE DESIGN OF TOUCH SENSING TECHNOLOGY; ENGINEERING SERVICES IN THE FIELD OF TOUCH SENSING TECHNOLOGY, IN CLASS 42 (U.S. CLS. 100 AND 101).

SERVICE MARK

FIRST USE 10-27-2008; IN COMMERCE 10-27-2008.

PRINCIPAL REGISTER

THE MARK CONSISTS OF STANDARD CHARACTERS WITHOUT CLAIM TO ANY PARTICULAR FONT, STYLE, SIZE, OR COLOR.

SER. NO. 85-318,915, FILED 5-12-2011.

JEFFREY LOOK, EXAMINING ATTORNEY



David J. Kyffers

Director of the United States Patent and Trademark Office

United States of America

United States Patent and Trademark Office

HGO

Reg. No. 4,074,077

JDM GOLF, LLC (ARIZONA LIMITED LIABILITY COMPANY)
2400 E. ARIZONA BILTMORE CIRCLE, BLDG 2
PHOENIX, AZ 85016

Registered Dec. 20, 2011

Int. Cl.: 41

FOR: PROVIDING FACILITIES FOR RECREATIONAL ACTIVITIES, NAMELY SKILLS CHALLENGES, IN CLASS 41 (U.S. CLS. 100, 101 AND 107).

SERVICE MARK

FIRST USE 4-1-2011; IN COMMERCE 4-1-2011.

PRINCIPAL REGISTER

THE MARK CONSISTS OF STANDARD CHARACTERS WITHOUT CLAIM TO ANY PARTICULAR FONT, STYLE, SIZE, OR COLOR.

SER. NO. 85-318,941, FILED 5-12-2011.

TOBY BULLOFF, EXAMINING ATTORNEY



David J. Kybas

Director of the United States Patent and Trademark Office

United States of America

United States Patent and Trademark Office

THE FUTURE BELONGS TO THOSE WHO PLAN

Reg. No. 4,074,078

RADIUS ENGINEERING INTERNATIONAL, INC. (NEW HAMPSHIRE CORPORATION)
11551 CR 314

Registered Dec. 20, 2011

TERRELL, TX 75161

Int. Cl.: 42

FOR: CUSTOM DESIGN AND ENGINEERING OF NEW AND EXISTING DISASTER SHELTERS AND DISASTER SHELTER SYSTEMS, IN CLASS 42 (U.S. CLS. 100 AND 101).

SERVICE MARK

FIRST USE 5-1-2005; IN COMMERCE 5-1-2005.

PRINCIPAL REGISTER

THE MARK CONSISTS OF STANDARD CHARACTERS WITHOUT CLAIM TO ANY PARTICULAR FONT, STYLE, SIZE, OR COLOR.

SER. NO. 85-318,972, FILED 5-12-2011.

NATALIE POLZER, EXAMINING ATTORNEY



David J. Kyffers

Director of the United States Patent and Trademark Office

United States of America

United States Patent and Trademark Office

CLEAN FREAK

Reg. No. 4,074,079

DEMERT BRANDS, INC. (FLORIDA CORPORATION)
15402 NORTH NEBRASKA AVENUE
LUTZ, FL 33549

Registered Dec. 20, 2011

Int. Cl.: 3

FOR: HAIR CARE PRODUCTS, NAMELY, DRY SHAMPOO, IN CLASS 3 (U.S. CLS. 1, 4, 6, 50, 51 AND 52).

TRADEMARK

FIRST USE 6-0-2010; IN COMMERCE 2-1-2011.

PRINCIPAL REGISTER

THE MARK CONSISTS OF STANDARD CHARACTERS WITHOUT CLAIM TO ANY PARTICULAR FONT, STYLE, SIZE, OR COLOR.

SER. NO. 85-318,995, FILED 5-12-2011.

REBECCA EISINGER, EXAMINING ATTORNEY



David J. Kybas

Director of the United States Patent and Trademark Office

United States of America

United States Patent and Trademark Office

Get loyal app users

Reg. No. 4,074,080

Registered Dec. 20, 2011

Int. Cl.: 35

SERVICE MARK

PRINCIPAL REGISTER

FIKSU, INC. (DELAWARE CORPORATION)
SUITE 304
101 ARCH STREET
BOSTON, MA 02110

FOR: ADVERTISING CONSULTANCY SERVICES IN THE FIELD OF APPLICATION SOFTWARE AND OTHER DIGITAL CONTENT; SERVICES FOR DISSEMINATING AND DISPLAYING ADVERTISING FOR OTHERS , IN CLASS 35 (U.S. CLS. 100, 101 AND 102).

FIRST USE 4-27-2011; IN COMMERCE 4-27-2011.

THE MARK CONSISTS OF THE PHRASE "GET LOYAL APP USERS" WITH A HEART REPLACING THE "O" IN "LOYAL".

SER. NO. 85-319,038, FILED 5-12-2011.

JEFFREY LOOK, EXAMINING ATTORNEY



David J. Kybas

Director of the United States Patent and Trademark Office

United States of America

United States Patent and Trademark Office

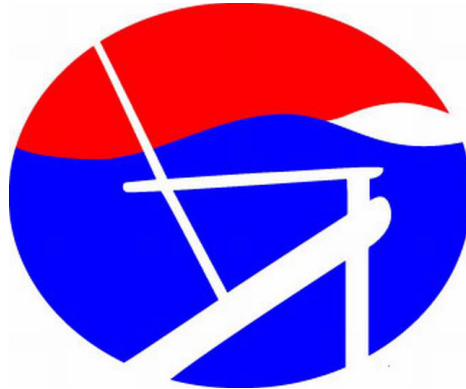

Reg. No. 4,074,081

Registered Dec. 20, 2011

Int. Cl.: 35

SERVICE MARK

PRINCIPAL REGISTER

BELL TOWER OUTDOOR LIVING COMPANY, LLC (MICHIGAN LIMITED LIABILITY COMPANY)
8880 N. 32ND STREET
RICHLAND, MI 49083

FOR: RETAIL STORE AND ON-LINE RETAIL STORE SERVICES FEATURING OUTDOOR LIVING FURNITURE, PATIO EQUIPMENT, DECORATIONS AND ACCESSORIES, OUTDOOR AND GARDEN DECORATIONS, EQUIPMENT AND ACCESSORIES, OUTDOOR PLAY SETS, GAMES AND TRAMPOLINES FOR CHILDREN, OUTDOOR KITCHEN AND DINING ACCESSORIES, BIRD FEEDERS AND ADULT AND CHILDREN'S APPAREL, IN CLASS 35 (U.S. CLS. 100, 101 AND 102).

FIRST USE 9-1-2008; IN COMMERCE 9-1-2008.

THE MARK CONSISTS OF AN OVAL CONTAINING THE SILHOUETTE OF AN ADIRONDACK CHAIR IN WHITE, WITH THE REMAINDER OF THE OVAL CONSISTING OF A BACKGROUND OF THE HORIZON, HILLY LAND AND THE SETTING SUN, WITH THE HORIZON OF THE SKY AS AN UNEVEN UPPER THIRD OF THE OVAL BEING RED, THE HILLY LAND AS THE BOTTOM TWO-THIRDS OF THE OVAL BEING BLUE, AND THE SETTING SUN IN THE SHAPE OF AN ELONGATED AND POINTED OVAL IN THE RIGHT HAND CORNER OF THE UPPER THIRD OF THE OVAL BETWEEN THE HORIZON AND THE LAND, BEING WHITE.

THE COLOR(S) RED, WHITE AND BLUE IS/ARE CLAIMED AS A FEATURE OF THE MARK.

SER. NO. 85-319,039, FILED 5-12-2011.

AMY KERTGATE, EXAMINING ATTORNEY



David J. Kyffers

Director of the United States Patent and Trademark Office

United States of America

United States Patent and Trademark Office

PROGRESS BREEDS PROGRESS

Reg. No. 4,074,082

MERITORIOUS CAPITAL, LLC (PENNSYLVANIA LIMITED LIABILITY COMPANY)
616 HITE ROAD

Registered Dec. 20, 2011

HARWICK, PA 15049

Int. Cl.: 36

FOR: INVESTMENT MANAGEMENT, IN CLASS 36 (U.S. CLS. 100, 101 AND 102).

SERVICE MARK

FIRST USE 12-0-2009; IN COMMERCE 12-0-2009.

PRINCIPAL REGISTER

THE MARK CONSISTS OF STANDARD CHARACTERS WITHOUT CLAIM TO ANY PARTICULAR FONT, STYLE, SIZE, OR COLOR.

SER. NO. 85-319,092, FILED 5-12-2011.

ALEX KEAM, EXAMINING ATTORNEY



David J. Kybas

Director of the United States Patent and Trademark Office

United States of America

United States Patent and Trademark Office

MASQUEPEN

Reg. No. 4,074,083

Registered Dec. 20, 2011

Int. Cl.: 2

TRADEMARK

PRINCIPAL REGISTER

PIKE, JOHN M (UNITED STATES INDIVIDUAL)
#266
638 LINDERO CANYON RD.
OAK PARK, CA 91377

FOR: PRINTING INKS, COATINGS, PIGMENTS AND DISPERSIONS FOR USE IN THE GRAPHIC ARTS INDUSTRY, IN CLASS 2 (U.S. CLS. 6, 11 AND 16).

FIRST USE 1-5-2011; IN COMMERCE 1-29-2011.

THE MARK CONSISTS OF STANDARD CHARACTERS WITHOUT CLAIM TO ANY PARTICULAR FONT, STYLE, SIZE, OR COLOR.

SER. NO. 85-319,093, FILED 5-12-2011.

ALEX KEAM, EXAMINING ATTORNEY



David J. Kyfos

Director of the United States Patent and Trademark Office

United States of America

United States Patent and Trademark Office

HyALD

Reg. No. 4,074,084

Registered Dec. 20, 2011

Int. Cl.: 1

TRADEMARK

PRINCIPAL REGISTER

L'AIR LIQUIDE, SOCIÉTÉ ANONYME POUR L'ETUDE ET L'EXPLOITATION DES
PROCÉDÉS GEORGES CLAUDE (FRANCE SOCIÉTÉ ANONYME (SA))
75 QUAI D'ORSAY
PARIS, FRANCE 75007

FOR: CHEMICALS FOR USE IN THE SEMICONDUCTOR INDUSTRY, IN CLASS 1 (U.S.
CLS. 1, 5, 6, 10, 26 AND 46).

FIRST USE 6-11-2010; IN COMMERCE 7-16-2010.

THE MARK CONSISTS OF STANDARD CHARACTERS WITHOUT CLAIM TO ANY PAR-
TICULAR FONT, STYLE, SIZE, OR COLOR.

SER. NO. 85-319,112, FILED 5-12-2011.

THEODORE MCBRIDE, EXAMINING ATTORNEY



David J. Kybas

Director of the United States Patent and Trademark Office

United States of America

United States Patent and Trademark Office



Reg. No. 4,074,085

MARVEL CHARACTERS, INC. (DELAWARE CORPORATION)
1600 ROSECRANS AVENUE
MANHATTAN BEACH, CA 90266

Registered Dec. 20, 2011

Int. Cl.: 14

FOR: CLOCKS AND WATCHES; CLOCKS INCORPORATING RADIOS; JEWELRY; JEWELRY, NAMELY, DOG TAGS FOR WEAR BY HUMANS FOR DECORATIVE PURPOSES; ORNAMENTAL PINS; RUBBER OR SILICON WRISTBANDS IN THE NATURE OF A BRACELET, IN CLASS 14 (U.S. CLS. 2, 27, 28 AND 50).

TRADEMARK

PRINCIPAL REGISTER

FIRST USE 1-1-2005; IN COMMERCE 1-1-2005.

OWNER OF U.S. REG. NOS. 1,754,033, 3,116,241 AND OTHERS.

THE COLOR(S) RED AND WHITE IS/ARE CLAIMED AS A FEATURE OF THE MARK.

THE MARK CONSISTS OF THE WORD "MARVEL" IN WHITE LETTERS IN A RED RECTANGLE.

SER. NO. 85-319,117, FILED 5-12-2011.

MARC LEIPZIG, EXAMINING ATTORNEY



David J. Kyffers

Director of the United States Patent and Trademark Office

United States of America

United States Patent and Trademark Office

MARVEL

Reg. No. 4,074,086

MARVEL CHARACTERS, INC. (DELAWARE CORPORATION)
1600 ROSECRANS AVENUE
MANHATTAN BEACH, CA 90266

Registered Dec. 20, 2011

Int. Cl.: 14

FOR: CLOCKS AND WATCHES; CLOCKS INCORPORATING RADIOS; JEWELRY; JEWELRY, NAMELY, DOG TAGS FOR WEAR BY HUMANS FOR DECORATIVE PURPOSES; ORNAMENTAL PINS; RUBBER OR SILICON WRISTBANDS IN THE NATURE OF A BRACELET, IN CLASS 14 (U.S. CLS. 2, 27, 28 AND 50).

TRADEMARK

PRINCIPAL REGISTER

FIRST USE 1-1-2005; IN COMMERCE 1-1-2005.

THE MARK CONSISTS OF STANDARD CHARACTERS WITHOUT CLAIM TO ANY PARTICULAR FONT, STYLE, SIZE, OR COLOR.

OWNER OF U.S. REG. NOS. 870,506, 2,918,286 AND OTHERS.

SER. NO. 85-319,119, FILED 5-12-2011.

MARC LEIPZIG, EXAMINING ATTORNEY



David J. Kyros

Director of the United States Patent and Trademark Office

United States of America

United States Patent and Trademark Office



Reg. No. 4,074,087

MARVEL CHARACTERS, INC. (DELAWARE CORPORATION)
1600 ROSECRANS AVENUE
MANHATTAN BEACH, CA 90266

Registered Dec. 20, 2011

Int. Cl.: 24

FOR: BEACH TOWELS; BED BLANKETS; BED LINEN; BED SHEETS; BED SPREADS; BLANKET THROWS; CHILDREN'S BLANKETS; CHILDREN'S TOWELS; COMFORTERS; FELT PENNANTS; HOODED TOWELS; PILLOW COVERS, IN CLASS 24 (U.S. CLS. 42 AND 50).

TRADEMARK

PRINCIPAL REGISTER

FIRST USE 12-31-2001; IN COMMERCE 12-31-2001.

OWNER OF U.S. REG. NOS. 1,754,033, 3,116,241 AND OTHERS.

THE COLOR(S) RED AND WHITE IS/ARE CLAIMED AS A FEATURE OF THE MARK.

THE MARK CONSISTS OF THE WORD "MARVEL" IN WHITE LETTERS IN A RED RECTANGLE.

SER. NO. 85-319,130, FILED 5-12-2011.

MARC LEIPZIG, EXAMINING ATTORNEY



David J. Kyffers

Director of the United States Patent and Trademark Office

United States of America

United States Patent and Trademark Office

MULTIVATOR

Reg. No. 4,074,088

FORD DISTRIBUTING, INC. (OHIO CORPORATION)
10784 INDUSTRIAL PARKWAY
MARYSVILLE, OH 43040

Registered Dec. 20, 2011

Int. Cl.: 7

FOR: POWER OPERATED CULTIVATORS, IN CLASS 7 (U.S. CLS. 13, 19, 21, 23, 31, 34 AND 35).

TRADEMARK

FIRST USE 6-27-1979; IN COMMERCE 6-27-1979.

PRINCIPAL REGISTER

THE MARK CONSISTS OF STANDARD CHARACTERS WITHOUT CLAIM TO ANY PARTICULAR FONT, STYLE, SIZE, OR COLOR.

SER. NO. 85-319,133, FILED 5-12-2011.

NICHOLAS COLEMAN, EXAMINING ATTORNEY



David J. Kybas

Director of the United States Patent and Trademark Office

United States of America

United States Patent and Trademark Office

KENGURU

Reg. No. 4,074,089

COMMUNITY CARS, INC. (DELAWARE CORPORATION)
700 LAVACA ST STE 720
AUSTIN, TX 78701

Registered Dec. 20, 2011

Int. Cl.: 12

FOR: LAND VEHICLES, NAMELY, LOW-SPEED ELECTRIC VEHICLES, IN CLASS 12 (U.S. CLS. 19, 21, 23, 31, 35 AND 44).

TRADEMARK

FIRST USE 6-25-2010; IN COMMERCE 6-25-2010.

PRINCIPAL REGISTER

THE MARK CONSISTS OF STANDARD CHARACTERS WITHOUT CLAIM TO ANY PARTICULAR FONT, STYLE, SIZE, OR COLOR.

THE ENGLISH TRANSLATION OF "KENGURU" IN THE MARK IS "KANGAROO".

SER. NO. 85-319,144, FILED 5-12-2011.

ROSELLE HERRERA, EXAMINING ATTORNEY



David J. Kybas

Director of the United States Patent and Trademark Office

United States of America

United States Patent and Trademark Office

Leg-a-pedic

Reg. No. 4,074,090

HERO DIRECT INC. (NEW YORK CORPORATION)

Registered Dec. 20, 2011

P.O. BOX 654
DEER PARK, NY 11729

Int. Cl.: 20

FOR: PILLOW-LIKE DEVICE COMPRISING PLASTIC CORE, FABRIC, AND CUSHION MATERIAL TO BE WORN ON ARM OR LEG WHILE SLEEPING OR AT REST, IN CLASS 20 (U.S. CLS. 2, 13, 22, 25, 32 AND 50).

TRADEMARK

FIRST USE 1-1-2011; IN COMMERCE 1-1-2011.

PRINCIPAL REGISTER

THE MARK CONSISTS OF STANDARD CHARACTERS WITHOUT CLAIM TO ANY PARTICULAR FONT, STYLE, SIZE, OR COLOR.

SER. NO. 85-319,147, FILED 5-12-2011.

HOWARD SMIGA, EXAMINING ATTORNEY



David J. Kyffers

Director of the United States Patent and Trademark Office

United States of America

United States Patent and Trademark Office

HeroMatchmaker

Reg. No. 4,074,091

CELIS, KURT (UNITED STATES INDIVIDUAL)
2761 VISTAMONTE GLEN
ESCONDIDO, CA 92027

Registered Dec. 20, 2011

Int. Cl.: 45

FOR: COMPUTER DATING SERVICES; DATING SERVICES, IN CLASS 45 (U.S. CLS. 100 AND 101).

SERVICE MARK

FIRST USE 2-1-2010; IN COMMERCE 3-1-2011.

PRINCIPAL REGISTER

THE MARK CONSISTS OF STANDARD CHARACTERS WITHOUT CLAIM TO ANY PARTICULAR FONT, STYLE, SIZE, OR COLOR.

SER. NO. 85-319,152, FILED 5-12-2011.

DORITT L. CARROLL, EXAMINING ATTORNEY



David J. Kybas

Director of the United States Patent and Trademark Office

United States of America

United States Patent and Trademark Office



Reg. No. 4,074,092

Registered Dec. 20, 2011

Int. Cl.: 41

SERVICE MARK

PRINCIPAL REGISTER

COMITÉ ORGANIZADOR DE LOS JUEGOS PANAMERICANOS GUADALAJARA 2011
(MEXICO DECENTRALIZED PUBLIC AGENCY)
PABLO NERUDA 3232, COL. PROVIDENCIA
GUADALAJARA, JALISCO, MEXICO

FOR: AMATEUR YOUTH SPORTS SERVICES, NAMELY, ORGANIZING AND PROVIDING YOUTH SPORTS ACTIVITIES; ARRANGING AND CONDUCTING SPECIAL EVENTS FOR SOCIAL ENTERTAINMENT PURPOSES; ARRANGING FOR TICKET RESERVATIONS FOR SHOWS AND OTHER ENTERTAINMENT EVENTS; ARRANGING, ORGANIZING, CONDUCTING, AND HOSTING SOCIAL ENTERTAINMENT EVENTS; ATHLETIC AND SPORTS EVENT SERVICES, NAMELY, ARRANGING, ORGANIZING, OPERATING AND CONDUCTING MARATHON RACES; BOOKING OF SEATS FOR SHOWS AND SPORTS EVENTS; CHARITABLE SERVICES, NAMELY, PROVIDING SPORTING GOODS IN THE NATURE OF HANDMADE SOCCER BALLS MANUFACTURED FROM DISCARDED PLASTIC BAGS TO UNDERPRIVILEGED CHILDREN; CHARITABLE SERVICES, NAMELY, PROVIDING SPORTING GOODS TO UNDERPRIVILEGED CHILDREN; COACHING IN THE FIELD OF SPORTS; EDUCATIONAL AND ENTERTAINMENT SERVICES, NAMELY, PROVIDING A VOLUNTEER PROGRAM FEATURING RECREATIONAL ACTIVITIES, LITERACY TRAINING, ART EVENTS, AND SPORTING EVENTS FOR CHILDREN IN FOSTER CARE; ENCOURAGING AMATEUR SPORTS AND PHYSICAL EDUCATION BY ORGANIZING, SANCTIONING, CONDUCTING, REGULATING AND GOVERNING AMATEUR ATHLETIC PROGRAMS AND ACTIVITIES; ENTERTAINMENT AND EDUCATIONAL SERVICES IN THE NATURE OF ON-LINE COMPETITIONS IN THE FIELD OF ENTERTAINMENT, EDUCATION, CULTURE, SPORTS, AND OTHER NON-BUSINESS AND NON-COMMERCIAL FIELDS; ENTERTAINMENT AND EDUCATIONAL SERVICES, NAMELY, PROVIDING A WEBSITE THAT DISPLAYS VARIOUS REQUESTS, REVIEWS, RECOMMENDATIONS, RANKINGS, TRACKINGS, VOTES, AND INFORMATION RELATING TO UNCREATED, UNRELEASED, NEW, SPECIAL, POPULAR, AND RARE PRODUCTS, SERVICES, AND EVENTS IN THE FIELDS OF POP CULTURE, ENTERTAINMENT, EDUCATION, AND SPORTS, ALL EXCLUSIVELY FOR NON-BUSINESS AND NON-COMMERCIAL TRANSACTIONS AND PURPOSES; ENTERTAINMENT IN THE NATURE OF PROVIDING AN INFORMATIONAL AND ENTERTAINMENT WEBSITE IN THE FIELDS OF CELEBRITY GOSSIP, ENTERTAINMENT, SPORTS AND FITNESS; ENTERTAINMENT IN THE NATURE OF OPEN WATER SWIMMING, BADMINTON, BASKETBALL, HANDBALL, BASEBALL, BOWLING, BOXING, DIVING, CANOEING, BMX BICYCLING, MOUNTAIN BICYCLING, TRACK BICYCLING, ROAD BICYCLING, EQUESTRIAN, FENCING, WATER SKIING, FOOTBALL, GYMNASTICS, RHYTHMIC GYMNASTICS, TRAMPOLINE-BASED GYMNASTICS,



David J. Kappas

Director of the United States Patent and Trademark Office

Reg. No. 4,074,092 HOCKEY, JUDO, KARATE, WEIGHTLIFTING, WRESTLING, SYNCHRONIZED SWIMMING, SWIMMING, FIGURE SKATING, MODERN PENTATHLON, WATER POLO, RACQUETBALL, ROWING, SEVEN-PER-SIDE RUGBY, SOFTBALL, SQUASH, TAEKWONDO, TENNIS, TABLE TENNIS, TARGET SHOOTING, ARCHERY, TRIATHLON, SAILING, INDOOR VOLLEYBALL, AND BEACH VOLLEYBALL GAMES FEATURING ATHLETES FROM COUNTRIES IN NORTH AMERICA, CENTRAL AMERICA, AND SOUTH AMERICA; ENTERTAINMENT SERVICES, NAMELY, PARTICIPATION IN BADMINTON, BASKETBALL, HANDBALL, BASEBALL, BOWLING, BOXING, DIVING, CANOEING, BMX BICYCLING, MOUNTAIN BICYCLING, TRACK BICYCLING, ROAD BICYCLING, EQUESTRIAN, FENCING, WATER SKIING, FOOTBALL, GYMNASTICS, RHYTHMIC GYMNASTICS, TRAMPOLINE-BASED GYMNASTICS, HOCKEY, JUDO, KARATE, WEIGHTLIFTING, WRESTLING, SYNCHRONIZED SWIMMING, SWIMMING, FIGURE SKATING, MODERN PENTATHLON, WATER POLO, RACQUETBALL, ROWING, SEVEN-PER-SIDE RUGBY, SOFTBALL, SQUASH, TAEKWONDO, TENNIS, TABLE TENNIS, TARGET SHOOTING, ARCHERY, TRIATHLON, SAILING, INDOOR VOLLEYBALL AND BEACH VOLLEYBALL EVENTS AND SWIMMING MEETS; ENTERTAINMENT SERVICES, NAMELY, PERSONAL APPEARANCES BY A SPORTS CELEBRITY; ENTERTAINMENT SERVICES, NAMELY, PROVIDING A WEB SITE FEATURING PHOTOGRAPHIC, AUDIO, VIDEO AND PROSE PRESENTATIONS FEATURING SPORTS; ENTERTAINMENT SERVICES, NAMELY, PROVIDING AN ON-LINE VIRTUAL ENVIRONMENT FOR TRADING VIRTUAL SPORTS TRADING CARDS AND TOKENS; HANDICAPPING FOR SPORTING EVENTS; OFFICIATING AT SPORTS CONTESTS; ON-LINE ADMISSION TICKET AGENCY SERVICES FOR ENTERTAINMENT, EDUCATIONAL, SPORTING AND CULTURAL EVENTS; OPERATION OF SPORTS CAMPS; ORGANIZATION OF SPORTS COMPETITIONS; ORGANIZATION OF SPORTS EVENTS IN THE FIELD OF FOOTBALL; ORGANIZING COMMUNITY FESTIVALS FEATURING PRIMARILY SPORTING EVENTS; ORGANIZING SPORTING EVENTS, NAMELY, OPEN WATER SWIMMING, BADMINTON, BASKETBALL, HANDBALL, BASEBALL, BOWLING, BOXING, DIVING, CANOEING, BMX BICYCLING, MOUNTAIN BICYCLING, TRACK BICYCLING, ROAD BICYCLING, EQUESTRIAN, FENCING, WATER SKIING, FOOTBALL, GYMNASTICS, RHYTHMIC GYMNASTICS, TRAMPOLINE-BASED GYMNASTICS, HOCKEY, JUDO, KARATE, WEIGHTLIFTING, WRESTLING, SYNCHRONIZED SWIMMING, SWIMMING, FIGURE SKATING, MODERN PENTATHLON, WATER POLO, RACQUETBALL, ROWING, SEVEN-PER-SIDE RUGBY, SOFTBALL, SQUASH, TAEKWONDO, TENNIS, TABLE TENNIS, TARGET SHOOTING, ARCHERY, TRIATHLON, SAILING, INDOOR VOLLEYBALL, AND BEACH VOLLEYBALL COMPETITIONS FEATURING ATHLETES FROM COUNTRIES IN NORTH AMERICA, CENTRAL AMERICA, AND SOUTH AMERICA; ORGANIZING, ARRANGING, AND CONDUCTING OPEN WATER SWIMMING, BADMINTON, BASKETBALL, HANDBALL, BASEBALL, BOWLING, BOXING, DIVING, CANOEING, BMX BICYCLING, MOUNTAIN BICYCLING, TRACK BICYCLING, ROAD BICYCLING, EQUESTRIAN, FENCING, WATER SKIING, FOOTBALL, GYMNASTICS, RHYTHMIC GYMNASTICS, TRAMPOLINE-BASED GYMNASTICS, HOCKEY, JUDO, KARATE, WEIGHTLIFTING, WRESTLING, SYNCHRONIZED SWIMMING, SWIMMING, FIGURE SKATING, MODERN PENTATHLON, WATER POLO, RACQUETBALL, ROWING, SEVEN-PER-SIDE RUGBY, SOFTBALL, SQUASH, TAEKWONDO, TENNIS, TABLE TENNIS, TARGET SHOOTING, ARCHERY, TRIATHLON, SAILING, INDOOR VOLLEYBALL, AND BEACH VOLLEYBALL EVENTS; PERFORMANCE HALL RENTAL SERVICES; PERSONAL TRAINING PROVIDED IN CONNECTION WITH WEIGHT LOSS AND EXERCISE PROGRAMS; PHYSICAL EDUCATION; PHYSICAL EDUCATION SERVICES; PROVIDING A WEB SITE FEATURING INFORMATION ON YOUTH SPORTS; PROVIDING A WEB SITE FEATURING SPORTING INFORMATION; PROVIDING A WEBSITE FOR ENTERTAINMENT PURPOSES WHERE USERS CAN VIEW AND POST PHOTOS AND VIDEOS FEATURING SPORTS COMPETITIONS; PROVIDING ADVICE AND INFORMATION IN THE FIELD OF EDUCATIONAL AND ENTERTAINMENT ACTIVITIES AND EVENTS FOR CHILDREN; PROVIDING AN INTERNET WEBSITE PORTAL IN THE FIELD OF ENTERTAINMENT, CULTURAL AND SPORTING EVENTS; PROVIDING FACILITIES FOR GAME SHOWS; PROVIDING FACILITIES FOR MOVIES, SHOWS, PLAYS, MUSIC OR EDUCATIONAL TRAINING; PROVIDING FACILITIES FOR PRODUCING VIDEO, CINEMA AND PHOTOGRAPHY PRODUCTIONS; PROVIDING FACILITIES FOR RECREATION ACTIVITIES;

Reg. No. 4,074,092 PROVIDING FACILITIES FOR SPORTS TOURNAMENTS; PROVIDING FACILITIES FOR ATHLETIC EVENTS TOURNAMENTS; PROVIDING GYMNASIUM FACILITIES; PROVIDING INFORMATION AND INSTRUCTION IN THE FIELD OF TRIATHLON EVENTS; PROVIDING NEWS AND INFORMATION IN THE FIELD OF SPORTS; PROVIDING ONLINE INTERVIEWS FEATURING ATHLETES IN THE FIELD OF SPORTS FOR ENTERTAINMENT PURPOSES; PROVIDING RECREATION FACILITIES; PROVIDING SPORTS FACILITIES; PROVIDING SPORTS INFORMATION BY MEANS OF TELEPHONE PRERECORDED MESSAGES; PROVIDING SWIMMING POOLS; PROVIDING TRACK AND FIELD FACILITIES; PROVIDING VARIOUS FACILITIES FOR AN ARRAY OF SPORTING EVENTS, SPORTS AND ATHLETIC COMPETITIONS AND AWARDS PROGRAMMES; PROVISION OF INFORMATION RELATING TO ORGANIZING COMMUNITY SPORTING AND CULTURAL ACTIVITIES, CONTESTS AND GAMES; PROVISION OF INFORMATION RELATING TO SPORTING, CULTURAL AND LIVE THEATRICAL PRODUCTIONS; PROVISION OF INFORMATION RELATING TO SPORTS AND SPORTING EVENTS; PROVISION OF INFORMATION RELATING TO TELEVISION, MOTION PICTURE FILM, AUDIO AND RADIO PRODUCTION; PROVISION OF INFORMATION RELATING TO THE ORGANIZING OF EDUCATIONAL, CULTURAL, SPORTING, OR ENTERTAINMENT EXHIBITIONS; RENTAL AND COMPUTERIZED ON-LINE RENTAL SERVICES FEATURING INTERACTIVE SOFTWARE AND HARDWARE HOME ENTERTAINMENT AND CONSUMER ELECTRONICS IN THE NATURE OF MOTION PICTURES, FILMS, MOVIES, PRERECORDED DIGITAL VERSATILE DISCS (OR DVDS), PRERECORDED VIDEOTAPE CASSETTES, AUDIO, AUDIO RECORDINGS IN A VARIETY OF GENRES; RENTAL OF SPORTS EQUIPMENT; RENTAL OF SPORTS GROUNDS; RENTAL OF STADIUM FACILITIES; TICKET RESERVATION AND BOOKING SERVICES FOR ENTERTAINMENT, SPORTING AND CULTURAL EVENTS; TIMING OF SPORTS EVENTS, IN CLASS 41 (U.S. CLS. 100, 101 AND 107).

OWNER OF MEXICO REG. NO. 998985, DATED 8-21-2007, EXPIRES 5-22-2017.

NO CLAIM IS MADE TO THE EXCLUSIVE RIGHT TO USE "GUADALAJARA 2011", APART FROM THE MARK AS SHOWN.

THE MARK CONSISTS OF THE WORDING "GUADALAJARA 2011" AND DESIGN. THE DESIGN FEATURES A STYLIZED FIGURE OF AN ATHLETE HOLDING A TORCH WITH FLAME IN ONE HAND. THE HAND ALSO REPRESENTS THE AGAVE PLANT FROM WHICH TEQUILA IS DISTILLED. THE STYLIZED SHAPE OF THE ATHLETE'S BODY IS BROADLY REMINISCENT OF THE SHAPE OF THE AMERICAN CONTINENT.

THE WORDING "GUADALAJARA" HAS NO MEANING IN A FOREIGN LANGUAGE.

SER. NO. 85-319,172, FILED 5-12-2011.

MICHAEL GAFFAR, EXAMINING ATTORNEY

United States of America

United States Patent and Trademark Office

HYDROSORBENT

Reg. No. 4,074,093

HYDROSORBENT DEHUMIDIFIERS (MASSACHUSETTS CORPORATION)

Registered Dec. 20, 2011

P.O. BOX 437, 25 SCHOOL STREET
ASHLEY FALLS, MA 01222

Int. Cl.: 11

FOR: DEHUMIDIFIERS; DEHUMIDIFIERS CONTAINING SILICA GEL, IN CLASS 11 (U.S. CLS. 13, 21, 23, 31 AND 34).

TRADEMARK

FIRST USE 0-0-1977; IN COMMERCE 0-0-1977.

PRINCIPAL REGISTER

THE MARK CONSISTS OF STANDARD CHARACTERS WITHOUT CLAIM TO ANY PARTICULAR FONT, STYLE, SIZE, OR COLOR.

SER. NO. 85-319,206, FILED 5-12-2011.

SALLY SHIH, EXAMINING ATTORNEY



David J. Kybas

Director of the United States Patent and Trademark Office

United States of America

United States Patent and Trademark Office

BEATBOTS

Reg. No. 4,074,094

BEATBOTS LLC (DELAWARE LIMITED LIABILITY COMPANY)
5412 NORMLEE PLACE
PITTSBURGH, PA 15217

Registered Dec. 20, 2011

Int. Cl.: 42

FOR: TECHNOLOGY CONSULTATION AND RESEARCH IN THE FIELD OF ROBOTICS; INDUSTRIAL DESIGN; SOFTWARE DESIGN AND DEVELOPMENT; MECHANICAL ENGINEERING; LEASING OF USER-PROGRAMMABLE ROBOTS, IN CLASS 42 (U.S. CLS. 100 AND 101).

SERVICE MARK

PRINCIPAL REGISTER

FIRST USE 0-0-2010; IN COMMERCE 0-0-2010.

THE MARK CONSISTS OF STANDARD CHARACTERS WITHOUT CLAIM TO ANY PARTICULAR FONT, STYLE, SIZE, OR COLOR.

SER. NO. 85-319,218, FILED 5-12-2011.

LINDA E. BLOHM, EXAMINING ATTORNEY



David J. Kyros

Director of the United States Patent and Trademark Office

United States of America

United States Patent and Trademark Office



Reg. No. 4,074,095

Registered Dec. 20, 2011

Int. Cl.: 41

SERVICE MARK

PRINCIPAL REGISTER

FURMAN UNIVERSITY (SOUTH CAROLINA CORPORATION)
3300 POINSETT HIGHWAY
GREENVILLE, SC 29613

FOR: EDUCATING AT UNIVERSITY OR COLLEGES; ENTERTAINMENT IN THE NATURE OF FOOTBALL, BASKETBALL, SOCCER, TENNIS AND SWIMMING GAMES, IN CLASS 41 (U.S. CLS. 100, 101 AND 107).

FIRST USE 3-1-1978; IN COMMERCE 3-1-1978.

THE MARK CONSISTS OF TOWER LOGO.

SER. NO. 85-319,230, FILED 5-12-2011.

NAAKWAMA ANKRAH, EXAMINING ATTORNEY



David J. Kyffers

Director of the United States Patent and Trademark Office

United States of America

United States Patent and Trademark Office

MARVEL

Reg. No. 4,074,096

MARVEL CHARACTERS, INC. (DELAWARE CORPORATION)
1600 ROSECRANS AVENUE
MANHATTAN BEACH, CA 90266

Registered Dec. 20, 2011

Int. Cl.: 24

FOR: BEACH TOWELS; BED BLANKETS; BED LINEN; BED SHEETS; BED SPREADS;
BLANKET THROWS; CHILDREN'S BLANKETS; CHILDREN'S TOWELS; COMFORTERS;
FELT PENNANTS; HOODED TOWELS; PILLOW COVERS, IN CLASS 24 (U.S. CLS. 42 AND
50).

TRADEMARK

PRINCIPAL REGISTER

FIRST USE 12-31-2008; IN COMMERCE 12-31-2008.

THE MARK CONSISTS OF STANDARD CHARACTERS WITHOUT CLAIM TO ANY PAR-
TICULAR FONT, STYLE, SIZE, OR COLOR.

OWNER OF U.S. REG. NOS. 1,754,033, 2,918,286 AND OTHERS.

SER. NO. 85-319,232, FILED 5-12-2011.

MARC LEIPZIG, EXAMINING ATTORNEY



David J. Kypos

Director of the United States Patent and Trademark Office

United States of America

United States Patent and Trademark Office

THE BEST WAY TO SEE AMERICA!

Reg. No. 4,074,097

AMERICA BY RAIL, INC. (MICHIGAN CORPORATION)

Registered Dec. 20, 2011

5000 NORTHWIND DRIVE, SUITE 226
EAST LANSING, MI 48823

Int. Cl.: 39

FOR: ORGANIZATION, BOOKING AND ARRANGEMENT OF EXCURSIONS, DAY TRIPS AND SIGHTSEEING TOURS; TOUR CONDUCTING OR ESCORTING; TOUR GUIDE SERVICES; TRAVEL AND TOUR INFORMATION SERVICE; TRAVEL AND TOUR TICKET RESERVATION SERVICE, IN CLASS 39 (U.S. CLS. 100 AND 105).

SERVICE MARK

PRINCIPAL REGISTER

FIRST USE 1-3-2011; IN COMMERCE 1-3-2011.

THE MARK CONSISTS OF STANDARD CHARACTERS WITHOUT CLAIM TO ANY PARTICULAR FONT, STYLE, SIZE, OR COLOR.

SER. NO. 85-319,239, FILED 5-12-2011.

KELLEY WELLS, EXAMINING ATTORNEY



David J. Kyffers

Director of the United States Patent and Trademark Office

United States of America

United States Patent and Trademark Office

AMERICAN JUNKIE

Reg. No. 4,074,098

Registered Dec. 20, 2011

Int. Cl.: 25

TRADEMARK

PRINCIPAL REGISTER

SOFIA L PROPERTIES, LLC (ARIZONA LIMITED LIABILITY COMPANY)
2ND FLOOR
3599 CAHUENGA BOULEVARD, WEST
LOS ANGELES, CA 90068

FOR: CLOTHING, NAMELY, SHIRTS AND HATS, IN CLASS 25 (U.S. CLS. 22 AND 39).

FIRST USE 11-19-2008; IN COMMERCE 11-19-2008.

THE MARK CONSISTS OF STANDARD CHARACTERS WITHOUT CLAIM TO ANY PARTICULAR FONT, STYLE, SIZE, OR COLOR.

OWNER OF U.S. REG. NO. 3,660,454.

SER. NO. 85-319,247, FILED 5-12-2011.

KELLEY WELLS, EXAMINING ATTORNEY



David J. Kyffers

Director of the United States Patent and Trademark Office

United States of America

United States Patent and Trademark Office



LECMPA

Reg. No. 4,074,099

Registered Dec. 20, 2011

Int. Cl.: 36

SERVICE MARK

PRINCIPAL REGISTER

LOCOMOTIVE ENGINEERS & CONDUCTORS MUTUAL PROTECTIVE ASSOCIATION
(MICHIGAN NON-PROFIT ASSOCIATION), AKA LECMPA
4000 TOWN CENTER, SUITE 1250
SOUTHFIELD, MI 48075

FOR: INSURANCE SERVICES, NAMELY ISSUING, UNDERWRITING AND ADMINISTERING
JOB, LIFE, DISABILITY AND HOSPITAL INSURANCE FOR WORKERS IN THE TRANS-
PORTATION INDUSTRY, IN CLASS 36 (U.S. CLS. 100, 101 AND 102).

FIRST USE 12-1-2009; IN COMMERCE 12-1-2009.

THE MARK CONSISTS OF THE STYLIZED LETTERS LECMPA BELOW A CIRCLE CON-
TAINING THE IMAGE OF THE FRONT OF A TRAIN ON A TRACK, PLACED BETWEEN
IMAGES OF A BUS AND A TRUCK, AND BELOW THE IMAGE OF AN AIRPLANE.

SER. NO. 85-319,272, FILED 5-12-2011.

LINDA ESTRADA, EXAMINING ATTORNEY



David J. Kybas

Director of the United States Patent and Trademark Office

United States of America

United States Patent and Trademark Office



SANDFIRE

Reg. No. 4,074,100

Registered Dec. 20, 2011

Int. Cl.: 9

TRADEMARK

PRINCIPAL REGISTER

SANDFIRE SCIENTIFIC LTD. (CANADA CORPORATION)
1019 VENTURE WAY
GIBSONS, CANADA

FOR: BEAKERS; BIOREACTOR FOR CELL CULTURING; CALIBRATED GLASSWARE; CHROMATOGRAPHY COLUMNS; CHROMATOGRAPHY COLUMNS FOR USE IN PURIFICATION IN THE LABORATORY; EVACUATED AMPOULES FOR USE IN TESTING AND ANALYZING FLUIDS FOR NON-MEDICAL PURPOSES; GLASS TUBES FOR SCIENTIFIC PURPOSES; GLASSWARE FOR SCIENTIFIC EXPERIMENTS IN LABORATORIES; GRADUATED GLASSWARE; LABORATORY APPARATUS AND INSTRUMENTS, NAMELY, PRE-PACKED COLUMNS FOR USE IN SEPARATION AND PURIFICATION; LABORATORY EQUIPMENT AND SUPPLIES, NAMELY, TEST TUBES; LABORATORY EQUIPMENT, NAMELY, FUNNELS; LABORATORY EQUIPMENT, NAMELY, PLASTIC, RUBBER AND ELASTOMER CLOSURES, SEALS AND STOPPERS FOR LABORATORY BOTTLES; LABORATORY GLASSWARE; LABORATORY GLASSWARE, NAMELY, BURETTES; LABORATORY GLASSWARE, NAMELY, FLASKS; LABORATORY STORAGE TUBES; MEASURING GLASSWARE; SCIENTIFIC APPARATUS AND INSTRUMENTS, NAMELY, CHROMATOGRAPHY COLUMNS FOR USE IN PURIFICATION IN THE LABORATORY AND PARTS AND FITTINGS THEREFOR; STILLS FOR LABORATORY EXPERIMENTS, IN CLASS 9 (U.S. CLS. 21, 23, 26, 36 AND 38).

FIRST USE 3-17-2004; IN COMMERCE 3-17-2004.

THE MARK CONSISTS OF AN EQUILATERAL TRIANGLE COVERED BY A STYLIZED GRIFFON (HALF EAGLE, HALF LION) BREATHING FLAME FROM ITS OPEN MOUTH. THE WORD "SANDFIRE" IS PRINTED BELOW THE BASE OF THE OPEN TRIANGLE.

SER. NO. 85-319,289, FILED 5-12-2011.

NAAKWAMA ANKRAH, EXAMINING ATTORNEY



David J. Kypos

Director of the United States Patent and Trademark Office

United States of America

United States Patent and Trademark Office

PROTECTOVISION

Reg. No. 4,074,101

Registered Dec. 20, 2011

Int. Cl.: 9

TRADEMARK

PRINCIPAL REGISTER

PROTECTOVISION LLC (FLORIDA LIMITED LIABILITY COMPANY)
13506 SUMMERPORT VILLAGE PARKWAY
WINDERMERE, FL 34786

FOR: HOME AND BUSINESS INVENTORY SOFTWARE FOR DOCUMENTING AND TRACKING ASSETS WITH WEB BASED ARCHIVE STORAGE, IN CLASS 9 (U.S. CLS. 21, 23, 26, 36 AND 38).

FIRST USE 12-31-2010; IN COMMERCE 12-31-2010.

THE MARK CONSISTS OF STANDARD CHARACTERS WITHOUT CLAIM TO ANY PARTICULAR FONT, STYLE, SIZE, OR COLOR.

SER. NO. 85-319,294, FILED 5-12-2011.

NAAKWAMA ANKRAH, EXAMINING ATTORNEY



David J. Kyffers

Director of the United States Patent and Trademark Office

United States of America

United States Patent and Trademark Office

We Keep Phoenix Smiling

Reg. No. 4,074,102

Registered Dec. 20, 2011

Int. Cl.: 44

SERVICE MARK

PRINCIPAL REGISTER

SAMEET KOPPIKAR DDS PC (ARIZONA CORPORATION)
SUITE B
4202 N. 32 ST
PHOENIX, AZ 85018

FOR: DENTISTRY, IN CLASS 44 (U.S. CLS. 100 AND 101).

FIRST USE 6-13-2006; IN COMMERCE 6-13-2006.

THE MARK CONSISTS OF STANDARD CHARACTERS WITHOUT CLAIM TO ANY PARTICULAR FONT, STYLE, SIZE, OR COLOR.

SER. NO. 85-319,307, FILED 5-12-2011.

KAREN K. BUSH, EXAMINING ATTORNEY



David J. Kyffers

Director of the United States Patent and Trademark Office

United States of America

United States Patent and Trademark Office

TREATMENT BEGINS WITH TRANSPORTATION

Reg. No. 4,074,103

AMERICAN LOGISTICS COMPANY, LLC (CALIFORNIA LIMITED LIABILITY COMPANY)
520 W. DYER ROAD
SANTA ANA, CA 92707

Registered Dec. 20, 2011

Int. Cls.: 35 and 39

FOR: MONITORING, TRACKING, AND LOCATING FOR OTHERS OF PEOPLE BEING TRANSPORTED THROUGH CHARTER, SHUTTLE, NON-EMERGENCY MEDICAL TRANSPORTATION, SCHOOL BUS/PUPIL TRANSPORTATION, AND PARATRANSIT OPERATIONS; PROVISION TO OTHERS OF ELECTRONIC MONITORING, TRACKING, AND LOCATING INFORMATION CONCERNING PEOPLE BEING TRANSPORTED THROUGH CHARTER, SHUTTLE, NON-EMERGENCY MEDICAL TRANSPORTATION, SCHOOL BUS/PUPIL TRANSPORTATION, AND PARATRANSIT OPERATIONS, IN CLASS 35 (U.S. CLS. 100, 101 AND 102).

SERVICE MARK

PRINCIPAL REGISTER

FIRST USE 5-9-2011; IN COMMERCE 5-9-2011.

FOR: PASSENGER TRANSPORTATION SERVICES FOR OTHERS, NAMELY, CHARTER, SHUTTLE, NON-EMERGENCY MEDICAL TRANSPORTATION, SCHOOL BUS/PUPIL TRANSPORTATION, AND PARATRANSIT OPERATIONS IN THE NATURE OF TRANSPORTATION OF PASSENGERS BY LAND VEHICLES, IN CLASS 39 (U.S. CLS. 100 AND 105).

FIRST USE 5-9-2011; IN COMMERCE 5-9-2011.

THE MARK CONSISTS OF STANDARD CHARACTERS WITHOUT CLAIM TO ANY PARTICULAR FONT, STYLE, SIZE, OR COLOR.

SER. NO. 85-319,311, FILED 5-12-2011.

KAREN K. BUSH, EXAMINING ATTORNEY



David J. Kyros

Director of the United States Patent and Trademark Office

United States of America

United States Patent and Trademark Office

UVADEX

Reg. No. 4,074,104

JOHNSON & JOHNSON (NEW JERSEY CORPORATION)
ONE JOHNSON & JOHNSON PLAZA
NEW BRUNSWICK, NJ 089337001

Registered Dec. 20, 2011

Int. Cl.: 5

FOR: PHARMACEUTICAL PREPARATIONS FOR TREATMENT OF SKIN DISORDERS, IN CLASS 5 (U.S. CLS. 6, 18, 44, 46, 51 AND 52).

TRADEMARK

FIRST USE 7-9-1999; IN COMMERCE 7-9-1999.

PRINCIPAL REGISTER

THE MARK CONSISTS OF STANDARD CHARACTERS WITHOUT CLAIM TO ANY PARTICULAR FONT, STYLE, SIZE, OR COLOR.

SER. NO. 85-319,332, FILED 5-12-2011.

JILL C. ALT, EXAMINING ATTORNEY



David J. Kyffers

Director of the United States Patent and Trademark Office

United States of America

United States Patent and Trademark Office



Reg. No. 4,074,105

HYDROSORBENT DEHUMIDIFIERS (MASSACHUSETTS CORPORATION)
P.O. BOX 437, 25 SCHOOL STREET
ASHLEY FALLS, MA 01222

Registered Dec. 20, 2011

Int. Cl.: 11

FOR: DEHUMIDIFIERS; DEHUMIDIFIERS CONTAINING SILICA GEL, IN CLASS 11 (U.S. CLS. 13, 21, 23, 31 AND 34).

TRADEMARK

FIRST USE 0-0-1992; IN COMMERCE 0-0-1992.

PRINCIPAL REGISTER

THE MARK CONSISTS OF A WATER DROPLET IN A CIRCLE WITH THE WORD "HYDROSORBENT" ACROSS THE FRONT.

SER. NO. 85-319,365, FILED 5-12-2011.

SALLY SHIH, EXAMINING ATTORNEY



David J. Kybas

Director of the United States Patent and Trademark Office

United States of America

United States Patent and Trademark Office

FLOODBREAK

Reg. No. 4,074,106

Registered Dec. 20, 2011

Int. Cl.: 6

TRADEMARK

PRINCIPAL REGISTER

FLOODBREAK, L.L.C. (TEXAS LIMITED LIABILITY COMPANY)
SUITE 5850
2800 POST OAK BLVD.
HOUSTON, TX 77056

FOR: METAL AND METAL COMPOSITE BARRIERS FOR PROTECTING BUILDING AND GARAGE ENTRANCES AND INTERIOR PASSAGeways, VENTILATION SHAFTS AND OPENINGS, ROADWAYS, LEVEES, AND RESIDENTIAL AND BUSINESS AREAS AGAINST FLOODING WATERS, AND PARTS FOR THE BARRIERS, IN CLASS 6 (U.S. CLS. 2, 12, 13, 14, 23, 25 AND 50).

FIRST USE 1-13-2003; IN COMMERCE 1-13-2003.

THE MARK CONSISTS OF STANDARD CHARACTERS WITHOUT CLAIM TO ANY PARTICULAR FONT, STYLE, SIZE, OR COLOR.

SER. NO. 85-319,383, FILED 5-12-2011.

CAROLYN CATALDO, EXAMINING ATTORNEY



David J. Kybas

Director of the United States Patent and Trademark Office

United States of America

United States Patent and Trademark Office

TRIPLE CROWN

Reg. No. 4,074,107

TRIPLE CROWN NUTRITION, INC. (MINNESOTA CORPORATION)
319 BARRY AVENUE SOUTH, SUITE 303
WAYZATA, MN 55391

Registered Dec. 20, 2011

Int. Cl.: 9

FOR: COMPUTER SOFTWARE, ELECTRONIC DATA FILES AND DATABASES FOR THE FORMULATION, MANUFACTURE AND DISTRIBUTION OF ANIMAL FEED, NUTRITIONAL SUPPLEMENTS, NUTRACEUTICAL AND PHARMACEUTICAL ADDITIVES FOR SUCH PRODUCTS, IN CLASS 9 (U.S. CLS. 21, 23, 26, 36 AND 38).

TRADEMARK

PRINCIPAL REGISTER

FIRST USE 12-0-1990; IN COMMERCE 12-0-1990.

THE MARK CONSISTS OF STANDARD CHARACTERS WITHOUT CLAIM TO ANY PARTICULAR FONT, STYLE, SIZE, OR COLOR.

SER. NO. 85-319,401, FILED 5-12-2011.

SUSAN STIGLITZ, EXAMINING ATTORNEY



David J. Kybas

Director of the United States Patent and Trademark Office

United States of America

United States Patent and Trademark Office

EMERGING THOUGHTS

Reg. No. 4,074,108

KATZ, LAUREN (UNITED STATES INDIVIDUAL)
28 PERRY ST., #4E
NEW YORK, NY 10014

Registered Dec. 20, 2011

Int. Cl.: 35

FOR: ON-LINE RETAIL STORE SERVICES FEATURING CLOTHING, ART, JEWELRY,
BAGS AND ACCESSORIES, IN CLASS 35 (U.S. CLS. 100, 101 AND 102).

SERVICE MARK

FIRST USE 6-6-2006; IN COMMERCE 10-10-2006.

PRINCIPAL REGISTER

THE MARK CONSISTS OF STANDARD CHARACTERS WITHOUT CLAIM TO ANY PAR-
TICULAR FONT, STYLE, SIZE, OR COLOR.

SER. NO. 85-319,421, FILED 5-12-2011.

ROSELLE HERRERA, EXAMINING ATTORNEY



David J. Kybas

Director of the United States Patent and Trademark Office

United States of America

United States Patent and Trademark Office

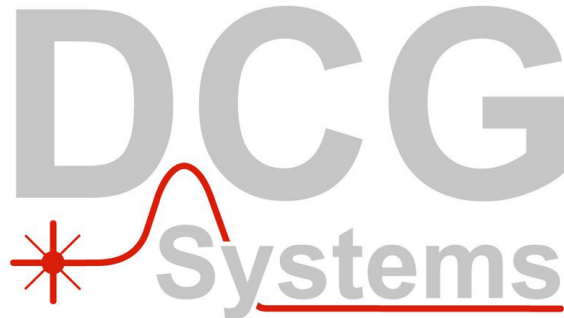

Reg. No. 4,074,109

Registered Dec. 20, 2011

Int. Cl.: 9

TRADEMARK

PRINCIPAL REGISTER

DCG SYSTEMS, INC. (DELAWARE CORPORATION)
45900 NORTHPORT LOOP EAST
FREMONT, CA 94538

FOR: CAPITAL EQUIPMENT FOR THE SEMICONDUCTOR MANUFACTURING INDUSTRY, NAMELY, INSPECTION, TEST AND DEBUG, AND CIRCUIT ALTERATION APPARATUS WHICH MEASURES PERFORMANCE CHARACTERISTICS OF SEMICONDUCTOR CIRCUITS, NAMELY, THE EMISSION OF LIGHT FROM TRANSISTORS, THE MODULATION OF LIGHT BY TRANSISTORS, THE INJECTION OF LIGHT INTO TRANSISTORS AND CIRCUITRY, THE CONTACT NANO-PROBING OF TRANSISTORS AND CIRCUITRY, THE MILLING OF CHIPS AND ALTERATION OF CIRCUITS, NAMELY, CREATING SHORTS AND BREAKS, FOR USE IN THE DESIGN AND MANUFACTURING OF SEMICONDUCTOR INTEGRATED CIRCUITS, IN CLASS 9 (U.S. CLS. 21, 23, 26, 36 AND 38).

FIRST USE 4-30-2008; IN COMMERCE 4-30-2008.

NO CLAIM IS MADE TO THE EXCLUSIVE RIGHT TO USE "SYSTEMS", APART FROM THE MARK AS SHOWN.

THE COLOR(S) GREY AND RED IS/ARE CLAIMED AS A FEATURE OF THE MARK.

THE MARK CONSISTS OF THE LETTERS "DCG" ON THE TOP LINE IN GREY AND THE WORD "SYSTEMS" IN GREY BELOW "DCG" AND A STARBURST DESIGN IN RED UNDER THE "D" AT THE BEGINNING OF "SYSTEMS" WITH A CURVED LINE IN RED OVER THE "S" AND A STRAIGHT LINE UNDER "STEMS" IN "SYSTEMS".

SER. NO. 85-319,434, FILED 5-12-2011.

ELLEN BURNS, EXAMINING ATTORNEY



David J. Kyffers

Director of the United States Patent and Trademark Office

United States of America

United States Patent and Trademark Office

HYDROXYDASE

Reg. No. 4,074,110

LABORATOIRES OMEGA PHARMA FRANCE (FRANCE COMPANY)
20 RUE ANDRÉ GIDE
CHÂTILLON, FRANCE 92320

Registered Dec. 20, 2011

Int. Cl.: 32

FOR: MINERAL AND AERATED WATER, IN CLASS 32 (U.S. CLS. 45, 46 AND 48).

TRADEMARK

THE MARK CONSISTS OF STANDARD CHARACTERS WITHOUT CLAIM TO ANY PARTICULAR FONT, STYLE, SIZE, OR COLOR.

PRINCIPAL REGISTER

OWNER OF FRANCE REG. NO. 1350938, DATED 4-16-1986, EXPIRES 4-16-2016.

SER. NO. 85-319,447, FILED 5-12-2011.

JACQUELINE A. LAVINE, EXAMINING ATTORNEY



David J. Kybas

Director of the United States Patent and Trademark Office

United States of America

United States Patent and Trademark Office

KILLSHOT

Reg. No. 4,074,111

BUGS-B-GONE, LLC (DELAWARE LIMITED LIABILITY COMPANY)
14411 WINDCHIME LANE
ORLANDO, FL 32837

Registered Dec. 20, 2011

Int. Cl.: 5

FOR: PESTICIDES; INSECTICIDES, IN CLASS 5 (U.S. CLS. 6, 18, 44, 46, 51 AND 52).

TRADEMARK

FIRST USE 8-4-2010; IN COMMERCE 8-24-2010.

PRINCIPAL REGISTER

THE MARK CONSISTS OF STANDARD CHARACTERS WITHOUT CLAIM TO ANY PARTICULAR FONT, STYLE, SIZE, OR COLOR.

SER. NO. 85-319,454, FILED 5-12-2011.

KATINA MISTER, EXAMINING ATTORNEY



David J. Kyffers

Director of the United States Patent and Trademark Office

United States of America

United States Patent and Trademark Office

ADJONEY

Reg. No. 4,074,112

SANOFI (FRANCE CORPORATION), FORMERLY SANOFI-AVENTIS
174, AVENUE DE FRANCE
PARIS, FRANCE 75013

Registered Dec. 20, 2011

Int. Cl.: 5

FOR: LOCAL ANESTHETICS, IN CLASS 5 (U.S. CLS. 6, 18, 44, 46, 51 AND 52).

TRADEMARK

THE MARK CONSISTS OF STANDARD CHARACTERS WITHOUT CLAIM TO ANY PARTICULAR FONT, STYLE, SIZE, OR COLOR.

PRINCIPAL REGISTER

OWNER OF FRANCE REG. NO. 09/3663237, DATED 7-9-2009, EXPIRES 7-9-2019.

OWNER OF U.S. REG. NO. 3,809,568.

SER. NO. 85-319,468, FILED 5-12-2011.

KAELIE KUNG, EXAMINING ATTORNEY



David J. Kyffers

Director of the United States Patent and Trademark Office

United States of America

United States Patent and Trademark Office

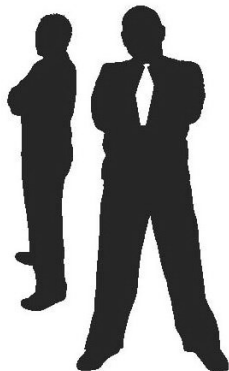

Reg. No. 4,074,113

Registered Dec. 20, 2011

Int. Cl.: 9

TRADEMARK

PRINCIPAL REGISTER

NLU PRODUCTS, LLC (UTAH LIMITED LIABILITY COMPANY)
1103 LONE PEAK
DRAPER, UT 84020

FOR: ACCESSORIES FOR ELECTRONIC DEVICES, NAMELY SCREEN PROTECTORS, BODY WRAPS, COVERS, OVERLAYS, STYLUSES, CASES, BATTERIES AND BATTERY CHARGERS, ALL OF THE FOREGOING FOR USE IN CONNECTION WITH PERSONAL DIGITAL ASSISTANTS, CELL PHONES, PORTABLE MEDIA PLAYERS, CAMERAS, GAMING CONSOLES, LAPTOP COMPUTERS AND NOTEBOOK COMPUTERS, IN CLASS 9 (U.S. CLS. 21, 23, 26, 36 AND 38).

FIRST USE 11-8-2006; IN COMMERCE 11-8-2006.

THE MARK CONSISTS OF TWO MEN, ONE FACING FORWARD AND ONE FACING SIDEWAYS WITH THEIR ARMS FOLDED.

SER. NO. 85-319,471, FILED 5-12-2011.

DARRYL SPRUILL, EXAMINING ATTORNEY



David J. Kybas

Director of the United States Patent and Trademark Office

United States of America

United States Patent and Trademark Office

SPT

Reg. No. 4,074,114

Registered Dec. 20, 2011

Int. Cl.: 42

SERVICE MARK

PRINCIPAL REGISTER

SPT ENERGY GROUP INC. (CAYMAN ISLANDS CORPORATION)
SCOTIA CENTRE, 4TH FLOOR, P.O. BOX 2804
GEORGE TOWN
GRAND CAYMAN, CAYMAN ISLANDS KY1-1112

FOR: ANALYSIS SERVICES FOR OIL FIELD EXPLORATION; TECHNICAL RESEARCH IN THE FIELD OF OIL FIELD EXPLORATION; GEOLOGICAL SURVEYS; GEOLOGICAL PROSPECTING; OIL PROSPECTING; MECHANICAL RESEARCH; GEOLOGICAL RESEARCH; ENGINEERING SERVICES IN THE FIELD OF OIL FIELD EXPLORATION; CHEMICAL RESEARCH; COMPUTER SOFTWARE DESIGN, IN CLASS 42 (U.S. CLS. 100 AND 101).

FIRST USE 2-1-2011; IN COMMERCE 2-1-2011.

THE MARK CONSISTS OF THE LETTERS "SPT" IN A STYLIZED FONT.

SER. NO. 85-319,475, FILED 5-12-2011.

DARRYL SPRUILL, EXAMINING ATTORNEY



David J. Kybas

Director of the United States Patent and Trademark Office

United States of America

United States Patent and Trademark Office

AFICEYO

Reg. No. 4,074,115

SANOFI (FRANCE CORPORATION), FORMERLY SANOFI-AVENTIS
174, AVENUE DE FRANCE
PARIS, FRANCE 75013

Registered Dec. 20, 2011

Int. Cl.: 5

FOR: LOCAL ANESTHETICS, IN CLASS 5 (U.S. CLS. 6, 18, 44, 46, 51 AND 52).

TRADEMARK

THE MARK CONSISTS OF STANDARD CHARACTERS WITHOUT CLAIM TO ANY PARTICULAR FONT, STYLE, SIZE, OR COLOR.

PRINCIPAL REGISTER

OWNER OF FRANCE REG. NO. 09/3664687, DATED 7-17-2009, EXPIRES 7-17-2019.

OWNER OF U.S. REG. NO. 3,809,570.

SER. NO. 85-319,482, FILED 5-12-2011.

KAELIE KUNG, EXAMINING ATTORNEY



David J. Kyffers

Director of the United States Patent and Trademark Office

United States of America

United States Patent and Trademark Office

ADJETTRO

Reg. No. 4,074,116

SANOFI (FRANCE CORPORATION), FORMERLY SANOFI-AVENTIS
174, AVENUE DE FRANCE
PARIS, FRANCE 75013

Registered Dec. 20, 2011

Int. Cl.: 5

FOR: LOCAL ANESTHETICS, IN CLASS 5 (U.S. CLS. 6, 18, 44, 46, 51 AND 52).

TRADEMARK

THE MARK CONSISTS OF STANDARD CHARACTERS WITHOUT CLAIM TO ANY PARTICULAR FONT, STYLE, SIZE, OR COLOR.

PRINCIPAL REGISTER

OWNER OF FRANCE REG. NO. 09/3665774, DATED 7-22-2009, EXPIRES 7-22-2019.

OWNER OF U.S. REG. NO. 3,802,286.

SER. NO. 85-319,508, FILED 5-12-2011.

KAELIE KUNG, EXAMINING ATTORNEY



David J. Kyffers

Director of the United States Patent and Trademark Office

United States of America

United States Patent and Trademark Office

Accubraid

Reg. No. 4,074,117

ACCURATE FISHING PRODUCTS (CALIFORNIA CORPORATION)
807 E. PARKRIDGE AVE
CORONA, CA 92879

Registered Dec. 20, 2011

Int. Cl.: 28

FOR: FISHING LINES, IN CLASS 28 (U.S. CLS. 22, 23, 38 AND 50).

TRADEMARK

FIRST USE 10-1-2008; IN COMMERCE 10-1-2008.

PRINCIPAL REGISTER

THE MARK CONSISTS OF STANDARD CHARACTERS WITHOUT CLAIM TO ANY PARTICULAR FONT, STYLE, SIZE, OR COLOR.

SER. NO. 85-319,525, FILED 5-12-2011.

DAVID ELTON, EXAMINING ATTORNEY



David J. Kyfos

Director of the United States Patent and Trademark Office

United States of America

United States Patent and Trademark Office



Reg. No. 4,074,118

Registered Dec. 20, 2011

Int. Cls.: 35 and 41

SERVICE MARK

PRINCIPAL REGISTER

GREEN BLUE INSTITUTE (DELAWARE TAX EXEMPT CORPORATION), DBA GREENBLUE
600 E. WATER STREET, SUITE C
CHARLOTTESVILLE, VA 22902

FOR: CONSULTING SERVICES IN THE AREA OF SUSTAINABLE BUSINESS SOLUTIONS;
PROVIDING INFORMATION IN THE FIELD OF THE SUSTAINABLE BUSINESS SOLUTIONS
INDUSTRY, IN CLASS 35 (U.S. CLS. 100, 101 AND 102).

FIRST USE 6-18-2011; IN COMMERCE 6-18-2011.

FOR: EDUCATION SERVICES, NAMELY, PROVIDING LIVE AND ON-LINE CONFERENCES
AND SEMINARS IN THE FIELD OF SUSTAINABLE BUSINESS SOLUTIONS, AND PRINTED
AND PRINTABLE MATERIAL DISTRIBUTED THEREWITH, IN CLASS 41 (U.S. CLS. 100,
101 AND 107).

FIRST USE 6-18-2011; IN COMMERCE 6-18-2011.

OWNER OF U.S. REG. NOS. 3,479,309 AND 3,483,550.

THE COLOR(S) GREEN, BLUE, AND GRAY IS/ARE CLAIMED AS A FEATURE OF THE
MARK.

THE MARK CONSISTS OF A CIRCLE WITH A HORIZONTAL TAIL ON THE TOP LEFT-
HAND SIDE, AND THE CIRCLE IS VERTICALLY SPLIT IN HALF BY A RIGHT FACING
ARROWHEAD AT 12 O'CLOCK AND A LEFT FACING ARROWHEAD AT 6 O'CLOCK. THE
LEFT HALF OF THE CIRCLE, INCLUDING THE TAIL, IS GREEN, AND THE RIGHT HALF
OF THE CIRCLE IS BLUE. THE CIRCLE IS FOLLOWED IMMEDIATELY TO THE RIGHT
BY THE WORD GREENBLUE IN ALL CAPITALIZED GRAY LETTERING.

SER. NO. 85-319,544, FILED 5-12-2011.

TINA MAI, EXAMINING ATTORNEY



David J. Kyffers

Director of the United States Patent and Trademark Office

United States of America

United States Patent and Trademark Office

STREET INFORMATION NETWORK

Reg. No. 4,074,119

Registered Dec. 20, 2011

**Int. Cls.: 9, 16, 18, 25
and 41**

PELEGRINO ENTERTAINMENT GROUP, INC. (NEW JERSEY CORPORATION)
353 WEST 46TH STREET
NEW YORK, NY 10036

FOR: SOUND RECORDINGS FEATURING INTERVIEWS WITH RECORDING ARTISTS;
DOWNLOADABLE ELECTRONIC NEWSLETTERS IN THE FIELD OF MUSIC AND THE
RECORDING INDUSTRY, IN CLASS 9 (U.S. CLS. 21, 23, 26, 36 AND 38).

TRADEMARK

FIRST USE 5-31-2007; IN COMMERCE 5-31-2007.

SERVICE MARK

FOR: PRINTED CALENDARS, IN CLASS 16 (U.S. CLS. 2, 5, 22, 23, 29, 37, 38 AND 50).

PRINCIPAL REGISTER

FIRST USE 1-1-1999; IN COMMERCE 1-1-1999.

FOR: TOTE BAGS, IN CLASS 18 (U.S. CLS. 1, 2, 3, 22 AND 41).

FIRST USE 12-8-2005; IN COMMERCE 12-8-2005.

FOR: T-SHIRTS, IN CLASS 25 (U.S. CLS. 22 AND 39).

FIRST USE 12-8-2005; IN COMMERCE 12-8-2005.

FOR: ENTERTAINMENT SERVICES, NAMELY, PROVIDING A WEB SITE FEATURING
NON-DOWNLOADABLE MUSICAL PERFORMANCES, MUSICAL VIDEOS, RELATED
FILM CLIPS, PHOTOGRAPHS AND OTHER MULTIMEDIA MATERIALS FEATURING RE-
CORDING ARTISTS, ENTERTAINERS AND RADIO, TELEVISION AND MOTION PICTURE
PERSONALITIES; ON-LINE NEWSLETTERS IN THE FIELD OF MUSIC AND THE RECORD-
ING INDUSTRY; NON-DOWNLOADABLE ELECTRONIC PUBLICATIONS IN THE NATURE
OF CALENDARS, IN CLASS 41 (U.S. CLS. 100, 101 AND 107).

FIRST USE 5-31-2007; IN COMMERCE 5-31-2007.

THE MARK CONSISTS OF STANDARD CHARACTERS WITHOUT CLAIM TO ANY PAR-
TICULAR FONT, STYLE, SIZE, OR COLOR.

OWNER OF U.S. REG. NO. 1,653,658.

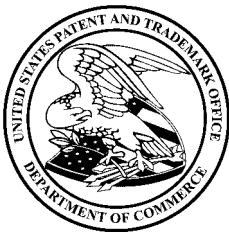

David J. Kyros

Director of the United States Patent and Trademark Office

Reg. No. 4,074,119 SER. NO. 85-319,548, FILED 5-12-2011.

ALICIA COLLINS, EXAMINING ATTORNEY

United States of America

United States Patent and Trademark Office

Making companies sweeter.

Reg. No. 4,074,120

Registered Dec. 20, 2011

Int. Cl.: 35

SERVICE MARK

PRINCIPAL REGISTER

SUGARMAKER MEDIA, LLC (VERMONT LIMITED LIABILITY COMPANY)
SUITE 315
300 CORNERSTONE DRIVE
WILLISTON, VT 05495

FOR: BUSINESS ASSISTANCE, ADVISORY AND CONSULTING SERVICES IN THE FIELD OF TECHNOLOGY PRODUCTS; BUSINESS SUPPORT SERVICES, NAMELY, BUSINESS CONSULTING TO FREELANCERS, START-UPS, EXISTING BUSINESSES AND NON-PROFIT ORGANIZATIONS, IN CLASS 35 (U.S. CLS. 100, 101 AND 102).

FIRST USE 5-5-2011; IN COMMERCE 5-5-2011.

THE MARK CONSISTS OF STANDARD CHARACTERS WITHOUT CLAIM TO ANY PARTICULAR FONT, STYLE, SIZE, OR COLOR.

SER. NO. 85-319,555, FILED 5-12-2011.

LINDA ESTRADA, EXAMINING ATTORNEY



David J. Kybas

Director of the United States Patent and Trademark Office

United States of America

United States Patent and Trademark Office



Reg. No. 4,074,121

Registered Dec. 20, 2011

Int. Cls.: 9 and 42

TRADEMARK

SERVICE MARK

PRINCIPAL REGISTER

RADHA KRUSHN COMMUNICATIONS, INC. (NEW JERSEY CORPORATION)
280 SAN MORENO PLACE
FREMONT, CA 94539

FOR: COMPUTER APPLICATION SOFTWARE FOR MOBILE PHONES, NAMELY, SOFTWARE FOR COLLECTING PERFORMANCE MEASUREMENT DATA FROM MOBILE DEVICES; COMPUTER APPLICATION SOFTWARE FOR HANDSETS, MOBILE PHONES AND WIRELESS DEVICES, NAMELY, SOFTWARE FOR COLLECTING PERFORMANCE MEASUREMENT DATA FROM MOBILE DEVICES; DOWNLOADABLE SOFTWARE FOR COLLECTING PERFORMANCE MEASUREMENTS DATA FROM TELECOMMUNICATION NETWORKS, IN CLASS 9 (U.S. CLS. 21, 23, 26, 36 AND 38).

FIRST USE 4-12-2011; IN COMMERCE 4-12-2011.

FOR: PROVIDING TEMPORARY USE OF ON-LINE NON-DOWNLOADABLE SOFTWARE FOR WEB BASED REPORTING SYSTEMS FOR TELECOMMUNICATION NETWORKS, IN CLASS 42 (U.S. CLS. 100 AND 101).

FIRST USE 4-12-2011; IN COMMERCE 4-12-2011.

THE MARK CONSISTS OF THE GRAY WORD HASATI ON A BLACK AND YELLOW BACKGROUND. THERE IS A YELLOW BALL BEHIND THE LETTER S.

THE COLOR(S) BLACK, YELLOW AND GRAY IS/ARE CLAIMED AS A FEATURE OF THE MARK.

THE WORDING HASATI HAS NO MEANING IN A FOREIGN LANGUAGE.

SER. NO. 85-319,561, FILED 5-12-2011.

CAROLYN CATALDO, EXAMINING ATTORNEY



David J. Kyros

Director of the United States Patent and Trademark Office

United States of America

United States Patent and Trademark Office

MIXOLOGY

Reg. No. 4,074,122

Registered Dec. 20, 2011

Int. Cl.: 45

SERVICE MARK

PRINCIPAL REGISTER

VOLTAIRE LLC (D.C. LIMITED LIABILITY COMPANY), DBA MIXOLOGY
SUITE 200
1412 - 14TH STREET, NW
WASHINGTON, DC 20005

FOR: MATCHMAKING SERVICES, IN CLASS 45 (U.S. CLS. 100 AND 101).

FIRST USE 3-0-2010; IN COMMERCE 3-0-2010.

THE MARK CONSISTS OF STANDARD CHARACTERS WITHOUT CLAIM TO ANY PARTICULAR FONT, STYLE, SIZE, OR COLOR.

SER. NO. 85-319,643, FILED 5-12-2011.

BERNICE MIDDLETON, EXAMINING ATTORNEY



David J. Kybas

Director of the United States Patent and Trademark Office

United States of America

United States Patent and Trademark Office

iSplash

Reg. No. 4,074,123

Registered Dec. 20, 2011

Int. Cl.: 42

SERVICE MARK

PRINCIPAL REGISTER

ISPLASH, INC. (MASSACHUSETTS CORPORATION)
14 PROSPECT STREET
HINGHAM, MA 02043

FOR: CONSULTING SERVICES IN THE FIELD OF SOFTWARE AS A SERVICE (SAAS), IN CLASS 42 (U.S. CLS. 100 AND 101).

FIRST USE 1-1-2004; IN COMMERCE 1-1-2004.

THE MARK CONSISTS OF STANDARD CHARACTERS WITHOUT CLAIM TO ANY PARTICULAR FONT, STYLE, SIZE, OR COLOR.

SER. NO. 85-319,724, FILED 5-12-2011.

MAYUR VAGHANI, EXAMINING ATTORNEY



David J. Kybas

Director of the United States Patent and Trademark Office

United States of America

United States Patent and Trademark Office

WHERE TODAY'S SCIENCE MEETS TOMORROW'S CARE

Reg. No. 4,074,124

AMERICAN THORACIC SOCIETY (NEW YORK CORPORATION)
61 BROADWAY
NEW YORK, NY 10006

Registered Dec. 20, 2011

Int. Cl.: 41

FOR: EDUCATIONAL SERVICES, NAMELY, CONDUCTING CONFERENCES IN THE FIELD OF PULMONARY, CRITICAL CARE AND SLEEP MEDICINE AND DISTRIBUTION OF EDUCATIONAL MATERIALS IN CONNECTION THEREWITH, IN CLASS 41 (U.S. CLS. 100, 101 AND 107).

SERVICE MARK

PRINCIPAL REGISTER

FIRST USE 6-0-2009; IN COMMERCE 6-0-2009.

THE MARK CONSISTS OF STANDARD CHARACTERS WITHOUT CLAIM TO ANY PARTICULAR FONT, STYLE, SIZE, OR COLOR.

SER. NO. 85-319,743, FILED 5-12-2011.

ANDREA HACK, EXAMINING ATTORNEY



David J. Kyffers

Director of the United States Patent and Trademark Office

United States of America

United States Patent and Trademark Office

SciMoto

Reg. No. 4,074,125

MUSSATTO, DONNA J. (UNITED STATES INDIVIDUAL)
35938 NORD COURT
WINCHESTER, CA 92596

Registered Dec. 20, 2011

Int. Cl.: 35

FOR: BUSINESS CONSULTING SERVICES IN THE FIELD OF ENERGY EFFICIENCY, IN CLASS 35 (U.S. CLS. 100, 101 AND 102).

SERVICE MARK

FIRST USE 5-12-2011; IN COMMERCE 5-12-2011.

PRINCIPAL REGISTER

THE MARK CONSISTS OF STANDARD CHARACTERS WITHOUT CLAIM TO ANY PARTICULAR FONT, STYLE, SIZE, OR COLOR.

THE WORDING SCIMOTO HAS NO MEANING IN A FOREIGN LANGUAGE.

SER. NO. 85-319,762, FILED 5-12-2011.

JAMES LOVELACE, EXAMINING ATTORNEY



David J. Kyffers

Director of the United States Patent and Trademark Office

United States of America

United States Patent and Trademark Office

BARRE BANTER

Reg. No. 4,074,126

SENA, KATHY (UNITED STATES INDIVIDUAL)
3512 PACIFIC AVENUE
MANHATTAN BEACH, CA 90266

Registered Dec. 20, 2011

Int. Cl.: 9

FOR: DOWNLOADABLE ELECTRONIC NEWSLETTERS IN THE FIELD OF GENERAL INTEREST, ADVICE, NETWORKING, ENCOURAGEMENT AND SUPPORT, GROUP AND CLUB INFORMATION, RECOMMENDATIONS, ARTICLES RELATING TO BALLET AND FORMER BALLERINAS, IN CLASS 9 (U.S. CLS. 21, 23, 26, 36 AND 38).

TRADEMARK

PRINCIPAL REGISTER

FIRST USE 5-9-2011; IN COMMERCE 5-9-2011.

THE MARK CONSISTS OF STANDARD CHARACTERS WITHOUT CLAIM TO ANY PARTICULAR FONT, STYLE, SIZE, OR COLOR.

SER. NO. 85-319,783, FILED 5-12-2011.

H. M. FISHER, EXAMINING ATTORNEY



David J. Kybas

Director of the United States Patent and Trademark Office

United States of America

United States Patent and Trademark Office

Totally Booked University

Reg. No. 4,074,127

CROSS, DENNIS (UNITED STATES INDIVIDUAL)
193 PURPLE FINCH LOOP
PATASKALA, OH 43062

Registered Dec. 20, 2011

Int. Cl.: 41

FOR: TRAINING COURSES IN STRATEGIC PLANNING RELATING TO ADVERTISING, PROMOTION, MARKETING AND BUSINESS SPECIFICALLY FOR THE CARPET CLEANING, DISASTER RESTORATION, AND CONTRACT CLEANING INDUSTRIES, IN CLASS 41 (U.S. CLS. 100, 101 AND 107).

SERVICE MARK

PRINCIPAL REGISTER

FIRST USE 3-10-2010; IN COMMERCE 3-10-2010.

THE MARK CONSISTS OF STANDARD CHARACTERS WITHOUT CLAIM TO ANY PARTICULAR FONT, STYLE, SIZE, OR COLOR.

NO CLAIM IS MADE TO THE EXCLUSIVE RIGHT TO USE "UNIVERSITY", APART FROM THE MARK AS SHOWN.

SER. NO. 85-319,785, FILED 5-12-2011.

H. M. FISHER, EXAMINING ATTORNEY



David J. Kybas

Director of the United States Patent and Trademark Office

United States of America

United States Patent and Trademark Office

Dream Arcades

Reg. No. 4,074,128

Registered Dec. 20, 2011

Int. Cl.: 28

TRADEMARK

PRINCIPAL REGISTER

WARE, MICHAEL J (UNITED STATES INDIVIDUAL), DBA DREAM ARCADES
792 TRAVIS ST
FOLSOM, CA 95630

FOR: ARCADE GAME MACHINES, IN CLASS 28 (U.S. CLS. 22, 23, 38 AND 50).

FIRST USE 10-1-2002; IN COMMERCE 10-5-2002.

THE MARK CONSISTS OF STANDARD CHARACTERS WITHOUT CLAIM TO ANY PARTICULAR FONT, STYLE, SIZE, OR COLOR.

OWNER OF U.S. REG. NO. 3,260,353.

NO CLAIM IS MADE TO THE EXCLUSIVE RIGHT TO USE "ARCADES", APART FROM THE MARK AS SHOWN.

SER. NO. 85-319,805, FILED 5-12-2011.

JOHN DWYER, EXAMINING ATTORNEY



David J. Kyffers

Director of the United States Patent and Trademark Office

United States of America

United States Patent and Trademark Office

VECTOR ONE

Reg. No. 4,074,129

Registered Dec. 20, 2011

Int. Cl.: 36

SERVICE MARK

PRINCIPAL REGISTER

PRIOR SURETY CHECK, L.L.C. (ARIZONA LIMITED LIABILITY COMPANY)
P. O. BOX 12368
SCOTTSDALE, AZ 85267

FOR: PROVIDING A DATABASE SYSTEM ON GLOBAL COMPUTER NETWORKS FEATURING TRADE INFORMATION IN THE FIELD OF INSURANCE, NAMELY, PROVIDING A DATABASE FEATURING INFORMATION ON INSURANCE AGENTS WITH DEBIT BALANCES OWED TO SUBSCRIBING INSURANCE COMPANIES FOR USE SOLELY BY SUBSCRIBING INSURANCE COMPANIES TO SCREEN INSURANCE LICENSE APPLICATIONS FROM INSURANCE AGENTS, IN CLASS 36 (U.S. CLS. 100, 101 AND 102).

FIRST USE 9-1-1989; IN COMMERCE 9-1-1989.

THE MARK CONSISTS OF STANDARD CHARACTERS WITHOUT CLAIM TO ANY PARTICULAR FONT, STYLE, SIZE, OR COLOR.

SER. NO. 85-319,822, FILED 5-12-2011.

EDWARD FENNESSY, EXAMINING ATTORNEY



David J. Kyfos

Director of the United States Patent and Trademark Office

United States of America

United States Patent and Trademark Office

DEBIT-CHECK.COM

Reg. No. 4,074,130

Registered Dec. 20, 2011

Int. Cl.: 36

SERVICE MARK

PRINCIPAL REGISTER

CAMP HOLDINGS, L.L.C. (WISCONSIN LIMITED LIABILITY COMPANY)
P. O. BOX 12368
SCOTTSDALE, AZ 85267

FOR: PROVIDING A DATABASE SYSTEM ON GLOBAL COMPUTER NETWORKS FEATURING TRADE INFORMATION IN THE FIELD OF INSURANCE, NAMELY, PROVIDING A DATABASE FEATURING INFORMATION ON INSURANCE AGENTS WITH DEBIT BALANCES OWED TO SUBSCRIBING INSURANCE COMPANIES FOR USE SOLELY BY SUBSCRIBING INSURANCE COMPANIES TO SCREEN AGENT CONTRACT APPLICATIONS, IN CLASS 36 (U.S. CLS. 100, 101 AND 102).

FIRST USE 6-1-1999; IN COMMERCE 6-1-2000.

THE MARK CONSISTS OF STANDARD CHARACTERS WITHOUT CLAIM TO ANY PARTICULAR FONT, STYLE, SIZE, OR COLOR.

SER. NO. 85-319,828, FILED 5-12-2011.

JOHN HWANG, EXAMINING ATTORNEY



David J. Kybas

Director of the United States Patent and Trademark Office

United States of America

United States Patent and Trademark Office

FASH-N-SLEEVES ON THE GO!

Reg. No. 4,074,131

MAFFEI, CAROLYN (UNITED STATES INDIVIDUAL)

Registered Dec. 20, 2011

7241 66TH PLACE
GLENDALE, NY 11385

Int. Cl.: 25

FOR: GARMENT ACCESSORY, NAMELY, DETACHABLE SLEEVES TO BE WORN TOGETHER WITH A SHIRT, BLOUSE, DRESS, JACKET OR OTHER TOP, IN CLASS 25 (U.S. CLS. 22 AND 39).

TRADEMARK

FIRST USE 12-15-2010; IN COMMERCE 12-30-2010.

PRINCIPAL REGISTER

THE MARK CONSISTS OF STANDARD CHARACTERS WITHOUT CLAIM TO ANY PARTICULAR FONT, STYLE, SIZE, OR COLOR.

SER. NO. 85-319,842, FILED 5-12-2011.

CAROLYN CATALDO, EXAMINING ATTORNEY



David J. Kyffers

Director of the United States Patent and Trademark Office

United States of America

United States Patent and Trademark Office

SUPERNOVA

Reg. No. 4,074,132

Registered Dec. 20, 2011

Int. Cl.: 11

TRADEMARK

PRINCIPAL REGISTER

INTERNATIONAL INNOVATIONS, INC. (HAWAII CORPORATION)
SECOND FLOOR
935 MAKAHIKI WAY
HONOLULU, HI 96826

FOR: FLASHLIGHTS; TACTICAL FLASHLIGHTS, IN CLASS 11 (U.S. CLS. 13, 21, 23, 31 AND 34).

FIRST USE 1-15-2008; IN COMMERCE 3-15-2008.

THE MARK CONSISTS OF STANDARD CHARACTERS WITHOUT CLAIM TO ANY PARTICULAR FONT, STYLE, SIZE, OR COLOR.

SER. NO. 85-319,861, FILED 5-12-2011.

BARBARA GAYNOR, EXAMINING ATTORNEY



David J. Kyffers

Director of the United States Patent and Trademark Office

United States of America

United States Patent and Trademark Office

HEIDI HAT

Reg. No. 4,074,133

Registered Dec. 20, 2011

Int. Cls.: 25 and 35

TRADEMARK

SERVICE MARK

PRINCIPAL REGISTER

HEIDI HAT, LLC (COLORADO LIMITED LIABILITY COMPANY)
40 BROWN COURT
CARBONDALE, CO 81623

FOR: BANDEAU TOPS; BEANIES; BOARD SHORTS; DRESSES; HATS; HEADBANDS;
NECK BANDS; PANTS; SCARFS; SHORTS; SKIRTS; SUN PROTECTIVE CLOTHING,
NAMELY, NOSE COVERS, IN CLASS 25 (U.S. CLS. 22 AND 39).

FIRST USE 10-11-1999; IN COMMERCE 11-30-2001.

FOR: ON-LINE RETAIL STORE SERVICES FEATURING HATS, DRESSES, SKIRTS, PANTS,
SHORTS, BEANIES, NOSE COVERS, NECK WARMERS, YOGA CLOTHING, NAMELY
YOGA SHORTS, BANDEAU TOPS AND HEADBANDS, IN CLASS 35 (U.S. CLS. 100, 101
AND 102).

FIRST USE 10-11-1999; IN COMMERCE 11-30-2001.

THE MARK CONSISTS OF STANDARD CHARACTERS WITHOUT CLAIM TO ANY PAR-
TICULAR FONT, STYLE, SIZE, OR COLOR.

NO CLAIM IS MADE TO THE EXCLUSIVE RIGHT TO USE "HAT", APART FROM THE
MARK AS SHOWN.

SER. NO. 85-319,862, FILED 5-12-2011.

ROBIN MITTLER, EXAMINING ATTORNEY



David J. Kyros

Director of the United States Patent and Trademark Office

United States of America

United States Patent and Trademark Office

VERSATHIN

Reg. No. 4,074,134

Registered Dec. 20, 2011

Int. Cl.: 19

TRADEMARK

PRINCIPAL REGISTER

HANSON BRICK EAST, LLC (DELAWARE LIMITED LIABILITY COMPANY)
15720 JOHN J. DELANEY DR., ST. 555
CHARLOTTE, NC 282771479

FOR: BRICK, IN CLASS 19 (U.S. CLS. 1, 12, 33 AND 50).

FIRST USE 4-7-2011; IN COMMERCE 4-7-2011.

THE MARK CONSISTS OF STANDARD CHARACTERS WITHOUT CLAIM TO ANY PARTICULAR FONT, STYLE, SIZE, OR COLOR.

SER. NO. 85-319,961, FILED 5-13-2011.

BRENDAN MCCAULEY, EXAMINING ATTORNEY



David J. Kyffers

Director of the United States Patent and Trademark Office

United States of America

United States Patent and Trademark Office

Bell of Honor

Reg. No. 4,074,135

Registered Dec. 20, 2011

Int. Cl.: 35

SERVICE MARK

PRINCIPAL REGISTER

BELL OF HONOR, INC. (MINNESOTA CORPORATION)
512 PORTLAND COURT NE
ROCHESTER, MN 55906

FOR: CHARITABLE SERVICES, NAMELY, ORGANIZING AND CONDUCTING VOLUNTEER PROGRAMS AND COMMUNITY SERVICE PROJECTS AIMED AT INCREASING SUPPORT AND MORALE OF FAMILIES OF DECEASED WAR VETERANS, WAR VETERANS, CURRENT MEMBERS AND FUTURE MEMBERS OF THE U.S. MILITARY; CHARITABLE SERVICES, NAMELY, ORGANIZING AND CONDUCTING VOLUNTEER PROGRAMS AND COMMUNITY SERVICE PROJECTS AIMED AT INCREASING SUPPORT AND MORALE OF MEMBERS OF THE U.S. MILITARY, IN CLASS 35 (U.S. CLS. 100, 101 AND 102).

FIRST USE 3-21-2011; IN COMMERCE 3-21-2011.

THE MARK CONSISTS OF STANDARD CHARACTERS WITHOUT CLAIM TO ANY PARTICULAR FONT, STYLE, SIZE, OR COLOR.

SER. NO. 85-319,980, FILED 5-13-2011.

JACQUELINE A. LAVINE, EXAMINING ATTORNEY



David J. Kyffers

Director of the United States Patent and Trademark Office

United States of America

United States Patent and Trademark Office

WHIP ASS

Reg. No. 4,074,136

Registered Dec. 20, 2011

Int. Cl.: 29

TRADEMARK

PRINCIPAL REGISTER

JACOBS, JEFFREY (UNITED STATES INDIVIDUAL), DBA SOUTHWEST SPECIALTY
FOOD, INC.
700 N. BULLARD AVENUE
GOODYEAR, AZ 85338

FOR: CHILI, IN CLASS 29 (U.S. CL. 46).

FIRST USE 6-1-2001; IN COMMERCE 6-1-2001.

THE MARK CONSISTS OF STANDARD CHARACTERS WITHOUT CLAIM TO ANY PAR-
TICULAR FONT, STYLE, SIZE, OR COLOR.

SER. NO. 85-319,985, FILED 5-13-2011.

MARK SHINER, EXAMINING ATTORNEY



David J. Kyffers

Director of the United States Patent and Trademark Office

United States of America

United States Patent and Trademark Office



Reg. No. 4,074,137

Registered Dec. 20, 2011

Int. Cl.: 43

SERVICE MARK

PRINCIPAL REGISTER

VAUGHAN ENTERPRISES, NV (NETHERLANDS ANTILLES CORPORATION)
21 VLAUN DRIVE
SIMPSON BAY ST.MAARTEN, NETHERLANDS ANTILLES

FOR: GUESTHOUSE, IN CLASS 43 (U.S. CLS. 100 AND 101).

FIRST USE 1-1-1976; IN COMMERCE 1-1-1976.

NO CLAIM IS MADE TO THE EXCLUSIVE RIGHT TO USE "GUEST HOUSE", APART FROM THE MARK AS SHOWN.

THE MARK CONSISTS OF THE WORDS "THE HORNY TOAD GUESTHOUSE" AND A DRAWING OF A TOAD.

SER. NO. 85-320,047, FILED 5-13-2011.

MIDGE BUTLER, EXAMINING ATTORNEY



David J. Kyffers

Director of the United States Patent and Trademark Office

United States of America

United States Patent and Trademark Office

SANDLOTQRM

Reg. No. 4,074,138

Registered Dec. 20, 2011

Int. Cl.: 42

SERVICE MARK

PRINCIPAL REGISTER

SANDLOT, LLC (TEXAS LIMITED LIABILITY COMPANY)
SUITE 200
1701 RIVER RUN
FORT WORTH, TX 76107

FOR: PROVIDING MEDICAL AND SCIENTIFIC ANALYSIS AND RESEARCH SERVICES REGARDING PATIENT AND PROVIDER OUTCOMES, HEALTH INFORMATION, QUALITY, DEMOGRAPHICS AND PATIENT SATISFACTION; APPLICATION SERVICE PROVIDER FEATURING SOFTWARE FOR USE IN COLLECTING, ANALYZING AND REPORTING MEDICAL DATA RELATING TO PATIENT MEDICAL CONDITIONS IN THE AREA OF PATIENT REGISTRIES, QUALITY IMPROVEMENT PROGRAMS AND OUTCOMES RESEARCH AND FOR USE IN CONDUCTING PATIENT REGISTRIES, POST-APPROVAL MARKETING STUDIES, ELECTRONIC DATA CAPTURE SERVICES FOR POST-APPROVAL MARKETING STUDIES, AND QUALITY IMPROVEMENT PROGRAMS IN THE HEALTH-CARE, BIOPHARMACEUTICAL, AND MEDICAL DEVICE AND DIAGNOSTIC INDUSTRIES; ONLINE APPLICATION SERVICES PROVIDER OF SOFTWARE THAT MEASURES THE QUALITY AND APPROPRIATENESS OF MEDICAL CARE; ONLINE APPLICATION SERVICES PROVIDER OF POINT-OF-CARE SOFTWARE FOR USE BY MEDICAL PROVIDERS, IN CLASS 42 (U.S. CLS. 100 AND 101).

FIRST USE 3-1-2011; IN COMMERCE 3-1-2011.

THE MARK CONSISTS OF STANDARD CHARACTERS WITHOUT CLAIM TO ANY PARTICULAR FONT, STYLE, SIZE, OR COLOR.

OWNER OF U.S. REG. NOS. 3,479,973 AND 3,625,328.

SER. NO. 85-320,091, FILED 5-13-2011.

MIDGE BUTLER, EXAMINING ATTORNEY



David J. Kypos

Director of the United States Patent and Trademark Office

United States of America

United States Patent and Trademark Office

ZVS

Reg. No. 4,074,139

Registered Dec. 20, 2011

Int. Cl.: 39

SERVICE MARK

PRINCIPAL REGISTER

CIBT, INC. (DELAWARE CORPORATION)
1650 TYSON'S BOULEVARD, SUITE 1350
MCLEAN, VA 22102

FOR: ARRANGING FOR TRAVEL VISAS, PASSPORTS AND TRAVEL DOCUMENTS FOR PERSONS TRAVELING ABROAD, IN CLASS 39 (U.S. CLS. 100 AND 105).

FIRST USE 2-0-2005; IN COMMERCE 2-0-2005.

THE MARK CONSISTS OF STANDARD CHARACTERS WITHOUT CLAIM TO ANY PARTICULAR FONT, STYLE, SIZE, OR COLOR.

SER. NO. 85-320,164, FILED 5-13-2011.

ELLEN B. AWRICH, EXAMINING ATTORNEY



David J. Kybas

Director of the United States Patent and Trademark Office

United States of America

United States Patent and Trademark Office

Haitianista

Reg. No. 4,074,140

Registered Dec. 20, 2011

Int. Cl.: 35

SERVICE MARK

PRINCIPAL REGISTER

RMG VENTURES LLC (FLORIDA LIMITED LIABILITY COMPANY)
266 NW 92ND STREET
MIAMI SHORES, FL 33150

FOR: ON-LINE RETAIL STORE SERVICES FEATURING HANDMADE JEWELRY, PURSES, CLUTCHES, CLOTHES, STYLIZED EYEGLASS CASES, HATS, SHOES AND SANDALS, AND ARTWORK, NAMELY, PAINTINGS, STATUES MADE OF STONE, JEWELS, ROCK, BUSTS, BOWLS, SERVING DISHES, SERVING PLATTERS, AND UTENSILS; VENDING IN THE FIELD OF HANDMADE JEWELRY, PURSES, CLUTCHES, CLOTHES, STYLIZED EYEGLASS CASES, HATS, SHOES AND SANDALS, AND ARTWORK, NAMELY, PAINTINGS, STATUES MADE OF STONE, JEWELS, ROCK, BUSTS, BOWLS, SERVING DISHES, SERVING PLATTERS, AND UTENSILS, IN CLASS 35 (U.S. CLS. 100, 101 AND 102).

FIRST USE 2-2-2011; IN COMMERCE 2-2-2011.

THE MARK CONSISTS OF STANDARD CHARACTERS WITHOUT CLAIM TO ANY PARTICULAR FONT, STYLE, SIZE, OR COLOR.

SER. NO. 85-320,194, FILED 5-13-2011.

DEIRDRE ROBERTSON, EXAMINING ATTORNEY



David J. Kybas

Director of the United States Patent and Trademark Office

United States of America

United States Patent and Trademark Office



TECHNOLOGY MANAGEMENT, INC.

Reg. No. 4,074,141

Registered Dec. 20, 2011

Int. Cl.: 42

SERVICE MARK

PRINCIPAL REGISTER

TECHNOLOGY MANAGEMENT, INC. (VIRGINIA CORPORATION)
SUITE 202
1840 WILSON BLVD
ARLINGTON, VA 22201

FOR: COMPUTER TECHNICAL SUPPORT SERVICES, NAMELY, 24/7 SERVICE DESK/HELP DESK SERVICES FOR IT INFRASTRUCTURE, OPERATING SYSTEMS, DATABASE SYSTEMS, AND WEB APPLICATIONS; DESIGN AND CREATING WEB SITES FOR OTHERS; IT CONSULTING SERVICES, IN CLASS 42 (U.S. CLS. 100 AND 101).

FIRST USE 12-31-1999; IN COMMERCE 12-31-1999.

NO CLAIM IS MADE TO THE EXCLUSIVE RIGHT TO USE "TECHNOLOGY MANAGEMENT, INC.", APART FROM THE MARK AS SHOWN.

THE MARK CONSISTS OF A RUNNING MAN WITH THE LETTERS "TMI". BELOW THERE IS THE STYLIZED TEXT "TECHNOLOGY MANAGEMENT, INC.".

SER. NO. 85-320,197, FILED 5-13-2011.

MAYUR VAGHANI, EXAMINING ATTORNEY



David J. Kybas

Director of the United States Patent and Trademark Office

United States of America

United States Patent and Trademark Office

REVVED UP KIDS

Reg. No. 4,074,142

Registered Dec. 20, 2011

Int. Cl.: 41

SERVICE MARK

PRINCIPAL REGISTER

REVVED UP KIDS, LLC (GEORGIA LIMITED LIABILITY COMPANY)
P.O. BOX 5145
ALPHARETTA, GA 300235145

FOR: EDUCATIONAL AND ENTERTAINMENT SERVICES, NAMELY, CONDUCTING CONFERENCES, WORKSHOPS, SEMINARS, AND CLASSES IN THE FIELD OF PERSONAL SAFETY, ABDUCTION PREVENTION, AND SELF-DEFENSE FOR CHILDREN AND DISTRIBUTION OF COURSE MATERIALS IN CONNECTION THEREWITH, AND EDUCATION CONSULTING RELATED THERETO; EDUCATIONAL SERVICES, NAMELY, CONDUCTING CONFERENCES, WORKSHOPS, SEMINARS, AND CLASSES IN THE FIELD OF PERSONAL SAFETY, ABDUCTION PREVENTION, AND SELF-DEFENSE FOR CHILDREN AND DISTRIBUTION OF PRINTED MATERIALS IN CONNECTION THEREWITH IN HARD COPY OR ELECTRONIC FORMAT ON THE SAME TOPICS; EDUCATIONAL SERVICES, NAMELY, CONDUCTING CONFERENCES, WORKSHOPS, SEMINARS, AND CLASSES IN THE FIELD OF PERSONAL SAFETY, ABDUCTION PREVENTION, AND SELF-DEFENSE FOR CHILDREN AND DISTRIBUTION OF EDUCATIONAL MATERIALS IN CONNECTION THEREWITH; EDUCATIONAL SERVICES, NAMELY, DEVELOPING CURRICULUM FOR OTHERS IN THE FIELD OF PERSONAL SAFETY, ABDUCTION PREVENTION, AND SELF-DEFENSE FOR CHILDREN; INSTRUCTION IN THE FIELD OF PERSONAL SAFETY, ABDUCTION PREVENTION, AND SELF-DEFENSE FOR CHILDREN, IN CLASS 41 (U.S. CLS. 100, 101 AND 107).

FIRST USE 10-29-2010; IN COMMERCE 11-0-2010.

THE MARK CONSISTS OF STANDARD CHARACTERS WITHOUT CLAIM TO ANY PARTICULAR FONT, STYLE, SIZE, OR COLOR.

SER. NO. 85-320,228, FILED 5-13-2011.

LINDA E. BLOHM, EXAMINING ATTORNEY



David J. Kyjars

Director of the United States Patent and Trademark Office

United States of America

United States Patent and Trademark Office

PARTNERS IN PROGRESS

Reg. No. 4,074,143

Registered Dec. 20, 2011

Int. Cl.: 36

SERVICE MARK

PRINCIPAL REGISTER

NATIONAL ORGANIZATION FOR RARE DISORDERS, INC. (NEW YORK CORPORATION)
55 KENOSIA AVE.
P.O. BOX 1968
DANBURY, CT 068131968

FOR: CHARITABLE FUNDRAISING SERVICES, IN CLASS 36 (U.S. CLS. 100, 101 AND 102).

FIRST USE 5-14-2009; IN COMMERCE 5-14-2009.

THE MARK CONSISTS OF STANDARD CHARACTERS WITHOUT CLAIM TO ANY PARTICULAR FONT, STYLE, SIZE, OR COLOR.

SER. NO. 85-320,233, FILED 5-13-2011.

LAURA HAMMEL, EXAMINING ATTORNEY



David J. Kyffers

Director of the United States Patent and Trademark Office

United States of America

United States Patent and Trademark Office

POT O'GOLD

Reg. No. 4,074,144

Registered Dec. 20, 2011

Int. Cl.: 30

TRADEMARK

PRINCIPAL REGISTER

WE ARE GOURMET CORP (NEVADA CORPORATION), DBA WCC HONEY CORP
636 TURNBILL CANYON RD
CITY OF INDUSTRY, CA 91745

FOR: HONEY; MOLASSES; MOLASSES SYRUP, IN CLASS 30 (U.S. CL. 46).

FIRST USE 0-0-1959; IN COMMERCE 0-0-1959.

THE MARK CONSISTS OF STANDARD CHARACTERS WITHOUT CLAIM TO ANY PARTICULAR FONT, STYLE, SIZE, OR COLOR.

SER. NO. 85-320,263, FILED 5-13-2011.

VERNA BETH RIRIE, EXAMINING ATTORNEY



David J. Kyffers

Director of the United States Patent and Trademark Office

United States of America

United States Patent and Trademark Office

EXCELSIOR XL

Reg. No. 4,074,145

SWIFT-LITE CHARCOAL USA INC. (NEW JERSEY CORPORATION)
P.O. BOX 3254

Registered Dec. 20, 2011

SOUTH AMBOY, NJ 08879

Int. Cl.: 34

FOR: SMOKERS' ARTICLES, NAMELY, HOOKAH CHARCOAL, IN CLASS 34 (U.S. CLS. 2, 8, 9 AND 17).

TRADEMARK

FIRST USE 2-15-2007; IN COMMERCE 2-15-2007.

PRINCIPAL REGISTER

THE MARK CONSISTS OF STANDARD CHARACTERS WITHOUT CLAIM TO ANY PARTICULAR FONT, STYLE, SIZE, OR COLOR.

NO CLAIM IS MADE TO THE EXCLUSIVE RIGHT TO USE "XL", APART FROM THE MARK AS SHOWN.

SER. NO. 85-320,274, FILED 5-13-2011.

KATHLEEN LORENZO, EXAMINING ATTORNEY



David J. Kybas

Director of the United States Patent and Trademark Office

United States of America

United States Patent and Trademark Office

MIYORI

Reg. No. 4,074,146

MIYORI JAPANESE STEAKHOUSE, INC. (ALABAMA CORPORATION)
1016 RUCKER BOULEVARD
ENTERPRISE, AL 36330

Registered Dec. 20, 2011

Int. Cl.: 43

FOR: RESTAURANT SERVICES, IN CLASS 43 (U.S. CLS. 100 AND 101).

SERVICE MARK

FIRST USE 3-15-2007; IN COMMERCE 3-15-2007.

PRINCIPAL REGISTER

THE MARK CONSISTS OF STANDARD CHARACTERS WITHOUT CLAIM TO ANY PARTICULAR FONT, STYLE, SIZE, OR COLOR.

SER. NO. 85-320,275, FILED 5-13-2011.

KAREN SEVERSON, EXAMINING ATTORNEY



David J. Kybas

Director of the United States Patent and Trademark Office

United States of America

United States Patent and Trademark Office

InstaForex

Reg. No. 4,074,147

EKATERINA POBEDINSKAYA (RUSSIAN FED. CORPORATION)
30 TEATRALNAYA, OFFICE 428

Registered Dec. 20, 2011

KALININGRAD, RUSSIAN FED. 236000

Int. Cl.: 36

FOR: ELECTRONIC FINANCIAL TRADING SERVICES; FINANCIAL ADVICE AND CONSULTANCY SERVICES; FINANCIAL ANALYSIS AND RESEARCH SERVICES; NEWS REPORTING SERVICES IN THE FIELD OF FINANCIAL NEWS, IN CLASS 36 (U.S. CLS. 100, 101 AND 102).

SERVICE MARK

PRINCIPAL REGISTER

FIRST USE 5-27-2007; IN COMMERCE 5-27-2007.

THE MARK CONSISTS OF STANDARD CHARACTERS WITHOUT CLAIM TO ANY PARTICULAR FONT, STYLE, SIZE, OR COLOR.

SER. NO. 85-320,322, FILED 5-13-2011.

LIEF MARTIN, EXAMINING ATTORNEY



David J. Kyros

Director of the United States Patent and Trademark Office

United States of America

United States Patent and Trademark Office

SOPHIA GLOBAL

Reg. No. 4,074,148

SOPHIA GLOBAL, LLC (KANSAS LIMITED LIABILITY COMPANY)
1705 HASKELL AVENUE, SUITE A
LAWRENCE, KS 66044

Registered Dec. 20, 2011

Int. Cl.: 2

FOR: FILLED INK AND TONER CARTRIDGES FOR COMPUTER PRINTERS, FAX MACHINES AND PHOTOCOPY MACHINES, IN CLASS 2 (U.S. CLS. 6, 11 AND 16).

TRADEMARK

FIRST USE 4-30-2011; IN COMMERCE 4-30-2011.

PRINCIPAL REGISTER

THE MARK CONSISTS OF STANDARD CHARACTERS WITHOUT CLAIM TO ANY PARTICULAR FONT, STYLE, SIZE, OR COLOR.

NO CLAIM IS MADE TO THE EXCLUSIVE RIGHT TO USE "GLOBAL", APART FROM THE MARK AS SHOWN.

SER. NO. 85-320,335, FILED 5-13-2011.

ELLEN B. AWRICH, EXAMINING ATTORNEY



David J. Kyffers

Director of the United States Patent and Trademark Office

United States of America

United States Patent and Trademark Office

UMPH

Reg. No. 4,074,149

Registered Dec. 20, 2011

Int. Cl.: 44

SERVICE MARK

PRINCIPAL REGISTER

UMPHOLOGY LLC (ARIZONA LIMITED LIABILITY COMPANY)
2036 N. GILBERT RD, SUITE 2-124
MESA, AZ 85203

FOR: PROVIDING A WEBSITE FEATURING CONTENT REGARDING HEALTHY LIVING AND LIFESTYLE WELLNESS; PROVIDING A WEBSITE FEATURING INFORMATION ABOUT HEALTH, WELLNESS AND NUTRITION; PROVIDING ASSISTANCE, FITNESS EVALUATION AND CONSULTATION TO CORPORATE CLIENTS TO HELP THEIR EMPLOYEES MAKE HEALTH, WELLNESS AND NUTRITIONAL CHANGES IN THEIR DAILY LIVING TO IMPROVE HEALTH; PROVIDING ASSISTANCE, FITNESS EVALUATION AND CONSULTATION TO INDIVIDUALS TO HELP THEM MAKE HEALTH, WELLNESS AND NUTRITIONAL CHANGES IN THEIR DAILY LIVING TO IMPROVE HEALTH; PROVIDING INFORMATION ON MAINTAINING A HEALTHY LIFESTYLE AND LOSING WEIGHT, IN CLASS 44 (U.S. CLS. 100 AND 101).

FIRST USE 5-30-2010; IN COMMERCE 6-15-2010.

THE MARK CONSISTS OF STANDARD CHARACTERS WITHOUT CLAIM TO ANY PARTICULAR FONT, STYLE, SIZE, OR COLOR.

SER. NO. 85-320,344, FILED 5-13-2011.

DAWN FELDMAN, EXAMINING ATTORNEY



David J. Kyros

Director of the United States Patent and Trademark Office

United States of America

United States Patent and Trademark Office

Plant Green Ideas

Reg. No. 4,074,150

Registered Dec. 20, 2011

Int. Cl.: 35

SERVICE MARK

PRINCIPAL REGISTER

PLANT GREEN IDEAS, INC (ILLINOIS CORPORATION)
#298
333 W NORTH AVENUE
CHICAGO, IL 60610

FOR: GENERAL BUSINESS MERCHANDISING SERVICES, NAMELY, MARKETING, IN CLASS 35 (U.S. CLS. 100, 101 AND 102).

FIRST USE 11-25-2010; IN COMMERCE 2-12-2011.

THE MARK CONSISTS OF STANDARD CHARACTERS WITHOUT CLAIM TO ANY PARTICULAR FONT, STYLE, SIZE, OR COLOR.

NO CLAIM IS MADE TO THE EXCLUSIVE RIGHT TO USE "GREEN IDEAS", APART FROM THE MARK AS SHOWN.

SER. NO. 85-320,444, FILED 5-13-2011.

CARRIE GENOVESE, EXAMINING ATTORNEY



David J. Kybas

Director of the United States Patent and Trademark Office

United States of America

United States Patent and Trademark Office

SACRED COMPASS

Reg. No. 4,074,151

SACRED COMPASS (WASHINGTON PARTNERSHIP)

Registered Dec. 20, 2011

10025 NE 13TH STREET
BELLEVUE, WA 98004

Int. Cl.: 41

FOR: EDUCATION SERVICES, NAMELY, PROVIDING LIVE AND ON-LINE CLASSES, SEMINARS, WORKSHOPS, AND KEYNOTE SPEECHES IN THE FIELD OF PERSONAL AND PROFESSIONAL DEVELOPMENT, IN CLASS 41 (U.S. CLS. 100, 101 AND 107).

SERVICE MARK

FIRST USE 3-1-2011; IN COMMERCE 5-8-2011.

PRINCIPAL REGISTER

THE MARK CONSISTS OF STANDARD CHARACTERS WITHOUT CLAIM TO ANY PARTICULAR FONT, STYLE, SIZE, OR COLOR.

SER. NO. 85-320,466, FILED 5-13-2011.

JAY FLOWERS, EXAMINING ATTORNEY



David J. Kybas

Director of the United States Patent and Trademark Office

United States of America

United States Patent and Trademark Office



Reg. No. 4,074,152

SWIFT-LITE CHARCOAL USA INC. (NEW JERSEY CORPORATION)
P.O. BOX 3254
SOUTH AMBOY, NJ 08879

Registered Dec. 20, 2011

Int. Cl.: 34

FOR: SMOKERS' ARTICLES, NAMELY, HOOKAH CHARCOAL, IN CLASS 34 (U.S. CLS. 2, 8, 9 AND 17).

TRADEMARK

FIRST USE 2-15-2007; IN COMMERCE 2-15-2007.

PRINCIPAL REGISTER

NO CLAIM IS MADE TO THE EXCLUSIVE RIGHT TO USE "XL", APART FROM THE MARK AS SHOWN.

THE COLOR(S) YELLOW, RED AND BLACK IS/ARE CLAIMED AS A FEATURE OF THE MARK.

THE MARK CONSISTS OF CURSIVE "EXCELSIOR" WRITTEN ABOVE A BLOCK-LETTERED "XL", ALL LETTERS IN YELLOW WITH BLACK OUTLINE ON RED BACKGROUND.

SER. NO. 85-320,476, FILED 5-13-2011.

KATHLEEN LORENZO, EXAMINING ATTORNEY



David J. Kybas

Director of the United States Patent and Trademark Office

United States of America

United States Patent and Trademark Office

MORE THAN JUST A BAG

Reg. No. 4,074,153

HAUL COUTURE, LLC (ALABAMA LIMITED LIABILITY COMPANY)
4800 WHITESBURG DRIVE, SUITE 30-282
HUNTSVILLE, AL 35802

Registered Dec. 20, 2011

Int. Cl.: 18

FOR: LUGGAGE; INSULATED TOTE BAGS; COLLAPSIBLE TEXTILE SHOPPING BAGS,
IN CLASS 18 (U.S. CLS. 1, 2, 3, 22 AND 41).

TRADEMARK

FIRST USE 10-14-2010; IN COMMERCE 10-14-2010.

PRINCIPAL REGISTER

THE MARK CONSISTS OF STANDARD CHARACTERS WITHOUT CLAIM TO ANY PAR-
TICULAR FONT, STYLE, SIZE, OR COLOR.

SER. NO. 85-320,489, FILED 5-13-2011.

ALEX KEAM, EXAMINING ATTORNEY



David J. Kybas

Director of the United States Patent and Trademark Office

United States of America

United States Patent and Trademark Office

PLEX

Reg. No. 4,074,154

Registered Dec. 20, 2011

Int. Cl.: 9

TRADEMARK

PRINCIPAL REGISTER

ATLAS COPCO MAFI-TRENCH COMPANY LLC (DELAWARE LIMITED LIABILITY COMPANY)
3037 INDUSTRIAL PARKWAY
SANTA MARIA, CA 93455

FOR: CONVERTER, NAMELY, A MECHANICAL DEVICE FOR CONVERTING THE PRESSURE ENERGY IN A GAS STREAM INTO USEABLE SHAFT POWER OR ELECTRIC POWER, IN CLASS 9 (U.S. CLS. 21, 23, 26, 36 AND 38).

FIRST USE 3-4-2003; IN COMMERCE 3-4-2003.

THE MARK CONSISTS OF STANDARD CHARACTERS WITHOUT CLAIM TO ANY PARTICULAR FONT, STYLE, SIZE, OR COLOR.

SER. NO. 85-320,522, FILED 5-13-2011.

YAT SYE, LEE, EXAMINING ATTORNEY



David J. Kybas

Director of the United States Patent and Trademark Office

United States of America

United States Patent and Trademark Office

BED BUG ANNIHILATOR

Reg. No. 4,074,155

MB TEXTILES, INC. (CALIFORNIA CORPORATION)
614 N. JUNE ST.

Registered Dec. 20, 2011

LOS ANGELES, CA 90004

Int. Cl.: 11

FOR: PORTABLE, COLLAPSIBLE, HEAT CHAMBER ATTACHED TO AN ELECTRIC HEATER TO KILL BED BUGS AND OTHER INSECTS, IN CLASS 11 (U.S. CLS. 13, 21, 23, 31 AND 34).

TRADEMARK

FIRST USE 3-25-2011; IN COMMERCE 3-25-2011.

PRINCIPAL REGISTER

THE MARK CONSISTS OF STANDARD CHARACTERS WITHOUT CLAIM TO ANY PARTICULAR FONT, STYLE, SIZE, OR COLOR.

NO CLAIM IS MADE TO THE EXCLUSIVE RIGHT TO USE "BED BUG", APART FROM THE MARK AS SHOWN.

SER. NO. 85-320,531, FILED 5-13-2011.

COLLEEN KEARNEY, EXAMINING ATTORNEY



David J. Kybas

Director of the United States Patent and Trademark Office

United States of America

United States Patent and Trademark Office

Greenbelt

Reg. No. 4,074,156

Registered Dec. 20, 2011

Int. Cl.: 20

TRADEMARK

PRINCIPAL REGISTER

RALPH RAPSON & ASSOCIATES, INC. (MINNESOTA CORPORATION), DBA RAPSON
ARCHITECTS
409 CEDAR AVE SOUTH
MINNEAPOLIS, MN 55454

FOR: FURNITURE, IN CLASS 20 (U.S. CLS. 2, 13, 22, 25, 32 AND 50).

FIRST USE 5-5-2011; IN COMMERCE 5-5-2011.

THE MARK CONSISTS OF STANDARD CHARACTERS WITHOUT CLAIM TO ANY PARTICULAR FONT, STYLE, SIZE, OR COLOR.

SER. NO. 85-320,577, FILED 5-13-2011.

EMILY CARLSEN, EXAMINING ATTORNEY



David J. Kyffers

Director of the United States Patent and Trademark Office

United States of America

United States Patent and Trademark Office

AIR RIDE

Reg. No. 4,074,157

Registered Dec. 20, 2011

Int. Cl.: 18

TRADEMARK

PRINCIPAL REGISTER

EUROW & O'REILLY CORPORATION (CALIFORNIA CORPORATION), DBA EQUINE
COMFORT PRODUCTS
365-B CAMINO CARILLO
CAMARILLO, CA 93012

FOR: PADS FOR HORSE SADDLES, IN CLASS 18 (U.S. CLS. 1, 2, 3, 22 AND 41).

FIRST USE 8-1-2009; IN COMMERCE 8-1-2009.

THE MARK CONSISTS OF STANDARD CHARACTERS WITHOUT CLAIM TO ANY PARTICULAR FONT, STYLE, SIZE, OR COLOR.

SER. NO. 85-320,585, FILED 5-13-2011.

CHARLOTTE CORWIN, EXAMINING ATTORNEY



David J. Kybas

Director of the United States Patent and Trademark Office

United States of America

United States Patent and Trademark Office

Improv Your Life

Reg. No. 4,074,158

FARAHNAKIAN, ALI (UNITED STATES INDIVIDUAL)
249 EAST 48TH ST. APT #5D
NEW YORK, NY 10017

Registered Dec. 20, 2011

Int. Cl.: 41

FOR: EDUCATIONAL SERVICES, NAMELY, CONDUCTING IMPROVISATIONAL COMEDY TECHNIQUE WORKSHOPS AND SEMINARS IN THE FIELD OF PERSONAL AND PROFESSIONAL GROWTH AND DISTRIBUTION OF COURSE AND EDUCATIONAL MATERIALS IN CONNECTION THEREWITH, IN CLASS 41 (U.S. CLS. 100, 101 AND 107).

SERVICE MARK

PRINCIPAL REGISTER

FIRST USE 12-1-2002; IN COMMERCE 12-1-2002.

THE MARK CONSISTS OF STANDARD CHARACTERS WITHOUT CLAIM TO ANY PARTICULAR FONT, STYLE, SIZE, OR COLOR.

NO CLAIM IS MADE TO THE EXCLUSIVE RIGHT TO USE "IMPROV", APART FROM THE MARK AS SHOWN.

SER. NO. 85-320,715, FILED 5-13-2011.

WENDY GOODMAN, EXAMINING ATTORNEY



David J. Kyros

Director of the United States Patent and Trademark Office

United States of America

United States Patent and Trademark Office

NeighborWood

Reg. No. 4,074,159

NEIGHBORWOOD, LLC (ILLINOIS LIMITED LIABILITY COMPANY)
3041 HARTZELL STREET
EVANSTON, IL 60201

Registered Dec. 20, 2011

Int. Cl.: 21

FOR: CUTTING BOARDS, IN CLASS 21 (U.S. CLS. 2, 13, 23, 29, 30, 33, 40 AND 50).

TRADEMARK

FIRST USE 9-15-2010; IN COMMERCE 2-1-2011.

PRINCIPAL REGISTER

THE MARK CONSISTS OF STANDARD CHARACTERS WITHOUT CLAIM TO ANY PARTICULAR FONT, STYLE, SIZE, OR COLOR.

SER. NO. 85-320,764, FILED 5-13-2011.

WANDA KAY PRICE, EXAMINING ATTORNEY



David J. Kyffers

Director of the United States Patent and Trademark Office

United States of America

United States Patent and Trademark Office

ALL CHILDREN WORLD UNITED

Reg. No. 4,074,160

Registered Dec. 20, 2011

Int. Cl.: 41

SERVICE MARK

PRINCIPAL REGISTER

CYPING, EZECHIAS J (CAMEROON INDIVIDUAL)
210
8611 S.CRENSHAW BLVD
INGLEWOOD, CA 90305

FOR: ENCOURAGING AMATEUR SPORTS AND PHYSICAL EDUCATION BY ORGANIZING, SANCTIONING, CONDUCTING, REGULATING AND GOVERNING AMATEUR ATHLETIC PROGRAMS AND ACTIVITIES, IN CLASS 41 (U.S. CLS. 100, 101 AND 107).

FIRST USE 1-28-2010; IN COMMERCE 1-28-2010.

THE MARK CONSISTS OF STANDARD CHARACTERS WITHOUT CLAIM TO ANY PARTICULAR FONT, STYLE, SIZE, OR COLOR.

SER. NO. 85-320,825, FILED 5-13-2011.

JENNIFER MARTIN, EXAMINING ATTORNEY



David J. Kybas

Director of the United States Patent and Trademark Office

United States of America

United States Patent and Trademark Office



Tectron

Reg. No. 4,074,161

WATCH CLUB, INC. (CALIFORNIA CORPORATION)

Registered Dec. 20, 2011

4632 PACIFIC BLVD.
VERNON, CA 90058

Int. Cl.: 9

TRADEMARK

PRINCIPAL REGISTER

FOR: ADAPTERS; ANTENNAS; ANTENNAS FOR RADIO, FOR TELEVISION; AUDIO CASSETTE AND CD PLAYERS; AUDIO CASSETTE PLAYERS; AUDIO CASSETTE RECORDERS; AUDIO HEADPHONES; AUDIO TAPE RECORDERS; BATTERIES; BLANK AUDIO CASSETTES; BLANK AUDIO TAPES; BLANK DIGITAL AUDIO TAPES; BLANK VIDEO CASSETTES; BLANK VIDEO TAPES; CALCULATORS; CAMERAS; CASES FOR MUSIC, AUDIO AND RELATED ELECTRONIC EQUIPMENT, NAMELY, CASES FOR AUDIO TUNERS, AUDIO RECEIVERS, AMPLIFIERS, TAPE PLAYERS, COMPACT DISC PLAYERS, MP3 CONTROLLERS/PLAYERS, AUDIO MIXERS, AUDIO SPEAKERS IN THE NATURE OF MUSIC STUDIO MONITORS, MICROPHONES, AUDIO SPEAKERS, COMPACT DISCS, AUDIO TAPES, PORTABLE COMPUTERS, ANTENNAS, PHONOGRAPHIC RECORD PLAYERS, AUDIO RECORDING EQUIPMENT, AND THE CABLES ASSOCIATED WITH ALL OF THE FOREGOING EQUIPMENT; CHILDREN'S VIDEO TAPES; CLEANING DISCS FOR CLEANING THE LENS OF OPTICAL DISC DRIVES USED IN COMPUTERS AND DIGITAL VIDEO RECORDERS; COMPUTER CURSOR CONTROL DEVICES, NAMELY, COMPUTER MOUSE; DIGITAL CAMERAS; DIGITAL VIDEO CAMERAS; EARPHONES AND HEADPHONES; ELECTRIC FLAT IRONS; ELECTRIC HAIR CURLING IRONS; ELECTRICAL POWER EXTENSION CORDS; ELECTRICAL SOCKETS; GAME CONTROLLERS FOR COMPUTER GAMES; HEAD CLEANING TAPES FOR VIDEO RECORDER; LOUDSPEAKERS, HEADPHONES, MICROPHONES AND CD PLAYERS; MOBILE RADIOS; POCKET CALCULATORS; PORTABLE RADIOS; RADIO SETS; RADIOS; RADIOS AND TELEPHONES; REMOTE CONTROL TRANSMITTER FOR RADIO-CONTROLLED DEVICES; REMOTE CONTROLS FOR MASSAGE CHAIRS; SOUND SYSTEMS COMPRISING REMOTE CONTROLS, AMPLIFIERS, LOUDSPEAKERS AND COMPONENTS THEREFOR; STEREO HEADPHONES; VIDEO GAME INTERACTIVE CONTROL FLOOR PADS OR MATS; VIDEO GAME INTERACTIVE HAND HELD REMOTE CONTROLS FOR PLAYING ELECTRONIC GAMES; VIDEO GAME INTERACTIVE REMOTE CONTROL UNITS; VINYL COVERS SPECIALLY ADAPTED FOR CELL PHONES, MP3 PLAYERS, LAPTOPS, COMPUTERS, PORTABLE SATELLITE RADIOS, PERSONAL DIGITAL ASSISTANTS, REMOTE CONTROLS, AND TELEVISION SATELLITE RECORDERS, IN CLASS 9 (U.S. CLS. 21, 23, 26, 36 AND 38).



David J. Kyffers

FIRST USE 7-6-1992; IN COMMERCE 7-6-1992.

Reg. No. 4,074,161 THE MARK CONSISTS OF THREE UPPERCASE LETTER "T" AND ONE LOWERCASE LETTER "I" INSIDE A TRIANGLE. BESIDE THAT TRIANGLE IS THE WORD "TECTRON".

SER. NO. 85-320,847, FILED 5-13-2011.

RICHARD WHITE, EXAMINING ATTORNEY

United States of America

United States Patent and Trademark Office

TK LIVING

Reg. No. 4,074,162

TK THEATERS INC. (NEW YORK CORPORATION)
247 WEST 35TH STREET
NEW YORK, NY 10001

Registered Dec. 20, 2011

Int. Cl.: 20

FOR: DECORATIVE NONMETAL PILASTERS, GRILLES AND DISPLAY UNITS FOR HOME THEATERS, IN CLASS 20 (U.S. CLS. 2, 13, 22, 25, 32 AND 50).

TRADEMARK

FIRST USE 0-0-2004; IN COMMERCE 0-0-2004.

PRINCIPAL REGISTER

THE MARK CONSISTS OF STANDARD CHARACTERS WITHOUT CLAIM TO ANY PARTICULAR FONT, STYLE, SIZE, OR COLOR.

SER. NO. 85-320,867, FILED 5-13-2011.

MARGERY A. TIERNEY, EXAMINING ATTORNEY



David J. Kybas

Director of the United States Patent and Trademark Office

United States of America

United States Patent and Trademark Office

WORLD NATURAL HAIR HEALTH & BEAUTY SHOW

Reg. No. 4,074,163

WAAJID, TALIAH (UNITED STATES INDIVIDUAL)
365 ETOWAH TRACE, SUITE 106
FAYETTEVILLE, GA 30214

Registered Dec. 20, 2011

Int. Cl.: 35

FOR: TRADE SHOW FEATURING BEAUTY PRODUCTS, IN CLASS 35 (U.S. CLS. 100, 101 AND 102).

SERVICE MARK

FIRST USE 4-0-1998; IN COMMERCE 4-0-1998.

PRINCIPAL REGISTER

THE MARK CONSISTS OF STANDARD CHARACTERS WITHOUT CLAIM TO ANY PARTICULAR FONT, STYLE, SIZE, OR COLOR.

OWNER OF U.S. REG. NO. 3,687,898.

NO CLAIM IS MADE TO THE EXCLUSIVE RIGHT TO USE "SHOW", APART FROM THE MARK AS SHOWN.

SEC. 2(F) AS TO "WORLD NATURAL HAIR HEALTH & BEAUTY".

SER. NO. 85-320,927, FILED 5-13-2011.

TOBY BULLOFF, EXAMINING ATTORNEY



David J. Kyffers

Director of the United States Patent and Trademark Office

United States of America

United States Patent and Trademark Office



Reg. No. 4,074,164

Registered Dec. 20, 2011

Int. Cl.: 35

SERVICE MARK

PRINCIPAL REGISTER

SPOKANE CARES, INC. (WASHINGTON CORPORATION)
13713 E. 41ST AVENUE
SPOKANE, WA 99206

FOR: CHARITABLE SERVICES, NAMELY, ORGANIZING AND CONDUCTING VOLUNTEER PROGRAMS AND COMMUNITY SERVICE PROJECTS; CHARITABLE SERVICES, NAMELY, PROVIDING A FREE ONLINE RESOURCE IN THE NATURE OF A WEBSITE FOR CONNECTING PEOPLE WHO HAVE SERVICE NEEDS WITH PEOPLE WHO ARE WILLING TO PROVIDE VOLUNTEER SERVICES, IN CLASS 35 (U.S. CLS. 100, 101 AND 102).

FIRST USE 1-13-2007; IN COMMERCE 5-7-2007.

THE MARK CONSISTS OF STYLIZED DEPICTION OF HANDS TOUCHING AT FINGERTIPS WITH FINGERS POINTING DOWNWARD SO THAT SPACE BETWEEN HANDS FORMS A HEART SHAPE ON A CIRCLE SURROUNDED BY A LIGHTER SHADED CIRCULAR BORDER.

SER. NO. 85-320,929, FILED 5-13-2011.

KEVON CHISOLM, EXAMINING ATTORNEY



David J. Kybas

Director of the United States Patent and Trademark Office

United States of America

United States Patent and Trademark Office

HEARTS THAT CARE HANDS THAT SHARE

Reg. No. 4,074,165

Registered Dec. 20, 2011

Int. Cl.: 35

SERVICE MARK

PRINCIPAL REGISTER

SPOKANE CARES, INC. (WASHINGTON CORPORATION)
13713 E. 41ST AVENUE
SPOKANE, WA 99206

FOR: CHARITABLE SERVICES, NAMELY, ORGANIZING AND CONDUCTING VOLUNTEER PROGRAMS AND COMMUNITY SERVICE PROJECTS; CHARITABLE SERVICES, NAMELY, PROVIDING A FREE ONLINE RESOURCE IN THE NATURE OF A WEBSITE FOR CONNECTING PEOPLE WHO HAVE SERVICE NEEDS WITH PEOPLE WHO ARE WILLING TO PROVIDE VOLUNTEER SERVICES, IN CLASS 35 (U.S. CLS. 100, 101 AND 102).

FIRST USE 1-13-2007; IN COMMERCE 5-7-2007.

THE MARK CONSISTS OF STANDARD CHARACTERS WITHOUT CLAIM TO ANY PARTICULAR FONT, STYLE, SIZE, OR COLOR.

SER. NO. 85-320,979, FILED 5-13-2011.

KEVON CHISOLM, EXAMINING ATTORNEY



David J. Kyros

Director of the United States Patent and Trademark Office

United States of America

United States Patent and Trademark Office

Northwest House of Hardtops

Reg. No. 4,074,166

Registered Dec. 20, 2011

Int. Cl.: 35

SERVICE MARK

PRINCIPAL REGISTER

THE CHEV CONNECTION, INC. (OREGON CORPORATION), DBA NORTHWEST HOUSE OF HARDTOPS
11834 S.E. STARK STREET
PORTLAND, OR 97216

FOR: AUTOMOBILE DEALERSHIPS, IN CLASS 35 (U.S. CLS. 100, 101 AND 102).

FIRST USE 1-25-2011; IN COMMERCE 1-25-2011.

THE MARK CONSISTS OF STANDARD CHARACTERS WITHOUT CLAIM TO ANY PARTICULAR FONT, STYLE, SIZE, OR COLOR.

SER. NO. 85-320,985, FILED 5-13-2011.

KEVON CHISOLM, EXAMINING ATTORNEY



David J. Kybas

Director of the United States Patent and Trademark Office

United States of America

United States Patent and Trademark Office

HYPERTHRIVE

Reg. No. 4,074,167

Registered Dec. 20, 2011

Int. Cl.: 35

SERVICE MARK

PRINCIPAL REGISTER

HYPERTHRIVE, LLC (NEVADA LIMITED LIABILITY COMPANY)
201 S. MOAPA VALLEY BLVD (P.O. BOX 340)
OVERTON, NV 89040

FOR: ADVERTISING SERVICES; ARRANGING AND CONDUCTING MARKETING PROMOTIONAL EVENTS FOR OTHERS; ARRANGING AND CONDUCTING SPECIAL EVENTS FOR BUSINESS PURPOSES; ARRANGING AND CONDUCTING SPECIAL EVENTS FOR COMMERCIAL, PROMOTIONAL OR ADVERTISING PURPOSES; BUSINESS CONSULTATION; BUSINESS CONSULTATION AND MANAGEMENT REGARDING MARKETING ACTIVITIES AND LAUNCHING OF NEW PRODUCTS; BUSINESS CONSULTATION IN THE FIELD OF BUSINESS LEADERSHIP DEVELOPMENT; BUSINESS CONSULTATION SERVICES; BUSINESS CONSULTING AND INFORMATION SERVICES; BUSINESS MANAGEMENT; BUSINESS MANAGEMENT AND CONSULTATION; BUSINESS MANAGEMENT CONSULTATION; EVENT PLANNING AND MANAGEMENT FOR MARKETING, BRANDING, PROMOTING OR ADVERTISING THE GOODS AND SERVICES OF OTHERS; MARKETING PLAN DEVELOPMENT; MARKETING SERVICES, NAMELY, PROMOTING OR ADVERTISING THE GOODS AND SERVICES OF OTHERS; ORGANIZATION OF EVENTS, EXHIBITIONS, FAIRS AND SHOWS FOR COMMERCIAL, PROMOTIONAL AND ADVERTISING PURPOSES; ORGANIZING, PROMOTING AND CONDUCTING EXHIBITIONS, TRADESHOWS AND EVENTS FOR BUSINESS PURPOSES; PROFESSIONAL BUSINESS CONSULTING; PROMOTING THE GOODS AND SERVICES OF OTHERS VIA A GLOBAL COMPUTER NETWORK, IN CLASS 35 (U.S. CLS. 100, 101 AND 102).

FIRST USE 7-12-2010; IN COMMERCE 7-12-2010.

THE MARK CONSISTS OF STANDARD CHARACTERS WITHOUT CLAIM TO ANY PARTICULAR FONT, STYLE, SIZE, OR COLOR.

SER. NO. 85-320,986, FILED 5-13-2011.

LAURA HAMMEL, EXAMINING ATTORNEY



David J. Kyros

Director of the United States Patent and Trademark Office

United States of America

United States Patent and Trademark Office

Perfect Storm Marketing

Reg. No. 4,074,168

Registered Dec. 20, 2011

Int. Cl.: 35

SERVICE MARK

PRINCIPAL REGISTER

HYPERTHRIVE, LLC (NEVADA LIMITED LIABILITY COMPANY)
201 S. MOAPA VALLEY BLVD (P.O. BOX 340)
OVERTON, NV 89040

FOR: ADVERTISING SERVICES; ARRANGING AND CONDUCTING MARKETING PROMOTIONAL EVENTS FOR OTHERS; ARRANGING AND CONDUCTING SPECIAL EVENTS FOR BUSINESS PURPOSES; ARRANGING AND CONDUCTING SPECIAL EVENTS FOR COMMERCIAL, PROMOTIONAL OR ADVERTISING PURPOSES; BUSINESS CONSULTATION; BUSINESS CONSULTATION AND MANAGEMENT REGARDING MARKETING ACTIVITIES AND LAUNCHING OF NEW PRODUCTS; BUSINESS CONSULTATION IN THE FIELD OF BUSINESS LEADERSHIP DEVELOPMENT; BUSINESS CONSULTATION SERVICES; BUSINESS CONSULTING AND INFORMATION SERVICES; BUSINESS MANAGEMENT; BUSINESS MANAGEMENT AND CONSULTATION; BUSINESS MANAGEMENT CONSULTATION; EVENT PLANNING AND MANAGEMENT FOR MARKETING, BRANDING, PROMOTING OR ADVERTISING THE GOODS AND SERVICES OF OTHERS; MARKETING PLAN DEVELOPMENT; MARKETING SERVICES, NAMELY, PROMOTING OR ADVERTISING THE GOODS AND SERVICES OF OTHERS; ORGANIZATION OF EVENTS, EXHIBITIONS, FAIRS AND SHOWS FOR COMMERCIAL, PROMOTIONAL AND ADVERTISING PURPOSES; ORGANIZING, PROMOTING AND CONDUCTING EXHIBITIONS, TRADESHOWS AND EVENTS FOR BUSINESS PURPOSES; PROFESSIONAL BUSINESS CONSULTING; PROMOTING THE GOODS AND SERVICES OF OTHERS VIA A GLOBAL COMPUTER NETWORK, IN CLASS 35 (U.S. CLS. 100, 101 AND 102).

FIRST USE 9-6-2010; IN COMMERCE 9-6-2010.

THE MARK CONSISTS OF STANDARD CHARACTERS WITHOUT CLAIM TO ANY PARTICULAR FONT, STYLE, SIZE, OR COLOR.

NO CLAIM IS MADE TO THE EXCLUSIVE RIGHT TO USE "MARKETING", APART FROM THE MARK AS SHOWN.

SER. NO. 85-320,989, FILED 5-13-2011.

LAURA HAMMEL, EXAMINING ATTORNEY



David J. Kyffers

Director of the United States Patent and Trademark Office

United States of America

United States Patent and Trademark Office

JULY 4TH SEDER

Reg. No. 4,074,169

Registered Dec. 20, 2011

Int. Cl.: 28

TRADEMARK

PRINCIPAL REGISTER

CELEBRATE OUR COUNTRY, INC. (CALIFORNIA CORPORATION)
707 PEARL ST.
REDONDO BEACH, CA 90277

FOR: EDUCATIONAL AND PARTY GAME KITS ENABLING PARTICIPANTS TO RECREATE THE SIGNING OF THE DECLARATION OF INDEPENDENCE IN 1776 BY PLAYING THE ROLES OF THE FOUNDING FATHERS PRIMARILY CONSISTING OF CARDS WHICH BEAR BIOGRAPHICAL INFORMATION ABOUT THE SIGNERS, A PICTORIAL REPRODUCTION OF EACH FOUNDING FATHER, AND A COPY OF JOHN TRUMBULL'S PAINTING "THE DECLARATION OF INDEPENDENCE" WITH AN ARROW POINTING TO THE APPROPRIATE FOUNDING FATHER, A REPLICATION OF THE DECLARATION OF INDEPENDENCE ENABLING THE PARTICIPANTS TO SEE WHERE THEIR FOUNDING FATHERS SIGNED THE DECLARATION, PIECES OF VELLUM PAPER TO BE LAID OVER THE SIGNATURE AREA OF THE DECLARATION USING DOUBLE-STICK TAPE TO ENABLE A SIGNING CEREMONY WHEREIN THE ORIGINAL SIGNATURES CAN BE DUPLICATED, QUESTION-AND-ANSWER MATERIALS THAT CAN BE PROVIDED TO PARTICIPANTS AND VIEWERS, FOUNDING FATHER NAME TAGS WITH MATCHING STORY CARDS, AND INSTRUCTIONS SUGGESTING THAT THE PARTICIPANTS MINGLE AND SHARE FACTS ABOUT THE FOUNDING FATHER THEY ARE PLAYING WITH EVERY GUEST THEY SPEAK TO, IN CLASS 28 (U.S. CLS. 22, 23, 38 AND 50).

FIRST USE 5-24-2011; IN COMMERCE 5-24-2011.

THE MARK CONSISTS OF STANDARD CHARACTERS WITHOUT CLAIM TO ANY PARTICULAR FONT, STYLE, SIZE, OR COLOR.

SER. NO. 85-321,000, FILED 5-13-2011.

MARK SHINER, EXAMINING ATTORNEY



David J. Kyffers

Director of the United States Patent and Trademark Office

United States of America

United States Patent and Trademark Office

WealthForge

Reg. No. 4,074,170

Registered Dec. 20, 2011

Int. Cl.: 36

SERVICE MARK

PRINCIPAL REGISTER

WEALTHFORGE HOLDINGS, INC. (VIRGINIA CORPORATION)
SUITE 118
501 E. FRANKLIN ST.
RICHMOND, VA 23219

FOR: CLEARING AND RECONCILING FINANCIAL TRANSACTIONS VIA A GLOBAL COMPUTER NETWORK; CONDUCTING FINANCIAL FEASIBILITY STUDIES; CREDIT AND FINANCIAL CONSULTATION; FINANCIAL AND INVESTMENT SERVICES, NAMELY, ASSET AND INVESTMENT ACQUISITION, CONSULTATION, ADVISORY AND DEVELOPMENT; FINANCIAL AND INVESTMENT SERVICES, NAMELY, MANAGEMENT AND BROKERAGE IN THE FIELDS OF STOCKS, BONDS, OPTIONS, COMMODITIES, FUTURES AND OTHER SECURITIES, AND THE INVESTMENT OF FUNDS OF OTHERS; FINANCIAL ASSET MANAGEMENT; FINANCIAL CLEARING HOUSES; FINANCIAL CONSULTANCY; FINANCIAL CONSULTATION; FINANCIAL CONSULTING; FINANCIAL CONSULTING AND ADVISING IN THE FIELD OF MERGERS AND ACQUISITIONS; FINANCIAL CONSULTING IN THE FIELD OF REAL ESTATE NOTE BROKERAGE; FINANCIAL CONSULTING SERVICES, NAMELY, ADVISING OTHERS REGARDING INTELLECTUAL PROPERTY INVESTMENTS; FINANCIAL CONSULTING SERVICES, NAMELY, EXPERT ANALYSIS IN FINANCE; FINANCIAL EXCHANGE; FINANCIAL FORECASTING; FINANCIAL INFORMATION AND EVALUATIONS; FINANCIAL INFORMATION SERVICES PROVIDED ONLINE FROM A COMPUTER DATABASE OR A GLOBAL COMPUTER NETWORK, NAMELY, PROVIDING INFORMATION IN THE FIELD OF FINANCIAL CLASSIFICATION OF COMPANIES AND SECURITIES; FINANCIAL INVESTMENT ANALYSIS AND STOCK RESEARCH; FINANCIAL INVESTMENT BROKERAGE; FINANCIAL INVESTMENT BROKERAGE SERVICES; FINANCIAL RESEARCH AND INFORMATION SERVICES; FINANCIAL SECURITIES EXCHANGE SERVICES; FINANCIAL SERVICES IN THE NATURE OF AN INVESTMENT SECURITY; FINANCIAL SERVICES, NAMELY, A TOTAL PORTFOLIO OFFERING FOR HIGH NET WORTH CLIENTS CONSISTING OF BOTH SEPARATE ACCOUNTS AND MUTUAL FUNDS FOR EQUITY AND FIXED INCOME INVESTMENTS; FINANCIAL SERVICES, NAMELY, ADMINISTRATION OF TRANSACTIONS INVOLVING FUNDS DRAWN FROM SECURITIES, STOCKS, FUNDS, EQUITIES, BONDS, CASH, OR OTHER TYPES OF FINANCIAL INVESTMENTS IN RETIREMENT PLANS USING A CHECK OR NEGOTIABLE ORDER OF WITHDRAWAL OVER A GLOBAL DATA NETWORK; FINANCIAL SERVICES, NAMELY, ADMINISTRATION OF TRANSACTIONS INVOLVING FUNDS DRAWN FROM SECURITIES, STOCKS, FUNDS, EQUITIES, BONDS, CASH, OR OTHER TYPES OF FINANCIAL INVESTMENTS IN RETIREMENT PLANS USING A



David J. Kyros

Director of the United States Patent and Trademark Office

Reg. No. 4,074,170 CREDIT OR DEBIT CARD OVER A GLOBAL DATA NETWORK; FINANCIAL SERVICES, NAMELY, ASSISTING OTHERS WITH THE COMPLETION OF FINANCIAL TRANSACTIONS FOR STOCKS, BONDS, SECURITIES AND EQUITIES; FINANCIAL SERVICES, NAMELY, BROKER/DEALER SERVICES ON SECURITIES EXCHANGES AND OVER-THE-COUNTER MARKETS; FINANCIAL SERVICES, NAMELY, BUSINESS FUNDRAISING FOR OTHERS; FINANCIAL SERVICES, NAMELY, BUSINESS FUNDRAISING PROVIDED OVER A COMPUTER NETWORK SUCH AS THE INTERNET; FINANCIAL SERVICES, NAMELY, CONDUCTING A SECURITIES AND DERIVATIVES EXCHANGE; FINANCIAL SERVICES, NAMELY, COORDINATION, WITHIN A SINGLE ACCOUNT, OF AN INVESTMENT PORTFOLIO'S MAINTENANCE, TRADING, REBALANCING, AND TAX MANAGEMENT NEEDS; FINANCIAL SERVICES, NAMELY, CORPORATE WORKOUT, DEBT RESTRUCTURING, RECEIVERSHIP, AND LOAN RESOLUTION FOR COMMERCIAL LOANS; FINANCIAL SERVICES, NAMELY, DEALING IN SECURITIES AS A MARKET MAKER AND IN TRADING COMMODITIES, SECURITIES, OPTIONS, FUTURES, EQUITIES AND FIXED INCOME PRODUCTS IN THE U.S. AND OVERSEAS MARKET SECURITIES; FINANCIAL SERVICES, NAMELY, INVESTMENT ADVICE, INVESTMENT MANAGEMENT, INVESTMENT CONSULTATION AND INVESTMENT OF FUNDS FOR OTHERS, INCLUDING PRIVATE AND PUBLIC EQUITY AND DEBT INVESTMENT SERVICES; FINANCIAL SERVICES, NAMELY, INVESTMENT FUND TRANSFER AND TRANSACTION SERVICES; FINANCIAL SERVICES, NAMELY, MICROFINANCE LENDING SERVICES; FINANCIAL SERVICES, NAMELY, OPERATION AND MANAGEMENT OF HEDGE FUNDS, COMMODITY POOLS AND OTHER COLLECTIVE INVESTMENT VEHICLES, AND TRADING FOR OTHERS OF SECURITIES, OPTIONS, FUTURES, DERIVATIVES, DEBT INSTRUMENTS AND COMMODITIES; FINANCIAL SERVICES, NAMELY, PROPRIETARY TRADING IN COMMODITIES, SECURITIES, OPTIONS, FUTURES, EQUITIES AND FIXED INCOME PRODUCTS IN THE U.S. AND OVERSEAS MARKET SECURITIES; FINANCIAL SERVICES, NAMELY, PROVIDING FOR THE EXCHANGE OF FOREIGN CURRENCY, COMMODITIES, FINANCIAL DERIVATIVES, INTEREST RATE PRODUCTS, AND EQUITIES VIA THE INTERNET AND INTRANET SYSTEMS; FINANCIAL SERVICES, NAMELY, RAISING DEBT AND EQUITY CAPITAL FOR OTHERS; FINANCIAL SERVICES, NAMELY, RAISING MONEY FOR THE HEDGE FUNDS OF OTHERS; FINANCIAL SERVICES, NAMELY, THE TRADING OF FINANCIAL INSTRUMENTS, SECURITIES, SHARES, OPTIONS AND OTHER DERIVATIVE PRODUCTS; FINANCIAL VALUATION OF PERSONAL PROPERTY AND REAL ESTATE; FINANCIAL VALUATIONS; LEVERAGED BUY OUTS AND INVESTMENTS IN FINANCIALLY DISTRESSED OR UNDERPERFORMING COMPANIES; ON-LINE TRADING OF FINANCIAL INSTRUMENTS, SHARES, OPTIONS AND OTHER DERIVATIVE PRODUCTS; ORGANIZATION OF ONLINE STOCK EXCHANGES FOR THE BENEFIT OF THE TRADE OF STOCKS AND OTHER FINANCIAL SECURITIES; ORGANIZATION OF STOCK EXCHANGES FOR THE BENEFIT OF THE TRADE OF STOCKS AND OTHER FINANCIAL VALUES; PROVIDING A WEB SITE FEATURING PERSONAL FINANCIAL INFORMATION AND FINANCIAL ADVICE; PROVIDING A WEB SITE THAT ASSISTS FINANCIAL PROFESSIONALS IN THE MANAGEMENT OF RETIREMENT ACCOUNTS; PROVIDING A WEB SITE WHERE USERS CAN POST RATINGS, REVIEWS AND RECOMMENDATIONS ON STOCKS, BONDS, MUTUAL FUNDS AND OTHER FINANCIAL INSTRUMENTS; PROVIDING A WEBSITE FEATURING NON-DOWNLOADABLE VIDEOS IN THE FIELD OF FINANCIAL PLANNING; PROVIDING FINANCIAL INFORMATION; PROVIDING FINANCIAL SERVICES WITH RESPECT TO SECURITIES AND OTHER FINANCIAL INSTRUMENTS AND PRODUCTS, NAMELY, MONEY MANAGEMENT SERVICES; PROVIDING FINANCIAL SERVICES WITH RESPECT TO SECURITIES AND OTHER FINANCIAL INSTRUMENTS AND PRODUCTS, NAMELY, PROVIDING FINANCIAL MARKET NEWS AND COMMENTARY; PROVIDING FINANCIAL SERVICES WITH RESPECT TO SECURITIES AND OTHER FINANCIAL INSTRUMENTS AND PRODUCTS, NAMELY, TRADING OF AND INVESTMENTS IN SECURITIES AND FINANCIAL INSTRUMENTS AND PRODUCTS FOR OTHERS; PROVIDING INFORMATION IN THE FIELD OF FINANCIAL STOCK AND EQUITY MARKETS; PROVIDING INVESTORS WITH FINANCIAL INFORMATION; PROVIDING ON-LINE FINANCIAL CALCULATORS; PROVISION OF A FINANCIAL EXCHANGE FOR THE TRADING OF SECURITIES, SHARES AND OPTIONS AND OTHER DERIVATIVE PRODUCTS; PROVISION OF FINANCIAL INFORMATION, IN CLASS 36 (U.S. CLS. 100, 101 AND 102).

Reg. No. 4,074,170 FIRST USE 0-0-2010; IN COMMERCE 0-0-2010.

THE MARK CONSISTS OF STANDARD CHARACTERS WITHOUT CLAIM TO ANY PARTICULAR FONT, STYLE, SIZE, OR COLOR.

SER. NO. 85-321,016, FILED 5-13-2011.

SHANNON TWOHIG, EXAMINING ATTORNEY

United States of America

United States Patent and Trademark Office

π Goes Round

Reg. No. 4,074,171

KENT A. ENGLISH (UNITED STATES INDIVIDUAL)

Registered Dec. 20, 2011

P.O. BOX 12354
RENO, NV 89510

Int. Cl.: 9

FOR: PHONOGRAPH RECORD PLAYER REPLACEMENT PARTS, IN CLASS 9 (U.S. CLS. 21, 23, 26, 36 AND 38).

TRADEMARK

FIRST USE 5-5-2011; IN COMMERCE 5-5-2011.

PRINCIPAL REGISTER

THE MARK CONSISTS OF THE GREEK LETTER "PI" FOLLOWED BY THE WORDS "GOES ROUND".

SER. NO. 85-321,039, FILED 5-13-2011.

SHANNON TWOHIG, EXAMINING ATTORNEY



David J. Kybas

Director of the United States Patent and Trademark Office

United States of America

United States Patent and Trademark Office

NONAMESITE

Reg. No. 4,074,172

Registered Dec. 20, 2011

Int. Cl.: 38

SERVICE MARK

PRINCIPAL REGISTER

TOPCODER, INC. (DELAWARE CORPORATION)
95 GLASTONBURY BLVD.
GLASTONBURY, CT 06033

FOR: COMMUNICATION SERVICES, NAMELY, ELECTRONIC TRANSMISSION OF DATA AND DOCUMENTS AMONG USERS OF COMPUTERS; PROVIDING ON-LINE ELECTRONIC BULLETIN BOARDS FOR TRANSMISSION OF MESSAGES AMONG COMPUTER USERS CONCERNING ONLINE GAMES, ACTIVITIES, AND CONTESTS, IN CLASS 38 (U.S. CLS. 100, 101 AND 104).

FIRST USE 3-3-2011; IN COMMERCE 3-3-2011.

THE MARK CONSISTS OF STANDARD CHARACTERS WITHOUT CLAIM TO ANY PARTICULAR FONT, STYLE, SIZE, OR COLOR.

SER. NO. 85-321,045, FILED 5-13-2011.

STEVEN R. FINE, EXAMINING ATTORNEY



David J. Kyffers

Director of the United States Patent and Trademark Office

United States of America

United States Patent and Trademark Office

NONAMESITE

Reg. No. 4,074,173

Registered Dec. 20, 2011

Int. Cl.: 41

SERVICE MARK

PRINCIPAL REGISTER

TOPCODER, INC. (CONNECTICUT CORPORATION)
LEGAL DEPT.
95 GLASTONBURY BLVD.
GLASTONBURY, CT 06033

FOR: EDUCATION SERVICES, NAMELY, PROVIDING ON-LINE GAMES, ACTIVITIES, AND CONTESTS IN THE FIELD OF COMPUTER SCIENCE, SCIENCE, TECHNOLOGY, ENGINEERING, AND MATHEMATICS; ENTERTAINMENT IN THE NATURE OF COMPETITIONS IN THE FIELD OF COMPUTER SCIENCE, SCIENCE, TECHNOLOGY, ENGINEERING, AND MATHEMATICS; ENTERTAINMENT SERVICES, NAMELY, PROVIDING ON-LINE COMPUTER GAMES, IN CLASS 41 (U.S. CLS. 100, 101 AND 107).

FIRST USE 5-9-2011; IN COMMERCE 5-9-2011.

THE MARK CONSISTS OF STANDARD CHARACTERS WITHOUT CLAIM TO ANY PARTICULAR FONT, STYLE, SIZE, OR COLOR.

SER. NO. 85-321,046, FILED 5-14-2011.

STEVEN R. FINE, EXAMINING ATTORNEY



David J. Kyffers

Director of the United States Patent and Trademark Office

United States of America

United States Patent and Trademark Office

NONAMESITE

Reg. No. 4,074,174

Registered Dec. 20, 2011

Int. Cl.: 42

SERVICE MARK

PRINCIPAL REGISTER

TOPCODER, INC. (DELAWARE CORPORATION)
TOPCODER - LEGAL DEPT.
95 GLASTONBURY BLVD.
GLASTONBURY, CT 06033

FOR: COMPUTER SERVICES, NAMELY, CREATING AN ON-LINE COMMUNITY FOR REGISTERED USERS TO PARTICIPATE IN COMPETITIONS, SHOWCASE THEIR SKILLS, GET FEEDBACK FROM THEIR PEERS, FORM VIRTUAL COMMUNITIES, ENGAGE IN SOCIAL NETWORKING; HOSTING AN ON-LINE COMMUNITY WEB SITE FEATURING ONLINE GAMES, ACTIVITIES, AND CONTESTS, IN CLASS 42 (U.S. CLS. 100 AND 101).

FIRST USE 3-3-2011; IN COMMERCE 3-3-2011.

THE MARK CONSISTS OF STANDARD CHARACTERS WITHOUT CLAIM TO ANY PARTICULAR FONT, STYLE, SIZE, OR COLOR.

SER. NO. 85-321,072, FILED 5-14-2011.

STEVEN R. FINE, EXAMINING ATTORNEY



David J. Kybas

Director of the United States Patent and Trademark Office

United States of America

United States Patent and Trademark Office

Planergy

Reg. No. 4,074,175

Registered Dec. 20, 2011

Int. Cls.: 16 and 45

ALT HOROSCOPES, LLC (NEVADA LIMITED LIABILITY COMPANY)
375 N. STEPHANIE ST.
SUITE 1411
HENDERSON, NV 89014

FOR: PRINTED HOROSCOPES, IN CLASS 16 (U.S. CLS. 2, 5, 22, 23, 29, 37, 38 AND 50).

TRADEMARK

FIRST USE 5-13-2011; IN COMMERCE 5-13-2011.

SERVICE MARK

FOR: HOROSCOPE CASTING; HOROSCOPE FORECASTING; HOROSCOPES; PROVIDING HOROSCOPE INFORMATION VIA COMPUTER NETWORKS, IN CLASS 45 (U.S. CLS. 100 AND 101).

PRINCIPAL REGISTER

FIRST USE 5-13-2011; IN COMMERCE 5-13-2011.

THE MARK CONSISTS OF STANDARD CHARACTERS WITHOUT CLAIM TO ANY PARTICULAR FONT, STYLE, SIZE, OR COLOR.

SER. NO. 85-321,086, FILED 5-14-2011.

DOMINICK J. SALEMI, EXAMINING ATTORNEY



David J. Kypos

Director of the United States Patent and Trademark Office

United States of America

United States Patent and Trademark Office

Noroscope

Reg. No. 4,074,176

Registered Dec. 20, 2011

Int. Cls.: 16 and 45

ALT HOROSCOPES, LLC (NEVADA LIMITED LIABILITY COMPANY)
SUITE 1411
375 N. STEPHANIE ST.
HENDERSON, NV 89014

FOR: PRINTED HOROSCOPES, IN CLASS 16 (U.S. CLS. 2, 5, 22, 23, 29, 37, 38 AND 50).

TRADEMARK

FIRST USE 5-13-2011; IN COMMERCE 5-13-2011.

SERVICE MARK

FOR: HOROSCOPE CASTING; HOROSCOPE FORECASTING; HOROSCOPES; PROVIDING HOROSCOPE INFORMATION VIA COMPUTER NETWORKS, IN CLASS 45 (U.S. CLS. 100 AND 101).

PRINCIPAL REGISTER

FIRST USE 5-13-2011; IN COMMERCE 5-13-2011.

THE MARK CONSISTS OF STANDARD CHARACTERS WITHOUT CLAIM TO ANY PARTICULAR FONT, STYLE, SIZE, OR COLOR.

SER. NO. 85-321,092, FILED 5-14-2011.

DOMINICK J. SALEMI, EXAMINING ATTORNEY



David J. Kybas

Director of the United States Patent and Trademark Office

United States of America

United States Patent and Trademark Office

Content Spree

Reg. No. 4,074,177

CONTENT SPREE LLC (NEW YORK LIMITED LIABILITY COMPANY)
204 ROSLYN RD.

Registered Dec. 20, 2011

MINEOLA, NY 11501

Int. Cl.: 35

FOR: BUSINESS SERVICES, NAMELY, PROVIDING AN ONLINE NETWORK FOR CONTRACTORS TO RECEIVE LEADS AND BIDDING OPPORTUNITIES BY MEANS OF AN ONLINE MARKETPLACE FOR THE PURPOSE OF DEVELOPING BUSINESS, IN CLASS 35 (U.S. CLS. 100, 101 AND 102).

SERVICE MARK

PRINCIPAL REGISTER

FIRST USE 5-12-2011; IN COMMERCE 5-12-2011.

THE MARK CONSISTS OF STANDARD CHARACTERS WITHOUT CLAIM TO ANY PARTICULAR FONT, STYLE, SIZE, OR COLOR.

SER. NO. 85-321,142, FILED 5-14-2011.

DOMINICK J. SALEMI, EXAMINING ATTORNEY



David J. Kyros

Director of the United States Patent and Trademark Office

United States of America

United States Patent and Trademark Office

Hexamid

Reg. No. 4,074,178

VALESKO, JOSEPH E (UNITED STATES INDIVIDUAL), DBA ZPACKS, LLC
1144 COLONNADE AVE SE
PALM BAY, FL 32909

Registered Dec. 20, 2011

Int. Cl.: 22

FOR: TENTS; TENTS FOR MOUNTAINEERING OR CAMPING, IN CLASS 22 (U.S. CLS. 1, 2, 7, 19, 22, 42 AND 50).

TRADEMARK

FIRST USE 5-10-2009; IN COMMERCE 5-10-2009.

PRINCIPAL REGISTER

THE MARK CONSISTS OF STANDARD CHARACTERS WITHOUT CLAIM TO ANY PARTICULAR FONT, STYLE, SIZE, OR COLOR.

SER. NO. 85-321,178, FILED 5-14-2011.

MARK T. MULLEN, EXAMINING ATTORNEY



David J. Kybas

Director of the United States Patent and Trademark Office

United States of America

United States Patent and Trademark Office

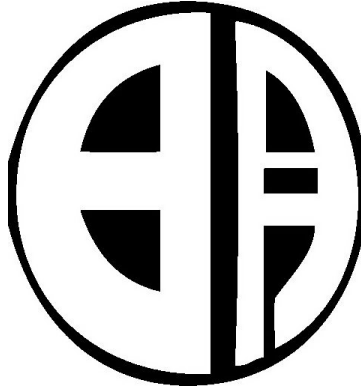

Reg. No. 4,074,179

Registered Dec. 20, 2011

Int. Cl.: 41

SERVICE MARK

PRINCIPAL REGISTER

MIRAKIAN, ANTHONY (UNITED STATES INDIVIDUAL)
77 STANDISH ROAD
WATERTOWN, MA 02472

FOR: KARATE INSTRUCTION, IN CLASS 41 (U.S. CLS. 100, 101 AND 107).

FIRST USE 4-1-1961; IN COMMERCE 0-0-1964.

OWNER OF U.S. REG. NOS. 1,515,845 AND 1,528,893.

THE NON-LATIN CHARACTERS IN THE MARK TRANSLITERATE TO THE WORDS "HI" AND "TSUKI" AND THIS MEANS THE WORDS "HI" MEANING "SUN" AND "TSUKI" MEANING "MOON" BUT WHEN COMBINED TRANSLITERATE TO THE WORD "HITOTSUKI" MEANING "TO KNOCK AN OPPONENT DOWN WITH ONE PUNCH". IN ENGLISH.

THE MARK CONSISTS OF A CIRCLE SPLIT INTO TWO SEPARATE PORTIONS. THE LEFT PORTION IS THE LARGER PORTION OCCUPYING APPROXIMATELY TWO-THIRDS OF THE CIRCLE AND IT IS SPLIT INTO TWO HALVES BY A HORIZONTAL BAR. THE RIGHT PORTION OCCUPIES APPROXIMATELY ONE-THIRD OF THE CIRCLE AND IS SPLIT BY TWO HORIZONTAL BARS.

SEC. 2(F).

SER. NO. 85-321,204, FILED 5-14-2011.

DOMINICK J. SALEMI, EXAMINING ATTORNEY



David J. Kybas

Director of the United States Patent and Trademark Office

United States of America
United States Patent and Trademark Office

lowtiderides

Reg. No. 4,074,180

Registered Dec. 20, 2011

Int. Cl.: 25

TRADEMARK

PRINCIPAL REGISTER

MCBRIDE, ALEXANDER E (UNITED STATES INDIVIDUAL)
WWW.LOWTIDERIDES.COM
420 TRADE WINDS LANE
SAINT AUGUSTINE, FL 32080

FOR: ATHLETIC APPAREL, NAMELY, SHIRTS, PANTS, JACKETS, FOOTWEAR, HATS
AND CAPS, ATHLETIC UNIFORMS, IN CLASS 25 (U.S. CLS. 22 AND 39).

FIRST USE 6-6-1998; IN COMMERCE 1-12-2011.

THE MARK CONSISTS OF STANDARD CHARACTERS WITHOUT CLAIM TO ANY PAR-
TICULAR FONT, STYLE, SIZE, OR COLOR.

SER. NO. 85-321,217, FILED 5-14-2011.

TRACY FLETCHER, EXAMINING ATTORNEY



David J. Kybas

Director of the United States Patent and Trademark Office

United States of America

United States Patent and Trademark Office

TKOSKIN

Reg. No. 4,074,181

Registered Dec. 20, 2011

Int. Cl.: 3

TRADEMARK

PRINCIPAL REGISTER

KNOCKOUT INDUSTRIES LLC. (NEW YORK LIMITED LIABILITY COMPANY)
4306 THIRD AVENUE
3RD FL
BROOKLYN, NY 11232 AND

DANIEL, TONYA J (UNITED STATES INDIVIDUAL)
4306 3RD AVENUE
3RD FL
BROOKLYN, NY 11232

FOR: AROMATIC BODY CARE PRODUCTS, NAMELY, BODY LOTION, SHOWER GEL, CUTICLE CREAM, SHAMPOO, CONDITIONER, NON-MEDICATED LIP BALM, SOAP, BODY POLISH, BODY AND FOOT SCRUB AND NON-MEDICATED FOOT CREAM, IN CLASS 3 (U.S. CLS. 1, 4, 6, 50, 51 AND 52).

FIRST USE 7-1-2009; IN COMMERCE 9-11-2009.

THE MARK CONSISTS OF STANDARD CHARACTERS WITHOUT CLAIM TO ANY PARTICULAR FONT, STYLE, SIZE, OR COLOR.

SER. NO. 85-321,234, FILED 5-15-2011.

INGA ERVIN, EXAMINING ATTORNEY



David J. Kyffers

Director of the United States Patent and Trademark Office

United States of America

United States Patent and Trademark Office

EstatePlansDirect.com

Reg. No. 4,074,182

DOYLE LAW PC (MICHIGAN CORPORATION)

Registered Dec. 20, 2011

PO BOX 16066
LANSING, MI 489016066

Int. Cl.: 45

FOR: LEGAL SERVICES, IN CLASS 45 (U.S. CLS. 100 AND 101).

SERVICE MARK

FIRST USE 5-9-2011; IN COMMERCE 5-9-2011.

PRINCIPAL REGISTER

THE MARK CONSISTS OF STANDARD CHARACTERS WITHOUT CLAIM TO ANY PARTICULAR FONT, STYLE, SIZE, OR COLOR.

SER. NO. 85-321,241, FILED 5-15-2011.

LINDSEY RUBIN, EXAMINING ATTORNEY



David J. Kybas

Director of the United States Patent and Trademark Office

United States of America

United States Patent and Trademark Office

SQUARE CIRCLE

Reg. No. 4,074,183

SQUARE CIRCLE NEW YORK CORP. (NEW YORK CORPORATION)
2 GOLD STREET, SUITE 2508
NEW YORK, NY 10038

Registered Dec. 20, 2011

Int. Cl.: 41

FOR: PROVIDING CLASSES, WORKSHOPS, SEMINARS AND CAMPS IN THE FIELDS OF FITNESS, EXERCISE, BOXING, KICK BOXING AND MIXED MARTIAL ARTS , IN CLASS 41 (U.S. CLS. 100, 101 AND 107).

SERVICE MARK

FIRST USE 8-1-2010; IN COMMERCE 8-1-2010.

PRINCIPAL REGISTER

THE MARK CONSISTS OF STANDARD CHARACTERS WITHOUT CLAIM TO ANY PARTICULAR FONT, STYLE, SIZE, OR COLOR.

SER. NO. 85-321,243, FILED 5-15-2011.

REBECCA GILBERT, EXAMINING ATTORNEY



David J. Kybas

Director of the United States Patent and Trademark Office

United States of America

United States Patent and Trademark Office

FUZE

Reg. No. 4,074,184

Registered Dec. 20, 2011

Int. Cl.: 21

TRADEMARK

PRINCIPAL REGISTER

VAL PRODUCTS, INC. (PENNSYLVANIA CORPORATION)
2710 28TH DIVISION HIGHWAY, PO BOX 8
NEW HOLLAND, PA 17557

FOR: NON-MECHANIZED ANIMAL FEEDERS, IN CLASS 21 (U.S. CLS. 2, 13, 23, 29, 30, 33, 40 AND 50).

FIRST USE 11-15-2009; IN COMMERCE 11-15-2009.

THE MARK CONSISTS OF STANDARD CHARACTERS WITHOUT CLAIM TO ANY PARTICULAR FONT, STYLE, SIZE, OR COLOR.

SER. NO. 85-321,246, FILED 5-15-2011.

KAPIL BHANOT, EXAMINING ATTORNEY



David J. Kybas

Director of the United States Patent and Trademark Office

United States of America
United States Patent and Trademark Office

HORIZON

Reg. No. 4,074,185

VAL PRODUCTS, INC. (PENNSYLVANIA CORPORATION)
2710 28TH DIVISION HIGHWAY, PO BOX 8
NEW HOLLAND, PA 17557

Registered Dec. 20, 2011

Int. Cl.: 9

FOR: ELECTRONIC CONTROL SYSTEMS, NAMELY, ELECTRONIC CONTROLLERS FOR
MANAGING BARN OPERATIONS, IN CLASS 9 (U.S. CLS. 21, 23, 26, 36 AND 38).

TRADEMARK

FIRST USE 1-26-2011; IN COMMERCE 1-26-2011.

PRINCIPAL REGISTER

THE MARK CONSISTS OF STANDARD CHARACTERS WITHOUT CLAIM TO ANY PAR-
TICULAR FONT, STYLE, SIZE, OR COLOR.

SER. NO. 85-321,248, FILED 5-15-2011.

KAPIL BHANOT, EXAMINING ATTORNEY



David J. Kybas

Director of the United States Patent and Trademark Office

United States of America

United States Patent and Trademark Office

PAYTIME

Reg. No. 4,074,186

PAYDATA, INC. (OHIO CORPORATION), AKA PAYTIME
31105 BAINBRIDGE ROAD
SOLON, OH 44139

Registered Dec. 20, 2011

Int. Cl.: 35

FOR: PAYROLL PREPARATION, ADMINISTRATION AND MANAGEMENT SERVICES, IN CLASS 35 (U.S. CLS. 100, 101 AND 102).

SERVICE MARK

FIRST USE 11-1-1981; IN COMMERCE 1-1-1990.

PRINCIPAL REGISTER

THE MARK CONSISTS OF STANDARD CHARACTERS WITHOUT CLAIM TO ANY PARTICULAR FONT, STYLE, SIZE, OR COLOR.

SER. NO. 85-321,255, FILED 5-15-2011.

KIMBERLY PERRY, EXAMINING ATTORNEY



David J. Kybas

Director of the United States Patent and Trademark Office

United States of America

United States Patent and Trademark Office

Freedom Isn't Free

Reg. No. 4,074,187

Registered Dec. 20, 2011

Int. Cl.: 33

TRADEMARK

PRINCIPAL REGISTER

MICHAEL T SHERLOCK (UNITED STATES INDIVIDUAL)
4509 INTERLAKE AVE NORTH BOX #247
SEATTLE, WA 98103

FOR: BLENDED SPIRITS; DISTILLED SPIRITS, IN CLASS 33 (U.S. CLS. 47 AND 49).

FIRST USE 5-11-2011; IN COMMERCE 6-20-2011.

THE MARK CONSISTS OF STANDARD CHARACTERS WITHOUT CLAIM TO ANY PARTICULAR FONT, STYLE, SIZE, OR COLOR.

SER. NO. 85-321,278, FILED 5-15-2011.

DANIEL CAPSHAW, EXAMINING ATTORNEY



David J. Kyffers

Director of the United States Patent and Trademark Office

United States of America

United States Patent and Trademark Office

Kimberly Valentine

Reg. No. 4,074,188

Registered Dec. 20, 2011

Int. Cl.: 25

TRADEMARK

PRINCIPAL REGISTER

VALENTINE, KIMBERLY (UNITED STATES INDIVIDUAL), FORMERLY ADAMS,
KIMBERLY
7808 WASHINGTON LN.
WYNCOTE, PA 19095

FOR: ATHLETIC APPAREL, NAMELY, SHIRTS, PANTS, JACKETS, FOOTWEAR, HATS
AND CAPS, ATHLETIC UNIFORMS; JACKETS; PANTS; SHORTS; SKIRTS; TOPS, IN CLASS
25 (U.S. CLS. 22 AND 39).

FIRST USE 3-0-2011; IN COMMERCE 3-0-2011.

THE MARK CONSISTS OF STANDARD CHARACTERS WITHOUT CLAIM TO ANY PAR-
TICULAR FONT, STYLE, SIZE, OR COLOR.

THE NAME(S), PORTRAIT(S), AND/OR SIGNATURE(S) SHOWN IN THE MARK IDENTIFIES
"KIMBERLY VALENTINE", WHOSE CONSENT(S) TO REGISTER IS MADE OF RECORD.

SER. NO. 85-321,280, FILED 5-15-2011.

ALLISON HOLTZ, EXAMINING ATTORNEY



David J. Kyros

Director of the United States Patent and Trademark Office

United States of America

United States Patent and Trademark Office

HAUL COUTURE

Reg. No. 4,074,189

HAUL COUTURE, LLC (ALABAMA LIMITED LIABILITY COMPANY)
4800 WHITESBURG DRIVE, SUITE 30-282
HUNTSVILLE, AL 35802

Registered Dec. 20, 2011

Int. Cl.: 18

FOR: LUGGAGE; INSULATED TOTE BAGS; COLLAPSIBLE TEXTILE SHOPPING BAGS,
IN CLASS 18 (U.S. CLS. 1, 2, 3, 22 AND 41).

TRADEMARK

FIRST USE 10-4-2010; IN COMMERCE 10-4-2010.

PRINCIPAL REGISTER

THE MARK CONSISTS OF STANDARD CHARACTERS WITHOUT CLAIM TO ANY PAR-
TICULAR FONT, STYLE, SIZE, OR COLOR.

NO CLAIM IS MADE TO THE EXCLUSIVE RIGHT TO USE "COUTURE", APART FROM
THE MARK AS SHOWN.

SER. NO. 85-321,694, FILED 5-16-2011.

ALEX KEAM, EXAMINING ATTORNEY



David J. Kyros

Director of the United States Patent and Trademark Office

United States of America

United States Patent and Trademark Office

Unleash Your Inner Hippie

Reg. No. 4,074,190

JODY'S GRANOLA LLC (COLORADO LIMITED LIABILITY COMPANY)
2873 SIXTH STREET
BOULDER, CO 80304

Registered Dec. 20, 2011

Int. Cl.: 30

FOR: GRANOLA; GRANOLA SNACKS; GRANOLA-BASED SNACK BARS, IN CLASS 30
(U.S. CL. 46).

TRADEMARK

FIRST USE 12-4-2010; IN COMMERCE 12-4-2010.

PRINCIPAL REGISTER

THE MARK CONSISTS OF STANDARD CHARACTERS WITHOUT CLAIM TO ANY PARTICULAR FONT, STYLE, SIZE, OR COLOR.

SER. NO. 85-322,089, FILED 5-16-2011.

MICHAEL TANNER, EXAMINING ATTORNEY



David J. Kybas

Director of the United States Patent and Trademark Office

United States of America

United States Patent and Trademark Office

DIDACTABLE

Reg. No. 4,074,191

CHURCHILL, STEVEN (UNITED STATES INDIVIDUAL)
7665 S. HARLAN ST.

Registered Dec. 20, 2011

LITTLETON, CO 80128

Int. Cl.: 42

FOR: DESIGN AND DEVELOPMENT OF MULTIMEDIA PRODUCTS, IN CLASS 42 (U.S. CLS. 100 AND 101).

SERVICE MARK

FIRST USE 2-8-2011; IN COMMERCE 2-8-2011.

PRINCIPAL REGISTER

THE MARK CONSISTS OF STANDARD CHARACTERS WITHOUT CLAIM TO ANY PARTICULAR FONT, STYLE, SIZE, OR COLOR.

SER. NO. 85-322,207, FILED 5-16-2011.

SIMON TENG, EXAMINING ATTORNEY



David J. Kybas

Director of the United States Patent and Trademark Office

United States of America

United States Patent and Trademark Office

GRIEF RELIEF

Reg. No. 4,074,192

Registered Dec. 20, 2011

Int. Cl.: 45

SUSAN DAVIES, LICENSED CLINICAL SOCIAL WORKER, INC. (CALIFORNIA CORPORATION), DBA GRIEF RELIEF THERAPY AND COUNSELING
24050 MADISON STREET
SUITE 100-N
TORRANCE, CA 90505

SERVICE MARK

PRINCIPAL REGISTER

FOR: PROVIDING GRIEF SUPPORT AND COUNSELING SERVICES TO PERSONS SUFFERING FROM THE LOSS OF LOVED ONES FROM SUICIDE, HOMICIDE, ACCIDENTAL DEATH, AND HOSPICE RELATED DEATHS, IN CLASS 45 (U.S. CLS. 100 AND 101).

FIRST USE 1-7-2000; IN COMMERCE 1-7-2000.

THE MARK CONSISTS OF STANDARD CHARACTERS WITHOUT CLAIM TO ANY PARTICULAR FONT, STYLE, SIZE, OR COLOR.

SER. NO. 85-322,256, FILED 5-16-2011.

MARK T. MULLEN, EXAMINING ATTORNEY



David J. Kyffers

Director of the United States Patent and Trademark Office

United States of America

United States Patent and Trademark Office

SPABREAK

Reg. No. 4,074,193

Registered Dec. 20, 2011

Int. Cl.: 35

SERVICE MARK

PRINCIPAL REGISTER

SALU BEAUTY, INC. (DELAWARE CORPORATION)
11344 COLOMA RD
SUITE 725
GOLD RIVER, CA 95670

FOR: ON-LINE RETAIL STORE SERVICES FEATURING BEAUTY AND SKIN CARE PRODUCTS, IN CLASS 35 (U.S. CLS. 100, 101 AND 102).

FIRST USE 6-16-2010; IN COMMERCE 6-16-2010.

THE MARK CONSISTS OF STANDARD CHARACTERS WITHOUT CLAIM TO ANY PARTICULAR FONT, STYLE, SIZE, OR COLOR.

SER. NO. 85-322,283, FILED 5-16-2011.

INGA ERVIN, EXAMINING ATTORNEY



David J. Kyros

Director of the United States Patent and Trademark Office

United States of America
United States Patent and Trademark Office

SPALOOT

Reg. No. 4,074,194

Registered Dec. 20, 2011

Int. Cl.: 35

SERVICE MARK

PRINCIPAL REGISTER

SALU BEAUTY, INC. (DELAWARE CORPORATION)
11344 COLOMA RD
SUITE 725
GOLD RIVER, CA 95670

FOR: ON-LINE RETAIL STORE SERVICES FEATURING BEAUTY AND SKIN CARE PRODUCTS, IN CLASS 35 (U.S. CLS. 100, 101 AND 102).

FIRST USE 9-30-2009; IN COMMERCE 9-30-2009.

THE MARK CONSISTS OF STANDARD CHARACTERS WITHOUT CLAIM TO ANY PARTICULAR FONT, STYLE, SIZE, OR COLOR.

SER. NO. 85-322,297, FILED 5-16-2011.

INGA ERVIN, EXAMINING ATTORNEY



David J. Kyffers

Director of the United States Patent and Trademark Office

United States of America

United States Patent and Trademark Office

SONICSWEAT

Reg. No. 4,074,195

SARAH MATHER (UNITED STATES INDIVIDUAL)
555 WEST 23RD ST (NME)
NEW YORK, NY 10011

Registered Dec. 20, 2011

Int. Cl.: 41

FOR: SERVICES IN THE NATURE OF CLASSES BY AN INDIVIDUAL PROVIDING INSTRUCTIONS AND METHODS ON EXERCISES AND A MUSIC-ORIENTED HEALTH AND FITNESS PROGRAM, IN CLASS 41 (U.S. CLS. 100, 101 AND 107).

SERVICE MARK

FIRST USE 4-1-2011; IN COMMERCE 4-1-2011.

PRINCIPAL REGISTER

THE MARK CONSISTS OF STANDARD CHARACTERS WITHOUT CLAIM TO ANY PARTICULAR FONT, STYLE, SIZE, OR COLOR.

SER. NO. 85-322,310, FILED 5-16-2011.

JAY FLOWERS, EXAMINING ATTORNEY



David J. Kyffers

Director of the United States Patent and Trademark Office

United States of America

United States Patent and Trademark Office

McTwist by Mike McGill

Reg. No. 4,074,196

Registered Dec. 20, 2011

Int. Cl.: 28

TRADEMARK

PRINCIPAL REGISTER

MCGILL, MICHAEL (UNITED STATES INDIVIDUAL)
335 SOUTH COAST HIGHWAY 101
#S
ENCINITAS, CA 92024

FOR: ELBOW PADS FOR ATHLETIC USE; KNEE PADS FOR ATHLETIC USE; SKATEBOARD RAILS; SKATEBOARD WHEELS; SKATEBOARDS; WRIST GUARDS FOR ATHLETIC USE, IN CLASS 28 (U.S. CLS. 22, 23, 38 AND 50).

FIRST USE 2-1-2006; IN COMMERCE 2-1-2006.

THE MARK CONSISTS OF STANDARD CHARACTERS WITHOUT CLAIM TO ANY PARTICULAR FONT, STYLE, SIZE, OR COLOR.

OWNER OF U.S. REG. NO. 3,341,660.

THE NAME "MIKE MCGILL" IDENTIFIES A LIVING INDIVIDUAL WHOSE CONSENT IS OF RECORD.

SER. NO. 85-322,312, FILED 5-16-2011.

JAY FLOWERS, EXAMINING ATTORNEY



David J. Kyffers

Director of the United States Patent and Trademark Office

United States of America

United States Patent and Trademark Office

SHE IS SAFE

Reg. No. 4,074,197

Registered Dec. 20, 2011

Int. Cl.: 35

SERVICE MARK

PRINCIPAL REGISTER

SHE IS SAFE, INC. (PENNSYLVANIA NON-PROFIT CORPORATION)
11095 HOUZE ROAD
SUITE 200
ROSWELL, GA 30076

FOR: CHARITABLE SERVICES, NAMELY, ORGANIZING AND DEVELOPING PROJECTS THAT AIM TO IMPROVE THE LIVES OF UNDERPRIVILEGED AND IMPOVERISHED PEOPLE, IN CLASS 35 (U.S. CLS. 100, 101 AND 102).

FIRST USE 2-1-2011; IN COMMERCE 2-1-2011.

THE MARK CONSISTS OF STANDARD CHARACTERS WITHOUT CLAIM TO ANY PARTICULAR FONT, STYLE, SIZE, OR COLOR.

SER. NO. 85-322,339, FILED 5-16-2011.

BARNEY CHARLON, EXAMINING ATTORNEY



David J. Kyffers

Director of the United States Patent and Trademark Office

United States of America

United States Patent and Trademark Office

XOJANE

Reg. No. 4,074,198

Registered Dec. 20, 2011

Int. Cl.: 41

SERVICE MARK

PRINCIPAL REGISTER

SAY MEDIA, INC. (DELAWARE CORPORATION)
180 TOWNSEND STREET
3RD FLOOR
SAN FRANCISCO, CA 94107

FOR: PROVIDING ON-LINE MAGAZINES IN THE FIELDS OF LIFESTYLE, PERSONAL RELATIONSHIPS, BEAUTY AND FASHION, ENTERTAINMENT, HEALTH AND FITNESS, AND TECHNOLOGY, IN CLASS 41 (U.S. CLS. 100, 101 AND 107).

FIRST USE 5-16-2011; IN COMMERCE 5-16-2011.

THE MARK CONSISTS OF STANDARD CHARACTERS WITHOUT CLAIM TO ANY PARTICULAR FONT, STYLE, SIZE, OR COLOR.

SER. NO. 85-322,342, FILED 5-16-2011.

ROBERT C. CLARK JR., EXAMINING ATTORNEY



David J. Kybas

Director of the United States Patent and Trademark Office

United States of America

United States Patent and Trademark Office

WHEN PLEADING GUILTY IS NOT AN OPTION

Reg. No. 4,074,199

Registered Dec. 20, 2011

Int. Cl.: 45

SERVICE MARK

PRINCIPAL REGISTER

STEPHEN L. JONES, P.C. (MASSACHUSETTS CORPORATION)
80 WASHINGTON SQUARE, BUILDING K
NORWELL, MA 02061

FOR: LEGAL SERVICES, IN CLASS 45 (U.S. CLS. 100 AND 101).

FIRST USE 11-28-2001; IN COMMERCE 11-28-2001.

THE MARK CONSISTS OF STANDARD CHARACTERS WITHOUT CLAIM TO ANY PARTICULAR FONT, STYLE, SIZE, OR COLOR.

SER. NO. 85-322,349, FILED 5-16-2011.

PATRICIA EVANKO, EXAMINING ATTORNEY



David J. Kyffers

Director of the United States Patent and Trademark Office

United States of America

United States Patent and Trademark Office

DESINNOVA

Reg. No. 4,074,200

Registered Dec. 20, 2011

Int. Cl.: 42

SERVICE MARK

PRINCIPAL REGISTER

DESINNOVA TECHNOLOGIES, INC. (NEVADA CORPORATION)
2828 SW CORBETT AVE STE 216
PORTLAND, OR 97201

FOR: CONSULTANCY IN THE FIELD OF SOFTWARE DESIGN; CONSULTING SERVICES IN THE FIELD OF THE DESIGN AND DEVELOPMENT OF MULTIMEDIA PRODUCTS; CONSULTING SERVICES IN THE FIELD OF NEW PRODUCT DESIGN AND DEVELOPMENT; CONSULTING SERVICES IN THE FIELD OF THE DESIGN OF MECHANICAL AND ELECTROMECHANICAL APPARATUS AND INSTRUMENTS; TECHNOLOGY CONSULTATION IN THE FIELD OF CONSUMER ELECTRONICS AND COMPUTERS, IN CLASS 42 (U.S. CLS. 100 AND 101).

FIRST USE 11-24-2009; IN COMMERCE 11-24-2009.

THE MARK CONSISTS OF WORD "DESINNOVA" IN BLUE COLOR.

THE COLOR(S) BLUE IS/ARE CLAIMED AS A FEATURE OF THE MARK.

SER. NO. 85-322,357, FILED 5-16-2011.

INGA ERVIN, EXAMINING ATTORNEY



David J. Kybas

Director of the United States Patent and Trademark Office

United States of America

United States Patent and Trademark Office

Creating Fame

Reg. No. 4,074,201

Registered Dec. 20, 2011

Int. Cl.: 35

SERVICE MARK

PRINCIPAL REGISTER

ROEDER STUDIOS, INC. (NEVADA CORPORATION)
PO BOX 1022
VENICE, CA 90294

FOR: CONSULTATION IN USE OF ONLINE MARKETING FOR BUSINESS DEVELOPMENT OF OTHERS, IN CLASS 35 (U.S. CLS. 100, 101 AND 102).

FIRST USE 5-1-2009; IN COMMERCE 5-1-2009.

THE MARK CONSISTS OF STANDARD CHARACTERS WITHOUT CLAIM TO ANY PARTICULAR FONT, STYLE, SIZE, OR COLOR.

SER. NO. 85-322,361, FILED 5-16-2011.

CAROLINE WOOD, EXAMINING ATTORNEY



David J. Kybas

Director of the United States Patent and Trademark Office

United States of America

United States Patent and Trademark Office

laura roeder

Reg. No. 4,074,202

ROEDER STUDIOS, INC. (NEVADA CORPORATION)
PO BOX 1022
VENICE, CA 90294

Registered Dec. 20, 2011

Int. Cl.: 35

FOR: CONSULTATION IN USE OF ONLINE MARKETING FOR BUSINESS DEVELOPMENT OF OTHERS, IN CLASS 35 (U.S. CLS. 100, 101 AND 102).

SERVICE MARK

FIRST USE 5-1-2007; IN COMMERCE 5-1-2007.

PRINCIPAL REGISTER

THE MARK CONSISTS OF STANDARD CHARACTERS WITHOUT CLAIM TO ANY PARTICULAR FONT, STYLE, SIZE, OR COLOR.

THE NAME "LAURA ROEDER" IDENTIFIES A LIVING INDIVIDUAL WHOSE CONSENT IS OF RECORD.

SER. NO. 85-322,371, FILED 5-16-2011.

CAROLINE WOOD, EXAMINING ATTORNEY



David J. Kyffers

Director of the United States Patent and Trademark Office

United States of America

United States Patent and Trademark Office

Lobbyfriend

Reg. No. 4,074,203

LOBBYFRIEND INC. (CANADA CORPORATION), DBA LOBBYFRIEND
30 CONCOURSE GATE, SUITE 37
OTTAWA, CANADA

Registered Dec. 20, 2011

Int. Cl.: 45

FOR: ONLINE SOCIAL NETWORKING SERVICES IN THE FIELD OF HOSPITALITY AND TRAVEL PROVIDED VIA A WEBSITE, IN CLASS 45 (U.S. CLS. 100 AND 101).

SERVICE MARK

FIRST USE 2-1-2011; IN COMMERCE 2-25-2011.

PRINCIPAL REGISTER

THE MARK CONSISTS OF STANDARD CHARACTERS WITHOUT CLAIM TO ANY PARTICULAR FONT, STYLE, SIZE, OR COLOR.

SER. NO. 85-322,379, FILED 5-16-2011.

CAROLINE WOOD, EXAMINING ATTORNEY



David J. Kybas

Director of the United States Patent and Trademark Office

United States of America

United States Patent and Trademark Office

Be the Bee

Reg. No. 4,074,204

KELLY G. MCATEE (VIRGINIA SOLE PROPRIETORSHIP), DBA JUSTBEEGENEROUS
128 MACAULAY RD.

Registered Dec. 20, 2011

WILLIAMSBURG, VA 23185

Int. Cl.: 25

FOR: SHORT-SLEEVED OR LONG-SLEEVED T-SHIRTS; T-SHIRTS, IN CLASS 25 (U.S. CLS. 22 AND 39).

TRADEMARK

FIRST USE 5-6-2011; IN COMMERCE 5-12-2011.

PRINCIPAL REGISTER

THE MARK CONSISTS OF STANDARD CHARACTERS WITHOUT CLAIM TO ANY PARTICULAR FONT, STYLE, SIZE, OR COLOR.

SER. NO. 85-322,407, FILED 5-16-2011.

LOURDES AYALA, EXAMINING ATTORNEY



David J. Kybas

Director of the United States Patent and Trademark Office

United States of America

United States Patent and Trademark Office

XRD

Reg. No. 4,074,205

Registered Dec. 20, 2011

Int. Cl.: 12

TRADEMARK

PRINCIPAL REGISTER

RAVX INC. (CALIFORNIA CORPORATION)
1210 KEYSTONE WAY, SUITE A
GLOBAL DESIGN CENTER
VISTA, CA 92081

FOR: HANDLE BAR STEMS FOR BICYCLES; BICYCLE WATER BOTTLE CAGES; BICYCLE SEATS; AUXILIARY HANDLE BARS FOR BICYCLES; BICYCLE SEAT POSTS; BICYCLE PARTS, NAMELY, DROP HANDLE BARS; BICYCLE PARTS, NAMELY, STRAIGHT HANDLE BARS; BICYCLE WHEELS, IN CLASS 12 (U.S. CLS. 19, 21, 23, 31, 35 AND 44).

FIRST USE 9-18-2010; IN COMMERCE 9-18-2010.

THE MARK CONSISTS OF STANDARD CHARACTERS WITHOUT CLAIM TO ANY PARTICULAR FONT, STYLE, SIZE, OR COLOR.

SER. NO. 85-322,409, FILED 5-16-2011.

KAPIL BHANOT, EXAMINING ATTORNEY



David J. Kybas

Director of the United States Patent and Trademark Office

United States of America

United States Patent and Trademark Office



Reg. No. 4,074,206

Registered Dec. 20, 2011

Int. Cl.: 29

TRADEMARK

PRINCIPAL REGISTER

SEAQUEST SEAFOOD CORPORATION (CALIFORNIA CORPORATION)
530 SOUTH SIXTH AVENUE
CITY OF INDUSTRY, CA 91746

FOR: SEAFOOD; FISH, IN CLASS 29 (U.S. CL. 46).

FIRST USE 5-16-2011; IN COMMERCE 5-16-2011.

THE MARK CONSISTS OF A STYLIZED DRAWING OF A CHEF HOLDING A TRAY, OUTLINED IN BLUE EXCEPT FOR A BOW TIE OUTLINED IN RED, ALL ON A WHITE BACKGROUND WITHIN A ROUND RED BORDER, WITH THE WORDS "CHEF'S DESIRE" APPEARING IN RED LETTERS ON A YELLOW BACKGROUND AT THE BOTTOM OF THE DRAWING.

THE COLOR(S) RED, BLUE, YELLOW, AND WHITE IS/ARE CLAIMED AS A FEATURE OF THE MARK.

SER. NO. 85-322,422, FILED 5-17-2011.

ALYSSA STEEL, EXAMINING ATTORNEY



David J. Kybas

Director of the United States Patent and Trademark Office

United States of America

United States Patent and Trademark Office

astronomy

Reg. No. 4,074,207

DON XIANGDONG HO (UNITED STATES INDIVIDUAL)
2707 E. VALLEY BLVD., SUITE 312
WEST COVINA, CA 91792

Registered Dec. 20, 2011

Int. Cls.: 14, 18 and 25

FOR: JEWELRY, CUFFLINKS, BRACELETS, PENDANTS, JEWELRY PINS, EARRINGS, RINGS, AND NECKLACES, IN CLASS 14 (U.S. CLS. 2, 27, 28 AND 50).

TRADEMARK

FIRST USE 4-14-2011; IN COMMERCE 4-14-2011.

PRINCIPAL REGISTER

FOR: LUGGAGE, TOTE BAGS, HAND BAGS, BEACH BAGS, ALL PURPOSE SPORT AND CARRYING BAGS, UMBRELLAS, SHOULDER BAGS, BACKPACKS, TOILETRY KITS SOLD EMPTY, KEY CASES, LEATHER KEY CHAINS, AND WALLETS, IN CLASS 18 (U.S. CLS. 1, 2, 3, 22 AND 41).

FIRST USE 4-14-2011; IN COMMERCE 4-14-2011.

FOR: CLOTHING, NAMELY, BEACHWEAR, BLOUSES, BOXER SHORTS, CAMISOLES, COATS, DRESSES, JACKETS, JEANS, KNIT SHIRTS, KNIT TOPS, LOUNGEWEAR, PAJAMAS, PANTS, SHIRTS, SHORTS, SKIRTS, SLACKS, SLEEPWEAR, SWEAT PANTS, SWEAT SHIRTS, SWEAT SHORTS, SWEATERS, SWIM WEAR, T-SHIRTS, TANK TOPS, UNDERPANTS, AND UNDERWEAR, IN CLASS 25 (U.S. CLS. 22 AND 39).

FIRST USE 4-14-2011; IN COMMERCE 4-14-2011.

THE MARK CONSISTS OF STANDARD CHARACTERS WITHOUT CLAIM TO ANY PARTICULAR FONT, STYLE, SIZE, OR COLOR.

SER. NO. 85-322,426, FILED 5-17-2011.

CHRISTINE COOPER, EXAMINING ATTORNEY



David J. Kybas

Director of the United States Patent and Trademark Office

United States of America

United States Patent and Trademark Office



Reg. No. 4,074,208

HAUL COUTURE, LLC (ALABAMA LIMITED LIABILITY COMPANY)
4800 WHITESBURG DRIVE, SUITE 30-282
HUNTSVILLE, AL 35802

Registered Dec. 20, 2011

Int. Cl.: 18

FOR: LUGGAGE; INSULATED TOTE BAGS; COLLAPSIBLE TEXTILE SHOPPING BAGS,
IN CLASS 18 (U.S. CLS. 1, 2, 3, 22 AND 41).

TRADEMARK

FIRST USE 10-14-2010; IN COMMERCE 10-14-2010.

PRINCIPAL REGISTER

THE MARK CONSISTS OF AN OVAL CONTAINING A WOMAN'S SILHOUETTE WEARING
A DRESS AND HAT AND CARRYING A PURSE.

SER. NO. 85-322,837, FILED 5-17-2011.

ALEX KEAM, EXAMINING ATTORNEY



David J. Kybas

Director of the United States Patent and Trademark Office

United States of America

United States Patent and Trademark Office

MOMDOC

Reg. No. 4,074,209

Registered Dec. 20, 2011

Int. Cl.: 44

SERVICE MARK

PRINCIPAL REGISTER

DRS. GOODMAN & PARTRIDGE OB/GYN, PLLC (ARIZONA LIMITED LIABILITY COMPANY)
1900 WEST CHANDLER ROAD #15-391
CHANDLER, AZ 85224

FOR: OBSTETRIC AND GYNECOLOGY SERVICES, IN CLASS 44 (U.S. CLS. 100 AND 101).

FIRST USE 5-18-2001; IN COMMERCE 5-18-2001.

THE MARK CONSISTS OF STANDARD CHARACTERS WITHOUT CLAIM TO ANY PARTICULAR FONT, STYLE, SIZE, OR COLOR.

SER. NO. 85-322,855, FILED 5-17-2011.

NAAKWAMA ANKRAH, EXAMINING ATTORNEY



David J. Kyffers

Director of the United States Patent and Trademark Office

United States of America

United States Patent and Trademark Office

MAXIS

Reg. No. 4,074,210

Registered Dec. 20, 2011

Int. Cls.: 7 and 8

TRADEMARK

PRINCIPAL REGISTER

SOUTHWIRE COMPANY (DELAWARE CORPORATION)
ONE SOUTHWIRE DRIVE
CARROLLTON, GA 30119

FOR: WIRE PULLING MACHINES, IN CLASS 7 (U.S. CLS. 13, 19, 21, 23, 31, 34 AND 35).

FIRST USE 6-1-2002; IN COMMERCE 6-1-2002.

FOR: HAND TOOLS USED IN CONSTRUCTION, NAMELY, WIRE CABLE PULLERS AND ACCESSORIES THEREFOR; CONDUIT BENDERS AND HANDLES; CABLE FEEDERS; HOLE MAKING TOOLS; CONDUIT LAYOUT TOOLS, NAMELY, A TOOL FOR QUICKLY AND EASILY SETTING OUT THE PROPER CONDUIT SIZE AND SPACING FOR A PARTICULAR JOB, IN CLASS 8 (U.S. CLS. 23, 28 AND 44).

FIRST USE 6-1-2002; IN COMMERCE 6-1-2002.

THE MARK CONSISTS OF STANDARD CHARACTERS WITHOUT CLAIM TO ANY PARTICULAR FONT, STYLE, SIZE, OR COLOR.

OWNER OF U.S. REG. NOS. 2,930,588 AND 3,040,040.

SER. NO. 85-323,498, FILED 5-18-2011.

HOWARD SMIGA, EXAMINING ATTORNEY



David J. Kypos

Director of the United States Patent and Trademark Office

United States of America
United States Patent and Trademark Office

AGEMA

Reg. No. 4,074,211

FLIR SYSTEMS, INC. (OREGON CORPORATION)
27700 SW PARKWAY AVENUE
WILSONVILLE, OR 97070

Registered Dec. 20, 2011

Int. Cl.: 9

FOR: THERMAL IMAGERS; INFRARED CAMERAS, IN CLASS 9 (U.S. CLS. 21, 23, 26, 36 AND 38).

TRADEMARK

FIRST USE 3-0-1985; IN COMMERCE 3-0-1985.

PRINCIPAL REGISTER

THE MARK CONSISTS OF STANDARD CHARACTERS WITHOUT CLAIM TO ANY PARTICULAR FONT, STYLE, SIZE, OR COLOR.

THE WORDING "AGEMA" HAS NO MEANING IN A FOREIGN LANGUAGE.

SER. NO. 85-323,546, FILED 5-18-2011.

BARBARA BROWN, EXAMINING ATTORNEY



David J. Kybas

Director of the United States Patent and Trademark Office

United States of America

United States Patent and Trademark Office

GOLD STANDARD

Reg. No. 4,074,212

THE DOLLFUS MIEG COMPANY, INC. (DELAWARE CORPORATION)
10 BASIN DRIVE, SUITE 130
KEARNY, NJ 07032

Registered Dec. 20, 2011

Int. Cl.: 24

FOR: PRECUT FABRICS FOR NEEDLECRAFT, IN CLASS 24 (U.S. CLS. 42 AND 50).

TRADEMARK

FIRST USE 0-0-1985; IN COMMERCE 0-0-1985.

PRINCIPAL REGISTER

THE MARK CONSISTS OF STANDARD CHARACTERS WITHOUT CLAIM TO ANY PARTICULAR FONT, STYLE, SIZE, OR COLOR.

SER. NO. 85-323,853, FILED 5-18-2011.

JUDITH HELFMAN, EXAMINING ATTORNEY



David J. Kybas

Director of the United States Patent and Trademark Office

United States of America

United States Patent and Trademark Office

OEM OFF-HIGHWAY

Reg. No. 4,074,213

CYGNUS BUSINESS MEDIA, INC. (DELAWARE CORPORATION)
1233 JANESVILLE AVENUE
FORT ATKINSON, WI 53538

Registered Dec. 20, 2011

Int. Cl.: 16

FOR: MAGAZINES IN THE FIELD OF VEHICLES AND EQUIPMENT FOR OTHER THAN ROADWAY USE, IN CLASS 16 (U.S. CLS. 2, 5, 22, 23, 29, 37, 38 AND 50).

TRADEMARK

FIRST USE 1-0-1990; IN COMMERCE 1-0-1990.

PRINCIPAL REGISTER

THE MARK CONSISTS OF STANDARD CHARACTERS WITHOUT CLAIM TO ANY PARTICULAR FONT, STYLE, SIZE, OR COLOR.

SEC. 2(F).

SER. NO. 85-324,109, FILED 5-18-2011.

SANJEEV VOHRA, EXAMINING ATTORNEY



David J. Kybas

Director of the United States Patent and Trademark Office

United States of America

United States Patent and Trademark Office

Design. Optimize. Deliver.

Reg. No. 4,074,214

Registered Dec. 20, 2011

Int. Cl.: 42

SERVICE MARK

PRINCIPAL REGISTER

BIOCRIST PHARMACEUTICALS, INC. (DELAWARE CORPORATION)
STE. 200
4505 EMPEROR BLVD
DURHAM, NC 27703

FOR: PHARMACEUTICAL RESEARCH AND DRUG DEVELOPMENT; MEDICAL AND SCIENTIFIC RESEARCH, NAMELY CONDUCTING CLINICAL TRIALS; DEVELOPMENT OF PHARMACEUTICALS FOR THE TREATMENT OF INFECTIOUS, VIRAL, INFLAMMATORY, IMMUNOLOGICAL AND AUTOIMMUNE DISEASES AND DISORDERS; DEVELOPMENT OF PHARMACEUTICALS FOR THE TREATMENT OF INFLUENZA, HEPATITIS, AIDS, SARS, AND WEST NILE VIRUS; DEVELOPMENT OF PHARMACEUTICALS FOR THE TREATMENT OF CANCER, NAMELY, CANCERS OF THE IMMUNE SYSTEM SUCH AS T-CELL AND B-CELL LEUKEMIAS AND LYMPHOMA, IN CLASS 42 (U.S. CLS. 100 AND 101).

FIRST USE 9-1-2009; IN COMMERCE 9-1-2009.

THE MARK CONSISTS OF STANDARD CHARACTERS WITHOUT CLAIM TO ANY PARTICULAR FONT, STYLE, SIZE, OR COLOR.

SER. NO. 85-324,610, FILED 5-19-2011.

GEORGE LORENZO, EXAMINING ATTORNEY



David J. Kypos

Director of the United States Patent and Trademark Office

United States of America

United States Patent and Trademark Office

EARTH HEART

Reg. No. 4,074,215

EARTH HEART INC. (ILLINOIS CORPORATION)

Registered Dec. 20, 2011

PO BOX 427
DUNDEE, IL 60018

Int. Cls.: 3 and 5

FOR: AROMATIC PREPARATIONS, NAMELY, BODY SPRAYS; BATH SALTS; BEAUTY CREAMS; FACE AND BODY LOTIONS; MASSAGE OILS; REEDS AND SCENTED OILS SOLD AS A UNIT FOR USE IN ROOM SCENT DIFFUSERS, IN CLASS 3 (U.S. CLS. 1, 4, 6, 50, 51 AND 52).

TRADEMARK

PRINCIPAL REGISTER

FIRST USE 5-0-1992; IN COMMERCE 5-0-1992.

FOR: AROMATHERAPY CREAMS FOR TREATING HEADACHES, RELIEVING STRESS, CURING INSOMNIA, ANXIETY AND NAUSEA; AROMATHERAPY LOTIONS FOR TREATING HEADACHES, RELIEVING STRESS, CURING INSOMNIA, ANXIETY AND NAUSEA; AROMATHERAPY OILS, OTHER THAN ESSENTIAL OILS, FOR TREATING ANXIETY; AROMATHERAPY SPRAYS FOR TREATING HEADACHES, RELIEVING STRESS, CURING INSOMNIA, ANXIETY AND NAUSEA; HERBAL ANTI-ITCH AND SORE SKIN OINTMENT FOR PETS; LINIMENTS; MEDICATED BALMS FOR TREATMENT OF TREATING HEADACHES, RELIEVING STRESS, CURING INSOMNIA, ANXIETY, SKIN IRRITATION, IMMUNE SYSTEM HEALTH AND NAUSEA; MEDICATED LOTIONS FOR TREATING HEADACHES, RELIEVING STRESS, CURING INSOMNIA, ANXIETY, SKIN IRRITATION, IMMUNE SYSTEM HEALTH AND NAUSEA; MEDICATED SERUMS FOR TREATMENT OF TREATING HEADACHES, RELIEVING STRESS, CURING INSOMNIA, ANXIETY, SKIN IRRITATION, IMMUNE SYSTEM HEALTH AND NAUSEA; NATURAL SUPPLEMENTS FOR TREATING DEPRESSION AND ANXIETY; NAUSEA TREATMENT PREPARATIONS, IN CLASS 5 (U.S. CLS. 6, 18, 44, 46, 51 AND 52).

FIRST USE 5-0-1992; IN COMMERCE 5-0-1992.

THE MARK CONSISTS OF STANDARD CHARACTERS WITHOUT CLAIM TO ANY PARTICULAR FONT, STYLE, SIZE, OR COLOR.

SER. NO. 85-324,713, FILED 5-19-2011.

CAROLYN CATALDO, EXAMINING ATTORNEY



David J. Kyros

Director of the United States Patent and Trademark Office

United States of America

United States Patent and Trademark Office

REEL IMAGE

Reg. No. 4,074,216

Registered Dec. 20, 2011

Int. Cl.: 9

TRADEMARK

PRINCIPAL REGISTER

BALLY GAMING, INC. (NEVADA CORPORATION), DBA BALLY TECHNOLOGIES
ATTN: LEGAL DEPT.
6601 SOUTH BERMUDA ROAD
LAS VEGAS, NV 89119

FOR: GAMING MACHINES, NAMELY, DEVICES WHICH ACCEPT A WAGER AND GAMING SOFTWARE THAT GENERATES OR DISPLAYS OUTCOMES FOR GAMING MACHINES, IN CLASS 9 (U.S. CLS. 21, 23, 26, 36 AND 38).

FIRST USE 3-1-2011; IN COMMERCE 3-1-2011.

THE MARK CONSISTS OF STANDARD CHARACTERS WITHOUT CLAIM TO ANY PARTICULAR FONT, STYLE, SIZE, OR COLOR.

SER. NO. 85-324,897, FILED 5-19-2011.

ELLEN B. AWRICH, EXAMINING ATTORNEY



David J. Kyros

Director of the United States Patent and Trademark Office

United States of America

United States Patent and Trademark Office

UP LINK

Reg. No. 4,074,217

Registered Dec. 20, 2011

Int. Cl.: 41

SERVICE MARK

PRINCIPAL REGISTER

PEOPLELINK, LLC (INDIANA LIMITED LIABILITY COMPANY)
SUITE 200
431 E. COLFAX AVENUE
SOUTH BEND, IN 46617

FOR: PROVIDING ON-LINE NEWSLETTERS IN THE FIELD OF EMPLOYMENT STAFFING,
IN CLASS 41 (U.S. CLS. 100, 101 AND 107).

FIRST USE 6-10-2009; IN COMMERCE 6-10-2009.

THE MARK CONSISTS OF STANDARD CHARACTERS WITHOUT CLAIM TO ANY PAR-
TICULAR FONT, STYLE, SIZE, OR COLOR.

SER. NO. 85-324,999, FILED 5-19-2011.

DANIEL CAPSHAW, EXAMINING ATTORNEY



David J. Kyros

Director of the United States Patent and Trademark Office

United States of America

United States Patent and Trademark Office

PROWITE

Reg. No. 4,074,218

YZY INC (FLORIDA CORPORATION)
6300 NW 72ND AVENUE
MIAMI, FL 33166

Registered Dec. 20, 2011

Int. Cl.: 3

FOR: FACE CREAMS FOR COSMETIC USE; LOTIONS FOR COSMETIC PURPOSES; LOTIONS FOR FACE AND BODY CARE; MOISTURIZING CREAMS; SKIN LIGHTENERS; SKIN LIGHTENING CREAMS; SKIN WHITENING CREAMS , IN CLASS 3 (U.S. CLS. 1, 4, 6, 50, 51 AND 52).

TRADEMARK

PRINCIPAL REGISTER

FIRST USE 1-15-2008; IN COMMERCE 1-15-2008.

THE MARK CONSISTS OF STANDARD CHARACTERS WITHOUT CLAIM TO ANY PARTICULAR FONT, STYLE, SIZE, OR COLOR.

SER. NO. 85-325,147, FILED 5-19-2011.

MICHAEL SOUDERS, EXAMINING ATTORNEY



David J. Kyffers

Director of the United States Patent and Trademark Office

United States of America

United States Patent and Trademark Office

RUBY RUSH

Reg. No. 4,074,219

Registered Dec. 20, 2011

Int. Cl.: 9

TRADEMARK

PRINCIPAL REGISTER

BALLY GAMING, INC. (NEVADA CORPORATION), DBA BALLY TECHNOLOGIES
ATTN: LAW DEPT.
6601 SOUTH BERMUDA ROAD
LAS VEGAS, NV 89119

FOR: GAMING MACHINES, NAMELY, DEVICES WHICH ACCEPT A WAGER AND GAMING SOFTWARE THAT GENERATES OR DISPLAYS OUTCOMES FOR GAMING MACHINES, IN CLASS 9 (U.S. CLS. 21, 23, 26, 36 AND 38).

FIRST USE 5-5-2010; IN COMMERCE 5-5-2010.

THE MARK CONSISTS OF STANDARD CHARACTERS WITHOUT CLAIM TO ANY PARTICULAR FONT, STYLE, SIZE, OR COLOR.

SER. NO. 85-325,261, FILED 5-19-2011.

ELLEN B. AWRICH, EXAMINING ATTORNEY



David J. Kyffers

Director of the United States Patent and Trademark Office

United States of America

United States Patent and Trademark Office

POWER MAX

Reg. No. 4,074,220

Registered Dec. 20, 2011

Int. Cl.: 9

TRADEMARK

PRINCIPAL REGISTER

BALLY GAMING, INC. (NEVADA CORPORATION), DBA BALLY TECHNOLOGIES
ATTN: LAW DEPT.
6601 SOUTH BERMUDA ROAD
LAS VEGAS, NV 89119

FOR: GAMING MACHINES, NAMELY, DEVICES WHICH ACCEPT A WAGER AND GAMING SOFTWARE THAT GENERATES OR DISPLAYS OUTCOMES FOR GAMING MACHINES, IN CLASS 9 (U.S. CLS. 21, 23, 26, 36 AND 38).

FIRST USE 5-4-2010; IN COMMERCE 5-4-2010.

THE MARK CONSISTS OF STANDARD CHARACTERS WITHOUT CLAIM TO ANY PARTICULAR FONT, STYLE, SIZE, OR COLOR.

SER. NO. 85-325,374, FILED 5-19-2011.

ELLEN B. AWRICH, EXAMINING ATTORNEY



David J. Kybas

Director of the United States Patent and Trademark Office

United States of America

United States Patent and Trademark Office

PSYCHIC SPIN

Reg. No. 4,074,221

Registered Dec. 20, 2011

Int. Cl.: 9

TRADEMARK

PRINCIPAL REGISTER

BALLY GAMING, INC. (NEVADA CORPORATION), DBA BALLY TECHNOLOGIES
ATTN: LAW DEPT.
6601 SOUTH BERMUDA ROAD
LAS VEGAS, NV 89119

FOR: GAMING MACHINES, NAMELY, DEVICES WHICH ACCEPT A WAGER AND GAMING SOFTWARE THAT GENERATES OR DISPLAYS OUTCOMES FOR GAMING MACHINES, IN CLASS 9 (U.S. CLS. 21, 23, 26, 36 AND 38).

FIRST USE 11-3-2010; IN COMMERCE 11-3-2010.

THE MARK CONSISTS OF STANDARD CHARACTERS WITHOUT CLAIM TO ANY PARTICULAR FONT, STYLE, SIZE, OR COLOR.

SER. NO. 85-325,416, FILED 5-19-2011.

ELLEN B. AWRICH, EXAMINING ATTORNEY



David J. Kyffers

Director of the United States Patent and Trademark Office

United States of America

United States Patent and Trademark Office

BBB

Reg. No. 4,074,222

ANAGALLIS HERBS LLC (DELAWARE LIMITED LIABILITY COMPANY)

Registered Dec. 20, 2011

P.O. BOX 1205
CASTLETON, VT 05735

Int. Cl.: 5

FOR: HERBAL TOPICAL CREAMS, GELS, SALVES, SPRAYS, POWDER, BALMS, LINIMENT AND OINTMENTS FOR THE RELIEF OF ACHES AND PAIN, IN CLASS 5 (U.S. CLS. 6, 18, 44, 46, 51 AND 52).

TRADEMARK

FIRST USE 9-30-2010; IN COMMERCE 9-30-2010.

PRINCIPAL REGISTER

THE MARK CONSISTS OF STANDARD CHARACTERS WITHOUT CLAIM TO ANY PARTICULAR FONT, STYLE, SIZE, OR COLOR.

SER. NO. 85-325,441, FILED 5-19-2011.

BILL DAWE, EXAMINING ATTORNEY



David J. Kyffers

Director of the United States Patent and Trademark Office

United States of America

United States Patent and Trademark Office

A87

Reg. No. 4,074,223

Registered Dec. 20, 2011

Int. Cl.: 35

SERVICE MARK

PRINCIPAL REGISTER

AEROPOSTALE PROCUREMENT COMPANY, INC. (DELAWARE CORPORATION)
112 W. 34TH STREET, 22ND FLOOR
NEW YORK, NY 10120

FOR: RETAIL STORE SERVICES AND ON-LINE RETAIL STORE SERVICES FEATURING CLOTHING, CLOTHING ACCESSORIES, FOOTWEAR, HEADGEAR, FRAGRANCE, COSMETICS, PERSONAL CARE PRODUCTS, SUNGLASSES, JEWELRY, WATCHES, BAGS, WALLETS, BEACH TOWELS, HAIR ACCESSORIES AND ITEMS OF GENERAL MERCHANDISE, IN CLASS 35 (U.S. CLS. 100, 101 AND 102).

FIRST USE 4-1-2008; IN COMMERCE 4-1-2008.

THE MARK CONSISTS OF STANDARD CHARACTERS WITHOUT CLAIM TO ANY PARTICULAR FONT, STYLE, SIZE, OR COLOR.

OWNER OF U.S. REG. NOS. 3,151,023 AND 3,477,550.

SER. NO. 85-325,662, FILED 5-20-2011.

GRETTA YAO, EXAMINING ATTORNEY



David J. Kybas

Director of the United States Patent and Trademark Office

United States of America

United States Patent and Trademark Office

Alt

Reg. No. 4,074,224

Registered Dec. 20, 2011

Int. Cl.: 45

SERVICE MARK

PRINCIPAL REGISTER

ALT HOROSCOPES, LLC (NEVADA LIMITED LIABILITY COMPANY)
375 N. STEPHANIE STREET
SUITE 1411, NV 89014

FOR: HOROSCOPE CASTING; HOROSCOPE FORECASTING; HOROSCOPES; PROVIDING HOROSCOPE INFORMATION VIA COMPUTER NETWORKS, IN CLASS 45 (U.S. CLS. 100 AND 101).

FIRST USE 5-14-2011; IN COMMERCE 5-14-2011.

THE MARK CONSISTS OF STANDARD CHARACTERS WITHOUT CLAIM TO ANY PARTICULAR FONT, STYLE, SIZE, OR COLOR.

SER. NO. 85-325,942, FILED 5-20-2011.

DOMINICK J. SALEMI, EXAMINING ATTORNEY



David J. Kybas

Director of the United States Patent and Trademark Office

United States of America

United States Patent and Trademark Office

DOMINION UNITED

Reg. No. 4,074,225

Registered Dec. 20, 2011

Int. Cl.: 35

SERVICE MARK

PRINCIPAL REGISTER

DOMINION ENTERPRISES (VIRGINIA PARTNERSHIP)
150 GRANBY STREET
NORFOLK, VA 23510

FOR: ADVERTISING, MARKETING AND PROMOTION SERVICES; BUSINESS, MARKETING, AND COMMERCIAL INFORMATION SERVICES FOR OTHERS IN THE FIELD OF VEHICLE INVENTORY, SALES, AND MANAGEMENT; PROVIDING REPORTS AND ALERTS REGARDING VEHICLE SALES, PRICING, VALUE, AND HISTORY; BUSINESS SERVICES, NAMELY, OBTAINING, TRACKING, AND MANAGING CONSUMER LEADS; COMPILING AND MANAGING CUSTOMER AND PROSPECTIVE CUSTOMER PROFILES, PREFERENCES, AND SALES AND SERVICE HISTORIES; PROVIDING VEHICLE INVENTORY MANAGEMENT SERVICES AND VEHICLE AND CUSTOMER DATABASE MANAGEMENT SERVICES; AND PROVIDING CONSUMER PRODUCT INFORMATION REGARDING VEHICLE PRICING, FINANCIAL DATA AND ADVERTISING OF AUTOMOBILES, IN CLASS 35 (U.S. CLS. 100, 101 AND 102).

FIRST USE 1-0-2011; IN COMMERCE 1-0-2011.

THE MARK CONSISTS OF STANDARD CHARACTERS WITHOUT CLAIM TO ANY PARTICULAR FONT, STYLE, SIZE, OR COLOR.

SER. NO. 85-325,986, FILED 5-20-2011.

DAVID I, EXAMINING ATTORNEY



David J. Kypos

Director of the United States Patent and Trademark Office

United States of America

United States Patent and Trademark Office

A LEANER YOU IN EVERY BOTTLE

Reg. No. 4,074,226

NEUROBRANDS, LLC (CALIFORNIA LIMITED LIABILITY COMPANY)
501 SANTA MONICA BLVD, SECOND FLOOR
SANTA MONICA, CA 90401

Registered Dec. 20, 2011

Int. Cls.: 5 and 32

FOR: DIETARY SUPPLEMENTAL DRINKS; NUTRITIONAL FORTIFIED BEVERAGES;
VITAMIN FORTIFIED BEVERAGES, IN CLASS 5 (U.S. CLS. 6, 18, 44, 46, 51 AND 52).

TRADEMARK

FIRST USE 6-1-2009; IN COMMERCE 7-2-2009.

PRINCIPAL REGISTER

FOR: NON-ALCOHOLIC BEVERAGES, NAMELY, MINERAL AND AERATED WATERS,
FRUIT DRINKS, ENERGY DRINKS, FRUIT FLAVORED DRINKS, HERBAL JUICES AND
ISOTONIC DRINKS, IN CLASS 32 (U.S. CLS. 45, 46 AND 48).

FIRST USE 6-1-2009; IN COMMERCE 7-2-2009.

THE MARK CONSISTS OF STANDARD CHARACTERS WITHOUT CLAIM TO ANY PAR-
TICULAR FONT, STYLE, SIZE, OR COLOR.

SER. NO. 85-326,060, FILED 5-20-2011.

MATTHEW KLINE, EXAMINING ATTORNEY



David J. Kypas

Director of the United States Patent and Trademark Office

United States of America

United States Patent and Trademark Office

BONACAPS

Reg. No. 4,074,227

NGUYEN, TUONG (UNITED STATES INDIVIDUAL)
10132 TYLER CT

Registered Dec. 20, 2011

WESTMINSTER, CA 92683

Int. Cl.: 5

FOR: NUTRITIONAL SUPPLEMENTS IN THE FORM OF CAPSULES, IN CLASS 5 (U.S. CLS. 6, 18, 44, 46, 51 AND 52).

TRADEMARK

FIRST USE 5-20-2011; IN COMMERCE 5-20-2011.

PRINCIPAL REGISTER

THE MARK CONSISTS OF STANDARD CHARACTERS WITHOUT CLAIM TO ANY PARTICULAR FONT, STYLE, SIZE, OR COLOR.

SER. NO. 85-327,384, FILED 5-23-2011.

TOBY BULLOFF, EXAMINING ATTORNEY



David J. Kyffers

Director of the United States Patent and Trademark Office

United States of America

United States Patent and Trademark Office

GRAVY

Reg. No. 4,074,228

Registered Dec. 20, 2011

Int. Cls.: 16 and 41

TRADEMARK

SERVICE MARK

PRINCIPAL REGISTER

GREY GLOBAL GROUP INC. (DELAWARE CORPORATION)
200 FIFTH AVENUE
NEW YORK, NY 100103372

FOR: MAGAZINES FEATURING INTERVIEWS, COMMENTARY, AND ARTICLES OF INTEREST TO THE CREATIVE COMMUNITY, IN CLASS 16 (U.S. CLS. 2, 5, 22, 23, 29, 37, 38 AND 50).

FIRST USE 11-30-2010; IN COMMERCE 11-30-2010.

FOR: PROVIDING ON-LINE NON-DOWNLOADABLE MAGAZINES FEATURING INTERVIEWS, COMMENTARY, AND ARTICLES OF INTEREST TO THE CREATIVE COMMUNITY, IN CLASS 41 (U.S. CLS. 100, 101 AND 107).

FIRST USE 11-30-2010; IN COMMERCE 11-30-2010.

THE MARK CONSISTS OF STANDARD CHARACTERS WITHOUT CLAIM TO ANY PARTICULAR FONT, STYLE, SIZE, OR COLOR.

SER. NO. 85-328,814, FILED 5-24-2011.

ERIN FALK, EXAMINING ATTORNEY



David J. Kybas

Director of the United States Patent and Trademark Office

United States of America

United States Patent and Trademark Office

ALES OF THE REVOLUTION

Reg. No. 4,074,229

YARDS BREWING COMPANY, LLC (PENNSYLVANIA LIMITED LIABILITY COMPANY)
901 N. DELAWARE AVENUE
PHILADELPHIA, PA 19123

Registered Dec. 20, 2011

Int. Cls.: 21, 25 and 32

FOR: DRINKING GLASSES, IN CLASS 21 (U.S. CLS. 2, 13, 23, 29, 30, 33, 40 AND 50).

TRADEMARK

FIRST USE 3-15-2011; IN COMMERCE 3-15-2011.

PRINCIPAL REGISTER

FOR: SHIRTS, IN CLASS 25 (U.S. CLS. 22 AND 39).

FIRST USE 2-15-2011; IN COMMERCE 2-15-2011.

FOR: BEER, ALE, LAGER, STOUT AND PORTER, IN CLASS 32 (U.S. CLS. 45, 46 AND 48).

FIRST USE 11-15-1999; IN COMMERCE 11-15-1999.

THE MARK CONSISTS OF STANDARD CHARACTERS WITHOUT CLAIM TO ANY PARTICULAR FONT, STYLE, SIZE, OR COLOR.

NO CLAIM IS MADE TO THE EXCLUSIVE RIGHT TO USE "ALES" IN CLASS 32, APART FROM THE MARK AS SHOWN.

SER. NO. 85-329,412, FILED 5-24-2011.

JAMES LOVELACE, EXAMINING ATTORNEY



David J. Kybas

Director of the United States Patent and Trademark Office

United States of America

United States Patent and Trademark Office



Reg. No. 4,074,230

TAMARA CIASULLI (UNITED STATES INDIVIDUAL)
4 GLANNON ROAD
LIVINGSTON, NJ 07039

Registered Dec. 20, 2011

Int. Cl.: 44

FOR: BEAUTY CARE, NAMELY, HAIRCUTS, HAIR STYLING, HAIR COLORING, HAIR HIGHLIGHTS, MAKE UP, AND HAIR EXTENSIONS, IN CLASS 44 (U.S. CLS. 100 AND 101).

SERVICE MARK

FIRST USE 3-3-2011; IN COMMERCE 3-3-2011.

PRINCIPAL REGISTER

THE MARK CONSISTS OF A WOMAN WEARING A FLOWER IN HER HAIR, A SCARF TIED AROUND HER NECK, THREE BRACELETS ON HER RIGHT WRIST, A BLOUSE TIED ABOVE HER WAIST WITH THE SLEEVES ROLLED UP, FORM-FITTING PANTS CUFFED ABOVE THE ANKLES, AND HIGH-HEELED SHOES. BEHIND THE WOMAN IS A WALL-MOUNTED, CORDED PHONE. THE WOMAN HAS THE RECEIVER OF THE PHONE PRESSED AGAINST THE RIGHT SIDE OF HER FACE WITH HER RIGHT HAND. THE WOMAN IS HOLDING A PAIR OF SCISSORS UP IN THE AIR IN HER LEFT HAND, AND HAS HER LEFT LEG KICKED UP BEHIND HER.

SER. NO. 85-329,570, FILED 5-25-2011.

ELI HELLMAN, EXAMINING ATTORNEY



David J. Kyffers

Director of the United States Patent and Trademark Office

United States of America

United States Patent and Trademark Office

HI DEMAND

Reg. No. 4,074,231

YZY INC (FLORIDA CORPORATION)
6300 NW 72ND AVENUE
MIAMI, FL 33166

Registered Dec. 20, 2011

Int. Cl.: 3

FOR: COLOGNES, PERFUMES AND COSMETICS; EAU DE TOILETTE AND EAU DE COLOGNE; PERFUMES AND COLOGNES; PERFUMES AND TOILET WATERS; PERFUMES, EAU DE COLOGNES AND AFTERSHAVES , IN CLASS 3 (U.S. CLS. 1, 4, 6, 50, 51 AND 52).

TRADEMARK

FIRST USE 8-2-2010; IN COMMERCE 8-2-2010.

PRINCIPAL REGISTER

THE MARK CONSISTS OF STANDARD CHARACTERS WITHOUT CLAIM TO ANY PARTICULAR FONT, STYLE, SIZE, OR COLOR.

SER. NO. 85-329,897, FILED 5-25-2011.

MICHAEL SOUDERS, EXAMINING ATTORNEY



David J. Kyffers

Director of the United States Patent and Trademark Office

United States of America

United States Patent and Trademark Office

NPB

Reg. No. 4,074,232

ALABAMA PRODUCTIONS, INC. (PENNSYLVANIA CORPORATION)
1120 OAKHURST LANE
LOWER GWYNEDD, PA 19002

Registered Dec. 20, 2011

Int. Cl.: 35

FOR: ENTERTAINMENT MARKETING SERVICES, NAMELY, MARKETING, PROMOTION AND ADVERTISING FOR RECORDING AND PERFORMING ARTISTS, IN CLASS 35 (U.S. CLS. 100, 101 AND 102).

SERVICE MARK

FIRST USE 12-15-2008; IN COMMERCE 12-15-2008.

PRINCIPAL REGISTER

THE MARK CONSISTS OF STANDARD CHARACTERS WITHOUT CLAIM TO ANY PARTICULAR FONT, STYLE, SIZE, OR COLOR.

SER. NO. 85-331,027, FILED 5-26-2011.

JULIE WATSON, EXAMINING ATTORNEY



David J. Kyffers

Director of the United States Patent and Trademark Office

United States of America

United States Patent and Trademark Office

ART INTERNET SOLUTIONS

Reg. No. 4,074,233

Registered Dec. 20, 2011

Int. Cl.: 42

SERVICE MARK

PRINCIPAL REGISTER

ACTIVE RELEASE TECHNIQUES, LLC (COLORADO LIMITED LIABILITY COMPANY)
SUITE 210
9240 EXPLORER DRIVE
COLORADO SPRINGS, CO 80920

FOR: APPLICATION SERVICE PROVIDER, NAMELY, HOSTING, MANAGING, DEVELOPING, AND MAINTAINING APPLICATIONS, SOFTWARE, AND WEBSITES, IN THE FIELD OF HEALTHCARE, IN CLASS 42 (U.S. CLS. 100 AND 101).

FIRST USE 1-1-2011; IN COMMERCE 1-1-2011.

THE MARK CONSISTS OF STANDARD CHARACTERS WITHOUT CLAIM TO ANY PARTICULAR FONT, STYLE, SIZE, OR COLOR.

OWNER OF U.S. REG. NO. 2,487,797.

NO CLAIM IS MADE TO THE EXCLUSIVE RIGHT TO USE "INTERNET SOLUTIONS", APART FROM THE MARK AS SHOWN.

SER. NO. 85-331,072, FILED 5-26-2011.

ELISSA GARBER KON, EXAMINING ATTORNEY



David J. Kybas

Director of the United States Patent and Trademark Office

United States of America

United States Patent and Trademark Office

GET 'EM TO GO!

Reg. No. 4,074,234

Registered Dec. 20, 2011

Int. Cl.: 30

TRADEMARK

PRINCIPAL REGISTER

MARS, INCORPORATED (DELAWARE CORPORATION)
TM DOCKET
6885 ELM STREET
MCLEAN, VA 221013883

FOR: GRAIN BASED SNACK FOODS, NAMELY, FLOUR-BASED BAKED HOLLOW SHELLS WITH FLAVORED FILLINGS, IN CLASS 30 (U.S. CL. 46).

FIRST USE 4-30-2011; IN COMMERCE 4-30-2011.

THE MARK CONSISTS OF STANDARD CHARACTERS WITHOUT CLAIM TO ANY PARTICULAR FONT, STYLE, SIZE, OR COLOR.

SER. NO. 85-331,585, FILED 5-26-2011.

GRETCHEN ULRICH, EXAMINING ATTORNEY



David J. Kyjars

Director of the United States Patent and Trademark Office

United States of America

United States Patent and Trademark Office



Reg. No. 4,074,235

CHIVAS HOLDINGS (IP) LIMITED (UNITED KINGDOM COMPANY)
111-113 RENFREW ROAD, PAISLEY
RENFREWSHIRE, UNITED KINGDOM PA34DY

Registered Dec. 20, 2011

Int. Cls.: 33 and 43

FOR: ALCOHOLIC BEVERAGES EXCEPT BEER, IN CLASS 33 (U.S. CLS. 47 AND 49).

TRADEMARK

FOR: PROVIDING FOOD AND DRINK SERVICES , IN CLASS 43 (U.S. CLS. 100 AND 101).

SERVICE MARK

OWNER OF ERPN CMNTY TM OFC REG. NO. 008554172, DATED 3-16-2010, EXPIRES 9-16-2019.

PRINCIPAL REGISTER

THE COLOR(S) GOLD IS/ARE CLAIMED AS A FEATURE OF THE MARK.

THE MARK CONSISTS OF A FANCIFUL DESIGN CONSISTING PRIMARILY OF A VINE WITH A SERIES OF INTERCONNECTED SWIRLS FEATURING A LION FIGURE, A CROWN FIGURE, FLOWERS, AND FANCIFUL ORNAMENTAL OBJECTS ALL IN THE COLOR GOLD.

SER. NO. 85-332,146, FILED 5-27-2011.

WILLIAM ROSSMAN, EXAMINING ATTORNEY



David J. Kyfos

Director of the United States Patent and Trademark Office

United States of America

United States Patent and Trademark Office

EndoGator

Reg. No. 4,074,236

Registered Dec. 20, 2011

Int. Cl.: 10

TRADEMARK

PRINCIPAL REGISTER

BYRNE MEDICAL, INC (TEXAS CORPORATION)
LEGAL DEPARTMENT
3150 POLLOK DR
CONROE, TX 77303

FOR: ENDOSCOPE ACCESSORIES, NAMELY, DISPOSABLE NON-METAL WATER BOTTLE ADAPTERS, IN CLASS 10 (U.S. CLS. 26, 39 AND 44).

FIRST USE 6-30-2004; IN COMMERCE 6-30-2004.

THE MARK CONSISTS OF STANDARD CHARACTERS WITHOUT CLAIM TO ANY PARTICULAR FONT, STYLE, SIZE, OR COLOR.

SER. NO. 85-332,597, FILED 5-27-2011.

B. PARADEWELAI, EXAMINING ATTORNEY



David J. Kyffers

Director of the United States Patent and Trademark Office

United States of America

United States Patent and Trademark Office

COMBINE 4.0

Reg. No. 4,074,237

WILLIAMS, EMORY L (UNITED STATES INDIVIDUAL)
11261 DOUGLAS DRIVE
MIAMI, FL 33176

Registered Dec. 20, 2011

Int. Cl.: 12

FOR: MOTOR VEHICLES, NAMELY, AUTOMOBILES, TRUCKS, VANS, SPORT UTILITY VEHICLES AND STRUCTURAL PARTS THEREFOR, IN CLASS 12 (U.S. CLS. 19, 21, 23, 31, 35 AND 44).

TRADEMARK

FIRST USE 11-5-2010; IN COMMERCE 11-5-2010.

PRINCIPAL REGISTER

THE MARK CONSISTS OF STANDARD CHARACTERS WITHOUT CLAIM TO ANY PARTICULAR FONT, STYLE, SIZE, OR COLOR.

SER. NO. 85-333,107, FILED 5-28-2011.

LAKEISHA LEWIS, EXAMINING ATTORNEY



David J. Kyffers

Director of the United States Patent and Trademark Office

United States of America

United States Patent and Trademark Office

iSession

Reg. No. 4,074,238

Registered Dec. 20, 2011

Int. Cl.: 9

TRADEMARK

PRINCIPAL REGISTER

F5 NETWORKS, INC. (WASHINGTON CORPORATION)
401 ELLIOTT AVE WEST
SEATTLE, WA 98119

FOR: COMPUTER SOFTWARE AND COMPUTER HARDWARE FOR USE IN MANAGING COMMUNICATIONS TRAFFIC OVER THE INTERNET AND NETWORKS WITH OR WITHOUT STATEFUL MIDDLEWARE, AND FOR IMPROVING THE AVAILABILITY, SECURITY AND PERFORMANCE OF INTERNET AND NETWORK SERVERS AND APPLICATIONS, AND FOR MANAGING COMMUNICATIONS TRAFFIC OVER THE INTERNET AND NETWORKS WITH OR WITHOUT STATEFUL MIDDLEWARE FOR THE PURPOSE OF MANAGING STORAGE VIRTUALIZATION DEVICES AND APPLICATIONS, IN CLASS 9 (U.S. CLS. 21, 23, 26, 36 AND 38).

FIRST USE 5-5-2009; IN COMMERCE 5-5-2009.

THE MARK CONSISTS OF STANDARD CHARACTERS WITHOUT CLAIM TO ANY PARTICULAR FONT, STYLE, SIZE, OR COLOR.

SER. NO. 85-334,323, FILED 5-31-2011.

MARK SPARACINO, EXAMINING ATTORNEY



David J. Kyffers

Director of the United States Patent and Trademark Office

United States of America
United States Patent and Trademark Office

my
Touch

Reg. No. 4,074,239

T-MOBILE USA, INC. (DELAWARE CORPORATION)
12920 S.E. 38TH STREET
BELLEVUE, WA 98006

Registered Dec. 20, 2011

Int. Cl.: 9

FOR: MOBILE PHONES, IN CLASS 9 (U.S. CLS. 21, 23, 26, 36 AND 38).

TRADEMARK

FIRST USE 7-8-2009; IN COMMERCE 7-8-2009.

PRINCIPAL REGISTER

OWNER OF U.S. REG. NOS. 3,729,926, 3,794,822 AND OTHERS.

THE MARK CONSISTS OF THE WORD "MY" WHICH APPEARS IN LOWER CASE LETTERS ABOVE THE WORD "TOUCH", AND THE BOTTOM OF THE LETTER "Y" IN "MY" IS USED TO REPRESENT THE LETTER "O" IN THE WORD "TOUCH".

SER. NO. 85-334,478, FILED 5-31-2011.

JENNIFER DIXON, EXAMINING ATTORNEY



David J. Kyros

Director of the United States Patent and Trademark Office

United States of America

United States Patent and Trademark Office

SANDBOX

Reg. No. 4,074,240

9 CLOUDS, INC. (SOUTH DAKOTA CORPORATION)
401 EAST 8TH STREET, SUITE 203A
SIOUX FALLS, SD 57103

Registered Dec. 20, 2011

Int. Cl.: 41

FOR: EDUCATION SERVICES, NAMELY CONDUCTING ONLINE TRAINING IN THE FIELD OF SOCIAL MEDIA AND DIGITAL TOOLS, IN CLASS 41 (U.S. CLS. 100, 101 AND 107).

SERVICE MARK

FIRST USE 3-11-2011; IN COMMERCE 3-11-2011.

PRINCIPAL REGISTER

THE MARK CONSISTS OF STANDARD CHARACTERS WITHOUT CLAIM TO ANY PARTICULAR FONT, STYLE, SIZE, OR COLOR.

SER. NO. 85-334,912, FILED 6-1-2011.

TOBY BULLOFF, EXAMINING ATTORNEY



David J. Kyffers

Director of the United States Patent and Trademark Office

United States of America

United States Patent and Trademark Office

IT'S MORE THAN THREE GAMES

Reg. No. 4,074,241

Registered Dec. 20, 2011

Int. Cl.: 41

SERVICE MARK

PRINCIPAL REGISTER

THE NATIONAL COLLEGIATE ATHLETIC ASSOCIATION (INDIANA UNINCORPORATED ASSOCIATION)
P.O. BOX 6222
INDIANAPOLIS, IN 46206

FOR: ENTERTAINMENT SERVICES IN THE NATURE OF ATHLETIC CONTESTS, GAMES, TOURNAMENTS, EXHIBITIONS AND EVENTS, IN CLASS 41 (U.S. CLS. 100, 101 AND 107).

FIRST USE 3-0-2011; IN COMMERCE 3-0-2011.

THE MARK CONSISTS OF STANDARD CHARACTERS WITHOUT CLAIM TO ANY PARTICULAR FONT, STYLE, SIZE, OR COLOR.

SER. NO. 85-335,628, FILED 6-1-2011.

ANDREA BUTLER, EXAMINING ATTORNEY



David J. Kybas

Director of the United States Patent and Trademark Office

United States of America

United States Patent and Trademark Office

(I. O. U.)

Reg. No. 4,074,242

CLIFFORD, TRACEY (UNITED STATES INDIVIDUAL)
920 VIEWPOINTE DR
ST. CHARLES, IL 60174

Registered Dec. 20, 2011

Int. Cls.: 41, 44 and 45

FOR: EDUCATION SERVICES, NAMELY, PROVIDING WORKSHOPS, SEMINARS, CLASSES IN THE FIELD OF BUSINESS LEADERSHIP, TEAM DEVELOPMENT, AND PSYCHOLOGY; PROFESSIONAL COACHING SERVICES IN THE FIELD OF PSYCHOLOGY, IN CLASS 41 (U.S. CLS. 100, 101 AND 107).

SERVICE MARK

PRINCIPAL REGISTER

FIRST USE 7-3-2003; IN COMMERCE 5-27-2005.

FOR: PSYCHOLOGICAL COUNSELING, IN CLASS 44 (U.S. CLS. 100 AND 101).

FIRST USE 7-3-2003; IN COMMERCE 5-27-2005.

FOR: COUNSELING IN THE FIELD OF PERSONAL DEVELOPMENT, NAMELY, SELF-IMPROVEMENT, SELF-FULFILLMENT, AND INTERPERSONAL COMMUNICATION, IN CLASS 45 (U.S. CLS. 100 AND 101).

FIRST USE 7-3-2003; IN COMMERCE 5-27-2005.

THE MARK CONSISTS OF STANDARD CHARACTERS WITHOUT CLAIM TO ANY PARTICULAR FONT, STYLE, SIZE, OR COLOR.

SER. NO. 85-335,668, FILED 6-1-2011.

JAMES STEIN, EXAMINING ATTORNEY



David J. Kybas

Director of the United States Patent and Trademark Office

United States of America

United States Patent and Trademark Office

BioLiner

Reg. No. 4,074,243

RAMONA HEADIFEN (UNITED STATES INDIVIDUAL)
305 DUNBOYNE PL
THIBODAU, LA 70301

Registered Dec. 20, 2011

Int. Cl.: 9

FOR: SOIL SAMPLING EQUIPMENT, NAMELY, TUBULAR LINERS OR TUBULAR SLEEVES,
IN CLASS 9 (U.S. CLS. 21, 23, 26, 36 AND 38).

TRADEMARK

FIRST USE 4-26-2010; IN COMMERCE 11-1-2010.

PRINCIPAL REGISTER

THE MARK CONSISTS OF STANDARD CHARACTERS WITHOUT CLAIM TO ANY PAR-
TICULAR FONT, STYLE, SIZE, OR COLOR.

SER. NO. 85-335,866, FILED 6-2-2011.

APRIL ROACH, EXAMINING ATTORNEY



David J. Kybas

Director of the United States Patent and Trademark Office

United States of America

United States Patent and Trademark Office

CONSISTENTLY DELIVERING
EXTRAORDINARY EXPERIENCES

Reg. No. 4,074,244

CERTA PROPAINTERS, LTD. (MASSACHUSETTS CORPORATION)
150 GREEN TREE ROAD, SUITE 1003
OAKS, PA 19456

Registered Dec. 20, 2011

Int. Cl.: 37

FOR: PAINTING SERVICES, NAMELY, PAINTING RESIDENTIAL AND COMMERCIAL BUILDINGS, IN CLASS 37 (U.S. CLS. 100, 103 AND 106).

SERVICE MARK

FIRST USE 1-4-2011; IN COMMERCE 1-4-2011.

PRINCIPAL REGISTER

THE MARK CONSISTS OF STANDARD CHARACTERS WITHOUT CLAIM TO ANY PARTICULAR FONT, STYLE, SIZE, OR COLOR.

SER. NO. 85-335,951, FILED 6-2-2011.

MARY BOAGNI, EXAMINING ATTORNEY



David J. Kyffers

Director of the United States Patent and Trademark Office

United States of America

United States Patent and Trademark Office

LIFE LANTERN

Reg. No. 4,074,245

SPARK INNOVATORS, CORP. (NEW JERSEY CORPORATION)
24 COMMERCE ROAD SUITE I
FAIRFIELD, NJ 07004

Registered Dec. 20, 2011

Int. Cl.: 11

FOR: LANTERNS; LANTERNS FOR LIGHTING, IN CLASS 11 (U.S. CLS. 13, 21, 23, 31 AND 34).

TRADEMARK

FIRST USE 12-10-2009; IN COMMERCE 1-10-2010.

PRINCIPAL REGISTER

THE MARK CONSISTS OF STANDARD CHARACTERS WITHOUT CLAIM TO ANY PARTICULAR FONT, STYLE, SIZE, OR COLOR.

NO CLAIM IS MADE TO THE EXCLUSIVE RIGHT TO USE "LANTERN", APART FROM THE MARK AS SHOWN.

SER. NO. 85-336,083, FILED 6-2-2011.

ANNE E. GUSTASON, EXAMINING ATTORNEY



David J. Kyffers

Director of the United States Patent and Trademark Office

United States of America

United States Patent and Trademark Office

supplies
Onthefly.com

Reg. No. 4,074,246

SYSKO CORPORATION (DELAWARE CORPORATION)
1390 ENCLAVE PARKWAY
HOUSTON, TX 770771390

Registered Dec. 20, 2011

Int. Cl.: 35

FOR: ON-LINE RETAIL STORE SERVICES FEATURING RESTAURANT SUPPLIES AND EQUIPMENT AND OFFICE SUPPLIES, IN CLASS 35 (U.S. CLS. 100, 101 AND 102).

SERVICE MARK

FIRST USE 8-20-2010; IN COMMERCE 8-20-2010.

PRINCIPAL REGISTER

NO CLAIM IS MADE TO THE EXCLUSIVE RIGHT TO USE "SUPPLIES", APART FROM THE MARK AS SHOWN.

THE MARK CONSISTS OF THE BROWN WORDS "SUPPLIES" ON TOP OF A STYLIZED "O" PLATE DESIGN WITH A FORK AND KNIFE BESIDE THE GREEN LETTERS "NTHEFLY.COM".

SER. NO. 85-336,318, FILED 6-2-2011.

WARREN L. OLANDRIA, EXAMINING ATTORNEY



David J. Kyros

Director of the United States Patent and Trademark Office

United States of America

United States Patent and Trademark Office

DURABIO

Reg. No. 4,074,247

MITSUBISHI CHEMICAL CORPORATION (JAPAN CORPORATION)

Registered Dec. 20, 2011

14-1, SHIBA 4-CHOME
MINATO-KU, TOKYO, JAPAN

Int. Cls.: 1 and 17

FOR: UNPROCESSED ARTIFICIAL RESINS; UNPROCESSED PLASTICS FOR INDUSTRIAL USE, IN CLASS 1 (U.S. CLS. 1, 5, 6, 10, 26 AND 46).

TRADEMARK

FOR: PLASTICS IN THE FORM OF FILMS; SEMI-PROCESSED PLASTICS, IN CLASS 17 (U.S. CLS. 1, 5, 12, 13, 35 AND 50).

PRINCIPAL REGISTER

THE MARK CONSISTS OF STANDARD CHARACTERS WITHOUT CLAIM TO ANY PARTICULAR FONT, STYLE, SIZE, OR COLOR.

OWNER OF JAPAN REG. NO. 5328174, DATED 6-4-2010, EXPIRES 6-4-2020.

SER. NO. 85-336,630, FILED 6-2-2011.

PAM WILLIS, EXAMINING ATTORNEY



David J. Kybas

Director of the United States Patent and Trademark Office

United States of America

United States Patent and Trademark Office

MELON PATCH

Reg. No. 4,074,248

Registered Dec. 20, 2011

Int. Cl.: 30

TRADEMARK

PRINCIPAL REGISTER

FARLEY'S & SATHERS CANDY COMPANY, INC. (DELAWARE CORPORATION)
P.O. BOX 28, ONE SATHER PLAZA
ROUND LAKE, MN 56167

FOR: CANDY, IN CLASS 30 (U.S. CL. 46).

FIRST USE 4-0-1994; IN COMMERCE 4-0-1994.

THE MARK CONSISTS OF STANDARD CHARACTERS WITHOUT CLAIM TO ANY PARTICULAR FONT, STYLE, SIZE, OR COLOR.

NO CLAIM IS MADE TO THE EXCLUSIVE RIGHT TO USE "MELON", APART FROM THE MARK AS SHOWN.

SER. NO. 85-337,146, FILED 6-3-2011.

KAREN BRACEY, EXAMINING ATTORNEY



David J. Kyffers

Director of the United States Patent and Trademark Office

United States of America

United States Patent and Trademark Office



TelaPoint

Reg. No. 4,074,249

Registered Dec. 20, 2011

Int. Cl.: 42

SERVICE MARK

PRINCIPAL REGISTER

WRIGHT EXPRESS CORPORATION (DELAWARE CORPORATION)
97 DARLING AVENUE
SOUTH PORTLAND, ME 04106

FOR: APPLICATION SERVICE PROVIDER (ASP) FEATURING SOFTWARE IN THE FIELD OF SUPPLY CHAIN MANAGEMENT, FOR FACILITATING AND MANAGING SUPPLY CHAIN COMMUNICATIONS AND BUSINESS TRANSACTIONS VIA THE INTERNET; APPLICATION SERVICE PROVIDER (ASP) FEATURING SOFTWARE IN THE FIELD OF ENVIRONMENTAL COMPLIANCE REPORTING, FOR FACILITATING COMPLIANCE WITH ENVIRONMENTAL LAWS AND REGULATIONS; PROVIDING TEMPORARY USE OF NON-DOWNLOADABLE COMPUTER SOFTWARE IN THE FIELD OF SUPPLY CHAIN MANAGEMENT, FOR FACILITATING AND MANAGING SUPPLY CHAIN COMMUNICATIONS AND BUSINESS TRANSACTIONS VIA THE INTERNET; PROVIDING TEMPORARY USE OF NON-DOWNLOADABLE COMPUTER SOFTWARE IN THE FIELD OF ENVIRONMENTAL COMPLIANCE REPORTING, FOR FACILITATING COMPLIANCE WITH ENVIRONMENTAL LAWS AND REGULATIONS, IN CLASS 42 (U.S. CLS. 100 AND 101).

FIRST USE 5-11-2009; IN COMMERCE 5-11-2009.

OWNER OF U.S. REG. NOS. 3,347,326, 3,347,331, AND 3,798,707.

THE MARK CONSISTS OF THE STYLIZED WORD "TELAPOINT" TO THE RIGHT OF A MISCELLANEOUS DESIGN WITH AN OVERALL DIAMOND SHAPE WITHIN WHICH ARE SIX CURVED BANDS.

SER. NO. 85-337,185, FILED 6-3-2011.

KAPIL BHANOT, EXAMINING ATTORNEY



David J. Kyros

Director of the United States Patent and Trademark Office

United States of America

United States Patent and Trademark Office

I AM A MAN OF GOD

Reg. No. 4,074,250

RAMOS, ROXANNE (UNITED STATES INDIVIDUAL)
360 CONNECTICUT AVE, #143
NORWALK, CT 06854

Registered Dec. 20, 2011

Int. Cl.: 25

FOR: HATS; PANTS; SHIRTS, IN CLASS 25 (U.S. CLS. 22 AND 39).

TRADEMARK

FIRST USE 10-0-2010; IN COMMERCE 10-20-2010.

PRINCIPAL REGISTER

THE MARK CONSISTS OF STANDARD CHARACTERS WITHOUT CLAIM TO ANY PARTICULAR FONT, STYLE, SIZE, OR COLOR.

OWNER OF U.S. REG. NO. 3,965,677.

SER. NO. 85-337,542, FILED 6-3-2011.

DAVID C. REIHNER, EXAMINING ATTORNEY



David J. Kyffers

Director of the United States Patent and Trademark Office

United States of America

United States Patent and Trademark Office

medialifTV

Reg. No. 4,074,251

MEDIALIFTV (CALIFORNIA LIMITED LIABILITY COMPANY)
17731 COWAN
IRVINE, CA 92614

Registered Dec. 20, 2011

Int. Cl.: 9

FOR: WATERPROOF TELEVISION ENCLOSURE FOR USE IN ENCLOSING TELEVISIONS FOR WHEN VIEWING THEM IN OUTDOOR SETTINGS AND SECURING THEM FROM ANY WEATHER-RELATED DAMAGE, IN CLASS 9 (U.S. CLS. 21, 23, 26, 36 AND 38).

TRADEMARK

FIRST USE 4-1-2011; IN COMMERCE 5-1-2011.

PRINCIPAL REGISTER

THE MARK CONSISTS OF STANDARD CHARACTERS WITHOUT CLAIM TO ANY PARTICULAR FONT, STYLE, SIZE, OR COLOR.

SER. NO. 85-338,548, FILED 6-6-2011.

RON FAIRBANKS, EXAMINING ATTORNEY



David J. Kyffers

Director of the United States Patent and Trademark Office

United States of America

United States Patent and Trademark Office

BEYOND THE BACKPACK

Reg. No. 4,074,252

VIACOM INTERNATIONAL INC. (DELAWARE CORPORATION)

Registered Dec. 20, 2011

1515 BROADWAY
NEW YORK, NY 10036

Int. Cl.: 35

FOR: PROVIDING A CONTINUING SERIES OF PUBLIC SERVICE CAMPAIGNS PROMOTING PUBLIC AWARENESS OF THE SOCIAL AND CULTURAL SIGNIFICANCE OF SCHOOL READINESS VIA ALL FORMS OF MEDIA, INCLUDING TELEVISION, LIVE EVENTS, PRINT, THE GLOBAL COMPUTER NETWORK AND RADIO, IN CLASS 35 (U.S. CLS. 100, 101 AND 102).

SERVICE MARK

PRINCIPAL REGISTER

FIRST USE 5-17-2010; IN COMMERCE 5-17-2010.

THE MARK CONSISTS OF STANDARD CHARACTERS WITHOUT CLAIM TO ANY PARTICULAR FONT, STYLE, SIZE, OR COLOR.

SER. NO. 85-338,965, FILED 6-6-2011.

TINA MAI, EXAMINING ATTORNEY



David J. Kyffers

Director of the United States Patent and Trademark Office

United States of America

United States Patent and Trademark Office

FUZZY'S TACO SHOP

Reg. No. 4,074,253

Registered Dec. 20, 2011

Int. Cl.: 35

SERVICE MARK

PRINCIPAL REGISTER

FUZZY'S TACO HOLDINGS, LLC (TEXAS LIMITED LIABILITY COMPANY)
200 BAILEY AVENUE
SUITE 100
FORT WORTH, TX 76107

FOR: ON-LINE RETAIL STORE SERVICES FEATURING CLOTHING, HEAD WEAR, FOOTWEAR, CONDIMENTS, KEY CHAINS, STICKERS, INSULATED BEVERAGE HOLDERS, CUPS, MUGS AND GLASSES, IN CLASS 35 (U.S. CLS. 100, 101 AND 102).

FIRST USE 12-1-2004; IN COMMERCE 12-1-2004.

THE MARK CONSISTS OF STANDARD CHARACTERS WITHOUT CLAIM TO ANY PARTICULAR FONT, STYLE, SIZE, OR COLOR.

OWNER OF U.S. REG. NOS. 3,494,474, 3,969,926, AND 3,969,929.

NO CLAIM IS MADE TO THE EXCLUSIVE RIGHT TO USE "SHOP", APART FROM THE MARK AS SHOWN.

SER. NO. 85-338,998, FILED 6-6-2011.

KATHLEEN LORENZO, EXAMINING ATTORNEY



David J. Kybas

Director of the United States Patent and Trademark Office

United States of America

United States Patent and Trademark Office



Reg. No. 4,074,254

Registered Dec. 20, 2011

Int. Cl.: 35

SERVICE MARK

PRINCIPAL REGISTER

FUZZY'S TACO HOLDINGS, LLC (TEXAS LIMITED LIABILITY COMPANY)
SUITE 100
200 BAILEY AVENUE
FORT WORTH, TX 76107

FOR: ON-LINE RETAIL STORE SERVICES FEATURING CLOTHING, HEAD WEAR, FOOTWEAR, CONDIMENTS, KEY CHAINS, STICKERS, INSULATED BEVERAGE HOLDERS, CUPS, MUGS AND GLASSES, IN CLASS 35 (U.S. CLS. 100, 101 AND 102).

FIRST USE 12-1-2004; IN COMMERCE 12-1-2004.

OWNER OF U.S. REG. NOS. 3,494,474, 3,969,929 AND OTHERS.

NO CLAIM IS MADE TO THE EXCLUSIVE RIGHT TO USE "SHOP", APART FROM THE MARK AS SHOWN.

THE MARK CONSISTS OF THE WORD, "FUZZY'S", IN OUTLINED CAPITAL STYLIZED LETTERING ABOVE A CHILI PEPPER HAVING A STEM AND CROWN SECTION AND A POD SECTION, WITH THE WORDS, "TACO SHOP", IN OUTLINED CAPITAL LETTERING IMPOSED OVER BOTH SECTIONS. COLOR IS NOT A CLAIMED COMPONENT OF THE MARK.

SER. NO. 85-339,007, FILED 6-6-2011.

KATHLEEN LORENZO, EXAMINING ATTORNEY



David J. Kyjars

Director of the United States Patent and Trademark Office

United States of America

United States Patent and Trademark Office

EARTH ELEMENTS

Reg. No. 4,074,255

Registered Dec. 20, 2011

Int. Cl.: 28

TRADEMARK

PRINCIPAL REGISTER

HUGGER-MUGGER YOGA PRODUCTS, LLC (DELAWARE LIMITED LIABILITY COMPANY)
1190 S. PIONEER ROAD
SALT LAKE CITY, UT 84104

FOR: YOGA MATS, IN CLASS 28 (U.S. CLS. 22, 23, 38 AND 50).

FIRST USE 2-3-2005; IN COMMERCE 2-3-2005.

THE MARK CONSISTS OF STANDARD CHARACTERS WITHOUT CLAIM TO ANY PARTICULAR FONT, STYLE, SIZE, OR COLOR.

SER. NO. 85-339,037, FILED 6-6-2011.

ANDREA BUTLER, EXAMINING ATTORNEY



David J. Kyffers

Director of the United States Patent and Trademark Office

United States of America

United States Patent and Trademark Office



Reg. No. 4,074,256

WIN PARTNERS, LLC (CALIFORNIA LIMITED LIABILITY COMPANY)
2150 N. LINCOLN ST.
BURBANK, CA 91504

Registered Dec. 20, 2011

Int. Cl.: 37

FOR: CHARGING STATION SERVICES FOR ELECTRIC VEHICLES, IN CLASS 37 (U.S. CLS. 100, 103 AND 106).

SERVICE MARK

FIRST USE 5-30-2011; IN COMMERCE 5-30-2011.

PRINCIPAL REGISTER

NO CLAIM IS MADE TO THE EXCLUSIVE RIGHT TO USE "CHARGING", APART FROM THE MARK AS SHOWN.

THE MARK CONSISTS OF A LIGHTNING BOLT NEXT TO THE STYLIZED WORDING "ZAP CHARGING".

SER. NO. 85-339,336, FILED 6-6-2011.

BRENDAN MCCAULEY, EXAMINING ATTORNEY



David J. Kybas

Director of the United States Patent and Trademark Office

United States of America
United States Patent and Trademark Office

TOVATEC

Reg. No. 4,074,257

INTERNATIONAL INNOVATIONS, INC. (HAWAII CORPORATION)
935 MAKAHIKI WAY, SECOND FLOOR
HONOLULU, HI 96826

Registered Dec. 20, 2011

Int. Cls.: 9 and 11

FOR: BATTERIES, IN CLASS 9 (U.S. CLS. 21, 23, 26, 36 AND 38).

TRADEMARK

FIRST USE 4-1-2011; IN COMMERCE 5-1-2011.

PRINCIPAL REGISTER

FOR: FLASHLIGHTS; TACTICAL FLASHLIGHTS, IN CLASS 11 (U.S. CLS. 13, 21, 23, 31 AND 34).

FIRST USE 4-1-2011; IN COMMERCE 5-1-2011.

THE MARK CONSISTS OF STANDARD CHARACTERS WITHOUT CLAIM TO ANY PARTICULAR FONT, STYLE, SIZE, OR COLOR.

SER. NO. 85-339,385, FILED 6-6-2011.

BARBARA GAYNOR, EXAMINING ATTORNEY



David J. Kyffers

Director of the United States Patent and Trademark Office

United States of America

United States Patent and Trademark Office



Reg. No. 4,074,258

WIN PARTNERS, LLC (CALIFORNIA LIMITED LIABILITY COMPANY)
2150 N. LINCOLN ST.
BURBANK, CA 91504

Registered Dec. 20, 2011

Int. Cl.: 37

FOR: CHARGING STATION SERVICES FOR ELECTRIC VEHICLES, IN CLASS 37 (U.S. CLS. 100, 103 AND 106).

SERVICE MARK

FIRST USE 5-30-2011; IN COMMERCE 5-30-2011.

PRINCIPAL REGISTER

NO CLAIM IS MADE TO THE EXCLUSIVE RIGHT TO USE "CHARGING.COM", APART FROM THE MARK AS SHOWN.

THE MARK CONSISTS OF A LIGHTNING BOLT NEXT TO THE STYLIZED WORDING "ZAP CHARGING.COM".

SER. NO. 85-339,422, FILED 6-7-2011.

BRENDAN MCCAULEY, EXAMINING ATTORNEY



David J. Kybas

Director of the United States Patent and Trademark Office

United States of America

United States Patent and Trademark Office

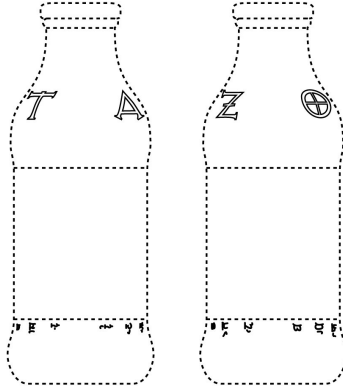

Reg. No. 4,074,259

Registered Dec. 20, 2011

Int. Cls.: 30 and 32

TRADEMARK

PRINCIPAL REGISTER

STARBUCKS CORPORATION (WASHINGTON CORPORATION), DBA STARBUCKS COFFEE COMPANY
2401 UTAH AVENUE SOUTH
SEATTLE, WA 98134

FOR: TEA AND HERBAL TEA; TEA-BASED BEVERAGES; HERBAL TEA-BASED BEVERAGES; TEA AND HERBAL TEA-BASED BEVERAGES WITH FRUIT FLAVORING; HERBAL AND NON-HERBAL TEA; TEA BEVERAGES; BEVERAGES MADE WITH A BASE OF TEA; READY-TO-DRINK TEA, IN CLASS 30 (U.S. CL. 46).

FIRST USE 1-31-2008; IN COMMERCE 1-31-2008.

FOR: FRUIT DRINKS AND SOFT DRINKS CONTAINING FRUIT JUICES; JUICE BASED BEVERAGES, IN CLASS 32 (U.S. CLS. 45, 46 AND 48).

FIRST USE 1-31-2008; IN COMMERCE 1-31-2008.

OWNER OF U.S. REG. NOS. 2,530,823, 3,664,059 AND OTHERS.

THE MARK CONSISTS OF A TWO DIMENSIONAL DRAWING OF THE "TAZO" BOTTLE CONTAINING RAISED STYLIZED LETTERING AROUND THE NECK OF THE BOTTLE THAT FORM THE WORD "TAZO" AND RAISED DECORATIVE SYMBOLS SURROUNDING THE BOTTOM OF THE BOTTLE.

SER. NO. 85-339,499, FILED 6-7-2011.

JOHN WILKE, EXAMINING ATTORNEY



David J. Kybas

Director of the United States Patent and Trademark Office

United States of America

United States Patent and Trademark Office

ChiroPAY

Reg. No. 4,074,260

PAYMENT ALLIANCE INTERNATIONAL, INC. (DELAWARE CORPORATION)
6060 DUTCHMANS LANE, SUITE 320
LOUISVILLE, KY 40205

Registered Dec. 20, 2011

Int. Cl.: 36

FOR: MERCHANT SERVICES, NAMELY, PAYMENT TRANSACTION PROCESSING SERVICES, IN CLASS 36 (U.S. CLS. 100, 101 AND 102).

SERVICE MARK

FIRST USE 6-6-2011; IN COMMERCE 6-6-2011.

PRINCIPAL REGISTER

THE MARK CONSISTS OF STANDARD CHARACTERS WITHOUT CLAIM TO ANY PARTICULAR FONT, STYLE, SIZE, OR COLOR.

SER. NO. 85-339,623, FILED 6-7-2011.

SHAILA SETTLES, EXAMINING ATTORNEY



David J. Kybas

Director of the United States Patent and Trademark Office

United States of America

United States Patent and Trademark Office

DentalPAY

Reg. No. 4,074,261

PAYMENT ALLIANCE INTERNATIONAL, INC. (DELAWARE CORPORATION)
6060 DUTCHMANS LANE, SUITE 320

Registered Dec. 20, 2011

LOUISVILLE, KY 40205

Int. Cl.: 36

FOR: MERCHANT SERVICES, NAMELY, PAYMENT TRANSACTION PROCESSING SERVICES, IN CLASS 36 (U.S. CLS. 100, 101 AND 102).

SERVICE MARK

FIRST USE 6-6-2011; IN COMMERCE 6-6-2011.

PRINCIPAL REGISTER

THE MARK CONSISTS OF STANDARD CHARACTERS WITHOUT CLAIM TO ANY PARTICULAR FONT, STYLE, SIZE, OR COLOR.

SER. NO. 85-339,650, FILED 6-7-2011.

SHAILA SETTLES, EXAMINING ATTORNEY



David J. Kyffers

Director of the United States Patent and Trademark Office

United States of America

United States Patent and Trademark Office

VetPAY

Reg. No. 4,074,262

PAYMENT ALLIANCE INTERNATIONAL, INC. (DELAWARE CORPORATION)
6060 DUTCHMANS LANE, SUITE 320
LOUISVILLE, KY 40205

Registered Dec. 20, 2011

Int. Cl.: 36

FOR: MERCHANT SERVICES, NAMELY, PAYMENT TRANSACTION PROCESSING SERVICES, IN CLASS 36 (U.S. CLS. 100, 101 AND 102).

SERVICE MARK

FIRST USE 6-6-2011; IN COMMERCE 6-6-2011.

PRINCIPAL REGISTER

THE MARK CONSISTS OF STANDARD CHARACTERS WITHOUT CLAIM TO ANY PARTICULAR FONT, STYLE, SIZE, OR COLOR.

SER. NO. 85-339,673, FILED 6-7-2011.

SHAILA SETTLES, EXAMINING ATTORNEY



David J. Kyffers

Director of the United States Patent and Trademark Office

United States of America

United States Patent and Trademark Office

MedSpaPAY

Reg. No. 4,074,263

PAYMENT ALLIANCE INTERNATIONAL, INC. (DELAWARE CORPORATION)
6060 DUTCHMANS LANE, SUITE 320
LOUISVILLE, KY 40205

Registered Dec. 20, 2011

Int. Cl.: 36

FOR: MERCHANT SERVICES, NAMELY, PAYMENT TRANSACTION PROCESSING SERVICES, IN CLASS 36 (U.S. CLS. 100, 101 AND 102).

SERVICE MARK

FIRST USE 6-6-2011; IN COMMERCE 6-6-2011.

PRINCIPAL REGISTER

THE MARK CONSISTS OF STANDARD CHARACTERS WITHOUT CLAIM TO ANY PARTICULAR FONT, STYLE, SIZE, OR COLOR.

SER. NO. 85-339,698, FILED 6-7-2011.

SHAILA SETTLES, EXAMINING ATTORNEY



David J. Kyffers

Director of the United States Patent and Trademark Office

United States of America

United States Patent and Trademark Office

VisionPAY

Reg. No. 4,074,264

PAYMENT ALLIANCE INTERNATIONAL, INC. (DELAWARE CORPORATION)
6060 DUTCHMANS LANE, SUITE 320

Registered Dec. 20, 2011

LOUISVILLE, KY 40205

Int. Cl.: 36

FOR: MERCHANT SERVICES, NAMELY, PAYMENT TRANSACTION PROCESSING SERVICES, IN CLASS 36 (U.S. CLS. 100, 101 AND 102).

SERVICE MARK

FIRST USE 6-6-2011; IN COMMERCE 6-6-2011.

PRINCIPAL REGISTER

THE MARK CONSISTS OF STANDARD CHARACTERS WITHOUT CLAIM TO ANY PARTICULAR FONT, STYLE, SIZE, OR COLOR.

SER. NO. 85-339,709, FILED 6-7-2011.

SHAILA SETTLES, EXAMINING ATTORNEY



David J. Kyffers

Director of the United States Patent and Trademark Office

United States of America
United States Patent and Trademark Office

**DUNGEON
RAIDER**

Reg. No. 4,074,265

Registered Dec. 20, 2011

Int. Cls.: 9 and 41

TRADEMARK

SERVICE MARK

PRINCIPAL REGISTER

SNEAKY GAMES, INC. (TEXAS CORPORATION)
SUITE 202
107 RANCH ROAD 620 S
AUSTIN, TX 78734

FOR: DOWNLOADABLE COMPUTER GAME SOFTWARE VIA A GLOBAL COMPUTER NETWORK AND WIRELESS DEVICES, IN CLASS 9 (U.S. CLS. 21, 23, 26, 36 AND 38).

FIRST USE 6-2-2011; IN COMMERCE 6-2-2011.

FOR: ENTERTAINMENT SERVICES, NAMELY, PROVIDING ON-LINE COMPUTER GAMES; ENTERTAINMENT SERVICES, NAMELY, PROVIDING TEMPORARY USE OF NON-DOWNLOADABLE COMPUTER GAMES; ENTERTAINMENT SERVICES, NAMELY, PROVIDING TEMPORARY USE OF NON-DOWNLOADABLE INTERACTIVE GAMES, IN CLASS 41 (U.S. CLS. 100, 101 AND 107).

FIRST USE 6-2-2011; IN COMMERCE 6-2-2011.

THE MARK CONSISTS OF THE WORD DUNGEON OVER THE WORD RAIDER USING STYLIZED LETTERINGS IN BLACK, WHITE, GRAY AND GREEN COLORING.

THE COLOR(S) BLACK, WHITE, GRAY AND GREEN IS/ARE CLAIMED AS A FEATURE OF THE MARK.

SER. NO. 85-340,564, FILED 6-7-2011.

CARRIE GENOVESE, EXAMINING ATTORNEY



David J. Kyffers

Director of the United States Patent and Trademark Office

United States of America

United States Patent and Trademark Office

DUNGEON RAIDER

Reg. No. 4,074,266

Registered Dec. 20, 2011

Int. Cls.: 9 and 41

TRADEMARK

SERVICE MARK

PRINCIPAL REGISTER

SNEAKY GAMES, INC. (TEXAS CORPORATION)
SUITE 202
107 RANCH ROAD 620 S
AUSTIN, TX 78734

FOR: DOWNLOADABLE COMPUTER GAME SOFTWARE VIA A GLOBAL COMPUTER NETWORK AND WIRELESS DEVICES, IN CLASS 9 (U.S. CLS. 21, 23, 26, 36 AND 38).

FIRST USE 6-2-2011; IN COMMERCE 6-2-2011.

FOR: ENTERTAINMENT SERVICES, NAMELY, PROVIDING ON-LINE COMPUTER GAMES; ENTERTAINMENT SERVICES, NAMELY, PROVIDING TEMPORARY USE OF NON-DOWNLOADABLE COMPUTER GAMES; ENTERTAINMENT SERVICES, NAMELY, PROVIDING TEMPORARY USE OF NON-DOWNLOADABLE INTERACTIVE GAMES, IN CLASS 41 (U.S. CLS. 100, 101 AND 107).

FIRST USE 6-2-2011; IN COMMERCE 6-2-2011.

THE MARK CONSISTS OF STANDARD CHARACTERS WITHOUT CLAIM TO ANY PARTICULAR FONT, STYLE, SIZE, OR COLOR.

SER. NO. 85-340,565, FILED 6-8-2011.

CARRIE GENOVESE, EXAMINING ATTORNEY



David J. Kyffers

Director of the United States Patent and Trademark Office

United States of America

United States Patent and Trademark Office

FURMAN ♦

Reg. No. 4,074,267

FURMAN UNIVERSITY (SOUTH CAROLINA CORPORATION)
3300 POINSETT HIGHWAY
GREENVILLE, SC 29613

Registered Dec. 20, 2011

Int. Cl.: 41

FOR: EDUCATING AT UNIVERSITY OR COLLEGES; ENTERTAINMENT IN THE NATURE OF FOOTBALL, BASKETBALL, BASEBALL, SOCCER, TENNIS AND SWIMMING GAMES, IN CLASS 41 (U.S. CLS. 100, 101 AND 107).

SERVICE MARK

FIRST USE 3-1-1978; IN COMMERCE 3-1-1978.

PRINCIPAL REGISTER

THE MARK CONSISTS OF "FURMAN" AND DIAMOND "F" LOGO.

SER. NO. 85-340,697, FILED 6-8-2011.

NAAKWAMA ANKRAH, EXAMINING ATTORNEY



David J. Kyffers

Director of the United States Patent and Trademark Office

United States of America

United States Patent and Trademark Office



Reg. No. 4,074,268

Registered Dec. 20, 2011

Int. Cl.: 16

TRADEMARK

PRINCIPAL REGISTER

THE CARE COURSES SCHOOL, INC. (VIRGINIA CORPORATION), DBA CARE COURSES
P.O. BOX 10526
MCLEAN, VA 22102

FOR: PRINTED PAMPHLETS, BROCHURES, MANUALS, BOOKS, BOOKLETS, LEAFLETS, FLYERS, INFORMATIONAL SHEETS AND NEWSLETTERS, ADHESIVE BACKED STICKERS, AND KITS COMPRISING ONE OR MORE OF THE FOREGOING MATERIALS IN THE FIELD OF DAY CARE COURSES, IN CLASS 16 (U.S. CLS. 2, 5, 22, 23, 29, 37, 38 AND 50).

FIRST USE 12-0-2005; IN COMMERCE 12-0-2005.

NO CLAIM IS MADE TO THE EXCLUSIVE RIGHT TO USE "EST. 1990", APART FROM THE MARK AS SHOWN.

THE MARK CONSISTS OF A ROUND SEAL WITH THREE CHILDREN AND A DOG IN THE CENTER. THE STYLIZED WORDING "CARING FOR CAREGIVERS" AND "FOR THE FUTURE IS IN THEIR HANDS" SURROUNDS THE DESIGN OF THE CHILDREN AND DOG AT THE INSIDE BORDER OF THE CIRCLE. THE STYLIZED WORDING, "THE CARE COURSES SCHOOL EST. 1990" APPEARS BELOW THE DESIGN OF THE CHILDREN AND DOG.

SEC. 2(F) AS TO "CARING FOR CAREGIVERS" AND "THE CARE COURSES SCHOOL".

SER. NO. 85-341,214, FILED 6-8-2011.

H. M. FISHER, EXAMINING ATTORNEY



David J. Kybas

Director of the United States Patent and Trademark Office

United States of America

United States Patent and Trademark Office

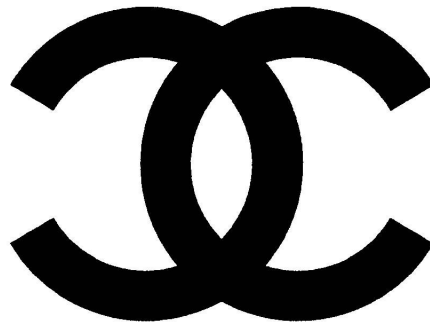

Reg. No. 4,074,269

Registered Dec. 20, 2011

Int. Cls.: 9, 16 and 18

TRADEMARK

PRINCIPAL REGISTER

CHANEL, INC. (NEW YORK CORPORATION)
CHANEL LEGAL DEPARTMENT
9 WEST 57TH STREET
NEW YORK, NY 10019

FOR: PROTECTIVE COVERS FOR PORTABLE ELECTRONIC DEVICES, HANDHELD DIGITAL DEVICES, PERSONAL COMPUTERS AND CELL PHONES, IN CLASS 9 (U.S. CLS. 21, 23, 26, 36 AND 38).

FIRST USE 4-1-2010; IN COMMERCE 4-1-2010.

FOR: TEMPORARY TATTOOS, IN CLASS 16 (U.S. CLS. 2, 5, 22, 23, 29, 37, 38 AND 50).

FIRST USE 4-1-2010; IN COMMERCE 4-1-2010.

FOR: KEY CASES, IN CLASS 18 (U.S. CLS. 1, 2, 3, 22 AND 41).

FIRST USE 4-1-2010; IN COMMERCE 4-1-2010.

OWNER OF U.S. REG. NOS. 1,501,898, 3,025,936 AND OTHERS.

THE MARK CONSISTS OF BACK-TO-BACK INTERLOCKING CS.

SER. NO. 85-341,276, FILED 6-8-2011.

DANNEAN HETZEL, EXAMINING ATTORNEY



David J. Kyffers

Director of the United States Patent and Trademark Office

United States of America

United States Patent and Trademark Office

MOISTURE SURGE

Reg. No. 4,074,270

CLINIQUE LABORATORIES, LLC (DELAWARE LIMITED LIABILITY COMPANY)
767 FIFTH AVENUE
NEW YORK, NY 10153

Registered Dec. 20, 2011

Int. Cl.: 3

FOR: COSMETICS; NON-MEDICATED SKIN CARE PREPARATIONS, IN CLASS 3 (U.S. CLS. 1, 4, 6, 50, 51 AND 52).

TRADEMARK

FIRST USE 8-11-1988; IN COMMERCE 8-11-1988.

PRINCIPAL REGISTER

THE MARK CONSISTS OF STANDARD CHARACTERS WITHOUT CLAIM TO ANY PARTICULAR FONT, STYLE, SIZE, OR COLOR.

OWNER OF U.S. REG. NO. 1,541,151.

NO CLAIM IS MADE TO THE EXCLUSIVE RIGHT TO USE "MOISTURE", APART FROM THE MARK AS SHOWN.

SER. NO. 85-341,278, FILED 6-8-2011.

ANNE MADDEN, EXAMINING ATTORNEY



David J. Kyffers

Director of the United States Patent and Trademark Office

United States of America

United States Patent and Trademark Office

INSIGHTFUL

Reg. No. 4,074,271

SEALY TECHNOLOGY LLC (NORTH CAROLINA LIMITED LIABILITY COMPANY)
ONE OFFICE PARKWAY
TRINITY, NC 27370

Registered Dec. 20, 2011

Int. Cl.: 20

FOR: BOX SPRINGS; MATTRESSES, IN CLASS 20 (U.S. CLS. 2, 13, 22, 25, 32 AND 50).

TRADEMARK

FIRST USE 2-1-2010; IN COMMERCE 2-1-2010.

PRINCIPAL REGISTER

THE MARK CONSISTS OF STANDARD CHARACTERS WITHOUT CLAIM TO ANY PARTICULAR FONT, STYLE, SIZE, OR COLOR.

SER. NO. 85-341,767, FILED 6-9-2011.

WILLIAM P. SHANAHAN, EXAMINING ATTORNEY



David J. Kyffers

Director of the United States Patent and Trademark Office

United States of America

United States Patent and Trademark Office

INTROSPECTION

Reg. No. 4,074,272

SEALY TECHNOLOGY LLC (NORTH CAROLINA LIMITED LIABILITY COMPANY)
ONE OFFICE PARKWAY
TRINITY, NC 27370

Registered Dec. 20, 2011

Int. Cl.: 20

FOR: BOX SPRINGS; MATTRESSES, IN CLASS 20 (U.S. CLS. 2, 13, 22, 25, 32 AND 50).

TRADEMARK

FIRST USE 2-1-2010; IN COMMERCE 2-1-2010.

PRINCIPAL REGISTER

THE MARK CONSISTS OF STANDARD CHARACTERS WITHOUT CLAIM TO ANY PARTICULAR FONT, STYLE, SIZE, OR COLOR.

SER. NO. 85-341,770, FILED 6-9-2011.

WILLIAM P. SHANAHAN, EXAMINING ATTORNEY



David J. Kyffers

Director of the United States Patent and Trademark Office

United States of America

United States Patent and Trademark Office

WE LOVE SENIORS

Reg. No. 4,074,273

Registered Dec. 20, 2011

Int. Cl.: 41

SERVICE MARK

PRINCIPAL REGISTER

BOYD GAMING CORPORATION (NEVADA CORPORATION)
ATTN: MR. LOU NUNZIATA
6465 SOUTH RAINBOW BOULEVARD
LAS VEGAS, NV 89118

FOR: CONDUCTING AND PROVIDING FACILITIES FOR SPECIAL EVENTS FEATURING CASINO AND GAMING CONTESTS AND TOURNAMENTS; ENTERTAINMENT SERVICES, NAMELY, CASINO GAMING; PROVIDING CASINO SERVICES FEATURING STORED VALUE MEMBERSHIP CARDS FOR REDEEMING CASH, DISCOUNTS, AND OTHER BENEFITS, IN CLASS 41 (U.S. CLS. 100, 101 AND 107).

FIRST USE 2-8-2011; IN COMMERCE 2-8-2011.

NO CLAIM IS MADE TO THE EXCLUSIVE RIGHT TO USE "SENIORS" OR "50+", APART FROM THE MARK AS SHOWN.

THE MARK CONSISTS OF THE STYLIZED WORDING "WE LOVE SENIORS" WITH A STYLIZED HEART CONTAINING THE TERM "50+" REPLACING THE LETTER "O" IN "LOVE".

SER. NO. 85-342,563, FILED 6-9-2011.

AMY KERTGATE, EXAMINING ATTORNEY



David J. Kyffers

Director of the United States Patent and Trademark Office

United States of America
United States Patent and Trademark Office

Womaid

Reg. No. 4,074,274

GREENSIDE, S.A. DE C.V. (MEXICO SOCIEDAD ANONIMA (SA DE CV)))
1007 LAZARO CÁRDENAS

Registered Dec. 20, 2011

SAN PEDRO G.G., N.L., MEXICO 78223

Int. Cl.: 30

FOR: BEVERAGES MADE OF TEA; FLAVOURINGS OF TEA; HERB TEA; HERBAL INFUSIONS; HERBAL TEA; ICED TEA; TEA; TEA BAGS; TEA EXTRACTS; TEA FOR INFUSIONS; TEA-BASED BEVERAGES; TEA-BASED BEVERAGES WITH FRUIT FLAVORING, IN CLASS 30 (U.S. CL. 46).

TRADEMARK

PRINCIPAL REGISTER

FIRST USE 3-2-2011; IN COMMERCE 4-15-2011.

THE MARK CONSISTS OF THE WORD "WOMAID" IN STYLIZED CHARACTERS.

SER. NO. 85-342,633, FILED 6-9-2011.

STEVEN R. FINE, EXAMINING ATTORNEY



David J. Kyros

Director of the United States Patent and Trademark Office

United States of America

United States Patent and Trademark Office



Reg. No. 4,074,275

Registered Dec. 20, 2011

Int. Cl.: 25

TRADEMARK

PRINCIPAL REGISTER

DYNASTY FOOTWEAR, LTD. (CALIFORNIA CORPORATION)
800 NORTH SEPULVEDA BOULEVARD
EL SEGUNDO, CA 90245

FOR: FOOTWEAR, IN CLASS 25 (U.S. CLS. 22 AND 39).

FIRST USE 6-7-2011; IN COMMERCE 6-7-2011.

THE MARK CONSISTS OF A FOOT PRINT DESIGN WITH THE TEXT "FREEFOOT".

SER. NO. 85-342,652, FILED 6-9-2011.

DAVID YONTEF, EXAMINING ATTORNEY



David J. Kyffers

Director of the United States Patent and Trademark Office

United States of America

United States Patent and Trademark Office



ESCOFFIER
SCHOOL OF CULINARY ARTS

Reg. No. 4,074,276

Registered Dec. 20, 2011

Int. Cl.: 41

SERVICE MARK

PRINCIPAL REGISTER

TRIUMPH GROUP, INC. (ILLINOIS CORPORATION)
SUITE 443
2300 N. BARRINGTON ROAD
HOFFMAN ESTATES, IL 60196

FOR: DEGREE AND DIPLOMA GRANTING VOCATIONAL EDUCATION IN THE FIELD OF CULINARY ARTS, IN CLASS 41 (U.S. CLS. 100, 101 AND 107).

FIRST USE 6-1-2011; IN COMMERCE 6-1-2011.

NO CLAIM IS MADE TO THE EXCLUSIVE RIGHT TO USE "SCHOOL OF CULINARY ARTS", APART FROM THE MARK AS SHOWN.

THE NAME(S), PORTRAIT(S), AND/OR SIGNATURE(S) SHOWN IN THE MARK DOES NOT IDENTIFY A PARTICULAR LIVING INDIVIDUAL.

THE MARK CONSISTS OF A RIBBON CONTAINING THE WORD "AUGUSTE" WITH SEVEN DIAMONDS SHOWN UNDER THE RIBBON, THE WORD "ESCOFFIER" IS SHOWN UNDER THE RIBBON AND ABOVE THE WORDS "SCHOOL OF CULINARY ARTS".

SER. NO. 85-343,143, FILED 6-10-2011.

PATRICIA EVANKO, EXAMINING ATTORNEY



David J. Kybas

Director of the United States Patent and Trademark Office

United States of America

United States Patent and Trademark Office

PRO LIFE PLANT VITALIZER

Reg. No. 4,074,277

DORAN, PAUL S. (UNITED STATES INDIVIDUAL)
5385 HWY 2 WEST
COLUMBIA FALLS, MT 59912 AND

Registered Dec. 20, 2011

Int. Cl.: 1

NISHIJIMA, TATSUHISA (JAPAN INDIVIDUAL)
948-52, KAMITATA, SHIMOKITAKATA-MACHI
MIYAZAKI, JAPAN 880-0035

TRADEMARK

FOR: PLANT NUTRITION PREPARATIONS, IN CLASS 1 (U.S. CLS. 1, 5, 6, 10, 26 AND 46).

PRINCIPAL REGISTER

FIRST USE 6-7-2011; IN COMMERCE 6-7-2011.

THE MARK CONSISTS OF STANDARD CHARACTERS WITHOUT CLAIM TO ANY PARTICULAR FONT, STYLE, SIZE, OR COLOR.

NO CLAIM IS MADE TO THE EXCLUSIVE RIGHT TO USE "PLANT VITALIZER", APART FROM THE MARK AS SHOWN.

SER. NO. 85-343,950, FILED 6-11-2011.

TEJBIR SINGH, EXAMINING ATTORNEY



David J. Kybas

Director of the United States Patent and Trademark Office

United States of America

United States Patent and Trademark Office

PEDS AND TREADS

Reg. No. 4,074,278

HARSCO TECHNOLOGIES LLC (MINNESOTA LIMITED LIABILITY COMPANY)
415 NORTH MAIN STREET
FAIRMONT, MN 56031

Registered Dec. 20, 2011

Int. Cl.: 6

FOR: METAL GRATINGS; STAIR TREADS OF METAL, IN CLASS 6 (U.S. CLS. 2, 12, 13, 14, 23, 25 AND 50).

TRADEMARK

FIRST USE 5-0-2011; IN COMMERCE 5-0-2011.

PRINCIPAL REGISTER

THE MARK CONSISTS OF STANDARD CHARACTERS WITHOUT CLAIM TO ANY PARTICULAR FONT, STYLE, SIZE, OR COLOR.

NO CLAIM IS MADE TO THE EXCLUSIVE RIGHT TO USE "TREADS", APART FROM THE MARK AS SHOWN.

SER. NO. 85-344,404, FILED 6-13-2011.

DAWN FELDMAN, EXAMINING ATTORNEY



David J. Kybas

Director of the United States Patent and Trademark Office

United States of America

United States Patent and Trademark Office

TWO WHEELS FOR LIFE

Reg. No. 4,074,279

GOOD SPORTS, INC. (CONNECTICUT CORPORATION)
349 PROGRESS DRIVE
MANCHESTER, CT 06045

Registered Dec. 20, 2011

Int. Cl.: 25

FOR: CLOTHING, NAMELY, TEE SHIRTS, SWEAT SHIRTS, HOODED SWEAT SHIRTS, TANK-TOPS, SLEEVELESS SHIRTS, HATS, CAPS, UNDERWEAR, JACKETS, BANDANNAS, GLOVES, IN CLASS 25 (U.S. CLS. 22 AND 39).

TRADEMARK

FIRST USE 1-1-2011; IN COMMERCE 1-1-2011.

PRINCIPAL REGISTER

THE MARK CONSISTS OF STANDARD CHARACTERS WITHOUT CLAIM TO ANY PARTICULAR FONT, STYLE, SIZE, OR COLOR.

SER. NO. 85-344,469, FILED 6-13-2011.

CHRISTINA SOBRAL, EXAMINING ATTORNEY



David J. Kybas

Director of the United States Patent and Trademark Office

United States of America

United States Patent and Trademark Office

ABRO

Reg. No. 4,074,280

Registered Dec. 20, 2011

Int. Cl.: 3

TRADEMARK

PRINCIPAL REGISTER

BARANAY INVESTMENTS, LLC (INDIANA LIMITED LIABILITY COMPANY)
5342 W. VERMONT STREET
INDIANAPOLIS, IN 46224

FOR: SANDPAPER, IN CLASS 3 (U.S. CLS. 1, 4, 6, 50, 51 AND 52).

FIRST USE 9-0-2009; IN COMMERCE 9-0-2009.

THE MARK CONSISTS OF STANDARD CHARACTERS WITHOUT CLAIM TO ANY PARTICULAR FONT, STYLE, SIZE, OR COLOR.

OWNER OF U.S. REG. NOS. 2,161,554, 3,471,702 AND OTHERS.

SER. NO. 85-344,627, FILED 6-13-2011.

JOHN GARTNER, EXAMINING ATTORNEY



David J. Kybas

Director of the United States Patent and Trademark Office

United States of America

United States Patent and Trademark Office

Provident Bank Park

Reg. No. 4,074,281

Registered Dec. 20, 2011

Int. Cl.: 43

SERVICE MARK

PRINCIPAL REGISTER

PROVIDENT BANK (UNITED STATES FEDERALLY CHARTERED SAVINGS ASSOCIATION)
400 RELLA BOULEVARD
MONTEBELLO, NY 10901

FOR: ARENA SERVICES, NAMELY, PROVIDING FACILITIES FOR SPORTS, CONCERTS, CONVENTIONS, EXHIBITIONS, AND FAMILY AND COMMUNITY EVENTS, IN CLASS 43 (U.S. CLS. 100 AND 101).

FIRST USE 5-17-2011; IN COMMERCE 5-17-2011.

THE MARK CONSISTS OF STANDARD CHARACTERS WITHOUT CLAIM TO ANY PARTICULAR FONT, STYLE, SIZE, OR COLOR.

NO CLAIM IS MADE TO THE EXCLUSIVE RIGHT TO USE "PARK", APART FROM THE MARK AS SHOWN.

SER. NO. 85-345,421, FILED 6-14-2011.

SANI KHOURI, EXAMINING ATTORNEY



David J. Kybas

Director of the United States Patent and Trademark Office

United States of America

United States Patent and Trademark Office

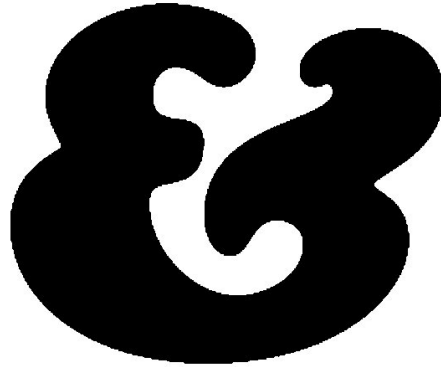

Reg. No. 4,074,282

Registered Dec. 20, 2011

Int. Cl.: 9

TRADEMARK

PRINCIPAL REGISTER

CONTRAST OPTICAL DESIGN & ENGINEERING, INC. (NEW MEXICO CORPORATION)
9 PUNTA LINDA
SANDIA PARK, NM 87047

FOR: DIGITAL CAMERAS; VIDEO CAMERAS, IN CLASS 9 (U.S. CLS. 21, 23, 26, 36 AND 38).

FIRST USE 4-0-2011; IN COMMERCE 4-0-2011.

THE MARK CONSISTS OF THE STYLIZED TEXT "&".

SER. NO. 85-345,463, FILED 6-14-2011.

CHRIS WELLS, EXAMINING ATTORNEY



David J. Kyffers

Director of the United States Patent and Trademark Office

United States of America

United States Patent and Trademark Office

MAGNUS

Reg. No. 4,074,283

Registered Dec. 20, 2011

Int. Cl.: 33

TRADEMARK

PRINCIPAL REGISTER

CONSTELLATION AUSTRALIA LIMITED (AUSTRALIA CORPORATION)
REYNELL ROAD
REYNELLA, AUSTRALIA 5161

FOR: WINES, IN CLASS 33 (U.S. CLS. 47 AND 49).

FIRST USE 7-0-2003; IN COMMERCE 7-0-2003.

THE MARK CONSISTS OF STANDARD CHARACTERS WITHOUT CLAIM TO ANY PARTICULAR FONT, STYLE, SIZE, OR COLOR.

OWNER OF U.S. REG. NO. 2,960,224.

SER. NO. 85-345,610, FILED 6-14-2011.

DAVID C. REIHNER, EXAMINING ATTORNEY



David J. Kybas

Director of the United States Patent and Trademark Office

United States of America

United States Patent and Trademark Office

LEASINGHAM

Reg. No. 4,074,284

Registered Dec. 20, 2011

Int. Cl.: 33

TRADEMARK

PRINCIPAL REGISTER

CONSTELLATION AUSTRALIA LIMITED (AUSTRALIA CORPORATION)
REYNELL ROAD
REYNELLA, AUSTRALIA 5161

FOR: WINES, IN CLASS 33 (U.S. CLS. 47 AND 49).

FIRST USE 7-0-2003; IN COMMERCE 7-0-2003.

THE MARK CONSISTS OF STANDARD CHARACTERS WITHOUT CLAIM TO ANY PARTICULAR FONT, STYLE, SIZE, OR COLOR.

OWNER OF U.S. REG. NO. 2,960,224.

SER. NO. 85-345,615, FILED 6-14-2011.

DAVID C. REIHNER, EXAMINING ATTORNEY



David J. Kyffers

Director of the United States Patent and Trademark Office

United States of America

United States Patent and Trademark Office

ACUIX

Reg. No. 4,074,285

Registered Dec. 20, 2011

Int. Cl.: 9

TRADEMARK

PRINCIPAL REGISTER

HONEYWELL INTERNATIONAL INC. (DELAWARE CORPORATION)
101 COLUMBIA ROAD
MORRISTOWN, NJ 07962

FOR: CAMERAS, IN CLASS 9 (U.S. CLS. 21, 23, 26, 36 AND 38).

FIRST USE 12-31-2007; IN COMMERCE 3-21-2008.

THE MARK CONSISTS OF STANDARD CHARACTERS WITHOUT CLAIM TO ANY PARTICULAR FONT, STYLE, SIZE, OR COLOR.

SER. NO. 85-345,790, FILED 6-14-2011.

LINDA E. BLOHM, EXAMINING ATTORNEY



David J. Kybas

Director of the United States Patent and Trademark Office

United States of America

United States Patent and Trademark Office

FIRST

Reg. No. 4,074,286

FURMAN UNIVERSITY (SOUTH CAROLINA CORPORATION)
3300 POINSETT HIGHWAY
GREENVILLE, SC 29613

Registered Dec. 20, 2011

Int. Cl.: 41

FOR: TRAINING SERVICES IN THE FIELD OF SPORTS, NAMELY, RUNNING, IN CLASS 41 (U.S. CLS. 100, 101 AND 107).

SERVICE MARK

FIRST USE 1-1-2003; IN COMMERCE 1-1-2003.

PRINCIPAL REGISTER

THE MARK CONSISTS OF STANDARD CHARACTERS WITHOUT CLAIM TO ANY PARTICULAR FONT, STYLE, SIZE, OR COLOR.

SER. NO. 85-346,051, FILED 6-14-2011.

NAAKWAMA ANKRAH, EXAMINING ATTORNEY



David J. Kybas

Director of the United States Patent and Trademark Office

United States of America

United States Patent and Trademark Office

BLUE

Reg. No. 4,074,287

Registered Dec. 20, 2011

Int. Cl.: 44

SERVICE MARK

PRINCIPAL REGISTER

BLUE CROSS AND BLUE SHIELD ASSOCIATION (ILLINOIS NON-PROFIT CORPORATION),
AKA BLUECROSS BLUESHIELD ASSOCIATION
225 NORTH MICHIGAN AVENUE
CHICAGO, IL 60601

FOR: PROVIDING ON-LINE INFORMATION, NEWS AND COMMENTARY IN THE FIELD
OF HEALTH AND WELLNESS RELATING TO HEALTH PLANS, HEALTH SUPPORT, FIT-
NESS, NUTRITION AND SELF CARE, IN CLASS 44 (U.S. CLS. 100 AND 101).

FIRST USE 6-3-2003; IN COMMERCE 6-3-2003.

THE MARK CONSISTS OF STANDARD CHARACTERS WITHOUT CLAIM TO ANY PAR-
TICULAR FONT, STYLE, SIZE, OR COLOR.

OWNER OF U.S. REG. NOS. 3,217,512, 3,769,986 AND OTHERS.

SER. NO. 85-346,475, FILED 6-15-2011.

MICHAEL WIENER, EXAMINING ATTORNEY



David J. Kyffers

Director of the United States Patent and Trademark Office

United States of America

United States Patent and Trademark Office

MyFly

Reg. No. 4,074,288

Registered Dec. 20, 2011

Int. Cl.: 18

TRADEMARK

PRINCIPAL REGISTER

LUGGAGE N' LEATHER CORPORATION (MINNESOTA CORPORATION)
13779 RIDGEDALE DRIVE
MINNETONKA, MN 55305

FOR: LUGGAGE; LUGGAGE TAGS; TRAVEL BAGS, IN CLASS 18 (U.S. CLS. 1, 2, 3, 22 AND 41).

FIRST USE 9-1-2010; IN COMMERCE 9-1-2010.

THE MARK CONSISTS OF STANDARD CHARACTERS WITHOUT CLAIM TO ANY PARTICULAR FONT, STYLE, SIZE, OR COLOR.

SER. NO. 85-346,810, FILED 6-15-2011.

MARGERY A. TIERNEY, EXAMINING ATTORNEY



David J. Kybas

Director of the United States Patent and Trademark Office

United States of America

United States Patent and Trademark Office

MORRI

Reg. No. 4,074,289

Registered Dec. 20, 2011

Int. Cl.: 16

TRADEMARK

PRINCIPAL REGISTER

SIMS, SUSAN MORRISON (UNITED STATES INDIVIDUAL)
6171 WEST SHORES ROAD
FLEMING ISLAND, FL 32003

FOR: PAINTINGS, IN CLASS 16 (U.S. CLS. 2, 5, 22, 23, 29, 37, 38 AND 50).

FIRST USE 3-20-2010; IN COMMERCE 3-20-2010.

THE MARK CONSISTS OF STANDARD CHARACTERS WITHOUT CLAIM TO ANY PARTICULAR FONT, STYLE, SIZE, OR COLOR.

THE NAME "MORRI" IDENTIFIES SUSAN MORRISON SIMS, A LIVING INDIVIDUAL WHOSE CONSENT IS OF RECORD.

SER. NO. 85-346,887, FILED 6-15-2011.

AMY KERTGATE, EXAMINING ATTORNEY



David J. Kybas

Director of the United States Patent and Trademark Office

United States of America

United States Patent and Trademark Office

GFI BACKUP

Reg. No. 4,074,290

Registered Dec. 20, 2011

Int. Cl.: 9

TRADEMARK

PRINCIPAL REGISTER

GFI SOFTWARE LTD. (BR. VIRGIN ISLANDS LIMITED LIABILITY COMPANY)
P. O. BOX 3149
ROMASCO PLACE, WICKHAMS CAY 1
ROAD TOWN, TORTOLA, BR. VIRGIN ISLANDS

FOR: SOFTWARE FOR BACKING UP AND RESTORING DATA ON NETWORKS; COMPUTER SOFTWARE AND DOWNLOADABLE COMPUTER SOFTWARE FOR DATA BACKUP AND RECOVERY ON NETWORKS; SOFTWARE FOR DATA BACKUP AND SYNCHRONIZATION ACROSS MULTIPLE SERVERS AND COMPUTERS, IN CLASS 9 (U.S. CLS. 21, 23, 26, 36 AND 38).

FIRST USE 5-7-2009; IN COMMERCE 5-7-2009.

THE MARK CONSISTS OF STANDARD CHARACTERS WITHOUT CLAIM TO ANY PARTICULAR FONT, STYLE, SIZE, OR COLOR.

NO CLAIM IS MADE TO THE EXCLUSIVE RIGHT TO USE "BACKUP", APART FROM THE MARK AS SHOWN.

SER. NO. 85-347,484, FILED 6-15-2011.

RICHARD WHITE, EXAMINING ATTORNEY



David J. Kyffers

Director of the United States Patent and Trademark Office

United States of America

United States Patent and Trademark Office

GFI MAILDEFENSE SUITE

Reg. No. 4,074,291

Registered Dec. 20, 2011

Int. Cl.: 9

TRADEMARK

PRINCIPAL REGISTER

GFI SOFTWARE LTD. (BR. VIRGIN ISLANDS LIMITED LIABILITY COMPANY)
P. O. BOX 3149
ROMASCO PLACE, WICKHAMS CAY 1
ROAD TOWN, TORTOLA, BR. VIRGIN ISLANDS

FOR: SOFTWARE FOR MANAGING ELECTRONIC MAIL (E-MAIL); ANTI-SPAM SOFTWARE; ANTI-PHISHING SOFTWARE; DOWNLOADABLE SOFTWARE FOR MANAGING E-MAIL AND SECURING E-MAIL AGAINST JUNK E-MAIL (SPAM) AND PHISHING ATTACKS; SOFTWARE FOR FILTERING JUNK E-MAIL AND OTHER UNSOLICITED E-MAIL MESSAGES; SOFTWARE FOR DETECTING AND BLOCKING PHISHING E-MAILS; E-MAIL SECURITY SOFTWARE; SOFTWARE FOR PREVENTING THE INTRODUCTION OF COMPUTER VIRUSES AND OTHER MALICIOUS AND UNAUTHORIZED SOFTWARE TO A NETWORK VIA E-MAIL, IN CLASS 9 (U.S. CLS. 21, 23, 26, 36 AND 38).

FIRST USE 7-31-2008; IN COMMERCE 7-31-2008.

THE MARK CONSISTS OF STANDARD CHARACTERS WITHOUT CLAIM TO ANY PARTICULAR FONT, STYLE, SIZE, OR COLOR.

NO CLAIM IS MADE TO THE EXCLUSIVE RIGHT TO USE "MAIL DEFENSE SUITE", APART FROM THE MARK AS SHOWN.

SER. NO. 85-347,486, FILED 6-15-2011.

RICHARD WHITE, EXAMINING ATTORNEY



David J. Kybas

Director of the United States Patent and Trademark Office

United States of America

United States Patent and Trademark Office

GFI WEBMONITOR

Reg. No. 4,074,292

Registered Dec. 20, 2011

Int. Cl.: 9

TRADEMARK

PRINCIPAL REGISTER

GFI SOFTWARE LTD. (BR. VIRGIN ISLANDS LIMITED LIABILITY COMPANY)
P. O. BOX 3149
ROMASCO PLACE, WICKHAMS CAY 1
ROAD TOWN, TORTOLA, BR. VIRGIN ISLANDS

FOR: SOFTWARE FOR USE IN MONITORING INTERNET AND WEBSITE USAGE, FILTERING INTERNET AND WEBSITE ACCESS, AND FOR IMPLEMENTING INTERNET AND WEBSITE SECURITY POLICIES RELATED TO ACCESS AND USAGE; COMPUTER SOFTWARE AND DOWNLOADABLE COMPUTER SOFTWARE FOR MANAGING AND CONTROLLING INTERNET AND WEBSITE ACCESS, SECURITY, AND USAGE AMONG AN ORGANIZATION'S COMPUTER USERS, IN CLASS 9 (U.S. CLS. 21, 23, 26, 36 AND 38).

FIRST USE 6-17-2004; IN COMMERCE 6-17-2004.

THE MARK CONSISTS OF STANDARD CHARACTERS WITHOUT CLAIM TO ANY PARTICULAR FONT, STYLE, SIZE, OR COLOR.

NO CLAIM IS MADE TO THE EXCLUSIVE RIGHT TO USE "WEB MONITOR", APART FROM THE MARK AS SHOWN.

SER. NO. 85-347,492, FILED 6-16-2011.

RICHARD WHITE, EXAMINING ATTORNEY



David J. Kyffers

Director of the United States Patent and Trademark Office

United States of America

United States Patent and Trademark Office

PRINTQUBE

Reg. No. 4,074,293

TIMEPLUS SYSTEMS, LLC (INDIANA CORPORATION)
25325 LEER DRIVE
ELKHART, IN 46514

Registered Dec. 20, 2011

Int. Cl.: 42

FOR: PROVIDING TEMPORARY USE OF NON-DOWNLOADABLE COMPUTER SOFTWARE THAT GIVES REGISTERED INTERNET NETWORKED INSTITUTIONS THE ABILITY TO UPLOAD, VIEW, COPY, PRINT, DOWNLOAD AND SHARE DOCUMENTS AND IMAGES GENERATED IN CONNECTION WITH THE SUBMISSION AND MANAGEMENT OF PAYROLL INFORMATION, HUMAN RESOURCE INFORMATION MANAGEMENT, BENEFIT ADMINISTRATION, EMPLOYEE/EMPLOYER SELF-SERVICE, PAYROLL PROCESSING, AND THE CALCULATING, FILING, DEPOSITING, AND RECONCILING OF AN EMPLOYER'S PAYROLL TAXES FOR ALL FEDERAL, STATE AND LOCAL AUTHORITIES, IN CLASS 42 (U.S. CLS. 100 AND 101).

SERVICE MARK

PRINCIPAL REGISTER

FIRST USE 3-1-2011; IN COMMERCE 3-1-2011.

THE MARK CONSISTS OF STANDARD CHARACTERS WITHOUT CLAIM TO ANY PARTICULAR FONT, STYLE, SIZE, OR COLOR.

SER. NO. 85-348,154, FILED 6-16-2011.

GRETCHEN ULRICH, EXAMINING ATTORNEY



David J. Kybas

Director of the United States Patent and Trademark Office

United States of America

United States Patent and Trademark Office

CHYMOSTAR

Reg. No. 4,074,294

Registered Dec. 20, 2011

Int. Cl.: 1

TRADEMARK

PRINCIPAL REGISTER

DANISCO A/S (DENMARK CORPORATION)
P.O. BOX 17
LANGEBROGADE 1
COPENHAGEN K, DENMARK DK-1001

FOR: ENZYME PREPARATIONS FOR MAKING CHEESE, IN CLASS 1 (U.S. CLS. 1, 5, 6, 10, 26 AND 46).

THE MARK CONSISTS OF STANDARD CHARACTERS WITHOUT CLAIM TO ANY PARTICULAR FONT, STYLE, SIZE, OR COLOR.

OWNER OF ERPN CMNTY TM OFC REG. NO. 004448809, DATED 6-20-2006, EXPIRES 5-19-2015.

OWNER OF U.S. REG. NO. 3,029,204.

SER. NO. 85-348,310, FILED 6-16-2011.

MICHELLE DUBOIS, EXAMINING ATTORNEY



David J. Kyffers

Director of the United States Patent and Trademark Office

United States of America

United States Patent and Trademark Office

iND

Reg. No. 4,074,295

IN DEMAND L.L.C. (DELAWARE LIMITED LIABILITY COMPANY)
345 HUDSON STREET, 17TH FL.
NEW YORK, NY 10014

Registered Dec. 20, 2011

Int. Cl.: 38

FOR: CABLE TELEVISION SERVICES, NAMELY, PROVISION OF TELECOMMUNICATION ACCESS TO FILMS AND TELEVISION PROGRAMS PROVIDED VIA A VIDEO-ON-DEMAND OR PAY PER VIEW SERVICE; VIDEO-ON-DEMAND TRANSMISSION SERVICES; PAY PER VIEW TELEVISION TRANSMISSION SERVICES, IN CLASS 38 (U.S. CLS. 100, 101 AND 104).

SERVICE MARK

PRINCIPAL REGISTER

FIRST USE 12-31-1999; IN COMMERCE 12-31-1999.

THE MARK CONSISTS OF STANDARD CHARACTERS WITHOUT CLAIM TO ANY PARTICULAR FONT, STYLE, SIZE, OR COLOR.

OWNER OF U.S. REG. NOS. 2,961,571, 2,995,436 AND OTHERS.

SER. NO. 85-351,173, FILED 6-20-2011.

B. PARADEWELAI, EXAMINING ATTORNEY



David J. Kybas

Director of the United States Patent and Trademark Office

United States of America

United States Patent and Trademark Office

iND

Reg. No. 4,074,296

IN DEMAND L.L.C. (DELAWARE LIMITED LIABILITY COMPANY)
345 HUDSON STREET, 17TH FL.
NEW YORK, NY 10014

Registered Dec. 20, 2011

Int. Cl.: 41

FOR: CABLE TELEVISION PROGRAMMING SERVICES; INTERACTIVE VIDEO-ON-DEMAND AND PAY PER VIEW TELEVISION PROGRAMMING SERVICES; PROVISION OF NON-DOWNLOADABLE FILMS AND TELEVISION PROGRAMS VIA A VIDEO-ON-DEMAND OR PAY PER VIEW SERVICE, IN CLASS 41 (U.S. CLS. 100, 101 AND 107).

SERVICE MARK

PRINCIPAL REGISTER

FIRST USE 12-31-1999; IN COMMERCE 12-31-1999.

THE MARK CONSISTS OF STANDARD CHARACTERS WITHOUT CLAIM TO ANY PARTICULAR FONT, STYLE, SIZE, OR COLOR.

OWNER OF U.S. REG. NOS. 2,961,571, 2,995,436 AND OTHERS.

SER. NO. 85-351,175, FILED 6-20-2011.

B. PARADEWELAI, EXAMINING ATTORNEY



David J. Kybas

Director of the United States Patent and Trademark Office

United States of America

United States Patent and Trademark Office

Reliant Cap-and-Save

Reg. No. 4,074,297

Registered Dec. 20, 2011

Int. Cl.: 39

SERVICE MARK

PRINCIPAL REGISTER

RELIANT ENERGY RETAIL HOLDINGS, LLC (TEXAS LIMITED LIABILITY COMPANY)
1201 FANNIN
NRG TOWER AT HOUSTON PAVILIONS
HOUSTON, TX 77002

FOR: DISTRIBUTION OF ELECTRICITY, THE PRICING OF WHICH INCLUDES AN ADJUSTABLE PRICE WITH A DEFINED MAXIMUM RATE, IN CLASS 39 (U.S. CLS. 100 AND 105).

FIRST USE 8-18-2010; IN COMMERCE 8-18-2010.

THE MARK CONSISTS OF STANDARD CHARACTERS WITHOUT CLAIM TO ANY PARTICULAR FONT, STYLE, SIZE, OR COLOR.

OWNER OF U.S. REG. NOS. 2,886,710, 3,097,811, AND 3,942,290.

SER. NO. 85-351,573, FILED 6-21-2011.

CHRIS WELLS, EXAMINING ATTORNEY



David J. Kybas

Director of the United States Patent and Trademark Office

United States of America

United States Patent and Trademark Office

COMFORT XL

Reg. No. 4,074,298

Registered Dec. 20, 2011

Int. Cl.: 11

TRADEMARK

PRINCIPAL REGISTER

POLYJOHN ENTERPRISES CORPORATION (DELAWARE CORPORATION)
2500 GASPAR AVENUE
WHITING, IN 463942175

FOR: PORTABLE CABANA TOILETS, IN CLASS 11 (U.S. CLS. 13, 21, 23, 31 AND 34).

FIRST USE 6-16-2011; IN COMMERCE 6-16-2011.

THE MARK CONSISTS OF STANDARD CHARACTERS WITHOUT CLAIM TO ANY PARTICULAR FONT, STYLE, SIZE, OR COLOR.

SER. NO. 85-351,654, FILED 6-21-2011.

CAROLYN CATALDO, EXAMINING ATTORNEY



David J. Kyffers

Director of the United States Patent and Trademark Office

United States of America

United States Patent and Trademark Office



Reg. No. 4,074,299

Registered Dec. 20, 2011

Int. Cl.: 12

TRADEMARK

PRINCIPAL REGISTER

AMERICAN SPORTS LICENSING, INC. (DELAWARE CORPORATION)
1101 CENTRE ROAD, SUITE 339
WILMINGTON, DE 19805

FOR: BICYCLES, IN CLASS 12 (U.S. CLS. 19, 21, 23, 31, 35 AND 44).

FIRST USE 5-5-2011; IN COMMERCE 5-5-2011.

OWNER OF U.S. REG. NO. 1,033,787.

THE MARK CONSISTS OF THE WORDING "NISHIKI BIKE MORE DRIVE LESS" WITH THE STYLIZED REPRESENTATIONS OF A BICYCLE AND A MOTOR VEHICLE.

THE ENGLISH TRANSLATION OF "NISHIKI" IN THE MARK IS "BROCADE".

SER. NO. 85-351,918, FILED 6-21-2011.

CAROLINE WOOD, EXAMINING ATTORNEY



David J. Kyffers

Director of the United States Patent and Trademark Office

United States of America

United States Patent and Trademark Office

RECKLESS RUNNING

Reg. No. 4,074,300

Registered Dec. 20, 2011

Int. Cl.: 25

TRADEMARK

PRINCIPAL REGISTER

RECKLESS RUNNING LLC (TENNESSEE LIMITED LIABILITY COMPANY)
187 HUNTINGTON LANE
MOORESVILLE, NC 28117

FOR: ATHLETIC APPAREL, NAMELY, SHIRTS, PANTS, JACKETS, FOOTWEAR, HATS AND CAPS, ATHLETIC UNIFORMS; ATHLETIC SHOES; CAMOUFLAGE SHIRTS; GYM PANTS; HEADBANDS AGAINST SWEATING; HOODED SWEAT SHIRTS; HOODED SWEATSHIRTS; JOGGING OUTFITS; JOGGING PANTS; JOGGING SUITS; LONG-SLEEVED SHIRTS; MOISTURE-WICKING SPORTS SHIRTS; RUNNING SHOES; RUNNING SUITS; SHORT-SLEEVED OR LONG-SLEEVED T-SHIRTS; SPORT SHIRTS; SWEAT JACKETS; SWEAT PANTS; SWEAT SHIRTS; SWEAT SHORTS; SWEAT SUITS; SWEATSHIRTS; T-SHIRTS; TRACK AND FIELD SHOES; TRACK JACKETS; TRACK PANTS; TRACK SUITS; TRIATHLON CLOTHING, NAMELY, TRIATHLON TIGHTS, TRIATHLON SHORTS, TRIATHLON SINGLET, TRIATHLON SHIRTS, TRIATHLON SUITS; WIND SHIRTS; YOGA SHIRTS, IN CLASS 25 (U.S. CLS. 22 AND 39).

FIRST USE 10-13-2007; IN COMMERCE 1-20-2008.

THE MARK CONSISTS OF STANDARD CHARACTERS WITHOUT CLAIM TO ANY PARTICULAR FONT, STYLE, SIZE, OR COLOR.

NO CLAIM IS MADE TO THE EXCLUSIVE RIGHT TO USE "RUNNING", APART FROM THE MARK AS SHOWN.

SER. NO. 85-352,042, FILED 6-21-2011.

LINDA ORNDORFF, EXAMINING ATTORNEY



David J. Kyros

Director of the United States Patent and Trademark Office

United States of America

United States Patent and Trademark Office

FLAME ON!

Reg. No. 4,074,301

WILLIAMS, EMORY L (UNITED STATES INDIVIDUAL)
11261 DOUGLAS DRIVE
MIAMI, FL 33176

Registered Dec. 20, 2011

Int. Cl.: 24

FOR: BATH TOWELS; BED LINEN; CHILDREN'S TOWELS; HAND TOWELS, IN CLASS 24 (U.S. CLS. 42 AND 50).

TRADEMARK

FIRST USE 10-12-2010; IN COMMERCE 10-12-2010.

PRINCIPAL REGISTER

THE MARK CONSISTS OF STANDARD CHARACTERS WITHOUT CLAIM TO ANY PARTICULAR FONT, STYLE, SIZE, OR COLOR.

SER. NO. 85-352,062, FILED 6-21-2011.

LAKEISHA LEWIS, EXAMINING ATTORNEY



David J. Kybas

Director of the United States Patent and Trademark Office

United States of America

United States Patent and Trademark Office

FLAME ON!

Reg. No. 4,074,302

WILLIAMS, EMORY L (UNITED STATES INDIVIDUAL)
11261 DOUGLAS DRIVE
MIAMI, FL 33176

Registered Dec. 20, 2011

Int. Cl.: 25

FOR: ATHLETIC APPAREL, NAMELY, SHIRTS, PANTS, JACKETS, FOOTWEAR, HATS AND CAPS, ATHLETIC UNIFORMS, IN CLASS 25 (U.S. CLS. 22 AND 39).

TRADEMARK

FIRST USE 9-10-2010; IN COMMERCE 9-10-2010.

PRINCIPAL REGISTER

THE MARK CONSISTS OF STANDARD CHARACTERS WITHOUT CLAIM TO ANY PARTICULAR FONT, STYLE, SIZE, OR COLOR.

SER. NO. 85-352,082, FILED 6-21-2011.

LAKEISHA LEWIS, EXAMINING ATTORNEY



David J. Kybas

Director of the United States Patent and Trademark Office

United States of America

United States Patent and Trademark Office

Money Back Challenge

Reg. No. 4,074,303

TENNESSEE COMMUNITY ENRICHMENT, INC. (TENNESSEE CORPORATION)
360 WILLOW BOUGH LANE
OLD HICKORY, TN 37138

Registered Dec. 20, 2011

Int. Cl.: 41

FOR: ENTERTAINMENT SERVICES IN THE NATURE OF AN AMUSEMENT PARK ATTRACTION, NAMELY, A THEMED AREA, IN CLASS 41 (U.S. CLS. 100, 101 AND 107).

SERVICE MARK

FIRST USE 9-1-2010; IN COMMERCE 10-1-2010.

PRINCIPAL REGISTER

THE MARK CONSISTS OF STANDARD CHARACTERS WITHOUT CLAIM TO ANY PARTICULAR FONT, STYLE, SIZE, OR COLOR.

NO CLAIM IS MADE TO THE EXCLUSIVE RIGHT TO USE "MONEY BACK", APART FROM THE MARK AS SHOWN.

SER. NO. 85-352,160, FILED 6-21-2011.

LIEF MARTIN, EXAMINING ATTORNEY



David J. Kyffers

Director of the United States Patent and Trademark Office

United States of America

United States Patent and Trademark Office

EyeSecret

Reg. No. 4,074,304

CANFO NATURAL PRODUCTS (CALIFORNIA CORPORATION)
9060 TELSTAR AVENUE, STE 202
EL MONTE, CA 91731

Registered Dec. 20, 2011

Int. Cl.: 5

FOR: HERBAL SUPPLEMENTS, IN CLASS 5 (U.S. CLS. 6, 18, 44, 46, 51 AND 52).

TRADEMARK

FIRST USE 5-29-2011; IN COMMERCE 6-21-2011.

PRINCIPAL REGISTER

THE MARK CONSISTS OF STANDARD CHARACTERS WITHOUT CLAIM TO ANY PARTICULAR FONT, STYLE, SIZE, OR COLOR.

SER. NO. 85-352,223, FILED 6-21-2011.

SETH A. RAPPAPORT, EXAMINING ATTORNEY



David J. Kyffers

Director of the United States Patent and Trademark Office

United States of America

United States Patent and Trademark Office



Reg. No. 4,074,305

ACE HARDWARE CORPORATION (DELAWARE CORPORATION)
2200 KENSINGTON COURT
OAK BROOK, IL 60523

Registered Dec. 20, 2011

Int. Cl.: 35

FOR: RETAIL STORE SERVICES IN THE FIELD OF HARDWARE AND RELATED GOODS,
IN CLASS 35 (U.S. CLS. 100, 101 AND 102).

SERVICE MARK

FIRST USE 2-1-2011; IN COMMERCE 2-1-2011.

PRINCIPAL REGISTER

THE MARK CONSISTS OF THE WORDS "TO DONE" WITH THE LETTERS "D" AND "E"
LARGER THAN THE OTHERS AND A PAINT BRUSH BY THE LETTER "E".

SER. NO. 85-352,542, FILED 6-22-2011.

VERNA BETH RIRIE, EXAMINING ATTORNEY



David J. Kybas

Director of the United States Patent and Trademark Office

United States of America

United States Patent and Trademark Office

LISA'S LEGIT BURRITOS

Reg. No. 4,074,306

LISA'S LEGIT BURRITOS, LLC (MAINE LIMITED LIABILITY COMPANY)
242 WATER ST.
GARDINER, ME 04345

Registered Dec. 20, 2011

Int. Cl.: 43

FOR: RESTAURANT SERVICES, IN CLASS 43 (U.S. CLS. 100 AND 101).

SERVICE MARK

FIRST USE 1-31-2011; IN COMMERCE 5-3-2011.

PRINCIPAL REGISTER

THE MARK CONSISTS OF STANDARD CHARACTERS WITHOUT CLAIM TO ANY PARTICULAR FONT, STYLE, SIZE, OR COLOR.

NO CLAIM IS MADE TO THE EXCLUSIVE RIGHT TO USE "BURRITOS", APART FROM THE MARK AS SHOWN.

THE NAME(S), PORTRAIT(S), AND/OR SIGNATURE(S) SHOWN IN THE MARK IDENTIFIES "LISA", WHOSE CONSENT(S) TO REGISTER IS MADE OF RECORD.

SER. NO. 85-353,007, FILED 6-22-2011.

DARRYL SPRUILL, EXAMINING ATTORNEY



David J. Kybas

Director of the United States Patent and Trademark Office

United States of America

United States Patent and Trademark Office

ALLIANT MANAGEMENT SERVICES

Reg. No. 4,074,307

Registered Dec. 20, 2011

Int. Cl.: 35

SERVICE MARK

PRINCIPAL REGISTER

BLUE MANAGEMENT SERVICES, LLC (KENTUCKY LIMITED LIABILITY COMPANY)
2650 EASTPOINT PARKWAY
SUITE 310
LOUISVILLE, KY 40223

FOR: HEALTHCARE FACILITY MANAGEMENT SERVICES FOR HEALTHCARE FACILITIES, NAMELY, HOSPITALS, NURSING HOMES, HOME HEALTH AND PHYSICIAN OFFICES, IN CLASS 35 (U.S. CLS. 100, 101 AND 102).

FIRST USE 1-18-2000; IN COMMERCE 1-18-2000.

THE MARK CONSISTS OF STANDARD CHARACTERS WITHOUT CLAIM TO ANY PARTICULAR FONT, STYLE, SIZE, OR COLOR.

NO CLAIM IS MADE TO THE EXCLUSIVE RIGHT TO USE "MANAGEMENT SERVICES", APART FROM THE MARK AS SHOWN.

SER. NO. 85-353,229, FILED 6-22-2011.

MICHAEL WIENER, EXAMINING ATTORNEY



David J. Kyffers

Director of the United States Patent and Trademark Office

United States of America

United States Patent and Trademark Office

The Human Beinz

Reg. No. 4,074,308

THE HUMAN BEINZ (NEW YORK PARTNERSHIP)
BOX 228

Registered Dec. 20, 2011

SALISBURY MILLS, NY 12577

Int. Cl.: 41

FOR: ENTERTAINMENT SERVICES IN THE NATURE OF PRESENTING LIVE MUSICAL PERFORMANCES, IN CLASS 41 (U.S. CLS. 100, 101 AND 107).

SERVICE MARK

FIRST USE 5-5-1998; IN COMMERCE 5-5-1998.

PRINCIPAL REGISTER

THE MARK CONSISTS OF STANDARD CHARACTERS WITHOUT CLAIM TO ANY PARTICULAR FONT, STYLE, SIZE, OR COLOR.

SER. NO. 85-353,401, FILED 6-22-2011.

ANTHONY RINKER, EXAMINING ATTORNEY



David J. Kybas

Director of the United States Patent and Trademark Office

United States of America

United States Patent and Trademark Office

Team Compound

Reg. No. 4,074,309

Registered Dec. 20, 2011

Int. Cl.: 41

SERVICE MARK

PRINCIPAL REGISTER

INCIPIIT GROUP LLC (CALIFORNIA LIMITED LIABILITY COMPANY)
SUITE 301
3907 OCEANIC DR
OCEANSIDE, CA 92056

FOR: MARTIAL ARTS INSTRUCTION, IN CLASS 41 (U.S. CLS. 100, 101 AND 107).

FIRST USE 3-1-2007; IN COMMERCE 3-1-2007.

THE MARK CONSISTS OF STANDARD CHARACTERS WITHOUT CLAIM TO ANY PARTICULAR FONT, STYLE, SIZE, OR COLOR.

SER. NO. 85-353,932, FILED 6-23-2011.

SAMUEL E. SHARPER JR., EXAMINING ATTORNEY



David J. Kyffers

Director of the United States Patent and Trademark Office

United States of America

United States Patent and Trademark Office

PURELY HOME

Reg. No. 4,074,310

Registered Dec. 20, 2011

Int. Cls.: 3, 4 and 11

TRADEMARK

PRINCIPAL REGISTER

MVP GROUP INTERNATIONAL, INC. (KENTUCKY CORPORATION)
1031 LE GRAND BLVD.
CHARLESTON, SC 29492

FOR: SCENTED ROOM SPRAYS, IN CLASS 3 (U.S. CLS. 1, 4, 6, 50, 51 AND 52).

FIRST USE 6-23-2011; IN COMMERCE 6-23-2011.

FOR: CANDLES; FRAGRANT WAX FOR USE IN POTPOURRI BURNERS; MELT TARTS, NAMELY, SCENTED WAX TO BE MELTED SLOWLY WITH A WARMER; SCENTED CANDLES; SCENTED WAX FOR USE IN CANDLE WARMERS; TEA LIGHT CANDLES, IN CLASS 4 (U.S. CLS. 1, 6 AND 15).

FIRST USE 6-23-2011; IN COMMERCE 6-23-2011.

FOR: ELECTRIC DISPENSERS FOR AIR FRESHENERS AND DEODORIZERS TO BE PLUGGED INTO WALL OUTLETS, IN CLASS 11 (U.S. CLS. 13, 21, 23, 31 AND 34).

FIRST USE 6-23-2011; IN COMMERCE 6-23-2011.

THE MARK CONSISTS OF STANDARD CHARACTERS WITHOUT CLAIM TO ANY PARTICULAR FONT, STYLE, SIZE, OR COLOR.

NO CLAIM IS MADE TO THE EXCLUSIVE RIGHT TO USE "HOME", APART FROM THE MARK AS SHOWN.

SER. NO. 85-354,396, FILED 6-23-2011.

PAM WILLIS, EXAMINING ATTORNEY



David J. Kybas

Director of the United States Patent and Trademark Office

United States of America

United States Patent and Trademark Office

DOUBLE FREEDOM REELS

Reg. No. 4,074,311

VIDEO GAMING TECHNOLOGIES, INC. (TENNESSEE CORPORATION)
155 FRANKLIN ROAD, SUITE 255
BRENTWOOD, TN 37027

Registered Dec. 20, 2011

Int. Cl.: 9

FOR: COMPUTER SOFTWARE AND FIRMWARE FOR GAMES OF CHANCE ON ANY COMPUTERIZED PLATFORM, NAMELY, DEDICATED GAMING CONSOLES, VIDEO BASED SLOT MACHINES, REEL BASED SLOT MACHINES, AND VIDEO LOTTERY TERMINALS; GAMING DEVICES, NAMELY, GAMING MACHINES, SLOT MACHINES, BINGO MACHINES, WITH OR WITHOUT VIDEO OUTPUT, IN CLASS 9 (U.S. CLS. 21, 23, 26, 36 AND 38).

TRADEMARK

PRINCIPAL REGISTER

FIRST USE 4-28-2007; IN COMMERCE 4-28-2007.

THE MARK CONSISTS OF STANDARD CHARACTERS WITHOUT CLAIM TO ANY PARTICULAR FONT, STYLE, SIZE, OR COLOR.

NO CLAIM IS MADE TO THE EXCLUSIVE RIGHT TO USE "DOUBLE" OR "REELS", APART FROM THE MARK AS SHOWN.

SER. NO. 85-354,571, FILED 6-23-2011.

LAURA KOVALSKY, EXAMINING ATTORNEY



David J. Kybas

Director of the United States Patent and Trademark Office

United States of America

United States Patent and Trademark Office

FREE SPINS OF FORTUNE

Reg. No. 4,074,312

Registered Dec. 20, 2011

Int. Cl.: 9

TRADEMARK

PRINCIPAL REGISTER

VIDEO GAMING TECHNOLOGIES, INC. (TENNESSEE CORPORATION)
155 FRANKLIN ROAD, SUITE 255
BRENTWOOD, TN 37027

FOR: COMPUTER SOFTWARE AND FIRMWARE FOR GAMES OF CHANCE ON ANY COMPUTERIZED PLATFORM, NAMELY, DEDICATED GAMING CONSOLES, VIDEO BASED SLOT MACHINES, REEL BASED SLOT MACHINES, AND VIDEO LOTTERY TERMINALS; GAMING DEVICES, NAMELY, GAMING MACHINES, SLOT MACHINES, BINGO MACHINES, WITH OR WITHOUT VIDEO OUTPUT, IN CLASS 9 (U.S. CLS. 21, 23, 26, 36 AND 38).

FIRST USE 10-31-2007; IN COMMERCE 10-31-2007.

THE MARK CONSISTS OF STANDARD CHARACTERS WITHOUT CLAIM TO ANY PARTICULAR FONT, STYLE, SIZE, OR COLOR.

NO CLAIM IS MADE TO THE EXCLUSIVE RIGHT TO USE "FREE SPINS", APART FROM THE MARK AS SHOWN.

SER. NO. 85-354,583, FILED 6-23-2011.

LAURA KOVALSKY, EXAMINING ATTORNEY



David J. Kyffers

Director of the United States Patent and Trademark Office

United States of America

United States Patent and Trademark Office

MONKEY BALLS

Reg. No. 4,074,313

ALOHA HAWAIIAN STORES, INC. (HAWAII CORPORATION)

Registered Dec. 20, 2011

74-5077 LANA PLACE
KAILUA KONA, HI 96740

Int. Cl.: 30

FOR: CANDIES; CHOCOLATE CANDIES; CHOCOLATE COVERED NUTS, IN CLASS 30 (U.S. CL. 46).

TRADEMARK

FIRST USE 6-1-2011; IN COMMERCE 6-1-2011.

PRINCIPAL REGISTER

THE MARK CONSISTS OF STANDARD CHARACTERS WITHOUT CLAIM TO ANY PARTICULAR FONT, STYLE, SIZE, OR COLOR.

NO CLAIM IS MADE TO THE EXCLUSIVE RIGHT TO USE "BALLS", APART FROM THE MARK AS SHOWN.

SER. NO. 85-356,168, FILED 6-24-2011.

KAELIE KUNG, EXAMINING ATTORNEY



David J. Kybas

Director of the United States Patent and Trademark Office

United States of America

United States Patent and Trademark Office

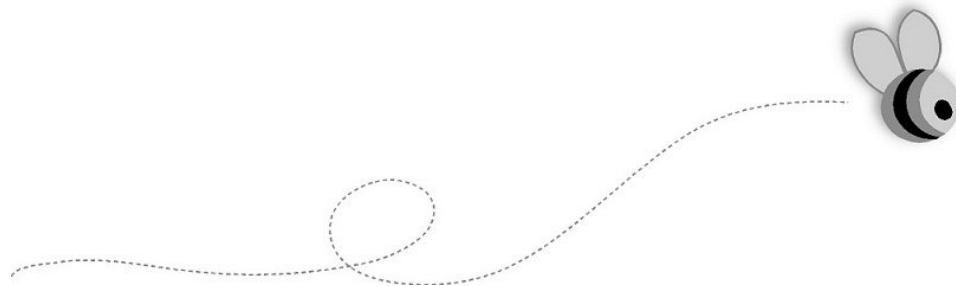

Reg. No. 4,074,314

Registered Dec. 20, 2011

Int. Cl.: 35

SERVICE MARK

PRINCIPAL REGISTER

FINDLY, INC. (DELAWARE CORPORATION)
SUITE 250
444 HIGH STREET
PALO ALTO, CA 94301

FOR: ONLINE RECRUITMENT SERVICES IN THE NATURE OF SOCIAL RECRUITING COMMUNITIES, NAMELY, JOB FINDING, JOB REFERRALS, GEOLOCATION-BASED JOB APPLICATIONS, RECRUITING, PLACEMENT, STAFFING AND CAREER NETWORKING SERVICES; CANDIDATE SOURCING, MATCHING AND SELECTION, NAMELY, ONLINE RECRUITMENT SERVICES IN THE NATURE OF PERSONNEL RECRUITMENT AND PLACEMENT, IN CLASS 35 (U.S. CLS. 100, 101 AND 102).

FIRST USE 6-11-2010; IN COMMERCE 6-11-2010.

THE MARK CONSISTS OF A BEE WITH DOTTED LINE SHOWING ITS FLIGHT PATH.

SER. NO. 85-356,488, FILED 6-26-2011.

KATHY DE JONGE, EXAMINING ATTORNEY



David J. Kybas

Director of the United States Patent and Trademark Office

United States of America

United States Patent and Trademark Office

YARDS

Reg. No. 4,074,315

Registered Dec. 20, 2011

Int. Cls.: 21 and 25

TRADEMARK

PRINCIPAL REGISTER

YARDS BREWING COMPANY, LLC (PENNSYLVANIA LIMITED LIABILITY COMPANY)
901 N. DELAWARE AVENUE
PHILADELPHIA, PA 19123

FOR: DRINKING GLASSES, IN CLASS 21 (U.S. CLS. 2, 13, 23, 29, 30, 33, 40 AND 50).

FIRST USE 10-15-1995; IN COMMERCE 10-15-1995.

FOR: HATS; SHIRTS, IN CLASS 25 (U.S. CLS. 22 AND 39).

FIRST USE 6-5-1995; IN COMMERCE 6-5-1995.

THE MARK CONSISTS OF STANDARD CHARACTERS WITHOUT CLAIM TO ANY PARTICULAR FONT, STYLE, SIZE, OR COLOR.

OWNER OF U.S. REG. NO. 2,200,071.

SER. NO. 85-357,337, FILED 6-27-2011.

JAMES LOVELACE, EXAMINING ATTORNEY



David J. Kyffers

Director of the United States Patent and Trademark Office

United States of America

United States Patent and Trademark Office

iPinot

Reg. No. 4,074,316

Registered Dec. 20, 2011

Int. Cl.: 33

TRADEMARK

PRINCIPAL REGISTER

AMALIE ROBERT ESTATE, LLC (OREGON LIMITED LIABILITY COMPANY)
P.O. BOX 395
DALLAS, OR 97338

FOR: GRAPE WINE, IN CLASS 33 (U.S. CLS. 47 AND 49).

FIRST USE 12-9-2010; IN COMMERCE 12-9-2010.

THE MARK CONSISTS OF STANDARD CHARACTERS WITHOUT CLAIM TO ANY PARTICULAR FONT, STYLE, SIZE, OR COLOR.

SER. NO. 85-357,511, FILED 6-27-2011.

KAELIE KUNG, EXAMINING ATTORNEY



David J. Kappas

Director of the United States Patent and Trademark Office

United States of America
United States Patent and Trademark Office

BARBIZON

Reg. No. 4,074,317

Registered Dec. 20, 2011

Int. Cl.: 3

TRADEMARK

PRINCIPAL REGISTER

BARBIZON INTERNATIONAL, LLC (FLORIDA LIMITED LIABILITY COMPANY)
SUITE 1002
3111 NORTH UNIVERSITY DRIVE
CORAL SPRINGS, FL 33065

FOR: COSMETICS AND MAKEUP; COSMETIC PREPARATIONS FOR SKIN CARE; NON-MEDICATED SKIN CARE PREPARATIONS, IN CLASS 3 (U.S. CLS. 1, 4, 6, 50, 51 AND 52).

FIRST USE 5-31-1984; IN COMMERCE 5-31-1984.

THE MARK CONSISTS OF STANDARD CHARACTERS WITHOUT CLAIM TO ANY PARTICULAR FONT, STYLE, SIZE, OR COLOR.

OWNER OF U.S. REG. NOS. 902,816 AND 2,914,716.

SER. NO. 85-358,609, FILED 6-28-2011.

LAURA HAMMEL, EXAMINING ATTORNEY



David J. Kyffers

Director of the United States Patent and Trademark Office

United States of America

United States Patent and Trademark Office

BE A MODEL...OR JUST LOOK
LIKE ONE!

Reg. No. 4,074,318

Registered Dec. 20, 2011

Int. Cl.: 3

TRADEMARK

PRINCIPAL REGISTER

BARBIZON INTERNATIONAL, LLC (FLORIDA LIMITED LIABILITY COMPANY)
SUITE 1002
3111 NORTH UNIVERSITY DRIVE
CORAL SPRINGS, FL 33065

FOR: COSMETICS AND MAKEUP; COSMETIC PREPARATIONS FOR SKIN CARE; NON-MEDICATED SKIN CARE PREPARATIONS, IN CLASS 3 (U.S. CLS. 1, 4, 6, 50, 51 AND 52).

FIRST USE 5-31-1984; IN COMMERCE 5-31-1984.

THE MARK CONSISTS OF STANDARD CHARACTERS WITHOUT CLAIM TO ANY PARTICULAR FONT, STYLE, SIZE, OR COLOR.

OWNER OF U.S. REG. NOS. 1,458,769, 2,914,716 AND OTHERS.

SER. NO. 85-358,647, FILED 6-28-2011.

LAURA HAMMEL, EXAMINING ATTORNEY



David J. Kybas

Director of the United States Patent and Trademark Office

United States of America

United States Patent and Trademark Office



Reg. No. 4,074,319

Registered Dec. 20, 2011

Int. Cl.: 40

SERVICE MARK

PRINCIPAL REGISTER

GREENSTAR, LLC (DELAWARE LIMITED LIABILITY COMPANY)
SUITE 700
3411 RICHMOND
HOUSTON, TX 77046

FOR: DOCUMENT SHREDDING SERVICES, IN CLASS 40 (U.S. CLS. 100, 103 AND 106).

FIRST USE 6-1-2011; IN COMMERCE 6-1-2011.

NO CLAIM IS MADE TO THE EXCLUSIVE RIGHT TO USE "SHREDDING", APART FROM THE MARK AS SHOWN.

THE MARK CONSISTS OF A DRAWING OF A STAR WITH THE WORDS "GREENSTAR SHREDDING" UNDERNEATH.

SER. NO. 85-358,699, FILED 6-28-2011.

MATTHEW KLINE, EXAMINING ATTORNEY



David J. Kappas

Director of the United States Patent and Trademark Office

United States of America

United States Patent and Trademark Office

ON THE ROCK ICE CREAMERY FROM FRESHËNS

Reg. No. 4,074,320

YOGURT VENTURES U.S.A., INC. (GEORGIA CORPORATION), AKA FRESHËNS
1750 THE EXCHANGE
ATLANTA, GA 30339

Registered Dec. 20, 2011

Int. Cl.: 30

FOR: ICE CREAM; ICE CREAM DESSERTS, IN CLASS 30 (U.S. CL. 46).

TRADEMARK

FIRST USE 0-0-1999; IN COMMERCE 0-0-1999.

PRINCIPAL REGISTER

THE MARK CONSISTS OF STANDARD CHARACTERS WITHOUT CLAIM TO ANY PARTICULAR FONT, STYLE, SIZE, OR COLOR.

OWNER OF U.S. REG. NOS. 1,419,551, 1,655,698, AND 2,518,130.

NO CLAIM IS MADE TO THE EXCLUSIVE RIGHT TO USE "ICE CREAMERY", APART FROM THE MARK AS SHOWN.

SER. NO. 85-359,011, FILED 6-29-2011.

TAMARA FRAZIER, EXAMINING ATTORNEY



David J. Kybas

Director of the United States Patent and Trademark Office

United States of America

United States Patent and Trademark Office

ISHOPFORALL.COM

Reg. No. 4,074,321

BIG DREAMER MEDIA LLC (DELAWARE LIMITED LIABILITY COMPANY)

Registered Dec. 20, 2011

P.O. BOX 699
COPPERAS COVE, TX 76522

Int. Cl.: 35

FOR: ON-LINE WHOLESALE AND RETAIL STORE SERVICES FEATURING GENERAL CONSUMER MERCHANDISE, NAMELY, CLOTHING, SHOES, BATH AND BODY PRODUCTS, JEWELRY, ELECTRONICS, COOKWARE, HOUSEWARES, APPLIANCES, FURNITURE, LINENS, PILLOWS, DECORATIVE ACCESSORIES, OFFICE FURNITURE AND ACCESSORIES, TOYS, GAMES, SPORTING GOODS, TOOLS, OUTDOOR LAWN AND GARDEN EQUIPMENT, PET SUPPLIES, AND PAPER PRODUCTS, IN CLASS 35 (U.S. CLS. 100, 101 AND 102).

SERVICE MARK

PRINCIPAL REGISTER

FIRST USE 5-19-2011; IN COMMERCE 5-19-2011.

THE MARK CONSISTS OF STANDARD CHARACTERS WITHOUT CLAIM TO ANY PARTICULAR FONT, STYLE, SIZE, OR COLOR.

SER. NO. 85-359,215, FILED 6-29-2011.

ROBERT C. CLARK JR., EXAMINING ATTORNEY



David J. Kyros

Director of the United States Patent and Trademark Office

United States of America

United States Patent and Trademark Office

XMLSPY

Reg. No. 4,074,322

Registered Dec. 20, 2011

Int. Cl.: 9

TRADEMARK

PRINCIPAL REGISTER

ALTOVA GMBH (AUSTRIA GMBH)
RUDOLFSPLATZ 13A/9 A-1010
WIEN (VIENNA), AUSTRIA

FOR: COMPUTER SOFTWARE FOR PROVIDING ACCESS TO OR MANIPULATION CAPABILITIES OF EXTENSIBLE MARKUP LANGUAGE DOCUMENTS, SPECIFICALLY STORING AND RETRIEVING EXTENSIBLE MARKUP LANGUAGE DOCUMENTS IN DATABASES, FILES, REPOSITORIES, OR WEB SERVICES, EDITING THE CONTENTS OF EXTENSIBLE MARKUP LANGUAGE DOCUMENTS, TRANSFORMING THE CONTENTS OF EXTENSIBLE MARKUP LANGUAGE DOCUMENTS THROUGH STYLESHEETS, DEFINING THE CONTENT MODELS FOR EXTENSIBLE MARKUP LANGUAGE DOCUMENTS IN A SCHEMA, VALIDATING EXTENSIBLE MARKUP LANGUAGE DOCUMENTS AGAINST THEIR SCHEMAS, PROVIDING DATA EXCHANGE FUNCTIONS BETWEEN EXTENSIBLE MARKUP LANGUAGE DOCUMENTS AND RELATIONAL DATABASES, ANALYZING THE CONTENTS OF EXTENSIBLE MARKUP LANGUAGE DOCUMENTS AND RELATIONAL DATABASES, ANALYZING THE CONTENTS OF EXTENSIBLE MARKUP LANGUAGE DOCUMENTS TO DERIVE SCHEMAS, FINDING DATA WITHIN EXTENSIBLE MARKUP LANGUAGE DOCUMENTS OR REPOSITORIES, AND PROVIDING ELECTRONIC FORMS FOR EDITING EXTENSIBLE MARKUP LANGUAGE DOCUMENTS, IN CLASS 9 (U.S. CLS. 21, 23, 26, 36 AND 38).

FIRST USE 3-26-2003; IN COMMERCE 3-26-2003.

THE MARK CONSISTS OF STANDARD CHARACTERS WITHOUT CLAIM TO ANY PARTICULAR FONT, STYLE, SIZE, OR COLOR.

OWNER OF U.S. REG. NOS. 2,673,569, 2,883,589, AND 3,353,927.

SER. NO. 85-359,609, FILED 6-29-2011.

ROBIN MITTLER, EXAMINING ATTORNEY



David J. Kyjars

Director of the United States Patent and Trademark Office

United States of America

United States Patent and Trademark Office

MULTIHOP

Reg. No. 4,074,323

TUNNEL RADIO OF AMERICA, INC. (OREGON CORPORATION)
6435 NE HYSLOP RD.
CORVALLIS, OR 97330

Registered Dec. 20, 2011

Int. Cl.: 9

FOR: DEVICES FOR RADIO COMMUNICATION AND TRACKING SYSTEMS, NAMELY, RADIO FREQUENCY IDENTIFICATION (RFID) READERS AND WIRELESS READERS, IN CLASS 9 (U.S. CLS. 21, 23, 26, 36 AND 38).

TRADEMARK

FIRST USE 11-22-2010; IN COMMERCE 12-15-2010.

PRINCIPAL REGISTER

THE MARK CONSISTS OF STANDARD CHARACTERS WITHOUT CLAIM TO ANY PARTICULAR FONT, STYLE, SIZE, OR COLOR.

SER. NO. 85-360,022, FILED 6-29-2011.

KEVON CHISOLM, EXAMINING ATTORNEY



David J. Kyffers

Director of the United States Patent and Trademark Office

United States of America

United States Patent and Trademark Office

OVOZYME

Reg. No. 4,074,324

NOVOZYMES A/S (DENMARK CORPORATION)
KROGSHOEJVEJ 36

Registered Dec. 20, 2011

BAGSVAERD, DENMARK DK-2880

Int. Cl.: 1

FOR: ENZYME PREPARATIONS FOR USE IN THE DETERGENTS INDUSTRY, IN CLASS 1 (U.S. CLS. 1, 5, 6, 10, 26 AND 46).

TRADEMARK

FIRST USE 5-0-2011; IN COMMERCE 5-0-2011.

PRINCIPAL REGISTER

THE MARK CONSISTS OF STANDARD CHARACTERS WITHOUT CLAIM TO ANY PARTICULAR FONT, STYLE, SIZE, OR COLOR.

SER. NO. 85-360,328, FILED 6-30-2011.

STEVEN R. FINE, EXAMINING ATTORNEY



David J. Kybas

Director of the United States Patent and Trademark Office

United States of America

United States Patent and Trademark Office

PING

Reg. No. 4,074,325

KARSTEN MANUFACTURING CORPORATION (ARIZONA CORPORATION)
2201 WEST DESERT COVE
PHOENIX, AZ 85029

Registered Dec. 20, 2011

Int. Cl.: 9

FOR: ELECTRONIC ACCESSORIES, NAMELY, MOUNTS AND HOLDERS FOR PORTABLE ELECTRONIC DEVICES, IN CLASS 9 (U.S. CLS. 21, 23, 26, 36 AND 38).

TRADEMARK

FIRST USE 6-17-2011; IN COMMERCE 6-17-2011.

PRINCIPAL REGISTER

THE MARK CONSISTS OF STANDARD CHARACTERS WITHOUT CLAIM TO ANY PARTICULAR FONT, STYLE, SIZE, OR COLOR.

OWNER OF U.S. REG. NOS. 2,810,552, 3,171,975, AND 3,617,336.

SER. NO. 85-360,393, FILED 6-30-2011.

HENRY S. ZAK, EXAMINING ATTORNEY



David J. Kyffers

Director of the United States Patent and Trademark Office

United States of America

United States Patent and Trademark Office

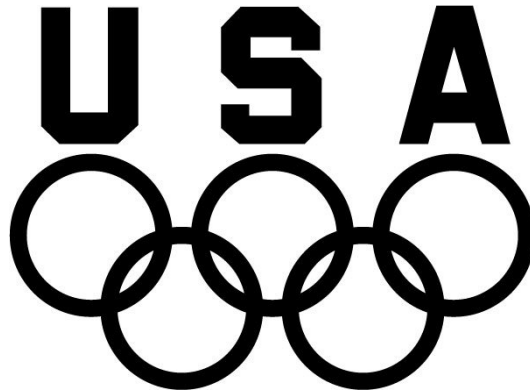

Reg. No. 4,074,326

Registered Dec. 20, 2011

Int. Cl.: 6

TRADEMARK

PRINCIPAL REGISTER

UNITED STATES OLYMPIC COMMITTEE (UNITED STATES CONGRESSIONALLY
CHARTERED NONPROFIT ORGANIZATION)
OFFICE OF THE GENERAL COUNSEL
1 OLYMPIC PLAZA
COLORADO SPRINGS, CO 80909

FOR: METAL LICENSE PLATES, IN CLASS 6 (U.S. CLS. 2, 12, 13, 14, 23, 25 AND 50).

FIRST USE 12-31-1994; IN COMMERCE 12-31-1994.

OWNER OF U.S. REG. NOS. 3,024,771, 3,903,015 AND OTHERS.

NO CLAIM IS MADE TO THE EXCLUSIVE RIGHT TO USE "USA", APART FROM THE
MARK AS SHOWN.

THE MARK CONSISTS OF FIVE INTERLOCKING RINGS BELOW THE TERM "USA".

SER. NO. 85-360,985, FILED 6-30-2011.

JEFFERY COWARD, EXAMINING ATTORNEY



David J. Kyffers

Director of the United States Patent and Trademark Office

United States of America

United States Patent and Trademark Office

MILLENNIUM ULTRA

Reg. No. 4,074,327

Registered Dec. 20, 2011

Int. Cl.: 5

TRADEMARK

PRINCIPAL REGISTER

NUFARM AMERICAS INC. (ILLINOIS CORPORATION)
SUTIE 200
150 HARVESTER DRIVE
BURR RIDGE, IL 60527

FOR: HERBICIDES FOR SELECTIVE BROADLEAF CONTROL IN ORNAMENTAL LAWNS,
TURF GRASSES AND SOD FARMS, IN CLASS 5 (U.S. CLS. 6, 18, 44, 46, 51 AND 52).

FIRST USE 1-26-1998; IN COMMERCE 1-26-1998.

THE MARK CONSISTS OF STANDARD CHARACTERS WITHOUT CLAIM TO ANY PAR-
TICULAR FONT, STYLE, SIZE, OR COLOR.

SER. NO. 85-361,100, FILED 6-30-2011.

YAT SYE, LEE, EXAMINING ATTORNEY



David J. Kyffers

Director of the United States Patent and Trademark Office

United States of America

United States Patent and Trademark Office

JACKPOT ISLAND

Reg. No. 4,074,328

KONAMI GAMING, INC. (NEVADA CORPORATION)
585 TRADE CENTER DRIVE
LAS VEGAS, NV 89119

Registered Dec. 20, 2011

Int. Cl.: 9

FOR: ELECTRONIC GAME PROGRAMS; GAMING EQUIPMENT, NAMELY, SLOT MACHINES WITH OR WITHOUT VIDEO OUTPUT; GAMING MACHINES; MACHINES FOR PLAYING GAMES OF CHANCE; SLOT MACHINES, IN CLASS 9 (U.S. CLS. 21, 23, 26, 36 AND 38).

TRADEMARK

PRINCIPAL REGISTER

FIRST USE 11-16-2010; IN COMMERCE 11-16-2010.

THE MARK CONSISTS OF STANDARD CHARACTERS WITHOUT CLAIM TO ANY PARTICULAR FONT, STYLE, SIZE, OR COLOR.

OWNER OF U.S. REG. NOS. 3,056,323, 3,459,735 AND OTHERS.

NO CLAIM IS MADE TO THE EXCLUSIVE RIGHT TO USE "JACKPOT", APART FROM THE MARK AS SHOWN.

SER. NO. 85-361,297, FILED 6-30-2011.

LESLIE RICHARDS, EXAMINING ATTORNEY



David J. Kyffers

Director of the United States Patent and Trademark Office

United States of America

United States Patent and Trademark Office

WESTERN SALOON

Reg. No. 4,074,329

KONAMI GAMING, INC. (NEVADA CORPORATION)
585 TRADE CENTER DRIVE
LAS VEGAS, NV 89119

Registered Dec. 20, 2011

Int. Cl.: 9

FOR: ELECTRONIC GAME PROGRAMS; GAMING EQUIPMENT, NAMELY, SLOT MACHINES WITH OR WITHOUT VIDEO OUTPUT; GAMING MACHINES; MACHINES FOR PLAYING GAMES OF CHANCE; SLOT MACHINES, IN CLASS 9 (U.S. CLS. 21, 23, 26, 36 AND 38).

TRADEMARK

PRINCIPAL REGISTER

FIRST USE 8-17-2010; IN COMMERCE 8-17-2010.

THE MARK CONSISTS OF STANDARD CHARACTERS WITHOUT CLAIM TO ANY PARTICULAR FONT, STYLE, SIZE, OR COLOR.

SER. NO. 85-361,305, FILED 6-30-2011.

LESLIE RICHARDS, EXAMINING ATTORNEY



David J. Kyffers

Director of the United States Patent and Trademark Office

United States of America

United States Patent and Trademark Office

ORIENT FEVER

Reg. No. 4,074,330

KONAMI GAMING, INC. (NEVADA CORPORATION)
585 TRADE CENTER DRIVE
LAS VEGAS, NV 89119

Registered Dec. 20, 2011

Int. Cl.: 9

FOR: ELECTRONIC GAME PROGRAMS; GAMING EQUIPMENT, NAMELY, SLOT MACHINES WITH OR WITHOUT VIDEO OUTPUT; GAMING MACHINES; MACHINES FOR PLAYING GAMES OF CHANCE; SLOT MACHINES, IN CLASS 9 (U.S. CLS. 21, 23, 26, 36 AND 38).

TRADEMARK

PRINCIPAL REGISTER

FIRST USE 8-18-2009; IN COMMERCE 8-18-2009.

THE MARK CONSISTS OF STANDARD CHARACTERS WITHOUT CLAIM TO ANY PARTICULAR FONT, STYLE, SIZE, OR COLOR.

OWNER OF U.S. REG. NOS. 3,060,999, 3,403,340 AND OTHERS.

SER. NO. 85-361,310, FILED 6-30-2011.

LESLIE RICHARDS, EXAMINING ATTORNEY



David J. Kyfos

Director of the United States Patent and Trademark Office

United States of America

United States Patent and Trademark Office

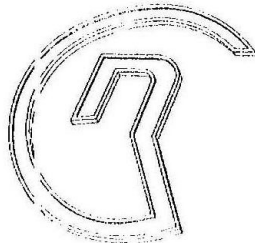

Reg. No. 4,074,331

Registered Dec. 20, 2011

Int. Cl.: 5

TRADEMARK

PRINCIPAL REGISTER

GLAXOSMITHKLINE LLC (DELAWARE LIMITED LIABILITY COMPANY)
CORPORATION SERVICE COMPANY
2711 CENTERVILLE ROAD, SUITE 400
WILMINGTON, DE 19808

FOR: PHARMACEUTICAL PREPARATIONS FOR THE TREATMENT OF CARDIOVASCULAR DISEASES AND DISORDERS , IN CLASS 5 (U.S. CLS. 6, 18, 44, 46, 51 AND 52).

FIRST USE 1-31-2000; IN COMMERCE 7-30-2000.

THE MARK CONSISTS OF AN OUTLINE OF A SEMICIRCLE WITH THE ONE END TURNED INTO THE CENTER OF THE SEMICIRCLE AND SHAPED LIKE A HOOK.

SER. NO. 85-361,751, FILED 7-1-2011.

JOHN WILKE, EXAMINING ATTORNEY



David J. Kyffers

Director of the United States Patent and Trademark Office

United States of America

United States Patent and Trademark Office

PureGear

Reg. No. 4,074,332

SUPERIOR COMMUNICATIONS, INC. (CALIFORNIA CORPORATION)
5027 IRWINDALE AVE., SUITE 900
IRWINDALE, CA 91706

Registered Dec. 20, 2011

Int. Cl.: 9

FOR: WIRELESS PHONE ACCESSORIES, NAMELY, CARRYING BAGS SPECIFICALLY ADAPTED FOR WIRELESS PHONES, WIRELESS PHONE CASES AND SPECIALTY HOLDERS FOR CARRYING WIRELESS PHONES, BATTERY CHARGERS, HEADSETS, AND SCREEN PROTECTORS, IN CLASS 9 (U.S. CLS. 21, 23, 26, 36 AND 38).

TRADEMARK

PRINCIPAL REGISTER

FIRST USE 8-1-2009; IN COMMERCE 11-1-2009.

THE MARK CONSISTS OF STANDARD CHARACTERS WITHOUT CLAIM TO ANY PARTICULAR FONT, STYLE, SIZE, OR COLOR.

OWNER OF U.S. REG. NO. 3,757,534.

SER. NO. 85-361,882, FILED 7-1-2011.

KAREN K. BUSH, EXAMINING ATTORNEY



David J. Kyffers

Director of the United States Patent and Trademark Office

United States of America

United States Patent and Trademark Office

Musique

Reg. No. 4,074,333

Registered Dec. 20, 2011

Int. Cl.: 33

TRADEMARK

PRINCIPAL REGISTER

KEVIN BROWN (UNITED STATES INDIVIDUAL)
1613 46TH AVE. SW
SEATTLE, WA 98116

FOR: WINE, IN CLASS 33 (U.S. CLS. 47 AND 49).

FIRST USE 6-1-2011; IN COMMERCE 6-1-2011.

THE MARK CONSISTS OF STANDARD CHARACTERS WITHOUT CLAIM TO ANY PARTICULAR FONT, STYLE, SIZE, OR COLOR.

THE ENGLISH TRANSLATION OF "MUSIQUE" IN THE MARK IS MUSIC.

SER. NO. 85-362,701, FILED 7-4-2011.

NICHOLAS COLEMAN, EXAMINING ATTORNEY



David J. Kyffers

Director of the United States Patent and Trademark Office

United States of America

United States Patent and Trademark Office

A Night in Madrid

Reg. No. 4,074,334

KEVIN BROWN (UNITED STATES INDIVIDUAL)

Registered Dec. 20, 2011

1613 46TH AVE. SW
SEATTLE, WA 98116

Int. Cl.: 33

FOR: WINE, IN CLASS 33 (U.S. CLS. 47 AND 49).

TRADEMARK

FIRST USE 6-1-2011; IN COMMERCE 6-1-2011.

PRINCIPAL REGISTER

THE MARK CONSISTS OF STANDARD CHARACTERS WITHOUT CLAIM TO ANY PARTICULAR FONT, STYLE, SIZE, OR COLOR.

SER. NO. 85-362,702, FILED 7-4-2011.

NICHOLAS COLEMAN, EXAMINING ATTORNEY



David J. Kyffers

Director of the United States Patent and Trademark Office

United States of America

United States Patent and Trademark Office

SAN ANTONIO FARMS

Reg. No. 4,074,335

THF EQUITIES, LP (DELAWARE LIMITED PARTNERSHIP)
2021 SPRING ROAD
OAK BROOK, IL 60523

Registered Dec. 20, 2011

Int. Cl.: 30

FOR: SAUCES, SALSA, IN CLASS 30 (U.S. CL. 46).

TRADEMARK

FIRST USE 2-28-1997; IN COMMERCE 2-28-1997.

PRINCIPAL REGISTER

THE MARK CONSISTS OF STANDARD CHARACTERS WITHOUT CLAIM TO ANY PARTICULAR FONT, STYLE, SIZE, OR COLOR.

SEC. 2(F) AS TO SAN ANTONIO.

SER. NO. 85-363,052, FILED 7-5-2011.

MARK SPARACINO, EXAMINING ATTORNEY



David J. Kyffers

Director of the United States Patent and Trademark Office

United States of America

United States Patent and Trademark Office



Reg. No. 4,074,336
Registered Dec. 20, 2011
Int. Cls.: 6, 14 and 25

UNITED STATES OLYMPIC COMMITTEE (UNITED STATES CONGRESSIONALLY
CHARTERED NONPROFIT ORGANIZATION)
OFFICE OF THE GENERAL COUNSEL
1 OLYMPIC PLAZA
COLORADO SPRINGS, CO 80909

TRADEMARK
PRINCIPAL REGISTER

FOR: METAL KEY CHAINS, IN CLASS 6 (U.S. CLS. 2, 12, 13, 14, 23, 25 AND 50).

FIRST USE 11-4-2009; IN COMMERCE 11-4-2009.

FOR: ORNAMENTAL LAPEL PINS, IN CLASS 14 (U.S. CLS. 2, 27, 28 AND 50).

FIRST USE 11-4-2009; IN COMMERCE 11-4-2009.

FOR: SNAP CROTCH SHIRTS FOR INFANTS AND TODDLERS; T-SHIRTS; TANK-TOPS,
IN CLASS 25 (U.S. CLS. 22 AND 39).

FIRST USE 11-4-2009; IN COMMERCE 11-4-2009.

OWNER OF U.S. REG. NOS. 2,455,565, 3,848,800 AND OTHERS.

THE MARK CONSISTS OF A SHIELD DESIGN WITH VERTICAL STRIPES ON THE BOTTOM
OF THE SHIELD AND "TEAM USA" WRITTEN ACROSS THE TOP PORTION OF THE
SHIELD.

SER. NO. 85-363,364, FILED 7-5-2011.

JEFFERY COWARD, EXAMINING ATTORNEY



David J. Kybas

Director of the United States Patent and Trademark Office

United States of America

United States Patent and Trademark Office



Reg. No. 4,074,337

Registered Dec. 20, 2011

Int. Cl.: 35

SERVICE MARK

PRINCIPAL REGISTER

UNITED STATES OLYMPIC COMMITTEE (UNITED STATES CONGRESSIONALLY
CHARTERED NONPROFIT ORGANIZATION)
OFFICE OF THE GENERAL COUNSEL
1 OLYMPIC PLAZA
COLORADO SPRINGS, CO 80909

FOR: ON-LINE RETAIL STORE SERVICES FEATURING A WIDE VARIETY OF SOUVENIR
AND FAN MERCHANDISE, IN CLASS 35 (U.S. CLS. 100, 101 AND 102).

FIRST USE 11-4-2009; IN COMMERCE 11-4-2009.

OWNER OF U.S. REG. NOS. 2,455,565, 3,848,800 AND OTHERS.

THE MARK CONSISTS OF A SHIELD DESIGN WITH VERTICAL STRIPES ON THE BOTTOM
OF THE SHIELD AND "TEAM USA" WRITTEN ACROSS THE TOP PORTION OF THE
SHIELD.

SER. NO. 85-363,399, FILED 7-5-2011.

JEFFERY COWARD, EXAMINING ATTORNEY



David J. Kyffers

Director of the United States Patent and Trademark Office

United States of America

United States Patent and Trademark Office

LAST NIGHT

Reg. No. 4,074,338

Registered Dec. 20, 2011

Int. Cl.: 3

TRADEMARK

PRINCIPAL REGISTER

EDWARD BESS, INC. (NEW YORK CORPORATION)
10TH FLOOR
115 EAST 57TH STREET
NEW YORK, NY 10022

FOR: FRAGRANCES, NAMELY, PERFUME, COLOGNE, EAU DE TOILETTE, AFTERSHAVE, SCENTED BODY SPRAYS AND PERSONAL DEODORANTS; SHOWER GELS; BODY LOTIONS; BODY POWDERS; SOAPS FOR PERSONAL USE, IN CLASS 3 (U.S. CLS. 1, 4, 6, 50, 51 AND 52).

FIRST USE 1-1-2011; IN COMMERCE 2-1-2011.

THE MARK CONSISTS OF STANDARD CHARACTERS WITHOUT CLAIM TO ANY PARTICULAR FONT, STYLE, SIZE, OR COLOR.

SER. NO. 85-364,350, FILED 7-6-2011.

ROBIN MITTLER, EXAMINING ATTORNEY



David J. Kyffers

Director of the United States Patent and Trademark Office

United States of America

United States Patent and Trademark Office

IN A SCENT

Reg. No. 4,074,339

Registered Dec. 20, 2011

Int. Cl.: 3

TRADEMARK

PRINCIPAL REGISTER

EDWARD BESS, INC. (NEW YORK CORPORATION)
10TH FLOOR
115 EAST 57TH STREET
NEW YORK, NY 10022

FOR: FRAGRANCES, NAMELY, PERFUME, COLOGNE, EAU DE TOILETTE, AFTERSHAVE, SCENTED BODY SPRAYS AND PERSONAL DEODORANTS; SHOWER GELS; BODY LOTIONS; BODY POWDERS; SOAPS FOR PERSONAL USE, IN CLASS 3 (U.S. CLS. 1, 4, 6, 50, 51 AND 52).

FIRST USE 1-1-2011; IN COMMERCE 2-1-2011.

THE MARK CONSISTS OF STANDARD CHARACTERS WITHOUT CLAIM TO ANY PARTICULAR FONT, STYLE, SIZE, OR COLOR.

SER. NO. 85-364,359, FILED 7-6-2011.

ROBIN MITTLER, EXAMINING ATTORNEY



David J. Kybas

Director of the United States Patent and Trademark Office

United States of America

United States Patent and Trademark Office

FREE YOUR SKIN

Reg. No. 4,074,340

Registered Dec. 20, 2011

Int. Cl.: 3

TRADEMARK

PRINCIPAL REGISTER

EVEREADY BATTERY COMPANY, INC. (DELAWARE CORPORATION)
SWS TRADEMARKS
533 MARYVILLE UNIVERSITY DRIVE
ST. LOUIS, MO 63141

FOR: SHAVING CREAMS; SHAVING FOAM; SHAVING GELS; SHAVING PREPARATIONS,
IN CLASS 3 (U.S. CLS. 1, 4, 6, 50, 51 AND 52).

FIRST USE 2-19-2010; IN COMMERCE 2-19-2010.

THE MARK CONSISTS OF STANDARD CHARACTERS WITHOUT CLAIM TO ANY PAR-
TICULAR FONT, STYLE, SIZE, OR COLOR.

OWNER OF U.S. REG. NO. 3,636,039.

SER. NO. 85-364,393, FILED 7-6-2011.

EMILY CARLSEN, EXAMINING ATTORNEY



David J. Kyffers

Director of the United States Patent and Trademark Office

United States of America

United States Patent and Trademark Office

THE MAGIC EASEL

Reg. No. 4,074,341

Registered Dec. 20, 2011

Int. Cl.: 41

SERVICE MARK

PRINCIPAL REGISTER

MCCUE, WILLIAM P (UNITED STATES INDIVIDUAL)
417 COYLE CURTAIN ROAD
MONONGAHELA, PA 15063

FOR: ENTERTAINMENT SERVICES, NAMELY, AN ONGOING CHILDREN'S TELEVISION SERIES IN THE FIELD OF CHILDREN'S ENTERTAINMENT, LIVE PERFORMANCES FEATURING COSTUMED CHARACTERS, PRODUCTION OF CARTOON VISUAL EFFECTS FOR VIDEOS, DVDS, TELEVISION, INTERNET WEB SITES; ORGANIZING EDUCATIONAL AND ENTERTAINING COMPETITIONS FOR CHILDREN AND ADULTS IN THE FIELDS OF MATH AND SPELLING; PUBLICATION OF BOOKS; PRODUCTION OF RADIO PROGRAMS; PRODUCTION OF TELEVISION PROGRAMS AND A TELEVISION SERIES; ENTERTAINMENT IN THE NATURE OF THEATRICAL PRODUCTIONS; PRODUCTION OF SOUND RECORDINGS; PRODUCTION OF VIDEO RECORDINGS AND VIDEO DISC RECORDINGS; PRODUCTION OF FILMS; PRODUCTION OF COMPACT DISCS AND CD ROMS; RENTAL OF MOTION PICTURES; RENTAL OF VIDEO PROGRAMS; PROVIDING NON-DOWNLOADABLE ON-LINE ENTERTAINMENT FOR CHILDREN IN THE NATURE OF SONGS, STORIES AND GAMES, IN CLASS 41 (U.S. CLS. 100, 101 AND 107).

FIRST USE 7-21-2003; IN COMMERCE 7-21-2003.

THE MARK CONSISTS OF STANDARD CHARACTERS WITHOUT CLAIM TO ANY PARTICULAR FONT, STYLE, SIZE, OR COLOR.

NO CLAIM IS MADE TO THE EXCLUSIVE RIGHT TO USE "THE", APART FROM THE MARK AS SHOWN.

SER. NO. 85-364,578, FILED 7-6-2011.

KRISTIN CARLSON, EXAMINING ATTORNEY



David J. Kyjars

Director of the United States Patent and Trademark Office

United States of America

United States Patent and Trademark Office

MEDITERRA

Reg. No. 4,074,342

Registered Dec. 20, 2011

Int. Cl.: 30

TRADEMARK

PRINCIPAL REGISTER

SALTWORKS, INC. (WASHINGTON CORPORATION)
15000 WOODINVILLE REDMOND ROAD, B-900
WOODINVILLE, WA 98072

FOR: SALT; SEA SALT FOR COOKING, IN CLASS 30 (U.S. CL. 46).

FIRST USE 6-0-2011; IN COMMERCE 6-0-2011.

THE MARK CONSISTS OF STANDARD CHARACTERS WITHOUT CLAIM TO ANY PARTICULAR FONT, STYLE, SIZE, OR COLOR.

SER. NO. 85-365,183, FILED 7-7-2011.

ASMAT KHAN, EXAMINING ATTORNEY



David J. Kyffers

Director of the United States Patent and Trademark Office

United States of America

United States Patent and Trademark Office

SOLU-CAL

Reg. No. 4,074,343

SOLUCAL-USA LTD. (MASSACHUSETTS CORPORATION)
33 OLD COUNTY ROAD
EAST SANDWICH, MA 02537

Registered Dec. 20, 2011

Int. Cl.: 1

FOR: FERTILIZERS; SOIL CONDITIONERS FOR AGRICULTURAL, DOMESTIC, AND COMMERCIAL USE, IN CLASS 1 (U.S. CLS. 1, 5, 6, 10, 26 AND 46).

TRADEMARK

FIRST USE 3-29-1999; IN COMMERCE 3-29-1999.

PRINCIPAL REGISTER

THE MARK CONSISTS OF STANDARD CHARACTERS WITHOUT CLAIM TO ANY PARTICULAR FONT, STYLE, SIZE, OR COLOR.

OWNER OF U.S. REG. NO. 3,822,623.

SER. NO. 85-365,561, FILED 7-7-2011.

ROBIN CHOSID, EXAMINING ATTORNEY



David J. Kyffers

Director of the United States Patent and Trademark Office

United States of America

United States Patent and Trademark Office

DRPH

Reg. No. 4,074,344

D&S CONSULTANTS, INC. (NEW JERSEY CORPORATION), DBA DSCI
PO BOX 479
EATONTOWN, NJ 07724

Registered Dec. 20, 2011

Int. Cl.: 36

FOR: REAL ESTATE MANAGEMENT OF COMMERCIAL PROPERTIES; REAL ESTATE SERVICES, NAMELY, RENTAL, BROKERAGE, LEASING AND MANAGEMENT OF COMMERCIAL PROPERTY, OFFICES AND OFFICE SPACE, IN CLASS 36 (U.S. CLS. 100, 101 AND 102).

SERVICE MARK

PRINCIPAL REGISTER

FIRST USE 5-1-2011; IN COMMERCE 5-1-2011.

THE MARK CONSISTS OF STANDARD CHARACTERS WITHOUT CLAIM TO ANY PARTICULAR FONT, STYLE, SIZE, OR COLOR.

SER. NO. 85-365,963, FILED 7-7-2011.

FRANK LATTUCA, EXAMINING ATTORNEY



David J. Kybas

Director of the United States Patent and Trademark Office

United States of America

United States Patent and Trademark Office

PLAN YOUR DAY WITH CONFIDENCE!

Reg. No. 4,074,345

COMBEX, INC. (WISCONSIN CORPORATION), DBA CHANEY INSTRUMENT COMPANY
965 WELLS STREET

Registered Dec. 20, 2011

LAKE GENEVA, WI 53147

Int. Cl.: 9

FOR: WEATHER STATIONS FOR HOUSEHOLD USE, NAMELY, ELECTRONIC WEATHER STATIONS COMPRISED OF ELECTRONIC SENSORS AND CIRCUITRY FOR MEASURING TEMPERATURE, HUMIDITY, BAROMETRIC PRESSURE AND OTHER WEATHER PARAMETERS, IN CLASS 9 (U.S. CLS. 21, 23, 26, 36 AND 38).

TRADEMARK

PRINCIPAL REGISTER

FIRST USE 6-25-2011; IN COMMERCE 6-25-2011.

THE MARK CONSISTS OF STANDARD CHARACTERS WITHOUT CLAIM TO ANY PARTICULAR FONT, STYLE, SIZE, OR COLOR.

SER. NO. 85-366,194, FILED 7-8-2011.

WILLIAM P. SHANAHAN, EXAMINING ATTORNEY



David J. Kyffers

Director of the United States Patent and Trademark Office

United States of America

United States Patent and Trademark Office

PRISMVUE

Reg. No. 4,074,346

Registered Dec. 20, 2011

Int. Cl.: 10

TRADEMARK

PRINCIPAL REGISTER

HOYA CORPORATION (JAPAN CORPORATION)
2-7-5, NAKA-OCHIAI, SHINJUKU-KU
TOKYO, JAPAN

FOR: DEFLECTION LOUPES FOR MEDICAL PURPOSES, NAMELY, MAGNIFYING GLASSES THAT FIT ON THE USER'S FACE IN THE MANNER OF EYEGLASSES, IN CLASS 10 (U.S. CLS. 26, 39 AND 44).

THE MARK CONSISTS OF STANDARD CHARACTERS WITHOUT CLAIM TO ANY PARTICULAR FONT, STYLE, SIZE, OR COLOR.

OWNER OF JAPAN REG. NO. 5119426, DATED 3-14-2008, EXPIRES 3-14-2018.

SER. NO. 85-366,374, FILED 7-8-2011.

WENDY JUN, EXAMINING ATTORNEY



David J. Kyffers

Director of the United States Patent and Trademark Office

United States of America

United States Patent and Trademark Office

CHARIOT EAGLE WEST

Reg. No. 4,074,347

Registered Dec. 20, 2011

Int. Cl.: 12

TRADEMARK

PRINCIPAL REGISTER

CHARIOT EAGLE, INC. (FLORIDA CORPORATION)
931 N.W. 37TH AVENUE
OCALA, FL 34475

FOR: RECREATIONAL VEHICLES, NAMELY, PARK TRAILERS, IN CLASS 12 (U.S. CLS. 19, 21, 23, 31, 35 AND 44).

FIRST USE 0-0-1986; IN COMMERCE 0-0-1986.

THE MARK CONSISTS OF STANDARD CHARACTERS WITHOUT CLAIM TO ANY PARTICULAR FONT, STYLE, SIZE, OR COLOR.

OWNER OF U.S. REG. NOS. 1,736,600 AND 3,355,724.

NO CLAIM IS MADE TO THE EXCLUSIVE RIGHT TO USE "WEST", APART FROM THE MARK AS SHOWN.

SER. NO. 85-366,653, FILED 7-8-2011.

ALICE BENMAMAN, EXAMINING ATTORNEY



David J. Kyffers

Director of the United States Patent and Trademark Office

United States of America

United States Patent and Trademark Office



Reg. No. 4,074,348

Registered Dec. 20, 2011

Int. Cl.: 9

TRADEMARK

PRINCIPAL REGISTER

NAVAJO MANUFACTURING COMPANY (COLORADO CORPORATION)
5330 FOX STREET
DENVER, CO 80216

FOR: SUNGLASSES, IN CLASS 9 (U.S. CLS. 21, 23, 26, 36 AND 38).

FIRST USE 12-29-2010; IN COMMERCE 12-29-2010.

THE MARK CONSISTS OF A STYLIZED LETTER "E".

SER. NO. 85-366,675, FILED 7-8-2011.

ROBIN CHOSID, EXAMINING ATTORNEY



David J. Kyffers

Director of the United States Patent and Trademark Office

United States of America

United States Patent and Trademark Office

THE INDEX

Reg. No. 4,074,349

Registered Dec. 20, 2011

Int. Cl.: 35

SERVICE MARK

PRINCIPAL REGISTER

GILT CITY, INC. (DELAWARE CORPORATION)
2 PARK AVENUE, 4TH FLOOR
NEW YORK, NY 10016

FOR: PROVIDING A SEARCHABLE WEBSITE FEATURING THE GOODS AND SERVICES OF OTHER VENDORS; PROVIDING A WEBSITE FEATURING THE GOODS AND SERVICES OF OTHERS BEING SOLD AT DISCOUNT PRICES; AND PROMOTING THE GOODS AND SERVICES OF OTHERS VIA A GLOBAL COMPUTER NETWORK, IN CLASS 35 (U.S. CLS. 100, 101 AND 102).

FIRST USE 7-8-2011; IN COMMERCE 7-8-2011.

THE MARK CONSISTS OF STANDARD CHARACTERS WITHOUT CLAIM TO ANY PARTICULAR FONT, STYLE, SIZE, OR COLOR.

SER. NO. 85-367,562, FILED 7-11-2011.

GRETТА YAO, EXAMINING ATTORNEY



David J. Kyffers

Director of the United States Patent and Trademark Office

United States of America

United States Patent and Trademark Office

WEDDING DAY

Reg. No. 4,074,350

THE YANKEE CANDLE COMPANY, INC. (MASSACHUSETTS CORPORATION)
POST OFFICE BOX 110
SOUTH DEERFIELD, MA 013730110

Registered Dec. 20, 2011

Int. Cl.: 4

FOR: CANDLES; FRAGRANT WAX FOR USE IN POTPOURRI BURNERS, IN CLASS 4 (U.S. CLS. 1, 6 AND 15).

TRADEMARK

FIRST USE 3-31-1999; IN COMMERCE 3-31-1999.

PRINCIPAL REGISTER

THE MARK CONSISTS OF STANDARD CHARACTERS WITHOUT CLAIM TO ANY PARTICULAR FONT, STYLE, SIZE, OR COLOR.

OWNER OF U.S. REG. NO. 2,439,652.

SEC. 2(F).

SER. NO. 85-367,874, FILED 7-11-2011.

ADA HAN, EXAMINING ATTORNEY



David J. Kyffers

Director of the United States Patent and Trademark Office

United States of America

United States Patent and Trademark Office

EXPAND THE EXPERIENCE

Reg. No. 4,074,351

Registered Dec. 20, 2011

Int. Cls.: 9 and 16

TRADEMARK

PRINCIPAL REGISTER

CHICAGO PROVINCE OF THE SOCIETY OF JESUS (ILLINOIS NON-PROFIT CORPORATION)
3441 NORTH ASHLAND AVENUE
CHICAGO, IL 60657

FOR: PROVIDING ON-LINE DOWNLOADABLE EDUCATIONAL PUBLICATIONS, NAMELY, EDUCATIONAL LEARNING CARDS, FLASH CARDS, AND ACTIVITY CARDS IN THE FIELD OF RELIGION, IN CLASS 9 (U.S. CLS. 21, 23, 26, 36 AND 38).

FIRST USE 8-1-2010; IN COMMERCE 8-1-2010.

FOR: EDUCATIONAL PUBLICATIONS, NAMELY, EDUCATIONAL LEARNING CARDS, FLASH CARDS, AND ACTIVITY CARDS IN THE FIELD OF RELIGION, IN CLASS 16 (U.S. CLS. 2, 5, 22, 23, 29, 37, 38 AND 50).

FIRST USE 8-1-2010; IN COMMERCE 8-1-2010.

THE MARK CONSISTS OF STANDARD CHARACTERS WITHOUT CLAIM TO ANY PARTICULAR FONT, STYLE, SIZE, OR COLOR.

SER. NO. 85-368,770, FILED 7-12-2011.

NAAKWAMA ANKRAH, EXAMINING ATTORNEY



David J. Kyffers

Director of the United States Patent and Trademark Office

United States of America

United States Patent and Trademark Office

Reliant Sell-Back

Reg. No. 4,074,352

Registered Dec. 20, 2011

Int. Cl.: 35

SERVICE MARK

PRINCIPAL REGISTER

RELIANT ENERGY RETAIL HOLDINGS, LLC (TEXAS LIMITED LIABILITY COMPANY)
1201 FANNIN
NRG TOWER AT HOUSTON PAVILIONS
HOUSTON, TX 77002

FOR: ENERGY MANAGEMENT SERVICES, NAMELY, PROVIDING A SERVICE THAT
ALLOWS OWNERS OF SOLAR POWER GENERATION EQUIPMENT TO PURCHASE AND
SELL ELECTRICITY, IN CLASS 35 (U.S. CLS. 100, 101 AND 102).

FIRST USE 6-13-2011; IN COMMERCE 6-13-2011.

THE MARK CONSISTS OF STANDARD CHARACTERS WITHOUT CLAIM TO ANY PAR-
TICULAR FONT, STYLE, SIZE, OR COLOR.

OWNER OF U.S. REG. NOS. 2,886,710, 3,097,811, AND 3,132,302.

NO CLAIM IS MADE TO THE EXCLUSIVE RIGHT TO USE "SELL-BACK", APART FROM
THE MARK AS SHOWN.

SER. NO. 85-369,439, FILED 7-12-2011.

CHRIS WELLS, EXAMINING ATTORNEY



David J. Kyffers

Director of the United States Patent and Trademark Office

United States of America

United States Patent and Trademark Office

EAU LA LA

Reg. No. 4,074,353

Registered Dec. 20, 2011

Int. Cl.: 3

TRADEMARK

PRINCIPAL REGISTER

EDWARD BESS, INC. (NEW YORK CORPORATION)
10TH FLOOR
115 EAST 57TH STREET
NEW YORK, NY 10022

FOR: FRAGRANCES, NAMELY, PERFUME, COLOGNE, EAU DE TOILETTE, AFTERSHAVE, AND SCENTED BODY SPRAYS AND PERSONAL DEODORANTS; SHOWER GELS; BODY LOTIONS; BODY POWDERS; SOAPS FOR PERSONAL USE, IN CLASS 3 (U.S. CLS. 1, 4, 6, 50, 51 AND 52).

FIRST USE 1-1-2011; IN COMMERCE 2-1-2011.

THE MARK CONSISTS OF STANDARD CHARACTERS WITHOUT CLAIM TO ANY PARTICULAR FONT, STYLE, SIZE, OR COLOR.

THE ENGLISH TRANSLATION OF "EAU" IN THE MARK IS "WATER". THE WORDING "LA LA" HAS NO MEANING IN A FOREIGN LANGUAGE.

SER. NO. 85-369,937, FILED 7-13-2011.

ROBIN MITTLER, EXAMINING ATTORNEY



David J. Kybas

Director of the United States Patent and Trademark Office

United States of America

United States Patent and Trademark Office

EPIC PINBALL

Reg. No. 4,074,354

EPIC GAMES, INC. (MARYLAND CORPORATION)
620 CROSSROADS BOULEVARD
CARY, NC 27518

Registered Dec. 20, 2011

Int. Cl.: 9

FOR: VIDEO GAME SOFTWARE, IN CLASS 9 (U.S. CLS. 21, 23, 26, 36 AND 38).

TRADEMARK

FIRST USE 11-6-1993; IN COMMERCE 11-6-1993.

PRINCIPAL REGISTER

THE MARK CONSISTS OF STANDARD CHARACTERS WITHOUT CLAIM TO ANY PARTICULAR FONT, STYLE, SIZE, OR COLOR.

OWNER OF U.S. REG. NOS. 2,168,887 AND 2,527,709.

NO CLAIM IS MADE TO THE EXCLUSIVE RIGHT TO USE "PINBALL", APART FROM THE MARK AS SHOWN.

SER. NO. 85-371,386, FILED 7-14-2011.

KAREN K. BUSH, EXAMINING ATTORNEY



David J. Kyffers

Director of the United States Patent and Trademark Office

United States of America

United States Patent and Trademark Office

BD Stemflow

Reg. No. 4,074,355

BECTON, DICKINSON AND COMPANY (NEW JERSEY CORPORATION)
1 BECTON DRIVE, MC 090
FRANKLIN LAKES, NJ 07417

Registered Dec. 20, 2011

Int. Cl.: 1

FOR: RESEARCH REAGENTS FOR RESEARCH LABORATORY USE, NAMELY, FLOW CYTOMETRY SINGLE-VIAL REAGENTS; FLOW CYTOMETRY KITS COMPRISED OF RESEARCH REAGENTS, BUFFERS AND CONTROLS FOR RESEARCH LABORATORY USE, IN CLASS 1 (U.S. CLS. 1, 5, 6, 10, 26 AND 46).

TRADEMARK

PRINCIPAL REGISTER

FIRST USE 8-19-2009; IN COMMERCE 8-19-2009.

THE MARK CONSISTS OF STANDARD CHARACTERS WITHOUT CLAIM TO ANY PARTICULAR FONT, STYLE, SIZE, OR COLOR.

OWNER OF U.S. REG. NOS. 442,281, 2,510,232 AND OTHERS.

SER. NO. 85-373,846, FILED 7-18-2011.

JASON TURNER, EXAMINING ATTORNEY



David J. Kybas

Director of the United States Patent and Trademark Office

United States of America

United States Patent and Trademark Office

CHACHING!

Reg. No. 4,074,356

ISLE OF CAPRI CASINOS, INC. (DELAWARE CORPORATION)
600 EMERSON DRIVE, SUITE 300
ST. LOUIS, MO 63141

Registered Dec. 20, 2011

Int. Cl.: 41

FOR: CASINOS; PROVIDING SLOT MACHINE PARLORS, IN CLASS 41 (U.S. CLS. 100, 101 AND 107).

SERVICE MARK

FIRST USE 12-0-2009; IN COMMERCE 12-0-2009.

PRINCIPAL REGISTER

THE MARK CONSISTS OF STANDARD CHARACTERS WITHOUT CLAIM TO ANY PARTICULAR FONT, STYLE, SIZE, OR COLOR.

SER. NO. 85-374,039, FILED 7-18-2011.

CAROLYN CATALDO, EXAMINING ATTORNEY



David J. Kybas

Director of the United States Patent and Trademark Office

United States of America

United States Patent and Trademark Office

NATURELIEF

Reg. No. 4,074,357

Registered Dec. 20, 2011

Int. Cl.: 5

TRADEMARK

PRINCIPAL REGISTER

CONCEPTS IN HEALTH, INC. (NEW YORK CORPORATION)
11 PINE GLEN DRIVE
BLAUVELT, NY 10913

FOR: DIETARY AND NUTRITIONAL SUPPLEMENTS, IN CLASS 5 (U.S. CLS. 6, 18, 44, 46, 51 AND 52).

FIRST USE 2-14-2011; IN COMMERCE 2-14-2011.

THE MARK CONSISTS OF STANDARD CHARACTERS WITHOUT CLAIM TO ANY PARTICULAR FONT, STYLE, SIZE, OR COLOR.

OWNER OF U.S. REG. NO. 3,952,324.

SER. NO. 85-374,113, FILED 7-18-2011.

SHANNON TWOHIG, EXAMINING ATTORNEY



David J. Kybas

Director of the United States Patent and Trademark Office

United States of America

United States Patent and Trademark Office

LMAO!!!

Reg. No. 4,074,358

Registered Dec. 20, 2011

Int. Cl.: 33

TRADEMARK

PRINCIPAL REGISTER

VISION WINE & SPIRITS, LLC (NEW JERSEY LIMITED LIABILITY COMPANY)
700 PLAZA DRIVE
2ND FLOOR
SECAUCUS, NJ 07094

FOR: WINE, SPIRITS AND LIQUORS, IN CLASS 33 (U.S. CLS. 47 AND 49).

FIRST USE 5-10-2011; IN COMMERCE 5-10-2011.

THE MARK CONSISTS OF STANDARD CHARACTERS WITHOUT CLAIM TO ANY PARTICULAR FONT, STYLE, SIZE, OR COLOR.

SER. NO. 85-374,163, FILED 7-18-2011.

COLLEEN DOMBROW, EXAMINING ATTORNEY



David J. Kybas

Director of the United States Patent and Trademark Office

United States of America

United States Patent and Trademark Office

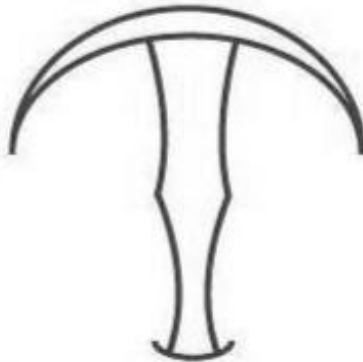

Reg. No. 4,074,359

Registered Dec. 20, 2011

Int. Cl.: 33

TRADEMARK

PRINCIPAL REGISTER

VELLUM WINE CRAFT, LLC (CALIFORNIA LIMITED LIABILITY COMPANY)
P.O. BOX 10800
NAPA, CA 94581

FOR: WINES, IN CLASS 33 (U.S. CLS. 47 AND 49).

FIRST USE 3-31-2009; IN COMMERCE 3-31-2009.

THE MARK CONSISTS OF A LUNELLUM, A CRESCENT-SHAPED KNIFE USED TO PREPARE PARCHMENT.

SER. NO. 85-374,761, FILED 7-19-2011.

JULIE GUTTADAURO, EXAMINING ATTORNEY



David J. Kyffers

Director of the United States Patent and Trademark Office

United States of America

United States Patent and Trademark Office

LED SOURCE

Reg. No. 4,074,360

Registered Dec. 20, 2011

Int. Cl.: 35

SERVICE MARK

PRINCIPAL REGISTER

LED SOURCE LLC (FLORIDA LIMITED LIABILITY COMPANY)
3101 FAIRLANE FARMS RD., SUITE 4
WELLINGTON, FL 33414

FOR: CONSULTING SERVICES IN THE FIELD OF ENERGY EFFICIENCY FEATURING LED LIGHTING FIXTURES AND LED LIGHTING SYSTEMS; ON-LINE RETAIL STORE SERVICES FEATURING LED LIGHTING FIXTURES AND LED LIGHTING SYSTEMS; DISTRIBUTORSHIPS IN THE FIELD OF LED LIGHTING FIXTURES AND LED LIGHTING SYSTEM, IN CLASS 35 (U.S. CLS. 100, 101 AND 102).

FIRST USE 9-1-2005; IN COMMERCE 9-1-2005.

THE MARK CONSISTS OF STANDARD CHARACTERS WITHOUT CLAIM TO ANY PARTICULAR FONT, STYLE, SIZE, OR COLOR.

OWNER OF U.S. REG. NOS. 3,713,570 AND 3,951,763.

NO CLAIM IS MADE TO THE EXCLUSIVE RIGHT TO USE "LED", APART FROM THE MARK AS SHOWN.

SEC. 2(F).

SER. NO. 85-374,772, FILED 7-19-2011.

KELLEY WELLS, EXAMINING ATTORNEY



David J. Kybas

Director of the United States Patent and Trademark Office

United States of America

United States Patent and Trademark Office



WASHITA CASINO

Reg. No. 4,074,361

THE CHICKASAW NATION (UNITED STATES FEDERALLY-RECOGNIZED INDIAN TRIBE)
520 E. ARLINGTON BLVD.
ADA, OK 74820

Registered Dec. 20, 2011

Int. Cl.: 41

SERVICE MARK

PRINCIPAL REGISTER

FOR: BETTING SERVICES; CASINOS; CONDUCTING AND PROVIDING FACILITIES FOR SPECIAL EVENTS FEATURING CASINO AND GAMING CONTESTS AND TOURNAMENTS; ENTERTAINMENT IN THE NATURE OF BOXING CONTESTS; ENTERTAINMENT IN THE NATURE OF CARD TOURNAMENTS; ENTERTAINMENT SERVICES IN THE NATURE OF LIVE MUSICAL PERFORMANCES; ENTERTAINMENT SERVICES IN THE NATURE OF PRESENTING LIVE MUSICAL PERFORMANCES; ENTERTAINMENT SERVICES, NAMELY, AN ON-GOING TELEVISION GAME SHOW AND GAMES OF CHANCE TO BE PLAYED AT A CASINO; ENTERTAINMENT SERVICES, NAMELY, CASINO GAMING; ENTERTAINMENT SERVICES, NAMELY, CONDUCTING LIVE BLACKJACK CARD GAME TOURNAMENTS; ENTERTAINMENT SERVICES, NAMELY, CONDUCTING LIVE POKER GAMES; ENTERTAINMENT, NAMELY, LIVE MUSIC CONCERTS; GAMBLING SERVICES; GAMING SERVICES IN THE NATURE OF CASINO GAMING; ORGANIZATION OF CULTURAL SHOWS; ORGANIZATION OF EVENTS FOR CULTURAL PURPOSES; ORGANIZATION OF EXHIBITIONS FOR CULTURAL OR EDUCATIONAL PURPOSES; ORGANIZATION OF SHOWS FOR CULTURAL PURPOSES; ORGANIZING AND HOSTING OF EVENTS FOR CULTURAL PURPOSES; ORGANIZING COMMUNITY SPORTING AND CULTURAL EVENTS; ORGANIZING CULTURAL AND ARTS EVENTS; PROVIDING CASINO FACILITIES; PROVIDING CASINO SERVICES FEATURING A CASINO PLAYERS REWARDS PROGRAM; PROVIDING CASINO SERVICES FEATURING STORED VALUE MEMBERSHIP CARDS FOR REDEEMING CASH, DISCOUNTS, AND OTHER BENEFITS; PROVIDING OFF-TRACK BETTING FACILITIES; PROVIDING ON-LINE CARD GAMES; PROVIDING ON-LINE POKER GAMES; WAGERING SERVICES, IN CLASS 41 (U.S. CLS. 100, 101 AND 107).



FIRST USE 6-0-2011; IN COMMERCE 6-0-2011.

NO CLAIM IS MADE TO THE EXCLUSIVE RIGHT TO USE "WASHITA CASINO", APART FROM THE MARK AS SHOWN.

THE MARK CONSISTS OF A FIVE-POINTED STAR, WITH RAYS IN THE SHAPE OF W'S EXTENDING OUTWARD FROM EACH POINT OF THE STAR, OVER THE STYLIZED WORDS "WASHITA CASINO".

David J. Kybas

Director of the United States Patent and Trademark Office

SER. NO. 85-374,842, FILED 7-19-2011.

Reg. No. 4,074,361 KATHLEEN M. VANSTON, EXAMINING ATTORNEY

United States of America

United States Patent and Trademark Office

CANNABANK

Reg. No. 4,074,362

CORNWELL, PAUL D (UNITED STATES INDIVIDUAL)
1231 DRUID PLACE NE
ATLANTA, GA 303071507

Registered Dec. 20, 2011

Int. Cl.: 38

FOR: PROVIDING AN ON-LINE FORUM FOR TRADING VIRTUAL REAL ESTATE, IN CLASS 38 (U.S. CLS. 100, 101 AND 104).

SERVICE MARK

FIRST USE 2-6-2007; IN COMMERCE 2-14-2007.

PRINCIPAL REGISTER

THE MARK CONSISTS OF STANDARD CHARACTERS WITHOUT CLAIM TO ANY PARTICULAR FONT, STYLE, SIZE, OR COLOR.

SER. NO. 85-375,231, FILED 7-19-2011.

LINDSEY RUBIN, EXAMINING ATTORNEY



David J. Kybas

Director of the United States Patent and Trademark Office

United States of America

United States Patent and Trademark Office

ERIN

Reg. No. 4,074,363

Registered Dec. 20, 2011

Int. Cl.: 18

TRADEMARK

PRINCIPAL REGISTER

ERIN FLETT (UNITED STATES INDIVIDUAL)
105 WOOD ROAD
GORHAM, ME 04038

FOR: HANDBAGS, IN CLASS 18 (U.S. CLS. 1, 2, 3, 22 AND 41).

FIRST USE 7-18-2011; IN COMMERCE 7-18-2011.

THE MARK CONSISTS OF STANDARD CHARACTERS WITHOUT CLAIM TO ANY PARTICULAR FONT, STYLE, SIZE, OR COLOR.

OWNER OF U.S. REG. NO. 3,799,533.

THE NAME(S), PORTRAIT(S), AND/OR SIGNATURE(S) SHOWN IN THE MARK IDENTIFIES "ERIN" FLETT, WHOSE CONSENT(S) TO REGISTER IS MADE OF RECORD.

SER. NO. 85-376,219, FILED 7-20-2011.

SKYE YOUNG, EXAMINING ATTORNEY



David J. Kyffers

Director of the United States Patent and Trademark Office

United States of America

United States Patent and Trademark Office

Bless-U-Gram

Reg. No. 4,074,364

SHARON LYNN CAMPBELL, LLC (VIRGINIA LIMITED LIABILITY COMPANY)
4390 SHELBY ROAD
ROCHELLE, VA 22738

Registered Dec. 20, 2011

Int. Cl.: 16

FOR: STATIONERY, GREETING CARDS, NOTE CARDS AND ENVELOPES, IN CLASS 16
(U.S. CLS. 2, 5, 22, 23, 29, 37, 38 AND 50).

TRADEMARK

FIRST USE 7-8-2011; IN COMMERCE 7-8-2011.

PRINCIPAL REGISTER

THE MARK CONSISTS OF STANDARD CHARACTERS WITHOUT CLAIM TO ANY PARTICULAR FONT, STYLE, SIZE, OR COLOR.

SER. NO. 85-377,461, FILED 7-21-2011.

WILLIAM ROSSMAN, EXAMINING ATTORNEY



David J. Kyros

Director of the United States Patent and Trademark Office

United States of America

United States Patent and Trademark Office



Reg. No. 4,074,365

FRANKLIN PAINT COMPANY, INC. (MASSACHUSETTS CORPORATION)
259 COTTAGE STREET
FRANKLIN, MA 02038

Registered Dec. 20, 2011

Int. Cl.: 2

FOR: PAINTS FOR MARKING ROAD SURFACES AND ATHLETIC FIELDS, IN CLASS 2
(U.S. CLS. 6, 11 AND 16).

TRADEMARK

FIRST USE 2-7-2011; IN COMMERCE 2-7-2011.

PRINCIPAL REGISTER

NO CLAIM IS MADE TO THE EXCLUSIVE RIGHT TO USE "PAINT", APART FROM THE
MARK AS SHOWN.

THE COLOR(S) BLACK, YELLOW AND WHITE IS/ARE CLAIMED AS A FEATURE OF THE
MARK.

THE MARK CONSISTS OF A BLACK ROADWAY WITH A DOUBLE YELLOW CENTER
DIVIDING LINE AND THE WORDS "FRANKLIN PAINT" IN WHITE APPEARING ABOVE,
AND WHITE LINES ALONG THE EDGE OF THE ROADWAY REPRESENTING THE
BREAKDOWN LANE FOR EACH DIRECTION OF TRAFFIC.

SER. NO. 85-378,337, FILED 7-22-2011.

STEPHANIE ALI, EXAMINING ATTORNEY



David J. Kyros

Director of the United States Patent and Trademark Office

United States of America

United States Patent and Trademark Office

TwitX

Reg. No. 4,074,366

Registered Dec. 20, 2011

Int. Cl.: 38

SERVICE MARK

PRINCIPAL REGISTER

RAYMOND, JAMES JOSEPH (UNITED STATES INDIVIDUAL), DBA TWITX
3823 CONNECTICUT STREET
SAINT LOUIS, MO 63116

FOR: COMMUNICATION SERVICES, NAMELY, ELECTRONIC TRANSMISSION OF DATA AND DOCUMENTS AMONG USERS OF COMPUTERS; COMMUNICATION SERVICES, NAMELY, TRANSMISSION OF VOICE, AUDIO, VISUAL IMAGES AND DATA BY TELECOMMUNICATIONS NETWORKS, WIRELESS COMMUNICATION NETWORKS, THE INTERNET, INFORMATION SERVICES NETWORKS AND DATA NETWORKS, IN CLASS 38 (U.S. CLS. 100, 101 AND 104).

FIRST USE 5-2-2011; IN COMMERCE 5-17-2011.

THE MARK CONSISTS OF STANDARD CHARACTERS WITHOUT CLAIM TO ANY PARTICULAR FONT, STYLE, SIZE, OR COLOR.

SER. NO. 85-378,689, FILED 7-22-2011.

REBECCA SMITH, EXAMINING ATTORNEY



David J. Kybas

Director of the United States Patent and Trademark Office

United States of America

United States Patent and Trademark Office



Reg. No. 4,074,367

Registered Dec. 20, 2011

Int. Cl.: 41

SERVICE MARK

PRINCIPAL REGISTER

SEMINOLE TRIBE OF FLORIDA (UNITED STATES FEDERALLY-RECOGNIZED INDIAN TRIBE)
6300 STIRLING ROAD
HOLLYWOOD, FL 33024

FOR: ENTERTAINMENT IN THE NATURE OF A FESTIVAL PRIMARILY FEATURING LIVE MUSIC, CULINARY COMPETITIONS, BEER BREWING COMPETITIONS AND ALSO PROVIDING FOOD AND ALCOHOLIC BEVERAGES, IN CLASS 41 (U.S. CLS. 100, 101 AND 107).

FIRST USE 3-15-2008; IN COMMERCE 3-15-2008.

NO CLAIM IS MADE TO THE EXCLUSIVE RIGHT TO USE "BLUES BREWS & BBQ", APART FROM THE MARK AS SHOWN.

THE MARK CONSISTS OF A GUITAR WITH THE NECK DEPICTED AS A FORK AND THE TUNING KEYS DEPICTED AS WATERMELON SEEDS. TO THE RIGHT OF THE GUITAR ARE THE WORDS "BLUES BREWS & BBQ" IN A STYLIZED FONT.

SER. NO. 85-379,334, FILED 7-24-2011.

KATHLEEN M. VANSTON, EXAMINING ATTORNEY



David J. Kybas

Director of the United States Patent and Trademark Office

United States of America

United States Patent and Trademark Office

ERIN FLETT

Reg. No. 4,074,368

FLETT, ERIN (UNITED STATES INDIVIDUAL)
105 WOOD ROAD
GORHAM, ME 04038

Registered Dec. 20, 2011

Int. Cl.: 20

FOR: DECORATIVE 3D PILLOWS AND CUSHIONS, IN CLASS 20 (U.S. CLS. 2, 13, 22, 25, 32 AND 50).

TRADEMARK

FIRST USE 6-1-2009; IN COMMERCE 11-1-2009.

PRINCIPAL REGISTER

THE MARK CONSISTS OF STANDARD CHARACTERS WITHOUT CLAIM TO ANY PARTICULAR FONT, STYLE, SIZE, OR COLOR.

OWNER OF U.S. REG. NO. 3,799,533.

THE NAME(S), PORTRAIT(S), AND/OR SIGNATURE(S) SHOWN IN THE MARK IDENTIFIES ERIN FLETT, WHOSE CONSENT(S) TO REGISTER IS MADE OF RECORD.

SER. NO. 85-379,778, FILED 7-25-2011.

SKYE YOUNG, EXAMINING ATTORNEY



David J. Kybas

Director of the United States Patent and Trademark Office

United States of America

United States Patent and Trademark Office



Reg. No. 4,074,369

Registered Dec. 20, 2011

Int. Cls.: 9 and 41

TABULA DIGITA, INC. (DELAWARE CORPORATION)
3RD FLOOR
5-14 51ST AVENUE
LONG ISLAND CITY, NY 11101

FOR: COMPUTER GAME SOFTWARE, IN CLASS 9 (U.S. CLS. 21, 23, 26, 36 AND 38).

TRADEMARK

FIRST USE 2-16-2010; IN COMMERCE 2-16-2010.

SERVICE MARK

FOR: ENTERTAINMENT AND EDUCATIONAL SERVICES, NAMELY, PROVIDING A WEB SITE FEATURING NONDOWNLOADABLE COMPUTER GAMES AND VIDEO GAMES, AND INFORMATION, NEWS, COMMENTARY, RANKINGS, DATA, GRAPHICS, AND GAME PLAY STRATEGIES IN THE FIELD OF COMPUTER GAMES AND VIDEO GAMES; PROVIDING EDUCATIONAL INFORMATION ON-LINE ON A VARIETY OF ACADEMIC SUBJECTS; ORGANIZING, ARRANGING AND CONDUCTING TOURNAMENTS AND COMPETITIONS, IN CLASS 41 (U.S. CLS. 100, 101 AND 107).

PRINCIPAL REGISTER

FIRST USE 2-16-2010; IN COMMERCE 2-16-2010.

THE MARK CONSISTS OF THE WORD "DIMENSION" IN LIGHT GRAY CAPITAL LETTERS THE "O" OF WHICH CONTAINS A YELLOW ARROW POINTING RIGHT WHICH WORD IS TO THE LEFT OF AN ORB DEPICTED IN GRAY, GREEN, BLUE, YELLOW, ORANGE, RED, PINK, PURPLE, AND WHITE IN WHICH SPHERE IS THE IMPRESSION OF A CAPITAL "U" IN YELLOW.

THE COLOR(S) GRAY, GREEN, BLUE, YELLOW, ORANGE, RED, PINK, PURPLE, AND WHITE IS/ARE CLAIMED AS A FEATURE OF THE MARK.

SER. NO. 85-380,248, FILED 7-25-2011.

FRANK LATTUCA, EXAMINING ATTORNEY



David J. Kybas

Director of the United States Patent and Trademark Office

United States of America

United States Patent and Trademark Office



Reg. No. 4,074,370

RAINFOREST FOUNDATION, INC. (CALIFORNIA CORPORATION)
180 VARICK ST., SUITE 528
NEW YORK, NY 10014

Registered Dec. 20, 2011

Int. Cl.: 36

FOR: CHARITABLE FUNDRAISING TO BENEFIT THE PRESERVATION OF THE WORLD'S TROPICAL RAINFORESTS AND EDUCATION PROGRAMS DEVOTED TO THAT CAUSE , IN CLASS 36 (U.S. CLS. 100, 101 AND 102).

SERVICE MARK

FIRST USE 5-1-2010; IN COMMERCE 5-1-2010.

PRINCIPAL REGISTER

OWNER OF U.S. REG. NOS. 2,320,523 AND 2,331,065.

THE COLOR(S) DARK GREEN, LIME GREEN AND WHITE IS/ARE CLAIMED AS A FEATURE OF THE MARK.

NO CLAIM IS MADE TO THE EXCLUSIVE RIGHT TO USE "FOUNDATION US", APART FROM THE MARK AS SHOWN.

THE MARK CONSISTS OF "ROCK FOR THE RAINFOREST" WRITTEN IN LIME GREEN ON THE UPPER LEFT PORTION OF THE LOGO, UNDERNEATH THAT IS WRITTEN "RAINFOREST FOUNDATION US" IN DARK GREEN. ON THE RIGHT OF THE LOGO THERE IS A GIANT "R" WITH DARK GREEN STRIPES AND GREEN AND WHITE PATTERNS ON THE INSIDE. THE COLOR WHITE APPEARING IN THE REST OF THE MARK REPRESENTS BACKGROUND AND IS NOT PART OF THE MARK.



SEC. 2(F) AS TO "RAINFOREST FOUNDATION".

SER. NO. 85-381,538, FILED 7-26-2011.

MATTHEW MCDOWELL, EXAMINING ATTORNEY

David J. Kybas

Director of the United States Patent and Trademark Office

United States of America

United States Patent and Trademark Office



Reg. No. 4,074,371

MEDIO SYSTEMS, INC. (DELAWARE CORPORATION)
701 PIKE STREET, SUITE 1500
SEATTLE, WA 98101

Registered Dec. 20, 2011

Int. Cl.: 35

FOR: PROMOTING THE GOODS AND SERVICES OF OTHERS OVER MOBILE DEVICES, NAMELY, PROVIDING INFORMATION REGARDING DISCOUNTS, COUPONS, REBATES, VOUCHERS AND SPECIAL OFFERS FOR THE GOODS AND SERVICES OF OTHERS, IN CLASS 35 (U.S. CLS. 100, 101 AND 102).

SERVICE MARK

PRINCIPAL REGISTER

FIRST USE 2-0-2011; IN COMMERCE 2-0-2011.

THE MARK CONSISTS OF THE STYLIZED WORD "LOTZA" IN BLACK, TO THE LEFT OF A CIRCLE MADE UP OF COLORED TAGS EACH A DIFFERENT COLOR GOING CLOCKWISE FROM THE LEFT THE COLORS ARE RED, PINK, DARK BLUE, LIGHT BLUE, YELLOW AND ENDING WITH ORANGE.

THE COLOR(S) BLACK, RED, PINK, DARK BLUE, LIGHT BLUE, YELLOW AND ORANGE IS/ARE CLAIMED AS A FEATURE OF THE MARK.

SER. NO. 85-381,635, FILED 7-26-2011.

HOWARD B. LEVINE, EXAMINING ATTORNEY



David J. Kyjars

Director of the United States Patent and Trademark Office

United States of America
United States Patent and Trademark Office

ECSTASY

Reg. No. 4,074,372

CHURCH & DWIGHT CO., INC. (DELAWARE CORPORATION)
469 NORTH HARRISON STREET LAW DEPARTMENT
PRINCETON, NJ 08543

Registered Dec. 20, 2011

Int. Cl.: 10

FOR: CONDOMS, IN CLASS 10 (U.S. CLS. 26, 39 AND 44).

TRADEMARK

FIRST USE 1-27-2009; IN COMMERCE 1-27-2009.

PRINCIPAL REGISTER

OWNER OF U.S. REG. NOS. 3,716,786, 3,998,108 AND OTHERS.

THE MARK CONSISTS OF THE WORD "ECSTASY" IN STYLIZED LETTERING.

SER. NO. 85-382,689, FILED 7-27-2011.

SCOTT BIBB, EXAMINING ATTORNEY



David J. Kybas

Director of the United States Patent and Trademark Office

United States of America

United States Patent and Trademark Office



Reg. No. 4,074,373

Registered Dec. 20, 2011

Int. Cl.: 43

SERVICE MARK

PRINCIPAL REGISTER

BUFFETS, INC. (MINNESOTA CORPORATION)
SUITE 100
1020 DISCOVERY ROAD
EAGAN, MN 55121

FOR: RESTAURANT SERVICES, IN CLASS 43 (U.S. CLS. 100 AND 101).

FIRST USE 10-31-2002; IN COMMERCE 10-31-2002.

OWNER OF U.S. REG. NOS. 2,617,451, 3,343,752 AND OTHERS.

NO CLAIM IS MADE TO THE EXCLUSIVE RIGHT TO USE "BUFFET", APART FROM THE MARK AS SHOWN.

THE MARK CONSISTS OF A FORK AND PLATE DESIGN OVERLAYED WITH THE WORDS "HOMETOWN BUFFET".

SER. NO. 85-389,278, FILED 8-4-2011.

KRISTIN CARLSON, EXAMINING ATTORNEY



David J. Kyffers

Director of the United States Patent and Trademark Office

United States of America

United States Patent and Trademark Office

METALGUARD

Reg. No. 4,074,374

ADDITIVE CHEMISTRY, INC. (WISCONSIN CORPORATION), DBA WEBBA TECHNOLOGY
1213 N. SHERMAN AVE. #351
MADISON, WI 53704

Registered Dec. 20, 2011

Int. Cl.: 1

FOR: CHEMICAL ADDITIVES USED IN AUTOMOTIVE ANTIFREEZE, HEAT TRANSFER FLUIDS AND FIRE RESISTANT HYDRAULIC FLUIDS, NAMELY, A MIXTURE OF CHEMICALS CREATING ADDITIVE PACKAGES FOR USE IN THE AUTOMOTIVE AND HEAT TRANSFER FLUID INDUSTRIES, IN CLASS 1 (U.S. CLS. 1, 5, 6, 10, 26 AND 46).

TRADEMARK

PRINCIPAL REGISTER

FIRST USE 2-14-2003; IN COMMERCE 2-14-2003.

THE MARK CONSISTS OF STANDARD CHARACTERS WITHOUT CLAIM TO ANY PARTICULAR FONT, STYLE, SIZE, OR COLOR.

SER. NO. 85-395,694, FILED 8-11-2011.

JOHN KELLY, EXAMINING ATTORNEY



David J. Kyffers

Director of the United States Patent and Trademark Office

United States of America

United States Patent and Trademark Office

Cord Buddy

Reg. No. 4,074,375

CABLE WAIT, INC. (ILLINOIS CORPORATION), DBA CORD BUDDY, INC.
875 LILAC WAY
LOMBARD, IL 60148

Registered Dec. 20, 2011

Int. Cl.: 20

FOR: DEVICES IN THE NATURE OF NON-METAL CLIPS AND CLAMPS MADE OF PLASTIC, WOOD OR OTHER SYNTHETIC MATERIALS FOR HOLDING ELECTRICAL CORDS, WIRES AND CABLES IN PLACE TO PREVENT DISPLACEMENT, IN CLASS 20 (U.S. CLS. 2, 13, 22, 25, 32 AND 50).

TRADEMARK

PRINCIPAL REGISTER

FIRST USE 2-1-2011; IN COMMERCE 5-30-2011.

THE MARK CONSISTS OF STANDARD CHARACTERS WITHOUT CLAIM TO ANY PARTICULAR FONT, STYLE, SIZE, OR COLOR.

NO CLAIM IS MADE TO THE EXCLUSIVE RIGHT TO USE "CORD", APART FROM THE MARK AS SHOWN.

SER. NO. 85-975,425, FILED 3-11-2011.

CHARLOTTE CORWIN, EXAMINING ATTORNEY



David J. Kyros

Director of the United States Patent and Trademark Office

United States of America

United States Patent and Trademark Office

KISS MY RULES!

Reg. No. 4,074,376

BIG TOE GAMES, INC. (MINNESOTA CORPORATION)
13033 RIDGEDALE DRIVE #158
MINNETONKA, MN 55305

Registered Dec. 20, 2011

Int. Cl.: 28

FOR: GAMES, NAMELY A CARD AND DICE GAME, IN CLASS 28 (U.S. CLS. 22, 23, 38 AND 50).

TRADEMARK

FIRST USE 6-9-2005; IN COMMERCE 6-10-2005.

PRINCIPAL REGISTER

THE MARK CONSISTS OF STANDARD CHARACTERS WITHOUT CLAIM TO ANY PARTICULAR FONT, STYLE, SIZE, OR COLOR.

SN 76-635,699, FILED 4-11-2005.

ANDREA K. NADELMAN, EXAMINING ATTORNEY



David J. Kyffers

Director of the United States Patent and Trademark Office

United States of America

United States Patent and Trademark Office

AQUA PAGES

Reg. No. 4,074,377

Registered Dec. 20, 2011

Int. Cl.: 41

SERVICE MARK

PRINCIPAL REGISTER

PAROTIS GROUP, INC. (GEORGIA CORPORATION)
2900 ROXBURGH DRIVE
ROSWELL, GA 30076

FOR: PROVIDING A WEBSITE FEATURING INFORMATION RELATING TO SPORTS, FITNESS AND RELATED SPORTS AND FITNESS SERVICES, IN CLASS 41 (U.S. CLS. 100, 101 AND 107).

FIRST USE 10-28-2011; IN COMMERCE 10-28-2011.

THE MARK CONSISTS OF STANDARD CHARACTERS WITHOUT CLAIM TO ANY PARTICULAR FONT, STYLE, SIZE, OR COLOR.

NO CLAIM IS MADE TO THE EXCLUSIVE RIGHT TO USE "PAGES", APART FROM THE MARK AS SHOWN.

SN 76-693,778, FILED 10-23-2008.

KATHLEEN M. VANSTON, EXAMINING ATTORNEY



David J. Kyffers

Director of the United States Patent and Trademark Office

United States of America

United States Patent and Trademark Office

AQUA PAGES

Reg. No. 4,074,378

Registered Dec. 20, 2011

Int. Cl.: 35

SERVICE MARK

PRINCIPAL REGISTER

PAROTIS GROUP, INC. (GEORGIA CORPORATION)
2900 ROXBURGH DRIVE
ROSWELL, GA 30076

FOR: PROVIDING AN ONLINE COMMERCIAL INFORMATION DIRECTORY IN THE FIELD OF SPORTING GOODS, FITNESS, SPORTING GOODS EQUIPMENT APPAREL, FOOTWEAR, AND RELATED SPORTING GOODS AND SERVICES, IN CLASS 35 (U.S. CLS. 100, 101 AND 102).

FIRST USE 10-28-2011; IN COMMERCE 10-28-2011.

THE MARK CONSISTS OF STANDARD CHARACTERS WITHOUT CLAIM TO ANY PARTICULAR FONT, STYLE, SIZE, OR COLOR.

NO CLAIM IS MADE TO THE EXCLUSIVE RIGHT TO USE "PAGES", APART FROM THE MARK AS SHOWN.

SN 76-693,779, FILED 10-23-2008.

KATHLEEN M. VANSTON, EXAMINING ATTORNEY



David J. Kyffers

Director of the United States Patent and Trademark Office

United States of America
United States Patent and Trademark Office

conisus

Reg. No. 4,074,379

Registered Dec. 20, 2011

Int. Cls.: 35 and 41

SERVICE MARK

PRINCIPAL REGISTER

CONISUS, LLC (DELAWARE LIMITED LIABILITY COMPANY)
1300 PARKWOOD CIRCLE
SUITE 425
ATLANTA, GA 30339

FOR: ARRANGING AND CONDUCTING MARKETING AND PROMOTIONAL EVENTS FOR OTHERS IN THE MEDICAL FIELD; BUSINESS CONSULTING SERVICES, NAMELY, PROVIDING BUSINESS ADVISORY BOARDS IN THE FIELD OF MEDICINE, IN CLASS 35 (U.S. CLS. 100, 101 AND 102).

FIRST USE 10-31-2008; IN COMMERCE 10-31-2008.

FOR: EDUCATIONAL SERVICES, NAMELY, PROVIDING SYMPOSIUMS, EDUCATIONAL SPEAKERS, AND TRAINING IN PUBLIC SPEAKING IN THE FIELD OF MEDICINE; EDUCATIONAL SERVICES, NAMELY, CONDUCTING INFORMAL ON-LINE PROGRAMS IN THE FIELD OF MEDICINE; E-BASED PROGRAMMING, NAMELY, PROVIDING A WEBSITE FEATURING ARCHIVED AND REAL-TIME VIDEO PRESENTATIONS AND WEBCASTS IN THE FIELD OF MEDICINE; EDITORIAL REPORTING SERVICES IN THE FIELD OF MEDICINE; INVESTIGATOR EDUCATIONAL MEETING PLANNING IN THE FIELD OF MEDICINE, IN CLASS 41 (U.S. CLS. 100, 101 AND 107).

FIRST USE 10-31-2008; IN COMMERCE 10-31-2008.

THE MARK CONSISTS OF THE TERM "CONISUS" APPEARING IN A STYLIZED SLANTED FONT.

SN 76-693,814, FILED 10-24-2008.

TINA BROWN, EXAMINING ATTORNEY



David J. Kyjars

Director of the United States Patent and Trademark Office

United States of America

United States Patent and Trademark Office

Figure 8 Fitness

Reg. No. 4,074,380

BODY FX LLC (NEVADA LIMITED LIABILITY COMPANY)
5644 KEANRY MESA RD. SUITE T
SAN DIEGO, CA 92101

Registered Dec. 20, 2011

Int. Cl.: 9

FOR: DVD CASES; PRE-RECORDED DVDS FEATURING FITNESS MATERIAL, NAMELY, EXERCISE ROUTINES, FITNESS PROGRAMS AND RELATED FITNESS INFORMATION, IN CLASS 9 (U.S. CLS. 21, 23, 26, 36 AND 38).

TRADEMARK

FIRST USE 9-1-2011; IN COMMERCE 9-1-2011.

PRINCIPAL REGISTER

THE MARK CONSISTS OF STANDARD CHARACTERS WITHOUT CLAIM TO ANY PARTICULAR FONT, STYLE, SIZE, OR COLOR.

NO CLAIM IS MADE TO THE EXCLUSIVE RIGHT TO USE "FITNESS", APART FROM THE MARK AS SHOWN.

SN 76-700,726, FILED 12-7-2009.

AMY HELLA, EXAMINING ATTORNEY



David J. Kyffers

Director of the United States Patent and Trademark Office

United States of America

United States Patent and Trademark Office



Reg. No. 4,074,381

WIRTGEN GMBH (FED REP GERMANY CORPORATION)
REINHARD-WIRTGEN-STRASSE
WINDHAGEN, FED REP GERMANY 53578

Registered Dec. 20, 2011

Int. Cl.: 25

FOR: OUTERWEAR, NAMELY, T-SHIRTS, SWEATSHIRTS, CAPS, TIES, OVERALLS, IN CLASS 25 (U.S. CLS. 22 AND 39).

TRADEMARK

FIRST USE 1-1-1990; IN COMMERCE 1-1-1990.

PRINCIPAL REGISTER

OWNER OF U.S. REG. NOS. 2,059,202, 3,769,619, AND OTHERS.

THE MARK CONSISTS OF THE WORDING "WIRTGEN" UNDERLINED BY TWO HORIZONTAL BANDS EACH INCLUDING A DIAGONAL PORTION, AND TO THE RIGHT OF THE LETTER "W" ENCASED IN A BLADE DESIGN.

SN 76-702,824, FILED 5-6-2010.

ALICIA COLLINS, EXAMINING ATTORNEY



David J. Kybas

Director of the United States Patent and Trademark Office

United States of America

United States Patent and Trademark Office



Reg. No. 4,074,382

Registered Dec. 20, 2011

Int. Cl.: 42

SERVICE MARK

PRINCIPAL REGISTER

WIRTGEN GMBH (FED REP GERMANY CORPORATION)
REINHARD-WIRTGEN-STRASSE
WINDHAGEN, FED REP GERMANY 53578

FOR: ENGINEERING CONSULTANCY SERVICES FOR STRUCTURAL AND CIVIL ENGINEERING PROJECTS, NAMELY, ROAD BUILDING PROJECTS, MINING AND SURFACE MINING PROJECTS, IN CLASS 42 (U.S. CLS. 100 AND 101).

FIRST USE 1-1-1990; IN COMMERCE 1-1-1990.

OWNER OF U.S. REG. NOS. 2,059,202, 3,769,619, AND OTHERS.

THE MARK CONSISTS OF THE WORDING "WIRTGEN" UNDERLINED BY TWO HORIZONTAL BANDS EACH INCLUDING A DIAGONAL PORTION, AND TO THE RIGHT OF THE LETTER "W" ENCASED IN A BLADE DESIGN.

SN 76-702,825, FILED 5-6-2010.

ALICIA COLLINS, EXAMINING ATTORNEY



David J. Kybas

Director of the United States Patent and Trademark Office

United States of America

United States Patent and Trademark Office



Reg. No. 4,074,383

Registered Dec. 20, 2011

Int. Cl.: 37

SERVICE MARK

PRINCIPAL REGISTER

WIRTGEN GMBH (FED REP GERMANY CORPORATION)
REINHARD-WIRTGEN-STRASSE
WINDHAGEN, FED REP GERMANY 53578

FOR: CONSTRUCTION CONSULTANCY FOR THE MANAGEMENT AND BUILDING OF STRUCTURAL AND CIVIL ENGINEERING PROJECTS, NAMELY, ROAD BUILDING CONSTRUCTION PROJECTS, UNDERGROUND MINING AND SURFACE MINING CONSTRUCTION PROJECTS; RENTAL AND SALE OF VEHICLES, MACHINES AND APPARATUS FOR STRUCTURAL AND CIVIL ENGINEERING, NAMELY, FOR ROAD BUILDING, UNDERGROUND MINING AND SURFACE MINING, AND APPARATUS AS WELL AS SPARE PARTS AND WEARING PARTS THEREFOR; CONSULTATION REGARDING THE MAINTENANCE AND REPAIR OF VEHICLES AND MACHINES FOR STRUCTURAL AND CIVIL ENGINEERING, NAMELY, FOR ROAD BUILDING, UNDERGROUND MINING AND SURFACE MINING, AND APPARATUS AS WELL AS SPARE PARTS AND WEARING PARTS THEREFOR; MAINTENANCE AND REPAIR OF VEHICLES AND MACHINES FOR STRUCTURAL AND CIVIL ENGINEERING, NAMELY, FOR ROAD BUILDING, UNDERGROUND MINING AND SURFACE MINING; BREAKDOWN SERVICES IN THE NATURE OF TOWING SERVICES FOR VEHICLES FOR STRUCTURAL AND CIVIL ENGINEERING, NAMELY, FOR ROAD BUILDING, UNDERGROUND MINING AND SURFACE MINING, IN CLASS 37 (U.S. CLS. 100, 103 AND 106).

FIRST USE 1-1-1990; IN COMMERCE 1-1-1990.

OWNER OF U.S. REG. NOS. 2,059,292, 2,783,677, AND 3,769,619.

THE MARK CONSISTS OF THE WORDING "WIRTGEN" UNDERLINED BY TWO HORIZONTAL BANDS EACH INCLUDING A DIAGONAL PORTION, AND TO THE RIGHT OF THE LETTER "W" ENCASED IN A BLADE DESIGN.

SN 76-702,826, FILED 5-6-2010.

ALICIA COLLINS, EXAMINING ATTORNEY



David J. Kybas

Director of the United States Patent and Trademark Office

United States of America

United States Patent and Trademark Office



Reg. No. 4,074,384

Registered Dec. 20, 2011

Int. Cl.: 7

TRADEMARK

PRINCIPAL REGISTER

WIRTGEN GMBH (FED REP GERMANY CORPORATION)
REINHARD-WIRTGEN-STRASSE
WINDHAGEN, FED REP GERMANY 53578

FOR: CONSTRUCTION MACHINES, MINING MACHINES AND REPROCESSING UNITS AND TOOLS THEREFOR, NAMELY, GROUND WORKING MACHINES IN THE NATURE OF SURFACE MINERS; MACHINES FOR GROUND REWORKING IN THE NATURE OF SOIL STABILIZERS; MACHINES FOR ROAD CONSTRUCTION IN THE NATURE OF SLIPFORM PAVERS, COLD MILLING MACHINES; MACHINES FOR REPAIRING ROADS IN THE NATURE OF COLD MILLING MACHINES, COLD RECYCLERS, HOT RECYCLERS, SLIPFORM PAVERS, ROAD SURFACE RECYCLING MACHINES; MACHINES FOR ROAD DEMOLITION IN THE NATURE OF COLD MILLING MACHINES; MINING MACHINES IN THE NATURE OF MACHINES FOR THE SELECTIVE MINING OF RAW MATERIALS FOR UNDERGROUND MINING AND SURFACE MINING IN THE NATURE OF SURFACE MINERS AND DINTING MACHINES; STRUCTURAL PARTS FOR THE AFORESAID GOODS; DRIVE ELEMENTS AS STRUCTURAL PARTS OF THE AFORESAID GOODS IN THE NATURE OF HYDRAULIC PUMPS, HYDRAULIC MOTORS, ELECTRIC MOTORS, COMBINATION MOTORS, TIRES AND WHEELS, CRAWLERS, CRAWLER UNIT PARTS, GEAR BOXES, CLUTCHES, POWER BELTS, CONVEYOR BELTS, AND BELT PULLEYS; HIGH-PERFORMANCE TOOLS MADE OF HARD METALS AS STRUCTURAL PARTS OF THE AFORESAID GOODS IN THE NATURE OF PICKS, TOOLHOLDERS, CHISELS, AND BITS; MILLING TOOLS AS STRUCTURAL PARTS OF THE AFORESAID GOODS IN THE NATURE OF MILLING DRUMS, MILLING CUTTERS, TOOLS FOR MILLING DRUMS; WEARING PARTS AS STRUCTURAL PARTS OF THE AFORESAID GOODS IN THE NATURE OF PICKS, TOOLHOLDERS, MILLING DRUMS, CONVEYORS, CRAWLER UNIT PARTS, ENGINE ATTACHMENT PARTS, GEARBOXES, CLUTCHES, AND HYDRAULIC PARTS, IN CLASS 7 (U.S. CLS. 13, 19, 21, 23, 31, 34 AND 35).

FIRST USE 1-1-1990; IN COMMERCE 1-1-1990.

OWNER OF U.S. REG. NOS. 2,059,202, 3,769,619, AND OTHERS.

THE MARK CONSISTS OF THE WORDING "WIRTGEN" UNDERLINED BY TWO HORIZONTAL BANDS EACH INCLUDING A DIAGONAL PORTION AND TO THE RIGHT OF THE LETTER "W" ENCASED IN A BLADE DESIGN.

SN 76-702,827, FILED 5-6-2010.



David J. Kybas

Director of the United States Patent and Trademark Office

Reg. No. 4,074,384 ALICIA COLLINS, EXAMINING ATTORNEY

United States of America

United States Patent and Trademark Office

DREAMZ

Reg. No. 4,074,385

Registered Dec. 20, 2011

Int. Cl.: 5

TRADEMARK

PRINCIPAL REGISTER

OLDE GRANDDAD INDUSTRIES, INC (NEW JERSEY CORPORATION)
160 PASSAIC AVENUE, BLDG. 31B
KEARNY, NJ 07032

FOR: FRAGRANCE PRODUCTS, NAMELY, AIR FRESHENERS FOR LAND VEHICLES, AIRCRAFT, MARINE CRAFT, PERSONAL, COMMERCIAL, INDUSTRIAL AND HOME USE, IN CLASS 5 (U.S. CLS. 6, 18, 44, 46, 51 AND 52).

FIRST USE 12-17-2010; IN COMMERCE 12-17-2010.

THE MARK CONSISTS OF STANDARD CHARACTERS WITHOUT CLAIM TO ANY PARTICULAR FONT, STYLE, SIZE, OR COLOR.

SN 76-702,870, FILED 5-10-2010.

CURTIS FRENCH, EXAMINING ATTORNEY



David J. Kyffers

Director of the United States Patent and Trademark Office

United States of America

United States Patent and Trademark Office

TRUE HEROES

Reg. No. 4,074,386

EVERTS, GINETTE (UNITED STATES INDIVIDUAL), DBA OUR TRUE HERO,
240 S. OHIO
MORTON, IL 61550

Registered Dec. 20, 2011

Int. Cl.: 14

FOR: JEWELRY, IN CLASS 14 (U.S. CLS. 2, 27, 28 AND 50).

TRADEMARK

FIRST USE 10-28-2010; IN COMMERCE 6-2-2011.

PRINCIPAL REGISTER

THE MARK CONSISTS OF STANDARD CHARACTERS WITHOUT CLAIM TO ANY PARTICULAR FONT, STYLE, SIZE, OR COLOR.

SN 76-704,040, FILED 8-6-2010.

MICHELE SWAIN, EXAMINING ATTORNEY



David J. Kybas

Director of the United States Patent and Trademark Office

United States of America

United States Patent and Trademark Office

IT FINDS IT

Reg. No. 4,074,387

Registered Dec. 20, 2011

Int. Cl.: 35

SERVICE MARK

PRINCIPAL REGISTER

JDR VENTURES, LLC (MICHIGAN LIMITED LIABILITY COMPANY)
5770 RAVEN ROAD
BLOOMFIELD HILLS, MI 48301

FOR: ADVERTISING AND BUSINESS SERVICES, NAMELY, MATCHING MERCHANTS' PRODUCTS WITH CONSUMERS BASED ON TARGET DEMOGRAPHICS DEFINED BY MERCHANTS , IN CLASS 35 (U.S. CLS. 100, 101 AND 102).

FIRST USE 3-10-2011; IN COMMERCE 3-10-2011.

THE MARK CONSISTS OF STANDARD CHARACTERS WITHOUT CLAIM TO ANY PARTICULAR FONT, STYLE, SIZE, OR COLOR.

SN 76-704,691, FILED 9-27-2010.

MYRIAH HABEEB, EXAMINING ATTORNEY



David J. Kyffers

Director of the United States Patent and Trademark Office

United States of America

United States Patent and Trademark Office

COOLING TOWER WORLD

Reg. No. 4,074,388

BALTIMORE AIRCOIL COMPANY, INC. (DELAWARE CORPORATION)
7600 DORSEY RUN ROAD
JESSUP, MD 20794

Registered Dec. 20, 2011

Int. Cl.: 35

FOR: ONLINE RETAIL STORE SERVICES FEATURING PARTS AND COMPONENTS FOR COOLING TOWERS AND HEAT EXCHANGERS, IN CLASS 35 (U.S. CLS. 100, 101 AND 102).

SERVICE MARK

FIRST USE 1-24-2011; IN COMMERCE 1-24-2011.

PRINCIPAL REGISTER

THE MARK CONSISTS OF STANDARD CHARACTERS WITHOUT CLAIM TO ANY PARTICULAR FONT, STYLE, SIZE, OR COLOR.

NO CLAIM IS MADE TO THE EXCLUSIVE RIGHT TO USE "COOLING TOWER", APART FROM THE MARK AS SHOWN.

SN 76-704,768, FILED 10-4-2010.

MARC LEIPZIG, EXAMINING ATTORNEY



David J. Kyfos

Director of the United States Patent and Trademark Office

United States of America
United States Patent and Trademark Office

Deary

Reg. No. 4,074,389

UNI-PRESIDENT BIOTECHNOLOGIES CO., LTD (TAIWAN CORPORATION)
NO. 340, ZIHCIANG RD.

Registered Dec. 20, 2011

YONGKANG CITY, TAINAN COUNTY, TAIWAN 710

Int. Cl.: 3

FOR: BEAUTY CREAMS FOR BODY CARE, BEAUTY MASKS, BODY LOTION, CLEANING PREPARATIONS FOR HUMAN BODY, COSMETICS, SUN BLOCK PREPARATIONS , IN CLASS 3 (U.S. CLS. 1, 4, 6, 50, 51 AND 52).

TRADEMARK

FIRST USE 6-7-2010; IN COMMERCE 6-7-2010.

PRINCIPAL REGISTER

THE MARK CONSISTS OF THE TERM "DEARY" WITH A HEART IN THE UPPER PORTION OF THE "D" WITH THREE STRAIGHT LINES EMANATING FROM THE HEART.

SN 76-704,855, FILED 10-12-2010.

CAROLINE WOOD, EXAMINING ATTORNEY



David J. Kyffers

Director of the United States Patent and Trademark Office

United States of America
United States Patent and Trademark Office

Befas

Reg. No. 4,074,390

UNI-PRESIDENT BIOTECHNOLOGIES CO., LTD (TAIWAN CORPORATION)
NO. 340, ZIHCIANG RD

Registered Dec. 20, 2011

YONGKANG CITY, TAINAN COUNTY, TAIWAN 710

Int. Cl.: 3

FOR: BEAUTY CREAMS FOR BODY CARE, BEAUTY MASKS, BODY LOTION, CLEANING PREPARATIONS FOR THE HUMAN BODY, COSMETICS, SUN BLOCK PREPARATIONS, IN CLASS 3 (U.S. CLS. 1, 4, 6, 50, 51 AND 52).

TRADEMARK

FIRST USE 6-7-2010; IN COMMERCE 6-7-2010.

PRINCIPAL REGISTER

THE ENGLISH TRANSLATION OF THE WORD "BEFAS" IN THE MARK IS "SHARP".

SN 76-704,856, FILED 10-12-2010.

CAROLINE WOOD, EXAMINING ATTORNEY



David J. Kyros

Director of the United States Patent and Trademark Office

United States of America

United States Patent and Trademark Office

The logo for "Beauty Story" features a stylized woman's face with three leaves emanating from the top, integrated into the letter "B". The word "Beauty Story" is written in a decorative, gothic-style font.

Reg. No. 4,074,391

UNI-PRESIDENT BIOTECHNOLOGIES CO., LTD (TAIWAN CORPORATION)
NO. 340, ZIHCIANG RD

Registered Dec. 20, 2011

YONGKANG CITY, TAINAN COUNTY, TAIWAN 710

Int. Cl.: 3

FOR: BEAUTY CREAMS FOR BODY CARE, BEAUTY MASKS, BODY LOTION, CLEANING PREPARATIONS FOR HUMAN BODY, COSMETICS, SUN BLOCK PREPARATIONS , IN CLASS 3 (U.S. CLS. 1, 4, 6, 50, 51 AND 52).

TRADEMARK

FIRST USE 7-7-2010; IN COMMERCE 6-7-2010.

PRINCIPAL REGISTER

THE MARK CONSISTS OF THE TERM "BEAUTY STORY". THE TOP PORTION OF THE "B" IN THE TERM "BEAUTY" IS IN THE FORM OF A WOMAN'S FACE AND HAS THREE LEAVES EMANATING FROM THE TOP. THE "O" IN THE TERM "STORY" CONTAINS FIVE PETALS FORMING A STYLIZED FLOWER.

SN 76-704,858, FILED 10-12-2010.

CAROLINE WOOD, EXAMINING ATTORNEY



David J. Kybas

Director of the United States Patent and Trademark Office

United States of America

United States Patent and Trademark Office

BAC PARTS DEPOT

Reg. No. 4,074,392

BALTIMORE AIRCOIL COMPANY, INC. (DELAWARE CORPORATION)
7600 DORSEY RUN ROAD
JESSUP, MD 20794

Registered Dec. 20, 2011

Int. Cl.: 35

FOR: ONLINE RETAIL STORE SERVICES FEATURING PARTS AND COMPONENTS FOR COOLING TOWERS AND HEAT EXCHANGERS, IN CLASS 35 (U.S. CLS. 100, 101 AND 102).

SERVICE MARK

FIRST USE 12-4-2003; IN COMMERCE 12-4-2003.

PRINCIPAL REGISTER

THE MARK CONSISTS OF STANDARD CHARACTERS WITHOUT CLAIM TO ANY PARTICULAR FONT, STYLE, SIZE, OR COLOR.

OWNER OF U.S. REG. NOS. 677,693, 926,854, AND 947,238.

NO CLAIM IS MADE TO THE EXCLUSIVE RIGHT TO USE "PARTS DEPOT", APART FROM THE MARK AS SHOWN.

SN 76-705,145, FILED 10-29-2010.

MARC LEIPZIG, EXAMINING ATTORNEY



David J. Kyffers

Director of the United States Patent and Trademark Office

United States of America

United States Patent and Trademark Office

BASELINE

Reg. No. 4,074,393

HENNESSY INDUSTRIES, INC. (DELAWARE CORPORATION)
1601 J.P. HENNESSY DRIVE
LAVERGNE, TN 370861986

Registered Dec. 20, 2011

Int. Cl.: 7

FOR: TIRE CHANGING MACHINES FOR LOOSENING OF TIRE BEADS AND DEMOUNTING AND MOUNTING OF A TIRE FROM A WHEEL RIM; WHEEL BALANCERS , IN CLASS 7 (U.S. CLS. 13, 19, 21, 23, 31, 34 AND 35).

TRADEMARK

FIRST USE 12-3-2010; IN COMMERCE 12-3-2010.

PRINCIPAL REGISTER

THE MARK CONSISTS OF STANDARD CHARACTERS WITHOUT CLAIM TO ANY PARTICULAR FONT, STYLE, SIZE, OR COLOR.

SN 76-705,315, FILED 11-12-2010.

TINA MAI, EXAMINING ATTORNEY



David J. Kybas

Director of the United States Patent and Trademark Office

United States of America

United States Patent and Trademark Office

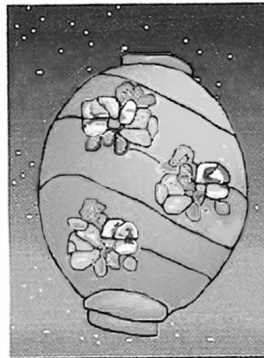

Reg. No. 4,074,394

AUGUST, GLORIA T. (UNITED STATES INDIVIDUAL)
536 W. HOPTREE CT.
LOUISVILLE, CO 80027

Registered Dec. 20, 2011

Int. Cl.: 16

FOR: BOOKS, NAMELY, NOVELS AND NON-FICTION BOOKS IN THE FIELD OF HISTORY,
IN CLASS 16 (U.S. CLS. 2, 5, 22, 23, 29, 37, 38 AND 50).

TRADEMARK

FIRST USE 7-7-2008; IN COMMERCE 7-7-2009.

PRINCIPAL REGISTER

THE MARK CONSISTS OF A CHINESE LANTERN DECORATED WITH FLOWERS ON A
RECTANGULAR BACKGROUND COMPOSED OF A STARRY SKY.

SN 76-706,670, FILED 3-7-2011.

KIM MONINGHOFF, EXAMINING ATTORNEY



David J. Kybas

Director of the United States Patent and Trademark Office

United States of America

United States Patent and Trademark Office

KENNY HOME DECOR

Reg. No. 4,074,395

KENNY PIPE & SUPPLY, INC. (TENNESSEE CORPORATION)
ONE VANTAGE WAY, SUITE E 100
NASHVILLE, TN 37228

Registered Dec. 20, 2011

Int. Cl.: 35

FOR: ON-LINE RETAIL STORE SERVICES FEATURING A WIDE VARIETY OF CONSUMER GOODS OF OTHERS, IN CLASS 35 (U.S. CLS. 100, 101 AND 102).

SERVICE MARK

FIRST USE 7-1-2011; IN COMMERCE 7-1-2011.

PRINCIPAL REGISTER

THE MARK CONSISTS OF STANDARD CHARACTERS WITHOUT CLAIM TO ANY PARTICULAR FONT, STYLE, SIZE, OR COLOR.

OWNER OF U.S. REG. NO. 3,669,675.

NO CLAIM IS MADE TO THE EXCLUSIVE RIGHT TO USE "HOME DECOR", APART FROM THE MARK AS SHOWN.

SN 76-707,072, FILED 4-1-2011.

ALEXANDER L. POWERS, EXAMINING ATTORNEY



David J. Kyros

Director of the United States Patent and Trademark Office

United States of America

United States Patent and Trademark Office

HIGH-DENSITY 7000

Reg. No. 4,074,396

SHARP KABUSHIKI KAISHA (JAPAN CORPORATION), TA SHARP CORPORATION,
22-22, NAGAIKE-CHO, ABENO-KU
OSAKA, JAPAN 5458522

Registered Dec. 20, 2011

Int. Cl.: 11

FOR: AIR PURIFIERS, IN CLASS 11 (U.S. CLS. 13, 21, 23, 31 AND 34).

TRADEMARK

FIRST USE 7-1-2011; IN COMMERCE 7-1-2011.

PRINCIPAL REGISTER

THE MARK CONSISTS OF STANDARD CHARACTERS WITHOUT CLAIM TO ANY PARTICULAR FONT, STYLE, SIZE, OR COLOR.

NO CLAIM IS MADE TO THE EXCLUSIVE RIGHT TO USE "HIGH-DENSITY", APART FROM THE MARK AS SHOWN.

SN 76-979,187, FILED 3-3-2009.

MAYUR VAGHANI, EXAMINING ATTORNEY



David J. Kyffers

Director of the United States Patent and Trademark Office

United States of America

United States Patent and Trademark Office



Reg. No. 4,074,397

Registered Dec. 20, 2011

Int. Cl.: 16

TRADEMARK

PRINCIPAL REGISTER

NATIONAL GEOGRAPHIC SOCIETY (D.C. CORPORATION)
1145 17TH STREET, N.W.
WASHINGTON, DC 20036

FOR: ADDRESS BOOKS; BLANK JOURNALS; DAILY PLANNERS; DESKTOP PLANNERS; PERSONAL PLANNERS; ALMANACS; APPLIQUÉS IN THE FORM OF DECALS; APPOINTMENT BOOKS; ART PRINTS; ARTS AND CRAFT PAINT KITS; AUTOGRAPH BOOKS; BABY BOOKS; BALL POINT PENS; BASEBALL CARDS; BINDERS; FOLDERS; BOOKENDS; BOOKMARKS; BOOKS, MAGAZINES, NEWSLETTERS AND PERIODICALS, ALL IN THE FIELD OF STORIES, GAMES AND ACTIVITIES FOR CHILDREN; BUMPER STICKERS; CALENDARS; CARTOON STRIPS; CHRISTMAS CARDS; CHALK; CHILDREN'S ACTIVITY BOOKS; COASTERS MADE OF PAPER; COIN ALBUMS; COLORING BOOKS; COLOR PENCILS; COMIC BOOKS; COMIC STRIPS; COUPON BOOKS; DECALS; DECORATIVE PAPER CENTERPIECES; DIARIES; DISPOSABLE DIAPERS FOR BABIES; DRAWING RULERS; ENVELOPES; ERASERS; FELT PENS; FLASH CARDS; GIFT CARDS; GIFT WRAPPING PAPER; GLOBES; GREETING CARDS; GUEST BOOKS; MAPS; MEMO PADS; MODELING CLAY; NEWSPAPERS; NOTE PAPER; NOTEBOOKS; NOTEBOOK PAPER; PAINTINGS; PAPER FLAGS; PAPER PARTY FAVORS; PAPER PARTY HATS; PAPER CAKE DECORATIONS; PAPER PARTY DECORATIONS; PAPER NAPKINS; PAPER PARTY BAGS; PAPERWEIGHTS; PAPER GIFT WRAP BOWS; PAPER PENNANTS; PAPER PLACE MATS; PAPER TABLE CLOTHS; PEN OR PENCIL HOLDERS; PENCILS; PENCIL SHARPENERS; PEN AND PENCIL CASES AND BOXES; PENS; PHOTOGRAPH ALBUMS; PHOTOGRAPHS; PHOTO-ENGRAVINGS; PICTORIAL PRINTS; PICTURE BOOKS; PORTRAITS; POSTCARDS; POSTERS; PRINTED AWARDS; PRINTED CERTIFICATES; PRINTED INVITATIONS; PRINTED MENUS; RECIPE BOOKS; RUBBER STAMPS; SCORE CARDS; STAMP ALBUMS; STATIONERY; STAPLERS; STICKERS; TRADING CARDS; UNGRADUATED RULERS; WRITING PAPER; WRITING IMPLEMENTS; SCRAPBOOKING PAPER, SCRAPBOOKING EMBELLISHMENTS, NAMELY, PAPER BRADS, GROMMETS FOR PAPER, PAPER FASTENERS, PAPER CLIPS; SCRAPBOOKING TOOLS, NAMELY, PAPER CUTTERS, STENCILS, PAPER STAPLERS, PAPER HOLE PUNCHES, SCRAPBOOK ALBUMS, PAPER STORAGE BOXES, MARKERS, PENCILS, DRAWING AND MARKING TEMPLATES; SCRAPBOOKING ADHESIVES, NAMELY, GLUE STICKS, GLUE PENS, TAPE RUNNERS, GLUE DOTS, DOUBLE SIDED TAPE, ADHESIVE FOAM SQUARES AND DOTS, ADHESIVE MAGNET SQUARES AND DOTS, ALL FOR STATIONERY OR HOUSEHOLD USE; STICKER BOOKS; ART PRINTS, IN CLASS 16 (U.S. CLS. 2, 5, 22, 23, 29, 37, 38 AND 50).



David J. Kappas

Director of the United States Patent and Trademark Office

FIRST USE 4-0-2007; IN COMMERCE 4-0-2007.

Reg. No. 4,074,397 OWNER OF U.S. REG. NOS. 908,046, 1,482,184, AND OTHERS.

THE COLOR(S) YELLOW IS/ARE CLAIMED AS A FEATURE OF THE MARK.

THE MARK CONSISTS OF A STYLIZED BORDER/FRAME DESIGN.

SN 77-081,826, FILED 1-12-2007.

SANJEEV VOHRA, EXAMINING ATTORNEY

United States of America

United States Patent and Trademark Office

K4

Reg. No. 4,074,398

Registered Dec. 20, 2011

Int. Cls.: 37 and 42

SERVICE MARK

PRINCIPAL REGISTER

K4 HOLDINGS, LLC (OHIO LIMITED LIABILITY COMPANY)
555 GEST STREET
CINCINNATI, OH 45203

FOR: CONSULTATION SERVICES IN THE FIELD OF CONSTRUCTION FOR THE BUILT ENVIRONMENT; CONSTRUCTION AND RENOVATION OF BUILDINGS; INSTALLATION OF FURNITURE, SECURITY SYSTEMS, BUSINESS EQUIPMENT, INDUSTRIAL EQUIPMENT, OFFICE EQUIPMENT, BANK EQUIPMENT, COMPUTER EQUIPMENT, ELECTRICAL AND ELECTRONIC EQUIPMENT, LABORATORY EQUIPMENT, MEDICAL EQUIPMENT, KITCHEN EQUIPMENT, MECHANICAL EQUIPMENT, HEATING EQUIPMENT, VENTILATION EQUIPMENT, AIR CONDITIONING EQUIPMENT, PLUMBING EQUIPMENT, COMMUNICATIONS SYSTEMS, AND SIGNAGE; REAL ESTATE SITE SELECTION AND REAL ESTATE DEVELOPMENT, IN CLASS 37 (U.S. CLS. 100, 103 AND 106).

FIRST USE 0-0-2002; IN COMMERCE 0-0-2002.

FOR: CONSULTATION SERVICES IN THE FIELD OF ARCHITECTURAL DESIGN, INTERIOR DESIGN, AND ENGINEERING FOR THE BUILT ENVIRONMENT; ARCHITECTURAL DESIGN; ARCHITECTURAL AND ENGINEERING SERVICES IN THE FIELD OF SITE PLANNING AND ANALYSIS; CONDUCTING FEASIBILITY STUDIES; ENGINEERING SERVICES FOR FACILITY MANAGEMENT, BUILDING INSTRUMENTATION AND MONITORING, AND ENVIRONMENTAL CONSULTING; GRAPHIC DESIGN, IN CLASS 42 (U.S. CLS. 100 AND 101).

FIRST USE 0-0-2002; IN COMMERCE 0-0-2002.

THE MARK CONSISTS OF STANDARD CHARACTERS WITHOUT CLAIM TO ANY PARTICULAR FONT, STYLE, SIZE, OR COLOR.

THE WORDING "K4" HAS NO MEANING IN A FOREIGN LANGUAGE.

SN 77-108,347, FILED 2-15-2007.

MICHAEL GAFFAR, EXAMINING ATTORNEY



David J. Kyffers

Director of the United States Patent and Trademark Office

United States of America

United States Patent and Trademark Office

HARMONIE CAFE

Reg. No. 4,074,399

HARMONIE HOLDINGS, LLC (MICHIGAN LIMITED LIABILITY COMPANY)
8986 HACKBERRY AVE.
PLYMOUTH, MI 48170

Registered Dec. 20, 2011

Int. Cl.: 43

FOR: RESTAURANT, CAFE AND COFFEE HOUSE SERVICES, IN CLASS 43 (U.S. CLS. 100 AND 101).

SERVICE MARK

FIRST USE 1-1-2007; IN COMMERCE 1-1-2007.

PRINCIPAL REGISTER

THE MARK CONSISTS OF STANDARD CHARACTERS WITHOUT CLAIM TO ANY PARTICULAR FONT, STYLE, SIZE, OR COLOR.

NO CLAIM IS MADE TO THE EXCLUSIVE RIGHT TO USE "CAFE", APART FROM THE MARK AS SHOWN.

SN 77-141,092, FILED 3-27-2007.

STEVEN R. FINE, EXAMINING ATTORNEY



David J. Kybas

Director of the United States Patent and Trademark Office

United States of America

United States Patent and Trademark Office

LITE & BREATHABLE CATH-SECURE

Reg. No. 4,074,400

M.C. JOHNSON CO., INC. (FLORIDA CORPORATION)
8801 BUSINESS PARK DRIVE, SUITE 201
FT. MYERS, FL 33912

Registered Dec. 20, 2011

Int. Cl.: 10

FOR: MEDICAL APPARATUS, NAMELY, A DEVICE EXTERNALLY SECURED TO THE SKIN THAT IS USED TO STABILIZE AND TO SECURE MEDICAL TUBES, NAMELY, CATHETERS, IN CLASS 10 (U.S. CLS. 26, 39 AND 44).

TRADEMARK

FIRST USE 8-2-2007; IN COMMERCE 8-2-2007.

PRINCIPAL REGISTER

THE MARK CONSISTS OF STANDARD CHARACTERS WITHOUT CLAIM TO ANY PARTICULAR FONT, STYLE, SIZE, OR COLOR.

OWNER OF U.S. REG. NO. 2,004,849.

SN 77-147,016, FILED 4-3-2007.

PAUL MORENO, EXAMINING ATTORNEY



David J. Kybas

Director of the United States Patent and Trademark Office

United States of America

United States Patent and Trademark Office



Reg. No. 4,074,401

Registered Dec. 20, 2011

Int. Cl.: 7

TRADEMARK

PRINCIPAL REGISTER

Q.E.P. CO., INC. (DELAWARE CORPORATION)
1001 BROKEN SOUND PARKWAY, NW SUITE A
BOCA RATON, FL 33487

FOR: CIRCULAR DIAMOND SAW BLADES FOR POWER SAWS FOR USE BY TILE INSTALLERS IN CUTTING TILE, IN CLASS 7 (U.S. CLS. 13, 19, 21, 23, 31, 34 AND 35).

FIRST USE 10-0-2007; IN COMMERCE 10-0-2007.

THE MARK CONSISTS OF A SPIDER WITH A DIAMOND IN ITS CENTER AND THE WORDS "BLACK WIDOW" WRITTEN ACROSS.

SN 77-149,743, FILED 4-5-2007.

SANI KHOURI, EXAMINING ATTORNEY



David J. Kybas

Director of the United States Patent and Trademark Office

United States of America

United States Patent and Trademark Office

METHOD SOLUTIONS

Reg. No. 4,074,402

Registered Dec. 20, 2011

Int. Cls.: 9 and 41

TRADEMARK

SERVICE MARK

PRINCIPAL REGISTER

METHOD SOLUTIONS LLC (TEXAS LIMITED LIABILITY COMPANY)
3939 BELT LINE ROAD #440
ADDISON, TX 75001

FOR: COMPUTER SOFTWARE FOR THE DEVELOPMENT, PREPARATION, POST-PRODUCTION AND DEPLOYMENT OF ELECTRONIC GAME CONTENT FOR MOBILE ELECTRONIC DEVICES, HANDHELD ELECTRONIC DEVICES, VIDEO AND COMPUTER GAME CONSOLES, COMPUTERS, LAPTOPS AND WIRELESS COMMUNICATION DEVICES; ELECTRONIC GAME SOFTWARE, IN CLASS 9 (U.S. CLS. 21, 23, 26, 36 AND 38).

FIRST USE 12-31-2006; IN COMMERCE 12-31-2006.

FOR: PRODUCTION OF VIDEO AND COMPUTER GAME SOFTWARE FOR MOBILE ELECTRONIC DEVICES, HANDHELD ELECTRONIC DEVICES, VIDEO AND COMPUTER GAME CONSOLES AND WIRELESS COMMUNICATION DEVICES; MOBILE MEDIA AND ENTERTAINMENT SERVICES IN THE NATURE OF ELECTRONIC GAME CONTENT DEVELOPMENT, PREPARATION, AND POST-PRODUCTION FOR MOBILE ELECTRONIC DEVICES, HANDHELD ELECTRONIC DEVICES, VIDEO AND COMPUTER GAME CONSOLES, COMPUTERS, LAPTOPS AND WIRELESS COMMUNICATION DEVICES, IN CLASS 41 (U.S. CLS. 100, 101 AND 107).

FIRST USE 12-31-2006; IN COMMERCE 12-31-2006.

THE MARK CONSISTS OF STANDARD CHARACTERS WITHOUT CLAIM TO ANY PARTICULAR FONT, STYLE, SIZE, OR COLOR.

NO CLAIM IS MADE TO THE EXCLUSIVE RIGHT TO USE "SOLUTIONS", APART FROM THE MARK AS SHOWN.

SN 77-155,268, FILED 4-12-2007.

BRIAN CALLAGHAN, EXAMINING ATTORNEY



David J. Kyffers

Director of the United States Patent and Trademark Office

United States of America

United States Patent and Trademark Office

Bright Ideas from a Small World

Reg. No. 4,074,403

NANOPORT TECHNOLOGIES (OREGON LIMITED LIABILITY COMPANY)
SUITE 401

Registered Dec. 20, 2011

PORTLAND, OR 97209

Int. Cl.: 9

FOR: ELECTRONIC REGULATING AND CONTROL DEVICES FOR THE OPERATION OF LIGHT EMITTING DIODES; ELECTRONIC SENSORS FOR MEASURING SOLAR RADIATION; LASER MEASURING SYSTEMS; LASERS FOR MEASURING PURPOSES; LIGHT DIODES; LIGHT EMITTING DIODE (LED) DISPLAYS; LIGHT EMITTING DIODES (LEDS); MEASUREMENT STANDARD DEVICES FOR NANOMETROLOGY, NAMELY, MEASURING TOOLS HAVING A PATTERN IN THE MICROMETER OR NANOMETER RANGES; RADIATION-MEASURING INSTRUMENTS; SCIENTIFIC APPARATUS, NAMELY, SENSING AND SIGNALING DEVICES FOR MEASUREMENT AND QUALITY CONTROL OF MATERIALS PROCESSING BY LASER; ALL USING MICRO AND NANOTECHNOLOGY, IN CLASS 9 (U.S. CLS. 21, 23, 26, 36 AND 38).

TRADEMARK

PRINCIPAL REGISTER

FIRST USE 4-1-2007; IN COMMERCE 2-17-2008.

THE MARK CONSISTS OF STANDARD CHARACTERS WITHOUT CLAIM TO ANY PARTICULAR FONT, STYLE, SIZE, OR COLOR.

SN 77-168,980, FILED 4-30-2007.

VIVIAN MICZNIK FIRST, EXAMINING ATTORNEY



David J. Kybas

Director of the United States Patent and Trademark Office

United States of America

United States Patent and Trademark Office

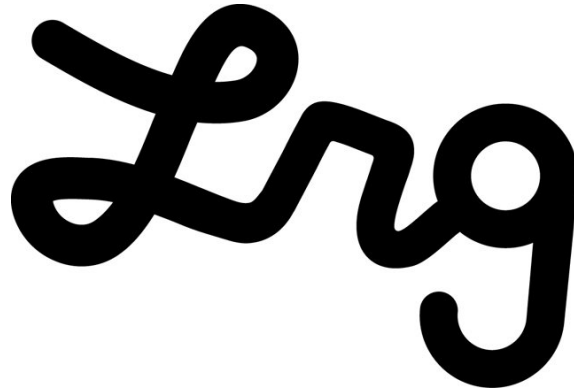

Reg. No. 4,074,404

Registered Dec. 20, 2011

Int. Cl.: 14

TRADEMARK

PRINCIPAL REGISTER

LIFTED RESEARCH GROUP, INC. (CALIFORNIA CORPORATION)
P.O. BOX 54668
IRVINE, CA 92619

FOR: CHRONOMETRIC INSTRUMENTS, NAMELY, WATCHES; GOODS IN PRECIOUS METALS OR COATED THEREWITH, NAMELY, JEWELRY, IN CLASS 14 (U.S. CLS. 2, 27, 28 AND 50).

FIRST USE 4-30-2011; IN COMMERCE 4-30-2011.

OWNER OF U.S. REG. NO. 2,633,832.

THE MARK CONSISTS OF THE LETTERS "LRG" IN STYLIZED FORM.

SN 77-174,963, FILED 5-7-2007.

CHRISTINE COOPER, EXAMINING ATTORNEY



David J. Kyffers

Director of the United States Patent and Trademark Office

United States of America

United States Patent and Trademark Office



Reg. No. 4,074,405

WYETH LLC (DELAWARE LIMITED LIABILITY COMPANY)
FIVE GIRALDA FARMS
MADISON, NJ 07940

Registered Dec. 20, 2011

Int. Cl.: 44

FOR: PROVIDING MEDICAL INFORMATION TO ASSIST AND EDUCATE PATIENTS ABOUT THE TREATMENT OF RENAL CELL CARCINOMA, IN CLASS 44 (U.S. CLS. 100 AND 101).

SERVICE MARK

FIRST USE 11-26-2008; IN COMMERCE 11-26-2008.

PRINCIPAL REGISTER

THE MARK CONSISTS OF THE WORD "TORISEL" AND A CIRCLE DESIGN; GRAY IS INTENDED TO SHOW SHADING OR CONTRAST ONLY.

SN 77-227,208, FILED 7-11-2007.

JUDITH HELFMAN, EXAMINING ATTORNEY



David J. Kybas

Director of the United States Patent and Trademark Office

United States of America

United States Patent and Trademark Office



Reg. No. 4,074,406

VIDA AB (SWEDEN STOCK COMPANY)
BOX 100

Registered Dec. 20, 2011

ALVESTA, SWEDEN S-34221

Int. Cl.: 19

FOR: BUILDING MATERIALS, NAMELY, CONSTRUCTION, SHAPED, AND STRUCTURAL TIMBER, WOOD MOLDINGS; SEMI-WORKED WOOD FOR MAKING HOUSEHOLD UTENSILS; PLANKS; WOOD PANELING; SEMI-WORKED WOOD FOR BARRELS AND TIMBER FOR BARREL STAVES; SHAPED TIMBER; DUCKBOARDS NOT OF METAL, IN CLASS 19 (U.S. CLS. 1, 12, 33 AND 50).

TRADEMARK

PRINCIPAL REGISTER

FIRST USE 6-30-1993; IN COMMERCE 10-31-2001.

THE MARK CONSISTS OF DESIGN IN THE FORM OF A SPHERE HAVING HORIZONTAL, MISALIGNED SECTIONS BEFORE THE TERM "VIDA", THE ENTIRE DESIGN AND WORDING IN THE COLOR MAROON.

THE COLOR(S) MAROON IS/ARE CLAIMED AS A FEATURE OF THE MARK.

THE ENGLISH TRANSLATION OF "VIDA" IN THE MARK IS WIDELY.

SN 77-227,277, FILED 7-11-2007.

TIMOTHY FINNEGAN, EXAMINING ATTORNEY



David J. Kybas

Director of the United States Patent and Trademark Office

United States of America

United States Patent and Trademark Office

HUMI-SORB

Reg. No. 4,074,407

Registered Dec. 20, 2011

Int. Cl.: 1

TRADEMARK

PRINCIPAL REGISTER

MULTISORB TECHNOLOGIES, INC. (NEW YORK CORPORATION)
325 HARLEM ROAD
BUFFALO, NY 14224

FOR: CHEMICAL PREPARATIONS FOR HUMIDITY CONTROL, NAMELY, HUMECTANTS IN THE FORM OF HUMIDITY CONTROL PACKETS, SACHETS, FOR USE IN CONTROLLING HUMIDITY IN ELECTRONIC AND DIAGNOSTIC DEVICES, PHARMACEUTICALS AND NUTRACEUTICALS; CHEMICALS, NAMELY, HUMIDITY CONTROL COMPOSITION FOR USE IN CONTROLLING HUMIDITY IN ELECTRONIC AND DIAGNOSTIC DEVICES, PHARMACEUTICALS AND NUTRACEUTICALS, IN CLASS 1 (U.S. CLS. 1, 5, 6, 10, 26 AND 46).

FIRST USE 10-3-2011; IN COMMERCE 10-3-2011.

THE MARK CONSISTS OF STANDARD CHARACTERS WITHOUT CLAIM TO ANY PARTICULAR FONT, STYLE, SIZE, OR COLOR.

SN 77-235,840, FILED 7-23-2007.

SHARON MEIER, EXAMINING ATTORNEY



David J. Kyros

Director of the United States Patent and Trademark Office

United States of America

United States Patent and Trademark Office

MAX 4 MEN

Reg. No. 4,074,408

Registered Dec. 20, 2011

Int. Cls.: 3 and 5

TRADEMARK

PRINCIPAL REGISTER

WTFN, INC. (CALIFORNIA CORPORATION)
20950 LASSEN STREET
CHATSWORTH, CA 91311

FOR: PREPARATIONS FOR PERSONAL CARE, NAMELY, RASH FREE SHAVE CREAM PREPARATIONS, PRE AND POST SHAVING CREAMS, AFTER-SHAVE BALMS AND LOTIONS, SKIN PROTECTION CONDITIONERS, BODY LOTIONS, BODY CREAMS, BODY OILS, COLOGNES AND BODY SPRAYS, KITS COMPRISED OF ONE OR MORE OF EACH OF THE AFOREMENTIONED ITEMS LISTED, IN CLASS 3 (U.S. CLS. 1, 4, 6, 50, 51 AND 52).

FIRST USE 7-8-2011; IN COMMERCE 7-8-2011.

FOR: MEDICATED TOPICAL PREPARATIONS FOR SEXUAL PERFORMANCE AND ENHANCING SEXUAL AROUSAL AND RESPONSIVENESS, NAMELY, OILS, GELS, CREAMS, BALMS, SPRAYS, LOTION; KITS COMPRISED OF ONE OR MORE OF EACH OF THE AFOREMENTIONED ITEMS LISTED, IN CLASS 5 (U.S. CLS. 6, 18, 44, 46, 51 AND 52).

FIRST USE 7-8-2011; IN COMMERCE 7-8-2011.

THE MARK CONSISTS OF STANDARD CHARACTERS WITHOUT CLAIM TO ANY PARTICULAR FONT, STYLE, SIZE, OR COLOR.

OWNER OF U.S. REG. NO. 3,124,919.

NO CLAIM IS MADE TO THE EXCLUSIVE RIGHT TO USE "FOR MEN", APART FROM THE MARK AS SHOWN.

SN 77-238,241, FILED 7-25-2007.

COLLEEN DOMBROW, EXAMINING ATTORNEY



David J. Kyffers

Director of the United States Patent and Trademark Office

United States of America
United States Patent and Trademark Office

EMSENSE

Reg. No. 4,074,409

EMSENSE CORPORATION (CALIFORNIA CORPORATION)
150 SPEAR STREET, SUITE 200
SAN FRANCISCO, CA 94105

Registered Dec. 20, 2011

Int. Cl.: 44

FOR: CONSULTING SERVICES FOR PSYCHOLOGICAL TESTING, NAMELY, ASSESSING PSYCHOLOGICAL RESPONSES BY INTERPRETING USERS' PHYSIOLOGICAL RESPONSES RECORDED BY PSYCHOPHYSIOLOGICAL INTERFACE DEVICES, COMPUTER INPUT DEVICES, AND BIOMETRIC FEEDBACK DEVICES, IN CLASS 44 (U.S. CLS. 100 AND 101).

SERVICE MARK

PRINCIPAL REGISTER

FIRST USE 12-27-2004; IN COMMERCE 12-27-2004.

THE MARK CONSISTS OF STANDARD CHARACTERS WITHOUT CLAIM TO ANY PARTICULAR FONT, STYLE, SIZE, OR COLOR.

SN 77-247,707, FILED 8-6-2007.

ANTHONY RINKER, EXAMINING ATTORNEY



David J. Kyjars

Director of the United States Patent and Trademark Office

United States of America

United States Patent and Trademark Office

LOLLIPOP TOP

Reg. No. 4,074,410

Registered Dec. 20, 2011

Int. Cls.: 30 and 32

TRADEMARK

PRINCIPAL REGISTER

CECERE, AL (UNITED STATES INDIVIDUAL)
511 PATTERSON LANE
GATLINBURG, TN 37738

FOR: CANDY, IN CLASS 30 (U.S. CL. 46).

FIRST USE 10-6-2011; IN COMMERCE 10-6-2011.

FOR: BEVERAGES, NAMELY, MINERAL WATER, SPRING WATER, FRUIT JUICES, FRUIT DRINKS, FRUIT-FLAVORED BEVERAGES, NON-ALCOHOLIC BEVERAGE, NAMELY, CARBONATED BEVERAGES, NON-ALCOHOLIC BEVERAGES WITH TEA FLAVOR, SPORTS DRINKS, SOFT DRINKS, SOFT DRINKS FLAVORED WITH TEA, IN CLASS 32 (U.S. CLS. 45, 46 AND 48).

FIRST USE 10-6-2011; IN COMMERCE 10-6-2011.

THE MARK CONSISTS OF STANDARD CHARACTERS WITHOUT CLAIM TO ANY PARTICULAR FONT, STYLE, SIZE, OR COLOR.

OWNER OF U.S. REG. NO. 2,772,913.

NO CLAIM IS MADE TO THE EXCLUSIVE RIGHT TO USE "LOLLIPOP" AS TO CLASS 30, APART FROM THE MARK AS SHOWN.

SN 77-256,576, FILED 8-16-2007.

REBECCA SMITH, EXAMINING ATTORNEY



David J. Kybas

Director of the United States Patent and Trademark Office

United States of America

United States Patent and Trademark Office



Reg. No. 4,074,411

WORRY WORM, LLC (DELAWARE LIMITED LIABILITY COMPANY)
4401 WILSHIRE BOULEVARD
LOS ANGELES, CA 90010

Registered Dec. 20, 2011

Int. Cl.: 25

FOR: CLOTHING, NAMELY, SHIRTS, SWEATERS, SWEATSHIRTS, BLOUSES, JERSEYS, PANTS, SHORTS, SKIRTS, DRESSES, SWIMWEAR, LOUNGEWEAR, SLEEPWEAR, UNDERWEAR, BOXER SHORTS, SOCKS, SCARVES, GLOVES, MITTENS, COATS, JACKETS; HEADWEAR; FOOTWEAR, IN CLASS 25 (U.S. CLS. 22 AND 39).

TRADEMARK

PRINCIPAL REGISTER

FIRST USE 10-6-2010; IN COMMERCE 10-6-2010.

THE MARK CONSISTS OF TWO STYLIZED FORM OF THE LETTER "W" FORMING THE SHAPE OF A SQUIGGLY WORM WITH THE END OF THE SECOND "W" GIVING THE APPEARANCE OF A WORM'S HEAD CONTAINING AN EYE.

SN 77-259,217, FILED 8-20-2007.

TINA L. SNAPP, EXAMINING ATTORNEY



David J. Kyjars

Director of the United States Patent and Trademark Office

United States of America

United States Patent and Trademark Office

UPLIFTV

Reg. No. 4,074,412

Registered Dec. 20, 2011

Int. Cls.: 35, 38, and 41

SERVICE MARK

PRINCIPAL REGISTER

OLYMPUSAT, INC. (FLORIDA CORPORATION)
SUITE 250
560 VILLAGE BLVD.
WEST PALM BEACH, FL 33409

FOR: ADVERTISING SERVICES FOR OTHERS IN THE FIELD OF TELEVISION PROGRAMMING, IN CLASS 35 (U.S. CLS. 100, 101 AND 102).

FIRST USE 1-0-2007; IN COMMERCE 9-0-2007.

FOR: BROADCASTING SERVICES IN THE NATURE OF TRANSMISSION OF PROGRAMS AND RELIGIOUS CONTENT DISTRIBUTED VIA BROADCAST TELEVISION, CABLE TELEVISION, SATELLITE, WIRELESS, INTERNET, AND BROADBAND, IN CLASS 38 (U.S. CLS. 100, 101 AND 104).

FIRST USE 1-0-2007; IN COMMERCE 9-0-2007.

FOR: ENTERTAINMENT SERVICES, NAMELY, PROVIDING TELEVISION PROGRAMS IN THE FIELD OF RELIGION DISTRIBUTED VIA BROADCAST TELEVISION, CABLE TELEVISION, SATELLITE, WIRELESS, INTERNET, AND BROADBAND, IN CLASS 41 (U.S. CLS. 100, 101 AND 107).

FIRST USE 1-0-2007; IN COMMERCE 9-0-2007.

THE MARK CONSISTS OF STANDARD CHARACTERS WITHOUT CLAIM TO ANY PARTICULAR FONT, STYLE, SIZE, OR COLOR.

SN 77-270,683, FILED 9-4-2007.

KEVIN CORWIN, EXAMINING ATTORNEY



David J. Kyros

Director of the United States Patent and Trademark Office

United States of America

United States Patent and Trademark Office

NO BOY'Z ON MY TOYZ

Reg. No. 4,074,413

ARNCE, JOHN (UNITED STATES INDIVIDUAL), DBA RAPID TRANSIT ENGINEERING,
3104 SUN UP CT.
CHULA VISTA, CA 91902

Registered Dec. 20, 2011

Int. Cl.: 25

FOR: CLOTHING, NAMELY, SHIRTS AND SHORTS; HEADGEAR, NAMELY, HATS AND
CAPS, IN CLASS 25 (U.S. CLS. 22 AND 39).

TRADEMARK

FIRST USE 9-14-2004; IN COMMERCE 10-18-2011.

PRINCIPAL REGISTER

THE MARK CONSISTS OF STANDARD CHARACTERS WITHOUT CLAIM TO ANY PAR-
TICULAR FONT, STYLE, SIZE, OR COLOR.

SN 77-270,918, FILED 9-4-2007.

TOBY BULLOFF, EXAMINING ATTORNEY



David J. Kyros

Director of the United States Patent and Trademark Office

United States of America

United States Patent and Trademark Office

SPEED AND STRENGTH

Reg. No. 4,074,414

Registered Dec. 20, 2011

Int. Cl.: 25

TRADEMARK

PRINCIPAL REGISTER

PARKER SYNERGIES LLC (FLORIDA LIMITED LIABILITY COMPANY)
10670 RIVERSIDE DR. EAST
WINDSOR, ONTARIO, CANADA N8P1A4

FOR: SHOES AND BOOTS, IN CLASS 25 (U.S. CLS. 22 AND 39).

FIRST USE 8-1-2008; IN COMMERCE 8-1-2008.

THE MARK CONSISTS OF STANDARD CHARACTERS WITHOUT CLAIM TO ANY PARTICULAR FONT, STYLE, SIZE, OR COLOR.

SN 77-273,056, FILED 9-6-2007.

ELLEN B. AWRICH, EXAMINING ATTORNEY



David J. Kybas

Director of the United States Patent and Trademark Office

United States of America

United States Patent and Trademark Office

GREEN-AGE

Reg. No. 4,074,415

CALERA CORPORATION (CALIFORNIA CORPORATION)
14600 WINCHESTER BLVD.

Registered Dec. 20, 2011

LOS GATOS, CA 95032

Int. Cl.: 19

FOR: NON-METALLIC CONSTRUCTION MATERIALS, NAMELY, MINERAL-BASED CEMENTITIOUS MATERIALS IN THE NATURE OF PORTLAND, HYDRAULIC, WHITE, MASONRY, PLASTIC, STUCCO, AND OIL WELL CEMENT, OTHER MINERAL-BASED CEMENTITIOUS MATERIALS; SUPPLEMENTARY CEMENTITIOUS MATERIALS, NAMELY, POZZOLANIC MATERIALS, IN CLASS 19 (U.S. CLS. 1, 12, 33 AND 50).

TRADEMARK

PRINCIPAL REGISTER

FIRST USE 10-12-2011; IN COMMERCE 10-12-2011.

THE MARK CONSISTS OF STANDARD CHARACTERS WITHOUT CLAIM TO ANY PARTICULAR FONT, STYLE, SIZE, OR COLOR.

SN 77-284,024, FILED 9-19-2007.

RAUL CORDOVA, EXAMINING ATTORNEY



David J. Kyffers

Director of the United States Patent and Trademark Office

United States of America

United States Patent and Trademark Office

CALERA

Reg. No. 4,074,416

Registered Dec. 20, 2011

Int. Cl.: 19

TRADEMARK

PRINCIPAL REGISTER

CALERA CORPORATION (CALIFORNIA CORPORATION)
14600 WINCHESTER BLVD.
LOS GATOS, CA 95032

FOR: NON-METALLIC CONSTRUCTION MATERIALS, NAMELY, MINERAL-BASED CEMENTITIOUS MATERIALS IN THE NATURE OF PORTLAND, HYDRAULIC, WHITE, MASONRY, PLASTIC, STUCCO, AND OIL WELL CEMENT, OTHER MINERAL-BASED CEMENTITIOUS MATERIALS; SUPPLEMENTARY CEMENTITIOUS MATERIALS, NAMELY, POZZOLANIC MATERIALS, IN CLASS 19 (U.S. CLS. 1, 12, 33 AND 50).

FIRST USE 10-12-2011; IN COMMERCE 10-12-2011.

THE MARK CONSISTS OF STANDARD CHARACTERS WITHOUT CLAIM TO ANY PARTICULAR FONT, STYLE, SIZE, OR COLOR.

THE FOREIGN WORDING IN THE MARK TRANSLATES INTO ENGLISH AS "LIMESTONE QUARRY", "PIT WHERE LIMESTONE IS MINED", "LIMEKILN", FURNACE IN WHICH "LIMESTONE" OR "SHELLS" ARE MADE INTO "LIME".

SN 77-284,027, FILED 9-19-2007.

EUGENIA MARTIN, EXAMINING ATTORNEY



David J. Kyros

Director of the United States Patent and Trademark Office

United States of America

United States Patent and Trademark Office

GIRLICIOUS

Reg. No. 4,074,417

Registered Dec. 20, 2011

Int. Cl.: 25

TRADEMARK

PRINCIPAL REGISTER

PUSSYCAT DOLLS, LLC (DELAWARE LIMITED LIABILITY COMPANY)
UNIVERSAL MUSIC GROUP
2220 COLORADO AVENUE
SANTA MONICA, CA 90404

FOR: LINGERIE, PAJAMAS, SHORTS, SHIRTS, T-SHIRTS, IN CLASS 25 (U.S. CLS. 22 AND 39).

FIRST USE 11-22-2010; IN COMMERCE 11-22-2010.

THE MARK CONSISTS OF STANDARD CHARACTERS WITHOUT CLAIM TO ANY PARTICULAR FONT, STYLE, SIZE, OR COLOR.

SN 77-285,162, FILED 9-20-2007.

BARBARA A. GOLD, EXAMINING ATTORNEY



David J. Kyffers

Director of the United States Patent and Trademark Office

United States of America

United States Patent and Trademark Office

GIRLICIOUS

Reg. No. 4,074,418

Registered Dec. 20, 2011

Int. Cl.: 38

SERVICE MARK

PRINCIPAL REGISTER

PUSSYCAT DOLLS, LLC (DELAWARE LIMITED LIABILITY COMPANY)
UNIVERSAL MUSIC GROUP
2220 COLORADO AVENUE
SANTA MONICA, CA 90404

FOR: BROADCAST OF CABLE TELEVISION PROGRAMS, BROADCASTING PROGRAMS VIA A GLOBAL COMPUTER NETWORK, TRANSMITTING STREAMED SOUND AND AUDIO-VISUAL RECORDINGS VIA THE INTERNET; STREAMING OF AUDIO AND VIDEO MATERIAL ON THE INTERNET; DIGITAL AND ELECTRONIC TRANSMISSION OF AUDIO AND VIDEO CONTENT IN THE NATURE OF VOICE, DATA, SOUND, IMAGES, AUDIO AND VIDEO MATERIAL, AND MESSAGES; PROVIDING ON-LINE CHAT ROOMS AND FORUMS AND ELECTRONIC BULLETIN BOARDS FOR TRANSMISSION OF MESSAGES AMONG USERS CONCERNING MUSIC AND ENTERTAINMENT, IN CLASS 38 (U.S. CLS. 100, 101 AND 104).

FIRST USE 6-1-2008; IN COMMERCE 6-1-2008.

THE MARK CONSISTS OF STANDARD CHARACTERS WITHOUT CLAIM TO ANY PARTICULAR FONT, STYLE, SIZE, OR COLOR.

SN 77-285,173, FILED 9-20-2007.

BARBARA A. GOLD, EXAMINING ATTORNEY



David J. Kyjars

Director of the United States Patent and Trademark Office

United States of America

United States Patent and Trademark Office

MAXIMO

Reg. No. 4,074,419

Registered Dec. 20, 2011

Int. Cls.: 9, 16, and 42

TRADEMARK

SERVICE MARK

PRINCIPAL REGISTER

INTERNATIONAL BUSINESS MACHINES CORPORATION (NEW YORK CORPORATION)
NEW ORCHARD ROAD
ARMONK, NY 10504

FOR: COMPUTER SOFTWARE, NAMELY, COMPUTER SOFTWARE APPLICATIONS FOR USE IN ASSET MANAGEMENT, WORK MANAGEMENT, SERVICE MANAGEMENT, CONTRACTS MANAGEMENT, MATERIALS MANAGEMENT, AND PROCUREMENT MANAGEMENT; AND INSTRUCTIONAL MANUALS SOLD AS A UNIT THEREWITH, IN CLASS 9 (U.S. CLS. 21, 23, 26, 36 AND 38).

FIRST USE 12-0-1985; IN COMMERCE 12-0-1985.

FOR: PRINTED MATTER, NAMELY, INSTRUCTIONAL MANUALS, INFORMATIONAL BROCHURES, AND TEACHING MATERIALS IN THE FIELD OF COMPUTER SOFTWARE, IN CLASS 16 (U.S. CLS. 2, 5, 22, 23, 29, 37, 38 AND 50).

FIRST USE 12-0-1985; IN COMMERCE 12-0-1985.

FOR: COMPUTER TECHNICAL SUPPORT SERVICES, NAMELY, TROUBLESHOOTING OF COMPUTER SOFTWARE PROBLEMS; COMPUTER SOFTWARE DESIGN FOR OTHERS; INSTALLATION, UPDATING AND MAINTENANCE OF COMPUTER SOFTWARE; CONSULTING SERVICES IN THE FIELD OF COMPUTER SOFTWARE, IN CLASS 42 (U.S. CLS. 100 AND 101).

FIRST USE 12-0-1985; IN COMMERCE 12-0-1985.

THE MARK CONSISTS OF STANDARD CHARACTERS WITHOUT CLAIM TO ANY PARTICULAR FONT, STYLE, SIZE, OR COLOR.

OWNER OF U.S. REG. NO. 1,378,985.

SN 77-294,819, FILED 10-3-2007.

TEJBIR SINGH, EXAMINING ATTORNEY



David J. Kyffers

Director of the United States Patent and Trademark Office

United States of America

United States Patent and Trademark Office

HYDRABOLT

Reg. No. 4,074,420

Registered Dec. 20, 2011

Int. Cl.: 6

TRADEMARK

PRINCIPAL REGISTER

INNOVATIVE MINING PRODUCTS (PTY) LTD (SOUTH AFRICA PROPRIETARY LIMITED COMPANY (P/L OR PTY. LTD.)), TA NEW CONCEPT MINING,
109 ADCOCK INGRAM AVENUE
AEROTON, JOHANNESBURG, SOUTH AFRICA

FOR: MATERIALS OF METAL, NAMELY, ROOF BOLTS AND ROOF TENDONS FOR SUPPORT OF UNDERGROUND AND SURFACE EXCAVATIONS IN MINING AND CIVIL APPLICATIONS; PIPES AND TUBES OF METAL; GOODS OF COMMON METAL, NAMELY, BOLTS OF METAL AND BOLTS OF METAL FOR ROCK SUPPORT, AND ROCK SUPPORT ANCHORS, IN CLASS 6 (U.S. CLS. 2, 12, 13, 14, 23, 25 AND 50).

FIRST USE 0-0-2003; IN COMMERCE 10-14-2011.

THE MARK CONSISTS OF STANDARD CHARACTERS WITHOUT CLAIM TO ANY PARTICULAR FONT, STYLE, SIZE, OR COLOR.

SN 77-316,915, FILED 10-30-2007.

ELI HELLMAN, EXAMINING ATTORNEY



David J. Kyfos

Director of the United States Patent and Trademark Office

United States of America

United States Patent and Trademark Office

BUILT FOR YIELD

Reg. No. 4,074,421

SYNGENTA PARTICIPATIONS AG (SWITZERLAND CORPORATION)
SCHWARZWALDALLEE 215
BASEL, SWITZERLAND CH4058

Registered Dec. 20, 2011

Int. Cl.: 1

FOR: PROTEIN OR OTHER MATERIAL, NAMELY, HERBICIDE TOLERANT GENES, THAT CONFERS IN-PLANT TOLERANCE TO HERBICIDES, IN-PLANT RESISTANCE TO SELECTED INSECT PESTS AND/OR OTHER IN-PLANT CHARACTERISTICS LEADING TO A RANGE OF DESIRABLE AGRONOMIC FUNCTIONS, IN CLASS 1 (U.S. CLS. 1, 5, 6, 10, 26 AND 46).

TRADEMARK

PRINCIPAL REGISTER

FIRST USE 1-15-2011; IN COMMERCE 1-15-2011.

THE MARK CONSISTS OF STANDARD CHARACTERS WITHOUT CLAIM TO ANY PARTICULAR FONT, STYLE, SIZE, OR COLOR.

SN 77-318,085, FILED 10-31-2007.

GISELLE AGOSTO, EXAMINING ATTORNEY



David J. Kybas

Director of the United States Patent and Trademark Office

United States of America

United States Patent and Trademark Office

OUR WORLD

Reg. No. 4,074,422

Registered Dec. 20, 2011

Int. Cls.: 38 and 41

SERVICE MARK

PRINCIPAL REGISTER

NEW MILLENNIUM MEDIA PARTNERS, LLC (DELAWARE LIMITED LIABILITY COMPANY)
130 FIFTH AVENUE
NEW YORK, NY 100104399

FOR: BROADCASTING OF TELEVISION PROGRAMS, IN CLASS 38 (U.S. CLS. 100, 101 AND 104).

FIRST USE 10-1-2006; IN COMMERCE 10-1-2006.

FOR: PRODUCTION AND SYNDICATION OF TELEVISION PROGRAMS; DISTRIBUTION OF TELEVISION PROGRAMS FOR OTHERS, IN CLASS 41 (U.S. CLS. 100, 101 AND 107).

FIRST USE 10-1-2006; IN COMMERCE 10-1-2006.

THE MARK CONSISTS OF STANDARD CHARACTERS WITHOUT CLAIM TO ANY PARTICULAR FONT, STYLE, SIZE, OR COLOR.

SN 77-318,158, FILED 10-31-2007.

JOHN WILKE, EXAMINING ATTORNEY



David J. Kyjars

Director of the United States Patent and Trademark Office

United States of America

United States Patent and Trademark Office

NAPATAGE

Reg. No. 4,074,423

MERLO RANCH LIMITED PARTNERSHIP (CALIFORNIA LIMITED PARTNERSHIP)
1001 SE SANDY BLVD
PORTLAND, OR 97214

Registered Dec. 20, 2011

Int. Cl.: 33

FOR: WINE DERIVED FROM GRAPES GROWN IN NAPA COUNTY, CALIFORNIA, LABELED AND ADVERTISED IN COMPLIANCE WITH U.S. LAWS FOR EITHER THE NAPA COUNTY APPELLATION OF ORIGIN OR THE NAPA VALLEY AMERICAN VITICULTURAL AREA APPELLATION OF ORIGIN, IN CLASS 33 (U.S. CLS. 47 AND 49).

TRADEMARK

PRINCIPAL REGISTER

FIRST USE 9-1-2009; IN COMMERCE 9-1-2009.

THE MARK CONSISTS OF STANDARD CHARACTERS WITHOUT CLAIM TO ANY PARTICULAR FONT, STYLE, SIZE, OR COLOR.

SN 77-327,511, FILED 11-12-2007.

ALEX KEAM, EXAMINING ATTORNEY



David J. Kybas

Director of the United States Patent and Trademark Office

United States of America

United States Patent and Trademark Office



Reg. No. 4,074,424

DAILEY G. THOMAS (UNITED STATES INDIVIDUAL)
153 PEARL ST.
PATERSON, NJ 07501

Registered Dec. 20, 2011

Int. Cl.: 14

TRADEMARK

PRINCIPAL REGISTER

FOR: BEADS FOR USE IN THE MANUFACTURE OF JEWELRY; BRACELETS; BRONZE JEWELRY; BROOCHES; CHARMS; COSTUME JEWELRY; DIAMOND JEWELRY; GEMSTONE JEWELRY; IDENTIFICATION BRACELETS; JEWELRY; JEWELRY AND IMITATION JEWELRY; JEWELRY BOXES; JEWELRY BOXES NOT OF METAL; JEWELRY BOXES OF METAL; JEWELRY BOXES OF PRECIOUS METAL; JEWELRY CASES; JEWELRY CASES NOT OF PRECIOUS METAL; JEWELRY CASES OF PRECIOUS METAL; JEWELRY CASKETS; JEWELRY CASKETS OF PRECIOUS METAL; JEWELRY CHAINS; JEWELRY FINDINGS; JEWELRY FOR THE HEAD; JEWELRY ORGANIZERS; JEWELRY PINS FOR USE ON HATS; JEWELRY RING HOLDERS; JEWELRY TO BE AFFIXED TO BIKINIS; JEWELRY WATCHES; JEWELRY, NAMELY, AMULETS; JEWELRY, NAMELY, CROSSES; JEWELRY, NAMELY, PRECIOUS METAL PLATED REAL LEAVES AND FLOWERS; LAPEL PINS; LEATHER JEWELRY AND ACCESSORY BOXES; METAL WIRE FOR USE IN THE MAKING OF JEWELRY, NAMELY, JEWELRY CABLE; PET JEWELRY; PINS BEING JEWELRY; RINGS; RINGS BEING JEWELRY; WATCHES AND JEWELRY; WATCHES, CLOCKS, JEWELRY AND IMITATION JEWELRY, IN CLASS 14 (U.S. CLS. 2, 27, 28 AND 50).

FIRST USE 11-19-2007; IN COMMERCE 11-19-2007.

NO CLAIM IS MADE TO THE EXCLUSIVE RIGHT TO USE "PRODUCTION INC.", APART FROM THE MARK AS SHOWN.

SN 77-333,138, FILED 11-19-2007.

BRIAN PINO, EXAMINING ATTORNEY



David J. Kybas

Director of the United States Patent and Trademark Office

United States of America

United States Patent and Trademark Office

SOUNDUNWOUND

Reg. No. 4,074,425

Registered Dec. 20, 2011

Int. Cl.: 38

SERVICE MARK

PRINCIPAL REGISTER

IMDB.COM, INC. (DELAWARE CORPORATION)
410 TERRY AVENUE NORTH
ATTN: TRADEMARKS
SEATTLE, WA 98109

FOR: PROVIDING ON-LINE ELECTRONIC BULLETIN BOARDS FOR TRANSMISSION OF MESSAGES AMONG COMPUTER USERS CONCERNING GENERAL NEWS AND INFORMATION REGARDING THE ENTERTAINMENT INDUSTRY, MUSIC, MUSIC COMMUNITY, ARTISTS, AUDIOVISUAL WORKS, VISUAL WORKS, AND LIVE MUSICAL PERFORMANCES; AUDIO BROADCASTING OF SPOKEN WORD, MUSIC, CONCERTS, AND RADIO PROGRAMS; STREAMING OF AUDIO, VISUAL AND AUDIOVISUAL MATERIAL VIA A GLOBAL COMPUTER NETWORK, NAMELY, STREAMING INFORMATION IN THE FIELDS OF MUSIC, MUSIC COMMUNITY, SONGS, ARTISTS, ALBUMS, FILMS, LYRICS, GRAPHICS, ANIMATION AND MULTIMEDIA PRESENTATIONS, AND OTHER AUDIOVISUAL WORKS OR MUSICAL WORKS, IN CLASS 38 (U.S. CLS. 100, 101 AND 104).

FIRST USE 9-2-2008; IN COMMERCE 9-2-2008.

THE MARK CONSISTS OF STANDARD CHARACTERS WITHOUT CLAIM TO ANY PARTICULAR FONT, STYLE, SIZE, OR COLOR.

SN 77-336,503, FILED 11-26-2007.

CAROL SPILS, EXAMINING ATTORNEY



David J. Kybas

Director of the United States Patent and Trademark Office

United States of America

United States Patent and Trademark Office

THUNDER THIGHZ

Reg. No. 4,074,426

KYLE PANTELIS (UNITED STATES INDIVIDUAL)
UNIT 27C 1550 N. LAKE SHORE DR.
CHICAGO, IL 60610

Registered Dec. 20, 2011

Int. Cl.: 25

FOR: WEARABLE APPAREL ACCESSORIES HAVING STORAGE POCKETS FOR PERSONAL ITEMS, IN THE NATURE OF A MONEY BELT, IN CLASS 25 (U.S. CLS. 22 AND 39).

TRADEMARK

FIRST USE 9-29-2009; IN COMMERCE 9-29-2009.

PRINCIPAL REGISTER

THE MARK CONSISTS OF STANDARD CHARACTERS WITHOUT CLAIM TO ANY PARTICULAR FONT, STYLE, SIZE, OR COLOR.

SN 77-340,952, FILED 11-30-2007.

KARANENDRA S. CHHINA, EXAMINING ATTORNEY



David J. Kybas

Director of the United States Patent and Trademark Office

United States of America

United States Patent and Trademark Office

enMotion

Reg. No. 4,074,427

Registered Dec. 20, 2011

Int. Cl.: 3

TRADEMARK

PRINCIPAL REGISTER

GEORGIA-PACIFIC CONSUMER PRODUCTS LP (DELAWARE LIMITED PARTNERSHIP)
GA030-41N
133 PEACHTREE STREET NE
ATLANTA, GA 30303

FOR: COMMERCIAL HAND SOAP FOR USE IN DISPENSERS IN PUBLIC ESTABLISHMENTS, IN CLASS 3 (U.S. CLS. 1, 4, 6, 50, 51 AND 52).

FIRST USE 6-30-2009; IN COMMERCE 6-30-2009.

OWNER OF U.S. REG. NOS. 2,664,519, 2,834,670, AND OTHERS.

SN 77-354,942, FILED 12-18-2007.

ROBIN MITTLER, EXAMINING ATTORNEY



David J. Kyffers

Director of the United States Patent and Trademark Office

United States of America

United States Patent and Trademark Office

ST BRIDE TYPE FOUNDRY

Reg. No. 4,074,428

SCHWARTZCO, INC. (NEW YORK CORPORATION)
8 RIVINGTON STREET, SUITE 12
NEW YORK, NY 10002

Registered Dec. 20, 2011

Int. Cl.: 9

FOR: DOWNLOADABLE PRINTING FONTS; TYPEFACE FONTS RECORDED ON MAGNETIC MEDIA, IN CLASS 9 (U.S. CLS. 21, 23, 26, 36 AND 38).

TRADEMARK

FIRST USE 9-16-2011; IN COMMERCE 9-16-2011.

PRINCIPAL REGISTER

THE MARK CONSISTS OF STANDARD CHARACTERS WITHOUT CLAIM TO ANY PARTICULAR FONT, STYLE, SIZE, OR COLOR.

NO CLAIM IS MADE TO THE EXCLUSIVE RIGHT TO USE "TYPE FOUNDRY", APART FROM THE MARK AS SHOWN.

SN 77-357,048, FILED 12-20-2007.

TINA BROWN, EXAMINING ATTORNEY



David J. Kybas

Director of the United States Patent and Trademark Office

United States of America

United States Patent and Trademark Office

BAREFACED

Reg. No. 4,074,429

EVY OF CALIFORNIA, INC. (CALIFORNIA CORPORATION)
1875 EAST 22ND STREET
LOS ANGELES, CA 90058

Registered Dec. 20, 2011

Int. Cls.: 35, 38, 42, and 45

FOR: COMPUTER SERVICES, NAMELY, PROVIDING ON-LINE COMPUTER DATABASES AND ON-LINE SEARCHABLE DATABASES IN THE FIELD OF SOCIALLY AND ENVIRONMENTALLY RESPONSIBLE PRODUCTS AND CLASSIFIEDS, IN CLASS 35 (U.S. CLS. 100, 101 AND 102).

SERVICE MARK

FIRST USE 10-1-2008; IN COMMERCE 10-1-2008.

PRINCIPAL REGISTER

FOR: PROVIDING ON-LINE COMPUTER DATABASES AND ON-LINE SEARCHABLE DATABASES IN THE FIELD OF TRANSMISSION OF PHOTOGRAPHIC IMAGES, IN CLASS 38 (U.S. CLS. 100, 101 AND 104).

FIRST USE 10-1-2008; IN COMMERCE 10-1-2008.

FOR: COMPUTER SERVICES, NAMELY, HOSTING ONLINE WEB FACILITIES FOR OTHERS FOR ORGANIZING AND CONDUCTING ONLINE MEETINGS, GATHERINGS, AND INTERACTIVE DISCUSSIONS; COMPUTER SERVICES IN THE NATURE OF CUSTOMIZED WEB PAGES FEATURING USER-DEFINED INFORMATION, PERSONAL PROFILES AND INFORMATION; PROVIDING A WEB SITE THAT GIVES COMPUTER USERS THE ABILITY TO UPLOAD, EXCHANGE AND SHARE PHOTOS, VIDEOS AND VIDEO LOGS; TESTING, ANALYSIS AND EVALUATION OF CONSUMER PRODUCTS, MANUFACTURING PROCESSES, EQUIPMENT, PLANT INSTALLATIONS, ENGINES, BUILDINGS, AND INTERNAL ACTIVITIES OF ORGANIZATIONS RELATED TO MAINTENANCE OF QUALITY, HEALTH, SAFETY, AND ENVIRONMENTAL PERFORMANCE STANDARDS IN A WIDE VARIETY OF FIELDS; TESTING OF GOODS AND SERVICES TO MEET QUALITY, HEALTH, SAFETY, AND ENVIRONMENTAL PERFORMANCE CERTIFICATION STANDARDS IN A WIDE VARIETY OF FIELDS, IN CLASS 42 (U.S. CLS. 100 AND 101).

FIRST USE 10-1-2008; IN COMMERCE 10-1-2008.

FOR: INTERNET-BASED INTRODUCTION AND SOCIAL NETWORKING SERVICES; PROVIDING ON-LINE COMPUTER DATABASES AND ON-LINE SEARCHABLE DATABASES IN THE FIELD OF SOCIAL NETWORKING, IN CLASS 45 (U.S. CLS. 100 AND 101).



David J. Kyjars

Director of the United States Patent and Trademark Office

Reg. No. 4,074,429 FIRST USE 10-1-2008; IN COMMERCE 10-1-2008.

THE MARK CONSISTS OF STANDARD CHARACTERS WITHOUT CLAIM TO ANY PARTICULAR FONT, STYLE, SIZE, OR COLOR.

SN 77-364,725, FILED 1-4-2008.

ESTHER A. BORSUK, EXAMINING ATTORNEY

United States of America

United States Patent and Trademark Office

B*BOSS

Reg. No. 4,074,430

Registered Dec. 20, 2011

Int. Cls.: 9 and 41

TRADEMARK

SERVICE MARK

PRINCIPAL REGISTER

BENJAMIN LEON VARADI (CANADA INDIVIDUAL)
76 LOWTHER AVENUE
TORONTO, CANADA M5R1C8

FOR: MUSICAL SOUND RECORDINGS AND MUSICAL VIDEO RECORDINGS, IN CLASS 9 (U.S. CLS. 21, 23, 26, 36 AND 38).

FIRST USE 3-7-2010; IN COMMERCE 3-7-2010.

FOR: ENTERTAINMENT, NAMELY, LIVE PERFORMANCES BY A MUSICAL GROUP, IN CLASS 41 (U.S. CLS. 100, 101 AND 107).

FIRST USE 8-14-2010; IN COMMERCE 8-14-2010.

THE MARK CONSISTS OF STANDARD CHARACTERS WITHOUT CLAIM TO ANY PARTICULAR FONT, STYLE, SIZE, OR COLOR.

PRIORITY CLAIMED UNDER SEC. 44(D) ON CANADA APPLICATION NO. 1,355,592, FILED 7-13-2007.

SN 77-366,516, FILED 1-8-2008.

LINDA M. KING, EXAMINING ATTORNEY



David J. Kyros

Director of the United States Patent and Trademark Office

United States of America

United States Patent and Trademark Office

VIVID

Reg. No. 4,074,431

TAKASAGO INTERNATIONAL CORP. (NEW YORK CORPORATION)
4 VOLVO DRIVE
ROCKLEIGH, NJ 07647

Registered Dec. 20, 2011

Int. Cl.: 2

FOR: COLORANTS FOR USE IN THE MANUFACTURE OF PERSONAL CARE PRODUCTS, HOUSEHOLD PRODUCTS, ODORANTS, DEODORANTS, INDUSTRIAL PRODUCTS, CLEANING PRODUCTS, SOAPS, PERFUMES, LOTIONS, COSMETICS, CANDLES AND CREAMS, PHARMACEUTICAL PRODUCTS, OVER-THE-COUNTER PREPARATIONS, BEVERAGES, FOODSTUFFS, FOOD INGREDIENTS, FOODS, FOOD EXTRACTS, NATURAL, ARTIFICIAL AND SYNTHETIC FLAVORING AND CONCENTRATES FOR FOODS AND SENSORY STIMULANTS, IN CLASS 2 (U.S. CLS. 6, 11 AND 16).

TRADEMARK

PRINCIPAL REGISTER

FIRST USE 10-7-2011; IN COMMERCE 10-7-2011.

THE MARK CONSISTS OF STANDARD CHARACTERS WITHOUT CLAIM TO ANY PARTICULAR FONT, STYLE, SIZE, OR COLOR.

SN 77-403,944, FILED 2-22-2008.

TRICIA SONNEBORN, EXAMINING ATTORNEY



David J. Kyros

Director of the United States Patent and Trademark Office

United States of America

United States Patent and Trademark Office

AROMATIC LIFE

Reg. No. 4,074,432

Registered Dec. 20, 2011

Int. Cls.: 3 and 11

TRADEMARK

PRINCIPAL REGISTER

SARAYA CO., LTD. (JAPAN CORPORATION)
2-8, YUZATO 2-CHOME, HIGASHISUMIYOSHI-KU
OSAKA, JAPAN

FOR: PERFUMERY, IN CLASS 3 (U.S. CLS. 1, 4, 6, 50, 51 AND 52).

FIRST USE 9-13-2011; IN COMMERCE 10-4-2011.

FOR: ELECTRIC AROMA DIFFUSER, IN CLASS 11 (U.S. CLS. 13, 21, 23, 31 AND 34).

FIRST USE 9-13-2011; IN COMMERCE 10-4-2011.

THE MARK CONSISTS OF STANDARD CHARACTERS WITHOUT CLAIM TO ANY PARTICULAR FONT, STYLE, SIZE, OR COLOR.

NO CLAIM IS MADE TO THE EXCLUSIVE RIGHT TO USE "AROMATIC", APART FROM THE MARK AS SHOWN.

SN 77-407,567, FILED 2-27-2008.

WENDY GOODMAN, EXAMINING ATTORNEY



David J. Kyfos

Director of the United States Patent and Trademark Office

United States of America

United States Patent and Trademark Office

AGILITY REAL RETURN ASSETS FUND

Reg. No. 4,074,433

PERELLA WEINBERG PARTNERS LLC (DELAWARE LIMITED LIABILITY COMPANY)
767 FIFTH AVENUE
NEW YORK, NY 10153

Registered Dec. 20, 2011

Int. Cl.: 36

FOR: FINANCIAL SERVICES, NAMELY, HEDGE FUND INVESTMENT SERVICES, IN CLASS 36 (U.S. CLS. 100, 101 AND 102).

SERVICE MARK

FIRST USE 10-1-2007; IN COMMERCE 10-1-2007.

PRINCIPAL REGISTER

THE MARK CONSISTS OF STANDARD CHARACTERS WITHOUT CLAIM TO ANY PARTICULAR FONT, STYLE, SIZE, OR COLOR.

OWNER OF U.S. REG. NOS. 3,247,765, 3,432,265, AND OTHERS.

NO CLAIM IS MADE TO THE EXCLUSIVE RIGHT TO USE "REAL RETURN ASSETS FUND", APART FROM THE MARK AS SHOWN.

SN 77-408,297, FILED 2-28-2008.

JASON BLAIR, EXAMINING ATTORNEY



David J. Kybas

Director of the United States Patent and Trademark Office

United States of America

United States Patent and Trademark Office

AGILITY COMPREHENSIVE SOLUTIONS FUND

Reg. No. 4,074,434

PERELLA WEINBERG PARTNERS LLC (DELAWARE LIMITED LIABILITY COMPANY)
767 FIFTH AVENUE
NEW YORK, NY 10153

Registered Dec. 20, 2011

Int. Cl.: 36

FOR: FINANCIAL SERVICES, NAMELY, HEDGE FUND INVESTMENT SERVICES, IN CLASS 36 (U.S. CLS. 100, 101 AND 102).

SERVICE MARK

FIRST USE 10-1-2007; IN COMMERCE 10-1-2007.

PRINCIPAL REGISTER

THE MARK CONSISTS OF STANDARD CHARACTERS WITHOUT CLAIM TO ANY PARTICULAR FONT, STYLE, SIZE, OR COLOR.

OWNER OF U.S. REG. NOS. 3,427,765, 3,432,265, AND OTHERS.

NO CLAIM IS MADE TO THE EXCLUSIVE RIGHT TO USE "FUND", APART FROM THE MARK AS SHOWN.

SN 77-408,334, FILED 2-28-2008.

JASON BLAIR, EXAMINING ATTORNEY



David J. Kybas

Director of the United States Patent and Trademark Office

United States of America

United States Patent and Trademark Office



Reg. No. 4,074,435

GUFFIN, GEORGE (UNITED STATES INDIVIDUAL)
4315 WEDGEWOOD STREET
JACKSON, MS 39211

Registered Dec. 20, 2011

Int. Cl.: 9

FOR: DUST PROTECTIVE GOGGLES AND MASKS; GOGGLES FOR SPORTS; MOTORCYCLE GOGGLES; SAFETY GOGGLES; SKI GOGGLES; SNOW GOGGLES; SPORT GOGGLES FOR USE IN SPORTS AND MOTOCROSS, ENDURO, DIRT BIKES, SUPERMOTARD, FREESTYLE, FOUR WHEELERS, SNOWMOBILES, IN CLASS 9 (U.S. CLS. 21, 23, 26, 36 AND 38).

TRADEMARK

PRINCIPAL REGISTER

FIRST USE 3-4-2008; IN COMMERCE 9-28-2011.

THE MARK CONSISTS OF THE WORD "ROOST" WITH THE LOWER PORTION OF THE LETTER "R" AND THE LETTERS "OOST" IN BLACK AND THE UPPER PORTION OF "R" COMPRISING A DESIGN ELEMENT INCORPORATING FEATHERS IN RED. A RED HORIZONTAL LINE EXTENDS FROM THE "R" OVER "OOST" AND THROUGH THE CROSS IN THE "T".

THE COLOR(S) RED AND BLACK IS/ARE CLAIMED AS A FEATURE OF THE MARK.

SN 77-412,963, FILED 3-4-2008.

KEVIN DINALLO, EXAMINING ATTORNEY



David J. Kyffers

Director of the United States Patent and Trademark Office

United States of America

United States Patent and Trademark Office

EARTH SNACKS

Reg. No. 4,074,436

Registered Dec. 20, 2011

Int. Cl.: 35

SERVICE MARK

PRINCIPAL REGISTER

LEVIN FAMILY 2010 IRREVOCABLE GIFT TRUST (UNITED STATES TRUST)
16150 E. STEPHENS STREET
CITY OF INDUSTRY, CA 91745

FOR: ONLINE RETAIL STORE SERVICES FEATURING SNACK MIXES, NUTS, DRIED FRUITS, CANDY, TOFFEE, COOKIES, BREAD, MUFFINS AND OTHER FOODSTUFFS; DISTRIBUTORSHIP SERVICES IN THE FIELD OF SNACK MIXES, NUTS, DRIED FRUITS, CANDY, TOFFEE, COOKIES, BREAD, MUFFINS AND OTHER FOODSTUFFS, IN CLASS 35 (U.S. CLS. 100, 101 AND 102).

FIRST USE 9-7-2011; IN COMMERCE 9-7-2011.

THE MARK CONSISTS OF STANDARD CHARACTERS WITHOUT CLAIM TO ANY PARTICULAR FONT, STYLE, SIZE, OR COLOR.

NO CLAIM IS MADE TO THE EXCLUSIVE RIGHT TO USE "SNACKS", APART FROM THE MARK AS SHOWN.

SN 77-413,053, FILED 3-4-2008.

GISELLE AGOSTO, EXAMINING ATTORNEY



David J. Kyffers

Director of the United States Patent and Trademark Office

United States of America

United States Patent and Trademark Office



Reg. No. 4,074,437

Registered Dec. 20, 2011

Int. Cl.: 9

TRADEMARK

PRINCIPAL REGISTER

GUFFIN, GEORGE (UNITED STATES INDIVIDUAL)
4315 WEDGEWOOD STREET
JACKSON, MS 39211

FOR: DUST PROTECTIVE GOGGLES AND MASKS; GOGGLES FOR SPORTS; MOTORCYCLE GOGGLES; SAFETY GOGGLES; SKI GOGGLES; SNOW GOGGLES; SPORT GOGGLES FOR USE IN SPORTS AND MOTOCROSS, ENDURO, DIRT BIKES, SUPERMOTARD, FREESTYLE, FOUR WHEELERS, SNOWMOBILES, IN CLASS 9 (U.S. CLS. 21, 23, 26, 36 AND 38).

FIRST USE 3-4-2008; IN COMMERCE 9-28-2011.

THE MARK CONSISTS OF THE STYLIZED LETTERS "TOL".

SN 77-413,983, FILED 3-5-2008.

KEVIN DINALLO, EXAMINING ATTORNEY



David J. Kybas

Director of the United States Patent and Trademark Office

United States of America

United States Patent and Trademark Office

MINDLESS EATING SOLUTIONS

Reg. No. 4,074,438

Registered Dec. 20, 2011

Int. Cl.: 16

TRADEMARK

PRINCIPAL REGISTER

CONSUMERPSYCH LABS, INC. (ILLINOIS CORPORATION), DBA BRANDPSYCH LABS,
INC.,
330 THE PARKWAY
ITHACA, NY 14850

FOR: PUBLICATIONS, NAMELY, BOOKS, WORKBOOKS, MANUALS, NEWSLETTERS, CALENDARS, NOTE CARDS, POSTERS, STICKERS, OVERHEAD DISPLAYS IN THE NATURE OF PLASTIC AND PAPER TRANSPARENCIES, AND PLASTIC AND PAPER TRANSPARENCIES FEATURING POWER POINT PRESENTATIONS, ALL FEATURING INFORMATION IN THE FIELDS OF BEHAVIOR MODIFICATION PSYCHOLOGY, EATING HABITS, DIETING AND WEIGHT MANAGEMENT, FAMILY AND PERSONAL NUTRITION, COMFORT FOODS, FINE DINING AND RESTAURANT DINING, IN CLASS 16 (U.S. CLS. 2, 5, 22, 23, 29, 37, 38 AND 50).

FIRST USE 10-26-2011; IN COMMERCE 10-26-2011.

THE MARK CONSISTS OF STANDARD CHARACTERS WITHOUT CLAIM TO ANY PARTICULAR FONT, STYLE, SIZE, OR COLOR.

NO CLAIM IS MADE TO THE EXCLUSIVE RIGHT TO USE "EATING SOLUTIONS", APART FROM THE MARK AS SHOWN.

SN 77-414,248, FILED 3-5-2008.

JASON TURNER, EXAMINING ATTORNEY



David J. Kybas

Director of the United States Patent and Trademark Office

United States of America

United States Patent and Trademark Office

MINDLESS EATING SOLUTIONS

Reg. No. 4,074,439

Registered Dec. 20, 2011

Int. Cl.: 41

SERVICE MARK

PRINCIPAL REGISTER

CONSUMERPSYCH LABS, INC. (ILLINOIS CORPORATION), DBA BRANDPSYCH LABS, INC.,
330 THE PARKWAY
ITHACA, NY 14850

FOR: EDUCATIONAL SERVICES, NAMELY, PROVIDING WORKSHOPS, SEMINARS, CONFERENCES, TRAINING, PROGRAMS, PERSONAL COACHING, AND SPEECHES ALL IN THE FIELDS OF BEHAVIOR MODIFICATION PSYCHOLOGY, EATING HABITS, DIETING AND WEIGHT MANAGEMENT, FAMILY AND PERSONAL NUTRITION, COMFORT FOODS, FINE DINING AND RESTAURANT DINING; PROVIDING LIVE AND ON-LINE TRAINING SEMINARS IN THE FIELDS OF BEHAVIOR MODIFICATION PSYCHOLOGY, EATING HABITS, DIETING AND WEIGHT MANAGEMENT, FAMILY AND PERSONAL NUTRITION, COMFORT FOODS, FINE DINING AND RESTAURANT DINING; ENTERTAINMENT SERVICES, NAMELY, PROVIDING NEWS BROADCASTS IN THE NATURE OF A CONTINUING NEWS BROADCAST SHOW OVER TELEVISION, SATELLITE, AUDIO AND VIDEO MEDIA, WEBCASTS AND PODCASTS, ALL IN THE FIELDS OF BEHAVIOR MODIFICATION PSYCHOLOGY, EATING HABITS, DIETING AND WEIGHT MANAGEMENT, FAMILY AND PERSONAL NUTRITION, COMFORT FOODS, FINE DINING AND RESTAURANT DINING; PROVIDING NEWSLETTERS IN THE FIELDS OF BEHAVIOR MODIFICATION PSYCHOLOGY, EATING HABITS, DIETING AND WEIGHT MANAGEMENT, FAMILY AND PERSONAL NUTRITION, COMFORT FOODS, FINE DINING AND RESTAURANT DINING VIA EMAIL AND PROVIDING A WEBSITE FEATURING EDUCATIONAL INFORMATION BY MEANS OF ONLINE ARTICLES, WORKSHOPS AND SEMINARS, ALL IN THE FIELDS OF BEHAVIOR MODIFICATION PSYCHOLOGY, EATING HABITS, DIETING AND WEIGHT MANAGEMENT, FAMILY AND PERSONAL NUTRITION, COMFORT FOODS, FINE DINING AND RESTAURANT DINING; MOTION PICTURE AND DOCUMENTARY FILM PRODUCTION, EDITING AND DISTRIBUTION ALL IN THE FIELDS OF BEHAVIOR MODIFICATION PSYCHOLOGY, EATING HABITS, DIETING AND WEIGHT MANAGEMENT, FAMILY AND PERSONAL NUTRITION, COMFORT FOODS, FINE DINING AND RESTAURANT DINING, IN CLASS 41 (U.S. CLS. 100, 101 AND 107).



FIRST USE 10-28-2011; IN COMMERCE 10-28-2011.

David J. Kyros

THE MARK CONSISTS OF STANDARD CHARACTERS WITHOUT CLAIM TO ANY PARTICULAR FONT, STYLE, SIZE, OR COLOR.

Reg. No. 4,074,439 NO CLAIM IS MADE TO THE EXCLUSIVE RIGHT TO USE "EATING SOLUTIONS", APART FROM THE MARK AS SHOWN.

SN 77-414,256, FILED 3-5-2008.

JASON TURNER, EXAMINING ATTORNEY

United States of America

United States Patent and Trademark Office

ELEVEN23

Reg. No. 4,074,440

Registered Dec. 20, 2011

Int. Cls.: 35 and 42

SERVICE MARK

PRINCIPAL REGISTER

LOUNGE 22 (CALIFORNIA LIMITED LIABILITY COMPANY)
1805 FLOWER STREET
GLENDALE, CA 91201

FOR: DESIGN AND DEVELOPMENT OF INTERACTIVE WEB CONTENT, NAMELY, DESIGN OF INTERNET ADVERTISING FOR OTHERS; ADVERTISING SERVICES, NAMELY, CREATING CORPORATE AND BRAND IDENTITY FOR OTHERS; CONCEPT AND BRAND DEVELOPMENT IN THE FIELD OF AUTOMOTIVES, MANUFACTURING, RESTAURANTS, RETAIL, AND HIGH TECHNOLOGY COMPANIES; DESIGN OF ADVERTISING MATERIAL FOR OTHERS; ADVICE IN THE FIELD OF BUSINESS MANAGEMENT AND MARKETING; BUSINESS CONSULTATION AND MANAGEMENT REGARDING MARKETING ACTIVITIES AND LAUNCHING OF NEW PRODUCTS; CREATING MARKETING DESIGN SERVICES; DEVELOPMENT OF MARKETING STRATEGIES AND CONCEPTS; BUSINESS MANAGEMENT CONSULTING WITH RELATION TO STRATEGY, MARKETING, PRODUCTION, PERSONNEL AND RETAIL SALES MATTERS; AND MARKETING CONSULTING, PROMOTION AND MARKETING SERVICES AND RELATED CONSULTING, IN CLASS 35 (U.S. CLS. 100, 101 AND 102).

FIRST USE 10-27-2011; IN COMMERCE 10-27-2011.

FOR: DESIGN AND DEVELOPMENT OF MULTIMEDIA PRODUCTS; DESIGN OF MULTIMEDIA GRAPHICS FOR OTHERS, FOR USE IN DIGITAL MEDIA SHOWS, INTERACTIVE WEB CONTENT, CONVENTIONS, PRODUCT LAUNCHES, TRADE SHOWS, KEY NOTE ADDRESSES, AND AWARD CEREMONIES, IN CLASS 42 (U.S. CLS. 100 AND 101).

FIRST USE 10-27-2011; IN COMMERCE 10-27-2011.

THE MARK CONSISTS OF STANDARD CHARACTERS WITHOUT CLAIM TO ANY PARTICULAR FONT, STYLE, SIZE, OR COLOR.

SN 77-417,817, FILED 3-10-2008.

JORDAN BAKER, EXAMINING ATTORNEY



David J. Kyffers

Director of the United States Patent and Trademark Office

United States of America

United States Patent and Trademark Office

ENVION

Reg. No. 4,074,441

Registered Dec. 20, 2011

Int. Cl.: 40

SERVICE MARK

PRINCIPAL REGISTER

ENVION INC (DELAWARE CORPORATION)
NW
1027 33RD ST.
WASHINGTON, DC 20007

FOR: CONVERTING WASTE PLASTICS TO HYDROCARBONS, IN CLASS 40 (U.S. CLS. 100, 103 AND 106).

FIRST USE 8-15-2010; IN COMMERCE 8-15-2010.

THE MARK CONSISTS OF STANDARD CHARACTERS WITHOUT CLAIM TO ANY PARTICULAR FONT, STYLE, SIZE, OR COLOR.

SN 77-418,146, FILED 3-10-2008.

CAROL SPILS, EXAMINING ATTORNEY



David J. Kybas

Director of the United States Patent and Trademark Office

United States of America

United States Patent and Trademark Office

RESULTS THAT GET NOTICED

Reg. No. 4,074,442

GUTHY-RENKER LLC (DELAWARE LIMITED LIABILITY COMPANY)
41-550 ECLECTIC STREET, SUITE 200
PALM DESERT, CA 92260

Registered Dec. 20, 2011

Int. Cls.: 3 and 5

FOR: SKIN AND BODY CARE PREPARATIONS, NAMELY, SKIN CLEANSERS, SKIN MOISTURIZERS, SKIN LOTIONS, SKIN SOAPS, SUN SCREEN PREPARATIONS, COSMETICS, NON-MEDICATED SKIN CARE PREPARATIONS, IN CLASS 3 (U.S. CLS. 1, 4, 6, 50, 51 AND 52).

TRADEMARK

PRINCIPAL REGISTER

FIRST USE 10-13-2011; IN COMMERCE 10-13-2011.

FOR: ACNE TREATMENT PREPARATIONS, IN CLASS 5 (U.S. CLS. 6, 18, 44, 46, 51 AND 52).

FIRST USE 10-13-2011; IN COMMERCE 10-13-2011.

THE MARK CONSISTS OF STANDARD CHARACTERS WITHOUT CLAIM TO ANY PARTICULAR FONT, STYLE, SIZE, OR COLOR.

SN 77-418,216, FILED 3-10-2008.

LAURIE KAUFMAN, EXAMINING ATTORNEY



David J. Kyffers

Director of the United States Patent and Trademark Office

United States of America

United States Patent and Trademark Office



Reg. No. 4,074,443

Registered Dec. 20, 2011

Int. Cl.: 16

TRADEMARK

PRINCIPAL REGISTER

SECURING AMERICA'S FUTURE ENERGY ALLIANCE, INC. (DELAWARE NON-PROFIT CORPORATION)
1111 19TH STREET, NW, SUITE 406
WASHINGTON, DC 20036 AND

SECURING AMERICA'S FUTURE ENERGY FOUNDATION (DELAWARE CORPORATION)
1111 19TH STREET, NW, SUITE 406
WASHINGTON, DC 20036

FOR: PROVIDING PRINTED REPORTS IN THE FIELDS OF FUEL AND ENERGY RESOURCES, POLICY, SECURITY AND MANAGEMENT, IN CLASS 16 (U.S. CLS. 2, 5, 22, 23, 29, 37, 38 AND 50).

FIRST USE 7-13-2011; IN COMMERCE 7-13-2011.

SN 77-422,189, FILED 3-14-2008.

CHERYL CLAYTON, EXAMINING ATTORNEY



David J. Kyjars

Director of the United States Patent and Trademark Office

United States of America

United States Patent and Trademark Office



Reg. No. 4,074,444

Registered Dec. 20, 2011

Int. Cl.: 41

SERVICE MARK

PRINCIPAL REGISTER

SECURING AMERICA'S FUTURE ENERGY ALLIANCE, INC. (DELAWARE NON-PROFIT CORPORATION)
1111 19TH STREET, NW, SUITE 406
WASHINGTON, DC 20036 AND

SECURING AMERICA'S FUTURE ENERGY FOUNDATION (DELAWARE CORPORATION)
1111 19TH STREET, NW, SUITE 406
WASHINGTON, DC 20036

FOR: EDUCATION SERVICES, NAMELY, CONDUCTING PROGRAMS IN THE FIELDS OF FUEL AND ENERGY RESOURCES, POLICY, SECURITY, AND MANAGEMENT; EDUCATIONAL SERVICES, NAMELY, DEVELOPING, ARRANGING, AND CONDUCTING EDUCATIONAL PROGRAMS IN THE FIELDS OF FUEL AND ENERGY RESOURCES, POLICY, SECURITY, AND MANAGEMENT; ORGANIZATION OF LIVE EDUCATIONAL GAMES IN THE FIELDS OF FUEL AND ENERGY RESOURCES, POLICY, SECURITY, AND MANAGEMENT, IN CLASS 41 (U.S. CLS. 100, 101 AND 107).

FIRST USE 6-23-2005; IN COMMERCE 6-23-2005.

SN 77-422,198, FILED 3-14-2008.

CHERYL CLAYTON, EXAMINING ATTORNEY



David J. Kybas

Director of the United States Patent and Trademark Office

United States of America

United States Patent and Trademark Office



Reg. No. 4,074,445

Registered Dec. 20, 2011

Int. Cls.: 35, 36, and 39

SERVICE MARK

PRINCIPAL REGISTER

DEUTSCHE POST AG (FED REP GERMANY JOINT STOCK COMPANY)
CHARLES-DE-GAULLE-STRASSE 20
BONN, FED REP GERMANY 53113

FOR: RETURN MANAGEMENT, NAMELY, MANAGEMENT OF RETURNED MERCHANDISE; ADVERTISING AND MARKETING; DIRECT MARKETING; BUSINESS MANAGEMENT SERVICES; BUSINESS ADMINISTRATION; BUSINESS CONSULTANCY, IN PARTICULAR IN THE FIELDS OF TRANSPORTATION AND LOGISTICS; PROVIDING OFFICE FUNCTIONS; CREATING AND UPDATING OF ADVERTISING MATERIAL; COST-PRICE ANALYSIS; BOOKKEEPING; ACCOUNT AUDITING; COMPUTERIZED FILE MANAGEMENT; RELOCATION SERVICES FOR BUSINESSES, NAMELY, PLANNING AND IMPLEMENTING MOVES OF OFFICES; ACCOUNTANCY; COMPILATION OF STATISTICS; MARKET RESEARCH; MARKET OPINION POLLING STUDIES; COMMERCIAL INFORMATION AND ADVICE FOR CONSUMERS; DISTRIBUTION OF SAMPLES; DOCUMENT REPRODUCTION; PUBLIC RELATIONS; PROFESSIONAL BUSINESS AND ORGANIZATIONAL CONSULTANCY; COLLECTING, BINDING, ADDRESSING, ENVELOPING AND FRANKING OF GOODS, IN PARTICULAR LETTERS, PARCELS AND PACKAGES; MARKETING CONSULTING; DEVELOPMENT OF ADVERTISING AND MARKETING STRATEGIES; DIRECT MARKETING CONSULTANCY; PROVIDING INFORMATION ON THE INTERNET ON THE DISSEMINATION OF ADVERTISING BROADCASTS; PROVIDING ELECTRONIC TRACKING OF FREIGHT INFORMATION, IN CLASS 35 (U.S. CLS. 100, 101 AND 102).

FIRST USE 1-0-2011; IN COMMERCE 1-0-2011.

FOR: CUSTOMS BROKERAGE FOR THIRD PARTIES; INSURANCE BROKERAGE, IN PARTICULAR TRANSPORT INSURANCE BROKERAGE; ELECTRONIC COMMERCE PAYMENT SERVICES, NAMELY, ESTABLISHING FUNDED ACCOUNTS USED TO PURCHASE GOODS AND SERVICES ON THE INTERNET; ELECTRONIC CREDIT CARD TRANSACTIONS, IN CLASS 36 (U.S. CLS. 100, 101 AND 102).

FIRST USE 1-0-2011; IN COMMERCE 1-0-2011.

FOR: ELECTRONIC STORAGE OF DATA; ELECTRONIC ARCHIVING OF ADDRESSES OR ADDRESS FILES IN COMPUTER DATABASES; TRANSPORT, IN PARTICULAR TRANSPORT OF GOODS BY MOTOR VEHICLE, LORRY, RAIL, SHIP AND AIRPLANE; PACKAGING OF GOODS FOR TRANSPORT; STORAGE OF GOODS; TRANSPORTATION INFORMATION; FREIGHT BROKERAGE, UNLOADING OF FREIGHT; STORAGE INFORMATION; COURIER



David J. Kybas

Director of the United States Patent and Trademark Office

Reg. No. 4,074,445 SERVICES; SUPPLY CHAIN, LOGISTICS AND REVERSE-LOGISTICS SERVICES, NAMELY, STORAGE, TRANSPORTATION AND DELIVERY OF DOCUMENTS, PACKAGES, RAW MATERIALS, AND OTHER FREIGHT FOR OTHERS BY AIR, RAIL, SHIP, OR TRUCK; RENTAL OF STORAGE CONTAINERS; LETTER, FREIGHT AND EXPRESS DELIVERY SERVICES; RENTAL OF WAREHOUSES; PROVIDING INFORMATION RELATING TO HANDLING, TRANSPORT AND LOGISTICS, IN PARTICULAR THE HANDLING OF DOCUMENTS, LETTERS, PACKAGES, PARCELS AND PALLETS; PROVIDING ONLINE INFORMATION IN THE FIELD OF THE TRANSPORT, PACKAGING AND STORAGE OF GOODS, IN CLASS 39 (U.S. CLS. 100 AND 105).

FIRST USE 1-0-2011; IN COMMERCE 1-0-2011.

THE MARK CONSISTS OF A STYLIZED "DHL" IN RED AND THE TERM "JETLINE" BELOW WITHIN A WHITE RECTANGULAR BACKGROUND. THE WORD "JET" IS COLORED RED AND THE WORD "LINE" IS COLORED BLACK. THE ENTIRE MARK CONTAINS A YELLOW BACKGROUND.

THE COLOR(S) YELLOW, RED, BLACK AND WHITE IS/ARE CLAIMED AS A FEATURE OF THE MARK.

SN 77-427,742, FILED 3-20-2008.

GIANCARLO CASTRO, EXAMINING ATTORNEY

United States of America

United States Patent and Trademark Office

MICROBLEND

Reg. No. 4,074,446

Registered Dec. 20, 2011

Int. Cl.: 34

TRADEMARK

PRINCIPAL REGISTER

SMOKE INN, LLC (FLORIDA LIMITED LIABILITY COMPANY)
SUITE 305
801 VILLAGE BLVD.
WEST PALM BEACH, FL 33409

FOR: CIGARS, IN CLASS 34 (U.S. CLS. 2, 8, 9 AND 17).

FIRST USE 1-6-2011; IN COMMERCE 1-6-2011.

THE MARK CONSISTS OF STANDARD CHARACTERS WITHOUT CLAIM TO ANY PARTICULAR FONT, STYLE, SIZE, OR COLOR.

SN 77-437,644, FILED 4-2-2008.

APRIL HESIK, EXAMINING ATTORNEY



David J. Kybas

Director of the United States Patent and Trademark Office

United States of America

United States Patent and Trademark Office

SUMO

Reg. No. 4,074,447

APOLLO ENDOSURGERY, INC. (DELAWARE CORPORATION)
7000 BEE CAVES ROAD, SUITE 250
AUSTIN, TX 78746

Registered Dec. 20, 2011

Int. Cl.: 10

FOR: MEDICAL DEVICES AND SURGICAL INSTRUMENTS FOR USE IN DIAGNOSIS AND SURGERY OF THE GASTROINTESTINAL TRACT, IN CLASS 10 (U.S. CLS. 26, 39 AND 44).

TRADEMARK

FIRST USE 10-2-2011; IN COMMERCE 10-2-2011.

PRINCIPAL REGISTER

THE MARK CONSISTS OF STANDARD CHARACTERS WITHOUT CLAIM TO ANY PARTICULAR FONT, STYLE, SIZE, OR COLOR.

SN 77-439,863, FILED 4-4-2008.

RUDY R. SINGLETON, EXAMINING ATTORNEY



David J. Kybas

Director of the United States Patent and Trademark Office

United States of America

United States Patent and Trademark Office

HOODRAIZED

Reg. No. 4,074,448

Registered Dec. 20, 2011

Int. Cl.: 25

TRADEMARK

PRINCIPAL REGISTER

TERRY, WINSTON S. (UNITED STATES INDIVIDUAL)
4090 E. CITRINE ROAD
SAN TAN VALLEY, AZ 85143

FOR: CLOTHING, NAMELY, SHIRTS, IN CLASS 25 (U.S. CLS. 22 AND 39).

FIRST USE 10-26-2011; IN COMMERCE 10-26-2011.

THE MARK CONSISTS OF STANDARD CHARACTERS WITHOUT CLAIM TO ANY PARTICULAR FONT, STYLE, SIZE, OR COLOR.

SN 77-445,132, FILED 4-10-2008.

LESLIE RICHARDS, EXAMINING ATTORNEY



David J. Kyffers

Director of the United States Patent and Trademark Office

United States of America

United States Patent and Trademark Office



Reg. No. 4,074,449

Registered Dec. 20, 2011

Int. Cl.: 34

TRADEMARK

PRINCIPAL REGISTER

BAHAMA MAMAS HOLDING, LLC (NEVADA LIMITED LIABILITY COMPANY)
7437 S EASTERN AVE
#128
LAS VEGAS, NV 89123

FOR: ABSORBENT PAPER FOR TOBACCO PIPES; ASHTRAYS, NOT OF PRECIOUS METAL; CIGAR CASES; CIGAR HUMIDIFIERS; CIGAR TUBES; MATCH BOXES; MATCHES; NON-ELECTRIC CIGAR LIGHTERS NOT OF PRECIOUS METAL; CIGARETTE ASH RECEPTACLES; CIGARETTES; HUMIDORS; ASHTRAYS; CIGARETTE BOXES; CIGAR CUTTERS, IN CLASS 34 (U.S. CLS. 2, 8, 9 AND 17).

FIRST USE 1-1-2010; IN COMMERCE 1-1-2010.

THE MARK CONSISTS OF A THREE DIMENSIONAL DESIGN FEATURING THE WORD "BAHAMA" IN THE COLOR RED FADING TO ORANGE FADING TO YELLOW FADING TO WHITE FOLLOWED UNDER WITH THE WORD "MAMAS" IN REVERSE FADING FROM WHITE TO YELLOW TO ORANGE TO RED IN STYLIZED FORM OUTLINED IN BLACK SUPERIMPOSED OVER AN OVAL SHAPE, COLORED RED FADING TO ORANGE FADING TO YELLOW FADING TO BLACK FADING TO ORANGE OUTLINED IN WHITE OUTLINED IN BLACK FEATURING A PALM TREE AND WAVES DESIGN IN BLACK SUPERIMPOSED OVER A SUN DESIGN COLORED ORANGE FADING OUTWARD TO YELLOW FADING TO WHITE.

THE COLOR(S) RED, ORANGE, YELLOW, WHITE, AND BLACK IS/ARE CLAIMED AS A FEATURE OF THE MARK.

SN 77-457,988, FILED 4-25-2008.

JORDAN BAKER, EXAMINING ATTORNEY



David J. Kyros

Director of the United States Patent and Trademark Office

United States of America

United States Patent and Trademark Office



Securing America's Future Energy

Reg. No. 4,074,450

Registered Dec. 20, 2011

Int. Cl.: 41

SERVICE MARK

PRINCIPAL REGISTER

SECURING AMERICA'S FUTURE ENERGY ALLIANCE, INC. (DELAWARE NON-PROFIT CORPORATION)
1111 19TH STREET, NW, SUITE 406
WASHINGTON, DC 20036 AND

SECURING AMERICA'S FUTURE ENERGY FOUNDATION (DELAWARE CORPORATION)
1111 19TH STREET, NW, SUITE 406
WASHINGTON, DC 20036

FOR: EDUCATIONAL SERVICES, NAMELY, DEVELOPING, ARRANGING, AND CONDUCTING PROGRAMS IN THE FIELDS OF FUEL AND ENERGY RESOURCES, POLICY, SECURITY, AND MANAGEMENT; PROVIDING NEWSLETTERS IN THE FIELDS OF FUEL AND ENERGY RESOURCES, POLICY, SECURITY, AND MANAGEMENT VIA E-MAIL; ORGANIZATION OF LIVE EDUCATIONAL GAMES IN THE FIELDS OF FUEL AND ENERGY RESOURCES, POLICY, SECURITY, AND MANAGEMENT, IN CLASS 41 (U.S. CLS. 100, 101 AND 107).

FIRST USE 6-23-2005; IN COMMERCE 6-23-2005.

SN 77-459,941, FILED 4-28-2008.

CHERYL CLAYTON, EXAMINING ATTORNEY



David J. Kybas

Director of the United States Patent and Trademark Office

United States of America

United States Patent and Trademark Office



Reg. No. 4,074,451

Registered Dec. 20, 2011

Int. Cl.: 16

TRADEMARK

PRINCIPAL REGISTER

SECURING AMERICA'S FUTURE ENERGY ALLIANCE, INC. (DELAWARE NON-PROFIT CORPORATION)
1111 19TH STREET, NW, SUITE 406
WASHINGTON, DC 20036 AND

SECURING AMERICA'S FUTURE ENERGY FOUNDATION (DELAWARE CORPORATION)
1111 19TH STREET, NW, SUITE 406
WASHINGTON, DC 20036

FOR: PROVIDING PRINTED REPORTS AND PRINTED EDUCATIONAL MATERIALS IN THE FIELDS OF FUEL AND ENERGY RESOURCES, POLICY, SECURITY, MANAGEMENT AND CONSERVATION, AND ALTERNATIVE FUEL SOURCES, ALTERNATIVE ENERGY SOURCES, AND ENVIRONMENTAL MATTERS CONCERNING FUEL AND ENERGY; EDUCATIONAL PUBLICATIONS, NAMELY, BOOKLETS IN THE FIELDS OF FUEL AND ENERGY RESOURCES, POLICY, SECURITY, MANAGEMENT, AND CONSERVATION, AND ALTERNATIVE FUEL SOURCES, ALTERNATIVE ENERGY SOURCES, AND ENVIRONMENTAL MATTERS CONCERNING FUEL AND ENERGY, IN CLASS 16 (U.S. CLS. 2, 5, 22, 23, 29, 37, 38 AND 50).

FIRST USE 12-0-2006; IN COMMERCE 12-0-2006.

SN 77-461,034, FILED 4-29-2008.

CHERYL CLAYTON, EXAMINING ATTORNEY



David J. Kyjars

Director of the United States Patent and Trademark Office

United States of America

United States Patent and Trademark Office

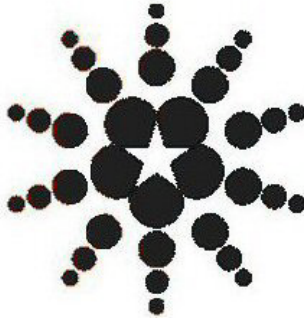

Reg. No. 4,074,452

Registered Dec. 20, 2011

Int. Cl.: 41

SERVICE MARK

PRINCIPAL REGISTER

SECURING AMERICA'S FUTURE ENERGY ALLIANCE, INC. (DELAWARE NON-PROFIT CORPORATION)
1111 19TH STREET, NW, SUITE 406
WASHINGTON, DC 20036 AND

SECURING AMERICA'S FUTURE ENERGY FOUNDATION (DELAWARE CORPORATION)
1111 19TH STREET, NW, SUITE 406
WASHINGTON, DC 20036

FOR: EDUCATIONAL SERVICES, NAMELY, DEVELOPING, ARRANGING, AND CONDUCTING PROGRAMS IN THE FIELDS OF FUEL AND ENERGY RESOURCES, POLICY, SECURITY, AND MANAGEMENT; PROVIDING NEWSLETTERS IN THE FIELDS OF FUEL AND ENERGY RESOURCES, POLICY, SECURITY, AND MANAGEMENT VIA E-MAIL; ORGANIZATION OF LIVE EDUCATIONAL GAMES IN THE FIELDS OF FUEL AND ENERGY RESOURCES, POLICY, SECURITY, AND MANAGEMENT, IN CLASS 41 (U.S. CLS. 100, 101 AND 107).

FIRST USE 6-23-2005; IN COMMERCE 6-23-2005.

SN 77-461,053, FILED 4-29-2008.

CHERYL CLAYTON, EXAMINING ATTORNEY



David J. Kybas

Director of the United States Patent and Trademark Office

United States of America

United States Patent and Trademark Office



Reg. No. 4,074,453

Registered Dec. 20, 2011

Int. Cl.: 45

SERVICE MARK

PRINCIPAL REGISTER

SECURING AMERICA'S FUTURE ENERGY ALLIANCE, INC. (DELAWARE NON-PROFIT CORPORATION)
1111 19TH STREET, NW, SUITE 406
WASHINGTON, DC 20036 AND

SECURING AMERICA'S FUTURE ENERGY FOUNDATION (DELAWARE CORPORATION)
1111 19TH STREET, NW, SUITE 406
WASHINGTON, DC 20036

FOR: PROVIDING INFORMATION AND A WEBSITE FEATURING INFORMATION IN THE FIELD OF NATIONAL SECURITY CONCERNING FUEL AND ENERGY, IN CLASS 45 (U.S. CLS. 100 AND 101).

FIRST USE 1-1-2006; IN COMMERCE 1-1-2006.

SN 77-461,073, FILED 4-29-2008.

CHERYL CLAYTON, EXAMINING ATTORNEY



David J. Kyjars

Director of the United States Patent and Trademark Office

United States of America

United States Patent and Trademark Office

EXPAREL

Reg. No. 4,074,454

PACIRA PHARMACEUTICALS, INC. (CALIFORNIA CORPORATION)
10450 SCIENCE CENTER DRIVE
SAN DIEGO, CA 92121

Registered Dec. 20, 2011

Int. Cl.: 5

FOR: ANALGESICS; PREPARATION FOR THE RELIEF OF PAIN; ANESTHETICS FOR PERI-OPERATIVE AND POST-OPERATIVE USE; PHARMACEUTICAL PREPARATIONS AND SUBSTANCES FOR USE IN ANESTHESIA AND FOR THE TREATMENT AND CONTROL OF PAIN; LIPOSOME FORMULATIONS CONTAINING PREPARATIONS AND SUBSTANCES FOR USE IN ANESTHESIA AND FOR THE TREATMENT AND CONTROL OF PAIN, IN CLASS 5 (U.S. CLS. 6, 18, 44, 46, 51 AND 52).

TRADEMARK

PRINCIPAL REGISTER

FIRST USE 10-20-2011; IN COMMERCE 10-20-2011.

THE MARK CONSISTS OF STANDARD CHARACTERS WITHOUT CLAIM TO ANY PARTICULAR FONT, STYLE, SIZE, OR COLOR.

SN 77-464,815, FILED 5-2-2008.

HAI-LY LAM, EXAMINING ATTORNEY



David J. Kyros

Director of the United States Patent and Trademark Office

United States of America

United States Patent and Trademark Office

Cordless Tools

Reg. No. 4,074,455

Registered Dec. 20, 2011

Int. Cl.: 7

TRADEMARK

PRINCIPAL REGISTER

PANASONIC CORPORATION OF NORTH AMERICA (DELAWARE CORPORATION)
ONE PANASONIC WAY
SECAUCUS, NJ 07094

FOR: CORDLESS POWER TOOLS, NAMELY, SCREWDRIVERS, DRILL-DRIVERS, HAMMERDRILL-DRIVERS, MULTI-IMPACT DRILL-DRIVERS, IMPACT DRIVERS, IMPACT WRENCHES, ROTARY HAMMERS, CIRCULAR SAWS, RECIPROCATING SAWS, AND JIG SAWS; KITS CONTAINING COMBINATIONS OF CORDLESS POWER TOOLS, NAMELY, DRILLS, HAMMERDRILLS, CIRCULAR SAWS, RECIPROCATING SAWS, JIG SAWS, AND FLASHLIGHTS, IN CLASS 7 (U.S. CLS. 13, 19, 21, 23, 31, 34 AND 35).

FIRST USE 9-30-2009; IN COMMERCE 9-30-2009.

NO CLAIM IS MADE TO THE EXCLUSIVE RIGHT TO USE "CORDLESS TOOLS", APART FROM THE MARK AS SHOWN.

THE MARK CONSISTS OF "CORDLESS TOOLS"- THE SECOND "O" OF "TOOLS" LOOKS LIKE A GEAR; THE "L" OF "TOOLS" LOOKS LIKE A DRILL BIT.

SN 77-488,771, FILED 6-2-2008.

KIM MONINGHOFF, EXAMINING ATTORNEY



David J. Kyffers

Director of the United States Patent and Trademark Office

United States of America

United States Patent and Trademark Office

Boomers Roc

Reg. No. 4,074,456

BOOMERS ROC, INC. (NEW YORK CORPORATION)
80 CEDAR DRIVE WEST
PLAINVIEW, NY 11803

Registered Dec. 20, 2011

Int. Cl.: 25

FOR: BOTTOMS; BOXER SHORTS; HATS; HEADGEAR, NAMELY, HATS; PANTS; SHIRTS;
SHORTS; T-SHIRTS; TOPS, IN CLASS 25 (U.S. CLS. 22 AND 39).

TRADEMARK

FIRST USE 7-2-2008; IN COMMERCE 7-2-2008.

PRINCIPAL REGISTER

THE MARK CONSISTS OF STANDARD CHARACTERS WITHOUT CLAIM TO ANY PARTICULAR FONT, STYLE, SIZE, OR COLOR.

SN 77-490,045, FILED 6-3-2008.

MAUREEN DALL, EXAMINING ATTORNEY



David J. Kyffers

Director of the United States Patent and Trademark Office

United States of America

United States Patent and Trademark Office



Reg. No. 4,074,457

Registered Dec. 20, 2011

Int. Cl.: 33

TRADEMARK

PRINCIPAL REGISTER

BLUE NECTAR SPIRITS COMPANY (FLORIDA LIMITED LIABILITY COMPANY)
SUITE 1000
201 S. BISCAYNE BLVD
MIAMI, FL 33131

FOR: ALCOHOLIC BEVERAGES, NAMELY, TEQUILA AND TEQUILA BASED BEVERAGES,
IN CLASS 33 (U.S. CLS. 47 AND 49).

FIRST USE 9-2-2011; IN COMMERCE 9-2-2011.

THE MARK CONSISTS OF A DESIGN OF AN AGAVE PLANT BODY WITH LEAVES OF
BLUEISH GREEN WITH ONE LEAF UNNATURALLY BENT AND THE CENTER OF THE
BODY CUT OPEN AND DRIPPING GOLD LIQUID.

THE COLOR(S) BLUEISH GREEN AND GOLD IS/ARE CLAIMED AS A FEATURE OF THE
MARK.

SN 77-492,724, FILED 6-6-2008.

JASON TURNER, EXAMINING ATTORNEY



David J. Kybas

Director of the United States Patent and Trademark Office

United States of America

United States Patent and Trademark Office

VISO

Reg. No. 4,074,458

VISION SOURCE L.P. (TEXAS LIMITED PARTNERSHIP)
1849 KINGWOOD DR., SUITE 101
KINGWOOD, TX 77339

Registered Dec. 20, 2011

Int. Cl.: 9

FOR: OPHTHALMIC LENSES, SPECTACLE LENSES, SUNGLASS LENSES, EYEGGLASS LENSES, AND OPTICAL EYEGGLASS LENSES, IN CLASS 9 (U.S. CLS. 21, 23, 26, 36 AND 38).

TRADEMARK

FIRST USE 11-8-2011; IN COMMERCE 11-8-2011.

PRINCIPAL REGISTER

THE MARK CONSISTS OF STANDARD CHARACTERS WITHOUT CLAIM TO ANY PARTICULAR FONT, STYLE, SIZE, OR COLOR.

SN 77-511,743, FILED 6-30-2008.

REBECCA GILBERT, EXAMINING ATTORNEY



David J. Kyffers

Director of the United States Patent and Trademark Office

United States of America

United States Patent and Trademark Office

SSB

Reg. No. 4,074,459

Registered Dec. 20, 2011

Int. Cl.: 40

SERVICE MARK

PRINCIPAL REGISTER

ROCKY MOUNTAIN RECYCLING LLC (UTAH LIMITED LIABILITY COMPANY)
2950 WEST 900 SOUTH
SALT LAKE CITY, UT 84104

FOR: RECYCLING SERVICES, IN CLASS 40 (U.S. CLS. 100, 103 AND 106).

FIRST USE 3-17-2010; IN COMMERCE 3-17-2010.

THE MARK CONSISTS OF STANDARD CHARACTERS WITHOUT CLAIM TO ANY PARTICULAR FONT, STYLE, SIZE, OR COLOR.

SN 77-519,206, FILED 7-10-2008.

BARBARA GAYNOR, EXAMINING ATTORNEY



David J. Kybas

Director of the United States Patent and Trademark Office

United States of America

United States Patent and Trademark Office

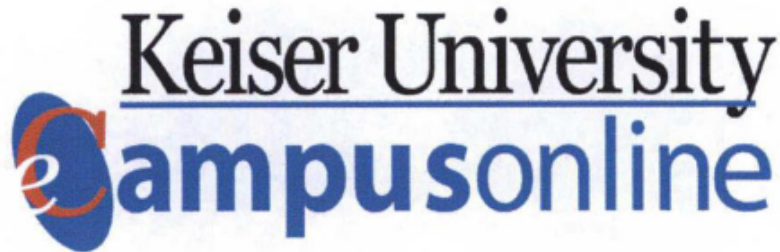

Reg. No. 4,074,460

Registered Dec. 20, 2011

Int. Cl.: 41

SERVICE MARK

PRINCIPAL REGISTER

THE KEISER SCHOOL, INC. (FLORIDA CORPORATION)
SUITE 180
1900 W. COMMERCIAL BLVD.
FT. LAUDERDALE, FL 33309

FOR: EDUCATIONAL SERVICES FEATURING COURSES OF STUDY AND INSTRUCTION AT THE POST SECONDARY LEVEL IN BUSINESS RELATED AND CAREER FIELDS , IN CLASS 41 (U.S. CLS. 100, 101 AND 107).

FIRST USE 1-1-2010; IN COMMERCE 1-1-2010.

NO CLAIM IS MADE TO THE EXCLUSIVE RIGHT TO USE "UNIVERSITY" AND "ECAMPUS ONLINE", APART FROM THE MARK AS SHOWN.

THE COLOR(S) DARK BLUE, TEAL BLUE, RED AND WHITE IS/ARE CLAIMED AS A FEATURE OF THE MARK.

THE MARK CONSISTS OF THE WORDS "KEISER UNIVERSITY" IN DARK BLUE ABOVE A TEAL BLUE HORIZONTAL LINE WITH A LOWERCASE "E" IN THE COLOR WHITE AND THE WORD "CAMPUSONLINE" WHERE THE FIRST LETTER "C" IS IN RED AND THE REST OF THE WORD IS IN TEAL BLUE; THE OVAL BEHIND THE LETTERS "EC" IS IN THE COLOR TEAL BLUE.

SN 77-538,351, FILED 8-4-2008.

COLLEEN DOMBROW, EXAMINING ATTORNEY



David J. Kybas

Director of the United States Patent and Trademark Office

United States of America

United States Patent and Trademark Office

GIBBON

Reg. No. 4,074,461

Registered Dec. 20, 2011

Int. Cls.: 25 and 28

TRADEMARK

PRINCIPAL REGISTER

ID SPORTS GMBH (FED REP GERMANY LIMITED LIABILITY COMPANY)
CALWERSTR. 11
70173 STUTTGART, FED REP GERMANY

FOR: SPORTSWEAR, NAMELY, FUNCTIONAL T-SHIRTS, WRISTBANDS, HEADBANDS, SHORTS, TRACKSUITS; CLOTHING, NAMELY, SHIRTS, SWEATSHIRTS, PANTS, TROUSERS, SOCKS, GLOVES, SWEATERS, BLOUSES, BELTS, JUMPERS, JACKETS, SKIRTS, SCARFS; HOODED SWEATSHIRTS; HEADGEAR, NAMELY, CAPS, HATS, IN CLASS 25 (U.S. CLS. 22 AND 39).

FIRST USE 8-20-2008; IN COMMERCE 8-20-2008.

FOR: GYMNASTIC APPARATUS; SPORTS EQUIPMENT, NAMELY, SLACKLINES COMPRISING WEBBING BETWEEN TWO ANCHORS AND USED FOR MOVING BETWEEN TWO POINTS; SPORTING GOODS, NAMELY, A SPORTS TRAINING DEVICE TO IMPROVE STRENGTH, TONING, CONDITIONING, BALANCE, AND PROPRIOCEPTION; OUTDOOR GAMES, NAMELY, PLASTIC TOY HOOPS, ACTION SKILL GAMES; PROTECTIVE SHIN AND ARM GUARDS FOR ATHLETIC USE, IN CLASS 28 (U.S. CLS. 22, 23, 38 AND 50).

FIRST USE 8-20-2008; IN COMMERCE 8-20-2008.

THE MARK CONSISTS OF STANDARD CHARACTERS WITHOUT CLAIM TO ANY PARTICULAR FONT, STYLE, SIZE, OR COLOR.

SN 77-539,085, FILED 8-5-2008.

BRETT J. GOLDEN, EXAMINING ATTORNEY



David J. Kypos

Director of the United States Patent and Trademark Office

United States of America

United States Patent and Trademark Office

CHEEKY BUTT

Reg. No. 4,074,462

Registered Dec. 20, 2011

Int. Cl.: 25

TRADEMARK

PRINCIPAL REGISTER

ABERCROMBIE & FITCH TRADING CO. (OHIO CORPORATION)
6301 FITCH PATH
ATTN: JACOB KRAMER
NEW ALBANY, OH 43054

FOR: BOTTOMS, IN CLASS 25 (U.S. CLS. 22 AND 39).

FIRST USE 8-0-2011; IN COMMERCE 8-0-2011.

THE MARK CONSISTS OF STANDARD CHARACTERS WITHOUT CLAIM TO ANY PARTICULAR FONT, STYLE, SIZE, OR COLOR.

SN 77-546,858, FILED 8-14-2008.

NAKIA HENRY, EXAMINING ATTORNEY



David J. Kyros

Director of the United States Patent and Trademark Office

United States of America

United States Patent and Trademark Office

CAPADOCIA

Reg. No. 4,074,463

Registered Dec. 20, 2011

Int. Cl.: 41

SERVICE MARK

PRINCIPAL REGISTER

HBO OLE PARTNERS (NEW YORK PARTNERSHIP)
8TH FLOOR
4000 PONCE DE LEON BOULEVARD
CORAL GABLES, FL 33146

FOR: ENTERTAINMENT SERVICES, NAMELY, PROVIDING A WEBSITE FEATURING AUDIO AND VIDEO CONTENT PERTAINING TO AN ONGOING DRAMATIC TELEVISION SERIES, IN CLASS 41 (U.S. CLS. 100, 101 AND 107).

FIRST USE 1-2-2008; IN COMMERCE 8-24-2011.

THE MARK CONSISTS OF STANDARD CHARACTERS WITHOUT CLAIM TO ANY PARTICULAR FONT, STYLE, SIZE, OR COLOR.

SN 77-549,011, FILED 8-18-2008.

REBECCA SMITH, EXAMINING ATTORNEY



David J. Kyffers

Director of the United States Patent and Trademark Office

United States of America

United States Patent and Trademark Office

CAPADOCIA

Reg. No. 4,074,464

Registered Dec. 20, 2011

Int. Cl.: 41

SERVICE MARK

PRINCIPAL REGISTER

HBO OLE PARTNERS (NEW YORK PARTNERSHIP)
8TH FLOOR
4000 PONCE DE LEON BOULEVARD
CORAL GABLES, FL 33146

FOR: ENTERTAINMENT SERVICES, NAMELY, PROVIDING A WEBSITE FEATURING AUDIO AND VIDEO CONTENT PERTAINING TO AN ONGOING DRAMATIC TELEVISION SERIES, IN CLASS 41 (U.S. CLS. 100, 101 AND 107).

FIRST USE 1-2-2008; IN COMMERCE 8-24-2011.

THE MARK CONSISTS OF THE STYLIZED TREATMENT OF THE WORD "CAPADOCIA".

SN 77-549,048, FILED 8-18-2008.

REBECCA SMITH, EXAMINING ATTORNEY



David J. Kyros

Director of the United States Patent and Trademark Office

United States of America

United States Patent and Trademark Office

CARDINAL

Reg. No. 4,074,465

CARDINAL INDUSTRIES, INC. (NEW YORK CORPORATION)

Registered Dec. 20, 2011

21-01 51ST AVENUE
LONG ISLAND, NY 11101

Int. Cl.: 28

FOR: TOYS, GAMES, AND PLAYTHINGS, NAMELY, ACTION SKILL GAMES; BACKGAMMON GAMES; BACKGAMMON GAME SETS; BINGO GAME PLAYING EQUIPMENT; BOARD GAMES; BUILDING GAMES; BUILDING GAMES, NAMELY, PUZZLES; CARD GAMES; CHESS GAMES; COUNTERS AND MARBLES FOR GAMES; DICE GAMES; EDUCATIONAL CARD GAMES; GAME EQUIPMENT, NAMELY, CHIPS; GAME TABLES; MAH JONG GAMES; MARBLES FOR GAMES; MEMORY GAMES; PARLOR GAMES; PARTY GAMES; PLAYING CARDS AND CARD GAMES; DISK TO TOSS IN PLAYING A GAME WHEREIN OTHER DISKS ARE FLIPPED AND COLLECTED; TRIVIA GAME PLAYED WITH CARDS AND GAME COMPONENTS; ALL THE FOREGOING NOT RELATING TO A BASEBALL OR SOFTBALL TEAM OR PREDOMINANTLY TO BASEBALL OR SOFTBALL, IN CLASS 28 (U.S. CLS. 22, 23, 38 AND 50).

TRADEMARK

PRINCIPAL REGISTER

FIRST USE 0-0-1946; IN COMMERCE 0-0-1946.

THE MARK CONSISTS OF STANDARD CHARACTERS WITHOUT CLAIM TO ANY PARTICULAR FONT, STYLE, SIZE, OR COLOR.

SN 77-549,780, FILED 8-18-2008.

CHRISTINA SOBRAL, EXAMINING ATTORNEY



David J. Kyros

Director of the United States Patent and Trademark Office

United States of America

United States Patent and Trademark Office

BEAUTYFEED

Reg. No. 4,074,466

BEAUTYFEED.COM LLC (NEW YORK LIMITED LIABILITY COMPANY)
16 EAST 40TH STREET
NEW YORK, NY 10016

Registered Dec. 20, 2011

Int. Cls.: 35, 38, and 41

FOR: PROVIDING A WEBSITE FEATURING EVENT INFORMATION FOR COMMERCIAL PURPOSES, NAMELY, FASHION SHOWS AND EVENTS IN THE BEAUTY AND THE FASHION INDUSTRIES, NAMELY, TRADE SHOWS, EDITORIAL EVENTS, ASSOCIATION AND INDUSTRY MEETINGS, AND PRODUCT INTRODUCTIONS IN THE COSMETICS, PERSONAL CARE, AND FASHION INDUSTRIES, IN CLASS 35 (U.S. CLS. 100, 101 AND 102).

SERVICE MARK

PRINCIPAL REGISTER

FIRST USE 1-23-2009; IN COMMERCE 1-23-2009.

FOR: COMPUTERS SERVICES, NAMELY, PROVIDING AN INTERACTIVE WEBSITE WITH ON LINE CHAT ROOMS, FORUMS, ELECTRONIC BULLETIN BOARDS, AND BLOGS, AND FOR THE TRANSMISSION OF LIVE BROADCASTS, MESSAGES AND INFORMATION BY VOICE, AUDIO, AND VISUAL IMAGES IN ALL MEDIUM OF TRANSMISSION INCLUDING THE WORLD WIDE WEB, AND WIRELESS AND MOBILE TRANSMISSION SERVICES, FEATURING INFORMATION, NEWS, TRENDS, EVENTS, EDITORIALS AND OTHER MATERIALS IN THE FIELDS OF PERSONAL CARE PRODUCTS, COSMETICS, FASHION AND STYLE, IN CLASS 38 (U.S. CLS. 100, 101 AND 104).

FIRST USE 1-23-2009; IN COMMERCE 1-23-2009.

FOR: PROVIDING A WEBSITE FEATURING EDITORIALS IN THE FIELDS OF PERSONAL CARE PRODUCTS, COSMETICS, FASHION AND STYLE; PROVIDING A WEBSITE FEATURING EVENT INFORMATION FOR ENTERTAINMENT PURPOSES, NAMELY, FASHION SHOWS AND EDITORIAL EVENTS IN THE BEAUTY AND THE FASHION INDUSTRIES, IN CLASS 41 (U.S. CLS. 100, 101 AND 107).

FIRST USE 1-23-2009; IN COMMERCE 1-23-2009.

THE MARK CONSISTS OF STANDARD CHARACTERS WITHOUT CLAIM TO ANY PARTICULAR FONT, STYLE, SIZE, OR COLOR.

SN 77-551,716, FILED 8-20-2008.



David J. Kyros

Director of the United States Patent and Trademark Office

Reg. No. 4,074,466 JULIE GUTTADAURO, EXAMINING ATTORNEY

United States of America

United States Patent and Trademark Office

TheCallSpace

Reg. No. 4,074,467

LINQWARE, INC. (DELAWARE CORPORATION)
6161 N.E. 175TH SUITE 205
KENMORE, WA 98028

Registered Dec. 20, 2011

Int. Cl.: 38

FOR: TELECOMMUNICATION SERVICES, NAMELY, PROVIDING INTERNET ACCESS VIA BROADBAND OPTICAL OR WIRELESS NETWORKS TO CONSUMERS, SAID SERVICES MARKETED TO CONSUMERS, IN CLASS 38 (U.S. CLS. 100, 101 AND 104).

SERVICE MARK

FIRST USE 1-17-2007; IN COMMERCE 1-24-2007.

PRINCIPAL REGISTER

THE MARK CONSISTS OF STANDARD CHARACTERS WITHOUT CLAIM TO ANY PARTICULAR FONT, STYLE, SIZE, OR COLOR.

SN 77-552,773, FILED 8-21-2008.

GEOFFREY FOSDICK, EXAMINING ATTORNEY



David J. Kybas

Director of the United States Patent and Trademark Office

United States of America

United States Patent and Trademark Office

Hunter Biopsy Marker

Reg. No. 4,074,468

VASCULAR SOLUTIONS, INC. (MINNESOTA CORPORATION)
6464 SYCAMORE COURT
MINNEAPOLIS, MN 55369

Registered Dec. 20, 2011

Int. Cl.: 10

FOR: A MEDICAL DEVICE USED IN OPEN SURGICAL OR PERCUTANEOUS ORGAN BIOPSY PROCEDURES TO MARK THE BIOPSY SITE FOR SUBSEQUENT INTERVENTION OR DIAGNOSTIC PROCEDURES, IN CLASS 10 (U.S. CLS. 26, 39 AND 44).

TRADEMARK

FIRST USE 11-16-2010; IN COMMERCE 11-16-2010.

PRINCIPAL REGISTER

THE MARK CONSISTS OF STANDARD CHARACTERS WITHOUT CLAIM TO ANY PARTICULAR FONT, STYLE, SIZE, OR COLOR.

NO CLAIM IS MADE TO THE EXCLUSIVE RIGHT TO USE "BIOPSY MARKER", APART FROM THE MARK AS SHOWN.

SN 77-561,102, FILED 9-3-2008.

LEIGH CAROLINE CASE, EXAMINING ATTORNEY



David J. Kyffers

Director of the United States Patent and Trademark Office

United States of America
United States Patent and Trademark Office

PANBLOK

Reg. No. 4,074,469

PROTEIN SCIENCES CORPORATION (DELAWARE CORPORATION)
1000 RESEARCH PARKWAY
MERIDEN, CT 06450

Registered Dec. 20, 2011

Int. Cl.: 5

FOR: PHARMACEUTICAL PREPARATION, NAMELY, AN INFLUENZA VACCINE, IN CLASS 5 (U.S. CLS. 6, 18, 44, 46, 51 AND 52).

TRADEMARK

FIRST USE 9-11-2008; IN COMMERCE 9-11-2008.

PRINCIPAL REGISTER

THE MARK CONSISTS OF STANDARD CHARACTERS WITHOUT CLAIM TO ANY PARTICULAR FONT, STYLE, SIZE, OR COLOR.

SN 77-568,078, FILED 9-11-2008.

ZACHARY BELLO, EXAMINING ATTORNEY



David J. Kyros

Director of the United States Patent and Trademark Office

United States of America

United States Patent and Trademark Office

N GAGE

Reg. No. 4,074,470

MAURICE SPORTING GOODS, INC. (DELAWARE CORPORATION)
1910 TECHNY ROAD
NORTHBROOK, IL 600653059

Registered Dec. 20, 2011

Int. Cls.: 18, 25, and 28

FOR: SHOULDER BAGS, IN CLASS 18 (U.S. CLS. 1, 2, 3, 22 AND 41).

TRADEMARK

FIRST USE 3-0-2010; IN COMMERCE 3-0-2010.

PRINCIPAL REGISTER

FOR: CLOTHING, NAMELY, T-SHIRTS AND HATS, IN CLASS 25 (U.S. CLS. 22 AND 39).

FIRST USE 2-0-2010; IN COMMERCE 2-0-2010.

FOR: FISHING PRODUCTS, NAMELY, LURES; FISHING PRODUCTS, NAMELY, ROD/REEL COMBOS, IN CLASS 28 (U.S. CLS. 22, 23, 38 AND 50).

FIRST USE 8-0-2006; IN COMMERCE 8-0-2006.

THE MARK CONSISTS OF STANDARD CHARACTERS WITHOUT CLAIM TO ANY PARTICULAR FONT, STYLE, SIZE, OR COLOR.

SN 77-575,379, FILED 9-22-2008.

ELLEN BURNS, EXAMINING ATTORNEY



David J. Kyros

Director of the United States Patent and Trademark Office

United States of America

United States Patent and Trademark Office

SHAMPILLO

Reg. No. 4,074,471

Registered Dec. 20, 2011

Int. Cl.: 20

TRADEMARK

PRINCIPAL REGISTER

RE VENTURES I, LLC (OHIO LIMITED LIABILITY COMPANY)
11801 SPIRAL PASS
CINCINNATI, OH 45249

FOR: A NON-MEDICAL PILLOW FOR PLACEMENT PRIMARILY IN BETWEEN A PERSON'S NECK AND A SHAMPOO BASIN; NON-MEDICAL PAD FOR PLACEMENT PRIMARILY IN BETWEEN A PERSON'S NECK AND A SHAMPOO BASIN; NON-MEDICAL CUSHIONING DEVICE FOR PLACEMENT PRIMARILY IN BETWEEN A PERSON'S NECK AND A SHAMPOO BASIN, IN CLASS 20 (U.S. CLS. 2, 13, 22, 25, 32 AND 50).

FIRST USE 10-13-2011; IN COMMERCE 10-13-2011.

THE MARK CONSISTS OF STANDARD CHARACTERS WITHOUT CLAIM TO ANY PARTICULAR FONT, STYLE, SIZE, OR COLOR.

SN 77-579,750, FILED 9-26-2008.

ANDREW RHIM, EXAMINING ATTORNEY



David J. Kyffers

Director of the United States Patent and Trademark Office

United States of America

United States Patent and Trademark Office

IMPERIO REAL

Reg. No. 4,074,472

RAFAEL, LOZA RUIZ (MEXICO INDIVIDUAL)
4022 SAGE COURT
PALMDALE, CA 93552 AND

Registered Dec. 20, 2011

Int. Cl.: 33

ANGEL, PALAFOX MIGUEL (MEXICO INDIVIDUAL)
12328 GLADSTONE AVE.
#9
SYLMAR, CA 91342

TRADEMARK

PRINCIPAL REGISTER

FOR: ALCOHOLIC BEVERAGES EXCEPT BEERS; TEQUILA, IN CLASS 33 (U.S. CLS. 47 AND 49).

FIRST USE 10-14-2011; IN COMMERCE 10-14-2011.

THE MARK CONSISTS OF STANDARD CHARACTERS WITHOUT CLAIM TO ANY PARTICULAR FONT, STYLE, SIZE, OR COLOR.

THE FOREIGN WORDING IN THE MARK TRANSLATES INTO ENGLISH AS REAL EMPIRE.

SN 77-593,269, FILED 10-15-2008.

MATTHEW KLINE, EXAMINING ATTORNEY



David J. Kypas

Director of the United States Patent and Trademark Office

United States of America

United States Patent and Trademark Office

RIB SHACK RED

Reg. No. 4,074,473

Registered Dec. 20, 2011

Int. Cl.: 33

TRADEMARK

PRINCIPAL REGISTER

DGB (PTY) LIMITED (SOUTH AFRICA COMPANY)
724 16TH ROAD, RANDJESPARK, MIDRAND
GAUTENG, SOUTH AFRICA

FOR: WINES, IN CLASS 33 (U.S. CLS. 47 AND 49).

FIRST USE 12-14-2010; IN COMMERCE 12-14-2010.

THE MARK CONSISTS OF STANDARD CHARACTERS WITHOUT CLAIM TO ANY PARTICULAR FONT, STYLE, SIZE, OR COLOR.

NO CLAIM IS MADE TO THE EXCLUSIVE RIGHT TO USE "RED", APART FROM THE MARK AS SHOWN.

SN 77-596,184, FILED 10-20-2008.

B. PARADEWELAI, EXAMINING ATTORNEY



David J. Kyffers

Director of the United States Patent and Trademark Office

United States of America

United States Patent and Trademark Office

LAVA

Reg. No. 4,074,474

3M ESPE AG (FED REP GERMANY CORPORATION)
ESPE PLATZ, D-82229

Registered Dec. 20, 2011

SEEFELD, FED REP GERMANY

Int. Cls.: 5, 9, 10, 40, and 44

FOR: DENTAL RESTORATION MATERIALS FOR MAKING CROWNS, BRIDGES, IMPLANT ABUTMENTS AND OTHER RESTORATIVES; AND SPRAY POWDERS TO ENHANCE IMAGE SCANNING OF TEETH AND THE MOUTH, IN CLASS 5 (U.S. CLS. 6, 18, 44, 46, 51 AND 52).

TRADEMARK

FIRST USE 9-0-2003; IN COMMERCE 9-0-2003.

SERVICE MARK

FOR: COMPUTER SOFTWARE FOR USE IN DENTISTRY, ORTHODONTICS AND ORAL HEALTHCARE FOR ORAL IMAGING, COLLECTING PATIENT DATA AND FOR MAKING RESTORATIONS, APPLIANCES, IMPLANT ABUTMENTS AND PROSTHETICS, IN CLASS 9 (U.S. CLS. 21, 23, 26, 36 AND 38).

PRINCIPAL REGISTER

FIRST USE 12-0-2007; IN COMMERCE 12-0-2007.

FOR: DENTAL RESTORATIONS, NAMELY, CROWNS, BRIDGES, IMPLANT ABUTMENTS, COPINGS, FRAMEWORKS, MARYLAND BRIDGES, INLAY BRIDGES AND ONLAY BRIDGES; ORAL SCANNERS AND RELATED SOFTWARE FOR USE WITH SUCH SCANNERS, ALL SOLD AS A UNIT, FOR USE IN DENTISTRY TO OBTAIN AND TRANSMIT IMAGES; DENTAL LABORATORY SCANNERS, MILLING UNITS, AND FURNACES, AND RELATED SOFTWARE SOLD WITH SUCH EQUIPMENT, AND REPAIR PARTS THEREFOR, FOR USE IN MAKING CROWNS, BRIDGES, IMPLANT ABUTMENTS, COPINGS AND FRAMEWORKS; BONDING TRAYS; AND DENTAL MODELS OF PATIENTS' TEETH AND MOUTHS, IN CLASS 10 (U.S. CLS. 26, 39 AND 44).

FIRST USE 9-0-2003; IN COMMERCE 9-0-2003.

FOR: DENTAL LABORATORY SERVICES AND CUSTOM MANUFACTURING OF DENTAL CROWNS, BRIDGES, IMPLANT ABUTMENTS, COPINGS, FRAMEWORKS AND OTHER RESTORATIVES, APPLIANCES, PROSTHETICS AND DENTAL MODELS, IN CLASS 40 (U.S. CLS. 100, 103 AND 106).

FIRST USE 10-0-2003; IN COMMERCE 10-0-2003.



David J. Kyjars

Director of the United States Patent and Trademark Office

Reg. No. 4,074,474 FOR: COMPUTER SERVICES, NAMELY, PROVIDING A COMPUTER NETWORK AND DATABASES FOR ALLOWING USERS TO MAINTAIN, PROCESS, MANIPULATE AND UTILIZE IMAGES AND DATA RELATED TO DENTISTRY AND ORTHODONTICS AND TO OBTAIN DENTAL AND ORTHODONTIC ELECTRONIC FILES FOR CREATING MODELS OF TEETH AND THE MOUTH, RESTORATIONS, APPLIANCES AND PROSTHETICS; AND PROVIDING A WEB SITE FEATURING DENTAL AND ORTHODONTIC INFORMATION, IMAGES AND DATA, IN CLASS 44 (U.S. CLS. 100 AND 101).

FIRST USE 9-0-2003; IN COMMERCE 9-0-2003.

THE MARK CONSISTS OF STANDARD CHARACTERS WITHOUT CLAIM TO ANY PARTICULAR FONT, STYLE, SIZE, OR COLOR.

OWNER OF U.S. REG. NO. 2,523,850.

SN 77-626,243, FILED 12-4-2008.

VIVIAN MICZNIK FIRST, EXAMINING ATTORNEY

United States of America

United States Patent and Trademark Office

Jagged Culture

Reg. No. 4,074,475

Registered Dec. 20, 2011

Int. Cl.: 25

TRADEMARK

PRINCIPAL REGISTER

VALDEZ, BERNISE (UNITED STATES INDIVIDUAL)
#115
1530 N. DETROIT STREET
LOS ANGELES, CA 90046

FOR: BLOUSES; DRESSES; HATS; JACKETS; PANTS; SHIRTS; SHOES; T-SHIRTS, IN CLASS 25 (U.S. CLS. 22 AND 39).

FIRST USE 10-0-2009; IN COMMERCE 10-0-2009.

THE MARK CONSISTS OF STANDARD CHARACTERS WITHOUT CLAIM TO ANY PARTICULAR FONT, STYLE, SIZE, OR COLOR.

SN 77-643,496, FILED 1-5-2009.

EUGENIA MARTIN, EXAMINING ATTORNEY



David J. Kybas

Director of the United States Patent and Trademark Office

United States of America

United States Patent and Trademark Office

EMOTION

Reg. No. 4,074,476

RICHLINE GROUP, INC. (DELAWARE CORPORATION)
1385 BROADWAY

Registered Dec. 20, 2011

MOUNT VERNON, NY 10018

Int. Cl.: 14

FOR: GEMSTONES; JEWELRY, IN CLASS 14 (U.S. CLS. 2, 27, 28 AND 50).

TRADEMARK

FIRST USE 9-1-2011; IN COMMERCE 9-1-2011.

PRINCIPAL REGISTER

THE MARK CONSISTS OF STANDARD CHARACTERS WITHOUT CLAIM TO ANY PARTICULAR FONT, STYLE, SIZE, OR COLOR.

SN 77-647,521, FILED 1-12-2009.

KARANENDRA S. CHHINA, EXAMINING ATTORNEY



David J. Kybas

Director of the United States Patent and Trademark Office

United States of America

United States Patent and Trademark Office

PISTOL SHRIMP

Reg. No. 4,074,477

SEAY, ROBERT (UNITED STATES INDIVIDUAL)
722 ELIZABETH SARAH BLVD.
GREER, SC 29650

Registered Dec. 20, 2011

Int. Cl.: 9

FOR: DIGITAL MATERIALS, NAMELY, AUDIO RECORDINGS, CDS FEATURING MUSIC,
IN CLASS 9 (U.S. CLS. 21, 23, 26, 36 AND 38).

TRADEMARK

FIRST USE 3-1-2009; IN COMMERCE 3-1-2009.

PRINCIPAL REGISTER

THE MARK CONSISTS OF STANDARD CHARACTERS WITHOUT CLAIM TO ANY PAR-
TICULAR FONT, STYLE, SIZE, OR COLOR.

SN 77-647,925, FILED 1-12-2009.

DOMINICK J. SALEMI, EXAMINING ATTORNEY



David J. Kyffers

Director of the United States Patent and Trademark Office

United States of America

United States Patent and Trademark Office

SIDERNA

Reg. No. 4,074,478

MASCO CORPORATION OF INDIANA (INDIANA CORPORATION)
55 EAST 111TH STREET
INDIANAPOLIS, IN 46280

Registered Dec. 20, 2011

Int. Cl.: 11

FOR: PLUMBING PRODUCTS, NAMELY, FAUCETS, IN CLASS 11 (U.S. CLS. 13, 21, 23, 31 AND 34).

TRADEMARK

FIRST USE 5-0-2011; IN COMMERCE 5-0-2011.

PRINCIPAL REGISTER

THE MARK CONSISTS OF STANDARD CHARACTERS WITHOUT CLAIM TO ANY PARTICULAR FONT, STYLE, SIZE, OR COLOR.

SN 77-655,050, FILED 1-23-2009.

AMEEN IMAM, EXAMINING ATTORNEY



David J. Kybas

Director of the United States Patent and Trademark Office

United States of America

United States Patent and Trademark Office

BLUEBERRY

Reg. No. 4,074,479

BLUEBERRY BENEFITS & SERVICES L.L.C. (TEXAS LIMITED LIABILITY COMPANY)
1849 KINGWOOD DRIVE, SUITE 101
KINGWOOD, TX 77339

Registered Dec. 20, 2011

Int. Cl.: 36

FOR: INSURANCE AGENCIES IN THE FIELDS OF PROPERTY, CASUALTY, AND HEALTH,
IN CLASS 36 (U.S. CLS. 100, 101 AND 102).

SERVICE MARK

FIRST USE 11-3-2011; IN COMMERCE 11-3-2011.

PRINCIPAL REGISTER

THE MARK CONSISTS OF STANDARD CHARACTERS WITHOUT CLAIM TO ANY PAR-
TICULAR FONT, STYLE, SIZE, OR COLOR.

SN 77-664,584, FILED 2-5-2009.

TIMOTHY FINNEGAN, EXAMINING ATTORNEY



David J. Kybas

Director of the United States Patent and Trademark Office

United States of America

United States Patent and Trademark Office

SGS

Reg. No. 4,074,480

Registered Dec. 20, 2011

Int. Cl.: 42

SERVICE MARK

PRINCIPAL REGISTER

FCI HOLDINGS DELEWARE, INC. (PENNSYLVANIA LIMITED LIABILITY COMPANY)
1105 NORTH MARKET STREET, SUITE 1300
WILMINGTON, DE 19801

FOR: ENGINEERING SERVICES, NAMELY, ANALYZING GEOLOGIC STRESS AND MATTER TO DEVELOP STRUCTURAL SUPPORT FOR UNDERGROUND MINES AND TUNNELS , IN CLASS 42 (U.S. CLS. 100 AND 101).

FIRST USE 1-0-2009; IN COMMERCE 1-0-2009.

THE MARK CONSISTS OF STANDARD CHARACTERS WITHOUT CLAIM TO ANY PARTICULAR FONT, STYLE, SIZE, OR COLOR.

SN 77-664,788, FILED 2-6-2009.

JANICE KIM, EXAMINING ATTORNEY



David J. Kyffers

Director of the United States Patent and Trademark Office

United States of America

United States Patent and Trademark Office

STRESS, GEOLOGIC AND SUPPORT

Reg. No. 4,074,481

Registered Dec. 20, 2011

Int. Cl.: 42

SERVICE MARK

PRINCIPAL REGISTER

FCI HOLDINGS DELAWARE, INC. (DELAWARE CORPORATION)
1105 NORTH MARKET STREET, SUITE 1300
WILMINGTON, DE 19801

FOR: ENGINEERING, IN CLASS 42 (U.S. CLS. 100 AND 101).

FIRST USE 1-0-2009; IN COMMERCE 1-0-2009.

THE MARK CONSISTS OF STANDARD CHARACTERS WITHOUT CLAIM TO ANY PARTICULAR FONT, STYLE, SIZE, OR COLOR.

NO CLAIM IS MADE TO THE EXCLUSIVE RIGHT TO USE "GEOLOGIC", APART FROM THE MARK AS SHOWN.

SN 77-664,803, FILED 2-6-2009.

JANICE KIM, EXAMINING ATTORNEY



David J. Kybas

Director of the United States Patent and Trademark Office

United States of America

United States Patent and Trademark Office



Reg. No. 4,074,482

MOR FURNITURE FOR LESS, INC. (CALIFORNIA CORPORATION)
8996 MIRAMAR ROAD, SUITE 360
SAN DIEGO, CA 92126

Registered Dec. 20, 2011

Int. Cl.: 20

FOR: BEDROOM FURNITURE AND MATTRESSES, IN CLASS 20 (U.S. CLS. 2, 13, 22, 25, 32 AND 50).

TRADEMARK

FIRST USE 1-4-2011; IN COMMERCE 1-4-2011.

PRINCIPAL REGISTER

OWNER OF U.S. REG. NOS. 2,462,769, 2,500,896, AND 3,335,965.

NO CLAIM IS MADE TO THE EXCLUSIVE RIGHT TO USE "KIDS & TEENS FOR LESS", APART FROM THE MARK AS SHOWN.

THE MARK CONSISTS OF THE WORD "MOR" IN A LARGER FONT WITH THE WORDS "KIDS & TEENS" IN A SMALLER FONT FLOATING THROUGH THE WORD "MOR", AND THE WORDS "FOR LESS" IN A SMALLER FONT CENTERED AND ON THE NEXT LINE.

SN 77-670,247, FILED 2-13-2009.

VIVIAN MICZNIK FIRST, EXAMINING ATTORNEY



David J. Kybas

Director of the United States Patent and Trademark Office

United States of America

United States Patent and Trademark Office

RANGER

Reg. No. 4,074,483

Registered Dec. 20, 2011

Int. Cl.: 12

TRADEMARK

PRINCIPAL REGISTER

RIGGING INNOVATIONS INC (ARIZONA CORPORATION)
BLDG. 1
4900 N. TUMBLEWEED ROAD
ELOY, AZ 85231

FOR: PERSONNEL PARACHUTE HARNESS AND CONTAINER SYSTEM, IN CLASS 12
(U.S. CLS. 19, 21, 23, 31, 35 AND 44).

FIRST USE 8-2-2010; IN COMMERCE 2-16-2011.

THE MARK CONSISTS OF STANDARD CHARACTERS WITHOUT CLAIM TO ANY PARTICULAR FONT, STYLE, SIZE, OR COLOR.

SN 77-672,373, FILED 2-17-2009.

RAUL CORDOVA, EXAMINING ATTORNEY



David J. Kyffers

Director of the United States Patent and Trademark Office

United States of America

United States Patent and Trademark Office



Reg. No. 4,074,484

Registered Dec. 20, 2011

Int. Cl.: 35

SERVICE MARK

PRINCIPAL REGISTER

GRUPO FAMSA, S.A. DE C.V. (MEXICO CORPORATION)
ZONA CENTRO C.P.
AV. PINO SUAREZ 1202 NTE.
MONTEREY, MEXICO 64000

FOR: RETAIL STORE AND ONLINE RETAIL STORE SERVICES FEATURING WASHERS, DRYERS, REFRIGERATORS, STOVES, BLENDERS, TOASTERS, MICROWAVES, FANS, IRONS, FOOD PROCESSORS, SMALL AND MAJOR HOME APPLIANCES, TELEVISIONS, RADIOS, VCRS, DVDS, HOME AND CAR STEREOS, MINI-COMPONENTS, CONSUMER ELECTRONIC ACCESSORIES AND EQUIPMENT, CELLULAR PHONES AND ACCESSORIES, CAMERAS AND CAMERA ACCESSORIES, CAMCORDERS AND CAMCORDER ACCESSORIES, TOYS, ELECTRONIC GAMES, JEWELRY AND WATCHES, COSMETICS, INDOOR AND OUTDOOR FURNITURE AND HOME FURNISHINGS, TIRES, BATTERIES, AUTOMOTIVE GOODS AND ACCESSORIES AND POWER AND HAND TOOLS, IN CLASS 35 (U.S. CLS. 100, 101 AND 102).

FIRST USE 3-31-2009; IN COMMERCE 3-31-2009.

OWNER OF U.S. REG. NOS. 2,698,662 AND 3,011,676.

NO CLAIM IS MADE TO THE EXCLUSIVE RIGHT TO USE "PRICE MATCH GUARANTEE", APART FROM THE MARK AS SHOWN.

THE MARK CONSISTS OF THE WORDS "FAMSA PRICE MATCH GUARANTEE" AND IS DEPICTED AS A STYLIZED CIRCLE CONTAINING THE TERMS "PRICE" ON TOP AND "GUARANTEE" ON THE BOTTOM WITH AN OVERLAID RIBBON DESIGN CONTAINING THE TERM "MATCH" AND A GEOMETRIC SHAPE CONTAINING THE TERM "FAMSA".

THE WORDING "FAMSA" HAS NO MEANING IN A FOREIGN LANGUAGE.

SN 77-676,148, FILED 2-23-2009.

JACQUELINE A. LAVINE, EXAMINING ATTORNEY



David J. Kyffers

Director of the United States Patent and Trademark Office

United States of America

United States Patent and Trademark Office

HOME BRAND VALUE

Reg. No. 4,074,485

CARRIAGE HOUSE COMPANIES, INC., THE (DELAWARE CORPORATION)
196 NEWTON STREET
FREDONIA, NY 14063

Registered Dec. 20, 2011

Int. Cl.: 30

FOR: PANCAKE SYRUP; SAUCES; TABLE SYRUP; TOPPING SYRUP, IN CLASS 30 (U.S. CL. 46).

TRADEMARK

FIRST USE 8-22-2011; IN COMMERCE 8-22-2011.

PRINCIPAL REGISTER

THE MARK CONSISTS OF STANDARD CHARACTERS WITHOUT CLAIM TO ANY PARTICULAR FONT, STYLE, SIZE, OR COLOR.

OWNER OF U.S. REG. NOS. 1,797,998 AND 2,845,109.

NO CLAIM IS MADE TO THE EXCLUSIVE RIGHT TO USE "BRAND", APART FROM THE MARK AS SHOWN.

SN 77-684,987, FILED 3-6-2009.

ROBIN CHOSID, EXAMINING ATTORNEY



David J. Kyros

Director of the United States Patent and Trademark Office

United States of America

United States Patent and Trademark Office



Reg. No. 4,074,486

DONALD J. WATKINS (UNITED STATES INDIVIDUAL)

Registered Dec. 20, 2011

P.O. BOX 11932
TEMPE, AZ 85284

Int. Cl.: 25

TRADEMARK

PRINCIPAL REGISTER

FOR: A-SHIRTS; ANGLERS' SHOES; ANKLE SOCKS; ANKLETS; ANTI-PERSPIRANT SOCKS; APRES-SKI SHOES; ATHLETIC APPAREL, NAMELY, SHIRTS, PANTS, JACKETS, FOOTWEAR, HATS AND CAPS, ATHLETIC UNIFORMS; ATHLETIC FOOTWEAR; ATHLETIC SHOES; ATHLETIC UNIFORMS; BALLOON PANTS; BALLROOM DANCING SHOES; BASEBALL CAPS; BASEBALL SHOES; BATHING CAPS; BEACH SHOES; BELTS; BELTS MADE OF LEATHER; BELTS OF TEXTILE; BERMUDA SHORTS; BIB SHORTS; BICYCLE GLOVES; BICYCLING GLOVES; BOARD SHORTS; BODY SHIRTS; BOLO TIES; BOMBER JACKETS; BOW TIES; BOWLING SHOES; BOXER SHORTS; BOXING SHOES; BUTTON-FRONT ALOHA SHIRTS; CAMP SHIRTS; CANVAS SHOES; CAP VISORS; CAPRI PANTS; CAPS; CAPS WITH VISORS; CARGO PANTS; CLOTHING FOR ATHLETIC USE, NAMELY, PADDED ELBOW COMPRESSION SLEEVES; CLOTHING FOR ATHLETIC USE, NAMELY, PADDED PANTS; CLOTHING FOR ATHLETIC USE, NAMELY, PADDED SHIRTS; CLOTHING FOR ATHLETIC USE, NAMELY, PADDED SHORTS; CLOTHING, NAMELY, KHAKIS; CREW NECK SWEATERS; CROSS-COUNTRY GLOVES; CYCLING SHOES; DANCE SHOES; DECK-SHOES; DENIM JACKETS; DENIMS; DOWN JACKETS; DRESS SHIRTS; DRIVERS; FABRIC BELTS; FISHERMEN'S JACKETS; FISHING VESTS; FLEECE SHORTS; FLEECE VESTS; FOOTBALL SHOES; FOOTWEAR; FOOTWEAR FOR MEN; FOOTWEAR FOR MEN AND WOMEN; FOOTWEAR FOR TRACK AND FIELD ATHLETICS; FUR COATS AND JACKETS; FUR HATS; FUR JACKETS; GARTER BELTS; GLOVES; GLOVES FOR PERSONAL HAND CONDITIONING USE; GLOVES INCLUDING THOSE MADE OF SKIN, HIDE OR FUR; GOLF CAPS; GOLF CLEATS; GOLF PANTS, SHIRTS AND SKIRTS; GOLF SHIRTS; GOLF SHOES; GOLF SPIKES; GOLF TROUSERS; GYM SHORTS; GYMNASTIC SHOES; HANDBALL SHOES; HATS; HEAVY JACKETS; HOCKEY SHOES; HOODED SWEAT SHIRTS; HUNTING VESTS; JACKET LINERS; JACKETS; JACKETS AND SOCKS; JAPANESE STYLE SOCKS (TABI COVERS); JAPANESE STYLE SOCKS (TABI); JEANS; JOGGING PANTS; KNIT SHIRTS; KNITTED CAPS; KNITTED GLOVES; LEATHER BELTS; LEATHER JACKETS; LEATHER PANTS; LEATHER SHOES; LEISURE SHOES; LIGHT-REFLECTING JACKETS; LONG JACKETS; LONG SLEEVED VESTS; LONG-SLEEVED SHIRTS; LOUNGE PANTS; MEN'S AND WOMEN'S JACKETS, COATS, TROUSERS, VESTS; MEN'S SOCKS; MOCK TURTLE-NECK SWEATERS; MOISTURE-WICKING SPORTS PANTS; MOISTURE-WICKING SPORTS SHIRTS; MONEY BELTS; MOTORCYCLE GLOVES; MOTORCYCLE JACKETS; MOUNTAINEERING SHOES; NIGHT SHIRTS; NON-DISPOSABLE CLOTH TRAINING PANTS; OPEN-NECKED SHIRTS; OUTDOOR GLOVES; OVER-



David J. Kybas

Director of the United States Patent and Trademark Office

Reg. No. 4,074,486 TROUSERS; PADDED JACKETS; PADDING JACKETS; PANTIES, SHORTS AND BRIEFS; PANTS; PAPER HATS FOR USE AS CLOTHING ITEMS; PARTY HATS; PETTI-PANTS; PIQUE SHIRTS; POLO SHIRTS; QUILTED VESTS; RAIN HATS; RAIN JACKETS; RAIN TROUSERS; RAINPROOF JACKETS; REVERSIBLE JACKETS; RIDING GLOVES; RUBBER SHOES; RUGBY SHIRTS; RUGBY SHOES; RUGBY SHORTS; RUNNING SHOES; SEDGE HATS (SUGE-GASA); SHELL JACKETS; SHIRT FRONTS; SHIRT YOKES; SHIRTS; SHIRTS FOR SUITS; SHOES; SHORT OVERCOAT FOR KIMONO (HAORI); SHORT SETS; SHORT TROUSERS; SHORT-SLEEVED OR LONG-SLEEVED T-SHIRTS; SHORT-SLEEVED SHIRTS; SHORTS; SHOWER CAPS; SKI AND SNOWBOARD SHOES AND PARTS THEREOF; SKI GLOVES; SKI JACKETS; SKI PANTS; SKI TROUSERS; SKIING SHOES; SKULL CAPS; SLACKS; SLEEP SHIRTS; SLEEVED OR SLEEVELESS JACKETS; SLIDING SHORTS; SMALL HATS; SMOKING JACKETS; SNOW PANTS; SNOWBOARD GLOVES; SNOWBOARD PANTS; SOCCER SHOES; SOCK SUSPENDERS; SOCKS; SOCKS AND STOCKINGS; SPORT SHIRTS; SPORTS JACKETS; SPORTS PANTS; SPORTS SHIRTS; SPORTS SHIRTS WITH SHORT SLEEVES; STRETCH PANTS; STUFF JACKETS; SUEDE JACKETS; SUSPENDER BELTS FOR MEN; SWEAT JACKETS; SWEAT PANTS; SWEAT SHIRTS; SWEAT SHORTS; SWEATERS; SWIM CAPS; SWIMMING CAPS; T-SHIRTS; TAP PANTS; TAP SHOES; TEE SHIRTS; TENNIS SHOES; THERMAL SOCKS; TIES; TOBOGGAN HATS, PANTS AND CAPS; TOE CAPS; TRACK AND FIELD SHOES; TRACK JACKETS; TRACK PANTS; TRAINING SHOES; TRAVEL CLOTHING CONTAINED IN A PACKAGE COMPRISING REVERSIBLE JACKETS, PANTS, SKIRTS, TOPS AND A BELT OR SCARF; TRIATHLON CLOTHING, NAMELY, TRIATHLON TIGHTS, TRIATHLON SHORTS, TRIATHLON SINGLET, TRIATHLON SHIRTS, TRIATHLON SUITS; TROUSERS; TROUSERS FOR SWEATING; TROUSERS OF LEATHER; TURTLENECK SWEATERS; TUXEDO BELTS; UNDERWEAR, NAMELY, BOY SHORTS; V-NECK SWEATERS; VEST EXTENDERS; VESTED SUITS; VESTS; VOLLEYBALL SHOES; WAIST BELTS; WALKING SHORTS; WATER SOCKS; WATERPROOF JACKETS AND PANTS; WEARABLE GARMENTS AND CLOTHING, NAMELY, SHIRTS; WET SUIT GLOVES; WIND PANTS; WIND RESISTANT JACKETS; WIND SHIRTS; WIND VESTS; WIND-JACKETS; WOOLLEN SOCKS; WOOLLY HATS; WORK SHOES AND BOOTS; WRAP BELTS FOR KIMONOS (DATEMAKI); YOGA PANTS; YOGA SHIRTS, IN CLASS 25 (U.S. CLS. 22 AND 39).

FIRST USE 12-31-2008; IN COMMERCE 10-22-2011.

THE MARK CONSISTS OF A STYLIZED WORD "DAD" AND A STAR BURST, WHEREIN THE "A" OF THE STYLIZED WORD "DAD" IS OF LARGER FONT TO ALLOW THE UPPER PORTION OF THE STYLIZED "A" TO RISE ABOVE THE STYLIZED "D'S OF THE STYLIZED WORD "DAD", WHEREIN THE STAR BURST CONSISTING OF FIVE (5) LINES PARTIALLY RADIALLY ALIGNED AROUND THE UPPER PORTION OF THE STYLIZED "A" OF THE STYLIZED WORD "DAD".

SN 77-688,497, FILED 3-11-2009.

ELLEN PERKINS, EXAMINING ATTORNEY

United States of America

United States Patent and Trademark Office

SERRACOR-NK

Reg. No. 4,074,487

Registered Dec. 20, 2011

Int. Cl.: 5

TRADEMARK

PRINCIPAL REGISTER

CAL INDIA FOODS INTERNATIONAL (CALIFORNIA CORPORATION), DBA SPECIALTY ENZYMES AND BIOTECHNOLOGIES,
13591 YORBA AVENUE
CHINO, CA 91710

FOR: DIETARY AND NUTRITIONAL SUPPLEMENTS, IN CLASS 5 (U.S. CLS. 6, 18, 44, 46, 51 AND 52).

FIRST USE 3-31-2009; IN COMMERCE 3-31-2009.

THE MARK CONSISTS OF STANDARD CHARACTERS WITHOUT CLAIM TO ANY PARTICULAR FONT, STYLE, SIZE, OR COLOR.

SN 77-689,736, FILED 3-12-2009.

MICHAEL TANNER, EXAMINING ATTORNEY



David J. Kyffers

Director of the United States Patent and Trademark Office

United States of America

United States Patent and Trademark Office



Reg. No. 4,074,488

MAX BURGERS LLC (NEW YORK LIMITED LIABILITY COMPANY)
5 CROSSWAY
SCARSDALE, NY 10583

Registered Dec. 20, 2011

Int. Cl.: 43

FOR: RESTAURANT SERVICES, INCLUDING SIT-DOWN SERVICE OF FOOD AND TAKE-OUT RESTAURANT SERVICES, IN CLASS 43 (U.S. CLS. 100 AND 101).

SERVICE MARK

FIRST USE 10-1-2009; IN COMMERCE 10-1-2009.

PRINCIPAL REGISTER

OWNER OF U.S. REG. NO. 1,956,943.

NO CLAIM IS MADE TO THE EXCLUSIVE RIGHT TO USE "EXPRESS", APART FROM THE MARK AS SHOWN.

THE MARK CONSISTS OF THE WORDS "ROCKWELLS EXPRESS" ARRANGED ONE ABOVE THE OTHER IN STYLIZED LETTERING, WITH A DESIGN OF AN ARC OVER THE WORD "ROCKWELLS", A BROKEN ARC TO THE LEFT OF THE WORD "EXPRESS", AN ARC TO THE RIGHT OF THE WORD "EXPRESS" AND TWO ARCS BELOW THE WORD "EXPRESS".

SN 77-694,740, FILED 3-19-2009.

MATTHEW KLINE, EXAMINING ATTORNEY



David J. Kappas

Director of the United States Patent and Trademark Office

United States of America

United States Patent and Trademark Office

Marrygold

Reg. No. 4,074,489

DANA M. GOLDSTEIN (UNITED STATES INDIVIDUAL)
3 EAST 84TH STREET PH
NEW YORK, NY 10028

Registered Dec. 20, 2011

Int. Cl.: 14

FOR: JEWELRY, IN CLASS 14 (U.S. CLS. 2, 27, 28 AND 50).

TRADEMARK

FIRST USE 8-15-2011; IN COMMERCE 8-15-2011.

PRINCIPAL REGISTER

THE MARK CONSISTS OF STANDARD CHARACTERS WITHOUT CLAIM TO ANY PARTICULAR FONT, STYLE, SIZE, OR COLOR.

SN 77-698,128, FILED 3-24-2009.

EUGENIA MARTIN, EXAMINING ATTORNEY



David J. Kybas

Director of the United States Patent and Trademark Office

United States of America

United States Patent and Trademark Office

WALDO, SLUGGO & ME

Reg. No. 4,074,490

WALDO, SLUGGO & ME LLC (D.C. CORPORATION)

Registered Dec. 20, 2011

1230 D STREET SE
WASHINGTON, DC 20003

Int. Cl.: 28

FOR: DOLLS, IN CLASS 28 (U.S. CLS. 22, 23, 38 AND 50).

TRADEMARK

FIRST USE 9-10-2009; IN COMMERCE 11-18-2009.

PRINCIPAL REGISTER

THE MARK CONSISTS OF STANDARD CHARACTERS WITHOUT CLAIM TO ANY PARTICULAR FONT, STYLE, SIZE, OR COLOR.

NO CLAIM IS MADE TO THE EXCLUSIVE RIGHT TO USE "LLC", APART FROM THE MARK AS SHOWN.

SN 77-702,556, FILED 3-30-2009.

SAMUEL E. SHARPER JR., EXAMINING ATTORNEY



David J. Kyffers

Director of the United States Patent and Trademark Office

United States of America

United States Patent and Trademark Office

VITAL DOSE

Reg. No. 4,074,491

CELANESE INTERNATIONAL CORPORATION (DELAWARE CORPORATION)
1601 LBJ FREEWAY
DALLAS, TX 75234

Registered Dec. 20, 2011

Int. Cl.: 1

FOR: UNPROCESSED COPOLYMER PLASTICS FOR USE IN CONTROLLED RELEASE
MEDICINAL AND PHARMACEUTICAL PACKAGING APPLICATIONS, IN CLASS 1 (U.S.
CLS. 1, 5, 6, 10, 26 AND 46).

TRADEMARK

FIRST USE 9-29-2011; IN COMMERCE 9-29-2011.

PRINCIPAL REGISTER

THE MARK CONSISTS OF STANDARD CHARACTERS WITHOUT CLAIM TO ANY PAR-
TICULAR FONT, STYLE, SIZE, OR COLOR.

SN 77-703,673, FILED 3-31-2009.

KYLE PEETE, EXAMINING ATTORNEY



David J. Kyffers

Director of the United States Patent and Trademark Office

United States of America

United States Patent and Trademark Office

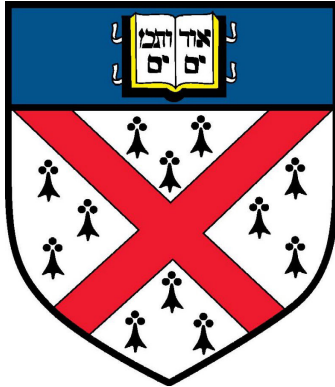

Reg. No. 4,074,492

Registered Dec. 20, 2011

Int. Cls.: 9 and 16

TRADEMARK

PRINCIPAL REGISTER

YALE UNIVERSITY (CONNECTICUT NON-PROFIT CORPORATION)
105 WALL STREET
NEW HAVEN, CT 06520

FOR: DOWNLOADABLE MP3 FILES, AUDIO VIDEO RECORDINGS, WEBCASTS AND PODCASTS RELATED TO YALE COLLEGE, IN CLASS 9 (U.S. CLS. 21, 23, 26, 36 AND 38).

FIRST USE 5-1-2011; IN COMMERCE 5-1-2011.

FOR: STATIONERY; LETTERHEAD PAPER; PRINTED MATERIALS, NAMELY, BUSINESS CARDS, IN CLASS 16 (U.S. CLS. 2, 5, 22, 23, 29, 37, 38 AND 50).

FIRST USE 5-5-2011; IN COMMERCE 5-5-2011.

THE MARK CONSISTS OF A SHIELD DESIGN WITH A RED CROSS ON A BLACK BACKGROUND, WITH A BLUE RECTANGULAR TOP PORTION ON WHICH IS AN OPEN BOOK CONTAINING THE HEBREW WORDS URIM AND THUMMIM. THE COVER OF THE BOOK IS BLACK, THE EDGES OF THE PAGES ARE YELLOW, AND THE PAGES THEMSELVES ARE WHITE. THE OUTLINE OF THE SHIELD AND THE DESIGNS WITHIN THE SHIELD ARE BLACK ON A WHITE BACKGROUND.

THE COLOR(S) BLUE, RED, YELLOW, BLACK AND WHITE IS/ARE CLAIMED AS A FEATURE OF THE MARK.

THE NON-LATIN CHARACTERS IN THE MARK transliterate to URIM AND THUMMIM AND THIS MEANS "LIGHT" AND "TRUTH" IN ENGLISH.

SN 77-705,295, FILED 4-2-2009.

NAKIA HENRY, EXAMINING ATTORNEY



David J. Kyjars

Director of the United States Patent and Trademark Office

United States of America

United States Patent and Trademark Office

THE GAP GENERATION

Reg. No. 4,074,493

GAP (APPAREL), LLC (CALIFORNIA LIMITED LIABILITY COMPANY)
2 FOLSOM STREET

Registered Dec. 20, 2011

SAN FRANCISCO, CA 94105

Int. Cl.: 25

FOR: CLOTHING, NAMELY, T-SHIRTS, SHIRTS, BLOUSES, SWEATERS, SWEATSHIRTS, TOPS, BOTTOMS, PANTS, SHORTS, JEANS, SKIRTS, DRESSES, JACKETS, BLAZERS, COATS, LOUNGEWEAR, FOOTWEAR, SOCKS, UNDERGARMENTS, HEADWEAR, SCARVES, GLOVES, IN CLASS 25 (U.S. CLS. 22 AND 39).

TRADEMARK

PRINCIPAL REGISTER

FIRST USE 8-28-2009; IN COMMERCE 8-28-2009.

THE MARK CONSISTS OF STANDARD CHARACTERS WITHOUT CLAIM TO ANY PARTICULAR FONT, STYLE, SIZE, OR COLOR.

OWNER OF U.S. REG. NOS. 2,719,435, 2,833,117, AND OTHERS.

SN 77-706,806, FILED 4-3-2009.

CHARLES L. JENKINS, EXAMINING ATTORNEY



David J. Kyros

Director of the United States Patent and Trademark Office

United States of America

United States Patent and Trademark Office

SECURITYVIBES

Reg. No. 4,074,494

Registered Dec. 20, 2011

Int. Cl.: 35

SERVICE MARK

PRINCIPAL REGISTER

QUALYS, INC. (DELAWARE CORPORATION)
1600 BRIDGE PARKWAY, SECOND FLOOR
REDWOOD SHORES, CA 94065

FOR: PROVIDING ONLINE BUSINESS NETWORKING SERVICES FOR PROFESSIONALS
IN THE FIELDS OF INFORMATION TECHNOLOGY AND NETWORK SECURITY , IN CLASS
35 (U.S. CLS. 100, 101 AND 102).

FIRST USE 10-31-2008; IN COMMERCE 10-31-2008.

THE MARK CONSISTS OF STANDARD CHARACTERS WITHOUT CLAIM TO ANY PAR-
TICULAR FONT, STYLE, SIZE, OR COLOR.

SN 77-708,853, FILED 4-7-2009.

TARAH HARDY, EXAMINING ATTORNEY



David J. Kybas

Director of the United States Patent and Trademark Office

United States of America

United States Patent and Trademark Office

SECURITYVIBES

Reg. No. 4,074,495

QUALYS, INC. (DELAWARE CORPORATION)
1600 BRIDGE PARKWAY, SECOND FLOOR
REDWOOD SHORES, CA 94065

Registered Dec. 20, 2011

Int. Cl.: 42

FOR: PROVIDING INFORMATION IN THE FIELD OF COMPUTER TECHNOLOGY AND PROGRAMMING, IN CLASS 42 (U.S. CLS. 100 AND 101).

SERVICE MARK

FIRST USE 10-31-2008; IN COMMERCE 10-31-2008.

PRINCIPAL REGISTER

THE MARK CONSISTS OF STANDARD CHARACTERS WITHOUT CLAIM TO ANY PARTICULAR FONT, STYLE, SIZE, OR COLOR.

SN 77-708,871, FILED 4-7-2009.

TARAH HARDY, EXAMINING ATTORNEY



David J. Kybas

Director of the United States Patent and Trademark Office

United States of America

United States Patent and Trademark Office

TALENT BANK

Reg. No. 4,074,496

Registered Dec. 20, 2011

Int. Cl.: 42

SERVICE MARK

PRINCIPAL REGISTER

RECRUITING.COM, INC. (DELAWARE CORPORATION), FORMERLY JOBSTER, INC.,
SUITE 600
3131 ELIOTT AVE.
SEATTLE, WA 98121

FOR: PROVIDING USE OF AN ON-LINE NON-DOWNLOADABLE RECRUITING SOFTWARE APPLICATION, FOR CREATING AND MAINTAINING A DATABASE WHEREIN THE CLIENT OF SAID SOFTWARE APPLICATION MAY ENTER INFORMATION CONCERNING PROSPECTIVE HIRE CANDIDATES, THEIR RESUMES AND OTHER RELATED DATA, IN CLASS 42 (U.S. CLS. 100 AND 101).

FIRST USE 11-2-2009; IN COMMERCE 11-2-2009.

THE MARK CONSISTS OF STANDARD CHARACTERS WITHOUT CLAIM TO ANY PARTICULAR FONT, STYLE, SIZE, OR COLOR.

SN 77-709,779, FILED 4-8-2009.

EUGENIA MARTIN, EXAMINING ATTORNEY



David J. Kybas

Director of the United States Patent and Trademark Office

United States of America

United States Patent and Trademark Office



Reg. No. 4,074,497

KURT A. KENDALL (UNITED STATES INDIVIDUAL)
6 MANCHESTER STREET
NASHUA, NH 03064

Registered Dec. 20, 2011

Int. Cl.: 34

FOR: CIGARS; TOBACCO, CIGARS AND CIGARETTES, IN CLASS 34 (U.S. CLS. 2, 8, 9 AND 17).

TRADEMARK

FIRST USE 8-10-2008; IN COMMERCE 4-1-2009.

PRINCIPAL REGISTER

NO CLAIM IS MADE TO THE EXCLUSIVE RIGHT TO USE "IN EVERY CASE" AND "FAMOUS FOR QUALITY", APART FROM THE MARK AS SHOWN.

THE COLOR(S) BLACK, BEIGE, RED AND GOLD IS/ARE CLAIMED AS A FEATURE OF THE MARK.

THE NAME(S), PORTRAIT(S), AND/OR SIGNATURE(S) SHOWN IN THE MARK IDENTIFIES "KURT A. KENDALL", A LIVING INDIVIDUAL, WHOSE CONSENT(S) TO REGISTER IS MADE OF RECORD.

THE MARK CONSISTS OF A BLACK BACKGROUND WITH THE WORDING "IN EVERY CASE 7-20-4 FAMOUS FOR QUALITY" IN BEIGE STYLIZED LETTERS, THE WORDING "K.A. KENDALL'S" IN BEIGE STYLIZED LETTERING ON A RED BANNER, A GOLD WREATH, BEIGE, GOLD AND RED RIBBONS AND A GOLD AND RED OUTLINED OCTAGON.

SN 77-710,537, FILED 4-9-2009.

KELLY TRUSILO, EXAMINING ATTORNEY



David J. Kybas

Director of the United States Patent and Trademark Office

United States of America

United States Patent and Trademark Office

GCAES

Reg. No. 4,074,498

Registered Dec. 20, 2011

Int. Cl.: 40

SERVICE MARK

PRINCIPAL REGISTER

GENERAL COMPRESSION, INC. (DELAWARE CORPORATION)
64 WATER STREET
ATTLEBORO, MA 02703

FOR: PRODUCTION OF ENERGY; GENERATION OF ENERGY; PROVIDING INFORMATION IN THE FIELD OF ENERGY GENERATION AND PRODUCTION; CONSULTATION IN THE FIELD OF ENERGY GENERATION AND PRODUCTION, IN CLASS 40 (U.S. CLS. 100, 103 AND 106).

FIRST USE 5-0-2011; IN COMMERCE 5-0-2011.

THE MARK CONSISTS OF STANDARD CHARACTERS WITHOUT CLAIM TO ANY PARTICULAR FONT, STYLE, SIZE, OR COLOR.

SN 77-712,732, FILED 4-13-2009.

ALLISON HOLTZ, EXAMINING ATTORNEY



David J. Kyffers

Director of the United States Patent and Trademark Office

United States of America

United States Patent and Trademark Office



Reg. No. 4,074,499

Registered Dec. 20, 2011

Int. Cl.: 9

TRADEMARK

PRINCIPAL REGISTER

UNITED PAYROLL SYSTEMS INTERNATIONAL, LLC (MARYLAND LIMITED LIABILITY COMPANY)
808 PRISCILLA STREET
SALISBURY, MD 21804

FOR: MAGNETICALLY ENCODED CREDIT CARDS, DEBIT CARDS AND STORED VALUE CARDS, IN CLASS 9 (U.S. CLS. 21, 23, 26, 36 AND 38).

FIRST USE 5-16-2007; IN COMMERCE 5-16-2007.

NO CLAIM IS MADE TO THE EXCLUSIVE RIGHT TO USE "SECURE PAY", APART FROM THE MARK AS SHOWN.

THE COLOR(S) GRAY, GREEN AND YELLOW IS/ARE CLAIMED AS A FEATURE OF THE MARK.

THE MARK CONSISTS OF FOUR CIRCLES ARRANGED IN A DIAMOND FORMATION WITH THE TOP AND BOTTOM CIRCLES SHADED YELLOW, THE LEFT AND RIGHT CIRCLES SHADED GREEN AND TO THE RIGHT OF THE SHADED CIRCLES ARE THE WORDS "SECURE PAY SOLUTION" IN GRAY LETTERING.

SN 77-715,047, FILED 4-16-2009.

KATHERINE CHANG, EXAMINING ATTORNEY



David J. Kyjars

Director of the United States Patent and Trademark Office

United States of America

United States Patent and Trademark Office

STORM BLADE

Reg. No. 4,074,500

Registered Dec. 20, 2011

Int. Cl.: 28

TRADEMARK

PRINCIPAL REGISTER

AGIT GLOBAL INC. (TAIWAN CORPORATION)
SHIN-REN ROAD
TAIPING CITY, TAICHUNG, TAIWAN 411

FOR: SNOW RECREATIONAL DEVICES, NAMELY, SNOW SLEDS, TOBOGGANS, DISC-SHAPED SNOW SLED, SNOW SAUCERS AND SLIDERS; WATER SPORTS EQUIPMENT, NAMELY, BODYBOARDS, SURFBOARDS, SKIMBOARDS AND ACCESSORIES THEREFOR, NAMELY, SURFBOARD CARRIER WORN ON THE BODY, LEASHES USED IN CONJUNCTION WITH SURFING, SURFING FINS AND WEB GLOVES; SWIM FINS, IN CLASS 28 (U.S. CLS. 22, 23, 38 AND 50).

FIRST USE 1-1-2009; IN COMMERCE 1-1-2009.

THE MARK CONSISTS OF STANDARD CHARACTERS WITHOUT CLAIM TO ANY PARTICULAR FONT, STYLE, SIZE, OR COLOR.

SN 77-717,856, FILED 4-20-2009.

EMILY CHUO, EXAMINING ATTORNEY



David J. Kyros

Director of the United States Patent and Trademark Office

United States of America

United States Patent and Trademark Office

STROLLER PATROLLER

Reg. No. 4,074,501

Registered Dec. 20, 2011

Int. Cl.: 16

TRADEMARK

PRINCIPAL REGISTER

STROLLER PATROLLER LIMITED LIABILITY COMPANY (NEW JERSEY LIMITED LIABILITY COMPANY)
13 EAGLES NOTCH DRIVE
ENGLEWOOD, NJ 07631

FOR: PAPER TAGS; PAPER IDENTIFICATION TAGS; PAPER HANG TAGS; PAPER IDENTIFICATION TAGS LISTING EMERGENCY INFORMATION FOR CHILDREN; AND PAPER IDENTIFICATION WRIST TAGS, IN CLASS 16 (U.S. CLS. 2, 5, 22, 23, 29, 37, 38 AND 50).

FIRST USE 9-1-2010; IN COMMERCE 10-11-2011.

THE MARK CONSISTS OF STANDARD CHARACTERS WITHOUT CLAIM TO ANY PARTICULAR FONT, STYLE, SIZE, OR COLOR.

NO CLAIM IS MADE TO THE EXCLUSIVE RIGHT TO USE "STROLLER", APART FROM THE MARK AS SHOWN.

SN 77-717,867, FILED 4-20-2009.

SUSAN STIGLITZ, EXAMINING ATTORNEY



David J. Kybas

Director of the United States Patent and Trademark Office

United States of America

United States Patent and Trademark Office

GREEN-PAQ



Reg. No. 4,074,502

Registered Dec. 20, 2011

Int. Cl.: 16

SHANGHAI NILU INTERNATIONAL IMPORT & EXPORT CO., LTD. (CHINA CORPORATION)
RM. 3501, BAOAN BUILDING
NO. 800, DONGFANG RD. PUDONG
SHANGHAI, CHINA

TRADEMARK

PRINCIPAL REGISTER

FOR: AIR-FILLED PLASTIC BAGS FOR INSULATING AND PACKAGING; BAGS OF PAPER OR PLASTICS, FOR PACKAGING; PACKAGING MATERIALS MADE OF PLASTIC, NAMELY, PLASTIC BUBBLE PACKS; PLASTIC BUBBLE PACKS FOR WRAPPING OR PACKAGING; PLASTIC FILM FOR WRAPPING, NAMELY, AIR-FILLED PLASTIC BAGS FOR INSULATING AND PACKAGING, IN CLASS 16 (U.S. CLS. 2, 5, 22, 23, 29, 37, 38 AND 50).

FIRST USE 3-18-2011; IN COMMERCE 8-2-2011.

NO CLAIM IS MADE TO THE EXCLUSIVE RIGHT TO USE "GREEN PACK", APART FROM THE MARK AS SHOWN.

THE MARK CONSISTS OF THE WORDING "GREEN-PAQ" WITH A CURVY LINE UNDER THE WORDING.

SN 77-719,347, FILED 4-22-2009.

SUE LAWRENCE, EXAMINING ATTORNEY



David J. Kyffers

Director of the United States Patent and Trademark Office

United States of America

United States Patent and Trademark Office

TRANSCRIBER AG

Reg. No. 4,074,503

Registered Dec. 20, 2011

**Int. Cls.: 9, 35, 41, and
42**

TRADEMARK

SERVICE MARK

PRINCIPAL REGISTER

ETAT FRANCAIS REPRÉSENTÉ PAR LE DÉLÉGUÉ GÉNÉRAL POUR L'ARMEMENT
(FRANCE COUNTRY GOVERNMENT)
16 BIS AVENUE PRIEUR DE LA CÔTE D'OR
ARCUEIL, FRANCE 94114

FOR: (BASED ON 44(E)) APPARATUS FOR DATA PROCESSING EQUIPMENT, NAMELY, DATA PROCESSORS AND COMPUTERS; BLANK SMARTCARDS; MICROPROCESSORS; (BASED ON 1(A)) COMPUTER SOFTWARE FOR LINGUISTIC ANNOTATION IN THE FIELD OF NATURAL LANGUAGE PROCESSING; INTERFACES FOR COMPUTERS; DATA PROCESSING SOFTWARE USED FOR PRODUCTION AND MANAGEMENT OF LANGUAGE RESOURCES FOR SOFTWARE LANGUAGES AUTOMATIC PROCESSING, ALLOWING MULTIMEDIA FILES MANUAL NOTES, LARGE CORPUS OF LANGUAGES MANAGEMENT AND BROWSING, IN CLASS 9 (U.S. CLS. 21, 23, 26, 36 AND 38).

FIRST USE 7-7-2011; IN COMMERCE 7-8-2011.

FOR: (BASED ON 44(E)) DISSEMINATION OF ADVERTISING MATTER; COMPUTER DATABASE MANAGEMENT; ON-LINE ADVERTISING ON A COMPUTER NETWORK, IN CLASS 35 (U.S. CLS. 100, 101 AND 102).

FOR: (BASED ON 44(E)) EDUCATION, NAMELY, CONDUCTING COURSES OF INSTRUCTION AND WORKSHOPS IN THE FIELD OF LINGUISTICS ANNOTATION; TRAINING IN THE FIELD OF LINGUISTICS ANNOTATION; PUBLICATION OF BOOKS; ON-LINE ELECTRONIC PUBLICATION OF BOOKS AND JOURNALS; PRACTICAL TRAINING IN THE FIELD OF LINGUISTICS ANNOTATION, IN CLASS 41 (U.S. CLS. 100, 101 AND 107).

FOR: (BASED ON 44(E)) TESTING, ANALYSIS, AND EVALUATION OF THE GOODS AND SERVICES OF OTHERS FOR THE PURPOSE OF CERTIFICATION; SCIENTIFIC RESEARCH AND TECHNICAL RESEARCH IN THE FIELD OF LINGUISTICS AND NATURAL LANGUAGE PROCESSING; DESIGN AND DEVELOPMENT OF COMPUTER HARDWARE AND SOFTWARE; NEW PRODUCTS RESEARCH AND DEVELOPMENT FOR OTHERS; DEVELOPMENT, INSTALLATION, MAINTENANCE, UPDATING AND RENTAL OF COMPUTER SOFTWARE; COMPUTER PROGRAMMING; DATA CONVERSION OF COMPUTER PROGRAMS AND DATA, NOT PHYSICAL CONVERSION; CONVERSION OF DATA OR DOCUMENTS FROM PHYSICAL TO ELECTRONIC MEDIA, IN CLASS 42 (U.S. CLS. 100 AND 101).



David J. Kyros

Director of the United States Patent and Trademark Office

Reg. No. 4,074,503 THE MARK CONSISTS OF STANDARD CHARACTERS WITHOUT CLAIM TO ANY PARTICULAR FONT, STYLE, SIZE, OR COLOR.

SEC. 2(F) AS TO "TRANSCRIBER".

PRIORITY CLAIMED UNDER SEC. 44(D) ON FRANCE APPLICATION NO. 083606703, FILED 10-23-2008, REG. NO. 083606703, DATED 3-27-2009, EXPIRES 10-23-2018.

SN 77-719,878, FILED 4-22-2009.

WILLIAM VERHOSEK, EXAMINING ATTORNEY

United States of America

United States Patent and Trademark Office

CENTRIQUIP

Reg. No. 4,074,504

Registered Dec. 20, 2011

Int. Cl.: 7

TRADEMARK

PRINCIPAL REGISTER

ASHBROOK SIMON-HARTLEY OPERATIONS, LP (TEXAS LIMITED PARTNERSHIP), DBA
ASHBROOK SIMON-HARTLEY,
11600 EAST HARDY STREET
HOUSTON, TX 77093

FOR: MATERIALS HANDLING MACHINES, NAMELY, CLASSIFIERS AND PARTS AND
FITTINGS THEREFOR; CENTRIFUGES AND PARTS AND FITTINGS THEREFOR, IN CLASS
7 (U.S. CLS. 13, 19, 21, 23, 31, 34 AND 35).

FIRST USE 4-22-2009; IN COMMERCE 4-22-2009.

THE MARK CONSISTS OF STANDARD CHARACTERS WITHOUT CLAIM TO ANY PAR-
TICULAR FONT, STYLE, SIZE, OR COLOR.

SN 77-719,880, FILED 4-22-2009.

KHANH LE, EXAMINING ATTORNEY



David J. Kyffers

Director of the United States Patent and Trademark Office

United States of America

United States Patent and Trademark Office

ADVANCE AUTO

Reg. No. 4,074,505

Registered Dec. 20, 2011

Int. Cl.: 35

SERVICE MARK

PRINCIPAL REGISTER

ADVANCE AUTO INNOVATIONS, LLC (VIRGINIA LIMITED LIABILITY COMPANY)
5008 AIRPORT ROAD
ROANOKE, VA 24012

FOR: RETAIL AUTO AND VEHICLE PARTS AND ACCESSORIES STORE SERVICES; RETAIL AUTO AND VEHICLE PARTS AND ACCESSORIES STORE SERVICES FOR COMMERCIAL CUSTOMERS; ONLINE RETAIL AUTO AND VEHICLE PARTS AND ACCESSORIES STORE SERVICES; ONLINE RETAIL AUTO AND VEHICLE PARTS AND ACCESSORIES STORE SERVICES FOR COMMERCIAL CUSTOMERS, IN CLASS 35 (U.S. CLS. 100, 101 AND 102).

FIRST USE 0-0-1974; IN COMMERCE 0-0-1974.

THE MARK CONSISTS OF STANDARD CHARACTERS WITHOUT CLAIM TO ANY PARTICULAR FONT, STYLE, SIZE, OR COLOR.

OWNER OF U.S. REG. NOS. 1,484,796, 1,847,137, AND OTHERS.

NO CLAIM IS MADE TO THE EXCLUSIVE RIGHT TO USE "AUTO" , APART FROM THE MARK AS SHOWN.

SN 77-726,509, FILED 4-30-2009.

JOHN KELLY, EXAMINING ATTORNEY



David J. Kyfos

Director of the United States Patent and Trademark Office

United States of America

United States Patent and Trademark Office

JamParty

Reg. No. 4,074,506

ZIVIX, LLC (MINNESOTA LIMITED LIABILITY COMPANY)
221 1ST STREET NORTH, SUITE 110
MINNEAPOLIS, MN 55401

Registered Dec. 20, 2011

Int. Cl.: 9

FOR: INTERACTIVE MULTIMEDIA COMPUTER PROGRAM FOR MUSIC COMPOSITION, PERFORMANCE AND COLLABORATION; INTERACTIVE VIDEO GAME PROGRAMS; VIDEO AND COMPUTER GAME PROGRAMS; VIDEO GAME CARTRIDGES AND DISCS, IN CLASS 9 (U.S. CLS. 21, 23, 26, 36 AND 38).

TRADEMARK

PRINCIPAL REGISTER

FIRST USE 1-15-2010; IN COMMERCE 8-10-2010.

THE MARK CONSISTS OF STANDARD CHARACTERS WITHOUT CLAIM TO ANY PARTICULAR FONT, STYLE, SIZE, OR COLOR.

SN 77-729,090, FILED 5-5-2009.

CHRISTOPHER BUONGIORNO, EXAMINING ATTORNEY



David J. Kyffers

Director of the United States Patent and Trademark Office

United States of America

United States Patent and Trademark Office

CabLED

Reg. No. 4,074,507

Registered Dec. 20, 2011

Int. Cls.: 9 and 11

TRADEMARK

PRINCIPAL REGISTER

HUIZHOU LIGHT ENGINE LTD (CHINA LIMITED LIABILITY COMPANY)
NO. 7 BUILDING, NO. 21 JIANG BEI YUN
SHAN, EAST ROAD
HUIZHOU CITY, GUANGDONG, CHINA

FOR: APPARATUS AND INSTRUMENTS FOR CONDUCTING, SWITCHING AND TRANSFORMING ELECTRICITY, NAMELY, ELECTRICITY CONNECTORS, ELECTRIC COLLECTORS, ELECTRIC RELAYS, ELECTRIC CONDUCTORS, ELECTRIC REGULATORS, ELECTRICITY TRANSFORMERS, AND ELECTRICITY REDUCERS, IN CLASS 9 (U.S. CLS. 21, 23, 26, 36 AND 38).

FIRST USE 1-1-2011; IN COMMERCE 9-1-2011.

FOR: ELECTRIC LIGHTING FIXTURES FOR USE IN DISPLAY, COMMERCIAL, INDUSTRIAL, RESIDENTIAL, AND ARCHITECTURAL LIGHTING APPLICATIONS; LED LIGHTING STRIPS; AND CONNECTORS AND MOUNTINGS FOR USE THEREWITH, IN CLASS 11 (U.S. CLS. 13, 21, 23, 31 AND 34).

FIRST USE 1-1-2011; IN COMMERCE 9-1-2011.

THE MARK CONSISTS OF STANDARD CHARACTERS WITHOUT CLAIM TO ANY PARTICULAR FONT, STYLE, SIZE, OR COLOR.

SN 77-730,568, FILED 5-6-2009.

KATHERINE CONNOLLY, EXAMINING ATTORNEY



David J. Kybas

Director of the United States Patent and Trademark Office

United States of America

United States Patent and Trademark Office

HAWX

Reg. No. 4,074,508

Registered Dec. 20, 2011

Int. Cls.: 9 and 35

TRADEMARK

SERVICE MARK

PRINCIPAL REGISTER

HAWX OUTDOORS, INC. (WASHINGTON CORPORATION)
1750 GRANT AVENUE
BLAINE, WA 98230

FOR: ELECTRICAL ANIMAL BEHAVIOR TRAINING AND CONTROL SYSTEMS, NAMELY, REMOTE TRAINING SYSTEMS CONSISTING OF TRANSMITTERS AND REMOTE CONTROLLED RECEIVER ANIMAL COLLARS; ELECTRONIC ANIMAL CONFINEMENT SYSTEMS CONSISTING OF TRANSMITTERS, ELECTRICAL TRANSFORMERS, WIRES, AND RECEIVER COLLARS; ELECTRICAL ANIMAL TRACKING AND LOCATING SYSTEMS CONSISTING OF ELECTRICAL RECEIVERS AND ELECTRICAL ANIMAL TRANSMITTER COLLARS; ANIMAL GPS TRACKING COLLARS; BATTERY POWERED ANTI-BARK COLLARS WHICH USE VIBRATION AND BEEPERS TO CONTROL DOG BEHAVIOR, IN CLASS 9 (U.S. CLS. 21, 23, 26, 36 AND 38).

FIRST USE 5-26-2011; IN COMMERCE 5-26-2011.

FOR: ONLINE AND MAIL ORDER RETAIL STORE SERVICES FEATURING PET ACCESSORIES, ANIMAL BEHAVIOR TRAINING AND CONTROL SYSTEMS, ELECTRONIC ANIMAL CONFINEMENT SYSTEMS, ELECTRONIC ANIMAL TRACKING AND LOCATING SYSTEMS, REMOTE CONTROL LAUNCHERS AND ACCESSORIES THEREFOR FOR LAUNCHING LIVE OR DEAD BIRDS AND PLASTIC AND FOAM CYLINDERS FOR RETRIEVAL BY DOGS, ANIMAL TOYS AND ANIMAL PLAY TOYS, IN CLASS 35 (U.S. CLS. 100, 101 AND 102).

FIRST USE 1-0-2010; IN COMMERCE 1-0-2010.

THE MARK CONSISTS OF STANDARD CHARACTERS WITHOUT CLAIM TO ANY PARTICULAR FONT, STYLE, SIZE, OR COLOR.

SN 77-734,070, FILED 5-11-2009.

EDWARD NELSON, EXAMINING ATTORNEY



David J. Kypos

Director of the United States Patent and Trademark Office

United States of America

United States Patent and Trademark Office

GOLD'S GYM

Reg. No. 4,074,509

Registered Dec. 20, 2011

Int. Cl.: 9

TRADEMARK

PRINCIPAL REGISTER

GOLD'S GYM LICENSING LLC (DELAWARE LIMITED LIABILITY COMPANY)
SUITE 1300
125 EAST JOHN CARPENTER FREEWAY
IRVING, TX 75062

FOR: DIGITAL MEDIA, NAMELY, DOWNLOADABLE VIDEO RECORDINGS AND DVDS
FEATURING INFORMATION AND INSTRUCTION IN THE FIELDS OF EXERCISE, HEALTH
AND WELLNESS, IN CLASS 9 (U.S. CLS. 21, 23, 26, 36 AND 38).

FIRST USE 3-31-2009; IN COMMERCE 3-31-2009.

THE MARK CONSISTS OF STANDARD CHARACTERS WITHOUT CLAIM TO ANY PAR-
TICULAR FONT, STYLE, SIZE, OR COLOR.

OWNER OF U.S. REG. NOS. 1,210,685, 1,845,939, AND OTHERS.

SN 77-737,285, FILED 5-14-2009.

LANA PHAM, EXAMINING ATTORNEY



David J. Kyffers

Director of the United States Patent and Trademark Office

United States of America

United States Patent and Trademark Office



Reg. No. 4,074,510

Registered Dec. 20, 2011

Int. Cl.: 9

TRADEMARK

PRINCIPAL REGISTER

GOLD'S GYM LICENSING LLC (DELAWARE LIMITED LIABILITY COMPANY)
SUITE 1300
125 EAST JOHN CARPENTER FREEWAY
IRVING, TX 75062

FOR: DIGITAL MEDIA, NAMELY, DOWNLOADABLE VIDEO RECORDINGS AND DVDS
FEATURING INFORMATION AND INSTRUCTION IN THE FIELDS OF EXERCISE, HEALTH
AND WELLNESS, IN CLASS 9 (U.S. CLS. 21, 23, 26, 36 AND 38).

FIRST USE 3-31-2009; IN COMMERCE 3-31-2009.

OWNER OF U.S. REG. NOS. 2,068,399, 3,316,556, AND OTHERS.

THE MARK CONSISTS OF A MAN IN SILHOUETTE LIFTING A BARBELL.

SN 77-737,681, FILED 5-15-2009.

LANA PHAM, EXAMINING ATTORNEY



David J. Kybas

Director of the United States Patent and Trademark Office

United States of America

United States Patent and Trademark Office

DISNEY G-FORCE

Reg. No. 4,074,511

DISNEY ENTERPRISES, INC. (DELAWARE CORPORATION)
500 SOUTH BUENA VISTA STREET
BURBANK, CA 91521

Registered Dec. 20, 2011

Int. Cl.: 41

FOR: DISTRIBUTION OF MOTION PICTURE FILMS; PROVISION OF INFORMATION IN THE FIELD OF ENTERTAINMENT VIA COMMUNICATION AND COMPUTER NETWORKS, IN CLASS 41 (U.S. CLS. 100, 101 AND 107).

SERVICE MARK

FIRST USE 12-15-2009; IN COMMERCE 12-15-2009.

PRINCIPAL REGISTER

THE MARK CONSISTS OF STANDARD CHARACTERS WITHOUT CLAIM TO ANY PARTICULAR FONT, STYLE, SIZE, OR COLOR.

SN 77-740,563, FILED 5-19-2009.

ANDREW LEASER, EXAMINING ATTORNEY



David J. Kyros

Director of the United States Patent and Trademark Office

United States of America
United States Patent and Trademark Office

ECOTROL

Reg. No. 4,074,512

GREENBILD MANUFACTURING, LLC (FLORIDA LIMITED LIABILITY COMPANY)
130 MAT TRAIL

Registered Dec. 20, 2011

PALATKA, FL 32177

Int. Cl.: 11

FOR: GEOTHERMAL HEAT PUMP SYSTEM COMPONENTS, NAMELY, GROUND LOOP
FLOW CONTROL UNIT, IN CLASS 11 (U.S. CLS. 13, 21, 23, 31 AND 34).

TRADEMARK

FIRST USE 6-30-2011; IN COMMERCE 6-30-2011.

PRINCIPAL REGISTER

THE MARK CONSISTS OF STANDARD CHARACTERS WITHOUT CLAIM TO ANY PAR-
TICULAR FONT, STYLE, SIZE, OR COLOR.

SN 77-745,317, FILED 5-27-2009.

VIVIAN MICZNIK FIRST, EXAMINING ATTORNEY



David J. Kybas

Director of the United States Patent and Trademark Office

United States of America

United States Patent and Trademark Office

FREEDOM: noun, The Responsible Exercise of Individual Authority. theBushwhacker.com

Reg. No. 4,074,513

HAHN, JAMES (UNITED STATES INDIVIDUAL)
302 HALYARD CT.

Registered Dec. 20, 2011

WILMINGTON, NC 28405

Int. Cl.: 41

FOR: ONLINE JOURNALS, NAMELY, BLOGS FEATURING REPORTS ON CONSTITUTIONAL LAW AS IT RELATES TO SOCIAL TOPICS, IN CLASS 41 (U.S. CLS. 100, 101 AND 107).

SERVICE MARK

FIRST USE 6-25-1996; IN COMMERCE 9-24-2009.

PRINCIPAL REGISTER

THE MARK CONSISTS OF STANDARD CHARACTERS WITHOUT CLAIM TO ANY PARTICULAR FONT, STYLE, SIZE, OR COLOR.

SN 77-750,817, FILED 6-3-2009.

KATHLEEN LORENZO, EXAMINING ATTORNEY



David J. Kybas

Director of the United States Patent and Trademark Office

United States of America

United States Patent and Trademark Office

HOODWINKED

Reg. No. 4,074,514

KANBAR ENTERTAINMENT, LLC (CALIFORNIA LIMITED LIABILITY COMPANY)
2100 JACKSON ST.

Registered Dec. 20, 2011

SAN FRANCISCO, CA 94115

Int. Cl.: 41

SERVICE MARK

PRINCIPAL REGISTER

FOR: ENTERTAINMENT IN THE NATURE OF A SERIES OF MOVIES, NAMELY, PRODUCTION AND DISTRIBUTION OF MOTION PICTURES; ENTERTAINMENT SERVICES, NAMELY, A MULTIMEDIA PROGRAM SERIES FEATURING COMEDY, ACTION AND ADVENTURE DISTRIBUTED VIA VARIOUS PLATFORMS ACROSS MULTIPLE FORMS OF TRANSMISSION MEDIA; ENTERTAINMENT SERVICES, NAMELY, AN ON-GOING SERIES FEATURING MOVIES, TRAILERS, VIDEOS, PHOTOS, AND AUDIO PROVIDED THROUGH MOVIE THEATRES AND WEB SITES; ENTERTAINMENT SERVICES, NAMELY, PROVIDING A WEB SITE FEATURING MUSICAL PERFORMANCES, MUSICAL VIDEOS, RELATED FILM CLIPS, PHOTOGRAPHS, AND OTHER MULTIMEDIA MATERIALS FEATURING A SERIES OF MOVIES; ENTERTAINMENT SERVICES, NAMELY, PROVIDING A WEB SITE FEATURING PHOTOGRAPHIC, AUDIO, VIDEO AND PROSE PRESENTATIONS FEATURING A SERIES OF MOVIES; ON-LINE PUBLICATION OF NEWSLETTERS, BLOGS, AND ARTICLES, FEATURING INFORMATION ON A SERIES OF MOVIES; ENTERTAINMENT SERVICES, NAMELY, PROVIDING A WEBSITE FEATURING MUSICAL VIDEOS, RELATED FILM CLIPS, PHOTOGRAPHS, AND OTHER MULTIMEDIA MATERIALS IN THE FIELD OF A SERIES OF MOVIES, IN CLASS 41 (U.S. CLS. 100, 101 AND 107).

FIRST USE 3-0-2011; IN COMMERCE 3-0-2011.

THE MARK CONSISTS OF STANDARD CHARACTERS WITHOUT CLAIM TO ANY PARTICULAR FONT, STYLE, SIZE, OR COLOR.

SN 77-752,412, FILED 6-4-2009.

MARLENE BELL, EXAMINING ATTORNEY



David J. Kybas

Director of the United States Patent and Trademark Office

United States of America

United States Patent and Trademark Office

LIGHTS WHERE YOU LOOK

Reg. No. 4,074,515

Registered Dec. 20, 2011

Int. Cl.: 25

TRADEMARK

PRINCIPAL REGISTER

WATERS INDUSTRIES, INC. (ILLINOIS CORPORATION)
213 WEST MAIN STREET
WEST DUNDEE, IL 60118

FOR: HEADWEAR WITH INTEGRATED LIGHTS, IN CLASS 25 (U.S. CLS. 22 AND 39).

FIRST USE 6-0-2009; IN COMMERCE 6-0-2009.

THE MARK CONSISTS OF STANDARD CHARACTERS WITHOUT CLAIM TO ANY PARTICULAR FONT, STYLE, SIZE, OR COLOR.

SN 77-754,539, FILED 6-8-2009.

MARK SHINER, EXAMINING ATTORNEY



David J. Kyffers

Director of the United States Patent and Trademark Office

United States of America

United States Patent and Trademark Office

sinsville

Reg. No. 4,074,516

BUILT FOR SIN (CALIFORNIA LIMITED LIABILITY COMPANY)
1517 S. BROADMOOR AVE
W. COVINA, CA 91790

Registered Dec. 20, 2011

Int. Cl.: 25

FOR: BELTS FOR CLOTHING; CLOTHING, NAMELY, KHAKIS; EYESHADES; GLOVES AS CLOTHING; HOODS; INFANT AND TODDLER ONE PIECE CLOTHING; JACKETS; JERSEYS; LEATHER BELTS; SHORT SETS; TOPS; WEARABLE GARMENTS AND CLOTHING, NAMELY, SHIRTS, IN CLASS 25 (U.S. CLS. 22 AND 39).

TRADEMARK

PRINCIPAL REGISTER

FIRST USE 5-1-2010; IN COMMERCE 5-1-2010.

THE MARK CONSISTS OF STANDARD CHARACTERS WITHOUT CLAIM TO ANY PARTICULAR FONT, STYLE, SIZE, OR COLOR.

SN 77-755,861, FILED 6-10-2009.

LINDA ESTRADA, EXAMINING ATTORNEY



David J. Kybas

Director of the United States Patent and Trademark Office

United States of America

United States Patent and Trademark Office

GAME OF THRONES

Reg. No. 4,074,517

HOME BOX OFFICE, INC. (DELAWARE CORPORATION)
1100 AVENUE OF THE AMERICAS
NEW YORK, NY 10036

Registered Dec. 20, 2011

Int. Cl.: 25

FOR: CLOTHING, NAMELY, SHIRTS; T-SHIRTS; HEADGEAR, NAMELY, CAPS; ALL THE
AFOREMENTIONED GOODS RELATING TO AN ONGOING TELEVISION SERIES, IN
CLASS 25 (U.S. CLS. 22 AND 39).

TRADEMARK

FIRST USE 4-17-2011; IN COMMERCE 4-17-2011.

PRINCIPAL REGISTER

THE MARK CONSISTS OF STANDARD CHARACTERS WITHOUT CLAIM TO ANY PAR-
TICULAR FONT, STYLE, SIZE, OR COLOR.

SN 77-756,225, FILED 6-10-2009.

LEIGH LOWRY, EXAMINING ATTORNEY



David J. Kybas

Director of the United States Patent and Trademark Office

United States of America

United States Patent and Trademark Office

FACEVSION

Reg. No. 4,074,518

Registered Dec. 20, 2011

Int. Cls.: 9, 38, and 42

TRADEMARK

SERVICE MARK

PRINCIPAL REGISTER

FACEVSION TECHNOLOGY INC. (TAIWAN CORPORATION)
SHIHLIN DISTRICT
9F., NO.116, HOUGANG ST.
TAIPEI CITY, TAIWAN 11170

FOR: WEBCAMS; MINI-PCI CARDS, ENCODED ELECTRONIC CHIP CARDS CONTAINING COMPUTER PROGRAMMING FOR USE IN ENCODING/DECODING/TRANSCODING DATA AND TO ALLOW REAL-TIME HIGH DEFINITION AUDIOVISUAL COMMUNICATIONS; TELECOMMUNICATIONS AND DATA NETWORKING HARDWARE, NAMELY, UNIVERSAL VIDEO CODING HARDWARE, NAMELY, DEVICES FOR TRANSPORTING AND AGGREGATING VOICE, DATA AND VIDEO COMMUNICATIONS ACROSS MULTIPLE NETWORK INFRASTRUCTURES AND COMMUNICATIONS PROTOCOLS; PORTABLE ELECTRONIC DEVICES, NAMELY, MP3 PLAYERS, TABLETS AND PORTABLE TELECOMMUNICATION INSTANT MESSAGING DEVICE AND BLANK SMART CARDS FOR USE IN FACILITATING VISUAL COMMUNICATIONS, AUDIO COMMUNICATIONS AND THE PROVISION OF ENTERTAINMENT CONTENT VIA MOBILE PHONES; DIGITAL ENHANCED CORDLESS TECHNOLOGY TELEPHONES; COMPUTER SOFTWARE FOR USE IN ORGANIZING, TRANSMITTING, EXCHANGING MANIPULATING, AND REVIEWING VIDEO AND AUDIO CONTENT ON PORTABLE CONSUMER ELECTRONIC DEVICES, IN CLASS 9 (U.S. CLS. 21, 23, 26, 36 AND 38).

FIRST USE 3-0-2009; IN COMMERCE 9-0-2009.

FOR: PROVIDING VOICE OVER INTERNET PROTOCOL (VOIP) SERVICES AND HD VIDEO COMMUNICATIONS SERVICES, NAMELY, VIDEO BROADCASTING SERVICES; ELECTRONIC TRANSMISSION OF DATA AND DOCUMENTS OVER COMPUTER TERMINALS, AND INSTANT MESSAGING SERVICES; WEBCASTING AND WEB CONFERENCING SERVICES, IN CLASS 38 (U.S. CLS. 100, 101 AND 104).

FIRST USE 3-0-2009; IN COMMERCE 9-0-2009.

FOR: COMPUTER SERVICES AND SOFTWARE DEVELOPMENT FOR OTHERS, NAMELY, DESIGN FOR OTHERS OF COMPUTER SOFTWARE AND HARDWARE FOR USE IN TELECOMMUNICATIONS AND VOICE OVER INTERNET PROTOCOL (VOIP) AND HD VIDEO COMMUNICATIONS APPLICATIONS, DATA TRANSMISSION AND INSTANT MESSAGING SERVICES, IN CLASS 42 (U.S. CLS. 100 AND 101).



David J. Kybas

Director of the United States Patent and Trademark Office

Reg. No. 4,074,518 FIRST USE 3-0-2009; IN COMMERCE 9-0-2009.

THE MARK CONSISTS OF STANDARD CHARACTERS WITHOUT CLAIM TO ANY PARTICULAR FONT, STYLE, SIZE, OR COLOR.

SN 77-756,358, FILED 6-10-2009.

EUGENIA MARTIN, EXAMINING ATTORNEY

United States of America

United States Patent and Trademark Office

KWIK-HITCH

Reg. No. 4,074,519

MOWRIS, RICHARD, W. (UNITED STATES INDIVIDUAL)
3638 HERMITAGE TRAIL
ROCKFORD, IL 61114

Registered Dec. 20, 2011

Int. Cl.: 12

FOR: METAL LOCKING DEVICE FOR TRAILER HITCH COUPLERS; TRAILER HITCH BALL COVERS; TRAILER HITCH COVERS; TRAILER HITCHES, IN CLASS 12 (U.S. CLS. 19, 21, 23, 31, 35 AND 44).

TRADEMARK

FIRST USE 6-0-2009; IN COMMERCE 6-0-2009.

PRINCIPAL REGISTER

THE MARK CONSISTS OF STANDARD CHARACTERS WITHOUT CLAIM TO ANY PARTICULAR FONT, STYLE, SIZE, OR COLOR.

SN 77-759,018, FILED 6-13-2009.

MATTHEW EINSTEIN, EXAMINING ATTORNEY



David J. Kyffers

Director of the United States Patent and Trademark Office

United States of America

United States Patent and Trademark Office

LOCKDOWN

Reg. No. 4,074,520

WARREN, ANDREW SCOTT (UNITED STATES INDIVIDUAL)
8802 N. 54TH AVE.
GLENDALE, AZ 85302 AND

Registered Dec. 20, 2011

Int. Cls.: 14, 25, and 35

BARKER, WILLIAM RAYMOND (UNITED STATES INDIVIDUAL)
16416 N. 38TH STREET
PHOENIX, AZ 85032

TRADEMARK

FOR: JEWELRY , IN CLASS 14 (U.S. CLS. 2, 27, 28 AND 50).

SERVICE MARK

FIRST USE 5-1-2011; IN COMMERCE 5-1-2011.

PRINCIPAL REGISTER

FOR: CLOTHING, NAMELY, SHIRTS, T-SHIRTS, TANK TOPS, SPAGHETTI STRAP SHIRTS, HATS, BEANIES, SWEAT SHIRTS, UNDERGARMENTS, IN CLASS 25 (U.S. CLS. 22 AND 39).

FIRST USE 10-1-2009; IN COMMERCE 10-1-2009.

FOR: ONLINE RETAIL STORE SERVICES FEATURING CLOTHING, BELT BUCKLES, AND JEWELRY, IN CLASS 35 (U.S. CLS. 100, 101 AND 102).

FIRST USE 8-1-2001; IN COMMERCE 8-1-2001.

THE MARK CONSISTS OF STANDARD CHARACTERS WITHOUT CLAIM TO ANY PARTICULAR FONT, STYLE, SIZE, OR COLOR.

SN 77-761,338, FILED 6-16-2009.

SOPHIA S. KIM, EXAMINING ATTORNEY



David J. Kybas

Director of the United States Patent and Trademark Office

United States of America

United States Patent and Trademark Office

Flippers

Reg. No. 4,074,521

DABBLE, INC. (TEXAS PARTNERSHIP)

Registered Dec. 20, 2011

P.O. BOX 500091
AUSTIN, TX 78750

Int. Cl.: 16

FOR: FLIP BOOKS, IN CLASS 16 (U.S. CLS. 2, 5, 22, 23, 29, 37, 38 AND 50).

TRADEMARK

FIRST USE 3-28-2008; IN COMMERCE 2-7-2011.

PRINCIPAL REGISTER

THE MARK CONSISTS OF STANDARD CHARACTERS WITHOUT CLAIM TO ANY PARTICULAR FONT, STYLE, SIZE, OR COLOR.

SN 77-771,709, FILED 6-30-2009.

KATHERINE STOIDES, EXAMINING ATTORNEY



David J. Kybas

Director of the United States Patent and Trademark Office

United States of America

United States Patent and Trademark Office

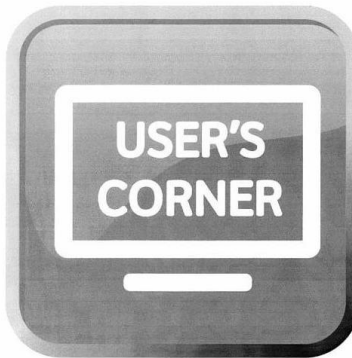

Reg. No. 4,074,522

Registered Dec. 20, 2011

Int. Cls.: 35, 37, and 42

SERVICE MARK

PRINCIPAL REGISTER

AT&T INTELLECTUAL PROPERTY II, L.P. (NEVADA LIMITED PARTNERSHIP)
645 EAST PLUMB LANE
RENO, NV 89502

FOR: PROVIDING A WEBSITE AT WHICH CUSTOMERS CAN MANAGE ACCOUNT INFORMATION FOR TELECOMMUNICATIONS SERVICES, INTERNET SERVICES, WIRELESS ELECTRONIC SERVICES, AND TELEVISION AND VIDEO TRANSMISSION SERVICES; CUSTOMER SERVICE IN THE FIELD OF TELECOMMUNICATIONS, NAMELY, PROVIDING A WEBSITE AND ON-LINE INFORMATION TO PROVIDE CUSTOMERS WITH CUSTOMER SERVICE ASSISTANCE FOR THEIR TELECOMMUNICATIONS SERVICES AND EQUIPMENT, INTERNET SERVICES AND EQUIPMENT, WIRELESS ELECTRONIC SERVICES AND EQUIPMENT, AND TELEVISION AND VIDEO TRANSMISSION SERVICES AND EQUIPMENT, IN CLASS 35 (U.S. CLS. 100, 101 AND 102).

FIRST USE 4-0-2010; IN COMMERCE 4-0-2010.

FOR: TECHNICAL SUPPORT SERVICES, NAMELY, PROVIDING A WEBSITE AND ON-LINE INFORMATION FEATURING TROUBLESHOOTING IN THE NATURE OF REPAIR OF COMPUTER HARDWARE, TELECOMMUNICATIONS EQUIPMENT, AND TELEVISION AND VIDEO EQUIPMENT, IN CLASS 37 (U.S. CLS. 100, 103 AND 106).

FIRST USE 4-0-2010; IN COMMERCE 4-0-2010.

FOR: TECHNICAL SUPPORT SERVICES, NAMELY, PROVIDING A WEBSITE AND ON-LINE INFORMATION FEATURING TROUBLESHOOTING IN THE NATURE OF DIAGNOSING PROBLEMS WITH COMPUTER HARDWARE, COMPUTER SOFTWARE, TELECOMMUNICATIONS EQUIPMENT, AND TELEVISION AND VIDEO EQUIPMENT, IN CLASS 42 (U.S. CLS. 100 AND 101).

FIRST USE 4-0-2010; IN COMMERCE 4-0-2010.

NO CLAIM IS MADE TO THE EXCLUSIVE RIGHT TO USE "USER'S", APART FROM THE MARK AS SHOWN.

THE MARK CONSISTS OF THE STYLIZED WORDING "USER'S" ABOVE THE STYLIZED WORDING "CORNER", ALL WITHIN THE DESIGN OF A TELEVISION SET REPRESENTED



David J. Kybas

Director of the United States Patent and Trademark Office

Reg. No. 4,074,522 BY THE OUTLINE OF A RECTANGLE AND A HORIZONTAL LINE. ALL OF THE ABOVE ELEMENTS ARE WITHIN THE DESIGN OF A SQUARE WITH ROUNDED CORNERS.

SN 77-772,013, FILED 7-1-2009.

JAY BESCH, EXAMINING ATTORNEY

United States of America

United States Patent and Trademark Office

Core Systems

Reg. No. 4,074,523

SUPERIOR INDUSTRIES, LLC (MINNESOTA LIMITED LIABILITY COMPANY)
315 EAST STATE HIGHWAY 28
MORRIS, MN 56267

Registered Dec. 20, 2011

Int. Cl.: 7

FOR: PULLEYS BEING PART OF MACHINES, NAMELY, ENGINEERED CLASS DRIVE PULLEYS, IN CLASS 7 (U.S. CLS. 13, 19, 21, 23, 31, 34 AND 35).

TRADEMARK

FIRST USE 10-31-2010; IN COMMERCE 10-31-2010.

PRINCIPAL REGISTER

THE MARK CONSISTS OF STANDARD CHARACTERS WITHOUT CLAIM TO ANY PARTICULAR FONT, STYLE, SIZE, OR COLOR.

NO CLAIM IS MADE TO THE EXCLUSIVE RIGHT TO USE "SYSTEMS", APART FROM THE MARK AS SHOWN.

SN 77-772,441, FILED 7-1-2009.

LINDA M. KING, EXAMINING ATTORNEY



David J. Kybas

Director of the United States Patent and Trademark Office

United States of America

United States Patent and Trademark Office

Invis-A-Rack

Reg. No. 4,074,524

Registered Dec. 20, 2011

Int. Cl.: 12

TRADEMARK

PRINCIPAL REGISTER

MCCALL, DONNY A (UNITED STATES INDIVIDUAL), DBA INVIS-A-RACK, LLC,
165 MAPLE STREET
SPARTA, NC 28675

FOR: AUTOMOTIVE CARGO RACK; BICYCLE RACKS FOR VEHICLES; CARGO CARRIERS FOR VEHICLES; MOTOR VEHICLES, NAMELY, AUTOMOBILES, TRUCKS, VANS, SPORT UTILITY VEHICLES AND STRUCTURAL PARTS THEREFOR; RACKS FOR VEHICLES FOR CANOES, KAYAKS, BICYCLES, BUILDING MATERIALS, LADDERS, IN CLASS 12 (U.S. CLS. 19, 21, 23, 31, 35 AND 44).

FIRST USE 7-20-2009; IN COMMERCE 8-1-2010.

THE MARK CONSISTS OF THE STYLIZED WORDING "INVIS-A-RACK" APPEARING IN YELLOW WITH BLACK SHADING GIVING THE LETTERS A THREE-DIMENSIONAL APPEARANCE

THE COLOR(S) YELLOW AND BLACK IS/ARE CLAIMED AS A FEATURE OF THE MARK.

SN 77-773,513, FILED 7-2-2009.

NICHOLAS ALTREE, EXAMINING ATTORNEY



David J. Kyffers

Director of the United States Patent and Trademark Office

United States of America

United States Patent and Trademark Office

BROADWIND

Reg. No. 4,074,525

BROADWIND ENERGY, INC. (DELAWARE CORPORATION)
47 EAST CHICAGO AVENUE
NAPERVILLE, IL 60540

Registered Dec. 20, 2011

Int. Cl.: 37

FOR: ENERGY SERVICES, NAMELY, PROVIDING INSTALLATION, MAINTENANCE AND REPAIR SERVICES FOR ENERGY SYSTEMS AND EQUIPMENT AND REPLACEMENT OF PARTS AND MAINTENANCE SUPPLIES IN CONNECTION THEREWITH, IN CLASS 37 (U.S. CLS. 100, 103 AND 106).

SERVICE MARK

PRINCIPAL REGISTER

FIRST USE 2-28-2008; IN COMMERCE 2-28-2008.

THE MARK CONSISTS OF STANDARD CHARACTERS WITHOUT CLAIM TO ANY PARTICULAR FONT, STYLE, SIZE, OR COLOR.

SN 77-774,923, FILED 7-6-2009.

KYLE PEETE, EXAMINING ATTORNEY



David J. Kyffers

Director of the United States Patent and Trademark Office

United States of America

United States Patent and Trademark Office



Reg. No. 4,074,526

BROADWIND ENERGY, INC. (DELAWARE CORPORATION)
47 EAST CHICAGO AVENUE
NAPERVILLE, IL 60540

Registered Dec. 20, 2011

Int. Cl.: 37

FOR: ENERGY SERVICES, NAMELY, PROVIDING INSTALLATION, MAINTENANCE AND REPAIR SERVICES FOR ENERGY SYSTEMS AND EQUIPMENT AND REPLACEMENT OF PARTS AND MAINTENANCE SUPPLIES IN CONNECTION THEREWITH, IN CLASS 37 (U.S. CLS. 100, 103 AND 106).

SERVICE MARK

PRINCIPAL REGISTER

FIRST USE 2-28-2008; IN COMMERCE 2-28-2008.

THE MARK CONSISTS OF THREE WAVY LINES CROSSING THROUGH EACH OTHER.

SN 77-774,926, FILED 7-6-2009.

KYLE PEETE, EXAMINING ATTORNEY



David J. Kybas

Director of the United States Patent and Trademark Office

United States of America

United States Patent and Trademark Office



Reg. No. 4,074,527

BROADWIND ENERGY, INC. (DELAWARE CORPORATION)
47 EAST CHICAGO AVENUE
NAPERVILLE, IL 60540

Registered Dec. 20, 2011

Int. Cl.: 37

FOR: ENERGY SERVICES, NAMELY, PROVIDING INSTALLATION, MAINTENANCE AND REPAIR SERVICES FOR ENERGY SYSTEMS AND EQUIPMENT AND REPLACEMENT OF PARTS AND MAINTENANCE SUPPLIES IN CONNECTION THEREWITH, IN CLASS 37 (U.S. CLS. 100, 103 AND 106).

SERVICE MARK

PRINCIPAL REGISTER

FIRST USE 2-28-2008; IN COMMERCE 2-28-2008.

NO CLAIM IS MADE TO THE EXCLUSIVE RIGHT TO USE "ENERGY", APART FROM THE MARK AS SHOWN.

THE MARK CONSISTS OF 3 WAVY LINES CROSSING THROUGH EACH OTHER. NEXT TO THE LINES IS THE WORD "BROADWIND" AND UNDERNEATH "BROADWIND" IS THE WORD "ENERGY".

SN 77-774,938, FILED 7-6-2009.

KYLE PEETE, EXAMINING ATTORNEY



David J. Kybas

Director of the United States Patent and Trademark Office

United States of America

United States Patent and Trademark Office

Hennessy Wood Floors

Reg. No. 4,074,528

Registered Dec. 20, 2011

Int. Cl.: 35

SERVICE MARK

PRINCIPAL REGISTER

ATAI, SOHRAB (UNITED STATES INDIVIDUAL), DBA HENNESSY WOOD FLOORS,
SUITE 5N
1440 S. STATE COLLEGE BLVD.
ANAHEIM, CA 92806

FOR: WHOLESALE DISTRIBUTORSHIPS FEATURING FLOORING; WHOLESALE AND
RETAIL STORE SERVICES FEATURING FLOORING; WHOLESALE ORDERING SERVICES
IN THE FIELD OF FLOORING, IN CLASS 35 (U.S. CLS. 100, 101 AND 102).

FIRST USE 4-1-2005; IN COMMERCE 4-1-2005.

THE MARK CONSISTS OF STANDARD CHARACTERS WITHOUT CLAIM TO ANY PAR-
TICULAR FONT, STYLE, SIZE, OR COLOR.

SEC. 2(F).

NO CLAIM IS MADE TO THE EXCLUSIVE RIGHT TO USE "WOOD FLOORS", APART
FROM THE MARK AS SHOWN.

SN 77-777,033, FILED 7-8-2009.

CHRISTINA SOBRAL, EXAMINING ATTORNEY



David J. Kybas

Director of the United States Patent and Trademark Office

United States of America

United States Patent and Trademark Office



Reg. No. 4,074,529

HORROR ENTERTAINMENT, LLC (DELAWARE LIMITED LIABILITY COMPANY)
5750 WILSHIRE BOULEVARD
LOS ANGELES, CA 90036

Registered Dec. 20, 2011

Int. Cls.: 9, 38, and 41

FOR: DOWNLOADABLE TELEVISION PROGRAMS, MOTION PICTURE FILMS, AUDIO CONTENT, VIDEO CONTENT, AND OTHER ENTERTAINMENT PROGRAMMING IN THE FIELDS OF HORROR, ACTION, ADVENTURE, DRAMA AND COMEDY PROVIDED VIA THE INTERNET; DOWNLOADABLE IMAGES, AUDIO CONTENT, AND VIDEO CONTENT VIA A GLOBAL COMPUTER NETWORK AND WIRELESS AND MOBILE COMMUNICATION DEVICES, IN CLASS 9 (U.S. CLS. 21, 23, 26, 36 AND 38).

TRADEMARK

SERVICE MARK

PRINCIPAL REGISTER

FIRST USE 7-31-2009; IN COMMERCE 7-31-2009.

FOR: TELEVISION BROADCASTING, BROADCASTING OF AUDIO AND VIDEO PROGRAMMING OVER A GLOBAL COMPUTER NETWORK; INTERNET BROADCASTING; CABLE TELEVISION BROADCASTING; CABLE TELEVISION TRANSMISSION; STREAMING OF TELEVISION PROGRAMMING, AND AUDIO, VIDEO AND AUDIOVISUAL MATERIAL VIA THE INTERNET AND VIA GLOBAL COMPUTER NETWORKS; VIDEO-ON-DEMAND TRANSMISSION SERVICES; WIRELESS ELECTRONIC TRANSMISSION OF VOICE SIGNALS, DATA, FACSIMILES, IMAGES AND INFORMATION, IN CLASS 38 (U.S. CLS. 100, 101 AND 104).

FIRST USE 7-31-2009; IN COMMERCE 7-31-2009.

FOR: ENTERTAINMENT SERVICES, NAMELY, PRODUCTION AND DISTRIBUTION OF TELEVISION, VIDEO ON DEMAND AND INTERNET PROGRAMS OR SEGMENTS THEREOF; PROVIDING INFORMATION RELATING TO HORROR OR SUSPENSE VIDEO OR AUDIO WORKS OR GAMES VIA THE INTERNET; AND PROVIDING ON-LINE NON-DOWNLOADABLE JOURNALS, MAGAZINES, NEWSPAPERS, NEWSLETTERS AND BLOGS IN ELECTRONIC FORM FEATURING HORROR, SUSPENSE ACTION, ADVENTURE AND DRAMA SUBJECT MATTER, IN CLASS 41 (U.S. CLS. 100, 101 AND 107).

FIRST USE 7-31-2009; IN COMMERCE 7-31-2009.

THE MARK CONSISTS OF A BLACK FACE, SIDE PROFILE WITH MOUTH WIDE OPEN AND SPLAT DESIGN ON THE TOP AND BACK OF THE HEAD.



David J. Kybas

Director of the United States Patent and Trademark Office

Reg. No. 4,074,529 SN 77-777,844, FILED 7-9-2009.

KATHERINE STOIDES, EXAMINING ATTORNEY

United States of America

United States Patent and Trademark Office

My Doctor Bk

Reg. No. 4,074,530

CARLTON, MARY E. (UNITED STATES INDIVIDUAL)
9152A SW 23RD STREET
DAVIE, FL 33324

Registered Dec. 20, 2011

Int. Cl.: 16

FOR: FILING FOLDERS, PAPER LABELS AND PRINTED INSTRUCTIONAL MATERIALS FOR ORGANIZING PERSONAL FILES; PERSONAL ORGANIZERS, IN CLASS 16 (U.S. CLS. 2, 5, 22, 23, 29, 37, 38 AND 50).

TRADEMARK

FIRST USE 12-28-2010; IN COMMERCE 8-29-2011.

PRINCIPAL REGISTER

THE MARK CONSISTS OF STANDARD CHARACTERS WITHOUT CLAIM TO ANY PARTICULAR FONT, STYLE, SIZE, OR COLOR.

NO CLAIM IS MADE TO THE EXCLUSIVE RIGHT TO USE "DOCTOR BK", APART FROM THE MARK AS SHOWN.

SN 77-780,215, FILED 7-14-2009.

B. PARADEWELAI, EXAMINING ATTORNEY



David J. Kyffers

Director of the United States Patent and Trademark Office

United States of America

United States Patent and Trademark Office

HEALTH COMMONS

Reg. No. 4,074,531

Registered Dec. 20, 2011

Int. Cls.: 35, 41, and 42

SERVICE MARK

PRINCIPAL REGISTER

CREATIVE COMMONS CORPORATION (MASSACHUSETTS NON-PROFIT CORPORATION)
444 CASTRO STREET
MOUNTAIN VIEW, CA 94041

FOR: PROMOTING THE EXCHANGE OF INFORMATION AND RESOURCES WITHIN THE SCIENTIFIC RESEARCH COMMUNITIES TO ACHIEVE ADVANCES IN THE FIELD OF HEALTHCARE; PROVIDING A WEBSITE THAT PROMOTES, FACILITATES AND ENCOURAGES THE FREE EXCHANGE OF SCIENTIFIC, MEDICAL AND PUBLIC HEALTH INFORMATION AND DATA; PROVIDING A WEBSITE THAT PROMOTES STANDARDIZATION OF SCIENTIFIC RESEARCH TECHNIQUES AND PROCESSES; PROVIDING A WEBSITE THAT PROMOTES BEST PRACTICES FOR SCIENTIFIC RESEARCH AND PRESENTATION OF RESEARCH DATA, IN CLASS 35 (U.S. CLS. 100, 101 AND 102).

FIRST USE 2-22-2009; IN COMMERCE 2-22-2009.

FOR: DEVELOPMENT AND DISSEMINATION OF EDUCATIONAL MATERIAL OF OTHERS IN THE FIELD OF SHARING RESEARCH DATA, IN CLASS 41 (U.S. CLS. 100, 101 AND 107).

FIRST USE 2-22-2009; IN COMMERCE 2-22-2009.

FOR: PROVIDING A WEBSITE FEATURING INFORMATION ABOUT HEALTH SCIENCES, BIOMEDICAL RESEARCH, BIOTECHNOLOGY, BIOLOGY, CHEMISTRY AND PHARMACOLOGY; PROVIDING A WEBSITE ALLOWING USERS TO UPLOAD SCIENTIFIC, MEDICAL AND PUBLIC HEALTH INFORMATION AND DATA; PROVIDING A WEBSITE ALLOWING USERS TO LINK TO AND PROVIDE LINKS TO SCIENTIFIC INFORMATION AND DATA, IN CLASS 42 (U.S. CLS. 100 AND 101).

FIRST USE 2-22-2009; IN COMMERCE 2-22-2009.

THE MARK CONSISTS OF STANDARD CHARACTERS WITHOUT CLAIM TO ANY PARTICULAR FONT, STYLE, SIZE, OR COLOR.

NO CLAIM IS MADE TO THE EXCLUSIVE RIGHT TO USE "HEALTH", APART FROM THE MARK AS SHOWN.

SN 77-782,595, FILED 7-16-2009.



David J. Kyffers

Director of the United States Patent and Trademark Office

Reg. No. 4,074,531 SAMUEL E. SHARPER JR., EXAMINING ATTORNEY

United States of America

United States Patent and Trademark Office



Reg. No. 4,074,532

Registered Dec. 20, 2011

Int. Cl.: 29

TRADEMARK

PRINCIPAL REGISTER

BLACK TIGER LLC (CALIFORNIA LIMITED LIABILITY COMPANY), DBA BLACK TIGER,
13837 MONTEREY LN
LA MIRADA, CA 90638

FOR: BEEF JERKY, IN CLASS 29 (U.S. CL. 46).

FIRST USE 4-1-2010; IN COMMERCE 4-1-2010.

SN 77-790,745, FILED 7-27-2009.

Laurie Kaufman, Examining Attorney

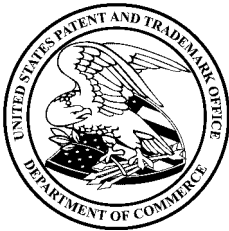

David J. Kybas

Director of the United States Patent and Trademark Office

United States of America

United States Patent and Trademark Office

EXACT STRETCH

Reg. No. 4,074,533

LIMITED STORES, LLC (DELAWARE LIMITED LIABILITY COMPANY)
7775 WALTON PARKWAY
NEW ALBANY, OH 43054

Registered Dec. 20, 2011

Int. Cl.: 25

FOR: CLOTHING, NAMELY, BLAZERS, BLOUSES, DRESSES, JACKETS, JEANS, KNIT SHIRTS, KNIT TOPS, PANTS, SHIRTS, SHORTS, SKIRTS, SLACKS, SUITS, SWEATERS AND T-SHIRTS, IN CLASS 25 (U.S. CLS. 22 AND 39).

TRADEMARK

FIRST USE 1-7-2008; IN COMMERCE 1-7-2008.

PRINCIPAL REGISTER

THE MARK CONSISTS OF STANDARD CHARACTERS WITHOUT CLAIM TO ANY PARTICULAR FONT, STYLE, SIZE, OR COLOR.

NO CLAIM IS MADE TO THE EXCLUSIVE RIGHT TO USE "STRETCH", APART FROM THE MARK AS SHOWN.

SN 77-792,358, FILED 7-29-2009.

JORDAN BAKER, EXAMINING ATTORNEY



David J. Kyros

Director of the United States Patent and Trademark Office

United States of America

United States Patent and Trademark Office



wings of courage

Reg. No. 4,074,534

Registered Dec. 20, 2011

Int. Cl.: 14

TRADEMARK

PRINCIPAL REGISTER

MIGHTY FINE VENTURES, LLC (CALIFORNIA LIMITED LIABILITY COMPANY)
135 SOUTH PARISH PLACE
BURBANK, CA 91506

FOR: (BASED ON USE IN COMMERCE) CHARMS; CHARMS FOR COLLAR JEWELRY AND BRACELET; CHARMS IN PRECIOUS METALS OR COATED THEREWITH; JEWELRY AND PRECIOUS STONES; JEWELRY; JEWELRY CHAINS; NECK CHAINS; NECKLACES; PENDANTS; PRECIOUS AND SEMI-PRECIOUS CRYSTAL STONES AND BEADS FOR USE IN JEWELRY; PRECIOUS AND SEMI-PRECIOUS GEMS; PRECIOUS AND SEMI-PRECIOUS STONES; PRECIOUS GEMSTONES; BRACELETS; BROOCHES; CUFF LINKS OF PRECIOUS METAL; EARRINGS; FANCY KEY RINGS OF PRECIOUS METALS; JEWELRY BOXES OF PRECIOUS METAL; JEWELRY CASES OF PRECIOUS METAL; JEWELRY WATCHES; JEWELRY, NAMELY, AMULETS; KEY CHAINS AS JEWELRY; KEY CHAINS OF PRECIOUS METAL; KEY RINGS OF PRECIOUS METAL; PINS; RINGS; TIE PINS; TIMEPIECES AND CHRONOMETRIC INSTRUMENTS; WATCH BANDS; WATCH BRACELETS; WATCH STRAPS; WATCHES, CLOCKS; WRIST WATCHES, IN CLASS 14 (U.S. CLS. 2, 27, 28 AND 50).

FIRST USE 5-4-2009; IN COMMERCE 5-4-2009.

THE MARK CONSISTS OF A BUTTERFLY WITH THE WORDS "WINGS OF COURAGE" UNDERNEATH.

SN 77-795,063, FILED 8-2-2009.

RAUL CORDOVA, EXAMINING ATTORNEY



David J. Kyros

Director of the United States Patent and Trademark Office

United States of America

United States Patent and Trademark Office

MEPS

Reg. No. 4,074,535

Registered Dec. 20, 2011

Int. Cl.: 7

TRADEMARK

PRINCIPAL REGISTER

EASY ENERGY SYSTEMS, INC. (MINNESOTA CORPORATION)
102 MILL STREET
WELCOME, MN 56181

FOR: CHEMICAL PROCESSING MACHINERY COMPRISED OF HOLDING TANKS, PROCESSING TANKS, DISTILLATION COLUMNS, LIQUID-SOLID SEPARATORS, AGITATORS, MICROWAVE HEATERS, PUMPS AND PROCESS CONTROLLERS FOR USE IN THE PRODUCTION OF ETHANOL, IN CLASS 7 (U.S. CLS. 13, 19, 21, 23, 31, 34 AND 35).

FIRST USE 10-17-2011; IN COMMERCE 10-17-2011.

THE MARK CONSISTS OF STANDARD CHARACTERS WITHOUT CLAIM TO ANY PARTICULAR FONT, STYLE, SIZE, OR COLOR.

SN 77-795,437, FILED 8-3-2009.

KATHERINE M. DUBRAY, EXAMINING ATTORNEY



David J. Kybas

Director of the United States Patent and Trademark Office

United States of America

United States Patent and Trademark Office

Owning Pink

Reg. No. 4,074,536

RANKIN, MELISSA K (UNITED STATES INDIVIDUAL)
69 STARBUCK DRIVE
MUIR BEACH, CA 94965

Registered Dec. 20, 2011

Int. Cls.: 9, 16, 41, and 44

FOR: ELECTRONIC PUBLICATIONS, NAMELY, BLOGS, ARTICLES, AND OTHER WRITINGS FEATURING WOMEN'S HEALTH, HEALTH, CREATIVITY, SPIRITUALITY, SEXUALITY, AUTHENTICITY, AGING, MOJO, EMPOWERMENT RECORDED ON COMPUTER MEDIA, IN CLASS 9 (U.S. CLS. 21, 23, 26, 36 AND 38).

TRADEMARK

FIRST USE 5-0-2009; IN COMMERCE 5-0-2009.

SERVICE MARK

PRINCIPAL REGISTER

FOR: BOOKS IN THE FIELD OF HEALTH, WOMEN'S HEALTH, CREATIVITY, SPIRITUALITY, SEXUALITY, AGING, MOJO, AUTHENTICITY, EMPOWERMENT; EDUCATIONAL PUBLICATIONS, NAMELY, BOOKS, MANUALS, ARTICLES, JOURNALS, AND OTHER WRITINGS IN THE FIELDS OF WOMEN'S HEALTH, HEALTH, CREATIVITY, SPIRITUALITY, SEXUALITY, AUTHENTICITY, AGING, MOJO, EMPOWERMENT; PUBLICATIONS, NAMELY, BOOKS, ARTICLES, JOURNALS, MANUALS IN THE FIELDS OF WOMEN'S HEALTH, HEALTH, CREATIVITY, SPIRITUALITY, SEXUALITY, AUTHENTICITY, AGING, MOJO, EMPOWERMENT, IN CLASS 16 (U.S. CLS. 2, 5, 22, 23, 29, 37, 38 AND 50).

FIRST USE 8-0-2010; IN COMMERCE 8-0-2010.



FOR: EDUCATIONAL SERVICES, NAMELY, PROVIDING CLASSES, WORKSHOPS, MENTORING, ONLINE WORKSHOPS, SEMINARS, ONLINE SEMINARS, MEETINGS IN THE FIELDS OF CREATIVITY, SPIRITUALITY, SEXUALITY, HEALTH, MOJO, AGING, AUTHENTICITY, EMPOWERMENT; MULTIMEDIA PUBLISHING OF BOOKS, MAGAZINES, JOURNALS, SOFTWARE, GAMES, MUSIC, AND ELECTRONIC PUBLICATIONS; PROVIDING A WEBSITE FEATURING E-BOOKS, BLOGS AND E-RECORDINGS IN THE FIELDS OF WOMEN'S HEALTH, HEALTH, CREATIVITY, SPIRITUALITY, SEXUALITY, AUTHENTICITY, AGING, MOJO, EMPOWERMENT, IN CLASS 41 (U.S. CLS. 100, 101 AND 107).

FIRST USE 1-1-2009; IN COMMERCE 1-1-2009.

David J. Kyros

FOR: HEALTHCARE, IN CLASS 44 (U.S. CLS. 100 AND 101).

FIRST USE 3-1-2009; IN COMMERCE 3-1-2009.

Director of the United States Patent and Trademark Office

Reg. No. 4,074,536 THE MARK CONSISTS OF STANDARD CHARACTERS WITHOUT CLAIM TO ANY PARTICULAR FONT, STYLE, SIZE, OR COLOR.

SN 77-801,075, FILED 8-10-2009.

KEVIN DINALLO, EXAMINING ATTORNEY

United States of America

United States Patent and Trademark Office

HEARTLAND

Reg. No. 4,074,537

Registered Dec. 20, 2011

Int. Cl.: 35

SERVICE MARK

PRINCIPAL REGISTER

HEARTLAND PAYMENT SYSTEMS, INC. (DELAWARE CORPORATION)
90 NASSAU STREET
PRINCETON, NJ 08542

FOR: PROMOTING THE ISSUANCE OF CREDIT CARD, DEBIT CARD, SMART CARD AND PAYMENT CARD ACCOUNTS THROUGH THE ADMINISTRATION OF INCENTIVE AWARD PROGRAMS, LOYALTY PROGRAMS AND AFFINITY PROGRAMS; PAYROLL PREPARATION SERVICES; ADMINISTRATION OF BUSINESS PAYROLL FOR OTHERS; BUSINESS ADVISORY SERVICES, CONSULTANCY AND INFORMATION; PUBLIC ADVOCACY TO PROMOTE AWARENESS OF CREDIT, DEBIT AND PAYMENT CARD PROCESSING PRACTICES, IN CLASS 35 (U.S. CLS. 100, 101 AND 102).

FIRST USE 9-0-2006; IN COMMERCE 9-0-2006.

THE MARK CONSISTS OF STANDARD CHARACTERS WITHOUT CLAIM TO ANY PARTICULAR FONT, STYLE, SIZE, OR COLOR.

OWNER OF U.S. REG. NOS. 2,742,163, 3,315,693, AND OTHERS.

SN 77-801,568, FILED 8-11-2009.

CURTIS FRENCH, EXAMINING ATTORNEY



David J. Kypos

Director of the United States Patent and Trademark Office

United States of America

United States Patent and Trademark Office

HEARTLAND

Reg. No. 4,074,538

Registered Dec. 20, 2011

Int. Cl.: 36

SERVICE MARK

PRINCIPAL REGISTER

HEARTLAND PAYMENT SYSTEMS, INC. (DELAWARE CORPORATION)
90 NASSAU STREET
PRINCETON, NJ 08542

FOR: FINANCIAL SERVICES, NAMELY, CREDIT CARD, DEBIT CARD, BANK CARD, SMART CARD AND PAYMENT CARD TRANSACTION PROCESSING SERVICES; CREDIT CARD, DEBIT CARD, BANK CARD, SMART CARD AND PAYMENT CARD VERIFICATION SERVICES; CHECK VERIFICATION AND PROCESSING SERVICES; CREDIT CARD, DEBIT CARD, BANK CARD, SMART CARD AND PAYMENT CARD AUTHORIZATION SERVICES; ELECTRONIC PROCESSING AND TRANSMISSION OF PAYMENT DATA; PROVIDING ELECTRONIC PROCESSING OF CREDIT CARD, DEBIT CARD, BANK CARD, SMART CARD AND PAYMENT CARD TRANSACTIONS VIA A PROPRIETARY AND SECURE FINANCIAL GLOBAL COMPUTER NETWORK; DEBIT CARD, SMART CARD AND PAYMENT CARD ACCOUNT SERVICES FEATURING A COMPUTER READABLE CARD; ELECTRONIC FUNDS TRANSFER SERVICES; PAYROLL TAX DEBITING SERVICES; PROVIDING ONLINE FINANCIAL SERVICES TO RETAIL MERCHANTS, NAMELY, PROVIDING FINANCIAL ACCOUNT MANAGEMENT SERVICES AND FINANCIAL CLEARANCE SERVICES IN THE NATURE OF CLEARING AND SETTLING FINANCIAL TRANSACTIONS FOR MERCHANTS; PROVIDING ACCOUNT TRANSACTION INFORMATION TO MERCHANTS, NAMELY, CREDIT CARD, DEBIT CARD, BANK CARD, SMART CARD AND PAYMENT CARD TRANSACTIONS INFORMATION AND BALANCES VIA A SECURE INTERNET WEBSITE; INFORMATION SERVICES, NAMELY, FINANCIAL INFORMATION PROVIDED BY ELECTRONIC MEANS, IN CLASS 36 (U.S. CLS. 100, 101 AND 102).

FIRST USE 12-18-1998; IN COMMERCE 12-18-1998.

THE MARK CONSISTS OF STANDARD CHARACTERS WITHOUT CLAIM TO ANY PARTICULAR FONT, STYLE, SIZE, OR COLOR.

OWNER OF U.S. REG. NOS. 2,742,163, 3,315,693, AND OTHERS.

SN 77-801,575, FILED 8-11-2009.

CURTIS FRENCH, EXAMINING ATTORNEY



David J. Kyfos

Director of the United States Patent and Trademark Office

United States of America

United States Patent and Trademark Office



Reg. No. 4,074,539

Registered Dec. 20, 2011

Int. Cl.: 3

TRADEMARK

PRINCIPAL REGISTER

CONOPCO, INC. (NEW YORK CORPORATION)
700 SYLVAN AVENUE
ENGLEWOOD CLIFFS, NJ 07632

FOR: BODY WASH, BEAUTY BARS FOR CLEANSING AND NOURISHING THE SKIN;
DEODORANT AND ANTIPERSPIRANT, IN CLASS 3 (U.S. CLS. 1, 4, 6, 50, 51 AND 52).

FIRST USE 2-0-2010; IN COMMERCE 2-0-2010.

THE MARK CONSISTS OF THE WORDS "MEN + CARE". A BIRD DESIGN IS DISPLAYED ON THE RIGHT SIDE OF THE WORD "MEN". THE BACKGROUND IS DARK GRAY BLUE. THE WORD "MEN" APPEARS IN WHITE. THE BIRD, PLUS SYMBOL AND THE WORD "CARE" ARE ALL SHADED GREY.

THE COLOR(S) WHITE, GRAY AND BLUE IS/ARE CLAIMED AS A FEATURE OF THE MARK.

SN 77-802,217, FILED 8-11-2009.

SKYE YOUNG, EXAMINING ATTORNEY



David J. Kybas

Director of the United States Patent and Trademark Office

United States of America

United States Patent and Trademark Office

AIR CANDY

Reg. No. 4,074,540

SIRIUS XM RADIO INC. (DELAWARE CORPORATION)
1221 AVENUE OF THE AMERICAS
NEW YORK, NY 10036

Registered Dec. 20, 2011

Int. Cl.: 41

FOR: ENTERTAINMENT SERVICES, NAMELY, AN ON-GOING AUDIO PROGRAM FEATURING MUSIC, PROVIDED VIA SATELLITE AND A GLOBAL COMMUNICATIONS NETWORK, IN CLASS 41 (U.S. CLS. 100, 101 AND 107).

SERVICE MARK

FIRST USE 8-0-2009; IN COMMERCE 8-0-2009.

PRINCIPAL REGISTER

THE MARK CONSISTS OF STANDARD CHARACTERS WITHOUT CLAIM TO ANY PARTICULAR FONT, STYLE, SIZE, OR COLOR.

SN 77-804,609, FILED 8-14-2009.

ALLISON HOLTZ, EXAMINING ATTORNEY



David J. Kyffers

Director of the United States Patent and Trademark Office

United States of America

United States Patent and Trademark Office

BE BLISSFUL

Reg. No. 4,074,541

MACKOWIAK, MANDY M (UNITED STATES INDIVIDUAL)
8107 W ROSEBURY DR
FRANKFORT, IL 60423

Registered Dec. 20, 2011

Int. Cl.: 18

FOR: HANDBAGS, PURSES AND MULTI-PURPOSE PURSES, IN CLASS 18 (U.S. CLS. 1, 2, 3, 22 AND 41).

TRADEMARK

FIRST USE 7-17-2011; IN COMMERCE 7-17-2011.

PRINCIPAL REGISTER

THE MARK CONSISTS OF STANDARD CHARACTERS WITHOUT CLAIM TO ANY PARTICULAR FONT, STYLE, SIZE, OR COLOR.

SN 77-810,675, FILED 8-22-2009.

ROBIN CHOSID, EXAMINING ATTORNEY



David J. Kyfos

Director of the United States Patent and Trademark Office

United States of America

United States Patent and Trademark Office

Bay Life

Reg. No. 4,074,542

Registered Dec. 20, 2011

Int. Cl.: 25

TRADEMARK

PRINCIPAL REGISTER

BAY LIFE LLC (ALABAMA LIMITED LIABILITY COMPANY)
4264 VEGA DRIVE
MOBILE, AL 36693

FOR: CLOTHING AND APPAREL, NAMELY, BATHING SUITS; BERMUDA SHORTS; BRIEFS; CAPS; CAPS WITH VISORS; FLEECE PULLOVERS; HATS; JACKETS; PANTIES; PANTS; SANDALS; SHIRTS; SHOES; SOCKS; SWEAT SHIRTS; SWEATERS; SWIM TRUNKS; SHORT SLEEVE AND LONG SLEEVE T-SHIRTS; UNDERWEAR; VISORS; WALKING SHORTS; WIND RESISTANT JACKETS, IN CLASS 25 (U.S. CLS. 22 AND 39).

FIRST USE 9-1-2009; IN COMMERCE 9-1-2009.

THE MARK CONSISTS OF STANDARD CHARACTERS WITHOUT CLAIM TO ANY PARTICULAR FONT, STYLE, SIZE, OR COLOR.

SN 77-811,939, FILED 8-25-2009.

FLORENTINA BLANDU, EXAMINING ATTORNEY



David J. Kybas

Director of the United States Patent and Trademark Office

United States of America

United States Patent and Trademark Office



Reg. No. 4,074,543

Registered Dec. 20, 2011

Int. Cls.: 40 and 42

SERVICE MARK

PRINCIPAL REGISTER

CARTON SERVICE, INC. (OHIO CORPORATION)
101 FIRST QUALITY DRIVE
NORRIS, TN 378281219

FOR: DESIGN PRINTING FOR OTHERS OF PACKAGING CARTONS, IN CLASS 40 (U.S. CLS. 100, 103 AND 106).

FIRST USE 12-31-2009; IN COMMERCE 12-31-2009.

FOR: PACKAGING DESIGN, NAMELY, PRIMARY AND SECONDARY PACKAGING CARTON DESIGN; PACKAGING DESIGN, NAMELY, BRAND PRIMARY AND SECONDARY PACKAGING DESIGN; PACKAGING DESIGN, NAMELY, PHARMACEUTICAL PRIMARY AND SECONDARY PACKAGING CARTON DESIGN, IN CLASS 42 (U.S. CLS. 100 AND 101).

FIRST USE 12-31-2009; IN COMMERCE 12-31-2009.

NO CLAIM IS MADE TO THE EXCLUSIVE RIGHT TO USE "PHARMA PACKAGING SOLUTIONS", APART FROM THE MARK AS SHOWN.

THE MARK CONSISTS OF A RECTANGLE WITH CONTRASTING LETTERING READING "PHARMA PACKAGING SOLUTIONS" WITH A SMALLER, CONTRASTING RECTANGLE ATTACHED TO THE LEFT WITH THE OUTLINE OF A CAPSULE INSIDE IT.

SN 77-813,112, FILED 8-26-2009.

PAUL MORENO, EXAMINING ATTORNEY



David J. Kybas

Director of the United States Patent and Trademark Office

United States of America

United States Patent and Trademark Office

The logo for JOMA WOOL features the words "JOMA WOOL" in a stylized, outlined font. Above the letters "O" and "M" in "JOMA", there is a decorative, wavy line that resembles a strand of yarn or a stylized wave.

Reg. No. 4,074,544

Registered Dec. 20, 2011

Int. Cls.: 22 and 24

TRADEMARK

PRINCIPAL REGISTER

JOHN MARSHALL AND COMPANY LIMITED (NEW ZEALAND LIMITED COMPANY (LTD.))
63 MANDEVILLE ST., 1ST FL., RICCARTON
CHRISTCHURCH, NEW ZEALAND

FOR: WOOL FIBERS, WOOL FIBERS AND FIBER FILL MATERIALS; WOOL FIBER FILL, IN CLASS 22 (U.S. CLS. 1, 2, 7, 19, 22, 42 AND 50).

FIRST USE 9-0-2011; IN COMMERCE 9-0-2011.

FOR: TEXTILES AND TEXTILE GOODS IN THIS CLASS, NAMELY, COVERS FOR BEDS, WOOL MATTRESS PROTECTORS, MATTRESS COVERS, ALL OF THE ABOVE GOODS CONSISTING WHOLLY OR IN SIGNIFICANT PART OF WOOL, IN CLASS 24 (U.S. CLS. 42 AND 50).

FIRST USE 9-0-2011; IN COMMERCE 9-0-2011.

OWNER OF U.S. REG. NO. 1,820,655.

NO CLAIM IS MADE TO THE EXCLUSIVE RIGHT TO USE "WOOL", APART FROM THE MARK AS SHOWN.

THE MARK CONSISTS OF "JOMA WOOL" IN STYLIZED FONT WITH A FANCIFUL YARN DESIGN ASSOCIATED WITH THE LETTER "J".

SN 77-813,539, FILED 8-26-2009.

MARK PILARO, EXAMINING ATTORNEY



David J. Kybas

Director of the United States Patent and Trademark Office

United States of America

United States Patent and Trademark Office

PARENT PULSE

Reg. No. 4,074,545

DISNEY ONLINE (CALIFORNIA CORPORATION)
500 SOUTH BUENA VISTA STREET
BURBANK, CA 91521

Registered Dec. 20, 2011

Int. Cl.: 41

FOR: PROVIDING INFORMATION DIRECTED TO PARENTS VIA A GLOBAL COMPUTER INFORMATION NETWORK IN THE FIELD OF PARENTING CONCERNING EDUCATION AND ENTERTAINMENT OF CHILDREN, IN CLASS 41 (U.S. CLS. 100, 101 AND 107).

SERVICE MARK

FIRST USE 1-31-2011; IN COMMERCE 1-31-2011.

PRINCIPAL REGISTER

THE MARK CONSISTS OF STANDARD CHARACTERS WITHOUT CLAIM TO ANY PARTICULAR FONT, STYLE, SIZE, OR COLOR.

NO CLAIM IS MADE TO THE EXCLUSIVE RIGHT TO USE "PARENT", APART FROM THE MARK AS SHOWN.

SN 77-815,731, FILED 8-28-2009.

ELIZABETH HUGHITT, EXAMINING ATTORNEY



David J. Kyjars

Director of the United States Patent and Trademark Office

United States of America

United States Patent and Trademark Office

AUTHENTIC GREEN

Reg. No. 4,074,546

GREEN DESIGN FURNITURE COMPANY (MAINE CORPORATION)
267 COMMERCIAL STREET
PORTLAND, ME 04104

Registered Dec. 20, 2011

Int. Cl.: 20

FOR: ENVIRONMENTALLY FRIENDLY FURNITURE, IN CLASS 20 (U.S. CLS. 2, 13, 22, 25, 32 AND 50).

TRADEMARK

FIRST USE 9-30-2009; IN COMMERCE 9-30-2009.

PRINCIPAL REGISTER

THE MARK CONSISTS OF STANDARD CHARACTERS WITHOUT CLAIM TO ANY PARTICULAR FONT, STYLE, SIZE, OR COLOR.

NO CLAIM IS MADE TO THE EXCLUSIVE RIGHT TO USE "GREEN", APART FROM THE MARK AS SHOWN.

SN 77-816,299, FILED 8-31-2009.

BRIAN CALLAGHAN, EXAMINING ATTORNEY



David J. Kyffers

Director of the United States Patent and Trademark Office

United States of America

United States Patent and Trademark Office

NEURO CHECK

Reg. No. 4,074,547

BAXANO, INC. (DELAWARE CORPORATION)
655 RIVER OAKS PARKWAY
SAN JOSE, CA 95134

Registered Dec. 20, 2011

Int. Cl.: 44

FOR: PROVIDING MEDICAL INFORMATION CONCERNING THE USE OF SURGICAL DEVICES AND INSTRUMENTS, IN CLASS 44 (U.S. CLS. 100 AND 101).

SERVICE MARK

FIRST USE 10-7-2009; IN COMMERCE 10-7-2009.

PRINCIPAL REGISTER

THE MARK CONSISTS OF STANDARD CHARACTERS WITHOUT CLAIM TO ANY PARTICULAR FONT, STYLE, SIZE, OR COLOR.

SN 77-817,687, FILED 9-1-2009.

VERNA BETH RIRIE, EXAMINING ATTORNEY



David J. Kyffers

Director of the United States Patent and Trademark Office

United States of America

United States Patent and Trademark Office

Resolution-3

Reg. No. 4,074,548

ARCANATURA LLC (CONNECTICUT LIMITED LIABILITY COMPANY)
37 SKYLINE DRIVE
GROTON, CT 06340

Registered Dec. 20, 2011

Int. Cl.: 5

FOR: ANIMAL FEED ADDITIVE FOR USE AS A NUTRITIONAL SUPPLEMENT FOR MEDICAL PURPOSES, IN CLASS 5 (U.S. CLS. 6, 18, 44, 46, 51 AND 52).

TRADEMARK

FIRST USE 1-10-2009; IN COMMERCE 1-10-2009.

PRINCIPAL REGISTER

THE MARK CONSISTS OF STANDARD CHARACTERS WITHOUT CLAIM TO ANY PARTICULAR FONT, STYLE, SIZE, OR COLOR.

SN 77-817,709, FILED 9-1-2009.

MARLENE BELL, EXAMINING ATTORNEY



David J. Kyffers

Director of the United States Patent and Trademark Office

United States of America

United States Patent and Trademark Office

My TCC

Reg. No. 4,074,549

Registered Dec. 20, 2011

Int. Cls.: 42 and 44

SERVICE MARK

PRINCIPAL REGISTER

H. LEE MOFFITT CANCER CENTER AND RESEARCH INSTITUTE, INC. (FLORIDA CORPORATION), AKA MOFFITT CANCER CENTER,
MRC-TTO
12902 MAGNOLIA DRIVE
TAMPA, FL 33612

FOR: MEDICAL AND SCIENTIFIC RESEARCH IN THE FIELD OF MEDICAL CONDITIONS AND DISEASE PREVENTION, EARLY DETECTION, AND CARE; MEDICAL AND SCIENTIFIC RESEARCH SERVICES IN THE FIELD OF CANCER TREATMENT AND DIAGNOSIS; PROVIDING MEDICAL AND SCIENTIFIC RESEARCH INFORMATION IN THE FIELD OF CLINICAL TRIALS, IN CLASS 42 (U.S. CLS. 100 AND 101).

FIRST USE 7-30-2011; IN COMMERCE 7-30-2011.

FOR: MEDICAL SERVICES, NAMELY, THE PREVENTION, EARLY DETECTION, DIAGNOSIS, STAGING AND TREATMENT OF DISEASE, IN CLASS 44 (U.S. CLS. 100 AND 101).

FIRST USE 7-30-2011; IN COMMERCE 7-30-2011.

THE MARK CONSISTS OF STANDARD CHARACTERS WITHOUT CLAIM TO ANY PARTICULAR FONT, STYLE, SIZE, OR COLOR.

OWNER OF U.S. REG. NO. 3,728,417.

SN 77-818,455, FILED 9-2-2009.

STEVEN R. FINE, EXAMINING ATTORNEY



David J. Kybas

Director of the United States Patent and Trademark Office

United States of America

United States Patent and Trademark Office

INNOVAFRY

Reg. No. 4,074,550

Registered Dec. 20, 2011

Int. Cl.: 29

TRADEMARK

PRINCIPAL REGISTER

CLABBER GIRL CORPORATION (INDIANA CORPORATION)
900 WABASH AVENUE
TERRE HAUTE, IN 47807

FOR: FOOD ADDITIVES IN THE NATURE OF FRYING OIL ORGANIC ADDITIVES FOR NON-NUTRITIONAL PURPOSES MADE FROM MINERALS AND ORGANIC ACIDS, IN CLASS 29 (U.S. CL. 46).

FIRST USE 7-14-2009; IN COMMERCE 7-14-2009.

THE MARK CONSISTS OF STANDARD CHARACTERS WITHOUT CLAIM TO ANY PARTICULAR FONT, STYLE, SIZE, OR COLOR.

SN 77-821,872, FILED 9-8-2009.

SANJEEV VOHRA, EXAMINING ATTORNEY



David J. Kyffers

Director of the United States Patent and Trademark Office

United States of America

United States Patent and Trademark Office

DUET

Reg. No. 4,074,551

Registered Dec. 20, 2011

**Int. Cls.: 9, 35, 42, and
44**

TRADEMARK

SERVICE MARK

PRINCIPAL REGISTER

ASSISTMED, INC. (CALIFORNIA CORPORATION)
21600 OXNARD STREET
SUITE1010
WOODLAND HILLS, CA 91367

FOR: COMPUTER SOFTWARE FOR USE IN CREATING, EDITING, DIGITIZING, REPORTING AND DELIVERING CLINICAL AND MEDICAL DOCUMENTATION SERVICES, IN CLASS 9 (U.S. CLS. 21, 23, 26, 36 AND 38).

FIRST USE 10-1-2010; IN COMMERCE 10-1-2010.

FOR: BUSINESS RECORDS MANAGEMENT SERVICES FOR THE MEDICAL INDUSTRY, IN CLASS 35 (U.S. CLS. 100, 101 AND 102).

FIRST USE 10-1-2010; IN COMMERCE 10-1-2010.

FOR: PROVIDING TEMPORARY USE OF ON-LINE NON-DOWNLOADABLE SOFTWARE FOR CLINICAL AND MEDICAL DOCUMENTATION SERVICES, ELECTRONIC HEALTH RECORD SERVICES, AND BUSINESS PROCESSES SERVICES FOR THE MEDICAL INDUSTRY, IN CLASS 42 (U.S. CLS. 100 AND 101).

FIRST USE 10-1-2010; IN COMMERCE 10-1-2010.

FOR: MAINTAINING ELECTRONIC HEALTH RECORD SERVICES, NAMELY, MAINTAINING PATIENT MEDICAL RECORDS AND FILES, IN CLASS 44 (U.S. CLS. 100 AND 101).

FIRST USE 10-1-2010; IN COMMERCE 10-1-2010.

THE MARK CONSISTS OF STANDARD CHARACTERS WITHOUT CLAIM TO ANY PARTICULAR FONT, STYLE, SIZE, OR COLOR.

SN 77-822,158, FILED 9-8-2009.

ALICE BENMAMAN, EXAMINING ATTORNEY



David J. Kyffers

Director of the United States Patent and Trademark Office

United States of America

United States Patent and Trademark Office

THE FISHING DOC

Reg. No. 4,074,552

ORSCHELN PRODUCTS L.L.C. (MISSOURI LIMITED LIABILITY COMPANY)

Registered Dec. 20, 2011

2000 US HWY 63 SOUTH
MOBERLY, MO 65270

Int. Cl.: 28

FOR: FISHING EQUIPMENT FOR PHYSICALLY CHALLENGED INDIVIDUALS, NAMELY, ELECTRICAL AND MECHANICAL APPARATUS FOR CASTING AND REELING FISHING EQUIPMENT, IN CLASS 28 (U.S. CLS. 22, 23, 38 AND 50).

TRADEMARK

FIRST USE 6-24-2009; IN COMMERCE 6-24-2009.

PRINCIPAL REGISTER

THE MARK CONSISTS OF STANDARD CHARACTERS WITHOUT CLAIM TO ANY PARTICULAR FONT, STYLE, SIZE, OR COLOR.

NO CLAIM IS MADE TO THE EXCLUSIVE RIGHT TO USE "FISHING", APART FROM THE MARK AS SHOWN.

SN 77-822,265, FILED 9-8-2009.

SOPHIA S. KIM, EXAMINING ATTORNEY



David J. Kybas

Director of the United States Patent and Trademark Office

United States of America

United States Patent and Trademark Office



Reg. No. 4,074,553

CAMPOY DE CORTES, MERCEDES (MEXICO INDIVIDUAL)
5014 SW 186TH WAY
MIRAMAR, FL 33029

Registered Dec. 20, 2011

Int. Cl.: 3

FOR: BODY AND BEAUTY CARE COSMETICS; BODY CREAM, IN CLASS 3 (U.S. CLS. 1, 4, 6, 50, 51 AND 52).

TRADEMARK

FIRST USE 10-1-2011; IN COMMERCE 10-1-2011.

PRINCIPAL REGISTER

THE MARK CONSISTS OF A YELLOW RECTANGLE WITH A BACKWARD WHITE "S" INSIDE IT, AND THE WORD "STRIDEL" APPEARS UNDER THE RECTANGLE IN BLACK.

THE COLOR(S) YELLOW, BLACK AND WHITE IS/ARE CLAIMED AS A FEATURE OF THE MARK.

SN 77-823,228, FILED 9-9-2009.

ANTHONY RINKER, EXAMINING ATTORNEY



David J. Kybas

Director of the United States Patent and Trademark Office

United States of America

United States Patent and Trademark Office

Chilli Time

Reg. No. 4,074,554

Registered Dec. 20, 2011

Int. Cl.: 9

TRADEMARK

PRINCIPAL REGISTER

AINSWORTH GAME TECHNOLOGY LIMITED (AUSTRALIA LIMITED LIABILITY COMPANY)
10 HOLKER ST
NEWINGTON, AUSTRALIA 2127

FOR: COMPUTER SOFTWARE AND FIRMWARE FOR GAMES OF CHANCE ON ANY COMPUTERIZED PLATFORM, INCLUDING DEDICATED GAMING CONSOLES, VIDEO BASED SLOT MACHINES, REEL BASED SLOT MACHINES, AND VIDEO LOTTERY TERMINALS, IN CLASS 9 (U.S. CLS. 21, 23, 26, 36 AND 38).

FIRST USE 9-20-2011; IN COMMERCE 9-20-2011.

THE MARK CONSISTS OF STANDARD CHARACTERS WITHOUT CLAIM TO ANY PARTICULAR FONT, STYLE, SIZE, OR COLOR.

SN 77-823,281, FILED 9-9-2009.

REBECCA SMITH, EXAMINING ATTORNEY



David J. Kybas

Director of the United States Patent and Trademark Office

United States of America

United States Patent and Trademark Office

RESVERATROL DRENCH

Reg. No. 4,074,555

FLAGEOLI, LTD. (NEVADA LIMITED LIABILITY COMPANY)
7310 SMOKE RANCH RD. - STE. "I"
LAS VEGAS, NV 89128

Registered Dec. 20, 2011

Int. Cl.: 3

FOR: NON-MEDICATED SKIN CARE PREPARATIONS CONTAINING RESVERATROL, IN CLASS 3 (U.S. CLS. 1, 4, 6, 50, 51 AND 52).

TRADEMARK

FIRST USE 1-20-2010; IN COMMERCE 1-20-2010.

PRINCIPAL REGISTER

THE MARK CONSISTS OF STANDARD CHARACTERS WITHOUT CLAIM TO ANY PARTICULAR FONT, STYLE, SIZE, OR COLOR.

NO CLAIM IS MADE TO THE EXCLUSIVE RIGHT TO USE "RESVERATROL", APART FROM THE MARK AS SHOWN.

SN 77-825,002, FILED 9-11-2009.

BRENDAN REGAN, EXAMINING ATTORNEY



David J. Kyffers

Director of the United States Patent and Trademark Office

United States of America

United States Patent and Trademark Office

DRAGON NEST

Reg. No. 4,074,556

NEXON AMERICA INC. (DELAWARE CORPORATION)
3460 WILSHIRE BOULEVARD, 7TH FLOOR
LOS ANGELES, CA 90010

Registered Dec. 20, 2011

Int. Cls.: 9 and 41

FOR: VIDEO AND COMPUTER GAME SOFTWARE; DOWNLOADABLE VIDEO AND COMPUTER GAME SOFTWARE, IN CLASS 9 (U.S. CLS. 21, 23, 26, 36 AND 38).

TRADEMARK

FIRST USE 7-26-2011; IN COMMERCE 8-11-2011.

SERVICE MARK

FOR: ENTERTAINMENT SERVICES, NAMELY, PROVIDING ONLINE INTERACTIVE COMPUTER GAMES, IN CLASS 41 (U.S. CLS. 100, 101 AND 107).

PRINCIPAL REGISTER

FIRST USE 7-26-2011; IN COMMERCE 8-11-2011.

THE MARK CONSISTS OF STANDARD CHARACTERS WITHOUT CLAIM TO ANY PARTICULAR FONT, STYLE, SIZE, OR COLOR.

SN 77-826,861, FILED 9-15-2009.

HOWARD SMIGA, EXAMINING ATTORNEY



David J. Kyros

Director of the United States Patent and Trademark Office

United States of America

United States Patent and Trademark Office

DI University

Reg. No. 4,074,557

Registered Dec. 20, 2011

Int. Cl.: 41

SERVICE MARK

PRINCIPAL REGISTER

DESTINATION IMAGINATION, INC. (NEW JERSEY CORPORATION)
114 EAST HIGH STREET
GLASSBORO, NJ 08028

FOR: EDUCATIONAL SERVICES, NAMELY, DEVELOPING AND CONDUCTING TRAINING COURSES, CLASSES, SEMINARS, WORKSHOPS IN THE FIELD OF TEAM BASED CREATIVE PROBLEM SOLVING AND DISTRIBUTION OF COURSE MATERIALS THEREWITH, IN CLASS 41 (U.S. CLS. 100, 101 AND 107).

FIRST USE 9-1-2011; IN COMMERCE 9-1-2011.

THE MARK CONSISTS OF STANDARD CHARACTERS WITHOUT CLAIM TO ANY PARTICULAR FONT, STYLE, SIZE, OR COLOR.

OWNER OF U.S. REG. NOS. 2,646,261, 3,199,833, AND OTHERS.

NO CLAIM IS MADE TO THE EXCLUSIVE RIGHT TO USE "UNIVERSITY", APART FROM THE MARK AS SHOWN.

SN 77-826,944, FILED 9-15-2009.

SANJEEV VOHRA, EXAMINING ATTORNEY



David J. Kybas

Director of the United States Patent and Trademark Office

United States of America

United States Patent and Trademark Office

02

Reg. No. 4,074,558

GROUP O (ILLINOIS CORPORATION)

Registered Dec. 20, 2011

4905 77TH AVENUE
MILAN, IL 61264

Int. Cl.: 42

FOR: PROVIDING ONLINE NON-DOWNLOADABLE COMPUTER SOFTWARE FOR USE IN OPTIMIZING MARKETING CAMPAIGNS AND THE MARKETING LIFECYCLE NOT INCLUDING CALL CENTER OR TELECOMMUNICATIONS GOODS AND/OR SERVICES, IN CLASS 42 (U.S. CLS. 100 AND 101).

SERVICE MARK

PRINCIPAL REGISTER

FIRST USE 1-0-2008; IN COMMERCE 1-0-2008.

THE MARK CONSISTS OF STANDARD CHARACTERS WITHOUT CLAIM TO ANY PARTICULAR FONT, STYLE, SIZE, OR COLOR.

SN 77-827,829, FILED 9-16-2009.

CHERYL CLAYTON, EXAMINING ATTORNEY



David J. Kyjars

Director of the United States Patent and Trademark Office

United States of America

United States Patent and Trademark Office



Reg. No. 4,074,559

Registered Dec. 20, 2011

Int. Cl.: 37

SERVICE MARK

PRINCIPAL REGISTER

PIT-STOP TIRE LLC (FLORIDA CORPORATION), TA PIT-STOP TIRE,
1635 W 32ND PL.
HIALEAH, FL 33012

FOR: INSTALLATION OF TIRES, IN CLASS 37 (U.S. CLS. 100, 103 AND 106).

FIRST USE 7-10-2009; IN COMMERCE 10-1-2010.

NO CLAIM IS MADE TO THE EXCLUSIVE RIGHT TO USE "TIRE", APART FROM THE MARK AS SHOWN.

THE STIPPLING IS FOR SHADING PURPOSES ONLY.

THE MARK CONSISTS OF A ROUND RING WITH THE WORDS "PIT-STOP TIRE" IN THE RING AND 2 CROSSED CHECKERED RACING FLAGS.

SN 77-830,896, FILED 9-21-2009.

HEATHER THOMPSON, EXAMINING ATTORNEY



David J. Kyffers

Director of the United States Patent and Trademark Office

United States of America

United States Patent and Trademark Office

RELAX

Reg. No. 4,074,560

Registered Dec. 20, 2011

Int. Cl.: 32

TRADEMARK

PRINCIPAL REGISTER

BALANCE WATER WORLDWIDE PTY LTD (AUSTRALIA LIMITED LIABILITY COMPANY)
35 BUCKINGHAM STREET
SUITE 209
SURRY HILLS, NSW, AUSTRALIA 2010

FOR: BOTTLED WATER; STILL, MINERAL AND AERATED WATERS; NON-ALCOHOLIC DRINKS, NAMELY, NON-ALCOHOLIC FRUIT JUICE BEVERAGES AND FLAVOURED SOFT DRINKS, PUNCH, LEMONADE; FRUIT DRINKS AND FRUIT JUICES; SYRUPS FOR MAKING BEVERAGES; PREPARATIONS FOR MAKING BEVERAGES, NAMELY, FRUIT JUICES; BOTTLED WATER CONTAINING FLOWER ESSENCES, IN CLASS 32 (U.S. CLS. 45, 46 AND 48).

FIRST USE 11-30-2009; IN COMMERCE 11-30-2009.

THE MARK CONSISTS OF STANDARD CHARACTERS WITHOUT CLAIM TO ANY PARTICULAR FONT, STYLE, SIZE, OR COLOR.

SN 77-832,906, FILED 9-23-2009.

WENDY JUN, EXAMINING ATTORNEY



David J. Kypos

Director of the United States Patent and Trademark Office

United States of America

United States Patent and Trademark Office

Minxed

Reg. No. 4,074,561

Registered Dec. 20, 2011

Int. Cl.: 3

TRADEMARK

PRINCIPAL REGISTER

MINX, INC. (CALIFORNIA CORPORATION)
301 INDUSTRIAL WAY UNIT 5
FALLBROOK, CA 92028

FOR: NAIL CARE PREPARATIONS, NAMELY, A SOLID POLYMER NAIL COATING WHICH IS APPLIED THROUGH AN ADHESIVE METHOD FOR COSMETIC PURPOSES, IN CLASS 3 (U.S. CLS. 1, 4, 6, 50, 51 AND 52).

FIRST USE 3-0-2010; IN COMMERCE 3-0-2010.

THE MARK CONSISTS OF STANDARD CHARACTERS WITHOUT CLAIM TO ANY PARTICULAR FONT, STYLE, SIZE, OR COLOR.

OWNER OF U.S. REG. NOS. 3,756,886 AND 3,756,887.

SN 77-833,400, FILED 9-23-2009.

REGINA DRUMMOND, EXAMINING ATTORNEY



David J. Kybas

Director of the United States Patent and Trademark Office

United States of America

United States Patent and Trademark Office



BrightStar

LIFECARE | KIDCARE | STAFFING

Reg. No. 4,074,562

24-7 BRIGHT STAR HEALTHCARE, LLC (NEVADA LIMITED LIABILITY COMPANY)
1125 TRI-STATE PARKWAY, SUITE 700
GURNEE, IL 60031

Registered Dec. 20, 2011

**Int. Cls.: 35, 39, 43, 44,
and 45**

FOR: MEDICAL AND NURSING PERSONNEL PLACEMENT, RECRUITING AND STAFFING,
IN CLASS 35 (U.S. CLS. 100, 101 AND 102).

FIRST USE 5-0-2009; IN COMMERCE 5-0-2009.

SERVICE MARK

FOR: TRANSPORTATION SERVICES PROVIDED TO INDIVIDUALS, IN CLASS 39 (U.S.
CLS. 100 AND 105).

PRINCIPAL REGISTER

FIRST USE 5-0-2009; IN COMMERCE 5-0-2009.

FOR: PROVIDING DAY CARE SERVICES FOR ADULTS AND CHILDREN, NAMELY,
PROVIDING ELDER CARE SERVICES FOR ADULTS AND DISABLED INDIVIDUALS AND
PROVIDING CHILD CARE SERVICES FOR CHILDREN AND DISABLED INDIVIDUALS,
IN CLASS 43 (U.S. CLS. 100 AND 101).

FIRST USE 5-0-2009; IN COMMERCE 5-0-2009.

FOR: HOME HEALTH CARE SERVICES, IN CLASS 44 (U.S. CLS. 100 AND 101).

FIRST USE 5-0-2009; IN COMMERCE 5-0-2009.

FOR: SOCIAL SERVICE, NAMELY, COMPANIONSHIP SERVICES FOR INFANTS, CHILDREN, THE ELDERLY, AND DISABLED; IN-HOME SUPPORT SERVICES TO SENIOR PERSONS, NAMELY, GERIATRIC CARE MANAGEMENT SERVICES AND PERSONAL AFFAIRS MANAGEMENT SERVICES IN THE NATURE OF THE COORDINATION OF NECESSARY SERVICES AND CARE FOR OLDER INDIVIDUALS; PROVIDING NON-MEDICAL PERSONAL ASSISTANT SERVICES FOR OTHERS IN THE NATURE OF PLANNING, ORGANIZING, COORDINATING, ARRANGING AND ASSISTING INDIVIDUALS TO PERFORM DAILY TASKS; PROVIDING NON-MEDICAL ASSISTED LIVING SERVICES FOR PERSONAL PURPOSES IN THE NATURE OF SCHEDULING APPOINTMENTS, ANSWERING THE TELEPHONE, CHECKING MESSAGES, MAIL SORTING, HANDLING AND RECEIVING, AND SECRETARIAL AND CLERICAL SERVICES; PERSONAL CARE ASSISTANCE OF ACTIVITIES OF DAILY LIVING, SUCH AS BATHING, GROOMING AND PERSONAL MO-



David J. Kybas

Director of the United States Patent and Trademark Office

Reg. No. 4,074,562 BILITY FOR MENTALLY AND PHYSICALLY CHALLENGED PEOPLE, THE ELDERLY, AND INFANTS AND CHILDREN; RUNNING ERRANDS FOR OTHERS; PERSONAL SHOPPING FOR OTHERS; PROVIDING PERSONAL SUPPORT SERVICES FOR FAMILIES OF PATIENTS WITH LIFE THREATENING DISORDERS AND OTHER ILLNESSES AND FAMILIES OF MENTALLY AND PHYSICALLY CHALLENGED INDIVIDUALS, NAMELY, COMPANIONSHIP, HELP WITH MEDICAL FORMS, COUNSELING AND EMOTIONAL SUPPORT, IN CLASS 45 (U.S. CLS. 100 AND 101).

FIRST USE 5-0-2009; IN COMMERCE 5-0-2009.

OWNER OF U.S. REG. NOS. 3,608,700, 3,608,702, AND OTHERS.

NO CLAIM IS MADE TO THE EXCLUSIVE RIGHT TO USE "LIFECARE" AND "KIDCARE" AND "STAFFING", APART FROM THE MARK AS SHOWN.

THE MARK CONSISTS OF THE WORDS "BRIGHTSAR", "LIFECARE", "KIDCARE", AND "STAFFING", ALONG WITH TWO VERTICAL BARS, ONE BAR SEPARATING THE TERMS "LIFECARE" AND "KIDCARE" AND THE OTHER BAR SEPARATING THE TERMS "KIDCARE" AND "STAFFING". IN ADDITION, THE MARK FEATURES THE STAR PORTION OF A SHOOTING STAR FORMING THE DOT OVER THE LETTER "I" IN THE WORD "BRIGHTSTAR" AND THE TAIL OF THE SHOOTING STAR MAKING A SWIRLING LINE ABOVE THE WORD "BRIGHTSTAR".

SN 77-834,678, FILED 9-25-2009.

BRIAN CALLAGHAN, EXAMINING ATTORNEY

United States of America

United States Patent and Trademark Office

I VIOLATED YOUR EULA

Reg. No. 4,074,563

Registered Dec. 20, 2011

Int. Cl.: 25

TRADEMARK

PRINCIPAL REGISTER

JOLOKIA CORPORATION (CALIFORNIA CORPORATION)
245-M MOUNT HERMON ROAD, SUITE 152
SCOTTS VALLEY, CA 95066

FOR: APPAREL, NAMELY, T-SHIRTS, IN CLASS 25 (U.S. CLS. 22 AND 39).

FIRST USE 4-1-2011; IN COMMERCE 4-1-2011.

THE MARK CONSISTS OF STANDARD CHARACTERS WITHOUT CLAIM TO ANY PARTICULAR FONT, STYLE, SIZE, OR COLOR.

SN 77-835,701, FILED 9-25-2009.

JANICE L. MCMORROW, EXAMINING ATTORNEY



David J. Kyffers

Director of the United States Patent and Trademark Office

United States of America

United States Patent and Trademark Office

TRACK TUNERS

Reg. No. 4,074,564

TIMOTHY A. SCHAFER (UNITED STATES INDIVIDUAL)
1459 WHITE POLE RD.
ADAIR, IA 50002

Registered Dec. 20, 2011

Int. Cl.: 12

FOR: AXLE ASSEMBLIES FOR ALL-TERRAIN VEHICLES, NAMELY, AXLE HUB PLATES, AXLE EXTENSIONS AND AXLE IDLER EXTENSIONS, IN CLASS 12 (U.S. CLS. 19, 21, 23, 31, 35 AND 44).

TRADEMARK

FIRST USE 10-24-2011; IN COMMERCE 10-24-2011.

PRINCIPAL REGISTER

THE MARK CONSISTS OF STANDARD CHARACTERS WITHOUT CLAIM TO ANY PARTICULAR FONT, STYLE, SIZE, OR COLOR.

SN 77-836,421, FILED 9-28-2009.

JOHN SCHUYLER YARD, EXAMINING ATTORNEY



David J. Kyffers

Director of the United States Patent and Trademark Office

United States of America

United States Patent and Trademark Office

HELL IN A CELL

Reg. No. 4,074,565

Registered Dec. 20, 2011

Int. Cl.: 16

TRADEMARK

PRINCIPAL REGISTER

WORLD WRESTLING ENTERTAINMENT, INC. (D.C. CORPORATION)
1241 EAST MAIN STREET
STAMFORD, CT 06902

FOR: PAPER HANGTAGS, CARDBOARD HANGTAGS; PACKAGING, NAMELY, BLISTER CARDS, PAPER FOR WRAPPING AND PACKAGING, PAPER POUCHES FOR PACKAGING, PLASTIC BAGS FOR PACKAGING, PLASTIC BUBBLE PACKS FOR WRAPPING OR PACKAGING; COLLECTOR ALBUMS, NAMELY, FOR STICKER COLLECTABLE CARDS AND PHOTO COLLECTABLES; LABELS, NAMELY, PRINTED PAPER LABELS, PRINTED SHIPPING LABELS; FOLDERS; PLASTIC BAGS FOR HOUSEHOLD USE; STICKERS; FRAMED PICTURE PHOTOS; PENS; PENCILS; POSTERS; NOTEBOOKS; TRADING CARDS; CALENDARS; PAPER TABLECLOTHS; PHOTOGRAPHS; BROCHURES ABOUT SPORTS ENTERTAINMENT; MAGAZINES IN THE FIELD OF SPORTS ENTERTAINMENT, AND NEWSPAPERS; POSTCARDS; GREETING CARDS; PICTURES; DECALS; COLORING BOOKS; CHILDREN'S ACTIVITY BOOKS; SOUVENIR PROGRAMS IN THE FIELD OF SPORTS ENTERTAINMENT; BOOKS FEATURING PICTORIAL BIOGRAPHIES OF SPORTS ENTERTAINMENT FIGURES; COMIC BOOKS; BOOK COVERS; PAPER BOOK MARKS; PAPER LUNCH BAGS; PICTURE BOOKS; MEMO PADS; DATE BOOKS; ADDRESS BOOKS; AGENDA BOOKS; PENCIL SHARPENERS; RUBBER STAMPS; STAMP PADS; COLLECTOR STAMPS, NAMELY, COMMEMORATIVE STAMP SHEETS; RETURN ADDRESS LABELS NOT OF TEXTILE; PAPER BANNERS; PRINTED PAPER SIGNS FOR DOORS; PENCIL CASES; SCRIBBLE PAD; PHOTO ALBUMS; BUMPER STICKERS; WINDOW DECALS; LITHOGRAPHS; PAPER PARTY BAGS; PAPER PARTY FAVORS, NAMELY, STENCILS FOR TRACING DESIGNS ONTO PAPER; PAPER GIFT WRAP; PAPER CAKE DECORATIONS, IN CLASS 16 (U.S. CLS. 2, 5, 22, 23, 29, 37, 38 AND 50).



FIRST USE 10-4-2009; IN COMMERCE 10-4-2009.

THE MARK CONSISTS OF STANDARD CHARACTERS WITHOUT CLAIM TO ANY PARTICULAR FONT, STYLE, SIZE, OR COLOR.

SN 77-837,102, FILED 9-29-2009.

MICHAEL WEBSTER, EXAMINING ATTORNEY

David J. Kyros

Director of the United States Patent and Trademark Office

United States of America

United States Patent and Trademark Office

IPAGE

Reg. No. 4,074,566

AURORA INTERNATIONAL GROUP, INC., THE (DELAWARE CORPORATION)
70 BLANCHARD ROAD
BURLINGTON, MA 01803

Registered Dec. 20, 2011

Int. Cls.: 38, 42, and 45

FOR: ELECTRONIC MAIL SERVICES; E-MAIL AND WEBSITE FORWARDING SERVICES; PROVIDING MULTIPLE USER-ACCESS TO A GLOBAL COMPUTER INFORMATION NETWORK, IN CLASS 38 (U.S. CLS. 100, 101 AND 104).

SERVICE MARK

FIRST USE 7-8-2008; IN COMMERCE 7-8-2008.

PRINCIPAL REGISTER

FOR: COMPUTER SERVICES, NAMELY, DOMAIN NAME SEARCHING SERVICES FOR THE PURPOSE OF FINDING URL ADDRESSES; DESIGN, CREATION, HOSTING, AND MAINTENANCE OF WEBSITES FOR OTHERS ON A GLOBAL COMPUTER NETWORK; DESIGN, CREATION, HOSTING, AND MAINTENANCE OF ON-LINE RETAIL STORE WEBSITES FOR OTHERS ON A GLOBAL COMPUTER NETWORK; PROVIDING INFORMATION REGARDING WEBSITE DEVELOPMENT; COMPUTER WEBSITE DESIGN CONSULTATION; PROVIDING TEMPORARY USE OF ON-LINE NON-DOWNLOADABLE COMPUTER SOFTWARE DEVELOPMENT TOOLS FOR CREATING WEB SITES, ONLINE STORES, ELECTRONIC BULLETIN BOARDS, AND BLOGS; TECHNICAL SUPPORT, NAMELY, MONITORING AND REPORTING OF WEB SITE TRAFFIC OF OTHERS; COMPUTER VIRUS PROTECTION SERVICES; TECHNICAL SUPPORT, NAMELY, TROUBLESHOOTING OF COMPUTER SOFTWARE PROBLEMS; PROVIDING TEMPORARY USE OF NON-DOWNLOADABLE SOFTWARE FOR USE IN E-COMMERCE SERVICES TO ALLOW USERS TO PERFORM ELECTRONIC TRANSACTIONS AND DESIGN AND DEVELOP PROMOTIONAL AND MARKETING CAMPAIGNS; PROVIDING CONSULTATION AND TECHNICAL SUPPORT FOR DESIGN AND MAINTENANCE OF ON-LINE RETAIL STORE WEBSITES FOR OTHERS, IN CLASS 42 (U.S. CLS. 100 AND 101).

FIRST USE 7-8-2008; IN COMMERCE 7-8-2008.

FOR: REGISTRATION SERVICES ENABLING ENTITIES TO MANAGE INFORMATION RELATED TO DOMAIN NAMES FOR USE ON A GLOBAL COMPUTER NETWORK, NAMELY, REGISTRATION OF DOMAIN NAMES AND E-MAIL ADDRESSES; MONITORING OF COMPUTER SYSTEMS FOR SECURITY PURPOSES; COMPUTER SERVICES, NAMELY, DOMAIN NAME SEARCHING SERVICES FOR THE PURPOSE OF DETERMINING URL AVAILABILITY FOR REGISTRATION, IN CLASS 45 (U.S. CLS. 100 AND 101).



David J. Kybas

Director of the United States Patent and Trademark Office

Reg. No. 4,074,566 FIRST USE 7-8-2008; IN COMMERCE 7-8-2008.

THE MARK CONSISTS OF STANDARD CHARACTERS WITHOUT CLAIM TO ANY PARTICULAR FONT, STYLE, SIZE, OR COLOR.

SN 77-838,309, FILED 9-30-2009.

JENNIFER DIXON, EXAMINING ATTORNEY

United States of America

United States Patent and Trademark Office

MY SAFE DRAWER

Reg. No. 4,074,567

Registered Dec. 20, 2011

Int. Cls.: 9 and 42

TRADEMARK

SERVICE MARK

PRINCIPAL REGISTER

CGI TECHNOLOGIES AND SOLUTIONS INC. (DELAWARE CORPORATION)
11325 RANDOM HILLS ROAD
FAIRFAX, VA 22030

FOR: COMPUTER SOFTWARE FOR THE COLLECTION, STORAGE AND RETRIEVAL OF PERSONAL RECORDS, DOCUMENTS AND DATA , IN CLASS 9 (U.S. CLS. 21, 23, 26, 36 AND 38).

FIRST USE 9-1-2009; IN COMMERCE 9-1-2009.

FOR: PROVIDING TEMPORARY USE OF WEB-BASED NON-DOWNLOADABLE SOFTWARE FOR ALLOWING USERS TO UPLOAD, STORE AND RETRIEVE PERSONAL RECORDS, DOCUMENTS AND DATA, IN CLASS 42 (U.S. CLS. 100 AND 101).

FIRST USE 9-1-2009; IN COMMERCE 9-1-2009.

THE MARK CONSISTS OF STANDARD CHARACTERS WITHOUT CLAIM TO ANY PARTICULAR FONT, STYLE, SIZE, OR COLOR.

SN 77-841,535, FILED 10-5-2009.

SUSAN RICHARDS, EXAMINING ATTORNEY



David J. Kybas

Director of the United States Patent and Trademark Office

United States of America

United States Patent and Trademark Office

CONCERTO

Reg. No. 4,074,568

Registered Dec. 20, 2011

Int. Cl.: 9

TRADEMARK

PRINCIPAL REGISTER

TEXAS INSTRUMENTS INCORPORATED (DELAWARE CORPORATION)
MS3999
12500 TI BOULEVARD
DALLAS, TX 752434136

FOR: INTEGRATED CIRCUITS, NAMELY, MICROCONTROLLERS FOR SALE TO ORIGINAL EQUIPMENT MANUFACTURERS AND NOT FOR SALE AT RETAIL STORES. THE MICROCONTROLLERS ARE IMPLEMENTED BY THE MANUFACTURERS IN A COMPLEX DESIGN PROCESS AS MICROCONTROLLERS IN EMBEDDED PROCESSING SYSTEMS USED IN INDUSTRIAL AND POWER APPLICATIONS, IN CLASS 9 (U.S. CLS. 21, 23, 26, 36 AND 38).

FIRST USE 7-19-2011; IN COMMERCE 7-19-2011.

THE MARK CONSISTS OF STANDARD CHARACTERS WITHOUT CLAIM TO ANY PARTICULAR FONT, STYLE, SIZE, OR COLOR.

SN 77-841,584, FILED 10-5-2009.

SANI KHOURI, EXAMINING ATTORNEY



David J. Kybas

Director of the United States Patent and Trademark Office

United States of America

United States Patent and Trademark Office



Reg. No. 4,074,569

JOSAM COMPANY (FLORIDA CORPORATION)
2501 S. FRONT STREET
PHILADELPHIA, PA 19148

Registered Dec. 20, 2011

Int. Cl.: 6

FOR: STAINLESS STEEL PLUMBING SUPPLIES, NAMELY, PIPES AND PIPE FITTINGS, IN CLASS 6 (U.S. CLS. 2, 12, 13, 14, 23, 25 AND 50).

TRADEMARK

FIRST USE 6-0-2010; IN COMMERCE 6-0-2010.

PRINCIPAL REGISTER

NO CLAIM IS MADE TO THE EXCLUSIVE RIGHT TO USE "COMPLETE DRAINAGE SYSTEM", "STAINLESS STEEL", OR "PUSH FIT", APART FROM THE MARK AS SHOWN.

THE MARK CONSISTS OF A STYLIZED LOGO DEPICTING TWO ROUND PIPES FACING EACH OTHER AND SPACED APART WITH AN ARROW IN THE MIDDLE, AND THE WORDS "PUSH" AND "FIT" ARE SUPERIMPOSED ON THE TWO PIPES, WITH PARTIAL CIRCLES ABOVE AND BELOW THE PIPES CONTAINING THE WORDS "STAINLESS" AND "STEEL". THE WORD "COMPLETE" APPEARS ABOVE THE TOP PARTIAL CIRCLE AND THE WORDING "DRAINAGE SYSTEM" APPEARS BELOW THE LOWER PARTIAL CIRCLE.

SN 77-841,958, FILED 10-5-2009.

VERNA BETH RIRIE, EXAMINING ATTORNEY



David J. Kybas

Director of the United States Patent and Trademark Office

United States of America

United States Patent and Trademark Office

HOT ROLLERS

Reg. No. 4,074,570

ROMANE FRAGRANCES, LLC (ILLINOIS CORPORATION)
851 CHURCH ST.

Registered Dec. 20, 2011

ELMHURST, IL 60126

Int. Cl.: 3

FOR: BODY CREAM; BODY LOTION; FRAGRANCES; SHOWER GEL; SOAPS FOR BODY CARE, IN CLASS 3 (U.S. CLS. 1, 4, 6, 50, 51 AND 52).

TRADEMARK

FIRST USE 9-7-2011; IN COMMERCE 9-7-2011.

PRINCIPAL REGISTER

THE MARK CONSISTS OF STANDARD CHARACTERS WITHOUT CLAIM TO ANY PARTICULAR FONT, STYLE, SIZE, OR COLOR.

SN 77-842,421, FILED 10-6-2009.

ZACHARY BELLO, EXAMINING ATTORNEY



David J. Kybas

Director of the United States Patent and Trademark Office

United States of America

United States Patent and Trademark Office

NIGHT MOVES

Reg. No. 4,074,571

ALLURE BRIDALS, INC. (TENNESSEE CORPORATION)
8415 WOLF LAKE DRIVE
BARTLETT, TN 38133

Registered Dec. 20, 2011

Int. Cl.: 25

FOR: WOMEN'S BELTS AND SHOES; BRIDAL GOWNS; BRIDAL DRESSES; BRIDESMAID DRESSES; PROM DRESSES; COCKTAIL AND EVENING WEAR, NAMELY, EVENING GOWNS, DRESSES, SKIRTS, BLOUSES AND JACKETS , IN CLASS 25 (U.S. CLS. 22 AND 39).

TRADEMARK

PRINCIPAL REGISTER

FIRST USE 11-1-2003; IN COMMERCE 11-1-2003.

THE MARK CONSISTS OF STANDARD CHARACTERS WITHOUT CLAIM TO ANY PARTICULAR FONT, STYLE, SIZE, OR COLOR.

SN 77-842,758, FILED 10-6-2009.

TINA BROWN, EXAMINING ATTORNEY



David J. Kyffers

Director of the United States Patent and Trademark Office

United States of America

United States Patent and Trademark Office



Reg. No. 4,074,572

Registered Dec. 20, 2011

Int. Cl.: 44

SERVICE MARK

PRINCIPAL REGISTER

HAIR CLUB FOR MEN LTD., INC. (FLORIDA CORPORATION)
1515 SOUTH FEDERAL HIGHWAY
BOCA RATON, FL 33432

FOR: HAIR CARE SERVICES, NAMELY, HAIR IMPLANTATION, HAIR REPLACEMENT, HAIR ADDITION AND HAIR RESTORATION; MEDICAL SERVICES IN THE NATURE OF DIAGNOSTICS AND TREATMENT OF HAIR LOSS AND HAIR TRANSPLANTATION SERVICES, ALL PERFORMED BY A LICENSED MEDICAL DOCTOR, IN CLASS 44 (U.S. CLS. 100 AND 101).

FIRST USE 8-0-2010; IN COMMERCE 8-0-2010.

OWNER OF U.S. REG. NOS. 1,123,852, 1,830,003, AND OTHERS.

NO CLAIM IS MADE TO THE EXCLUSIVE RIGHT TO USE "HAIR" AND "MEDICAL GROUP", APART FROM THE MARK AS SHOWN.

THE MARK CONSISTS OF THE WORDING "HAIR CLUB" IN STYLIZED FONT WITH A CURVED LINE PASSING THROUGH THE WORDS "HAIR CLUB" AND THE WORDING "MEDICAL GROUP" BENEATH THE LETTERS "AIR CLUB" IN THE WORDS "HAIR CLUB".

SN 77-842,964, FILED 10-6-2009.

TINA BROWN, EXAMINING ATTORNEY



David J. Kyros

Director of the United States Patent and Trademark Office

United States of America

United States Patent and Trademark Office



Reg. No. 4,074,573

HAIR CLUB FOR MEN LTD., INC. (FLORIDA CORPORATION)
1515 SOUTH FEDERAL HIGHWAY
BOCA RATON, FL 33432

Registered Dec. 20, 2011

Int. Cl.: 44

FOR: HAIR CARE SERVICES, NAMELY, HAIR IMPLANTATION, HAIR REPLACEMENT, HAIR ADDITION AND HAIR RESTORATION; MEDICAL SERVICES IN THE NATURE OF DIAGNOSTICS AND TREATMENT OF HAIR LOSS AND HAIR TRANSPLANTATION SERVICES, ALL PERFORMED BY A LICENSED MEDICAL DOCTOR, IN CLASS 44 (U.S. CLS. 100 AND 101).

SERVICE MARK

PRINCIPAL REGISTER

FIRST USE 11-9-2011; IN COMMERCE 11-9-2011.

OWNER OF U.S. REG. NOS. 1,123,852, 1,830,003, AND OTHERS.

NO CLAIM IS MADE TO THE EXCLUSIVE RIGHT TO USE "HAIR", "MEDICAL GROUP" AND THE DESIGN OF A CADUCEUS, APART FROM THE MARK AS SHOWN.

THE MARK CONSISTS OF THE WORDING "HAIR CLUB" IN STYLIZED FONT WITH A CURVED LINE PASSING THROUGH THE WORDS "HAIR CLUB" AND A CADUCEUS BETWEEN THE WORD "HAIR" AND THE WORD "CLUB". THE WORDING "MEDICAL GROUP" IS BENEATH THE LETTERS "AIR CLUB" IN THE WORDS "HAIR CLUB".

SN 77-842,981, FILED 10-6-2009.

TINA BROWN, EXAMINING ATTORNEY



David J. Kyros

Director of the United States Patent and Trademark Office

United States of America

United States Patent and Trademark Office

GROOVY SPOON

Reg. No. 4,074,574

BERRYLICIOUS INC. (CALIFORNIA CORPORATION)
5503 RESEDA BLVD.

Registered Dec. 20, 2011

TARZANA, CA 91356

Int. Cl.: 35

FOR: RETAIL STORE SERVICES FEATURING FROZEN YOGURT, IN CLASS 35 (U.S. CLS. 100, 101 AND 102).

SERVICE MARK

FIRST USE 6-20-2008; IN COMMERCE 6-20-2008.

PRINCIPAL REGISTER

THE MARK CONSISTS OF STANDARD CHARACTERS WITHOUT CLAIM TO ANY PARTICULAR FONT, STYLE, SIZE, OR COLOR.

SN 77-843,616, FILED 10-7-2009.

COLLEEN DOMBROW, EXAMINING ATTORNEY



David J. Kybas

Director of the United States Patent and Trademark Office

United States of America

United States Patent and Trademark Office

LEVMIXER

Reg. No. 4,074,575

ATMI PACKAGING, INC. (MINNESOTA CORPORATION)
7 COMMERCE DRIVE
DANBURY, CT 06810

Registered Dec. 20, 2011

Int. Cl.: 20

FOR: CONTAINERS, NOT OF METAL FOR COMMERCIAL USE, IN CLASS 20 (U.S. CLS. 2, 13, 22, 25, 32 AND 50).

TRADEMARK

FIRST USE 3-23-2011; IN COMMERCE 3-23-2011.

PRINCIPAL REGISTER

THE MARK CONSISTS OF STANDARD CHARACTERS WITHOUT CLAIM TO ANY PARTICULAR FONT, STYLE, SIZE, OR COLOR.

OWNER OF U.S. REG. NO. 3,573,131.

SN 77-846,315, FILED 10-12-2009.

TINA BROWN, EXAMINING ATTORNEY



David J. Kybas

Director of the United States Patent and Trademark Office

United States of America

United States Patent and Trademark Office

SIMJUNIOR

Reg. No. 4,074,576

LAERDAL MEDICAL AS (NORWAY CORPORATION)

Registered Dec. 20, 2011

P.O. BOX 377
STAVANGER, NORWAY N4002

Int. Cls.: 9 and 41

FOR: MEDICAL TEACHING MANNEQUINS, NAMELY, PATIENT SIMULATORS IN THE FORM OF PARTIAL AND FULL BODY ANIMATED HUMANOID MANNEQUINS SIMULATING SOUNDS, SYMPTOMS, MEDICAL CONDITIONS AND EVENTS, WITH SIMULATED INJECTION, MONITORING AND ANALYSIS SITES, INCORPORATING SUB-ASSEMBLY SYSTEMS CONSISTING OF ELECTRONICS, PNEUMATICS AND ELECTRO-MECHANICALS, WITH COMPUTERIZED PROGRAMS, TRAINING SYSTEMS, DIAGNOSTIC PROCEDURES, ANALYSIS, AND REPORTING FUNCTIONS, IN CLASS 9 (U.S. CLS. 21, 23, 26, 36 AND 38).

TRADEMARK

SERVICE MARK

PRINCIPAL REGISTER

FIRST USE 8-26-2011; IN COMMERCE 10-3-2011.

FOR: EDUCATIONAL SERVICES, NAMELY, PROVIDING COURSES OF INSTRUCTION REGARDING USE OF MEDICAL TEACHING MANNEQUINS, NAMELY, PATIENT SIMULATORS IN THE FORM OF PARTIAL AND FULL BODY ANIMATED HUMANOID MANNEQUINS SIMULATING SOUNDS, SYMPTOMS, MEDICAL CONDITIONS AND EVENTS, WITH SIMULATED INJECTION, MONITORING AND ANALYSIS SITES, INCORPORATING SUB-ASSEMBLY SYSTEMS CONSISTING OF ELECTRONICS, PNEUMATICS AND ELECTRO-MECHANICALS, WITH COMPUTERIZED PROGRAMS, TRAINING SYSTEMS, DIAGNOSTIC PROCEDURES, ANALYSIS, AND REPORTING FUNCTIONS, AND EDUCATIONAL MATERIALS AND PRINTED REPORTS DISTRIBUTED THEREWITH, IN CLASS 41 (U.S. CLS. 100, 101 AND 107).

FIRST USE 8-26-2011; IN COMMERCE 10-3-2011.

THE MARK CONSISTS OF STANDARD CHARACTERS WITHOUT CLAIM TO ANY PARTICULAR FONT, STYLE, SIZE, OR COLOR.

SN 77-846,750, FILED 10-12-2009.

CHRIS WELLS, EXAMINING ATTORNEY



David J. Kypos

Director of the United States Patent and Trademark Office

United States of America

United States Patent and Trademark Office

AVS ANCHOR

Reg. No. 4,074,577

STRYKER SPINE (FRANCE CORPORATION)

Registered Dec. 20, 2011

Z.I. DE MARTICOT
CESTAS, FRANCE F-33610

Int. Cl.: 10

FOR: ORTHOPEDIC IMPLANTS AND ORTHOPEDIC INSTRUMENTS TO FACILITATE THE IMPLANTATION OF ORTHOPEDIC IMPLANTS, IN CLASS 10 (U.S. CLS. 26, 39 AND 44).

TRADEMARK

FIRST USE 7-0-2011; IN COMMERCE 7-0-2011.

PRINCIPAL REGISTER

THE MARK CONSISTS OF STANDARD CHARACTERS WITHOUT CLAIM TO ANY PARTICULAR FONT, STYLE, SIZE, OR COLOR.

NO CLAIM IS MADE TO THE EXCLUSIVE RIGHT TO USE "ANCHOR", APART FROM THE MARK AS SHOWN.

SN 77-848,339, FILED 10-14-2009.

KARANENDRA S. CHHINA, EXAMINING ATTORNEY



David J. Kybas

Director of the United States Patent and Trademark Office

United States of America

United States Patent and Trademark Office

LIFE VALUE

Reg. No. 4,074,578

BANNER LIFE INSURANCE COMPANY (MARYLAND CORPORATION)
3275 BENNETT CREEK AVENUE
FREDERICK, MD 21704

Registered Dec. 20, 2011

Int. Cl.: 36

FOR: INSURANCE SERVICES, NAMELY, UNDERWRITING, ISSUING AND ADMINISTRATION OF LIFE INSURANCE, IN CLASS 36 (U.S. CLS. 100, 101 AND 102).

SERVICE MARK

FIRST USE 11-18-2009; IN COMMERCE 11-18-2009.

PRINCIPAL REGISTER

THE MARK CONSISTS OF STANDARD CHARACTERS WITHOUT CLAIM TO ANY PARTICULAR FONT, STYLE, SIZE, OR COLOR.

NO CLAIM IS MADE TO THE EXCLUSIVE RIGHT TO USE "LIFE", APART FROM THE MARK AS SHOWN.

SN 77-849,199, FILED 10-15-2009.

IRA J. GOODSaid, EXAMINING ATTORNEY



David J. Kyffers

Director of the United States Patent and Trademark Office

United States of America

United States Patent and Trademark Office

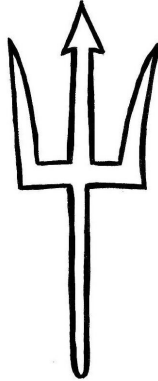

Reg. No. 4,074,579

Registered Dec. 20, 2011

Int. Cl.: 25

TRADEMARK

PRINCIPAL REGISTER

ARIZONA BOARD OF REGENTS, FOR AND ON BEHALF OF ARIZONA STATE UNIVERSITY
(UNITED STATES BODY CORPORATE)
P.O. BOX 877405
TEMPE, AZ 852877405

FOR: ATHLETIC UNIFORMS; CAPS; CAPS WITH VISORS; JERSEYS; SHIRTS; TOPS; AND
UNIFORMS, IN CLASS 25 (U.S. CLS. 22 AND 39).

FIRST USE 2-22-2006; IN COMMERCE 2-22-2006.

OWNER OF U.S. REG. NOS. 1,449,790, 1,470,103, AND 3,092,912.

THE MARK CONSISTS OF THE DESIGN OF A PITCHFORK.

SN 77-850,944, FILED 10-16-2009.

JESSICA FATHY, EXAMINING ATTORNEY



David J. Kyffers

Director of the United States Patent and Trademark Office

United States of America

United States Patent and Trademark Office



Reg. No. 4,074,580

Registered Dec. 20, 2011

Int. Cl.: 28

TRADEMARK

PRINCIPAL REGISTER

FACTORY ENTERTAINMENT, INC. (CALIFORNIA CORPORATION)
2350 WHITMAN ROAD
CONCORD, CA 94518

FOR: TOYS AND NOVELTY ITEMS, NAMELY, PROP REPLICAS OF PROPS FEATURED IN TELEVISION PROGRAMS, MOTION PICTURES AND VIDEO GAMES, NAMELY, TOY WEAPONS, TOY COLLECTIBLE WEAPONS, MECHANICAL TOYS, AND ELECTRIC ACTION TOYS; BOARD GAMES, DIORAMAS, NAMELY, PLAY SETS FOR ACTION FIGURES AND CASES FOR ACTION FIGURES, DOLLS, TOY VEHICLES, COLLECTIBLE TOY FIGURES, ACTION FIGURES, PLAY FIGURES, STUFFED AND PLUSH TOYS, TRADING CARD GAMES, IN CLASS 28 (U.S. CLS. 22, 23, 38 AND 50).

FIRST USE 7-0-2010; IN COMMERCE 7-0-2010.

NO CLAIM IS MADE TO THE EXCLUSIVE RIGHT TO USE "ENTERTAINMENT", APART FROM THE MARK AS SHOWN.

THE MARK CONSISTS OF THE WORDS "FACTORY ENTERTAINMENT" SUPERIMPOSED ON A STYLIZED REPRESENTATION OF A BUILDING, WITH THE WORD "ENTERTAINMENT" UNDERLINED AND PLACED UNDER THE WORD "FACTORY".

SN 77-853,885, FILED 10-21-2009.

JESSICA A. POWERS, EXAMINING ATTORNEY



David J. Kyffers

Director of the United States Patent and Trademark Office

United States of America

United States Patent and Trademark Office

BAR CODE

Reg. No. 4,074,581

JRD IMC, LLC (DELAWARE LIMITED LIABILITY COMPANY)
15-24 132ND STREET

Registered Dec. 20, 2011

COLLEGE POINT, NY 11356

Int. Cl.: 32

FOR: NON-ALCOHOLIC COCKTAIL MIXES, IN CLASS 32 (U.S. CLS. 45, 46 AND 48).

TRADEMARK

FIRST USE 5-7-2011; IN COMMERCE 5-7-2011.

PRINCIPAL REGISTER

THE MARK CONSISTS OF STANDARD CHARACTERS WITHOUT CLAIM TO ANY PARTICULAR FONT, STYLE, SIZE, OR COLOR.

SN 77-854,376, FILED 10-21-2009.

TRACY WHITTAKER-BROWN, EXAMINING ATTORNEY



David J. Kyffers

Director of the United States Patent and Trademark Office

United States of America

United States Patent and Trademark Office

TRON LEGACY

Reg. No. 4,074,582

DISNEY ENTERPRISES, INC. (DELAWARE CORPORATION)
500 SOUTH BUENA VISTA STREET
BURBANK, CA 91521

Registered Dec. 20, 2011

Int. Cl.: 16

FOR: APPLIQUES IN THE FORM OF DECALS; ART PRINTS; BALL POINT PENS; A SERIES OF FICTION BOOKS; BOOKS, IN THE FIELD OF STORIES FOR CHILDREN; CALENDARS; DECALS; GREETING CARDS; PENS; PICTURE BOOKS; POSTERS; WRITING IMPLEMENTS, IN CLASS 16 (U.S. CLS. 2, 5, 22, 23, 29, 37, 38 AND 50).

TRADEMARK

PRINCIPAL REGISTER

FIRST USE 10-10-2010; IN COMMERCE 10-10-2010.

THE MARK CONSISTS OF STANDARD CHARACTERS WITHOUT CLAIM TO ANY PARTICULAR FONT, STYLE, SIZE, OR COLOR.

SN 77-859,345, FILED 10-28-2009.

WON TEAK OH, EXAMINING ATTORNEY



David J. Kyffers

Director of the United States Patent and Trademark Office

United States of America

United States Patent and Trademark Office

BINGOMAX

Reg. No. 4,074,583

Registered Dec. 20, 2011

Int. Cls.: 9 and 41

TRADEMARK

SERVICE MARK

PRINCIPAL REGISTER

MULTIMEDIA GAMES, INC. (TEXAS CORPORATION)
4TH FLOOR, BUILDING B
206 WILD BASIN RD SOUTH
AUSTIN, TX 78746

FOR: COMPUTER SOFTWARE, NAMELY, GAME ENGINE SOFTWARE FOR VIDEO GAME DEVELOPMENT AND OPERATION; GAMING DEVICES, NAMELY, GAMING MACHINES, SLOT MACHINES, BINGO MACHINES, WITH OR WITHOUT VIDEO OUTPUT, IN CLASS 9 (U.S. CLS. 21, 23, 26, 36 AND 38).

FIRST USE 11-16-2010; IN COMMERCE 11-16-2010.

FOR: GAMING SERVICES IN THE NATURE OF CASINO GAMING, IN CLASS 41 (U.S. CLS. 100, 101 AND 107).

FIRST USE 11-16-2010; IN COMMERCE 11-16-2010.

THE MARK CONSISTS OF STANDARD CHARACTERS WITHOUT CLAIM TO ANY PARTICULAR FONT, STYLE, SIZE, OR COLOR.

SN 77-862,618, FILED 11-2-2009.

ALAIN LAPTER, EXAMINING ATTORNEY



David J. Kyfos

Director of the United States Patent and Trademark Office

United States of America

United States Patent and Trademark Office

CEREVAST

Reg. No. 4,074,584

CEREVAST THERAPEUTICS, INC. (DELAWARE CORPORATION)
12277 134TH CT. NE, STE. 202
REDMOND, WA 98052

Registered Dec. 20, 2011

Int. Cls.: 10 and 44

FOR: ULTRASOUND DIAGNOSTIC AND TREATMENT APPARATUS, IN CLASS 10 (U.S. CLS. 26, 39 AND 44).

TRADEMARK

FIRST USE 12-31-2009; IN COMMERCE 12-31-2009.

SERVICE MARK

FOR: MEDICAL SERVICES, NAMELY, ULTRASOUND FOR THE TREATMENT OF BLOOD CLOTS, VASCULAR DISORDERS, INCLUDING STROKE, PERIPHERAL ARTERIAL OCCLUSION, DEEP VEIN THROMBOSIS, AND MYOCARDIAL INFARCTION; SURGERY ACCOMPANIED BY THE USE OF ULTRASOUND FOR THE TREATMENT OF BLOOD CLOTS, VASCULAR DISORDERS, INCLUDING STROKE, PERIPHERAL ARTERIAL OCCLUSION, DEEP VEIN THROMBOSIS, AND MYOCARDIAL INFARCTION, IN CLASS 44 (U.S. CLS. 100 AND 101).

PRINCIPAL REGISTER

FIRST USE 12-31-2009; IN COMMERCE 12-31-2009.

THE MARK CONSISTS OF STANDARD CHARACTERS WITHOUT CLAIM TO ANY PARTICULAR FONT, STYLE, SIZE, OR COLOR.

SN 77-863,164, FILED 11-2-2009.

LINDA MICKLEBURGH, EXAMINING ATTORNEY



David J. Kyffers

Director of the United States Patent and Trademark Office

United States of America

United States Patent and Trademark Office

POSITIVE CHARGE

Reg. No. 4,074,585

BRISTOL-MYERS SQUIBB COMPANY (DELAWARE CORPORATION)
345 PARK AVENUE
NEW YORK, NY 10154

Registered Dec. 20, 2011

Int. Cl.: 16

FOR: PRINTED MATTER, NAMELY, BOOKLETS, BROCHURES, PAMPHLETS, NEWSLETTERS REPORTS AND GUIDES, ALL IN THE FIELD OF HIV/AIDS AND HIV/AIDS ADVOCACY, IN CLASS 16 (U.S. CLS. 2, 5, 22, 23, 29, 37, 38 AND 50).

TRADEMARK

FIRST USE 5-1-2010; IN COMMERCE 5-1-2010.

PRINCIPAL REGISTER

THE MARK CONSISTS OF STANDARD CHARACTERS WITHOUT CLAIM TO ANY PARTICULAR FONT, STYLE, SIZE, OR COLOR.

SN 77-863,547, FILED 11-3-2009.

LOURDES AYALA, EXAMINING ATTORNEY



David J. Kybas

Director of the United States Patent and Trademark Office

United States of America

United States Patent and Trademark Office

STRETCH 'N LOCK

Reg. No. 4,074,586

POLY-AMERICA, L.P. (TEXAS LIMITED PARTNERSHIP)
2000 WEST MARSHALL DRIVE
GRAND PRAIRIE, TX 75051

Registered Dec. 20, 2011

Int. Cl.: 16

FOR: PLASTIC TRASH BAGS, IN CLASS 16 (U.S. CLS. 2, 5, 22, 23, 29, 37, 38 AND 50).

TRADEMARK

FIRST USE 2-1-2011; IN COMMERCE 2-1-2011.

PRINCIPAL REGISTER

THE MARK CONSISTS OF STANDARD CHARACTERS WITHOUT CLAIM TO ANY PARTICULAR FONT, STYLE, SIZE, OR COLOR.

NO CLAIM IS MADE TO THE EXCLUSIVE RIGHT TO USE "STRETCH", APART FROM THE MARK AS SHOWN.

SN 77-867,747, FILED 11-8-2009.

SUE LAWRENCE, EXAMINING ATTORNEY



David J. Kyffers

Director of the United States Patent and Trademark Office

United States of America

United States Patent and Trademark Office

Replenishment.com

Reg. No. 4,074,587

Registered Dec. 20, 2011

Int. Cl.: 35

SERVICE MARK

PRINCIPAL REGISTER

GREEN MARKET SYSTEMS, INC. (OREGON CORPORATION), DBA
REPLENISHMENT.COM,
161 HIGH STREET SE, SUITE 206A
SALEM, OR 97301

FOR: PROVIDING A WEBSITE FEATURING INFORMATION IN THE FIELD OF SALES ANALYSIS AND RECOMMENDATIONS FOR RETAIL SELLERS OF LIVE PLANTS , IN CLASS 35 (U.S. CLS. 100, 101 AND 102).

FIRST USE 11-1-2009; IN COMMERCE 11-1-2009.

THE MARK CONSISTS OF STANDARD CHARACTERS WITHOUT CLAIM TO ANY PARTICULAR FONT, STYLE, SIZE, OR COLOR.

SN 77-869,056, FILED 11-10-2009.

KEVON CHISOLM, EXAMINING ATTORNEY



David J. Kybas

Director of the United States Patent and Trademark Office

United States of America

United States Patent and Trademark Office

RISK CONSCIOUS

Reg. No. 4,074,588

Registered Dec. 20, 2011

Int. Cl.: 36

SERVICE MARK

PRINCIPAL REGISTER

GRESHAM PARTNERS, LLC (DELAWARE LIMITED LIABILITY COMPANY)
SUITE 700
CHICAGO, IL 60606

FOR: FINANCIAL SERVICES, NAMELY, INTEGRATED WEALTH MANAGEMENT AND ESTATE PLANNING, FINANCIAL PLANNING, INVESTMENT ADVICE, INVESTMENT MANAGEMENT, INVESTMENT CONSULTATION AND INVESTMENT OF FUNDS FOR OTHERS, INCLUDING PRIVATE AND PUBLIC EQUITY AND DEBT INVESTMENT SERVICES, IN CLASS 36 (U.S. CLS. 100, 101 AND 102).

FIRST USE 9-7-2011; IN COMMERCE 9-7-2011.

THE MARK CONSISTS OF STANDARD CHARACTERS WITHOUT CLAIM TO ANY PARTICULAR FONT, STYLE, SIZE, OR COLOR.

NO CLAIM IS MADE TO THE EXCLUSIVE RIGHT TO USE "RISK", APART FROM THE MARK AS SHOWN.

SN 77-869,567, FILED 11-10-2009.

REBECCA POVARCHUK, EXAMINING ATTORNEY



David J. Kyros

Director of the United States Patent and Trademark Office

United States of America

United States Patent and Trademark Office

NOVA METAL

Reg. No. 4,074,589

Registered Dec. 20, 2011

Int. Cl.: 26

TRADEMARK

PRINCIPAL REGISTER

M/S. INDEUTSCH INTERNATIONAL (INDIA PARTNERSHIP)
PLOT NO. 42, NOIDA SPECIAL ECONOMIC ZONE
NOIDA, INDIA 201305

FOR: LACE AND EMBROIDERY, RIBBONS AND BRAID, BUTTON, HOOKS AND EYES, PINS, NAMELY, SAFETY PINS, HAIR PINS, PUSH PINS, SEWING PINS, MARKING PINS, KNITTING PINS, BOBBY PINS, TAPESTRY PINS, STITCHING PINS, PATCHWORK PINS, CROSS STITCH PINS, CROCHET PINS, NEEDLES, ARTIFICIAL FLOWER BROOCHES, ORNAMENTAL ARTIFICIAL FLOWERS FOR ATTACHMENT TO CLOTHING, KNEE BANDS, HAIR BANDS, ARM BANDS, ZIPPER FASTENERS, ELASTIC TAPES, ORNAMENTAL NOVELTY BADGES, FASTENING FOR SUSPENDERS, BELT BUCKLES, CLOTHING BUCKLES, SHOE BUCKLES, HAIR BUCKLES, DECORATIVE CORDS FOR CLOTHING, EYE LEADS FOR NEEDLE THREADING, BRAID EYES, SNAP FASTENERS AND LACE TRIMMING, IN CLASS 26 (U.S. CLS. 37, 39, 40, 42 AND 50).

FIRST USE 9-2-2011; IN COMMERCE 9-2-2011.

THE MARK CONSISTS OF STANDARD CHARACTERS WITHOUT CLAIM TO ANY PARTICULAR FONT, STYLE, SIZE, OR COLOR.

NO CLAIM IS MADE TO THE EXCLUSIVE RIGHT TO USE "METAL", APART FROM THE MARK AS SHOWN.

SN 77-870,099, FILED 11-11-2009.

JANICE KIM, EXAMINING ATTORNEY



David J. Kypos

Director of the United States Patent and Trademark Office

United States of America

United States Patent and Trademark Office



Reg. No. 4,074,590

Registered Dec. 20, 2011

Int. Cl.: 36

SERVICE MARK

PRINCIPAL REGISTER

AMBESS ENTERPRISES, INC. (PENNSYLVANIA CORPORATION)
1103 E. WALTON AVE
ALTOONA, PA 16602

FOR: PRE-PAID PURCHASE CARD SERVICES, NAMELY, PROCESSING ELECTRONIC PAYMENTS MADE THROUGH PREPAID CARDS; PROVIDING ELECTRONIC PROCESSING OF ACH AND CREDIT CARD TRANSACTIONS AND ELECTRONIC PAYMENTS VIA A GLOBAL COMPUTER NETWORK; PROVIDING ELECTRONIC PROCESSING OF ELECTRONIC FUNDS TRANSFER, ACH, CREDIT CARD, DEBIT CARD, ELECTRONIC CHECK AND ELECTRONIC PAYMENTS, IN CLASS 36 (U.S. CLS. 100, 101 AND 102).

FIRST USE 12-15-2009; IN COMMERCE 12-15-2009.

NO CLAIM IS MADE TO THE EXCLUSIVE RIGHT TO USE "PREPAID", APART FROM THE MARK AS SHOWN.

THE MARK CONSIST OF THE DESIGN OF A TRIANGLE WITH SWIRLS INSIDE THE TRIANGLE. THE TERM "AMBESS" IS BELOW THE DESIGN AND BELOW THAT IS THE TERM "PREPAID". THE TERM "PROFIT. NOW." IS BELOW THE TERM "PREPAID".

SN 77-870,914, FILED 11-12-2009.

NICHOLAS ALTREE, EXAMINING ATTORNEY



David J. Kybas

Director of the United States Patent and Trademark Office

United States of America

United States Patent and Trademark Office

PROFESSIONAL MEDICAL COUNSEL FOR YOU AND YOUR HEALTH

Reg. No. 4,074,591

PREMIER HEALTH ADVOCATES LLC (DELAWARE LIMITED LIABILITY COMPANY)
16192 COASTAL HIGHWAY
LEWES, DE 19958

Registered Dec. 20, 2011

Int. Cl.: 44

FOR: MEDICAL COUNSELING SERVICES WHERE NON-TREATING PHYSICIANS ACT AS LIAISONS BETWEEN PATIENTS AND THE PATIENTS' MEDICAL PROVIDERS AND DO NOT PROVIDE MEDICAL TREATMENT, IN CLASS 44 (U.S. CLS. 100 AND 101).

SERVICE MARK

FIRST USE 2-14-2010; IN COMMERCE 2-14-2010.

PRINCIPAL REGISTER

THE MARK CONSISTS OF STANDARD CHARACTERS WITHOUT CLAIM TO ANY PARTICULAR FONT, STYLE, SIZE, OR COLOR.

SN 77-876,171, FILED 11-19-2009.

DANNEAN HETZEL, EXAMINING ATTORNEY



David J. Kyros

Director of the United States Patent and Trademark Office

United States of America

United States Patent and Trademark Office

ALPINE ICE BOWL

Reg. No. 4,074,592

MIGLIOZZI, SUE WOOD (UNITED STATES INDIVIDUAL)
15766 LAKEWOOD LANE
GRASS VALLEY, CA 95945

Registered Dec. 20, 2011

Int. Cl.: 21

FOR: BOWLS, IN CLASS 21 (U.S. CLS. 2, 13, 23, 29, 30, 33, 40 AND 50).

TRADEMARK

FIRST USE 6-15-2010; IN COMMERCE 6-15-2010.

PRINCIPAL REGISTER

THE MARK CONSISTS OF STANDARD CHARACTERS WITHOUT CLAIM TO ANY PARTICULAR FONT, STYLE, SIZE, OR COLOR.

NO CLAIM IS MADE TO THE EXCLUSIVE RIGHT TO USE "ICE BOWL", APART FROM THE MARK AS SHOWN.

SN 77-876,811, FILED 11-19-2009.

CAROL SPILS, EXAMINING ATTORNEY



David J. Kybas

Director of the United States Patent and Trademark Office

United States of America

United States Patent and Trademark Office

VillageVines

Reg. No. 4,074,593

Registered Dec. 20, 2011

Int. Cl.: 35

SERVICE MARK

PRINCIPAL REGISTER

VILLAGEVINES LLC (DELAWARE LIMITED LIABILITY COMPANY)
113 BARKSDALE PROFESSIONAL CENTER
NEWARK, DE 197113258

FOR: PROVIDING A SEARCHABLE ONLINE ADVERTISING GUIDE FEATURING THE GOODS AND SERVICES OF ONLINE VENDORS, IN CLASS 35 (U.S. CLS. 100, 101 AND 102).

FIRST USE 5-1-2010; IN COMMERCE 5-28-2010.

THE MARK CONSISTS OF STANDARD CHARACTERS WITHOUT CLAIM TO ANY PARTICULAR FONT, STYLE, SIZE, OR COLOR.

SN 77-877,756, FILED 11-20-2009.

RUSS HERMAN, EXAMINING ATTORNEY



David J. Kyffers

Director of the United States Patent and Trademark Office

United States of America

United States Patent and Trademark Office

Venture500

Reg. No. 4,074,594

ALPHA MARKETING (ALABAMA LIMITED LIABILITY COMPANY)
3616 KINGSHILL ROAD
BIRMINGHAM, AL 35223

Registered Dec. 20, 2011

Int. Cl.: 35

FOR: BUSINESS ADVISORY SERVICES, CONSULTANCY AND INFORMATION, IN CLASS 35 (U.S. CLS. 100, 101 AND 102).

SERVICE MARK

FIRST USE 3-15-2011; IN COMMERCE 3-15-2011.

PRINCIPAL REGISTER

THE MARK CONSISTS OF STANDARD CHARACTERS WITHOUT CLAIM TO ANY PARTICULAR FONT, STYLE, SIZE, OR COLOR.

SN 77-877,799, FILED 11-20-2009.

ROBIN MITTLER, EXAMINING ATTORNEY



David J. Kybas

Director of the United States Patent and Trademark Office

United States of America

United States Patent and Trademark Office



Reg. No. 4,074,595

Registered Dec. 20, 2011

Int. Cl.: 25

TRADEMARK

PRINCIPAL REGISTER

KLEINEBREIL, SHARILYN (UNITED STATES INDIVIDUAL)
12970 SUNDANCE AVENUE
SAN DIEGO, CA 92129

FOR: CLOTHING, NAMELY, SHIRTS, T-SHIRTS, PANTS, SHORTS, SKIRTS, DRESSES, JACKETS, SWEATPANTS, SWEATSHIRTS, LOUNGEWEAR, JOGGING SUITS, EXERCISE PANTS AND TOPS, BEACHWEAR; SWEATERS, SWIMWEAR, FOOTWEAR, HEADWEAR, IN CLASS 25 (U.S. CLS. 22 AND 39).

FIRST USE 8-0-1997; IN COMMERCE 4-7-1999.

THE MARK CONSISTS OF A WOMAN WEARING A BATHING SUIT AND DARK SUNGLASSES. THE WOMAN IS LAYING ON A BEACH TOWEL, RESTING ONE ARM ON THE TOWEL AND RAISING A GLASS IN THE AIR WITH THE OTHER ARM. THREE DIAGONAL BARS EMANATE FROM THE TOWEL ON EACH SIDE.

SN 77-881,056, FILED 11-25-2009.

SHAILA SETTLES, EXAMINING ATTORNEY



David J. Kyros

Director of the United States Patent and Trademark Office

United States of America

United States Patent and Trademark Office

BASTINE

Reg. No. 4,074,596

HEMP FORTEX INDUSTRIES LTD (CHINA LIMITED PARTNERSHIP)
266 NINGXIA ROAD #1F
QINGDAO, CHINA

Registered Dec. 20, 2011

Int. Cl.: 22

FOR: HEMP FIBERS, IN CLASS 22 (U.S. CLS. 1, 2, 7, 19, 22, 42 AND 50).

TRADEMARK

FIRST USE 7-27-2011; IN COMMERCE 7-27-2011.

PRINCIPAL REGISTER

THE MARK CONSISTS OF STANDARD CHARACTERS WITHOUT CLAIM TO ANY PARTICULAR FONT, STYLE, SIZE, OR COLOR.

SN 77-884,913, FILED 12-2-2009.

JAY BESCH, EXAMINING ATTORNEY



David J. Kybas

Director of the United States Patent and Trademark Office

United States of America

United States Patent and Trademark Office

AquaGlas

Reg. No. 4,074,597

PIEDMONT PLASTICS, INC. (NORTH CAROLINA CORPORATION)
5010 WEST W.T. HARRIS BLVD.
CHARLOTTE, NC 28269

Registered Dec. 20, 2011

Int. Cl.: 17

FOR: PLASTICS IN THE FORM OF SHEETS, FILMS, BLOCKS, RODS AND TUBES, IN CLASS 17 (U.S. CLS. 1, 5, 12, 13, 35 AND 50).

TRADEMARK

FIRST USE 1-1-2000; IN COMMERCE 1-1-2000.

PRINCIPAL REGISTER

THE MARK CONSISTS OF STANDARD CHARACTERS WITHOUT CLAIM TO ANY PARTICULAR FONT, STYLE, SIZE, OR COLOR.

SN 77-887,233, FILED 12-7-2009.

ALLISON SCHRODY, EXAMINING ATTORNEY



David J. Kybas

Director of the United States Patent and Trademark Office

United States of America

United States Patent and Trademark Office



Reg. No. 4,074,598

Registered Dec. 20, 2011

Int. Cl.: 16

TRADEMARK

PRINCIPAL REGISTER

BRISTOL-MYERS SQUIBB COMPANY (DELAWARE CORPORATION)
345 PARK AVENUE
NEW YORK, NY 10154

FOR: PRINTED MATTER, NAMELY, BOOKLETS, BROCHURES, PAMPHLETS, NEWSLETTERS REPORTS AND GUIDES, ALL IN THE FIELD OF HIV/AIDS AND HIV/AIDS ADVOCACY, IN CLASS 16 (U.S. CLS. 2, 5, 22, 23, 29, 37, 38 AND 50).

FIRST USE 5-1-2010; IN COMMERCE 5-1-2010.

THE MARK CONSISTS OF THE WORDS "POSITIVE CHARGE" WITH A "+" SIGN IN PLACE OF THE LETTER T AND WITH A LOOP DESIGN ELEMENT.

SN 77-887,580, FILED 12-7-2009.

LOURDES AYALA, EXAMINING ATTORNEY



David J. Kybas

Director of the United States Patent and Trademark Office

United States of America

United States Patent and Trademark Office

MILES

Reg. No. 4,074,599

KANGARO INDUSTRIES (REGD.) (INDIA PARTNERSHIP)
B-XXX-6754, FOCAL POINT
LUDHIANA, INDIA 141010

Registered Dec. 20, 2011

Int. Cl.: 16

FOR: STAPLERS, STAPLES, STAPLE REMOVERS, OFFICE PERFORATORS, PAPER HOLE PUNCHES, IN CLASS 16 (U.S. CLS. 2, 5, 22, 23, 29, 37, 38 AND 50).

TRADEMARK

FIRST USE 6-30-1995; IN COMMERCE 10-31-2011.

PRINCIPAL REGISTER

THE MARK CONSISTS OF STANDARD CHARACTERS WITHOUT CLAIM TO ANY PARTICULAR FONT, STYLE, SIZE, OR COLOR.

SN 77-887,677, FILED 12-7-2009.

MARC LEIPZIG, EXAMINING ATTORNEY



David J. Kybas

Director of the United States Patent and Trademark Office

United States of America

United States Patent and Trademark Office

ORACLES OF DELPHI

Reg. No. 4,074,600

IGT (NEVADA CORPORATION)
9295 PROTOTYPE DRIVE
RENO, NV 895218986

Registered Dec. 20, 2011

Int. Cl.: 9

FOR: GAMING MACHINES, NAMELY, DEVICES WHICH ACCEPT A WAGER, IN CLASS 9 (U.S. CLS. 21, 23, 26, 36 AND 38).

TRADEMARK

FIRST USE 10-19-2011; IN COMMERCE 10-19-2011.

PRINCIPAL REGISTER

THE MARK CONSISTS OF STANDARD CHARACTERS WITHOUT CLAIM TO ANY PARTICULAR FONT, STYLE, SIZE, OR COLOR.

SN 77-888,291, FILED 12-8-2009.

WARREN L. OLANDRIA, EXAMINING ATTORNEY



David J. Kybas

Director of the United States Patent and Trademark Office

United States of America

United States Patent and Trademark Office

BIOGLAN KIDS SMART HI DHA-OMEGA 3 FISH OIL

Reg. No. 4,074,601

Registered Dec. 20, 2011

Int. Cl.: 5

TRADEMARK

PRINCIPAL REGISTER

PHARM-A-CARE LABORATORIES PTY LIMITED (AUSTRALIA PROPRIETARY LIMITED COMPANY (P/L OR PTY. LTD.))
18 JUBILEE AVENUE, WARRIEWOOD
NEW SOUTH WALES, AUSTRALIA 2102

FOR: NUTRITIONAL SUPPLEMENTS IN CAPSULE FORM CONTAINING OMEGA 3'S DERIVED FROM FISH OIL; NUTRITIONAL AND FOOD SUPPLEMENTS CONTAINING OMEGA 3'S DERIVED FROM FISH OIL, IN CLASS 5 (U.S. CLS. 6, 18, 44, 46, 51 AND 52).

FIRST USE 7-5-2010; IN COMMERCE 7-5-2010.

THE MARK CONSISTS OF STANDARD CHARACTERS WITHOUT CLAIM TO ANY PARTICULAR FONT, STYLE, SIZE, OR COLOR.

NO CLAIM IS MADE TO THE EXCLUSIVE RIGHT TO USE "KIDS SMART HI DHA-OMEGA 3 FISH OIL", APART FROM THE MARK AS SHOWN.

SN 77-893,136, FILED 12-14-2009.

PAULA MAHONEY, EXAMINING ATTORNEY



David J. Kypos

Director of the United States Patent and Trademark Office

United States of America

United States Patent and Trademark Office



Reg. No. 4,074,602

Registered Dec. 20, 2011

Int. Cl.: 7

TRADEMARK

PRINCIPAL REGISTER

NORRIS SCREEN AND MANUFACTURING, LLC (WEST VIRGINIA LIMITED LIABILITY COMPANY)
21405 GOV, G.C. PERRY HIGHWAY
TAZEWELL, VA 24651

FOR: VIBRATORY SCREEN SEPARATORS, VIBRATING SCREENS, NON-VIBRATING SCREENS, INCLINE SCREENS, HORIZONTAL SCREENS, MODIFIED HORIZONTAL SCREENS, BANANA SCREENS CONSISTING OF ONE OR MULTIPLE DECKS OR COMBINATIONS, RETENTION SCREENS, FLAT DRAIN SCREENS, AND TROMMEL SCREENS ALL USED FOR MACHINES; COMPONENT PARTS THEREOF USED IN COAL PROCESSING AND MINERAL RECOVERY PLANTS AND BUILDINGS, AND USED AT MINE BUILDINGS AND FACILITIES AT MINES FOR THE MINING AND/OR CONVEYANCE OF COAL; COANDA EFFECT WIRE SCREENS AND WEDGE-WIRE SCREENS FOR DOMESTIC, AGRICULTURAL AND INDUSTRIAL USE, PARTICULARLY IN WATER AND WASTE WATER SCREENING, NAMELY, IN HYDRO-TURBINE INTAKES, HYDRO-ELECTRIC FACILITIES, IRRIGATION, WATER RESOURCE MANAGEMENT, WATER PURIFICATION, RAINWATER HARVESTING, FISH, SAND, SEDIMENT, DEBRIS, AND AQUATIC GROWTH EXCLUSION, AND INDUSTRIAL WATER TREATMENT; SIEVE BENDS, STATIC SIEVES, DEWATERING SIEVES, DSM SIEVE SCREENS AND AIR-FLOW CLEANERS USED IN THE PROCESSING OF COAL AND MINERALS, AND IN WASTE AND METALS RECOVERY, IN CLASS 7 (U.S. CLS. 13, 19, 21, 23, 31, 34 AND 35).

FIRST USE 9-30-1999; IN COMMERCE 9-30-1999.

THE MARK CONSISTS OF THE LETTERS "N", "S" IN BLUE ARRANGED DIAGONALLY INSIDE A BLUE OUTLINE OF A RECTANGLE WITH ROUNDED CORNERS.

THE COLOR(S) BLUE IS/ARE CLAIMED AS A FEATURE OF THE MARK.

SN 77-895,917, FILED 12-17-2009.

BRETT J. GOLDEN, EXAMINING ATTORNEY



David J. Kyffers

Director of the United States Patent and Trademark Office

United States of America

United States Patent and Trademark Office

God Belongs In My City

Reg. No. 4,074,603

SANABRIA, DANIEL (UNITED STATES INDIVIDUAL)
98 5TH AVE

Registered Dec. 20, 2011

BROOKLYN, NY 11217

Int. Cl.: 25

FOR: T-SHIRTS, IN CLASS 25 (U.S. CLS. 22 AND 39).

FIRST USE 11-14-2010; IN COMMERCE 11-14-2010.

TRADEMARK

THE MARK CONSISTS OF STANDARD CHARACTERS WITHOUT CLAIM TO ANY PARTICULAR FONT, STYLE, SIZE, OR COLOR.

PRINCIPAL REGISTER

SN 77-897,300, FILED 12-18-2009.

NAKIA HENRY, EXAMINING ATTORNEY



David J. Kyffers

Director of the United States Patent and Trademark Office

United States of America

United States Patent and Trademark Office

OCEAN DEFENDER

Reg. No. 4,074,604

KALAMA ORIANA (UNITED STATES INDIVIDUAL), DBA OCEAN DEFENDER,
276 KAHIKO ST.

Registered Dec. 20, 2011

PAIA, HI 96779

Int. Cl.: 25

FOR: T-SHIRTS, IN CLASS 25 (U.S. CLS. 22 AND 39).

TRADEMARK

FIRST USE 3-28-2010; IN COMMERCE 3-28-2010.

PRINCIPAL REGISTER

THE MARK CONSISTS OF STANDARD CHARACTERS WITHOUT CLAIM TO ANY PARTICULAR FONT, STYLE, SIZE, OR COLOR.

SN 77-897,646, FILED 12-19-2009.

BARBARA A. GOLD, EXAMINING ATTORNEY



David J. Kyffers

Director of the United States Patent and Trademark Office

United States of America

United States Patent and Trademark Office



Reg. No. 4,074,605

Registered Dec. 20, 2011

Int. Cl.: 29

TRADEMARK

PRINCIPAL REGISTER

SAN MIGUEL CORPORATION (PHILIPPINES CORPORATION)
NO. 40 SAN MIGUEL AVENUE
MANDALUYONG CITY
METRO MANILA, PHILIPPINES

FOR: LUNCHEON MEATS, IN CLASS 29 (U.S. CL. 46).

FIRST USE 12-12-2009; IN COMMERCE 12-12-2009.

OWNER OF U.S. REG. NOS. 917,805, 3,232,640, AND OTHERS.

NO CLAIM IS MADE TO THE EXCLUSIVE RIGHT TO USE "PUREFOODS LUNCHEON MEAT" AND THE REALISTIC DEPICTION OF THE LUNCHEON MEAT, APART FROM THE MARK AS SHOWN.

THE MARK CONSISTS OF A RECTANGLE CONTAINING THE WORDING "SAN MIGUEL", "PUREFOODS" AND "LUNCHEON MEAT" AND A STYLIZED DEPICTION OF LUNCHEON MEAT GARNISHED WITH LETTUCE AND VEGETABLES, WHICH IS ENCOMPASSED BY A RECTANGULAR BORDER WITH THE CORNERS CUT OFF. THE "I" IN "SAN MIGUEL" IS FORMED BY A STYLIZED DEPICTION OF TWO LEAVES. TWO OBLONG SHAPES APPEAR ABOVE THE WORDING "PUREFOODS" AND TWO OBLONG SHAPES APPEAR BELOW THE WORDING "PUREFOODS".

SN 77-899,698, FILED 12-22-2009.

CHRISIE B. KING, EXAMINING ATTORNEY



David J. Kybas

Director of the United States Patent and Trademark Office

United States of America

United States Patent and Trademark Office



Reg. No. 4,074,606

Registered Dec. 20, 2011

Int. Cls.: 16, 35, and 41

TRADEMARK

SERVICE MARK

PRINCIPAL REGISTER

SPECIAL CARE & CAREER SERVICES (TEXAS CORPORATION)
SUITE 100
4350 SIGMA
FARMERS BRANCH, TX 75244

FOR: PRINTED EDUCATIONAL MATERIALS IN THE FIELDS OF COGNITIVE DEVELOPMENT AND PHYSICAL DEVELOPMENT FOR USE BY PERSONS WITH SPECIAL NEEDS, IN CLASS 16 (U.S. CLS. 2, 5, 22, 23, 29, 37, 38 AND 50).

FIRST USE 3-8-2010; IN COMMERCE 3-8-2010.

FOR: JOB PLACEMENT TO PERSONS WITH SPECIAL NEEDS, IN CLASS 35 (U.S. CLS. 100, 101 AND 102).

FIRST USE 3-8-2010; IN COMMERCE 3-8-2010.

FOR: EDUCATIONAL SERVICES, NAMELY, PROVIDING CLASSES, SEMINARS AND WORKSHOPS REGARDING THE CARE OF PERSONS WITH SPECIAL NEEDS AND DISTRIBUTION OF MATERIAL IN CONNECTION THEREWITH; VOCATIONAL GUIDANCE AND CAREER COUNSELING, IN CLASS 41 (U.S. CLS. 100, 101 AND 107).

FIRST USE 3-8-2010; IN COMMERCE 3-8-2010.

THE MARK CONSISTS OF AN ABSTRACT HUMAN FIGURE EXTENDING THROUGH THE MARK "LAUNCHABILITY".

SN 77-904,424, FILED 1-4-2010.

NORA BUCHANAN WILL, EXAMINING ATTORNEY



David J. Kyjars

Director of the United States Patent and Trademark Office

United States of America

United States Patent and Trademark Office

CITIZEN SERVICE BEFORE SELF HONORS

Reg. No. 4,074,607

Registered Dec. 20, 2011

Int. Cls.: 35 and 41

SERVICE MARK

PRINCIPAL REGISTER

CONGRESSIONAL MEDAL OF HONOR FOUNDATION (PENNSYLVANIA NON-PROFIT ORGANIZATION)
40 PATRIOT POINT ROAD
MOUNT PLEASANT, SC 29464

FOR: PROMOTING PUBLIC AWARENESS OF THE IMPORTANCE OF HAVING THE COURAGE TO DO THE RIGHT THING IN DIFFICULT SITUATIONS AND CONSIDERING OTHERS BEFORE ONESELF AS A MEANS OF BUILDING CHARACTER AND MORE RESPONSIBLE CITIZENSHIP, IN CLASS 35 (U.S. CLS. 100, 101 AND 102).

FIRST USE 3-25-2011; IN COMMERCE 3-25-2011.

FOR: EDUCATIONAL AND RECOGNITION SERVICES, NAMELY, ARRANGING AND CONDUCTING EVENTS AND PRESENTING HONORS AND AWARDS TO CITIZENS WHO DEMONSTRATE COURAGE AND SELFLESSNESS IN THEIR DAILY LIVES EITHER THROUGH A SINGULAR ACT OF EXTRAORDINARY HEROISM OR A PROLONGED SERIES OF ACTS THAT CLEARLY PLACE OTHERS BEFORE THEMSELVES AS THE MEDAL OF HONOR RECIPIENTS DID IN COMBAT, IN CLASS 41 (U.S. CLS. 100, 101 AND 107).

FIRST USE 3-25-2011; IN COMMERCE 3-25-2011.

THE MARK CONSISTS OF STANDARD CHARACTERS WITHOUT CLAIM TO ANY PARTICULAR FONT, STYLE, SIZE, OR COLOR.

SN 77-905,070, FILED 1-5-2010.

RAUL CORDOVA, EXAMINING ATTORNEY



David J. Kyffers

Director of the United States Patent and Trademark Office

United States of America

United States Patent and Trademark Office

PEACH PASS

Reg. No. 4,074,608

Registered Dec. 20, 2011

Int. Cls.: 9, 36, and 39

STATE ROAD AND TOLLWAY AUTHORITY (GEORGIA A BODY CORPORATE AND
POLITIC AND AN INSTRUMENTALITY AND PUBLIC CORPORATION)
FOURTH FLOOR
47 TRINITY AVENUE
ATLANTA, GA 30334

TRADEMARK

FOR: TRANSPONDERS , IN CLASS 9 (U.S. CLS. 21, 23, 26, 36 AND 38).

SERVICE MARK

FIRST USE 4-20-2011; IN COMMERCE 4-20-2011.

PRINCIPAL REGISTER

FOR: HIGHWAY TOLL COLLECTION SERVICES, IN CLASS 36 (U.S. CLS. 100, 101 AND
102).

FIRST USE 7-1-2011; IN COMMERCE 7-1-2011.

FOR: PROVIDING A WEBSITE FEATURING TRANSPORTATION INFORMATION AND
NEWS ON GEORGIA'S TOLL ROADS AND OTHER TRANSPORTATION ISSUES; TRANS-
PORTATION INFORMATION REGARDING HIGHWAY TOLL ROADS, IN CLASS 39 (U.S.
CLS. 100 AND 105).

FIRST USE 8-17-2010; IN COMMERCE 8-17-2010.

THE MARK CONSISTS OF STANDARD CHARACTERS WITHOUT CLAIM TO ANY PAR-
TICULAR FONT, STYLE, SIZE, OR COLOR.

NO CLAIM IS MADE TO THE EXCLUSIVE RIGHT TO USE "PASS", APART FROM THE
MARK AS SHOWN.

SN 77-912,842, FILED 1-15-2010.

TEJBIR SINGH, EXAMINING ATTORNEY



David J. Kyffers

Director of the United States Patent and Trademark Office

United States of America

United States Patent and Trademark Office



Reg. No. 4,074,609

Registered Dec. 20, 2011

Int. Cl.: 25

TRADEMARK

PRINCIPAL REGISTER

ON OPTIMUM NUTRITION LIMITED (IRELAND LIMITED COMPANY (LTD.))
GLANBIA PLC
GLANBIA HOUSE
KILKENNY CITY, IRELAND

FOR: GYM SHORTS; HATS; T-SHIRTS; TOPS, IN CLASS 25 (U.S. CLS. 22 AND 39).

FIRST USE 2-1-2010; IN COMMERCE 2-1-2010.

OWNER OF U.S. REG. NOS. 2,811,132, 3,114,540, AND OTHERS.

NO CLAIM IS MADE TO THE EXCLUSIVE RIGHT TO USE "PERFORMANCE", APART FROM THE MARK AS SHOWN.

THE MARK CONSISTS OF THE IMAGE OF AN EAGLE AND THE LETTERS, "ABB" FOLLOWED BY THE WORD, "PERFORMANCE".

SN 77-913,965, FILED 1-18-2010.

DOMINIC FATHY, EXAMINING ATTORNEY



David J. Kybas

Director of the United States Patent and Trademark Office

United States of America

United States Patent and Trademark Office

Boot Hill Baits

Reg. No. 4,074,610

RUSH, BRAD (UNITED STATES INDIVIDUAL)
1803 RUHL RD.

Registered Dec. 20, 2011

KOKOMO, IN 46902

Int. Cl.: 28

FOR: ARTIFICIAL FISHING LURES, IN CLASS 28 (U.S. CLS. 22, 23, 38 AND 50).

TRADEMARK

FIRST USE 1-25-2008; IN COMMERCE 11-1-2011.

PRINCIPAL REGISTER

THE MARK CONSISTS OF STANDARD CHARACTERS WITHOUT CLAIM TO ANY PARTICULAR FONT, STYLE, SIZE, OR COLOR.

NO CLAIM IS MADE TO THE EXCLUSIVE RIGHT TO USE "BAITS", APART FROM THE MARK AS SHOWN.

SN 77-914,430, FILED 1-19-2010.

KELLEY WELLS, EXAMINING ATTORNEY



David J. Kyffers

Director of the United States Patent and Trademark Office

United States of America

United States Patent and Trademark Office

ReVel

Reg. No. 4,074,611

Registered Dec. 20, 2011

Int. Cl.: 10

TRADEMARK

PRINCIPAL REGISTER

CAREFUSION CORPORATION (DELAWARE CORPORATION)
3750 TORREY VIEW COURT
SAN DIEGO, CA 92130

FOR: MEDICAL VENTILATORS, IN CLASS 10 (U.S. CLS. 26, 39 AND 44).

FIRST USE 9-19-2011; IN COMMERCE 9-19-2011.

THE MARK CONSISTS OF STANDARD CHARACTERS WITHOUT CLAIM TO ANY PARTICULAR FONT, STYLE, SIZE, OR COLOR.

SN 77-914,442, FILED 1-19-2010.

DANIEL CAPSHAW, EXAMINING ATTORNEY



David J. Kybas

Director of the United States Patent and Trademark Office

United States of America

United States Patent and Trademark Office

MY MESS. MY RESPONSIBILITY.
THE END OF THE LINE AND
ANGLER TRASH

Reg. No. 4,074,612

Registered Dec. 20, 2011

Int. Cl.: 21

TRADEMARK

PRINCIPAL REGISTER

BUDRYK, PETER (UNITED STATES INDIVIDUAL)
APT. 405
285 HARVARD STREET
CAMBRIDGE, MA 02139

FOR: PORTABLE PLASTIC REFUSE CONTAINERS USED BY FISHERMEN SPECIFICALLY FOR THE IMMEDIATE AND PROPER TEMPORARY STORAGE OF AND EVENTUAL RECYCLING OF DISCARDED FISHING LINES AS WELL AS THE PROPER TEMPORARY STORAGE OF AND EVENTUAL RECYCLING OF FISHING RELATED TRASH, IN CLASS 21 (U.S. CLS. 2, 13, 23, 29, 30, 33, 40 AND 50).

FIRST USE 1-4-2011; IN COMMERCE 7-12-2011.

THE MARK CONSISTS OF STANDARD CHARACTERS WITHOUT CLAIM TO ANY PARTICULAR FONT, STYLE, SIZE, OR COLOR.

SN 77-914,658, FILED 1-19-2010.

JAMES GRIFFIN, EXAMINING ATTORNEY



David J. Kyffers

Director of the United States Patent and Trademark Office

United States of America

United States Patent and Trademark Office

ORIGINAL 1853 CHIPS

Reg. No. 4,074,613

MCCAIN FOODS USA, INC. (MAINE CORPORATION)
2275 CABOT DRIVE
LISLE, IL 605323653

Registered Dec. 20, 2011

Int. Cl.: 29

FOR: FROZEN PROCESSED VEGETABLES, IN CLASS 29 (U.S. CL. 46).

TRADEMARK

FIRST USE 1-0-2011; IN COMMERCE 1-0-2011.

PRINCIPAL REGISTER

THE MARK CONSISTS OF STANDARD CHARACTERS WITHOUT CLAIM TO ANY PARTICULAR FONT, STYLE, SIZE, OR COLOR.

NO CLAIM IS MADE TO THE EXCLUSIVE RIGHT TO USE "CHIPS", APART FROM THE MARK AS SHOWN.

SN 77-914,797, FILED 1-19-2010.

RAUL CORDOVA, EXAMINING ATTORNEY



David J. Kyffers

Director of the United States Patent and Trademark Office

United States of America

United States Patent and Trademark Office



Reg. No. 4,074,614

Registered Dec. 20, 2011

Int. Cl.: 43

SERVICE MARK

PRINCIPAL REGISTER

GHAZALE, KAZEM ABU (JORDAN INDIVIDUAL), DBA KAZEM ABU GHAZALE FOR IMPORT & EXPORT ESTABLISHMENT, ABU TAWEELE PLAZA, MECCA STREET AMMAN, JORDAN

FOR: FAST-FOOD RESTAURANTS; FAST-FOOD RESTAURANTS AND SNACKBARS; PROVISION OF FOOD AND DRINK IN RESTAURANTS; RESTAURANT AND CAFE SERVICES; RESTAURANT SERVICES; RESTAURANT SERVICES FEATURING SANDWICHES; RESTAURANT SERVICES, INCLUDING SIT-DOWN SERVICE OF FOOD AND TAKE-OUT RESTAURANT SERVICES; RESTAURANT SERVICES, NAMELY, PROVIDING OF FOOD AND BEVERAGES FOR CONSUMPTION ON AND OFF THE PREMISES, IN CLASS 43 (U.S. CLS. 100 AND 101).

FIRST USE 7-29-2011; IN COMMERCE 7-29-2011.

THE MARK CONSISTS OF THE WORDS "SHAWERMIZE" AND "IT" IN LOWER CASE, BLOCK LETTERING IN THE COLOR WHITE. THERE IS A PICTURE OF A WHITE STICK WITH RINGS SURROUNDING THE STICK AND DEPICTED IN THE COLORS ORANGE, LIGHT GREEN, TEAL, AND BLUE, WHEREIN THE STICK AND RINGS APPEAR BETWEEN THE WORDS "SHAWERMIZE" AND "IT". THE BACKGROUND IS GREEN, AND THERE IS GRAY SHADOWING AROUND THE LETTERING, THE STICK, AND THE RINGS.

THE COLOR(S) ORANGE, LIGHT GREEN, TEAL, BLUE, GREEN, WHITE, AND GRAY IS/ARE CLAIMED AS A FEATURE OF THE MARK.

SN 77-915,968, FILED 1-20-2010.

PRISCILLA MILTON, EXAMINING ATTORNEY



David J. Kyjars

Director of the United States Patent and Trademark Office

United States of America

United States Patent and Trademark Office

NIOEX

Reg. No. 4,074,615

Registered Dec. 20, 2011

Int. Cl.: 6

TRADEMARK

PRINCIPAL REGISTER

NIOEX SYSTEMS INC. (CANADA CORPORATION)
171 WAVERLY DRIVE
BRANDON MANITOBA, CANADA R7B4A4

FOR: METAL CONTAINER VESSELS FOR USE IN COMPOSTING OF ANIMAL CARCASSES AND ORGANIC SUBSTANCES, REPLACEMENT PARTS FOR SUCH VESSELS, AND ACCESSORIES SOLD TOGETHER WITH THE METAL CONTAINER VESSELS AS A UNIT, NAMELY, BONE SCREENERS AND PROGRAMMABLE LOGIC COMPUTERS FOR CONTROLLING COMPOSTING, IN CLASS 6 (U.S. CLS. 2, 12, 13, 14, 23, 25 AND 50).

FIRST USE 9-2-2011; IN COMMERCE 9-2-2011.

THE MARK CONSISTS OF STANDARD CHARACTERS WITHOUT CLAIM TO ANY PARTICULAR FONT, STYLE, SIZE, OR COLOR.

SN 77-916,111, FILED 1-20-2010.

VIVIAN MICZNIK FIRST, EXAMINING ATTORNEY



David J. Kybas

Director of the United States Patent and Trademark Office

United States of America

United States Patent and Trademark Office

BUTLER

Reg. No. 4,074,616

Registered Dec. 20, 2011

Int. Cls.: 16, 18, 21, and 25

BUTLER UNIVERSITY (INDIANA CORPORATION)
4600 SUNSET AVENUE
INDIANAPOLIS, IN 46208

FOR: OFFICE SUPPLIES AND ACCESSORIES, NAMELY, STICKERS, GREETING CARDS, AND PICTURES, IN CLASS 16 (U.S. CLS. 2, 5, 22, 23, 29, 37, 38 AND 50).

FIRST USE 9-0-2011; IN COMMERCE 9-0-2011.

TRADEMARK

FOR: UMBRELLAS, IN CLASS 18 (U.S. CLS. 1, 2, 3, 22 AND 41).

PRINCIPAL REGISTER

FIRST USE 3-10-2005; IN COMMERCE 3-10-2005.

FOR: INSULATED CONTAINERS FOR BEVERAGE CANS OR BOTTLES FOR DOMESTIC USE, DRINKING GLASSES, MUGS, DRINKWARE IN THE NATURE OF CUPS, GRILL COVERS, COASTERS MADE OF MATERIAL OTHER THAN PAPER AND NOT BEING LINEN, IN CLASS 21 (U.S. CLS. 2, 13, 23, 29, 30, 33, 40 AND 50).

FIRST USE 9-0-2011; IN COMMERCE 9-0-2011.

FOR: CLOTHING, NAMELY, JACKETS, CAPS, SWEATERS, T-SHIRTS, SHIRTS, PANTS, SWEATSHIRTS, NECKTIES, SWEATPANTS, SCARVES, BABY CLOTHING AND ACCESSORIES, NAMELY, ONE PIECE JUMPSUITS; JERSEYS, SOCKS, BOXER SHORTS, AND LOUNGE-WEAR, IN CLASS 25 (U.S. CLS. 22 AND 39).

FIRST USE 9-0-2011; IN COMMERCE 9-0-2011.

THE MARK CONSISTS OF STANDARD CHARACTERS WITHOUT CLAIM TO ANY PARTICULAR FONT, STYLE, SIZE, OR COLOR.

SN 77-918,379, FILED 1-22-2010.

WON TEAK OH, EXAMINING ATTORNEY



David J. Kyfos

Director of the United States Patent and Trademark Office

United States of America

United States Patent and Trademark Office

TOMBERLIN VANISH

Reg. No. 4,074,617

TOMBERLIN AUTOMOTIVE GROUP, INC (GEORGIA CORPORATION)
3123 WASHINGTON ROAD
AUGUSTA, GA 30907

Registered Dec. 20, 2011

Int. Cl.: 12

FOR: ELECTRIC MOTOR VEHICLES, NAMELY, LOW SPEED LAND VEHICLES FOR ROAD USE, OFF ROAD UTILITY VEHICLES AND ALL TERRAIN VEHICLES , IN CLASS 12 (U.S. CLS. 19, 21, 23, 31, 35 AND 44).

TRADEMARK

FIRST USE 9-29-2010; IN COMMERCE 9-29-2010.

PRINCIPAL REGISTER

THE MARK CONSISTS OF STANDARD CHARACTERS WITHOUT CLAIM TO ANY PARTICULAR FONT, STYLE, SIZE, OR COLOR.

OWNER OF U.S. REG. NOS. 3,172,271 AND 3,175,239.

SN 77-919,342, FILED 1-25-2010.

STEVEN PEREZ, EXAMINING ATTORNEY



David J. Kyffers

Director of the United States Patent and Trademark Office

United States of America

United States Patent and Trademark Office

BELIEVE WALK

Reg. No. 4,074,618

Registered Dec. 20, 2011

Int. Cl.: 35

SERVICE MARK

PRINCIPAL REGISTER

STATER BROS. CHARITIES (CALIFORNIA CORPORATION)
301 S. TIPPECANOE AVENUE
SAN BERNARDINO, CA 92408

FOR: WALKING AND RUNNING EVENTS DESIGNED TO BENEFIT AND DRAW ATTENTION TO CANCER DETECTION, TREATMENT, RESEARCH AND AWARENESS PROGRAMS, IN CLASS 35 (U.S. CLS. 100, 101 AND 102).

FIRST USE 6-1-2010; IN COMMERCE 6-1-2010.

THE MARK CONSISTS OF STANDARD CHARACTERS WITHOUT CLAIM TO ANY PARTICULAR FONT, STYLE, SIZE, OR COLOR.

NO CLAIM IS MADE TO THE EXCLUSIVE RIGHT TO USE "WALK", APART FROM THE MARK AS SHOWN.

SN 77-919,430, FILED 1-25-2010.

WARREN L. OLANDRIA, EXAMINING ATTORNEY



David J. Kyffers

Director of the United States Patent and Trademark Office

United States of America

United States Patent and Trademark Office

Duo Desk

Reg. No. 4,074,619

Registered Dec. 20, 2011

Int. Cl.: 20

MADISON, GREG (WYOMING LIMITED LIABILITY COMPANY), DBA ELECTRONIC
CLASSROOM FURNITURE SYSTEMS, LC,
P.O. BOX 627
25 MOUNTAIN HOME ROAD
STORY, WY 82842

TRADEMARK

PRINCIPAL REGISTER

FOR: DESKS, IN CLASS 20 (U.S. CLS. 2, 13, 22, 25, 32 AND 50).

FIRST USE 3-1-2010; IN COMMERCE 3-1-2010.

THE MARK CONSISTS OF STANDARD CHARACTERS WITHOUT CLAIM TO ANY PARTICULAR FONT, STYLE, SIZE, OR COLOR.

NO CLAIM IS MADE TO THE EXCLUSIVE RIGHT TO USE "DESK", APART FROM THE MARK AS SHOWN.

SN 77-921,100, FILED 1-27-2010.

KYLE PEETE, EXAMINING ATTORNEY



David J. Kyffers

Director of the United States Patent and Trademark Office

United States of America

United States Patent and Trademark Office

Curian Dynamic Risk Advantage

Reg. No. 4,074,620

JACKSON NATIONAL LIFE INSURANCE COMPANY (MICHIGAN CORPORATION)
1 CORPORATE WAY
LANSING, MI 48951

Registered Dec. 20, 2011

Int. Cl.: 36

FOR: FINANCIAL SERVICES, NAMELY, FINANCIAL PLANNING, PORTFOLIO MANAGEMENT, AND FINANCIAL RESEARCH; INVESTMENT SERVICES, NAMELY, INVESTMENT ANALYSIS, ADVICE, CONSULTATION AND MANAGEMENT, IN CLASS 36 (U.S. CLS. 100, 101 AND 102).

SERVICE MARK

PRINCIPAL REGISTER

FIRST USE 4-0-2010; IN COMMERCE 4-0-2010.

THE MARK CONSISTS OF STANDARD CHARACTERS WITHOUT CLAIM TO ANY PARTICULAR FONT, STYLE, SIZE, OR COLOR.

OWNER OF U.S. REG. NOS. 2,897,748, 2,957,509, AND OTHERS.

NO CLAIM IS MADE TO THE EXCLUSIVE RIGHT TO USE "DYNAMIC RISK ADVANTAGE", APART FROM THE MARK AS SHOWN.

SN 77-926,550, FILED 2-3-2010.

KAREN SEVERSON, EXAMINING ATTORNEY



David J. Kypos

Director of the United States Patent and Trademark Office

United States of America
United States Patent and Trademark Office

X-FACTOR

Reg. No. 4,074,621

Registered Dec. 20, 2011

Int. Cl.: 28

TRADEMARK

PRINCIPAL REGISTER

GANDER MOUNTAIN COMPANY (MINNESOTA CORPORATION)
SUITE 1300
180 EAST FIFTH STREET
ST. PAUL, MN 55101

FOR: FISHING RODS; FISHING REELS; FISHING JIGS; FISHING TACKLE, IN CLASS 28
(U.S. CLS. 22, 23, 38 AND 50).

FIRST USE 1-31-2010; IN COMMERCE 1-31-2010.

THE MARK CONSISTS OF STANDARD CHARACTERS WITHOUT CLAIM TO ANY PARTICULAR FONT, STYLE, SIZE, OR COLOR.

SN 77-926,727, FILED 2-3-2010.

AISHA CLARKE, EXAMINING ATTORNEY



David J. Kyros

Director of the United States Patent and Trademark Office

United States of America

United States Patent and Trademark Office

DOCTORS CHOSEN BY DOCTORS

Reg. No. 4,074,622

Registered Dec. 20, 2011

Int. Cl.: 44

SERVICE MARK

PRINCIPAL REGISTER

PREMIER HEALTH ADVOCATES LLC (DELAWARE LIMITED LIABILITY COMPANY)
16192 COASTAL HIGHWAY
LEWES, DE 19958

FOR: MEDICAL COUNSELING SERVICES WHERE NON-TREATING PHYSICIANS ACT AS LIAISONS BETWEEN PATIENTS AND THE PATIENTS' MEDICAL PROVIDERS AND DO NOT PROVIDE MEDICAL TREATMENT, IN CLASS 44 (U.S. CLS. 100 AND 101).

FIRST USE 2-14-2010; IN COMMERCE 2-14-2010.

THE MARK CONSISTS OF STANDARD CHARACTERS WITHOUT CLAIM TO ANY PARTICULAR FONT, STYLE, SIZE, OR COLOR.

SN 77-929,497, FILED 2-5-2010.

RAUL CORDOVA, EXAMINING ATTORNEY



David J. Kybas

Director of the United States Patent and Trademark Office

United States of America

United States Patent and Trademark Office

LashesMD

Reg. No. 4,074,623

Registered Dec. 20, 2011

Int. Cl.: 5

TRADEMARK

PRINCIPAL REGISTER

FOLICA LABS, LLC (DELAWARE LIMITED LIABILITY COMPANY)
STE 143
277 ROYAL POINCIANA WAY
PALM BEACH, FL 33480

FOR: HAIR GROWTH STIMULANTS, IN CLASS 5 (U.S. CLS. 6, 18, 44, 46, 51 AND 52).

FIRST USE 11-10-2009; IN COMMERCE 11-10-2009.

THE MARK CONSISTS OF STANDARD CHARACTERS WITHOUT CLAIM TO ANY PARTICULAR FONT, STYLE, SIZE, OR COLOR.

SN 77-929,855, FILED 2-6-2010.

KAELIE KUNG, EXAMINING ATTORNEY



David J. Kyffers

Director of the United States Patent and Trademark Office

United States of America

United States Patent and Trademark Office

HousingNow.com

Reg. No. 4,074,624

PROPERTY BROKERS, INC. (MISSOURI CORPORATION), DBA HOUSINGNOW.COM,
2359 W FR 76

Registered Dec. 20, 2011

SPRINGFIELD, MO 65803

Int. Cl.: 36

FOR: PROVIDING RESIDENTIAL REAL ESTATE LISTINGS FOR ECONOMY RENTALS
LOCATED IN SOUTHWEST MISSOURI VIA THE INTERNET, IN CLASS 36 (U.S. CLS. 100,
101 AND 102).

SERVICE MARK

FIRST USE 2-8-2010; IN COMMERCE 2-8-2010.

PRINCIPAL REGISTER

THE MARK CONSISTS OF STANDARD CHARACTERS WITHOUT CLAIM TO ANY PAR-
TICULAR FONT, STYLE, SIZE, OR COLOR.

SN 77-930,365, FILED 2-8-2010.

LIEF MARTIN, EXAMINING ATTORNEY



David J. Kyffers

Director of the United States Patent and Trademark Office

United States of America

United States Patent and Trademark Office

FINALLY LOSING WEIGHT CLICKS

Reg. No. 4,074,625

WEIGHT WATCHERS INTERNATIONAL, INC. (VIRGINIA CORPORATION)

Registered Dec. 20, 2011

11 MADISON AVENUE
NEW YORK, NY 10010

Int. Cl.: 41

FOR: CONDUCTING SEMINARS, LECTURES AND WORKSHOPS IN THE FIELDS OF WEIGHT LOSS, WEIGHT CONTROL, NUTRITION AND FITNESS, IN CLASS 41 (U.S. CLS. 100, 101 AND 107).

SERVICE MARK

FIRST USE 5-1-2010; IN COMMERCE 5-1-2010.

PRINCIPAL REGISTER

THE MARK CONSISTS OF STANDARD CHARACTERS WITHOUT CLAIM TO ANY PARTICULAR FONT, STYLE, SIZE, OR COLOR.

SN 77-933,593, FILED 2-11-2010.

KELLY TRUSILO, EXAMINING ATTORNEY



David J. Kyffers

Director of the United States Patent and Trademark Office

United States of America

United States Patent and Trademark Office

ACROS

Reg. No. 4,074,626

Registered Dec. 20, 2011

Int. Cl.: 6

TRADEMARK

PRINCIPAL REGISTER

KABUSHIKI KAISHA KOBE SEIKO SHO (JAPAN CORPORATION), TA KOBE STEEL, LTD.,
10-26, WAKINOHAMA-CHO 2-CHOME, CHUO-KU
KOBE-SHI
HYOGO, JAPAN 651-8585

FOR: STEEL WIRE, STEEL WIRE ROD, IN CLASS 6 (U.S. CLS. 2, 12, 13, 14, 23, 25 AND 50).

FIRST USE 2-10-2011; IN COMMERCE 2-10-2011.

THE MARK CONSISTS OF STANDARD CHARACTERS WITHOUT CLAIM TO ANY PARTICULAR FONT, STYLE, SIZE, OR COLOR.

SN 77-933,749, FILED 2-11-2010.

ANGELA DUONG, EXAMINING ATTORNEY



David J. Kyros

Director of the United States Patent and Trademark Office

United States of America

United States Patent and Trademark Office

Mail Shield

Reg. No. 4,074,627

Registered Dec. 20, 2011

Int. Cl.: 6

TRADEMARK

PRINCIPAL REGISTER

EPOCH DESIGN, LLC (WASHINGTON LIMITED LIABILITY COMPANY)
SUITE 2
17617 NE 65TH ST
REDMOND, WA 98052

FOR: SECURITY FEATURE OF METAL MAILBOXES, IN CLASS 6 (U.S. CLS. 2, 12, 13, 14, 23, 25 AND 50).

FIRST USE 9-3-2009; IN COMMERCE 9-3-2009.

THE MARK CONSISTS OF STANDARD CHARACTERS WITHOUT CLAIM TO ANY PARTICULAR FONT, STYLE, SIZE, OR COLOR.

NO CLAIM IS MADE TO THE EXCLUSIVE RIGHT TO USE "MAIL", APART FROM THE MARK AS SHOWN.

SN 77-936,905, FILED 2-16-2010.

MARGARET POWER, EXAMINING ATTORNEY



David J. Kyffers

Director of the United States Patent and Trademark Office

United States of America

United States Patent and Trademark Office



Reg. No. 4,074,628

Registered Dec. 20, 2011

Int. Cls.: 10 and 25

TRADEMARK

PRINCIPAL REGISTER

JAMIESON, LINDA (UNITED STATES INDIVIDUAL)
1340 GULF BLVD 12B
CLEARWATER, FL 33767

FOR: GLOVES FOR MEDICAL USE; MEDICAL GOWNS; MEDICAL WEARING APPAREL, NAMELY, CAPS; MEDICAL WEARING APPAREL, NAMELY, SCRUB PANTS; MEDICAL WEARING APPAREL, NAMELY, SCRUB TOPS; PATIENT EXAMINATION GOWNS; SURGICAL GOWNS; SURGICAL SCRUB SUITS, IN CLASS 10 (U.S. CLS. 26, 39 AND 44).

FIRST USE 2-16-2011; IN COMMERCE 2-28-2011.

FOR: DO RAGS; GLOVES; HATS; JACKETS; NURSE'S APPAREL, NAMELY, SHIRTS, PANTS; PAJAMAS; SHIRTS; SOCKS; SWEAT SHIRTS; T-SHIRTS, IN CLASS 25 (U.S. CLS. 22 AND 39).

FIRST USE 2-16-2011; IN COMMERCE 2-28-2011.

THE STIPPLING IS FOR SHADING PURPOSES ONLY.

THE MARK CONSISTS OF THE STYLIZED TEXT "LIPZ" OVER A PAIR OF LIPS. BELOW THERE IS THE STYLIZED TEXT "LIFE IN THE POSITIVE ZONE".

SN 77-937,030, FILED 2-16-2010.

MATTHEW MCDOWELL, EXAMINING ATTORNEY



David J. Kybas

Director of the United States Patent and Trademark Office

United States of America

United States Patent and Trademark Office

DARK ATTITUDE

Reg. No. 4,074,629

INHALE, INC. (CALIFORNIA CORPORATION)

Registered Dec. 20, 2011

8616 CUYAMACA ST
SANTEE, CA 92071

Int. Cl.: 25

FOR: APPAREL, NAMELY, T-SHIRTS, SHIRTS, PANTS, HATS, JACKETS, UNDERWEAR,
IN CLASS 25 (U.S. CLS. 22 AND 39).

TRADEMARK

FIRST USE 11-1-2010; IN COMMERCE 11-1-2010.

PRINCIPAL REGISTER

THE MARK CONSISTS OF STANDARD CHARACTERS WITHOUT CLAIM TO ANY PAR-
TICULAR FONT, STYLE, SIZE, OR COLOR.

SN 77-937,249, FILED 2-17-2010.

KYLE PEETE, EXAMINING ATTORNEY



David J. Kybas

Director of the United States Patent and Trademark Office

United States of America

United States Patent and Trademark Office

CRAPPY BIRTHDAY

Reg. No. 4,074,630

REALLY BIG IDEAS LLC (MISSOURI LIMITED LIABILITY COMPANY)
815 SOUTH MERAMEC AVE
ST. LOUIS, MO 63105

Registered Dec. 20, 2011

Int. Cl.: 28

FOR: BOARD GAMES; CARD GAMES; PARLOR GAMES; PARTY GAMES, IN CLASS 28
(U.S. CLS. 22, 23, 38 AND 50).

TRADEMARK

FIRST USE 2-14-2011; IN COMMERCE 8-30-2011.

PRINCIPAL REGISTER

THE MARK CONSISTS OF STANDARD CHARACTERS WITHOUT CLAIM TO ANY PARTICULAR FONT, STYLE, SIZE, OR COLOR.

SN 77-939,579, FILED 2-19-2010.

ROBIN MITTLER, EXAMINING ATTORNEY



David J. Kybas

Director of the United States Patent and Trademark Office

United States of America

United States Patent and Trademark Office

FEMININE PROTECTION

Reg. No. 4,074,631

HARRY J. PAPPAS (UNITED STATES INDIVIDUAL)
POST OFFICE BOX 28668
LAS VEGAS, NV 89126

Registered Dec. 20, 2011

Int. Cl.: 16

FOR: PRINTED, MATTER, NAMELY, POSTERS AND BUMPER STICKERS, IN CLASS 16
(U.S. CLS. 2, 5, 22, 23, 29, 37, 38 AND 50).

TRADEMARK

FIRST USE 12-31-2002; IN COMMERCE 10-17-2011.

PRINCIPAL REGISTER

THE MARK CONSISTS OF STANDARD CHARACTERS WITHOUT CLAIM TO ANY PARTICULAR FONT, STYLE, SIZE, OR COLOR.

SN 77-940,474, FILED 2-19-2010.

RUSS HERMAN, EXAMINING ATTORNEY



David J. Kappas

Director of the United States Patent and Trademark Office

United States of America

United States Patent and Trademark Office

Edify

Reg. No. 4,074,632

Registered Dec. 20, 2011

Int. Cl.: 3

TRADEMARK

PRINCIPAL REGISTER

BELOVED MINISTRIES, INC. (GEORGIA CORPORATION)
8005 DEPFORD WAY
CUMMING, GA 30041

FOR: COSMETICS, IN CLASS 3 (U.S. CLS. 1, 4, 6, 50, 51 AND 52).

FIRST USE 11-7-2011; IN COMMERCE 11-7-2011.

THE MARK CONSISTS OF STANDARD CHARACTERS WITHOUT CLAIM TO ANY PARTICULAR FONT, STYLE, SIZE, OR COLOR.

SN 77-941,887, FILED 2-22-2010.

VERNA BETH RIRIE, EXAMINING ATTORNEY



David J. Kybas

Director of the United States Patent and Trademark Office

United States of America
United States Patent and Trademark Office

DUE VOCI

Reg. No. 4,074,633

Registered Dec. 20, 2011

Int. Cl.: 9

TRADEMARK

PRINCIPAL REGISTER

DUE VOCI LLC (DELAWARE LIMITED LIABILITY COMPANY)
C/O AVNET MANAGEMENT, SUITE 410
4111 W. ALAMEDA AVE.
BURBANK, CA 91505

FOR: MUSICAL SOUND RECORDINGS RELATING TO MUSIC; DOWNLOADABLE AUDIO
FEATURING MUSIC, IN CLASS 9 (U.S. CLS. 21, 23, 26, 36 AND 38).

FIRST USE 6-8-2010; IN COMMERCE 6-8-2010.

THE MARK CONSISTS OF STANDARD CHARACTERS WITHOUT CLAIM TO ANY PAR-
TICULAR FONT, STYLE, SIZE, OR COLOR.

THE ENGLISH TRANSLATION OF "DUE VOCI" IN THE MARK IS "TWO VOICES".

SN 77-942,843, FILED 2-23-2010.

KYLE PEETE, EXAMINING ATTORNEY



David J. Kyros

Director of the United States Patent and Trademark Office

United States of America

United States Patent and Trademark Office

My Pal

Reg. No. 4,074,634

Registered Dec. 20, 2011

Int. Cl.: 16

TRADEMARK

PRINCIPAL REGISTER

BORONAT, LORETTA D. (UNITED STATES INDIVIDUAL)
11 DANA PLACE
WEST CALDWELL, NJ 07006

FOR: BOOKS IN THE FIELD OF AUTISM AND OTHER DISABILITIES OR DISORDERS; CHILDREN'S INTERACTIVE EDUCATIONAL BOOKS; PRINTED EDUCATIONAL MATERIALS IN THE FIELD OF AUTISM AND OTHER DISABILITIES OR DISORDERS, PUBLICATIONS, NAMELY, BROCHURES, BOOKLETS, AND TEACHING MATERIALS IN THE FIELDS OF AUTISM AND OTHER DISABILITIES OR DISORDERS, IN CLASS 16 (U.S. CLS. 2, 5, 22, 23, 29, 37, 38 AND 50).

FIRST USE 11-2-2009; IN COMMERCE 1-5-2010.

THE MARK CONSISTS OF STANDARD CHARACTERS WITHOUT CLAIM TO ANY PARTICULAR FONT, STYLE, SIZE, OR COLOR.

SN 77-943,528, FILED 2-24-2010.

ELLEN PERKINS, EXAMINING ATTORNEY



David J. Kyffers

Director of the United States Patent and Trademark Office

United States of America
United States Patent and Trademark Office

GENOVIVE

Reg. No. 4,074,635

GENOVIVE, LLC (DELAWARE LIMITED LIABILITY COMPANY)
250 PLAUCHE STREET
HARAHAN, LA 70123

Registered Dec. 20, 2011

Int. Cl.: 44

FOR: WEIGHT REDUCTION, DIET PLANNING AND SUPERVISION, DIETARY AND NUTRITIONAL GUIDANCE FEATURING NUTRIGENOMICS, PERSONALIZED DIET ADVISORY SERVICES, IN CLASS 44 (U.S. CLS. 100 AND 101).

SERVICE MARK

FIRST USE 8-22-2011; IN COMMERCE 8-22-2011.

PRINCIPAL REGISTER

THE MARK CONSISTS OF STANDARD CHARACTERS WITHOUT CLAIM TO ANY PARTICULAR FONT, STYLE, SIZE, OR COLOR.

SN 77-944,957, FILED 2-25-2010.

SOPHIA S. KIM, EXAMINING ATTORNEY



David J. Kyros

Director of the United States Patent and Trademark Office

United States of America

United States Patent and Trademark Office

IT'S A FUN PACED JOB

Reg. No. 4,074,636

Registered Dec. 20, 2011

Int. Cl.: 35

SERVICE MARK

PRINCIPAL REGISTER

DD IP HOLDER LLC (DELAWARE LIMITED LIABILITY COMPANY)
P.O. BOX 9141
CANTON, MA 02021

FOR: BUSINESS MANAGEMENT SERVICES, NAMELY, PROVIDING ADVICE AND ASSISTANCE IN THE FIELD OF EMPLOYEE RECRUITMENT; PROVIDING TECHNICAL ASSISTANCE IN THE RECRUITMENT OF EMPLOYEES; PROVIDING AN EMPLOYEE RECRUITMENT CAMPAIGN; PROVIDING AN EMPLOYEE RECRUITMENT WEBSITE, IN CLASS 35 (U.S. CLS. 100, 101 AND 102).

FIRST USE 3-24-2010; IN COMMERCE 3-24-2010.

THE MARK CONSISTS OF STANDARD CHARACTERS WITHOUT CLAIM TO ANY PARTICULAR FONT, STYLE, SIZE, OR COLOR.

NO CLAIM IS MADE TO THE EXCLUSIVE RIGHT TO USE "JOB", APART FROM THE MARK AS SHOWN.

SN 77-946,192, FILED 2-26-2010.

ERIN FALK, EXAMINING ATTORNEY



David J. Kybas

Director of the United States Patent and Trademark Office

United States of America

United States Patent and Trademark Office

SLIMMACCINO

Reg. No. 4,074,637

Registered Dec. 20, 2011

Int. Cls.: 5 and 30

TRADEMARK

PRINCIPAL REGISTER

DSM IP ASSETS B.V. (NETHERLANDS BESLOTEN VENNOOTSCHAP (B.V.))
HET OVERLOON 1
HEERLEN, NETHERLANDS 6411TE

FOR: DIETETIC BEVERAGES ADAPTED FOR MEDICAL USE; POWDERS FOR USE IN THE PREPARATION OF DIETETIC BEVERAGES ADAPTED FOR MEDICAL USE, IN CLASS 5 (U.S. CLS. 6, 18, 44, 46, 51 AND 52).

FIRST USE 5-31-2011; IN COMMERCE 5-31-2011.

FOR: COFFEE; COFFEE BASED BEVERAGES; POWDERS USED IN THE PREPARATION OF COFFEE BASED BEVERAGES, IN CLASS 30 (U.S. CL. 46).

FIRST USE 5-31-2011; IN COMMERCE 5-31-2011.

THE MARK CONSISTS OF STANDARD CHARACTERS WITHOUT CLAIM TO ANY PARTICULAR FONT, STYLE, SIZE, OR COLOR.

SN 77-948,885, FILED 3-2-2010.

LANA PHAM, EXAMINING ATTORNEY



David J. Kyros

Director of the United States Patent and Trademark Office

United States of America

United States Patent and Trademark Office

AVENGER HEAT

Reg. No. 4,074,638

Registered Dec. 20, 2011

Int. Cl.: 12

TRADEMARK

PRINCIPAL REGISTER

CHRYSLER GROUP LLC (DELAWARE LIMITED LIABILITY COMPANY)
CIMS 485-13-32
1000 CHRYSLER DRIVE
AUBURN HILLS, MI 48326

FOR: MOTOR VEHICLES, NAMELY, PASSENGER AUTOMOBILES, THEIR STRUCTURAL PARTS, TRIM AND BADGES, IN CLASS 12 (U.S. CLS. 19, 21, 23, 31, 35 AND 44).

FIRST USE 12-0-2010; IN COMMERCE 12-0-2010.

THE MARK CONSISTS OF STANDARD CHARACTERS WITHOUT CLAIM TO ANY PARTICULAR FONT, STYLE, SIZE, OR COLOR.

OWNER OF U.S. REG. NO. 3,341,833.

SN 77-949,181, FILED 3-3-2010.

SHARON MEIER, EXAMINING ATTORNEY



David J. Kyffers

Director of the United States Patent and Trademark Office

United States of America

United States Patent and Trademark Office

TIGER BOND

Reg. No. 4,074,639

BEACON ADHESIVES CORPORATION (NEW YORK CORPORATION)
125 MACQUESTEN PARKWAY SOUTH
NEW YORK, NY 10550

Registered Dec. 20, 2011

Int. Cl.: 1

FOR: ADHESIVES AND GLUE FOR INDUSTRIAL AND COMMERCIAL USE, IN CLASS 1
(U.S. CLS. 1, 5, 6, 10, 26 AND 46).

TRADEMARK

FIRST USE 7-30-2011; IN COMMERCE 7-30-2011.

PRINCIPAL REGISTER

THE MARK CONSISTS OF STANDARD CHARACTERS WITHOUT CLAIM TO ANY PARTICULAR FONT, STYLE, SIZE, OR COLOR.

NO CLAIM IS MADE TO THE EXCLUSIVE RIGHT TO USE "BOND", APART FROM THE MARK AS SHOWN.

SN 77-949,529, FILED 3-3-2010.

JANET LEE, EXAMINING ATTORNEY



David J. Kyffers

Director of the United States Patent and Trademark Office

United States of America

United States Patent and Trademark Office

ILION+

Reg. No. 4,074,640

GATAN, INC. (PENNSYLVANIA CORPORATION)
5794 W. LAS POSITAS BLVD.
PLEASANTON, CA 94588

Registered Dec. 20, 2011

Int. Cl.: 9

FOR: A SPECIMEN PREPARATION TOOL, NAMELY, A NOBLE GAS ION BEAM GENERATOR FOR GENERATING A NOBLE GAS ION BEAM USED TO CUT CROSS-SECTIONS OF SAMPLES SUITABLE FOR OBSERVATION AND ANALYSIS IN AN ELECTRON MICROSCOPE, IN CLASS 9 (U.S. CLS. 21, 23, 26, 36 AND 38).

TRADEMARK

PRINCIPAL REGISTER

FIRST USE 5-28-2010; IN COMMERCE 5-28-2010.

THE MARK CONSISTS OF STANDARD CHARACTERS WITHOUT CLAIM TO ANY PARTICULAR FONT, STYLE, SIZE, OR COLOR.

SN 77-949,549, FILED 3-3-2010.

JANET LEE, EXAMINING ATTORNEY



David J. Kyffers

Director of the United States Patent and Trademark Office

United States of America

United States Patent and Trademark Office

INSIDE NETWORK

Reg. No. 4,074,641

Registered Dec. 20, 2011

Int. Cls.: 35 and 42

SERVICE MARK

PRINCIPAL REGISTER

WEBMEDIABRANDS INC. (DELAWARE CORPORATION)
50 WASHINGTON STREET
NORWALK, CT 06854

FOR: MARKET ANALYSIS AND RESEARCH SERVICES; PROMOTING AND CONDUCTING TRADE SHOW EXHIBITIONS IN THE FIELD OF INFORMATION TECHNOLOGY, IN CLASS 35 (U.S. CLS. 100, 101 AND 102).

FIRST USE 6-30-2008; IN COMMERCE 6-30-2008.

FOR: PROVIDING A WEBSITE FEATURING INFORMATION ABOUT INFORMATION TECHNOLOGY, IN CLASS 42 (U.S. CLS. 100 AND 101).

FIRST USE 6-30-2008; IN COMMERCE 6-30-2008.

THE MARK CONSISTS OF STANDARD CHARACTERS WITHOUT CLAIM TO ANY PARTICULAR FONT, STYLE, SIZE, OR COLOR.

SN 77-950,272, FILED 3-4-2010.

ZACHARY BELLO, EXAMINING ATTORNEY



David J. Kybas

Director of the United States Patent and Trademark Office

United States of America

United States Patent and Trademark Office

LUIZA BARCELOS

Reg. No. 4,074,642

Registered Dec. 20, 2011

Int. Cls.: 18 and 25

TRADEMARK

PRINCIPAL REGISTER

LUIZA BARCELOS CALÇADOS LTDA. (BRAZIL SOCIEDADE POR QUOTAS DE RESPONSABILIDADE LIMITADA (LTDA))
RUA DINAL 300
BELO HORIZONTE, MG, BRAZIL

FOR: LEATHER; LEATHER AND IMITATION LEATHER; LEATHER BAGS AND WALLETS; LEATHER BAGS, SUITCASES AND WALLETS; LEATHER BRIEFCASES; LEATHER FOR SHOES; LEATHER HANDBAGS; LEATHER PURSES; LEATHER STRAPS, IN CLASS 18 (U.S. CLS. 1, 2, 3, 22 AND 41).

FIRST USE 1-1-2009; IN COMMERCE 10-1-2010.

FOR: LEATHER SHOES; SHOES; WOMEN'S SHOES, IN CLASS 25 (U.S. CLS. 22 AND 39).

FIRST USE 1-1-2009; IN COMMERCE 10-1-2010.

THE MARK CONSISTS OF STANDARD CHARACTERS WITHOUT CLAIM TO ANY PARTICULAR FONT, STYLE, SIZE, OR COLOR.

THE NAME(S), PORTRAIT(S), AND/OR SIGNATURE(S) SHOWN IN THE MARK IDENTIFIES "LUIZA BARCELOS", WHOSE CONSENT(S) TO REGISTER IS MADE OF RECORD.

SN 77-950,284, FILED 3-4-2010.

VIVIAN MICZNIK FIRST, EXAMINING ATTORNEY



David J. Kypos

Director of the United States Patent and Trademark Office

United States of America

United States Patent and Trademark Office



Reg. No. 4,074,643

Registered Dec. 20, 2011

Int. Cl.: 31

TRADEMARK

PRINCIPAL REGISTER

DESTILADORA DE LOS ALTOS S.A. DE C.V. (MEXICO CORPORATION)
FRANCISCO MEDINA ASENCIO 472
ARANDAS, JALISCO, MEXICO 47180

FOR: LIVE ANIMALS, IN CLASS 31 (U.S. CLS. 1 AND 46).

FIRST USE 9-24-2010; IN COMMERCE 9-24-2010.

NO CLAIM IS MADE TO THE EXCLUSIVE RIGHT TO USE "HACIENDA", APART FROM THE MARK AS SHOWN.

THE COLOR(S) BROWN, YELLOW, WHITE, GRAY AND GREEN IS/ARE CLAIMED AS A FEATURE OF THE MARK.

THE MARK CONSISTS OF ROUND SIGN WITH A "T" FORM ON TOP HAVING THE COLORS GREEN AND GRAY, AND BENEATH THE SIGN ARE THE WORDS "HACIENDA BAÑUELOS" IN STYLIZED BROWN LETTERS. THE DESIGN AND WORDING ARE ON A BACKGROUND OF VARIOUS SHADES OF YELLOW, WHITE, AND GRAY.

THE ENGLISH TRANSLATION OF "HACIENDA" IN THE MARK IS "RANCH". THE WORDING "BAÑUELOS" HAS NO MEANING IN A FOREIGN LANGUAGE.

SN 77-951,737, FILED 3-5-2010.

ROBIN MITTLER, EXAMINING ATTORNEY



David J. Kyffers

Director of the United States Patent and Trademark Office

United States of America

United States Patent and Trademark Office



Reg. No. 4,074,644

Registered Dec. 20, 2011

Int. Cl.: 43

SERVICE MARK

PRINCIPAL REGISTER

CARLSON HOSPITALITY GROUP, INC. (MINNESOTA CORPORATION)
CARLSON PARKWAY P.O. BOX 59159
MINNEAPOLIS, MN 554598249

FOR: RESTAURANT AND BAR SERVICES, IN CLASS 43 (U.S. CLS. 100 AND 101).

FIRST USE 11-1-2011; IN COMMERCE 11-1-2011.

THE MARK CONSISTS OF THE WORD "FILINI" IN STYLIZED LETTERS WITHIN A CIRCLE.

SN 77-952,032, FILED 3-5-2010.

ERNEST SHOSHO, EXAMINING ATTORNEY



David J. Kyffers

Director of the United States Patent and Trademark Office

United States of America

United States Patent and Trademark Office

ANTIBIONATX6FORTE

Reg. No. 4,074,645

Registered Dec. 20, 2011

Int. Cl.: 5

TRADEMARK

PRINCIPAL REGISTER

USA COMMERCE (CALIFORNIA CORPORATION)
7577 AIRWAY ROAD
SAN DIEGO, CA 92154

FOR: CALCIUM SUPPLEMENTS; DIETARY AND NUTRITIONAL SUPPLEMENTS; DIETARY BEVERAGE SUPPLEMENTS FOR HUMAN CONSUMPTION IN LIQUID AND DRY MIX FORM FOR THERAPEUTIC PURPOSES; DIETARY FOOD SUPPLEMENTS; DIETARY SUPPLEMENT FOR ELIMINATING TOXINS FROM THE INTESTINAL TRACT; DIETARY SUPPLEMENTAL DRINKS; DIETARY SUPPLEMENTAL DRINKS IN THE NATURE OF VITAMIN AND MINERAL BEVERAGES; DIETARY SUPPLEMENTS; DIETARY SUPPLEMENTS FOR ANIMALS; DIETARY SUPPLEMENTS FOR CONTROLLING CHOLESTEROL; DIETARY SUPPLEMENTS FOR HUMAN CONSUMPTION; DIETARY SUPPLEMENTS FOR PETS; NATURAL HERBAL SUPPLEMENTS; NUTRACEUTICALS FOR USE AS A DIETARY SUPPLEMENT; NUTRITIONAL SUPPLEMENT FOR ELIMINATING TOXINS FROM THE BODY; NUTRITIONAL SUPPLEMENT FOR ELIMINATING TOXINS FROM THE INTESTINAL TRACT; NUTRITIONAL SUPPLEMENT IN THE NATURE OF A NUTRIENT-DENSE, PROTEIN-BASED DRINK MIX; NUTRITIONAL SUPPLEMENTS; NUTRITIONAL SUPPLEMENTS IN LOTION FORM SOLD AS A COMPONENT OF NUTRITIONAL SKIN CARE PRODUCTS; POWDERED FRUIT-FLAVORED DIETARY SUPPLEMENT DRINK MIX; POWDERED NUTRITIONAL SUPPLEMENT DRINK MIX; PROTEIN SUPPLEMENTS; VITAMIN AND MINERAL SUPPLEMENTS; VITAMIN SUPPLEMENT IN TABLET FORM FOR USE IN MAKING AN EFFERVESCENT BEVERAGE WHEN ADDED TO WATER; VITAMIN SUPPLEMENTS; WEIGHT MANAGEMENT SUPPLEMENTS; WHEAT FOR USE AS A DIETARY SUPPLEMENT; WHEY PROTEIN SUPPLEMENTS, IN CLASS 5 (U.S. CLS. 6, 18, 44, 46, 51 AND 52).



FIRST USE 3-3-2010; IN COMMERCE 9-20-2010.

THE MARK CONSISTS OF STANDARD CHARACTERS WITHOUT CLAIM TO ANY PARTICULAR FONT, STYLE, SIZE, OR COLOR.

SN 77-952,033, FILED 3-5-2010.

LOURDES AYALA, EXAMINING ATTORNEY

David J. Kyros

Director of the United States Patent and Trademark Office

United States of America

United States Patent and Trademark Office

DAVID YURMAN ELEMENTS

Reg. No. 4,074,646

YURMAN STUDIO, INC. (NEW YORK CORPORATION)
24 VESTRY STREET
NEW YORK, NY 10013

Registered Dec. 20, 2011

Int. Cl.: 14

FOR: JEWELRY, IN CLASS 14 (U.S. CLS. 2, 27, 28 AND 50).

TRADEMARK

FIRST USE 10-24-2011; IN COMMERCE 10-24-2011.

PRINCIPAL REGISTER

THE MARK CONSISTS OF STANDARD CHARACTERS WITHOUT CLAIM TO ANY PARTICULAR FONT, STYLE, SIZE, OR COLOR.

OWNER OF U.S. REG. NOS. 1,553,674, 2,460,107, AND OTHERS.

THE NAME(S), PORTRAIT(S), AND/OR SIGNATURE(S) SHOWN IN THE MARK IDENTIFIES "DAVID YURMAN", WHOSE CONSENT(S) TO REGISTER IS MADE OF RECORD.

SN 77-952,782, FILED 3-8-2010.

BARBARA BROWN, EXAMINING ATTORNEY



David J. Kyffers

Director of the United States Patent and Trademark Office

United States of America

United States Patent and Trademark Office



Reg. No. 4,074,647

Registered Dec. 20, 2011

Int. Cls.: 9 and 42

TRADEMARK

SERVICE MARK

PRINCIPAL REGISTER

IDENTITYMINE, INCORPORATED (WASHINGTON CORPORATION)
SUITE 1200
1015 A STREET
TACOMA, WA 98402

FOR: COMPUTER SOFTWARE FOR BUILDING COMPUTER SOFTWARE APPLICATIONS OR INTERNET SOFTWARE APPLICATIONS, IN CLASS 9 (U.S. CLS. 21, 23, 26, 36 AND 38).

FIRST USE 7-31-2010; IN COMMERCE 7-31-2010.

FOR: COMPUTER CONSULTATION, NAMELY, CUSTOM SOFTWARE DEVELOPMENT, SOFTWARE INTERFACE DESIGN, CONFIGURATION AND PROGRAMMING SERVICES FOR OTHERS; INSTALLATION OF COMPUTER SOFTWARE; COMPUTER SERVICES, NAMELY, CREATION AND MAINTENANCE OF WEB SITES FOR OTHERS; COMPUTER SOFTWARE CONSULTATION; UP-DATING OF EXISTING SOFTWARE FOR SPECIFIC APPLICATIONS; TESTING OF NEW SOFTWARE PRODUCTS FOR OTHERS; TECHNICAL WRITING FOR OTHERS IN THE FIELD OF SOFTWARE AND, MAINTENANCE OF COMPUTER SOFTWARE, IN CLASS 42 (U.S. CLS. 100 AND 101).

FIRST USE 7-31-2010; IN COMMERCE 7-31-2010.

THE MARK CONSISTS OF STYLIZED LETTERS "IM" WITHIN A STYLIZED CIRCLE.

SN 77-953,204, FILED 3-8-2010.

FONG HSU, EXAMINING ATTORNEY



David J. Kyffers

Director of the United States Patent and Trademark Office

United States of America

United States Patent and Trademark Office

VALUETALE

Reg. No. 4,074,648

Registered Dec. 20, 2011

Int. Cl.: 16

TRADEMARK

PRINCIPAL REGISTER

SPENCER JOHNSON (UNITED STATES INDIVIDUAL)
200 PARK AVENUE
C/O R. ELINGS, GREENBERG TRAUIG, LLP
NEW YORK, NY 10166

FOR: CHILDREN'S BOOKS, IN CLASS 16 (U.S. CLS. 2, 5, 22, 23, 29, 37, 38 AND 50).

FIRST USE 11-0-1975; IN COMMERCE 11-0-1975.

THE MARK CONSISTS OF STANDARD CHARACTERS WITHOUT CLAIM TO ANY PARTICULAR FONT, STYLE, SIZE, OR COLOR.

OWNER OF U.S. REG. NOS. 1,108,644 AND 3,357,876.

SN 77-953,384, FILED 3-8-2010.

TARA PATE, EXAMINING ATTORNEY



David J. Kybas

Director of the United States Patent and Trademark Office

United States of America

United States Patent and Trademark Office

calzado Jugueton Kids

Reg. No. 4,074,649

DIANA ZAPATERIA, INC. (CALIFORNIA CORPORATION)
14537 GARFIELD AVE.

Registered Dec. 20, 2011

PARAMOUNT, CA 90723

Int. Cl.: 25

FOR: CLOTHING FOR CHILDREN, NAMELY, FOOTWEAR, IN CLASS 25 (U.S. CLS. 22 AND 39).

TRADEMARK

FIRST USE 10-21-2011; IN COMMERCE 10-21-2011.

PRINCIPAL REGISTER

THE MARK CONSISTS OF STANDARD CHARACTERS WITHOUT CLAIM TO ANY PARTICULAR FONT, STYLE, SIZE, OR COLOR.

NO CLAIM IS MADE TO THE EXCLUSIVE RIGHT TO USE "CALZADO" OR "KIDS", APART FROM THE MARK AS SHOWN.

THE ENGLISH TRANSLATION OF THE WORD "CALZADO JUGUETON" IN THE MARK IS "PLAYFUL FOOTWEAR".

SN 77-953,765, FILED 3-8-2010.

ELLEN PERKINS, EXAMINING ATTORNEY



David J. Kyffers

Director of the United States Patent and Trademark Office

United States of America

United States Patent and Trademark Office



Reg. No. 4,074,650

Registered Dec. 20, 2011

Int. Cl.: 35

PALATINE TOWNSHIP (ILLINOIS BODY POLITIC AND CORPORATE), AKA TOWNSHIP OF PALATINE,
SUITE 101
721 S. QUENTIN RD.
PALATINE, IL 60067

SERVICE MARK

PRINCIPAL REGISTER

FOR: CHARITABLE SERVICES, NAMELY, COORDINATION OF THE PROCUREMENT AND DISTRIBUTION OF FOOD DONATIONS FROM MANUFACTURERS, WHOLESALERS, RETAILERS, AND GOVERNMENT AGENCIES TO ORGANIZATIONS PROVIDING FREE FOOD TO NEEDY PEOPLE; CHARITABLE SERVICES, NAMELY, COORDINATION OF THE PROCUREMENT AND DISTRIBUTION OF GIFT-IN-KIND PRODUCT DONATIONS FROM MANUFACTURERS, WHOLESALERS, RETAILERS, AND GOVERNMENT AGENCIES TO ORGANIZATIONS PROVIDING FREE PRODUCTS TO NEEDY PEOPLE, IN CLASS 35 (U.S. CLS. 100, 101 AND 102).

FIRST USE 1-1-1965; IN COMMERCE 5-15-2005.

NO CLAIM IS MADE TO THE EXCLUSIVE RIGHT TO USE "TOWNSHIP OF PALATINE" OR "1850", APART FROM THE MARK AS SHOWN.

THE COLOR(S) RED, WHITE AND BLUE IS/ARE CLAIMED AS A FEATURE OF THE MARK.

THE MARK CONSISTS OF A ROUND SEAL DESIGN WITH A RED OUTER RING FOLLOWED BY THE WHITE WORDING "TOWNSHIP OF PALATINE SERVING PEOPLE" ON BLUE BACKGROUND; THE CENTER OF SEAL CONSISTS OF THE FOLLOWING ELEMENTS: A TREE, RAILROAD TRACKS, BUILDINGS, PEOPLE, AN AIRPLANE, AND THE NUMBERS "1850", ALL IN THE COLOR RED AND DEPICTED ON A WHITE BACKGROUND.



SN 77-954,336, FILED 3-9-2010.

TINA L. SNAPP, EXAMINING ATTORNEY

David J. Kybas

Director of the United States Patent and Trademark Office

United States of America

United States Patent and Trademark Office

NATUROKINETICS

Reg. No. 4,074,651

NOW HEALTH GROUP, INC. (ILLINOIS CORPORATION)
395 S. GLEN ELLYN ROAD
BLOOMINGDALE, IL 60108

Registered Dec. 20, 2011

Int. Cl.: 42

FOR: RESEARCH AND DEVELOPMENT IN THE FIELD OF DESIGNING NUTRITIONAL SUPPLEMENTS AND MEASURING THEIR BIOAVAILABILITY, IN CLASS 42 (U.S. CLS. 100 AND 101).

SERVICE MARK

FIRST USE 5-0-2011; IN COMMERCE 5-0-2011.

PRINCIPAL REGISTER

THE MARK CONSISTS OF STANDARD CHARACTERS WITHOUT CLAIM TO ANY PARTICULAR FONT, STYLE, SIZE, OR COLOR.

SN 77-954,718, FILED 3-9-2010.

ELLEN PERKINS, EXAMINING ATTORNEY



David J. Kybas

Director of the United States Patent and Trademark Office

United States of America

United States Patent and Trademark Office

Kosan⁺

Reg. No. 4,074,652

Registered Dec. 20, 2011

Int. Cl.: 11

TRADEMARK

PRINCIPAL REGISTER

CAVAGNA GROUP S.P.A. (ITALY SOCIETÀ PER AZIONI (SPA))
PONTE S. MARCO
VIA STATALE 11/13
CALCINATO, BRESCIA, ITALY 25011

FOR: LIQUID PROPANE GAS REGULATORS; REGULATING ACCESSORIES FOR GAS APPARATUS, NAMELY, PRESSURE REGULATORS OR LIQUID PROPANE GAS AND SINGLE DOUBLE FIRST AND SECOND STAGE REGULATORS, IN CLASS 11 (U.S. CLS. 13, 21, 23, 31 AND 34).

FIRST USE 3-0-2010; IN COMMERCE 9-0-2010.

THE MARK CONSISTS OF THE WORD "KOSAN" WITH THE PORTION OF THE MARK COMPRISED OF A SUPERSCRIT PLUS DESIGN IS NOT INTENDED TO CONNOTE A CROSS AND IS NOT DISPLAYED IN RED OR A COLOURABLE IMITATION THEREOF ON A WHITE BACKGROUND.

SN 77-954,801, FILED 3-9-2010.

CAROLINE WOOD, EXAMINING ATTORNEY



David J. Kyfos

Director of the United States Patent and Trademark Office

United States of America

United States Patent and Trademark Office

MicroCeps

Reg. No. 4,074,653

MICROLINE SURGICAL, INC. (DELAWARE CORPORATION)
800 CUMMINGS CENTER, SUITE 166T
BEVERLY, MA 01915

Registered Dec. 20, 2011

Int. Cl.: 10

FOR: SURGICAL INSTRUMENTS AND APPARATUS, IN CLASS 10 (U.S. CLS. 26, 39 AND 44).

TRADEMARK

FIRST USE 7-16-2010; IN COMMERCE 8-19-2010.

PRINCIPAL REGISTER

THE MARK CONSISTS OF STANDARD CHARACTERS WITHOUT CLAIM TO ANY PARTICULAR FONT, STYLE, SIZE, OR COLOR.

OWNER OF U.S. REG. NO. 3,255,083.

SN 77-955,891, FILED 3-10-2010.

MARY ROSSMAN, EXAMINING ATTORNEY



David J. Kyffers

Director of the United States Patent and Trademark Office

United States of America

United States Patent and Trademark Office

SoftLoc

Reg. No. 4,074,654

Registered Dec. 20, 2011

Int. Cl.: 42

SERVICE MARK

PRINCIPAL REGISTER

911 ETC, INC. (WASHINGTON CORPORATION)
15655 W ROOSEVELT ST
STE 109
GOODYEAR, AZ 85338

FOR: SOFTWARE AS A SERVICE (SAAS) SERVICES FEATURING SOFTWARE IN THE FIELD OF ENHANCED 911 SERVICES, IN CLASS 42 (U.S. CLS. 100 AND 101).

FIRST USE 9-1-2010; IN COMMERCE 3-15-2011.

THE MARK CONSISTS OF STANDARD CHARACTERS WITHOUT CLAIM TO ANY PARTICULAR FONT, STYLE, SIZE, OR COLOR.

SN 77-957,284, FILED 3-12-2010.

ESTHER BELENKER, EXAMINING ATTORNEY



David J. Kyros

Director of the United States Patent and Trademark Office

United States of America

United States Patent and Trademark Office



Reg. No. 4,074,655

Registered Dec. 20, 2011

Int. Cl.: 41

SERVICE MARK

PRINCIPAL REGISTER

HAZELL, EARL (UNITED STATES INDIVIDUAL)
#172
5103 S. MILL AVE
TEMPE, AZ 85282

FOR: ENTERTAINMENT SERVICES IN THE NATURE OF LIVE MUSICAL PERFORMANCES,
IN CLASS 41 (U.S. CLS. 100, 101 AND 107).

FIRST USE 1-15-2010; IN COMMERCE 6-18-2010.

NO CLAIM IS MADE TO THE EXCLUSIVE RIGHT TO USE "INC.", APART FROM THE
MARK AS SHOWN.

THE MARK CONSISTS OF THE WORDING "JAZZOPERETRY INC." BELOW THE STYLIZED
TEXT "JAZZOPERETRY" WITH A PIANO TO THE RIGHT THEREOF, WHERE THE LETTER
"J" IS MADE OUT OF A FOUNTAIN PEN AND SWIRL OF INK, THE LETTER "O" CONSISTS
OF A PAIR OF LIPS, AND ALL OF THE ELEMENTS ARE INSIDE AN OVAL.

SN 77-957,877, FILED 3-12-2010.

MARC LEIPZIG, EXAMINING ATTORNEY



David J. Kyffers

Director of the United States Patent and Trademark Office

United States of America

United States Patent and Trademark Office

love glove

Reg. No. 4,074,656

HOWARD, RHEYNARD (UNITED STATES INDIVIDUAL)
PO BOX 20011
HOUSTON, UT 77053

Registered Dec. 20, 2011

Int. Cl.: 10

FOR: ADULT SEXUAL STIMULATION AIDS, NAMELY, GLOVES USED FOR APPLICATION OF COLOGNES, PERFUMES AND FLAVORS TO THE INSIDE OR OUTSIDE OF THE HUMAN BODY, IN CLASS 10 (U.S. CLS. 26, 39 AND 44).

TRADEMARK

FIRST USE 3-1-2009; IN COMMERCE 7-16-2011.

PRINCIPAL REGISTER

THE MARK CONSISTS OF STANDARD CHARACTERS WITHOUT CLAIM TO ANY PARTICULAR FONT, STYLE, SIZE, OR COLOR.

NO CLAIM IS MADE TO THE EXCLUSIVE RIGHT TO USE "GLOVE", APART FROM THE MARK AS SHOWN.

SN 77-958,238, FILED 3-12-2010.

TINA BROWN, EXAMINING ATTORNEY



David J. Kybas

Director of the United States Patent and Trademark Office

United States of America

United States Patent and Trademark Office

BIOPOLYPETG+

Reg. No. 4,074,657

INPRO CORPORATION (WISCONSIN CORPORATION)
S80 W18766 APOLLO DRIVE
MUSKEGO, WI 53150

Registered Dec. 20, 2011

Int. Cl.: 19

FOR: PLASTIC WALL PROTECTION PRODUCTS, NAMELY, WALL PANELS, WALL GUARDS, CORNER GUARDS, WALL BASES, AND HAND RAILS; PLASTIC DOOR PROTECTION PRODUCTS, NAMELY, KNOB PROTECTORS, KICKPLATES, FRAME GUARDS, CLADDING, AND EDGE PROTECTORS, IN CLASS 19 (U.S. CLS. 1, 12, 33 AND 50).

TRADEMARK

PRINCIPAL REGISTER

FIRST USE 3-15-2010; IN COMMERCE 3-15-2010.

THE MARK CONSISTS OF STANDARD CHARACTERS WITHOUT CLAIM TO ANY PARTICULAR FONT, STYLE, SIZE, OR COLOR.

SN 77-959,745, FILED 3-16-2010.

JANET LEE, EXAMINING ATTORNEY



David J. Kyffers

Director of the United States Patent and Trademark Office

United States of America

United States Patent and Trademark Office

TWISTERZ

Reg. No. 4,074,658

TWISTERZ TOYS, LLC (CALIFORNIA LIMITED LIABILITY COMPANY)
221 KING STREET, SUITE 343
SAN FRANCISCO, CA 94107

Registered Dec. 20, 2011

Int. Cl.: 28

FOR: HANDHELD, MANIPULATIVE EDUCATIONAL PUZZLES AND GAMES FOR TEACHING EARLY CHILDHOOD DEVELOPMENTAL SKILLS, NAMELY, CREATIVITY, LOGIC, SPELLING, PROBLEM SOLVING, AND HAND/EYE COORDINATION, IN CLASS 28 (U.S. CLS. 22, 23, 38 AND 50).

TRADEMARK

PRINCIPAL REGISTER

FIRST USE 7-27-2010; IN COMMERCE 7-27-2010.

THE MARK CONSISTS OF STANDARD CHARACTERS WITHOUT CLAIM TO ANY PARTICULAR FONT, STYLE, SIZE, OR COLOR.

SN 77-960,586, FILED 3-16-2010.

AMY HELLA, EXAMINING ATTORNEY



David J. Kybas

Director of the United States Patent and Trademark Office

United States of America

United States Patent and Trademark Office

WARREN THE APE

Reg. No. 4,074,659

Registered Dec. 20, 2011

Int. Cl.: 41

SERVICE MARK

PRINCIPAL REGISTER

CHEEK FULL OF NUTS, INC., BAKER, SEAN AND CHINOY, SPENCER (CALIFORNIA
JOINT OWNERS PURSUANT TO TMEP 803.03(D))
1957 N. EDGEMONT ST.
LOS ANGELES, CA 90027

FOR: ENTERTAINMENT IN THE NATURE OF ON-GOING TELEVISION PROGRAMS IN THE FIELD OF COMEDY, PARODY AND SATIRE; ENTERTAINMENT IN THE NATURE OF LIVE COMEDY, PARODY AND SATIRE SHOWS; ENTERTAINMENT SERVICES IN THE NATURE OF COMEDY SHOWS; ENTERTAINMENT SERVICES, NAMELY, AN ON-GOING SERIES FEATURING COMEDY, PARODY AND SATIRE PROVIDED THROUGH TELEVISION, RADIO, SATELLITE, THE INTERNET, LIVE OR DIGITAL MEDIA; ENTERTAINMENT SERVICES, NAMELY, PROVIDING ON-GOING TELEVISION PROGRAMS IN THE FIELD OF COMEDY, PARODY AND SATIRE VIA A GLOBAL COMPUTER NETWORK; ENTERTAINMENT SERVICES, NAMELY, PROVIDING PODCASTS IN THE FIELD OF COMEDY, PARODY AND SATIRE; ENTERTAINMENT SERVICES, NAMELY, PROVIDING VIDEO PODCASTS IN THE FIELD OF COMEDY, PARODY AND SATIRE; ENTERTAINMENT SERVICES, NAMELY, PROVIDING WEBCASTS IN THE FIELD OF COMEDY, PARODY AND SATIRE; ENTERTAINMENT SERVICES, NAMELY, THE PROVISION OF CONTINUING TELEVISION SERIES FEATURING COMEDY, PARODY AND SATIRE DELIVERED BY TELEVISION, RADIO, SATELLITE, THE INTERNET, LIVE OR DIGITAL MEDIA; PRODUCTION OF DVDS, VIDEOTAPES AND TELEVISION PROGRAMS FEATURING COMEDY, PARODY AND SATIRE, IN CLASS 41 (U.S. CLS. 100, 101 AND 107).

FIRST USE 0-0-1999; IN COMMERCE 0-0-1999.

THE MARK CONSISTS OF STANDARD CHARACTERS WITHOUT CLAIM TO ANY PARTICULAR FONT, STYLE, SIZE, OR COLOR.

SN 77-961,361, FILED 3-17-2010.

TINA L. SNAPP, EXAMINING ATTORNEY



David J. Kybas

Director of the United States Patent and Trademark Office

United States of America

United States Patent and Trademark Office

EnviroMeta

Reg. No. 4,074,660

Registered Dec. 20, 2011

Int. Cl.: 37

SERVICE MARK

PRINCIPAL REGISTER

ENVIROMETA LLC (DELAWARE LIMITED LIABILITY COMPANY)
SUITE 300
1401 F STREET
MODESTO, CA 95354

FOR: ENVIRONMENTAL REMEDIATION SERVICES, NAMELY, WASTE DISPOSAL, IN CLASS 37 (U.S. CLS. 100, 103 AND 106).

FIRST USE 3-0-2010; IN COMMERCE 3-0-2010.

THE MARK CONSISTS OF STANDARD CHARACTERS WITHOUT CLAIM TO ANY PARTICULAR FONT, STYLE, SIZE, OR COLOR.

SN 77-962,477, FILED 3-18-2010.

SARA BENJAMIN, EXAMINING ATTORNEY



David J. Kybas

Director of the United States Patent and Trademark Office

United States of America

United States Patent and Trademark Office

VCORE

Reg. No. 4,074,661

Registered Dec. 20, 2011

Int. Cl.: 9

TRADEMARK

PRINCIPAL REGISTER

NEXTIO, INC. (DELAWARE CORPORATION)
8303 NORTH MOPAC EXPRESSWAY, SUITE A-210
AUSTIN, TX 78759

FOR: GRAPHICS PROCESSING UNIT-BASED (GPU-BASED) HARDWARE ACCELERATORS AND SOFTWARE FOR USE THEREWITH FOR INCREASING THE COMPUTATIONAL PERFORMANCE OF IMAGE AND SIGNAL PROCESSING APPLICATIONS; HARDWARE ACCELERATORS FOR HIGH PERFORMANCE COMPUTER PROCESSING; GPU-BASED HARDWARE ACCELERATORS; PROCESSOR CIRCUIT BOARDS FOR USE IN HIGH PERFORMANCE COMPUTER SYSTEMS TO PERFORM REAL-TIME DATA, IMAGE AND GRAPHICS PROCESSING, IN CLASS 9 (U.S. CLS. 21, 23, 26, 36 AND 38).

FIRST USE 7-14-2010; IN COMMERCE 7-14-2010.

THE MARK CONSISTS OF STANDARD CHARACTERS WITHOUT CLAIM TO ANY PARTICULAR FONT, STYLE, SIZE, OR COLOR.

SN 77-962,551, FILED 3-18-2010.

AISHA CLARKE, EXAMINING ATTORNEY



David J. Kyros

Director of the United States Patent and Trademark Office

United States of America

United States Patent and Trademark Office

VNET

Reg. No. 4,074,662

Registered Dec. 20, 2011

Int. Cl.: 9

TRADEMARK

PRINCIPAL REGISTER

NEXTIO, INC. (DELAWARE CORPORATION)
8303 NORTH MOPAC EXPRESSWAY, SUITE A-210
AUSTIN, TX 78759

FOR: COMPUTER HARDWARE, INTEGRATED CIRCUITS, PRINTED CIRCUIT BOARDS, AND INTERFACES FOR COMPUTERS, ALL FOR USE IN VIRTUALIZING COMPUTER INPUT/OUTPUT DEVICES, COMPUTER NETWORKING AND INTERCONNECTION OF COMPUTER OPERATING SYSTEMS AND COMPUTER PERIPHERALS, IN CLASS 9 (U.S. CLS. 21, 23, 26, 36 AND 38).

FIRST USE 10-11-2011; IN COMMERCE 10-11-2011.

THE MARK CONSISTS OF STANDARD CHARACTERS WITHOUT CLAIM TO ANY PARTICULAR FONT, STYLE, SIZE, OR COLOR.

SN 77-962,563, FILED 3-18-2010.

AISHA CLARKE, EXAMINING ATTORNEY



David J. Kybas

Director of the United States Patent and Trademark Office

United States of America

United States Patent and Trademark Office

NUMO

Reg. No. 4,074,663

Registered Dec. 20, 2011

Int. Cl.: 9

TRADEMARK

PRINCIPAL REGISTER

NCOMPUTING, INC. (DELAWARE CORPORATION)
1 LAGOON DRIVE, SUITE 110
REDWOOD CITY, CA 94065

FOR: DESKTOP VIRTUALIZATION KIT COMPRISING DESKTOP VIRTUALIZATION SOFTWARE AND A HARDWARE ACCESS DEVICE FOR CONNECTION TO A COMPUTER; COMPUTER HARDWARE FOR USE IN DESKTOP VIRTUALIZATION SOFTWARE; DESKTOP VIRTUALIZATION SOFTWARE; COMPUTER CHIPS AND SILICON CHIPS, IN CLASS 9 (U.S. CLS. 21, 23, 26, 36 AND 38).

FIRST USE 3-19-2010; IN COMMERCE 3-19-2010.

THE MARK CONSISTS OF STANDARD CHARACTERS WITHOUT CLAIM TO ANY PARTICULAR FONT, STYLE, SIZE, OR COLOR.

SN 77-962,677, FILED 3-18-2010.

LANA PHAM, EXAMINING ATTORNEY



David J. Kybas

Director of the United States Patent and Trademark Office

United States of America

United States Patent and Trademark Office



Reg. No. 4,074,664

Registered Dec. 20, 2011

**Int. Cls.: 9, 35, 37, 39,
and 42**

TRADEMARK

SERVICE MARK

PRINCIPAL REGISTER

HITACHI CONSTRUCTION MACHINERY CO., LTD. (JAPAN CORPORATION)
5-1 KORAKU 2-CHOME, BUNKYO-KU
TOKYO, JAPAN 112-8563

FOR: COMPUTER-BASED CONTROL SYSTEMS FOR MANAGEMENT OF OPERATIONS AND MAINTENANCE OF EQUIPMENT, COMPRISING A CENTRAL COMPUTER, DISPLAYS, A WIRELESS COMMUNICATION NETWORK AND ONBOARD CIRCUIT BOARDS, PROCESSORS, POSITIONING SYSTEMS AND SENSORS FOR HAULING VEHICLES, EXCAVATORS AND OTHER RELATED HEAVY EQUIPMENT USED IN LARGE-SCALE MINING, CONSTRUCTION, AND INDUSTRIAL OPERATIONS FOR RECEIVING AND DISPLAYING INFORMATION REMOTELY TO AND FROM A CENTRAL COMPUTER; SOFTWARE AND RADIO TRANSCEIVERS FOR LINKING INFORMATION TO A CENTRAL COMPUTER; CIRCUIT BOARDS AND AUTONOMOUS EQUIPMENT CONTROLS CONSISTING OF COMPUTER HARDWARE AND COMPUTER SOFTWARE BASED ON GPS TECHNOLOGY TO MOVE, POSITION AND GUIDE EXCAVATORS, OFF-HIGHWAY VEHICLES, DOZERS AND DRILLS IN THE FIELDS OF LARGE-SCALE MINING, CONSTRUCTION, AND INDUSTRIAL OPERATORS, IN CLASS 9 (U.S. CLS. 21, 23, 26, 36 AND 38).

FIRST USE 5-27-2002; IN COMMERCE 5-27-2002.

FOR: SYSTEMIZATION OF INFORMATION INTO COMPUTER DATABASES, IN CLASS 35 (U.S. CLS. 100, 101 AND 102).

FIRST USE 5-27-2002; IN COMMERCE 5-27-2002.

FOR: INSTALLATION, MAINTENANCE AND REPAIR OF COMPUTER HARDWARE, IN CLASS 37 (U.S. CLS. 100, 103 AND 106).

FIRST USE 5-27-2002; IN COMMERCE 5-27-2002.

FOR: TRANSPORTATION INFORMATION, IN CLASS 39 (U.S. CLS. 100 AND 105).

FIRST USE 5-27-2002; IN COMMERCE 5-27-2002.

FOR: COMPUTER PROGRAMMING; COMPUTER SYSTEM DESIGN, IN CLASS 42 (U.S. CLS. 100 AND 101).



David J. Kyffers

Director of the United States Patent and Trademark Office

Reg. No. 4,074,664 FIRST USE 5-27-2002; IN COMMERCE 5-27-2002.

THE MARK CONSISTS OF A LETTER "W" FORMING AN INCOMPLETE OVAL AROUND
THE LETTER "W" WITH THE WORD "WENCO" ON THE RIGHT OF THE LETTER "W".

SN 77-963,204, FILED 3-19-2010.

TINA BROWN, EXAMINING ATTORNEY

United States of America

United States Patent and Trademark Office

BEYOND THE CODE

Reg. No. 4,074,665

Registered Dec. 20, 2011

Int. Cls.: 35, 36, and 38

SERVICE MARK

PRINCIPAL REGISTER

NEW RULES MARKETING, INC. (MICHIGAN CORPORATION)
203 SOUTH CUTLER STREET
SPRING LAKE, MI 49456

FOR: FACILITATING PURCHASES THROUGH THE INTERNET, NAMELY, THE BRINGING TOGETHER, FOR THE BENEFIT OF OTHERS, OF A VARIETY OF GOODS AND SERVICES, ENABLING CUSTOMERS TO CONVENIENTLY VIEW PRODUCT INFORMATION AND PURCHASE THOSE GOODS AND SERVICES FROM AN INTERNET WEBSITE PARTICULARLY SPECIALIZING IN THE MARKETING OF THE SALE OF GOODS AND SERVICES OF OTHERS; BUSINESS INFORMATION MANAGEMENT SERVICES PROVIDED VIA MOBILE COMMUNICATION DEVICES, IN CLASS 35 (U.S. CLS. 100, 101 AND 102).

FIRST USE 1-15-2010; IN COMMERCE 1-15-2010.

FOR: FACILITATING PURCHASES THROUGH THE INTERNET, NAMELY, ELECTRONIC COMMERCE PAYMENT SERVICES IN THE NATURE OF ESTABLISHING FUNDED ACCOUNTS USED TO PURCHASE GOODS AND SERVICES ON THE INTERNET FOR OTHERS, IN CLASS 36 (U.S. CLS. 100, 101 AND 102).

FIRST USE 1-15-2010; IN COMMERCE 1-15-2010.

FOR: PROVIDING TELECOMMUNICATION CONNECTIONS TO THE INTERNET OR DATABASES, NAMELY, PROVIDING MOBILE COMMUNICATION DEVICE CONNECTIONS AND LINKS TO THE INTERNET, AND TRANSMISSION OF INFORMATION VIA ELECTRONIC COMMUNICATIONS NETWORKS FOR OTHERS; TO FACILITATE CONNECTION OF POTENTIAL CONSUMERS AND ADVERTISERS, IN CLASS 38 (U.S. CLS. 100, 101 AND 104).

FIRST USE 1-15-2010; IN COMMERCE 1-15-2010.

THE MARK CONSISTS OF STANDARD CHARACTERS WITHOUT CLAIM TO ANY PARTICULAR FONT, STYLE, SIZE, OR COLOR.

SN 77-963,309, FILED 3-19-2010.

FONG HSU, EXAMINING ATTORNEY



David J. Kyffers

Director of the United States Patent and Trademark Office

United States of America

United States Patent and Trademark Office

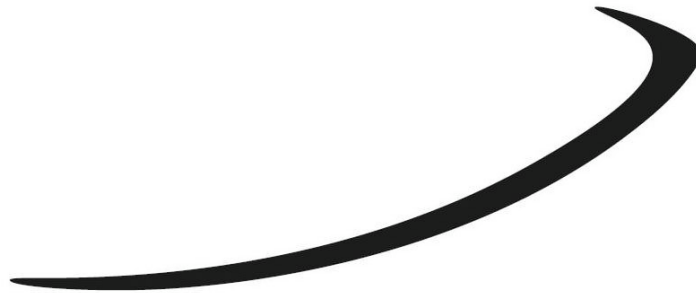

Reg. No. 4,074,666

INVISIBLE GADGET GUARD, INC. (UTAH CORPORATION)
3939 SOUTH WASATCH BLVD.
SALT LAKE CITY, UT 84124

Registered Dec. 20, 2011

Int. Cl.: 9

FOR: COVERS FOR CELL PHONES AND MP3 PLAYERS, IN CLASS 9 (U.S. CLS. 21, 23, 26, 36 AND 38).

TRADEMARK

FIRST USE 3-24-2010; IN COMMERCE 3-24-2010.

PRINCIPAL REGISTER

THE MARK CONSISTS OF A HORIZONTALLY ORIENTED HOOK DESIGN.

SN 77-963,377, FILED 3-19-2010.

BERNICE MIDDLETON, EXAMINING ATTORNEY



David J. Kyffers

Director of the United States Patent and Trademark Office

United States of America

United States Patent and Trademark Office



Reg. No. 4,074,667

Registered Dec. 20, 2011

Int. Cls.: 4 and 35

TRADEMARK

SERVICE MARK

PRINCIPAL REGISTER

QUESTAR GAS COMPANY (UTAH CORPORATION)
180 EAST 100 SOUTH
SALT LAKE CITY, UT 84145

FOR: NATURAL GAS, IN CLASS 4 (U.S. CLS. 1, 6 AND 15).

FIRST USE 6-1-2011; IN COMMERCE 6-1-2011.

FOR: PROMOTING PUBLIC AWARENESS OF NATURAL GAS AS A FUEL FOR VEHICLES,
IN CLASS 35 (U.S. CLS. 100, 101 AND 102).

FIRST USE 6-1-2011; IN COMMERCE 6-1-2011.

OWNER OF U.S. REG. NOS. 1,793,157, 3,501,894, AND OTHERS.

NO CLAIM IS MADE TO THE EXCLUSIVE RIGHT TO USE "GAS NGV NATURAL GAS
FOR VEHICLES", APART FROM THE MARK AS SHOWN.

THE MARK CONSISTS OF THE WORDING "QUESTAR GAS NGV NATURAL GAS FOR
VEHICLES" WITHIN A RECTANGLE WITH SLIGHTLY ROUNDED CORNERS, THE
WORDING "QUESTAR GAS" ABOVE THE WORDING "NGV NATURAL GAS FOR
VEHICLES" AND A LEAF FORMING AN UPPER PORTION OF THE LETTER "G" IN THE
WORD "NGV".

SN 77-963,794, FILED 3-19-2010.

GILBERT SWIFT, EXAMINING ATTORNEY



David J. Kyffers

Director of the United States Patent and Trademark Office

United States of America

United States Patent and Trademark Office



Reg. No. 4,074,668

Registered Dec. 20, 2011

Int. Cls.: 4 and 35

TRADEMARK

SERVICE MARK

PRINCIPAL REGISTER

QUESTAR GAS COMPANY (UTAH CORPORATION)
180 EAST 100 SOUTH
SALT LAKE CITY, UT 84145

FOR: NATURAL GAS, IN CLASS 4 (U.S. CLS. 1, 6 AND 15).

FIRST USE 9-1-2010; IN COMMERCE 9-1-2010.

FOR: PROMOTING PUBLIC AWARENESS OF NATURAL GAS AS A FUEL FOR VEHICLES,
IN CLASS 35 (U.S. CLS. 100, 101 AND 102).

FIRST USE 9-1-2010; IN COMMERCE 9-1-2010.

OWNER OF U.S. REG. NO. 1,793,157.

NO CLAIM IS MADE TO THE EXCLUSIVE RIGHT TO USE "NGV NATURAL GAS FOR VEHICLES", APART FROM THE MARK AS SHOWN.

THE MARK CONSISTS OF THE WORDING "NGV NATURAL GAS FOR VEHICLES" WITHIN A RECTANGLE WITH SLIGHTLY ROUNDED CORNERS, THE WORDING "NGV" ABOVE THE WORDING "NATURAL GAS", THE WORDING "NATURAL GAS" ABOVE THE WORDING FOR VEHICLES AND A LEAF FORMING AN UPPER PORTION OF THE WORDING "NGV".

SN 77-963,852, FILED 3-19-2010.

GILBERT SWIFT, EXAMINING ATTORNEY



David J. Kybas

Director of the United States Patent and Trademark Office

United States of America

United States Patent and Trademark Office

 powered by clean **natural gas**

Reg. No. 4,074,669

QUESTAR GAS COMPANY (UTAH CORPORATION)
180 EAST 100 SOUTH
SALT LAKE CITY, UT 84145

Registered Dec. 20, 2011

Int. Cl.: 35

FOR: PROMOTING PUBLIC AWARENESS OF NATURAL GAS AS A FUEL FOR VEHICLES,
IN CLASS 35 (U.S. CLS. 100, 101 AND 102).

SERVICE MARK

FIRST USE 9-1-2010; IN COMMERCE 9-1-2010.

PRINCIPAL REGISTER

NO CLAIM IS MADE TO THE EXCLUSIVE RIGHT TO USE "CLEAN NATURAL GAS",
APART FROM THE MARK AS SHOWN.

THE MARK CONSISTS OF THE WORDING "POWERED BY CLEAN NATURAL GAS" AND
A LEAF BEHIND THE LETTER "P" AND PART OF THE LETTER "O".

SN 77-963,898, FILED 3-19-2010.

GILBERT SWIFT, EXAMINING ATTORNEY



David J. Kyffers

Director of the United States Patent and Trademark Office

United States of America

United States Patent and Trademark Office

SMARTER LIVING

Reg. No. 4,074,670

Registered Dec. 20, 2011

Int. Cls.: 38 and 45

SERVICE MARK

PRINCIPAL REGISTER

SEARS BRANDS, LLC (ILLINOIS LIMITED LIABILITY COMPANY)
3333 BEVERLY ROAD
HOFFMAN ESTATES, IL 60179

FOR: PROVIDING ELECTRONIC BULLETIN BOARDS FOR THE TRANSMISSION AND EXCHANGE OF MESSAGES AND FOR SOCIAL NETWORKING AMONG USERS; PROVIDING ON-LINE FORUMS FOR TRANSMISSION OF MESSAGES AMONG COMPUTER USERS CONCERNING SHOPPING, WITH A FOCUS ON PRODUCT REVIEWS, BLOGS, SURVEYS, AND COMMUNITY INFORMATION, IN CLASS 38 (U.S. CLS. 100, 101 AND 104).

FIRST USE 5-0-2010; IN COMMERCE 5-0-2010.

FOR: PROVIDING ONLINE SOCIAL NETWORKING SERVICES IN THE FIELD OF SHOPPING, IN CLASS 45 (U.S. CLS. 100 AND 101).

FIRST USE 5-0-2010; IN COMMERCE 5-0-2010.

THE MARK CONSISTS OF STANDARD CHARACTERS WITHOUT CLAIM TO ANY PARTICULAR FONT, STYLE, SIZE, OR COLOR.

SN 77-965,613, FILED 3-23-2010.

MICHAEL GAAFAR, EXAMINING ATTORNEY



David J. Kyffers

Director of the United States Patent and Trademark Office

United States of America

United States Patent and Trademark Office

THE ROYAL TREATMENT

Reg. No. 4,074,671

LINMAR TECHNOLOGY INC. (NEW YORK CORPORATION)

Registered Dec. 20, 2011

1776 59TH STREET
BROOKLYN, NY 11204

Int. Cl.: 3

FOR: PREPARATIONS FOR POLISHING FURNITURE, AUTOMOBILES AND FLOORS;
PREPARATIONS FOR SPOT AND STAIN REMOVAL TREATMENT FOR CLOTHING;
CONCENTRATE USED FOR CLEANING WINDSHIELDS , IN CLASS 3 (U.S. CLS. 1, 4, 6,
50, 51 AND 52).

TRADEMARK

PRINCIPAL REGISTER

FIRST USE 10-10-2011; IN COMMERCE 10-10-2011.

THE MARK CONSISTS OF STANDARD CHARACTERS WITHOUT CLAIM TO ANY PARTICULAR FONT, STYLE, SIZE, OR COLOR.

SN 77-965,841, FILED 3-23-2010.

ANTHONY RINKER, EXAMINING ATTORNEY



David J. Kyffers

Director of the United States Patent and Trademark Office

United States of America

United States Patent and Trademark Office

TECH WEALTH MANAGEMENT

Reg. No. 4,074,672

Registered Dec. 20, 2011

Int. Cl.: 36

SERVICE MARK

PRINCIPAL REGISTER

TECHNOLOGY CREDIT UNION (CALIFORNIA CORPORATION)
2010 NORTH 1ST STREET
SAN JOSE, CA 95131

FOR: FINANCIAL SERVICES, NAMELY, PROVIDING BANKING SERVICES, SAVINGS ACCOUNT SERVICES, SAFE DEPOSIT SERVICES, CHECKING ACCOUNT SERVICES, CERTIFICATES OF DEPOSIT, CONSUMER AND MORTGAGE LOAN SERVICES, SECURITIES BROKERAGE, INDIVIDUAL RETIREMENT ACCOUNTS, DEBIT CARD SERVICES, CREDIT CARD SERVICES, FINANCIAL PLANNING, RETIREMENT PLANNING, WEALTH PLANNING AND ONLINE BANKING SERVICES, IN CLASS 36 (U.S. CLS. 100, 101 AND 102).

FIRST USE 12-1-2010; IN COMMERCE 12-1-2010.

THE MARK CONSISTS OF STANDARD CHARACTERS WITHOUT CLAIM TO ANY PARTICULAR FONT, STYLE, SIZE, OR COLOR.

NO CLAIM IS MADE TO THE EXCLUSIVE RIGHT TO USE "WEALTH MANAGEMENT", APART FROM THE MARK AS SHOWN.

SN 77-966,575, FILED 3-23-2010.

AISHA CLARKE, EXAMINING ATTORNEY



David J. Kyros

Director of the United States Patent and Trademark Office

United States of America

United States Patent and Trademark Office

Simplicity Solutions

Reg. No. 4,074,673

Registered Dec. 20, 2011

Int. Cl.: 9

TRADEMARK

PRINCIPAL REGISTER

BROOKS AUTOMATION, INC. (DELAWARE CORPORATION)
15 ELIZABETH DRIVE
CHELMSFORD, MA 01824

FOR: MASS SPECTROMETER AND SUB-ASSEMBLIES, IN CLASS 9 (U.S. CLS. 21, 23, 26, 36 AND 38).

FIRST USE 12-8-2010; IN COMMERCE 12-8-2010.

NO CLAIM IS MADE TO THE EXCLUSIVE RIGHT TO USE "SOLUTIONS", APART FROM THE MARK AS SHOWN.

THE COLOR(S) LIGHT BLUE, DARK BLUE AND WHITE IS/ARE CLAIMED AS A FEATURE OF THE MARK.

THE MARK CONSISTS OF THE WORD "SIMPLICITY" IN LIGHT BLUE ABOVE THE WORD "SOLUTIONS" IN LIGHT BLUE WITH THE LOWERCASE LETTER "L" OF "SIMPLICITY" CONNECTED TO THE "L" OF "SOLUTIONS" WITH A DARK BLUE BOX FOLLOWING THE "Y" IN "SIMPLICITY" AND A WHITE CURVED DESIGN BISECTING THE BOX.

SN 77-966,899, FILED 3-24-2010.

KYLE PEETE, EXAMINING ATTORNEY



David J. Kyros

Director of the United States Patent and Trademark Office

United States of America

United States Patent and Trademark Office



Reg. No. 4,074,674

Registered Dec. 20, 2011

Int. Cl.: 30

TRADEMARK

PRINCIPAL REGISTER

LT OVERSEAS NORTH AMERICA, INC. (CALIFORNIA CORPORATION)
1211 MCGAW AVENUE
IRVINE, CA 926145536

FOR: RICE, IN CLASS 30 (U.S. CL. 46).

FIRST USE 3-1-2010; IN COMMERCE 3-1-2010.

THE MARK CONSISTS OF A WOMAN'S HEAD WITH A HEADDRESS.

SN 77-967,773, FILED 3-24-2010.

VIVIAN MICZNIK FIRST, EXAMINING ATTORNEY



David J. Kybas

Director of the United States Patent and Trademark Office

United States of America

United States Patent and Trademark Office

SOCIAL SYNERGY SYSTEM

Reg. No. 4,074,675

Registered Dec. 20, 2011

Int. Cl.: 35

SERVICE MARK

PRINCIPAL REGISTER

CHANGE LEADERSHIP GROUP, LLC (WASHINGTON LIMITED LIABILITY COMPANY)
SUITE F1-144
14150 NE 20TH STREET
BELLEVUE, WA 98007

FOR: CONSULTING IN THE FIELDS OF MARKETING AND SALES PROMOTION, IN CLASS
35 (U.S. CLS. 100, 101 AND 102).

FIRST USE 10-1-2011; IN COMMERCE 10-1-2011.

THE MARK CONSISTS OF STANDARD CHARACTERS WITHOUT CLAIM TO ANY PAR-
TICULAR FONT, STYLE, SIZE, OR COLOR.

NO CLAIM IS MADE TO THE EXCLUSIVE RIGHT TO USE "SYSTEM", APART FROM THE
MARK AS SHOWN.

SN 77-967,987, FILED 3-25-2010.

JOHN SCHUYLER YARD, EXAMINING ATTORNEY



David J. Kypos

Director of the United States Patent and Trademark Office

United States of America

United States Patent and Trademark Office

IRONCLAD CORPORATE RETIREMENT SERVICES

Reg. No. 4,074,676

IRON HOLDINGS, LLC (ILLINOIS LIMITED LIABILITY COMPANY)
630 DUNDEE RD, SUITE 200
NORTHBROOK, IL 60062

Registered Dec. 20, 2011

Int. Cl.: 36

FOR: RETIREMENT FUND INVESTMENT SERVICES, NAMELY, INVESTMENT OF FUNDS FOR OTHERS; FINANCIAL INFORMATION AND CONSULTATION IN THE NATURE OF RETIREMENT PLANNING, RETIREMENT PLAN DESIGN AND SUPPORT AND RETIREMENT PLAN ADMINISTRATION SERVICES; FIXED INCOME FINANCIAL MANAGEMENT AND CONSULTATION SERVICES; FINANCIAL PORTFOLIO MANAGEMENT; RETIREMENT FUND ADMINISTRATION SERVICES, NAMELY, PLAN DESIGN, ADMINISTRATION, AND RECORDKEEPING, IN CLASS 36 (U.S. CLS. 100, 101 AND 102).

SERVICE MARK

PRINCIPAL REGISTER

FIRST USE 5-0-2010; IN COMMERCE 5-0-2010.

THE MARK CONSISTS OF STANDARD CHARACTERS WITHOUT CLAIM TO ANY PARTICULAR FONT, STYLE, SIZE, OR COLOR.

NO CLAIM IS MADE TO THE EXCLUSIVE RIGHT TO USE "CORPORATE RETIREMENT SERVICES", APART FROM THE MARK AS SHOWN.

SN 77-969,366, FILED 3-26-2010.

EUGENIA MARTIN, EXAMINING ATTORNEY



David J. Kybas

Director of the United States Patent and Trademark Office

United States of America

United States Patent and Trademark Office



Reg. No. 4,074,677

Registered Dec. 20, 2011

Int. Cl.: 31

TRADEMARK

PRINCIPAL REGISTER

PIONEER HI-BRED INTERNATIONAL, INC. (IOWA CORPORATION)
PO BOX 1014
7100 N.W. 62ND AVENUE
JOHNSTON, IA 501311014

FOR: AGRICULTURAL SEEDS CONTAINING HERBICIDE TOLERANT, DROUGHT TOLERANT, INSECT RESISTANT, AND/OR DISEASE RESISTANT TRAITS, IN CLASS 31 (U.S. CLS. 1 AND 46).

FIRST USE 11-4-2010; IN COMMERCE 11-4-2010.

OWNER OF U.S. REG. NOS. 2,003,320, 3,357,613, AND OTHERS.

THE MARK CONSISTS OF THE STYLIZED WORD "OPTIMUM" WITH THE "O" DEPICTED AS THE DESIGN OF A BUDDING SEED.

SN 77-982,573, FILED 12-1-2009.

ERIN FALK, EXAMINING ATTORNEY



David J. Kybas

Director of the United States Patent and Trademark Office

United States of America

United States Patent and Trademark Office

CALYPSOUL

Reg. No. 4,074,678

Registered Dec. 20, 2011

Int. Cl.: 28

TRADEMARK

PRINCIPAL REGISTER

PITTMAN, PAUL (UNITED STATES INDIVIDUAL)
7820 NETHERLANDS DRIVE
RALEIGH, NC 27606

FOR: RECREATIONAL FISHING EQUIPMENT, NAMELY, FISHING TACKLE, FISHING REELS, FISHING RODS, LINES, LURES, HOOKS, GAFFS, CREELS, FLOATS, FLIES, SINKERS, CRAB, FISH AND LOBSTER POTS, FISH CAGES, HAND-HELD FISHING NETS FOR RECREATIONAL USE, FISHING SINKERS, FISHING SPINNERS, FISHING TACKLE BOXES, FISHING TACKLE CONTAINERS, FISHING WEIGHTS; INFLATABLE FLOAT TUBES FOR FISHING, SPORTSMAN'S FISHING BAGS, FISHING PLUGS, FISHING POLE HOLDERS WORN ON THE BODY, FISHING ROD BLANKS, FISHING ROD CASES, FISHING ROD HANDLES, FISHING ROD HOLDERS, FISHING ROD RACKS, FISHING SAFETY HARNESS, FISH HOOK REMOVERS, CLAMPS FOR SECURING FISHING EQUIPMENT ON THE BODY, FISHING BUOYS, FISHING CREELS, WINGING MATERIAL FOR FISHING JIGS AND STREAMERS, FISHING FLIES, FISHING FLOATS, FISHING LEADERS, FISHING LURE BOXES AND FISHING LURE PARTS; GOLF EQUIPMENT, NAMELY, GOLF CLUBS, GOLF PUTTERS, GOLF BAGS, GOLF BALLS AND GOLF TEES, IN CLASS 28 (U.S. CLS. 22, 23, 38 AND 50).

FIRST USE 7-6-2011; IN COMMERCE 7-6-2011.

THE MARK CONSISTS OF STANDARD CHARACTERS WITHOUT CLAIM TO ANY PARTICULAR FONT, STYLE, SIZE, OR COLOR.

SN 77-982,654, FILED 3-10-2009.

BRIAN NEVILLE, EXAMINING ATTORNEY



David J. Kybas

Director of the United States Patent and Trademark Office

United States of America

United States Patent and Trademark Office

digital

Reg. No. 4,074,679

ECR SOFTWARE CORPORATION (NORTH CAROLINA CORPORATION)
227 HOWARD STREET
BOONE, NC 28607

Registered Dec. 20, 2011

Int. Cl.: 9

FOR: ELECTRONIC COMPONENTS FOR COMPUTERS, EMBEDDED ELECTRONICS IN THE NATURE OF COMPUTER SERVERS, IN CLASS 9 (U.S. CLS. 21, 23, 26, 36 AND 38).

TRADEMARK

FIRST USE 6-30-2011; IN COMMERCE 6-30-2011.

PRINCIPAL REGISTER

NO CLAIM IS MADE TO THE EXCLUSIVE RIGHT TO USE "DIGITAL", APART FROM THE MARK AS SHOWN.

THE MARK CONSISTS OF THE LETTERS COMPRISING THE WORD "DIGITAL", EACH LETTER IN A RECTANGLE, EACH RECTANGLE SEPARATED FROM ITS NEIGHBOR.

SN 77-982,655, FILED 3-2-2010.

MARC LEIPZIG, EXAMINING ATTORNEY



David J. Kyffers

Director of the United States Patent and Trademark Office

United States of America

United States Patent and Trademark Office

FASHION'S NIGHT OUT

Reg. No. 4,074,680

ADVANCE MAGAZINE PUBLISHERS INC. (NEW YORK CORPORATION)
4 TIMES SQUARE
NEW YORK, NY 10036

Registered Dec. 20, 2011

Int. Cls.: 18, 25, and 35

FOR: TOTE BAGS, CARRY ALL BAGS, IN CLASS 18 (U.S. CLS. 1, 2, 3, 22 AND 41).

TRADEMARK

FIRST USE 9-0-2010; IN COMMERCE 9-0-2010.

SERVICE MARK

FOR: APPAREL, NAMELY, T-SHIRTS, TANK TOPS, SWEATSHIRTS AND CAPS, IN CLASS 25 (U.S. CLS. 22 AND 39).

PRINCIPAL REGISTER

FIRST USE 9-0-2009; IN COMMERCE 9-0-2009.

FOR: ADVERTISING AND PROMOTION SERVICES IN THE FIELD OF FASHION; ARRANGING AND CONDUCTING MARKETING PROMOTIONAL EVENTS FOR OTHERS TO STIMULATE THE FASHION INDUSTRY FOR THE BENEFIT OF DESIGNERS, MANUFACTURERS, BRICK AND MORTAR AND ONLINE SELLERS, STORES AND CONSUMERS, IN CLASS 35 (U.S. CLS. 100, 101 AND 102).

FIRST USE 9-0-2009; IN COMMERCE 9-0-2009.

THE MARK CONSISTS OF STANDARD CHARACTERS WITHOUT CLAIM TO ANY PARTICULAR FONT, STYLE, SIZE, OR COLOR.

NO CLAIM IS MADE TO THE EXCLUSIVE RIGHT TO USE "FASHION'S", APART FROM THE MARK AS SHOWN.

SN 77-982,657, FILED 6-24-2009.

NAKIA HENRY, EXAMINING ATTORNEY



David J. Kybas

Director of the United States Patent and Trademark Office

United States of America

United States Patent and Trademark Office

HENDO

Reg. No. 4,074,681

DANIEL J. HENDERSON (UNITED STATES INDIVIDUAL)
39444 CALLE PORTILLO
TEMECULA, CA 92592

Registered Dec. 20, 2011

Int. Cl.: 25

FOR: APPAREL, NAMELY, T-SHIRTS, SHIRTS, SHORTS, BOARDSHORTS, SWIM SUITS, PANTS, SWEATSHIRTS, SWEATPANTS, JACKETS, HATS, VISORS, SHOES, SANDALS, JACKETS, UNDERWEAR, SOCKS, AND BELTS, IN CLASS 25 (U.S. CLS. 22 AND 39).

TRADEMARK

FIRST USE 6-17-2007; IN COMMERCE 6-17-2007.

PRINCIPAL REGISTER

THE MARK CONSISTS OF STANDARD CHARACTERS WITHOUT CLAIM TO ANY PARTICULAR FONT, STYLE, SIZE, OR COLOR.

THE NAME "HENDO" IDENTIFIES A LIVING INDIVIDUAL WHOSE CONSENT IS OF RECORD.

SN 77-982,661, FILED 3-9-2010.

KYLE PEETE, EXAMINING ATTORNEY



David J. Kybas

Director of the United States Patent and Trademark Office

United States of America

United States Patent and Trademark Office

TOUCHTUNES PLAYPORTT

Reg. No. 4,074,682

TOUCHTUNES MUSIC CORPORATION (DELAWARE CORPORATION)
850 THIRD AVENUE, SUITE 11A
NEW YORK, NY 10022

Registered Dec. 20, 2011

Int. Cl.: 9

FOR: PORTABLE GAME, MUSIC, BROWSER AND ENTERTAINMENT SYSTEM, COMPRISING VIDEO TOUCH SCREEN, INTERNAL AUDIO SPEAKERS, BATTERY SUPPLY AND CHARGERS, VIDEO PROCESSOR FOR EXECUTION OF INTERACTIVE GAMES AND DATA PROCESSING PROGRAMS FOR THE COLLECTION OF FINANCIAL AND ADVERTISING INFORMATION RELATING TO THE USE OF THE SYSTEM; DIGITAL JUKEBOX INCLUDING COMPUTER HARDWARE AND SOFTWARE FOR DISTRIBUTING, SELECTING AND PLAYING AUDIO AND VIDEO MUSICAL INFORMATION; SATELLITE, WIRE, CABLE OR OPTICAL FIBER TELECOMMUNICATION NETWORK FOR REMOTE DOWNLOADING OF DIGITAL INFORMATION ON A DIGITAL TERMINAL OR DIGITAL JUKEBOX; COMPUTER HARDWARE AND SOFTWARE FOR AUDIO AND VISUAL PLAYBACK FOR KARAOKE PERFORMANCES; AUDIOVISUAL SYSTEM COMPRISING DISKS, SPEAKERS, DIGITAL SOUND BOARDS, DIGITAL TELECOMMUNICATION NETWORK, TELECOMMUNICATION BOARDS, TELECOMMUNICATION MODEM, DIGITAL JUKEBOXES, TOUCH SCREENS AND DISPLAY MONITORS; COMPUTER SOFTWARE FOR STORING, ACCESSING AND TRANSMITTING DIGITAL INFORMATION, NAMELY, MUSIC, GAMES, MANAGEMENT INFORMATION, STATISTICS, ROYALTY STATEMENTS, ADVERTISEMENTS, SOUNDS, AND VIDEO; COMPUTER PERIPHERALS, NAMELY, HAND-HELD COMPUTERS, MONITORS, JUKEBOXES, REMOTE CONTROL FOR VIDEO OR AUDIO DIGITAL JUKEBOXES, TOUCH SCREEN, MOUSE, KEYBOARDS AND COMPUTER CABLES, IN CLASS 9 (U.S. CLS. 21, 23, 26, 36 AND 38).

TRADEMARK

PRINCIPAL REGISTER



FIRST USE 0-0-2009; IN COMMERCE 0-0-2009.

THE MARK CONSISTS OF STANDARD CHARACTERS WITHOUT CLAIM TO ANY PARTICULAR FONT, STYLE, SIZE, OR COLOR.

OWNER OF U.S. REG. NOS. 2,239,433, 3,367,040, AND OTHERS.

SN 77-982,705, FILED 10-23-2007.

LINDA M. KING, EXAMINING ATTORNEY

David J. Kyros

Director of the United States Patent and Trademark Office

United States of America

United States Patent and Trademark Office

RAM'S GATE

Reg. No. 4,074,683

RAM'S GATE WINERY, LLC (CALIFORNIA LIMITED LIABILITY COMPANY)
28700 ARNOLD DRIVE
SONOMA, CA 95476

Registered Dec. 20, 2011

Int. Cl.: 33

FOR: WINE; SPARKLING WINE, IN CLASS 33 (U.S. CLS. 47 AND 49).

TRADEMARK

FIRST USE 9-17-2011; IN COMMERCE 9-17-2011.

PRINCIPAL REGISTER

THE MARK CONSISTS OF STANDARD CHARACTERS WITHOUT CLAIM TO ANY PARTICULAR FONT, STYLE, SIZE, OR COLOR.

SN 77-982,707, FILED 4-2-2009.

AMY KERTGATE, EXAMINING ATTORNEY



David J. Kyffers

Director of the United States Patent and Trademark Office

United States of America

United States Patent and Trademark Office

RACQUET & JOG

Reg. No. 4,074,684

DALE GRIMES ENTERPRISES, INC. (TEXAS CORPORATION)
14250 FM ROAD 344 WEST
BULLARD, TX 75757

Registered Dec. 20, 2011

Int. Cl.: 25

FOR: T-SHIRTS, TANK TOPS, SWEAT SHIRTS, AND JACKETS, IN CLASS 25 (U.S. CLS. 22 AND 39).

TRADEMARK

FIRST USE 1-1-1978; IN COMMERCE 1-1-1978.

PRINCIPAL REGISTER

THE MARK CONSISTS OF STANDARD CHARACTERS WITHOUT CLAIM TO ANY PARTICULAR FONT, STYLE, SIZE, OR COLOR.

NO CLAIM IS MADE TO THE EXCLUSIVE RIGHT TO USE "JOG", APART FROM THE MARK AS SHOWN.

SN 77-982,717, FILED 11-16-2009.

WILLIAM VERHOSEK, EXAMINING ATTORNEY



David J. Kyros

Director of the United States Patent and Trademark Office

United States of America

United States Patent and Trademark Office

COLD CREEK

Reg. No. 4,074,685

LIFESTYLE PRODUCTS (UTAH LIMITED LIABILITY COMPANY)
P.O. BOX 4614

Registered Dec. 20, 2011

LOGAN, UT 84323

Int. Cl.: 20

FOR: CAMPING FURNITURE, NAMELY, GAME PROCESSING TABLES, FILLET STATION TABLES AND BLOW-MOLDED TABLES WITH STEEL FRAMES, IN CLASS 20 (U.S. CLS. 2, 13, 22, 25, 32 AND 50).

TRADEMARK

FIRST USE 10-0-2011; IN COMMERCE 10-0-2011.

PRINCIPAL REGISTER

THE MARK CONSISTS OF STANDARD CHARACTERS WITHOUT CLAIM TO ANY PARTICULAR FONT, STYLE, SIZE, OR COLOR.

SN 77-982,724, FILED 3-19-2010.

LOURDES AYALA, EXAMINING ATTORNEY



David J. Kyffers

Director of the United States Patent and Trademark Office

United States of America

United States Patent and Trademark Office

ANTAÑO

Reg. No. 4,074,686

J. GARCIA CARRION, S.A. (SPAIN CORPORATION)

Registered Dec. 20, 2011

CARRETERA DE MURCIA, S/N
30520 JUMILLA (MURCIA), SPAIN

Int. Cl.: 33

FOR: SPANISH WINES FROM THE REGION OF LA RIOJA, IN CLASS 33 (U.S. CLS. 47 AND 49).

TRADEMARK

FIRST USE 1-31-2000; IN COMMERCE 2-21-2007.

PRINCIPAL REGISTER

THE ENGLISH TRANSLATION OF "ANTAÑO" IS LONG AGO OR IN YEARS PAST OR IN YEARS GONE BY.

SN 78-282,777, FILED 8-4-2003.

KATHRYN COWARD, EXAMINING ATTORNEY



David J. Kyffers

Director of the United States Patent and Trademark Office

United States of America

United States Patent and Trademark Office

SYNERGY ORGANIC & RAW

Reg. No. 4,074,687

MILLENNIUM PRODUCTS, INC. (CALIFORNIA CORPORATION)
4646 HAMPTON STREET
VERNON, CA 90058

Registered Dec. 20, 2011

Int. Cl.: 30

FOR: ORGANIC KOMBUCHA TEA WITH NATURAL FRUIT JUICE FLAVORING, IN CLASS 30 (U.S. CL. 46).

TRADEMARK

FIRST USE 1-0-2005; IN COMMERCE 1-0-2005.

PRINCIPAL REGISTER

THE MARK CONSISTS OF STANDARD CHARACTERS WITHOUT CLAIM TO ANY PARTICULAR FONT, STYLE, SIZE, OR COLOR.

NO CLAIM IS MADE TO THE EXCLUSIVE RIGHT TO USE "ORGANIC AND RAW", APART FROM THE MARK AS SHOWN.

SN 78-507,804, FILED 10-28-2004.

RAMONA ORTIGA, EXAMINING ATTORNEY



David J. Kyffers

Director of the United States Patent and Trademark Office

United States of America

United States Patent and Trademark Office

marie claire

Reg. No. 4,074,688

Registered Dec. 20, 2011

Int. Cl.: 18

TRADEMARK

PRINCIPAL REGISTER

MARIE CLAIRE ALBUM (FRANCE CORPORATION)
10 BOULEVARD DES FRERES VOISIN
92792 ISSY-LES-MOULINEAUX, FRANCE

FOR: UMBRELLAS, IN CLASS 18 (U.S. CLS. 1, 2, 3, 22 AND 41).

FIRST USE 11-0-2010; IN COMMERCE 11-0-2010.

OWNER OF U.S. REG. NOS. 1,224,181, 3,011,657, AND OTHERS.

"MARIE CLAIRE" IS NOT THE NAME OF A LIVING INDIVIDUAL.

SN 78-706,202, FILED 9-2-2005.

COLLEEN DOMBROW, EXAMINING ATTORNEY



David J. Kybas

Director of the United States Patent and Trademark Office

United States of America

United States Patent and Trademark Office

DUB

Reg. No. 4,074,689

Registered Dec. 20, 2011

Int. Cls.: 16 and 41

TRADEMARK

SERVICE MARK

PRINCIPAL REGISTER

DUB PUBLISHING, INC. (CALIFORNIA CORPORATION)
16815 JOHNSON DRIVE
CITY OF INDUSTRY, CA 917451819

FOR: PRINTED MATERIAL, NAMELY, CALENDARS, AND POSTERS, IN CLASS 16 (U.S. CLS. 2, 5, 22, 23, 29, 37, 38 AND 50).

FIRST USE 0-0-2000; IN COMMERCE 0-0-2000.

FOR: PROVIDING INFORMATION RELATING TO MUSIC AND ENTERTAINMENT VIA A GLOBAL COMPUTER NETWORK, IN CLASS 41 (U.S. CLS. 100, 101 AND 107).

FIRST USE 0-0-2006; IN COMMERCE 0-0-2006.

THE MARK CONSISTS OF STANDARD CHARACTERS WITHOUT CLAIM TO ANY PARTICULAR FONT, STYLE, SIZE, OR COLOR.

OWNER OF U.S. REG. NOS. 2,408,405, 3,092,268, AND OTHERS.

SN 78-761,591, FILED 11-28-2005.

JAMES GRIFFIN, EXAMINING ATTORNEY



David J. Kyffers

Director of the United States Patent and Trademark Office

United States of America

United States Patent and Trademark Office

PuraMed BioScience

Reg. No. 4,074,690

PURAMED BIOSCIENCE INC. (MINNESOTA CORPORATION)

Registered Dec. 20, 2011

P.O. BOX 677
SCHOFIELD, WI 54476

Int. Cl.: 5

FOR: NUTRACEUTICALS AND HOMEOPATHIC PHARMACEUTICALS FOR THE TREATMENT OF PAIN AND ASSOCIATED SYMPTOMS, AND DIETARY SUPPLEMENTS, IN CLASS 5 (U.S. CLS. 6, 18, 44, 46, 51 AND 52).

TRADEMARK

FIRST USE 8-9-2010; IN COMMERCE 8-9-2010.

PRINCIPAL REGISTER

THE MARK CONSISTS OF STANDARD CHARACTERS WITHOUT CLAIM TO ANY PARTICULAR FONT, STYLE, SIZE, OR COLOR.

NO CLAIM IS MADE TO THE EXCLUSIVE RIGHT TO USE "BIOSCIENCE", APART FROM THE MARK AS SHOWN.

SN 78-891,599, FILED 5-24-2006.

LESLEY LAMOTHE, EXAMINING ATTORNEY



David J. Kyjars

Director of the United States Patent and Trademark Office

United States of America

United States Patent and Trademark Office

ATELIER LB

Reg. No. 4,074,691

MMS USA HOLDINGS, INC. (DELAWARE CORPORATION)
35 W. WACKER DRIVE
CHICAGO, IL 60601

Registered Dec. 20, 2011

Int. Cl.: 35

FOR: ADVERTISING AGENCY SERVICES IN ALL MEDIA, IN CLASS 35 (U.S. CLS. 100, 101 AND 102).

SERVICE MARK

FIRST USE 11-3-2011; IN COMMERCE 11-3-2011.

PRINCIPAL REGISTER

THE MARK CONSISTS OF STANDARD CHARACTERS WITHOUT CLAIM TO ANY PARTICULAR FONT, STYLE, SIZE, OR COLOR.

THE ENGLISH TRANSLATION OF THE WORD "ATELIER" IN THE MARK IS WORKSHOP.

SN 78-909,206, FILED 6-15-2006.

FRANK LATTUCA, EXAMINING ATTORNEY



David J. Kyffers

Director of the United States Patent and Trademark Office

United States of America

United States Patent and Trademark Office

If You Had To Choose...?

Reg. No. 4,074,692

CHOOSE GAMES, INC. (CANADA CORPORATION)
#2515-45 DUNFILED AVE.

Registered Dec. 20, 2011

TORONTO, CANADA M4S2H4

Int. Cl.: 41

FOR: ENTERTAINMENT SERVICES, NAMELY, PROVIDING A TELEVISION PROGRAM IN THE FIELD OF TV REALITY GAME SHOW VIA A GLOBAL COMPUTER NETWORK; ENTERTAINMENT SERVICES, NAMELY, PROVIDING AN ON-LINE COMPUTER GAME, IN CLASS 41 (U.S. CLS. 100, 101 AND 107).

SERVICE MARK

PRINCIPAL REGISTER

FIRST USE 4-8-2011; IN COMMERCE 4-8-2011.

THE MARK CONSISTS OF STANDARD CHARACTERS WITHOUT CLAIM TO ANY PARTICULAR FONT, STYLE, SIZE, OR COLOR.

SN 78-913,348, FILED 6-21-2006.

EUGENIA MARTIN, EXAMINING ATTORNEY



David J. Kyros

Director of the United States Patent and Trademark Office

United States of America

United States Patent and Trademark Office

ALL

Reg. No. 4,074,693

Registered Dec. 20, 2011

Int. Cl.: 9

TRADEMARK

PRINCIPAL REGISTER

KOENIG, ERIC HADDAD (MEXICO INDIVIDUAL)
MONTES APALACHES NO. 420
COLONIA LOMÁS DE VIRREYES
MEXICO, D.F., MEXICO C.P. 1100

FOR: AUDIO RECORDINGS FEATURING MUSIC; DOWNLOADABLE AUDIO, VIDEO, MUSIC, IN MP4, WAV, AIFF, WMA, OGG, VQF, PCA, RM, MID, AC3, FORMATS; MP4, WAV, AIFF, WMA, OGG, VQF, PCA, RM, MID, AC3, ASF, RP9 RECORDINGS, ALL FEATURING MUSIC, NEWS BROADCASTS, TELEVISIONS SHOWS, MOVIES, PHOTOGRAPHS AND GRAPHICS; AND SOFTWARE FOR DATABASE MANAGEMENT, USE AS A SPREADSHEET, AND WORD PROCESSING, IN CLASS 9 (U.S. CLS. 21, 23, 26, 36 AND 38).

FIRST USE 4-24-2010; IN COMMERCE 4-24-2010.

THE MARK CONSISTS OF STANDARD CHARACTERS WITHOUT CLAIM TO ANY PARTICULAR FONT, STYLE, SIZE, OR COLOR.

SN 78-923,609, FILED 7-6-2006.

GISELLE AGOSTO, EXAMINING ATTORNEY



David J. Kybas

Director of the United States Patent and Trademark Office

United States of America

United States Patent and Trademark Office



Reg. No. 4,074,694

Registered Dec. 20, 2011

Int. Cls.: 9 and 44

TRADEMARK

SERVICE MARK

PRINCIPAL REGISTER

WILLIAMSON, JEFFREY F. (UNITED STATES INDIVIDUAL)
345 CENTRAL AVENUE
ALAMEDA, CA 94501

FOR: DOWNLOADABLE VIDEO AND AUDIO RECORDINGS FEATURING MATERIAL FOR USE BY SPEECH IMPAIRED INDIVIDUALS, IN CLASS 9 (U.S. CLS. 21, 23, 26, 36 AND 38).

FIRST USE 4-28-2010; IN COMMERCE 4-28-2010.

FOR: SPEECH THERAPY AND COMMUNICATION THERAPY FOR SPEECH IMPAIRED INDIVIDUALS UTILIZING VIDEO ASSISTED SPEECH TECHNOLOGY, IN CLASS 44 (U.S. CLS. 100 AND 101).

FIRST USE 9-2-2011; IN COMMERCE 9-2-2011.

THE MARK CONSISTS OF THE STYLIZED WORD "VAST" WITH THE LETTER "V" INCLUDING LIPS AND A FILM SLICE DESIGN.

SN 85-000,443, FILED 3-29-2010.

HOWARD B. LEVINE, EXAMINING ATTORNEY



David J. Kyros

Director of the United States Patent and Trademark Office

United States of America

United States Patent and Trademark Office

GILDED REVOLUTION

Reg. No. 4,074,695

COCHRAN CABRERA, CARRIE (UNITED STATES INDIVIDUAL)
425 N 14TH AVENUE

Registered Dec. 20, 2011

HOLLYWOOD, FL 33020

Int. Cl.: 18

FOR: FANNY PACKS; TRAVEL KIT COMPRISING A TRAVEL BAG, A NECK PILLOW, AN EYE MASK, AND A BLANKET, IN CLASS 18 (U.S. CLS. 1, 2, 3, 22 AND 41).

TRADEMARK

FIRST USE 1-1-2011; IN COMMERCE 1-1-2011.

PRINCIPAL REGISTER

THE MARK CONSISTS OF STANDARD CHARACTERS WITHOUT CLAIM TO ANY PARTICULAR FONT, STYLE, SIZE, OR COLOR.

SN 85-000,787, FILED 3-29-2010.

WILLIAM BRECKENFELD, EXAMINING ATTORNEY



David J. Kyfos

Director of the United States Patent and Trademark Office

United States of America

United States Patent and Trademark Office

CHARITYSAVER

Reg. No. 4,074,696

WRIGHT-PATT CREDIT UNION, INC. (OHIO CORPORATION)
2455 EXECUTIVE PARK BOULEVARD
FAIRBORN, OH 45324

Registered Dec. 20, 2011

Int. Cl.: 36

FOR: BANKING SERVICES, NAMELY, ACCOUNTS IN THE NAMES OF SPECIFIC CHARITIES INTO WHICH DIVIDENDS FROM REGULAR ACCOUNTS WOULD BE TRANSFERRED WITH THE PERMISSION OR INSTRUCTIONS OF THE OWNERS OF THE REGULAR ACCOUNTS, IN CLASS 36 (U.S. CLS. 100, 101 AND 102).

SERVICE MARK

PRINCIPAL REGISTER

FIRST USE 4-30-2010; IN COMMERCE 4-30-2010.

THE MARK CONSISTS OF STANDARD CHARACTERS WITHOUT CLAIM TO ANY PARTICULAR FONT, STYLE, SIZE, OR COLOR.

SN 85-000,863, FILED 3-29-2010.

KATHERINE STOIDES, EXAMINING ATTORNEY



David J. Kybas

Director of the United States Patent and Trademark Office

United States of America

United States Patent and Trademark Office

Socon Media

Reg. No. 4,074,697

Registered Dec. 20, 2011

Int. Cl.: 42

SERVICE MARK

PRINCIPAL REGISTER

LINDLEY, MICHAEL B. (UNITED STATES INDIVIDUAL)
7 MOET COURT
RANCHO MIRAGE, CA 92270

FOR: PROVIDING TEMPORARY USE OF ON-LINE NON-DOWNLOADABLE COMMUNICATIONS SOFTWARE FOR CONNECTING COMPUTER NETWORK USERS, IN CLASS 42 (U.S. CLS. 100 AND 101).

FIRST USE 3-22-2011; IN COMMERCE 3-22-2011.

THE MARK CONSISTS OF STANDARD CHARACTERS WITHOUT CLAIM TO ANY PARTICULAR FONT, STYLE, SIZE, OR COLOR.

NO CLAIM IS MADE TO THE EXCLUSIVE RIGHT TO USE "MEDIA", APART FROM THE MARK AS SHOWN.

SN 85-001,418, FILED 3-29-2010.

KRISTIN DAHLING, EXAMINING ATTORNEY



David J. Kybas

Director of the United States Patent and Trademark Office

United States of America

United States Patent and Trademark Office

Teach Your Children Well

Reg. No. 4,074,698

Registered Dec. 20, 2011

Int. Cls.: 16 and 41

TRADEMARK

SERVICE MARK

PRINCIPAL REGISTER

BEHAVIOR ANALYSTS, INC (CALIFORNIA CORPORATION)
SUITE A
311 LENNON AVENUE
WALNUT CREEK, CA 94598

FOR: EDUCATIONAL KITS SOLD AS A UNIT IN THE FIELD OF AUTISM AND OTHER DEVELOPMENTAL DISORDERS CONSISTING PRIMARILY OF EDUCATIONAL BOOKS, FLASH CARDS AND WORKSHEETS, AND ALSO INCLUDING AN EDUCATIONAL DVD, IN CLASS 16 (U.S. CLS. 2, 5, 22, 23, 29, 37, 38 AND 50).

FIRST USE 1-1-2011; IN COMMERCE 1-1-2011.

FOR: PROVIDING CLASSES, SEMINARS, WORKSHOPS, AND TRAINING FOR PARENTS, INSTRUCTORS, AND OTHER INDIVIDUALS IN THE FIELD OF EDUCATION FOR INDIVIDUALS WITH AUTISM AND OTHER DEVELOPMENTAL DISORDERS, IN CLASS 41 (U.S. CLS. 100, 101 AND 107).

FIRST USE 1-1-2011; IN COMMERCE 1-1-2011.

THE MARK CONSISTS OF STANDARD CHARACTERS WITHOUT CLAIM TO ANY PARTICULAR FONT, STYLE, SIZE, OR COLOR.

SN 85-001,550, FILED 3-30-2010.

REGINA DRUMMOND, EXAMINING ATTORNEY



David J. Kyjars

Director of the United States Patent and Trademark Office

United States of America

United States Patent and Trademark Office

Ecto-Spreader

Reg. No. 4,074,699

MT. CARMEL STABILIZATION GROUP, INC. (ILLINOIS CORPORATION)
P.O. BOX 458

Registered Dec. 20, 2011

MT. CARMEL, IL 62863

Int. Cl.: 44

FOR: SPREADING OF FERTILIZERS AND OTHER AGRICULTURAL CHEMICALS;
SPREADING OF SOIL AMENDMENTS, IN CLASS 44 (U.S. CLS. 100 AND 101).

SERVICE MARK

FIRST USE 5-26-2010; IN COMMERCE 5-26-2010.

PRINCIPAL REGISTER

THE MARK CONSISTS OF STANDARD CHARACTERS WITHOUT CLAIM TO ANY PARTICULAR FONT, STYLE, SIZE, OR COLOR.

SN 85-002,741, FILED 3-31-2010.

BARBARA BROWN, EXAMINING ATTORNEY



David J. Kybas

Director of the United States Patent and Trademark Office

United States of America

United States Patent and Trademark Office

love sex glove

Reg. No. 4,074,700

HOWARD, RHEYNARD (UNITED STATES INDIVIDUAL)
P.O. BOX 20011

Registered Dec. 20, 2011

HOUSTON, TX 772250011

Int. Cl.: 10

FOR: ADULT SEXUAL STIMULATION AIDS, NAMELY, GLOVES USED FOR APPLICATION OF COLOGNES, PERFUMES AND FLAVORS TO THE INSIDE OR OUTSIDE OF THE HUMAN BODY, IN CLASS 10 (U.S. CLS. 26, 39 AND 44).

TRADEMARK

FIRST USE 3-1-2009; IN COMMERCE 7-16-2011.

PRINCIPAL REGISTER

THE MARK CONSISTS OF STANDARD CHARACTERS WITHOUT CLAIM TO ANY PARTICULAR FONT, STYLE, SIZE, OR COLOR.

NO CLAIM IS MADE TO THE EXCLUSIVE RIGHT TO USE "SEX GLOVE", APART FROM THE MARK AS SHOWN.

SN 85-002,892, FILED 3-31-2010.

TINA BROWN, EXAMINING ATTORNEY



David J. Kyffers

Director of the United States Patent and Trademark Office

United States of America

United States Patent and Trademark Office

OME-Q

Reg. No. 4,074,701

Registered Dec. 20, 2011

Int. Cl.: 5

TRADEMARK

PRINCIPAL REGISTER

VITAL HEALTH PHARMACEUTICALS, INC. (NEVADA CORPORATION)
SUITE 700
101 CONVENTION CENTER DRIVE
LAS VEGAS, NV 89109

FOR: VITAMIN AND DIETARY SUPPLEMENTS, IN CLASS 5 (U.S. CLS. 6, 18, 44, 46, 51 AND 52).

FIRST USE 1-18-2011; IN COMMERCE 1-18-2011.

THE MARK CONSISTS OF STANDARD CHARACTERS WITHOUT CLAIM TO ANY PARTICULAR FONT, STYLE, SIZE, OR COLOR.

SN 85-003,003, FILED 3-31-2010.

EUGENIA MARTIN, EXAMINING ATTORNEY



David J. Kybas

Director of the United States Patent and Trademark Office

United States of America

United States Patent and Trademark Office

BLUEPRINT

Reg. No. 4,074,702

Registered Dec. 20, 2011

Int. Cl.: 41

SERVICE MARK

PRINCIPAL REGISTER

MANDEL COMMUNICATIONS, INC. (CALIFORNIA CORPORATION)
SUITE 113
820 BAY AVENUE
CAPITOLA, CA 95010

FOR: PROVIDING AN ONLINE INTERACTIVE EDUCATIONAL WEBSITE IN THE NATURE OF A TUTORIAL; TRAINING, WORKSHOPS, AND COACHING ALL IN THE FIELD OF DEVELOPING AND CREATING EFFECTIVE COMMUNICATION SKILLS AND PRESENTATIONS; DEVELOPMENT OF EDUCATIONAL MANUALS FOR OTHERS IN THE FIELD OF COMMUNICATION SKILLS AND PRESENTATIONS, IN CLASS 41 (U.S. CLS. 100, 101 AND 107).

FIRST USE 12-1-1998; IN COMMERCE 12-1-1998.

THE MARK CONSISTS OF STANDARD CHARACTERS WITHOUT CLAIM TO ANY PARTICULAR FONT, STYLE, SIZE, OR COLOR.

SN 85-003,573, FILED 3-31-2010.

SUE LAWRENCE, EXAMINING ATTORNEY



David J. Kyros

Director of the United States Patent and Trademark Office

United States of America

United States Patent and Trademark Office

MYTHIC BLACK LABEL

Reg. No. 4,074,703 SOUTHERN DIVERSIFIED PRODUCTS, LLC (MISSISSIPPI LIMITED LIABILITY COMPANY)
2714 HARDY STREET
Registered Dec. 20, 2011 HATTIESBURG, MS 39401

Int. Cl.: 2 FOR: EXTERIOR PAINT; HOUSE PAINT; INTERIOR PAINT; PAINTS, IN CLASS 2 (U.S. CLS. 6, 11 AND 16).

TRADEMARK FIRST USE 2-21-2011; IN COMMERCE 2-21-2011.

PRINCIPAL REGISTER THE MARK CONSISTS OF STANDARD CHARACTERS WITHOUT CLAIM TO ANY PARTICULAR FONT, STYLE, SIZE, OR COLOR.

OWNER OF U.S. REG. NOS. 3,434,540, 3,439,520, AND 3,439,521.

SN 85-004,055, FILED 4-1-2010.

LEIGH LOWRY, EXAMINING ATTORNEY



David J. Kyffers

Director of the United States Patent and Trademark Office

United States of America

United States Patent and Trademark Office

MYTHIC CLASSIC

Reg. No. 4,074,704 SOUTHERN DIVERSIFIED PRODUCTS, LLC (MISSISSIPPI LIMITED LIABILITY COMPANY)
2714 HARDY STREET
Registered Dec. 20, 2011 HATTIESBURG, MS 39401

Int. Cl.: 2 FOR: EXTERIOR PAINT; HOUSE PAINT; INTERIOR PAINT; PAINTS, IN CLASS 2 (U.S. CLS. 6, 11 AND 16).

TRADEMARK FIRST USE 2-21-2011; IN COMMERCE 2-21-2011.

PRINCIPAL REGISTER THE MARK CONSISTS OF STANDARD CHARACTERS WITHOUT CLAIM TO ANY PARTICULAR FONT, STYLE, SIZE, OR COLOR.

OWNER OF U.S. REG. NOS. 3,434,540, 3,439,520, AND 3,439,521.

SN 85-004,059, FILED 4-1-2010.

LEIGH LOWRY, EXAMINING ATTORNEY

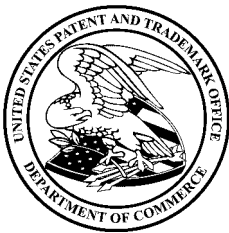

David J. Kyffers

Director of the United States Patent and Trademark Office

United States of America

United States Patent and Trademark Office

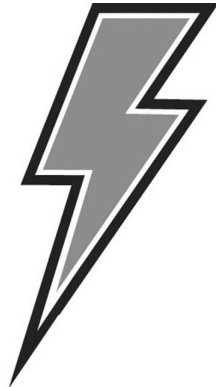

Reg. No. 4,074,705

Registered Dec. 20, 2011

Int. Cls.: 12 and 35

TRADEMARK

SERVICE MARK

PRINCIPAL REGISTER

XP INNOVATION, LLC (INDIANA LIMITED LIABILITY COMPANY), DBA DAN'S COMP,
1 COMPETITION WAY
MT. VERNON, IN 47620

FOR: BICYCLES, IN CLASS 12 (U.S. CLS. 19, 21, 23, 31, 35 AND 44).

FIRST USE 7-8-2009; IN COMMERCE 7-8-2009.

FOR: MAIL ORDER CATALOG SERVICES FEATURING BICYCLES, BICYCLE PARTS AND
CLOTHING AND ACCESSORIES USED THEREWITH, IN CLASS 35 (U.S. CLS. 100, 101
AND 102).

FIRST USE 4-0-2000; IN COMMERCE 4-0-2000.

OWNER OF U.S. REG. NOS. 2,176,580, 2,609,458, AND OTHERS.

THE MARK CONSISTS OF A FLAT TOPPED VERTICAL TWO STEP LIGHTNING BOLT.

SN 85-004,465, FILED 4-1-2010.

HOWARD SMIGA, EXAMINING ATTORNEY



David J. Kyffers

Director of the United States Patent and Trademark Office

United States of America

United States Patent and Trademark Office

WEIGHT LOSS DESIGNED BY SCIENCE

Reg. No. 4,074,706

GENOVIVE, LLC (DELAWARE LIMITED LIABILITY COMPANY)
250 PLAUCHE STREET
HARAHAN, LA 70123

Registered Dec. 20, 2011

Int. Cl.: 44

FOR: WEIGHT REDUCTION, DIET PLANNING AND SUPERVISION, DIETARY AND NUTRITIONAL GUIDANCE FEATURING NUTRIGENOMICS, PERSONALIZED DIET ADVISORY SERVICES, IN CLASS 44 (U.S. CLS. 100 AND 101).

SERVICE MARK

FIRST USE 8-22-2011; IN COMMERCE 8-22-2011.

PRINCIPAL REGISTER

THE MARK CONSISTS OF STANDARD CHARACTERS WITHOUT CLAIM TO ANY PARTICULAR FONT, STYLE, SIZE, OR COLOR.

NO CLAIM IS MADE TO THE EXCLUSIVE RIGHT TO USE "WEIGHT LOSS", APART FROM THE MARK AS SHOWN.

SN 85-004,586, FILED 4-1-2010.

SOPHIA S. KIM, EXAMINING ATTORNEY



David J. Kyros

Director of the United States Patent and Trademark Office

United States of America

United States Patent and Trademark Office

PERENNIAFLEX

Reg. No. 4,074,707

CYBERONICS, INC. (DELAWARE CORPORATION)
100 CYBERONICS BLVD.
HOUSTON, TX 77058

Registered Dec. 20, 2011

Int. Cl.: 10

FOR: MEDICAL LEAD FOR AN ELECTRICAL PULSE GENERATOR, IN CLASS 10 (U.S. CLS. 26, 39 AND 44).

TRADEMARK

FIRST USE 2-2-2009; IN COMMERCE 2-2-2009.

PRINCIPAL REGISTER

THE MARK CONSISTS OF STANDARD CHARACTERS WITHOUT CLAIM TO ANY PARTICULAR FONT, STYLE, SIZE, OR COLOR.

OWNER OF U.S. REG. NO. 3,420,485.

SN 85-004,776, FILED 4-1-2010.

NAPOLEON SHARMA, EXAMINING ATTORNEY



David J. Kybas

Director of the United States Patent and Trademark Office

United States of America

United States Patent and Trademark Office

MISTY

Reg. No. 4,074,708

Registered Dec. 20, 2011

Int. Cl.: 42

SERVICE MARK

PRINCIPAL REGISTER

PARENTAL HEALTH, LLC (TENNESSEE LIMITED LIABILITY COMPANY)
256 SEABOARD LANE H103
FRANKLIN, TN 37067

FOR: COMPUTER SERVICES, NAMELY, PROVIDING A WEB BASED SYSTEM AND ONLINE PORTAL ENABLING THE ELDERLY TO MONITOR THEIR VITAL SIGNS AND BIOMETRICS, MANAGE PRESCRIPTIONS, ACCESS THEIR PERSONAL HEALTH RECORDS, ALERT CAREGIVERS TO AN EMERGENCY, ORDER NECESSARY SUPPLIES, RECORD DAILY ACTIVITIES, COMMUNICATE WITH OTHERS VIA EMAIL AND TEXT MESSAGE, ACCESS INFORMATION REGARDING COMMUNITY ACTIVITIES AND ACCESS A CALL CENTER FOR THE PURPOSE OF OBTAINING ASSISTANCE WITH ISSUES RELATING TO HEALTH AND WELL BEING, IN CLASS 42 (U.S. CLS. 100 AND 101).

FIRST USE 2-0-2011; IN COMMERCE 2-0-2011.

THE MARK CONSISTS OF STANDARD CHARACTERS WITHOUT CLAIM TO ANY PARTICULAR FONT, STYLE, SIZE, OR COLOR.

SN 85-004,912, FILED 4-2-2010.

BRETT J. GOLDEN, EXAMINING ATTORNEY



David J. Kyfos

Director of the United States Patent and Trademark Office

United States of America

United States Patent and Trademark Office

SAFEROUTE PRODUCTS

Reg. No. 4,074,709

Registered Dec. 20, 2011

Int. Cl.: 19

TRADEMARK

PRINCIPAL REGISTER

SAFEROUTE PRODUCTS, LLC (FLORIDA LIMITED LIABILITY COMPANY)
UNIT #108
5649 SECOND STREET WEST
LEHIGH ACRES, FL 33971

FOR: DETECTABLE WARNING TILES AND MATS FOR USE IN CONSTRUCTION, IN CLASS 19 (U.S. CLS. 1, 12, 33 AND 50).

FIRST USE 3-26-2010; IN COMMERCE 3-26-2010.

THE MARK CONSISTS OF STANDARD CHARACTERS WITHOUT CLAIM TO ANY PARTICULAR FONT, STYLE, SIZE, OR COLOR.

NO CLAIM IS MADE TO THE EXCLUSIVE RIGHT TO USE "PRODUCTS", APART FROM THE MARK AS SHOWN.

SN 85-005,008, FILED 4-2-2010.

LOURDES AYALA, EXAMINING ATTORNEY



David J. Kybas

Director of the United States Patent and Trademark Office

United States of America
United States Patent and Trademark Office

TORNADO

Reg. No. 4,074,710

PACCAR INC (DELAWARE CORPORATION)

Registered Dec. 20, 2011

777 106TH AVENUE NE
BELLEVUE, WA 98004

Int. Cl.: 7

FOR: HYDRAULIC POWERED DRIVE UNIT FOR AN AUGER, IN CLASS 7 (U.S. CLS. 13, 19, 21, 23, 31, 34 AND 35).

TRADEMARK

FIRST USE 12-0-2010; IN COMMERCE 12-0-2010.

PRINCIPAL REGISTER

THE MARK CONSISTS OF STANDARD CHARACTERS WITHOUT CLAIM TO ANY PARTICULAR FONT, STYLE, SIZE, OR COLOR.

SN 85-005,459, FILED 4-2-2010.

KYLE PEETE, EXAMINING ATTORNEY



David J. Kyffers

Director of the United States Patent and Trademark Office

United States of America

United States Patent and Trademark Office

TEAM B&B

Reg. No. 4,074,711

ARMOUR, GARY H. (UNITED STATES INDIVIDUAL)
6314 NEESE-COMMERCE RD

Registered Dec. 20, 2011

HULL, GA 30646

Int. Cl.: 43

FOR: CAFE AND RESTAURANT SERVICES; CARRY-OUT RESTAURANTS; FAST FOOD AND NON-STOP RESTAURANT SERVICES; FOOD PREPARATION SERVICES; PROVIDING OF FOOD AND DRINK; RESTAURANT; RESTAURANT SERVICES; RESTAURANT SERVICES FEATURING SANDWICHES, IN CLASS 43 (U.S. CLS. 100 AND 101).

SERVICE MARK

PRINCIPAL REGISTER

FIRST USE 10-17-2011; IN COMMERCE 10-17-2011.

THE MARK CONSISTS OF STANDARD CHARACTERS WITHOUT CLAIM TO ANY PARTICULAR FONT, STYLE, SIZE, OR COLOR.

SN 85-005,843, FILED 4-4-2010.

GRETТА YAO, EXAMINING ATTORNEY



David J. Kyros

Director of the United States Patent and Trademark Office

United States of America

United States Patent and Trademark Office

Impervite

Reg. No. 4,074,712

CG THERMAL, LLC (OHIO LIMITED LIABILITY COMPANY), DBA CG THERMAL, LLC,
8950 DUTTON DRIVE
TWINSBURG, OH 44087

Registered Dec. 20, 2011

Int. Cl.: 1

FOR: GRAPHITE IN RAW OR SEMI-FINISHED FORM FOR USE IN MANUFACTURE, IN
CLASS 1 (U.S. CLS. 1, 5, 6, 10, 26 AND 46).

TRADEMARK

FIRST USE 3-0-2010; IN COMMERCE 3-0-2010.

PRINCIPAL REGISTER

THE MARK CONSISTS OF STANDARD CHARACTERS WITHOUT CLAIM TO ANY PAR-
TICULAR FONT, STYLE, SIZE, OR COLOR.

SN 85-005,870, FILED 4-4-2010.

ANDREW LEASER, EXAMINING ATTORNEY



David J. Kybas

Director of the United States Patent and Trademark Office

United States of America

United States Patent and Trademark Office

TIP

Reg. No. 4,074,713

Registered Dec. 20, 2011

Int. Cls.: 35 and 42

SERVICE MARK

PRINCIPAL REGISTER

SUNRICH LLC (MINNESOTA LIMITED LIABILITY COMPANY)
3824 93RD STREET
HOPE, MN 56046

FOR: AGRICULTURAL BUSINESS MANAGEMENT SERVICES, NAMELY, PROVIDING DOCUMENTATION IN THE FORM OF BUSINESS REPORTS FOR OTHERS RELATING TO THE TRACING AND MONITORING OF SEED VARIETIES AND CROPS, IN CLASS 35 (U.S. CLS. 100, 101 AND 102).

FIRST USE 8-27-2010; IN COMMERCE 8-27-2010.

FOR: AGRICULTURAL SERVICES, NAMELY, MANAGING, MAINTAINING, ASSESSING AND TRACKING TRAITS AND QUALITY OF CROPS AND SEEDS; AGRICULTURAL SERVICES, NAMELY, TESTING AND MONITORING OF SEED VARIETIES AND CROPS, IN CLASS 42 (U.S. CLS. 100 AND 101).

FIRST USE 8-27-2010; IN COMMERCE 8-27-2010.

THE MARK CONSISTS OF STANDARD CHARACTERS WITHOUT CLAIM TO ANY PARTICULAR FONT, STYLE, SIZE, OR COLOR.

SN 85-006,183, FILED 4-5-2010.

PAM WILLIS, EXAMINING ATTORNEY



David J. Kyffers

Director of the United States Patent and Trademark Office

United States of America

United States Patent and Trademark Office

KNOWHEN

Reg. No. 4,074,714

Registered Dec. 20, 2011

Int. Cl.: 5

TRADEMARK

PRINCIPAL REGISTER

HILIN LIFE PRODUCTS, INC. (NEW JERSEY CORPORATION)
SUITE 211
211 WARREN STREET
NEWARK, NJ 07103

FOR: PREGNANCY TEST KITS FOR HOME USE, IN CLASS 5 (U.S. CLS. 6, 18, 44, 46, 51 AND 52).

FIRST USE 8-3-2009; IN COMMERCE 8-3-2009.

THE MARK CONSISTS OF STANDARD CHARACTERS WITHOUT CLAIM TO ANY PARTICULAR FONT, STYLE, SIZE, OR COLOR.

SN 85-006,247, FILED 4-5-2010.

REBECCA POVARCHUK, EXAMINING ATTORNEY



David J. Kyffers

Director of the United States Patent and Trademark Office

United States of America

United States Patent and Trademark Office

NEXTIO NCONTROL

Reg. No. 4,074,715

Registered Dec. 20, 2011

Int. Cl.: 9

TRADEMARK

PRINCIPAL REGISTER

NEXTIO, INC. (DELAWARE CORPORATION)
8303 NORTH MOPAC EXPRESSWAY, SUITE A-210
AUSTIN, TX 78759

FOR: COMPUTER HARDWARE, INTEGRATED CIRCUITS, PRINTED CIRCUIT BOARDS, AND INTERFACES FOR COMPUTERS, ALL FOR USE IN VIRTUALIZING COMPUTER INPUT/OUTPUT DEVICES, COMPUTER NETWORKING AND INTERCONNECTION OF COMPUTER OPERATING SYSTEMS AND COMPUTER PERIPHERALS, IN CLASS 9 (U.S. CLS. 21, 23, 26, 36 AND 38).

FIRST USE 4-15-2010; IN COMMERCE 4-15-2010.

THE MARK CONSISTS OF STANDARD CHARACTERS WITHOUT CLAIM TO ANY PARTICULAR FONT, STYLE, SIZE, OR COLOR.

SN 85-006,462, FILED 4-5-2010.

AISHA CLARKE, EXAMINING ATTORNEY



David J. Kyffers

Director of the United States Patent and Trademark Office

United States of America

United States Patent and Trademark Office



Reg. No. 4,074,716

BEANUM, JOHN O. (UNITED STATES INDIVIDUAL)
19045 SABRINA AVENUE
CERRITOS, CA 90703

Registered Dec. 20, 2011

Int. Cl.: 36

SERVICE MARK

PRINCIPAL REGISTER

FOR: PROVIDING A DATABASE OF INFORMATION ABOUT RESIDENTIAL REAL ESTATE LISTINGS IN DIFFERENT NEIGHBORHOODS AND COMMUNITIES; PROVIDING A DATABASE OF RESIDENTIAL REAL ESTATE LISTINGS WITHIN NEIGHBORHOODS AND COMMUNITIES SPECIFICALLY IDENTIFIED BY USERS; PROVIDING AN INTERNET WEBSITE PORTAL OFFERING INFORMATION IN THE FIELDS OF REAL ESTATE CONCERNING THE PURCHASE AND SALE OF NEW AND RESALE HOMES AND CONDOS; PROVIDING INFORMATION IN THE FIELD OF REAL ESTATE BY MEANS OF LINKING THE WEB SITE TO OTHER WEB SITES FEATURING REAL ESTATE INFORMATION; PROVIDING INFORMATION IN THE FIELD OF REAL ESTATE VIA THE INTERNET; PROVIDING REAL ESTATE LISTINGS AND REAL ESTATE INFORMATION VIA THE INTERNET; REAL ESTATE CONSULTATION; REAL ESTATE LISTING, IN CLASS 36 (U.S. CLS. 100, 101 AND 102).

FIRST USE 3-4-2010; IN COMMERCE 3-4-2010.

NO CLAIM IS MADE TO THE EXCLUSIVE RIGHT TO USE "LA", APART FROM THE MARK AS SHOWN.

THE COLOR(S) BLUE, GRAY, YELLOW IS/ARE CLAIMED AS A FEATURE OF THE MARK.

THE MARK CONSISTS OF TWO GRAY HOUSES, EACH WITH BLUE WINDOWS, AND A BLUE PALM TREE IN BETWEEN THE TWO HOUSES. THERE IS A YELLOW ARC EXTENDING FROM ONE HOUSE TO THE OTHER HOUSE, AND A BLUE BIRD ABOVE THE HOUSE ON THE RIGHT. THE TWO HOUSES ARE PLACED DIRECTLY OVER THE "ING" IN THE TERM "SELLING LA" WHICH APPEARS IN BLUE. BELOW THE TERM "SELLING LA" APPEARS THE WORDING "WWW.SELLINGLA.COM" IN GRAY.

SN 85-006,720, FILED 4-5-2010.

CAROLINE WOOD, EXAMINING ATTORNEY



David J. Kappas

Director of the United States Patent and Trademark Office

United States of America

United States Patent and Trademark Office

YASO

Reg. No. 4,074,717

Registered Dec. 20, 2011

Int. Cl.: 14

TRADEMARK

PRINCIPAL REGISTER

A.V. DENIM INC. (NEW YORK CORPORATION), DBA A&V DENIM INC.,
1407 BROADWAY, SUITE 3601
NEW YORK, NY 10018

FOR: ANKLE BRACELETS; BRACELETS; BRACELETS OF PRECIOUS METAL; CLIP EARRINGS; DIVING WATCHES; EARRINGS; JEWELRY WATCHES; NECKLACES; RINGS; WATCH BANDS AND STRAPS; WATCH BOXES; WATCH BRACELETS; WATCH CASES; WATCH CHAINS; WATCHES CONTAINING A GAME FUNCTION; WATCHES CONTAINING AN ELECTRONIC GAME FUNCTION; WATCHES FOR OUTDOOR USE, IN CLASS 14 (U.S. CLS. 2, 27, 28 AND 50).

FIRST USE 6-12-2011; IN COMMERCE 6-12-2011.

THE MARK CONSISTS OF STANDARD CHARACTERS WITHOUT CLAIM TO ANY PARTICULAR FONT, STYLE, SIZE, OR COLOR.

OWNER OF U.S. REG. NOS. 3,283,940 AND 3,552,190.

SN 85-007,120, FILED 4-6-2010.

TRACY WHITTAKER-BROWN, EXAMINING ATTORNEY



David J. Kyros

Director of the United States Patent and Trademark Office

United States of America

United States Patent and Trademark Office

MOVE FORWARD

Reg. No. 4,074,718

KARHU HOLDING B.V. (NETHERLANDS BESLOTEN VENNOOTSCHAP (B.V.))
KAREL DOORMANSTRAAT 32

Registered Dec. 20, 2011

ROTTERDAM, NETHERLANDS 3012GJ

Int. Cl.: 25

FOR: LEISURE FOOTWEAR; SPORTS SHOES; JOGGING SHOES; RUNNING SHOES, IN CLASS 25 (U.S. CLS. 22 AND 39).

TRADEMARK

FIRST USE 9-0-2011; IN COMMERCE 9-0-2011.

PRINCIPAL REGISTER

THE MARK CONSISTS OF STANDARD CHARACTERS WITHOUT CLAIM TO ANY PARTICULAR FONT, STYLE, SIZE, OR COLOR.

SN 85-007,190, FILED 4-6-2010.

LESLIE RICHARDS, EXAMINING ATTORNEY



David J. Kybas

Director of the United States Patent and Trademark Office

United States of America

United States Patent and Trademark Office

VOVITO

Reg. No. 4,074,719

Registered Dec. 20, 2011

Int. Cls.: 30 and 43

TRADEMARK

SERVICE MARK

PRINCIPAL REGISTER

GULAMANI, ARIFF (CANADA INDIVIDUAL)
19251 NE 149TH STREET
WOODINVILLE, WA 98077 AND

GULAMANI, SHAIROSE (CANADA INDIVIDUAL)
19251 NE 149TH STREET
WOODINVILLE, WA 98077

FOR: ICE CREAM AND GELATO, IN CLASS 30 (U.S. CL. 46).

FIRST USE 7-25-2010; IN COMMERCE 7-25-2010.

FOR: RESTAURANT; CAFE; COFFEE SHOP, IN CLASS 43 (U.S. CLS. 100 AND 101).

FIRST USE 7-25-2010; IN COMMERCE 7-25-2010.

THE MARK CONSISTS OF STANDARD CHARACTERS WITHOUT CLAIM TO ANY PARTICULAR FONT, STYLE, SIZE, OR COLOR.

THE WORDING "VOVITO" HAS NO MEANING IN A FOREIGN LANGUAGE.

SN 85-007,202, FILED 4-6-2010.

WON TEAK OH, EXAMINING ATTORNEY

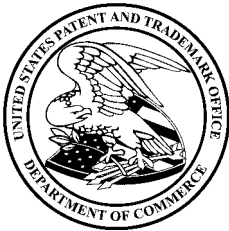

David J. Kybas

Director of the United States Patent and Trademark Office

United States of America

United States Patent and Trademark Office

P.S. TO THE WORLD

Reg. No. 4,074,720

TYNER, CHELSEA (UNITED STATES INDIVIDUAL)

Registered Dec. 20, 2011

P.O. BOX 974
LONG BEACH, MS 39560

Int. Cl.: 25

FOR: CLOTHING, NAMELY, SHIRTS, T-SHIRTS, SWEAT SHIRTS AND TOPS, IN CLASS 25 (U.S. CLS. 22 AND 39).

TRADEMARK

FIRST USE 10-20-2011; IN COMMERCE 10-20-2011.

PRINCIPAL REGISTER

THE MARK CONSISTS OF STANDARD CHARACTERS WITHOUT CLAIM TO ANY PARTICULAR FONT, STYLE, SIZE, OR COLOR.

SN 85-008,997, FILED 4-8-2010.

LINDA M. KING, EXAMINING ATTORNEY



David J. Kyffers

Director of the United States Patent and Trademark Office

United States of America
United States Patent and Trademark Office

STEMCARE

Reg. No. 4,074,721

MIRACLECORD, INC. (ILLINOIS CORPORATION)
875 N. MICHIGAN AVE., SUITE 3100
CHICAGO, IL 60611

Registered Dec. 20, 2011

Int. Cl.: 44

FOR: BLOOD BANKS; TISSUE BANK SERVICES; COLLECTION AND PRESERVATION OF HUMAN BLOOD AND TISSUE, IN CLASS 44 (U.S. CLS. 100 AND 101).

SERVICE MARK

FIRST USE 10-7-2011; IN COMMERCE 10-7-2011.

PRINCIPAL REGISTER

THE MARK CONSISTS OF STANDARD CHARACTERS WITHOUT CLAIM TO ANY PARTICULAR FONT, STYLE, SIZE, OR COLOR.

SN 85-009,004, FILED 4-8-2010.

LINDA M. KING, EXAMINING ATTORNEY



David J. Kybas

Director of the United States Patent and Trademark Office

United States of America

United States Patent and Trademark Office

TURTLE MELON

Reg. No. 4,074,722

YOUNG DENTAL MANUFACTURING 1, LLC (MISSOURI LIMITED LIABILITY COMPANY)
13705 SHORELINE COURT EAST

Registered Dec. 20, 2011

EARTH CITY, MO 63045

Int. Cl.: 3

FOR: DENTAL PREPARATIONS, NAMELY, PROPHY PASTE FOR CLEANING TEETH, IN CLASS 3 (U.S. CLS. 1, 4, 6, 50, 51 AND 52).

TRADEMARK

FIRST USE 3-0-2010; IN COMMERCE 3-0-2010.

PRINCIPAL REGISTER

THE MARK CONSISTS OF STANDARD CHARACTERS WITHOUT CLAIM TO ANY PARTICULAR FONT, STYLE, SIZE, OR COLOR.

NO CLAIM IS MADE TO THE EXCLUSIVE RIGHT TO USE "MELON", APART FROM THE MARK AS SHOWN.

SN 85-009,134, FILED 4-8-2010.

AMY KERTGATE, EXAMINING ATTORNEY



David J. Kybas

Director of the United States Patent and Trademark Office

United States of America

United States Patent and Trademark Office

SPEARMINT SAFARI

Reg. No. 4,074,723 YOUNG DENTAL MANUFACTURING 1, LLC (MISSOURI LIMITED LIABILITY COMPANY)
Registered Dec. 20, 2011 13705 SHORELINE COURT EAST
EARTH CITY, MO 63045

Int. Cl.: 3 FOR: DENTAL PREPARATIONS, NAMELY, PROPHY PASTE FOR CLEANING TEETH, IN CLASS 3 (U.S. CLS. 1, 4, 6, 50, 51 AND 52).

TRADEMARK FIRST USE 3-0-2010; IN COMMERCE 3-0-2010.

PRINCIPAL REGISTER THE MARK CONSISTS OF STANDARD CHARACTERS WITHOUT CLAIM TO ANY PARTICULAR FONT, STYLE, SIZE, OR COLOR.

NO CLAIM IS MADE TO THE EXCLUSIVE RIGHT TO USE "SPEARMINT", APART FROM THE MARK AS SHOWN.

SN 85-009,152, FILED 4-8-2010.

AMY KERTGATE, EXAMINING ATTORNEY



David J. Kybas

Director of the United States Patent and Trademark Office

United States of America

United States Patent and Trademark Office

CHOCOLATE CHOW

Reg. No. 4,074,724 YOUNG DENTAL MANUFACTURING 1, LLC (MISSOURI LIMITED LIABILITY COMPANY)
Registered Dec. 20, 2011 13705 SHORELINE COURT EAST
EARTH CITY, MO 63045

Int. Cl.: 3 FOR: DENTAL PREPARATIONS, NAMELY, PROPHY PASTE FOR CLEANING TEETH, IN CLASS 3 (U.S. CLS. 1, 4, 6, 50, 51 AND 52).

TRADEMARK FIRST USE 3-0-2010; IN COMMERCE 3-0-2010.

PRINCIPAL REGISTER THE MARK CONSISTS OF STANDARD CHARACTERS WITHOUT CLAIM TO ANY PARTICULAR FONT, STYLE, SIZE, OR COLOR.

NO CLAIM IS MADE TO THE EXCLUSIVE RIGHT TO USE "CHOCOLATE", APART FROM THE MARK AS SHOWN.

SN 85-009,185, FILED 4-8-2010.

AMY KERTGATE, EXAMINING ATTORNEY



David J. Kybas

Director of the United States Patent and Trademark Office

United States of America

United States Patent and Trademark Office

HAPPY HIPPO CAKE

Reg. No. 4,074,725 YOUNG DENTAL MANUFACTURING 1, LLC (MISSOURI LIMITED LIABILITY COMPANY)
Registered Dec. 20, 2011 13705 SHORELINE COURT EAST
EARTH CITY, MO 63045

Int. Cl.: 3 FOR: DENTAL PREPARATIONS, NAMELY, PROPHY PASTE FOR CLEANING TEETH, IN CLASS 3 (U.S. CLS. 1, 4, 6, 50, 51 AND 52).

TRADEMARK FIRST USE 3-0-2010; IN COMMERCE 3-0-2010.

PRINCIPAL REGISTER THE MARK CONSISTS OF STANDARD CHARACTERS WITHOUT CLAIM TO ANY PARTICULAR FONT, STYLE, SIZE, OR COLOR.

NO CLAIM IS MADE TO THE EXCLUSIVE RIGHT TO USE "CAKE", APART FROM THE MARK AS SHOWN.

SN 85-009,202, FILED 4-8-2010.

AMY KERTGATE, EXAMINING ATTORNEY



David J. Kappas

Director of the United States Patent and Trademark Office

United States of America

United States Patent and Trademark Office

GROWLIN' GRRRAPE

Reg. No. 4,074,726 YOUNG DENTAL MANUFACTURING 1, LLC (MISSOURI LIMITED LIABILITY COMPANY)
Registered Dec. 20, 2011 13705 SHORELINE COURT EAST
EARTH CITY, MO 63045

Int. Cl.: 3 FOR: DENTAL PREPARATIONS, NAMELY, PROPHY PASTE FOR CLEANING TEETH, IN CLASS 3 (U.S. CLS. 1, 4, 6, 50, 51 AND 52).

TRADEMARK FIRST USE 3-0-2010; IN COMMERCE 3-0-2010.

PRINCIPAL REGISTER THE MARK CONSISTS OF STANDARD CHARACTERS WITHOUT CLAIM TO ANY PARTICULAR FONT, STYLE, SIZE, OR COLOR.

NO CLAIM IS MADE TO THE EXCLUSIVE RIGHT TO USE "GRAPE", APART FROM THE MARK AS SHOWN.

SN 85-009,232, FILED 4-8-2010.

AMY KERTGATE, EXAMINING ATTORNEY



David J. Kybas

Director of the United States Patent and Trademark Office

United States of America

United States Patent and Trademark Office

ISSE MIDWEST

Reg. No. 4,074,727

Registered Dec. 20, 2011

Int. Cl.: 35

SERVICE MARK

PRINCIPAL REGISTER

PROFESSIONAL BEAUTY ASSOCIATION (ARIZONA NON-PROFIT CORPORATION)
15825 NORTH 71ST STREET
SUITE 100
SCOTTSDALE, AZ 85254

FOR: ORGANIZING, PROMOTING AND CONDUCTING TRADE SHOWS IN THE FIELD OF PROFESSIONAL BEAUTY CARE, SALON AND SPA INDUSTRIES, IN CLASS 35 (U.S. CLS. 100, 101 AND 102).

FIRST USE 3-30-2010; IN COMMERCE 3-30-2010.

THE MARK CONSISTS OF STANDARD CHARACTERS WITHOUT CLAIM TO ANY PARTICULAR FONT, STYLE, SIZE, OR COLOR.

OWNER OF U.S. REG. NOS. 2,636,821 AND 2,675,517.

NO CLAIM IS MADE TO THE EXCLUSIVE RIGHT TO USE "MIDWEST", APART FROM THE MARK AS SHOWN.

SN 85-009,720, FILED 4-8-2010.

JIM RINGLE, EXAMINING ATTORNEY



David J. Kyffers

Director of the United States Patent and Trademark Office

United States of America

United States Patent and Trademark Office

MOUSEMAIL

Reg. No. 4,074,728

Registered Dec. 20, 2011

Int. Cls.: 9 and 38

TRADEMARK

SERVICE MARK

PRINCIPAL REGISTER

SAFE COMMUNICATIONS, INC. (NEVADA CORPORATION)
7740 E. EVANS RD, SUITE 101
SCOTTSDALE, AZ 85260

FOR: COMPUTER SOFTWARE FOR USE IN TRANSMITTING ELECTRONIC COMMUNICATIONS SUCH AS ELECTRONIC MAIL; CREATING AND MANAGING CALENDARS, AND MAINTAINING A SYSTEM OF POINTS, SCHEDULES, AND TASKS FOR AN AWARDS PROGRAM FOR CHILDREN, IN CLASS 9 (U.S. CLS. 21, 23, 26, 36 AND 38).

FIRST USE 8-10-2010; IN COMMERCE 8-10-2010.

FOR: ELECTRONIC MAIL SERVICES, IN CLASS 38 (U.S. CLS. 100, 101 AND 104).

FIRST USE 8-10-2010; IN COMMERCE 8-10-2010.

THE MARK CONSISTS OF STANDARD CHARACTERS WITHOUT CLAIM TO ANY PARTICULAR FONT, STYLE, SIZE, OR COLOR.

SN 85-009,723, FILED 4-8-2010.

KAREN BRACEY, EXAMINING ATTORNEY



David J. Kyjars

Director of the United States Patent and Trademark Office

United States of America

United States Patent and Trademark Office

VOLTGENIE

Reg. No. 4,074,729

JEANNE DE SANCTIS (UNITED STATES INDIVIDUAL)
3970 NE BREAKWATER DRIVE
JENSEN BEACH, FL 34957

Registered Dec. 20, 2011

Int. Cl.: 9

FOR: BATTERY CHARGERS, NAMELY, PORTABLE BATTERY CHARGING STATIONS,
IN CLASS 9 (U.S. CLS. 21, 23, 26, 36 AND 38).

TRADEMARK

FIRST USE 10-1-2011; IN COMMERCE 10-1-2011.

PRINCIPAL REGISTER

THE MARK CONSISTS OF STANDARD CHARACTERS WITHOUT CLAIM TO ANY PARTICULAR FONT, STYLE, SIZE, OR COLOR.

SN 85-010,167, FILED 4-9-2010.

SEAN CROWLEY, EXAMINING ATTORNEY



David J. Kybas

Director of the United States Patent and Trademark Office

United States of America

United States Patent and Trademark Office

THE MIND, BODY & SOUL SURFING CLUB

Reg. No. 4,074,730

THE MIND, BODY & SOUL SURFING CLUB (FLORIDA LIMITED LIABILITY COMPANY)
4853 S. ORANGE AVENUE SUITE B
ORLANDO, FL 32806

Registered Dec. 20, 2011

Int. Cls.: 35 and 41

FOR: PROMOTING THE GOODS AND SERVICES OF OTHERS BY PROVIDING A WEBSITE FEATURING HYPERTEXT LINKS TO THE WEBSITES AND RETAIL WEBSITES OF OTHERS IN REGARD TO SURFING APPAREL AND EQUIPMENT, IN CLASS 35 (U.S. CLS. 100, 101 AND 102).

SERVICE MARK

PRINCIPAL REGISTER

FIRST USE 9-9-2010; IN COMMERCE 9-9-2010.

FOR: PROVIDING A WEBSITE FEATURING INFORMATION ON SURFING, SURF REPORTS, NAMELY, INFORMATION ON WAVE CONDITIONS, WAVE LOCATIONS, AND DURATION OF SURFING SESSION, AND SURFING INFORMATION, NAMELY, INFORMATION ON WAVE CONDITIONS AND WAVE LOCATIONS FOR USE ON SURF TRIPS, IN CLASS 41 (U.S. CLS. 100, 101 AND 107).

FIRST USE 9-9-2010; IN COMMERCE 9-9-2010.

THE MARK CONSISTS OF STANDARD CHARACTERS WITHOUT CLAIM TO ANY PARTICULAR FONT, STYLE, SIZE, OR COLOR.

NO CLAIM IS MADE TO THE EXCLUSIVE RIGHT TO USE "SURFING CLUB", APART FROM THE MARK AS SHOWN.

SN 85-010,447, FILED 4-9-2010.

SETH A. RAPPAPORT, EXAMINING ATTORNEY



David J. Kyffers

Director of the United States Patent and Trademark Office

United States of America

United States Patent and Trademark Office

ONE FORCE

Reg. No. 4,074,731

RAYTHEON COMPANY (DELAWARE CORPORATION)
870 WINTER STREET

Registered Dec. 20, 2011

WALTHAM, MA 024511449

Int. Cl.: 9

FOR: HANDHELD DIGITAL COMMUNICATION DEVICES FOR USE BY MILITARY PERSONNEL OR FIRST RESPONDERS, IN TRACKING ENEMY OR TERRORIST ACTIVITY AND FOR USE IN COLLABORATIVE PLANNING, AND GENERATING MAPS OF AREAS OF INTEREST, IN CLASS 9 (U.S. CLS. 21, 23, 26, 36 AND 38).

TRADEMARK

PRINCIPAL REGISTER

FIRST USE 3-8-2011; IN COMMERCE 3-8-2011.

THE MARK CONSISTS OF STANDARD CHARACTERS WITHOUT CLAIM TO ANY PARTICULAR FONT, STYLE, SIZE, OR COLOR.

SN 85-010,598, FILED 4-9-2010.

REGINA DRUMMOND, EXAMINING ATTORNEY



David J. Kybas

Director of the United States Patent and Trademark Office

United States of America

United States Patent and Trademark Office

STUDIO DARIEN

Reg. No. 4,074,732

Registered Dec. 20, 2011

Int. Cls.: 9 and 41

TRADEMARK

SERVICE MARK

PRINCIPAL REGISTER

GOLD, DARIEN (UNITED STATES INDIVIDUAL), DBA STUDIO DARIEN,
7507 W. SUNSET BLVD., SUITE 14
LOS ANGELES, CA 90046

FOR: COMPUTER APPLICATION SOFTWARE FOR MOBILE PHONES, NAMELY, SOFTWARE FOR PROVIDING PILATES INSTRUCTION AND TRAINING, IN CLASS 9 (U.S. CLS. 21, 23, 26, 36 AND 38).

FIRST USE 5-13-2010; IN COMMERCE 5-13-2010.

FOR: PROVIDING FITNESS AND EXERCISE STUDIO SERVICES, NAMELY, PILATES INSTRUCTION AND TRAINING, IN CLASS 41 (U.S. CLS. 100, 101 AND 107).

FIRST USE 2-17-2001; IN COMMERCE 2-17-2001.

THE MARK CONSISTS OF STANDARD CHARACTERS WITHOUT CLAIM TO ANY PARTICULAR FONT, STYLE, SIZE, OR COLOR.

NO CLAIM IS MADE TO THE EXCLUSIVE RIGHT TO USE "STUDIO", APART FROM THE MARK AS SHOWN.

THE NAME "DARIEN" IDENTIFIES A LIVING INDIVIDUAL WHOSE CONSENT IS OF RECORD.

SN 85-010,914, FILED 4-9-2010.

VERNA BETH RIRIE, EXAMINING ATTORNEY



David J. Kyffers

Director of the United States Patent and Trademark Office

United States of America

United States Patent and Trademark Office



Reg. No. 4,074,733

Registered Dec. 20, 2011

Int. Cl.: 25

TRADEMARK

PRINCIPAL REGISTER

ANDIS WINES, LLC (CALIFORNIA LIMITED LIABILITY COMPANY)
P.O. BOX 190
PLYMOUTH, CA 95669

FOR: T-SHIRTS, SHIRTS AND HEADWEAR, IN CLASS 25 (U.S. CLS. 22 AND 39).

FIRST USE 4-22-2011; IN COMMERCE 4-22-2011.

THE MARK CONSISTS OF A STYLIZED LETTER "A".

SN 85-010,980, FILED 4-9-2010.

LAURIE KAUFMAN, EXAMINING ATTORNEY



David J. Kyffers

Director of the United States Patent and Trademark Office

United States of America

United States Patent and Trademark Office

CREATIVE QUILTERS FABRIC CLUB

Reg. No. 4,074,734

DRG TEXAS, LP (INDIANA LIMITED PARTNERSHIP)
306 EAST PARR ROAD
BERNE, IN 46711

Registered Dec. 20, 2011

Int. Cl.: 24

FOR: KITS COMPRISED OF FABRIC FOR MAKING QUILTS AND INSTRUCTION SHEETS,
IN CLASS 24 (U.S. CLS. 42 AND 50).

TRADEMARK

FIRST USE 7-2-2010; IN COMMERCE 7-2-2010.

PRINCIPAL REGISTER

THE MARK CONSISTS OF STANDARD CHARACTERS WITHOUT CLAIM TO ANY PAR-
TICULAR FONT, STYLE, SIZE, OR COLOR.

NO CLAIM IS MADE TO THE EXCLUSIVE RIGHT TO USE "QUILTERS FABRIC", APART
FROM THE MARK AS SHOWN.

SN 85-011,452, FILED 4-12-2010.

MIDGE BUTLER, EXAMINING ATTORNEY



David J. Kybas

Director of the United States Patent and Trademark Office

United States of America

United States Patent and Trademark Office

STARSCRIBER

Reg. No. 4,074,735

Registered Dec. 20, 2011

Int. Cl.: 38

SERVICE MARK

PRINCIPAL REGISTER

STARSCRIBER CORPORATION (DELAWARE CORPORATION)
207 WEST HASTINGS STREET
SUITE 803
VANCOUVER, CANADA V6B1H7

FOR: DATA TRANSMISSION AND RECEPTION SERVICES VIA TELECOMMUNICATION MEANS; SIGNAL TRANSMISSION FOR ELECTRONIC COMMERCE VIA TELECOMMUNICATION SYSTEMS AND DATA COMMUNICATION SYSTEMS; TELECOMMUNICATIONS GATEWAY SERVICES; TELECOMMUNICATIONS ROUTING AND JUNCTION SERVICES; TRANSFER OF DATA BY TELECOMMUNICATIONS, IN CLASS 38 (U.S. CLS. 100, 101 AND 104).

FIRST USE 2-26-2011; IN COMMERCE 2-26-2011.

THE MARK CONSISTS OF STANDARD CHARACTERS WITHOUT CLAIM TO ANY PARTICULAR FONT, STYLE, SIZE, OR COLOR.

SN 85-011,534, FILED 4-12-2010.

MICHAEL GAAFAR, EXAMINING ATTORNEY



David J. Kyros

Director of the United States Patent and Trademark Office

United States of America

United States Patent and Trademark Office

GRADES LEARNING CENTERS

Reg. No. 4,074,736

Registered Dec. 20, 2011

Int. Cl.: 41

SERVICE MARK

PRINCIPAL REGISTER

OXFORD LEARNING CENTRES, INC. (CANADA CORPORATION)
747 HYDE PARK RD.
SUITE 230
LONDON, ONTARIO, CANADA N6H3S3

FOR: EDUCATIONAL SERVICES, NAMELY, OPERATION OF SCHOOLS TEACHING PRE-SCHOOL CHILDREN; SUPPLEMENTAL AND/OR REMEDIAL EDUCATION SERVICES, NAMELY, PERSONAL COACHING IN THE FIELD OF COGNITIVE SKILLS TO FACILITATE ACADEMIC GROWTH THROUGH INTERACTIVE COACHING; TUTORING OF STUDENTS ON ALL SUBJECTS TO ENHANCE AND DEVELOP ACADEMIC SKILLS; CONDUCTING COURSES OF INSTRUCTION AND LEARNING ENHANCEMENT THROUGH THE DEVELOPMENT OF CRITICAL THINKING, PROBLEM SOLVING AND GENERALIZATION COGNITIVE SKILLS, IN CLASS 41 (U.S. CLS. 100, 101 AND 107).

FIRST USE 5-0-2010; IN COMMERCE 5-0-2010.

THE MARK CONSISTS OF STANDARD CHARACTERS WITHOUT CLAIM TO ANY PARTICULAR FONT, STYLE, SIZE, OR COLOR.

NO CLAIM IS MADE TO THE EXCLUSIVE RIGHT TO USE "LEARNING CENTERS", APART FROM THE MARK AS SHOWN.

SN 85-011,540, FILED 4-12-2010.

DAVID YONTEF, EXAMINING ATTORNEY



David J. Kyros

Director of the United States Patent and Trademark Office

United States of America

United States Patent and Trademark Office

GRADES

Reg. No. 4,074,737

Registered Dec. 20, 2011

Int. Cl.: 41

SERVICE MARK

PRINCIPAL REGISTER

OXFORD LEARNING CENTRES, INC. (CANADA CORPORATION)
747 HYDE PARK RD., SUITE 230
LONDON, ONTARIO, CANADA N6H3S3

FOR: EDUCATIONAL SERVICES, NAMELY, OPERATION OF SCHOOLS TEACHING PRE-SCHOOL CHILDREN; SUPPLEMENTAL AND/OR REMEDIAL EDUCATION SERVICES, NAMELY, PERSONAL COACHING IN THE FIELD OF COGNITIVE SKILLS TO FACILITATE ACADEMIC GROWTH THROUGH INTERACTIVE COACHING; TUTORING OF STUDENTS ON ALL SUBJECTS TO ENHANCE AND DEVELOP ACADEMIC SKILLS; CONDUCTING COURSES OF INSTRUCTION AND LEARNING ENHANCEMENT THROUGH THE DEVELOPMENT OF CRITICAL THINKING, PROBLEM SOLVING AND GENERALIZATION COGNITIVE SKILLS, IN CLASS 41 (U.S. CLS. 100, 101 AND 107).

FIRST USE 5-0-2010; IN COMMERCE 5-0-2010.

THE MARK CONSISTS OF STANDARD CHARACTERS WITHOUT CLAIM TO ANY PARTICULAR FONT, STYLE, SIZE, OR COLOR.

SN 85-011,545, FILED 4-12-2010.

DAVID YONTEF, EXAMINING ATTORNEY



David J. Kypos

Director of the United States Patent and Trademark Office

United States of America

United States Patent and Trademark Office

LEAFWING

Reg. No. 4,074,738

CALIFORNIA INSTITUTE OF BEHAVIOR ANALYSIS, INC. (CALIFORNIA CORPORATION)
7149 WOODLEY AVE.
VAN NUYS, CA 91406

Registered Dec. 20, 2011

Int. Cls.: 41, 44, and 45

FOR: CONTINUING EDUCATION SERVICES, NAMELY, PROVIDING LIVE AND ON-LINE CONTINUING PROFESSIONAL EDUCATION IN THE FIELDS OF MENTAL HEALTH, PSYCHOTHERAPY, EMOTIONAL DISORDERS, BEHAVIORAL DISORDERS, LEARNING DISORDERS, MENTAL DISORDERS, AND BRAIN DISORDERS; PROVIDING CONTINUING EDUCATION COURSES IN THE FIELDS OF MENTAL HEALTH, PSYCHOTHERAPY, EMOTIONAL DISORDERS, BEHAVIORAL DISORDERS, LEARNING DISORDERS, MENTAL DISORDERS, AND BRAIN DISORDERS, IN CLASS 41 (U.S. CLS. 100, 101 AND 107).

SERVICE MARK

PRINCIPAL REGISTER

FIRST USE 9-17-2011; IN COMMERCE 9-17-2011.

FOR: COUNSELING SERVICES IN THE FIELDS OF MENTAL HEALTH, PSYCHOTHERAPY, EMOTIONAL DISORDERS, BEHAVIORAL DISORDERS, LEARNING DISORDERS, MENTAL DISORDERS, AND BRAIN DISORDERS; PSYCHOTHERAPY AND PSYCHOTHERAPY COUNSELING FOR CHILDREN AND ADULTS IN INDIVIDUAL AND FAMILY SESSIONS; MENTAL HEALTH COUNSELING AND PSYCHOTHERAPY, IN CLASS 44 (U.S. CLS. 100 AND 101).

FIRST USE 10-31-2010; IN COMMERCE 10-31-2010.



FOR: EMOTIONAL COUNSELING AND EMOTIONAL SUPPORT SERVICES FOR TROUBLED AND AT-RISK YOUTH AND THEIR FAMILIES; EMOTIONAL COUNSELING AND EMOTIONAL SUPPORT SERVICES FOR INDIVIDUALS SUFFERING FROM EMOTIONAL DISORDERS, BEHAVIORAL DISORDERS, LEARNING DISORDERS, MENTAL DISORDERS, AND BRAIN DISORDERS; COUNSELING IN THE FIELD OF DEVELOPING, STRENGTHENING AND SUSTAINING WELL-BALANCED FAMILIES AND FAMILY RELATIONSHIPS; COUNSELING IN THE FIELD OF PERSONAL DEVELOPMENT, NAMELY, SELF-IMPROVEMENT, SELF-FULFILLMENT, AND INTERPERSONAL COMMUNICATION, IN CLASS 45 (U.S. CLS. 100 AND 101).

FIRST USE 10-31-2010; IN COMMERCE 10-31-2010.

David J. Kyjars

THE MARK CONSISTS OF STANDARD CHARACTERS WITHOUT CLAIM TO ANY PARTICULAR FONT, STYLE, SIZE, OR COLOR.

Director of the United States Patent and Trademark Office

Reg. No. 4,074,738 SN 85-012,328, FILED 4-13-2010.

RONALD AIKENS, EXAMINING ATTORNEY

United States of America

United States Patent and Trademark Office

LeafWing 

Reg. No. 4,074,739

CALIFORNIA INSTITUTE OF BEHAVIOR ANALYSIS, INC. (CALIFORNIA CORPORATION)
7149 WOODLEY AVE.
VAN NUYS, CA 91406

Registered Dec. 20, 2011

Int. Cls.: 41, 44, and 45

FOR: CONTINUING EDUCATION SERVICES, NAMELY, PROVIDING LIVE AND ON-LINE CONTINUING PROFESSIONAL EDUCATION IN THE FIELDS OF MENTAL HEALTH, PSYCHOTHERAPY, EMOTIONAL DISORDERS, BEHAVIORAL DISORDERS, LEARNING DISORDERS, MENTAL DISORDERS, AND BRAIN DISORDERS; PROVIDING CONTINUING EDUCATION COURSES IN THE FIELDS OF MENTAL HEALTH, PSYCHOTHERAPY, EMOTIONAL DISORDERS, BEHAVIORAL DISORDERS, LEARNING DISORDERS, MENTAL DISORDERS, AND BRAIN DISORDERS, IN CLASS 41 (U.S. CLS. 100, 101 AND 107).

SERVICE MARK

PRINCIPAL REGISTER

FIRST USE 9-17-2011; IN COMMERCE 9-17-2011.

FOR: COUNSELING SERVICES IN THE FIELDS OF MENTAL HEALTH, PSYCHOTHERAPY, EMOTIONAL DISORDERS, BEHAVIORAL DISORDERS, LEARNING DISORDERS, MENTAL DISORDERS, AND BRAIN DISORDERS; PSYCHOTHERAPY AND PSYCHOTHERAPY COUNSELING FOR CHILDREN AND ADULTS IN INDIVIDUAL AND FAMILY SESSIONS; MENTAL HEALTH COUNSELING AND PSYCHOTHERAPY, IN CLASS 44 (U.S. CLS. 100 AND 101).

FIRST USE 10-31-2010; IN COMMERCE 10-31-2010.



FOR: EMOTIONAL COUNSELING AND EMOTIONAL SUPPORT SERVICES FOR TROUBLED AND AT-RISK YOUTH AND THEIR FAMILIES; EMOTIONAL COUNSELING AND EMOTIONAL SUPPORT SERVICES FOR INDIVIDUALS SUFFERING FROM EMOTIONAL DISORDERS, BEHAVIORAL DISORDERS, LEARNING DISORDERS, MENTAL DISORDERS, AND BRAIN DISORDERS; COUNSELING IN THE FIELD OF DEVELOPING, STRENGTHENING AND SUSTAINING WELL-BALANCED FAMILIES AND FAMILY RELATIONSHIPS; COUNSELING IN THE FIELD OF PERSONAL DEVELOPMENT, NAMELY, SELF-IMPROVEMENT, SELF-FULFILLMENT, AND INTERPERSONAL COMMUNICATION, IN CLASS 45 (U.S. CLS. 100 AND 101).

David J. Kyjars

FIRST USE 10-31-2010; IN COMMERCE 10-31-2010.

THE MARK CONSISTS OF THE WORD "LEAFWING" WITH A BUTTERFLY.

Reg. No. 4,074,739 SN 85-012,329, FILED 4-13-2010.

RONALD AIKENS, EXAMINING ATTORNEY

United States of America

United States Patent and Trademark Office

TOBA

Reg. No. 4,074,740

CYCLES LAMBERT INC. (CANADA CORPORATION)
1000 DES RIVEURS STREET
LEVIS, CANADA G6V9G3

Registered Dec. 20, 2011

Int. Cls.: 7, 8, 12, and 25

FOR: PNEUMATIC TOOLS IN THE NATURE OF PUMPS, IN CLASS 7 (U.S. CLS. 13, 19, 21, 23, 31, 34 AND 35).

TRADEMARK

FIRST USE 7-11-2011; IN COMMERCE 7-11-2011.

PRINCIPAL REGISTER

FOR: BICYCLE TOOLS, NAMELY, HAND TOOLS FOR REPAIR AND MAINTENANCE OF BICYCLES IN THE NATURE OF TOOLS FOR WHEELS AND TIRES; COMBINATION TOOLS IN THE NATURE OF HEX KEYS, HEXALOBULAR KEYS, CHAIN TOOLS, PHILLIPS SCREWDRIVERS, FLAT SCREWDRIVERS, SPOKE WRENCHES, TIRE LEVERS, BOX END WRENCHES, ADJUSTABLE WRENCHES, LOCK RING HOOKS, PEDAL WRENCHES, SOCKETS, DUST CAP REMOVERS; HEX KEYS; CHAIN TOOLS; DRAWPLATES; SPLINE WRENCHES, IN CLASS 8 (U.S. CLS. 23, 28 AND 44).

FIRST USE 1-9-2011; IN COMMERCE 1-9-2011.

FOR: BICYCLE PARTS AND ACCESSORIES, NAMELY, FORKS, STEMS, HANDLEBARS, HANDLEBAR END FITTINGS IN THE NATURE OF EXTENSIONS, BICYCLE PANNIERS, GRIPS AND HANDLEBAR TAPES, WHEEL RIMS, INNER TUBES, SADDLE POSTS, SADDLES, QUICK RELEASES FOR BICYCLE WHEELS, SADDLE COLLARS, SEAT CLAMPS, FORK ADAPTORS, BICYCLE STANDS; SADDLE COLLARS, BOTTLE HOLDERS, BICYCLE PUMPS, MIRRORS, BASKETS ADAPTED FOR BICYCLES, BICYCLE STANDS, BICYCLE BAGS, SEATS, SEAT COVERS, HANDLES, PEDALS, STEMS, SEAT POSTS, SEAT CLAMPS, SADDLES, GRIPS, IN CLASS 12 (U.S. CLS. 19, 21, 23, 31, 35 AND 44).

FIRST USE 2-2-2011; IN COMMERCE 2-2-2011.

FOR: SPORTING APPAREL, NAMELY, VESTS, APRONS, CYCLING SHOES, BANNERS IN THE NATURE OF COMPETITORS NUMBERS OF TEXTILE, TOQUES, PEAK CAPS, CAPS, IN CLASS 25 (U.S. CLS. 22 AND 39).

FIRST USE 7-11-2011; IN COMMERCE 7-11-2011.



David J. Kyros

Director of the United States Patent and Trademark Office

Reg. No. 4,074,740 THE MARK CONSISTS OF STANDARD CHARACTERS WITHOUT CLAIM TO ANY PARTICULAR FONT, STYLE, SIZE, OR COLOR.

SN 85-012,421, FILED 4-13-2010.

MICHAEL KEATING, EXAMINING ATTORNEY

United States of America

United States Patent and Trademark Office

DERBY DIVAS

Reg. No. 4,074,741

DERBY DIVAS, LLC (GEORGIA LIMITED LIABILITY COMPANY)
124 FAIRMEADE RD.

Registered Dec. 20, 2011

LOUISVILLE, KY 40207

Int. Cls.: 21 and 36

FOR: DINNERWARE, NAMELY, DECORATIVE AND HAND-PAINTED DINNERWARE, CUPS, MUGS, AND STEMWARE, IN CLASS 21 (U.S. CLS. 2, 13, 23, 29, 30, 33, 40 AND 50).

TRADEMARK

FIRST USE 4-21-2011; IN COMMERCE 4-21-2011.

SERVICE MARK

FOR: CHARITABLE FUND RAISING; CHARITABLE SERVICES, NAMELY, ORGANIZING FUNDRAISING SERVICES AND EVENTS TO RAISE FUNDS IN THE FIELD OF BREAST CANCER RESEARCH, AWARENESS, CARE AND SUPPORT, IN CLASS 36 (U.S. CLS. 100, 101 AND 102).

PRINCIPAL REGISTER

FIRST USE 10-1-2005; IN COMMERCE 10-1-2005.

THE MARK CONSISTS OF STANDARD CHARACTERS WITHOUT CLAIM TO ANY PARTICULAR FONT, STYLE, SIZE, OR COLOR.

OWNER OF U.S. REG. NOS. 3,225,849 AND 3,547,493.

SN 85-012,522, FILED 4-13-2010.

CHRISTINA SOBRAL, EXAMINING ATTORNEY



David J. Kybas

Director of the United States Patent and Trademark Office

United States of America

United States Patent and Trademark Office

loud by design

Reg. No. 4,074,742

Registered Dec. 20, 2011

Int. Cl.: 25

TRADEMARK

PRINCIPAL REGISTER

KAHN LUCAS LANCASTER, INC. (PENNSYLVANIA CORPORATION)
SUITE 600
112 WEST 34TH STREET
NEW YORK, NY 10120

FOR: GIRLS' APPAREL, NAMELY, DRESSES, SKIRTS, TOPS, AND PANTS, IN CLASS 25
(U.S. CLS. 22 AND 39).

FIRST USE 8-1-2011; IN COMMERCE 8-1-2011.

THE MARK CONSISTS OF STANDARD CHARACTERS WITHOUT CLAIM TO ANY PARTICULAR FONT, STYLE, SIZE, OR COLOR.

SN 85-013,208, FILED 4-13-2010.

JILL PRATER, EXAMINING ATTORNEY



David J. Kybas

Director of the United States Patent and Trademark Office

United States of America

United States Patent and Trademark Office

GRAPHNET

Reg. No. 4,074,743

Registered Dec. 20, 2011

Int. Cl.: 10

TRADEMARK

PRINCIPAL REGISTER

TECME S.A. (ARGENTINA CORPORATION)
CALLE PÚBLICA SIN NÚMERO, LOTE 43
BARRIO LOS BOULEVARES
CÓRDOBA, CÓRDOBA, ARGENTINA X5008HJY

FOR: RESPIRATORS FOR ARTIFICIAL RESPIRATION, IN CLASS 10 (U.S. CLS. 26, 39 AND 44).

FIRST USE 4-7-2011; IN COMMERCE 4-7-2011.

THE MARK CONSISTS OF STANDARD CHARACTERS WITHOUT CLAIM TO ANY PARTICULAR FONT, STYLE, SIZE, OR COLOR.

THE WORDING "GRAPHNET" HAS NO MEANING IN A FOREIGN LANGUAGE.

SN 85-013,336, FILED 4-14-2010.

EMILY CHUO, EXAMINING ATTORNEY



David J. Kyffers

Director of the United States Patent and Trademark Office

United States of America

United States Patent and Trademark Office

NEUMOVENT

Reg. No. 4,074,744

Registered Dec. 20, 2011

Int. Cl.: 10

TRADEMARK

PRINCIPAL REGISTER

TECME S.A. (ARGENTINA CORPORATION)
CALLE PÚBLICA SIN NÚMERO, LOTE 43
BARRIO LOS BOULEVARES
CÓRDOBA, CÓRDOBA, ARGENTINA X5008HJY

FOR: RESPIRATORS FOR ARTIFICIAL RESPIRATION, IN CLASS 10 (U.S. CLS. 26, 39 AND 44).

FIRST USE 4-7-2011; IN COMMERCE 4-7-2011.

THE MARK CONSISTS OF STANDARD CHARACTERS WITHOUT CLAIM TO ANY PARTICULAR FONT, STYLE, SIZE, OR COLOR.

THE WORDING "NEUMOVENT" HAS NO MEANING IN A FOREIGN LANGUAGE.

SN 85-013,338, FILED 4-14-2010.

EMILY CHUO, EXAMINING ATTORNEY



David J. Kyffers

Director of the United States Patent and Trademark Office

United States of America

United States Patent and Trademark Office

GOOD DOG

Reg. No. 4,074,745

V. RICHARD LITTLE, JR. (UNITED STATES INDIVIDUAL)
3916 CLAIRMONT AVENUE
BIRMINGHAM, AL 35222

Registered Dec. 20, 2011

Int. Cls.: 4, 21, and 30

FOR: CANDLES, IN CLASS 4 (U.S. CLS. 1, 6 AND 15).

FIRST USE 7-1-2010; IN COMMERCE 7-1-2010.

TRADEMARK

FOR: MUGS , IN CLASS 21 (U.S. CLS. 2, 13, 23, 29, 30, 33, 40 AND 50).

PRINCIPAL REGISTER

FIRST USE 12-1-2010; IN COMMERCE 12-1-2010.

FOR: COFFEE, HONEY, CHOCOLATE, AND SPICES, IN CLASS 30 (U.S. CL. 46).

FIRST USE 12-1-2010; IN COMMERCE 12-1-2010.

THE MARK CONSISTS OF STANDARD CHARACTERS WITHOUT CLAIM TO ANY PARTICULAR FONT, STYLE, SIZE, OR COLOR.

SN 85-014,845, FILED 4-15-2010.

DAVID C. REIHNER, EXAMINING ATTORNEY



David J. Kybas

Director of the United States Patent and Trademark Office

United States of America

United States Patent and Trademark Office



Reg. No. 4,074,746

BIOPLAST MANUFACTURING, LLC (NEW JERSEY LIMITED LIABILITY COMPANY)
2521 KUSER ROAD
HAMILTON, NJ 08690

Registered Dec. 20, 2011

Int. Cl.: 17

FOR: PLASTICS IN THE FORM OF SHEETS, FILMS, BLOCKS, RODS AND TUBES, IN CLASS 17 (U.S. CLS. 1, 5, 12, 13, 35 AND 50).

TRADEMARK

FIRST USE 1-6-2009; IN COMMERCE 6-6-2009.

PRINCIPAL REGISTER

THE MARK CONSISTS OF A LETTER "B" AND A LETTER "P". THE LETTER "B" IS IN GREEN AND THE LETTER "P" IS IN BLUE, WITH THE LETTER "B" INTERLOCKED WITH THE LETTER "P". A CRESCENT IS DEPICTED WITH THE BOTTOM OF THE CRESCENT BEGINNING ON THE LEFT OF THE LETTER "P" AND THE TOP OF THE CRESCENT ENDING ABOVE THE LETTER "B". THE CRESCENT IS PORTRAYED AS NARROW AT THE BOTTOM AND WIDER AT THE TOP. THE CRESCENT IS LIGHT GRAY ON THE OUTSIDE AND DARK GRAY ON THE INSIDE.

THE COLOR(S) GREEN, BLUE, LIGHT GRAY AND DARK GRAY IS/ARE CLAIMED AS A FEATURE OF THE MARK.

SN 85-015,007, FILED 4-15-2010.

DAVID MURRAY, EXAMINING ATTORNEY



David J. Kyffers

Director of the United States Patent and Trademark Office

United States of America

United States Patent and Trademark Office

TWIN VALUE

Reg. No. 4,074,747

KEY FOOD STORES CO-OPERATIVE, INC. (NEW YORK CORPORATION)
1200 SOUTH AVENUE

Registered Dec. 20, 2011

STATEN ISLAND, NY 103143413

Int. Cl.: 35

FOR: SUPERMARKET SERVICES, IN CLASS 35 (U.S. CLS. 100, 101 AND 102).

SERVICE MARK

FIRST USE 10-30-2011; IN COMMERCE 10-30-2011.

PRINCIPAL REGISTER

THE MARK CONSISTS OF STANDARD CHARACTERS WITHOUT CLAIM TO ANY PARTICULAR FONT, STYLE, SIZE, OR COLOR.

SN 85-015,821, FILED 4-16-2010.

HANNO RITTNER, EXAMINING ATTORNEY



David J. Kyffers

Director of the United States Patent and Trademark Office

United States of America

United States Patent and Trademark Office

EARTH WISE TREE FREE

Reg. No. 4,074,748

HOFFMASTER GROUP, INC. (DELAWARE CORPORATION)
2920 N. MAIN STREET
OSHKOSH, WI 54903

Registered Dec. 20, 2011

Int. Cls.: 8, 16, and 21

FOR: DISPOSABLE TABLEWARE, NAMELY, KNIVES, FORKS AND SPOONS, IN CLASS 8 (U.S. CLS. 23, 28 AND 44).

TRADEMARK

FIRST USE 12-0-2010; IN COMMERCE 12-0-2010.

PRINCIPAL REGISTER

FOR: DISPOSABLE NAPKINS, IN CLASS 16 (U.S. CLS. 2, 5, 22, 23, 29, 37, 38 AND 50).

FIRST USE 12-0-2010; IN COMMERCE 12-0-2010.

FOR: DISPOSABLE KITCHEN WARE AND DINNERWARE, NAMELY, TABLE PLATES, BOWLS, AND SERVING TRAYS; DISPOSABLE PLASTIC STORAGE CONTAINERS FOR HOUSEHOLD USE, IN CLASS 21 (U.S. CLS. 2, 13, 23, 29, 30, 33, 40 AND 50).

FIRST USE 12-0-2010; IN COMMERCE 12-0-2010.

THE MARK CONSISTS OF STANDARD CHARACTERS WITHOUT CLAIM TO ANY PARTICULAR FONT, STYLE, SIZE, OR COLOR.

NO CLAIM IS MADE TO THE EXCLUSIVE RIGHT TO USE "TREE FREE", APART FROM THE MARK AS SHOWN.

SN 85-015,965, FILED 4-16-2010.

REBECCA SMITH, EXAMINING ATTORNEY



David J. Kyros

Director of the United States Patent and Trademark Office

United States of America

United States Patent and Trademark Office



Reg. No. 4,074,749

HOFFMASTER GROUP, INC. (DELAWARE CORPORATION)
2920 N. MAIN STREET
OSHKOSH, WI 54903

Registered Dec. 20, 2011

Int. Cls.: 8, 16, and 21

FOR: DISPOSABLE TABLEWARE, NAMELY, KNIVES, FORKS AND SPOONS, IN CLASS 8 (U.S. CLS. 23, 28 AND 44).

TRADEMARK

FIRST USE 12-0-2010; IN COMMERCE 12-0-2010.

PRINCIPAL REGISTER

FOR: DISPOSABLE NAPKINS, IN CLASS 16 (U.S. CLS. 2, 5, 22, 23, 29, 37, 38 AND 50).

FIRST USE 12-0-2010; IN COMMERCE 12-0-2010.

FOR: DISPOSABLE KITCHEN WARE AND DINNERWARE, NAMELY, TABLE PLATES, BOWLS, AND SERVING TRAYS; DISPOSABLE PLASTIC STORAGE CONTAINERS FOR HOUSEHOLD USE, IN CLASS 21 (U.S. CLS. 2, 13, 23, 29, 30, 33, 40 AND 50).

FIRST USE 12-0-2010; IN COMMERCE 12-0-2010.

NO CLAIM IS MADE TO THE EXCLUSIVE RIGHT TO USE "TREE FREE" , APART FROM THE MARK AS SHOWN.

THE COLOR(S) GREEN AND BLACK IS/ARE CLAIMED AS A FEATURE OF THE MARK.

THE MARK CONSISTS OF THE WORDS "EARTH WISE TREE FREE" WITH A STYLIZED W AND PLANT DESIGNS ALL APPEARING IN GREEN.

SN 85-015,967, FILED 4-16-2010.

REBECCA SMITH, EXAMINING ATTORNEY



David J. Kybas

Director of the United States Patent and Trademark Office

United States of America

United States Patent and Trademark Office

BOTOX ONTRACK

Reg. No. 4,074,750

ALLERGAN, INC. (DELAWARE CORPORATION)
2525 DUPONT DRIVE
IRVINE, CA 92612

Registered Dec. 20, 2011

Int. Cl.: 44

FOR: HEALTH CARE SERVICES, NAMELY, PATIENT TREATMENT MANAGEMENT PROGRAMS FOR USE BY PATIENTS AND THEIR CAREGIVERS, IN CLASS 44 (U.S. CLS. 100 AND 101).

SERVICE MARK

FIRST USE 10-15-2011; IN COMMERCE 10-15-2011.

PRINCIPAL REGISTER

THE MARK CONSISTS OF STANDARD CHARACTERS WITHOUT CLAIM TO ANY PARTICULAR FONT, STYLE, SIZE, OR COLOR.

OWNER OF U.S. REG. NOS. 1,692,384, 2,510,675, AND OTHERS.

SN 85-016,215, FILED 4-16-2010.

HAI-LY LAM, EXAMINING ATTORNEY



David J. Kybas

Director of the United States Patent and Trademark Office

United States of America

United States Patent and Trademark Office

SQRSOLUTIONS

Reg. No. 4,074,751

SPACEBOUND, INC. (OHIO CORPORATION)
280 OPPORTUNITY WAY
LAGRANGE, OH 44050

Registered Dec. 20, 2011

Int. Cl.: 35

SERVICE MARK

PRINCIPAL REGISTER

FOR: RETAIL STORE SERVICES TO GOVERNMENTAL ENTITIES FEATURING COMPUTER ACCESSORIES, COMPUTER PERIPHERAL DEVICES, OFFICE DESKTOP ACCESSORIES, AND PROMOTIONAL PRODUCTS FOR OTHERS, NAMELY, CALENDARS, ELECTRONICS, COMPUTER PRODUCTS, DESK AND OFFICE ACCESSORIES, CONSUMER ELECTRONICS, NAMELY, HANDHELD MUSIC DEVICES, HANDHELD GLOBAL POSITIONING DEVICES, HANDHELD CAMERA DEVICES, HANDHELD COMPUTER MEMORY DEVICES, HANDHELD COMPUTER MEMORY STORAGE DEVICES, AND COMPUTER SOFTWARE, NAMELY, COMPUTER PROGRAMS IN THE FIELDS OF ANIMALS AND WILDLIFE, AUDIO AND VIDEO APPLICATIONS, BIBLE AND RELIGION, BUSINESS CLIP ART, COOKING, DICTIONARIES AND ENCYCLOPEDIAS, EDUCATIONAL ELECTRONICS, GARDENING AND LANDSCAPING, GENEALOGY, GRAPHICS AND DESKTOP PUBLISHING, GREETING CARD MAKERS, HOBBIES, HOME DESIGN AND REMODELING, INTERNET AND INTERNET TOOLS, LANGUAGES, MAPS AND TRAVEL, MEDICINE AND HEALTH, OFFICE APPLICATIONS, PROGRAMMING, REFERENCE, SHAREWARE, TOOLS, UTILITIES AND TUTORIALS, NOT INCLUDING COMPUTER PROGRAMS AND USER MANUALS FOR USE AS A REPORT WRITER AND PROCEDURAL LANGUAGE FOR RELATIONAL DATABASES, IN CLASS 35 (U.S. CLS. 100, 101 AND 102).

FIRST USE 4-1-2010; IN COMMERCE 9-8-2010.

THE MARK CONSISTS OF STANDARD CHARACTERS WITHOUT CLAIM TO ANY PARTICULAR FONT, STYLE, SIZE, OR COLOR.

SN 85-016,635, FILED 4-18-2010.

KATHERINE CONNOLLY, EXAMINING ATTORNEY



David J. Kyjars

Director of the United States Patent and Trademark Office

United States of America

United States Patent and Trademark Office

Peace, Love & Juicy Couture

Reg. No. 4,074,752

JUICY COUTURE, INC. (CALIFORNIA CORPORATION)
12720 WENTWORTH STREET
PACOIMA, CA 91331

Registered Dec. 20, 2011

Int. Cl.: 3

FOR: BODY CREAMS; EAU DE PARFUM; PERFUMES IN SOLID FORM; SHOWER GEL,
IN CLASS 3 (U.S. CLS. 1, 4, 6, 50, 51 AND 52).

TRADEMARK

FIRST USE 9-0-2010; IN COMMERCE 9-0-2010.

PRINCIPAL REGISTER

THE MARK CONSISTS OF STANDARD CHARACTERS WITHOUT CLAIM TO ANY PAR-
TICULAR FONT, STYLE, SIZE, OR COLOR.

OWNER OF U.S. REG. NOS. 2,348,674, 3,194,741, AND OTHERS.

SN 85-016,984, FILED 4-19-2010.

NELSON SNYDER, EXAMINING ATTORNEY



David J. Kyffers

Director of the United States Patent and Trademark Office

United States of America

United States Patent and Trademark Office

CLOSET AT A TIME

Reg. No. 4,074,753

RUBBERMAID INCORPORATED (OHIO CORPORATION)
3 GLENLAKE PARKWAY
ATLANTA, GA 30328

Registered Dec. 20, 2011

Int. Cl.: 39

FOR: PACKAGING ARTICLES, NAMELY, INDIVIDUAL COMPONENTS FOR CLOSETS AND HOME STORAGE SYSTEMS, TO THE ORDER AND SPECIFICATION OF OTHERS, NAMELY, CONTRACTORS, ON A CUSTOM ORDER BASIS AND PALLET SHIPPING OF SAID PACKAGES TO CONTRACTORS, IN CLASS 39 (U.S. CLS. 100 AND 105).

SERVICE MARK

PRINCIPAL REGISTER

FIRST USE 5-1-2010; IN COMMERCE 5-1-2010.

THE MARK CONSISTS OF STANDARD CHARACTERS WITHOUT CLAIM TO ANY PARTICULAR FONT, STYLE, SIZE, OR COLOR.

NO CLAIM IS MADE TO THE EXCLUSIVE RIGHT TO USE "CLOSET", APART FROM THE MARK AS SHOWN.

SN 85-017,188, FILED 4-19-2010.

ANDREA K. NADELMAN, EXAMINING ATTORNEY



David J. Kybas

Director of the United States Patent and Trademark Office

United States of America

United States Patent and Trademark Office

LIFELINE

Reg. No. 4,074,754

LIFELINE SKIN CARE INC. (CALIFORNIA CORPORATION)
5950 PRIESTLY DRIVE
CARLSBAD, CA 92008

Registered Dec. 20, 2011

Int. Cls.: 3 and 5

FOR: COSMETICS, NAMELY, DAY-AND-NIGHT BEAUTY SERUMS AND CREAMS, ANTI-AGING, MOISTURIZING, REHYDRATING, AND SUN-PROTECTING SERUMS AND CREAMS, SKIN CLEANSERS AND NON-MEDICATED BODY SERUMS, IN CLASS 3 (U.S. CLS. 1, 4, 6, 50, 51 AND 52).

TRADEMARK

PRINCIPAL REGISTER

FIRST USE 11-16-2010; IN COMMERCE 11-16-2010.

FOR: MEDICATED COSMETICS, NAMELY, DAY-AND-NIGHT MEDICATED SERUMS AND CREAMS, ANTI-AGING, MOISTURIZING, REHYDRATING, AND SUN-PROTECTING SERUMS AND CREAMS, MEDICAL SKIN CLEANSERS AND SKIN SERUMS FOR PARTS OF THE BODY OTHER THAN THE FACIAL AREA, IN CLASS 5 (U.S. CLS. 6, 18, 44, 46, 51 AND 52).

FIRST USE 11-16-2010; IN COMMERCE 11-16-2010.

THE MARK CONSISTS OF STANDARD CHARACTERS WITHOUT CLAIM TO ANY PARTICULAR FONT, STYLE, SIZE, OR COLOR.

SN 85-017,525, FILED 4-19-2010.

JUDITH HELFMAN, EXAMINING ATTORNEY



David J. Kyffers

Director of the United States Patent and Trademark Office

United States of America

United States Patent and Trademark Office

UMI HEALTH SHOT

Reg. No. 4,074,755

RHEE, MICHAEL (UNITED STATES INDIVIDUAL)
4473 SHEILA STREET
COMMERCE, CA 90023

Registered Dec. 20, 2011

Int. Cl.: 5

FOR: DIETARY SUPPLEMENTAL DRINKS, IN CLASS 5 (U.S. CLS. 6, 18, 44, 46, 51 AND 52).

TRADEMARK

FIRST USE 6-30-2009; IN COMMERCE 6-30-2009.

PRINCIPAL REGISTER

THE MARK CONSISTS OF STANDARD CHARACTERS WITHOUT CLAIM TO ANY PARTICULAR FONT, STYLE, SIZE, OR COLOR.

NO CLAIM IS MADE TO THE EXCLUSIVE RIGHT TO USE "HEALTH SHOT", APART FROM THE MARK AS SHOWN.

SN 85-017,692, FILED 4-19-2010.

WILLIAM P. SHANAHAN, EXAMINING ATTORNEY



David J. Kyros

Director of the United States Patent and Trademark Office

United States of America

United States Patent and Trademark Office

DALUC

<http://www.daluc.jp>

Reg. No. 4,074,756

TOMS CO., LTD. (JAPAN CORPORATION)
17-4, NINGYO-CHO 1-CHOME, NIHONBASHI
CHUO-KU, TOKYO, JAPAN 103-0013

Registered Dec. 20, 2011

Int. Cl.: 25

FOR: CLOTHING, NAMELY, TEE-SHIRTS, UNDERWEAR, IN CLASS 25 (U.S. CLS. 22 AND 39).

TRADEMARK

FIRST USE 4-21-2010; IN COMMERCE 4-21-2010.

PRINCIPAL REGISTER

THE MARK CONSISTS OF THE TERMS "DALUC" IN UPPER CASE ON THE FIRST LINE AND "HTTP://WWW.DALUC.JP" IN LOWER CASE ON THE SECOND LINE.

SN 85-019,282, FILED 4-21-2010.

VIVIAN MICZNIK FIRST, EXAMINING ATTORNEY



David J. Kyros

Director of the United States Patent and Trademark Office

United States of America

United States Patent and Trademark Office

ProSole

Reg. No. 4,074,757

Registered Dec. 20, 2011

Int. Cl.: 25

TRADEMARK

PRINCIPAL REGISTER

ATLANTIC FOOTCARE, INC (RHODE ISLAND CORPORATION)
UNIT B
95 LOCUST LANE
OAKLAND, RI 02858

FOR: HEEL INSERTS; INSOLES FOR FOOTWEAR, IN CLASS 25 (U.S. CLS. 22 AND 39).

FIRST USE 10-1-2010; IN COMMERCE 10-1-2010.

THE MARK CONSISTS OF STANDARD CHARACTERS WITHOUT CLAIM TO ANY PARTICULAR FONT, STYLE, SIZE, OR COLOR.

SN 85-019,445, FILED 4-21-2010.

PAUL MORENO, EXAMINING ATTORNEY



David J. Kyffers

Director of the United States Patent and Trademark Office

United States of America

United States Patent and Trademark Office

WE'VE GOT YOUR BACK

Reg. No. 4,074,758

IRAQ AND AFGHANISTAN VETERANS OF AMERICA (D.C. NON-PROFIT CORPORATION)
292 MADISON AVENUE, 10TH FLOOR
NEW YORK, NY 10017

Registered Dec. 20, 2011

Int. Cl.: 35

FOR: CHARITABLE SERVICES, NAMELY, ORGANIZING AND CONDUCTING VOLUNTEER PROGRAMS AND COMMUNITY SERVICE PROJECTS AIMED AT INCREASING SUPPORT AND MORALE OF FAMILIES OF DECEASED WAR VETERANS, WAR VETERANS, CURRENT MEMBERS AND FUTURE MEMBERS OF THE U.S. MILITARY, IN CLASS 35 (U.S. CLS. 100, 101 AND 102).

SERVICE MARK

PRINCIPAL REGISTER

FIRST USE 11-11-2009; IN COMMERCE 11-11-2009.

THE MARK CONSISTS OF STANDARD CHARACTERS WITHOUT CLAIM TO ANY PARTICULAR FONT, STYLE, SIZE, OR COLOR.

SN 85-019,527, FILED 4-21-2010.

CHRISTINA SOBRAL, EXAMINING ATTORNEY



David J. Kybas

Director of the United States Patent and Trademark Office

United States of America

United States Patent and Trademark Office



ISLAMORADA

Reg. No. 4,074,759

PIRATE ENTERPRISES, LLC (FLORIDA LIMITED LIABILITY COMPANY)
15400 NW 34TH AVENUE
MIAMI, FL 33054

Registered Dec. 20, 2011

Int. Cl.: 25

FOR: KNIT AND WOVEN CLOTHING, NAMELY, JACKETS, TOPS, TEE SHIRTS, HEAD WEAR, VESTS, PANTS AND SHORTS, IN CLASS 25 (U.S. CLS. 22 AND 39).

TRADEMARK

FIRST USE 3-3-2011; IN COMMERCE 3-3-2011.

PRINCIPAL REGISTER

NO CLAIM IS MADE TO THE EXCLUSIVE RIGHT TO USE "ISLAMORADA", APART FROM THE MARK AS SHOWN.

THE MARK CONSISTS OF THE PHRASE "YO-HO-HO" IN LARGE STYLIZED LETTERING CURVED OVER THE DESIGN OF A SKULL AND CROSSBONES, THE SKULL WEARING A STRIPED BANDANNA. BELOW THE DESIGN, THE WORD "ISLAMORADA" APPEARS IN SMALLER CAPITAL LETTERS.

SN 85-019,781, FILED 4-21-2010.

JILL C. ALT, EXAMINING ATTORNEY



David J. Kybas

Director of the United States Patent and Trademark Office

United States of America

United States Patent and Trademark Office

Fireline 520
WallGuard Series

Reg. No. 4,074,760

FIRELINE 520, LLC (NEW YORK LIMITED LIABILITY COMPANY)
803-B WALDEN AVENUE
BUFFALO, NY 14211

Registered Dec. 20, 2011

Int. Cl.: 17

FOR: FACTORY ASSEMBLED FIRE-BARRIERS COMPRISED OF INSULATING FIREPROOF TEXTILES IN SYMMETRICALLY ARRANGED LAYERS, IN CLASS 17 (U.S. CLS. 1, 5, 12, 13, 35 AND 50).

TRADEMARK

FIRST USE 4-5-2010; IN COMMERCE 5-1-2010.

PRINCIPAL REGISTER

OWNER OF U.S. REG. NOS. 3,336,727 AND 3,810,515.

THE COLOR(S) BLACK, ORANGE, YELLOW, WHITE AND LIGHT BROWN IS/ARE CLAIMED AS A FEATURE OF THE MARK.

NO CLAIM IS MADE TO THE EXCLUSIVE RIGHT TO USE "SERIES", APART FROM THE MARK AS SHOWN.

THE MARK CONSISTS OF THE BLACK WORDING AND BLACK NUMBER: "FIRELINE 520 WALLGUARD SERIES", WHEREIN THE NUMERAL "520" IS STYLIZED WITH A COLORED FLAME INSIDE OF THE "0" AND THE WORD "SERIES" IS SUPERIMPOSED OVER AN ORANGE, YELLOW AND LIGHT BROWN FLAME.

SN 85-020,553, FILED 4-22-2010.

JAY BESCH, EXAMINING ATTORNEY



David J. Kybas

Director of the United States Patent and Trademark Office

United States of America

United States Patent and Trademark Office

KEEPSTOCK SECURE

Reg. No. 4,074,761

W.W. GRAINGER, INC. (ILLINOIS CORPORATION)
100 GRAINGER PARKWAY
LAKE FOREST, IL 600455201

Registered Dec. 20, 2011

Int. Cl.: 35

FOR: INVENTORY CONTROL AND BUSINESS CONSULTATION SERVICES IN THE FIELD OF TOOL CRIB REPLENISHMENT AND MAINTENANCE, IN CLASS 35 (U.S. CLS. 100, 101 AND 102).

SERVICE MARK

FIRST USE 8-30-2011; IN COMMERCE 8-30-2011.

PRINCIPAL REGISTER

THE MARK CONSISTS OF STANDARD CHARACTERS WITHOUT CLAIM TO ANY PARTICULAR FONT, STYLE, SIZE, OR COLOR.

OWNER OF U.S. REG. NOS. 3,111,846 AND 3,332,077.

SN 85-021,308, FILED 4-22-2010.

KAELIE KUNG, EXAMINING ATTORNEY



David J. Kyffers

Director of the United States Patent and Trademark Office

United States of America

United States Patent and Trademark Office

LAS VEGAS STYLE CASINO BRICK

Reg. No. 4,074,762

DIAMOND MOUNTAIN DISTRIBUTORS LLC (NEVADA LIMITED LIABILITY COMPANY)
7440 COMMERCIAL WAY
HENDERSON, NV 89011

Registered Dec. 20, 2011

Int. Cl.: 28

FOR: USED PLAYING CARDS, IN CLASS 28 (U.S. CLS. 22, 23, 38 AND 50).

TRADEMARK

FIRST USE 2-14-2011; IN COMMERCE 2-14-2011.

PRINCIPAL REGISTER

THE MARK CONSISTS OF STANDARD CHARACTERS WITHOUT CLAIM TO ANY PARTICULAR FONT, STYLE, SIZE, OR COLOR.

SEC. 2(F) AS TO "LAS VEGAS STYLE".

OWNER OF U.S. REG. NO. 2,708,147.

NO CLAIM IS MADE TO THE EXCLUSIVE RIGHT TO USE "CASINO BRICK", APART FROM THE MARK AS SHOWN.

SN 85-021,897, FILED 4-23-2010.

JOHN HWANG, EXAMINING ATTORNEY



David J. Kyffers

Director of the United States Patent and Trademark Office

United States of America

United States Patent and Trademark Office

DISCOVERY DOLLARS

Reg. No. 4,074,763

Registered Dec. 20, 2011

Int. Cl.: 25

TRADEMARK

PRINCIPAL REGISTER

SEA WORLD LLC (DELAWARE LIMITED LIABILITY COMPANY)
SUITE 400
9205 SOUTH PARK CENTER LOOP
ORLANDO, FL 32819

FOR: WRISTBANDS, IN CLASS 25 (U.S. CLS. 22 AND 39).

FIRST USE 2-0-2011; IN COMMERCE 2-0-2011.

THE MARK CONSISTS OF STANDARD CHARACTERS WITHOUT CLAIM TO ANY PARTICULAR FONT, STYLE, SIZE, OR COLOR.

SN 85-022,431, FILED 4-24-2010.

KELLY BOULTON, EXAMINING ATTORNEY



David J. Kybas

Director of the United States Patent and Trademark Office

United States of America

United States Patent and Trademark Office

LOCK & KEY

Reg. No. 4,074,764

SUTTER HOME WINERY, INC. (CALIFORNIA CORPORATION)
100 ST. HELENA HWY SOUTH, P.O. BOX 248
ST. HELENA, CA 94574

Registered Dec. 20, 2011

Int. Cl.: 33

FOR: ALCOHOLIC BEVERAGES EXCEPT BEERS, IN CLASS 33 (U.S. CLS. 47 AND 49).

TRADEMARK

FIRST USE 9-7-2011; IN COMMERCE 9-7-2011.

PRINCIPAL REGISTER

THE MARK CONSISTS OF STANDARD CHARACTERS WITHOUT CLAIM TO ANY PARTICULAR FONT, STYLE, SIZE, OR COLOR.

SN 85-023,561, FILED 4-26-2010.

RONALD MCMORROW, EXAMINING ATTORNEY



David J. Kyffers

Director of the United States Patent and Trademark Office

United States of America

United States Patent and Trademark Office

ELEVATION

Reg. No. 4,074,765

Registered Dec. 20, 2011

Int. Cl.: 19

TRADEMARK

PRINCIPAL REGISTER

ATLAS ROOFING CORPORATION (MISSISSIPPI CORPORATION)
SUITE 190
802 HIGHWAY 19 NORTH
MERIDIAN, MS 39307

FOR: EXPANDED POLYSTYRENE (EPS) PRODUCTS USED FOR DIRT REPLACEMENT, FILLING VOIDS AND STRUCTURAL APPLICATIONS, NAMELY, FOAM BLOCKS FOR LANDSCAPING AND ROAD EMBANKMENTS, IN CLASS 19 (U.S. CLS. 1, 12, 33 AND 50).

FIRST USE 3-11-2011; IN COMMERCE 3-11-2011.

THE MARK CONSISTS OF STANDARD CHARACTERS WITHOUT CLAIM TO ANY PARTICULAR FONT, STYLE, SIZE, OR COLOR.

SN 85-024,258, FILED 4-27-2010.

ZACHARY BELLO, EXAMINING ATTORNEY



David J. Kyffers

Director of the United States Patent and Trademark Office

United States of America

United States Patent and Trademark Office

BIOAGAVE

Reg. No. 4,074,766

CORN PRODUCTS INTERNATIONAL, INC. (DELAWARE CORPORATION)
5 WESTBROOK CORPORATE CENTER
WESTCHESTER, IL 60154

Registered Dec. 20, 2011

Int. Cl.: 30

FOR: NATURAL SWEETENER, NAMELY, AGAVE SYRUP, FOR USE AS AN INGREDIENT
IN FOOD PRODUCTS, IN CLASS 30 (U.S. CL. 46).

TRADEMARK

FIRST USE 6-11-2010; IN COMMERCE 6-11-2010.

PRINCIPAL REGISTER

THE MARK CONSISTS OF STANDARD CHARACTERS WITHOUT CLAIM TO ANY PAR-
TICULAR FONT, STYLE, SIZE, OR COLOR.

OWNER OF U.S. REG. NO. 3,617,021.

THE WORDING "BIOAGAVE" HAS NO MEANING IN A FOREIGN LANGUAGE.

SN 85-024,928, FILED 4-28-2010.

MICHAEL GAAFAR, EXAMINING ATTORNEY



David J. Kyffers

Director of the United States Patent and Trademark Office

United States of America

United States Patent and Trademark Office

TOBIAS FLATS

Reg. No. 4,074,767

ROSEN HOTELS AND RESORTS, INC. (FLORIDA CORPORATION)
9840 INTERNATIONAL DRIVE
ORLANDO, FL 32819

Registered Dec. 20, 2011

Int. Cl.: 43

FOR: RESTAURANT, CAFE AND COCKTAIL LOUNGE SERVICES, IN CLASS 43 (U.S. CLS. 100 AND 101).

SERVICE MARK

FIRST USE 1-0-2011; IN COMMERCE 1-0-2011.

PRINCIPAL REGISTER

THE MARK CONSISTS OF STANDARD CHARACTERS WITHOUT CLAIM TO ANY PARTICULAR FONT, STYLE, SIZE, OR COLOR.

SN 85-025,195, FILED 4-28-2010.

TINA L. SNAPP, EXAMINING ATTORNEY



David J. Kybas

Director of the United States Patent and Trademark Office

United States of America

United States Patent and Trademark Office

ICEMONKEY

Reg. No. 4,074,768

Registered Dec. 20, 2011

Int. Cl.: 35

SERVICE MARK

PRINCIPAL REGISTER

WHOLESALE PLUS WIRELESS, LLC (NEW YORK LIMITED LIABILITY COMPANY)
SUITE 3
1529 DEAN ST
BROOKLYN, NY 11213

FOR: ON-LINE RETAIL STORE SERVICES FEATURING CONSUMER ELECTRONICS AND GIFTS, IN CLASS 35 (U.S. CLS. 100, 101 AND 102).

FIRST USE 11-22-2010; IN COMMERCE 11-22-2010.

THE MARK CONSISTS OF STANDARD CHARACTERS WITHOUT CLAIM TO ANY PARTICULAR FONT, STYLE, SIZE, OR COLOR.

SN 85-025,514, FILED 4-28-2010.

WILLIAM ROSSMAN, EXAMINING ATTORNEY



David J. Kybas

Director of the United States Patent and Trademark Office

United States of America

United States Patent and Trademark Office

NetWitness IMPACT

Reg. No. 4,074,769

Registered Dec. 20, 2011

Int. Cl.: 9

TRADEMARK

PRINCIPAL REGISTER

EMC CORPORATION (MASSACHUSETTS CORPORATION)
176 SOUTH STREET
HOPKINTON, MA 01748

FOR: SOFTWARE USED TO CALCULATE AND REMEDIATE RISKS ASSOCIATED WITH NETWORK VULNERABILITIES, CONFIGURATION, AND SENSITIVE DATA ON COMPUTER AND NETWORK DEVICES, IN CLASS 9 (U.S. CLS. 21, 23, 26, 36 AND 38).

FIRST USE 10-0-2010; IN COMMERCE 10-0-2010.

THE MARK CONSISTS OF STANDARD CHARACTERS WITHOUT CLAIM TO ANY PARTICULAR FONT, STYLE, SIZE, OR COLOR.

OWNER OF U.S. REG. NOS. 2,674,324 AND 3,541,286.

SN 85-025,933, FILED 4-29-2010.

RONALD AIKENS, EXAMINING ATTORNEY



David J. Kyros

Director of the United States Patent and Trademark Office

United States of America

United States Patent and Trademark Office

NULUBE

Reg. No. 4,074,770

NUCOR CORPORATION (DELAWARE CORPORATION)
1915 REXFORD ROAD
CHARLOTTE, NC 28211

Registered Dec. 20, 2011

Int. Cl.: 6

FOR: METAL FASTENERS, NAMELY, NUTS WHEREIN THE NUTS ARE LUBRICATED ON ONE BEARING SURFACE AND ON THE INTERNAL THREADS, IN CLASS 6 (U.S. CLS. 2, 12, 13, 14, 23, 25 AND 50).

TRADEMARK

FIRST USE 12-0-2010; IN COMMERCE 12-0-2010.

PRINCIPAL REGISTER

THE MARK CONSISTS OF STANDARD CHARACTERS WITHOUT CLAIM TO ANY PARTICULAR FONT, STYLE, SIZE, OR COLOR.

SN 85-026,287, FILED 4-29-2010.

JENNIFER DIXON, EXAMINING ATTORNEY



David J. Kybas

Director of the United States Patent and Trademark Office

United States of America

United States Patent and Trademark Office

Small Tales

Reg. No. 4,074,771

LAWLOR, MELISSA ROJA (UNITED STATES INDIVIDUAL)
P.O. BOX 1042

Registered Dec. 20, 2011

WOLFEBORO FALLS, NH 03896

Int. Cl.: 9

FOR: CHILDREN'S EDUCATIONAL MUSIC CDS AND DVDS; DIGITAL MEDIA, NAMELY, PRE-RECORDED VIDEO CASSETTES, DIGITAL VIDEO DISCS, DIGITAL VERSATILE DISCS, DOWNLOADABLE AUDIO AND VIDEO RECORDINGS, DVDS, AND HIGH DEFINITION DIGITAL DISCS FEATURING PUPPETS; DOWNLOADABLE VIDEO RECORDINGS FEATURING PUPPETS, IN CLASS 9 (U.S. CLS. 21, 23, 26, 36 AND 38).

TRADEMARK

PRINCIPAL REGISTER

FIRST USE 5-1-2010; IN COMMERCE 6-10-2010.

THE MARK CONSISTS OF STANDARD CHARACTERS WITHOUT CLAIM TO ANY PARTICULAR FONT, STYLE, SIZE, OR COLOR.

SN 85-026,589, FILED 4-29-2010.

ALICIA COLLINS, EXAMINING ATTORNEY



David J. Kybas

Director of the United States Patent and Trademark Office

United States of America

United States Patent and Trademark Office

SCREAMIN' DEALZ

Reg. No. 4,074,772

MOUNTAIN VIEW MARKETING, INC. (UTAH CORPORATION)
215 N. 1800 W.

Registered Dec. 20, 2011

LINDON, UT 84063

Int. Cl.: 35

FOR: ON-LINE WHOLESALE AND RETAIL STORE SERVICES FEATURING GENERAL CONSUMER MERCHANDISE, NAMELY, CLOTHING, SUNGLASSES, NOVELTY ITEMS, LIGHTERS, VITAMIN SUPPLEMENTS, GLOVES, HATS, SHOES, BATH AND BODY PRODUCTS, JEWELRY, ELECTRONICS, DECORATIVE CLOTHING ACCESSORIES, TOYS, GAMES, SPORTING GOODS, AND TOOLS, IN CLASS 35 (U.S. CLS. 100, 101 AND 102).

SERVICE MARK

PRINCIPAL REGISTER

FIRST USE 4-1-2011; IN COMMERCE 4-1-2011.

THE MARK CONSISTS OF STANDARD CHARACTERS WITHOUT CLAIM TO ANY PARTICULAR FONT, STYLE, SIZE, OR COLOR.

NO CLAIM IS MADE TO THE EXCLUSIVE RIGHT TO USE "DEALS", APART FROM THE MARK AS SHOWN.

SN 85-027,893, FILED 4-30-2010.

SETH A. RAPPAPORT, EXAMINING ATTORNEY



David J. Kyffers

Director of the United States Patent and Trademark Office

United States of America

United States Patent and Trademark Office

ENGAGED IQ

Reg. No. 4,074,773

Registered Dec. 20, 2011

Int. Cl.: 9

TRADEMARK

PRINCIPAL REGISTER

YOUR FAST TRACK, INC. (FLORIDA CORPORATION), DBA QUALITICK,
311 SO. MISSOURI AVE.
CLEARWATER, FL 33756

FOR: COMPUTER SOFTWARE FOR PROVIDING STAFFING AND/OR EMPLOYEE INFORMATION AND FEEDBACK AND BENCHMARKING ANALYSIS AND REPORTING OF EMPLOYEE TO EMPLOYEE DATA , IN CLASS 9 (U.S. CLS. 21, 23, 26, 36 AND 38).

FIRST USE 2-1-2010; IN COMMERCE 8-1-2011.

THE MARK CONSISTS OF STANDARD CHARACTERS WITHOUT CLAIM TO ANY PARTICULAR FONT, STYLE, SIZE, OR COLOR.

OWNER OF U.S. REG. NO. 3,386,105.

SN 85-028,380, FILED 5-3-2010.

HEATHER THOMPSON, EXAMINING ATTORNEY



David J. Kyros

Director of the United States Patent and Trademark Office

United States of America

United States Patent and Trademark Office

PEERED IQ

Reg. No. 4,074,774

Registered Dec. 20, 2011

Int. Cl.: 9

TRADEMARK

PRINCIPAL REGISTER

YOUR FAST TRACK, INC. (FLORIDA CORPORATION), DBA QUALITICK,
311 SO. MISSOURI AVE.
CLEARWATER, FL 33756

FOR: COMPUTER SOFTWARE FOR PROVIDING PEER TO PEER FEEDBACK AND
BENCHMARKING ANALYSIS AND REPORTING OF PEER TO PEER DATA, IN CLASS 9
(U.S. CLS. 21, 23, 26, 36 AND 38).

FIRST USE 2-1-2010; IN COMMERCE 8-1-2011.

THE MARK CONSISTS OF STANDARD CHARACTERS WITHOUT CLAIM TO ANY PAR-
TICULAR FONT, STYLE, SIZE, OR COLOR.

OWNER OF U.S. REG. NO. 3,386,105.

SN 85-028,387, FILED 5-3-2010.

HEATHER THOMPSON, EXAMINING ATTORNEY



David J. Kyffers

Director of the United States Patent and Trademark Office

United States of America

United States Patent and Trademark Office



Reg. No. 4,074,775

Registered Dec. 20, 2011

Int. Cls.: 21 and 25

TRADEMARK

PRINCIPAL REGISTER

BOARD OF REGENTS OF THE UNIVERSITY SYSTEM OF GEORGIA (GEORGIA STATE AGENCY)
270 WASHINGTON STREET, S.W.
ATLANTA, GA 30334

FOR: CUPS AND MUGS, IN CLASS 21 (U.S. CLS. 2, 13, 23, 29, 30, 33, 40 AND 50).

FIRST USE 8-1-2011; IN COMMERCE 8-1-2011.

FOR: HATS; SWEAT SHIRTS; T-SHIRTS, IN CLASS 25 (U.S. CLS. 22 AND 39).

FIRST USE 8-1-2011; IN COMMERCE 8-1-2011.

THE MARK CONSISTS OF A RUNNING BIRD CARICATURE.

SN 85-028,393, FILED 5-3-2010.

TOBY BULLOFF, EXAMINING ATTORNEY



David J. Kybas

Director of the United States Patent and Trademark Office

United States of America

United States Patent and Trademark Office

DIVE QUEST

Reg. No. 4,074,776

Registered Dec. 20, 2011

Int. Cl.: 9

TRADEMARK

PRINCIPAL REGISTER

MULTIMEDIA GAMES, INC. (TEXAS CORPORATION)
BUILDING B, 4TH FLOOR
206 WILD BASIN ROAD SOUTH
AUSTIN, TX 78746

FOR: GAMING MACHINES, NAMELY, ELECTRONIC SLOT AND BINGO MACHINES;
VIDEO LOTTERY TERMINALS, IN CLASS 9 (U.S. CLS. 21, 23, 26, 36 AND 38).

FIRST USE 10-4-2011; IN COMMERCE 10-4-2011.

THE MARK CONSISTS OF STANDARD CHARACTERS WITHOUT CLAIM TO ANY PARTICULAR FONT, STYLE, SIZE, OR COLOR.

SN 85-028,472, FILED 5-3-2010.

ANNE FARRELL, EXAMINING ATTORNEY



David J. Kyffers

Director of the United States Patent and Trademark Office

United States of America

United States Patent and Trademark Office

PHA: IT'S LIKE HAVING A DOCTOR IN THE FAMILY!

Reg. No. 4,074,777

PREMIER HEALTH ADVOCATES LLC (DELAWARE LIMITED LIABILITY COMPANY)
16192 COASTAL HIGHWAY
LEWES, DE 19958

Registered Dec. 20, 2011

Int. Cl.: 44

FOR: MEDICAL COUNSELING SERVICES WHERE NON-TREATING PHYSICIANS ACT AS LIAISONS BETWEEN PATIENTS AND THE PATIENTS' MEDICAL PROVIDERS AND DO NOT PROVIDE MEDICAL TREATMENT, IN CLASS 44 (U.S. CLS. 100 AND 101).

SERVICE MARK

FIRST USE 1-1-2010; IN COMMERCE 1-28-2010.

PRINCIPAL REGISTER

THE MARK CONSISTS OF STANDARD CHARACTERS WITHOUT CLAIM TO ANY PARTICULAR FONT, STYLE, SIZE, OR COLOR.

SN 85-028,733, FILED 5-3-2010.

CHRIS WELLS, EXAMINING ATTORNEY



David J. Kybas

Director of the United States Patent and Trademark Office

United States of America

United States Patent and Trademark Office

SAMSUNG EXHIBIT

Reg. No. 4,074,778

Registered Dec. 20, 2011

Int. Cl.: 9

TRADEMARK

PRINCIPAL REGISTER

SAMSUNG ELECTRONICS CO., LTD. (REPUBLIC OF KOREA CORPORATION)
416, MAETAN-DONG, YEONGTONG-GU
SUWON-SI, GYEONGGI-DO, REPUBLIC OF KOREA

FOR: MOBILE PHONES; SMARTPHONES, IN CLASS 9 (U.S. CLS. 21, 23, 26, 36 AND 38).

FIRST USE 6-22-2011; IN COMMERCE 6-22-2011.

THE MARK CONSISTS OF STANDARD CHARACTERS WITHOUT CLAIM TO ANY PARTICULAR FONT, STYLE, SIZE, OR COLOR.

OWNER OF U.S. REG. NOS. 2,882,774, 3,713,355, AND OTHERS.

THE ENGLISH TRANSLATION OF "SAMSUNG" IN THE MARK IS "THREE STARS".

SN 85-028,829, FILED 5-3-2010.

BRENDAN REGAN, EXAMINING ATTORNEY



David J. Kyjars

Director of the United States Patent and Trademark Office

United States of America

United States Patent and Trademark Office

GIVE & GET

Reg. No. 4,074,779

GAP (APPAREL), LLC (CALIFORNIA LIMITED LIABILITY COMPANY)
2 FOLSOM STREET

Registered Dec. 20, 2011

SAN FRANCISCO, CA 94105

Int. Cl.: 36

FOR: ACCEPTING AND ADMINISTERING MONETARY CHARITABLE CONTRIBUTIONS;
CHARITABLE FUND RAISING SERVICES, IN CLASS 36 (U.S. CLS. 100, 101 AND 102).

SERVICE MARK

FIRST USE 8-1-2008; IN COMMERCE 8-1-2008.

PRINCIPAL REGISTER

THE MARK CONSISTS OF STANDARD CHARACTERS WITHOUT CLAIM TO ANY PARTICULAR FONT, STYLE, SIZE, OR COLOR.

OWNER OF U.S. REG. NO. 3,753,303.

SN 85-029,737, FILED 5-4-2010.

FLORENTINA BLANDU, EXAMINING ATTORNEY



David J. Kyffers

Director of the United States Patent and Trademark Office

United States of America

United States Patent and Trademark Office

TOASTY

Reg. No. 4,074,780

Registered Dec. 20, 2011

Int. Cl.: 28

TRADEMARK

PRINCIPAL REGISTER

AMERICAN GIRL, LLC (DELAWARE LIMITED LIABILITY COMPANY)
M1-1518
333 CONTINENTAL BOULEVARD
EL SEGUNDO, CA 90245

FOR: TOY ANIMALS AND ACCESSORIES THEREFOR, IN CLASS 28 (U.S. CLS. 22, 23, 38 AND 50).

FIRST USE 8-29-2011; IN COMMERCE 8-29-2011.

THE MARK CONSISTS OF STANDARD CHARACTERS WITHOUT CLAIM TO ANY PARTICULAR FONT, STYLE, SIZE, OR COLOR.

SN 85-029,761, FILED 5-4-2010.

DAVID YONTEF, EXAMINING ATTORNEY



David J. Kyffers

Director of the United States Patent and Trademark Office

United States of America

United States Patent and Trademark Office

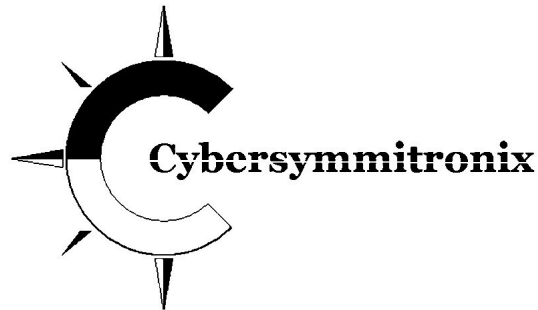

Reg. No. 4,074,781

Registered Dec. 20, 2011

Int. Cl.: 9

TRADEMARK

PRINCIPAL REGISTER

CORTES, SANTOS (UNITED STATES INDIVIDUAL)
P.O. BOX 28948
SAN JOSE, CA 95159

FOR: TACTICAL ROBOTS UTILIZING STRONG ARTIFICIAL INTELLIGENCE (SAI) FOR MILITARY, PUBLIC, AND/OR THE PRIVATE SECTORS, FOR THE PURPOSE OF AUTONOMOUSLY PERFORMING SPECIFIC PHYSICAL FUNCTIONS ALLOWING INTERACTION WITH THE ENVIRONMENT TO FULFILL TASKS THAT MIGHT BE HAZARDOUS TO HUMANS, IN CLASS 9 (U.S. CLS. 21, 23, 26, 36 AND 38).

FIRST USE 9-23-2000; IN COMMERCE 7-7-2007.

THE MARK CONSISTS OF A DESIGN OF A STAR OF VENUS WITH A STYLIZED LETTER "C" INCORPORATED WITHIN IT. TO THE RIGHT OF THE DESIGN IS THE WORD "CYBERSYMMITRONIX" WITH THE LETTERS DIVIDED HORIZONTALLY DOWN THE MIDDLE AS IF BY A RAY OF LIGHT.

SN 85-031,244, FILED 5-5-2010.

JAMES GRIFFIN, EXAMINING ATTORNEY



David J. Kyffers

Director of the United States Patent and Trademark Office

United States of America

United States Patent and Trademark Office

PREMYR

Reg. No. 4,074,782

SPIRITS INTERNATIONAL B.V. (NETHERLANDS BESLOTEN VENNOOTSCHAP (B.V.))
7, RUE NICOLAS BOVE
LUXEMBOURG, LUXEMBOURG L-1253

Registered Dec. 20, 2011

Int. Cl.: 33

FOR: DISTILLED SPIRITS; VODKA; FLAVORED VODKA, IN CLASS 33 (U.S. CLS. 47 AND 49).

TRADEMARK

FIRST USE 10-1-2011; IN COMMERCE 10-1-2011.

PRINCIPAL REGISTER

THE MARK CONSISTS OF STANDARD CHARACTERS WITHOUT CLAIM TO ANY PARTICULAR FONT, STYLE, SIZE, OR COLOR.

THE WORDING "PREMYR" HAS NO MEANING IN A FOREIGN LANGUAGE.

SN 85-031,410, FILED 5-6-2010.

APRIL HESIK, EXAMINING ATTORNEY



David J. Kybas

Director of the United States Patent and Trademark Office

United States of America

United States Patent and Trademark Office

SHIELDSTRAND

Reg. No. 4,074,783

Registered Dec. 20, 2011

Int. Cl.: 24

TRADEMARK

PRINCIPAL REGISTER

OCV INTELLECTUAL CAPITAL, LLC (DELAWARE LIMITED LIABILITY COMPANY)
ONE OWENS CORNING PARKWAY
TOLEDO, OH 43659

FOR: SEMI-FINISHED BALLISTIC RESISTANT FABRICS CONTAINING GLASS FIBERS
FOR USE IN THE MANUFACTURE OF HARD ARMOR FOR AIRCRAFT VEHICLES, LAND
VEHICLES, MARINE SHIPS, AND BODY ARMOR, IN CLASS 24 (U.S. CLS. 42 AND 50).

FIRST USE 10-5-2009; IN COMMERCE 10-5-2009.

THE MARK CONSISTS OF STANDARD CHARACTERS WITHOUT CLAIM TO ANY PAR-
TICULAR FONT, STYLE, SIZE, OR COLOR.

OWNER OF U.S. REG. NO. 3,606,445.

SN 85-031,547, FILED 5-6-2010.

ALYSSA STEEL, EXAMINING ATTORNEY



David J. Kyjars

Director of the United States Patent and Trademark Office

United States of America

United States Patent and Trademark Office

BEEBAY

Reg. No. 4,074,784

Registered Dec. 20, 2011

Int. Cl.: 25

TRADEMARK

PRINCIPAL REGISTER

M/S. ROYAL EMBROIDERY (INDIA PARTNERSHIP)
PLOT NO. 9, SECTOR 27 A
MAIN MATHURA ROAD, FARIDABAD - 121001
HARYANA, INDIA

FOR: CLOTHING, NAMELY, HOSIERY, READYMADE DRESSES, SHIRTS, PANTS,
BLOUSES, PLAY SUITS, HATS AND FOOTWEAR, IN CLASS 25 (U.S. CLS. 22 AND 39).

FIRST USE 6-1-2000; IN COMMERCE 5-17-2011.

THE MARK CONSISTS OF STANDARD CHARACTERS WITHOUT CLAIM TO ANY PAR-
TICULAR FONT, STYLE, SIZE, OR COLOR.

THE WORD "BEEBAY" IN THE MARK IS FANCIFUL AND HAS NO TRANSLATION.

SN 85-031,847, FILED 5-6-2010.

DAVID C. REIHNER, EXAMINING ATTORNEY



David J. Kyfos

Director of the United States Patent and Trademark Office

United States of America

United States Patent and Trademark Office

Eat Local Fish

Reg. No. 4,074,785

ALLYSON JORDAN (UNITED STATES INDIVIDUAL)
C/O ROBERT EDMOND MITTEL; PO 427
PORTLAND, ME 04112

Registered Dec. 20, 2011

Int. Cl.: 25

FOR: CAPS; T-SHIRTS, IN CLASS 25 (U.S. CLS. 22 AND 39).

TRADEMARK

FIRST USE 10-24-2011; IN COMMERCE 10-24-2011.

PRINCIPAL REGISTER

THE MARK CONSISTS OF STANDARD CHARACTERS WITHOUT CLAIM TO ANY PARTICULAR FONT, STYLE, SIZE, OR COLOR.

SN 85-032,660, FILED 5-7-2010.

DEBRA LEE, EXAMINING ATTORNEY



David J. Kyffers

Director of the United States Patent and Trademark Office

United States of America

United States Patent and Trademark Office

HEALTHY RECIPE

Reg. No. 4,074,786

TOPCO HOLDINGS, INC. (WISCONSIN CORPORATION)
7711 GROSS POINT ROAD
SKOKIE, IL 60077

Registered Dec. 20, 2011

Int. Cl.: 29

FOR: SOUPS, IN CLASS 29 (U.S. CL. 46).

TRADEMARK

FIRST USE 9-0-2009; IN COMMERCE 9-0-2009.

PRINCIPAL REGISTER

THE MARK CONSISTS OF STANDARD CHARACTERS WITHOUT CLAIM TO ANY PARTICULAR FONT, STYLE, SIZE, OR COLOR.

NO CLAIM IS MADE TO THE EXCLUSIVE RIGHT TO USE "HEALTHY", APART FROM THE MARK AS SHOWN.

SN 85-033,052, FILED 5-7-2010.

KARANENDRA S. CHHINA, EXAMINING ATTORNEY



David J. Kybas

Director of the United States Patent and Trademark Office

United States of America

United States Patent and Trademark Office

REAL MEN SWING PINK

Reg. No. 4,074,787

HILLERICH & BRADSBY CO. (KENTUCKY CORPORATION)
800 WEST MAIN STREET
LOUISVILLE, KY 40202

Registered Dec. 20, 2011

Int. Cl.: 28

FOR: BASEBALL BATS, IN CLASS 28 (U.S. CLS. 22, 23, 38 AND 50).

TRADEMARK

FIRST USE 5-0-2010; IN COMMERCE 5-0-2010.

PRINCIPAL REGISTER

THE MARK CONSISTS OF STANDARD CHARACTERS WITHOUT CLAIM TO ANY PARTICULAR FONT, STYLE, SIZE, OR COLOR.

SN 85-033,286, FILED 5-7-2010.

TRICIA SONNEBORN, EXAMINING ATTORNEY



David J. Kyffers

Director of the United States Patent and Trademark Office

United States of America

United States Patent and Trademark Office

deal of the day
NEVER MISS A DEAL

Reg. No. 4,074,788

Registered Dec. 20, 2011

Int. Cl.: 35

SERVICE MARK

PRINCIPAL REGISTER

FREEDOM COMMUNICATIONS, INC. (DELAWARE CORPORATION)
17666 FITCH AVENUE
IRVINE, CA 92614

FOR: PROMOTIONAL SERVICES, NAMELY, PROMOTING THE GOODS OF OTHERS BY MEANS OF PROVIDING ONLINE COUPONS, REBATES, PRICE-COMPARISON INFORMATION, AND DISCOUNT INFORMATION, IN CLASS 35 (U.S. CLS. 100, 101 AND 102).

FIRST USE 5-13-2010; IN COMMERCE 5-13-2010.

NO CLAIM IS MADE TO THE EXCLUSIVE RIGHT TO USE "DEAL OF THE DAY", APART FROM THE MARK AS SHOWN.

THE MARK CONSISTS OF THE WORDING "DEAL OF THE DAY, NEVER MISS A DEAL" AND A DESIGN. THE WORDING "DEAL OF THE DAY" IS ABOVE THE WORDING "NEVER MISS A DEAL" AND ALL OF THE WORDING IS CONTAINED WITHIN A RECTANGULAR BACKGROUND CARRIER. THE TOP RIGHT HAND CORNER OF THE RECTANGLE IS FOLDED OVER AND DOTTED LINES REPLACE THAT PORTION OF THE RECTANGLE. SCISSORS APPEAR TO BE CUTTING THE TOP RIGHT HAND CORNER OF THE RECTANGLE ALONG THE DOTTED LINES.

SN 85-033,559, FILED 5-7-2010.

SHARON MEIER, EXAMINING ATTORNEY



David J. Kyjars

Director of the United States Patent and Trademark Office

United States of America

United States Patent and Trademark Office

SPRING BEE HONEY

Reg. No. 4,074,789

SRING B ENTERPRISES,LTD. (WISCONSIN LIMITED LIABILITY COMPANY)
W2960 HWY 63

Registered Dec. 20, 2011

SPRINGBROOK, WI 54875

Int. Cl.: 30

FOR: STAPLE FOOD PRODUCTS, NAMELY, HONEY AND ROYAL JELLY, IN CLASS 30
(U.S. CL. 46).

TRADEMARK

FIRST USE 5-1-2011; IN COMMERCE 5-1-2011.

PRINCIPAL REGISTER

THE MARK CONSISTS OF STANDARD CHARACTERS WITHOUT CLAIM TO ANY PARTICULAR FONT, STYLE, SIZE, OR COLOR.

NO CLAIM IS MADE TO THE EXCLUSIVE RIGHT TO USE "HONEY", APART FROM THE MARK AS SHOWN.

SN 85-033,864, FILED 5-10-2010.

LINDA M. KING, EXAMINING ATTORNEY



David J. Kybas

Director of the United States Patent and Trademark Office

United States of America

United States Patent and Trademark Office

ROSE BUDS

Reg. No. 4,074,790

Registered Dec. 20, 2011

Int. Cls.: 41 and 43

SERVICE MARK

PRINCIPAL REGISTER

ROSEWOOD HOTELS AND RESORTS, L.L.C. (DELAWARE LIMITED LIABILITY COMPANY)
500 CRESCENT COURT; STE 300
DALLAS, TX 75201

FOR: EDUCATION AND ENTERTAINMENT SERVICES IN THE NATURE OF PROVIDING CLASSES IN ARTS AND CRAFTS FOR CHILDREN; SWIMMING INSTRUCTION, IN CLASS 41 (U.S. CLS. 100, 101 AND 107).

FIRST USE 7-0-2010; IN COMMERCE 7-0-2010.

FOR: RENTAL OF BABY CRIBS, IN CLASS 43 (U.S. CLS. 100 AND 101).

FIRST USE 7-0-2010; IN COMMERCE 7-0-2010.

THE MARK CONSISTS OF STANDARD CHARACTERS WITHOUT CLAIM TO ANY PARTICULAR FONT, STYLE, SIZE, OR COLOR.

SN 85-034,027, FILED 5-10-2010.

KATHY DE JONGE, EXAMINING ATTORNEY



David J. Kypos

Director of the United States Patent and Trademark Office

United States of America

United States Patent and Trademark Office

FROM BEE TO YOU

Reg. No. 4,074,791

SRING B ENTERPRISES, LTD. (WISCONSIN LIMITED LIABILITY COMPANY)
W2960 HWY 63

Registered Dec. 20, 2011

SPRINGBROOK, WI 54875

Int. Cl.: 30

FOR: STAPLE FOOD PRODUCTS, NAMELY, HONEY AND ROYAL JELLY, IN CLASS 30
(U.S. CL. 46).

TRADEMARK

FIRST USE 5-1-2011; IN COMMERCE 5-1-2011.

PRINCIPAL REGISTER

THE MARK CONSISTS OF STANDARD CHARACTERS WITHOUT CLAIM TO ANY PARTICULAR FONT, STYLE, SIZE, OR COLOR.

SN 85-034,902, FILED 5-11-2010.

LINDA M. KING, EXAMINING ATTORNEY



David J. Kyffers

Director of the United States Patent and Trademark Office

United States of America

United States Patent and Trademark Office

TRION ACCELERATOR

Reg. No. 4,074,792

Registered Dec. 20, 2011

Int. Cl.: 35

SERVICE MARK

PRINCIPAL REGISTER

TRION, LLC (TEXAS LIMITED LIABILITY COMPANY)
5910 N CENTRAL EXPY
1660
DALLAS, TX 75206

FOR: PROVIDING BUSINESS MANAGEMENT AND CONSULTATION, IN CLASS 35 (U.S. CLS. 100, 101 AND 102).

FIRST USE 4-29-2011; IN COMMERCE 4-29-2011.

THE MARK CONSISTS OF STANDARD CHARACTERS WITHOUT CLAIM TO ANY PARTICULAR FONT, STYLE, SIZE, OR COLOR.

NO CLAIM IS MADE TO THE EXCLUSIVE RIGHT TO USE "ACCELERATOR", APART FROM THE MARK AS SHOWN.

SN 85-035,530, FILED 5-11-2010.

EUGENIA MARTIN, EXAMINING ATTORNEY



David J. Kyffers

Director of the United States Patent and Trademark Office

United States of America

United States Patent and Trademark Office

Testology

Reg. No. 4,074,793

CAMACHO, SERGIO (UNITED STATES INDIVIDUAL)

Registered Dec. 20, 2011

P.O. BOX 24013
LOS ANGELES, CA 90024

Int. Cl.: 41

FOR: EDUCATION SERVICES, NAMELY, PROVIDING TUTORING IN THE FIELDS OF STANDARDIZED TEST PREPARATION, COLLEGE PREPARATION, AND HIGH SCHOOL ACADEMICS, IN CLASS 41 (U.S. CLS. 100, 101 AND 107).

SERVICE MARK

FIRST USE 3-3-2011; IN COMMERCE 4-13-2011.

PRINCIPAL REGISTER

THE MARK CONSISTS OF STANDARD CHARACTERS WITHOUT CLAIM TO ANY PARTICULAR FONT, STYLE, SIZE, OR COLOR.

SN 85-035,868, FILED 5-11-2010.

AMEEN IMAM, EXAMINING ATTORNEY



David J. Kybas

Director of the United States Patent and Trademark Office

United States of America

United States Patent and Trademark Office

ONE MORE TIME

Reg. No. 4,074,794

GRAND VISION GAMING, LLC (MONTANA LIMITED LIABILITY COMPANY)
P.O. BOX 20956

Registered Dec. 20, 2011

BILLINGS, MT 59104

Int. Cl.: 9

FOR: VIDEO GAMING MACHINES, IN CLASS 9 (U.S. CLS. 21, 23, 26, 36 AND 38).

TRADEMARK

FIRST USE 8-31-2010; IN COMMERCE 8-31-2010.

PRINCIPAL REGISTER

THE MARK CONSISTS OF STANDARD CHARACTERS WITHOUT CLAIM TO ANY PARTICULAR FONT, STYLE, SIZE, OR COLOR.

SN 85-036,867, FILED 5-12-2010.

JEFFREY LOOK, EXAMINING ATTORNEY



David J. Kybas

Director of the United States Patent and Trademark Office

United States of America

United States Patent and Trademark Office

QUALITY PRODUCTS WITHOUT THE NAME BRAND PRICE

Reg. No. 4,074,795

ADVANCE AUTO INNOVATIONS, LLC (VIRGINIA LIMITED LIABILITY COMPANY)
5008 AIRPORT ROAD
ROANOKE, VA 24012

Registered Dec. 20, 2011

Int. Cl.: 35

FOR: RETAIL STORE SERVICES FOR COMMERCIAL CUSTOMERS FEATURING HARDWARE, AND AUTO AND VEHICLE PARTS AND ACCESSORIES; ONLINE RETAIL STORE SERVICES FOR COMMERCIAL CUSTOMERS FEATURING HARDWARE, AND AUTO AND VEHICLE PARTS AND ACCESSORIES, IN CLASS 35 (U.S. CLS. 100, 101 AND 102).

SERVICE MARK

PRINCIPAL REGISTER

FIRST USE 4-0-2010; IN COMMERCE 4-0-2010.

THE MARK CONSISTS OF STANDARD CHARACTERS WITHOUT CLAIM TO ANY PARTICULAR FONT, STYLE, SIZE, OR COLOR.

SN 85-039,466, FILED 5-14-2010.

SUSAN RICHARDS, EXAMINING ATTORNEY



David J. Kybas

Director of the United States Patent and Trademark Office

United States of America

United States Patent and Trademark Office

AIR BOSS

Reg. No. 4,074,796

Registered Dec. 20, 2011

Int. Cl.: 7

TRADEMARK

PRINCIPAL REGISTER

AIRGAS, INC. (DELAWARE CORPORATION)
259 N. RADNOR-CHESTER ROAD
RADNOR, PA 19087

FOR: TRAILER-MOUNTED AIR COMPRESSOR SYSTEM COMPRISED OF AN AIR COMPRESSOR, COOLING AIR UNIT, AIR FILTRATION DEVICE, AIR ANALYZER AND MONITORING SYSTEM, THAT DELIVERS FILTERED AND COOLED GRADE D BREATHING AIR USING BREATHING AIR LINES AND RESPIRATOR/FACE MASKS FOR UP TO ONE HUNDRED WORKERS ON A JOB SITE, IN CLASS 7 (U.S. CLS. 13, 19, 21, 23, 31, 34 AND 35).

FIRST USE 10-0-2010; IN COMMERCE 10-0-2010.

THE MARK CONSISTS OF STANDARD CHARACTERS WITHOUT CLAIM TO ANY PARTICULAR FONT, STYLE, SIZE, OR COLOR.

NO CLAIM IS MADE TO THE EXCLUSIVE RIGHT TO USE "AIR", APART FROM THE MARK AS SHOWN.

SN 85-040,346, FILED 5-17-2010.

CURTIS FRENCH, EXAMINING ATTORNEY



David J. Kybas

Director of the United States Patent and Trademark Office

United States of America

United States Patent and Trademark Office

CLEVEDON CLOCK CO.

Reg. No. 4,074,797

PATTON PICTURE COMPANY (OHIO CORPORATION)
207 LYNNDALE COURT
MECHANICSBURG, PA 17050

Registered Dec. 20, 2011

Int. Cl.: 14

FOR: CLOCKS, IN CLASS 14 (U.S. CLS. 2, 27, 28 AND 50).

TRADEMARK

FIRST USE 7-13-2011; IN COMMERCE 7-13-2011.

PRINCIPAL REGISTER

THE MARK CONSISTS OF STANDARD CHARACTERS WITHOUT CLAIM TO ANY PARTICULAR FONT, STYLE, SIZE, OR COLOR.

NO CLAIM IS MADE TO THE EXCLUSIVE RIGHT TO USE "CLOCK CO.", APART FROM THE MARK AS SHOWN.

SN 85-041,755, FILED 5-18-2010.

CHRISTINA SOBRAL, EXAMINING ATTORNEY



David J. Kybas

Director of the United States Patent and Trademark Office

United States of America

United States Patent and Trademark Office

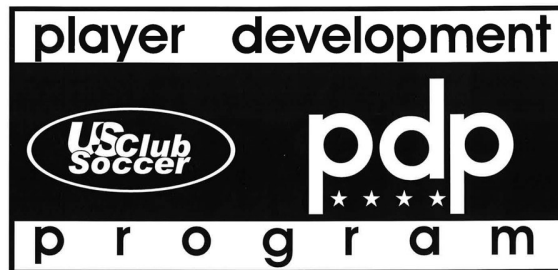

Reg. No. 4,074,798

Registered Dec. 20, 2011

Int. Cl.: 41

NATIONAL ASSOCIATION OF COMPETITIVE SOCCER CLUBS (CALIFORNIA CORPORATION)

#301
192 EAST BAY STREET
CHARLESTON, SC 29401

SERVICE MARK

PRINCIPAL REGISTER

FOR: PROVIDING A TRAINING PROGRAM FOR THE DEVELOPMENT OF ELITE SOCCER PLAYERS; PUBLICATION OF TEXTS IN THE NATURE OF TEXT BOOKS, PERIODICALS, LEAFLETS, AND BROCHURES; ARRANGING AND CONDUCTING EDUCATIONAL DEMONSTRATIONS; LIVE DEMONSTRATIONS, NAMELY, PERSONAL APPEARANCES OF OR BY SPORTS PERSONALITIES FOR TEACHING, ENTERTAINMENT, EDUCATIONAL AND PERSONAL COACHING PURPOSES, IN CLASS 41 (U.S. CLS. 100, 101 AND 107).

FIRST USE 6-0-2011; IN COMMERCE 6-0-2011.

OWNER OF U.S. REG. NOS. 2,958,764 AND 3,751,594.

SEC. 2(F) AS TO "US CLUB SOCCER".

NO CLAIM IS MADE TO THE EXCLUSIVE RIGHT TO USE "SOCCER" AND "PLAYER DEVELOPMENT PROGRAM", APART FROM THE MARK AS SHOWN.

THE MARK CONSISTS OF A RECTANGLE WITHIN A RECTANGLE. THE INNERMOST RECTANGLE CONTAINS THE STYLIZED WORDS "US CLUB SOCCER" WITHIN AN OVAL ON THE LEFT SIDE AND THE STYLIZED LETTERS "PDP" LOCATED ON THE RIGHT SIDE, WITH FOUR STARS LOCATED UNDER THE FIRST "P" AND THE "D" IN "PDP". THE WORDS "PLAYER DEVELOPMENT" ARE LOCATED WITHIN THE TOP PART OF THE OUTERMOST RECTANGLE AND THE WORD "PROGRAM" IS LOCATED WITHIN THE BOTTOM PART OF THE OUTERMOST RECTANGLE.

SN 85-042,461, FILED 5-19-2010.

KEVIN CORWIN, EXAMINING ATTORNEY



David J. Kyffers

Director of the United States Patent and Trademark Office

United States of America

United States Patent and Trademark Office

ROBATECH

Reg. No. 4,074,799

Registered Dec. 20, 2011

Int. Cls.: 7 and 9

TRADEMARK

PRINCIPAL REGISTER

ROBATECH AG (SWITZERLAND CORPORATION)
PILATUSRING 10
MURI, SWITZERLAND CH-5630

FOR: HOTMELT AND COLDMELT APPLICATOR MACHINES; HOTMELT APPLICATION MACHINES WITH GEAR PUMPS; MACHINE PARTS, NAMELY, DRUM UNLOADERS; MACHINE PARTS, NAMELY, APPLICATOR HEADS FOR HOTMELT AND COLDGLUE APPLICATOR MACHINES; ELECTRICALLY-CONTROLLED COLD GLUE APPLICATOR HEADS FOR MACHINES; ELECTRO-PNEUMATIC AND ELECTRICALLY-CONTROLLED HOT MELT GLUE APPLICATION HEADS FOR MACHINES; MACHINE PARTS, NAMELY, PUR APPLICATORS FOR HOTMELT AND COLDGLUE APPLICATOR MACHINES; HOTMELT APPLICATION MACHINE COMPONENTS AND ACCESSORIES, NAMELY, APPLICATORS, HEADS, MODULES, NOZZLES, HOSES, HEATERS, PUMPS, AND SENSORS SOLD IN CONNECTION THEREWITH; GLUING SYSTEM FOR ROTARY OFFSET PRINTING MACHINES COMPRISING HOTMELT AND COLDGLUE APPLICATION HEADS, BOOK SPINE GLUING MACHINES; MACHINE PARTS, NAMELY, COATING HEADS FOR WIDE HOTMELT APPLICATION MACHINES; MACHINE PARTS, NAMELY, MODULAR COATING HEADS FOR HOTMELT AND COLDGLUE APPLICATION MACHINES; MACHINE PARTS, NAMELY, PUR HOTMELT BLOCK MELTING UNITS, NAMELY, DRUM UNLOADER MELTING GRILL, ELECTRIC GLUE GUNS, HOT MELT GLUE GUNS; ENGINEERED-WOOD GLUING MACHINES; MACHINE PARTS, NAMELY, MULTIMELT UNIVERSAL HOTMELT APPLICATION UNITS, NAMELY, PROFILES WRAPPING MACHINES, EDGE BANDING MACHINES, WOOD REPAIR MACHINES, ELECTRIC GLUE GUNS, HOT MELT GLUE GUNS; HAND-OPERATED HOTMELT APPLICATORS, NAMELY, HAND APPLICATORS, IN CLASS 7 (U.S. CLS. 13, 19, 21, 23, 31, 34 AND 35).

FIRST USE 0-0-2006; IN COMMERCE 0-0-2006.

FOR: MICROPROCESSOR CONTROLLER FOR HOTMELT AND COLDGLUE AND ADHESIVE OPERATIONS; DEVICES FOR PARAMETERIZATION AND MONITORING OF HOTMELT AND COLDGLUE, NAMELY, ELECTRONIC PATTERN CONTROLLERS, ELECTRONIC ADHESIVE APPLICATION CONTROLLERS, GLUE DETECTION SENSORS, IN CLASS 9 (U.S. CLS. 21, 23, 26, 36 AND 38).

FIRST USE 0-0-2005; IN COMMERCE 0-0-2005.



David J. Kyjars

Director of the United States Patent and Trademark Office

Reg. No. 4,074,799 THE MARK CONSISTS OF STANDARD CHARACTERS WITHOUT CLAIM TO ANY PARTICULAR FONT, STYLE, SIZE, OR COLOR.

SN 85-042,862, FILED 5-19-2010.

LAURIE KAUFMAN, EXAMINING ATTORNEY

United States of America

United States Patent and Trademark Office

RO

Robatech
Gluing Technology

Reg. No. 4,074,800

Registered Dec. 20, 2011

Int. Cls.: 7 and 9

TRADEMARK

PRINCIPAL REGISTER

ROBATECH AG (SWITZERLAND CORPORATION)
PILATUSRING 10
MURI, SWITZERLAND CH-5630

FOR: HOTMELT AND COLDMELT APPLICATOR MACHINES; HOTMELT APPLICATION MACHINES WITH GEAR PUMPS; MACHINE PARTS, NAMELY, DRUM UNLOADERS; MACHINE PARTS, NAMELY, APPLICATOR HEADS FOR HOTMELT AND COLDGLUE APPLICATOR MACHINES; ELECTRICALLY-CONTROLLED COLD GLUE APPLICATOR HEADS FOR MACHINES; ELECTRO-PNEUMATIC AND ELECTRICALLY-CONTROLLED HOT MELT GLUE APPLICATION HEADS FOR MACHINES; MACHINE PARTS, NAMELY, PUR APPLICATORS FOR HOTMELT AND COLDGLUE APPLICATOR MACHINES; HOTMELT APPLICATION MACHINE COMPONENTS AND ACCESSORIES, NAMELY, APPLICATORS, HEADS, MODULES, NOZZLES, HOSES, HEATERS, PUMPS, AND SENSORS SOLD IN CONNECTION THEREWITH; GLUING SYSTEM FOR ROTARY OFFSET PRINTING MACHINES COMPRISING HOTMELT AND COLDGLUE APPLICATION HEADS, BOOK SPINE GLUING MACHINES; MACHINE PARTS, NAMELY, COATING HEADS FOR WIDE HOTMELT APPLICATION MACHINES; MACHINE PARTS, NAMELY, MODULAR COATING HEADS FOR HOTMELT AND COLDGLUE APPLICATION MACHINES; MACHINE PARTS, NAMELY, PUR HOTMELT BLOCK MELTING UNITS, NAMELY, DRUM UNLOADER MELTING GRILL, ELECTRIC GLUE GUNS, HOT MELT GLUE GUNS; ENGINEERED-WOOD GLUING MACHINES; MACHINE PARTS, NAMELY, MULTIMELT UNIVERSAL HOTMELT APPLICATION UNITS, NAMELY, PROFILES WRAPPING MACHINES, EDGE BANDING MACHINES, WOOD REPAIR MACHINES, ELECTRIC GLUE GUNS, HOT MELT GLUE GUNS; HAND-OPERATED HOTMELT APPLICATORS, NAMELY, HAND APPLICATORS, IN CLASS 7 (U.S. CLS. 13, 19, 21, 23, 31, 34 AND 35).

FIRST USE 12-31-2006; IN COMMERCE 12-31-2006.

FOR: MICROPROCESSOR CONTROLLER FOR HOTMELT AND COLDGLUE AND ADHESIVE OPERATIONS; DEVICES FOR PARAMETERIZATION AND MONITORING OF HOTMELT AND COLDGLUE, NAMELY, ELECTRONIC PATTERN CONTROLLERS, ELECTRONIC ADHESIVE APPLICATION CONTROLLERS, GLUE DETECTION SENSORS, IN CLASS 9 (U.S. CLS. 21, 23, 26, 36 AND 38).

FIRST USE 12-31-2005; IN COMMERCE 12-31-2005.



David J. Kyjars

Director of the United States Patent and Trademark Office

Reg. No. 4,074,800 NO CLAIM IS MADE TO THE EXCLUSIVE RIGHT TO USE "GLUING TECHNOLOGY",
APART FROM THE MARK AS SHOWN.

THE MARK CONSISTS OF THE LETTERS "RO" ABOVE THE WORDS "ROBATECH GLUING
TECHNOLOGY".

SN 85-042,867, FILED 5-19-2010.

LAURIE KAUFMAN, EXAMINING ATTORNEY

United States of America

United States Patent and Trademark Office

SEE IT BIGGER

Reg. No. 4,074,801

PLANAHEAD, LLC (CALIFORNIA LIMITED LIABILITY COMPANY)
3130 WILSHIRE BOULEVARD, SUITE 555
SANTA MONICA, CA 90403

Registered Dec. 20, 2011

Int. Cl.: 16

FOR: PAPER GOODS AND PRINTED MATTER, NAMELY, DAILY PLANNERS, PERSONAL PLANNERS AND DESKTOP PLANNERS; TELEPHONE/ADDRESS BOOKS; APPOINTMENT BOOKS, IN CLASS 16 (U.S. CLS. 2, 5, 22, 23, 29, 37, 38 AND 50).

TRADEMARK

FIRST USE 9-23-2011; IN COMMERCE 10-17-2011.

PRINCIPAL REGISTER

THE MARK CONSISTS OF STANDARD CHARACTERS WITHOUT CLAIM TO ANY PARTICULAR FONT, STYLE, SIZE, OR COLOR.

SN 85-042,882, FILED 5-19-2010.

KEVIN DINALLO, EXAMINING ATTORNEY



David J. Kybas

Director of the United States Patent and Trademark Office

United States of America

United States Patent and Trademark Office

YO MON

Reg. No. 4,074,802

CULTURE CLUB FROZEN YOGURT LLC (NEW JERSEY LIMITED LIABILITY COMPANY)
42 OAKES ROAD
LITTLE SILVER, NJ 07739

Registered Dec. 20, 2011

Int. Cls.: 25 and 43

FOR: CLOTHING, NAMELY, T-SHIRTS, HATS, AND SWEATSHIRTS, IN CLASS 25 (U.S. CLS. 22 AND 39).

TRADEMARK

FIRST USE 6-15-2011; IN COMMERCE 6-15-2011.

SERVICE MARK

FOR: RESTAURANT SERVICES FEATURING PRIMARILY FROZEN YOGURT, IN CLASS 43 (U.S. CLS. 100 AND 101).

PRINCIPAL REGISTER

FIRST USE 2-14-2011; IN COMMERCE 2-14-2011.

THE MARK CONSISTS OF STANDARD CHARACTERS WITHOUT CLAIM TO ANY PARTICULAR FONT, STYLE, SIZE, OR COLOR.

SN 85-043,744, FILED 5-20-2010.

ZHALEH DELANEY, EXAMINING ATTORNEY



David J. Kybas

Director of the United States Patent and Trademark Office

United States of America

United States Patent and Trademark Office



Reg. No. 4,074,803

CHUMAS-KING, JILL M. (UNITED STATES INDIVIDUAL)
3915 WHITE PINE DRIVE EAST
EAU CLAIRE, WI 54701

Registered Dec. 20, 2011

Int. Cl.: 21

FOR: LAUNDRY BINS FOR DOMESTIC OR HOUSEHOLD USE, IN CLASS 21 (U.S. CLS. 2, 13, 23, 29, 30, 33, 40 AND 50).

TRADEMARK

FIRST USE 6-1-2011; IN COMMERCE 6-1-2011.

PRINCIPAL REGISTER

NO CLAIM IS MADE TO THE EXCLUSIVE RIGHT TO USE "LAUNDRY", APART FROM THE MARK AS SHOWN.

THE MARK CONSISTS OF THE WORDS "BACK" AND "YARD" IN STYLIZED BLOCK LETTERING OVER A CURVY LINE WITH TWO HORIZONTAL SHAPES ON EACH END WITH A BIRD DESIGN OVER THE LETTER "A" IN "BACK" AND THE WORD "LAUNDRY" IN BLOCK LETTERING CENTERED BELOW THE WORDS "BACK" AND "YARD".

SN 85-046,114, FILED 5-24-2010.

LAURIE KAUFMAN, EXAMINING ATTORNEY



David J. Kybas

Director of the United States Patent and Trademark Office

United States of America

United States Patent and Trademark Office

PREVATHON

Reg. No. 4,074,804

Registered Dec. 20, 2011

Int. Cl.: 5

TRADEMARK

PRINCIPAL REGISTER

E. I. DU PONT DE NEMOURS AND COMPANY (DELAWARE CORPORATION)
1007 MARKET STREET
WILMINGTON, DE 19898

FOR: INSECTICIDES FOR USE IN AGRICULTURE, IN CLASS 5 (U.S. CLS. 6, 18, 44, 46, 51 AND 52).

FIRST USE 6-8-2011; IN COMMERCE 6-8-2011.

THE MARK CONSISTS OF STANDARD CHARACTERS WITHOUT CLAIM TO ANY PARTICULAR FONT, STYLE, SIZE, OR COLOR.

SN 85-047,179, FILED 5-25-2010.

JUDITH HELFMAN, EXAMINING ATTORNEY



David J. Kybas

Director of the United States Patent and Trademark Office

United States of America

United States Patent and Trademark Office

GLENMONT CLOCK CO.

Reg. No. 4,074,805

Registered Dec. 20, 2011

Int. Cl.: 14

TRADEMARK

PRINCIPAL REGISTER

PATTON PICTURE COMPANY (OHIO CORPORATION)
207 LYNNDALE COURT
MECHANICSBURG, PA 17050

FOR: CLOCKS, IN CLASS 14 (U.S. CLS. 2, 27, 28 AND 50).

FIRST USE 6-21-2010; IN COMMERCE 6-21-2010.

THE MARK CONSISTS OF STANDARD CHARACTERS WITHOUT CLAIM TO ANY PARTICULAR FONT, STYLE, SIZE, OR COLOR.

NO CLAIM IS MADE TO THE EXCLUSIVE RIGHT TO USE "CLOCK CO.", APART FROM THE MARK AS SHOWN.

SN 85-047,494, FILED 5-25-2010.

CHRISTINA SOBRAL, EXAMINING ATTORNEY



David J. Kybas

Director of the United States Patent and Trademark Office

United States of America

United States Patent and Trademark Office

ADDISON CLOCK CO.

Reg. No. 4,074,806

PATTON PICTURE COMPANY (OHIO CORPORATION)
207 LYNNDALE COURT
MECHANICSBURG, PA 17050

Registered Dec. 20, 2011

Int. Cl.: 14

FOR: CLOCKS, IN CLASS 14 (U.S. CLS. 2, 27, 28 AND 50).

TRADEMARK

FIRST USE 1-12-2010; IN COMMERCE 1-12-2010.

PRINCIPAL REGISTER

THE MARK CONSISTS OF STANDARD CHARACTERS WITHOUT CLAIM TO ANY PARTICULAR FONT, STYLE, SIZE, OR COLOR.

NO CLAIM IS MADE TO THE EXCLUSIVE RIGHT TO USE "CLOCK CO.", APART FROM THE MARK AS SHOWN.

SN 85-047,512, FILED 5-25-2010.

CHRISTINA SOBRAL, EXAMINING ATTORNEY



David J. Kyffers

Director of the United States Patent and Trademark Office

United States of America

United States Patent and Trademark Office

KITCHEN CHOICE

Reg. No. 4,074,807

Registered Dec. 20, 2011

Int. Cl.: 21

TRADEMARK

PRINCIPAL REGISTER

CONAIR CORPORATION (DELAWARE CORPORATION)
ONE CUMMINGS POINT ROAD
STAMFORD, CT 06902

FOR: CUTTING BOARDS, IN CLASS 21 (U.S. CLS. 2, 13, 23, 29, 30, 33, 40 AND 50).

FIRST USE 6-23-2009; IN COMMERCE 6-23-2009.

THE MARK CONSISTS OF STANDARD CHARACTERS WITHOUT CLAIM TO ANY PARTICULAR FONT, STYLE, SIZE, OR COLOR.

OWNER OF U.S. REG. NO. 3,804,100.

NO CLAIM IS MADE TO THE EXCLUSIVE RIGHT TO USE "KITCHEN", APART FROM THE MARK AS SHOWN.

SN 85-048,287, FILED 5-26-2010.

YAT SYE, LEE, EXAMINING ATTORNEY



David J. Kyros

Director of the United States Patent and Trademark Office

United States of America

United States Patent and Trademark Office

CLAUDIA ROSS CONSULTING

Reg. No. 4,074,808

Registered Dec. 20, 2011

Int. Cl.: 35

SERVICE MARK

PRINCIPAL REGISTER

CROSS MARKETING CORP. (CALIFORNIA CORPORATION)
3518 OLIVER COURT
LAFAYETTE, CA 94549

FOR: ADVERTISEMENT AND PUBLICITY SERVICES BY TELEVISION, RADIO, MAIL; ADVERTISING AGENCY SPECIALIZING IN THE DESIGN AND EXECUTION OF WORD OF MOUTH, VIRAL, BUZZ AND EXPERIENTIAL MARKETING PROGRAMS; ADVERTISING AND MARKETING; ADVERTISING AND MARKETING CONSULTANCY; ADVERTISING AND MARKETING SERVICES, NAMELY, PROMOTING THE GOODS AND SERVICES OF OTHERS; ADVERTISING AND PROMOTION SERVICES AND RELATED CONSULTING; ADVERTISING AND PUBLICITY SERVICES; ADVERTISING AND PUBLICITY SERVICES, NAMELY, PROMOTING THE GOODS, SERVICES, BRAND IDENTITY AND COMMERCIAL INFORMATION AND NEWS OF THIRD PARTIES THROUGH PRINT, AUDIO, VIDEO, DIGITAL AND ON-LINE MEDIUM; ADVERTISING BY TRANSMISSION OF ON-LINE PUBLICITY FOR THIRD PARTIES THROUGH ELECTRONIC COMMUNICATIONS NETWORKS; ADVERTISING RELATING TO PHARMACEUTICAL PRODUCTS AND IN-VIVO IMAGING PRODUCTS; ADVERTISING SERVICES, NAMELY, PROMOTING AND MARKETING THE GOODS AND SERVICES OF OTHERS IN THE FIELD OF UPSCALE CHOICES SUCH AS CULTURAL EVENTS, RESTAURANTS, SHOPPING, AND TRAVEL VIA PRINT AND ELECTRONIC MEDIA; ADVERTISING SERVICES, NAMELY, PROMOTING AND MARKETING THE GOODS AND SERVICES OF OTHERS THROUGH ALL PUBLIC COMMUNICATION MEANS; ADVERTISING SERVICES, PUBLIC RELATIONS AND MARKETING SERVICES, NAMELY, PROMOTING AND MARKETING THE GOODS AND SERVICES OF OTHERS THROUGH ALL PUBLIC COMMUNICATION MEANS; ADVERTISING TEXT PUBLICATION SERVICES; ADVERTISING THROUGH ALL PUBLIC COMMUNICATION MEANS; ADVERTISING, INCLUDING PROMOTION RELATING TO THE SALE OF ARTICLES AND SERVICES FOR THIRD PARTIES BY THE TRANSMISSION OF ADVERTISING MATERIAL AND THE DISSEMINATION OF ADVERTISING MESSAGES ON COMPUTER NETWORKS; ADVERTISING, MARKETING AND PROMOTION SERVICES; ADVERTISING, PROMOTION AND MARKETING SERVICES IN THE NATURE OF E-MAIL BLAST CAMPAIGNS FOR OTHERS; BUSINESS MANAGEMENT CONSULTING WITH RELATION TO STRATEGY, MARKETING, PRODUCTION, PERSONNEL AND RETAIL SALE MATTERS; BUSINESS MANAGEMENT CONSULTING WITH RELATION TO STRATEGY, MARKETING, SALES, OPERATION, PRODUCT DESIGN PARTICULARLY SPECIALIZING IN THE USE OF ANALYTIC AND STATISTIC MODELS FOR THE UNDERSTANDING AND PREDICTING OF CONSUMERS, BUSINESSES, AND MARKET TRENDS AND ACTIONS; BUSINESS MARKETING AND DIRECT MAIL CONSULTING SERVICES; BUSINESS MARKETING CONSULTING SER-



David J. Kybas

Director of the United States Patent and Trademark Office

Reg. No. 4,074,808 VICES; BUSINESS MARKETING SERVICES; CONSULTING SERVICES RELATING TO PUBLICITY; DISTRIBUTION OF SAMPLES FOR PUBLICITY PURPOSES; MARKETING CONSULTING; MARKETING PLAN DEVELOPMENT; MARKETING, ADVERTISING AND PROMOTING THE GOODS AND SERVICES OF OTHERS IN THE FIELD OF TRAVEL AND TOURISM, NAMELY, PROVIDING INFORMATION VIA MAIL AND ELECTRONIC MAIL; MARKETING, ADVERTISING, AND PROMOTING THE RETAIL GOODS AND SERVICES OF OTHERS TO WIRELESS ELECTRONIC DEVICES; PROMOTING THE GOODS AND SERVICES OF OTHERS BY MEANS OF WORD-OF-MOUTH AND NONTRADITIONAL MARKETING PROGRAMS; PROMOTION AND MARKETING SERVICES AND RELATED CONSULTING; PROMOTIONAL MARKETING AND REPRESENTATION SERVICES FOR SALES TO THE PUBLIC SECTOR; PROVIDING MARKETING AND PROMOTION OF SPECIAL EVENTS; SPECIAL EVENT PLANNING FOR BUSINESS PURPOSES; SPECIAL EVENT PLANNING FOR COMMERCIAL, PROMOTIONAL OR ADVERTISING PURPOSES, IN CLASS 35 (U.S. CLS. 100, 101 AND 102).

FIRST USE 2-27-2006; IN COMMERCE 2-27-2006.

THE MARK CONSISTS OF STANDARD CHARACTERS WITHOUT CLAIM TO ANY PARTICULAR FONT, STYLE, SIZE, OR COLOR.

NO CLAIM IS MADE TO THE EXCLUSIVE RIGHT TO USE "CONSULTING", APART FROM THE MARK AS SHOWN.

THE NAME(S), PORTRAIT(S), AND/OR SIGNATURE(S) SHOWN IN THE MARK IDENTIFIES "CLAUDIA ROSS", WHOSE CONSENT(S) TO REGISTER IS MADE OF RECORD.

SN 85-049,485, FILED 5-27-2010.

MIDGE BUTLER, EXAMINING ATTORNEY

United States of America

United States Patent and Trademark Office



LA JOLLA GROVES
INSANELY GOOD FOOD, HEALTHIER INGREDIENTS

Reg. No. 4,074,809

Registered Dec. 20, 2011

Int. Cl.: 31

TRADEMARK

PRINCIPAL REGISTER

THE LEMON GROVE RESTAURANT, LLC (UTAH LIMITED LIABILITY COMPANY)
SUITE 420
86 NORTH UNIVERSITY AVENUE
PROVO, UT 84601

FOR: GIFT BASKETS OF FRESH FRUIT, IN CLASS 31 (U.S. CLS. 1 AND 46).

FIRST USE 5-20-2010; IN COMMERCE 5-20-2010.

NO CLAIM IS MADE TO THE EXCLUSIVE RIGHT TO USE "GOOD FOOD" AND "HEALTHIER INGREDIENTS", APART FROM THE MARK AS SHOWN.

THE COLOR(S) YELLOW, GREEN, GREY, BROWN AND BLACK IS/ARE CLAIMED AS A FEATURE OF THE MARK.

THE MARK CONSISTS OF A GREY AND BLACK STONE ARCHWAY AND GREY AND BLACK STONE FENCE WITH THE IMAGE OF A LEMON TREE WITH YELLOW LEMONS AND GREEN LEAVES THAT CAN BE SEEN IN THE DISTANCE THROUGH AND ABOVE THE ARCHWAY THAT IS SET ON THE GROUND IN LIGHT BROWN AND WHICH FADES INTO A LIGHT GREEN BACKGROUND. BELOW THE LEMON TREE AND THE ARCHWAY ARE THE WORDS "LA JOLLA GROVES" IN GREEN, WHICH ARE ABOVE THE WORDS "INSANELY GOOD FOOD, HEALTHIER INGREDIENTS" IN BLACK.

THE WORDING "LA JOLLA" HAS NO MEANING IN ENGLISH.

SN 85-050,413, FILED 5-28-2010.

BERNICE MIDDLETON, EXAMINING ATTORNEY



David J. Kybas

Director of the United States Patent and Trademark Office

United States of America

United States Patent and Trademark Office

PUREWOW

Reg. No. 4,074,810

WOW MEDIA PRODUCTS INC. (DELAWARE CORPORATION)
568 BROADWAY
NEW YORK, NY 10012

Registered Dec. 20, 2011

Int. Cls.: 9, 41, 44, and 45

FOR: DOWNLOADABLE SOFTWARE, NAMELY, MOBILE APPLICATION FOR DISSEMINATION OF INFORMATION, ADVICE, NEWS, CONTENT AND SERVICES RELATED TO ISSUES AFFECTING WOMEN; ELECTRONIC DOWNLOADABLE PUBLICATIONS, NAMELY, NEWSLETTERS FEATURING INFORMATION IN THE FIELD OF WOMEN'S LIFESTYLES, FASHION, HEALTH, WELLNESS, FITNESS, ARTS, CULTURE, BOOKS, FOOD, COOKING, BEAUTY, SKIN CARE, HOME DÉCOR, INTERIOR DESIGN, TRAVEL, PARENTING, CHILDREN, CURRENT EVENTS AND CONSUMER INFORMATION ABOUT GOODS AND SERVICES FOR WOMEN, IN CLASS 9 (U.S. CLS. 21, 23, 26, 36 AND 38).

TRADEMARK

SERVICE MARK

PRINCIPAL REGISTER

FIRST USE 9-5-2010; IN COMMERCE 9-5-2010.

FOR: PROVIDING INFORMATION, NEWS AND COMMENTARY IN THE FIELD OF CURRENT EVENTS RELATING TO WOMEN VIA AN INTERACTIVE WEBSITE; ONLINE NON-DOWNLOADABLE ELECTRONIC PUBLICATIONS, NAMELY, NEWSLETTERS FEATURING INFORMATION IN THE FIELD OF WOMEN'S LIFESTYLES, FASHION, HEALTH, WELLNESS, FITNESS, ARTS, CULTURE, BOOKS, FOOD, COOKING, BEAUTY, SKIN CARE, HOME DÉCOR, INTERIOR DESIGN, TRAVEL, PARENTING, CHILDREN, CURRENT EVENTS AND CONSUMER INFORMATION ABOUT GOODS AND SERVICES FOR WOMEN PROVIDED VIA AN INTERACTIVE WEBSITE AND OTHER ELECTRONIC MEANS INCLUDING ELECTRONIC MAIL AND MESSAGES AND MOBILE WIRELESS FORM; ARRANGING AND CONDUCTING CULTURAL EVENTS AND SPECIAL EVENTS FOR SOCIAL ENTERTAINMENT PURPOSES, IN CLASS 41 (U.S. CLS. 100, 101 AND 107).

FIRST USE 9-5-2010; IN COMMERCE 9-5-2010.

FOR: PROVIDING AN INTERACTIVE WEBSITE FEATURING INFORMATION AND ADVICE RELATED TO WOMEN'S LIFESTYLE WELLNESS AND HEALTH ISSUES AFFECTING WOMEN, IN CLASS 44 (U.S. CLS. 100 AND 101).

FIRST USE 9-5-2010; IN COMMERCE 9-5-2010.



David J. Kyjars

Director of the United States Patent and Trademark Office

Reg. No. 4,074,810 FOR: PROVIDING AN INTERACTIVE WEBSITE FEATURING INFORMATION, ADVICE RELATED TO WOMEN'S LIFESTYLES AND DIVERSE HUMAN CULTURES, BELIEFS, AND LIFESTYLE ISSUES AFFECTING WOMEN, IN CLASS 45 (U.S. CLS. 100 AND 101).

FIRST USE 9-5-2010; IN COMMERCE 9-5-2010.

THE MARK CONSISTS OF STANDARD CHARACTERS WITHOUT CLAIM TO ANY PARTICULAR FONT, STYLE, SIZE, OR COLOR.

SN 85-050,495, FILED 5-28-2010.

HEATHER BIDDULPH, EXAMINING ATTORNEY

United States of America

United States Patent and Trademark Office



Reg. No. 4,074,811

Registered Dec. 20, 2011

Int. Cl.: 9

TRADEMARK

PRINCIPAL REGISTER

SZWEJTYS, TOMMY (UNITED STATES INDIVIDUAL)
66 ORCHARD STREET
YONKERS, NY 10703

FOR: VENDING MACHINES, IN CLASS 9 (U.S. CLS. 21, 23, 26, 36 AND 38).

FIRST USE 8-25-2008; IN COMMERCE 4-27-2011.

THE MARK CONSISTS OF THE WORDS "BREAK" AND "STATION" SEPARATED BY A FORK AND KNIFE IMAGE SURROUNDED BY A CIRCLE ALL OF WHICH IS IN A RECTANGULAR FRAME.

SN 85-050,811, FILED 5-28-2010.

BRETT J. GOLDEN, EXAMINING ATTORNEY



David J. Kybas

Director of the United States Patent and Trademark Office

United States of America

United States Patent and Trademark Office

CUPETTE

Reg. No. 4,074,812

ARTHUR BELOFF (UNITED STATES INDIVIDUAL)
2660 S. OCEAN BLVD. 503-S
PALM BEACH, FL 33480

Registered Dec. 20, 2011

Int. Cl.: 30

FOR: BREAD, IN CLASS 30 (U.S. CL. 46).

TRADEMARK

FIRST USE 3-0-2011; IN COMMERCE 7-12-2011.

PRINCIPAL REGISTER

THE MARK CONSISTS OF STANDARD CHARACTERS WITHOUT CLAIM TO ANY PARTICULAR FONT, STYLE, SIZE, OR COLOR.

SN 85-052,421, FILED 6-2-2010.

KHANH LE, EXAMINING ATTORNEY



David J. Kybas

Director of the United States Patent and Trademark Office

United States of America

United States Patent and Trademark Office

PRORX

Reg. No. 4,074,813

RUBBERMAID COMMERCIAL PRODUCTS LLC (DELAWARE CORPORATION)
3 GLENLAKE PARKWAY
ATLANTA, GA 30328

Registered Dec. 20, 2011

Int. Cl.: 21

FOR: DISPENSER FOR LIQUID SOAPS, CREAMS AND LOTIONS FOR COMMERCIAL USE,
IN CLASS 21 (U.S. CLS. 2, 13, 23, 29, 30, 33, 40 AND 50).

TRADEMARK

FIRST USE 11-12-2010; IN COMMERCE 11-12-2010.

PRINCIPAL REGISTER

THE MARK CONSISTS OF STANDARD CHARACTERS WITHOUT CLAIM TO ANY PAR-
TICULAR FONT, STYLE, SIZE, OR COLOR.

SN 85-052,983, FILED 6-2-2010.

DAVID ELTON, EXAMINING ATTORNEY



David J. Kyfos

Director of the United States Patent and Trademark Office

United States of America

United States Patent and Trademark Office

VEIL

Reg. No. 4,074,814

SILVERTON CASINO, LLC (NEVADA LIMITED LIABILITY COMPANY)
3333 BLUE DIAMOND ROAD
LAS VEGAS, NV 89139

Registered Dec. 20, 2011

Int. Cl.: 43

FOR: ARENA SERVICES, NAMELY, PROVIDING FACILITIES FOR SPORTS, CONCERTS, CONVENTIONS AND EXHIBITIONS; PROVIDING BANQUET AND SOCIAL FUNCTION FACILITIES FOR SPECIAL OCCASIONS, IN CLASS 43 (U.S. CLS. 100 AND 101).

SERVICE MARK

FIRST USE 2-20-2010; IN COMMERCE 2-20-2010.

PRINCIPAL REGISTER

THE MARK CONSISTS OF STANDARD CHARACTERS WITHOUT CLAIM TO ANY PARTICULAR FONT, STYLE, SIZE, OR COLOR.

SN 85-053,349, FILED 6-2-2010.

BRIDGETT SMITH, EXAMINING ATTORNEY



David J. Kyffers

Director of the United States Patent and Trademark Office

United States of America

United States Patent and Trademark Office

FORSYTH OF CANADA INC. SHIRTMAKER SINCE 1903

Reg. No. 4,074,815

FORSYTH OF CANADA, INC. (DELAWARE CORPORATION)
6789 AIRPORT ROAD
MISSISSAUGA, CANADA L4V1N2

Registered Dec. 20, 2011

Int. Cl.: 25

FOR: MEN'S AND WOMEN'S WEARING APPAREL, NAMELY, SHIRTS, BLOUSES, T-SHIRTS, POLO SHIRTS, PULLOVERS, CARDIGANS, SWEATSHIRTS, SWEATPANTS, BLAZERS, VESTS, SKIRTS, DRESSES, SUITS, PANTS, JEANS, SHORTS, COATS, WIND RESISTANT JACKETS, JACKETS, RAINCOATS, HOSIERY, SOCKS, NECKTIES, IN CLASS 25 (U.S. CLS. 22 AND 39).

TRADEMARK

PRINCIPAL REGISTER

FIRST USE 6-30-2000; IN COMMERCE 7-31-2001.

THE MARK CONSISTS OF STANDARD CHARACTERS WITHOUT CLAIM TO ANY PARTICULAR FONT, STYLE, SIZE, OR COLOR.

NO CLAIM IS MADE TO THE EXCLUSIVE RIGHT TO USE "CANADA INC." AND "SHIRTMAKER SINCE 1903", APART FROM THE MARK AS SHOWN.

SN 85-054,370, FILED 6-3-2010.

RENEE SERVANCE, EXAMINING ATTORNEY



David J. Kypos

Director of the United States Patent and Trademark Office

United States of America

United States Patent and Trademark Office

FANVISION

Reg. No. 4,074,816

KANGAROO MEDIA, INC. (CANADA CORPORATION)
11600 LOUIS-BISSON, BLOC A
MIRABEL, QUEBEC J7N1, CANADA

Registered Dec. 20, 2011

Int. Cl.: 41

FOR: RENTAL OF PORTABLE MULTIMEDIA VIEWING TERMINALS, IN CLASS 41 (U.S. CLS. 100, 101 AND 107).

SERVICE MARK

FIRST USE 10-2-2011; IN COMMERCE 10-2-2011.

PRINCIPAL REGISTER

THE MARK CONSISTS OF STANDARD CHARACTERS WITHOUT CLAIM TO ANY PARTICULAR FONT, STYLE, SIZE, OR COLOR.

SN 85-054,505, FILED 6-4-2010.

SETH A. RAPPAPORT, EXAMINING ATTORNEY



David J. Kybas

Director of the United States Patent and Trademark Office

United States of America
United States Patent and Trademark Office

PURECARE

Reg. No. 4,074,817

FABRICTECH 2000, LLC (NEW JERSEY LIMITED LIABILITY COMPANY)
218 LITTLE FALLS RD, SUITE #2
CEDAR GROVE, NJ 07009

Registered Dec. 20, 2011

Int. Cl.: 20

FOR: PILLOWS, IN CLASS 20 (U.S. CLS. 2, 13, 22, 25, 32 AND 50).

TRADEMARK

FIRST USE 7-0-2011; IN COMMERCE 7-0-2011.

PRINCIPAL REGISTER

THE MARK CONSISTS OF STANDARD CHARACTERS WITHOUT CLAIM TO ANY PARTICULAR FONT, STYLE, SIZE, OR COLOR.

SN 85-054,913, FILED 6-4-2010.

KAREN BRACEY, EXAMINING ATTORNEY



David J. Kyffers

Director of the United States Patent and Trademark Office

United States of America

United States Patent and Trademark Office

ChefConnections

Reg. No. 4,074,818

Registered Dec. 20, 2011

Int. Cl.: 41

SERVICE MARK

PRINCIPAL REGISTER

CHEFADVANTAGE, INC. (GEORGIA CORPORATION)
SUITE 305
975 COBB PLACE BOULEVARD
KENNESAW, GA 30144

FOR: EDUCATIONAL SERVICES, NAMELY, CONDUCTING AND PROVIDING SEMINARS, WORKSHOPS, TUTORING, AND MENTORING IN THE FIELD OF FOOD SERVICE AND NUTRITION FOR STUDENTS AND TEACHERS OF ALL GRADE LEVELS AND ACADEMIC AREAS AND DISTRIBUTION OF PRINTED MATERIALS IN CONNECTION THEREWITH IN HARD COPY OR ELECTRONIC FORMAT ON THE SAME TOPICS, IN CLASS 41 (U.S. CLS. 100, 101 AND 107).

FIRST USE 1-1-2010; IN COMMERCE 1-1-2010.

THE MARK CONSISTS OF STANDARD CHARACTERS WITHOUT CLAIM TO ANY PARTICULAR FONT, STYLE, SIZE, OR COLOR.

SN 85-057,193, FILED 6-8-2010.

PAUL MORENO, EXAMINING ATTORNEY



David J. Kyros

Director of the United States Patent and Trademark Office

United States of America

United States Patent and Trademark Office

GOLD MEDAL CONSULTANCY

Reg. No. 4,074,819

FREEMAN III, CLAUDE (UNITED STATES INDIVIDUAL)
1273 JUHL STREET
EUGENE, OR 97402

Registered Dec. 20, 2011

Int. Cl.: 35

FOR: BUSINESS DEVELOPMENT CONSULTATION SERVICES IN THE FIELD OF INTERNATIONAL AGRICULTURE, IN CLASS 35 (U.S. CLS. 100, 101 AND 102).

SERVICE MARK

FIRST USE 9-0-2011; IN COMMERCE 9-0-2011.

PRINCIPAL REGISTER

THE MARK CONSISTS OF STANDARD CHARACTERS WITHOUT CLAIM TO ANY PARTICULAR FONT, STYLE, SIZE, OR COLOR.

NO CLAIM IS MADE TO THE EXCLUSIVE RIGHT TO USE "CONSULTANCY", APART FROM THE MARK AS SHOWN.

SN 85-057,265, FILED 6-8-2010.

CHRISTINE COOPER, EXAMINING ATTORNEY



David J. Kybas

Director of the United States Patent and Trademark Office

United States of America

United States Patent and Trademark Office

prOrize
PRICING INTELLIGENCE

Reg. No. 4,074,820

Registered Dec. 20, 2011

Int. Cl.: 9

PRORIZE PRICING INTELLIGENCE (GEORGIA LIMITED LIABILITY COMPANY), DBA
PRORIZE LLC,
SUITE 400
3399 PEACHTREE RD NE
ATLANTA, GA 30326

TRADEMARK

PRINCIPAL REGISTER

FOR: COMPUTER SOFTWARE FOR COMPUTER SYSTEM AND APPLICATION DEVELOPMENT, DEPLOYMENT AND MANAGEMENT; COMPUTER SOFTWARE FOR PROVIDING AN ON-LINE DATABASE IN THE FIELD OF TRANSACTION PROCESSING TO UPLOAD TRANSACTIONAL DATA, PROVIDE STATISTICAL ANALYSIS, AND PRODUCE NOTIFICATIONS AND REPORTS; COMPUTER SOFTWARE THAT PROVIDES REAL-TIME, INTEGRATED BUSINESS MANAGEMENT INTELLIGENCE BY COMBINING INFORMATION FROM VARIOUS DATABASES AND PRESENTING IT IN AN EASY-TO-UNDERSTAND USER INTERFACE, IN CLASS 9 (U.S. CLS. 21, 23, 26, 36 AND 38).

FIRST USE 10-1-2011; IN COMMERCE 10-2-2011.

NO CLAIM IS MADE TO THE EXCLUSIVE RIGHT TO USE "PRICING INTELLIGENCE", APART FROM THE MARK AS SHOWN.

THE COLOR(S) BLACK AND ORANGE IS/ARE CLAIMED AS A FEATURE OF THE MARK.

THE MARK CONSISTS OF THE STYLIZED WORDING "PRORIZE" IN BLACK HAVING THE LETTER "O" CONSISTING OF AN INCOMPLETE CIRCLE WITH AN ORANGE CRESCENT-SHAPED BAND PROJECTING OUTWARD FROM THE CENTER; BELOW IS THE STYLIZED WORDING "PRICING INTELLIGENCE" IN ORANGE.

SN 85-058,704, FILED 6-9-2010.

JULIE GUTTADAURO, EXAMINING ATTORNEY



David J. Kyffers

Director of the United States Patent and Trademark Office

United States of America

United States Patent and Trademark Office



Reg. No. 4,074,821

O'CONNOR, THOMAS (UNITED STATES INDIVIDUAL)
15516 WEST 80TH STREET
LENEXA, KS 66219

Registered Dec. 20, 2011

Int. Cl.: 36

FOR: ADMINISTRATION OF EMPLOYEE BENEFIT PLANS CONCERNING INSURANCE AND FINANCE, IN CLASS 36 (U.S. CLS. 100, 101 AND 102).

SERVICE MARK

FIRST USE 3-1-2010; IN COMMERCE 4-1-2010.

PRINCIPAL REGISTER

NO CLAIM IS MADE TO THE EXCLUSIVE RIGHT TO USE "BENEFITS ADVISORS", APART FROM THE MARK AS SHOWN.

THE MARK CONSISTS OF THE STYLIZED WORDING "WELLSTONE BENEFITS ADVISORS" TO THE LEFT OF THE DESIGN OF FOUR STONES.

SN 85-059,358, FILED 6-10-2010.

KIM SAITO, EXAMINING ATTORNEY



David J. Kybas

Director of the United States Patent and Trademark Office

United States of America

United States Patent and Trademark Office

MIRACLE GUTTER GUARD

Reg. No. 4,074,822

Registered Dec. 20, 2011

Int. Cl.: 19

TRADEMARK

PRINCIPAL REGISTER

GUTTERFILTER COMPANY, L.L.C. (MICHIGAN LIMITED LIABILITY COMPANY), DBA
GUTTERFILTER COMPANY,
2773 SHIRE STREET
GRAND RAPIDS, MI 49534

FOR: NON-METAL POROUS GUTTER PROTECTOR, IN CLASS 19 (U.S. CLS. 1, 12, 33 AND 50).

FIRST USE 10-6-2011; IN COMMERCE 10-6-2011.

THE MARK CONSISTS OF STANDARD CHARACTERS WITHOUT CLAIM TO ANY PARTICULAR FONT, STYLE, SIZE, OR COLOR.

NO CLAIM IS MADE TO THE EXCLUSIVE RIGHT TO USE "GUTTER GUARD", APART FROM THE MARK AS SHOWN.

SN 85-060,006, FILED 6-10-2010.

ALAIN LAPTER, EXAMINING ATTORNEY



David J. Kyfos

Director of the United States Patent and Trademark Office

United States of America

United States Patent and Trademark Office

SUPERSAT

Reg. No. 4,074,823

GROSS, SANFORD M. (UNITED STATES INDIVIDUAL)

Registered Dec. 20, 2011

P.O. BOX 141
STEVENSON, MD 21153

Int. Cl.: 9

FOR: HIGH FIDELITY AUDIO EQUIPMENT SPECIFICALLY LOUDSPEAKERS AND LOUDSPEAKER SYSTEMS, IN CLASS 9 (U.S. CLS. 21, 23, 26, 36 AND 38).

TRADEMARK

FIRST USE 12-7-2010; IN COMMERCE 12-7-2010.

PRINCIPAL REGISTER

THE MARK CONSISTS OF STANDARD CHARACTERS WITHOUT CLAIM TO ANY PARTICULAR FONT, STYLE, SIZE, OR COLOR.

SN 85-060,300, FILED 6-11-2010.

MARY CRAWFORD, EXAMINING ATTORNEY



David J. Kybas

Director of the United States Patent and Trademark Office

United States of America

United States Patent and Trademark Office

Life Step UL

Reg. No. 4,074,824

BANNER LIFE INSURANCE COMPANY (MARYLAND CORPORATION)
3275 BENNETT CREEK AVENUE
FREDERICK, MD 21704

Registered Dec. 20, 2011

Int. Cl.: 36

FOR: INSURANCE SERVICES, NAMELY, UNDERWRITING, ISSUING AND ADMINISTRATION OF LIFE INSURANCE, IN CLASS 36 (U.S. CLS. 100, 101 AND 102).

SERVICE MARK

FIRST USE 11-1-2010; IN COMMERCE 11-1-2010.

PRINCIPAL REGISTER

THE MARK CONSISTS OF STANDARD CHARACTERS WITHOUT CLAIM TO ANY PARTICULAR FONT, STYLE, SIZE, OR COLOR.

NO CLAIM IS MADE TO THE EXCLUSIVE RIGHT TO USE "LIFE" AND "UL", APART FROM THE MARK AS SHOWN.

SN 85-060,832, FILED 6-11-2010.

KATHERINE M. DUBRAY, EXAMINING ATTORNEY



David J. Kybas

Director of the United States Patent and Trademark Office

United States of America

United States Patent and Trademark Office

Life Step UL 121

Reg. No. 4,074,825

BANNER LIFE INSURANCE COMPANY (MARYLAND CORPORATION)
3275 BENNETT CREEK AVENUE
FREDERICK, MD 20714

Registered Dec. 20, 2011

Int. Cl.: 36

FOR: INSURANCE SERVICES, NAMELY, UNDERWRITING, ISSUING AND ADMINISTRATION OF LIFE INSURANCE, IN CLASS 36 (U.S. CLS. 100, 101 AND 102).

SERVICE MARK

FIRST USE 11-1-2010; IN COMMERCE 11-1-2010.

PRINCIPAL REGISTER

THE MARK CONSISTS OF STANDARD CHARACTERS WITHOUT CLAIM TO ANY PARTICULAR FONT, STYLE, SIZE, OR COLOR.

NO CLAIM IS MADE TO THE EXCLUSIVE RIGHT TO USE "LIFE" AND "UL 121", APART FROM THE MARK AS SHOWN.

SN 85-060,934, FILED 6-11-2010.

KATHERINE M. DUBRAY, EXAMINING ATTORNEY



David J. Kybas

Director of the United States Patent and Trademark Office

United States of America

United States Patent and Trademark Office

BIG BITE

Reg. No. 4,074,826

LEM PRODUCTS LLC (OHIO LIMITED LIABILITY COMPANY)
109 MAY DRIVE
HARRISON, OH 45030

Registered Dec. 20, 2011

Int. Cl.: 7

FOR: POWER-OPERATED MEAT GRINDERS AND MEAT AUGERS, IN CLASS 7 (U.S. CLS. 13, 19, 21, 23, 31, 34 AND 35).

TRADEMARK

FIRST USE 10-1-2011; IN COMMERCE 10-1-2011.

PRINCIPAL REGISTER

THE MARK CONSISTS OF STANDARD CHARACTERS WITHOUT CLAIM TO ANY PARTICULAR FONT, STYLE, SIZE, OR COLOR.

SN 85-061,843, FILED 6-14-2010.

GRETTA YAO, EXAMINING ATTORNEY



David J. Kybas

Director of the United States Patent and Trademark Office

United States of America

United States Patent and Trademark Office



Reg. No. 4,074,827

Registered Dec. 20, 2011

Int. Cl.: 36

SERVICE MARK

PRINCIPAL REGISTER

LIU, YUNG-SUNG (TAIWAN INDIVIDUAL)
ROOM B, 52F
NO7, SEC5, XIN YI RD
TAIPEI, TAIWAN 110

FOR: PRECIOUS METAL AND PRECIOUS METAL ALLOY APPRAISAL; PRECIOUS METAL TRINKET APPRAISAL; JEWEL AND JEWEL TRINKET APPRAISAL; JEWELRY AND SYNTHETIC JEWELRY APPRAISAL; PRECIOUS AND SEMI-PRECIOUS STONE APPRAISAL; CLOCK AND WATCH APPRAISAL, IN CLASS 36 (U.S. CLS. 100, 101 AND 102).

FIRST USE 3-16-2008; IN COMMERCE 12-1-2010.

THE MARK CONSISTS OF AN IMAGE OF A DESIGN DIAMOND TO THE RIGHT OF THE LETTERS "DSC".

SN 85-062,746, FILED 6-15-2010.

SHARON MEIER, EXAMINING ATTORNEY



David J. Kybas

Director of the United States Patent and Trademark Office

United States of America

United States Patent and Trademark Office



Reg. No. 4,074,828

PURE GLASS BOTTLE INC. (MARYLAND CORPORATION)
65 BEECHAM COURT
OWNINGS MILLS, MD 21117

Registered Dec. 20, 2011

Int. Cl.: 21

FOR: SAFETY COATED GLASS DRINKING BOTTLE, IN CLASS 21 (U.S. CLS. 2, 13, 23, 29, 30, 33, 40 AND 50).

TRADEMARK

FIRST USE 1-3-2011; IN COMMERCE 1-3-2011.

PRINCIPAL REGISTER

NO CLAIM IS MADE TO THE EXCLUSIVE RIGHT TO USE "PURE PUREGLASS-BOTTLE.COM REUSABLE DISHWASHER SAFE SHATTER RESISTANT", APART FROM THE MARK AS SHOWN.

THE COLOR(S) BLUE IS/ARE CLAIMED AS A FEATURE OF THE MARK.

THE MARK CONSISTS OF THE BLUE WORD "PURE" WITH 3 WAVY BLUE LINES TO THE RIGHT, ABOVE THE BLUE WORDS "PUREGLASSBOTTLE.COM (REUSABLE - DISHWASHER SAFE - SHATTER RESISTANT)".

SN 85-062,916, FILED 6-15-2010.

RONALD AIKENS, EXAMINING ATTORNEY



David J. Kybas

Director of the United States Patent and Trademark Office

United States of America

United States Patent and Trademark Office



Reg. No. 4,074,829

SOUP COWBOY LLC (TEXAS LIMITED LIABILITY COMPANY)
3411 RICHMOND AVENUE, SUITE 420
HOUSTON, TX 77046

Registered Dec. 20, 2011

Int. Cl.: 43

FOR: RESTAURANT SERVICES, IN CLASS 43 (U.S. CLS. 100 AND 101).

SERVICE MARK

FIRST USE 7-13-2011; IN COMMERCE 7-13-2011.

PRINCIPAL REGISTER

NO CLAIM IS MADE TO THE EXCLUSIVE RIGHT TO USE "SOUP", APART FROM THE MARK AS SHOWN.

THE MARK CONSISTS OF THE IMAGE OF A COWBOY BENT OVER AND STIRRING A COOKING POT ON A CAMPFIRE CENTERED ABOVE THE WORD "SOUP" WHICH IS CENTERED OVER THE WORD "COWBOY".

SN 85-063,872, FILED 6-15-2010.

ZACHARY BELLO, EXAMINING ATTORNEY



David J. Kybas

Director of the United States Patent and Trademark Office

United States of America

United States Patent and Trademark Office



Reg. No. 4,074,830

SOUP COWBOY LLC (TEXAS LIMITED LIABILITY COMPANY)
3411 RICHMOND AVENUE, SUITE 420
HOUSTON, TX 77046

Registered Dec. 20, 2011

Int. Cl.: 43

FOR: RESTAURANT SERVICES, IN CLASS 43 (U.S. CLS. 100 AND 101).

SERVICE MARK

FIRST USE 7-13-2011; IN COMMERCE 7-13-2011.

PRINCIPAL REGISTER

NO CLAIM IS MADE TO THE EXCLUSIVE RIGHT TO USE "SOUP", APART FROM THE MARK AS SHOWN.

THE MARK CONSISTS OF A FANCIFUL DESIGN OF A COWBOY BENT OVER AND STIRRING A COOKING POT ON A CAMPFIRE CENTERED BETWEEN THE WORDS "SOUP" AND "COWBOY" WITH A ROPE DESIGN UNDERLINING THE WORDS.

SN 85-063,873, FILED 6-15-2010.

ZACHARY BELLO, EXAMINING ATTORNEY



David J. Kyros

Director of the United States Patent and Trademark Office

United States of America

United States Patent and Trademark Office

GLITCH

Reg. No. 4,074,831

TINY SPECK, INC. (DELAWARE CORPORATION)
360 CLEMENTINA ST.
SAN FRANCISCO, CA 94103

Registered Dec. 20, 2011

Int. Cl.: 41

FOR: ENTERTAINMENT SERVICES, NAMELY, PROVIDING ONLINE MULTIPLAYER COMPUTER GAMES, IN CLASS 41 (U.S. CLS. 100, 101 AND 107).

SERVICE MARK

FIRST USE 2-9-2010; IN COMMERCE 2-9-2010.

PRINCIPAL REGISTER

THE MARK CONSISTS OF STANDARD CHARACTERS WITHOUT CLAIM TO ANY PARTICULAR FONT, STYLE, SIZE, OR COLOR.

SN 85-064,218, FILED 6-16-2010.

SETH A. RAPPAPORT, EXAMINING ATTORNEY



David J. Kybas

Director of the United States Patent and Trademark Office

United States of America

United States Patent and Trademark Office

GOODWELL'S

Reg. No. 4,074,832

Registered Dec. 20, 2011

Int. Cl.: 30

TRADEMARK

PRINCIPAL REGISTER

TEC FOODS, INC. (ILLINOIS CORPORATION)
4300 WEST OHIO STREET
CHICAGO, IL 60624

FOR: PANCAKE MIX, IN CLASS 30 (U.S. CL. 46).

FIRST USE 6-0-2011; IN COMMERCE 6-0-2011.

THE MARK CONSISTS OF STANDARD CHARACTERS WITHOUT CLAIM TO ANY PARTICULAR FONT, STYLE, SIZE, OR COLOR.

SN 85-064,309, FILED 6-16-2010.

WENDY JUN, EXAMINING ATTORNEY



David J. Kyros

Director of the United States Patent and Trademark Office

United States of America

United States Patent and Trademark Office

PRESTOLINK

Reg. No. 4,074,833

PRESTOLITE WIRE LLC (DELAWARE LIMITED LIABILITY COMPANY)
200 GALLERIA OFFICENTRE, SUITE 212
SOUTHFIELD, MI 48034

Registered Dec. 20, 2011

Int. Cl.: 9

FOR: ELECTRIC WIRES; ELECTRICAL CABLES, IN CLASS 9 (U.S. CLS. 21, 23, 26, 36 AND 38).

TRADEMARK

FIRST USE 10-0-2010; IN COMMERCE 10-0-2010.

PRINCIPAL REGISTER

THE MARK CONSISTS OF STANDARD CHARACTERS WITHOUT CLAIM TO ANY PARTICULAR FONT, STYLE, SIZE, OR COLOR.

SN 85-064,440, FILED 6-16-2010.

KARANENDRA S. CHHINA, EXAMINING ATTORNEY



David J. Kybas

Director of the United States Patent and Trademark Office

United States of America

United States Patent and Trademark Office

HD Crystal Film

Reg. No. 4,074,834

POWER SUPPORT USA, INC. (CALIFORNIA CORPORATION)
3202 W. MAGNOLIA BLVD
BURBANK, CA 91505

Registered Dec. 20, 2011

Int. Cl.: 9

FOR: PROTECTIVE FILM, NAMELY, FITTED PLASTIC FILMS KNOWN AS SKINS FOR COVERING AND PROVIDING A SCRATCH PROOF BARRIER OR PROTECTION FOR ELECTRIC DEVICES, NAMELY, MP3 PLAYERS, MOBILE TELEPHONES, SMART TELEPHONES, DIGITAL CAMERAS, GLOBAL POSITIONING SYSTEMS AND PERSONAL DIGITAL ASSISTANTS, LAPTOPS AND PORTABLE MEDIA PLAYERS, PORTABLE VIDEO PLAYERS, PORTABLE MUSIC PLAYERS AND GLOBAL POSITIONING SYSTEMS; PROTECTIVE SHEETS OF FILMS FOR CELL PHONES, LAPTOPS AND PORTABLE MEDIA PLAYERS, PORTABLE VIDEO PLAYERS, PORTABLE MUSIC PLAYERS, MP3 PLAYERS, SMART TELEPHONES, DIGITAL CAMERAS, GLOBAL POSITIONING SYSTEMS AND PERSONAL DIGITAL ASSISTANTS, IN CLASS 9 (U.S. CLS. 21, 23, 26, 36 AND 38).

TRADEMARK

PRINCIPAL REGISTER

FIRST USE 7-1-2010; IN COMMERCE 7-1-2010.

THE MARK CONSISTS OF STANDARD CHARACTERS WITHOUT CLAIM TO ANY PARTICULAR FONT, STYLE, SIZE, OR COLOR.

NO CLAIM IS MADE TO THE EXCLUSIVE RIGHT TO USE "HD" AND "FILM", APART FROM THE MARK AS SHOWN.

SN 85-065,867, FILED 6-17-2010.

EUGENIA MARTIN, EXAMINING ATTORNEY



David J. Kyros

Director of the United States Patent and Trademark Office

United States of America

United States Patent and Trademark Office

TROON GOLF VACATIONS

Reg. No. 4,074,835

Registered Dec. 20, 2011

Int. Cls.: 41 and 43

SERVICE MARK

PRINCIPAL REGISTER

TROON GOLF, L.L.C. (DELAWARE LIMITED LIABILITY COMPANY)
SUITE 300
15044 NORTH SCOTTSDALE ROAD
SCOTTSDALE, AZ 85254

FOR: ARRANGING GOLF VACATIONS PACKAGES, NAMELY, MAKING RESERVATIONS FOR TEE TIMES AT GOLF COURSES, IN CLASS 41 (U.S. CLS. 100, 101 AND 107).

FIRST USE 11-1-2011; IN COMMERCE 11-1-2011.

FOR: ARRANGING GOLF VACATIONS PACKAGES, NAMELY, MAKING RESERVATIONS AND BOOKING FOR TEMPORARY LODGING, RESTAURANTS AND MEALS AT A GOLF RESORT, IN CLASS 43 (U.S. CLS. 100 AND 101).

FIRST USE 11-1-2011; IN COMMERCE 11-1-2011.

THE MARK CONSISTS OF STANDARD CHARACTERS WITHOUT CLAIM TO ANY PARTICULAR FONT, STYLE, SIZE, OR COLOR.

OWNER OF U.S. REG. NOS. 2,299,833, 3,372,598, AND OTHERS.

NO CLAIM IS MADE TO THE EXCLUSIVE RIGHT TO USE "GOLF VACATIONS", APART FROM THE MARK AS SHOWN.

SN 85-066,380, FILED 6-18-2010.

JENNIFER MARTIN, EXAMINING ATTORNEY



David J. Kybas

Director of the United States Patent and Trademark Office

United States of America

United States Patent and Trademark Office

CITRACHARGE

Reg. No. 4,074,836

NUVO RESIDENTIAL, LLC (UTAH LIMITED LIABILITY COMPANY)
6740 SOUTH 1300 EAST, STE 250
SALT LAKE CITY, UT 84121

Registered Dec. 20, 2011

Int. Cl.: 3

FOR: WATER CONDITIONING ADDITIVE FOR CLEANING AND PREVENTING BUILD UP OF HARD WATER SCALE IN WATER-USING APPLIANCES, AROUND WATER SOURCES, AND IN LIQUID-CARRYING CONTAINERS, IN CLASS 3 (U.S. CLS. 1, 4, 6, 50, 51 AND 52).

TRADEMARK

PRINCIPAL REGISTER

FIRST USE 11-10-2010; IN COMMERCE 11-10-2010.

THE MARK CONSISTS OF STANDARD CHARACTERS WITHOUT CLAIM TO ANY PARTICULAR FONT, STYLE, SIZE, OR COLOR.

SN 85-066,690, FILED 6-18-2010.

JOSETTE BEVERLY, EXAMINING ATTORNEY



David J. Kyros

Director of the United States Patent and Trademark Office

United States of America

United States Patent and Trademark Office

TRI-O

Reg. No. 4,074,837

Registered Dec. 20, 2011

Int. Cl.: 10

TRADEMARK

PRINCIPAL REGISTER

MOMENTUM MANAGEMENT, LLC (CALIFORNIA LIMITED LIABILITY COMPANY), DBA
BUSHMAN PRODUCTS,
1206 W. JON STREET
TORRANCE, CA 90502

FOR: ADULT SEXUAL AIDS, NAMELY, VIBRATING RUBBER RINGS FOR THE PENIS,
VIBRATORS, CONDOMS, IN CLASS 10 (U.S. CLS. 26, 39 AND 44).

FIRST USE 5-6-2008; IN COMMERCE 5-6-2008.

THE MARK CONSISTS OF STANDARD CHARACTERS WITHOUT CLAIM TO ANY PAR-
TICULAR FONT, STYLE, SIZE, OR COLOR.

SN 85-066,712, FILED 6-18-2010.

REGINA DRUMMOND, EXAMINING ATTORNEY



David J. Kybas

Director of the United States Patent and Trademark Office

United States of America

United States Patent and Trademark Office

BONG-O

Reg. No. 4,074,838

Registered Dec. 20, 2011

Int. Cl.: 10

TRADEMARK

PRINCIPAL REGISTER

MOMENTUM MANAGEMENT, LLC (CALIFORNIA LIMITED LIABILITY COMPANY), DBA
BUSHMAN PRODUCTS,
1206 W. JON STREET
TORRANCE, CA 90502

FOR: ADULT SEXUAL AIDS, NAMELY, VIBRATING RUBBER RINGS FOR THE PENIS,
VIBRATORS, CONDOMS, IN CLASS 10 (U.S. CLS. 26, 39 AND 44).

FIRST USE 1-3-2008; IN COMMERCE 1-3-2008.

THE MARK CONSISTS OF STANDARD CHARACTERS WITHOUT CLAIM TO ANY PAR-
TICULAR FONT, STYLE, SIZE, OR COLOR.

SN 85-066,717, FILED 6-18-2010.

REGINA DRUMMOND, EXAMINING ATTORNEY



David J. Kyros

Director of the United States Patent and Trademark Office

United States of America

United States Patent and Trademark Office

O WOW

Reg. No. 4,074,839

Registered Dec. 20, 2011

Int. Cl.: 10

TRADEMARK

PRINCIPAL REGISTER

MOMENTUM MANAGEMENT, LLC (CALIFORNIA LIMITED LIABILITY COMPANY), DBA
BUSHMAN PRODUCTS,
1206 W. JON STREET
TORRANCE, CA 90502

FOR: ADULT SEXUAL AIDS, NAMELY, VIBRATING RUBBER RINGS FOR THE PENIS,
VIBRATORS, CONDOMS, IN CLASS 10 (U.S. CLS. 26, 39 AND 44).

FIRST USE 1-3-2008; IN COMMERCE 1-3-2008.

THE MARK CONSISTS OF STANDARD CHARACTERS WITHOUT CLAIM TO ANY PAR-
TICULAR FONT, STYLE, SIZE, OR COLOR.

SN 85-066,725, FILED 6-18-2010.

REGINA DRUMMOND, EXAMINING ATTORNEY



David J. Kybas

Director of the United States Patent and Trademark Office

United States of America

United States Patent and Trademark Office

RICH TEXAN

Reg. No. 4,074,840

HOUSTON, NORMAN J. (UNITED STATES INDIVIDUAL)
8100 CYPRESSWOOD DR., APT. 516
SPRING, TX 77379

Registered Dec. 20, 2011

Int. Cl.: 41

FOR: ENTERTAINMENT SERVICES, NAMELY, CONDUCTING LIVE POKER GAMES;
PROVIDING ON-LINE POKER GAMES, IN CLASS 41 (U.S. CLS. 100, 101 AND 107).

SERVICE MARK

FIRST USE 11-25-2010; IN COMMERCE 10-22-2011.

PRINCIPAL REGISTER

THE MARK CONSISTS OF STANDARD CHARACTERS WITHOUT CLAIM TO ANY PARTICULAR FONT, STYLE, SIZE, OR COLOR.

OWNER OF U.S. REG. NOS. 3,536,300, 3,817,518, AND OTHERS.

NO CLAIM IS MADE TO THE EXCLUSIVE RIGHT TO USE "TEXAN", APART FROM THE MARK AS SHOWN.

SN 85-067,104, FILED 6-19-2010.

BARBARA A. GOLD, EXAMINING ATTORNEY



David J. Kyros

Director of the United States Patent and Trademark Office

United States of America

United States Patent and Trademark Office

Baker Shake

Reg. No. 4,074,841

RW BAKER COMPANY INC (CALIFORNIA CORPORATION)
8930 SWITZER DR
SPRING VALLEY, CA 91977

Registered Dec. 20, 2011

Int. Cl.: 30

FOR: FLAVOURINGS AND SEASONINGS, IN CLASS 30 (U.S. CL. 46).

TRADEMARK

FIRST USE 6-1-2009; IN COMMERCE 9-1-2010.

PRINCIPAL REGISTER

THE MARK CONSISTS OF STANDARD CHARACTERS WITHOUT CLAIM TO ANY PARTICULAR FONT, STYLE, SIZE, OR COLOR.

NO CLAIM IS MADE TO THE EXCLUSIVE RIGHT TO USE "BAKER", APART FROM THE MARK AS SHOWN.

SN 85-069,485, FILED 6-23-2010.

STEVEN PEREZ, EXAMINING ATTORNEY



David J. Kyffers

Director of the United States Patent and Trademark Office

United States of America

United States Patent and Trademark Office

INTELLISENSE

Reg. No. 4,074,842

Registered Dec. 20, 2011

Int. Cl.: 9

TRADEMARK

PRINCIPAL REGISTER

WAGNER ELECTRONIC PRODUCTS, INC. (OREGON CORPORATION)
326 PINE GROVE ROAD
ROGUE RIVER, OR 97537

FOR: MOISTURE MEASUREMENT DEVICE, NAMELY, AN ELECTRONIC SENSOR USED FOR MEASURING MOISTURE CONTENT IN WOOD, IN CLASS 9 (U.S. CLS. 21, 23, 26, 36 AND 38).

FIRST USE 10-28-2011; IN COMMERCE 10-28-2011.

THE MARK CONSISTS OF STANDARD CHARACTERS WITHOUT CLAIM TO ANY PARTICULAR FONT, STYLE, SIZE, OR COLOR.

SN 85-069,610, FILED 6-23-2010.

REGINA DRUMMOND, EXAMINING ATTORNEY



David J. Kyffers

Director of the United States Patent and Trademark Office

United States of America

United States Patent and Trademark Office

ISIMPLE GET CONNECTED

Reg. No. 4,074,843

Registered Dec. 20, 2011

Int. Cl.: 9

TRADEMARK

PRINCIPAL REGISTER

AAMP OF FLORIDA, INC. (FLORIDA CORPORATION)
SUITE 401
13190 56TH COURT
CLEARWATER, FL 33760

FOR: AUDIO DEVICES, NAMELY, AMPLIFIER INTEGRATION INTERFACES, AUDIO CABLES, AUDIO EQUALIZERS, AUDIO INTERFACES, AUDIO SIGNAL AMPLIFIERS, AUDIO SIGNAL SWITCHERS, AUXILIARY INPUT DEVICES FOR AUTOMOTIVE RADIOS, BAND-PASS FILTERS FOR USE WITH AUDIO CIRCUITS AND SPEAKER ENCLOSURES, BASS BLOCKERS IN THE NATURE OF A HIGH PASS FILTER THAT ATTENUATES LOWER FREQUENCIES; CD CHANGER INTERFACES, FLOATING GROUND ADAPTERS, FM MODULATED AUDIO RECEIVERS, FM MODULATED AUDIO TRANSMITTERS, HIGH-PASS FILTERS; LINE OUTPUT CONVERTERS, LOWPASS FILTERS, POWER RESISTORS, RADIO FREQUENCY AUDIO RECEIVERS, RADIO FREQUENCY AUDIO TRANSMITTERS, RADIO INSTALLATION INTERFACES, RCA LEVEL ATTENUATORS, RCA LEVEL CONTROLLER, RCA SWITCHER SATELLITE, RADIO INTERFACES, VOLUME CONTROLS; NOISE CONTROL, NAMELY, ANTENNA GROUND LOOP ISOLATORS, CHOKE FILTERS, FILTERING CAPACITORS, POWER LEAD FILTERS; CELL PHONE DEVICES, NAMELY, CELL PHONE INTERFACES, CHARGE CORDS, DOORLOCK INTERFACES; PORTABLE ELECTRONIC INTERFACES, NAMELY, PDA INTERFACES, PORTABLE VIDEO PLAYER INTERFACES; DVD CHANGER INTERFACES, DVD INTERFACES, GAME SYSTEM INTERFACES, IN-CAR ENTERTAINMENT SYSTEM INTERFACES, LCD VIDEO MONITORING INTERFACES, NAVIGATION AUDIO AND RADIO INTERFACES, NAVIGATION SYSTEM INTERFACES, RADIO FREQUENCY AUDIO/VIDEO RECEIVERS, RADIO FREQUENCY AUDIO/VIDEO TRANSMITTERS, RADIO FREQUENCY VIDEO RECEIVERS, RADIO FREQUENCY TRANSMITTERS, VIDEO CABLES, VIDEO SIGNAL AMPLIFIERS, VIDEO SIGNAL SWITCHERS; TIMERS; AUDIO SIGNAL DISTRIBUTION PRODUCTS NAMELY, SIGNAL PROCESSORS, CABLES FOR AUDIO SIGNAL TRANSMISSION; DIGITAL SIGNAL PROCESSORS, AUDIO DEVICES, NAMELY, LINE DRIVERS; SECURITY DEVICES, NAMELY, INDUSTRIAL AUTOMATION AND PROCESS CONTROL SIGNAL TRANSMISSION CABLE DOORLOCK INTERFACES, KEYLESS ENTRY SYSTEMS, NAMELY, ELECTRONIC PROGRAMMABLE KEYLESS ACTIVATION UNLOCKING SYSTEM COMPRISED OF A MICRO-PROCESSOR, SIGNAL DETECTOR AND SIGNAL EMITTER; SHORT RANGE RADIO INTERFACES FOR MOBILE DEVICES; MP3 PLAYER ACCESSORIES AND MP3 PLAYER INTERFACE KITS COMPRISING PLAYER ELECTRICAL POWER CORD AND PLAYER TRANSMITTERS; AUDIOVISUAL DEVICES, NAMELY, VIDEO PROCESSORS; VIDEO SIGNAL DISTRIBUTION PRODUCTS, NAMELY, VIDEO TRANSMISSION APPARATUS;



David J. Kybas

Director of the United States Patent and Trademark Office

Reg. No. 4,074,843 COMPUTER OPERATING SYSTEMS, LOUDSPEAKER SYSTEMS; INTERFACES FOR INDUSTRIAL AUTOMATION AND PROCESS CONTROL SIGNAL TRANSMISSION CABLES; INFRARED CAMERA REPEATERS; INFRARED CAMERA TRANSMITTERS; PULSE GENERATORS FOR TESTING ELECTRIC CURRENT; AND DEVICES FOR HANDS-FREE USE OF MOBILE PHONES, IN CLASS 9 (U.S. CLS. 21, 23, 26, 36 AND 38).

FIRST USE 10-23-2009; IN COMMERCE 10-23-2009.

THE MARK CONSISTS OF STANDARD CHARACTERS WITHOUT CLAIM TO ANY PARTICULAR FONT, STYLE, SIZE, OR COLOR.

OWNER OF U.S. REG. NO. 3,386,693.

SN 85-069,750, FILED 6-23-2010.

KELLY BOULTON, EXAMINING ATTORNEY

United States of America

United States Patent and Trademark Office

EDGEWATER

Reg. No. 4,074,844

EDGEWATER TECHNOLOGY, INC. (DELAWARE CORPORATION)
20 HARVARD MILL SQUARE
WAKEFIELD, MA 01880

Registered Dec. 20, 2011

Int. Cl.: 9

FOR: COMPUTER SOFTWARE FOR USE IN EXECUTING MAINFRAME AND SERVER APPLICATION PROGRAMS, FOR INTEGRATING THE FINANCIAL, MANUFACTURING AND SALES FUNCTIONS OF A BUSINESS, IN CLASS 9 (U.S. CLS. 21, 23, 26, 36 AND 38).

TRADEMARK

FIRST USE 9-30-2011; IN COMMERCE 9-30-2011.

PRINCIPAL REGISTER

THE MARK CONSISTS OF STANDARD CHARACTERS WITHOUT CLAIM TO ANY PARTICULAR FONT, STYLE, SIZE, OR COLOR.

SN 85-069,957, FILED 6-23-2010.

PAUL E. FAHRENKOPF, EXAMINING ATTORNEY



David J. Kyros

Director of the United States Patent and Trademark Office

United States of America

United States Patent and Trademark Office

NOMAD

Reg. No. 4,074,845

DIRECTV, INC. (CALIFORNIA CORPORATION)
2230 EAST IMPERIAL HWY
EL SEGUNDO, CA 90245

Registered Dec. 20, 2011

Int. Cl.: 38

FOR: TELECOMMUNICATION SERVICES, NAMELY, RECEIVING, TRANSMITTING, AND STREAMING AUDIO, VIDEO, GRAPHICS, IMAGES, DATA AND INFORMATION RECORDED ON DIGITAL VIDEO RECORDERS, IN CLASS 38 (U.S. CLS. 100, 101 AND 104).

SERVICE MARK

FIRST USE 10-6-2011; IN COMMERCE 10-6-2011.

PRINCIPAL REGISTER

THE MARK CONSISTS OF STANDARD CHARACTERS WITHOUT CLAIM TO ANY PARTICULAR FONT, STYLE, SIZE, OR COLOR.

SN 85-070,134, FILED 6-23-2010.

DAYNA BROWNE, EXAMINING ATTORNEY



David J. Kyros

Director of the United States Patent and Trademark Office

United States of America

United States Patent and Trademark Office



Reg. No. 4,074,846

MAXIM INTEGRATED PRODUCTS, INC. (DELAWARE CORPORATION)
120 SAN GABRIEL DRIVE
SUNNYVALE, CA 94086

Registered Dec. 20, 2011

Int. Cl.: 9

FOR: INTEGRATED CIRCUITS; SEMICONDUCTORS, IN CLASS 9 (U.S. CLS. 21, 23, 26, 36 AND 38).

TRADEMARK

FIRST USE 7-17-1984; IN COMMERCE 7-17-1984.

PRINCIPAL REGISTER

OWNER OF U.S. REG. NO. 1,337,707.

THE MARK CONSISTS OF THE WORD "MAXIM" IN STYLIZED CHARACTERS.

SN 85-070,622, FILED 6-24-2010.

CHRISIE B. KING, EXAMINING ATTORNEY



David J. Kyffers

Director of the United States Patent and Trademark Office

United States of America

United States Patent and Trademark Office

histobot

Reg. No. 4,074,847

ASHLEY ARBAUGH (UNITED STATES INDIVIDUAL)
230 RIVERSIDE DR., APT. 18-O
NEW YORK, NY 10025 AND

Registered Dec. 20, 2011

Int. Cl.: 25

MANI HAMEDI (UNITED STATES INDIVIDUAL)
230 RIVERSIDE DR., APT. 18-O
NEW YORK, NY 10025

TRADEMARK

PRINCIPAL REGISTER

FOR: LONG-SLEEVED SHIRTS; LOUNGE PANTS; MATERNITY LEGGINGS, NAMELY, LEGGINGS FEATURING BUILT-IN MATERNITY BANDS; MEN'S SUITS; MEN'S SUITS, WOMEN'S SUITS; PANTS; PARTS OF CLOTHING, NAMELY, GUSSETS FOR TIGHTS, GUSSETS FOR STOCKINGS, GUSSETS FOR BATHING SUITS, GUSSETS FOR UNDERWEAR, GUSSETS FOR LEOTARDS AND GUSSETS FOR FOOTLETS; SHIRT FRONTS; SHIRTS; SKIRT SUITS; SKIRTS; SKIRTS AND DRESSES; SNOW SUITS; SNOWBOARD PANTS; STRETCH PANTS; WIND PANTS; WIND SHIRTS; APPAREL FOR DANCERS, NAMELY, TEE SHIRTS, SWEATSHIRTS, PANTS, LEGGINGS, SHORTS AND JACKETS; ATHLETIC APPAREL, NAMELY, SHIRTS, PANTS, JACKETS, FOOTWEAR, HATS AND CAPS, ATHLETIC UNIFORMS; BATHING COSTUMES FOR WOMEN; BATHING SUITS FOR MEN; BATHING TRUNKS; BODY SHIRTS; BODY SUITS; CAPRI PANTS; CARGO PANTS; DENIMS; HOODED SWEAT SHIRTS; LADIES' UNDERWEAR; LEG-WARMERS; LEGGINGS; LONG UNDERWEAR; NIGHT SHIRTS; POLO SHIRTS; SHIRT YOKES; SLEEP PANTS; SWEAT PANTS; SWEAT SHIRTS; SWEAT SUITS; SWIMMING CAPS; T-SHIRTS; TEE SHIRTS; THERMAL UNDERWEAR; TRACK PANTS; TRACK SUITS; TRAINING SUITS; TURTLE NECK SHIRTS; UNDERWEAR; WARM UP SUITS; WOMEN'S UNDERWEAR; WOVEN OR KNITTED UNDERWEAR; YOGA PANTS; YOGA SHIRTS, IN CLASS 25 (U.S. CLS. 22 AND 39).



FIRST USE 9-1-2011; IN COMMERCE 9-1-2011.

THE MARK CONSISTS OF STANDARD CHARACTERS WITHOUT CLAIM TO ANY PARTICULAR FONT, STYLE, SIZE, OR COLOR.

SN 85-070,898, FILED 6-24-2010.

ERNEST SHOSHO, EXAMINING ATTORNEY

David J. Kyros

Director of the United States Patent and Trademark Office

United States of America

United States Patent and Trademark Office



Reg. No. 4,074,848

Registered Dec. 20, 2011

Int. Cls.: 29 and 30

TRADEMARK

PRINCIPAL REGISTER

ALEX'S MEAT DISTRIBUTORS, CORP. (NEW YORK CORPORATION)
5600 FIRST AVENUE
BROOKLYN, NY 11220

FOR: CANNED FRUITS; CANNED FRUITS AND VEGETABLES; CANNED VEGETABLES; CHEESE; COTTAGE CHEESE; DRIED VEGETABLES; FROZEN FRUITS; FROZEN VEGETABLES; FRUIT PRESERVES; MEAT, FISH, POULTRY AND GAME; PICKLED CUCUMBERS; PICKLED FRUITS; PICKLED VEGETABLES; PICKLES; PRESERVED FRUIT AND VEGETABLES; PRESERVED FRUITS; PROCESSED CHEESE; PROCESSED MEAT; PROCESSED VEGETABLES AND FRUITS; SALTED MEAT; SOFT CHEESE; WHITE CHEESE, IN CLASS 29 (U.S. CL. 46).

FIRST USE 5-1-2011; IN COMMERCE 5-1-2011.

FOR: BARLEY FLOUR; BUCKWHEAT FLOUR; CORNMEAL; CRUSHED BARLEY; FARINA; FLOUR; FROZEN CONFECTIONERY; FROZEN CUSTARDS; FROZEN DESSERT CONSISTING OF FRUIT AND CREAM OR CREAM SUBSTITUTES; OATMEAL; PEARL BARLEY; RICE; SALT; SUGAR, IN CLASS 30 (U.S. CL. 46).

FIRST USE 5-1-2011; IN COMMERCE 5-1-2011.

THE MARK CONSISTS OF THE FOLLOWING: A LANDSCAPE SCENE CONTAINED IN AN IRREGULAR SHAPED SEMI-CIRCLE AND OUTLINED IN ORANGE WITH YELLOW STREAKS IMBEDDED IN THE ORANGE ON THE RIGHT SIDE AND THE BOTTOM OF THE SEMI-CIRCLE; THE LANDSCAPE SCENE HAS A BLUE SKY, WHITE CLOUDS, A BLUE RIVER WHICH TURNS YELLOW TOWARDS THE RIGHT SIDE OF THE SCENE, AND VARIOUS COLOR GREEN ROLLING HILLS; BELOW THE LANDSCAPE SCENE IS THE TERM "PYCCKUU" ABOVE THE TERM "KPAU"; BOTH WORDS ARE IN YELLOW SUPERIMPOSED ON AN ORANGE BACKGROUND.

THE COLOR(S) ORANGE, BLUE, WHITE, GREEN AND YELLOW IS/ARE CLAIMED AS A FEATURE OF THE MARK.

THE NON-LATIN CHARACTERS IN THE MARK TRANSLITERATE TO RUSSKI KRAI AND THIS MEANS RUSSIAN LAND IN ENGLISH.



David J. Kyros

Director of the United States Patent and Trademark Office

SN 85-071,584, FILED 6-25-2010.

Reg. No. 4,074,848 ALAIN LAPTER, EXAMINING ATTORNEY

United States of America

United States Patent and Trademark Office



Eco Build
systems

all eco ♻️ no ego

Reg. No. 4,074,849

Registered Dec. 20, 2011

Int. Cl.: 37

SERVICE MARK

PRINCIPAL REGISTER

ECOBUILD SYSTEMS LLC (FLORIDA LIMITED LIABILITY COMPANY)
31343 ANNISTON DRIVE
WESLEY CHAPEL, FL 33543

FOR: BUILDING CONSTRUCTION; BUILDING CONSTRUCTION AND REPAIR; BUILDING CONSTRUCTION INFORMATION; BUILDING CONSTRUCTION SERVICES; BUILDING CONSTRUCTION SUPERVISION; BUILDING CONSTRUCTION, REMODELING AND REPAIR; BUILDING INSPECTION; CHARITABLE SERVICES, NAMELY, RENOVATING AND CONSTRUCTING HOMES FOR LOW INCOME FAMILIES; CONSTRUCTION AND RENOVATION OF BUILDINGS; CONSTRUCTION AND REPAIR OF BUILDINGS; CONSTRUCTION AND REPAIR OF MOVIE AND THEATRICAL SETS AND SCENERY; CONSTRUCTION CONSULTANCY; CONSTRUCTION CONSULTATION; CONSTRUCTION DEWATERING, NAMELY, THE REMOVAL OF SURFACE WATERS AND GROUNDWATER TO FACILITATE THE CONSTRUCTION OF STRUCTURES AND PIPELINES; CONSTRUCTION GRADING SERVICES; CONSTRUCTION MANAGEMENT; CONSTRUCTION OF AIRPORTS; CONSTRUCTION OF AQUATICS FACILITIES; CONSTRUCTION OF BUILDINGS; CONSTRUCTION PLANNING; CONSTRUCTION PROJECT MANAGEMENT SERVICES; CONSTRUCTION PROJECT MANAGEMENT SERVICES IN THE FIELD OF CONSTRUCTION OF RENEWABLE ENERGY AND ENERGY GENERATION EQUIPMENT SUPPORT STRUCTURES AND ANCILLARY STRUCTURES FOR SUPPORTING METEOROLOGICAL DATA GATHERING EQUIPMENT; CONSTRUCTION SERVICES, NAMELY, CONCRETE PAVING, SITE CLEARING, EXCAVATION, PAD PREPARATION, GRADING, AND ASPHALT PAVING SERVICES; CONSTRUCTION SERVICES, NAMELY, INSTALLATION OF ENVIRONMENTAL CONTAINMENT SYSTEMS; CONSTRUCTION SERVICES, NAMELY, PLANNING, LAYING OUT AND CONSTRUCTION OF A PLANNED RESIDENTIAL COMMUNITY; CONSTRUCTION SERVICES, NAMELY, PLANNING, LAYING OUT AND CUSTOM CONSTRUCTION OF COMMERCIAL BUILDINGS; CONSTRUCTION SERVICES, NAMELY, PLANNING, LAYING OUT AND CUSTOM CONSTRUCTION OF RESIDENTIAL AND COMMERCIAL COMMUNITIES; CONSTRUCTION SUPERVISION; CONSTRUCTION, MAINTENANCE AND RENOVATION OF PROPERTY; CONSULTATION IN BUILDING CONSTRUCTION SUPERVISION; CONSULTATION SERVICES IN THE FIELD OF CONSTRUCTION OF ENVIRONMENTALLY-CONSCIOUS BUILDINGS; CONSULTING IN THE FIELD OF BUILDING CONSTRUCTION; CONSULTING SERVICES FOR THE CONSTRUCTION OF WATER TREATMENT AND PURIFICATION PLANTS, SOLID WASTE TREATMENT PLANTS AND OTHER MUNICIPAL INFRASTRUCTURE FACILITIES; CONSULTING SERVICES IN THE FIELD OF CONSTRUCTION OF WIND ENERGY FACILITIES; CRANE RENTAL AND LEASING FOR CONSTRUCTION PURPOSES; CUSTOM CONSTRUCTION



David J. Kybas

Director of the United States Patent and Trademark Office

Reg. No. 4,074,849 OF HOMES; FACTORY CONSTRUCTION; GENERAL CONSTRUCTION CONTRACTING; HARBOR CONSTRUCTION; HOUSING SERVICES, NAMELY, DEVELOPMENT OF REAL PROPERTY, NAMELY, REPAIR, IMPROVEMENT, AND NEW CONSTRUCTION; HOUSING SERVICES, NAMELY, REPAIR, IMPROVEMENT, AND CONSTRUCTION OF RESIDENTIAL REAL PROPERTY; HYDRO-ELECTRIC FACTORY CONSTRUCTION; INFORMATION CONCERNING RENTAL OF EQUIPMENT FOR CONSTRUCTIONS AND BUILDINGS; LEASING OF CONSTRUCTION EQUIPMENT; PLANT CONSTRUCTION, MAINTENANCE AND CONSTRUCTION PROJECT MANAGEMENT SERVICES FOR BUSINESSES IN THE ENERGY PRODUCTION AND TRANSMISSION SECTOR; PROVIDING ON-LINE INFORMATION TO ASSIST CUSTOMERS IN SELECTING APPROPRIATE FOUNDATIONS FOR CONSTRUCTING AND SUPPORTING STREET LIGHTING STRUCTURES; RENTAL OF CONSTRUCTION AND BUILDING EQUIPMENT; RENTAL OF CONSTRUCTION EQUIPMENT; RENTAL OF CONSTRUCTION MACHINES AND APPARATUS; REPAIR OR MAINTENANCE OF CONSTRUCTION MACHINES AND APPARATUS; RESIDENTIAL AND BUILDING CONSTRUCTION CONSULTING; RESIDENTIAL AND COMMERCIAL BUILDING CONSTRUCTION; SCAFFOLDING, EARTHWORKS OR CONCRETE CONSTRUCTION; SELF-PERFORM CONSTRUCTION SKILLED TRADES, NAMELY, CONCRETE WORK, CARPENTRY AND SELECTIVE DEMOLITION SERVICES; STEEL STRUCTURE CONSTRUCTION WORKS; STREET CONSTRUCTION; TECHNICAL CONSULTATION IN THE FIELD OF BUILDING CONSTRUCTION; UNDERWATER BUILDING AND CONSTRUCTION; WAREHOUSE CONSTRUCTION AND REPAIR, IN CLASS 37 (U.S. CLS. 100, 103 AND 106).

FIRST USE 1-2-2010; IN COMMERCE 1-2-2010.

NO CLAIM IS MADE TO THE EXCLUSIVE RIGHT TO USE "ECO BUILD SYSTEMS" AND "ALL ECO", APART FROM THE MARK AS SHOWN.

THE COLOR(S) GREEN AND GRAY IS/ARE CLAIMED AS A FEATURE OF THE MARK.

THE MARK CONSISTS OF THE STYLIZED WORDING "ECO BUILD SYSTEMS" SET ABOVE THE WORDING "ALL ECO" AND "NO EGO", WITH A LARGE STYLIZED DEPICTION OF A YIN-YANG STYLE SYMBOL FORMED BY TWO OVERLAPPING CURVED BANDS PLACED ABOVE THE WORDING "ECO BUILD SYSTEMS", AND A SMALL STYLIZED DEPICTION OF A YIN-YANG STYLE SYMBOL FORMED BY TWO OVERLAPPING CURVED BANDS PLACED BETWEEN THE WORDING "ALL ECO" AND "NO EGO". THE COLOR GREEN APPEARS IN THE WORDING "ECO BUILD", IN THE WORDING "ALL ECO", IN THE SHADING IN THE HORIZONTAL CURVED BAND IN THE LARGE STYLIZED DEPICTION OF THE YIN-YANG STYLE SYMBOL, AND IN THE SHADING IN THE HORIZONTAL CURVED BAND IN THE SMALL STYLIZED DEPICTION OF THE YIN-YANG STYLE SYMBOL. THE COLOR GRAY APPEARS IN THE WORDING "SYSTEMS", IN THE WORDING "NO EGO", IN THE SHADING IN THE VERTICAL CURVED BAND IN THE LARGE STYLIZED DEPICTION OF THE YIN-YANG STYLE SYMBOL, AND IN THE SHADING IN THE VERTICAL CURVED BAND IN THE SMALL STYLIZED DEPICTION OF THE YIN-YANG STYLE SYMBOL.

SN 85-072,397, FILED 6-26-2010.

MICHAEL GAAFAR, EXAMINING ATTORNEY

United States of America

United States Patent and Trademark Office



Reg. No. 4,074,850

Registered Dec. 20, 2011

Int. Cl.: 28

TRADEMARK

PRINCIPAL REGISTER

JIM PEREZ SCHOOL OF GOLF (CALIFORNIA SOLE PROPRIETORSHIP)
#203
6173 N. FIGARDEN DRIVE
FRESNO, CA 93722

FOR: GOLF BALL MARKERS, IN CLASS 28 (U.S. CLS. 22, 23, 38 AND 50).

FIRST USE 8-0-2010; IN COMMERCE 10-0-2010.

NO CLAIM IS MADE TO THE EXCLUSIVE RIGHT TO USE "GOLFER'S", APART FROM THE MARK AS SHOWN.

THE MARK CONSISTS OF THE WORDS, "GOLFER'S GUIDING LIGHT", IN A SEMI-CIRCLE ENCLOSING THE DESIGN OF A CROSS WITH GOLF CLUBS INSIDE.

SN 85-072,623, FILED 6-28-2010.

BARBARA A. GOLD, EXAMINING ATTORNEY



David J. Kybas

Director of the United States Patent and Trademark Office

United States of America

United States Patent and Trademark Office

78TH STREET

Reg. No. 4,074,851

AGC, LLC (DELAWARE LIMITED LIABILITY COMPANY)
ONE AMERICAN ROAD
CLEVELAND, OH 44144

Registered Dec. 20, 2011

Int. Cl.: 16

FOR: GREETING CARDS, IN CLASS 16 (U.S. CLS. 2, 5, 22, 23, 29, 37, 38 AND 50).

TRADEMARK

FIRST USE 8-31-1986; IN COMMERCE 7-31-2011.

PRINCIPAL REGISTER

THE MARK CONSISTS OF STANDARD CHARACTERS WITHOUT CLAIM TO ANY PARTICULAR FONT, STYLE, SIZE, OR COLOR.

SN 85-072,824, FILED 6-28-2010.

ROBIN MITTLER, EXAMINING ATTORNEY



David J. Kybas

Director of the United States Patent and Trademark Office

United States of America

United States Patent and Trademark Office

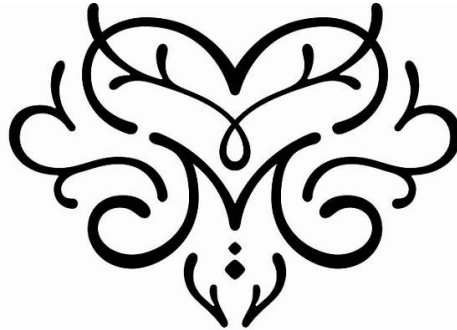

CORAZÓN DE MELÓN

Reg. No. 4,074,852

Registered Dec. 20, 2011

Int. Cl.: 35

SERVICE MARK

PRINCIPAL REGISTER

LABORATORIOS DE MODA S.A. DE C.V (MEXICO CORPORATION)
GRUPO AMPLIO NO. 206, COL. EYUPOL
LEÓN, GUANAJUATO, MEXICO

FOR: CATALOG ORDERING SERVICE FEATURING HANDBAGS, BILLFOLDS, CHANGE PURSES, DOCUMENT SUITCASES, LUGGAGE, TRAVEL BAGS, WALLETS, POCKET WALLETS, SUITCASES, SMALL SUITCASES, BRIEFCASES, PURSES, PANTS, BLOUSES, SHIRTS, T-SHIRTS, UNDERWEAR, SHOES, BELTS, TENNIS SHOES, BRACELETS, TIARAS, HEADBANDS, RINGS, EARRINGS, CHOKERS, NECKLACES, BANGLES, HATS AND SNEAKERS; WHOLESALE AND RETAIL STORE SERVICES AND ON-LINE RETAIL AND WHOLESALE STORE SERVICES FEATURING HANDBAGS, BILLFOLDS, CHANGE PURSES, DOCUMENT SUITCASES, LUGGAGE, TRAVEL BAGS, WALLETS, POCKET WALLETS, SUITCASES, SMALL SUITCASES, BRIEFCASES, PURSES, PANTS, BLOUSES, SHIRTS, T-SHIRTS, UNDERWEAR, SHOES, BELTS, TENNIS SHOES, BRACELETS, TIARAS, HEADBANDS, RINGS, EARRINGS, CHOKERS, NECKLACES, BANGLES, HATS AND SNEAKERS; WHOLESALE DISTRIBUTORSHIPS FEATURING HANDBAGS, BILLFOLDS, CHANGE PURSES, DOCUMENT SUITCASES, LUGGAGE, TRAVEL BAGS, WALLETS, POCKET WALLETS, SUITCASES, SMALL SUITCASES, BRIEFCASES, PURSES, PANTS, BLOUSES, SHIRTS, T-SHIRTS, UNDERWEAR, SHOES, BELTS, TENNIS SHOES, BRACELETS, TIARAS, HEADBANDS, RINGS, EARRINGS, CHOKERS, NECKLACES, BANGLES, HATS AND SNEAKERS, IN CLASS 35 (U.S. CLS. 100, 101 AND 102).

FIRST USE 1-26-2006; IN COMMERCE 9-2-2009.



THE MARK CONSISTS OF AN ABSTRACT DESIGN WHOSE UPPER AREA LOOKS LIKE A HEART AND WHOSE LOWER AREA LOOKS LIKE A STYLIZED CAPITAL LETTER "M". THE DESIGN CONTAINS ADDITIONAL ABSTRACT DECORATIVE ELEMENTS. BENEATH THE DESIGN APPEAR THE WORDS "CORAZÓN DE MELÓN" IN STYLIZED LETTERS.

THE LITERAL TRANSLATION OF THE SPANISH PHRASE "CORAZÓN DE MELÓN" IS "HEART OF MELON". THIS IS A TERM OF ENDEARMENT IN SPANISH.

SN 85-073,043, FILED 6-28-2010.

KIM SAITO, EXAMINING ATTORNEY

David J. Kybas

Director of the United States Patent and Trademark Office

United States of America

United States Patent and Trademark Office



Reg. No. 4,074,853

Registered Dec. 20, 2011

Int. Cl.: 9

TRADEMARK

PRINCIPAL REGISTER

SEEGRID CORPORATION (DELAWARE CORPORATION)
216 RIDC PARK WEST DRIVE
PITTSBURGH, PA 15275

FOR: COMPONENTS FOR INDUSTRIAL MOBILE ROBOTS SOLD AS A KIT PRIMARILY COMPOSED OF A VISION GUIDED NAVIGATION DEVICE HAVING STEREO CAMERAS, COMPUTER HARDWARE AND COMPUTER SOFTWARE FOR CREATING A 3-D REPRESENTATION OF THE ENVIRONMENT SCANNED BY THE STEREO CAMERAS, COMPUTER SOFTWARE AND COMPUTER HARDWARE TO POWER AND GUIDE THE ROBOT, AND A GRAPHICAL OPERATOR INTERFACE, NAMELY, A KEYBOARD AND A COLOR VGA DISPLAY SCREEN, IN CLASS 9 (U.S. CLS. 21, 23, 26, 36 AND 38).

FIRST USE 7-0-2011; IN COMMERCE 7-0-2011.

OWNER OF U.S. REG. NOS. 3,186,929, 3,192,993, AND OTHERS.

THE MARK CONSISTS OF THE WORDS "GUIDED BY SEEGRID" AND APPEARING TO THE LEFT OF THE WORDS, A DESIGN CONSIST OF TWO ANGLED LINES AND A TWO DIMENSIONAL REPRESENTATION OF A CUBE WITH GRID LINES AND A CIRCLE IN THE MIDDLE.

SN 85-076,837, FILED 7-2-2010.

GISELLE AGOSTO, EXAMINING ATTORNEY



David J. Kybas

Director of the United States Patent and Trademark Office

United States of America

United States Patent and Trademark Office

Protohit

Reg. No. 4,074,854

Registered Dec. 20, 2011

Int. Cl.: 42

SERVICE MARK

PRINCIPAL REGISTER

PROTOHIT, INC. (DELAWARE CORPORATION)
4801 LANG AVE. NE, SUITE 110
ALBUQUERQUE, NM 87109

FOR: SOFTWARE AS A SERVICE (SAAS) SERVICES FEATURING SOFTWARE IN THE FIELD OF PATIENT TREATMENT OPTIMIZATION FOR USE BY PHYSICIANS, NURSES, PHYSICAL THERAPISTS, AND OTHER HEALTH CARE PROVIDERS, CLINICS, MANAGED HEALTHCARE ORGANIZATIONS, HEALTH PLAN PROVIDERS, MEDICAL INSURERS, EMPLOYEE ASSISTANCE PLANS, PRIVATE AND PUBLIC EMPLOYERS, SOCIAL WORKERS AND COUNSELORS, THAT ALLOWS USERS TO ENTER, PROCESS AND MANAGE PATIENT-RELATED DATA AND WHICH SOFTWARE COLLECTS AND ANALYZES HEALTH DATA TO DEVELOP, MONITOR AND REPORT EFFECTIVE TREATMENT PROCEDURES AND PROTOCOLS, IN CLASS 42 (U.S. CLS. 100 AND 101).

FIRST USE 8-1-2010; IN COMMERCE 8-1-2010.

THE MARK CONSISTS OF STANDARD CHARACTERS WITHOUT CLAIM TO ANY PARTICULAR FONT, STYLE, SIZE, OR COLOR.

SN 85-077,743, FILED 7-3-2010.

BARBARA GAYNOR, EXAMINING ATTORNEY



David J. Kybas

Director of the United States Patent and Trademark Office

United States of America

United States Patent and Trademark Office

SURECHARGE

Reg. No. 4,074,855

Registered Dec. 20, 2011

Int. Cl.: 11

TRADEMARK

PRINCIPAL REGISTER

NII NORTHERN INTERNATIONAL INC. (CANADA CORPORATION)
SUITE 101
1 BURBRIDGE STREET
COQUITLAM, CANADA V3K7B2

FOR: BATTERY OPERATED ELECTRIC CANDLES, IN CLASS 11 (U.S. CLS. 13, 21, 23, 31 AND 34).

FIRST USE 6-1-2009; IN COMMERCE 6-1-2009.

THE MARK CONSISTS OF STANDARD CHARACTERS WITHOUT CLAIM TO ANY PARTICULAR FONT, STYLE, SIZE, OR COLOR.

SN 85-078,830, FILED 7-6-2010.

MICHAEL SOUDERS, EXAMINING ATTORNEY



David J. Kyffers

Director of the United States Patent and Trademark Office

United States of America

United States Patent and Trademark Office

EZ-CAPS

Reg. No. 4,074,856

NATUREX, INC. (DELAWARE CORPORATION)
375 HUYLER STREET
SOUTH HACKENSACK, NJ 07606

Registered Dec. 20, 2011

Int. Cls.: 3 and 30

FOR: SOAPS, PERFUMES, COSMETICS, ESSENTIAL OILS; NATURAL ESSENTIAL OILS, NAMELY, RAW AROMATIC OLEORESIN; COSMETICS, NAMELY, COSMETIC PRODUCTS IN ALL GALENIC FORMS NOT FOR MEDICAL PURPOSES PRIMARILY COMPRISED OF PLANT EXTRACTS, IN CLASS 3 (U.S. CLS. 1, 4, 6, 50, 51 AND 52).

TRADEMARK

PRINCIPAL REGISTER

FIRST USE 7-0-2010; IN COMMERCE 7-0-2010.

FOR: NUTRITIONAL FOOD ADDITIVES, NOT FOR MEDICAL PURPOSES, MADE FROM COFFEE, TEA, COCOA, SUGAR, RICE, TAPIOCA, SAGO, PASTA, AND CEREALS; FLAVORINGS OTHER THAN ESSENTIAL OILS; AROMATIC PREPARATIONS FOR FOOD, NAMELY, EDIBLE SPICES, PROCESSED HERBS, FLAVOR ENHANCERS USED IN FOOD PRODUCTS, EXTRACTS USED AS FLAVORINGS EXCLUDING ESSENTIAL OILS; NATURAL SWEETENERS; FOOD ESSENCES EXCLUDING ETHEREAL ESSENCES AND ESSENTIAL OILS, NAMELY, COFFEE ESSENCES, IN CLASS 30 (U.S. CL. 46).

FIRST USE 7-0-2010; IN COMMERCE 7-0-2010.

THE MARK CONSISTS OF STANDARD CHARACTERS WITHOUT CLAIM TO ANY PARTICULAR FONT, STYLE, SIZE, OR COLOR.

SN 85-079,798, FILED 7-7-2010.

ANNE FARRELL, EXAMINING ATTORNEY



David J. Kyffers

Director of the United States Patent and Trademark Office

United States of America

United States Patent and Trademark Office

AQUAREADY

Reg. No. 4,074,857

NATUREX, INC. (DELAWARE CORPORATION)
375 HUYLER STREET
SOUTH HACKENSACK, NJ 07606

Registered Dec. 20, 2011

Int. Cls.: 3 and 30

FOR: SOAPS, PERFUMES, COSMETICS, ESSENTIAL OILS; NATURAL ESSENTIAL OILS, NAMELY, RAW AROMATIC OLEORESIN; COSMETICS, NAMELY, COSMETIC PRODUCTS IN ALL GALENIC FORMS NOT FOR MEDICAL PURPOSES PRIMARILY COMPRISED OF PLANT EXTRACTS, IN CLASS 3 (U.S. CLS. 1, 4, 6, 50, 51 AND 52).

TRADEMARK

PRINCIPAL REGISTER

FIRST USE 7-0-2010; IN COMMERCE 7-0-2010.

FOR: NUTRITIONAL FOOD ADDITIVES, NOT FOR MEDICAL PURPOSES, MADE FROM COFFEE, TEA, COCOA, SUGAR, RICE, TAPIOCA, SAGO, PASTA, AND CEREALS; FLAVORINGS OTHER THAN ESSENTIAL OILS; AROMATIC PREPARATIONS FOR FOOD, NAMELY, EDIBLE SPICES, PROCESSED HERBS, FLAVOR ENHANCERS USED IN FOOD PRODUCTS, EXTRACTS USED AS FLAVORINGS EXCLUDING ESSENTIAL OILS; NATURAL SWEETENERS; FOOD ESSENCES EXCLUDING ETHEREAL ESSENCES AND ESSENTIAL OILS, NAMELY, COFFEE ESSENCES, IN CLASS 30 (U.S. CL. 46).

FIRST USE 7-0-2010; IN COMMERCE 7-0-2010.

THE MARK CONSISTS OF STANDARD CHARACTERS WITHOUT CLAIM TO ANY PARTICULAR FONT, STYLE, SIZE, OR COLOR.

SN 85-079,805, FILED 7-7-2010.

ANNE FARRELL, EXAMINING ATTORNEY



David J. Kyffers

Director of the United States Patent and Trademark Office

United States of America

United States Patent and Trademark Office



BODY SHIELD
A P P A R E L

Reg. No. 4,074,858

Registered Dec. 20, 2011

Int. Cl.: 25

TRADEMARK

PRINCIPAL REGISTER

SACCANI, DANIEL B (UNITED STATES INDIVIDUAL)
603 EDBURTON COURT
HILLSBOROUGH, NC 27278

FOR: ATHLETIC APPAREL, NAMELY, SHIRTS, PANTS, JACKETS, FOOTWEAR, HATS AND CAPS, ATHLETIC UNIFORMS; CLOTHING FOR ATHLETIC USE, NAMELY, PADDED ELBOW COMPRESSION SLEEVES BEING PART OF AN ATHLETIC GARMENT; CLOTHING FOR ATHLETIC USE, NAMELY, PADDED SHIRTS; CLOTHING, NAMELY, BASE LAYERS; GLOVES AS CLOTHING; JACKETS; JERSEYS, IN CLASS 25 (U.S. CLS. 22 AND 39).

FIRST USE 7-30-2011; IN COMMERCE 10-31-2011.

NO CLAIM IS MADE TO THE EXCLUSIVE RIGHT TO USE APPAREL, APART FROM THE MARK AS SHOWN.

THE MARK CONSISTS OF THE WORDING "BODY SHIELD APPAREL" AND A SHIELD DESIGN. THE SHIELD DESIGN DISPLAYS A STYLIZED CROSS AND RIVETS ON ITS FACE.

SN 85-079,839, FILED 7-7-2010.

PAUL MORENO, EXAMINING ATTORNEY



David J. Kybas

Director of the United States Patent and Trademark Office

United States of America

United States Patent and Trademark Office

SUSTAINABLE ACTION ZONES

Reg. No. 4,074,859

Registered Dec. 20, 2011

Int. Cl.: 35

SERVICE MARK

PRINCIPAL REGISTER

ELEMENTAL IMPACT, INC. (GEORGIA CORPORATION)
UNIT C-33
91 RUMSON ROAD NE
ATLANTA, GA 30305

FOR: CONSULTING SERVICES IN THE AREA OF SUSTAINABLE BUSINESS SOLUTIONS,
IN CLASS 35 (U.S. CLS. 100, 101 AND 102).

FIRST USE 9-21-2011; IN COMMERCE 9-21-2011.

THE MARK CONSISTS OF STANDARD CHARACTERS WITHOUT CLAIM TO ANY PAR-
TICULAR FONT, STYLE, SIZE, OR COLOR.

NO CLAIM IS MADE TO THE EXCLUSIVE RIGHT TO USE "SUSTAINABLE", APART FROM
THE MARK AS SHOWN.

SN 85-080,206, FILED 7-8-2010.

MARK SPARACINO, EXAMINING ATTORNEY



David J. Kyffers

Director of the United States Patent and Trademark Office

United States of America

United States Patent and Trademark Office

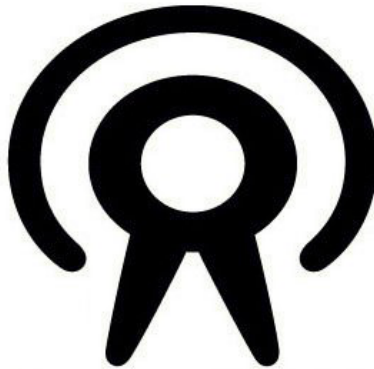

Reg. No. 4,074,860

Registered Dec. 20, 2011

Int. Cl.: 41

SERVICE MARK

PRINCIPAL REGISTER

GRAPSEED MEDIA LTD. (HONG KONG LIMITED LIABILITY COMPANY)
8/F HENLEY BLDG., 5 QUEEN'S ROAD
CENTRAL, HONG KONG

FOR: EDUCATIONAL SERVICES, NAMELY, ENGLISH LANGUAGE AND CULTURE INSTRUCTION, VIRTUAL AND REALWORLD, IN THE FORM OF CLASSES, SEMINARS, CONFERENCES AND WORKSHOPS, IN CLASS 41 (U.S. CLS. 100, 101 AND 107).

FIRST USE 2-20-2009; IN COMMERCE 4-1-2010.

THE MARK CONSISTS OF A NEARLY COMPLETE CIRCLE FORMING AN ARCH OVER A CIRCLE WITH TWO PRONGS AT THE BOTTOM.

SN 85-080,482, FILED 7-8-2010.

AMY KERTGATE, EXAMINING ATTORNEY



David J. Kybas

Director of the United States Patent and Trademark Office

United States of America

United States Patent and Trademark Office

jakett

Reg. No. 4,074,861

Registered Dec. 20, 2011

Int. Cl.: 25

DJG DIRECT MARKETING LLC (NEW YORK LIMITED LIABILITY COMPANY), DBA
JAKETT,
3RD FLOOR
244 WEST 39TH ST.
NEW YORK, NY 10018

TRADEMARK

PRINCIPAL REGISTER

FOR: LEATHER PANTS; LEATHER SHIRTS; LEATHER SKIRTS; LEATHER VESTS; MEN'S
AND WOMEN'S VESTS; PANTS; SHIRTS; SKIRTS; TOPS, IN CLASS 25 (U.S. CLS. 22 AND
39).

FIRST USE 3-0-2010; IN COMMERCE 8-0-2010.

THE MARK CONSISTS OF STANDARD CHARACTERS WITHOUT CLAIM TO ANY PAR-
TICULAR FONT, STYLE, SIZE, OR COLOR.

SN 85-080,754, FILED 7-8-2010.

KAREN K. BUSH, EXAMINING ATTORNEY



David J. Kyffers

Director of the United States Patent and Trademark Office

United States of America

United States Patent and Trademark Office

FLY BY NIGHT

Reg. No. 4,074,862

Registered Dec. 20, 2011

Int. Cl.: 25

TRADEMARK

PRINCIPAL REGISTER

SUBSTANCE OVER FORM, INC. (CALIFORNIA CORPORATION)
1639 N. MAIN STREET
LOS ANGELES, CA 90012

FOR: BUTTON DOWN SHIRTS; COLLARED SHIRTS; DRESS SHIRTS; KNIT SHIRTS;
SHIRTS; SHIRTS AND SHORT-SLEEVED SHIRTS; SHORT-SLEEVED OR LONG-SLEEVED
T-SHIRTS; SHORT-SLEEVED SHIRTS; T-SHIRTS, IN CLASS 25 (U.S. CLS. 22 AND 39).

FIRST USE 8-1-2010; IN COMMERCE 11-1-2010.

THE MARK CONSISTS OF STANDARD CHARACTERS WITHOUT CLAIM TO ANY PAR-
TICULAR FONT, STYLE, SIZE, OR COLOR.

SN 85-081,689, FILED 7-9-2010.

KATHERINE CHANG, EXAMINING ATTORNEY



David J. Kyffers

Director of the United States Patent and Trademark Office

United States of America

United States Patent and Trademark Office



Reg. No. 4,074,863

Registered Dec. 20, 2011

Int. Cl.: 43

SERVICE MARK

PRINCIPAL REGISTER

SASSY GREENS LLC (NORTH CAROLINA LIMITED LIABILITY COMPANY), DBA
CHOPPED GREENS,
210 N. COLUMBIA STREET
CHAPEL HILL, NC 27514

FOR: RESTAURANT SERVICES, NAMELY, PROVIDING OF FOOD AND BEVERAGES FOR
CONSUMPTION ON AND OFF THE PREMISES, IN CLASS 43 (U.S. CLS. 100 AND 101).

FIRST USE 1-3-2011; IN COMMERCE 1-3-2011.

NO CLAIM IS MADE TO THE EXCLUSIVE RIGHT TO USE "CHOPPED GREENS", APART
FROM THE MARK AS SHOWN.

THE MARK CONSISTS OF CIRCLES AND PARTIAL CIRCLES OVER THE WORDING
"CHOPPED GREENS".

SN 85-082,102, FILED 7-11-2010.

RAMONA ORTIGA, EXAMINING ATTORNEY



David J. Kybas

Director of the United States Patent and Trademark Office

United States of America

United States Patent and Trademark Office

ICABIN

Reg. No. 4,074,864

Registered Dec. 20, 2011

Int. Cl.: 37

SERVICE MARK

PRINCIPAL REGISTER

DUNCAN AVIATION INC. (NEBRASKA CORPORATION)
P.O. BOX 81887
3701 AVIATION ROAD
LINCOLN, NE 68501

FOR: INSTALLATION OF INTERIOR DECORATIONS AND AMENITIES FOR AIRCRAFT INTERIORS, IN CLASS 37 (U.S. CLS. 100, 103 AND 106).

FIRST USE 5-17-2011; IN COMMERCE 5-17-2011.

THE MARK CONSISTS OF STANDARD CHARACTERS WITHOUT CLAIM TO ANY PARTICULAR FONT, STYLE, SIZE, OR COLOR.

SN 85-082,230, FILED 7-12-2010.

BERYL GARDNER, EXAMINING ATTORNEY



David J. Kyffers

Director of the United States Patent and Trademark Office

United States of America

United States Patent and Trademark Office

WYLE TRUSTED SERVICES AND SOLUTIONS

Reg. No. 4,074,865

Registered Dec. 20, 2011

Int. Cl.: 42

SERVICE MARK

PRINCIPAL REGISTER

WYLE LABORATORIES, INC (DELAWARE CORPORATION)
1960 EAST GRAND AVENUE, SUITE 900
EL SEGUNDO, CA 902455023

FOR: ACOUSTIC RESEARCH SERVICES, AERONAUTICAL COMPUTER SYSTEMS INTEGRATION SERVICES, MANAGEMENT OF AERONAUTICAL SYSTEMS, ENGINEERING DESIGN SERVICES, TECHNICAL CONSULTANCY IN THE FIELD OF ENVIRONMENTAL SCIENCE, INFORMATION TECHNOLOGY DESIGN SERVICES, COMPUTER NETWORK MANAGEMENT SERVICES, SOFTWARE ENGINEERING AND DEVELOPMENT SERVICES, CONSULTATION AND RESEARCH IN THE FIELD OF AEROSPACE ENGINEERING, CONSULTING SERVICES IN THE FIELD OF INDUSTRIAL ENGINEERING, ENGINEERING SERVICES IN THE FIELDS OF TRAFFIC AND TRANSPORTATION, MANAGEMENT AND CONSULTATION IN THE FIELD OF HUMAN FACTORS ENGINEERING, PROFESSIONAL COMPUTER SERVICES, NAMELY, NETWORK ANALYSIS, LAN/WAN DESIGN, WIRELESS ENGINEERING, VIRTUALIZATION AND COMPUTER PROJECT MANAGEMENT, PROVIDING PLANNING AND ENGINEERING SERVICES IN THE FIELD OF INFORMATION AND COMMUNICATIONS NETWORKS, TECHNOLOGY CONSULTATION AND RESEARCH IN THE FIELD OF AEROSPACE ENGINEERING, ENVIRONMENTAL ENGINEERING, TESTING, AND INSPECTION SERVICES; AND TESTING, ANALYSIS, AND EVALUATION OF THE GOODS AND SERVICES OF OTHERS FOR THE PURPOSE OF CERTIFICATION, IN CLASS 42 (U.S. CLS. 100 AND 101).

FIRST USE 8-31-2010; IN COMMERCE 8-31-2010.

THE MARK CONSISTS OF STANDARD CHARACTERS WITHOUT CLAIM TO ANY PARTICULAR FONT, STYLE, SIZE, OR COLOR.

OWNER OF U.S. REG. NOS. 3,350,896 AND 3,625,823.

NO CLAIM IS MADE TO THE EXCLUSIVE RIGHT TO USE "SERVICES AND SOLUTIONS", APART FROM THE MARK AS SHOWN.

SN 85-083,787, FILED 7-13-2010.

PAUL F. GAST, EXAMINING ATTORNEY



David J. Kyppas

Director of the United States Patent and Trademark Office

United States of America

United States Patent and Trademark Office

MAGIC RELEASE

Reg. No. 4,074,866

Registered Dec. 20, 2011

Int. Cl.: 3

TRADEMARK

PRINCIPAL REGISTER

PURE & NATURAL COMPANY (ARIZONA CORPORATION)
MS 04.50
19001 NORTH SCOTTSDALE ROAD
SCOTTSDALE, AZ 85255

FOR: LAUNDRY BLEACH; LAUNDRY STAIN REMOVERS, IN CLASS 3 (U.S. CLS. 1, 4, 6, 50, 51 AND 52).

FIRST USE 10-13-2010; IN COMMERCE 10-13-2010.

THE MARK CONSISTS OF STANDARD CHARACTERS WITHOUT CLAIM TO ANY PARTICULAR FONT, STYLE, SIZE, OR COLOR.

SN 85-085,297, FILED 7-15-2010.

VIVIAN MICZNIK FIRST, EXAMINING ATTORNEY



David J. Kyffers

Director of the United States Patent and Trademark Office

United States of America

United States Patent and Trademark Office

VREE

Reg. No. 4,074,867

Registered Dec. 20, 2011

Int. Cl.: 44

SERVICE MARK

PRINCIPAL REGISTER

MERCK SHARP & DOHME CORP. (NEW JERSEY CORPORATION)
ONE MERCK DRIVE
WHITEHOUSE STATION, NJ 088890100

FOR: MOBILE HEALTHCARE SERVICES, NAMELY, PROVIDING PATIENTS AND CARE-GIVERS WITH CONSULTING SERVICES CONCERNING MANAGING CHRONIC DISEASES, IN CLASS 44 (U.S. CLS. 100 AND 101).

FIRST USE 10-0-2011; IN COMMERCE 10-0-2011.

THE MARK CONSISTS OF STANDARD CHARACTERS WITHOUT CLAIM TO ANY PARTICULAR FONT, STYLE, SIZE, OR COLOR.

SN 85-085,299, FILED 7-15-2010.

DEIRDRE ROBERTSON, EXAMINING ATTORNEY



David J. Kybas

Director of the United States Patent and Trademark Office

United States of America

United States Patent and Trademark Office

WE ♡ LOGISTICS

Reg. No. 4,074,868

Registered Dec. 20, 2011

Int. Cl.: 35

SERVICE MARK

PRINCIPAL REGISTER

UNITED PARCEL SERVICE OF AMERICA, INC. (DELAWARE CORPORATION)
55 GLENLAKE PARKWAY, NE
ATLANTA, GA 30328

FOR: LOGISTICS MANAGEMENT IN THE FIELD OF TRANSPORTATION AND DELIVERY; PROVIDING BUSINESS CONSULTING SERVICES, NAMELY, SUPPLY CHAIN MANAGEMENT; AND LOGISTIC MANAGEMENT IN THE FIELD OF TRANSPORTATION AND DELIVERY OF GOODS; MANAGEMENT ASSISTANCE SERVICES IN THE FIELD OF TRANSPORTATION AND DELIVERY; PROVIDING COMPUTERIZED TRACKING AND TRACING OF PACKAGES IN TRANSIT; RETAIL STORE SERVICES FEATURING STAMPS AND OFFICE SUPPLIES; PHOTOCOPYING SERVICES; DOCUMENT REPRODUCTION SERVICES; TRANSPORTATION NETWORK MANAGEMENT SOLUTION SERVICES; ARRANGING EXPEDITED PICK-UP, STORAGE, TRANSPORTATION AND DELIVERY SERVICES; CUSTOMS CLEARANCE SERVICES; FREIGHT LOGISTICS MANAGEMENT, IN CLASS 35 (U.S. CLS. 100, 101 AND 102).

FIRST USE 9-13-2010; IN COMMERCE 9-13-2010.

THE MARK CONSISTS OF THE WORDS "WE" AND "LOGISTICS" AND THE OUTLINE OF A HEART FORMED BY AN ARROW WITH THE HEAD OF THE ARROW MEETING THE TAIL OF THE ARROW IN THE MIDDLE OF THE RIGHT SIDE IN BETWEEN THE TWO WORDS.

SN 85-085,851, FILED 7-15-2010.

RAUL CORDOVA, EXAMINING ATTORNEY



David J. Kyjars

Director of the United States Patent and Trademark Office

United States of America

United States Patent and Trademark Office



Reg. No. 4,074,869

Registered Dec. 20, 2011

CROSS MARKETING CORPORATION (CALIFORNIA CORPORATION)
3518 OLIVER COURT
LAFAYETTE, CA 94549

Int. Cl.: 35

SERVICE MARK

PRINCIPAL REGISTER

FOR: ADVERTISING AND MARKETING; ADVERTISING AND MARKETING CONSULTANCY; ADVERTISING AND MARKETING SERVICES, NAMELY, PROMOTING THE GOODS AND SERVICES OF OTHERS; ADVERTISING AND PUBLICITY SERVICES; ADVERTISING AND PUBLICITY SERVICES, NAMELY, PROMOTING THE GOODS, SERVICES, BRAND IDENTITY AND COMMERCIAL INFORMATION AND NEWS OF THIRD PARTIES THROUGH PRINT, AUDIO, VIDEO, DIGITAL AND ON-LINE MEDIUM; ADVERTISING BY TRANSMISSION OF ON-LINE PUBLICITY FOR THIRD PARTIES THROUGH ELECTRONIC COMMUNICATIONS NETWORKS; ADVERTISING SERVICES, NAMELY, PROMOTING AND MARKETING THE GOODS AND SERVICES OF OTHERS THROUGH ALL PUBLIC COMMUNICATION MEANS; ADVERTISING SERVICES, PUBLIC RELATIONS AND MARKETING SERVICES, NAMELY, PROMOTING AND MARKETING THE GOODS AND SERVICES OF OTHERS THROUGH ALL PUBLIC COMMUNICATION MEANS; ADVERTISING TEXT PUBLICATION SERVICES; ADVERTISING THROUGH ALL PUBLIC COMMUNICATION MEANS; ADVERTISING, INCLUDING PROMOTION RELATING TO THE SALE OF ARTICLES AND SERVICES FOR THIRD PARTIES BY THE TRANSMISSION OF ADVERTISING MATERIAL AND THE DISSEMINATION OF ADVERTISING MESSAGES ON COMPUTER NETWORKS; ADVERTISING, MARKETING AND PROMOTION SERVICES; ADVERTISING, PROMOTION AND MARKETING SERVICES IN THE NATURE OF E-MAIL BLAST CAMPAIGNS FOR OTHERS; BUSINESS MARKETING SERVICES; DEVELOPMENT OF MARKETING STRATEGIES AND CONCEPTS; DISSEMINATION OF ADVERTISING FOR OTHERS VIA PUBLIC AND PRIVATE WIRELESS NETWORKS FOR DISPLAY ON MOBILE DEVICES; DISTRIBUTION OF SAMPLES FOR PUBLICITY PURPOSES; MARKETING AND CONSULTING SERVICES IN THE FIELD OF PROMOTING AND TRACKING THE GOODS, SERVICES, AND BRANDS OF OTHERS THROUGH ALL PUBLIC COMMUNICATION MEANS, PARTICULARLY SPECIALIZING IN THE USE OF MOBILE, SOCIAL, AND PRINT MEDIA TO DRIVE CONSUMER INTEREST, ENGAGEMENT AND ACTION; MARKETING CONSULTING; MARKETING PLAN DEVELOPMENT; PROMOTING THE GOODS AND SERVICES OF OTHERS BY MEANS OF WORD-OF-MOUTH AND NONTRADITIONAL MARKETING PROGRAMS; PROMOTIONAL MARKETING AND REPRESENTATION SERVICES FOR SALES TO THE PUBLIC SECTOR; PROVIDING MARKETING AND PROMOTION OF SPECIAL EVENTS; SPECIAL EVENT PLANNING FOR BUSINESS PURPOSES; SPECIAL EVENT PLANNING FOR COMMERCIAL, PROMOTIONAL OR ADVERTISING PURPOSES, IN CLASS 35 (U.S. CLS. 100, 101 AND 102).



David J. Kybas

Director of the United States Patent and Trademark Office

Reg. No. 4,074,869 FIRST USE 2-27-2006; IN COMMERCE 2-27-2006.

THE MARK CONSISTS OF TWO WHITE CIRCLES OUTLINED IN BLUE, ONE INSIDE THE OTHER, WITH A BLUE "C" IN THE MIDDLE OF THE INNER CIRCLE AND A BLUE AND WHITE CROWN ON TOP OF THE OUTER CIRCLE.

THE COLOR(S) BLUE AND WHITE IS/ARE CLAIMED AS A FEATURE OF THE MARK.

SN 85-086,048, FILED 7-15-2010.

JULIE GUTTADAURO, EXAMINING ATTORNEY

United States of America

United States Patent and Trademark Office

GET SET FOR SCHOOL

Reg. No. 4,074,870

Registered Dec. 20, 2011

Int. Cl.: 16

TRADEMARK

PRINCIPAL REGISTER

NO TEARS LEARNING, INC. (MARYLAND CORPORATION), DBA HANDWRITING WITHOUT TEARS,
8001 MACARTHUR BLVD.
CABIN JOHN, MD 20818

FOR: EDUCATIONAL PUBLICATIONS, NAMELY, WORK BOOKS AND RELATED TEACHERS GUIDES FOR PRE-K CHILDREN TO HELP DEVELOP FOUNDATION SKILLS INCLUDING SOCIALIZATION, LANGUAGE DEVELOPMENT, COORDINATION AND VISUAL RECALL SKILLS, IN CLASS 16 (U.S. CLS. 2, 5, 22, 23, 29, 37, 38 AND 50).

FIRST USE 8-0-2003; IN COMMERCE 8-0-2003.

THE MARK CONSISTS OF STANDARD CHARACTERS WITHOUT CLAIM TO ANY PARTICULAR FONT, STYLE, SIZE, OR COLOR.

SN 85-086,363, FILED 7-16-2010.

ZHALEH DELANEY, EXAMINING ATTORNEY



David J. Kyffers

Director of the United States Patent and Trademark Office

United States of America

United States Patent and Trademark Office

MCW JACQUELINE'S HUMAN RIGHTS CORNER

Reg. No. 4,074,871

Registered Dec. 20, 2011

Int. Cl.: 36

SERVICE MARK

PRINCIPAL REGISTER

MIRACLE CORNERS OF THE WORLD, INC. (NEW YORK CHARITABLE NOT-FOR-PROFIT CORPORATION)
166 MADISON AVENUE, FIFTH FLOOR
NEW YORK, NY 10016

FOR: CHARITABLE SERVICES, NAMELY, PROVIDING FUNDRAISING SERVICES FOR COMMUNITY MEMBERS, EDUCATIONAL INSTITUTIONS, GOVERNMENTAL AGENCIES AND NON-PROFIT ORGANIZATIONS THROUGHOUT THE WORLD TO RAISE AWARENESS ABOUT THE CRIME OF GENOCIDE AND TO DEVELOP PROGRAMS THAT ADVANCE CROSS-CULTURAL UNDERSTANDING AND PROMOTE IMPROVEMENT IN THE EDUCATION, HEALTHCARE AND ECONOMIC WELL BEING OF SOCIOECONOMICALLY DISADVANTAGED COMMUNITIES, IN CLASS 36 (U.S. CLS. 100, 101 AND 102).

FIRST USE 6-25-2010; IN COMMERCE 6-25-2010.

THE MARK CONSISTS OF STANDARD CHARACTERS WITHOUT CLAIM TO ANY PARTICULAR FONT, STYLE, SIZE, OR COLOR.

OWNER OF U.S. REG. NO. 2,939,379.

NO CLAIM IS MADE TO THE EXCLUSIVE RIGHT TO USE "HUMAN RIGHTS", APART FROM THE MARK AS SHOWN.

SN 85-087,946, FILED 7-19-2010.

JAMES LOVELACE, EXAMINING ATTORNEY



David J. Kypos

Director of the United States Patent and Trademark Office

United States of America
United States Patent and Trademark Office

DELICATA

Reg. No. 4,074,872

TSUKINEKO CO., LTD. (JAPAN CORPORATION)

Registered Dec. 20, 2011

5-11-10 ARAKAWA, ARAKAWA-KU
TOKYO, JAPAN 1160002

Int. Cls.: 1 and 16

FOR: CHEMICAL COMPOSITIONS FOR IMPREGNATING STAMP PADS, IN CLASS 1 (U.S. CLS. 1, 5, 6, 10, 26 AND 46).

TRADEMARK

FIRST USE 9-30-2011; IN COMMERCE 9-30-2011.

PRINCIPAL REGISTER

FOR: STAMP PADS AND CONTAINERS THEREFOR, IN CLASS 16 (U.S. CLS. 2, 5, 22, 23, 29, 37, 38 AND 50).

FIRST USE 7-11-2011; IN COMMERCE 7-11-2011.

THE MARK CONSISTS OF STANDARD CHARACTERS WITHOUT CLAIM TO ANY PARTICULAR FONT, STYLE, SIZE, OR COLOR.

THE ENGLISH TRANSLATION OF "DELICATA" IN THE MARK IS "DELICATE".

SN 85-088,788, FILED 7-20-2010.

WILLIAM BRECKENFELD, EXAMINING ATTORNEY



David J. Kybas

Director of the United States Patent and Trademark Office

United States of America

United States Patent and Trademark Office

CRUX

Reg. No. 4,074,873

EUE/SCREEN GEMS LTD (NEW YORK CORPORATION)
222 E. 44TH STREET
NEW YORK, NY 10017

Registered Dec. 20, 2011

Int. Cls.: 35, 41, and 42

FOR: BUSINESS MANAGEMENT AND CONSULTATION IN THE FIELD OF FILM PRODUCTION, VIDEO PRODUCTION, AND WEB DEVELOPMENT, IN CLASS 35 (U.S. CLS. 100, 101 AND 102).

SERVICE MARK

FIRST USE 9-1-2010; IN COMMERCE 9-1-2010.

PRINCIPAL REGISTER

FOR: DIGITAL CONTENT PRODUCTION SERVICES, NAMELY, MOTION PICTURE PRODUCTION, ANIMATION PRODUCTION, FILM AND VIDEO PRODUCTION, IN CLASS 41 (U.S. CLS. 100, 101 AND 107).

FIRST USE 9-1-2011; IN COMMERCE 9-1-2011.

FOR: WEB SITE DEVELOPMENT FOR OTHERS; CREATION, DESIGN, DEVELOPMENT AND MAINTENANCE OF WEB SITES FOR THIRD PARTIES, IN CLASS 42 (U.S. CLS. 100 AND 101).

FIRST USE 9-1-2010; IN COMMERCE 9-1-2010.

THE MARK CONSISTS OF STANDARD CHARACTERS WITHOUT CLAIM TO ANY PARTICULAR FONT, STYLE, SIZE, OR COLOR.

SN 85-088,866, FILED 7-20-2010.

JANICE KIM, EXAMINING ATTORNEY



David J. Kybas

Director of the United States Patent and Trademark Office

United States of America

United States Patent and Trademark Office

HUFFLEPUFF

Reg. No. 4,074,874

WARNER BROS. ENTERTAINMENT INC. (DELAWARE CORPORATION)
4000 WARNER BOULEVARD
BURBANK, CA 91522

Registered Dec. 20, 2011

Int. Cl.: 28

FOR: TOYS, NAMELY, TOY SNOW GLOBES, IN CLASS 28 (U.S. CLS. 22, 23, 38 AND 50).

TRADEMARK

FIRST USE 6-18-2010; IN COMMERCE 6-18-2010.

PRINCIPAL REGISTER

THE MARK CONSISTS OF STANDARD CHARACTERS WITHOUT CLAIM TO ANY PARTICULAR FONT, STYLE, SIZE, OR COLOR.

OWNER OF U.S. REG. NO. 2,505,434.

SN 85-089,049, FILED 7-20-2010.

LINDA MICKLEBURGH, EXAMINING ATTORNEY



David J. Kybas

Director of the United States Patent and Trademark Office

United States of America

United States Patent and Trademark Office



Reg. No. 4,074,875

Registered Dec. 20, 2011

Int. Cl.: 25

TRADEMARK

PRINCIPAL REGISTER

BIBBLE, LLC (VIRGINIA LIMITED LIABILITY COMPANY)
12000 MARKET STREET #187
RESTON, VA 20190

FOR: CLOTH BIBS, IN CLASS 25 (U.S. CLS. 22 AND 39).

FIRST USE 12-1-2010; IN COMMERCE 12-1-2010.

THE MARK CONSISTS OF THE WORDING "LE BIBBLE FUNFUNCTIONAL." IN BROWN AND FIVE COLORED CIRCLES, EACH OF WHICH IS PINK, GOLD, BROWN, BLUE AND GREEN.

THE COLOR(S) BROWN, PINK, GOLD, BLUE AND GREEN IS/ARE CLAIMED AS A FEATURE OF THE MARK.

THE WORDING "LE BIBBLE" AND "BIBBLE" HAS NO MEANING IN A FOREIGN LANGUAGE.

SN 85-089,257, FILED 7-21-2010.

DAVID C. REIHNER, EXAMINING ATTORNEY



David J. Kyffers

Director of the United States Patent and Trademark Office

United States of America

United States Patent and Trademark Office

MOL

Money Online

Reg. No. 4,074,876

Registered Dec. 20, 2011

Int. Cl.: 38

SERVICE MARK

PRINCIPAL REGISTER

MOL ACCESSPORTAL BERHAD (MALAYSIA CORPORATION)
LOT 07-03 & 08-03, LEVEL 7 & 8
BERJAYA TIMES SQUARE, NO. 1, JALAN IMBI
KUALA LUMPUR, MALAYSIA 55100

FOR: CHAT ROOM SERVICES FOR SOCIAL NETWORKING; COMMUNICATION SERVICES, NAMELY, TRANSMISSION OF VOICE, AUDIO, VISUAL IMAGES AND DATA BY TELECOMMUNICATIONS NETWORKS, WIRELESS COMMUNICATION NETWORKS, THE INTERNET, INFORMATION SERVICES NETWORKS AND DATA NETWORKS; COMPUTER AIDED TRANSMISSION OF INFORMATION AND IMAGES; ELECTRONIC TRANSMISSION OF MESSAGES AND DATA; ELECTRONIC TRANSMISSION OF VOICE, DATA AND IMAGES BY TELEVISION AND VIDEO BROADCASTING; ELECTRONIC, ELECTRIC, AND DIGITAL TRANSMISSION OF VOICE, DATA, IMAGES, SIGNALS, AND MESSAGES; FIXED AND MOBILE TELEPHONE SERVICES; INTERNET SERVICE PROVIDER (ISP); ON-LINE SERVICES, NAMELY, MESSAGE SENDING; PROVIDING ACCESS TO TELECOMMUNICATION NETWORKS; PROVIDING INTERNET ACCESS; RENTAL OF TELECOMMUNICATION EQUIPMENT; SATELLITE TRANSMISSION SERVICES; STREAMING OF AUDIO MATERIAL ON THE INTERNET; TELECOMMUNICATION SERVICES, NAMELY, WIRELESS TELEPHONE SERVICES; TRANSMISSION OF SOUND AND VISION VIA SATELLITE OR INTERACTIVE MULTIMEDIA NETWORKS, IN CLASS 38 (U.S. CLS. 100, 101 AND 104).

FIRST USE 10-17-2011; IN COMMERCE 10-17-2011.

NO CLAIM IS MADE TO THE EXCLUSIVE RIGHT TO USE "ONLINE", APART FROM THE MARK AS SHOWN.

THE MARK CONSISTS OF THE ACRONYM "MOL" IN STYLIZED LOWER-CASE LETTERING ABOVE THE WORDS "MONEY ONLINE" IN SMALLER FONT WITH UPPER-AND-LOWER CASE LETTERS.

SN 85-089,761, FILED 7-21-2010.

JILL C. ALT, EXAMINING ATTORNEY



David J. Kybas

Director of the United States Patent and Trademark Office

United States of America

United States Patent and Trademark Office

SECTOR SMART

Reg. No. 4,074,877

Registered Dec. 20, 2011

Int. Cl.: 35

SERVICE MARK

PRINCIPAL REGISTER

TRION, LLC (TEXAS LIMITED LIABILITY COMPANY)
5910 N CENTRAL EXPY, SUITE 1660
DALLAS, TX 75206

FOR: BUSINESS CONSULTATION AND MANAGEMENT REGARDING MARKETING ACTIVITIES AND LAUNCHING OF NEW PRODUCTS, IN CLASS 35 (U.S. CLS. 100, 101 AND 102).

FIRST USE 4-29-2011; IN COMMERCE 4-29-2011.

THE MARK CONSISTS OF STANDARD CHARACTERS WITHOUT CLAIM TO ANY PARTICULAR FONT, STYLE, SIZE, OR COLOR.

NO CLAIM IS MADE TO THE EXCLUSIVE RIGHT TO USE "SECTOR", APART FROM THE MARK AS SHOWN.

SN 85-090,820, FILED 7-22-2010.

EUGENIA MARTIN, EXAMINING ATTORNEY



David J. Kybas

Director of the United States Patent and Trademark Office

United States of America

United States Patent and Trademark Office

TRANSITION PRO

Reg. No. 4,074,878

TRION, LLC (TEXAS LIMITED LIABILITY COMPANY)
5910 N CENTRAL EXPY, SUITE 1660
DALLAS, TX 75206

Registered Dec. 20, 2011

Int. Cl.: 35

FOR: BUSINESS MANAGEMENT AND CONSULTATION, IN CLASS 35 (U.S. CLS. 100, 101 AND 102).

SERVICE MARK

FIRST USE 4-29-2011; IN COMMERCE 4-29-2011.

PRINCIPAL REGISTER

THE MARK CONSISTS OF STANDARD CHARACTERS WITHOUT CLAIM TO ANY PARTICULAR FONT, STYLE, SIZE, OR COLOR.

NO CLAIM IS MADE TO THE EXCLUSIVE RIGHT TO USE "TRANSITION", APART FROM THE MARK AS SHOWN.

SN 85-090,826, FILED 7-22-2010.

EUGENIA MARTIN, EXAMINING ATTORNEY



David J. Kybas

Director of the United States Patent and Trademark Office

United States of America

United States Patent and Trademark Office



Reg. No. 4,074,879

Registered Dec. 20, 2011

Int. Cl.: 25

TRADEMARK

PRINCIPAL REGISTER

JOSE CASTANEDA (UNITED STATES INDIVIDUAL)
APT. B 4221 45TH STREET
SAN DIEGO, CA 92115

FOR: T-SHIRTS, IN CLASS 25 (U.S. CLS. 22 AND 39).

FIRST USE 3-17-2011; IN COMMERCE 3-17-2011.

THE MARK CONSISTS OF A CIRCULAR FACE HAVING RAISED EYEBROWS, NARROWED EYES, AND A DEVILISH GRIN.

SN 85-091,120, FILED 7-22-2010.

RAMONA ORTIGA, EXAMINING ATTORNEY



David J. Kybas

Director of the United States Patent and Trademark Office

United States of America

United States Patent and Trademark Office

LMISIGHT

Reg. No. 4,074,880

Registered Dec. 20, 2011

Int. Cl.: 42

SERVICE MARK

PRINCIPAL REGISTER

LITIGATION MANAGEMENT, INC. (OHIO CORPORATION)
6000 PARKLAND BOULEVARD
MAYFIELD HEIGHTS, OH 44124

FOR: COMPUTER SERVICES, NAMELY, ACTING AS AN APPLICATION SERVICE PROVIDER IN THE FIELD OF LITIGATION TO HOST COMPUTER APPLICATION SOFTWARE FOR WEB-ENABLED ELECTRONIC DATA ACCESS TO SEARCHABLE DATABASES OF EVIDENCE AND LEGAL INFORMATION AND DATA FOR CENTRALIZED MANAGEMENT OF LITIGATION MATTERS, IN CLASS 42 (U.S. CLS. 100 AND 101).

FIRST USE 10-14-2002; IN COMMERCE 10-14-2002.

THE MARK CONSISTS OF STANDARD CHARACTERS WITHOUT CLAIM TO ANY PARTICULAR FONT, STYLE, SIZE, OR COLOR.

OWNER OF U.S. REG. NO. 3,058,191.

SN 85-092,347, FILED 7-25-2010.

GRETCHEN ULRICH, EXAMINING ATTORNEY



David J. Kybas

Director of the United States Patent and Trademark Office

United States of America

United States Patent and Trademark Office

MANGELSEN

Reg. No. 4,074,881

THOMAS D. MANGELSEN, INC. (NEBRASKA CORPORATION)
13303 F STREET
OMAHA, NE 68137

Registered Dec. 20, 2011

Int. Cl.: 16

FOR: CALENDARS; GIFT CARDS; MOUNTED POSTERS; NOTE CARDS; UNMOUNTED POSTERS, IN CLASS 16 (U.S. CLS. 2, 5, 22, 23, 29, 37, 38 AND 50).

TRADEMARK

FIRST USE 12-31-1993; IN COMMERCE 12-31-1993.

PRINCIPAL REGISTER

THE MARK CONSISTS OF STANDARD CHARACTERS WITHOUT CLAIM TO ANY PARTICULAR FONT, STYLE, SIZE, OR COLOR.

SEC. 2(F).

SN 85-092,507, FILED 7-26-2010.

STEVEN JACKSON, EXAMINING ATTORNEY



David J. Kybas

Director of the United States Patent and Trademark Office

United States of America

United States Patent and Trademark Office

PRIMAFLEX

Reg. No. 4,074,882

Registered Dec. 20, 2011

Int. Cl.: 1

TRADEMARK

PRINCIPAL REGISTER

PLASTIC SOLUTIONS, INC. (GEORGIA CORPORATION)
SUITE 220
695 MANSELL ROAD
ROSWELL, GA 30076

FOR: UNPROCESSED THERMOPLASTIC RESINS FOR USE IN MANUFACTURING IN A WIDE VARIETY OF INDUSTRIES, IN CLASS 1 (U.S. CLS. 1, 5, 6, 10, 26 AND 46).

FIRST USE 9-28-2010; IN COMMERCE 10-6-2010.

THE MARK CONSISTS OF STANDARD CHARACTERS WITHOUT CLAIM TO ANY PARTICULAR FONT, STYLE, SIZE, OR COLOR.

SN 85-092,777, FILED 7-26-2010.

AISHA CLARKE, EXAMINING ATTORNEY



David J. Kyffers

Director of the United States Patent and Trademark Office

United States of America

United States Patent and Trademark Office

AMERICAN MADE MATTERS

Reg. No. 4,074,883

BOLLMAN HAT COMPANY (PENNSYLVANIA CORPORATION)
P.O. BOX 517, 110 EAST MAIN STREET
ADAMSTOWN, PA 19501

Registered Dec. 20, 2011

Int. Cl.: 35

FOR: PROMOTING PUBLIC AWARENESS OF THE BENEFITS OF MANUFACTURING IN THE UNITED STATES, IN CLASS 35 (U.S. CLS. 100, 101 AND 102).

SERVICE MARK

FIRST USE 5-26-2009; IN COMMERCE 5-26-2009.

PRINCIPAL REGISTER

THE MARK CONSISTS OF STANDARD CHARACTERS WITHOUT CLAIM TO ANY PARTICULAR FONT, STYLE, SIZE, OR COLOR.

NO CLAIM IS MADE TO THE EXCLUSIVE RIGHT TO USE "AMERICAN MADE", APART FROM THE MARK AS SHOWN.

SN 85-092,822, FILED 7-26-2010.

DEBRA LEE, EXAMINING ATTORNEY



David J. Kyffers

Director of the United States Patent and Trademark Office

United States of America
United States Patent and Trademark Office

EL GUIDO

Reg. No. 4,074,884

AZZOLINI, JOSEPH (UNITED STATES INDIVIDUAL)
2902 24TH AVE

Registered Dec. 20, 2011

ASTORIA, NY 11102

Int. Cl.: 25

FOR: CLOTHING, NAMELY, HATS, SHIRTS, TOPS, PANTS, SHORTS, BOTTOMS, AND JACKETS, IN CLASS 25 (U.S. CLS. 22 AND 39).

TRADEMARK

FIRST USE 7-27-2010; IN COMMERCE 7-29-2011.

PRINCIPAL REGISTER

THE MARK CONSISTS OF STANDARD CHARACTERS WITHOUT CLAIM TO ANY PARTICULAR FONT, STYLE, SIZE, OR COLOR.

SN 85-093,372, FILED 7-27-2010.

JESSICA A. POWERS, EXAMINING ATTORNEY



David J. Kybas

Director of the United States Patent and Trademark Office

United States of America

United States Patent and Trademark Office

DREAMFORM

Reg. No. 4,074,885

Registered Dec. 20, 2011

Int. Cl.: 25

TRADEMARK

PRINCIPAL REGISTER

HBI BRANDED APPAREL ENTERPRISES, LLC (DELAWARE LIMITED LIABILITY COMPANY)
1000 EAST HANES MILL ROAD
WINSTON-SALEM, NC 27105

FOR: BRAS, IN CLASS 25 (U.S. CLS. 22 AND 39).

FIRST USE 3-15-2011; IN COMMERCE 3-15-2011.

THE MARK CONSISTS OF STANDARD CHARACTERS WITHOUT CLAIM TO ANY PARTICULAR FONT, STYLE, SIZE, OR COLOR.

SN 85-093,460, FILED 7-27-2010.

DEBRA LEE, EXAMINING ATTORNEY



David J. Kybas

Director of the United States Patent and Trademark Office

United States of America

United States Patent and Trademark Office

PROSENSE

Reg. No. 4,074,886

AUTOMATIONDIRECT.COM INC. (GEORGIA CORPORATION)
3505 HUTCHINSON STREET
CUMMING, GA 30130

Registered Dec. 20, 2011

Int. Cl.: 9

FOR: A FULL LINE OF ELECTRONIC SENSORS FOR MONITORING AND CONTROLLING THE PROCESSES AND FUNCTIONS OF AUTOMATED SYSTEMS, IN CLASS 9 (U.S. CLS. 21, 23, 26, 36 AND 38).

TRADEMARK

FIRST USE 4-30-2008; IN COMMERCE 4-30-2008.

PRINCIPAL REGISTER

THE MARK CONSISTS OF STANDARD CHARACTERS WITHOUT CLAIM TO ANY PARTICULAR FONT, STYLE, SIZE, OR COLOR.

OWNER OF U.S. REG. NO. 3,629,935.

SN 85-094,547, FILED 7-28-2010.

VIVIAN MICZNIK FIRST, EXAMINING ATTORNEY



David J. Kybas

Director of the United States Patent and Trademark Office

United States of America

United States Patent and Trademark Office

THERE'S A DWEEB IN ALL OF US

Reg. No. 4,074,887

DWEEBSRULE.COM, LLC (IDAHO LIMITED LIABILITY COMPANY), DBA DWEEBS RULE,
1632 E. DAYLESFORT CT.

Registered Dec. 20, 2011

EAGLE, ID 83616

Int. Cls.: 21 and 25

FOR: MUGS, IN CLASS 21 (U.S. CLS. 2, 13, 23, 29, 30, 33, 40 AND 50).

TRADEMARK

FIRST USE 8-12-2011; IN COMMERCE 8-12-2011.

PRINCIPAL REGISTER

FOR: SHIRTS, IN CLASS 25 (U.S. CLS. 22 AND 39).

FIRST USE 8-12-2011; IN COMMERCE 8-12-2011.

THE MARK CONSISTS OF STANDARD CHARACTERS WITHOUT CLAIM TO ANY PARTICULAR FONT, STYLE, SIZE, OR COLOR.

SN 85-094,944, FILED 7-28-2010.

VIVIAN MICZNIK FIRST, EXAMINING ATTORNEY



David J. Kyffers

Director of the United States Patent and Trademark Office

United States of America

United States Patent and Trademark Office

DWEEBS RULE

Reg. No. 4,074,888

DWEEBSRULE.COM, LLC (IDAHO LIMITED LIABILITY COMPANY), DBA DWEEBS RULE,
1632 E. DAYLESFORT CT.

Registered Dec. 20, 2011

EAGLE, ID 83616

Int. Cls.: 21 and 25

FOR: MUGS, IN CLASS 21 (U.S. CLS. 2, 13, 23, 29, 30, 33, 40 AND 50).

TRADEMARK

FIRST USE 8-12-2011; IN COMMERCE 8-12-2011.

PRINCIPAL REGISTER

FOR: SHIRTS, IN CLASS 25 (U.S. CLS. 22 AND 39).

FIRST USE 8-12-2011; IN COMMERCE 8-12-2011.

THE MARK CONSISTS OF STANDARD CHARACTERS WITHOUT CLAIM TO ANY PARTICULAR FONT, STYLE, SIZE, OR COLOR.

SN 85-094,948, FILED 7-28-2010.

VIVIAN MICZNIK FIRST, EXAMINING ATTORNEY



David J. Kybas

Director of the United States Patent and Trademark Office

United States of America

United States Patent and Trademark Office

Mississippi Miracle Clay

Reg. No. 4,074,889

PASCHAL, GLENDA S. (UNITED STATES INDIVIDUAL)
235 HWY 487 W

Registered Dec. 20, 2011

CARTHAGE, MS 39051

Int. Cl.: 5

FOR: MAGNESIUM BENTONITE CLAY USED FOR THERAPEUTIC PURPOSES FOR HUMAN AND ANIMAL USE, IN CLASS 5 (U.S. CLS. 6, 18, 44, 46, 51 AND 52).

TRADEMARK

FIRST USE 1-1-2009; IN COMMERCE 4-1-2009.

PRINCIPAL REGISTER

THE MARK CONSISTS OF STANDARD CHARACTERS WITHOUT CLAIM TO ANY PARTICULAR FONT, STYLE, SIZE, OR COLOR.

NO CLAIM IS MADE TO THE EXCLUSIVE RIGHT TO USE "MISSISSIPPI" OR "CLAY", APART FROM THE MARK AS SHOWN.

SN 85-094,992, FILED 7-28-2010.

JAMES GRIFFIN, EXAMINING ATTORNEY



David J. Kybas

Director of the United States Patent and Trademark Office

United States of America

United States Patent and Trademark Office

RUN WITH THE BULL

Reg. No. 4,074,890

Registered Dec. 20, 2011

Int. Cl.: 42

SERVICE MARK

PRINCIPAL REGISTER

BULL HN INFORMATION SYSTEMS INC. (DELAWARE CORPORATION)
SUITE 200
285 BILLERICA ROAD
CHELMSFORD, MA 018244174

FOR: MANAGED HOSTING SERVICES, NAMELY, HOSTING COMPUTER SOFTWARE APPLICATIONS OF OTHERS, HOSTING AND MANAGING THE WEB SITES OF OTHERS USING HARDENED DATA CENTER AND DISASTER RECOVERY FACILITIES, HOSTING OF DIGITAL CONTENT ON THE INTERNET, TECHNICAL SUPPORT SERVICES, NAMELY, ADMINISTRATION AND MAINTENANCE OF DIGITAL CONTENT AND MEDIA FOR USE IN CONNECTION WITH DATA TRANSMISSION NETWORKS, IN CLASS 42 (U.S. CLS. 100 AND 101).

FIRST USE 9-30-2010; IN COMMERCE 9-30-2010.

THE MARK CONSISTS OF STANDARD CHARACTERS WITHOUT CLAIM TO ANY PARTICULAR FONT, STYLE, SIZE, OR COLOR.

SN 85-095,069, FILED 7-28-2010.

MATTHEW PAPPAS, EXAMINING ATTORNEY



David J. Kyppas

Director of the United States Patent and Trademark Office

United States of America

United States Patent and Trademark Office

politiXOpoly

Reg. No. 4,074,891

Registered Dec. 20, 2011

Int. Cls.: 9 and 41

TRADEMARK

SERVICE MARK

PRINCIPAL REGISTER

GOODRICH, JOEL (UNITED STATES INDIVIDUAL)
850 POWELL STREET, #904
SAN FRANCISCO, CA 94108

FOR: COMPUTER GAME PROGRAMMES; COMPUTER GAME PROGRAMMES DOWNLOADABLE VIA THE INTERNET; COMPUTER GAME SOFTWARE; COMPUTER GAME SOFTWARE DOWNLOADABLE FROM A GLOBAL COMPUTER NETWORK; COMPUTER GAME SOFTWARE FOR PERSONAL COMPUTERS AND HOME VIDEO GAME CONSOLES; COMPUTER GAME SOFTWARE FOR USE ON MOBILE AND CELLULAR PHONES; DOWNLOADABLE COMPUTER GAME PROGRAMS; DOWNLOADABLE COMPUTER GAME SOFTWARE VIA A GLOBAL COMPUTER NETWORK AND WIRELESS DEVICES, IN CLASS 9 (U.S. CLS. 21, 23, 26, 36 AND 38).

FIRST USE 3-24-2011; IN COMMERCE 3-24-2011.

FOR: ENTERTAINMENT SERVICES, NAMELY, PROVIDING ONLINE ELECTRONIC GAMES; ENTERTAINMENT SERVICES, NAMELY, PROVIDING ONLINE VIDEO GAMES, IN CLASS 41 (U.S. CLS. 100, 101 AND 107).

FIRST USE 3-24-2011; IN COMMERCE 3-24-2011.

THE MARK CONSISTS OF STANDARD CHARACTERS WITHOUT CLAIM TO ANY PARTICULAR FONT, STYLE, SIZE, OR COLOR.

SN 85-095,257, FILED 7-28-2010.

MARK T. MULLEN, EXAMINING ATTORNEY



David J. Kyros

Director of the United States Patent and Trademark Office

United States of America

United States Patent and Trademark Office



Reg. No. 4,074,892

Registered Dec. 20, 2011

Int. Cl.: 41

SERVICE MARK

PRINCIPAL REGISTER

FDRSAFETY LLC (TENNESSEE LIMITED LIABILITY COMPANY)
278 FRANKLIN ROAD
SUITE 123
BRENTWOOD, TN 37027

FOR: EDUCATIONAL AND TRAINING SERVICES, NAMELY, PROVIDING CLASSES AND TRAINING RELATING TO SAFETY ISSUES FOR BUSINESSES, IN CLASS 41 (U.S. CLS. 100, 101 AND 107).

FIRST USE 10-25-2011; IN COMMERCE 10-25-2011.

OWNER OF U.S. REG. NOS. 3,183,259 AND 3,257,834.

NO CLAIM IS MADE TO THE EXCLUSIVE RIGHT TO USE "SUSTAINABILITY SOLUTIONS", APART FROM THE MARK AS SHOWN.

THE MARK CONSISTS OF THE PHRASE "FDRSAFETY" WITH TWO GEOMETRIC SHAPES ABOVE AND TO THE RIGHT OF IT, UNDER WHICH APPEAR THE WORDS "SUSTAINABILITY SOLUTIONS".

SN 85-095,879, FILED 7-29-2010.

YAT SYE, LEE, EXAMINING ATTORNEY



David J. Kyffers

Director of the United States Patent and Trademark Office

United States of America

United States Patent and Trademark Office

PINK NOW

Reg. No. 4,074,893

Registered Dec. 20, 2011

Int. Cls.: 14 and 25

TRADEMARK

PRINCIPAL REGISTER

LIVE THE LIFE CLOTHING, INC. (VIRGINIA CORPORATION)
SUITE 2900
2951 WEST FRONT STREET
RICHLANDS, VA 24641

FOR: RUBBER OR SILICON WRISTBANDS IN THE NATURE OF A BRACELET, IN CLASS 14 (U.S. CLS. 2, 27, 28 AND 50).

FIRST USE 10-0-2010; IN COMMERCE 10-0-2010.

FOR: SHIRTS, IN CLASS 25 (U.S. CLS. 22 AND 39).

FIRST USE 10-0-2010; IN COMMERCE 10-0-2010.

THE MARK CONSISTS OF STANDARD CHARACTERS WITHOUT CLAIM TO ANY PARTICULAR FONT, STYLE, SIZE, OR COLOR.

SN 85-096,182, FILED 7-29-2010.

JENNIFER MARTIN, EXAMINING ATTORNEY



David J. Kyros

Director of the United States Patent and Trademark Office

United States of America

United States Patent and Trademark Office

GLADSTONE EVALUATION INDEX

Reg. No. 4,074,894

Registered Dec. 20, 2011

Int. Cl.: 42

SERVICE MARK

PRINCIPAL REGISTER

GLADSTONE ASSOCIATES, LLC (PENNSYLVANIA LIMITED LIABILITY COMPANY)
SUITE 400
500 OFFICE CENTER DRIVE
FORT WASHINGTON, PA 19034

FOR: DEVELOPMENT AND IMPLEMENTATION OF SOFTWARE AND TECHNOLOGY SOLUTIONS FOR THE PURPOSE OF BENCHMARKING, IMPROVING AND VALUING BUSINESSES; PROVIDING TEMPORARY USE OF A WEB-BASED NON-DOWNLOADABLE SOFTWARE APPLICATION FOR USE IN DATABASE MANAGEMENT, FOR USE AS A SPREADSHEET, FOR WORD PROCESSING; PROVIDING A WEB SITE FEATURING TEMPORARY USE OF NON-DOWNLOADABLE SOFTWARE FOR USE IN DATABASE MANAGEMENT, USE AS A SPREADSHEET, WORD PROCESSING; CONSULTING IN THE AREAS OF COMPUTERS, COMPUTER SYSTEMS AND COMPUTER SYSTEMS DESIGN; INSTALLATION, IMPLEMENTATION, AND MAINTENANCE WITH RESPECT TO COMPUTER SOFTWARE; PROJECT MANAGEMENT IN THE FIELD OF INFORMATION SYSTEMS DESIGN AND SPECIFICATION, IN CLASS 42 (U.S. CLS. 100 AND 101).

FIRST USE 5-1-2011; IN COMMERCE 5-1-2011.

THE MARK CONSISTS OF STANDARD CHARACTERS WITHOUT CLAIM TO ANY PARTICULAR FONT, STYLE, SIZE, OR COLOR.

NO CLAIM IS MADE TO THE EXCLUSIVE RIGHT TO USE "EVALUATION INDEX", APART FROM THE MARK AS SHOWN.

SN 85-097,119, FILED 7-30-2010.

KATHERINE CHANG, EXAMINING ATTORNEY



David J. Kyros

Director of the United States Patent and Trademark Office

United States of America

United States Patent and Trademark Office

Co-Activation

Reg. No. 4,074,895

Registered Dec. 20, 2011

Int. Cl.: 42

SERVICE MARK

PRINCIPAL REGISTER

EPISTAR CORPORATION (TAIWAN CORPORATION)
SCIENCE-BASED INDUSTRIAL PARK NO. 5
LI HSIN 5TH ROAD
HSINCHU, TAIWAN

FOR: TECHNOLOGY RESEARCH RELATED TO SEMICONDUCTOR CHIPS; RESEARCH AND DEVELOPMENT RELATED TO SEMICONDUCTOR CHIPS FOR OTHERS, IN CLASS 42 (U.S. CLS. 100 AND 101).

FIRST USE 10-29-2010; IN COMMERCE 10-29-2010.

THE MARK CONSISTS OF STANDARD CHARACTERS WITHOUT CLAIM TO ANY PARTICULAR FONT, STYLE, SIZE, OR COLOR.

SN 85-098,027, FILED 8-2-2010.

EUGENIA MARTIN, EXAMINING ATTORNEY



David J. Kyjars

Director of the United States Patent and Trademark Office

United States of America

United States Patent and Trademark Office

THERMALPORT

Reg. No. 4,074,896

Registered Dec. 20, 2011

Int. Cl.: 11

TRADEMARK

PRINCIPAL REGISTER

W. F. HARRIS LIGHTING, INC. (NORTH CAROLINA CORPORATION)
P.O. BOX 5023
4015 AIRPORT EXT. ROAD
MONROE, NC 28111

FOR: LED (LIGHT EMITTING DIODE) LIGHTING FIXTURES AND ELECTRIC LIGHTING FIXTURES, IN CLASS 11 (U.S. CLS. 13, 21, 23, 31 AND 34).

FIRST USE 9-11-2011; IN COMMERCE 9-11-2011.

THE MARK CONSISTS OF STANDARD CHARACTERS WITHOUT CLAIM TO ANY PARTICULAR FONT, STYLE, SIZE, OR COLOR.

SN 85-098,311, FILED 8-2-2010.

PAUL MORENO, EXAMINING ATTORNEY



David J. Kybas

Director of the United States Patent and Trademark Office

United States of America

United States Patent and Trademark Office



GENERAL ASSEMBLY

Reg. No. 4,074,897

Registered Dec. 20, 2011

Int. Cls.: 35 and 42

SERVICE MARK

PRINCIPAL REGISTER

EL FAROLITO, LLC (DELAWARE LIMITED LIABILITY COMPANY)
C/O TIMMONS ADVISORS, LLC
3555 TIMMONS LANE, SUITE 800
HOUSTON, TX 77027

FOR: BUSINESS DEVELOPMENT SERVICES, NAMELY, PROVIDING START-UP SUPPORT FOR BUSINESSES OF OTHERS; BUSINESS SERVICES, NAMELY, MATCHING POTENTIAL PRIVATE INVESTORS WITH ENTREPRENEURS NEEDING FUNDING; NEW BUSINESS VENTURE DEVELOPMENT AND FORMATION CONSULTING SERVICES; BUSINESS PLANNING; ASSISTANCE WITH BUSINESS MANAGEMENT AND PLANNING; PROVIDING BUSINESS DEVELOPMENT SERVICES, NAMELY, OFFERING ORGANIZATIONAL AND MANAGEMENT ADVICE FOR ENTREPRENEURS AND DESIGNERS THROUGH AN INCUBATOR AND EDUCATIONAL PROGRAM; BUSINESS CONCEPT EVALUATION THROUGH MARKET FEASIBILITY STUDIES; ASSISTANCE WITH BUSINESS MANAGEMENT AND PLANNING, OPERATIONS MANAGEMENT, BUSINESS MANAGEMENT CONSULTING WITH RELATION TO STRATEGY, MARKETING, SALES, OPERATION, PRODUCT DESIGN PARTICULARLY SPECIALIZING IN THE USE OF ANALYTIC AND STATISTIC MODELS FOR THE UNDERSTANDING AND PREDICTING OF CONSUMERS, BUSINESS, MARKET TRENDS AND ACTIONS; BUSINESS ACQUISITION CONSULTATION; ECONOMIC FORECASTING AND ANALYSIS, IN CLASS 35 (U.S. CLS. 100, 101 AND 102).

FIRST USE 8-16-2010; IN COMMERCE 8-16-2010.

FOR: CONSULTING IN THE FIELD OF PRODUCT DESIGN AND DEVELOPMENT FOR OTHERS, IN CLASS 42 (U.S. CLS. 100 AND 101).

FIRST USE 8-16-2010; IN COMMERCE 8-16-2010.

THE MARK CONSISTS OF A GEAR SHAPED CIRCULAR OBJECT WITH THE INITIALS "GA" CENTERED WITHIN AND WITH THE WORDS "GENERAL ASSEMBLY" APPEARING TO THE RIGHT OF THE GEAR.

SN 85-098,693, FILED 8-3-2010.

SUSAN LESLIE DUBOIS, EXAMINING ATTORNEY



David J. Kyffers

Director of the United States Patent and Trademark Office

United States of America

United States Patent and Trademark Office

SPLASHWORX

Reg. No. 4,074,898

SPLASHTACULAR, INC. (KANSAS CORPORATION)
78-670 HIGHWAY 111

Registered Dec. 20, 2011

LA QUINTA, CA 99253

Int. Cl.: 42

FOR: PRODUCT DESIGN AND DEVELOPMENT FOR OTHERS OF RECREATIONAL WATER SLIDES THROUGH THE USE OF SOFTWARE, IN CLASS 42 (U.S. CLS. 100 AND 101).

SERVICE MARK

FIRST USE 2-0-2006; IN COMMERCE 2-0-2006.

PRINCIPAL REGISTER

THE MARK CONSISTS OF STANDARD CHARACTERS WITHOUT CLAIM TO ANY PARTICULAR FONT, STYLE, SIZE, OR COLOR.

SN 85-098,997, FILED 8-3-2010.

ANTHONY RINKER, EXAMINING ATTORNEY



David J. Kyffers

Director of the United States Patent and Trademark Office

United States of America

United States Patent and Trademark Office

PROJEQT

Reg. No. 4,074,899

TBWA WORLDWIDE INC. (DELAWARE CORPORATION)
488 MADISON AVENUE
NEW YORK, NY 10022

Registered Dec. 20, 2011

Int. Cl.: 9

FOR: SOFTWARE FOR AN INTERACTIVE APPLICATION TO ASSIST A USER IN THE CREATION OF A PRESENTATION OR OTHER SHOWING, IN CLASS 9 (U.S. CLS. 21, 23, 26, 36 AND 38).

TRADEMARK

FIRST USE 10-17-2010; IN COMMERCE 10-17-2010.

PRINCIPAL REGISTER

THE MARK CONSISTS OF STANDARD CHARACTERS WITHOUT CLAIM TO ANY PARTICULAR FONT, STYLE, SIZE, OR COLOR.

SN 85-100,097, FILED 8-4-2010.

ALLISON SCHRODY, EXAMINING ATTORNEY



David J. Kybas

Director of the United States Patent and Trademark Office

United States of America

United States Patent and Trademark Office

TROON GOLF VACATIONS

Reg. No. 4,074,900

Registered Dec. 20, 2011

Int. Cls.: 41 and 43

SERVICE MARK

PRINCIPAL REGISTER

TROON GOLF, L.L.C. (DELAWARE LIMITED LIABILITY COMPANY)
SUITE 300
15044 NORTH SCOTTSDALE ROAD
SCOTTSDALE, AZ 85254

FOR: ARRANGING GOLF VACATIONS PACKAGES, NAMELY, MAKING RESERVATIONS FOR TEE TIMES AT GOLF COURSES, IN CLASS 41 (U.S. CLS. 100, 101 AND 107).

FIRST USE 11-1-2011; IN COMMERCE 11-1-2011.

FOR: ARRANGING GOLF VACATIONS PACKAGES, NAMELY, MAKING RESERVATIONS AND BOOKING FOR TEMPORARY LODGING, RESTAURANTS AND MEALS AT A GOLF RESORT, IN CLASS 43 (U.S. CLS. 100 AND 101).

FIRST USE 11-1-2011; IN COMMERCE 11-1-2011.

OWNER OF U.S. REG. NOS. 2,299,833, 3,372,598, AND OTHERS.

NO CLAIM IS MADE TO THE EXCLUSIVE RIGHT TO USE "GOLF VACATIONS", APART FROM THE MARK AS SHOWN.

SN 85-100,796, FILED 8-5-2010.

JENNIFER MARTIN, EXAMINING ATTORNEY



David J. Kyffers

Director of the United States Patent and Trademark Office

United States of America

United States Patent and Trademark Office

BATTLE IN THE BACKYARD

Reg. No. 4,074,901

SILVERTON CASINO, LLC (NEVADA LIMITED LIABILITY COMPANY)
3333 BLUE DIAMOND ROAD

Registered Dec. 20, 2011

LAS VEGAS, NV 89139

Int. Cl.: 41

FOR: ENTERTAINMENT IN THE NATURE OF BOXING CONTESTS; ENTERTAINMENT IN THE NATURE OF LIVE ATHLETIC COMPETITIONS, NAMELY, MIXED MARTIAL ARTS (MMA) EVENTS; ENTERTAINMENT SERVICES IN THE NATURE OF LIVE MIXED MARTIAL ARTS (MMA) EVENTS; ORGANIZING LIVE MIXED MARTIAL ARTS EVENTS AND COMPETITIONS, IN CLASS 41 (U.S. CLS. 100, 101 AND 107).

SERVICE MARK

PRINCIPAL REGISTER

FIRST USE 10-16-2010; IN COMMERCE 10-16-2010.

THE MARK CONSISTS OF STANDARD CHARACTERS WITHOUT CLAIM TO ANY PARTICULAR FONT, STYLE, SIZE, OR COLOR.

SN 85-101,181, FILED 8-5-2010.

DAVID HOFFMAN, EXAMINING ATTORNEY



David J. Kyffers

Director of the United States Patent and Trademark Office

United States of America

United States Patent and Trademark Office

Bad Dog Knives

Reg. No. 4,074,902

YOCOM, GARY (UNITED STATES INDIVIDUAL)
403 WEST MAIN ST
STANFORD, KY 40484

Registered Dec. 20, 2011

Int. Cl.: 8

FOR: POCKET KNIVES, IN CLASS 8 (U.S. CLS. 23, 28 AND 44).

TRADEMARK

FIRST USE 10-1-2011; IN COMMERCE 10-1-2011.

PRINCIPAL REGISTER

THE MARK CONSISTS OF STANDARD CHARACTERS WITHOUT CLAIM TO ANY PARTICULAR FONT, STYLE, SIZE, OR COLOR.

NO CLAIM IS MADE TO THE EXCLUSIVE RIGHT TO USE "KNIVES", APART FROM THE MARK AS SHOWN.

SN 85-101,751, FILED 8-6-2010.

JAY BESCH, EXAMINING ATTORNEY



David J. Kyffers

Director of the United States Patent and Trademark Office

United States of America

United States Patent and Trademark Office

MXE

Reg. No. 4,074,903

Registered Dec. 20, 2011

Int. Cl.: 9

TRADEMARK

PRINCIPAL REGISTER

AGILENT TECHNOLOGIES, INC. (DELAWARE CORPORATION)
5301 STEVENS CREEK BOULEVARD
SANTA CLARA, CA 95051

FOR: ELECTRONIC TEST AND MEASUREMENT EQUIPMENT, NAMELY, EMI (ELECTROMAGNETIC INTERFERENCE) RECEIVERS, SPECTRUM ANALYZERS AND EMC (ELECTROMAGNETIC COMPLIANCE) PRODUCTS, NAMELY, EMI RECEIVERS FOR TESTING ELECTROMAGNETIC COMPLIANCE AND MAKING CONDUCTIVE EMISSION MEASUREMENTS, IN CLASS 9 (U.S. CLS. 21, 23, 26, 36 AND 38).

FIRST USE 3-0-2011; IN COMMERCE 3-0-2011.

THE MARK CONSISTS OF STANDARD CHARACTERS WITHOUT CLAIM TO ANY PARTICULAR FONT, STYLE, SIZE, OR COLOR.

SN 85-102,807, FILED 8-9-2010.

JULIE GUTTADAURO, EXAMINING ATTORNEY



David J. Kyffers

Director of the United States Patent and Trademark Office

United States of America

United States Patent and Trademark Office

JAGUAR EXPLORATION

Reg. No. 4,074,904

JAGUAR EXPLORATION, INC. (TEXAS CORPORATION)
1155 DAIRY ASHFORD RD., SUITE 610
HOUSTON, TX 77079

Registered Dec. 20, 2011

Int. Cl.: 42

FOR: CONSULTING SERVICES IN THE FIELD OF SEISMIC EXPLORATION, IN CLASS 42
(U.S. CLS. 100 AND 101).

SERVICE MARK

FIRST USE 10-18-2011; IN COMMERCE 10-18-2011.

PRINCIPAL REGISTER

THE MARK CONSISTS OF STANDARD CHARACTERS WITHOUT CLAIM TO ANY PARTICULAR FONT, STYLE, SIZE, OR COLOR.

NO CLAIM IS MADE TO THE EXCLUSIVE RIGHT TO USE "EXPLORATION", APART FROM THE MARK AS SHOWN.

SN 85-104,014, FILED 8-10-2010.

TINA L. SNAPP, EXAMINING ATTORNEY



David J. Kybas

Director of the United States Patent and Trademark Office

United States of America

United States Patent and Trademark Office



Reg. No. 4,074,905

EAT BETTER SRL (ITALY CORPORATION)
VIA MUZZIOLI 33/1
MODENA, ITALY 41121

Registered Dec. 20, 2011

Int. Cl.: 30

FOR: PIZZA AND SNACKS, NAMELY, GRAIN-BASED SNACK FOODS; PIZZA CRUST;
PIZZA CRUST MIXES; PIZZA DOUGH; PIZZA SAUCE, IN CLASS 30 (U.S. CL. 46).

TRADEMARK

FIRST USE 1-15-2008; IN COMMERCE 6-15-2009.

PRINCIPAL REGISTER

NO CLAIM IS MADE TO THE EXCLUSIVE RIGHT TO USE "PIZZERIA ITALIANA" AND
"PIZZA", APART FROM THE MARK AS SHOWN.

THE MARK CONSISTS OF THE WORDS "PIZZERIA ITALIANA LA VERA PIZZA DI EAT
BETTER" AND A DESIGN OF A SHADED CIRCLE.

THE ENGLISH TRANSLATION OF "PIZZERIA ITALIANA LA VERA PIZZA DI" IN THE
MARK IS "ITALIAN PIZZERIA: THE AUTHENTIC PIZZA OF".

SN 85-105,791, FILED 8-12-2010.

SUSAN RICHARDS, EXAMINING ATTORNEY



David J. Kybas

Director of the United States Patent and Trademark Office

United States of America
United States Patent and Trademark Office

COINCIDE

Reg. No. 4,074,906

MONARCH SCIENTIFIC LLC (GEORGIA LIMITED LIABILITY COMPANY)
P.O. BOX 641

Registered Dec. 20, 2011

ALPHARETTA, GA 30009

Int. Cl.: 1

FOR: FERTILIZERS FOR AGRICULTURAL, COMMERCIAL AND DOMESTIC USE, IN CLASS 1 (U.S. CLS. 1, 5, 6, 10, 26 AND 46).

TRADEMARK

FIRST USE 6-0-2011; IN COMMERCE 6-0-2011.

PRINCIPAL REGISTER

THE MARK CONSISTS OF STANDARD CHARACTERS WITHOUT CLAIM TO ANY PARTICULAR FONT, STYLE, SIZE, OR COLOR.

SN 85-106,433, FILED 8-12-2010.

CHRISTOPHER BUONGIORNO, EXAMINING ATTORNEY



David J. Kybas

Director of the United States Patent and Trademark Office

United States of America

United States Patent and Trademark Office

SYNG

Reg. No. 4,074,907

SYNG CORPORATION (DELAWARE CORPORATION)

Registered Dec. 20, 2011

P.O. BOX 91954
LOS ANGELES, CA 90009

Int. Cl.: 35

FOR: ADVERTISEMENT FOR OTHERS ON THE INTERNET; DISSEMINATION OF ADVERTISING FOR OTHERS VIA THE INTERNET, IN CLASS 35 (U.S. CLS. 100, 101 AND 102).

SERVICE MARK

FIRST USE 10-16-2011; IN COMMERCE 10-16-2011.

PRINCIPAL REGISTER

THE MARK CONSISTS OF STANDARD CHARACTERS WITHOUT CLAIM TO ANY PARTICULAR FONT, STYLE, SIZE, OR COLOR.

SN 85-106,649, FILED 8-12-2010.

KELLY CHOE, EXAMINING ATTORNEY



David J. Kybas

Director of the United States Patent and Trademark Office

United States of America

United States Patent and Trademark Office

GREEN EMERALD SEEDLESS

Reg. No. 4,074,908

Registered Dec. 20, 2011

Int. Cl.: 31

TRADEMARK

PRINCIPAL REGISTER

JAKOV P. DULCICH AND SONS, LLC (CALIFORNIA LIMITED LIABILITY COMPANY)
31956 PETERSON ROAD
MCFARLAND, CA 93250

FOR: FRUITS, NAMELY, FRESH TABLE GRAPES, IN CLASS 31 (U.S. CLS. 1 AND 46).

FIRST USE 8-26-2011; IN COMMERCE 9-5-2011.

THE MARK CONSISTS OF STANDARD CHARACTERS WITHOUT CLAIM TO ANY PARTICULAR FONT, STYLE, SIZE, OR COLOR.

NO CLAIM IS MADE TO THE EXCLUSIVE RIGHT TO USE "SEEDLESS", APART FROM THE MARK AS SHOWN.

SN 85-107,532, FILED 8-13-2010.

CHRISTINA SOBRAL, EXAMINING ATTORNEY



David J. Kyros

Director of the United States Patent and Trademark Office

United States of America

United States Patent and Trademark Office

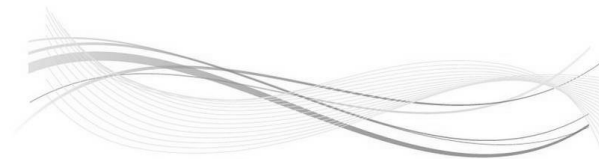

Reg. No. 4,074,909

DFINE, INC. (DELAWARE CORPORATION)
3047 ORCHARD PARKWAY
SAN JOSE, CA 95134

Registered Dec. 20, 2011

Int. Cls.: 5 and 10

FOR: ENERGY RESPONSIVE CONTROLLABLE VISCOSITY BONE CEMENT FOR ORTHOPEDIC USE, IN CLASS 5 (U.S. CLS. 6, 18, 44, 46, 51 AND 52).

TRADEMARK

FIRST USE 10-1-2010; IN COMMERCE 12-1-2010.

PRINCIPAL REGISTER

FOR: CANNULA BASED MEDICAL INJECTION SYSTEMS FOR USE IN ORTHOPEDIC PROCEDURES AND BONE REPAIR, IN CLASS 10 (U.S. CLS. 26, 39 AND 44).

FIRST USE 10-1-2010; IN COMMERCE 12-1-2010.

THE MARK CONSISTS OF A MISCELLANEOUS DESIGN, NAMELY, A GEOMETRIC FORM REPRESENTATIVE OF WAVES DURING A CONTROLLED FLOW.

SN 85-107,620, FILED 8-13-2010.

JILL PRATER, EXAMINING ATTORNEY



David J. Kybas

Director of the United States Patent and Trademark Office

United States of America

United States Patent and Trademark Office

Bend Fate To Your Will

Reg. No. 4,074,910

ANDERSON, SCOTT M. (UNITED STATES INDIVIDUAL)
821 TOYOPA DRIVE

Registered Dec. 20, 2011

PACIFIC PALISADES, CA 90272

Int. Cl.: 25

FOR: HATS; JACKETS; PANTS; SHIRTS; SHORT-SLEEVED OR LONG-SLEEVED T-SHIRTS;
SWEAT SHIRTS, IN CLASS 25 (U.S. CLS. 22 AND 39).

TRADEMARK

FIRST USE 9-14-2010; IN COMMERCE 9-14-2010.

PRINCIPAL REGISTER

THE MARK CONSISTS OF STANDARD CHARACTERS WITHOUT CLAIM TO ANY PARTICULAR FONT, STYLE, SIZE, OR COLOR.

SN 85-107,748, FILED 8-14-2010.

SUSAN LESLIE DUBOIS, EXAMINING ATTORNEY



David J. Kybas

Director of the United States Patent and Trademark Office

United States of America

United States Patent and Trademark Office

VIPER-SKIN

Reg. No. 4,074,911

NEPTUNE RESEARCH, INC. (FLORIDA CORPORATION)
1346 SOUTH KILLIAN DRIVE
LAKE PARK, FL 33403

Registered Dec. 20, 2011

Int. Cl.: 17

FOR: RESIN IMPREGNATED CARBON FIBER COMPOSITE TAPE FOR THE REPAIR, REINFORCEMENT, OR CORROSION PROTECTION OF PIPES, VESSELS, OR CONVEYANCES, IN CLASS 17 (U.S. CLS. 1, 5, 12, 13, 35 AND 50).

TRADEMARK

FIRST USE 7-22-2010; IN COMMERCE 7-22-2010.

PRINCIPAL REGISTER

THE MARK CONSISTS OF STANDARD CHARACTERS WITHOUT CLAIM TO ANY PARTICULAR FONT, STYLE, SIZE, OR COLOR.

SN 85-107,921, FILED 8-16-2010.

RONALD AIKENS, EXAMINING ATTORNEY



David J. Kyffers

Director of the United States Patent and Trademark Office

United States of America

United States Patent and Trademark Office

DENTAL RESERVE

Reg. No. 4,074,912

DENTAL TRADE ALLIANCE (D.C. NON-PROFIT CORPORATION)
2300 CLARENDON BLVD., SUITE 1003
ARLINGTON, VA 22201

Registered Dec. 20, 2011

Int. Cl.: 35

FOR: CHARITABLE SERVICES, NAMELY, COORDINATING THE PROCUREMENT AND DISTRIBUTION OF DENTAL EQUIPMENT AND SUPPLIES FROM COMPANIES TO NON-PROFIT ORGANIZATIONS THAT PROVIDE FREE DENTAL CARE TO THOSE IN NEED, IN CLASS 35 (U.S. CLS. 100, 101 AND 102).

SERVICE MARK

PRINCIPAL REGISTER

FIRST USE 7-0-2011; IN COMMERCE 7-0-2011.

THE MARK CONSISTS OF STANDARD CHARACTERS WITHOUT CLAIM TO ANY PARTICULAR FONT, STYLE, SIZE, OR COLOR.

NO CLAIM IS MADE TO THE EXCLUSIVE RIGHT TO USE "DENTAL", APART FROM THE MARK AS SHOWN.

SN 85-108,321, FILED 8-16-2010.

JAMES A. RAUEN, EXAMINING ATTORNEY



David J. Kyffers

Director of the United States Patent and Trademark Office

United States of America

United States Patent and Trademark Office



OPINION JUNGLE

Reg. No. 4,074,913

Registered Dec. 20, 2011

Int. Cl.: 35

SERVICE MARK

PRINCIPAL REGISTER

OPINION JUNGLE LLC (TEXAS LIMITED LIABILITY COMPANY)
7941 KATY FREEWAY
SUITE 323
HOUSTON, TX 77024

FOR: PROVIDING A WEBSITE WHERE USERS CAN POST CONSUMER RATINGS, REVIEWS, COMMENTS, EVALUATIONS AND RECOMMENDATIONS ON THIRD PARTY PRODUCTS AND SERVICES REGARDING AN UNLIMITED RANGE OF CONSUMER GOODS AND SERVICES OF OTHERS; PROVIDING A WEBSITE FOR BUSINESSES MARKETING THEIR PRODUCTS AND SERVICES TO RECEIVE CONSUMER RATINGS, REVIEWS, COMMENTS, EVALUATIONS AND RECOMMENDATIONS; PROVIDING A WEBSITE FOR BUSINESSES MARKETING THEIR PRODUCTS AND SERVICES, WHERE THE WEBSITE IS ACCESSIBLE TO THEIR CUSTOMERS, IN CLASS 35 (U.S. CLS. 100, 101 AND 102).

FIRST USE 1-14-2011; IN COMMERCE 1-14-2011.

OWNER OF U.S. REG. NO. 3,659,053.

THE MARK CONSISTS OF THE WORDS "OPINION JUNGLE" WITH THE DRAWING OF A CARICATURE OF A MAN WITH RADIO WAVES ABOVE HIS HEAD BETWEEN THE LETTERS "P" AND "N" IN THE WORD "OPINION".

SN 85-109,768, FILED 8-17-2010.

RAUL CORDOVA, EXAMINING ATTORNEY



David J. Kybas

Director of the United States Patent and Trademark Office

United States of America

United States Patent and Trademark Office



Reg. No. 4,074,914

Registered Dec. 20, 2011

Int. Cl.: 35

SERVICE MARK

PRINCIPAL REGISTER

OPINION JUNGLE LLC (TEXAS LIMITED LIABILITY COMPANY)
7941 KATY FREEWAY
SUITE 323
HOUSTON, TX 77024

FOR: PROVIDING A WEBSITE WHERE USERS CAN POST CONSUMER RATINGS, REVIEWS, COMMENTS, EVALUATIONS AND RECOMMENDATIONS ON THIRD PARTY PRODUCTS AND SERVICES REGARDING AN UNLIMITED RANGE OF CONSUMER GOODS AND SERVICES OF OTHERS; PROVIDING A WEBSITE FOR BUSINESSES MARKETING THEIR PRODUCTS AND SERVICES TO RECEIVE CONSUMER RATINGS, REVIEWS, COMMENTS, EVALUATIONS AND RECOMMENDATIONS; PROVIDING A WEBSITE FOR BUSINESSES MARKETING THEIR PRODUCTS AND SERVICES, WHERE THE WEBSITE IS ACCESSIBLE TO THEIR CUSTOMERS, IN CLASS 35 (U.S. CLS. 100, 101 AND 102).

FIRST USE 1-14-2011; IN COMMERCE 1-14-2011.

THE MARK CONSISTS OF THE CARICATURE OF A MAN WITH RADIO WAVES ABOVE HIS HEAD.

SN 85-109,770, FILED 8-17-2010.

RAUL CORDOVA, EXAMINING ATTORNEY



David J. Kybas

Director of the United States Patent and Trademark Office

United States of America

United States Patent and Trademark Office

SIDEKICK

Reg. No. 4,074,915

LEATHERMAN TOOL GROUP, INC. (OREGON CORPORATION)

Registered Dec. 20, 2011

P.O. BOX 20595
PORTLAND, OR 97294

Int. Cl.: 8

FOR: MULTI-FUNCTION HAND TOOLS COMPRISED OF TWO OR MORE OF THE FOLLOWING TOOL ELEMENTS -- SCREWDRIVER, PLIERS, WIRE CUTTER, WOOD SAW, PACKAGE OPENER, SERRATED UTILITY BLADE, BOTTLE AND CAN OPENER, FILE, RULER, WIRE STRIPPER, CARABINER, CAP LIFTER, KNIFE BLADE, AND NYLON AND LEATHER SHEATHS THEREFOR, IN CLASS 8 (U.S. CLS. 23, 28 AND 44).

TRADEMARK

PRINCIPAL REGISTER

FIRST USE 9-5-2011; IN COMMERCE 9-5-2011.

THE MARK CONSISTS OF STANDARD CHARACTERS WITHOUT CLAIM TO ANY PARTICULAR FONT, STYLE, SIZE, OR COLOR.

SN 85-109,817, FILED 8-17-2010.

SOPHIA S. KIM, EXAMINING ATTORNEY



David J. Kybas

Director of the United States Patent and Trademark Office

United States of America

United States Patent and Trademark Office

DRILLING FOR ENERGY EFFICIENCY

Reg. No. 4,074,916

Registered Dec. 20, 2011

Int. Cl.: 35

SERVICE MARK

PRINCIPAL REGISTER

LAROE CONSULTING SERVICES, LLC (MARYLAND LIMITED LIABILITY COMPANY)
6109 CROMWELL DR
BETHESDA, MD 20816

FOR: CONDUCTING ENERGY AUDITS OF COMMERCIAL AND INSTITUTIONAL FACILITIES FOR THE PURPOSE OF IMPROVING ENERGY EFFICIENCY; CONSULTING SERVICES IN THE FIELD OF ENERGY USAGE MANAGEMENT AND ENERGY EFFICIENCY; ENERGY AUDITING; ENERGY USAGE MANAGEMENT; NONE OF THE AFOREMENTIONED SERVICES BEING RELATED TO DRILLING OR THE SUBJECT MATTER OF DRILLING, IN CLASS 35 (U.S. CLS. 100, 101 AND 102).

FIRST USE 11-2-2011; IN COMMERCE 11-2-2011.

THE MARK CONSISTS OF STANDARD CHARACTERS WITHOUT CLAIM TO ANY PARTICULAR FONT, STYLE, SIZE, OR COLOR.

NO CLAIM IS MADE TO THE EXCLUSIVE RIGHT TO USE "ENERGY EFFICIENCY", APART FROM THE MARK AS SHOWN.

SN 85-109,829, FILED 8-17-2010.

ANDREA HACK, EXAMINING ATTORNEY



David J. Kyjars

Director of the United States Patent and Trademark Office

United States of America

United States Patent and Trademark Office

SAY MEDIA

Reg. No. 4,074,917

Registered Dec. 20, 2011

Int. Cl.: 35

SERVICE MARK

PRINCIPAL REGISTER

SAY MEDIA, INC. (DELAWARE CORPORATION)
180 TOWNSEND STREET
THIRD FLOOR
SAN FRANCISCO, CA 94107

FOR: ADVERTISING SERVICES, NAMELY, PROMOTING THE GOODS AND SERVICES OF OTHERS THROUGH AUDIO, VIDEO, DIGITAL AND ON-LINE MEDIUM; PROVIDING ADVERTISING SERVICE TO DISTRIBUTE ADVERTISEMENTS FOR DISPLAY ON THE INTERNET, NAMELY, IN WEBSITES, SOCIAL CONVERSATIONS OVER THE INTERNET, BLOGS, ELECTRONIC MESSAGES, INSTANT MESSAGES, TEXT MESSAGES, MULTIMEDIA MESSAGES, SOCIAL NETWORKS, STATUS UPDATES, FORUMS, ELECTRONIC BULLETIN BOARDS, IN CLASS 35 (U.S. CLS. 100, 101 AND 102).

FIRST USE 9-21-2010; IN COMMERCE 9-21-2010.

THE MARK CONSISTS OF STANDARD CHARACTERS WITHOUT CLAIM TO ANY PARTICULAR FONT, STYLE, SIZE, OR COLOR.

NO CLAIM IS MADE TO THE EXCLUSIVE RIGHT TO USE "MEDIA", APART FROM THE MARK AS SHOWN.

SN 85-109,872, FILED 8-17-2010.

WILLIAM P. SHANAHAN, EXAMINING ATTORNEY



David J. Kyros

Director of the United States Patent and Trademark Office

United States of America

United States Patent and Trademark Office

DICK VAN PATTEN'S NATURAL BALANCE SKIN AND COAT PROMISE

Reg. No. 4,074,918

NATURAL BALANCE PET FOODS, INC. (CALIFORNIA CORPORATION)
12924 PIERCE STREET
PACOIMA, CA 91331

Registered Dec. 20, 2011

Int. Cl.: 31

FOR: DOG FOOD, DOG TREATS, CAT FOOD AND CAT TREATS, IN CLASS 31 (U.S. CLS. 1 AND 46).

TRADEMARK

FIRST USE 8-0-2009; IN COMMERCE 8-0-2009.

PRINCIPAL REGISTER

THE MARK CONSISTS OF STANDARD CHARACTERS WITHOUT CLAIM TO ANY PARTICULAR FONT, STYLE, SIZE, OR COLOR.

OWNER OF U.S. REG. NOS. 2,452,855, 3,044,178, AND OTHERS.

NO CLAIM IS MADE TO THE EXCLUSIVE RIGHT TO USE "SKIN AND COAT", APART FROM THE MARK AS SHOWN.

THE NAME(S), PORTRAIT(S), AND/OR SIGNATURE(S) SHOWN IN THE MARK IDENTIFIES "DICK VAN PATTEN", WHOSE CONSENT(S) TO REGISTER IS MADE OF RECORD.

SN 85-110,581, FILED 8-18-2010.

DEIRDRE ROBERTSON, EXAMINING ATTORNEY



David J. Kyros

Director of the United States Patent and Trademark Office

United States of America

United States Patent and Trademark Office

THOMAS IV

Reg. No. 4,074,919

THOMAS THE FOURTH (FLORIDA CORPORATION)
21 ORCHARD STREET, #1
NEW YORK, NY 10002

Registered Dec. 20, 2011

Int. Cl.: 18

FOR: HANDBAGS; HOBO BAGS; MESSENGER BAGS; TOTE BAGS, IN CLASS 18 (U.S. CLS. 1, 2, 3, 22 AND 41).

TRADEMARK

FIRST USE 10-1-2010; IN COMMERCE 2-15-2011.

PRINCIPAL REGISTER

THE MARK CONSISTS OF THE STYLIZED WORD AND LETTERS "THOMAS IV".

SN 85-110,779, FILED 8-18-2010.

SKYE YOUNG, EXAMINING ATTORNEY



David J. Kyffers

Director of the United States Patent and Trademark Office

United States of America

United States Patent and Trademark Office

MTOKEN

Reg. No. 4,074,920

Registered Dec. 20, 2011

Int. Cls.: 9 and 42

TRADEMARK

SERVICE MARK

PRINCIPAL REGISTER

MERCURY PAYMENT SYSTEMS, LLC (DELAWARE LIMITED LIABILITY COMPANY)
TECH CENTER PLAZA
10 BURNETT COURT, SUITE 300
DURANGO, CO 81301

FOR: COMPUTER PROGRAMS FOR USE IN THE TOKENIZATION OF CONFIDENTIAL FINANCIAL AND PERSONAL DATA FOR LONG-TERM DATA STORAGE, DATA TRANSMISSION AND RECALL, AND FOR USE IN INTEGRATED PAYMENT PROCESSING INCLUDING CREDIT CARD, DEBIT CARD AND GIFT CARD TRANSACTION PROCESSING AND PAYMENT, IN CLASS 9 (U.S. CLS. 21, 23, 26, 36 AND 38).

FIRST USE 5-0-2010; IN COMMERCE 5-0-2010.

FOR: PROVIDING TEMPORARY USE OF ONLINE NONDOWNLOADABLE COMPUTER PROGRAMS FOR USE IN THE TOKENIZATION OF CONFIDENTIAL FINANCIAL AND PERSONAL DATA FOR LONG-TERM DATA STORAGE, DATA TRANSMISSION AND RECALL, AND FOR USE IN INTEGRATED PAYMENT PROCESSING INCLUDING CREDIT CARD, DEBIT CARD AND GIFT CARD TRANSACTION PROCESSING AND PAYMENT, IN CLASS 42 (U.S. CLS. 100 AND 101).

FIRST USE 5-0-2010; IN COMMERCE 5-0-2010.

THE MARK CONSISTS OF STANDARD CHARACTERS WITHOUT CLAIM TO ANY PARTICULAR FONT, STYLE, SIZE, OR COLOR.

SN 85-111,635, FILED 8-19-2010.

HEATHER BIDDULPH, EXAMINING ATTORNEY



David J. Kybas

Director of the United States Patent and Trademark Office

United States of America

United States Patent and Trademark Office

PUBLICHEALING

Reg. No. 4,074,921

Registered Dec. 20, 2011

Int. Cl.: 41

SERVICE MARK

PRINCIPAL REGISTER

FINKEL, DAVID (UNITED STATES INDIVIDUAL)
SUITE 415
315 SO. BEVERLY DRIVE
BEVERLY HILLS, CA 90212

FOR: CONDUCTING WORKSHOPS AND SEMINARS IN PERSONAL WELLNESS, HEALTH, AND FITNESS; CONSULTING SERVICES IN THE FIELDS OF FITNESS AND EXERCISE; EDUCATION SERVICES, NAMELY, PROVIDING SEMINARS AND WORKSHOPS IN THE FIELDS OF PERSONAL WELLNESS, HEALTH, AND FITNESS, IN CLASS 41 (U.S. CLS. 100, 101 AND 107).

FIRST USE 10-15-2011; IN COMMERCE 10-15-2011.

THE MARK CONSISTS OF STANDARD CHARACTERS WITHOUT CLAIM TO ANY PARTICULAR FONT, STYLE, SIZE, OR COLOR.

NO CLAIM IS MADE TO THE EXCLUSIVE RIGHT TO USE "PUBLIC", APART FROM THE MARK AS SHOWN.

SN 85-113,959, FILED 8-23-2010.

SAIMA MAKHDOOM, EXAMINING ATTORNEY



David J. Kybas

Director of the United States Patent and Trademark Office

United States of America

United States Patent and Trademark Office



Reg. No. 4,074,922

Registered Dec. 20, 2011

Int. Cl.: 29

TRADEMARK

PRINCIPAL REGISTER

CARGILL, INCORPORATED (DELAWARE CORPORATION)
15407 MCGINTY ROAD WEST
WAYZATA, MN 55391

FOR: EDIBLE OILS AND FATS; LARD, IN CLASS 29 (U.S. CL. 46).

FIRST USE 10-20-2010; IN COMMERCE 10-20-2010.

THE MARK CONSISTS OF THE WORDS "LA TRADICIONAL" UNDERLINED AND ABOVE THE WORDS "SABOR DEL ALMA" AND THE DESIGN OF A PARROT WITH ITS TAIL HANGING BETWEEN THE WORDS "LA" AND "TRADICIONAL" AND TO THE LEFT OF THE WORDS "SABOR DEL ALMA".

THE ENGLISH TRANSLATION OF "LA TRADICIONAL SABOR DEL ALMA" IN THE MARK IS "THE TRADITIONAL FLAVOR OF THE SOUL".

SN 85-114,314, FILED 8-24-2010.

TARA PATE, EXAMINING ATTORNEY



David J. Kybas

Director of the United States Patent and Trademark Office

United States of America

United States Patent and Trademark Office

Personal Summer Comfort

Reg. No. 4,074,923

CLAYMAN COMPANY (PENNSYLVANIA SOLE PROPRIETORSHIP)
154 FAIRVIEW AVENUE
YEADON, PA 19050

Registered Dec. 20, 2011

Int. Cl.: 5

FOR: VITAMINS IN LIQUID FORM, IN CLASS 5 (U.S. CLS. 6, 18, 44, 46, 51 AND 52).

TRADEMARK

FIRST USE 6-1-2011; IN COMMERCE 6-1-2011.

PRINCIPAL REGISTER

THE MARK CONSISTS OF STANDARD CHARACTERS WITHOUT CLAIM TO ANY PARTICULAR FONT, STYLE, SIZE, OR COLOR.

SN 85-114,550, FILED 8-24-2010.

JANICE KIM, EXAMINING ATTORNEY



David J. Kyffers

Director of the United States Patent and Trademark Office

United States of America

United States Patent and Trademark Office

Timechanic

Reg. No. 4,074,924

YIATRAS, MICHELLE M. (UNITED STATES INDIVIDUAL)
1715 DUNEVILLE ST.

Registered Dec. 20, 2011

LAS VEGAS, NV 89146 AND

Int. Cl.: 35

ZIVOT, DAVID E. (UNITED STATES INDIVIDUAL)
1715 DUNEVILLE ST.
LAS VEGAS, NV 89146

SERVICE MARK

PRINCIPAL REGISTER

FOR: ADVERTISING AND MARKETING SERVICES, NAMELY, PROMOTING THE GOODS AND SERVICES OF OTHERS; ADVERTISING AND PROMOTION SERVICES AND RELATED CONSULTING; ADVERTISING AND PROMOTIONAL SERVICES; ADVERTISING AND PUBLICITY SERVICES, NAMELY, PROMOTING THE GOODS, SERVICES, BRAND IDENTITY AND COMMERCIAL INFORMATION AND NEWS OF THIRD PARTIES THROUGH PRINT, AUDIO, VIDEO, DIGITAL AND ON-LINE MEDIUM; ADVERTISING PARTICULARLY SERVICES FOR THE PROMOTION OF GOODS; ADVERTISING SERVICES, NAMELY, PROMOTING AND MARKETING THE GOODS AND SERVICES OF OTHERS THROUGH ALL PUBLIC COMMUNICATION MEANS; ADVERTISING, MARKETING AND PROMOTION SERVICES; ARRANGING AND CONDUCTING SPECIAL EVENTS FOR COMMERCIAL, PROMOTIONAL OR ADVERTISING PURPOSES; MODELING FOR ADVERTISING OR SALES PROMOTION; MODELING SERVICES FOR ADVERTISING OR SALES PROMOTION; ON-LINE PROMOTION OF COMPUTER NETWORKS AND WEBSITES; PROMOTING PUBLIC AWARENESS OF SHOPPING LOCALLY; PROMOTING RECREATION AND TOURISM IN LAS VEGAS, NV; PROMOTING SPORTS COMPETITIONS AND/OR EVENTS OF OTHERS; PUBLICITY AND SALES PROMOTION RELATING TO GOODS AND SERVICES, OFFERED AND ORDERED BY TELECOMMUNICATION OR THE ELECTRONIC WAY; PUBLICITY AND SALES PROMOTION SERVICES; SALES PROMOTION; SALES PROMOTION SERVICES; SPECIAL EVENT PLANNING FOR COMMERCIAL, PROMOTIONAL OR ADVERTISING PURPOSES, IN CLASS 35 (U.S. CLS. 100, 101 AND 102).



FIRST USE 7-28-2010; IN COMMERCE 7-28-2010.

THE MARK CONSISTS OF STANDARD CHARACTERS WITHOUT CLAIM TO ANY PARTICULAR FONT, STYLE, SIZE, OR COLOR.

David J. Kyros

SN 85-114,920, FILED 8-24-2010.

GISELLE AGOSTO, EXAMINING ATTORNEY

United States of America

United States Patent and Trademark Office

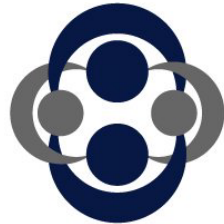

Advance
THERAPEUTIC CONCEPTS
Empowering Families and Communities

Reg. No. 4,074,925

Registered Dec. 20, 2011

Int. Cl.: 44

SERVICE MARK

PRINCIPAL REGISTER

SAVAGE, CAREY A. (UNITED STATES INDIVIDUAL), DBA ADVANCE THERAPEUTIC CONCEPTS,
2795 MAIN STREET WEST, BUILDING 20-B
SNELLVILLE, GA 30078

FOR: MENTAL HEALTH SERVICES, IN CLASS 44 (U.S. CLS. 100 AND 101).

FIRST USE 3-28-2011; IN COMMERCE 3-28-2011.

NO CLAIM IS MADE TO THE EXCLUSIVE RIGHT TO USE "THERAPEUTIC CONCEPTS", APART FROM THE MARK AS SHOWN.

THE COLOR(S) DARK BLUE AND GRAY IS/ARE CLAIMED AS A FEATURE OF THE MARK.

THE MARK CONSISTS OF THE WORDS "ADVANCE" AND "EMPOWERING FAMILIES AND COMMUNITIES" IN DARK BLUE AND "THERAPEUTIC CONCEPTS" IN DARK GRAY. THE DESIGN DEPICTS A STYLIZED FAMILY UNITED, TOUCHING EACH OTHER IN DARK BLUE AND GRAY.

SN 85-115,178, FILED 8-25-2010.

HOWARD SMIGA, EXAMINING ATTORNEY



David J. Kyffers

Director of the United States Patent and Trademark Office

United States of America

United States Patent and Trademark Office

EXIT

Reg. No. 4,074,926

PLAZA CREATIONS INC. (CANADA CORPORATION)
1363, BERGAR

Registered Dec. 20, 2011

LAVAL (QUEBEC), CANADA H7L4Z7

Int. Cl.: 18

FOR: BABY BAGS, NAMELY, BAGS FOR CARRYING BABIES' ACCESSORIES AND BABY CARRYING BAGS, WRAP BAGS IN THE NATURE OF BOOK BAGS, SHOULDER BAGS AND SLING BAGS, COURIER BAGS, URBAN MESSENGER BAGS, BUSINESS EXECUTIVE BAGS, NAMELY, BRIEFCASES, IN CLASS 18 (U.S. CLS. 1, 2, 3, 22 AND 41).

TRADEMARK

PRINCIPAL REGISTER

FIRST USE 9-30-2006; IN COMMERCE 9-12-2011.

THE MARK CONSISTS OF STANDARD CHARACTERS WITHOUT CLAIM TO ANY PARTICULAR FONT, STYLE, SIZE, OR COLOR.

SN 85-115,674, FILED 8-25-2010.

SUE LAWRENCE, EXAMINING ATTORNEY



David J. Kyffers

Director of the United States Patent and Trademark Office

United States of America

United States Patent and Trademark Office



Reg. No. 4,074,927

PLAZA CREATIONS INC. (CANADA CORPORATION)
1363, BERGAR

Registered Dec. 20, 2011

LAVAL (QUEBEC), CANADA H7L4Z7

Int. Cl.: 18

FOR: BABY BAGS, NAMELY, BAGS FOR CARRYING BABIES' ACCESSORIES AND BABY CARRYING BAGS, WRAP BAGS IN THE NATURE OF BOOK BAGS, SHOULDER BAGS AND SLING BAGS, COURIER BAGS, URBAN MESSENGER BAGS, BUSINESS EXECUTIVE BAGS, NAMELY, BRIEFCASES, IN CLASS 18 (U.S. CLS. 1, 2, 3, 22 AND 41).

TRADEMARK

PRINCIPAL REGISTER

FIRST USE 8-5-2010; IN COMMERCE 9-12-2011.

THE MARK CONSISTS OF THE TERM "EXIT", EACH LETTER OF WHICH IS BORDERED BY A THIN LINE. THE LETTER "T" OF SAID WORD FORMS A DESIGN OF AN ARROW, AND THE WHOLE APPEARS IN THE MIDDLE OF A RECTANGLE.

SN 85-116,156, FILED 8-26-2010.

SUE LAWRENCE, EXAMINING ATTORNEY



David J. Kybas

Director of the United States Patent and Trademark Office

United States of America

United States Patent and Trademark Office



Reg. No. 4,074,928

Registered Dec. 20, 2011

Int. Cl.: 30

TRADEMARK

PRINCIPAL REGISTER

5TH ELEMENT, LLC (ARKANSAS LIMITED LIABILITY COMPANY)
523 GARRISON AVENUE
SUITE 300
FORT SMITH, AR 72901

FOR: GRAIN-BASED FOOD BARS ALSO CONTAINING DRIED FRUITS, NUTS, AND CHOCOLATE, IN CLASS 30 (U.S. CL. 46).

FIRST USE 1-1-2011; IN COMMERCE 3-1-2011.

THE MARK CONSISTS OF THE A COLORED SPHERE WITH PRIMARY COLOR MIXES OF ORANGE TO THE TOP FADING TO RED TO THE RIGHT, RED FADING TO MAGENTA, MAGENTA FADING TO PURPLE AT THE RIGHT BOTTOM, THE ORANGE FADING TO BEIGE TO THE LEFT, BEIGE FADING TO GREEN, GREEN FADING TO TEAL AND TEAL FADING TO DARK BLUE AT THE BOTTOM, THE NUMBER "5" IN THE MIDDLE OF THE SPHERE IN WHITE WITH GRAY OUTLINE, THE LETTERS "TH" IN WHITE TO THE RIGHT OF "5", GRAY PARENTHESES TO THE LEFT AND RIGHT OF THE SPHERE, THE WORDING "ELEMENT" IN BLACK OUTLINED IN GRAY ON A WHITE BACKGROUND IN AN UPWARD ARC.

THE COLOR(S) GRAY, BLACK, WHITE, ORANGE, BEIGE, RED, PURPLE, MAGENTA, GREEN, TEAL, AND DARK BLUE IS/ARE CLAIMED AS A FEATURE OF THE MARK.

SN 85-116,251, FILED 8-26-2010.

JENNY PARK, EXAMINING ATTORNEY



David J. Kybas

Director of the United States Patent and Trademark Office

United States of America

United States Patent and Trademark Office

FOX SHOTS

Reg. No. 4,074,929

Registered Dec. 20, 2011

Int. Cl.: 41

SERVICE MARK

PRINCIPAL REGISTER

TWENTIETH CENTURY FOX FILM CORPORATION (DELAWARE CORPORATION)
10201 WEST PICO BOULEVARD
LOS ANGELES, CA 90035

FOR: ENTERTAINMENT SERVICES, NAMELY, PROVIDING A WEBSITE FEATURING AUDIO CLIPS IN THE FIELD OF CURRENT EVENT NEWS, ENTERTAINMENT, SPORTS, VIDEO CLIPS IN THE FIELD OF CURRENT EVENT NEWS, ENTERTAINMENT, SPORTS, PHOTOGRAPHS, AND INFORMATION IN THE FIELD OF AUDIO CLIPS IN THE FIELD OF CURRENT EVENT NEWS, ENTERTAINMENT, SPORTS, VIDEO CLIPS IN THE FIELD OF CURRENT EVENT NEWS, ENTERTAINMENT, SPORTS, AND PHOTOGRAPHS; PROVIDING ON-LINE INFORMATION IN THE FIELD OF CURRENT EVENT NEWS, ENTERTAINMENT, SPORTS VIA THE INTERNET AND WIRELESS COMMUNICATION NETWORKS; PRESENTATION AND DISTRIBUTION OF NON-DOWNLOADABLE VIDEOS AND IMAGES FEATURING CURRENT EVENT NEWS, ENTERTAINMENT, SPORTS TRANSMITTED VIA THE INTERNET AND WIRELESS COMMUNICATION NETWORKS, IN CLASS 41 (U.S. CLS. 100, 101 AND 107).

FIRST USE 7-5-2011; IN COMMERCE 7-5-2011.

THE MARK CONSISTS OF STANDARD CHARACTERS WITHOUT CLAIM TO ANY PARTICULAR FONT, STYLE, SIZE, OR COLOR.

OWNER OF U.S. REG. NOS. 1,795,301, 2,301,920, AND OTHERS.

SN 85-116,627, FILED 8-26-2010.

BRIDGETT SMITH, EXAMINING ATTORNEY



David J. Kyros

Director of the United States Patent and Trademark Office

United States of America

United States Patent and Trademark Office

FOX SHOTS

Reg. No. 4,074,930

TWENTIETH CENTURY FOX FILM CORPORATION (DELAWARE CORPORATION)
10201 WEST PICO BOULEVARD
LOS ANGELES, CA 90035

Registered Dec. 20, 2011

Int. Cl.: 42

FOR: APPLICATION SERVICE PROVIDER (ASP) FEATURING SOFTWARE TO ENABLE UPLOADING, POSTING, SHOWING, DISPLAYING, SHARING OR OTHERWISE PROVIDING ELECTRONIC MEDIA OR INFORMATION OVER THE INTERNET OR OTHER COMMUNICATIONS NETWORK, IN CLASS 42 (U.S. CLS. 100 AND 101).

SERVICE MARK

PRINCIPAL REGISTER

FIRST USE 7-5-2011; IN COMMERCE 7-5-2011.

THE MARK CONSISTS OF STANDARD CHARACTERS WITHOUT CLAIM TO ANY PARTICULAR FONT, STYLE, SIZE, OR COLOR.

SN 85-116,630, FILED 8-26-2010.

BRIDGETT SMITH, EXAMINING ATTORNEY



David J. Kyros

Director of the United States Patent and Trademark Office

United States of America

United States Patent and Trademark Office

BIODAPTIVE PRODUCING MEDICAL ADVANCES

Reg. No. 4,074,931

Registered Dec. 20, 2011

Int. Cl.: 40

SERVICE MARK

PRINCIPAL REGISTER

BIODAPTIVE, LLC (MINNESOTA LIMITED LIABILITY COMPANY)
SUITE 2100
444 CEDAR STREET,
ST. PAUL, MN 551012136

FOR: MANUFACTURE OF MEDICAL PRODUCTS TO ORDER AND/OR SPECIFICATION OF OTHERS, IN CLASS 40 (U.S. CLS. 100, 103 AND 106).

FIRST USE 8-31-2010; IN COMMERCE 8-31-2010.

THE MARK CONSISTS OF STANDARD CHARACTERS WITHOUT CLAIM TO ANY PARTICULAR FONT, STYLE, SIZE, OR COLOR.

NO CLAIM IS MADE TO THE EXCLUSIVE RIGHT TO USE "PRODUCING", "MEDICAL" OR "ADVANCES", APART FROM THE MARK AS SHOWN.

SN 85-116,707, FILED 8-26-2010.

HOWARD B. LEVINE, EXAMINING ATTORNEY



David J. Kybas

Director of the United States Patent and Trademark Office

United States of America

United States Patent and Trademark Office

IRT DEADLIEST ROADS

Reg. No. 4,074,932

A&E TELEVISION NETWORKS LLC (DELAWARE LIMITED LIABILITY COMPANY)
235 EAST 45TH STREET
NEW YORK, NY 10017

Registered Dec. 20, 2011

Int. Cls.: 9 and 41

FOR: MULTIMEDIA GOODS, NAMELY, PRERECORDED DIGITAL VIDEO DISCS AND DVDS FEATURING TRUCKING ADVENTURES; DIGITAL MEDIA, NAMELY, DOWNLOADABLE AUDIO AND VIDEO FILES FEATURING TRUCKING ADVENTURES; DOWNLOADABLE WEBCASTS FEATURING TRUCKING ADVENTURES; AND DOWNLOADABLE ON-LINE DISCUSSION BOARDS FEATURING STORIES FEATURING TRUCKING ADVENTURES, IN CLASS 9 (U.S. CLS. 21, 23, 26, 36 AND 38).

TRADEMARK

SERVICE MARK

PRINCIPAL REGISTER

FIRST USE 10-3-2010; IN COMMERCE 10-3-2010.

FOR: ENTERTAINMENT SERVICES, NAMELY, A MULTIMEDIA PROGRAM SERIES FEATURING STORIES ABOUT TRUCKING ADVENTURES DISTRIBUTED VIA VARIOUS PLATFORMS ACROSS MULTIPLE FORMS OF TRANSMISSION MEDIA, IN CLASS 41 (U.S. CLS. 100, 101 AND 107).

FIRST USE 10-3-2010; IN COMMERCE 10-3-2010.

THE MARK CONSISTS OF STANDARD CHARACTERS WITHOUT CLAIM TO ANY PARTICULAR FONT, STYLE, SIZE, OR COLOR.

NO CLAIM IS MADE TO THE EXCLUSIVE RIGHT TO USE "DEADLIEST ROADS", APART FROM THE MARK AS SHOWN.

SN 85-116,752, FILED 8-26-2010.

KATINA MISTER, EXAMINING ATTORNEY



David J. Kyros

Director of the United States Patent and Trademark Office

United States of America

United States Patent and Trademark Office

ZEROWICK

Reg. No. 4,074,933

JACKS' TECHNOLOGIES AND INDUSTRIES, INC. (CALIFORNIA CORPORATION)
225 N. PALOMARES
POMONA, CA 91767

Registered Dec. 20, 2011

Int. Cl.: 6

FOR: SOLDER REMOVING PRODUCTS, NAMELY, BRAIDED COPPER WICK FOR USE IN THE ELECTRONICS MANUFACTURING AND REPAIR INDUSTRIES, IN CLASS 6 (U.S. CLS. 2, 12, 13, 14, 23, 25 AND 50).

TRADEMARK

FIRST USE 8-1-2011; IN COMMERCE 8-1-2011.

PRINCIPAL REGISTER

THE MARK CONSISTS OF STANDARD CHARACTERS WITHOUT CLAIM TO ANY PARTICULAR FONT, STYLE, SIZE, OR COLOR.

SN 85-116,895, FILED 8-26-2010.

EMILY CARLSEN, EXAMINING ATTORNEY



David J. Kyffers

Director of the United States Patent and Trademark Office

United States of America
United States Patent and Trademark Office

PROTERRA

Reg. No. 4,074,934

Registered Dec. 20, 2011

Int. Cl.: 21

TRADEMARK

PRINCIPAL REGISTER

HOME PRODUCTS INTERNATIONAL - NORTH AMERICA, INC. (DELAWARE CORPORATION)
4501 WEST 47TH STREET
CHICAGO, IL 60632

FOR: PLASTIC STORAGE CONTAINERS FOR HOUSEHOLD USE, IN CLASS 21 (U.S. CLS. 2, 13, 23, 29, 30, 33, 40 AND 50).

FIRST USE 2-0-2011; IN COMMERCE 2-0-2011.

THE MARK CONSISTS OF STANDARD CHARACTERS WITHOUT CLAIM TO ANY PARTICULAR FONT, STYLE, SIZE, OR COLOR.

SN 85-117,037, FILED 8-26-2010.

TARA PATE, EXAMINING ATTORNEY



David J. Kybas

Director of the United States Patent and Trademark Office

United States of America

United States Patent and Trademark Office

TARTUFO TEMPTATION

Reg. No. 4,074,935

Registered Dec. 20, 2011

Int. Cl.: 3

TRADEMARK

PRINCIPAL REGISTER

ALOXXI INTERNATIONAL CORPORATION (CALIFORNIA CORPORATION)
14144 VENTURA BOULEVARD, SUITE 110
SHERMAN OAKS, CA 91423

FOR: HAIR BLEACHING PREPARATIONS, NON-MEDICATED HAIR PREPARATIONS, HAIR CLEANING PREPARATIONS, HAIR COLOR REMOVERS, HAIR COLORING SOLUTIONS, HAIR LIGHTENERS, HAIR COLORING RINSE, HAIR LIGHTENING BLEACH, HAIR RINSES, HAIR COLOR FORMULATIONS, ALL IN THE FORM OF LIQUID, GEL AND CREAM, IN CLASS 3 (U.S. CLS. 1, 4, 6, 50, 51 AND 52).

FIRST USE 5-1-2011; IN COMMERCE 5-1-2011.

THE MARK CONSISTS OF STANDARD CHARACTERS WITHOUT CLAIM TO ANY PARTICULAR FONT, STYLE, SIZE, OR COLOR.

THE ENGLISH TRANSLATION OF "TARTUFO" IN THE MARK IS "TRUFFLE".

SN 85-117,475, FILED 8-27-2010.

JANICE L. MCMORROW, EXAMINING ATTORNEY



David J. Kyros

Director of the United States Patent and Trademark Office

United States of America

United States Patent and Trademark Office



Reg. No. 4,074,936

Registered Dec. 20, 2011

Int. Cls.: 35 and 41

SERVICE MARK

PRINCIPAL REGISTER

VISION 2:2 PRODUCTIONS LLC (GEORGIA LIMITED LIABILITY COMPANY)
1415 HWY 85 NORTH
FAYETTEVILLE, GA 30214

FOR: ENTERTAINMENT EMPLOYMENT STAFFING SERVICES IN THE NATURE OF TALENT CASTING AND PRODUCTION CREW PLACEMENT SERVICES IN THE FIELDS OF TV, FILM, MOTION PICTURE, AND THEATER; PRODUCING PROMOTIONAL VIDEOTAPES, VIDEO DISCS AND AUDIO VISUAL RECORDINGS; ENTERTAINMENT RELATED PRODUCT MERCHANDISING; BUSINESS CONSULTING SERVICES IN THE FIELD OF SCRIPT DEVELOPMENT, FILM, TV AND INTERNET CONTENT PRODUCTION; PRODUCTION OF TELEVISION COMMERCIALS, IN CLASS 35 (U.S. CLS. 100, 101 AND 102).

FIRST USE 8-5-2011; IN COMMERCE 8-5-2011.

FOR: ENTERTAINMENT CONSULTATION SERVICES, NAMELY, IN THE FIELD OF SCRIPT WRITING, SCRIPT DEVELOPMENT, AND FREELANCE WRITING; TELEVISION, FILM, THEATER AND ON-LINE PRODUCTION SERVICES, NAMELY, DIRECTING TELEVISION SHOWS, FILMS, AND THEATER PRODUCTIONS; PERFORMANCE ARTIST SERVICES, NAMELY, VOCALISTS, ACTORS AND VOICE OVER TALENT SERVICES, IN THE NATURE OF VISUAL AND AUDIO PERFORMANCES BY AN ACTOR; MUSIC PRODUCTION SERVICES, NAMELY, RECORDING SERVICES FOR MUSIC PRODUCTION, DISTRIBUTION OR AUDIO RECORDINGS, SONGWRITING AND VOICE-OVER SERVICES; ANIMATION PRODUCTION SERVICES; ENTERTAINMENT SPECIAL EVENT CONSULTATION SERVICES; ENTERTAINMENT EVENT PRODUCTION SERVICES, NAMELY, ARRANGING, ORGANIZING, CONDUCTING, AND HOSTING SOCIAL ENTERTAINMENT EVENTS; ENTERTAINMENT INDUSTRY RELATED TRAINING, SEMINAR, AND EDUCATIONAL SERVICES, NAMELY, CONDUCTING WORKSHOPS AND SEMINARS IN THE FIELD OF SCRIPT WRITING, SCRIPT DEVELOPMENT AND MULTIMEDIA CONTENT PRODUCTION; MOTION PICTURE FILM PRODUCTION AND DISTRIBUTION OF MOTION PICTURE FILMS; PRODUCTION AND DISTRIBUTION OF TELEVISION SHOWS, MOVIES, WEB TELEVISION SERIES, VIDEOS, AND RADIO PROGRAMS; ENTERTAINMENT SERVICES, NAMELY, MULTIMEDIA ENTERTAINMENT CONTENT DEVELOPMENT, PRODUCTION AND POST-PRODUCTION SERVICES OF MULTIMEDIA ENTERTAINMENT CONTENT; PROVIDING VOICE OVERS FOR TAPES, RECORDS AND OTHER RECORDED MEDIA FOR ENTERTAINMENT AND EDUCATION PURPOSES; ENTERTAINMENT MEDIA PRODUCTION SERVICES FOR MOTION PICTURES, TELEVISION AND INTERNET; ENTER-



David J. Kyros

Director of the United States Patent and Trademark Office

Reg. No. 4,074,936 TAINMENT AND EDUCATIONAL SERVICES IN THE NATURE OF A SERIES OF SHORT SHOWS FEATURING VARIETY, NEWS, DRAMA AND COMEDY DISTRIBUTED TO MOBILE HANDSETS, WHICH MAY INCLUDE VIDEO, TEXT, PHOTOS, ILLUSTRATIONS OR HYPERTEXT; ENTERTAINMENT AND EDUCATIONAL SERVICES, NAMELY, PROVIDING LIVE SEMINARS, WORKSHOPS, ADVICE AND INFORMATION FOR MUSIC, VIDEO, TELEVISION, WEB TELEVISION SERIES, FILM CONCEPTS, SCRIPT DEVELOPMENT, AND PRODUCTION; ENTERTAINMENT SERVICES, NAMELY, PROVIDING ON-GOING WEBISODES FEATURING COMEDY, DRAMA, AND NEWS VIA A GLOBAL COMPUTER NETWORK; WRITING FOR MUSIC AND PRINTED AND ELECTRONIC MEDIA, NAMELY, FREELANCE CUSTOM WRITING SERVICES AND SONG WRITING SERVICES; SPECIAL EVENT CONSULTATION SERVICES FOR SOCIAL ENTERTAINMENT PURPOSES, IN CLASS 41 (U.S. CLS. 100, 101 AND 107).

FIRST USE 8-5-2011; IN COMMERCE 8-5-2011.

NO CLAIM IS MADE TO THE EXCLUSIVE RIGHT TO USE "PRODUCTIONS", APART FROM THE MARK AS SHOWN.

THE COLOR(S) RED, BLACK, WHITE AND GRAY IS/ARE CLAIMED AS A FEATURE OF THE MARK.

THE MARK CONSISTS OF THE STYLIZED WORDING "VISION" IN RED, STYLIZED "PRODUCTIONS" IN GRAY, STYLIZED "WRITE THE VISION...MAKE IT PLAIN" IN GRAY, STYLIZED "2:2" IN BLACK WITH DIAMOND SHAPE WITH RED AT THE TOP AND BLACK AT THE BOTTOM CONTAINING A WHITE LETTER "V" AND A GRAY SHADOW OF THE DESIGN BELOW WITH A WHITE LETTER "V".

SN 85-117,490, FILED 8-27-2010.

BRIAN PINO, EXAMINING ATTORNEY

United States of America

United States Patent and Trademark Office



NACD

Reg. No. 4,074,937

Registered Dec. 20, 2011

Int. Cls.: 16, 35, and 41

TRADEMARK

SERVICE MARK

PRINCIPAL REGISTER

NATIONAL ASSOCIATION OF CORPORATE DIRECTORS (D.C. NON-PROFIT CORPORATION)
1133 21ST ST. N.W.
SUITE 700, DC 20036

FOR: PRINTED MATERIALS, NAMELY, BOOKS, MANUALS, LEAFLETS, RESEARCH REPORTS, PERIODICALS AND NEWSLETTERS IN THE FIELD OF CORPORATE GOVERNANCE AND CORPORATE DIRECTORSHIP, IN CLASS 16 (U.S. CLS. 2, 5, 22, 23, 29, 37, 38 AND 50).

FIRST USE 5-31-2010; IN COMMERCE 5-31-2010.

FOR: ASSOCIATION SERVICES, NAMELY, PROMOTING THE INTERESTS OF CORPORATE DIRECTORS; CONSULTING SERVICES IN THE FIELD OF CORPORATE GOVERNANCE AND CORPORATE DIRECTORSHIP; PROVIDING A WEBSITE FEATURING BUSINESS NEWS AND INFORMATION IN THE FIELD OF CORPORATE GOVERNANCE AND CORPORATE DIRECTORSHIP, IN CLASS 35 (U.S. CLS. 100, 101 AND 102).

FIRST USE 5-31-2010; IN COMMERCE 5-31-2010.

FOR: EDUCATIONAL SERVICES, NAMELY, CONDUCTING CONTINUING EDUCATION COURSES OF INSTRUCTION, SEMINARS, WEBINARS, AND CERTIFICATION PROGRAMS OF INSTRUCTION ALL IN THE FIELD OF CORPORATE GOVERNANCE AND CORPORATE DIRECTORSHIP; PROVIDING ONLINE PUBLICATIONS, NAMELY, PROVIDING ONLINE NEWSLETTERS, SURVEY REPORTS, RESEARCH REPORTS, AND ARTICLES ALL IN THE FIELD OF CORPORATE GOVERNANCE AND CORPORATE DIRECTORSHIP, IN CLASS 41 (U.S. CLS. 100, 101 AND 107).

FIRST USE 5-31-2010; IN COMMERCE 5-31-2010.

OWNER OF U.S. REG. NOS. 2,859,760, 3,401,050, AND OTHERS.

THE MARK CONSISTS OF A PYRAMID DESIGN COMPRISING TWO TRIANGLES WITH THE LETTERS "NACD" PROTRUDING TO THE RIGHT FROM THE PYRAMID.

SN 85-117,803, FILED 8-27-2010.



David J. Kyjars

Director of the United States Patent and Trademark Office

Reg. No. 4,074,937 JOHN SCHUYLER YARD, EXAMINING ATTORNEY

United States of America

United States Patent and Trademark Office

NAKED DISPLAY

Reg. No. 4,074,938

JANDORF SPECIALTY HARDWARE (OHIO LIMITED LIABILITY COMPANY)
60 MEADOW LANE
NORTHFIELD, OH 44067

Registered Dec. 20, 2011

Int. Cl.: 20

FOR: DISPLAY CASES FOR MERCHANDISE, IN CLASS 20 (U.S. CLS. 2, 13, 22, 25, 32 AND 50).

TRADEMARK

FIRST USE 10-31-2010; IN COMMERCE 10-31-2010.

PRINCIPAL REGISTER

THE MARK CONSISTS OF STANDARD CHARACTERS WITHOUT CLAIM TO ANY PARTICULAR FONT, STYLE, SIZE, OR COLOR.

NO CLAIM IS MADE TO THE EXCLUSIVE RIGHT TO USE "DISPLAY", APART FROM THE MARK AS SHOWN.

SN 85-118,342, FILED 8-30-2010.

ESTHER A. BORSUK, EXAMINING ATTORNEY



David J. Kybas

Director of the United States Patent and Trademark Office

United States of America

United States Patent and Trademark Office



OLD FLORIDA
NATIONAL BANK

Reg. No. 4,074,939

Registered Dec. 20, 2011

Int. Cl.: 36

SERVICE MARK

PRINCIPAL REGISTER

OLD FLORIDA BANCSHARES, INC. (FLORIDA CORPORATION)
60 NORTH COURT AVE
ORLANDO, FL 32801

FOR: BANKING SERVICES, IN CLASS 36 (U.S. CLS. 100, 101 AND 102).

FIRST USE 2-17-2011; IN COMMERCE 2-17-2011.

OWNER OF U.S. REG. NOS. 3,670,594 AND 3,719,894.

NO CLAIM IS MADE TO THE EXCLUSIVE RIGHT TO USE "FLORIDA" & "NATIONAL BANK", APART FROM THE MARK AS SHOWN.

THE MARK CONSISTS OF THE WORDING "OLD FLORIDA NATIONAL BANK" IN STYLIZED LETTERING WITH A STYLIZED CIRCULAR DESIGN OF AN ORANGE ABOVE THE LETTERING, WITH A STYLIZED GEOMETRIC DESIGN OF A LEAF WITHIN THE CIRCULAR DESIGN.

SN 85-118,765, FILED 8-30-2010.

KARANENDRA S. CHHINA, EXAMINING ATTORNEY



David J. Kybas

Director of the United States Patent and Trademark Office

United States of America

United States Patent and Trademark Office

LIVE TANGLE-FREE

Reg. No. 4,074,940

CJD LLC (DELAWARE LIMITED LIABILITY COMPANY)
50 WEST 57TH STREET, 15TH FLOOR
NEW YORK, NY 10019

Registered Dec. 20, 2011

Int. Cl.: 22

FOR: ALL-PURPOSE STRAPS FOR MANAGING AND SECURING ALL TYPES OF CORDS AND CABLES, IN CLASS 22 (U.S. CLS. 1, 2, 7, 19, 22, 42 AND 50).

TRADEMARK

FIRST USE 9-12-2011; IN COMMERCE 9-12-2011.

PRINCIPAL REGISTER

THE MARK CONSISTS OF STANDARD CHARACTERS WITHOUT CLAIM TO ANY PARTICULAR FONT, STYLE, SIZE, OR COLOR.

NO CLAIM IS MADE TO THE EXCLUSIVE RIGHT TO USE "TANGLE-FREE", APART FROM THE MARK AS SHOWN.

SN 85-119,103, FILED 8-30-2010.

SHAUNIA CARLYLE, EXAMINING ATTORNEY



David J. Kybas

Director of the United States Patent and Trademark Office

United States of America

United States Patent and Trademark Office

The logo for the Women's Tennis Association (WTA) is displayed in a bold, stylized, sans-serif font. The letters 'W', 'T', and 'A' are connected, and a small grey circle is positioned below the letter 'A'.

Reg. No. 4,074,941

Registered Dec. 20, 2011

Int. Cl.: 35

SERVICE MARK

PRINCIPAL REGISTER

WTA TOUR, INC. (NEW YORK CORPORATION)
SUITE 1500
ONE PROGRESS PLAZA
SAINT PETERSBURG, FL 33701

FOR: ADMINISTRATION AND PROMOTION OF A CIRCUIT OF COMPETITIVE, PROFESSIONAL WOMEN'S TENNIS; ASSOCIATION SERVICES, NAMELY, PROMOTING THE INTERESTS OF WOMEN'S TENNIS, IN CLASS 35 (U.S. CLS. 100, 101 AND 102).

FIRST USE 8-0-2011; IN COMMERCE 8-0-2011.

OWNER OF U.S. REG. NOS. 1,692,134, 2,385,106, AND OTHERS.

THE MARK CONSISTS OF "WTA" IN STYLIZED FORMAT.

SN 85-119,285, FILED 8-30-2010.

EUGENIA MARTIN, EXAMINING ATTORNEY



David J. Kyjars

Director of the United States Patent and Trademark Office

United States of America

United States Patent and Trademark Office



Reg. No. 4,074,942

Registered Dec. 20, 2011

Int. Cl.: 35

SERVICE MARK

PRINCIPAL REGISTER

WTA TOUR, INC. (NEW YORK CORPORATION)
SUITE 1500
ONE PROGRESS PLAZA
SAINT PETERSBURG, FL 33701

FOR: ADMINISTRATION AND PROMOTION OF A CIRCUIT OF COMPETITIVE, PROFESSIONAL WOMEN'S TENNIS; ASSOCIATION SERVICES, NAMELY, PROMOTING THE INTERESTS OF WOMEN'S TENNIS, IN CLASS 35 (U.S. CLS. 100, 101 AND 102).

FIRST USE 10-0-2010; IN COMMERCE 10-0-2010.

OWNER OF U.S. REG. NOS. 1,692,134, 2,385,106, AND OTHERS.

THE MARK CONSISTS OF "WTA" IN STYLIZED FORMAT ENCLOSED WITHIN AN ELLIPSE.

SN 85-119,294, FILED 8-30-2010.

EUGENIA MARTIN, EXAMINING ATTORNEY



David J. Kyffers

Director of the United States Patent and Trademark Office

United States of America
United States Patent and Trademark Office

BIOFOAM

Reg. No. 4,074,943

Registered Dec. 20, 2011

Int. Cl.: 27

TRADEMARK

PRINCIPAL REGISTER

LET'S GEL, INC. (TEXAS CORPORATION)
13809 RESEARCH BLVD., SUITE 1000
ATTN.: SABRINA EATON
AUSTIN, TX 78750

FOR: FLOOR MATS, IN CLASS 27 (U.S. CLS. 19, 20, 37, 42 AND 50).

FIRST USE 8-31-2010; IN COMMERCE 10-1-2010.

THE MARK CONSISTS OF STANDARD CHARACTERS WITHOUT CLAIM TO ANY PARTICULAR FONT, STYLE, SIZE, OR COLOR.

SN 85-119,713, FILED 8-31-2010.

ZACHARY BELLO, EXAMINING ATTORNEY



David J. Kybas

Director of the United States Patent and Trademark Office

United States of America

United States Patent and Trademark Office

BACTIFEED - GIVE YOUR SOIL ORGANISMS!!

Reg. No. 4,074,944

FEED MY SOIL, LLC (KANSAS LIMITED LIABILITY COMPANY)
11392 E HWY 42

Registered Dec. 20, 2011

NORWICH, KS 67118

Int. Cl.: 1

FOR: ORGANIC SOIL ENHANCEMENT POWDERS AND PREPARATIONS, IN CLASS 1 (U.S. CLS. 1, 5, 6, 10, 26 AND 46).

TRADEMARK

FIRST USE 0-0-2010; IN COMMERCE 0-0-2010.

PRINCIPAL REGISTER

THE MARK CONSISTS OF STANDARD CHARACTERS WITHOUT CLAIM TO ANY PARTICULAR FONT, STYLE, SIZE, OR COLOR.

SN 85-120,441, FILED 9-1-2010.

REBECCA SMITH, EXAMINING ATTORNEY



David J. Kyffers

Director of the United States Patent and Trademark Office

United States of America

United States Patent and Trademark Office

DIRECT HEAT

Reg. No. 4,074,945

Registered Dec. 20, 2011

Int. Cl.: 35

SERVICE MARK

PRINCIPAL REGISTER

WPP PROPERTIES (DELAWARE PARTNERSHIP)
4TH FLOOR
100 PARK AVENUE
NEW YORK, NY 10017

FOR: ADVERTISING SERVICES, PUBLIC RELATIONS AND MARKETING SERVICES, NAMELY, PROMOTING AND MARKETING THE GOODS, SERVICES, BRAND IDENTITY AND COMMERCIAL INFORMATION AND NEWS OF THIRD PARTIES THROUGH PRINT, AUDIO, VIDEO, DIGITAL AND ON-LINE MEDIUM; MARKET RESEARCH AND ANALYSIS; BUSINESS MARKETING CONSULTING SERVICES; MANAGEMENT CONSULTING SERVICES; CONSULTING IN THE FIELD OF MARKETING AND BRAND DEVELOPMENT; PREPARATION AND REALIZATION OF MEDIA AND ADVERTISING PLANS AND CONCEPTS; BRANDING SERVICES, NAMELY, CONSULTING, DEVELOPMENT, MANAGEMENT AND MARKETING OF BRANDS FOR BUSINESSES; PROVIDING ANALYSIS OF ONLINE CONTENT TO OTHERS FOR BUSINESS PURPOSES; MEDIA MONITORING SERVICES, NAMELY, MONITORING PRINT MEDIA, TELEVISION, RADIO, AND OTHER MEDIA FOR CUSTOMER-SPECIFIED TOPICS, GATHERING RELEVANT CONTENT ON THOSE TOPICS, AND PROVIDING DOCUMENTATION AND ANALYSIS OF THAT MEDIA CONTENT TO OTHERS FOR BUSINESS PURPOSES; PROVIDING A SEARCHABLE ON-LINE ADVERTISING WEBSITE FEATURING THE GOODS AND SERVICES OF OTHERS VIA THE INTERNET, IN CLASS 35 (U.S. CLS. 100, 101 AND 102).

FIRST USE 10-3-2010; IN COMMERCE 10-3-2010.

THE MARK CONSISTS OF STANDARD CHARACTERS WITHOUT CLAIM TO ANY PARTICULAR FONT, STYLE, SIZE, OR COLOR.

SN 85-120,689, FILED 9-1-2010.

BRIAN NEVILLE, EXAMINING ATTORNEY



David J. Kyffers

Director of the United States Patent and Trademark Office

United States of America
United States Patent and Trademark Office

TRUSHOT

Reg. No. 4,074,946

TRUGLO, INC. (TEXAS CORPORATION)
710 PRESIDENTIAL DRIVE
RICHARDSON, TX 75081

Registered Dec. 20, 2011

Int. Cl.: 9

FOR: GUN SCOPES; RIFLE SCOPES, IN CLASS 9 (U.S. CLS. 21, 23, 26, 36 AND 38).

TRADEMARK

FIRST USE 12-6-2010; IN COMMERCE 12-6-2010.

PRINCIPAL REGISTER

THE MARK CONSISTS OF STANDARD CHARACTERS WITHOUT CLAIM TO ANY PARTICULAR FONT, STYLE, SIZE, OR COLOR.

SN 85-120,895, FILED 9-1-2010.

ALICE BENMAMAN, EXAMINING ATTORNEY



David J. Kyffers

Director of the United States Patent and Trademark Office

United States of America

United States Patent and Trademark Office

OLLIE & ME

Reg. No. 4,074,947

OLLIE & ME, LLC (CALIFORNIA LIMITED LIABILITY COMPANY)

Registered Dec. 20, 2011

2647 GATEWAY ROAD, #104
CARLSBAD, CA 92009

Int. Cl.: 35

FOR: RETAIL SHOPS FEATURING BEDDING, BATH, PERSONAL CARE, BABY, AND MATERNITY PRODUCTS; RETAIL STORE SERVICES FEATURING BEDDING, BATH, PERSONAL CARE, BABY, AND MATERNITY PRODUCTS; RETAIL STORES FEATURING BEDDING, BATH, PERSONAL CARE, BABY, AND MATERNITY PRODUCTS, IN CLASS 35 (U.S. CLS. 100, 101 AND 102).

SERVICE MARK

PRINCIPAL REGISTER

FIRST USE 9-3-2010; IN COMMERCE 10-19-2010.

THE MARK CONSISTS OF STANDARD CHARACTERS WITHOUT CLAIM TO ANY PARTICULAR FONT, STYLE, SIZE, OR COLOR.

SN 85-121,002, FILED 9-1-2010.

SANI KHOURI, EXAMINING ATTORNEY



David J. Kybas

Director of the United States Patent and Trademark Office

United States of America
United States Patent and Trademark Office

GEO-PERF

Reg. No. 4,074,948

Registered Dec. 20, 2011

Int. Cl.: 42

SERVICE MARK

PRINCIPAL REGISTER

THRUBIT B.V. (NETHERLANDS CORPORATION)
LANGE KLEIWEG 60F
RIJSWIJK, NETHERLANDS 2288GK

FOR: WELL LOGGING, IN CLASS 42 (U.S. CLS. 100 AND 101).

FIRST USE 10-5-2010; IN COMMERCE 10-31-2010.

THE MARK CONSISTS OF STANDARD CHARACTERS WITHOUT CLAIM TO ANY PARTICULAR FONT, STYLE, SIZE, OR COLOR.

SN 85-122,076, FILED 9-2-2010.

LINDA ESTRADA, EXAMINING ATTORNEY



David J. Kybas

Director of the United States Patent and Trademark Office

United States of America
United States Patent and Trademark Office

FITBRIT

Reg. No. 4,074,949

GREENAWAY, PAUL (UNITED STATES INDIVIDUAL), DBA FITBRIT.NET,
23 20 29TH AVE # 3R

Registered Dec. 20, 2011

ASTORIA, QUEENS, NY 11102

Int. Cl.: 41

FOR: PHYSICAL FITNESS TRAINING SERVICES; PROVIDING A WEB SITE FEATURING INFORMATION ON EXERCISE AND FITNESS; PROVIDING AN ON-LINE COMPUTER DATABASE FEATURING INFORMATION REGARDING EXERCISE AND FITNESS; PROVIDING AN ON-LINE COMPUTER DATABASE FEATURING INFORMATION REGARDING EXERCISE AND FITNESS BEFORE AND AFTER PREGNANCY, IN CLASS 41 (U.S. CLS. 100, 101 AND 107).

SERVICE MARK

PRINCIPAL REGISTER

FIRST USE 3-1-2011; IN COMMERCE 3-1-2011.

THE MARK CONSISTS OF STANDARD CHARACTERS WITHOUT CLAIM TO ANY PARTICULAR FONT, STYLE, SIZE, OR COLOR.

SN 85-122,265, FILED 9-2-2010.

KYLE PEETE, EXAMINING ATTORNEY



David J. Kyffers

Director of the United States Patent and Trademark Office

United States of America

United States Patent and Trademark Office

LOL

Reg. No. 4,074,950

Registered Dec. 20, 2011

Int. Cl.: 9

TRADEMARK

PRINCIPAL REGISTER

FRONTIER FASHION, INC. (CALIFORNIA CORPORATION)
1295 S. JOHNSON DR.
CITY OF INDUSTRY, CA 91745

FOR: EYEWEAR; SUNGLASSES, IN CLASS 9 (U.S. CLS. 21, 23, 26, 36 AND 38).

FIRST USE 6-1-2010; IN COMMERCE 6-1-2010.

THE MARK CONSISTS OF STANDARD CHARACTERS WITHOUT CLAIM TO ANY PARTICULAR FONT, STYLE, SIZE, OR COLOR.

SN 85-122,435, FILED 9-3-2010.

TINA BROWN, EXAMINING ATTORNEY



David J. Kyffers

Director of the United States Patent and Trademark Office

United States of America

United States Patent and Trademark Office

MAKE YOUR MARK

Reg. No. 4,074,951

Registered Dec. 20, 2011

Int. Cls.: 39 and 42

SERVICE MARK

PRINCIPAL REGISTER

ORLANDO UTILITIES COMMISSION (FLORIDA STATE AGENCY)
100 WEST ANDERSON STREET
ORLANDO, FL 32801

FOR: PUBLIC UTILITY SERVICES IN THE NATURE OF WATER DISTRIBUTION; PUBLIC UTILITY SERVICES IN THE NATURE OF ELECTRICITY DISTRIBUTION , IN CLASS 39 (U.S. CLS. 100 AND 105).

FIRST USE 1-18-2010; IN COMMERCE 1-18-2010.

FOR: CONSULTING SERVICES IN THE FIELDS OF ENERGY AND WATER MEASUREMENT TO IMPROVE ENERGY AND WATER EFFICIENCY, IN CLASS 42 (U.S. CLS. 100 AND 101).

FIRST USE 1-18-2010; IN COMMERCE 1-18-2010.

THE MARK CONSISTS OF STANDARD CHARACTERS WITHOUT CLAIM TO ANY PARTICULAR FONT, STYLE, SIZE, OR COLOR.

SN 85-122,981, FILED 9-3-2010.

DAVID C. REIHNER, EXAMINING ATTORNEY



David J. Kyros

Director of the United States Patent and Trademark Office

United States of America

United States Patent and Trademark Office



Reg. No. 4,074,952

Registered Dec. 20, 2011

Int. Cl.: 29

TRADEMARK

PRINCIPAL REGISTER

SEAFRESH INDUSTRY PUBLIC COMPANY LIMITED (THAILAND CORPORATION)
31ST FL., CHARTERED SQUARE BLDG.
152/25 NORTH SATHON ROAD
BANGKOK 10500, THAILAND

FOR: FROZEN SHRIMP, IN CLASS 29 (U.S. CL. 46).

FIRST USE 9-9-2011; IN COMMERCE 9-9-2011.

SN 85-123,048, FILED 9-3-2010.

LAURIE KAUFMAN, EXAMINING ATTORNEY



David J. Kybas

Director of the United States Patent and Trademark Office

United States of America

United States Patent and Trademark Office



PLASMID+

Reg. No. 4,074,953

SCIENTIFIC PLASTIC PRODUCTS, INC. (CALIFORNIA CORPORATION)
1121 SOUTH CLEVELAND STREET
OCEANSIDE, CA 92054

Registered Dec. 20, 2011

Int. Cl.: 5

FOR: CELL GROWTH MEDIA FOR GROWING MEDIA FOR MEDICAL, CLINICAL AND PHARMACEUTICAL USE, IN CLASS 5 (U.S. CLS. 6, 18, 44, 46, 51 AND 52).

TRADEMARK

FIRST USE 11-16-2010; IN COMMERCE 11-16-2010.

PRINCIPAL REGISTER

NO CLAIM IS MADE TO THE EXCLUSIVE RIGHT TO USE "PLASMID", APART FROM THE MARK AS SHOWN.

THE MARK CONSISTS OF THE STYLIZED WORDING "PLASMID" WHERE THE LETTER "S" IS FORMED BY THE DESIGN OF A DOUBLE HELIX DNA STRAND AND THE DESIGN OF A GREEK CROSS TO THE RIGHT OF THE WORDING.

SN 85-123,062, FILED 9-3-2010.

JAY BESCH, EXAMINING ATTORNEY



David J. Kyros

Director of the United States Patent and Trademark Office

United States of America

United States Patent and Trademark Office

GROW OLD WITH GOLD

Reg. No. 4,074,954

ALEXANDERS DENTAL LAB (NEW YORK SOLE PROPRIETORSHIP)
37 WEST LAWRENCE STREET
JORDAN, NY 13080

Registered Dec. 20, 2011

Int. Cl.: 36

FOR: FINANCIAL SERVICES, NAMELY, GOLD TRADING, IN CLASS 36 (U.S. CLS. 100, 101 AND 102).

SERVICE MARK

FIRST USE 1-15-2011; IN COMMERCE 1-15-2011.

PRINCIPAL REGISTER

THE MARK CONSISTS OF STANDARD CHARACTERS WITHOUT CLAIM TO ANY PARTICULAR FONT, STYLE, SIZE, OR COLOR.

SN 85-123,087, FILED 9-3-2010.

JAY BESCH, EXAMINING ATTORNEY



David J. Kyffers

Director of the United States Patent and Trademark Office

United States of America

United States Patent and Trademark Office

BOAT HOUSE

Reg. No. 4,074,955

HOMEGOODS, INC. (DELAWARE CORPORATION)
770 COCHITUATE ROAD
FRAMINGHAM, MA 01701

Registered Dec. 20, 2011

**Int. Cls.: 4, 8, 11, 16, 20,
21, and 24**

FOR: CANDLES AND PATIO TORCHES, IN CLASS 4 (U.S. CLS. 1, 6 AND 15).

FIRST USE 4-30-2011; IN COMMERCE 4-30-2011.

TRADEMARK

FOR: FLATWARE, IN CLASS 8 (U.S. CLS. 23, 28 AND 44).

PRINCIPAL REGISTER

FIRST USE 4-30-2011; IN COMMERCE 4-30-2011.

FOR: LAMPS; OUTDOOR LIGHTING, NAMELY, PAVER LIGHTS AND ELECTRIC LIGHTING FIXTURES, IN CLASS 11 (U.S. CLS. 13, 21, 23, 31 AND 34).

FIRST USE 4-30-2011; IN COMMERCE 4-30-2011.

FOR: DESK ACCESSORIES, NAMELY, DESK PADS, LETTER HOLDERS, LETTER OPENERS, PEN AND PENCIL HOLDERS, PAPERWEIGHTS; DESK BASKETS FOR DESK ACCESSORIES, IN CLASS 16 (U.S. CLS. 2, 5, 22, 23, 29, 37, 38 AND 50).

FIRST USE 4-30-2011; IN COMMERCE 4-30-2011.

FOR: DECORATIVE PILLOWS; PICTURE FRAMES; WIND CHIMES; AND NON-METAL DECORATIVE GARDEN STAKES, IN CLASS 20 (U.S. CLS. 2, 13, 22, 25, 32 AND 50).

FIRST USE 4-30-2011; IN COMMERCE 4-30-2011.

FOR: BATHROOM HARDWARE AND ACCESSORIES, NAMELY, TOWEL BARS, TOILET PAPER HOLDERS, SOAP DISHES, TOOTHBRUSH HOLDERS, SHOWER CADDIES; LIQUID SOAP AND LOTION DISPENSERS SOLD EMPTY; TISSUE HOLDERS; BASKETS FOR DOMESTIC USE NOT MADE OF METAL; DINNERWARE; SERVING TRAYS AND PLATTERS NOT OF PRECIOUS METAL; SALT AND PEPPER SHAKERS; BEVERAGE WARE AND STEMWARE; SERVINGWARE FOR SERVING FOOD AND DRINKS; NAPKIN RINGS; CANDLE HOLDERS; BOWLS; TRIVETS; TRAYS; VASES; PLANTERS AND HANGING BASKETS FOR FLOWERS AND PLANTS, IN CLASS 21 (U.S. CLS. 2, 13, 23, 29, 30, 33, 40 AND 50).



David J. Kybas

Director of the United States Patent and Trademark Office

Reg. No. 4,074,955 FIRST USE 4-30-2011; IN COMMERCE 4-30-2011.

FOR: BEDDING, NAMELY, BED SHEETS, PILLOW CASES, PILLOW SHAMS, DUST RUFFLES, BEDSPREADS, BLANKETS, COMFORTERS, DUVET COVERS, QUILTS, COVERLETS, THROWS, MATTRESS PADS, TABLE LINENS, IN CLASS 24 (U.S. CLS. 42 AND 50).

FIRST USE 4-30-2011; IN COMMERCE 4-30-2011.

THE MARK CONSISTS OF STANDARD CHARACTERS WITHOUT CLAIM TO ANY PARTICULAR FONT, STYLE, SIZE, OR COLOR.

SN 85-123,798, FILED 9-7-2010.

CAROL SPILS, EXAMINING ATTORNEY

United States of America

United States Patent and Trademark Office



Reg. No. 4,074,956

Registered Dec. 20, 2011

Int. Cl.: 9

TRADEMARK

PRINCIPAL REGISTER

DECHNIA, LLC (OKLAHOMA LIMITED LIABILITY COMPANY), DBA DECHNIA, OSCIUM, ISNAPME,
5909 NW EXPRESSWAY, SUITE 269
OKLAHOMA CITY, OK 73132

FOR: ELECTRONIC INSTRUMENTS, NAMELY, LOGIC ANALYZERS; OSCILLOSCOPES, IN CLASS 9 (U.S. CLS. 21, 23, 26, 36 AND 38).

FIRST USE 3-1-2011; IN COMMERCE 5-1-2011.

THE MARK CONSISTS OF THE WORD "OSCIUM" IN WHITE SURROUNDED BY BLACK WITH A FLAME THAT FADES FROM LIGHT TO DARK BLUE WITH THE LIGHT BLUE ON BOTTOM.

THE COLOR(S) WHITE, LIGHT BLUE, DARK BLUE, BLACK IS/ARE CLAIMED AS A FEATURE OF THE MARK.

SN 85-123,984, FILED 9-7-2010.

BARNEY CHARLON, EXAMINING ATTORNEY



David J. Kybas

Director of the United States Patent and Trademark Office

United States of America

United States Patent and Trademark Office



Reg. No. 4,074,957

HYUNDAI METAL COMPANY (REPUBLIC OF KOREA CORPORATION)
NO. 514 GAMJEON-DONG, SASANG-GU
BUSAN, REPUBLIC OF KOREA

Registered Dec. 20, 2011

Int. Cl.: 6

FOR: ANCHORS; METAL BOLTS; METAL DOOR BOLTS; METAL NUTS, IN CLASS 6 (U.S. CLS. 2, 12, 13, 14, 23, 25 AND 50).

TRADEMARK

FIRST USE 7-1-2011; IN COMMERCE 7-1-2011.

PRINCIPAL REGISTER

THE MARK CONSISTS OF A STYLIZED LETTER "M" IN BETWEEN STYLIZED SYMBOLS.

SN 85-124,010, FILED 9-7-2010.

SOPHIA S. KIM, EXAMINING ATTORNEY



David J. Kybas

Director of the United States Patent and Trademark Office

United States of America

United States Patent and Trademark Office

PRESTOBLUE

Reg. No. 4,074,958

LIFE TECHNOLOGIES CORPORATION (DELAWARE CORPORATION)
5791 VAN ALLEN WAY
CARLSBAD, CA 92008

Registered Dec. 20, 2011

Int. Cl.: 1

FOR: FLUORESCENT DYE FOR SCIENTIFIC OR RESEARCH USE, IN CLASS 1 (U.S. CLS. 1, 5, 6, 10, 26 AND 46).

TRADEMARK

FIRST USE 10-15-2010; IN COMMERCE 10-15-2010.

PRINCIPAL REGISTER

THE MARK CONSISTS OF STANDARD CHARACTERS WITHOUT CLAIM TO ANY PARTICULAR FONT, STYLE, SIZE, OR COLOR.

SN 85-124,971, FILED 9-8-2010.

JILL PRATER, EXAMINING ATTORNEY



David J. Kybas

Director of the United States Patent and Trademark Office

United States of America

United States Patent and Trademark Office

LEWI

Reg. No. 4,074,959

Registered Dec. 20, 2011

Int. Cl.: 15

TRADEMARK

PRINCIPAL REGISTER

CAJON DRUMZ, LLC (MICHIGAN LIMITED LIABILITY COMPANY), DBA LEWI CUSTOM
CAJON DRUMZ,
485 CHARLESINA DRIVE
OAKLAND TOWNSHIP, MI 48306

FOR: PERCUSSION INSTRUMENTS, IN CLASS 15 (U.S. CLS. 2, 21 AND 36).

FIRST USE 7-4-2010; IN COMMERCE 7-4-2010.

THE MARK CONSISTS OF STANDARD CHARACTERS WITHOUT CLAIM TO ANY PARTICULAR FONT, STYLE, SIZE, OR COLOR.

SN 85-125,029, FILED 9-8-2010.

KHANH LE, EXAMINING ATTORNEY



David J. Kybas

Director of the United States Patent and Trademark Office

United States of America

United States Patent and Trademark Office

TOTALIENROLL

Reg. No. 4,074,960

Registered Dec. 20, 2011

Int. Cl.: 9

TRADEMARK

PRINCIPAL REGISTER

INTEGRATED MEDIA MANAGEMENT LLC (NEW JERSEY LIMITED LIABILITY COMPANY)
330 DALZIEL ROAD
LINDEN, NJ 07036

FOR: COMPUTER SOFTWARE FOR USE IN THE FIELD OF BANKING, NAMELY, AN APPLICATION ALLOWING CERTAIN FINANCIAL INSTITUTIONS TO ADMIT MEMBERS, VIEW DATA STORED IN A COMPUTER DATABASE IN REAL TIME USING A MOBILE DEVICE, AND THAT CAPTURES ELECTRONIC SIGNATURES FOR STORING AND ARCHIVING, IN CLASS 9 (U.S. CLS. 21, 23, 26, 36 AND 38).

FIRST USE 9-27-2010; IN COMMERCE 1-26-2011.

THE MARK CONSISTS OF STANDARD CHARACTERS WITHOUT CLAIM TO ANY PARTICULAR FONT, STYLE, SIZE, OR COLOR.

SN 85-125,413, FILED 9-8-2010.

ANGELA DUONG, EXAMINING ATTORNEY



David J. Kyjars

Director of the United States Patent and Trademark Office

United States of America

United States Patent and Trademark Office



Reg. No. 4,074,961

Registered Dec. 20, 2011

Int. Cl.: 35

SERVICE MARK

PRINCIPAL REGISTER

SPORTSWEAR INC. (WASHINGTON CORPORATION)
4660 OHIO AVE. S.
SUITE A
SEATTLE, WA 98134

FOR: ON-LINE RETAIL STORE SERVICES FEATURING PRINTED GOODS, WALL GRAPHICS, POSTERS, AND AWARDS, SPORTS EQUIPMENT, PRODUCTS, AND GEAR, AND OTHER SCHOOL SPIRIT AND ATHLETIC PROGRAM PROMOTIONAL ITEMS; DISTRIBUTORSHIP SERVICES IN THE FIELD OF SPORTS EQUIPMENT, PRODUCTS, AND GEAR, IN CLASS 35 (U.S. CLS. 100, 101 AND 102).

FIRST USE 8-15-2006; IN COMMERCE 8-15-2006.

THE MARK CONSISTS OF THE STYLIZED LETTERS "PS" ON A STRIP OVERLAYING A BORDERED CIRCLE DESIGN.

SN 85-125,483, FILED 9-8-2010.

GRETТА YAO, EXAMINING ATTORNEY



David J. Kyffers

Director of the United States Patent and Trademark Office

United States of America
United States Patent and Trademark Office

FORNO52

Reg. No. 4,074,962

Registered Dec. 20, 2011

Int. Cls.: 30 and 43

TRADEMARK

SERVICE MARK

PRINCIPAL REGISTER

FORNO52, INC. (FLORIDA CORPORATION)
17225 SOUTH DIXIE HIGHWAY
PALMETTO BAY, FL 33157

FOR: PIZZA, IN CLASS 30 (U.S. CL. 46).

FIRST USE 2-0-2011; IN COMMERCE 2-0-2011.

FOR: RESTAURANT AND CATERING SERVICES, IN CLASS 43 (U.S. CLS. 100 AND 101).

FIRST USE 2-0-2011; IN COMMERCE 2-0-2011.

THE MARK CONSISTS OF STANDARD CHARACTERS WITHOUT CLAIM TO ANY PARTICULAR FONT, STYLE, SIZE, OR COLOR.

SN 85-125,921, FILED 9-9-2010.

RONALD MCMORROW, EXAMINING ATTORNEY



David J. Kybas

Director of the United States Patent and Trademark Office

United States of America
United States Patent and Trademark Office

ECOCLEAN

Reg. No. 4,074,963

Registered Dec. 20, 2011

Int. Cl.: 6

TRADEMARK

PRINCIPAL REGISTER

ALCOA INC. (PENNSYLVANIA CORPORATION)
ALCOA CORPORATE CENTER
201 ISABELLA STREET
PITTSBURGH, PA 152125858

FOR: COATED AND ANODIZED ALUMINUM FOR BUILDING WALLS AND ROOF PANELS,
IN CLASS 6 (U.S. CLS. 2, 12, 13, 14, 23, 25 AND 50).

FIRST USE 9-12-2011; IN COMMERCE 9-12-2011.

THE MARK CONSISTS OF STANDARD CHARACTERS WITHOUT CLAIM TO ANY PAR-
TICULAR FONT, STYLE, SIZE, OR COLOR.

SN 85-125,958, FILED 9-9-2010.

KEVON CHISOLM, EXAMINING ATTORNEY



David J. Kybas

Director of the United States Patent and Trademark Office

United States of America

United States Patent and Trademark Office

ECOCLEAN

Reg. No. 4,074,964

Registered Dec. 20, 2011

Int. Cl.: 2

TRADEMARK

PRINCIPAL REGISTER

ALCOA INC. (PENNSYLVANIA CORPORATION)
ALCOA CORPORATE CENTER
201 ISABELLA STREET
PITTSBURGH, PA 152125858

FOR: COATING, NAMELY, CLEAR COATING PROTECTANT FOR ALUMINUM SURFACES,
IN CLASS 2 (U.S. CLS. 6, 11 AND 16).

FIRST USE 9-12-2011; IN COMMERCE 9-12-2011.

THE MARK CONSISTS OF STANDARD CHARACTERS WITHOUT CLAIM TO ANY PAR-
TICULAR FONT, STYLE, SIZE, OR COLOR.

SN 85-125,962, FILED 9-9-2010.

KEVON CHISOLM, EXAMINING ATTORNEY



David J. Kyffers

Director of the United States Patent and Trademark Office

United States of America
United States Patent and Trademark Office

GRIDFOX

Reg. No. 4,074,965

Registered Dec. 20, 2011

Int. Cl.: 9

TRADEMARK

PRINCIPAL REGISTER

WELLHEAD ENERGY SYSTEMS LLC (KENTUCKY LIMITED LIABILITY COMPANY)
203 NORTH MAIN STREET
SOMERSET, KY 42501

FOR: ENERGY CONVERSION STATION, NAMELY, AN APPARATUS FOR CONVERTING
NATURAL GAS AND OTHER RESOURCES TO ELECTRICAL ENERGY, IN CLASS 9 (U.S.
CLS. 21, 23, 26, 36 AND 38).

FIRST USE 1-17-2011; IN COMMERCE 1-17-2011.

THE MARK CONSISTS OF STANDARD CHARACTERS WITHOUT CLAIM TO ANY PAR-
TICULAR FONT, STYLE, SIZE, OR COLOR.

SN 85-125,969, FILED 9-9-2010.

KEVON CHISOLM, EXAMINING ATTORNEY



David J. Kybas

Director of the United States Patent and Trademark Office

United States of America

United States Patent and Trademark Office

MATHEMATICS

Reg. No. 4,074,966

Registered Dec. 20, 2011

Int. Cl.: 41

SERVICE MARK

PRINCIPAL REGISTER

STINNETT, MICHAEL (UNITED STATES INDIVIDUAL)
6850 PARSONS AVE
GWYNN OAK, MD 21207

FOR: AUDIO RECORDING AND PRODUCTION; ENTERTAINMENT SERVICES IN THE NATURE OF LIVE MUSICAL PERFORMANCES; ENTERTAINMENT SERVICES, NAMELY, PROVIDING A WEB SITE FEATURING PHOTOGRAPHIC, AUDIO, VIDEO AND PROSE PRESENTATIONS FEATURING MUSIC AND MUSICAL ENTERTAINMENT, IN CLASS 41 (U.S. CLS. 100, 101 AND 107).

FIRST USE 4-1-2011; IN COMMERCE 4-1-2011.

THE MARK CONSISTS OF STANDARD CHARACTERS WITHOUT CLAIM TO ANY PARTICULAR FONT, STYLE, SIZE, OR COLOR.

SN 85-126,592, FILED 9-10-2010.

JERI J. FICKES, EXAMINING ATTORNEY



David J. Kybas

Director of the United States Patent and Trademark Office

United States of America

United States Patent and Trademark Office

4CATS ARTS STUDIO

Reg. No. 4,074,967

Registered Dec. 20, 2011

**Int. Cls.: 2, 16, 25, 35,
and 41**

4CATS ARTS ACADEMY LTD. (CANADA CORPORATION)
280 UPPER EAST 5TH AVENUE
VANCOUVER, BC, CANADA V5T-1H3

FOR: PAINT FOR ARTISTS, IN CLASS 2 (U.S. CLS. 6, 11 AND 16).

FIRST USE 12-1-2010; IN COMMERCE 12-1-2010.

TRADEMARK

FOR: ART PAPER; ARTS AND CRAFT CLAY KITS; ARTS AND CRAFT PAINT KITS; BOOKS IN THE FIELD OF ART; CANVAS FOR PAINTING; CHILDREN'S ARTS AND CRAFTS PAPER KITS; COLOR PENCILS; COLORING BOOKS; CRAFT PAPER; CRAYONS; MAGAZINES FEATURING ART; MODELING CLAY; PAINT BRUSHES; PAINTING SETS FOR CHILDREN; PAPER; PENCILS, IN CLASS 16 (U.S. CLS. 2, 5, 22, 23, 29, 37, 38 AND 50).

FIRST USE 12-1-2010; IN COMMERCE 12-1-2010.

SERVICE MARK

FOR: T-SHIRTS , IN CLASS 25 (U.S. CLS. 22 AND 39).

FIRST USE 12-1-2010; IN COMMERCE 12-1-2010.

PRINCIPAL REGISTER

FOR: FRANCHISE SERVICES, NAMELY, OFFERING BUSINESS MANAGEMENT ASSISTANCE IN THE ESTABLISHMENT AND OPERATION OF RETAIL ART SUPPLY STORES; ON-LINE RETAIL STORE SERVICES FEATURING ART SUPPLIES; RETAIL ART SUPPLY STORES, IN CLASS 35 (U.S. CLS. 100, 101 AND 102).

FIRST USE 12-1-2010; IN COMMERCE 12-1-2010.



FOR: EDUCATIONAL SERVICES, NAMELY, CONDUCTING CLASSES IN THE FIELD OF ART; ENTERTAINMENT SERVICES, NAMELY, CONDUCTING PARTIES; ON-LINE JOURNALS, NAMELY, BLOGS FEATURING ART; PARTY PLANNING; PROVIDING ON-LINE MAGAZINES IN THE FIELD OF ART, IN CLASS 41 (U.S. CLS. 100, 101 AND 107).

FIRST USE 12-1-2010; IN COMMERCE 12-1-2010.

David J. Kybas

THE MARK CONSISTS OF STANDARD CHARACTERS WITHOUT CLAIM TO ANY PARTICULAR FONT, STYLE, SIZE, OR COLOR.

Reg. No. 4,074,967 NO CLAIM IS MADE TO THE EXCLUSIVE RIGHT TO USE "ARTS STUDIO", APART FROM THE MARK AS SHOWN.

SN 85-126,924, FILED 9-10-2010.

LINDA ORNDORFF, EXAMINING ATTORNEY

United States of America

United States Patent and Trademark Office

Called to Adoption

Reg. No. 4,074,968

CALDWELL, MARDIE (UNITED STATES INDIVIDUAL)
PO BOX 1116

Registered Dec. 20, 2011

NEVADA CITY, CA 95959

Int. Cls.: 9, 16, and 41

FOR: DIGITAL MEDIA, NAMELY, PRE-RECORDED VIDEO CASSETTES, DIGITAL VIDEO DISCS, DIGITAL VERSATILE DISCS, DOWNLOADABLE AUDIO AND VIDEO RECORDINGS, DVDS, AND HIGH DEFINITION DIGITAL DISCS FEATURING INFORMATION ON ADOPTION; DOWNLOADABLE ELECTRONIC PUBLICATIONS IN THE NATURE OF EBOOKS, ENEWSLETTERS, PODCASTS IN THE FIELD OF ADOPTION, IN CLASS 9 (U.S. CLS. 21, 23, 26, 36 AND 38).

TRADEMARK

SERVICE MARK

PRINCIPAL REGISTER

FIRST USE 1-1-2011; IN COMMERCE 1-1-2011.

FOR: A SERIES OF BOOKS, WRITTEN ARTICLES, HANDOUTS AND WORKSHEETS IN THE FIELD OF ADOPTION, IN CLASS 16 (U.S. CLS. 2, 5, 22, 23, 29, 37, 38 AND 50).

FIRST USE 1-1-2011; IN COMMERCE 1-1-2011.

FOR: EDUCATION SERVICES, NAMELY, PROVIDING LIVE AND ON-LINE SEMINARS, WORKSHOPS, WEBINARS IN THE FIELD OF ADOPTION; EDUCATIONAL AND ENTERTAINMENT SERVICES, NAMELY, A CONTINUING PROGRAM ABOUT ADOPTION ACCESSIBLE BY RADIO, TELEVISION, SATELLITE, AUDIO, VIDEO AND COMPUTER NETWORKS, IN CLASS 41 (U.S. CLS. 100, 101 AND 107).

FIRST USE 1-1-2011; IN COMMERCE 1-1-2011.

THE MARK CONSISTS OF STANDARD CHARACTERS WITHOUT CLAIM TO ANY PARTICULAR FONT, STYLE, SIZE, OR COLOR.

OWNER OF U.S. REG. NOS. 2,916,148, 2,922,761, AND 3,819,870.

SN 85-127,731, FILED 9-12-2010.

ANDREA BUTLER, EXAMINING ATTORNEY



David J. Kyffers

Director of the United States Patent and Trademark Office

United States of America

United States Patent and Trademark Office

GREENLIGHT

Reg. No. 4,074,969

Registered Dec. 20, 2011

Int. Cls.: 1, 9, and 10

TRADEMARK

PRINCIPAL REGISTER

LUXCEL BIOSCIENCES LTD. (IRELAND CORPORATION)
BIOINNOVATION CENTRE, SUITE 3.32
BIO TRANSFER UNIT
UCC CORK, IRELAND

FOR: CHEMICAL TEST KITS FOR DETECTION OF BIOLOGICAL OXYGEN CONSUMPTION AND MICROBIOLOGICAL CONTAMINATION OF FOOD AND BEVERAGES FOR LABORATORY OR RESEARCH USE, IN CLASS 1 (U.S. CLS. 1, 5, 6, 10, 26 AND 46).

FIRST USE 7-21-2011; IN COMMERCE 7-21-2011.

FOR: LABORATORY INSTRUMENT FOR DETECTING AND MEASURING MICROBIOLOGICAL CONTAMINATION IN FOOD AND BEVERAGES; LABORATORY INSTRUMENT FOR DETECTING AND MEASURING CONCENTRATIONS OF AN ANALYTE IN FOOD AND BEVERAGES, IN CLASS 9 (U.S. CLS. 21, 23, 26, 36 AND 38).

FIRST USE 4-22-2011; IN COMMERCE 4-22-2011.

FOR: DIAGNOSTIC KITS CONSISTING PRIMARILY OF PROBES, BUFFERS AND REAGENTS FOR USE IN MICROBIAL TESTING, IN CLASS 10 (U.S. CLS. 26, 39 AND 44).

FIRST USE 7-21-2011; IN COMMERCE 7-21-2011.

THE MARK CONSISTS OF STANDARD CHARACTERS WITHOUT CLAIM TO ANY PARTICULAR FONT, STYLE, SIZE, OR COLOR.

SN 85-127,795, FILED 9-13-2010.

LAURA KOVALSKY, EXAMINING ATTORNEY



David J. Kyros

Director of the United States Patent and Trademark Office

United States of America

United States Patent and Trademark Office

COMPENDIUM KIDS

Reg. No. 4,074,970

Registered Dec. 20, 2011

Int. Cl.: 16

TRADEMARK

PRINCIPAL REGISTER

COMPENDIUM INCORPORATED (WASHINGTON CORPORATION)
SUITE 400 600 NORTH 36TH STREET
SEATTLE, WA 98103

FOR: BLANK JOURNALS; GREETING CARDS; PAPER NOTEBOOKS; KIT COMPOSED OF CHILDREN'S BOOKS AND PLUSH TOYS, ALL SOLD TOGETHER AS A UNIT, IN CLASS 16 (U.S. CLS. 2, 5, 22, 23, 29, 37, 38 AND 50).

FIRST USE 2-0-2011; IN COMMERCE 2-0-2011.

THE MARK CONSISTS OF STANDARD CHARACTERS WITHOUT CLAIM TO ANY PARTICULAR FONT, STYLE, SIZE, OR COLOR.

NO CLAIM IS MADE TO THE EXCLUSIVE RIGHT TO USE "KIDS", APART FROM THE MARK AS SHOWN.

SN 85-127,853, FILED 9-13-2010.

SANI KHOURI, EXAMINING ATTORNEY



David J. Kybas

Director of the United States Patent and Trademark Office

United States of America
United States Patent and Trademark Office

SOROBAN

Reg. No. 4,074,971

SOROBAN CAPITAL PARTNERS LLC (DELAWARE LIMITED LIABILITY COMPANY)
444 MADISON AVENUE, 12TH FLOOR
NEW YORK, NY 10022

Registered Dec. 20, 2011

Int. Cl.: 36

FOR: FINANCIAL ASSET MANAGEMENT; INVESTMENT ADVISORY SERVICES, IN CLASS 36 (U.S. CLS. 100, 101 AND 102).

SERVICE MARK

FIRST USE 6-30-2010; IN COMMERCE 6-30-2010.

PRINCIPAL REGISTER

THE MARK CONSISTS OF STANDARD CHARACTERS WITHOUT CLAIM TO ANY PARTICULAR FONT, STYLE, SIZE, OR COLOR.

THE ENGLISH TRANSLATION OF "SOROBAN" IN THE MARK IS "AN ABACUS DEVICE".

SN 85-127,972, FILED 9-13-2010.

ALICE BENMAMAN, EXAMINING ATTORNEY



David J. Kyffers

Director of the United States Patent and Trademark Office

United States of America

United States Patent and Trademark Office

MENOPAUSE OUTLAWS

Reg. No. 4,074,972

Registered Dec. 20, 2011

Int. Cls.: 9 and 35

TRADEMARK

SERVICE MARK

PRINCIPAL REGISTER

THE MENOPAUSE OUTLAWS, LLC (MARYLAND LIMITED LIABILITY COMPANY)
2009 FRALEY LANE
PASADENA, MD 21122

FOR: AUDIO RECORDINGS FEATURING MUSIC AND ARTISTIC PERFORMANCES;
DOWNLOADABLE MUSICAL SOUND RECORDINGS , IN CLASS 9 (U.S. CLS. 21, 23, 26,
36 AND 38).

FIRST USE 10-12-2011; IN COMMERCE 10-12-2011.

FOR: ON-LINE RETAIL STORE SERVICES FEATURING DOWNLOADABLE PRE-RECORDED
MUSIC; PROVIDING AN INTERNET WEBSITE PORTAL FEATURING LINKS TO MUSIC-
RELATED MERCHANDISE FOR RETAIL PURPOSES, IN CLASS 35 (U.S. CLS. 100, 101 AND
102).

FIRST USE 10-12-2011; IN COMMERCE 10-12-2011.

THE MARK CONSISTS OF STANDARD CHARACTERS WITHOUT CLAIM TO ANY PAR-
TICULAR FONT, STYLE, SIZE, OR COLOR.

NO CLAIM IS MADE TO THE EXCLUSIVE RIGHT TO USE "MENOPAUSE", APART FROM
THE MARK AS SHOWN.

SN 85-128,224, FILED 9-13-2010.

ALEXANDER L. POWERS, EXAMINING ATTORNEY



David J. Kyros

Director of the United States Patent and Trademark Office

United States of America

United States Patent and Trademark Office



Reg. No. 4,074,973

Registered Dec. 20, 2011

Int. Cls.: 16 and 17

TRADEMARK

PRINCIPAL REGISTER

INDUSTRIAS TUK, S.A. DE C.V. (MEXICO SOCIEDAD ANONIMA (SA DE CV))
BLVD. CARLOS SALINAS DE GORTARI KM 7.5
COL. VALLE DEL MEZQUITAL, APODACA
NUEVO LEÓN, MEXICO C.P.66632

FOR: ADHESIVE TAPES FOR HOUSEHOLD AND STATIONERY USE , IN CLASS 16 (U.S. CLS. 2, 5, 22, 23, 29, 37, 38 AND 50).

FIRST USE 7-0-2010; IN COMMERCE 10-0-2010.

FOR: ADHESIVE TAPES FOR INDUSTRIAL USE, IN CLASS 17 (U.S. CLS. 1, 5, 12, 13, 35 AND 50).

FIRST USE 7-0-2010; IN COMMERCE 10-0-2010.

THE MARK CONSISTS OF THE STYLIZED WORDING "FILMSTIK" AND THE DESIGN OF AN OVERLINE AND UNDERLINE ABOVE AND BELOW THE WORDING.

SN 85-128,297, FILED 9-13-2010.

JAY BESCH, EXAMINING ATTORNEY



David J. Kyros

Director of the United States Patent and Trademark Office

United States of America

United States Patent and Trademark Office

EXCEL

Reg. No. 4,074,974

Registered Dec. 20, 2011

Int. Cl.: 10

TRADEMARK

PRINCIPAL REGISTER

LIFE CORE TECHNOLOGIES, LLC (OHIO LIMITED LIABILITY COMPANY)
9100 S. HILLS BLVD., SUITE 220
BROADVIEW HTS., OH 44147

FOR: MEDICAL ICE PACKS, IN CLASS 10 (U.S. CLS. 26, 39 AND 44).

FIRST USE 6-23-2010; IN COMMERCE 11-23-2010.

THE MARK CONSISTS OF STANDARD CHARACTERS WITHOUT CLAIM TO ANY PARTICULAR FONT, STYLE, SIZE, OR COLOR.

SN 85-128,368, FILED 9-13-2010.

JULIE GUTTADAURO, EXAMINING ATTORNEY



David J. Kyffers

Director of the United States Patent and Trademark Office

United States of America

United States Patent and Trademark Office

MOTOSTANCE

Reg. No. 4,074,975

Registered Dec. 20, 2011

Int. Cl.: 12

TRADEMARK

PRINCIPAL REGISTER

APOLLO INDUSTRIES LIMITED (HONG KONG LIMITED LIABILITY COMPANY)
UNIT 3A 20/F, FAR EAST CONSORTIUM BUILDING
121 DES VOEUX ROAD
CENTRAL, HONG KONG

FOR: METAL STANDS FOR HOLDING STATIONARY MOTORCYCLES IN AN UPRIGHT POSITION, IN CLASS 12 (U.S. CLS. 19, 21, 23, 31, 35 AND 44).

FIRST USE 9-0-2011; IN COMMERCE 9-0-2011.

THE MARK CONSISTS OF STANDARD CHARACTERS WITHOUT CLAIM TO ANY PARTICULAR FONT, STYLE, SIZE, OR COLOR.

SN 85-128,762, FILED 9-14-2010.

MARTHA FROMM, EXAMINING ATTORNEY



David J. Kyffers

Director of the United States Patent and Trademark Office

United States of America

United States Patent and Trademark Office

ENERGYLOK

Reg. No. 4,074,976

Registered Dec. 20, 2011

Int. Cls.: 35 and 41

SERVICE MARK

PRINCIPAL REGISTER

UPSITE TECHNOLOGIES, INC. (DELAWARE CORPORATION)
SUITE 204
4900 LANG AVENUE
ALBUQUERQUE, NM 87109

FOR: CONSULTING AND ANALYSIS SERVICES REGARDING THE ENERGY EFFICIENCY AND INFRASTRUCTURE THERMAL EFFICIENCY OF DATA CENTERS, IN CLASS 35 (U.S. CLS. 100, 101 AND 102).

FIRST USE 10-0-2010; IN COMMERCE 10-0-2010.

FOR: EDUCATIONAL SERVICES, NAMELY, TRAINING AND EDUCATIONAL SEMINARS IN THE AREAS OF DATA CENTER PHYSICAL LAYOUT, TEMPERATURE, AND INFRASTRUCTURE EFFICIENCY, IN CLASS 41 (U.S. CLS. 100, 101 AND 107).

FIRST USE 10-0-2010; IN COMMERCE 10-0-2010.

THE MARK CONSISTS OF STANDARD CHARACTERS WITHOUT CLAIM TO ANY PARTICULAR FONT, STYLE, SIZE, OR COLOR.

OWNER OF U.S. REG. NOS. 2,783,950 AND 3,454,832.

SN 85-128,845, FILED 9-14-2010.

BARBARA BROWN, EXAMINING ATTORNEY



David J. Kyros

Director of the United States Patent and Trademark Office

United States of America

United States Patent and Trademark Office

IT'S ALL GOOD

Reg. No. 4,074,977

MYERS, ELLEN JO (UNITED STATES INDIVIDUAL)

Registered Dec. 20, 2011

P.O. BOX 609
BRIDGEHAMPTON, NY 11932

Int. Cl.: 9

FOR: PROVIDING DOWNLOADABLE E-CARDS, NAMELY, GREETING CARDS AND RINGTONES VIA A GLOBAL COMPUTER NETWORK AND WIRELESS DEVICES, IN CLASS 9 (U.S. CLS. 21, 23, 26, 36 AND 38).

TRADEMARK

FIRST USE 10-1-2011; IN COMMERCE 10-1-2011.

PRINCIPAL REGISTER

THE MARK CONSISTS OF STANDARD CHARACTERS WITHOUT CLAIM TO ANY PARTICULAR FONT, STYLE, SIZE, OR COLOR.

SN 85-128,959, FILED 9-14-2010.

AISHA CLARKE, EXAMINING ATTORNEY



David J. Kyros

Director of the United States Patent and Trademark Office

United States of America

United States Patent and Trademark Office

VORTEX OF ATTRACTION

Reg. No. 4,074,978

ESTHER HICKS (UNITED STATES INDIVIDUAL)
28800 OLD FREDERICKSBURG ROAD
BOERNE, TX 78015 AND

Registered Dec. 20, 2011

Int. Cl.: 16

JERRY HICKS (UNITED STATES INDIVIDUAL)
28800 OLD FREDERICKSBURG ROAD
BOERNE, TX 78015

TRADEMARK

PRINCIPAL REGISTER

FOR: PRINTED MATTER AND PAPER GOODS, NAMELY, BOOKS IN THE FIELDS OF INSPIRATION, SELF-IMPROVEMENT, FINANCE, SPIRITUALITY AND PERSONAL EMPOWERMENT, IN CLASS 16 (U.S. CLS. 2, 5, 22, 23, 29, 37, 38 AND 50).

FIRST USE 3-28-2011; IN COMMERCE 3-28-2011.

THE MARK CONSISTS OF STANDARD CHARACTERS WITHOUT CLAIM TO ANY PARTICULAR FONT, STYLE, SIZE, OR COLOR.

SN 85-129,083, FILED 9-14-2010.

TINA BROWN, EXAMINING ATTORNEY



David J. Kyros

Director of the United States Patent and Trademark Office

United States of America

United States Patent and Trademark Office

Smog City

Reg. No. 4,074,979

BEER LAB INC. (CALIFORNIA CORPORATION)
7299 WEST 85TH STREET
LOS ANGELES, CA 90045

Registered Dec. 20, 2011

Int. Cl.: 32

FOR: BEER, IN CLASS 32 (U.S. CLS. 45, 46 AND 48).

TRADEMARK

FIRST USE 9-25-2011; IN COMMERCE 9-25-2011.

PRINCIPAL REGISTER

THE MARK CONSISTS OF STANDARD CHARACTERS WITHOUT CLAIM TO ANY PARTICULAR FONT, STYLE, SIZE, OR COLOR.

SN 85-129,097, FILED 9-14-2010.

SHAUNIA CARLYLE, EXAMINING ATTORNEY



David J. Kybas

Director of the United States Patent and Trademark Office

United States of America

United States Patent and Trademark Office

VORTEX OF ATTRACTION

Reg. No. 4,074,980

Registered Dec. 20, 2011

Int. Cl.: 41

SERVICE MARK

PRINCIPAL REGISTER

ESTHER HICKS (UNITED STATES INDIVIDUAL)
28800 OLD FREDERICKSBURG ROAD
BOERNE, TX 87104 AND

JERRY HICKS (UNITED STATES INDIVIDUAL)
28800 OLD FREDERICKSBURG ROAD
BOERNE, TX 87104

FOR: EDUCATIONAL SERVICES, NAMELY, CONDUCTING SEMINARS, WORKSHOPS AND LECTURES IN THE FIELDS OF INSPIRATION, SELF-IMPROVEMENT, FINANCE, SPIRITUALITY AND PERSONAL EMPOWERMENT, IN CLASS 41 (U.S. CLS. 100, 101 AND 107).

FIRST USE 3-28-2011; IN COMMERCE 3-28-2011.

THE MARK CONSISTS OF STANDARD CHARACTERS WITHOUT CLAIM TO ANY PARTICULAR FONT, STYLE, SIZE, OR COLOR.

SN 85-129,107, FILED 9-14-2010.

TINA BROWN, EXAMINING ATTORNEY



David J. Kybas

Director of the United States Patent and Trademark Office

United States of America

United States Patent and Trademark Office

SHOCKTOBER

Reg. No. 4,074,981

WPIX, INC. (DELAWARE CORPORATION)
220 EAST 42ND STREET
NEW YORK, NY 10017

Registered Dec. 20, 2011

Int. Cl.: 38

FOR: TELEVISION BROADCASTING; VIDEO BROADCASTING, IN CLASS 38 (U.S. CLS. 100, 101 AND 104).

SERVICE MARK

FIRST USE 9-1-2010; IN COMMERCE 9-1-2010.

PRINCIPAL REGISTER

THE MARK CONSISTS OF STANDARD CHARACTERS WITHOUT CLAIM TO ANY PARTICULAR FONT, STYLE, SIZE, OR COLOR.

SN 85-129,328, FILED 9-14-2010.

ANGELA DUONG, EXAMINING ATTORNEY



David J. Kappas

Director of the United States Patent and Trademark Office

United States of America

United States Patent and Trademark Office

FloBooks Simple Billing

Reg. No. 4,074,982

Registered Dec. 20, 2011

Int. Cl.: 42

SERVICE MARK

PRINCIPAL REGISTER

WEBFLO TECHNOLOGIES, LLC (FLORIDA LIMITED LIABILITY COMPANY)
STE 202
1937 E ATLANTIC BLVD
POMPANO BEACH, FL 33060

FOR: PROVIDING ON-LINE NON-DOWNLOADABLE SOFTWARE FOR PREPARING AND PROCESSING ESTIMATES, INVOICES AND PAYMENTS, BOOKKEEPING, PROCESSING AND RECORDING FINANCIAL TRANSACTIONS, EXPENSES AND TIME TRACKING, PREPARING AND MANAGING JOB ORDERS, SHARING DOCUMENTS VIA ONLINE AND FOR SENDING AND RECEIVING ELECTRONIC MESSAGES, IN CLASS 42 (U.S. CLS. 100 AND 101).

FIRST USE 5-15-2011; IN COMMERCE 5-15-2011.

THE MARK CONSISTS OF STANDARD CHARACTERS WITHOUT CLAIM TO ANY PARTICULAR FONT, STYLE, SIZE, OR COLOR.

NO CLAIM IS MADE TO THE EXCLUSIVE RIGHT TO USE "SIMPLE BILLING", APART FROM THE MARK AS SHOWN.

SN 85-129,365, FILED 9-14-2010.

SCOTT BIBB, EXAMINING ATTORNEY



David J. Kyffers

Director of the United States Patent and Trademark Office

United States of America

United States Patent and Trademark Office

PARLOR

Reg. No. 4,074,983

SCHWARTZ, JOEL (UNITED STATES INDIVIDUAL)
230 FIRST STREET

Registered Dec. 20, 2011

LAKWOOD, NJ 08701

Int. Cl.: 45

FOR: COMPUTER DATING SERVICES; DATING SERVICES; INTERNET BASED SOCIAL NETWORKING, INTRODUCTION, AND DATING SERVICES; INTERNET-BASED SOCIAL NETWORKING SERVICES; ON-LINE SOCIAL NETWORKING SERVICES, IN CLASS 45 (U.S. CLS. 100 AND 101).

SERVICE MARK

PRINCIPAL REGISTER

FIRST USE 4-30-2011; IN COMMERCE 4-30-2011.

THE MARK CONSISTS OF STANDARD CHARACTERS WITHOUT CLAIM TO ANY PARTICULAR FONT, STYLE, SIZE, OR COLOR.

SN 85-129,398, FILED 9-14-2010.

KEVIN DINALLO, EXAMINING ATTORNEY



David J. Kyros

Director of the United States Patent and Trademark Office

United States of America

United States Patent and Trademark Office

YES WE CAN?

Reg. No. 4,074,984

Registered Dec. 20, 2011

Int. Cl.: 28

TRADEMARK

PRINCIPAL REGISTER

FOUNDING FATHERS ENTERTAINMENT LLC (COLORADO LIMITED LIABILITY COMPANY)
1140 US HWY 287
SUITE 400-182
BROOMFIELD, CO 80020

FOR: BOARD GAMES, IN CLASS 28 (U.S. CLS. 22, 23, 38 AND 50).

FIRST USE 12-31-2010; IN COMMERCE 12-31-2010.

THE MARK CONSISTS OF STANDARD CHARACTERS WITHOUT CLAIM TO ANY PARTICULAR FONT, STYLE, SIZE, OR COLOR.

SN 85-129,438, FILED 9-14-2010.

VIVIAN MICZNIK FIRST, EXAMINING ATTORNEY



David J. Kybas

Director of the United States Patent and Trademark Office

United States of America

United States Patent and Trademark Office

SOCIALOGUE

Reg. No. 4,074,985

Registered Dec. 20, 2011

Int. Cl.: 42

SERVICE MARK

PRINCIPAL REGISTER

ROBERSON, CHARLES S. (UNITED STATES INDIVIDUAL)
601 CHARLES VAN DAMME WAY
SONOMA, CA 95476

FOR: PROVIDING TEMPORARY USE OF A WEB-BASED SOFTWARE TO MANAGE ON-LINE POINTS-OF-PRESENCE AND TO MONITOR AND TO ANALYZE CONTENT AS TO BRANDS AND IDENTITIES ON THE INTERNET AS RELATED TO SOCIAL MEDIA, IN CLASS 42 (U.S. CLS. 100 AND 101).

FIRST USE 3-31-2011; IN COMMERCE 3-31-2011.

THE MARK CONSISTS OF STANDARD CHARACTERS WITHOUT CLAIM TO ANY PARTICULAR FONT, STYLE, SIZE, OR COLOR.

SN 85-129,514, FILED 9-14-2010.

ALICE BENMAMAN, EXAMINING ATTORNEY



David J. Kyffers

Director of the United States Patent and Trademark Office

United States of America

United States Patent and Trademark Office

SOLNO

Reg. No. 4,074,986

TAKAZONO TECHNOLOGY INCORPORATED (JAPAN CORPORATION)
2-8-1, TSUDAYAMATE, HIRAKATA-SHI
OSAKA, JAPAN

Registered Dec. 20, 2011

Int. Cls.: 10, 16, 42, and 44

FOR: MEDICAL APPARATUS AND INSTRUMENTS FOR DOSAGE, MEASURING AND MONITORING, NAMELY, DRUG DISPENSING, PACKAGING AND DELIVERY DEVICES AND SYSTEMS, IN CLASS 10 (U.S. CLS. 26, 39 AND 44).

TRADEMARK

FIRST USE 4-25-2011; IN COMMERCE 4-25-2011.

SERVICE MARK

FOR: PAPER BAGS FOR PACKING MEDICINE; INDUSTRIAL PACKAGING CONTAINERS OF PAPER; PLASTIC BAGS FOR PACKING MEDICINE; PACKAGING PAPER FOR MEDICAL PACKAGING MACHINES, IN CLASS 16 (U.S. CLS. 2, 5, 22, 23, 29, 37, 38 AND 50).

PRINCIPAL REGISTER

FIRST USE 11-18-2009; IN COMMERCE 11-18-2009.

FOR: COMPUTER PROGRAMMING; MAINTENANCE AND UPDATING OF COMPUTER SOFTWARE, IN CLASS 42 (U.S. CLS. 100 AND 101).

FIRST USE 8-23-2010; IN COMMERCE 8-23-2010.

FOR: PROVIDING MEDICAL INFORMATION, CONSULTANCY AND ADVISORY SERVICES, IN CLASS 44 (U.S. CLS. 100 AND 101).

FIRST USE 5-20-2010; IN COMMERCE 5-20-2010.

THE MARK CONSISTS OF STANDARD CHARACTERS WITHOUT CLAIM TO ANY PARTICULAR FONT, STYLE, SIZE, OR COLOR.

SN 85-129,643, FILED 9-14-2010.

SANJEEV VOHRA, EXAMINING ATTORNEY



David J. Kypos

Director of the United States Patent and Trademark Office

United States of America

United States Patent and Trademark Office

SOLNO

Reg. No. 4,074,987

TAKAZONO TECHNOLOGY INCORPORATED (JAPAN CORPORATION)
2-8-1, TSUDAYAMATE, HIRAKATA-SHI
OSAKA, JAPAN

Registered Dec. 20, 2011

Int. Cls.: 10, 16, 42, and 44

FOR: MEDICAL APPARATUS AND INSTRUMENTS FOR DOSAGE, MEASURING AND MONITORING, NAMELY, DRUG DISPENSING, PACKAGING AND DELIVERY DEVICES AND SYSTEMS, IN CLASS 10 (U.S. CLS. 26, 39 AND 44).

TRADEMARK

FIRST USE 4-25-2011; IN COMMERCE 4-25-2011.

SERVICE MARK

FOR: PAPER BAGS FOR PACKING MEDICINE; INDUSTRIAL PACKAGING CONTAINERS OF PAPER; PLASTIC BAGS FOR PACKING MEDICINE; PACKAGING PAPER FOR MEDICAL PACKAGING MACHINES, IN CLASS 16 (U.S. CLS. 2, 5, 22, 23, 29, 37, 38 AND 50).

PRINCIPAL REGISTER

FIRST USE 11-18-2009; IN COMMERCE 11-18-2009.

FOR: COMPUTER PROGRAMMING; MAINTENANCE AND UPDATING OF COMPUTER SOFTWARE, IN CLASS 42 (U.S. CLS. 100 AND 101).

FIRST USE 8-23-2010; IN COMMERCE 8-23-2010.

FOR: PROVIDING MEDICAL INFORMATION, CONSULTANCY AND ADVISORY SERVICES, IN CLASS 44 (U.S. CLS. 100 AND 101).

FIRST USE 5-20-2010; IN COMMERCE 5-20-2010.

THE MARK CONSISTS OF THE WORD "SOLNO" IN STYLIZED LETTERING SHOWN WITH A TRIANGLE INSIDE THE LETTER "L".

SN 85-129,646, FILED 9-14-2010.

SANJEEV VOHRA, EXAMINING ATTORNEY



David J. Kybas

Director of the United States Patent and Trademark Office

United States of America

United States Patent and Trademark Office

SEA KING

Reg. No. 4,074,988

SABIA JR., VINCENT F. (UNITED STATES INDIVIDUAL)
421 12TH PLACE SE
VERO BEACH, FL 32962

Registered Dec. 20, 2011

Int. Cl.: 7

FOR: BOAT ENGINES, IN CLASS 7 (U.S. CLS. 13, 19, 21, 23, 31, 34 AND 35).

TRADEMARK

FIRST USE 10-7-2011; IN COMMERCE 10-7-2011.

PRINCIPAL REGISTER

THE MARK CONSISTS OF STANDARD CHARACTERS WITHOUT CLAIM TO ANY PARTICULAR FONT, STYLE, SIZE, OR COLOR.

NO CLAIM IS MADE TO THE EXCLUSIVE RIGHT TO USE "SEA", APART FROM THE MARK AS SHOWN.

SN 85-130,006, FILED 9-15-2010.

VIVIAN MICZNIK FIRST, EXAMINING ATTORNEY



David J. Kyffers

Director of the United States Patent and Trademark Office

United States of America

United States Patent and Trademark Office

SERALITY

Reg. No. 4,074,989

Registered Dec. 20, 2011

Int. Cl.: 35

SERVICE MARK

PRINCIPAL REGISTER

SERALITY, INC. (DELAWARE CORPORATION)
225 WINTER STREET
HOPKINTON, MA 01748

FOR: ADVERTISING AND MARKETING SERVICES, NAMELY, PROMOTING THE GOODS AND SERVICES OF OTHERS; ADMINISTERING GROUP PURCHASING PROGRAMS, NAMELY, NEGOTIATING CONTRACTS WITH PROVIDERS OF GOODS AND SERVICES, TO ENABLE CAREGIVERS AND FAMILIES OF THE ELDERLY, ILL, AND/OR DISABLED TO EFFICIENTLY PROCURE AND/OR OBTAIN DISCOUNTS ON THE PURCHASE OF GOODS AND SERVICES OF OTHERS; PUBLIC ADVOCACY TO PROMOTE AWARENESS OF CARE OF THE ELDERLY, ILL, AND/OR DISABLED, AND ECONOMIC, SOCIAL, AND POLITICAL ISSUES RELATED TO SAME, IN CLASS 35 (U.S. CLS. 100, 101 AND 102).

FIRST USE 4-27-2011; IN COMMERCE 4-27-2011.

THE MARK CONSISTS OF STANDARD CHARACTERS WITHOUT CLAIM TO ANY PARTICULAR FONT, STYLE, SIZE, OR COLOR.

SN 85-130,042, FILED 9-15-2010.

MARLENE BELL, EXAMINING ATTORNEY



David J. Kyffers

Director of the United States Patent and Trademark Office

United States of America

United States Patent and Trademark Office

EPICENTRAL

Reg. No. 4,074,990

Registered Dec. 20, 2011

Int. Cl.: 9

TRADEMARK

PRINCIPAL REGISTER

TRANSACTION TECHNOLOGIES INCORPORATED (DELAWARE CORPORATION)
SUITE 3B
2319 WHITNEY AVENUE
HAMDEN, CT 06518

FOR: COMPUTER APPLICATION AND NETWORKING SOFTWARE FOR USE IN CONNECTION WITH PRINTABLE PROMOTIONAL COUPONS, IN CLASS 9 (U.S. CLS. 21, 23, 26, 36 AND 38).

FIRST USE 11-16-2010; IN COMMERCE 11-16-2010.

THE MARK CONSISTS OF STANDARD CHARACTERS WITHOUT CLAIM TO ANY PARTICULAR FONT, STYLE, SIZE, OR COLOR.

SN 85-130,062, FILED 9-15-2010.

DOMINICK J. SALEMI, EXAMINING ATTORNEY



David J. Kybas

Director of the United States Patent and Trademark Office

United States of America

United States Patent and Trademark Office

DUALREST

Reg. No. 4,074,991

PACIFIC COAST FEATHER COMPANY (WASHINGTON CORPORATION)
P.O. BOX 80385
SEATTLE, WA 98108

Registered Dec. 20, 2011

Int. Cl.: 20

FOR: PILLOWS, IN CLASS 20 (U.S. CLS. 2, 13, 22, 25, 32 AND 50).

TRADEMARK

FIRST USE 10-1-2011; IN COMMERCE 10-1-2011.

PRINCIPAL REGISTER

THE MARK CONSISTS OF STANDARD CHARACTERS WITHOUT CLAIM TO ANY PARTICULAR FONT, STYLE, SIZE, OR COLOR.

OWNER OF U.S. REG. NO. 3,540,297.

SN 85-130,281, FILED 9-15-2010.

MARLENE BELL, EXAMINING ATTORNEY



David J. Kyffers

Director of the United States Patent and Trademark Office

United States of America

United States Patent and Trademark Office

TISSU-TRANS SYRINGE FILL

Reg. No. 4,074,992

SHIPPERT ENTERPRISES, LTD. (COLORADO CORPORATION)
6248 S. TROY CIRCLE, UNIT A
CENTENNIAL, CO 80111

Registered Dec. 20, 2011

Int. Cl.: 10

FOR: SURGICAL AND MEDICAL APPARATUS AND INSTRUMENTS FOR USE IN LIPOSUCTION SURGERY, IN CLASS 10 (U.S. CLS. 26, 39 AND 44).

TRADEMARK

FIRST USE 11-0-2010; IN COMMERCE 11-0-2010.

PRINCIPAL REGISTER

THE MARK CONSISTS OF STANDARD CHARACTERS WITHOUT CLAIM TO ANY PARTICULAR FONT, STYLE, SIZE, OR COLOR.

OWNER OF U.S. REG. NO. 3,160,819.

NO CLAIM IS MADE TO THE EXCLUSIVE RIGHT TO USE "SYRINGE", APART FROM THE MARK AS SHOWN.

SN 85-130,352, FILED 9-15-2010.

JENNIFER MARTIN, EXAMINING ATTORNEY



David J. Kybas

Director of the United States Patent and Trademark Office

United States of America

United States Patent and Trademark Office



Reg. No. 4,074,993

ARZIKIA CURRY (UNITED STATES INDIVIDUAL)
PO BOX 551064
JACKSONVILLE, FL 32255

Registered Dec. 20, 2011

Int. Cl.: 16

FOR: STICKERS, IN CLASS 16 (U.S. CLS. 2, 5, 22, 23, 29, 37, 38 AND 50).

TRADEMARK

FIRST USE 3-1-2011; IN COMMERCE 4-25-2011.

PRINCIPAL REGISTER

NO CLAIM IS MADE TO THE EXCLUSIVE RIGHT TO USE "CHRIST" OR "GOD" OR "JESUS" OR THE DESIGN OF AN ANGLICAN CROSS, APART FROM THE MARK AS SHOWN.

THE MARK CONSISTS OF THE WORDING, "CHRIST GOD JESUS", WITH THE FIRST LETTERS OF EACH WORD, "C" "G" AND "J", INTERTWINED SO THE LETTER "G" IS FORMED BY A COMBINATION OF THE LETTERS "C" AND "J", AND WITH THE DESIGN OF THE ANGLICAN CROSS AT THE TOP LEFT CORNER ABOVE THE COMBINED LETTERS "C" "G" AND "J".

SN 85-130,809, FILED 9-16-2010.

BARBARA A. GOLD, EXAMINING ATTORNEY



David J. Kybas

Director of the United States Patent and Trademark Office

United States of America

United States Patent and Trademark Office

OPENLEND

Reg. No. 4,074,994

Registered Dec. 20, 2011

Int. Cl.: 36

SERVICE MARK

PRINCIPAL REGISTER

CITIGROUP INC. (DELAWARE CORPORATION)
399 PARK AVENUE
NEW YORK, NY 10043

FOR: FINANCIAL SERVICES IN THE NATURE OF SECURITIES LENDING SERVICES, SECURED FINANCING SERVICES, AND CASH INVESTMENT SERVICES FOR INSTITUTIONAL CLIENTS; FINANCIAL REPORTING SERVICES, CUSTODIAL SERVICES RELATING TO INVESTMENT MANAGEMENT, CASH MANAGEMENT SERVICES, FINANCIAL COLLATERAL MANAGEMENT SERVICES, NAMELY, MANAGING ASSETS USED TO SECURE LOANS AND FINANCIAL PORTFOLIO MANAGEMENT SERVICES, ALL RELATED TO THE FOREGOING SERVICES, IN CLASS 36 (U.S. CLS. 100, 101 AND 102).

FIRST USE 10-0-2010; IN COMMERCE 10-0-2010.

THE MARK CONSISTS OF STANDARD CHARACTERS WITHOUT CLAIM TO ANY PARTICULAR FONT, STYLE, SIZE, OR COLOR.

SN 85-130,833, FILED 9-16-2010.

DAVID COLLIER, EXAMINING ATTORNEY



David J. Kyffers

Director of the United States Patent and Trademark Office

United States of America

United States Patent and Trademark Office

Sassy Slang

Reg. No. 4,074,995

Registered Dec. 20, 2011

Int. Cl.: 25

TRADEMARK

PRINCIPAL REGISTER

PFF ENTERTAINMENT, LLC (NEW YORK LIMITED LIABILITY COMPANY)
201 EAST 87TH STREET, SUITE 3D
NEW YORK, NY 10128

FOR: T-SHIRTS, IN CLASS 25 (U.S. CLS. 22 AND 39).

FIRST USE 7-1-2011; IN COMMERCE 7-1-2011.

THE MARK CONSISTS OF STANDARD CHARACTERS WITHOUT CLAIM TO ANY PARTICULAR FONT, STYLE, SIZE, OR COLOR.

SN 85-131,122, FILED 9-16-2010.

GRETTA YAO, EXAMINING ATTORNEY



David J. Kybas

Director of the United States Patent and Trademark Office

United States of America

United States Patent and Trademark Office

GOURMET RECORDS

Reg. No. 4,074,996

Registered Dec. 20, 2011

Int. Cl.: 9

TRADEMARK

PRINCIPAL REGISTER

NETWORK INTERNATIONAL, LLC (RHODE ISLAND LIMITED LIABILITY COMPANY)
282 COUNTY ROAD, SUITE 2
BARRINGTON, RI 02806

FOR: MUSICAL SOUND RECORDINGS, IN CLASS 9 (U.S. CLS. 21, 23, 26, 36 AND 38).

FIRST USE 7-22-2011; IN COMMERCE 7-22-2011.

THE MARK CONSISTS OF STANDARD CHARACTERS WITHOUT CLAIM TO ANY PARTICULAR FONT, STYLE, SIZE, OR COLOR.

NO CLAIM IS MADE TO THE EXCLUSIVE RIGHT TO USE "RECORDS", APART FROM THE MARK AS SHOWN.

SN 85-131,207, FILED 9-16-2010.

H. M. FISHER, EXAMINING ATTORNEY



David J. Kyffers

Director of the United States Patent and Trademark Office

United States of America

United States Patent and Trademark Office

Titration Therapy

Reg. No. 4,074,997

O'BANION, JAMIE L (UNITED STATES INDIVIDUAL)
3538 GRANADA AVENUE
DALLAS, TX 75205

Registered Dec. 20, 2011

Int. Cl.: 3

FOR: COSMETIC PREPARATIONS, IN CLASS 3 (U.S. CLS. 1, 4, 6, 50, 51 AND 52).

FIRST USE 10-15-2010; IN COMMERCE 6-15-2011.

TRADEMARK

THE MARK CONSISTS OF STANDARD CHARACTERS WITHOUT CLAIM TO ANY PARTICULAR FONT, STYLE, SIZE, OR COLOR.

PRINCIPAL REGISTER

NO CLAIM IS MADE TO THE EXCLUSIVE RIGHT TO USE "THERAPY", APART FROM THE MARK AS SHOWN.

SN 85-131,252, FILED 9-16-2010.

LAURIE KAUFMAN, EXAMINING ATTORNEY



David J. Kyffers

Director of the United States Patent and Trademark Office

United States of America

United States Patent and Trademark Office

ARCTIC BERRY LISTERINE

Reg. No. 4,074,998

JOHNSON & JOHNSON (NEW JERSEY CORPORATION)
ONE JOHNSON & JOHNSON PLAZA
NEW BRUNSWICK, NJ 089337001

Registered Dec. 20, 2011

Int. Cl.: 3

FOR: BREATH FRESHENERS; DISSOLVABLE ORAL CARE STRIPS, IN CLASS 3 (U.S. CLS. 1, 4, 6, 50, 51 AND 52).

TRADEMARK

FIRST USE 8-31-2011; IN COMMERCE 8-31-2011.

PRINCIPAL REGISTER

THE MARK CONSISTS OF STANDARD CHARACTERS WITHOUT CLAIM TO ANY PARTICULAR FONT, STYLE, SIZE, OR COLOR.

OWNER OF U.S. REG. NOS. 3,218,073, 3,822,872, AND OTHERS.

NO CLAIM IS MADE TO THE EXCLUSIVE RIGHT TO USE "BERRY", APART FROM THE MARK AS SHOWN.

SN 85-131,886, FILED 9-17-2010.

NAPOLEON SHARMA, EXAMINING ATTORNEY



David J. Kyros

Director of the United States Patent and Trademark Office

United States of America

United States Patent and Trademark Office

THE PRO

Reg. No. 4,074,999

CALGOLF LLC (CALIFORNIA LIMITED LIABILITY COMPANY)
1530 FAIRMONT ROAD
WESTLAKE VILLAGE, CA 91362

Registered Dec. 20, 2011

Int. Cl.: 28

FOR: GOLF TRAINING APPARATUS FOR IMPROVING THE GOLF SWING, NAMELY, A DEVICE COMPRISED OF A GOLF CLUB HANDLE WITH A WEIGHT TETHERED TO IT, AND A TARGET , IN CLASS 28 (U.S. CLS. 22, 23, 38 AND 50).

TRADEMARK

FIRST USE 6-1-2011; IN COMMERCE 6-1-2011.

PRINCIPAL REGISTER

THE MARK CONSISTS OF STANDARD CHARACTERS WITHOUT CLAIM TO ANY PARTICULAR FONT, STYLE, SIZE, OR COLOR.

SN 85-132,378, FILED 9-17-2010.

BARBARA A. GOLD, EXAMINING ATTORNEY



David J. Kybas

Director of the United States Patent and Trademark Office

United States of America

United States Patent and Trademark Office

PROTEUS

Reg. No. 4,075,000

Registered Dec. 20, 2011

Int. Cl.: 28

TRADEMARK

PRINCIPAL REGISTER

CARVER INTERNATIONAL INC. (CALIFORNIA CORPORATION)
111 SIERRA STREET
EL SEGUNDO, CA 90245

FOR: BAGS ESPECIALLY DESIGNED FOR SURFBOARDS; BAGS FOR SKATEBOARDS; BALL BEARINGS FOR SKATEBOARDS; BODY BOARDS; FINS FOR BODY BOARDS; HARNESSES SPECIALLY ADAPTED FOR CARRYING SNOWBOARDS, SKIS AND SKATEBOARDS; NUTS AND BOLTS FOR SKATEBOARDS; PROTECTIVE PADDING FOR SKATEBOARDING; PROTECTIVE PADDING FOR SNOWBOARDING; SKATEBOARD DECKS; SKATEBOARD GRIP TAPES; SKATEBOARD RAILS; SKATEBOARD RISER PADS; SKATEBOARD TRUCKS; SKATEBOARD WHEELS; SKATEBOARDS; SNOW BOARDS; SNOWBOARD BINDINGS; SNOWBOARD DECKS; SNOWBOARD WAX; SNOWBOARDS; SURFBOARD FINS; SURFBOARD LEASHES; SURFBOARD TRACTION PADS; SURFBOARD WAX; SURFBOARDS, IN CLASS 28 (U.S. CLS. 22, 23, 38 AND 50).

FIRST USE 8-30-2010; IN COMMERCE 8-30-2010.

THE MARK CONSISTS OF STANDARD CHARACTERS WITHOUT CLAIM TO ANY PARTICULAR FONT, STYLE, SIZE, OR COLOR.

SN 85-132,544, FILED 9-17-2010.

JILL C. ALT, EXAMINING ATTORNEY



David J. Kybas

Director of the United States Patent and Trademark Office

United States of America

United States Patent and Trademark Office

INSIDE JOB

Reg. No. 4,075,001

MYBODY, L.L.C. (ARIZONA LIMITED LIABILITY COMPANY)
5080 NORTH 40TH STREET, SUITE 375
PHOENIX, AZ 85018

Registered Dec. 20, 2011

Int. Cl.: 5

FOR: NUTRITIONAL SUPPLEMENTS FOR PROMOTING HEALTHY SKIN, IN CLASS 5
(U.S. CLS. 6, 18, 44, 46, 51 AND 52).

TRADEMARK

FIRST USE 1-28-2011; IN COMMERCE 1-28-2011.

PRINCIPAL REGISTER

THE MARK CONSISTS OF STANDARD CHARACTERS WITHOUT CLAIM TO ANY PARTICULAR FONT, STYLE, SIZE, OR COLOR.

SN 85-132,768, FILED 9-18-2010.

MARK RADEMACHER, EXAMINING ATTORNEY



David J. Kybas

Director of the United States Patent and Trademark Office

United States of America

United States Patent and Trademark Office



Reg. No. 4,075,002

JOHNSON & JOHNSON (NEW JERSEY CORPORATION)
ONE JOHNSON & JOHNSON PLAZA
NEW BRUNSWICK, NJ 089337001

Registered Dec. 20, 2011

Int. Cl.: 21

FOR: TOOTHBRUSHES, IN CLASS 21 (U.S. CLS. 2, 13, 23, 29, 30, 33, 40 AND 50).

TRADEMARK

FIRST USE 4-21-2011; IN COMMERCE 4-21-2011.

PRINCIPAL REGISTER

OWNER OF U.S. REG. NO. 1,849,328.

THE MARK CONSISTS OF A STYLIZED WORD "WONDERGRIP" WITH AN IMAGE OF A TOOTHBRUSH AS THE "I".

SN 85-133,106, FILED 9-20-2010.

NAPOLEON SHARMA, EXAMINING ATTORNEY



David J. Kyffers

Director of the United States Patent and Trademark Office

United States of America

United States Patent and Trademark Office

AMPLI5

Reg. No. 4,075,003

AMPLI5, LLC (NEVADA LIMITED LIABILITY COMPANY)
375 N. STEPHANIE ST
HENDERSON, NV 890148909

Registered Dec. 20, 2011

Int. Cls.: 5 and 32

FOR: NUTRITIONALLY FORTIFIED WATER, IN CLASS 5 (U.S. CLS. 6, 18, 44, 46, 51 AND 52).

TRADEMARK

FIRST USE 10-10-2011; IN COMMERCE 10-10-2011.

PRINCIPAL REGISTER

FOR: BOTTLED WATER, IN CLASS 32 (U.S. CLS. 45, 46 AND 48).

FIRST USE 10-10-2011; IN COMMERCE 10-10-2011.

THE MARK CONSISTS OF STANDARD CHARACTERS WITHOUT CLAIM TO ANY PARTICULAR FONT, STYLE, SIZE, OR COLOR.

SN 85-133,188, FILED 9-20-2010.

LEIGH CAROLINE CASE, EXAMINING ATTORNEY



David J. Kyfos

Director of the United States Patent and Trademark Office

United States of America

United States Patent and Trademark Office

NETWORK ROULETTE

Reg. No. 4,075,004

BRAZEN CAREERIST, INC. (DELAWARE CORPORATION)
222 W. WASHINGTON AVE., SUITE 108
MADISON, WI 53703

Registered Dec. 20, 2011

Int. Cl.: 35

FOR: ON-LINE BUSINESS NETWORKING SERVICES; ON-LINE PROFESSIONAL NETWORKING SERVICES, IN CLASS 35 (U.S. CLS. 100, 101 AND 102).

SERVICE MARK

FIRST USE 11-9-2010; IN COMMERCE 11-9-2010.

PRINCIPAL REGISTER

THE MARK CONSISTS OF STANDARD CHARACTERS WITHOUT CLAIM TO ANY PARTICULAR FONT, STYLE, SIZE, OR COLOR.

NO CLAIM IS MADE TO THE EXCLUSIVE RIGHT TO USE "NETWORK", APART FROM THE MARK AS SHOWN.

SN 85-133,191, FILED 9-20-2010.

AISHA SALEM, EXAMINING ATTORNEY



David J. Kybas

Director of the United States Patent and Trademark Office

United States of America

United States Patent and Trademark Office

LA RESERVE DU BOULANGER

Reg. No. 4,075,005

BAKERY DE FRANCE, INC. (DELAWARE CORPORATION)
603-6 DOVER ROAD
ROCKVILLE, MD 20850

Registered Dec. 20, 2011

Int. Cl.: 30

FOR: BAKERY PRODUCTS, NAMELY, BREADS AND RAW, PARTIALLY BAKED OR FULLY BAKED FRESH OR FROZEN DOUGH FOR USE AS BREAD OR OTHER BREAD-TYPE PRODUCTS, IN CLASS 30 (U.S. CL. 46).

TRADEMARK

FIRST USE 9-16-2010; IN COMMERCE 9-16-2010.

PRINCIPAL REGISTER

THE MARK CONSISTS OF STANDARD CHARACTERS WITHOUT CLAIM TO ANY PARTICULAR FONT, STYLE, SIZE, OR COLOR.

THE ENGLISH TRANSLATION OF "LA RESERVE DU BOULANGER" IN THE MARK IS "THE BAKER'S RESERVE".

SN 85-133,234, FILED 9-20-2010.

SANDRA BUJA, EXAMINING ATTORNEY



David J. Kybas

Director of the United States Patent and Trademark Office

United States of America

United States Patent and Trademark Office

PACIFIC INCOME PROVIDER

Reg. No. 4,075,006

Registered Dec. 20, 2011

Int. Cl.: 36

SERVICE MARK

PRINCIPAL REGISTER

PACIFIC LIFE INSURANCE COMPANY (NEBRASKA CORPORATION)
700 NEWPORT CENTER DRIVE
NEWPORT BEACH, CA 92660

FOR: UNDERWRITING ANNUITIES, ANNUITY ADMINISTRATION; FINANCIAL INVESTMENT IN THE FIELD OF ANNUITIES; FINANCIAL SERVICES, NAMELY, PLANNING AND MANAGEMENT SERVICES IN THE FIELD OF ANNUITIES, NAMELY, ACCOUNT AND INVESTMENT ADMINISTRATION, INVESTMENT, AND DISTRIBUTION OF ANNUITIES, IN CLASS 36 (U.S. CLS. 100, 101 AND 102).

FIRST USE 10-1-2010; IN COMMERCE 10-1-2010.

THE MARK CONSISTS OF STANDARD CHARACTERS WITHOUT CLAIM TO ANY PARTICULAR FONT, STYLE, SIZE, OR COLOR.

OWNER OF U.S. REG. NOS. 2,168,494, 2,411,140, AND OTHERS.

NO CLAIM IS MADE TO THE EXCLUSIVE RIGHT TO USE "INCOME PROVIDER", APART FROM THE MARK AS SHOWN.

SN 85-133,267, FILED 9-20-2010.

ALLISON HOLTZ, EXAMINING ATTORNEY



David J. Kyffers

Director of the United States Patent and Trademark Office

United States of America

United States Patent and Trademark Office

LEFIT

Reg. No. 4,075,007

PHSI, LLC (FLORIDA LIMITED LIABILITY COMPANY)
9240 BONITA BEACH RD, SUITE 3305
BONITA SPRINGS, FL 34135

Registered Dec. 20, 2011

Int. Cl.: 10

FOR: HEARING AIDS, IN CLASS 10 (U.S. CLS. 26, 39 AND 44).

TRADEMARK

FIRST USE 9-30-2010; IN COMMERCE 9-30-2010.

PRINCIPAL REGISTER

THE MARK CONSISTS OF STANDARD CHARACTERS WITHOUT CLAIM TO ANY PARTICULAR FONT, STYLE, SIZE, OR COLOR.

SN 85-133,327, FILED 9-20-2010.

HANNO RITTNER, EXAMINING ATTORNEY



David J. Kyffers

Director of the United States Patent and Trademark Office

United States of America

United States Patent and Trademark Office



Reg. No. 4,075,008

APPINO, JAMES (UNITED STATES INDIVIDUAL)
12410 FIRE ISLAND DRIVE
LOVES PARK, IL 61111

Registered Dec. 20, 2011

Int. Cl.: 41

FOR: EDUCATION SERVICES, NAMELY, PROVIDING CLASSES, SEMINARS, WORKSHOPS IN THE FIELDS OF HEALTH AND WELLNESS; PHYSICAL FITNESS TRAINING OF INDIVIDUALS AND GROUPS, IN CLASS 41 (U.S. CLS. 100, 101 AND 107).

SERVICE MARK

FIRST USE 1-4-2010; IN COMMERCE 4-5-2010.

PRINCIPAL REGISTER

NO CLAIM IS MADE TO THE EXCLUSIVE RIGHT TO USE "STRENGTH", APART FROM THE MARK AS SHOWN.

SN 85-133,352, FILED 9-20-2010.

SIMON TENG, EXAMINING ATTORNEY



David J. Kybas

Director of the United States Patent and Trademark Office

United States of America

United States Patent and Trademark Office

Race To Win

Reg. No. 4,075,009

TEXAS ALLIED CHEMICALS, INC. (DELAWARE CORPORATION)
P.O. BOX 33911

Registered Dec. 20, 2011

SAN ANTONIO, TX 78265

Int. Cl.: 4

FOR: FUELS FOR SMALL ENGINES USED IN TOY MODEL HOBBY CRAFTS, IN CLASS 4 (U.S. CLS. 1, 6 AND 15).

TRADEMARK

FIRST USE 11-1-2010; IN COMMERCE 11-1-2010.

PRINCIPAL REGISTER

THE MARK CONSISTS OF STANDARD CHARACTERS WITHOUT CLAIM TO ANY PARTICULAR FONT, STYLE, SIZE, OR COLOR.

SN 85-133,401, FILED 9-20-2010.

ALAIN LAPTER, EXAMINING ATTORNEY



David J. Kybas

Director of the United States Patent and Trademark Office

United States of America

United States Patent and Trademark Office



Reg. No. 4,075,010

Registered Dec. 20, 2011

Int. Cl.: 35

SERVICE MARK

PRINCIPAL REGISTER

IDT ENERGY, INC. (DELAWARE CORPORATION)
520 BROAD STREET
NEWARK, NJ 07102

FOR: RETAIL ELECTRIC POWER AND NATURAL GAS PROVIDER SERVICES, NAMELY, PROVIDING A SERVICE THAT ALLOWS CUSTOMERS TO PURCHASE ENERGY, NAMELY, ELECTRICITY AND NATURAL GAS, IN CLASS 35 (U.S. CLS. 100, 101 AND 102).

FIRST USE 2-0-2011; IN COMMERCE 2-0-2011.

NO CLAIM IS MADE TO THE EXCLUSIVE RIGHT TO USE "ENERGY", APART FROM THE MARK AS SHOWN.

THE COLOR(S) GREEN, YELLOW AND BLACK IS/ARE CLAIMED AS A FEATURE OF THE MARK.

THE MARK CONSISTS OF A VERTICAL ORIENTED RECTANGLE SHOWN IN THE COLOR GREEN AND CONTAINING THE LETTERS "IDT" SHOWN IN YELLOW AT THE BOTTOM BELOW A HORIZONTAL ORIENTED YELLOW SINGLE LINE RECTANGLE, CONTAINING A CURVED OUTER PORTION OF A STYLIZED SUN SHOWN IN YELLOW WITH A GREEN CURVED STRIPE NEAR ITS OUTER EDGE AND FIVE YELLOW SUNBEAMS. BELOW THIS DESIGN, THE WORD "ENERGY" IS SHOWN IN GREEN ABOVE A BLACK HORIZONTAL LINE AND THE WORDS "WE TURN YOU ON!" BELOW THE HORIZONTAL LINE SHOWN IN BLACK.

SN 85-133,490, FILED 9-20-2010.

JENNIFER DIXON, EXAMINING ATTORNEY



David J. Kybas

Director of the United States Patent and Trademark Office

United States of America

United States Patent and Trademark Office



Reg. No. 4,075,011

IDT ENERGY, INC. (DELAWARE CORPORATION)
520 BROAD STREET
NEWARK, NJ 07102

Registered Dec. 20, 2011

Int. Cl.: 35

FOR: RETAIL ELECTRIC POWER AND NATURAL GAS PROVIDER SERVICES, NAMELY, PROVIDING A SERVICE THAT ALLOWS CUSTOMERS TO PURCHASE ENERGY, NAMELY, ELECTRICITY AND NATURAL GAS, IN CLASS 35 (U.S. CLS. 100, 101 AND 102).

SERVICE MARK

FIRST USE 12-0-2010; IN COMMERCE 12-0-2010.

PRINCIPAL REGISTER

NO CLAIM IS MADE TO THE EXCLUSIVE RIGHT TO USE "ENERGY", APART FROM THE MARK AS SHOWN.

THE COLOR(S) GREEN AND YELLOW IS/ARE CLAIMED AS A FEATURE OF THE MARK.

THE MARK CONSISTS OF A VERTICAL ORIENTED RECTANGLE SHOWN IN THE COLOR GREEN AND CONTAINING THE LETTERS "IDT" SHOWN IN YELLOW AT THE BOTTOM BELOW A HORIZONTAL ORIENTED YELLOW SINGLE LINE RECTANGLE, CONTAINING A CURVED OUTER PORTION OF A STYLIZED SUN SHOWN IN YELLOW WITH A GREEN CURVED STRIPE NEAR ITS OUTER EDGE AND FIVE YELLOW SUNBEAMS. BELOW THIS DESIGN, THE WORD "ENERGY" IS SHOWN IN GREEN.

SN 85-133,495, FILED 9-20-2010.

JENNIFER DIXON, EXAMINING ATTORNEY



David J. Kybas

Director of the United States Patent and Trademark Office

United States of America

United States Patent and Trademark Office



Reg. No. 4,075,012

Registered Dec. 20, 2011

Int. Cl.: 30

TRADEMARK

PRINCIPAL REGISTER

PEPPERIDGE FARM, INCORPORATED (CONNECTICUT CORPORATION)
595 WESTPORT AVENUE
NORWALK, CT 06851

FOR: BREAD; ROLLS, IN CLASS 30 (U.S. CL. 46).

FIRST USE 3-31-2011; IN COMMERCE 3-31-2011.

OWNER OF U.S. REG. NOS. 360,512, 2,396,052, AND OTHERS.

NO CLAIM IS MADE TO THE EXCLUSIVE RIGHT TO USE "STONE BAKED", APART FROM THE MARK AS SHOWN.

THE MARK CONSISTS OF A MILL BENEATH A BANNER CONTAINING THE WORDS "PEPPERIDGE FARM" AND TWO STALKS OF WHEAT BENEATH THE WORDS "STONE BAKED", AND CURVED LINES ON THE LEFT AND RIGHT OF THE TERMS "STONE BAKED" AND BELOW THE STALKS OF WHEAT.

SN 85-133,499, FILED 9-20-2010.

JENNIFER DIXON, EXAMINING ATTORNEY



David J. Kyros

Director of the United States Patent and Trademark Office

United States of America

United States Patent and Trademark Office

IDT ENERGY

Reg. No. 4,075,013

IDT ENERGY, INC. (DELAWARE CORPORATION)
520 BROAD STREET
NEWARK, NJ 07102

Registered Dec. 20, 2011

Int. Cl.: 35

FOR: RETAIL ELECTRIC POWER AND NATURAL GAS PROVIDER SERVICES, NAMELY, PROVIDING A SERVICE THAT ALLOWS CUSTOMERS TO PURCHASE ENERGY, NAMELY, ELECTRICITY AND NATURAL GAS, IN CLASS 35 (U.S. CLS. 100, 101 AND 102).

SERVICE MARK

FIRST USE 12-0-2004; IN COMMERCE 12-0-2004.

PRINCIPAL REGISTER

THE MARK CONSISTS OF STANDARD CHARACTERS WITHOUT CLAIM TO ANY PARTICULAR FONT, STYLE, SIZE, OR COLOR.

NO CLAIM IS MADE TO THE EXCLUSIVE RIGHT TO USE "ENERGY", APART FROM THE MARK AS SHOWN.

SN 85-133,500, FILED 9-20-2010.

JENNIFER DIXON, EXAMINING ATTORNEY



David J. Kybas

Director of the United States Patent and Trademark Office

United States of America

United States Patent and Trademark Office

CHIRX

Reg. No. 4,075,014

Registered Dec. 20, 2011

Int. Cl.: 3

TRADEMARK

PRINCIPAL REGISTER

FAROUK SYSTEMS, INC. (TEXAS CORPORATION)
250 PENNBRIGHT
HOUSTON, TX 77090

FOR: HAIR CARE PREPARATIONS, IN CLASS 3 (U.S. CLS. 1, 4, 6, 50, 51 AND 52).

FIRST USE 2-28-2011; IN COMMERCE 2-28-2011.

THE MARK CONSISTS OF STANDARD CHARACTERS WITHOUT CLAIM TO ANY PARTICULAR FONT, STYLE, SIZE, OR COLOR.

OWNER OF U.S. REG. NOS. 2,660,257, 3,107,769, AND OTHERS.

SN 85-133,904, FILED 9-20-2010.

CHRISTINE COOPER, EXAMINING ATTORNEY



David J. Kyffers

Director of the United States Patent and Trademark Office

United States of America

United States Patent and Trademark Office

knives and fire

Reg. No. 4,075,015

Registered Dec. 20, 2011

Int. Cl.: 41

SERVICE MARK

PRINCIPAL REGISTER

DEREK BURNS (UNITED STATES INDIVIDUAL)
658 MOANA WAY
PACIFICA, CA 94044

FOR: ON-LINE JOURNALS, NAMELY, BLOGS FEATURING INFORMATION REGARDING CULINARY ARTS; ENTERTAINMENT IN THE NATURE OF A FOOD AND CULINARY SHOW; ENTERTAINMENT, NAMELY, A CONTINUING FOOD AND CULINARY SHOW BROADCAST OVER TELEVISION, SATELLITE, AUDIO, INTERNET, AND VIDEO MEDIA; ENTERTAINMENT SERVICES, NAMELY, PROVIDING A WEB SITE FEATURING PHOTOGRAPHIC, AUDIO AND VIDEO PRESENTATIONS FEATURING FOOD AND CULINARY PRESENTATIONS; EDUCATIONAL SERVICES, NAMELY, PROVIDING CLASSES AND WORKSHOPS IN THE FIELD OF CULINARY ARTS; SPECIAL EVENT PLANNING FOR SOCIAL ENTERTAINMENT RELATED TO CULINARY ARTS, IN CLASS 41 (U.S. CLS. 100, 101 AND 107).

FIRST USE 3-0-1995; IN COMMERCE 3-0-1995.

THE MARK CONSISTS OF STANDARD CHARACTERS WITHOUT CLAIM TO ANY PARTICULAR FONT, STYLE, SIZE, OR COLOR.

SN 85-134,069, FILED 9-20-2010.

NAKIA HENRY, EXAMINING ATTORNEY



David J. Kyffers

Director of the United States Patent and Trademark Office

United States of America

United States Patent and Trademark Office

SUNWELD

Reg. No. 4,075,016

Registered Dec. 20, 2011

Int. Cl.: 6

TRADEMARK

PRINCIPAL REGISTER

CARLISLE INTANGIBLE COMPANY (DELAWARE CORPORATION)
250 SOUTH CLINTON STREET
SUITE 201
SYRACUSE, NY 13202

FOR: SKYLIGHTS, MADE PRIMARILY OF METAL, IN CLASS 6 (U.S. CLS. 2, 12, 13, 14, 23, 25 AND 50).

FIRST USE 2-1-2011; IN COMMERCE 2-1-2011.

THE MARK CONSISTS OF STANDARD CHARACTERS WITHOUT CLAIM TO ANY PARTICULAR FONT, STYLE, SIZE, OR COLOR.

SN 85-134,193, FILED 9-21-2010.

VIVIAN MICZNIK FIRST, EXAMINING ATTORNEY



David J. Kyffers

Director of the United States Patent and Trademark Office

United States of America

United States Patent and Trademark Office

Nine Lives Blood Services, PLLC

Reg. No. 4,075,017

Registered Dec. 20, 2011

Int. Cl.: 44

SERVICE MARK

PRINCIPAL REGISTER

NINE LIVES BLOOD SERVICES, PLLC (MICHIGAN PROFESSIONAL LIMITED LIABILITY COMPANY)
1026 DAISY LANE
EAST LANSING, MI 48823

FOR: BLOOD BANK SERVICES; VETERINARY SERVICES, IN CLASS 44 (U.S. CLS. 100 AND 101).

FIRST USE 4-1-2011; IN COMMERCE 4-1-2011.

THE MARK CONSISTS OF STANDARD CHARACTERS WITHOUT CLAIM TO ANY PARTICULAR FONT, STYLE, SIZE, OR COLOR.

NO CLAIM IS MADE TO THE EXCLUSIVE RIGHT TO USE "BLOOD SERVICES, PLLC", APART FROM THE MARK AS SHOWN.

SN 85-134,206, FILED 9-21-2010.

ALYSSA STEEL, EXAMINING ATTORNEY



David J. Kyros

Director of the United States Patent and Trademark Office

United States of America

United States Patent and Trademark Office



Reg. No. 4,075,018

Registered Dec. 20, 2011

Int. Cl.: 20

TRADEMARK

PRINCIPAL REGISTER

BUILDING HEALTHY LIVES FOUNDATION (OHIO CHARITABLE, NON-PROFIT CORPORATION)
625 EDEN PARK DRIVE
CINCINNATI, OH 45202

FOR: NON-METAL TROPHIES, IN CLASS 20 (U.S. CLS. 2, 13, 22, 25, 32 AND 50).

FIRST USE 8-31-2011; IN COMMERCE 8-31-2011.

OWNER OF U.S. REG. NOS. 3,341,692, 3,776,343, AND OTHERS.

THE MARK CONSISTS OF THE LITERAL ELEMENT "CLEVER CRAZES FOR KIDS" WITH AN OVAL BACKGROUND AND WITH A DEPICTION OF EARTH BETWEEN THE WORDING "CLEVER CRAZES" AND "FOR KIDS".

SN 85-134,240, FILED 9-21-2010.

SARA BENJAMIN, EXAMINING ATTORNEY



David J. Kybas

Director of the United States Patent and Trademark Office

United States of America

United States Patent and Trademark Office

LOGIC FIT

Reg. No. 4,075,019

EXACTECH, INC. (FLORIDA CORPORATION)
2320 NORTH WEST 66TH COURT
GAINESVILLE, FL 32653

Registered Dec. 20, 2011

Int. Cl.: 10

FOR: IMPLANTABLE ORTHOPEDIC KNEE PROSTHESIS, IN CLASS 10 (U.S. CLS. 26, 39 AND 44).

TRADEMARK

FIRST USE 10-0-2010; IN COMMERCE 10-0-2010.

PRINCIPAL REGISTER

THE MARK CONSISTS OF STANDARD CHARACTERS WITHOUT CLAIM TO ANY PARTICULAR FONT, STYLE, SIZE, OR COLOR.

OWNER OF U.S. REG. NO. 3,686,762.

SN 85-134,315, FILED 9-21-2010.

JANET LEE, EXAMINING ATTORNEY



David J. Kybas

Director of the United States Patent and Trademark Office

United States of America

United States Patent and Trademark Office

ARTICHOKE'S HEART

Reg. No. 4,075,020

MORETT, CARLOS ANAYA (MEXICO INDIVIDUAL)
CALLE REFORMA NO. 2947

Registered Dec. 20, 2011

GUADALAJARA, JALISCO, MEXICO

Int. Cl.: 43

FOR: BAR AND RESTAURANT SERVICES, IN CLASS 43 (U.S. CLS. 100 AND 101).

SERVICE MARK

FIRST USE 5-5-2011; IN COMMERCE 5-5-2011.

PRINCIPAL REGISTER

THE MARK CONSISTS OF STANDARD CHARACTERS WITHOUT CLAIM TO ANY PARTICULAR FONT, STYLE, SIZE, OR COLOR.

SN 85-134,409, FILED 9-21-2010.

LAURIE MAYES, EXAMINING ATTORNEY



David J. Kyffers

Director of the United States Patent and Trademark Office

United States of America

United States Patent and Trademark Office

DON'T PROSCUIOTTO THE MESSENGER

Reg. No. 4,075,021

Registered Dec. 20, 2011

Int. Cl.: 3

TRADEMARK

PRINCIPAL REGISTER

ALOXXI INTERNATIONAL CORPORATION (CALIFORNIA CORPORATION)
14144 VENTURA BOULEVARD, SUITE 110
SHERMAN OAKS, CA 91423

FOR: HAIR BLEACHING PREPARATIONS, NON-MEDICATED HAIR CARE PREPARATIONS, HAIR CLEANING PREPARATIONS, HAIR COLOR REMOVERS, HAIR COLORING PREPARATIONS, HAIR LIGHTENERS, HAIR COLORING RINSE, HAIR LIGHTENING BLEACH, HAIR RINSES, HAIR COLORANTS, ALL IN THE FORM OF LIQUID, GEL AND CREAM, IN CLASS 3 (U.S. CLS. 1, 4, 6, 50, 51 AND 52).

FIRST USE 1-15-2011; IN COMMERCE 1-15-2011.

THE MARK CONSISTS OF STANDARD CHARACTERS WITHOUT CLAIM TO ANY PARTICULAR FONT, STYLE, SIZE, OR COLOR.

SN 85-134,415, FILED 9-21-2010.

ANTHONY RINKER, EXAMINING ATTORNEY



David J. Kyffers

Director of the United States Patent and Trademark Office

United States of America

United States Patent and Trademark Office

PUCCINI AND ME

Reg. No. 4,075,022

Registered Dec. 20, 2011

Int. Cl.: 3

TRADEMARK

PRINCIPAL REGISTER

ALOXXI INTERNATIONAL CORPORATION (CALIFORNIA CORPORATION)
14144 VENTURA BOULEVARD, SUITE 110
SHERMAN OAKS, CA 91423

FOR: HAIR BLEACHING PREPARATIONS, NON-MEDICATED HAIR CARE PREPARATIONS, HAIR CLEANING PREPARATIONS, HAIR COLOR REMOVERS, HAIR COLORING PREPARATIONS, HAIR LIGHTENERS, HAIR COLORING RINSE, HAIR LIGHTENING BLEACH, HAIR RINSES, HAIR COLORANTS, ALL IN THE FORM OF LIQUID, GEL AND CREAM, IN CLASS 3 (U.S. CLS. 1, 4, 6, 50, 51 AND 52).

FIRST USE 1-15-2011; IN COMMERCE 1-15-2011.

THE MARK CONSISTS OF STANDARD CHARACTERS WITHOUT CLAIM TO ANY PARTICULAR FONT, STYLE, SIZE, OR COLOR.

SN 85-134,467, FILED 9-21-2010.

ANTHONY RINKER, EXAMINING ATTORNEY



David J. Kyffers

Director of the United States Patent and Trademark Office

United States of America

United States Patent and Trademark Office

THE LAST RISOTTO

Reg. No. 4,075,023

Registered Dec. 20, 2011

Int. Cl.: 3

TRADEMARK

PRINCIPAL REGISTER

ALOXXI INTERNATIONAL CORPORATION (CALIFORNIA CORPORATION)
14144 VENTURA BOULEVARD, SUITE 110
SHERMAN OAKS, CA 91423

FOR: HAIR BLEACHING PREPARATIONS, NON-MEDICATED HAIR CARE PREPARATIONS, HAIR CLEANING PREPARATIONS, HAIR COLOR REMOVERS, HAIR COLORING PREPARATIONS, HAIR LIGHTENERS, HAIR COLORING RINSE, HAIR LIGHTENING BLEACH, HAIR RINSES, HAIR COLORANTS, ALL IN THE FORM OF LIQUID, GEL AND CREAM, IN CLASS 3 (U.S. CLS. 1, 4, 6, 50, 51 AND 52).

FIRST USE 1-15-2011; IN COMMERCE 1-15-2011.

THE MARK CONSISTS OF STANDARD CHARACTERS WITHOUT CLAIM TO ANY PARTICULAR FONT, STYLE, SIZE, OR COLOR.

SN 85-134,485, FILED 9-21-2010.

ANTHONY RINKER, EXAMINING ATTORNEY



David J. Kyffers

Director of the United States Patent and Trademark Office

United States of America

United States Patent and Trademark Office

SKY2BLUE SHIELD

Reg. No. 4,075,024

EASTERN WHOLESALE FENCE CO., INC. (NEW YORK CORPORATION)
274 MIDDLE ISLAND ROAD
MEDFORD, NY 11763

Registered Dec. 20, 2011

Int. Cl.: 19

FOR: NON-METAL FENCE PANELS, POSTS AND CAPS; NON-METAL FENCES AND GATES; PVC RAILINGS, IN CLASS 19 (U.S. CLS. 1, 12, 33 AND 50).

TRADEMARK

FIRST USE 1-1-2011; IN COMMERCE 1-1-2011.

PRINCIPAL REGISTER

THE MARK CONSISTS OF STANDARD CHARACTERS WITHOUT CLAIM TO ANY PARTICULAR FONT, STYLE, SIZE, OR COLOR.

SN 85-134,762, FILED 9-21-2010.

EUGENIA MARTIN, EXAMINING ATTORNEY



David J. Kybas

Director of the United States Patent and Trademark Office

United States of America

United States Patent and Trademark Office

EXPERIENCE LIFE...BY DESIGN

Reg. No. 4,075,025

HKS, INC. (TEXAS CORPORATION)
1919 MCKINNEY AVENUE
DALLAS, TX 75201

Registered Dec. 20, 2011

Int. Cl.: 42

FOR: COMPREHENSIVE ARCHITECTURAL PLANNING AND DESIGN SERVICES, IN CLASS 42 (U.S. CLS. 100 AND 101).

SERVICE MARK

FIRST USE 4-0-2010; IN COMMERCE 4-0-2010.

PRINCIPAL REGISTER

THE MARK CONSISTS OF STANDARD CHARACTERS WITHOUT CLAIM TO ANY PARTICULAR FONT, STYLE, SIZE, OR COLOR.

SN 85-134,799, FILED 9-21-2010.

JULIE GUTTADAURO, EXAMINING ATTORNEY



David J. Kybas

Director of the United States Patent and Trademark Office

United States of America

United States Patent and Trademark Office

SAMUEL ADAMS REVOLUTIONARY RYE

Reg. No. 4,075,026

Registered Dec. 20, 2011

Int. Cl.: 32

TRADEMARK

PRINCIPAL REGISTER

BOSTON BEER CORPORATION (MASSACHUSETTS LIMITED LIABILITY COMPANY)
ONE DESIGN CENTER PLACE
SUITE 850
BOSTON, MA 02116

FOR: BEVERAGES, NAMELY, BEER AND ALE, IN CLASS 32 (U.S. CLS. 45, 46 AND 48).

FIRST USE 4-0-2011; IN COMMERCE 4-0-2011.

THE MARK CONSISTS OF STANDARD CHARACTERS WITHOUT CLAIM TO ANY PARTICULAR FONT, STYLE, SIZE, OR COLOR.

OWNER OF U.S. REG. NOS. 1,987,061, 2,597,646, AND OTHERS.

NO CLAIM IS MADE TO THE EXCLUSIVE RIGHT TO USE "RYE", APART FROM THE MARK AS SHOWN.

THE NAME "SAMUEL ADAMS" DOES NOT IDENTIFY A PARTICULAR LIVING INDIVIDUAL.

SN 85-134,804, FILED 9-21-2010.

KATHERINE STOIDES, EXAMINING ATTORNEY



David J. Kyffers

Director of the United States Patent and Trademark Office

United States of America
United States Patent and Trademark Office

CrunchIt

Reg. No. 4,075,027

JETBOIL, INC. (DELAWARE CORPORATION)
540 NORTH COMMERCIAL STREET
MANCHESTER, NH 03101

Registered Dec. 20, 2011

Int. Cl.: 8

FOR: MANUALLY-OPERATED FUEL CANISTER RECYCLING TOOL, IN CLASS 8 (U.S. CLS. 23, 28 AND 44).

TRADEMARK

FIRST USE 11-2-2010; IN COMMERCE 11-2-2010.

PRINCIPAL REGISTER

THE MARK CONSISTS OF STANDARD CHARACTERS WITHOUT CLAIM TO ANY PARTICULAR FONT, STYLE, SIZE, OR COLOR.

SN 85-134,826, FILED 9-21-2010.

ELLEN BURNS, EXAMINING ATTORNEY



David J. Kybas

Director of the United States Patent and Trademark Office

United States of America

United States Patent and Trademark Office

PIPELINE RA

Reg. No. 4,075,028

MOONBAY TECHNOLOGY (CALIFORNIA CORPORATION)
254 PALOMA AVENUE
EL GRANADA, CA 940181322

Registered Dec. 20, 2011

Int. Cl.: 42

FOR: PROVIDING TEMPORARY USE OF ON-LINE NON-DOWNLOADABLE SOFTWARE FOR USE IN THE LIFE SCIENCES INDUSTRY FOR DATA AND DOCUMENT MANAGEMENT, ELECTRONIC PUBLISHING, AND WORK FLOW PROCESSES, IN CLASS 42 (U.S. CLS. 100 AND 101).

SERVICE MARK

PRINCIPAL REGISTER

FIRST USE 6-0-2009; IN COMMERCE 6-0-2009.

THE MARK CONSISTS OF STANDARD CHARACTERS WITHOUT CLAIM TO ANY PARTICULAR FONT, STYLE, SIZE, OR COLOR.

SN 85-135,501, FILED 9-22-2010.

DOMINICK J. SALEMI, EXAMINING ATTORNEY



David J. Kybas

Director of the United States Patent and Trademark Office

United States of America

United States Patent and Trademark Office

LEVAMIX

Reg. No. 4,075,029

INVERSIONES QUEENCORP S.A. (CHILE CORPORATION)
EL ROSAL 4644

Registered Dec. 20, 2011

HUECHURABA, SANTIAGO, CHILE

Int. Cl.: 30

FOR: FOOD LEAVENING AGENTS FOR USE IN BAKERY APPLICATIONS, IN CLASS 30
(U.S. CL. 46).

TRADEMARK

FIRST USE 6-1-1998; IN COMMERCE 3-1-2010.

PRINCIPAL REGISTER

THE MARK CONSISTS OF STANDARD CHARACTERS WITHOUT CLAIM TO ANY PARTICULAR FONT, STYLE, SIZE, OR COLOR.

SN 85-135,629, FILED 9-22-2010.

EUGENIA MARTIN, EXAMINING ATTORNEY



David J. Kybas

Director of the United States Patent and Trademark Office

United States of America

United States Patent and Trademark Office



MASKE

Reg. No. 4,075,030

Registered Dec. 20, 2011

Int. Cl.: 9

TRADEMARK

PRINCIPAL REGISTER

SONICONN CO., LTD. (TAIWAN LIMITED LIABILITY COMPANY)
NO. 24
LN. 118, FULE ST., SINJHUANG CITY
TAIPEI COUNTY, TAIWAN

FOR: CELL PHONE BATTERY CHARGERS, BATTERY CHARGERS, CELL PHONE BATTERY CHARGERS FOR USE IN VEHICLES, CELL PHONE COVERS, EARPHONES AND HEADPHONES, HANDS FREE DEVICES FOR MOBILE-PHONES, COMPUTER BAGS, BACKPACKS SPECIALLY ADAPTED FOR HOLDING LAPTOPS AND NOTEBOOK COMPUTERS, PROTECTIVE CARRYING CASES SPECIALLY ADAPTED FOR PERSONAL DIGITAL ASSISTANTS, LEATHER PROTECTIVE COVERS SPECIALLY ADAPTED FOR PERSONAL ELECTRONIC DEVICES, IN CLASS 9 (U.S. CLS. 21, 23, 26, 36 AND 38).

FIRST USE 9-1-2011; IN COMMERCE 9-1-2011.

THE MARK CONSISTS OF THE LITERAL ELEMENT "MASKE" BETWEEN TWO HORIZONTAL PARALLEL LINES, WITH A STYLIZED "M" ABOVE THE TOP HORIZONTAL LINE.

SN 85-135,989, FILED 9-22-2010.

EUGENIA MARTIN, EXAMINING ATTORNEY



David J. Kybas

Director of the United States Patent and Trademark Office

United States of America

United States Patent and Trademark Office

グパチ

Reg. No. 4,075,031

GALACTIC INNOVATIONS (UTAH LIMITED LIABILITY COMPANY)
4136 WESTLAKE DRIVE
ROY, UT 84067

Registered Dec. 20, 2011

Int. Cl.: 28

FOR: CARD GAMES, IN CLASS 28 (U.S. CLS. 22, 23, 38 AND 50).

TRADEMARK

FIRST USE 1-1-2011; IN COMMERCE 1-1-2011.

PRINCIPAL REGISTER

THE MARK CONSISTS OF JAPANESE TEXT.

THE NON-LATIN CHARACTERS IN THE MARK TRANSLITERATE TO GU PA CHI. THE NON-LATIN CHARACTERS THAT TRANSLITERATE TO GU PA TRANSLATE TO ROCK PAPER IN ENGLISH. THE NON-LATIN CHARACTER THAT TRANSLITERATES TO CHI HAS NO MEANING IN ENGLISH.

SN 85-136,037, FILED 9-22-2010.

AISHA CLARKE, EXAMINING ATTORNEY



David J. Kyffers

Director of the United States Patent and Trademark Office

United States of America

United States Patent and Trademark Office

ICARTRIDGE

Reg. No. 4,075,032

IM CAPITAL GROUP, LLC (DELAWARE LIMITED LIABILITY COMPANY)
P.O. BOX 333
HARTSDALE, NY 10530

Registered Dec. 20, 2011

Int. Cls.: 2 and 35

FOR: FILLED INK CARTRIDGES; INK JET CARTRIDGES; PHOTOCOPIER TONER IN CARTRIDGES; TONER CARTRIDGES, IN CLASS 2 (U.S. CLS. 6, 11 AND 16).

TRADEMARK

FIRST USE 2-23-2011; IN COMMERCE 2-23-2011.

SERVICE MARK

FOR: ON-LINE RETAIL STORE SERVICES FEATURING REFILLED AND REFURBISHED INK JET CARTRIDGES AND TONER CARTRIDGES; RETAIL STORES FEATURING REFILLED AND REFURBISHED INK JET CARTRIDGES AND TONER CARTRIDGES, IN CLASS 35 (U.S. CLS. 100, 101 AND 102).

PRINCIPAL REGISTER

FIRST USE 2-23-2011; IN COMMERCE 2-23-2011.

THE MARK CONSISTS OF STANDARD CHARACTERS WITHOUT CLAIM TO ANY PARTICULAR FONT, STYLE, SIZE, OR COLOR.

SN 85-136,120, FILED 9-22-2010.

Laurie Kaufman, Examining Attorney



David J. Kybas

Director of the United States Patent and Trademark Office

United States of America

United States Patent and Trademark Office

IAN VELARDI

Reg. No. 4,075,033

Registered Dec. 20, 2011

Int. Cls.: 18 and 25

TRADEMARK

PRINCIPAL REGISTER

IAN VELARDI, LLC (NEW YORK LIMITED LIABILITY COMPANY)
168 WEST 25TH STREET, SUITE 4
NEW YORK, NY 10001

FOR: BAGS, NAMELY, CARRYALL BAGS, BACKPACKS, DUFFEL BAGS, BRIEFCASE TYPE PORTFOLIOS, AND TOTE BAGS; LEATHER GOODS, NAMELY, WALLETS, AND CREDIT CARDHOLDERS; UMBRELLAS, IN CLASS 18 (U.S. CLS. 1, 2, 3, 22 AND 41).

FIRST USE 10-1-2010; IN COMMERCE 11-1-2010.

FOR: CLOTHING, NAMELY, HATS, SCARVES, BELTS, GLOVES, NECKWEAR, SHIRTS, SWEATERS, JACKETS, COATS, TROUSERS, SHORTS AND SOCKS; FOOTWEAR, NAMELY, SHOES AND SNEAKERS, IN CLASS 25 (U.S. CLS. 22 AND 39).

FIRST USE 10-1-2010; IN COMMERCE 11-1-2010.

THE MARK CONSISTS OF STANDARD CHARACTERS WITHOUT CLAIM TO ANY PARTICULAR FONT, STYLE, SIZE, OR COLOR.

THE NAME(S), PORTRAIT(S), AND/OR SIGNATURE(S) SHOWN IN THE MARK IDENTIFIES "IAN VELARDI", WHOSE CONSENT(S) TO REGISTER IS MADE OF RECORD.

SN 85-136,781, FILED 9-23-2010.

KARANENDRA S. CHHINA, EXAMINING ATTORNEY



David J. Kyros

Director of the United States Patent and Trademark Office

United States of America

United States Patent and Trademark Office



Reg. No. 4,075,034

Registered Dec. 20, 2011

Int. Cls.: 16 and 41

TRADEMARK

SERVICE MARK

PRINCIPAL REGISTER

SAFAR ENTERPRISE INC. (NEW JERSEY CORPORATION)
236 ERNSTON ROAD
PARLIN, NJ 08859

FOR: MAGAZINE FEATURING CURRENT EVENTS, IN CLASS 16 (U.S. CLS. 2, 5, 22, 23, 29, 37, 38 AND 50).

FIRST USE 7-0-2011; IN COMMERCE 7-0-2011.

FOR: PROVIDING ON-LINE MAGAZINES FEATURING CURRENT EVENTS; PROVIDING AN INTERNET NEWS PORTAL FEATURING LINKS TO NEWS STORIES AND ARTICLES IN THE FIELD OF CURRENT EVENTS, IN CLASS 41 (U.S. CLS. 100, 101 AND 107).

FIRST USE 7-0-2011; IN COMMERCE 7-0-2011.

NO CLAIM IS MADE TO THE EXCLUSIVE RIGHT TO USE "SOUTH ASIA JOURNAL" AND DESIGN OF THE OUTLINE MAP OF SOUTH ASIA., APART FROM THE MARK AS SHOWN.

THE MARK CONSISTS OF FIVE RECTANGLES WITH GRAPHIC REPRESENTATIONS OF PARTS OF ASIA WITH THE WORDS "SOUTH ASIA" ABOVE A LINE AND THE WORD "JOURNAL".

SN 85-137,415, FILED 9-24-2010.

JOSETTE BEVERLY, EXAMINING ATTORNEY



David J. Kybas

Director of the United States Patent and Trademark Office

United States of America

United States Patent and Trademark Office

MAD PAX

Reg. No. 4,075,035

MAD PAX, L.L.C. (ARIZONA LIMITED LIABILITY COMPANY)
P.O. BOX 73157

Registered Dec. 20, 2011

PHOENIX, AZ 85050

Int. Cl.: 18

FOR: BACKPACKS, BOOK BAGS, SPORTS BAGS, BUM BAGS, WALLETS AND HANDBAGS,
IN CLASS 18 (U.S. CLS. 1, 2, 3, 22 AND 41).

TRADEMARK

FIRST USE 11-9-2011; IN COMMERCE 11-9-2011.

PRINCIPAL REGISTER

THE MARK CONSISTS OF STANDARD CHARACTERS WITHOUT CLAIM TO ANY PAR-
TICULAR FONT, STYLE, SIZE, OR COLOR.

NO CLAIM IS MADE TO THE EXCLUSIVE RIGHT TO USE "PACKS", APART FROM THE
MARK AS SHOWN.

SN 85-137,585, FILED 9-24-2010.

ELLEN BURNS, EXAMINING ATTORNEY



David J. Kybas

Director of the United States Patent and Trademark Office

United States of America

United States Patent and Trademark Office

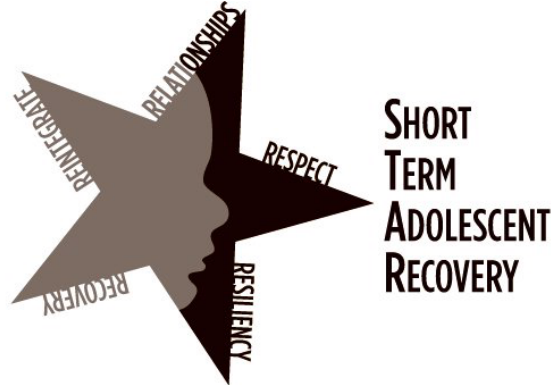

Reg. No. 4,075,036

BEACON LIGHT BEHAVIORAL HEALTH SYSTEMS (PENNSYLVANIA CORPORATION)
800 E. MAIN STREET
BRADFORD, PA 16701

Registered Dec. 20, 2011

Int. Cl.: 44

FOR: RESIDENTIAL BEHAVIORAL HEALTH TREATMENT SERVICES FOR CHILDREN AND ADOLESCENTS, IN CLASS 44 (U.S. CLS. 100 AND 101).

SERVICE MARK

FIRST USE 9-1-2011; IN COMMERCE 9-1-2011.

PRINCIPAL REGISTER

NO CLAIM IS MADE TO THE EXCLUSIVE RIGHT TO USE "RELATIONSHIPS RESPECT RESILIENCY RECOVERY REINTEGRATE SHORT TERM ADOLESCENT RECOVERY", APART FROM THE MARK AS SHOWN.

THE MARK CONSISTS OF A FIVE POINTED STAR WHICH INCLUDES A SIDE PROFILE OF A FACE WITH THE WORDS "RELATIONSHIPS RESPECT RESILIENCY RECOVERY REINTEGRATE" ON ONE SIDE OF EACH ARM OF THE STAR AND THE WORDS "SHORT TERM ADOLESCENT RECOVERY" TO THE RIGHT OF THE STAR VERTICALLY ARRANGED SUCH THAT THE FIRST LETTER OF EACH WORD SPELLS OUT THE WORD "STAR".

SN 85-137,816, FILED 9-24-2010.

GRETТА YAO, EXAMINING ATTORNEY



David J. Kyffers

Director of the United States Patent and Trademark Office

United States of America

United States Patent and Trademark Office

BEAVER CUE COMPANY

Reg. No. 4,075,037

MUELLER RECREATIONAL PRODUCTS, INC. (NEBRASKA CORPORATION)
4825 SOUTH 16TH STREET
LINCOLN, NE 68512

Registered Dec. 20, 2011

Int. Cls.: 25 and 28

FOR: WEARABLE GARMENTS AND CLOTHING, NAMELY, SHIRTS, IN CLASS 25 (U.S. CLS. 22 AND 39).

TRADEMARK

FIRST USE 1-0-2011; IN COMMERCE 1-0-2011.

PRINCIPAL REGISTER

FOR: BILLIARD EQUIPMENT, IN CLASS 28 (U.S. CLS. 22, 23, 38 AND 50).

FIRST USE 1-0-2011; IN COMMERCE 1-0-2011.

THE MARK CONSISTS OF STANDARD CHARACTERS WITHOUT CLAIM TO ANY PARTICULAR FONT, STYLE, SIZE, OR COLOR.

NO CLAIM IS MADE TO THE EXCLUSIVE RIGHT TO USE "COMPANY" FOR GOODS IN CLASS 25 AND "CUE COMPANY" FOR GOODS IN CLASS 28, APART FROM THE MARK AS SHOWN.

SN 85-137,826, FILED 9-24-2010.

REBECCA EISINGER, EXAMINING ATTORNEY



David J. Kyffers

Director of the United States Patent and Trademark Office

United States of America
United States Patent and Trademark Office

MONOCLE

Reg. No. 4,075,038

BLUE GECKO, INC. (WASHINGTON CORPORATION)
1408 4TH AVENUE SUITE 200
SEATTLE, WA 98101

Registered Dec. 20, 2011

Int. Cl.: 42

FOR: SOFTWARE AS A SERVICE (SAAS), NAMELY, COMPUTER SOFTWARE FOR USE
IN DATABASE MONITORING, IN CLASS 42 (U.S. CLS. 100 AND 101).

SERVICE MARK

FIRST USE 12-31-2007; IN COMMERCE 12-31-2007.

PRINCIPAL REGISTER

THE MARK CONSISTS OF STANDARD CHARACTERS WITHOUT CLAIM TO ANY PAR-
TICULAR FONT, STYLE, SIZE, OR COLOR.

SN 85-138,060, FILED 9-24-2010.

DOUGLAS LEE, EXAMINING ATTORNEY



David J. Kybas

Director of the United States Patent and Trademark Office

United States of America

United States Patent and Trademark Office

DURABELT

Reg. No. 4,075,039

CMRG APPAREL, LLC (DELAWARE LIMITED LIABILITY COMPANY)
555 TURNPIKE STREET
CANTON, MA 02021

Registered Dec. 20, 2011

Int. Cl.: 25

FOR: BELTS, IN CLASS 25 (U.S. CLS. 22 AND 39).

TRADEMARK

FIRST USE 9-15-2010; IN COMMERCE 9-15-2010.

PRINCIPAL REGISTER

THE MARK CONSISTS OF STANDARD CHARACTERS WITHOUT CLAIM TO ANY PARTICULAR FONT, STYLE, SIZE, OR COLOR.

SN 85-138,582, FILED 9-27-2010.

JASON BLAIR, EXAMINING ATTORNEY



David J. Kybas

Director of the United States Patent and Trademark Office

United States of America

United States Patent and Trademark Office

SWITCH BLADE

Reg. No. 4,075,040

SIMS, THOMAS P. (UNITED STATES INDIVIDUAL)
340 CALLE LIPPIZANI
SANTA BARBARA, CA 93117

Registered Dec. 20, 2011

Int. Cl.: 28

FOR: PROTECTIVE PADDING FOR SNOWBOARDING; SNOWBOARD BINDINGS;
SNOWBOARDS, IN CLASS 28 (U.S. CLS. 22, 23, 38 AND 50).

TRADEMARK

FIRST USE 4-15-1987; IN COMMERCE 4-15-1987.

PRINCIPAL REGISTER

THE MARK CONSISTS OF STANDARD CHARACTERS WITHOUT CLAIM TO ANY PARTICULAR FONT, STYLE, SIZE, OR COLOR.

SN 85-139,106, FILED 9-27-2010.

JOHN DALIER, EXAMINING ATTORNEY



David J. Kybas

Director of the United States Patent and Trademark Office

United States of America

United States Patent and Trademark Office

letsartparty

Reg. No. 4,075,041

BUSTER'S & CO., LLC (DELAWARE LIMITED LIABILITY COMPANY)
6474 PEMBERTON DRIVE
DALLAS, TX 75230

Registered Dec. 20, 2011

Int. Cl.: 41

FOR: EDUCATIONAL AND ENTERTAINMENT SERVICES, NAMELY, PROVIDING INSTRUCTION IN THE FIELD OF ART, IN CLASS 41 (U.S. CLS. 100, 101 AND 107).

SERVICE MARK

FIRST USE 11-30-2010; IN COMMERCE 11-30-2010.

PRINCIPAL REGISTER

THE MARK CONSISTS OF THE WORD "LETS" IN LOWER-CASE, BLACK LETTERS, NO SPACING, FOLLOWING BY THE WORD "ART" IN LOWER-CASE LETTERS, WITH THE "A" IN THE COLOR ORANGE, THE "R" IN A GOLD COLOR AND THE "T" IN A GREEN COLOR, NO SPACING, FOLLOWED BY THE WORD "PARTY" IN LOWER-CASE, BLACK LETTERS.

THE COLOR(S) BLACK, ORANGE, GOLD AND GREEN IS/ARE CLAIMED AS A FEATURE OF THE MARK.

SN 85-139,333, FILED 9-27-2010.

ANNE FARRELL, EXAMINING ATTORNEY



David J. Kybas

Director of the United States Patent and Trademark Office

United States of America

United States Patent and Trademark Office

Fiduciary Doctors

Reg. No. 4,075,042

Registered Dec. 20, 2011

Int. Cl.: 36

SERVICE MARK

PRINCIPAL REGISTER

FIDUCIARY DOCTORS, LLC (ARIZONA LIMITED LIABILITY COMPANY)
500 E. BENRICH DRIVE
GILBERT, AZ 85295

FOR: FIDUCIARY REPRESENTATIVES; FIDUCIARY SERVICES, NAMELY, ADVISING, PROTECTING AND INSULATING OTHER FIDUCIARIES IN MEETING THEIR FIDUCIARY RESPONSIBILITIES TO THEIR CLIENTS; FIDUCIARY SERVICES, NAMELY, ADVISING FIDUCIARIES RELATING TO THEIR RESPONSIBILITIES FOR FIDUCIARY COMPLIANCE, IN CLASS 36 (U.S. CLS. 100, 101 AND 102).

FIRST USE 11-1-2010; IN COMMERCE 11-1-2010.

THE MARK CONSISTS OF STANDARD CHARACTERS WITHOUT CLAIM TO ANY PARTICULAR FONT, STYLE, SIZE, OR COLOR.

NO CLAIM IS MADE TO THE EXCLUSIVE RIGHT TO USE "FIDUCIARY", APART FROM THE MARK AS SHOWN.

SN 85-139,841, FILED 9-28-2010.

PATRICIA EVANKO, EXAMINING ATTORNEY



David J. Kyjars

Director of the United States Patent and Trademark Office

United States of America

United States Patent and Trademark Office

QUICK BEVERAGES

Reg. No. 4,075,043

QUICK BEVERAGES LLC (MICHIGAN LIMITED LIABILITY COMPANY)
27777 FRANKLIN ROAD
SOUTHFIELD, MI 48034

Registered Dec. 20, 2011

Int. Cl.: 5

FOR: DIETARY SUPPLEMENT BEVERAGE, IN CLASS 5 (U.S. CLS. 6, 18, 44, 46, 51 AND 52).

TRADEMARK

FIRST USE 12-31-2010; IN COMMERCE 12-31-2010.

PRINCIPAL REGISTER

THE MARK CONSISTS OF STANDARD CHARACTERS WITHOUT CLAIM TO ANY PARTICULAR FONT, STYLE, SIZE, OR COLOR.

NO CLAIM IS MADE TO THE EXCLUSIVE RIGHT TO USE "BEVERAGES", APART FROM THE MARK AS SHOWN.

SN 85-140,181, FILED 9-28-2010.

JEAN IM, EXAMINING ATTORNEY



David J. Kybas

Director of the United States Patent and Trademark Office

United States of America
United States Patent and Trademark Office

EYESYNC

Reg. No. 4,075,044

GLOBAL ANIMAL MANAGEMENT, INC. (DELAWARE CORPORATION)
556 MORRIS AVENUE
SUMMIT, NJ 07901

Registered Dec. 20, 2011

Int. Cls.: 44 and 45

FOR: HEALTHCARE SERVICES, NAMELY, PROVIDING A DATABASE IN THE FIELD OF EQUINE HEALTH MANAGEMENT OFFERED VIA GLOBAL COMPUTER NETWORK FEATURING INPUTTING AND COLLECTION OF DATA AND INFORMATION ALL FOR EQUINE TREATMENT AND DIAGNOSTIC PURPOSES, IN CLASS 44 (U.S. CLS. 100 AND 101).

SERVICE MARK

PRINCIPAL REGISTER

FIRST USE 2-1-2010; IN COMMERCE 2-1-2010.

FOR: IDENTIFICATION VERIFICATION SERVICES, NAMELY, PROVIDING AUTHENTICATION OF EQUINE IDENTIFICATION INFORMATION VIA A GLOBAL COMPUTER NETWORK, IN CLASS 45 (U.S. CLS. 100 AND 101).

FIRST USE 2-1-2010; IN COMMERCE 2-1-2010.

THE MARK CONSISTS OF STANDARD CHARACTERS WITHOUT CLAIM TO ANY PARTICULAR FONT, STYLE, SIZE, OR COLOR.

SN 85-140,780, FILED 9-29-2010.

LAURIE KAUFMAN, EXAMINING ATTORNEY



David J. Kyffers

Director of the United States Patent and Trademark Office

United States of America

United States Patent and Trademark Office

LetsPour

Reg. No. 4,075,045

SIXTHEYE INC. (DELAWARE CORPORATION)
704 228TH AVE NE #832
SAMMAMISH, WA 980747222

Registered Dec. 20, 2011

Int. Cls.: 35, 39, 41, and 43

FOR: PROVIDING A WEBSITE WHERE USERS CAN POST RATINGS, REVIEWS AND RECOMMENDATIONS ON RESTAURANTS, FOOD AND WINE FOR COMMERCIAL PURPOSES, IN CLASS 35 (U.S. CLS. 100, 101 AND 102).

SERVICE MARK

FIRST USE 5-1-2010; IN COMMERCE 8-1-2010.

PRINCIPAL REGISTER

FOR: WINE CLUB SERVICES FEATURING PERIODIC SHIPMENTS OF WINE TO MEMBERS, IN CLASS 39 (U.S. CLS. 100 AND 105).

FIRST USE 5-1-2010; IN COMMERCE 1-1-2011.

FOR: ENTERTAINMENT SERVICES, NAMELY, WINE AND FOOD TASTINGS; ENTERTAINMENT SERVICES, NAMELY, WINE TASTINGS, IN CLASS 41 (U.S. CLS. 100, 101 AND 107).

FIRST USE 8-1-2010; IN COMMERCE 8-1-2010.

FOR: PROVIDING A WEB SITE WHERE USERS CAN POST RATINGS, REVIEWS AND RECOMMENDATIONS ON WINES FOR WINE APPRECIATION PURPOSES, IN CLASS 43 (U.S. CLS. 100 AND 101).

FIRST USE 8-1-2010; IN COMMERCE 8-1-2010.

THE MARK CONSISTS OF STANDARD CHARACTERS WITHOUT CLAIM TO ANY PARTICULAR FONT, STYLE, SIZE, OR COLOR.

SN 85-141,196, FILED 9-29-2010.

WON TEAK OH, EXAMINING ATTORNEY



David J. Kyfos

Director of the United States Patent and Trademark Office

United States of America

United States Patent and Trademark Office



Reg. No. 4,075,046

Registered Dec. 20, 2011

Int. Cls.: 35 and 42

SERVICE MARK

PRINCIPAL REGISTER

COMMUNITYASSIST OF WV, INC. (WEST VIRGINIA CORPORATION)
SUITE 212
200 STAR AVENUE
PARKERSBURG, WV 26101

FOR: ADMINISTRATION AND MANAGEMENT OF GRANTS BY TRACKING GRANT ACTIVITY AND GRANT REPORTING SERVICES FOR PRIVATE, FAMILY AND COMMUNITY FOUNDATIONS AND CHARITABLE ORGANIZATIONS; PROVIDING AN ONLINE DATABASE IN THE FIELD OF GRANT ACTIVITY TRACKING FOR PRIVATE, FAMILY AND COMMUNITY FOUNDATIONS AND CHARITABLE ORGANIZATIONS; ADMINISTRATIVE SUPPORT SERVICES FOR PRIVATE, FAMILY AND COMMUNITY FOUNDATIONS AND CHARITABLE ORGANIZATIONS, NAMELY, WRITING GRANT PROPOSALS AND MANAGEMENT OF GRANTS, IN CLASS 35 (U.S. CLS. 100, 101 AND 102).

FIRST USE 9-29-2010; IN COMMERCE 12-1-2010.

FOR: COMPUTER SERVICES, NAMELY, PROVIDING TEMPORARY USE OF NON-DOWNLOADABLE COMPUTER SOFTWARE VIA AN ONLINE WEBSITE FOR THE PURPOSE OF OBTAINING, ANALYZING, AND COMPARING DATA AND FOR PERFORMING ECONOMIC RESEARCH REGARDING THE PURPOSE AND ACTIVITIES OF NONPROFIT, TAX-EXEMPT, CHARITABLE AND PHILANTHROPIC ORGANIZATIONS; PROVIDING TEMPORARY USE OF NON-DOWNLOADABLE COMPUTER SOFTWARE VIA AN ONLINE WEBSITE FOR COMPARING AND SEARCHING POTENTIAL SOURCES OF FUNDING FOR NON-PROFIT, TAX-EXEMPT, CHARITABLE AND/OR PHILANTHROPIC ORGANIZATIONS FROM PRIVATE, FAMILY OR COMMUNITY FOUNDATIONS AND ELSEWHERE, IN CLASS 42 (U.S. CLS. 100 AND 101).

FIRST USE 9-29-2010; IN COMMERCE 12-1-2010.

THE MARK CONSISTS OF THREE PARTS, NAMELY, (1) AN OUTER ANNULAR RING DIVIDED INTO FOUR EQUAL SECTORS, WITH THE UPPER LEFT SECTOR BEING VIOLET, THE LOWER LEFT SECTOR BEING LILAC, THE UPPER RIGHT SECTOR BEING WINE, AND THE LOWER RIGHT SECTOR BEING MAROON, WITH THE LOWER RIGHT SECTOR BEING OFFSET FROM THE REMAINDER OF THE OUTER ANNULAR RING; (2) AN INNER CIRCLE DIVIDED INTO FOUR CIRCULAR SECTORS, WITH THE UPPER LEFT CIRCULAR SECTOR BEING PINK, THE LOWER LEFT CIRCULAR SECTOR BEING WARM GRAY, THE UPPER RIGHT CIRCULAR SECTOR BEING LIGHT FUCHSIA, AND THE LOWER



David J. Kyffers

Director of the United States Patent and Trademark Office

Reg. No. 4,075,046 RIGHT CIRCULAR SECTOR BEING MAROON, WITH THE LOWER RIGHT CIRCULAR SECTOR BEING OFFSET FROM THE REMAINDER OF THE INNER CIRCLE; AND, (3) A WHITE INNER ANNULAR RING POSITIONED BETWEEN THE OUTER ANNULAR RING AND THE INNER CIRCLE.

THE COLOR(S) VIOLET, LILAC, WINE, MAROON, PINK, WARM GRAY, LIGHT FUCHSIA AND WHITE IS/ARE CLAIMED AS A FEATURE OF THE MARK.

SN 85-141,804, FILED 9-30-2010.

DOUGLAS LEE, EXAMINING ATTORNEY

United States of America

United States Patent and Trademark Office



GORILLITARY WEAR

Reg. No. 4,075,047

Registered Dec. 20, 2011

Int. Cl.: 25

TRADEMARK

PRINCIPAL REGISTER

BRUCE, JONATHAN (UNITED STATES INDIVIDUAL)
230 SAWYER AVENUE
LA GRANGE, IL 60525

FOR: HATS; SHIRTS; SWEATERS, IN CLASS 25 (U.S. CLS. 22 AND 39).

FIRST USE 8-29-2011; IN COMMERCE 8-29-2011.

NO CLAIM IS MADE TO THE EXCLUSIVE RIGHT TO USE "WEAR", APART FROM THE MARK AS SHOWN.

THE MARK CONSISTS OF AN IMAGE OF A GORILLA WITH ITS MOUTH WIDE OPEN, SHOWING ITS FANGS, THE TONGUE IS ON THE INSIDE, AND THE TEXT "GORILLITARY WEAR" BELOW IN STENCIL FONT.

SN 85-142,086, FILED 9-30-2010.

MELISSA VALLILLO, EXAMINING ATTORNEY



David J. Kybas

Director of the United States Patent and Trademark Office

United States of America
United States Patent and Trademark Office

SILENTFX

Reg. No. 4,075,048

CERTAINTEED GYPSUM, INC. (DELAWARE CORPORATION)
4300 W. CYPRESS STREET, SUITE 500
TAMPA, FL 33607

Registered Dec. 20, 2011

Int. Cl.: 19

FOR: HIGH ACOUSTIC, SOUND DAMPENING LAMINATED GYPSUM BOARD AND PAPER-FACED GYPSUM BOARD, IN CLASS 19 (U.S. CLS. 1, 12, 33 AND 50).

TRADEMARK

FIRST USE 7-0-2010; IN COMMERCE 1-0-2011.

PRINCIPAL REGISTER

THE MARK CONSISTS OF STANDARD CHARACTERS WITHOUT CLAIM TO ANY PARTICULAR FONT, STYLE, SIZE, OR COLOR.

SN 85-142,130, FILED 9-30-2010.

KATHY DE JONGE, EXAMINING ATTORNEY



David J. Kybas

Director of the United States Patent and Trademark Office

United States of America

United States Patent and Trademark Office

PROVIDIAN STAFFING

Reg. No. 4,075,049

Registered Dec. 20, 2011

Int. Cl.: 35

SERVICE MARK

PRINCIPAL REGISTER

PROVIDIAN STAFFING CORPORATION (DELAWARE CORPORATION)
#315
1249 S. DIAMOND BAR BLVD
DIAMOND BAR, CA 91765

FOR: EMPLOYMENT AGENCY SERVICES, NAMELY, FILLING THE TEMPORARY AND PERMANENT STAFFING NEEDS OF BUSINESSES, IN CLASS 35 (U.S. CLS. 100, 101 AND 102).

FIRST USE 1-5-2000; IN COMMERCE 1-5-2000.

THE MARK CONSISTS OF STANDARD CHARACTERS WITHOUT CLAIM TO ANY PARTICULAR FONT, STYLE, SIZE, OR COLOR.

NO CLAIM IS MADE TO THE EXCLUSIVE RIGHT TO USE "STAFFING", APART FROM THE MARK AS SHOWN.

SN 85-142,424, FILED 9-30-2010.

JUDITH HELFMAN, EXAMINING ATTORNEY



David J. Kyros

Director of the United States Patent and Trademark Office

United States of America

United States Patent and Trademark Office

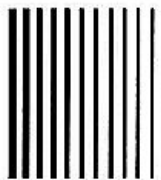
 **N.S.PRO** 
MODUS³

Reg. No. 4,075,050

NHK SPRING CO., LTD. (JAPAN CORPORATION)
10, FUKUURA 3-CHOME, KANAZAWA-KU
YOKOHAMA-SHI, KANAGAWA, JAPAN

Registered Dec. 20, 2011

Int. Cl.: 28

FOR: GOLF CLUB SHAFT, IN CLASS 28 (U.S. CLS. 22, 23, 38 AND 50).

TRADEMARK

FIRST USE 10-14-2011; IN COMMERCE 10-14-2011.

PRINCIPAL REGISTER

THE MARK CONSISTS OF THE WORDING "N.S.PRO" WITH TWELVE VERTICAL BARS ON EITHER SIDE OF IT, THE SAME HEIGHT AS THE LETTERING, ON EACH SIDE THE BARS ARE GRADATED FROM THIN TO THICK AS THEY APPROACH THE WORDING; THIS WORDING IS CENTERED ABOVE THE WORD "MODUS³".

SN 85-142,980, FILED 10-1-2010.

JANICE KIM, EXAMINING ATTORNEY



David J. Kybas

Director of the United States Patent and Trademark Office

United States of America

United States Patent and Trademark Office

N.S.PRO MODUS³

Reg. No. 4,075,051

NHK SPRING CO., LTD. (JAPAN CORPORATION)
10, FUKUURA 3-CHOME, KANAZAWA-KU
YOKOHAMA-SHI, KANAGAWA, JAPAN

Registered Dec. 20, 2011

Int. Cl.: 28

FOR: GOLF CLUB SHAFT, IN CLASS 28 (U.S. CLS. 22, 23, 38 AND 50).

TRADEMARK

FIRST USE 6-11-2011; IN COMMERCE 6-11-2011.

PRINCIPAL REGISTER

THE MARK CONSISTS OF THE WORDING "N.S.PRO MODUS³".

SN 85-143,034, FILED 10-1-2010.

JANICE KIM, EXAMINING ATTORNEY



David J. Kybas

Director of the United States Patent and Trademark Office

United States of America

United States Patent and Trademark Office

COMPASSIONATE TOMMY'S FARMS

Reg. No. 4,075,052

WHITE, THOMAS (UNITED STATES INDIVIDUAL)
220 E. COLORADO AVE
GLEN DORA, CA 91740

Registered Dec. 20, 2011

Int. Cl.: 25

FOR: JACKETS; PANTS; SHIRTS; SHOES, IN CLASS 25 (U.S. CLS. 22 AND 39).

TRADEMARK

FIRST USE 10-1-2010; IN COMMERCE 11-1-2011.

PRINCIPAL REGISTER

THE MARK CONSISTS OF STANDARD CHARACTERS WITHOUT CLAIM TO ANY PARTICULAR FONT, STYLE, SIZE, OR COLOR.

THE NAME(S), PORTRAIT(S), AND/OR SIGNATURE(S) SHOWN IN THE MARK IDENTIFIES "TOMMY" WHOSE CONSENT(S) TO REGISTER IS MADE OF RECORD.

SN 85-143,631, FILED 10-1-2010.

BRIDGETT SMITH, EXAMINING ATTORNEY



David J. Kybas

Director of the United States Patent and Trademark Office

United States of America

United States Patent and Trademark Office

THE
UBE

Multistate
Uniform Bar Examination

Reg. No. 4,075,053

Registered Dec. 20, 2011

Int. Cls.: 16 and 41

TRADEMARK

SERVICE MARK

PRINCIPAL REGISTER

NATIONAL CONFERENCE OF BAR EXAMINERS (ILLINOIS CORPORATION)
302 SOUTH BEDFORD STREET
MADISON, WI 537033622

FOR: TECHNICAL MANUALS, ALL IN THE FIELD OF LEGAL LICENSURE EXAMINATIONS, IN CLASS 16 (U.S. CLS. 2, 5, 22, 23, 29, 37, 38 AND 50).

FIRST USE 2-22-2011; IN COMMERCE 2-22-2011.

FOR: LEGAL LICENSURE EXAMINATION SERVICES; LEGAL LICENSURE, NAMELY, PREPARING, ADMINISTERING, AND SCORING STANDARDIZED TESTS AND ANALYZING LEGAL LICENSURE TEST SCORES AND DATA FOR OTHERS, IN CLASS 41 (U.S. CLS. 100, 101 AND 107).

FIRST USE 8-2-2011; IN COMMERCE 8-2-2011.

NO CLAIM IS MADE TO THE EXCLUSIVE RIGHT TO USE "MULTISTATE UNIFORM BAR EXAMINATION", APART FROM THE MARK AS SHOWN.

THE MARK CONSISTS OF THE WORDING "THE" ON TOP OF THE BOLD LETTERS "UBE" ON TOP OF THE WORDING "MULTISTATE" ON TOP OF THE WORDING "UNIFORM BAR EXAMINATION" WITH THE WORDING "MULTISTATE UNIFORM BAR EXAMINATION" WITHIN A BLACK LINE ON TOP AND ON THE BOTTOM.

SN 85-144,227, FILED 10-4-2010.

KEVIN DINALLO, EXAMINING ATTORNEY



David J. Kyffers

Director of the United States Patent and Trademark Office

United States of America

United States Patent and Trademark Office

Algorithm Zoo

Reg. No. 4,075,054

Registered Dec. 20, 2011

Int. Cl.: 42

SERVICE MARK

PRINCIPAL REGISTER

ALGORITHM ALPHA LLC (SOUTH CAROLINA LIMITED LIABILITY COMPANY)
361 THIRD BAXTER STREET
FORT MILL, SC 29708

FOR: PROVIDING A SUBSCRIPTION-BASED, ONLINE, INTERACTIVE WEBSITE THAT FEATURES INFORMATION FOR AGGREGATING MARKET-TIMING ALGORITHMS FOR USE IN ANALYZING FINANCIAL MARKETS FOR BUSINESS PURPOSES, AND ORGANIZING THEM ACCORDING TO THE SPECIFIC MARKET FOR WHICH THE ALGORITHM IS WRITTEN, IN CLASS 42 (U.S. CLS. 100 AND 101).

FIRST USE 1-1-2011; IN COMMERCE 10-8-2011.

THE MARK CONSISTS OF STANDARD CHARACTERS WITHOUT CLAIM TO ANY PARTICULAR FONT, STYLE, SIZE, OR COLOR.

NO CLAIM IS MADE TO THE EXCLUSIVE RIGHT TO USE "ALGORITHM", APART FROM THE MARK AS SHOWN.

SN 85-144,680, FILED 10-4-2010.

RUSS HERMAN, EXAMINING ATTORNEY



David J. Kyros

Director of the United States Patent and Trademark Office

United States of America

United States Patent and Trademark Office

AXE GANG

Reg. No. 4,075,055

Registered Dec. 20, 2011

Int. Cls.: 8 and 25

TRADEMARK

PRINCIPAL REGISTER

COLD STEEL, INC. (CALIFORNIA CORPORATION)
6060 NICOLLE STREET
VENTURA, CA 93003

FOR: TOMAHAWKS; HATCHETS; AXES, IN CLASS 8 (U.S. CLS. 23, 28 AND 44).

FIRST USE 1-5-2011; IN COMMERCE 1-5-2011.

FOR: T-SHIRTS; SWEATSHIRTS; HOODED SWEATSHIRTS; POLO SHIRTS; BASEBALL CAPS; KNIT CAPS, IN CLASS 25 (U.S. CLS. 22 AND 39).

FIRST USE 11-4-2011; IN COMMERCE 11-4-2011.

THE MARK CONSISTS OF STANDARD CHARACTERS WITHOUT CLAIM TO ANY PARTICULAR FONT, STYLE, SIZE, OR COLOR.

NO CLAIM IS MADE TO THE EXCLUSIVE RIGHT TO USE "AXE" AS TO INTERNATIONAL CLASS 8, APART FROM THE MARK AS SHOWN.

SN 85-145,091, FILED 10-5-2010.

JORDAN BAKER, EXAMINING ATTORNEY



David J. Kyros

Director of the United States Patent and Trademark Office

United States of America

United States Patent and Trademark Office



Reg. No. 4,075,056

Registered Dec. 20, 2011

Int. Cl.: 45

SERVICE MARK

PRINCIPAL REGISTER

WORD OF FAITH INTERNATIONAL CHRISTIAN CENTER (MICHIGAN CORPORATION)
20000 W. NINE MILE ROAD
SOUTHFIELD, MI 48075

FOR: EVANGELICAL AND MINISTERIAL SERVICES IN THE NATURE OF CONDUCTING CHURCH SERVICES CONDUCTING CHURCH SERVICES IN SUPPORT OF CHRISTIAN BELIEFS THROUGH A RELIGIOUS ORGANIZATION; RELIGIOUS SERVICES, NAMELY, MINISTERIAL SERVICES, EVANGELICAL SERVICES, PREACHING SERVICES, CONDUCTING RELIGIOUS SERVICES, AND PERSONAL RELIGIOUS COUNSELING, IN CLASS 45 (U.S. CLS. 100 AND 101).

FIRST USE 1-1-2011; IN COMMERCE 1-1-2011.

NO CLAIM IS MADE TO THE EXCLUSIVE RIGHT TO USE "CHURCH", APART FROM THE MARK AS SHOWN.

THE MARK CONSISTS OF A CIRCLE WITH A LOWER CASE "F" IN THE MIDDLE AND THE WORDS "FAITH4LIFE CHURCH" BELOW.

SN 85-145,400, FILED 10-5-2010.

EDWARD NELSON, EXAMINING ATTORNEY



David J. Kyffers

Director of the United States Patent and Trademark Office

United States of America

United States Patent and Trademark Office

NATURAL FAVORITE

Reg. No. 4,075,057

Registered Dec. 20, 2011

Int. Cl.: 29

TRADEMARK

PRINCIPAL REGISTER

U.S. FOODSERVICE, INC. (DELAWARE CORPORATION)
9399 W. HIGGINS ROAD
SUITE 600
ROSEMONT, IL 60018

FOR: FRESH AND FROZEN BEEF, POULTRY AND PORK; CHEESE; SOUPS, IN CLASS 29
(U.S. CL. 46).

FIRST USE 3-15-2010; IN COMMERCE 3-15-2010.

THE MARK CONSISTS OF STANDARD CHARACTERS WITHOUT CLAIM TO ANY PARTICULAR FONT, STYLE, SIZE, OR COLOR.

SN 85-145,411, FILED 10-5-2010.

REBECCA SMITH, EXAMINING ATTORNEY



David J. Kybas

Director of the United States Patent and Trademark Office

United States of America

United States Patent and Trademark Office

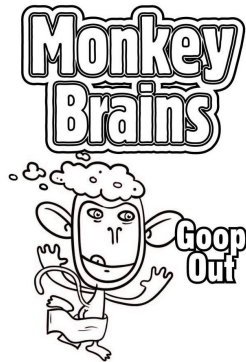

Reg. No. 4,075,058

GOLDEN SUN, INC. (CALIFORNIA CORPORATION)
26529 RUETHNER AVENUE
SANTA CLARITA, CA 91350

Registered Dec. 20, 2011

Int. Cl.: 3

FOR: HAIR SHAMPOO, IN CLASS 3 (U.S. CLS. 1, 4, 6, 50, 51 AND 52).

TRADEMARK

FIRST USE 1-18-2011; IN COMMERCE 1-18-2011.

PRINCIPAL REGISTER

THE MARK CONSISTS OF THE STYLIZED WORDING "MONKEY BRAINS" APPEARING ABOVE THE STYLIZED IMAGE OF A MONKEY WITH SOAPY LATHER ON ITS HEAD AND CLAD IN A TOWEL. THE STYLIZED WORDING "GOOP OUT" APPEARS TO THE RIGHT OF THE MONKEY AND THE LETTER "G" SLIGHTLY OVERLAPS THE MONKEY'S LEFT EAR.

SN 85-145,629, FILED 10-5-2010.

AMY KERTGATE, EXAMINING ATTORNEY



David J. Kybas

Director of the United States Patent and Trademark Office

United States of America

United States Patent and Trademark Office

NANOCOOL

Reg. No. 4,075,059

CARPENTER CO. (VIRGINIA CORPORATION)
5016 MONUMENT AVENUE
RICHMOND, VA 23261

Registered Dec. 20, 2011

Int. Cl.: 20

FOR: MOISTURE WICKING FABRIC SOLD AS AN INTEGRAL COMPONENT OF PILLOWS AND POLYESTER BED PILLOWS; MOISTURE WICKING FABRIC SOLD AS AN INTEGRAL COMPONENT OF MATTRESS TOPPERS , IN CLASS 20 (U.S. CLS. 2, 13, 22, 25, 32 AND 50).

TRADEMARK

FIRST USE 12-0-2010; IN COMMERCE 12-0-2010.

PRINCIPAL REGISTER

THE MARK CONSISTS OF STANDARD CHARACTERS WITHOUT CLAIM TO ANY PARTICULAR FONT, STYLE, SIZE, OR COLOR.

SN 85-145,910, FILED 10-6-2010.

BARBARA GAYNOR, EXAMINING ATTORNEY



David J. Kyffers

Director of the United States Patent and Trademark Office

United States of America

United States Patent and Trademark Office

ORGANIC STRETCHING

Reg. No. 4,075,060

HENRY, PATRICIA (UNITED STATES INDIVIDUAL)

Registered Dec. 20, 2011

2163 LIMA LOOP #130-362
LAREDO, TX 78045

Int. Cls.: 9 and 41

FOR: AUDIO AND VIDEO RECORDINGS FEATURING EDUCATIONAL TRAINING AND INSTRUCTION IN THE FIELD OF PAIN MANAGEMENT AND THE CONNECTIVE TISSUE SYSTEM; DOWNLOADABLE VIDEO RECORDINGS FEATURING INSTRUCTION IN THE FIELD OF PAIN MANAGEMENT AND THE CONNECTIVE TISSUE SYSTEM; PRE-RECORDED DIGITAL VIDEO DISCS FEATURING INSTRUCTION IN THE FIELD OF PAIN MANAGEMENT AND THE CONNECTIVE TISSUE SYSTEM, IN CLASS 9 (U.S. CLS. 21, 23, 26, 36 AND 38).

TRADEMARK

SERVICE MARK

PRINCIPAL REGISTER

FIRST USE 10-4-2011; IN COMMERCE 10-4-2011.

FOR: EDUCATION SERVICES, NAMELY, PROVIDING LIVE AND ON-LINE CLASSES, SEMINARS, AND WORKSHOPS IN THE FIELD OF PAIN MANAGEMENT AND THE CONNECTIVE TISSUE SYSTEM; ENTERTAINMENT SERVICES, NAMELY, PROVIDING A WEB SITE FEATURING PHOTOGRAPHIC, VIDEO AND PROSE PRESENTATIONS FEATURING EDUCATION AND INSTRUCTION IN THE FIELD OF PAIN MANAGEMENT AND THE CONNECTIVE TISSUE SYSTEM, IN CLASS 41 (U.S. CLS. 100, 101 AND 107).

FIRST USE 10-4-2011; IN COMMERCE 10-4-2011.

THE MARK CONSISTS OF STANDARD CHARACTERS WITHOUT CLAIM TO ANY PARTICULAR FONT, STYLE, SIZE, OR COLOR.

NO CLAIM IS MADE TO THE EXCLUSIVE RIGHT TO USE "STRETCHING", APART FROM THE MARK AS SHOWN.

SN 85-145,935, FILED 10-6-2010.

DOMINICK J. SALEMI, EXAMINING ATTORNEY



David J. Kypos

Director of the United States Patent and Trademark Office

United States of America

United States Patent and Trademark Office

PETCAKES

Reg. No. 4,075,061

LUCKY PAWS, LLC (FLORIDA LIMITED LIABILITY COMPANY)
525 FIFTH STREET, SUITE 219
COVINGTON, KY 41011

Registered Dec. 20, 2011

Int. Cl.: 31

FOR: PET TREATS IN THE FORM OF ORGANIC MATERIAL TO BE MIXED WITH OTHER MATERIAL AND MICROWAVED IN A MICROWAVE PAN; PREPACKAGED PET KIT COMPRISING MICROWAVE PAN AND PET TREATS IN THE FORM OF ORGANIC MATERIAL TO BE MIXED WITH OTHER MATERIAL AND MICROWAVED IN THE MICROWAVE PAN, IN CLASS 31 (U.S. CLS. 1 AND 46).

TRADEMARK

PRINCIPAL REGISTER

FIRST USE 10-11-2010; IN COMMERCE 10-11-2010.

THE MARK CONSISTS OF STANDARD CHARACTERS WITHOUT CLAIM TO ANY PARTICULAR FONT, STYLE, SIZE, OR COLOR.

SN 85-146,252, FILED 10-6-2010.

ZACHARY BELLO, EXAMINING ATTORNEY



David J. Kyffers

Director of the United States Patent and Trademark Office

United States of America

United States Patent and Trademark Office

PRIDEORITY

Reg. No. 4,075,062

GARRETT, CONNIE CATHERINE (UNITED STATES INDIVIDUAL)
10707 E. SEMINOLE ST.
TULSA, OK 74116

Registered Dec. 20, 2011

Int. Cl.: 18

FOR: LEATHER HANDBAGS, WALLETS, ANIMAL LEASHES, ANIMAL HARNESSSES, COLLARS FOR ANIMALS AND LEATHER KEY CHAINS, IN CLASS 18 (U.S. CLS. 1, 2, 3, 22 AND 41).

TRADEMARK

FIRST USE 4-29-2011; IN COMMERCE 5-31-2011.

PRINCIPAL REGISTER

THE MARK CONSISTS OF STANDARD CHARACTERS WITHOUT CLAIM TO ANY PARTICULAR FONT, STYLE, SIZE, OR COLOR.

SN 85-146,341, FILED 10-6-2010.

BRIDGETT SMITH, EXAMINING ATTORNEY



David J. Kyffers

Director of the United States Patent and Trademark Office

United States of America

United States Patent and Trademark Office

Night Armor

Reg. No. 4,075,063

Registered Dec. 20, 2011

Int. Cl.: 8

TRADEMARK

PRINCIPAL REGISTER

POWERTECH, INC (TENNESSEE CORPORATION)
360 EAST SOUTH STREET
COLLIERVILLE, TN 38017

FOR: DIVING KNIVES; FOLDING KNIVES; HOUSEHOLD KNIVES; HUNTING KNIVES;
JACK KNIVES; KNIVES; KNIVES FOR HOBBY USE; LEATHER SHEATHS FOR KNIVES;
PEN KNIVES; POCKET KNIVES; SIDE ARMS, NOT INCLUDING FIREARMS, NAMELY,
HUNTING KNIVES; SPORT KNIVES; THROWING KNIVES; UTILITY KNIVES; WHITTILING
KNIVES, IN CLASS 8 (U.S. CLS. 23, 28 AND 44).

FIRST USE 10-1-2010; IN COMMERCE 1-1-2011.

THE MARK CONSISTS OF STANDARD CHARACTERS WITHOUT CLAIM TO ANY PAR-
TICULAR FONT, STYLE, SIZE, OR COLOR.

SN 85-146,728, FILED 10-6-2010.

ROBIN MITTLER, EXAMINING ATTORNEY



David J. Kyffers

Director of the United States Patent and Trademark Office

United States of America

United States Patent and Trademark Office

SMARTPLATE CHARGING PLATFORM

Reg. No. 4,075,064

Registered Dec. 20, 2011

Int. Cl.: 9

TRADEMARK

PRINCIPAL REGISTER

FOR YOUR EASE ONLY, INC. (ILLINOIS CORPORATION)
1301 NORTH DEARBORN PARKWAY
CHICAGO, IL 60610

FOR: PLASTIC ELECTRICAL OUTLET COVERS INTENDED TO HOLD PERSONAL ELECTRONIC DEVICES WHEN CHARGING BATTERIES, IN CLASS 9 (U.S. CLS. 21, 23, 26, 36 AND 38).

FIRST USE 11-0-2010; IN COMMERCE 11-0-2010.

THE MARK CONSISTS OF STANDARD CHARACTERS WITHOUT CLAIM TO ANY PARTICULAR FONT, STYLE, SIZE, OR COLOR.

NO CLAIM IS MADE TO THE EXCLUSIVE RIGHT TO USE "CHARGING PLATFORM", APART FROM THE MARK AS SHOWN.

SN 85-147,025, FILED 10-7-2010.

JOHN WILKE, EXAMINING ATTORNEY



David J. Kyffers

Director of the United States Patent and Trademark Office

United States of America

United States Patent and Trademark Office

employify

Reg. No. 4,075,065

PRESTON, TAMARIN L. (UNITED STATES INDIVIDUAL)
9832 DRAGON CIRCLE
HUNTINGTON BEACH, CA 92646

Registered Dec. 20, 2011

Int. Cl.: 35

FOR: PROVIDING AN ON-LINE SEARCHABLE DATABASE FEATURING EMPLOYMENT OPPORTUNITIES AND CONTENT ABOUT EMPLOYMENT, IN CLASS 35 (U.S. CLS. 100, 101 AND 102).

SERVICE MARK

FIRST USE 3-1-2011; IN COMMERCE 3-1-2011.

PRINCIPAL REGISTER

THE MARK CONSISTS OF STANDARD CHARACTERS WITHOUT CLAIM TO ANY PARTICULAR FONT, STYLE, SIZE, OR COLOR.

SN 85-147,669, FILED 10-7-2010.

RICHARD WHITE, EXAMINING ATTORNEY



David J. Kyfos

Director of the United States Patent and Trademark Office

United States of America

United States Patent and Trademark Office

AMERICAN LIGHTS

Reg. No. 4,075,066

Registered Dec. 20, 2011

Int. Cl.: 13

TRADEMARK

PRINCIPAL REGISTER

AMERICAN PROMOTIONAL EVENTS, INC (ALABAMA CORPORATION), DBA TNT
FIREWORKS,
4511 HELTON DRIVE
FLORENCE, AL 35630

FOR: FIREWORK FOUNTAINS; FIREWORKS; FIREWORKS; FIREWORKS, NAMELY,
SPARKLERS, IN CLASS 13 (U.S. CLS. 2 AND 9).

FIRST USE 5-23-2011; IN COMMERCE 6-8-2011.

THE MARK CONSISTS OF STANDARD CHARACTERS WITHOUT CLAIM TO ANY PAR-
TICULAR FONT, STYLE, SIZE, OR COLOR.

NO CLAIM IS MADE TO THE EXCLUSIVE RIGHT TO USE "AMERICAN", APART FROM
THE MARK AS SHOWN.

SN 85-148,500, FILED 10-8-2010.

MICHAEL SOUDERS, EXAMINING ATTORNEY



David J. Kyffers

Director of the United States Patent and Trademark Office

United States of America
United States Patent and Trademark Office

AUTOSEIS

Reg. No. 4,075,067

GLOBAL GEOPHYSICAL SERVICES, INC. (TEXAS CORPORATION)
13927 SOUTH GESSNER ROAD
MISSOURI CITY, TX 77489

Registered Dec. 20, 2011

Int. Cl.: 9

FOR: GEOPHYSICAL INSTRUMENTATION, NAMELY, SEISMIC DATA ACQUISITION AND RECORDING INSTRUMENTATION AND DEVICES, IN CLASS 9 (U.S. CLS. 21, 23, 26, 36 AND 38).

TRADEMARK

FIRST USE 10-17-2010; IN COMMERCE 10-17-2010.

PRINCIPAL REGISTER

THE MARK CONSISTS OF STANDARD CHARACTERS WITHOUT CLAIM TO ANY PARTICULAR FONT, STYLE, SIZE, OR COLOR.

SN 85-148,740, FILED 10-8-2010.

DORITT L. CARROLL, EXAMINING ATTORNEY



David J. Kybas

Director of the United States Patent and Trademark Office

United States of America

United States Patent and Trademark Office

JET SPRAY

Reg. No. 4,075,068

HISAMITSU PHARMACEUTICAL CO., INC. (JAPAN CORPORATION)
408, TASHIRODAIKAN-MACHI
TOSU-SHI SAGA, JAPAN 841-0017

Registered Dec. 20, 2011

Int. Cl.: 5

FOR: ANTIPHLOGISTIC AND ANALGESIC SPRAY FOR THE TEMPORARY RELIEF OF MINOR MUSCULAR ACHES AND PAINS, IN CLASS 5 (U.S. CLS. 6, 18, 44, 46, 51 AND 52).

TRADEMARK

FIRST USE 7-27-2011; IN COMMERCE 7-27-2011.

PRINCIPAL REGISTER

THE MARK CONSISTS OF STANDARD CHARACTERS WITHOUT CLAIM TO ANY PARTICULAR FONT, STYLE, SIZE, OR COLOR.

NO CLAIM IS MADE TO THE EXCLUSIVE RIGHT TO USE "SPRAY", APART FROM THE MARK AS SHOWN.

SN 85-148,879, FILED 10-8-2010.

RENEE SERVANCE, EXAMINING ATTORNEY



David J. Kyros

Director of the United States Patent and Trademark Office

United States of America

United States Patent and Trademark Office

ZEGNASPORT

Reg. No. 4,075,069

Registered Dec. 20, 2011

Int. Cl.: 18

TRADEMARK

PRINCIPAL REGISTER

ERMENEGILDO ZEGNA CORPORATION (NEW YORK CORPORATION)
100 WEST FOREST AVENUE
UNIT A
ENGLEWOOD, NJ 07631

FOR: LEATHER GOODS, NAMELY, WALLETS, CREDIT CARD HOLDERS, BUSINESS CARD CASES, TIE CASES FOR TRAVELLING, KEY CHAINS, KEY CASES, BRIEF CASES, BAGS, BACKPACKS, IN CLASS 18 (U.S. CLS. 1, 2, 3, 22 AND 41).

FIRST USE 6-0-2000; IN COMMERCE 6-0-2000.

THE MARK CONSISTS OF STANDARD CHARACTERS WITHOUT CLAIM TO ANY PARTICULAR FONT, STYLE, SIZE, OR COLOR.

OWNER OF U.S. REG. NOS. 3,121,451, 3,410,924, AND OTHERS.

SN 85-149,607, FILED 10-11-2010.

ANGELA M. MICHELI, EXAMINING ATTORNEY



David J. Kybas

Director of the United States Patent and Trademark Office

United States of America

United States Patent and Trademark Office

SCOUT

Reg. No. 4,075,070

KLEIN TOOLS, INC. (DELAWARE CORPORATION)
450 BOND STREET

Registered Dec. 20, 2011

LINCOLNSHIRE, IL 60069

Int. Cl.: 9

FOR: CONTINUITY TESTERS; CABLE IDENTIFIERS, NAMELY, CONTINUITY TEST APPARATUS FOR IDENTIFYING WIRES BY TESTING THEIR CONTINUITY, IN CLASS 9 (U.S. CLS. 21, 23, 26, 36 AND 38).

TRADEMARK

FIRST USE 10-3-2010; IN COMMERCE 10-3-2010.

PRINCIPAL REGISTER

THE MARK CONSISTS OF STANDARD CHARACTERS WITHOUT CLAIM TO ANY PARTICULAR FONT, STYLE, SIZE, OR COLOR.

SN 85-149,628, FILED 10-11-2010.

MICHAEL TANNER, EXAMINING ATTORNEY



David J. Kyffers

Director of the United States Patent and Trademark Office

United States of America

United States Patent and Trademark Office

XikBal
BAIA

Reg. No. 4,075,071

Registered Dec. 20, 2011

Int. Cl.: 33

TRADEMARK

PRINCIPAL REGISTER

HASTA QUE SE AGOTEN, S.A. DE C.V. (MEXICO CORPORATION)
PRESIDENTE MASARYK NO. 29-E, 3RD FLOOR
COLONIA CHAPULTEPEC MORALES
MEXICO, 11570, DISTRITO FEDERAL, MEXICO

FOR: WINE, IN CLASS 33 (U.S. CLS. 47 AND 49).

FIRST USE 8-3-2011; IN COMMERCE 8-3-2011.

THE NAME(S), PORTRAIT(S), AND/OR SIGNATURE(S) SHOWN IN THE MARK DOES NOT IDENTIFY A PARTICULAR LIVING INDIVIDUAL.

THE MARK CONSISTS OF THE STYLIZED TERMS "XIK BAL BAIA".

THE ENGLISH TRANSLATION OF "BAIA" IN THE MARK IS "BAY".

SN 85-150,064, FILED 10-11-2010.

YAT SYE, LEE, EXAMINING ATTORNEY



David J. Kyffers

Director of the United States Patent and Trademark Office

United States of America

United States Patent and Trademark Office



Reg. No. 4,075,072

Registered Dec. 20, 2011

Int. Cl.: 43

SERVICE MARK

PRINCIPAL REGISTER

SINANAJ BROS RESTAURANT LLC (NEW YORK LIMITED LIABILITY COMPANY), DBA
EMPIRE STEAK HOUSE,
36 WEST 52ND STREET
NEW YORK, NY 10019

FOR: RESTAURANT SERVICES; CARRY-OUT RESTAURANT SERVICES; CATERING
SERVICES, IN CLASS 43 (U.S. CLS. 100 AND 101).

FIRST USE 10-18-2010; IN COMMERCE 10-18-2010.

NO CLAIM IS MADE TO THE EXCLUSIVE RIGHT TO USE "STEAK HOUSE", APART FROM
THE MARK AS SHOWN.

THE COLOR(S) GOLD, BLACK, RED AND WHITE IS/ARE CLAIMED AS A FEATURE OF
THE MARK.

THE MARK CONSISTS OF THE WORDS "EMPIRE STEAK HOUSE" IN STYLIZED BLACK
LETTERING WITH THE TERM "EMPIRE" APPEARING ABOVE THE TERM "STEAK HOUSE".
BETWEEN THE TERM "EMPIRE" AND THE TERM "STEAK HOUSE" ARE TWO RED HO-
RIZONTAL LINES, AND ABOVE THE WORDING IS A STYLIZED DEPICTION OF A GOLD
STEER WITH BLACK AND WHITE SHADING AND HIGHLIGHTS. THE BACKGROUND
OF THE ENTIRE MARK IS WHITE.

SN 85-150,681, FILED 10-12-2010.

JIM RINGLE, EXAMINING ATTORNEY



David J. Kyros

Director of the United States Patent and Trademark Office

United States of America

United States Patent and Trademark Office

UNLEASHED

Reg. No. 4,075,073

Registered Dec. 20, 2011

Int. Cl.: 25

TRADEMARK

PRINCIPAL REGISTER

ROCKET DOG BRANDS LLC (DELAWARE LIMITED LIABILITY COMPANY)
24610 INDUSTRIAL BLVD.
HAYWARD, CA 94545

FOR: FOOTWEAR, IN CLASS 25 (U.S. CLS. 22 AND 39).

FIRST USE 2-22-2011; IN COMMERCE 2-22-2011.

THE MARK CONSISTS OF STANDARD CHARACTERS WITHOUT CLAIM TO ANY PARTICULAR FONT, STYLE, SIZE, OR COLOR.

SN 85-150,742, FILED 10-12-2010.

JAMES STEIN, EXAMINING ATTORNEY



David J. Kybas

Director of the United States Patent and Trademark Office

United States of America

United States Patent and Trademark Office



Reg. No. 4,075,074

KELLWOOD COMPANY (DELAWARE CORPORATION)
600 KELLWOOD PARKWAY
CHESTERFIELD, MO 63017

Registered Dec. 20, 2011

Int. Cl.: 25

FOR: BLOUSES; CARDIGANS; COATS; DRESSES; LEGGINGS; PANTS; SHIRTS; SKIRTS;
SWEATERS; TOPS; TROUSERS, IN CLASS 25 (U.S. CLS. 22 AND 39).

TRADEMARK

FIRST USE 9-13-2011; IN COMMERCE 9-13-2011.

PRINCIPAL REGISTER

OWNER OF U.S. REG. NO. 3,117,128.

THE MARK CONSISTS OF THE WORDS "LOVE ADAM" IN A STYLIZED FONT.

SN 85-151,346, FILED 10-13-2010.

DAVID COLLIER, EXAMINING ATTORNEY



David J. Kybas

Director of the United States Patent and Trademark Office

United States of America

United States Patent and Trademark Office

ZŌN

Reg. No. 4,075,075

HUMANSCALE CORPORATION (NEW YORK CORPORATION)
11 EAST 26TH STREET , 8TH FLOOR
NEW YORK, NY 10010

Registered Dec. 20, 2011

Int. Cl.: 11

FOR: AIR PURIFIERS AND AIR CLEANING UNITS FOR HOME OR OFFICE USE, IN CLASS 11 (U.S. CLS. 13, 21, 23, 31 AND 34).

TRADEMARK

FIRST USE 9-26-2011; IN COMMERCE 9-26-2011.

PRINCIPAL REGISTER

THE MARK CONSISTS OF STANDARD CHARACTERS WITHOUT CLAIM TO ANY PARTICULAR FONT, STYLE, SIZE, OR COLOR.

SN 85-151,455, FILED 10-13-2010.

MICHELE SWAIN, EXAMINING ATTORNEY



David J. Kybas

Director of the United States Patent and Trademark Office

United States of America

United States Patent and Trademark Office



Reg. No. 4,075,076

Registered Dec. 20, 2011

Int. Cls.: 6, 14, and 28

TRADEMARK

PRINCIPAL REGISTER

FROM WAR TO PEACE (CALIFORNIA CORPORATION), DBA FROM WAR TO PEACE,
1055 CAPISTRANO COURT
SAN LUIS OBISPO, CA 93405

FOR: BRONZE HOLIDAY ORNAMENTS, IN CLASS 6 (U.S. CLS. 2, 12, 13, 14, 23, 25 AND 50).

FIRST USE 10-31-2010; IN COMMERCE 10-31-2010.

FOR: BRONZE JEWELRY, IN CLASS 14 (U.S. CLS. 2, 27, 28 AND 50).

FIRST USE 0-0-2009; IN COMMERCE 0-0-2010.

FOR: CHRISTMAS TREE ORNAMENTS OF BRONZE, IN CLASS 28 (U.S. CLS. 22, 23, 38 AND 50).

FIRST USE 10-31-2010; IN COMMERCE 10-31-2010.

THE MARK CONSISTS OF THE WORDS "FROM WAR TO PEACE" WITH OLIVE BRANCHES.

SN 85-151,666, FILED 10-13-2010.

ANNE FARRELL, EXAMINING ATTORNEY



David J. Kybas

Director of the United States Patent and Trademark Office

United States of America

United States Patent and Trademark Office

DYNAMIC DESIGN

Reg. No. 4,075,077

Registered Dec. 20, 2011

Int. Cls.: 6 and 21

TRADEMARK

PRINCIPAL REGISTER

AMES TRUE TEMPER, INC. (DELAWARE CORPORATION)
465 RAILROAD AVENUE
CAMP HILL, PA 17011

FOR: METAL BRACKETS FOR HANGING PLANTS; METAL PLANT TRELIS, IN CLASS 6 (U.S. CLS. 2, 12, 13, 14, 23, 25 AND 50).

FIRST USE 0-0-1998; IN COMMERCE 0-0-1998.

FOR: WATERING CANS, SAUCERS FOR FLOWER POTS, AND PLANT CADDIES IN THE NATURE OF PLANT CARRYING BASKETS, IN CLASS 21 (U.S. CLS. 2, 13, 23, 29, 30, 33, 40 AND 50).

FIRST USE 0-0-1998; IN COMMERCE 0-0-1998.

THE MARK CONSISTS OF STANDARD CHARACTERS WITHOUT CLAIM TO ANY PARTICULAR FONT, STYLE, SIZE, OR COLOR.

OWNER OF U.S. REG. NO. 3,733,076.

NO CLAIM IS MADE TO THE EXCLUSIVE RIGHT TO USE "DESIGN", APART FROM THE MARK AS SHOWN.

SN 85-151,777, FILED 10-13-2010.

SOPHIA S. KIM, EXAMINING ATTORNEY



David J. Kybas

Director of the United States Patent and Trademark Office

United States of America

United States Patent and Trademark Office

LOVE, ADORNED

Reg. No. 4,075,078

LEVEN, LORI (UNITED STATES INDIVIDUAL)
47 SECOND AVENUE
NEW YORK, NY 10003

Registered Dec. 20, 2011

Int. Cl.: 35

FOR: RETAIL STORE SERVICES FEATURING JEWELRY, CLOTHING, ARTWORK AND SHOES, IN CLASS 35 (U.S. CLS. 100, 101 AND 102).

SERVICE MARK

FIRST USE 12-4-2010; IN COMMERCE 12-4-2010.

PRINCIPAL REGISTER

THE MARK CONSISTS OF STANDARD CHARACTERS WITHOUT CLAIM TO ANY PARTICULAR FONT, STYLE, SIZE, OR COLOR.

SN 85-151,903, FILED 10-13-2010.

COLLEEN DOMBROW, EXAMINING ATTORNEY



David J. Kybas

Director of the United States Patent and Trademark Office

United States of America

United States Patent and Trademark Office

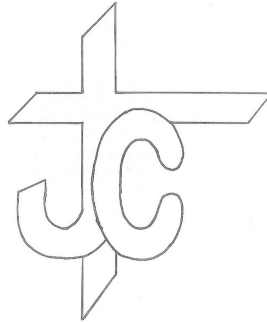

Reg. No. 4,075,079

Registered Dec. 20, 2011

Int. Cl.: 14

TRADEMARK

PRINCIPAL REGISTER

ROSADO, GEORGE J. (UNITED STATES INDIVIDUAL)
5804 FARR OAK DRIVE
PLANO, TX 75093

FOR: JEWELRY, IN CLASS 14 (U.S. CLS. 2, 27, 28 AND 50).

FIRST USE 10-2-2011; IN COMMERCE 3-22-2011.

THE MARK CONSISTS OF THE STYLIZED LETTERS OF "T", "J", AND "C".

SN 85-152,779, FILED 10-14-2010.

CHRISTOPHER BUONGIORNO, EXAMINING ATTORNEY



David J. Kybas

Director of the United States Patent and Trademark Office

United States of America

United States Patent and Trademark Office



Reg. No. 4,075,080

Registered Dec. 20, 2011

Int. Cls.: 41 and 44

SERVICE MARK

PRINCIPAL REGISTER

PRUETT, TIMOTHY (UNITED STATES INDIVIDUAL)
2355 MORNINGSIDE DRIVE
MT. DORA, FL 32757 AND

PRUETT, HEATHER (UNITED STATES INDIVIDUAL)
2355 MORNINGSIDE DRIVE
MT. DORA, FL 32757

FOR: EDUCATIONAL AND ENTERTAINMENT SERVICES, NAMELY, A CONTINUING PROGRAM ABOUT HEALTHY COOKING ACCESSIBLE BY RADIO, TELEVISION, SATELLITE, AUDIO, VIDEO AND COMPUTER NETWORKS; ENTERTAINMENT IN THE NATURE OF ON-GOING TELEVISION PROGRAMS IN THE FIELD OF HEALTHY COOKING, IN CLASS 41 (U.S. CLS. 100, 101 AND 107).

FIRST USE 1-1-2011; IN COMMERCE 1-1-2011.

FOR: PROVIDING INFORMATION, NEWS AND COMMENTARY IN THE FIELD OF NUTRITION, HEALTH AND WELLNESS, IN CLASS 44 (U.S. CLS. 100 AND 101).

FIRST USE 1-1-2011; IN COMMERCE 1-1-2011.

NO CLAIM IS MADE TO THE EXCLUSIVE RIGHT TO USE "KITCHEN", APART FROM THE MARK AS SHOWN.

THE MARK CONSISTS OF THE WORDS "THE LOVING KITCHEN" NEXT TO A SKILLET WITH HEART-SHAPED STEAM COMING UP FROM THE PAN.

SN 85-152,802, FILED 10-14-2010.

CHERYL CLAYTON, EXAMINING ATTORNEY



David J. Kybas

Director of the United States Patent and Trademark Office

United States of America

United States Patent and Trademark Office

My House My Rules

Reg. No. 4,075,081

Registered Dec. 20, 2011

Int. Cl.: 9

TRADEMARK

PRINCIPAL REGISTER

JERICO SYSTEMS CORPORATION (DELAWARE CORPORATION)
SUITE 250
6600 LBJ FWY
DALLAS, TX 75240

FOR: COMPUTER SOFTWARE FOR COMPUTER SYSTEM AND APPLICATION DEVELOPMENT, DEPLOYMENT AND MANAGEMENT; COMPUTER SOFTWARE FOR CONTROLLING AND MANAGING ACCESS SERVER APPLICATIONS, IN CLASS 9 (U.S. CLS. 21, 23, 26, 36 AND 38).

FIRST USE 8-8-2011; IN COMMERCE 8-8-2011.

THE MARK CONSISTS OF STANDARD CHARACTERS WITHOUT CLAIM TO ANY PARTICULAR FONT, STYLE, SIZE, OR COLOR.

SN 85-153,798, FILED 10-15-2010.

CARYN GLASSER, EXAMINING ATTORNEY



David J. Kyjars

Director of the United States Patent and Trademark Office

United States of America

United States Patent and Trademark Office

CHI AIR

Reg. No. 4,075,082

Registered Dec. 20, 2011

Int. Cl.: 8

TRADEMARK

PRINCIPAL REGISTER

FAROUK SYSTEMS, INC. (TEXAS CORPORATION)
250 PENNBRIGHT, SUITE 150
HOUSTON, TX 77090

FOR: HAIR CLIPPERS, HAIR SHEARS AND SCISSORS, HAIR TRIMMERS, RAZORS, AND
BLADES FOR HAIR CLIPPERS, HAIR TRIMMERS, AND RAZORS, IN CLASS 8 (U.S. CLS.
23, 28 AND 44).

FIRST USE 3-31-2010; IN COMMERCE 3-31-2010.

THE MARK CONSISTS OF STANDARD CHARACTERS WITHOUT CLAIM TO ANY PAR-
TICULAR FONT, STYLE, SIZE, OR COLOR.

OWNER OF U.S. REG. NOS. 2,660,257, 3,107,769, AND OTHERS.

SN 85-154,384, FILED 10-16-2010.

CHRISTINE COOPER, EXAMINING ATTORNEY



David J. Kyffers

Director of the United States Patent and Trademark Office

United States of America

United States Patent and Trademark Office

CHI AIR

Reg. No. 4,075,083

FAROUK SYSTEMS, INC. (TEXAS CORPORATION)
250 PENNBRIGHT, SUITE 150
HOUSTON, TX 77090

Registered Dec. 20, 2011

Int. Cl.: 21

FOR: HAIR BRUSHES, AND HAIR COMBS, IN CLASS 21 (U.S. CLS. 2, 13, 23, 29, 30, 33, 40 AND 50).

TRADEMARK

FIRST USE 3-31-2010; IN COMMERCE 3-31-2010.

PRINCIPAL REGISTER

THE MARK CONSISTS OF STANDARD CHARACTERS WITHOUT CLAIM TO ANY PARTICULAR FONT, STYLE, SIZE, OR COLOR.

OWNER OF U.S. REG. NOS. 2,660,257, 3,107,769, AND OTHERS.

SN 85-154,385, FILED 10-16-2010.

CHRISTINE COOPER, EXAMINING ATTORNEY



David J. Kyffers

Director of the United States Patent and Trademark Office

United States of America

United States Patent and Trademark Office

OH, SUGAR! EVENT DESIGN + PAPERIE

Reg. No. 4,075,084

OH, SUGAR! EVENT DESIGN + PAPERIE, LLC (ARIZONA LIMITED LIABILITY COMPANY)
5716 E. CAMELBACK ROAD
PHOENIX, AZ 85018

Registered Dec. 20, 2011

Int. Cl.: 16

FOR: STATIONERY; STATIONERY WRITING PAPER AND ENVELOPES; INVITATION CARDS; PRINTED INVITATIONS, IN CLASS 16 (U.S. CLS. 2, 5, 22, 23, 29, 37, 38 AND 50).

TRADEMARK

FIRST USE 10-14-2010; IN COMMERCE 10-14-2010.

PRINCIPAL REGISTER

THE MARK CONSISTS OF STANDARD CHARACTERS WITHOUT CLAIM TO ANY PARTICULAR FONT, STYLE, SIZE, OR COLOR.

NO CLAIM IS MADE TO THE EXCLUSIVE RIGHT TO USE "EVENT DESIGN + PAPERIE", APART FROM THE MARK AS SHOWN.

SN 85-154,782, FILED 10-18-2010.

DAYNA BROWNE, EXAMINING ATTORNEY



David J. Kyffers

Director of the United States Patent and Trademark Office

United States of America

United States Patent and Trademark Office

OH, SUGAR! EVENT DESIGN + PAPERIE

Reg. No. 4,075,085

OH, SUGAR! EVENT DESIGN + PAPERIE, LLC (ARIZONA LIMITED LIABILITY COMPANY)
5716 E. CAMELBACK ROAD
PHOENIX, AZ 85018

Registered Dec. 20, 2011

Int. Cl.: 41

FOR: PARTY AND WEDDING PLANNING, COORDINATION AND CONSULTATION SERVICES; SPECIAL EVENT PLANNING FOR SOCIAL ENTERTAINMENT PURPOSES , IN CLASS 41 (U.S. CLS. 100, 101 AND 107).

SERVICE MARK

FIRST USE 10-15-2010; IN COMMERCE 10-15-2010.

PRINCIPAL REGISTER

THE MARK CONSISTS OF STANDARD CHARACTERS WITHOUT CLAIM TO ANY PARTICULAR FONT, STYLE, SIZE, OR COLOR.

NO CLAIM IS MADE TO THE EXCLUSIVE RIGHT TO USE "EVENT DESIGN + PAPERIE", APART FROM THE MARK AS SHOWN.

SN 85-154,800, FILED 10-18-2010.

DAYNA BROWNE, EXAMINING ATTORNEY



David J. Kyffers

Director of the United States Patent and Trademark Office

United States of America

United States Patent and Trademark Office

GRILLOLOGY

Reg. No. 4,075,086

Registered Dec. 20, 2011

**Int. Cls.: 3, 11, 21, 25,
and 30**

TRADEMARK

PRINCIPAL REGISTER

HOMEGOODS, INC. (DELAWARE CORPORATION)
770 COCHITUATE ROAD
FRAMINGHAM, MA 01701

FOR: GRILL HOUSEHOLD CLEANING PREPARATIONS, IN CLASS 3 (U.S. CLS. 1, 4, 6, 50, 51 AND 52).

FIRST USE 6-1-2011; IN COMMERCE 6-1-2011.

FOR: CHARCOAL GRILLS AND GAS GRILLS; LIGHTERS PRIMARILY FOR LIGHTING GRILLS, FIREPLACES AND CANDLES, IN CLASS 11 (U.S. CLS. 13, 21, 23, 31 AND 34).

FIRST USE 6-1-2011; IN COMMERCE 6-1-2011.

FOR: COOKING UTENSILS FOR GRILLING, NAMELY, HOUSEHOLD SPATULAS, SERVING TONGS, COOKING FORKS, COOKING SKEWERS, GRILLING WIRE BASKETS, BRUSHES FOR BASTING MEAT; COOKING UTENSILS, NAMELY, GRILL COVERS, AND CLEANING BRUSHES FOR HOUSEHOLD USE; NON-ELECTRIC WOKS; SERVING PLATTERS AND SERVING TRAYS, IN CLASS 21 (U.S. CLS. 2, 13, 23, 29, 30, 33, 40 AND 50).

FIRST USE 6-1-2011; IN COMMERCE 6-1-2011.

FOR: APRONS, IN CLASS 25 (U.S. CLS. 22 AND 39).

FIRST USE 6-1-2011; IN COMMERCE 6-1-2011.

FOR: GRILLING SAUCES, HAM GLAZES, MARINADES, SPICE RUBS, SAUCE MIXES, IN CLASS 30 (U.S. CL. 46).

FIRST USE 6-1-2011; IN COMMERCE 6-1-2011.

THE MARK CONSISTS OF STANDARD CHARACTERS WITHOUT CLAIM TO ANY PARTICULAR FONT, STYLE, SIZE, OR COLOR.

SN 85-154,944, FILED 10-18-2010.

CAROL SPILS, EXAMINING ATTORNEY



David J. Kyros

Director of the United States Patent and Trademark Office

United States of America

United States Patent and Trademark Office

GATOR ESCAPE

Reg. No. 4,075,087

Registered Dec. 20, 2011

Int. Cl.: 28

TRADEMARK

PRINCIPAL REGISTER

MATTEL, INC. (DELAWARE CORPORATION)
M1-1518
333 CONTINENTAL BOULEVARD
EL SEGUNDO, CA 90245

FOR: TOY VEHICLE TRACK SETS AND ACCESSORIES THEREFOR, IN CLASS 28 (U.S. CLS. 22, 23, 38 AND 50).

FIRST USE 4-18-2011; IN COMMERCE 4-18-2011.

THE MARK CONSISTS OF STANDARD CHARACTERS WITHOUT CLAIM TO ANY PARTICULAR FONT, STYLE, SIZE, OR COLOR.

SN 85-155,394, FILED 10-18-2010.

MATTHEW PAPPAS, EXAMINING ATTORNEY



David J. Kyffers

Director of the United States Patent and Trademark Office

United States of America

United States Patent and Trademark Office

NEAT ROLL

Reg. No. 4,075,088

WALKEY, JESSICA (UNITED STATES INDIVIDUAL)
80633 APPLE CT
INDIO, CA 92201

Registered Dec. 20, 2011

Int. Cl.: 16

FOR: DEVICES, NAMELY, SPRING STEEL WRAPPED IN PAPER, FABRIC, PLASTIC OR RUBBER, WITH A COIL FEATURE, FOR CONFINING FLEXIBLE SHEETS OF PAPER, FABRIC, METAL, PLASTIC, RUBBER, OR CLOTH IN A CYLINDRICAL CONFIGURATION, AND FOR BUNDLING PAINT BRUSHES, PIPE CLEANERS, WOODEN CRAFT STICKS, WRITING INSTRUMENTS, PENCILS, ELECTRICAL CORDS, COMPUTER CABLES, DRINKING STRAWS, JEWELRY, BRACELETS, NECKLACES, WOODEN STICKS FOR HOLDING CANDY OR ICE CREAM, YOGA MATS, SLEEPING BAGS, CARPETS AND RUGS, ARROWS, BOLTS, PROJECTILES, FLEXIBLE PVC PIPES, METAL PIPES, WIRES, CUTLERY AND UTENSILS, NAMELY, FORKS, KNIVES, AND SPOONS, ROPES, BELTS FOR CLOTHING, AND YARN, IN CLASS 16 (U.S. CLS. 2, 5, 22, 23, 29, 37, 38 AND 50).

TRADEMARK

PRINCIPAL REGISTER

FIRST USE 9-16-2010; IN COMMERCE 7-1-2011.

THE MARK CONSISTS OF STANDARD CHARACTERS WITHOUT CLAIM TO ANY PARTICULAR FONT, STYLE, SIZE, OR COLOR.

NO CLAIM IS MADE TO THE EXCLUSIVE RIGHT TO USE "ROLL", APART FROM THE MARK AS SHOWN.

SN 85-155,403, FILED 10-18-2010.

LINDA M. KING, EXAMINING ATTORNEY



David J. Kyros

Director of the United States Patent and Trademark Office

United States of America

United States Patent and Trademark Office

neat roll

Reg. No. 4,075,089

WALKEY, JESSICA (UNITED STATES INDIVIDUAL)
80633 APPLE CT
INDIO, CA 92201

Registered Dec. 20, 2011

Int. Cl.: 16

TRADEMARK

PRINCIPAL REGISTER

FOR: DEVICES, NAMELY, SPRING STEEL WRAPPED IN PAPER, FABRIC, PLASTIC OR RUBBER, WITH A COIL FEATURE, FOR CONFINING FLEXIBLE SHEETS OF PAPER, FABRIC, METAL, PLASTIC, RUBBER, OR CLOTH IN A CYLINDRICAL CONFIGURATION, AND FOR BUNDLING PAINT BRUSHES, PIPE CLEANERS, WOODEN CRAFT STICKS, WRITING INSTRUMENTS, PENCILS, ELECTRICAL CORDS, COMPUTER CABLES, DRINKING STRAWS, JEWELRY, BRACELETS, NECKLACES, WOODEN STICKS FOR HOLDING CANDY OR ICE CREAM, YOGA MATS, SLEEPING BAGS, CARPETS AND RUGS, ARROWS, BOLTS, PROJECTILES, FLEXIBLE PVC PIPES, METAL PIPES, WIRES, CUTLERY AND UTENSILS, NAMELY, FORKS, KNIVES, AND SPOONS, ROPES, BELTS FOR CLOTHING, AND YARN, IN CLASS 16 (U.S. CLS. 2, 5, 22, 23, 29, 37, 38 AND 50).

FIRST USE 9-16-2010; IN COMMERCE 7-1-2011.

NO CLAIM IS MADE TO THE EXCLUSIVE RIGHT TO USE "ROLL", APART FROM THE MARK AS SHOWN.

THE COLOR(S) RED, WHITE AND BLUE IS/ARE CLAIMED AS A FEATURE OF THE MARK.

THE MARK CONSISTS OF THE WORDS "NEAT ROLL", IN WHITE LETTERS, EACH LETTER HAVING A BLUE BORDER, CENTERED ON A RED RECTANGLE.

SN 85-155,420, FILED 10-18-2010.

LINDA M. KING, EXAMINING ATTORNEY



David J. Kybas

Director of the United States Patent and Trademark Office

United States of America

United States Patent and Trademark Office

LABEL+thread

Reg. No. 4,075,090

LABEL+THREAD, INC. (NEW YORK CORPORATION)
312 EAST 23RD STREET, 10C
NEW YORK, NY 10010

Registered Dec. 20, 2011

Int. Cl.: 25

FOR: BLOUSES; BOTTOMS; COATS; DRESSES; JACKETS; KNITTED CAPS; KNITTED GLOVES; LEGGINGS; LOUNGE PANTS; PANTS; SCARVES; SHAWLS; SHIRTS; SKIRTS; SWEATERS; TOPS, IN CLASS 25 (U.S. CLS. 22 AND 39).

TRADEMARK

FIRST USE 1-1-2011; IN COMMERCE 1-7-2011.

PRINCIPAL REGISTER

THE MARK CONSISTS OF STANDARD CHARACTERS WITHOUT CLAIM TO ANY PARTICULAR FONT, STYLE, SIZE, OR COLOR.

SN 85-155,442, FILED 10-18-2010.

ANDREA HACK, EXAMINING ATTORNEY



David J. Kyffers

Director of the United States Patent and Trademark Office

United States of America

United States Patent and Trademark Office



Reg. No. 4,075,091

ANDERSON, MARIE ARMS (UNITED STATES INDIVIDUAL)
2312 CASTLEWOOD DRIVE
NASHVILLE, TN 37214

Registered Dec. 20, 2011

Int. Cl.: 14

FOR: JEWELRY, IN CLASS 14 (U.S. CLS. 2, 27, 28 AND 50).

TRADEMARK

FIRST USE 9-1-2010; IN COMMERCE 9-1-2011.

PRINCIPAL REGISTER

THE MARK CONSISTS OF THE WORDING "PEACE EASY" ARCHED ABOVE AND "LIKE A RIVER" ARCHED BELOW AN OVAL, WITH THE WORD "MARIE" WRITTEN IN STYLIZED SCRIPT INSIDE THE OVAL.

SN 85-155,494, FILED 10-18-2010.

ELISSA GARBER KON, EXAMINING ATTORNEY



David J. Kyffers

Director of the United States Patent and Trademark Office

United States of America

United States Patent and Trademark Office

MARATHON

Reg. No. 4,075,092

Registered Dec. 20, 2011

Int. Cl.: 7

TRADEMARK

PRINCIPAL REGISTER

MATE PRECISION TOOLING INC. (MINNESOTA CORPORATION)
1295 LUND BOULEVARD
ANOKA, MN 55303

FOR: SHEET METAL PUNCHING TOOL, CONSISTING OF A SPRING LOADED GUIDED PUNCH, A KEYED STEEL STRIPPER AND A HARDENED AND GROUND PUNCH HOLDER ASSEMBLY, FOR PUNCH PRESSES, IN CLASS 7 (U.S. CLS. 13, 19, 21, 23, 31, 34 AND 35).

FIRST USE 9-1-1987; IN COMMERCE 9-29-1987.

THE MARK CONSISTS OF STANDARD CHARACTERS WITHOUT CLAIM TO ANY PARTICULAR FONT, STYLE, SIZE, OR COLOR.

OWNER OF U.S. REG. NO. 1,590,519.

SN 85-156,001, FILED 10-19-2010.

SHAUNIA CARLYLE, EXAMINING ATTORNEY



David J. Kybas

Director of the United States Patent and Trademark Office

United States of America

United States Patent and Trademark Office

GREEN-ZONE

Reg. No. 4,075,093

WILBUR-ELLIS COMPANY (CALIFORNIA CORPORATION)
345 CALIFORNIA STREET, 27TH FLOOR
SAN FRANCISCO, CA 94104

Registered Dec. 20, 2011

Int. Cl.: 1

FOR: FERTILIZERS FOR AGRICULTURAL USE, IN CLASS 1 (U.S. CLS. 1, 5, 6, 10, 26 AND 46).

TRADEMARK

FIRST USE 2-8-2011; IN COMMERCE 2-8-2011.

PRINCIPAL REGISTER

THE MARK CONSISTS OF STANDARD CHARACTERS WITHOUT CLAIM TO ANY PARTICULAR FONT, STYLE, SIZE, OR COLOR.

OWNER OF U.S. REG. NO. 1,963,892.

SN 85-156,003, FILED 10-19-2010.

DEBRA LEE, EXAMINING ATTORNEY



David J. Kyffers

Director of the United States Patent and Trademark Office

United States of America

United States Patent and Trademark Office

DOUBLE DOUBLE DOMINOES

Reg. No. 4,075,094

COMPOUND FUN LLC (WASHINGTON LIMITED LIABILITY COMPANY)
P.O. BOX 7448
BELLEVUE, WA 98008

Registered Dec. 20, 2011

Int. Cl.: 28

FOR: BOARD GAMES, IN CLASS 28 (U.S. CLS. 22, 23, 38 AND 50).

TRADEMARK

FIRST USE 8-2-2011; IN COMMERCE 8-2-2011.

PRINCIPAL REGISTER

THE MARK CONSISTS OF STANDARD CHARACTERS WITHOUT CLAIM TO ANY PARTICULAR FONT, STYLE, SIZE, OR COLOR.

NO CLAIM IS MADE TO THE EXCLUSIVE RIGHT TO USE "DOMINOES", APART FROM THE MARK AS SHOWN.

SN 85-156,249, FILED 10-19-2010.

DEIRDRE ROBERTSON, EXAMINING ATTORNEY



David J. Kybas

Director of the United States Patent and Trademark Office

United States of America

United States Patent and Trademark Office

VIA INDIGO

Reg. No. 4,075,095

Registered Dec. 20, 2011

Int. Cl.: 25

TRADEMARK

PRINCIPAL REGISTER

DEANTEK, INC. (NEW YORK CORPORATION)
305 NORTHERN BLVD., SUITE 102
GREAT NECK, NY 11021

FOR: SHIRTS, JACKETS, VESTS, HOODED PULLOVERS, SWEATSHIRTS, SPORTS SHIRTS, POLO SHIRTS, T-SHIRTS, TANK TOPS, PANTS, KHAKIS, DENIMS, SHORTS, IN CLASS 25 (U.S. CLS. 22 AND 39).

FIRST USE 4-21-2011; IN COMMERCE 5-1-2011.

THE MARK CONSISTS OF STANDARD CHARACTERS WITHOUT CLAIM TO ANY PARTICULAR FONT, STYLE, SIZE, OR COLOR.

NO CLAIM IS MADE TO THE EXCLUSIVE RIGHT TO USE "INDIGO", APART FROM THE MARK AS SHOWN.

SN 85-156,461, FILED 10-19-2010.

IRA J. GOODSID, EXAMINING ATTORNEY



David J. Kyffers

Director of the United States Patent and Trademark Office

United States of America

United States Patent and Trademark Office

PLUSHKIES

Reg. No. 4,075,096

PLUSHKIES, LLC (TEXAS LIMITED LIABILITY COMPANY)
801 W. 5TH STREET, APT. 1010
AUSTIN, TX 78703

Registered Dec. 20, 2011

Int. Cl.: 28

FOR: HIGH DESIGN PLUSH CHARACTERS CONFIGURED IN THE SHAPE OF COUNTRIES OF THE WORLD, IN CLASS 28 (U.S. CLS. 22, 23, 38 AND 50).

TRADEMARK

FIRST USE 10-4-2011; IN COMMERCE 10-4-2011.

PRINCIPAL REGISTER

THE MARK CONSISTS OF STANDARD CHARACTERS WITHOUT CLAIM TO ANY PARTICULAR FONT, STYLE, SIZE, OR COLOR.

SN 85-156,682, FILED 10-20-2010.

LINDA E. BLOHM, EXAMINING ATTORNEY



David J. Kybas

Director of the United States Patent and Trademark Office

United States of America

United States Patent and Trademark Office

SIDEWINDER

Reg. No. 4,075,097

AMERICAN ROOF, INC. (WASHINGTON CORPORATION)
8522 216TH ST SE
WOODINVILLE, WA 98072

Registered Dec. 20, 2011

Int. Cl.: 9

FOR: FALL PROTECTION SAFETY EQUIPMENT, NAMELY, SELF-RETRACTING SAFETY LINES, IN CLASS 9 (U.S. CLS. 21, 23, 26, 36 AND 38).

TRADEMARK

FIRST USE 11-16-2010; IN COMMERCE 11-16-2010.

PRINCIPAL REGISTER

THE MARK CONSISTS OF STANDARD CHARACTERS WITHOUT CLAIM TO ANY PARTICULAR FONT, STYLE, SIZE, OR COLOR.

SN 85-156,824, FILED 10-20-2010.

VERNA BETH RIRIE, EXAMINING ATTORNEY



David J. Kybas

Director of the United States Patent and Trademark Office

United States of America
United States Patent and Trademark Office

MAXFORCE

Reg. No. 4,075,098

AMERICAN ROOF, INC. (WASHINGTON CORPORATION)

Registered Dec. 20, 2011

8522 216TH ST SE
WOODINVILLE, WA 98072

Int. Cl.: 9

FOR: FALL PROTECTION EQUIPMENT FOR FALL RESTRAINT AND FALL ARREST, NAMELY, TIE-OFF STRAPS, ROPE GRABS, LANYARDS, AND ENERGY ABSORBERS FOR SAFETY LINES AND SAFETY HARNESSSES , IN CLASS 9 (U.S. CLS. 21, 23, 26, 36 AND 38).

TRADEMARK

FIRST USE 9-9-2011; IN COMMERCE 9-9-2011.

PRINCIPAL REGISTER

THE MARK CONSISTS OF STANDARD CHARACTERS WITHOUT CLAIM TO ANY PARTICULAR FONT, STYLE, SIZE, OR COLOR.

SN 85-156,858, FILED 10-20-2010.

VERNA BETH RIRIE, EXAMINING ATTORNEY



David J. Kyffers

Director of the United States Patent and Trademark Office

United States of America
United States Patent and Trademark Office

PLUSHKIES

Reg. No. 4,075,099

PLUSHKIES, LLC (TEXAS LIMITED LIABILITY COMPANY)
801 W. 5TH STREET, APT. 1010
AUSTIN, TX 78703

Registered Dec. 20, 2011

Int. Cl.: 28

FOR: HIGH DESIGN PLUSH CHARACTERS CONFIGURED IN THE SHAPE OF COUNTRIES OF THE WORLD, IN CLASS 28 (U.S. CLS. 22, 23, 38 AND 50).

TRADEMARK

FIRST USE 10-4-2011; IN COMMERCE 10-4-2011.

PRINCIPAL REGISTER

THE MARK CONSISTS OF STYLIZED RENDERING OF THE WORD "PLUSHKIES" IN WHICH THE "P" IS TWICE THE SIZE OF THE REMAINING LETTERS IN THE WORD AND HAS A SWIRL IN CLOSING THE TOP OF THE "P" AND IN WHICH THE "H" HAS A LONGER FIRST LEG THAN SECOND LEG.

SN 85-156,991, FILED 10-20-2010.

LINDA E. BLOHM, EXAMINING ATTORNEY



David J. Kyffers

Director of the United States Patent and Trademark Office

United States of America

United States Patent and Trademark Office

\$ECOND CHANCE KENO

Reg. No. 4,075,100

Registered Dec. 20, 2011

Int. Cl.: 9

TRADEMARK

PRINCIPAL REGISTER

TOURNAMENT ONE CORP (DELAWARE CORPORATION), AKA T1 GAMING,
1200 HIGH RIDGE ROAD
STAMFORD, CT 06905

FOR: COMPUTER APPLICATION SOFTWARE FOR LOTTERY MONITORS, KENO SERVERS,
MOBILE PHONES, SMARTPHONES AND WIRELESS DEVICES, NAMELY, SOFTWARE
FOR PLAYING KENO GAMES , IN CLASS 9 (U.S. CLS. 21, 23, 26, 36 AND 38).

FIRST USE 10-1-2010; IN COMMERCE 10-24-2011.

THE MARK CONSISTS OF STANDARD CHARACTERS WITHOUT CLAIM TO ANY PAR-
TICULAR FONT, STYLE, SIZE, OR COLOR.

NO CLAIM IS MADE TO THE EXCLUSIVE RIGHT TO USE "KENO", APART FROM THE
MARK AS SHOWN.

SN 85-157,265, FILED 10-20-2010.

ANGELA DUONG, EXAMINING ATTORNEY



David J. Kyros

Director of the United States Patent and Trademark Office

United States of America

United States Patent and Trademark Office

INFORM.NET

Reg. No. 4,075,101

Registered Dec. 20, 2011

Int. Cl.: 9

TRADEMARK

PRINCIPAL REGISTER

VEEDER-ROOT COMPANY (DELAWARE CORPORATION)
125 POWDER FOREST DRIVE
SIMSBURY, CT 06070

FOR: COMPUTER SOFTWARE FOR USE IN CONNECTION WITH AUTOMATIC TANK GAUGES THAT ARE CONNECTED TO FUEL STORAGE TANKS AT VEHICLE FUELING STATIONS, SUCH SOFTWARE FOR THE PROVISION OF FUEL INVENTORY DATA, LEAK DETECTION AND DIAGNOSTIC INFORMATION, AND FOR PROVIDING WEB-BASED ACCESS TO ALL OF THE FOREGOING FUNCTIONS, IN CLASS 9 (U.S. CLS. 21, 23, 26, 36 AND 38).

FIRST USE 9-12-2011; IN COMMERCE 9-12-2011.

THE MARK CONSISTS OF STANDARD CHARACTERS WITHOUT CLAIM TO ANY PARTICULAR FONT, STYLE, SIZE, OR COLOR.

SN 85-157,324, FILED 10-20-2010.

MARK RADEMACHER, EXAMINING ATTORNEY



David J. Kyffers

Director of the United States Patent and Trademark Office

United States of America

United States Patent and Trademark Office

EnergyFit Alliance

Reg. No. 4,075,102

ANLIN INDUSTRIES, INC. (CALIFORNIA CORPORATION)
1665 TOLLHOUSE ROAD
CLOVIS, CA 93612

Registered Dec. 20, 2011

Int. Cl.: 36

FOR: FINANCING AND LOAN SERVICES, IN CLASS 36 (U.S. CLS. 100, 101 AND 102).

SERVICE MARK

FIRST USE 11-1-2010; IN COMMERCE 11-1-2010.

PRINCIPAL REGISTER

THE MARK CONSISTS OF STANDARD CHARACTERS WITHOUT CLAIM TO ANY PARTICULAR FONT, STYLE, SIZE, OR COLOR.

NO CLAIM IS MADE TO THE EXCLUSIVE RIGHT TO USE "ALLIANCE", APART FROM THE MARK AS SHOWN.

SN 85-157,463, FILED 10-20-2010.

DOUGLAS LEE, EXAMINING ATTORNEY



David J. Kyffers

Director of the United States Patent and Trademark Office

United States of America

United States Patent and Trademark Office

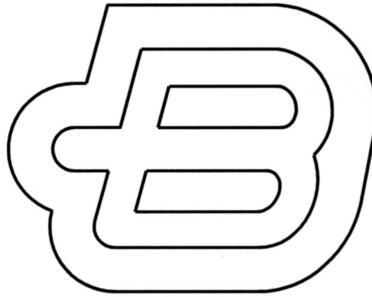

Reg. No. 4,075,103

Registered Dec. 20, 2011

Int. Cls.: 3 and 21

TRADEMARK

PRINCIPAL REGISTER

BENEDENT CORPORATION (TEXAS CORPORATION)
16810 BARKER SPRINGS, SUITE 217
HOUSTON, TX 77084

FOR: TOOTHPASTE, IN CLASS 3 (U.S. CLS. 1, 4, 6, 50, 51 AND 52).

FIRST USE 4-30-2010; IN COMMERCE 4-30-2010.

FOR: TOOTHBRUSH, IN CLASS 21 (U.S. CLS. 2, 13, 23, 29, 30, 33, 40 AND 50).

FIRST USE 4-30-2010; IN COMMERCE 4-30-2010.

THE MARK CONSISTS OF THE STYLIZED LETTER "B" WITH OUTLINE SURROUNDING THE LETTER.

SN 85-157,552, FILED 10-20-2010.

TRACY FLETCHER, EXAMINING ATTORNEY



David J. Kybas

Director of the United States Patent and Trademark Office

United States of America

United States Patent and Trademark Office

ALLFIT HD

Reg. No. 4,075,104

OHIO STEEL INDUSTRIES, INC. (OHIO CORPORATION)
2575 FERRIS RD
COLUMBUS, OH 432242597

Registered Dec. 20, 2011

Int. Cl.: 7

FOR: TOWED LAWN AND GARDEN EQUIPMENT, NAMELY, BROADCAST SPREADERS, DE-THATCHERS, LAWN PLUGGERS, SPIKE AERATORS, AND LEAF RAKES, IN CLASS 7 (U.S. CLS. 13, 19, 21, 23, 31, 34 AND 35).

TRADEMARK

FIRST USE 3-4-2011; IN COMMERCE 3-4-2011.

PRINCIPAL REGISTER

THE MARK CONSISTS OF STANDARD CHARACTERS WITHOUT CLAIM TO ANY PARTICULAR FONT, STYLE, SIZE, OR COLOR.

SN 85-157,995, FILED 10-21-2010.

JACLYN KIDWELL WALKER, EXAMINING ATTORNEY



David J. Kyffers

Director of the United States Patent and Trademark Office

United States of America

United States Patent and Trademark Office



Reg. No. 4,075,105

Registered Dec. 20, 2011

Int. Cl.: 36

SERVICE MARK

PRINCIPAL REGISTER

SOUL MISSION INC. (OKLAHOMA CORPORATION)
8908 N. 124TH E. AVE
OWASSO, OK 74055

FOR: CHARITABLE SERVICES, NAMELY, ORGANIZING FUNDRAISING SERVICES FOR MISSIONARIES, IN CLASS 36 (U.S. CLS. 100, 101 AND 102).

FIRST USE 5-20-2010; IN COMMERCE 5-20-2010.

NO CLAIM IS MADE TO THE EXCLUSIVE RIGHT TO USE "MISSION", APART FROM THE MARK AS SHOWN.

THE MARK CONSISTS OF 2 SETS OF 3 ROUGH EDGED RECTANGLES. THE FIRST SET IS ARRANGED HORIZONTALLY TO REPRESENT THE LETTER "S". THE SECOND SET OF RECTANGLES IS ARRANGED VERTICALLY TO REPRESENT THE LETTER "M". BELOW THERE IS THE STYLIZED TEXT "SOUL MISSION".

SN 85-158,884, FILED 10-22-2010.

MARC LEIPZIG, EXAMINING ATTORNEY



David J. Kybas

Director of the United States Patent and Trademark Office

United States of America

United States Patent and Trademark Office

NOUR

Reg. No. 4,075,106

MANS, SAM (UNITED STATES INDIVIDUAL)
210 N CRESCENT WAY, UNIT B
ANAHEIM, CA 92801

Registered Dec. 20, 2011

Int. Cl.: 34

FOR: MOLASSES TOBACCO; TOBACCO, IN CLASS 34 (U.S. CLS. 2, 8, 9 AND 17).

TRADEMARK

FIRST USE 5-0-2011; IN COMMERCE 5-0-2011.

PRINCIPAL REGISTER

THE MARK CONSISTS OF STANDARD CHARACTERS WITHOUT CLAIM TO ANY PARTICULAR FONT, STYLE, SIZE, OR COLOR.

NO CLAIM IS MADE TO THE EXCLUSIVE RIGHT TO USE "TOBACCO", APART FROM THE MARK AS SHOWN.

THE ENGLISH TRANSLATION OF "NOUR" IN THE MARK IS DAYLIGHT.

SN 85-160,876, FILED 10-26-2010.

ALLISON HOLTZ, EXAMINING ATTORNEY



David J. Kyffers

Director of the United States Patent and Trademark Office

United States of America

United States Patent and Trademark Office

MUD TRAX

Reg. No. 4,075,107

Registered Dec. 20, 2011

Int. Cl.: 9

TRADEMARK

PRINCIPAL REGISTER

TOURNAMENT ONE CORP (DELAWARE CORPORATION)
1200 HIGH RIDGE ROAD
STAMFORD, CT 06905

FOR: COMPUTER GAME SOFTWARE; COMPUTER GRAPHICS SOFTWARE; COMPUTER PROGRAMS FOR LOTTERY, CASINO AND ONLINE WAGERING GAMES; DOWNLOADABLE SOFTWARE FOR PLAYING OR REPLAYING CASINO, LOTTERY OR ONLINE WAGERING GAMES; ELECTRONIC GAME PROGRAMS; ELECTRONIC GAME SOFTWARE; ELECTRONIC GAME SOFTWARE FOR CELLULAR TELEPHONES; ELECTRONIC GAME SOFTWARE FOR HANDHELD ELECTRONIC DEVICES; ELECTRONIC GAME SOFTWARE FOR WIRELESS DEVICES; GAME SOFTWARE; VIRTUAL REALITY GAME SOFTWARE; VIRTUAL REALITY SOFTWARE FOR LOTTERIES, CASINOS AND ONLINE GAMING, IN CLASS 9 (U.S. CLS. 21, 23, 26, 36 AND 38).

FIRST USE 10-26-2010; IN COMMERCE 10-24-2011.

THE MARK CONSISTS OF STANDARD CHARACTERS WITHOUT CLAIM TO ANY PARTICULAR FONT, STYLE, SIZE, OR COLOR.

NO CLAIM IS MADE TO THE EXCLUSIVE RIGHT TO USE "MUD", APART FROM THE MARK AS SHOWN.

SN 85-161,722, FILED 10-26-2010.

ANGELA DUONG, EXAMINING ATTORNEY



David J. Kybas

Director of the United States Patent and Trademark Office

United States of America

United States Patent and Trademark Office

SPOILER SPORT

Reg. No. 4,075,108

Registered Dec. 20, 2011

Int. Cl.: 28

TRADEMARK

PRINCIPAL REGISTER

MATTEL, INC. (DELAWARE CORPORATION)
M1-1518
333 CONTINENTAL BOULEVARD
EL SEGUNDO, CA 90245

FOR: TOY VEHICLES AND ACCESSORIES THEREFOR, IN CLASS 28 (U.S. CLS. 22, 23, 38 AND 50).

FIRST USE 9-2-2011; IN COMMERCE 9-2-2011.

THE MARK CONSISTS OF STANDARD CHARACTERS WITHOUT CLAIM TO ANY PARTICULAR FONT, STYLE, SIZE, OR COLOR.

SN 85-161,819, FILED 10-26-2010.

JIM RINGLE, EXAMINING ATTORNEY



David J. Kyffers

Director of the United States Patent and Trademark Office

United States of America

United States Patent and Trademark Office

MAKE EVERY STEP REWARDING

Reg. No. 4,075,109

Registered Dec. 20, 2011

Int. Cls.: 35 and 36

SERVICE MARK

PRINCIPAL REGISTER

WALGREEN CO. (ILLINOIS CORPORATION)
200 WILMOT ROAD
DEERFIELD, IL 60015

FOR: RETAIL DRUG STORE SERVICES; PROMOTING THE CHARITABLE SERVICES OF OTHERS, NAMELY, PROVIDING INDIVIDUALS WITH INFORMATION FOR THE PURPOSE OF MAKING DONATIONS TO CHARITIES, IN CLASS 35 (U.S. CLS. 100, 101 AND 102).

FIRST USE 3-27-2011; IN COMMERCE 3-27-2011.

FOR: CHARITABLE FUNDRAISING SERVICES, IN CLASS 36 (U.S. CLS. 100, 101 AND 102).

FIRST USE 4-10-2011; IN COMMERCE 4-10-2011.

THE MARK CONSISTS OF STANDARD CHARACTERS WITHOUT CLAIM TO ANY PARTICULAR FONT, STYLE, SIZE, OR COLOR.

SN 85-162,141, FILED 10-27-2010.

TARA PATE, EXAMINING ATTORNEY



David J. Kyros

Director of the United States Patent and Trademark Office

United States of America

United States Patent and Trademark Office

ROCK VALLEY SNACK COMPANY

Reg. No. 4,075,110

SHOPKO STORES OPERATING CO., LLC (DELAWARE LIMITED LIABILITY COMPANY)
700 PILGRIM WAY
GREEN BAY, WI 54304

Registered Dec. 20, 2011

Int. Cls.: 29 and 30

FOR: CANDIED NUTS; POTATO CHIPS; PROCESSED NUTS; ROASTED NUTS; SNACK MIX CONSISTING OF PRIMARILY OF PROCESSED NUTS, SEEDS, DRIED FRUIT AND ALSO INCLUDING CHOCOLATE; SNACK MIX CONSISTING PRIMARILY OF PROCESSED FRUITS, PROCESSED NUTS AND/OR RAISINS, IN CLASS 29 (U.S. CL. 46).

TRADEMARK

PRINCIPAL REGISTER

FIRST USE 5-15-2011; IN COMMERCE 5-15-2011.

FOR: CANDY; CHOCOLATE COVERED NUTS; CRACKERS; PRETZELS; SESAME STICKS; SNACK MIX CONSISTING PRIMARILY OF CRACKERS, PRETZELS AND/OR POPPED POPCORN, IN CLASS 30 (U.S. CL. 46).

FIRST USE 5-15-2011; IN COMMERCE 5-15-2011.

THE MARK CONSISTS OF STANDARD CHARACTERS WITHOUT CLAIM TO ANY PARTICULAR FONT, STYLE, SIZE, OR COLOR.

NO CLAIM IS MADE TO THE EXCLUSIVE RIGHT TO USE "SNACK COMPANY", APART FROM THE MARK AS SHOWN.

SN 85-162,212, FILED 10-27-2010.

DAVID H. STINE, EXAMINING ATTORNEY



David J. Kybas

Director of the United States Patent and Trademark Office

United States of America

United States Patent and Trademark Office

DOCTOR PHRESH

Reg. No. 4,075,111

DOCTOR PHRESH NUTRITIONALS, L.L.C. (ARIZONA LIMITED LIABILITY COMPANY)
8618 N. TATUM BLVD.

Registered Dec. 20, 2011

PHOENIX, AZ 85028

Int. Cl.: 5

FOR: DIETARY AND NUTRITIONAL SUPPLEMENTS; MINERAL NUTRITIONAL SUPPLEMENTS; NUTRITIONAL OILS NOT FOR FOOD OR COSMETIC PURPOSES; NUTRITIONAL SUPPLEMENTS, IN CLASS 5 (U.S. CLS. 6, 18, 44, 46, 51 AND 52).

TRADEMARK

FIRST USE 2-21-2011; IN COMMERCE 2-21-2011.

PRINCIPAL REGISTER

THE MARK CONSISTS OF STANDARD CHARACTERS WITHOUT CLAIM TO ANY PARTICULAR FONT, STYLE, SIZE, OR COLOR.

SN 85-163,055, FILED 10-27-2010.

SIMON TENG, EXAMINING ATTORNEY



David J. Kybas

Director of the United States Patent and Trademark Office

United States of America

United States Patent and Trademark Office

Comic Sutra

Reg. No. 4,075,112

ROCK HARD WOOD, INC (MARYLAND CORPORATION)
2610 LINWOOD RD
PARKVILLE, MD 21234

Registered Dec. 20, 2011

Int. Cls.: 9 and 28

FOR: DOWNLOADABLE ELECTRONIC GAME PROGRAMS, IN CLASS 9 (U.S. CLS. 21, 23, 26, 36 AND 38).

TRADEMARK

FIRST USE 10-3-2011; IN COMMERCE 11-8-2011.

PRINCIPAL REGISTER

FOR: PARTY GAMES , IN CLASS 28 (U.S. CLS. 22, 23, 38 AND 50).

FIRST USE 11-1-2010; IN COMMERCE 10-10-2011.

THE MARK CONSISTS OF STANDARD CHARACTERS WITHOUT CLAIM TO ANY PARTICULAR FONT, STYLE, SIZE, OR COLOR.

SN 85-163,061, FILED 10-27-2010.

MICHAEL KEATING, EXAMINING ATTORNEY



David J. Kybas

Director of the United States Patent and Trademark Office

United States of America

United States Patent and Trademark Office

GREEN MISSION

Reg. No. 4,075,113

WHOLE FOODS MARKET IP, L.P. (DELAWARE LIMITED PARTNERSHIP)
550 BOWIE STREET, 6TH FLOOR
AUSTIN, TX 78703

Registered Dec. 20, 2011

Int. Cl.: 16

FOR: PAPER TOWELS; BATHROOM TISSUE, IN CLASS 16 (U.S. CLS. 2, 5, 22, 23, 29, 37, 38 AND 50).

TRADEMARK

FIRST USE 2-0-2011; IN COMMERCE 2-0-2011.

PRINCIPAL REGISTER

THE MARK CONSISTS OF STANDARD CHARACTERS WITHOUT CLAIM TO ANY PARTICULAR FONT, STYLE, SIZE, OR COLOR.

OWNER OF U.S. REG. NOS. 3,121,198 AND 3,264,496.

NO CLAIM IS MADE TO THE EXCLUSIVE RIGHT TO USE "GREEN", APART FROM THE MARK AS SHOWN.

SN 85-163,591, FILED 10-28-2010.

WENDY JUN, EXAMINING ATTORNEY



David J. Kybas

Director of the United States Patent and Trademark Office

United States of America

United States Patent and Trademark Office

TESTPOINTS

Reg. No. 4,075,114

Registered Dec. 20, 2011

Int. Cls.: 9 and 16

TRADEMARK

PRINCIPAL REGISTER

THE NATIONAL BOARD OF EXAMINERS IN OPTOMETRY, INC. (MARYLAND CORPORATION)
200 SOUTH COLLEGE STREET
CHARLOTTE, NC 28202

FOR: ELECTRONIC NEWSLETTERS IN THE FIELD OF OPTOMETRY, IN CLASS 9 (U.S. CLS. 21, 23, 26, 36 AND 38).

FIRST USE 11-4-2010; IN COMMERCE 11-4-2010.

FOR: PRINTED NEWSLETTERS IN THE FIELD OF OPTOMETRY, IN CLASS 16 (U.S. CLS. 2, 5, 22, 23, 29, 37, 38 AND 50).

FIRST USE 11-4-2010; IN COMMERCE 11-4-2010.

THE MARK CONSISTS OF STANDARD CHARACTERS WITHOUT CLAIM TO ANY PARTICULAR FONT, STYLE, SIZE, OR COLOR.

SN 85-163,843, FILED 10-28-2010.

LINDA POWELL, EXAMINING ATTORNEY



David J. Kyjars

Director of the United States Patent and Trademark Office

United States of America

United States Patent and Trademark Office

SOUTHERN BUTTER

Reg. No. 4,075,115

SIERRA SAGE HERBS LLC (IDAHO LIMITED LIABILITY COMPANY)
708 E. MCKINLEY STREET
BOISE, ID 83712

Registered Dec. 20, 2011

Int. Cl.: 3

FOR: NON-MEDICATED HERBAL BODY CARE PRODUCTS, NAMELY, SALVES, IN CLASS 3 (U.S. CLS. 1, 4, 6, 50, 51 AND 52).

TRADEMARK

FIRST USE 8-0-2011; IN COMMERCE 8-0-2011.

PRINCIPAL REGISTER

THE MARK CONSISTS OF STANDARD CHARACTERS WITHOUT CLAIM TO ANY PARTICULAR FONT, STYLE, SIZE, OR COLOR.

NO CLAIM IS MADE TO THE EXCLUSIVE RIGHT TO USE "BUTTER", APART FROM THE MARK AS SHOWN.

SN 85-166,031, FILED 11-1-2010.

JANICE KIM, EXAMINING ATTORNEY



David J. Kybas

Director of the United States Patent and Trademark Office

United States of America

United States Patent and Trademark Office



Reg. No. 4,075,116

Registered Dec. 20, 2011

Int. Cl.: 3

TRADEMARK

PRINCIPAL REGISTER

COSMOS CORPORATION (MISSOURI CORPORATION)
103 ENTERPRISE DR.
WENTZVILLE, MO 63385

FOR: CARPET CLEANING PREPARATIONS; CARPET CLEANING PREPARATIONS WITH DEODORIZERS; STAIN REMOVING PREPARATIONS; STAIN REMOVING PREPARATIONS WITH DEODORIZERS; PET STAIN REMOVERS, IN CLASS 3 (U.S. CLS. 1, 4, 6, 50, 51 AND 52).

FIRST USE 12-0-2010; IN COMMERCE 12-0-2010.

OWNER OF U.S. REG. NOS. 2,959,292 AND 3,834,669.

NO CLAIM IS MADE TO THE EXCLUSIVE RIGHT TO USE "NATURALLY GREEN" "STAIN" "ODOR", APART FROM THE MARK AS SHOWN.

THE MARK CONSISTS OF THE WORDS "NATURALLY GREEN TROPICLEAN STOP IT STOPS THE STAIN STOPS THE ODOR STOPS THE HABIT", WITH A PALM TREE REPRESENTING THE LETTER "T" IN "TROPICLEAN", ALL OF WHICH IS WITHIN A STOP SIGN.

SN 85-166,369, FILED 11-1-2010.

FONG HSU, EXAMINING ATTORNEY



David J. Kyffers

Director of the United States Patent and Trademark Office

United States of America

United States Patent and Trademark Office

EXTERMINITE

Reg. No. 4,075,117

Registered Dec. 20, 2011

Int. Cls.: 11 and 20

TRADEMARK

PRINCIPAL REGISTER

MONSTER BASHER LLC (OREGON LIMITED LIABILITY COMPANY)
7498 STERLING CREEK RD
JACKSONVILLE, OR 97530

FOR: ELECTRIC NIGHT LIGHTS, IN CLASS 11 (U.S. CLS. 13, 21, 23, 31 AND 34).

FIRST USE 1-29-2011; IN COMMERCE 1-29-2011.

FOR: NOVELTY GOODS IN THE NATURE OF A PLACEBO SPRAY USED TO LESSEN A CHILD'S REACTION TO A FEARFUL SITUATION, IN CLASS 20 (U.S. CLS. 2, 13, 22, 25, 32 AND 50).

FIRST USE 1-29-2011; IN COMMERCE 1-29-2011.

THE MARK CONSISTS OF STANDARD CHARACTERS WITHOUT CLAIM TO ANY PARTICULAR FONT, STYLE, SIZE, OR COLOR.

SN 85-166,615, FILED 11-1-2010.

REBECCA GILBERT, EXAMINING ATTORNEY



David J. Kybas

Director of the United States Patent and Trademark Office

United States of America

United States Patent and Trademark Office

MONSTER BASHER

Reg. No. 4,075,118

Registered Dec. 20, 2011

Int. Cls.: 11 and 20

TRADEMARK

PRINCIPAL REGISTER

MONSTER BASHER LLC (OREGON LIMITED LIABILITY COMPANY)
7498 STERLING CREEK RD
JACKSONVILLE, OR 97530

FOR: ELECTRIC NIGHT LIGHTS, IN CLASS 11 (U.S. CLS. 13, 21, 23, 31 AND 34).

FIRST USE 1-29-2011; IN COMMERCE 1-29-2011.

FOR: NOVELTY GOODS IN THE NATURE OF A PLACEBO SPRAY USED TO LESSEN A CHILD'S REACTION TO A FEARFUL SITUATION, IN CLASS 20 (U.S. CLS. 2, 13, 22, 25, 32 AND 50).

FIRST USE 1-29-2011; IN COMMERCE 1-29-2011.

THE MARK CONSISTS OF STANDARD CHARACTERS WITHOUT CLAIM TO ANY PARTICULAR FONT, STYLE, SIZE, OR COLOR.

SN 85-166,624, FILED 11-1-2010.

REBECCA GILBERT, EXAMINING ATTORNEY



David J. Kyros

Director of the United States Patent and Trademark Office

United States of America

United States Patent and Trademark Office

INDRID

Reg. No. 4,075,119

Registered Dec. 20, 2011

Int. Cl.: 28

TRADEMARK

PRINCIPAL REGISTER

PRETTY UGLY LLC (DELAWARE LIMITED LIABILITY COMPANY)
45 FERNWOOD AVENUE
EDISON, NJ 08837 AND

DAVID HORVATH (UNITED STATES INDIVIDUAL)
45 FERNWOOD AVENUE
EDISON, NJ 08837 AND

SUN-MIN KIM (REPUBLIC OF KOREA INDIVIDUAL)
45 FERNWOOD AVENUE
EDISON, NJ 08837

FOR: STUFFED AND PLUSH TOYS, IN CLASS 28 (U.S. CLS. 22, 23, 38 AND 50).

FIRST USE 10-15-2011; IN COMMERCE 10-15-2011.

THE MARK CONSISTS OF STANDARD CHARACTERS WITHOUT CLAIM TO ANY PARTICULAR FONT, STYLE, SIZE, OR COLOR.

SN 85-166,635, FILED 11-1-2010.

AMEEN IMAM, EXAMINING ATTORNEY



David J. Kyffers

Director of the United States Patent and Trademark Office

United States of America

United States Patent and Trademark Office

JIKER

Reg. No. 4,075,120

Registered Dec. 20, 2011

Int. Cl.: 28

TRADEMARK

PRINCIPAL REGISTER

PRETTY UGLY LLC (DELAWARE LIMITED LIABILITY COMPANY)
45 FERNWOOD AVENUE
EDISON, NJ 08837 AND

DAVID HORVATH (UNITED STATES INDIVIDUAL)
45 FERNWOOD AVENUE
EDISON, NJ 08837 AND

SUN-MIN KIM (REPUBLIC OF KOREA INDIVIDUAL)
45 FERNWOOD AVENUE
EDISON, NJ 08837

FOR: STUFFED AND PLUSH TOYS, IN CLASS 28 (U.S. CLS. 22, 23, 38 AND 50).

FIRST USE 10-19-2011; IN COMMERCE 10-19-2011.

THE MARK CONSISTS OF STANDARD CHARACTERS WITHOUT CLAIM TO ANY PARTICULAR FONT, STYLE, SIZE, OR COLOR.

SN 85-166,636, FILED 11-1-2010.

AMEEN IMAM, EXAMINING ATTORNEY



David J. Kyffers

Director of the United States Patent and Trademark Office

United States of America

United States Patent and Trademark Office

IMGTRACER

Reg. No. 4,075,121

Registered Dec. 20, 2011

Int. Cl.: 9

TRADEMARK

PRINCIPAL REGISTER

BIOMEDICAL TECHNOLOGIES, INC. (COLORADO CORPORATION)
208 OTTER GLEN COURT
ROSEVILLE, CA 95661

FOR: COMPUTER PROGRAMS FOR USE IN MEDICAL IMAGE ANALYSIS, DIAGNOSIS, AND TREATMENT, NAMELY, SOFTWARE FOR PROCESSING DIGITAL IMAGES OF THE ANATOMY FOR ANALYSIS, DIAGNOSIS AND TREATMENT, AND SOFTWARE FOR PROCESSING DIGITAL IMAGES OF THE ANATOMY TO ADD ADDITIONAL VISUAL ELEMENTS TO THE DIGITAL IMAGES FOR ENHANCED ANALYSIS, DIAGNOSIS AND TREATMENT; COMPUTER SOFTWARE FOR CREATING SEARCHABLE MEDICAL DIAGNOSIS AND TREATMENT DATABASES, IN CLASS 9 (U.S. CLS. 21, 23, 26, 36 AND 38).

FIRST USE 10-2-2010; IN COMMERCE 5-2-2011.

THE MARK CONSISTS OF STANDARD CHARACTERS WITHOUT CLAIM TO ANY PARTICULAR FONT, STYLE, SIZE, OR COLOR.

SN 85-166,642, FILED 11-1-2010.

TEJBIR SINGH, EXAMINING ATTORNEY



David J. Kyros

Director of the United States Patent and Trademark Office

United States of America

United States Patent and Trademark Office

ALLSTATE MALL

Reg. No. 4,075,122

Registered Dec. 20, 2011

Int. Cl.: 35

SERVICE MARK

PRINCIPAL REGISTER

ALLSTATE INSURANCE COMPANY (ILLINOIS CORPORATION)
ALLSTATE PLAZA
NORTHBROOK, IL 60062

FOR: PROMOTING THE GOODS AND SERVICES OF OTHERS BY MEANS OF OPERATING AN ON-LINE SHOPPING MALL WITH LINKS TO THE RETAIL WEB SITES OF OTHERS, IN CLASS 35 (U.S. CLS. 100, 101 AND 102).

FIRST USE 11-15-2010; IN COMMERCE 11-15-2010.

THE MARK CONSISTS OF STANDARD CHARACTERS WITHOUT CLAIM TO ANY PARTICULAR FONT, STYLE, SIZE, OR COLOR.

OWNER OF U.S. REG. NOS. 3,060,470, 3,202,222, AND 3,801,141.

NO CLAIM IS MADE TO THE EXCLUSIVE RIGHT TO USE "MALL", APART FROM THE MARK AS SHOWN.

SN 85-166,807, FILED 11-2-2010.

ZACHARY BELLO, EXAMINING ATTORNEY



David J. Kyfos

Director of the United States Patent and Trademark Office

United States of America

United States Patent and Trademark Office

ABBEY BOMINABLE

Reg. No. 4,075,123

Registered Dec. 20, 2011

Int. Cl.: 28

TRADEMARK

PRINCIPAL REGISTER

MATTEL, INC. (DELAWARE CORPORATION)
M1-1518
333 CONTINENTAL BOULEVARD
EL SEGUNDO, CA 90245

FOR: DOLLS, DOLL CLOTHING AND DOLL ACCESSORIES, IN CLASS 28 (U.S. CLS. 22, 23, 38 AND 50).

FIRST USE 7-20-2011; IN COMMERCE 7-20-2011.

THE MARK CONSISTS OF STANDARD CHARACTERS WITHOUT CLAIM TO ANY PARTICULAR FONT, STYLE, SIZE, OR COLOR.

SN 85-166,995, FILED 11-2-2010.

GRETТА YAO, EXAMINING ATTORNEY



David J. Kybas

Director of the United States Patent and Trademark Office

United States of America

United States Patent and Trademark Office

My Trazom

Reg. No. 4,075,124

MOZART NETWORKS, LLC (NEW YORK LIMITED LIABILITY COMPANY)
P.O. BOX 3452

Registered Dec. 20, 2011

NEW YORK, NY 10163

Int. Cl.: 42

FOR: PROVIDING A WEB SITE THAT GIVES COMPUTER USERS THE ABILITY TO UP-LOAD, EXCHANGE AND SHARE PHOTOS, VIDEOS AND VIDEO LOGS, IN CLASS 42 (U.S. CLS. 100 AND 101).

SERVICE MARK

FIRST USE 2-10-2011; IN COMMERCE 2-10-2011.

PRINCIPAL REGISTER

THE MARK CONSISTS OF STANDARD CHARACTERS WITHOUT CLAIM TO ANY PARTICULAR FONT, STYLE, SIZE, OR COLOR.

SN 85-167,085, FILED 11-2-2010.

KATHERINE CHANG, EXAMINING ATTORNEY



David J. Kyffers

Director of the United States Patent and Trademark Office

United States of America

United States Patent and Trademark Office

Objet d'Love

Reg. No. 4,075,125

Registered Dec. 20, 2011

Int. Cl.: 3

TRADEMARK

PRINCIPAL REGISTER

NAKED PRINCESS WORLDWIDE, LLC (DELAWARE LIMITED LIABILITY COMPANY)
132-B LASKY DRIVE
BEVERLY HILLS, CA 90212

FOR: LIP BALM, IN CLASS 3 (U.S. CLS. 1, 4, 6, 50, 51 AND 52).

FIRST USE 10-28-2011; IN COMMERCE 10-28-2011.

THE MARK CONSISTS OF STANDARD CHARACTERS WITHOUT CLAIM TO ANY PARTICULAR FONT, STYLE, SIZE, OR COLOR.

THE ENGLISH TRANSLATION OF "OBJET D'" IN THE MARK IS OBJECT OF.

SN 85-167,095, FILED 11-2-2010.

AMY HELLA, EXAMINING ATTORNEY



David J. Kyffers

Director of the United States Patent and Trademark Office

United States of America

United States Patent and Trademark Office

GARANANCE QUIET STORYTELLERS

Reg. No. 4,075,126

GARANANCE, INC. D/B/A QUIET STORYTELLERS (NEW JERSEY CORPORATION)
31 RANDALL ROAD
PRINCETON, NJ 08540

Registered Dec. 20, 2011

Int. Cl.: 35

FOR: BUSINESS MANAGEMENT, CONSULTANCY AND ADVISORY SERVICES, NAMELY, THE MANAGEMENT AND REPRESENTATION OF ARTISTS, IN CLASS 35 (U.S. CLS. 100, 101 AND 102).

SERVICE MARK

FIRST USE 10-19-2010; IN COMMERCE 10-19-2010.

PRINCIPAL REGISTER

THE MARK CONSISTS OF STANDARD CHARACTERS WITHOUT CLAIM TO ANY PARTICULAR FONT, STYLE, SIZE, OR COLOR.

SN 85-167,187, FILED 11-2-2010.

MARK SPARACINO, EXAMINING ATTORNEY



David J. Kyffers

Director of the United States Patent and Trademark Office

United States of America

United States Patent and Trademark Office

In2See

Reg. No. 4,075,127

Registered Dec. 20, 2011

Int. Cl.: 16

TRADEMARK

PRINCIPAL REGISTER

O'CONNOR, CATHY (UNITED STATES INDIVIDUAL)
1672 JACKSON
WHITEHALL, PA 18052

FOR: GREETING CARDS, IN CLASS 16 (U.S. CLS. 2, 5, 22, 23, 29, 37, 38 AND 50).

FIRST USE 11-1-2010; IN COMMERCE 11-1-2010.

THE MARK CONSISTS OF STANDARD CHARACTERS WITHOUT CLAIM TO ANY PARTICULAR FONT, STYLE, SIZE, OR COLOR.

SN 85-167,571, FILED 11-2-2010.

IRA J. GOODSaid, EXAMINING ATTORNEY



David J. Kyffers

Director of the United States Patent and Trademark Office

United States of America

United States Patent and Trademark Office

VINALYTICS

Reg. No. 4,075,128

Registered Dec. 20, 2011

Int. Cl.: 35

SERVICE MARK

PRINCIPAL REGISTER

VINALYTICS LTD (UNITED KINGDOM CORPORATION)
20 HANOVER SQUARE
LONDON, UNITED KINGDOM W1S1JY

FOR: DATA COMPILING AND ANALYZING IN THE FIELD OF WINES; PROVIDING AN ON-LINE CONSUMER COMPUTER DATABASE IN THE FIELD OF LOCATING WINE PRODUCTS, DESCRIBING WINE PRODUCTS, RATING WINE PRODUCTS; PROMOTING THE GOODS AND SERVICES OF OTHERS BY PROVIDING A WEB SITE AT WHICH USERS CAN LINK TO WINE GROWERS, WINE MERCHANTS AND WINE RELATED GOODS AND SERVICES, IN CLASS 35 (U.S. CLS. 100, 101 AND 102).

FIRST USE 10-3-2011; IN COMMERCE 10-3-2011.

THE MARK CONSISTS OF STANDARD CHARACTERS WITHOUT CLAIM TO ANY PARTICULAR FONT, STYLE, SIZE, OR COLOR.

SN 85-167,973, FILED 11-3-2010.

GRETTA YAO, EXAMINING ATTORNEY



David J. Kyffers

Director of the United States Patent and Trademark Office

United States of America

United States Patent and Trademark Office

WHERE THE LITTLE THINGS MEAN EVERYTHING

Reg. No. 4,075,129

HLT DOMESTIC IP LLC (DELAWARE LIMITED LIABILITY COMPANY)
7930 JONES BRANCH DRIVE
MCLEAN, VA 22102

Registered Dec. 20, 2011

Int. Cl.: 43

FOR: HOTEL SERVICES, IN CLASS 43 (U.S. CLS. 100 AND 101).

SERVICE MARK

FIRST USE 8-13-2011; IN COMMERCE 8-13-2011.

PRINCIPAL REGISTER

THE MARK CONSISTS OF STANDARD CHARACTERS WITHOUT CLAIM TO ANY PARTICULAR FONT, STYLE, SIZE, OR COLOR.

SN 85-168,172, FILED 11-3-2010.

SETH A. RAPPAPORT, EXAMINING ATTORNEY



David J. Kybas

Director of the United States Patent and Trademark Office

United States of America

United States Patent and Trademark Office

QUICK SIX

Reg. No. 4,075,130

Registered Dec. 20, 2011

Int. Cl.: 41

SERVICE MARK

PRINCIPAL REGISTER

BOSS ESTATES TRUST (CALIFORNIA TRUST)
8TH FLOOR
450 N. ROXBURY DRIVE
BEVERLY HILLS, CA 90210

FOR: ENTERTAINMENT MEDIA PRODUCTION SERVICES FOR MOTION PICTURES, TELEVISION AND INTERNET; ENTERTAINMENT SERVICES IN THE NATURE OF CREATION, DEVELOPMENT, AND PRODUCTION OF TELEVISION PROGRAMMING; MOTION PICTURE FILM PRODUCTION; PRODUCTION AND DISTRIBUTION OF MOTION PICTURES; PRODUCTION AND DISTRIBUTION OF TELEVISION SHOWS AND MOVIES; PRODUCTION OF TELEVISION PROGRAMS, IN CLASS 41 (U.S. CLS. 100, 101 AND 107).

FIRST USE 9-23-2011; IN COMMERCE 9-23-2011.

THE MARK CONSISTS OF STANDARD CHARACTERS WITHOUT CLAIM TO ANY PARTICULAR FONT, STYLE, SIZE, OR COLOR.

SN 85-169,296, FILED 11-4-2010.

KEVON CHISOLM, EXAMINING ATTORNEY



David J. Kyros

Director of the United States Patent and Trademark Office

United States of America

United States Patent and Trademark Office

SAN FRANCISCO WORK SHIRTS

Reg. No. 4,075,131

Registered Dec. 20, 2011

Int. Cl.: 25

TRADEMARK

PRINCIPAL REGISTER

CLUB HOUSE CREATIONS, INC. (NEW YORK CORPORATION)
SUITE 1200
485 SEVENTH AVENUE
NEW YORK, NY 10018

FOR: MENS AND BOYS WEARING APPAREL, NAMELY, SUITS, PANTS, JACKETS, SHIRTS, VESTS, COATS, SHORTS AND SWEATERS, IN CLASS 25 (U.S. CLS. 22 AND 39).

FIRST USE 5-15-2011; IN COMMERCE 5-15-2011.

THE MARK CONSISTS OF STANDARD CHARACTERS WITHOUT CLAIM TO ANY PARTICULAR FONT, STYLE, SIZE, OR COLOR.

NO CLAIM IS MADE TO THE EXCLUSIVE RIGHT TO USE "WORK SHIRTS", APART FROM THE MARK AS SHOWN.

SN 85-169,327, FILED 11-4-2010.

JANICE KIM, EXAMINING ATTORNEY



David J. Kybas

Director of the United States Patent and Trademark Office

United States of America

United States Patent and Trademark Office

BRMobile

Reg. No. 4,075,132

Registered Dec. 20, 2011

Int. Cl.: 9

TRADEMARK

PRINCIPAL REGISTER

BUILDINGREPORTS.COM, INC. (GEORGIA CORPORATION)
SUITE 1607
1325 SATELLITE BOULEVARD
SUWANEE, GA 30024

FOR: DOWNLOADABLE SOFTWARE IN THE NATURE OF A MOBILE APPLICATION FOR INTERFACING WITH A SECURE ONLINE DATABASE IN ORDER TO ACCESS, REVIEW, AND MANAGE LIFE SAFETY INSPECTION INFORMATION, IN CLASS 9 (U.S. CLS. 21, 23, 26, 36 AND 38).

FIRST USE 11-4-2011; IN COMMERCE 11-4-2011.

THE MARK CONSISTS OF STANDARD CHARACTERS WITHOUT CLAIM TO ANY PARTICULAR FONT, STYLE, SIZE, OR COLOR.

SN 85-169,334, FILED 11-4-2010.

ADA HAN, EXAMINING ATTORNEY



David J. Kybas

Director of the United States Patent and Trademark Office

United States of America

United States Patent and Trademark Office

OPTIREAD

Reg. No. 4,075,133

TREK DIAGNOSTIC SYSTEMS, INC. (DELAWARE CORPORATION)
982 KEYNOTE CIRCLE, SUITE 6
CLEVELAND, OH 44131

Registered Dec. 20, 2011

Int. Cl.: 9

FOR: LABORATORY INSTRUMENTATION, NAMELY, APPARATUS AND COMPUTER SOFTWARE FOR DETECTING AND ASSAYING CELLULAR MATERIAL IN SAMPLES FOR CLINICAL, LABORATORY, RESEARCH, EDUCATIONAL AND/OR MEDICAL USE, IN CLASS 9 (U.S. CLS. 21, 23, 26, 36 AND 38).

TRADEMARK

PRINCIPAL REGISTER

FIRST USE 9-1-2011; IN COMMERCE 9-1-2011.

THE MARK CONSISTS OF STANDARD CHARACTERS WITHOUT CLAIM TO ANY PARTICULAR FONT, STYLE, SIZE, OR COLOR.

SN 85-169,528, FILED 11-4-2010.

TASNEEM HUSSAIN, EXAMINING ATTORNEY



David J. Kybas

Director of the United States Patent and Trademark Office

United States of America

United States Patent and Trademark Office

401(k) ALCHEMY

Reg. No. 4,075,134

FRANKLIN RESOURCES, INC. (DELAWARE CORPORATION)
ONE FRANKLIN PARKWAY
SAN MATEO, CA 944031906

Registered Dec. 20, 2011

Int. Cl.: 41

FOR: TRAINING SERVICES IN THE FIELD OF SALES, RETIREMENT SAVINGS AND CLIENT DEVELOPMENT, IN CLASS 41 (U.S. CLS. 100, 101 AND 107).

SERVICE MARK

FIRST USE 11-29-2010; IN COMMERCE 11-29-2010.

PRINCIPAL REGISTER

THE MARK CONSISTS OF STANDARD CHARACTERS WITHOUT CLAIM TO ANY PARTICULAR FONT, STYLE, SIZE, OR COLOR.

NO CLAIM IS MADE TO THE EXCLUSIVE RIGHT TO USE "401(K)", APART FROM THE MARK AS SHOWN.

SN 85-169,629, FILED 11-4-2010.

ALEX KEAM, EXAMINING ATTORNEY



David J. Kybas

Director of the United States Patent and Trademark Office

United States of America

United States Patent and Trademark Office

HW EXOTICS

Reg. No. 4,075,135

Registered Dec. 20, 2011

Int. Cl.: 28

TRADEMARK

PRINCIPAL REGISTER

MATTEL, INC. (DELAWARE CORPORATION)
M1-1518
333 CONTINENTAL BOULEVARD
EL SEGUNDO, CA 90245

FOR: TOY VEHICLES AND ACCESSORIES THEREFOR, IN CLASS 28 (U.S. CLS. 22, 23, 38 AND 50).

FIRST USE 6-22-2011; IN COMMERCE 6-22-2011.

THE MARK CONSISTS OF STANDARD CHARACTERS WITHOUT CLAIM TO ANY PARTICULAR FONT, STYLE, SIZE, OR COLOR.

SN 85-169,699, FILED 11-4-2010.

NICHOLAS ALTREE, EXAMINING ATTORNEY



David J. Kyffers

Director of the United States Patent and Trademark Office

United States of America

United States Patent and Trademark Office

REVOLUTION STUNT PARK

Reg. No. 4,075,136

Registered Dec. 20, 2011

Int. Cl.: 28

TRADEMARK

PRINCIPAL REGISTER

MATTEL, INC. (DELAWARE CORPORATION)
M1-1518
333 CONTINENTAL BOULEVARD
EL SEGUNDO, CA 90245

FOR: TOY VEHICLE TRACK SETS AND ACCESSORIES THEREFOR, IN CLASS 28 (U.S. CLS. 22, 23, 38 AND 50).

FIRST USE 6-22-2011; IN COMMERCE 6-22-2011.

THE MARK CONSISTS OF STANDARD CHARACTERS WITHOUT CLAIM TO ANY PARTICULAR FONT, STYLE, SIZE, OR COLOR.

SN 85-169,700, FILED 11-4-2010.

NICHOLAS ALTREE, EXAMINING ATTORNEY



David J. Kyffers

Director of the United States Patent and Trademark Office

United States of America

United States Patent and Trademark Office

AFTERSHOCK

Reg. No. 4,075,137

Registered Dec. 20, 2011

Int. Cl.: 28

TRADEMARK

PRINCIPAL REGISTER

TSA STORES, INC. (DELAWARE CORPORATION)
1050 WEST HAMPDEN AVENUE
ENGLEWOOD, CO 80110

FOR: SOCCER BALLS, IN CLASS 28 (U.S. CLS. 22, 23, 38 AND 50).

FIRST USE 4-0-2011; IN COMMERCE 4-0-2011.

THE MARK CONSISTS OF STANDARD CHARACTERS WITHOUT CLAIM TO ANY PARTICULAR FONT, STYLE, SIZE, OR COLOR.

SN 85-170,291, FILED 11-5-2010.

PAUL F. GAST, EXAMINING ATTORNEY



David J. Kyffers

Director of the United States Patent and Trademark Office

United States of America

United States Patent and Trademark Office



AH Holdings

Reg. No. 4,075,138

Registered Dec. 20, 2011

Int. Cl.: 35

SERVICE MARK

PRINCIPAL REGISTER

AH HOLDINGS, LLC (INDIANA LIMITED LIABILITY COMPANY)
SUITE 400
6325 DIGITAL WAY
INDIANAPOLIS, IN 46278

FOR: HOLDING COMPANY SERVICES, NAMELY, PROVIDING BUSINESS MANAGEMENT AND BUSINESS ADMINISTRATION SERVICES, AND CONSOLIDATING SHARED SERVICES, NAMELY, OFFICE FUNCTIONS AND HUMAN RESOURCES FOR SUBSIDIARIES AND AFFILIATES WHICH PROVIDE PRODUCTS AND SERVICES IN THE HEALTHCARE FIELD; BUSINESS INCUBATION SERVICES IN THE NATURE OF DEVELOPING NEW BUSINESS CONCEPTS AND START-UP BUSINESSES AND BUSINESS DEVELOPMENT SERVICES, NAMELY, BUSINESS ADVISORY SERVICES, BUSINESS CONSULTANCY AND BUSINESS INFORMATION TO BUSINESSES IN THE FIELD OF HEALTHCARE, IN CLASS 35 (U.S. CLS. 100, 101 AND 102).

FIRST USE 11-17-2010; IN COMMERCE 10-6-2011.

NO CLAIM IS MADE TO THE EXCLUSIVE RIGHT TO USE "HOLDINGS", APART FROM THE MARK AS SHOWN.

THE COLOR(S) PURPLE, RED, ORANGE, GREEN, LIGHT BLUE, DARK BLUE AND BLACK IS/ARE CLAIMED AS A FEATURE OF THE MARK.

THE MARK CONSISTS OF A STAR SHAPED FIGURE WITH SIX CURVED, NON-INTERSECTING SIDES. EACH SIDE IS A DIFFERENT COLOR. BEGINNING AT THE TOP AND MOVING CLOCKWISE, THE COLORS ARE PURPLE, RED, ORANGE, GREEN, LIGHT BLUE AND DARK BLUE. THE WORDS "AH HOLDINGS" ARE POSITIONED TO THE RIGHT OF THE FIGURE IN BLACK LETTERING WITH THE DOT OVER THE "I" IN PURPLE.

SN 85-170,353, FILED 11-5-2010.

CARYN GLASSER, EXAMINING ATTORNEY



David J. Kyros

Director of the United States Patent and Trademark Office

United States of America

United States Patent and Trademark Office

ourvoice

Reg. No. 4,075,139

EFFICIENCYLAB, LLC (NORTH CAROLINA LIMITED LIABILITY COMPANY)
124 NORTH MAIN STREET
WEAVERVILLE, NC 28787

Registered Dec. 20, 2011

Int. Cl.: 35

FOR: PUBLIC OPINION POLLING VIA THE INTERNET, IN CLASS 35 (U.S. CLS. 100, 101 AND 102).

SERVICE MARK

FIRST USE 3-16-2011; IN COMMERCE 4-1-2011.

PRINCIPAL REGISTER

THE MARK CONSISTS OF THE WORD "OURVOYCE" IN WHICH (1) "OUR" IS BLUE, (2) "VOYCE" IS RED, AND (3) THE LETTER "Y" WITHIN THE WORD "VOYCE" CONSISTS OF A REPRESENTATION OF A HUMAN BEING UNDER DESIGN CODE 27.03.02.

THE COLOR(S) BLUE AND RED IS/ARE CLAIMED AS A FEATURE OF THE MARK.

SN 85-170,818, FILED 11-5-2010.

ROSELLE HERRERA, EXAMINING ATTORNEY



David J. Kybas

Director of the United States Patent and Trademark Office

United States of America

United States Patent and Trademark Office



Reg. No. 4,075,140

Registered Dec. 20, 2011

Int. Cl.: 35

SERVICE MARK

PRINCIPAL REGISTER

EFFICIENCYLAB, LLC (NORTH CAROLINA LIMITED LIABILITY COMPANY)
124 NORTH MAIN STREET
WEAVERVILLE, NC 28787

FOR: PUBLIC OPINION POLLING VIA THE INTERNET, IN CLASS 35 (U.S. CLS. 100, 101 AND 102).

FIRST USE 3-16-2011; IN COMMERCE 4-1-2011.

THE MARK CONSISTS OF A RED REPRESENTATION OF A HUMAN BEING STANDING WITH ARMS HELD UP AND OUTSTRETCHED, AND FEET TOGETHER.

THE COLOR(S) RED IS/ARE CLAIMED AS A FEATURE OF THE MARK.

SN 85-170,965, FILED 11-7-2010.

ROSELLE HERRERA, EXAMINING ATTORNEY



David J. Kyffers

Director of the United States Patent and Trademark Office

United States of America

United States Patent and Trademark Office



Reg. No. 4,075,141

Registered Dec. 20, 2011

Int. Cl.: 36

SERVICE MARK

PRINCIPAL REGISTER

CATHOLIC COMMUNITY FOUNDATION IN THE ARCHDIOCESE OF ST. PAUL AND MINNEAPOLIS (MINNESOTA CHARITABLE, NON-PROFIT CORPORATION)
ONE WATER STREET WEST
ST. PAUL, MN 55107

FOR: CHARITABLE FOUNDATION SERVICES, NAMELY, PROVIDING FUNDRAISING ACTIVITIES, SUPPLEMENTAL FUNDING, CAPITAL IMPROVEMENT FUNDING, SCHOLARSHIPS AND FINANCIAL ASSISTANCE FOR PROGRAMS AND SERVICES OF OTHERS; CHARITABLE FUNDRAISING SERVICES; CHARITABLE FUNDRAISING SERVICES, NAMELY, BY PROVIDING INDIVIDUALS WITH THE INFORMATION AND OPPORTUNITY TO MAKE MONETARY DONATIONS TO THEIR FAVORITE CHARITY; FINANCIAL CONSULTING SERVICES IN THE FIELD OF PLANNED GIVING FOR NON-PROFIT AND CHARITABLE ORGANIZATIONS; FINANCIAL PLANNING SERVICES, NAMELY, DEVELOPING AND MANAGING CHARITABLE GIVING PROGRAMS ON BEHALF OF WEALTHY INDIVIDUALS OR FAMILIES; PROVIDING ON-LINE INFORMATION IN THE FIELD OF CHARITABLE MONETARY GIVING THROUGH FINANCIAL AND ESTATE PLANNING, IN CLASS 36 (U.S. CLS. 100, 101 AND 102).

FIRST USE 9-30-2010; IN COMMERCE 9-30-2010.

NO CLAIM IS MADE TO THE EXCLUSIVE RIGHT TO USE "CATHOLIC COMMUNITY" OR "FOUNDATION", APART FROM THE MARK AS SHOWN.

THE MARK CONSISTS OF AN IMAGE OF A TREE WITHIN A HALF CIRCLE ABOVE THE WORDS "CATHOLIC COMMUNITY FOUNDATION" HAVING A HORIZONTAL LINE BELOW "COMMUNITY" AND ABOVE "FOUNDATION".

SN 85-171,345, FILED 11-8-2010.

ANDREW LEASER, EXAMINING ATTORNEY



David J. Kybas

Director of the United States Patent and Trademark Office

United States of America

United States Patent and Trademark Office

TROFEO

Reg. No. 4,075,142

Registered Dec. 20, 2011

Int. Cl.: 25

TRADEMARK

PRINCIPAL REGISTER

ERMENEGILDO ZEGNA CORPORATION (NEW YORK CORPORATION)
UNIT A
100 WEST FOREST AVENUE
ENGLEWOOD, NJ 07631

FOR: CLOTHING, NAMELY, SUITS, JACKETS, PANTS, IN CLASS 25 (U.S. CLS. 22 AND 39).

FIRST USE 5-0-1989; IN COMMERCE 5-0-1989.

THE MARK CONSISTS OF STANDARD CHARACTERS WITHOUT CLAIM TO ANY PARTICULAR FONT, STYLE, SIZE, OR COLOR.

THE ENGLISH TRANSLATION OF "TROFEO" IN THE MARK IS "TROPHY".

SN 85-171,407, FILED 11-8-2010.

ANGELA M. MICHELI, EXAMINING ATTORNEY



David J. Kybas

Director of the United States Patent and Trademark Office

United States of America

United States Patent and Trademark Office

DOCODILE

Reg. No. 4,075,143

Registered Dec. 20, 2011

Int. Cl.: 9

TRADEMARK

PRINCIPAL REGISTER

TOWERLINE SOFTWARE, LLC (MICHIGAN LIMITED LIABILITY COMPANY)
SUITE 110
240 S. BRIDGE ST.
DEWITT, MI 48820

FOR: SOFTWARE FOR MANAGEMENT OF DOCUMENTS AND ELECTRONIC DATA, IN CLASS 9 (U.S. CLS. 21, 23, 26, 36 AND 38).

FIRST USE 7-1-2011; IN COMMERCE 7-1-2011.

THE MARK CONSISTS OF STANDARD CHARACTERS WITHOUT CLAIM TO ANY PARTICULAR FONT, STYLE, SIZE, OR COLOR.

SN 85-171,744, FILED 11-8-2010.

BARBARA GAYNOR, EXAMINING ATTORNEY



David J. Kybas

Director of the United States Patent and Trademark Office

United States of America

United States Patent and Trademark Office

PASS THE GOOD

Reg. No. 4,075,144

Registered Dec. 20, 2011

Int. Cl.: 35

SERVICE MARK

PRINCIPAL REGISTER

TSA STORES, INC. (DELAWARE CORPORATION)
1050 WEST HAMPDEN AVENUE
ENGLEWOOD, CO 80110

FOR: RETAIL SPORTING GOODS STORES, IN CLASS 35 (U.S. CLS. 100, 101 AND 102).

FIRST USE 11-21-2010; IN COMMERCE 11-21-2010.

THE MARK CONSISTS OF STANDARD CHARACTERS WITHOUT CLAIM TO ANY PARTICULAR FONT, STYLE, SIZE, OR COLOR.

SN 85-173,589, FILED 11-10-2010.

PAUL F. GAST, EXAMINING ATTORNEY



David J. Kyffers

Director of the United States Patent and Trademark Office

United States of America

United States Patent and Trademark Office



Reg. No. 4,075,145

Registered Dec. 20, 2011

Int. Cl.: 41

SERVICE MARK

PRINCIPAL REGISTER

FASHION LAW INSTITUTE (DELAWARE CORPORATION)
FORDHAM UNIVERSITY SCHOOL OF LAW
140 WEST 62ND STREET
NEW YORK, NY 10023

FOR: EDUCATIONAL SERVICES, NAMELY, CONDUCTING AND PROVIDING WORKSHOPS, SEMINARS, CLASSES, CONFERENCES, INTERNSHIPS, AND MENTORING, AND TRAINING MATERIALS DISTRIBUTED IN CONNECTION WITH SUCH SERVICES, IN THE FIELD OF FASHION LAW PROVIDING CONTINUING LEGAL EDUCATION COURSES, IN CLASS 41 (U.S. CLS. 100, 101 AND 107).

FIRST USE 8-4-2010; IN COMMERCE 8-4-2010.

THE MARK CONSISTS OF A SPOOL OF THREAD AND A NEEDLE, FORMING A GAVEL.

SN 85-173,989, FILED 11-10-2010.

BARBARA A. GOLD, EXAMINING ATTORNEY



David J. Kybas

Director of the United States Patent and Trademark Office

United States of America

United States Patent and Trademark Office

THE CONNECTED COMBINE

Reg. No. 4,075,146

Registered Dec. 20, 2011

Int. Cl.: 44

SERVICE MARK

PRINCIPAL REGISTER

MACHINERYLINK, INC. (DELAWARE CORPORATION)
SUITE 700
1600 GENESSEE STREET
KANSAS CITY, MO 64102

FOR: PROVISION OF DATA IN THE FIELDS OF AGRICULTURAL HARVEST YIELDS AND AGRICULTURAL MACHINE OPERATION AND PERFORMANCE, IN CLASS 44 (U.S. CLS. 100 AND 101).

FIRST USE 12-15-2010; IN COMMERCE 12-15-2010.

THE MARK CONSISTS OF STANDARD CHARACTERS WITHOUT CLAIM TO ANY PARTICULAR FONT, STYLE, SIZE, OR COLOR.

NO CLAIM IS MADE TO THE EXCLUSIVE RIGHT TO USE "COMBINE", APART FROM THE MARK AS SHOWN.

SN 85-174,201, FILED 11-11-2010.

NAPOLEON SHARMA, EXAMINING ATTORNEY



David J. Kybas

Director of the United States Patent and Trademark Office

United States of America

United States Patent and Trademark Office

LUMINOSITY

Reg. No. 4,075,147

SUNNY SMILES USA INC. (FLORIDA CORPORATION)
801 MONROE BLVD

Registered Dec. 20, 2011

KING OF PRUSSIA, PA 194064350

Int. Cl.: 35

FOR: RETAIL STORE SERVICES IN THE AREA OF TEETH WHITENING SUPPLIES, IN CLASS 35 (U.S. CLS. 100, 101 AND 102).

SERVICE MARK

FIRST USE 7-15-2011; IN COMMERCE 7-15-2011.

PRINCIPAL REGISTER

THE MARK CONSISTS OF STANDARD CHARACTERS WITHOUT CLAIM TO ANY PARTICULAR FONT, STYLE, SIZE, OR COLOR.

SN 85-174,634, FILED 11-11-2010.

KATHERINE CHANG, EXAMINING ATTORNEY



David J. Kybas

Director of the United States Patent and Trademark Office

United States of America

United States Patent and Trademark Office

ECONOMIC REGIME MANAGEMENT

Reg. No. 4,075,148

Registered Dec. 20, 2011

Int. Cl.: 36

SERVICE MARK

PRINCIPAL REGISTER

MEKETA INVESTMENT GROUP, INC. (MASSACHUSETTS CORPORATION)
100 LOWDER BROOK DRIVE
SUITE 1100
WESTWOOD, MA 02090

FOR: DESIGN AND IMPLEMENTATION OF INVESTMENT ALLOCATION STRATEGIES BASED ON MACROECONOMIC FACTORS, NAMELY, GEOPOLITICAL, GOVERNMENTAL, AND MARKET-STABILITY OR CRISIS-POTENTIAL, POLITICAL AND ECONOMIC INDICATORS IN THE NATURE OF INFLATION, DEFLATION, STAGFLATION, CURRENCY RISK, INTEREST-RATE RISK, AND GROWTH, IN CLASS 36 (U.S. CLS. 100, 101 AND 102).

FIRST USE 5-25-2011; IN COMMERCE 5-25-2011.

THE MARK CONSISTS OF STANDARD CHARACTERS WITHOUT CLAIM TO ANY PARTICULAR FONT, STYLE, SIZE, OR COLOR.

NO CLAIM IS MADE TO THE EXCLUSIVE RIGHT TO USE "MANAGEMENT", APART FROM THE MARK AS SHOWN.

SN 85-174,647, FILED 11-11-2010.

MICHAEL KEATING, EXAMINING ATTORNEY



David J. Kybas

Director of the United States Patent and Trademark Office

United States of America

United States Patent and Trademark Office

THE CURE FOR SEPARATION ANXIETY

Reg. No. 4,075,149

BALCONES RESOURCES, INC. (TEXAS CORPORATION)
1101 EAST 11TH STREET
AUSTIN, TX 78702

Registered Dec. 20, 2011

Int. Cl.: 40

FOR: RECYCLING SERVICES, IN CLASS 40 (U.S. CLS. 100, 103 AND 106).

SERVICE MARK

FIRST USE 11-0-2010; IN COMMERCE 11-0-2010.

PRINCIPAL REGISTER

THE MARK CONSISTS OF STANDARD CHARACTERS WITHOUT CLAIM TO ANY PARTICULAR FONT, STYLE, SIZE, OR COLOR.

SN 85-174,745, FILED 11-11-2010.

JORDAN BAKER, EXAMINING ATTORNEY



David J. Kyffers

Director of the United States Patent and Trademark Office

United States of America

United States Patent and Trademark Office

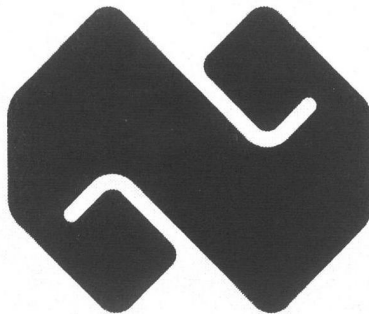

Reg. No. 4,075,150

Registered Dec. 20, 2011

Int. Cls.: 1, 7, and 10

TRADEMARK

PRINCIPAL REGISTER

NITTA GELATIN INC. (JAPAN CORPORATION)
4-26, SAKURAGAWA 4-CHOME
NANIWA-KU, OSAKA-SHI
OSAKA, JAPAN

FOR: COLLAGEN FOR USE IN FOODSTUFFS, NAMELY, NON-NUTRITIVE MIXTURE OF COLLAGEN PROTEIN AND WATER FOR FORMING AN EDIBLE CASING ON FOOD PRODUCTS AND IN CO-EXTRUSION FOOD PROCESSING, COLLAGEN POWDER FOR PRODUCING ADDITIVES FOR PROCESSED FOODS, IN CLASS 1 (U.S. CLS. 1, 5, 6, 10, 26 AND 46).

FIRST USE 11-30-1993; IN COMMERCE 7-31-2010.

FOR: SAUSAGE MACHINES, IN CLASS 7 (U.S. CLS. 13, 19, 21, 23, 31, 34 AND 35).

FIRST USE 7-31-2010; IN COMMERCE 7-31-2010.

FOR: PROCESSED COLLAGEN FOR USE IN MEDICAL TREATMENTS, NAMELY, CUTANEOUS REGENERATION, COATING OF ARTIFICIAL BLOOD VESSELS AND VALIDATION AND DEMONSTRATION OF SURGICAL DEVICES, IN CLASS 10 (U.S. CLS. 26, 39 AND 44).

FIRST USE 1-31-1996; IN COMMERCE 5-31-2011.

OWNER OF U.S. REG. NO. 3,701,063.

THE MARK CONSISTS OF A STYLIZED "N" DESIGN.

SN 85-175,176, FILED 11-12-2010.

DAYNA BROWNE, EXAMINING ATTORNEY



David J. Kypos

Director of the United States Patent and Trademark Office

United States of America

United States Patent and Trademark Office

PHRESH HARVEST

Reg. No. 4,075,151

DOCTOR PHRESH NUTRITIONALS, L.L.C. (ARIZONA LIMITED LIABILITY COMPANY)
8618 N. TATUM BLVD.
PHOENIX, AR 85028

Registered Dec. 20, 2011

Int. Cl.: 5

FOR: POWDERED NUTRITIONAL SUPPLEMENT DRINK MIX, IN CLASS 5 (U.S. CLS. 6, 18, 44, 46, 51 AND 52).

TRADEMARK

FIRST USE 2-21-2011; IN COMMERCE 2-21-2011.

PRINCIPAL REGISTER

THE MARK CONSISTS OF STANDARD CHARACTERS WITHOUT CLAIM TO ANY PARTICULAR FONT, STYLE, SIZE, OR COLOR.

SN 85-175,380, FILED 11-12-2010.

SIMON TENG, EXAMINING ATTORNEY



David J. Kyffers

Director of the United States Patent and Trademark Office

United States of America

United States Patent and Trademark Office



Reg. No. 4,075,152

Registered Dec. 20, 2011

Int. Cl.: 22

TRADEMARK

PRINCIPAL REGISTER

NEW PENDULUM CORP. (DELAWARE CORPORATION)
1105 N. MARKET STREET, SUITE 1300
WILMINGTON, DE 19801

FOR: POLYMERIC BAGS FOR INDUSTRIAL AND COMMERCIAL USE, NAMELY, BAGS FOR LIFTING AND TRANSPORTING EQUIPMENT AND DRUMS, IN CLASS 22 (U.S. CLS. 1, 2, 7, 19, 22, 42 AND 50).

FIRST USE 2-18-2010; IN COMMERCE 2-18-2010.

THE MARK CONSISTS OF AN INNER DARKENED RECTANGLE SURROUNDED BY AN OUTER RECTANGLE WITH THE LETTERS "P", "I", "G" IN LOWER-CASE STYLIZED FONT AND LOCATED INSIDE THE INNER DARKENED RECTANGLE.

SN 85-175,812, FILED 11-12-2010.

NAKIA HENRY, EXAMINING ATTORNEY



David J. Kyffers

Director of the United States Patent and Trademark Office

United States of America

United States Patent and Trademark Office



Reg. No. 4,075,153

Registered Dec. 20, 2011

Int. Cl.: 43

SERVICE MARK

PRINCIPAL REGISTER

BOUDIN IP, INC. (DELAWARE CORPORATION)
221 MAIN STREET, SUITE 1250
SAN FRANCISCO, CA 94105

FOR: RESTAURANT SERVICES, IN CLASS 43 (U.S. CLS. 100 AND 101).

FIRST USE 3-28-2011; IN COMMERCE 3-28-2011.

NO CLAIM IS MADE TO THE EXCLUSIVE RIGHT TO USE "CHOWDER" AND "GRILL",
APART FROM THE MARK AS SHOWN.

THE MARK CONSISTS OF THE STYLIZED WORDS "CHOWDER HUT GRILL" SET ON A
WATER BACKGROUND WITH TWO BIRDS IN THE UPPER RIGHT HAND CORNER ALL
SET WITHIN A FRAME.

SN 85-176,776, FILED 11-15-2010.

KEVIN DINALLO, EXAMINING ATTORNEY



David J. Kybas

Director of the United States Patent and Trademark Office

United States of America

United States Patent and Trademark Office



Reg. No. 4,075,154

ROBERT RAY GRANT III (UNITED STATES INDIVIDUAL)
18800 SHORE DRIVE
HUDSON, FL 34667

Registered Dec. 20, 2011

Int. Cl.: 28

FOR: OUTDOOR ACTIVITY GAME CONSISTING OF A STICK AND LOOP USED TO HIT AND/OR REDIRECT THE LOOP WITH THE STICK, IN CLASS 28 (U.S. CLS. 22, 23, 38 AND 50).

TRADEMARK

FIRST USE 3-1-1996; IN COMMERCE 1-1-2011.

PRINCIPAL REGISTER

NO CLAIM IS MADE TO THE EXCLUSIVE RIGHT TO USE "THE ORIGINAL", APART FROM THE MARK AS SHOWN.

THE MARK CONSISTS OF A DESIGN ELEMENT, SANDWICHED BETWEEN THE WORDS "TULEE" AND "LOOPA", CONSISTING OF TWO OVALS WITHIN TWO CIRCLES, THE CIRCLES AND OVALS BEING BISECTED BY A DIAGONAL LINE WITH AN OVAL AT THE TIP. THE WORDS "THE ORIGINAL" ARE ABOVE THE DESIGN ELEMENT.

SN 85-176,788, FILED 11-15-2010.

JUSTINE D. PARKER, EXAMINING ATTORNEY



David J. Kybas

Director of the United States Patent and Trademark Office

United States of America

United States Patent and Trademark Office

GRILLED ESSENTIALS

Reg. No. 4,075,155

Registered Dec. 20, 2011

Int. Cl.: 29

TRADEMARK

PRINCIPAL REGISTER

SARA LEE FOODS, LLC (DELAWARE LIMITED LIABILITY COMPANY)
3500 LACEY ROAD
DOWNS GROVE, IL 60515

FOR: PACKAGED MEATS, IN CLASS 29 (U.S. CL. 46).

FIRST USE 9-1-2011; IN COMMERCE 9-1-2011.

THE MARK CONSISTS OF STANDARD CHARACTERS WITHOUT CLAIM TO ANY PARTICULAR FONT, STYLE, SIZE, OR COLOR.

NO CLAIM IS MADE TO THE EXCLUSIVE RIGHT TO USE "GRILLED", APART FROM THE MARK AS SHOWN.

SN 85-177,084, FILED 11-15-2010.

DOMINICK J. SALEMI, EXAMINING ATTORNEY



David J. Kybas

Director of the United States Patent and Trademark Office

United States of America

United States Patent and Trademark Office



Reg. No. 4,075,156

Registered Dec. 20, 2011

Int. Cl.: 41

SERVICE MARK

PRINCIPAL REGISTER

VHOT TRAINING INC. (GEORGIA CORPORATION)
3401
1850 COTILLION DR
ATLANTA, GA 30338

FOR: IT TRAINING SERVICES; TRAINING SERVICES IN THE FIELD OF HOW TO USE COMMERCIAL SOFTWARE, IN CLASS 41 (U.S. CLS. 100, 101 AND 107).

FIRST USE 6-1-2010; IN COMMERCE 2-1-2011.

NO CLAIM IS MADE TO THE EXCLUSIVE RIGHT TO USE "HANDS ON TRAINING" AND "VIRTUAL HANDS ON TRAINING.COM", APART FROM THE MARK AS SHOWN.

THE MARK CONSISTS OF A MAGNIFYING LENS AND CURVES. BELOW THERE IS THE STYLIZED TEXT "VHOT HANDS ON TRAINING VIRTUALHANDSONTRAINING.COM".

SN 85-177,296, FILED 11-15-2010.

ALICE BENMAMAN, EXAMINING ATTORNEY



David J. Kyros

Director of the United States Patent and Trademark Office

United States of America

United States Patent and Trademark Office

KYDEX

THERMOPLASTIC SHEET

Reg. No. 4,075,157

KYDEX, LLC (DELAWARE LIMITED LIABILITY COMPANY)
6685 LOW STREET
BLOOMSBURG, PA 17815

Registered Dec. 20, 2011

Int. Cl.: 17

FOR: SYNTHETIC RESINOUS MATERIALS IN THE FORM OF SHEETS, NAMELY, THERMOPLASTIC SHEETS FOR USE IN THE MANUFACTURE OF A WIDE VARIETY OF PRODUCTS, IN CLASS 17 (U.S. CLS. 1, 5, 12, 13, 35 AND 50).

TRADEMARK

FIRST USE 4-18-2011; IN COMMERCE 4-18-2011.

PRINCIPAL REGISTER

OWNER OF U.S. REG. NOS. 783,815, 2,465,702, AND OTHERS.

NO CLAIM IS MADE TO THE EXCLUSIVE RIGHT TO USE "THERMOPLASTIC SHEET", APART FROM THE MARK AS SHOWN.

THE MARK CONSISTS OF THE WORD "KYDEX" WITH THE TOP BAR OF THE "E" SEPARATED FROM THE REST OF THE LETTER "E" ABOVE THE WORDS "THERMOPLASTIC SHEET".

SN 85-177,925, FILED 11-16-2010.

JIM RINGLE, EXAMINING ATTORNEY



David J. Kyffers

Director of the United States Patent and Trademark Office

United States of America

United States Patent and Trademark Office

SIMPLY SILVER. SIMPLY GOLD.

Reg. No. 4,075,158

RICHLINE GROUP, INC. (DELAWARE CORPORATION)

Registered Dec. 20, 2011

1385 BROADWAY
NEW YORK, NY 10018

Int. Cl.: 14

FOR: JEWELRY MADE IN WHOLE OR SUBSTANTIAL PART OF SILVER OR GOLD OR A COMBINATION OF SILVER AND GOLD, IN CLASS 14 (U.S. CLS. 2, 27, 28 AND 50).

TRADEMARK

FIRST USE 7-1-2011; IN COMMERCE 7-1-2011.

PRINCIPAL REGISTER

THE MARK CONSISTS OF STANDARD CHARACTERS WITHOUT CLAIM TO ANY PARTICULAR FONT, STYLE, SIZE, OR COLOR.

NO CLAIM IS MADE TO THE EXCLUSIVE RIGHT TO USE "SILVER" AND "GOLD", APART FROM THE MARK AS SHOWN.

SN 85-177,986, FILED 11-16-2010.

PAUL E. FAHRENKOPF, EXAMINING ATTORNEY



David J. Kyffers

Director of the United States Patent and Trademark Office

United States of America

United States Patent and Trademark Office

BOAT HOUSE

Reg. No. 4,075,159

Registered Dec. 20, 2011

Int. Cls.: 18, 21, and 24

TRADEMARK

PRINCIPAL REGISTER

HOMEGOODS, INC. (DELAWARE CORPORATION)
770 COCHITUATE ROAD
FRAMINGHAM, MA 01701

FOR: BEACH BAGS AND TOTE BAGS, IN CLASS 18 (U.S. CLS. 1, 2, 3, 22 AND 41).

FIRST USE 4-30-2011; IN COMMERCE 4-30-2011.

FOR: LAUNDRY HAMPERS FOR HOUSEHOLD USE, IN CLASS 21 (U.S. CLS. 2, 13, 23, 29, 30, 33, 40 AND 50).

FIRST USE 4-30-2011; IN COMMERCE 4-30-2011.

FOR: BATH TOWELS, BEACH TOWELS AND SHOWER CURTAINS, IN CLASS 24 (U.S. CLS. 42 AND 50).

FIRST USE 4-30-2011; IN COMMERCE 4-30-2011.

THE MARK CONSISTS OF STANDARD CHARACTERS WITHOUT CLAIM TO ANY PARTICULAR FONT, STYLE, SIZE, OR COLOR.

SN 85-178,040, FILED 11-16-2010.

CAROL SPILS, EXAMINING ATTORNEY



David J. Kyffers

Director of the United States Patent and Trademark Office

United States of America

United States Patent and Trademark Office

ICO

Reg. No. 4,075,160

Registered Dec. 20, 2011

Int. Cl.: 9

TRADEMARK

PRINCIPAL REGISTER

SONY COMPUTER ENTERTAINMENT AMERICA LLC (DELAWARE LIMITED LIABILITY COMPANY)
919 E. HILLSDALE BLVD.
FOSTER CITY, CA 94404

FOR: COMPUTER GAME SOFTWARE AND VIDEO GAME SOFTWARE, IN CLASS 9 (U.S. CLS. 21, 23, 26, 36 AND 38).

FIRST USE 9-24-2001; IN COMMERCE 9-24-2001.

THE MARK CONSISTS OF STANDARD CHARACTERS WITHOUT CLAIM TO ANY PARTICULAR FONT, STYLE, SIZE, OR COLOR.

SN 85-178,452, FILED 11-16-2010.

ZACHARY BELLO, EXAMINING ATTORNEY



David J. Kyffers

Director of the United States Patent and Trademark Office

United States of America

United States Patent and Trademark Office

SHADOW OF THE COLOSSUS

Reg. No. 4,075,161

Registered Dec. 20, 2011

Int. Cl.: 9

TRADEMARK

PRINCIPAL REGISTER

SONY COMPUTER ENTERTAINMENT AMERICA LLC (DELAWARE LIMITED LIABILITY COMPANY)
919 E. HILLSDALE BLVD.
FOSTER CITY, CA 94404

FOR: COMPUTER GAME SOFTWARE AND VIDEO GAME SOFTWARE, IN CLASS 9 (U.S. CLS. 21, 23, 26, 36 AND 38).

FIRST USE 10-18-2005; IN COMMERCE 10-18-2005.

THE MARK CONSISTS OF STANDARD CHARACTERS WITHOUT CLAIM TO ANY PARTICULAR FONT, STYLE, SIZE, OR COLOR.

SN 85-178,465, FILED 11-16-2010.

ZACHARY BELLO, EXAMINING ATTORNEY



David J. Kyffers

Director of the United States Patent and Trademark Office

United States of America

United States Patent and Trademark Office

NEVERDIE

Reg. No. 4,075,162

LITHIONICS, LLC (FLORIDA LIMITED LIABILITY COMPANY)
3026 HARGETT LANE
SAFETY HARBOR, FL 34695

Registered Dec. 20, 2011

Int. Cl.: 9

FOR: BATTERIES; ELECTRICAL CELLS AND BATTERIES, IN CLASS 9 (U.S. CLS. 21, 23, 26, 36 AND 38).

TRADEMARK

FIRST USE 4-15-2011; IN COMMERCE 4-15-2011.

PRINCIPAL REGISTER

THE MARK CONSISTS OF STANDARD CHARACTERS WITHOUT CLAIM TO ANY PARTICULAR FONT, STYLE, SIZE, OR COLOR.

SN 85-178,596, FILED 11-17-2010.

TIMOTHY FINNEGAN, EXAMINING ATTORNEY



David J. Kyffers

Director of the United States Patent and Trademark Office

United States of America

United States Patent and Trademark Office

ChloroFill

Reg. No. 4,075,163

CHLOROFILL LLC (CALIFORNIA LIMITED LIABILITY COMPANY)
4425 CALLE MAR DE ARMONIA
SAN DIEGO, CA 92130

Registered Dec. 20, 2011

Int. Cl.: 19

FOR: BUILDING MATERIALS, NAMELY, STRUCTURAL AND ARCHITECTURAL MEMBERS FORMED OF PRESSED PLANT FIBERS; FIBERBOARD MADE FROM SORGHUM STALKS , IN CLASS 19 (U.S. CLS. 1, 12, 33 AND 50).

TRADEMARK

FIRST USE 10-12-2011; IN COMMERCE 10-12-2011.

PRINCIPAL REGISTER

THE MARK CONSISTS OF STANDARD CHARACTERS WITHOUT CLAIM TO ANY PARTICULAR FONT, STYLE, SIZE, OR COLOR.

SN 85-178,650, FILED 11-17-2010.

ALAIN LAPTER, EXAMINING ATTORNEY



David J. Kybas

Director of the United States Patent and Trademark Office

United States of America

United States Patent and Trademark Office

Walleye An FLW Outdoors Publication

Reg. No. 4,075,164

OPERATION BASS, INC. (KENTUCKY CORPORATION)
30 GAMBLE LANE
BENTON, KY 42025

Registered Dec. 20, 2011

Int. Cl.: 16

FOR: MAGAZINES IN THE FIELD OF FISHING, IN CLASS 16 (U.S. CLS. 2, 5, 22, 23, 29, 37, 38 AND 50).

TRADEMARK

FIRST USE 1-0-2011; IN COMMERCE 1-0-2011.

PRINCIPAL REGISTER

OWNER OF U.S. REG. NOS. 2,452,208, 2,887,398, AND OTHERS.

SEC. 2(F) AS TO "OUTDOORS".

NO CLAIM IS MADE TO THE EXCLUSIVE RIGHT TO USE "WALLEYE" AND "PUBLICATION", APART FROM THE MARK AS SHOWN.

THE MARK CONSISTS OF THE WORDS: "WALLEYE AN FLW OUTDOORS PUBLICATION" WITH A HOOK DESIGN OVER THE "W" OF "WALLEYE".

SN 85-178,814, FILED 11-17-2010.

FRANK LATTUCA, EXAMINING ATTORNEY



David J. Kyros

Director of the United States Patent and Trademark Office

United States of America

United States Patent and Trademark Office

ESSENTIAL BASICS

Reg. No. 4,075,165

Registered Dec. 20, 2011

Int. Cl.: 27

TRADEMARK

PRINCIPAL REGISTER

MOHAWK CARPET DISTRIBUTION, INC. (DELAWARE CORPORATION)
P.O. BOX 800
MISTY YOUNG - LEGAL DEPT
CHATSWORTH, GA 30705

FOR: CARPETS, IN CLASS 27 (U.S. CLS. 19, 20, 37, 42 AND 50).

FIRST USE 1-12-2011; IN COMMERCE 1-12-2011.

THE MARK CONSISTS OF STANDARD CHARACTERS WITHOUT CLAIM TO ANY PARTICULAR FONT, STYLE, SIZE, OR COLOR.

SN 85-178,895, FILED 11-17-2010.

ANGELA DUONG, EXAMINING ATTORNEY



David J. Kybas

Director of the United States Patent and Trademark Office

United States of America

United States Patent and Trademark Office

LDNA

Reg. No. 4,075,166

Registered Dec. 20, 2011

Int. Cl.: 42

SERVICE MARK

PRINCIPAL REGISTER

CARNEY, INC. (VIRGINIA CORPORATION)
SUITE 401
100 N. PITT STREET
ALEXANDRIA, VA 22314

FOR: APPLICATION SERVICE PROVIDER FEATURING SOFTWARE FOR PROVIDING AN ON-LINE DATABASE OF HUMAN TRAITS, INCLUDING INDIVIDUAL PROFILES OF SKILLS, COMPETENCIES, EXPERIENCES, ATTITUDES, AND PERSONAL TRAITS, AND PRODUCE NOTIFICATIONS AND REPORTS THAT CAN INTERFACE WITH OTHER SOFTWARE APPLICATIONS, IN CLASS 42 (U.S. CLS. 100 AND 101).

FIRST USE 12-0-2000; IN COMMERCE 12-0-2000.

THE MARK CONSISTS OF STANDARD CHARACTERS WITHOUT CLAIM TO ANY PARTICULAR FONT, STYLE, SIZE, OR COLOR.

SN 85-179,054, FILED 11-17-2010.

WENDY JUN, EXAMINING ATTORNEY



David J. Kyffers

Director of the United States Patent and Trademark Office

United States of America

United States Patent and Trademark Office

GRANDIN

Reg. No. 4,075,167

Registered Dec. 20, 2011

Int. Cls.: 9, 16, and 41

TRADEMARK

SERVICE MARK

PRINCIPAL REGISTER

GRANDIN PRESS, LLC (UTAH LIMITED LIABILITY COMPANY)
651 WEST 1080 NORTH, 3RD FLOOR
AMERICAN FORK, UT 84003

FOR: ELECTRONIC PUBLICATIONS DOWNLOADABLE FROM THE INTERNET AND RECORDED ON COMPUTER MEDIA, NAMELY, FICTION AND NON-FICTION E-BOOKS, AUDIO BOOKS, ESSAYS AND ILLUSTRATIONS THAT MAY INCLUDE ADDITIONAL MATERIAL IN THE NATURE OF PHOTOGRAPHS, DIGITAL IMAGES AND MULTIMEDIA FILES CONTAINING ARTWORK, TEXT, AUDIO, AND VIDEO, ALL FEATURING A VARIETY OF TOPICS; AUDIO AND VIDEO RECORDINGS FEATURING MUSIC, IN CLASS 9 (U.S. CLS. 21, 23, 26, 36 AND 38).

FIRST USE 11-30-2010; IN COMMERCE 1-31-2011.

FOR: SERIES OF FICTION AND NON-FICTION BOOKS ON A VARIETY OF TOPICS, IN CLASS 16 (U.S. CLS. 2, 5, 22, 23, 29, 37, 38 AND 50).

FIRST USE 11-30-2010; IN COMMERCE 11-1-2011.

FOR: PUBLISHING OF E-BOOKS, BOOKS, AUDIO BOOKS, ESSAYS, MULTIMEDIA ELECTRONIC PUBLICATIONS, MUSIC AND ILLUSTRATIONS THAT MAY INCLUDE ADDITIONAL MATERIAL IN THE NATURE OF PHOTOGRAPHS, DIGITAL IMAGES AND MULTIMEDIA FILES CONTAINING ARTWORK, TEXT, AUDIO AND VIDEO, ALL FEATURING A VARIETY OF TOPICS; PROVIDING INFORMATION VIA THE INTERNET PERTAINING TO BOOK PUBLISHING AND PROVIDING ONLINE REVIEWS OF BOOKS, IN CLASS 41 (U.S. CLS. 100, 101 AND 107).

FIRST USE 11-30-2010; IN COMMERCE 11-30-2010.

THE MARK CONSISTS OF STANDARD CHARACTERS WITHOUT CLAIM TO ANY PARTICULAR FONT, STYLE, SIZE, OR COLOR.

SN 85-179,671, FILED 11-18-2010.

APRIL HESIK, EXAMINING ATTORNEY



David J. Kyffers

Director of the United States Patent and Trademark Office

United States of America

United States Patent and Trademark Office

LIFEMAP

Reg. No. 4,075,168

Registered Dec. 20, 2011

Int. Cls.: 41 and 44

SERVICE MARK

PRINCIPAL REGISTER

ROCHE DIAGNOSTICS GMBH (FED REP GERMANY LIMITED LIABILITY COMPANY)
SANDHOFER STRASSE 116
68305 MANNHEIM, FED REP GERMANY

FOR: EDUCATION AND TEACHING SERVICES, NAMELY, PROVIDING GUIDANCE, CLASSES, WORKSHOPS AND SEMINARS IN THE FIELD OF DIABETES MANAGEMENT, PUBLICATION OF PRINTED PRODUCTS, NAMELY, BOOKS, BROCHURES, LEAFLETS, AND JOURNALS RELATED TO THE FIELD OF DIABETES FOR PROFESSIONALS AND PATIENTS, IN CLASS 41 (U.S. CLS. 100, 101 AND 107).

FIRST USE 10-24-2011; IN COMMERCE 10-24-2011.

FOR: SERVICES TO OTHERS RELATED TO THE FIELD OF DIABETES FOR PROFESSIONALS AND PATIENTS, NAMELY, MEDICAL CONSULTATION, DOCUMENTATION IN THE NATURE OF MAINTAINING FILES AND RECORDS CONCERNING THE MEDICAL CONDITION OF INDIVIDUALS, WEIGHT REDUCTION DIET PLANNING AND SUPERVISION, AND PROVIDING INFORMATION ABOUT DIABETES VIA WEBSITES ON THE INTERNET, IN CLASS 44 (U.S. CLS. 100 AND 101).

FIRST USE 10-24-2011; IN COMMERCE 10-24-2011.

THE MARK CONSISTS OF STANDARD CHARACTERS WITHOUT CLAIM TO ANY PARTICULAR FONT, STYLE, SIZE, OR COLOR.

SN 85-179,724, FILED 11-18-2010.

ANDREA HACK, EXAMINING ATTORNEY



David J. Kyffers

Director of the United States Patent and Trademark Office

United States of America

United States Patent and Trademark Office

ZEON

Reg. No. 4,075,169

NORWAY INDUSTRIES, INC. (OREGON CORPORATION)
P.O. BOX 516
MYRTLE POINT, OR 97458

Registered Dec. 20, 2011

Int. Cl.: 28

FOR: ARCHERY EQUIPMENT, NAMELY, VANES FOR ARROWS, IN CLASS 28 (U.S. CLS. 22, 23, 38 AND 50).

TRADEMARK

FIRST USE 12-7-2010; IN COMMERCE 12-7-2010.

PRINCIPAL REGISTER

THE MARK CONSISTS OF STANDARD CHARACTERS WITHOUT CLAIM TO ANY PARTICULAR FONT, STYLE, SIZE, OR COLOR.

SN 85-180,250, FILED 11-18-2010.

SUNG IN, EXAMINING ATTORNEY



David J. Kybas

Director of the United States Patent and Trademark Office

United States of America

United States Patent and Trademark Office

PROCURE THE CURE

Reg. No. 4,075,170

Registered Dec. 20, 2011

Int. Cl.: 16

TRADEMARK

PRINCIPAL REGISTER

MARIE'S WORDS, INC. (CALIFORNIA CORPORATION)
3602 AMES PLACE
CARLSBAD, CA 92020

FOR: FLASH CARDS, IN CLASS 16 (U.S. CLS. 2, 5, 22, 23, 29, 37, 38 AND 50).

FIRST USE 1-7-2011; IN COMMERCE 1-7-2011.

THE MARK CONSISTS OF STANDARD CHARACTERS WITHOUT CLAIM TO ANY PARTICULAR FONT, STYLE, SIZE, OR COLOR.

SN 85-180,289, FILED 11-18-2010.

PAUL E. FAHRENKOPF, EXAMINING ATTORNEY



David J. Kyffers

Director of the United States Patent and Trademark Office

United States of America

United States Patent and Trademark Office

SUITE FINEST

Reg. No. 4,075,171

Registered Dec. 20, 2011

Int. Cl.: 24

TRADEMARK

PRINCIPAL REGISTER

HOME SOURCE INTERNATIONAL (GEORGIA CORPORATION)
SUITE 120
1100 WESTLAKE PARKWAY
ATLANTA, GA 30336

FOR: BEACH TOWELS, BATH TOWELS, KITCHEN TOWELS, TABLECLOTHS, TABLE RUNNERS ALL MADE OF FABRIC; VINYL TABLECLOTHS, TABLE MATS MADE OF FABRIC, BED SHEETS, PILLOWCASES, COMFORTERS, IN CLASS 24 (U.S. CLS. 42 AND 50).

FIRST USE 7-1-2011; IN COMMERCE 7-1-2011.

THE MARK CONSISTS OF STANDARD CHARACTERS WITHOUT CLAIM TO ANY PARTICULAR FONT, STYLE, SIZE, OR COLOR.

OWNER OF U.S. REG. NOS. 2,976,137 AND 3,797,059.

NO CLAIM IS MADE TO THE EXCLUSIVE RIGHT TO USE "FINEST", APART FROM THE MARK AS SHOWN.

SN 85-180,550, FILED 11-18-2010.

PAUL MORENO, EXAMINING ATTORNEY



David J. Kyros

Director of the United States Patent and Trademark Office

United States of America

United States Patent and Trademark Office

Gulp n Go

Reg. No. 4,075,172

Registered Dec. 20, 2011

Int. Cl.: 5

TRADEMARK

PRINCIPAL REGISTER

PROTICA INC. (DELAWARE CORPORATION)
1002 MACARTHUR RD
WHITEHALL, PA 18052

FOR: DIETARY AND NUTRITIONAL SUPPLEMENTS, IN CLASS 5 (U.S. CLS. 6, 18, 44, 46, 51 AND 52).

FIRST USE 8-4-2011; IN COMMERCE 8-4-2011.

THE MARK CONSISTS OF STANDARD CHARACTERS WITHOUT CLAIM TO ANY PARTICULAR FONT, STYLE, SIZE, OR COLOR.

SN 85-181,803, FILED 11-20-2010.

DAVID COLLIER, EXAMINING ATTORNEY



David J. Kyffers

Director of the United States Patent and Trademark Office

United States of America
United States Patent and Trademark Office

KANEKA

Reg. No. 4,075,173

KANEKA CORPORATION (JAPAN CORPORATION)
2-4, NAKANOSHIMA 3-CHOME, KITA-KU
OSAKA, JAPAN

Registered Dec. 20, 2011

Int. Cl.: 9

FOR: LABORATORY APPARATUS AND INSTRUMENTS, NAMELY, PRE-PACKED COLUMNS FOR USE IN CELL SEPARATION AND PURIFICATION, IN CLASS 9 (U.S. CLS. 21, 23, 26, 36 AND 38).

TRADEMARK

FIRST USE 10-31-2009; IN COMMERCE 6-16-2010.

PRINCIPAL REGISTER

THE MARK CONSISTS OF THE STYLIZED WORD "KANEKA".

SN 85-182,528, FILED 11-22-2010.

LINDA M. KING, EXAMINING ATTORNEY



David J. Kyffers

Director of the United States Patent and Trademark Office

United States of America

United States Patent and Trademark Office

LIVE. LOVE. REIGN.

Reg. No. 4,075,174

Registered Dec. 20, 2011

Int. Cl.: 3

TRADEMARK

PRINCIPAL REGISTER

NAKED PRINCESS WORLDWIDE, LLC (DELAWARE LIMITED LIABILITY COMPANY)
132-B LASKY DRIVE
BEVERLY HILLS, CA 90212

FOR: BATH GELS; BLUSH; BODY AND BEAUTY CARE COSMETICS; BODY CREAMS; BODY SCRUB; BODY SPLASH; BODY SPRAYS; BODY SPRAYS, NAMELY, WATER IN ATOMIZED CONTAINERS USED TO PRODUCE A COOLING EFFECT; CLEANER FOR COSMETIC BRUSHES; CONCEALERS FOR THE SKIN; COSMETIC PREPARATIONS FOR EYE LASHES; COSMETICS; COTTON FOR COSMETIC PURPOSES; COTTON PUFFS FOR COSMETIC PURPOSES; COTTON STICKS FOR COSMETIC PURPOSES; COTTON SWABS FOR COSMETIC PURPOSES; EYE CREAM; EYE GELS; EYE LINER; EYE LOTIONS; EYE MAKE-UP; EYE MAKE-UP REMOVER; EYE PENCILS; EYE SHADOWS; EYEBROW COLORS; EYEBROW COSMETICS; EYEBROW PENCILS; HAND CREAM; LIP BALM; LIP BALM; LIP GLOSS; LIP LINER; LIP POLISHER; LIPSTICK; MAKE UP FOUNDATIONS; MAKE-UP; MAKE-UP FOR THE FACE AND BODY; MASCARA; NON-MEDICATED LIP CARE PREPARATIONS; PERFUME; PERFUME OILS; SHAMPOOS; SHOWER GELS; SKIN BRONZER; SKIN MOISTURIZER; SKIN MOISTURIZER MASKS; SKIN SOAP; SOAPS FOR BODY CARE, IN CLASS 3 (U.S. CLS. 1, 4, 6, 50, 51 AND 52).

FIRST USE 10-28-2011; IN COMMERCE 10-28-2011.

THE MARK CONSISTS OF STANDARD CHARACTERS WITHOUT CLAIM TO ANY PARTICULAR FONT, STYLE, SIZE, OR COLOR.

SN 85-182,693, FILED 11-22-2010.

AMY HELLA, EXAMINING ATTORNEY



David J. Kyros

Director of the United States Patent and Trademark Office

United States of America

United States Patent and Trademark Office

PATIENT ACTIVATOR CONCIERGE

Reg. No. 4,075,175

Registered Dec. 20, 2011

Int. Cl.: 9

TRADEMARK

PRINCIPAL REGISTER

FUTURE DONTICS, INC. (CALIFORNIA CORPORATION)
6060 CENTER DRIVE
7TH FLOOR
LOS ANGELES, CA 90045

FOR: INTERACTIVE COMMUNICATIONS MANAGEMENT SOFTWARE THAT PROVIDES DENTISTS AN INTEGRATED COMMUNICATION SYSTEM FOR DELIVERING ALL EMAIL, TEXT MESSAGE, TELEPHONE AND OTHER COMMUNICATIONS TO PATIENTS, IN CLASS 9 (U.S. CLS. 21, 23, 26, 36 AND 38).

FIRST USE 12-23-2010; IN COMMERCE 12-23-2010.

THE MARK CONSISTS OF STANDARD CHARACTERS WITHOUT CLAIM TO ANY PARTICULAR FONT, STYLE, SIZE, OR COLOR.

OWNER OF U.S. REG. NO. 3,495,519.

NO CLAIM IS MADE TO THE EXCLUSIVE RIGHT TO USE "PATIENT", APART FROM THE MARK AS SHOWN.

SN 85-182,854, FILED 11-22-2010.

MARK RADEMACHER, EXAMINING ATTORNEY



David J. Kybas

Director of the United States Patent and Trademark Office

United States of America

United States Patent and Trademark Office

AQUATEC

Reg. No. 4,075,176

EX-CELL HOME FASHIONS, INC. (NEW YORK CORPORATION)
295 5TH AVENUE

Registered Dec. 20, 2011

NEW YORK, NY 10016

Int. Cl.: 24

FOR: WATER-REPELLENT FINISHED FABRIC FOR USE IN THE MANUFACTURE OF SHOWER CURTAINS AND SHOWER CURTAIN LINERS; SHOWER CURTAINS AND SHOWER CURTAIN LINERS, IN CLASS 24 (U.S. CLS. 42 AND 50).

TRADEMARK

FIRST USE 6-15-2011; IN COMMERCE 6-15-2011.

PRINCIPAL REGISTER

THE MARK CONSISTS OF STANDARD CHARACTERS WITHOUT CLAIM TO ANY PARTICULAR FONT, STYLE, SIZE, OR COLOR.

SN 85-183,140, FILED 11-23-2010.

KYLE PEETE, EXAMINING ATTORNEY



David J. Kyros

Director of the United States Patent and Trademark Office

United States of America

United States Patent and Trademark Office

YOGURT PALOOZA

Reg. No. 4,075,177

YOGURT PALOOZA INC (MICHIGAN CORPORATION)

Registered Dec. 20, 2011

34250 FORD RD
WESTLAND, MI 48185

Int. Cl.: 30

FOR: FROZEN YOGURT, IN CLASS 30 (U.S. CL. 46).

TRADEMARK

FIRST USE 7-8-2011; IN COMMERCE 7-8-2011.

PRINCIPAL REGISTER

THE MARK CONSISTS OF STANDARD CHARACTERS WITHOUT CLAIM TO ANY PARTICULAR FONT, STYLE, SIZE, OR COLOR.

NO CLAIM IS MADE TO THE EXCLUSIVE RIGHT TO USE "YOGURT", APART FROM THE MARK AS SHOWN.

SN 85-183,380, FILED 11-23-2010.

JAY FLOWERS, EXAMINING ATTORNEY



David J. Kyffers

Director of the United States Patent and Trademark Office

United States of America

United States Patent and Trademark Office



Reg. No. 4,075,178

Registered Dec. 20, 2011

Int. Cls.: 1 and 17

TRADEMARK

PRINCIPAL REGISTER

CHINA XD PLASTICS COMPANY LIMITED (NEW YORK CORPORATION)
11 BROADWAY SUITE 1004
NEW YORK, NY 10004

FOR: ARTIFICIAL AND SYNTHETIC RESINS; ARTIFICIAL RESINS; EPOXY RESINS; POLYAMIDE; POLYPROPYLENE RESINS; POLYVINYL CHLORIDE RESINS; SYNTHETIC RESINS FOR USE IN THE MANUFACTURE OF PLASTIC MOLDING COMPOUNDS; UNPROCESSED ACRYLIC RESINS FOR INDUSTRIAL USE; UNPROCESSED ARTIFICIAL RESINS; UNPROCESSED PLASTICS; UNPROCESSED SYNTHETIC RESINS, IN CLASS 1 (U.S. CLS. 1, 5, 6, 10, 26 AND 46).

FIRST USE 5-12-2011; IN COMMERCE 6-10-2011.

FOR: EBONITE; PLASTIC COMPOSITE MATERIAL IN THE FORM OF PROFILES, BOARDS, SHEETS, BLOCKS, RODS, POWDER, AND PELLETS FOR USE IN MANUFACTURING; PLASTIC TUBES FOR GENERAL INDUSTRIAL USE; RUBBER; SEMI-FINISHED ACRYLIC MOLDED PLASTIC SUBSTANCES, FOR USE IN THE MANUFACTURE OF PLASTIC MOLDING COMPOUNDS; SEMI-PROCESSED ACRYLIC RESINS; SEMI-PROCESSED PLASTIC IN THE FORM OF FILMS, SHEETS, TUBES, BARS, OR RODS; VULCANIZED FIBER, IN CLASS 17 (U.S. CLS. 1, 5, 12, 13, 35 AND 50).

FIRST USE 5-12-2011; IN COMMERCE 6-10-2011.

THE MARK CONSISTS OF "X" DESIGN.

SN 85-184,213, FILED 11-23-2010.

ELLEN BURNS, EXAMINING ATTORNEY



David J. Kyros

Director of the United States Patent and Trademark Office

United States of America

United States Patent and Trademark Office

TD BANK BUSINESS CONVENIENCE CHECKING

Reg. No. 4,075,179

Registered Dec. 20, 2011

Int. Cl.: 36

SERVICE MARK

PRINCIPAL REGISTER

THE TORONTO-DOMINION BANK (CANADA CHARTERED BANK)
12TH FLOOR TORONTO-DOMINION TOWER
66 WELLINGTON STREET
TORONTO, CANADA M5K1A2

FOR: BANKING SERVICES, IN CLASS 36 (U.S. CLS. 100, 101 AND 102).

FIRST USE 7-23-2011; IN COMMERCE 7-23-2011.

THE MARK CONSISTS OF STANDARD CHARACTERS WITHOUT CLAIM TO ANY PARTICULAR FONT, STYLE, SIZE, OR COLOR.

OWNER OF U.S. REG. NOS. 1,649,009, 3,041,170, AND OTHERS.

NO CLAIM IS MADE TO THE EXCLUSIVE RIGHT TO USE "BANK BUSINESS CONVENIENCE CHECKING", APART FROM THE MARK AS SHOWN.

SN 85-184,598, FILED 11-24-2010.

GRETCHEN ULRICH, EXAMINING ATTORNEY



David J. Kybas

Director of the United States Patent and Trademark Office

United States of America

United States Patent and Trademark Office

CLEARLY KOMBUCHA

Reg. No. 4,075,180

Registered Dec. 20, 2011

Int. Cls.: 30 and 32

TRADEMARK

PRINCIPAL REGISTER

TOP SHELF BEVERAGES, LLC (CALIFORNIA LIMITED LIABILITY COMPANY)
501 FOREST AVENUE, # 609
PALO ALTO, CA 94301

FOR: BEVERAGES MADE OF TEA; ICED TEA; TEA-BASED BEVERAGES; TEA-BASED BEVERAGES WITH FRUIT FLAVORING, IN CLASS 30 (U.S. CL. 46).

FIRST USE 10-25-2011; IN COMMERCE 10-25-2011.

FOR: ENERGY DRINKS; SOFT DRINKS; SOFT DRINKS FLAVORED WITH TEA; SPORTS DRINKS; SPORTS DRINKS, NAMELY, ENERGY DRINKS, IN CLASS 32 (U.S. CLS. 45, 46 AND 48).

FIRST USE 10-25-2011; IN COMMERCE 10-25-2011.

THE MARK CONSISTS OF STANDARD CHARACTERS WITHOUT CLAIM TO ANY PARTICULAR FONT, STYLE, SIZE, OR COLOR.

NO CLAIM IS MADE TO THE EXCLUSIVE RIGHT TO USE "KOMBUCHA", APART FROM THE MARK AS SHOWN.

SN 85-184,942, FILED 11-24-2010.

SARA BENJAMIN, EXAMINING ATTORNEY



David J. Kyros

Director of the United States Patent and Trademark Office

United States of America

United States Patent and Trademark Office

Appraisal19

Reg. No. 4,075,181

APPRAISAL19 (CALIFORNIA CORPORATION)

Registered Dec. 20, 2011

37 GOLF ROAD
PLEASANTON, CA 94566

Int. Cl.: 36

FOR: REAL ESTATE APPRAISAL SERVICES FOR RESIDENTIAL SINGLE FAMILY HOMES, TOWNHOMES, AND CONDOMINIUMS, IN CLASS 36 (U.S. CLS. 100, 101 AND 102).

SERVICE MARK

FIRST USE 2-1-2011; IN COMMERCE 2-1-2011.

PRINCIPAL REGISTER

THE MARK CONSISTS OF STANDARD CHARACTERS WITHOUT CLAIM TO ANY PARTICULAR FONT, STYLE, SIZE, OR COLOR.

SN 85-186,055, FILED 11-29-2010.

CAROLINE WOOD, EXAMINING ATTORNEY



David J. Kybas

Director of the United States Patent and Trademark Office

United States of America

United States Patent and Trademark Office

EcoLiving LED Your Eco Lighting Solution

Reg. No. 4,075,182

LOTSTAR LIMITED (HONG KONG LIMITED LIABILITY COMPANY)
7C, 524 NATHAN ROAD
KOWLOON, HONG KONG

Registered Dec. 20, 2011

Int. Cl.: 11

FOR: LAMPS; LAMP BULBS; LIGHTING FIXTURES; LED LIGHTING FIXTURES FOR IN-DOOR AND OUTDOOR LIGHTING APPLICATIONS; LED LAMPS; LED LIGHT BULBS; LED LUMINARIES; LIGHTING APPARATUS, NAMELY, LIGHTING INSTALLATIONS, IN CLASS 11 (U.S. CLS. 13, 21, 23, 31 AND 34).

TRADEMARK

PRINCIPAL REGISTER

FIRST USE 7-1-2011; IN COMMERCE 7-1-2011.

THE MARK CONSISTS OF STANDARD CHARACTERS WITHOUT CLAIM TO ANY PARTICULAR FONT, STYLE, SIZE, OR COLOR.

NO CLAIM IS MADE TO THE EXCLUSIVE RIGHT TO USE "LED" AND "ECO LIGHTING SOLUTION", APART FROM THE MARK AS SHOWN.

SN 85-186,185, FILED 11-29-2010.

MATTHEW EINSTEIN, EXAMINING ATTORNEY



David J. Kyros

Director of the United States Patent and Trademark Office

United States of America

United States Patent and Trademark Office

Leaving Footprints Custom Digital Scrapbooks

Reg. No. 4,075,183

WEBSTER, BARBARA L. (TEXAS SOLE PROPRIETORSHIP)
3712 - 63RD DR

Registered Dec. 20, 2011

LUBBOCK, TX 79413

Int. Cl.: 45

FOR: DIGITAL SCRAPBOOKING, NAMELY, PREPARATION OF CUSTOM DIGITAL SCRAPBOOKS FOR OTHERS, IN CLASS 45 (U.S. CLS. 100 AND 101).

SERVICE MARK

FIRST USE 1-1-2010; IN COMMERCE 1-1-2010.

PRINCIPAL REGISTER

THE MARK CONSISTS OF STANDARD CHARACTERS WITHOUT CLAIM TO ANY PARTICULAR FONT, STYLE, SIZE, OR COLOR.

NO CLAIM IS MADE TO THE EXCLUSIVE RIGHT TO USE "CUSTOM DIGITAL SCRAPBOOKS", APART FROM THE MARK AS SHOWN.

SN 85-186,381, FILED 11-29-2010.

LINDA ORNDORFF, EXAMINING ATTORNEY



David J. Kybas

Director of the United States Patent and Trademark Office

United States of America

United States Patent and Trademark Office

GATORADE REPLAY

Reg. No. 4,075,184

Registered Dec. 20, 2011

Int. Cl.: 41

SERVICE MARK

PRINCIPAL REGISTER

STOKELY-VAN CAMP, INC. (INDIANA CORPORATION)
555 WEST MONROE STREET
CHICAGO, IL 60661

FOR: ENTERTAINMENT, NAMELY, CONTINUING SHOWS BROADCAST OVER TELEVISION AND THE INTERNET THAT CHRONICLE THE JOURNEYS OF FORMER ATHLETES WHO ARE TRAINING FOR AND COMPETING IN SPORTS COMPETITIONS, IN CLASS 41 (U.S. CLS. 100, 101 AND 107).

FIRST USE 12-30-2010; IN COMMERCE 12-30-2010.

THE MARK CONSISTS OF STANDARD CHARACTERS WITHOUT CLAIM TO ANY PARTICULAR FONT, STYLE, SIZE, OR COLOR.

OWNER OF U.S. REG. NOS. 848,245, 1,605,457, AND OTHERS.

SN 85-186,464, FILED 11-29-2010.

KIM SAITO, EXAMINING ATTORNEY



David J. Kyffers

Director of the United States Patent and Trademark Office

United States of America

United States Patent and Trademark Office

iFileGREEN



Clean, Green Record Storage



Reg. No. 4,075,185

IFILEGREEN, LLC (NEW YORK LIMITED LIABILITY COMPANY)
370 CONCORD AVENUE
BRONX, NY 10454

Registered Dec. 20, 2011

Int. Cl.: 16

FOR: FILE BOXES FOR STORAGE OF BUSINESS AND PERSONAL RECORD, IN CLASS 16 (U.S. CLS. 2, 5, 22, 23, 29, 37, 38 AND 50).

TRADEMARK

FIRST USE 5-6-2011; IN COMMERCE 5-6-2011.

PRINCIPAL REGISTER

NO CLAIM IS MADE TO THE EXCLUSIVE RIGHT TO USE "GREEN RECORD STORAGE", APART FROM THE MARK AS SHOWN.

THE MARK CONSISTS OF THE LITERAL ELEMENT "IFILEGREEN" LOCATED ABOVE THE LITERAL ELEMENT "CLEAN, GREEN RECORD STORAGE" WITH A TREE DESIGN TO THE LEFT AND RIGHT OF "CLEAN, GREEN RECORD STORAGE".

SN 85-187,081, FILED 11-30-2010.

INGRID C. EULIN, EXAMINING ATTORNEY



David J. Kybas

Director of the United States Patent and Trademark Office

United States of America

United States Patent and Trademark Office

Get Out Gear

Reg. No. 4,075,186

Registered Dec. 20, 2011

Int. Cl.: 20

TRADEMARK

PRINCIPAL REGISTER

FIRST LINK PRODUCTS CORP (ILLINOIS CORPORATION)
28022 N. HICKORY LN
WAUCONDA, IL 60084

FOR: FURNITURE FOR CAMPING, IN CLASS 20 (U.S. CLS. 2, 13, 22, 25, 32 AND 50).

FIRST USE 6-15-2011; IN COMMERCE 6-15-2011.

THE MARK CONSISTS OF STANDARD CHARACTERS WITHOUT CLAIM TO ANY PARTICULAR FONT, STYLE, SIZE, OR COLOR.

NO CLAIM IS MADE TO THE EXCLUSIVE RIGHT TO USE "GEAR", APART FROM THE MARK AS SHOWN.

SN 85-187,347, FILED 11-30-2010.

SHAUNIA CARLYLE, EXAMINING ATTORNEY



David J. Kyffers

Director of the United States Patent and Trademark Office

United States of America

United States Patent and Trademark Office



Reg. No. 4,075,187

WEYERBACHER, MEGHAN (UNITED STATES INDIVIDUAL)
180 C BOB CORPUS LANE
MADISONVILLE, KY 42431

Registered Dec. 20, 2011

Int. Cl.: 25

FOR: INFANT AND TODDLER CLOTHING, NAMELY, INFANT AND TODDLER ONE PIECE CLOTHING, T-SHIRTS, HOODED SWEAT SHIRTS, ARM WARMERS, UNDERGARMENTS, IN CLASS 25 (U.S. CLS. 22 AND 39).

TRADEMARK

FIRST USE 1-18-2011; IN COMMERCE 1-18-2011.

PRINCIPAL REGISTER

THE MARK CONSISTS OF TWO TSHIRTS NEXT TO EACH OTHER. THE STYLIZED TEXT "TEE" AND "TOTS" APPEARS INSIDE THE TSHIRTS. IN THE MIDDLE THERE IS THE STYLIZED TEXT "RIFIC".

SN 85-187,665, FILED 11-30-2010.

KEVON CHISOLM, EXAMINING ATTORNEY



David J. Kybas

Director of the United States Patent and Trademark Office

United States of America

United States Patent and Trademark Office

QUICK PIC

Reg. No. 4,075,188

CABIN CREEK, LLC (UTAH LIMITED LIABILITY COMPANY)
1199 W 700 SOUTH
PLEASANT GROVE, UT 84062

Registered Dec. 20, 2011

Int. Cl.: 16

FOR: SCRAPBOOK ALBUMS, IN CLASS 16 (U.S. CLS. 2, 5, 22, 23, 29, 37, 38 AND 50).

TRADEMARK

FIRST USE 1-1-2011; IN COMMERCE 1-1-2011.

PRINCIPAL REGISTER

THE MARK CONSISTS OF STANDARD CHARACTERS WITHOUT CLAIM TO ANY PARTICULAR FONT, STYLE, SIZE, OR COLOR.

NO CLAIM IS MADE TO THE EXCLUSIVE RIGHT TO USE "PIC", APART FROM THE MARK AS SHOWN.

SN 85-188,784, FILED 12-1-2010.

TINA BROWN, EXAMINING ATTORNEY



David J. Kyffers

Director of the United States Patent and Trademark Office

United States of America

United States Patent and Trademark Office



Reg. No. 4,075,189

Registered Dec. 20, 2011

Int. Cl.: 16

TRADEMARK

PRINCIPAL REGISTER

BANKERS PEN (1991) INC. (CANADA CORPORATION)
5700 KIERAN ROAD
SAINT-LAURENT QC, CANADA H4S2B5

FOR: PEN INK REFILLS; REFILLS FOR BALLPOINT PENS, IN CLASS 16 (U.S. CLS. 2, 5, 22, 23, 29, 37, 38 AND 50).

FIRST USE 1-1-2011; IN COMMERCE 1-1-2011.

THE MARK CONSISTS OF THE TERM "SUREWRITE" AND A BLACK HORIZONTAL PEN SUPERIMPOSED ON THE OUTLINE OF A RECTANGLE .

SN 85-188,882, FILED 12-2-2010.

JANET LEE, EXAMINING ATTORNEY



David J. Kybas

Director of the United States Patent and Trademark Office

United States of America

United States Patent and Trademark Office

THE TRUSTED AUTHORITY

Reg. No. 4,075,190

Registered Dec. 20, 2011

Int. Cl.: 18

TRADEMARK

PRINCIPAL REGISTER

CAVALLO HORSE & RIDER (2006) INC (CANADA CORPORATION)
WWW.CAVALLO-INC.COM
1714 LOCKYER RD
ROBERTS CREEK, CANADA

FOR: HORSE FLY VEILS FOR HORSES; HORSE HALTERS; NON-METAL HORSESHOES;
PADS FOR HORSE SADDLES, IN CLASS 18 (U.S. CLS. 1, 2, 3, 22 AND 41).

FIRST USE 4-1-2011; IN COMMERCE 4-1-2011.

THE MARK CONSISTS OF STANDARD CHARACTERS WITHOUT CLAIM TO ANY PAR-
TICULAR FONT, STYLE, SIZE, OR COLOR.

SN 85-189,232, FILED 12-2-2010.

MIDGE BUTLER, EXAMINING ATTORNEY



David J. Kyffers

Director of the United States Patent and Trademark Office

United States of America

United States Patent and Trademark Office

EXPLOSION

Reg. No. 4,075,191

ERIE PROFESSIONAL FOOTBALL TEAM (PENNSYLVANIA CORPORATION)
2047 W. 12TH ST
ERIE, PA 16505

Registered Dec. 20, 2011

Int. Cl.: 41

FOR: ENTERTAINMENT IN THE NATURE OF FOOTBALL GAMES, IN CLASS 41 (U.S. CLS. 100, 101 AND 107).

SERVICE MARK

FIRST USE 12-2-2010; IN COMMERCE 9-15-2011.

PRINCIPAL REGISTER

THE MARK CONSISTS OF STANDARD CHARACTERS WITHOUT CLAIM TO ANY PARTICULAR FONT, STYLE, SIZE, OR COLOR.

SN 85-189,274, FILED 12-2-2010.

RUDY R. SINGLETON, EXAMINING ATTORNEY



David J. Kybas

Director of the United States Patent and Trademark Office

United States of America

United States Patent and Trademark Office

FYI

Reg. No. 4,075,192

FUNDEX GAMES, LTD. (NEVADA CORPORATION)
P.O. BOX 421309
INDIANAPOLIS, IL 46242

Registered Dec. 20, 2011

Int. Cl.: 28

FOR: BOARD GAMES AND CARD GAMES, IN CLASS 28 (U.S. CLS. 22, 23, 38 AND 50).

TRADEMARK

FIRST USE 11-2-2011; IN COMMERCE 11-2-2011.

PRINCIPAL REGISTER

THE MARK CONSISTS OF STANDARD CHARACTERS WITHOUT CLAIM TO ANY PARTICULAR FONT, STYLE, SIZE, OR COLOR.

SN 85-189,319, FILED 12-2-2010.

WILLIAM VERHOSEK, EXAMINING ATTORNEY



David J. Kybas

Director of the United States Patent and Trademark Office

United States of America

United States Patent and Trademark Office

OMG

Reg. No. 4,075,193

Registered Dec. 20, 2011

Int. Cl.: 28

TRADEMARK

PRINCIPAL REGISTER

FUNDEX GAMES, LTD. (NEVADA CORPORATION)
P.O. BOX 421309
INDIANAPOLIS, IL 46242

FOR: BOARD GAMES AND CARD GAMES, IN CLASS 28 (U.S. CLS. 22, 23, 38 AND 50).

FIRST USE 11-2-2011; IN COMMERCE 11-2-2011.

THE MARK CONSISTS OF STANDARD CHARACTERS WITHOUT CLAIM TO ANY PARTICULAR FONT, STYLE, SIZE, OR COLOR.

SN 85-189,325, FILED 12-2-2010.

WILLIAM VERHOSEK, EXAMINING ATTORNEY



David J. Kybas

Director of the United States Patent and Trademark Office

United States of America

United States Patent and Trademark Office

Pier Pale Ale

Reg. No. 4,075,194

Registered Dec. 20, 2011

Int. Cl.: 32

TRADEMARK

PRINCIPAL REGISTER

CHICAGO BEER COMPANY (ILLINOIS CORPORATION)
2733 N. SOUTHPORT AVE SUITE 3
CHICAGO, IL 60614

FOR: BEER, IN CLASS 32 (U.S. CLS. 45, 46 AND 48).

FIRST USE 6-4-2011; IN COMMERCE 6-4-2011.

THE MARK CONSISTS OF STANDARD CHARACTERS WITHOUT CLAIM TO ANY PARTICULAR FONT, STYLE, SIZE, OR COLOR.

NO CLAIM IS MADE TO THE EXCLUSIVE RIGHT TO USE "PALE ALE", APART FROM THE MARK AS SHOWN.

SN 85-189,486, FILED 12-2-2010.

HOWARD SMIGA, EXAMINING ATTORNEY



David J. Kyros

Director of the United States Patent and Trademark Office

United States of America

United States Patent and Trademark Office

TASTE THE MAGIC

Reg. No. 4,075,195

SAN ANTONIO WINERY, INC. (CALIFORNIA CORPORATION)
737 LAMAR STREET
LOS ANGELES, CA 90031

Registered Dec. 20, 2011

Int. Cls.: 21 and 33

FOR: ICE BUCKETS, IN CLASS 21 (U.S. CLS. 2, 13, 23, 29, 30, 33, 40 AND 50).

TRADEMARK

FIRST USE 2-28-2011; IN COMMERCE 2-28-2011.

PRINCIPAL REGISTER

FOR: WINE , IN CLASS 33 (U.S. CLS. 47 AND 49).

FIRST USE 2-28-2011; IN COMMERCE 2-28-2011.

THE MARK CONSISTS OF STANDARD CHARACTERS WITHOUT CLAIM TO ANY PARTICULAR FONT, STYLE, SIZE, OR COLOR.

SN 85-189,991, FILED 12-3-2010.

KAELIE KUNG, EXAMINING ATTORNEY



David J. Kyffers

Director of the United States Patent and Trademark Office

United States of America

United States Patent and Trademark Office

Confirm

INSECTICIDE

Reg. No. 4,075,196

NIPPON SODA CO., LTD. (JAPAN CORPORATION)
2-1, OHTEMACHI 2-CHOME, CHIYODA-KU
TOKYO, JAPAN

Registered Dec. 20, 2011

Int. Cl.: 5

FOR: INSECTICIDES FOR AGRICULTURAL AND HORTICULTURAL USE, IN CLASS 5
(U.S. CLS. 6, 18, 44, 46, 51 AND 52).

TRADEMARK

FIRST USE 8-12-2010; IN COMMERCE 8-12-2010.

PRINCIPAL REGISTER

OWNER OF U.S. REG. NO. 1,912,197.

THE COLOR(S) BLUE AND BLACK IS/ARE CLAIMED AS A FEATURE OF THE MARK.

NO CLAIM IS MADE TO THE EXCLUSIVE RIGHT TO USE "INSECTICIDE", APART FROM
THE MARK AS SHOWN.

THE MARK CONSISTS OF THE TERM "CONFIRM", IN BLUE WITH THE DOT ABOVE THE
LETTER "I" IN GREEN, SITUATED ABOVE THE TERM "INSECTICIDE" WHICH IS IN
BLACK.

SN 85-190,992, FILED 12-6-2010.

ALYSSA STEEL, EXAMINING ATTORNEY



David J. Kyros

Director of the United States Patent and Trademark Office

United States of America

United States Patent and Trademark Office

CSL

Reg. No. 4,075,197

Registered Dec. 20, 2011

Int. Cl.: 28

TRADEMARK

PRINCIPAL REGISTER

FUNDEX GAMES, LTD. (NEVADA CORPORATION)
P.O. BOX 421309
INDIANAPOLIS, IL 46242

FOR: BOARD GAMES AND CARD GAMES, IN CLASS 28 (U.S. CLS. 22, 23, 38 AND 50).

FIRST USE 11-2-2011; IN COMMERCE 11-2-2011.

THE MARK CONSISTS OF STANDARD CHARACTERS WITHOUT CLAIM TO ANY PARTICULAR FONT, STYLE, SIZE, OR COLOR.

SN 85-191,074, FILED 12-6-2010.

WILLIAM VERHOSEK, EXAMINING ATTORNEY



David J. Kybas

Director of the United States Patent and Trademark Office

United States of America

United States Patent and Trademark Office

ULTIMATE PARTY BLOCK

Reg. No. 4,075,198

FUNDEX GAMES, LTD. (NEVADA CORPORATION)
P.O. BOX 421309

Registered Dec. 20, 2011

INDIANAPOLIS, IL 46242

Int. Cl.: 28

FOR: BOARD GAMES AND CARD GAMES, IN CLASS 28 (U.S. CLS. 22, 23, 38 AND 50).

TRADEMARK

FIRST USE 11-2-2011; IN COMMERCE 11-2-2011.

PRINCIPAL REGISTER

THE MARK CONSISTS OF STANDARD CHARACTERS WITHOUT CLAIM TO ANY PARTICULAR FONT, STYLE, SIZE, OR COLOR.

SN 85-191,081, FILED 12-6-2010.

WILLIAM VERHOSEK, EXAMINING ATTORNEY



David J. Kyffers

Director of the United States Patent and Trademark Office

United States of America

United States Patent and Trademark Office

ImmYounity

Reg. No. 4,075,199

CONNAUGHT TECHNOLOGY CORPORATION (DELAWARE CORPORATION)
3711 KENNETT PIKE
GREENVILLE, DE 19807

Registered Dec. 20, 2011

Int. Cls.: 35 and 44

FOR: PROMOTING PUBLIC AWARENESS OF THE NEED FOR REGULAR VACCINATIONS,
IN CLASS 35 (U.S. CLS. 100, 101 AND 102).

SERVICE MARK

FIRST USE 8-31-2011; IN COMMERCE 8-31-2011.

PRINCIPAL REGISTER

FOR: MEDICAL INFORMATION SERVICES, NAMELY, PROVIDING INFORMATION ABOUT
VACCINES TO THE PUBLIC, IN CLASS 44 (U.S. CLS. 100 AND 101).

FIRST USE 8-31-2011; IN COMMERCE 8-31-2011.

THE MARK CONSISTS OF STANDARD CHARACTERS WITHOUT CLAIM TO ANY PAR-
TICULAR FONT, STYLE, SIZE, OR COLOR.

SN 85-191,489, FILED 12-6-2010.

LANA PHAM, EXAMINING ATTORNEY



David J. Kybas

Director of the United States Patent and Trademark Office

United States of America

United States Patent and Trademark Office



Reg. No. 4,075,200

GLOCK, GASTON J. (AUSTRIA INDIVIDUAL)
SCHREIBERWEG 16
WIEN 1190, AUSTRIA

Registered Dec. 20, 2011

Int. Cl.: 18

FOR: SPORTS BAGS; ATHLETIC BAGS; BACK PACKS; RUCK SACKS; TRAVEL BAGS;
DUFFLE BAGS, IN CLASS 18 (U.S. CLS. 1, 2, 3, 22 AND 41).

TRADEMARK

FIRST USE 4-1-2011; IN COMMERCE 9-1-2011.

PRINCIPAL REGISTER

THE MARK CONSISTS OF A WHITE "G" INSIDE A RED CIRCLE DESIGN LOGO.

THE COLOR(S) RED AND WHITE IS/ARE CLAIMED AS A FEATURE OF THE MARK.

SN 85-191,801, FILED 12-7-2010.

JANICE L. MCMORROW, EXAMINING ATTORNEY



David J. Kybas

Director of the United States Patent and Trademark Office

United States of America

United States Patent and Trademark Office



Reg. No. 4,075,201

GLOCK, GASTON J. (AUSTRIA INDIVIDUAL)
SCHREIBERWEG 16
WIEN 1190, AUSTRIA

Registered Dec. 20, 2011

Int. Cl.: 25

FOR: SPORTSWEAR, SHOOTING AND HUNTING APPAREL, NAMELY, SHIRTS, JACKETS, TROUSERS, PANTS, SHOES, BOOTS, SOCKS, CAPS, HATS, KNITTED HATS, BEANIES, HEADBANDS, SHAWLS, HEADSCARVES, SCARVES, GLOVES, HAND-WARMERS, UNDERGARMENTS, VESTS, PULLOVERS, AND EAR MUFFS, IN CLASS 25 (U.S. CLS. 22 AND 39).

TRADEMARK

PRINCIPAL REGISTER

FIRST USE 4-1-2011; IN COMMERCE 9-1-2011.

THE MARK CONSISTS OF A WHITE "G" INSIDE A RED CIRCLE DESIGN LOGO.

THE COLOR(S) RED AND WHITE IS/ARE CLAIMED AS A FEATURE OF THE MARK.

SN 85-191,804, FILED 12-7-2010.

JANICE L. MCMORROW, EXAMINING ATTORNEY



David J. Kybas

Director of the United States Patent and Trademark Office

United States of America

United States Patent and Trademark Office

OH MY GIRLS!

Reg. No. 4,075,202

Registered Dec. 20, 2011

Int. Cls.: 41 and 44

SERVICE MARK

PRINCIPAL REGISTER

ROSEN, LISA (UNITED STATES INDIVIDUAL)
55 PASTURE LANE
ROSLYN, NY 11577

FOR: EDUCATION SERVICES, NAMELY, CLASSES, SEMINARS, WORKSHOPS AND ONE-ON-ONE TUTORIALS IN THE FIELDS OF FOOD AND COOKING, NUTRITION, EXERCISE, WELLNESS, AND LIFESTYLE; HEALTH CLUB SERVICES, NAMELY, PROVIDING INSTRUCTION AND EQUIPMENT IN THE FIELD OF PHYSICAL EXERCISE; GYMNASIUMS; CONSULTING SERVICES IN THE FIELDS OF FITNESS AND EXERCISE, IN CLASS 41 (U.S. CLS. 100, 101 AND 107).

FIRST USE 9-12-2011; IN COMMERCE 9-12-2011.

FOR: COUNSELING SERVICES IN THE FIELDS OF HEALTH, NUTRITION AND LIFESTYLE WELLNESS; PROVIDING ASSISTANCE, FITNESS EVALUATION AND CONSULTATION TO INDIVIDUALS TO HELP THEM MAKE HEALTH, WELLNESS AND NUTRITIONAL CHANGES; WELLNESS AND HEALTH-RELATED CONSULTING SERVICES; HEALTH CARE SERVICES, NAMELY, WELLNESS PROGRAMS, IN CLASS 44 (U.S. CLS. 100 AND 101).

FIRST USE 9-12-2011; IN COMMERCE 9-12-2011.

THE MARK CONSISTS OF STANDARD CHARACTERS WITHOUT CLAIM TO ANY PARTICULAR FONT, STYLE, SIZE, OR COLOR.

SN 85-192,540, FILED 12-7-2010.

GILBERT SWIFT, EXAMINING ATTORNEY



David J. Kypos

Director of the United States Patent and Trademark Office

United States of America

United States Patent and Trademark Office

UNITED IN SERVICE AND FINANCIAL SECURITY

Reg. No. 4,075,203

Registered Dec. 20, 2011

Int. Cls.: 16, 35, and 41

AMERICAN FRATERNAL ALLIANCE (ILLINOIS CORPORATION)
1301 WEST 22ND STREET
SUITE 700
OAK BROOK, IL 60523

FOR: PUBLICATIONS, NAMELY, YEARBOOKS IN THE FIELD OF FRATERNAL BENEFIT SOCIETIES, IN CLASS 16 (U.S. CLS. 2, 5, 22, 23, 29, 37, 38 AND 50).

FIRST USE 1-5-2011; IN COMMERCE 1-5-2011.

TRADEMARK

SERVICE MARK

PRINCIPAL REGISTER

FOR: PROMOTING PUBLIC AWARENESS OF FRATERNAL BENEFIT SOCIETIES; ASSOCIATION AND ADVOCACY SERVICES ON BEHALF OF FRATERNAL BENEFIT SOCIETIES; AND LOBBYING SERVICES, NAMELY, PROMOTING THE INTERESTS OF FRATERNAL BENEFIT SOCIETIES IN THE FIELDS OF LEGISLATION AND REGULATION; ENCOURAGING FRATERNAL BENEFIT SOCIETIES BY PROVIDING GOVERNANCE, RULES AND REGULATIONS, IN CLASS 35 (U.S. CLS. 100, 101 AND 102).

FIRST USE 1-5-2011; IN COMMERCE 1-5-2011.

FOR: EDUCATIONAL SERVICES, NAMELY, PROVIDING CONFERENCES, SEMINARS, AND WEBINARS IN THE FIELD OF FRATERNAL BENEFIT SOCIETIES; AND PROVIDING NON-DOWNLOADABLE ONLINE PUBLICATIONS IN THE NATURE OF NEWSLETTERS AND BLOGS IN THE FIELD OF FRATERNAL BENEFIT SOCIETIES, IN CLASS 41 (U.S. CLS. 100, 101 AND 107).

FIRST USE 1-5-2011; IN COMMERCE 1-5-2011.

THE MARK CONSISTS OF STANDARD CHARACTERS WITHOUT CLAIM TO ANY PARTICULAR FONT, STYLE, SIZE, OR COLOR.

SN 85-193,189, FILED 12-8-2010.

BRIAN PINO, EXAMINING ATTORNEY



David J. Kybas

Director of the United States Patent and Trademark Office

United States of America

United States Patent and Trademark Office

ROSE'S SWEET RED

Reg. No. 4,075,204

OPICI IMPORT CO. INC. (NEW JERSEY CORPORATION)
25 DEBOER DRIVE
GLEN ROCK, NJ 07430

Registered Dec. 20, 2011

Int. Cl.: 33

FOR: WINE, IN CLASS 33 (U.S. CLS. 47 AND 49).

TRADEMARK

FIRST USE 10-25-2011; IN COMMERCE 10-25-2011.

PRINCIPAL REGISTER

THE MARK CONSISTS OF STANDARD CHARACTERS WITHOUT CLAIM TO ANY PARTICULAR FONT, STYLE, SIZE, OR COLOR.

NO CLAIM IS MADE TO THE EXCLUSIVE RIGHT TO USE "SWEET RED", APART FROM THE MARK AS SHOWN.

THE NAME(S), PORTRAIT(S), AND/OR SIGNATURE(S) SHOWN IN THE MARK DOES NOT IDENTIFY A PARTICULAR LIVING INDIVIDUAL.

SN 85-193,376, FILED 12-8-2010.

TEJBIR SINGH, EXAMINING ATTORNEY



David J. Kybas

Director of the United States Patent and Trademark Office

United States of America

United States Patent and Trademark Office

Hangover Protection

Reg. No. 4,075,205

LIQUID INNOVATIONS LLC (MICHIGAN LIMITED LIABILITY COMPANY)
1885 BEVANDA COURT
BAY CITY, MI 48706

Registered Dec. 20, 2011

Int. Cl.: 5

FOR: DIETARY SUPPLEMENTS, IN CLASS 5 (U.S. CLS. 6, 18, 44, 46, 51 AND 52).

TRADEMARK

FIRST USE 12-1-2010; IN COMMERCE 12-1-2010.

PRINCIPAL REGISTER

THE MARK CONSISTS OF STANDARD CHARACTERS WITHOUT CLAIM TO ANY PARTICULAR FONT, STYLE, SIZE, OR COLOR.

NO CLAIM IS MADE TO THE EXCLUSIVE RIGHT TO USE "HANGOVER", APART FROM THE MARK AS SHOWN.

SN 85-193,420, FILED 12-8-2010.

JULIE GUTTADAURO, EXAMINING ATTORNEY



David J. Kyffers

Director of the United States Patent and Trademark Office

United States of America

United States Patent and Trademark Office

KEEPSTOCK MOBILE

Reg. No. 4,075,206

W. W. GRAINGER, INC. (ILLINOIS CORPORATION)
100 GRAINGER PARKWAY
LAKE FOREST, IL 600455201

Registered Dec. 20, 2011

Int. Cl.: 35

FOR: INVENTORY CONTROL AND BUSINESS CONSULTATION SERVICES IN THE FIELD OF TOOL CRIB REPLENISHMENT AND MAINTENANCE, IN CLASS 35 (U.S. CLS. 100, 101 AND 102).

SERVICE MARK

FIRST USE 1-15-2011; IN COMMERCE 1-15-2011.

PRINCIPAL REGISTER

THE MARK CONSISTS OF STANDARD CHARACTERS WITHOUT CLAIM TO ANY PARTICULAR FONT, STYLE, SIZE, OR COLOR.

OWNER OF U.S. REG. NO. 3,332,077.

NO CLAIM IS MADE TO THE EXCLUSIVE RIGHT TO USE "MOBILE", APART FROM THE MARK AS SHOWN.

SN 85-193,664, FILED 12-8-2010.

MARC LEIPZIG, EXAMINING ATTORNEY



David J. Kyffers

Director of the United States Patent and Trademark Office

United States of America

United States Patent and Trademark Office

KEEPSTOCK ONSITE

Reg. No. 4,075,207

W. W. GRAINGER, INC. (ILLINOIS CORPORATION)
100 GRAINGER PARKWAY
LAKE FOREST, IL 600455201

Registered Dec. 20, 2011

Int. Cl.: 35

FOR: INVENTORY CONTROL AND BUSINESS CONSULTATION SERVICES IN THE FIELD OF TOOL CRIB REPLENISHMENT AND MAINTENANCE, IN CLASS 35 (U.S. CLS. 100, 101 AND 102).

SERVICE MARK

FIRST USE 3-2-2011; IN COMMERCE 3-2-2011.

PRINCIPAL REGISTER

THE MARK CONSISTS OF STANDARD CHARACTERS WITHOUT CLAIM TO ANY PARTICULAR FONT, STYLE, SIZE, OR COLOR.

OWNER OF U.S. REG. NO. 3,332,077.

NO CLAIM IS MADE TO THE EXCLUSIVE RIGHT TO USE "ONSITE", APART FROM THE MARK AS SHOWN.

SN 85-193,665, FILED 12-8-2010.

MARC LEIPZIG, EXAMINING ATTORNEY



David J. Kyffers

Director of the United States Patent and Trademark Office

United States of America

United States Patent and Trademark Office

ROOF SPARKLE

Reg. No. 4,075,208

AMOROSSO, DOMINICK (UNITED STATES INDIVIDUAL)
149 SOUTH CENTERVILLE RD.
MIDDLETOWN, NY 10940

Registered Dec. 20, 2011

Int. Cl.: 37

FOR: ROOF CLEANING SERVICES, IN CLASS 37 (U.S. CLS. 100, 103 AND 106).

SERVICE MARK

FIRST USE 5-15-2010; IN COMMERCE 5-15-2010.

PRINCIPAL REGISTER

THE MARK CONSISTS OF STANDARD CHARACTERS WITHOUT CLAIM TO ANY PARTICULAR FONT, STYLE, SIZE, OR COLOR.

NO CLAIM IS MADE TO THE EXCLUSIVE RIGHT TO USE "ROOF", APART FROM THE MARK AS SHOWN.

SN 85-193,792, FILED 12-9-2010.

RAUL CORDOVA, EXAMINING ATTORNEY



David J. Kyffers

Director of the United States Patent and Trademark Office

United States of America

United States Patent and Trademark Office



Reg. No. 4,075,209

Registered Dec. 20, 2011

Int. Cl.: 44

SERVICE MARK

PRINCIPAL REGISTER

SANJIV K. SAINI, M.D., L.L.C. (MARYLAND LIMITED LIABILITY COMPANY)
5 PERDER LANE
EDGEWATER, MD 21037

FOR: DERMATOLOGY SERVICES; LASER AND INTENSE PULSE LIGHT SKIN ENHANCEMENT PROCEDURES; PROVIDING LASER THERAPY FOR TREATING MEDICAL CONDITIONS, IN CLASS 44 (U.S. CLS. 100 AND 101).

FIRST USE 11-20-2010; IN COMMERCE 1-11-2011.

THE MARK CONSISTS OF A FACE IN PROFILE VIEW FACING UP WITH A SEMICIRCULAR SHADED BACKGROUND BEHIND THE FACE.

SN 85-194,288, FILED 12-9-2010.

JEFFREY LOOK, EXAMINING ATTORNEY



David J. Kybas

Director of the United States Patent and Trademark Office

United States of America

United States Patent and Trademark Office

Swiss Cellars

Reg. No. 4,075,210

NOUVEAU VENTURES, LLC (WISCONSIN LIMITED LIABILITY COMPANY)
405 NORDIC TRAIL
MT HOREB, WI 53572

Registered Dec. 20, 2011

Int. Cl.: 35

FOR: IMPORT AGENCY IN THE FIELD OF WINES, BEERS AND LIQUORS; WHOLESALE DISTRIBUTORSHIPS AND ON-LINE RETAIL STORE SERVICES FEATURING WINES, BEERS AND LIQUORS , IN CLASS 35 (U.S. CLS. 100, 101 AND 102).

SERVICE MARK

FIRST USE 4-18-2003; IN COMMERCE 4-18-2003.

PRINCIPAL REGISTER

NO CLAIM IS MADE TO THE EXCLUSIVE RIGHT TO USE "SWISS CELLARS", APART FROM THE MARK AS SHOWN.

THE COLOR(S) BLACK, RED AND WHITE IS/ARE CLAIMED AS A FEATURE OF THE MARK.

THE MARK CONSISTS OF THE WORDS "SWISS CELLARS" IN STYLIZED BLACK FONT IN THE FOREGROUND AND AN ABSTRACT DESIGN IN THE BACKGROUND WHICH CONSISTS OF AN ABSTRACT RED SHAPE WITH A WHITE CROSS IN THE CENTER OF THE SHAPE.

SN 85-195,192, FILED 12-10-2010.

TRICIA SONNEBORN, EXAMINING ATTORNEY



David J. Kyros

Director of the United States Patent and Trademark Office

United States of America

United States Patent and Trademark Office

CAROLINA

Reg. No. 4,075,211

MVP GROUP INTERNATIONAL, INC. (KENTUCKY CORPORATION)
1031 LE GRAND BLVD.
CHARLESTON, SC 29492

Registered Dec. 20, 2011

Int. Cls.: 4 and 11

FOR: MELT TARTS, NAMELY, SCENTED WAX TO BE MELTED SLOWLY WITH A WARMER, IN CLASS 4 (U.S. CLS. 1, 6 AND 15).

TRADEMARK

FIRST USE 1-31-2011; IN COMMERCE 1-31-2011.

PRINCIPAL REGISTER

FOR: ELECTRIC WARMERS FOR MELTING SCENTED WAX, IN CLASS 11 (U.S. CLS. 13, 21, 23, 31 AND 34).

FIRST USE 1-31-2011; IN COMMERCE 1-31-2011.

THE MARK CONSISTS OF STANDARD CHARACTERS WITHOUT CLAIM TO ANY PARTICULAR FONT, STYLE, SIZE, OR COLOR.

SN 85-195,329, FILED 12-10-2010.

MIDGE BUTLER, EXAMINING ATTORNEY



David J. Kyros

Director of the United States Patent and Trademark Office

United States of America

United States Patent and Trademark Office



Reg. No. 4,075,212

Registered Dec. 20, 2011

Int. Cl.: 3

TRADEMARK

PRINCIPAL REGISTER

BEIERSDORF AG (FED REP GERMANY CORPORATION)
UNNASTRASSE 48
HAMBURG, FED REP GERMANY 20253

FOR: NON-MEDICATED LIP CARE PREPARATIONS, IN CLASS 3 (U.S. CLS. 1, 4, 6, 50, 51 AND 52).

FIRST USE 8-24-2011; IN COMMERCE 8-24-2011.

OWNER OF U.S. REG. NOS. 3,528,909, 3,528,912, AND OTHERS.

THE COLOR(S) BLUE, SILVER, PINK, RED AND WHITE IS/ARE CLAIMED AS A FEATURE OF THE MARK.

THE MARK CONSISTS OF THE DESIGNATION "NIVEA" IN WHITE LETTERS AGAINST A BLUE RECTANGLE EDGED IN SILVER, DISPLAYED UPON A WOMAN'S PINK AND WHITE FACE WHICH APPEARS ABOVE THE DESIGNATION "A KISS OF BERRY SWIRL" IN BLUE LETTERS AGAINST A RECTANGULAR WHITE AND PINK BACKGROUND, BEHIND, ABOVE AND BELOW WHICH ARE RED BERRIES AGAINST A SWIRLING PINK AND WHITE BACKGROUND. IN THE LOWER RIGHT PORTION OF THE MARK IS A SILVER BORDER DISPLAYING, ON ITS RIGHT SIDE, A SILVER CIRCULAR ARROW SURROUNDING A BLUE AND WHITE DROPLET AGAINST A WHITE CIRCULAR BACKGROUND. ON THE LEFT SIDE OF THE MARK APPEARS A LIGHT BLUE AND WHITE SPLASH OF WATER AGAINST A LIGHT BLUE AND DARK BLUE RECTANGULAR BACKGROUND.

SN 85-195,914, FILED 12-11-2010.

CAROL SPILS, EXAMINING ATTORNEY



David J. Kyffers

Director of the United States Patent and Trademark Office

United States of America

United States Patent and Trademark Office

GIBBON

Reg. No. 4,075,213

Registered Dec. 20, 2011

Int. Cl.: 25

TRADEMARK

PRINCIPAL REGISTER

ID SPORTS GMBH (FED REP GERMANY LIMITED LIABILITY COMPANY)
CALWERSTRASSE 11
70173 STUTTGART, FED REP GERMANY

FOR: SHOES, SPORTS SHOES; SPORTSWEAR, NAMELY, FUNCTIONAL T-SHIRTS, WRISTBANDS, HEADBANDS, SHORTS, TRACKSUITS, CLOTHING, NAMELY, SHIRTS, SWEATSHIRTS, PANTS, TROUSERS, SOCKS, GLOVES, SWEATERS, BLOUSES, BELTS, JUMPERS, JACKETS, SKIRTS, SCARFS; HOODED SWEATSHIRTS; HEADGEAR, NAMELY, CAPS, HATS, IN CLASS 25 (U.S. CLS. 22 AND 39).

FIRST USE 8-20-2008; IN COMMERCE 8-20-2008.

THE MARK CONSISTS OF STANDARD CHARACTERS WITHOUT CLAIM TO ANY PARTICULAR FONT, STYLE, SIZE, OR COLOR.

SN 85-196,841, FILED 12-13-2010.

GEOFFREY FOSDICK, EXAMINING ATTORNEY



David J. Kybas

Director of the United States Patent and Trademark Office

United States of America

United States Patent and Trademark Office

A FAMILY BUSINESS PUBLICATION

Reg. No. 4,075,214

FAMILY BUSINESS CONSULTING GROUP, INC., THE (GEORGIA CORPORATION)
1220-B KENNESTONE CIRCLE
MARIETTA, GA 30066

Registered Dec. 20, 2011

Int. Cl.: 16

FOR: PUBLICATIONS, NAMELY, BOOKS IN THE FIELDS OF BUSINESS MANAGEMENT AND ASSET PROTECTION, IN CLASS 16 (U.S. CLS. 2, 5, 22, 23, 29, 37, 38 AND 50).

TRADEMARK

FIRST USE 12-15-2010; IN COMMERCE 12-15-2010.

PRINCIPAL REGISTER

THE MARK CONSISTS OF STANDARD CHARACTERS WITHOUT CLAIM TO ANY PARTICULAR FONT, STYLE, SIZE, OR COLOR.

SEC. 2(F) AS TO "FAMILY BUSINESS".

OWNER OF U.S. REG. NOS. 2,847,126 AND 2,852,819.

NO CLAIM IS MADE TO THE EXCLUSIVE RIGHT TO USE "PUBLICATION", APART FROM THE MARK AS SHOWN.

SN 85-197,398, FILED 12-14-2010.

CURTIS FRENCH, EXAMINING ATTORNEY



David J. Kybas

Director of the United States Patent and Trademark Office

United States of America

United States Patent and Trademark Office

RESTORING THE RHYTHM OF YOUR LIFE

Reg. No. 4,075,215

CALIBER HOLDINGS CORPORATION (DELAWARE CORPORATION)
17771 COWAN AVENUE, SUITE 100
IRVINE, CA 92614

Registered Dec. 20, 2011

Int. Cl.: 37

FOR: BODY AND PAINT REPAIR SERVICES FOR COLLISION DAMAGED VEHICLES, IN CLASS 37 (U.S. CLS. 100, 103 AND 106).

SERVICE MARK

FIRST USE 4-0-2011; IN COMMERCE 4-0-2011.

PRINCIPAL REGISTER

THE MARK CONSISTS OF STANDARD CHARACTERS WITHOUT CLAIM TO ANY PARTICULAR FONT, STYLE, SIZE, OR COLOR.

SN 85-197,486, FILED 12-14-2010.

SARA BENJAMIN, EXAMINING ATTORNEY



David J. Kyffers

Director of the United States Patent and Trademark Office

United States of America

United States Patent and Trademark Office

ACELLA

Reg. No. 4,075,216

DILON TECHNOLOGIES, INC. (DELAWARE CORPORATION)
12050 JEFFERSON AVENUE
NEWPORT NEWS, VA 23606

Registered Dec. 20, 2011

Int. Cl.: 10

FOR: MEDICAL APPARATUS AND INSTRUMENTS FOR USE IN MEDICAL GAMMA IMAGING, IN CLASS 10 (U.S. CLS. 26, 39 AND 44).

TRADEMARK

FIRST USE 6-30-2010; IN COMMERCE 6-30-2010.

PRINCIPAL REGISTER

THE MARK CONSISTS OF STANDARD CHARACTERS WITHOUT CLAIM TO ANY PARTICULAR FONT, STYLE, SIZE, OR COLOR.

SN 85-198,109, FILED 12-15-2010.

GISELLE AGOSTO, EXAMINING ATTORNEY



David J. Kybas

Director of the United States Patent and Trademark Office

United States of America

United States Patent and Trademark Office

Protica Cares

Reg. No. 4,075,217

Registered Dec. 20, 2011

Int. Cl.: 35

SERVICE MARK

PRINCIPAL REGISTER

PROTICA INC. (DELAWARE CORPORATION)
1002 MACARTHUR RD
WHITEHALL, PA 18052

FOR: CHARITABLE SERVICES, NAMELY, COORDINATION OF THE PROCUREMENT AND DISTRIBUTION OF GIFT-IN-KIND PRODUCT DONATIONS FROM MANUFACTURERS, WHOLESALERS, RETAILERS, AND GOVERNMENT AGENCIES TO ORGANIZATIONS PROVIDING FREE PRODUCTS TO NEEDY PEOPLE, IN CLASS 35 (U.S. CLS. 100, 101 AND 102).

FIRST USE 12-27-2010; IN COMMERCE 12-27-2010.

THE MARK CONSISTS OF STANDARD CHARACTERS WITHOUT CLAIM TO ANY PARTICULAR FONT, STYLE, SIZE, OR COLOR.

OWNER OF U.S. REG. NO. 2,660,915.

SN 85-198,350, FILED 12-15-2010.

DAVID COLLIER, EXAMINING ATTORNEY



David J. Kyros

Director of the United States Patent and Trademark Office

United States of America

United States Patent and Trademark Office

POLYTWIST

Reg. No. 4,075,218

BEDFORD INDUSTRIES, INC. (SOUTH DAKOTA CORPORATION)
1659 ROWE AVENUE
WORTHINGTON, MN 56187

Registered Dec. 20, 2011

Int. Cl.: 20

FOR: POLYMERIC TWIST TIE CLOSURES FOR USE WITH PACKAGING, IN CLASS 20
(U.S. CLS. 2, 13, 22, 25, 32 AND 50).

TRADEMARK

FIRST USE 6-13-2011; IN COMMERCE 6-13-2011.

PRINCIPAL REGISTER

THE MARK CONSISTS OF STANDARD CHARACTERS WITHOUT CLAIM TO ANY PARTICULAR FONT, STYLE, SIZE, OR COLOR.

OWNER OF U.S. REG. NOS. 2,306,305 AND 2,730,128.

SN 85-199,245, FILED 12-16-2010.

MARTHA FROMM, EXAMINING ATTORNEY



David J. Kybas

Director of the United States Patent and Trademark Office

United States of America

United States Patent and Trademark Office

COMBAT OF GIANTS

Reg. No. 4,075,219

Registered Dec. 20, 2011

Int. Cl.: 9

TRADEMARK

PRINCIPAL REGISTER

UBISOFT ENTERTAINMENT (FRANCE CORPORATION)
107 AVENUE HENRI FREVILLE
RENNES, FRANCE 35200

FOR: GAME SOFTWARE AND ELECTRONIC GAME PROGRAMS, NAMELY, SOFTWARE GAMES RECORDED ON CARTRIDGES FOR CONSOLE AND INDIVIDUAL, PORTABLE GAMING SYSTEMS, IN CLASS 9 (U.S. CLS. 21, 23, 26, 36 AND 38).

FIRST USE 3-31-2011; IN COMMERCE 3-31-2011.

THE MARK CONSISTS OF STANDARD CHARACTERS WITHOUT CLAIM TO ANY PARTICULAR FONT, STYLE, SIZE, OR COLOR.

OWNER OF U.S. REG. NO. 3,709,915.

SN 85-199,260, FILED 12-16-2010.

JOHN WILKE, EXAMINING ATTORNEY



David J. Kyffers

Director of the United States Patent and Trademark Office

United States of America

United States Patent and Trademark Office

PEST DEFIER

Reg. No. 4,075,220

Registered Dec. 20, 2011

Int. Cl.: 19

TRADEMARK

PRINCIPAL REGISTER

FXI, INC. (DELAWARE CORPORATION)
1400 NORTH PROVIDENCE ROAD, SUITE 2000
MEDIA, PA 19063

FOR: NON-METAL GUTTER PROTECTION PRODUCTS, NAMELY, GUTTERS, GUTTER PIPES, DOWNSPOUT COVERS, GUTTER COVERS, END CAPS AND EAVES, IN CLASS 19 (U.S. CLS. 1, 12, 33 AND 50).

FIRST USE 2-0-2011; IN COMMERCE 2-0-2011.

THE MARK CONSISTS OF STANDARD CHARACTERS WITHOUT CLAIM TO ANY PARTICULAR FONT, STYLE, SIZE, OR COLOR.

OWNER OF U.S. REG. NO. 3,027,215.

NO CLAIM IS MADE TO THE EXCLUSIVE RIGHT TO USE "PEST", APART FROM THE MARK AS SHOWN.

SN 85-199,398, FILED 12-16-2010.

VERNA BETH RIRIE, EXAMINING ATTORNEY



David J. Kyffers

Director of the United States Patent and Trademark Office

United States of America

United States Patent and Trademark Office

MSGR

Reg. No. 4,075,221

Registered Dec. 20, 2011

Int. Cl.: 25

TRADEMARK

PRINCIPAL REGISTER

YUGEN KAISHA FORTY FOUR (FORTY FOUR CO., LTD.) (JAPAN CORPORATION)
SAKAI BLDG. 1F,
4-CHOME 25-13 HAKATA-EKI-MAE, HAKATA-KU,
FUKUOKA-SHI, FUKUOKA, JAPAN

FOR: APRONS; BANDANAS; BASEBALL CAPS AND HATS; BATHING CAPS; BELTS;
BOOTS; BRACES; COATS; EAR MUFFS; GARTERS; GLOVES; HATS; JACKETS AND
SOCKS; JEANS; MASQUERADE COSTUMES; MUFFLERS; NECKERCHIEFS; NECKTIES;
PAJAMAS; PANTS; SANDALS; SCARVES; SHIRTS; SHOES; SHORTS; SKULL CAPS;
SNEAKERS; STOLEES; SUSPENDERS; SWEATERS; SWIMSUITS; T-SHIRTS; UNDERWEAR;
VESTS, IN CLASS 25 (U.S. CLS. 22 AND 39).

FIRST USE 6-1-2000; IN COMMERCE 7-1-2011.

THE MARK CONSISTS OF STANDARD CHARACTERS WITHOUT CLAIM TO ANY PAR-
TICULAR FONT, STYLE, SIZE, OR COLOR.

SN 85-199,407, FILED 12-16-2010.

CHRISIE B. KING, EXAMINING ATTORNEY



David J. Kybas

Director of the United States Patent and Trademark Office

United States of America

United States Patent and Trademark Office

LUNATIK

Reg. No. 4,075,222

Registered Dec. 20, 2011

Int. Cls.: 9 and 14

TRADEMARK

PRINCIPAL REGISTER

WIMO LABS LLC (ILLINOIS LIMITED LIABILITY COMPANY)
1032 WEST FULTON MARKET
SUITE 201
CHICAGO, IL 60607

FOR: WRISTBANDS SPECIALLY DESIGNED TO HOLD MOBILE TELEPHONES, TO HOLD MOBILE COMPUTERS, TO HOLD PERSONAL DIGITAL ASSISTANTS (PDA), AND TO HOLD MP3 PLAYERS, IN CLASS 9 (U.S. CLS. 21, 23, 26, 36 AND 38).

FIRST USE 4-14-2011; IN COMMERCE 4-14-2011.

FOR: WATCH BANDS, IN CLASS 14 (U.S. CLS. 2, 27, 28 AND 50).

FIRST USE 4-14-2011; IN COMMERCE 4-14-2011.

THE MARK CONSISTS OF STANDARD CHARACTERS WITHOUT CLAIM TO ANY PARTICULAR FONT, STYLE, SIZE, OR COLOR.

SN 85-199,408, FILED 12-16-2010.

JOHN KELLY, EXAMINING ATTORNEY



David J. Kyfos

Director of the United States Patent and Trademark Office

United States of America

United States Patent and Trademark Office



OLEballnchain

Reg. No. 4,075,223

PANIZZI, BRIAN (UNITED STATES INDIVIDUAL)
7123 S 250 E

Registered Dec. 20, 2011

LAFAYETTE, IN 47909

Int. Cl.: 18

FOR: DOG RESTRAINT PRODUCT, NAMELY, A HOLLOW PLASTIC BALL THAT IS ATTACHED TO A DOG BY WAY OF A TUBE COVERED CHAIN, WHICH IS AFFIXED TO A DOG COLLAR OR HARNESS; PET CLOTHING; ANIMAL HARNESES, IN CLASS 18 (U.S. CLS. 1, 2, 3, 22 AND 41).

TRADEMARK

PRINCIPAL REGISTER

FIRST USE 6-1-2011; IN COMMERCE 9-26-2011.

THE MARK CONSISTS OF THE TEXT "OLEBALLNCHAIN" WITH A FLYING BEAGLE ATTACHED BY LEASH TO THE FIRST LETTER, "O".

SN 85-200,528, FILED 12-17-2010.

ALLISON SCHRODY, EXAMINING ATTORNEY



David J. Kybas

Director of the United States Patent and Trademark Office

United States of America

United States Patent and Trademark Office

APPGRADE

Reg. No. 4,075,224

Registered Dec. 20, 2011

Int. Cl.: 42

SERVICE MARK

PRINCIPAL REGISTER

HITACHI CONSULTING CORPORATION (DELAWARE CORPORATION)
123 N. WACKER DR.
SUITE 1200
CHICAGO, IL 60606

FOR: COMPUTER SOFTWARE CONSULTING SERVICES IN THE FIELD OF EVALUATING SOFTWARE ENVIRONMENTS FOR OTHERS, IN CLASS 42 (U.S. CLS. 100 AND 101).

FIRST USE 1-31-2011; IN COMMERCE 1-31-2011.

THE MARK CONSISTS OF STANDARD CHARACTERS WITHOUT CLAIM TO ANY PARTICULAR FONT, STYLE, SIZE, OR COLOR.

SN 85-201,794, FILED 12-20-2010.

EMILY CHUO, EXAMINING ATTORNEY



David J. Kyffers

Director of the United States Patent and Trademark Office

United States of America

United States Patent and Trademark Office



Reg. No. 4,075,225

Registered Dec. 20, 2011

Int. Cl.: 43

SERVICE MARK

PRINCIPAL REGISTER

BECK FAMILY RESTAURANTS, LLC. (TEXAS LIMITED LIABILITY COMPANY)
5055 LAKEHILL COURT
DALLAS, TX 752202134

FOR: RESTAURANT SERVICES, INCLUDING SIT-DOWN SERVICE OF FOOD AND TAKE-OUT RESTAURANT SERVICES, IN CLASS 43 (U.S. CLS. 100 AND 101).

FIRST USE 4-1-2011; IN COMMERCE 4-1-2011.

NO CLAIM IS MADE TO THE EXCLUSIVE RIGHT TO USE "DINER", APART FROM THE MARK AS SHOWN.

THE MARK CONSISTS OF A CIRCLE ENCLOSING THE WORDS "DI DI'S TAMALE DINER", WITH "TAMALE" CENTERED IN ALL CAPITAL LETTERS AND THE OTHER WORDS IN A STYLIZED SCRIPT. ABOVE "TAMALE" ARE THREE REPRESENTATIONS OF EARS OF CORN WITH THE TERM "DI DI'S" TO THEIR LEFT. BELOW "TAMALE" AND "DINER" ARE THREE STARS.

SN 85-202,556, FILED 12-21-2010.

VIVIAN MICZNIK FIRST, EXAMINING ATTORNEY



David J. Kybas

Director of the United States Patent and Trademark Office

United States of America

United States Patent and Trademark Office

PEACE LOVE YOGURT

Reg. No. 4,075,226

Registered Dec. 20, 2011

Int. Cl.: 30

TRADEMARK

PRINCIPAL REGISTER

YOGURT PALOOZA INC (MICHIGAN CORPORATION)
34250 FORD RD
WESTLAND, MI 48185

FOR: FROZEN YOGURT, IN CLASS 30 (U.S. CL. 46).

FIRST USE 7-8-2011; IN COMMERCE 7-8-2011.

THE MARK CONSISTS OF STANDARD CHARACTERS WITHOUT CLAIM TO ANY PARTICULAR FONT, STYLE, SIZE, OR COLOR.

NO CLAIM IS MADE TO THE EXCLUSIVE RIGHT TO USE "YOGURT", APART FROM THE MARK AS SHOWN.

SN 85-203,408, FILED 12-21-2010.

JAY FLOWERS, EXAMINING ATTORNEY



David J. Kyffers

Director of the United States Patent and Trademark Office

United States of America

United States Patent and Trademark Office

TRUDEFINITION

Reg. No. 4,075,227

Registered Dec. 20, 2011

Int. Cl.: 19

TRADEMARK

PRINCIPAL REGISTER

OWENS CORNING INTELLECTUAL CAPITAL, LLC (DELAWARE LIMITED LIABILITY COMPANY)
ONE OWENS CORNING PARKWAY
TOLEDO, OH 43659

FOR: NON-METAL SHINGLES, IN CLASS 19 (U.S. CLS. 1, 12, 33 AND 50).

FIRST USE 6-30-2011; IN COMMERCE 6-30-2011.

THE MARK CONSISTS OF STANDARD CHARACTERS WITHOUT CLAIM TO ANY PARTICULAR FONT, STYLE, SIZE, OR COLOR.

SN 85-203,852, FILED 12-22-2010.

ALICE BENMAMAN, EXAMINING ATTORNEY



David J. Kybas

Director of the United States Patent and Trademark Office

United States of America

United States Patent and Trademark Office

REPLY RIDES FREE

Reg. No. 4,075,228

Registered Dec. 20, 2011

Int. Cls.: 35 and 39

SERVICE MARK

PRINCIPAL REGISTER

UNITED STATES POSTAL SERVICE (UNITED STATES INDEPENDENT ESTABLISHMENT OF THE EXECUTIVE BRANCH OF THE GOVERNMENT OF THE UNITED STATES OF AMERICA)

475 L'ENFANT PLAZA, SW
WASHINGTON, DC 202601136

FOR: SORTING HANDLING, AND RECEIVING PACKAGES AND LETTERS; ARRANGING AND CONDUCTING INCENTIVE REWARD PROGRAMS TO PROMOTE THE SALE OF POSTAGE AND MAILING AND DELIVERY SERVICES, IN CLASS 35 (U.S. CLS. 100, 101 AND 102).

FIRST USE 1-2-2011; IN COMMERCE 1-2-2011.

FOR: PICKUP, TRANSPORTATION AND DELIVERY OF PACKAGES AND DOCUMENTS BY VARIOUS MODES OF TRANSPORTATION, IN CLASS 39 (U.S. CLS. 100 AND 105).

FIRST USE 1-2-2011; IN COMMERCE 1-2-2011.

THE MARK CONSISTS OF STANDARD CHARACTERS WITHOUT CLAIM TO ANY PARTICULAR FONT, STYLE, SIZE, OR COLOR.

SN 85-203,928, FILED 12-22-2010.

JEFFERY COWARD, EXAMINING ATTORNEY



David J. Kybas

Director of the United States Patent and Trademark Office

United States of America

United States Patent and Trademark Office

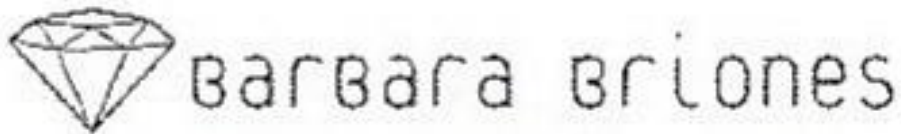

Reg. No. 4,075,229

BARBARA BRIONES MARASOVIC (CHILE INDIVIDUAL)
88 LEONARD STREET, APT 1101
NEW YORK, NY 10013

Registered Dec. 20, 2011

Int. Cl.: 25

FOR: SHOES, IN CLASS 25 (U.S. CLS. 22 AND 39).

TRADEMARK

FIRST USE 7-31-2011; IN COMMERCE 7-31-2011.

PRINCIPAL REGISTER

THE NAME "BARBARA BRIONES" IDENTIFIES A LIVING INDIVIDUAL WHOSE CONSENT IS OF RECORD.

THE MARK CONSISTS OF A DESIGN OF A DIAMOND TO THE SIDE OF THE NAME "BARBARA BRIONES".

SN 85-204,124, FILED 12-22-2010.

JENNIFER DIXON, EXAMINING ATTORNEY



David J. Kyffers

Director of the United States Patent and Trademark Office

United States of America

United States Patent and Trademark Office

SMASHER

Reg. No. 4,075,230

LUCKY CRAFT CO., LTD. (JAPAN CORPORATION)
21 KANAYAHONGOU

Registered Dec. 20, 2011

OYABE-SHI, TOYAMA, JAPAN

Int. Cl.: 28

FOR: FISHING EQUIPMENT, NAMELY, FISHING LURES, IN CLASS 28 (U.S. CLS. 22, 23, 38 AND 50).

TRADEMARK

FIRST USE 1-1-2011; IN COMMERCE 1-1-2011.

PRINCIPAL REGISTER

THE MARK CONSISTS OF STANDARD CHARACTERS WITHOUT CLAIM TO ANY PARTICULAR FONT, STYLE, SIZE, OR COLOR.

SN 85-204,293, FILED 12-22-2010.

JANET LEE, EXAMINING ATTORNEY



David J. Kybas

Director of the United States Patent and Trademark Office

United States of America

United States Patent and Trademark Office

TEAM STREAM

Reg. No. 4,075,231

BLEACHER REPORT, INC. (DELAWARE CORPORATION)
330 TOWNSEND STREET, SUITE 212
SAN FRANCISCO, CA 94107

Registered Dec. 20, 2011

Int. Cl.: 41

FOR: PROVIDING INFORMATION IN THE FIELD OF SPORTS; PROVIDING LINKS TO THE WEBSITES OF OTHERS FEATURING INFORMATION AND ENTERTAINMENT IN THE FIELD OF SPORTS, IN CLASS 41 (U.S. CLS. 100, 101 AND 107).

SERVICE MARK

FIRST USE 11-2-2010; IN COMMERCE 11-2-2010.

PRINCIPAL REGISTER

THE MARK CONSISTS OF STANDARD CHARACTERS WITHOUT CLAIM TO ANY PARTICULAR FONT, STYLE, SIZE, OR COLOR.

SN 85-204,434, FILED 12-22-2010.

FLORENTINA BLANDU, EXAMINING ATTORNEY



David J. Kybas

Director of the United States Patent and Trademark Office

United States of America

United States Patent and Trademark Office

IT THINKS LIKE A TRADER.

Reg. No. 4,075,232

Registered Dec. 20, 2011

Int. Cls.: 9 and 36

TRADEMARK

SERVICE MARK

PRINCIPAL REGISTER

CHARLES SCHWAB & CO., INC. (CALIFORNIA CORPORATION)
211 MAIN STREET
SAN FRANCISCO, CA 94105

FOR: DOWNLOADABLE COMPUTER SOFTWARE FOR USE IN ON-LINE TRADING OF SECURITIES AND PORTFOLIO MANAGEMENT IN THE FIELDS OF FINANCE AND INVESTMENT, IN CLASS 9 (U.S. CLS. 21, 23, 26, 36 AND 38).

FIRST USE 3-1-2011; IN COMMERCE 3-1-2011.

FOR: INVESTMENT BROKERAGE AND INVESTMENT PORTFOLIO MANAGEMENT SERVICES PROVIDED VIA GLOBAL ELECTRONIC NETWORKS; PROVIDING INFORMATION AND ANALYSIS IN THE FIELDS OF FINANCE AND INVESTMENT VIA GLOBAL ELECTRONIC NETWORKS; PROVIDING INFORMATION REGARDING INVESTMENT ACCOUNT ACTIVITY VIA GLOBAL ELECTRONIC NETWORKS, IN CLASS 36 (U.S. CLS. 100, 101 AND 102).

FIRST USE 3-1-2011; IN COMMERCE 3-1-2011.

THE MARK CONSISTS OF STANDARD CHARACTERS WITHOUT CLAIM TO ANY PARTICULAR FONT, STYLE, SIZE, OR COLOR.

SN 85-204,764, FILED 12-23-2010.

LINDSEY RUBIN, EXAMINING ATTORNEY



David J. Kyjars

Director of the United States Patent and Trademark Office

United States of America

United States Patent and Trademark Office

ZIPCLAVE

Reg. No. 4,075,233

SDS DENTAL INC. (FLORIDA CORPORATION), AKA SUMMIT DENTAL SYSTEMS,
6277 NW 28TH WAY
FORT LAUDERDALE, FL 33309

Registered Dec. 20, 2011

Int. Cl.: 10

FOR: AUTOCLAVES FOR MEDICAL USE, IN CLASS 10 (U.S. CLS. 26, 39 AND 44).

TRADEMARK

FIRST USE 9-0-2011; IN COMMERCE 9-0-2011.

PRINCIPAL REGISTER

THE MARK CONSISTS OF STANDARD CHARACTERS WITHOUT CLAIM TO ANY PARTICULAR FONT, STYLE, SIZE, OR COLOR.

SN 85-204,899, FILED 12-23-2010.

ROBIN CHOSID, EXAMINING ATTORNEY



David J. Kyffers

Director of the United States Patent and Trademark Office

United States of America

United States Patent and Trademark Office



Reg. No. 4,075,234

MANN'S MANUFACTURING, INC (OREGON CORPORATION)
31235 S. BOND ROAD
HUBBARD, OR 97032

Registered Dec. 20, 2011

Int. Cl.: 20

FOR: FURNITURE; FURNITURE MADE FROM WOOD OR SUBSTITUTES FOR WOOD, IN CLASS 20 (U.S. CLS. 2, 13, 22, 25, 32 AND 50).

TRADEMARK

FIRST USE 7-5-2011; IN COMMERCE 7-5-2011.

PRINCIPAL REGISTER

NO CLAIM IS MADE TO THE EXCLUSIVE RIGHT TO USE "MANUFACTURING, INC.", APART FROM THE MARK AS SHOWN.

THE STIPPLING IS FOR SHADING PURPOSES ONLY.

THE MARK CONSISTS OF A STYLIZED SETTING SUN BEHIND A FLYING GOOSE AND THE TEXT "MANN'S MANUFACTURING, INC. MMI".

SN 85-205,411, FILED 12-23-2010.

PAUL E. FAHRENKOPF, EXAMINING ATTORNEY



David J. Kybas

Director of the United States Patent and Trademark Office

United States of America

United States Patent and Trademark Office



Reg. No. 4,075,235

AMELIA'S DREAM, INC (NEW YORK CORPORATION)
111 W. 96TH STREET, APT. 1
NEW YORK, NY 10025

Registered Dec. 20, 2011

Int. Cls.: 21 and 25

FOR: COFFEE CUPS, TEA CUPS AND MUGS, IN CLASS 21 (U.S. CLS. 2, 13, 23, 29, 30, 33, 40 AND 50).

TRADEMARK

FIRST USE 5-22-2010; IN COMMERCE 11-13-2010.

PRINCIPAL REGISTER

FOR: FLEECE PULLOVERS; FLEECE TOPS; HOODED SWEATSHIRTS; JACKETS; PANTS; POLO SHIRTS; SHIRTS; SHOES; SHORTS; SOCKS; SWEATERS; SWEATPANTS; T-SHIRTS, IN CLASS 25 (U.S. CLS. 22 AND 39).

FIRST USE 5-22-2010; IN COMMERCE 11-13-2010.

THE MARK CONSISTS OF THE TEXT "ANGST! WWW.PARENTSWITHANGST.COM" INSIDE A SPEECH BUBBLE.

SN 85-205,970, FILED 12-27-2010.

IRA J. GOODSaid, EXAMINING ATTORNEY



David J. Kybas

Director of the United States Patent and Trademark Office

United States of America

United States Patent and Trademark Office

mycool

Reg. No. 4,075,236

Registered Dec. 20, 2011

Int. Cls.: 9 and 11

TRADEMARK

PRINCIPAL REGISTER

BAILIDA INTERNATIONAL, INC. (NEW JERSEY CORPORATION)
468 STATE ROAD
468 STATE ROAD
PRINCETON, NJ 08540

FOR: 3D CAMERA SYSTEMS, NAMELY, ADAPTERS FOR ALLOWING 3D SHOOTING; AUDIO-VIDEO RECEIVERS; CALCULATING MACHINES, DATA-PROCESSING EQUIPMENT AND COMPUTERS; COMPUTER KEYBOARDS; DIGITAL CAMERAS; DVD PLAYERS; GPS NAVIGATION DEVICE; HOME THEATER PRODUCTS, NAMELY, LCD; KEYBOARDS; MOBILE PHONES; MP3 PLAYERS; MP4 PLAYERS; TELEVISIONS AND MONITORS; VIDEO GAME MACHINES FOR USE WITH TELEVISIONS; WIRELESS INDOOR AND OUTDOOR SPEAKERS, IN CLASS 9 (U.S. CLS. 21, 23, 26, 36 AND 38).

FIRST USE 7-1-2011; IN COMMERCE 10-1-2011.

FOR: AIR CLEANING UNITS; AIR CONDITIONERS; AIR PURIFIERS; COMBINATION MICROWAVE/CONVECTION OVEN; DEHUMIDIFIERS; ELECTRIC FANS; ELECTRIC RADIANT HEATERS; ELECTRIC RICE COOKER; FREEZERS; HOODS FOR RANGES; ICE MAKING MACHINES; INDUCTION OVENS; LED LIGHTING FIXTURES FOR INDOOR AND OUTDOOR LIGHTING APPLICATIONS; MICROWAVE OVENS; RANGE HOODS; REFRIGERATORS; SOLAR LIGHT FIXTURES, NAMELY, INDOOR AND OUTDOOR SOLAR POWERED LIGHTING UNITS AND FIXTURES; SOLAR WATER HEATERS; WINE COOLERS, NAMELY, REFRIGERATED CABINETS CONTAINING RACKS FOR WINE BOTTLES AND STORAGE SHELVES, IN CLASS 11 (U.S. CLS. 13, 21, 23, 31 AND 34).

FIRST USE 8-1-2011; IN COMMERCE 10-1-2011.

THE MARK CONSISTS OF STANDARD CHARACTERS WITHOUT CLAIM TO ANY PARTICULAR FONT, STYLE, SIZE, OR COLOR.

SN 85-206,058, FILED 12-27-2010.

MICHELLE DUBOIS, EXAMINING ATTORNEY



David J. Kybas

Director of the United States Patent and Trademark Office

United States of America

United States Patent and Trademark Office

COPS & BOBBERS

Reg. No. 4,075,237

COPS AND KIDS FOUNDATION, INC. (WISCONSIN CORPORATION)
W249N8120 HILLSIDE RD.
SUSSEX, WI 53089

Registered Dec. 20, 2011

Int. Cl.: 36

FOR: CHARITABLE FUNDRAISING TO SUPPORT YOUTH PROGRAMS IN THE FIELD OF SPORTS AND RECREATION, IN CLASS 36 (U.S. CLS. 100, 101 AND 102).

SERVICE MARK

FIRST USE 0-0-2001; IN COMMERCE 10-0-2010.

PRINCIPAL REGISTER

THE MARK CONSISTS OF STANDARD CHARACTERS WITHOUT CLAIM TO ANY PARTICULAR FONT, STYLE, SIZE, OR COLOR.

SN 85-208,503, FILED 12-31-2010.

ANTHONY RINKER, EXAMINING ATTORNEY



David J. Kybas

Director of the United States Patent and Trademark Office

United States of America

United States Patent and Trademark Office

GUTTER BUSTERS

Reg. No. 4,075,238

COPS AND KIDS FOUNDATION, INC. (WISCONSIN CORPORATION)
W249N8120 HILLSIDE RD.
SUSSEX, WI 53089

Registered Dec. 20, 2011

Int. Cl.: 36

FOR: CHARITABLE FUNDRAISING TO SUPPORT YOUTH PROGRAMS IN THE FIELD OF SPORTS AND RECREATION, IN CLASS 36 (U.S. CLS. 100, 101 AND 102).

SERVICE MARK

FIRST USE 0-0-2002; IN COMMERCE 10-0-2010.

PRINCIPAL REGISTER

THE MARK CONSISTS OF STANDARD CHARACTERS WITHOUT CLAIM TO ANY PARTICULAR FONT, STYLE, SIZE, OR COLOR.

SN 85-208,509, FILED 12-31-2010.

ANTHONY RINKER, EXAMINING ATTORNEY



David J. Kybas

Director of the United States Patent and Trademark Office

United States of America

United States Patent and Trademark Office

BADGES & BULLS EYES

Reg. No. 4,075,239

COPS AND KIDS FOUNDATION, INC. (WISCONSIN CORPORATION)
W249N8120 HILLSIDE RD.
SUSSEX, WI 53089

Registered Dec. 20, 2011

Int. Cl.: 36

FOR: CHARITABLE FUNDRAISING TO SUPPORT YOUTH PROGRAMS IN THE FIELD OF SPORTS AND RECREATION, IN CLASS 36 (U.S. CLS. 100, 101 AND 102).

SERVICE MARK

FIRST USE 0-0-2003; IN COMMERCE 10-0-2010.

PRINCIPAL REGISTER

THE MARK CONSISTS OF STANDARD CHARACTERS WITHOUT CLAIM TO ANY PARTICULAR FONT, STYLE, SIZE, OR COLOR.

SN 85-208,514, FILED 12-31-2010.

ANTHONY RINKER, EXAMINING ATTORNEY



David J. Kybas

Director of the United States Patent and Trademark Office

United States of America

United States Patent and Trademark Office



Reg. No. 4,075,240

Registered Dec. 20, 2011

Int. Cl.: 41

SERVICE MARK

PRINCIPAL REGISTER

BOURGET, HAZEL (CALIFORNIA LIMITED LIABILITY COMPANY), DBA BLU
BUNGALOW,
2068 UNION STREET
SAN FRANCISCO, CA 94043

FOR: CONSULTATION IN THE FIELD OF SPECIAL EVENT PLANNING FOR SOCIAL ENTERTAINMENT PURPOSES; PARTY AND WEDDING PLANNING, COORDINATION AND CONSULTATION SERVICES, IN CLASS 41 (U.S. CLS. 100, 101 AND 107).

FIRST USE 3-12-2011; IN COMMERCE 3-12-2011.

THE MARK CONSISTS OF A CIRCLE WITH A FLOWER-LIKE DESIGN INSIDE IT WITH THE TERM "BLU" APPEARING IN STYLIZED FONT INSIDE THE DESIGN, WITH THE TERM "BUNGALOW" DISPLAYED IN STYLIZED FONT NEXT TO THE DESIGN.

SN 85-208,740, FILED 12-31-2010.

HELENE LIWINSKI, EXAMINING ATTORNEY



David J. Kybas

Director of the United States Patent and Trademark Office

United States of America

United States Patent and Trademark Office

STREET SLEUTH

Reg. No. 4,075,241

ALLSTATE INSURANCE COMPANY (ILLINOIS CORPORATION)

Registered Dec. 20, 2011

ALLSTATE PLAZA
NORTHBROOK, IL 60062

Int. Cl.: 42

FOR: SOFTWARE IN THE NATURE OF A NON-DOWNLOADABLE INTERNET APPLICATION FOR EDUCATING THE USER ABOUT THE DANGERS OF DISTRACTED DRIVING, IN CLASS 42 (U.S. CLS. 100 AND 101).

SERVICE MARK

FIRST USE 1-17-2011; IN COMMERCE 1-17-2011.

PRINCIPAL REGISTER

THE MARK CONSISTS OF STANDARD CHARACTERS WITHOUT CLAIM TO ANY PARTICULAR FONT, STYLE, SIZE, OR COLOR.

SN 85-208,956, FILED 1-3-2011.

ZACHARY BELLO, EXAMINING ATTORNEY



David J. Kyffers

Director of the United States Patent and Trademark Office

United States of America

United States Patent and Trademark Office



Reg. No. 4,075,242

Registered Dec. 20, 2011

Int. Cl.: 35

SERVICE MARK

PRINCIPAL REGISTER

ENTERPRISE HOLDINGS, INC. (MISSOURI CORPORATION)
600 CORPORATE PARK DRIVE
ST. LOUIS, MO 63105

FOR: PROMOTING PUBLIC AWARENESS OF ENVIRONMENTAL ISSUES BY PROVIDING A WEBSITE, PRINTED AND BROADCAST MARKETING MATERIALS FEATURING INFORMATION IN THE FIELDS OF ENVIRONMENTAL SUSTAINABILITY, CONSERVATION AND STEWARDSHIP, IN CLASS 35 (U.S. CLS. 100, 101 AND 102).

FIRST USE 1-24-2011; IN COMMERCE 1-24-2011.

OWNER OF U.S. REG. NOS. 1,234,835, 2,136,409, AND OTHERS.

THE COLOR(S) GREEN, WHITE, BLACK, BLUE AND BROWN IS/ARE CLAIMED AS A FEATURE OF THE MARK.

THE MARK CONSISTS OF A WHITE BANNER BEARING A WHITE LETTER "E" INSIDE A GREEN SQUARE AND THE LITERAL ELEMENT "ENTERPRISE" IN BLACK TO THE RIGHT OF THE GREEN SQUARE, AND A TEARDROP-SHAPED DEPICTION OF THE EARTH IN THE COLORS BLUE, WHITE, GREEN AND BROWN.

SN 85-210,214, FILED 1-4-2011.

JOHN WILKE, EXAMINING ATTORNEY



David J. Kybas

Director of the United States Patent and Trademark Office

United States of America

United States Patent and Trademark Office



Reg. No. 4,075,243

Registered Dec. 20, 2011

Int. Cls.: 29 and 43

TRADEMARK

SERVICE MARK

PRINCIPAL REGISTER

LONG JOHN SILVER'S INC. (DELAWARE CORPORATION)
LEGAL - TRADEMARKS
1441 GARDINER LANE
LOUISVILLE, KY 40213

FOR: PREPARED ENTREES CONSISTING PRIMARILY OF SEAFOOD AND/OR CHICKEN FOR CONSUMPTION ON OR OFF PREMISES, IN CLASS 29 (U.S. CL. 46).

FIRST USE 2-10-2011; IN COMMERCE 2-10-2011.

FOR: RESTAURANT SERVICES, IN CLASS 43 (U.S. CLS. 100 AND 101).

FIRST USE 2-10-2011; IN COMMERCE 2-10-2011.

THE MARK CONSISTS OF STYLIZED BLUE FISH CONTAINING WHITE INTERIOR PORTIONS (INCLUDING AN EYE) WITH A YELLOW SPLASH OF WATER COMING OFF THE TOP FIN AND AN AQUA SPLASH OF WATER COMING OFF BOTTOM FIN.

THE COLOR(S) WHITE, BLUE, YELLOW, AND AQUA IS/ARE CLAIMED AS A FEATURE OF THE MARK.

SN 85-210,339, FILED 1-4-2011.

KARANENDRA S. CHHINA, EXAMINING ATTORNEY



David J. Kybas

Director of the United States Patent and Trademark Office

United States of America

United States Patent and Trademark Office

CUDDLEBUGS

Reg. No. 4,075,244

HEIRLOOM PORTRAITS, INC. (TEXAS CORPORATION)

Registered Dec. 20, 2011

1474 SH 123 SOUTH
STOCKDALE, TX 78160

Int. Cl.: 16

FOR: PORTRAITS, IN CLASS 16 (U.S. CLS. 2, 5, 22, 23, 29, 37, 38 AND 50).

TRADEMARK

FIRST USE 1-1-2011; IN COMMERCE 1-1-2011.

PRINCIPAL REGISTER

THE MARK CONSISTS OF STANDARD CHARACTERS WITHOUT CLAIM TO ANY PARTICULAR FONT, STYLE, SIZE, OR COLOR.

SN 85-211,539, FILED 1-6-2011.

RAUL CORDOVA, EXAMINING ATTORNEY



David J. Kyffers

Director of the United States Patent and Trademark Office

United States of America

United States Patent and Trademark Office

READYRECEPTOR

Reg. No. 4,075,245

Registered Dec. 20, 2011

Int. Cl.: 1

TRADEMARK

PRINCIPAL REGISTER

INTEGRAL MOLECULAR, INC. (DELAWARE CORPORATION)
4TH FLOOR,
3701 MARKET STREET
PHILADELPHIA, PA 19104

FOR: CELLULAR AND VIRAL MEMBRANE PROTEINS FOR USE IN SCIENTIFIC AND BIOMEDICAL RESEARCH AND DRUG DISCOVERY, IN CLASS 1 (U.S. CLS. 1, 5, 6, 10, 26 AND 46).

FIRST USE 12-7-2010; IN COMMERCE 12-7-2010.

THE MARK CONSISTS OF STANDARD CHARACTERS WITHOUT CLAIM TO ANY PARTICULAR FONT, STYLE, SIZE, OR COLOR.

SN 85-213,025, FILED 1-7-2011.

EUGENIA MARTIN, EXAMINING ATTORNEY



David J. Kyjars

Director of the United States Patent and Trademark Office

United States of America

United States Patent and Trademark Office

PDC-CP

Reg. No. 4,075,246

Registered Dec. 20, 2011

Int. Cl.: 9

TRADEMARK

PRINCIPAL REGISTER

MANS, MITCHELL C. (UNITED STATES INDIVIDUAL)
149 KINGSPORT ROAD
HOLLY SPRINGS, NC 27540 AND

MANS, LENA L. (UNITED STATES INDIVIDUAL)
149 KINGSPORT ROAD
HOLLY SPRINGS, NC 27540

FOR: COMPUTER APPLICATION SOFTWARE FOR CARB COUNTING, NAMELY, SOFTWARE FOR TABULATING THE CARBOHYDRATE TO INSULIN RATIO FOR DIABETES MAINTENANCE AND CONTROL; COMPUTER PROGRAMS FOR USING THE INTERNET AND THE WORLDWIDE WEB; DOWNLOADABLE SOFTWARE FOR CARB COUNTING FOR DIABETES CONTROL, IN CLASS 9 (U.S. CLS. 21, 23, 26, 36 AND 38).

FIRST USE 6-1-2006; IN COMMERCE 6-10-2010.

THE MARK CONSISTS OF STANDARD CHARACTERS WITHOUT CLAIM TO ANY PARTICULAR FONT, STYLE, SIZE, OR COLOR.

SN 85-213,640, FILED 1-9-2011.

CHARLES L. JENKINS, EXAMINING ATTORNEY



David J. Kybas

Director of the United States Patent and Trademark Office

United States of America
United States Patent and Trademark Office

TALKFREE

Reg. No. 4,075,247

TALK FREE, INC. (DELAWARE CORPORATION)
101 TOWNSEND STREET, SUITE 301
SAN FRANCISCO, CA 94107

Registered Dec. 20, 2011

Int. Cl.: 38

FOR: VOICE OVER INTERNET PROTOCOL (VOIP) SERVICES, IN CLASS 38 (U.S. CLS. 100, 101 AND 104).

SERVICE MARK

FIRST USE 10-31-2004; IN COMMERCE 10-31-2004.

PRINCIPAL REGISTER

THE MARK CONSISTS OF STANDARD CHARACTERS WITHOUT CLAIM TO ANY PARTICULAR FONT, STYLE, SIZE, OR COLOR.

SN 85-215,423, FILED 1-11-2011.

AISHA CLARKE, EXAMINING ATTORNEY



David J. Kybas

Director of the United States Patent and Trademark Office

United States of America

United States Patent and Trademark Office

GLUTA-TRĒN

Reg. No. 4,075,248

PROMERA HEALTH LLC (MASSACHUSETTS LIMITED LIABILITY COMPANY)
61 ACCORD PARK DRIVE
NORWELL, MA 02061

Registered Dec. 20, 2011

Int. Cl.: 5

FOR: DIETARY SUPPLEMENTS, IN CLASS 5 (U.S. CLS. 6, 18, 44, 46, 51 AND 52).

TRADEMARK

FIRST USE 5-24-2011; IN COMMERCE 5-24-2011.

PRINCIPAL REGISTER

THE MARK CONSISTS OF STANDARD CHARACTERS WITHOUT CLAIM TO ANY PARTICULAR FONT, STYLE, SIZE, OR COLOR.

SN 85-215,712, FILED 1-12-2011.

GILBERT SWIFT, EXAMINING ATTORNEY



David J. Kyffers

Director of the United States Patent and Trademark Office

United States of America
United States Patent and Trademark Office

QUADLINK

Reg. No. 4,075,249

Registered Dec. 20, 2011

Int. Cl.: 9

TRADEMARK

PRINCIPAL REGISTER

PULSETECH PRODUCTS CORPORATION (TEXAS CORPORATION)
1100 SOUTH KIMBALL AVENUE
SOUTHLAKE, TX 76092

FOR: BATTERY CHARGER MULTIPLEXER, IN CLASS 9 (U.S. CLS. 21, 23, 26, 36 AND 38).

FIRST USE 10-20-2011; IN COMMERCE 10-20-2011.

THE MARK CONSISTS OF STANDARD CHARACTERS WITHOUT CLAIM TO ANY PARTICULAR FONT, STYLE, SIZE, OR COLOR.

SN 85-216,197, FILED 1-12-2011.

KAREN BRACEY, EXAMINING ATTORNEY



David J. Kyffers

Director of the United States Patent and Trademark Office

United States of America

United States Patent and Trademark Office

MONTAGUE TECHNOSTAR

Reg. No. 4,075,250

MONTAGUE COMPANY, THE (CALIFORNIA CORPORATION)
1830 STEARMAN AVE.
HAYWARD, CA 94540

Registered Dec. 20, 2011

Int. Cl.: 11

FOR: COOKING OVENS; COOKING RANGES, IN CLASS 11 (U.S. CLS. 13, 21, 23, 31 AND 34).

TRADEMARK

FIRST USE 5-31-2011; IN COMMERCE 5-31-2011.

PRINCIPAL REGISTER

THE MARK CONSISTS OF STANDARD CHARACTERS WITHOUT CLAIM TO ANY PARTICULAR FONT, STYLE, SIZE, OR COLOR.

OWNER OF U.S. REG. NOS. 2,741,188, 3,460,633, AND OTHERS.

SN 85-216,469, FILED 1-12-2011.

EUGENIA MARTIN, EXAMINING ATTORNEY



David J. Kyros

Director of the United States Patent and Trademark Office

United States of America

United States Patent and Trademark Office



Reg. No. 4,075,251

MONTAGUE COMPANY, THE (CALIFORNIA CORPORATION)
1830 STEARMAN AVE.
HAYWARD, CA 94540

Registered Dec. 20, 2011

Int. Cl.: 11

FOR: COOKING OVENS; COOKING RANGES, IN CLASS 11 (U.S. CLS. 13, 21, 23, 31 AND 34).

TRADEMARK

FIRST USE 5-31-2011; IN COMMERCE 5-31-2011.

PRINCIPAL REGISTER

OWNER OF U.S. REG. NOS. 2,741,188, 3,460,633, AND OTHERS.

THE COLOR(S) BLACK, WHITE AND GOLD IS/ARE CLAIMED AS A FEATURE OF THE MARK.

THE MARK CONSISTS OF THE WORD "MONTAGUE" IN STYLIZED FORM ABOVE THE LARGE WORD "TECHNOSTAR" IN A DIFFERENT STYLIZED FORM, WITH A 8-POINT STAR BEHIND THE "O" IN "TECHNOSTAR", THE WORDS SURROUNDED BY A GENERALLY RECTANGULAR BORDER. THE WORD "TECHNOSTAR" AND THE 8-POINT STAR ARE IN A GOLD BURST COLOR; THE WORD "MONTAGUE" IS WHITE, AND BORDER OF THE RECTANGLE IS GOLD AND THE INTERIOR OF THE RECTANGLE IS OTHERWISE BLACK.

SN 85-216,474, FILED 1-12-2011.

EUGENIA MARTIN, EXAMINING ATTORNEY



David J. Kyros

Director of the United States Patent and Trademark Office

United States of America

United States Patent and Trademark Office

TEAR-IFIC

Reg. No. 4,075,252

WESTERN STATES ENVELOPE COMPANY (WISCONSIN CORPORATION)
4480 NORTH 132ND STREET
BUTLER, WI 53007

Registered Dec. 20, 2011

Int. Cl.: 16

FOR: ENVELOPES, IN CLASS 16 (U.S. CLS. 2, 5, 22, 23, 29, 37, 38 AND 50).

TRADEMARK

FIRST USE 4-14-2011; IN COMMERCE 4-14-2011.

PRINCIPAL REGISTER

THE MARK CONSISTS OF STANDARD CHARACTERS WITHOUT CLAIM TO ANY PARTICULAR FONT, STYLE, SIZE, OR COLOR.

SN 85-217,068, FILED 1-13-2011.

VIVIAN MICZNIK FIRST, EXAMINING ATTORNEY



David J. Kybas

Director of the United States Patent and Trademark Office

United States of America

United States Patent and Trademark Office

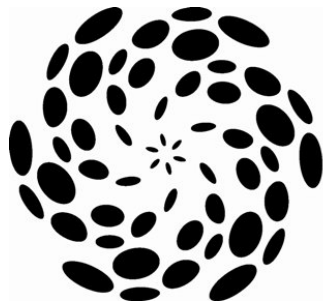

THE INSTITUTE FOR
FUNCTIONAL
MEDICINE

Reg. No. 4,075,253

Registered Dec. 20, 2011

Int. Cl.: 16

TRADEMARK

PRINCIPAL REGISTER

BLAND, SUSAN (UNITED STATES INDIVIDUAL)
P.O. BOX 477
FOX ISLAND, WA 98333 AND

BLAND, JEFFREY S. (UNITED STATES INDIVIDUAL)
P.O. BOX 477
FOX ISLAND, WA 98333

FOR: BOOKS IN THE FIELD OF DISEASE PREVENTION AND MANAGEMENT , IN CLASS
16 (U.S. CLS. 2, 5, 22, 23, 29, 37, 38 AND 50).

FIRST USE 5-1-2011; IN COMMERCE 5-1-2011.

OWNER OF U.S. REG. NOS. 3,694,744 AND 3,694,745.

SEC. 2(F) AS TO "THE INSTITUTE FOR FUNCTIONAL MEDICINE" .

NO CLAIM IS MADE TO THE EXCLUSIVE RIGHT TO USE "INSTITUTE", APART FROM
THE MARK AS SHOWN.

THE MARK CONSISTS OF THE WORDS "THE INSTITUTE FOR FUNCTIONAL MEDICINE"
STACKED ON THREE LINES WITH A SPIRAL DESIGN WHICH IS COMPRISED OF SPOTS
TO THE LEFT OF THE WORDS.

SN 85-217,281, FILED 1-13-2011.

BRIDGETT SMITH, EXAMINING ATTORNEY



David J. Kybas

Director of the United States Patent and Trademark Office

United States of America

United States Patent and Trademark Office

AGGIE NETWORK

Reg. No. 4,075,254

THE ASSOCIATION OF FORMER STUDENTS (TEXAS NON-PROFIT CORPORATION)
505 GEORGE BUSH DRIVE
COLLEGE STATION, TX 77840

Registered Dec. 20, 2011

Int. Cl.: 35

FOR: ASSOCIATION SERVICES, NAMELY, PROMOTING THE INTERESTS OF ALUMNI,
IN CLASS 35 (U.S. CLS. 100, 101 AND 102).

SERVICE MARK

FIRST USE 9-21-2011; IN COMMERCE 9-21-2011.

PRINCIPAL REGISTER

THE MARK CONSISTS OF STANDARD CHARACTERS WITHOUT CLAIM TO ANY PARTICULAR FONT, STYLE, SIZE, OR COLOR.

OWNER OF U.S. REG. NO. 3,912,028.

NO CLAIM IS MADE TO THE EXCLUSIVE RIGHT TO USE "NETWORK", APART FROM THE MARK AS SHOWN.

SN 85-217,533, FILED 1-13-2011.

MICHAEL GAFFAR, EXAMINING ATTORNEY



David J. Kyros

Director of the United States Patent and Trademark Office

United States of America
United States Patent and Trademark Office

ROLLPRO

Reg. No. 4,075,255

PHILLIPS MANUFACTURING CO. (NEBRASKA CORPORATION)
4949 SOUTH 30TH STREET
OMAHA, NE 68107

Registered Dec. 20, 2011

Int. Cl.: 19

FOR: BUILDING MATERIALS, NAMELY, NON-METAL CORNER FINISH TRIM USED IN DRYWALL CONSTRUCTION, IN CLASS 19 (U.S. CLS. 1, 12, 33 AND 50).

TRADEMARK

FIRST USE 4-6-2011; IN COMMERCE 4-6-2011.

PRINCIPAL REGISTER

THE MARK CONSISTS OF STANDARD CHARACTERS WITHOUT CLAIM TO ANY PARTICULAR FONT, STYLE, SIZE, OR COLOR.

SN 85-218,972, FILED 1-17-2011.

BARBARA A. GOLD, EXAMINING ATTORNEY



David J. Kybas

Director of the United States Patent and Trademark Office

United States of America

United States Patent and Trademark Office

SMART EGGS

Reg. No. 4,075,256

EASTER UNLIMITED, INC. (NEW YORK CORPORATION)
80 VOICE ROAD, CARLE PLACE
NEW YORK, NY 11514

Registered Dec. 20, 2011

Int. Cl.: 28

FOR: TOYS AND NOVELTIES, NAMELY, MOLDED PLASTIC EASTER EGG TOYS AND TOY CONTAINERS, PLASTIC TOY FIGURINES, NOVELTY PLUSH TOYS BEING PLUSH EASTER EGGS AND PLUSH ANIMALS, EGG CATCH TOYS, AND TOY VEHICLES, IN CLASS 28 (U.S. CLS. 22, 23, 38 AND 50).

TRADEMARK

PRINCIPAL REGISTER

FIRST USE 3-0-2010; IN COMMERCE 3-0-2010.

THE MARK CONSISTS OF STANDARD CHARACTERS WITHOUT CLAIM TO ANY PARTICULAR FONT, STYLE, SIZE, OR COLOR.

NO CLAIM IS MADE TO THE EXCLUSIVE RIGHT TO USE "EGGS", APART FROM THE MARK AS SHOWN.

SN 85-219,356, FILED 1-17-2011.

LINDA POWELL, EXAMINING ATTORNEY



David J. Kyros

Director of the United States Patent and Trademark Office

United States of America

United States Patent and Trademark Office

URBANOOG

Reg. No. 4,075,257

URBANOOG INC. (CALIFORNIA CORPORATION)
15469 DUPONT AVE.
CHINO, CA 91710

Registered Dec. 20, 2011

Int. Cls.: 25 and 35

FOR: SHOES, IN CLASS 25 (U.S. CLS. 22 AND 39).

FIRST USE 6-20-2011; IN COMMERCE 6-20-2011.

TRADEMARK

SERVICE MARK

FOR: ON-LINE RETAIL STORE SERVICES FEATURING CLOTHING, SHOES, JEWELRY, ACCESSORIES, COSTUMES, AND SWIMWEAR, IN CLASS 35 (U.S. CLS. 100, 101 AND 102).

PRINCIPAL REGISTER

FIRST USE 7-1-2007; IN COMMERCE 7-1-2007.

THE MARK CONSISTS OF STANDARD CHARACTERS WITHOUT CLAIM TO ANY PARTICULAR FONT, STYLE, SIZE, OR COLOR.

SN 85-219,387, FILED 1-17-2011.

PATRICIA EVANKO, EXAMINING ATTORNEY



David J. Kyros

Director of the United States Patent and Trademark Office

United States of America

United States Patent and Trademark Office

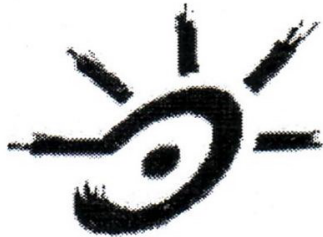

LITTLE SUN

Reg. No. 4,075,258

Registered Dec. 20, 2011

Int. Cl.: 3

TRADEMARK

PRINCIPAL REGISTER

FOSHAN SHUNDE LITTLE SUN ABRASIVE CO., LTD. (CHINA LIMITED COMPANY (LTD.))
YUCHONG INDUSTRIAL AREAS, LELIU TOWN
SHUNDE DISTRICT, FOSHAN CITY
GUANGDONG PROVINCE, CHINA

FOR: ABRASIVE CLOTH; ABRASIVE PAPER; ABRASIVE PASTE; ABRASIVE SAND;
CLEANING AND POLISHING PAPER; EMERY BOARDS; POLISHING POWDERS; POLISH-
ING PREPARATIONS; POLISHING WAX; POLISHING, SCOURING AND ABRASIVE PRE-
PARATIONS, IN CLASS 3 (U.S. CLS. 1, 4, 6, 50, 51 AND 52).

FIRST USE 3-14-2003; IN COMMERCE 5-31-2011.

THE MARK CONSISTS OF THE WORDS "LITTLE SUN" BELOW A SUN DESIGN.

SN 85-219,440, FILED 1-17-2011.

JAMES LOVELACE, EXAMINING ATTORNEY



David J. Kyffers

Director of the United States Patent and Trademark Office

United States of America

United States Patent and Trademark Office

Suicide Watch

Reg. No. 4,075,259

JONES, CAROL (UNITED STATES INDIVIDUAL)
3318 WINLOW STREET
SAN DIEGO, CA 92105

Registered Dec. 20, 2011

Int. Cl.: 30

FOR: HOT SAUCE, IN CLASS 30 (U.S. CL. 46).

TRADEMARK

FIRST USE 9-1-2011; IN COMMERCE 9-1-2011.

PRINCIPAL REGISTER

THE MARK CONSISTS OF STANDARD CHARACTERS WITHOUT CLAIM TO ANY PARTICULAR FONT, STYLE, SIZE, OR COLOR.

SN 85-219,662, FILED 1-18-2011.

KIMBERLY PERRY, EXAMINING ATTORNEY



David J. Kyffers

Director of the United States Patent and Trademark Office

United States of America

United States Patent and Trademark Office

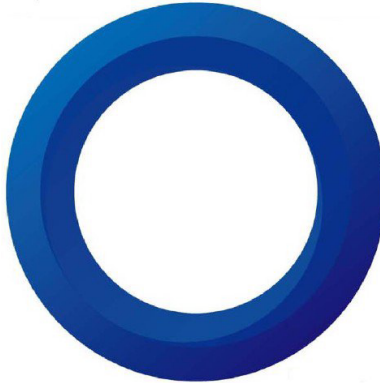

Reg. No. 4,075,260

Registered Dec. 20, 2011

Int. Cl.: 9

TRADEMARK

PRINCIPAL REGISTER

KANEKA CORPORATION (JAPAN CORPORATION)
2-4, NAKANOSHIMA 3-CHOME, KITA-KU
OSAKA, JAPAN

FOR: LABORATORY APPARATUS AND INSTRUMENTS, NAMELY, PRE-PACKED COLUMNS FOR USE IN CELL SEPARATION AND PURIFICATION, IN CLASS 9 (U.S. CLS. 21, 23, 26, 36 AND 38).

FIRST USE 10-31-2009; IN COMMERCE 6-16-2010.

THE MARK CONSISTS OF TWO CONCENTRIC CIRCLES IN SHADES OF BLUE.

THE COLOR(S) BLUE IS/ARE CLAIMED AS A FEATURE OF THE MARK.

SN 85-221,206, FILED 1-19-2011.

LINDA M. KING, EXAMINING ATTORNEY



David J. Kyffers

Director of the United States Patent and Trademark Office

United States of America

United States Patent and Trademark Office



Reg. No. 4,075,261

Registered Dec. 20, 2011

Int. Cl.: 3

TRADEMARK

PRINCIPAL REGISTER

GREENOLOGY PRODUCTS, INC. (NORTH CAROLINA CORPORATION)
SUITE 206
8305 FALLS OF NEUSE ROAD
RALEIGH, NC 27615

FOR: ORGANIC AND ENVIRONMENTALLY FRIENDLY CLEANING PREPARATIONS, NAMELY, LAUNDRY AND DISH DETERGENTS, IN CLASS 3 (U.S. CLS. 1, 4, 6, 50, 51 AND 52).

FIRST USE 2-0-2011, THE MARK WAS FIRST USED ANYWHERE IN A DIFFERENT FORM OTHER THAN THAT SOUGHT TO BE REGISTERED AT LEAST AS EARLY AS 10/11/2010.; IN COMMERCE 2-0-2011, THE MARK WAS FIRST USED IN COMMERCE IN A DIFFERENT FORM OTHER THAN THAT SOUGHT TO BE REGISTERED AT LEAST AS EARLY AS 10/11/2010..

OWNER OF U.S. REG. NOS. 3,819,319 AND 3,902,095.

NO CLAIM IS MADE TO THE EXCLUSIVE RIGHT TO USE ORGANIC, APART FROM THE MARK AS SHOWN.

THE MARK CONSISTS OF THE LITERAL ELEMENT "GREENSHIELD" LISTED ABOVE THE LITERAL ELEMENT "ORGANIC" WITH A LEAF-LIKE DESIGN WITH DEW DROPS ALL ABOVE THE LITERAL ELEMENTS "ELITE CARE".

SN 85-221,303, FILED 1-19-2011.

B. PARADEWELAI, EXAMINING ATTORNEY



David J. Kyffers

Director of the United States Patent and Trademark Office

United States of America

United States Patent and Trademark Office

GOGLOBAL

Reg. No. 4,075,262

Registered Dec. 20, 2011

Int. Cls.: 9 and 18

TRADEMARK

PRINCIPAL REGISTER

CONAIR CORPORATION (DELAWARE CORPORATION)
ONE CUMMINGS POINT ROAD
STAMFORD, CT 06902

FOR: ADAPTER PLUGS; BATTERIES AND BATTERY CHARGERS; CONVERTERS FOR ELECTRIC PLUGS, IN CLASS 9 (U.S. CLS. 21, 23, 26, 36 AND 38).

FIRST USE 9-0-2011; IN COMMERCE 9-0-2011.

FOR: LUGGAGE TAGS, IN CLASS 18 (U.S. CLS. 1, 2, 3, 22 AND 41).

FIRST USE 9-0-2011; IN COMMERCE 9-0-2011.

THE MARK CONSISTS OF STANDARD CHARACTERS WITHOUT CLAIM TO ANY PARTICULAR FONT, STYLE, SIZE, OR COLOR.

SN 85-223,371, FILED 1-21-2011.

KRISTIN DAHLING, EXAMINING ATTORNEY



David J. Kybas

Director of the United States Patent and Trademark Office

United States of America

United States Patent and Trademark Office

Physique Sculptor

Reg. No. 4,075,263

PRESTANO, MICHAEL (UNITED STATES INDIVIDUAL)
85 NEWMAN AVE.

Registered Dec. 20, 2011

HAWTHORNE, NY 10532

Int. Cl.: 41

FOR: PERSONAL TRAINER SERVICES, IN CLASS 41 (U.S. CLS. 100, 101 AND 107).

SERVICE MARK

FIRST USE 8-17-2011; IN COMMERCE 8-17-2011.

PRINCIPAL REGISTER

THE MARK CONSISTS OF STANDARD CHARACTERS WITHOUT CLAIM TO ANY PARTICULAR FONT, STYLE, SIZE, OR COLOR.

NO CLAIM IS MADE TO THE EXCLUSIVE RIGHT TO USE "PHYSIQUE", APART FROM THE MARK AS SHOWN.

SN 85-225,513, FILED 1-25-2011.

MARC LEIPZIG, EXAMINING ATTORNEY



David J. Kyffers

Director of the United States Patent and Trademark Office

United States of America
United States Patent and Trademark Office

LIQUITINE

Reg. No. 4,075,264

Registered Dec. 20, 2011

Int. Cl.: 1

TRADEMARK

PRINCIPAL REGISTER

LUDOVICO, INC. (CALIFORNIA CORPORATION)
PH12
111 W. 7TH STREET
LOS ANGELES, CA 90014

FOR: LIQUID NICOTINE FOR USE IN ELECTRONIC CIGARETTES, IN CLASS 1 (U.S. CLS. 1, 5, 6, 10, 26 AND 46).

FIRST USE 11-4-2011; IN COMMERCE 11-4-2011.

THE MARK CONSISTS OF STANDARD CHARACTERS WITHOUT CLAIM TO ANY PARTICULAR FONT, STYLE, SIZE, OR COLOR.

SN 85-225,999, FILED 1-25-2011.

BARBARA GAYNOR, EXAMINING ATTORNEY



David J. Kybas

Director of the United States Patent and Trademark Office

United States of America

United States Patent and Trademark Office



Anchor-CD

Reg. No. 4,075,265

IPSEN PHARMA S.A.S. (FRANCE SOCIÉTÉ PAR ACTIONS SIMPLIFIÉE (SAS))
65, QUAI GEORGES GORSE

Registered Dec. 20, 2011

BOULOGNE BILLANCOURT, FRANCE 92650

Int. Cl.: 42

FOR: PROGRAM OF MEDICAL AND SCIENTIFIC STUDIES, NAMELY, SCIENTIFIC INVESTIGATIONS FOR MEDICAL PURPOSES; MEDICAL AND SCIENTIFIC RESEARCH, NAMELY, CONDUCTING CLINICAL TRIALS, STUDIES AND ANALYSES; MEDICAL AND SCIENTIFIC RESEARCH, IN CLASS 42 (U.S. CLS. 100 AND 101).

SERVICE MARK

PRINCIPAL REGISTER

FIRST USE 4-27-2011; IN COMMERCE 4-27-2011.

THE MARK CONSISTS OF A FANCIFUL ANCHOR DESIGN IN BLUE AND YELLOW WITH A DOT IN YELLOW AT THE TOP AND THE WORDS "ANCHOR-CD" IN BLACK BELOW THE DESIGN.

THE COLOR(S) BLUE, YELLOW AND BLACK IS/ARE CLAIMED AS A FEATURE OF THE MARK.

SN 85-226,563, FILED 1-26-2011.

KAELIE KUNG, EXAMINING ATTORNEY



David J. Kappas

Director of the United States Patent and Trademark Office

United States of America

United States Patent and Trademark Office



Reg. No. 4,075,266

Registered Dec. 20, 2011

Int. Cl.: 25

TRADEMARK

PRINCIPAL REGISTER

THY ENTERPRISES, INC. (ALABAMA CORPORATION)
440 HILLABEE STREET
ALEXANDER CITY, AL 35010

FOR: MEN'S AND WOMEN'S CLOTHING AND THERMAL CLOTHING, NAMELY, UNDER-GARMENTS, PANTS, LONG JOHNS, SHIRTS, UNDERSHIRTS, LONG SLEEVE UNDER-SHIRTS, UNDERPANTS, BRIEFS, IN CLASS 25 (U.S. CLS. 22 AND 39).

FIRST USE 8-2-2011; IN COMMERCE 8-2-2011.

THE MARK CONSISTS OF THE STYLIZED LETTERS "N" AND "Q" IN WHITE WITH AN OUTLINE OF BLACK AND RED. THE LETTER "Q" IS CONNECTED AND PART OF THE BOTTOM, RIGHT SIDE OF THE LETTER "N". THE WORD, "THY" IS SITUATED IN SMALLER WHITE LETTERS BELOW THE LEFT SIDE OF THE LETTER "N". THERE IS AN UPWARD ARC OF RED EXTENDING FROM THE RIGHT, TOP SIDE OF THE LETTER "Q". THERE IS A DOWNWARD ARC OF RED EXTENDING FROM THE LEFT SIDE OF THE LETTER "N".

THE COLOR(S) RED, BLACK AND WHITE IS/ARE CLAIMED AS A FEATURE OF THE MARK.

SN 85-226,650, FILED 1-26-2011.

CAROLINE WOOD, EXAMINING ATTORNEY



David J. Kyffers

Director of the United States Patent and Trademark Office

United States of America

United States Patent and Trademark Office

WALKING WEST

Reg. No. 4,075,267

Registered Dec. 20, 2011

Int. Cl.: 41

SERVICE MARK

PRINCIPAL REGISTER

ARCHIVE ENTERTAINMENT, INC. (CALIFORNIA CORPORATION)
6632 BLUE HERON DRIVE
HUNTINGTON BEACH, CA 92648

FOR: PRODUCTION AND DISTRIBUTION OF MOTION PICTURES AND TELEVISION SHOWS; MULTIMEDIA PRODUCTION SERVICES, IN CLASS 41 (U.S. CLS. 100, 101 AND 107).

FIRST USE 1-18-2011; IN COMMERCE 4-23-2011.

THE MARK CONSISTS OF STANDARD CHARACTERS WITHOUT CLAIM TO ANY PARTICULAR FONT, STYLE, SIZE, OR COLOR.

SN 85-227,709, FILED 1-27-2011.

INGRID C. EULIN, EXAMINING ATTORNEY



David J. Kyffers

Director of the United States Patent and Trademark Office

United States of America

United States Patent and Trademark Office

MITTMI

Reg. No. 4,075,268

MI GROUP CO. (FLORIDA CORPORATION)
2082 N.W. 18TH AVE
MIAMI, FL 33142

Registered Dec. 20, 2011

Int. Cl.: 25

FOR: DRESSES, SHIRTS, BLOUSES, SWIMWEAR, PANTS, JUMPERS, JUMPSUITS, ROMPERS, TANK-TOPS, SKIRTS, SWEATERS, LOUNGE-WEAR, DENIMS, TROUSERS, T-SHIRTS, POLO SHIRTS, SLACKS, COATS, JACKETS, VESTS, CAMISOLES, CARDIGANS, IN CLASS 25 (U.S. CLS. 22 AND 39).

TRADEMARK

PRINCIPAL REGISTER

FIRST USE 11-7-2011; IN COMMERCE 11-7-2011.

THE MARK CONSISTS OF STANDARD CHARACTERS WITHOUT CLAIM TO ANY PARTICULAR FONT, STYLE, SIZE, OR COLOR.

SN 85-228,027, FILED 1-27-2011.

DOMINIC FATHY, EXAMINING ATTORNEY



David J. Kyffers

Director of the United States Patent and Trademark Office

United States of America

United States Patent and Trademark Office



Reg. No. 4,075,269

Registered Dec. 20, 2011

Int. Cl.: 36

SERVICE MARK

PRINCIPAL REGISTER

ENTERPRISE HOLDINGS, INC. (MISSOURI CORPORATION)
600 CORPORATE PARK DRIVE
ST. LOUIS, MO 63105

FOR: CHARITABLE FOUNDATION SERVICES, NAMELY, PROVIDING FUNDING TO PROJECTS AND ORGANIZATIONS IN THE FIELDS OF HEALTH CARE, EDUCATION, HUMAN SERVICES, AND THE PERFORMING ARTS, IN CLASS 36 (U.S. CLS. 100, 101 AND 102).

FIRST USE 3-31-2011; IN COMMERCE 3-31-2011.

THE MARK CONSISTS OF A BLUE LETTER "T" AND A GREEN STEM CURVED INTO THE SHAPE OF A LETTER "C" WITH LEAVES EXTENDING FROM THE UPPER END OF THE STEM, AND THE BOTTOM OF THE STEM CROSSING OVER THE LOWER PORTION OF THE LETTER "T".

THE COLOR(S) GREEN AND BLUE IS/ARE CLAIMED AS A FEATURE OF THE MARK.

SN 85-230,163, FILED 1-31-2011.

JOHN WILKE, EXAMINING ATTORNEY



David J. Kybas

Director of the United States Patent and Trademark Office

United States of America

United States Patent and Trademark Office

TRADE PRO

Reg. No. 4,075,270

Registered Dec. 20, 2011

Int. Cl.: 36

SERVICE MARK

PRINCIPAL REGISTER

BANK OF AMERICA CORPORATION (DELAWARE CORPORATION)
100 NORTH TRYON STREET
CHARLOTTE, NC 28255

FOR: BANKING AND RELATED FINANCIAL SERVICES, NAMELY, PROVIDING FOREIGN TRADE TRANSACTION INITIATION AND FINANCIAL INFORMATION TO CUSTOMERS RELATED TO IMPORT AND EXPORT TRADE TRANSACTIONS, LETTER OF CREDIT ACTIVITIES, AND OTHER FINANCIAL INFORMATION RELATED TO TRADE, IN CLASS 36 (U.S. CLS. 100, 101 AND 102).

FIRST USE 9-19-2011; IN COMMERCE 9-19-2011.

THE MARK CONSISTS OF STANDARD CHARACTERS WITHOUT CLAIM TO ANY PARTICULAR FONT, STYLE, SIZE, OR COLOR.

NO CLAIM IS MADE TO THE EXCLUSIVE RIGHT TO USE "TRADE", APART FROM THE MARK AS SHOWN.

SN 85-231,859, FILED 2-1-2011.

LAURIE KAUFMAN, EXAMINING ATTORNEY



David J. Kyros

Director of the United States Patent and Trademark Office

United States of America

United States Patent and Trademark Office

Diva Dash

Reg. No. 4,075,271

ADVENTURE FIT INC (TEXAS CORPORATION)
700 ATWOOD ST.

Registered Dec. 20, 2011

LONGMONT, CO 80501

Int. Cl.: 41

FOR: ENTERTAINMENT SERVICES, NAMELY, THE PLANNING, ORGANIZATION AND PRODUCTION OF ATHLETIC COMPETITIONS INVOLVING INDIVIDUAL WOMEN OR TEAMS OF WOMEN RUNNING THROUGH A DESIGNATED ROUTE WITH OBSTACLE COURSES, IN CLASS 41 (U.S. CLS. 100, 101 AND 107).

SERVICE MARK

PRINCIPAL REGISTER

FIRST USE 1-20-2011; IN COMMERCE 1-20-2011.

THE MARK CONSISTS OF STANDARD CHARACTERS WITHOUT CLAIM TO ANY PARTICULAR FONT, STYLE, SIZE, OR COLOR.

NO CLAIM IS MADE TO THE EXCLUSIVE RIGHT TO USE "DASH", APART FROM THE MARK AS SHOWN.

SN 85-232,220, FILED 2-2-2011.

KATHERINE CONNOLLY, EXAMINING ATTORNEY



David J. Kyros

Director of the United States Patent and Trademark Office

United States of America

United States Patent and Trademark Office



Reg. No. 4,075,272

Registered Dec. 20, 2011

Int. Cls.: 25 and 41

TRADEMARK

SERVICE MARK

PRINCIPAL REGISTER

ROCKIN' JUMP INC. (CALIFORNIA CORPORATION), DBA ROCKIN' JUMP,
5875 ARNOLD DR.,
DUBLIN, CA 94568

FOR: ATHLETIC APPAREL, NAMELY, SHIRTS, PANTS, JACKETS, FOOTWEAR, HATS
AND CAPS, ATHLETIC UNIFORMS, IN CLASS 25 (U.S. CLS. 22 AND 39).

FIRST USE 12-20-2010; IN COMMERCE 5-16-2011.

FOR: CHILDREN'S ENTERTAINMENT AND AMUSEMENT CENTERS, NAMELY, INTER-
ACTIVE PLAY AREAS, IN CLASS 41 (U.S. CLS. 100, 101 AND 107).

FIRST USE 12-20-2010; IN COMMERCE 5-16-2011.

THE MARK CONSISTS OF THE WORD "ROCKIN'" IN DISTRESSED BLOCK LETTERING
WITH THE WORD "JUMP" UNDERNEATH IT IN SLIGHTLY LARGER SOLID BLOCK
LETTERING. TO THE LEFT OF THE WORDS "ROCKIN' JUMP" IS A STYLIZED FROG WITH
ITS LIMBS SPREAD OUT AND WITH ITS RIGHT HIND LEG DANGLING OFF OF THE
HOOK OF THE LETTER "J" IN THE WORD "JUMP". THE STYLIZED FROG ALSO HAS A
PROMINENT HOLLOW EYEBALL THAT STANDS OUT ON THE SOLID COLORED FROG.

SN 85-233,610, FILED 2-3-2011.

IRA J. GOODSaid, EXAMINING ATTORNEY



David J. Kybas

Director of the United States Patent and Trademark Office

United States of America

United States Patent and Trademark Office

CONQUEROR

Reg. No. 4,075,273

GATEWAY SAFETY, INC. (OHIO CORPORATION)
11111 MEMPHIS AVENUE
CLEVELAND, OH 44144

Registered Dec. 20, 2011

Int. Cl.: 9

FOR: PROTECTIVE EYEWEAR, IN CLASS 9 (U.S. CLS. 21, 23, 26, 36 AND 38).

TRADEMARK

FIRST USE 5-0-2011; IN COMMERCE 5-0-2011.

PRINCIPAL REGISTER

THE MARK CONSISTS OF STANDARD CHARACTERS WITHOUT CLAIM TO ANY PARTICULAR FONT, STYLE, SIZE, OR COLOR.

SN 85-234,787, FILED 2-4-2011.

NICHOLAS COLEMAN, EXAMINING ATTORNEY



David J. Kyffers

Director of the United States Patent and Trademark Office

United States of America

United States Patent and Trademark Office

USA N.I.C.E.

Reg. No. 4,075,274

SERVICE INSTITUTE, INC (FLORIDA CORPORATION)
1711 ELLIS ST. SUITE 201
BELLINGHAM, WA 98225

Registered Dec. 20, 2011

Int. Cl.: 41

FOR: CONDUCTING WORKSHOPS AND SEMINARS IN CUSTOMER SERVICE SKILL BUILDING AND DELIVERY FOR EMPLOYEES IN TRAVEL/TOURISM, HOSPITALITY, RETAIL, HEALTHCARE AND GENERAL OFFICE BUSINESSES, IN CLASS 41 (U.S. CLS. 100, 101 AND 107).

SERVICE MARK

PRINCIPAL REGISTER

FIRST USE 6-1-2008; IN COMMERCE 4-1-2011.

THE MARK CONSISTS OF STANDARD CHARACTERS WITHOUT CLAIM TO ANY PARTICULAR FONT, STYLE, SIZE, OR COLOR.

NO CLAIM IS MADE TO THE EXCLUSIVE RIGHT TO USE "USA", APART FROM THE MARK AS SHOWN.

SN 85-235,021, FILED 2-5-2011.

GIANCARLO CASTRO, EXAMINING ATTORNEY



David J. Kyffers

Director of the United States Patent and Trademark Office

United States of America

United States Patent and Trademark Office



Reg. No. 4,075,275

MIRUS BIO LLC (WISCONSIN LIMITED LIABILITY COMPANY)
545 SCIENCE DR.
MADISON, WI 53711

Registered Dec. 20, 2011

Int. Cl.: 42

FOR: PROVIDING A DATABASE TO ASSIST SCIENTIFIC RESEARCHERS IN THE FIELD OF BIOLOGY, IN CLASS 42 (U.S. CLS. 100 AND 101).

SERVICE MARK

FIRST USE 3-31-2011; IN COMMERCE 3-31-2011.

PRINCIPAL REGISTER

NO CLAIM IS MADE TO THE EXCLUSIVE RIGHT TO USE "AGENT", APART FROM THE MARK AS SHOWN.

THE COLOR(S) RED, WHITE, BLACK IS/ARE CLAIMED AS A FEATURE OF THE MARK.

THE MARK CONSISTS OF A PREDOMINANTLY BLACK SILHOUETTE OF A PERSON WEARING A WHITE SHIRT WITH WHITE MARKINGS ON THE BLACK JACKET, AND HOLDING A BEAKER CONTAINING A WHITE AND BLACK BUBBLING FLUID SUPERIMPOSED UPON A GRADUATED RED STRIPE FROM SIDE TO SIDE HAVING THE LETTERS "RA" IN WHITE ON THE RIGHT SIDE OF THE RED STRIPE; AND TWO WHITE BACKGROUND STRIPES FROM SIDE TO SIDE ABOVE AND BELOW THE RED STRIPE. THE WHITE STRIPE ABOVE THE RED STRIPE CONTAINS THE WORD "MIRUS" IN BLACK WITH A WAVY LINE UNDER THE WORD TO THE RIGHT SIDE OF THE STRIPE; ON THE WHITE STRIPE BELOW THE RED STRIPE ARE THE WORDS "REAGENT AGENT" TO THE RIGHT SIDE.

THE ENGLISH TRANSLATION OF "MIRUS" IN THE MARK IS "MIRACLE".

SN 85-235,037, FILED 2-5-2011.

INGA ERVIN, EXAMINING ATTORNEY



David J. Kybas

Director of the United States Patent and Trademark Office

United States of America

United States Patent and Trademark Office

BOTTLE & BOTTEGA ART UNCORKED

Reg. No. 4,075,276

BOTTLE & BOTTEGA, INC. (ILLINOIS CORPORATION)
2900 N. LINCOLN AVE
CHICAGO, IL 60657

Registered Dec. 20, 2011

Int. Cl.: 41

FOR: INSTRUCTION IN THE FIELD OF ART; ORGANIZING, ARRANGING, AND CONDUCTING ART EVENTS, IN CLASS 41 (U.S. CLS. 100, 101 AND 107).

SERVICE MARK

FIRST USE 2-11-2011; IN COMMERCE 2-11-2011.

PRINCIPAL REGISTER

THE MARK CONSISTS OF STANDARD CHARACTERS WITHOUT CLAIM TO ANY PARTICULAR FONT, STYLE, SIZE, OR COLOR.

NO CLAIM IS MADE TO THE EXCLUSIVE RIGHT TO USE "ART", APART FROM THE MARK AS SHOWN.

SN 85-235,232, FILED 2-6-2011.

PRISCILLA MILTON, EXAMINING ATTORNEY



David J. Kybas

Director of the United States Patent and Trademark Office

United States of America

United States Patent and Trademark Office



bottle & bottega
ART UNCORKED

Reg. No. 4,075,277

BOTTLE & BOTTEGA, INC. (ILLINOIS CORPORATION)
2900 N. LINCOLN AVE
CHICAGO, IL 60657

Registered Dec. 20, 2011

Int. Cl.: 41

FOR: INSTRUCTION IN THE FIELD OF ART; ORGANIZING, ARRANGING, AND CONDUCTING ART EVENTS, IN CLASS 41 (U.S. CLS. 100, 101 AND 107).

SERVICE MARK

FIRST USE 2-11-2011; IN COMMERCE 2-11-2011.

PRINCIPAL REGISTER

NO CLAIM IS MADE TO THE EXCLUSIVE RIGHT TO USE "ART", APART FROM THE MARK AS SHOWN.

THE MARK CONSISTS OF A LINE OF SEVEN BOTTLES ABOVE THE WORDS "BOTTLE & BOTTEGA", ALL ABOVE THE WORDS "ART UNCORKED".

SN 85-235,237, FILED 2-6-2011.

PRISCILLA MILTON, EXAMINING ATTORNEY



David J. Kybas

Director of the United States Patent and Trademark Office

United States of America

United States Patent and Trademark Office

THE HOLE-IN-ONE VODKA

Reg. No. 4,075,278

Registered Dec. 20, 2011

Int. Cl.: 33

TRADEMARK

PRINCIPAL REGISTER

FUZZY'S SPIRITS, LLC (DELAWARE LIMITED LIABILITY COMPANY)
9455 DELEGATES ROW
INDIANAPOLIS, IN 46240

FOR: VODKA, IN CLASS 33 (U.S. CLS. 47 AND 49).

FIRST USE 2-0-2011; IN COMMERCE 2-0-2011.

THE MARK CONSISTS OF STANDARD CHARACTERS WITHOUT CLAIM TO ANY PARTICULAR FONT, STYLE, SIZE, OR COLOR.

NO CLAIM IS MADE TO THE EXCLUSIVE RIGHT TO USE "VODKA", APART FROM THE MARK AS SHOWN.

SN 85-235,546, FILED 2-7-2011.

JEFFERY COWARD, EXAMINING ATTORNEY



David J. Kyros

Director of the United States Patent and Trademark Office

United States of America

United States Patent and Trademark Office

CROSBY KUPLEX

Reg. No. 4,075,279

THE CROSBY GROUP LLC (DELAWARE LIMITED LIABILITY COMPANY)
2857 DAWSON ROAD
TULSA, OK 74110

Registered Dec. 20, 2011

Int. Cl.: 6

FOR: METAL CHAINS AND FITTINGS AND ATTACHMENTS THEREFOR, NAMELY, CHAIN LATCHES, HOOKS AND CONNECTING LINKS ALL OF METAL, IN CLASS 6 (U.S. CLS. 2, 12, 13, 14, 23, 25 AND 50).

TRADEMARK

FIRST USE 8-1-2010; IN COMMERCE 8-1-2010.

PRINCIPAL REGISTER

THE MARK CONSISTS OF STANDARD CHARACTERS WITHOUT CLAIM TO ANY PARTICULAR FONT, STYLE, SIZE, OR COLOR.

OWNER OF U.S. REG. NOS. 1,100,565, 3,812,973, AND OTHERS.

SN 85-237,041, FILED 2-8-2011.

KATHERINE CONNOLLY, EXAMINING ATTORNEY



David J. Kybas

Director of the United States Patent and Trademark Office

United States of America

United States Patent and Trademark Office

CROSBY TRAWLEX

Reg. No. 4,075,280

Registered Dec. 20, 2011

Int. Cl.: 6

TRADEMARK

PRINCIPAL REGISTER

THE CROSBY GROUP LLC (DELAWARE LIMITED LIABILITY COMPANY)
2857 DAWSON ROAD
TULSA, OK 74110

FOR: METAL CHAIN AND COMPONENTS, NAMELY, SHACKLES, SWIVELS, RECESSED LINKS, HOOKS, COUPLERS, STOPPERS, CONNECTORS, EYES, AND RECEIVABLE EGG LINKS, FOR RIGGING FISHING NETS TO VESSELS, ALL OF METAL, IN CLASS 6 (U.S. CLS. 2, 12, 13, 14, 23, 25 AND 50).

FIRST USE 8-1-2010; IN COMMERCE 8-1-2010.

THE MARK CONSISTS OF STANDARD CHARACTERS WITHOUT CLAIM TO ANY PARTICULAR FONT, STYLE, SIZE, OR COLOR.

OWNER OF U.S. REG. NOS. 1,054,949, 1,139,374, AND OTHERS.

SN 85-237,061, FILED 2-8-2011.

KATHERINE CONNOLLY, EXAMINING ATTORNEY



David J. Kyffers

Director of the United States Patent and Trademark Office

United States of America

United States Patent and Trademark Office



Reg. No. 4,075,281

Registered Dec. 20, 2011

Int. Cl.: 10

TRADEMARK

PRINCIPAL REGISTER

FISHER, RICHARD JOHN (UNITED STATES INDIVIDUAL)
5830 PIONEERS COURT
WORTHINGTON, OH 43085

FOR: ELECTROTHERAPY DEVICES FOR PROVIDING TRANSCUTANEOUS ELECTRICAL NERVE STIMULATION, INFRARED HEAT AND COMPRESSION, IN CLASS 10 (U.S. CLS. 26, 39 AND 44).

FIRST USE 3-9-2011; IN COMMERCE 3-9-2011.

NO CLAIM IS MADE TO THE EXCLUSIVE RIGHT TO USE "PAIN MANAGEMENT THROUGH ELECTRO THERAPY", APART FROM THE MARK AS SHOWN.

THE COLOR(S) ORANGE, PINK, RED, BURGUNDY, AND BLACK IS/ARE CLAIMED AS A FEATURE OF THE MARK.

THE MARK CONSISTS OF OPPOSING OVALS COLORED ORANGE, PINK, BURGUNDY AND RED, AND THE WORD "SAFE" IN BLACK WITH THE TAG LINE "PAIN MANAGEMENT THROUGH ELECTROTHERAPY" IN BLACK.

SN 85-237,938, FILED 2-9-2011.

ANDREW LEASER, EXAMINING ATTORNEY



David J. Kyjars

Director of the United States Patent and Trademark Office

United States of America

United States Patent and Trademark Office

MAJISEAL

Reg. No. 4,075,282

Registered Dec. 20, 2011

Int. Cl.: 5

TRADEMARK

PRINCIPAL REGISTER

MAJESTIC DRUG CO. INC. (NEW YORK CORPORATION)
P.O. BOX 490, MAIN STREET
SOUTH FALLSBURG, NY 12779

FOR: DENTURE PRODUCTS, NAMELY, A SEALING SYSTEM COMPRISED OF AN ACRYLIC SEALANT AND AN APPLICATOR FOR USE IN SEALING DENTURE MARKINGS , IN CLASS 5 (U.S. CLS. 6, 18, 44, 46, 51 AND 52).

FIRST USE 1-28-2011; IN COMMERCE 1-28-2011.

THE MARK CONSISTS OF STANDARD CHARACTERS WITHOUT CLAIM TO ANY PARTICULAR FONT, STYLE, SIZE, OR COLOR.

SN 85-238,152, FILED 2-9-2011.

JAY FLOWERS, EXAMINING ATTORNEY



David J. Kyffers

Director of the United States Patent and Trademark Office

United States of America

United States Patent and Trademark Office



Reg. No. 4,075,283

Registered Dec. 20, 2011

Int. Cl.: 25

TRADEMARK

PRINCIPAL REGISTER

GAMEMASTERS, LLC (COLORADO LIMITED LIABILITY COMPANY)
999 18TH ST
SUITE 2500
DENVER, CO 80202

FOR: ATHLETIC APPAREL, NAMELY, SHIRTS, PANTS, JACKETS, FOOTWEAR, HATS AND CAPS, ATHLETIC UNIFORMS; ATHLETIC SHOES, IN CLASS 25 (U.S. CLS. 22 AND 39).

FIRST USE 6-1-2011; IN COMMERCE 7-21-2011.

THE MARK CONSISTS OF A BLOCK FONT CAPITAL LETTER "G" WITH A PARTIAL BASKETBALL PATTERN WITHIN THE BLOCK OUTLINE OF THE "G". THE SHADING OF THE BASKETBALL PATTERN INCREASES FROM TOP RIGHT WITH THE DARKEST SHADING AT THE BOTTOM AND BOTTOM LEFT OF THE "G". BEHIND THE "G" IS AN ELLIPSE WITH ONLY THE ENDS SHOWING. DARK BACKGROUND SURROUNDS THE "G", BOTH INSIDE AND OUTSIDE OF THE ELLIPSE.

SN 85-238,282, FILED 2-9-2011.

MARK PILARO, EXAMINING ATTORNEY



David J. Kyffers

Director of the United States Patent and Trademark Office

United States of America

United States Patent and Trademark Office

MR. FRESH

Reg. No. 4,075,284

Registered Dec. 20, 2011

Int. Cl.: 20

TRADEMARK

PRINCIPAL REGISTER

JAMSON, ARI SYRQUIN (MEXICO INDIVIDUAL)
NAVE 2B
VÍA LÓPEZ PORTILLO NO 92 COL. BEUNAVISTA
TULTITLAN, MEXICO 54944

FOR: PLASTIC ARTICLES, NAMELY, CAPS, LIDS AND STORAGE CONTAINERS FOR COMMERCIAL OR INDUSTRIAL USE; CONTAINERS NOT OF METAL FOR COMMERCIAL USE, IN CLASS 20 (U.S. CLS. 2, 13, 22, 25, 32 AND 50).

FIRST USE 3-31-2011; IN COMMERCE 3-31-2011.

THE MARK CONSISTS OF STANDARD CHARACTERS WITHOUT CLAIM TO ANY PARTICULAR FONT, STYLE, SIZE, OR COLOR.

SN 85-238,429, FILED 2-9-2011.

SAMUEL E. SHARPER JR., EXAMINING ATTORNEY



David J. Kyros

Director of the United States Patent and Trademark Office

United States of America

United States Patent and Trademark Office



Reg. No. 4,075,285

Registered Dec. 20, 2011

Int. Cl.: 30

TRADEMARK

PRINCIPAL REGISTER

SIZZLE, INC. (FLORIDA CORPORATION)
#307
6090 N. SABAL PALM BLVD.
TAMARAC, FL 33319

FOR: CHUTNEYS; FOOD CONDIMENT CONSISTING PRIMARILY OF KETCHUP AND SALSA; SALSA; TOMATO-BASED SALSA, IN CLASS 30 (U.S. CL. 46).

FIRST USE 5-27-2011; IN COMMERCE 5-27-2011.

NO CLAIM IS MADE TO THE EXCLUSIVE RIGHT TO USE "ALL NATURAL", APART FROM THE MARK AS SHOWN.

THE COLOR(S) BLACK, RED AND GREEN IS/ARE CLAIMED AS A FEATURE OF THE MARK.

THE MARK CONSISTS OF THE BLACK SILHOUETTE OF A WOMAN LAYING ON A RED AND GREEN CHILI PEPPER WITH THE TERM "SIZZLE" IN BLACK ABOVE THE FEMALE SILHOUETTE WITH THE WOMAN'S SHOE FORMING THE LETTER I, AND A RED PEPPER WITH A GREEN TOP FORMING THE DOT OVER THE I, AND THE BLACK WORDS "SAUCINESS IN A BOTTLE" BENEATH THE CHILI PEPPER.

SN 85-238,895, FILED 2-10-2011.

VIVIAN MICZNIK FIRST, EXAMINING ATTORNEY



David J. Kyros

Director of the United States Patent and Trademark Office

United States of America

United States Patent and Trademark Office

CROSS COUNTRY TOUR

Reg. No. 4,075,286

POLARIS INDUSTRIES INC. (DELAWARE CORPORATION)
2100 HIGHWAY 55
MEDINA, MN 553409770

Registered Dec. 20, 2011

Int. Cl.: 12

FOR: MOTORCYCLES AND STRUCTURAL PARTS THEREFOR, IN CLASS 12 (U.S. CLS. 19, 21, 23, 31, 35 AND 44).

TRADEMARK

FIRST USE 7-26-2011; IN COMMERCE 7-26-2011.

PRINCIPAL REGISTER

THE MARK CONSISTS OF STANDARD CHARACTERS WITHOUT CLAIM TO ANY PARTICULAR FONT, STYLE, SIZE, OR COLOR.

OWNER OF U.S. REG. NO. 3,765,353.

NO CLAIM IS MADE TO THE EXCLUSIVE RIGHT TO USE "TOUR", APART FROM THE MARK AS SHOWN.

SN 85-239,258, FILED 2-10-2011.

VIVIAN MICZNIK FIRST, EXAMINING ATTORNEY



David J. Kybas

Director of the United States Patent and Trademark Office

United States of America

United States Patent and Trademark Office

BIO-TEA

Reg. No. 4,075,287

LIMB WALKER TREE SERVICE, INC. (KENTUCKY CORPORATION)
901 DUMESNIL STREET
LOUISVILLE, KY 40203

Registered Dec. 20, 2011

Int. Cls.: 1 and 44

FOR: COMPOST TEA, IN CLASS 1 (U.S. CLS. 1, 5, 6, 10, 26 AND 46).

TRADEMARK

FIRST USE 6-0-2010; IN COMMERCE 3-0-2011.

SERVICE MARK

FOR: ARBORICULTURAL SERVICES, NAMELY, COMPOST TEA SPREADING, IN CLASS 44 (U.S. CLS. 100 AND 101).

PRINCIPAL REGISTER

FIRST USE 6-0-2010; IN COMMERCE 3-0-2011.

THE MARK CONSISTS OF STANDARD CHARACTERS WITHOUT CLAIM TO ANY PARTICULAR FONT, STYLE, SIZE, OR COLOR.

SN 85-239,702, FILED 2-11-2011.

TINA MAI, EXAMINING ATTORNEY



David J. Kybas

Director of the United States Patent and Trademark Office

United States of America

United States Patent and Trademark Office

Full House Auction

Reg. No. 4,075,288

FULL HOUSE AUCTION, LLC (MARYLAND LIMITED LIABILITY COMPANY)
7960 CESSNA AVENUE
GAITHERSBURG, MD 20879

Registered Dec. 20, 2011

Int. Cl.: 35

FOR: ARRANGING AND CONDUCTING AUCTIONS; PROVIDING ON-LINE AUCTION SERVICES, IN CLASS 35 (U.S. CLS. 100, 101 AND 102).

SERVICE MARK

FIRST USE 12-15-2010; IN COMMERCE 7-29-2011.

PRINCIPAL REGISTER

THE MARK CONSISTS OF STANDARD CHARACTERS WITHOUT CLAIM TO ANY PARTICULAR FONT, STYLE, SIZE, OR COLOR.

NO CLAIM IS MADE TO THE EXCLUSIVE RIGHT TO USE "AUCTION", APART FROM THE MARK AS SHOWN.

SN 85-239,999, FILED 2-11-2011.

MICHAEL GAAFAR, EXAMINING ATTORNEY



David J. Kyffers

Director of the United States Patent and Trademark Office

United States of America

United States Patent and Trademark Office

TECT POWERFORM

Reg. No. 4,075,289

Registered Dec. 20, 2011

Int. Cl.: 40

SERVICE MARK

PRINCIPAL REGISTER

TURBINE ENGINE COMPONENTS TECHNOLOGIES CORPORATION (DELAWARE CORPORATION)
1211 OLD ALBANY ROAD
THOMASVILLE, GA 31792

FOR: MACHINING AND FORGING OF LEADING EDGES FOR TURBINE FAN BLADES TO THE ORDER AND SPECIFICATION OF OTHERS, IN CLASS 40 (U.S. CLS. 100, 103 AND 106).

FIRST USE 7-0-2010; IN COMMERCE 8-0-2011.

THE MARK CONSISTS OF STANDARD CHARACTERS WITHOUT CLAIM TO ANY PARTICULAR FONT, STYLE, SIZE, OR COLOR.

OWNER OF U.S. REG. NOS. 2,762,591, 3,957,130, AND OTHERS.

SN 85-241,823, FILED 2-14-2011.

KYLE PEETE, EXAMINING ATTORNEY



David J. Kyros

Director of the United States Patent and Trademark Office

United States of America

United States Patent and Trademark Office

TECT ECOTHRUST

Reg. No. 4,075,290

Registered Dec. 20, 2011

Int. Cl.: 40

SERVICE MARK

PRINCIPAL REGISTER

TURBINE ENGINE COMPONENTS TECHNOLOGIES CORPORATION (DELAWARE CORPORATION)
1211 OLD ALBANY ROAD
THOMASVILLE, GA 31792

FOR: MANUFACTURING SERVICES FOR OTHERS OF TURBINE ENGINE COMPONENTS, IN CLASS 40 (U.S. CLS. 100, 103 AND 106).

FIRST USE 7-0-2010; IN COMMERCE 8-0-2011.

THE MARK CONSISTS OF STANDARD CHARACTERS WITHOUT CLAIM TO ANY PARTICULAR FONT, STYLE, SIZE, OR COLOR.

OWNER OF U.S. REG. NOS. 2,762,591, 3,957,130, AND OTHERS.

SN 85-242,510, FILED 2-15-2011.

KYLE PEETE, EXAMINING ATTORNEY



David J. Kybas

Director of the United States Patent and Trademark Office

United States of America

United States Patent and Trademark Office

The logo for "Liberty Link" features the word "Liberty" in a stylized, cursive font with a thin black arc above it. To the right, the word "Link" is in a simpler, sans-serif font, also with a thin black arc above it. The two arcs are connected at their ends.

Reg. No. 4,075,291

Registered Dec. 20, 2011

Int. Cl.: 10

TRADEMARK

PRINCIPAL REGISTER

POLYMEDICA CORPORATION (MASSACHUSETTS CORPORATION)
11 STATE STREET
WOBURN, MA 01801

FOR: LANCING DEVICES, IN CLASS 10 (U.S. CLS. 26, 39 AND 44).

FIRST USE 8-17-2011; IN COMMERCE 8-17-2011.

OWNER OF U.S. REG. NOS. 3,040,046, 3,618,554, AND OTHERS.

THE MARK CONSISTS OF THE WORDS "LIBERTY LINK" IN TWO SEPARATE STYLIZED FONTS. SEPARATE BRUSH-STROKE GRAPHICS APPEAR BELOW THE WORD "LIBERTY" AND ABOVE THE WORD "LINK".

SN 85-242,688, FILED 2-15-2011.

KAREN SEVERSON, EXAMINING ATTORNEY



David J. Kyffers

Director of the United States Patent and Trademark Office

United States of America

United States Patent and Trademark Office

SECURESMILES

Reg. No. 4,075,292

SHLOSBERG, STUART (UNITED KINGDOM INDIVIDUAL)
414 N CAMDEN DRIVE, SUITE 925
BEVERLY HILLS, CA 90210

Registered Dec. 20, 2011

Int. Cl.: 44

FOR: DENTISTRY SERVICES, NAMELY, DENTAL IMPLANTS SERVICES, IN CLASS 44
(U.S. CLS. 100 AND 101).

SERVICE MARK

FIRST USE 6-1-2006; IN COMMERCE 11-25-2006.

PRINCIPAL REGISTER

THE MARK CONSISTS OF STANDARD CHARACTERS WITHOUT CLAIM TO ANY PARTICULAR FONT, STYLE, SIZE, OR COLOR.

SN 85-243,094, FILED 2-15-2011.

HANNO RITTNER, EXAMINING ATTORNEY



David J. Kybas

Director of the United States Patent and Trademark Office

United States of America

United States Patent and Trademark Office



Reg. No. 4,075,293

Registered Dec. 20, 2011

Int. Cl.: 45

SERVICE MARK

PRINCIPAL REGISTER

MOTHERS AGAINST DRUNK DRIVING (D.C. NON-PROFIT CORPORATION)
SUITE 700
511 E. JOHN CARPTENTER FREEWAY
IRVING, TX 75062

FOR: PROVIDING PERSONAL SUPPORT SERVICES FOR VICTIMS OF DRUNK DRIVING AND THEIR FAMILIES AND FRIENDS, NAMELY, COMPANIONSHIP, HELP WITH LEGAL, FINANCIAL AND MEDICAL FORMS, COUNSELING AND EMOTIONAL SUPPORT, IN CLASS 45 (U.S. CLS. 100 AND 101).

FIRST USE 4-12-2011; IN COMMERCE 4-12-2011.

OWNER OF U.S. REG. NOS. 1,250,706, 3,100,555, AND OTHERS.

THE MARK CONSISTS OF THE LITERAL ELEMENT "MADD" IN LOWERCASE LETTERS PRECEDED BY A DESIGN ELEMENT CONSISTING OF A GLASS AND KEY ENCIRCLED BY "X" SHAPED BRUSHSTROKES.

SN 85-243,606, FILED 2-16-2011.

LINDA M. KING, EXAMINING ATTORNEY



David J. Kyffers

Director of the United States Patent and Trademark Office

United States of America

United States Patent and Trademark Office

LOVE GROWS

Reg. No. 4,075,294

LOS ANGELES GEM & JEWELRY DESIGN, INC. (CALIFORNIA CORPORATION)
659 SOUTH BROADWAY STREET, 7TH FLOOR
LOS ANGELES, CA 90014

Registered Dec. 20, 2011

Int. Cl.: 14

FOR: BANGLES; BRACELETS; CHARMS; EARRINGS; JEWELRY; LOCKETS; NECKLACES;
PENDANTS; RINGS; WOMEN'S JEWELRY, IN CLASS 14 (U.S. CLS. 2, 27, 28 AND 50).

TRADEMARK

FIRST USE 1-15-2010; IN COMMERCE 1-15-2010.

PRINCIPAL REGISTER

THE MARK CONSISTS OF STANDARD CHARACTERS WITHOUT CLAIM TO ANY PARTICULAR FONT, STYLE, SIZE, OR COLOR.

SN 85-243,794, FILED 2-16-2011.

EDWARD NELSON, EXAMINING ATTORNEY



David J. Kybas

Director of the United States Patent and Trademark Office

United States of America

United States Patent and Trademark Office

ONESIGN ANYWHERE

Reg. No. 4,075,295

Registered Dec. 20, 2011

Int. Cl.: 9

TRADEMARK

PRINCIPAL REGISTER

IMPRIVATA, INC. (DELAWARE CORPORATION)
SUITE 210
10 MAGUIRE ROAD
LEXINGTON, MA 02412

FOR: COMPUTER HARDWARE AND SOFTWARE THAT PROVIDES AGENTLESS REMOTE STRONG AUTHENTICATION AND SINGLE SIGN-ON ON APPLICATIONS TO MOBILE USERS, IN CLASS 9 (U.S. CLS. 21, 23, 26, 36 AND 38).

FIRST USE 5-16-2011; IN COMMERCE 5-16-2011.

THE MARK CONSISTS OF STANDARD CHARACTERS WITHOUT CLAIM TO ANY PARTICULAR FONT, STYLE, SIZE, OR COLOR.

OWNER OF U.S. REG. NOS. 2,777,653 AND 3,815,524.

SN 85-243,978, FILED 2-16-2011.

SUNG IN, EXAMINING ATTORNEY



David J. Kyfos

Director of the United States Patent and Trademark Office

United States of America

United States Patent and Trademark Office

API

Reg. No. 4,075,296

Registered Dec. 20, 2011

Int. Cl.: 31

TRADEMARK

PRINCIPAL REGISTER

MARS FISHCARE NORTH AMERICA, INC. (PENNSYLVANIA CORPORATION)
50 E. HAMILTON STREET, P.O. BOX 218
CHALFONT, PA 18914

FOR: FISH FOOD, IN CLASS 31 (U.S. CLS. 1 AND 46).

FIRST USE 5-1-2011; IN COMMERCE 5-1-2011.

THE MARK CONSISTS OF STANDARD CHARACTERS WITHOUT CLAIM TO ANY PARTICULAR FONT, STYLE, SIZE, OR COLOR.

SN 85-244,035, FILED 2-16-2011.

JOHN WILKE, EXAMINING ATTORNEY



David J. Kybas

Director of the United States Patent and Trademark Office

United States of America

United States Patent and Trademark Office

3G Cardio

Reg. No. 4,075,297

3G CARDIO, LLC (ARIZONA LIMITED LIABILITY COMPANY)
6969 E. SHEA BLVD
SCOTTSDALE, AZ 85254

Registered Dec. 20, 2011

Int. Cl.: 28

FOR: FITNESS MACHINES AND EQUIPMENT, NAMELY, WEIGHTS, TREADMILLS, ROWING MACHINES, STAIR STEPPING MACHINES, RESISTANCE MACHINES, STATIONARY CYCLES, IN CLASS 28 (U.S. CLS. 22, 23, 38 AND 50).

TRADEMARK

FIRST USE 10-3-2011; IN COMMERCE 10-3-2011.

PRINCIPAL REGISTER

THE MARK CONSISTS OF STANDARD CHARACTERS WITHOUT CLAIM TO ANY PARTICULAR FONT, STYLE, SIZE, OR COLOR.

NO CLAIM IS MADE TO THE EXCLUSIVE RIGHT TO USE "CARDIO", APART FROM THE MARK AS SHOWN.

SN 85-245,519, FILED 2-17-2011.

JANICE KIM, EXAMINING ATTORNEY



David J. Kyros

Director of the United States Patent and Trademark Office

United States of America

United States Patent and Trademark Office

OURGROUP

Reg. No. 4,075,298

Registered Dec. 20, 2011

Int. Cls.: 42 and 45

SERVICE MARK

PRINCIPAL REGISTER

OURGROUP, INC. (DELAWARE CORPORATION)
SUITE 101 #329
556 SOUTH FAIR OAKS AVENUE
PASADENA, CA 91105

FOR: COMPUTER SERVICES, NAMELY, ACTING AS AN APPLICATION SERVICE PROVIDER IN THE FIELD OF KNOWLEDGE MANAGEMENT TO HOST COMPUTER APPLICATION SOFTWARE FOR THE COLLECTION, EDITING, ORGANIZING, MODIFYING, BOOK MARKING, TRANSMISSION, STORAGE AND SHARING OF DATA AND INFORMATION; COMPUTER SERVICES, NAMELY, ACTING AS AN APPLICATION SERVICE PROVIDER TO HOST COMPUTER APPLICATION SOFTWARE FOR ASSISTING CHARITABLE ORGANIZATIONS TO MONETIZE GROUP MEMBERSHIP THROUGH FUNDRAISING, DONATIONS, INTER-GROUP RELATIONSHIPS, GROUP STATISTICS, AND GROUP SUCCESSES, IN CLASS 42 (U.S. CLS. 100 AND 101).

FIRST USE 9-1-2011; IN COMMERCE 9-1-2011.

FOR: ONLINE SOCIAL NETWORKING SERVICES, IN CLASS 45 (U.S. CLS. 100 AND 101).

FIRST USE 9-1-2011; IN COMMERCE 9-1-2011.

THE MARK CONSISTS OF STANDARD CHARACTERS WITHOUT CLAIM TO ANY PARTICULAR FONT, STYLE, SIZE, OR COLOR.

SN 85-245,904, FILED 2-18-2011.

KYLE PEETE, EXAMINING ATTORNEY



David J. Kyros

Director of the United States Patent and Trademark Office

United States of America

United States Patent and Trademark Office



Reg. No. 4,075,299

Registered Dec. 20, 2011

Int. Cl.: 42

SERVICE MARK

PRINCIPAL REGISTER

CABARET PARTNERS LLC (ILLINOIS LIMITED LIABILITY COMPANY)
UNIT 606
873 N. LARRABEE ST.
CHICAGO, IL 60610

FOR: COMPUTER SERVICES, NAMELY, CREATING AN ON-LINE COMMUNITY FOR REGISTERED USERS TO ORGANIZE GROUPS, MARKET AND PROMOTE EVENTS, PARTICIPATE IN DISCUSSIONS, AND ENGAGE IN SOCIAL, BUSINESS AND COMMUNITY NETWORKING RELATED TO ENTERTAINMENT CLUBS, IN CLASS 42 (U.S. CLS. 100 AND 101).

FIRST USE 9-20-2011; IN COMMERCE 9-20-2011.

THE MARK CONSISTS OF THE WORD "CLUBBUZZ" IN A STYLIZED FONT, WITH INK-LIKE SPLATTERS SURROUNDING THE LETTERS. "CLUB" IS IN LOWERCASE LETTERS, AND "BUZZ" IS IN CAPITAL LETTERS. A BEE IS IN FLIGHT ABOVE THE "C" IN "CLUBBUZZ".

SN 85-246,094, FILED 2-18-2011.

JANET LEE, EXAMINING ATTORNEY



David J. Kyffers

Director of the United States Patent and Trademark Office

United States of America

United States Patent and Trademark Office



Reg. No. 4,075,300

JINHUA CHEN (CHINA INDIVIDUAL)
226 CHARLES STREET #2
CAMBRIDGE, MA 02141

Registered Dec. 20, 2011

Int. Cl.: 25

FOR: CHILDREN'S AND INFANT'S APPAREL, NAMELY, JUMPERS, OVERALL SLEEPWEAR, PAJAMAS, ROMPERS AND ONE-PIECE GARMENTS, IN CLASS 25 (U.S. CLS. 22 AND 39).

TRADEMARK

FIRST USE 8-24-2011; IN COMMERCE 8-24-2011.

PRINCIPAL REGISTER

THE MARK CONSISTS OF PURPLE COLORED "XWEET" WITH "X" IN SHAPE OF A BUTTERFLY AND WEET IN REGULAR FONT OF TIMES NEW ROMAN.

THE COLOR(S) PURPLE IS/ARE CLAIMED AS A FEATURE OF THE MARK.

SN 85-246,699, FILED 2-18-2011.

SUE LAWRENCE, EXAMINING ATTORNEY



David J. Kyffers

Director of the United States Patent and Trademark Office

United States of America

United States Patent and Trademark Office

JUST STICKS

Reg. No. 4,075,301

JMG INTERNATIONAL, INC. (CALIFORNIA CORPORATION)

Registered Dec. 20, 2011

1440 KOLL CIRCLE, SUITE 104
SAN JOSE, CA 95112

Int. Cl.: 34

FOR: CIGARS, IN CLASS 34 (U.S. CLS. 2, 8, 9 AND 17).

TRADEMARK

FIRST USE 8-31-2011; IN COMMERCE 8-31-2011.

PRINCIPAL REGISTER

THE MARK CONSISTS OF STANDARD CHARACTERS WITHOUT CLAIM TO ANY PARTICULAR FONT, STYLE, SIZE, OR COLOR.

SN 85-246,719, FILED 2-18-2011.

KATHERINE CONNOLLY, EXAMINING ATTORNEY



David J. Kybas

Director of the United States Patent and Trademark Office

United States of America

United States Patent and Trademark Office

POSSIBILITIES ARE ENDLESS

Reg. No. 4,075,302

Registered Dec. 20, 2011

Int. Cl.: 14

TRADEMARK

PRINCIPAL REGISTER

QUALITY GOLD, INC. (OHIO CORPORATION)
500 QUALITY BOULEVARD
FAIRFIELD, OH 45018

FOR: JEWELRY, IN CLASS 14 (U.S. CLS. 2, 27, 28 AND 50).

FIRST USE 3-0-2011; IN COMMERCE 3-0-2011.

THE MARK CONSISTS OF STANDARD CHARACTERS WITHOUT CLAIM TO ANY PARTICULAR FONT, STYLE, SIZE, OR COLOR.

SN 85-247,255, FILED 2-21-2011.

KAREN BRACEY, EXAMINING ATTORNEY



David J. Kyffers

Director of the United States Patent and Trademark Office

United States of America

United States Patent and Trademark Office

ENERGY FACTOR

Reg. No. 4,075,303

Registered Dec. 20, 2011

Int. Cl.: 14

TRADEMARK

PRINCIPAL REGISTER

ENERGY FACTOR INC (FLORIDA CORPORATION)
SUIT 212
15019 ARBOR RESERVE CIR
TAMPA, FL 33624

FOR: PRECIOUS METALS AND THEIR ALLOYS; RUBBER OR SILICON WRISTBANDS IN THE NATURE OF A BRACELET; METAL AND SILICONE NECKLACES; JEWELLERY, IN CLASS 14 (U.S. CLS. 2, 27, 28 AND 50).

FIRST USE 12-1-2010; IN COMMERCE 3-1-2011.

THE MARK CONSISTS OF STANDARD CHARACTERS WITHOUT CLAIM TO ANY PARTICULAR FONT, STYLE, SIZE, OR COLOR.

NO CLAIM IS MADE TO THE EXCLUSIVE RIGHT TO USE "ENERGY", APART FROM THE MARK AS SHOWN.

SN 85-249,054, FILED 2-23-2011.

MARTHA FROMM, EXAMINING ATTORNEY



David J. Kyros

Director of the United States Patent and Trademark Office

United States of America

United States Patent and Trademark Office



Reg. No. 4,075,304

SALLY RAMIREZ (UNITED STATES INDIVIDUAL)
830 ROBINAIR DR.
SAN ANTONIO, TX 78245

Registered Dec. 20, 2011

Int. Cl.: 24

FOR: UNFITTED SEAT COVERS OF TEXTILE, IN CLASS 24 (U.S. CLS. 42 AND 50).

TRADEMARK

FIRST USE 3-9-2011; IN COMMERCE 3-9-2011.

PRINCIPAL REGISTER

NO CLAIM IS MADE TO THE EXCLUSIVE RIGHT TO USE "STADIUM SEAT SAVER", APART FROM THE MARK AS SHOWN.

THE MARK CONSISTS OF THE STYLIZED WORDING "STADIUM SEAT SAVER" SET ABOVE THE STYLIZED WORDING "MARK YOUR TERRITORY", WITH THE TERMS "STADIUM" AND "SAVER" SET INSIDE GEOMETRIC DESIGNS OF A GENERALLY RECTANGULAR SHAPE WITH STYLIZED DEPICTIONS OF KNOTS PLACED ON THE OUTER EDGES OF THE RECTANGULAR GEOMETRIC DESIGNS.

SN 85-249,346, FILED 2-23-2011.

MICHAEL GAAFAR, EXAMINING ATTORNEY



David J. Kyffers

Director of the United States Patent and Trademark Office

United States of America

United States Patent and Trademark Office

NETWORTH REALTY

Reg. No. 4,075,305

Registered Dec. 20, 2011

Int. Cl.: 36

SERVICE MARK

PRINCIPAL REGISTER

NETWORTH REALTY USA, LLC (TEXAS LIMITED LIABILITY COMPANY)
6110 RICHMOND AVENUE
HOUSTON, TX 77057

FOR: REAL ESTATE INVESTMENT SERVICES, IN CLASS 36 (U.S. CLS. 100, 101 AND 102).

FIRST USE 3-1-2008; IN COMMERCE 3-1-2008.

THE MARK CONSISTS OF STANDARD CHARACTERS WITHOUT CLAIM TO ANY PARTICULAR FONT, STYLE, SIZE, OR COLOR.

NO CLAIM IS MADE TO THE EXCLUSIVE RIGHT TO USE "REALTY", APART FROM THE MARK AS SHOWN.

SN 85-249,940, FILED 2-23-2011.

TINA MAI, EXAMINING ATTORNEY



David J. Kybas

Director of the United States Patent and Trademark Office

United States of America

United States Patent and Trademark Office

ENDURO

Reg. No. 4,075,306

UNIVERSAL SEWING SUPPLY, INC. (MISSOURI CORPORATION)
1011 EAST PARK INDUSTRIAL DRIVE
ST. LOUIS, MO 63130

Registered Dec. 20, 2011

Int. Cl.: 7

FOR: SERVO MOTORS FOR SEWING MACHINES, IN CLASS 7 (U.S. CLS. 13, 19, 21, 23, 31, 34 AND 35).

TRADEMARK

FIRST USE 8-19-2011; IN COMMERCE 8-19-2011.

PRINCIPAL REGISTER

THE MARK CONSISTS OF STANDARD CHARACTERS WITHOUT CLAIM TO ANY PARTICULAR FONT, STYLE, SIZE, OR COLOR.

SN 85-250,341, FILED 2-24-2011.

BARBARA A. GOLD, EXAMINING ATTORNEY



David J. Kybas

Director of the United States Patent and Trademark Office

United States of America

United States Patent and Trademark Office

ROYAL WING

Reg. No. 4,075,307

TRACTOR SUPPLY CO. OF TEXAS, LP (TEXAS LIMITED PARTNERSHIP)
200 POWELL PLACE
BRENTWOOD, TN 37027

Registered Dec. 20, 2011

Int. Cl.: 21

FOR: BIRD FEEDERS; BIRD HOUSES, IN CLASS 21 (U.S. CLS. 2, 13, 23, 29, 30, 33, 40 AND 50).

TRADEMARK

FIRST USE 3-1-2004; IN COMMERCE 3-1-2004.

PRINCIPAL REGISTER

THE MARK CONSISTS OF STANDARD CHARACTERS WITHOUT CLAIM TO ANY PARTICULAR FONT, STYLE, SIZE, OR COLOR.

OWNER OF U.S. REG. NOS. 1,597,724 AND 3,167,322.

SN 85-251,401, FILED 2-25-2011.

ANGELA DUONG, EXAMINING ATTORNEY



David J. Kybas

Director of the United States Patent and Trademark Office

United States of America

United States Patent and Trademark Office

HUNGRY HOLLOW

Reg. No. 4,075,308

Registered Dec. 20, 2011

Int. Cl.: 33

TRADEMARK

PRINCIPAL REGISTER

NAVARRO VINEYARDS LLC (CALIFORNIA LIMITED LIABILITY COMPANY)
P.O. BOX 47
PHILO, CA 95466

FOR: WINE, IN CLASS 33 (U.S. CLS. 47 AND 49).

FIRST USE 9-16-2011; IN COMMERCE 9-16-2011.

THE MARK CONSISTS OF STANDARD CHARACTERS WITHOUT CLAIM TO ANY PARTICULAR FONT, STYLE, SIZE, OR COLOR.

SN 85-251,788, FILED 2-25-2011.

HAI-LY LAM, EXAMINING ATTORNEY



David J. Kybas

Director of the United States Patent and Trademark Office

United States of America

United States Patent and Trademark Office

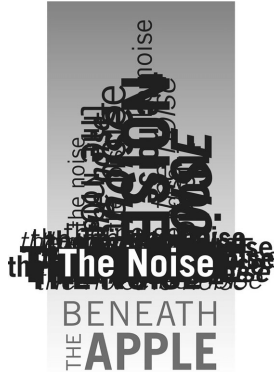

Reg. No. 4,075,309

Registered Dec. 20, 2011

Int. Cl.: 41

SERVICE MARK

PRINCIPAL REGISTER

JACKS, HEATHER (UNITED STATES INDIVIDUAL)
1234 6TH STREET #411
SANTA MONICA, CA 90401

FOR: PROVIDING ON-LINE E-ZINES IN THE FIELD OF MUSIC AND ENTERTAINMENT,
IN CLASS 41 (U.S. CLS. 100, 101 AND 107).

FIRST USE 4-2-2011; IN COMMERCE 4-2-2011.

THE MARK CONSISTS OF THE WORDS "THE NOISE BENEATH THE APPLE" IN A COL-
LAGE SHAPED LIKE AN URBAN SKYSCRAPER AGAINST A RECTANGLE BACKGROUND,
WITH THE WORDS "THE NOISE BENEATH THE APPLE" ON TOP AND UNDERNEATH.

SN 85-252,165, FILED 2-25-2011.

TINA MAI, EXAMINING ATTORNEY



David J. Kyros

Director of the United States Patent and Trademark Office

United States of America

United States Patent and Trademark Office

ANVANCA

Reg. No. 4,075,310

CAIRNS, BRIAN (UNITED STATES INDIVIDUAL)
100 W. 26TH ST.

Registered Dec. 20, 2011

NEW YORK, NY 10001

Int. Cl.: 5

FOR: DIETARY SUPPLEMENTS, IN CLASS 5 (U.S. CLS. 6, 18, 44, 46, 51 AND 52).

TRADEMARK

FIRST USE 9-1-2011; IN COMMERCE 9-1-2011.

PRINCIPAL REGISTER

THE MARK CONSISTS OF STANDARD CHARACTERS WITHOUT CLAIM TO ANY PARTICULAR FONT, STYLE, SIZE, OR COLOR.

SN 85-252,488, FILED 2-26-2011.

RUDY R. SINGLETON, EXAMINING ATTORNEY



David J. Kyffers

Director of the United States Patent and Trademark Office

United States of America

United States Patent and Trademark Office

TG Lite

Reg. No. 4,075,311

Registered Dec. 20, 2011

Int. Cl.: 19

TRADEMARK

PRINCIPAL REGISTER

GEOPRO, INC. (SOUTH DAKOTA CORPORATION)
302 E. WAREHOUSE ST.
ELKTON, SD 57026

FOR: GROUT, NAMELY, GROUT USED TO SEAL AND PROVIDE THERMAL CONDUCTIVITY FOR IN GROUND SOURCE HEAT LOOPS THAT USE THE EARTH TO HEAT AND COOL, IN CLASS 19 (U.S. CLS. 1, 12, 33 AND 50).

FIRST USE 7-0-2011; IN COMMERCE 7-0-2011.

THE MARK CONSISTS OF STANDARD CHARACTERS WITHOUT CLAIM TO ANY PARTICULAR FONT, STYLE, SIZE, OR COLOR.

SN 85-253,552, FILED 2-28-2011.

LINDA POWELL, EXAMINING ATTORNEY



David J. Kybas

Director of the United States Patent and Trademark Office

United States of America

United States Patent and Trademark Office

ASSESSABLES

Reg. No. 4,075,312

JONELLE KRIER (UNITED STATES INDIVIDUAL)
3724 - 19TH AVENUE EAST
HIBBING, MN 55746

Registered Dec. 20, 2011

Int. Cl.: 10

FOR: MEDICAL GOWNS; PATIENT EXAMINATION GOWNS, IN CLASS 10 (U.S. CLS. 26, 39 AND 44).

TRADEMARK

FIRST USE 6-26-2011; IN COMMERCE 9-28-2011.

PRINCIPAL REGISTER

THE MARK CONSISTS OF STANDARD CHARACTERS WITHOUT CLAIM TO ANY PARTICULAR FONT, STYLE, SIZE, OR COLOR.

SN 85-253,627, FILED 2-28-2011.

JASON TURNER, EXAMINING ATTORNEY



David J. Kybas

Director of the United States Patent and Trademark Office

United States of America

United States Patent and Trademark Office

TG Select

Reg. No. 4,075,313

Registered Dec. 20, 2011

Int. Cl.: 19

TRADEMARK

PRINCIPAL REGISTER

GEOPRO, INC. (SOUTH DAKOTA CORPORATION)
302 E. WAREHOUSE ST.
ELKTON, SD 57026

FOR: GROUT, NAMELY, GROUT USED TO SEAL AND PROVIDE THERMAL CONDUCTIVITY FOR IN GROUND SOURCE HEAT LOOPS THAT USE THE EARTH TO HEAT AND COOL, IN CLASS 19 (U.S. CLS. 1, 12, 33 AND 50).

FIRST USE 7-0-2011; IN COMMERCE 7-0-2011.

THE MARK CONSISTS OF STANDARD CHARACTERS WITHOUT CLAIM TO ANY PARTICULAR FONT, STYLE, SIZE, OR COLOR.

SN 85-253,649, FILED 2-28-2011.

LINDA POWELL, EXAMINING ATTORNEY



David J. Kyros

Director of the United States Patent and Trademark Office

United States of America

United States Patent and Trademark Office

doctor facials

Reg. No. 4,075,314

Registered Dec. 20, 2011

Int. Cl.: 3

TRADEMARK

PRINCIPAL REGISTER

GRAHAM, TARSHA (UNITED STATES INDIVIDUAL), DBA DOCTOR FACIALS,
141 W. BAYRIDGE DRIVE
WESONT, FL 33326

FOR: COSMETIC PREPARATIONS, IN CLASS 3 (U.S. CLS. 1, 4, 6, 50, 51 AND 52).

FIRST USE 5-20-2010; IN COMMERCE 2-1-2011.

THE MARK CONSISTS OF STANDARD CHARACTERS WITHOUT CLAIM TO ANY PARTICULAR FONT, STYLE, SIZE, OR COLOR.

NO CLAIM IS MADE TO THE EXCLUSIVE RIGHT TO USE "FACIALS", APART FROM THE MARK AS SHOWN.

SN 85-253,825, FILED 2-28-2011.

KYLE PEETE, EXAMINING ATTORNEY



David J. Kyffers

Director of the United States Patent and Trademark Office

United States of America

United States Patent and Trademark Office

MYPIX GAMES

Reg. No. 4,075,315

FARBOLIN, GREG (UNITED STATES INDIVIDUAL)
200 CESSNA BLVD
PORT ORANGE, FL 32128

Registered Dec. 20, 2011

Int. Cl.: 41

FOR: ENTERTAINMENT SERVICES IN THE NATURE OF ONLINE FANTASY SPORTS GAMES, ONLINE FANTASY SOCIAL GAMES, IN CLASS 41 (U.S. CLS. 100, 101 AND 107).

SERVICE MARK

FIRST USE 9-1-2011; IN COMMERCE 9-1-2011.

PRINCIPAL REGISTER

THE MARK CONSISTS OF STANDARD CHARACTERS WITHOUT CLAIM TO ANY PARTICULAR FONT, STYLE, SIZE, OR COLOR.

NO CLAIM IS MADE TO THE EXCLUSIVE RIGHT TO USE "GAMES", APART FROM THE MARK AS SHOWN.

SN 85-253,936, FILED 2-28-2011.

KATHRYN COWARD, EXAMINING ATTORNEY



David J. Kybas

Director of the United States Patent and Trademark Office

United States of America

United States Patent and Trademark Office

MAGIC MESH

Reg. No. 4,075,316

ALLSTAR MARKETING GROUP, LLC (NEW YORK LIMITED LIABILITY COMPANY)
2 SKYLINE DRIVE

Registered Dec. 20, 2011

HAWTHORNE, NY 10532

Int. Cl.: 19

FOR: NON-METAL TEMPORARY REMOVABLE SCREEN DOORS, IN CLASS 19 (U.S. CLS. 1, 12, 33 AND 50).

TRADEMARK

FIRST USE 8-15-2011; IN COMMERCE 8-15-2011.

PRINCIPAL REGISTER

THE MARK CONSISTS OF STANDARD CHARACTERS WITHOUT CLAIM TO ANY PARTICULAR FONT, STYLE, SIZE, OR COLOR.

NO CLAIM IS MADE TO THE EXCLUSIVE RIGHT TO USE "MESH", APART FROM THE MARK AS SHOWN.

SN 85-254,377, FILED 3-1-2011.

JOSETTE BEVERLY, EXAMINING ATTORNEY



David J. Kyffers

Director of the United States Patent and Trademark Office

United States of America

United States Patent and Trademark Office

tickets now 

Reg. No. 4,075,317

TNOW ENTERTAINMENT GROUP, INC. (ILLINOIS CORPORATION)
3800 GOLF ROAD
ROLLING MEADOWS, IL 60008

Registered Dec. 20, 2011

Int. Cl.: 35

FOR: ONLINE AND TELEPHONE ORDERING SERVICES IN THE FIELD OF TICKETS TO LIVE ENTERTAINMENT AND SPORTING EVENTS, IN CLASS 35 (U.S. CLS. 100, 101 AND 102).

SERVICE MARK

FIRST USE 6-3-2011; IN COMMERCE 6-3-2011.

PRINCIPAL REGISTER

OWNER OF U.S. REG. NOS. 2,433,275 AND 3,366,812.

THE MARK CONSISTS OF THE WORDS "TICKETSNOW" IN LOWERCASE LETTERING FOLLOWED BY A STAR LIKE DESIGN.

SN 85-254,531, FILED 3-1-2011.

ODESSA BIBBINS, EXAMINING ATTORNEY



David J. Kyffers

Director of the United States Patent and Trademark Office

United States of America

United States Patent and Trademark Office

SET IT - FORGET IT

Reg. No. 4,075,318

CABIN CREEK, INC. (WEST VIRGINIA CORPORATION)

Registered Dec. 20, 2011

P.O. BOX 272
TRIADELPHIA, WV 26059

Int. Cl.: 7

FOR: CONVEYOR ACCESSORIES, NAMELY, CONVEYOR BELT SCRAPERS, IN CLASS 7
(U.S. CLS. 13, 19, 21, 23, 31, 34 AND 35).

TRADEMARK

FIRST USE 7-6-2011; IN COMMERCE 7-6-2011.

PRINCIPAL REGISTER

THE MARK CONSISTS OF STANDARD CHARACTERS WITHOUT CLAIM TO ANY PARTICULAR FONT, STYLE, SIZE, OR COLOR.

SN 85-254,606, FILED 3-1-2011.

KAELIE KUNG, EXAMINING ATTORNEY



David J. Kyffers

Director of the United States Patent and Trademark Office

United States of America

United States Patent and Trademark Office

MAGIC MAX

Reg. No. 4,075,319

CABIN CREEK, INC. (WEST VIRGINIA CORPORATION)

Registered Dec. 20, 2011

P.O. BOX 272
TRIADELPHIA, WV 26059

Int. Cl.: 7

FOR: CONVEYOR ACCESSORIES, NAMELY, CONVEYOR BELT SCRAPERS, IN CLASS 7
(U.S. CLS. 13, 19, 21, 23, 31, 34 AND 35).

TRADEMARK

FIRST USE 7-6-2011; IN COMMERCE 7-6-2011.

PRINCIPAL REGISTER

THE MARK CONSISTS OF STANDARD CHARACTERS WITHOUT CLAIM TO ANY PARTICULAR FONT, STYLE, SIZE, OR COLOR.

SN 85-254,623, FILED 3-1-2011.

KAELIE KUNG, EXAMINING ATTORNEY



David J. Kyffers

Director of the United States Patent and Trademark Office

United States of America

United States Patent and Trademark Office

WHITZORB

Reg. No. 4,075,320

Registered Dec. 20, 2011

Int. Cl.: 19

TRADEMARK

PRINCIPAL REGISTER

THE WHITMORE MANUFACTURING COMPANY (DELAWARE CORPORATION)
930 WHITMORE DRIVE
ROCKWALL, TX 75087

FOR: OIL ABSORBENTS, NAMELY, GRANULAR ABSORBENT WOOD FIBER-BASED COMPOSITIONS FOR ABSORBING OIL SPILLS ON FLOORS, WORK SURFACES OR OTHER AREAS, IN CLASS 19 (U.S. CLS. 1, 12, 33 AND 50).

FIRST USE 7-18-2011; IN COMMERCE 7-18-2011.

THE MARK CONSISTS OF STANDARD CHARACTERS WITHOUT CLAIM TO ANY PARTICULAR FONT, STYLE, SIZE, OR COLOR.

OWNER OF U.S. REG. NOS. 526,618, 1,311,920, AND OTHERS.

SN 85-255,378, FILED 3-2-2011.

DEBRA LEE, EXAMINING ATTORNEY



David J. Kybas

Director of the United States Patent and Trademark Office

United States of America

United States Patent and Trademark Office

ANONYA

Reg. No. 4,075,321

RITUAL ACTIVEWEAR, LLC (DELAWARE LIMITED LIABILITY COMPANY)
472 18TH AVENUE

Registered Dec. 20, 2011

SAN FRANCISCO, CA 94121

Int. Cl.: 25

FOR: BEANIES; BRAS; DRESSES; HATS; HEADBANDS; JACKETS; LEOTARDS; LONG-SLEEVED SHIRTS; PANTS; PULLOVERS; SCARVES; SHIRTS; SHORTS; SKIRTS; SOCKS; SPORTS BRA; SWEATSHIRTS; T-SHIRTS; TUNICS; UNITARDS; WOMEN'S ATHLETIC TOPS WITH BUILT-IN BRAS, IN CLASS 25 (U.S. CLS. 22 AND 39).

TRADEMARK

PRINCIPAL REGISTER

FIRST USE 3-2-2011; IN COMMERCE 4-20-2011.

THE MARK CONSISTS OF STANDARD CHARACTERS WITHOUT CLAIM TO ANY PARTICULAR FONT, STYLE, SIZE, OR COLOR.

THE NAME(S), PORTRAIT(S), AND/OR SIGNATURE(S) SHOWN IN THE MARK DOES NOT IDENTIFY A PARTICULAR LIVING INDIVIDUAL.

SN 85-255,591, FILED 3-2-2011.

HANNO RITTNER, EXAMINING ATTORNEY



David J. Kyros

Director of the United States Patent and Trademark Office

United States of America
United States Patent and Trademark Office

SUNPLUS

Reg. No. 4,075,322

ALCAN PRODUCTS CORPORATION (TEXAS CORPORATION)
8770 WEST BRYN MAWR AVENUE
CHICAGO, IL 60631

Registered Dec. 20, 2011

Int. Cl.: 9

FOR: ELECTRICAL CONDUCTORS, NAMELY, ELECTRICAL CABLES, IN CLASS 9 (U.S. CLS. 21, 23, 26, 36 AND 38).

TRADEMARK

FIRST USE 4-25-2011; IN COMMERCE 4-25-2011.

PRINCIPAL REGISTER

THE MARK CONSISTS OF STANDARD CHARACTERS WITHOUT CLAIM TO ANY PARTICULAR FONT, STYLE, SIZE, OR COLOR.

SN 85-256,479, FILED 3-3-2011.

KATHRYN COWARD, EXAMINING ATTORNEY



David J. Kybas

Director of the United States Patent and Trademark Office

United States of America

United States Patent and Trademark Office

SANZI

Reg. No. 4,075,323

Registered Dec. 20, 2011

Int. Cl.: 3

TRADEMARK

PRINCIPAL REGISTER

E I H DISTRIBUTING INC. (WEST VIRGINIA CORPORATION)
2 SUBURBAN COURT
MORGANTOWN, WV 26505

FOR: HAIR SHAMPOO; HAIR CONDITIONERS, IN CLASS 3 (U.S. CLS. 1, 4, 6, 50, 51 AND 52).

FIRST USE 11-23-2010; IN COMMERCE 12-3-2010.

THE MARK CONSISTS OF STANDARD CHARACTERS WITHOUT CLAIM TO ANY PARTICULAR FONT, STYLE, SIZE, OR COLOR.

SN 85-257,702, FILED 3-4-2011.

ZACHARY BELLO, EXAMINING ATTORNEY



David J. Kyffers

Director of the United States Patent and Trademark Office

United States of America

United States Patent and Trademark Office

MY NYCB VIRTUAL BANKER

Reg. No. 4,075,324

Registered Dec. 20, 2011

Int. Cl.: 36

SERVICE MARK

PRINCIPAL REGISTER

NEW YORK COMMUNITY BANCORP, INC. (DELAWARE CORPORATION)
615 MERRICK AVENUE
WESTBURY, NY 11590

FOR: BANKING SERVICES, IN CLASS 36 (U.S. CLS. 100, 101 AND 102).

FIRST USE 3-18-2011; IN COMMERCE 3-18-2011.

THE MARK CONSISTS OF STANDARD CHARACTERS WITHOUT CLAIM TO ANY PARTICULAR FONT, STYLE, SIZE, OR COLOR.

OWNER OF U.S. REG. NOS. 3,128,399, 3,267,548, AND OTHERS.

NO CLAIM IS MADE TO THE EXCLUSIVE RIGHT TO USE "VIRTUAL BANKER", APART FROM THE MARK AS SHOWN.

SN 85-258,242, FILED 3-4-2011.

BRIAN PINO, EXAMINING ATTORNEY



David J. Kyros

Director of the United States Patent and Trademark Office

United States of America

United States Patent and Trademark Office

Paleo Boot Camp

Reg. No. 4,075,325

Registered Dec. 20, 2011

Int. Cl.: 41

SERVICE MARK

PRINCIPAL REGISTER

RESNIK, ROBERT S. (UNITED STATES INDIVIDUAL), DBA PALEO BOOT CAMP,
1356 GUINNESS WAY
GARDNERVILLE, NV 89410

FOR: CONSULTING SERVICES IN THE FIELDS OF FITNESS AND EXERCISE; PHYSICAL FITNESS STUDIO SERVICES, NAMELY, PROVIDING GROUP EXERCISE INSTRUCTION, EQUIPMENT, AND FACILITIES; PROVIDING A WEB SITE FEATURING INFORMATION ON EXERCISE AND FITNESS; PROVIDING A WEBSITE FEATURING INFORMATION ON EXERCISE AND FITNESS; PROVIDING AN ON-LINE COMPUTER DATABASE FEATURING INFORMATION REGARDING EXERCISE AND FITNESS; PROVIDING INFORMATION IN THE FIELD OF EXERCISE TRAINING; PROVIDING INFORMATION ON PHYSICAL EXERCISE, IN CLASS 41 (U.S. CLS. 100, 101 AND 107).

FIRST USE 10-12-2011; IN COMMERCE 10-12-2011.

THE MARK CONSISTS OF STANDARD CHARACTERS WITHOUT CLAIM TO ANY PARTICULAR FONT, STYLE, SIZE, OR COLOR.

NO CLAIM IS MADE TO THE EXCLUSIVE RIGHT TO USE "BOOT CAMP", APART FROM THE MARK AS SHOWN.

SN 85-259,238, FILED 3-6-2011.

BRETT J. GOLDEN, EXAMINING ATTORNEY



David J. Kyros

Director of the United States Patent and Trademark Office

United States of America

United States Patent and Trademark Office

STRAWBERRIES ARE FOREVER SHORTCAKE

Reg. No. 4,075,326

Registered Dec. 20, 2011

Int. Cl.: 30

TRADEMARK

PRINCIPAL REGISTER

WELLS ENTERPRISES, INC. (IOWA CORPORATION)
P.O. BOX 1310, ONE BLUE BUNNY DRIVE
LE MARS, IA 51031

FOR: FROZEN CONFECTIONS, IN CLASS 30 (U.S. CL. 46).

FIRST USE 2-1-2011; IN COMMERCE 2-8-2011.

THE MARK CONSISTS OF STANDARD CHARACTERS WITHOUT CLAIM TO ANY PARTICULAR FONT, STYLE, SIZE, OR COLOR.

NO CLAIM IS MADE TO THE EXCLUSIVE RIGHT TO USE "STRAWBERRIES" AND "SHORTCAKE", APART FROM THE MARK AS SHOWN.

SN 85-261,013, FILED 3-8-2011.

LAURIE MAYES, EXAMINING ATTORNEY



David J. Kybas

Director of the United States Patent and Trademark Office

United States of America

United States Patent and Trademark Office

FOR EASY, MEMORABLE MEALS

Reg. No. 4,075,327

AMAZING TASTE FOODS, INC. (CALIFORNIA CORPORATION)
2633 COAL CANYON ROAD
MALIBU, CA 90265

Registered Dec. 20, 2011

Int. Cl.: 30

FOR: COATINGS FOR FOODS MADE OF BREADING; MARINADE MIXES; MARINADES; MIXES FOR MAKING BREADING; SAUCES; SEASONINGS; STUFFING MIXES CONTAINING BREAD, IN CLASS 30 (U.S. CL. 46).

TRADEMARK

FIRST USE 7-5-2011; IN COMMERCE 7-5-2011.

PRINCIPAL REGISTER

THE MARK CONSISTS OF STANDARD CHARACTERS WITHOUT CLAIM TO ANY PARTICULAR FONT, STYLE, SIZE, OR COLOR.

SN 85-261,396, FILED 3-8-2011.

KAREN SEVERSON, EXAMINING ATTORNEY



David J. Kybas

Director of the United States Patent and Trademark Office

United States of America

United States Patent and Trademark Office

GET YOUR RIDE ON

Reg. No. 4,075,328

TUF RACK INC. (CANADA CORPORATION)
29-775 PACIFIC ROAD

Registered Dec. 20, 2011

OAKVILLE, ONTARIO, CANADA L6L6M4

Int. Cl.: 12

FOR: BICYCLE CARRIERS FOR VEHICLES AND PARTS THEREOF, IN CLASS 12 (U.S. CLS. 19, 21, 23, 31, 35 AND 44).

TRADEMARK

FIRST USE 6-8-2011; IN COMMERCE 6-8-2011.

PRINCIPAL REGISTER

THE MARK CONSISTS OF STANDARD CHARACTERS WITHOUT CLAIM TO ANY PARTICULAR FONT, STYLE, SIZE, OR COLOR.

SN 85-261,815, FILED 3-9-2011.

JOHN WILKE, EXAMINING ATTORNEY



David J. Kyfos

Director of the United States Patent and Trademark Office

United States of America

United States Patent and Trademark Office

TRANSMISSION
NORTH AMERICA

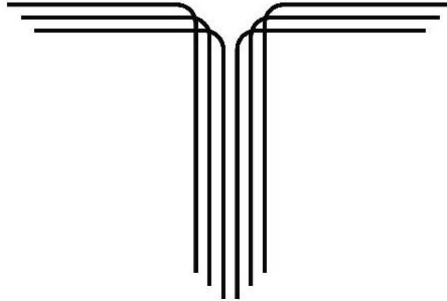

Reg. No. 4,075,329

Registered Dec. 20, 2011

Int. Cl.: 37

SERVICE MARK

PRINCIPAL REGISTER

ALCAN PRODUCTS CORPORATION (TEXAS CORPORATION)
8770 WEST BRYN MAWR AVENUE
CHICAGO, IL 60631

FOR: CONSTRUCTION OF ELECTRICAL TRANSMISSION LINES AND FACILITIES, IN CLASS 37 (U.S. CLS. 100, 103 AND 106).

FIRST USE 3-20-2011; IN COMMERCE 3-20-2011.

NO CLAIM IS MADE TO THE EXCLUSIVE RIGHT TO USE "TRANSMISSION NORTH AMERICA", APART FROM THE MARK AS SHOWN.

THE MARK CONSISTS OF A STYLIZED LETTER "T" COMPRISED OF SIX LINES UNDERNEATH THE WORDS "TRANSMISSION NORTH AMERICA".

SN 85-262,229, FILED 3-9-2011.

KATHRYN COWARD, EXAMINING ATTORNEY



David J. Kybas

Director of the United States Patent and Trademark Office

United States of America

United States Patent and Trademark Office

SULPHUR - AN ADVANTAGED ELEMENT

Reg. No. 4,075,330

Registered Dec. 20, 2011

Int. Cl.: 35

SERVICE MARK

PRINCIPAL REGISTER

THE SULPHUR INSTITUTE, INC. (DELAWARE CORPORATION)
SUITE 520
1020 19TH STREET NW
WASHINGTON, DC 20036

FOR: ARRANGING AND CONDUCTING BUSINESS CONFERENCES; ASSOCIATION SERVICES, NAMELY, PROMOTING THE INTERESTS OF THE SULPHUR INDUSTRY AND RELATED STAKEHOLDERS, IN CLASS 35 (U.S. CLS. 100, 101 AND 102).

FIRST USE 4-13-2011; IN COMMERCE 4-13-2011.

THE MARK CONSISTS OF STANDARD CHARACTERS WITHOUT CLAIM TO ANY PARTICULAR FONT, STYLE, SIZE, OR COLOR.

NO CLAIM IS MADE TO THE EXCLUSIVE RIGHT TO USE "SULPHUR", APART FROM THE MARK AS SHOWN.

SN 85-262,253, FILED 3-9-2011.

KEVIN DINALLO, EXAMINING ATTORNEY



David J. Kyjars

Director of the United States Patent and Trademark Office

United States of America

United States Patent and Trademark Office

CLEAN LINE

Reg. No. 4,075,331

Registered Dec. 20, 2011

Int. Cls.: 19 and 22

TRADEMARK

PRINCIPAL REGISTER

INTERNATIONAL VECTORS, LTD. (PENNSYLVANIA CORPORATION), DBA PEN
FABRICATORS,
310 EMIG ROAD
EMIGSVILLE, PA 17318

FOR: FITTED SWIMMING POOL LINERS, COVERS AND SAFETY COVERS, IN CLASS 19
(U.S. CLS. 1, 12, 33 AND 50).

FIRST USE 6-6-2011; IN COMMERCE 6-6-2011.

FOR: UNFITTED COVERS OF FLEXIBLE VINYL FOR SWIMMING POOLS, IN CLASS 22
(U.S. CLS. 1, 2, 7, 19, 22, 42 AND 50).

FIRST USE 8-15-2011; IN COMMERCE 8-15-2011.

THE MARK CONSISTS OF STANDARD CHARACTERS WITHOUT CLAIM TO ANY PAR-
TICULAR FONT, STYLE, SIZE, OR COLOR.

SN 85-263,173, FILED 3-10-2011.

MARILYN IZZI, EXAMINING ATTORNEY



David J. Kyffers

Director of the United States Patent and Trademark Office

United States of America

United States Patent and Trademark Office



Reg. No. 4,075,332

Registered Dec. 20, 2011

Int. Cls.: 19 and 22

TRADEMARK

PRINCIPAL REGISTER

INTERNATIONAL VECTORS, LTD. (PENNSYLVANIA CORPORATION), DBA PEN FABRICATORS,
310 EMIG ROAD
EMIGSVILLE, PA 17318

FOR: FITTED SWIMMING POOL LINERS, COVERS AND SAFETY COVERS, IN CLASS 19 (U.S. CLS. 1, 12, 33 AND 50).

FIRST USE 6-6-2011; IN COMMERCE 6-6-2011.

FOR: UNFITTED COVERS OF FLEXIBLE VINYL FOR SWIMMING POOLS, IN CLASS 22 (U.S. CLS. 1, 2, 7, 19, 22, 42 AND 50).

FIRST USE 8-15-2011; IN COMMERCE 8-15-2011.

NO CLAIM IS MADE TO THE EXCLUSIVE RIGHT TO USE "FABRICATORS", APART FROM THE MARK AS SHOWN.

THE MARK CONSISTS OF THE WORD "PEN" IN STYLIZED LETTERS ABOVE THE WORD "FABRICATORS" IN STYLIZED CAPITAL LETTERS, THE WORD "FABRICATORS" APPEARING AGAINST THE BACKDROP OF A STYLIZED SWIMMING POOL, BOTH THE WORDS "PEN" AND "FABRICATORS" SUPERIMPOSED UPON A DIMPLED SPHERE HAVING A BRIGHT SPOT BETWEEN THE LETTERS "P" AND "E" IN "PEN", WITH A WATER DROP LOCATED AT THE BASE OF AND FOLLOWING THE LETTER "N" IN "PEN".

SN 85-263,234, FILED 3-10-2011.

MARILYN IZZI, EXAMINING ATTORNEY



David J. Kybas

Director of the United States Patent and Trademark Office

United States of America

United States Patent and Trademark Office



Reg. No. 4,075,333

Registered Dec. 20, 2011

Int. Cl.: 41

SERVICE MARK

PRINCIPAL REGISTER

NORMAN, KEVIN D (UNITED STATES INDIVIDUAL), DBA SHADOWCAST
ENTERTAINMENT,
P.O. BOX 23274
HOUSTON, TX 77228

FOR: ENTERTAINMENT SERVICES, NAMELY, THE PROVISION OF CONTINUING MOVIES, SHOWS, AND PROGRAMS FEATURING NEWS, COMMENTARY, FICTION, AND DOCUMENTARIES DELIVERED BY INTERNET, IN CLASS 41 (U.S. CLS. 100, 101 AND 107).

FIRST USE 5-25-2011; IN COMMERCE 5-25-2011.

NO CLAIM IS MADE TO THE EXCLUSIVE RIGHT TO USE "BLACK INDEPENDENT MEDIA CHANNEL", APART FROM THE MARK AS SHOWN.

THE COLOR(S) BLACK, RED, GREEN, AND WHITE IS/ARE CLAIMED AS A FEATURE OF THE MARK.

THE MARK CONSISTS OF BLACK RECTANGLE WITH A RED AND GREEN CIRCLE IN THE CENTER, WITH THE WORDS "BLACK INDEPENDENT MEDIA CHANNEL" IN WHITE LETTERS IN THE FONT "PUMP DEMI BOLD LET" ACROSS THE CENTER OF THE IMAGE.

SN 85-263,953, FILED 3-10-2011.

DANIEL BRODY, EXAMINING ATTORNEY



David J. Kybas

Director of the United States Patent and Trademark Office

United States of America

United States Patent and Trademark Office

Your Imagination...Our Innovation

Reg. No. 4,075,334

Registered Dec. 20, 2011

Int. Cl.: 40

SERVICE MARK

PRINCIPAL REGISTER

CONTRACT MANUFACTURING SOLUTIONS, INC. (FLORIDA CORPORATION), AKA
CMSI,
1880 NORTH COMMERCE PARKWAY
WESTON, FL 33326

FOR: CONTRACT MANUFACTURING IN THE FIELD OF MEDICAL DEVICES, IN CLASS
40 (U.S. CLS. 100, 103 AND 106).

FIRST USE 9-30-2011; IN COMMERCE 9-30-2011.

THE MARK CONSISTS OF STANDARD CHARACTERS WITHOUT CLAIM TO ANY PAR-
TICULAR FONT, STYLE, SIZE, OR COLOR.

SN 85-264,472, FILED 3-11-2011.

ERNEST SHOSHO, EXAMINING ATTORNEY



David J. Kyffers

Director of the United States Patent and Trademark Office

United States of America

United States Patent and Trademark Office



Reg. No. 4,075,335

Registered Dec. 20, 2011

Int. Cl.: 19

TRADEMARK

PRINCIPAL REGISTER

GEOPRO, INC. (SOUTH DAKOTA CORPORATION)
302 E. WAREHOUSE ST.
ELKTON, SD 57026

FOR: GROUT, NAMELY, GROUT USED TO SEAL AND PROVIDE THERMAL CONDUCTIVITY FOR IN GROUND SOURCE HEAT LOOPS THAT USE THE EARTH TO HEAT AND COOL, IN CLASS 19 (U.S. CLS. 1, 12, 33 AND 50).

FIRST USE 7-0-2011; IN COMMERCE 7-0-2011.

NO CLAIM IS MADE TO THE EXCLUSIVE RIGHT TO USE "INC.", APART FROM THE MARK AS SHOWN.

THE MARK CONSISTS OF THE WORDS "GEOPRO, INC." CENTERED WITHIN AN OVAL THAT IS BROKEN ON BOTH SIDES BY THE WORDING.

SN 85-264,725, FILED 3-11-2011.

LINDA POWELL, EXAMINING ATTORNEY



David J. Kybas

Director of the United States Patent and Trademark Office

United States of America

United States Patent and Trademark Office

BOOGIE MONSTER

Reg. No. 4,075,336

COMPENDIUM INCORPORATED (WASHINGTON CORPORATION)
SUITE 400 600 NORTH 36TH STREET
SEATTLE, WA 98103

Registered Dec. 20, 2011

Int. Cl.: 16

FOR: KIT COMPOSED OF CHILDREN'S BOOKS AND PLUSH LEGGINGS, SOLD TOGETHER AS A UNIT, IN CLASS 16 (U.S. CLS. 2, 5, 22, 23, 29, 37, 38 AND 50).

TRADEMARK

FIRST USE 3-0-2011; IN COMMERCE 6-0-2011.

PRINCIPAL REGISTER

THE MARK CONSISTS OF STANDARD CHARACTERS WITHOUT CLAIM TO ANY PARTICULAR FONT, STYLE, SIZE, OR COLOR.

SN 85-264,769, FILED 3-11-2011.

ROBIN CHOSID, EXAMINING ATTORNEY



David J. Kybas

Director of the United States Patent and Trademark Office

United States of America

United States Patent and Trademark Office

PACIFICHOST

Reg. No. 4,075,337

WIREFUSEMEDIA LLC (WASHINGTON LIMITED LIABILITY COMPANY)
800 BELLEVUE WAY NE FL 4
BELLEVUE, WA 98004

Registered Dec. 20, 2011

Int. Cl.: 42

FOR: HOSTING OF WEB SITES, IN CLASS 42 (U.S. CLS. 100 AND 101).

SERVICE MARK

FIRST USE 8-20-2009; IN COMMERCE 8-20-2009.

PRINCIPAL REGISTER

THE MARK CONSISTS OF STANDARD CHARACTERS WITHOUT CLAIM TO ANY PARTICULAR FONT, STYLE, SIZE, OR COLOR.

SN 85-265,330, FILED 3-12-2011.

HANNO RITTNER, EXAMINING ATTORNEY



David J. Kybas

Director of the United States Patent and Trademark Office

United States of America

United States Patent and Trademark Office

ZICO

Reg. No. 4,075,338

Registered Dec. 20, 2011

Int. Cl.: 34

TRADEMARK

PRINCIPAL REGISTER

ZICO USA, INC. (CALIFORNIA CORPORATION)
17005 EVERGREEN PLACE STE. B
CITY OF INDUSTRY, CA 91745

FOR: LIGHTERS FOR SMOKERS, IN CLASS 34 (U.S. CLS. 2, 8, 9 AND 17).

FIRST USE 4-26-2011; IN COMMERCE 4-26-2011.

THE MARK CONSISTS OF STANDARD CHARACTERS WITHOUT CLAIM TO ANY PARTICULAR FONT, STYLE, SIZE, OR COLOR.

SN 85-266,740, FILED 3-14-2011.

SCOTT BIBB, EXAMINING ATTORNEY



David J. Kyffers

Director of the United States Patent and Trademark Office

United States of America

United States Patent and Trademark Office

WATERCOOLER

Reg. No. 4,075,339

Registered Dec. 20, 2011

Int. Cl.: 9

TRADEMARK

PRINCIPAL REGISTER

VIDEO DESIGN SOFTWARE, INC. (NEW YORK CORPORATION)
92 CENTRAL AVENUE
FARMINGDALE, NY 11768

FOR: COMPUTER SOFTWARE FOR MANAGING, AUTOMATING, AND BROADCASTING SOCIAL MEDIA MESSAGES BASED ON TELEVISION CONTENT AND PROGRAMMING, IN CLASS 9 (U.S. CLS. 21, 23, 26, 36 AND 38).

FIRST USE 4-4-2011; IN COMMERCE 4-11-2011.

THE MARK CONSISTS OF STANDARD CHARACTERS WITHOUT CLAIM TO ANY PARTICULAR FONT, STYLE, SIZE, OR COLOR.

SN 85-266,844, FILED 3-15-2011.

DOMINIC J. FERRAIUOLO, EXAMINING ATTORNEY



David J. Kyffers

Director of the United States Patent and Trademark Office

United States of America

United States Patent and Trademark Office

JEWELISTA

FASHION DISCOVERS JEWELRY

Reg. No. 4,075,340

AAROHI DIAMONDS, INC. (NEW YORK CORPORATION), DBA ADNY,
145 WEST 45TH STREET
NEW YORK, NY 10036

Registered Dec. 20, 2011

Int. Cl.: 35

FOR: ONLINE MARKETING, NAMELY, ONLINE ADVERTISING AND PROMOTIONAL SERVICES AND ONLINE RETAIL STORE SERVICES AND ONLINE ORDERING SERVICES FEATURING FINE JEWELRY, JEWELRY, DIAMONDS, AND PRECIOUS STONES PROVIDED THROUGH WEB SITES, IN CLASS 35 (U.S. CLS. 100, 101 AND 102).

SERVICE MARK

PRINCIPAL REGISTER

FIRST USE 4-14-2011; IN COMMERCE 9-7-2011.

THE MARK CONSISTS OF THE WORD "JEWELISTA" IN BLACK STYLIZED FONT WITH A PINK DIAMOND FORMING THE DOT ABOVE THE LETTER "I". THE WORDING "FASHION DISCOVERS JEWELRY" APPEARS IN GRAY STYLIZED FONT CENTERED BELOW THE LETTERS "WELISTA" IN THE WORD "JEWELISTA".

THE COLOR(S) BLACK, PINK AND GRAY IS/ARE CLAIMED AS A FEATURE OF THE MARK.

SN 85-266,929, FILED 3-15-2011.

TINA BROWN, EXAMINING ATTORNEY



David J. Kybas

Director of the United States Patent and Trademark Office

United States of America

United States Patent and Trademark Office

COOKING MADE EASY

Reg. No. 4,075,341

JEANETTE M. RICHARDSON (UNITED STATES INDIVIDUAL)
2 N. OAKDALE AVE.
MEDFORD, OR 97501

Registered Dec. 20, 2011

Int. Cl.: 29

FOR: FROZEN FOODS, NAMELY, READY TO COOK ENTREES CONSISTING PRIMARILY OF MEAT, SAUCE, AND VEGETABLES, IN CLASS 29 (U.S. CL. 46).

TRADEMARK

FIRST USE 10-24-2011; IN COMMERCE 10-25-2011.

PRINCIPAL REGISTER

THE MARK CONSISTS OF STANDARD CHARACTERS WITHOUT CLAIM TO ANY PARTICULAR FONT, STYLE, SIZE, OR COLOR.

SN 85-267,838, FILED 3-15-2011.

BRIAN PINO, EXAMINING ATTORNEY



David J. Kyffers

Director of the United States Patent and Trademark Office

United States of America

United States Patent and Trademark Office

GOOD AS NEW

Reg. No. 4,075,342

Registered Dec. 20, 2011

Int. Cl.: 3

TRADEMARK

PRINCIPAL REGISTER

LANE BRYANT PURCHASING CORP. (OHIO CORPORATION)
3344 MORSE CROSSING ROAD
COLUMBUS, OH 43219

FOR: PERSONAL CARE PRODUCTS, NAMELY, EXFOLIATING PREPARATIONS FOR THE SKIN, BODY SCRUB, BODY WASH, BUBBLE BATH, SCRUBS FOR THE SKIN, SHOWER CREAM, SHOWER GEL, SOAP FOR THE BODY, SKIN MOISTURIZER, IN CLASS 3 (U.S. CLS. 1, 4, 6, 50, 51 AND 52).

FIRST USE 4-12-2011; IN COMMERCE 4-12-2011.

THE MARK CONSISTS OF STANDARD CHARACTERS WITHOUT CLAIM TO ANY PARTICULAR FONT, STYLE, SIZE, OR COLOR.

SN 85-268,121, FILED 3-16-2011.

KEVIN CORWIN, EXAMINING ATTORNEY



David J. Kyffers

Director of the United States Patent and Trademark Office

United States of America

United States Patent and Trademark Office

SHIMMER TIME

Reg. No. 4,075,343

Registered Dec. 20, 2011

Int. Cl.: 3

TRADEMARK

PRINCIPAL REGISTER

LANE BRYANT PURCHASING CORP. (OHIO CORPORATION)
3344 MORSE CROSSING ROAD
COLUMBUS, OH 43219

FOR: PERSONAL CARE PRODUCTS, NAMELY, CREAM FOR THE BODY, LOTION FOR THE BODY, SKIN MOISTURIZER, BODY GLITTER, IN CLASS 3 (U.S. CLS. 1, 4, 6, 50, 51 AND 52).

FIRST USE 4-12-2011; IN COMMERCE 4-12-2011.

THE MARK CONSISTS OF STANDARD CHARACTERS WITHOUT CLAIM TO ANY PARTICULAR FONT, STYLE, SIZE, OR COLOR.

SN 85-268,174, FILED 3-16-2011.

KEVIN CORWIN, EXAMINING ATTORNEY



David J. Kyffers

Director of the United States Patent and Trademark Office

United States of America

United States Patent and Trademark Office

REVIVE & KICKING

Reg. No. 4,075,344

Registered Dec. 20, 2011

Int. Cl.: 3

TRADEMARK

PRINCIPAL REGISTER

LANE BRYANT PURCHASING CORP. (OHIO CORPORATION)
3344 MORSE CROSSING ROAD
COLUMBUS, OH 43219

FOR: PERSONAL CARE PRODUCTS, NAMELY, NON-MEDICATED SKIN CREAM FOR THE LEGS, NON-MEDICATED SKIN LOTION FOR THE LEGS, MASSAGE CREAM, MASSAGE LOTION, AND SKIN MOISTURIZER, IN CLASS 3 (U.S. CLS. 1, 4, 6, 50, 51 AND 52).

FIRST USE 4-12-2011; IN COMMERCE 4-12-2011.

THE MARK CONSISTS OF STANDARD CHARACTERS WITHOUT CLAIM TO ANY PARTICULAR FONT, STYLE, SIZE, OR COLOR.

SN 85-268,232, FILED 3-16-2011.

KEVIN CORWIN, EXAMINING ATTORNEY



David J. Kybas

Director of the United States Patent and Trademark Office

United States of America

United States Patent and Trademark Office

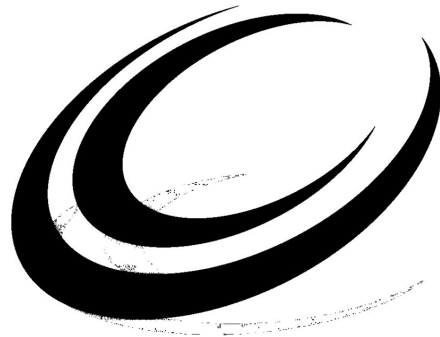

Reg. No. 4,075,345

Registered Dec. 20, 2011

Int. Cl.: 41

SERVICE MARK

PRINCIPAL REGISTER

THE BOARD OF TRUSTEES OF COMMUNITY COLLEGE DISTRICT NO. 508 COUNTY OF COOK (ILLINOIS BODY POLITIC AND CORPORATE)
14TH FLOOR
226 W. JACKSON BLVD.
CHICAGO, IL 60606

FOR: EDUCATIONAL SERVICES, NAMELY, PROVIDING COURSES OF INSTRUCTION AT THE COLLEGE LEVEL, IN CLASS 41 (U.S. CLS. 100, 101 AND 107).

FIRST USE 5-11-2011; IN COMMERCE 5-11-2011.

THE MARK CONSISTS OF TWO BOLDER, CONCENTRIC, ELLIPTICAL CRESCENTS, A SMALLER CRESCENT SPACED INSIDE A LARGER CRESCENT, AND A FAINTER SHADOW OF THE CRESCENTS APPEARING TO BE IN A PLANE AT AN ACUTE ANGLE TO THE BOLDER CRESCENTS.

SN 85-268,568, FILED 3-16-2011.

KAPIL BHANOT, EXAMINING ATTORNEY



David J. Kybas

Director of the United States Patent and Trademark Office

United States of America

United States Patent and Trademark Office

formula AM

Reg. No. 4,075,346

LIVEWELL COLLECTIVE, LLC (OHIO LIMITED LIABILITY COMPANY)
544 S. FRONT ST., UNIT 315
COLUMBUS, OH 43215

Registered Dec. 20, 2011

Int. Cl.: 32

FOR: OXYGENATED FRUIT DRINKS; OXYGENATED FRUIT JUICES; OXYGENATED SPORTS DRINKS; OXYGENATED ENERGY DRINKS; OXYGENATED DRINKING WATER, IN CLASS 32 (U.S. CLS. 45, 46 AND 48).

TRADEMARK

FIRST USE 7-15-2011; IN COMMERCE 10-23-2011.

PRINCIPAL REGISTER

THE MARK CONSISTS OF STANDARD CHARACTERS WITHOUT CLAIM TO ANY PARTICULAR FONT, STYLE, SIZE, OR COLOR.

NO CLAIM IS MADE TO THE EXCLUSIVE RIGHT TO USE "FORMULA", APART FROM THE MARK AS SHOWN.

SN 85-269,049, FILED 3-16-2011.

JOHN SCHUYLER YARD, EXAMINING ATTORNEY



David J. Kyros

Director of the United States Patent and Trademark Office

United States of America

United States Patent and Trademark Office

WOODLINEPARQUETRY

Reg. No. 4,075,347

SINGH, GURJEET (MALAYSIA INDIVIDUAL)
LEVEL 8, WISMA GENERAL LUMBER, BLOCK D
SHAH ALAM, SELANGOR, MALAYSIA 40150

Registered Dec. 20, 2011

Int. Cl.: 19

FOR: ENGINEERED HARDWOOD FLOORING; PARQUET WOOD FLOORING; WOODEN FLOORING, IN CLASS 19 (U.S. CLS. 1, 12, 33 AND 50).

TRADEMARK

FIRST USE 4-12-2009; IN COMMERCE 4-12-2009.

PRINCIPAL REGISTER

THE MARK CONSISTS OF STANDARD CHARACTERS WITHOUT CLAIM TO ANY PARTICULAR FONT, STYLE, SIZE, OR COLOR.

SN 85-269,125, FILED 3-17-2011.

JOHN DWYER, EXAMINING ATTORNEY



David J. Kybas

Director of the United States Patent and Trademark Office

United States of America

United States Patent and Trademark Office

PROSPERITEA

Reg. No. 4,075,348

Registered Dec. 20, 2011

Int. Cl.: 30

TRADEMARK

PRINCIPAL REGISTER

MIRANDA, JAVIER (COSTA RICA INDIVIDUAL)
600N Y 75E DE EMBAJADA AMERICANA
PAVAS, COSTA RICA

FOR: TEA; HERBAL TEA; INSTANT TEA, IN CLASS 30 (U.S. CL. 46).

FIRST USE 1-1-2011; IN COMMERCE 10-4-2011.

THE MARK CONSISTS OF STANDARD CHARACTERS WITHOUT CLAIM TO ANY PARTICULAR FONT, STYLE, SIZE, OR COLOR.

SN 85-269,140, FILED 3-17-2011.

ZACHARY BELLO, EXAMINING ATTORNEY



David J. Kybas

Director of the United States Patent and Trademark Office

United States of America

United States Patent and Trademark Office

DREAM VAN XGW

Reg. No. 4,075,349

Registered Dec. 20, 2011

Int. Cl.: 28

TRADEMARK

PRINCIPAL REGISTER

MATTEL, INC. (DELAWARE CORPORATION)
333 CONTINENTAL BOULEVARD
M1-1518
EL SEGUNDO, CA 90245

FOR: TOY VEHICLES AND ACCESSORIES THEREFOR, IN CLASS 28 (U.S. CLS. 22, 23, 38 AND 50).

FIRST USE 10-21-2011; IN COMMERCE 10-21-2011.

THE MARK CONSISTS OF STANDARD CHARACTERS WITHOUT CLAIM TO ANY PARTICULAR FONT, STYLE, SIZE, OR COLOR.

OWNER OF U.S. REG. NO. 3,716,259.

NO CLAIM IS MADE TO THE EXCLUSIVE RIGHT TO USE "VAN", APART FROM THE MARK AS SHOWN.

SN 85-269,989, FILED 3-17-2011.

CYNTHIA TRIPI, EXAMINING ATTORNEY



David J. Kyffers

Director of the United States Patent and Trademark Office

United States of America

United States Patent and Trademark Office



Reg. No. 4,075,350

Registered Dec. 20, 2011

Int. Cl.: 41

SERVICE MARK

PRINCIPAL REGISTER

MINNESOTA STATE UNIVERSITY MOORHEAD (MINNESOTA NON-PROFIT CORPORATION)
1104 7TH AVENUE SOUTH
MOORHEAD, MN 56563

FOR: EDUCATION SERVICES, NAMELY, PROVIDING LIVE AND ON-LINE COURSES OF INSTRUCTION, CLASSES, TRAINING, SEMINARS, LECTURES AND CONFERENCES AT THE UNIVERSITY LEVEL, AND DISTRIBUTING EDUCATIONAL MATERIALS USED THEREWITH, IN CLASS 41 (U.S. CLS. 100, 101 AND 107).

FIRST USE 7-20-2011; IN COMMERCE 7-20-2011.

THE MARK CONSISTS OF A STYLIZED LETTER "M" SPLIT IN TWO PARTS, WITH THE LEFT HALF OF THE "M" BEING RED, THE RIGHT HALF OF THE "M" BEING GRAY, A DESIGN OF TWO STACKED FLAMES EXTEND UPWARD FROM DOWN STROKE OF THE LEFT HALF OF THE "M", THE BOTTOM FLAME IS AN OUTLINE CUT OUT OF THE DOWN STROKE AND EXTENDS UPWARD TO THE RED UPPER FLAME WHICH EXTENDS ABOVE THE "M".

THE COLOR(S) RED AND GRAY IS/ARE CLAIMED AS A FEATURE OF THE MARK.

SN 85-270,067, FILED 3-17-2011.

ANTHONY RINKER, EXAMINING ATTORNEY



David J. Kybas

Director of the United States Patent and Trademark Office

United States of America

United States Patent and Trademark Office

TV DINNER

Reg. No. 4,075,351

TV DINNER LLC (NEW YORK LIMITED LIABILITY COMPANY)

Registered Dec. 20, 2011

1401 HUDSON ST., #801
HOBOKEN, NJ 07030

Int. Cl.: 9

FOR: COMPUTER APPLICATION SOFTWARE FOR PERSONAL COMPUTERS, MOBILE PHONES, PORTABLE MEDIA PLAYERS, HANDHELD COMPUTERS, TABLETS AND OTHER WIRED AND WIRELESS NETWORK BASED DEVICES, NAMELY, SOFTWARE FOR ONLINE SOCIAL NETWORKING, PROVIDING INFORMATION IN THE FIELD OF TELEVISION PROGRAMMING, PROVIDING A FEED OF USER-GENERATED CONTENT, AND PROVIDING AN INTERACTIVE SOCIAL NETWORKING GAME, IN CLASS 9 (U.S. CLS. 21, 23, 26, 36 AND 38).

TRADEMARK

PRINCIPAL REGISTER

FIRST USE 7-27-2011; IN COMMERCE 7-27-2011.

THE MARK CONSISTS OF STANDARD CHARACTERS WITHOUT CLAIM TO ANY PARTICULAR FONT, STYLE, SIZE, OR COLOR.

SN 85-270,087, FILED 3-17-2011.

SKYE YOUNG, EXAMINING ATTORNEY



David J. Kyros

Director of the United States Patent and Trademark Office

United States of America

United States Patent and Trademark Office



Reg. No. 4,075,352

TV DINNER LLC (NEW YORK LIMITED LIABILITY COMPANY)

Registered Dec. 20, 2011

1401 HUDSON ST., #801
HOBOKEN, NJ 07030

Int. Cl.: 9

FOR: COMPUTER APPLICATION SOFTWARE FOR PERSONAL COMPUTERS, MOBILE PHONES, PORTABLE MEDIA PLAYERS, HANDHELD COMPUTERS, TABLETS AND OTHER WIRED AND WIRELESS NETWORK BASED DEVICES, NAMELY, SOFTWARE FOR ONLINE SOCIAL NETWORKING, PROVIDING INFORMATION IN THE FIELD OF TELEVISION PROGRAMMING, PROVIDING A FEED OF USER-GENERATED CONTENT, AND PROVIDING AN INTERACTIVE SOCIAL NETWORKING GAME, IN CLASS 9 (U.S. CLS. 21, 23, 26, 36 AND 38).

TRADEMARK

PRINCIPAL REGISTER

FIRST USE 7-27-2011; IN COMMERCE 7-27-2011.

THE MARK CONSISTS OF THE WORDS "TV DINNER" WITH THE LETTERS "TV" ENCLOSED WITHIN A PARTIAL DESIGN OF A TELEVISION.

SN 85-270,118, FILED 3-17-2011.

SKYE YOUNG, EXAMINING ATTORNEY



David J. Kybas

Director of the United States Patent and Trademark Office

United States of America

United States Patent and Trademark Office

TV DINNER

Reg. No. 4,075,353

TV DINNER LLC (NEW YORK LIMITED LIABILITY COMPANY)
1401 HUDSON ST., #801
HOBOKEN, NJ 07030

Registered Dec. 20, 2011

Int. Cl.: 45

FOR: ONLINE SOCIAL NETWORKING SERVICES, IN CLASS 45 (U.S. CLS. 100 AND 101).

SERVICE MARK

FIRST USE 7-27-2011; IN COMMERCE 7-27-2011.

PRINCIPAL REGISTER

THE MARK CONSISTS OF STANDARD CHARACTERS WITHOUT CLAIM TO ANY PARTICULAR FONT, STYLE, SIZE, OR COLOR.

SN 85-270,129, FILED 3-17-2011.

SKYE YOUNG, EXAMINING ATTORNEY



David J. Kybas

Director of the United States Patent and Trademark Office

United States of America

United States Patent and Trademark Office



Reg. No. 4,075,354

TV DINNER LLC (NEW YORK LIMITED LIABILITY COMPANY)
1401 HUDSON ST., #801
HOBOKEN, NJ 07030

Registered Dec. 20, 2011

Int. Cl.: 45

FOR: ONLINE SOCIAL NETWORKING SERVICES, IN CLASS 45 (U.S. CLS. 100 AND 101).

SERVICE MARK

FIRST USE 7-27-2011; IN COMMERCE 7-27-2011.

PRINCIPAL REGISTER

THE MARK CONSISTS OF THE WORDS "TV DINNER" WITH THE LETTERS "TV" WITHIN A PARTIAL DESIGN OF A TELEVISION.

SN 85-270,138, FILED 3-17-2011.

SKYE YOUNG, EXAMINING ATTORNEY



David J. Kyffers

Director of the United States Patent and Trademark Office

United States of America

United States Patent and Trademark Office



E. Lebrón

Reg. No. 4,075,355

LEJH LLC (GEORGIA LIMITED LIABILITY COMPANY)
1590 MAY AVE SE
ATLANTA, GA 30316

Registered Dec. 20, 2011

Int. Cl.: 25

FOR: BRIDESMAID DRESSES; EVENING GOWNS; WEDDING GOWNS, IN CLASS 25 (U.S. CLS. 22 AND 39).

TRADEMARK

FIRST USE 2-15-2011; IN COMMERCE 4-15-2011.

PRINCIPAL REGISTER

THE NAME SHOWN IN THE MARK IDENTIFIES EFRAN LEBRON, WHOSE CONSENT TO REGISTER IS MADE OF RECORD.

THE MARK CONSISTS OF A STYLIZED, SCRIPT LETTER "E" INSIDE A RECTANGULAR BORDER, ALL ABOVE THE STYLIZED, SCRIPT WORDING "E. LEBRON".

SN 85-270,248, FILED 3-17-2011.

CORY BOONE, EXAMINING ATTORNEY



David J. Kybas

Director of the United States Patent and Trademark Office

United States of America

United States Patent and Trademark Office



Reg. No. 4,075,356

Registered Dec. 20, 2011

Int. Cl.: 25

TRADEMARK

PRINCIPAL REGISTER

YANNI ENTERPRISES, INC. (ARIZONA CORPORATION)
4402 N. 36TH STREET, UNIT 17
PHOENIX, AZ 85018

FOR: BOXER SHORTS; HATS; JEANS; JACKETS; CAPS; PANTS; SANDALS; SHIRTS; SHOES; SHORTS; SKIRTS AND DRESSES; UNDERWEAR, IN CLASS 25 (U.S. CLS. 22 AND 39).

FIRST USE 11-22-2010; IN COMMERCE 11-22-2010.

THE MARK CONSISTS OF A CLOVER LIKE GRAPHIC INSIDE A CIRCLE WITH THE LETTERS "IC" IN THE UPPER LEFT LEAF, THE LETTERS "XC" IN THE UPPER RIGHT LEAF, THE LETTERS "NI" IN THE LOWER LEFT LEAF AND THE LETTERS "KA" IN THE LOWER RIGHT LEAF.

THE ENGLISH TRANSLATION OF "IC XC NIKA" IN THE MARK IS "JESUS CHRIST CONQUERS".

SN 85-270,680, FILED 3-18-2011.

CAROLINE WOOD, EXAMINING ATTORNEY



David J. Kyffers

Director of the United States Patent and Trademark Office

United States of America

United States Patent and Trademark Office

HOPZ

Reg. No. 4,075,357

Registered Dec. 20, 2011

Int. Cl.: 34

TRADEMARK

PRINCIPAL REGISTER

SPALDING GROUP, INC. (KENTUCKY CORPORATION)
2306 FRANKFORT AVENUE
LOUISVILLE, KY 40206

FOR: CIGARS, IN CLASS 34 (U.S. CLS. 2, 8, 9 AND 17).

FIRST USE 5-1-2011; IN COMMERCE 5-1-2011.

THE MARK CONSISTS OF STANDARD CHARACTERS WITHOUT CLAIM TO ANY PARTICULAR FONT, STYLE, SIZE, OR COLOR.

SN 85-270,996, FILED 3-18-2011.

ELIZABETH KAJUBI, EXAMINING ATTORNEY



David J. Kybas

Director of the United States Patent and Trademark Office

United States of America

United States Patent and Trademark Office



Reg. No. 4,075,358

ILLINOIS SOYBEAN ASSOCIATION (ILLINOIS CORPORATION)
1605 COMMERCE PARKWAY
BLOOMINGTON, IL 61704

Registered Dec. 20, 2011

Int. Cl.: 35

FOR: PROMOTING PUBLIC AWARENESS OF THE ROLE OF SOYBEANS IN FOOD PRODUCTION, IN CLASS 35 (U.S. CLS. 100, 101 AND 102).

SERVICE MARK

FIRST USE 6-12-2011; IN COMMERCE 6-12-2011.

PRINCIPAL REGISTER

NO CLAIM IS MADE TO THE EXCLUSIVE RIGHT TO USE "ILLINOIS SOY", APART FROM THE MARK AS SHOWN.

THE COLOR(S) DARK ORANGE, GREEN AND BROWN IS/ARE CLAIMED AS A FEATURE OF THE MARK.

THE MARK CONSISTS OF THE WORDING "ILLINOIS SOY" IN DARK ORANGE, A LIGHT GREEN POD WITH THREE DARK GREEN SOY BEANS INSIDE, AND THE WORDING "WHAT FOOD GETS FED" IN BROWN IN A CURVED LINE UNDERNEATH THE POD DESIGN.

SN 85-271,001, FILED 3-18-2011.

COLLEEN KEARNEY, EXAMINING ATTORNEY



David J. Kyjars

Director of the United States Patent and Trademark Office

United States of America

United States Patent and Trademark Office

The W Dental Group

Reg. No. 4,075,359

Registered Dec. 20, 2011

Int. Cl.: 44

SERVICE MARK

PRINCIPAL REGISTER

WAKEFIELD, DR. CANDACE T. (UNITED STATES INDIVIDUAL), AKA DR. CANDACE T. WAKEFIELD L.L.C.,
1611 LOCUST ST., SUITE 501
ST. LOUIS, MO 63103

FOR: DENTISTRY, IN CLASS 44 (U.S. CLS. 100 AND 101).

FIRST USE 4-4-2011; IN COMMERCE 4-4-2011.

THE MARK CONSISTS OF STANDARD CHARACTERS WITHOUT CLAIM TO ANY PARTICULAR FONT, STYLE, SIZE, OR COLOR.

NO CLAIM IS MADE TO THE EXCLUSIVE RIGHT TO USE "DENTAL GROUP", APART FROM THE MARK AS SHOWN.

SN 85-271,098, FILED 3-18-2011.

TINA BROWN, EXAMINING ATTORNEY



David J. Kybas

Director of the United States Patent and Trademark Office

United States of America

United States Patent and Trademark Office

BADGER FORCE

Reg. No. 4,075,360

BADGER SPORTSWEAR (NORTH CAROLINA CORPORATION)
111 BADGER LANE
STATESVILLE, NC 28625

Registered Dec. 20, 2011

Int. Cl.: 25

FOR: CLOTHING, NAMELY, SHIRTS, PANTS, SHORTS, IN CLASS 25 (U.S. CLS. 22 AND 39).

TRADEMARK

FIRST USE 2-0-2009; IN COMMERCE 2-0-2009.

PRINCIPAL REGISTER

THE MARK CONSISTS OF STANDARD CHARACTERS WITHOUT CLAIM TO ANY PARTICULAR FONT, STYLE, SIZE, OR COLOR.

OWNER OF U.S. REG. NO. 2,906,328.

SN 85-271,316, FILED 3-18-2011.

NAPOLEON SHARMA, EXAMINING ATTORNEY



David J. Kyffers

Director of the United States Patent and Trademark Office

United States of America

United States Patent and Trademark Office

Bite Size

Reg. No. 4,075,361

Registered Dec. 20, 2011

Int. Cl.: 43

SERVICE MARK

PRINCIPAL REGISTER

SWEISS, JOHN (UNITED STATES INDIVIDUAL)
G34
332 BLEECKER STREET
NEW YORK, NY 10014

FOR: BISTRO SERVICES; BRASSERIE SERVICES; CAFE AND RESTAURANT SERVICES;
CATERING SERVICES; COFFEE SHOPS; MOBILE CAFE SERVICES FOR PROVIDING
FOOD AND DRINK; WINE BARS, IN CLASS 43 (U.S. CLS. 100 AND 101).

FIRST USE 4-1-2011; IN COMMERCE 7-1-2011.

THE MARK CONSISTS OF STANDARD CHARACTERS WITHOUT CLAIM TO ANY PAR-
TICULAR FONT, STYLE, SIZE, OR COLOR.

SN 85-272,085, FILED 3-21-2011.

TINA MAI, EXAMINING ATTORNEY



David J. Kyffers

Director of the United States Patent and Trademark Office

United States of America

United States Patent and Trademark Office

IRUNTODRINK

Reg. No. 4,075,362

ABERNATHY, CHUCK (UNITED STATES INDIVIDUAL)
8509 LANDING WAY CT.
FORT WORTH, TX 76179

Registered Dec. 20, 2011

Int. Cl.: 25

FOR: ATHLETIC APPAREL, NAMELY, SHIRTS, PANTS, JACKETS, FOOTWEAR, HATS AND CAPS, ATHLETIC UNIFORMS, IN CLASS 25 (U.S. CLS. 22 AND 39).

TRADEMARK

FIRST USE 9-29-2011; IN COMMERCE 9-29-2011.

PRINCIPAL REGISTER

THE MARK CONSISTS OF STANDARD CHARACTERS WITHOUT CLAIM TO ANY PARTICULAR FONT, STYLE, SIZE, OR COLOR.

SN 85-273,338, FILED 3-22-2011.

REBECCA EISINGER, EXAMINING ATTORNEY



David J. Kybas

Director of the United States Patent and Trademark Office

United States of America

United States Patent and Trademark Office

Playdation

Reg. No. 4,075,363

PLAYDATION INC. (DELAWARE CORPORATION)
171 WEST 71ST STREET, APT. 6E
NEW YORK, NY 10023

Registered Dec. 20, 2011

Int. Cl.: 42

FOR: PROVIDING ONLINE NON-DOWNLOADABLE SOFTWARE FOR MANAGING A CHILD'S CALENDAR AND EVENTS, IN CLASS 42 (U.S. CLS. 100 AND 101).

SERVICE MARK

FIRST USE 3-1-2011; IN COMMERCE 6-1-2011.

PRINCIPAL REGISTER

THE MARK CONSISTS OF STANDARD CHARACTERS WITHOUT CLAIM TO ANY PARTICULAR FONT, STYLE, SIZE, OR COLOR.

SN 85-274,068, FILED 3-23-2011.

DEIRDRE ROBERTSON, EXAMINING ATTORNEY



David J. Kybas

Director of the United States Patent and Trademark Office

United States of America

United States Patent and Trademark Office

GLOVOLOGY

Reg. No. 4,075,364

Registered Dec. 20, 2011

Int. Cl.: 10

TRADEMARK

PRINCIPAL REGISTER

MIKKEN INTERNATIONAL, LLC (MICHIGAN LIMITED LIABILITY COMPANY)
31550 NORTHWESTERN HIGHWAY
SUITE 165
FARMINGTON HILLS, MI 48334

FOR: CONDOMS, IN CLASS 10 (U.S. CLS. 26, 39 AND 44).

FIRST USE 9-13-2011; IN COMMERCE 9-13-2011.

THE MARK CONSISTS OF STANDARD CHARACTERS WITHOUT CLAIM TO ANY PARTICULAR FONT, STYLE, SIZE, OR COLOR.

OWNER OF U.S. REG. NOS. 3,785,315 AND 3,785,316.

SN 85-274,339, FILED 3-23-2011.

AMY KERTGATE, EXAMINING ATTORNEY



David J. Kybas

Director of the United States Patent and Trademark Office

United States of America

United States Patent and Trademark Office

SIMBA

Reg. No. 4,075,365

Registered Dec. 20, 2011

Int. Cls.: 29, 30, and 31

TRADEMARK

PRINCIPAL REGISTER

SANDS IMPEX (ILLINOIS CORPORATION), DBA ASLI FINE FOODS,
SUITE 1000
2145 INTERNATIONALE PKWY
WOODRIDGE, IL 60517

FOR: CANNED BEANS; DRIED BEANS; DRIED DATES; DRIED FRUIT AND VEGETABLES; DRIED FRUIT MIXES; DRIED FRUIT-BASED SNACKS; DRIED FRUITS; DRIED LENTILS; DRIED MILK FOR FOOD; DRIED MILK POWDER; DRIED SOYBEANS; GRAM FLOUR; NUT FLOURS; PROCESSED BEANS; PROCESSED GARBANZO BEANS; PROCESSED OILS AND FATS; PROCESSED SOY BEANS; RAPE OIL; SALAD OIL; SESAME OIL; SOY BEAN OIL; SOYBEAN OIL; SOYBEAN OIL FOR COOKING; SUNFLOWER OIL; TRAIL MIX CONSISTING PRIMARILY OF PROCESSED NUTS, SEEDS, DRIED FRUIT AND ALSO INCLUDING CHOCOLATE; VEGETABLE OILS; VEGETABLE OILS AND FATS, IN CLASS 29 (U.S. CL. 46).

FIRST USE 5-25-2011; IN COMMERCE 5-25-2011.

FOR: BAKING SPICES; BARLEY FLOUR; BUCKWHEAT FLOUR; CHILI OIL FOR USE AS A SEASONING OR CONDIMENT; CINNAMON POWDER; CLOVE POWDER; COFFEE BEANS; COOKED RICE; CORN FLAKES; CORN FLOUR; CORN MEAL; CORN STARCH FLOUR; CORN-BASED SNACK FOODS; CURRY; CURRY POWDER; DRIED COOKED-RICE; DRIED CORN HUSKS FOR TAMALES; DRIED PASTA; DRY SPICE RUB FOR MEATS AND FISH; EDIBLE FLOUR; EDIBLE SPICES; ENRICHED RICE; EXTRUDED CORN SNACKS; FLOUR; FLOUR FOR FOOD; FLOUR FOR MAKING DUMPLINGS OF GLUTINOUS RICE; FLOUR-BASED CHIPS; GINGER; GROUND COFFEE BEANS; HOT PEPPER POWDER; HUSKED RICE; MAIZE GLUTEN FEED, NAMELY, MAIZE GLUTEN AND CORN GLUTEN ALL FOR HUMAN CONSUMPTION; MASALA POWDER AND SPICES; MASALA RICE FOR BIRYANI; PEPPER; PEPPER POWDER; PEPPER SPICE; PROCESSED CORN; PROCESSED GRAINS; PROTEIN REDUCED AND GLUTEN FREE FLOUR AND BREAD; PUFFED RICE; RICE; RICE FLOUR; RICE NOODLES; RICE STARCH FLOUR; RICE-BASED SNACK FOODS; ROASTED COFFEE BEANS; ROASTED CORN; SOYA FLOUR; SPICE BLENDS; SPICES; STEAMED CORN KERNELS BITS; TAPIOCA FLOUR; TOASTED CORN KERNELS; UNPOPPED POPCORN; VANILLA BEANS; WHEAT FLOUR; WHEAT STARCH FLOUR, IN CLASS 30 (U.S. CL. 46).

FIRST USE 5-25-2011; IN COMMERCE 5-25-2011.



David J. Kybas

Director of the United States Patent and Trademark Office

Reg. No. 4,075,365 FOR: DRIED CORN HUSKS; FRESH CORN; RAW CORN; UNPROCESSED CORN; UNPROCESSED GRAINS FOR EATING, IN CLASS 31 (U.S. CLS. 1 AND 46).

FIRST USE 5-25-2011; IN COMMERCE 5-25-2011.

THE MARK CONSISTS OF STANDARD CHARACTERS WITHOUT CLAIM TO ANY PARTICULAR FONT, STYLE, SIZE, OR COLOR.

THE ENGLISH TRANSLATION OF "SIMBA" IN THE MARK IS LION.

SN 85-274,529, FILED 3-23-2011.

VERNA BETH RIRIE, EXAMINING ATTORNEY

United States of America

United States Patent and Trademark Office

LOOPTY LOO

Reg. No. 4,075,366

BATTAT INCORPORATED (DELAWARE CORPORATION)
1560 MILITARY TURNPIKE
PLATTSBURGH, NY 12901

Registered Dec. 20, 2011

Int. Cl.: 28

FOR: CHILDREN'S MULTIPLE ACTIVITY TOYS, IN CLASS 28 (U.S. CLS. 22, 23, 38 AND 50).

TRADEMARK

FIRST USE 7-31-2011; IN COMMERCE 7-31-2011.

PRINCIPAL REGISTER

THE MARK CONSISTS OF STANDARD CHARACTERS WITHOUT CLAIM TO ANY PARTICULAR FONT, STYLE, SIZE, OR COLOR.

SN 85-276,101, FILED 3-24-2011.

WILLIAM P. SHANAHAN, EXAMINING ATTORNEY



David J. Kyffers

Director of the United States Patent and Trademark Office

United States of America

United States Patent and Trademark Office



Reg. No. 4,075,367

Registered Dec. 20, 2011

Int. Cl.: 9

TRADEMARK

PRINCIPAL REGISTER

THE LAMAR COMPANY, L.L.C. (LOUISIANA LIMITED LIABILITY COMPANY)
5321 CORPORATE BOULEVARD
BATON ROUGE, LA 70809

FOR: DOWNLOADABLE SOFTWARE FOR MOBILE DEVICES SUCH AS CELL PHONES AND SMART PHONES, NAMELY, SOFTWARE FOR USE IN PROVIDING TRAVELERS INFORMATION REGARDING SERVICES OFFERED AT HIGHWAY LOCATIONS, IN CLASS 9 (U.S. CLS. 21, 23, 26, 36 AND 38).

FIRST USE 10-13-2011; IN COMMERCE 10-13-2011.

THE MARK CONSISTS OF A ROUND BALL WITH A HORIZONTAL CUT-OUT AND TWO HALF CIRCLES INSERTED THEREON, WITH SOLID AND STRIPED LINES BELOW THE BALL, SUCH THAT THE FIGURE RESEMBLES A STYLIZED FACE AND FIGURE OF A PERSON.

SN 85-276,175, FILED 3-24-2011.

JASON TURNER, EXAMINING ATTORNEY



David J. Kybas

Director of the United States Patent and Trademark Office

United States of America

United States Patent and Trademark Office

Site Locator_{mobile}

Reg. No. 4,075,368

AMERICAN TOWER CORPORATION (DELAWARE CORPORATION)
116 HUNTINGTON AVENUE
BOSTON, MA 02116

Registered Dec. 20, 2011

Int. Cl.: 42

FOR: INTERACTIVE COMPUTER BASED SERVICES FOR LOCATION IDENTIFICATION OF WIRELESS TELECOMMUNICATIONS AND BROADCAST TOWERS, IN CLASS 42 (U.S. CLS. 100 AND 101).

SERVICE MARK

FIRST USE 5-26-2011; IN COMMERCE 5-26-2011.

PRINCIPAL REGISTER

OWNER OF U.S. REG. NO. 3,448,679.

NO CLAIM IS MADE TO THE EXCLUSIVE RIGHT TO USE "SITE LOCATOR MOBILE", APART FROM THE MARK AS SHOWN.

THE MARK CONSISTS OF THE WORDS "SITE LOCATOR MOBILE". OVER THE FIRST LETTER, "O" IN "LOCATOR", ARE TWO CONCENTRIC PARTIAL CIRCLES AND A PIN SHAPED VERTICAL LINE IN THE CENTER OF THE PARTIAL CIRCLES. THE PIN SHAPED VERTICAL LINE EXTENDS DOWNWARD INTO THE LETTER "O".

SN 85-276,780, FILED 3-25-2011.

PAULA MAHONEY, EXAMINING ATTORNEY



David J. Kyros

Director of the United States Patent and Trademark Office

United States of America

United States Patent and Trademark Office

Site Locator

Reg. No. 4,075,369

Registered Dec. 20, 2011

Int. Cl.: 42

SERVICE MARK

PRINCIPAL REGISTER

AMERICAN TOWER CORPORATION (DELAWARE CORPORATION)
116 HUNTINGTON AVENUE
BOSTON, MA 02116

FOR: INTERACTIVE COMPUTER BASED SERVICES FOR LOCATION IDENTIFICATION OF WIRELESS TELECOMMUNICATIONS AND BROADCAST TOWERS, IN CLASS 42 (U.S. CLS. 100 AND 101).

FIRST USE 4-21-2011; IN COMMERCE 4-21-2011.

OWNER OF U.S. REG. NO. 3,448,679.

NO CLAIM IS MADE TO THE EXCLUSIVE RIGHT TO USE "SITE LOCATOR", APART FROM THE MARK AS SHOWN.

THE MARK CONSISTS OF THE WORDS "SITE LOCATOR". OVER THE FIRST LETTER "O" IN "LOCATOR", ARE TWO CONCENTRIC PARTIAL CIRCLES AND A PIN SHAPED VERTICAL LINE IN THE CENTER OF THE PARTIAL CIRCLES. THE PIN SHAPED VERTICAL LINE EXTENDS DOWNWARD INTO THE LETTER "O".

SN 85-276,821, FILED 3-25-2011.

PAULA MAHONEY, EXAMINING ATTORNEY



David J. Kyros

Director of the United States Patent and Trademark Office

United States of America

United States Patent and Trademark Office

QUEENSCLIFF

Reg. No. 4,075,370

Registered Dec. 20, 2011

Int. Cl.: 36

SERVICE MARK

PRINCIPAL REGISTER

QUEENSCLIFF PARTNERS LP (DELAWARE LIMITED PARTNERSHIP)
SUITE 201-10
900 THIRD AVENUE
NEW YORK, NY 10022

FOR: FINANCIAL SERVICES, NAMELY, ASSET MANAGEMENT SERVICES, INVESTMENT MANAGEMENT SERVICES AND INVESTMENT ADVISORY SERVICES, IN CLASS 36 (U.S. CLS. 100, 101 AND 102).

FIRST USE 8-1-2011; IN COMMERCE 8-1-2011.

THE MARK CONSISTS OF STANDARD CHARACTERS WITHOUT CLAIM TO ANY PARTICULAR FONT, STYLE, SIZE, OR COLOR.

SN 85-277,057, FILED 3-25-2011.

DANNEAN HETZEL, EXAMINING ATTORNEY



David J. Kyffers

Director of the United States Patent and Trademark Office

United States of America

United States Patent and Trademark Office

EnduroEvent Ener-G

Reg. No. 4,075,371

Registered Dec. 20, 2011

Int. Cl.: 31

TRADEMARK

PRINCIPAL REGISTER

PENNFIELD CORPORATION (PENNSYLVANIA CORPORATION)
711 ROHRERSTOWN ROAD
LANCASTER, PA 17604

FOR: ANIMAL FEED, IN CLASS 31 (U.S. CLS. 1 AND 46).

FIRST USE 6-1-1996; IN COMMERCE 6-1-1996.

THE MARK CONSISTS OF STANDARD CHARACTERS WITHOUT CLAIM TO ANY PARTICULAR FONT, STYLE, SIZE, OR COLOR.

NO CLAIM IS MADE TO THE EXCLUSIVE RIGHT TO USE "ENERGY", APART FROM THE MARK AS SHOWN.

SN 85-277,199, FILED 3-25-2011.

TRACY WHITTAKER-BROWN, EXAMINING ATTORNEY



David J. Kyffers

Director of the United States Patent and Trademark Office

United States of America

United States Patent and Trademark Office

Grand Prix Granola

Reg. No. 4,075,372

PENNFIELD CORPORATION (PENNSYLVANIA CORPORATION)
2260 ERIN COURT, PO BOX 4366
LANCASTER, PA 17604

Registered Dec. 20, 2011

Int. Cl.: 31

FOR: ANIMAL FEED, IN CLASS 31 (U.S. CLS. 1 AND 46).

TRADEMARK

FIRST USE 6-1-1996; IN COMMERCE 6-1-1996.

PRINCIPAL REGISTER

THE MARK CONSISTS OF STANDARD CHARACTERS WITHOUT CLAIM TO ANY PARTICULAR FONT, STYLE, SIZE, OR COLOR.

NO CLAIM IS MADE TO THE EXCLUSIVE RIGHT TO USE "GRANOLA", APART FROM THE MARK AS SHOWN.

SN 85-277,210, FILED 3-25-2011.

TRACY WHITTAKER-BROWN, EXAMINING ATTORNEY



David J. Kyffers

Director of the United States Patent and Trademark Office

United States of America

United States Patent and Trademark Office

Fibregized Omega

Reg. No. 4,075,373

PENNFIELD CORPORATION (PENNSYLVANIA CORPORATION)
2260 ERIN COURT, PO BOX 4366
LANCASTER, PA 17604

Registered Dec. 20, 2011

Int. Cl.: 31

FOR: ANIMAL FEED, IN CLASS 31 (U.S. CLS. 1 AND 46).

TRADEMARK

FIRST USE 6-1-1996; IN COMMERCE 6-1-1996.

PRINCIPAL REGISTER

THE MARK CONSISTS OF STANDARD CHARACTERS WITHOUT CLAIM TO ANY PARTICULAR FONT, STYLE, SIZE, OR COLOR.

NO CLAIM IS MADE TO THE EXCLUSIVE RIGHT TO USE "OMEGA", APART FROM THE MARK AS SHOWN.

SN 85-277,233, FILED 3-25-2011.

TRACY WHITTAKER-BROWN, EXAMINING ATTORNEY



David J. Kyffers

Director of the United States Patent and Trademark Office

United States of America

United States Patent and Trademark Office

MATCHUPS

Reg. No. 4,075,374

Registered Dec. 20, 2011

Int. Cl.: 35

SERVICE MARK

PRINCIPAL REGISTER

GROCIO, INC. (OKLAHOMA CORPORATION)
2632 SOUTH TRENTON AVENUE
TULSA, OK 74114

FOR: PROMOTING THE GOODS AND SERVICES OF OTHERS BY PROVIDING A WEBSITE FEATURING COUPONS, REBATES, AND PRICE-COMPARISON INFORMATION, IN CLASS 35 (U.S. CLS. 100, 101 AND 102).

FIRST USE 12-12-2010; IN COMMERCE 12-12-2010.

THE MARK CONSISTS OF STANDARD CHARACTERS WITHOUT CLAIM TO ANY PARTICULAR FONT, STYLE, SIZE, OR COLOR.

SN 85-277,364, FILED 3-25-2011.

JASON TURNER, EXAMINING ATTORNEY



David J. Kyffers

Director of the United States Patent and Trademark Office

United States of America

United States Patent and Trademark Office

DESATANDO LA VERDAD DE DIOS UN VERSICULO A LA VEZ

Reg. No. 4,075,375

GRACE TO YOU (CALIFORNIA NONPROFIT RELIGIOUS CORPORATION)
28001 HARRISON PARKWAY
VALENCIA, CA 91355

Registered Dec. 20, 2011

Int. Cls.: 16, 41, and 45

FOR: PRINTED MATTER, NAMELY, RELIGIOUS NEWSLETTERS, BROCHURES, CATALOGS AND PAMPHLETS; AND PRINTED INSTRUCTIONAL AND TEACHING MATERIALS, NAMELY, BOOKS AND BOOKLETS IN THE FIELD OF RELIGION, IN CLASS 16 (U.S. CLS. 2, 5, 22, 23, 29, 37, 38 AND 50).

TRADEMARK

SERVICE MARK

FIRST USE 1-1-2000; IN COMMERCE 1-1-2000.

PRINCIPAL REGISTER

FOR: RADIO PROGRAMS WITH RELIGIOUS SUBJECT MATTER, IN CLASS 41 (U.S. CLS. 100, 101 AND 107).

FIRST USE 1-1-2000; IN COMMERCE 1-1-2000.

FOR: PROVIDING INFORMATION OF A RELIGIOUS NATURE VIA A GLOBAL COMPUTER NETWORK, IN CLASS 45 (U.S. CLS. 100 AND 101).

FIRST USE 1-1-2000; IN COMMERCE 1-1-2000.

THE MARK CONSISTS OF STANDARD CHARACTERS WITHOUT CLAIM TO ANY PARTICULAR FONT, STYLE, SIZE, OR COLOR.

OWNER OF U.S. REG. NOS. 2,216,086 AND 2,261,534.

THE ENGLISH TRANSLATION OF "DESATANDO LA VERDAD DE DIOS UN VERSICULO A LA VEZ" IN THE MARK IS UNLEASHING GOD'S TRUTH ONE VERSE AT A TIME.

SN 85-277,654, FILED 3-25-2011.

ELIZABETH HUGHITT, EXAMINING ATTORNEY



David J. Kyjars

Director of the United States Patent and Trademark Office

United States of America

United States Patent and Trademark Office

EcoLeeser

Reg. No. 4,075,376

HUPP, RANDY (UNITED STATES INDIVIDUAL)
C/O RANDYDEEP6 3755 AVODCADO BLVD. #420
LA MESA, CA 919417301

Registered Dec. 20, 2011

Int. Cl.: 28

FOR: FISH DESCENDING DEVICE USED FOR REMOVABLY ATTACHING ROCKFISH WITH BAROTRAUMA AT SURFACE AND DESCENDING THE FISH TO A SAFE DEPTH FOR RELEASE , IN CLASS 28 (U.S. CLS. 22, 23, 38 AND 50).

TRADEMARK

FIRST USE 3-1-2011; IN COMMERCE 8-30-2011.

PRINCIPAL REGISTER

THE MARK CONSISTS OF STANDARD CHARACTERS WITHOUT CLAIM TO ANY PARTICULAR FONT, STYLE, SIZE, OR COLOR.

SN 85-278,425, FILED 3-28-2011.

CHRISIE B. KING, EXAMINING ATTORNEY



David J. Kyros

Director of the United States Patent and Trademark Office

United States of America

United States Patent and Trademark Office

CERTAFORM

Reg. No. 4,075,377

CERTAINTEED CORPORATION (DELAWARE CORPORATION)
750 E. SWEDESFORD ROAD
VALLEY FORGE, PA 194820101

Registered Dec. 20, 2011

Int. Cl.: 19

FOR: NON-METAL CASTING FORMS FOR CONCRETE; NON-METAL FORMING SYSTEMS FOR CONCRETE AND OTHER CURABLE CONSTRUCTION MATERIALS COMPRISED OF NON-METAL MODULAR CASTING FORMS, BOARDS AND RAILS, IN CLASS 19 (U.S. CLS. 1, 12, 33 AND 50).

TRADEMARK

PRINCIPAL REGISTER

FIRST USE 5-5-2011; IN COMMERCE 8-10-2011.

THE MARK CONSISTS OF STANDARD CHARACTERS WITHOUT CLAIM TO ANY PARTICULAR FONT, STYLE, SIZE, OR COLOR.

SN 85-278,545, FILED 3-28-2011.

CARRIE GENOVESE, EXAMINING ATTORNEY



David J. Kybas

Director of the United States Patent and Trademark Office

United States of America

United States Patent and Trademark Office

UFERTAS

Reg. No. 4,075,378

UNIVISION COMMUNICATIONS INC. (DELAWARE CORPORATION)
5999 CENTER DRIVE

Registered Dec. 20, 2011

LOS ANGELES, CA 90045

Int. Cl.: 35

FOR: ADVERTISING SERVICES, NAMELY, PROMOTING GOODS AND SERVICES OF OTHERS THROUGH A WEBSITE FEATURING PRODUCT REVIEWS, PRICE-COMPARISON INFORMATION, AND PRICE DISCOUNT INFORMATION, INCLUDING COUPONS AND REBATES, IN CLASS 35 (U.S. CLS. 100, 101 AND 102).

SERVICE MARK

PRINCIPAL REGISTER

FIRST USE 5-4-2011; IN COMMERCE 5-4-2011.

THE MARK CONSISTS OF STANDARD CHARACTERS WITHOUT CLAIM TO ANY PARTICULAR FONT, STYLE, SIZE, OR COLOR.

SN 85-278,575, FILED 3-28-2011.

ZACHARY BELLO, EXAMINING ATTORNEY



David J. Kyffers

Director of the United States Patent and Trademark Office

United States of America

United States Patent and Trademark Office

The Squatty Potty

Reg. No. 4,075,379

EDWARDS, WILLIAM T. (UNITED STATES INDIVIDUAL)
2053 WEST 1820 NORTH
SAINT GEORGE, UT 84770 AND

Registered Dec. 20, 2011

Int. Cl.: 11

EDWARDS, JUDY M. (UNITED STATES INDIVIDUAL)
2053 WEST 1820 NORTH
SAINT GEORGE, UT 84770 AND

TRADEMARK

PRINCIPAL REGISTER

EDWARDS, ROBERT (UNITED STATES INDIVIDUAL)
2053 WEST 1820 NORTH
SAINT GEORGE, UT 84770 AND

EDWARDS, SAMUEL H. (UNITED STATES INDIVIDUAL)
2053 WEST 1820 NORTH
SAINT GEORGE, UT 84770

FOR: SMALL STOOLS DESIGNED TO FIT AROUND A TOILET TO AID IN THE ELIMINATION PROCESS, BY ALLOWING THE USER TO BE IN A SQUATTING POSITION OVER HIS TOILET FOR THE PURPOSE OF HELPING TO PREVENT HEMORRHOIDS AND CONSTIPATION AND OTHER COLON ISSUES, IN CLASS 11 (U.S. CLS. 13, 21, 23, 31 AND 34).

FIRST USE 3-1-2011; IN COMMERCE 3-1-2011.

THE MARK CONSISTS OF STANDARD CHARACTERS WITHOUT CLAIM TO ANY PARTICULAR FONT, STYLE, SIZE, OR COLOR.

SN 85-279,085, FILED 3-28-2011.

JAMES LOVELACE, EXAMINING ATTORNEY



David J. Kyros

Director of the United States Patent and Trademark Office

United States of America

United States Patent and Trademark Office

DRINK NATION

Reg. No. 4,075,380

Registered Dec. 20, 2011

Int. Cl.: 35

SERVICE MARK

PRINCIPAL REGISTER

FRUITION CAPITAL, LLC (PENNSYLVANIA LIMITED LIABILITY COMPANY)
1904 SPRING GARDEN ST. #16
PHILADELPHIA, PA 19106

FOR: ADVERTISING SERVICES, NAMELY, PROVIDING AN ADVERTISING WEB SITE THAT ADVERTISES RESTAURANT AND NIGHTCLUB DISCOUNTS SPECIALS, IN CLASS 35 (U.S. CLS. 100, 101 AND 102).

FIRST USE 9-22-2011; IN COMMERCE 9-22-2011.

THE MARK CONSISTS OF STANDARD CHARACTERS WITHOUT CLAIM TO ANY PARTICULAR FONT, STYLE, SIZE, OR COLOR.

NO CLAIM IS MADE TO THE EXCLUSIVE RIGHT TO USE "DRINK", APART FROM THE MARK AS SHOWN.

SN 85-279,125, FILED 3-28-2011.

MARK SPARACINO, EXAMINING ATTORNEY



David J. Kyffers

Director of the United States Patent and Trademark Office

United States of America

United States Patent and Trademark Office

FOUNDRY

Reg. No. 4,075,381

Registered Dec. 20, 2011

Int. Cl.: 12

TRADEMARK

PRINCIPAL REGISTER

QUALITY BICYCLE PRODUCTS, INC. (MINNESOTA CORPORATION)
6400 WEST 105TH STREET
BLOOMINGTON, MN 55438

FOR: BICYCLES, IN CLASS 12 (U.S. CLS. 19, 21, 23, 31, 35 AND 44).

FIRST USE 6-22-2011; IN COMMERCE 7-15-2011.

THE MARK CONSISTS OF STANDARD CHARACTERS WITHOUT CLAIM TO ANY PARTICULAR FONT, STYLE, SIZE, OR COLOR.

SN 85-279,443, FILED 3-29-2011.

JOHN GARTNER, EXAMINING ATTORNEY



David J. Kyffers

Director of the United States Patent and Trademark Office

United States of America

United States Patent and Trademark Office

WHISKY

Reg. No. 4,075,382

QUALITY BICYCLE PRODUCTS, INC. (MINNESOTA CORPORATION)
6400 WEST 105TH STREET
BLOOMINGTON, MN 55438

Registered Dec. 20, 2011

Int. Cl.: 12

FOR: BICYCLE PARTS, NAMELY, STEMS, SEATPOSTS, HANDLEBARS, WHEELS AND FORKS, IN CLASS 12 (U.S. CLS. 19, 21, 23, 31, 35 AND 44).

TRADEMARK

FIRST USE 6-22-2011; IN COMMERCE 8-28-2011.

PRINCIPAL REGISTER

THE MARK CONSISTS OF STANDARD CHARACTERS WITHOUT CLAIM TO ANY PARTICULAR FONT, STYLE, SIZE, OR COLOR.

SN 85-279,634, FILED 3-29-2011.

JOHN GARTNER, EXAMINING ATTORNEY



David J. Kyffers

Director of the United States Patent and Trademark Office

United States of America

United States Patent and Trademark Office



Reg. No. 4,075,383

Registered Dec. 20, 2011

Int. Cl.: 36

SERVICE MARK

PRINCIPAL REGISTER

CLASSIC BICYCLE RACING LLC (DELAWARE LIMITED LIABILITY COMPANY)
TOWER 1, 10TH FLOOR 1515 ARAPAHOE STREET
DENVER, CO 80202

FOR: CHARITABLE FUNDRAISING, IN CLASS 36 (U.S. CLS. 100, 101 AND 102).

FIRST USE 8-22-2011; IN COMMERCE 8-22-2011.

THE MARK CONSISTS OF A RED, ORANGE AND YELLOW SUN BEHIND THE WHITE SILHOUETTE OF A CYCLIST ALL OVER STYLIZED LITERAL ELEMENTS WITH "SPOKES" IN GREEN, "OF" IN YELLOW, AND "CHANGE" IN PURPLE.

THE COLOR(S) RED, ORANGE, YELLOW, WHITE, GREEN, AND PURPLE IS/ARE CLAIMED AS A FEATURE OF THE MARK.

SN 85-279,968, FILED 3-29-2011.

Laurie Kaufman, Examining Attorney



David J. Kybas

Director of the United States Patent and Trademark Office

United States of America

United States Patent and Trademark Office

Bansela

Reg. No. 4,075,384

Registered Dec. 20, 2011

Int. Cl.: 14

TRADEMARK

PRINCIPAL REGISTER

BANSELA, L.L.C. (TEXAS LIMITED LIABILITY COMPANY)
7800 JOHN CARPENTER FREEWAY
DALLAS, TX 75247

FOR: JEWELRY, IN CLASS 14 (U.S. CLS. 2, 27, 28 AND 50).

FIRST USE 9-1-2011; IN COMMERCE 9-1-2011.

THE MARK CONSISTS OF STANDARD CHARACTERS WITHOUT CLAIM TO ANY PARTICULAR FONT, STYLE, SIZE, OR COLOR.

SN 85-281,017, FILED 3-30-2011.

JOHN SCHUYLER YARD, EXAMINING ATTORNEY



David J. Kybas

Director of the United States Patent and Trademark Office

United States of America

United States Patent and Trademark Office

party in style

Reg. No. 4,075,385

Registered Dec. 20, 2011

Int. Cl.: 14

TRADEMARK

PRINCIPAL REGISTER

BANSELA, L.L.C. (TEXAS LIMITED LIABILITY COMPANY)
7800 JOHN CARPENTER FREEWAY
DALLAS, TX 75247

FOR: JEWELRY, IN CLASS 14 (U.S. CLS. 2, 27, 28 AND 50).

FIRST USE 9-1-2011; IN COMMERCE 9-1-2011.

THE MARK CONSISTS OF STANDARD CHARACTERS WITHOUT CLAIM TO ANY PARTICULAR FONT, STYLE, SIZE, OR COLOR.

SN 85-281,048, FILED 3-30-2011.

JOHN SCHUYLER YARD, EXAMINING ATTORNEY



David J. Kyffers

Director of the United States Patent and Trademark Office

United States of America

United States Patent and Trademark Office

Gentle Care for Down There

Reg. No. 4,075,386

FINA BUENO, INC. (WASHINGTON CORPORATION), DBA HEALTHY HOOHOO,
3603 SW FINDLAY ST.
SEATTLE, WA 98126

Registered Dec. 20, 2011

Int. Cl.: 3

FOR: FEMININE HYGIENE CLEANSING TOWELETTES; FOAM CLEANSERS FOR PERSONAL USE; NON-MEDICATED FEMININE HYGIENE WASH, IN CLASS 3 (U.S. CLS. 1, 4, 6, 50, 51 AND 52).

TRADEMARK

FIRST USE 8-1-2011; IN COMMERCE 8-1-2011.

PRINCIPAL REGISTER

THE MARK CONSISTS OF STANDARD CHARACTERS WITHOUT CLAIM TO ANY PARTICULAR FONT, STYLE, SIZE, OR COLOR.

SN 85-281,325, FILED 3-30-2011.

NICHOLAS ALTREE, EXAMINING ATTORNEY



David J. Kyffers

Director of the United States Patent and Trademark Office

United States of America

United States Patent and Trademark Office

dnik eb

Reg. No. 4,075,387

HERNANDEZ, CHRISTOPHER (UNITED STATES INDIVIDUAL)
4440 MENLO AVENUE
SAN DIEGO, CA 92115

Registered Dec. 20, 2011

Int. Cl.: 25

FOR: ATHLETIC APPAREL, NAMELY, SHIRTS, PANTS, JACKETS, FOOTWEAR, HATS AND CAPS, ATHLETIC UNIFORMS, IN CLASS 25 (U.S. CLS. 22 AND 39).

TRADEMARK

FIRST USE 5-10-2011; IN COMMERCE 10-1-2011.

PRINCIPAL REGISTER

THE MARK CONSISTS OF STANDARD CHARACTERS WITHOUT CLAIM TO ANY PARTICULAR FONT, STYLE, SIZE, OR COLOR.

SN 85-284,425, FILED 4-1-2011.

TOBY BULLOFF, EXAMINING ATTORNEY



David J. Kybas

Director of the United States Patent and Trademark Office

United States of America

United States Patent and Trademark Office



Reg. No. 4,075,388

Registered Dec. 20, 2011

Int. Cl.: 43

SERVICE MARK

PRINCIPAL REGISTER

SHONEY'S NORTH AMERICA CORP. (GEORGIA CORPORATION)
1717 ELM HILL PIKE, SUITE B-1
NASHVILLE, TN 37210

FOR: RESTAURANT SERVICES, IN CLASS 43 (U.S. CLS. 100 AND 101).

FIRST USE 10-28-2011; IN COMMERCE 10-28-2011.

THE MARK CONSISTS OF THE WORD "SHONEY'S" IN RED ABOVE A RED OVAL CONTAINING THE WORDS "ON THE GO", IN THE COLOR WHITE AND UNDERLINED IN YELLOW.

THE COLOR(S) RED, YELLOW AND WHITE IS/ARE CLAIMED AS A FEATURE OF THE MARK.

SN 85-284,644, FILED 4-2-2011.

KAREN BRACEY, EXAMINING ATTORNEY



David J. Kybas

Director of the United States Patent and Trademark Office

United States of America

United States Patent and Trademark Office

SHONEY'S ON THE GO

Reg. No. 4,075,389

Registered Dec. 20, 2011

Int. Cl.: 43

SERVICE MARK

PRINCIPAL REGISTER

SHONEY'S NORTH AMERICA CORP. (GEORGIA CORPORATION)
1717 ELM HILL PIKE, SUITE B-1
NASHVILLE, TN 37210

FOR: RESTAURANT SERVICES, IN CLASS 43 (U.S. CLS. 100 AND 101).

FIRST USE 10-28-2011; IN COMMERCE 10-28-2011.

THE MARK CONSISTS OF STANDARD CHARACTERS WITHOUT CLAIM TO ANY PARTICULAR FONT, STYLE, SIZE, OR COLOR.

SN 85-284,645, FILED 4-2-2011.

KAREN BRACEY, EXAMINING ATTORNEY



David J. Kybas

Director of the United States Patent and Trademark Office

United States of America

United States Patent and Trademark Office

LAVAfuel

Reg. No. 4,075,390

VERGNE, LOUIS (UNITED STATES INDIVIDUAL)
3433 E. HATCHER ROAD
PHOENIX, AZ 85028

Registered Dec. 20, 2011

Int. Cls.: 29 and 30

FOR: PEANUT BUTTER, IN CLASS 29 (U.S. CL. 46).

TRADEMARK

FIRST USE 10-18-2011; IN COMMERCE 10-18-2011.

PRINCIPAL REGISTER

FOR: GRANOLA; GRANOLA-BASED SNACK BARS, IN CLASS 30 (U.S. CL. 46).

FIRST USE 10-18-2011; IN COMMERCE 10-18-2011.

THE MARK CONSISTS OF STANDARD CHARACTERS WITHOUT CLAIM TO ANY PARTICULAR FONT, STYLE, SIZE, OR COLOR.

SN 85-285,680, FILED 4-4-2011.

BENJAMIN OKEKE, EXAMINING ATTORNEY



David J. Kybas

Director of the United States Patent and Trademark Office

United States of America

United States Patent and Trademark Office



Reg. No. 4,075,391

Registered Dec. 20, 2011

Int. Cl.: 42

SERVICE MARK

PRINCIPAL REGISTER

J2 GLOBAL COMMUNICATIONS, INC. (DELAWARE CORPORATION)
6922 HOLLYWOOD BLVD., 5TH FLOOR
HOLLYWOOD, CA 90028

FOR: COMPUTER SERVICES, NAMELY, REMOTE AND ON-SITE MANAGEMENT OF CLOUD COMPUTING SYSTEMS AND APPLICATIONS FOR OTHERS; COMPUTER SERVICES, NAMELY, CLOUD HOSTING PROVIDER SERVICES; CONSULTING SERVICES IN THE FIELD OF CLOUD COMPUTING; PROVIDING VIRTUAL COMPUTER SYSTEMS AND VIRTUAL COMPUTER ENVIRONMENTS THROUGH CLOUD COMPUTING; TECHNICAL CONSULTING SERVICES IN THE FIELDS OF DATACENTER ARCHITECTURE, PUBLIC AND PRIVATE CLOUD COMPUTING SOLUTIONS, AND EVALUATION AND IMPLEMENTATION OF INTERNET TECHNOLOGY AND SERVICES; APPLICATION SERVICE PROVIDER (ASP), NAMELY, HOSTING COMPUTER SOFTWARE APPLICATIONS OF OTHERS; HOSTING OF DIGITAL CONTENT ON THE INTERNET; AND CLOUD COMPUTING FEATURING SOFTWARE FOR USE IN ACCESSING, MANAGING, HOSTING AND CONTROLLING REMOTELY STORED DATA AND DOCUMENTS, IN CLASS 42 (U.S. CLS. 100 AND 101).

FIRST USE 11-29-2000; IN COMMERCE 11-29-2000.

OWNER OF U.S. REG. NOS. 2,716,130, 2,747,752, AND 3,139,471.

THE MARK CONSISTS OF THE TERM "J2" WITHIN A PARTIAL CRESCENT DESIGN.

SN 85-287,679, FILED 4-6-2011.

APRIL ROACH, EXAMINING ATTORNEY



David J. Kyjars

Director of the United States Patent and Trademark Office

United States of America

United States Patent and Trademark Office

J2

Reg. No. 4,075,392

Registered Dec. 20, 2011

Int. Cl.: 42

SERVICE MARK

PRINCIPAL REGISTER

J2 GLOBAL COMMUNICATIONS, INC. (DELAWARE CORPORATION)
6922 HOLLYWOOD BLVD., 5TH FLOOR
HOLLYWOOD, CA 90028

FOR: COMPUTER SERVICES, NAMELY, REMOTE AND ON-SITE MANAGEMENT OF CLOUD COMPUTING SYSTEMS AND APPLICATIONS FOR OTHERS; COMPUTER SERVICES, NAMELY, CLOUD HOSTING PROVIDER SERVICES; CONSULTING SERVICES IN THE FIELD OF CLOUD COMPUTING; PROVIDING VIRTUAL COMPUTER SYSTEMS AND VIRTUAL COMPUTER ENVIRONMENTS THROUGH CLOUD COMPUTING; TECHNICAL CONSULTING SERVICES IN THE FIELDS OF DATACENTER ARCHITECTURE, PUBLIC AND PRIVATE CLOUD COMPUTING SOLUTIONS, AND EVALUATION AND IMPLEMENTATION OF INTERNET TECHNOLOGY AND SERVICES; APPLICATION SERVICE PROVIDER (ASP), NAMELY, HOSTING COMPUTER SOFTWARE APPLICATIONS OF OTHERS; HOSTING OF DIGITAL CONTENT ON THE INTERNET; AND CLOUD COMPUTING FEATURING SOFTWARE FOR USE IN ACCESSING, MANAGING, HOSTING AND CONTROLLING REMOTELY STORED DATA AND DOCUMENTS, IN CLASS 42 (U.S. CLS. 100 AND 101).

FIRST USE 11-29-2000; IN COMMERCE 11-29-2000.

THE MARK CONSISTS OF STANDARD CHARACTERS WITHOUT CLAIM TO ANY PARTICULAR FONT, STYLE, SIZE, OR COLOR.

OWNER OF U.S. REG. NOS. 2,716,130, 2,747,752, AND 3,139,471.

SN 85-287,682, FILED 4-6-2011.

APRIL ROACH, EXAMINING ATTORNEY



David J. Kyffers

Director of the United States Patent and Trademark Office

United States of America

United States Patent and Trademark Office

WHODELICIOUS

Reg. No. 4,075,393

Registered Dec. 20, 2011

Int. Cl.: 35

SERVICE MARK

PRINCIPAL REGISTER

KASS, DAN (UNITED STATES INDIVIDUAL)
1187 COAST VILLAGE ROAD, SUITE 1-111
MONTECITO, CA 93108 AND

JEPSEN, HELEN (UNITED STATES INDIVIDUAL)
1386 ONSTOTT ROAD
LOMPOC, CA 93436

FOR: ONLINE RETAIL STORE SERVICES AND RETAIL STORE SERVICES FEATURING
BAKED GOODS, CANDY AND SWEETS, IN CLASS 35 (U.S. CLS. 100, 101 AND 102).

FIRST USE 5-0-2011; IN COMMERCE 6-0-2011.

THE MARK CONSISTS OF STANDARD CHARACTERS WITHOUT CLAIM TO ANY PAR-
TICULAR FONT, STYLE, SIZE, OR COLOR.

SN 85-287,684, FILED 4-6-2011.

BRENDAN REGAN, EXAMINING ATTORNEY



David J. Kyros

Director of the United States Patent and Trademark Office

United States of America

United States Patent and Trademark Office



Reg. No. 4,075,394

Registered Dec. 20, 2011

Int. Cl.: 35

SERVICE MARK

PRINCIPAL REGISTER

KASS, DAN (UNITED STATES INDIVIDUAL)
1187 COAST VILLAGE ROAD, SUITE 1-111
MONTECITO, CA 93108 AND

JEPSEN, HELEN (UNITED STATES INDIVIDUAL)
1386 ONSTOTT ROAD
LOMPOC, CA 93436

FOR: ONLINE RETAIL STORE SERVICES AND RETAIL STORE SERVICES FEATURING BAKED GOODS, CANDY AND SWEETS, IN CLASS 35 (U.S. CLS. 100, 101 AND 102).

FIRST USE 5-0-2011; IN COMMERCE 6-0-2011.

THE MARK CONSISTS OF THE STYLIZED LIGHT-PINK WORDING "WHODELICIOUS" HAVING A MEDIUM-WIDTH PURPLE STROKE FOLLOWED BY A THIN LIGHT-PINK STROKE AND FINALLY A THICK DARK-PINK STROKE ON THE OUTERMOST EDGE. A BEIGE-WRAPPED CUPCAKE WITH WHITE FROSTING AND A GREEN-STEMMED RED CHERRY ON TOP DOT THE FIRST "I"; A LARGER MATCHING RED CHERRY WITH A GREEN STEM IS USED AS THE FIRST "O", AND THE WHOLE IMAGE IS OUTLINED IN EXPLODING BLUE LIGHTNING STREAKS.

THE COLOR(S) WHITE, RED, BEIGE, PURPLE, LIGHT PINK, DARK PINK, BLUE AND GREEN IS/ARE CLAIMED AS A FEATURE OF THE MARK.

SN 85-287,689, FILED 4-6-2011.

BRENDAN REGAN, EXAMINING ATTORNEY



David J. Kyffers

Director of the United States Patent and Trademark Office

United States of America

United States Patent and Trademark Office

PLUSWICK

Reg. No. 4,075,395

Registered Dec. 20, 2011

Int. Cl.: 4

TRADEMARK

PRINCIPAL REGISTER

SMITH MOUNTAIN INDUSTRIES, INC. (DELAWARE CORPORATION)
1000 DILLARD DRIVE
FOREST, VA 24551

FOR: CANDLES; SCENTED CANDLES, IN CLASS 4 (U.S. CLS. 1, 6 AND 15).

FIRST USE 6-0-2011; IN COMMERCE 6-0-2011.

THE MARK CONSISTS OF STANDARD CHARACTERS WITHOUT CLAIM TO ANY PARTICULAR FONT, STYLE, SIZE, OR COLOR.

SN 85-287,987, FILED 4-6-2011.

MICHAEL SOUDERS, EXAMINING ATTORNEY



David J. Kyffers

Director of the United States Patent and Trademark Office

United States of America

United States Patent and Trademark Office

Jeannette's

Reg. No. 4,075,396

Registered Dec. 20, 2011

Int. Cl.: 30

TRADEMARK

PRINCIPAL REGISTER

J & J PROCESSING, INC. (CALIFORNIA CORPORATION)
14715 ANSON AVENUE
SANTA FE SPRINGS, CA 90670

FOR: MIXES FOR BAKERY GOODS, IN CLASS 30 (U.S. CL. 46).

FIRST USE 5-20-2011; IN COMMERCE 5-20-2011.

THE MARK CONSISTS OF STANDARD CHARACTERS WITHOUT CLAIM TO ANY PARTICULAR FONT, STYLE, SIZE, OR COLOR.

SN 85-288,135, FILED 4-6-2011.

TEJBIR SINGH, EXAMINING ATTORNEY



David J. Kybas

Director of the United States Patent and Trademark Office

United States of America

United States Patent and Trademark Office

STYLELIST HOME

Reg. No. 4,075,397

AOL INC. (DELAWARE CORPORATION)
22000 AOL WAY
DULLES, VA 20166

Registered Dec. 20, 2011

Int. Cl.: 42

FOR: PROVIDING INFORMATION IN THE FIELD OF HOME DECORATING, IN CLASS 42 (U.S. CLS. 100 AND 101).

SERVICE MARK

FIRST USE 9-20-2011; IN COMMERCE 9-20-2011.

PRINCIPAL REGISTER

THE MARK CONSISTS OF STANDARD CHARACTERS WITHOUT CLAIM TO ANY PARTICULAR FONT, STYLE, SIZE, OR COLOR.

OWNER OF U.S. REG. NOS. 3,322,474, 3,346,873, AND OTHERS.

NO CLAIM IS MADE TO THE EXCLUSIVE RIGHT TO USE "HOME", APART FROM THE MARK AS SHOWN.

SN 85-288,760, FILED 4-7-2011.

GIANCARLO CASTRO, EXAMINING ATTORNEY



David J. Kybas

Director of the United States Patent and Trademark Office

United States of America

United States Patent and Trademark Office

STYLELIST HOME

Reg. No. 4,075,398

AOL INC. (DELAWARE CORPORATION)
22000 AOL WAY
DULLES, VA 20166

Registered Dec. 20, 2011

Int. Cl.: 45

FOR: PROVIDING INFORMATION IN THE FIELD OF HOME ORGANIZATION, IN CLASS 45 (U.S. CLS. 100 AND 101).

SERVICE MARK

FIRST USE 9-20-2011; IN COMMERCE 9-20-2011.

PRINCIPAL REGISTER

THE MARK CONSISTS OF STANDARD CHARACTERS WITHOUT CLAIM TO ANY PARTICULAR FONT, STYLE, SIZE, OR COLOR.

OWNER OF U.S. REG. NOS. 3,322,474, 3,346,873, AND OTHERS.

NO CLAIM IS MADE TO THE EXCLUSIVE RIGHT TO USE "HOME", APART FROM THE MARK AS SHOWN.

SN 85-288,766, FILED 4-7-2011.

GIANCARLO CASTRO, EXAMINING ATTORNEY



David J. Kyros

Director of the United States Patent and Trademark Office

United States of America

United States Patent and Trademark Office

Ecosomatic Leadership

Reg. No. 4,075,399

Registered Dec. 20, 2011

Int. Cl.: 41

SERVICE MARK

PRINCIPAL REGISTER

YES! GLOBAL INC. (NORTH CAROLINA CORPORATION), AKA SILSBEE, DOUGLAS K.,
179 MACON AVE.
ASHEVILLE, NC 28804

FOR: BUSINESS EDUCATION AND TRAINING SERVICES, NAMELY, DEVELOPING AND FACILITATING CUSTOMIZED LEADERSHIP AND EXECUTIVE DEVELOPMENT PROGRAMS, PROVIDING EXECUTIVE COACHING SERVICES, AND PROVIDING BUSINESS EDUCATION PROGRAMS TO EMPLOYEES AND EXECUTIVES, IN CLASS 41 (U.S. CLS. 100, 101 AND 107).

FIRST USE 6-15-2011; IN COMMERCE 6-15-2011.

THE MARK CONSISTS OF STANDARD CHARACTERS WITHOUT CLAIM TO ANY PARTICULAR FONT, STYLE, SIZE, OR COLOR.

NO CLAIM IS MADE TO THE EXCLUSIVE RIGHT TO USE "LEADERSHIP", APART FROM THE MARK AS SHOWN.

SN 85-288,770, FILED 4-7-2011.

MICHAEL WIENER, EXAMINING ATTORNEY



David J. Kypos

Director of the United States Patent and Trademark Office

United States of America

United States Patent and Trademark Office

Wardrobe Wear

Reg. No. 4,075,400

WARDROBE WEAR (CALIFORNIA PARTNERSHIP)
1908 SAN YSIDRO DRIVE
BEVERLY HILLS, CA 90210

Registered Dec. 20, 2011

Int. Cl.: 45

FOR: PERSONAL WARDROBE STYLING SERVICES, IN CLASS 45 (U.S. CLS. 100 AND 101).

SERVICE MARK

FIRST USE 1-20-2011; IN COMMERCE 2-28-2011.

PRINCIPAL REGISTER

THE MARK CONSISTS OF STANDARD CHARACTERS WITHOUT CLAIM TO ANY PARTICULAR FONT, STYLE, SIZE, OR COLOR.

NO CLAIM IS MADE TO THE EXCLUSIVE RIGHT TO USE "WARDROBE", APART FROM THE MARK AS SHOWN.

SN 85-289,924, FILED 4-8-2011.

MARK T. MULLEN, EXAMINING ATTORNEY



David J. Kybas

Director of the United States Patent and Trademark Office

United States of America

United States Patent and Trademark Office

Make The Harder Choice

Reg. No. 4,075,401

BARCZYKOWSKI, BONNIE E. (UNITED STATES INDIVIDUAL)
44 WINDCASTLE DRIVE
SAINT CHARLES, MO 63304

Registered Dec. 20, 2011

Int. Cl.: 41

FOR: EDUCATIONAL SERVICES, NAMELY, CONDUCTING WORKSHOPS, CLASSES AND SEMINARS IN THE FIELDS OF FITNESS AND NUTRITION TO STAY ACTIVE, HEALTHY AND FIT, AND DISTRIBUTION OF TRAINING MATERIALS IN CONNECTION THEREWITH, IN CLASS 41 (U.S. CLS. 100, 101 AND 107).

SERVICE MARK

PRINCIPAL REGISTER

FIRST USE 9-3-2011; IN COMMERCE 9-3-2011.

THE MARK CONSISTS OF STANDARD CHARACTERS WITHOUT CLAIM TO ANY PARTICULAR FONT, STYLE, SIZE, OR COLOR.

SN 85-290,126, FILED 4-8-2011.

KIM SAITO, EXAMINING ATTORNEY



David J. Kybas

Director of the United States Patent and Trademark Office

United States of America

United States Patent and Trademark Office

COMFORT-PEDIC

Reg. No. 4,075,402

KHUBANI, NEIL (UNITED STATES INDIVIDUAL)
490 ROUTE 46 EAST
FAIRFIELD, NJ 07004

Registered Dec. 20, 2011

Int. Cl.: 25

FOR: BATH SLIPPERS; SLIPPERS, IN CLASS 25 (U.S. CLS. 22 AND 39).

TRADEMARK

FIRST USE 11-2-2005; IN COMMERCE 11-2-2005.

PRINCIPAL REGISTER

THE MARK CONSISTS OF STANDARD CHARACTERS WITHOUT CLAIM TO ANY PARTICULAR FONT, STYLE, SIZE, OR COLOR.

OWNER OF U.S. REG. NO. 3,031,997.

SN 85-290,227, FILED 4-8-2011.

SANJEEV VOHRA, EXAMINING ATTORNEY



David J. Kybas

Director of the United States Patent and Trademark Office

United States of America

United States Patent and Trademark Office



Reg. No. 4,075,403

Registered Dec. 20, 2011

Int. Cl.: 38

SERVICE MARK

PRINCIPAL REGISTER

CURRENT MEDIA, LLC (DELAWARE LIMITED LIABILITY COMPANY)
118 KING STREET
SAN FRANCISCO, CA 94107

FOR: CABLE, SATELLITE, TELEVISION, WIRELESS, MOBILE AND INTERNET BROADCASTING SERVICES EXCLUDING MUSIC VIDEOS AND CONTENT RELATING TO THE MUSIC ENTERTAINMENT INDUSTRY, IN CLASS 38 (U.S. CLS. 100, 101 AND 104).

FIRST USE 6-20-2011; IN COMMERCE 6-20-2011.

OWNER OF U.S. REG. NOS. 3,678,149 AND 3,681,814.

THE MARK CONSISTS OF THE WORD "CURRENT" IN A WAVY TEXT WITH A LINE ABOVE AND BELOW THE WORD.

SN 85-291,769, FILED 4-11-2011.

JILL PRATER, EXAMINING ATTORNEY



David J. Kybas

Director of the United States Patent and Trademark Office

United States of America

United States Patent and Trademark Office

VITAKIST

Reg. No. 4,075,404

IMPORT & EXPORT TRADING, LLC (VIRGINIA LIMITED LIABILITY COMPANY)
25223 DUNVEGAN SQUARE
SOUTH RIDING, VA 20152

Registered Dec. 20, 2011

Int. Cl.: 5

FOR: DIETARY SUPPLEMENTS; NUTRITIONAL SUPPLEMENTS; VITAMIN AND MINERAL SUPPLEMENTS; VITAMINS, IN CLASS 5 (U.S. CLS. 6, 18, 44, 46, 51 AND 52).

TRADEMARK

FIRST USE 4-21-2011; IN COMMERCE 4-21-2011.

PRINCIPAL REGISTER

THE MARK CONSISTS OF STANDARD CHARACTERS WITHOUT CLAIM TO ANY PARTICULAR FONT, STYLE, SIZE, OR COLOR.

SN 85-293,493, FILED 4-12-2011.

VIVIAN MICZNIK FIRST, EXAMINING ATTORNEY



David J. Kybas

Director of the United States Patent and Trademark Office

United States of America

United States Patent and Trademark Office

AFFINIA

Reg. No. 4,075,405

MELALEUCA, INC. (IDAHO CORPORATION)
3910 S. YELLOWSTONE HWY.
IDAHO FALLS, ID 83402

Registered Dec. 20, 2011

Int. Cl.: 3

FOR: HAIR CONDITIONER; HAIR SHAMPOO; HAIR STYLING GEL; HAIR STYLING PREPARATIONS; HAIR STYLING SPRAY, IN CLASS 3 (U.S. CLS. 1, 4, 6, 50, 51 AND 52).

TRADEMARK

FIRST USE 8-4-2011; IN COMMERCE 8-4-2011.

PRINCIPAL REGISTER

THE MARK CONSISTS OF STANDARD CHARACTERS WITHOUT CLAIM TO ANY PARTICULAR FONT, STYLE, SIZE, OR COLOR.

SN 85-296,811, FILED 4-15-2011.

SUSAN LESLIE DUBOIS, EXAMINING ATTORNEY



David J. Kyros

Director of the United States Patent and Trademark Office

United States of America

United States Patent and Trademark Office

FROSTY CHEWY LEMONHEAD & FRIENDS

Reg. No. 4,075,406

FERRARA PAN CANDY CO., INC. (ILLINOIS CORPORATION)
7301 WEST HARRISON STREET
FOREST PARK, IL 60130

Registered Dec. 20, 2011

Int. Cl.: 30

FOR: CANDY, IN CLASS 30 (U.S. CL. 46).

TRADEMARK

FIRST USE 10-19-2011; IN COMMERCE 10-19-2011.

PRINCIPAL REGISTER

THE MARK CONSISTS OF STANDARD CHARACTERS WITHOUT CLAIM TO ANY PARTICULAR FONT, STYLE, SIZE, OR COLOR.

OWNER OF U.S. REG. NOS. 781,824, 3,635,238, AND OTHERS.

NO CLAIM IS MADE TO THE EXCLUSIVE RIGHT TO USE "CHEWY", APART FROM THE MARK AS SHOWN.

SN 85-314,155, FILED 5-6-2011.

CHRISTINE COOPER, EXAMINING ATTORNEY



David J. Kybas

Director of the United States Patent and Trademark Office

United States of America

United States Patent and Trademark Office

RUSSIAN FANTASY

Reg. No. 4,075,407

SARGSYAN, HENRIK (UNITED STATES INDIVIDUAL)
4062 VERDUGO ROAD

Registered Dec. 20, 2011

LOS ANGELES, CA 90065

Int. Cl.: 33

FOR: VODKA PRODUCED IN WHOLE OR IN PART IN RUSSIA, IN CLASS 33 (U.S. CLS. 47 AND 49).

TRADEMARK

FIRST USE 9-1-2011; IN COMMERCE 9-1-2011.

PRINCIPAL REGISTER

THE MARK CONSISTS OF STANDARD CHARACTERS WITHOUT CLAIM TO ANY PARTICULAR FONT, STYLE, SIZE, OR COLOR.

NO CLAIM IS MADE TO THE EXCLUSIVE RIGHT TO USE "RUSSIAN", APART FROM THE MARK AS SHOWN.

SN 85-326,346, FILED 5-20-2011.

LEIGH CAROLINE CASE, EXAMINING ATTORNEY



David J. Kyffers

Director of the United States Patent and Trademark Office

United States of America

United States Patent and Trademark Office

FONTAINEBLEAU

Reg. No. 4,075,408

JS IP LLC (DELAWARE LIMITED LIABILITY COMPANY)
19950 W COUNTRY CLUB DR. 10TH FL
AVENTURA, FL 33180

Registered Dec. 20, 2011

Int. Cl.: 24

FOR: BEACH TOWELS, IN CLASS 24 (U.S. CLS. 42 AND 50).

TRADEMARK

FIRST USE 11-21-2008; IN COMMERCE 11-21-2008.

PRINCIPAL REGISTER

THE MARK CONSISTS OF STANDARD CHARACTERS WITHOUT CLAIM TO ANY PARTICULAR FONT, STYLE, SIZE, OR COLOR.

OWNER OF U.S. REG. NOS. 3,061,814, 3,164,415, AND OTHERS.

SN 85-975,493, FILED 4-5-2010.

TIMOTHY FINNEGAN, EXAMINING ATTORNEY



David J. Kyffers

Director of the United States Patent and Trademark Office

United States of America

United States Patent and Trademark Office

KISS

Reg. No. 4,075,409

KISS NAIL PRODUCTS, INC. (NEW YORK CORPORATION)
57 SEAVIEW BLVD.

Registered Dec. 20, 2011

PORT WASHINGTON, NY 11050

Int. Cl.: 9

FOR: ELECTRIC HAIR CURLING IRONS AND ELECTRIC FLAT IRONS, IN CLASS 9 (U.S. CLS. 21, 23, 26, 36 AND 38).

TRADEMARK

FIRST USE 7-18-2011; IN COMMERCE 7-18-2011.

PRINCIPAL REGISTER

THE MARK CONSISTS OF STANDARD CHARACTERS WITHOUT CLAIM TO ANY PARTICULAR FONT, STYLE, SIZE, OR COLOR.

SN 85-975,696, FILED 6-4-2010.

KARANENDRA S. CHHINA, EXAMINING ATTORNEY



David J. Kybas

Director of the United States Patent and Trademark Office

United States of America

United States Patent and Trademark Office

THIS IS BOXING

Reg. No. 4,075,410

TOP RANK INC. (NEVADA CORPORATION)
3980 HOWARD HUGHES PARKWAY
LAS VEGAS, NV 89169

Registered Dec. 20, 2011

Int. Cl.: 25

FOR: APPAREL, NAMELY, T-SHIRTS AND SHIRTS, IN CLASS 25 (U.S. CLS. 22 AND 39).

TRADEMARK

FIRST USE 5-5-2011; IN COMMERCE 5-5-2011.

PRINCIPAL REGISTER

THE MARK CONSISTS OF STANDARD CHARACTERS WITHOUT CLAIM TO ANY PARTICULAR FONT, STYLE, SIZE, OR COLOR.

OWNER OF U.S. REG. NOS. 3,959,393 AND 4,032,332.

NO CLAIM IS MADE TO THE EXCLUSIVE RIGHT TO USE "BOXING", APART FROM THE MARK AS SHOWN.

SN 85-975,721, FILED 4-2-2010.

PAUL E. FAHRENKOPF, EXAMINING ATTORNEY



David J. Kyffers

Director of the United States Patent and Trademark Office

United States of America

United States Patent and Trademark Office

Baker's Band

Reg. No. 4,075,411

DENNIS L. MILLER (UNITED STATES INDIVIDUAL)
3730 ELDORADO DRIVE
BETTENDORF, IA 52722

Registered Dec. 20, 2011

Int. Cl.: 21

FOR: HIGH TEMPERATURE NYLON AND POLYETHYLENE PAN LINERS THAT HELP PREVENT FOOD FROM STICKING TO THE PAN WHILE STORING, WARMING AND COOKING FOOD, IN CLASS 21 (U.S. CLS. 2, 13, 23, 29, 30, 33, 40 AND 50).

TRADEMARK

FIRST USE 9-1-2010; IN COMMERCE 7-1-2011.

PRINCIPAL REGISTER

THE MARK CONSISTS OF STANDARD CHARACTERS WITHOUT CLAIM TO ANY PARTICULAR FONT, STYLE, SIZE, OR COLOR.

NO CLAIM IS MADE TO THE EXCLUSIVE RIGHT TO USE "BAKER'S", APART FROM THE MARK AS SHOWN.

SN 85-975,790, FILED 8-13-2010.

PATRICIA EVANKO, EXAMINING ATTORNEY



David J. Kybas

Director of the United States Patent and Trademark Office

United States of America

United States Patent and Trademark Office

GRAVE DIGGER THE LEGEND

Reg. No. 4,075,412

FELD MOTOR SPORTS, INC. (DELAWARE CORPORATION)
8607 WESTWOOD CENTER DRIVE
VIENNA, VA 22182

Registered Dec. 20, 2011

Int. Cls.: 25 and 41

FOR: CLOTHING USED IN THE PROMOTION OF MONSTER TRUCK EVENTS, NAMELY, SHIRTS AND HEADWEAR, IN CLASS 25 (U.S. CLS. 22 AND 39).

TRADEMARK

FIRST USE 1-8-2011; IN COMMERCE 1-8-2011.

SERVICE MARK

FOR: ENTERTAINMENT SERVICES, NAMELY, PERFORMING AND COMPETING IN MONSTER TRUCK EVENTS, IN CLASS 41 (U.S. CLS. 100, 101 AND 107).

PRINCIPAL REGISTER

FIRST USE 12-21-2010; IN COMMERCE 1-8-2011.

THE MARK CONSISTS OF STANDARD CHARACTERS WITHOUT CLAIM TO ANY PARTICULAR FONT, STYLE, SIZE, OR COLOR.

OWNER OF U.S. REG. NOS. 1,710,119, 2,390,991, AND OTHERS.

SN 85-975,854, FILED 10-1-2010.

THEODORE MCBRIDE, EXAMINING ATTORNEY



David J. Kyffers

Director of the United States Patent and Trademark Office

United States of America

United States Patent and Trademark Office

CHANGE YOUR MILK. CHANGE
YOUR LIFE.

Reg. No. 4,075,413

TURTLE MOUNTAIN, LLC (DELAWARE LIMITED LIABILITY COMPANY)
P.O. BOX 21938
EUGENE, OR 97402

Registered Dec. 20, 2011

Int. Cl.: 32

FOR: COCONUT JUICE; COCONUT MILK; COCONUT WATER; COCONUT-BASED BEVERAGES; COCONUT-BASED NON-ALCOHOLIC BEVERAGES, IN CLASS 32 (U.S. CLS. 45, 46 AND 48).

TRADEMARK

FIRST USE 2-1-2011; IN COMMERCE 2-1-2011.

PRINCIPAL REGISTER

THE MARK CONSISTS OF STANDARD CHARACTERS WITHOUT CLAIM TO ANY PARTICULAR FONT, STYLE, SIZE, OR COLOR.

SN 85-975,855, FILED 10-12-2010.

GIANCARLO CASTRO, EXAMINING ATTORNEY



David J. Kybas

Director of the United States Patent and Trademark Office

United States of America

United States Patent and Trademark Office

TEMASEK REPORT

Reg. No. 4,075,414

Registered Dec. 20, 2011

Int. Cl.: 16

TRADEMARK

PRINCIPAL REGISTER

TEMASEK HOLDINGS (PRIVATE) LIMITED (SINGAPORE PRIVATE LIMITED COMPANY)
60B ORCHARD ROAD #60-18 TOWER 2
THE ATRIUM@ORCHARD
SINGAPORE, SINGAPORE 238891

FOR: PRINTED REPORTS, ALL IN THE FIELDS OF FINANCE, FINANCIAL DOCUMENTS,
AND FINANCIAL NEWSLETTERS, IN CLASS 16 (U.S. CLS. 2, 5, 22, 23, 29, 37, 38 AND 50).

FIRST USE 7-0-2010; IN COMMERCE 7-0-2010.

THE MARK CONSISTS OF STANDARD CHARACTERS WITHOUT CLAIM TO ANY PAR-
TICULAR FONT, STYLE, SIZE, OR COLOR.

OWNER OF U.S. REG. NO. 3,187,580.

NO CLAIM IS MADE TO THE EXCLUSIVE RIGHT TO USE "REPORT", APART FROM THE
MARK AS SHOWN.

SN 85-975,859, FILED 5-11-2010.

KATHERINE CONNOLLY, EXAMINING ATTORNEY



David J. Kyffers

Director of the United States Patent and Trademark Office

United States of America

United States Patent and Trademark Office

BORGHESE GARDENS

Reg. No. 4,075,415

Registered Dec. 20, 2011

Int. Cl.: 4

TRADEMARK

PRINCIPAL REGISTER

BORGHESE TRADEMARKS, INC. (DELAWARE CORPORATION)
SUITE 713
1201 ORANGE ST. ONE COMMERCE CTR.
WILMINGTON, DE 19801

FOR: CANDLES, IN CLASS 4 (U.S. CLS. 1, 6 AND 15).

FIRST USE 10-1-2011; IN COMMERCE 10-1-2011.

THE MARK CONSISTS OF STANDARD CHARACTERS WITHOUT CLAIM TO ANY PARTICULAR FONT, STYLE, SIZE, OR COLOR.

OWNER OF U.S. REG. NOS. 1,134,398, 3,387,006, AND 3,703,691.

THE ENGLISH TRANSLATION OF "BORGHESE" IN THE MARK IS "MIDDLE CLASS".

SN 85-975,872, FILED 2-22-2011.

ZHALEH DELANEY, EXAMINING ATTORNEY



David J. Kybas

Director of the United States Patent and Trademark Office

United States of America

United States Patent and Trademark Office



Reg. No. 4,075,416

Registered Dec. 20, 2011

Int. Cl.: 28

TRADEMARK

PRINCIPAL REGISTER

MOULIN ROUGE SA (BELGIUM CORPORATION)
RUE ROYALE 97
BRUSSELS, BELGIUM 1000

FOR: DOLLS, IN CLASS 28 (U.S. CLS. 22, 23, 38 AND 50).

FIRST USE 9-7-2011; IN COMMERCE 9-7-2011.

OWNER OF U.S. REG. NOS. 2,852,285, 3,239,920, AND OTHERS.

THE COLOR(S) RED IS/ARE CLAIMED AS A FEATURE OF THE MARK.

THE MARK CONSISTS OF RED WINDMILL.

SN 85-975,876, FILED 4-30-2010.

FONG HSU, EXAMINING ATTORNEY



David J. Kyffers

Director of the United States Patent and Trademark Office

United States of America

United States Patent and Trademark Office

Michigan Life

Reg. No. 4,075,417

AVRAM GOLDEN, INC. (MICHIGAN CORPORATION)
1606 10TH STREET
BAY CITY, MI 48708

Registered Dec. 20, 2011

Int. Cl.: 41

FOR: PUBLISHING OF ELECTRONIC PUBLICATIONS, IN CLASS 41 (U.S. CLS. 100, 101 AND 107).

SERVICE MARK

FIRST USE 7-29-2010; IN COMMERCE 10-25-2011.

PRINCIPAL REGISTER

THE MARK CONSISTS OF STANDARD CHARACTERS WITHOUT CLAIM TO ANY PARTICULAR FONT, STYLE, SIZE, OR COLOR.

NO CLAIM IS MADE TO THE EXCLUSIVE RIGHT TO USE "MICHIGAN", APART FROM THE MARK AS SHOWN.

SN 85-975,886, FILED 9-15-2010.

VIVIAN MICZNIK FIRST, EXAMINING ATTORNEY



David J. Kyffers

Director of the United States Patent and Trademark Office

United States of America

United States Patent and Trademark Office

iCAN

Reg. No. 4,075,418

Registered Dec. 20, 2011

Int. Cls.: 41 and 42

SERVICE MARK

PRINCIPAL REGISTER

AVANT ASSESSMENT, LLC (OREGON LIMITED LIABILITY COMPANY)
160 SOUTH PARK STREET
EUGENE, OR 97401

FOR: SKILL, KNOWLEDGE AND PROFICIENCY TESTING AND ASSESSMENT SERVICES, NAMELY, ASSESSMENT AND TESTING IN THE FIELD OF EDUCATOR TRAINING FOR PURPOSES OF EDUCATOR TRAINING AND PERFORMANCE, IN CLASS 41 (U.S. CLS. 100, 101 AND 107).

FIRST USE 8-19-2011; IN COMMERCE 8-19-2011.

FOR: PROVIDING TEMPORARY USE OF NON-DOWNLOADABLE SOFTWARE, NAMELY, WEB PAGES FEATURING USER-DEFINED INFORMATION, PERSONAL PORTFOLIOS OR PROFILES, SELF-ASSESSMENTS AGAINST SETS OF STANDARDS DEFINING LEVELS OF PROFICIENCIES, AND AUDIO AND VISUAL RECORDINGS, FOR ALLOWING WEB SITE USERS TO COMMUNICATE, VIEW, UPLOAD, POST, AND DISPLAY INFORMATION, INCLUDING VISUAL AND AUDIO RECORDINGS, TEXT AND DATA, AND TO PRESENT, DESCRIBE, DEMONSTRATE, AND ASSESS THEIR PERSONAL, EDUCATIONAL AND PROFESSIONAL ABILITIES, SKILLS, PROFICIENCIES, KNOWLEDGE AND ACCOMPLISHMENTS, AND TO PROVIDE FEEDBACK REGARDING THOSE OF OTHER WEB SITE USERS, FOR EDUCATIONAL, BUSINESS, SOCIAL, AND COMMUNITY NETWORKING PURPOSES, INCLUDING CAREER AND PERSONAL DEVELOPMENT, RECRUITMENT AND EMPLOYMENT, IN CLASS 42 (U.S. CLS. 100 AND 101).

FIRST USE 8-19-2011; IN COMMERCE 8-19-2011.

THE MARK CONSISTS OF STANDARD CHARACTERS WITHOUT CLAIM TO ANY PARTICULAR FONT, STYLE, SIZE, OR COLOR.

SN 85-975,921, FILED 4-27-2010.

WILLIAM VERHOSEK, EXAMINING ATTORNEY



David J. Kyros

Director of the United States Patent and Trademark Office

United States of America

United States Patent and Trademark Office

CARDIO TENNIS

Reg. No. 4,075,419

TENNIS INDUSTRY ASSOCIATION (ILLINOIS NON-PROFIT CORPORATION)
117 EXECUTIVE CENTER
HILTON HEAD, SC 29928

Registered Dec. 20, 2011

Int. Cl.: 41

FOR: PROVIDING PHYSICAL FITNESS INSTRUCTIONS AND PROGRAMS FEATURING
TENNIS TRAINING, IN CLASS 41 (U.S. CLS. 100, 101 AND 107).

SERVICE MARK

FIRST USE 4-16-1995; IN COMMERCE 4-16-1995.

SUPPLEMENTAL REGISTER

THE MARK CONSISTS OF STANDARD CHARACTERS WITHOUT CLAIM TO ANY PARTICULAR FONT, STYLE, SIZE, OR COLOR.

NO CLAIM IS MADE TO THE EXCLUSIVE RIGHT TO USE "TENNIS", APART FROM THE MARK AS SHOWN.

SER. NO. 76-661,028, FILED 6-5-2006.

MARTHA FROMM, EXAMINING ATTORNEY



David J. Kyffers

Director of the United States Patent and Trademark Office

United States of America

United States Patent and Trademark Office

I-LINK

Reg. No. 4,075,420

Registered Dec. 20, 2011

Int. Cl.: 9

TRADEMARK

SUPPLEMENTAL REGISTER

AMERICAN MEDICAL ALERT CORP. (NEW YORK CORPORATION)
3265 LAWSON BOULEVARD, P.O. BOX 40
OCEANSIDE, NY 11572

FOR: HEALTH MANAGEMENT AND MONITORING SYSTEM THAT UTILIZES WIRELESS AND HARDWIRED COMMUNICATION TECHNOLOGY TO COLLECT AND TRANSMIT OBJECTIVE AND SUBJECTIVE DATA FROM A PATIENT LIVING AT HOME OR IN AN INSTITUTION TO A CENTRAL MONITORING PLATFORM VIA THE INTERNET, BROADBAND, TELEPHONE LINE OR WIRELESS COMMUNICATION SYSTEM, NAMELY, HARDWIRED AND WIRELESS MEDICAL DEVICES, EMERGENCY RESPONSE ACCESS, MEDICATION REMINDERS AND DISPENSING, PATIENT EDUCATION MODULES, INTERACTIVE SCREEN, WEB BASED MONITORING SYSTEM, TELEPHONE SURVEYS AND REMINDERS TO IMPROVE PATIENT KNOWLEDGE AND SELF CARE ACTIVITIES AND PROVIDE THE MEDICAL COMMUNITY WITH VITAL HEALTH INFORMATION AND MEASUREMENTS, IN CLASS 9 (U.S. CLS. 21, 23, 26, 36 AND 38).

FIRST USE 3-14-2007; IN COMMERCE 3-14-2007.

THE MARK CONSISTS OF STANDARD CHARACTERS WITHOUT CLAIM TO ANY PARTICULAR FONT, STYLE, SIZE, OR COLOR.

SER. NO. 76-667,247, FILED P.R. 10-10-2006; AM. S.R. 6-25-2007.

EDWARD NELSON, EXAMINING ATTORNEY



David J. Kyjars

Director of the United States Patent and Trademark Office

United States of America

United States Patent and Trademark Office

ALIANZA PARA EL AHORRO FAMILIAR

Reg. No. 4,075,421

UNITED MARKETING GROUP, L.L.C. (ILLINOIS LIMITED LIABILITY COMPANY)
929 NORTH PLUM GROVE ROAD
SCHAUMBURG, IL 60173

Registered Dec. 20, 2011

Int. Cl.: 35

FOR: MEMBERSHIP CLUB SERVICES PROVIDING DISCOUNTS AND PROCESSING REBATES FOR THE SERVICES OF OTHERS, NAMELY, AUTOMOTIVE REBATES, SALON REBATES, GROCERY DISCOUNTS, RESTAURANT DISCOUNTS, PRESCRIPTION DRUG DISCOUNTS, USED VEHICLE HISTORY REPORT DISCOUNTS, IDENTITY THEFT PROTECTION SERVICE DISCOUNTS, AND ONLINE SHOPPING DISCOUNTS, IN CLASS 35 (U.S. CLS. 100, 101 AND 102).

SERVICE MARK

SUPPLEMENTAL REGISTER

FIRST USE 5-26-2011; IN COMMERCE 5-26-2011.

THE MARK CONSISTS OF STANDARD CHARACTERS WITHOUT CLAIM TO ANY PARTICULAR FONT, STYLE, SIZE, OR COLOR.

THE ENGLISH TRANSLATION OF THE MARK IS "FAMILY SAVINGS ALLIANCE".

SER. NO. 76-700,071, FILED P.R. 10-26-2009; AM. S.R. 6-3-2011.

DAVID TAYLOR, EXAMINING ATTORNEY



David J. Kypos

Director of the United States Patent and Trademark Office

United States of America

United States Patent and Trademark Office

SHOWERCLEANSE

Reg. No. 4,075,422

STOKER INVENTORS GROUP, INC. (FLORIDA CORPORATION)
3015 NORTH OCEAN BLVD, SUITE 17-G
FORT LAUDERDALE, FL 33308

Registered Dec. 20, 2011

Int. Cl.: 11

FOR: PLUMBING APPARATUS, NAMELY, AN INJECTION DEVICE WITH A PORT AND FOR CLEANING AND DISINFECTING ONE OR MORE SHOWERHEAD, IN CLASS 11 (U.S. CLS. 13, 21, 23, 31 AND 34).

TRADEMARK

FIRST USE 4-10-2011; IN COMMERCE 4-10-2011.

SUPPLEMENTAL REGISTER

THE MARK CONSISTS OF STANDARD CHARACTERS WITHOUT CLAIM TO ANY PARTICULAR FONT, STYLE, SIZE, OR COLOR.

SER. NO. 76-705,969, FILED P.R. 1-12-2011; AM. S.R. 9-23-2011.

LIEF MARTIN, EXAMINING ATTORNEY



David J. Kyffers

Director of the United States Patent and Trademark Office

United States of America

United States Patent and Trademark Office

PRIME CHIPS

Reg. No. 4,075,423

SMOKEHOUSE PET PRODUCTS, INC. (CALIFORNIA CORPORATION)
11850 SHELDON STREET
SUN VALLEY, CA 91352

Registered Dec. 20, 2011

Int. Cl.: 31

FOR: MEAT PRODUCTS FOR PETS, NAMELY, EDIBLE TREATS FOR DOGS AND CATS,
IN CLASS 31 (U.S. CLS. 1 AND 46).

TRADEMARK

FIRST USE 4-18-2011; IN COMMERCE 4-18-2011.

SUPPLEMENTAL REGISTER

THE MARK CONSISTS OF STANDARD CHARACTERS WITHOUT CLAIM TO ANY PARTICULAR FONT, STYLE, SIZE, OR COLOR.

NO CLAIM IS MADE TO THE EXCLUSIVE RIGHT TO USE "CHIPS", APART FROM THE MARK AS SHOWN.

SER. NO. 76-707,932, FILED P.R. 6-10-2011; AM. S.R. 10-11-2011.

ROBIN MITTLER, EXAMINING ATTORNEY



David J. Kybas

Director of the United States Patent and Trademark Office

United States of America

United States Patent and Trademark Office

THE AYERS FOUNDATION

Reg. No. 4,075,424

Registered Dec. 20, 2011

Int. Cl.: 41

SERVICE MARK

SUPPLEMENTAL REGISTER

THE AYERS FOUNDATION (TENNESSEE CORPORATION)
450 TENNESSEE AVENUE SOUTH
SUITE 101
PARSONS, TN 38363

FOR: EDUCATIONAL COUNSELING SERVICES TO ASSIST STUDENTS IN PLANNING AND PREPARING FOR FURTHER EDUCATION; EDUCATIONAL SERVICES, NAMELY, CONDUCTING CLASSES, SEMINARS, CONFERENCES AND WORKSHOPS IN THE FIELD OF COLLEGE SCHEDULING AND ADMISSIONS, IN CLASS 41 (U.S. CLS. 100, 101 AND 107).

FIRST USE 3-30-2009; IN COMMERCE 6-18-2009.

THE MARK CONSISTS OF STANDARD CHARACTERS WITHOUT CLAIM TO ANY PARTICULAR FONT, STYLE, SIZE, OR COLOR.

NO CLAIM IS MADE TO THE EXCLUSIVE RIGHT TO USE "FOUNDATION", APART FROM THE MARK AS SHOWN.

SER. NO. 76-708,338, FILED P.R. 7-14-2011; AM. S.R. 11-7-2011.

DAVID YONTEF, EXAMINING ATTORNEY



David J. Kyffers

Director of the United States Patent and Trademark Office

United States of America

United States Patent and Trademark Office

AIRWAVE

Reg. No. 4,075,425

Registered Dec. 20, 2011

Int. Cls.: 37, 38, and 42

SERVICE MARK

SUPPLEMENTAL REGISTER

AIRWAVE SOLUTIONS LIMITED (UNITED KINGDOM LIMITED COMPANY (LTD.))
50 WINDSOR ROAD
CHARTER COURT
SLOUGH, BERKSHIRE, UNITED KINGDOM SL1 2EJ

FOR: CONSTRUCTION, MAINTENANCE, INSTALLATION AND REPAIR OF TELECOMMUNICATIONS NETWORKS; INSTALLATION, MAINTENANCE AND REPAIR OF TELECOMMUNICATIONS APPARATUS AND INSTRUMENTS; INSTALLATION, MAINTENANCE AND REPAIR OF COMMUNICATIONS NETWORKS AND APPARATUS; PROVIDING INFORMATION IN RELATION TO THE INSTALLATION, REPAIR AND MAINTENANCE OF TELECOMMUNICATIONS NETWORKS AND APPARATUS; INFORMATION, CONSULTANCY AND ADVISORY SERVICES IN RELATION TO ALL THE AFORESAID, IN CLASS 37 (U.S. CLS. 100, 103 AND 106).

FOR: TELECOMMUNICATIONS SERVICES, NAMELY, MOBILE TELECOMMUNICATIONS SERVICES AND MOBILE TELECOMMUNICATIONS NETWORK SERVICES FOR USE IN CONNECTION WITH PUBLIC SAFETY SERVICES INCLUDING AMBULANCE, FIRE, POLICE, CIVIL DEFENSE, ARMED FORCES, U.S. BORDER CONTROL, U.S. CUSTOMS, INTERNAL SECURITY, EMERGENCY SERVICES, PUBLIC TRANSPORTATION SERVICES BY AIR, RAIL, SEA AND ROAD, HEALTHCARE AND EMERGENCY MEDICAL SERVICES; PROVIDING ACCESS TO TELECOMMUNICATION NETWORKS; INFORMATION, CONSULTANCY AND ADVISORY SERVICES RELATING TO THE AFORESAID, IN CLASS 38 (U.S. CLS. 100, 101 AND 104).



FOR: DESIGN OF TELECOMMUNICATIONS NETWORKS; DESIGNING INSTALLATIONS AND EQUIPMENT FOR TELECOMMUNICATIONS; PROJECT STUDIES AND PLANNING SERVICES RELATING TO EQUIPMENT FOR TELECOMMUNICATIONS; TECHNICAL ADVICE IN RELATION TO TELECOMMUNICATIONS; TECHNICAL SUPPORT SERVICES RELATING TO TELECOMMUNICATION NETWORKS AND APPARATUS; MONITORING SERVICES RELATING TO TELECOMMUNICATIONS NETWORKS AND APPARATUS; INFORMATION, CONSULTANCY AND ADVISORY SERVICES RELATING TO THE AFORESAID, IN CLASS 42 (U.S. CLS. 100 AND 101).

David J. Kyros

THE MARK CONSISTS OF STANDARD CHARACTERS WITHOUT CLAIM TO ANY PARTICULAR FONT, STYLE, SIZE, OR COLOR.

Reg. No. 4,075,425 PRIORITY CLAIMED UNDER SEC. 44(D) ON ERPN CMNTY TM OFC APPLICATION NO. 6360564, FILED 11-2-2007, REG. NO. 006360564, DATED 3-30-2010, EXPIRES 11-2-2017.

OWNER OF ERPN CMNTY TM OFC REG. NO. 004387122, DATED 10-4-2006, EXPIRES 4-13-2015.

SER. NO. 77-463,442, FILED P.R. 5-1-2008; AM. S.R. 5-12-2011.

LINDA ESTRADA, EXAMINING ATTORNEY

United States of America

United States Patent and Trademark Office



Reg. No. 4,075,426

Registered Dec. 20, 2011

Int. Cl.: 25

NATIONAL HIGH SCHOOL BASKETBALL ASSOCIATION (ARKANSAS NON-PROFIT CORPORATION)
P. O. BOX 22
EMERSON, AR 71740

FOR: CLOTHING, NAMELY, SHIRTS, IN CLASS 25 (U.S. CLS. 22 AND 39).

TRADEMARK

FIRST USE 1-17-2011; IN COMMERCE 1-17-2011.

SUPPLEMENTAL REGISTER

THE MARK CONSISTS OF THE LETTERS "N", "H", "S", "B", "A" DISPLAYED VERTICALLY TO THE LEFT OF THE SILHOUETTE OF A GRADUATING STUDENT IN CAP, GOWN, AND ATHLETIC SHOES, HOLDING A DIPLOMA IN HIS RIGHT HAND AND A BASKETBALL IN HIS LEFT HAND.

SER. NO. 77-527,269, FILED P.R. 7-21-2008; AM. S.R. 11-11-2011.

AMY HELLA, EXAMINING ATTORNEY



David J. Kybas

Director of the United States Patent and Trademark Office

United States of America

United States Patent and Trademark Office

LOWCOUNTRY RESTAURANTS NEW | SOUTHERN | CUISINE

Reg. No. 4,075,427

Registered Dec. 20, 2011

Int. Cl.: 43

SERVICE MARK

SUPPLEMENTAL REGISTER

T.C. MOSBY INVESTMENTS LLC (DELAWARE LIMITED LIABILITY COMPANY)
TWENTY-FIFTH FLOOR
515 SOUTH FLOWER STREET
LOS ANGELES, CA 90071

FOR: HOTEL, BAR AND RESTAURANT SERVICES; HOTEL, RESTAURANT AND CATERING SERVICES; PROVISION OF FOOD AND DRINK IN RESTAURANTS; RESTAURANT; RESTAURANT AND BAR SERVICES; RESTAURANT AND CATERING SERVICES; RESTAURANT SERVICES; RESTAURANT, BAR AND CATERING SERVICES, IN CLASS 43 (U.S. CLS. 100 AND 101).

FIRST USE 10-15-2007; IN COMMERCE 12-1-2007.

THE MARK CONSISTS OF STANDARD CHARACTERS WITHOUT CLAIM TO ANY PARTICULAR FONT, STYLE, SIZE, OR COLOR.

NO CLAIM IS MADE TO THE EXCLUSIVE RIGHT TO USE "RESTAURANTS", APART FROM THE MARK AS SHOWN.

SER. NO. 77-611,581, FILED P.R. 11-11-2008; AM. S.R. 7-29-2009.

AMY HELLA, EXAMINING ATTORNEY



David J. Kyffers

Director of the United States Patent and Trademark Office

United States of America

United States Patent and Trademark Office

DEEP WATER EQUIPPED

Reg. No. 4,075,428

M-I L.L.C. (DELAWARE LIMITED LIABILITY COMPANY)
5950 NORTH COURSE DRIVE
HOUSTON, TX 77072

Registered Dec. 20, 2011

Int. Cls.: 35 and 42

FOR: LOGISTICS MANAGEMENT SERVICES PROVIDED AT SPECIALLY EQUIPPED OIL AND GAS DRILLING, EXPLORATION AND PRODUCTION FACILITIES, IN CLASS 35 (U.S. CLS. 100, 101 AND 102).

SERVICE MARK

FIRST USE 1-1-2009; IN COMMERCE 1-1-2009.

SUPPLEMENTAL REGISTER

FOR: TECHNICAL CONSULTING SERVICES PROVIDED AT SPECIALLY EQUIPPED OIL AND GAS DRILLING, EXPLORATION AND PRODUCTION FACILITIES, NAMELY, EVALUATION AND MEASUREMENT OF DRILLING FLUID ISSUES, EVALUATION OF ENVIRONMENTAL IMPACT AND DESIGN AND IMPLEMENTATION OF WELLBORE PRODUCTIVITY SOLUTIONS, IN CLASS 42 (U.S. CLS. 100 AND 101).

FIRST USE 1-1-2009; IN COMMERCE 1-1-2009.

THE MARK CONSISTS OF STANDARD CHARACTERS WITHOUT CLAIM TO ANY PARTICULAR FONT, STYLE, SIZE, OR COLOR.

SER. NO. 77-616,344, FILED P.R. 11-18-2008; AM. S.R. 10-6-2010.

DAVID ELTON, EXAMINING ATTORNEY



David J. Kyfos

Director of the United States Patent and Trademark Office

United States of America

United States Patent and Trademark Office



Reg. No. 4,075,429

FOLDS OF HONOR FOUNDATION (DELAWARE CORPORATION)
7030 S YALE AVE, SUITE 600
TULSA, OK 74136

Registered Dec. 20, 2011

Int. Cl.: 25

FOR: ATHLETIC APPAREL, NAMELY, SHIRTS, PANTS, JACKETS, FOOTWEAR, HATS
AND CAPS, ATHLETIC UNIFORMS, IN CLASS 25 (U.S. CLS. 22 AND 39).

TRADEMARK

FIRST USE 7-1-2009; IN COMMERCE 7-1-2009.

SUPPLEMENTAL REGISTER

OWNER OF U.S. REG. NO. 3,646,948.

THE MARK CONSISTS A STYLIZED DEPICTION OF A FIGHTER PLANE WITH THREE
(3) STARS ARRAYED ABOVE.

SER. NO. 77-793,251, FILED P.R. 7-30-2009; AM. S.R. 11-2-2011.

KIM SAITO, EXAMINING ATTORNEY



David J. Kybas

Director of the United States Patent and Trademark Office

United States of America

United States Patent and Trademark Office

LAW FIRM SUITES

Reg. No. 4,075,430

Registered Dec. 20, 2011

Int. Cl.: 36

SERVICE MARK

SUPPLEMENTAL REGISTER

LFIS, INC. (NEW YORK CORPORATION), DBA LAW FIRM SUITES,
11 BROADWAY, SUITE 615
NEW YORK, NY 10538

FOR: OFFICE RENTAL SERVICES; ADMINISTRATIVE SERVICES AND OFFICE INFRA-
STRUCTURE SERVICES IN THE NATURE OF MANAGEMENT OF COMMERCIAL PROP-
ERTY, OFFICES AND OFFICE SPACE, IN CLASS 36 (U.S. CLS. 100, 101 AND 102).

FIRST USE 11-1-2009; IN COMMERCE 11-1-2009.

THE MARK CONSISTS OF STANDARD CHARACTERS WITHOUT CLAIM TO ANY PAR-
TICULAR FONT, STYLE, SIZE, OR COLOR.

NO CLAIM IS MADE TO THE EXCLUSIVE RIGHT TO USE "SUITES", APART FROM THE
MARK AS SHOWN.

SER. NO. 77-884,330, FILED P.R. 12-2-2009; AM. S.R. 3-21-2011.

MATTHEW MCDOWELL, EXAMINING ATTORNEY



David J. Kybas

Director of the United States Patent and Trademark Office

United States of America

United States Patent and Trademark Office

VetXML

Reg. No. 4,075,431

Registered Dec. 20, 2011

Int. Cl.: 9

TRADEMARK

SUPPLEMENTAL REGISTER

VET-XML CONSORTIUM LIMITED (UNITED KINGDOM LIMITED LIABILITY COMPANY)
SPVS, THE GOVERNOR'S HOUSE, CAPE ROAD
WARWICK, UNITED KINGDOM CV345DL

FOR: COMPUTER SOFTWARE FOR USE IN DATABASE MANAGEMENT IN THE MEDICAL OR VETERINARY FIELDS; COMPUTER SOFTWARE FOR USE AS A SPREADSHEET IN THE MEDICAL OR VETERINARY FIELDS; COMPUTER SOFTWARE FOR USE IN GENERATING, STORING, EXCHANGING, COMBINING, RECEIVING AND/OR READING MEDICAL OR VETERINARY RECORDS IN ANY ELECTRONIC FORMAT OR MEDIA; COMPUTER SOFTWARE FOR CONTROLLING AND MANAGING MEDICAL AND VETERINARY RECORDS AND INFORMATION; DOWNLOADABLE ELECTRONIC DATA FILES AND DOWNLOADABLE ELECTRONIC XML-BASED FILES FOR USE IN GENERATING, STORING, EXCHANGING, COMBINING, RECEIVING AND/OR READING MEDICAL OR VETERINARY RECORDS, IN CLASS 9 (U.S. CLS. 21, 23, 26, 36 AND 38).

THE MARK CONSISTS OF STANDARD CHARACTERS WITHOUT CLAIM TO ANY PARTICULAR FONT, STYLE, SIZE, OR COLOR.

PRIORITY CLAIMED UNDER SEC. 44(D) ON ERPN CMNTY TM OFC APPLICATION NO. 008765752, FILED 12-17-2009, REG. NO. 8765752, DATED 6-11-2010, EXPIRES 12-17-2019.

SER. NO. 77-905,976, FILED P.R. 1-6-2010; AM. S.R. 11-14-2011.

CHRISTOPHER BUONGIORNO, EXAMINING ATTORNEY



David J. Kyjars

Director of the United States Patent and Trademark Office

United States of America

United States Patent and Trademark Office

HuntFishNetwork

Reg. No. 4,075,432

OSABOYS LLC (CALIFORNIA LIMITED LIABILITY COMPANY)
106 CATLIN COURT
FOLSOM, CA 95630

Registered Dec. 20, 2011

Int. Cls.: 35 and 41

FOR: COMPUTER SERVICES, NAMELY, PROVIDING ON-LINE COMPUTER DATABASES AND ON-LINE SEARCHABLE DATABASES FEATURING CONSUMER INFORMATION ON A WIDE VARIETY OF TOPICS RELATED TO OUTDOOR SPORTING ACTIVITIES; ADVERTISING AND DIRECTORY SERVICES, NAMELY, PROMOTING THE GOODS AND SERVICES OF OTHERS BY PROVIDING A WEB PAGE FEATURING LINKS TO THE WEBSITES OF OTHERS, IN CLASS 35 (U.S. CLS. 100, 101 AND 102).

SERVICE MARK

SUPPLEMENTAL REGISTER

FIRST USE 11-15-2009; IN COMMERCE 2-1-2010.

FOR: PROVIDING INFORMATION REGARDING OUTDOOR SPORTING ACTIVITIES BY MEANS OF A GLOBAL COMPUTER NETWORK, IN CLASS 41 (U.S. CLS. 100, 101 AND 107).

FIRST USE 11-15-2009; IN COMMERCE 2-1-2010.

THE MARK CONSISTS OF STANDARD CHARACTERS WITHOUT CLAIM TO ANY PARTICULAR FONT, STYLE, SIZE, OR COLOR.

SER. NO. 77-910,512, FILED P.R. 1-12-2010; AM. S.R. 9-6-2010.

ALYSSA STEEL, EXAMINING ATTORNEY



David J. Kyffers

Director of the United States Patent and Trademark Office

United States of America

United States Patent and Trademark Office

NATIONAL SERVICE PARTNERS

Reg. No. 4,075,433

NATIONAL SERVICE PARTNERS (CALIFORNIA CORPORATION)
1108 WILLOW PASS CT.
CONCORD, CA 94520

Registered Dec. 20, 2011

Int. Cls.: 36 and 37

FOR: INSURANCE ADMINISTRATION SERVICES, NAMELY, ASSISTING OTHERS WITH ADJUSTING INSURANCE CLAIMS, IN CLASS 36 (U.S. CLS. 100, 101 AND 102).

SERVICE MARK

FIRST USE 1-1-2010; IN COMMERCE 4-30-2010.

SUPPLEMENTAL REGISTER

FOR: AUTOMOTIVE MAINTENANCE AND REPAIR; MOTOR VEHICLE MAINTENANCE AND REPAIR; REPAIR OR MAINTENANCE OF AUTOMOBILES, IN CLASS 37 (U.S. CLS. 100, 103 AND 106).

FIRST USE 1-1-2010; IN COMMERCE 4-30-2010.

THE MARK CONSISTS OF STANDARD CHARACTERS WITHOUT CLAIM TO ANY PARTICULAR FONT, STYLE, SIZE, OR COLOR.

NO CLAIM IS MADE TO THE EXCLUSIVE RIGHT TO USE "SERVICE", APART FROM THE MARK AS SHOWN.

SER. NO. 77-925,221, FILED P.R. 2-1-2010; AM. S.R. 10-20-2011.

LINDA POWELL, EXAMINING ATTORNEY



David J. Kybas

Director of the United States Patent and Trademark Office

United States of America

United States Patent and Trademark Office

SUPER FRUIT ANTIOXIDANTS

Reg. No. 4,075,434

Registered Dec. 20, 2011

Int. Cl.: 5

TRADEMARK

SUPPLEMENTAL REGISTER

PRIMARY INVESTMENTS GROUP LIMITED (BR.VIRGIN ISLANDS CORPORATION)
C/O TRUSTNET CHAMBERS
P. O. BOX 3444
ROAD TOWN, TORTOLA, BR.VIRGIN ISLANDS

FOR: DIETARY SUPPLEMENTS; FOOD SUPPLEMENTS; HERBAL SUPPLEMENTS; NUTRI-
TIONAL SUPPLEMENTS; VITAMIN SUPPLEMENTS; MINERAL SUPPLEMENTS; MULTI-
VITAMIN AND MINERAL SUPPLEMENTS; ALL OF THE FOREGOING GOODS CONTAIN-
ING ANTIOXIDANTS, IN CLASS 5 (U.S. CLS. 6, 18, 44, 46, 51 AND 52).

FIRST USE 4-30-2010; IN COMMERCE 4-30-2010.

THE MARK CONSISTS OF STANDARD CHARACTERS WITHOUT CLAIM TO ANY PAR-
TICULAR FONT, STYLE, SIZE, OR COLOR.

NO CLAIM IS MADE TO THE EXCLUSIVE RIGHT TO USE "ANTIOXIDANTS", APART
FROM THE MARK AS SHOWN.

SER. NO. 77-963,834, FILED P.R. 3-19-2010; AM. S.R. 4-20-2011.

SIMON TENG, EXAMINING ATTORNEY



David J. Kyfos

Director of the United States Patent and Trademark Office

United States of America

United States Patent and Trademark Office

GREAT LAKES COPPER

Reg. No. 4,075,435

GREAT LAKES COPPER INC. (CANADA CORPORATION)
1010 CLARKE ROAD

Registered Dec. 20, 2011

LONDON, ONTARIO, CANADA N5V 3B2

Int. Cls.: 6 and 40

FOR: COATED COPPER TUBING AND COATED BRASS FLANGES; METAL TUBES AND PIPES; UNCOATED COPPER TUBING, IN CLASS 6 (U.S. CLS. 2, 12, 13, 14, 23, 25 AND 50).

TRADEMARK

FIRST USE 6-11-2010; IN COMMERCE 6-11-2010.

SERVICE MARK

FOR: MANUFACTURING SERVICES FOR OTHERS IN THE FIELD OF METAL TUBES, PIPES AND METAL FLANGES; CUSTOM MANUFACTURE OF METAL TUBES, PIPES AND

SUPPLEMENTAL REGISTER

METAL FLANGES, IN CLASS 40 (U.S. CLS. 100, 103 AND 106).

FIRST USE 6-11-2010; IN COMMERCE 6-11-2010.

THE MARK CONSISTS OF STANDARD CHARACTERS WITHOUT CLAIM TO ANY PARTICULAR FONT, STYLE, SIZE, OR COLOR.

NO CLAIM IS MADE TO THE EXCLUSIVE RIGHT TO USE "COPPER", APART FROM THE MARK AS SHOWN.

SER. NO. 77-966,033, FILED P.R. 3-23-2010; AM. S.R. 7-13-2011.

MICHAEL WEBSTER, EXAMINING ATTORNEY



David J. Kybas

Director of the United States Patent and Trademark Office

United States of America

United States Patent and Trademark Office

**CARB & SUGAR
CONTROL**

Reg. No. 4,075,436

THE DANNON COMPANY, INC. (DELAWARE CORPORATION)
100 HILLSIDE AVENUE
WHITE PLAINS, NY 106032863

Registered Dec. 20, 2011

Int. Cl.: 29

FOR: DAIRY PRODUCTS, EXCLUDING ICE CREAM, ICE MILK, AND FROZEN YOGURT;
DAIRY-BASED BEVERAGES, IN CLASS 29 (U.S. CL. 46).

TRADEMARK

FIRST USE 12-0-2005; IN COMMERCE 12-0-2005.

SUPPLEMENTAL REGISTER

SER. NO. 78-844,571, FILED P.R. 3-23-2006; AM. S.R. 10-24-2011.

KAPIL BHANOT, EXAMINING ATTORNEY



David J. Kyffers

Director of the United States Patent and Trademark Office

United States of America

United States Patent and Trademark Office

Welcome to Alcohell

Reg. No. 4,075,437

SANDLER RICHARD A (UNITED STATES INDIVIDUAL), DBA RIC SANDLER,
555 NORTH DUPONT AVE. D95
MADISON, TN 37115

Registered Dec. 20, 2011

Int. Cl.: 25

FOR: T-SHIRTS, IN CLASS 25 (U.S. CLS. 22 AND 39).

TRADEMARK

FIRST USE 1-1-2011; IN COMMERCE 1-1-2011.

SUPPLEMENTAL REGISTER

THE MARK CONSISTS OF STANDARD CHARACTERS WITHOUT CLAIM TO ANY PARTICULAR FONT, STYLE, SIZE, OR COLOR.

SER. NO. 85-006,994, FILED P.R. 4-6-2010; AM. S.R. 11-8-2011.

JENNIFER WILLISTON, EXAMINING ATTORNEY



David J. Kyffers

Director of the United States Patent and Trademark Office

United States of America

United States Patent and Trademark Office

ADVANCED UV PROTECTION

Reg. No. 4,075,438

DIOPTICS MEDICAL PRODUCTS, INC. (CALIFORNIA CORPORATION)
500 GEORGE WASHINGTON HIGHWAY
SMITHFIELD, RI 02917

Registered Dec. 20, 2011

Int. Cl.: 9

FOR: SUNGLASSES, IN CLASS 9 (U.S. CLS. 21, 23, 26, 36 AND 38).

TRADEMARK

FIRST USE 12-31-2000; IN COMMERCE 12-31-2000.

SUPPLEMENTAL REGISTER

THE MARK CONSISTS OF STANDARD CHARACTERS WITHOUT CLAIM TO ANY PARTICULAR FONT, STYLE, SIZE, OR COLOR.

SER. NO. 85-010,961, FILED P.R. 4-9-2010; AM. S.R. 10-24-2011.

LAURIE KAUFMAN, EXAMINING ATTORNEY



David J. Kyffers

Director of the United States Patent and Trademark Office

United States of America

United States Patent and Trademark Office

L'HOMME

Reg. No. 4,075,439

Registered Dec. 20, 2011

Int. Cl.: 18

TRADEMARK

SUPPLEMENTAL REGISTER

HOLMES, REGINALD W (UNITED STATES INDIVIDUAL), DBA L'HOMME APPAREL & ACCESSORIES,
2102 SEVEN PINES ST.
SAN ANTONIO, TX 78245

FOR: ALL PURPOSE SPORT BAGS; ALL-PURPOSE ATHLETIC BAGS; ATHLETIC BAGS; BABY BACKPACKS; BACKPACKS; BACKPACKS, BOOK BAGS, SPORTS BAGS, BUM BAGS, WALLETS AND HANDBAGS; COSMETIC BAGS SOLD EMPTY; DIAPER BAGS; DUFFEL BAGS; DUFFEL BAGS FOR TRAVEL; GARMENT BAGS FOR TRAVEL; GARMENT BAGS FOR TRAVEL MADE OF LEATHER; HOBO BAGS; LEATHER AND IMITATION LEATHER BAGS; LEATHER AND IMITATION LEATHER SPORT BAGS AND GENERAL PURPOSE TROLLEY BAGS; LEATHER BAGS AND WALLETS; LEATHER BAGS, SUITCASES AND WALLETS; LUGGAGE AND TRUNKS; MAKE-UP BAGS SOLD EMPTY; MEN'S CLUTCH BAGS; MESSENGER BAGS; MILITARY DUFFLE BAGS, GARMENT BAGS FOR TRAVEL, TOTE BAGS, SHOULDER BAGS AND BACKPACKS; MULTI-PURPOSE PURSES; POUCHES AND BAGS SOLD EMPTY FOR ATTACHMENT TO BACKPACKS; ROLL BAGS; SCHOOL BOOK BAGS; SCHOOLCHILDREN'S BACKPACKS; SHOE BAGS FOR TRAVEL; SHOPPING BAGS WITH WHEELS ATTACHED; TOTE BAGS; TRAVELLING BAGS; TRUNKS AND SUITCASES, IN CLASS 18 (U.S. CLS. 1, 2, 3, 22 AND 41).

FIRST USE 12-1-2005; IN COMMERCE 12-4-2006.

THE MARK CONSISTS OF STANDARD CHARACTERS WITHOUT CLAIM TO ANY PARTICULAR FONT, STYLE, SIZE, OR COLOR.

OWNER OF U.S. REG. NO. 3,523,179.

THE ENGLISH TRANSLATION OF "L'HOMME" IN THE MARK IS THE MAN.

SER. NO. 85-012,915, FILED P.R. 4-13-2010; AM. S.R. 10-27-2011.

SHAUNIA CARLYLE, EXAMINING ATTORNEY



David J. Kyffers

Director of the United States Patent and Trademark Office

United States of America

United States Patent and Trademark Office

Type Coach

Reg. No. 4,075,440

TYPE COACH, LLC (MASSACHUSETTS LIMITED LIABILITY COMPANY)
119 CUSHING STREET
NEWMARKET, NH 03857

Registered Dec. 20, 2011

Int. Cl.: 41

FOR: EDUCATION SERVICES, NAMELY, PROVIDING ONLINE COGNITIVE ASSESSMENTS AND TRAINING PROGRAMS THAT HELP IDENTIFY COGNITIVE STRENGTHS AND WEAKNESSES OF AN INDIVIDUAL, IN CLASS 41 (U.S. CLS. 100, 101 AND 107).

SERVICE MARK

FIRST USE 8-12-2011; IN COMMERCE 8-12-2011.

SUPPLEMENTAL REGISTER

THE MARK CONSISTS OF STANDARD CHARACTERS WITHOUT CLAIM TO ANY PARTICULAR FONT, STYLE, SIZE, OR COLOR.

SER. NO. 85-014,137, FILED P.R. 4-14-2010; AM. S.R. 9-22-2011.

JAMES STEIN, EXAMINING ATTORNEY



David J. Kyffers

Director of the United States Patent and Trademark Office

United States of America

United States Patent and Trademark Office

MIXOLOGY COLLECTION

Reg. No. 4,075,441 SPIRITS INTERNATIONAL B.V. (NETHERLANDS BESLOTEN VENNOOTSCHAP (B.V.))
Registered Dec. 20, 2011 7, RUE NICOLAS BOVE
LUXEMBOURG, LUXEMBOURG L-1253

Int. Cl.: 33 FOR: DISTILLED SPIRITS; VODKA; FLAVORED VODKA, IN CLASS 33 (U.S. CLS. 47 AND 49).

TRADEMARK FIRST USE 10-1-2011; IN COMMERCE 10-1-2011.

SUPPLEMENTAL REGISTER THE MARK CONSISTS OF STANDARD CHARACTERS WITHOUT CLAIM TO ANY PARTICULAR FONT, STYLE, SIZE, OR COLOR.

SER. NO. 85-031,408, FILED P.R. 5-6-2010; AM. S.R. 11-11-2011.

APRIL HESIK, EXAMINING ATTORNEY



David J. Kyros

Director of the United States Patent and Trademark Office

United States of America

United States Patent and Trademark Office

BURNHAM

Reg. No. 4,075,442

OUT OF CONTROL HOLDINGS, LLC (DELAWARE LIMITED LIABILITY COMPANY)
7 TIMES SQUARE, C/O PRYOR CASHMAN LLP
NEW YORK, NY 10036

Registered Dec. 20, 2011

Int. Cl.: 9

FOR: MUSICAL SOUND RECORDINGS; AUDIO-VISUAL RECORDINGS, NAMELY, COMPACT DISCS, DOWNLOADABLE MP3 FILES, ALL FEATURING MUSIC; DOWNLOADABLE MUSICAL SOUND RECORDINGS; DOWNLOADABLE VIDEO RECORDINGS FEATURING MUSIC, IN CLASS 9 (U.S. CLS. 21, 23, 26, 36 AND 38).

TRADEMARK

SUPPLEMENTAL REGISTER FIRST USE 10-19-2010; IN COMMERCE 10-19-2010.

THE MARK CONSISTS OF STANDARD CHARACTERS WITHOUT CLAIM TO ANY PARTICULAR FONT, STYLE, SIZE, OR COLOR.

SER. NO. 85-041,167, FILED P.R. 5-18-2010; AM. S.R. 10-13-2011.

DAVID TAYLOR, EXAMINING ATTORNEY

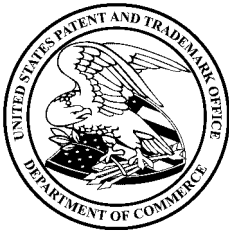

David J. Kyffers

Director of the United States Patent and Trademark Office

United States of America
United States Patent and Trademark Office

BURNHAM

Reg. No. 4,075,443

OUT OF CONTROL HOLDINGS, LLC (DELAWARE LIMITED LIABILITY COMPANY)
7 TIMES SQUARE, C/O PRYOR CASHMAN LLP
NEW YORK, NY 10036

Registered Dec. 20, 2011

Int. Cl.: 16

FOR: POSTERS, IN CLASS 16 (U.S. CLS. 2, 5, 22, 23, 29, 37, 38 AND 50).

TRADEMARK

FIRST USE 10-22-2010; IN COMMERCE 10-22-2010.

SUPPLEMENTAL REGISTER

THE MARK CONSISTS OF STANDARD CHARACTERS WITHOUT CLAIM TO ANY PARTICULAR FONT, STYLE, SIZE, OR COLOR.

SER. NO. 85-041,174, FILED P.R. 5-18-2010; AM. S.R. 10-13-2011.

DAVID TAYLOR, EXAMINING ATTORNEY



David J. Kyffers

Director of the United States Patent and Trademark Office

United States of America
United States Patent and Trademark Office

BURNHAM

Reg. No. 4,075,444

OUT OF CONTROL HOLDINGS, LLC (DELAWARE LIMITED LIABILITY COMPANY)
7 TIMES SQUARE, C/O PRYOR CASHMAN LLP
NEW YORK, NY 10036

Registered Dec. 20, 2011

Int. Cl.: 25

FOR: CLOTHING, NAMELY, T-SHIRTS, WRIST BANDS, IN CLASS 25 (U.S. CLS. 22 AND 39).

TRADEMARK

FIRST USE 10-31-2010; IN COMMERCE 10-31-2010.

SUPPLEMENTAL REGISTER

THE MARK CONSISTS OF STANDARD CHARACTERS WITHOUT CLAIM TO ANY PARTICULAR FONT, STYLE, SIZE, OR COLOR.

SER. NO. 85-041,175, FILED P.R. 5-18-2010; AM. S.R. 10-13-2011.

DAVID TAYLOR, EXAMINING ATTORNEY



David J. Kyffers

Director of the United States Patent and Trademark Office

United States of America

United States Patent and Trademark Office

GAUDI EYEWEAR

Reg. No. 4,075,445

MARIA DOLORES TOMAS FELIP (SPAIN INDIVIDUAL)
SUGRANYES, 108-110, PRIMERO 3ª
BARCELONA, SPAIN 08028

Registered Dec. 20, 2011

Int. Cl.: 9

FOR: EYE GLASSES, SUN GLASSES, FRAMES FOR GLASSES AND EYE GLASS CASES,
IN CLASS 9 (U.S. CLS. 21, 23, 26, 36 AND 38).

TRADEMARK

THE MARK CONSISTS OF STANDARD CHARACTERS WITHOUT CLAIM TO ANY PAR-
TICULAR FONT, STYLE, SIZE, OR COLOR.

SUPPLEMENTAL REGISTER

OWNER OF ERPN CMNTY TM OFC REG. NO. 2132611, DATED 6-7-2002, EXPIRES 3-16-
2021.

NO CLAIM IS MADE TO THE EXCLUSIVE RIGHT TO USE "EYEWEAR", APART FROM
THE MARK AS SHOWN.

THE WORDING "GAUDI" HAS NO MEANING IN A FOREIGN LANGUAGE.

SER. NO. 85-047,457, FILED P.R. 5-25-2010; AM. S.R. 3-8-2011.

LINDA ORNDORFF, EXAMINING ATTORNEY



David J. Kybas

Director of the United States Patent and Trademark Office

United States of America

United States Patent and Trademark Office

THE SCIENCE OF SAFE WATER

Reg. No. 4,075,446

BLUE EARTH LABS, LLC (DELAWARE LIMITED LIABILITY COMPANY)
5055 WEST PATRICK LANE, SUITE 102
LAS VEGAS, NV 89118

Registered Dec. 20, 2011

Int. Cl.: 40

FOR: WATER TREATMENT SERVICES; WATER FILTRATION AND CONDITIONING SERVICES, IN CLASS 40 (U.S. CLS. 100, 103 AND 106).

SERVICE MARK

FIRST USE 10-20-2010; IN COMMERCE 10-20-2010.

SUPPLEMENTAL REGISTER

THE MARK CONSISTS OF STANDARD CHARACTERS WITHOUT CLAIM TO ANY PARTICULAR FONT, STYLE, SIZE, OR COLOR.

SER. NO. 85-052,289, FILED P.R. 6-1-2010; AM. S.R. 10-12-2011.

SAIMA MAKHDOOM, EXAMINING ATTORNEY



David J. Kyros

Director of the United States Patent and Trademark Office

United States of America

United States Patent and Trademark Office

PORTMAN HOUSE

Reg. No. 4,075,447

PORTMAN HOLDINGS, LLC (GEORGIA LIMITED LIABILITY COMPANY)
303 PEACHTREE CENTER AVENUE, SUITE 575
ATLANTA, GA 30303

Registered Dec. 20, 2011

Int. Cl.: 43

FOR: HOTEL ACCOMMODATION SERVICES; HOTEL AND MOTEL SERVICES; HOTEL, BAR AND RESTAURANT SERVICES, IN CLASS 43 (U.S. CLS. 100 AND 101).

SERVICE MARK

FIRST USE 9-1-2011; IN COMMERCE 9-1-2011.

SUPPLEMENTAL REGISTER

THE MARK CONSISTS OF STANDARD CHARACTERS WITHOUT CLAIM TO ANY PARTICULAR FONT, STYLE, SIZE, OR COLOR.

NO CLAIM IS MADE TO THE EXCLUSIVE RIGHT TO USE "HOUSE", APART FROM THE MARK AS SHOWN.

SER. NO. 85-055,019, FILED P.R. 6-4-2010; AM. S.R. 10-3-2011.

ROBERT STRUCK, EXAMINING ATTORNEY



David J. Kybas

Director of the United States Patent and Trademark Office

United States of America

United States Patent and Trademark Office

RivetLess

Reg. No. 4,075,448

Registered Dec. 20, 2011

Int. Cl.: 16

TRADEMARK

SUPPLEMENTAL REGISTER

BENSONS INTERNATIONAL SYSTEMS INC. (NEW YORK CORPORATION)
SUITE 1
300 LACKAWANNA AVENUE
WOODLAWN PARK, NJ 07424

FOR: MECHANICAL BINDER SETS COMPRISED OF RING FASTENERS, IN CLASS 16 (U.S. CLS. 2, 5, 22, 23, 29, 37, 38 AND 50).

FIRST USE 1-5-1998; IN COMMERCE 1-5-1998.

THE MARK CONSISTS OF STANDARD CHARACTERS WITHOUT CLAIM TO ANY PARTICULAR FONT, STYLE, SIZE, OR COLOR.

SER. NO. 85-056,100, FILED P.R. 6-7-2010; AM. S.R. 3-22-2011.

AMEEN IMAM, EXAMINING ATTORNEY



David J. Kyfos

Director of the United States Patent and Trademark Office

United States of America
United States Patent and Trademark Office

MARCIANO

Reg. No. 4,075,449

MARCIANO, MAURICE (UNITED STATES INDIVIDUAL)
144 SOUTH BEVERLY DRIVE
BEVERLY HILLS, CA 90212

Registered Dec. 20, 2011

Int. Cl.: 33

FOR: WINES, IN CLASS 33 (U.S. CLS. 47 AND 49).

TRADEMARK

FIRST USE 4-0-2011; IN COMMERCE 4-0-2011.

SUPPLEMENTAL REGISTER

THE MARK CONSISTS OF STANDARD CHARACTERS WITHOUT CLAIM TO ANY PARTICULAR FONT, STYLE, SIZE, OR COLOR.

SER. NO. 85-057,389, FILED P.R. 6-8-2010; AM. S.R. 10-24-2011.

SHAUNIA CARLYLE, EXAMINING ATTORNEY



David J. Kybas

Director of the United States Patent and Trademark Office

United States of America

United States Patent and Trademark Office

TECH BUSINESS BANKING

Reg. No. 4,075,450

TECHNOLOGY CREDIT UNION (CALIFORNIA CORPORATION)

Registered Dec. 20, 2011

2010 NORTH 1ST STREET
SAN JOSE, CA 95131

Int. Cl.: 36

FOR: FINANCIAL SERVICES, NAMELY, PROVIDING BANKING SERVICES, SAVINGS ACCOUNT SERVICES, SAFE DEPOSIT SERVICES, CHECKING ACCOUNT SERVICES, CERTIFICATES OF DEPOSIT, CONSUMER AND MORTGAGE LOAN SERVICES, SECURITIES BROKERAGE, INDIVIDUAL RETIREMENT ACCOUNTS, DEBIT CARD SERVICES, CREDIT CARD SERVICES, FINANCIAL PLANNING, RETIREMENT PLANNING, WEALTH PLANNING AND ONLINE BANKING SERVICES, IN CLASS 36 (U.S. CLS. 100, 101 AND 102).

SERVICE MARK

SUPPLEMENTAL REGISTER

FIRST USE 10-18-2011; IN COMMERCE 10-18-2011.

THE MARK CONSISTS OF STANDARD CHARACTERS WITHOUT CLAIM TO ANY PARTICULAR FONT, STYLE, SIZE, OR COLOR.

NO CLAIM IS MADE TO THE EXCLUSIVE RIGHT TO USE "BUSINESS BANKING", APART FROM THE MARK AS SHOWN.

SER. NO. 85-057,846, FILED P.R. 6-8-2010; AM. S.R. 10-18-2011.

AISHA CLARKE, EXAMINING ATTORNEY



David J. Kybas

Director of the United States Patent and Trademark Office

United States of America

United States Patent and Trademark Office

TextRx

Reg. No. 4,075,451

Registered Dec. 20, 2011

Int. Cls.: 35, 36, and 44

SERVICE MARK

SUPPLEMENTAL REGISTER

TRIALCARD INCORPORATED (NORTH CAROLINA CORPORATION)
SUITE 370
6501 WESTON PARKWAY
CARY, NC 27513

FOR: PROVIDING INFORMATION REGARDING FREE TRIAL OFFERS OF PRESCRIPTION MEDICATION VIA TEXT MESSAGING, IN CLASS 35 (U.S. CLS. 100, 101 AND 102).

FIRST USE 7-22-2010; IN COMMERCE 7-0-2010.

FOR: PROVIDING INFORMATION VIA TEXT MESSAGING ABOUT FINANCIAL PAYMENT ASSISTANCE TO OTHERS FOR PRESCRIPTION MEDICATION COVERAGE, IN CLASS 36 (U.S. CLS. 100, 101 AND 102).

FIRST USE 7-0-2010; IN COMMERCE 7-0-2010.

FOR: PRESCRIPTION REFILL REMINDER SERVICES SENT VIA TEXT MESSAGING; AND PROVIDING MEDICAL INFORMATION ABOUT DISEASES VIA TEXT MESSAGING, IN CLASS 44 (U.S. CLS. 100 AND 101).

FIRST USE 7-0-2010; IN COMMERCE 7-0-2010.

THE MARK CONSISTS OF STANDARD CHARACTERS WITHOUT CLAIM TO ANY PARTICULAR FONT, STYLE, SIZE, OR COLOR.

SER. NO. 85-059,221, FILED P.R. 6-10-2010; AM. S.R. 10-10-2011.

JENNIFER MARTIN, EXAMINING ATTORNEY



David J. Kybas

Director of the United States Patent and Trademark Office

United States of America

United States Patent and Trademark Office

CASHWIRE.COM

Reg. No. 4,075,452

Registered Dec. 20, 2011

Int. Cl.: 36

SERVICE MARK

SUPPLEMENTAL REGISTER

CASHWIRE.COM, LLC (ILLINOIS LIMITED LIABILITY COMPANY)
SUITE 100
385 AIRPORT ROAD
ELGIN, IL 60123

FOR: CREDIT AND LOAN SERVICES, IN CLASS 36 (U.S. CLS. 100, 101 AND 102).

FIRST USE 10-1-2008; IN COMMERCE 10-1-2008.

THE MARK CONSISTS OF STANDARD CHARACTERS WITHOUT CLAIM TO ANY PARTICULAR FONT, STYLE, SIZE, OR COLOR.

SER. NO. 85-060,214, FILED P.R. 6-11-2010; AM. S.R. 10-24-2011.

JASON TURNER, EXAMINING ATTORNEY



David J. Kybas

Director of the United States Patent and Trademark Office

United States of America

United States Patent and Trademark Office

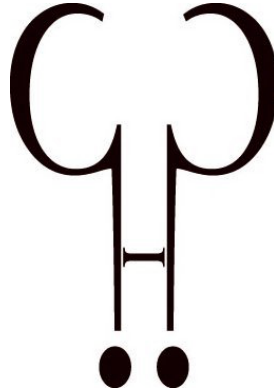

Reg. No. 4,075,453

Registered Dec. 20, 2011

Int. Cl.: 14

PAMELA ELAINE BAILEY (UNITED STATES INDIVIDUAL), DBA FADING INTO REALITY PUBLISHING, LLC,
2313 F DUNWOODY XING
DUNWOODY, GA 30338

FOR: JEWELRY, IN CLASS 14 (U.S. CLS. 2, 27, 28 AND 50).

TRADEMARK

FIRST USE 4-25-2011; IN COMMERCE 4-25-2011.

SUPPLEMENTAL REGISTER

THE MARK CONSISTS OF A REVERSE QUESTION MARK FACING ANOTHER QUESTION MARK WITH A HORIZONTAL LETTER "I" CONNECTING THE TWO QUESTION MARKS ON THE BOTTOM VERTICAL LINES OF THE QUESTION MARKS.

SER. NO. 85-063,851, FILED P.R. 6-15-2010; AM. S.R. 11-8-2011.

ELIZABETH KAJUBI, EXAMINING ATTORNEY



David J. Kyffers

Director of the United States Patent and Trademark Office

United States of America

United States Patent and Trademark Office

WorldEmergencyReport

Reg. No. 4,075,454

Registered Dec. 20, 2011

Int. Cls.: 35, 41, and 45

SERVICE MARK

SUPPLEMENTAL REGISTER

WORLD EMERGENCY NETWORK, LTD. (CANADA LIMITED COMPANY (LTD.))
SUITE 307
600 1ST AVENUE NORTH
ST. PETERSBURG, FL 33701

FOR: PROVIDING AN INTERNET WEB SITE FEATURING NEWS AND INFORMATION COLLECTED FROM LOCAL, STATE, NATIONAL AND INTERNATIONAL GOVERNMENT AGENCIES; PROVIDING AN INTERNET WEB SITE FEATURING LOCAL, STATE, NATIONAL AND INTERNATIONAL GOVERNMENT INFORMATION IN THE NATURE OF CURRENT EVENTS, NEWS BRIEFINGS, PRESS RELEASES, SECURITY ALERTS, EMERGENCY PREPAREDNESS AND/OR EMERGENCY INFORMATION, IN CLASS 35 (U.S. CLS. 100, 101 AND 102).

FIRST USE 4-27-2009; IN COMMERCE 4-27-2009.

FOR: PROVIDING ON-LINE INFORMATION FROM LOCAL, STATE, NATIONAL AND INTERNATIONAL GOVERNMENT AGENCIES IN THE NATURE OF CURRENT EVENTS, NEWS BRIEFINGS, PRESS RELEASES, SECURITY ALERTS, EMERGENCY PREPAREDNESS AND EMERGENCY INFORMATION, IN CLASS 41 (U.S. CLS. 100, 101 AND 107).

FIRST USE 4-27-2009; IN COMMERCE 4-27-2009.

FOR: PROVIDING AN INTERNET WEB SITE FEATURING NEWS AND INFORMATION IN THE FIELDS OF COMMUNITY SECURITY, EMERGENCY PREPAREDNESS, HOMELAND SECURITY AND EMERGENCY INFORMATION COLLECTED FROM LOCAL, STATE, NATIONAL AND INTERNATIONAL GOVERNMENT AGENCIES, IN CLASS 45 (U.S. CLS. 100 AND 101).

FIRST USE 4-27-2009; IN COMMERCE 4-27-2009.

THE MARK CONSISTS OF STANDARD CHARACTERS WITHOUT CLAIM TO ANY PARTICULAR FONT, STYLE, SIZE, OR COLOR.

SER. NO. 85-071,072, FILED P.R. 6-24-2010; AM. S.R. 4-7-2011.

WILLIAM BRECKENFELD, EXAMINING ATTORNEY



David J. Kyffers

Director of the United States Patent and Trademark Office

United States of America

United States Patent and Trademark Office

EmergencyReport

Reg. No. 4,075,455

Registered Dec. 20, 2011

Int. Cls.: 35, 38, 41, and 45

SERVICE MARK

SUPPLEMENTAL REGISTER

WORLD EMERGENCY NETWORK, LTD. (CANADA LIMITED COMPANY (LTD.))
SUITE 307
600 1ST AVENUE NORTH
ST. PETERSBURG, FL 33701

FOR: PROVIDING AN INTERNET WEB SITE FEATURING BUSINESS, NATIONAL AND INTERNATIONAL POLITICAL NEWS AND INFORMATION COLLECTED FROM LOCAL, STATE, NATIONAL AND INTERNATIONAL GOVERNMENT AGENCIES; PROVIDING AN INTERNET WEB SITE FEATURING LOCAL, STATE, NATIONAL AND INTERNATIONAL GOVERNMENT INFORMATION IN THE NATURE OF NEWS BRIEFINGS, PRESS RELEASES AND ALERTS IN THE FIELDS OF BUSINESS, NATIONAL AND INTERNATIONAL POLITICAL NEWS AND INFORMATION, IN CLASS 35 (U.S. CLS. 100, 101 AND 102).

FIRST USE 4-27-2009; IN COMMERCE 4-27-2009.

FOR: ELECTRONIC TRANSMISSION OF MESSAGES VIA MULTIPLE COMMUNICATION FORMATS FOR THE DISSEMINATION OF INFORMATION COLLECTED FROM LOCAL, STATE, NATIONAL AND INTERNATIONAL GOVERNMENT AGENCIES; ELECTRONIC TRANSMISSION OF MESSAGES VIA MULTIPLE COMMUNICATION FORMATS FOR THE DISSEMINATION OF INFORMATION IN THE NATURE OF CURRENT EVENTS, NEWS BRIEFINGS, PRESS RELEASES, SECURITY ALERTS, EMERGENCY PREPAREDNESS AND/OR EMERGENCY INFORMATION, IN CLASS 38 (U.S. CLS. 100, 101 AND 104).

FIRST USE 4-27-2009; IN COMMERCE 4-27-2009.

FOR: PROVIDING ON-LINE INFORMATION FROM LOCAL, STATE, NATIONAL AND INTERNATIONAL GOVERNMENT AGENCIES IN THE NATURE OF CURRENT EVENTS REPORTING, IN CLASS 41 (U.S. CLS. 100, 101 AND 107).

FIRST USE 4-27-2009; IN COMMERCE 4-27-2009.

FOR: PROVIDING AN INTERNET WEB SITE FEATURING NEWS AND INFORMATION IN THE FIELDS OF COMMUNITY SECURITY, EMERGENCY PREPAREDNESS, HOMELAND SECURITY AND EMERGENCY INFORMATION COLLECTED FROM LOCAL, STATE, NATIONAL AND INTERNATIONAL GOVERNMENT AGENCIES, IN CLASS 45 (U.S. CLS. 100 AND 101).



David J. Kyffers

Director of the United States Patent and Trademark Office

Reg. No. 4,075,455 FIRST USE 4-27-2009; IN COMMERCE 4-27-2009.

THE MARK CONSISTS OF STANDARD CHARACTERS WITHOUT CLAIM TO ANY PARTICULAR FONT, STYLE, SIZE, OR COLOR.

SER. NO. 85-071,086, FILED P.R. 6-24-2010; AM. S.R. 4-7-2011.

WILLIAM BRECKENFELD, EXAMINING ATTORNEY

United States of America

United States Patent and Trademark Office

READ AND NOTE

Reg. No. 4,075,456

READ AND NOTE LLC (DELAWARE LIMITED LIABILITY COMPANY)
46 ATHERTON STREET
BOSTON, MA 02119

Registered Dec. 20, 2011

Int. Cl.: 42

FOR: SOFTWARE AS A SERVICE (SAAS) SERVICES, NAMELY, HOSTING SOFTWARE FOR USE BY OTHERS FOR USE IN RETRIEVING, LABELING AND COMMENTING ON DIGITAL CONTENT, IN CLASS 42 (U.S. CLS. 100 AND 101).

SERVICE MARK

FIRST USE 4-22-2008; IN COMMERCE 4-22-2008.

SUPPLEMENTAL REGISTER

THE MARK CONSISTS OF STANDARD CHARACTERS WITHOUT CLAIM TO ANY PARTICULAR FONT, STYLE, SIZE, OR COLOR.

SER. NO. 85-074,099, FILED P.R. 6-29-2010; AM. S.R. 11-7-2011.

SIMON TENG, EXAMINING ATTORNEY



David J. Kybas

Director of the United States Patent and Trademark Office

United States of America

United States Patent and Trademark Office

READ AND NOTE

Reg. No. 4,075,457

Registered Dec. 20, 2011

Int. Cl.: 9

TRADEMARK

SUPPLEMENTAL REGISTER

READ AND NOTE LLC (DELAWARE LIMITED LIABILITY COMPANY)
46 ATHERTON STREET
BOSTON, MA 02119

FOR: COMPUTER SOFTWARE FOR RETRIEVING, LABELING AND COMMENTING ON DIGITAL CONTENT THAT MAY BE DOWNLOADED FROM A GLOBAL COMPUTER NETWORK; DOWNLOADABLE COMPUTER SOFTWARE FOR RETRIEVING, LABELING AND COMMENTING ON DIGITAL CONTENT, IN CLASS 9 (U.S. CLS. 21, 23, 26, 36 AND 38).

FIRST USE 4-22-2008; IN COMMERCE 4-22-2008.

THE MARK CONSISTS OF STANDARD CHARACTERS WITHOUT CLAIM TO ANY PARTICULAR FONT, STYLE, SIZE, OR COLOR.

SER. NO. 85-074,108, FILED P.R. 6-29-2010; AM. S.R. 11-7-2011.

SIMON TENG, EXAMINING ATTORNEY



David J. Kybas

Director of the United States Patent and Trademark Office

United States of America

United States Patent and Trademark Office

LOGWATCH

Reg. No. 4,075,458

Registered Dec. 20, 2011

Int. Cl.: 42

SERVICE MARK

SUPPLEMENTAL REGISTER

ENTERPRISE RISK MANAGEMENT, INC. (FLORIDA CORPORATION)
SUITE 835
800 S. DOUGLAS RD., NORTH TOWER
CORAL GABLES, FL 33134

FOR: APPLICATION SERVICE PROVIDER SERVICES FEATURING SOFTWARE FOR SECURITY MONITORING AND ANALYSIS, IN CLASS 42 (U.S. CLS. 100 AND 101).

FIRST USE 1-1-2007; IN COMMERCE 1-1-2007.

THE MARK CONSISTS OF STANDARD CHARACTERS WITHOUT CLAIM TO ANY PARTICULAR FONT, STYLE, SIZE, OR COLOR.

SER. NO. 85-075,925, FILED P.R. 7-1-2010; AM. S.R. 10-6-2011.

ALICE BENMAMAN, EXAMINING ATTORNEY



David J. Kybas

Director of the United States Patent and Trademark Office

United States of America

United States Patent and Trademark Office



Reg. No. 4,075,459

LG ELECTRONICS INC. (REPUBLIC OF KOREA CORPORATION)
20, YEUIDO-DONG, YEONGDEUNGPO-GU
SEOUL, REPUBLIC OF KOREA 150-721

Registered Dec. 20, 2011

Int. Cls.: 7 and 11

FOR: CLOTHES WASHING MACHINES, NAMELY, AN ENERGY-SAVING WASH CYCLE FEATURE SOLD AS AN INTEGRAL COMPONENT PART OF CLOTHES WASHING MACHINES, IN CLASS 7 (U.S. CLS. 13, 19, 21, 23, 31, 34 AND 35).

TRADEMARK

FOR: CLOTHES DRYERS, NAMELY, AN ENERGY-SAVING DRYING CYCLE FEATURE SOLD AS AN INTEGRAL COMPONENT PART OF CLOTHES DRYERS, IN CLASS 11 (U.S. CLS. 13, 21, 23, 31 AND 34).

SUPPLEMENTAL REGISTER

PRIORITY CLAIMED UNDER SEC. 44(D) ON REPUBLIC OF KOREA APPLICATION NO. 40-2010-0031, FILED 6-17-2010, REG. NO. 009241282, DATED 8-9-2011, EXPIRES 7-13-2020.

THE MARK CONSISTS OF THE WORD "COLDWASH" WITH A SNOWFLAKE DESIGN ABOVE THE "C".

SER. NO. 85-077,368, FILED P.R. 7-2-2010; AM. S.R. 10-21-2011.

JILL PRATER, EXAMINING ATTORNEY



David J. Kybas

Director of the United States Patent and Trademark Office

United States of America

United States Patent and Trademark Office

Snap-On Disposable Stethoscope Covers

Reg. No. 4,075,460

DEPHILLIA MARIE JOSEPH (UNITED STATES INDIVIDUAL)
2606 ROSEDALE APT.2
HOUSTON, TX 77004

Registered Dec. 20, 2011

Int. Cl.: 10

FOR: SANITIZATION UNITS FOR STETHOSCOPIES; STETHOSCOPIES, IN CLASS 10 (U.S. CLS. 26, 39 AND 44).

TRADEMARK

FIRST USE 9-1-2011; IN COMMERCE 10-10-2011.

SUPPLEMENTAL REGISTER

THE MARK CONSISTS OF STANDARD CHARACTERS WITHOUT CLAIM TO ANY PARTICULAR FONT, STYLE, SIZE, OR COLOR.

NO CLAIM IS MADE TO THE EXCLUSIVE RIGHT TO USE "DISPOSABLE STETHOSCOPE COVERS", APART FROM THE MARK AS SHOWN.

SER. NO. 85-082,720, FILED P.R. 7-12-2010; AM. S.R. 10-17-2011.

JOHN WILKE, EXAMINING ATTORNEY



David J. Kyros

Director of the United States Patent and Trademark Office

United States of America

United States Patent and Trademark Office

TICKETXCHANGE

Reg. No. 4,075,461

WESTERN MONEY SYSTEMS (NEVADA CORPORATION)

Registered Dec. 20, 2011

620 KRESGE LANE
SPARKS, NV 89431

Int. Cl.: 9

FOR: ELECTRONIC TERMINALS WHICH GENERATE CASINO VOUCHERS FOR GAMING PATRONS; INTERACTIVE COMPUTER KIOSKS COMPRISING COMPUTERS, COMPUTER HARDWARE, COMPUTER PERIPHERALS, AND COMPUTER OPERATING SOFTWARE, FOR USE IN PROCESSING FINANCIAL TRANSACTIONS FOR GAMING PATRONS; AUTOMATED TELLER MACHINES (ATM), IN CLASS 9 (U.S. CLS. 21, 23, 26, 36 AND 38).

TRADEMARK

SUPPLEMENTAL REGISTER

FIRST USE 12-31-2006; IN COMMERCE 12-31-2006.

THE MARK CONSISTS OF STANDARD CHARACTERS WITHOUT CLAIM TO ANY PARTICULAR FONT, STYLE, SIZE, OR COLOR.

SER. NO. 85-089,860, FILED P.R. 7-21-2010; AM. S.R. 10-5-2011.

MAUREEN DALL, EXAMINING ATTORNEY



David J. Kyffers

Director of the United States Patent and Trademark Office

United States of America

United States Patent and Trademark Office

QUOTE COUTURE

Reg. No. 4,075,462

SPLENIUM, INC. (CALIFORNIA CORPORATION)
1248 UNION ST.

Registered Dec. 20, 2011

SAN FRANCISCO, CA 94109

Int. Cls.: 16, 18, and 25

FOR: PAPER GOODS, AND PRINTED MATTER, NAMELY, GREETING CARDS, POSTCARDS, NOTE CARDS, NOTEBOOKS, NOTEPADS, ENVELOPES, STATIONERY, CALENDARS, POSTERS, PRINTS, ART PRINTS, ART PRINTS ON CANVAS, FRAMED ART PRINTS, STICKERS, BUMPER STICKERS, IN CLASS 16 (U.S. CLS. 2, 5, 22, 23, 29, 37, 38 AND 50).

TRADEMARK

SUPPLEMENTAL REGISTER

FIRST USE 1-11-2010; IN COMMERCE 7-11-2010.

FOR: BAGS, NAMELY, TOTE BAGS, CANVAS SHOPPING BAGS, BEACH BAGS, SHOULDER BAGS, MESSENGER BAGS, DUFFEL BAGS, SPORT BAGS, ALL-PURPOSE CARRYING BAGS; DOG APPAREL, NECKWEAR FOR DOGS; UMBRELLAS, IN CLASS 18 (U.S. CLS. 1, 2, 3, 22 AND 41).

FIRST USE 1-11-2010; IN COMMERCE 7-11-2010.

FOR: CLOTHING, NAMELY, T-SHIRTS, SHIRTS, SPORTS SHIRTS, LONG-SLEEVED SHIRTS, POLO SHIRTS, TOPS, TANK TOPS, SWEAT SHIRTS, HOODED SWEAT SHIRTS, JACKETS, SPORTS JACKETS, SWEAT PANTS, SHORTS, SKIRTS, DRESSES, BATHROBES, APRONS, BABY BODYSUITS, CLOTH BIBS; HEADWEAR, NAMELY, CAPS, HATS, NECKWEAR, SCARVES, TIES; UNDERWEAR; FOOTWEAR, IN CLASS 25 (U.S. CLS. 22 AND 39).

FIRST USE 1-11-2010; IN COMMERCE 7-11-2010.

THE MARK CONSISTS OF STANDARD CHARACTERS WITHOUT CLAIM TO ANY PARTICULAR FONT, STYLE, SIZE, OR COLOR.

NO CLAIM IS MADE TO THE EXCLUSIVE RIGHT TO USE "COUTURE", APART FROM THE MARK AS SHOWN.

SER. NO. 85-101,617, FILED P.R. 8-6-2010; AM. S.R. 11-7-2011.

SAIMA MAKHDOOM, EXAMINING ATTORNEY



David J. Kyffers

Director of the United States Patent and Trademark Office

United States of America

United States Patent and Trademark Office



Reg. No. 4,075,463

SPIEDIE & RIB PIT, INC. (NEW YORK CORPORATION)
1258 FRONT STREET
BINGHAMTON, NY 13905

Registered Dec. 20, 2011

Int. Cl.: 42

FOR: RESTAURANT SERVICES, IN CLASS 42 (U.S. CLS. 100 AND 101).

SERVICE MARK

FIRST USE 2-2-1993; IN COMMERCE 2-2-1993.

SUPPLEMENTAL REGISTER

NO CLAIM IS MADE TO THE EXCLUSIVE RIGHT TO USE "RIB" , APART FROM THE MARK AS SHOWN.

THE MARK CONSISTS OF A BOX OUTLINED CONTAINING THE WORDING "SPIEDIE" ON TOP OF "RIB PIT" WITH AN AMPERSAND SYMBOL "&" APPEARING BENEATH "SPIEDIE". THE WORDING CONTAINS A SHADOW EFFECT; ON EACH SIDE OF THE AMPERSAND APPEAR FOUR HORIZONTAL LINES.

SER. NO. 85-134,569, FILED P.R. 9-21-2010; AM. S.R. 9-15-2011.

RON FAIRBANKS, EXAMINING ATTORNEY



David J. Kybas

Director of the United States Patent and Trademark Office

United States of America

United States Patent and Trademark Office

US PROPERTY

Reg. No. 4,075,464

LANDMARK MANAGEMENT, LLC (WASHINGTON LIMITED LIABILITY COMPANY)
290 MADISON AVENUE NORTH
BAINBRIDGE ISLAND, WA 98110

Registered Dec. 20, 2011

Int. Cl.: 36

FOR: REAL ESTATE BROKERAGE, IN CLASS 36 (U.S. CLS. 100, 101 AND 102).

FIRST USE 9-27-2011; IN COMMERCE 9-27-2011.

SERVICE MARK

THE MARK CONSISTS OF STANDARD CHARACTERS WITHOUT CLAIM TO ANY PARTICULAR FONT, STYLE, SIZE, OR COLOR.

SUPPLEMENTAL REGISTER

NO CLAIM IS MADE TO THE EXCLUSIVE RIGHT TO USE "PROPERTY", APART FROM THE MARK AS SHOWN.

SER. NO. 85-135,463, FILED P.R. 9-22-2010; AM. S.R. 10-4-2011.

MARIA-VICTORIA SUAREZ, EXAMINING ATTORNEY



David J. Kybas

Director of the United States Patent and Trademark Office

United States of America

United States Patent and Trademark Office

American Candle Wood

Reg. No. 4,075,465

AMERICAN CANDLE WOOD, LLC (NEW YORK LIMITED LIABILITY COMPANY)
50 AERO RD

Registered Dec. 20, 2011

BOHEMIA, NY 11716

Int. Cls.: 35 and 40

FOR: WHOLESALE DISTRIBUTORSHIPS OF ALL NATURAL WOOD CANDLE WICKS, WICK CLIPS, AND WICK CLIPPERS, IN CLASS 35 (U.S. CLS. 100, 101 AND 102).

SERVICE MARK

FIRST USE 7-1-2010; IN COMMERCE 7-1-2010.

SUPPLEMENTAL REGISTER

FOR: CUSTOM MANUFACTURE OF ALL NATURAL WOOD CANDLE WICKS, IN CLASS 40 (U.S. CLS. 100, 103 AND 106).

FIRST USE 7-1-2010; IN COMMERCE 7-1-2010.

THE MARK CONSISTS OF STANDARD CHARACTERS WITHOUT CLAIM TO ANY PARTICULAR FONT, STYLE, SIZE, OR COLOR.

NO CLAIM IS MADE TO THE EXCLUSIVE RIGHT TO USE "CANDLE WOOD", APART FROM THE MARK AS SHOWN.

SER. NO. 85-138,396, FILED P.R. 9-26-2010; AM. S.R. 11-14-2011.

GEOFFREY FOSDICK, EXAMINING ATTORNEY



David J. Kyros

Director of the United States Patent and Trademark Office

United States of America

United States Patent and Trademark Office

EMERGENCY TREE JOBS .COM, LLC

Reg. No. 4,075,466

EMERGENCY TREE JOBS . COM, LLC (GEORGIA LIMITED LIABILITY COMPANY)
P.O. BOX 2783
ACWORTH, GA 30102

Registered Dec. 20, 2011

Int. Cl.: 44

FOR: PROVIDING EMERGENCY TREE SERVICES, NAMELY, TREE REMOVAL SERVICES, TREE SURGERY, GARDEN TREE PLANTING, AND TREE PRUNING, IN CLASS 44 (U.S. CLS. 100 AND 101).

SERVICE MARK

FIRST USE 2-1-2009; IN COMMERCE 2-1-2009.

SUPPLEMENTAL REGISTER

THE MARK CONSISTS OF STANDARD CHARACTERS WITHOUT CLAIM TO ANY PARTICULAR FONT, STYLE, SIZE, OR COLOR.

NO CLAIM IS MADE TO THE EXCLUSIVE RIGHT TO USE "EMERGENCY TREE" AND ".COM, LLC", APART FROM THE MARK AS SHOWN.

SER. NO. 85-138,876, FILED P.R. 9-27-2010; AM. S.R. 9-29-2011.

MYRIAH HABEEB, EXAMINING ATTORNEY



David J. Kyffers

Director of the United States Patent and Trademark Office

United States of America

United States Patent and Trademark Office

RIM DRIVE

Reg. No. 4,075,467

Registered Dec. 20, 2011

Int. Cl.: 37

SERVICE MARK

SUPPLEMENTAL REGISTER

KEUKA ENERGY, LLC (IOWA LIMITED LIABILITY COMPANY)
SUITE 205
110 SOUTHEAST GRANT STREET
ANKENY, IA 50021

FOR: MAINTENANCE AND INSTALLATION OF WIND TURBINES AND PARTS THEREFOR,
IN CLASS 37 (U.S. CLS. 100, 103 AND 106).

FIRST USE 7-1-2011; IN COMMERCE 7-1-2011.

THE MARK CONSISTS OF STANDARD CHARACTERS WITHOUT CLAIM TO ANY PAR-
TICULAR FONT, STYLE, SIZE, OR COLOR.

SER. NO. 85-145,174, FILED P.R. 10-5-2010; AM. S.R. 10-21-2011.

JENNIFER VASQUEZ, EXAMINING ATTORNEY



David J. Kyffers

Director of the United States Patent and Trademark Office

United States of America

United States Patent and Trademark Office

DANGEROUSLY  HUMAN

Reg. No. 4,075,468

CLAIRDAY, ROBYNN O. (UNITED STATES INDIVIDUAL)
2305 W. HORIZON RIDGE PARKWAY # 2421
HENDERSON, NV 89052

Registered Dec. 20, 2011

Int. Cl.: 14

FOR: BRACELETS, IN CLASS 14 (U.S. CLS. 2, 27, 28 AND 50).

TRADEMARK

FIRST USE 9-15-2010; IN COMMERCE 10-1-2010.

SUPPLEMENTAL REGISTER

THE MARK CONSISTS OF "DANGEROUSLY HUMAN" IN STYLIZED FONT WITH A STYLIZED EYE DESIGN PLACED BETWEEN THE WORDS.

SER. NO. 85-146,121, FILED P.R. 10-6-2010; AM. S.R. 10-27-2011.

STEVEN PEREZ, EXAMINING ATTORNEY



David J. Kyffers

Director of the United States Patent and Trademark Office

United States of America

United States Patent and Trademark Office

CHAPERONE MOLECULE

Reg. No. 4,075,469

JAMIESON, JAMES (UNITED STATES INDIVIDUAL)
750 FAIRFIELD LAKE DRIVE
TOWN & COUNTRY, MO 63017

Registered Dec. 20, 2011

Int. Cl.: 5

FOR: DISSACHARIDES AND SURFACTANTS BEING INGREDIENTS SOLD AS INTEGRAL COMPONENTS OF NUTRACEUTICALS FOR USE AS A DIETARY SUPPLEMENT AND OF VITAMINS , IN CLASS 5 (U.S. CLS. 6, 18, 44, 46, 51 AND 52).

TRADEMARK

FIRST USE 1-0-1972; IN COMMERCE 6-0-1972.

SUPPLEMENTAL REGISTER

THE MARK CONSISTS OF STANDARD CHARACTERS WITHOUT CLAIM TO ANY PARTICULAR FONT, STYLE, SIZE, OR COLOR.

SER. NO. 85-154,115, FILED P.R. 10-15-2010; AM. S.R. 10-20-2011.

EVELYN BRADLEY, EXAMINING ATTORNEY



David J. Kybas

Director of the United States Patent and Trademark Office

United States of America

United States Patent and Trademark Office

MASSAGE FOAM

Reg. No. 4,075,470

HISAMITSU PHARMACEUTICAL CO., INC. (JAPAN CORPORATION)
408, TASHIRODAIKAN-MACHI
TOSU-SHI SAGA, JAPAN 841-0017

Registered Dec. 20, 2011

Int. Cl.: 5

FOR: MEDICATED SPRAYS FOR THE RELIEF OF ACHES AND PAINS OF MUSCLES AND JOINTS ASSOCIATED WITH ARTHRITIS, SIMPLE BACKACHES, STRAINS, BRUISES AND SPRAINS, IN CLASS 5 (U.S. CLS. 6, 18, 44, 46, 51 AND 52).

TRADEMARK

FIRST USE 7-8-2011; IN COMMERCE 7-8-2011.

SUPPLEMENTAL REGISTER

THE MARK CONSISTS OF STANDARD CHARACTERS WITHOUT CLAIM TO ANY PARTICULAR FONT, STYLE, SIZE, OR COLOR.

NO CLAIM IS MADE TO THE EXCLUSIVE RIGHT TO USE "FOAM", APART FROM THE MARK AS SHOWN.

SER. NO. 85-166,751, FILED P.R. 11-2-2010; AM. S.R. 10-2-2011.

KRISTINA MORRIS, EXAMINING ATTORNEY



David J. Kybas

Director of the United States Patent and Trademark Office

United States of America

United States Patent and Trademark Office

RETIREMENT RESEARCH INSTITUTE

Reg. No. 4,075,471

ING NORTH AMERICA INSURANCE CORPORATION (DELAWARE CORPORATION)
5780 POWERS FERRY ROAD
ATLANTA, GA 30327

Registered Dec. 20, 2011

Int. Cl.: 36

FOR: FINANCIAL PLANNING, FINANCIAL INVESTMENTS; RESEARCH IN THE FIELD
OF RETIREMENT SAVINGS BEHAVIOR, IN CLASS 36 (U.S. CLS. 100, 101 AND 102).

SERVICE MARK

FIRST USE 8-17-2011; IN COMMERCE 8-17-2011.

SUPPLEMENTAL REGISTER

THE MARK CONSISTS OF STANDARD CHARACTERS WITHOUT CLAIM TO ANY PAR-
TICULAR FONT, STYLE, SIZE, OR COLOR.

NO CLAIM IS MADE TO THE EXCLUSIVE RIGHT TO USE "RESEARCH INSTITUTE",
APART FROM THE MARK AS SHOWN.

SER. NO. 85-176,508, FILED P.R. 11-15-2010; AM. S.R. 8-19-2011.

ELLEN PERKINS, EXAMINING ATTORNEY



David J. Kybas

Director of the United States Patent and Trademark Office

United States of America

United States Patent and Trademark Office

AMERICAN PROPERTY

Reg. No. 4,075,472

LANDMARK MANAGEMENT, LLC (WASHINGTON LIMITED LIABILITY COMPANY)
290 MADISON AVENUE NORTH
BAINBRIDGE ISLAND, WA 98110

Registered Dec. 20, 2011

Int. Cl.: 36

FOR: REAL ESTATE BROKERAGE, IN CLASS 36 (U.S. CLS. 100, 101 AND 102).

SERVICE MARK

FIRST USE 9-27-2011; IN COMMERCE 9-27-2011.

SUPPLEMENTAL REGISTER

THE MARK CONSISTS OF STANDARD CHARACTERS WITHOUT CLAIM TO ANY PARTICULAR FONT, STYLE, SIZE, OR COLOR.

NO CLAIM IS MADE TO THE EXCLUSIVE RIGHT TO USE "PROPERTY", APART FROM THE MARK AS SHOWN.

SER. NO. 85-182,247, FILED P.R. 11-22-2010; AM. S.R. 10-4-2011.

MARIA-VICTORIA SUAREZ, EXAMINING ATTORNEY



David J. Kyffers

Director of the United States Patent and Trademark Office

United States of America

United States Patent and Trademark Office

CENTER FOR SPINAL EXCELLENCE

Reg. No. 4,075,473

SPINAL DECOMPRESSION INSTITUTE, LLC (OHIO LIMITED LIABILITY COMPANY)
27511 HOLIDAY LANE, #105
PERRYSBURG, OH 43551

Registered Dec. 20, 2011

Int. Cl.: 44

FOR: MEDICAL, PHYSICAL REHABILITATION AND PHYSICAL THERAPY SERVICES;
PHYSICAL THERAPY, IN CLASS 44 (U.S. CLS. 100 AND 101).

SERVICE MARK

FIRST USE 6-1-2011; IN COMMERCE 6-1-2011.

SUPPLEMENTAL REGISTER

THE MARK CONSISTS OF STANDARD CHARACTERS WITHOUT CLAIM TO ANY PARTICULAR FONT, STYLE, SIZE, OR COLOR.

SER. NO. 85-193,240, FILED P.R. 12-8-2010; AM. S.R. 9-30-2011.

ROBIN CHOSID, EXAMINING ATTORNEY



David J. Kybas

Director of the United States Patent and Trademark Office

United States of America

United States Patent and Trademark Office

HARDENED SMART MICROGRID

Reg. No. 4,075,474

SHAW INTELLECTUAL PROPERTY HOLDINGS, INC. (LOUISIANA CORPORATION)
4171 ESSEN LANE
BATON ROUGE, LA 70809

Registered Dec. 20, 2011

Int. Cls.: 37 and 42

FOR: INSTALLATION AND MAINTENANCE OF SECURE LOCALIZED ELECTRIC POWER SUPPLY AND DISTRIBUTION SYSTEMS WHICH ARE PROTECTED FROM MANMADE AND NATURAL DISRUPTIONS, NAMELY, INSTALLATION AND MAINTENANCE OF MICROGRIDS WHICH ARE PROTECTED FROM MANMADE AND NATURAL DISRUPTIONS, IN CLASS 37 (U.S. CLS. 100, 103 AND 106).

SERVICE MARK

SUPPLEMENTAL REGISTER

FIRST USE 4-14-2011; IN COMMERCE 4-14-2011.

FOR: DESIGN AND CONSULTATION FOR OTHERS IN THE FIELD OF SECURE LOCALIZED ELECTRIC POWER SUPPLY AND DISTRIBUTION SYSTEMS WHICH ARE PROTECTED FROM MANMADE AND NATURAL DISRUPTIONS, NAMELY, DESIGN AND CONSULTATION SERVICES FOR MICROGRIDS, IN CLASS 42 (U.S. CLS. 100 AND 101).

FIRST USE 4-14-2011; IN COMMERCE 4-14-2011.

THE MARK CONSISTS OF STANDARD CHARACTERS WITHOUT CLAIM TO ANY PARTICULAR FONT, STYLE, SIZE, OR COLOR.

NO CLAIM IS MADE TO THE EXCLUSIVE RIGHT TO USE "SMART MICROGRID", APART FROM THE MARK AS SHOWN.

SER. NO. 85-194,070, FILED P.R. 12-9-2010; AM. S.R. 9-26-2011.

JENNIFER MARTIN, EXAMINING ATTORNEY



David J. Kyros

Director of the United States Patent and Trademark Office

United States of America

United States Patent and Trademark Office

The San Francisco Triathlon at Alcatraz

Reg. No. 4,075,475

TRI-CALIFORNIA EVENTS, INC. (CALIFORNIA CORPORATION)
1284 ADOBE LANE
PACIFIC GROVE, CA 93950

Registered Dec. 20, 2011

Int. Cl.: 41

FOR: ORGANIZING, ARRANGING, AND CONDUCTING TRIATHLON EVENTS, IN CLASS 41 (U.S. CLS. 100, 101 AND 107).

SERVICE MARK

FIRST USE 12-1-2010; IN COMMERCE 12-1-2010.

SUPPLEMENTAL REGISTER

THE MARK CONSISTS OF STANDARD CHARACTERS WITHOUT CLAIM TO ANY PARTICULAR FONT, STYLE, SIZE, OR COLOR.

NO CLAIM IS MADE TO THE EXCLUSIVE RIGHT TO USE "TRIATHLON", APART FROM THE MARK AS SHOWN.

SER. NO. 85-204,018, FILED P.R. 12-22-2010; AM. S.R. 9-28-2011.

STEVEN R. FINE, EXAMINING ATTORNEY



David J. Kybas

Director of the United States Patent and Trademark Office

United States of America

United States Patent and Trademark Office

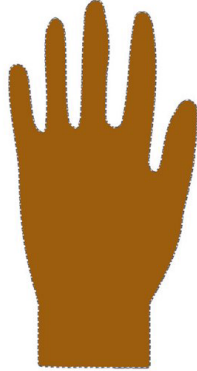

Reg. No. 4,075,476

PREVENTIVE CARE, INC. (MINNESOTA CORPORATION)
15215 BOULDER TRAIL
ROSEMOUNT, MN 55068

Registered Dec. 20, 2011

Int. Cls.: 9, 10, and 21

FOR: DISPOSABLE LATEX AND SYNTHETIC PROTECTIVE GLOVES FOR SCIENTIFIC, LABORATORY, INDUSTRIAL, AGRICULTURAL AND LAW ENFORCEMENT USE, IN CLASS 9 (U.S. CLS. 21, 23, 26, 36 AND 38).

TRADEMARK

FIRST USE 9-15-2010; IN COMMERCE 9-15-2010.

SUPPLEMENTAL REGISTER

FOR: DISPOSABLE LATEX AND SYNTHETIC PROTECTIVE GLOVES FOR MEDICAL, DENTAL, AND VETERINARY USE, IN CLASS 10 (U.S. CLS. 26, 39 AND 44).

FIRST USE 9-15-2010; IN COMMERCE 9-15-2010.

FOR: DISPOSABLE LATEX AND SYNTHETIC PROTECTIVE GLOVES FOR USE IN THE FOOD SERVICE AND CLEANING INDUSTRY AND FOR GENERAL USE, IN CLASS 21 (U.S. CLS. 2, 13, 23, 29, 30, 33, 40 AND 50).

FIRST USE 9-15-2010; IN COMMERCE 9-15-2010.

THE MARK CONSISTS OF THE COLOR COPPER AS APPLIED TO THE ENTIRE SURFACE OF THE GOODS, NAMELY, PROTECTIVE GLOVES. THE DOTTED OUTLINE OF THE GOODS IS INTENDED TO SHOW THE POSITION OF THE MARK AND IS NOT A PART OF THE MARK.

THE COLOR(S) COPPER IS/ARE CLAIMED AS A FEATURE OF THE MARK.

SER. NO. 85-208,210, FILED P.R. 12-30-2010; AM. S.R. 9-28-2011.

ANGELA M. MICHELI, EXAMINING ATTORNEY



David J. Kyjars

Director of the United States Patent and Trademark Office

United States of America

United States Patent and Trademark Office

2KHAAT

Reg. No. 4,075,477

2KHAAT LLC (VIRGINIA LIMITED LIABILITY COMPANY)
10056 OAKLEY COURT
VIENNA, VA 22181

Registered Dec. 20, 2011

Int. Cl.: 25

FOR: CLOTHING, NAMELY, T-SHIRTS, HOODED SWEAT SHIRTS, OUTERWEAR, NAMELY, COATS AND JACKETS, BELTS, HATS AND WRISTBANDS, IN CLASS 25 (U.S. CLS. 22 AND 39).

TRADEMARK

FIRST USE 3-18-2008; IN COMMERCE 3-18-2009.

SUPPLEMENTAL REGISTER

THE MARK CONSISTS OF STANDARD CHARACTERS WITHOUT CLAIM TO ANY PARTICULAR FONT, STYLE, SIZE, OR COLOR.

SER. NO. 85-209,655, FILED P.R. 1-4-2011; AM. S.R. 9-28-2011.

NANCY CLARKE, EXAMINING ATTORNEY



David J. Kybas

Director of the United States Patent and Trademark Office

United States of America

United States Patent and Trademark Office

U.S. ASSET REALTY

Reg. No. 4,075,478

U.S. ASSET REALTY, LLC (CONNECTICUT LIMITED LIABILITY COMPANY)
611 ACCESS RD

Registered Dec. 20, 2011

STRATFORD, CT 06615

Int. Cl.: 36

FOR: REAL ESTATE AGENCIES; REAL ESTATE BROKERAGE, REAL ESTATE MANAGEMENT SERVICES, IN CLASS 36 (U.S. CLS. 100, 101 AND 102).

SERVICE MARK

FIRST USE 2-4-2010; IN COMMERCE 2-4-2010.

SUPPLEMENTAL REGISTER

THE MARK CONSISTS OF STANDARD CHARACTERS WITHOUT CLAIM TO ANY PARTICULAR FONT, STYLE, SIZE, OR COLOR.

NO CLAIM IS MADE TO THE EXCLUSIVE RIGHT TO USE "REALTY", APART FROM THE MARK AS SHOWN.

SER. NO. 85-209,664, FILED P.R. 1-4-2011; AM. S.R. 9-28-2011.

SUSAN RICHARDS, EXAMINING ATTORNEY



David J. Kybas

Director of the United States Patent and Trademark Office

United States of America

United States Patent and Trademark Office

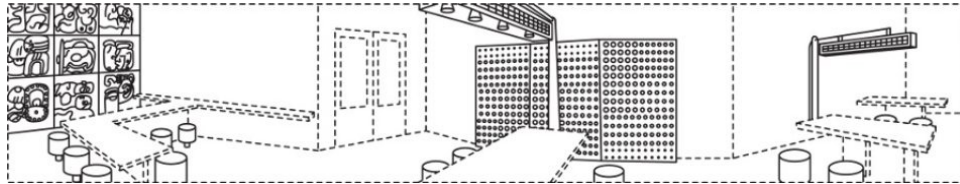

Reg. No. 4,075,479

Registered Dec. 20, 2011

Int. Cl.: 43

SERVICE MARK

SUPPLEMENTAL REGISTER

CHIPOTLE MEXICAN GRILL, INC. (DELAWARE CORPORATION)
1401 WYNKOOP ST., SUITE 500
DENVER, CO 80202

FOR: RESTAURANT SERVICES; TAKE-OUT RESTAURANT SERVICES, IN CLASS 43 (U.S. CLS. 100 AND 101).

FIRST USE 10-30-2008; IN COMMERCE 10-30-2008.

THE MARK CONSISTS OF THE THREE DIMENSIONAL CONFIGURATION OR "TRADE DRESS" OF THE APPEARANCE AND DESIGN OF THE INTERIOR OF A RESTAURANT, SPECIFICALLY INCLUDING LIGHTING MOUNTED ON A GOOSENECK-SHAPED ARM AFFIXED TO THE SIDE OF THE TABLE, RELIEF IMAGES ON STONE OR CONCRETE OR STONE-LOOK-A-LIKE, WALL PANELS DRILLED WITH VARIABLE-SIZED PERFORATED HOLES, AND MARSHMALLOW-STYLE SEATING. THE MATTER SHOWN IN BROKEN OR DOTTED LINES IS NOT PART OF THE MARK AND SERVES ONLY TO SHOW THE POSITION OR PLACEMENT OF THE MARK.

SER. NO. 85-209,978, FILED P.R. 1-4-2011; AM. S.R. 9-26-2011.

CAROL SPILS, EXAMINING ATTORNEY



David J. Kyffers

Director of the United States Patent and Trademark Office

United States of America

United States Patent and Trademark Office

Texas Senior Benefits

Reg. No. 4,075,480

Registered Dec. 20, 2011

Int. Cl.: 36

SERVICE MARK

SUPPLEMENTAL REGISTER

TEXAS SENIOR BENEFITS, LLC (TEXAS LIMITED LIABILITY COMPANY)
4621 S. COOPER ST.
SUITE 131-323
ARLINGTON, TX 76017

FOR: ANNUITY SERVICES, NAMELY, ACCOUNT AND INVESTMENT ADMINISTRATION AND THE INVESTMENT AND DISTRIBUTION OF ANNUITY FUNDS; CONSULTING AND INFORMATION CONCERNING INSURANCE; FINANCIAL EVALUATION FOR INSURANCE PURPOSES; INSURANCE AGENCY AND BROKERAGE IN THE FIELD OF LIFE, HEALTH, HMO, ANNUITY, MEDICARE SUPPLEMENT, MEDICARE ADVANTAGE, LONG TERM CARE, DENTAL, PRESCRIPTION, SENIOR BENEFITS; INSURANCE CONSULTING IN THE FIELD OF LIFE, HEALTH, HMO, ANNUITY, MEDICARE SUPPLEMENT, MEDICARE ADVANTAGE, LONG TERM CARE, DENTAL, PRESCRIPTION, SENIOR BENEFITS; INSURANCE PREMIUM RATE COMPUTING; INSURANCE SERVICES, NAMELY, INSURANCE ELIGIBILITY REVIEW AND VERIFICATION AND CONSULTATION IN THE FIELD OF LIFE, HEALTH, HMO, ANNUITY, MEDICARE, SUPPLEMENT, MEDICARE ADVANTAGE, LONG TERM CARE, DENTAL, PRESCRIPTION, SENIOR BENEFITS; INSURANCE SERVICES, NAMELY, PROVIDING INFORMATION FOR THE PURPOSE OF REVIEW AND VERIFICATION OF MEDICAID AND MEDICARE ELIGIBILITY STATUS AND RELATED INFORMATION; INSURANCE SERVICES, NAMELY, RETIREMENT MANAGEMENT SERVICES; INSURANCE SERVICES, NAMELY, WEALTH MANAGEMENT SERVICES; INSURANCE SERVICES, PROVIDING PREMIUM RATE QUOTES VIA ON-LINE, TELEPHONE AND MAIL MEANS; PROVIDING A WEBSITE FEATURING INSURANCE RELATED INFORMATION; PROVIDING A WEBSITE FEATURING NON-DOWNLOADABLE VIDEOS IN THE FIELD OF INSURANCE; PROVIDING INFORMATION IN INSURANCE MATTERS, IN CLASS 36 (U.S. CLS. 100, 101 AND 102).



FIRST USE 2-14-2008; IN COMMERCE 2-14-2008.

THE MARK CONSISTS OF STANDARD CHARACTERS WITHOUT CLAIM TO ANY PARTICULAR FONT, STYLE, SIZE, OR COLOR.

NO CLAIM IS MADE TO THE EXCLUSIVE RIGHT TO USE "SENIOR BENEFITS", APART FROM THE MARK AS SHOWN.

SER. NO. 85-210,652, FILED P.R. 1-5-2011; AM. S.R. 9-30-2011.

David J. Kybas

Director of the United States Patent and Trademark Office

Reg. No. 4,075,480 WILLIAM P. SHANAHAN, EXAMINING ATTORNEY

United States of America

United States Patent and Trademark Office

DOUBLEWAL

Reg. No. 4,075,481

Registered Dec. 20, 2011

Int. Cl.: 19

TRADEMARK

SUPPLEMENTAL REGISTER

UNITED CONCRETE PRODUCTS, INC. (CONNECTICUT CORPORATION)
173 CHURCH STREET
YALESVILLE, CT 06492

FOR: CONCRETE BUILDING MATERIALS, NAMELY, PRECAST CONCRETE UNITS USED IN RETAINING WALL SYSTEMS AND IN OTHER WALLS, IN CLASS 19 (U.S. CLS. 1, 12, 33 AND 50).

FIRST USE 9-16-2010; IN COMMERCE 10-1-2010.

THE MARK CONSISTS OF STANDARD CHARACTERS WITHOUT CLAIM TO ANY PARTICULAR FONT, STYLE, SIZE, OR COLOR.

SER. NO. 85-211,150, FILED P.R. 1-5-2011; AM. S.R. 9-29-2011.

ALLISON HOLTZ, EXAMINING ATTORNEY



David J. Kyffers

Director of the United States Patent and Trademark Office

United States of America

United States Patent and Trademark Office

NORTH CAROLINA GOVERNOR'S CONFERENCE FOR WOMEN

Reg. No. 4,075,482

Registered Dec. 20, 2011

Int. Cl.: 35

SERVICE MARK

SUPPLEMENTAL REGISTER

TRIBBLE, MARY (UNITED STATES INDIVIDUAL)
#226
400 NORTH CHURCH STREET
CHARLOTTE, NC 28202

FOR: ARRANGING AND CONDUCTING A BUSINESS CONFERENCE FOR WOMEN, IN CLASS 35 (U.S. CLS. 100, 101 AND 102).

FIRST USE 10-0-2009; IN COMMERCE 10-0-2009.

THE MARK CONSISTS OF STANDARD CHARACTERS WITHOUT CLAIM TO ANY PARTICULAR FONT, STYLE, SIZE, OR COLOR.

OWNER OF U.S. REG. NO. 3,506,799.

NO CLAIM IS MADE TO THE EXCLUSIVE RIGHT TO USE "CONFERENCE FOR WOMEN", APART FROM THE MARK AS SHOWN.

SER. NO. 85-211,843, FILED 1-6-2011.

ANNE FARRELL, EXAMINING ATTORNEY



David J. Kybas

Director of the United States Patent and Trademark Office

United States of America

United States Patent and Trademark Office

RACK JACKET

Reg. No. 4,075,483

ENDURAFIT, LLC (MARYLAND LIMITED LIABILITY COMPANY)
3706 CRONDALL LANE, SUITE 103

Registered Dec. 20, 2011

OWINGS MILLS, MD 21117

Int. Cl.: 12

FOR: FITTED BICYCLE COVERS; TRIATHLON EQUIPMENT, NAMELY, FITTED BICYCLE COVERS, IN CLASS 12 (U.S. CLS. 19, 21, 23, 31, 35 AND 44).

TRADEMARK

FIRST USE 9-19-2010; IN COMMERCE 9-19-2010.

SUPPLEMENTAL REGISTER

THE MARK CONSISTS OF STANDARD CHARACTERS WITHOUT CLAIM TO ANY PARTICULAR FONT, STYLE, SIZE, OR COLOR.

SER. NO. 85-212,777, FILED P.R. 1-7-2011; AM. S.R. 10-25-2011.

MEGHAN REINHART, EXAMINING ATTORNEY



David J. Kybas

Director of the United States Patent and Trademark Office

United States of America

United States Patent and Trademark Office

WELL BOOM

Reg. No. 4,075,484

UNIVERSAL REMEDIATION, INC. (PENNSYLVANIA CORPORATION)
1405 PARKWAY VIEW DRIVE
PITTSBURGH, PA 15205

Registered Dec. 20, 2011

Int. Cl.: 4

FOR: NON-COMBUSTIBLE, NON-REACTIVE GRANULAR WAX SPHERES FOR ABSORBING HYDROCARBON CONTAMINANTS FROM GROUNDWATER WELLS, CONTAINED IN PERFORATED FABRIC, IN CLASS 4 (U.S. CLS. 1, 6 AND 15).

TRADEMARK

FIRST USE 0-0-2007; IN COMMERCE 0-0-2007.

SUPPLEMENTAL REGISTER

THE MARK CONSISTS OF STANDARD CHARACTERS WITHOUT CLAIM TO ANY PARTICULAR FONT, STYLE, SIZE, OR COLOR.

SER. NO. 85-212,871, FILED P.R. 1-7-2011; AM. S.R. 10-11-2011.

MEGHAN REINHART, EXAMINING ATTORNEY



David J. Kyros

Director of the United States Patent and Trademark Office

United States of America

United States Patent and Trademark Office

PREMIUM LOGISTICS

Reg. No. 4,075,485

Registered Dec. 20, 2011

Int. Cls.: 35 and 39

SERVICE MARK

SUPPLEMENTAL REGISTER

PANTHER II TRANSPORTATION, INC. (OHIO CORPORATION)
4940 PANTHER PARKWAY
SEVILLE, OH 442738929

FOR: SUPPLY CHAIN MANAGEMENT SERVICES AND TRANSPORTATION MANAGEMENT OF DOMESTIC AND INTERNATIONAL SHIPMENTS; AND CONSULTATION SERVICES IN THE FIELD OF TRANSPORTATION MANAGEMENT, SHIPMENT PLANNING, ADMINISTRATION FOR FREIGHT BILL AUDITING, PAYMENT INVOICING AND REPORTING, IN CLASS 35 (U.S. CLS. 100, 101 AND 102).

FIRST USE 8-31-2009; IN COMMERCE 8-31-2009.

FOR: PICK-UP, TRANSPORTATION, STORAGE AND DELIVERY OF DOCUMENTS, PACKAGES AND FREIGHT BY LAND AND AIR, IN CLASS 39 (U.S. CLS. 100 AND 105).

FIRST USE 8-31-2009; IN COMMERCE 8-31-2009.

THE MARK CONSISTS OF STANDARD CHARACTERS WITHOUT CLAIM TO ANY PARTICULAR FONT, STYLE, SIZE, OR COLOR.

NO CLAIM IS MADE TO THE EXCLUSIVE RIGHT TO USE "LOGISTICS", APART FROM THE MARK AS SHOWN.

SER. NO. 85-212,951, FILED P.R. 1-7-2011; AM. S.R. 10-24-2011.

MICHELLE DUBOIS, EXAMINING ATTORNEY



David J. Kybas

Director of the United States Patent and Trademark Office

United States of America

United States Patent and Trademark Office

CHELSEA CREEK FARMS

Reg. No. 4,075,486

J. MAHERAS CO. INC. (MASSACHUSETTS CORPORATION)
100 NEW ENGLAND PRODUCE CENTER
CHELSEA, MA 02150

Registered Dec. 20, 2011

Int. Cl.: 31

FOR: RAW ONIONS; RAW POTATOES, IN CLASS 31 (U.S. CLS. 1 AND 46).

TRADEMARK

FIRST USE 12-1-2008; IN COMMERCE 12-1-2008.

SUPPLEMENTAL REGISTER

THE MARK CONSISTS OF STANDARD CHARACTERS WITHOUT CLAIM TO ANY PARTICULAR FONT, STYLE, SIZE, OR COLOR.

SER. NO. 85-213,945, FILED P.R. 1-10-2011; AM. S.R. 1-10-2011.

KATHERINE M. DUBRAY, EXAMINING ATTORNEY



David J. Kybas

Director of the United States Patent and Trademark Office

United States of America

United States Patent and Trademark Office

odigia

Reg. No. 4,075,487

Registered Dec. 20, 2011

Int. Cl.: 42

SERVICE MARK

SUPPLEMENTAL REGISTER

ODIGIA, INC. (NORTH CAROLINA CORPORATION)
211 E THIRD STREET
WINSTON-SALEM, NC 27101

FOR: PROVIDING A WEB-BASED SYSTEM AND ONLINE PORTAL FEATURING ONLINE NON-DOWNLOADABLE SOFTWARE THAT ENABLES USERS TO ACCESS TRAINING, EDUCATION AND TESTING MATERIALS CREATED TO CUSTOMER SPECIFICATION FOR COURSES OF INSTRUCTION PROVIDED IN WORKFORCE TRAINING AND DEVELOPMENT, K-12 EDUCATION, COLLEGE LEVEL INSTRUCTION, AND PERSONAL DEVELOPMENT, IN CLASS 42 (U.S. CLS. 100 AND 101).

FIRST USE 3-25-2010; IN COMMERCE 3-25-2010.

THE MARK CONSISTS OF STANDARD CHARACTERS WITHOUT CLAIM TO ANY PARTICULAR FONT, STYLE, SIZE, OR COLOR.

THE ENGLISH TRANSLATION OF "ODIGIA" IS "INSTRUCTION."

SER. NO. 85-215,069, FILED P.R. 1-11-2011; AM. S.R. 9-7-2011.

MAUREEN DALL, EXAMINING ATTORNEY



David J. Kyffers

Director of the United States Patent and Trademark Office

United States of America

United States Patent and Trademark Office

BIG ISLAND PLANTS

Reg. No. 4,075,488

DILLMAN, KIM (UNITED STATES INDIVIDUAL)
PO BOX 338
VOLCANO, HI 96785

Registered Dec. 20, 2011

Int. Cl.: 31

FOR: LIVE PLANTS, IN CLASS 31 (U.S. CLS. 1 AND 46).

TRADEMARK

FIRST USE 9-15-2010; IN COMMERCE 12-28-2010.

SUPPLEMENTAL REGISTER

THE MARK CONSISTS OF STANDARD CHARACTERS WITHOUT CLAIM TO ANY PARTICULAR FONT, STYLE, SIZE, OR COLOR.

NO CLAIM IS MADE TO THE EXCLUSIVE RIGHT TO USE "PLANTS", APART FROM THE MARK AS SHOWN.

SER. NO. 85-215,547, FILED P.R. 1-12-2011; AM. S.R. 10-3-2011.

EDWARD NELSON, EXAMINING ATTORNEY



David J. Kyffers

Director of the United States Patent and Trademark Office

United States of America
United States Patent and Trademark Office

santa barbara
Latino

Reg. No. 4,075,489

Registered Dec. 20, 2011

Int. Cl.: 16

TRADEMARK

SUPPLEMENTAL REGISTER

AMPERSAND PUBLISHING, LLC (DELAWARE LIMITED LIABILITY COMPANY)
C/O KOENIG & ASSOCIATES
920 GARDEN STREET, SUITE A
SANTA BARBARA, CA 93101

FOR: NEWSPAPERS, IN CLASS 16 (U.S. CLS. 2, 5, 22, 23, 29, 37, 38 AND 50).

FIRST USE 1-19-2011; IN COMMERCE 1-19-2011.

THE MARK CONSISTS OF THE STYLIZED TEXT "SANTA BARBARA LATINO" WITH A LINE UNDER "LATINO".

SER. NO. 85-217,386, FILED P.R. 1-13-2011; AM. S.R. 10-25-2011.

CHRISIE B. KING, EXAMINING ATTORNEY



David J. Kappas

Director of the United States Patent and Trademark Office

United States of America

United States Patent and Trademark Office



Reg. No. 4,075,490

Registered Dec. 20, 2011

Int. Cls.: 12 and 28

TRADEMARK

SUPPLEMENTAL REGISTER

CHAPOUTON, JEAN-LUC (FRANCE INDIVIDUAL)
3 IMPASSE DE LA ROCHE
F26600 PONT DE L'ISERE, FRANCE AND

CHAPOUTON, MICHÈLE (FRANCE INDIVIDUAL)
3 IMPASSE DE LA ROCHE
F26600 PONT DE L'ISERE, FRANCE

FOR: LAND VEHICLES; APPARATUS FOR LOCOMOTION BY LAND, AIR OR WATER, NAMELY, CARS, MOTORCYCLES, BOATS, AIRPLANES; NON-SKID DEVICES, NAMELY, AUTOMATIC TRACTION AND ANTI-SKID CONTROLS FOR VEHICLE TIRES; ANTI DAZZLE AND ANTI GLARE DEVICES, NAMELY, TINTED WINDOWS, VISORS, AND ANTI-GLARE MIRRORS FOR VEHICLES; AUTOMOBILE TIRES; AUTOMOBILE BONNETS; AUTOMOBILE BODIES; TRANSMISSION CHAINS FOR LAND VEHICLES; AUTOMOBILE CHASSIS; AUTOMOBILE BUMPERS; SUN-BLINDS ADAPTED FOR AUTOMOBILES; ANTI-THEFT ALARMS FOR LAND VEHICLES; LUGGAGE RACKS FOR VEHICLES; TIRES FOR VEHICLES; TREADS FOR RETREADING TIRES; INNER TUBES FOR VEHICLE TIRES; POWER CLUTCHES FOR LAND VEHICLES; SAFETY SEATS FOR CHILDREN FOR VEHICLES; HUB CAPS; CASINGS FOR PNEUMATIC TIRES; LAND VEHICLE PARTS, NAMELY, AXLES AND AXLE JOURNALS; BRAKES FOR VEHICLES; BRAKE LININGS FOR VEHICLES; WINDSCREEN WIPERS; FITTED VEHICLE COVERS; SEAT COVERS FOR VEHICLES; FITTED STEERING WHEEL COVERS FOR VEHICLES; VEHICLE WHEEL RIMS; VEHICLE WHEEL HUBS; VEHICLE WINDSCREENS; PNEUMATIC TIRES; TRAILERS; SUSPENSION SPRINGS FOR MOTOR CARS; VEHICLE WHEELS; VEHICLE WHEEL SPOKES; SHOCK ABSORBERS FOR VEHICLES; UPHOLSTERY FOR VEHICLES; DOOR PANELS FOR VEHICLES; VEHICLE SEATS; STEERING WHEELS FOR VEHICLES, IN CLASS 12 (U.S. CLS. 19, 21, 23, 31, 35 AND 44).

FOR: MODEL TOY VEHICLES; SCALE-MODEL VEHICLES; RADIO-CONTROLLED TOY VEHICLES; SHUTTLECOCKS, IN CLASS 28 (U.S. CLS. 22, 23, 38 AND 50).

OWNER OF ERPN CMNTY TM OFC REG. NO. 008870172, DATED 2-9-2010, EXPIRES 2-9-2020.

THE COLOR(S) BLACK, WHITE, RED IS/ARE CLAIMED AS A FEATURE OF THE MARK.



David J. Kybas

Director of the United States Patent and Trademark Office

Reg. No. 4,075,490 THE MARK CONSISTS OF THE WORDING "GOTTI" IN STYLIZED FONT IN BLACK WITH WHITE TRIM AND SHADOWED IN RED.

SER. NO. 85-217,615, FILED P.R. 1-14-2011; AM. S.R. 10-10-2011.

STEVEN JACKSON, EXAMINING ATTORNEY

United States of America

United States Patent and Trademark Office

CLOUD CAPITAL PARTNERS

Reg. No. 4,075,491

CLOUD CAPITAL PARTNERS LLC (DELAWARE LIMITED LIABILITY COMPANY)
64 OLD HILL ROAD
WESTPORT, CT 06880

Registered Dec. 20, 2011

Int. Cl.: 36

FOR: VENTURE CAPITAL FUND MANAGEMENT SERVICES, IN CLASS 36 (U.S. CLS. 100, 101 AND 102).

SERVICE MARK

FIRST USE 10-15-2010; IN COMMERCE 10-15-2010.

SUPPLEMENTAL REGISTER

THE MARK CONSISTS OF STANDARD CHARACTERS WITHOUT CLAIM TO ANY PARTICULAR FONT, STYLE, SIZE, OR COLOR.

NO CLAIM IS MADE TO THE EXCLUSIVE RIGHT TO USE "PARTNERS", APART FROM THE MARK AS SHOWN.

SER. NO. 85-219,932, FILED P.R. 1-18-2011; AM. S.R. 10-8-2011.

HANNO RITTNER, EXAMINING ATTORNEY



David J. Kybas

Director of the United States Patent and Trademark Office

United States of America

United States Patent and Trademark Office

PARANORMAL ACTIVITY SURVEILLANCE TEAM

Reg. No. 4,075,492

RANGEL, JUSTIN (UNITED STATES INDIVIDUAL)
8306 MOSSBERG DR
ARLINGTON, TX 76002

Registered Dec. 20, 2011

Int. Cl.: 45

FOR: PARANORMAL INVESTIGATION SERVICES, IN CLASS 45 (U.S. CLS. 100 AND 101).

SERVICE MARK

FIRST USE 2-1-2005; IN COMMERCE 2-1-2005.

SUPPLEMENTAL REGISTER

THE MARK CONSISTS OF STANDARD CHARACTERS WITHOUT CLAIM TO ANY PARTICULAR FONT, STYLE, SIZE, OR COLOR.

SER. NO. 85-220,546, FILED P.R. 1-19-2011; AM. S.R. 10-19-2011.

MIDGE BUTLER, EXAMINING ATTORNEY



David J. Kyffers

Director of the United States Patent and Trademark Office

United States of America

United States Patent and Trademark Office

THOMSON

Reg. No. 4,075,493

Registered Dec. 20, 2011

Int. Cl.: 9

DONGFENG-FUJI-THOMSON THERMOSTAT CO., LTD (CHINA LIMITED LIABILITY COMPANY)

WUHAN ECONOMIC & TECHNOLOGICAL DEV.

ZONE; THE SECOND FENGSHU ROAD

WUHAN, HUBEI 430056, CHINA

TRADEMARK

FOR: ELECTRIC LIGHT DIMMERS; ELECTRIC SENSORS; ELECTRICAL INDUCTORS; PYROMETERS; SURVEYING MACHINES AND INSTRUMENTS; THERMOSTATS; VEHICLE ENGINE PARTS, NAMELY, THERMOSTATS, IN CLASS 9 (U.S. CLS. 21, 23, 26, 36 AND 38).

SUPPLEMENTAL REGISTER

FIRST USE 1-20-2009; IN COMMERCE 6-21-2009.

THE MARK CONSISTS OF STANDARD CHARACTERS WITHOUT CLAIM TO ANY PARTICULAR FONT, STYLE, SIZE, OR COLOR.

SER. NO. 85-221,711, FILED P.R. 1-20-2011; AM. S.R. 10-17-2011.

BENJAMIN OKEKE, EXAMINING ATTORNEY



David J. Kyffers

Director of the United States Patent and Trademark Office

United States of America

United States Patent and Trademark Office

Night Boat

Reg. No. 4,075,494

JOHN GEARY (UNITED STATES INDIVIDUAL)
1555 SHAGBARK LANE
NORTHBROOK, IL 60062

Registered Dec. 20, 2011

Int. Cl.: 41

FOR: ENTERTAINMENT IN THE NATURE OF BOAT CRUISE ARRANGEMENT AND PLEASURE BOAT CRUISES WITH ENTERTAINMENT, MUSICAL OR OTHERWISE, IN CLASS 41 (U.S. CLS. 100, 101 AND 107).

SERVICE MARK

FIRST USE 1-19-2011; IN COMMERCE 1-19-2011.

SUPPLEMENTAL REGISTER

THE MARK CONSISTS OF STANDARD CHARACTERS WITHOUT CLAIM TO ANY PARTICULAR FONT, STYLE, SIZE, OR COLOR.

NO CLAIM IS MADE TO THE EXCLUSIVE RIGHT TO USE "BOAT", APART FROM THE MARK AS SHOWN.

SER. NO. 85-221,713, FILED P.R. 1-20-2011; AM. S.R. 10-18-2011.

BENJAMIN OKEKE, EXAMINING ATTORNEY



David J. Kyffers

Director of the United States Patent and Trademark Office

United States of America

United States Patent and Trademark Office

NOALLERGENS

Reg. No. 4,075,495

GUTHY-RENKER LLC (DELAWARE LIMITED LIABILITY COMPANY)
41-550 ECLECTIC STREET, SUITE #200
PALM DESERT, CA 92260

Registered Dec. 20, 2011

Int. Cl.: 5

FOR: VITAMINS; MINERAL SUPPLEMENTS; NUTRITIONAL SUPPLEMENTS; DIETARY SUPPLEMENTS; DIETARY FOOD SUPPLEMENTS, IN CLASS 5 (U.S. CLS. 6, 18, 44, 46, 51 AND 52).

TRADEMARK

FIRST USE 5-27-2011; IN COMMERCE 5-27-2011.

SUPPLEMENTAL REGISTER

THE MARK CONSISTS OF STANDARD CHARACTERS WITHOUT CLAIM TO ANY PARTICULAR FONT, STYLE, SIZE, OR COLOR.

SER. NO. 85-222,066, FILED P.R. 1-20-2011; AM. S.R. 9-29-2011.

AISHA SALEM, EXAMINING ATTORNEY



David J. Kybas

Director of the United States Patent and Trademark Office

United States of America

United States Patent and Trademark Office

NUCLEAR CYBER COLLABORATION COMMUNITY PORTAL

Reg. No. 4,075,496

Registered Dec. 20, 2011

Int. Cl.: 42

SERVICE MARK

SUPPLEMENTAL REGISTER

SHEFFIELD SCIENTIFIC, LLC (TEXAS LIMITED LIABILITY COMPANY)
SUITE 200G
9660 HILLCROFT STREET
HOUSTON, TX 77096

FOR: PROVIDING DIGITAL ASSET MANAGEMENT SERVICES TO INDUSTRIAL FACILITIES, NAMELY, PROVIDING AN ONLINE WEBSITE AND DATABASE OF DIGITAL ASSET INFORMATION IN THE FIELD OF INFORMATION AND COMPUTER TECHNOLOGY, DIGITAL ASSET COMPUTER SECURITY ANALYSIS AND DOCUMENTATION RELATED THERETO; PROVIDING DIGITAL ASSET MANAGEMENT SERVICES TO NUCLEAR POWER FACILITIES IN THE NATURE OF MANAGING AND ANALYZING DIGITAL ASSETS IN NUCLEAR POWER FACILITIES, NAMELY, PROVIDING AN ONLINE WEBSITE AND DATABASE OF DIGITAL ASSET INFORMATION IN THE FIELD OF INFORMATION AND COMPUTER TECHNOLOGY, DIGITAL ASSET COMPUTER SECURITY ANALYSIS AND DOCUMENTATION RELATED THERETO; AND MANAGING AND ANALYZING DIGITAL ASSETS IN NUCLEAR POWER FACILITIES TO IDENTIFY SECURITY CONTROLS FOR DIGITAL ASSETS IN THE NATURE OF DIGITAL COMPUTER AND COMMUNICATION SYSTEMS AND NETWORKS, SENSORS AND CONTROLLERS, NAMELY, PROVIDING AN ONLINE WEBSITE AND DATABASE OF DIGITAL ASSET INFORMATION IN THE FIELD OF INFORMATION AND COMPUTER TECHNOLOGY, DIGITAL ASSET COMPUTER SECURITY ANALYSIS AND DOCUMENTATION RELATED THERETO, IN CLASS 42 (U.S. CLS. 100 AND 101).

FIRST USE 9-1-2011; IN COMMERCE 9-1-2011.

THE MARK CONSISTS OF STANDARD CHARACTERS WITHOUT CLAIM TO ANY PARTICULAR FONT, STYLE, SIZE, OR COLOR.

NO CLAIM IS MADE TO THE EXCLUSIVE RIGHT TO USE "PORTAL", APART FROM THE MARK AS SHOWN.

SER. NO. 85-223,412, FILED P.R. 1-21-2011; AM. S.R. 10-28-2011.

KATHERINE E. HALMEN, EXAMINING ATTORNEY



David J. Kyros

Director of the United States Patent and Trademark Office

United States of America

United States Patent and Trademark Office

World's Best Frozen Yogurt

Reg. No. 4,075,497

Registered Dec. 20, 2011

Int. Cl.: 43

SERVICE MARK

SUPPLEMENTAL REGISTER

ZINGA INVESTMENTS LLC (DELAWARE LIMITED LIABILITY COMPANY)
SUITE 360
11325 RANDOM HILLS ROAD
FAIRFAX, VA 20169

FOR: RESTAURANT SERVICES, IN CLASS 43 (U.S. CLS. 100 AND 101).

FIRST USE 9-28-2011; IN COMMERCE 9-28-2011.

THE MARK CONSISTS OF STANDARD CHARACTERS WITHOUT CLAIM TO ANY PARTICULAR FONT, STYLE, SIZE, OR COLOR.

SER. NO. 85-223,687, FILED P.R. 1-21-2011; AM. S.R. 10-11-2011.

HEATHER BIDDULPH, EXAMINING ATTORNEY



David J. Kybas

Director of the United States Patent and Trademark Office

United States of America

United States Patent and Trademark Office

Walker Sliders

Reg. No. 4,075,498

Registered Dec. 20, 2011

Int. Cl.: 20

TRADEMARK

SUPPLEMENTAL REGISTER

THE GLIDE STORE, L.C. (LOUISIANA LIMITED LIABILITY COMPANY)
402 ZACHARY STREET
SCOTT, LA 70583

FOR: FITTED FURNITURE LEG COVERS FOR FLOOR PROTECTION PURPOSES, NAMELY, PRE-CUT BALLS USED AS PADS ON THE LEGS OF CHAIRS, STOOLS, ADULT WALKERS, TABLES, AND DESKS, IN CLASS 20 (U.S. CLS. 2, 13, 22, 25, 32 AND 50).

FIRST USE 5-15-2010; IN COMMERCE 5-15-2010.

THE MARK CONSISTS OF STANDARD CHARACTERS WITHOUT CLAIM TO ANY PARTICULAR FONT, STYLE, SIZE, OR COLOR.

NO CLAIM IS MADE TO THE EXCLUSIVE RIGHT TO USE "SLIDERS", APART FROM THE MARK AS SHOWN.

SER. NO. 85-224,150, FILED P.R. 1-24-2011; AM. S.R. 9-28-2011.

GEOFFREY FOSDICK, EXAMINING ATTORNEY



David J. Kyfos

Director of the United States Patent and Trademark Office

United States of America

United States Patent and Trademark Office

The Glide Store

Reg. No. 4,075,499

Registered Dec. 20, 2011

Int. Cl.: 35

SERVICE MARK

SUPPLEMENTAL REGISTER

THE GLIDE STORE, L.C. (LOUISIANA LIMITED LIABILITY COMPANY)
402 ZACHARY STREET
SCOTT, LA 70583

FOR: RETAIL, WHOLESALE, AND ONLINE STORE SERVICES FEATURING PROTECTIVE PADS USED WITH FURNITURE, NAMELY, PRE-CUT BALLS USED AS PADS ON THE LEGS OF CHAIRS, STOOLS, ADULT WALKERS, TABLES, AND DESKS, IN CLASS 35 (U.S. CLS. 100, 101 AND 102).

FIRST USE 3-22-2010; IN COMMERCE 5-15-2010.

THE MARK CONSISTS OF STANDARD CHARACTERS WITHOUT CLAIM TO ANY PARTICULAR FONT, STYLE, SIZE, OR COLOR.

NO CLAIM IS MADE TO THE EXCLUSIVE RIGHT TO USE "STORE", APART FROM THE MARK AS SHOWN.

SER. NO. 85-224,160, FILED P.R. 1-24-2011; AM. S.R. 10-19-2011.

GEOFFREY FOSDICK, EXAMINING ATTORNEY



David J. Kyfos

Director of the United States Patent and Trademark Office

United States of America

United States Patent and Trademark Office

VOICE SAVE TECHNOLOGY

Reg. No. 4,075,500

Registered Dec. 20, 2011

Int. Cl.: 16

TRADEMARK

SUPPLEMENTAL REGISTER

HALLMARK LICENSING, INC. (DELAWARE CORPORATION)
MD 339
2440 PERSHING ROAD
KANSAS CITY, MO 64108

FOR: PRINTED CHILDREN'S BOOKS AND PRINTED CHILDREN'S STORYBOOKS WITH A RECORDABLE FEATURE THAT ALLOWS THE USER TO READ PASSAGES FROM THE BOOK AND STORYBOOK AND RECORD THEIR VOICE IN THE BOOK, THEREBY ALLOWING OTHERS TO READ ALONG LATER WHILE LISTENING TO THE RECORDED VOICE, IN CLASS 16 (U.S. CLS. 2, 5, 22, 23, 29, 37, 38 AND 50).

FIRST USE 11-9-2010; IN COMMERCE 11-9-2010.

THE MARK CONSISTS OF STANDARD CHARACTERS WITHOUT CLAIM TO ANY PARTICULAR FONT, STYLE, SIZE, OR COLOR.

SER. NO. 85-225,643, FILED P.R. 1-25-2011; AM. S.R. 10-19-2011.

ANDREA HACK, EXAMINING ATTORNEY



David J. Kybas

Director of the United States Patent and Trademark Office

United States of America

United States Patent and Trademark Office

The Original Helmet Hair

Reg. No. 4,075,501

CUSH CREATIONS LLC (NEBRASKA LIMITED LIABILITY COMPANY)
7816 SOUTH 173RD STREET
OMAHA, NE 68136

Registered Dec. 20, 2011

Int. Cl.: 26

FOR: DECORATIVE ARTIFICIAL HAIR FEATURING HOOK-AND-LOOP FASTENERS THAT ARE ATTACHABLE FOR HELMETS, IN CLASS 26 (U.S. CLS. 37, 39, 40, 42 AND 50).

TRADEMARK

FIRST USE 12-20-2010; IN COMMERCE 12-20-2010.

SUPPLEMENTAL REGISTER

THE MARK CONSISTS OF STANDARD CHARACTERS WITHOUT CLAIM TO ANY PARTICULAR FONT, STYLE, SIZE, OR COLOR.

NO CLAIM IS MADE TO THE EXCLUSIVE RIGHT TO USE "HAIR", APART FROM THE MARK AS SHOWN.

SER. NO. 85-228,627, FILED P.R. 1-28-2011; AM. S.R. 10-21-2011.

SIMON TENG, EXAMINING ATTORNEY



David J. Kybas

Director of the United States Patent and Trademark Office

United States of America

United States Patent and Trademark Office

BEAR SHOCK

Reg. No. 4,075,502

UDAP INDUSTRIES, INC. (MONTANA CORPORATION)
13160 YONDER ROAD
BOZEMAN, MT 59718

Registered Dec. 20, 2011

Int. Cl.: 9

FOR: ELECTRIC FENCES, IN CLASS 9 (U.S. CLS. 21, 23, 26, 36 AND 38).

TRADEMARK

FIRST USE 2-7-2005; IN COMMERCE 2-7-2005.

SUPPLEMENTAL REGISTER

THE MARK CONSISTS OF STANDARD CHARACTERS WITHOUT CLAIM TO ANY PARTICULAR FONT, STYLE, SIZE, OR COLOR.

SER. NO. 85-228,920, FILED P.R. 1-28-2011; AM. S.R. 10-21-2011.

LIEF MARTIN, EXAMINING ATTORNEY



David J. Kyffers

Director of the United States Patent and Trademark Office

United States of America

United States Patent and Trademark Office

MUGGER FOGGER

Reg. No. 4,075,503

UDAP INDUSTRIES, INC. (MONTANA CORPORATION)
13160 YONDER ROAD
BOZEMAN, MT 59718

Registered Dec. 20, 2011

Int. Cl.: 13

FOR: PEPPER SPRAY, IN CLASS 13 (U.S. CLS. 2 AND 9).

TRADEMARK

FIRST USE 1-10-2011; IN COMMERCE 1-10-2011.

SUPPLEMENTAL REGISTER

THE MARK CONSISTS OF STANDARD CHARACTERS WITHOUT CLAIM TO ANY PARTICULAR FONT, STYLE, SIZE, OR COLOR.

OWNER OF U.S. REG. NO. 2,984,543.

NO CLAIM IS MADE TO THE EXCLUSIVE RIGHT TO USE "FOGGER", APART FROM THE MARK AS SHOWN.

SER. NO. 85-228,973, FILED P.R. 1-28-2011; AM. S.R. 10-21-2011.

LIEF MARTIN, EXAMINING ATTORNEY



David J. Kyffers

Director of the United States Patent and Trademark Office

United States of America

United States Patent and Trademark Office

ApneaRx

Reg. No. 4,075,504

Registered Dec. 20, 2011

Int. Cl.: 10

APNEA SCIENCES CORPORATION (CALIFORNIA CORPORATION), AKA APNEA SCIENCES CORPORATION,
17 BROWNSBURY ROAD LAGUNA NIGUEL, CA. 92
LAGUNA NIGUEL, CA. 92677-9382
LAGUNA NIGUEL, CA 926779382

TRADEMARK

FOR: DENTAL PRODUCT, NAMELY, ORAL APPLIANCE IN THE NATURE OF A MOUTH GUARD USED TO TREAT SLEEP APNEA AND SNORING, IN CLASS 10 (U.S. CLS. 26, 39 AND 44).

SUPPLEMENTAL REGISTER

FIRST USE 1-21-2008; IN COMMERCE 1-21-2008.

THE MARK CONSISTS OF STANDARD CHARACTERS WITHOUT CLAIM TO ANY PARTICULAR FONT, STYLE, SIZE, OR COLOR.

SER. NO. 85-229,137, FILED 1-28-2011.

MARK SPARACINO, EXAMINING ATTORNEY



David J. Kyffers

Director of the United States Patent and Trademark Office

United States of America

United States Patent and Trademark Office

hearingcareEXPERTS

Reg. No. 4,075,505

OTONIX (CALIFORNIA CORPORATION)

Registered Dec. 20, 2011

1700 E CESAR CHAVEZ AVE #2300
LOS ANGELES, CA 90033

Int. Cls.: 38 and 44

FOR: PROVIDING INFORMATION ABOUT HEARING LOSS TO PERSONS WHO ARE DEAF OR HEARING IMPAIRED VIA THE INTERNET, TELEPHONES AND WIRELESS DEVICES, IN CLASS 38 (U.S. CLS. 100, 101 AND 104).

SERVICE MARK

FIRST USE 10-0-2011; IN COMMERCE 10-0-2011.

SUPPLEMENTAL REGISTER

FOR: HEARING AID SERVICES; SPEECH AND HEARING THERAPY; PROVIDING INFORMATION ABOUT HEARING LOSS TO PERSONS WHO ARE DEAF OR HEARING IMPAIRED VIA THE INTERNET, TELEPHONES AND WIRELESS DEVICES, IN CLASS 44 (U.S. CLS. 100 AND 101).

FIRST USE 10-0-2011; IN COMMERCE 10-0-2011.

THE MARK CONSISTS OF THE STYLIZED TEXT "HEARINGCAREEXPERTS".

SER. NO. 85-235,469, FILED P.R. 2-7-2011; AM. S.R. 11-3-2011.

JANICE KIM, EXAMINING ATTORNEY



David J. Kyros

Director of the United States Patent and Trademark Office

United States of America

United States Patent and Trademark Office

IN FIELD

Reg. No. 4,075,506

MCELROY MANUFACTURING, INC. (OKLAHOMA CORPORATION)
833 N. FULTON STREET
TULSA, OK 74115

Registered Dec. 20, 2011

Int. Cl.: 9

FOR: TENSILE TESTING MACHINE, IN CLASS 9 (U.S. CLS. 21, 23, 26, 36 AND 38).

TRADEMARK

FIRST USE 3-31-2010; IN COMMERCE 3-31-2010.

SUPPLEMENTAL REGISTER

THE MARK CONSISTS OF STANDARD CHARACTERS WITHOUT CLAIM TO ANY PARTICULAR FONT, STYLE, SIZE, OR COLOR.

SER. NO. 85-236,954, FILED P.R. 2-8-2011; AM. S.R. 10-25-2011.

JORDAN BAKER, EXAMINING ATTORNEY



David J. Kyffers

Director of the United States Patent and Trademark Office

United States of America

United States Patent and Trademark Office

3-In-1-Batting Tee

Reg. No. 4,075,507

BELT, TONY (UNITED STATES INDIVIDUAL)

Registered Dec. 20, 2011

3880 A. ROAD, LOT B3
SHELBY, NE 68662

Int. Cl.: 28

FOR: BODY-TRAINING APPARATUS AND DEVICES FOR PHYSICAL EXERCISES, NAMELY, BASEBALL BATS AND BASEBALL SWING TRAINING DEVICES, IN CLASS 28 (U.S. CLS. 22, 23, 38 AND 50).

TRADEMARK

FIRST USE 10-15-2011; IN COMMERCE 10-15-2011.

SUPPLEMENTAL REGISTER

THE MARK CONSISTS OF STANDARD CHARACTERS WITHOUT CLAIM TO ANY PARTICULAR FONT, STYLE, SIZE, OR COLOR.

NO CLAIM IS MADE TO THE EXCLUSIVE RIGHT TO USE "BATTING TEE", APART FROM THE MARK AS SHOWN.

SER. NO. 85-237,572, FILED P.R. 2-9-2011; AM. S.R. 11-14-2011.

ANNE E. GUSTASON, EXAMINING ATTORNEY



David J. Kyros

Director of the United States Patent and Trademark Office

United States of America

United States Patent and Trademark Office

ShakesNotes

Reg. No. 4,075,508

DCG ARTS, INC. (NEW YORK CORPORATION)
228 PARK AVENUE S
NEW YORK, NY 10003

Registered Dec. 20, 2011

Int. Cl.: 9

FOR: EDUCATIONAL SOFTWARE FEATURING INSTRUCTION IN SHAKESPEARE, IN CLASS 9 (U.S. CLS. 21, 23, 26, 36 AND 38).

TRADEMARK

FIRST USE 10-7-2011; IN COMMERCE 10-7-2011.

SUPPLEMENTAL REGISTER

THE MARK CONSISTS OF STANDARD CHARACTERS WITHOUT CLAIM TO ANY PARTICULAR FONT, STYLE, SIZE, OR COLOR.

SER. NO. 85-239,641, FILED 2-11-2011.

BARBARA A. GOLD, EXAMINING ATTORNEY



David J. Kybas

Director of the United States Patent and Trademark Office

United States of America

United States Patent and Trademark Office

ESSENTIAL M

Reg. No. 4,075,509

Registered Dec. 20, 2011

Int. Cl.: 31

TRADEMARK

SUPPLEMENTAL REGISTER

VITA PLUS CORPORATION (WISCONSIN CORPORATION)
P. O. BOX 259126
2514 FISH HATCHERY ROAD
MADISON, WI 537259126

FOR: ANIMAL FEED FOR SALE TO ANIMAL FEED DEALERSHIPS AND DAIRY FARMERS,
IN CLASS 31 (U.S. CLS. 1 AND 46).

FIRST USE 9-15-2008; IN COMMERCE 9-15-2008.

THE MARK CONSISTS OF STANDARD CHARACTERS WITHOUT CLAIM TO ANY PAR-
TICULAR FONT, STYLE, SIZE, OR COLOR.

SER. NO. 85-240,562, FILED P.R. 2-11-2011; AM. S.R. 10-12-2011.

REBECCA SMITH, EXAMINING ATTORNEY



David J. Kyffers

Director of the United States Patent and Trademark Office

United States of America

United States Patent and Trademark Office

PRINTED CIRCUIT UNIVERSITY

Reg. No. 4,075,510

WADDELL, CARL L. (UNITED STATES INDIVIDUAL)
166 COKER DRIVE
BALL GROUND, GA 30107

Registered Dec. 20, 2011

Int. Cl.: 41

FOR: EDUCATIONAL SERVICES, NAMELY, THE OFFERING OF WEB BASED TRAINING IN THE FIELD OF ENGINEERING AND PRINTED CIRCUIT BOARDS, IN CLASS 41 (U.S. CLS. 100, 101 AND 107).

SERVICE MARK

FIRST USE 2-1-2010; IN COMMERCE 2-1-2011.

SUPPLEMENTAL REGISTER

THE MARK CONSISTS OF STANDARD CHARACTERS WITHOUT CLAIM TO ANY PARTICULAR FONT, STYLE, SIZE, OR COLOR.

NO CLAIM IS MADE TO THE EXCLUSIVE RIGHT TO USE "UNIVERSITY", APART FROM THE MARK AS SHOWN.

SER. NO. 85-242,205, FILED P.R. 2-15-2011; AM. S.R. 10-24-2011.

TINA MAI, EXAMINING ATTORNEY



David J. Kyffers

Director of the United States Patent and Trademark Office

United States of America

United States Patent and Trademark Office

Plant Wrapz

Reg. No. 4,075,511

Registered Dec. 20, 2011

Int. Cl.: 16

TRADEMARK

SUPPLEMENTAL REGISTER

HANKE, LINDA A (UNITED STATES INDIVIDUAL), DBA FLUFFY SCARSDALE ENTERPRISES,
2729 W. REDWOOD LANE
PHOENIX, AZ 85045

FOR: PLASTIC GIFT WRAP, IN CLASS 16 (U.S. CLS. 2, 5, 22, 23, 29, 37, 38 AND 50).

FIRST USE 9-1-2009; IN COMMERCE 9-1-2009.

THE MARK CONSISTS OF STANDARD CHARACTERS WITHOUT CLAIM TO ANY PARTICULAR FONT, STYLE, SIZE, OR COLOR.

NO CLAIM IS MADE TO THE EXCLUSIVE RIGHT TO USE "WRAPS", APART FROM THE MARK AS SHOWN.

SER. NO. 85-242,513, FILED P.R. 2-15-2011; AM. S.R. 10-21-2011.

ANDREW LEASER, EXAMINING ATTORNEY



David J. Kyffers

Director of the United States Patent and Trademark Office

United States of America

United States Patent and Trademark Office

ILUMENITE

Reg. No. 4,075,512

Registered Dec. 20, 2011

Int. Cl.: 11

TRADEMARK

SUPPLEMENTAL REGISTER

NEO-NEON LED LIGHTING INTERNATIONAL LTD. (HONG KONG CORPORATION)
TSIM SHA TSUI, KOWLOON NOS R1 & 8
2/F. 33 CANTON ROAD
HONG KONG, HONG KONG

FOR: LED (LIGHT EMITTING DIODES) LIGHTING FIXTURES FOR USE IN DISPLAY, COMMERCIAL, INDUSTRIAL, RESIDENTIAL, AND ARCHITECTURAL ACCENT LIGHTING APPLICATIONS, NAMELY, PAR CANS, LED PAR CANS, LED PIN SPOTS, LED EFFECT LIGHTS, LED WASHES, LED STAGES WASHES, LED LINEAR WASHES, LED WASH PANELS, LED BALLS AND CUBES, AND DISCHARGE LAMPS, IN CLASS 11 (U.S. CLS. 13, 21, 23, 31 AND 34).

FIRST USE 10-13-2010; IN COMMERCE 10-13-2010.

THE MARK CONSISTS OF STANDARD CHARACTERS WITHOUT CLAIM TO ANY PARTICULAR FONT, STYLE, SIZE, OR COLOR.

SER. NO. 85-248,219, FILED P.R. 2-22-2011; AM. S.R. 10-21-2011.

CAROLINE WOOD, EXAMINING ATTORNEY



David J. Kyffers

Director of the United States Patent and Trademark Office

United States of America

United States Patent and Trademark Office

IRRADIANT

Reg. No. 4,075,513

Registered Dec. 20, 2011

Int. Cl.: 11

TRADEMARK

SUPPLEMENTAL REGISTER

NEO-NEON LED LIGHTING INTERNATIONAL LTD. (HONG KONG CORPORATION)
TSIM SHA TSUI, KOWLOON NOS R1 & 8
2/F. 33 CANTON ROAD
HONG KONG, HONG KONG

FOR: LED (LIGHT EMITTING DIODES) LIGHTING FIXTURES FOR USE IN DISPLAY, COMMERCIAL, INDUSTRIAL, RESIDENTIAL, AND ARCHITECTURAL ACCENT LIGHTING APPLICATIONS, NAMELY, PAR CANS, LED PAR CANS, LED PIN SPOTS, LED EFFECT LIGHTS, LED WASHES, LED STAGES WASHES, LED LINEAR WASHES, LED WASH PANELS, LED BALLS AND CUBES, AND DISCHARGE LAMPS, IN CLASS 11 (U.S. CLS. 13, 21, 23, 31 AND 34).

FIRST USE 6-30-2008; IN COMMERCE 6-30-2008.

THE MARK CONSISTS OF STANDARD CHARACTERS WITHOUT CLAIM TO ANY PARTICULAR FONT, STYLE, SIZE, OR COLOR.

SER. NO. 85-248,388, FILED P.R. 2-22-2011; AM. S.R. 10-21-2011.

CAROLINE WOOD, EXAMINING ATTORNEY



David J. Kybas

Director of the United States Patent and Trademark Office

United States of America

United States Patent and Trademark Office

BIGSBY

Reg. No. 4,075,514

Registered Dec. 20, 2011

Int. Cl.: 28

TRADEMARK

SUPPLEMENTAL REGISTER

HALLMARK LICENSING, INC. (DELAWARE CORPORATION)
MD 339
2440 PERSHING ROAD
KANSAS CITY, MO 64108

FOR: PLUSH TOYS SOLD AS A UNIT WITH BOOKS, IN CLASS 28 (U.S. CLS. 22, 23, 38 AND 50).

FIRST USE 10-6-2011; IN COMMERCE 10-6-2011.

THE MARK CONSISTS OF STANDARD CHARACTERS WITHOUT CLAIM TO ANY PARTICULAR FONT, STYLE, SIZE, OR COLOR.

THE NAME(S), PORTRAIT(S), AND/OR SIGNATURE(S) SHOWN IN THE MARK DOES NOT IDENTIFY A PARTICULAR LIVING INDIVIDUAL.

SER. NO. 85-258,340, FILED P.R. 3-4-2011; AM. S.R. 10-19-2011.

ANDREA HACK, EXAMINING ATTORNEY



David J. Kybas

Director of the United States Patent and Trademark Office

United States of America
United States Patent and Trademark Office

WATSON

Reg. No. 4,075,515

Registered Dec. 20, 2011

Int. Cl.: 28

HALLMARK LICENSING, INC. (DELAWARE CORPORATION)
MD 339
2440 PERSHING ROAD
KANSAS CITY, MO 64108

FOR: PLUSH TOYS, IN CLASS 28 (U.S. CLS. 22, 23, 38 AND 50).

TRADEMARK

FIRST USE 2-28-2011; IN COMMERCE 2-28-2011.

SUPPLEMENTAL REGISTER

THE MARK CONSISTS OF STANDARD CHARACTERS WITHOUT CLAIM TO ANY PARTICULAR FONT, STYLE, SIZE, OR COLOR.

THE NAME(S), PORTRAIT(S), AND/OR SIGNATURE(S) SHOWN IN THE MARK DOES NOT IDENTIFY A PARTICULAR LIVING INDIVIDUAL.

SER. NO. 85-258,397, FILED P.R. 3-4-2011; AM. S.R. 10-19-2011.

ANDREA HACK, EXAMINING ATTORNEY



David J. Kyros

Director of the United States Patent and Trademark Office

United States of America

United States Patent and Trademark Office

YOUR VIDEO MEMORIES ON DEMAND

Reg. No. 4,075,516

Registered Dec. 20, 2011

Int. Cls.: 35, 38, 39, and 42

SERVICE MARK

SUPPLEMENTAL REGISTER

PIXORIAL, INC. (COLORADO CORPORATION)
UNIT 100
7670 S. CHESTER STREET
ENGLEWOOD, CO 80112

FOR: PRESERVATION, ORGANIZATION, AND INDEXING OF ELECTRONIC OR DIGITAL MEDIA, NAMELY, SERVICES CONSISTING OF REGISTRATION, COLLECTION, AND COMPILATION OF DATA, NAMELY, ELECTRONIC OR DIGITAL MEDIA, IN CLASS 35 (U.S. CLS. 100, 101 AND 102).

FIRST USE 2-17-2011; IN COMMERCE 2-17-2011.

FOR: TRANSMISSION AND DISTRIBUTION OF ELECTRONIC OR DIGITAL MEDIA, NAMELY, DISTRIBUTION OF DATA, NAMELY, ELECTRONIC OR DIGITAL MEDIA VIA A GLOBAL COMPUTER NETWORK OR THE INTERNET, IN CLASS 38 (U.S. CLS. 100, 101 AND 104).

FIRST USE 2-17-2011; IN COMMERCE 2-17-2011.

FOR: STORAGE OF VIDEO AND AUDIO MEDIA, NAMELY, ELECTRONIC STORAGE OF VIDEO AND AUDIO MEDIA, IN CLASS 39 (U.S. CLS. 100 AND 105).

FIRST USE 2-17-2011; IN COMMERCE 2-17-2011.

FOR: CONVERSION OF VIDEO AND AUDIO MEDIA INTO AN ELECTRONIC OR DIGITAL FORM, IN CLASS 42 (U.S. CLS. 100 AND 101).

FIRST USE 2-17-2011; IN COMMERCE 2-17-2011.

THE MARK CONSISTS OF STANDARD CHARACTERS WITHOUT CLAIM TO ANY PARTICULAR FONT, STYLE, SIZE, OR COLOR.

SER. NO. 85-260,067, FILED P.R. 3-7-2011; AM. S.R. 10-14-2011.

ELIZABETH KAJUBI, EXAMINING ATTORNEY



David J. Kypos

Director of the United States Patent and Trademark Office

United States of America

United States Patent and Trademark Office

DOMAINSCAN

Reg. No. 4,075,517

PEGASUS CONSULTANTS, INC. (PENNSYLVANIA CORPORATION)
P.O. BOX 1177

Registered Dec. 20, 2011

MORRISVILLE, PA 19067

Int. Cl.: 35

FOR: PREPARATION OF MARKET REPORTS AND STUDIES FOR CUSTOMERS, WHICH INDEX WEBSITES FOR PATTERN ANALYSIS SHOWING WEBSITE USAGE AND CONTENT, SENT VIA E-MAIL, IN CLASS 35 (U.S. CLS. 100, 101 AND 102).

SERVICE MARK

FIRST USE 7-1-2001; IN COMMERCE 8-1-2001.

SUPPLEMENTAL REGISTER

THE MARK CONSISTS OF STANDARD CHARACTERS WITHOUT CLAIM TO ANY PARTICULAR FONT, STYLE, SIZE, OR COLOR.

SER. NO. 85-269,404, FILED P.R. 3-17-2011; AM. S.R. 10-24-2011.

ODESSA BIBBINS, EXAMINING ATTORNEY



David J. Kyros

Director of the United States Patent and Trademark Office

United States of America

United States Patent and Trademark Office

NOTIFI

Reg. No. 4,075,518

Registered Dec. 20, 2011

Int. Cl.: 42

SERVICE MARK

SUPPLEMENTAL REGISTER

IFACTOR CONSULTING, INC. (DELAWARE CORPORATION)
SUITE 210
4505 EAST CHANDLER BLVD.
PHOENIX, AZ 85048

FOR: SOFTWARE AS A SERVICE, NAMELY, SOFTWARE FOR PROVIDING COMMUNICATION AND SUPPORT SERVICES FOR THE UTILITY INDUSTRY, IN CLASS 42 (U.S. CLS. 100 AND 101).

FIRST USE 1-4-2007; IN COMMERCE 1-4-2007.

THE MARK CONSISTS OF STANDARD CHARACTERS WITHOUT CLAIM TO ANY PARTICULAR FONT, STYLE, SIZE, OR COLOR.

SER. NO. 85-269,573, FILED P.R. 3-17-2011; AM. S.R. 10-20-2011.

MARK T. MULLEN, EXAMINING ATTORNEY



David J. Kyffers

Director of the United States Patent and Trademark Office

United States of America

United States Patent and Trademark Office

COLLATERALIZED DEPOSIT MANAGER THE COMPLETE DEPOSIT SECURITY SOLUTION

Reg. No. 4,075,519

NORTHWEST BANK AND TRUST COMPANY (IOWA CORPORATION)
100 E. KIMBERLY ROAD
DAVENPORT, IA 52806

Registered Dec. 20, 2011

Int. Cl.: 36

FOR: FINANCIAL SERVICES TO ASSIST FINANCIAL INSTITUTIONS, NAMELY, FINANCIAL MANAGEMENT AND FINANCIAL ADMINISTRATION OF COLLATERALIZED DEPOSITS IN THE NATURE OF TURNKEY PACKAGES, IN CLASS 36 (U.S. CLS. 100, 101 AND 102).

SERVICE MARK

SUPPLEMENTAL REGISTER FIRST USE 2-20-2011; IN COMMERCE 2-20-2011.

THE MARK CONSISTS OF STANDARD CHARACTERS WITHOUT CLAIM TO ANY PARTICULAR FONT, STYLE, SIZE, OR COLOR.

NO CLAIM IS MADE TO THE EXCLUSIVE RIGHT TO USE "COLLATERALIZED DEPOSIT", APART FROM THE MARK AS SHOWN.

SER. NO. 85-274,272, FILED P.R. 3-23-2011; AM. S.R. 9-12-2011.

TINA L. SNAPP, EXAMINING ATTORNEY



David J. Kybas

Director of the United States Patent and Trademark Office

United States of America

United States Patent and Trademark Office

MEET & COOK

Reg. No. 4,075,520

Registered Dec. 20, 2011

Int. Cl.: 35

SERVICE MARK

SUPPLEMENTAL REGISTER

DEMARLE AT HOME, INC (NEVADA CORPORATION)
SUITE 280
525 NORTH MAIN STREET
MILFORD, MI 48381

FOR: RETAIL SHOP-AT-HOME PARTY SERVICES IN THE FIELD OF COOKING AND COOKWARE; RETAIL SHOPS FEATURING COOKING AND COOKWARE, IN CLASS 35 (U.S. CLS. 100, 101 AND 102).

FIRST USE 3-23-2011; IN COMMERCE 3-28-2011.

NO CLAIM IS MADE TO THE EXCLUSIVE RIGHT TO USE "COOK", APART FROM THE MARK AS SHOWN.

THE MARK CONSISTS OF THE WORDS "MEET" AND "COOK" IN TIMES NEW ROMAN FONT, "&" IN FRENCH SCRIPT FONT.

SER. NO. 85-281,046, FILED P.R. 3-30-2011; AM. S.R. 10-18-2011.

ROSELLE HERRERA, EXAMINING ATTORNEY



David J. Kyffers

Director of the United States Patent and Trademark Office

United States of America

United States Patent and Trademark Office

Deluxe Fins

Reg. No. 4,075,521

WHITE WATER VENTURES INC. (CALIFORNIA CORPORATION)
2320 LA LINDA PLACE

Registered Dec. 20, 2011

NEWPORT BEACH, CA 92660

Int. Cl.: 28

FOR: AQUATIC SPORTING GOODS, NAMELY, SWIM FINS USED FOR BOARD RIDING AND SURFING, IN CLASS 28 (U.S. CLS. 22, 23, 38 AND 50).

TRADEMARK

FIRST USE 3-30-2011; IN COMMERCE 3-30-2011.

SUPPLEMENTAL REGISTER

THE MARK CONSISTS OF STANDARD CHARACTERS WITHOUT CLAIM TO ANY PARTICULAR FONT, STYLE, SIZE, OR COLOR.

NO CLAIM IS MADE TO THE EXCLUSIVE RIGHT TO USE "FINS", APART FROM THE MARK AS SHOWN.

SER. NO. 85-288,323, FILED P.R. 4-6-2011; AM. S.R. 10-3-2011.

CAROLINE WOOD, EXAMINING ATTORNEY



David J. Kyffers

Director of the United States Patent and Trademark Office

United States of America

United States Patent and Trademark Office

TASTE BEST

Reg. No. 4,075,522

Registered Dec. 20, 2011

Int. Cl.: 30

TRADEMARK

SUPPLEMENTAL REGISTER

THE PILLSBURY COMPANY, LLC (DELAWARE LIMITED LIABILITY COMPANY)
NUMBER ONE GENERAL MILLS BOULEVARD
MINNEAPOLIS, MN 55426

FOR: MIXES FOR BAKERY GOODS, IN CLASS 30 (U.S. CL. 46).

FIRST USE 12-31-2008; IN COMMERCE 12-31-2008.

THE MARK CONSISTS OF STANDARD CHARACTERS WITHOUT CLAIM TO ANY PARTICULAR FONT, STYLE, SIZE, OR COLOR.

SER. NO. 85-290,195, FILED P.R. 4-8-2011; AM. S.R. 10-7-2011.

DAVID C. REIHNER, EXAMINING ATTORNEY



David J. Kybas

Director of the United States Patent and Trademark Office

United States of America

United States Patent and Trademark Office

THRIFT BOOKS

Reg. No. 4,075,523

THRIFT BOOKS LLC (WASHINGTON LIMITED LIABILITY COMPANY)
18200 CASCADE AVENUE S, SUITE 204
TUKWILA, WA 98188

Registered Dec. 20, 2011

Int. Cl.: 35

FOR: ON-LINE RETAIL STORE SERVICES FEATURING BOOKS, IN CLASS 35 (U.S. CLS. 100, 101 AND 102).

SERVICE MARK

FIRST USE 0-0-2003; IN COMMERCE 0-0-2003.

SUPPLEMENTAL REGISTER

THE MARK CONSISTS OF STANDARD CHARACTERS WITHOUT CLAIM TO ANY PARTICULAR FONT, STYLE, SIZE, OR COLOR.

NO CLAIM IS MADE TO THE EXCLUSIVE RIGHT TO USE "BOOKS", APART FROM THE MARK AS SHOWN.

SER. NO. 85-291,546, FILED P.R. 4-11-2011; AM. S.R. 10-20-2011.

KELLY BOULTON, EXAMINING ATTORNEY



David J. Kybas

Director of the United States Patent and Trademark Office

United States of America

United States Patent and Trademark Office

The IRS Defenders

Reg. No. 4,075,524

BRAVO, LUIS A. (UNITED STATES INDIVIDUAL)
388 E. OCEAN BLVD SUITE 706
LONG BEACH, CA 90802

Registered Dec. 20, 2011

Int. Cl.: 35

FOR: PREPARATION OF TAX RETURNS FOR OTHERS AND NATIONWIDE IRS TAX DEFENSE SERVICES, IN CLASS 35 (U.S. CLS. 100, 101 AND 102).

SERVICE MARK

FIRST USE 4-1-2010; IN COMMERCE 4-1-2010.

SUPPLEMENTAL REGISTER

THE MARK CONSISTS OF STANDARD CHARACTERS WITHOUT CLAIM TO ANY PARTICULAR FONT, STYLE, SIZE, OR COLOR.

NO CLAIM IS MADE TO THE EXCLUSIVE RIGHT TO USE "IRS", APART FROM THE MARK AS SHOWN.

SER. NO. 85-291,831, FILED P.R. 4-11-2011; AM. S.R. 10-24-2011.

KATINA MISTER, EXAMINING ATTORNEY



David J. Kybas

Director of the United States Patent and Trademark Office

United States of America

United States Patent and Trademark Office

Half Shell Oyster House

Reg. No. 4,075,525

GULF COAST RESTAURANT GROUP INC. (MISSISSIPPI CORPORATION)
4300 AIR CARGO ROAD
GULFPORT, MS 39501

Registered Dec. 20, 2011

Int. Cl.: 43

FOR: BAR AND RESTAURANT SERVICES; CAFE AND RESTAURANT SERVICES; CAFE-RESTAURANTS; CARRY-OUT RESTAURANTS; MOBILE RESTAURANT SERVICES; RESTAURANT; RESTAURANT AND BAR SERVICES; RESTAURANT AND BAR SERVICES, INCLUDING RESTAURANT CARRYOUT SERVICES; RESTAURANT AND CAFE SERVICES; RESTAURANT AND CATERING SERVICES; RESTAURANT AND HOTEL SERVICES; RESTAURANT SERVICES; RESTAURANT SERVICES FEATURING OYSTERS; RESTAURANT SERVICES, INCLUDING SIT-DOWN SERVICE OF FOOD AND TAKE-OUT RESTAURANT SERVICES; RESTAURANT SERVICES, NAMELY, PROVIDING OF FOOD AND BEVERAGES FOR CONSUMPTION ON AND OFF THE PREMISES; RESTAURANT, BAR AND CATERING SERVICES; RESTAURANTS, IN CLASS 43 (U.S. CLS. 100 AND 101).

SERVICE MARK

SUPPLEMENTAL REGISTER

FIRST USE 2-1-2009; IN COMMERCE 7-1-2009.

THE MARK CONSISTS OF STANDARD CHARACTERS WITHOUT CLAIM TO ANY PARTICULAR FONT, STYLE, SIZE, OR COLOR.

NO CLAIM IS MADE TO THE EXCLUSIVE RIGHT TO USE "HOUSE", APART FROM THE MARK AS SHOWN.

SER. NO. 85-293,057, FILED P.R. 4-12-2011; AM. S.R. 10-19-2011.

SUSAN STIGLITZ, EXAMINING ATTORNEY



David J. Kyros

Director of the United States Patent and Trademark Office

United States of America

United States Patent and Trademark Office

ALPINE MOUNTAIN COASTERS

Reg. No. 4,075,526

AQUATIC DEVELOPMENT GROUP, INC. (NEW YORK CORPORATION)
13 GREEN MOUNTAIN DRIVE
COHOES, NY 12047

Registered Dec. 20, 2011

Int. Cl.: 28

FOR: DOWNHILL RECREATIONAL VEHICLE SYSTEMS IN THE NATURE OF AMUSEMENT PARK RIDES COMPRISED OF TRACKS, CARTS AND SAFETY BELTS, IN CLASS 28 (U.S. CLS. 22, 23, 38 AND 50).

TRADEMARK

FIRST USE 4-11-2011; IN COMMERCE 4-11-2011.

SUPPLEMENTAL REGISTER

THE MARK CONSISTS OF STANDARD CHARACTERS WITHOUT CLAIM TO ANY PARTICULAR FONT, STYLE, SIZE, OR COLOR.

NO CLAIM IS MADE TO THE EXCLUSIVE RIGHT TO USE "MOUNTAIN COASTERS", APART FROM THE MARK AS SHOWN.

SER. NO. 85-298,462, FILED 4-19-2011.

RONALD MCMORROW, EXAMINING ATTORNEY



David J. Kyffers

Director of the United States Patent and Trademark Office

United States of America

United States Patent and Trademark Office

Colorado's First World-Class Zipline Tour

Reg. No. 4,075,527

Registered Dec. 20, 2011

Int. Cl.: 39

SERVICE MARK

SUPPLEMENTAL REGISTER

A BRITWAY CORPORATION (COLORADO CORPORATION), DBA CAPTAIN ZIPLINE,
L.L.C.,
P.O. BOX 3
SALIDA, CO 81201

FOR: ARRANGING OF TOURS, IN CLASS 39 (U.S. CLS. 100 AND 105).

FIRST USE 4-15-2011; IN COMMERCE 4-15-2011.

THE MARK CONSISTS OF STANDARD CHARACTERS WITHOUT CLAIM TO ANY PARTICULAR FONT, STYLE, SIZE, OR COLOR.

NO CLAIM IS MADE TO THE EXCLUSIVE RIGHT TO USE "TOUR", APART FROM THE MARK AS SHOWN.

SER. NO. 85-298,537, FILED P.R. 4-19-2011; AM. S.R. 10-20-2011.

LEIGH CAROLINE CASE, EXAMINING ATTORNEY



David J. Kybas

Director of the United States Patent and Trademark Office

United States of America

United States Patent and Trademark Office

ALPINE SUPERSLIDES

Reg. No. 4,075,528

AQUATIC DEVELOPMENT GROUP, INC. (NEW YORK CORPORATION)
13 GREEN MOUNTAIN DRIVE
COHOES, NY 12047

Registered Dec. 20, 2011

Int. Cl.: 28

FOR: DOWNHILL RECREATIONAL VEHICLE SYSTEMS IN THE NATURE OF AMUSEMENT PARK RIDES COMPRISED OF SLIDES, SLEDS AND SAFETY BELTS, IN CLASS 28 (U.S. CLS. 22, 23, 38 AND 50).

TRADEMARK

FIRST USE 1-1-2005; IN COMMERCE 1-1-2005.

SUPPLEMENTAL REGISTER

THE MARK CONSISTS OF STANDARD CHARACTERS WITHOUT CLAIM TO ANY PARTICULAR FONT, STYLE, SIZE, OR COLOR.

SER. NO. 85-299,876, FILED 4-20-2011.

RONALD MCMORROW, EXAMINING ATTORNEY



David J. Kyffers

Director of the United States Patent and Trademark Office

United States of America

United States Patent and Trademark Office

Zafirro

Reg. No. 4,075,529

HAMILTON, HAYDEN D (UNITED STATES INDIVIDUAL)
115 NW 1ST AVE STE 200
PORTLAND, OR 97209

Registered Dec. 20, 2011

Int. Cl.: 8

FOR: RAZORS FOR WHICH THE BLADES ARE MADE OF SAPPHIRE AND RAZOR BLADES
MADE OF SAPPHIRE, IN CLASS 8 (U.S. CLS. 23, 28 AND 44).

TRADEMARK

FIRST USE 6-20-2011; IN COMMERCE 6-20-2011.

SUPPLEMENTAL REGISTER

THE MARK CONSISTS OF STANDARD CHARACTERS WITHOUT CLAIM TO ANY PARTICULAR FONT, STYLE, SIZE, OR COLOR.

WHILE "ZAFIRRO" HAS NO MEANING IN A FOREIGN LANGUAGE, "ZAFFIRO" TRANSLATED INTO ENGLISH MEANS "SAPPHIRE."

SER. NO. 85-307,090, FILED P.R. 4-28-2011; AM. S.R. 10-20-2011.

PAUL E. FAHRENKOPF, EXAMINING ATTORNEY



David J. Kybas

Director of the United States Patent and Trademark Office

United States of America

United States Patent and Trademark Office

EPA Smart

Reg. No. 4,075,530

BLUE SKY SOFTWARE SOLUTIONS, INC. (ARIZONA CORPORATION)
1230 WEST WASHINGTON STREET, SUITE 207
TEMPE, AZ 85281

Registered Dec. 20, 2011

Int. Cl.: 35

FOR: UTILITY BILL MANAGEMENT SERVICES, NAMELY, TRACKING, REPORTING, ANALYZING AND DELIVERING ENERGY INFORMATION IN THE FORM OF UTILITY BILLS AND UTILITY METER DATA RATE SCHEDULES VIA AN ELECTRONIC DATA EXCHANGE INTERFACE DESIGNED TO COMMUNICATE WITH THE EPA'S PORTFOLIO MANAGER SYSTEM FOR DOWNLOADING UTILITY CONSUMPTION DATA, IN CLASS 35 (U.S. CLS. 100, 101 AND 102).

SERVICE MARK

SUPPLEMENTAL REGISTER

FIRST USE 2-15-2011; IN COMMERCE 4-15-2011.

THE MARK CONSISTS OF STANDARD CHARACTERS WITHOUT CLAIM TO ANY PARTICULAR FONT, STYLE, SIZE, OR COLOR.

NO CLAIM IS MADE TO THE EXCLUSIVE RIGHT TO USE "EPA", APART FROM THE MARK AS SHOWN.

SER. NO. 85-309,168, FILED P.R. 4-30-2011; AM. S.R. 10-25-2011.

SHAILA SETTLES, EXAMINING ATTORNEY



David J. Kyffers

Director of the United States Patent and Trademark Office

United States of America

United States Patent and Trademark Office

PURCHASER RATING POINTS

Reg. No. 4,075,531

TRA GLOBAL, INC. (DELAWARE CORPORATION), DBA TRA, INC.,
52 VANDERBILT AVENUE, 17TH FLOOR
NEW YORK, NY 10017

Registered Dec. 20, 2011

Int. Cl.: 35

FOR: MARKET ANALYSIS AND RESEARCH SERVICES; TARGETING SERVICES, NAMELY, SERVICES TO DETERMINE THE AUDIENCE REACHED AND/OR AFFECTED BY ADVERTISEMENTS OR BRANDED PROGRAMMING EFFORTS, IN CLASS 35 (U.S. CLS. 100, 101 AND 102).

SERVICE MARK

SUPPLEMENTAL REGISTER FIRST USE 4-18-2011; IN COMMERCE 4-18-2011.

THE MARK CONSISTS OF STANDARD CHARACTERS WITHOUT CLAIM TO ANY PARTICULAR FONT, STYLE, SIZE, OR COLOR.

SER. NO. 85-313,353, FILED P.R. 5-5-2011; AM. S.R. 10-5-2011.

LINDA ORNDORFF, EXAMINING ATTORNEY



David J. Kyffers

Director of the United States Patent and Trademark Office

United States of America

United States Patent and Trademark Office

International Chiari Association

Reg. No. 4,075,532

DAL BELLO, PETER T. (UNITED STATES INDIVIDUAL)
16 ALAMEDA PADRE SERRA RD.
SANTA BARBARA, CA 93103

Registered Dec. 20, 2011

Int. Cl.: 35

FOR: CHARITABLE SERVICES, NAMELY, PROMOTING THE PUBLIC AWARENESS OF CHIARI MALFORMATION AND PROMOTING THE PUBLIC AWARENESS OF THE NEED FOR RESEARCH IN THE FIELD OF CHIARI MALFORMATION, IN CLASS 35 (U.S. CLS. 100, 101 AND 102).

SERVICE MARK

SUPPLEMENTAL REGISTER FIRST USE 9-17-2011; IN COMMERCE 9-17-2011.

THE MARK CONSISTS OF STANDARD CHARACTERS WITHOUT CLAIM TO ANY PARTICULAR FONT, STYLE, SIZE, OR COLOR.

NO CLAIM IS MADE TO THE EXCLUSIVE RIGHT TO USE "CHIARI ASSOCIATION", APART FROM THE MARK AS SHOWN.

SER. NO. 85-316,424, FILED P.R. 5-9-2011; AM. S.R. 10-6-2011.

JEFFREY LOOK, EXAMINING ATTORNEY



David J. Kyffers

Director of the United States Patent and Trademark Office

United States of America

United States Patent and Trademark Office

Counsel To California Employers

Reg. No. 4,075,533

Registered Dec. 20, 2011

Int. Cl.: 45

CAROTHERS DISANTE & FREUDENBERGER, LLP (CALIFORNIA LIMITED LIABILITY PARTNERSHIP)
2600 MICHELSON DRIVE
SUITE 800
IRVINE, CA 92612

SERVICE MARK

SUPPLEMENTAL REGISTER

FOR: LEGAL CONSULTATION SERVICES; LEGAL SERVICES; LEGAL SERVICES, NAMELY, PROVIDING CUSTOMIZED INFORMATION, COUNSELING, ADVICE AND LITIGATION SERVICES IN ALL AREAS OF EMPLOYMENT AND LABOR LAW FOR BOTH EMPLOYEES AND EMPLOYERS; LEGAL SERVICES, NAMELY, PROVIDING CUSTOMIZED INFORMATION, COUNSELING, ADVICE AND LITIGATION SERVICES IN ALL AREAS OF IMMIGRATION LAW, IN CLASS 45 (U.S. CLS. 100 AND 101).

FIRST USE 12-1-2004; IN COMMERCE 12-1-2004.

THE MARK CONSISTS OF STANDARD CHARACTERS WITHOUT CLAIM TO ANY PARTICULAR FONT, STYLE, SIZE, OR COLOR.

NO CLAIM IS MADE TO THE EXCLUSIVE RIGHT TO USE "COUNSEL" , APART FROM THE MARK AS SHOWN.

SER. NO. 85-317,301, FILED P.R. 5-10-2011; AM. S.R. 10-3-2011.

KELLY TRUSILO, EXAMINING ATTORNEY



David J. Kyjars

Director of the United States Patent and Trademark Office

United States of America

United States Patent and Trademark Office

STRATEGICACTION

Reg. No. 4,075,534

GLOBAL EQUITY CONSULTING LLC (MICHIGAN LIMITED LIABILITY COMPANY)
303 N. ROSE STREET, SUITE 218

Registered Dec. 20, 2011

KALAMAZOO, MI 49007

Int. Cl.: 35

FOR: BUSINESS MANAGEMENT CONSULTING SERVICES, IN CLASS 35 (U.S. CLS. 100, 101 AND 102).

SERVICE MARK

FIRST USE 8-1-2011; IN COMMERCE 8-1-2011.

SUPPLEMENTAL REGISTER

THE MARK CONSISTS OF STANDARD CHARACTERS WITHOUT CLAIM TO ANY PARTICULAR FONT, STYLE, SIZE, OR COLOR.

SER. NO. 85-322,687, FILED P.R. 5-17-2011; AM. S.R. 10-19-2011.

JAMES STEIN, EXAMINING ATTORNEY



David J. Kybas

Director of the United States Patent and Trademark Office

United States of America

United States Patent and Trademark Office

The logo for 'The EVENT' features the word 'The' in a large, stylized font. The letter 'T' is filled with a vertical gradient of purple shades. The letters 'h' and 'e' are white with a black outline and a drop shadow. To the right of 'The', the word 'EVENT' is written in a smaller, bold, white font with a black outline and a drop shadow.

Reg. No. 4,075,535

ATLAS INTELLECTUAL PROPERTIES, LLC (DELAWARE LIMITED LIABILITY COMPANY)
44 E MAIN STREET, SUITE 1014
NEWARK, DE 19711

Registered Dec. 20, 2011

Int. Cl.: 41

FOR: EDUCATION SERVICES, NAMELY, PROVIDING A TALENT SHOW EVENT, A SEMINAR AND/OR OTHER PRESENTATION IN THE FIELDS OF NONACADEMIC, AVOCATIONAL PROGRAM FOR CHILDREN AND TEENS DESIGNED TO HELP ENROLLEES UNDERSTAND AND MASTER THE CRITICAL ARTISTIC AND BUSINESS SKILLS NEEDED FOR THE ENTERTAINMENT INDUSTRY, IN CLASS 41 (U.S. CLS. 100, 101 AND 107).

SERVICE MARK

SUPPLEMENTAL REGISTER

FIRST USE 5-14-2011; IN COMMERCE 5-14-2011.

OWNER OF U.S. REG. NO. 3,824,522.

THE COLOR(S) PURPLE, SILVER, WHITE, BLACK AND GRAY IS/ARE CLAIMED AS A FEATURE OF THE MARK.

THE MARK CONSISTS OF THE WORD "THE" OUTLINED IN BLACK, WHEREIN THE CAPITAL LETTER "T" IS SEVERAL DIFFERENT SHADES OF PURPLE IN PLAIN TYPEFACE, AND THE LETTERS "H" AND "E" ARE SILVER, GRAY AND WHITE; SAID LETTER "H" TILTS RIGHTWARDS IN THE MANNER OF ITALIC TYPEFACE; SAID LETTER "E" IS TILTED COUNTER-CLOCKWISE IN THE OPPOSITE DIRECTION; THE WORD "EVENT" APPEARS IN SMALLER FONT TO THE RIGHT OF THE WORD "THE" AND USES WHITE LETTERS WITH BLACK OUTLINING.

SER. NO. 85-322,724, FILED 5-17-2011.

TRACY WHITTAKER-BROWN, EXAMINING ATTORNEY



David J. Kypos

Director of the United States Patent and Trademark Office

United States of America

United States Patent and Trademark Office

AGENT SUMMIT

Reg. No. 4,075,536

Registered Dec. 20, 2011

Int. Cl.: 41

SERVICE MARK

SUPPLEMENTAL REGISTER

BOBIT BUSINESS MEDIA, INC. (DELAWARE CORPORATION)
3520 CHALLENGER STREET
TORRANCE, CA 90503

FOR: ORGANIZING AND CONDUCTING AN EDUCATIONAL CONFERENCE FOR PROFESSIONAL AGENTS TO ASSIST THEM IN IMPROVING AND DEVELOPING RELATIONSHIPS WITH AUTOMOTIVE DEALERS, IN CLASS 41 (U.S. CLS. 100, 101 AND 107).

FIRST USE 2-0-2011; IN COMMERCE 2-0-2011.

THE MARK CONSISTS OF STANDARD CHARACTERS WITHOUT CLAIM TO ANY PARTICULAR FONT, STYLE, SIZE, OR COLOR.

NO CLAIM IS MADE TO THE EXCLUSIVE RIGHT TO USE SUMMIT, APART FROM THE MARK AS SHOWN.

SER. NO. 85-322,975, FILED P.R. 5-17-2011; AM. S.R. 10-24-2011.

JACLYN KIDWELL WALKER, EXAMINING ATTORNEY



David J. Kyffers

Director of the United States Patent and Trademark Office

United States of America

United States Patent and Trademark Office

Wei's-l.e.d

Reg. No. 4,075,537

WEI'S INTERNATIONAL TRADING CORP. (NEW YORK CORPORATION)
127 ALEX CIR

Registered Dec. 20, 2011

STATEN ISLAND, NY 10305

Int. Cl.: 11

FOR: LED (LIGHT EMITTING DIODE) LIGHTING FIXTURES; LED (LIGHT EMITTING DIODES) LIGHTING FIXTURES FOR USE IN DISPLAY, COMMERCIAL, INDUSTRIAL, RESIDENTIAL, AND ARCHITECTURAL ACCENT LIGHTING APPLICATIONS; LED LANDSCAPE LIGHTS; LED LIGHT ASSEMBLIES FOR STREET LIGHTS, SIGNS, COMMERCIAL LIGHTING, AUTOMOBILES, BUILDINGS, AND OTHER ARCHITECTURAL USES; LED LIGHT BULBS; LED LIGHTING FIXTURES FOR INDOOR AND OUTDOOR LIGHTING APPLICATIONS; LED LIGHTS FOR STRINGS, FLOWERS, BRANCHES AND OTHER ORNAMENTAL DECORATIONS; LED LUMINAIRES; LED UNDERWATER LIGHTS; LIGHT EMITTING DIODE (LED) PLANT GROW LIGHT; LUMINAIRES, USING LIGHT EMITTING DIODES (LEDS) AS A LIGHT SOURCE, FOR STREET OR ROADWAY LIGHTING; OPTICAL LENS COVERS THAT IMPROVE LIGHT OUTPUT AND UNIFORMITY AND PROTECT THE LED, SOLD AS A FEATURE OF AN LED LIGHTING SYSTEM; RED LED FLASHLIGHTS FOR ILLUMINATION PURPOSES, IN CLASS 11 (U.S. CLS. 13, 21, 23, 31 AND 34).

TRADEMARK

SUPPLEMENTAL REGISTER

FIRST USE 3-1-2011; IN COMMERCE 3-1-2011.

NO CLAIM IS MADE TO THE EXCLUSIVE RIGHT TO USE "L.E.D", APART FROM THE MARK AS SHOWN.

SER. NO. 85-323,455, FILED P.R. 5-17-2011; AM. S.R. 9-30-2011.

SARA BENJAMIN, EXAMINING ATTORNEY



David J. Kypos

Director of the United States Patent and Trademark Office

United States of America

United States Patent and Trademark Office

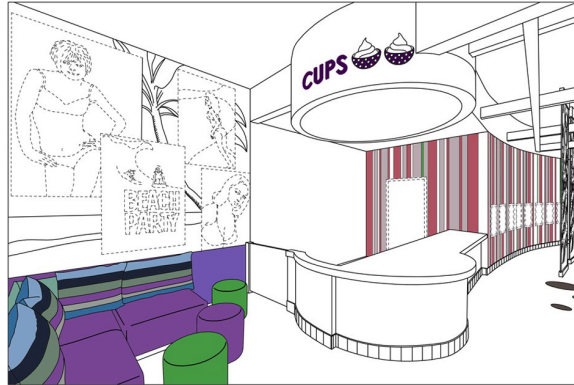

Reg. No. 4,075,538

Registered Dec. 20, 2011

Int. Cl.: 43

SERVICE MARK

SUPPLEMENTAL REGISTER

CUPS LLC (NEVADA LIMITED LIABILITY COMPANY)
79 OKNER PARKWAY
LIVINGSTON, NJ 07039

FOR: FROZEN YOGURT SHOP SERVICES IN THE NATURE OF A RESTAURANT, IN CLASS 43 (U.S. CLS. 100 AND 101).

FIRST USE 11-12-2010; IN COMMERCE 11-12-2010.

THE MARK CONSISTS OF THREE DIMENSIONAL CONFIGURATION OR "TRADE DRESS" FOR THE APPEARANCE AND DESIGN OF THE INTERIOR OF A RESTAURANT. THE STYLIZED WORDING "CUPS" IN PURPLE AND A DESIGN OF TWO PURPLE POLKA DOTTED YOGURT CUPS FILLED WITH YOGURT APPEARING ON AN OVAL OVERHANG IN THE FRONT OF THE RESTAURANT INTERIOR. A LOUNGE SEATING AREA IN THE COLORS PURPLE, DARK GREEN, LIGHT GREEN, LIGHT BLUE, DARK BLUE, AND GRAY ALSO APPEARS IN THE FRONT OF THE RESTAURANT INTERIOR. THE LOUNGE AREA ALSO CONTAINS PURPLE AND GREEN TABLES. THE LOUNGE AREA IS FLANKED WITH A FUN WALL MONTAGE COMPRISING OF BEACH IMAGERY AND POSTERS. A CURVED SHAPED COUNTER APPEARS IN THE FRONT OF THE RESTAURANT INTERIOR. THERE ARE DECORATIVE BEAMS ON THE CEILING OF THE FRONT AND THE BACK OF THE INTERIOR. TOWARD THE BACK THERE IS A LONG WALL COLORED WITH VERTICAL TILES IN SHADES OF THE COLORS PURPLE AND GREEN. THAT WALL HOUSES SEVERAL FROZEN YOGURT DISPENSERS AND OPPOSITE ARE DECORATIVE CURVED GLASS PARTITIONS EMBEDDED WITH PURPLE AND GREEN POLKA DOTS TO REINFORCE A POLKA DOT THEME. UNDERNEATH THE GLASS PARTITIONS ARE TWO BROWN CIRCLES AND A GREEN SEMI CIRCLE. THE POSTERS AND DOOR IN THE FRONT OF THE RESTAURANT INTERIOR AND THE YOGURT DISPENSERS IN THE BACK OF THE RESTAURANT INTERIOR SHOWN IN BROKEN OR DOTTED LINES ARE NOT PART OF THE MARK AND SERVE ONLY TO SHOW THE POSITION OR PLACEMENT OF THE MARK. THE WHITE APPEARING IN THE YOGURT CUPS DESIGN ON THE FRONT OVERHANG, CURVED SHAPED COUNTER, FRONT WALL AND WALL MONTAGE, CEILING AND FLOOR REPRESENTS BACKGROUND AND IS NOT CLAIMED AS COLOR. THE BLACK APPEARING IN THE LOUNGE SEATING, LOUNGE TABLES, WALL MONTAGE, COUNTER, CEILING, AND GLASS PARTITIONS IS OUTLINING AND IS NOT CLAIMED AS COLOR. THE MATTER SHOWN IN BROKEN LINES IS NOT PART OF THE MARK AND SERVES ONLY TO SHOW THE POSITION OF THE MARK.



David J. Kappas

Director of the United States Patent and Trademark Office

Reg. No. 4,075,538 THE COLOR(S) PURPLE, DARK GREEN, LIGHT GREEN, LIGHT BLUE, DARK BLUE, GRAY, GREEN, AND BROWN IS/ARE CLAIMED AS A FEATURE OF THE MARK.

SER. NO. 85-327,599, FILED P.R. 5-23-2011; AM. S.R. 10-21-2011.

B. PARADEWELAI, EXAMINING ATTORNEY

United States of America

United States Patent and Trademark Office

Napa Brewing Company

Reg. No. 4,075,539

THE WOODMAR GROUP LLC (CALIFORNIA LIMITED LIABILITY COMPANY)
1247 DURANT COURT
WALNUT CREEK, CA 94596

Registered Dec. 20, 2011

Int. Cl.: 32

FOR: BEER, IN CLASS 32 (U.S. CLS. 45, 46 AND 48).

FIRST USE 9-2-2011; IN COMMERCE 9-2-2011.

TRADEMARK

THE MARK CONSISTS OF STANDARD CHARACTERS WITHOUT CLAIM TO ANY PARTICULAR FONT, STYLE, SIZE, OR COLOR.

SUPPLEMENTAL REGISTER

NO CLAIM IS MADE TO THE EXCLUSIVE RIGHT TO USE "BREWING COMPANY", APART FROM THE MARK AS SHOWN.

SER. NO. 85-329,857, FILED P.R. 5-25-2011; AM. S.R. 11-10-2011.

INGA ERVIN, EXAMINING ATTORNEY



David J. Kyffers

Director of the United States Patent and Trademark Office

United States of America

United States Patent and Trademark Office

TOVAR

Reg. No. 4,075,540

KIS HOLDINGS INC. (CANADA CORPORATION)
46 ADASTRA CRES

Registered Dec. 20, 2011

MARKHAM, CANADA L6C3G7

Int. Cl.: 25

FOR: CLOTHING, NAMELY, TOPS, BOTTOMS, JACKETS, PANTS, SHORTS, SHIRTS, SWEATERS, BLAZERS, T-SHIRTS, POLO SHIRTS, VESTS, SUITS, JEANS, CAPRIS, COATS, UNDERWEAR, HATS, SOCKS, SHOES, IN CLASS 25 (U.S. CLS. 22 AND 39).

TRADEMARK

FIRST USE 8-15-2011; IN COMMERCE 8-15-2011.

SUPPLEMENTAL REGISTER

THE MARK CONSISTS OF STANDARD CHARACTERS WITHOUT CLAIM TO ANY PARTICULAR FONT, STYLE, SIZE, OR COLOR.

THE WORDING "TOVAR" HAS NO MEANING IN A FOREIGN LANGUAGE.

SER. NO. 85-330,578, FILED P.R. 5-26-2011; AM. S.R. 10-14-2011.

JERI J. FICKES, EXAMINING ATTORNEY



David J. Kyros

Director of the United States Patent and Trademark Office

United States of America

United States Patent and Trademark Office

Virtual Health Network

Reg. No. 4,075,541

Registered Dec. 20, 2011

Int. Cls.: 9 and 42

TRADEMARK

SERVICE MARK

SUPPLEMENTAL REGISTER

SMARTRONIX, INC. (MARYLAND CORPORATION)
44150 SMARTRONIX WAY
LEGAL DEPARTMENT
HOLLYWOOD, MD 20636

FOR: COMMUNICATIONS SOFTWARE FOR CONNECTING HEALTH INFORMATION NETWORKS TOGETHER SECURELY; COMPUTER SOFTWARE FOR CONTROLLING AND MANAGING PATIENT MEDICAL INFORMATION, IN CLASS 9 (U.S. CLS. 21, 23, 26, 36 AND 38).

FIRST USE 7-1-2008; IN COMMERCE 7-1-2008.

FOR: CLOUD COMPUTING FEATURING SOFTWARE FOR USE IN HEALTH INFORMATION SHARING AND EXCHANGE SOLUTIONS; CONSULTING SERVICES IN THE FIELD OF CLOUD COMPUTING; PROVIDING VIRTUAL COMPUTER SYSTEMS AND VIRTUAL COMPUTER ENVIRONMENTS THROUGH CLOUD COMPUTING; TECHNICAL CONSULTING SERVICES IN THE FIELDS OF DATACENTER ARCHITECTURE, PUBLIC AND PRIVATE CLOUD COMPUTING SOLUTIONS, AND EVALUATION AND IMPLEMENTATION OF INTERNET TECHNOLOGY AND SERVICES; TECHNICAL SUPPORT SERVICES, NAMELY, REMOTE AND ON-SITE INFRASTRUCTURE MANAGEMENT SERVICES FOR MONITORING, ADMINISTRATION AND MANAGEMENT OF PUBLIC AND PRIVATE CLOUD COMPUTING IT AND APPLICATION SYSTEMS, IN CLASS 42 (U.S. CLS. 100 AND 101).

FIRST USE 3-1-2011; IN COMMERCE 3-1-2011.

THE MARK CONSISTS OF STANDARD CHARACTERS WITHOUT CLAIM TO ANY PARTICULAR FONT, STYLE, SIZE, OR COLOR.

NO CLAIM IS MADE TO THE EXCLUSIVE RIGHT TO USE "NETWORK", APART FROM THE MARK AS SHOWN.

SER. NO. 85-336,370, FILED P.R. 6-2-2011; AM. S.R. 10-18-2011.

AMY HELLA, EXAMINING ATTORNEY



David J. Kyffers

Director of the United States Patent and Trademark Office

United States of America

United States Patent and Trademark Office

MassMoms.com

Reg. No. 4,075,542

NYT MANAGEMENT SERVICES, INC. (DELAWARE CORPORATION)
2202 WESTSHORE BLVD.
TAMPA, FL 33067

Registered Dec. 20, 2011

Int. Cl.: 41

FOR: INFORMATION IN THE FIELD OF PARENTING CONCERNING EDUCATION OF CHILDREN; INFORMATION IN THE FIELD OF PARENTING CONCERNING ENTERTAINMENT OF CHILDREN; ON-LINE JOURNALS, NAMELY, BLOGS FEATURING NEWS, INFORMATION AND COMMENTARY IN THE FIELD OF PARENTING, CHILDREN, AND INTRAFAMILY RELATIONSHIPS; PROVIDING A WEBSITE FEATURING BLOGS AND NON-DOWNLOADABLE PUBLICATIONS IN THE NATURE OF NEWSPAPERS, NEWSLETTERS AND MAGAZINES IN THE FIELD(S) OF PARENTING, CHILDREN, AND INTRAFAMILY RELATIONSHIPS; PROVIDING ADVICE AND INFORMATION TO ADULT FAMILY MEMBERS ON APPROPRIATE ENTERTAINMENT AND LEISURE ACTIVITIES FOR YOUNGER FAMILY MEMBERS; PROVIDING NEWSLETTERS IN THE FIELD OF PARENTING, CHILDREN, AND INTRAFAMILY RELATIONSHIPS VIA E-MAIL; PROVIDING ON-LINE PUBLICATIONS IN THE NATURE OF NEWSPAPERS, NEWSLETTERS AND MAGAZINES IN THE FIELD OF PARENTING, CHILDREN, AND INTRAFAMILY RELATIONSHIPS, IN CLASS 41 (U.S. CLS. 100, 101 AND 107).

SERVICE MARK

SUPPLEMENTAL REGISTER

FIRST USE 12-0-2007; IN COMMERCE 12-0-2007.

THE MARK CONSISTS OF STANDARD CHARACTERS WITHOUT CLAIM TO ANY PARTICULAR FONT, STYLE, SIZE, OR COLOR.

SER. NO. 85-337,778, FILED P.R. 6-3-2011; AM. S.R. 10-7-2011.

MARY BOAGNI, EXAMINING ATTORNEY



David J. Kyros

Director of the United States Patent and Trademark Office

United States of America

United States Patent and Trademark Office

TUNNEL SOLUTIONS

Reg. No. 4,075,543

Registered Dec. 20, 2011

Int. Cl.: 7

TRADEMARK

SUPPLEMENTAL REGISTER

CAROLINA PRIDE CARWASH INC. (NORTH CAROLINA CORPORATION), DBA TUNNEL SOLUTIONS,
417 SOUTH MADISON BLVD
ROXBORO, NC 27573

FOR: CAR WASH INDUSTRIAL MACHINERY, NAMELY, CLEANING SOLUTION DISPENSING EQUIPMENT, NAMELY, CAR WASH CLEANING SOLUTION DISPENSING MACHINES, IN CLASS 7 (U.S. CLS. 13, 19, 21, 23, 31, 34 AND 35).

FIRST USE 4-13-2011; IN COMMERCE 4-13-2011.

THE MARK CONSISTS OF STANDARD CHARACTERS WITHOUT CLAIM TO ANY PARTICULAR FONT, STYLE, SIZE, OR COLOR.

SER. NO. 85-338,086, FILED P.R. 6-4-2011; AM. S.R. 10-26-2011.

ALICE BENMAMAN, EXAMINING ATTORNEY



David J. Kybas

Director of the United States Patent and Trademark Office

United States of America

United States Patent and Trademark Office

React2Sun

Reg. No. 4,075,544

Registered Dec. 20, 2011

Int. Cl.: 9

TRADEMARK

SUPPLEMENTAL REGISTER

LEGG, J MARTYN (UNITED KINGDOM INDIVIDUAL)
COTMARIS
BRIMSCOMBE HILL
STROUD GLOUCESTERSHIRE, GREAT BRITAIN GL52QR

FOR: SPECTACLE LENSES, IN CLASS 9 (U.S. CLS. 21, 23, 26, 36 AND 38).

THE MARK CONSISTS OF STANDARD CHARACTERS WITHOUT CLAIM TO ANY PARTICULAR FONT, STYLE, SIZE, OR COLOR.

OWNER OF GREAT BRITAIN REG. NO. 2560212, DATED 9-30-2010, EXPIRES 9-30-2020.

SER. NO. 85-338,458, FILED P.R. 6-6-2011; AM. S.R. 9-30-2011.

TINA BROWN, EXAMINING ATTORNEY



David J. Kybas

Director of the United States Patent and Trademark Office

United States of America

United States Patent and Trademark Office

KOATED KERNELS

Reg. No. 4,075,545

AMERICAN POP CORN COMPANY (IOWA CORPORATION)
BOX 178

Registered Dec. 20, 2011

SIOUX CITY, IA 51102

Int. Cl.: 30

FOR: POPPED POP CORN COATED WITH A VARIETY OF SWEET TO SAVORY SEASONINGS, IN CLASS 30 (U.S. CL. 46).

TRADEMARK

FIRST USE 8-0-2010; IN COMMERCE 8-0-2010.

SUPPLEMENTAL REGISTER

THE MARK CONSISTS OF STANDARD CHARACTERS WITHOUT CLAIM TO ANY PARTICULAR FONT, STYLE, SIZE, OR COLOR.

SER. NO. 85-340,300, FILED P.R. 6-7-2011; AM. S.R. 10-19-2011.

ANN E. SAPPENFIELD, EXAMINING ATTORNEY



David J. Kyros

Director of the United States Patent and Trademark Office

United States of America

United States Patent and Trademark Office

FAST&PROFITABLE

Reg. No. 4,075,546

BUNGE OILS, INC. (DELAWARE CORPORATION)
11720 BORMAN DRIVE
ST. LOUIS, MO 63146

Registered Dec. 20, 2011

Int. Cls.: 9 and 16

FOR: DOWNLOADABLE ELECTRONIC PODCASTS FEATURING PROMOTIONAL AND INFORMATIONAL TEXT AND GRAPHICS IN THE FIELD OF MENU CONCEPTS AND RECIPES FOR THE FOOD AND BEVERAGE INDUSTRY, IN CLASS 9 (U.S. CLS. 21, 23, 26, 36 AND 38).

TRADEMARK

SUPPLEMENTAL REGISTER FIRST USE 4-0-2011; IN COMMERCE 4-0-2011.

FOR: PUBLICATIONS, NAMELY, PROMOTIONAL AND INFORMATIONAL MAGAZINES AND BROCHURES IN THE FIELD OF MENU CONCEPTS AND RECIPES FOR THE FOOD AND BEVERAGE INDUSTRY, IN CLASS 16 (U.S. CLS. 2, 5, 22, 23, 29, 37, 38 AND 50).

FIRST USE 2-0-2010; IN COMMERCE 2-0-2010.

THE MARK CONSISTS OF STANDARD CHARACTERS WITHOUT CLAIM TO ANY PARTICULAR FONT, STYLE, SIZE, OR COLOR.

SER. NO. 85-342,968, FILED 6-10-2011.

ANDREW RHIM, EXAMINING ATTORNEY



David J. Kyffers

Director of the United States Patent and Trademark Office

United States of America

United States Patent and Trademark Office

Personal Printing

Reg. No. 4,075,547

THINPRINT AG (FED REP GERMANY CORPORATION)
ALT-MOABIT 91B

Registered Dec. 20, 2011

BERLIN, FED REP GERMANY 10559

Int. Cl.: 9

FOR: COMPUTER HARDWARE, COMPUTER SOFTWARE USED TO FACILITATE AND ENHANCE OPERATION OF COMPUTER PRINTERS IN SERVER-BASED COMPUTING, IN CLASS 9 (U.S. CLS. 21, 23, 26, 36 AND 38).

TRADEMARK

FIRST USE 2-21-2011; IN COMMERCE 2-21-2011.

SUPPLEMENTAL REGISTER

THE MARK CONSISTS OF STANDARD CHARACTERS WITHOUT CLAIM TO ANY PARTICULAR FONT, STYLE, SIZE, OR COLOR.

NO CLAIM IS MADE TO THE EXCLUSIVE RIGHT TO USE "PRINTING", APART FROM THE MARK AS SHOWN.

SER. NO. 85-343,192, FILED 6-10-2011.

JOHN WILKE, EXAMINING ATTORNEY



David J. Kyffers

Director of the United States Patent and Trademark Office

United States of America

United States Patent and Trademark Office

TEXAS MUSIC HALL OF FAME

Reg. No. 4,075,548

Registered Dec. 20, 2011

Int. Cl.: 41

SERVICE MARK

SUPPLEMENTAL REGISTER

CAN AND WILL MUSIC FOUNDATION, INC. (TEXAS CORPORATION), DBA TEXAS
MUSIC HALL OF FAME,
3532 BEE CAVES RD., SUITE 115
WEST LAKE HILLS, TX 78746

FOR: PROVIDING RECOGNITION AND INCENTIVES BY WAY OF AWARDS TO DEMONSTRATE EXCELLENCE IN THE FIELD OF MUSIC, NAMELY, ORGANIZING AND CONDUCTING RECOGNITION AWARDS PROGRAMS RECOGNIZING ACHIEVEMENT IN THE FIELD OF MUSIC AND RECOGNIZING PROMINENT PERFORMERS, PROMOTERS, MANAGERS AND OTHER MUSIC BUSINESS PROFESSIONALS WHO HAVE MADE SIGNIFICANT CONTRIBUTIONS TO THE ADVANCEMENT AND PROMOTION OF MUSIC; ENTERTAINMENT SERVICES, NAMELY, LIVE MUSIC CONCERTS; PROVIDING A WEBSITE FEATURING INFORMATION IN THE FIELD OF MUSIC; PROVIDING EDUCATIONAL PROGRAMS IN THE FIELD OF MUSIC, IN CLASS 41 (U.S. CLS. 100, 101 AND 107).

FIRST USE 6-1-2010; IN COMMERCE 6-1-2011.

THE MARK CONSISTS OF STANDARD CHARACTERS WITHOUT CLAIM TO ANY PARTICULAR FONT, STYLE, SIZE, OR COLOR.

NO CLAIM IS MADE TO THE EXCLUSIVE RIGHT TO USE "MUSIC HALL OF FAME", APART FROM THE MARK AS SHOWN.

SER. NO. 85-344,803, FILED P.R. 6-13-2011; AM. S.R. 10-7-2011.

RUDY R. SINGLETON, EXAMINING ATTORNEY



David J. Kyffers

Director of the United States Patent and Trademark Office

United States of America

United States Patent and Trademark Office

IWELLNESSEXAM

Reg. No. 4,075,549

OPTOVUE, INC (DELAWARE CORPORATION)
45531 NORTHPORT LOOP WEST
FREMONT, CA 94538

Registered Dec. 20, 2011

Int. Cls.: 10 and 44

FOR: DIAGNOSTIC IMAGING SOFTWARE THAT IS AN INTEGRAL COMPONENT OF MEDICAL EYE SCANNING MACHINES FOR USE AS A CLINICAL AID IN DIAGNOSING VARIOUS EYE DISEASES, IN CLASS 10 (U.S. CLS. 26, 39 AND 44).

TRADEMARK

FIRST USE 5-2-2011; IN COMMERCE 5-2-2011.

SERVICE MARK

FOR: RENTAL OF MEDICAL MACHINES AND APPARATUS; RENTAL OF MEDICAL EQUIPMENT, IN CLASS 44 (U.S. CLS. 100 AND 101).

SUPPLEMENTAL REGISTER

FIRST USE 5-2-2011; IN COMMERCE 5-2-2011.

THE MARK CONSISTS OF STANDARD CHARACTERS WITHOUT CLAIM TO ANY PARTICULAR FONT, STYLE, SIZE, OR COLOR.

SER. NO. 85-345,635, FILED 6-14-2011.

MICHAEL TANNER, EXAMINING ATTORNEY



David J. Kybas

Director of the United States Patent and Trademark Office

United States of America

United States Patent and Trademark Office

SmartExhaust

Reg. No. 4,075,550

LIPIDEX CORP (MASSACHUSETTS CORPORATION)
411 PLAIN STREET
MARSHFIELD, MA 02050

Registered Dec. 20, 2011

Int. Cl.: 9

FOR: CLIMATE CONTROL SYSTEMS CONSISTING OF DIGITAL THERMOSTATS, AIR CONDITIONING, HEATING, VENTILATION AND DRYING CONTROL DEVICES, IN CLASS 9 (U.S. CLS. 21, 23, 26, 36 AND 38).

TRADEMARK

FIRST USE 9-15-2008; IN COMMERCE 12-15-2008.

SUPPLEMENTAL REGISTER

THE MARK CONSISTS OF STANDARD CHARACTERS WITHOUT CLAIM TO ANY PARTICULAR FONT, STYLE, SIZE, OR COLOR.

SER. NO. 85-346,831, FILED 6-15-2011.

ARETHA SOMERVILLE, EXAMINING ATTORNEY



David J. Kyffers

Director of the United States Patent and Trademark Office

United States of America

United States Patent and Trademark Office

CloudAccess

Reg. No. 4,075,551

CLOUDACCESS, INC. (CALIFORNIA CORPORATION)
12121 WILSHIRE BOULEVARD, SUITE 1111
LOS ANGELES, CA 90025

Registered Dec. 20, 2011

Int. Cl.: 45

FOR: ANALYZING DATA IN COMPUTER DATABASES FOR CRIMINAL ACTIVITY; COMPUTER SECURITY SERVICES IN THE NATURE OF PROVIDING AN INTERNET TRUST CENTER, NAMELY, COMPUTER SECURITY ASSURANCE AND ADMINISTRATION OF DIGITAL KEYS AND DIGITAL CERTIFICATES; CONSULTING SERVICES IN THE FIELD OF MAINTAINING THE SECURITY AND INTEGRITY OF DATABASES; MONITORING OF COMPUTER SYSTEMS FOR SECURITY PURPOSES; MONITORING OF SECURITY SYSTEMS; SECURITY SERVICES, NAMELY, PROVIDING A WEBSITE NOTIFYING INDIVIDUALS OF A CHANGED STATUS OR CONDITION OF A SENSING DEVICE IN A SECURITY SYSTEM VIA ELECTRONIC MESSAGE ALERTS; SECURITY SERVICES, NAMELY, PROVIDING SECURITY ASSESSMENTS OF PHYSICAL LOCATIONS, INFORMATION SYSTEMS, AND WORKING ENVIRONMENTS, IN CLASS 45 (U.S. CLS. 100 AND 101).

SERVICE MARK

SUPPLEMENTAL REGISTER

FIRST USE 1-15-2011; IN COMMERCE 1-15-2011.

THE MARK CONSISTS OF STANDARD CHARACTERS WITHOUT CLAIM TO ANY PARTICULAR FONT, STYLE, SIZE, OR COLOR.

SER. NO. 85-349,371, FILED P.R. 6-17-2011; AM. S.R. 10-21-2011.

JANICE L. MCMORROW, EXAMINING ATTORNEY



David J. Kybas

Director of the United States Patent and Trademark Office

United States of America

United States Patent and Trademark Office

THE AFRICA MEMORY GAME

Reg. No. 4,075,552

Registered Dec. 20, 2011

Int. Cl.: 28

PAULETTE L MPOUMA (MARYLAND SOLE PROPRIETORSHIP), DBA THE AFRICA
MEMORY GAME,
7616 WOODBINE DRIVE
LAUREL, MD 20707

FOR: BOARD GAMES, IN CLASS 28 (U.S. CLS. 22, 23, 38 AND 50).

TRADEMARK

FIRST USE 6-30-2009; IN COMMERCE 6-30-2009.

SUPPLEMENTAL REGISTER

THE MARK CONSISTS OF STANDARD CHARACTERS WITHOUT CLAIM TO ANY PARTICULAR FONT, STYLE, SIZE, OR COLOR.

NO CLAIM IS MADE TO THE EXCLUSIVE RIGHT TO USE "GAME", APART FROM THE MARK AS SHOWN.

SER. NO. 85-351,487, FILED P.R. 6-21-2011; AM. S.R. 10-19-2011.

CORY BOONE, EXAMINING ATTORNEY



David J. Kybas

Director of the United States Patent and Trademark Office

United States of America
United States Patent and Trademark Office

DEFCON1

Reg. No. 4,075,553

ACCURATE WORKS LLC (NEW JERSEY LIMITED LIABILITY COMPANY)
828 MAIN ST 'F'
BELLEVILLE, NJ 07109

Registered Dec. 20, 2011

Int. Cl.: 25

FOR: CLOTHING, NAMELY, T-SHIRTS, SHIRTS, SWEATERS, JACKETS, PANTS, SHORTS, ROMPERS, JOGGING SUITS, VEST, DRESSES, JUMP SUITS, HATS, SKIRTS, TOPS, UNDER GARMENTS, UNDER WEAR, IN CLASS 25 (U.S. CLS. 22 AND 39).

TRADEMARK

FIRST USE 6-23-2011; IN COMMERCE 6-23-2011.

SUPPLEMENTAL REGISTER

THE MARK CONSISTS OF STANDARD CHARACTERS WITHOUT CLAIM TO ANY PARTICULAR FONT, STYLE, SIZE, OR COLOR.

SER. NO. 85-353,957, FILED 6-23-2011.

CHARLOTTE CORWIN, EXAMINING ATTORNEY



David J. Kyffers

Director of the United States Patent and Trademark Office

United States of America

United States Patent and Trademark Office

THEORIES OF PSYCHOTHERAPY SERIES

Reg. No. 4,075,554

AMERICAN PSYCHOLOGICAL ASSOCIATION (D.C. NON-PROFIT CORPORATION)
750 FIRST STREET, N.E.

Registered Dec. 20, 2011

WASHINGTON, DC 20002

Int. Cl.: 16

FOR: PRINTED BOOKS PERTAINING TO THE HISTORY, KEY CONCEPTS, AND APPLICATION OF THEORETICAL APPROACHES IN THE ASSESSMENT, DIAGNOSIS, AND TREATMENT OF CLIENTS IN THE PSYCHOLOGICAL AND SOCIAL SCIENCES, IN CLASS 16 (U.S. CLS. 2, 5, 22, 23, 29, 37, 38 AND 50).

TRADEMARK

SUPPLEMENTAL REGISTER FIRST USE 5-1-2009; IN COMMERCE 9-15-2009.

THE MARK CONSISTS OF STANDARD CHARACTERS WITHOUT CLAIM TO ANY PARTICULAR FONT, STYLE, SIZE, OR COLOR.

NO CLAIM IS MADE TO THE EXCLUSIVE RIGHT TO USE "SERIES", APART FROM THE MARK AS SHOWN.

SER. NO. 85-354,553, FILED P.R. 6-23-2011; AM. S.R. 10-24-2011.

MICHAEL KEATING, EXAMINING ATTORNEY



David J. Kyjars

Director of the United States Patent and Trademark Office

United States of America

United States Patent and Trademark Office

CHATTANOOGA CORPORATE COUNSEL NETWORK

Reg. No. 4,075,555

Registered Dec. 20, 2011

Int. Cl.: 35

SERVICE MARK

SUPPLEMENTAL REGISTER

MILLER & MARTIN PLLC (TENNESSEE LIMITED LIABILITY COMPANY)
SUITE 1000 VOLUNTEER BUILDING
832 GEORGIA AVENUE
CHATTANOOGA, TN 374022289

FOR: ASSOCIATION SERVICES, NAMELY, PROMOTING THE INTERESTS OF AND FOSTERING RELATIONS, COMMUNICATIONS AND EXCHANGES OF IDEAS BETWEEN AND AMONG CORPORATE LEGAL COUNSEL AND OTHER PERSONS, IN CLASS 35 (U.S. CLS. 100, 101 AND 102).

FIRST USE 6-23-2011; IN COMMERCE 6-23-2011.

THE MARK CONSISTS OF STANDARD CHARACTERS WITHOUT CLAIM TO ANY PARTICULAR FONT, STYLE, SIZE, OR COLOR.

NO CLAIM IS MADE TO THE EXCLUSIVE RIGHT TO USE "CORPORATE COUNSEL NETWORK", APART FROM THE MARK AS SHOWN.

SER. NO. 85-355,657, FILED P.R. 6-24-2011; AM. S.R. 10-11-2011.

EMILY CHUO, EXAMINING ATTORNEY



David J. Kyffers

Director of the United States Patent and Trademark Office

United States of America

United States Patent and Trademark Office

TRUCKS, TRUCKS, AND MORE TRUCKS

Reg. No. 4,075,556

NORTHWEST MOTORSPORT, INC. (WASHINGTON CORPORATION)
1502 RIVER ROAD
PUYALLUP, WA 98371

Registered Dec. 20, 2011

Int. Cl.: 35

FOR: AUTOMOBILE DEALERSHIPS; DEALERSHIPS IN THE FIELD OF AUTOMOBILES, INCLUDING BUT NOT LIMITED TO, CARS, VANS, AND TRUCKS; RETAIL AUTOMOBILE PARTS AND ACCESSORIES STORES, IN CLASS 35 (U.S. CLS. 100, 101 AND 102).

SERVICE MARK

FIRST USE 2-1-2010; IN COMMERCE 2-1-2010.

SUPPLEMENTAL REGISTER

THE MARK CONSISTS OF STANDARD CHARACTERS WITHOUT CLAIM TO ANY PARTICULAR FONT, STYLE, SIZE, OR COLOR.

NO CLAIM IS MADE TO THE EXCLUSIVE RIGHT TO USE "TRUCKS", APART FROM THE MARK AS SHOWN.

SER. NO. 85-356,902, FILED P.R. 6-27-2011; AM. S.R. 10-13-2011.

SUSAN LESLIE DUBOIS, EXAMINING ATTORNEY



David J. Kybas

Director of the United States Patent and Trademark Office

United States of America

United States Patent and Trademark Office

360 PANORAMA

Reg. No. 4,075,557

Registered Dec. 20, 2011

Int. Cls.: 9 and 42

TRADEMARK

SERVICE MARK

SUPPLEMENTAL REGISTER

OCCIPITAL, LLC (DELAWARE LIMITED LIABILITY COMPANY)
SUITE 202
1801 13TH STREET
BOULDER, CO 80302

FOR: DOWNLOADABLE SOFTWARE IN THE NATURE OF A MOBILE APPLICATION FOR IMAGE CAPTURE, IMAGE SHARING AND IMAGE COLLABORATION , IN CLASS 9 (U.S. CLS. 21, 23, 26, 36 AND 38).

FIRST USE 7-30-2010; IN COMMERCE 7-30-2010.

FOR: SOFTWARE AS A SERVICE (SAAS) SERVICES FEATURING WEBSITE-BASED SOFTWARE IN THE NATURE OF AN APPLICATION FOR IMAGE SHARING, IMAGE SEARCH AND IMAGE COLLABORATION, IN CLASS 42 (U.S. CLS. 100 AND 101).

FIRST USE 7-30-2010; IN COMMERCE 7-30-2010.

THE MARK CONSISTS OF STANDARD CHARACTERS WITHOUT CLAIM TO ANY PARTICULAR FONT, STYLE, SIZE, OR COLOR.

SER. NO. 85-356,976, FILED P.R. 6-27-2011; AM. S.R. 10-19-2011.

TOBY BULLOFF, EXAMINING ATTORNEY



David J. Kyros

Director of the United States Patent and Trademark Office

United States of America

United States Patent and Trademark Office

treeClaims

Reg. No. 4,075,558

Registered Dec. 20, 2011

Int. Cls.: 35 and 44

SERVICE MARK

SUPPLEMENTAL REGISTER

HORTICULTURAL ASSET MANAGEMENT, INC. (NORTH CAROLINA CORPORATION)
SUITE 205
107 EDINBURGH SOUTH DRIVE
CARY, NC 27511

FOR: COST ASSESSMENT CONSULTING SERVICES, NAMELY, PROVIDING TREE AND PLANT REPLACEMENT COST VALUATIONS, HEALTH RATING AND RISK RATING FOR OTHERS; COST ASSESSMENT SERVICES, NAMELY, ASSESSING THE SALVAGEABILITY OF DAMAGED TREES AND PROPERTY RELATED THERETO; TAX ASSESSMENT SERVICES PERTAINING TO TREE DAMAGE CLAIMS; ACCOUNTING CONSULTATION PERTAINING TO TREE DAMAGE CLAIMS, IN CLASS 35 (U.S. CLS. 100, 101 AND 102).

FIRST USE 12-1-2008; IN COMMERCE 12-1-2008.

FOR: HORTICULTURAL SERVICES; TREE PRESERVATION, REPAIR, REMOVAL AND REPLACEMENT SERVICES; CONSULTING SERVICES IN THE FIELD OF TREE CARE , IN CLASS 44 (U.S. CLS. 100 AND 101).

FIRST USE 12-1-2008; IN COMMERCE 12-1-2008.

THE MARK CONSISTS OF THE LITERAL ELEMENT "TREECLAIMS" APPEARING IN A STYLIZED FORM WITH THE TERM "TREE" APPEARING IN DARK GREEN AND THE TERM "CLAIMS" APPEARING IN A LIGHTER SHADE OF GREEN WITH A STYLIZED LEAF DESIGN APPEARING WITHIN THE LETTER "A" OF THE TERM "CLAIMS".

THE COLOR(S) DARK GREEN & LIGHT GREEN IS/ARE CLAIMED AS A FEATURE OF THE MARK.

SER. NO. 85-358,988, FILED P.R. 6-29-2011; AM. S.R. 10-19-2011.

MICHELE SWAIN, EXAMINING ATTORNEY



David J. Kyjars

Director of the United States Patent and Trademark Office

United States of America

United States Patent and Trademark Office

PolicyView

Reg. No. 4,075,559

MAG MUTUAL INSURANCE COMPANY (GEORGIA CORPORATION)
3525 PIEDMONT ROAD; BLDG 8; SUITE 600
ATLANTA, GA 30022

Registered Dec. 20, 2011

Int. Cl.: 36

FOR: PROVIDING INSURANCE INFORMATION FEATURING POLICY PREMIUMS, ELECTRONIC PROCESSING OF INSURANCE CLAIMS AND PAYMENT DATA INFORMATION OVER A WEB BASED COMPUTER-NETWORK, IN CLASS 36 (U.S. CLS. 100, 101 AND 102).

SERVICE MARK

SUPPLEMENTAL REGISTER FIRST USE 4-1-2011; IN COMMERCE 6-1-2011.

THE MARK CONSISTS OF STANDARD CHARACTERS WITHOUT CLAIM TO ANY PARTICULAR FONT, STYLE, SIZE, OR COLOR.

SER. NO. 85-361,402, FILED P.R. 7-1-2011; AM. S.R. 10-25-2011.

B. PARADEWELAI, EXAMINING ATTORNEY



David J. Kyffers

Director of the United States Patent and Trademark Office

United States of America

United States Patent and Trademark Office

Residential Salvage Solutions Inc.

Reg. No. 4,075,560

RESIDENTIAL SALVAGE SOLUTIONS INC (ILLINOIS CORPORATION), AKA RSSI,
1554 CRESCENT LAKE DRIVE
MONTGOMERY, IL 60538

Registered Dec. 20, 2011

Int. Cl.: 36

FOR: INSURANCE SUBROGATION AND SALVAGE, IN CLASS 36 (U.S. CLS. 100, 101 AND 102).

SERVICE MARK

FIRST USE 1-1-2009; IN COMMERCE 1-1-2009.

SUPPLEMENTAL REGISTER

THE MARK CONSISTS OF STANDARD CHARACTERS WITHOUT CLAIM TO ANY PARTICULAR FONT, STYLE, SIZE, OR COLOR.

NO CLAIM IS MADE TO THE EXCLUSIVE RIGHT TO USE "SALVAGE SOLUTIONS INC.", APART FROM THE MARK AS SHOWN.

SER. NO. 85-361,635, FILED P.R. 7-1-2011; AM. S.R. 10-25-2011.

JENNIFER MARTIN, EXAMINING ATTORNEY



David J. Kybas

Director of the United States Patent and Trademark Office

United States of America

United States Patent and Trademark Office

Hospitality Recruiters

Reg. No. 4,075,561

Registered Dec. 20, 2011

Int. Cl.: 35

SERVICE MARK

SUPPLEMENTAL REGISTER

HOSPITALITY RECRUITERS OF NEW HAMPSHIRE, LLC (NEW HAMPSHIRE LIMITED LIABILITY COMPANY)
45 WOODHILL HOOKSETT ROAD
BOW, NH 03304

FOR: PROFESSIONAL STAFFING AND RECRUITING SERVICES, IN CLASS 35 (U.S. CLS. 100, 101 AND 102).

FIRST USE 12-1-2005; IN COMMERCE 12-1-2005.

THE MARK CONSISTS OF STANDARD CHARACTERS WITHOUT CLAIM TO ANY PARTICULAR FONT, STYLE, SIZE, OR COLOR.

SER. NO. 85-361,760, FILED P.R. 7-1-2011; AM. S.R. 10-20-2011.

DAVID YONTEF, EXAMINING ATTORNEY



David J. Kyffers

Director of the United States Patent and Trademark Office

United States of America

United States Patent and Trademark Office

FRIZZ FORECAST

Reg. No. 4,075,562

TEXTUREMEDIA, INC. (DELAWARE CORPORATION)
6604 NORTH LAMAR BLVD.
AUSTIN, TX 78752

Registered Dec. 20, 2011

Int. Cl.: 42

FOR: PROVIDING ONLINE WEATHER CONDITION INFORMATION FOR DIFFERENT GEOGRAPHIC LOCATIONS ALONG WITH RECOMMENDATIONS ON HOW TO MANAGE PARTICULAR TYPES OF HAIR BASED ON THE WEATHER CONDITION INFORMATION, IN CLASS 42 (U.S. CLS. 100 AND 101).

SERVICE MARK

SUPPLEMENTAL REGISTER FIRST USE 3-0-2008; IN COMMERCE 3-0-2008.

THE MARK CONSISTS OF STANDARD CHARACTERS WITHOUT CLAIM TO ANY PARTICULAR FONT, STYLE, SIZE, OR COLOR.

NO CLAIM IS MADE TO THE EXCLUSIVE RIGHT TO USE "FORECAST", APART FROM THE MARK AS SHOWN.

SER. NO. 85-363,411, FILED P.R. 7-5-2011; AM. S.R. 10-24-2011.

ANDREW RHIM, EXAMINING ATTORNEY



David J. Kyros

Director of the United States Patent and Trademark Office

United States of America

United States Patent and Trademark Office

Instrument Depot

Reg. No. 4,075,563

INSTRUMENT DEPOT INC. (NEW YORK CORPORATION)
115 METRO PARK

Registered Dec. 20, 2011

ROCHESTER, NY 14623

Int. Cl.: 35

FOR: MAIL ORDER CATALOG SERVICES FEATURING ENVIRONMENTAL MONITORING EQUIPMENT, IN CLASS 35 (U.S. CLS. 100, 101 AND 102).

SERVICE MARK

FIRST USE 11-30-1999; IN COMMERCE 11-30-1999.

SUPPLEMENTAL REGISTER

THE MARK CONSISTS OF STANDARD CHARACTERS WITHOUT CLAIM TO ANY PARTICULAR FONT, STYLE, SIZE, OR COLOR.

SER. NO. 85-370,279, FILED 7-13-2011.

ANNE E. GUSTASON, EXAMINING ATTORNEY



David J. Kybas

Director of the United States Patent and Trademark Office

United States of America

United States Patent and Trademark Office

JETPERF&DRILL

Reg. No. 4,075,564

BUCKMAN JET DRILLING INC. (DELAWARE CORPORATION)
2413 NASHVILLE ROAD, C-16, SUITE 216
BOWLING GREEN, KY 42101

Registered Dec. 20, 2011

Int. Cl.: 40

FOR: OIL AND GAS WELL TREATMENT, IN CLASS 40 (U.S. CLS. 100, 103 AND 106).

SERVICE MARK

FIRST USE 7-13-2011; IN COMMERCE 7-13-2011.

SUPPLEMENTAL REGISTER

THE MARK CONSISTS OF STANDARD CHARACTERS WITHOUT CLAIM TO ANY PARTICULAR FONT, STYLE, SIZE, OR COLOR.

SER. NO. 85-371,678, FILED 7-14-2011.

MARK PILARO, EXAMINING ATTORNEY



David J. Kyfos

Director of the United States Patent and Trademark Office

United States of America

United States Patent and Trademark Office

Lithium Exploration Group

Reg. No. 4,075,565

LITHIUM EXPLORATION GROUP, INC. (NEVADA CORPORATION)
3200 N HAYDEN ROAD, SUITE 300
SCOTTSDALE, AZ 85251 AND

Registered Dec. 20, 2011

Int. Cl.: 42

ALEXANDER WALSH (UNITED STATES INDIVIDUAL)
3200 N HAYDEN ROAD, SUITE 300
SCOTTSDALE, AZ 85251

SERVICE MARK

SUPPLEMENTAL REGISTER

FOR: MINING EXPLORATION, NAMELY, LITHIUM EXPLORATION SERVICES, IN CLASS
42 (U.S. CLS. 100 AND 101).

FIRST USE 11-10-2010; IN COMMERCE 11-10-2010.

THE MARK CONSISTS OF STANDARD CHARACTERS WITHOUT CLAIM TO ANY PARTICULAR FONT, STYLE, SIZE, OR COLOR.

NO CLAIM IS MADE TO THE EXCLUSIVE RIGHT TO USE "LITHIUM EXPLORATION", APART FROM THE MARK AS SHOWN.

SER. NO. 85-377,857, FILED P.R. 7-21-2011; AM. S.R. 11-10-2011.

JOHN HWANG, EXAMINING ATTORNEY



David J. Kybas

Director of the United States Patent and Trademark Office

United States of America

United States Patent and Trademark Office



Reg. No. 4,075,566

CHUNMA USA., INC. (CALIFORNIA CORPORATION), DBA ALBA BAGS,
2000 E. 25TH ST.
VERNON, CA 90058

Registered Dec. 20, 2011

Int. Cl.: 18

FOR: HANDBAGS, TOTE BAGS, BACKPACKS, LUGGAGE, WALLETS AND PURSES, IN CLASS 18 (U.S. CLS. 1, 2, 3, 22 AND 41).

TRADEMARK

FIRST USE 3-24-2011; IN COMMERCE 5-10-2011.

SUPPLEMENTAL REGISTER

THE MARK CONSISTS OF A MEDIEVAL CROSS CONTAINING DECORATIVE STITCHED SCROLLING AROUND THE EDGES, A SCROLLING, DECORATIVE FRAMEWORK WITH NUMEROUS OVAL DIAMONDS, AND A LARGE HEART DIAMOND IN THE CENTER SURROUNDED BY A SQUARE.

SER. NO. 85-380,394, FILED P.R. 7-25-2011; AM. S.R. 10-20-2011.

JAMES MACFARLANE, EXAMINING ATTORNEY



David J. Kybas

Director of the United States Patent and Trademark Office

United States of America

United States Patent and Trademark Office

REGISTRAR SUMMIT

Reg. No. 4,075,567

GODADDY.COM, INC. (ARIZONA CORPORATION)
14455 N. HAYDEN RD., SUITE 219
SCOTTSDALE, AZ 85260

Registered Dec. 20, 2011

Int. Cls.: 35 and 41

FOR: ARRANGING AND CONDUCTING BUSINESS CONFERENCES, IN CLASS 35 (U.S. CLS. 100, 101 AND 102).

SERVICE MARK

FIRST USE 4-21-2008; IN COMMERCE 4-21-2008.

SUPPLEMENTAL REGISTER

FOR: EDUCATIONAL SERVICES, NAMELY, CONDUCTING CONFERENCES IN THE FIELD OF INTERNET LAW AND POLICY, IN CLASS 41 (U.S. CLS. 100, 101 AND 107).

FIRST USE 4-21-2008; IN COMMERCE 4-21-2008.

THE MARK CONSISTS OF STANDARD CHARACTERS WITHOUT CLAIM TO ANY PARTICULAR FONT, STYLE, SIZE, OR COLOR.

NO CLAIM IS MADE TO THE EXCLUSIVE RIGHT TO USE "SUMMIT", APART FROM THE MARK AS SHOWN.

SER. NO. 85-404,801, FILED P.R. 8-23-2011; AM. S.R. 10-21-2011.

SUE LAWRENCE, EXAMINING ATTORNEY



David J. Kyros

Director of the United States Patent and Trademark Office

United States of America

United States Patent and Trademark Office

SOFT PRETZEL TASTE IN A BAGEL SHAPE

Reg. No. 4,075,568

Registered Dec. 20, 2011

Int. Cl.: 30

TRADEMARK

SUPPLEMENTAL REGISTER

GRUPO BIMBO, S.A. B. DE C.V. (MEXICO CORPORATION)
PROLONGACION PASEO DE LA REFORMA
NO. 1000, COL. PENA BLANCA SANTA FE
MEXICO CITY, MEXICO

FOR: BAKERY PRODUCTS, IN CLASS 30 (U.S. CL. 46).

FIRST USE 7-25-2011; IN COMMERCE 7-25-2011.

THE MARK CONSISTS OF STANDARD CHARACTERS WITHOUT CLAIM TO ANY PARTICULAR FONT, STYLE, SIZE, OR COLOR.

SER. NO. 85-436,630, FILED 9-30-2011.

TIMOTHY FINNEGAN, EXAMINING ATTORNEY



David J. Kybas

Director of the United States Patent and Trademark Office

United States of America

United States Patent and Trademark Office

CALTON NUTRITION

Reg. No. 4,075,569

1 2 8 WORLDWIDE, INC. (FLORIDA CORPORATION)
110 PORTOFINO DRIVE
NORTH VENICE, FL 34275

Registered Dec. 20, 2011

Int. Cl.: 44

FOR: PROVIDING DIETARY AND NUTRITION PLANNING, TREATMENT AND SUPERVISION THROUGH WEIGHT REDUCTION PROGRAMS, COUNSELING AND CREATING DIETARY AND NUTRITIONAL REGIMES AND DISCUSSIONS; PROVIDING ADVICE, CONSULTATION AND INFORMATION IN THE FIELD OF WEIGHT CONTROL AND NUTRITION, IN CLASS 44 (U.S. CLS. 100 AND 101).

SERVICE MARK

SUPPLEMENTAL REGISTER

FIRST USE 10-11-2008; IN COMMERCE 10-11-2008.

THE MARK CONSISTS OF STANDARD CHARACTERS WITHOUT CLAIM TO ANY PARTICULAR FONT, STYLE, SIZE, OR COLOR.

NO CLAIM IS MADE TO THE EXCLUSIVE RIGHT TO USE "NUTRITION", APART FROM THE MARK AS SHOWN.

SER. NO. 85-441,187, FILED 10-6-2011.

JAMES LOVELACE, EXAMINING ATTORNEY



David J. Kyros

Director of the United States Patent and Trademark Office

United States of America

United States Patent and Trademark Office



Reg. No. 4,075,570

Registered Dec. 20, 2011

Int. Cls.: 16, 35, 41, and 45

TRADEMARK

SERVICE MARK

SUPPLEMENTAL REGISTER

ARTHRITIS FOUNDATION, MID-ATLANTIC REGION, INC. (GEORGIA CORPORATION)
2011 PENNSYLVANIA AVENUE, NW 6TH FLOOR
WASHINGTON, DC 20006

FOR: BROCHURES, POSTERS, FLYERS, HAND-OUTS, AND TEACHING MATERIAL IN THE FIELD OF PEDIATRIC RHEUMATIC DISEASE, IN CLASS 16 (U.S. CLS. 2, 5, 22, 23, 29, 37, 38 AND 50).

FIRST USE 4-9-2010; IN COMMERCE 4-9-2010.

FOR: PUBLIC ADVOCACY TO PROMOTE AWARENESS OF PEDIATRIC RHEUMATIC DISEASE, IN CLASS 35 (U.S. CLS. 100, 101 AND 102).

FIRST USE 8-8-2010; IN COMMERCE 8-8-2010.

FOR: EDUCATION SERVICES, NAMELY, PROVIDING CLASSES, SEMINARS, WORKSHOPS IN THE FIELD OF PEDIATRIC RHEUMATIC DISEASE; NONDOWNLOADABLE ELECTRONIC PUBLICATIONS IN THE NATURE OF NEWSLETTERS IN THE FIELD OF PEDIATRIC RHEUMATIC DISEASE; PROVIDING A WEBSITE FEATURING RESOURCES, NAMELY, NON-DOWNLOADABLE PUBLICATIONS IN THE NATURE OF NEWSLETTERS IN THE FIELD OF PEDIATRIC RHEUMATIC DISEASE; PUBLICATION AND EDITING OF PRINTED MATTER INCLUDING POSTERS AND BROCHURES, IN CLASS 41 (U.S. CLS. 100, 101 AND 107).

FIRST USE 4-9-2010; IN COMMERCE 4-9-2010.

FOR: ORGANIZING AND CONDUCTING SUPPORT GROUPS IN THE FIELD OF PEDIATRIC RHEUMATIC DISEASE, IN CLASS 45 (U.S. CLS. 100 AND 101).

FIRST USE 8-14-2010; IN COMMERCE 8-14-2010.

NO CLAIM IS MADE TO THE EXCLUSIVE RIGHT TO USE "RHEUM" AND "RHEUMATIC DISEASE", APART FROM THE MARK AS SHOWN.

THE MARK CONSISTS OF "KIDS RHEUM" IN LARGER TYPE WITH THE "S" BACKWARDS AND THE PHRASE "A NETWORK FOR CHILDREN WITH RHEUMATIC DISEASE" IN SMALLER TYPE BELOW THE WORD "KIDS RHEUM" ARRANGED IN A RECTANGLE.



David J. Kyffers

Director of the United States Patent and Trademark Office

Reg. No. 4,075,570 SER. NO. 85-975,837, FILED P.R. 1-19-2011; AM. S.R. 10-18-2011.

TEJBIR SINGH, EXAMINING ATTORNEY

United States of America

United States Patent and Trademark Office

KIDS RHEUM

Reg. No. 4,075,571

ARTHRITIS FOUNDATION, MID-ATLANTIC REGION, INC. (GEORGIA CORPORATION)
2011 PENNSYLVANIA AVENUE, NW 6TH FLOOR
WASHINGTON, DC 20006

Registered Dec. 20, 2011

Int. Cls.: 16, 35, 41, and 45

FOR: BROCHURES, POSTERS, FLYERS, HAND-OUTS, AND TEACHING MATERIAL IN THE FIELD OF PEDIATRIC RHEUMATIC DISEASE, IN CLASS 16 (U.S. CLS. 2, 5, 22, 23, 29, 37, 38 AND 50).

TRADEMARK

FIRST USE 4-9-2010; IN COMMERCE 4-9-2010.

SERVICE MARK

FOR: PUBLIC ADVOCACY TO PROMOTE AWARENESS OF PEDIATRIC RHEUMATIC DISEASE, IN CLASS 35 (U.S. CLS. 100, 101 AND 102).

SUPPLEMENTAL REGISTER

FIRST USE 8-8-2010; IN COMMERCE 8-8-2010.

FOR: EDUCATION SERVICES, NAMELY, PROVIDING CLASSES, SEMINARS, WORKSHOPS IN THE FIELD OF PEDIATRIC RHEUMATIC DISEASE; NONDOWNLOADABLE ELECTRONIC PUBLICATIONS IN THE NATURE OF NEWSLETTERS IN THE FIELD OF PEDIATRIC RHEUMATIC DISEASE; PROVIDING A WEBSITE FEATURING RESOURCES, NAMELY, NON-DOWNLOADABLE PUBLICATIONS IN THE NATURE OF NEWSLETTERS IN THE FIELD OF PEDIATRIC RHEUMATIC DISEASE; PUBLICATION AND EDITING OF PRINTED MATTER INCLUDING POSTERS AND BROCHURES, IN CLASS 41 (U.S. CLS. 100, 101 AND 107).



FIRST USE 4-9-2010; IN COMMERCE 4-9-2010.

FOR: ORGANIZING AND CONDUCTING SUPPORT GROUPS IN THE FIELD OF PEDIATRIC RHEUMATIC DISEASE, IN CLASS 45 (U.S. CLS. 100 AND 101).

FIRST USE 8-14-2010; IN COMMERCE 8-14-2010.

THE MARK CONSISTS OF STANDARD CHARACTERS WITHOUT CLAIM TO ANY PARTICULAR FONT, STYLE, SIZE, OR COLOR.

David J. Kyros

NO CLAIM IS MADE TO THE EXCLUSIVE RIGHT TO USE "RHEUM", APART FROM THE MARK AS SHOWN.

Reg. No. 4,075,571 SER. NO. 85-975,838, FILED P.R. 1-19-2011; AM. S.R. 10-18-2011.

TEJBIR SINGH, EXAMINING ATTORNEY

United States of America

United States Patent and Trademark Office

Kids Rheum A network for children with Rheumatic Disease

Reg. No. 4,075,572

Registered Dec. 20, 2011

**Int. Cls.: 16, 35, 41, and
45**

TRADEMARK

SERVICE MARK

SUPPLEMENTAL REGISTER

ARTHRITIS FOUNDATION, MID-ATLANTIC REGION, INC. (GEORGIA CORPORATION)
2011 PENNSYLVANIA AVENUE, NW
6TH FLOOR
WASHINGTON, DC 20006

FOR: BROCHURES, POSTERS, FLYERS, HAND-OUTS, AND TEACHING MATERIAL IN THE FIELD OF PEDIATRIC RHEUMATIC DISEASE, IN CLASS 16 (U.S. CLS. 2, 5, 22, 23, 29, 37, 38 AND 50).

FIRST USE 4-9-2010; IN COMMERCE 4-9-2010.

FOR: PUBLIC ADVOCACY TO PROMOTE AWARENESS OF PEDIATRIC RHEUMATIC DISEASE, IN CLASS 35 (U.S. CLS. 100, 101 AND 102).

FIRST USE 8-8-2010; IN COMMERCE 8-8-2010.

FOR: EDUCATION SERVICES, NAMELY, PROVIDING CLASSES, SEMINARS, WORKSHOPS IN THE FIELD OF PEDIATRIC RHEUMATIC DISEASE; NON-DOWNLOADABLE ELECTRONIC PUBLICATIONS IN THE NATURE OF NEWSLETTERS IN THE FIELD OF PEDIATRIC RHEUMATIC DISEASE; PROVIDING A WEBSITE FEATURING RESOURCES, NAMELY, NON-DOWNLOADABLE PUBLICATIONS IN THE NATURE OF NEWSLETTERS IN THE FIELD OF PEDIATRIC RHEUMATIC DISEASE; PUBLICATION AND EDITING OF PRINTED MATTER INCLUDING POSTERS AND BROCHURES, IN CLASS 41 (U.S. CLS. 100, 101 AND 107).

FIRST USE 4-9-2010; IN COMMERCE 4-9-2010.

FOR: ORGANIZING AND CONDUCTING SUPPORT GROUPS IN THE FIELD OF PEDIATRIC RHEUMATIC DISEASE, IN CLASS 45 (U.S. CLS. 100 AND 101).

FIRST USE 8-14-2010; IN COMMERCE 8-14-2010.

THE MARK CONSISTS OF STANDARD CHARACTERS WITHOUT CLAIM TO ANY PARTICULAR FONT, STYLE, SIZE, OR COLOR.

NO CLAIM IS MADE TO THE EXCLUSIVE RIGHT TO USE "RHEUM" AND "RHEUMATIC DISEASE", APART FROM THE MARK AS SHOWN.



David J. Kyjars

Director of the United States Patent and Trademark Office

Reg. No. 4,075,572 SER. NO. 85-975,839, FILED P.R. 1-20-2011; AM. S.R. 10-18-2011.

TEJBIR SINGH, EXAMINING ATTORNEY